

Still  
**£2.00**

*P. Jones*

# Hi-Fi WORLD

NOVEMBER 1994 £2.00

**5 MINI MONITORS**  
**Harbeth HL-P3**  
**Systemdek 931**  
**ProAc Tablette Signature III**  
**Rogers Studio 3**  
**Rogers BBC LS3/5a**

**SCOOP!**

## **NEW SPENDOR SP3/1 LOUDSPEAKERS**

**SCOOP!**

**ARCAM BLACK BOX 500  
DISCRETE CD CONVERTOR**

**DIY SUPPLEMENT No. 11  
banded to this issue**

**SCOOP!**

## **CHAMELEON 300W PROFESSIONAL POWER AMPLIFIER**

**COMPETITION - WIN A  
COMPLETE AURA SYSTEM**



# The most complex DAC in the World



*The PDM ten twenty-four - packed full of dpa innovations that redefine CD performance.*

## is also the simplest.

It has long been held as a tenet of audiophile wisdom that the simpler the analogue circuitry, the better the sound quality. We have spent many years developing our own DAC technology that results in an order of magnitude improvement in analogue simplicity. This is achieved by the use of our patent pending DX processor DAC that employs up to 128 times digital filtering. This gives a very simple analogue topology - just our op-amp and four passive components in the direct signal path.

This is some ten times simpler than conventional DAC's - and the sonic result it gives is extraordinary. Words cannot convey the sense of excitement when listening to music through it. Instruments sound much more tangible with better focus and separation. Sound stage and detail resolution are remarkable. Indeed, we are convinced our DX DAC technology completely redefines the capability of digital music.

However, this performance comes at a price - one being the complexity of the digital domain. An amazing one billion single bit additions are performed each second. The PDM ten twenty-four also features nearly 2,000 discrete components, 4,000 gates, 8 noiseshapers, 8 digital filters, 8 programmable dither sources and gold plated solid copper construction throughout - to name but some of the features. It is modular in construction, thus allowing future upgrades.

Moreover, the DX processor technology can be applied to more affordable DAC's. The PDM two fifty-six (our replacement for the highly regarded PDM two) is available. We are currently developing the PDM sixty-four that features a scaled down version of this technology for only £1250. For more information please telephone or write to:

dpa Digital Ltd.,  
7&8 Willowbrook Lab Units,  
Crickhowell Rd., St Mellons,  
Cardiff, Wales CF3 0EF  
Tel: (0222) 795621  
Fax: (0222) 794267

The logo for dpa Digital Ltd., consisting of the lowercase letters 'dpa' in a stylized, white, sans-serif font.

A logo for the 'dx 128 processor' featuring the text 'dx 128 processor' in a white, sans-serif font, enclosed within a white, rounded rectangular border with horizontal lines.



# EXPERIENCE MUSICAL TRUTH

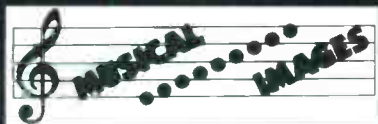

45 High Street, Hounslow, Middx.  
TW3 1RH  
Tel: 081 569 5802  
(Also at Edgware, Middx,  
Tel. 081 952 5535)



93 Hobs Moat Road,  
Solihull,  
W. Midlands  
Tel: 021 742 0254

**Zen Audio**  
35 George Street,  
Hull HU1 3RE  
Tel: 0482 587397

## NEW 200S PRE POWER £1250

**audible difference**  
Scale, Diss, Norfolk.  
IP21 4DX.  
Tel : 0379 740227

**Doug Brady Hi-Fi**  
Kingsway Studios,  
Kingsway North,  
Warrington.  
Tel: 0925 828009  
(Also at Liverpool, London  
and Otley, Nr Leeds)



34, Buckingham palace  
Road, London SW1W 0RE  
Tel: 071 - 233 0774  
Fax: 071 - 233 7226

**Oxford Audio Consultants**  
Cantay House,  
Park End Street,  
Oxford OX1 1JE  
Tel: 0865 790879  
Fax: 0865 791665

**CA Chantry Audio**  
Chantry Walk,  
16/18A Eldon Street,  
Tuxford, Nr Newark,  
Notts NG22 0LH.  
Tel: 0777 870372

**Audio Suite**  
42 St. Andrews Street,  
Aberdeen AB1 1JA.  
Tel: 0224 625 635



152A High Street,  
Bloxwich,  
West Midlands.  
Tel: 0922 493499

**PJ Hi-Fi**  
3 Bridge Street,  
Guildford,  
Surrey.  
Tel: 0483 504801

**SHROPSHIRE HI-FI**  
St. Michael's Street,  
Shrewsbury,  
Shropshire SY1 2ES.  
Tel: 0743 232317



41 Victoria Road,  
Cambridge.  
CB4 3BW.  
Tel: 0223 68305



2/4 Great Victoria Street,  
Belfast BT2 7BA.  
Northern Ireland.  
Tel: 0232 332522



**KJ WEST ONE**  
26 New Cavendish  
Street,  
London W1M 7LH.  
Tel: 071 486 8262

## AT OUR KEY DEALERS

# dpa digital ltd

Unit 7, Willowbrook Technical Units,  
Crickhowell Road, St. Mellons, Cardiff CF3 0EF, Wales, UK  
Phone: 0222 795621 Fax: 0222 794267



Cover Photograph by  
Paul Hartley Studio 071-482 3768

## THIS MONTH'S REVIEWS

### AMPLIFIERS

- SCOOP** CHAMELEON POWER AMPLIFIER 18  
A compact but incredibly powerful amplifier from the studio world. Will its stylish casework find favour with the audiophile?



- SCOOP** ORELLE SA100 50  
Orelle are the latest to join the increasingly crowded integrated amplifier market. Will the SA100 at £379 topple the best, asks Dominic Todd?

- SCOOP** ROTEL RQ970BX 31  
This new phono head amplifier from Rotel offers superb audio grade components for a modest £129. We have a listen and then describe a few simple DIY tweaks to further enhance performance.

- KENWOOD 3020SE 35  
Can Kenwood's new 3020SE amplifier steal the limelight from Pioneer's A400X, asks Eric Braithwaite?

### COMPACT DISC

- SCOOP** ARCAM BLACK BOX 500 13  
Arcam join the elite few with their first discrete one-bit CD convertor - the most affordable yet. Does it make the grade though? Noel Keywood listens intently.

### LOUDSPEAKERS

- MINI-MONITOR GROUP TEST 21  
We test five mini-monitors and their originator, the BBC LS3/5a.

- Harbeth HL-P3  
ProAc Tablette III Signature  
Rogers Studio 3  
Systemdek 931  
Rogers Original LS3/5a

- SCOOP** SPENDOR SP3/1 44  
Replacing the much loved S20s, the new SP3/1s have a tough act to follow. We audition them closely and give our verdict.

- SCOOP** GLL MEZZO 52  
A look at the revised £159.95 Goodmans Mezzo by Peter Downs.

### TURNTABLES

- NAD 533 57  
NAD's affordable turntable based on the renowned Rega Planar 2. Dominic Todd takes a listen.



- ORTOFON VMS-2E 59  
A quality Moving Magnet cartridge - for £10! Dominic Todd marries the NAD 533 turntable with this amazing value cartridge from Ortofon

### CASSETTE

- AIWA AD-F450 64  
From Aiwa's new range here's an affordable two-head cassette deck. Eric Braithwaite listens and records its abilities.



### TUNERS

- SCOOP** BURMESTER 931 36  
A super high-end £4000 chrome plated tuner from Germany. Eric Braithwaite gets to grips with serious German engineering.



AMERICAN  
and  
CANADIAN  
SUBSCRIPTIONS  
- see page 68

Editor  
**Noel Keywood**

Assistant Editor  
**Dominic Baker**

Production Editor  
**Ferewini T. Michael**

General Manager  
**Mark Winfield**

Marketing Manager  
**Richard Johnson**

Advertising Executive  
**Amanda Sweeney**  
Advertising Tel: 071-266 0969

Design Engineer  
**Andy Grove**

Technical Assistant  
**Nick Lucas**

Contributors  
**Eric Braithwaite**  
**Richard Brice**  
**Giovanni Dadomo**  
**Peter Herring**  
**Simon Hopkins**  
**Dominic Todd**

Cartoonist  
**Freddy Ahmet**

Distributed by:  
COMAG, Tavistock Road, West  
Drayton, Middlesex, UB7 7QE  
Tel: 0895 444055

Origination by:  
Ashford Scanning  
2 Norfolk Drive,  
Fairwood Industrial Park,  
Ashford, Kent TN23 2FB  
Tel: 0233 622042

Printed by:  
Southernprint, Poole, Dorset.  
Tel: 0202 622226

AUDIO PUBLISHING LTD.,  
64 Castellain Road, Maida Vale,  
London W9 1EX.  
Tel: 071-289 3533  
10 am. - 6pm.  
Fax: 071-289 5620  
Queries cannot be answered  
by telephone.

MAIL ORDER  
Tel: 071-266 0461 (24 hours)

Subscription Rates:  
UK: £22,  
Overseas Surface: £29, Airmail:  
£42 (Europe) £52 (USA, Middle  
East), £62 (Australia, Japan).

No material may be reproduced  
from this magazine without  
the publisher's written  
permission.  
© Audio Publishing Ltd

## REGULARS

- NEWS** 8  
Tasty new products galore in this month's News section.
- LETTERS** 38  
Write to Hi-Fi World with your views. It's your chance to get your views out in the open.
- Q&A** 111  
Our team of hi-fi experts and engineers set about solving your troubles and improving your musical enjoyment.
- COLUMNS** 61,63,69,71  
The regular team push pen across paper to bring you their thoughts for the month.
- NEXT ISSUE** 60  
Don't look now, but there's another DIY Supplement next month, along with all the usual reviews and features.
- SUBSCRIPTIONS** 68  
If you'd rather be listening to music than venturing outside to your your newsagent, there's only one answer - SUBSCRIBE!
- ACCESSORIES** 97  
Goodies for cleaning, tuning and getting the best from your hi-fi system.
- HI-FI WORLD LIBRARY** 101  
Our own library of books for the enthusiast, be it valve amplifiers, transistors or loudspeakers that interest you.
- DIAL-A-DEALER** 89  
Who sells what and how to get in touch.

## MUSIC

Our guide to some of the best new releases.

### ROCK RECORD OF THE MONTH:

Neil Young & Crazy Horse: Sleeps With Angels

### CLASSICAL RECORD OF THE MONTH:

Schumann/Mahler/Brahms/Bach - Piano Concertos

**ROCK AND POP** 73

**CLASSICAL** 85

**JAZZ** 93

- WORLD AUDIO DESIGN** 81  
Engineered for outstanding sound and performance, the World Audio Design range of kits is the hobbyists dream.
- MEET YOUR MAKER** 84  
The manufacturers' directory.
- CLASSIFIEDS ADS** 121  
Hi-Fi on the cheap.
- SPECIALIST HI-FI DEALERS** 77  
Need a specialist, look no further.
- ADVERTISERS' INDEX** 130

## FEATURES

- ROOM ACOUSTICS** 42  
Douglas Floyd-Douglass of RPG acoustics begins a series of articles explaining room acoustics, the effect they have on the sound of your system and how to improve your room.

## DIY SUPPLEMENT

Once again you'll find a FREE DIY hi-fi Supplement banded to this issue of Hi-Fi World. Inside the supplement there's a design for a compact standmounting loudspeaker using carbon fibre drive units for exceptional clarity, a test of the new Maplin Millennium 4-20 valve amplifier, the theory behind the legendary Tractrix horn loudspeaker explained, a test on an affordable noise meter from Valley Audio as well as letters and news from the world of kits.

## COMPETITION

Your chance to win a superb chrome plated Aura system worth over £1150. The system comprises Aura CD-50 CD player VA-80 amplifier and SP-50 loudspeakers. 66



# CONTENTS

# What does perfect sound look like ?

For 25 Years we have created superb sound and now we have produced the perfect combination of sound and design with the Lifestyle range. To create loudspeakers which produce pure full bodied sound without coloration was an achievement, then to create stunning designs to match was a unique, unparalleled technical and engineering accomplishment.

The Lifestyle range - The Total Listening Experience



## Jamo

"The Sound of Excellence"

World Radio History

## Pure and Precise

**Dealer**  
 Adams & Jarrett  
 Brighton Audio  
 Canterbury Hi-Fi  
 Dawson's  
 Howes of South Borough  
 Kimberley's Hi-Fi  
 Tru-Fi  
 Universal Hi-Fi  
 Weybridge Audio  
 Alphabec  
 Ask Electronics  
 Atlantic Electronics  
 Babber Electronics  
 Galaxy Audio  
 Hi Spek Electronics  
 Hi Way Hi-Fi  
 Kamla  
 Laysyl Ltd  
 MCD Entertainments  
 Musical Images  
 Musical Images  
 Myers Audio  
 Rightway  
 Selfridges  
 Time & Tune  
 Hi-Fi Corner  
 Cas Sac  
 Clearstone Hi-Fi  
 D Eckersley  
 D Eckersley  
 Geoff Jackson  
 J R Gough  
 Riley Electronics  
 Scratch Music  
 Westgate Audio Visual  
 Westside Music Centre  
 Amadeus Sound & Vision  
 Car & Home Stereo  
 Chris Pettit  
 Peter Martin  
 Snellings  
 A N Audio  
 Carvels of Rugby  
 Discount Hi-Fi  
 Fenway  
 Hi-Fi City  
 PJ's Hi-Fi & Video  
 Pounds Limited  
 Select TV  
 Sound Stage  
 Techno Sound  
 The Hi-Fi Exchange  
 The Videofactor  
 Fortuna Ltd  
**Excel Venture Trad. Co.**  
**Jamo Hi-Fi USA Inc.**  
**Pan International Company**  
**Scan Audio**  
**Taiwan Audio Trad. Co.**  
**Jamo UK Ltd**

**Town**  
 St Leonards on Sea  
 Brighton  
 Canterbury  
 Boumemouth  
 Tunbridge Wells  
 Bexley Heath  
 Redhill  
 Croydon  
 Weybridge  
 London NW2  
 London W1  
 London NW10  
 London W13  
 London W1  
 London NW3  
 London W2  
 London W1  
 London SW14  
 London SE17  
 Edgware  
 Hounslow  
 Walthamstow  
 London  
 London  
 London E1  
 Dublin (Eire)  
 Bradford  
 Bolton  
 Bury  
 Leigh  
 Leeds  
 South Shields  
 York  
 Doncaster  
 Bradford  
 Sheffield  
 Sutton Coldfield  
 Wacclefield  
 Grantham  
 Congleton  
 Norwich  
 St Neots  
 Rugby  
 Potters Bar  
 Newmarket  
 Watford  
 Centre Banbury  
 Hoddesdon  
 Bristol  
 Broxbourne  
 Luton  
 Bristol  
 Gerrards Cross  
 Jersey  
**Singapore**  
**USA**  
**Hong Kong**  
**Australia**  
**Taiwan**  
**Daventry**

**Telephone**  
 0424 437165  
 0273 622871  
 0227 765315  
 0202 764965  
 0892 28682  
 081 304 3272  
 0737 766128  
 081 654 1919  
 0932 851121  
 071 431 9133  
 071 637 0590  
 081 451 0392  
 081 579 5315  
 071 637 2624  
 081 349 1166  
 071 723 5251  
 071 323 2747  
 081 876 7632  
 071 701 3204  
 081 952 5535  
 081 569 5802  
 081 520 7277  
 W2 071 723 7565  
 W1 071 629 1234  
 071 247 0567  
 01 714343  
 0274 626211  
 0204 31423  
 061 797 5979  
 0942 673371  
 0532 781513  
 091 455 3663  
 0904 679859  
 0302 850030  
 0274 732947  
 0742 670718  
 021 354 2311  
 0625 432707  
 0476 593464  
 0260 273206  
 0603 712202  
 0480 472071  
 0788 541341  
 0707 643593  
 0636 663166  
 0923 226169  
 0295 263222  
 0992 465531  
 0275 833135  
 0992 440549  
 0582 471078  
 0272 664930  
 0753 884552  
 0534 32549  
**65-3832200**  
**1-7084984648**  
**852-8891989**  
**61-38195352**  
**886-42237609**  
**0327 301300**

**Jamo**

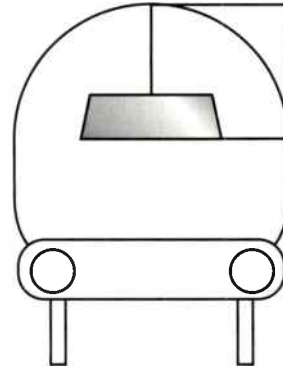

# TRAIN

OF THOUGHT

For details of products and stockists, phone B&W UK on 01903-750750

## campaign audio design



Getting a better, more involving, sound often means spending a lot of hard earned money. It's such a waste, because every system can benefit from our cables and accessories, at a fraction of the cost of some new "black box". Here are some of the ways we can help.

We have Oxygen Free Copper interconnects (£12.48) up to Pure Silver cables (£120.00) and high definition loudspeaker cables in Silver plated Copper

or Pure Silver. Our main cables add weight, power and scale. Non inductive RF filtering (£10.00) and over voltage protection (£3.00) enhance performance still further. Gold plated AV cables, both RF (£19.95) and Scart (£23.52), help bring picture quality in line with NICAM sound resolution.

Valves, capacitors and transistors are all microphonic, they cannot perform optimally if vibrated. Our set of three Brass Isolation cones (£6.50) are worth their weight in gold - revealing low level resolution and dynamics hitherto hidden beneath electronic noise. We also have a cure for your noisy fridge or central heating motor (£3.50), enabling you to throw away your big mains noise suppressor, which has been giving you that "sat upon sound" for years.

There's lots we can do to bring you closer to the emotion and energy of the performance. So confident are we, that we offer a 14 day money back guarantee.

Ring or write for details:-

**CAMPAIGN AUDIO DESIGN**  
**Llandudno Road (HW)**  
**Cardiff CF3 8PG**  
**Tel:- 0222 779401**

Trade and International Enquiries Welcome.



### Lumley ST70 power amp

"In many ways the ST70 is a quite remarkable amplifier"

Hi-Fi News June '94

## BRENTWOOD HI FIDELITY

**Aura • Audio Innovation • Castle • Chord • Crimson •  
 Denon • DNM • E.A.R. • Impulse • Lumley • Marantz • Mission •  
 Micromega • Musical Fidelity • NAD • Pink Triangle • Project •  
 Quad • Ruark • Rehdeko • Shearpe Audio • Systemdek • Tannoy •  
 TDL • Thule Audio**

**Tel: 0277 221 210**

**2 INGRAVE ROAD, BRENTWOOD**  
 Near corner of Brentwood High St.

trade winds

tra



# trade winds

trade winds

trade winds



trade winds



## COMPACT DISC TO BE REPLACED!

**SCOOP!**

### PHILIPS, SONY AND MATSUSHITA READY TO ANNOUNCE HIGH DEFINITION CD.

After lengthy secret talks to reach agreement on a new worldwide standard, Philips, Sony and Matsushita (Technics/Panasonic) will shortly announce a greatly upgraded CD format, to be called HDCD (high density CD). Not to be confused with the HDCD (High Definition Compatible Digital) system of Pacific Microsonics in the USA, this new system relies on technology advances right across the board.

Normal 5in discs will be used for compatibility, but with a storage capacity increased to approximately four times that of current CDs, rising from 600 megabytes to an astonishing 2,500 megabytes. This has been achieved by improving the lasers and the disc production process, in order to tighten tolerances and pack more tracks onto a disc. Doubtless, a more efficient digital encoding system will be adopted too, which will also contribute to the capacity increase.

Apparently, every aspect of the CD specification will be improved for HDCD. Bandwidth will rise from 21kHz to at least 30kHz - and it may go further. The digital description of signal level will also improve, increasing to 18-bit or more. Sources tell us this tends to make HDCD sound less hard and sterile than ordinary CD - more analogue like in fact.

Old CDs will play on new HDCD players, but new HDCDs will not play on old players. After the official announcement of the new standard, due mid-October, players are set to reach the shops within a year or so.

The big question is: how will the music business price HDCDs? If they display the sort of naked avarice paraded with DAT, MD and DCC, where discs and tapes were priced from £15-£30, then HDCD may be stillborn, even in the absence of any competitive system. Otherwise HDCD will, ultimately, replace CD as we know it today.

### NEW KEF REFERENCES FOR '94

KEF Audio have announced their latest line of Reference Series loudspeakers. There are four new models to start with, all using a revised Uni-Q driver. It combines a 160mm midrange cone with a 25mm cloth dome tweeter mounted co-axially.

Features of the new range include gold plated terminals, OFC copper wiring, gold plated solid brass feet, and a rigid plinth-like base that can be loaded with lead shot. Unfortunately, prices were unavailable at the time of going to press, but a KEF spokesman did say that the new Reference Series should be available by the middle of September, to coincide with Live '94.

**KEF Audio**  
Tovil, Maidstone,  
Kent. ME15 6QP  
Tel: 0622 672261



## **SUPER SIMPLE NAD**

NAD have just announced a new budget amplifier aimed at the first time audiophile and students alike. The NAD 310, released at the end of August, costs just £129.95 and offers 20watts power output, but with very high current ability due to a hefty toroidal transformer, allowing it to drive low impedance speakers. NAD claim that the low price and high performance are a result of their new 'Super Simple' circuit topology which uses fewer components than usual.

### **NAD Marketing**

**NAD Building, 410-405 Nether Street,  
London. N3 1QG  
Tel: 081 343 3240**

## **TANNOY'S NEW PROFILE**

Tannoy have launched their new range of loudspeakers, the Profile series. There are six loudspeakers in the range, two stand mounters and four floorstanders. Tannoy claim they offer an enormous step forward in design, aesthetics, materials, technology, sound quality and value, so with all this going for them they ought to be something special.

The range extends from the £149 631s up to the £599 638s, all benefiting from low diffraction rounded baffles, rigid side rail cabinets and quality drive units. We hope to bring you reviews of the Profile series loudspeakers in the coming months.

### **Tannoy**

**Rosehall Industrial Estate,  
Coatbridge, Strathclyde.  
ML5 4TF  
Tel: 0236 420199**

## **A NEW CLAVIS FROM LYRA**

Scan-Tech have announced a replacement for the Lyra branded Clavis moving coil cartridge. A range of improvements are said to give the Clavis D.C. more resolution, dynamics, and improved sound-staging. The Clavis D.C. will cost £995.

### **Path Premier**

**Unit 2, Desborough Industrial Park,  
Desborough Park Road,  
High Wycombe, Bucks. HP12 3BG  
Tel: 0494 441736**

## **INTERCONNECT SOLUTIONS**

Acoustic Solutions, a new company based in North Staffordshire, have launched into the hi-fi market with what they claim is an innovative range of interconnects. There are six cables in their range, from the entry level copper Nexus cable at £24.95 for 0.3m terminated with phono plugs, up to the silver plated, solid

screened Intrinsic Link at £189.95.

### **Acoustic Solutions**

**46a Market Street, Longton,  
Staffordshire. ST3 1BS  
Tel: 0782 595330**

## **THE ART OF NOISE**

The omni-directional Art Noise loudspeaker, using the unique omni-directional Top 101 drive unit previewed a few years ago in Hi-Fi World, has finally been formally launched by Tabula Rasa.

### **Tabula Rasa**

**Tel: 0302 772218**

## **ORANGES & LEMONS**

No, the old rhyme hasn't been launched as a single just yet, but a new hi-fi dealer going by its title has just opened in Battersea, South London. Oranges & Lemons has comfortable home-like demonstration rooms in which equipment from Arcam, Meridian, Mission, NAD, Naim and many others can be auditioned.

### **Oranges & Lemons**

**61-63 Webbs Rd,  
Battersea, SW11  
Tel: 071 924 2040/3665**

## **SON OF ORPHEUS**

Following the £8500 Orpheus with its own dedicated CD convertor and valve drive amplifier, Sennheiser have launched a more affordable headphone, the HE60. The HE60 headphones feature an advanced electrostatic driver which Sennheiser claim offers almost perfect piston motion. The foil polymer diaphragm is coated with a 1-micron thick layer of gold and then dynamically suspended between two gold-plated counter electrodes.

Power is delivered to the HE60 headphones via the dedicated HEV70 pure Class A high voltage amplifier. Other touches include leather and velvet ear cushions and a Kevlar reinforced headset lead. The HE60/HEV70 headphone system is priced at £995.95.

### **Sennheiser**

**12 Davies Way,  
Knaves Beech Business Centre,  
Loudwater, High Wycombe,  
Bucks. HP10 9QY  
Tel: 0628 850811**



## **SHOWS**

### **SCOTTISH HI-FI SHOW**

Scotland will be having its own hi-fi show at the Royal Scot Hotel, Edinburgh, over the 4th, 5th and 6th of November 1994. Organised by Hi-Fi Corner, who have stores in Glasgow, Edinburgh and Falkirk, a wide range of exhibitors will be present, including Hi-Fi World, together with World Audio Design kits.

If you'd like to see and hear real esoterica, like our zero-feedback 300B valve amplifier or carbon fibre loudspeakers - come along. Impecunious? (skint!) Don't worry, 'cos we'll have our budget 4W Single-Ended and K5881 valve amps too.

Exhibitors - Arion, Audiolab, Arcam, Aiwa, Audioquest, Audiomeca, Bose, B&O, Beyer, Chario, Cyrus, Counterpoint, Finlux, Jamo, Kenwood, Kelvin, McIntosh, Mission, NAD, Onkyo, Project, Panasonic, Ruark, Sennheiser, Target, Teac, Tannoy, Triangle, TDK, TDL, Technics, World Audio Design.

(Linn will be exhibiting at the Edinburgh Sheraton on Sunday

6th - see below)

Royal Scot Hotel, Glasgow Road, Edinburgh.

Friday 4th November 11am - 7pm;

Saturday 5th, 10am - 7pm; Sunday 6th, 10am - 6pm.

Admission free. Contact Hi-Fi Corner: 031 556 7901

### **HEAR LINN LIVE**

Linn go on the road soon, demonstrating their entire product range in one-day shows held in conjunction with Linn dealers. There will be seminars and live performances too. They kick off at the Grosvenor House Hotel, Park Lane, London on Sunday October 16th, 1994, then move on to the Crown Plaza Holiday Inn, Manchester, on Sunday October 23rd. The last venue is Edinburgh's Sheraton on Sunday 6th November 1994, at the same time as the Scottish Hi-Fi Show at the Royal Scot Hotel (see above), Edinburgh

# VISIT THE WORLD OF HOME ENTERTAINMENT

## A GREAT DAY OUT FOR ALL THE FAMILY

### BE PART OF THE UK'S ORIGINAL CONSUMER ELECTRONICS SHOW

In this, the show's 15th year, AV'94 will be bigger and far better than in any previous year.

### YOU CAN SEE THE BEST PRODUCTS EVER INVENTED

in HiFi, Television, Satellite, Home Cinema, Camcorders, In-Car, Karaoke, Accessories and Telecommunications all on show and available to buy

### WHY NOT TEST THE WORLD'S LEADING BRANDS

including Sony, JVC, Panasonic, Trio Kenwood, Bose, Arcam, Wharfedale, Misson, BSKyB, Pace, Denon, Akai, Marantz, Harman Audio, Aiwa, Path Group, Sennheiser, Vivanco, Target Audio, TDK, Caliope, The AV Association, Apollo Zenith Crown, Videotech Design, Midsat International, Campower Remu, KRP Video, plus loads more.

### BE THERE FOR THE LATEST PRODUCT LAUNCHES

and apart from the huge array of state of the art goods on show, there will be

### 1000's OF £££'s WORTH OF PRIZES FOR YOU TO WIN

throughout the exhibition and

### TAKE PART IN THE DAILY MIRROR COMPETITION

### SEE LIVE ON STAGE

the finals and awards ceremony of the highly prestigious

### BBC YOUNG BROADCASTER OF THE YEAR COMPETITION

As with previous years there will be other attractions

### COME AND MEET FAMOUS CELEBRITIES

And in case you were wondering how the professionals do it, you can join in as the

### LIVE BBC BROADCASTS

You can also take this opportunity to

### MEET THE EDITORS

and get independent advice or attend seminars held by

### THE UK'S LEADING CONSUMER ELECTRONICS MAGAZINES

including Home Entertainment, Video Camera, HiFi Choice, Car Stereo & Security, Satellite TV Europe, Home Cinema



CLEARTONE

G - M E X  
MANCHESTER  
2 8 / 2 9 / 3 0  
O C T O B E R  
1 9 9 4  
1 0 A M - 6 P M  
D A I



T I C K E T S AVAILABLE FROM

CLEARTONE

BRANCHES AT:  
Bolton-Manchester  
Rochdale-Wolverhampton  
Altrincham-Walsall  
Wigan-Gloucester  
Bradford-Keighley  
Brighouse-Birmingham  
Coventry-Worcester  
Phone 0204 31423 for details

For Tickets ring:

Clearstone: 0204 31423 G-Mex box office: 061-832 9000

Please send me: Tickets @ £2.50

Total £:

Seminar tickets available at AV'94 at the cost of £1.95

Name: Address:

Postcode:

CREDIT CARD ORDERS PHONE 0204-31423

Please send this coupon to: AV'94, Clearstone, 235 Blackburn Road, Bolton BL1 8HB. Cheques & Postal Orders to be made payable to RN CLEARSTONE LTD. For credit card orders phone 0204-31423. \*Discount tickets for Under 18's, OAP's, Students & Unemployed on production proof of status. CHILDREN UNDER 6 - FREE ENTRY.

Main organisers

**HI-FI-CORNER**  
GLASGOW  
FALKIRK  
EDINBURGH

**Carl Dyson**  
Sound & Vision Centres

**Ray Smith**  
CAR HI-FI

in attendance

**RADIO SCOTLAND**  
MW 810  
FM 92.95

Scottish  
**HI-FI**  
and  
**video**  
Exhibition '94

**Royal Scot Hotel,**

Glasgow Road,  
Edinburgh

**4th, 5th 6th  
November**

Times: Friday 11am-7pm  
Saturday 10am-7pm  
Sunday 10am-6pm

**World Audio Design will be demonstrating their latest 300B valve amplifier and Carbon fibre loudspeakers in the ESK suite.**



ORANGES & LEMONS  
THE INNOVATIVE  
AUDIO/VISUAL RETAILER

**O&L**

SERVING LONDON FROM BATTERSEA

071-924 2040/3665

61/63 WEBBS ROAD, SW11

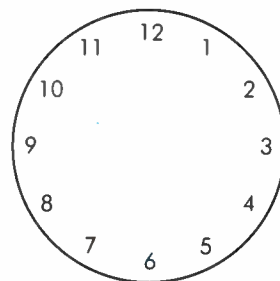

**TIME**

YOU BOUGHT YOURSELF A NAKAMICHI

For details of products and stockists, phone B&W UK on 01903-750750

**AUDIO  
ILLUSION**

23 Langley Broom  
Langley Berkshire SL3 8NB  
(Near Slough, 2 mins Junc 5, M4)  
TEL: (0753) 542761

.....*See the music*

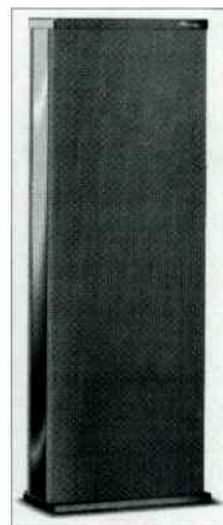

**Mirage™**  
MIRAGE LOUDSPEAKERS

THE ORIGINAL BIPOLAR LOUDSPEAKER

*Where the search ends  
and the pleasure begins .....*

**SECONDHAND BARGAINS**

MIRAGE	M-1s	£2495
MARK LEVINSON	ML10A Pre-Amplifier	£995
MARK LEVINSON	ML9 Pre-Amplifier	£1995

Air Tangent: Apogee: Audio Research: Classe: Copland: Davidson  
Roth: Jadis: Koetsu: Krell: Lineaum: Magnepan: Martin Logan:  
Micro Seiki: Mirage: Musical Fidelity: PS Audio: Sonus Faber:  
Theta: Wilson: Siltech and Transparent Cables: WBT

OPENING HOURS 10.00am Mon - Sat Sunday by arrangement



# ARCAM'S CONVERSION

**Noel Keywood assesses Arcam's conversion from silicon chips to in-house circuitry in their new Black Box 500 CD convertor.**

**A**t first I thought the Black Box 500 CD convertor was a sort of goodied up Black Box 50 - same electronics, but with more gizmos. It has lots of inputs and outputs, remote control of volume and looks very busy. I was wrong. With Black Box 500 Arcam have quickly followed in the footsteps of Pink Triangle and DPA Digital who, with Da Capo and 1024 respectively, have sought to improve on current one-bit convertor chips - especially Philips'

TDA1547. The new Arcam Black Box 500 has its own one bit convertor inside, which makes it quite a lot different from most other digital convertors - and potentially better too.

In Arcam fashion, the Black Box 500 seeks to be competitive - it's priced at £749.90, which is quite a lot lower than the Pink and DPA convertors. Put it with the Arcam Delta 250 transport and you've got a top flight two-box CD player costing just under £1500. Yet

even with this pricing, Black Box 500 offers a host of user friendly facilities, most notably remote control. It has no fewer than seven digital inputs and two digital outputs for recording which can be switched to any input, giving separate record and listen functions. All switching can be carried out by remote control.

In providing so many inputs it appears Arcam have tried to cater for every whim. There are so many, not because they expect owners to possess

# Art Audio

## MAESTRO

*"They are just so stunningly gorgeous and open to listen to, I can barely imagine anything more alluring"*

NK Hi-Fi World, June '91

Valve amplifiers from £750 to £4150 Cables from £27 to £1700

Select Audio  
Glasgow (041) 226 4268

Doncaster Hi-Fi Studios  
Sunnyfields (0302) 781387

Paul Green Hi-Fi  
Bath, Avon  
(0225) 316197

Hazelmere Audio  
High Wycombe, Bucks  
(0494) 437892

Audio Venture  
Banbury, Oxon (0295) 261863

The Hi-Fi Consultants  
London (071) 380 0866  
Evenings (071) 482 0003

Audible Difference  
Diss, Norfolk  
(0850) 983233 or  
(0379) 740227

K.A.I. (UK) Ltd  
Folkstone (0303) 245005

The Hi-Fi Consultants  
Nottingham (0602) 232450

Impulse Audio Consultants  
Westcliff-on-sea, Essex  
(0831) 616426 or 0374 277736

Sound Academy  
Blaxwich, West Midlands  
(0922) 473499

New A4 brochure containing full details of our amplifier and silver cable range contact

Art Audio (UK) Ltd., 130 Main Street, Calverton,  
Nottingham, NG14 6LU  
England UK  
Tel. 0602 - 653604  
Fax 0602 - 637795

## LOUDSPEAKERS WHEN MUSIC MATTERS



FEATURING  
ACTIVE/PASSIVE X-OVERS  
REAL WOOD VENEERS  
ALUMINIUM CONES  
OFC CABLING · STANDS

### Q.T.A. SYSTEMS

2 WHEATSHEAF WAY · LINTON  
CAMBS · CB1 6XB · TEL: 01223 891091



# VIKINGS

WOULD HAVE BOUGHT A NAKAMICHI

For details of products and stockists, phone B&W UK on 01903-750750

## Studio One

117-119 HAMMERSMITH ROAD  
LONDON, W14 0QH.

Tel: 071 371 3037

Fax: 071 371 1790

We are Mon-Sat 9.30 -6.30



*Audio Specialists  
Classical and Jazz  
Vinyl on Sale*



*We offer home demos on  
Hi-Fi equipment and  
cables.*

*So you can make  
your choice.*

Agents for:- Alchemist, Audio Innovations, Aura, Alphason, Atacama, Audio Technica, Boston, B&W, Chord Company, Castle, Denon, Dynavector, Harmon-Kardon, L.A. Audio, JBL, Jecklin, Jamo Oriel, Kinshaw, Michell, Moth, Musical Fidelity, Nakamichi, Ortofon, Pro-ject, S.M.E., Sequence, Teac, Thorens, Totem, Tannoy, Townshend, Tube Technology, Van - Den - Hul, and many more.

- \* Home Installations\*
- \* Free Local Deliveries\*

*"Call Joseph or Ossie now for Free advice"*

*"Unique Offer" - The Last Musical Fidelity A1 F.E.*

*"Final Edition" Hurry Now!!*

*"Records cleaned and sleeved on Nagaoka antistatic for £1.50 per album"*

*Pay us a visit, we are near Olympia*

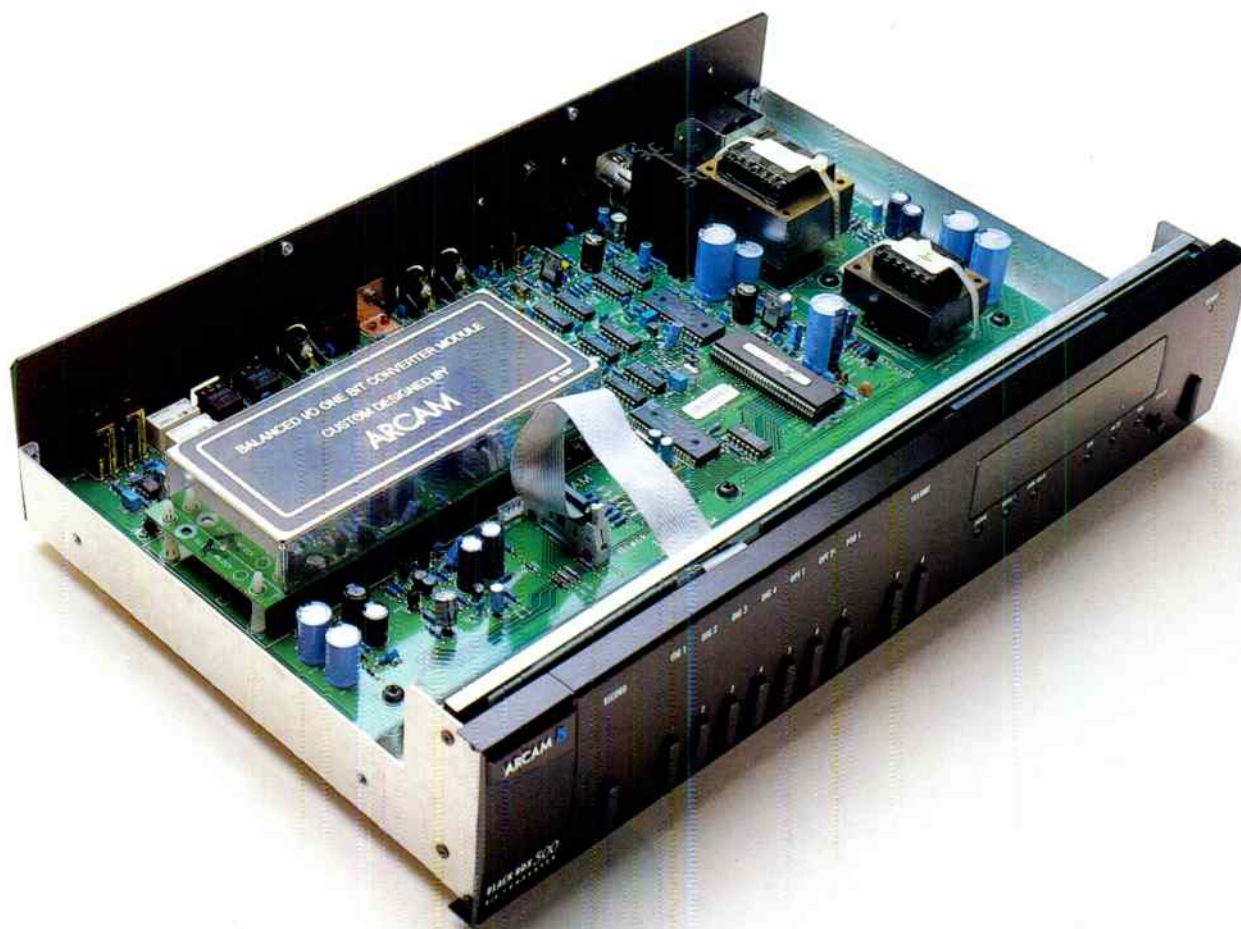

seven CD transports and will want to switch between them, but because enthusiasts buying equipment at this level have specific ideas about what they want and will bypass products that can't provide it, so all options have been provided. There's a balanced AES/EBU standard input (50/15 $\mu$ S de-emphasis) through an XLR socket, two electrical inputs through normal phono sockets, another two electrical inputs through BNC sockets (75 $\Omega$ ) and two optical inputs through TOSLINK cables.

Arcam rate XLR/BNC most highly, phono next and TOSLINK last. However, whilst TOSLINK has become a little discredited lately I would suggest it is an option always worth trying, giving an easier and often more fulsome sound than the generally more precise electrical connections.

The BB500 has its own remote control handset, which is different to that supplied with the Delta 250 transport. Since the two work together Arcam give owners conflicting options here, but the difficulty isn't a major one. Main differences are that the transport handset has a numerical keypad for track selection, but no input selector for the BB500, whilst the BB500 handset lacks a keypad,

but can input select, as well as control an Arcam amplifier and tuner. Not wanting to do any of this I found the transport handset most useful. Both have volume control and both have Display off too.

The transport also has the most useful display, showing track and time simultaneously in large green numerals. BB500 shows the input selected and volume control level, available in 1dB steps from full output (2.3V) down to -90dB. Whilst remote control of volume is very convenient, it always carries drawbacks. Arcam have decided to employ a hybrid solution giving digital control of volume over a 17dB range, with switched analogue attenuator steps. It's been very cleverly implemented. The attenuator pauses momentarily whilst the analogue part kicks in. However, digital volume control reduces resolution and increases distortion. It's generally best to leave these things at maximum and use an ordinary volume control - and this was very much the case with the BB500. Only at maximum and -10dB (-28dB/-38dB etc) did the volume control produce no extra distortion.

### SOUND QUALITY

I used the BB500 against a Pink Triangle

Da Capo and EMF Crystal to assess it, finding some distinctive properties and fairly strong system dependency - much like Black Box 50. Put bluntly, this means you can love it or hate it, depending much upon the system you use. Black Box 500 certainly has a bright sound, one that at times I found acidic and hard, yet you may never notice. It all depends upon the tweeter of the loudspeaker: if it goes all the way up to 20kHz, flat, like our KLS4 or the Tonigen ribbon of the Heybrook Sextets - both of which I used with BB500 - then BB500 can sound unpleasantly bright, producing piercing treble from some CDs in particular. I ran into trouble with Londonbeat's Katie, thin sounding guitars and sharply sibilant vocals making listening difficult. The closely miked guitar strings of Steve Earle on *Guitar Town* are incisive at the best of times, but from BB500 they developed a graininess that was none too pleasant.

However, many loudspeaker tweeters don't reach 20kHz smoothly; they either roll off gently or dive down precipitously above 16kHz or so. This makes for fairly amenable - often sweet - treble. It also removed the obvious sharpness from BB500 I found. The convertor worked well through many of



Just what you've always wanted. Speakers that don't make a sound.

And so it was written that the advanced "silent" cabinet design of Tannoy Profile speakers should offer a purity of sound and absence of distortion that other manufacturers could only

dream of. Allowing the powerful drive units to produce a volume of music sufficient to bring down the walls of Jericho. And the people heard this, and there was great rejoicing.

**TANNOY** PROFILE

RING THE PROFILE HOTLINE ON 0236-425407. OR WRITE TO TANNOY LTD., ROSEHALL INDUSTRIAL ESTATE, COATBRIDGE, STRATHCLYDE ML5 4TF.

World Radio History



the loudspeakers in our loudspeaker group test this month.

So much for the BB500's brightness.

There was more to it than just this however. Two fine properties that I'd attribute to its in-house designed one-bit convertor are excellent denseness of timbre (I'll explain!), plus an ability to keep separate musical strands apart, making for better than usual intelligibility.

Somehow, I couldn't say the BB500 has richness of timbre. This could be misleading, because it doesn't have a rich sound - nor does Da Capo - as such; both convertors are very analytical and perhaps a trifle remorseless. All the same, BB500 gives vocalists and instruments a good sense of solidity and timbral denseness. Perhaps this comes from the way it finds and separates detail; John Lee Hooker's gruff tones come over well and the band members stayed apart on Boom Boom; on some convertors/players this track descends into a muddle. BB500 could not quite match Da Capo for sheer clarity or dynamics, but it came very close most of the time, which is a fine performance for the price (Da Capo is more expensive and, in my view, one of the best convertors available).

A dry, almost reticent bass quality became apparent in contrast to EMF's Crystal convertor. The Crystal chip set is known for its powerful bass; it was a pity that BB500 couldn't rustle up a bit more in order to achieve a better sense of balance.

Violin and massed strings seem to stress hi-fi components like no other instrument, probably because of the high frequency energy they possess. It was with strings that I found BB500 sounded least happy. The massed strings of the Royal Philharmonic merged together and sounded compressed during crescendos in the 1812. Here, Da Capo showed it was in another league altogether.

Also, I more clearly began to discern something almost subliminal that had been bothering me about BB500 - its peculiar 'greyness' of tone. With strings this character became more obvious, seeming to be a combination of upper midband muddle and compression producing a hardness and greyness in the sound. Unlike EMF's Crystal, or Quad's 67 CD player, the BB500 possesses little sweetness.

Perhaps after cataloguing a litany of weaknesses I need to get some perspective into this review. Black Box 500 does sound clearer in its portrayal of instruments than most CD players and equivalently priced rival convertors. It also comes over as full bodied in its sound. In these important areas it can

battle it out with the best of them. But with me it ran into heavy waters. I just happened to listen to CD through

Heybrook Sextets (flat to 20kHz), our own KLS3s (same) and KLS4s (same). I'm sensitive to treble quality and BB500 doesn't do very well either with such loudspeakers and a listener of my outlook.

Paired with, for example, Rogers

Studio 3s it sounded much more amenable, except with orchestral strings, when strain obviously set in.

Pink Triangle's Da Capo is an impossibly hard act to follow, but I can say in its favour that BB500 stayed close

*“The BB500 gives vocalists and instruments a good sense of solidity and timbral denseness.”*

on rock music, falling behind conspicuously only with classical. That's a great performance for the price. Had I used BB500 after an ordinary CD player, with a system less analytically revealing at high frequencies, then this review might have been altogether more flattering.

As it stands though, I have to say that whilst this convertor is good value, some of its characteristics are a little less than aurally friendly and, put into the wrong system, it won't please. It's definitely worth a listen, but preferably in a complementary system able to make the most of its strengths whilst concealing its weaknesses ●

**Arcam BB500** £749.90

**Arcam 250** £749.90

**A&R Cambridge Ltd.,  
Pembroke Avenue,  
Denny Ind. Centre,  
Waterbeach,  
Cambridge CB5 9PB  
Tel: 0233 440964**

MEASURED PERFORMANCE

Our frequency response analysis clearly shows a steady treble rise above 5kHz and even though the total lift amounts to only +0.15dB or so, our experience shows that such a lift is audible as brightness in the sound. With CD, tonal neutrality comes from a slight fall in response, something Arcam have traditionally offered with their players, so the BB500 is something of a departure in this respect. In line with past experience I identified brightness in the sound before measuring this convertor, so the treble lift came as no surprise.

Along with brightness I felt there was a hint of treble coarseness in the sound. This is more difficult to explain, but there was some uncorrelated quantisation noise in one channel of our review sample and the digital volume control produces additional noise and distortion. The other channel was clean, however, and overall distortion levels proved very low right through the convertor's dynamic range providing the digital volume control was set to maximum and left there.

There were virtually no unwanted spurious products above 21kHz; Arcam have used excellent filtering. Channel separation was high, output normal at 2.2V and noise low. Low distortion helped toward a high dynamic range value of 107dB.

The Arcam Black Box 500 measured well, but there are indications as to why it has the sound I heard. All the same, few companies in the world are able to design and produce a dedicated one-bit convertor and wringing this performance out of an original design is impressive. **NK**

Frequency response	3Hz-21.2kHz	
Distortion %		
-6dB	0.003	0.002
-30dB	0.007	0.006
-60dB	0.4	0.4
-90dB	29	30
-90dB dithered	5	8
Separation dB	left	right
1kHz	100	106
20kHz	82	88
Noise		-97dB
with emphasis		-97dB
Dynamic range	107dB	
Output	2.2V	

Frequency Response

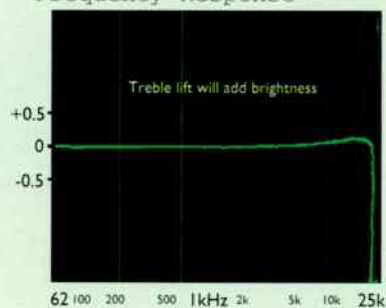

62 100 200 500 1kHz 2k 5k 10k 25k

Distortion

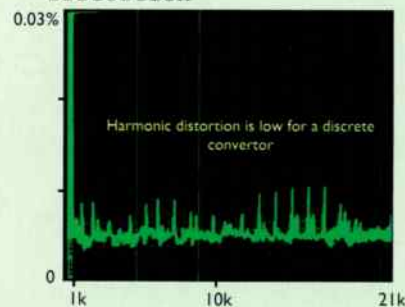

TEST RESULTS

"The audio levels generated by Chameleon can cause serious hearing damage. Suitable ear protectors should be used in any high audio level environment." I pushed my Cerwin Vega ear plugs into place and pressed play on the remote control. After a few seconds I realised all was safe: the Quads were still standing. Instead of a vicious onslaught of harsh treble, hard and cold midrange and massive bass - something I was partly expecting - a surprisingly subtle, sweet and gentle rendition of Primal Scream appeared from the Quad Electrostatics.

Looking at the front panel of the Chameleon 900S I noticed that the signal indicators weren't lit, even though the insensitive Quads were filling the room with sound quite nicely. Pushing the volume control up a notch higher gave a brief flicker: obviously the Chameleon wasn't delivering what Malcolm Hill, the designer, deems as an "adequate signal". As far as the Chameleon was concerned, driving the 82dB sensitive Quads to high levels in a domestic environment was a walk in the park, not even worthy of bothering the signal indicators.

This was just a hint of what the Chameleon could offer; Noel later measured 288watts into 8ohms and an impressive 440 into 4ohms. Malcolm Hill calmly mentions that when monoblocked, the Chameleon can deliver a full 2000watts. This is the kind of power you'd

with the pro style front panel attenuator controls on the fascia. If you have to have insensitive loudspeakers, the Chameleon provides the tonic needed to get them going.

Something had to be missing, and it was - the hype. There is no techno jargon in the handbook, just helpful information and a circuit diagram so that any engineer can quickly service and repair anything that may go wrong. This is a no-nonsense power amplifier: you can plug it in and forget it. You need never worry about the load your loudspeakers are presenting nor of running out of power at one of those noisy parties you have now and again.

As I mentioned above, the most surprising thing about the Chameleon is its smooth and rich sound, almost more valve than transistor. It was noticeably warmer in the treble and richer lower down than the DPA 50S I normally favour for review purposes. The DPA is one of the cleanest sounding transistor amplifiers I've come across in the treble, and although the Chameleon didn't have quite the same ultimate level of clarity, it had a similar ability to steer clear of the semiconductor coarseness that plagues many solid state power amps.

The atmosphere of Counting

Crows' August and Everything was captured beautifully by the Chameleon. This recording was made in the living room of the band's house in Los Angeles, then mixed at a local studio. Much of the atmosphere of the room survived the production process and the result is a superbly live acoustic, helped along by energetically played Hammond organ, harmonica, pedal steel guitar and a wealth of other well recorded instruments. Vocals were produced with a liquid fluidity, forward and textured giving the sound stage real scale.

As you'd expect, bass was pretty good too. The Quads have a tendency to flap here if left to their own devices. The Chameleon was having none of it though, gripping the diaphragms firmly and producing a taut and staunch bass line from bass guitar and drums. Again, as with the upper registers, it had character too, the resonant strings of Lou Reed's Walk on the Wild Side allowed to flourish and grow without becoming hard or forced in any manner.

## KILLER

expect from an amp the size of a small fridge, not the slimline and elegant 1U (42mm) height alloy case sitting between the speakers.

Whilst I'm talking about the casework, you may have noticed it's a little out of the ordinary. The whole amplifier is made from a complex arrangement of alloy extrusions, to give an aerodynamic space age style; it wouldn't look out of place in Star Trek: "watch out Captain Kirk, the Chameleons are attacking from the starboard bow".

So, stylishly built, immensely powerful, and with a delicate and detailed sound - what price for such an amplifier? If I told you it was £2000 I doubt if you'd be surprised. But it's not, and you will be surprised to learn that it could be yours for just £760. In fact, if you wait a month or so, there'll be a £699 version that does away

William Baker inserts his ear plugs to  
enjoy the Chameleon 900S 300W  
professional power amplifier.

**MEASURED PERFORMANCE**

It's been a long time since I've seen an amplifier as radical as this one, at least in chassis design. Some areas of performance are startling too. Power output, for example, measured no less than 288watts into 8ohms and an astonishing 440watts into 4ohms. Before you gasp and ask how they do it, let me say that technically it isn't so difficult, providing the amplifier is Class A/B or B. It's the heat sinking and dissipation that's potentially a problem and in this respect the Chameleon is meant strictly for music. With test signals its all-alloy case, which doubles as a heatsink, rocketed in temperature, the heat sink area is so small.

Traditionally, the trouble with big power amps has been a lack of subtlety in their sound. Quite often, piercing treble, caused by crossover distortion, has been the culprit. The Chameleon avoids this problem quite effectively, producing predominantly second order harmonic

distortion at high frequencies, albeit with some small contribution from higher order crossover components, shown in our analysis of a 10kHz signal at 1W output. Distortion levels were low all round, even at high frequencies and high power outputs; I measured a maximum of 0.1%.

Sensitivity was low at 1V, meaning the Chameleon needs a preamplifier with gain. Bandwidth stretched from 12Hz up to 70kHz, -1dB - a fairly wide window at high frequencies. It's certainly appropriate for hi-fi work. There was a small amount of d.c. output offset at the speaker terminals, but at -40mV maximum it was low enough not to be a problem.

The Chameleon is very well engineered and very well suited to hi-fi use, for those that want something different, when different means just that - not worse! **NK**

**TEST RESULTS**

Power	288watts
CD/tuner/aux.	
Frequency response	12Hz-70kHz
Separation	80dB
Noise	-109dB
Distortion	0.035%
Sensitivity	1V
dc offset	-40/-21mV

**Distortion**

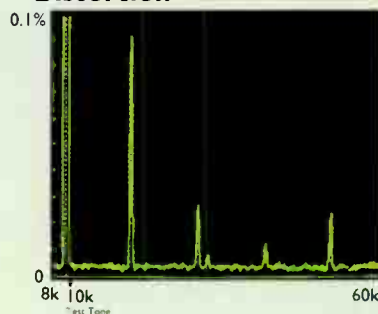

Where the Chameleon does draw some criticism is in its ability to resolve fine detail. The DPA excels here, resolving low level information that passes most amplifiers by.

The Chameleon, although good, couldn't retrieve quite as much from a recording. The main lead instruments were clear and focused, and not compressed in any way, but behind these there wasn't quite the depth of information that a few of the better solid state designs can reach.

# CHAMELEON



It could sound a little two dimensional in this respect, if that's the best way to describe it. I doubt if this would be quite so obvious on average-sensitivity cone loudspeakers, but both the Quads and highly sensitive cone loudspeakers can be ruthlessly revealing in this area. As a partner for any of the lower sensitivity mini-monitors in this month's group test though, the Chameleon does the job as well as any hi-fi amplifier could, if not better ●

**Chameleon 900S** £760  
**Malcolm Hill Associates,**  
**Hollingbourne House,**  
**Hollingbourne,**  
**Kent.**  
**ME17 1QJ**  
**Tel: 0622 880644**

# FI - RAX

## ADJUSTABLE AUDIO FURNITURE

High quality  
Aluminium  
Construction  
Various Finishes  
available.

Adjustable  
Glass Shelves  
sitting on  
Isolating Rings.



**Tel: 0924 277626**

**FAX: 0924 270759**

Any size or  
shape custom  
made on request.

**JEM DISTRIBUTION  
SPRINGFIELD MILLS SPA ST.,  
OSSETT, WAKEFIELD,  
WEST YORKS WF5 0HW**

**NEW... Diamond shaped crystal clear Big sound deep bass line... Bright and life like sound... Even from the smallest one... Home trial or no trial this must be done... Better price better design. 1994.....**

**For free full colour brochure  
Phone 081 986 4455**

**Elvins Acoustic Technology. 12 Brett Road, London E8 1JP England.**

# Great tracking

Ortofon is famed the world over for the tracking capability of its cartridges. Cartridges which will breathe new life into a cherished LP collection, divulging detail as never before.

The cartridge is always the key factor in the reproduction of music from records and Ortofon has dedicated nearly 50 years to the manufacture of the finest pick-ups possible. Enjoying constant critical acclaim along the way.

So if you want to bring more out of your records than ever imagined, an Ortofon Cartridge will have you hot on the scent.



**500 Series**  
Moving magnet  
cartridges from £30-£100



**MC Series**  
Moving coil cartridges  
from £40-£110



**Q Series**  
Moving coil cartridges  
from £140-£500



**1000 Series**  
Moving coil cartridges  
from £600-£1500

# ortofon

Ortofon (UK) Limited, Chiltern Hill, Chalfont St Peter, Bucks SL9 9UG.  
Tel: 0753 889949.



# SPACE SAVERS

Here are five high quality mini-monitors for those with space problems.

Dominic Baker finds little boxes can make a big impact. Alestar Kells gives a second opinion.

Not everyone has space for a large floorstanding loudspeaker, but that doesn't mean that you can't enjoy high quality sound reproduction. There are a large number of high performance miniature speakers available that can be stand, bookshelf or even wall

bracket mounted. Here's a group of some of the finest.

First of all, I should introduce the BBC LS3/5a, which is as much a specification as a loudspeaker. For those who are new to hi-fi, or have somehow missed out on this compact little monitor, it's the

miniature 'speaker that set standards back in 1974. Developed by the BBC for Grade II outside broadcast monitoring, it found its way into studios and other areas where accurate monitoring was expected. It used, and still uses, high quality KEF drive units and was engineered to give a particularly neutral

and accurate sound. The level of engineering was so good in fact that three companies still produce the LS3/5a under licence today, Rogers (who supplied the review samples for this test), Spondor and Harbeth. In fact, Spencer Hughes and Dudley Harwood were the original BBC engineers responsible for the LS3/5a and went on to form Spondor and Harbeth respectively. KEF also hold a licence, but don't actually build the LS3/5a, but do supply the drive units.

The other four that make up this test group of mini monitors are Harbeth's HL-P3s, Rogers Studio 3s, ProAc's Tablette III Signatures and Systemdek's System 931s. All use high quality drive units and crossover components in a compact enclosure in similar style to the original LS3/5a, but each reflects their designer's outlook.

All of these mini monitors were treated to a 20hour run in period and were used with a powerful solid-state DPA power amplifier. This gives them a chance to show what they could do, regardless of the load they present. But beware, because some are an

awkward load and care with amplifier matching is necessary.

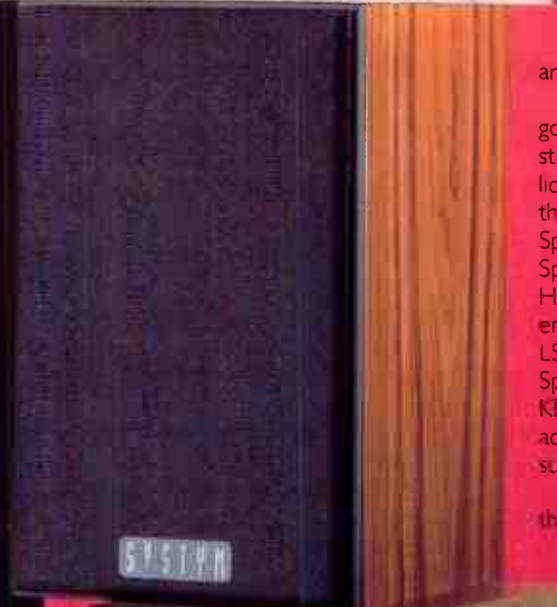

£479

HARBETH HL-P3

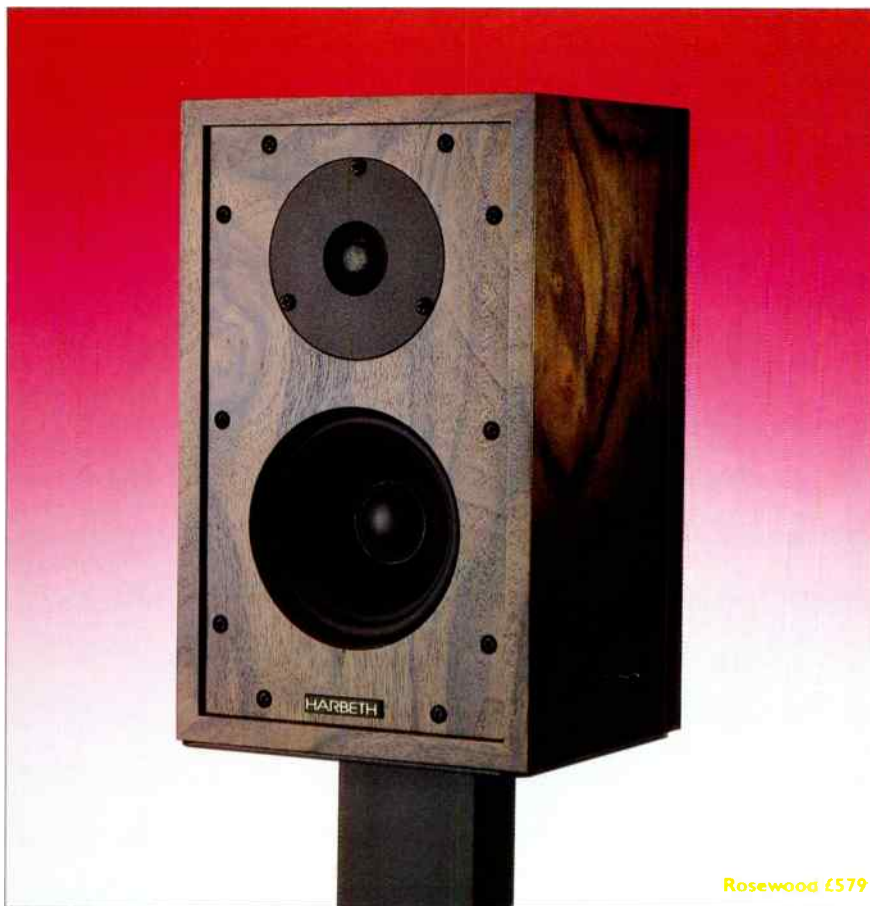

Rosewood £579

From the first few bars of Lou Reed's *Transformer* I knew that there was something unmistakably right about the HL-P3's sound. On the intro of *Walk on the Wild Side* they went low enough to catch the fundamentals of the double bass complete with its resonating fret board, giving it a rich, woody character. Whilst the low bass was a little muted and softer than it really should have been, what was happening above caught my attention.

The highly pitched, soaring violin sounded smooth and unbroken as its notes slowly slid into each other. The treble possessed the ability to clearly differentiate each individual note, yet at the same time convey a tune. Lou Reed's voice had real body, the full contribution of his chest and throat revealed when he sang into the closely positioned microphone. The HL-P3s offer strong insight into recordings, drawing my attention to an error about three minutes into the track where his voice becomes muffled on the left loudspeaker, caused by what sounds like a sloppy bit of tape editing.

But the slow bluesy nature of *Transformer* isn't the only style in which the HL-P3s excel. Blur's upbeat pop songs on *Parklife* fared equally well. The punchy upper bass of the P3s was used to the full by the speedily plucked bass strings and cymbals, aided by a suitably metallic ring from the metal dome tweeter. The richness in the upper midrange that suited Lou Reed so well wasn't quite as successful with Damon Albarn's higher pitched and dryer vocal tone, removing a touch of clarity. This was a minor point though, and considering how well focused the

midrange is, not one to worry unduly over.

These 'speakers knit a performance together, working extremely well to produce a firm and believable image that stretches to fill either side and back-to-front on the soundstage. I suspect that this effect is produced by a combination of accurate pair matching and coherent phase between the two drivers in each cabinet.

This ability to see into a recording couldn't be more noticeable than with the Cranberries' album *Every One Else Is Doing It, So Why Can't We?* The airy and ambient atmosphere of Dolores O'Riordan's rich folksy tones at centre stage were delivered as a complete and cohesive whole. Cymbals sounded sweet, vocals pushed out from the midrange and kick-drums punched forwards in the bass, collectively uniting to present a realistic performance **DB**

The HL-P3s struck me as a well balanced speaker capable of dealing with most types of music. Going in with a touch of Billy Idol proved rewarding, marred by a slight treble colouration I found a little undesirable. On rock tracks in general the bass can really drop to a low frequency. Carly Simon's vocals sounded beautiful through these speakers; they give natural vocals. As Dominic mentions, the HL-P3s are revealing, making them unforgiving of bad studio engineers. They give a good feel for what is going on in the studio. **AK**

**Harbeth Acoustics Ltd., £479**  
**Unit 1, Bridge Road,**  
**Haywards Heath,**  
**W. Sussex. RH16 1UA**  
**Tel: 0444 440955**

## MEASURED PERFORMANCE

Under measurement, Harbeth's HL-P3s had a smooth and well controlled frequency response. From lower midband through to upper treble there is only around +/-1dB of variation - a superb result. Treble does show a slight lift, but I'd suspect this to add a pleasant brightness to the sound rather than a sharp sting.

The bass peaks up in similar fashion to that of the original LS3/5a, which should give the HL-P3s a similarly speedy, punchy bass. I'd expect the HL-P3s to sound tonally smooth and neutral, with good bass attack.

Of the group though, the HL-P3s are the most awkward load for an amplifier. Loudspeakers are always a trade-off and this is the one Harbeth have chosen for the HL-P3s. Sensitivity measured at 1m using a nominal watt of pink noise was just 83dB, only 1dB higher than the original LS3/5as. So, straight away you are going to need plenty of volts to get good volume levels. But for amplifiers, things get worse with the impedance characteristic.

The overall figure of 6.7Ω hinted that the 'P3s were going to need an amplifier capable of delivering a healthy dose of current. Looking at the impedance curve it is easy to see where the 6.7Ω overall figure comes from, at 200Hz and again below 50Hz impedance falls to a crippling 3.5Ω. I'd recommend searching out a high current, solid-state 150watt power amplifier for optimum results. **DB**

### Frequency Response

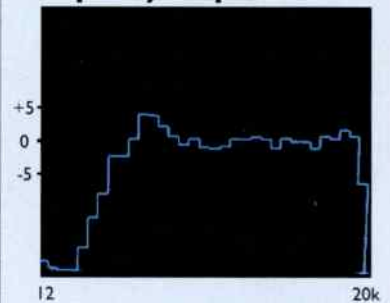

Smooth response, but bass peak will add good bass punch and treble lift some brightness.

### Impedance

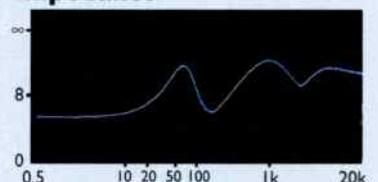

Impedance dips to 3.5Ω in the bass so use an amplifier that can deliver plenty of current.

## MEASURED PERFORMANCE

ProAc's Tablette III Signatures had the least flat response of them all, which is surprising. Firstly, because they are the most expensive and, secondly, because this is one area where ProAc are usually very good. Their bass was flat with no lift so I'd expect lighter bass than the other speakers in the test.

Between 1kHz and 5kHz there was a wide dip in output, 2-3dB below the bass and tweeter level. This I would almost certainly expect to reduce midrange presence and attack, possibly causing the Tablettes to sound a little soft or recessed. Above this you can see the tweeter come in, rising in output to a peak at 16kHz. This rising treble response usually results in a bright or sharp character, but in this case the use of a high quality soft dome tweeter should ensure the former rather than the latter.

As far as driving the ProAcs is concerned, they are one of the easiest in the group. The sensitivity measured at 1m using a nominal watt of pink noise was 84dB, lower than most loudspeakers, but higher than all but the Systemdeks in this mini-monitor test. Impedance was high too at 11.2Ω, so they will not demand much current from amplifiers. Use an amplifier of at least 80watts for best results.

The ProAcs don't have the smoothest response, but they are one of the easier miniatures to drive, in this group at least. They are probably best suited to bookshelves rather than stands in free space due to their limited bass output. **DB**

### Frequency Response



Rising treble level will give the ProAcs a bright balance and dip in midrange may reduce projection.

### Impedance

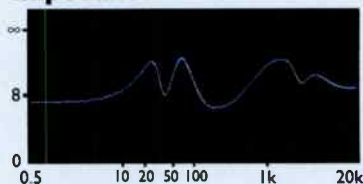

High overall impedance of 11.2Ω means the Tablettes will not demand much current.

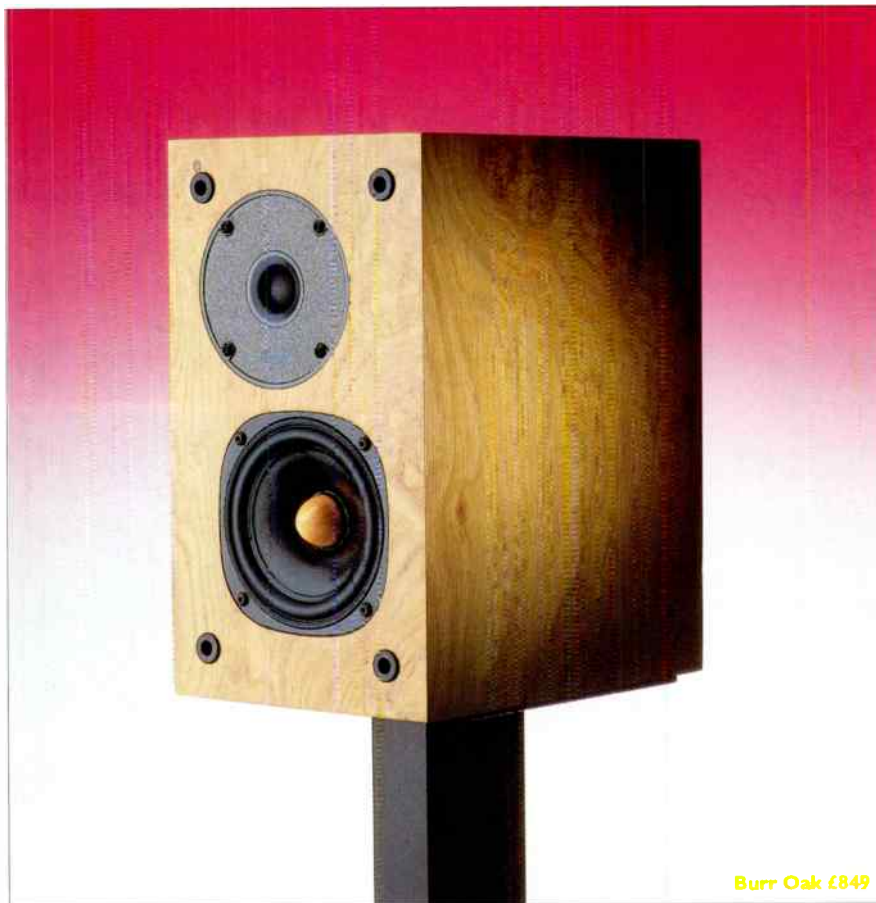

Burr Oak £849

The most surprising thing about the ProAc Tablette III Signatures is the way they produce reasonably deep and, for the size of the cone, extremely powerful bass. The impact of foot pedal against drum skin on the intro of the Cranberries' 'Pretty was fast 'n' clear' with a real kick behind it. Admittedly, some of the deeper resonances were missed altogether, but what they do produce comes across with real verve. Occasionally, bass could become a little detached from the rest of the mix, tending towards a one note 'thud', but even then it was fast and agile.

The Tablettes suffer a similar trait at the top end. Their treble is clear but bright too, which tends to draw attention to itself. There is a slight phasey quality in the upper midband that moves into the lower treble, suggesting the two drivers aren't perfectly in tune with each other. This will probably present more of a problem with solo violin and vocal work, which tends to be centred right on the crossover point, moving up and down to either driver.

Taken as separate entities though, both the midrange and treble are exceptionally clear and clean. The midrange has the ability to project tremendous detail, propelling it forwards for the listener to revel in. Coupled with the crisp and similarly detailed treble and firm bass below, the Tablettes have a fantastically energetic and exciting sound. It is here that the Tablette Signatures have their strength, suiting the more forward and upbeat nature of rock and jazz.

Recordings really came alive with the Signatures. Crash Test Dummies, that I'd written off as mournful and dull, both in

performance and recording terms, was given a new lease of life. Percussion gained attack and a sharpness that made it sound far more pronounced, pushing its way forwards to lead the tracks along. With the treble sparkling away above and the solid bass below, this album gained some impact and speed.

The soundstage produced by the ProAcs wasn't in quite the same league as some of the others in this test, possessing a slightly two dimensional portrayal of depth. But the bright treble gives them an airy and open quality which goes some way to ameliorate this.

Imaging wasn't especially convincing either, despite the handed tweeters. The Tablettes tend to keep the two channels of a stereo signal separate, rather than blending them to fill in between the speakers. Having said this though, they still image better than most larger stand-mounters and floorstanders, if not as well as the best in this particular group.

**DB**

These speakers look good. You rarely see veneer looking this good. Pachelbel's Canon had a real dreamlike quality - it was easy to forget about hi-fi and drift away. Stereolab's Ping Pong was reproduced wonderfully, only marred by a grumbling bass line that kept interrupting the rest of the music, rather than co-existing with it.

**AK**

**ProAc**  
130-132 Thirsk Road,  
Borehamwood,  
Herts. WD6 5BA  
Tel: 081 207 1150

£779

PROAC TABLETTE III SIGNATURE £779

# Don't trip up on your speaker cable!



When you invest in good quality hi-fi equipment, why skimp on the cable?

Especially now that Ortofon can offer 3 types of top-quality cable for under £10.

Each cable is made up of very fine core copper strands rated at 6-Nines (that's a copper purity of 99.9999% - it doesn't come much better), is flat and flexible for easy installation and features a 'tack-rack' for panel-pin fixing.

Cable Type	Description
SPK 100	Twin-core white cable, each core with 130 copper strands (total 260 strands).
SPK 200	Triple-core grey cable for bi-wiring with twin-core treble (260 strands) and 3-core bass (390 strands).
SPK 300	7-core blue cable having 13 strands per core (each strand laminated). Requires soldering.

You'd better hound us for the name of your nearest stockist.

## ortofon

Ortofon (UK) Limited, Chiltern Hill, Chalfont St Peter, Bucks SL9 9UG. Tel: 0753 889949.



Tesseract Audio.  
If you've never heard of it,  
you should hear it.

For an appointment  
call 081 568 8808.

For full details of the Tesseract range of head amplifiers, pre-amplifiers, power amplifiers, Gyrodec power supplies and dealer list contact: Choice Audio Marketing, Butter Field House, Church Street, Old Isleworth, Middlesex TW7 6BE.

Tel/Fax: 081 568 8808



TESSERAC AUDIO  
The Best of British High End

His master...

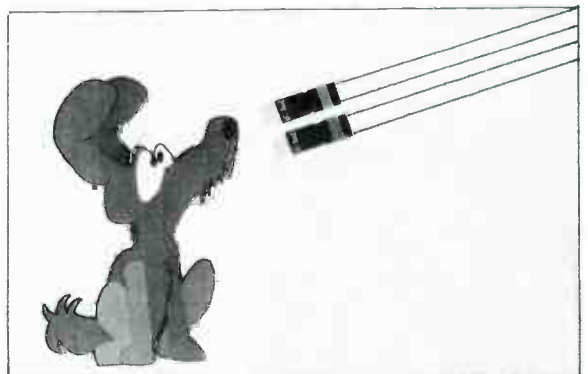

...is well connected

Acoustic Solutions present a wide range of hand made interconnects from £25 to £400+. Whatever your requirements we can produce a bespoke interconnect to suit. Feel free to call for advice on the most sound upgrade path for your system. For more details about ASL see this month's 'Trade Winds'.

**ASL**  
Acoustic SoLutions

46a Market Street,  
Longton,  
Staffordshire,  
ST3 1BS  
Tel 01782 595 330  
Fax 01782 593187

'Sound Engineering for the Future'



## MEASURED PERFORMANCE

The BBC LS3/5a must be one of the longest standing loudspeakers in production today. The samples supplied for this test by Rogers use the same classic combination of KEF B110 Bextrene bass unit and T27 tweeter, which fill the front baffle. They were engineered to be an accurate near-field monitor for top quality studio work. The smooth, flat response they engineered some 20 years ago would still cause many to blush even today.

There is, however, a strong peak in the bass which gives them their characteristic bass speed and punch. A smooth, but gently rising response through the midband and up into the treble is responsible for providing an even and apparently balanced sound that is, at the same time, clear and open. The treble response does get a little lumpy, but not enough to cause serious problems.

By today's standards though, sensitivity is desperately low. Measured at 1m using a nominal watt of pink noise, I could just squeeze 82dB level from them. That's 1dB less than the notoriously insensitive Quad ESL63. Overall impedance was quite high at 10.2Ω and the impedance curve has no strong dips where heavy current would be drawn. So the LS3/5as don't actually need a lot of current, but they do need volts. I'd recommend at least 100 watts for decent levels and good drive.

The original LS3/5a still measures well technically and in this respect the newer contenders in this test have made little progress. **DB**

### Frequency Response

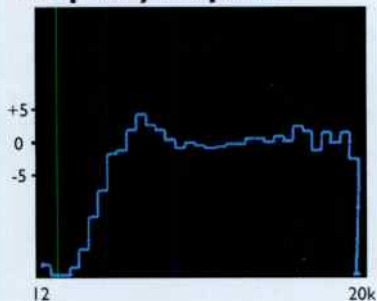

Bass peak will give the LS3/5as punch and speed and the smooth response with rising treble a bright and open sound.

### Impedance

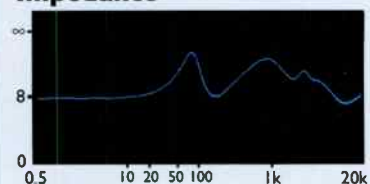

Impedance is high overall at 10.2Ω and never dips below 8Ω so the LS3/5as will not demand much current.



The LS3/5as go surprisingly low in the bass for their size. It was solid too, with plenty of weight behind it. At times it did become a little confused though, hanging around on one note a little too long, which detached bass from midrange. The deep bass kick at the beginning of the Cranberries' *Pretty* had the little Bextrene core wallowing around trying to catch itself in time for the next beat. This waffle had a tendency to set in whenever a heavy, continuous bass line was played.

The treble however, was surprisingly good. It changed from note to note precisely and without any associated resonant ringing. It has a fast, but damped character. Cymbal crashes, were quickly damped out, leaving a clear path for the following strike. This effectively separated one note from another, giving the impression of clear and articulate treble, but some of the upper harmonics that describe the atmosphere and give an openness to the sound were lost, leaving the LS3/5as with a sterile character.

The harpsichord on Blur's *Clover Over Dover* had a lovely delicate touch, but some of the 'zing' from its complex harmonic structure was missing from the top. With a more processed pop track though, the damped and speedy treble suited quite well. With strongly vocal pieces, the sheer brightness of the tweeter could add some unnecessary and unpleasant 'spitch'. Suzanne Vega suffered at the hands of this, her normally dry and hollow voice gaining a wispy sibilance in the upper reaches and a chesty thickness in the lower octaves.

Totally, the LS3/5as still came over as

accurate, though, Rogers Studio 3s, with their dryer, cooler midband are more faithful to the original, but the 3/5as weren't far behind.

Where these speakers have always been good and still compare with the best is their coherent and focused sound. A wide soundstage is created with good depth detail, giving an insight into the music. They don't produce quite the same level of information in this area as the Harbeths, which really excel, but they do enough to conjure a convincing picture for the listener.

The image focus is impressive too: they have a very directional sound which sets up a stable image without interference from reflected energy confusing things. Ultimately, more modern mini-monitors all find higher energy and more atmosphere in music, but the 3/5as have aged well and in some areas still manage to come close to modern rivals. **DB**

Although the smallest on test, the LS3/5as can kick out a good tune and plenty of bass. Any group with a guitar in their midst had a lovely sound, due to crisp upper midband projection. In my opinion, the vocals were in general a little coloured. It really didn't help to form a great overall opinion. I would class the LS3/5as as a good vintage design. There aren't many who can still perform so well twenty years on. **AK**

**Rogers, Swisstone Electronics, £690**  
**310 Commonsides East,**  
**Mitcham,**  
**Surrey. CR4 1HX**  
**Tel: 081 640 2172**

£690

ROGERS LS3/5a

£499.90

ROGERS STUDIO 3



I found Rogers Studio 3s have a softer, more laid back presentation than their competitors in this test. Whereas ProAc's Tabletes were on the verge of becoming too intense, the Studio 3s occupied the opposite end of the field. Bass was soft and warm, albeit staying tuneful and articulate throughout, whilst the midrange seemed so smooth that after some of the more forward speakers in this group it could be considered over relaxed.

However, although the midrange sounded a little less forward and lacked some of the projection of the other speakers, it was possibly the most tonally accurate of the bunch.

Bass was deep and powerful enough to give a good, balanced sound and treble came over as sweet and detailed, without justifying any accusation of being bright or peaky. The Studio 3s are very balanced in this respect, not altering the tonal balance of recordings either for better or for worse.

The super smooth Free from Primal Scream's latest album had an aura of class to it. The richly textured vocals were free from coarseness or undue colouration. Lightly strummed acoustic guitars were delicate and full bodied with a lovely resonant bloom from the thin, wooden guitar body. The Studio 3s are the kind of loudspeaker you could listen to for hours, managing to be both relaxing and informative without becoming intense.

Out of interest I tried Blur's Parklife to see if the Studio 3s were perhaps just a little too smooth to do justice to this pacy pop album. Listening to the title track, their muted upper bass punch did remove a little force and immediacy.

However, the midband and treble gained considerable numbers of browny points. The Studio 3s are very well integrated in this area, giving the correct amount of prominence to individual performers and allowing them to form a cohesive whole.

Another notable asset of the Studio 3s is their ability to fill in the gap between the two speakers. There is a solid spread of sound right across the stage.

This quality is most noticeable and convincing with performers such as Grant Lee Buffalo. Here the whole performance is held together by the solid, centrally placed image. The atmosphere of the studio was convincingly reproduced too, with a defined soundstage staying focused right to its outer edges.

It is this blend of accuracy, together with a smooth presentation that gives the Studio 3s their enjoyable and musical character. **DB**

There is always a favourite and this speaker turned out to be mine. When something actually sounds like fun it becomes hard to fault it. Only on one Angelique Kidjo track, Idje Idje, did I find the bass plodding a little. That apart, the Studio 3s were brilliant. No boxiness or colouration crept in, especially on a tricky Geoffrey Oreyama track which can kill most speakers. On all types of music there was a lovely forward projection - a little 3D is rather marvellous. **AK**

**Rogers, Swisstone Electronics, £499.99**  
**310 Commonside East,**  
**Mitcham,**  
**Surrey. CR4 1HX**  
**Tel: 081 640 2172**

## MEASURED PERFORMANCE

Rogers' Studio 3s possess a smooth, flat response from the bass up through to the midrange. There are a couple of peaks in the treble, at 8kHz and 16kHz, but these may well serve more to add a little brightness and sparkle rather than an unpleasant sharpness.

As with nearly all of the monitors in this test, there is an overall trend toward a wide, shallow dip through the midrange. This may remove a little projection from the midrange, but thanks to the small, rigid enclosure, I'd doubt if box colouration will result. Bass rises gently towards lower frequencies, which is likely to give the Studio 3s a firm bass quality, if not an overpowering one.

Of the bunch, the Rogers had the most well mannered impedance curve, one exhibiting a high overall impedance of 12.5Ω; both factors ease drive requirements. It was smooth and remains above 8Ω across the entire audio band, making the speaker an easy load and one of the few that will perform well with valve amplifiers. In fact, good results are likely with a zero feedback amplifier; the rising impedance through the midband will alter frequency response, pushing vocals forwards. Sensitivity was low at 83.5dB, making a good 80watts necessary for decent volume levels.

Rogers have combined a smooth response with reasonably easy drive characteristics to produce one of the best compromises in this test of mini monitors, but low sensitivity is a drawback. **DB**

### Frequency Response

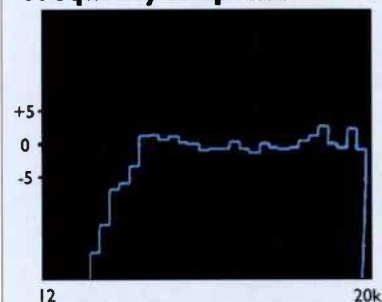

Frequency response is smooth which should give a neutral balance. The treble peaks may add some brightness though.

### Impedance

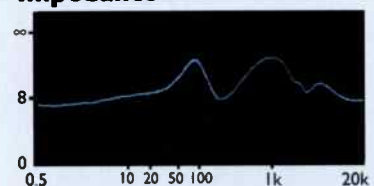

Impedance is high at 12.5Ω and smooth so the Studio 3s will not draw much current.

## MEASURED PERFORMANCE

Systemdek's 931s have the flattest overall frequency response of the group. There is neither bass nor treble lift, and the midband in between is even too. I'd expect them to have a neutral balance and a reasonably faithful sound as a result.

Lack of bass or treble emphasis may give the 931s a slightly less exciting balance than the others in the group, but a smoother and more polite balance can also be an advantage. There is a small lift in the upper midband that may help to project vocals out of the box, but following it is a small crossover dip, although I suspect it is not wide or deep enough to have any serious effect.

The Systemdek 931s are the most modern miniature in this group and they show it in the load they present to an amplifier. Sensitivity measured at 1m using a nominal watt of pink noise was a healthy 85.5dB, some 1.5-3.5dB more than others in the group. They will go significantly louder for the same volume control setting.

The impedance curve was also high and reasonably smooth, so the extra sensitivity hasn't been gained at the expense of drawing more current from the amplifier. Overall impedance measured 12.5Ω, a high value. In combination with high sensitivity it is feasible to use the 931s with an amplifier of 50watts or so.

The Systemdek 931s are well engineered, combining a flat response with easier drive characteristics than the other speakers on test in this group. **DB**

### Frequency Response

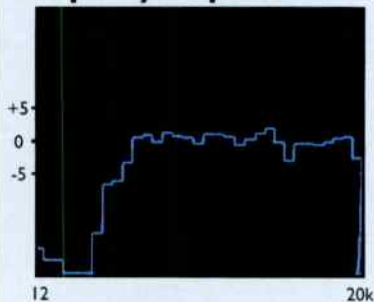

Frequency response is very smooth and flat. This will give the 931s a neutral balance without treble emphasis.

### Impedance

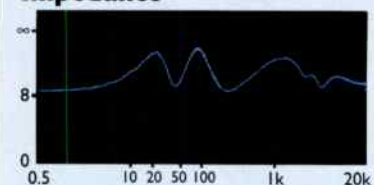

Overall impedance is high at 12.5Ω so the 931s will not draw much current. They are reasonably sensitive too making them the easiest load in this test.

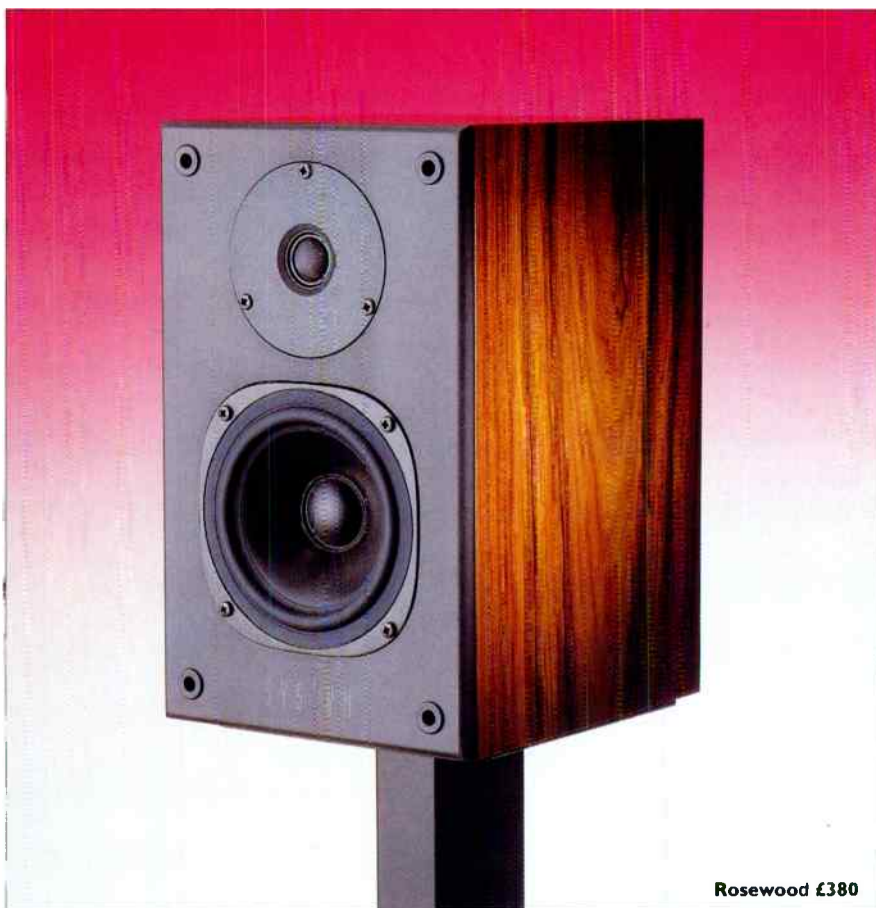

Rosewood £380

The Systemdek System 931s are a more exciting version of Rogers' Studio 3s. They share the same balanced sound and polite, inoffensive delivery, but they do it with more enthusiasm. The midrange gains a little warmth in comparison to the dryer Studio 3s, but they were also a touch more forward, projecting midrange detail with more confidence.

With Pink Floyd's *The Division Bell* the most noticeable difference was the extra weight and authority the 931s put behind each note. Here, the 931s were only outclassed by the more expensive Harbeths. Don't take this as meaning that they're aggressive or harsh in any way, they just project so well that a performance becomes so much more real.

The bass of the Systemdek 931s benefits from a larger cabinet and reflex loading. This gave them deeper bass than I'd expected, without softness or loss of articulation appearing. It also explained why the midrange had better projection and detail. The extra bass the 931s produce allows the midrange to be pushed a little further forwards without it becoming tinny. The double bass intro on Lou Reed's *Walk on the Wild Side* had good weight and scale behind it, never becoming monotonous or overblown.

The live atmosphere of Counting Crows' *August and Everything After* was opened out by the 931s, their strong midrange projection conveying the atmosphere of the room where this album was recorded. Dry vocals, and the wide range of instruments including piano, harmonica and steel guitars, were all produced with superb focus and clarity,

only a slight thickening of tone making itself known in the upper midband. The extra brace fitted to the new 931s does seem to damp the box well in this area, leaving only the cone material's character to colour the sound.

The treble of the 931s was clear and sweet and played a tune respectably well. It didn't have quite the same ability as that of either the Harbeths or the ProAcs, both of which could change from note to note in the treble precisely and cleanly, and with a dexterity normally found in more expensive designs. The 931s weren't far behind, but didn't seem to have quite the same number of notes in their vocabulary. Having said this though, their treble was less forced, adding a delicate brightness to the upper midrange without drawing attention away from it. **DB**

As the 931s are very similar to the Rogers Studio 3s, their sonic performance was familiar. You can tell that these speakers are close partners. Differences between Dominic's observations and my own are attributable to differences in partnering equipment. I heard a definite boxiness, especially with Joan Baez and Zouk Machine. Deep bass, however, was apparent. This is always an eye opener when you're dealing with a speaker of this size. You can't fault the 931s for their big sound. Partnered correctly I feel they perform competently. **AK**

**Systemdek,** £330  
**34 Kyle Road, Irvine Ind. Est.,**  
**Irvine, Scotland.**  
**KA12 8LD**  
**Tel: 0294 271251**

£330

SYSTEMDEK SYSTYM 931S

Here's what the UK's leading publications have to say about the new Q Series.

Q10

"ALL ROUND THE USER-FRIENDLY Q10s LOOK LIKE WINNERS FOR KEF - AND MUSIC LOVERS SHORT ON SPACE."

What Hi Fi?, February 1994

Q30

"WHERE THE KEFs REALLY SCORE IS IN THEIR ABILITY TO BRING EVERY SEGMENT OF THE MUSIC TOGETHER IN A HIGHLY INVOLVING MANNER."

What Hi Fi?, February 1994

Q50

"THE OPENESS, CLARITY AND SPEED OF THE Q50... MAKE IT PRE-EMINENT OF ITS TYPE."

Alvin Gold, Audiophile, June 1994

Q70

"...THE Q70s WILL DELIGHT YOU WITH THE SHEER TOGETHERNESS OF THEIR MUSIC MAKING."

What Hi Fi?, June 1994

SEE YOUR NEAREST DEALER FOR A DEMONSTRATION.

<b>ABERDEEN</b>	
HOLBURN HI FI	0224 585713
<b>ALLOA</b>	
McMICHAEL BROTHERS	0259 724230
<b>BIRMINGHAM</b>	
MUSIC MATTERS	021 429 2811
(3 BRANCHES IN WEST MIDLANDS)	
<b>BLOXWICH</b>	
SOUND ACADEMY	0922 473499
<b>BRISTOL</b>	
RADFORD HI FI	0272 428247/8
(7 BRANCHES IN THE SOUTH WEST)	
<b>CARDIFF</b>	
AUDIO EXCELLENCE	0222 228565
(4 BRANCHES IN THE SOUTH WEST)	
<b>CHELTENHAM</b>	
SEVENOAKS	0242 241171
(12 BRANCHES IN THE STM & MIDLANDS)	
<b>COLWYN BAY</b>	
ELECTRO TRADER	0492 548932
<b>CREWE</b>	
NORMAN AUDIO	0270 211091
(ALSO IN LANCASHIRE)	
<b>CROYDON</b>	
ZEBRA	081 688 2491
<b>EDGWARE</b>	
MUSICAL IMAGES	081 952 5535
(ALSO IN HOUNSLOW)	
<b>EDINBURGH</b>	
IN HI FI	031 225 3854
<b>GLASGOW</b>	
BILL HUTCHINSON HI FI	041 204 4433
(5 BRANCHES IN THE NORTH)	
<b>GUERNSEY</b>	
MELODONIA	0481 56647
<b>GUILDFORD</b>	
P J HI FI	0483 504801
<b>HUDDERSFIELD</b>	
READYVISION	0484 532294
<b>JERSEY</b>	
BASE HI FI	0534 58518
<b>KNUTSFORD</b>	
WILMSLOW AUDIO	0565 650605
<b>LEEDS</b>	
AUDIO PROJECTS	0532 304565
<b>LEICESTER</b>	
LEICESTER HI FI	0533 539753
<b>LONDON</b>	
HI FI EXPERIENCE	071 580 3535
K J LEISURESOUND	071 486 8262/3
AUDIO CONCEPT	081 567 8703
<b>MANCHESTER</b>	
D & T ELECTRONICS	061 445 2694
<b>NEWCASTLE</b>	
J G WINDOWS	091 232 1356
<b>NEW MALDEN</b>	
UNILET	081 942 9567
<b>NOTTINGHAM</b>	
NOTTINGHAM HI FI	0602 786919
<b>OTLEY</b>	
DOUG BRADY HI FI	0943 467689
<b>PETERBOROUGH</b>	
THE HI FI COMPANY	0733 892231
(ALSO IN LEAMINGTON SPA)	
<b>READING</b>	
B & B HI FI	0734 583730
(5 BRANCHES IN BERKS/BUCKS)	
<b>SHEFFIELD</b>	
SOUND WITH STYLE	0742 737893
(ALSO IN DONCASTER)	
<b>SHREWSBURY</b>	
CREATIVE AUDIO	0743 241924
<b>SWINDON</b>	
AUDIO T	0793 538222
(7 BRANCHES IN THE SOUTH)	
<b>ROCHDALE</b>	
JOE KOZUR	0706 42107
<b>THAME</b>	
THAME AUDIO	0844 215431
<b>TWICKENHAM</b>	
RIVERSIDE HI FI	081 892 7613
<b>WILMSLOW</b>	
SWIF'S OF WILMSLOW	0625 526213
<b>WORTING</b>	
PHASE 3	0903 245577

THIS DOES NOT CONSTITUTE A FULL DEALER LIST. FOR A COMPLETE DEALER LIST PLEASE CONTACT KEF ON 0622 672261.



The experience of sound

KEF and Uni-Q are registered trade marks. Uni-Q is protected under GB Patent 2 236929 - worldwide patents pending.

It's that  
**KEF**  
feeling  
The  
**NEW Qseries**



Q10



Q30



Q50



Q70

World Radio History



# CONCLUSION

This was one of the most interesting group tests I've done for quite some time. All five of the loudspeakers on test have been very well engineered, but each one has been optimised slightly differently. With loudspeakers of this size, there is always a trade off between the level of bass produced and ease of drive. So all five are a compromise, and it was interesting to see the different compromises each designer had chosen.

Unsurprisingly, the LS3/5a shows its age against its newer rivals. After twenty years it is still an impressive piece of engineering in some respects. It has a smooth response and high overall impedance, but is very insensitive. The drive units are well made, but there are lighter, faster more transparent sounding materials available today, making the LS3/5a sound coloured in comparison.

It still has a clear and focused sound and bass is surprisingly deep and punchy, but recordings don't open out to give a convincing atmosphere and there is a lack of fine detail to the sound. This gives them a sterile balance, one that doesn't exactly make for the most exciting performance, but they stand testament to good engineering when it has taken twenty years for the others to catch up.

On sound quality alone, the HL-P3s are out there ahead of the group. The bass isn't quite as good as say the Systemdek 931s, being a touch oversize and soft, but the way they pulled together to create a clear, wide soundstage and a

captivating performance was simply superb. Treble was sweet and detailed and played a tune impeccably well, giving them a level of detail that few can match. This is integrated extremely well into a similarly detailed and cohesive midrange to give an almost seamless transition between the two units. The down side is that if you like the sound of the HL-P3s, you're going to need a powerful, high current amplifier to drive them to their full ability.



Next, in sound quality terms alone, come the Systemdek 931s. In fact it was a pretty close run thing between these and the Harbeths, the HL-P3s just taking it for their superb coherence. For classical, the HL-P3s had the superb integration and tonal neutrality needed, but for rock the 931s offer solid bass and a more energetic

sound. The midrange was especially good, being notably more forward and clearer than the others, but still sounding balanced.

Rogers' Studio3s come close behind the 931s, having a lovely relaxed and unforced presentation. They lacked the solid bass and some of the attack of the 931s, but the midrange was super smooth and refined. They are the kind of 'speakers you could sit back and listen to for hours, but ultimately I preferred the more upbeat and energetic presentation of both the HL-P3s and the 931s.

The ProAcS Tablette III Signatures are just plain bright. I don't mind a bright loudspeaker; in fact I prefer it to a dull and over-warm balance, but I must say that the ProAcS were just too bright for me. Going some way to saving this was an incredibly deep and powerful bass for such a small driver, but midrange projection did suffer as a result of these raised frequency extremes. They have other qualities that are certainly of merit, such as excellent detail resolution and a lively sound, but the sting from the tweeter was just a little too much.

The Harbeth HL-P3s, Systemdek System 931s and Rogers' Studio 3s are all worth a careful audition, each producing a superb sound in their own right. If you are looking for value for money, the Systemdek 931s win hands down. Not only are they more than a hundred pounds cheaper, but they are the easiest to drive, making it feasible to power them with a good integrated amplifier ●

# AUDION

EST.1987



300B SINGLE ENDED  
PURE TRIODE  
STEREO

**£995\***  
UK MODEL RETAIL

**GOLD MEDAL WINNERS DO IT AGAIN!!!**



A hi fi dream  
Germany

SO LIFELIKE  
hi fi news

"HERE'S AN AMPLIFIER  
THAT SETS STANDARDS"  
HI-FI WORLD

"INCREDIBLY POWERFUL!"  
HI-FI EXCLUSIVE GERMANY

TONALLY SUPERB  
SPAIN

"THESE ARE TRULY  
EXTRAORDINARY AMPLIFIERS"  
STEREOPHILE  
U.S.A.

A WONDERFULL power AMP  
SUONO ITALY

**"OUR AMPLIFIERS SPEAK FOR THEMSELVES!"**

**\*\*\* 92db IMPEDANCE MATCHED TRANSDUCERS NOW AVAILABLE \*\*\***

CONTACT YOUR NEAREST DISTRIBUTOR OR SHOP FOR MORE INFO

LONDON  
K J LEISURE  
071-4868262/3

HEATHROW  
AUDIOCRAFT  
0895-253340

KENT  
PROGRESSIVE  
0634-389004

HEREFORD  
ENGLISH AUDIO  
0432-355081

ABERDEEN  
ASTRAL  
0224-582825

SUFFOLK  
SIGNALS  
0473-622866

NOTTS  
CHANTRY AUDIO  
0777-870372

SURREY  
FARNHAM AUDIO  
0252-714555

WEST MIDLANDS  
SOUND ACADEMY  
0922-473499

SUSSEX  
JEFFRIES  
0273-609431

HUMBERSIDE  
ZEN AUDIO  
0482-587397

NORFOLK  
AUDIBLE  
DIFFERENCE  
0850-983233

**\*EXPORT MODEL £1250.00**

## OVERSEAS DISTRIBUTERS

SWEDEN  
TURNING POINT  
+46-8-7443477

ITALY  
ART OF MUSIC  
+39-51-231172

GREECE  
EXCLUSIVE  
+30-18236225

HONG KONG  
ELITE AUDIO  
+852-530-1567

SINGAPORE  
LANDMARK AUDIO  
+65-3383867

SPAIN  
MULTIMEDIA  
+34-77-240794

JAPAN  
SB INTERNATIONAL  
+81-3-34057177

CANADA  
CANORUS INC  
+1-416-972-1387

SLOVENIA  
K.A.T.  
064-43391

PORTUGAL  
LUZESOM  
+351-2-9532235

PHILLIPINES  
UPSCALE  
+632-7415167

FRANCE  
MAGAVOX  
+33-59321134

AUSTRIA  
LIVING SOUND  
+43-316-82281044

HOLLAND  
AUDIOVORM  
+31-23-322774

AUSTRALIA  
KEDKORP PTY  
+61-2-708-4388

NEW ZEALAND  
INTRINSIC  
+64-3-33499119

GERMANY  
MARVEL HEISS  
+44-234-37430

SWITZERLAND  
MAR ELECTRONICS  
+41-1463-81-05

**AUDION AMPLIFIERS UNITED KINGDOM  
ALEMA UK FAX 0273 722250**

# VINYL DRIVE

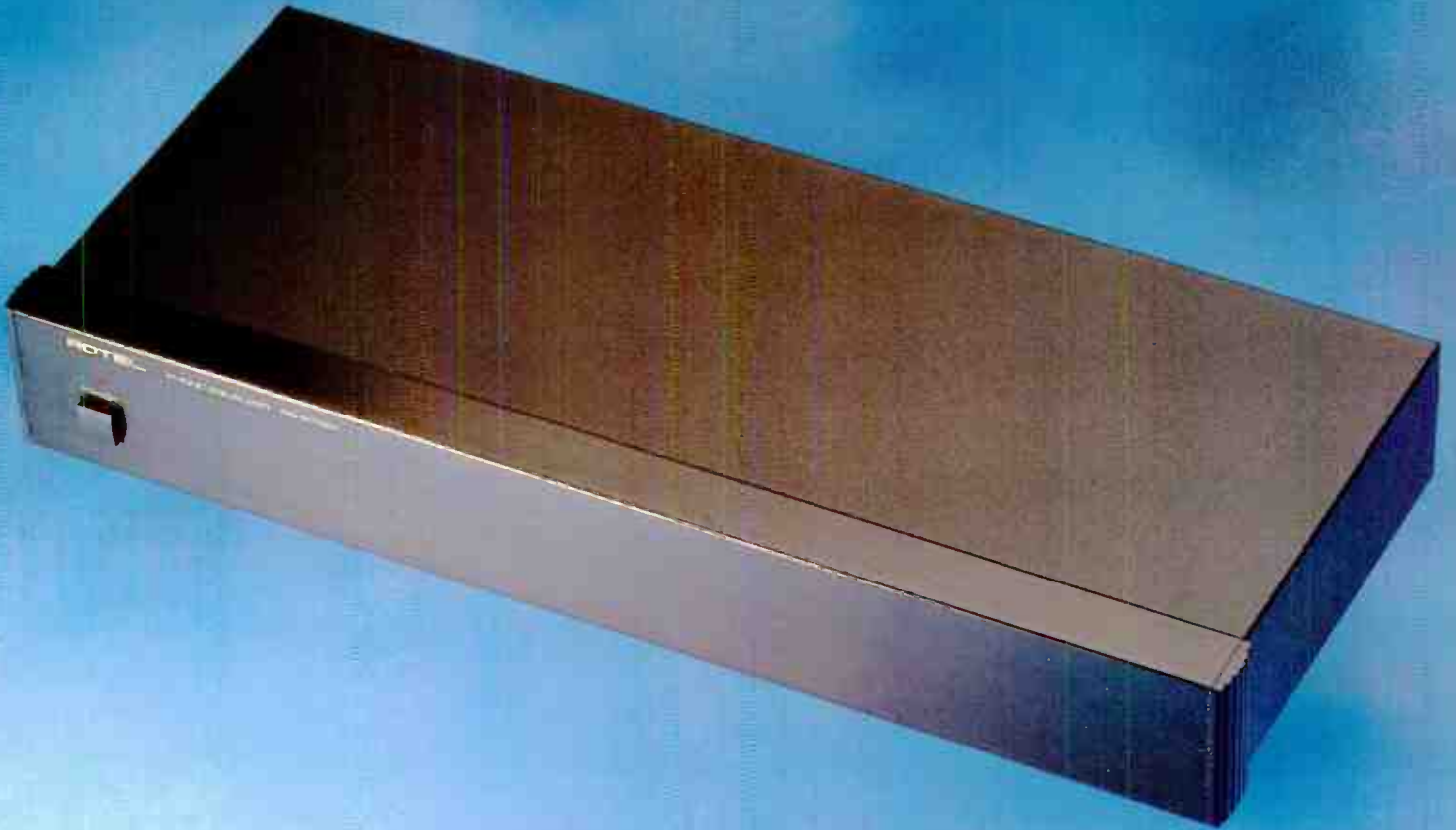

**Rotel's new RQ-970BX phono-stage has Eric Braithwaite blowing cobwebs from his LP collection.**

Vinyl didn't exactly die, it just faded away from the display racks in the shops. But the turntable soldiers on. There are still millions of black discs around, and more and more companies are licensing the classic Decca and RCA recordings of the fifties and sixties.

Rotel, being sensible about affordable audiophile electronics, has stepped in with what is probably the most affordable mainstream company phono stage around. For a mere £130, the RQ-970BX Phono Equalizer makes vinyl replay through a line-level amplifier as accessible and as cheap as a plug-in module - and with a sound better than most.

Switchable between moving magnet and moving coil, its performance on both was very respectable, not in the least cheap-sounding. Unadulterated, for this review covers Hi-Fi World's modifications as well, its showing with a Goldring

1042GX was very vivid. On both MM and MC, the Rotel displays a very fleet-footed turn of speed, rhythmically adept and controlled. Common to both was a top-rank degree of depth definition, albeit on MC with a tinge more hollowness in the mid-range which tended to make second violins a spot more laid-back than is really correct.

Less distinguishable on jazz or rock recordings, this actually produced a concomitant benefit, with the studio echoes of a drumkit neatly defined so that a listener could enjoy that rare detail of spotting where the baffles were placed; usually the province of much more expensive phono stages.

Only two traits say that the Rotel was built to be affordable rather than cost-no-object. On MC, the RQ-970BX lacked that ability to flow into and fill out the upper registers of the treble clef that the

top-ranking stages have. There was a feeling of dynamic restraint there. And while the breadth of the soundstage is creditable, it couldn't quite find the extra bit of distance between brass instruments or cellos and double basses at its further extremes, on MM particularly putting a boundary within the outer edges of the speakers. But the Rotel is as far ahead in sound quality of the average amplifier phono stage as a Williams is in advance of a Fraser Nash.

## WORLD UPGRADED RQ-970BX

The Hi-Fi World-modified Rotel made a noticeable improvement, especially on MC. My Morch da Capo tended to push the original a little too hard dynamically, but this, you will note, was also true of more expensive stages. On the revised

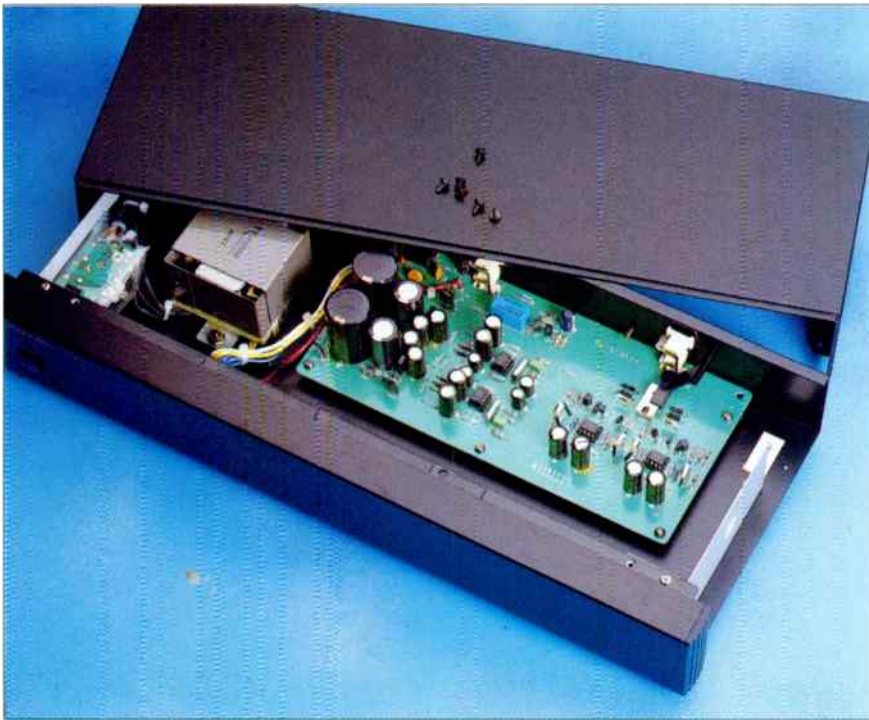

Inside the RQ-970BX is a wealth of high quality components, including polystyrene and Rubycon Black Gate capacitors.

version, there was a more dynamic top end, albeit still somewhat restrained.

The most marked alteration was the now more discernible separation between instruments both physically and in tonal colour. Cellos and basses close to the same note on the staff were now clearly distinct, brass instruments and strings now more laterally separated. Vocals - this is either a change in the plus or minus side entirely dependent on taste - now projected forward, having been more on a plane with the 'speakers' before. The Rotel's already fast subjective speed was marginally even tighter, with the lower resonances of

instruments that bit more defined. Individual images, too, had just that bit more of a perceptible outline than before. While the modifications still don't put the Rotel into the £400 league, and I don't expect that was anticipated, they do turn a very good disc stage into a worthy one. If they put it into the £200-ish bracket, it's worth every penny and more. Meanwhile, all those people with LP collections and a good quality cartridge in the £40-£200 range, need look no further than a Rotel RQ-970BX to blow the cobwebs off their discs. Buy a good £250 line-level amp to go with it and even that minimalistic

combination will surprise you with how good vinyl can be. Like going from a midi-system deck to a Systemdek.

### UPGRADING THE RQ-970BX by Andy Grove

The modifications to the Rotel RQ-970BX turned out to be simple but effective. The most straightforward modifications are the component substitutions, although the component quality is already excellent with Rubycon Black Gate power supply bypass capacitors and 1% polystyrenes in the EQ network.

The first mod is to remove the two NE5534 (yuk!) op-amps and replace them with the AD744s which are currently being used at the front end. Fill the gaps left by the AD744s with AD743s (available from Electromail), a rather costly op-amp, but one of excellent sound quality. Be sure to remove and replace these very carefully. A solder sucker and good quality temperature controlled soldering iron are absolutely essential.

When you remove the AD744 and NE5534 op-amps you may like to fit IC sockets in their place which makes it easier to change the op-amps around or experiment with different types. Be very careful to make sure, whether you use sockets or solder the op-amps directly to the board, that they are the right way around. One end of the chip is marked either with an indent or small dot.

C121 and C122 are the output decoupling capacitors (10µF, 50V), these are Black Gate electrolytic types as standard. In my view, even though the Black Gates are excellent, they aren't really suitable here because of the lack of DC polarization voltage across them. A high

## Schematic of Modifications.

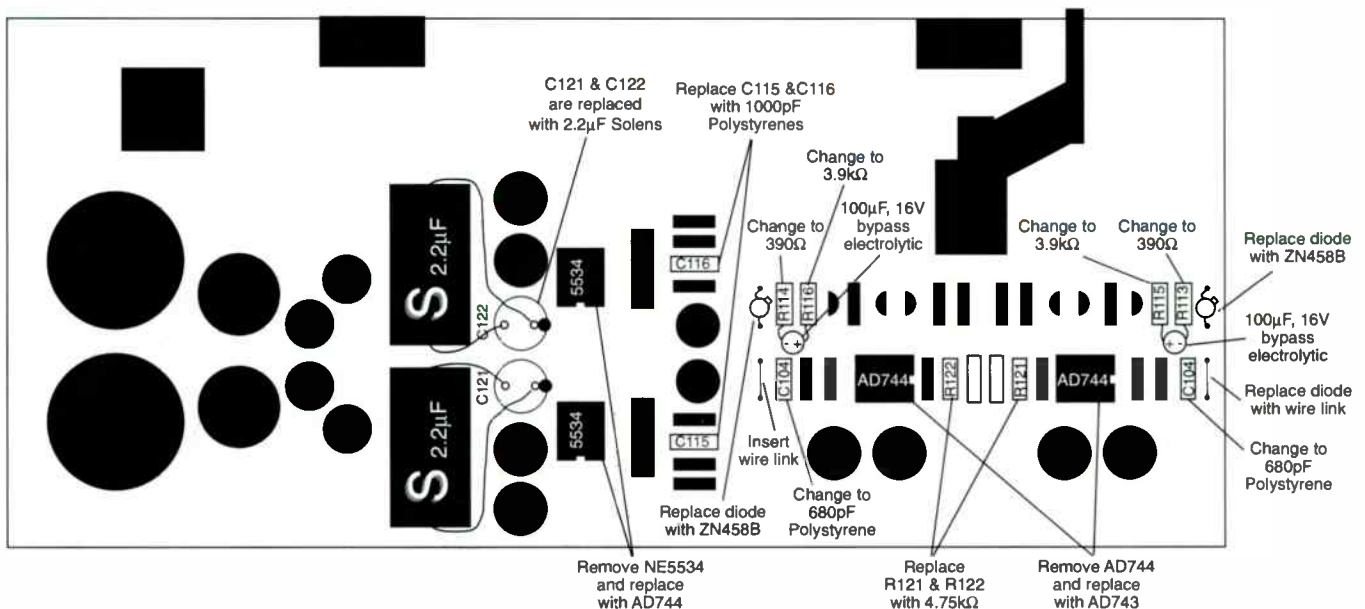



quality polypropylene such as a Solen or Ansar (available from Falcon Acoustics) will give a clearer, less grainy sound, 2.2µF is plenty. The physical size of these is an order of magnitude greater than the original so you need to use your dexterity and imagination to get them in. C115 and C116 (1000pF) are polypropylene in the original circuit, which although good, can be replaced with 1% polystyrene capacitors for better sound quality.

The gain of the original was too low on both MM and MC for many preamps. I changed R121 and R122 from 2.74k to 4.75k, which reduces the feedback and increases the gain to a more useable level.

The final modification is the most comprehensive. It reduces the noise at the input stage and allows the input op-amp to operate more optimally by reducing the DC common mode input voltage. The main change is to increase the current through the input Long Tailed Pair. As standard it is about 2.5mA total, 1.25mA per transistor. I have increased this to 4.5mA total, 2.25mA per transistor. The two 1N4148 diodes which provide the

1.4V reference voltage for the current source are replaced by a precision bandgap reference IC of 2.45V (type ZN458B from Electromail). This increased voltage also improves the performance of the current source. So D101, D102, D103, D104 all go, R113 and R114 change from 274R to 390R, R115 and R116 change from 22.1k to 3.9k. For some reason the original diodes were left unbypassed, injecting noise into the Long Tailed Pair. 100µF, 16V capacitors are added to bypass the voltage references, soldered to the legs of R113/115 and R114/116 (note polarity). These changes to the input pair increase its transconductance and extend its frequency response. To keep the stage stable C103 and C104 should be changed from 330pF to 680pF 1% polystyrene ●

### Component List.

Capacitors:  
 2 x 680pF 1% Polystyrene  
 2 x 1000pF 1% Polystyrene  
 2 x 2.2µF Polypropylene  
 2 x 100µF 16V Electrolytic

Resistors:  
 2 x 390R 1% 1/4W  
 2 x 3.9k 1% 1/4W  
 2 x 4.75k 1% 1/4W  
 Semiconductors:  
 2 x AD743JN  
 2 x ZN458B

Hardware:  
 4 x 8-pin IC sockets

### SUPPLIERS

**Electromail**  
**P.O. Box 33, Corby,**  
**Northants. NN17 9EL**  
**Tel: 0536 204555**

**Falcon Acoustics,**  
**Tabor House, Norwich Road,**  
**Mulbarton, Norwich. NR14 8JT**  
**Tel: 0602 578272**

**RQ-970BX £130**  
**Gamepath,**  
**25 Heathfields, Stacey Bushes,**  
**Milton Keynes, Bucks. MK12 6HR**  
**Tel: 0908 317707**

## MEASURED PERFORMANCE

Relying on silicon chips, like most disc stages, the RQ-970BX has a maximum output of 11V. Most competitors give 9V-11V or so and this largely determines most other parameters. If a designer wants good overload figures - and it looks like Rotel have placed a priority on this - then overall gain must be kept down. The RQ-970BX has very low gain values of x67 for moving magnet (MM) cartridges and x700 for moving coil (MC) cartridges. That's just enough for amplifiers with sensitive line inputs.

For example, with a 300mV line (i.e. Tuner/Aux/Tape) input sensitivity this pre-amp offers 4.4mV input sensitivity for MM and 0.42mV for MC. Most disc stages have twice as much gain (x150 MM/ x 1500MC) but less overload headroom. Anyone considering the RQ-970BX will need a good modern amplifier and they must expect to turn the volume up. It cannot be used to drive most power amps through a passive volume control, except those that are very sensitive (like our own or Leak TL12, for example).

Interestingly, Rotel have omitted the IEC recommended warp filter, so there's plenty of gain right down to 10Hz. Equalisation was accurate, giving a measured response on both MM and MC of 10Hz-100kHz (-1dB). Those with compliant moving magnet cartridges, heavy-ish arms, warped records and reflex loudspeakers should beware of cone flap.

Input hiss values - the only valid way of specifying noise - were good at 0.5µV and 0.086µV (CCIR) for MM/MC respectively. It is possible to get -6dB quieter MC stages from Audiolab, EAR, so for this reason and low gain the Rotel is best off paired with

high-ish output moving coil cartridges, not the very best low output types. **NK**

### TEST RESULTS

Frequency response	10Hz-100kHz
Separation	90dB
Noise (MM/MC)	0.5/0.08µV
Distortion	0.003%
Sensitivity (MM/MC)	4/0.4mV
Overload (MM/MC)	164/16mV

### MODIFIED VERSION

The biggest change Andy made to this phono stage lies in its increased gain, which improves sensitivity and general application. Moving magnet gain has increased from x77 up to x100 and moving coil gain has increased from x700 up to x1100. When feeding an amplifier with a line input of 300mV sensitivity - about average these days - the RQ970BX then has effective sensitivities of 3mV for MM and 0.27mV for MC. This is far more appropriate for high quality, low output cartridges - especially quality moving coils. For example, an Ortofon MC15 Super II produces 0.53mV at 5cms/sec rms, typical average music level from LP, so the amp system has enough gain to reach full output.

Andy changed the feedback compensation capacitors to ensure a good stability margin at the new higher gain, bringing bandwidth down to 50kHz - there's no need to reach 100kHz in our view. His increase in current into the long tail pair causes noise to decrease by -1.5dB from 0.5µV to 0.42µV (CCIR weighted

equivalent input noise) on MM, and -1.2dB from 0.08µV to 0.07µV on MC. (Note for engineers: this noise improvement has nothing to do with bandwidth reduction, since CCIR weighting concentrates on noise around 7kHz only).

Distortion remained very low, measuring just 0.004% at 1kHz (MC), second harmonic only - as our analysis shows.

So there you are. Courtesy of a very tolerant Rotel, Dennis the Menace Dominic and Amplifier Andy, you can buy a straight RQ-970BX and apply tweaks when you feel ready. **NK**

### TEST RESULTS

Frequency response	10Hz-50kHz
Separation	90dB
Noise, MM/MC (CCIR)	0.4/0.07µV
Distortion	0.003%
Sensitivity (MM/MC)	3/0.27mV
Overload (MM/MC)	110/10mV

### Distortion

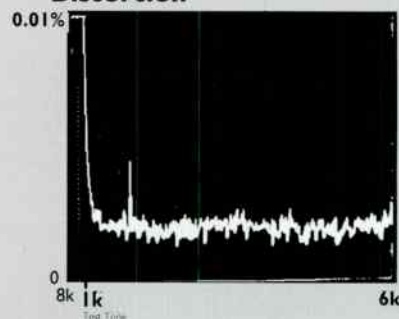

# MICHELL GYRODEC AND QC POWER SUPPLY



A SYMBOL OF PRECISION



**"THE MOST DESIRABLE DECK BELOW £1500"**  
Ken Kessler - Hi-Fi News & Record Review August '94

**Michell Engineering, 2 Theobald Street, Borehamwood, Herts WD6 4SE**  
**Tel:- 081 953 0771**

*Listening*

THE HI-FI  SPECIALISTS

STOCKISTS OF

ARCAM  
AUDIOLAB  
CHORD COMPANY  
CREEK  
CYRUS  
DENON  
EPOS  
HEYBROOK  
LINN  
MARANTZ  
MISSION  
NAD  
NAIM  
NEAT  
NAKAMICHI  
ONIX  
REGA  
ROTEL  
ROYD  
TDL

6 HOTEL ST, LEICESTER  
TEL: 0533 623754

32 GOLD ST, NORTHAMPTON  
TEL: 0604 37871

*...and she thought she was getting a new washing machine*

## *Loricraft Audio*

**Specialists in Garrard, Thorens and SME.**

Last month Loricraft exhibited a Garrard 401 with an SME Series IV arm, complete with electronic power supply which gave stunning results at the RCA Living Stereo Records launch.

Many thanks to Impulse Loudspeakers for their generosity and glorious sounds.

Manufacturer of dedicated part supplies for Garrard 301/401 and Thorens TD124 (review copies available). Supply and service of Garrard, Thorens and other high quality turntables using genuine and manufactured parts to original specifications. Also manufacturers of high quality plinths for Garrard 301/401 and Thorens TD124.

We are happy to quote on any aspect of high quality equipment, electronic, electrical and mechanical.

Loricraft high quality record cleaning machines as used by the professionals. Please send for details

High quality Audiophile Records stocked including, RCA, Living Stereo, Decca SXL with many more titles to follow.

**•New 1995 catalogue in preparation•**

**Loricraft Audio**

4 Big Lanes, Goose Green  
Lambourn, Berks RG16 7XQ

**Tel: 0488 72267**

Garrard, Thorens Goldring, SME, Decca (London)

# TWEAKED UP



Eric Braithwaite auditions Kenwood's 3020SE integrated amplifier.

Though Kenwood's 3020SE has the usual Japanese bulky case, inside beats a slimmer British heart of gold. There's none of that burly but brash syndrome that used to be associated with sound of the big Japanese names, though it has to be said, that is the impression it gave with Gary Moore through the MM phono stage. Rather on the harsh side, however fast and vivid that made it, the phono stage squeezed the refinement out of a very good cartridge and left it forceful and sharp, but on the whole rather brutal.

On CD, though, this is a refined performer. On classical music, for smoothness and evenness, the KA-3020SE could even be a little too restrained. It is rare to hear a perfectly proportioned amount of air and space in a recording venue from a budget amplifier. Yet this is what you hear, with every instrumental section spread around fore, aft and sideways with a cogent realism and total lack of artifice. Beethoven's Eighth could have been a live Radio 3 broadcast, sans compression, of course.

The restraint comes in not in a washed-out top end or woolly bass, but in dynamics. Dynamically, as a full orchestra swept up to a fortissimo the Kenwood seemed to need a bit more muscle. The 3020SE did sound a trifle confused in deciding how much power to allocate a full chorus while it's being tormented by all the strings and brass sections in full flight, but conversely it pulls off the trick of knowing the difference between trumpets and trombones that others seldom cope

with.

In other respects the Kenwood's discriminatory ability is of a high enough order to be as off-putting as the best at twice the price. Slot in one of these wretched be-limited and gain-ridden rock recordings that abound these days and the boring old pan-potting and cheap mixing quality will not be glossed over. If your taste runs to Apache Indian, however, then the Kenwood does unleash a raw

spirit that thunders out a strong deep beat and plenty enough power to keep even Notting Hill Camiva' goers happy ●

**Kenwood 3020SE** £199.95  
**Kenwood House,**  
**Dwight Road,**  
**Watford,**  
**Herts. WD1 8EB**  
**Tel: 0923 816444**

## MEASURED PERFORMANCE

I was surprised at the low output power I measured from the Kenwood, but the handbook quotes it at just 30watts per channel. Clipping was strongly asymmetric, suggesting poor factory adjustment, peculiar for an amplifier posing as a 'special'. Power increased to 56watts into 4ohms, a reasonable performance.

Frequency response was satisfactorily wide, stretching from a low 5Hz right up to 82kHz. This will give a brighter sound than amplifiers band limited to 20kHz.

Sensitivity was high at 220mV and distortion low at all outputs and frequencies, not rising past 0.02% (full output at 10kHz). Our distortion analysis shows predominantly odd order components. This also suggests a bright, possibly sharp sound.

The Kenwood KA-3020SE is a budget amplifier in a big case. **NK**

## TEST RESULTS

Power	36watts
CD/tuner/aux.	
Frequency response	5Hz-82kHz
Separation	70dB
Noise	-97dB
Distortion	0.004%
Sensitivity	220V
dc offset	4/2mV

## Distortion

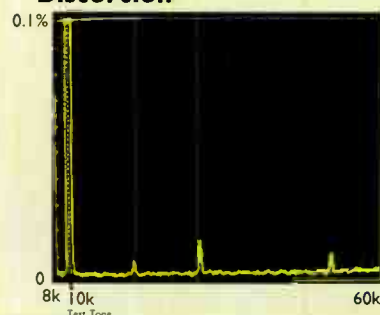



# BURMESTER TUNE-IN

**Can Burmester tune into the competitive British market? Eric Braithwaite scans the airwaves with a top tuner from Berlin.**

In the bad old days of the Berlin Wall, one of the targets of consumer envy from East Berlin must have been the glossy chromed Burmester hi-fi made on the Western side. Quite how many Trabbies would have to be put together to raise the Deutschmark equivalent of the £4,347 this Burmester tuner costs I don't know. Probably all that were ever made. Even for the Brits, this is luxury hi-fi.

Burmester, from the evidence of the tuner, is a luxury look company, though in design a little on the old-fashioned side compared to, say, Meridian. Also somewhat on the old-fashioned side, in an FM-only tuner, at this price, is the lack of anything other than the simplest facilities.

There is no provision for RDS, let alone RDS EON, now becoming common in tuners that cost little more than a thirtieth of the Burmester, though Revox included it in their high-end tuner years ago. There is no narrow/wide IF band switching. Tracking through the thirty-odd presets requires searching up or down rather than direct

numerical entry. Though effective visually, the signal strength indicator is only a row of green LEDs, and the tuning indicator, rather Arcam T-60 like, is one central green LED with a red one either side to indicate being off-tune.

*“ What marked out this tuner as high-end quality was the accuracy of tonal shading, instrumental colour and tempo. ”*

Remote control, however, is possible: an optional handset, costing £170, will scan through the memorised stations.

Neatly, a couple of the five controls are dual-purpose. Pressing the mono/stereo button while switching on from standby turns off the display except when station-hunting, hiding the LEDs and associated circuit board behind a silvered window like the mirrored shades which were once street fashion. Deleting stations from memory was a minor puzzle until the instruction manual compendium - which covers the pre/power amplifiers and CD players in the same 'Basic' range as well - arrived. With the instructions to hand, the answer was simple: pick the Station with the search button and hold down the Memory button until the unwanted station like Kiss FM (well, OK, Melody) is forgotten.

Though there is little in gadgetry and flounces to justify a price tag that would set my chequebook bouncing like a cricket captain's treated ball, Burmester's tuner has a luxury sound. The review period coincided with the

Berlin Philharmonic playing Mussorgsky's Pictures at an Exhibition at the Proms. The unmistakable high-gloss technique came over loud and clear. Extremely clear, with marked mic amplifier hiss on the left channel, and the only drawback being a coarse string quality on upper notes, attributable, cross-checking with my Quad FM4, not to the normally silky violins of the BPO going off, but to the microphones and mixing. If the 'Great Gate of Kiev' lacked some of the fierce dynamic range when it's on CD, it was at least comprehensible as limiting, inevitable in broadcasting a work of this scale.

What marked out this tuner as high-end quality was the accuracy of tonal shading, instrumental colour and tempo. There was no doubt, for example, of the BPO using a gong in 'Pictures' rather than a set of tubular bells; nor of its superbly synchronised string and brass playing. If it also showed that the performance was technically exact, but lacking in 'Russian vigour' in the early movements, that was a judgement confirmed half-an-hour later by friends who went to the live performance.

Most impressive, even more so than the Naim NAT 01 tuner, was the sheer expanse of sound-stage, very wide and

very cohesive. The Quad is no slouch, but sounded almost anaemic by comparison, with the Burmester unleashing a veritable rainbow of orchestral colour. Burmester claims that listening to the wireless can be almost as good as CD and, since this expansiveness was almost as grandiose as my favourite Sugden SDD-1 DAC, no-one who has a chance to hear this tuner would deny it.

*“ Most impressive was the sheer expanse of sound-stage, very wide and very cohesive. ”*

A studio broadcast of Biber confirmed this tuner's supreme ability to deal with very tricky tonalities and downright weird violin tuning with some extraordinary harmonics that few replay systems would have a hope in hell of reproducing. The Burmester showed not the slightest sign of faltering or skirting round the notes. The combination was entrancing.

The Burmester doesn't just pull off this trick with classical, it is just as adept and flourishes as well with Rock. Allowing for some vocal hollowness -

detectable, again, as compression - Four Non Blondes on GLR came through the speakers with tremendous clarity, precision and vigour, as though there was nothing more than a metre of interconnect (vdH The Second, at that) between the tuner and the studio CD cartridge player.

This is not a cheap tuner, even when the cost of the high quality flight case it's supplied in is allowed for. We are in the rarified air of the Day Sequerras. But it is very serious: rich, subtle, dynamic, superbly detailed, a wide open window into the recording studio. It's the modern Marantz 10B of tuners. And it's cheaper than

buying a broadcasting company, which is just about the only possible alternative ●

**Burmester 931** £4,347  
**Tabula Rasa**  
**No. 1 Silkin,**  
**Dalton Close,**  
**Crawley, West Sussex,**  
**RH11 9JD**  
**Tel: 0293 531 190**

**MEASURED PERFORMANCE**

The Burmester 931 needs a reasonably strong signal from an aerial for best results - it isn't really meant to cope with fringe reception conditions. This is justifiable with a quality audiophile tuner even if, these days, sensitivity need not be traded against sound quality. Hiss sank to a low -75dB with 2.5mV or more from the aerial, but this is half the sensitivity of other tuners, most of which need 1mV. So the Burmester must be paired with a good aerial able to provide strong signals.

Sensitivity apart, the 931 returned very good performance figures in all areas. It has a flat audio frequency response that reaches 16kHz (see our analysis), very deep pilot tone (19kHz) and sub-carrier (38kHz) filtering and super low distortion of around 0.08% (50% mod.) on mono and stereo signals. Channel separation was wide at all frequencies, lack of degradation at high frequencies being unusual but impressive. Burmester have also engineered this tuner to be very selective yet mute gracefully when overwhelmed by a strong signal.

The 931 tuner measures very well, but it does need a strong signal from the aerial for optimum results. **NK**

**TEST RESULTS**

Frequency response	10Hz-16kHz
Stereo separation	40dB
Distortion (50% mod.)	0.08%
Hiss (CCIR)	-75dB
Signal for minimum hiss	2.5mV

Selectivity (at 0.4MHz)	80dB
Sensitivity	
mono	3µV
stereo	60µV
signal strength meter	
LED No.level (µV)1-9	0.5µV-250µV

**Frequency Response**

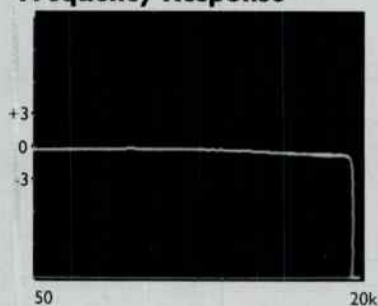

Flat response reaches 16KHz

**Distortion**

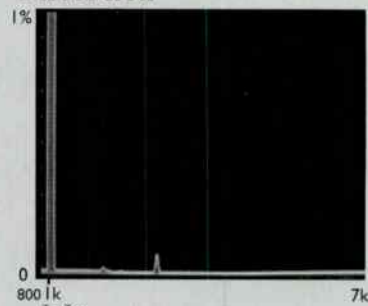

Very low distortion



### CD SOUND QUALITY

In your interesting and informative review of the Audiolab 8000CDM CD transport (Hi-Fi World, August) you discuss various factors which influence the sound quality produced by a particular CD transport mechanism. My own experiences in upgrading my hi-fi system may be of interest to you.

My main source of music is a 5-year-old Cambridge Audio CD2 compact disc player (the purchase of which was, incidentally, influenced by your enthusiastic review in Hi-Fi Review). Over the years I have since made worthwhile improvements to my system by upgrading interconnect and loudspeaker cables, and by placing it on a proper equipment stand.

After making what was, I thought, the last possible improvement by powering my system via a Lynwood Advanced mains conditioner (my mains supply is rather 'dirty'), I began to think about upgrading the CD player, an exercise which I dreaded since it would probably involve spending upwards of £1000 to get the sound quality I want. I then speculatively borrowed a Townshend Audio Seismic Sink from my hi-fi dealer.

The improvements in sound quality from my CD2 were dramatic, to say the least. Not only did it produce deeper bass, smoother midrange and cleaner, grit free treble, but other improvements such as better retrieval of detail and clearer instrumental separation became apparent with longer listening trials. The separate musical threads of a Bach prelude or fugue played on piano became more obvious,

for example. How on earth, I wondered, can putting my CD player on a lump of metal resting on an air bag make such an improvement?

I work in the computer industry, and so have a slight technical interest in how information is stored and

retrieved from compact disc. I have briefly looked at the underlying standards for audio CD and am appalled at the relative laxity of the standards regarding 'error correction' compared to what would be required for the safe retrieval of 100% of the original data.

Loss of a few data bits can be corrected by use of redundant data held on the CD, but greater losses have to be covered up by a process of error concealment which has to interpolate between

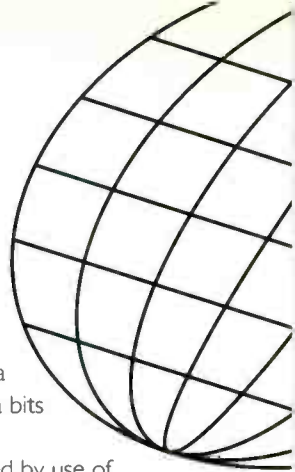

# World

## Letter of

### GETTING INTO HI-FI

Every hi-fi buff has a tale to tell of how their interest started; I hope mine will be of interest.

It was in 1963, when I was five years old and on holiday in Cayton Bay with Mum and Dad. In the caravan site where we were staying there was a coffee bar with an amazing machine. It had a glass dome with a row of buttons on the front and the machine was covered in chrome and festooned with lights. When someone put a sixpence in its slot and pressed a few of the buttons it would click and whirr into life. A round black object would be picked out of a stack by a robot-like arm, to be set down on a rotating circular platform. Another arm would come out and plonk itself onto the now revolving black object with a sort of 'boof' noise. Then Cliff Richard, Gene Pitney, Joe Brown or The Tornados would play one after the other.

To a child aged five years, standing on a stool,

staring through the dome and watching the fascinating mechanism at work was something unforgettable and is my first real memory of being exposed to recorded music and the machinery that reproduces it.

Our home machine was a Kolster Brandes 'Junior' radiogram and throughout the '60s and on into the early '70s it provided the family with musical entertainment. Opening the mahogany veneered, french-polished drop front of the cabinet revealed a BSR 'Monarch automatic record changer.' The autochanger sported chunky brown, gold-lettered knobs, a brown ribbed-rubber turntable mat and bounced like a trampoline at the slightest touch. When the whole thing was fired up and ready to rock it seemed to have a life all its own. It gave off a wonderful warm odour of lavender polish, rubber and shellac and hummed expectantly to itself whilst it waited for Dad to choose the music. All in all it was pretty neat.

The KB continued to give sterling service all the way through the 1960s. Christine and Ray, our babysitters, used to bring their Beatles and Stones records around to play them on it whilst Mum and Dad were out. But as the '70s dawned, Dad decided that the KB was old hat. He bought a fancy new Ferguson 'Unit Audio' with separate speakers, a brushed aluminium fascia and a smoked plastic dust cover that hid a puny BSR 'Superslim' autochanger with a tonearm barely thicker than a drinking straw. It sounded just as feeble as it looked, even though it was stereo. Small wonder the Japanese took over!

The KB? It was passed into my custody. We heaved it upstairs to my teenage bedroom where it happily blasted out The Sweet, Slade, Garry Glitter, T Rex and Alice Cooper for all it was worth. As I grew older I was able to keep it going when it broke down by replacing valves or the bulbs behind the tuning dial

Send your letters to Hi-Fi World Letter Page,

# writes



adjacent samples. This process means that subtle details in the original recording are lost, and extra harmonics are presumably introduced which can produce the coarse, gritty, sound quality for which CD players used to

be notorious.

The simplest explanation for the improvement produced by the Seismic Sink, I believe, is that it allows my CD player to retrieve more information from the disc without the need for error concealment, by reducing the

harmful effect of airborne vibrations on the transport mechanism and disc, and by damping vibrations due to imperfections in the balance of the disc itself. The upshot of all this is that I now see no need to upgrade my CD player in the near future, and virtually every CD in my collection sounds better.

I propose the following technical challenge to you: devise a test which enables you to measure the percentage of the original recorded data which a CD transport can retrieve under normal playing conditions. This is presumably difficult to do, since the only way to take account of the quality of the disc itself is to play it in a CD player! If this could be achieved, however, then the differences between low-tech budget CD players and their more expensive, better-engineered, competitors would become more apparent, and perhaps manufacturers would be

encouraged to produce better-engineered products which don't need a second mortgage to buy.

Thanks for an interesting review. I look forward to reading more of your thoughts on the factors contributing to CD sound quality.

**Mr. A. J. Rew  
Didcot,  
Oxon.**

I too have found similar results when using a Seismic Sink, although with not quite such a dramatic effect. Judging from other readers' letters and speaking to people who have tried the Seismic Sink, its effect seems to vary from system to system. Some, like you, experience a dramatic improvement, others only hear a small change.

The most obvious explanation for the effect the Seismic Sink has on CD transports does appear to be related to a reduction of

continued on page 41...

## the Month

where required. It provided radio listening via a long wire dangled out of my bedroom window.

I'm now a 36 years old former B.T. engineer turned student teacher and own an excellent Linn hi-fi system, hundreds of records and CDs and have a love of music and hi-fi that is undiminished after more than twenty years. The whole family use the Linn system. It has pride of place in our living room, just as the KB did in Mum's and Dad's.

I owe all of my early musical education to that KB radiogram, the BBC and to Christine and Ray. It wasn't stereo, it wasn't even hi-fi, but as Mum used to say, it had "a lovely tone." The thing simply played music superbly well: end of story. 21 years and thousands of pounds later, I have finally found a system that plays music better than that radiogram did; well most of the time anyway!

**Steve Cresswell  
Mexborough,  
S. Yorks.**

I'm sure a lot of readers have interesting formative experiences like yours. We all do. Mine include being pushed into a fancy dress contest, aged 8, dressed as a ship, wired up with port and starboard lights on my shoulders, on a liner somewhere in the middle of the Indian Ocean. I could have done without the funnel, but the lights fascinated me!

Next came train sets with lots of red and green signals then, after seeing my frantic efforts with crystal sets, around the age of 14, my Dad gave me something I'll never forget - a small brown box with a green label on top with the capitals HAC, short for Hear All Continents. That was a one-valve receiver that got me hooked. Soon there were valves everywhere, amplifiers following radios when the Mullard Circuits for Audio Amplifiers (8s 6d) was discovered in a bookshop in Exeter. I exchanged oscillation for music - magic. I was hooked. **NK**

64, Castellain Road, Maida Vale, London W9 1EX.

### WIN HI-FI WORLD INTERCONNECT CABLES

### OR PERFECT PITCH'S FRANCINSTIEN CD

### ENHANCER





The writer of the most interesting or funniest letter will receive a choice of either: a free set of Hi-Fi World's silver plated copper interconnect cables, worth £69.95, or a Francinstien CD convertor enhancer worth £150.





# A QUESTION OF QUALITY



 If you enjoy the touch of injection-moulded plastic, you'll probably go to pieces when buying loudspeakers  The Castle customer never falls for fools mate and his strategy allows the choice of seven handcrafted models in nine real wood veneers before making an important move  To play the game, advance to your local Castle dealer or contact us for his position 



**CASTLE**



.... continued from page 39

vibration that could disturb the laser and therefore result in less error correction. If this is the case, and it certainly seems to add up, then all CD players could be improved by paying more attention to the effect of vibration and the design of the transport mechanism itself.

To try and get an idea of what effect reducing the vibration to a CD transport would have on its error rate, I set up a little test system. Using our Cambridge CD1 QA unit which measures errors, i.e. the number of times the error correction circuitry has to be called upon, and a loudspeaker placed on the same surface playing a constant level of pink noise to introduce constant vibration, I ran three tests.

Firstly I ran a disc through the Cambridge to count the total errors with the loudspeaker disconnected, which gave me the error count for the disc. Then plugging in the loudspeakers to vibrate the transport, I ran the test again to find the number of extra errors caused by vibration. I then repeated the whole test with the transport on Sorbothane feet.

Sadly, the vibration, even from high levels of pink noise (the whole transport was vibrating and buzzing like mad), didn't appear to upset the error correction circuits. Whether the loudspeaker was on, off or the transport sitting on Sorbothane, the error count was identical every time. So, either the Cambridge isn't sensitive enough to detect such errors, the vibration stimulus wasn't realistic enough, or Sorbothane has some other property that alters the sound.

However, we are still as keen as you are to discover what does make a difference to CD transport sound

quality, and why things such as Sorbothane feet and Seismic Sinks make a difference. We hope to be able to offer further discussion on this subject in the near future. **DB**

Unfortunately, the Cambridge CD-1 was one of the first players to recognise this problem, so it has an isolated transport with a lead weight to add mass. But it's also the only CD player to come with an optional QC unit. **NK**

### **ANALOGUE FOR ADDICTS**

Like Mr Hall (Letters, September '94), I discovered The Record Shop in Kingston-upon-Thames as a result of their advertisement in Hi-Fi World. I can only concur with his endorsement. That, however, is not why I am writing.

He, and other readers of like mind, might be interested to learn of a recent discovery of mine. There is an organisation called Analogue Addicts, and it exists for those of us who prefer the sound of vinyl discs.

The principal direct benefit of Analogue Addicts membership is the newsletter, Voice. Amongst other things, Voice includes a list of recommended dealers who stock vinyl (both new and second-hand).

Anyone interested can contact Analogue Addicts at 22 High Street, Keighley, West Yorkshire, BD21 2AA. Membership costs £10, and covers four issues of Voice.

**Peter Miles.  
Reigate,  
Surrey.**

We are aware of Analogue Addicts and have printed their details previously, but as it is such a worthy organisation devoted to vinyl, here it is again for those who missed it. **DB**

### **RECORDING QUALITY**

I'm writing in response to your

article "Where's Hi-Fi Going?". I work in pro audio design and sent the letter attached below to one of the UK pro audio mags which had recently run an article asking whether any people working in the pro audio industry, i.e. the recording side, applied or considered applying hi-fi concepts to their work. It was never published, but you might find it interesting:

I have just finished reading your questioning article as regards hi-fi concepts in the pro audio industry. It makes some nice points, but what amazes me is that the question needs to be asked at all, as if hi-fi and music lovers as a group need justification. This seems to betray a certain professional smugness, as if 'we' professionals were the ones who truly know about sound. This is a complacent attitude and one which I feel relies on concepts of technical prowess which have not always fulfilled their promise. At its worst, our dedication to our learning gives rise to what I call the "Tomorrows World" syndrome, namely that the sound industry just keeps getting better and better.

This seems not true. I have a reasonably large collection of recordings covering 1965 to 1994 (mostly vinyl). When I compare recordings of the nineties with earlier recordings I don't feel they are better. Well, they are better in two respects. They have lower background noise and a wider frequency response. So what? If older recordings are lacking at the ends of the spectrum, this can be easily compensated for by judicious use of the tone controls. What about background noise? The one thing that human beings are really good at is ignoring background noise. We learn it as part of life. It's no trouble. In many other respects the recordings are not as good. And they are not as good in ways that I have no ability to compensate for. To demonstrate this it's necessary

to do some listening and here is what I'd suggest as essential listening:

Desire Walks On, Heart, 1993  
BeBe Le Strange, Heart, 1975  
After Bathing at Baxter's, Jefferson Airplane, 1967

Play the albums in reverse chronological order. Heart is a fantastic band. They don't show any tendency to lie down and release a greatest hits album. The music on their latest release, Desire Walks On, is every bit as good as anything they've ever put out. The album sounds good. It sounds like what you'd expect it to sound like.

Now play their BeBe Le Strange album. Immediately the sound is thicker and more dense. Cymbals sound really like cymbals. The lead singers come out of the speakers and inhabit the space in front of you. They taunt and tease, threaten, frighten, and soothe. This album involves you in a way that the 1993 album just can't. But not for musical reasons.

Now finish with the Jefferson Airplane album. What a feast! Immensely complex harmonic vocal structures full of power without that annoying little sizzle that seems to hang out just below many backing vocal tracks. Electric bass! Electric guitar! The eerie wail of Grace Slick just breaking free of this wall of sound. This isn't meant to be a record review, but I have no technical terms to describe what is happening here. This thing is so powerful it could change you.

If you're thinking I've gone native, all I can say is that something is happening here. Ignore it at your peril. Hi-fi people may have been the first to notice it, or the first to speak about it, but it's there. So here we are - 1994 - no reason to be complacent at all.

What I'd like to say to you at Hi-Fi World is to fight your

**continued on page 47 ....**

**D**evelopments in audio component design, loudspeaker performance and the transition from analogue to digital sources have all contributed to the high standards of playback quality to which we have grown accustomed. However, even the finest combination of equipment, accessories and isolation plinths cannot, and do not, guarantee a perfect listening environment.

Sound heard at the listening position is a combination of direct sound from the source and the reflected sound from the room, which is heavily influenced by the furnishings, structure, and surfaces.

During a recent visit to a colleague in Wimbledon, I had an inspiring experience. Glenmorangies in hand, we settled down in his well stocked library to discuss a project. He had selected some music for a conducive ambience, when I found myself drifting away far from the work at hand. The music seemed entrancing, simply because it was so listenable, so uncomplicated, open and seeming to caress the ear in the way that a baroque flute sonata would. The cello and harpsichord played in an almost tangible sound stage. I was gently lulled into a euphoric state of suspended audiotopia.

What made this system sound so

different was not entirely down to the mix of components. It was not even the compatibility of the speakers, amplifier, DAC and transport, or even the interconnects. This room, with its many shelves heavily laden with books in organised irregularity held a vital secret: acoustical diffusion.

### ENERGY DISTRIBUTION IN A TYPICAL LISTENING ROOM

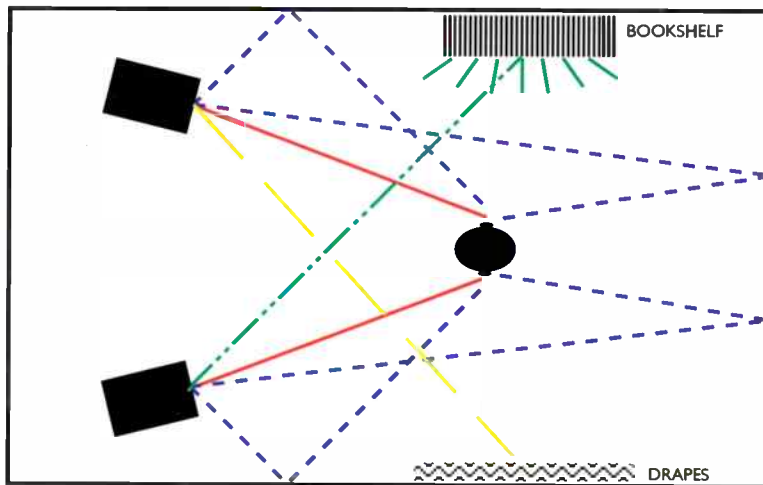

DIRECT ———— DIFFUSION ————  
 REFLECTED - - - - ABSORPTION - - - -

### DIFFUSION e.g. bookcase

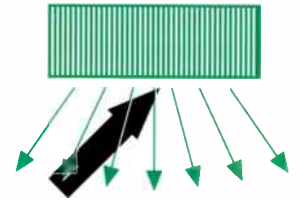

Diffusion occurs when sound waves are scattered off surfaces in random directions. Diffusion is extremely important in listening rooms and music rooms. This is because when satisfactory diffusion is achieved, listeners have the sensation of equal amplitude ie. sound coming from all directions at equal levels. A library, with all its irregular surfaces, dips and wells within the shelves, is an audible example of diffusion at work. Imagine a single point light source flashed in front of your eyes. Your immediate reaction would be much the same as to a piercing directional sound in front of the ear drums. Then imagine the torch shone at you through frosted glass. The energy is the same, but pleasantly diffused.

### REFLECTION e.g. glass

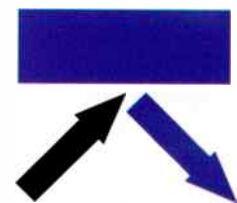

Reflection as implied, is the re-direction of a sound from a surface or object. Reflection is highly directional and can impair the sound stage significantly. In reflective areas, there are noticeable problems which are easily recognisable in both the high (treble) and low (bass) frequency domains. Conjure in your mind, the acoustical characteristic of a bathroom. An abundance of tiles, hard surfaces and mirrors create an environment where great excitation of sound occurs. The adjectives 'echoy' and 'reverberate' spring to

# HOW TO TUNE YOUR ROOM

**Douglas Floyd-Douglass of European Acoustic**

**Repertoire explains what effect your room's acoustics will have on the sound of your hi-fi and how to make simple improvements.**

mind. Whilst large reverberant spaces (cathedrals, churches) have their place in some choral works, they are quite unsuitable for audio playback.

A simple favourite bathtub rendition of 'Summertime' may find you gawping at a certain note where the volume increases suddenly and unexpectedly. The bathroom comes to life and appears to resonate involuntarily (probably in sympathy with your co-habitants!). This is called a standing wave. The note you are singing has a proportionate or equal size wavelength to one or more of the dimensions of the bathroom or shower. Try singing the note one octave higher and the room will react in much the same way.

This is a fine experiment for pulverising Pavarotti, but reflection and standing waves alike can wreak havoc in the pursuit of audio fidelity and listening enjoyment. Much the same may be experienced in listening rooms with parallel, reflective surfaces. These can however be treated, and sometimes with great success. In the high frequency domain, a handclap produces a "flutter" or fast echo. Lower resonant notes are referred to as bass boom.

In contrast to absorption where a room is characteristically 'dry' reflective rooms can be described as 'harsh' or 'bright'. This environment is uncomfortable to sit in for long periods resulting in listening fatigue. A combination of diffusion and careful placement of absorption can usually provide an inexpensive solution to this problem.

### ABSORPTION e.g. drapes

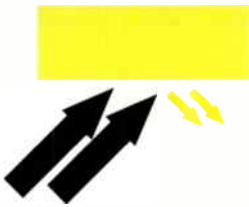

Not unlike a sponge to water, absorbing materials soak up musical energy. Different surface areas of absorption affect different frequencies. In days past "absorption" was synonymous with acoustical treatment. We now know this to be largely untrue. Whilst absorption has its uses (where trained acousticians would use materials to reduce reverberation and high sound pressure levels), it is by nature highly selective. This means that it will affect only a portion of the music programme, but not all and not simultaneously. Imagine a thirty band graphic equaliser with a flat setting

across the spectrum with five or so bands completely attenuated in the crucial mid-high frequencies. A noticeable gap in the sound occurs which in turn gives rise to a change in the balance of the other parts of the material. In the quest for a linear or natural soundfield, this sometimes extreme effect can be quite unpleasant. For example, thick velvet drapes hung around a recital area may seem to improve the 'boom' of a timpani or resonance of a trombone. But this same 'remedy' then also removes the subtle nuances of cellos, strings and woodwinds. In modern music, ambient reverb or digital delay may be added in post production to ensure that original recordings preserve energy across the entire frequency spectrum. Generally, domestic absorption affects higher frequencies more than the lower order, producing a sometimes 'boomy', 'dull' or 'dry' environment, as if the treble control has been turned down. This can be remedied by introducing diffusion, and careful relocation of room furniture. Absorption is used to best effect in tandem with diffusion.

### THE MIRROR TEST

Using a mirror to reflect an image of your loudspeaker, the sound path can be traced to your listening position. This can accurately determine the room's reflections. All loudspeakers have unique dispersion characteristics. That is, soundwaves leave the 'speaker cones at different times and intervals, travelling until they meet a surface where this energy is either absorbed (where it virtually disappears), reflected (sometimes causing bass boom or flutter echos), or diffused, where as discussed the preferable redistribution of sound is randomly

scattered, creating a soundfield that sometimes can appear to extend beyond the physical boundaries of the room. By the nature of its dimensions and furnishings, the room has characteristics of its own and indeed forms a relationship with the loudspeakers.

The experiment below will assist in optimising your room/speaker relationship. Using diffusion to treat early reflections will result in a new, open and natural sound stage.

Have an assistant run a mirror at your ear level in your favourite listening position along the side walls of your listening room (Fig. 1). At some point, out of the corner of your eye you will see a "reflection" of the tweeter or HF driver. Mark this spot with masking tape/blue tak, and repeat this exercise on the front and rear walls, and if absolutely fanatical, the ceiling and floor as well. (Don't worry, you may not be able to walk in this room, but it's going to sound fantastic!)

Having marked these areas, you will have located primary areas of early reflections. This is the sound system/room relationship's erogenous zone. Treat carefully and the results will be amazing. In order to create a diffuse environment, strategically place diffusive materials or objects (bookcases, CD/LP racks and to a lesser extent tapestries and plants) where your Xs are marked. This should result in an immediate and positive change. If sufficient diffusion is achieved the room boundaries will seem to disappear. If your room has inherent structural problems, we can treat these with combinations of diffusion, reflection and absorption ●



**The mirror test: the mirror leaning against the chest of drawers shows an image of the loudspeaker. This identifies the position of an acoustic image - a source of reflections.**



# A LITTLE SPLENDOR

Master Skills borrow no time  
www.spendor.com  
Spendor.

Spendor's new SP3/1 loudspeakers are a replacement for the much loved S20s. A lot of attention has been paid to detail in this new model, using components normally found only in more expensive speakers, something that usually makes for an interesting product. Combined with an attractive Rosewood veneer cabinet, these SP3/1 'speakers look enticing, even at £890.

They are bi-wireable with smart looking gold terminals. Removing the grills (with some difficulty) revealed Spendor's own homopolymer bass driver, along with a ScanSpeak soft dome tweeter - a potential recipe for success. The Spendors will sit on any medium size stand, but they looked and sounded best on Epos ES11 open frame stands.

The running-in time for the Spendors was considerably longer than I would normally expect, but they performed well enough to keep my attention fresh from the box, which is important for any product in my opinion. It was only after a few days though, that they really started to sing.

I paired the SP3/1s with a basic system of Micromega's Stage1 and the Naim Nait, which produced a very fast and clean sound. Angelique Kidjo's Agolo had well defined vocals and smooth, fluid bass. But it didn't reach down especially low, which was a little disappointing. Deciding more running-in was called for, I left them playing for a further few days, after which the initial weaknesses started to disappear.

Also, moving up through the Naim equipment range proved far more rewarding, using the 92/90 pre/power with a CD3 player was much better. Crash Test Dummies' MMMMM track came into its own, sounding well balanced in most respects - it was hard to pick out any real flaws.

In true BBC tradition it was obvious that whatever equipment was put with the Spendor's, treble and midrange were never going to be a problem. The 'speakers are well balanced in this area, being neither too bright nor forward, but staying clear and detailed all the same.

Trying to squeeze the best possible from the SP3/1s, I used them in a high-end Naim system, the cost of which was veering towards silly money. Here Propaganda's Jewel was startling, soundstaging was remarkable, percussion, driving and powerful. The keyboards really started to flow, and indeed the real acid test of whether a new piece of equipment truly performs is if my mock stage diving antics don't just upset my

dog, but leave him genuinely disturbed. These Spendors have a real 'turn up the volume' feel to them, but the bass unit couldn't quite keep up. I frequently had to turn down the volume, or risk waving goodbye to the drive units. I was listening in quite a large room and expecting high levels, so I wouldn't anticipate such a

problem in normal use.

Moving over to Linn's own Mimik and Magik proved a rewarding experience, Propaganda took on a bit more power in the bass, the deep bass lines had, plenty of oomph, I could have easily have been listening to more expensive speaker's, so

much so that there was constant temptation to be stupid and review them only with top end equipment.

Trying Carly Simons' Nobody Does It Better had the SP3/1s singing, and me drooling, and dog upset again. The clarity

was amazing, bass became a little restrained, but that could be easily ignored. Working up through the Linn range and finally reaching the top wasn't futile. The upper ranges are so good that the SP3/1s can perform well in any system, never disgracing themselves. Partnering them with the full Linn entourage of Karik/Numerik/Kaim/Klout they could still hold their own and turn in a tidy performance. With something heavier like Jellyfish's, Ghost Of Number One, the swinging really started.

Other manufacturers should take a leaf out of Spendor's book. When replacing a product that is already well regarded, padding it out with flavourless stuffing is not enough. Spendor's SP3/1s turned out to be a lovely little speaker. And as a replacement for the S20s, they're really jolly good ●

**Spendor SP3/1 Rosewood**  
**Spendor Audio Systems,**  
**Station Road Ind. Est.,**  
**Hailsham,**  
**E. Sussex. BN27 2ER**  
**Tel: 0323 843474**

£890

*“The upper ranges are so good that the SP3/1s can perform well in any system, never disgracing themselves.”*

#### MEASURED PERFORMANCE

Spendor's new SP3/1s are designed to update and replace the S20s. They use Spendor's familiar homopolymer bass cone and the same ScanSpeak soft dome tweeter used in the more expensive SP2/3s.

These units are used to good effect, as can be seen by the smooth and nicely integrated frequency response below. There is a slight dip as the tweeter comes in, but it is neither wide enough nor deep enough for the effect to be especially audible. Bass peaks up a little towards low frequencies, which should add some useful speed and punch as well as giving a firm bass. Overall, the trend of the response suggests that midrange detail will not project as far forward as with some loudspeakers, but the cabinets are very solid so I wouldn't expect a boxy colouration to prevail.

Overall, the impedance measures a high 12.5Ω and the curve only dips down as far as 6Ω in the bass, so the SP3/1s are an easy load - as far as current delivery is concerned at least.

As expected for the high overall impedance figure though, they are insensitive. Using a nominal watt of pink noise measured at 1m, I could only get 84dB from the SP3/1s, 2dB below average. This means that a powerful amplifier will be needed if you want decent levels in a reasonably sized room. I'd recommend 80watts or so.

The new SP3/1s have a well engineered and smooth frequency response. They are not the easiest load for an amplifier though, meaning they do need a good, high output amplifier. **DB**

#### Frequency Response

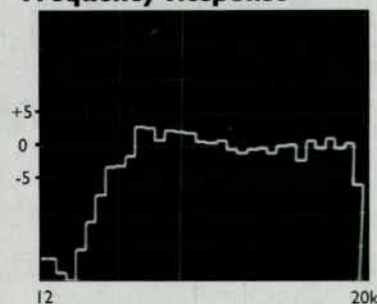

The SP3/1s have a smooth frequency response and bass lift should give them a solid bottom end.

#### Impedance

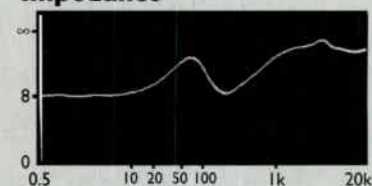

Impedance is high overall at 12.5Ω

# close your eyes and see



## the new improved Arcam Alpha 5 system

Close your eyes and see the difference between Arcam's new Alpha 5 system of hi-fi components and anything else in its price range.

Ignore the fact that the Alpha 5 amplifier is our best 'budget audiophile' amplifier ever, outselling all others in the UK for the past year. Don't be tempted by its attractive styling or a price tag which looks too good to be true. Just listen, and discover for yourself a quality of sound that can only be described as exceptional.

Next, try the Alpha 5 FM tuner. Again, don't let its surprising affordability seduce you. Instead, listen to broadcast sound that is natural, clear and dynamic - qualities which gained it a class leading

Recommendation in the 1994 What Hi-Fi? Awards.

Finally, feast your ears on the new Alpha 5 Plus CD player - quite simply, the best value high performance CD player ever produced by a UK manufacturer. Over the past year the critics have heaped praise on its predecessor, the Alpha 5 CD player, calling it "the player to beat" (What Hi-Fi?) and "standing head and shoulders above the rest" (Hi-Fi News)\*. Now, thanks to new master clock circuitry, the 5 Plus sounds even better and once again sets the standards for other CD players to match.

Just listen. Close your eyes, open your mind, and see the light.

\*If you already own an Alpha 5 CD player, we'd be happy to update it to full 5 Plus specification. Please call our service department at the number below during office hours for full details and prices.

# ARCAM

For more information, including the nearest place you can listen to Arcam, complete the coupon and post it to:  
 Arcam, Pembroke Avenue, Waterbeach, Cambridge CB5 9PB, England. Or telephone: (01223) 440964 (24 hours). Fax: (01223) 863384

In Canada: Avalon Audio Ltd, 101 Hanlan Rd., Woodbridge, Ontario L4L 3P5 Tel: (905) 850 7511 In New Zealand: Avalon Audio, 587 Mount Eden Rd., Auckland Tel: (9) 639 9000 In the USA: Audio Influx Corporation, PO Box 381, Highland Lakes, New Jersey 07422-0381 Tel: (201) 764 8958.

Please send me information and reviews on (please tick boxes):

Arcam CD players

Arcam tuners

Arcam amplifiers

Arcam's cassette deck

Please send me a brochure with details of all your products

Arcam speakers

AudioQuest cables

Title \_\_\_\_\_ First Name \_\_\_\_\_ Surname \_\_\_\_\_

Address \_\_\_\_\_ Postcode \_\_\_\_\_

World Radio History

HWAS1194

.... continued from page 41

corner harder. I've seen authoritative and angry articles in the AES journal (Audio Engineering Society) which prove beyond a shadow of a doubt that all this business with different types of wire is a load of bunkum. One day I too changed over to a set of linear crystal etc leads I made up. I expected no difference and I made the changeover casually and without interest. The first music that reached my ears stunned me and yet I freely admit I have no idea what to measure to explain what I was hearing.

Nevertheless the manufacturers, even the pro audio ones, are now offering equipment with linear crystal wire in it. They may only be doing it because the 'punters' want it, but they are doing it. So if you roll over and accept whatever is on offer people will take your word for it, i.e. this is what music sounds like. If enough people insist on better formats, or equipment, or whatever, then that equipment will first be available through small dedicated and esoteric suppliers. If it's seen to be a small success it will survive and grow. I do hope though that we never see a Japanese midi valve system. Maybe I'm being snobby.

**David J. Mate**  
**Long Compton**  
**Warwickshire**

**MAKING THE BEST OF THINGS**

It's an ill wind init? I'm sittin' here, having committed heresy of the worst kind and feeling rather pleased with myself.

The ill wind bit is bankruptcy. I'm half way through, still unemployed and on my own again. Common enough story these days I'm sure, but still not recommended.

Anyway, during the move to the present slum (I had to move back to London from sunny Suffolk and I miss it badly) a very kind and helpful

personage dropped one of the Electrostatics (old style) down three flights of stairs (I live at the top of course). The speaker didn't appear to appreciate the therapeutic intentions behind this treatment and refused to work on both bass panels. Now, in the good old days of wine, women and song (well two out of three ain't bad) I would have gaily sent the bits to Quad and three days later they would be singing happily again. Here comes the bankruptcy bit - NO CASH.

I realise that living at the top of the building offered an instant remedy to my problem, but there was no point as the receiver nicked all my life insurance policies. The thing is of course that it's only music and books that are keeping me sane (ish). So what could I do?

What have we all done since time immoral? Bodge that's what. But with Quads! Bloody 'ell. I had two working treble panels, two working bass panels and miraculously, considering the number of bounces, two sets of working transformers. Obvious really, but what would it sound like? (see drawings of result!) From my limited knowledge of acoustics, there would be cancellation effects in the bass because of the narrowness of a single panel. It seemed likely however, that the else's wonderful imaging would be enhanced as the two panels were vertically in line and there would be less interference between them. From way back, I had a bass bin with two old shape KEF B139s in it. This was duly cut up and I now have two odd shaped speakers which sit

inside the Quads (can I still call them that?) With the bin came simple crossovers that bring the bass in gradually at around 400Hz.

I tried it with just the treble panels but preferred the slightly warmer result using both. I wrote to Quad expecting the same response as your query regarding Tim De Paravicini's Valve powered ESL 63, but they proved that they live in the real world and confirmed that the crossover point wouldn't be too far out so why spend any money on experimenting. I never fail to

hate to claim that I have improved anything but whereas before, I could tell exactly where each instrument was, I can now tell how wide it is, how high it is and how it's being played. It's amazingly obvious which way round a piano is recorded for example - the instrument is now its proper size, the B139s giving the sound real weight. The Leak Stereo 20 has no trouble at all with the strange load it must be seeing - the speakers are run in parallel.

This is where I started - it's an ill wind! I realise that no-

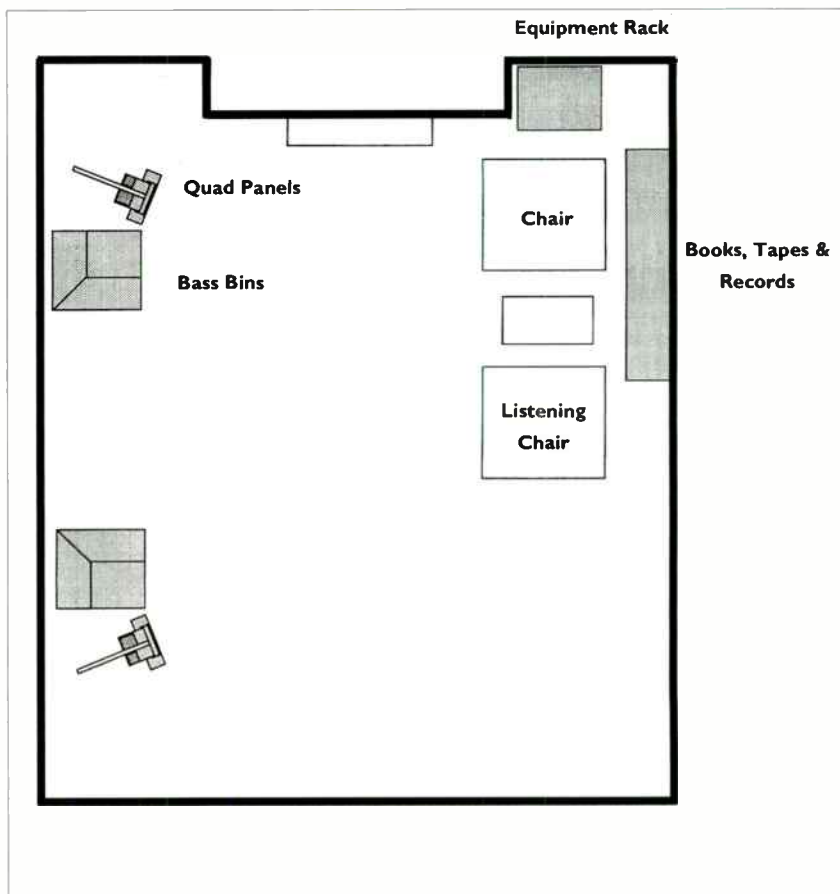

**Gordan Steadman is making the best of things with modified Quad electrostatics and KEF B139 bass units.**

be impressed with the service they provide, but I thought this kind of butchery would be just too much in spite of the mitigating circumstances.

The room I have to use is over square (about 15') and has an awful boom everywhere but in the main listening chair where everything sounds very natural. I couldn't fit everything in with any other arrangement of the room. Now I would

one should start cutting up Quads or any other fine equipment, but all is never lost given a willingness to experiment and a bit of imagination. My imagination is quite vivid and I saw myself sizzling away merrily on the high voltage bits - I was very, very careful! I knew the rubber gloves would come in handy sometime. I must protect the

continued on page 49 ....

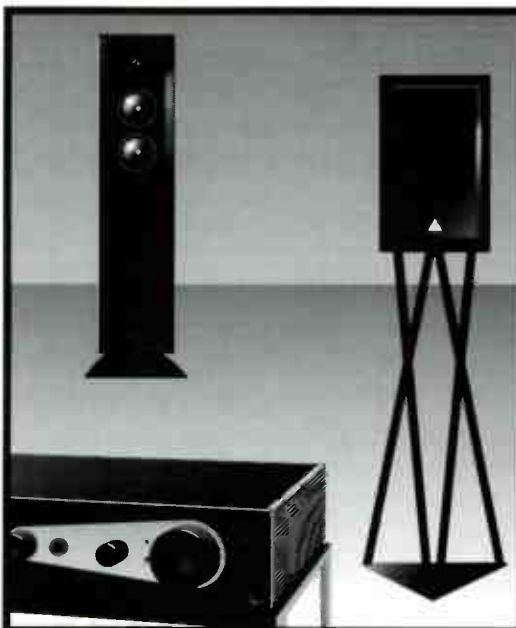

# TRIANGLE

ELECTROACOUSTIC

## FRENCH SPEAKERS

...as reviewed by English speakers...

"The Alicante's big, fluid, wide-ranging and open presentation lets the music speak for itself."

Jonathan Kettle. *AUDIOPHILE*. November 1993

"The Titus E has an absolutely riveting sound with openness and rhythmic drive."

WHAT HI-FI?. March 1993

"The Icares are fast and enthusiastic; there's nothing twee or laid-back about their presentation of music - whether reserved classical or high energy rock."

WHAT HI-FI. October 1992

## AND AS FOR THE AMPLIFIER...

"The Triangle TE60...has very clean treble...separation is first class...bass is outstanding...an excellent product. A super little amplifier, nicely styled and beautifully finished."

Jimmy Hughes. *AUDIOPHILE*. March 1994

## T H E R O M A N C E O F F R E N C H H I - F I

<p>Berks <b>THE AUDIO ROOM</b> 3 Little brook Avenue Burnham, Slough, Berks 0628 - 668112</p>	<p>Cornwall <b>RJF AUDIOVISUAL</b> 84 Pendarves Street Tuckingmill, Camborne 0209-710777</p>	<p>Dublin <b>ACOUSTIC DIMENSION</b> 16 Idrone Mews, Idrone Lane Black Rock, Co. Dublin 0103531 - 2884612</p>	<p>Norwich <b>SOUND APPROACH</b> 161 Unthank Road Norwich 0603 - 622833</p>	<p>London <b>DOUG BRADY HI-FI</b> (See Dial-A-Dealer) 071 - 379 4010</p>
<p>Liverpool <b>DOUG BRADY HI-FI</b> (See Dial-A-Dealer) 051 7336859</p>	<p>Warrington <b>DOUG BRADY HI-FI</b> (See Dial-A-Dealer) 0925 828009</p>	<p>London <b>DIVA</b> Workshop 30, Royal Victoria Patriotic Bdg., Wandsworth 081-875 9593</p>	<p>Greater Manchester <b>ORPHEUS AUDIO</b> Wigan WN6 0PD 0257 426100</p>	<p>Scotland <b>HI-FI EXCELLENCE</b> 293 Union Grove Aberdeen 0224-322520</p>

Triangle loudspeakers cost from as little as £265. TE60 Integrated Amplifier £549 - for more details phone Ortofon UK (0753-889949) or Kronos (08687-48632)

# HARBETH® HL-P3

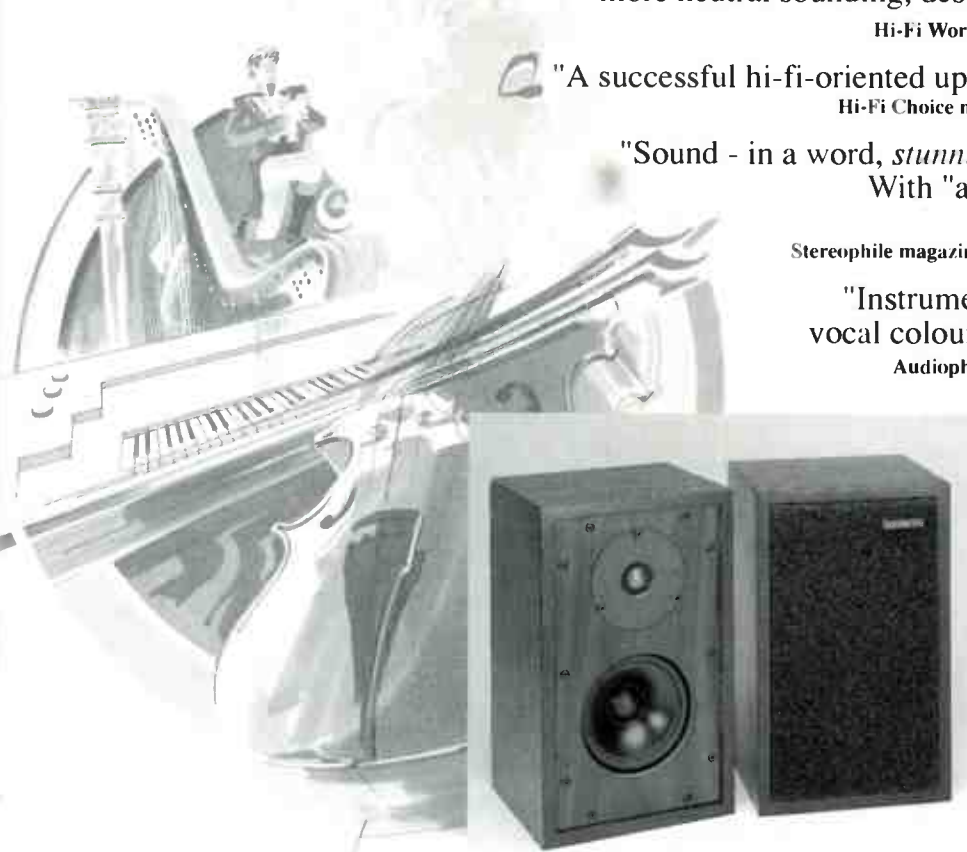

"Listening to the HL-P3, I found its mid-band clarity and life the most striking feature... Imagery is also clear and highly three-dimensional... I would be hard pressed to find a better, more neutral sounding, design anywhere near the price."

Hi-Fi World magazine - Alan Sircom - February 1993

"A successful hi-fi-oriented update on the revered LS3/5A."

Hi-Fi Choice magazine - Recommended - September 1993

"Sound - in a word, *stunning*. In another word, *clean*."

With "an astonishing amount of bass for such a small speaker."

Stereophile magazine (USA) - John Atkinson - December 1993

"Instruments had near perfect tonality; vocal colour and intonation is excellent."

Audiophile magazine - Eric Braithwaite - July 1993

HARBETH ACOUSTICS LTD.  
Unit 1, Bridge Road, Haywards Heath,  
West Sussex RH16 1UA, U.K.  
Tel. 01444 440955 Fax. 440688

Please send information on:

HL-P3  Full Range

Title \_\_\_\_\_

Name \_\_\_\_\_

Address \_\_\_\_\_

\_\_\_\_\_

\_\_\_\_\_

Postcode \_\_\_\_\_ HW/10/94



.... continued from page 47

nasty bits before the cats come to live with me! I always did get tired of telling guests not to warm their hands on the 'radiators' but that takes on a new meaning at the moment.

So real music is restored to the Steadman household. If I was still with my ex it would be instant divorce! The design and finish could be improved somewhat, but I tell myself that these are the prototypes and I'll finish them off properly later - have you heard that one before?

I would be grateful if you will do one thing for me. The bass bins seem to work best with a reflex port even though I expected them to be best fully sealed. The tube is 8cms wide and 12cm long. Could you ask your computer if I could do better? The boxes are 2.5 cu feet, hopefully you know what the resonant frequency of the drive units is.

**Gordon Steadman  
South Wimbledon,  
London.**

I ran the Thiele-Small parameters of the KEF B139 through our computer box designer to come up with the following results. At present it appears that you have a 1.5dB peak in the bass response around 60Hz. This is almost certainly the cause of the boom you get at other positions in the room. The predicted response of the bass system at present is shown in Fig. 1.

Fortunately, you have chosen a wide diameter port, making it easy to re-tune the bass. By lengthening the port to nearly double its existing length, this peak will be reduced without taking away any bass depth. I found that a 21cm length port of the same diameter gave the result shown in Fig. 2, which reduces the bass lift. You can continue lengthening the port to get a dryer and more taut bass if necessary. I hope this is of some help. **DB**

## AUDIOQUEST ALBUMS

First I would just like to say how much I enjoy reading your magazine. I find it to be just the right balance between technical and how equipment actually sounds. I have been an avid reader since the first issue, and have bought every issue since. Though I admit I was victim of the mad rush for the April 1993 issue, I wasn't able to get my hands on a copy.

Now to my query. I notice that you no longer sell records or CDs by mail order, which is shame because having purchased the Audioquest sampler from you some months ago, I now wish to purchase some of the actual titles, and maybe some that have been produced since.

I found these recordings to be the best I have heard in a long while, easily outdoing anything available on the record market as a whole. I'm talking about the recordings that the shops sell. I have not been able to hear many other audiophile recordings, except at hi-fi exhibitions.

Back to the query. I was wondering if you know of any other distributors of the Audioquest label. I have tried a few likely outlets and so forth, with no luck. I was advised to try a "top quality hi-fi shop". Perhaps you know of one.

I would be sincerely grateful if you could help me in my quest.

**Tim Peary  
Bolton  
Lancs.**

For any information regarding Audioquest releases call Stuart Perriam at Arcam on 0223 440964 who will be pleased to help. **RJ**

## SINGLE-ENDED POWER

I am a Hi-Fi World reader of about two years now, having defected from two previous hi-fi magazines due to their repetitive coverage of uninspiring black box, mass-market, Japanese noise-making machines. I feel the

improvements in reproduction quality and the sheer interestingness of serious, dedicated equipment and its circuitry really can make music and thus hi-fi far more appealing and involving. Further improvements over the dial-laden-and-all-look-the-same boxes and freedom to sonically proportion sound to one's own taste can be had by building proven circuitry from specialised components whose price and thus quality really only depended upon the depth of your purse or the length of the bank manager's employment contract.

It is in regard to the liberty which DIY gives that I write. As a bit of a budding electronics chap, I decided to have a go at designing an amplifier. Fully believing in the principle of single-ended working and deciding it was this principle upon which my design would function, I sat down and began the intensely recondite mathematics. Firstly, I wanted the output transformer to reach 20kHz at least, to keep treble body. Also, I wanted response to go to about 10 Hz for CD subsonics. To top it all off, I wanted a little more than the average 9-25 watts usually on offer for such designs. Ask old Tim and he'll tell you such a beast of a component isn't easy to design, so I didn't, I settled on two already constructed, from the substation down the road.

Having run them in with the patch I have into the flat below's electrical supply, I took measurements and found that they were just the ticket. To drive the transformers in quasi-complementary auto-bias anode cathode zenode tetrode pentode mode, I calculated the design of valve would have to be a little unusual, as is always the case with the best hi-fi, so I'm told. I decided to build the valve from a fridge motor, a section of zinc-plated wire fencing, fifteen wire-tensioned, auto-balanced, super-bright filament bed springs, a lawn-mower, and a specially coated hexagonal fish tank to serve as

the enclosure, the formulation of the coating of which I do not wish to divulge.

The Results? - Outstanding! When partnered with a pair of electrostatics I designed and built earlier this year and powered by my own silver-wound nuclear reactor PSU in the kitchen- magnificent! The revolving anode lawn-mower cylinders glow as bright as the sun. The 400 MW heaters - blistering! Such now is the quality and ease with which music is conveyed, the 15 square metres of ultra-light polyarsenide-doped 600 GV mylar sound diaphragms of the electrostatics become completely invisible, conveying concrete-fracturing dynamics and unbelievable imaging. It really must be heard to be believed, such is the system's utter completeness and musicality.

Finally, connecting back to an old three-phase amp and sixteen-pole moving-cabinet speaker system I built last year really was an eye-opener. The distortion I hadn't noticed before - ugh! How painfully obvious the single-ended design makes such lesser equipment's foibles starkly known.

So it seems the problems of designing a high-power single-ended amplifier are very real. Indeed, the fiendishly complex mathematics and poor measured performance would make the most capable of designers think twice before attempting such a design. But then again, with designs like the Yoshino, Ongaku, and now the Subaroo (measuring markedly better than both of these two - output: 12.2 KW; Freq. -3 dB: 0.01 Hz- 19.88763 GHz) clearly demonstrating what the technology has to offer, perhaps designers may think twice and consider the enormous advantages of such technology.

**Royston Briggs  
Moxley,  
Wednesbury.**

continued on page 55....

**A**fter having much success with their latest offering, the CD480, in the mid-range CD market, Orelle now plan the same for the amplifier market. Until now Orelle haven't had much luck in the amplifier market as a whole (at least in this country) despite a worthy range of integrated and pre/power amps.

Their latest offering, SA-100, pitches into a market where there's even greater competition than the equivalent CD sector. Priced at £379, the Orelle looks conspicuously good value next to rivals such as the Audiolab 8000A (an old timer, but still highly regarded), Cyrus 3, Arcam Delta 290 and literally dozens of other hopefuls from Britain, Japan, France and Scandinavia. Which ever way you look at it, the Orelle is going to have its work cut out convincing thick-skinned reviewers, dealers and the public alike that the SA-100 is different from the rest of the pack.

In terms of build quality and styling, the Orelle creates the right impression. The slim grey casing that was beginning to look slightly dated has given way to a new look reminiscent of Sugden (and none the worse for that), although some of the details are a matter of taste. The specification is good too. Although internal wiring is no longer by van den Hul, there are still silver plated switches, chunky gold binding posts and phono sockets on the back, and a hefty toroidal transformer which supplies a claimed 50W. The one thing there isn't, however, is a phono-stage, which is rapidly becoming the norm in this price range.

I coupled the Orelle up to my usual Cambridge and Roksan sources. As far as the 'speakers were concerned, my usual SL600s were substituted for something a little more efficient, in this case Castle Durham 900s.

Grace Jones' Nightclubbing and Slave to the Rhythm albums proved good choices to test the amp's low level bass retrieval and dynamics. The SA-100 breezed through the tracks, showing the ability to unravel complex bass rhythms and putting plenty of weight and substance into the mix too. The downside of this particular characteristic is that the bass could occasionally drag on faster tracks, as I discovered later. However, in this respect it's superior to previous Orelle amps which could really sludge up the bass. The Orelle had a greater "grip" on the music than many budget pre/power amps I've heard. More to the point, it's rather too close for Orelle's comfort to



**Dominic  
Todd assesses  
Orelle's mid-market pitch,  
with its new SA-100 amplifier.**

their pre/power amps in this respect.

As a whole the balance could, if anything, be accused of being slightly restrained, but not to the extent of, say, Quad or Albarray. The treble was clean and reasonably detailed, but without the "stripped bare" analytical nature of some of competitors. Yet this quality lends the amplifier to brighter systems and to long term listening, where the Orelle is totally relaxed.

Brighter recordings also benefit from the SA-100's easy going nature. All About Eve's, Scarlet and other Stories is one such recording, and can sound overbearing on some systems. The Orelle refined the recording, whilst at the same time retaining the finely

detailed guitar work. Vocals were a little recessed in comparison to an 8000A or Alchemist Kraken, but not seriously so. For

and it didn't seem to suffer the timing difficulties of its ancestors. The Orelle also showed good separation, a broad sound stage with plenty happening and with no particular frequency seeming to be masked. I was impressed too, by the Orelle's ability to unravel complex bass lines into something that resembled the particular instruments that actually produced the bass in the first place. Again the SA-100 was reminiscent of a much more expensive amp here.

Orelle have certainly made an effort with the SA-100. It's enough like the rest of the pack in terms of build quality and conservative design not to be shunned by a similarly conservative buying public at this price level. Yet, it produces an overall sound quality that is unlike most of its competitors. It possesses the smooth easy going nature of Quad or Albarray, yet at the same time, manages to pull out far more detail than you'd expect from such a balance. Overall, it works well and is exceptional value at the price. All it

really lacks is the ability of some of its rivals to get the best out of any system. It doesn't have the drive of, say, an



those used to such amps, however, I could see how Orelle could be seen as being just too polite and there were times when I wished the SA-100 would "let rip" a little. The guitar in Only One Reason had me turning up the volume as a substitute for the slight lack of blood and guts.

But then not everybody wants rip roaring excitement. With a gentler mix of the Little Feat and Acoustic Alchemy, the Orelle proved to be an involving and enjoyable performer. The bass lines always integrated smoothly with the rest of the mix, something which couldn't be said of previous Orelle integrated amps,

Audiolab, to tackle difficult speakers, or that final degree of raw emotion you'd get from a Nait 3 or Kraken.

Nonetheless, it's an exceptionally well-rounded amp, and a big step forward for Orelle. Now they finally have a competitive product battling it out in the mid-market amp war - and it's a good 'un ●

**Orelle SA 100**  
**Orelle Hi-Fi,**  
**Unit 11, I-MEX House,**  
**6 Wadsworth Road,**  
**Perivale,**  
**Middx. UB6 7JD**  
**Tel: 081 810 9388**

£379

## MEASURED PERFORMANCE

The SA-100 is a MOSFET amplifier with a useful output of 50watts. This is enough to drive sensitive loudspeakers (86dB or more) loud in normal size rooms, if not shatteringly loud. Power output into 4ohms rose little, reaching just 56watts. However, we're told that in production a mains transformer with better regulation will be used, giving more power into low loads.

Bandwidth was satisfactorily wide at 5Hz-50kHz through the Aux, Tape and Tuner inputs. Sensitivity was normal at 260mV and noise low at -100dB. Separation also proved fine at 82dB.

I wasn't especially impressed at the amount of crossover distortion though, which rose to 0.2% at 10kHz, from just a few watts of output. With an extended harmonic structure, this is likely to tinge the sound a little and be subjectively discernible as a little coarseness or hardness.

Another dubious feature which Orelle need to look at was d.c. bounce when the volume control was adjusted, with offsets of up to 80mV occurring, accompanied by a long settling time of around 10seconds before a (satisfactory) quiescent value of around 10mV was reached.

The Orelle SA-100 is a neat, simple design that uses good components. There are some areas where I feel it would usefully benefit from a little tidying. NK

## TEST RESULTS

Power	50watts
CD/tuner/aux.	
Frequency response	5Hz-50kHz
Separation	82dB
Noise	-100dB
Distortion	0.025%
Sensitivity	260V
dc offset	10/8mV

### Distortion

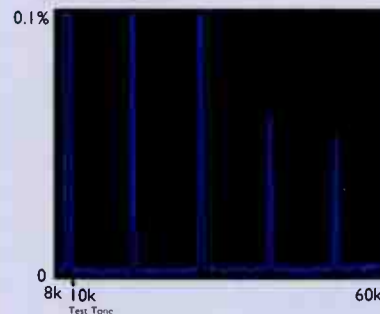

Extended harmonic distortion may give a sharp sound.

# INTERMEZZO



**Goodmans have interrupted production of the Mezzo loudspeakers to improve the crossover. Peter Downs is first to listen after the intermission.**

The Goodmans Mezzo has been reviewed in these pages before, "so why again?" I hear you ask. Well, following our comments about the first pair, Goodmans have improved the balance of the speakers. They are still a two-way, rear-ported design, featuring a 6.5inch polypropylene bass/mid range unit, but with the addition of a concentric ring in the cone to improve the midrange. The treble is handled by a 19mm metal dome tweeter, which is horn loaded, complete with a phase correction plate, ferrofluid cooling and what Goodmans call "DRD damping" to suppress the ultrasonic treble peak which metal dome tweeters exhibit.

The crossover is hard-wired to the back of the nickel plated binding posts which is surprising at the price - push on tags are usually used for production speed. The 12mm chipboard carcass, with MDF front baffle, is unbraced and quite resonant when tapped with a knuckle, but the enclosure is lightly filled with BAF wadding which does help damp out some of the 'boing'. Both drive units are bonded to the front panel. This may aid rigidity, but it won't make servicing particularly easy. The large port, positioned behind the tweeter, tunes the enclosure down to 50Hz. The plastic framed grill, with bevelled edge, clips over a plastic-leather look-a-like finished baffle to create a neat looking package. The review pair were finished in rosewood effect vinyl.

The system used with the Mezzos comprised Pink Triangle PT TOO with SME IV tonearm and AT-OC30 cartridge, PS Audio 4.6 pre-amp running passive into a pair of Audio Innovations First Audio monoblocks. Also used was a Myst G Ohm Mosfet power amp. Interconnect cable was plaited 19 strand silver plated copper, with solid core speaker cable.

Goodmans recommend that the Mezzos are placed on 15-18inch high stands positioned 9-12inches from a rear wall. In my room, I ended up using the Mezzos on 22inch open framed stands, around 4ft from the sides and 2ft from the back wall. This gave me the best compromise between bass reinforcement and an open presentation. Toeing them in so you could just see the inside edge of each speaker from the listening position gave the best image with clearest focus.

The first record onto the turntable was Beethoven's Fifth Symphony (Walter Weller, Chandos). This is a very good disc for checking whether bass boom is present; the massed strings produce an awful lot of energy and can sound confused and boomy. I am happy to say that the Mezzo didn't have a problem in this area, in fact they handled the recording with a gusto I wasn't prepared for. Switching to Mahler's Ninth Symphony (Sir John

Barberolli, EMI ) produced a similar effect, the brass on the opening side conveying the excitement and tension of the performance well. This is a speaker that's not frightened when the music starts getting difficult. David Sanbom's "Hideaway" is a good Jazz Funk record, foot tapping stuff with the music fairly bouncing along. While not entirely neutral the overriding message was fast and tuneful.

Bass went quite deep, being slightly one note at times due to cabinet resonance, but the difference between double bass and kick drum was clearly discernible. The individual notes of the double bass on Rickie Lee Jones' Pop Pop also came over vividly, and on Mary Black's No Frontiers the track The Shadows has some deep synthesizer under the violin and piano which was also handled well, although it was a little more obvious than I am used to.

Moving up to the mid-range, piano on both jazz and classical fared quite well. This is a difficult instrument to get right; it can sound as if it is made from concrete - not wood - on some 'speakers. The Mezzo had a slight hollowness in the lower midrange, changing as frequency increased, getting brighter and harder as the metal dome came in.

Acoustic guitar fared much better though. A roundness of tone was there and plucked strings broke free from the rest of the mix. Robben Ford's nylon strings on Pop Pop could easily be identified and Joni Mitchell's guitar was beautifully formed. Sax and trumpet were also handled with verve. Listening to John Coltrane and Lee Morgan on Blue Train, I could readily hear the studio atmosphere around the instruments as each came forwards to the microphone for his solo.

Vocals had clear diction, but were slightly squashed in the lower mid-range. Joni Mitchell, Mary Black and even Old Blue Eyes were given a crispness without it becoming brightness. Treble was not overpowering, which it can be with some metal domes. Being used to a ribbon tweeter the difference was mainly a graininess which was always present despite different recordings.

Regarding imaging, compared to my usual speakers, SD OBSR, the acoustic window was much reduced, but not absent. Rimsky-Korsakov's Scheherazade (Chandos) had the orchestra well laid out in an arc between the speakers, if slightly veiled when compared with the best. Going back to the Blue Train album I still felt the intimacy of the performance. Likewise Billy Holiday's Songs for Distingue Lovers shows analogue at its best, her frail voice backed by the dreamy quality of Ben Webster's sax. The depth in this recording is fantastic, 'Sweets' Edison sometimes standing miles behind the band, but unfortunately this effect was

not entirely recreated by the Mezzos. Their shallowness was not an overriding problem though.

The Goodmans Mezzo reminded me of a young pup with bags of energy, wanting to be loved, but sometimes showing its immaturity ●

**Goodmans Mezzo** £170  
**Goodmans Loudspeakers Ltd.,**  
**3 Ridgeway Havant,**  
**Hampshire. PO9 1JS**  
**Tel: 0705 492777**

**MEASURED PERFORMANCE**

The GLL Mezzos have undergone subtle crossover refinements since we last reviewed them. Originally, we criticised their soft treble, so the new Mezzos have the treble better aligned to the midrange. There is still a bass lift towards lower frequencies which will add good weight and punch.

The frequency response plot shows that although the treble level better matches that of the midrange, there is still a shallow dip through the upper midrange which will pull vocals back into the box a little.

Elsewhere little has changed. Impedance has gone up from 7.5Ω to 7.8Ω, along with a corresponding fall in sensitivity from 88.5dB to 88dB. This will make little difference in terms of an amplifier's ability to drive the Mezzos - they are still an easy load.

Overall, the Mezzos have changed little in terms of their measured performance. Treble level has been raised slightly, which may have quite a strong subjective effect, giving some needed sparkle to the top end. **DB**

**Frequency Response**



**Impedance**



# SPALDINGS

The South East's Leading Hi-Fi Specialists

352-354 Lower Addiscombe Road, Croydon, Surrey. CR0 7AF

# 081 654 1231/2040

Arcam, Audiolab, Linn, Meridian, Naim, Mission, Quad, Denon, Marantz, Ruark

## Are you making the right connections?

Send for Britain's biggest catalogue of specialist cable and connections.

All available by mail order.

Phone 081-9429124 or clip the coupon for your Free copy.

**CUSTOM CABLE**  
**SERVICE**

PO Box 4007, London SW17 8XG

Please send me your FREE Custom Cable Catalogue

Name \_\_\_\_\_

Address \_\_\_\_\_

Postcode \_\_\_\_\_

NO FURTHER INFORMATION REQUIRED

Send to: Custom Cable Service  
PO Box 4007  
London SW17 8XG

HFW7/94

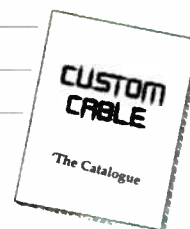

## Pentachord – classic speakers



### Hi-Fi World reviews 1991

#### Pentachord System (May)

"...The subwoofer appears to have integrated beautifully, with no obvious gaps at the frequency extremes"

"With particular reference to the Pentachords' imaging properties, the loudspeakers are up there with the very best ...Strongly projected sound stage, replete with clear, sharp images of vocalists and instruments.... The manner in which the soundstage was constructed seemed quite unlike that from most cabinet loudspeakers; it had an engagingly lifelike quality dramatic enough to demand attention"

"Amongst the most refined and integrated subwoofer/satellite systems on the market today"

"We all felt they sounded superb, a measure of unanimity that is rare for any loudspeaker" (*The Editor*, June 1991)

#### Pentacolumns (December)

"...one of the finest loudspeakers to grace my system to date"

"Once the pentacolumns were running in a well balanced system, their imagery was remarkable"

"It was difficult to find a single area where the Pentacolumns excelled; they were good at everything"

"The Pentacolumns are among the most revealing loudspeakers that I have heard"

"The price is more than matched by their superior sound quality"

These speakers have also received superb reviews from other discerning experts. The Mark II versions are even better. Send for details and arrange for a demonstration.

**Pentachord Loudspeakers, 49 Rusholme Road, London SW15 3 LF; 081 788 2228**

... continued from page 49

PS: Can you recommend a suitable loudspeaker cable?

I was most interested in your letter, especially the rotating blade anode structure of your valve. I am sure that the swirling electron stream inside will convey as yet unrealized sonic performance from single ended operation. I have also found that to get optimum performance from amplifiers of this type a separate mains spur is advisable. Running the spur from the flat below however may cause some problems as the electricity will have difficulty climbing up the wires, I suggest making the mains cable into a superconductor by running it through the freezer compartment of your fridge.

I have found that the intense neutron bombardment of the membrane in nuclear powered electrostatics can cause deterioration of the mylar film - this is something to watch out for. Don't pay any attention to the pseudo-audiophiles, the only way to listen to these is "stripped down". To do this chisel away the metre or so of concrete, then carefully cut away the lead to reveal the reactor inside. The bright blue glow you will now see is ionization of the air by the massive radiation emissions, this will illuminate your room and save money on haircuts, any blistering of the skin should be treated with Tweak or Cramolin.

Finally, you may like to try making a valve using Strontium 90 as a cathode material, it is a very powerful emitter of Alpha particles which may work better than the usual electrons, and as an added bonus Strontium 90 has a half life of 10 trillion years so your valve will still be working when there are troglodytes inhabiting the earth like in The Time

Machine by H.G. Wells., and it may well be responsible for their existence.

In answer to your question on cables - I generally don't bother with speaker cables as the output voltage of my amp is sufficient to jump the 6 or 7 ft gap between it and the speakers. **AG**

### SEEING THE LIGHT

On a recent visit to one of my local audio specialists (Norman Audio of Blackpool) I was pleased to find that they had both the Audiolab 8000A and Cyrus III amps available for demo. I had already listened to both these amps and favoured either of them as a replacement for my Pioneer A400, but this was to be my first opportunity to listen to them together and perhaps to reach a decision for purchasing later in the year (when funds permit). I also noticed a second hand Audio Innovations A200 pre-amp, and enquired as to the possibility of using that with the A400 as a power-amp. I have fancied the idea of valves, having liked what I have read in Hi-Fi World, although I had no experience of them at that time. Also, many dealers had suggested that to get a worthwhile improvement on the A400 I needed to be listening to pre/power combinations.

I booked an appointment for the following Saturday morning, and turned up with a good selection of classical music (and some rock) both on CD and vinyl to give all three amplifiers a good trial. I started with the pre-amp and never got any further. The vinyl, as was to be expected with valves, sounded beautiful - still very detailed yet much warmer, the stereo imagery was clearer than I was used to and the overall ambience breathtaking. Bass sounded softer but it was still went low with plenty of control, which I liked. I played one particular track that I had never warmed

to on any system I have had (Sir George Solti conducting "Ride of the Valkyrie") and enjoyed it fully.

The vinyl was well beyond my expectations but the CD was not expected to be anywhere near as good since the line stages on the AI A200 are passive, so no valves to help out. However, even the two sales assistants who were eagerly listening along with me were taken aback by the sound of the CDs. I'm not sure why, I can only assume it is because of the pre/power split, but even CD was a great improvement on the Pioneer's usual performance. It sounded much more natural and vinyl like, with the same sort of improvements as I found with vinyl. It took a lot to convince me that the valves were not used, but the pre-amp does not even require switching on when not using the phono stage. Pagannini's Caprices proved that it still retained a good range, but I had lost the shrill accompanying some of the higher bars that now sounded sweet and transparent.

Having spent nearly two hours being fully entertained I did not bother with the other two amps as I knew from previous listening sessions they could not match the A200/A400 combination. The cost was a mere £200 - less than half the cost of the others and I was able to get it now rather than later. Installed at home I am still impressed - even my wife can tell the difference (no mean feat I assure you). I have the pre-amp resting on a Cyrus Isoplat (just overhangs it nicely) and it is linked to the A400 CD input via Ixos 103 interconnects; the A400 is set with volume at half level.

The rest of my system consists of Revolver Rosewood turntable and arm with Corus Blue cartridge, Pioneer PD-S901 CD Player (Ixos 102 interconnects), Marantz SD60 cassette deck and Sony ST5370 tuner; I also have my Nicam TV/Video

linked through the auxiliary input. I have found great improvement on all these sources with the new combination. My speakers are Mordaunt Short 3.30 supported by Foundation FRED (Budget) 18" stands and connected by Supra 4 cable.

When I bought my A400 2 years ago I got hooked on hi-fi. Now I've got caught again - this time it's valves. So, much as I like the combination, I still want to replace the A400 with a dedicated valve power amp.

Okay, question time now. Maybe (for the sake of my marriage and bank balance) I shall have to wait a while, but which power amps would you recommend? I have thought of the matching A200 power amp but I wonder if my speakers are really sensitive enough (90dB) for their low output; and I am considering your own K5881 kit (an electronics engineer friend of mine will eagerly assist in its construction - I'll hold the tools). Although I listen to most types of music, I spend most time with classical and want a system that is good for opera and acoustic music in particular.

**Richard Browne  
Fleetwood,  
Lancashire.**

**One of our contributors, Dominic Todd, has arrived at a very similar amplification system to yourself. He too finds the A400 makes a superb power amplifier, but has added an external phono stage with excellent results.**

**The A200 power amplifier isn't that powerful and won't drive many loudspeakers as a result. The Mordaunt Short loudspeakers you are using should be next on the list for upgrading. This will give you the chance of picking a more efficient loudspeaker that will get the best out of your A400 and be more suitable for a valve amplifier in the future. **DB****

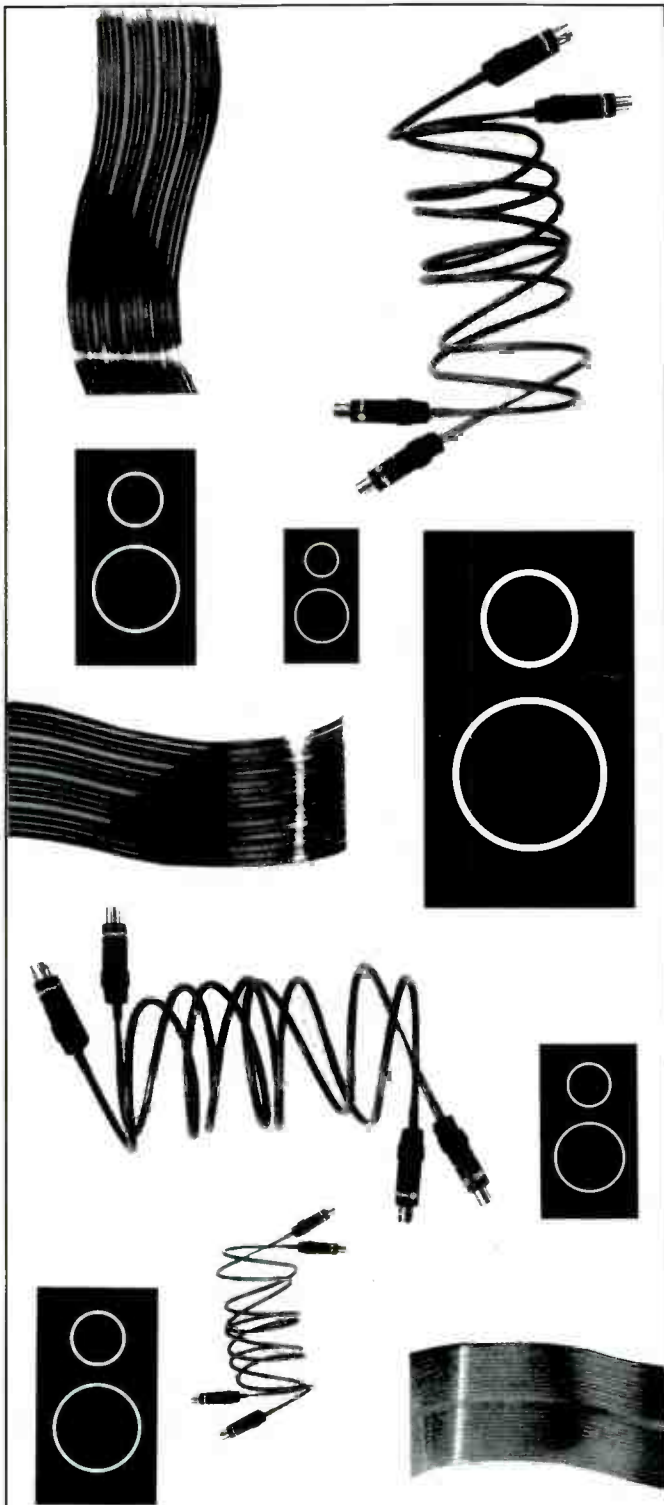

**INTERCONNECTS  
SPEAKER CABLE  
LOUDSPEAKERS  
BY**

30a Sarum  
Business Park,  
Portway,  
Salisbury,  
Wiltshire  
SP4 6EA



Telephone  
(0722) 331674

Fax  
(0722) 411388

For advice, sales and service or simply a brochure - call, fax or send the coupon

NAME \_\_\_\_\_

ADDRESS \_\_\_\_\_

Interconnects    Speaker Cables    Speakers   Please tick required box

**THE  
RECORD  
SHOP**

66 FIFE ROAD  
KINGSTON-UPON-  
THAMES  
SURREY  
KT1 1SP  
TEL: 081-546 3880  
FAX: 0372 360996  
EST. 1968

**SPECIALIST IN NEW VINYL  
RECORDS**

SORRY ABOUT LAST MONTH'S ADVERT  
- IT WAS NOT OUR FAULT!

HOW MANY OF YOU NOTICED THE REPETITION?

THANKS AGAIN TO EVERYONE WHO HAS WRITTEN OR PHONED  
AND A SPECIAL MENTION TO EVERYONE WHO HAS PAID US A VISIT  
- SOME FROM GREAT DISTANCES.

SOPHIE B HAWKINS - 'WHALER' £9.95

DAVE EDMUNDS - 'PLUGGED IN' £9.95

TOAD THE WET SPROCKET - 'DULCIMA' £9.49

GIL-SCOTT HERON - SPIRITS £9.95

JEFF BUCKLEY - GRACE £9.95

(AS GOOD AS HIS DAD)

NEIL YOUNG - SLEEPS WITH ANGELS £12.95

(HIS BEST YET? - DOUBLE VINYL)

PAVAROTTI DOMINGO CARRERAS - 3 TENORS IN CONCERT

(DOUBLE VINYL) £14.95

JUNE TABOR - AGAINST THE STREAMS £8.95

CLAIRE MARTIN - OLD BOY FRIENDS £8.99

(3RD LINN ALBUM FROM WINNER OF BEST RISING STAR IN  
BRITISH JAZZ AWARDS 1994)

LIZ PHAIR - WHIP SMART £9.95

VICTORIA WILLIAMS - LOOSE £9.95

MARY CHAPIN CARPENTER - STONES IN THE ROAD £9.49

MARY CHAPIN CARPENTER - COME ON COME ON £9.95

(BUY ONE BEFORE IT GETS DELETED!)

JAMIRIQUOI - RETURN OF THE SPACE COWBOY £8.95

TONY EMMANUEL - THE JOURNEY £9.95

GLORIA ESTEFAN - HOLD ME, THRILL ME, KISS ME £9.49

FOREST GUMP - SOUNDTRACK £13.95

(DOUBLE VINYL - MEGA TRACK, 32 AMERICAN CLASSICS)

BASIA - THE SWEETEST ILLUSION £9.49

PAT METHENY - SECRET STORY £13.95

(NOW DELETED IN UK)

VAN MORRISON - T.B. SHEETS £7.95

EDWIN COLLINS - GORGEOUS GEORGE £8.49

(WONDERFUL NEW ALBUM FROM

SINGER/SONGWRITER/ARRANGER

- YOU NAME IT. HIGHLY RECOMMENDED)

CREEDENCE CLEARWATER - CHRONICAL VOLS I & II

- BOTH DOUBLE VINYL @ £11.95

DELBERT MCCLINTON - NEVER BEEN ROCKED ENOUGH £5.99

JOHN COLTRANE - AFRO BLUE IMPRESSION £11.99

(PABLO DOUBLE VINYL)

HERBIE HANCOCK, WAYNE SHORTER, RON CARTER,

WALLACE RONEY, TONY WILLIAMS - TRIBUTE TO MILES £12.95

RICKIE LEE JONES - 1ST ALBUM

(THE ONE WITH CHUCK 'E'S IN LOVE) £7.95

JONI MITCHELL - MINCUS £7.95

AMERICA - HISTORY £7.95

PAT METHENY - LETTER FROM HOME £12.95

GRANT LEE BUFFALO - MIGHTY JOE MOON £8.49

JOE COCKER - HAVE A LITTLE FAITH £8.95

ERIC CLAPTON - FROM THE CRADLE

(ERIC GOES BACK TO HIS ROOTS

- WAITED 20 YEARS FOR THIS!) £9.99

BRYAN FERRY - MAMOUNA £9.49

BLUE NOTE CONNOISSEUR LP SERIES 180G

VIRGIN USA VINYL - PHONE FOR TITLES - (EACH) £9.95





**Built by Rega to NAD's specification, Dominic Todd finds  
the new NAD 533 turntable fit for a king.**

**D**on't be surprised if you're faced with a sense of déjà vu when eyeing up NAD's latest offering to the budget turntable market. To all intents and purposes it is essentially a rebadged Rega Planar 2. NAD aren't alone in offering a badge engineered Rega, though. At about the same time the NAD was announced, Akai launched a similar product. This has since been discontinued and was no doubt the cause of the delay in actually launching the NAD turntable.

Being related to the Planar 2 is no bad thing. In fact it's quite the opposite: it allows NAD to instantly inherit the excellent reputation that the Planar 2 has built up over the years. The classic elegance of the deck remains untouched, as well as its simplicity of operation. There's no doubt that the Rega hides its years well, still standing out as a fresh and clean cut design on the shelves of

hi-fi retailers. Yet differences do exist between the two brands. For one, the NAD's platter is turned from MDF, rather than the Planar's glass. NAD also choose to include a cartridge, Goldring's basic Elektra, in with the package price of £199.95.

Initially this may seem like a shrewd marketing move on NAD's part, especially when one considers the Rega equivalent costs a mere £15 less without cartridge. However, this apparent shrewdness on NAD's part turns out to back-fire somewhat when it comes to sound quality. Although, in essence, the NAD strikes the listener as being a fine sounding turntable, it doesn't take long to realise that there's something amiss, something holding back the deck from sounding as good as it could do.

Higher frequencies sounded uncharacteristically ragged for a Rega based machine and bass extension, whilst

being deep, was almost painfully ponderous. It didn't take me long to suspect that it was the cheap and cheerful Goldring badged cartridge that was at fault here. Changing this for a 1012GX from the same company proved an eye opener, and an instant upgrade I'd advise anyone to consider before buying the NAD.

Once up and running with the 1012, the NAD's heritage shone through, demonstrating the well rounded, yet capable qualities of its namesake. Richard Thompson's "Mimor Blue" album showed the deck to have an uncommon (at this price range) ability to unravel complex nuances from the music. Nothing seemed forced, yet by the same token the NAD couldn't be accused of being bland - it simply got on with the task of making music in a relaxed and informative manner.

Dissecting this general critique of the 533, it is the arm that must take the lion's share of the credit for the transparent and at times bewitching mid-range. The ragged treble had disappeared with the fitment of the more refined 1012, yet Grace Jones' "Bulletproof Heart" showed the bass could still occasionally sound a little too soft and lacking in attack. Not one of the

**SONOLITH® LOUDSPEAKERS**

*No Wood*

*No Veneer*

*No Contest*

**MINERAL-POLYMER ENCLOSURES**

**CONTROLLED-FLEXURE ALLOY CONES**

27 Fournier Street, London E1 6QE  
Telephone: 071 247 0813



**ELECTROFLUIDICS**  
THE SOUND FOUNDATION

## PRICE STUDIO MONITOR

- \* Direct from manufacturer
- \* Why pay more?



Each Price Studio Monitor is **individually** calibrated.

By using the very best drive units available coupled to ceramic-resin bonded cabinet of immense rigidity, the result is a loudspeaker with an incredible dynamic range and extremely flat frequency response extended from 28Hz to 20KHZ.

Loudspeakers of this quality normally cost £2,500

The price Studio Monitor is available direct from the manufacturer for **only £1,500** (VAT is included and there's no charge for delivery!)

For a free home trial or further information simply phone:

**0443 - 480258**

**The Sound Company )))**

23 Whiterock Drive, Pontypridd, Mid Glam., CF37 2HA

Proprietor: D. Price

## fuller's audio



The new high sensitivity SULTAN H.E. Loudspeakers from Fuller's Audio are rated at 98dB 1w/1m

This has been achieved without sacrificing sound quality and imaging. An ideal partner for low powered amplification, you can now attain realistic music levels without having

to put up with the resulting distortion. The matching, optional sub woofer can be added to give truly extended bass, without boom or drag.

For a demonstration visit your dealer or contact us direct

SULTAN H.E. - £439 Sub Woffer - £559

Fuller's Audio 20 Tunbridge Road  
Southend-on-Sea Essex SS2 6LT

Telephone - 0702 612116

arm's strong points, but possibly exaggerated by the switch to an MDF platter, since glass sounds punchier in the lower registers. This change of material could also account for the slight lack of sparkle at the top end, although this is greatly preferred to the shrill nature that was present with the standard cartridge.

Bear in mind that these criticisms are in relation to decks often costing much more than the NAD, such is the standard expected from the deck, and that in day to day use they hardly detract from the performance. Comparison with the similarly priced Pro-ject I did reveal that the Rega could sound slightly euphonic and not the most cleanly etched of performers. Yet at the same time it had a fuller presentation than the Pro-ject and a more expansive soundstage to boot.

Various Van Morrison tracks also showed the NAD to lack the dynamic impact of certain rivals, with a slight softening of transients present. Yet, despite this quibble, the 533 was always involving, such was its articulation and, above all, coherence with whatever type of music was being played.

In the final analysis, the NAD's sound can be described as transparent and informative, smooth yet still able to unravel complex signals. Its dynamics are softened somewhat and slightly ponderous bass doesn't make it the best choice for large scale orchestras. Yet - to use an industry cliché - at heart the 533 is "musical".

The 533 marks a useful step forward for NAD in terms of turntables. Put next to the still fine sounding, yet poorly built 5120, the 533 is nothing short of a

revelation. With a change of cartridge the 533 is a deck that is both pleasant to use and look at, unfailingly reliable, well built and offers mature sound quality. What more could you possibly ask for from a turntable costing around £200? The NAD merits recommendation, and with it continues Rega's reputation for providing a taste of the high end at a bargain price ●

**NAD 533** £199.95  
**NAD Marketing Ltd.,**  
**NAD Building,**  
**401-405 Nether Street,**  
**London N3 1QG**  
**Tel: 081-343 3240**

# GOOD VIBRATIONS

**Ortofon keeps the price down and the quality high for its new budget priced cartridge, finds Dominic Todd.**

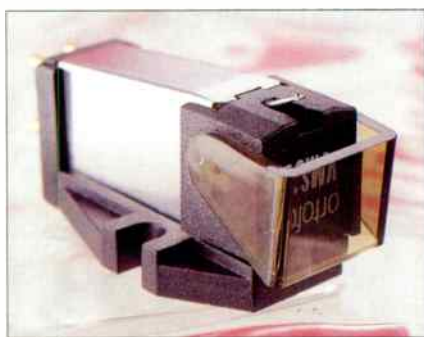

There's not much you can get for a tenner these days, not even a half decent CD. So it came as a surprise to find that was all Ortofon were asking for their latest VMS 2E. Have Ortofon gone mad? Or are they simply trying to win the award for the greatest price differential between cartridges (£10 - £2,000)? The answer is that it's a shrewd move on Ortofon's behalf to produce a cartridge retailers can sell at a replacement stylus price and it can be fitted as standard on budget turntables, to keep the price down.

Fitted to the NAD 533, it produced a smoother treble than the Goldring Elektra with cleaner transients too. With Eric Clapton it sounded punchy and fast, drilling the rhythm into the listener. Fitting the cartridge to a reference source, a Michell Gyrodec QC with SME IV, revealed the Ortofon does have limitations. Vocals sounded nasal, bass somewhat plummy and it became confused with more complex sections. The basic character, however, was of an honest product that could still sound good.

The bass on Brian Ferry's Taxi was deep enough but, even on the NAD, rather loose. In the best tradition of Moving Magnets, the Ortofon produced a broad expanse of sound and good projection that made the Goldring sound compressed in comparison. On some systems, this could become wearing, but generally this quality is ideal, adding a little sparkle. Ferry's vocals were distinctive and clearly separated from the rest of the mix, and the atmosphere of the album was captured on both the NAD and the reference deck.

Anita Baker's Giving You The Best I Got revealed no problems with female vocalists (namely sibilance), although the bass could occasionally "plod". Vocals were clean-cut and, again, well projected from the 'speakers.

Considering the Ortofon's ludicrously low price, it tracked exceptionally well, even with dusty old demo. records. The highish tracking weight of 2gms no doubt helps here.

The VMS 2E is no giant slayer, in the mould of an Audio Technica AT110E, and anyone considering a decent budget cartridge would be better off with an AT95E at the very least. Yet, if you are really strapped for cash, or plan to upgrade quickly (the VMS 2E is compatible with all of Ortofon's VMS styluses) then it's difficult to go wrong with the new Ortofon. If you're considering a new NAD 533 you might even be able to twist a dealer's arm to swap the VMS for the Elektra. But don't tell them I said that!

## MEASURED PERFORMANCE

The new VMS 2E has superb tracking ability at all frequencies, very high output and low distortion, plus good separation - especially for an Ortofon. Only frequency response was a little wonky, exhibiting a large midband suckout of -3dB, as our analysis shows. This got worse towards the centre of the disc and heavy capacitive loading improved matters little. The VMS 2E will sound very warm and full bodied as a result of this response. **NK**

## TEST RESULTS

Tracking force	2gms
Weight	5.5gms
Vertical tracking angle	22degrees
Frequency response (+/-3dB)	20-20k
Channel separation	30dB
Tracking ability (300Hz)	
lateral	90µm
vertical	45µm
lateral (1kHz)	25cms/sec.
Distortion (45µm)	
lateral	1.4%
vertical	2%
Output (5cms/sec rms)	7.7mV
Channel imbalance	0dB

## Frequency Response



# IN THE DECEMBER ISSUE

You'd be mad to miss the December issue of Hi-Fi World, there'll be so much to read and keep you entertained. Once again we'll be giving away a FREE DIY hi-fi Supplement. There's a fabulous competition to enter, and reviews and features on all of the latest equipment and developments in the world of hi-fi. Here's just some of what we hope to bring you in December -

## AUDIOPHILE CD PLAYERS

We test a group of CD players around £350, including Arcam's new Alpha One, the cheapest British built CD player available.

## MISSION 73 I

Mission have launched a new 'affordable' loudspeaker to stand alongside the regarded 760is. We audition these high tech miniatures.



## SD ACOUSTICS SD-3R

SD Acoustics have been hard at work on this new loudspeaker, featuring a custom built ribbon tweeter. For £399 these stand mounting loudspeakers look set to be a winner.

## DPA INTEGRATED AMPLIFIER

At last, DPA bring their magic down into the crowded, competitive but popular integrated market. Will surface mount technology let them prevail here too? Find out next month.



## LINN KAIRN/KLOUT

We were so impressed with this top end pre/power from Linn when we used it to drive the massive TDL References in the October issue, we decided it was worth a more in-depth review.

Hi-Fi World is still only £2, but with more editorial than most rivals. With the most enthusiastic and expert editorial team in hi-fi journalism, can you afford to miss it? Make sure you don't by filling in this order form and handing it to your newsagent.

## DIY SUPPLEMENT No. 12

It appears that you just can't get enough of DIY hi-fi projects, but neither can we, so once again there'll be another FREE Supplement with the December issue of Hi-Fi World. We'll be testing new high tech Audax High Definition Aerogel drive units and giving suggestions for using them. They're the best you could possibly buy for DIY loudspeakers, yet not madly expensive. As well, there are other projects, letters, news from the DIY scene, book reviews etc. Miss it at your peril.

## COMPETITION - WIN A COMPLETE VINYL SYSTEM WORTH OVER £1300.

A complete vinyl system to get the very best from your records comprising Systemdek IIX900 turntable, DPA integrated amplifier and Systemdek System 931 loudspeakers.



Please reserve/deliver\* Hi-Fi World on a regular basis, commencing with the next issue, until further notice.

Name: \_\_\_\_\_

Address \_\_\_\_\_

\_\_\_\_\_

\_\_\_\_\_

\_\_\_\_\_

Signed: \_\_\_\_\_ Date: \_\_\_\_\_

• Delete as appropriate

Distributed to the news trade by

**COMAG**  
MAGAZINE MARKETING

Loudspeakers drive me nuts - but they're great fun. Everyone finds great satisfaction in engineering a loudspeaker that they think is right, including me, but there's also a great sense of frustration in knowing that any and every loudspeaker offers only an interpretation of the sound. Whether others will like it depends upon a bewilderingly large number of factors, many of which interact. How I have been reminded of all these things when listening and tweaking KLS4, as well as necessarily canvassing the opinion of others about its sound.

In the past, engineers have tried to invoke so-called technical perfection as a defence for their loudspeakers, KEF in particular championing this approach. I got into a great argument the other night at a KEF dinner defending KEF founders Fincham and Cooke as great engineers, if unable to fool all of the people all of the time - including me. In the end, you have to submit to the opinion of others. If the man from Del Monte says "no", then NO it is. That, especially, neither Fincham nor Cooke - both great autocrats - could take on board.

After twenty years of reviewing loudspeakers, giving me the benefit of hearing more commercial models than probably any speaker engineer, I am a firm believer that the drive unit overwhelmingly dominates the sound of a loudspeaker above 200Hz - all other things being equal. To make a better loudspeaker, we need a better driver and, believe it or not, there are plenty around, though not in common use.

The reason for this is partly economic. Better drivers cost more and, in the competitive speaker business, drive unit cost is commonly kept to a minimum. The DIYer can happily spend a relative fortune on the drive units, since besides this there's little more to shell out for. This is a great advantage,

putting anyone with the time and ability to make a couple of MDF cabinets well ahead in the quality stakes.

Having heard Audax carbon-fibre drivers doing a wonderful job in KLS3, demonstrating vivid clarity, I couldn't but help decide to use them in a smaller, less expensive and domestically less intrusive loudspeaker. Keeping the same tweeter and using the midrange unit from KLS3 as a bass/mid, KLS4 was born. Getting deep bass from a small driver and cabinet is always difficult. I



manufacturers have found with CD players, treble needs to be gently rolled off for 'natural' treble from CD. I decided to let KLS4 run flat to 20kHz all the same. It's less amenable as a result, but it is very analytical.

Another conscious choice made in the design process was in a similar vein. The bass/midrange unit has a response that starts to fall gently above 500Hz, becoming about -2dB down at high frequencies. Most designers would, I suspect, leave well alone, knowing

## Reflections from Noel Keywood kaleidoscope

fitted a long port as well as a short one and found after experiment that strong, deep bass could be obtained from this stagger tuned system. Listeners have remarked upon how low KLS4 goes, but they also commonly feel it has light bass too.

That to quite some extent is true, being part of a conscious trade off I made in the design. Most small speakers these days have rising bass output, whilst KLS4 has a flat bass response. As a result it typically sounds less bassy than usual. However, it is meant to be used close to a rear wall, which raises bass output, and it gives a great result with the right partnering equipment, having good bass definition and little boom. But being on the forward and lean side in its presentation, it does favour partnering equipment capable of delivering a good, strong bass signal. I was forcefully reminded of this by swapping from the Arcam Black Box 500 convertor to an EMF Crystal convertor.

The system sounded a little shrill and acidic in its treble with the Arcam; it sounded sweet in the treble and fulsome in the bass with the Crystal.

The differences between the two convertors were made very obvious by the revealing nature of the KLS4 carbon fibre drive units, but just as importantly the Arcam Black Box 500 did not suit the very up-front presentation I have deliberately engineered into KLS4. This convertor may breathe life into polypropylene cone speakers in the way Black Box 50 does, but neither are happily paired with a speaker like KLS4 and I'm reminded that any bright CD player/amplifier may be unsuitable.

There are some good reasons, ones that could be engineered out of the speaker. Firstly, KLS4 has a truly flat frequency response. This gives a bright sound with many or most CDs, even though it'll sound properly balanced with LP. As British

this makes for the warm, fulsome sound most people like. I decided to raise mid-band/treble output in order to lower the impedance curve, increase sensitivity and, most of all, ensure superb vocal projection.

Sure enough, KLS4 produces a vivid sound stage, right out of the box, with superb projection forward of vocalists. But whilst this is a function both of the drive units and the way I've engineered the crossover for them, it isn't necessarily to everyone's taste. KLS4 is a dry, revealing speaker and dramatic in this sense. It's also very fast, which is great for rock, but it isn't especially warm, laid back or relaxing. Somebody commented that it had been designed by an electrostatic man - too true!

So there you are. The perfect speaker is a long way off, which is just as well. We can all have fun trying to make the perfect speaker - that's what DIY is all about - but believe me, no such thing exists, which drives me nuts!



*Explosive bass dynamics, a midrange clear as a bell & shimmering treble.....  
.....A tighter rendition of Music....  
In a world of black boxes,  
valve amplifiers like this are  
scene stealers.....*

*Hi-Fi World, June 1994*



*A Sense of Rhythm*



Prophet PreAmp



Genesis Monobloc



Unisis Integrated

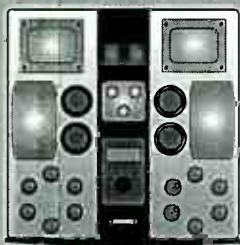

Synergy Pre/Power

**Tube Technology, Design & Manufacturers of High Quality Tube Amplification and Distributors of Gold Aero Vacuum Tubes.**

Please enquire for further information. Foxhills Farm, Longcross Road, Ottershaw, Surrey, KT16 0DN, England. Tel: 0932 873444 ~ Fax: 0932 873012

*Pictured:- The Genesis 100 watt All Tube Monoblocs.*

# Recital

WHAT ARE YOU REALLY LOOKING FOR?

- \* A SYSTEM THAT WILL REALISTICALLY REPRODUCE ALL YOUR FAVOURITE RECORDINGS.
- \* COMPONENTS THAT ARE RELIABLE AND BEAUTIFULLY FINISHED
- \* RELAXED DEMONSTRATIONS THAT ALLOW YOU TO CHOOSE THE EQUIPMENT
- \* FRIENDLY EFFICIENT SERVICE THAT IS SECOND TO NONE
- \* EVENING, SUNDAY AND HOME AUDITIONS BY ARRANGEMENT

TELEPHONE REX ON: 071-731 0340  
10 TIL 6, MONDAY TO SATURDAY

**RECITAL**  
289 NEW KINGS ROAD  
FULHAM  
LONDON SW6 4RE

PRODUCTS STOCKED: MICROMEGA, MICHELL, DPA, CHORD CO, HARBETH, CARY, TRILOGY, AVI, ATC, TRIANGLE, PIERRE LURNE, NAD, AURA, CHARIOS, RUARK, PINK, C.R. DEVS, LUMLEY, PARASOUND, SUMIKO, SME, HEYBROOK, CAT, IMPULSE, JORDAN WATTS, NVA, DYNAVECTOR, ORELLE, AUDIOVECTOR, CABASSE, AUDIO ALCHEMY, ARION

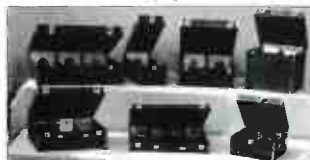

STANDARD CASE



FULL AND SEMI FLIGHT CASES

**THE ULTIMATE IN RECORD/COMPACT DISC/CASSETTE PROTECTION**

Presenting a selection of cases carefully designed to meet the needs of Collectors, DJ's and all Buyers of Records, CD's, Cassettes

**Introducing our new range of semi and full flight cases for '94**

These Cases are constructed from Plywood/M.d.f. Full Flight finished in Stucco Alloy covering will all heavy duty Aluminium/Steel Corners, Catches, Lift-off Hinges and Angle Trim. Semi-Flight same as full Flight but Finished in Black Vynide Covering.

	Standard	Semi-Flight	Full-Flight
A - holds 200 singles	£39.99	£59.99	£69.99
B - holds 400 singles	£45.99	£64.99	£75.99
C - holds 600 singles	£49.99	£69.99	£79.99
D - holds 50 albums	£45.99	£64.99	£75.99
E - holds 100 albums	£49.99	£69.99	£79.99
F - holds 100 CD's	£45.99	£59.99	£69.99
G - holds 200 CD's	£49.99	£69.99	£79.99
H - holds 100 cassettes	£45.99	£69.99	£79.99

All prices include Postage & Packaging in the UK. Overseas customers add £25 per case for delivery

**Ring now and order by ACCESS/VISA 0803 855746**

Standard cases are constructed from high density chipboard/P. and finished with black viny, cloth with protective aluminium trim, with lockable catches and lift off hinges.

Please send cheque/PO made payable to TRAXS, BODENA WORKSHOPS, HORSEPOOL ST., BRIXHAM, DEVON TQ5 9LD. Allow up to 21 days delivery.



A couple of months ago in this column, I described some of the ways in which valves are finding their way back into professional recording equipment. About five to ten years ago, professional audio engineers, producers and musicians started hunting out old valve microphones and valve outboard gear to take some of the 'edge' off the new digital sound. Now, new equipment is being designed and built to satiate the ever increasing demand for the 'valve' sound. AKG and Sony have started producing valve microphones and TLA now produce valve equalizers and a valve mixing desk.

My own company, originally commissioned to produce a valve model of our Francinstien Stereo Enhancement System as a special, now sell more of the valve model than the original solid state version! I have recently also completed the development of a hybrid power amplifier which handles the audio signal in the power output stage by sharing the job between a high-power MOSFET stage and a single-ended triode

Another area in which valve circuitry is making a burgeoning return is in the field known as 'dynamics processing'. The most common processor of this type is known as a compressor, and it is an absolutely indispensable part of a recording engineer's electronic armoury. In effect, a compressor does just what it says: it compresses the volume range of an audio signal.

There are a number of occasions when a signal must be dynamically 'squashed' in this way. The most common is on a vocal track where, in order for the singer to express the emotion necessary to deliver a convincing performance, they may modulate their voice from a bare whisper to a near shout. Unfortunately, such a performance - with its attendant vast dynamic range - is either unrecordable, unmixable or both. So, something must be done to shrink the size of the

vocal into a smaller dynamic package without bullying the singer into reducing their emotional gamut of vocal possibilities.

Listen to any well produced record and you will notice that the vocal remains at an unrealistically constant intensity despite very considerable changes in vocal modulation. Listen, for instance, to Sinnead O'Connor who has made this effect a part of her vocal style. Interestingly, this need to compress the volume, but not the emotion of a vocal is not limited to the sung



P3. The compression action is obtained because as signal peaks depress the bias volts on V1, the stage 'slides' further down the valve's curved Vg-k/la characteristic. The required voltage change for a given change in anode current is reduced and the stage-gain is lowered. The compression signal remains inaudible because it is applied equally to both input valves, whereas the audio signal is applied differentially - in other words the common-mode control signal is cancelled out in the differential

# recorded message

## Left by Richard Brice

voice. Speech, especially the modulated tones of a BBC announcer, needs compressing too. This is the reason why it's so often so difficult to set recording levels when doing something apparently as simple as recording speech directly into a microphone onto a domestic cassette recorder.

An example of one of the great valve compressors of yesteryear currently being sought out and copied today is the Altec Lansing 436C. The design dates from 1963, yet Jim Dowler of ADT tells me an original 436C was still in use at Olympic Studios when he was involved in recording many of the early punk classics. The reason why this compressor is especially interesting is its consummate valve-ness. The 436C is no modern compressor built with valves, instead, it relies on the inherent distortion characteristic of a triode valve to compress the sound.

The circuit operates like this: large negative signal peaks on the anodes of the

V2 cause double-diode V3 to conduct and thus drag down the bias volts to the input stage valve V1. This action is damped by the time constant formed by R9, P2 and C4 which allows for some adjustment of the compressor's release time. The level threshold at which the compression action is required to commence is adjustable too by means of the simple expedient of biasing the cathodes of the double-diode V3 with a constant positive bias derived from the slider of

amplifier.

The Altec Lansing 436C is one of the best examples I know of for a case for the indispensability of valves in pro audio. This compressor has a wonderful sound all of its own, borne of its internal technology. If a triode valve was a linear device (which it certainly isn't) this compressor would not work at all. The Altec Lansing 436C is living proof that the phrase 'valve compressor' does not mean the same thing as a compressor with valves in it ●

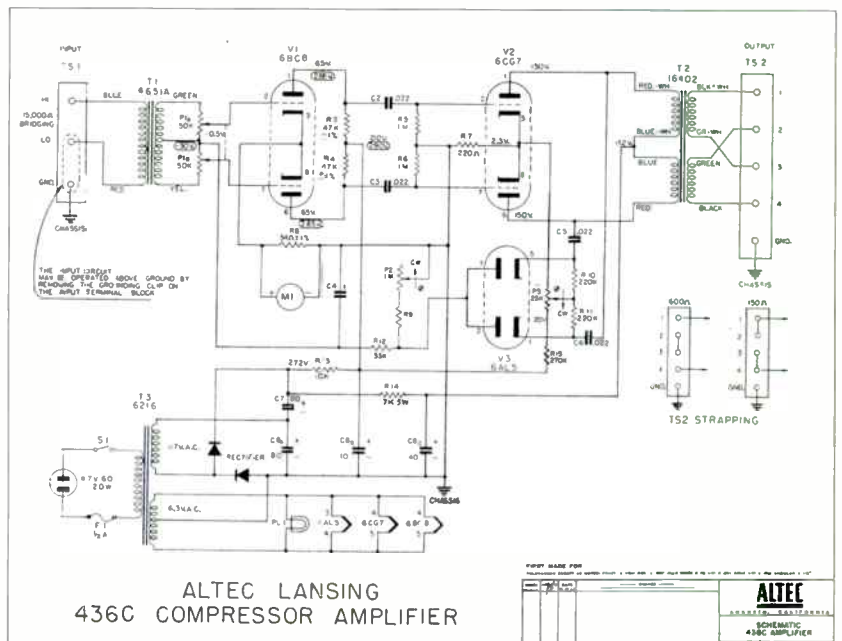

Aiwa have long held a good reputation for making a more than decent cassette deck. The AD-F450 is no exception to the general rule. Even better, Aiwa, having pretty well pioneered user-friendliness in down-market decks, have put in a couple of very handy facilities that are still usually the province of another rung up the price ladder.

For £130 there is Dolby HX-Pro and both B and C noise reduction; a mechanism that is well up to Aiwa's already high and reliable standard, 'Music Search' and a very effective variable bias.

Even when the ability to 'tune in' different tapes is included in much more expensive decks than this, not many owners use it. That is a great shame, for it makes the difference between having a sparkling spanking-new sounding home recording and the

second-rate one that gives cassette a good name. As always, Aiwa cover a sensible range of tapes, even with the control centred (where too many leave it) and the instruction manual gives pleasingly accurate rule of thumb

Matrow Bias Bug and a tone generator, Aiwa's own suggested settings were pretty near spot-on.

It is on home recordings that this matters, for on good-quality ferric, chrome and metal tapes the Aiwa produced a sparkingly clear and clean treble and a very healthy midrange. A tiny twist to the bias setting and chrome particularly could be brightened up just that side of true to convince even the most ardent Dolby-hater that noise reduction really does not dull a recording. And, by the way, tracking on Dolby B and C was excellent.

The days when a deck had to be expensive to achieve that are long gone and Aiwa deserve congratulations.

Now, although this is a good deck, it's

# AIWA'S MODEST MARVEL

**Eric Braithwaite listens to Aiwa's budget priced**

**AD-F450 cassette deck.**

positions for the usual breeds for those who either do not trust their ears or find comparison between a few seconds' recording and playback tedious. Using a

## MEASURED PERFORMANCE

For a budget deck this one has a good tape transport mechanism. As our speed stability analysis shows by its thin test-tone peak (at right) with few unwanted side peaks or shoulders, basic speed was tightly held, with little degradation from drift. I'd expect this deck to maintain a firm grip upon tempo and not meander or wow in pitch. It should sound reasonably clean and free from the papery colouration characteristic of cassette flutter.

The replay amplifiers were quiet and replay equalisation fairly good too, although high frequency gain rolls off a little early, limiting replay frequency response, which affects pre-recorded tapes, to 16kHz (-2dB). Unfortunately, Dolby amplifies response errors so some small amount of dullness will be introduced by this.

Recordings made on the deck had a flat frequency response, at least when bias was correctly adjusted. As it stands, at normal bias the deck gives mildly falling treble with TDK MA but not enough to sound dull. Since the deck under-biases metals in any case, as the overload figures (MOLs & SATs) show, this isn't the best balance. However, providing record level isn't pushed much above +3 on peaks the '450 should give a clean sound.

The head suffered low frequency overload and had a wavy bass response,

like most other budget heads. I'd expect wooly bass.

Standard chromes matched in well, but bias has been set to suit high performance ferrics like TDK AD and Maxell XL-IS, rather than TDK AR, which needed lower bias to give balanced results. Treble overload levels were high due to low bias and Dolby HX Pro.

The AD-F450 gives balanced results, due to good all-round adjustment and competent basic design. Recording levels cannot be pushed too high but otherwise recording and replay quality with all tapes should be good. **NK**

## TEST RESULTS

### REPLAY (pre-recorded tapes)

Frequency response (-2dB) 30Hz-16kHz  
Speed accuracy +0.7%  
Hiss (70uS, Dolby out) - 60dB

### RECORDING (blank tapes)

Frequency response (IEC Primary Refs.)  
ferric (IECI) 10Hz-16kHz  
chrome (IECII) 10Hz-17kHz  
metal (IECIV) 10Hz-19kHz  
Separation (1kHz) -49dB  
Distortion (315Hz) 1.6%  
Hiss (70uS, Dolby out) -57dB  
Speed variations (DIN total) 0.08%

Flutter energy (3-3.13kHz)	-23dB
MOL/SAT (IEC Refs)	315/10k
IEC I (ferric)	+2dB/-3dB
IECII (chrome)	+1.5dB/-3.5dB
IECIV (metal)	+2dB/+0.5dB

## Frequency Response

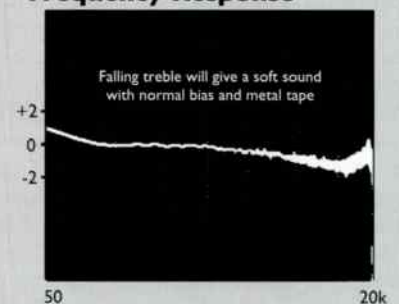

## Speed Stability

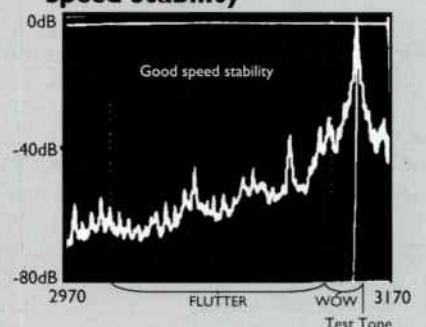





still a budget one. For all that, there was a remarkable amount of air coming out of a wonderful big rasping sax on a jazz recording, along with space around the drummer's kit that gave a very decent representation of studio space. Inevitably, on orchestral music there was some confusion in the tutti passages, but the overall clarity inherent in the deck produced a very good impression of the size and scope of an orchestra. Tonal colour was pretty fair, too, with upper strings sounding a spot shrill and lacking some body, but with enough clarity to be acceptable.

Rock music fared equally well, with a forward drive and tight positioning between the speakers while delivering enough studio ambience to reproduce a picture much less flat than the majority of budget decks. Vocals could come nicely forward without landing in anyone's lap, although double-tracked vocals, while being discernible as double-tracked, didn't quite separate as much as perhaps a deck a little more expensive might manage.

Bass performance was, however, more of a give-away. There's nothing wrong with its timing, but plucked double-basses, timpani or bass guitars had a softness and subdued definition. Admittedly, this is the curse of the majority, not restricted only to this deck, but against the clarity of the rest of the frequency range the 'elastic band' sound of bass strings and slightly soggy kick

drums was mildly disappointing. Not to grumble too much, however, bearing in mind that would-be owners are not likely to be counting on the definition from the rest of their equipment.

The Aiwa's strengths are in an all-round believable quality of sound and presentation that makes it ideal for taping both for home use and abroad in the car or on the hoof. The slight degree of sharpness would be a positive benefit in the average in-car player or personal, while avoiding that edginess or coarseness that tends to knock budget - and some mid-price - cassette decks down to the bottom of the system hierarchy. As a recording machine, Aiwa's little marvel wouldn't disgrace systems with components that cost double or treble.

Turning to pre-recorded tapes, however, the picture alters somewhat. On the benefit side is a transport which is stable enough to replay piano recordings with a timing ability which is well beyond the usual ability at this price. The same goes for rock rhythm. All the best aspects of home-recorded tapes also came across. Chiefly, the amount of recorded detail, the placing of vocalists and guitarists on rock tapes was quite an eye-opener. If it hadn't been for one snag, pre-recordeds would have sounded by no means a second-rate source.

The main drawback, where the Teac V-600 reviewed recently was rather better, was the notably restrained treble,

which on average rock band tapes just took a slice off the top end and left a lingering impression of their being recordings made with an FM bandwidth. It also meant, of course, that orchestral strings failed to soar and cymbals lost their shimmer. Against the apparent immediacy of many personals, in a home system many commercial tapes played back on the Aiwa might well sound disappointingly dulled.

Lest anyone think they hear only the sound of faint damns or fainter praise, Aiwa has produced a deck which in relative performance and facilities would have cost twice the price not much more than a year ago. It's a reminder that when the name is now often associated with A/V midis or personals, although the hi-fi separates range may be less wide than it once was, Aiwa takes it seriously. When being towed away because the parking meter ran out costs as much as this cassette deck, it occurs to me I'd better ask for the conclusion to be printed the size of a Sunday Sport headline. This is a very good bargain. Feed the meter, save the fine, buy it ●

**Aiwa AD-F450**

**£130**

**Aiwa**

**5 Heathrow Summit Centre,  
West Drayton,  
Middlesex. UB7 0LY  
Tel: 081 897 7000**

# WIN A COMPLETE AURA HI-FI SYSTEM WORTH OVER £1150

**U**p for grabs this month - for the price of a stamp - is another complete system. It comprises the sleek and elegant chrome plated Aura CD-50 CD player, VA-80 amplifier and high tech SP-50 loudspeakers. As you can see from the photograph opposite, there's certainly an aura of elegance about this system.

The Aura CD-50 is a slimline, minimalist styled CD player with a bare minimum of buttons (play, stop, track skip and open/close) gracing its deep chrome plated fascia. A wider range of facilities can be found on the remote control. There's elegance to be found inside too, where a high quality Philips CDM-9 transport, SAA7321 bitstream

chip and Burr Brown op-amps can be found, amongst other audio grade components.

When we reviewed the Aura CD-50, we found it possessed "a degree of refined elegance which presents chamber music, soloists or a singer like Rory Block with a clear, polished air and even a fair degree of airiness to boot". In fact, the openness of the Aura was one of its strong points, having a "well-defined, broad soundstage that was nearly up to the quality of the references, which is a remarkable achievement for a four-hundred pound player".

From the CD-50 CD player the signal is fed to the new VA-80 amplifier, the replacement for the highly regarded VA-50. Reviewed only last month, the VA-80 was deemed a worthy successor to the VA-50, with its "tight flowing rhythm, driving pieces along". Also noted was its ability in the critical midband, where "vocalists were allowed to breathe, performing with space around them".

Completing the system, the SP-50 loudspeakers use high tech drive units - carbon fibre in fact. This gives them a smooth and detailed sound. When we reviewed them in the March '94 issue they were praised for their "good pace and timing" and "relaxed and informative" sound.

To enter this fabulous competition for a complete AURA system worth over £1150, simply complete the questions opposite.

Please send your entry on a POSTCARD, or the back of a SEALED ENVELOPE, and completed in block capitals, to arrive no later than Friday 4th November 1994 to :

**AURA Competition  
Hi-Fi World Magazine,  
64 Castellain Road,  
Maida Vale,  
London. W9 1EX.**

## COMPETITION ENTRY QUESTIONS

1) What is the finish of the Aura system being offered as a prize?

- |          |           |
|----------|-----------|
| A. Brass | B. Chrome |
| C. Gold  | D. Silver |

2) What transport mechanism does the Aura CD-50 use?

- |                  |                     |
|------------------|---------------------|
| A. Philips CDM-4 | B. Philips CDM-12   |
| C. Philips CDM-9 | D. Philips CDM-9Pro |

3) The new Aura VA-80 replaces which previous model?

- |          |           |
|----------|-----------|
| A. VA-50 | B. VA-60  |
| C. VA-90 | D. VA-100 |

4) Which high tech cone material do the Aura SP-50s use?

- |                 |                  |
|-----------------|------------------|
| A. Paper        | B. Polypropylene |
| C. Carbon fibre | D. Glass fibre   |

Don't forget to include your name, address and a telephone number so we can contact the winners promptly.

In the event of more than one entrant submitting all the correct answers, the winners will be picked by the Editor from a hat. We will endeavour to publish the results in the January 1995 issue. Purchase of the magazine is not a precondition to entry.

No correspondence about this competition will be entered into and the Editor's decision is final.

No employees of Audio Publishing Ltd. or any of the companies associated with production or distribution of the prizes may enter.

Your name and address may be added to our mailing list only. If you would prefer not to receive details of new products or special offers from us alone please state so on your competition reply form. Hi-Fi World magazine is published by Audio Publishing Ltd.

**SEPTEMBER ISSUE COMPETITION  
- WINNER - AUDIONOTE OTO SE  
VALVE AMPLIFIER AND CALLAS  
WALNUT LOUDSPEAKERS**

Only one lucky winner this month, and sure to be the envy of us all with such a fabulous prize. The winner of the Audionote OTO single-ended valve amplifier and solid walnut UKD Callas loudspeakers is:

James Cook of Orpington in Kent.

Congratulations.

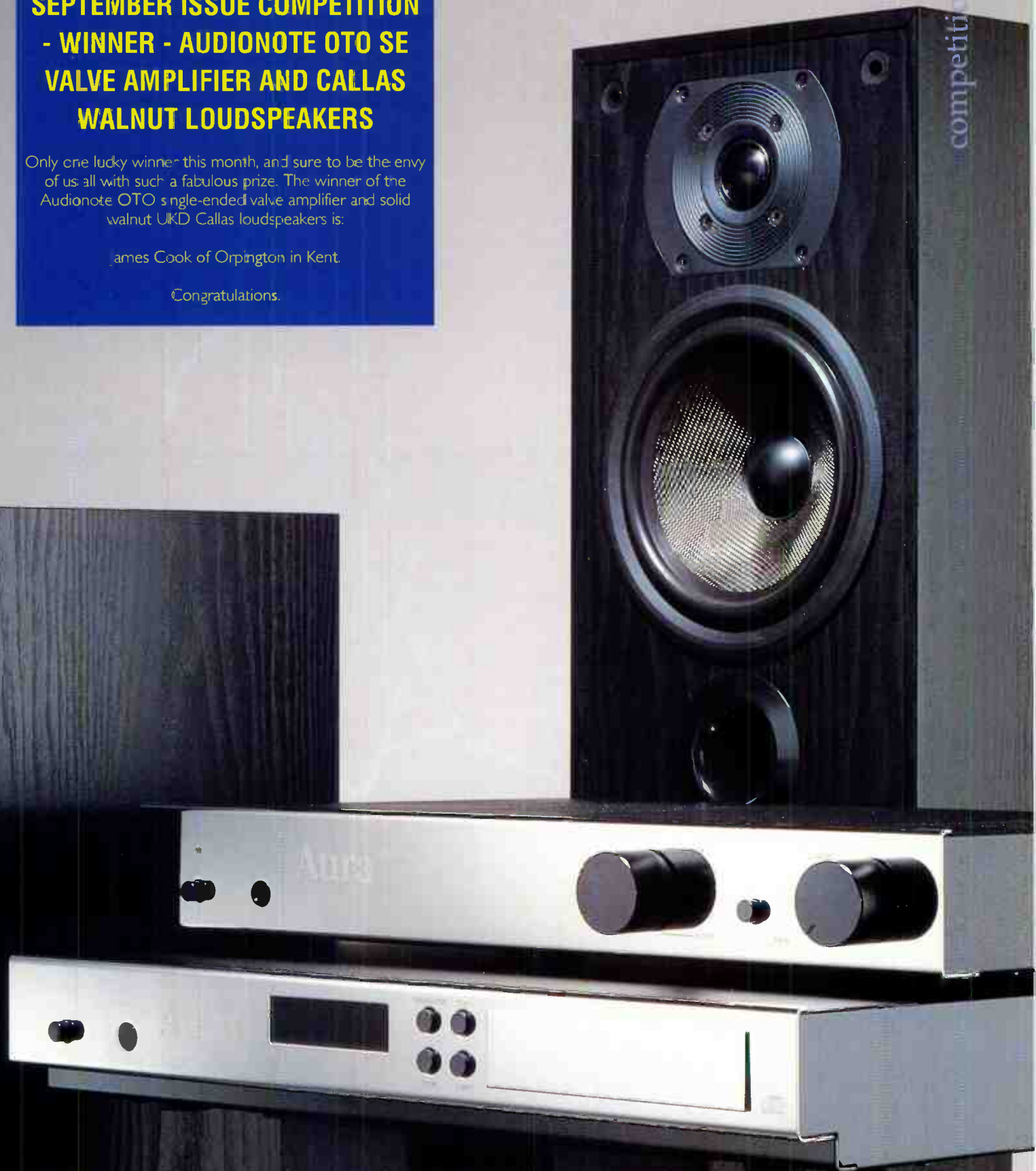

# Subscriptions

## 12 ISSUES FOR ONLY £22 (UK only)

### HI-FI WORLD SUBSCRIPTION FORM

Please send me the next 12 issues of Hi-Fi World, starting with the \_\_\_\_\_ issue.

I enclose my cheque/postal order for £22 (UK only) made payable to **Audio Publishing Ltd.**

Name \_\_\_\_\_

Address \_\_\_\_\_

Daytime Tel No: \_\_\_\_\_

Please debit my VISA/ACCESS Card No:

Expiry Date: \_\_\_\_\_

Tel: 071-266 0461

Send to: **Audio Publishing Ltd.**, 64 Castellain Road, Maida Vale, London W9 1EX.

Overseas subscription rates.

Surface Mail: £29.

Airmail: £42 Europe, £52 Middle East, Hong Kong, Singapore & Malaysia, £62 Australia, Japan, Korea & China.

Airmail

Surface Mail (tick as appropriate)

8/94 E&OE



# U.S. & Canadian Subscriptions



## Hi-Fi World

U.S. & Canadian Subscriptions

P.O. Box 754, Manhasset, N.Y. 11030 - 0754  
Telephone: 516 627 3836 Fax: 516 627 1972

I wish to subscribe right now - and receive monthly copies of Hi-Fi World Air Speeded direct from the Publisher in London U.K. to the N.Y. Office

I enclose my payment to :- FRJ/Hi-Fi as checked below  
1 Year - 12 Issues \$66 (U.S.)

U.S. FUNDS ONLY PLEASE - Add \$10 U.S. for Canada.

OR

Please charge my Credit Card with the amount indicated.  
(All major Credit Cards accepted)

No:

Expiry Date:

Signature: \_\_\_\_\_ Name: \_\_\_\_\_

Address: \_\_\_\_\_

City: \_\_\_\_\_ State: \_\_\_\_\_ Zip: \_\_\_\_\_

Or Telephone:

**516 627 3836**

Or Fax:

**516 627 1972**

8/94

# Back Issues

Unfortunately, all issues prior to December 1991 are completely sold out, but subsequent issues, as listed below are available for £2.00 excluding postage and packing.

### HI-FI WORLD BACK ISSUES ORDER FORM

Please tick the box next to the issue(s) you wish to order

- |  |       |   |       |
|--|-------|---|-------|
| <input type="checkbox"/> December 1991 | £2.00 | <input type="checkbox"/> September 1993 | £2.00 |
| <input type="checkbox"/> January 1992  | £2.00 | <input type="checkbox"/> October 1993   | £2.00 |
| <input type="checkbox"/> October 1992  | £2.00 | <input type="checkbox"/> November 1993  | £2.00 |
| <input type="checkbox"/> January 1993  | £2.00 | <input type="checkbox"/> January 1994   | £2.00 |
| <input type="checkbox"/> February 1993 | £2.00 | <input type="checkbox"/> February 1994  | £2.00 |
| <input type="checkbox"/> March 1993    | £2.00 | <input type="checkbox"/> March 1994     | £2.00 |
| <input type="checkbox"/> May 1993      | £2.00 | <input type="checkbox"/> April 1994     | £2.00 |
| <input type="checkbox"/> June 1993     | £2.00 | <input type="checkbox"/> May 1994       | £2.00 |
| <input type="checkbox"/> July 1993     | £2.00 | <input type="checkbox"/> June 1994      | £2.00 |
| <input type="checkbox"/> August 1993   | £2.00 | <input type="checkbox"/> July 1994      | £2.00 |

Total no of issues ordered.....Total price.....

8/94

Please allow 28 days for delivery

(Overseas add £1.00 p+p for every issue UK p+p £0.50 inc)

I enclose cheque/PO for £ .....made payable to **Audio Publishing Ltd.**  
I wish to pay by Visa/Access (orders for 3 copies or more only), please debit my account no:

Expiry date:

Name.....

Address.....

Post Code.....Tel:.....

Please send completed order form together with your cheque/PO to:  
**HI-FI WORLD**, 64 Castellain Road, Maida Vale, London W9 1EX.

**W**ith the Ramada show on whilst I'm writing this, and Live '94 - The Consumer Electronics show, just around the corner, are there too many shows too closely spaced to give either manufacturers the full benefit of displaying their new products or the public a chance of seeing all that is new?

Ramada looks set to quickly become the enthusiasts show, where small manufacturers can display esoteric equipment for a reasonable outlay. Live '94 is drawing in the big boys, Sony, Philips, Marantz etc. But is this division healthy or not for hi-fi and music in general?

Sadly I think not. And it's the smaller manufacturers that could stand to lose most. Before last year, as far as most manufacturers were concerned, there were two big shows that they had to attend - Bristol and Heathrow Penta (now Ramada). They were the big venues where new products were launched, and the whole hi-fi industry came together to discuss, speculate and argue about various hi-fi topics, like the meaning of life and the cost of beer at the bar.

The close proximity of the two shows to each other has caused us problems too. Deciding that the magazine really ought to be seen at the biggest show of the year, Live '94, meant that we couldn't afford the extra burden of Ramada; in fact it was difficult to even find time to visit to catch up on new products.

Now, with competition from Live '94, the general public will be drawn away from Ramada. When the masses visit Live '94 again this year they will see only products from manufacturers that can afford to attend, and come away with a very narrow view of what hi-fi has to offer. The smaller manufacturers at Ramada will basically be demonstrating to enthusiasts that in most

cases already know about their products. The new customers, ones that turn up to Live '94 to look at video games and such like, will never see the kind of equipment that is on offer from small specialist manufacturers.

I don't think that Live '94 was supposed to be a spoiler though, and in the end I think that it will be a good thing that there is once again a major show attracting hundreds of thousands of visitors. I hope that next year a greater effort will be made to make sense of things,



Dominic Baker

## dB on the level

perhaps the way forwards being a section of more affordable stands at Live for the smaller specialist manufacturers. This needs to be considered carefully by the organisers, since these specialist companies are responsible for some of the most innovative and colourful products around.

If the organisers of Live do make it easier for smaller specialist manufacturers to display their products, a whole new variety of equipment will be on show to the rather unaware public. I think it will enhance the appeal of the show; the wonder of a valve amplifier is every bit as good as the latest wide screen TV.

Another boost to the industry may well come from BADA's 'Real Hi-Fi' campaign. This, unlike Live '94, is specifically designed to make the man on the street aware that there is a difference between a mass produced midi system and separates hi-fi from specialist manufacturers. You can only display the 'Real Hi-

Fi' logo on a product if you conform to BADA's rules, some of which may be difficult for small manufacturers to meet. There are fears that esoteric high fidelity equipment such as valve amplifiers, turntables, special Class A transistor amplifiers, produced in limited numbers by small manufacturers, may well not be allowed the 'Real Hi-Fi' description. But this may be just speculation, and certainly a couple of the smaller manufacturers

I've spoken to have been granted a 'Real Hi-Fi' licence. The cost has been low enough to encourage membership: around £100 a product. This, I'm sure, will encourage many to get behind the campaign, and I suspect that those who do so will gain most in years to come.

The combination of a large and well publicised consumer electronics show and BADA's 'Real Hi-Fi' campaign should be used by manufacturers for their advantage. They have a chance to display their products to a massive

audience, many of whom probably don't even know what real hi-fi is all about and displaying the 'Real hi-fi' logo will help them to explain and promote hi-fi for what it is.

Hi-fi has turned around in the last few years. DIY and tweaking are back, there's a major show in central London and valve amplifiers are popular once again. It's slowly rebuilding as a serious hobby as it was in the past. Then we had Olympia; now we have Earls Court ●

### EDITORIAL ASSISTANT

Getting busier and busier daily, we are looking for yet another editorial assistant. A good background of experience in hi-fi is needed, plus respectable educational qualifications, particularly in English. We want someone who can listen and write, as well as organise.

In the first instance, please write, enclosing CV and/or details to

**EDITORIAL ASSISTANT VACANCY**  
**HI-FI WORLD**  
**64 CASTELLAIN ROAD,**  
**MAIDA VALE**  
**LONDON W9 1EX**

Distributor clears stock, export-  
discount **50%** or more

# HIGH END SALE

## WELL TEMPERED



Record Player,  
Classic, Signature **£590**  
export price from

## AUDIO RESEARCH

DAC1, SP9, SP15, D250 MkII, S,  
M300 MkII, Classic150

**KOETSU** Black, Rosewood  
Signature, Onyx Signature

## MARK LEVINSON

MLC1, JC1, ML6, HQD-system  
(2xML6A, 2xLNC2, 6xML2,  
2xHartley/Quad/Decca-array)

*Also:* **Berning, Breuer,  
Cotter, Eureka, Fidelity  
Research, Linn,  
Moersch...**

**Call for catalogue!**

Glotta AB, phone +46 8345251, fax +46 8346533

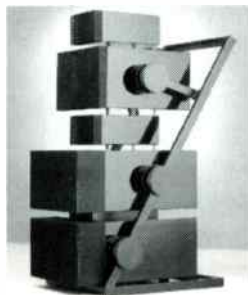

## GOLDMUND

Studietto, ST4, T5,  
Cartridge, Mimesis amplifier  
series, Super-Dialogue,  
Apologue (picture)

# SINGLE ENDED

Single ended valve mono block power  
amplifiers

KT66 .....£350.00/pair  
KT88 .....£528.75/pair

Valve phono stage MM .....£179.00  
- variable output -

MC step up transformers.....£42.00

*The Garrard 301/401 power supply*  
*100/130 volt setting* .....£64.45

All units are fully assembled and tested.  
Prices include Delivery and VAT  
2 week money back guarantee

SAE for data sheet

**F&S Trading**

**31 Brooks Road, Sutton Coldfield**

**West Midlands B72 1HP**

**Tel: 021 321 3357**

# Wilmslow Audio

## THE ULTIMATE HI-FI EXPERIENCE

Arcam Aiwa Audiolab B&W Castle  
Denon Dual Heybrook Kef Marantz  
Monitor Audio Mordaunt-Short  
Nakamichi Qed Revolver Rogers  
Tannoy Target Teac . . .

*Britain's leading loudspeaker kit  
and drive unit suppliers*

Catalogue of our full range £2.00

*Four demonstration rooms*

Wellington Close, Parkgate Trading  
Estate, Knutsford, Cheshire WA16 8DX  
(Dpt HFW)

No appointment necessary Closed  
Monday

**Telephone (0565) 650605**

**Fax (0565) 650080**

# The WIZARD



**Hand made  
Adjustable Shelf  
Rotary Unit.**

Can hold 1536 CDs  
or 1440 Cassettes  
or 384 Videotapes  
or 575 Penguin  
Books; or any  
mixture. Books up  
to 6 1/2" deep.

Revolves on Ball  
Bearings in 30.4"  
turning circle  
21 1/2 x 21 1/2 x 75" high.

Teak, oak, pine  
mahogany, ash,  
£1550 inc.  
VAT & Delivery.

**FOR OUR BROCHURE  
of  
CD/Video Drawer Chests  
CD racks  
Bookshelves  
LP, music · Hi-Fi  
Cabinets &  
the Budget Line  
—Specials made to  
order—**

Please send 3 x 2nd  
class stamps to:

**Ian Edwards** The Old Chapel  
282 Skipton Road, Harrogate  
HG1 3HB. Tel: 0423 500442

"Perfect Sound - Forever" was the rather optimistic (to put it mildly) marketing spiel Philips used to launch Compact Disc. The 'perfect' part of the equation was rather dubious from day one. Recently we have also seen that the 'forever' aspect has been discredited with the discovery of 'rusting' CDs (see "Not Fade Away" HFW June).

You may be thinking that here is yet another column lambasting Philips' marketing or even the deficiencies of CD. In fact it is neither. Instead, it's the phrase itself or, to be more precise the 'perfect sound' part that provoked the grey matter into action. Rather than simply limiting thought to the CD section of hi-fi, I applied the term to hi-fi in general, and invited friends', customers' and colleagues' opinions on what exactly constituted a 'perfect sound'.

The first part was easy. A 'perfect' sounding hi-fi is unobtainable, it exists simply as an ideal (unless you believe what the bloke in the pub tells you about his Technics midi system). A system would have to overcome the difficulties of reproducing the huge variety of music, not to mention appealing to differing tastes. Once it has been established that there is no such thing as 'the perfect system', I looked into what people wanted in the pursuit of 'perfect sound'.

One view I often hear is that a hi-fi system should sound just like being at a live concert. After having attended many live concerts (Suzanne Vega, Julia Fordham, Richard Thompson for example) and the odd acoustic performance, I'm not too sure. For a start "amplified" concerts are usually conducted at volumes totally unsuitable in most domestic settings, and are not the best things to unwind to after a hard day's slog. Most of the concerts I've been to have also been technically diabolical, with bass that

would flap Lycra cycling shorts - let alone trousers! Yet the bass also tends to drown any subtleties out and is usually ponderous and lacking any sort of articulation.

Much loved 'stereo imaging' is totally non-existent also, especially with large orchestras, and live vocals commonly sound harsh and nasal. On top of all that, the environment is often uncomfortable and, inevitably it seems, the person sitting next to me decides to hum along to the music or claps out of time.

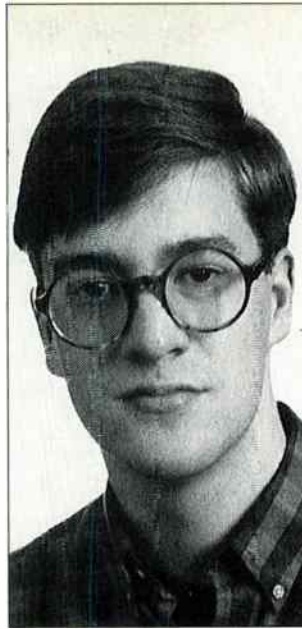

many such products born from such an ideology are superb components (witness Audiolab, Pink Triangle and SME to name but three). Yet as ever, there can be a negative side. In pursuing technical excellence, manufacturers can find themselves ending up with products that are technically superb, but leave the listener cold rather than left with the feeling of wanting to go through their entire music collection (always the sign of a good system).

The outcome of the

## Fair Views

- from Dominic Todd, our man in Scarborough

Don't get me wrong, though, I love concerts and I don't sit there moaning about not being able to hear 'the shimmering decay of cymbals' either! There's nothing like a good live concert to really get the blood running and the rabble roused. My point is that such concerts are 'occasions' and as such, lose the whole point if repeated in the domestic environment.

Acoustic concerts are often the complete opposite. I'm often struck as to how 'overblown' hi-fi systems can sound when producing such music. One particular example that springs to mind is the way some systems produce a double bass with a rich, deep and full sound whilst others sound rather bass light and thin. The irony is that when I went to see a jazz musician live, the double bass didn't sound rich or deep, but was portrayed in a similar

manner to the system I would have judged as light, thin and inferior.

Another term I heard a lot when asking people about their 'perfect' sounding system, was 'involvement'. I've always been a little uneasy with the term as it's somewhat vague and difficult to pin down to any particular aspect of sound reproduction. Having said that, there is a lot to be said for a system with 'character' that will entertain and even, dare I say it, involve the listener. Where such systems usually lose out is in the reproduction of a wide variety of music. On certain types of music their lack of technical ability can be frustrating.

The opposite approach is the pursuit of a system that can strip as much off the original master tape as possible. The emphasis here is firmly on technical excellence, and indeed

quest for a 'perfect sound' is as complex and varied as you'd expect from posing such a question. Obviously, don't expect a perfect sound in the first place (at any price), but do have an idea of the type of sound you are looking for. This may not be easy at first; when you haven't heard a variety of hi-fi systems it can be confusing. What a lot of people I spoke to found, though, is that if a particular piece of equipment doesn't fit sonically, then it is quickly replaced, or worse, the hi-fi remains dormant for a while. As you experience more hi-fi then you'll probably find your system fitting into one of the above (rather loose) categories, possibly unintentionally.

But, at the end of the day it's best not to get too hung up about your system's niggling faults, and get on with enjoying your record or CD collection ●

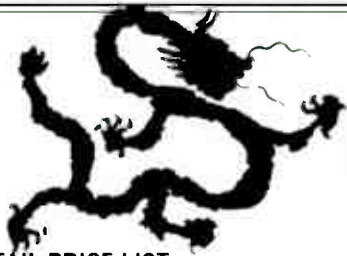

# Golden Dragon

## RETAIL PRICE LIST

Golden Dragon Pre-Amplifier Tubes	Singles
6AQ8/ECC85	£6.50
12AT7A/E81CC/ECC81	£6.95
12AU7A/E82CC/ECC82	£6.95
12AX7A/E88CC/ECC83	£6.95
6DJ8/E88CC/ECC88	£10.95
6SN7GT/ECC33	£8.95

## Special Quality Golden Dragon Pre-Amplifier Tubes

	Singles
E81CC-01 Gold Pins Low Microphony Low Noise	£10.50
E82CC-01 Gold Pins Low Microphony Low Noise	£10.50
E83CC-01 Gold Pins Low Microphony Low Noise	£9.50
E88CC-01 Gold Pins Low Microphony Low Noise	£14.50

## Golden Dragon Triodes

	Singles	Pairs	Quads
2A3 4PIN	£22.50	£50.00	£100.00
2A3 OCTAL	£22.50	£50.00	£100.00
211	£28.50	£60.00	£120.00
811A	£11.50	£25.00	£50.00
845	£36.50	£75.00	£150.00
805	£36.50	£75.00	£150.00

## Golden Dragon 300B Range

	Singles	Pairs	Quads
300B Super	£79.00	£160.00	£320.00
4.300B	£84.00	£170.00	£340.00
4.300B Super	£124.00	£250.00	£500.00

Please enquire of any tube types not listed. We have an inventory of over 2,500 different types in stock.

## Golden Dragon Power Tubes

	Pairs	Quads	Octets
EL34/6CA7	£25.00	£50.00	£100.00
EL34L (Laminated EL34)	£29.95	£60.00	£120.00
EL84 (Special Quality EL84)	£12.50	£25.00	£50.00
6L6WGB/5881	£25.00	£50.00	£100.00
KT66	£25.00	£52.00	£104.00
KT88 (New Design)	£57.95	£116.00	£232.00
KT88 Super (Laminated)	£67.95	£136.00	£272.00
*KT88 Special (Gold Plated)	£64.95	£136.00	£272.00
6L6GC	£19.95	£40.00	£80.00
6550A	£42.95	£86.00	£172.00
6550A Special (Gold Plated)	£64.95	£130.00	£260.00
50CA10	£84.95	£170.00	£340.00
807	£25.00	£50.00	£100.00

## Ceramic Sockets and Hardware

	Standard	Gold Plated
Locking 4 Pin (300B etc.)	£6.95	£15.00
4 Pin UX4 (300B etc.)	£2.5	£3.50
Jumbo (211 etc.)	£14.50	£25.00
Octal Chassis (EL34 etc.)	£1.25	£3.50
Octal PCB (EL34 etc.)	£1.25	£3.50
B9A Chassis (pre amp)	£2.50	£2.50
B9A PCB (pre amp)	£0.95	£2.50
Screening Can & Skirt (pre amp)	£8.50	£8.50
Damping Can (pre amp)	£4.50	£4.50
Power Valve Retainer (EL34 etc.)	£5.50	£5.50

## High Quality Plastic Sockets and Hardware

B9A Chassis	(pre amp)	£1.15
B9A PCB	(pre amp)	£0.95
Octal Chassis	(EL34 etc.)	£1.25
B7G Chassis	(85A2 etc.)	£0.95
B9A Skirted Chassis		
Socket & Can	(pre amp)	£1.75
Power Valve Retainer	(EL34 etc.)	£1.95

Carriage charge £2.50 on any U.K order. Cash with order or Visa - Mastercard accepted. 24 Hour Answerphone Service.

We have a vast range of tubes available from manufacturers all over the world including rare and vintage types. A 50 page booklet of valves available is updated monthly and can be provided at a cost of £2.50 per copy including U.K postage or you may telephone our Sales Desk for prompt a quotation. VAT at 17.5%.

## A selection from our stock of over 2,500 different audio quality valves. Please enquire for items not listed

ECC81	BRIMAR	4.50	LS9B	COSSOR	6.95	6SL7GT	BRIMAR	4.50
ECH81	MULLARD	3.50	M8136	MULLARD	8.50	6SN7GT	BRIMAR	4.50
EC82	GE	4.50	M8162	MULLARD	8.50	6SN7GT	TEONEX	3.50
ECC82	RFT	4.50	M8137	MULLARD	15.00	6SQ7GT	TONEX	4.50
ECL82	TEONEX	3.50	MHL6	MAZDA	5.50	6V6G	RCA	5.50
ECC83	TEONEX	3.50	OA2WA	TEONEX	3.50	6V6GT	TEONEX	4.50
ECC85	TEONEX	3.50	PCC88	SIEMENS	3.50	6X4	TEONEX	2.50
ECL86	TEONEX	3.50	PL36	MAZDA	3.50	6550A	TEONEX	12.50
ECC88	BRIMAR	4.50	PL504	MAZDA	2.50	12AT6	BRIMAR	2.50
ECC88	GE	5.50	PL509	MAZDA	5.50	12AV6	RCA	2.50
ECC88	TEONEX	4.50	PL519	THORN	5.95	12BA6	WESTINGHOUSE	3.50
EF86	TEONEX	4.50	PY32	MULLARD	2.50	12J5GT	RCA	3.95
EF804S	TELEFUNKEN	25.00	TT100	GEC	65.00	12E1	RCA	3.95
EL32	MULLARD	4.50	U19	GEC	8.50	12E1	STC	15.00
EL85	MULLARD	4.50	UCC85	MULLARD	3.50	13E1	STC	140.00
EL86	MULLARD	4.50	UU5	MAZDA	5.50	13D3	BRIMAR	6.50
EL504	TEONEX	3.50	UU6	MAZDA	6.50	85A2	MULLARD	6.50
EL509	TEONEX	5.50	2X2A	RCA	5.00	1625	RCA	6.50
EL519	TEONEX	5.50	3A/167M	ITT	10.00	5687WA	RCA	6.50
EM84	TEONEX	3.50	5Y3WGTA	SYLVANIA	4.50	5751	RCA	6.50
GZ32	MULLARD	8.50	5V4G	BRIMAR	3.50	5814A	GE	5.50
GZ33	MULLARD	5.50	6AG7	RCA	3.50	5881	USSR	4.95
GZ34	MULLARD	12.50	6A7G	RCA	8.50	6146B	TEONEX	8.50
GZ37	MULLARD	4.50	6BH6	BRIMAR	3.50	6158	BRIMAR	6.50
GZ34	TEONEX	5.50	6C8G	RCA	3.50	6189	SYLVANIA	6.50
KT66	TEONEX	6.00	6DQ6B	PHILIPS	3.50	6201	GE	6.50
KT66	GE	16.50	6K7G	RCA	3.50	6463	UNITED	7.50
						6870	BRIMAR	11.50

## EXPORT WELCOME CARRIAGE AT COST

P.M. COMPONENTS LTD., Springhead Enterprise Park, Springhead Road, Gravesend, Kent DA11 8HD, England  
Sales Desk Tel: 0474 560521. Fax: 0474 333762





Giovanni Dadomo

INDEX

RECORD REVIEWS

**ROCK & POP** .....73  
 Giovanni Dadomo

**CLASSICAL** .....85  
 Peter Hernng

**JAZZ** .....93  
 Simon Hopkins  
 Simon Cooke



**OASIS**  
**Definitely Maybe**  
 CREATION CRE CD 169

● If anyone remains in even the slightest doubt that Creation are the class record label of the decade then the debut from Manchester's Oasis dispels them once and for all. It is, quite simply, yet another Record of the Year in a twelve month period that's had more than its share of fab pop discs. From their sublime single debut with 'Supersonic', the quintet haven't missed a trick, and this is the proof of the pudding par excellence. It has all the catchy, crazy, distinctly loveable singles aboard - 'Shakemaker' and 'Live Forever' - plus who knows how many other hits lurk in them grooves.

This, like Pulp's Boys & Girls comes on like another ready-made Greatest Hits

collection, and so too the remaining cuts, with their languorously laid-back vocals, hooks by the busload, and playing just right. This is frequently Britpop at its very best, combining the screw-you arrogance and magic invention of everyone from early Who and Kinks through to Sex Pistols and co., and all the way to such more recent naughty boys as the Stone Roses or Shaun Rider (who's he?) and cronies. Those weirdo lyrics - the wackiness of 'I know a girl called Elsa / she's into Alka-Seltzer' recalls John Lennon and 'Isadora Duncan, worked a Telefunken' from Let It Be - and there are echoes aplenty of classic past glories in the driving rhythms of items like 'Up In The Sky', which has the audacity to rip off one of the Moptops most over the top psychedelic grooves with nary a hint of remorse and what's more, makes it work perfectly, backwards guitar fade and all. I'll leave you to work out what it is.

There's Beatley bits all over the place - 'Columbia? Tomorrow never knows what inspired that, hee hee, hee - but it's never done with the pain-in-the-fanny obviousness that poleaxed the late Flamin' Groovies and hosts of other would-be successors to the Fab Four. There are loads of other lifts too, but the only time Oasis come close to blowing it is with a T Rex re-write which is really too Bolan-ish for comfort. But that's a small flaw in a thoroughly enjoyable first outing.

Let's face it, these guys look great,

## RECORD OF THE MONTH

### **NEIL YOUNG & CRAZY HORSE**

**Sleeps With Angels**  
REPRISE 9362-45749-2

● It doesn't take a rock'n'roll Einstein to see that this is shaping up to be one of those golden years for pop music, and the British variety in particular, what with such spectacular LPs as recent offerings from Blur, Pulp and – qui vide – the debut long-player from Oasis. That said, it's salutary to find that one of the most exciting, vibrant and deeply moving of the latest releases should be the work of the coolest Canuck. Neil Young may be long in the tooth, but he's been on a spectacular roll since at least *Freedom* – how time flies – a good five years old and still hot stuff.

Ironically, it was the tragically premature exit of relative greenhorn Kurt Cobain that inspired the title track of what is probably Young's best album in a decade. Cobain, you no doubt recall, quoted Neil's line "it's better to burn out than fade away" in his suicide note. That's a hard burden for anyone to bear, but then Mr. Young is no stranger to premature, tragic death, from 'The Needle And The Damage Done', to the indisputably

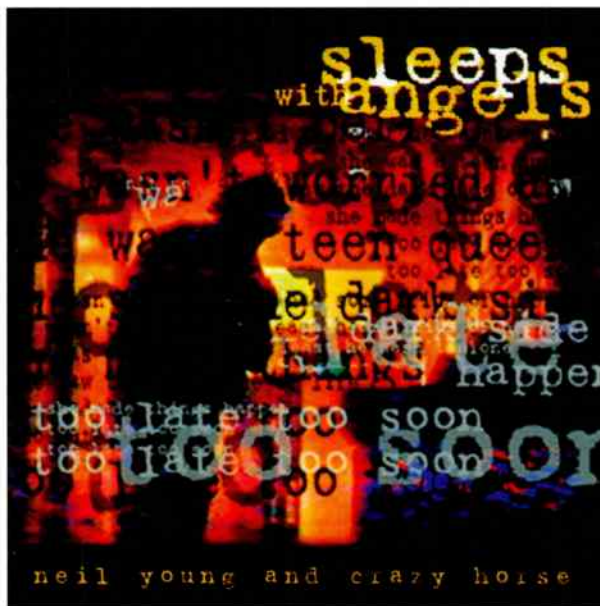

classic 'Tonight's The Night', a record dedicated to Danny Whitten, Crazy Horse roadie-cum-guitarist and a victim of a drugs overdose.

Thus 'Sleeps With Angels', with Young's voice at its most haunting, his lyrics as touching as any he's written, and the two carried in the arms of a

intricately wrought, incessantly inspired. Even a relatively lightweight item like the grunge-ish 'Piece Of Crap' – one of the few light moments on the record – manages to knock most of the competition into the proverbial cocked hat.

'Change Your Mind' and 'Trans Am' are Young at his – by turns – most poignant and rockiest, the first with a melody to die for, the latter a riff blitz that could get Mother Theresa in front of the mirror with a tennis racket. And the self-explanatory 'Drive By' is proof positive that Young lives very much in the present, plus there's the added irony that the victim here happens to be a girl.

And so on; for once it's true that *Sleeps With Angels* has no dud tracks, no lingerers even in the lengthier instrumental sections, Young's guitar as inventive as it's ever been and Crazy Horse – Frank Sampedro, Billy Talbot, Ralph Molina – rising to the master's challenge throughout. A breathtaking record which

melody and instrumentation that combine to make this one of the most beautiful songs you'll hear this or any other year – it could make a statue weep, no exaggeration. But that's just the opener to a record that continuously astonishes: at times

evokes the very best of Young's previous work, from *Harvest* and *Zuma* through to latterday gems like *Tonight's The Night* and *Eldorado* or the aforementioned *Freedom*. But even if you've never even heard those discs on no account miss this one. Brilliant.

singer Liam Gallagher has a lazy, coolly arrogant vocal style that's perfect for the excellent tunes delivered by his brother Noel's fevered lead guitar and helpmates Paul Arthurs (rhythm), Paul McGuigan (bass) and drummer Tony McCarroll. Hot lyrics too, and contemporary as they come, including references to "selling The Big Issue", the nightmare of going down the Social, and what I believe is the first time a pop song's included the jailbird slang of "when it comes on top". On the closing 'Married With Children' Liam spits a scowful "Your music's shite / it keeps me up all night". This music's anything but fecal – but it will run and run!

### **SUGAR**

**File Under: Easy Listening**  
CREATION CRE CD 172

● Regular readers ought to know the ballad of Bob Mould already – how he fathered one of the great bands of the Eighties, Hüsker Du, gave up through a combination of alcohol and exhaustion, exorcised his demons on a pair of intermittently brilliant solo albums, and

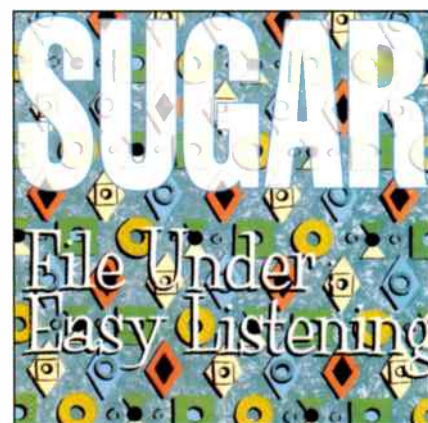

thundered back to greatness with Sugar's *Copper Blue* debut last year. A mini-LP later and here he is again. The more studio-comfy richness of sound and arrangements of Sugar's debut have since been stripped down as the band's rocked its way around the planet, so this instalment's title is richly misleading.

Mould (vox, lead), bassist Dave Barbe and drum maniac Malcolm Travis are

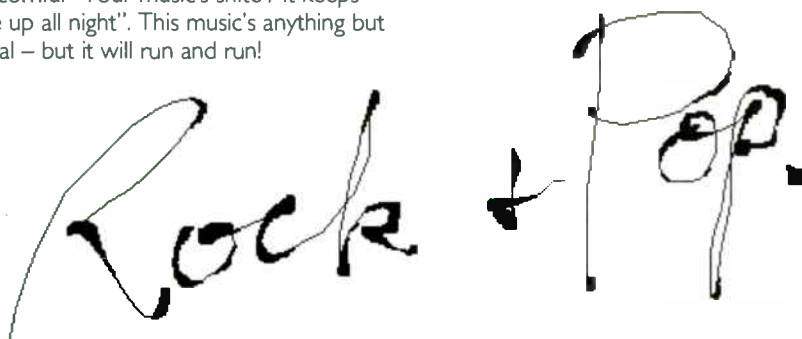

## SHORT CUTS

every bit as fearsomely fiery as the Hüskers at their best here. Simply put, F.U.E.L. is a roller-coaster ride through hell. Mould's gruff vocals and soaring guitars simply never let up on a set that'll make your hair stand on end. And, as I've said many times before, Mould's characteristic strong melody lines take all the instrumental fire and thunder and give it shape, cohesion and, most important, excellence and imaginativeness aplenty in the tune department.

Check 'Company Book' or 'Gee Angel' for textbook examples of contemporary guitar rock at it's very, very best. And there's what has to be my top song title of '94 – 'Explode And Make Up'. Love it to death.

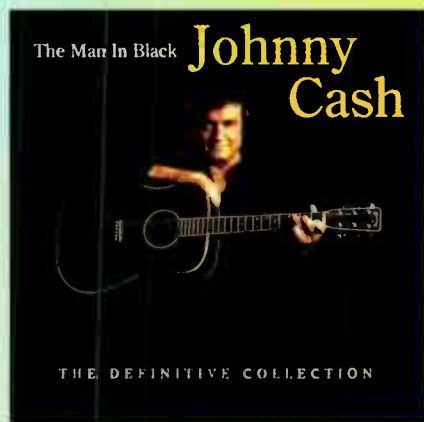

**JOHNNY CASH**  
**The Man In Black**  
COLUMBIA MOOD CD35

● Every home should have its Johnny Cash record and this 24-cut selection of his best known songs is it. Cash has no match when it comes to evoking both John Wayne's America – 'Riders In The Sky', 'Ring Of Fire', 'Don't Take Your Guns To Town', etc – as well as the gritty blue collar world of the here and now, witness the way he takes some of the world's most hardened criminals on the live 'Folsom Prison Blues' and 'San Quentin' and holds them in the palm of his hand.

He also has a fine ear for a good tune, as on irresistibly catchy items such as 'A Thing Called Love' or 'Jackson'. He also has a cool sense of humour, as evinced on 'One Piece At A Time' – about a car worker who steals a motor bit by bit, year by year, with hilarious consequences. And, of course, there's 'A Boy Named Sue', while the darker side of life has few evocations as world-wearily convincing as cash is on 'Sunday Morning Coming Down'.

A handsome thorough accompanying booklet tells you everything you want to know about Cash and his up-and-down life and times. It also says that the version of 'Boy Named Sue' featured here is the first time the song's been released uncensored. Not on my version it ain't. Still essential for any thorough collection.



**PRINCE**  
**Come**  
WARNER BROTHERS 9362-45700-2

● Some say Prince's final recording prior to changing his name to some silly symbol is a contract filler cobbled together out of bits and pieces left over from the last few years of prolific writing and recording. Was a time I thought the litt'un could never make a bad record. Not any more – this is a bunch of the usual wet dream nonsense delivered over familiar – nay, over familiar – rhythms with barely a good tune in sight. 'Come'? It's a stiffy.



**LOVE AND ROCKETS**  
**Hot Trip To Heaven**

● Back together after five years of solo excursions, these former members of Bauhaus tread an uneasy line between contemporary dance rhythms and a tendency to sound like wizened electro popsters or worse – 'Body And Soul', the 14 minute opener sounds at times like an unused backing track from 'Dark Side Of The Moon'. Probably sounds better on drugs, a dance floor, or both. And then there's the one with the woman pretending to have an orgasm – where have we heard that before?



**RADIAL SPANGLE**  
**Syrup Macrame**  
BEGGARS BANQUET BBQ CD

Accompanied by a press release more ludicrously pretentious than anything this side of a 1965 Bob Dylan sleeve note – apparently the title refers to "the sticky effect one creates after lots of pleasurable sex after that magic sticky gets in your hair. You know, down there, it gets to be a syrup macrame" – this is the sad face of Indie all ultra weedy male/female vox over musical doodles that pastiche everyone from the Velvets to the Pixies but equal neither. The tunes? I counted at least two, maybe three re-writes of B.A.D.'s 'Medicine Show' in there. Pass it by unless you're (a) in the band, (b) the band's mums and dads, or (c) stark raving mad and stone deaf. No, I loved it really, kids. Not.

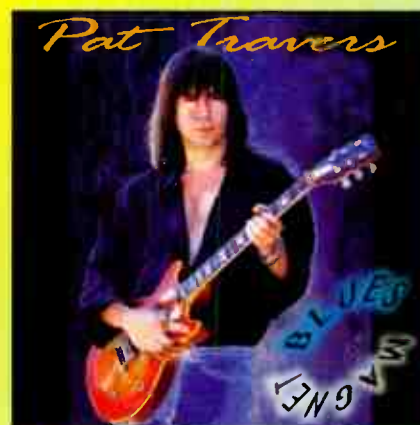

**PAT TRAVERS**  
**Blues Magnet**  
FRVVOGUE PRD 76682

● He may not be black or past retirement age, but Travers plays a mean axe. Helped out by old hand Aynsley Dunbar on drums and bassman Michael Amico, he follows his selection of classic cover versions – last year's 'Blues Tracks' – with this set of originals. He may not out-write Willy Dixon or Johnny Winter, but if you like your Blues hard, sturdy, and with a contemporary edge, he may well be the man you need.

# SLATE AUDIO

HI-FI Design & Cable Services

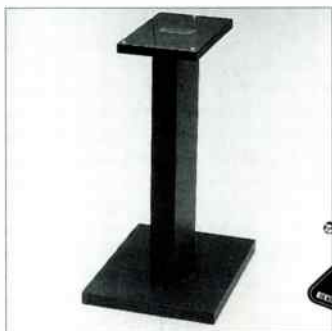

## THE FINEST SPEAKER SUPPORTS IN THE WORLD

I found that, as it had done last year, the stand offered a sound that was characterised by its lack of intrusive character.

On the Slate Stand, speakers seemed to shake off unmusical, unnatural qualities that were audible on other stands.

I noticed this lack of added colour particularly with female vocal music. Voices had openness and a tangibility that reinforced their communicative qualities. Singers appeared more expressive and technically more impressive. Last year, I remarked upon the stand's 'cleanliness and lack of clutter' and nowhere was this better demonstrated than on the Annie Golden and Frank Carillo CD, which can appear far less polished on a system whose set-up is below par. The Slate stand's ability to refine a speaker's presentation was evident even with the Mordaunt-Short MS10, for which it's not ideal. Golden's taxing voice and Carillo's acoustic guitar both sang out with striking verve yet never approached coarseness, nor did they fall short of refinement.

The stand's sonic transparency and musical fluency are partly a function of its excellent control at the frequency extremes. The Slate allows bass lines to thunder without wallowing, and treble to sing without zing. Having lived with, and appreciated, a pair for a year now I'm not going to do what I did last year and allow their cost to stop them obtaining a Recommended flag.

Verdict: (The Slate stand is unusual and expensive. But if you're after an exceedingly neutral stand it's the leading contender. This stand offers an exceptionally neutral platform for speakers: highly transparent sound leads to musical performances with real insight.)

Sound Quality: ■■■■■■

47 GEMINI CLOSE, LEIGHTON BUZZARD, BEDS, LU7 8UD. TEL: 0525 384174

# WOLLATON A•U•D•I•O

presents



The Audio valve Assistent-S valve  
integrated amplifier

Phone for further information  
and current dealer list

Wollaton Audio

134 Parkside, Wollaton, Nottingham, NG8 2NP  
Tel (0115) 9284147 Fax (0115) 9280625

# FREE Audio Catalogue

## That Will Change The Way You Buy Hifi

### Inside the new RDL catalogue you'll discover:

- The secret to picking the right speakers.
- Why your home is the only place to test audio equipment.
- How to get more audio for your money.
- How to buy home theatre systems.
- Why the reviewers say RDL offers superior audio equipment at unbelievably low prices.



Buying from RDL is easy and risk free with our 100% "no strings attached" money back guarantee.

Roy Allison, President and Chief Designer of RDL Acoustics has put together two new, superb ranges of speakers to fit every situation at prices well below normal shop retails.

FREE  
32 pg.  
AUDIO  
catalogue

Order your free catalogue, call:

**0484 603333**

or fax on 0484 607774

**RDL**  
ACOUSTICS

20 Cleveland Way, Shelley  
Huddersfield, HD8 8NQ

# Specialist Hi-Fi Dealers

## WHO SAYS YOU CAN TRUST A BADA DEALER?

### VOX MAGAZINE:

"You can be confident that BADA members are reputable, financially sound businesses which will sell your hi-fi in a professional manner."

### HOMES & GARDENS:

"A tried and tested way of finding trustworthy dealers... BADA whose members are specialist Hi-Fi Dealers."

### GRAMOPHONE:

"Over 100 member shops... from Aberdeen to Plymouth... Helping customers to identify, clarify and satisfy their needs through the demonstration of suitable hi-fi products."

BRITISH AUDIO DEALERS ASSOCIATION



## CHOOSE YOUR HI-FI FROM A DEALER YOU CAN TRUST

Write for a FREE Fact Sheet, BADA benefits and full members list to P.O. Box 229, London N1 7UU. Tel: 0171 226 4044 Fax: 0171 359 7620

**SOUTH**

**SOUND GALLERY**

**BUCKINGHAMSHIRE'S PREMIER HI-FI DEALER**

Arcam, Denon, Linn Products, Naim Audio, Meridian, Rotel, Yamaha, NAD, Quad, Tripod, Nakamichi, Rega, Creek, Epos, Mordaunt Short, Celestion, Marantz, Mission, Cyrus, etc. ...

65 Castle Street, High Wycombe, Buckinghamshire.  
Open Monday - Saturday  
0494 531682 / 464670

**INHAUS AUDIO**

Suppliers of the finest Hi-Fi equipment available

Tel. (0702) 465892 or Mobile (0831) 616426  
Viewing & demonstrations strictly by appointment only

**SURREY HIFI**

**SPECIALIST HI-FI OUTLET DEMONSTRATION ROOM - PARKING**

- QUAD • AUDIOLAB • REL • TUBE TECHNOLOGY •
- TDL • TAMMOY • KEF • DENON • NAKAMICHI • THORENS •
- TARGET • MAGNUM • ROTEL • MARANTZ • MICHELL •
- SENNHEISER • BEYER HEADPHONES • JPW •
- SOUND ORGANISATION • SOUNDSTYLE TRIPODS •
- VAN DEN HUL CABLES • BOSE • MUSICAL FIDELITY • SEISMIC SINK •

**'HOME CINEMA NOW ON DEMONSTRATION'**

Just 2 minutes off Junc. 6 M25, (A25)

**GODSTONE 0883 744755**  
45 High St., Godstone, Surrey RH9 8LS

**CHICHESTER HIGH FIDELITY**

7 ST. PANCRAS, CHICHESTER, WEST SUSSEX  
CLOSED ALL DAY MONDAY  
Tel: (0243) 776402

Appointed stockists of: A+R Cambridge, Castle Acoustic, Creek, Dual, Goldring, Linn Products, Monitor Audio, Naim, Nakamichi, Quad, Rega, Rogers, Royd Audio, Spondor

**PRO**

ROKSAN □ NAIM □ REGA □ MICROMEGA □ ARCAM □ CREEK  
□ ROTEL □ MARANTZ □ DENON □ RUARK □ EPOS □  
SYSTEMDEK □ AUDIOLAB □ NEAT □ SHAHINIEN □ SOUND ORGANISATION □ SOUND FACTORY □ CHORD COMPANY □  
AUDIO TECHNICA □ MANA ACOUSTICS □

Records also available  
**PRO MUSICA**  
8 Vineyard St., Colchester, Essex  
• 0206 577619

**AUDIO CONCEPT**

27 BOND STREET, EALING  
LONDON W5 5AS  
TEL. 081 - 567 8703

AMC, Acoustic Energy, Aura, Audiolab, Audio Innovations, B&O, B&W, Cannon, Castle, Cyrus, Denon, Dual, Evolution, JPW, KEF, Marantz, Micromega, Mission, Monitor audio, Musical Fidelity, NAD, Nakamichi, Onix, Onkyo, Quad, REL, Rogers, Rotel, Systemdek, Target, Teac, Thorens, Van den Hul.

10 - 6 pm Mon., Tues., Friday, & Sat.  
Late night Thur., closed Wed.

Two demonstration rooms.  
Free local delivery and installation.  
Repairs and Services

*the powerplant*

**BRIGHTON'S LEADING HI-FI SHOP**

Cyrus, Roksan, Micromega, Audionote, Audiolab, Rega, Arcam, Exposure, Aura, Epos, Thiel, Ruark, Rotel, Marantz and other fine equipment

66 Upper North Street, Brighton  
Telephone 0273 775978

## LONDON & SOUTH EAST

**"One of the 5 best hi-fi shops in the world"**

**GRAHAMS HI-FI**

Canonbury Yard, 190a New North Road  
London N1 7BS, ☎ 071-226 5500  
*Ring for a chat, an appointment and a map!*

**studio 99**

79/81 Fairfax Road  
Swiss Cottage  
London NW6 4DY  
071 624 8855/6  
Mon-Fri 10.7-5at 10.6

**WORTHING AUDIO**

20 Treville Gate, W.Sussex. BN11 1UA  
(0903) 212133

The friendly shop with the best sound system in the South, Friendly advice

- 3yr guarantees • easy parking

Open Mon.-Sat. 10am-6pm Late night Wed. 7.30pm  
Agencies include: Arcam, Exposure, Kinshaw, Naim Audio, Marantz, Ruark, Audio Technica, Target, Tripod, JPW, TDL, Orelle, and many more.....

For the great sound of sound :

**The Comflake Shop**  
37 Windmill Street London W1P 1HH  
071 631 0472 Fax. 071 436 7165

We stock ATC, Arcam, Meridian, Naim, Rega, Royde, Roksan, AVI, Monitor Audio, DNM: as well as offering a marvellous mail-order worldwide service • Crunch •

**The Hi-Fi Shop**  
GUILDFORD'S SPECIALIST SINCE 1950

We are at:  
3 BRIDGE STREET, GUILDFORD  
(By the traffic lights - just down to Alfred Works)  
0483 504801 • 0483 304756  
Access • Visa • Switch  
Open Monday-Saturday 9am-6pm (later by appointment)

Stockists of: ARCAM • CREEK • EPOS  
HEYBROOK • MICROMEGA • NAIM AUDIO  
NEAT • REGA • ROKSAN • ROTEL • ROYD  
TEAC • YAMAHA

**Infidelity**  
indecently good hi-fi

9 High Street, Hampton Wick, Kingston upon Thames, Surrey KT1 4DA. Tel: 081-943 3330  
Open Tues - Sat 10.30am - 7.00pm.

alphason apollo audio innovations audion audio note audiquest dpa fuller helius heybrook impulse iwas kar lyra michell morel orlaton pierre lorne pro-ject projekt qed royd sonic link sound organisation soundstyle townshend trichord van den hul voyd home demonstrations wide range valve/transistor/analogue/digital nice people peculiar adverts .....

**Signals** hifi for grown-ups  
martlesham heath ipswich (0473) 622866

**FRANKIE IS BACK!**

Ex-Luxman, Carver & Hafler chief engineer with his own back up team can custom-modify, rebuild, up-grade or repair any high-end equipment. Japanese spares, speaker bi-wiring service. To restore the best sound for modern & old classics, call Francis Wong on:-

Tel: (0582) 411480 or Fax (0582) 451957

專音家响

**Spaldings**  
ESTABLISHED IN SOUND

☎ 081-654 1231/2040  
352/4 LOWER ADDISCOMBE RD., CROYDON, SURREY

**The Audio File**

27 HOCKERILL STREET, BISHOP'S STORTFORD, HERTS.  
TEL: 0279 50576

**BADA**  
THE ULTIMATE IN SOUND ADVICE

# Specialist Hi-Fi Dealers

**EIRE**

*Acoustic Dimension*

"How can I buy the best HiFi?"  
Phone us to find out!

Choose from: AVI • Audio Innovations • LFD • Albany • Heybrook  
• Triangle • Amrita • Proac • TDL • ATC • Micromega • Pierre  
Lurné • AMC • Rotel • Marantz • Kinshaw.

We can help you choose wisely!  
Part exchange • Credit Card accepted • 3 demo rooms.  
Acoustic Dimension 16, Idrone mews, Idrone Lane,  
Black Rock, Co Dublin Fax/Tel: 01-2884612

**We Never Compromise On Quality**

*Meridian Arcam Classe Philips Naim Bowers Epos B&W*

**CLONEY Audio**

55 Main St Blackrock Co Dublin  
Tel 2889449/2886477 Fax 2834887  
Open Tue/Sat 10AM-6PM. Thur/Fri 'till 9pm - Closed Monday

**Peter Dand & Company Ltd**  
Established 1963

Bang & Olufsen, Quad, KEF, Thorens,  
TEAC, and many more!  
2 Demonstration Rooms  
2 Year Guarantee

111 Clonskeagh Road, Dublin 6  
Tel. 01035 31 269 4433

**MIDLANDS**

**THE STATE OF THE ART....**

- EXPERT ADVICE  
- CREDIT FACILITIES  
- PART EXCHANGE WELCOME  
- REPAIRS

Come and hear - NAD • B&W •  
NAKAMICHI • BOSE • QUAD •  
BEYER-DYNAMIC •  
SENNHEISER • AURA - and  
lots more in our listening room.

Tel. 0743 - 355166

**WON Hi-Fi Limited**  
12 Barker St. Shrewsbury  
Plenty of parking - park and ride buses stop outside!

**CREATIVE AUDIO**  
9 DOGPOLE, SHREWSBURY,  
SHROPSHIRE  
Tel: (0743) 241924  
Closed Mondays

- Comfortable listening rooms
- Home demonstrations available
- Part exchange welcome
- Free home installation
- Interest Free credit

Authorised retailer for:  
A & R ARCAM, AUDIOLAB,  
CELESTION, CYRUS, DENON, DUAL,  
MERIDIAN, MISSION, MONITOR,  
AUDIO, QUAD, REVOLVER, ROKSAN,  
ROTEL, YAMAHA, EPOS, NAIM, KEF,  
RUARK

**MUSIC MATTERS**

**THE AUDIO SPECIALISTS**  
for the most exciting range of equipment  
available in the Midlands which includes:

Aiwa, AKG, Alchemist, Alphason, Apollo, Arcam,  
Audiolab, Audioquest, Audio Technica, Aura, Beyer, B+  
W, Cabletalk, Cambridge Audio, Canon, Celestion,  
Chord, Cyrus, Deltac, Denon, DPA, Dual, Epos,  
Exposure, Harman, Heybrook, Impulse, Infinity, KEF,  
Kenwood, Kinshaw, Lexicon, Lumley, Marantz,  
Meridian, Michell, Micromega, Mission, Mordaunt-  
Short, Monitor Audio, Monster, Musical Fidelity, NAD,  
Nakamichi, NVA, Onkyo, Panasonic, Pink Triangle,  
Pioneer, Polk, Pro-Ac, Pro-ject, REL, Revox, Rogers,  
Roksan, Rotel, Royd, Ruark, Sansui, SD Acoustics,  
Sennheiser, SME, Straitwire, Systemdek, Systym,  
Tannoy, Target, Thorens, Wharfedale, Yamaha etc...

**OPENING TIMES:**  
Tues - Thurs 10.30 - 6.00  
Friday 10.30 - 8.00  
Saturday 10.00 - 5.00  
Demonstration by Appointment

**351 HAGLEY ROAD, EGBASTON,  
BIRMINGHAM B17 80L**  
Tel: 021-429 2811

**156/7 LOWER HIGH STREET  
STOURBRIDGE, WEST MIDLANDS DY8 1TS**  
Tel: 0384 444 184

**93-95 HOBBSMOAT RD, SOLIHULL,  
WEST MIDLANDS B92 6JL**  
Tel: 021-742 0254

"We are a BADA dealer" and "full service facilities"  
INTEREST FREE  
(for Ltd Period) APR 0%  
Written details on request. Licensed Credit Broker  
Switch card accepted

**W. OWEN** EST 1901  
Audio/Video Specialists

Pioneer • Reference Point • Kenwood  
Sony • Akai • B&W

Free Installation and Home Delivery

58 Market Street, Oakengates 2A Stratford Street  
Telford, Shropshire Newport, Shropshire  
Tel: (0952) 613818 Telford Tel: (0952) 810876

**Moorgate Acoustics Hi-Fi**



**Frustrated and confused?**  
Call in and get some help and advice from a company  
that cares enough about its customers to put them first.  
184 Fitzwilliam St., Sheffield. Tel: (0742) 756048  
8 Westgate Chambers, Rotherham. Tel: (0709) 370666

**Peter Ellis Audio**

A wide range of audio products always in stock including:-  
Quad, Denon, Stax, Marantz, Arcam, Creek, Sugden, QED,  
Castle, Rogers, Celestion, Tannoy, Nakamichi, Yamaha

\* Home Cinema available \*  
\* Demonstration Room \*

29, Kirkgate, Newark,  
Nottinghamshire NG24 1AD  
0636 704571

Well engineered products for accurate sound  
reproduction from: Arcam, ATC, Audioquest, Audio  
Technica, AVI, Beyer, Cable Talk, Castle, Chord,  
Denon, Dual, Klipsch, Michell, Nakamichi, Ortofon,  
QED, Quad, Revox, Sennheiser, Sequence Design,  
SME, Spendor, Target, TDK, TDL, Thorens, etc., Keith  
Monks Record Cleaning Machine.

**Five Ways Hi-Fidelity Ltd., (Est. 1972)**  
12 Islington Row  
Edgbaston, Birmingham B15 1LD

You can come and visit us at:  
**25 HENLEY STREET,  
STRATFORD CV37 6QW**

Contact Dirk or Jamie on:  
Tel/fax No. 0789 414533  
We are stockists of the leading  
Hi-Fi brands including:

ARCAM, SONY, PANASONIC, NAKAMICHI, B&W, PIONEER,  
TECHNICS, DENON, NAD, KEF, MARANTZ, ROTEL, MUSICAL  
FIDELITY, MONITOR AUDIO, MISSION, TANNAY, QUAD, TDL &  
SENNHEISER, YAMAHA, CELESTION, ACOUSTIC RESEARCH,  
AUDIOQUEST, MONSTER, TARGET, BEYER, SYSTEMDEK.

2% Finance is available on selected products and all major credit cards  
accepted. We also have a Demonstration Room and Service Facilities.  
Monday to Saturday 9.30-5.30. Late night Wednesday  
"WHERE FRIENDLY SERVICE STILL COUNTS!"

**FRANK HARVEY**  
Hi-Fi EXCELLENCE

163 Spon Street, Coventry, CV1 3BB Tel : 0203 525200.  
Mon to Sat 9.30 till 5.30. Closed Thursday

**MUCH MORE THAN HI-FI**  
WE ARE A  
SADA DEALER  
MAILORDER - EXPORT - HOME TRIALS

3 Floors. 3 Dem rooms. 3000 sq feet in the pursuit of Hi-Fi Excellence



Audiolab • Audio Alchemy • Arcam • Alphason • Bose • Bang & Olufsen • Celestion • Cyrus • Denon • Dual • Foundation  
Kef • Marantz • Monitor Audio • Mission • Musical Fidelity  
Nakamichi • NAD • Quad • Rega • Rogers • Rotel • Target  
Tpad • Tannoy • Thorens • Van Den Hul • Yamaha

**AUDIO EQUIPMENT FROM LEADING AND SPECIALIST BRANDS ON TWO FLOORS FOR YOU TO LISTEN AND CHOOSE FROM**

- 3 Demonstration Rooms
- Home Trials
- Home Cinema - Instore Demonstration Theatre
- Audio Visual Equipment
- Evening Demonstrations by appointment
- Inhouse Service Department
- Mail Order Available
- Interest Free Credit on Selected Items (Apr. 0% - Written details on request)

**Hi-Fi for the Beginner, the Enthusiast and the Audiophile Telephone (0922) 493499/473499**

**SOUND ACADEMY**

CINEMA 1950s

Quality, Clarity, Expertise... and that's just the service!

Sharing the ASDA Carpark with ample free parking - Off High Street, Bloxwich, Mr. Wainall, West Midlands Near M6 Jnc. 10 & 11

Open 6 Days, 9am - 6pm  
Late night Friday



ACQUSTIC ENERGY • ARCAM • ALEMA • AUDIO LAB • APOLLO • A.T. • AUDIO ALCHEMY • AUDIO QUEST • B&W • BOSE • BEYER • CABLE TALK • CHORD COMPANY • CHORD • CYRUS • CELESTION • DPA • EPOS • EXPOSURE • INFINITY  
JRW • KEF REFERENCE • KENWOOD • MARANTZ • MICHELL • MONITOR AUDIO • MONSTER • MORDAUNT SHORT • MERIDIAN • MICROMEGA • MISSION • MOTH • MUSICAL FIDELITY • NAKAMICHI • ORTOFON • PROJECT • QUAD  
ROKSAN • ROGERS • ROTEL • SENNHEISER • SONY • SPENDOR • SUMIKO • SYSTEMDEK • TARGET • TDL • THORENS • TRIANGLE • TUBE TECHNOLOGY • VAN DEN HUL • VANDERSTEEN • YAMAHA • YBA

# Specialist Hi-Fi Dealers

## WEST & WALES

### ENGLISH

audio

3AD4

#### CYRUS CENTRE

PINK TRIANGLE-AUDION-SYSTEMDEK-HEYBROOK  
MICH-KF-REFERENCE-MICROMEGA-NAKAMICHI-CHORD-  
ARCAM-MUSICAL FIDELITY-ROGERS-NAD-ROTEL-DENON-  
TANNOY-MARANTZ MISSION-STAX-DUAL-TDL-AI HARRY JPW-  
CELESTION-IXOS-SME-RUARK-MOTH-AUDIO TECHNIC-A-  
EXPOSURE-AND OTHERS

Free installations • Credit Facilities • Service Department

Mon - Sat 10 - 6

95 Whitcross Road, Hereford HR4 0DG (0432) 358081

### NORLOSTONE

MARBLE - GRANITE - STONE SPECIALISTS

GRANITE AUDIO STANDS. The ultimate solution to problems of resonance and tonal accuracy. For 'bespoke' designs consult **NORLOSTONE**, West Dean Road, West Tytherley, Salisbury, SP5 1QG. Tel: 0980 862253

### V'AUDIO

Tel: 0272 686005

36 Druid Hill  
Stoke Bishop

ATC, AVI, Acoustic Energy, Audio Innovations, Audiomeca, Audio Technica, AMC, Analogue Electronics, Cadence Valve, Chord AMPS, Electronic Companiet, Exposure, Goldring, Harman Kardon, Heybrook, Jamo, LFD, Lyra, Ortofon, Perception, Pink Triangle, Ruark, Michell, REL, Sansui, SME (inc. 20A), Sonic Link, Stax, Sugden, Sumiko, Townshend, Triangle, Wadia.

Demos by appointment only. Home trial facilities. Free installations. Servicing facilities. We are not a shop

## NORTH

### ASTON AUDIO HI-FI SPECIALISTS

ARCAM • MERIDIAN • MISSION • CYRUS • AUDIOCAB • B & W • NAKAMICHI • AURA • DENON • QUAD • YAMAHA • KEF • MARANTZ •

ROKSAN • NAD • MF • AIWA • DUAL • CELESTION • ROGERS • AUDIOQUEST • TECHNICS •

WEST STREET • ALDERLEY EDGE • PLUS HOME CINEMA • CHESHIRE • TEL 0625 582704 • INTEREST FREE CREDIT • DISCOUNT CD & TAPE • BADA •

# Swift

## THE hi-fi SPECIALISTS

STANN'S PARADE (ON A34) WILMSLOW CHESHIRE

☎ (0625) 526213

● 2 YEAR GUARANTEE ● EASY PARKING ● DEM ROOM ● PART EXCHANGE

Aiwa • Audio Lab • Aura • B & W • Castle • Denon • Cyrus • Celestion • JPW • Kenwood • Marantz • Mission • NAD • Pioneer • Rotel • Systemdek • Tannoy • Technics

Retailers of Fine Audio Equipment  
Congleton

- ▶▶ EPOS
- ▶▶ QNIX
- ▶▶ DENON
- ▶▶ LINN
- ▶▶ AUDIO ALCHEMY
- ▶▶ ARCAM
- ▶▶ B&W
- ▶▶ NAKAMICHI
- ▶▶ ROYD
- ▶▶ TARGET
- ▶▶ TRIPOD
- ▶▶ LOUSY COFFEE

▶▶ SUPERB DEMO FACILITIES

▶▶ FULL INSTALLATION & HOME DEMO SERVICE

OPEN 6 DAYS A WEEK  
OTHER TIMES BY  
APPOINTMENT

0260  
297544

1/1A Duke St Congleton Cheshire CW12 1AP

Near Norwich  
Norfolk  
Tel. (0508) 570829



Basically Sound of Norfolk  
STOCKISTS OF LEADING HI-FI

Arcam, Naim, Audiolab, Epos, Denon, Nakamichi, Acoustic Energy, Heybrook, Micromega, Rotel, TDL, The Chord Company, Sound Style etc...

HI-FI YOU CAN'T AFFORD not to listen to

EQUIPMENT BY ABSOLUTE SOUNDS, AUDIO INNOVATIONS, SUGDEN, IMPULSE, MICHELL, ROKSAN, PINK TRIANGLE, ACCUPHASE, THIEL, COUNTERPOINT, SONIC FRONTIERS, TRICHORD RESEARCH ETC.  
By appointment only

### SERIOUS KIT

061-707 4823

### REPAIRS/DIY

CVC Chelmer Valve Company for Audio Valves

Buy CVC PREMIUM Hi-Fi valves direct from us. All valves processed for improved performance. We also have Stock of MAJOR BRAND types including: MULLARD, GEC, BRIMAR, RCA, GE, etc

130, New London Road, Chelmsford, Essex, CM2 0RG  
Tel: 0245 265865 Fax: 0245 490064

### TECHNICAL & GENERAL

THE ORIGINAL TURNTABLE SPECIALISTS for the Great Classic Turntable, Arms, Cartridges, Styli.

CONNOISSEUR • GARRARD • GOLDRING • Lenco • ORTOFON • SHURE • S.M.E. • THORENS • WATTS

All available Genuine spares and our own re-manufacture of obsolete parts Servicing and Overhauls, to original technical specifications.

NO ILLUSORY 'IMPROVEMENTS' NO DUBIOUS OR HARMFUL 'MODIFICATIONS'  
Remedial Services available

Cartridges and styli, correct radius diamonds, for early recordings - 78s & LPs

### TECHNICAL & GENERAL

P.O. Box 53 Crowborough, East Sussex TN6 2BY  
Tel: 08 32 65 45 34

### LOOKING FOR REAL HI-FI or HOME CINEMA IN SWINDON

Audio Technica, Acoustic Energy, Audio Innovations (valve Amp), Beard (Valve Amp), Cerwin Vega, Impulse, Red/Acoustics, and many more....

We also stock quality ex demonstration and secondhand hi-fi • Quality car Audio, new, used and secondhand, also available Repair and refurbishment classic equipment

52 Audio Exchange 52

52 Morse St, Swindon Tel. 539008

(Off Commercial Road, Swindon) Open 10am - 6pm, Mon - sat

### SOUNDS AROUND

NEW & USED HIFI  
Professional Service Repairs and Accessories

146A Clarendon Park Road, Leicester  
Telephone : 0533 702442

### Sussex Surplus

Original Mullard GEC Valves for sale & wanted for cash

Sussex Surplus  
13 Station Road, Horsham, West Sussex.  
Tel: 0403 251302

Sowter Transformers  
EA Sowters Ltd  
PO Box 36  
Ipswich IP1 2EL  
0473 219390/252794

Output and mains transformers for GEC KT88 circuits. Can also make any other transformer to order. Send SA for lists and data.

## Lockwood Audio

Tel: 081-207 4472

Fax: 081-207 5283

WE BUY AND SELL NEW, USED AND VINTAGE SPEAKERS, DRIVERS, CABINETS, PARTS.

SPEAKER REPAIRS THE

Authorised **TANNOY** Specialist



MAJOR CREDIT CARDS WELCOME

IMPERIAL STUDIOS,  
MAXWELL ROAD,  
BOREHAMWOOD, HERTS. WD6 1WE

### SOVTEK VALVES

6550WA. 6L6WGC/5881. EL34G.

12AX7WB/7025. EF86/6267

Over 1000 different types of valves stocked S.A.E. for list DEPT. HFV

Wilson Valves, 28 Banks Ave, Golcar, Huddersfield, West Yorks, HD7 4LZ

Tel: 0484 654650/420774 Fax: 0484 655699

Mail order only, Visa etc.

## GT AUDIO

Specialises in the repair of all types of audio equipment (including valve). All work is guaranteed and carried out to the highest standard.

Tel: 0895 833099

### AUDIO COUNSEL HI-FI SPECIALISTS

LINN, NAIM, REGA, ARCAM, ROTEL, ROYD, SHAHINIAN, DYNAVECTOR, EPOS, MARANTZ, NAKAMICHI, MICROMEGA and many more....

"Time spent with staff may prove to be a particularly wise investment"

Audiophile

12/14 Shaw Road, Oldham OLI 3LQ  
Tel. 061 633 2602

### MUSIC

### CD SELECTIONS

The UK's leading suppliers of bargain CDs and music for your free catalogue contact

CD SELECTIONS  
PO BOX 1011  
DORCHESTER DORSET O12 7YG  
Tel. 0305 848 725

### THE Music Station

MISSION • DENON • ROTEL • PIONEER • SONY • KEF • TEAC • WHARFEDALE • CELESTION • JAMO • MUSICAL FIDELITY • MARANTZ •

LISTENING FACILITIES AVAILABLE FOR ALL THE BEST IN HI-FI

Contact

THE MUSIC STATION  
49 Church Street, Inverness, Tel: (0463) 225523

# Specialist Hi-Fi Dealers

## SERVICES & CONSULTANTS

**service and repairs**  
 maintenance to almost all brands of hi-fi.  
 in guarantee repairs to Kenwood,  
 pioneer, Aiwa, Panasonic, Technics,  
 Teac, Yamaha and others.  
 All repairs guaranteed for 3 months.  
**mwes electronic services.**  
 5, King St. Delph, Oldham.   
 Tel/fax 0457 820862

**CLOCK THIS**  
 CD Transport/player clocking to ultimate performance. This is a  
 modification to the digital processing circuitry with unbelievable  
 result. External DAC's can still be used to advantage, resulting in  
 further enhancement. Probably the best CD upgrade you will ever  
 make. Technically proficient engineers will also handle all your high  
 end repair, servicing or modification requirements.  
 Please call us on (0209) 612260 for further details.  
**RJF AUDIO VISUAL 84 Pendarvas Street,  
 Tuckingmill, Camborne, Cornwall TR14 8NJ**  
 • Also High End Retail •

**REVOX SERVICE**  
**A77, B77 PR99**  
 For fully guaranteed professional service and  
 repairs, call RamTek.  
**Tel: (081) 207 6159. Fax: (081) 953 1118**  
 Suite 33, Kinetic Centre, Theobald Street,  
 Borehamwood, Herts WD6 4SE

**R. J. F.** 84 Pendarvas Street, Tuckingmill,  
 Camborne, Cornwall TR14 8NJ  
 Tel: (0209) 710777  
**AUDIO VISUAL**  
 Dealers for Audio Technica, B & W, Beyer, Cerni Vega, Denon, Dynavector,  
 Foundation Audio, Goldring, Harman Karson, JBL, Marantz, Mitchell, Micromega,  
 Musical Fidelity, Nakamichi, Ortofon, Perception, Pura Triangle, Prolect, QED,  
 Sansui, S.D Acoustics, Sharp, SME, Targel, TDL, Townshend, Innuos, Audio  
 Innovations, Audionote, Audiomatch, New Firm, Sugden, TEAC, Triangle plus many  
 Much second hand equipment available plus repairs to all brands  
 

**L.G.S AUDIO SERVICES.**  
 Quality Audio Equipment and Hi-Fi Systems  
 Repaired and Serviced at Reasonable Cost  
**2nd Floor, Forest Mills, 133 Alfreton Road,  
 Radford, Nottingham NG7 3JL**  
 Tel:- 0602 24443

## STAFFS & DERBY

**HOW TO SAVE £100 ON YOUR HI-FI**  
 Choosing the right Hi-fi and saving money is a difficult  
 task, make it easy on yourself.  
 To get your copy of "Guide to Buying Hi-fi"  
 just telephone  
**FREEPHONE 0800 373039**  
 We will send you one Free of Charge together with our  
 Fact Pack and see how you can save £100 on  
 recommended Hi-fi Systems.  
**Active Audio**  
 12 Osmaston Rd. 29 Market Street. 95 Stafford Street.  
 The Spot, Tamworth Hanley.  
 Derby Staffs. Stoke-on-Trent.  
 Tel: 0332 380385 Tel: (0827) 53355 Tel: 0782 214994

## SCOTLAND

**RIVERSIDE AUDIO**  
**South West Scotland Tel: 0475 631 066**  
**Argyll and Bute Tel: 0700 504845**  
 The mystique of valve amplification demonstrated in the  
 comfort of your own home. Art Audio, Concordant  
 Valve Amplification, Atacama Audio Supports, J.P.W.  
 Speaker Systems, Fullers Audio Loudspeakers.

**ANCURUM ELECTRONICS**  
**YOUR LOCAL HI-FI SHOP**  
 PIONEER, TECHNICS, PROLOGIC AMPS + LASER  
 DISC FOR HOME ENTERTAINMENT  
 TEL: (0382) 480030  
 39 GRAY ST., BROUGHTY FERRY DUNDEE  
 Dedicated Dolby, Pro-logic listening rooms

Silver Sounde and Sonio Link cables tailor-made to your  
 requirements.  
 Check out the latest impedance matched Goertz cable  
 from Townsend Audio. Cogan-Hall Cables.  
 Contact Mike Gilmour for professional advice and friendly  
 service.  
 **Lismore, Avonch, Ross-shire IV9 8RP**  
**TEL/FAX 0381 620655**

## OVERSEAS

**Sum of the parts.**



**ALPS NOBLE**  
 Volume and balance pots used  
 by the best manufacturers.

**KIMBER KABLE**  
 Precision crafted wire,  
 connectors and caps.

**VISHAY**  
 A resistor  
 without equal.

**GOLD AERO**  
 Selected, tested,  
 guaranteed.

**MIT MULTICAP**  
 World's finest film capacitor!

The very best in audio grade parts,  
 upgrade/mod kits and complete kit products.  
 Call, write or fax for our catalogue.  
**SONIC FRONTIERS**  
 INCORPORATED  
 2790 Brighton Road, Oakville, Ontario, Canada L6H 5T4  
 Telephone (905) 847-3245 - Fax (905) 847-5471

MIT MultiCap • Wonder Cap • Kimber Kap • Solen • Siemens  
 Hovland MusiCap • Wima • Holco • Draloric • Vishay • Caddock  
 Mills • Matsushita • Noble • Kimber Kable • Cardas • Discovery  
 Audioquest • Alps • Bourns • Shallico Attenuators • Electroschick  
 Elma • CTS • Elna • Nichicon • Gold Aero • RAM • N.O.S. Tubes  
 Linear Technology • Burr Brown • Analog Devices/PMI • Motorola  
 Edison Price • Pearl • Tube Sockets • WBT • Neutrik • Kits

## OVERSEAS

**ANDY'S AERIALS**  
 • TV & FM AERIALS SUPPLIED & INSTALLED  
 • MULTIPoint SYSTEMS REPAIRS  
 • DIY SALES FULLY INSURED COMPETITIVE PRICES  
 • ALL WORK GUARANTEED FREE SITE SURVEYS  
 7 DAY SERVICE Areas Covered  
 HARROW, BUSLIP, NORTHWOOD, EALING, ACTON, HAYES,  
 SOUTHALL, HEATHROW etc.  
**CALL US FOR A PROFESSIONAL & RELIABLE SERVICE**  
 081864 4890 OR 08660 830283  
 SHOWROOM AT: 345c NORTHOLT RD., OPP SAINSBURY'S)  
 SOUTH HARROW, MIDD. OPEN 9am-5.30 MON-SAT

**THE AERIAL SHOP**  
 188 Halfway St, Sidcup, Kent. (London SE & Kent areas covered)  
 Tel:- 081 300 5588/8990/7454  
**GET THE BEST FROM YOUR HI-FI**  
 100's of Aerials, 100's of fittings for Hi-Fi Aerials, TV  
 Aerials & Satellite Dishes DIY or fitted by our Engineers.  
 Quality equipment stocked e.g.  
 ANTIFERRENCE, TRIAX, LAB GEAR ETC.....

**T.V.M. Audio Visual**  
 The Antenna Specialists  
 52 St Andrews Street  
 Northampton NN1 2HY  
 Tel:- (0604) 37769  
 Fax:- (0604) 601845  
 High quality FM Radio and T.V. Aerials. Mail Order  
 Please phone for more details

## Hi-Fi World Specialist Dealer Directory Order

**Book 12 Months For A 30% Discount!!  
 Or 6 Months For A 20% Discount.**

I wish to be included in Hi-Fi  
 World's Specialist Dealer Directory  
 starting the \_\_\_\_\_ issue for a  
 total of \_\_\_\_\_ insertions.

Please find enclosed my  
 artwork/copy details.

I wish to book \_\_\_\_\_ column  
 centimetres at £12.50 per col. cm.

Name \_\_\_\_\_  
 Company \_\_\_\_\_  
 Address \_\_\_\_\_  
 \_\_\_\_\_  
 \_\_\_\_\_  
 \_\_\_\_\_  
 \_\_\_\_\_  
 \_\_\_\_\_

Postcode \_\_\_\_\_  
 Telephone No. \_\_\_\_\_

Please return to **Amanda Sweeney**  
 Hi-Fi World,  
 64 Castellain Road,  
 London W9 1EX





# WORLD DESIGNS

## by Mail Order

world audio design mail order

### K5881 KIT

£395 ▼



A superb, Class A, 20watt stereo power amplifier that uses the Russian 5881 output valve, a military version of the American 6L6, designed for low distortion audio work. It has super-quality output transformers (4/8/16Ω selected internally) to minimise distortion and the input stage uses triode working. A rugged, sixteen-gauge, all-welded steel chassis is provided, together with protective bottom plate for safety.

Designed for long life, low running costs and excellent sound quality, K5881 is sensitive enough to be used with a simple passive pre-amp. or our own line-drive pre-amp, and it matches modern loudspeakers well. There is a choke-regulated power supply and the channels can be paralleled to turn it into a 40W monoblock if desired.

#### SPECIFICATION

Power	20watts/ch.	Separation	60dB
Frequency resp.	16Hz-40kHz	Noise (CCIR)	-103dB
Distortion	0.02%	Sensitivity	240mV
		Weight	16kgs(34lbs)

### 300B VALVE AMP KIT

£850 ▼



This is a specialised amplifier based on the highly linear 300B triode valve. Our 300B runs in Class A, giving one of the most sweet, open and neutral sounds possible today. Matched with good loudspeakers, it is unsurpassed.

The kit comprises a strong 16-gauge mild steel chassis, fully punched, welded and ground smooth. Finish is a durable 'powder coat' black. A protective bottom plate is provided for safety. Output terminals (one pair) take 4mm plugs axially and radially for

bi-wiring, or heavy gauge bare cable. Output options of 4/8/16Ω are selected internally at the transformer. A small circuit board carries most of the components. Can be monoblocked for 60watts.

All parts are included in the kit, except valves since different 300B makes are available.

#### SPECIFICATION

Power	28watts	Separation	54dB
Frequency resp.	5-18k-nfb	Noise (hiss/hum)	-100dB/-72dB
	50k-fb	Sensitivity	240mV
Distortion	0.2%	Weight	20kgs(44lbs)

### 4W SINGLE-ENDED VALVE AMP KIT

£385 ▼



The 4W Single-Ended amplifier kit is a line level integrated amplifier. It comes with three line level inputs and a tape output. High quality components are used throughout, including polypropylene signal capacitors, Alps volume control, custom C&K gold plated selector switch etc. Valves are included.

#### SPECIFICATION

Power	4watts	Noise (hiss)	-100dB
Freq. Response	9Hz-64kHz	(hum)	0.7mV
Distortion	1.3%	Sensitivity	180mV
Separation	74dB	Weight	10Kgs (22lbs)

#### DEMONSTRATIONS!!

Most of our products are on demonstration at Hi-Fi Confidential, 34 Buckingham Palace Road, Victoria, London. Phone the patient and understanding Luigi on 071-233-0774 to check availability. He's a valve afficianado, and stocks plenty of good products - including World Audio Design.

See page 83 for order form...

# WORLD DESIGNS

## by Mail Order

### VALVE LINE LEVEL PRE-AMPLIFIER £295

Constructed from heavy gauge steel with an aluminium anodised and polished front panel. This new chassis comes with the complete kit of parts necessary to build the valve line level pre-amp.

The components are all high quality and include a special screened toroidal transformer, Military Spec. Russian valves, Alps potentiometer, polypropylene signal capacitors,



**NEW**

### CLASS A 36W SOLID STATE MONOBLOCKS

£580/pr.

A pure Class A transistor design offering superb clarity and

Picture of final production monoblocks will appear next month.

### HIGH DEFINITION LOUDSPEAKER

The High Definition loudspeaker is ideal for low power, high quality amplifiers, transistor or valve. It goes very loud with just 1-5watts, having an enormous sensitivity of 94dB - that's 8dB more than most other speakers. It is also a very easy load for valve amps (8ohms) and it gives a terrifically dynamic and fast sound. This speaker is also unusually suited to low powered vintage amplifiers, such as Quad IIs, Radfords, Pye Mozarts and such like.

The High Definition loudspeaker is available in two forms; as a drive unit pack containing two bass units and two tweeters modified and tested, or complete with all crossover components, gold plated bi-wire terminal dishes, silver plated copper wiring and long haired wool.

Drive Unit & Crossover kit etc £195  
Drive Unit Pack £145



transparency. The kit comes complete with a heavy-gauge steel chassis chrome plated for an attractive and hard wearing finish. All components necessary to complete these super monoblock amplifiers are provided in the kit and it comes with clear, easy to understand instructions.

The Class A monoblocks use special new super grade audio transistors. They are extremely fast and linear, giving a super measured performance without the need for high levels for feedback.

### SPECIFICATION

Power (8Ω)	36watts	Distortion (%)		
Frequency Resp.	1Hz-50kHz	1W	Full	O/P
Noise	-104dB	1kHz	0.003	0.005
d.c. offset	3mV max	10kHz	0.008	0.04

**NEW**

### THREE WAY CARBON-FIBRE DRIVER LOUDSPEAKER

This is our third loudspeaker design and the most advanced to date. KLS3 uses extremely light and stiff carbon fibre cone drive units for a fast and accurate sound. A dedicated 4inch carbon fibre midrange drive unit provides the cleanest, smoothest and most detailed midrange characterised by superb projection. The treble is handled by a sweet sounding fabric dome tweeter and for real bass power and articulation a light and stiff 8inch carbon fibre bass driver is employed.

KLS3 has been engineered to get the best from your amplifier, be it valve, solid state, single-ended or zero feedback. Its High 90dB sensitivity and near flat 8Ω impedance make it one of the easiest loudspeakers to drive.

KLS3 is available in three forms: Drive unit pack £230; Drive units + crossover etc (just about everything but the wood) £350; fully built, tested and finished in high quality, real wood veneer for £1500.



**NEW**

### HIGH TECH AUDAX DRIVE UNITS

The 1994 range of Audax drive units sees many modern high tech materials and technologies that would normally be unavailable to the home constructor. We offer a small range of the highest quality drivers, including High Definition Aerogel (HDA) units, carbon fibre and three superb soft dome tweeters. Sadly there isn't enough room to print the specs, but if you are interested in any of the following drivers, please ask us for a detailed spec sheet.

#### Audax Drive Units:

##### CAST CHASSIS UNITS

	4 inch mid	6.5inch bass/mid	8inch bass
HDA.....	HM130Z0.....	HM170Z0.....	HM210Z0
CARBON FIBRE.....	HM130C0.....	HM170C0.....	HM210C0

##### FABRIC DOME TWEETERS

- TW025M0 (25mm 92dB suitable for 2-way systems)
- TW025M1 (25mm 92dB suitable for 3-way systems)
- TW034X0 (34mm 93dB a large dome with powerful sound)



# Meet-Your-Maker

A reference guide to Britain's Manufacturers and Distributors.

**ACOUSTIC ENERGY**, 3a Alexandra Road, London W13 0NP. Tel. 081 840 6305. Acoustic Energy manufacture the award winning Reference Series AE1 and AE2 loudspeakers and the new Aegis Series Model 1, all of which feature the unique AE metal cone drive units. The AE distribution division offers superb high end products from WADIA, GRYPHON, ENSEMBLE and TARA LABS.

**ACOUSTIC SOLUTIONS** Present an innovative range of interconnect for the audiophile. We specialise in bespoke manufacture to your exact requirements. Phone us for a chat on 0782 595330. ASL 46a Market Street, London, Staffs ST3 1BS

**ALCHEMIST PRODUCTS**, 4 Rosebury Mews, London N10 2LG. Call us for a list of our dealers in many areas including:- London, Kent, Hampshire, Wilts, Milton Keynes and N. Ireland and for product information on the Kraken, Freya, Bragi, Odin, Genesis and more. Tel: 081 883 3008

**ALEMA UK LTD.**, 25 Montifore Road, Hove, BN3 1RD. Tel. 0273 202637. Audion "Edison" Andersson "Trade enquiries welcome for our newly extended range).

**APPDLLO**, The UK based designers and manufacturers of high quality speaker stands and equipment racks have now added to their comprehensive range a modular system ideal for housing audio visual products and CD storage. Please send for our free brochure to Zenith Crown Ltd, Tipton Rd, Dudley, West Midlands, DY14 Tel. 021 520 5070. Fax. 021 522 2055. - All export trade enquiries welcome.

**ARCAM**, Pembroke Ave, Denny Industrial Centre, Waterbeach, Cambridge, CB5 9PB. Tel. 0223 440964 or Fax. 0223 863384. Manufacturers of the Delta 290 Amplifier and the Delta 280 Digital FM Tuner. The two together produce a sound that has been described as 'subtle and intriguing' and that provide 'real clout' - discover this for yourself. For information on not only these products but also the Arcam CD Players, Speakers, Cassette Decks etc.. Phone or write in to request a brochure - The pleasure is all yours!

**ATACAMA AUDIO SUPPORTS** from Sambell Engineering Ltd. We are the sole manufacturers of the 'SE' range of speaker stands, consisting of an 8", 12", 16", 20" and the award winning 24" high stand. Also three specialist models for the Tannoy 'sixes' Loudspeakers.

**AUDIIONOTE CD**, Unit 1, Block C, Hove Business Ctr, Fonthill Road, Hove BN3 6HA. Tel. 0273 220511. Audionote supply a range of very high quality and very expensive audiophile components including valve output transformers.

**AUDIO SYNTHESIS**, 99 Lapwing Lane, Manchester, M20 0UT. Tel. 061 434 0126. Audiophile design, development and distribution. Please contact us for details of: PASSION the passive controller everyone's talking about. SILVERBLUE pure silver interconnect cable and the ultra analog based cad - DSM.

**BANDRIDGE LTD** are the premier suppliers of quality audio and video leads, connectors and speaker cables in the UK. In addition to probably the widest range available, including PRDFI GOLD, SUPER GD&D and SUPER +, offering a level of quality that meets the needs of the most exacting specification. Bandridge of London Ltd, Premier House, Deer Park Road, Wimbledon SW19 0B1 543 3633.

**BYBLE TALK** PO Box 413, Woking, Surrey, GU22 8YZ. Telephone 0483 750667. Fax 0344 360866. Designers and manufacturers of British made high quality value for money, interconnect and speaker cables. Phone or fax for a free full colour brochure on our What Hi-Fi? 5 star rated products.

**CAMPAIGN AUDIO DESIGN**, Llandudno Road, Cardiff CF3 8PG. Tel. 0222 779 401. Supplies / manufactures mailorder, high purity silver interconnects, loudspeaker cables, internal wires and bespoke mains cables. Generous two week trial period.

**CHORD ELECTRONICS**, 3 Bower Mount Road, Maidstone, Kent. Tel. 0622 764874. Audition the Chord SPM 1200 at any of the following branches. Doug Brady Hill - Liverpool / Leeds/London/Cheshire, Audio Reflections - Leeds, Music Matters - West Midlands and many others. Please call us for details.

**CREEK AUDIO LTD** 2 Bellevue Road, Frien Barnet London N11 3ES. Tel: 081 361 4133, Fax: 081 361 4136. Manufacturers of the 4240 Integrated Amp, P42 and A42 Pre/Power Amps, CD42 CD Player. Please write for further details.

The Exultant Power Amp fitted to Quad II Hardware  
**DBS AUDIO** PO Box 91 Bury St Edmunds Suffolk, IP3 0NF. Tel: 0284 828926 Fax: 0284 828026. The DBS6 loudspeaker kit as designed by Dave Berriman

and featured in Hi-Fi News Feb/Mar 92, is still available - only from DBS Audio. To find out what these comprise, cost and how to order plus any other information on DBS products please telephone, fax or write in to the above address and numbers.

**D H M DESIGN - BUNDEE CD REPAIR PROTECTION SYSTEM**- Tried and tested on Tomorrow's World. Repairs and protects over 50 CD's, even those scrubbed with steel wool. Effective for all laserdisc formats including CD ROM, MiniDisc and CDi. RRP £14.95. Why buy a new one when you can clean, repair and protect fifty? Contact David Mather for details of your nearest stockist or distributor. Export enquiries welcome. DHM Design Ltd, Studio 6, Bentinck Court, Bentinck Road, West Drayton, Middlesex. UB7 7RG. Tel: 0895 449559 Fax: 0895 420540

**ECA DISTRIBUTION** For the "naturally neutral" chain. Nothing added, nothing taken away. The VISTA line-up, the LECTERN S power-amp and the SERVO A.2 speakers. Resulting from their own Research and Development, the ECA Design Team provides a "super-symmetry" circuit with the barest minimum of wiring in the amps vacuum impregnated air-coils in the custom-made midrange unit for the speakers. P.O. Box 3023 London NW2 7RW. Tel: 081 830 5128  
**IAN EDWARDS**, The Old Chapel, 282 Skipton Road, Harrogate, Yorks. Tel. 0423 500442. Somebody Somewhere must make better storage units for CDs. Music, LPs, HiFi, Books, etc. than Ian Edwards. BUT until he appears, why not send for the brochure showing a selection of HAND MADE units. To do this please send 3 x 2nd class stamps.

**E J JORDAN DESIGNS**, The Oak, Manor Bier, nr Tenby, S Pembrokeshire, SA70 8OR. Tel. 0834 871 209, or Fax. 0834 871 770. Curvilinear metal cones loud speakers were first developed by Ted Jordan in 1963.

EJ Jordan Designs are now World leaders in foil cone technology. First and foremost.

**ELECTROMAIL**, PO Box 33 Corby, Northants, NN17 9EL. Tel: 0536 204 555. The branch of the well known R.S. Components trade mail-order business that deals with the public. They have a huge range of components - and catalogues to match.

**EMF**, 2a Bellevue Road, Frien, Barnet, N11 3ES. Tel. 081 361 6734. Manufacturer of Sequel 50w integrated amplifier and the Crystal D2A converter. Amplifier and DAC. Please write in for details.

**FALCON ACOUSTICS LTD.**, Tabor House, Norwich Road, Mulbarton, Norwich, Norfolk, NR14 8JT. Tel. (0508) 78272. U.K. distributors of FDCAL drive units and SDLEN (chateauroux) polypropylene capacitors and the largest inductor manufacturer in the U.K. Comprehensive range of DIY Speaker Parts and Kits, Sub-Bass and Electronic Filters.

"Everything but the wood"

**FARADAY SOUND**, 248 Hall Road, Norwich, NR1 2PW. Tel: 0603 762967. Loudspeakers in CONCRETE: the ultimate enclosure. Now you can build your own low density concrete cabinet enclosure Faraday FS1, Siren, FSS, FS10 or a design of your own choice. Stunning sound and reviews. Simple DIY skills only. Full instruction guide including cabinet construction for only £3.95. Includes reviews, photos etc. and at least £5 discount off any further products purchased from us e.g. ready made cabinets. Also £25-£150 off any complete loudspeakers!!!

**FOUNDATION AUDIO**, 53 Beecroft Way, Dunstable, Beds. LU6 1EE. Tel. 0582 477550 or Fax. 0582 604001. We have long been acknowledged as the market leader in sonically superior stands and major in 'specials'. Send for our brochure and details of your nearest stockists.

**FULLERS AUDIO**, 20 Tunbridge Road, Southend on Sea, Essex SS2 6LT. Tel. 0702 612116. Fuller's audio produce a range of innovative products. Amplification - a10 a single ended class A semiconductor power amplifier - £1200, b70 a mosfet power amplifier of high standard - £599, pre1 and pre2 + matching pre-amplifiers - £599/£649, lgnl phono stage for mm and mc cartridges £299. Loudspeakers - Pharaoh system, upgradable from 1 pair of cabinets to 3 pairs for truly extended bass. passive/active options £649-£2499, Sphinx a 3 way floor standing unit £849, Sultan H.E., 98dB sensitivity £439, matching Sub Woofer £559, Sultan, 91.5dB sensitivity £309.

**F & S TRADING LTD** 31 Brooks Road, Sutton Coldfield, West Midlands B72 1HP. Tel: 021 321 3357. "Single-ended amplifiers"

**J E SUGDEN & CO LTD**, Valley Works, Station Lane, Heckmondwike, West Yorkshire, WF16 0NF. Tel. 0924 404088. Manufacturers of hand crafted audio

products. "A world of Music". Call or write in for information on our SDA-I Digital to Analogue Converter, SDT-I CD Player, A21a Class 'A' Amplifier, A25B Intergrated Amplifier, A48 Intergrated Amplifier, Au51c Pre Amplifier, Au51p Power Amplifier and more.

**JORDAN WATTS ACOUSTICS LTD**, Cyntra Place, 201 Mare Street, Hackney, London E8 3QE. Tel. 081 985 1646. Jordan Watts Acoustics for Sight AND Sound.

**KESWICK AUDIO RESEARCH**, 54 Coach Road, Outwood, Wakefield, W Yorks, WF1 3EX. Tel/Fax 0924 870606. "I'd say that the Figaro is the best miniature speaker I have heard" Audiophile March 1993. Write in or call for details on our full product range and your nearest stockist.

**KRONOS DISTRIBUTION**, 35 Farlowe Road, Dunganon, N. Ireland, BT17 14 DJ. Tel: 0868 748632. Fax: 0868 448281. Kronos is the UK distributor of some of the finest Hi Fi products in Europe. These include Audiomeca digital products and turntables; Lieder silver speaker and interconnect cables; Pro-Ject turn-ables and amplifiers; Triangle spesslers and electronics; and YBA amplifiers. We also handle Frameworks equipment tables; Anon valve amplifiers and mains filters and Essex Audio digital products from the UK. Please telephone or write for product details and dealer lists.

**LANGREX SUPPLIES LTD**, 1, Mayo Road, Croyden, Surrey CR0 2QP. Tel: 081 684 1166. Fax: 081 684 3056. We are one of the largest stockists and distributors of electronic valves, tubes and semiconductor in the UK. Over 6,000 types in stock. We specialise in obsolete types including original UK and USA made audio valves. Telephone or fax for an immediate quotation.

**LECSON SYSTEMS LTD.** Unit 19, Nuffield Rd. Ind. Est., St. Ives, Huntingdon, Cambs, PE17 4LD. Tel: 0480 498211. Call for info on our range of integrated and four channel integrated bi-amplifiers. Stereoplus, Quattrra and Quattraplus analogue and digital interconnects and loudspeaker cables. As a compliment to the LFD range of accessories GOLD plated mains 13A plugs and sockets now available.

**LDCKWOOD AUDIO**, Imperial Studios, Maxwell Road, Borehamwood, Herts, WD6 1WE. Tel. 081 207 4472/  
**LDRICRAFT AUDIO**, 4 Big Lane, Goose Green, Lambourn Berks. RG16 7SD. Tel. 0488 72267.

Specialist restoration of 301's and 401's using genuine spares and re-manufactured parts to original pristine standards in our newly built work shops designed primarily for these purposes.

**LYNWODD ELECTRONICS**, Coley Lane Farm, Wentworth, Rotherham, S62 7SD. Tel. 0709 873667. Lynwood Electronics is famous for manufacturing the only range of audio mains cleaners that really work. A complete range is now available to suit every system and every pocket.

**MAY AUDIO MARKETING U.K. LTD.** 83 Main Street, Bury in Wharfedale, North Yorkshire, LS21 7BU. Tel: 0943 864930. Distributors of High Quality audio products from Duson Electronics, Totem Loudspeakers, Jectlin Float Headphones and quality recordings from Proprius, Prophone, Dpus, MAP and Swedish Society. IF ITS MUSIC YOU LOVE, TELEPHONE OR WRITE FOR LITERATURE.

**MICHELL**, 2 Theobold Street, Boreham Wood, Herts, WD6 4SE. For full information on our full range of excellent products including the Gyrodec, Alecto, Iso, Argo and others please telephone us on 081 953 0771. Michell - Symbol of Precision

**NORLOSTONE**, Granite Audio Stands. The ultimate solution to problems of resonance and tonal accuracy. For 'bespoke' designs consult NORLOSTONE. West Dean Road, West Tytherley, Salisbury SP5 1QG. Tel: 0980 862253

**QUANTUM AUDIO LTD**, PO Box 26, 1 Oliphant Drive, Kilmarnock KA3 7JA. Tel: 0563 71122 Fax 0563 71133. Quantum's craftsmen produce the £899.99 MINSTREL 30 Watt, Ultra Linear, zero feedback correction, integrated, line level, valve amplifier. Don't buy any old fashioned valve amplifier before hearing the unique improvements modern technology provides to valve sounds. An audition will immediately convince the listener of the Minstrel's superiority.

**SELECT SYSTEMS (PERFECT PITCH MUSIC)**, Hanworth Trading Estate, Hampton Road West, Feltham, Middlesex, TW13 6DH. Tel: 081 893 8662. Fax: 081 893 4318. We manufacture the Franconstein CD enhancement system, The Dacula DAC and Perfect Digital and Analogue interconnects. Perfect Pitch also provide freelance design manufacture prototyping and test, also valve and solidstate specials. Trade

enquiries welcome.

**REL ACOUSTICS**, Unit 2, New Street, Bridgend Ind Est. Bridgend, Mid Glamorgan, CF31 3UD. UK. Tel. 0656 768 777, international +44 656 768 777. Fax. 0656 766 093. international. +44 656 766 093. The UK's only specialist sub-bass speaker manufacturer. "The only one that works". Get your dealer to give you a home demo and find out what the fuss is all about.

**REL. HARMAN AUDIO**, Unit 2, Borehamwood Ind. Park, Rowley Lane, Borehamwood, Herts. WD6 5PZ. Tel: 081 207 5050, Fax 081 207 4572. Sub Base Systems - Rel Strata, Stadium Stentor, Studio

**RICHARD ALLAN AUDIO**, Bradford Road, Gomersal, Cleckheaton, W Yorks. BD19 4AZ. Tel. 0274 872442. Fax 0274 869935. Manufacturers of very high quality loudspeaker enclosures and drive units. Examples being the £270 RA8 series 2 as supplied to the BBC and the 5" reviewed Minette 2 at £120.

**SAMBELL ENGINEERING LTD**, Winston Avenue, Croft Leicestershire LE9 6GQ. Tel 0455 283251.

**SEQUENCE DESIGN LTD**, 83 Main Street, Burley-in-Wharfedale, Yorkshire, LS29 7BU. Tel. 071 495 0775. Fax 071 495 0281. Slim loudspeakers which stand close to a wall or hang like pictures. "Likely to cause a gaint in the audiophile's eye" (Audiophile); "the answer to a prayer.... a bargain in the extreme" (HiFi News). Available with light or dark grilles and various solid wood finishes. From £199.95 a pair. Call or write in for an information kit and reviews re-prints.

**SHEARNE AUDIO**, PO Box 22, Stevenage, Herts, SG2 8HF. Tel. 0438740953. Following the success of John Shearn's Phase 1 pre power combination, (reviewed in HFW), is the phase 2 reviewed earlier in HFW and listed as a world favourite. Having many of the design features of the phase 1 R.R.P. £549, 50 wpc and same finish as Phase 1 pre-power. Also. option of phono stage for phase 2 mm £65 mc £75

**SLATE AUDIO**, makers of "THE FINEST SPEAKER SUPPORTS IN THE WORLD" have never had a bad review, our reputation is legendary. Contact us now for details on our CUSTOM STANDS, as well as our solid marble GARRARD 301/401 PLINTH SYSTEM (Hi-Fi World Dec 93) THE GLASSMATT platter mat and the very special SME GARRARD 301 or 401 CELEBRATION ARMS 47 Gemini Close, Leighton Buzzard Bedfordshire, LU7 8UD. Tel: 0525 384174.

**THE SPEAKER COMPANY**, Unit 9, Waterside Mill, Waterside, Macclesfield, Cheshire, SK11 7HG. Tel. 0625 500507. The Speaker Company are a new company offering a wide range of loud speaker units from Audax, Celestion, KEF, Morel SEAS and many more. Also a wide range of speaker accessories the keen builders.

**THE TOI GROUP**, Unit 1 Summerlea Court, Alton Road, Herriard, BASINGSTOKE, Hampshire, RG25 2PN. Tel: 0256 381 514. Fax : 0256 381 692. Electronic Components distributors specialising in: Mains Power Connectors, Jack Plugs and Sockets, 4mm Connectors, Din and Mini Din Connectors, Phono Connectors, DC Connectors, XLR Connectors, Rotary Potentiometers, D Type and IDC Type Connectors, Co Axial and BNC Connectors, Switches, LEDs, Diodes, Bridges and Rectifiers, Fuses and Thermal Tips. - Have you got one of our new 1994 General Product Catalogues?

**TARGET AUDIO PRODUCTS PLC**, Britannia House, Leagrave Road, Luton, LU1 1RJ. The Audio equipment, rack and speaker stand specialist. For information on our products please telephone or write.

**TRICHO RO RESEARCH LIMITED** Following on from the highly acclaimed CD clock oscillator modifications the Pulsar Series One digital to analogue converter. This unique design is part multibit and part bitstream to give absolute linearity over an extremely wide dynamic range. Switchable between 18 or 20 bit resolution this converter will become the standard for CD replay. For details telephone (0684)573524

**WOLLATON AUDIO**, 134 Parkside, Wollaton, Notts, NG8 2NP. Tel/Fax. 0602 284147. Imported high end at lower prices. XLO interconnects and loudspeaker cables - "The Best in the World". Clements loudspearing ribbon and transmission line technology to reproduce the finest sounds. Monarchy digital - trant, DAC, DAC+ pre and DIP anti jitter module. Matches the best at a fraction of the price. "NEW" Audio Valve aers - Simply gorgeous. Call us for details.

**WILMSLOW AUDIO LTD**, Wellington Close, Parkgate Trading Est. Knutsford, Cheshire, WA16 8DX. Tel. 0565 650605. Extensive range of drive units and over 30 different designs of self-assembly kits. Everything required for the loudspeaker builder and four dem rooms to listen to the kits in built-up form.

# Classical

*Peter Herring*

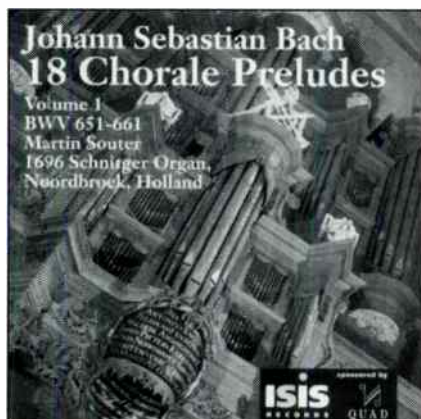

**JOHANN SEBASTIAN BACH**  
**The 'Leipzig' Chorale Preludes;**  
**Volume One No. 1-11**  
**BWV 651-661**

Martin Souter, Organ  
ISIS RECORDS CD007 (DDD/73.25)

**An all-German programme this month, featuring J.S. Bach and his illustrious contemporary, Georg Philipp Telemann, Beethoven, Schumann and assorted composers from Bavaria. The performers come from far and wide; Russia, Britain, the United States, but the instruments are even more exotic; a 1695 Dutch organ and the ear-catching sound of a 1750 viola d'amore.**

● "Inside the church it is very dark and below freezing. It is also well after midnight. Despite being cold, I am enjoying a truly magical experience - hearing Bach played on fragile keys and pedals worn by 300 years of use. The original Schnitger organ with its tremendous baroque sound speaks, lives and breathes with such character, radiating a personality all its own".

The words of recording producer, Edward Hom, certainly convey the atmosphere of this latest release from the Oxford-based Isis label. It is the first of two CDs, again produced with sponsorship from the hi-fi manufacturers Quad, which will embrace all eighteen of Bach's so-called 'Leipzig' chorale preludes.

The church in question is in the village of Noordbroek, in the north-eastern corner of the Netherlands. What makes it special is that it possesses one of the last unrestored Baroque organs in the country. Noordbroek was never a wealthy community, yet in 1695 it was able to persuade arguably the finest of north German organ builders, Arp Schnitger, to supply an instrument for its parish church.

Unlike so many other organs from this period, which have been substantially

renewed and rebuilt over the ensuing centuries, the Noordbroek instrument has undergone little change. What work has been done has been accomplished sensitively and without disturbing the innate character of the sound.

Almost certainly Schnitger based the new organ on the style of the church's existing instrument and probably reused some of its pipes, some of which may date back to the sixteenth century. Modifications by the organ builder Hinsz, undertaken in 1768, generally enhanced the sound of the instrument, and the rebuilding in 1809 by Hermann Freytag was entirely sympathetic to the work of his predecessors. Since then, the instrument has remained virtually unchanged, its sound closer to that of the eighteenth century than probably any other organ extant in northern Europe.

Given its history, it is easy to imagine how Martin Souter must have relished the opportunity to record Bach on this instrument and it is one that he seizes



Mikhail Kazakevich is the latest in the long line of piano virtuosos to emerge from the musical academies of Russia. He was born in Nizhni Novgorod (Gorky) in 1959 and began learning the piano at six. He studied with the revered Isaac Katz and graduated in conducting and teaching as well as piano. Although Kazakevich toured extensively within the former Soviet Union, he did not make his first visit outside the country until 1991, when he appeared at the International Schubert Competition in Dortmund, Germany. Although he was not placed first in the competition - unjustly in the view of many who heard him play - he impressed the likes of the

conductor, Moshe Atzmon, who arranged for Kazakevich to appear with the Dortmund Philharmonic Orchestra, playing Mozart. His playing also made its mark with the Schubert Society who awarded him a scholarship which enabled him to come and play in London. While there, he so impressed Conifer Records' Richard Wenn that Wenn immediately recommended that the label sign the Russian pianist.

Kazakevich's concert debut in London came at the Wigmore Hall in May of last year and earlier this year I heard him give a memorable performance of Schubert's last piano sonata, the B flat D960. Although

Schubert is evidently close to his heart, Kazakevich's repertoire is broad-based and includes Bach, Rachmaninov, Brahms, Honegger and Alban Berg, whose piano sonata he has recorded. In another recent Conifer recording, Kazakevich plays Beethoven's Second and Fourth Piano Concertos, with the English Chamber Orchestra under Sir Charles Mackerras, in what are described as 'newly discovered final editions'. But for this debut recording on Conifer, Mikhail Kazakevich has chosen the music of Robert Schumann. However, buyers will be delighted to discover that the CD contains more than they bargained for...

**ROBERT SCHUMANN**  
**Piano Sonata No2 in G minor**  
**Op22/Intermezzi Op4/**  
**Symphonic Etudes**  
**Op13/Symphonic Etudes Op.**  
**posthumous/Toccata in C**  
**Major Op7.**

**GUSTAV MAHLER (arr.**  
**KAZAKEVICH)**  
**Symphony No1 in D Major -**  
**Scherzo**

**JOHANNES BRAHMS**  
**Intermezzo in E**  
**Major No4, in E**  
**minor No5**  
**JOHANN SEBASTIAN**  
**BACH**

**Prelude and fugue in**  
**E flat minor (from**  
**Das Wohltemperierte**  
**Klavier, Book One)**

Mikhail Kazakevich, piano  
**CONIFER CLASSICS CDCF227**  
**(101.02)**

● A disc with a difference: it's two discs in one. Open the box and there's Mikhail Kazakevich's Schumann recital. Lift the CD tray from the left hand edge and underneath you will find a twenty-four minute 'bonus CD' containing tracks from Kazakevich's forthcoming Conifer issues, some Brahms and Bach, and his own arrangement for piano of the scherzo from Mahler's First Symphony (which surprisingly takes to the treatment reasonably well, if rather leaden-footed compared to the original). This 'trailer' CD doesn't add to the price, or increase the width of the box, and Conifer must be congratulated on a fine piece of promotion.

But what of Kazakevich's Schumann? The programme is a generous one and,

technically, a demanding one, too. He opens with the Second Sonata of 1838, a work criticised at the time for the looseness of its structure, which is surely to miss the point of this impassioned, intense music. Schumann's tempo markings for the first movement are intriguing. He first asks for it to be played "So rasch wie möglich" (as fast as possible) but then adds "schneller" (faster) and "nach schneller" (still faster), at which point the pianist is presumably

any pianist's qualities and Kazakevich passes with honours, not just for the technical prowess of his playing - which evinces open-mouthed admiration - but for the way he colours in what is essentially a set of variations, albeit on a lofty scale. Kazakevich displays both insight and imagination in his treatment of the Etudes, yet retains an air of thrilling spontaneity and unbridled energy. Moreover, he elects to play the full version of the work as published by

Schumann's friend, Brahms, in 1893, some forty years after the composer's death. Schumann omitted five variations from the first edition of the Etudes Symphoniques because he thought the work would be over-long if he retained them. Kazakevich inserts the extra variations between Variations Five and Six of the original score, playing them in the order 2,3,4,5,1.

Kazakevich concludes his recital with a dazzling performance of the Toccata Op7, a breezy, almost festive piece of pianistic gymnastics that suggests nothing of the darker side of the soul of Robert Schumann. It rounds off this fine debut recital in style. The piano

sound is first-rate, crisp, full, detailed and with convincing scale. Coincidentally, the recordings were made in All Saints Church, Petersham, near Richmond in Surrey, which was also the venue used by Decca for some of its earliest recordings of another young Russian virtuoso, Vladimir Ashkenazy. Will All Saints also prove a catalyst in the career of Mikhail Kazakevich?

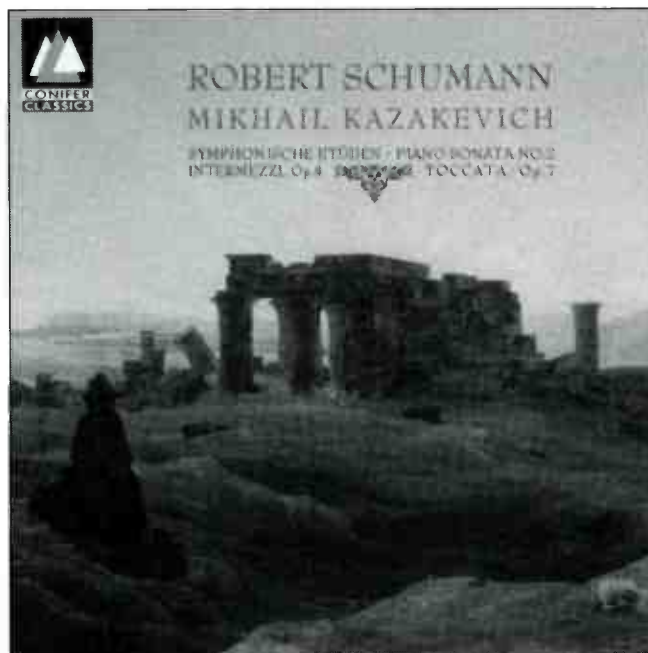

in orbit. Presumably there was a touch of humour in these instructions.

Kazakevich is certainly no slouch, but with what clarity and precision he plays and how well he shades the dynamics. He brings the same qualities to his playing of the Six Intermezzi of 1832, a delightful sequence of character pieces.

Schumann's Etudes Symphoniques of 1837 supply a testing examination of

with both hands - literally. I found myself rapidly immersed in this wonderfully atmospheric recording, and in Martin Souter's fine playing of the first eleven of the chorales which Bach collected together during the last year of his life. Altogether, there are eighteen 'Leipzig' chorale preludes, a puzzling number since it does not relate to any liturgical requirement. All the pieces are reworkings to a greater or lesser degree of versions composed during Bach's Weimar years and it could be that he was simply making one last, great compendium of his favourite organ compositions.

Robert Schumann believed the fourth chorale, *Schmücke dich, o liebe Seele* (Bedeck thyself, o soul) "as priceless, deep and full of soul as any piece of music that ever sprang from a true artist's imagination". It is a description that could readily apply to any of the pieces here and one which Martin Souter, given his intelligent, refined and lucid playing of them, evidently concurs with.

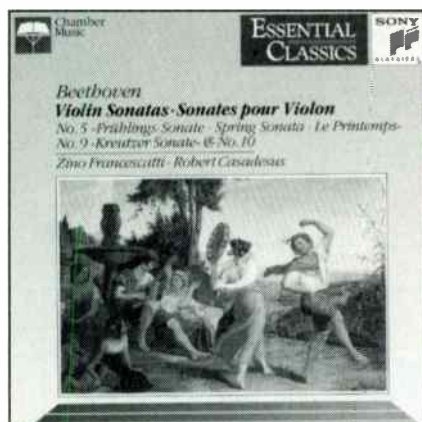

**LUDWIG VAN BEETHOVEN  
Violin Sonatas; No5 in F  
Major Op24 'Spring'; No9 in A  
Major Op47 'Kreutzer'; No10  
in G Major Op96.**

Zino Francescatti, violin; Robert Casadesus, piano

**SONY ESSENTIAL CLASSICS SBK46342  
(AAD/76.14)**

● Beethoven wrote ten sonatas for violin and piano between 1797 and 1812 each of which is a joy to both play and hear. But, in terms of popularity, two stand head-and-shoulders above the rest: No5 in F Major from 1801 and No9 in A Major, composed between 1802 and 1803. Both have acquired nicknames: that of the F Major, 'Spring', is purely a fanciful invention based on the gentle, bucolic charm and lyricism of the music; the appendage to the A Major, 'Kreutzer Sonata', has more substance. It could just as easily have become the 'Bridgetower Sonata' since the original dedicatee was one George Augustus Polgreen Bridgetower, son of a negro page at the court of Prince Nicholas I of Esterhazy

and what the history books term 'a Saxon woman'. Bridgetower was a phenomenal violinist and gave the first performance of the Op47 sonata in Vienna. He then had a disagreement with the composer - a not uncommon occurrence where Beethoven was concerned - and the work was instead dedicated to the gifted French virtuoso Rodolphe Kreutzer.

In contrast to the genial 'Spring Sonata', the 'Kreutzer' is a far more dramatic piece, almost symphonic in its style and use of bold gesture. The writing for both violin and piano is richly inventive and hugely effective. The often stormy aggression of the outer movements raises this work way above the level of genteel salon music; this is Beethoven at his most original and vital, and it is one of his finest chamber works.

Both the 'Spring' and 'Kreutzer' sonatas receive magical performances here from Francescatti and Casadesus, even if the recordings - from 1959 and 1962 - show their age a little; tape hiss is evident, but not distracting and the balance is very much 'left-right'. The sound lacks the fullness of more recent efforts, and the violin tune is bright, even shrill at times. Yet all is overridden by the enduring qualities of these classic interpretations; that of the 'Kreutzer' remains among the finest ever committed to tape.

The attractions of this Sony reissue are further enhanced by an eloquent performance of the Tenth Sonata, Beethoven's last and again dedicated to a French virtuoso, Pierre Rode. It is a more introspective work than the 'Kreutzer Sonata', but with its song-like melodies, tense scherzo and multi-faceted finale, no less captivating and rewarding, which is an apt description of this entire CD.

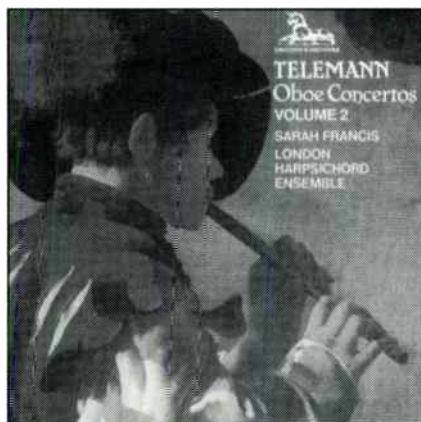

**GEORG PHILIPP TELEMANN  
Oboe Concertos**

Sarah Francis, oboe and oboe d'amore'; Graham Mayger, flute; Elizabeth Watson, viola d'amore; London Harpsichord Ensemble  
**UNICORN-KANCHANA DKP (CD) 9131  
(DDD/66.37)**

● Another welcome addition to the Telemann discography to join the BIS issue of chamber music reviewed a couple of months back. This is the second volume in a series of Telemann concerto recordings from Unicorn-Kanchana and offers six works, including the floriously unbuttoned E Major concerto for flute, oboe d'amore, viola d'amore and strings. The viola d'amore is a splendidly exotic instrument, with its bowed strings - six or seven of them - augmented by a similar number of sympathetic strings below. It may be of oriental origin and been introduced into Spain, and eventually the rest of Europe, by the Moors. Whatever, the Viennese instrument of c. 1750, superbly played here by Elizabeth Watson, almost steals the show.

Throughout, this collection of concertos shows the rich range of Telemann's influences, from the folk music of Poland and Moravia to the courtly classicism of France and the vibrant virtuosity of Italy. The concertos also demonstrate how well Telemann could distil these influences within his own abundant talent.

One work here, the concerto for oboe d'amore and strings in E minor, with its clear Italian influence, receives its first recording, in an edition prepared by the soloist, Sarah Francis. Throughout, she plays with a winning combination of assurance and exuberance and is ably supported by her fellow soloists and by the strings of the London Harpsichord Ensemble. Jane Dodd plays the harpsichord continuo.

An almost tangible spontaneity to the playing makes for some thoroughly enjoyable and undemanding music-making - which is not to diminish the quality of Telemann's writing; there is some ravishing music to be discovered here. A well-focused, vivid sound supplies the ideal setting for these fine performances.

Classical

# RINGMAT FOR RECORD LOVERS

First record support to be properly designed

Hear what reviewers say:

"A carefully researched and innovative product which genuinely transforms analogue replay at nominal cost. The string bass was more dynamic, the separation cleaner and, more importantly, the phrasing of the music was more fluid - you heard the vocal line arch fall." **Christopher Breunig (Hi-Fi News, September '93)**

"I found I preferred the RINGMAT and will carry on using it. The results were wholly positive..." **Jason Kennedy (Hi-Fi Choice, April '93)**

"RINGMAT gave a sharper, cleaner, more solid sound, with better fine detail and clarity. On complex material the improvement in stability and focus was remarkable; easily comparable to an expensive tonearm, cartridge or power supply upgrade... Any drawbacks? None I could detect..." **Jimmy Hughes (Audiophile, October '93)**

"I found the sound of my LPs improved significantly, reminding me of the experience of listening to records on a Goldmund reference turntable with a van den Hul Grasshopper cartridge with its nude stylus. All of a sudden, much more of the music, and the space in which it was performed, was evident. I'm sure that the legions of Linn and Rega owners out there who still play their LPs will want to make the modest investment required for major improvement in vinyl play." **Andrew Marshall (Audio Ideas Guide, Winter '94)**

Hear what your fellow music lovers say:

"I would agree with everything you claim for this product. The music is more natural, more musical, and with a loss of a certain rawness which persisted, no matter what, beforehand." **Mr. C.R., Northants**

"RINGMAT goes on my very short list of things that make differences I care about." **Mr. P.F., Washington D.C.**

"This product must be one of the most cost-effective accessories ever to be offered to music lovers." **Mr. R.A., Norway**  
Can RINGMAT really be that good?

Yes, it is, but there is only one way for you to find out - try it yourself.

But be warned: if you let your best friend borrow it, you will finish up buying another!



## Prices

Different versions to suit turntable or budget from £25 for RINGMAT 200 to £40 for RINGMAT 330 MKI

They can be obtained through good Hi-Fi retailer or on mail order direct from:

### RINGMAT DEVELOPMENTS

PO BOX 200 BRENTWOOD ESSEX CM15 8QG

Tel.: 0277 200 210 Fax: 0277 201 225

(p&p: additional £2.50 UK, £5.50 outside)

USA: Something Worth Hearing, Rochester, N.Y.

Tel.: 716 461 1295

TAIWAN: Taifu Electronic Corporation, Taipei,

Tel.: 8862 341 9137

GERMANY: Fortissimo, Düsseldorf, Tel.: 211 482 372

# "Excellence amongst mediocrity"



*Linn Naim Rega Arcam Quad Audiolab  
Royd Kef Epos Mission Nakamichi Denon  
Rotel Teac Micromega*

Access & Visa  
% Finance  
BADA

**Real Hi Fi**

Hear the difference

Demonstration  
Installation  
Service

**BETTER HI-FI**

The Essence of Music.....

16 COOK STREET, LIVERPOOL L2 9RF ☎ 051-227 5007



# V' audio

Hi-Fi Consultants

## 'After the Ramada Show'

Yet another show gone by - though little of outstanding quality from the sound point of view. It's nice to see British Amplifier build quality improving so that it competes favourably with European Standards, but still disappointing to find that most European Speakers sound just clear and seldom plummet the depths. As a result although many of the European amps may have been good you could'nt tell because of the speakers. We will be investigating some however so watch this space.

In the meantime we will be demonstrating our favourite amps from AVI, Heybrook, Chord, Electrocompaniet, Triangle, Cadence and Audio Innovations Valves, AMC Hybrid. New items are the 100 Watt Integrated (complete with R/C) from AVI plus it's matching CD Player, selling for £799 and £899 respectively, available mid-Oct. If anyone is interested in hearing the powerful American Boulder Amps that can be arranged, and the big Alon V is worth hearing if in the market for a big powerful sound and you have a large room. We have'nt yet got in any of the large 'TOCA' stone fronted Amps that you may have seen downstairs but we will have the 22 Watt Single-Ended Class 'A' Power Amp which is superb on the ESL 63's. One thing is certain - you'll hear better sound here than you did at the show!

Ian C. Vaudin

36 Druid Hill, Stock Bishop,  
Bristol BS9 1EJ.

Tel. Bristol (0272) 686005 (+ Fax)



# Hi-Fi World Dial-a-Dealer

**AUDIO EXCELLENCE** 'Where the music matters', 65 Park Street, Bristol BS1 5PB Tel. 0272 264975 Fax: 0272 251327. Great Hi-Fi carefully selected and demonstrated by friendly enthusiastic staff. Home installations and check-ups. Two year warranty from our own service department. Open 9.00-5.30 Tuesday - Saturday closed Monday.

**PAUL GREEN HI-FI LTD.** Kensington Showrooms, London Road, Bath. Tel. (0225) 316197. Musical Fidelity, Krell, Creek Rogers, Quad, Cust. car park Best selection in the West.

**VAUDIO**, 36 Druid Hill, Stoke Bishop, Bristol, BS9 1EJ. Tel. 0272 686005. ATC, Acoustic Energy, Ruark, AVI, Exposure, Pink Triangle, Wadia, Audio Innovations, SME (incl 20A), Chord Amps, Michell, AMC, Analogue Electronics, Cadence Valve, Jamo, LFD, REL, Sansui, Sonic Link, Stax, Townsend, Audio Technica, Goldring, Lira, Ortofon, Sumiko. Demos by appt only. Home trial facilities. Free install. Service Dept.

**WENTWORTH AUDIO**, 83 High Street North, Dunstable, Beds. NUG 1JJ. Tel: 0582 6633 83. Marantz, Pioneer, Rotel, Audiobab, Mission, Cyrus, Moth, Sony, HK, NAD, Pink Triangle, Yamaha, Systemdek, Albury, etc. Free installation & delivery. Home dems. Part exchange. Interest free credit - 6.9, 12, 18 & 24 month terms. Free car parking at rear of shop. Free refreshments (alcoholic or otherwise!) Open 10-6pm Tues-Sat

**TECHNOSOUND LTD.** 79 West Street, Dunstable. Beds. Tel: 0582 663297 - See our main entry under Bucks

**NEWBURY AUDIO**, 2 Weavers Walk, Northbrook Street, Newbury, Berks. RG13 1A1. Tel. 0635 33929 Linn, Creek, Epos, Denon, Nakamichi, Shahinian, Marantz, Micromega, J.P.W. Ruark. Single speaker dem room. Appt necessary. Home trial facilities. Free install. Service dept. late appts. Access: Visa. Interest free credit subject to status. 6 days 9.30am - 6.00pm.

**ARC AUDIO**, 9 Dukes Ride, Crowthorne, Berks. RG1 16L. (0344) 762201. Denon, Harman Kardon, J.P.W. Marantz, Monitor Audio, Dnyx, Rogers, Tannoy, Thorens, Yamana. Demonstration facilities, no appointments necessary. Home trial facilities. Free installation. Access: Visa. Diners. Open Mon-Sat 9-6pm (closed Wed & 1pm)

**READING HI-FI CENTRE**, 4 Queen's Walk, Reading RG1 7QF. Tel. 0734 585463. "The best equipment, advice and service from Berkshire's premier Hi-Fi emporium". Products include Arcam, exposure, Audiobab, Meridian, Rotel, Sony, Sennheiser, Top Tape Centre, and many more.

**ASTLEY AUDIO**, Wallingford, 0491 839305. See our entry under OXFORDSHIRE

**D.L. CHITENDEN LIMITED**, 59-61 The Broadway, Chesham, Bucks. HP5 1BX (Opposite Boots). Tel. 0494 784441. Philips, Denon, Kenwood, Canon Audio, Koss, Wharfedale, Mitsubishi, Target, Grundig, QED, Mordaunt-Short, Toshiba, Dolby Pro-Logic Systems, Nicam TV and Video, Surround Sound, AV Systems. Showroom Demonstrations from expert and friendly staff. No appointments necessary. Service Department. Credit facilities available. Open 8.30 to 5.30 Mon-Sat.

**AUDIO INSIGHT** - 53 Wolverton Rd, Stony Stratford, Milton Keynes. Bucks - 0908 561551 - See our main entry under Technosound.

**DEJAC HI-FI Consultants**, 21 The Broadway, Old Amersham Bucks. HP7 0HL. Tel. (0494) 433173. AMC, Arcam, Bose, Meridian, Quad, Denon, NAD, Tannoy, Mission, TDL, 2 dem rooms. Appts necessary. Free installation, Tricity finance, instant credit. open 9.30-5.30 pm, including Saturdays

**NORTHWOOD AUDIO II**, 98 Cambridge St, Aylesbury, Bucks HP20 1BA. Tel. 0296 28790 (A/P). Selected sounds from Alchemist, Aura, Boston, B & W, Cabletalk, Castle, Celestion, Denon, Exposure, Gyrodek, Harman Kardon, Heybrook, Marantz, Micromega, Monitor Audio, Moth, NAD, Nakamichi, Rose, Rotel, Royd, Ruark, Systemdek, Tannoy, TDL, Thorens etc. Export orders welcome. 2 Dem rooms. Credit facilities available.

**TECHNOSOUND LTD**, 7 Granville Square, Willen, Milton Keynes. MK15 9JL. Tel. 0908 604949. Audiophile Hi-Fi Specialists. All major brands stocked from Arcam to Yamaha. Demonstration facilities and expert advice. Mon-Sat 9.30-5.30. Late night Friday. Credit Cards accepted. Finance available.

**CAMBRIDGE HI-FI**, 1-3 Hawthorne Way, Chesterton, Cambs. CB4 1AT. Tel. 0223 67773. Kenwood, Pioneer, Arison, Kef, Technics, Yamaha, Marantz, B&W, AR, Mordaunt-Short, Bose. Single speaker dem room. Tues-Sat 9.30-5.30pm. Closed Monday. Free install, service dept. Vis/Access credit facilities.

**STEVE BOXSHALL AUDIO**, 41 Victoria Road, Cambs. CB4 3BW. Tel. 0223 66305. 10.00-6.00pm 6 days, 3 dem/rooms. Denon, Rotel, Yamaha, Mission, Nakamichi, Tannoy, Audiobab, Marantz, Krell, Martin Logan, Magneplanar, Wadia. Home trial facilities. Appointments preferred. Free install and service dept. Access: Visa.

**FENWAY**, 5 High St, Ely. Tel. 0353 664421. Contact Gary Holland For Sony, Technics, Rotel, Tannoy, Pioneer, QED, equipment and accessories. Demonstration facility, In-House Service Dept.

**SWIFT HI-FI**, St. Annes Parade, Wiltshire. 0625 526213. Aura, B&W, Denon, Kenwood, Marantz, NAD, Pioneer, Rotel, Systemdek, Tannoy, Revolver, J.P.W., M. Short, Mission, Celestion, Technics, Audiobab, Castle. Open 9.30-6. Dem room. No pressure. BADA member.

**THE HI-FI SHOWROOMS**, 12A West Str. Congleton, Cheshire (0260)280017. 1 Stanley St. Leek(0533)383780. Celestion, Creek, Exposure, Marantz, Musical Fidelity, Pink Triangle, Project, Rotel, Ruark, Systemdek, Tannoy, Technics, 5 Dem Rooms. Noappts necce. Home trial. Free install, Service dept. Access: Visa. Lombard Tricity. Open 9-5.30 Closed Wed.

**HALE HI-FI**, 2 Bold St, Hale Road, Altrincham, Cheshire WA14 2ER. Tel: 061 929 0834. Open Mon - Sat 10am-6pm & later by appointment. Specialising in equipment by: Naim, Quad, Royd NAD. Denon plus selected others. Large range of quality accessories. On site service department. Installation & delivery. Home demonstrations a pleasure.

**ASTON AUDIO**, 4 West Street, Alderley Edge, Cheshire. Tel. 0625 582704. Products include: Celestion, Creek, Yamaha, Monitor Audio, B&W, Avira, Aura, AKG, Musical Fidelity, Tannoy, Sennheiser, Marantz, Dual, Denon, Quad, Sansui, Technics, Spondor, Mission, SME, Nakamichi, Audiobab, Rogers, Audioquest, Mordaunt-short, Meridian, Deltac, Roksan, Arcam, Kef, NAD, Cyrus and others. Discount CD and tape. Extended guarantee, interest free credit and written details on request.

**CHRIS BROOKS AUDIO**, 29 Gaskell Street, Stockton Heath, Warrington, Cheshire, WA1 2UN. Tel: (0925) 261212. Tues-Sat 10.00-6.00. 2 dem-rooms. credit facilities. All credit cards. Established 1978. Total absence of bulls\*\*t.

**CONGLETON HI-FI**, 1/1a Duke St, Congleton, Cheshire CW12 1AP. (0260) 297544. Acoustic Energy, Arcam, B&W, Denon, Epos, Linn, NAD, Nakamichi, Dnyx, Royd, Target, etc. Superiorly appointed single speaker dem facilities. No appointments necessary. Home trial facilities, free installation. 2 year guarantee on all equipment. Access: Visa. Open Mon-Sat, closed Weds.

**DOUG BRADY HI-FI**, Kingsway Studios, Kingsway North, Warrington, Cheshire, WA1 3NW. (0925) 828009. "Largest choice of specialist hi-fi in NW. All credit cards. 3 dem rooms. Fair demonstrations and home trial facilities. Open 6 days.

**PRACTICAL HI-FI**, 88 Briqge Street, Warrington, WA1 2RF. Tel: 0925 632179. See our main entry under Preston. Lancs

**GILSON AUDIO LTD**, 172 Borough Rd, Middlesbrough (0642) 248793. Linn, Exposure, Arcam, Mission, Cyrus, Denon, Marantz, Rotel, Pioneer, Audiobab, Tannoy, Demonstration facilities in main shop and one demonstration room. Appointments necessary. Home trial facilities. Free installation on request. Service department. Access: Visa. H.P. 10-5-6 days.

**ACTION LOGISTICS**, 155-157 High Street, Redcar, Cleveland. TS10 3AN. 0642 480723. Audio Innovations, Denon, Harman Kardon, JBL, Michell, Musical Fidelity, Pink Triangle, Revox, Rogers, Thorens, etc. Dem room. Appointments nec. Home trial facilities, free installation. service dept. Access: Visa & HP. Open 9.15-5.30.

**RJF AUDIO VISUAL**, 84 Pendarves Street, Tucking Mill, Camborne, Cornwall. TR14 8NJ. 0209 710777/612260. TDL, Michell, Musical Fidelity, NAD, Nakamichi, B&W, SME, Micromega, Pink Triangle, Pro-ject, Perception, Harman Kardon, Tannoy, Integral, dem/room/showroom and special home dems. Appts nec. home trial, free install, service dept. All cards Switch and Transax. Open Mon-Sat 9.30-5.30

**HI-FI EXCHANGE DARLINGTON**, 30a Larchfield Street, Darlington, County Durham. The North's only used Hi-Fi Specialist. Hear our Quad, Naim, Oracle, Neat, Thorens etc. Separate Dem Room. 3 months warranty on all systems. Full range of leading Japanese makes Technics, Sony etc. Tel: 0325 463007

**MISON'S SOUND & VISION**, 11 Warwick Road, Carlisle CA1 1DH. Tel: (0228) 22620. Bang & Olufson, B & W, Castle, Sonic

Link, Quad, NAD, Yamaha, Sony, Rotel, Demo Suite. No appts nec. Home trial facilities. Free installation. Service Department 9 - 5.30 Mon - Fri. Thurs 9.1-9.1 Sat - 9 - 5

**PETER TYSON** 6 Abbey Street, Carlisle, Cumbria. CA3 8TX. 'Cumbria's premiere hi-fi centre'. Part exchange welcome (0228) 46756. Linn, Musical Fidelity, Cyrus, Marantz, Denon, Philips, Nakamichi, Technics, Pioneer, Creek and more. Dem Rooms. Dem's without obligation. Home trial. Free installation in-house service dept. Access: Visa, HP. 9-5.30pm

**PRACTICAL HI-FI**, 106 English Street, Carlisle, CA3 8ND. Tel: 0228 44792. See our main entry under Lancaster.

**THE HI-FI ATTIC**, 58 New George St, Plymouth, Devon PL1 1RR. 0752 669511. We stock most leading brands including Linn, Arcam, Denon, Pioneer, Musical Fidelity amongst others, and have an expert enthusiastic staff. Premises include attractive hi-fi and home cinema demonstration rooms. We offer free installation and credit facilities (written details on request) also a fully equipped service department. We can also provide a mail order service for all your LaserDisc requirements. We accept Visa. Access: Amex.

**CELESTION HI-FI**, 38 Walnut Road, Chelston, Torquay, Devon TQ2 6HS. Tel: (0803) 608663. Denon, Marantz, Rotel, Musical Fidelity, Acoustic Energy, NAD, Castle, Heybrook, Celestion, J.P.W. etc. Two dem rooms. Home trial. Free installation. Access: Visa, Amex. Diners. HiFi Markets Chgecard. Credit facilities. 9.30-7.30 Mon-Fri. 9.30-6.00 Sat

**UPTON ELECTRONICS**, 31 Torquay Road, Paignton, Devon TQ3 3DT. Tel: 0803 551329. Pioneer Reference Point Dealer. Denon, Sony, Technics, Harmon-Kardon, Dreile, Kinshaw, Creek, Quad, Audio-Innovations, Target, Tannoy, Mordaunt-Short, Castle, TDL, Ruark, J.P.W. Royd, Project, Monitor-Audio, Micromega, Chord, van den Hul, Jamo. Full range of accessories etc. Demonstration room. Home dems. free delivery and installation, own in-house service dept. Access: Visa, Amex. Credit facilities 9.00 - 5.30, 9.00 - 1.00 Wed

**STRAD TRADITIONAL AUDIO**, 29 Meadowfield, Whaleybridge, nr Buxton, Derbyshire SK12 7AX. Tel. 0663 733383. We construct custom made reproductions of classic 1950's loudspeaker enclosure designs using authentic blueprints. These have never been bettered for valve amplification. Requests for specific designs considered and researched. Superb new speaker units from Richard Allan and Lowther are used.

**ACTIVE AUDIO**, 12, Dsmaston Street, The Spot, Derby. Tel. 0332 380385. Fax 0332 385185. We have three studios including a dedicated Audio Visual studio for the demonstration of quality equipment from the largest range in the Midlands. Open six days per week. Own service department. Free local delivery. Home trial facility. Current special offers and buyers fact pack and quotation on request.

**DFWSONS**, 23 Seamount Road, Westbourne, Bournemouth. Dorset. 0202 764965. B&O, Castle, Canon, Jamo, JBL, Pioneer, Sony, Target, TDL, Technics. No appts necessary. Free installation. Service dept. Various credit facilities available. Open 9-5.30 6 days a week

**SUTTONS HI-FI**, 18 Westover Road, Bournemouth, Hants. Tel. 0202555152. Linn, Arcam, Mission, Quad, Audiobab, Rotel, Yamaha, Denon, etc. 2 single speaker listening rooms. Home demonstrations and free installation. Mon-Sat 9.00-5.30. Call for details

**BRENTWOOD HI FIDELITY**, 2 Ingrave Road, Brentwood, Essex. CM15 8AT. Tel. 0277 221210. Aura, Audio Innovations, Castle, Chord, Crimson, Denon, DNM, E.A.R., Impulse, Marantz, Mission, Micromega, NAD, Pink Triangle, Project, QUAD, Ruark, Rehdero, Shearne Audio, Systemdek, Tannoy, TDL, Thule Audio Single speaker dem rooms, home trials, dems and installations. Mon-Sat 9.30-5.30. Access: Visa, service facilities. Simply THE place to visit if you're serious about music.

**TWENTY 20 AUDIO VISUAL LTD**, Unit 205 Lakeside Shopping Centre, West Thurrock, Grays, Essex DM16. Tel. 0708 891818. Fax: 0708891300. For your total home entertainment requirements. From a 2" Casio to a 50" Pioneer screen. Dolby surround specialists with three dem rooms dedicated to polylog, laser disc software in stock, from Harman Kardon, Pro Logic from Yamaha, Marantz, Pioneer, Technics, Kenwood & B&D.

**RAYLEIGH HI-FI**, Chelmsford, 216 Moulsham St. 0245 265245. RAYLEIGH HI-FI, Rayleigh, 44a High Street. 0268 779762. RAYLEIGH HI-FI, Southend, 132/4 London Rd. 0702 435255. Over 21 years experience of supplying the best. "The best dealer, the best Hi-Fi equipment, the best service" Carefully selected Hi-Fi from: Arcam, Audiobab, Cyrus, Denon, Epos, Linn, Meridian, Mission, Naim, Nakamichi, Quad, Rega, Roksan, etc. etc. .... 3 years guarantee on Hi-Fi systems. 0% credit facilities.

**AUDIO T**, 44244 Cranbrook Road, Gants Hill, Ilford, Essex, IG2 6LL. (081) 518 0915. Fax (081) 554 8463. Great Hi-Fi from Arcam, Audiobab, B&D, Bose, Cyrus, Denon, Kef, Marantz, Meridian, Mission, Micromega, Nakamichi, Rotel, Sony, Yamaha & many more. Mon-Sat 10-6. 3 year guarantee on Hi-Fi. Free delivery & installation. 30 day free upgrade scheme. Home demonstrations. Part exchange. 2 listening rooms. Home Cinema specialists. BADA Bonded.

**AUDIO EXCELLENCE 'WHERE THE MUSIC MATTERS'**, 58 Bristol Road, Gloucester GL1 5SD. Tel. 0452 300046. Fax: 0452 310680. Great Hi-Fi carefully selected and demonstrated by friendly enthusiastic staff. Home installations and check-ups. Two year warranty from our own service department. Open 9.00-5.30 Tuesday - Saturday closed Monday.

**AUDIO T**, 40-42 Albion Street, Cheltenham, Gloucestershire, GL52 2RQ. (0242)533960. Fax (0242) 226435. Great Hi-Fi from Arcam, Audiobab, Denon, Epos, Linn, Marantz, Meridian, Mission, Quad, Rogers, Rotel, Yamaha, & many more. Mon-Fri 10-6. Sat 9.30-5.30. 3 year guarantee on Hi-Fi. Free delivery & installation. 30 day free upgrade scheme. Home demonstrations. Part exchange. Single speaker listening room. BADA Bonded.

**ALCHEMIST**, Near Petersfield, Hampshire, Mana, Castle, Alchemist, Albarry, Audio Innovations, Wadia, Deltac, Tube Technology, Denon, Pioneer, Alphason, Tripod, NAD, Teac, Audio Alchemy, Klipsch, AMC, Proac, J.P.W. Moth, Pink Triangle. Mail order cabinets supplied to order in any size, wood & hand painted finishes, stone-granite-marble shelving. For a demonstration with home comforts call us for an appointment on 0730 895194

**HOPKINS HI-FI**, 'FOR THE BEST SEAT IN THE HOUSE' experience home cinema sound with Technics, Denon and Kenwood Award winning products. Now on demo at HOPKINS HI-FI. 38-40 Fraiton Road, Portsmouth, Hants, PO1 5BX. Tel. 0705 822 155, Fax 0705 830 753

**HAMPSHIRE AUDIO LTD.**, 2-12 Hursley Road, Chandlers Ford, Hants SD5 2FU. (0703) 252827/265232. 3 hi-fi and 2 home cinema surround sound dem studios. Thurs late evening, closed Mondays (except in December). Service dept on site (2 yr guarantee). Large free car park - junctions 4 (M27-M3), 5 (M27), 12 (M3) and 13 (M3) all within 3 miles, est. 1969

**AUDIO T**, 4 Feathers Lane, Basingstoke, Hampshire, RG21 1AS. (0256) 24311. Fax (0256) 24430. Great Hi-Fi from Arcam, Audiobab, Denon, Linn, Meridian, Mission, Naim, Rotel, Sony, Yamaha & many more. Mon-Sat 9.30-5.30. 3 year guarantee on Hi-Fi. Free delivery & installation. 30 day free upgrade scheme. Home demonstrations. Part exchange. Single speaker listening room. BADA Bonded.

**ENGLISH AUDIO**, 95 Whitecross Road, Hereford, HR4 0DG (0432) 355081. Musical Fidelity, Arcam, Castle, Ruark, Rogers, J.P.W. Micromega, Chord, Audion, Systemdek, Heybrook, Kef, Stax, Pink Triangle, Denon, Marantz, Mission, Cyrus, A.I., Rotel, NAD, Nakamichi, TDL and others. Single speaker dem room. Home trial facilities. Free installation, service dept, Access: Visa. Credit arranged. Open Mon-Sat, 10-6pm. BADA members

**DAVID ORTON AUDIO VISUAL**, 6-8 Bancroft, Hitchin, Herts. Tel: 0462 - 452248. Mission, Cyrus, Denon, Pioneer, Marantz, Aura, Kenwood, Rotel, Ruark, Celestion, JVC, Polk and many more. Open Mon-Sat 9.30-5.30. All major credit cards accepted. Finance available. (See our main advert pg 106)

**DYNAMICS**, Welwyn, Herts - Europe's largest stockist of ex-dem and second hand equipment. High End Audio - Bought, Sold or Exchanged. Many items in stock (see our main ad pg. 128). Efficient servicing Dept. All items guaranteed. All major credit cards accepted. Please telephone 0438 - 714038 for appointment.

**GO SPEL MUSIC AUDIO**, 32a High Street, Kington, Herefordshire, HR5 3BJ. (0544) 230254. Alphason, Allison, Revolver, Luxman, Yamaha, QED Audio, Systemline

**ACOUSTIC ARTS LTD**, 101, St Albans Rd., Watford, Herts. 0923 242520. Fax 0923 230798. Absolute Sounds, Adcom, Acoustic Energy, Audiobab, Chord, Denon, Marantz, Meridian, Dreile, S.M.E., T.D.L. 3 dem rooms, multi-room & home theatre. Expert installation. Credit facilities available. Tues-Sat 10-6.

**STUDIO 82**, 82 High Street, Harpenden, Herts AL5 2SP. 0582 764246. Fax 0582 467022. ATC/AVI, Arcam, Aura, Audiobab, B&D, Denon, Epos, Mission, Cyrus, Naim Audio, Nakamichi, Quad, NAD etc. Quiet single speaker dem room. Appts nec. Home trial, free installation. Service dept. Visa. Access and finance terms. 9-5.30 (Mon-Sat) Closed Weds.

**THE AUDIO FILE**, 27 Hockerill St., Bishop's Stortford, Herts. CM23 2DH. Tel. 0279 506676. Fax 0279 506638. Linn, Naim, Roksan, Quad, Rega, Mission, Arcam, ProAc, Marantz, Sony etc. 4 dem rooms, installation service. Min 3 year warranty, 0%, BADA.

# Hi-Fi World Dial-a-Dealer

**HERTFORD MUSIC.** We want you to feel good when choosing your system in our 3 demonstration rooms (and bar!). Systems from budget to £15,000. Products include: CR Developments, Micromega, REL Acoustics, Acoustic Energy, Michell, Magnon, Diamond Acoustics, Beard, Lumley, Renaissance etc. Access/Visa Mail Order. Please telephone: 0992 442425.

**RADETT AUDIO,** 141 Wailing Street, Radlett, Herts. WD7 7ND Tel: 0923 856497. Mark Levinson, Proceed, Proac, Magnepan, Martin Logan, Tube Technology, Teac, Roksan, Audiobab, Stax, Systemdek, Jards, Copland, ATC, Audio Alchemy, AVI, EAR, Sumiko, Quad Sonus Faber. Home trial facilities: free installation, Service Dept. Visa/Access 9-5.30 Mon-Fri 10-5.30 Sat.

**REVEX SERVICE & REPAIRS,** Suite 10, Smugock Business Centre, Lye Lane, Bucklewood, Herts. AL2 3UG. Tel: 0923 893711. Seventeen years experience, ex-Bauch. Authorised agents for Revex products: sales and spares. All repairs carried out are guaranteed. Fast turnaround. Any enquiries telephone: 0923 893711.

**ZEN AUDIO** - George Street, Hull Tel: (0482) 587397 - Evening (0964) 670849. Audiobab, Audio Innovations, Aura, B&W Cabletalk OPA, Heybrook, JPW KAR, Micromega, Michell, Harmon Kardon, Impulse, RuArk, Rotel, Sugden. Comfortable Listening Room. Home trial facilities, free installations - personal friendly service.

**PROGRESSIVE AUDIO,** 2 Maryland Court, Rainham, Nr Gillingham, Kent. ME8 8DY. Tel: 0634 389004. Agencies include: Audio Innovations, Audion, Audionote, Audiostatic, Audiotechnica, Chord amps, Cogan Hall, Conrad Johnson, Convergent, DALI, Decca, Eminent Technology, Goldring, Impulse, Koetsu, Levinson, L.F.D. Lyr, Lumley Reference, Meridian, Michell, Micromega, Moth, Origin Live, Pink Triangle, Proac, Proceed, Ruark, Silversounds, SME, Sugden, Sumiko, Systemdek, Snell, Target, T.O.L., Transfiguration, Townshend, Tube Technology, Voyd, V.P.I. etc. etc. Demonstrations by appointment please.

**JOHN MARLEY HI-FI CENTRES,** 2 Station Road, West Canterbury (0227) 769329. Also at Dover - 0304 207562. Arcam, Aura, B&W, Heybrook, JPW, Proac, Pioneer, Rotel, Ruark, Tannoy, Technics. Dem rooms and home trial facilities. Mon-Sat 9-5.30. Thurs. Free install. Credit to £1,000. Access/Visa and credit charge. Service Dept.

**KIMBERLEY HI-FI,** 193 Broadway, Bexleyheath, Kent. Tel: 081 3043272. Pioneer, Technics, Kenwood, Marantz, Denon, NAD, Aiwa, Tannoy, Mission, Rotel, Wharfedale, Castle. Separate dem room, no apt necessary. Free installation, service dept. instant credit facilities. no early closing.

**V.J. HI-FI,** 29 Guildhall Street, Folkestone, Tel: 0303 256960. Mon-Sat 9-6. NAO, Yamaha, Marantz, Sony, Tannoy, Denon, Kenwood, Rogers, Musical Fidelity, Quad, Aiwa, Heybrook, Castle, Mission, Yamaha, REL, JBL, Polk. Dem rooms in both stores. Free install. Credit facilities available. Specialists in home theatre. Amex, Diners, Visa, Access, Service Dept. We are BADA dealers.

**THE WESTGATE HI-FI,** 2 Station Road West, Canterbury, Kent. 0227 769329. Suppliers of quality hi-fi equipment including: Arcam, Akai, Aura, B&W, Denon, JMW, JPW, Mordaunt Short, NAO, Panasonic, ProAc, Quad, Rotel, RuArk, TOL, Technics, Tannoy. Part exchange, listening room. Service and repairs. Credit facilities. Access/Visa. Open 6 days 9-5.30.

**DOVER HI-FI,** 43 High Street, Dover. Tel: 01392 207562. Suppliers of quality hi-fi equipment including: Arcam, Akai, Aura, B&W, Denon, JMW, JPW, Mordaunt Short, NAO, Panasonic, ProAc, Quad, Rotel, RuArk, TOL, Technics, Tannoy. Part exchange, listening room. Service and repairs. Credit facilities. Access/Visa. Open 6 days 9-5.30.

## LANCASHIRE

**AUDIO CLASSICS,** 8 Lowe Mill Lane, Hindley, Wigan, Lancs. WN2 3AF. Sorry but we are unable to answer queries in writing. I buy, sell, modify and repair all vintage and valve hi-fi equipment. Advice is free. New equipment by EAR, Croft, Ortofon and more soon. Phone it just for a chat. Credit cards accepted. Quick worldwide delivery, callers by appointment. Tel: 0942 57525 or Fax: 0942 525861. 7 days a week.

**ROMENS HI-FI CENTRE,** 94-96 High Street, Rishton, Blackburn, Lancs. Tel: 0254 887799. Stockists of: Sony, Esprit HiFi, Technics, Marantz, Musical Fidelity, Pioneer, Kenwood, Rotel, Tannoy, Mission, Ruark, B&W and many others. Dem room, service dept, free delivery and installation (local area) Access/Visa and Switch.

**PRACTIAL HI-FI,** 43 Friargate, Preston. Tel: 0772 883958. The audio visual specialist, expert advice, instant demonstrations, best prices, instant free credit, part exchange welcome. Extended warranty. Stockists of: Yamaha, Kenwood, Denon, Sony, Technics, Onkyo, Marantz, Pioneer, Mission, Kef, Jamo, Celestion, B&W. Also stockists of LaserDiscs.

**PRACTICAL HI-FI,** 84 Penny Street, Lancaster, LA1 1XN. Tel: 0254 39657. See our main entry under Lancaster.

**PRACTICAL HI-FI,** 33/35 Knowlesy Street, Bolton, Lancs. Tel: 0204 395789. See our main entry under Lancaster.

**PRACTICAL HI-FI,** 10 Preston New Road, Blackburn, BB2 1AW. Tel: 0254 691104. See our main entry under Lancaster.

**PRACTICAL HI-FI,** 81 Whitegate Drive, Blackpool, FY3 9DA. Tel: 0253 300599. See our main entry under Lancaster.

**LEICESTER HI-FI COMPANY,** 6 Silver Walk, St Martin's Square, Leics. LE1 5EW. Tel: (0533) 539753. Fax: (0533) 626097. Acoustic Energy, Arcam, Marantz, Micromega, Mission, Cyrus, Musical Fidelity, Nakamichi, Meridian, Rogers, Roksan and 'oddes more'. 2 dem rooms, home trial arranged, free install, service dept. Credit facilities. Access/Visa/Diners/Amex. 6 days 9.30-5.30.

**THE LISTENING ROOMS,** 6 Hotel Street, Leicester. Tel: 0533 623754. Fax: 0533 623758. Linn, Audiobab, Arcam, Tannoy, Definition, Denon, Rotel, Nad, Heybrook, TDL etc. Open 10.00-5.30 (Six days.)

**STEREO SHACK,** 1-3 Guildhall Lane, Leicester. Tel: 0533 530330. Aiwa, A.R., Denon, Kenwood, Jamo, Mission, NAO, Philips, Pioneer, Home Cinema specialists. Free installation. Open 9.30-5.30 6 days. Credit available.

**WIMBORNE AUDIO,** 65a Wide Bargate, John Adams Way, Boston. Lincs PE21 6SG. Tel: 0205 365477. Quad, Nakamichi, Arcam, Marantz, NAD, Castle, Tannoy, Rogers etc. Separate demonstration studio inc. home cinema. Free installation. Access/Visa Tues-Sat 9-5 pm.

**COTTAGE AUDIO,** 17 Bridge Street, Saxilby, Nr Lincoln. LN1 2PZ. Tel: (0522) 702834. Evenings (0522) 696708. ATC, AVI, Chord amplifiers, Harbeth, LFD, Michell, Origin Live, Kinshaw, QED, Royo, Sansui, Sequence, Something solid, Sonic Link, etc. Demonstration rooms. Home trial facilities. Free installations and above all a personal, friendly service.

**STAMFORD HI-FI CENTRE** - 9 Red Lion Square, Stamford, Lincs. PE9 2AL. (0708) 62128. Pioneer, Technics, Cyrus, Mission, Rotel, NAO, Yamaha, Kenwood, Marantz. Quad plus all major speaker manufacturers. Expert Advice. Comparison demonstrations, part-exchange HiFi purchased for cash. No appts necessary. Home trial facility free installation. Service Dept. Mastercard, Visa and credit charge. Mon-Sat 9.5-3.30 pm. Closed Thursdays.

**ANALOG AUDIO,** 849 High Road, Finchley, N12. (081) 445 3267. For friendly service and advice. AR, AKG, Allison, AT, Cerwin, Vega, Denon, Dual, Harmon Kardon, Jamo, Infinity, Marantz, NAD, Pioneer, Rotel, Revolver, Sonab, Teac, Thorens, Tannoy, Wharfedale, Yamaha. Speaker cables and accessories. Free installation service.

**AUDIO CONCEPT,** 27 Bond Street, Ealing, W5 5AS. Tel: (081) 567 8703. Acoustic Energy, Audiobab, Aura, B&O, B&W, Boston Acoustics, Canon, Castle, Denon, Dual, Evolution, Infinity, JPW, Kef, Marantz, Mission, Monitor Audio, Musical Fidelity, NAO, Nakamichi, Onix, Quad, Revox, Rogers, Rotel, Systemdek, Target, Teac, Thorens, Van den Hul, Two dem rooms. Interest free credit, free local delivery & installation, service department. Hi-Fi Specialists without the attitude.

**BABBER ELECTRONICS,** 158 Uxbridge Road, West Ealing, London. W13 8SB. (081) 579 6315. Akai, Aiwa, A&R, Celestion, Dual, Godmans, Harman, Kardon, JBL, JVC, Kenwood, Marantz, Panasonic, Sennheiser, Sony ES range, Tannoy, Technics, Wharfedale, Yamaha.

**THE CARTRIDGE MAN** - Front end problems? It doesn't have to cost an arm and a leg to get the best listen to your Koetsu - and - Decca - Eater. Also agents for Croft, Sugden, Thorens, Pentachord Speakers and Notts Analogue. (Plus a cartridge re-tipping service. Tel: 081 688 6565.

**GOLF ELECTRONICS,** 311 Kentish Town Road, NW5 2TJ. Tel: 071 482 2518. Fax: 071 284 3381. Authorised dealers for: Sony, Panasonic, Aiwa, Akai, Mitsubishi, Philips, Grundig, Bose. We carry an extensive range of hardware from Walkmans to camcorders, including a wide range of TV and video equipment. Free local delivery & installation on selected items. Open 10-6 Mon-Sat. We regularly have special offers on different products. A visit to GOLF ELECTRONICS could save you £££s.

**HI-FI & COMPONENTS,** 84 Battersea Rise, London, SW11 1EH. (071) 223 1110. Denon, Tannoy, NAO, Rotel, Bose, Dual, QED, Wharfedale, Jamo, Celestion, Kenwood, Ortofon, Infinity, Shure, to name but a few! Established over 29 yrs. Appts necessary. Service dept. 10-6 (closed Weds).

**HIFI EXPERIENCE,** 227 Tottenham Court Road, London W11 071 580 3535. Arcam, Audiobab, Mission, Cyrus, Quad, Celestion, Kef, Meridian, Rogers, Tannoy, Yamaha, TDL, Thorens, Marantz, Nakamichi, Musical Fidelity and many more. Open 10.00-7.00 Mon-Fri. 9-6 on Sat. Service dept. Credit facilities, delivery and free installation.

**THE HIFI SURPLUS STORE,** 62 Weymouth Street, W1 Tel: 071 486 9981/071 935 7582. Stock a full range of goods including: Aiwa, Akai, B&W, Bose, Dual, JVC, Jamo, Kenwood, Marantz, Mordaunt-Short, Mission, NAD, Pioneer, Rotel, Sony, Technics, Teac, Thorens, Tannoy, Wharfedale. Full range of "Target" speaker stands always on stock. All goods are brand new in sealed cartons with full 1 yr guarantee. We guarantee you can not buy cheaper elsewhere. Give us your genuine quote and we will beat that price by £10 (goods must be in stock). Access/Visa welcome. Open Mon-Sat 9.30-6pm. Late night 'tilf 6.30 Thurs.

**KAMLA ELECTRONICS,** 251 Tottenham Court Road, London W1P 9AD. Telephone: 071 323 2747. Fax: 071 637 2690. Acoustic Research, Aiwa, Akai, Albarray, Alchemit, Alphason, Audio Alchemy, Audio Innovations, Audio Technica, Audioquest, Aura, Audiostatic, B&W, Cerwin Vega, Conrad Johnson, Copenhagen, Furukawa, Goldring, Infinity, IXOS, JPW, JVC, Kef, Kenwood, Kuzma, Linwood, Maxwell, Micromega, Mitsubishi, Monster, Mordaunt Short, Moth, Nakamichi, Ortofon, Ortofon, Panasonic, Pioneer, Proac, QED, Rotel, Ruark, Sansui, Stax, TDK, and many more!

**K J WEST ONE,** 26 New Cavendish St., London W1M 7LH. 071 486 8262/63. Fax: 071 487 3452. Two hi-fi & dedicated home cinema dem studios. Appts pref. Home trial installation by arrangement. Service dept. Major credit cards. Interest free credit on selected items. Major brands stocked. Acoustic Energy, Arcam, Audio Innovations, Audio Technica, Audioquest, Aura, Audio Research, B&W, Chord, OPA, Epos, Impulse, Krell, Martin Logan, Meridian, Michell, Musical Fidelity, Nakamichi, Nifty, Gritty, Orelle, Pink, ProAc, Quad, Roksan, Sonus Faber, Stax, Tannoy, Theta. Open 6 days.

**BILLY VEE SOUND SYSTEMS,** 248 Lee High Road, London SE13. (081) 318 5755. Arcam, Linn, Naim, Quad, Creek, Cyrus, Marantz, Nad, Rotel, Rega, Denon, Yamaha, Tannoy, Mission, Micromega, Heybrook etc. 2 dem rooms instant free credit. Access/Visa. Closed Thursdays.

**CONNECTIONS,** 13 John Prince's Street, London W1M 9AH. Tel: 081 348 5676. Dealers in: Absolute, Audio Note, Audioquest, Oeltec, Harmonix, Kimber, Mandrake, MIT, Siltech, Symo, Van den Hul, WBT and others.

**THE LISTENING ROOMS,** 161 Old Brompton Road, London SW5 0LJ. (071) 244 7750/59. Fax: (071) 370 0192. Linn, Quad, Meridian, Nakamichi, Arcam, Audiobab, Acoustic Energy, SME, Audio Research, Krell, Wadia, Theta, Apogee, Martin Logan, Pioneer, Tannoy, Systemdek, Stax, Pink Triangle, Michell, Monitor Audio, Yamaha, Marantz, Kef, Bose, Celestion, Epos, Mission, Denon. Neat Petite. Mon-Sat 10-6 pm.

**THE CORNFLAKE SHOP,** 37 Windmill Street, London W1 (071) 631 0472 (domestic). (071) 323 4554 (multiroom). Fax: (071) 436 7165. Tues-Sat 10-7 Rega, Roksan, Naim, Monitor Audio, Arcam, Nakamichi, Rotel, Epos etc. 3 dem rooms (incl. home cinema). Friendly

professional service. Home trial facilities, appts preferred. Full delivery and repair service. Multiroom specialists. Access & Visa.

**MUSICAL IMAGES,** 173 Station Road, Edgware, Middlesex. Tel: (081) 952 5535. See advert under Middlesex for more information.

**MUSICAL IMAGES,** 45 High Street, Hounslow, Middlesex. Tel: (081) 569 5802. See advert under Middlesex for more information.

**AUDIO T,** 190 West End Lane, West Hampstead, London NW3 1SQ. (071) 794 7848. Fax: (071) 431 3570. Great Hi-Fi from Adcom, Arcam, Audiobab, B&W, Denon, Epos, Marantz, Meridian, Michell, Mission, Philips, Rotel, Proac, Micromega, Nakamichi, Yamaha, & many more. Mon-Sat 10-6 3 year guarantee on Hi-Fi. Free delivery & installation. 30 day free upgrade scheme. Home demonstrations. Part exchange. 2 listening rooms. BADA Bonded.

**ORANGES & LEMONS,** 61-63 Webbs Road, Battersea, SW11. Tel: 071 - 924 2040/3665. Juicy fruit from London's newest, freshest Hi-Fi/Home Cinema retailer. Telephone demonstrations, or just pop in. All the usual, friendly and efficient service, free home installation, credit cards, plus... all the very best from Arcam, Chord Co., Meridian, Mission, NAD, NAIM, Roksan, Royd, Cable Talk, QUAD... with more to come. The innovative Audio/Visual retailer.

**ZEBRA,** 18-24 Brighton Road, South Croydon. Tel: 081 - 688 2093. The UK's First and Finest Home Cinema Store. 3 Demonstration Rooms. Laser Disc CRT and Projection TV Centre. Many brands stocked including Arcam, Audiobab, Meridian, Lexicon, Kef, Pioneer, Rotel, Yamaha, REL and Panasonic. Mon-Sat 9.30-6.00pm. All major credit cards accepted. Finance available. Evening demonstrations by appointment.

## GREATER MANCHESTER

**THE AUDIO COUNSEL,** 12 Shaw Road, Oldham, Manchester OL1 3LQ. Tel: 061 633 2602. Linn, Arcam, Naim, Yamaha, Creek, Nakamichi, Denon, JPW, Marantz, Royd, Lexicon. 3 dem rooms, free install. Visa/Access. Licensed credit brokers up to £1,000 instant credit. Full multi-room & A.V. installation. 10.00-5.30pm Mon, Tues, Wed, Sat. 10.00-7.00pm Thurs & Fri.

**CENTRAL RADIO (Manchester) Ltd,** 30-32 Shudehill, Manchester M4 1EZ. Tel: 061 834 6700. Est: 1946. We have a wide range of Hi-Fi separates, systems, Pro-logic TV, Video, Portable Audio, Tape, Stylus and Accessories. In House Service Dept. Agents for: Aiwa, Beyer, Bose, B&W, Cerwin-Vega, Canon, JBL, Kenwood, Marantz, Mission, Panasonic, Pioneer, Sennheiser, Sony, Technics, Thorens, Wharfedale, etc. We accept Access/Visa/AmEx/Switch. Cheques up to £1500 & Finance subject to status. Open 9.00am to 5.30pm Mon to Sat. Easy Parking. Call for directions.

**ORPHENUS AUDIO (HOME DEMONSTRATION SPECIALIST)** - for a 'Musical' system tailor-made (sonically and visually) to your Home requirements. Arion Acoustics (Valves), Audiomeca, Audio Synthesis, Audio Valve Amplication.

## TO FIND YOUR AREA Use our COLOUR REFERENCE



To Advertise in this section, please contact Caroline Knott on:

071 266 0969

# Hi-Fi World Dial-a-Dealer

**KINSHAW, LIDER, ORFON, PRO-JECT, TEAC, TRIANGLE, YBA, DIRPHEUS AUDIO.** please tel: 0257 426100 or Fax: 0257 473175 for appointment.

**HALE HI-FI,** Tel 061 929 0834  
See our main entry under Cheshire.

**BILL HUTCHINSON HI-FI,** 50-52 Deansgate, Manchester M3 2FE (061) 8321600. For the largest selection of Hi-Fi and audio visual equipment in the North West. Specialist AV demonstrations of the highest quality. Best prices guaranteed. Minimum 2 year warranty and an optional 5 yr guarantee available. Instant credit and mail order service on offer throughout the U.K. Pioneer, Denon, Kenwood, Yamaha, Technics, Marantz, Mission, Tannoy plus many more.

**PRACTICAL HI-FI,** 65 Bridge Street, Manchester M3 3BQ Tel: 061 839 8869. See our main entry under Lancaster.

## MERSEYSIDE

**DOUG BRADY HI-FI,** 401 Smithdown Road, Liverpool, L13 3JJ (051) 733 6859. Fair demonstrations and home trial facilities. All credit cards. Largest choice of specialist hi-fi in N.W. Closed Wednesdays and lunch 1-2.15pm

## NOTTINGHAM

**HARROW AUDIO,** 27, Springfield Rd., Harrow, Middlesex. Tel 081 863 0938. Open Mon-Sat 9.30-5.30. Most brands available - see our regular advert for full range including Audiobab, Arcam, Audioquest, Apogee, Aura, B&W, Cyrus, Denon, Epos, Krell, Marantz, Mission, Nakamichi, Tannoy, Target, Yamaha etc. AV Specialist including installation, interest free credit - ask for details. The largest range of accessories for miles around 2 dem rooms. Plus Carriage Free Mail Order.

**AUDIOCRAFT,** 18 Hillingdon Road, Uxbridge, Middlesex UB10 0AD (0895) 253340. Unbelievable but true you can audition these brands here. Audio, Proac, Michell, Erelle, LFD Lumley, Lawson, Lume, Triangle, Sentic Mag Audio, Teac, VHO Silver Sounds, YBA, Stax, Theta, Monitor Audio, Fuller Audio, Trinity, Lyra, Sennoko, Ortofon, Decca Target Project, Moth, Kelvin, Townsend, Edison. Audio Alchemy Keski, Musical Fidelity.

**MUSICAL IMAGES,** 45 High Street, Hounslow, Middlesex. Tel (081) 569 5802. Fax (081) 569 6353.

**MUSICAL IMAGES,** 173 Station Road, Edgware, Middlesex. Tel (081) 952 5535. Fax (081) 952 5535. Most brands available - see our page advert. Interest free credit. Ask for details. Demo rooms. Repairs & Service. Sunday opening - Open all week. A Home Cinema Specialist. Mail order. Part exchange.

**AUDIO T,** 159a Chase S de, Enfield, Middlesex EN2 0PW (081) 367 3132. Fax (081) 367 1638. Great Hi-Fi from Adcom, Arcam, Audiobab, Celestion, Denon, Marantz, Meridian, Micromega, Mission, Philips, Rotel, Yamaha, & many more. Mon-Fri 10-6 Sat 9.30-5.30. 3 year guarantee on Hi-Fi. Free delivery & installation. 30 day free upgrade scheme. Home demonstrations. Part exchange. 2 listening rooms. Home Cinema specialists. BADA Bonded.

## NORFOLK

**BASICALLY SOUND,** The Old School, School Road, Bracon Ash, Norwich, Norfolk NR14 8HG. Tel. (0508) 5 70829. Arcam, Heybrook, Chord Co, Rotel, Sound Style, TOL, Royd, Denon, Naim, Spondor, Sound Organisation, Audio Technica, Creek, Epos, etc. 2 comprehensive dem rooms. Home trial facilities. Free installations. Visa Access, HP facilities. Tues-Fri 9.30-1.00pm, 2.00-5.30pm. Saturday 9.30-5.30pm.

**PROTECT-A-DISC,** Unit 4, Elvin Way, Sweetbriar Industrial Estate, Norwich, NR3 2BB. Tel 0603 482193. Producers and suppliers of finest quality card record and CD sleeves with taped edges, poly-lined or unlined, mailers and crouchforms etc. Please send SAE for full current price list. Trade enquiries welcomed. Tel: 0603 482193.

## NORTHAMPTON

**LISTEN INN,** 32 Gold Street, Northants NN1 1RS. Tel: 0604 37871. Fax 0604 601430. Naim, Linn, Rega, Audiolab, Arcam, Cyrus, Royd, Nakamichi, Mission, Oenon, Rotel, Nad, Heybrook, Marantz, Chord Co etc. etc. Open 10.00-5.30 (Closed Thurs)

**THE AUDIO SHOP,** Hi-Fi Specialists. Appointed stockists of - Ariston, Creek, Demor, Qual, Goodmans, JPW, Mordaunt-Short, Rotel, Royd, Tannoy, 6 Hill Street, Raunds, Northamptonshire. Tel:- 0933 622325

## NOTTINGHAMSHIRE

**DEFINITIVE AUDIO,** Tel: (0602) 813562. For a carefully considered approach to building a true high fidelity audio system with components derived from the following

manufacturers: Audio Innovations, Wadia, Micromega, Deltac, E.M.T., Horning, Voyd, Systemdek, SME, Revox, Impulse, Ortofon, Pioneer. Also the remarkable Living Voice Air Partner loud speaker system. Demos by appt. Please phone for further details. Install, free of charge. Mon-Sat 10.00-7pm. Closed Wed & Thur.

**PETER ELLIS AUDIO,** 29 Kirkgate, Newark, Notts NG24 1AD. Tel: 0536 704571. QUAD, Castle, Arcam, QED, Suggden, Tannoy, Thorens, Marantz, Genon, Teac. Demo room, free install. Service dept. Access. Visa American Express. Mon Sat 9-5.30. Closed Thursdays PM.

**CHANTRY AUDIO,** 18-18a Eldon Street, Tuxford, Nk Newark, Notts, NG22 0LH. Tel: 0777 870372. Pink Triangle, DPA, Rotel, Michi, Micromega, MVA, Alchemis, Michell, Monitor Audio, Lumley, SME, Audio, and much more! Three dem rooms, home trial, free installation, service department, Access & Visa credit facilities, Mail order, Mon-Sat 9.30-6.00. Sun and evenings home dem by appointment.

**NOTTINGHAM HI-FI CENTRE,** 126-122 Alfreton Road, Nottingham. Tel: 0602 786919. Over 25 years experience. superb demo rooms, extensive range. Free parking. Mon-Sat 9-5.30

**JOHN KIRK SALES & SERVICE,** 70 Chilwell Road, Beestons Notts, NG9 1FD. Tel: 0502 - 252936. Your specialist Hi-Fi Dealer for AKG, Alpnason, AARcam, Aura, B&W, Beyer, Canon, Castle, Celestion, Denon, Dual, Hunt, Eda, Marantz, Mordant-Short, Nakamichi, Panasonic, Philips, Pirelli, QED, Quad, Revox, Roberts, Rogers, Sennheisser, SME, Suggden, Tandberg, service TOL, Technics, Talar, Thorens, Perveemil, IXOS. Come and see our range of quality Nokia, Finlux, Panasonic TV and Video Records.

## OXFORDSHIRE

**AUDIO T,** 19 Old High Street, Headington, Oxford OX3 9HS (0865) 659661. Fax (0865) 66415. Great Hi-Fi from Arcam, Audiobab, Cyrus, Denon, Epos, KEF, Marantz, Meridian, Mission, Musical Fidelity, Rotel, Sony, Yamaha & many more. Mon-Fri 10-6. Sat 9.30-5.30. 3 year guarantee on Hi-Fi. Free delivery & installation. 30 day upgrade scheme. Home Demonstrations. Part exchange. 2 listening rooms. Home Cinema specialists. BADA Bonded.

**WESTWOOD & MASON,** 46 George Street, Oxford. Tel: 0865 24783. Creek, Marantz, Naim, Arcam, Rotel, Rega, Epos, Tannoy, Mission, Nakamichi, Denon, Awa, Quad, Yamaha, Monitor Audio. Open 9.30-5.00pm. Dem room. Closed Thursdays.

**ASTLEY AUDIO LTD,** 3 Market Lane, Watlington (3 miles from Berkshire border) O41 839055. Aura B&W, Technics, Panasonic, Pioneer, Kenwood, Sony, Yamaha, Denon, Dual, Marantz, Mission, Tannoy. 1 listening room. Home trial, free installation. Service department. Access. Visa Amex, Diners. Instant credit. Tues-Fri 9-5.30. Sat 9-5. Records & CDs stocked.

## SHROPSHIRE

**AVON HI-FI,** 12 Barker Street, Shrewsbury, Shropshire, SY1 1QJ. Tel: 0743 355166. Awa, Revex, Dynamic, NAD, Quad, B&W, Mordaunt-Short, Kenwood, Bose, Nakamichi, Onko, Teac, Sennheiser. Dem room. Home trial. Free install. Service dept. Access/Visa £1,000 instant credit. Mon, Tues, Wed, Fri, Sat, 9-5.30.

**SHROPSHIRE HI-FI,** St. Nicholas Street, Shrewsbury. Shrops SY1 2FS. Tel: 0743 212020. Stockists of Musical Fidelity, Mordaunt Short, Sony, Kenwood, Pioneer, Rotel, Denon, B&W. Proac Audio Visual. Products available. Open 9.30-5.30pm Mon-Sat.

**MID SHROPSHIRE AUDIO,** 24 Everell Bank, Dawley. Tel: 0524 2812. Tel: 09521 532197. Pink Triangle, T.O.L., Marantz, Denon, JPW, Ortofon, Project, Yamaha, Ruark, Royd, Michell, Musical Fidelity, Yamaha, Target, Tables Speaker Stands, best prices! Free Delivery nationwide. Good D.I.Y. counts with no pix. Surround sound specialist. Home demonstrations a pleasure. 0% finance.

**MIKE MANNING AUDIO,** 110 Middle Street, Yeovil, Somerset. BA20 1NE. Tel: 0935 79361. Fax: 0935 32923. Mobile 0850 325965. Naim, Roksan, Pink Triangle, A&R (ARCAM) IOM NAD, Pioneer, Rotel, Denon etc. Dedicated listening lounge for relaxed and unpressured demo. Appts not necessary but best to telephone first. Home trial facilities on request. Free installation and service dept. instant credit. Access/Visa etc 9-5.30. closed Mondays.

## SOMERSET

**ACTIVE AUDIO,** 95, Stafford Street, Hanley, Stoke-on-Trent, Staffs. Tel: 0782 214484. Fax: 0782 283346. We have four studios including a dedicated Audio Visual studio for the demonstration of quality equipment from the largest range in the Midlands. Open six days per week. Own

## STAFFORDSHIRE

**ACTIVE AUDIO,** 95, Stafford Street, Hanley, Stoke-on-Trent, Staffs. Tel: 0782 214484. Fax: 0782 283346. We have four studios including a dedicated Audio Visual studio for the demonstration of quality equipment from the largest range in the Midlands. Open six days per week. Own

service department. Free local delivery, home trial facility. Current special offers and buyers fact pack and quotation service on request.

**MUSICAL APPROACH,** Unit 7, Woodings Yard, Bailey Street, Stafford. Tel: 0785 55154. Also branch at 37 High Street, Aldridge, nr Walsall. Tel: 0922 57926. Linn, Rega, Arcam, Rotel, Royd, Heybrook, Marantz, Teac, Celestion, Appollo, Target. Mon-Sat 9.30-5.30. Home cinema equipment stocked. 2 single speaker dem rooms. Service dept and free install. Credit facilities. We are now agents for Rega products. Stafford branch only.

**ACTIVE AUDIO,** 29 Market Street, Tamworth. Staffs. Tel: 0827 53355. Fax: 0827 59513. We have two studios including a dedicated Audio Visual studio for the demonstration of quality equipment from the largest range in the Midlands. Open six days per week. Own service department. Free local delivery, home trial facility. Current special offers and buyers fact pack and quotation service on request.

## SUFFOLK

**AUDIO IMAGES,** 7 All Saints Road, Pakefield, South Lowestoft, Suffolk, NR33 6JL. Tel: fax 0502 582853. Quad, Triangle, Arcam, Castle, Rotel, Moth, JPW, Finlux, Audio Innovations, plus the amazing RDTHWELL range. Separate dem room. no appts nec. 10-6.30 Tues-Thurs 7pm Fri 6pm Sat.

**SIGNALS,** Martlesham Heath, Ipswich. Tel: (0473) 622866. See display advertisement for brands. Turntables, high end CD drives DACs as well as integrated players, valve and solid state amplification, wide range of cables and loudspeakers. Home demonstrations/equipment trial service. Please telephone for directions and to book appointment.

**BURY AUDIO,** 47 Churchgate Street, Bury St Edmunds, Suffolk IP33 1RG. Tel: 0284 724337. Arcam, Audio Alchemy, Heybrook, Marantz, Michell, Meridian, Nakamichi, Pink Triangle, Quad, Rotel, Sonus Faber, Stax, Tube Technology. Single speaker dem room. Free install. Credit facilities. Mon-Sat 9.30-6.00, closed Wed. Evening demos by appointment.

**EASTERN AUDIO,** 41 Bramford Road, Ipswich. Tel: 0473 217 217. Fax 0473 215705. Quad, Arcam, Audiobab, Meridian, Mission, Denon, Rotel, Marantz, NAD, Sony, Rogers, Nakamichi, Systemdek, Technics, Celestion, B&W, Tannoy, Mores Thorens and Top Tape. Also stock a wide range of accessories. usual credit facilities. A BADA dealer.

**FENWAY,** 71 The Rookery Centre, Newmarket. Tel: 0638 66166. Contact Mark Pearson for Sony Technics, Rotel, Tannoy, Pioneer, QED, equipment and accessories. Demonstration facility. In-House Service Dept. "FREE INSTALLATION BY EXPERTS"

## SURREY

**SPALDING'S HI-FI,** 352-4 Lower Addiscombe Rd., Croydon, Surrey. 081 654 1231/2040. 3 dem rooms and home dem. Free installation/credit. Linn, Naim, Quad, Arcam, Audiobab, Cyrus, Marantz, Denon, Ruark. Mon-Sat 9-6. Tues 9-8. Closed Wed. Service dept.

**PJ HI-FI, THE HI-FI SHOP,** 3 Bridge Street, Guildford. Surrey GU1 4RY. Tel: (0483) 504801. 9-6 Mon-Sat. Linn, Meridian, Rega, Arcam, Quad, Revox, Musical Fidelity, Rotel, NAD, Nakamichi, Marantz, KEF, Reference etc.

**ROGERS HI-FI,** 13 Bridge Street, Guildford. Surrey (0483) 61049. Awa, Creek, Denon, Dual, JPW, Marantz, Omix, Pioneer, Systemdek, Ruark, Tannoy, Teac. Dem facilities available. no appts necessary. free installation, service dept. Access/Visa. Instant credit upto £1,000 subject to status. Monday-Saturday, 9.30-6pm. later by appt.

**SURBITON PARK RADIO,** 48 Surbiton Road, Kingston-upon-Thames. Surrey (081) 546 5549. QUAD, Castle, Denon, Dual, Kenwood, Mordaunt-Short, JBL, Rotel, Pioneer, QED, B&W and Tannoy. Demo facil. Access, Visa and Switch 9.30-5pm.

**SURREY HI-FI,** 45 High Street, Godstone, Surrey, RH9 8LS (0883) 744755. Specialist Hi-Fi outlet, demonstration room and parking available. Quad, Audiobab, TDL, Tube Technology, Rel Acoustics, Nakamichi, Kef, Thorens, Musical Fidelity, Van Den Hul cables, Bose, Sennheiser, Beyer headphones, Marantz, Denon, Michell, Van Den Hul, Musical Fidelity, Tannoy, Target, JPW. Single speaker dem rooms. Free installation service dept. Access/Visa/Mastercard. Open 9-6pm. Closed all day Wednesday.

## SUSSEX (EAST)

**THE POWERPLANT "Brighton's Leading HiFi Shop"** 66 North Street, Brighton, Tel: 0273 775978. Comfortable listening rooms. Knowledgeable and approachable staff. Roksan, Micromega, Exposure, Audiobab, Epos, Rotel, Marantz, Cyrus, Regal, Arcam, Mission and more.

**WORTHING AUDIO,** 20 Treville Gate, W Sussex BN11 1VA. Tel: 0903 212133. The friendly shop with the best sound systems in the South. Friendly advice. 3 yr guarantees, easy parking, open Mon-Sat 9-6pm. Late night Wed. Arcam, Exposure, Naim Audio, Marantz, Ruark, Restek, Clear Audio, Audio Technica, Target, Tripod, Sennheiser, AR and many more.

**CHURCHERS HI-FI,** 154 Monique St, Worthing, Sussex. EN11 3HH. Tel: 0903 821595. All major well know brands of Hi-Fi stocked. Please call for details.

**HEATHERDALE AUDIO LTD,** 202 Findon Road, Worthing, Sussex. Tel: 0903 872288 or 0860 660001.eves. Three comfortable demonstration lounges where you can audition: Audionote, Krell, Audio Research, Klipsch, Martin Logan, Apogee, Sonus Faber, Theta, S.M.E. Copland, Voyd, Magnephaner, E.M.F., Lumley Reference, Creek, Rotel, Heybrook, Clearaudio. Phone for used stock list. We are the South Coast's Premier Hi-Fi Specialist.

## WILTSHIRE

**BOWERS & WILKINS LTD,** (est. 1945), 1 Becket Buildings, Little Hampton Road, Wokingham, Tel. (0903) 2 64141. Top names in Hi-Fi and audio visual including B&W, Nakamichi, Castle, Denon, Philips, Quad, Technics, Aura, Teac, Suggden, Mission, Thorens and many more. 4 dem rooms (budget-high end) expert friendly advice, service dept, local installations free, one minute from A24 & A27, free local parking, Access/Visa. Instant Credit up to £1,000 subject to status. Open 6 days.

**CHICHESTER HI-FI,** 7 St Pancras, Chichester, W Sussex. PO19 1SU. Tel: 0243 776402. Linn, Naim, Rega, Creek, Nakamichi, A&R, Denon, Roksa, Epos, JPW, Ruark, Rotel, Quad, Spondor. Evening appts available.

## TYNE & WEAR

**BILL HUTCHINSON HI-FI,** 87a Castle Street, Newcastle-Upon-Tyne, (091) 230 3600. For the largest selection of Hi-Fi and audio visual equipment in the North East. Specialist AV demonstrations of the highest quality. Best prices guaranteed. Minimum 2 year warranty and an optional 5 yr guarantee available. instant credit and mail order service on offer throughout the U.K. Pioneer, Denon, Kenwood, Yamaha, Technics, Marantz, Mission, Tannoy plus many more.

## WAINWICKSHIRE

**STRATFORD HI-FI,** 25 Henley Street, Stratford-upon-Avon. CV3 0W. Tel: 0789 414533. Pioneer, Technics, Denon, Marantz, NAD, Rotel, Musical Fidelity, Monitor Audio, Mission, Tannoy, Quad, TDL, Sennheiser, 0% finance is available on selected products and all major credit cards accepted. Dem Rooms, Service facilities, open 9.30-5.30pm. Late night Thursday until 8.00pm.

## WEST MIDLANDS

**FRANK HARVEY HI-FI EXCELLENCE,** 163, Spon Street, Coventry CV2 3BB. Tel: 0203 525700. The Midlands first choice for specialist Hi-Fi. Audiobab, Audio Alchemy, Arcam, Audio Quest, Adiphsion, Bose, Bang & Olufsen, Celestion, Cyrus, Denon, Dual, Foundation, Kef, Reference, Marantz, Monitor Audio, Mission, Musical Fidelity, Nakamichi, Nad, Rega, Rogers, Rotel, Quad, Systemdek, Target, Tripod, Tannoy, Thorens, Van den Hul, Yamaha 3 floors, 3 demonstration rooms. Open 9.30 till 5.30. Closed Thursday. All credit cards incl. Amex & Diners. Instant credit and interest free facilities. Home trials. Free installation, home cinema AV floor. We are a BADA dealer.

**MIOLAND VALVE HI-FI,** Specialising in true fidelity systems built around valve amplification - Audion 300B, Silver Nights, Audio Innovations, Impulse, Audio Note, K&L, Townsend Audio, Ortofon, Voyd, Micromega, Edison, Stax, Apollo, Oynavactor, Seismic Sink, Valves. Home demonstrations and part exchange. Also vintage, Leak, Quad, Croft, Radford, etc. Flexible opening 7 days. phone Gary 021 722 2317.

**MUSICAL MATTERS,** 351 Hagley Road, Edgbaston, Birmingham, B17 8DL. Tel: 021 429 2811. Roksan, Nakamichi, Arcam, Audiobab, Kenwood, DPA, Tannoy, Royd, Heybrook, Michell, Panasonic, Aura, Celestion, Musical Fidelity, Mission, Cyrus, Meridian, Kef, Monitor Audio, Pink Triangle, Ruark, Epos, Exposure, Pioneer and many, many more! 2 single speaker dem rooms. Appts necessary. Home trial facilities and free install. Service dept. Access/Visa instant credit upto £1,000. Interest free credit available also. Tues-Thurs 10.30-6pm, Friday 10.30-8.00pm, Saturday 10.00-5.30pm. Check out the new branch in Solihull - Phil works there so it can't be bad! 021 742 0284.

**COVENTRY HI-FI,** 126, Church Lane (off Walsgrave Road), Coventry, CV2 4AJ. Tel: 0203 440529. Quad sales & service agent, Pioneer Reference Point, Kenwood, Awa, T.O.L, B&W, Tannoy etc. Private listening room. 2 year guarantee on all hi-fi. Open 9.30-5.30 Mon-Sat. Closed Thursdays.

# Hi-Fi World Dial-a-Dealer

**ELECTRO CENTRE**, 244 Soho Road, Handsworth, Birmingham. Tel 021 554 1878. Full range of Hi-Fi Pioneer Technics Kenwood JVC Sony Aiwa Akai. "Guaranteed the lowest price in the UK". 24 hour mail order facility available.

**ELMDON AUDIO**, Tel 021 784 8765. Reference Imports Lumley, Aion etc. Esoteric Audio Research B34 integrated on demonstration. Home demonstration can be arranged. Top part exchange prices. Lots of used bargains. Quad Leak etc. Valves and valve testers. New GEC K7665 available.

**FIVEWAYS HI-FIDELITY LTD.**, 12 Islington Row, Edgbaston Birmingham B15 1LD. 021 4550667. Arcam, ATC, AAudioquest, Audio Technica, AVI, Beyer, Cable Talk, Castle, Chord, Denon, Dual, Klipsch, Michie, Nakamichi, Ortofon, QED Quad Revox, Sennheiser, Sequence Design, SMF, Spendor, Target, TDK, TDL, Thorens etc. Keith Monks Record Cleaning Machine. Closed Mondays.

**MUSICAL APPROACH**, 37 High Street, Aldridge, nr Walsall. Tel 0922 57926. Linn, Arcam, Rotel, Royd, Heybrook, Marantz, Teac, Celestion, Apollo, Target, and others. Mon-Sat 9.30 - 5.30. Closed Thursdays. Home Cinema equipment stocked. Dem rooms, service dept. Free installation and credit facilities. Free parking at rear of shop.

**SOUND ACADEMY**, The ultimate experience for those seeking Hi-Fi. Arcam, Audioblast, AudioQuest, B&W, Bose, Chord, Cyrus, Cable Talk, DPA, Epos, Kef, Ref, Marantz, Meridian, Mission, Mus. Fid., Nakamichi, Ortofon, Project, Quad, Roksan, Tube Tech, Rotel, Micromega, KAR, Kenwood, Lexicon, Cannon, Celestion, Beyer & KORE. 3 single speaker dem. room on two floors incl. A/V Cinema. Open 6 days a week. Mon-Sat. All major credit cards taken. Part exchange enquiries welcome. Just off the High Street, Bromwich, Walsall, W. Midlands. Tel: 0922 493499. (amp free parking).

**AMADEUS SOUND & VISION**, 10 Boldmere Road, Sutton Coldfield West Midlands. Tel 021 354 2311. Audio Innovations, B&O, Castle, QED, Wharfedale. Single speaker demo, appts preferred, service available. Installations, B&O link instal, home trials. Access/Visa. Interest free credit available subject to status. 9.30-6.00pm 6 days.

**GRIFFIN AUDIO**, 9<sup>th</sup> Bristol St, Birmingham. Tel 021 622 2230/021 692 1349. Tues-Sat 10 am - 6 pm. Enjoy music at home with a system from Griffin Audio. We demonstrate and install the very best hi-fi, with systems from £500 to £25,000. Ask for Bob, Tim or Alex. Linn, Naim, Shalman, Quad, Arcam, Rega, Denon, Marantz, Rotel.

## WILTSHIRE

**THE AUDIO EXCHANGE**, 52 Morse Street, Swindon, Wiltshire. SN1 5GP. 0793 539908. Acoustic Energy, Audio Innovations, Beard, Cerwin Vega, C.R. Developments, Impulse, Magnur, Micromega, Mitchell, REL, Sequance, AVI and single speaker dem. room. Home trial facilities. Free installation, service dept. Mon-Sat 10-6.

**AUDIO T**, 60 Fleet Street, Swindon, Wiltshire, SN1 1RA. (0793) 538222. Fax (0793) 487260. Great Hi-Fi from Arcam, Audioblast, Denon, Linn, Marantz, Meridian, Mission, Rotel, Sony, Yamaha & many more. Mon-Sat 9.30-5.30. 3 year guarantee on Hi-Fi. Free delivery & installation. 30 day free upgrade scheme. Home demonstrations. Part exchange. 2 listening rooms. Home Cinema specialists. BADA Banded.

**P.R. SOUNDS**, 58 Castle Street, Trowbridge, Wilts BA14 8AU. Tel: 0225 771799. Authorised dealer for Pioneer, Technics, Marantz, Kenwood, Mission, JVC, and many more. Cinema Sound Specialists with Listening Room. "For all things best of Hi-Fi at a Price you can afford". Open Mon-Sat 9-6. Credit Cards accepted. Finance available.

## WORCESTERSHIRE

**SPAINS HI-FI**, 2 1/2a New Rd, Bromsgrove, Worcs. Tel 0527 872460. Aute, B&W, Beyer, Denon, Heco, JVC, Kenwood, Marantz, Mission, Monitor Audio, NAD, Nakamichi, Pioneer, Rotel, Sennheiser, Soundstyle, Sony, Systemdeck, Tannoy, Target, Thorens. Integral demo room/showroom for instant comparisons on Hi-Fi & AV equipment. Free installation. Part exchange welcome. Service department. Access, Visa. 0% finance on selected products. Mon-Sat 9.00-5.30 pm. Closed Thursdays.

**COLORAMA HI-FI**, 27 Kingfisher Walk, Kingfisher Centre, Redditch, Worcs B97 4EY. (0527) 597260. Aute, NAD, Onkyo, Kenwood, Denon, TDL, Polk Audio, B&W, Tannoy. Full Pro-logic products. In-store integrated dem facilities. No appts required, service dept. Access, Visa. Open 9-5.30, closed Thursdays.

## WEST MIDLANDS

**WEST MIDLANDS AUDIO**, 158 Ombersley Road, Worcester WR3 7HA. Tel 0905 458046. Fax 0905 457585. Naim,

Rega, Rotel, Marantz, Nakamichi, NAD, Audioblast, Roksan, Meridian, B&W, Audio Research, Krell, Martin Logan. Arcam 9-5.30 Mon-Sat. eves by appt. only. Free.

## YORKSHIRE (SOUTH)

**HIFI STUDIO'S**, Sunningfields, Doncaster. Tel 0302 781387. TDL, Sugden, ProAc, Ruark, Teac, impulse, Systemdek, Alphon Target, Albany, Heybrook, Monitor Audio, JPW, Totem, Harbeth, Keswick Audio Research, Michie Engineering, AMC (CD and Valves), CR Developments (Valves), Art Audio (Valves), Rel Acoustics, Projekt, Origin Live, Dual, Yamaha plus home Cinema pro-logic dems. Listening room demo's. Home trial, free install, licensed credit broker. 2 yr guarantee on all equipment. Service available. Access/Visa. 10-8pm 6 days. phone for further information and free fact pack.

**TRC HIFI**, 3 Kings Cross Street, Halifax, HX1 (0422) 366432. Agents for Kenwood, Denon, Castle, Rotel. Demonstrations and advice a pleasure. Call at any time to audition some of the best Hi-Fi and pro-logic systems. Delivering and installation free within 20 miles. "The family firm where the customer matters most."

## YORKSHIRE (NORTH)

**AUDIO CLINIC**, 22 Lord Mayors Walk, Yorks, YO3 7HA. Tel (0904) 646309. Revox, QED, Audio Innovation, Allison-Celestion, Yamaha, Teac, Revoxer, PW-Kenwood, Bose, Thorens, Mission, Snell, B&W, Heco, Cannon, NAD, JVC, Musical Fidelity, Wharfedale, Micromega, Ruark, Heybrook. Surround sound and memo rooms. Free installation. Service Dept. Credit facilities on request. Access/Visa. Oper 10am - 5pm 6 days a week.

**SCARBOROUGH HIFI**, 14 Northway, Scarborough, North Yorkshire YO11 1JL. Tel 0723 374547. Albarr, Aute, B&W, Matrix, Cyrus, Pioneer, Philips, Marantz, Cabasse, Bose, Tannoy, DCC wide screen and laser vision. Home trial facilities and free installation. Service dept. Access/Visa. Credit charge, £1,000 instant credit. Amex/Diners.

**THE SOUND ORGANISATION (YORK)**, 2b Gillygate, York, YO3. Tel (0904) 627198. Linn, Meridian, Micromega, Naim, Rega, Arcam, Creek, Nakamichi, Mission, Denon, Epos, Royd, Rotel. 3 single speaker dem rooms. appts preferred. Home trial facilities. Free install. Service dept. Credit facilities on request. Access/Visa. 10.00am - 5.30pm. Tues-Sat. Sony dealer award nominated '86-'87 and '88.

**VICKERS HIFI**, 24 Gillygate, York. (0904) 629659. Audioblast, Harmon Kartron, Marantz, Musical Fidelity, Pink Triangle, Quad, Systemdek, Tannoy, Technics and its more. 3 dem studios. (2 by appointment). Superb Showrooms. 2 yr guarantee on all hi products. Appts, as above. Home trial facilities. Free install. Service dept. Qualified and experienced staff. over 25 yrs experience. 12 mths interest free credit. 10.30-5.30 Mon-Sat.

## YORKSHIRE (WEST)

**BILL HUTCHINSON HIFI**, 26-28 Woodhouse Lane, Leeds. (0532) 427777. For the largest selection of Hi-Fi and audio visual equipment to the Yorkshire. Specialist A.V. demonstrations of the highest quality. Best prices guaranteed. Minimum 1 year warranty and an optional 5 yr guarantee available. Instant credit and mail order service on offer throughout the U.K. Pioneer, Denon, Kenwood, Yamaha, Technics, Marantz, Mission, Tannoy plus many more.

**DOUG BRADY HIFI**, The Forge Cottage, 19 Cross Gate, Otley, West Yorks, LS2 1AA. Tel (0943) 467689. Naim, Arcam, Rotel, Pink Triangle, Meridian, Epos, Castle, Two dem rooms for demonstrations and home trial facilities. Access/Visa. Open 10.00-6pm Tues-Sat.

**HUDDERSFIELD HI-FI CENTRE**, 4 Cross Church St, Huddersfield. (0484) 544668. B&W, Cyrus, Kenwood, Denon, Rotel, Arcam, Musical Fidelity, Quad, Audio Lab, Marantz, Mission ect. Dem facilities - appointment reqd. Mon-Sat 9-5.30. Thurs 9-8. Closed Wed. Free installation. Credit facilities. Access, Visa.

**AUDIO PROJECTS**, 45 Headingley Lane, Leeds. Tel - 0532 304565. A&R, Audioblast, Creek, Heybrook, Linn, Musical Fidelity, Naim, Quad, Rega etc. Free installation. Home trial, 2 year warranty, appts preferred. Tues-Fri 9.30-6, Sat 2.30 - 5.30.

## SCOTLAND

### EDINBURGH

**BILL HUTCHINSON HIFI**, 43 South Clark Street, Edinburgh. (031) 667 2877. For the largest selection of Hi-Fi and audio visual equipment in Lothian. Specialist A.V. demonstrations of the highest quality. Best prices guaranteed. Minimum 2 year warranty and an optional 5

yr guarantee available. Instant credit and mail order service on offer throughout the U.K. Pioneer, Denon, Kenwood, Yamaha, Technics, Marantz, Mission, Tannoy plus many more.

**72 Newhaven, Road, Edinburgh EH6 5GG**. Tel 031 555 3963. Stockists of Micromega, Proac, Audio Innovations, Lumley, Reference, Tube Technology, DNI, B&W, Systemdek, Nottingham Analogue, Nakamichi, Rehder, etc. Common Harmon Kardon Golding. Mon-Sat 10-4.30 pm by appt. Closed Wednesdays. All Major Credit Cards Accepted. Contact Fraser or Mark.

## ABERDEEN

**HOLBURN HI-FI**, 441 Holburn Street, Aberdeen. Tel 0224 585713. Arcam, Audioblast, B&W, Celestion, Denon, Dual, Epos, Heybrook, JON, Kenwood, Creek, Marantz, Meridian, Mission, Cyrus, M.S. NAD, Nakamichi, Pioneer, QED, Quad, Revox, Rotel, Ruark, Tannoy, Technics, Wharfedale, Yamaha. 9.30-5.30 Mon-Sat.

**HI-FI EXCELLENCE**, Hi-Fi innovators & product designers with 15 years experience. Very much in the business for the music. Musical Fidelity, key dealer. Largest Rotel retailer in the area. Particularly keen to make the buying of Hi-Fi a fun experience. Situated in the West End away from the bustle of the City centre - the perfect environment to enjoy quality Hi-Fi. Full time service engineer. Open Mon-Tues 10-6. Wed 10-1. Thurs 10-7. Sat 10-5 or later by appointment. Hi-Fi Excellence, 293 Union Grove, Aberdeen. Tel 0224 322520.

**AUDIO SUITE**, -2 St. Andrews Street, Aberdeen. Tel 0224 625635. Single Room Demonstrations available. Full Service Department. Free Delivery and installation anywhere in Scotland. Authorised dealer for Linn, Chord, Proac, Mordant Short, Audio Research, Sinus Faber. All major credit cards accepted.

## AYRSHIRE

**LASER AUDIO**, Now at new premises. 1 St Marnock Place, Kilmarnock. KA1 1DT. Tel 0563 40292. Audioblast, Aiwa, Celestion, Cyrus, Denon, Dual, Marantz, Mission, Philips, Pioneer, Systemdek and Tannoy. 2 demonstration rooms. AV dem room. Appointments preferred. Home trial facilities. Free installation service facilities. Access/Visa and written credit. Open Tues - Fri 10-5.30. Sat 9.30-5.30.

## GLASGOW

**STEREO STEREO**, 278 St Vincent Street, Glasgow, Scotland. Tel 041 248 4079. Closed Tuesdays. Installations throughout Scotland. Credit facilities available.

**BILL HUTCHINSON HIFI**, 43 Hope Street, Glasgow. (041) 243 2857. For the largest selection of Hi-Fi and audio visual equipment in South West Scotland. Specialist A.V. demonstrations of the highest quality. Best prices guaranteed. Minimum 2 year warranty, and an optional 5 year guarantee available. Instant credit and mail order service on offer throughout the U.K. Pioneer, Denon, Kenwood, Yamaha, Technics, Marantz, Mission, Tannoy plus many more.

## INVERNESS

**THE MUSIC STATION**, 49 Church Street, Inverness, IV 1DR. Tel 0463 225823. Beyer, Dybamic, Celestion, Denon, Jomo, Kef, Kenwood, Mission, Pioneer, Rotel, Sony. Listening room. service department. free local delivery, part exchange, full range of credit facilities.

## TAYSIDE

**J.D. BROWN**, 28-36 Castle Street, Dundee DD1 9NZ. Tel (0382) 26591. Rotel, Denon, Pioneer, Technics, Aiwa, Mission, Castle, Mordant-Short, Monitor Audio, Bose. Infillly All equipment ready for demonstration. No appt. nec. free installation service dept. Open 9.30-6pm six days a week. closure 5pm Sat.

## IRELAND

### DUBLIN

**ACOUSTIC DIMENSION**, 16 Idrome Lane, Rear of Main Street, Blackrock, Co. Dublin. Tel 2E84612. Fax 2E33521. (from UK + 0103531). Stockists for speakers - ATC, Acoustic Energy, JPW, Triangle, ProAc, Ref 3A, RuArk, Heybrook, Polk Audio, TDL, impulse, Chario, Audio Static. Amps by: Albarry, AVI, LFD, NVA, Alchemist, Marantz, Audio Innovations, Rotel, CR Developments, EAR, Kinshaw, CD Players and DACs by: AVI, Pierre Lurie, Micromega, Kinshaw. Turntables by: Project, Tables/Stand: Apollo. Cables: Straightwire, Ixos, VLS, Eagle. Credit cards and mail order.

**CLONEY AUDIO**, 55 Main Street, Blackrock, Co. Dublin. Tel 2E84948/2E88477. Fax 2E34867. Products include: Arcam, Classe, Philips, Rogers, Epos, B&W, Naim Audio, Meridian and others. Open Tues-Sat 10am-6pm. Thurs/Fri 11-9pm. Closed Mondays.

**LAURETTI HIFI**, 50 Wellington Quay - Dublin. Tel 010 353 1577 0443. Dublin's Hi-Fi Separates Specialists. All leading brands. demonstrations available on request. Open Monday - Saturday 10 am - 6 pm.

**PETER DAND & CO LTD**, 111 Clonskeagh Road, Dublin 6. Tel 0103531 2694433. Products include B&O, Quad, Kef, Thorens, TEAC & many more! 2 demonstration rooms and 2 year guarantee.

## BELFAST

**LYRIC HIFI**, 163 Stanmillis Road, Belfast (0232) 381296. Linn, Naim, Rega, Arcam, Denon, Rotel and more. Mon-Sat 10.00-6.00pm. Late night Thurs.

**ZEUS AUDIO**, 6 Hope Street, Belfast. (0232) 332522. Audio Innovations, Pink Triangle, Roksan, Marantz, Celestion, Meridian and more. Mon-Sat 10.00-5.30pm. Late night Thursday.

## COUNTY DOWN

**ASTON AUDIO**, Unit 8 Kings Road Shopping Centre, Kings Road, Belfast. (0232) 402220. Akai, Technics, JVC, Samsung, Toshiba, Panasonic and many more. Demos. Open Mon-Fri 10.00am Sat 10-5pm.

## LONDONDERY

**ZEUS AUDIO**, 23a Kingsgate Street, Coleraine BT52 4LB. Tel (0265) 56634. Marantz, Mission, Cyrus, Aiwa, Akai, Alphason, Sony, Pink Triangle, Celestion, Rotel. Mon-Sat 10-5.30pm. Closed Thurs.

## WALES

### NORTH WALES

**ACTON AUDIO**, 4 Ruabon Road, Wrexham, North Wales. Tel 0978 364 500. Audio Visual Specialists: Aiwa, Arcam, AVC, Bose, B&W, Beard, Canon, Celestion, Castle, Cyrus, Jomo, Marantz, Michie, Mission, Mordant Short, Musical Fidelity, NAD, Nakamichi, Micromega, Quad, Rayford, Rote, Rogers, Rega, Ruark, Spendor, Tannoy, Thorens, Wharfedale, UKD, Yamaha. DSP Club Member. Demo Room. installation service. Easy Parking and Motorway access. All major credit cards accepted. 9.30 - 5.30 daily. Closed Weds pm.

**ELECTRO TRADER**, 19 Colwyn Crescent, Rhos on Sea, Colwyn Bay, Clwyd, Wales, LL28 4RN. (0492) 548932. NOW APPOINTED SUGDEN DEALER FOR THE NORTH WEST ROTEL, Yamaha, NAD, Harman, Tannoy, Teac, Alphason, Heco, Infinity, Kef, JBL, Sugden, Tannoy, Rotel, M.A.I., Heybrook, Acoustic Research, Ruarc and Soundstyle tri-prod racks etc. Dem room appts preferred. Home trial. Free install. Access, Visa. Open 9.30 - 1.00, 2.00 - 5.30 Mon-Sat.

## GLAMORGAN (SOUTH)

**AUDIO EXCELLENCE 'WHERE THE MUSIC MATTERS'**, 134-6 Craws Road, Cardiff CF2 4NR. Tel 0222 228565. Fax 0222398201. Great Hi-Fi carefully selected and demonstrated by friendly enthusiastic staff. Home installations and check-ups. Two year warranty from our own service department. Open 9.00-5.30 Tuesday - Saturday closed Monday.

## GLAMORGAN (WEST)

**AUDIO EXCELLENCE 'WHERE THE MUSIC MATTERS'**, 9 High Street, Swansea, SA1 1LE. Tel 0792 474608. Fax 0792 645087. Great Hi-Fi carefully selected and demonstrated by friendly enthusiastic staff. Home installations and check-ups. Two year warranty from our own service department. Open 9.00-5.30 Tuesday - Saturday closed Monday.

## GWYNEDD

**I&H GRIFFITHS & SDNS**, 313 High Street, Bangor LL57 1YA. 0248 373655. Yamaha, Tannoy, Teac, Sony, B&W, Wharfedale, Rotel, JVC. Home trial facilities. Free installation, service dept. After hours dems by appointment. Access/Visa. Lombard credit charge. Mon-Sat 9-5.30. Wed 9-1. Audio Visual Specialists.

**TOP TAPE**, 1 Crystal Way, Elm Grove Road, Hurrell, Middlesex, HA1 2RJ. Tel 081 427 1404. The UK's oldest and largest Tape Mail Order Service. TDK, Maxell, Sony, Ampex audio cassettes plus Fuji, JVC, Konica, Memorex, Scotch & TDK video tapes. Send for complete list of latest prices and offers including Video 8, VHS-II, S-VHS, DAT, MiniDisc and Open Reel and tape accessories including Allsort. Local Dealer Listing available. Telephone orders on 081 427 1404. Mastercard, Visa & Switch accepted.

## Simon Hopkins

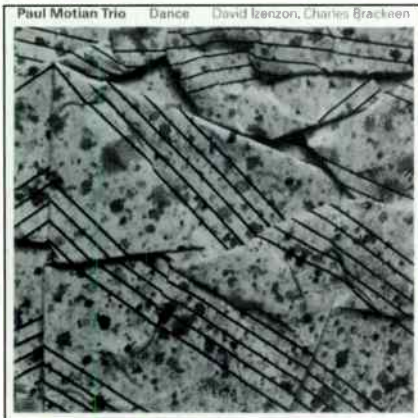

**PAUL MOTIAN TRIO**  
**Dance**  
ECM 519 282-2

● The German ECM label continue their CD reissue series apace, alongside their ever expanding catalogue of new jazz and classical recordings. This quartet of reissues all roughly date from the late 70s, by which time the label had coalesced its identity musically and had established itself both as an extremely successful proposition commercially with a clutch of rising stars that included the Americans Keith Jarrett and Pat Metheny and the Norwegian saxophone player Jan Garbarek. By this stage the label had also

already established what would become both its prime selling point and its chief attraction of adverse criticism: a definitely recognizable sound and, even, style.

For my money the pick of the crop here is The Paul Motian Trio's *Dance*, but then that's an opinion helped along by the general belief that drummer Motian is at once one of the most creative and yet overlooked musicians to have worked in contemporary jazz over the last thirty years. Despite a background in both the military and traditional post-bop jazz, from the beginning of his professional career Motian always seemed drawn towards maverick music makers. Case in point: he first came to widespread public attention as one third of perhaps one of the finest groups to have ever graced modern jazz, the Bill Evans trio of pianist Evans, bassist Scott La Faro and Motian. Like Jimmy Giuffre, Evans contributed a lyrical approach to jazz improvisation which owed as much to the European impressionist music of the turn of the century as it did to the cry of the blues, and helped create an arena for romantically inclined jazz which a record label like ECM would mine so fruitfully.

Certainly Motian himself learned a great deal beyond drumming from his years with Evans. Over the nigh-on thirty years between then and now he has contributed some of the most arresting music imaginable to the jazz canon. He's done this as a sideman - most notably alongside Keith Jarrett (Jarrett has worked with many fine drummers, Jack De Johnette and Jon Christensen chief among them, but I reckon his music has never sounded finer than with Motian behind it), but it's his work as a leader that has been his most consistently probing yet satisfying.

For alongside his drumming - of which more later - Motian has two other stand-out musical traits: he's a fantastic composer - easily as fine a writer as has

ever graced modern jazz - a writer of music by turns elegaic, serene, urgent, lyrical, folkish, abstract, mesmeric; music which draws on Free Jazz and folk music and contemporary classical music and military marches and pop tunes without ever resorting to anything quite as modishly post-modern as collage or cut-and-paste; and he's got an unfailing ear for great musicians. Over the years his groups have practically launched the careers of musicians as diversely gifted as guitarist Bill Frisell, tenor saxophonist Joe Lovano (indeed, his current group with Frisell and Lovano truly ranks with the Evans-La Faro-Motian groups as one of the great trios of modern jazz), pianist Geri Allen, bassist Ed Schuller and tenor and alto saxophonist Billy Drewes. And then, of course, there's his drumming. As much a drumming melodist as a time keeper, Motian combines urgent hard-bop swinging with a painterly abstraction that verges on the gauche in a way which is seldomly less than awe inspiring. Put simply, he's very possibly the finest drummer to have been playing creative jazz for the last twenty years.

*Dance* dates from 1978 and features easily one of his very best trios: himself, bassist David Izenzon and tenor and soprano saxophonist Charles Brackeen. In many ways this was almost an inconceivable trio to have brought together. Izenzon had emerged in the sixties as a leading light of the New Thing, the blazing, black, urban Free Jazz which represented the polar opposite of the pastorally lyrical free improvisation coming from the likes of Evans and Giuffre. At the time of this recording, Izenzon had actually been retired from music making for some years (he'd actually been working as a psychoanalyst) which only goes to underline the unlikelihood of his presence in the trio. Brackeen by contrast, had been associated with Free Jazz through his working with the "Rhythm X" group of Ornette Coleman and friends; Ornette's impact on jazz had been, of course, as revolutionary as the arrival of Shepp, Ayler and co in the New Thing, but his approach was always more elliptical than incendiary, and that approach worked its way into Brackeen's sound, which was at once indisputably Ornette-inspired and unmistakably his own.

Yet together this group worked like a dream. Playing their way through six Motian originals, the trio bring a combination of rabid energy, mesmerisingly beautiful mysticism and unexpected, obtuse abstraction to compositions which range from the Caribbean pop song-meets-military march of 'Kalypso' to the folkish tone poem of 'Asia'. They do all this and yet remain resolutely accessible. This, I reckon, was as good as acoustic music-making got in the seventies, and the very pinnacle of the acoustic side of the classic late 70s "ECM sound". Highly recommended.



**GARY BURTON**  
**Times Square**  
 ECM 521 982-2

● Vibraphonist Gary Burton is another bandleader to have had a long-standing association with ECM, and another to have kick-started the careers of several recent jazz luminaries, guitarist-superstar Pat Metheny and pianist Makoto Ozone among them. But his music-making has been one both more self-consciously virtuosic yet less obviously visionary than that of Motian (relevantly, Burton's records don't feature his own compositions). Straddling post-bop and jazz-rock, Burton's music in many ways prefigured the "acoustic fusion" approach of eighties groups like Steps Ahead, and although I personally figure that the whole point of jazz-rock is to be able to make as much racket as possible while maintaining the improvisatory madness of jazz (like, the boring thing about being a rock musician was always having to play the same thing the same way night after night, week after week), nonetheless, this highly virtuosic, restrained version of fusion has proved highly popular.

The group here is certainly a hard playing quartet: Burton on vibes, bassist (and - circles-within-circles - Jimmy Giuffrè alumnus) Steve Swallow, drummer Roy Haynes and trumpeter Tiger Okoshi, and from the rip-roaring hard bop opener, Keith Jarrett's 'Semblence' (sic) it's clear they mean business. Burning stuff.

**AZIMUTH**  
**Azimuth/Touchstone/Depart**  
 ECM 523 010-2

● If Paul Motian represents the truly visionary side of the ECM canon - alongside, say, the Keith Jarrett of The Koln Concert and the Jan Garbarek of Paths, Prints or It's OK to Listen to the Gray Voice - and Burton represents the label's solid, musicianly, determinedly jazzish side, then Azimuth represents what many listeners and critics have always seen as its most characteristic approach: a post-impressionistic, abstract, ethereal, pastoral music which borders on New Age tranquility, but retains enough jazz spirit to give it an edge which lifts it above

the anodyne. This description is, in truth, too broad to be fair to either Azimuth or their record label, but it's one which'll stick.

The group came together in 1977 as a recording outlet for the music of pianist John Taylor. Taylor isn't the world's most revolutionary musician, but he's certainly one of this country's finest post-bop pianists, indeed one of the finest in Europe, and always one to accompany visiting American superstars - like, say, John Abercrombie - on their European tours. In Azimuth he played organ and synthesizers in addition to piano, and was joined by the stunning improvising vocalist Norma Winstone and trumpeter-flugelhorn player Kenny Wheeler.

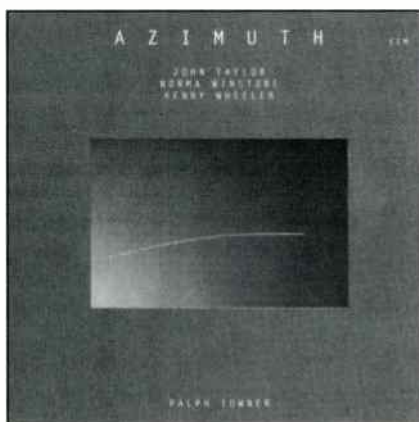

This three CD set brings together their first three recordings for ECM: 1977's eponymous debut, 1978's The Touchstone and 1979's Depart, on which they're joined by Ralph Towner on acoustic 12-string guitar, who's frankly a welcome addition after two CDs of some fairly stark arrangements - Taylor's compositions are often very beautiful, and his keyboard textures are extremely fine, but this is music whose emphasis is on lightness and space. Overall, this music is an acquired taste, and 3 CDs' worth is a lot to get through for the neophyte, but in the age of the three-second attention and MTV-happy-shiny-people aesthetic, art of this breadth and solemnity is welcome indeed. A vital reissue.

**GEORGE ADAMS**  
**Sound Suggestions**  
 ECM 517 755-2

● And from definitive ECM stuff to a real one off. Georgia-born tenorist and sometime flautist George Adams first emerged in the sixties as a Coltrane-influenced player of considerable power, but an increasing romanticism and a deep, deep affinity with the blues pulled him towards a more traditional - if still highly invigorating - approach than the noisemaking-as-art favoured by his New Thing contemporaries, and the musician he chose to work with - Dannie Richmond and Don Pullen chief among them.

He recorded just one album for ECM,

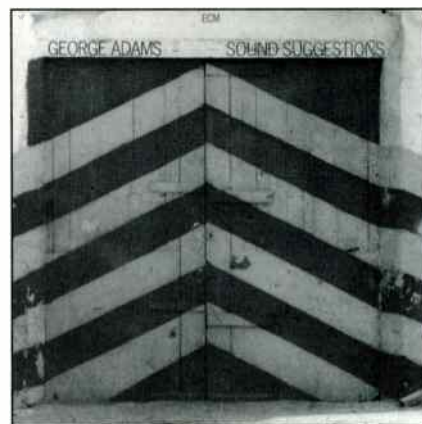

1979's Sound Suggestion on which he was joined by a sterling "little big band" of Heinz Sauer on tenor saxophone, Kenny Wheeler on trumpet and flugelhorn, Richie Beirach on piano, Dave Holland on bass and Jack de Johnette on drums. They swagger their way triumphantly through pieces by Wheeler and Sauer and a blues penned by Adams to which he contributes his characteristic, gruff blues vocals. A rare marriage of contemporary jazz finesse and raw blues power. A corker.

## Simon Cooke

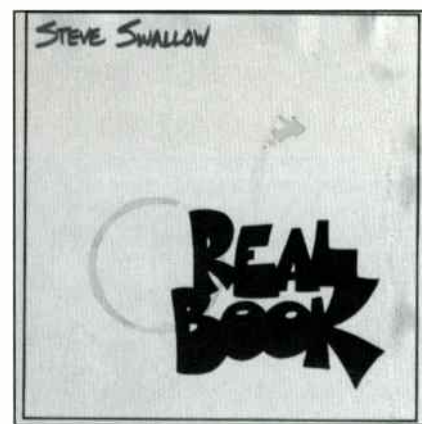

**STEVE SWALLOW**  
**Real Book**  
 521 637-2

● Steve Swallow wrote the ten tracks on this excellent release to honour an early sixties book of Jazz scores - the 'Real Book' - and arranged them for Joe Lovano and Tom Harrell's brass, Mulgrew Miller's ivories and the impressive Jack de Johnette on drums, with Swallow himself on bass. Playing as a perfectly-judged unit these musicians turn in excellent group and solo work. They really sound as though they enjoyed these sessions, and that's always infectious.

The first track storms from the 'speakers, balanced by an assured, strutting second track. Thereafter, mood and tempo are varied from track to track, in an eclectic palette of emotional hues mixed smoothly by the broad sweep of

group's easy bebop style.

Technically, the recording is unusual, giving the same intriguing, inveigling, by-the-seat-of-the-pants performance with a variety of systems, from a 'one box' hi-fi to an audiophile system. One last point; there are no sleeve notes, but instead a booklet of the working scores of each track; nothing more. It's a masterful ploy that completes the package.

This is already a benchmark CD for me, and I could eulogise ad infinitum given space, but there are not superlatives enough. If there's a better pure jazz release this year, I'll eat my DAC. More than a recording, it's the unadulterated Elixir of Jazz. Drink deep.



**TINA MAY**  
**It Ain't Necessarily So**  
33JAZZ017

● A far better work than her second album - *Fun* (which sold well anyway) - and well worth hearing. This album feels slower than *Fun*, giving Tina time to develop and hold notes to kill the breathless quality of that earlier work. She's been less closely miked here, enhancing the softness in her voice to balance her occasional tendency to 'squeak'. This produces a sense of space and atmosphere enhanced further by the fact that the band is softer and less forward, expanding this recording from the flat wash of sound which was *Fun*, into something resembling a live set.

Three tracks stand out; the Gershwin title track, a bass/vocal 'duet' which stands comparison with Carol Kidd's recent recording of the song. This may be less operatic and technically correct than Kidd's interpretation, but in my opinion



May scores for soulful ease and gut feeling. The two tracks recorded with the Britten String Quartet - 'Chelsea Bridge' and 'Solitude' - are excellent despite the Quartet's slightly leaden handling of the tunes which counterpoints May's voice particularly well; Tina's spine-tingling vocal on 'Chelsea Bridge' stands comparison with any version I know, while 'Solitude' is simply haunting.

So, this is an album which finally does justice to an outstanding live artist. Well performed, well recorded, well worth hearing.



**ZUBOP**  
**Freewheeling**  
33JAZZ015

● What can you say about Zubop? An instant Afro-Latin-Salsa-Reggae-Funk-'World Jazz' party; the kind of group that could cut a wax cylinder in a Citroen 2CV travelling between gigs and still turn out a release with enough energy and style to wipe most recording artists off the map. Maybe not a great recording, but great fun, and often challenging.



**SCOTT HAMILTON**  
**Scott Hamilton, 2**  
CONCORD JAZZ CCD-4061

Recorded in 1978, and now re-released on CD, '2' effectively bridges the intervening years by opening with 'East of the Sun', the title track from his most recent album. '2' is another meander - with Nat Pierce on piano, Monty Budwig on bass, Jake Hanna on drums and Cal

Collins on guitar - through Scott's home turf of mid-tempo standards. The only mould breaking track is 'I want to be happy', played fast, but unlikely to worry even the most slothful system.

I suspect that a few undesirable characteristics have crept in while this was being re-mastered; Pierce's piano is noticeably splashier than on vinyl, and Scott's tone is a little thinner, too. However, that's academic, really, and the result is a recording which only just falls short of Concorde's usual quality, but not enough to prevent it being worth hearing. If you want a decent collection of good jazz, '2' should be there simply for being Scott Hamilton, although absolute purists may prefer the vinyl.

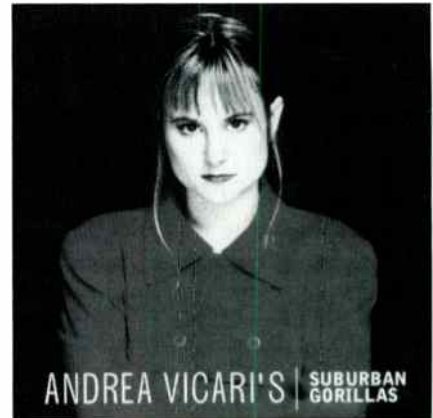

**ANDREA VICARI'S**  
**SUBURBAN GORILLAS**  
**Andrea Vicari's Suburban Gorillas**  
33JAZZ016CD

● The debut album of Ms. Vicari's group is a mix of well performed contemporary jazz recorded with the workmanlike precision of most of "33" Records' releases. The line-up is one that includes many of Britain's finest young musicians such as Mornington and Dorian Lockett, and Leigh Etherington to name but three. Ms. Vicari herself is a keyboard player of talent enough to hold her own in this choice selection of young British talent sauntering through a 78 minute set.

The only track I didn't take to was the 'Pin Stripe Woman' boogie, but after the excellent 'In Africa Maibouye' - cod township jive like you've heard ten thousand times since 'Graceland' but set firmly in a contemporary jazz framework and descending into squealing midtown horns - I can forgive it. The three-piece 'French Suite' - an Arts Council commission - is also, in my opinion, worth whatever public money that body paid. The group looks like a promising line-up who are perhaps not yet at ease as a group (perhaps due to the vagaries of Arts Council funding?) but they should have a bright future ahead of them, and will be worth keeping an eye on, especially when backed by "33" Records high recording standards. A CD worth seeking out.

## An invitation from Bill Wilson

Cut the cost of your CD buying by as much as 50% with...

# THE CD SCOOP OF 1994

Buy your CDs the easy way and save £££'s at the same time with Bill Wilson's CD Warehouse.

## Autumn Stocktaking Clearance Sale

Save as much as 50% off this enormous collection of classical and popular CD's at really giveaway prices.

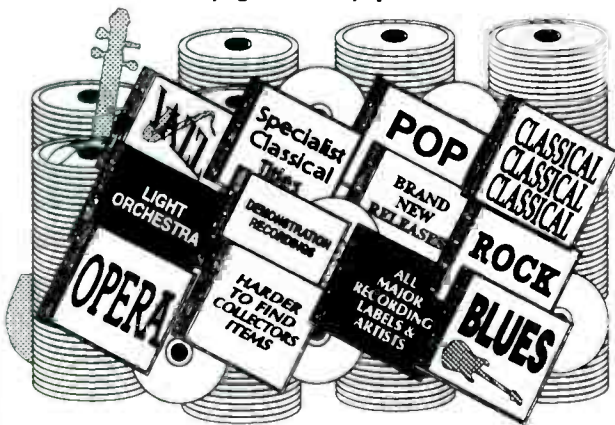

### COLLECTORS CHOICE

In addition, we can obtain virtually any CD available in the UK at greatly discounted prices.

*It's just part of the WSL CD service which includes...*

- A unique library 'try before you buy' service.
- The CD Index — the only book that tells you all you want to know about CDs.

If you want the kind of service no other CD club can offer you, contact me now for full details of the Wilson Stereo Library CD service — I'll reply personally and make you a very special offer of membership including details of the Autumn Stocktaking Clearance Sale — the Scoop of 1994.



*OK Bill Wilson! Tell me about the WSL CD Service and the benefits I can get from it. Including the New CD Warehouse including the Autumn Stocktaking Clearance Sale — the Scoop of 1994. Without obligation (I enclose two first class stamps for speedy reply).*

Name: \_\_\_\_\_

Address: \_\_\_\_\_

\_\_\_\_\_

Postcode: \_\_\_\_\_



To: Bill Wilson Wilson Stereo Library PO Box 32  
St. Leonards-on-Sea East Sussex TN38 0UZ  
Telephone: (0424) 718254 Fax: (0424) 718262

HEW11/94

# The Troika



The Troika is a handsome piece of furniture for storing away CDs and cassettes.

The Troika has 3 drawers and a definitive, patented system for arranging any combination of CDs, and audio and video cassettes. It measures approx. 23" high x 20" wide x 17" deep, and can store away up to 306 CDs.

The Troika is available fully-assembled in light or dark oak finish £295 including delivery.

For details, write or fax:

Reflection Furniture  
Hill Cottage Workshop  
Moon Hall Road  
Ewhurst Surrey GU6 7NP  
Fax 0483 277352



## JORDAN JX Series

**Congratulations to the rest of the world - you're finally waking up.**

E.J. Jordan Designs has been working with metal cone loudspeakers for over 40 years. We've tried and rejected avenues other manufacturers are still exploring today and our JX Series of drive units represent the cutting edge of loudspeaker technology.

Our design services, supported by in-house R & D facilities and unmatched experience have been commissioned by a number of major high end clients at home and abroad including the BBC.

Our JX Series of foil cone drivers are now available world wide, from ourselves or our appointed agents.

Please contact us for colour brochure.

### E.J. JORDAN DESIGNS

The Dak, Manorbier, Tenby, South Pembrokeshire, SA70 8QR. Tel: 0834 871209 Fax: 0834 871770



# AUDIO ACCESSORIES



## HI-FI WORLD SOLID SILVER INTERCONNECTS.

Constructed from solid strands of pure silver wire, and with a thick outer casing and screening braid, these interconnects offer the ultimate in transparency, openness and detail. Superb Neutrik Profi phono plugs are silver soldered to the cables in pseudo-balanced configuration for lowest noise/interference and extensive use of adhesive heat-shrink is used to strengthen the join between cable and plug for long life. Available exclusively through Hi-Fi World Mail Order.

.....£139.95/1M PAIR.

## HI-FI WORLD SILVER PLATED COPPER INTERCONNECTS.

A similar construction to our solid silver cables, but using silver plated copper and standard Gold Phono plugs. Because the majority of the audio signal passes through the skin of a cable these can approach the quality of silver, but at the cost of normal high quality copper cable.

.....£69.95/1M PAIR.

## HIGH QUALITY MAINS CABLES.

Supplied to Hi-Fi World by Campaign Audio Design these mains cables are screened to reduce Radio Frequency and Electromagnetic Noise. They also come

with a VDR fitted which protects equipment from mains spikes. The MK plugs have a silver plated fuse and holder for the cleanest supply. Available with IEC or Figure eight (Marantz/Philips CD players) equipment plugs or with a hard wired, soldered 4-way mains block.

**1M WITH IEC PLUG** .....£19.20  
**1M FIGURE 8 PLUG** .....£15.75  
**1M 4-WAY BLOCK**.....£31.95



## 4-WAY MAINS BLOCK WITH RF FILTER

Similar to the standard 4-way mains block featuring 2m screened mains cable, MK plug with silver plated fuse and holder and VDR to stop mains spikes reaching your equipment. A special RF filter has now been added which cuts out even more mains boome interference. Suitable for top-end systems

.....£45.50

## EQUIPMENT SPIKES

Machined from solid brass these equipment spikes can be placed under equipment to help ground harmful vibration and enhance the visual appearance of your equipment. The spikes come in sets of three and will

support equipment weighing up to 10kg. We hope to introduce a larger spike suitable for heavier equipment and loudspeakers within the coming months.

.....£6.50

## AFFORDABLE SILVER PLATED COPPER INTERCONNECT

A 'budget' interconnect featuring high quality silver plated copper co-axial cable and standard gold plated phono plugs is now available. The plugs are silver soldered to the cable for good electrical contact and high mechanical strength.

.....£28.00/1M PAIR



## HIGH QUALITY AERIAL LEADS

If you've just spent a lot of money on a good tuner and aerial, then you'll want to connect the two together with the best cable possible to ensure the signal is preserved. We now have a high quality copper co-axial cable furnished with gold plated connectors which does just that. Because the length of cable required for different circumstances will vary greatly, we are offering a custom termination service for this cable.

.....£19.95/M +£2/EXTRA M



## GARRARD 401 CELEBRATION SME IV TONEARM

A special version of the SME IV cast magnesium alloy tonearm, dedicated to the Garrard 401. The SME IV is precision engineered to be fully adjustable, making set-up easy and precise. If you want to get the best from your Garrard 401, this is a fantastic tonearm, sympathetically styled to form a perfect combination.

**GARRARD 401 CELEBRATION SME IV TONEARM** .....£820

# AUDIO ACCESSORIES



LP together. Review in Hi-Fi World August 1994, these machines are a must for the dedicated Vinyl collector.

### BASIC RECORD CLEANING SYSTEM

£199.90

**RECORD MASTER RECORD CLEANING SYSTEM FOR ALL SIZES (7/10/12") WITHOUT ADAPTOR** ..... £249.90

**1.5 FI FULLY AUTOMATIC SINGLE SIDED RECORD CLEANING SYSTEM** ..... £399.00

**MINI-PRO I RECORD CLEANING SYSTEM BOTH SIDES CLEANED SIMULTANEOUSLY** ..... £599.00

For further details and cleaning fluid cost please contact the Mail Order Department on 071 - 266 0461

**NEW**

### NITTY GRITTY RECORD CLEANER

Bring a glossy shine to your LPs with the Nitty Gritty series of record cleaners. Several versions are available from the basic machine to the near fully-automated Mini-Pro (pictured) which cleans both sides of the

### BUG AUDIO

A fascinating little device no larger than a hand-held remote which allows the user to adjust bias on any cassette deck perfectly for any tape. You can check the state of your cables and connections with it, too! Supplied with a cassette test tape and full instructions. (See review, Nov. 1992 issue.)

**BUG AUDIO** .....£59.99



### MICHELL ENGINEERING PLUGS

Craftsmanship marks out Michell Engineering's range of gold and rhodium plated plugs from the competition.

**GOLD-PLATED SIDE ENTRY BANANA PLUGS (4)** .....£10.00  
**GOLD-PLATED SURE-LOC**



**BANANA PLUGS (4)** .....£14.95  
**RHODIUM-PLATED SURE-LOC BANANA PLUGS** .....£18.95  
**GOLD-PLATED SPEAKER CABLE CONNECTORS**...£10.00

### GOLD PLATED 4MM BANANA PLUGS

Heavy-duty, gold-plated banana plug with a unique type of axial solderless connection for loudspeaker cables. The cable is stripped back and pushed into a clamping collar which is then screwed down tight, accepting cable up to 6mm external diameter and 4mm core diameter. Supplied in sets of four.

**BANANA PLUGS (4)** .....£8.00

### RECORD STORAGE CUBE

Designed to hold about a hundred LPs, with an internal width of 37cm, height of 32.5cm and depth of 32cm. The cubes can be stacked or placed alongside each other - and are even strong enough to be used as seats! Made from 15mm MDF (Medium Density Fibreboard) with a smart durable black paint finish, the cube is supplied in flat-pack

form ready for home assembly.

**RECORD STORAGE CUBE** .....£45 EACH

**SIX CUBES FOR THE PRICE OF FIVE** ..... £225.00  
**EIGHT CUBES FOR THE PRICE OF SEVEN!**.....£315.00



### ANTI-STATIC RECORD SLEEVES

Translucent sleeves, treated to reduce static and dust attraction, supplied in packs of fifty.

They will fit inside ordinary printed inners.

**LP SLEEVES (50) PRICE £8.15**

### SOUND SWIVEL

A rotating, upright, double-sided, storage cabinet with space for up to 160 Compact Discs, including 8 double jewel-cases. Mounted on an all-steel turntable, it swivels smoothly through 360 degrees giving easy access to the storage compartments either side. Manufactured in durable MDF with a Black Ash effect finish, the Sound swivel comes packed for self assembly with full instructions.

**SOUND SWIVEL** .....£49.95

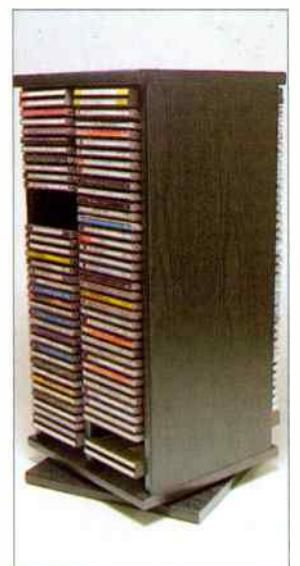

# Hi-Fi World

# AUDIO ACCESSORIES

## AUDIO-TECHNICA RECORD CLEANING SYSTEM

Removes both dirt and static; a tiny amount of cleaning agent in the handle removes fingerprints, oil and film, while a pad lifts off dust. Pad brush and fluid are supplied.

**AUDIO-TECHNICA RECORD CLEANING SYSTEM £10.50**



## AUDIO-TECHNICA COMPACT DISC LENS CLEANER

A disc the size of a CD, with fine brushes - one of which is dampened with cleaning fluid. As the disc spins in the player, the brushes clean the laser lens. It may not suit all machines.

**CD LENS CLEANER .....£16.25**



## KONTAK

An effective cleaning solution that removes contaminants from electrical connections. After application, a system regains its original life, sparkle and vigour.

**KONTAK .....£19.00**

## HI-FI WORLD DRY STYLUS CLEANER

Keep your stylus sharp and bright for perfect tracking without using fluid. Cut a strip about the size of a matchbox striker off this sheet of card and draw it gently under the stylus from back to front. One sheet of this card, with its aluminium-oxide micro-abrasive coating, should be enough to clean your stylus at least forty times.

**DRY STYLUS CLEANER ..£1.95**

## EQUIPMENT SUPPORTS

FrameWorks is an innovative range of versatile hi-fi supports whose high standard of strength and rigidity results from their 'triangulate' design. The shelves are supported on struts of thin cross-section and four sturdy corner columns, to reduce resonances.

Versatility is guaranteed by two or three shelf options, an additional isolation shelf and a stacking unit to expand the system as the hi-fi grows. All you need to do is add components as and

when you feel the need.

FrameWorks stands come with attractive 10mm thick toughened smoked glass shelves, supported on rubber-damped spikes to reduce vibration and lessen the tendency for the glass to slide. Metal parts are finished in a hardwearing satin black powder coat.

FrameWorks stands will extract the best out of any equipment.

FrameWorks' excellent hi-fi equipment stands are now available through our Mail Order Department.

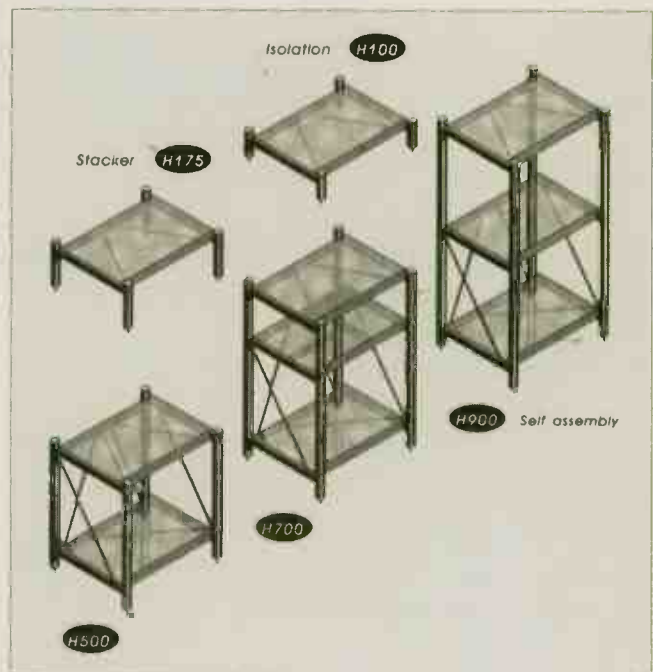

PRICES FOR FRAMEWORKS EQUIPMENT STANDS ARE AS FOLLOWS;

CODE	HEIGHT	PRICE
H100	100MM	£109
H175	175MM	£119
H500	500MM	£205
H700	700MM	£275
H900	900MM	£305

ALL FRAMEWORKS SHELVES ARE 550MM WIDE BY 450MM DEEP. All prices include VAT & p+p for UK only.



**H100 ISOLATION TABLE**

# AUDIO ACCESSORIES

## GOLDRING EXSTATIC MAT

For vinyl users, the Goldring Exstatic is a felt mat made with fine carbon fibre strands. This helps to reduce positively charged static electricity that builds up on the surface of records.

**GOLDRING EXSTATIC MAT** £7.50



## SUPER EXSTATIC CARBON FIBRE DISC CLEANER

Effectively removes dust and grime from record grooves, this cleaner is a combination of one million carbon fibre filaments and a soft velvet cleaning pad.

**EXSTATIC CARBON FIBRE CLEANER** £9.95



## MILTY TRIPLE A

Suitable for all types of cassette players including auto-reverse, the Milty Triple A wipes clean single/dual capstans and pinch rollers with a non-abrasive cleaning action.

**MILTY TRIPLE A** £6.50

## MILTY MAGNET IX

The Milty Magnet IX comes complete with battery. It requires approx one second to de-magnetise the heads removing magnetic charge build up. Recommended after every 30 hours of playing time.

**MILTY MAGNET IX** £10.50

## HI-FI WORLD SPECIAL AUDIO ACCESSORIES ORDER FORM

Please send me:

- Audio Technica CD Lens cleaner.....£16.25 each
- Audio Technica Green CD Ring Stabilizers.....£6.50 (Pack of 5)
- Audio Technica Record Cleaning System.....£10.50
- Basic Record Cleaning System.....£199.90
- Record Master Record Cleaning System (without adaptor)....£249.90
- 1.5 Fully Automatic Single Sided Record Cleaning System.....£399.00
- Mini-Pro Record Cleaning System.....£599.00
- Bug Audio Biasbug.....£59.99
- CD sound swivel.....£49.95
- Equipment Spikes.....£6.50
- Garrard 401 Celebration SME IV Tonearm.....£820.00
- Gold plated 4mm plugs.....£8.00 (4)
- Goldring Exstatic Mat.....£7.50
- Goldring Super Exstatic Carbon Fibre Disc Cleaner.....£9.95
- Standard Silver Plated Copper Interconnects (1m pair).....£28.00
- Hi-Fi World Silver Plated Copper Interconnects (1m pair).....£69.95
- Hi-Fi World Solid Silver Interconnects (1m pair).....£139.95
- Hi-Fi World Aerial Leads.....£19.95 per m + £2.00 per extra m
- Hi-Fi World Dry Stylus Cleaner.....£1.95 per sheet
- Kontak cleaning fluid.....£19.00each
- Michell Gold-Plated Side Entry Banana Plugs (4).....£10.00
- Michell Gold-Plated Speaker Cable Connectors.....£10.00
- Michell Gold-Plated Sure-Loc Banana Plugs (4).....£14.95
- Michell Rhodium-Plated Sure-Loc Banana Plugs (4).....£18.95
- Milty Magnet IX.....£10.50
- Milty Triple A.....£6.50
- Nagaoka Anti-static record sleeves.....£8.15 (50)
- Pixall MkII Record Cleaner.....£10.75 each
- Pixall refill roller.....£2.75each
- Record storage cube.....£45.00 each
- Screened Mains Cable With 4-Way Block (1m).....£31.95
- Screened Mains Cable With RF FILTER4-Way Block (2m).....£45.50
- Screened Mains Cable With Fig 8, Plug (1m).....£15.75
- Screened Mains Cable With IEC Plug (1m).....£19.20

Prices are exclusive of postage & packing, please add £1.00 for postage in the UK and £2.00 for postage overseas. With the exception of the Record Cleaning Systems which are £4.00 UK and £10.00 overseas.

Your name and address may be added to our mailing list only. If you would prefer not to receive details of new products or special offers please tick box. Hi-Fi World magazine is published by Audio Publishing Ltd.

10/94

Please allow 28 days for delivery

### Books

- Electrostatic 'Speaker Design & Construction.....£19.95 + £2.00 p&p
- The Williamson Amplifier.....£9.95 + £1.00 p&p
- Mullard Circuits for Audio Amplifiers.....£13.95 + £2.00 p&p
- The Loudspeaker Design Cookbook.....£23.75 + £2.00 p&p
- The Art of Electronics.....£35.00 + £4.00 p&p
- The Art of Linear Electronics.....£16.95 + £2.00 p&p
- Audio & Hi-Fi Handbook.....£40.00 + £4.00 p&p
- Loudspeakers: The Why & How.....£10.95 + £1.00 p&p

All prices are exclusive of postage & packing. For U.K. and Europe please see above. For 10 or more books p&p is free. Outside Europe please contact us for rates.

I enclose cheque/PO for £.....made payable to **World Audio Publishing Ltd.**

I wish to pay by Visa/Access, please debit my account no:

--	--	--	--	--	--	--	--	--	--	--	--	--	--	--	--	--	--	--	--

Expiry date: 

--	--	--	--

Signature:.....

Name.....

Delivery Address.....

N.B. If delivery address is different to the credit card holder's address please supply both.

Tel:.....

Please send completed order form together with your cheque/PO to:

**HI-FI WORLD,**  
64 Castellain Road,  
Maida Vale,  
London W9 1EX.

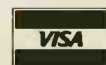

Credit Card Orders  
Telephone 071 - 266 0461  
24 hour Mail Order Answerphone

# Hi-Fi World WORLD LIBRARY

## **ELECTROSTATIC LOUDSPEAKER DESIGN AND CONSTRUCTION, by Ronald Wagner. £19.95**

This book takes you step by step through the design and construction of a full range electrostatic loudspeaker, including the basic operating principles behind electrostatics. Whether you intend to build your own electrostatic, repair and restore a vintage electrostatic or are just interested in the principles behind electrostatics, this book is a must.

The author takes you deep into his design decisions and offers practical advice on how to build the amplifier and set it up for best performance.

principles through to full design exercises and practical circuits.

## **LOUDSPEAKERS: THE WHY AND HOW OF GOOD REPRODUCTION, by G. A. Briggs. £10.95**

A popular and easy to understand book on building loudspeakers, using empirical techniques that pre-date computer analysis. A fine grounding, written by a manufacturer with first hand experience - recommended for beginners.

## **THE LOUDSPEAKER DESIGN COOKBOOK, by Vance Dickason. £23.75**

This best selling book in the field of loudspeakers offers good, up-to-date practical design information for the home constructor. Like today's manufacturers it uses modern Thiele Small theory and parameters.

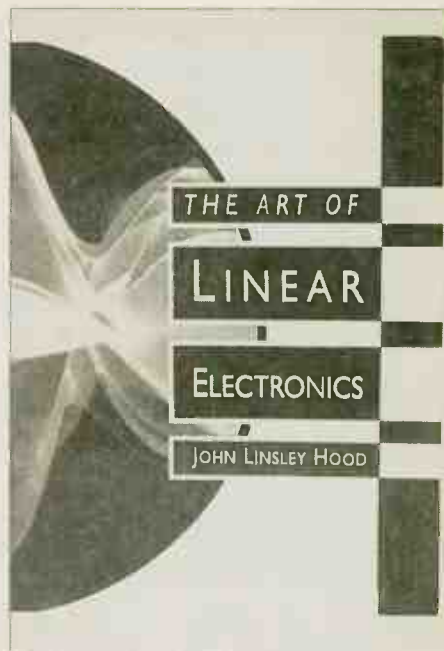

THE ART OF  
LINEAR  
ELECTRONICS  
JOHN LINSLEY HOOD

## **AUDIO AND HI-FI HANDBOOK, edited by I. R. Sinclair. £40.00**

The Audio and Hi-Fi Handbook is written by some of the best known designers and spokespeople of the audio industry. It offers an insight into every area of audio, from sound waves and acoustics, through to car hi-fi.

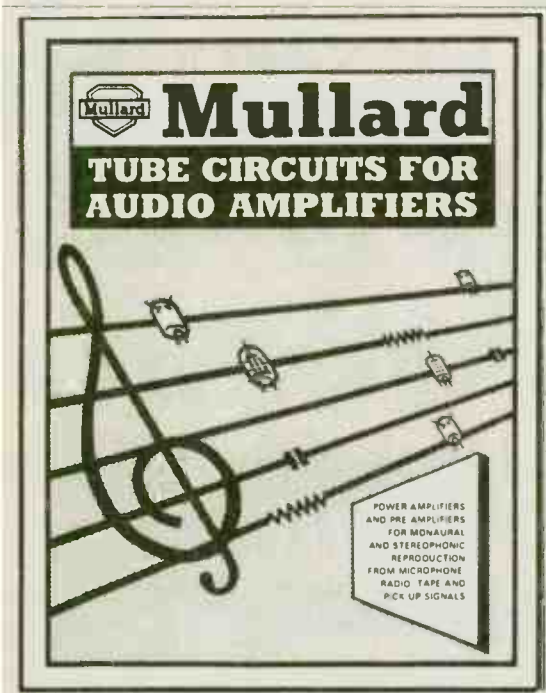

## **MULLARD TUBE CIRCUITS FOR AUDIO AMPLIFIERS. £13.95**

First published in 1959 by Mullard, this book includes full designs for eleven power and control amplifiers, including the 5-20, using valves. This book begins with a four-chapter tutorial on getting the best sound from valve amplifiers.

## **THE ART OF LINEAR ELECTRONICS, by J. Linsley-Hood. £16.95**

Concentrates specifically on analogue electronics for audio and goes into detail on obscure topics like the drawbacks of feedback, as well as its advantages. Covers mainly solid state but also includes valves. A must for serious enthusiasts and budding designers.

## **THE WILLIAMSON AMPLIFIER, by D. T. N. Williamson. £9.95**

In April 1947, Williamson's valve power amplifier became an overnight success.

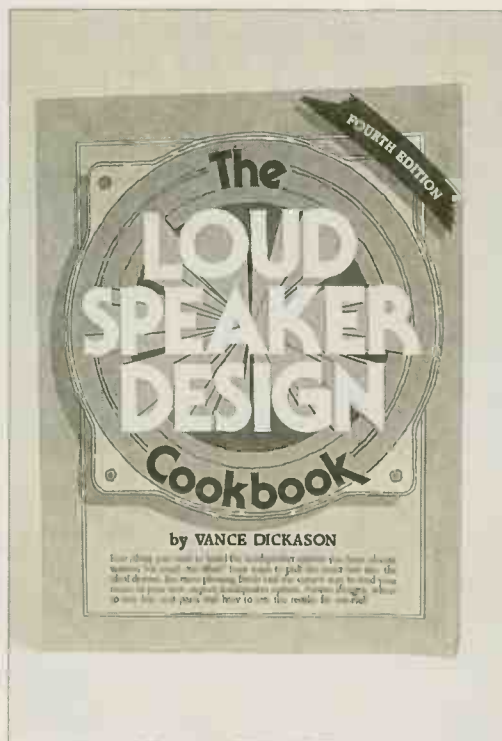

## **THE ART OF ELECTRONICS, by P. Horowitz and W. Hill. £35**

The definitive electronics book. The Art of Electronics is an ideal book for the beginner through to the engineer. Written in easy to understand English, each chapter takes you from basic first

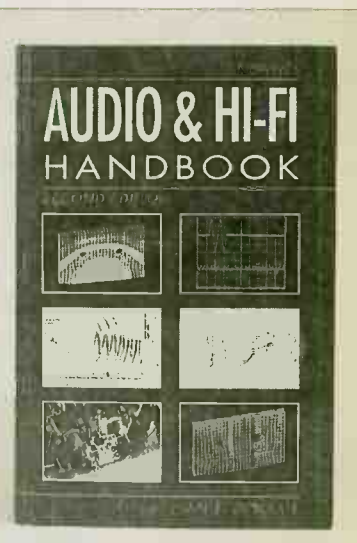

# **Try me & see** **For the very best** **DEALS for 1994!**

**on any current Hi-Fi, A/V,  
Home Cinema unit or VCR -  
AND all Award Winners**

**AMAZING PRICES GUARANTEED**

**PHONE NOW**—*you'll get first-class  
service, savings and support.*

- ✔ Budget, Regular and Esoteric Equipment.
- ✔ Insured Overnight Delivery, anywhere in the U.K.
- ✔ Major Credit Cards, Switch/Connect accepted.
- ✔ All goods carry comprehensive Warranty.
- ✔ Goods under Warranty collected and delivered FREE.
- ✔ Extended Warranties up to 5 years available.

*You can always buy from TMS with the complete confidence that we will never let you down.  
We ever put our customers first and constantly upgrade and update our systems in order to improve our service.*

**081-563 0003**  
**Fax 081-563 0300**

**Try Me & See Ltd,**  
**5 Rocks Lane, Barnes,**  
**London SW13 0DB**

Can I try it at home?

**YES!**

To arrange a home demonstration (with no obligation) or just for friendly chat ring 0257-426100 anytime



ARION ACOUSTICS • AUDIOMECA (FRANCE) • AUDIO SYNTHESIS • AUDIO VALVE AMPLIFICATION (GERMANY) • KINSHAW • LIEDER • ORTOFON • PRO-JECT • TEAC • TRIANGLE • YBA (FRANCE) and other selected brands

definitive audio nottingham

Tel/Fax (0602) 813562

Import/Export

LIVING VOICE HÖRNING WADIA AUDIO INNOVATIONS MIRO IMPULSE SME TOWNSHEND VITAVOX EMT XLO GOLDRING DALI VOYD SYSTEMDEK PIONEER REVOX LOWTHER MICROMEGA

During the past few years there has been a significant increase in the availability of simple low power valve amplifiers - particularly in single ended configuration. This would have been a more valuable development if there had been a corresponding increase in availability of high sensitivity loudspeakers. A 5-9 watt valve amplifier needs to see a very even load and a sensitivity of 98 dB/W @ 1m, or more. Without this the full benefit of these simple amplifiers cannot be fully realised. In many ways the amplifier/loudspeaker relationship is so important that it should be considered as a single unit. Definitive Audio represents a coherent hierarchy of such loudspeaker/amplifier combinations ranging from 3 to 50 watts, 94 to 108 dB/W and from £450 to £14,000.

USED ITEM FOR SALE

\*denotes full warranty

Ortofon Quartz	100		Voyd 5 Reference oak	2000	3600
Quazar	150		Lowther Accousta - Walnut	300	
*Audionote I 0.			* Linn Index + KU Stone		
(10 hours use)	700	1500	-12 months old	150	350
Kesiki Purple Heart			Silver Sound i/c cables	100	140
Saphire (200 hours use)	400	850	Audio Innovations Alto		
			3 months old	200	300
Audio Innovations 200			Souther Linear Arm	250	1300
pre amp (mm)	200	350	Silver Sound Whisper S/C	75	
NVA phono stage	150		Horning Agathon (mahog)	2800	3400
* Snel All mahogany (mc)	2000	5000	Audio Innovations S1000 pre amp	700	1350
Mendian Argant II	300	800	Rega II plus arm	120	
Tanno/ 601 inc stands	100	200	Living Voice Tone Scout		
* Audionote AN-J. [ANSP] oak	400	1000	ex review exhibition	3800	6000
Linn Axis Akito K9	330				

CARRIAGE EXTRA  
PHONE OR FAX DIRECT (0602) 813562

You should be looking for only one kind of Hi-Fi.

**The Best!**

Call me, it's the only kind I deal with.

For the Best...

*Apogee, Audio Research, Classé, Copland, Linaeum, Magnepan, Martin Logan, PS Audio, Sonus Faber, Theta, Van den hul*

And the Best of British...

*DPA, LFD, Michell, Orelle, Pink Triangle*

Ex Demo equipment: All Guaranteed.

DPA T1 transport/Bigger Bit was £1590 now £1250  
DPA 200S pre/power was £1250 now £1000

Orelle 10T transport/DAC180 was £1400 now £1100  
Orelle 200 pre/power, mm, mc was £1300 now £1050  
Orelle Orator speakers was £ 699 now £500

LFD PA2 power was £1099 now £875

Sonus Faber Electa was £1790 now £1300

All World Favourites

Phone or fax me:

**0252 - 377952**

Mobile:

**0385 - 317952**

Mike Harvey's

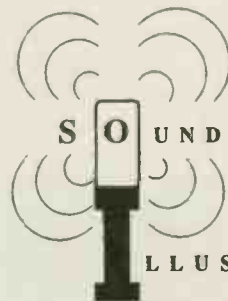

**No one was  
ever sorry that  
they bought  
the best!**



As audiophiles you demand the best.

Groove Tubes Performance tested valves certainly measure up every time to those demanding standards. Whatever kind of music you prefer, you'll appreciate it better with Groove Tubes. Simply changing to Groove Tubes will create a whole different set of tonal characteristics to your amplifier, and they are used or approved as the ultimate upgrade to any preamplifier or any power amplifier, by many manufacturers.

Hundreds of professional musicians like Bryan Adams, ZZ Top, Tina Turner, Genesis and Chris Rea use Groove Tubes and G.T. Electronics in their stage and recording amplification.

Now we are introducing the Groove Tubes D.75s power amplifier which is a professional 75 watts per channel stereo amplifier currently in use in top recording studios around the world and of course it comes complete with Groove Tubes as standard. *Retail price £1950.00*

**and now...**

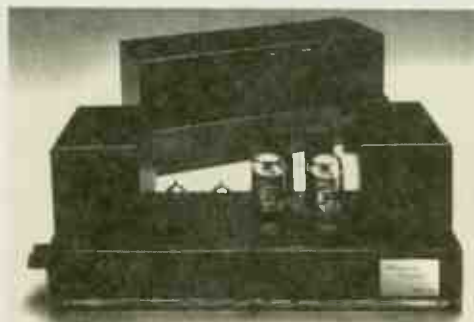

We are pleased to announce an exciting new range of British made valve pre and power amplifiers. Models currently available include:

**AMESON-COOPER TWIN 44 MONOBLOCKS**

44 watts per channel based on Groove tubes 6L6 valves.

*Retail price £1300.00 per pair.*

For further information and your nearest stockist contact the Groove Tubes Hotline now.

**Telephone: 0902.620156  
Fax: 0902.620207**

The Groove Tube Centre, Groove Tubes UK, 8 Barn Green, Bradmore, Wolverhampton WV3 7AY England.

**DYNAMICS**

**HIGH END AUDIO  
BOUGHT/SOLD  
EXCHANGED**

	PRICE	STATUS	LIST
MARK LEVINSON ML7A PREAMP. MINT	2995	S/HAND	£6800
SOTA COSMOS VACUUM PLATTER SME V MINT	£3.750	S/HAND	£15.300
WELL TEMPERED WTA1 TURNTABLE & ARM. MINT	£1.000	EX/DEMO	£1.200
MERIDIAN 60L TRANSPORT 606 DAC 7 LATEST MINT	£2250	EX/DEMO	£3.100
CAMBRIDGE CD1 CD PLAYER HEAVILY MODIFIED WITH			
NIASIVE POWER SUPPLY SUPERB	£1.200	S/HAND	PHONE
METAXIUS ICARUS INTEGRATED AMPLIFIER CHROME. MINT	£3.500	EX/BLMO	£3900
AUDIO RESEARCH SP15 REVISION A PREAMP BLACK	£3.400	S/HAND	£7.100
AUDIONOTE M7 SILVER PREAMP V.G.C	£3.350	S/HAND	£2.500
PINK TRIANGLE PIP 2 MK2 VISHAY MODIFIED PREAMP. MINT	£1.700	S/HAND	£4.500
GARY CAD 5500S PREAMP PHONO & PROCESSOR. MINT	£995	EX/DEMO	£2.500
COUNTERPOINT SAIL LINE STAGE & S&B PHONO STAGE GO BLOW			
YOUR MIND & WALLET MEGA. V.G.C	£6.995	S/HAND	£12.600
BURMEISTER 303 MK3 PREAMP BALANCED. MINT	£3.995	S/HAND	£6.000
AUDIO RESEARCH D70 MK2 POWER AMP. MINT	£895	S/HAND	£1.929
COUNTERPOINT SA4 OTL MONO AMPS V.G.C	£2.995	S/HAND	£8.000
MARK LEVINSON ML2 REFERENCE MONO POWER AMPS.			
BALANCED SUPERB V.G.C	£3.995	S/HAND	£15.000
MARK LEVINSON ML3 POWER AMP. MINT	£3.995	S/HAND	£8.250
NFG A201S POWER AMP BALANCED LATEST SPEC. MINT	£3.495	S/HAND	£6.000
NFG A 401 400 WATT CLASS A MONO POWER HOUSES			
BALANCED HIGH POWER WITH SEDUCTION V.G.C	£5.500	S/HAND	£13.000
CONRAD JOHNSON MV75 VALVE POWER AMP. MINT	£1.295	S/HAND	£2.500
OCTAVE RESEARCH ORI POWER AMP. V.G.C	£1.795	S/HAND	£4.500
MERIDIAN D6000 DIGITAL ACTIVE SPEAKERS STUNNING			
LOOKS AND SOUND TO MATCH. MINT	£5.750	EX/DEMO	£7.600
ACOUSTIC ENERGY AE3 SPEAKERS & STANDS. MINT	£995	EX/DEMO	£2.000
BATH TUB & SPONGES SIMILAR WATTS & PUPPIES WALNUT			
VERY INTERESTING 1000 V.G.C	£2.995	EX/DEMO	PHONE
CELLO AMATI SPEAKERS TWIN MOUNTED PAIR IN OAK ON			
GRANITE STANDS SUPERB V.G.C	£6.500	S/HAND	£20.000
CANYON ESO SPEAKERS & STANDS BLACK MINT	£26	S/HAND	£400
DYNAUDIO D FACETTE SPEAKERS BLACK OR CHERRYWOOD MINT	£1.595	EX/DEMO	£2.619
DYNAUDIO CONSEQUENCE SPEAKERS FLAGSHIP MODEL IN			
CHERRYWOOD DYNAMIC DRAMA STUNNING MINT	£10.250	EX/DEMO	£15.275
GALE 401 SPEAKERS & CHROME STANDS. BLACK GOOD	£333	S/HAND	£1.000
GENESIS 8300 SPEAKERS & STANDS PIANO BLACK. MINT	£1.399	EX/DEMO	£1.895
MERIDIAN ARGENT 1 SPEAKERS PIANO BLACK MINT	£699	NEW	£995
MERIDIAN ARGENT 3 SPEAKERS ROSEWOOD MINT	£895	NEW	£1.495
PRODAC PROSTATIC ELECTROSTATIC SPEAKERS RARE V.G.C	£1.995	S/HAND	PHONE
SNELL A3 SPEAKERS WALNUT V.G.C	£4.495	S/HAND	£6.995
APOGEE DVA & DAX TAPE SPEAKERS MINT	£6.995	S/HAND	£15.000
MARTIN LOGAN MONOLITH SPEAKERS OAK MINT	£3.995	S/HAND	£8.123
METAXIUS IRAKLIS MK2 POWER AMP CHROME MINT	£895	EX/DEMO	£1.500
AUDIO RESEARCH I125 KT90 VALVES AMP. MINT	£2.250	S/HAND £	4.650
METAL FIDELITY P270 MK2 POWER AMP. MINT	£895	S/HAND	£1.900
APOGEE CALIPER SIGNATURE SPEAKERS GREY MINT	£1.995	S/HAND	£3.999
SYNTHESIS REFERENCE SPEAKER SYSTEM ASH MINT	£3.995	S/HAND	£8.000
AUDIOPLAN KOWTRAST 2 SPEAKERS ROSEWOOD MINT	£1.595	S/HAND	£2.800
METAXIUS CHARISMA PREAMP CHROME MINT	£895	EX/DEMO	£1.500
MARK LEVINSON M17 PREAMP MINT	£2.495	S/HAND	£5.800
PI HW19 TURNTABLE TRI PLANAR MK3 ARM	£1.995	S/HAND	£4.000
SONOGRAPHIE AIRTIGHT ATM1 AMPLIFIER MINT	£1255	S/HAND	£2.400
DUNTECH CROWN PRINCE SPEAKERS PIANO BLACK MINT	£3.980	S/HAND	£8.500
EQUATION ZERO SPEAKERS PIANO BLACK MINT	£1895	S/HAND	£1.300
CRYSTAL REFERENCE MK2 WITH ARTANGENT MINT	£3.495	S/HAND	£6.500
MARANTZ LEZ CD PLAYER LTD EDITION BALANCED	£1.5.495	S/HAND	£3.000
SETA STAR SAPPHIRE 3 ETZ ARM MINT	£1.795	EX/DEMO	£4.000
QUICKSILVER PRE AMP MINT	£1.250	NEW	£1.750
MERIDIAN 631 DEDICATED AMP. BALANCED MINT	£1.995	EX/DEMO	£2.750
NESTROVIC NAI VALVE MONO POWER AMPS BALANCED	£2.995	S/HAND	£1.995
CARY 2A3 VALVE POWER AMP 15 WATT TRIODE MINT	£895	EX/DEMO	£1.400
CARY 300B VALVE MONO POWER AMPS 40 WATT TRIODE	£2.995	EX/DEMO	£1.995
APOGEE SCINTILLA SPEAKERS GREY 10TH V.G.C	£895	S/HAND	£1.345
SUMO ARIAS SPEAKERS OAK V.G.C	£1.495	S/HAND	£2.995
SNELL A2 SPEAKERS WALNUT V.G.C	£2.495	S/HAND	£2.250
ORACLE DELPHI MK3 URNTABLE SME IV			
SPECIAL WITH SILVER WIRE & SILICON TROL/SH MINT	£1.395	S/HAND	£2.800
GYRODC EXPORT BLACK & GOLD GYROPOWER SME V MINT	£795	S/HAND	£2.200
HELVIS CYALENE ARM MINT	£795	S/HAND	£1.800
MERIDIAN 200 MK2 CD TRANSPORT 263 SIGMA DAC MINT	£895	EX/DEMO	£1.900
WADIA 6 CD PLAYER BALANCED OUTPUT MINT	£2.395	EX/DEMO	£3.995
APOGEE DAX ELECTRONIC CROSSOVER MINT	£1.995	S/HAND	£4.500
BEARD BB100 MK2 VALVE INTEGRATED AMO MINT	£895	EX/DEMO	£1.300
PINK TRIANGLE DECAPO DAC MINT	£1.195	EX/DEMO	£1.500
AUDIO RESEARCH CLASSIC 60 POWER AMP MINT	£2.250	S/HAND	£3.600
AUDIO RESEARCH M100 VALVE MONO AMPS MINT	£2.995	S/HAND	£7.000
AUDIO RESEARCH M300 MK2 VALVE MONO AMPS MINT	£1.995	S/HAND	£12.000
CHORD 1200 POWER AMP. MINT	£1.995	S/HAND	£3.000
CABSSE IROISE MC SPEAKERS CHERRYWOOD MINT	£1.995	EX/DEMO	£2.700
CABSSE SKIFF SPEAKERS WALNUT MINT	£1.200	EX/DEMO	£1.500
MERIDIAN M30 ACTIVE SPEAKERS STANDS MINT	£595	S/HAND	£1.110
<b>NEW IN THIS MONTH</b>			
AUDIO RESEARCH SP14 PREAMP BLACK MINT	£1.995	S/HAND	£3.200
MUSICAL FIDELITY BA PREAMP MINT	£725	S/HAND	£400
RESTEK CHALLENGER INTERGRATED AMP. MINT NEW	£799		
RESTEK EXPONENT REFERENCE MONO BALANCED MINT	£7.495	EX/DEMO	£12.000
DIAMOND ACOUSTIC REF 2 SPEAKERS & STANDS OAK MINT	£995	S/HAND	£2.250
B & W ACTIVE 1 SPEAKERS OAK & STANDS VGC	£695	S/HAND	£1.400
BURMEISTER 846 LINE PREAMP CHROME BALANCED MINT	£795	S/HAND	£1.650
AUDIO RESEARCH LSI PREAMP SILVER MINT	£995	S/HAND	£1.797
AUDIO RESEARCH CLASSIC 30 POWER AMP MINT	£1.395	S/HAND	£2.600
ROKSAN DPI CD TRANSPORT MINT	£795	S/HAND	£1.195
ENLIGHTENED AUDIO DSP1000 DAC MINT	£1.595	S/HAND	£1.800
CONCORDANT EXHILARANT VALVE PREAMP MINT	£1.595	S/HAND	£1.000
AUDIO RESEARCH LS2 LINE PREAMP BALANCED MINT	£1.395	S/HAND	£2.795
CONRAD JOHNSON PREMIER 3C VALVE PREAMP MINT	£1.595	S/HAND	£3600
CONRAD JOHNSON PREMIER 4C VALVE PREAMP MINT	£1.995	S/HAND	£8400
YAMAHA DSP 1300A AV AMP MINT	£395	S/HAND	£1000
DYNACO ST 70 SERIES VALVE POWER AMP MINT	£1895	S/HAND	£1100
MARTIN LOGAN CL31 ELECTROSTATIC SPEAKERS VGC	£1495	S/HAND	£3300
APOGEE DEVITTA SIGNATURE & DAX CROSSOVER MINT	£895	S/HAND	£10900
LYNX PULSAR PRE & POWER AMPS MINT	£795	S/HAND	£1450
CAMBRIDGE CDI CD PLAYER MINT	£795	S/HAND	£1500
AUDIO INNOVATIONS 800 PRE & POWER MODIFIED VGC	£795	S/HAND	£1400+
MELOS 222B PREAMP BALANCED MINT	£1695	EX/DEMO	£2995
MICROMEGA TRIO CD PLAYER MINT	£495	S/HAND	£499
KLYNE SK 5A PREAMP MINT	£1495	S/HAND	£2750
CITATION 18 TUNER ORIGINAL AMERICAN V.G.C	£295	S/HAND	£650
MUSICAL FIDELITY MVT 31 PREAMP MINT	£395	S/H	£1100
SUGDEN A51C PREAMP 2 BOC MODIFIED BY AVONDALE V.G.C	£395	S/HAND	£1800
JADIS DA 30 VALVE INTEGRATED AMP MINT	£1495	S/HAND	£2700
ROWLAND MODEL 3 MONOS POWER AMP BALANCED MINT	£2495	S/HAND	£4000
POSSELT ALBATROSS SPEAKERS PIANO BLACK MINT	£1495	S/HAND	£2200
MARTIN LOGAN AERIUS SPEAKERS BLACK MINT	£1695	S/HAND	£2400
MAGNAPLANAR MG 1.5QR SPEAKERS OAK MINT	£1095	ED	£1597
SME 20 TURNTABLE WITH ARM MINT	£395	S/HAND	£3500
WHEATON TRIP PLANAR MK2&3 ARMS FROM	£995	S/HAND	£3000
ARCAM 1700D TRANSPORT MINT	£395	S/HAND	£700
ARCAM 110 PREAMP DAC MINT	£395	ED	£1995
MERIDIAN 605 MONO AMPS BALANCED MINT	£1350	S/HAND	£1100
MARK LEVINSON NO 20 REFERENCE MONO BALANCED	£5495	S/HAND	£11000

"OODLES OF HIGH END CARTRIDGES AVAILABLE RING FOR DETAILS" MANY MORE ITEMS IN STOCK, EFFICIENT SERVICING DEPARTMENT. WE ARE LOCATED IN WELWYN, HERTS

ALL ITEMS GUARANTEED - ALL MAJOR CREDIT CARDS ACCEPTED RING FOR DETAILS AND DEMONSTRATION 0438 714038  
10.00 AM - 7.00 PM MON - SAT 10.00 AM - 1.00 PM SUN



Credit Cards



**HI-FI**  
CONFIDENTIAL

Open: 10 - 6pm Mon-Sat  
10 - 9pm Thursday  
World wide tax free export

Welcome  
24 hrs. delivery service

071 - 233 0774

# ENJOY THE MAGIC OF VALVES

## Pure Natural Sound

**0%**  
INTEREST FREE CREDIT  
ON SELECTED ITEMS



*Audio Innovation, E.A.R.,  
Lumley Reference, Tube  
Technology, Conrad Johnson,  
D.D. Audio, Hi-Fi World Kit*

**We Offer**

- 24hrs. delivery services
- Part x-change
- Free three years warranty on selected product
- Home load
- Home installation
- Interest free credit
- We are located very new to Victoria main line underground station. One minute walk & open late 9pm (Thursday)

We have in stock:  
Spendor • Quad • Royd • Triangle • KEF •  
Tannoy • Proac • Castle Speakers  
Please ASK for our special offer list

CD Player From:- Quad • Micromega • Teac • Marantz • Rotel • AMC •  
Pioneer • Orelle Musical Fidelity  
Cassette Decks from:- Aiwa • Denon • Sony • Naackamichi • Harman • Marantz  
Amps From:- DPA • Orelle • Quad • Alberry • Musical Fidelity • Alchemist  
• John Shearn • Aiwa • Pioneer  
Turntables From:- Pink Triangle, Thoren, Alphason, Townsend Rock

DACS from  
Pink Triangle • DPA • Kinshaw  
Orell • Musical idelity • Teac

**HI-FI CONFIDENTIAL LTD**

34 Buckingham Palace Road, London SW1W 0RE (Victoria Station) Phone 071 - 233 0774 Fax. 071 - 233 7226

# DAVID ORTON AUDIO VISUAL



## Cyrus Centre

Marantz, Denon, Pioneer,  
Cyrus, Mission, Rotel, Ruark,  
B&W, Thorens, Oracle, Aura,  
Kenwood, Polk, Celestion,  
JVC, and many more!!



Dolby Prologic Dem. Room &  
Hi-Fi Listening Room

6-8 BANCROFT, HITCHIN, HERTS

TEL: 0462 452248



Announcing . . . the  
Elektra Integrated &  
Eos Power Amplifiers

ELEKTRA INTEGRATED £999  
EOS POWER AMP £899  
TITAN MAINS FILTER £125  
SILVER INTERCONNECT AND DIGITAL  
CABLES FROM £75  
SILVER SPEAKER CABLES FROM £25 per m

Arion  
ACOUSTICS

MAKE THE LEAP  
FROM AUDIO TO  
. . . REALITY

*Worldwide sales agents*

**KRONOS DISTRIBUTION**

35 Farlough Road • Newmills  
Dungannon • N. Ireland

Tel. 0868 748632

Fax. 0868 748281

**KRONOS**

*Extraordinary hi-fi for ordinary people.*

That would sum up our approach to how we choose the products that we import and distribute.

*Pro-ject* turntables. *Audiomeca* analogue and digital disc players. *Triangle* amps and speakers. *Lieder* cables. *YBA* and *Arion* amplifiers.

Style, character, top class performance and value for money: another way to sum

**PUTTING THE GROOVE BACK INTO MUSIC**

For more information, contact

Kronos on: 08687-48632



MAIN AUTHORISED DEALERS FOR OVER  
100 MANUFACTURERS

YELLOW TAG  
SALE

UP TO  
50%  
OFF

FRIDAY 30th SEPT  
to  
SUNDAY 9th OCT 1994

(Sale prices not available with any other offer)

E&OE

NEW BRANCH FROM 30th SEPT  
COVENT GARDEN 071 497 1346

18 Monmouth Street  
Covent Garden, London  
WC2H 9HB  
Fax: 071 497 9205

Central  
London

EDGWARE 081 952 5535

173 Station Road  
Edgware Middx.  
HA8 7JX  
Fax: 081 951 5864

North/West  
London

HOUNSLOW 081 569 5802

45 High Street  
Hounslow, Middx.  
TN3 1RH  
Fax 081 569 6353

West/South  
London

MAIL ORDER  
WORLDWIDE

WE ARE OPEN  
SUNDAYS

6 DEMO ROOMS

HOME CINEMA  
SPECIALISTS

EXAMPLES - 1000'S MORE BARGAINS IN STORE

Arcam Alpha 6 Amp }  
Arcam Alpha 5 CD } £1060  
Castle Durham 900 }  
Black spks }

**CLAIM** Atacama SE24  
**FREE £300** 10M NEW Monstor Bi-Wire  
**WORTH** cable 3 sets IXOS 204 plugs  
Target MB5/16 5MDF Rack

Aura VA 100 amp }  
Aura TU 50 tuner } £800  
Aura CD 50 CD player }  
(graded) }

**SAVING A MASSIVE £330**

Tannoy D500 *Demo spks*  
Normally £1470 *rosewood*  
*extra £50*

**CLAIM FREE AWARD WINNING CAS DECK SONY TCK68S**

**PARKING MADE EASY AT COVENT GARDEN. ASK FOR DETAILS**

Quad 66 Pre Amp  
Quad 606 Power Amp  
Quad CD67 CD Player  
Quad FM 66 Tuner  
Quad ESL63 Speakers  
Gradient Subwoofer  
Quad 606 Power Amp

3 Interconnects }  
speaker plugs } £420  
speaker cable }

ALL THIS  
RRP  
£8600

**PAY ONLY £150**

PER MONTH  
DEPOSIT  
£1100

ON **0%** APR INTEREST  
FREE CREDIT  
SUBJECT TO STATUS  
FOR 18 MONTHS

**CASTLE HOWARD** *spks*  
(EX DEMO) £1000 *deluxe finish*  
*£100 extra*

**SALE PRICE £800 + CLAIM FREE**  
£120 worth Monstor  
Bi wire cable + INOS banana plugs

**MISSION 752** £500  
(graded)

**CLAIM FREE PAIR OF MISSION 760i SPEAKERS**

MONEY OFF OFFERS

Model	Was	Now	SAVE
NAD 705 (graded) Receiver	£330	£230	£100
Marantz PM44SE Mk1 Amp	£200	£150	£50
Rotel RCD945 CD	£230	£160	£70
Celestion 3 SPKS	£130	£90	£40
B&W Solid Monitors	SPKS £250	£200	£50
TANNOY 605II SPKS	£170	£120	£50
SONY STS 3 II Tuner	£200	£160	£40



New range includes: 4240 Integrated Amp £249  
 P42 Pre-Amplifier £249  
 A42 50W Power Amp £249

Over the last 12 years Creek Audio has designed and constructed Hi-Fi equipment for thousands of enthusiasts. Now that it is once again an independent company the story is set to continue, with a new range of equipment designed for the nineties.

For further information and a list of stockists

Phone 081-361 4133 or send coupon to:

CREEK AUDIO LTD, 2 BELLEVUE ROAD, FRIERN BARNET, LONDON N11 3ES

Name ..... Address .....

HFV 11/94

MARTIN LOGAN • ALCHEMIST • AUDIO RESEARCH • AUDIO INNOVATIONS

**AUDIO GALLERY**

NR PETERSFIELD HAMPSHIRE

MISSION: MUSICAL FIDELITY  
 KLIPSCH, DECAPO, AEGIS SPEAKERS  
 LYRA CARTRIDGES, DPA200S HY-BROOK

FOR OPENING HOURS AND APPOINTMENTS PLEASE RING 9.30am - 7pm

HOME DEMO  
 AUDIO SYNTHESIS ACUSTIC ENERGY  
 WADIA 6, MICROMEGA STAGE, DAC-IN-A-BOX, TDE, S.M.E. TEAC, VRDS 10, AUDIONOTE + AV

**0730 - 895194**

A VALVE SPECIALISTS ON A SUPERIOR LEVEL

AUDIO ALCHEMY • TEAC • SAE • TRIPPOD • ALPHASON • PIONEER • DENON

**NORLOSTONE** MARBLE - GRANITE - STONE SPECIALISTS

GRANITE AUDIO STANDS. The ultimate solution to problems resonance and tonal accuracy. For 'bespoke' designs consult Norlostone specialist in marble, slate and granite.

NORLOSTONE LTD., WEST DEAN ROAD, WEST TYTHERLEY, SALISBURY, WILTSHIRE. SP5 1QG  
 TELEPHONE (0980) 862253 FAX (0980) 863070

**Cricklewood Electronics Ltd**

You don't have to spend a fortune on High Quality Valves. Our valves are manufactured to a very high standard and compare favourably to brand names costing much more.

*Good valves at economical prices*

ECC81	4.50	GZ34	7.5
ECC82	4.50	6L6G	6.50
ECC83	4.50	6V6GT	4.50
EF 86	4.50		
EL 34	8.50		
EL 84	4.50		

P&P £3.50 + VAT up to 6 valves

*Supersound Axial Polypropylene Capacitors*

- \* Extremely low distortion
- \* Detailed acoustic properties
- \* High purity tinned copper leads
- \* Tight wound thick dielectric for resonance elimination.
- \* Low dissipation factor
- \* All units proof voltage for tested at 150% rated voltage for 15 mins

Tol + 5%	250v	400v
100nF	0.85	1.00
220nF	0.85	1.00
470nF	0.85	1.00
1uF	1.00	1.25
2u2	1.35	1.50
3u3	1.50	1.75
4u7	1.75	2.00
6u8	2.25	2.50
10u	3.00	3.50
15u	4.00	4.50
22u	6.25	6.95
25u	6.25	6.95
50u	10.00	11.00
75u	15.00	17.00
100u	19.00	21.00
125u	20.00	22.00

P&P £2.50 + VAT

**Elna Cerafine Ultra High Quality Reservoir Capacitors.**  
 The electro-chemical action of superfine particles of ceranic material between the separating sheets ensures extremely even/discharge cycles to produce an excellent reservoir, that allows purity of sound, exceptionally low distortion (3rd HD-150db at 10kHz) and superb low frequency response.

10,000uF 80V Ripple 7.1A £19.00  
 22,000uF 56V Ripple 10.8A £22.00  
 P&P 1.00 + VAT per capacitor

**Bravox Loudspeaker Chassis**  
 Excellent quality though economic price.

**Woofers 8 ohms Foam edge**

5" 50W Res freq: 70Hz	12.00
6 1/2" 70W Res freq: 50Hz	£13.25
8" 70W Res freq: 45Hz	16.25
10" 100W Res freq: 28Hz	24.00

**Full range 8 ohms Paper edge**

12" 200W Res freq: 72Hz	46.00
-------------------------	-------

**Tweeter 8 ohms polycarb dome**  
 100W 1.2KHz - 20KHz 7.50

Please phone for post & packing options.  
 Please add VAT to the above price.

We stock a vast range of power transistors, diodes & ICs, cable, connectors, capacitors etc. Please phone for your requirements. 1995 Catalogue due Oct 94 price £2.50.

Cricklewood Electronics Ltd  
 40 Cricklewood Broadway  
 London NW2 3ET  
 Tel: 081 452 0161, 081 450 0995  
 Fax: 081 208 1441

**•SALE•SALE•SALE• IAN HARRISON HI-FI TEL: 0283 702875**

SENNHEISER	BEYER	AUDIO TECHNICA	CARTRIDGES
HEV70 £300	DT811 £170		I SUPPLY: AUDIO TECHNICA, ORTOFON, DENON, DYNVECTOR, SHURE, GOLDRING ARCAM & STANTON. TRADE IN YOUR OLD MOVING COIL(S); ANY MAKE, ANY CONDITION AND SAVE UP TO 45% OFF THE NORMAL SELLING PRICE!! NO OLD MOVING COIL? DON'T WORRY, JUST PHONE.
HE60 £399	DT901 £155	ATH9000 EPOA	
HD500M £108	IRS890 £155	ATH911 EPOA	
HD1000 £173	IRS790 £140	ATH910P EPOA	
HD25 £109	DT811 £140	ATH90611 EPOA	
ORPHEUS EPOA	DT801 £119		
IS850 EPOA	DT511 £ 77	KOSS	
IS950 £140	DT431 £ 80		
IS450 £119	DT411 £ 55	ESP950 £650	
OTHER MODELS EPOA	OTHER MODELS EPOA	OTHER MODELS POA	
NAKAMICHI	TEAC	AWA	HI FI FURNITURE
DRAGON £2150	V7010 EPOA	XDS1100 £750	I SUPPLY: APOLLO, SOUND ORGANISATION, SOUND FACTORY TRIPOD, SOUNDSTYLE. PLEASE PHONE OR WRITE FOR BROCHURES & PRICES.
CR7E £1850	V8000S £625	XKS3000 EPOA	
DR1 EPOA	R9800S £450	XKS7000 EPOA	
DR2 EPOA	VRDS-7 £550		
DR3 EPOA	VRDS-10 £699	SONY	
OTHER MODELS EPOA	VRDS-20 £1170		
	X-1 EPOA	DT802ES £999	
	X-1S EPOA	TC007 EPOA	
		PCM2900 EPOA	
		PCM2700 EPOA	
QUAD	OED	MARANTZ	CABLES
CD67 £725	DIGIT £109		I SUPPLY: AUDIOQUEST, SONIC LINK, QED & GOLDRING.
66 £775	DIGIFLEX £18		
606 £825	DAC PACK £169	CD63 £199	
34 £385	DIGIT REF £350	CD53 £160	
FM4 £390	POSITRON £99	CD52 EPOA	
FM66 £485	AMPS EPOA	SD83 £215	
ESL-83 £2500	OPTIFLEX £20	SD83 £185	
		SD415 £189	
		SD415 £139	
		ST40L £175	
DENON	SHURE	PH700AV	TEST CASSETTES AND CDs
DL 304 £180	VNSMR £115		I SUPPLY MY OWN REAL TIME, INDIVIDUALLY MASTERED RANGE OF AUDIO TEST CASSETTES FROM £5-£20. THE MULTI-PURPOSE TEST CASSETTE TESTS: DOLBY LEVEL, AZIMUTH, REPLAY FREQUENCY RESPONSE (30Hz-15KHz), DOLBY B/C TRACKING & TAPE SPEED. AVAILABLE IN 120us & 70us eq VERSIONS. £20 POST FREE.
DL110 £ 60	OTHER		
DL103 £75	STYL1 EPOA	PM43 £199	
DL103D EPOA	PM43	PM43 £185	
DL160 £70	ME97HE EPOA	PM32 £115	
	TR117	SR82 £599	
	TEST RECORD	SR73 £599	
		SR83 £285	
		SR53 £215	

**BLANK TAPES & ACCESSORIES**  
 I SUPPLY: TDK, MAXELL, SONY, JVC, SCOTCH, AMPEX, BASF, LONICA, PANASONIC, FUJI, DISCWASHER, AUDIOQUEST, GOLDRING.

PLEASE NOTE:  
 ALL GOODS ARE BRAND NEW WITH FULL U.K. GUARANTEES.  
 NO EX-DEM EQUIPMENT. INSURED DELIVERY IS £5.  
 CARTRIDGES ARE POST FREE. PLEASE PHONE PRIOR TO ORDERING TO CONFIRM PRICE & AVAILABILITY.  
 MAIL ORDER FROM: IAN HARRISON HI FI,  
 7 MILL HILL, REPTON, DERBY, DE65 6GQ.  
 TEL: 0283 702875 9am-9pm.

**SPECTRA**  
*Dynamics*

# DEFLEX<sup>®</sup> PRODUCTS

For further details and a **FREE** comprehensive literature pack  
Tel. (0745) 571800 Fax (0745) 570199  
*(We also have a range of specialist damping pads for hi-fi speakers)* **POWERPADS**

## DEFLEX<sup>®</sup> acoustic PANELS

The simplest and most cost effective way to upgrade your existing system

Buy at least 2 Deflex panels specially designed and patented by Spectra Dynamics



Remove foam and/or wool damping from the inside of your speaker (if fitted)



Place the flexible Deflex panel thru' the speaker cut-out and stick to the inside of the cabinet

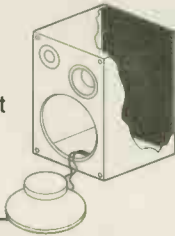

Sit back and listen to extra detail in sound, and far less distortion when played loud



**What the experts have to say...**  
"...a marked improvement was obvious from the first few bars of REM's Automatic for the people album..."  
*HI-FI News & Record Review - March 1994*

"...the result was sharper imaging, wider dynamics and a more natural sound..."  
*HI-FI Choice - January 1994*

"...Deflex panels seemed to give greater tightness and control, improved internal clarity, and pitch definition - all without deadening the sound in any way..."  
*Audiophile - January 1994*

**Standard Panel £7.95 (280 x 210mm)**  
**Sub Woofer £11.95 (340mm dia)**  
**Adhesive £3.50 (200ml)**

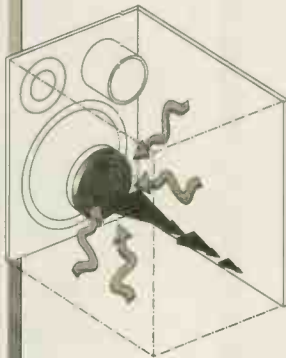

## MAGNAPAD GOLD

Used in professional stage monitors where the bass resolution is significantly improved

MAGNAPADS INCORPORATE THE SAME ADVANCED TECHNOLOGY ALREADY SUCCESSFULLY PROVEN IN SPECTRA DYNAMICS' "DEFLEX PANEL"

PRIMARYLY DESIGNED TO ABSORB UNWANTED VIBRATIONS DIRECTED AT SPEAKER COILS AND MAGNETS, AND TO PREVENT FURTHER SOUND REFLECTIONS OFF THE FLAT SURFACES

SIMPLE TO FIT - APPLY A FEW SPOTS OF "SUPER GLUE" TO THE MAGNET AND PLACE THE MAGNAPAD IN POSITION.

Available in four sizes: 75mm, 125mm, 175mm & 225mm diameter

Prices from £7.95 per pack of 2

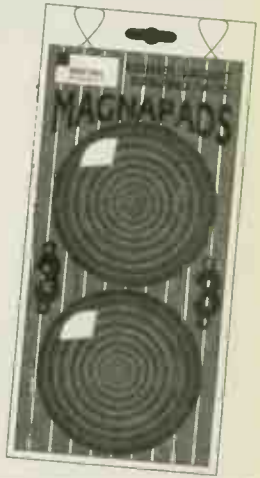

## FOCULPODS

Foculpods are high performance vibration absorbing supports designed to be placed under Compact Disc Players, Turntables, Amplifiers, Loudspeakers and all other Audio, Video and Computer equipment.

The material is a specially formulated low resilience polymer with excellent shock absorbing properties.

At nearly half the price of similar products, Foculpods not only save you money, but are equal, if not better in performance.

Available from most good HI-FI shops.

£19.95 per pack of 4

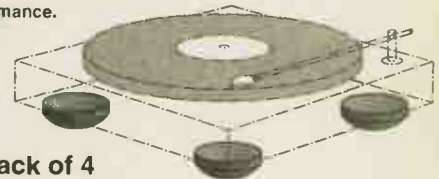

## DEFLEX<sup>®</sup> "WRAP"

This Deflex material is supplied in sheet form with a parallel "rib" running down its length. It can be used in a number of applications,

e.g. it can be cut to fit as a wrap around ports on reflex designs (see Inset)

or on the flat panels inside transmission line or horn loaded speakers.

Deflex Wrap £14.95 (280 x 210mm)



### DISTRIBUTORS WORLDWIDE

U.K. Tel. (0625) 500507 - Fax (0625) 500508

Australia Tel. 3 429 2199

Canada Tel. 514-691-2584 - Fax. 514-693-9280

France Tel. 1 48 76 34 74 - Fax. 1 43 77 08 94

France Tel. 78 95 04 82 - Fax. 78 50 76 35

Germany Tel. 2961 / 51211 - Fax. 2961 / 51640

Germany Tel. 0208 / 35977 - Fax. 0208 / 361370

Greece Tel. 01 8028406 - Fax. 01 8064802

Holland Tel. 076-715010 - Fax. 076 714773

Indonesia Tel./ Fax. 31 311 598

Italy Tel. 33-9727-1191

Norway Tel. 700 1111

Russia Tel. 700 1111

South Africa Tel. 201 422 1111

Spain Tel. 90 20 20 20

Switzerland Tel. 700 1111

Switzerland Tel. 700 1111

U.S.A. Tel. 415 615 615

U.S.A. Tel. 415 615 615

# MONOSTEM Audio Support System

hi-fi wall units speaker stands accessory stems  
Designed by Ashley Miles Dennis

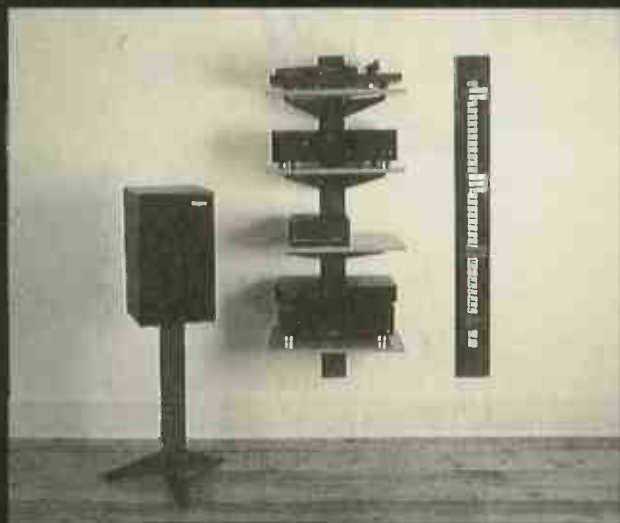

**tel or fax 0533 433233  
for a full colour brochure**

innovative design the coach house school lane  
houghton - on - the - hill leicestershire le7 9gd

**LASER**  
AUDIO

## AUTHORISED DEALER FOR:

AIWA, ALPHASON, ARCAM, AUDIOLAB,  
AUDIOQUEST, BEYER DYNAMIC, CYRUS, DENON,  
LINN, MARANTZ, MISSION, PIONEER,  
SENNHEISER, SOUNDSTYLE, SYSTEM, TANNOY,  
TARGET, TDL.

Relax in one of our three demonstration  
rooms and enjoy the thrill of Music and  
Home Cinema.

We take Access, Visa, Amex or ask  
about our excellent finance packages.

**Laser Audio, 1 St. Marnock Place,  
Kilmarnock, Scotland.  
Tel: 0563 40292**

Open Tues - Fri 10-5.30 Sat 9.30-5.30

*LEONARD BOOTH*



**WHY WAIT A LIFETIME  
BEFORE YOU SEE & HEAR  
..... AND BUY  
YOUR QUAD EQUIPMENT  
CALL IN NOW FOR YOUR  
IMMEDIATE DEMONSTRATION**

**35 SOUTH STREET  
EASTBOURNE  
0323 731755**

## ACTON GATE AUDIO

THE HIGH-FI CENTRE IN  
**WREXHAM**

Aiwa, Arcam, B&W, Canon,  
Celestion, Jamo, Marantz,  
Micromega-Royd, Mission, Musical  
Fidelity, NAD, Quad, Radford, Rega,  
Rogers, Rotel, Ruark, Tannoy,  
Thorens, Wharfedale, Yamaha  
Demonstration Rooms available  
Mail Order a Speciality

**4, RUABON ROAD,  
WREXHAM  
Tel: (0978) 364500**





# readers' queries

## TWEAKING THE THORENS TD150

I am at the moment contemplating up-grading my record player which is a Thorens TD 150 (approximately 15 years old) to which I added, two years ago, a Linn Akito arm and A&R C77mg cartridge.

I have considered the following combinations and would like your advice on them to get the best musical quality.

1. Thorens 166 MK6 motor unit only (putting Linn Akito on).
2. Systemdek IIX or IIXE (putting Linn Akito on) or getting hold of a Roksan Tabriz or Tabriz zi. Would this be an up-grade over an Akito arm?
3. Mantra. Again, as above, putting the Linn arm or Tabriz (zi) on to it.

The sound I would like to obtain is a deep bass, open and detailed midrange and detailed treble. Because these mid-priced turntables are not cost-no-object designs, I can only expect so much from them, so I would like you to advise me on which would be best overall.

I am also in need of a better cartridge than the C77. Would I be better off getting the P77 stylus or going for a different cartridge altogether? Again, I would appreciate your

**Write in with your problems to Hi-Fi World, 64 Castellain Road, Maida Vale, London W9 1EX. Our panel of experts will endeavour to solve them, or at least offer some practical advice.**

advice.

My system is as follows: Thorens TD 150/Linn Akito/C77mg/Rotel 820BX (I'm in the process of buying speakers after sorting the turntable out - listening through headphones at the moment).

I have written to various people and have had no replies from them, which I feel strange to understand. I am ready to buy a turntable/arm/cartridge combination soon and I would like it to be the right choice.

**Andrew Waller  
Rotherham,  
S. Yorkshire.**

You certainly need to improve both cartridge and amplifier. Rather than go for a new Thorens, why not stick

with the 150, spending the money on tweaking it up and on a new arm? The Linn Akito is a rather basic one. Way back, there were a whole series of tweaks published for a 150. First is to cut a piece of marine ply of the same thickness to the same size as the arm-board, with a suitable mounting hole cut into it for the arm and mount it in place of the original. (Painting it black is worthwhile). Next is replacing the suspension springs with those for a Thorens TD160 (if you can persuade Thorens in Germany to part with a set) and applying damping pads to the underneath of the sub-chassis, round the inside of the plinth and the hardboard base. Everyone used to suggest sound-deadening pads from Halfords for this purpose, but I've never found a Halfords that knew anything about them. A mastic-type roofing felt strip will do.

If you go this route, a fair bit of money can be spent on a new arm - Rega RB300 as a minimum. I can see no reason why a Tabriz-zi shouldn't work, but I've never seen the combination in action. A cartridge upgrade is essential. While the P77 would improve things, a Goldring 1022GX or 1042GX would suit much better. This now

allows improvement to the amplifier, which looks long overdue. Rotel have a new range about to appear, and given their success in 'Britishising' their CD players of late, they should be well worth a listen and should be a marked improvement on the 820.

Of the decks you suggest, I would be very tempted by the Systemdek IIXE 900, but would take their advice on the Tabriz-zi arm, since it was designed in conjunction with a rather different type of turntable. The Mantra, alas, I have no experience of, though it has a strong following. Since you're in Rotherham, it may be worth a trip to Doncaster Hi-Fi Studios to have a listen to their own turntable, which I saw at the Chesterfield Show, although I was unable to assess it. The Michell Mycro, with RB300, is also well worth considering in the same price bracket. (I don't like its green acrylic cover myself, but I believe Mr Michell can be persuaded to do one in clear acrylic).

At this point, a word of warning. Unless you are using very exceptional headphones, you are going to be misled as to what you are hearing. Very few reproduce much bass, or

Continued ...



# REFRESHINGLY DIFFERENT

*the powerplant*

CYRUS, REGA and ARCAM products now on demonstration

Roksan, Micromega, Audiolab., Rega, Arcam, Aura, ATC, Exposure, Marantz, Ruark, Epos, Thiel and other fine equipment

66 Upper North Street Brighton 0273 775978

# DAN DULEY HI-FI

AT GRAMEX  
25 Lower Marsh  
(By Waterloo Station)  
London SE1 7AB.  
Technical enquiries:  
081 470 9795  
Gramex: 071 401 3830

THE NEGUS SYSTEM, and other specialist units including PHONO HEAD AMP and HISS-KILLERS, is now on demonstration.



NEGUS Electronics:-

COMBINED PRE-AMP AND CROSSOVER

THREE MATCHED 50W<sub>RMS</sub> PER CHANNEL AMPLIFIERS

POWER PAK:- SUPPLIES ALL UNITS

## Sussex Surplus

13 STATION ROAD, HORSHAM, WEST SUSSEX RH13 5EZ  
Telephone: (0403) 251302 Fax: (0403) 270339

Test Equipment • Components • Accessories  
Electromechanical • Mechanical • Engineering

### Valves Mostly UK. Oil Filled Chokes

Type	Price	Type	Price
DA100 GEC	POA	10H 25mA	£8
PX25 MARCONI	POA	10H 35mA	£10
KT61 GEC	£25	10H 170mA	£15
KT66 GEC	£65	10H 180mA	£15
KT88 GEC	£85	10H 250mA	£25
GZ34 MULL	£10	10H 75mA	£12
EL34 MULL	£25	10H 120mA	£12
EF86 MULL	£6	5H 200mA	£12
ECC81 MULL	£5	5H 400mA	£20
ECC82 MULL	£5	5H 120mA	£12
ECC83 MULL	£10	4.5H 220mA	£12
5R4GY	£4	20H 120mA	£15
6080	£10	6H 30mA	£10
GZ37	£3	6H 250mA	£15
EL84 MAZDA	£4	2H 300mA	£12
A2900 GEC	£20	16H 150mA	£20
6SN7 GT	£4	20H 100mA	£15
U19 RECT	£10	5H 500mA	£30
6X4 RECT	£3	40mH 3A	£30
6L6	£10		
4212E STC	£100		

### Varnished Chokes

10H 75mA	£10
3H 40mA	£10
9H 240mA	£20
5H 430mA	£25
5H 350mA	£20

### Oil Filled Paper Capacitors

1 MFD 600V	£6
2 MFD 600V	£6
4 MFD 600V	£6
8 MFD 600V	£8
8 MFD 800V	£10
8 MFD 1000V	£12
0.5 MFD 1000V	£6
0.5 MFD 5000V	£15
12 MFD 350V	£8
1 MFD 2500V	£15
0.25 MFD 1000V	£6
2 MFD 1500V	£15
8 MFD 1500V	£30
8 MFD 2500V	£40
4 MFD 1000V	£12
4 MFD 800V	£12

P.T.F.E. silver plated wire various colours and sizes 50p per mtr.  
A.V.O CT160 Valve Tester EX M.O.D tested and supplied with data book £99 + £20p+p  
Solartron varifiable H.T power supplies with meter 0-500V+DC 100MA/3-15-0-3-15 3A tested very good condition £75 + £20p+p  
P+p add £5.00 +VAT per order UK only unless otherwise stated.  
Overseas postage at cost  
VAT at 17.5% to be added to all UK orders.  
All items in this advert are made to mill spec

### Oil Filled H.T Transformers

Primary	Secondary	
115/230V	1250-0-1250V	230V
	310MA	£35.00
	725/700-0-725/700	385MA
	4.6V 100MA	180-0-180 55MA
		6.3V 6A
		5V 6A £50.00
115/230V	400-0-4-00	6.3V1A
	250MA	£18.00
	30V 100MA	
115/230V	350-0-350 150MA	115/230V
	6.3V 1A	300/250-0-250/300
	6.3V 2A	£37.00
	6.3V 6A	125MA
		£20.00

### Oil Filled Heater Transformers

Primary	Secondary	
115/230V	6.4V 3A x2	
	2.5-5V-6.4x2	£15.00
115/230V	6.4V 10A	
	10V 650MA	
	26V 650MA	£15.00
115/230V	2-5V-5V-6.4V	
	2A x 4	£15.00
115/230V	6.4V 5A x 3	£20.00

All items in this advert are made to mill spec.



.... Continued

even any bass accurately, and only the electrostatic headphone's reproduction of treble frequencies can entirely be relied on. Consider your choice of amplifier and speakers first.  
**EB**

### IN SEARCH OF SENSITIVE SPEAKERS

What I am looking for are some speakers. I have a hotch-potch of a system consisting of Hitachi PS 17 turntable Ortofon FF15 cartridge, Teac Z500 CD player, Rotel RC850 pre-amp, a Leak Stereo 20 amplifier and Wharfedale 3XP loudspeakers.

Apart from the record deck and amplifier, which were given to me, all the other components were purchased second hand. The amplifier has been upgraded with new capacitors, resistors and regulated power supplies, the valves are from Golden Dragon, this work having been done by a dedicated valve man in Dorchester; it's certainly breathed new life into it.

I have no firm ideas on speakers, like makes, models etc., but having been through several copies of your magazine it seems to me that an efficient design would be more appropriate to partner the Leak amplifier. I am not keen on buying speakers second hand and my budget being about £350 I would be interested in your ideas of manufactured speakers and also kit speakers, some adverts for which appear in your magazine. My amplifier has a much more tuneful bass than it used to have and this is a quality I also like in speakers - something to bear in mind.

I shall, when I can afford to, change the record deck. This will probably be purchased second hand. I have a very helpful hi-fi dealer in Chesterfield and I keep scanning the window for second hand bargains. I can recommend this to anyone on a tight budget, especially where the equipment is demonstrated and guaranteed.

My musical tastes are wide, covering everything from Mozart to Miles Davis, Joni Mitchell and Led Zeppelin.

**John House Wingerworth, Derbyshire.**

You are right to consider an efficient loudspeaker, since the Leak Stereo 20 will sound at its best with a 'speaker of 87dB sensitivity or more and with a high overall impedance, which is usually the domain of British loudspeakers. The high sensitivity means that they will need little power to go loud, and a high overall impedance will draw less current from the valves, producing less

distortion.

Fortunately there are more and more loudspeakers becoming available with these qualities. At £279 there are Castle's Durham 900s. They are stand mounters, come as a handed pair for improved stereo imaging and, having a really firm and tuneful bass, should suit your tastes. If you want deeper, more powerful bass and have the room for a small floorstander, TDL's £250 RTL2s may be just the thing. If the bass is too heavy you can raise them off the ground a little on a low stand (a few inches is enough) which will also improve their ability to play a tune well.

TDL RTL3s are also worth considering if you've got the space, even if they're a touch over your budget at £399. All of these three 'speakers have soft dome tweeters which tend to give the smoothest treble.

On the kit side, IPL's S3s seem to be your best option. These floorstanding transmission line loaded 'speakers are sensitive, have a high overall impedance and possess very good bass quality. £290 buys you everything you need, including grilles and small stands. Or if you're a little more ambitious, have a go at our KLS3s. These use superb carbon fibre drive units, but you'll have to build your own boxes and wire the crossover. **DB**

### ROGERS RAVENSBORNE

My present system was established during the 1970s and comprises the following - Acoustic Research record deck and tone arm, Ortofon cartridge, Rogers Ravensbourne amplifier and Acoustic Research AR4 speakers on low (cheap) stands.

I'm seeking to re-new and or upgrade my equipment. A Marantz CD-72 now provides the primary source of music and, operating through a DNM Interconnect, has served to rekindle my passion for

listening to music. My tastes are fairly eclectic, spanning Blues, Soul, Jazz, Opera, and light Classical.

The listening room is 20ft x 12ft overall, L shaped with a low (7ft) ceiling and too much furniture. I am aware that the speakers are a little lacking in the treble, but of more concern is the rather lacklustre sound at low volumes which all too quickly becomes harsh and uncomfortable as the level is raised.

I do expect to replace the cartridge, but my main problem is that I am not sure what to do about amplification. Should I service and retain the Rogers? Probably the cheapest option, but is it out of date totally, not up to comparison with modern equipment, and also the source of some of my dissatisfaction with the sound?

Should I purchase a modern amp. like the John Sheame integrated, Audiolab 8000A, Technics SU-A900 or Cyrus III?

Should I buy second-hand, probably a Quad 33/303? Good value and I've always admired them, but would it be up to the task when compared with the above and will it give me the detail and solid imaging I prefer?

Loudspeakers I hope to narrow down when the core elements are in place, though I guess that I may find the CD, which got me started, may be lacking when I finally do get to the other end.

I would be grateful for your observations.

**R. W. Farrow Manningtree, Essex.**

You are living in the past. I went through that period too and can assure you that things have improved, even if not that much in some areas. The Ravensbourne really isn't very good by today's standards. Even in its day it was a budget amp. and no, a Quad 33/303 may be one of the best styled

Continued ....

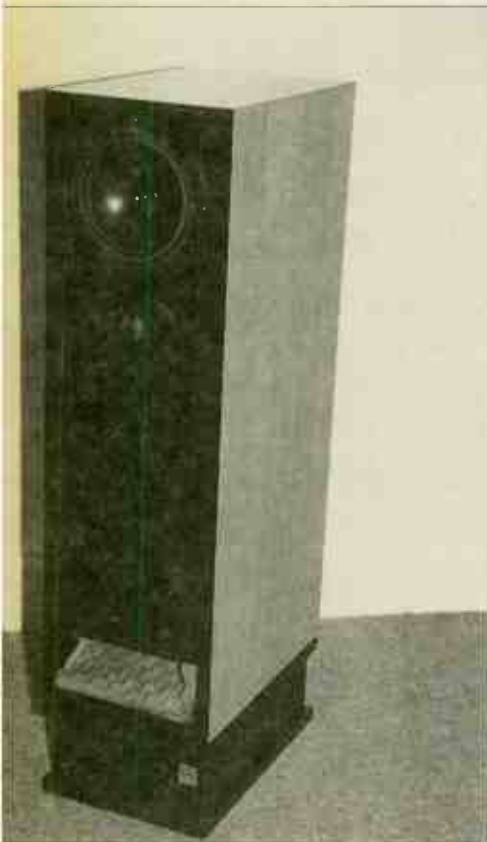

IPL's S3 kit transmission line loudspeakers.

# CABLE TALK

BRITISH  
MADE

★★★★★ Rated interconnects and speaker cables are available from your local specialist dealer.

.....STOP PRESS.....STOP PRESS .....STOP PRESS.

"Talk 3's great sound quality and value for money"

(Dec '92 WHAT HI-FI?)

Can now be obtained in a convenient bi-wire format at £4.50 per metre.

Please telephone 0483-750667 Fax 0344-360866  
For Further Information

Part I

## Gold Aero

"The Cream of the Crop"

Gold Aero USA was founded in 1973 by an audiophile, for audiophiles. The founding principle of the company was to provide the high end audio consumer with the highest quality vacuum tubes. This tradition continues into the nineties.

Our years of experience testing and listening to a variety of tubes has revealed that only a very small portion of tubes commercially available are suitable for the demanding audiophile. We are able to purchase large volumes of tubes from premium sources worldwide for our selection of the "Cream of the Crop". The remaining tubes which are unacceptable for Gold Aero are then assimilated into the industrial market.

For Further Details Contact; Tube Technology, Foxhills Farm, Ottershaw, Surrey, KT16 ODN, Tel: 0932 873444



# New for Winter '94

## CLARITY RECORDINGS™

Naturally balanced, two Microphone, Audiofile recordings.

### 'Foundation ATLAS'

A range of low, rigid, welded, 4 stem stand.

Coming soon, Foundation's dedicated stands to suit popular speakers.

Watch this space



Call us now for more information and our colour brochure!

### Foundation Audio Ltd

53 Beecroft Way, Dunstable, Beds., LU6 1EE  
Tel: 0582 477550 Fax: 0582 604001

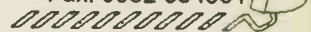

PURE HIGH FIDELITY

Telephone: 0753 680868

## marantz

# WORTHING AUDIO

20, Teville Gate Precinct,  
West Sussex BN11 1UA

The Friendly Shop With The Best Sound Systems In The South

- Friendly Advice \*Three Year Guarantees
- Easy Parking
- Open Monday To Saturday 10am to 6pm
- Late Night Wednesday, 7.30pm

Agencies include: Arcam, Audio Technica, Clear Audio, Exposure, Kinshaw Electronics, Marantz, Naim Audio, Orelle, Origin Live, Restek, Ruark, Sennheiser, Target, TDL, Thorens, Tripod and many more

Telephone (0903) 212133

## AUDIO COUNSEL — HI-FI SPECIALISTS —

LINN, NAIM, CREEK,  
YAMAHA, ROTEL,  
NAKAMICHI,  
MORDAUNT-SHORT,  
A&R, DUAL,  
REGA, NAD, JPW  
SHAHINIAN,  
DYNAVECTOR

and many more....

12 SHAW ROAD  
OLDHAM

TEL: 061-633 2602

.... Continued

and built amps of all time, but it doesn't sound so hot either. I ditched mine long ago, back in the seventies, even though it served me well and I loved it. I've thought of buying one again, as well as a Cambridge P50 which was a seriously radical amplifier in all respects (yet nobody writes to us about this one), but only for museum use.

The harder treble of modern amplifiers may shock you, so try auditioning an Aura VA-50 or an Arcam Alpha 5 in addition to the fine short list you've compiled, except for the Technics amplifier, which we wouldn't recommend.

You really should consider new loudspeakers, even if they are only a pair of small Missions like the 760iSEs (£150 or thereabouts). And watch out for reflections off that low ceiling. Try acoustically treating it to absorb and disperse sound. A few egg cartons wouldn't go amiss, perhaps with a muslin or light cloth covering to hide them.

**NK**

### BI-WIRE BLUES

After 20 years with my old system, I happened to pick up one of your magazines and start browsing. That was fatal, and I now get it regularly (the magazine, I mean!). As a result, I recently purchased a new hi-fi, comprising a Marantz PM44SE amplifier and CD-52 II SE CD, with Mission 760iSE speakers, Denon TU260 tuner and Aiwa 828 cassette. The speaker connection instructions given in the amplifier manual are not too clear - or I'm too thick - and I would very much welcome advice from an unbiased expert.

If I bi-wire the speakers, do I connect both pairs of leads to either the A or B output terminals on the amplifier, or do I connect the bass/mid-range wires to terminals A and

the treble wires to terminals B?

Is there any internal difference in the amplifier feeds to the A and B terminals?

In addition, I'm considering connecting an additional pair of speakers (not bi-wireable), for use in my workshop. Because I would have to use existing low grade wiring for this (it runs under concrete and can't be changed), I would wish to connect the speakers in parallel, so as not to degrade the feed to the 760is. I would like to be able to install a switch unit so that I could run either, or both, speakers.

Do you have any recommendations about connecting both bi-wireable and ordinary speakers, without degrading the feed to the good speakers? In addition, do you know where I can get a switch unit - the only ones I have seen connect the two sets of speakers in series, which I do not want. If I have to make my own switch unit, what electrical load characteristics would the switches need, again to avoid degrading performance? (Because of the location of the hi-fi, and a bad back, I do not wish to have to use banana plugs and disconnect them manually every time I have to switch speakers).

I must apologise for troubling you with questions which are simply a reflection of how uneducated I am. The advances since I bought my last system are quite amazing. However, I have retained my old Pioneer PL12D turntable.

If you are good enough to try and help me, then I would like to thank you in anticipation.

**Jim Taylor  
Charnock Richard,  
Chorley.**

In your system, I'd connect both pairs of bi-wire leads from the loudspeakers to the 'A' terminals, either by connecting them to the same banana plug, or by screwing both cables into the same set

of terminal posts. This will leave the 'B' terminals free for your second pair in the workshop. The amplifier you have will then enable you to select either 'A' speakers - the Missions, 'B' speakers - the ones in the workshop, or both pairs.

Both 'A' and 'B' outputs are normally the same inside the amplifier, and the signal shouldn't be degraded by running both pairs. By switching both pairs on, 'A+B', the impedance seen by the amplifier will reduce and more power will be drawn. But most of the Japanese amps are designed to be able to cope with this and it shouldn't affect sound quality. Make sure that the amplifier doesn't overheat though, as it may do if other equipment is stacked on top. **DB**

### FUTURE UPGRADE

I would like your advice on upgrading my system which currently comprises the following mixed bag: - Nakamichi CD4 CD Player (Original model), Deltec Slink interconnect, Rega Planar 3 turntable with RB300 tonearm and Bias cartridge, Marantz PM40SE amplifier and KEF Coda 3 speakers with Linn K20 cable on Sound Organisation stands. I also use a Creek 3040 tuner, Aiwa AD-F350 cassette deck and Sony CD750 headphones.

The CD player was purchased 18 months ago as a secondary source to the turntable. Since then, due to the lack of available vinyl, CD has become my primary source and I would like to concentrate my efforts here. My musical tastes are varied, but include Folk/Rock (Van Morrison, Hothouse Flowers, Mary Black, etc.) and Classical (Chamber and Opera) played at moderate levels only. Sound quality is reasonable on simple recordings, but seems to struggle with more complex material. I am seeking a more detailed sound without introducing brightness. I will

soon be in the position of having approximately £1500 - £2000 available for upgrading.

I wish to replace the speakers (as they are getting long in the tooth) and upgrade the CD player as a priority, followed by the amplifier if funds allow. Can you please advise on the best way to upgrade within my budget?

I like the idea of CD player and amplifier from the same manufacturer in order to take advantage of a system remote control (Arcam, Linn, Meridian, Quad etc.). Any replacement amplifier must have a MM phono input and a headphone socket which cuts out the sound from the speakers when in use.

Would I get more improvement by adding an off-board DAC rather than replacing the whole CD player?

I also favour compact floor standing speakers, both to eliminate the need for stands and for cosmetic reasons. They need to be suitable for placement within a couple of feet of the room corners (room size 18 by 12ft). For the same cosmetic reasons, my present system is housed in a wooden cabinet (my wife is not keen on the looks of specialised hi-fi stands!). Can you advise on the best means of improving the isolation of the electronics within this? Any recommendations will be carefully auditioned so I am basically looking for a short list to work with.

**Steve Callan  
Warrington,  
Cheshire.**

To start with, the best way to plan an upgrade like this is to audition a complete system. You need to find a CD player, amplifier and loudspeakers that work well together as a system. Of the manufacturers you mention, Quad make the most suitable CD player to start with, the 67. It is a super player to upgrade to, having high

Continued ....





# The Audio Room



# Pure Sound



Hi-Fi Consultants

## High End CD

If you are looking for a quality CD sound for your system, we can help. We have, in stock and available for audition, a range of players and transports including:

- Micromega CD 3.1, Duo Pro.2
- Counterpoint DA10, DA11
- Audiomeca Mephisto, Kreatura
- YBA integrated CD2
- Audio Note DAC 2

We are approved and authorised agents for all of the above ranges, so you can listen, and buy from us with complete confidence!

## Audio Note

We have taken delivery of the NEW Meishu from Audio Note, and this triode class A design exceeds all expectations. Use it with sensitive speakers such as Impulse or Triangle and you'll be astounded. Don't wait for the reviews, hear it for yourself. Book a demonstration with us ASAP!

## Demonstrations

To arrange a demo, to discuss what you need, or just for a hi-fi chat, call us and ask for Paul or Mark:

081 893 4485 / 0784 458176

## Lumley Reference

This range just gets better and better. If you are using speakers which need a bit more power to achieve realistic listening levels, then the Lumley Reference range is as accurate and detailed as any we have heard, and has enough clout to do justice to orchestral ffs, and meatloafish rock. The amps are now complemented by a superb range of Lumley Monitor speakers which are also quite extraordinary value for money, from £399 to £7,500. Come and listen.

## Impulse

We carry the whole range of Impulse for demo. Come and hear them.

Pure Sound + The Audio Room, Whitton, Twickenham and Staines. Personal service, home demonstrations, excellent hi-fi

**JORDAN WATTS ACOUSTICS LTD**  
 201 MARE STREET LONDON E.5  
 PHONE 081 985 1646  
 FAX 081 986 0112



A DESIGN NOT COPIED  
 BUT A DESIGN COPIED  
 PROBABLY THE BEST SOUND AROUND  
 TO ARRANGE FOR A DEMONSTRATION  
 SUPPLY DEALER'S NAME AND ADDRESS

**MANTRA AUDIO** • CARTRIDGES AND STYLI  
 • MAIL ORDER DIRECT 1-10 DAYS  
 • COMPETITIVE PRICE (inc P&P)

MAKE	MODEL	CARTRIDGE	STYLUS	MAKE	MODEL	CARTRIDGE	STYLUS
Audio Technica	AT 95	£21.00	£19.50	Ortofon	010	£29.00	£18.00
	AT 110 E	£26.00	£16.00		520 520P (T4P)	£49.50	£36.00
	AT 450 E	£37.00	£33.00		MC 1 TURBO	£54.00	£45.00*
	AT420 E	£36.00	£22.00		MC 3 TURBO	£99.00	£82.50*
	AT OC 3	£95.00	£64.00+		MC 15	£76.00	£65.00
	AT OC 5	£110.00+	£90.00*		MC 15 Suplrim	£98.00	£82.00
Denon	DL 110 MC	£65.00	£52.00*		MC 20 Suplrim	£220.00	£150.00*
	DL 150 MC	£75.00+	£68.00*		MC 20 Suplrim	£315.00	£236.00*
	DL 304 MC	£180.00	£155.00*	Shure	VN 35 MR	(V 15 III)	£83.00
Goldring	ELECTRA	£24.00	£18.00		VN 45 MR	(V 15 IV)	£90.00
	1006	£44.00	£29.00		V 15 VMR	£225.00	£130.00
	1012 GX	£58.00	£38.00				
	1022 GX	£76.00	£49.00				
	1042	£94.00	£61.00				
	Ereca (LX/H)	£90.00	£55.00*				
Nagaoka	MP 11	£25.00	£12.50				
	MP 11 Boron	N/A	N/A				
Ortofon	OM10, OMP10 (T4P)	£25.00	£18.00				
	OM20, OMP20 (T4P)	£34.00	£31.50				
	OM30, OMP30 (T4P)	£72.00	£58.00				
	OM N'CLUB S	£29.00	£18.00				

**SWISS QUALITY DIAMOND STYLI**

MAKE	MODEL	PRICE
AOC	R20 XE, OLM 32/34/36, XLM III	£12.50
Aiwa	AN 5/11/8745	£8.00
Alai	RS 33/35/38/84/85/90	£8.00
Dual	DN 145/155/165E DN 149S	£12.50
Ortofon	FF 15/VMS 10/20 EII OMP 10/20	£12.50
Shure	N75 ED/EJ T2, M95 ED/EJ	£10.00
Sony	ND 133/134/142/150/155/200 G	£8.00
Technics	EPS 23/24/25/27/290 P 30/33 D	£8.00

\* Exchange any MC \*\*\* Over 500 styli type stocked \*\*\* Tel (0757) 288652  
 All above prices UK mainland UK guarantees No grey imports

**MANTRA AUDIO (HFW), 22 GARTH AVENUE NORTH OUFFIELD SELBY, NORTH YORKS YO8 7RP**

## Inaccessible accessories by post.

If you can't get to us, we'll get our accessories to you.

**CARTRIDGES:** Arcam, Audio Technica, Denon, Dynavector, Goldring, Lyra, Ortofon, Sumiko. **CABLES:** Audioquest, Cable Talk, Goertz, Heybrook, Ixos, Kimber, Kontak, LFD, Monster, Ortofon, Precious Metals, QED, Sonic Link, Van den Hull, XLO. **STANDS:** Alphason, Apollo, Atacama, Sound Organisation, Sounds Style, Stands Unique, Target. **HEADPHONES:** Beyer, Sennheiser, Stax. **ACCESSORIES:** Audio Technica, Audioquest, BIB, Discwasher, Goldring, Hunt, Ixos, Kontak, Last, Michell, Milty, Moth, Nagaoka, Pixall, QED, Shure, Townshend. Plus a full range of quality equipment available.

PLUS A FULL RANGE OF QUALITY EQUIPMENT AVAILABLE. SEE OUR MAIN ADVERTISEMENT.

**BURY AUDIO** 47 CHURCHGATE STREET,  
 BURY ST. EDMUNDS,  
 SUFFOLK IP33 1RG.  
 TEL & FAX: 0284 724337  
 MOBILE: 0850 565693

.... Continued

quality sound, Quad's excellent back-up service and a good transport should you wish to upgrade to even further heights in the future. But if you want to have a system remote control, the matching 66 pre-amp will add £840 to the £790 67 CD player. This only leaves £370 of your budget for an amplifier and 'speakers, and so far no headphone socket in sight.

To stay within your budget I'd stick with the Quad 67 CD player and source an amplifier from a different manufacturer. To start with, try the £460 Audiolab 8000A. This has everything you need; headphone socket, high quality MM and MC stage as well as being reliable and capable of producing a superb sound. It is very clean, some describe it as sterile, but this should balance the characterful and full sounding Quad 67 very nicely.

The Audiolab 8000A has plenty of power, so almost any loudspeaker will work well on the end of it. But I'd try Rogers' £449 LS8a2s first for their ability to play music in an enjoyable and entertaining manner. I also think that they'll be a particularly good match for the system and room. This brings the total up to £1700. Any remaining funds should be spent on music to enjoy on your new system; your interconnects and 'speaker cables are already of good quality. **DB**

### VINYL SURPRISE

Here's an easy question (or maybe not). Last year, starting from scratch, I auditioned and assembled a system, expecting to use CD (Arcam Alpha 5 and DITB) or tuner (Audiolab 8000T) as the principal sources. I bought a Pro-ject 6 turntable as well, thinking that I might be able to pick up a few second-hand records to listen to now and then. To my

surprise, I discovered that I liked vinyl most of all, for two reasons - I can collect more music for my money, and the quality of sound reproduction, even with the modest Pro-ject 6, is far better than I could ever have imagined.

Amplification is handled by an EAR 834P and John Sheame Phase II integrated with Heybrook Quartets, and they work together to produce a marvellous sound, with a lot of weight to the bottom end. Of the few albums which I have on both CD and vinyl, I prefer listening to the latter.

Here's the question.

Assuming that I have taken great care with mechanical isolation, cabling, interconnects and the occasional tweaky accessory (a Ringmat), how can I reasonably improve the performance of the deck?

I thought of a better cartridge (the new Ortofon MC20/30 Supreme), or a better arm (what would fit?), but how much does the basic construction and quality of the deck limit the potential of such attempts at improvement?

Would I be better off saving for another turntable? How much could I modify the Pro-ject 6 before it all became a waste of money? Rumour has it that the importers are planning updates for the deck, but I can't confirm this.

Please can you help me?

**David Howes  
Woodchurch,  
Kent.**

P.S. For your information, the full set-up includes Roksan blue bi-wired speaker cable, Isoda hybrid interconnects (HC-05-PSR) and the turntable is supported by a very sturdy wall shelf. No amount of jumping (literally) up and down on the floorboards seems to disturb the stylus, so the deck must be well-isolated from vibration. I have a Seismic Sink under the CD, but for the reason given above, I have not considered using it under the turntable. Should I? The Pro-ject 6 has been customised by adding a

heavy hardwood plinth (like an LP12) to enclose and support the lightweight baseboard.

Since, in my view, the Pro-ject arm is the weakest element, you are close to the maximum of what can be achieved, since there's not much more mileage left. The deck is certainly well-isolated as it stands, but since you already have a Seismic Sink, swap it from under the CD player (where it is certainly beneficial) to the turntable just to see.

While reviewing a Pro-ject 6, it did occur to me to wonder about arm-replacement, but the job would require dis-assembling the base and sub-chassis and then finding an arm with the same column diameter.

Ortofon tell me it's near-impossible to re-drill the arm-board, but they will be bringing in a Sumiko arm for the Pro-ject in the next few months. Hang on to your wallet, and be first in the queue for it.

In the meantime, however, an upgrade to an Ortofon MC20 Supreme would be worthwhile: the Pro-ject arm will (just!) support a cartridge of this quality. **EB**

### ARMSTRONG SERVICE

Inspired no doubt in part by the coverage in your magazine devoted to elderly, ahem, vintage hi-fi, I recently bought an Armstrong integrated valve amplifier. I've no idea how old this particular specimen is, but it had a label which bears the legend "as selected for the Design Centre London" attached - rather carelessly I thought - to some wires inside. In addition, another label, this time stuck on the back of the amplifier, bears the legend "MODEL 222". Perhaps these offer some clue as to the age and/or worth (if any) of the item in question?

Anyway the latter is of less concern to me than finding an honest enthusiast who would

be willing to check over the amplifier and carry out any repairs at a reasonable cost even.

To my, admittedly untutored, ear the amplifier sounds fine on all inputs - except phono - and then only when the source is the turntable (Rega Planar 3/RB300). With this set-up there is simply no volume. On the other hand, inputting a CD or Tuner through phono (or "pickup" as it is referred to on the amplifier) works just fine.

On a visual audit the only thing which seems amiss is that a small green cylinder, clipped to the base of the amplifier and located beneath the internal Off/On/Input Selector switch appears to have blown its top and leaked (some of?) its contents. Could this be the cause of the lack of volume with the turntable-source?

I welcome whatever speculations/advice you may be able to offer on any of the above.

Many thanks in advance.

**G. R. Thomson  
London.**

It surprised us to find out recently that Armstrong are still running as a service centre for a wide range of products, including vintage valve equipment and, of course, all Armstrong products. Your 222 can be repaired they told us. Contact: Armstrong Hi-Fi Video Services Ltd. 32A Blackhorse Lane, Walthamstow, London E17 6HJ or telephone 081-523-0051/0023/fax 081-523-4395. It sounds like the input labelled phono is in fact line level and is probably intended for connection to an external phono head amp. which will amplify the signal from your cartridge up to suit. Amps like this have little open market value and are best seen as valuable for the entertainment they can provide rather than the hard cash they can raise. Only a few sought after rarities can justify large prices. **NK**



Win a free weekend for two in our beautiful country cottage and relax to some of the best sounds in Hi Fi to be found anywhere in the world!

## Cottage Audio

17 Bridge Street, Saxilby, Nr. Lincoln. LN1 2PZ

Tel: (0522) 702834

Just answer three simple questions below and send the coupon to us. The draw will be held on 5th November 1994 to discover the lucky winner.

1. Who composed *The Marriage of Figaro* ?

- a. Leopold Mozart
- b. Wolfgang Mozart
- c. Maria Mozart

2. Which famous jazz musician was the film *Bird* based on?

- a. Charlie Parker
- b. Theolonius Monk
- c. Miles Davis

3. What was the name of The Beatles record label?

- a. Banana
- b. Orange
- c. Apple

Name .....

Address.....

Tel. N<sup>o</sup> .....

Prize includes double room ensuite, breakfast and use of demonstration room.  
The Judges decision is final, no correspondence will be entered into.

## AMADEUS SOUND & VISION

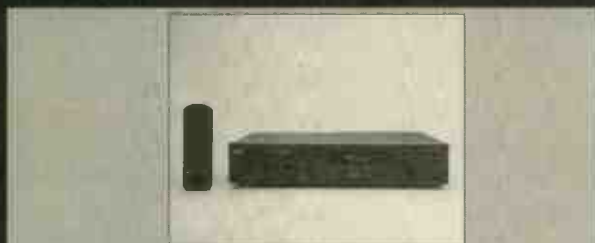

Aura, Audio Innovations, Bang & Olufsen, Castle Acoustics, Micromega, Musical Fidelity, Nakamichi, NAD, Pioneer, Quad, Royd, Spendor, Technics.

10 BOLDMERE ROAD  
SUTTON COLDFIELD  
WEST MIDLANDS  
Tel: 021 - 354 2311



Interest Free Credit Facilities

Demo room with A/V system set-up.

## Classic Hi-Fi & Video



NAD • MARANTZ

• ROTEL •

HEYBROOK •

AURA • SUGDEN

• YAMAHA •

PIONEER • LFD •

KEF • JPW •

ROGERS •

MONITOR AUDIO

• CELESTION •

KENWOOD • TDL

• CASTLE •

ONKYO •

KESWICK AUDIO

& MORE



Classic Hi-Fi & Video  
School Lane, Kettering, Northants.  
Tel: 0536 - 515766



# Haden Boardman

INCA TECH 'Claymore' 8 inputs, solid state Amp	£120
Musical Fidelity P270, 130 wpc solid state P/Amp	£680
Musical Fidelity MVT, solid state Pre-Amp	£450
Technics SL7 Parallel tracking T/Table	£75
Hitachi FT 5500MD, digital preset tuner	£75
KEF Corelli, T27 & B100 Speakers	£75
Audio Research D70 Mk II 70 wpc tube P/Amp	£700
E.A.R. 509 Mk 1 P/Amp 90 wpc	£800
Leak TL12+, Pair, valve monoblocks	£300
Heath 599 Integrated Valve Amp	£75
QUAD 33 Pre-Amp (solid state)	£50
Radford FMT2 Tuner, matches STA25/SC22	£75
Radford SC22 Pre-Amp PSN	£50
Lowther PM6C New Pair	£250
Lowther PM6A New Pair	£300
JR 149 T27/B110 Speakers	£100
Musical Fidelity THE PREAMP	£125
Leak Troughline II / E.A.R. Deck	£175
Leak TL25+ singles / All colours available from	£350
Leak TL50+ single, Black	£250
Leak TL12 point one, wrong o/p Ux pair	£400
Leak TL18, Sandwich Speakers	£25
Goodmans Tri Axcom 12/20 12" horn tweeter, Pair	£100
Oracle Delphi, Well tempered arm	£650
Rogers Cadet III	£100
Marantz PM4, Class A Integrated Amp	£250
QUAD 50E Monoblock P/Amps	£200
Thorens TD150 Chassis	£20
Naum Nait	£125
Nytech 302 Amplifier	£100
DNM series 3 primus, Ring for details	£250
Electrocompaniet Class A P/Amp	£30
Sony TA1010, transistor integrated	£50
Goodmans 150 receiver	£50
ProAC EBT, pair walnut	£125

## Amplifiers - The How and Why of Good Reproduction

Leak and QUAD valve power amplifiers are capable with gentle 'tuning' of out performing far more expensive modern designs

Due to the huge amount of Leak TL12 plus and STEREO 20 amplifiers on the secondhand market, I designed a new drive circuit for these classics (Nick-named PERFECT PHASE PLUS). A triode is used instead of the EF 86 pentode and a high current driver tube is used. All of the components (including the valves) are replaced but with 'period' thinking. The sound becomes far more open, with greater dynamic clarity and space between the instruments. Dynamics are accurately followed. Bass notes are no longer hidden, nor is the sound 'muddy'. Any customer with very high efficiency loudspeakers can opt for 'TRIODE' mode-output operation at no extra cost.

For a STEREO 20, I will totally rebuild and modify for £125. A pair of TL12+ mono blocks we rebuild for £160. Anyone wanting a repair to original condition can contact me direct for a quote. My competitive repairs service, charges just £15 per hour. If you are unlucky enough to have a burnt out STEREO 20 mains transformer, we now have a replacement which fits inside your old end caps. Price £50 exchange.

I can improve the performance of most classic amplifiers by gentle tuning. Any hard wired designs can easily be updated. Please let me quote for your requirements. Thorens TD150 chassis

Customers looking for a cheaper control unit to use with their vintage amplifiers should listen to the new MELLOTONE passive pre amp, precision made, price £150. For a full-function phono preamp with regulated PSU and cathode follower outputs, come and listen to Glen Crofts latest MICRO at £450.

Don't forget the excellent range of Esoteric Audio Research in stock. The brand new 859 single ended enhanced triode mode amplifier is a sure fire winner. On audition now at £1599. 834P phono stages are also now in free stock (£349), and by the time this advert hits the stands, hopefully the new 834L line stage pre amp, for digitally oriented customers (expected price £400, please check)

QUAD ESL users should be aware of E.A.R. new 'direct coupled' electrostatic tube amp.

Tim has also designed a cunning sub woofer system free of the usual bass bloom you would associate with other inferior designs. This will be on demo around mid December.

I am sorry, I do not sell individual components or circuit diagrams for vintage amplifiers or equipment.

## NEXT MONTH TUNERS AND TURNTABLES

ESS Amt Loudspeakers	£200
IMF ALS40 Loudspeakers	£150
Rogers LS7, Classics, NOT Y version	£175
AR ZAX Loudspeakers	£35
Leak 2030 Loudspeakers	£35
SPICA Angitrus, as new	£700
DMF TL380 Mk IV, Transmission lines	£350
Goodmans Mezzo Loudspeakers	£35
AR 18 Loudspeakers, bi-wireable	£35
AKAI GX400D, open reel 10 1/2 inch reels	£450
AKAI 1722W, open reel	£50
AKAI X300, open reel 10 1/2 inch reels	£100
Ferragross S6, stereo open reel	£50
Truvox PD92, stereo open reel	£50
Sony EL7, 3 head ELCASET, tapes available	£250
AIWA ADF660 3 head cassette deck	£75
Pioneer CT4040 cassette deck	£35
£20	
Thorens TD150 in base	£30
Philips 101 electronic turntable	£25
Garrard 401 chassis	£125
Alphason HR100MCS, tone arm, boxed, newer used	£200
SME 3009 S/II various	£50
Decca F55 arm & pick up	£75
Ortofon tone arm (9")	£50
Wharfedale 3 way speaker system c. 1955	£OFFERS
Wharfedale corner speaker c. 1948	£OFFERS
Acoustical (QUAD) M31 30 watt tube amp	£150
Rogers Corner Horn, with Lowther PM6	£50
Wharfedale W2 'Dovecote' pair	£50
Rowe AMI RI-3 juke box, small, c. 1980	£350
Rock Ola 1448 juke box, silver age c. 1954	£3000
Garrard 301, Bastin 'Max Plank' plinth, SME arm	£350
Hadcock GH220 arm, boxed	£50
Phillips CD960 CD player, boxed	£200

Mellotone Acoustics Co., P.O. Box 67, Wigan, Lancashire, WN2 3AG, U.K.  
Tel. (01942) 57525 Fax (01942) 525861

## Bury Audio. Chosen by hand appreciated by ears.

For the best in Hi-End hi fi Bury Audio is a must. All the names stocked are individually chosen to complement one another to give the best sound in their class. Whether you're after an upgrade or a full system, we can offer advice and experience together with full demonstration facilities to ensure you make the right choice. Naturally we offer a full installation and set-up service

### Analogue CD Amplification Speakers.

<b>Replay.</b>	<b>CD</b>	<b>Replay.</b>	<b>Speakers.</b>
Denon,	Arcam,	Arcam,	Arcam,
Goldring,	Albany,	Albany,	Castle,
Kinshaw,	Audio Alchemy,	Audio Innovations,	Heybrook,
Lyra,	Counterpoint,	Aura,	Keswick Audio,
Michell,	Marantz,	Heybrook,	Monitor Audio,
Ortofon,	Meridian,	Marantz,	ProAc,
Pink Triangle,	Musical Fidelity,	Meridian,	Royd,
Project,	Orelle,	Michell,	Ruark
Rega,	Pink Triangle,	Musical Fidelity,	Spendor.
SME,	Quad,	Quad,	
Sumiko	Rotel,	Rotel,	
Tesseract.	Teac.	Shearme,	
		Tesseract	
		Tube Technology.	



**BURY AUDIO**  
47 CHURCHGATE STREET,  
BURY ST. EDMUNDS, SUFFOLK IP33 1RG.  
TEL/FAX: 0284 724337

Mon-Sat. 9.30am - 6.00pm. Closed Wed.  
Mail Order and Export enquires welcome.

## DARBY'S OF ST ALBANS

END OF SEASON CLEARANCE OF DISPLAY  
USED PLUS SOME BOXED HI-FI EQUIPMENT (All with guarantees)  
PLEASE PHONE FOR FURTHER DETAILS

PRODUCT	OUR PRICE	NORMAL PRICE	PRODUCT	OUR PRICE	NORMAL PRICE
ACOUSTIC ENERGY AE32000		999	DENON DAP5500	849	649
YAMAHA NS1000	1300	999	REVOX B251	1000	499
RUARK BROADSWORD	879	599	SONY CDPX222ES	299	239
RUARK SWORDSMAN	299	239			
RUARK SABRE	385	299			
RUARK RHAPSODY	799	499			
ARCAM DELTA 60	299	229			
ARCAM DELTA 80	329	249			
ARCAM DELTA 170.3/BB51149		849			
ARCAM DELTA 100	849	699			
QUAD 34 (One Only)	399	219			
SONY STS570	200	179			
SONY TAF670	399	349			
SONY CDPX303ES	549	399			
SONY CDPX338ES	599	399			
DENON AVC3020	729	599			
DENON AVC3530	999	899			
JBL XPL90	699	529			

SOME ITEMS SECOND HAND  
PLEASE ENQUIRE FOR  
DETAILS

SONY CDPX229ES	329	269
MONITOR AND 10 MA14	479	349
MUSICAL FIDELITY CD2	349	269
HARMAN KARDON TV909	199	129
DENON DRA545RD	319	269
LYNX QUASAR	499	399
YAMAHA CDX560	199	179
PIONEER CLD1750	579	499

PLUS MANY OTHER SPECIAL OFFERS ON ACCESSORIES  
AND CABLES, PICK UP CARTRIDGES, ETC

6 MARKET PLACE, ST ALBANS HERTS  
TEL: 0727 851596/850961  
ACCESS/VISA/SWITCH/MAIL ORDER WELCOME

*hi* **Best prices for new, xdem & s/h equipment** *fi*

NRG 401 S Stereo pwr	as new	£4500	Wadia 7+9 tran/dac	mint s/h	£15995
Tube Tech Genesis monoblocks			Mark Levinson 30/31 tran/dac	mint s/h	£15500
	mint/sh	£1495	Meridian 200/263	mint s/h	£895
Krell KSA 250	mint s/h	£3995	CAL Tempest mkII	mint s/h	£1395
Audio Note OGANKU	mint s/h	£25000	ATC S2000 c.d.	mint s/h	£895
Krell KSA 100 mkII	mint s/h	£1595	Magneplanar 1.4	as new	£750
JADIS Dely 7	mint s/h	£3500	Audio Note ANK Sp +		
Conrad Johnson MF200	mint s/h	£895	foundation	as new	£550
Musical Fidelity P180	as new	£495	Snell type E's + Foundation	as new	£850
Nestrovic Labs NA1	mint s/h	£1995	Sonus Faber Extrema + stds	mint s/h	£4250
VTL Manley 350	mint s/h	£2750	Sonus Faber Electa Amator	mint s/h	£1800
Mark Levinson No.27.5	mint s/h	£3500	Heybrook Sextet + stds	as new	£550
Audio Innovations 1st Audio	as new	£850	SD Acoustics SD5	mint s/h	£850
Naim NAP 135	mint s/h	£1800	ATC SCM 100A	mint s/h	£3500
Threshold S150	mint s/h	£795	Gold mkII	as new	£325
Mark Levinson No.38	mint s/h	£2600	Meridian D600B	mint s/h	£1595
Cadence 2/MA2 pre/pwr	x-dem	£1995	JPW AP2's	as new	£95
Musical Fidelity MA100	mint s/h	£650	JPW Minims	as new	£60
Counterpoint SA7			Castle Acoustics York deluxe	as new	£250
Linn Kairn Pro	x-dem	£750	Infinity IRS BETA	mint s/h	£4995
Naim NAC 52	mint s/h	£2800	Martin Logan Quest	mint s/h	£2800
Counterpoint SA9/SA11	mint s/h	£5995	Ruark Talisman II	mint s/h	£650
Matisse Ref Pre (latest)	mint s/h	£1895	Naim SBL's	mint s/h	£1100
Trilogy 902 pre	as new	£795	Impulse H2's	vgc	£1595
Audio Research SP15 mkII	mint s/h	£3500	Acoustic Energy AE1 + Stds	mint s/h	£695
Audio Research SP14	mint s/h	£1595	ATC SCM 20	mint s/h	£850
LFD LS11	mint s/h	£495	Audio Note M7 phono	mint s/h	£7995
Audio Research SP8 mkII	mint s/h	£795	Rotel Michi RHQ10	mint s/h	£495
Michell Argo/Hera	mint s/h	£550	Koetsu 80th Ann.	mint s/h	£1600
Audio Note M7	mint s/h	£7900	VPI HW19 MKIII	mint s/h	£895
Mark Levinson 26S/25S	mint s/h	£4995	Alphason Ssymphony HR 100 MCS/ATLAS		
Albarré PP1	mint s/h	£295		mint s/h	£1495
Marantz CD10	mint s/h	£795	TNT mkII/ETII/STD	mint s/h	£3995
WADIA 2000 tran/dac	mint s/h	£3750	Manticore Mantra/RB 300	mint s/h	£450
Meridian 200/203	mint s/h	£695	Koetsu 80th anniversary	mint s/h	£1595
Meridian 602/606	mint s/h	£1795	Linn ARKIU	x-dem	£695
DPA PDM 1 mkII	mint s/h	£250	Burmester 838 phono	mint s/h	£550
Micromega Duo BS	mint s/h	£250	Tesserac TAADA phono mm/mc	as new	£995
Roksan Rok DP1	as new	£695			

**MINT S/H** - Second hand as good an example as we've seen anywhere  
**AS NEW** - Typically less than 4 months old in new condition  
**X-DEM** - Typically 'as new' but may be older  
**G.C/V.G.C** - In perfect working condition but may be marked

*hi* **CHOICE** *fi*  
**(081) 568 8808**

Equipment bought or part exchanged  
 Full demonstration facility - by appointment  
 Major credit cards accepted  
 9.30am - 8.00pm 7days

**Can't Find What Your Looking For?**

**THE HI-FI EXCHANGE**

Whether buying or selling Audiophile equipment register your requirements with us now. All enquiries are entered on our sophisticated database where equipment matching takes place. A complete catalogue of equipment wanted and for sale, available weekly, is free \* to anyone both here and abroad. The Hi-Fi Exchange is continually updated and is the most comprehensive source of second hand and s-dem equipment anywhere.

\* 1st issue free to advertisers, subscriptions available.  
 Trade enquiries welcomed.

**Choice Too**  
**(081) 568 8808**  
**9.30am - 8.00pm**

The NORFOLK/SUFFOLK High End Dealer  
**audible difference**  
 near DISS, NORFOLK

Audio Research	<i>Audion (Alema)</i>	ART Audio
ATC	<i>Audio Innovations</i>	Audio Note
AVI	<b>CHORD</b>	<b>Copland</b>
Croft	<b>DAWN AUDIO</b>	<b>dpa</b>
EAR	Impulse	Kinshaw Perception
Linaeum	<i>Lyra</i>	LFD Audio
Magnepan	Micromega	<b>neat</b>
<i>Orelle</i>	Pink Triangle	ROKSAN
Sumiko	<b>SME</b>	Sonus Faber
SUGDEN	Tube Technology	van den Hul

At this level of equipment we believe that the highest level of service should be offered.

We will book only three demonstrations a day to ensure that you have ample time to evaluate the option YOU choose,

**DEMONSTRATIONS IN OUR LISTENING ROOM OR YOUR HOME**  
**EQUIPMENT LOAN SERVICE AVAILABLE**

Tuesday to Friday, 12 to 9 pm  
 Saturday 9 to 5 pm  
**PLEASE RING FOR AN APPOINTMENT**

**0379 740227 OR 0850 983233**

CLEARAUDIO, S.M.E, AUDIO RESEARCH, CREEK, E.M.F, GRAHAM

**HEATHERDALE AUDIO LTD.**  
 202, Findon Road, Findon Valley, Worthing, West Sussex.  
 Tel. 0903-872288. Fax 0903-872234

**CLEARAUDIO**

"In my introduction I described the Clearaudio Signature's performance as stunning. It's the only word that does this cartridge justice."  
 Chirs Beeching. Hi-Fi News & RR. Aug. 94.

This months pre owned bargains;	Audio Research SP9	
Magnum Reference 300 pre-amp	£325	Pre (black) £1895
Magnum Reference Int amp	£299	Linn LP12 £395
Audio Innovations 1st Audio	£995	Wadia X32 DAC £795
Audio Innovations 1000 pre-amp	£995	Sony 702 DAC £795
Audio Innovations 200 pre-amp	£295	Magneplanar Tympani
Audio Innovations 200 pwr-amp	£295	IV Speakers £2495
		Martin Logan Quest's £3595

THREE COMFORTABLE DEMONSTRATION LOUNGES.  
 VISA WELCOME.

MAGNEPLANAR, MARTIN LOGAN, ROTEL, THETA, BASIS, VOYD

**Audio Physics**

**CLEANLINE** - Modification for the Naim HICAP

**Would you believe that the already excellent sound of your Naim equipment could be improved?**

Replace the IC regulator in the HICAP with our easily fitted very low noise regulator module, built with selected discrete components. **Like our many satisfied customers you too can gain a clearly demonstrable improvement in clarity and enjoyment.**

The CleanLine module is £125 inc, with clear fitting instructions, a help line and a full refund if not completely satisfied.

Phone Geoff Mead on 0895 637846 for full details



A & R CAM A60 Integrated Amp. Excellent condition £110. Rogers LS7s Speakers. Original (& best) model VGC £220 including stands. superb combination. Will Dem. Telephone: Graham (0737) 223425 (Surrey).

REVOX B77 MR11 Two Track Recorder 7.5 & 15 IPS. 10.5" Tapes. Absolutely immaculate condition. £1,900 new only £700 ono. Telephone: (0344) 867 589 or (0374) 194 069.

MERIDIAN MCA 1 Amp with CD, tape, MC Modules also matching MFM Tuner great sound boxed bargain £200 or will swap for new style Naim Nait 2. Ring Tony (0742) 723138.

AUDIOPHILE SPEAKERS. US Imported Ryan Acoustic Speakers (£1,000+ new). Fantastic sound stage and imaging. £575, includes high quality target R1 speaker stands. Telephone: (0276) 61350 evenings (after 7pm)/weekend.

ARCAM DELTA 170 CD Player with black box and Audioquest cables. Boxed. Perfect condition. Will gladly demonstrate. £350 ovno. (0977) 620558.

ARMSTRONG 626 RECEIVER boxed with manuals, £100. Armstrong 521 amplifier, £45, both in excellent condition. Goldring Lenco GL75 Transcription turntable, £65. Telephone: (0252) 622403 (NE Hants)

LINN LP12/LINGO/Cirkus/Aro/Klyde/Equinox Head Amplifier £1,700. Naim new style NAC72, old style Hi-Cap pair NAPI 35s complete system £2,000. Audiovector F3/LYD speakers freestanding three-way floorstanding excellent imaging. £1,200 new. Only three months use £750. (Tilbury) 0375 843713.

MAGNUM MF250 Power-amp 125 WRMS £275 Mendian M3s Active + M30 Stands £395, 101 pre amp £130, 200/203 DAC7 £745. Albany M1008II/AP4 £795. Artimiz £295. Naim Nait £150, Marantz CD56 £100. (0206) 861457.

LINN LP12/Ittok/Asaka - £650; Linn LK280 - £400; Cambndge P50II (1973, faulty, use case for DIY preamp?) - offers. Northampton (0604) 403947 after 7pm.

MANA ACOUSTICS Reference Table in immaculate condition, with box £250. Also two Cornflake Shop, single tier equipment tables £25 each. Telephone: (071) 239 0398 (Simon Bance) days.

CASTLE WINCHESTER Speakers, Yew Wood Veneered, C/W floor stabilisers, 3 years old. £850, less than half price. Reason for sale too large for new location. Buyer collects. Telephone: (0983) (I.O.W.) 565849.

REL STENTOR Sub-woofer costs new £1,500 accept £700. (0803) 297691 evenings (Torquay, Devon).

COPPER CHASSIS - non magnetic, high conductance material for the best sound. 2 sizes available: 405x305x75 mm stereo amp \$125.00 330x230x50 mm preamp or monoblock \$100. Bottom plates \$15.00 Tubes: WE275A, WE274, 6V6, 6550 etc. Oil Caps: over 3000 signal and reservoir in stock. Many other parts. Send for complete list. C.Phaneuf, 972 Guillaume Boisset, Cap-Rouge (Quebec) Canada G1Y 1Y9.

DPA 200S PRE and Monoblocks 200 WPC with 2 pairs white slink, 2 power filters, stunning sound cost over £2,400. 6 months old, absolutely as new accept £1,895 ono. Tel: 0454 201043

JPV RUBY 4 Floorstanders, stunning sound and looks in Santos Rosewood. Cost £1,500 in March accept £1,100 ono. DPA 200S Pre/monoblocks etc. cost £2,400 accept £1,895 ono. Tel: 0454 201043

MERIDIAN: 200 CD transport, 6 months old; 203 DAC7 converter. Both mint, boxed. Optical + coax cables. Genuine reason for sale £795. Ph. (0223) 69300 (Paul) evenings.

KENWOOD DP X9010 Transport, as new, boxed, half price £300 or exchange for Mendian 200 Transport. Telephone: Marc (0392) 422357 Exeter.

BARGAIN: One pair of KEF 105.III mint condition. Black Ash for quick sale £1,300 no offers. Will deliver within reasonable distance. Tel: 0522 693373

ALBARRY 1008, 100 watt Mono Block Amplifiers £650. Albany S508, 50 watt Stereo Power Amplifier £300. Audioquest Video-Z digital interconnect 0.5 metre £25. All mint condition, little used, will demonstrate. Telephone: (0277) 355769 (Essex).

KEF 104.2 Speakers £800, Akai CD A7 £100, Pioneer A88X Amplifier £200, Nakamichi BX125 Cassette Deck £150. All in Good Condition, all with receipts. Telephone: (0543) 256697 Lichfield.

REVOX A77 Reel-to-Reel tape deck. Factory fitted high speed and vanspeed plus TEAC AN-180 dedicated Dolby N/R system. Domestic use only. Full service history. £450. Telephone: Robert (0603) 222230 (Norwich).

KEF 107II, Rosewood, £1,400. Celestion SL600 £260. Audionote Ks £225. Sony 228ES CD Player £220. Rogers LS3/5A with active subwoofer £600. Inca Tech Claymore amp £110. Telephone: (0977) 643629.

LINN SONDEK - Valhalla - Ekos - K18 - Ex Cond. new stylus. Plus Sound Organisation table. Can dem with your system. £925 ono call Steve on (0273) 679500.

NAIM NAP90 Power Amp brand new un-used with guarantee £285. Also Sound Organisation Z021 two tier equipment table £65. (0708) 470706.

LINN LP12 VALHALLA Akro £450 Linn Keilidh Speakers eight metres K400 £450 or will swap your newish Audiolab 8000A for either (021) 561 1889.

QUAD II/22 SET V.G.C. £350. FM1 Tuners, £20-£60. Multiplex Decoder £40. Troughline Ills Mono, G.W.O. £80-£95. Lindley Troughline, Internal Decoder £250. Wanted. Single bronze TL12+. Swaps Possible. (0550) 4272.

LOOK!! Audiolab 8000All and Epos ESIIIs with Epos stands for sale. Superb sound quality. Still guaranteed. Condition as new. Demonstration welcome. £595 o.n.o. Call Adnan on Llandudno (0492) 879244 anytime!

ALBARRY M408 Mono-blocks, DMPI active preamp, APS1 power supply £595. Concordant Quadll amps £275. Transcriptors Skeleton turntable, vestibule arm, A.T. cartndge, £135. Tannoy Cheviot speakers £265 (12" HPD). Telephone: (0604) 584630.

MISSION CYRUS II Amplifier, £125. Linn Kan Speakers with Kann II Stands, £175. Carefully and lovingly used. Telephone: (091) 273 6916 after 6pm and weekends.

LEAK TL/50+ Amplifier with vanlope three preamp, spare original output and mains transformers and spare set of valves. £275. No offers. Demo. (0386) 553942.

NAIM 82 preamp £1,300, Hi-Cap £425, 250 amp £1,000 Micromega CD3.1, Pro 2 Dac £2,000 5 months old. KEF 104/2 Ref Black £500. Or whole system for £5,000. (0235) 765986.

LINN SONDEK LP12 Turntable, Linn Ittok K9 arm & cartndge, Marantz CD51IIE CD Player, Audiolab 8000A amp, Monitor Audio R700 Gold Speakers and matching stands, 2 x 5 metres Monster bi-wire speaker cable. Complete system £850. Phone (0202) 570675.

LINN LP12, Ittok, new K18, Skyline Platform. All in perfect condition. £550. Beaconsfield (0494) 677628.

SME IV ARM £450, SOTA Sapphire plus SOTA clamp and custom power supply £500, RATA torlyte stand £50, Thorens TD150 in hardwood plinth plus Mayware arm £120, SME 3009 Series II arm £40. Tunbridge Wells (0892) 862302.

LINN ISOBARIKS, Rosewood, with stands and panels, immaculate condition, boxed, £950 (new £2,500). Telephone: (0204) 842367.

LINN KAN II Speakers. Bi-wired Walnut finish complete with Kan stands. Immaculate condition. All boxes. Also 13 metres of K400 bi-wired speaker cable. £485. Telephone: (0483) 37286. Surrey.

KEF B139 Elliptical/B110/T27/Coles 4001G Drive Units for sale, no data sheets, 1 pair of each, offers. Call Les (021) 777 5497, 6-9pm.

TESSERAC TALA, Line Level Pre-amp: silver wire, Alps Pots etc. (£1,500), £1,000 ono. Meridian 263 Dac, £300 ovno. Both mint and less than 12 months old. Telephone Phil (0208) 75376.

RUARK TALISMANS Rosewood finish, modified, mint condition. £400 o.n.o. (0525) 382710.

NAIM CD1 3 months old, £1,400. Naim 72/140 £795, boxed including all appropriate leads. (0703) 738271.

NAIM NAIT2 £225. Rega RB300, Van den hul rewired £175, Goldring Eroica LX. £75. Lentek Step-up £25. Thorens TD150, re-plinthed, Valhalla P/supply. £75. Wharfedale 505.2. £95. (0993) 811480 (Oxfordshire).

MICHELL ALECTO Monoblocks £1,150, Yamaha DSP-A2070 - £650, Panasonic NVF588B SVHS - £550, Yamaha N5-C90 - £60, B+W Rock Solids - £150, Celestion 7000 Ribbon Speakers - £650. All mint condition. Phone Tobey (0244) 814666.

CONCORDANT EXCELSIOR Valve Amp £400, Exemplar Transistor Amp (class A) £400; Ear 834P Phono Amp (unused) £240 (with volume control). (0865) 63160.

LINN ISOBARIKS with stands and 2 x 8m NAC A4 cable. £650. (0728) 747 735.

QUAD 34/405 II both very light use, mint, boxed £375. Stax SR34 Pro, very little use, still under warranty £80. SME 1115 mint boxed, offers. Tel: 0296 826197

A & R A60 AMPLIFIER and MC60 moving coil board, good condition £50, Audio technica ATF5 moving coil cartndge, light use £15, Quart PMB 45II headphones, as new £15. Telephone: (0702) 711817.

TANNOY LANCASTERS 12" Golds Teak, exceptional condition £400 o.n.o. Can demonstrate. SME ARM 3009 S2 complete boxed £30. Telephone: (0453) 546191. Glos.

PIONEER PD-S901 CD Player with remote. £220 Mission 762 speakers with matching stands, £130. All as new, boxed. Glasgow (041) 248 2686, Pete. Wanted Teac P700.

**RHODIUM PLATED MK  
MAINS PLUG FOR A  
LONGER LASTING  
CLEAN CONTACT  
SUPERIOR THAN  
GOLD RHODIUM WILL  
LAST TEN TIMES  
LONGER!!**

**13 Amp            £10.75  
15 Amp            £12.75**

**Wall Socket  
Single            £18.75  
Double           £26.75**

**(p+p included)**

## COURT & SPARK



**TO ORDER SEND  
CHEQUE/POSTAL  
ORDER WITH NAME  
AND ADDRESS MADE  
PAYABLE TO:**

**T. WESTERMAN  
41 GREVILLE STREET  
HATTON GARDEN  
LONDON EC1**

**TEL. 071 - 242 2329**



**CABLES**

**Tel: (0255) 422533**

## HALE HI FI



**We stock:-**

**ROYD, NAD, NAIM, LINN, CREEK, ARCAM,  
QUAD, YAMAHA, AMC.**

**A wide range of accessories always available.  
Full demonstration facilities - no appointment  
necessary - full service department.**

**Free delivery and installation**

**2 Bold Street, Hale Road  
Altrincham, Cheshire WA14 2ER**

**Telephone: (061) 929 0834**

PRIVATE

ATTENTION WOMEN READERS. Female Hi-Fi enthusiast (25 years), keen on Pop and Classical music, wishes to meet like-minded FEMALE 18-35 years with a view to sharing all interests. Please phone Silvana on (0273) 206767. Evenings.

SONY PRO WALKMAN WMD6C Perfect £100. B & W DM2 MK2s Perfect matched units one corner of one cabinet chipped hence £75 pair. Cash only, buyer collects. Please phone (0273) 206 767. Evenings.

FOR SALE. Brand new boxed set of Bose 101 Monitor Speaker with 5 years warranty. Unwanted gift, bought 30.6.94. Only £165 for quick sale. Worth over £200. Terry (0753) 549642.

AVO VALVE tester type 160, recent service and calibration, supplied with hand book, valve data manual and calibration certificate £90. (0373) 463474.

LEAK STEREO Troughline £125 also Leak Venslope 2 pre-amp £40, both for £150, prefer buyer collects. M/C/R area (061) 790 9059.

QUAD ELS Loudspeakers, Bronze, excellent £350. Sage Audio Supermos 2 250WPC Class A pre and power amplifier, better than A Krell? £400. Relive Hi Fi history, over 250 assorted Hi Fi Magazines 1972-1983, many more since! Offers: Glasgow (041) 776 3642.

P.T. ANNIVERSARY/SME IV/OC5, Deitec 50S pre+ power, Epos ES14, Rotel 965 BX CD, Hitachi FTMD5500 Akai GX6. Complete system with 2 x 50 tables + dedicated stands and cables. £4,500 o.n.o. (071) 277 6012.

SD ACOUSTICS 'OBS' Loud-speaker, truly seamless and transparent sound - Highly rated and reviewed - beautiful, deep walnut and black finish. Accept £330 o.n.o. (£860 list). Tel: 081 347 6077

QUAD 405, BOXED etc, mint, £150. Leak TL10/Point one, excellent, £150. Leak Stereo/20 Vanslope, excellent, £200. Wharfedale Rosedale Speakers, produced early/mid '70's, beautiful cabinets, excellent. £200. Could securely pack and freight any of above if required. Wanted Sony EL - cassette player. (0886) 833655. Evenings.

QUAD ELS Black, overhauled, protection circuits fitted, excellent, boxed £400. Audio Innovations S800 class A power amp. £325. Tel: 0883 349298 (Surrey)

D.A.T. SONY Portable Recorder (Model TDC-T7). As new, only £265 o.n.o. (£450 new). Tel: 081 347 6077

MISSION DAD5 CD Player £200; Celestion DL3 II Speakers with stands £75. All boxed as new. Tel: 0703 328573.

DPA T1 CD Transport, £575. DPA PDM 2 two box converter, £1,350. Audio Innovations L2 pre-amp, £475. Audio Innovations 2nd Audio monoblocks, £1,875. Impulse H2 horns, £1,475. DPA The Power filter £59.00. All as new, boxed, warranted. Can demo. Best offers. Tel: 0472 852240.

EXPOSURE 17 pre-amplifier, mint, under warranty, boxed, £500. Audio Technica AT OC3 MC cartridge £50. Sennheiser Ovation HD560III headphones £60. All 16 months old. Tel: Guildford 0483 69443.

NAIM NAP 250 £725, NAPI 60 £375, HICAP £325, NAXO 3/6 £325, Snaps £185, NAC 32.5 £315, Arcam Alpha CD £300, Micromega Microdac £175, Meridian 101 pre-amp £95, JPN mini monitors £50 All VGC. WANTED Meridian 105 Mono Blocks, NAC 72, LP12 & Armageddon. Tel: 0243 8285555.

MAGNEPLANAR MG2.5 Panels, as new £850.00. Quad 33/303 Amp £160. Good working order. Tel: 081-657 7141 after 7.00pm.

LINN ACTIVE SYSTEM, comprising LP12 Lingo, Ittok, Asaka, Kairm, Aktiv Kaber Crossover, 3 x LK280s, pair Kabers, excellent condition, boxed, originally cost £8,500, will accept £4,500 or may split. Tel: 0978-780580.

PINK TRIANGLE GTI, RB300 arm, new. Audio Technica OC10, turntable shelf and brass cones. Boxed. £500. Folkestone Tel: 0303 244626.

MANTICORE MANTRA ELECTRONIC M.B.6 Musician (S) tone arm just serviced by Manticore with new Roksan blue cartridge other upgrades included. Must sell £350 ono. Tel: 071 739 2397 after 7.00 pm. Excellent condition.

GARRARD 301 + SME 3009 £110 JVC JT-V6 tuner £35 Lecson AC1 pre/APIX power amp £190 Gale 401A spkrs £290 c.i. stands £45. Manuals, cartons. All g.w.o. Or £599 the lot. Tel: 0764 664 037.

BROKEN-HEARTED last resort sale, bargains for good home. Mission 751, Arcam Alpha 5 Amp, Linn Basik+Akito+K5, Sennheiser HD 320 and Mission stands - £800 all immaculate condition. Tel: 0926 812496.

NAIM 72 Pre-amp plus HiCap with spare variable boards. Excellent condition £700 No offers. Tel: 0825 840279 (evenings) East Sussex, Lewes area.

LINN AKITO Tonearm. Rotel 820 BX amplifier £60. Both in mint condition and original packaging. Tel: 0709 547176.

SE-M100 Technics digital power amp. Optical fibre outputs cost new £611.00. Used twice as new including manual £299.00 O.N.O. Tel: 0706 343777.

EXPOSURE TWENTY, £325; Leak Stereo 20, Point One pre-amplifier £180; Leak Stereofetic FM tuner, £50; Ferrograph 4A and G33T, £100 each; Vortexion WVa £140, Hi-Fi Year Book 1959, £10. Tel: 081 686 3850.

MICHI AMPLIFIERS, Rotel Flagship comprising of passive pre-amp for CD, one phono pre, power amp 200 W.P.C. Excellent reviews, sale £2,300 New £3,340. All immaculate and boxed. Tel: 0276 858481.

TURNTABLE THORENS TD160 MKII, Mayware Formula4 MKIII tonearm, Denon DL-110 Cartridge, ADC XLM MKIII cartridge. Various great extras. Excellent condition, little used, one loving owner. £100 ono. Tel: 081-898 2872.

TOM EVANS Pioneer A400GTE Boxed £150. Tel: 0633-872998.

ORTOFON QUASAR moving coil cartridge. Boxed. Unused. With all accessories. Cost £350, will sell for £175.00 ono. Contact (0480) 468165 after 7 pm.

MERIDIAN 200/203 DAC 7-mint, (cost new £1,395) accept £650 inc. interconnects - IXOS + Audioquest. Audiotech turntable stand, (cost new £136) accept £50. Tel: 0204 29443 (Bolton).

SONUS FABER 'Minuetto' speakers, new with warranty, solid walnut with leather, bargain £750.00. LINN BASIK turntable, with Linn arm, immaculate, £180.00 (350.00). Hi-fi Cabinet, mahogany, swivel top, swing doors, cost £169.00 quick sale at £50.00. Tel: 081 347 6077.

NAIM AMPLIFICATION, NAC72 (including moving-coil and variable level boards), Hi-CAP, NAPI40. New style, mint, boxed. Bargain £999. Tel: 081 309 7589 (Sidcup).

MERIDIAN 200/263 CD Audiolab 8000C MKII pre-amp, Meridian 205 amps, Nakamichi DR2 cassette, KEF 104/2 speakers and Kube 200, Rotel tuner, Dual CS505/4 turntable, 3. Two tier Target stand, Mission Isoplats and various Van Den Hul leads. Must be sold as complete system. All boxed, receipts, as new £2,995. No time wasters. Tel: 0181-502 5634.

BEREAVEMENT SALE of radio and amplifier components. Mainly valves, coils, transformers, etc. Some unused 8"/10" speakers. Most of these items have never been used and are either boxed or well wrapped in original packing. Phone for details 061-439 7007.

KRELL KSA150 power amplifier £2,500. Quad 34/306 £400. Gyrodec RB300 K9 £495. Tannoy York 15" Monitor Golds £600. IMF TLS-50s £175. KEF 104 Reference £150. Revox A77III HS 2T complete overhaul £550. Tel: 0403 251587.

AUDIOLAB DAC (latest) £550. Ortofon Quasar MC cartridge, unused £200. Musical Fidelity pre-amp 8 + pair MA65 power amps. New, £900. Project 6 turntable + MC15 cartridge, new £325. 10% off all Marantz, Denon, etc. Tel: Telford 0952 502097.

NVA P50 Passive/phono module/A30 power, £415. Leak Troughline 3, £125. Audio Innovations 300, £250. Linn Troika, £225. Monitor Audio 352s, £135. Strinx PU2 arm, £80. Chris Tel: 0223 69245.

VALVE CHARACTERISTIC METER, AVO MK IV. Good Condition £250. Tel: 0483 68654.

NAIM 02 TUNER £550. Linn Lingo 1994 spec. Ekos Klyde £2,000. All as new, boxed. Tel: 0279 412902.

SEQUENCE SPEAKERS Model 40 £225, Model 30 £175, Model 20 £110. All black, new, unused, studio power satellite and sub-wofer speakers, silver grey £50, rear surround speakers £20. Tel: 081 875 0831.

TRANSMISSION Line Speakers - Quest Audio Designs K100s. 32 x 26 x 75cm with Sonus Faber drive units. £325 ono includes stands, cable (5mm dia. x 182 strands x 8m long) and gold plated bullion connectors. Tel: 081-514 5720.

J.P.W. MINI Monitors Gold. What Hi-Fi 5 star award winner. Used as rear surround speakers. Unmarked. Boxed. 15 months guarantee left. Can demo stunning little speakers £50. Tel: 081 402 1486. Martin.

QUAD 606 power amplifier £375, Quad 34 pre amplifier £195, Sansui AU-G90X integrated amplifier, 350W per channel £195, Denon DR-M30HX, 3-head cassette deck £90. Tel: 0252 615545.

IDEAL WITH Valve amplification - Audio Note K/SP loudspeakers (siler-wired) with Huygens K4 stands £625. Telephone: (081) 572 2504.

AUDION 300B Signature Monoblock amps (1500). Audion active Valve Preamp with Dual PSU (1200). All significantly upgraded. Audio Innovations Nova Transformer (600). Audio Note Silver SP spk cable 4 x 1.5mtrs (400). Tel: 0635 36599.

# ABERDEEN



- \* Single Room Demonstrations available.
- \* Full Service Department
- \* Free Delivery and Installation anywhere in Scotland

Authorised dealer for:- Linn, Chord, Proac, Mordaunt Short, Audio Research, Sonus Faber



42 St Andrew Street, Aberdeen  
Tel/Fax 0224 - 625635

## Francis of Streatham

Established 1913

Hi-Fi Video Specialists



Appointed Stockists for:-

Panasonic/Technics, Hi-Fi + Video, Dolby Prologic  
Come and listen to the new Technics SCCA1080  
Dolby Prologic mini system and the range of  
Technics separates

Large Stockists of Styli & Accessories

Own Service Department  
Part Exchange available

081 - 769 0466/0192

169 Streatham High Road, London SW16 6EG

## Oxford Audio Consultants

### HI-FI SPECIALISTS



Our superb service is the same,  
regardless of price.

#### AUDIO RESEARCH LS7/VT60

At last a combination at an affordable price! Quite  
sensational sound quality to boot!

#### NOW DEMONSTRATING

- AUDIO RESEARCH CD1/CDT 1
- AUDIO ALCHEMY DAC IN THE BOX - staggering sound for £199.95
- MICROMEGA STAGE - the new concept in upgradeability
- ORELLE CD480 - a serious British competitor to the ARCAM
- PINK TRIANGLE DA CAPO - NOW IN STOCK
- THETA DATA BASIC & GENERATION V - real high end
- TEAC VRDS 7/10/20 AND 700 2 BOX SYSTEM
- SME 20 - the finest engineering with superb sonics
- PROJECT TURNTABLES - value for money
- LYRA CLAVIS Mk 2 - even better and only £995
- KINSHAW PERCEPTION PHONO STAGE
- AUDIO INNOVATIONS ALTO - lovely sound and styling
- COPLAND CSA 14 - bargain of the century!!
- DPA 200 SERIES PRE/POWER
- KRELL KRC/KRC 2 preamps with the latest S SERIES power amps - seriously high end - wait till you see the new KPS digital series
- MUSICAL FIDELITY F SERIES - very, very good value
- HEYBROOK SEXTET/QUARTET - very room friendly
- MARTIN LOGAN AERIUS - magic looks and sound
- QUAD ESL 63 - we are now main agents for the complete range of QUAD
- REL STRATA AND STADIUM SUBWOOFERS
- RUARK EQUINOX - furniture for the living room
- SONUS FABER - no apologies!! these are our favourites
- DENON DF 10 - mini size components available separately
- BOSE LIFESTYLE SYSTEM - almost invisible hi-fi!

#### EX DEM & P/EX BARGAINS

- ORACLE DELPHI MK3/SME V £1595
- KRELL KSA200B POWER AMP £3495
- AKG K1000 HEADPHONES £250
- STAX LAMBDA SIGNATURE/SRMT 1 ENERGISER £995
- PROCEED PCB 3 CD PLAYER EX DEM £2195
- PIONEER CLD 800 LASERDISC PLAYER £275
- MUSICAL FIDELITY A370 MK2 POWER AMP £995
- KRELL KSL PREAMPLIFIER £1750
- NAIM 32.5/HICAP/250 £950
- MISSION CYRUS 2 AMPLIFIER £150
- MUSICAL FIDELITY T1 TUNER £100
- KRELL KRC2 £3195
- MUSICAL FIDELITY PRE3A PREAMP £195
- AUDIO RESEARCH V70 EX DEM £2995
- KRELL CD DSP CD PLAYER EX DEM £2995
- THETA DS PRO PRIME £895



Please ask for details or our current list

Agencies include: Aura, Accuphase, Acoustic Energy, Air Tangent, Apogee, Audio Alchemy, Audio Research, Audio Technica, Basis, B&W, Castle, Classe, Copland, Denon, Denon Cartridges, DPA, Dual, Goldring, Harmonix, Heybrook, HPW, Kimber, Koetsu, Jadis, Krell, Lyra, Magneplanar, Magnum, Mandrake, Marantz, Martin Logan, Michell, Micromega, Music Fidelity, NAD, Nakamichi, Onix, Orelle, Ortofon, Pink Triangle, Pioneer, Polk, Proceed, PS Audio, QED, Quad, REL Subwoofer, Revox, Rogers, Roksan, Rotel, Ruark, SD Acoustics, Seismic Sink, Sennheiser, Sequence, Sequerra, Slate Audio, SME, Sonus Faber, Stax, Target, TDL, Teac, Theta, Thorens, Van den Hul, Wadia, Wharfedale, Wilson

TAX-FREE EXPORT SERVICE  
MAIL-ORDER AVAILABLE ON MANY ITEMS  
Open Mon-Sat 10am-6pm

## Oxford Audio Consultants

Oxford Audio Consultants, Cantay House, Park End Street OX1 1JE  
Telephone: Oxford (0865) 790879 Facsimile: Oxford (0865) 791665

LINN EQUIPMENT: Kaber £699. Kaim Pro £649. Arkiv £599. Basik/KS £199. Tune box £250. K9 £40. Nakamichi 700 TRI Tracer offers. Tel: 0585 373735 (days), 0628 782040 (eves/weekends) Berks.

GARRARD 401/SME 3009 S2 in heavy plinth. Unmarked and in perfect working order, £250. Tel: 081 747 4764 after 7pm.

NAIM SBL loudspeakers, black, passive crossovers, £900. Sony Walkman Pro WM-D6C £160. Pioneer car CD player/Tuner, removable fascia, remote control, four months old £175. Tel: 0635 869107.

SPENDOR BCII, custom stands and cables £600 ono. Demo possible Tel: 0689 874438 evenings. Near London (SE).

TDL MONITOR speakers. Mint condition, black Ash finish, incredible performance and clarity. Move forces reluctant sale. Cost £2,000.00 new, a bargain at £1,350.00. Tel: 0727 866384 (St. Albans).

MUSICAL FIDELITY A370 II with circuit diagram £995. Naim 135s, NAC72, Hi-Cap £2,095, EMT 928 with EMT arm EMT HSD15 M.C. (unused) £1,495, Silver interconnect £75. Lowther Acoustas, offers Exchanges Tel: 0642 559543.

ROTEL RCD-965 BX CD, sorbothene feet, good quality leads, £190. Rega RB-300 arm, £90. May purchase together for £260, or swap for Pioneer 1750 Laserdisc. Items in excellent condition. John Tel: 0256 20608.

QUAD II power amps (2), 22 pre-amps (2) F.M. tuners, early models (2), A.M. tuner, £350.00. Tel: 0722 (Salisbury) 339497.

**SPECIAL LFD LS2/PA2** integrated amplifier, new, excellent, boxed, cables/interconnects. £895. (£1,695). New Nottingham Analogue Spacedeck/silver wired, Mentor arm, marble base £895 (£1,495). Immaculate Myst TMA (amplifier), TMR (tuner) original, boxed, Myst Interconnects, manuals, rare, excellent £325 both. Nakamichi tapedeck, boxed, manuals £295. Excellent. Tel: Paul (0482) 842740.

LP12, LINGO Ittok, Dynavector £850. Michel ISO/Hera £350. Both for £1,100. Michell Argo/Hera £600. Pair Albany 100 watt monoblocks £600. All pristine condition. Tel: 0223 (Cambridge) 322215.

JOHN LINSLEY-HOOD Discrete phono stage, plus power supply. Excellent design and sound £200. Tel: 0724 870432.

SD ACCOUSTICS OBS speakers, mint £349.00 (860). Leak Troughline Stereo FM3, £150.00. Sony D.A.T. portable, new £245.00 (459). Dual 505-3, slightly marked otherwise OK, hence £50.00. Tel: 081 347 6077.

REGA PLANAR 2 £125. Dual 505-4 £125. Toshiba SS45-GB speakers £50. Quality analogue tuner £30. Wharfedale Laser 100 Cabinets £25, Arcam Black Box-1 £75. 0274 572924 (Bradford).

MERIDIAN 206B CD player, barely used. Boxed as new £650 o.n.o. Tel: Nick 0737 222968 - daytime, Tel: 0737 761163 - evening. (Surrey).

NAIM NAIT 3 Integrated amplifier with MM phono stage, mint condition, boxed £400.00. Naim IBL speakers passive black with 2 x 5 mtrs NAC5 cable £350.00. No offers. Tel: 081 699 1011.

LINN KANS (Black Ash) plus Kan stands, immaculate £220.00 ONO. Audiotech spiked sub-table, Italian elegance £45.00. Sound Organisation two - shelf table £20.00. Will dem/deliver Londonish. Tel: 081 460 1124.

EQUINOX PRE-AMP cost £1,800, sell £650. Sugden A21 amp £120. Sumo tuner cost £700, sell £375. Meridian M3 active speakers £275. Musical Fidelity Studio 'T' amp £475. Tel: (0977) 643629.

SONUS FABER ELECTA speakers. Retail £1,790 selling for £950. Target R2 speaker stands one month old. Retail £287 selling for £150. All items boxed. Tel: 081 299 0075.

CROFT INTEGRATED valve amp 35WPC mint £350. Michell ISO MC pre-amp, 8 months old, £250. Tel: 0706 869428.

KEF 105/3 Rosewood, mint, boxed, latest spec. £1,550.00 ONO. Stax SR 34s £70.00 ONO boxed. Naim 32.5 NAP 90 £350 ONO. LP12, Val, Ittok LV2, 1991 spec, £800 ono. Tel: 0792 280061.

NAIM 250/32/Snaps, old style. £850 o.n.o. Kenwood DPX 9010 CD. Transport/Arcam Black Box 5. £500 o.n.o. Will separate. Pye Mozart pre/power amps £250. All equipment in very good condition. Tel: 091 4877796 (Tyneside).

QUAD E.L.S. Full Quad service, 1993, £350, ono or swap for Quad FM4 or Quad 405 II. Tel: 0904 626915, after 6.30pm.

NAKAMICHI GMS4E CD player "A major bench mark in CD sound" used every day, good condition, for sale £300. Tel: (0362) 858515.

QUAD II amplifiers, tuner and pre-amp £300. Rogers Cadet 3 amplifier £80. Troughline 3 in case with stereo 30 amp £150. Sugden T21 tuner £50 Linn Klyde, hardly used £200. Tel: 031 229 5020.

RUARK CRUSADER II speakers - £1,250 ONO. Meridian 208 CD player + remote control - £1,000. Michell Argo HR pre-amp £900 ono. Bang & Olufsen Beocord 8000 tape recorder £300 ono. Michell Alecto monoblocks £1,500 ono. Tel: 0602 672541 X5703 (day) 821785 (eves).

MISSION DAD5 CD Player £149. Meridian 203 DAC £195. Rothwell passive pre-amp £75. Tel: Roger 0270 625159.

LEAK TL12 + PAIR Audio Classic rebuild £250. Stereo 20 Holco resistors Poly caps £250. Troughline Stereo, mint £125. Wanted TL12 0.1 Gold enclosed transformers. Tel: 0524 423516.

MAGNEPAN SMGa Planar speakers, £350. Arcam Alpha CD player, £200. Arcam Alpha 2 tuner, £80. Thorens TD280 MK II turntable, £125. All boxed, good/excellent condition. Tel: 081 888 2537 eve 071 405 4377 x 2226 day.

GARRAD 401, SME Plinth, SME 3009 Arm £125. Elektor M/C head amp £75, Beard CA 506 valve pre-amp, boxed as new £475. Kit built reflex ported speakers, cost £225, accept £125. Tel: 0742 459698.

AMC 3030 amplifier valve/transistor hybrid, 18 months old, excellent condition. Sale due to up-grade. £280. Tel: Cambridge 0223 290619. (Day/Evening - answerphone).

WANTED. LEAK Stereo 70 amplifier in good condition. Please contact Mr. Snow Tel: 0273 583675.

SYSTEMDEK IIX 900. Roksan Tabriz, AT 110. Excellent condition. Boxed with receipts. Can demo. Sondek reason for sale. Bargain £300. Wanted Linn Ittok or Ekos, also Lingo. Castleford Tel: 0977 519454.

"AUDIOPHILE" COMPONENTS at realistic prices. Vast range of highest quality electronic components and accessories for the D.I.Y. builder. Tel: 0724 870432.

60 VALVE AMPLIFIER circuit diagrams for KT88, KT66, EL34, EL84, 6L6, 2A3, 300B, 211, 845 etc. and data sheets for 30 Audio Valves English Text 90 pages. Send £20 Cash or Bankers Cheque. Matjaz Seliskar, Riharjeva 3, Ljubljana 61000 Slovenia.

FOR SALE: Accuphase T100 FM/AM stereo tuner. One of the best analogue tuners. Sell/Exchange. Best offer secures. Further details. Tel: 0736 60367.

SONY CARBON FIBRE Monitors (94dB/IW) £195. Linn Ittok £195. Linn Kans and stands £230. Michell reference turntable £90. NVA AP30MC £95. Pioneer 4 head, DD, AR, open reel £195 ATOC9 unused £190. Tel: 06974 78537 or 0273 846290.

GARRARD 401, SME 3009 IMP, Shure V153, SME 2000 Teak Plinth, All excellent, £120. Garrard 301, Decca FFSS Arm, MK2 Head, good condition with spare new turntable control knobs. £75. Thorens TD124 MK1 Chassis Model with arm board (SME). Excellent, with new spare idlers and belts £50. Decca London cartridge £10. Decca MK3 head £10, both boxed. SME 3009R stainless steel arm, new boxed, unused £60. 2 used PX4 valves £50. Tel: 0273 583675.

AUDIOLAB 8000All, mint, boxed £295 ono, RB300 tonearm, Ex condition £95 ono. S/Cables: Cyrus S/Core, 4 x 3M £15.00, Linn K20, 4 x 5m, £65.00. I/Connect: Silver Sounds 12/2 2 x 1m. £65.00. Chord mono's 2 x 1m £25.00. David Tel: 081 741 3119 (days), 081 348 0612 (eves).

FOR SALE. Studer Revox B77 MKII. Twin speed 7.5 / 15.IPS. Immaculate condition. Very little use. Now almost £2,000 new. Will accept £600 ono. Tel: Paul (0831) 686927 or (0707) 322662 anytime.

GARRARD 301 £125, Leak Stereo 70 £50, Leak Stereofetic £30, Leak Varislope 3, Mono Preamp £30, Ferrograph Series 4 two track £50, Brenell Mono two track £25, Armstrong 626 £20, Metal Reels (8.25") for Ferrograph £5 each (24). Tel: 0794 322782 (Hants).

ELITE ROCK MK II, Excalibur Arm, Goldring 1022 Avondale Taps Power Supply Seismic Sink £800. Linn Basik plus arm £40. Offers. Tel: 0902 762395. Evenings.

TECHNICS SV-DA10 DAT deck £275. Pioneer CLD 1750 PAL/NTSC laser disc with 13 movies £450. Sony TAE1000ES Digital pro-logic pre-amp £475. Sony TAN220 Four channel bridgeable power-amp £99.00. B/W Rock solids £125. Meridian M30s with stands £495. All mint condition with manuals, most boxed. Tel: 01661 822564.

JPW AP3s + Stands £135. Celestion 1s + stands, absolutely as new, packaging, guarantee, £89 (£159). Naim IBLs (latest drivers) £459. Alpha CD £210. A1 amplifier £115. All excellent. carriage included. Tel: 091 4144221.

AN EXCLUSIVE

HI-FI DEALER



CAMBRIDGE HI-FI LTD



FOR THE TOTAL EXPERIENCE IN HI-FI

B&W, BOSE, KEF, KENWOOD,  
MARANTZ, TECHNICS,  
YAMAHA

AND MANY OTHER QUALITY BRITISH &  
JAPANESE HI-FI PRODUCTS INC. TAPES  
AND ACCESSORIES

VISIT OUR SHOWROOM FOR ADVICE & A DEMONSTRATION IN OUR DEMO ROOM

1 -3 HAWTHORN WAY, CAMBRIDGE  
AMPLE CAR PARKING

CAMBRIDGE (0223) 67773



FAX NO. (0223) 353741

VISA

## RARE RECORDS BY MAIL

**JON TAYLOR**

29 A Lambs Conduit Street,  
Holborn, London WC1N 3NG  
Tel. & Fax: 071 831 9907; Mobile 0385 323393

**Specialising in rare 60s/70s/80s/90s  
Progressive, Psychedelic, Underground, Acid Rock,  
Rhythm & Blues, West Coast, Country Rock, Hard  
Rock, Thrash, New Wave, Punk, Rock & Pop  
Memorabilia.**

**Buy, Sell, Trade. Send your wants lists.**

Free lists available on all major artists including Abba, AC/DC, Adam & The Ants, Bryan Adams, Aerosmith, A-Ha, Tori Amos, Bangles, Beach Boys, Beatles, Black Sabbath, Blondie, Marc Bolan, Bon Jovi, David Bowie, Kate Bush, Byrds, Belinda Carlisle, Cher, Eric Clapton, Alice Cooper, Cult, Cure, Deep Purple, Def Leppard, Depeche Mode, Dire Straits, Doors, Duran Duran, Bob Dylan, ELO, Eurythmics, Fleetwood Mac, Free, Genesis, Grateful Dead, Guns 'N' Roses, Hawkwind, Jimi Hendrix, INXS, Iron Maiden, Michael Jackson, Jam, Jethro Tull, Elton John, Kinks, Kiss, KLF, Led Zeppelin, Level 42, L7, Madonna, Marillion, Metallica, Meatloaf, New Order, Nirvana, Pearl Jam, Pet Shop Boys, Pink Floyd, Pixies, Elvis Presley, Prince, Queen, R.E.M., Cliff Richard, Rolling Stones, Roxette, Rush, Sex Pistols, Simple Minds, Simply Red, Smiths, Bruce Springsteen, Status Quo, Rod Stewart, Sweet, Thin Lizzy, U2, Velvet Underground, Wham!, Who, Yardbirds, Yes, Neil Young, Frank Zappa.

Please include a SAE or IRC.

**Top prices paid for Records, CD's, Cassettes, Music  
Books, Videos, Pop Magazines and Music  
Memorabilia.**

**Whole Collections bought.**

*o v e r t u r e*

## Tears for Fears ?

Save the distress, visit the best !

- ◆ Linn Products ◆ Arcam ◆
- ◆ Naim Audio ◆ Meridian ◆
- ◆ Quad ◆ Nakamichi ◆
- ◆ Denon ◆ Heybrook ◆
- ◆ Mission ◆ Epos ◆
- ◆ Audioquest cables ◆
- ◆ Open 6 days ◆ 10.00 to 18.00 ◆ BADA ◆



" If only Mr Fears had  
discovered Overture  
earlier "

**Overture HiFi Specialists**

3 Church Lane  
BANBURY

OXON

(0295) 272158

## COMPACT DISCS

The Classical CD Specialist

**H & R CLOAKE LTD**

(Established 1946)

OVER 10,000 CD's IN STOCK  
3,000 Cassettes  
3,000 LP's (POP)  
and Laserdiscs to order (list available)

SPECIAL OFFERS  
each month

ALSO MAIL ORDER SERVICE AVAILABLE  
CD'S SENT POST FREE (UK)  
CASSETTES/LP'S AT COST

Access/Visa Accepted

29 High Street, Croydon CR0 1QB  
081 - 681 - 3965 - Classical  
081 - 686 - 1336 - Pop/Jazz

**COMPACT DISCS**

C  
L  
A  
S  
S  
I  
C  
A  
L

P  
O  
P  
U  
L  
A  
R

PRIVATE

WANTED NAIM 82 Hi Cap and 250 power amp. Must be new shape + excellent condition. Cash waiting. Tel: 0333 424642 after 6pm.

FOR SALE: NAIM Nait 2 integrated amplifier. Lots of power from a little box! £200 ono. moving up to Hi-Fi World 300B, Nait sale buys valves! Ring Guy Tel: 0923 262895 - Answerphone.

SD ACOUSTICS SD 5 floor standing speakers, new, unused, full manufacturers guarantee, Hi-Fi recommended, highly reviewed, £750 (new £1,250). Nakamichi 580 cassette deck, vgc, superb sound £300. Tel: 0494 721274, Bucks.

NAIM NAP 110 (£100), NAC 42.5K (£130) and Hi-Cap (£280) - No longer required due to recent up-grade. (All boxed). Also Yamaha K300 Cassette (£50). Tel: 0349 877243.

MUSICAL FIDELITY MVT pre-amp & P270 power amp. Excellent condition - can demo £1,250 ono. Tel: 031 661 6040 (anytime).

ORACLE ALEXANDRIA turntable, Oracle silver wired tone arm, Grado signature 8 cartridge, massive power supply by Mod Squad probably the best sound for £400 ono. Tel: 0908 502795 (Milton Keynes).

EARLY 60s LEAK STEREO Equipment: Lenco Goldring GL68 turntable, FM Troughline III, Leak Stereo 30 amp. Wharfedale Airdale speakers (4 corner units). Sensible offers. Tel: 0885 400312 after 6pm.

ROKSAN XERXES/Artemis/Chorus Black. Latest spec power supply, matt black finish, ex demo condition, boxed £775. Tel: 0989 764396 Evenings.

SILVER SOUNDS 1/64 1 metre stereo pair bi-wired speaker cables fully terminated. Cost £400, accept £175. Hi-Fi Choice recommended. Tel: 0623 798210.

MUSICAL FIDELITY P270 MkII 150wpc power amplifier £745 Musical Fidelity Pre3a pre-amplifier £155 AlphaSon Sonata turntable HRI100MCS arm Ortofon Quasar £675. Pair KEF C95 floorstanders Walnut £295 all boxed v.g.c. Paravicini "The Head" TX4 MC transformer £195. Tel: 0843 862603 (Kent).

KENWOOD DP5030 CD player £110, KRA5020 receiver £100, KXW6030 tape deck £50, HECO 220S speakers £110, Target AERS equipment support £90, QED Cables £15. Or all for £450. Excellent condition. 2 years old. Mostly boxed. Tel: 0734 662620.

LINN LP12, VALHALLA, Ittok, new K5, spares, dealer serviced £595. Naim Nap 140 power amp £280. Epos ES 14 + dedicated stands £430. Receipts available for all items. Tel: 0423 863770.

PINK TRIANGLE LPT GTi, Mantcore Musician tonearm, Goldring 1042. Cost new £1,000.00, asking price £400.00 o.n.o. Sale due to up-grade. Tel: Edenbridge 0732 866817.

SPEAKER CABLE, 2 x 4 metre lengths of silver sounds cost £280 (£35 per metre). Sell for £128 (£16 per metre). Tel: 0884 32465 (Devon).

CROFT SERIES 4 valve amplifier (KT88s) £375. Four Bandor 50mm Speakers (instant Pentachords!) £100. Pioneer tuner £50. Wilmslow Microbass sub-woofer £70. Stacked Quad Els frames, offers? Weightman Tel: 0782 658114 evenings (Stoke)

SPENDOR SPI/2 + M.A.F. Stands two months old £900. Leak Stereo 20 fully re-built £320. Trilogy 948 tube stereo amp 50 W.P.C. £550. Tel: 081 531 5979 any time.

GARRARD 401 - £150 SME 3009/2. Damper, spare head £50 Technics EPA500 Arm (unused) £75 Wharfedale RS12/DD £35. All mint and boxed. Lowther PM6C (four) need reconing £100 lot. Tel: 0423 868144 (Harrogate).

DUNLOP SYSTEMDEK/Helius arm/Ortofon MC20 vgc £200. Tresham DRI pre-amp + PS1 power supply £50. Tel: 0909 (Worksop) 475890 (evenings).

MUSICAL FIDELITY BI £100. Denon DCD 1420 £100 QED T260 £100. Gale AS220s + stands £100 Sony ICF5WI £80. Sony D99 £80. Audio Technica ATH911 £40. (0705) 753054 (Portsmouth).

ROGERS CADET III integrated valve amp £85. Rotel 965 BX CD player £180. Denon TU 260L tuner (rare gold version!) mint £85. Audio Alchemy DDE V.1. DAC (mint) £235. Power Station Two Up-grade for DDE (mint) £140. Furukawa PCOCC Interconnect £25. Tel: 0462 678158 (N.Herts).

DENON HEAVYWEIGHT CD player (14Kg) £245 Marantz CD63. Sony CDP.101 R/C £150 (£549) TD160B/Grace/P77 £150, Magnum MF250 Power-amp £275. Yamaha KX630 £150. Isobanks £795 P/X? Tel: 0206 861457 (6-7pm Jim).

AUDIONOTE VALVE system. Unwanted prize worth £6,000. Will sell unused £3,750. Comprises DAC 3 signature feeding PISE valve amp. Speakers & stands high quality cables & interconnects. Willing to split. Tel: 0303 840 303 anytime.

TDL STUDIO 1 Speakers with TDL stands, black ash veneer, perfect condition, boxed, £375. Tel: 0734 869789 (Berkshire).

TASCAM 32 2 TRACK recorder/ reproducer, boxed as new (RRP £1,549) will accept £750 and include 10 Ampex tapes. Tel: 0480 464132.

VTL DELUXE valve pre amplifier cost £1,300 sell £650. Audio Research SP9 £950. Electro '25' Class A power amplifier with matching pre £350. Mission 737R £120. Wanted Nakamichi. Mick Tel: 0926 831388.

ONEARM Alphason Xenon (Titanium) Linn fitting. (cartridge available). £95. Speaker/Crossover design package for your computer - many complete designs and data files. £30. Tel: Hinckley (0455) 619007 (evenings) 637765 (day).

ORTOFON/SME 30H cartridge in CA1 type arm VGC £25. Two Fane 3" tweeters, two Fane 8" units, one Fane 12" unit in 4.5 cubic foot enclosure. Smaller units in their own enclosures £50. Radford amplifier type SCA 30 good condition, Teak case. £40. Tel: 0903 247779.

NEAT PETITE Loudspeakers, boxed as new £350, Quad 33/303 pre/power £150, Quad Racks for 66 series (£30) and 34/FM4/306 (£25), Empire MC1000 Cartridge recent re-tip £175. Tel: 0603 714528.

MISSION 752 speakers, Rosewood, 1 month old, mint, boxes, £325 ono, London. Tel: 071 387 7189.

EAR MOVING Coil step-up, the head. Brand new and unused, big saving. £365 (£590). Tel: 081 659 9538.

CABLES & BITS. Audioplane Super AF 1m. £60. 1/2m. £40. Type 4 1/2m. £25. XLO Pro.100 1m. £45. Sittech MC4.24 1m. £125. VdH. The First 0.6m. £65. All pairs. Sittech HF6 Digital 1/2m. £40. Audioquest Optilink X 1m. £20. Kimber BTC Mains 1/2m. £15. DPA Power Slink 1m. £20. Fitted MK/IEC. Lynwood Mains Cleaners. Basic £25. Advanced £80. Meridian 209 Remote £30. Tel: 081 871 2345.

REGA RB300 Pick-up arm, brand new and unused, £105. Tel: 0403 254117.

OLD VALVES FOR SALE: Osram PX 4; Marconi MHL 4; National 6D6; National 75; Cossor 10V/G; Marconi U14; Raytheon 6A7; National 185/R8; Mazda AC/HL; Mullard 76; Osram VMP4G; National 12Z3; Brimar 6D6; Mullard PCL86. Offers or swaps. Tel: 0956 362699.

MERIDIAN 203 DAC, £250. Kenwood DP X 9010 transport £250. Both £450 ono. Or exchange for SME IV arm. Tel: Marc 0392 498913 Exeter.

MONOBLOC ULTRALINEAR valve amplifiers, custom-built to high standard, 30 watt £325, 100 watt £525, or can supply complete build plans, parts lists, PCBs etc. Tel: 081 427 1378.

PAIR EARLY Quad ESLs, fitted black grilles, new treble units and clamp boards last year. £245. Tel: 081 742 1170 daytime or 081 940 7289 evenings till 9pm.

GARRARD 301 Serial No 26827 (grease bearing). White slight dust bug mark but with new sealed Dust bug (collectors item) included. £120. Tel: 081 742 1140 daytime or 081 940 7289 evenings till 9pm.

LEAK STEREO Troughline tuner (black and silver) with matching Stereo 70 integrated amplifier. Both working perfectly. £220. Tel: 081 742 1140 daytime or 081 940 7289 evenings till 9pm.

**SITUATIONS WANTED**

QUALIFIED MANAGEMENT Accountant who loves Hi-Fi and music wants to contribute enthusiasm and financial management expertise to manufacturer or retailer within the industry. Greater London and South East. Jim (081) 889 2524.

HI-FI NUT SEEKS new opportunity. I would love to work in the Hi-Fi market. Can you find it in your heart to give this man a break? Telephone: Keith (061) 437 5819.

HI-FI ENTHUSIAST, 38, Ex D.J. and oil industry, seeks position in Hi-Fi industry on full / part-time or home consultancy basis (large lounge, great for home demos!). Friendly, good communicator, open minded (i.e. valves / trannies / C.D. / L.P. can "all" sound good / bad!), varied musical interests, Brighton based. Telephone: Chris (0273) 541462 (24 hour A/V).

MAKE ME HAPPY - give a job. Budding designer, completes 3D design degree at Sheffield Hallam, June 1995. Interested in Audio/ Visual industry. Hard worker, sense of humour. Home (0873) 811619. College (0742) 509337. Adam Norbury.

**CLASSIFIED ADS: CONTACT RICHARD JOHNSON FOR DEADLINES AND QUERIES TEL: 071 289 3533**

# HI-FI EXCHANGE DARLINGTON

The North's only used Hi-Fi Specialists

	List	S/H
Audio Research D115 Valve Power Amp	£3500	1200
Audio Note Preamp - Custom Built (rosewood sleeve)		£795
Snell JIII's ex-dem	£800	£550
Neat Petite	£600	£420
Thorens 2001 ex-dem (boxed)	£700	£480
Teac 3440		£425
Quad 306/34	£750	£475
Heybrook Solo new	£130	£110
Spendor BC1 Walnut mint		£350
Oracle Delphi (no arm) excellent	£1500	£650
Gyrodec (no arm) mint		£450
Musical Fidelity 3a Preamp & P140		
Power Amp excellent	£750	£350
Yamaha Pre Power combination (annoy the neighbours!!) - Awesome		£650
Garrard 401 Chassis excellent	£80	



Large stock of Japanese separates by Technics, Marantz, Sony etc.

All types of Hi-Fi bought and exchanged

Tel:- 0325 463007

Hi-Fi Exchange Darlington  
30a Larchfield Street  
Darlington  
Co. Durham

## Eye

### ENTERTAINMENT UK LTD

**BUY AT A PRICE NOBODY CAN BEAT !!**

AVERAGE SAVINGS OF AT LEAST 25%

**CD'S TAPES VINYL AND IMPORTS**

ALL AT TRADE PRICE - ABSOLUTELY NO MARK UP!!!

\*No minimum purchase amount  
\*No minimum membership period

\*No club recommendations to buy  
\*No restrictions on material

CHECK THESE PRICES FOR A REAL DEAL

ALL FULL PRICE CD'S ONLY £8.99 - TAPES & VINYL ONLY £6.49

WE SUPPLY EVERYTHING  
FREE SEARCH FACILITY INCLUDING TRACK LISTINGS AND  
PRICE

Membership is only £7.95 a year, which most people recover with  
their first order

Don't delay, JOIN NOW and save.

Freephone 0500 78 45 33 9.00am to 8.00 pm

**FREE CD OR TAPE WHEN YOU JOIN**

## ADDA

### SUPER CASES LTD.

PO BOX 366, Cambridge CB4 5AX  
Tel: (0223) 233101 Fax: (0223) 233080

All cases  
made from  
quality black  
Polypropelene



**Prices Including VAT**

12" LP (70).....	£32.50	7" (500).....	£42.50
12" LP (90).....	£37.00	CD (40).....	£30.00
12" LP (200).....	£65.00	CD (100).....	£39.00
7" (100).....	£27.70	CD (150).....	£42.00
7" (200).....	£29.00	CD (200).....	£45.00
7" (300).....	£37.60	VIDEO (30).....	£32.50
7" (400).....	£40.00	CASSETTE (50).....	£32.50
		CASSETTE (100).....	£47.50

**Also available:**

Slip Mats	£7.80 per pair - Black with red logo
7" Sleeves	£4.70 per 50 - Plain white cardboard
12" Sleeves	£4.70 per 20 - Plain white cardboard
CD Sleeves	£4.70 per 50 - Plain white cardboard

**DELIVERY - 7 DAYS**

**INCREDIBLY LIGHTWEIGHT - EXTREMELY STRONG**



## ORDER FORM

**SPECIAL OFFER!** Now you can advertise in the Classified Section for only £10 or £15 in a display black box (incl. VAT). Maximum length is thirty words, each additional word 50p extra. Telephone and model numbers are treated as one word. All advertisement copy should be typed or written in block capitals and accompanied by the form on this page.

### SPECIAL OFFER!

**BOOK 1 MONTH GET 1 MONTH FREE.  
OFFER APPLIES TO PRIVATE ADVERTISERS ONLY.**

Cheques should be made payable to **Audio Publishing Ltd.** Please send your copy to:  
**Hi-Fi World Classified Ads.,  
Audio Publishing Ltd.,  
64 Castellain Road,  
London W9 1EX.**  
Classifieds will be published in the first available issue after receipt.

### HI-FI WORLD CLASSIFIED ADS

Please write your advertisement copy on a separate sheet of paper and return with this completed form.

Name \_\_\_\_\_

Address \_\_\_\_\_

Post Code \_\_\_\_\_

Daytime Tel No: \_\_\_\_\_

Private Advertiser    Trader    Situations Wanted (Tick where applicable)

Display (boxed £15 inc. VAT.)

I enclose cheque/postal order for £ \_\_\_\_\_ Made payable to **Audio Publishing Ltd.**

Please debit my VISA/ACCESS Card No.

--	--	--	--	--	--	--	--	--	--	--	--	--	--	--	--	--	--	--	--

Expiry Date: \_\_\_\_\_

Send to: **Hi-Fi World Classified Ads.,  
Audio Publishing Ltd., 64 Castellain Road, London W9 1EX.**



### UNIQUE OFFER!

**Looking for a job in the hi-fi/audio market? Hi-Fi World can help you. Advertise yourself free for one month in these pages under the heading SITUATIONS WANTED. Maximum length 30 words.**

### TRADE

**WANTED** Tannoy Autograph, Decca-Decola, Vitavox Drivers, Garrard 301 (V.G.D.) Westrex Drivers 2080, 2090, Lowther PM-2, PM-3, PM-4, single TP-1, valves PX4/PP3-250, STC 4300, DA 30/60 STC 4274 ED/AD-1 EMT 927/R-80. Telephone: (0444) 881 184 before 8.00 pm.

**RESTORATION OF CLASSIC EQUIPMENT** by electronics engineer, suitably qualified (degree/MAEs) and 40years of experience. Quad service agent and specialist knowledge of Radford, Leak, Rogers, Armstrong, etc. Extensive workshop enables original design standards, accompanied by detailed reports. 7 days. Woodford, Essex. Tel: 081-504 5467.

**VINTAGE** Radio Restoration. Leak and Quad Tuner Repairs, upgrades, stereo decoders fitted. New valve pre-amps from £245. Please phone 0903 501 158.

### TRADE

**FLUFFY SLIPPERS** from the spiked listening shoe! Cheap, warm and comfortable sounding OFC – £34.74 1M pair. Also silver and silver plated copper. Any length, any termination. Tel: 0777 711534 evenings for quote.

**I BUY – SELL – EXCHANGE –** 1930's – 1960's! Vintage – Classic Wireless + Audio Equipment Repairs – Spares, Restoration, upgrading – modification to all classic valve equipment. Collectable gifts on display. Visit us 17 Bell Street, NW1. (Next Edg Road. BKR Line). 071-258 3448.

**MICHELL SALES** bargains. Autumn sale of Ex Display & Demo models. Alecto, Argo, Iso, including high resolution models, Gyro & AC power supply. Greatly reduced prices. Michell approved dealer. Tel: 0460 68444.

**NAIM/LINN** Buy/Sell 52, CDS, 250, 135, 140, SBL, ARO, etc. Bob Tel: 0382 819 732.

### TRADE

**LINN** LK280/Spark £579. Kaim £799. LK1/LK2 £495. LK280 £389. Pre-Tek Power-Tek £489. Exposure XV £379. Linn Axis £199. Marantz CD85 £249. Neat Petites £350. Quantum D102/202 pre/pwr £149. Incatech Amps from £165. Objective Audio (0279) 426647 or fax (0279) 860460.

**PROAC RESPONSE** Twos £899, Response One "S" £699 latest. Albany DMP1 Pre/PSU £249. Heybrook C3/P3 Pre/Power Ex Dem £899. Musical Fidelity MX Preamp (£1,299) £599. Naim NAC 42/NAP 110 £299. NAC42/NAP 140 £349. Arcam Delta 70/3 CD £349. Others available, Hi-Fi purchased for cash. Objective Audio (0279) 426647 or (0850) 484464.

**ABSOLUTELY VINYL.** For our latest free catalogue of used Rock/Jazz/Classical Vinyl LPs send 19p SAE to: P.O. Box 55, Reading, RG4 0UE.

### TRADE

**VINTAGE RADIO** Restoration. Troughline 3 tuners from £125. Quad II repairs spares and overhauled. Arun valve pre-amp Line Level £299. Older valves bought and sold. Tel: (0903) 501 158

### WANTED - EARLY HI-FI

**LOUDSPEAKERS**  
Tannoy, Lowther, Parmeko, Voigt, Vitavox, RCA, WE etc.

**TURNTABLES**  
Garrard, BBC301, EMT, SME, Ortofon, Decca, etc.

**VALVE AMPLIFIERS**  
AEI, EMI, Leak, Rogers, PYE, Quad, WE etc.

**AUDIO VALVES**  
DA30, KT66, KT88, PX4, PX25, PP3/250, WE 300

**CLEAR CRYSTAL SYSTEMS**

John Petrie-Baker  
Tel: 071 328 9275  
Fax: 071 833 3008  
Mobile: 0831 860499

# Advertisers Index

## MAIN ISSUE

ACOUSTIC SOLUTIONS	24	FOUNDATION AUDIO	114	SOUND COMPANY	58
ACTON GATE AUDIO	110	FRANCIS AUDIO	124	SOUND ILLUSION	103
ADDA SUPERCASES	128	FULLERS AUDIO	58	SPALDINGS	54
ALEMA UK	30	G-MEX MANCHESTER	10	SPEAKER CO.	103
AMADEUS S&V	118	GLOTTA AB	70	SPECTRA DYNAMICS	109
ARCAM	46	GROOVE TUBES	104	STUDIO ONE	14
ARION ACOUSTICS	106	H & R CLOAKE	126	SUSSEX SURPLUS	112
ART AUDIO	14	HADEN BOARDMAN	119	TANNOY	16
AUDIBLE DIFFERENCE	120	HALE HI-FI	122	TESSERAC	24
AUDIO COUNSEL	114	HARBETH ACOUSTICS	48	THE RECORD SHOP	56
AUDIO GALLERY	108	HEATHERDALE AUDIO	120	TRAXS	62
AUDIO ILLUSION	12	HI-FI CONFIDENTIAL	105	TRIANGLE	48
AUDIO PHYSICS	120	HI-FI EXCHANGE DARLINGTON	128	TRY ME & SEE	102
AUDIO ROOM	116	IAN EDWARDS	70	TUBE TECHNOLOGY	62,114
AUDIO SUITE	124	IAN HARRISON HI-FI	108	V'AUDIO	88
B&W	6,12,14	INNOVATIVE DESIGNS	110	WILMSLOW AUDIO	70
BETTER HI-FI	88	J E SUGDEN	IBC	WILSON STEREO LIBRARY	96
BRENTWOOD MUSIC CENTRE	7	JAMO	6,7	WOLLATON AUDIO	76
BURY AUDIO	116,119	JEM DISTRIBUTION	20	WORTHING AUDIO	114
C.A.D.	7	JORDAN WATTS	116		
CABLE TALK	114	KEF	28		
CAMBRIDGE HI-FI	126	KRONOS	106		
CASTLE ACOUSTICS	34	L.F.D. AUDIO	122		
CHOICE HIFI	120	LASER AUDIO	110		
CHORD COMPANY	56	LEONARD BOOTH	110		
CLASSIC HIFI	118	LISTEN INN	34		
COTTAGE AUDIO	118	LORICRAFT	34		
COURT 'N' SPARK	122	MANTRA AUDIO	116		
CREEK	108	MICHELL ENGINEERING	34		
CRICKLEWOOD ELECTRONICS	108	MUSICAL IMAGES	107		
CUSTOM CABLE SVCS	54	NORLOSTONE	108		
DAN DULEY	112	ONKYO	BC		
DARBY'S OF ST ALBANS	119	ORANGES & LEMONS	12		
DAVID ORTON	105	ORTOFON	20,24		
DCN ASSOCIATES	96	OVERTURE	126		
DEFINITIVE	103	OXFORD AUDIO CONS.	124		
DPA	IFC,3	P M COMPONENTS	72		
DYNAMICS	104	PENTACHORD	54		
E J JORDAN	96	POWER PLANT	112		
ELECTROFLUIDICS	58	RARE RECORDS	126		
ELVINS	20	RDL ACOUSTICS	76		
EZEE ENTERTAINMENT	128	RECITAL	62		
F & S TRADING	70	RINGMAT DEVELOPMENTS	88		
		SLATE AUDIO	76		
		SME	14		

## DIY SUPPLEMENT

AP ELECTRONICS	22,23
AUDIO CAB	4
BILLINGTON EXPORT	14
CHELMER VALVE CO.	IBC
G.T. AUDIO	4
GLASS AUDIO	BC
HART ELECTRONICS	18
I.P.L. ACOUSTICS	12
KIT SUPPLIERS	16
LANGREX SUPPLIES	12
LED	19
LOCKWOOD AUDIO	4
P.M. COMPONENTS	10
SERIOUS KITS	IFC
SJS	4
SONIC FRONTIERS	19
SOWTER	4,19
SPEAKER COMPANY	26
VACUUM STATE ELECTRONICS	19
WILMSLOW AUDIO	14
WOLLATON AUDIO	14



# SUGDEN

HAND CRAFTED ■ FAIT À LA MAIN

DESIGNERS & MANUFACTURERS OF HI-FI & AUDIO EQUIPMENT

J. E. SUGDEN & CO. LTD.

Valley Works,  
 Station Lane, Heckmondwike,  
 West Yorkshire WF16 0NF  
 Tel. Heckmondwike 0924 404088/9  
 Fax No 0924 410069

World Radio History

**ONKYO**<sup>®</sup>  
U · L · T · I · M · A · T · E  
T E C H N O L O G Y

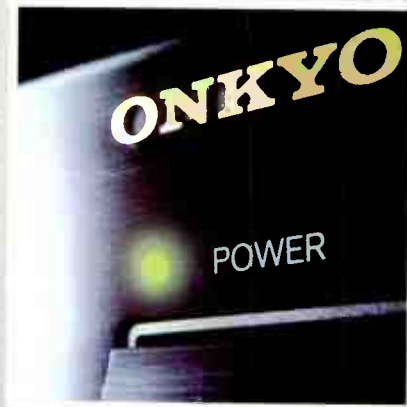

A RANGE OF HI-FI SEPARATES, MINI-AUDIO COMPONENTS AND HOME-THEATRE SYSTEMS  
COMBINING PURE, NATURAL REPRODUCTION WITH LEADING-EDGE TECHNOLOGY AND A BUILD QUALITY OF SUCH  
RELIABILITY THAT EVERY PRODUCT CARRIES A NO QUIBELE 3 YEAR PARTS AND LABOUR GUARANTEE.

ONLY AVAILABLE THROUGH SPECIALIST INDEPENDENT DEALERS.

**ONKYO**  
**3** YEAR  
PARTS &  
LABOUR  
WARRANTY

**ONKYO**<sup>®</sup>  
HIGH FIDELITY



ONKYO UK LIMITED · 401-405 NETHER STREET · LONDON N3 1QG · TELEPHONE 081-343 2082

World Radio History