

# Wireless World

RADIO AND ELECTRONICS

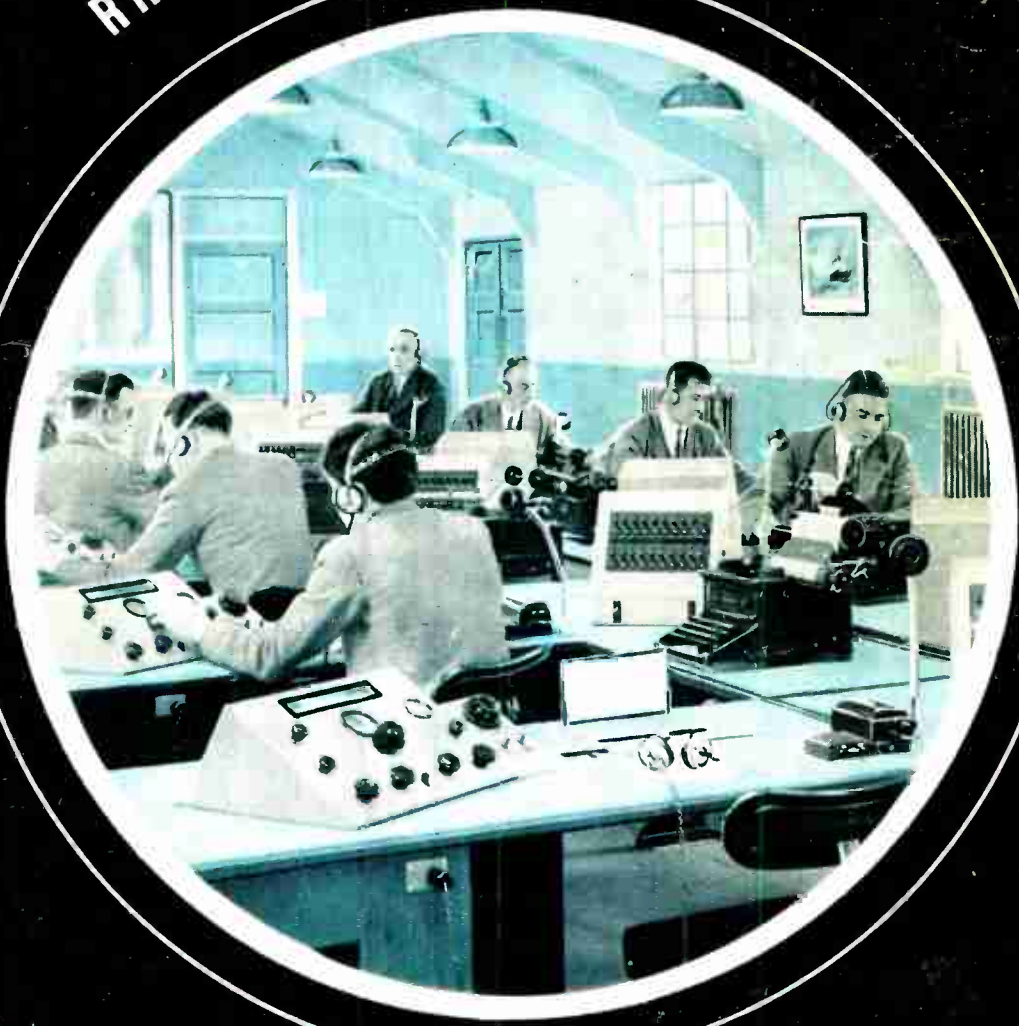

MAR. 1949

2/-

Vol. LV. No. 3

IN THIS  
ISSUE :

DESIGN FOR MIDGET A.C. SET



# Interference?

*never heard  
of it!*

Never had your favourite programmes spoilt by a background of hissing, crackling and spluttering noises? No? Lucky you! But for thousands living in towns and cities near industrial electrical apparatus or trolley-bus routes such interference is only too common.



The B.I.C.C. Anti-Interference Aerial, when properly erected, will give you better listening and reveal many stations you never heard before.

The aerial is a 60-ft. polyethylene insulated dipole type with suspension insulator and matching transformer. The 80-ft. down lead is a fully screened coaxial cable with polyethylene plugs moulded to each end; it is matched to the receiver by a transformer with easily fixed suction mounting.

It acts as a "T"-type aerial on long and medium waves and as a true dipole on short waves.

Write to-day for descriptive folder No. 221S on "Anti-Interference Aerial."

Obtainable through Radio Dealers.

Price **£6 18 0**

Licensed under Amy Aceves & King, Inc., Patents Nos. 413917, 424239 and 491220.



## *All-Wave* **ANTI-INTERFERENCE AERIAL**

BRITISH INSULATED CALLENDER'S CABLES LIMITED  
NORFOLK HOUSE, NORFOLK STREET, LONDON, W.C.2

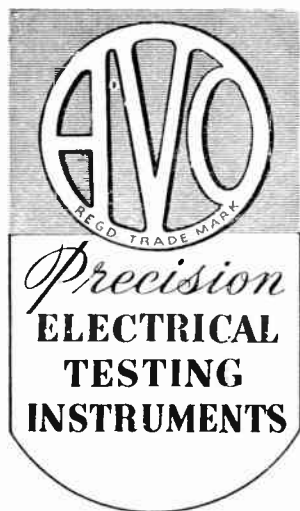

PRICE

**£19 : 10s.**

Size : 8 3/8" x 7" x 4 1/2" Weight : 7 1/2 lbs.

This recently developed High Resistance Avometer has a sensitivity of 20,000 ohms per volt on the D.C. voltage ranges and 1,000 ohms per volt on the A.C. ranges.

It is a compact and portable multi-range instrument having many advantages which will commend it for use in laboratory or workshop. A 5-inch clearly marked scale with an anti-parallax mirror is used for the following ranges of readings:—

D.C. CURRENT : 50 $\mu$ A to 1,000 mA

D.C. VOLTAGE : 2.5 v. to 2,500 v.

A.C. VOLTAGE : 10 v. to 2,500 v.

RESISTANCE : 0.1 ohm to 5 megohms  
(with internal battery)

The instrument can be supplied, if required, fitted with magnetic screening for protection against stray magnetic fields. It will stand up to heavy overload and is protected by an automatic cut-out.

In addition to its multi-range facilities, it can be used as a Galvanometer, for which purpose the zero can be offset to the extent of 30% of full scale deflection by a simple knob adjustment.

Sole Proprietors and Manufacturers :

**The AUTOMATIC COIL WINDER & ELECTRICAL EQUIPMENT CO. LTD.**  
WINDER HOUSE • DOUGLAS STREET • LONDON • S.W.1 Telephone : VICTORIA 3404/9

H.R.1

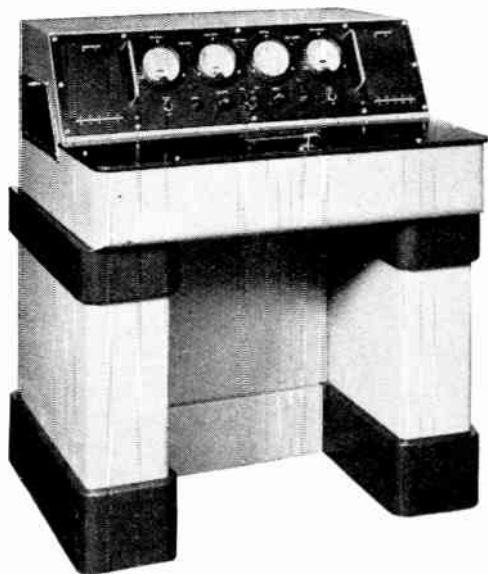

# RESISTOR NOISE METER

Manufactured to an approved Ministry of Supply specification for the measurement of inherent noise above one microvolt in fixed and variable resistors.

PLEASE WRITE FOR FULL DETAILS TO

**ERSKINE LABORATORIES LTD—SCALBY, SCARBOROUGH, YORKS.**



**Twin-cone  
assembly  
brings  
new realism  
to sound reproduction**

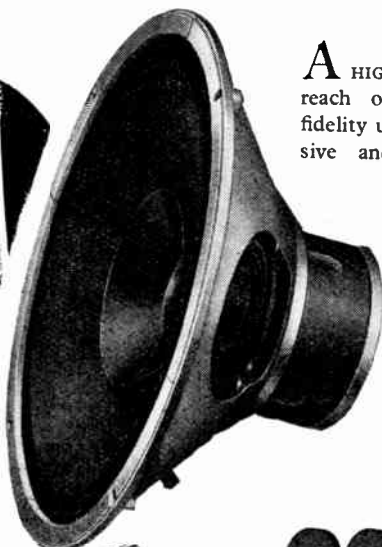

A HIGH FIDELITY LOUDSPEAKER that brings within reach of all the means of achieving a degree of fidelity usually obtained only from the most expensive and elaborate equipment. From the rich pulsation of the organ's pedal register to the delicate whisper of the E-string of the violin, the whole complement of the orchestra is strikingly recreated, and all the varied inflections of the human voice are so naturally rendered that this may truly be called "Living Reproduction." Send for fully descriptive leaflet D.39.



# GOODMANS

**AXIOM-TWELVE  
12" P.M. LOUDSPEAKER**

*Fully Dustproof*

For use with the 'Axiom Twelve' Goodmans High Fidelity Output Transformer Type H.4 is recommended. Supplied wound to individual specification.

GOODMANS INDUSTRIES, LTD., LANCELOT ROAD, WEMBLEY, MIDDX. Phone: Wembley, 1200. Cables: "Goodmans, Wembley 1200."

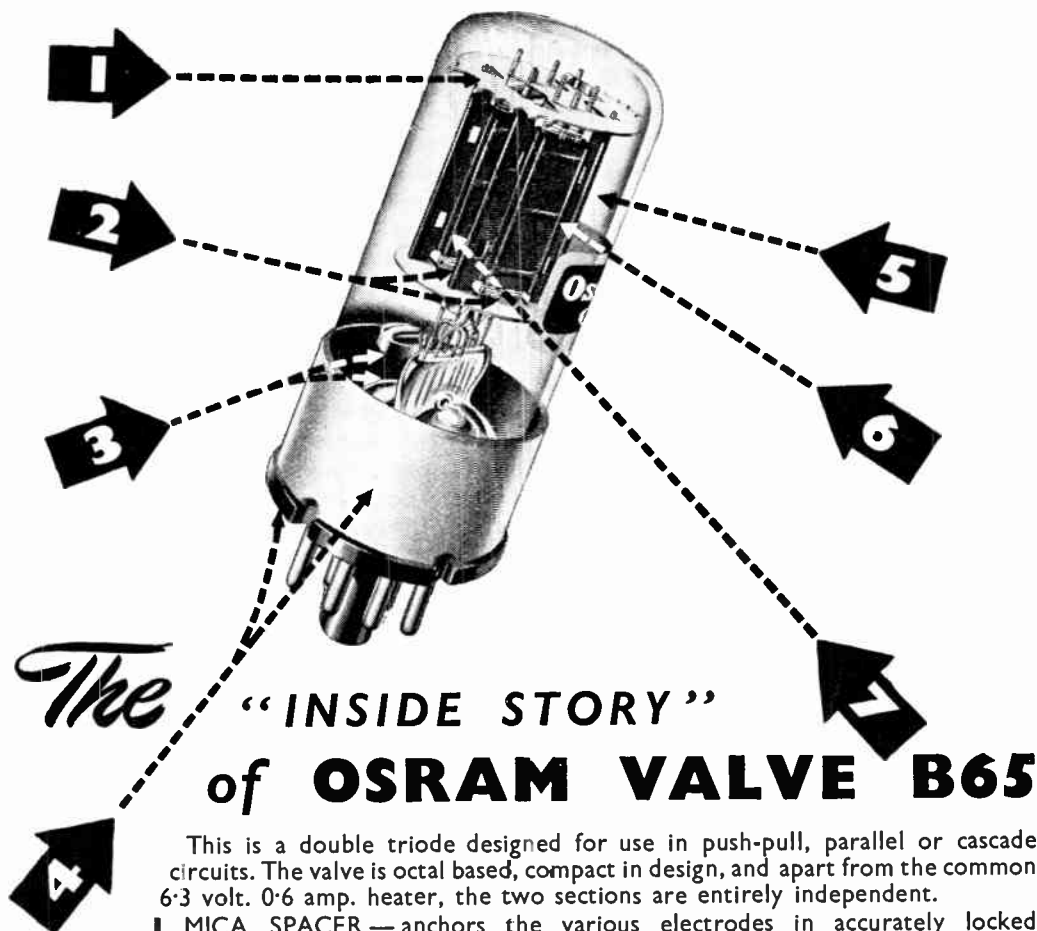

*The* "INSIDE STORY"  
of **OSRAM VALVE B65**

This is a double triode designed for use in push-pull, parallel or cascade circuits. The valve is octal based, compact in design, and apart from the common 6.3 volt, 0.6 amp. heater, the two sections are entirely independent.

- 1 MICA SPACER**—anchors the various electrodes in accurately locked positions. It is sprayed with magnesia to provide high surface insulation.
- 2 CONTROL GRIDS**—Molybdenum wire wound onto copper rod supports.
- 3 GETTER CUP & PATCH.** The metal barium, contained in the cup is deposited in a silvery film on the inside wall of the bulb. It maintains a high vacuum condition during the life of the valve.
- 4 TWO PART BASE** ensures reliable fixture of base to bulb.
- 5 ANODES** are carbonised externally to enhance heat radiation.
- 6 ANODE RIBBING.** Designed to impart additional mechanical strength to anode assembly.
- 7 EYELETS** for easy assembly of anode plates. Reducing spot welding to a minimum.



**THE POWER IN THE PACKAGE**

**Osram**  
PHOTO CELLS

**G.E.C.**  
CATHODE RAY TUBES

**Osram**  
VALVES

THE GENERAL ELECTRIC CO., LTD., MAGNET HOUSE, KINGSWAY, W.C.2.



To that exclusive coterie—The 'Sound Repro' Engineers, Technicians and Recordists, the initials M.S.S. need no introduction. Much that is today acknowledged as standard practice in Disc Recording was conceived and developed by M.S.S.

During the war the Company was greatly enlarged and development was accelerated to provide improved disc recording equipment of all kinds for the Service Departments. Now, however, enhanced facilities coupled with improved material supplies are making M.S.S. Equipment available to a wider circle of users.

The well-tried and well-proven advantages of M.S.S. technique are at the service of all who seek the highest possible fidelity and operating efficiency in Disc Sound Reproducing Equipment.

*Among the users of M.S.S. equipment are:—*

The British Broadcasting Corporation,  
The Admiralty,  
The Ministry of Supply,  
The General Post Office  
and  
Broadcasting Authorities  
& professional recordists  
in all parts of the world.

◆  
The illustration shows the Type D.S.R. Reproducing Console as used by broadcasting stations, commercial studios and theatres, etc.

*Details of the M.S.S. Range available from*

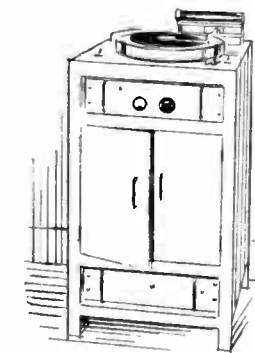

**M.S.S. RECORDING COMPANY LIMITED**  
POYLE CLOSE, COLNBROOK, BUCKS. Tel: Colnbrook 115 & 87

# SILENT POWER

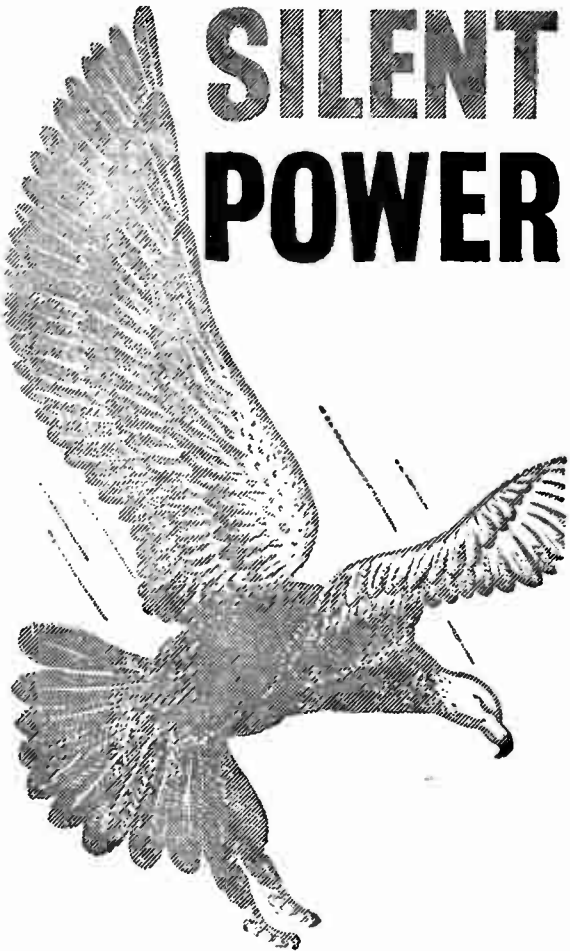

**PERTRIX**  
RADIO BATTERIES  
*'Always worth more!'*

For clean, crisp reception a silent source of power is essential. Pertrix Radio Batteries give silent power.

**HOLSUN BATTERIES LIMITED**  
137 Victoria Street • London • S.W.1

# They speak for themselves...

*fidelity of response  
speaks for itself to the*

*discriminating ear.*

*Precision manufacture is  
no less eloquent to the  
trained engineer. These*

*qualities make*

*TRUVOX speakers famous*

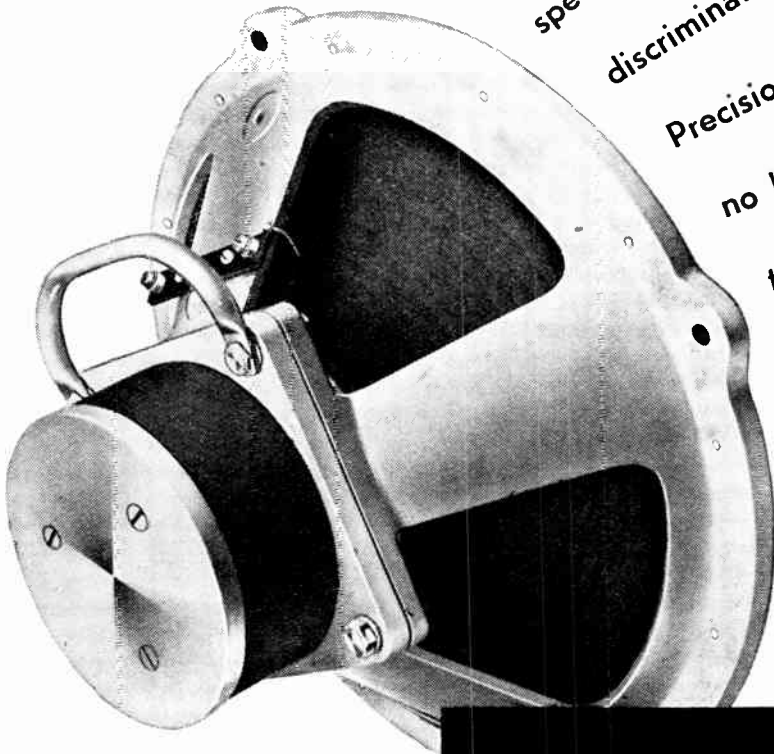

*The SS10A 12-inch Heavy Duty Speaker, illustrated, offering a frequency response from 55 to 11,000 c.p.s. and handling 10 watts is a typical example of TRUVOX workmanship.*

# TRUVOX

**TRUVOX ENGINEERING CO. LTD · EXHIBITION GDS · WEMBLEY · ENGLAND**

T.A. 47

## AN ANNOUNCEMENT OF EXCEPTIONAL INTEREST . . . .

The FOX HELICAL  
POTENTIOMETER type PXF  
5 H10 is now available for gen-  
eral release to the Electronic  
Industry.

### BRIEF SPECIFICATION

Resistance Range 20 ohms to 50 K-ohms.  
Helical Turns 10. Rotation 3,600°.  
No. of wire turns 2,000 to 12,000.  
Wattage 5.

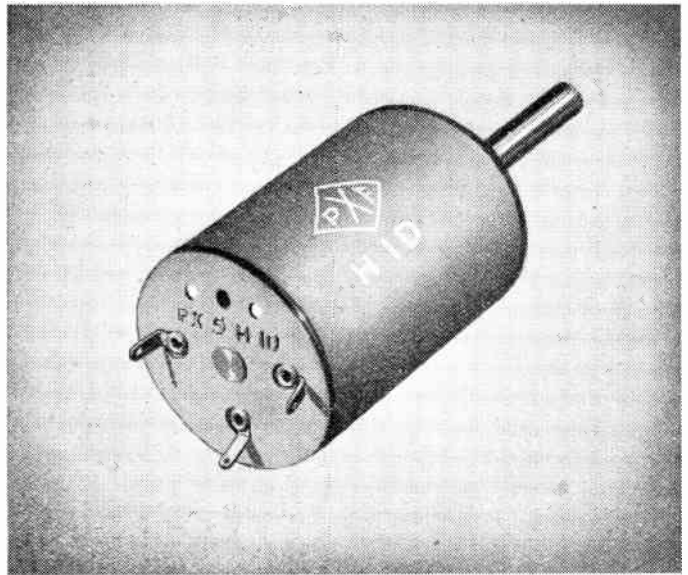

Write for full details to .

## P. X. FOX LTD.

TOROIDAL POTENTIOMETER SPECIALISTS

HORSFORTH, YORKSHIRE, ENGLAND.

Telephone: Horsforth 2831/2. Telegrams: "Toroidal, Leeds."

n.t.b.

## PRECISION COMPONENTS

### CORD DRIVES

Now available in five types as  
illustrated (left to right) Standard,  
R/V, Reverse, "D" type and  
"A" type.

### GANG CONDENSERS

A wide range is now available  
in 1, 2, 3 or 4 gang types of  
various capacities.

Write for Catalogue No. (W.W.I.)

# JACKSON

**BROS (LONDON) LIMITED**

KINGSWAY · WADDON · SURREY

TELEPHONE: CROYDON 2754-5 TELEGRAMS: WALFILCO.  
PHONE LONDON

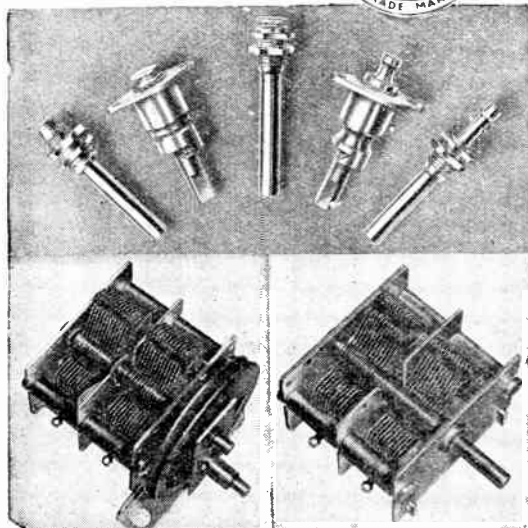



# 'A NEW DRIVE'

## for Perfect Performance

featuring **SIMPLICITY**  
**LIGHTNESS & LOW COST**

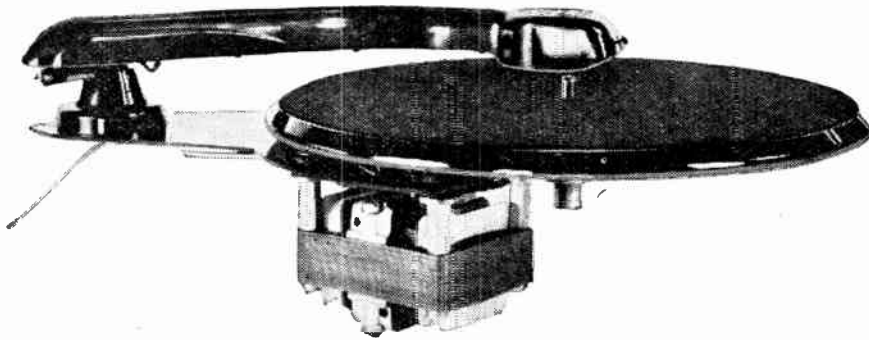

The new Collaro A.C.49 Rim-Drive Gramophone Unit is an extremely simple and practical design, beautifully made and finished to the usual high Collaro standard, yet it is available at surprisingly low cost. The powerful induction type Motor is suitable for 100/130 and 200/250 volts, and is fitted with a cooling fan . . . the AUTOMATIC STOP is independent of length of playing surface—is fully automatic . . . four types of PICKUP HEAD are available—all fitted with ball-bearing bases . . . the complete unit, including baseplate, turntable and

The **COLLARO**  
A.C.49

some types of pickup, finished in a hard scratch-proof enamel. Write today for trade terms and free leaflet which fully describes the new Collaro A.C.49 Rim-Drive Gramophone Unit.

## RIM-DRIVE GRAMOPHONE UNIT

### COLLARO LIMITED

Ripple Works, By-Pass Road,  
Barking, Essex.

Telephones :  
RIPPLEWAY 3333

Telegrams :  
"KORLLARO, BARKING"

MAKERS OF FINE QUALITY GRAMOPHONE COMPONENTS, INCLUDING:— COLLARO AUTOMATIC RECORD CHANGERS, GRAMOPHONE UNITS, INDUCTION MOTORS, DE LUXE MICROGRAM PORTABLE ELECTRIC GRAMOPHONES.

# ULTRASONICS

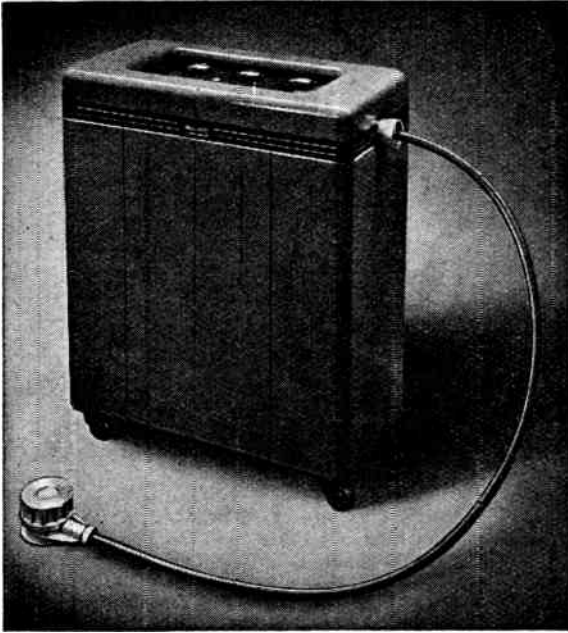

*Mullard Ultrasonic Generator Type E.7562*

Here is another example of how Mullard Research is helping forward Industry. The Mullard Laboratory Ultrasonic Generator is the first commercial generator to be produced in this country. It has been designed to fulfil the need for an experimental unit of wide flexibility.

These features are unique :

- Power output into a water load of 500 watts at 2 Mc/s.
- Transducer head designed for operation in conductive or non-conductive liquids.
- Wide range of generator frequencies.
- Styled to match modern laboratory surroundings.



## Mullard Electronic Products Ltd.

*Electronic Equipment Division*

ABOYNE WORKS, ABOYNE ROAD, LONDON, S.W.17

(M1.283)

The  
**MAGNAVISTA**  
TELEVISION LENS

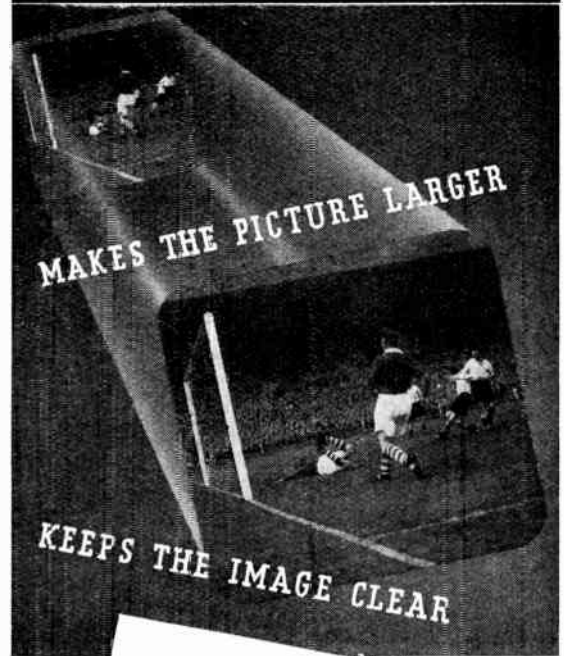

The product of the latest scientific research undertaken in conjunction with eminent independent authorities on lens computation.

Embodying fundamental improvements on all previous designs, yet involving **NO INCREASE IN PRICE.**

Angle of view equal to manufacturers' original. **GUARANTEED** against **DISCOLORATION.**

Acclaimed the best by the viewing public and Television societies.

**METRO PEX LTD**

71 Queens Road  
London, S.E.15

Phone: New Cross 2442

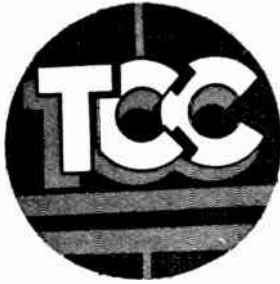

# VISCONOL

## CATHODRAY CONDENSERS

for

### TELEVISION & OTHER HIGH VOLTAGE APPLICATIONS



This well-known range of high voltage condensers is now processed with a new impregnant—"Visconol," a highly viscous mineral oil which affords the following advantages:—adequate voltage rating, low power factor, stability of dielectric, and power to withstand sharp-front short-time surges. The mechanical construction and unique sealing technique renders them normally impervious to breakdown or flashover. Temperature ranges extend from  $-30^{\circ}$  to  $+71^{\circ}\text{C}$ . Further development permits the temperature for maximum working conditions to be raised to  $60^{\circ}\text{C}$ . and for  $71^{\circ}\text{C}$  voltages to be derated to only 80% of those shown in the table below. Capacitance tolerance is  $\pm 20\%$  for all values.

A selection from the range available is given in the table below. Send for details of the complete range of this and other T.C.C. Condensers.

CAPACITANCE in Mfd.s.	MAX. WORKING VOLTS (at $60^{\circ}\text{C}$ )	DIMENSIONS IN INCHES		TYPE NUMBER	LIST PRICE each
		Overall Length	Overall Diameter		
.0005	25000	$5 \frac{1}{16}$	$1 \frac{3}{4}$	CP57HOO	13/6
.001	12500	3	$1 \frac{1}{4}$	CP56VO	7/6
.002	18000	$5 \frac{1}{16}$	$1 \frac{1}{2}$	CP57XO	13/6
.0025	3000	$2 \frac{3}{4}$	$1 \frac{1}{2}$	CP55HO	4/6
.005	6000	3	$1 \frac{1}{2}$	CP56QO	7/6
.01	6000	3	$1 \frac{1}{2}$	CP56QO	7/6
.05	6000	$5 \frac{1}{16}$	$1 \frac{1}{2}$	CP57QO	13/6
.1	7000	$6 \frac{3}{8}$	2	CP58QO	15/-
.25	1000	3	$2 \frac{1}{2}$	CP56V	7/6
.5	3000	$6 \frac{3}{4}$	$2 \frac{1}{2}$	CP59HO	23/-
1.0	750	$5 \frac{1}{16}$	1	CP57T	13/6

IN THE BEST SETS  
YOU'LL SEE



**THE TELEGRAPH CONDENSER CO., LTD.**

RADIO DIVISION

NORTH ACTON · LONDON · W.3

Telephone. ACORN 0061

# MASTERPIECE IN MINIATURE

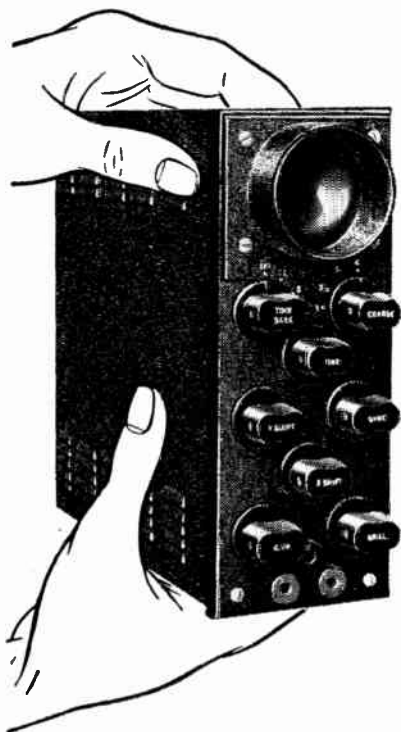

WIDTH	2½"
-------	-----

HEIGHT	6¾"
--------	-----

DEPTH	9¼"
-------	-----

C.R.T. DIAMETER	1½"
-----------------	-----

NETT WEIGHT	7½lbs
-------------	-------

## Miniscope

MINIATURE CATHODE RAY OSCILLOSCOPE BY

# S.E.C.

Full specification from: THE GENERAL ELECTRIC CO., LTD., MAGNET HOUSE, KINGSWAY, LONDON, W.C.2

## Stabilised Insulation BY MODERN IMPREGNATION METHODS

# HYMEG

### HIGH-SPEED PRODUCTION

Now, special methods of continuous conveyor impregnation and baking developed with the use of HYMEG have still further reduced processing times to a fraction of those previously believed necessary.

Often faster than infra-red baking with none of the defects, reduced handling, absence of special jigs, with complete freedom from blistering, bubbling and porosity, are some of the advantages claimed and substantiated for HYMEG High Speed Production methods.

HYMEG Synthetic Insulating Varnishes are recognised and widely used for their mechanical rigidity, improvement of electrical properties of windings; heat, moisture, oil, acid and alkali resistance as well as for the considerably reduced stoving time necessary.

# HYMEGLAS

### GLASS FIBRE INSULATION SYSTEM

This integrated system of development is successful in enabling machines to be designed and operated without weak links in the chain of insulation below 200°C. Thus the fullest advantage is taken of modern glass fibre insulation by providing a degree of bonding and insulation at every point in which the uniting of Hymeg impregnation with the Hymeg as used for subsidiary insulations gives a solid homogeneous winding of equally efficient characteristics and heat resistance throughout.

Hymeglas therefore virtually eliminates any risk of insulation failure and enables motors and the like to operate under abnormal conditions for long periods without risk of electrical breakdown.

Due to the excellent space factor of glass fibre as compared with the more usual asbestos and mica Class B insulations, it is often possible in redesigning with the Hymeglas system to employ larger copper sections with well-known advantages.

The Berger Technical Service—the research work of which produced "HYMEG" and "HYMEGLAS" is available to advise manufacturers on all problems of insulation. Get in touch now with—

**LEWIS BERGER & SONS LTD. (Est. 1760)**  
35, BERKELEY SQUARE, LONDON, W.1.

Telephone: MAYfair 9171.

MANUFACTURERS OF HIGH - PERFORMANCE INSULATING VARNISHES AND ENAMELS

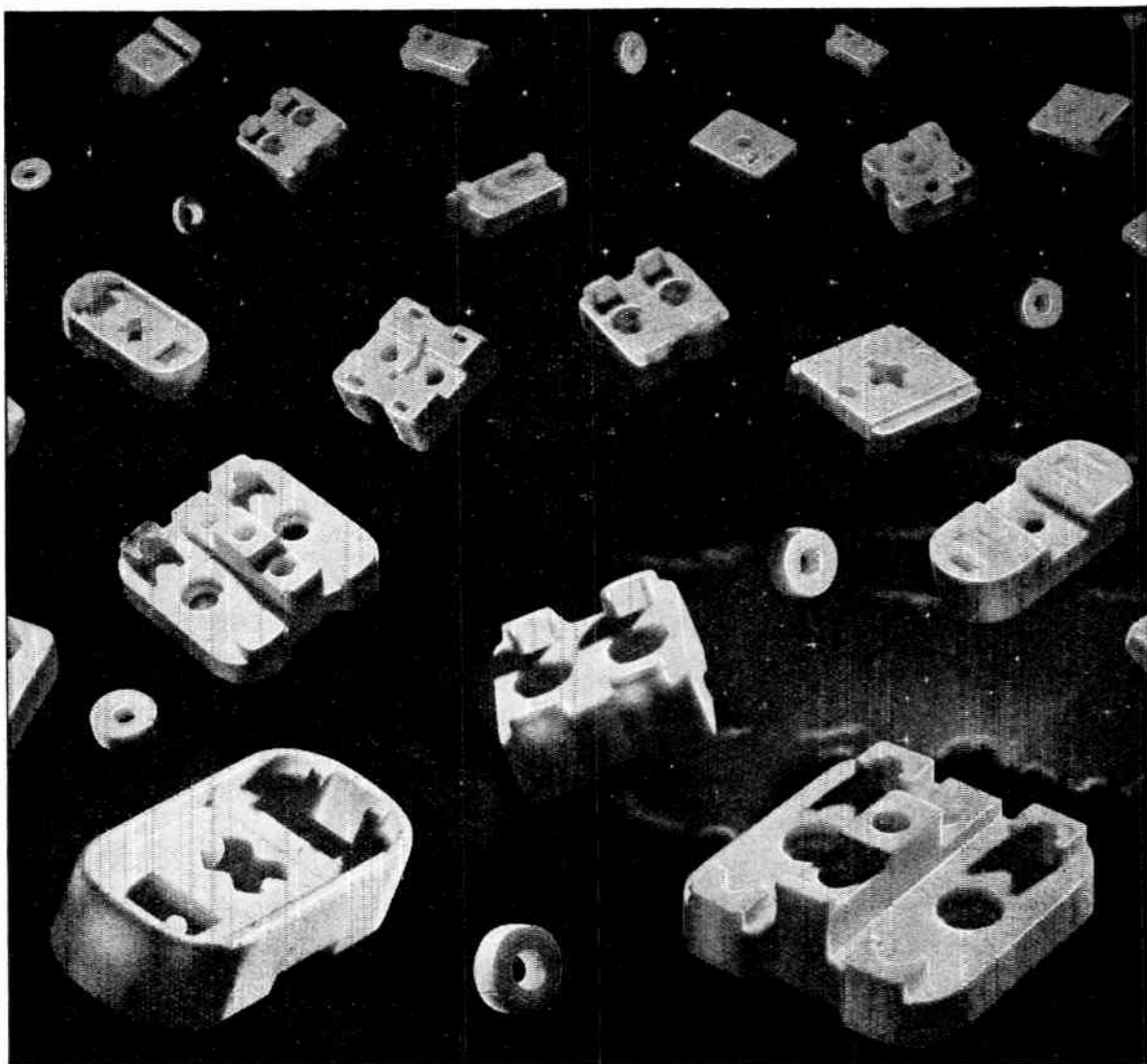

# CERAMICS

FOR TRIMMER CONDENSERS  
and all radio components  
FREQUENTITE-FARADIX-TEMPRADIX

**STEATITE & PORCELAIN PRODUCTS LTD.**

Stourport on Severn, Worcester. Telephone: Stourport 111. Telegrams: Steatint, Stourport



S.P. 51

# ONE MILLIVOLT TO 100 VOLTS

10 c/s TO 500 kc/s

THE NEW Furzehill Sensitive Valve Voltmeter Type 378B/2 has an extended frequency range, now going down to 10 c/s and up to half a megacycle.

This, coupled with the already established features of high sensitivity, high input impedance and logarithmic scale providing constant reading accuracy and immunity from damage by overload, makes this an essential instrument in the communications laboratory. Feedback circuiting ensures stability of calibration over both long and short periods.

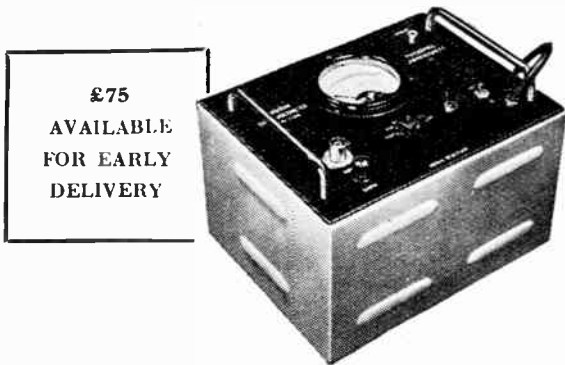

£75  
AVAILABLE  
FOR EARLY  
DELIVERY

For further particulars  
please write for our new brochure of Electronic  
Instruments.

*Furzehill*

LABORATORIES LTD



BOREHAM WOOD · HERTFORDSHIRE  
TELEPHONE · · ELSTREE 1137

# BENTALLS OF KINGSTON CHOSE

# TANNOY

SOUND EQUIPMENT



COURTESY OF BENTALLS LTD.

MAKE IT YOUR CHOICE TOO !

SOLE DISTRIBUTORS SOUND RENTALS LTD.,  
CANTERBURY GROVE, LONDON, S.E.27. 'Phone GIP 1131

## BRIERLEY MICROARMATURE PICKUP

Type JB/P/A/I

Frequency range, 30 to 20,000 c/s.  
Permanent Point 6 times longer wearing than sapphire.  
Average point pressure, 1/4 oz.  
Floating Element design prevents arm torsional resonance.  
Output voltage: Model (a) 1/12th v. Model (b) 1/50th v.  
Price: Model (a) complete with mumetal screened coupling transformer and including Purchase Tax, £8/19/6. Model (b) (no transformer required), £7/17/8, including Purchase Tax.  
Point replacement, £1.

The illustration shows :  
A. Standard Armature and Needle. B. Miniature Needle to which is normally attached an armature or coil. C. The Brierley Microarmature complete with point.  
Wide frequency range necessitates small size, particularly if one rejects the possibility of working within and above the resonance band. Small size also permits the use of low point pressure with corresponding increased point life and lower record wear, but it also inevitably results in lower output. The Brierley Microarmature Pickup will not work with most domestic wireless sets but the output is high enough for most amplifiers and above the level below which the inexperienced are troubled with amplifier problems. The movement is robust and suitable for adult family use. Point life—on the basis that a sapphire tip will play 150 records with 1/4 oz.—is about 2,000 records.

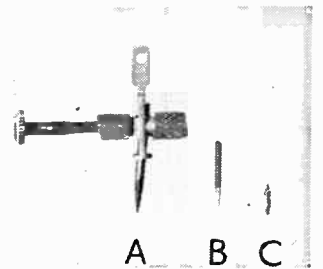

Details of this pickup, together with information on our new specialised JB/P/R/2 Ribbon Pickup—now provided with feedback ribbon and available with either standard or diamond point—will be sent on request.

J. H. BRIERLEY (GRAMOPHONES & RECORDINGS), LTD.,  
46, TITHEBARN STREET, LIVERPOOL.

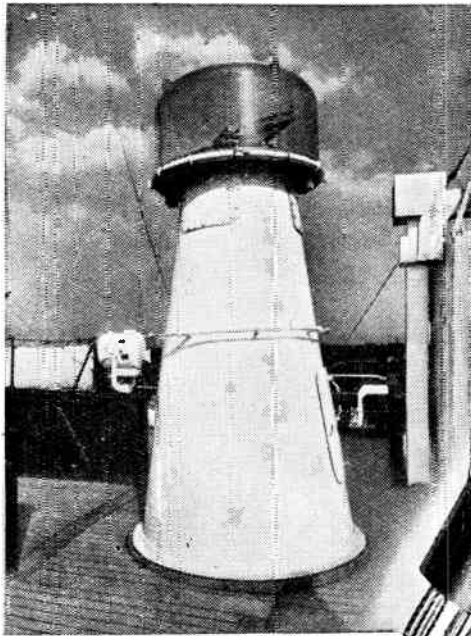

The illustration shows the scanner of the Metropolitan-Vickers "Seascan" Radar equipment installed in R.M.S. "Queen Mary"



11E3

**VALVES** for **SPECIAL PURPOSES**

The Mazda 11E3 is a Beam Power Amplifier designed for use as a break or series modulator with a short duration pulse input signal. An example of one of its many applications is given by its use, with other Mazda Special Purpose Valves, in the "Seascan" Radar Equipment manufactured by The Metropolitan-Vickers Electrical Co. Ltd.

TYPICAL OPERATION		Series Modulator	Break Modulator
Quiescent Anode Voltage (volts) ... ..	$V_a(o)$	3,500	500
Screen Voltage (volts) ... ..	$V_{g2}$	500	500
Signal Voltage Positive (volts) ... ..		50	25
Peak Anode Current (amps) ... ..	$I_a(pk)$	2	1
Approximate Knee Voltage (volts) ... ..		200	
Peak Anode Output Voltage (volts) ... ..		3,300	10,000
Approximate Peak Grid Current (amps) .. ..	$I_{g1}(pk)$	0.12	0.05

Base: 7-pin B.V.A. Top Cap: Standard B.V.A.

RATING			
Heater Voltage (volts) ... ..	$V_h$	4.2	
Heater Current (amps) ... ..	$I_h$	2.5	
Maximum Anode Voltage as Series Modulator (volts DC) ... ..	$V_a(max)$	3,500	
Maximum Peak Anode Voltage as Break Modulator (volts) ... ..	$V_a(pk)max$	12,500	
Maximum Screen Voltage (volts) ... ..	$V_{g2}(max)$	700	
Maximum Control Grid Negative Bias (volts-ve) ... ..	$V_{g1}(max)$	-700	
Maximum Peak Cathode Current (amps) ... ..	$I_k(pk)max$	† 3.5	
Inner $\mu$ ... ..	$\mu_{g1-g2}$	‡ 9.0	
Maximum Anode Dissipation (watts) ... ..	$W_a(max)$	10.0	
Maximum Screen Dissipation as Series Modulator (watts) ... ..	$W_{g2}(max)Series$	0.9	
Maximum Screen Dissipation as Break Modulator (watts) ... ..	$W_{g2}(max)Break$	2.0	
Maximum Potential Heater/Cathode (volts DC) ... ..	$V_h-k(max)$	150	

† Taken under Pulse Conditions of approximately 10 micro-seconds duration and 400:1 minimum off-on ratio.

‡ Taken at  $V_a=200$ ;  $V_{g2}=200$ ;  $I_a=40$  mA.

Further details given on request.

# EDISWAN

## MAZDA

### RADIO VALVES AND CATHODE RAY TUBES

THE EDISON SWAN ELECTRIC CO. LTD., 155 CHARING CROSS ROAD, LONDON, W.C.2

RA99

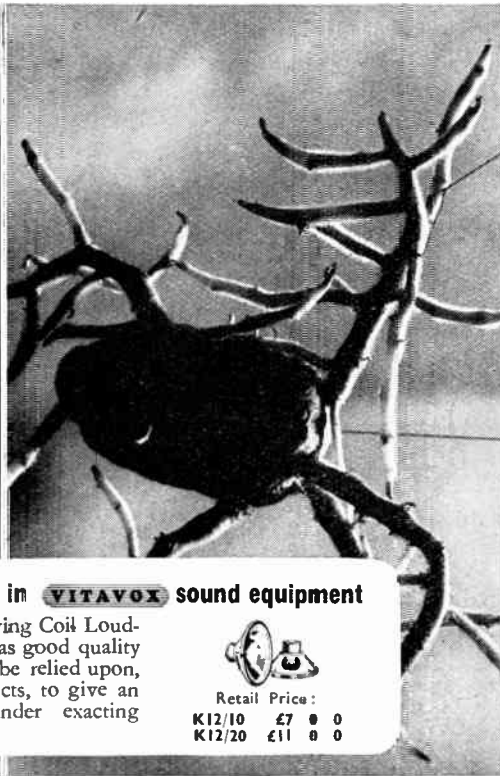

... but there is a difference in **VITAVOX** sound equipment

The K12/10 and K12/20 Moving Coil Loudspeakers, designed especially as good quality single unit reproducers, can be relied upon, as can all VITAVOX products, to give an outstanding performance under exacting conditions.



Retail Price:  
 K12/10 £7 0 0  
 K12/20 £11 0 0

VITAVOX LTD., WESTMORLAND ROAD, LONDON, N.W.9. Tele: COLindale 8571.

**M.R. SUPPLIES Ltd.**

have, for the past fourteen years, supplied electro-technical equipment to many of the largest industrial concerns in the country, giving them complete satisfaction. Our discriminate buying is your guarantee of satisfaction.

**FRACTIONAL MAINS MOTORS.** 200-250 v. A.C. Brand new shaded pole. Running torque 400 gram/cm, 1200 r.p.m., 100% starting torque. Silent in operation. Shaft 1in. long by 1/16in. Frame 3 1/2in. by 3 1/2in. Shaded pole motors, being subject to temperature rise, should be used in slip-stream unless for short periods. First delivery of these fine motors, 32/6 each.

**REMOVE READING THERMOMETERS,** bifid and capillary type. Scaled - 35 deg. C. to + 55 deg. C. covering 0-140 deg. F., 2in. luminous dial. With 10ft. capillary and 12in. bifid (temperature rod). Ideal for all warning readings and for reading, in situ, outside temperatures, etc., 15/-.

**THERMOSTATS (ex A.M.).** Switch 1.5 amp. On at 32 deg. F. off at 49 deg. F., therefore right for frost protection. 4/6 each, 45/- doz. Also brand new Room, Laboratory, Workshop and Greenhouse model by British Thermostat Co., range 40/80 deg. F. (differential 4 deg. F.), capacity 10 amp. A.C. with manual on/off control. Calibrated external adjustment. Size 6in. by 2 1/2in. by 1 1/2in. (approx.), 30/6.

**A.C. MAINS CONTACTORS.** Coil 230 v. 50 c. Contacts 3-pole each 10-amp., supplied with these wired in parallel for 30-amp switching. Smart, silent action. On panel 6in. by 4 1/2in., with metal cover, 17/6.

**MEASURING INSTRUMENTS.** 2in. square range m/v. oil. 0/1 m.a., 9/6. Same style, thermo-couple 0/2.5 amp., 8/6. 3 1/2in. round flush panel A.C. (or D.C.) Ammeter, 0/15, 1st Grade M/Iron, 17/6. Very limited supply large 0/300 A.C. Voltmeters, 6in. Projecting (with flush adaptor) first-grade jewelled movement, 37/6 (despatch 2/-).

**ELECTRIC WATER PUMPS (Stuart).** Operation 220/250 v. A.C. or D.C. Specially constructed non-ferrous metals for exposure and long life. No. 10 (120 g.p.h.), 25/15/- (des. 2/-); No. 12 (600 g.p.h.), 28/10/- (des. 3/6). These are brand new, with instructions and maker's guarantee.

**STAGE LIGHTING DIMMERS.** Correctly rated to control stated load from full-bright to blackout at 220/240 volts. With screw motion and handwheel, with "off" position. 600-watts, 23/18/6; 1,000-watts, 27/2/6; 1,500-watts, 28/12/6 (des. any one 4/6); 2,500-watts, 29/15/0 (des. 5/6).

**SYNCHRONOUS ELECTRIC CLOCK MOVEMENTS,** 200/250 v. 50 c. Collets for hours, minutes and seconds hands. Single hole mount, silent running. With dust cover 3 1/2in. diameter by 2in. deep, and flex, 37/6. Set of three hands to fit, suiting 5/6in. dial, 2/- (not sold separately).

**CLOSE-RANGE AUTO TRANSFORMERS,** for adjusting mains volt-drop or rise. Cover range of 200/250 v. in 10 v. tap, loading 500-watts, 27/6 (des. 2/6).

**MINIATURE L.V. MOTORS,** 3/12 v. A.C./D.C. size only 2 1/2in. by 2in. (approx.), shaft 1/8th in. dia. Considerable torque, low consumption, 12/6.

**ROTARY TRANSFORMERS (Anode Converters),** input 12 v. D.C., output 250 v. D.C. 125 m.a. Brand new, by Hoover, 21/- (des. 1/6).

**IN STOCK.** New Signal Generators U.S.W. models as advertised in February issue. Hoover 1/4th h.p. A.C. Induction Motors, silent running, resilient mount, 1,425 r.p.m. 220/250 v. 50 c., 26/18/6 (we cannot despatch these).

Please include sufficient for packing/despatch.

**M. R. SUPPLIES Ltd., 68, New Oxford Street, London, W.C.1**  
 Telephone: MUSeum 2958

**CHARLES AMPLIFIERS**

FOR THE  
 UTMOST  
 REALISM FROM  
 RECORDS AND  
 RADIO

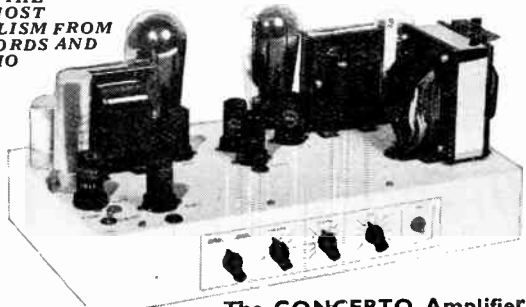

The CONCERTO Amplifier

... acclaimed by music lovers for its exceptionally high fidelity, this magnificent amplifier covers a normal requirements for home or concert hall. Distortion level below 0.5 per cent. Two channels of bass boost ensure unusually smooth balance and depth. Designed for any type of pick-up. Radio input socket provided. Two year guarantee. Price £27.10.0. Heavy perforated steel cover with bottom plate and rubber feet, 37s. 6d. extra. Delivery by passenger train, Carriage Paid, 10s. deposit (returnable) for crate.

DEFERRED TERMS NOW AVAILABLE

*Charles*  
**AMPLIFIERS**

"LIVING MUSIC"  
 ... our fully illustrated 16pp catalogue showing complete range of amplifiers and tuning units. Write for your copy today, enclosing 5d. in stamps.

1m PALACE GATE KENSINGTON, LONDON, W.8

Telephone: WESTern 3350

Our equipment can now be seen and heard at  
 UNIVERSITY RECORDING CO. 16 BURLEIGH PLACE, CAMBRIDGE  
 Telephone: CAMBRIDGE 54947





# The LATEST Dubilier Volume Control

- Fully Tropical to withstand extreme conditions of temperature and humidity.
- Miniature size.
- Minimum weight.
- Extremely robust.
- Also available in Non-Tropical form.

---

**RESISTANCE RANGE**

Linear Law . . . . .	1,000Ω to 10MΩ
Log Law . . . . .	5,000Ω to 5MΩ

---

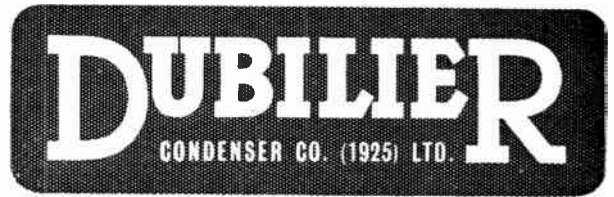

DUBILIER CONDENSER CO. (1925) LTD., DUCON WORKS, VICTORIA ROAD, NORTH ACTON, W.3  
 Telephone: Acorn 2241 (5 lines)      Telegrams: Hivoltcon, Phone, London      Cables: Hivoltcon, London. Marconi International Code D14

*The Greatest  
'Advance' yet!*  
100 Kc/s to 100 Mc/s  
on fundamentals

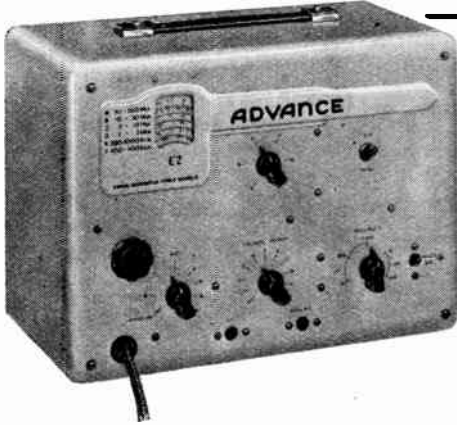

The new Advance Signal Generator Type E.2 has all the advantages of the popular Model 1 plus a greatly extended range to cover the Birmingham Television frequency. The wider range, 100 Kc/s to 100 Mc/s, gives greater scope for advanced experimental work than ever before.

In common with the earlier model, the new generator offers an instrument of laboratory standard at a price within the reach of moderate purses. The remarkable high frequency accuracy of  $\pm 1\%$  extends over the whole range.

**Range:** 100 Kc/s — 100 Mc/s in 6 bands.

**Frequency:** Guaranteed within  $\pm 1\%$ .

**Output:** Approx. 1 volt unattenuated and variable from  $1\mu\text{V}$  to 100 mV into a 75 ohm load through a matched transmission line.

**Stray Field:** Less than 3 microvolts at 100 Mc/s.

**Illuminated Dial:** Total scale length 30".

**Power Supply:** 100 - 210 - 230 - 250 volts. 40 - 100 c/s.

**Dimension:**  $9\frac{1}{2}$ " high  $\times$  13" wide  $\times$  8" deep.

**Weight:** 15 lbs.

Send for fully descriptive leaflet



ADVANCE COMPONENTS LTD.

Back Rd., Shernhall St., Walthamstow, London, E. 17

Telephone: LARKWOOD 4366/7/8

## THE COIL PICK-UP

### OUTPUT OVER ONE TON

This figure was recently arrived at in the course of completing a Government return.

Gross output, however, is not a characteristic of the pick-up. On the contrary, users are particularly impressed by the fact that the electrical output is substantially free from all forms of distortion.

When used with an appropriate amplifier and reproducer, the resulting sound output is as near to perfection as the record will allow.

Full technical details from:—

**WILKINS & WRIGHT LTD.**  
Utility Works, Holyhead Road,  
Handsworth, Birmingham, 21

The outstanding name in Radio—  
Radiogramophones and Television  
in 1949 will be

# AMBASSADOR

SEE THEM AT THE B.I.F.  
OLYMPIA

May 2nd — 13th

For advance information apply to  
Sales Department:

**AMBASSADOR RADIO**  
HUTCHINSON LANE,  
BRIGHOUSE - - - YORKS.

Tel.: 283-50

**NOTICE**

"POINT ONE" is the Trade Mark of H. J. Leak & Co., Ltd. It was originally applied to the first power amplifiers having a total distortion as low as point one of one per cent, when in June, 1945, H. J. Leak, M. Brit. I.R.E., revolutionised the performance standards for audio amplifiers by designing the original "POINT ONE" series.

NEW  
**LEAK**  
**"POINT ONE"**  
AMPLIFIERS

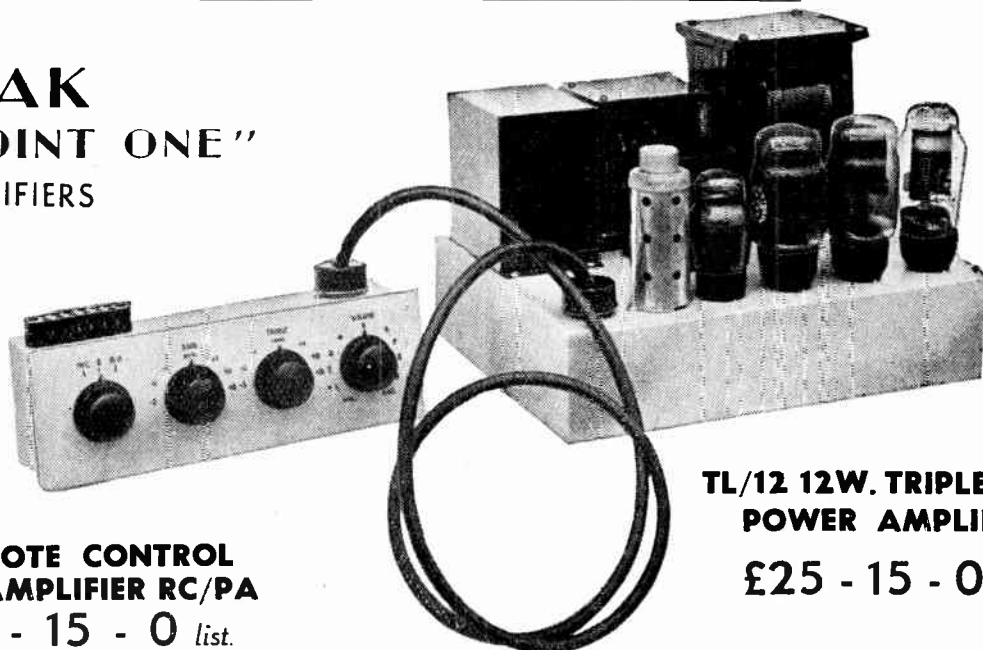

**REMOTE CONTROL  
PRE-AMPLIFIER RC/PA**  
**£6 - 15 - 0 list.**

**TL/12 12W. TRIPLE LOOP  
POWER AMPLIFIER**  
**£25 - 15 - 0 list.**

An original feedback tone-control circuit which will become a standard.

No resonant circuits employed.

- Distortion: Less than 0.05%.
  - Switching for Pick-up, Microphone and Radio, with automatic alteration of tone-control characteristics.
  - High sensitivities. Will operate from any moving-coil, moving iron or crystal P.-U.; from any moving-coil microphone; from any radio unit.
  - Controls: Input Selector; Bass Gain and Loss; Treble Gain and Loss; Volume.
- Output Impedance: 0-30,000Ω at 20 kc.p.s.

The unit will mount on motor-board through a cut-out of 10½ in. x 3½ in., or it can be bolted to the power amplifier, when, with a top cover, the whole assembly becomes portable.

For use only with LEAK amplifiers.

Used with the RC/PA pre-amplifier and the best complementary equipment the TL/12 power amplifier gives to the music-lover a quality of reproduction unsurpassed by any equipment at any price. It is designed in a form so that the power amplifier can be housed in the base of a cabinet and the small pre-amplifier mounted in a position best suited to the user.

DO YOU KNOW what these performance figures mean?—

PHASE MARGIN 20° ± 10°

GAIN MARGIN 10db ± 6db

YOU MOST PROBABLY DO NOT, for they are uncommon. Yet they are of vital importance, for the "goodness" of a multi-stage feedback amplifier cannot be taken for granted in the absence of this information, however impressive the rest of the specification may seem. We believe ourselves to be the only organisation advertising these figures. If you would like to know more about amplifiers in general, and the TL/12 and RC/PA in particular,

**WRITE FOR BOOKLET W/TL/12.**

**H. J. LEAK & CO. LTD. (Est. 1934)**

**BRUNEL ROAD, WESTWAY FACTORY ESTATE, ACTON, W.3.**

Phone: SHEpherds Bush 5626.

Telegrams: Sinusoidal, Ealux, London.

Foreign: Sinusoidal London.

A Leak triple loop feedback circuit, the main loop giving 26 db. feedback over 3 stages and the output transformer.

- Push-pull triode output stage. 400 V. on anodes.
- No H.T. electrolytic smoothing or decoupling condensers.
- Impregnated transformers; tropically finished components.
- H.T. and L.T. supplies for pre-amp. and radio units.
- Distortion: at 1,000 c/s and 10 W. output, 0.1%; at 60 c/s and 10 W. output, 0.19%; at 40 c/s and 10 W. output 0.21%.
- Hum and Noise: -80 db. on 10 W.
- Frequency response: ±0.1 db., 20 c/s-20 kc/s.
- Sensitivity: 160 mV.
- Damping Factor: 20. Input impedance: 1 MΩ
- Output impedances: 2Ω; 7-9 Ω; 15-20 Ω

25 W. model available at £27.10.0.

## Eliminate Positive Feedback

(Mechanical) "EQUIFLEX" PATENT MOUNTINGS will eliminate Mechanical and acoustic Vibration from being amplified and a Black Spot on Quality Reproduction. Call at your Dealers to see a complete set of special "EQUIFLEX." Damped units with all fittings and assembly chart suitable for the GARRARD R C 60 Turntable.

**GARRARD** Price 21/6 Per Complete Boxed set  
**RC 60 UNIT** of 4 Mountings and all fittings.

"EQUIFLEX" special Damped Mountings as illustrated for Chassis Suspension can be obtained from your Radio Dealer. Loadings of these units are from 2 lb. to 12 lbs. Giving a choice of distributed loading of from 8 lbs. to 50 lbs. where a four Point-Suspension is used.

Ask to see these special Units at your Dealers.

### TYPICAL RADIO CHASSIS

Wholesale Distributors and Dealers write for Terms and Particulars. Export Enquiries Welcomed. Illustrated Brochure upon request.

Sole Manufacturers:

**A. WELLS & CO. LTD.,**

**PROGRESS WORKS, STIRLING RD., LONDON, E.17**

PHONE: LARKSWOOD 2691-4

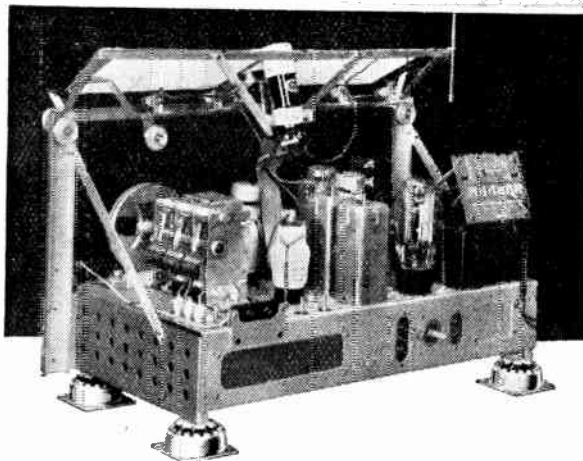
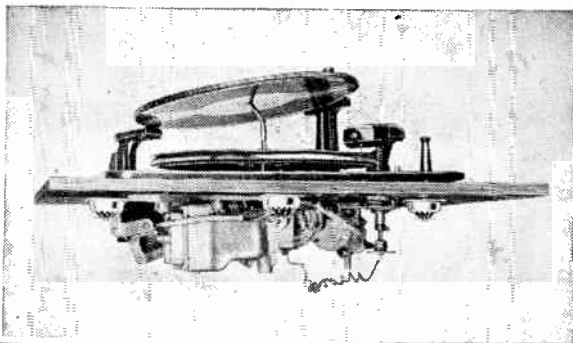

## Headphones which uphold British Prestige



TYPE "K."

**S. G. BROWN, Type 'K'**  
Moving Coil Headphones,  
supply that High Fidelity  
Reproduction demanded for  
DX work, monitoring and  
laboratory purposes, etc.

### OUTSTANDING CHARACTERISTICS.

D.C. RESISTANCE, 47 Ohms.  
IMPEDANCE, 52 Ohms at 1,000  
c.p.s.  
SENSITIVITY,  $1.2 \times 10^{-12}$  Watts  
at 1kc. = .0002 Dyne/cm<sup>2</sup>.

Descriptive Literature on request.

PRICE **£5.5.0** PER PAIR

Your Local Dealer can supply

For details of other S. G. Brown Headphones (prices from 30/- to 63/-) write for illustrated Brochure "W.W."

HEADPHONES WHICH UPHOLD BRITISH PRESTIGE

Telephone:  
Watford 7241

**S. G. Brown, Ltd.**

SHAKESPEARE STREET, WATFORD, HERTS.

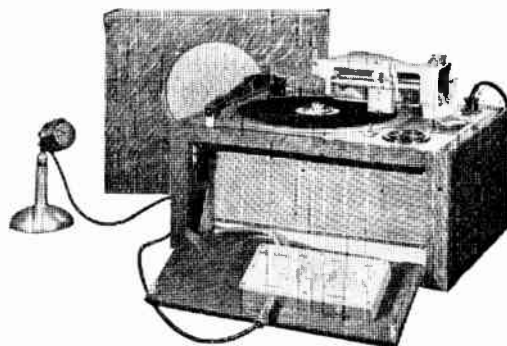

BROWN—E.R.D. 13 inch Portable Disc Recorder  
An important S. G. Brown product

# Brown-E.R.D.

## DISC RECORDER

Incorporating the latest advances  
in Sound-on-Disc Recording

Write for interesting brochures presenting full technical details of this latest development in Sound-on-Disc recording. Also 17 inch models for the Professional user.

**S. G. BROWN LTD., Shakespeare St., WATFORD**

Established in Electro Acoustics and high precision Engineering for over 40 years. Manufacturers of the world-famous 'BROWN' Gyro Compass.

Telephone: Watford 7241

# LONDON CENTRAL RADIO STORES

Government Surplus - Immediate Delivery from Stock

**NEW EX-NAVAL DOUBLE TWIN SLIDING AND TAPPED RESISTANCE**

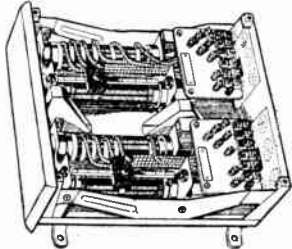

2,000 ohms, 0.2 amp. In metal cabinet ..... **38/6**

**NEW TAPPED VARIABLE RESISTANCE**  
200-250 v.

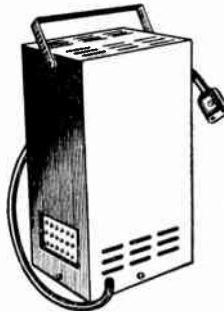

Tapped 500, 750, 1,000 wats. Complete with mains lead in crackle finish metal cabinet, 14in. x 8in. x 6in., with carrying handle. **47/6**

**EX-R.A.F. CINE CAMERA. Type G45B**  
To take 16 mm. film. Fixed focus lens approx. 5 cm.,  $f/3.5$ . The illustration shows loading chamber partly open. In metal case. Dimensions 12 x 3 1/2 x 2 1/2 in. With 12 v. motor drive ..... **£3**  
Spare small 24 v. Motors for above, 8/9



**PHOTO-ELECTRIC CELLS**  
Type GS16

These cells are the gas-filled type with caesium Cathode. Made by Cintel. Minimum sensitivity 100  $\mu$ A/lumen, working volts 100 D.C. or peak A.C. Projected cathode area 16 sq. cm. Suitable for 16 mm. Home Cinema Talkie equipment, Safety Devices, Colour and Photo Matching, Burglar Alarms, Automatic Counting, Door Opening, etc. Brand new in original cartons... **42/6**

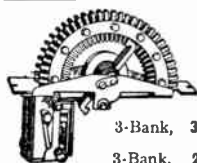

**TELEPHONE LINE OR UNI-SELECTOR SWITCHES**  
Brand New.

3-Bank, **38/6**. 5-Bank, **45/-**. Used  
3-Bank, **20/-**. 6-Bank, **25/-**

**RADAR VIEWING UNITS, Type 182A**

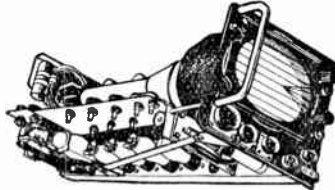

With 6in. VCR517 C.R. Tube, three EF50, four SP61, one 5U4 valves, 8 potentiometers, condensers, etc. Carr. and pkg. 7/6 ..... **37/6**

**MISCELLANEOUS BARGAINS**

**CO-AXIAL CABLE, 8/-**  
75 ohms, per doz. yds.  
**FIVE-WAY RUBBER COVERED CABLE.** Suitable for all purposes. Per doz. yds. .... **6/-**  
**EX-GOVT. 100ft. COPPER AERIALS,** ebonite chain insulators, 30ft. guy rope ..... **4/3**  
**2-VALVE UNIVERSAL RECEIVERS, Type 1125.** 13 v. heaters. Fixed Frequency. Less Power Pack .. **10/6**  
**MOVING COIL HAND MICROPHONE** ..... **5/6**  
**2-VOLT POWER PACKS,** complete with Vibrator. Output approx. 200 v. 60 mA. Size 9 x 5 x 3 1/2 in. A first-class job. **£1-17-6**

**VIBRATORS.** 2 v. input. Self-rectifying type. Output approx. 200 v., 60 mA. .... **7/6**

**SMALL SLIDING RESISTANCES**  
Ex-Admiralty. Finest quality. Suitable for Voltage Controls, Speed Regulators, 50 ohms, 0.5 amp. Dimensions 6in. x 4in. x 2 1/2 in. high. **8/6**

**7-VALVE U.H.F. RECEIVER**  
Type R1147A Range approx. 200 megacycles (with 4 Acorn valves). A Real Opportunity. Beautifully constructed and fitted with micro-condenser drive. Valve types: two EF36, one EBC33, three 954, one 955. In black metal case, 8 x 7 x 6 in. Set complete with ..... **£1-17-6**

**U.S. ARMY MIDGET LIGHT-WEIGHT HEADPHONES.** 200 ohms. Suitable for ..... **15/-**  
Deaf Aids

**3-VALVE R.F. AMPLIFIERS**  
V.H.F. Types 24 and 25. 40/50 mcs. Complete with 3 SP41 valves. In metal case. Slightly used but in perfect working order. Plus carriage & pkg. 1/6 **10/6**

**AZIMUTH RELEASE RELAY.**  
In glass fronted, cast aluminium case, size 12 x 4 x 2 in. Contains A.C. Relay, D.C. Relay, Alarm Relay, etc. .... **£2-7-6**  
Carr. 1/6.

**N.B.**—All carriage paid unless otherwise stated. We do not issue lists or catalogues. We have hundreds of items in stock too numerous to list. So when in Town pay us a visit.

**NEW 3-VALVE AMPLIFIER PANELS** With three 1T4 valves, condensers, etc. New spare valves for above **15/-**  
5/- each  
**NEW MILES H.T. UNITS**  
(Everlasting), 120 v. 600 mA. Will charge from 6 v. accumulator ..... **67/6**  
**CATHODE RAY TUBES.** Ex-Govt. 6in. VCR97 27/6; 6in. VCR517 22/6; 12in. VCR140 27/-; 12in. VCR511 27/-  
**METAL RECTIFIERS.** 15/-  
6 v. 2 1/2 amp.  
**EX-GOVT. TELEPHONE HAND-SETS.** Self-Energising. Needs no battery or current. Less Wall bracket. Each. **5/6**

**THE FAMOUS EDDYSTONE 355 COMMUNICATIONS RECEIVER.** Great Reduction in Price. Range 31 Mc/s to 90 kc/s, 9 Plug-in coils, 7 valves and rectifier, variable selectivity, B.F.O. stand-by switch, A.V.C. switch, band-spread dial, valve check meter. In heavy black crackle finished steel cabinet with chrome fittings. Complete with 200-250 v. A.C. Power Supply Unit. Carriage and packing 17/6 extra ..... **£20**

**R11-5 10-VALVE COMMUNICATIONS RECEIVERS.** These sets are as new. Freq. range 7.5 mc/s, 75 kc/s in five wavebands. Complete with 10 valves, including magic eye. Enclosed in metal case. Every receiver is aerial tested. Complete with Power Pack and Loud speaker, for A.C. mains 200-250 v. **£17**  
(Carr. and pkg. 10/6 extra)  
**FREE** with each receiver 1 Complete circuit, description and modifications for civil use, reprinted from "W.W." July, 1946.

**ROTHERMEL CRYSTAL MICROPHONE**  
This "Torpedo" model has a driver type of crystal element. A new method of suspension eliminates unwanted peaks and background noise. Sensitivity level is minus 54 D.B. Has high impedance of 30,000 ohms at 1,000 c/s. Frequency response is fairly flat from 30- to above 6,000 c/s. Dimens. **£3-19-6**  
8 1/2 x 3 1/2 in.

**R.A.F. 6-VALVE SUPERHET RECEIVING UNIT No. 25**

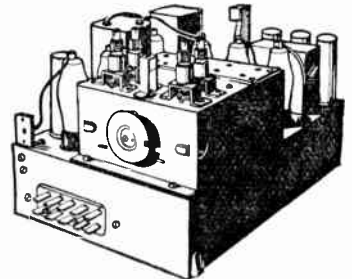

Easily adapted for short-wave reception for home use. Contains two EF36, two EF39, one EK32, one EBC33 valves, condensers, resistances etc. Free circuit diagram **25/-**

**1/30th H.P. AC/DC MOTORS**

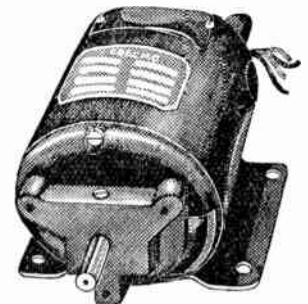

Double-ended spindles, 220-250 v. As illustrated ..... **57/6**

**1/30th H.P. A.C. MOTORS**

Double-ended spindles, 220-250 v. Without feet ..... **52/6**  
These motors are new, not surplus conversions and are suitable for 16 mm. projectors and many other purposes.

**WESTINGHOUSE METAL RECTIFIERS, Style LT42**

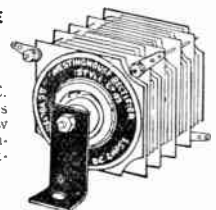

A.C. volts 11, D.C. volts 6, D.C. amps 1. Brand new condition. Complete with mounting bracket. **12/6**

**CHARGING BOARDS**  
Control Panels Only

24 v., 1,260 wats. Includes five 1 1/2 in. moving coil ammeters (1, 0-40 a., 4, 0-15 a.). One moving coil voltmeter 0-40 v. Five heavy duty sliding resistances, etc., complete in metal case as shown with fold-back doors. Size, 18 x 17 x 8 in. Offered at less than half the component value. Price, **£4-19-6**  
carriage extra.

**LONDON CENTRAL RADIO STORES, 23, LISLE ST. (GERard 2969) LONDON, W.C.2**

Closed Thursday 1 p.m. Open all day Saturday and weekdays 9 a.m.—6 p.m.

# TAYLOR FOR LASTING ACCURACY

COMPLETE RANGE OF PANEL INSTRUMENTS



**MODEL 500**  
Scale Length 5"



**MODEL 400**  
Scale Length 4"



**MODEL 350**  
Scale Length 3½"



**MODEL 200**  
Scale Length 1½"



**MODEL 415**  
Scale Length 4"



**MODEL 250**  
Scale Length 2½"

These panel instruments are available as moving coil, rectifier and thermo-couple types and cover a wide range of measurements. Series 350, 400, 415 and 500 are also available as moving iron instruments for use on A.C. or D.C.

**IMMEDIATE DELIVERY**  
of most types and ranges



Taylor Products Include :  
MULTIRANGE A.C. D.C. TEST METERS • SIGNAL GENERATORS • VALVE TESTERS • A.C. BRIDGES • CIRCUIT ANALYSERS • CATHODE RAY OSCILLOGRAPHS • HIGH AND LOW RANGE OHMMETERS • OUTPUT METERS • INSULATION TESTERS • MOVING COIL INSTRUMENTS

**TAYLOR ELECTRICAL INSTRUMENTS LTD.**  
419 - 424 MONTROSE AVENUE, SLOUGH, BUCKS, ENGLAND  
Telephone SLOUGH 21381 (4 lines) Grams & Cables "TAYLINS" SLOUGH

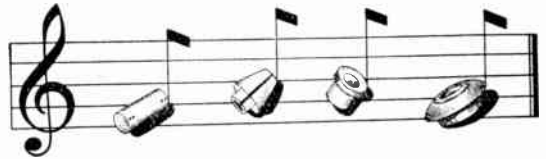

*make a note of Thompson's wood turnings*

If you have a special fitting in mind which you think could be made better, or more economically or quicker in wood ask Thompson's advice on it—wood-turnings for 1001 trades.

Any turning in any wood to engineers' precision standards from blueprints, drawings or samples.

## W. & J. R. THOMPSON

(WOODTURNERS) LIMITED. EST. 1862  
CROSS HILLS, KEIGHLEY, YORKSHIRE.

Phone: Crosshills 2312 (two lines)

Grams: Turnwood, Crosshills

### Transformers made to measure

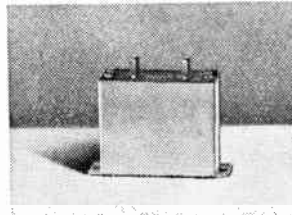

SAVAGE TRANSFORMERS are built to satisfy customer's individual requirements—they are *not* mass-produced. They are designed specially for the work they have to perform.

Every SAVAGE TRANSFORMER is subjected to exhaustive electrical and mechanical tests before despatch, to ensure years of faultless service. Available in all capacities up to 5kVA.

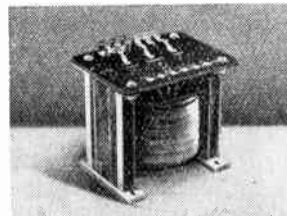

If yours is a TRANSFORMER PROBLEM—write to us. We can solve it. Please address technical enquiries personally to W. BRYAN SAVAGE

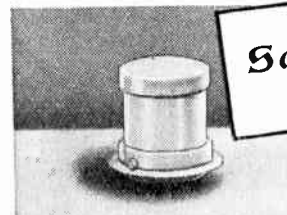

**Savage** TRANSFORMERS LTD  
OF *Devizes*

**SAVAGE TRANSFORMERS LTD.**  
NURSTEED ROAD, DEVIZES,  
WILTS.  
Telephone 536.

14128B

# The Rimington Jewel

*Will Revolutionise your Gramophone Reproduction*



Straight for Crystal pick-up only.



Lightweight for new miniature pick-up.



Trailer type for Heavier pick-up.

READERS of the *Wireless World* will be interested in the Rimington Jewel Needle. The sapphire or jewel-tipped needle invaded the gramophone market with the advent of the lightweight pick-up. We know that electrical recording has brought wonders to the gramophone world, and that its scope for development is unlimited. Many of us know, too, that the frequency range represented in the record according to the claims made by Manufacturers is up to 14,000 cycles per second, a phenomenal achievement.

The sapphire or jewel-tipped needle is an integral part of this progress because by its use the maximum recorded frequency range can be reproduced, and it is far more effective in every way than other types of needles. Space does not permit a lengthy article by me on this subject, but I am giving here illustrations of the Rimington Jewels and strongly advocate their use. Before introducing our jewel I submitted it to the eminent firm of Messrs. W. R. Prior and Co., Ltd., microscope manufacturers, of Bishops Stortford, who have stated that the sapphire is free from blemish and perfect in every detail. They further say that the angle is well set and that the angle is correct. I am fully satisfied that here is the best method I know, at the present time, of reproducing gramophone records—the Rimington Jewel will preserve them, for there is practically no record wear, and it will reveal to you, Listener, new beauties which you have heretofore unsuspected. FRED SMITH.

Numerous are the expressions of enthusiasm from delighted Users. Typical examples are from:

**Mr. W. F. George:** "I have no hesitation in describing it as the finest reproducing needle I have ever used in over 30 years' experience."

**Mr. J. G. Cook:** "I have used your jewel needle and find the results most satisfactory, and I would like to express my appreciation on your achievement."

**Mr. F. G. Wallace-Hadrill:** "I have found your claims to be wonderfully justified and I am completely satisfied with the needle."

**Mr. J. Dolphin:** "Will you please accept my grateful thanks for bringing your needle to my notice, for I know now that it is going to bring me many, many hours of pleasant listening."

**Order your Rimington Jewel Needle NOW and Revolutionise your Gramophone Reproduction.** Price 9/9 Postage 3d.

TRADE ENQUIRIES INVITED.

## RIMINGTONS

RIMINGTON, VAN WYCK LTD., 42-43 Cranbourn Street, London, W.C. 2 - - - Gerrard 1171  
RIMINGTON, VAN WYCK (Mail Order) LTD., 28a Devonshire Street, Marylebone, London: W.1 Welbeck 4695

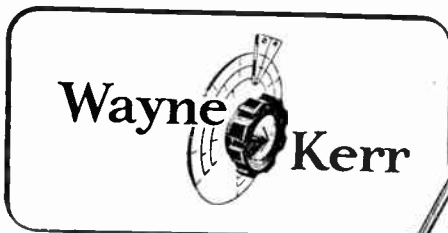

**I N D U C T A N C E M E T E R**

Designed to provide simple and direct reading measurement of inductance values between 0.05 microhenry and 100 millihenrys. A stable variable-frequency oscillator is used to resonate the unknown inductance with a fixed standard capacitor. Provision is made for the measurement of Q at resonance frequency.

Calibration and scale reading accuracy are sufficient to provide direct readings of inductance values within 2 per cent. above one microhenry. Relative measurement can be made with greater accuracy. The instrument is very compact, measuring only 7 1/4" high, 7 1/2" wide and 7 1/2" deep at base. PRICE £38.5.0

THE WAYNE KERR LABORATORIES LTD. NEW MALDEN SURREY · MALDEN 2202

*Compact-Efficient*

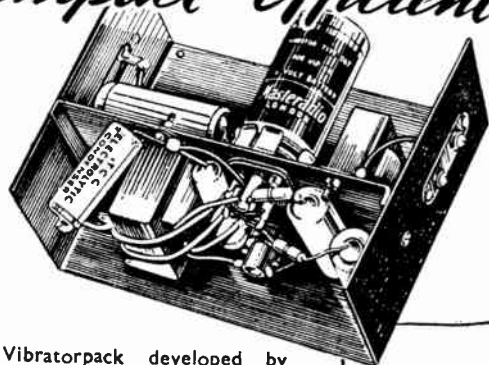

This Vibratorpack developed by Specialists will enable users of battery sets to operate from a 6-volt car accumulator, thus eliminating expensive H.T. battery replacements. Careful design has eliminated all interference. Consumption is less than 1/2 amp.

**SMALLER**  
than a H.T.  
Battery.  
Size: 7 x 5 1/2 x 3



**Masteradio  
VIBRATORPACK**

MASTERADIO LTD., Sales Dept., 19/32, Luston Road, London, N.V.1

*the finest in  
electronic valves*



*carry this emblem*

Supplied to ADA by R.C.A., ADA electron valves are designed to satisfy completely the requirements of radio receivers, service, amateur and laboratory equipment. Sturdily constructed and thoroughly tested, every ADA valve is guaranteed to give long, trouble-free use.

The ADA trademark is your assurance of dependable performance and durability.

- Other ADA products :  
Household and Commercial Refrigerators  
Radios and Components  
Home Appliances

**AD. AURIEMA, INC.** 89 Broad St., New York 4, N.Y., U.S.A.

Cable Address : AURIEMA, NEW YORK





# TELCON THERMOSTATIC BIMETALS

**A COMPLETE RANGE  
NOW AVAILABLE  
TO MEET ALL  
REQUIREMENTS**

### PHYSICAL CHARACTERISTICS OF AVAILABLE TYPES

TYPE	COMPOSITION		Deflection Constant* per °C. (d)	Resistivity microhms/cm. cube at 20°C.	Maximum Working Tem. °C.
	Low Expansion % Ni	High Expansion % Ni			
BIMETAL 140	38	20	14.0 x 10 <sup>-6</sup>	75	300
BIMETAL 160	36	20	15.6 x ..	78	250
BIMETAL 400	42	20	11.0 x ..	70	430
BIMETAL 15	36	100	9.7 x ..	15	200

\* The deflection constant (d) is defined as the deflection of a strip of unit length and unit thickness for each °C. rise in temperature over the linear part of the deflection curve.

Further details on application.



**THE TELEGRAPH CONSTRUCTION & MAINTENANCE CO. LTD.**

Head Office: 22 OLD BROAD STREET, LONDON, E.C.2. Telephone: LONdon Wall 3141  
Enquiries to: TELCON WORKS, GREENWICH, S.E.10. Telephone: GREenwich 3291\*



## READ THIS!

Something new to sell—showing a substantial profit margin . . . **THE HADLEY MULTICOM.** The only equipment of its kind to give complete loudspeaking intercommunication. The flick of a switch gives instant contact with any department. All departments can contact each other. All units identical and no larger than a telephone.

**EASY TO SELL. EASY TO INSTALL.**

Write for illustrated literature and details of trade terms.

**Hadley**

Sound

Equipments

Phone: BEARwood 2575/6

BEARWOOD ROAD, SMETHWICK, STAFFS.

All export enquiries to Charles Baglin, 411 Coventry Road, Birmingham, 10. Telegrams: Pentagons, Birmingham.

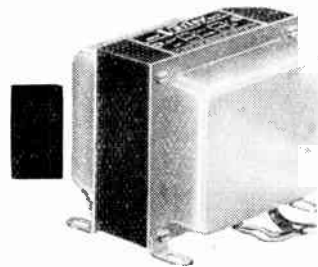

## MAINS TRANSFORMERS & CHOKES



All "Varley" products are manufactured from the highest quality materials.

Transformers etc., are individually wound and have interleaved windings with ample insulation, ensuring freedom from breakdown.

The comprehensive range of Shielded and Open type Transformers available meets the requirements of every circuit.

Write for list etc.

MADE BY

**OLIVER PELL CONTROL LTD**

CAMBRIDGE ROW · WOOLWICH · S·E·18

Telephone: WOOLWICH 1422

# HOARSE ORATOR MAKES REVOLUTIONARY SPEECH

SPEAKING to a colossal mob of Workers, Industrialists, Non-Workers, Bloated Capitalists, de-bloated Capitalists, two small boys and a stray dog, our Managing Directorsaid:

This nation never did nor never shall (' Two negatives make an infirmity ' said one of the small boys) lie at the foot of a proud conqueror. In this hour of stress we must strike the overall target with a wide margin in hand. This can only be done by applying horse-sense to production methods and thus ironing out far-reaching bottlenecks. Let us leave no plants unturned. Let us . . . .

"Who is he?" asked a Big Industrialist. "I think he's an ex-Artificial Limb Manufacturer, trying to earn an honest living" replied a Well-Spoken Worker. "Shoot him" cried a Rather Dirty Man waving a large sickle.

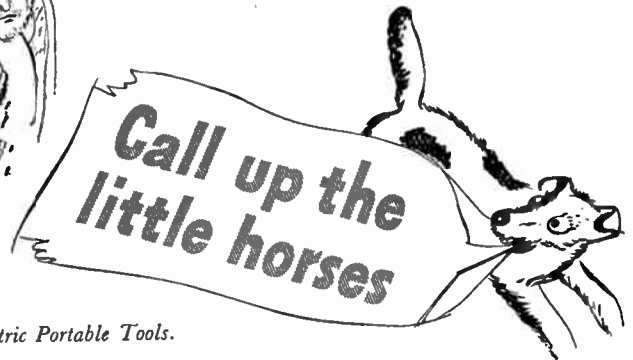
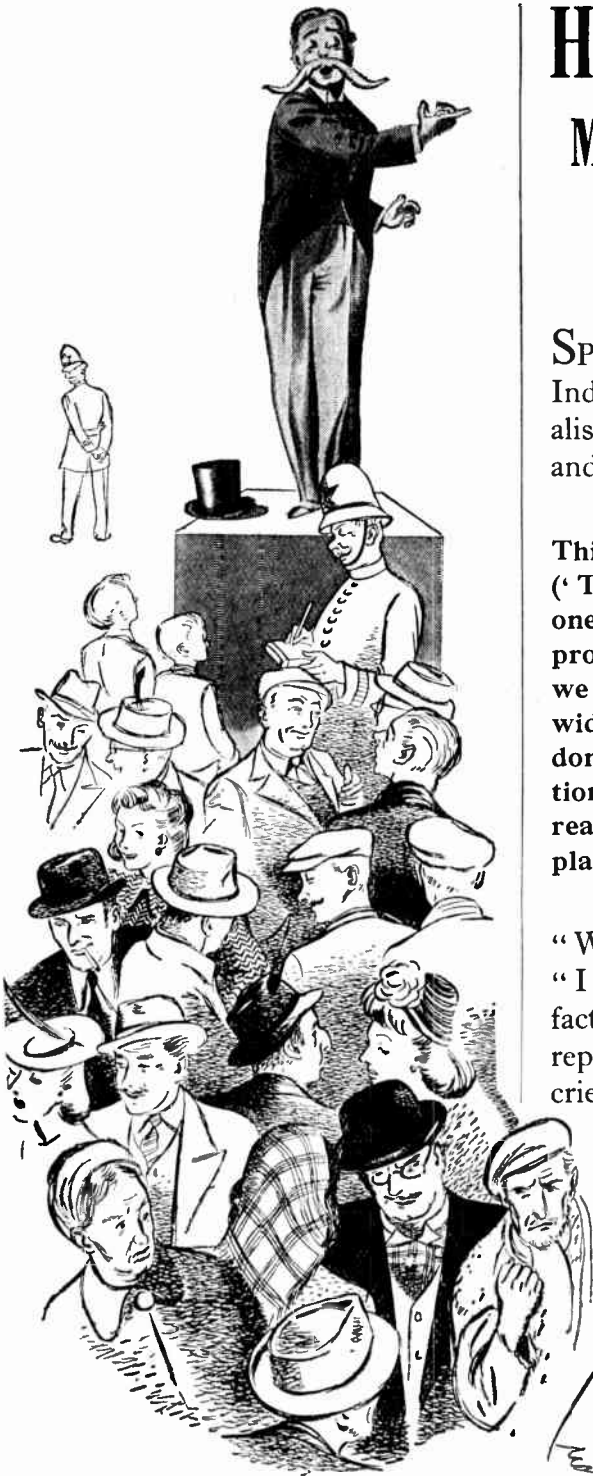

*Specialists in Lightweight, Pneumatic and Electric Portable Tools.*

# Keeping the gap under control...



"The Story of Co-Axial Construction" explains how our speakers are built. We will gladly send a copy to any manufacturer or overseas buyer who writes for one.

Nothing short of the proverbial sledge hammer will disturb the alignment or alter the clearance between the inner and outer poles in the R. & A. "700" Series speaker. With co-axial construction R. & A. have produced a Reproducer entirely free from the mechanical weaknesses found in loudspeakers generally. The essence of this design is the extreme accuracy of alignment along the central axis of the speaker. The R. & A. "700" Series are precision components, sensitive yet strong, simple yet foolproof. A phenomenal development keeping pace with the past achievements of the R. & A. technicians. Co-axial construction is covered by British Patents and Foreign Patent Applications.

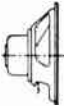

REPRODUCERS AND AMPLIFIERS LIMITED  
FREDERICK ST. WOLVERHAMPTON ENGLAND  
Telephone Wolverhampton 22241  
Telegrams "Audio Wolverhampton"



## MODERN SERVICING METHOD

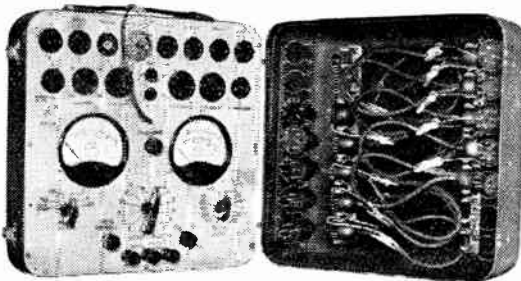

The "L.S.L." Servicing Method is a combined fault analyser and circuit tester; simultaneously capable of indicating all voltage, current and resistance on each valve electrode without removing the chassis from the cabinet. Readings can be taken whilst the set is under actual operating conditions. The "L.S.L." Analyser is a combination of multi-range instrument and valve tester.

PRICE: £18. 18. 0 Subject.

## THE "LSL" PORTABLE ANALYSER

- ★ Saves time and trouble.
- ★ Greatly increases Profit in the Service Department.
- ★ Is portable, can be used on the bench or in the home.
- ★ Is simple to operate.

Send for further particulars from the sole distributors:



WARTON ROAD, STRATFORD, LONDON, E.15.  
Telephone: Maryland 6611 AND BRANCHES  
Export Address: 23-26 St. DUNSTONS HILL, E.C.1

## THE NEW "ACRU 24"

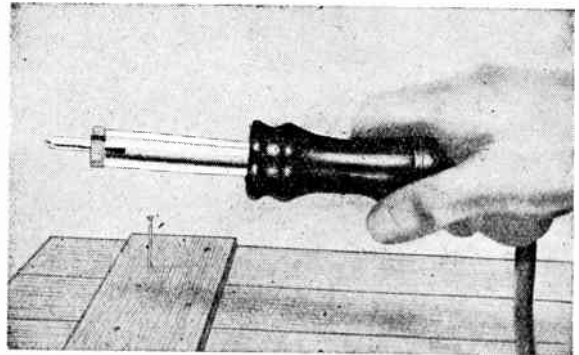

## ELECTRIC SOLDERING IRON ... is CRASHPROOF!

... could even be used as a hammer without harm.

Element of unique construction; totally enclosed; wound on steel tube with air-tight, die-cast case; withstands the roughest treatment without damage. Instantly detachable and interchangeable copper bits with cam locking.

Ask your Radio Dealer or write direct for full details.

## THE ACRU ELECTRIC TOOL MFG. CO. LTD.

123 HYDE ROAD, ARDWICK, MANCHESTER, 12.  
Phone: ARDWICK 4284.

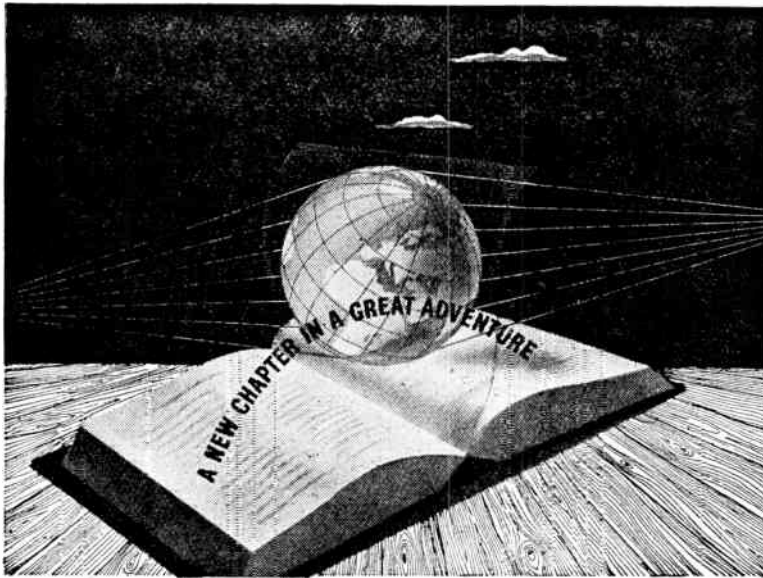

From the first great adventure of wireless communication half a century ago, the story of Marconi has been one of successive achievement. Wireless telegraphy, wireless telephony, broadcasting, television, radar, wireless navigational aids at sea, on land, and in the air — Marconi's have played a pioneer part in their development. With a vast accumulation of knowledge and experience behind them, Marconi's are now engaged on new developments which will more than maintain their shining reputation.

# Marconi

THE GREATEST NAME IN WIRELESS



MARCONI'S WIRELESS TELEGRAPH COMPANY LIMITED, MARCONI HOUSE, CHELMSFORD, ESSEX

## OF SPECIAL INTEREST TO QUALITY ENTHUSIASTS

### LOUDSPEAKERS

#### WEARFEDALE

Golden 10in. P.M. 12,500 lines, 2/3 ohms or 12/15 ohms, 8 watts max., 70 to 10,000 cps. Price £3/15/-.

W10/C/S. 10in. P.M. 14,000 lines, 2/3 ohms or 12/15 ohms, 5 watts max., 65 to 18,000 cps. Price £7.

W12. 12in. P.M. 13,000 lines, 15 ohms, 15 watts, max. BASS resonance 65 cps.

W12 C/S. 12in. P.M. Similar to W12, but cone fitted with cloth suspension, giving improved extreme treble and bass response. Recommended for use in acoustic chamber in conjunction with W10C/S speaker and cross-over unit.

W15 C/S. 15in. P.M. Fitted with cone with cloth suspension. 13,500 lines. Resonance 25/30 cps., 15 watts max. Ideal for use in acoustic chamber with W10C/S and cross-over unit.

**WEARFEDALE LOUDSPEAKER SEPARATOR UNIT.** Divides the Bass or Treble between two speakers of similar impedance. Prevents distortion of upper register when reproducing full bass. Cross-over at 1,000 cps. Two 15 ohm speakers will match into 15 ohm load. Two 3 ohm speakers match into 6 ohm load. Price £3/5/-. Send for free leaflet giving full details and response curves of these and other loudspeakers and Wearfedale accessories. Leaflet available on the latest design of bass reflex cabinet using W15/C/S unit. W10/C/S unit and separator.

"LOUDSPEAKERS" by G. A. Briggs. Giving up-to-date information about loudspeakers, acoustic loading and many other problems relating to Quality Reproduction. Makes excellent reading as well as being a mine of information. Price 5/6 post free.

### LIGHTWEIGHT PICK-UPS

**LExINGTON SENIOR.** Moving Coil. Complete with sapphire, automatic needle extractors and inserter, matching transformer in muntal box and instruction manual with pre-amplifier circuit. Price £9/14/7.

**SPEEDY POSTAL SERVICE C.W.O. or C.O.D.**

**MARCONI "14."** Miniature Moving Iron. Complete with transformer and instructions. Uses H.M.V. Silent Stylus, miniature fibre or sapphire needles. Price £4/16/8.

**CONNOISSEUR.** Miniature Moving Iron. Complete with transformer and instructions. Price £4/10/4.

**GOLDBRING.** Needle Armature type with permanent sapphire. Price £3/5/-.

**S.E.I.** Miniature high output moving coil. Uses Silent Stylus or similar needles. This pick-up will fully load a good domestic receiver. Complete with matching transformer. Price £3/10/0.

**ROTHERMEL.** Senior Crystal. Price £3/4/2.

**COSMOCORD.** G.P.10. Crystal. Price £2/12/-.

### OUTPUT TRANSFORMERS

**GARDNEFS OP750.** Special high-fidelity transformer for Single PX4 or PX25 class valve. Primary, 3,800 ohms. Secondary, 0-2.5/5/7.5/15 ohms. Price £2/0/4.

**OP750.** Special high fidelity transformer for two PX4 class valves in push pull. Primary, 6,000 ohms. Secondary, 0-2.5/5/7.5/15 ohms. Price £2/6/0.

**OP750.** Special high fidelity transformer for two PX25 class valves in push pull. Primary, 6,000 ohms. Secondary, 0-2.5/5/7.5/15 ohms. Price £2/9/6.

**SOUND SALES X038.** Suitable for PX4 or PX25 valves in push pull. Response substantially level from 20 to 20,000 cps. Primary Inductances, 77 henries—tapped for 10,000 ohms and 6,400 ohms. Secondary, 0-6/15 ohms. Price £2/8/9.

### OUTPUT VALVES

PX4's, PP3/250's, ACO44's (all equivalents) matched pairs, £1/13/-.

Tungarans P27/500's (equivalent to PX25) matched pairs, £2/5/-.

Marconi/Osram KT66's matched pairs, £1/16/6.

When sending C.W.O. please include sufficient extra for post and packing.

## VALLANCE & DAVISON LTD.

Staff Call Signs :  
G2HHV, G3ABD.

W.W. Dept., 144, BRIGGATE, LEEDS, 1.

Phone  
29428/9.

# Optimum Characteristics from this EFFICIENT DOUBLE-TRIODE

## A FEW OF THE APPLICATIONS OF THE MULLARD ECC33

- ★ Counting and Scaling
- ★ Photocell Amplifiers
- ★ Balanced Bridges
- ★ Multi-Vibrators
- ★ Motor Control Circuits
- ★ Watt and Power Factor Meters
- ★ Voltage Control Circuits
- ★ Time Delay Circuits
- ★ Relay Circuits
- ★ R.C. Oscillators
- ★ Coincidence Circuits
- ★ Pulse Shaping Circuits

### ECC33 VALVE DATA

Heater Voltage	- - - - -	6.3V
Heater Current	- - - - -	0.4A
Anode Voltage	- - - - -	250V
Anode Current	- - - - -	9mA
Anode Resistance	- - - - -	9,700 ohms.
Mutual Conductance	- - - - -	3.6mA/V
Amplification Factor	- - - - -	35



Please write to Transmitting & Industrial Valve Dept. for full technical details of this and other double-triodes in the Mullard range.

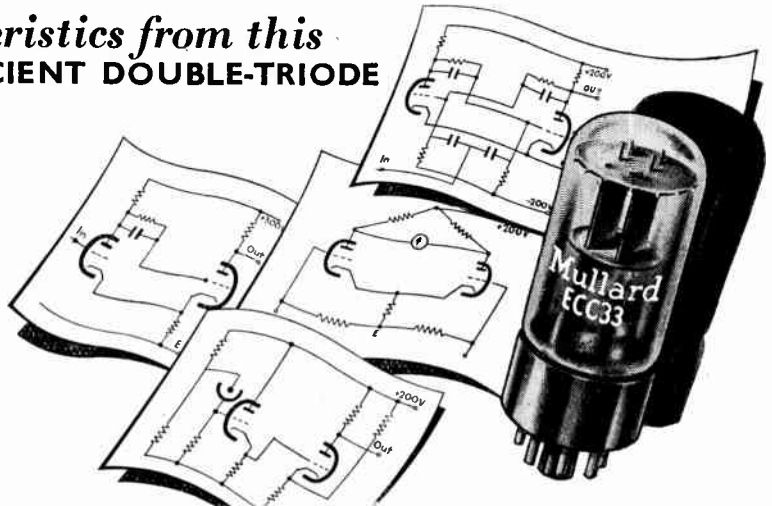

The combination of medium/low anode resistance, high working current, high slope and low heater current, make this new Mullard double-triode an ideal valve for an unusually large number of functions. One practical advantage of this versatility is that it is often possible for the one type of valve to be used throughout an equipment with obvious economies in design and maintenance. Manufacturers of electronic counters will especially appreciate the low heater current and G.T. size, whilst designers of industrial control equipment will welcome the series arrangement of the heaters.

## Mullard THERMIONIC VALVES & ELECTRON TUBES

MULLARD ELECTRONIC PRODUCTS LIMITED, CENTURY HOUSE, SHAFTESBURY AVENUE, LONDON, W.C.2  
MVT38G

## STEWART TRANSFORMERS

TRANSFORMERS  
AND CHOKES FOR  
EVERY  
PURPOSE  
DESIGNED  
FOR THE JOB.

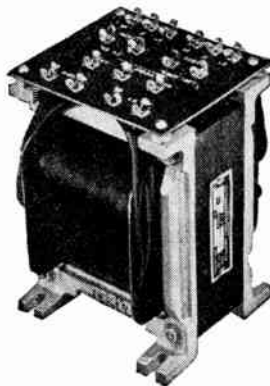

● For Radio and Television up to 10 k.v. and for instruments and Audio Frequency apparatus. Industrial Types up to 20 k.v.a.

● Ex Stock: Transformers and Chokes for "Electronic Engineering" Televisor.

**STEWART TRANSFORMERS Ltd.**  
1021 FINCHLEY RD., LONDON, N.W.11

Tel.: SPEedwell 3000 and 3533

## Wolsey TELEVISION AERIALS

SIX TYPES SUITABLE FOR ALL  
MAKES OF RECEIVERS AND FOR  
ALL LOCAL CONDITIONS

Wolsey Television Aerials combine all essentials for efficiency—quality materials, sound construction, lightness of weight with rigidity, waterproof joints, simple and secure fitting.

Model H/M, illustrated, constructed with steel tubing, zinc plated. Masthead cup fitting for pole mounting. Aerial and Reflector elements of Duralumin. P.V.C. waterproof and weather-resisting fittings at joints. Reflector spaced at  $\frac{1}{4}$ th wavelength and suitable where maximum signal strength is required, or for reduction of severe interference in Town **67/6** areas. Weight under 4lb. AERIAL, **67/6**

Lashings and Pole extra, 60/6

NEW TRIPLE REFLECTOR ARRAY, for use in areas on fringe of or beyond normal transmission limits, **£6.15.0**

SEND FOR BROCHURES describing full range, also giving details of our Television Aerial Installation Service.

### WOLSEY TELEVISION LTD.

75 GRESHAM ROAD, BRIXTON, LONDON, S.W.13  
BRIXTON 6651/2  
Established 1934

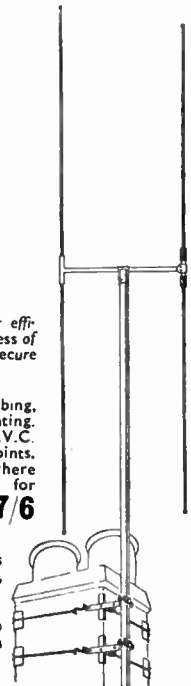

EDX.16'

# The best- HIGH and LOW



# Exide

L.T. ACCUMULATORS  
and  
**Drydex**  
H.T. BATTERIES

for better  
battery radio reception

ISSUED BY THE CHLORIDE ELECTRICAL STORAGE COMPANY LIMITED



## PICK-UPS for Quality Reproduction

### MAGNETIC TYPES GP 6 & GP 7



A modest priced moving-iron instrument with outstanding performance; output .36v.; range 100-4,500 c/s.; needle pressure 2 oz. (adjustable). The GP 7 head for replacing acoustic sound boxes has similar characteristics.

GP 6, Price 27/- plus Tax;  
GP 7, Price 21/- plus Tax

### CRYSTAL TYPE GP 10

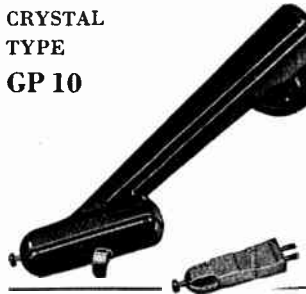

With an output of 1.7 v. at 1,000 c/s., range 70-8,000 c/s., this instrument combines great robustness with the enhanced performance of a well-designed crystal pick-up. The "acos" patented assembly makes the crystal unbreakable.

GP 10, Price 36/- plus Tax

### HIGH FIDELITY CRYSTAL TYPE GP 12



A model of exceptional performance for the connoisseur. With permanent sapphire stylus capable of 5,000 playings; output 1 v. at 1,000 c/s., range 30-14,000 c/s., needle pressure 22 gms.

GP 12, Price 72/- plus Tax

★ Post this coupon for informative folders

to **COSMOCORD LTD.**  
ENFIELD MIDDLESEX

Name .....

Address .....

W.W. 349 .....



**DIRECT CURRENT to RADIO FREQUENCY**  
*The only oscilloscope combining . . .*



- Linear Response from Zero Frequency (DC) to Radio Frequency (0-100 k/c.)
- High Deflection Sensitivity on both axes (70 mV. cm.)
- Complete freedom from amplifier drift under D.C. conditions.
- Absolute independence of controls.
- Perfect synchronising at all Frequencies.
- True portability (weight only 18lbs.)
- Price **£32.0.0**
- Six months guarantee.

Model 1400 B Visual Alignment Signal Generator shows the shape and characteristics of a tuned circuit response curve on the oscilloscope screen. Perfect Alignment of I.F. or R.F. circuits is easily accomplished without an additional signal generator.

Price **£8. 10. 0**

Write for Specifications

**INDUSTRIAL ELECTRONICS**

99, Gray's Inn Road, London, W.C.1.

Tel.: HOLborn 9873/4.

Makers of Precision Instruments.

**The DENCO RANGE**

now includes

(SEND 9d FOR DETAILED CATALOGUE)

- DCR.19 Communication Receiver ..... £49 10 0  
(Delivery 8-10 weeks) (No Purchase Tax).
- DR.21 5-valve Luxury Broadcast. 5-band Superhet ..... £20 12 6  
Tax £4 8 3
- DR.23 "Dencadet" compact. 4-valve AC/DC Superhet ..... £10 14 8  
Tax £2 5 9
- DR.21U KIT, for a luxury 5-valve. 5 Band chassis ..... £11 11 0  
Tax £2 9 5
- CT.4 Super 6 Band Turret tuning Unit for Communication Receiver ..... £10 10 0  
Tax £2 4 11
- CT.4/C As above, but with RF mixer and oscillator sub-chassis ..... £13 1 0  
Tax £2 15 0
- CT.4/SW As CT.4 but no MW/LW ..... £9 6 0  
No Tax
- CT.6. The well-known 5 Band complete Turret Tuning Unit. Mixer/Osc. .... £4 19 6  
Tax £1 1 3
- CT.7 Luxury Broadcast Turret. Like CT.6 but with RF stage ..... £7 2 6  
Tax £1 10 6

"MAXI-Q" COILS. (a coil for every purpose) and further well-designed components.

Send to:

**DENCO (CLACTON) LTD., OLD ROAD, CLACTON, ESSEX**

or London Area (including Trade)

**DENCO DISTRIBUTORS, 115 FLEET STREET, E.C.4**

**COMMUNICATION RECEIVERS**  
**RADIOMART**

Offer the following Communication Receivers all in First Class Condition

Secure Yours Now!

RCA AR88. 115 v. or 230 v. cy. input. Freq. coverage 75-350 kc/s., 1.5-30 mc/s ..... £39 15 0

NATIONAL HRO Senior. Complete with 230 v. power supply and 4 coils covering 1.7-30 mc/s. (A few extra coils available) ... £37 10 0

NATIONAL HRO Junior. Complete with 230 v. power supply and 4 coils covering 1.7-30 mc/s in crackle finish coil container. (A few extra coils available) ... £25 0 0

NATIONAL NC120. 115 v. power supply. Requires auto trans. for 230 v. operation. Freq. coverage, 5 wavebands switched 3-16.0 mc/s £30 0 0

EDDYSTONE 358. Complete with 7 coils. Requires separate power pack to give 6.3 amp. L.F. and 300 v. 100 m/A H.T. (We can supply power pack components if required)... £22 10 0

Full range of Raymart Quality components now available. Send 2½d. for lists

**RAYMART**

Quality Components

Vacancies are available for representation in a number of towns throughout the British Isles. Applicants should state date established.

Apply to address below

**RADIOMART**  
— CHINEE GRAM LTD. —

**48, HOLLOWAY HEAD, BIRMINGHAM, 1**

Tel.: Midland 3254

**ANNOUNCEMENT**

Will clients kindly note that we are now established at more commodious and up-to-date premises and our address is now:—

**ETA TOOL CO**

(LEICESTER) LTD.

ETA WORKS

**29a, WELFORD ROAD, LEICESTER**

PHONE: 5386

**SOLE AGENTS ABROAD**

K. G. Khosla & Co., 22, School Lane, New Delhi, India.

Etablis Octave Houart, 14, Quai de L'Industrie, Sclessin-lez-Liege.

J.P. Fielding Co. (Canada) 131 Ontario Street, St. Catharines, Ontario.

Heftye & Frogg, Oslo, Norway, Storgaten, 15,



# EDDYSTONE and the AMATEUR

## CERAMIC MICRODENSERS

The Eddystone Ceramic Microdenser is made to a rigid specification and possesses the essential features called for in a variable condenser used in modern equipment.

The fourteen different types available (listed below) include sizes for almost every amateur requirement—HF or VHF. Those marked with an asterisk have a vane spacing of .030 inches or more and are suitable for transmitting purposes.

The ceramic end plate is  $1\frac{3}{8}$ " square—hence comparatively little mounting space is required. The vanes are soldered to their supports and all metal-work is heavily silver-plated. All except two are single-hole mounting. The spindle is extended at the rear for ganging purposes (Cat. No. 738 excepted).

Cat. No. 580*	12.5 pF single	6/-	Cat. No. 476	15x15 pF Split-Stator	7/3
588*	27.5 pF "	7/3	583	25x25 pF " "	7/6
589*	54 pF "	7/3	739*	8x8 pF Butterfly	7/-
582	60 pF "	7/-	587*	15x15 pF "	8/-
581	60 pF "	6/6	584	34x34 pF "	7/9
	(trimmer type)		719	25x25 pF Differential	7/6
585	100 pF "	7/6	738*	100pF High Stability	15/-
586	140 pF "	7/9			

\* POSSESSES INCREASED VANE SPACING.

The new illustrated Eddystone Catalogue (price 6d.) gives further details. Please order from your nearest agent—we do not supply direct.

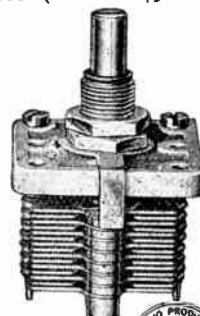

**EDDYSTONE** "Puts Perfection into Performance"



### STRATTON & Co., LTD

EDDYSTONE WORKS · WEST HEATH · BIRMINGHAM, 31



# A New Range of E.H.T. TRANSFORMERS

by GARDNERS

IN presenting the new standard range of "Somerford" Hermetically Sealed E.H.T. Transformers, we are offering you years of specialised research on the design of transformers for high voltage low current power supplies.

A unique method of hermetic sealing permits the use of a fluid insulation, which eliminates minor sources of corona discharge within the transformer, prolonging its life indefinitely.

The transformers are available in ratings of 1000-5000 volts at 5 mA with appropriate rectifier and cathode ray tube heater windings, and are suitable for both positive and negative D.C. supplies. The containers are finished in stove enamel for tropical use and are suitable for inverted mounting.

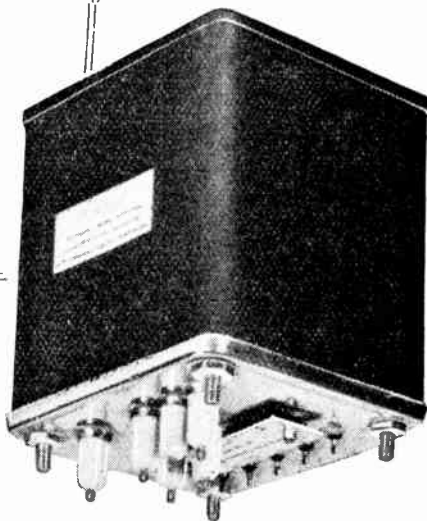

Please send for leaflet giving types available for prompt delivery.

# GARDNERS RADIO Ltd

SOMERFORD : CHRISTCHURCH : HANTS

# Presenting...

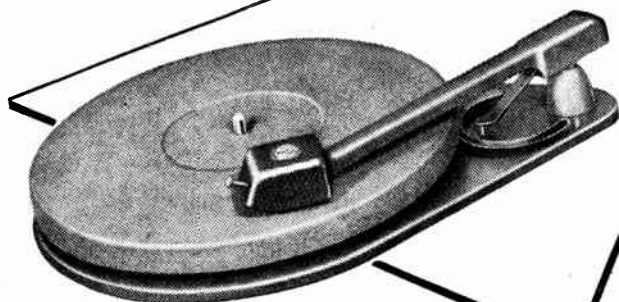

## NEW MOTOR UNIT TYPE G.U.2

- ★ The B.S.R. Gramophone Unit sets a high standard in design and production skill at an attractive price.

The finish and presentation of the G.U.2 are of a new conception, departing entirely from the dowdy colours of the past.

Two models are available for set makers and home constructors :

G.U.2 complete, Unit Plate and Pick-up . . . . . £3 17s. 6d., plus £1 3s. 2d. tax

T.U.2 Gramophone Motor and Turntable only . . . . . £2 5s. 0d., plus 19s. 3d. tax

- ★ THE PICK-UP

High output magnetic unit.  
 Correct Tracking Angle.  
 Smooth even response.  
 New Polymerised Chloroprene damping material.  
 No perishable or age-hardening materials.  
 Withstands tropical conditions.  
 Weight at needle point, 2 oz.  
 Reduced record wear with standard needles.  
 Superb tonal quality.  
 Highly attractive tone arm.

- ★ THE MOTOR

A two-pole induction type of new design.  
 High torque and speed constancy.  
 Free from "wow."  
 Silent in operation.  
 Vibration-free mounting by double mechanical filtering.  
 Re-designed, adjustable auto-stop.  
 Precision machined die-castings.  
 Self-oiling Compo bearings.  
 Turntable: machine turned die-casting cushioned with velvet soft flock.



### Birmingham Sound Reproducers Ltd.

Claremont Works, Old Hill, Staffs. Phone Cradley Heath 6212/3.

# Wireless World

RADIO AND ELECTRONICS

MARCH

1949

38th YEAR OF PUBLICATION

Proprietors: ILIFFE & SONS LTD.  
 Managing Editor: HUGH S. POCOCK, M.I.E.E.  
 Editor: H. F. SMITH

Editorial, Advertising and Publishing Offices:  
 DORSET HOUSE, STAMFORD STREET,  
 LONDON, S.E.1.

Telephone: Waterlooo 3333 (60 lines).  
 Telegrams: "Echaworld, Sedist, London."

PUBLISHED MONTHLY

Price: 2-

(Publication date 26th of preceding month)

Subscription Rate: 26/- per annum. Home and Abroad

Branch Offices:

Birmingham: King Edward House, New Street, 2.  
 Coventry: 8-10, Corporation Street.  
 Glasgow: 26B, Renfield Street, C.2.  
 Manchester: 260, Deansgate, 3.

## In This Issue

OUR COVER: G.P.O. Receiving Centre, Burnham (See Page 96)

EDITORIAL COMMENT .. .. .	81
P.C.M. By Thomas Roddam .. .. .	82
TELEVISION "GOODNESS FACTOR" By R. W. Hallows ..	87
SINGLE SIDEBAND RADIO-TELEPHONY By H. D. B. Kirby	90
CARONIA RADIO EQUIPMENT .. .. .	91
ELECTRONIC CIRCUITRY By J. McG. Sowerby .. .. .	92
MIDGET A.C. MAINS RECEIVER By S. W. Amos .. .. .	94
SUPERHETERODYNE TELEVISION UNIT (Concluded) ..	97
SHORT-WAVE CONDITIONS .. .. .	102
VOIGT PERMANENT-MAGNET LOUDSPEAKER .. .. .	103
WORLD OF WIRELESS .. .. .	104
RANGE OF V.H.F. By M. V. Callendar .. .. .	107
THÉVENIN'S THEOREM By "Cathode Ray" .. .. .	109
CLASSIFICATION OF BROADCAST AERIALS .. .. .	113
UNBIASED By "Free Grid" .. .. .	114
LETTERS TO THE EDITOR .. .. .	115
RANDOM RADIATIONS By "Diallist" .. .. .	118
RECENT INVENTIONS .. .. .	120

2845



# New Approach COMPONENTS

Keeping abreast of fast-moving technical development calls for a new approach to production problems. The "WEARITE" Pressed Circuit System represents a substantial advance in production science to speed assembly and lower costs. The first of these "Wearite" New Approach Components is a Coil Pack comprising coils, switches, trimmers and padders completely wired and ready for instant incorporation into any standard Superhet circuit.

Sides removed for clarity of illustration

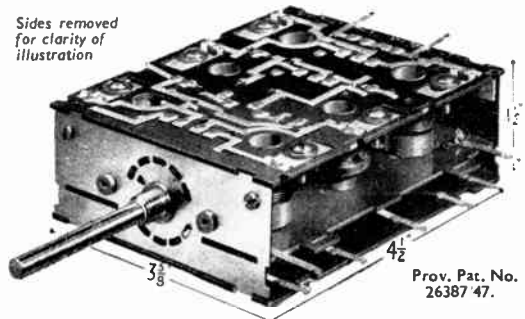

Prov. Pat. No. 26387/47.

- 3 ranges
- Gram switching
- 2-hole fixing at 1 5/8" centres
- All trimmers and adjusters conveniently placed in one surface

Manufacturers are urged to write for full technical details.

Owing to raw material restrictions supplies, for the time being, are confined to Radio Receiver Manufacturers at home and abroad.

# Wright and Weaire Limited

138, SLOANE ST. · LONDON · S.W.1 TEL SLOANE 22145 · FACTORY: SOUTH SHIELDS, CO. DURHAM



## Valves and their applications

### EC91 GROUNDED-GRID AMPLIFIER

The sensitivity of a V.H.F. receiver is largely determined by the first valve. In most cases the design is a compromise between good performance and simplicity of construction, and a circuit which

meets both requirements is of great value. In this respect the EC91 grounded-grid triode is a very useful valve in the 100-250 Mc/s frequency range.

The signal-to-noise ratio which can be obtained in a receiver with a given signal voltage at the aerial terminals is limited by two factors, receiver noise and noise radiation external to the receiver. At frequencies up to 90 Mc/s the external noise level due to atmospheric interference or noise radiation from the Milky Way is relatively high and only a small increase in signal-to-noise ratio can be achieved by reducing the receiver noise below that of a modern high-frequency pentode such as the EF91 or the EF42. At higher frequencies, however, the receiver noise becomes progressively more important and improvements in the receiver will give an effective increase in signal-to-noise ratio.

The receiver noise at V.H.F. is almost entirely dependent on the equivalent noise resistance and input impedance of the first valve. The triode is superior to the pentode because (a) partition noise (due to random current division between screen-grid and anode) is absent, (b) negative feedback by an impedance in the cathode circuit has little effect on the signal-to-noise ratio, and (c) the signal-to-noise ratio is less critically dependent on the aerial coupling.

Various circuits have been devised to make a triode amplifier stable at high frequencies, and of these the most simple is the grounded-grid circuit in which the grid is used as a screen between input and output. The EC91 miniature triode (B7C base) has been designed for grounded-grid operation and is particularly suitable for the frequency range 100-250 Mc/s. Its static characteristics are summarised below:

$V_h$	6.3V	$V_a$	250V	$r_a$	12,000 $\Omega$
$I_h$	0.3A	$V_g$	-1.5V	$R_{eq}$	400 $\Omega$
$c_{a-g}$	2.5 $\mu\text{F}$	$I_a$	10mA	$w_a \text{ max}$	2.5W
$c_{a-k+h}$	<0.2 $\mu\text{F}$	$g_m$	8.5mA/V	$I_k \text{ max}$	15mA
$c_{g-k+h}$	8.5 $\mu\text{F}$	$\mu$	100		

The feedback input impedance of a grounded-grid amplifier is approximately  $1/g_m$  when the load resistance is small. The input circuit may therefore have a very wide bandwidth (about 100 Mc/s) without the deterioration in signal-to-noise ratio which a damping resistor would produce. The receiver construction may be simplified by leaving the input circuit tuned approximately to the centre of the frequency range. The signal-to-noise ratio is not critically dependent upon the aerial coupling.

A typical EC91 circuit which has been used at 180 Mc/s is shown in figure 1. The aerial tap is about 2/3 of the tuning coil for an 80-ohm source. The measured sensitivity (for unity signal-to-noise ratio) expressed as an open-circuit signal voltage at the aerial terminals was  $3.5 \sqrt{\Delta f} \mu\text{V}$  where  $\Delta f$  is the bandwidth in Mc/s. This figure was measured at the output of the last intermediate-frequency amplifier.

It may be noted in conclusion that a grounded-grid EC91 provides a satisfactory input circuit for a 90 Mc/s AM/FM receiver for the reception of the B.B.C.'s experimental transmissions.

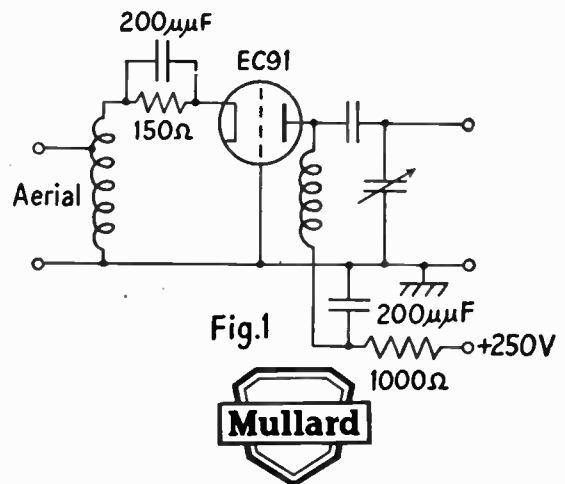

Reprints of this report from the Mullard Laboratories together with additional circuit notes can be obtained free of charge from the address below.

**MULLARD ELECTRONIC PRODUCTS LTD.,  
TECHNICAL PUBLICATIONS DEPARTMENT,  
CENTURY HOUSE, SHAFTESBURY AVE., W.C.2**

(MVM86)

# Wireless World

VOL. LV. NO. 3

MARCH 1949

RADIO AND ELECTRONICS

## *Comments of the Month*

**INTERNATIONAL TELEVISION STANDARDS** LESS than six months ago the Post Office, the Television Advisory Committee and the Radio Industry Council affirmed with complete unanimity their faith in the B.B.C. 405-line television standards and stated that the British system was to remain unchanged for a number of years. At the same time, strong hopes were expressed that these standards might be accepted to some extent internationally, it only for Western Europe. The advantages of doing this from the point of view of international programme exchanges are self-evident. Equally obvious are the benefits likely to accrue to industry through a form of standardization that would facilitate export trade.

Unfortunately, we are forced to admit that the efforts made in so many quarters to gain international acceptance of these ideas have so far failed. The French have adopted an 819-line system, while other countries are obviously inclining towards a considerably greater number of lines than in the B.B.C. system. Facing this, the British radio industry has evidently decided, if there cannot be a 405-line international standard, it is better to have some kind of standard. As a result, consultations have been held, and an agreement was announced between the main British manufacturers of transmitting equipment and the Dutch firm of Philips. Later, one of the British firms—E.M.I.—disclaimed any part in the agreement.

This agreement, which applied only to the mainland of Europe, provided for a 625-line definition, positive modulation, 25 frames a second with 2:1 interlacing, vestigial sideband operation and 6-Mc/s bandwidth.

At the present time, when the effectiveness of the agreement may well be negated by the non-participation of one of the principal British manufacturers, comment does not seem very useful. In any case, is the European adoption of any par-

ticular standard—other of course than our 405-line system—of any very great value to British industry, especially to makers of transmitting gear? Surely everyone abroad knows that our designers have the knowledge and ability to produce equipment for any reasonable standard. Also they know the commercial axiom “the customer is always right” is sufficiently valid to ensure that demands for television equipment of the kind to which their fancy inclines will be met.

At the same time, the art of the best kind of tradesman, who takes the long-term view, lies in leading the customer's fancy towards the thing that will ultimately be best for him. We still think that for large sections of the world, and especially for Europe, 405 lines is best. It is the system most suited for countries suffering from the economic aftermath of war and which are geographically capable of taking advantage of the relatively easy international exchange of programme material which the system makes possible.

**THE NEW ACT** At the time of writing the Wireless Telegraphy Bill is passing through its final stages and will presumably become law without any further amendments. The passing of the new Act will mark an important stage in the history of British radio, which, since its inception, has virtually been governed exclusively by the Act of 1904.

In spite of the great developments that have taken place, the Act introduces practically no new ideas beyond conferring on the Postmaster-General the right to control man-made interference. The main purpose of the measure is to define much more closely than before the powers vested in the P.M.G., which can now be described without exaggeration as sweeping. Almost all the activities with which this journal and its readers are concerned become—or are capable of becoming—what is legally defined as “wireless telegraphy.”

# P.C.M.

IT is not so very long since modulation meant, quite unambiguously, amplitude modulation. People were talking about frequency modulation, but that, we said knowingly, was all just some obscure racket: someone or another had proved that it didn't really do any good. Then frequency modulation turned out to be quite something after all, even if the mathematics were a bit tricky for some of the old stagers. Finally, if that is a safe word to use, everyone began on pulse modulation: they modulated the amplitude of pulses, they modulated the duration of pulses, they modulated the spacing between a pair of pulses and they modulated the pulse epoch, which is a way of saying the phase, though rather more pedantically. Fortunately for the sanity of those of us who have to plan radio systems, there is usually a good reason for choosing one or other modulation technique. The barriers are weakening, however, as the pressure rises: the amplitude modulation party is making better noise limiters, the pulse party is shaping its pulses for greater bandwidth economy. Soon it will cost us more to choose our design basis than to make the design itself!

Meanwhile, using the cycles\* lavishly, a new modulation system has been under test in America. The original patent, filed in France by an Englishman, dates to before the war, but wartime developments in circuit technique have probably helped to bring the system to its present state. This system is p.c.m.: these letters at first stood for pulse code modulation, but since this article was first begun references to pulse count modulation have appeared.

Now this is not just another way of modulating a train of pulses. Although it is called p.c.m., the modulation is not at all the sort of thing we usually associate with the word modulation. P.c.m. is, in fact, half-way towards the "Vocoder": the message transmitted is essentially an instruction

\* To write "cycles per second's" would be absurd, and the plural of "hertz" is awkward.

## Being an Elucidation of the Mysteries of Pulse { Code Count } Modulation

By THOMAS RODDAM

to the receiving equipment, not a replica, in some direct form, of the signal. This must not be misunderstood; the breaking down of speech by the "Vocoder" has no obvious counterpart in the coding circuits of p.c.m. In both, however, there is a breaking down of the speech, the transmission by a means which does not contain the intelligence directly, and then a synthesis at the receiver.

To understand the principle of p.c.m. we can take a very simple analogy. The Editor has rung me

up to tell me that I have forgotten to enclose a curve, Figure X, for an article. As I cannot afford a stamp to send the curve by post, I give him the co-ordinates of a selected number of points on the curve, which he then causes one of his faithful stooges to plot, and a fine smooth line is drawn joining them. This, of course, is the idea we use in all pulse modulation systems: we sample the signal curve regularly and then smooth the resulting stepped output with a low-pass filter. P.c.m. involves two extra features. First of all, instead of modifying the transmitted pulse by an amount depending on the sample\* number, a group of pulses is transmitted for each sample, and the group forms a sort of inner message giving the amplitude for that particular sample. It is as though instead of saying "the next ordinate is 2.54," I were to use the morse code.

This leads us to the second feature of p.c.m. As I pass the points on my curve over the telephone, I do not say 2.5437, but round the value to 2.54, or more probably to 2.5. If the curve is drawn through the modified points it will not be quite the right shape, and I choose the approximation closely enough for the error to be unimportant. In p.c.m. there is the same problem. To get reasonably good speech the signal must be sampled 8,000 times a second.

Each sample is a number, which is to be transmitted as a code signal, so that there are 8,000 groups a second. Each group is made up of a number of pulses; we shall see why later. Suppose that a group consists of only one "pulse." Then there may be an actual pulse, or it may be suppressed, and the sample size may therefore be either 0 or 1. We

\* "Sample" is here used as the statisticians use it, to mean a single thing, which in this case has a numerical magnitude.

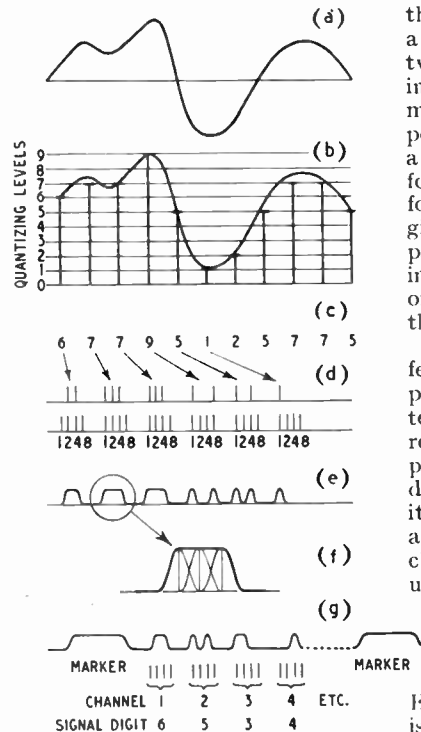

Fig. 1. Stages in the development of a p.c.m. signal: (a) original waveform (b) sampling at regular intervals to find nearest discrete step in amplitude (c) resultant message in digits (d) coded train of pulses with basic train for reference (e) rounding of pulses so that neighbours run together (f) detail of a pulse group (g) combination with pulse trains from other channels and marker pulses.

**P.C.M.—**

could produce a signal of this kind by really savage peak chopping of the speech, then using the chopped speech to open a gate to let pulses through. Only when the speech happened to be passing through the zero amplitude axis would a zero be sent. If we use two pulses, the first pulse can stand for an amplitude of 2, and the second for an amplitude of 1. Then two pulses together mean 3; if the second is missing the amplitude is 2; if the first is missing but the second is there the amplitude is 1. This is what is known as operation in the scale of two, and anyone who has worked with thyatron or multi-vibrator counter circuits will recognize it. If we have  $n$  pulse positions, in which pulses either are there, or are omitted, we can send any digit from 0 up to  $2^n - 1$ ; thus with 5 pulse positions we can send any whole number up to 31. Suppose that my curve in the example above was a valve characteristic, with a maximum current of 15 mA: then, using a five impulse code, I should have to give the current at any bias to the nearest 0.5 mA. By using a six digit code, I could give it to the nearest 0.25 mA. A little thought will show that near cut-off a line through these "nearest" points will look rather distorted, and that the more digits I use, the better it will be.

In p.c.m., we are actually transmitting a point-by-point plot of

most interesting features of p.c.m., and both its virtue and its limitation. The limitation is, of course, the distortion. As we have

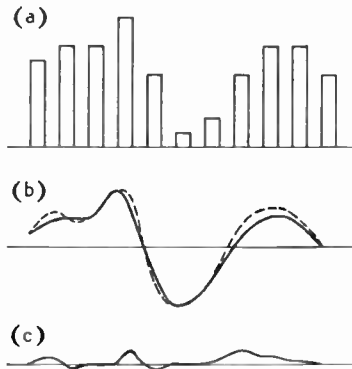

Fig. 2. Reception of pulse code modulation: (a) signal as reconstructed (b) after smoothing (the dotted curve is the original signal) (c) quantizing false signal.

seen, we don't transmit the actual waveform, but an approximation to it. The difference is, in effect, a false signal, and is called "quantization noise": it is only 33 db below full signal level when a 5 pulse code is used, although even this means that 40,000

of pulses whose exact timing and amplitude are not significant, clean regular pulses can be produced by selecting the middle of the received signals, and so long as no noise impulse is large enough to produce a false triggering of the receiver circuits, the system is completely undisturbed by normal noise. Consequently lower power levels can be used, because the receiver no longer demands a large signal to override the internal first-circuit noise. With the rather low duty ratio involved in p.c.m. links and the high frequency which must be used to provide the bandwidth, there is at present some advantage in using low power for transmission even at the cost of complication.

The number of steps needed is reduced by a most ingenious arrangement. Very roughly, the ear is sensitive to fractional changes of level, not absolute changes of level. That is why the loudness scale is a logarithmic one. It is therefore reasonable to make the voltage steps not equal but increasing in magnitude from step to step. In this way the half-step size, which is the error in specifying the instantaneous voltage, is proportional to the

Fig. 3. Diode and triode sampling circuits.

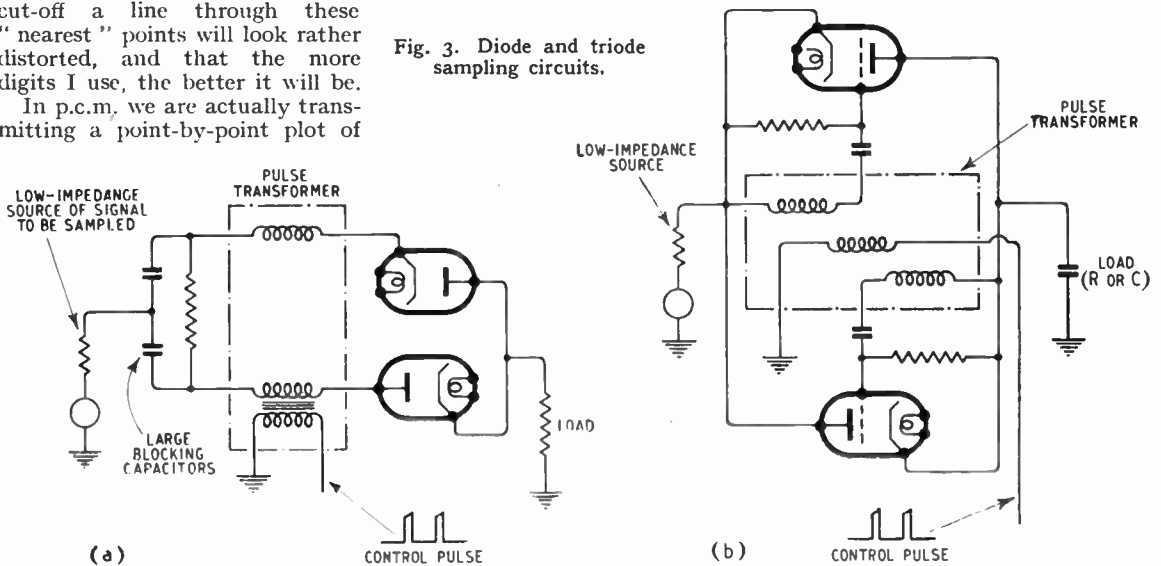

the waveform, and, of course, we cannot do it exactly. This taking of the measured points to the nearest fixed step is called "quantizing"; it is one of the

pulses a second are being used to transmit 4,000 c/s of speech. The virtue of quantizing is that circuit noise can be eliminated completely. As a message is made up

actual magnitude of the voltage, and the result is a constant "quantizing fractional error" for all signal magnitudes. This can be done by applying the audio-

**P.C.M.—**

frequency signal to a potential divider which includes a non-linear resistor and thus acts as an instantaneous compressor. Equal sizes of step after this compressor correspond to a graded series before the compressor.

Let us recapitulate the essentials of the system. The input audio-frequency signal is first passed through a low-pass filter to keep the bandwidth down to the standard telephony bandwidth. Then it is applied to the instantaneous compressor, which

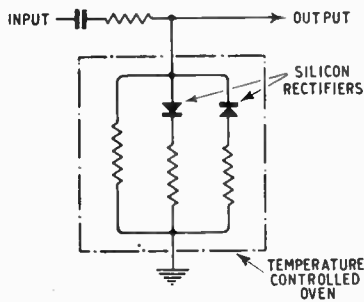

Fig. 4. Circuit of instantaneous compressor.

squashes down the larger amplitudes. Somewhere before the compressor a constant-volume amplifier, or "Vogad," may be fitted, to bring the speech level to that required on the circuit. Then the speech is applied to the sampler, which decides which of the 2<sup>n</sup> levels is the appropriate one at the instant of measurement. This information goes to the coder, which sends out a group of *n* pulses or spaces between pulses, corresponding to the number given by the sampler. The signal is then fed to the combining unit, where the interlacing of a number of channels takes place, and the whole complex pulse system is applied to the magnetron modulator.

At the receiver the pulse groups belonging to the different channels are sorted out, and each pulse group is then examined by the decoder. This produces a pulse, the amplitude of which is dependent on the actual code group. These amplitude-modulated pulses are sent through the instantaneous expander, which opens up the larger amplitudes, and then through a low-pass filter which

removes the pulse structure, leaving only the audio-frequency signal. This sequence is shown in Fig. 2.

This description of the process is rather over-simplified and does not represent the latest system. As described, the signal consists of groups of separate pulses. This would mean an unnecessarily large bandwidth, as all that is needed is the information that a pulse is or is not there. The pulses are therefore rounded off, so that two or more pulses in succession run together to form a single long pulse. This gives a useful reduction in the bandwidth required, and there is a very good reason for reducing the bandwidth. Although there is plenty of room in the microwave region, the video-frequency amplifiers will have an amplification, which is inversely proportional to bandwidth, so that halving the bandwidth enables the same gain to be obtained with half the number of stages. Another requirement is that the receiver should be able to pick out groups of pulses from the continuous train which it receives. A marker pulse is therefore added at the transmitter so that the receiver can be synchronized.

The experimental system\* was a twelve channel system; that is, twelve audio-frequency circuits were combined in the one radio circuit. This number was chosen because it corresponds to present-day multi-channel carrier telephony practice; most telephone systems are now planned on a basis of primary trunk groups of twelve channels. As each speech band extends up to 3,400 c/s a sampling repetition rate of 8 kc/s is used, requiring 96,000 signals per

second for a 12-channel group. A seven-digit code is used, so that the number of pulses per second is 672,000. The pulse length used within the terminal equipment is 0.4  $\mu$ sec, but the pulses radiated are longer than this.

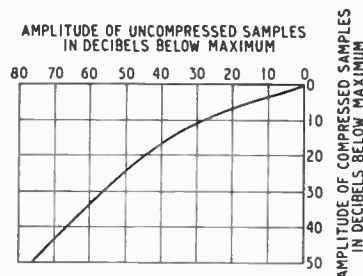

Fig. 5. Characteristic of instantaneous compressor.

As we have already seen, the speech for transmission is first passed through a low-pass filter, to eliminate frequencies above 3,400 c/s. After the filter a peak-chopper circuit is used to restrict the amplitude applied to the following equipment. To this point the twelve channels remain separate: they are now sampled and joined together. The sampling

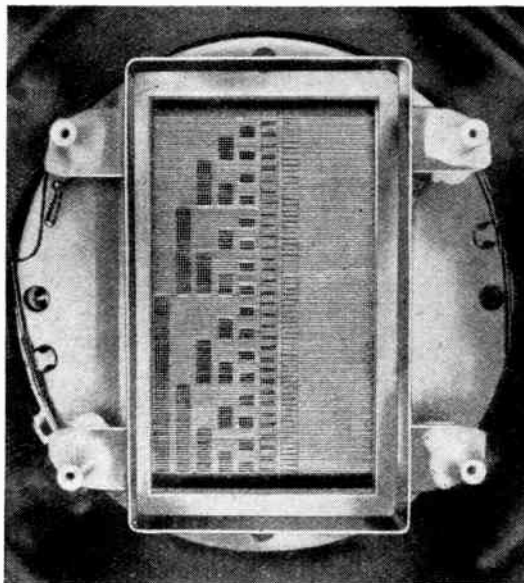

Fig. 6. Interior of coder tube viewed from gun end.

\* "An Experimental Multichannel Pulse Code Modulation System of Toll Quality," by L. A. Meacham and E. Peterson, *Bell System Technical Journal*, Vol. XXVII, No. 1, Jan., 1948.

circuit consists of two diodes, shown in Fig. 3(a). (This is Fig. 12 of *B.S.T.J.*, Vol. XXVII,



No. 1). When the control pulse appears at the pulse transformer both diodes conduct and connect the input to the load: the blocking capacitors are charged up, and at the end of the pulse the charge remains to keep the diodes cut off for the relatively low signal voltage. The next pulse again opens the diode gate. The triode circuit in Fig. 3(b) operates in the same way, except that the gate is opened by the pulse applied to the grid while the signal path is from cathode to anode. The output of the sampling circuit is a series of pulses, the amplitude of which is the peak signal amplitude at the instant the pulse is on. By connecting one of those circuits to each speech channel, supplying a

some ways. The pulses are applied to the Y plates and the Y deflection is then held constant while the beam is swept across by a horizontal sweep circuit. The beam is then cut off until the next pulse deflects it again. As the

takes place: the resulting electrons go to the collector and produce a bias which moves the

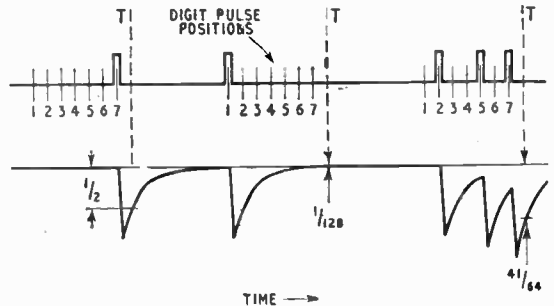

Fig. 8. Decoding waveforms from simple R-C circuit.

beam sweeps in the X direction it passes over an aperture plate, which has a pattern of slots in it.

beam into the space between two wires. This is actually a feedback amplifier circuit and the equivalent of 20 db of feedback is provided. The collector, the quantizing grid and the aperture plate are all visible in Fig. 6. The collector is the box structure which frames the aperture plate. The output takes the form shown in Fig. 7 (Fig. 9, p. 56 of *B.S.T.J.*, Vol. XXVII, No. 1).

The circuits which follow are fairly straightforward. The decoding circuit used at the receiver is perhaps the only other circuit of special interest. The input to this circuit is, of course, a group of up to 7 pulses. A resistance-capacitance circuit is used: if a charge is put on the capacitor, the voltage across it falls during some time  $t$  to 50%. During the next interval  $t$ , it falls to 50% of the value at the beginning of the

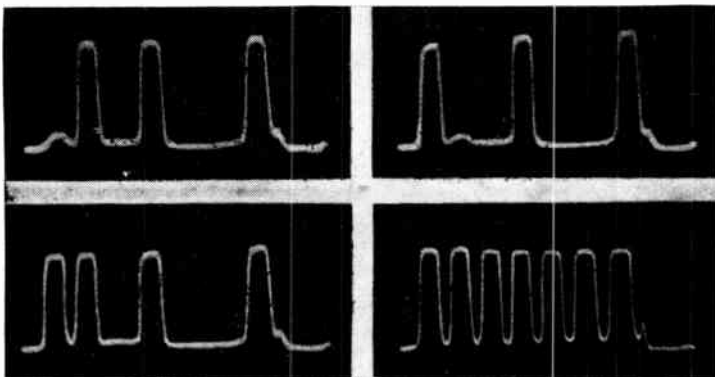

Fig. 7. Typical pulse code outputs.

train of "12-way interlaced" pulses to each gate and paralleling the outputs a single set of interlaced amplitude-modulated pulses is provided which contains all the intelligence from the twelve channels.

These pulses are now applied to the instantaneous compressor. In the simplified description it was stated that this was before the sampler, but that was purely to help to indicate the action. The compressor leaves unaffected the lower level signals, but reduces the higher levels considerably so that an increase of 15 db in the input produces only 5 db rise in output. The circuit and its characteristics are shown in Figs. 4 and 5 (Figs. 13 and 14, *loc. cit.*)

The compressed amplitude-modulated pulses are now applied to the coding valve, which both quantizes and codes. This valve resembles a cathode-ray tube in

The electrons which pass through slots fall on a pulse plate and produce impulses in the output circuit. The impulse pattern depends on the slot pattern at the particular value of Y and the slots are so arranged that they give the required code. The aperture plate, with its slots, is shown in Fig. 6 (Fig. 19, *loc. cit.*). To make sure that the beam sweeps across at a definite "quantized" level, a parallel wire grid and a rectangular collector electrode are mounted in front of the aperture plate, and feedback is provided from this collector to the vertical amplifier. If the beam falls on a wire, secondary emission

Fig. 9. Shannon-Rack decoder and modified waveform.

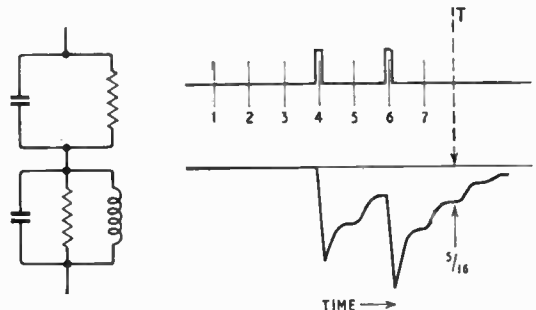

second interval, that is to  $\frac{1}{2}$  of the initial value. By making this time  $t$  equal to the pulse interval, the contribution to the voltage across the capacitor made by the

**P.C.M.—**

last pulse will be  $\frac{1}{2} \frac{Q}{C}$  where  $Q$  is the charge, and the voltage is measured one pulse period after

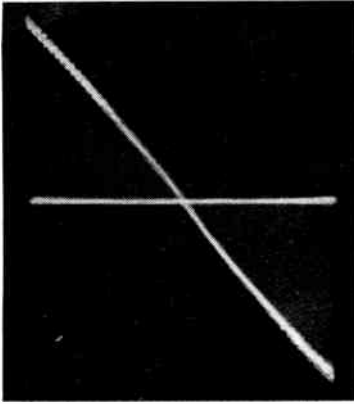

Fig. 10. Overall characteristic of coder (horizontal) and decoder (vertical) including compressor and expander.

the last pulse. The last but one pulse will contribute  $\frac{1}{4} \frac{Q}{C}$  and earlier pulses  $\frac{1}{8}, \frac{1}{16} \dots \frac{1}{128}$ ,

all multiplied by  $Q/C$ . If a full set of 7 pulses is present, the final voltage will be  $127/128$  and any intermediate multiple of  $1/128$  can be produced. The decoding circuit is arranged so that each digit pulse delivers a standard charge to the capacitor, and the result is the waveform shown in Fig. 8 (lower half of Fig. 21 *loc. cit.*). By adding a tuned circuit, as shown in Fig. 9 (Fig. 22 *loc. cit.*) a "flat" is put on the waveform so that accurate timing in sampling the decoded wave at  $T$  is not so necessary.

The input-output characteristic of the system is shown in Fig. 10 (Fig. 25 *loc. cit.*). The tapered steps can be seen quite clearly and the overall linearity gives an indication of the accuracy of matching between the compressor and the expander, which is an amplifier with a compressor in the negative feedback path.

In measurements of noise on ten links in tandem, a maximum audio signal-to-noise ratio of 58 db was obtained. Crosstalk from any one channel to any other was 66 db down and perfect reception was obtained when the radio signal-to-noise ratio was 18 db.

## MANUFACTURERS' PRODUCTS

### Television Magnifiers

AN increase of effective picture size of  $2\frac{1}{2}$  times is claimed for the Magnavista television lenses made by Metro Pex, Ltd., 71, Queens Road, Peckham, London, S.E.15. Sizes suitable for 9-in and 10-in tubes are available, either for mounting directly to the receiver, or on separate telescopic stands. Prices range from £6 6s to £8 18s 6d.

### Modified Oscilloscope

AN alternative cathode-ray tube having a blue trace with yellow-green afterglow can now be supplied by Taylor Electrical Instruments, 419-424, Montrose Avenue, Slough, Bucks, in their Model 30A oscilloscope. The price of the instrument, which is known as "30A with persistent trace," is £33 10s.

### New Drive Mechanisms

TWO new condenser drive mechanisms have been added to the range made by Jackson Bros., Kingsway, Waddon, Surrey. Both

models are fitted with three-wave-band coloured scales, calibrated with station names on medium and long waves and framed in florentine bronze escutcheons. Type SL8 at 25s has a cord drive with spin-wheel control knob, and type SL5 at 24s is fitted with a reverse vernier control.

### New Domestic Receivers

A BATTERY set giving power output and quality comparable with those of mains-operated receivers has been introduced by Murphy Radio, Welwyn Garden City, Herts. The four-valve superhet circuit covers short, medium and long waves, and a QP25 push-pull output valve feeds an 8-in permanent magnet loudspeaker. The type number is B141 and the price is £21 4s 9d including tax. The new Murphy A122M for a.c. mains is a modified version of the A122 with a redesigned cabinet and costs £26 17s 9d including tax.

Two new a.c./d.c. superhets (4 valves plus rectifier) have been developed for the export market by Vidor, Ltd., West Street, Erith, Kent. Both are housed in walnut

and sycamore inlaid cabinets with "mirror" finish. Model CN385 covers 13.5-32m, 32-100m, 190-550m and 1,000-2,000m, while Model CN 386 covers 10-12m (band-spread), 13.5-32m, 32-100m and 190-550m.

A special c.r. tube giving enhanced picture brightness, and coupled contrast and brightness controls are features of the new Marconiphone VRC52A and H.M.V. Model 1805 television receivers. Automatic interference suppression on sound and a vision interference limiter are provided and the picture size is  $8\frac{3}{4} \times 6\frac{1}{2}$  in. The H.M.V. Model 1805 costs £89 5s and the

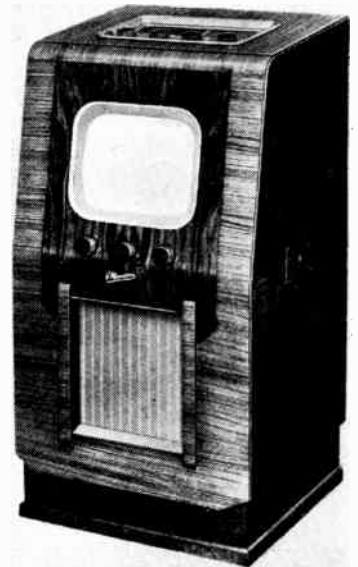

Marconiphone VRC52A television and radio receiver.

Marconiphone Model VRC52A, which includes a radio receiver for short, medium and long waves with preset tuning for two stations in medium waves, costs £110, both prices including purchase tax.

### Metal Detector

AN industrial electronic metal detector has been produced for Cinema Television, Ltd., Worsley Bridge Road, Lower Sydenham, London, S.E.26. This has been designed for use in conjunction with a conveyer-belt system for the examination of chocolate and other food products which are carried through a search head which detects any metal particles, operates a suitable alarm and automatically stops the conveyer belt in the presence of either ferrous or non-ferrous particles.

# TELEVISION "GOODNESS FACTOR"

## Why More Lines May Mean a Worse Picture

By R. W. HALLOWS,  
M.A. Cantab, M.I.E.E.

FROM discussions that I have heard and from questions that I have been asked I know that not a few people find the statement that a larger number of scanning lines may result in a worse image on the screen of the television receiver a dark saying. This article attempts two things. It aims at giving the initiated some useful figures and it offers them a way of answering the dread seeker after enlightenment. Further, the article suggests straightforward methods of determining whether or not a given television system is capable of providing a balanced image (the term "balanced" will be explained in a moment), of finding the extent of the unbalance, should this be present, and of calculating the number of scanning lines that can be employed to the best advantage for any range of modulation frequencies genuinely transmitted and received.

When a person suffering from ocular astigmatism looks at two crossed wires, or two black straight lines crossing on a white background, he may see them as shown in Fig. 1 (a). If he focuses the horizontal line AB sharply, then PQ is muzzy. The angle  $\theta$  at which the defocusing of PQ is most marked varies from eye to eye and is mainly dependent on the departure from simple spherical form of the cornea, and not as a rule the lens of the eye. The oculist's part is to discover the degree of inequality between the horizontal and vertical focusing powers of the eye and the angle at which this inequality is at its worst. He then prescribes a corrector in the form of a spectacle lens with both "sphere" and "cylinder" elements. If the spherical element enables the eye to obtain a sharp focus horizontally, the cylindrical element, placed at the proper angle, counteracts the deformity of the living optical system and enables it to provide sharp focusing in the vertical sense as well. Aided by the correcting lens, the eye now

sees both of the crossing lines equally clearly as in Fig. 1(b).

In other words, the living optical system, plus the correcting lens, gives perfectly balanced focusing in both directions. The term "balance" as used in this article means that resolution of an image is equally good in the vertical and the horizontal directions. Without such balance no image can be perfectly clear. It

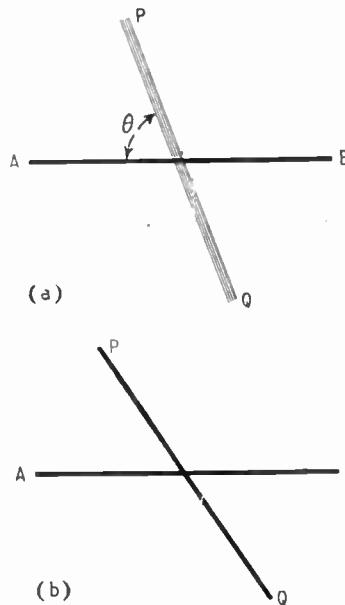

Fig. 1. (a) Crossed wires as seen with the unaided eye by a sufferer from optical astigmatism. The angle  $\theta$  at which the defocusing of PQ is at its worst depends upon the deformity of the individual optical system. Diagram (b) shows the same wires as seen by an eye with no astigmatism or by the astigmatic eye looking through a correcting lens. At (a) horizontal and vertical definition are unbalanced; at (b) they are balanced.

may be acceptable if the unbalance is slight; but so long as there is any unbalance it is not so good as it might be. The greater the

unbalance, the worse the image.

In television the angle at which unbalance may occur is fixed. It is always a right angle.\* The scanning lines slice the image into horizontal strips and thus determine the degree of definition in the vertical sense; the changing brightness of the scanning spot divides the image into minute light and dark patches as it moves from side to side of the c.r.t. screen and so limits the horizontal definition. Perfect balance in the transmitted and received image cannot be ensured unless the system in use is capable of slicing the image into vertical strips as narrow as the horizontal.

Don't be confused by the terms "horizontal" and "vertical" as applied to the slicing of the image and the corresponding sense of definition. A moment's thought will show that the number of horizontal cuts (scanning lines) determines the top-to-bottom, or vertical definition. The greater the number of these, the narrower are the alternate black and white horizontal lines that can be resolved: if the image is built up by 377 active scanning lines interlaced, it would be possible for it to show  $188\frac{1}{2}$  white lines and the same number of black. To make the horizontal definition equally good it must be possible to resolve vertical lines as narrow as the narrowest horizontal lines that the system can handle. Since the aspect ratio of the B.B.C. transmission is  $\frac{5}{4}$ , it follows that for its transmission with 377 active scans per image this number of alternate vertical black and white lines is  $377 \times 1.25 = 471$  (1).

When a pattern consisting of alternate black and white vertical lines is scanned by the electron beam of the Emitron the output of the head amplifier for each scanning line is a.c. of the form shown in Fig. 2(b). These a.c. voltage waveforms are used as modulation frequencies in the

\* Or as nearly a right angle as makes no matter. Actually, the scanning lines are of course, not quite horizontal, but have a slight downward slope.

**Television "Goodness Factor"—**

transmitter. In the receiver a.c. at vision frequency appears at the output of the video amplifier stage and is converted into d.c. voltage fluctuations for application to the grid of the c.r.t. by the action of the d.c. restorer.

It will be seen that a change from black to white or *vice versa* requires one half-cycle of a.c. For this change to be as sharp as it is between the white background of this page of *Wireless World* and the outlines of the letters printed upon it a.c. of square waveform would be required. The rise from *p* to *q* and the fall from *q* to *p* would have to be perfectly vertical. In other words these rises and falls would occur in no time at all, or in zero wavelength, which corresponds to infinite frequency. Hence to produce the perfectly square waveforms required for absolutely sharp contrasts the modulation would have to contain all frequencies up to infinity. Actually, there is no need for this since the resolving powers of our eyes are limited to something not much better than one minute of angle. Examine a printed page with a powerful magnifier and you will find that the transitions from black to white are not what the unaided eye reports them to be. Sinusoidal waveforms such as those in Fig. 2(b) where the middle of each white vertical line results in a "crest" and the middle of each black line in a trough give the quite acceptable reproduction on the c.r.t. screen indicated in Fig. 2(c).

What this comes to is that to be able to resolve adequately the 471 vertical lines of (1) we need

$$471/2 = 235\frac{1}{2} \text{ cycles} \dots (2)$$

in the active portion of each scanning line. But the active portion of the line lasts only 83.5  $\mu$ sec and the time for the whole line is 99  $\mu$ sec. Hence the number of cycles required for the whole line is approximately

$$235.5 \times 1.2 = 282.6 \text{ cycles} \dots (3)$$

The total modulation bandwidth needed to give balanced definition in a 405-line system with 25 images per second of 5/4 aspect ratio is:

$$f = 282.6 \times 405 \times 25 = 2.86 \text{ Mc/s} \dots (4)$$

We can tidy up the results of

(1), (2), (3) and (4) into the handy form:

$$f_{m.i.} = \frac{L'}{2} \times arLn \times 10^{-6} \text{ Mc/s} \dots (5)$$

where

$f_{min}$  = minimum modulation bandwidth to give balanced definition;

$a$  = aspect ratio

$r$  = ratio of whole line to active portion

$n$  = images per second

$L$  = total scanning lines

$L'$  = active scanning lines:

From (5) we can obtain a means of ascertaining the maximum

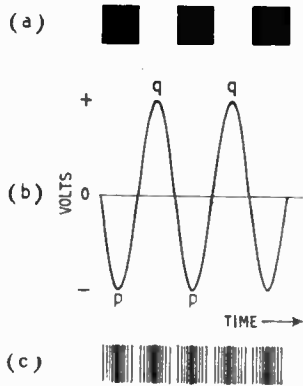

Fig. 2. (a) Consecutive elements of a scanning line for an image consisting of alternate black and white vertical lines. (b) Corresponding a.c. voltage waveform at output of head amplifier. (c) Resulting reproduction on screen of receiver cathode-ray tube.

permissible number of scanning lines for any given modulation bandwidth. A slight reshuffling is necessary, for both  $L$  and  $L'$  are unknowns. Since  $L' = pL$ , we have:

$$L_{max} = \sqrt{\frac{2f_{mod}}{ar n p}} \dots (6)$$

where

$L_{max}$  = greatest permissible number of lines

$f_{mod}$  = actual modulation bandwidth

$p$  = ratio of active lines to total scanning lines

and the remaining factors  $a$ ,  $r$ ,  $n$  are as before.

Further, we can obtain what may be termed a Definition Ratio, or "goodness factor" for any television system, or for a particular transmitter. Calling this factor  $D$ , we have

$$D = \frac{f_{mod}}{f_{min}} \dots (7)$$

For the present B.B.C. system

$$D = \frac{2.7}{2.86} = 0.944$$

My suggestion is that television systems should be described not just by the number of their scanning lines, but by this number *and* the definition factor. The B.B.C.'s, for example, would be termed a 405-line, 0.944 system. This method could also be applied to receivers in test reports and possibly in manufacturers' specifications; in this case, of course,  $D_r$  would be the ratio of the maximum frequency adequately dealt with by the set and the maximum modulation frequency of the transmission. If a British receiver cut off at 2.4 Mc/s it could be described as having  $\frac{2.4}{2.7} = 0.89$  or 89 per cent. definition.

From (5) and (6) the truth of the statement that more lines may mean a worse image is readily seen: they certainly will unless the range of the modulation frequencies is increased accordingly. Two other statements, both rather puzzling at first sight, may also be shown to be true. These are (1) with the standard 405 lines . . . increasing the bandwidth to some 4-5 Mc/s results in very noticeably higher definition; † and (2) no one has yet seen a real 405-line picture. ‡

The figure arrived at in (5) gives the *minimum* modulation bandwidth for balanced definition. The resolution resulting is of the kind shown in much exaggerated form in Fig. 2(c). Black shades off into white through greys, which may be regarded as paler and paler blacks and less and less dark whites. Make the frequency higher and the waveforms become squarer, with the result that the transitions are more abrupt and vertical lines more clearly painted on the receiving screen. Hence a bandwidth of 4-5 Mc/s is bound to result in a noticeable improvement in definition.

This is one reason why we have never yet seen a 405-line image as it might be. There are at least two others of importance.

† Television Standards, *Wireless World*, Oct. 1948, p. 382, Col. 1, line 20.  
‡ *ibid.*, "Editorial Comment," p. 351, Col. 2, line 28.

With 377 active lines the greatest bandwidth that can be usefully employed is probably not more than 5 Mc/s. This is due partly to the limited resolving powers of our eyes and partly to the fact that a slight blurring of outlines may be necessary to aid persistence of vision in producing the illusion of movement from the observation of a rapid succession of still images. Such lack of sharpness is certainly to be found in individual frames of a cine film. But why should only 377 of the 405 lines be active and 28—nearly 7 per cent—be used for the frame sync pulses? Some systems use only 5 per cent; some, possibly even less. An increase in the number of active lines would improve the vertical definition and the bandwidth might then be put up to a little over 5 Mc/s to give a corresponding improvement in the horizontal definition.

The second point is that there are minute gaps between the scanning lines: it is as though the image were sliced horizontally with a rather coarse saw rather than with a razor blade. To eliminate the gaps is a difficult problem, but a solution will no doubt be found. When "lininess" has been removed the television image will be much more pleasing.

It is interesting to see how the balance of definition works out for 525-line television. There are now a great many 525-line systems in operation in the United States,

but there appear to be no generally accepted standards of bandwidth or number of frame sync pulses. The only standards adopted by all in addition to 525 scanning lines are an aspect ratio of approximately 4/3 and an image frequency of 30 per second. The last is probably a liability rather than an asset. It is demanded by the standard 60-c/s periodicity of American a.c. mains supplies; but since an image frequency of 25 per second gives all the necessary steadiness, the greater number means that part of the modulation bandwidth available must be employed in serving no very useful purpose.

Let us take the case of a 525-line system with a bandwidth of 3 Mc/s and 94 per cent of the scanning lines and 84 per cent of each line active. Then  $L'$  works out at 488.25, which we may take as 489, since interlaced scanning demands an odd number of active lines;  $a = 1.33$ ,  $n = 30$ ,  $r = 1.19$ . From (5) we have:

$$f_{min} = \frac{489}{2} \times 1.33 \times 1.19 \times 30 \times 525 \times 10^{-6} = \text{approximately } 6.1 \text{ Mc/s}$$

From (6) we have a surprising result:

$$L_{max} = \sqrt{\frac{6 \times 10^6}{1.33 \times 1.19 \times 0.94 \times 30}} = 365$$

Here, indeed, the increased number of scanning lines means a poorer image than that given by our 405-line system, even though the bandwidth is assumed to be greater by 0.3 Mc/s. From (7)

the definition ratio is  $\frac{3}{6.1}$ , or 0.492

as compared with 0.944. If a 525-line system were used with a 5/4 aspect ratio in a country where there is a 50-c/s a.c. supply,  $f_{min}$  would come down to 4.75 Mc/s. Assuming an actual modulation bandwidth of 3 Mc/s, the definition ratio would be 3/4.75 or 0.632.

It seems clear that it is of little use to go beyond about 405 lines unless and until transmitters, relay links and moderately-priced televisors can deal adequately with modulation bandwidths well above 5 Mc/s. It is actually disadvantageous to do so owing to the inferior definition of the images.

### HIGH QUALITY REPRODUCER

TWIN elliptical diaphragm loudspeakers fed from an 8-watt push-pull output stage with negative feedback form the backbone of the new H.M.V. Model 2000 record reproducer. The automatic record changer is fitted with the latest

H.M.V. lightweight pickup and there are independent tone controls for bass and treble—the latter with five positions to give the best compromise between h.f. response and surface noise on records of all types and ages. A low-impedance input of 5 ohms is provided for coupling to a radio receiver, a power of 0.5 watt being required for full audio input.

The Model 2500 high-quality receiver unit has been designed to work



H.M.V. Model 2500.

in conjunction with the Model 2000 reproducer and has the requisite 5 ohms output impedance. It is a push-button superhet with an r.f. stage and wide-band intervalve couplings. A specially stabilized oscillator has been provided to minimize frequency drift. There are five push buttons for medium-wave stations and two for long waves. A three-position "fidelity" switch gives variable bandwidth in the i.f. coupling. The receiver has an output of 2½ watts and can be used with a loudspeaker direct, where the extra power of the Model 2000 reproducer is not required.

The makers are the Gramophone Co., Hayes, Middlesex, and the prices are: Model 2000, £112 17s 6d; Model 2500 £45 19s 10d, both prices including purchase tax.

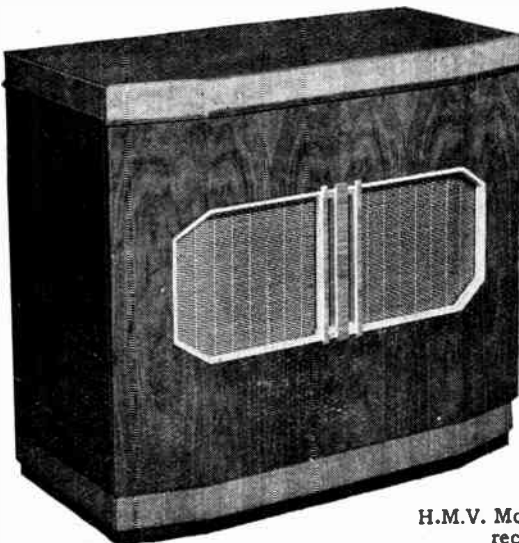

H.M.V. Model 2000 "Celebrity" record reproducer.

# SINGLE SIDEBAND RADIO-TELEPHONY

## First Use of the System in Marine Communications

By H. D. B. KIRBY

(Standard Telephones and Cables)

**T**HERE has been since the war a general extension of the use of single-sideband operation on long-distance point-to-point radio-telephone links throughout the world. Now the use of this system has been extended to the long-distance ship services with the installation of single-sideband equipment in the new Cunard White Star liner *Caronia*.

What exactly is this system, and what advantages can it offer over the normal double-sideband method of transmission? To answer these questions it is necessary to consider first what happens when a speech wave is used to modulate an r.f. carrier. This has been discussed at some length in previous issues of this journal,<sup>1, 2</sup> so it will simply be stated here that the ordinary process of amplitude modulation produces a wave which may be analysed into three groups of sine waves, the upper sideband, the lower sideband and the carrier. If the carrier has a frequency  $f_0$  and the modulating signal consists of a number of frequencies between 100 and 5,000 c/s then the upper

sideband is, as it were, a mirror image of the other, so that each contains the same intelligence as the other. Consequently the only medium necessary to convey the modulating signal from the transmitter to the receiver is one of the sidebands. Unfortunately, however, although the intelligence is present in the sideband, it cannot be extracted at the receiver without the use of the carrier. In the ordinary d.s.b. system the carrier is transmitted together with both sidebands, and when these are applied to a non-linear impedance in the demodulator stage of the receiver a number of new frequencies are produced among which are the original signal frequencies. In the s.s.b. system the carrier is still necessary for the process of demodulation, but since it does not vary with modulation it can either be generated at the receiver or transmitted at a very low level and amplified separately.

The advantages of the system may be summarized as follows:  
 1. Improved signal-to-noise ratio at the receiver for a given transmitter power.  
 2. Less bandwidth occupied per channel.  
 3. Freedom from the distortion normally caused by selective fading

powerful transmitters and more sensitive receivers on land. This is not effective above a certain point, at least in the ship to shore direction, since noise then becomes the limiting factor. By the use of s.s.b., however, it is possible to concentrate the whole of the available output power in the one intelligence-bearing sideband. The effect of this is that the signal at the receiver is equivalent to that which would be received from a d.s.b. transmitter about four times as powerful. This will double the distance at which the level of the received signal will be satisfactory for public use.

The decrease in bandwidth will reduce the noise picked up at the receiver since it will be possible to tune the filter circuit more sharply. This again will increase the useful range of the equipment.

Thirdly, much of the unpleasant distortion usually caused by selective fading is considerably reduced, so that a link which is quite unworkable on d.s.b. may well provide a reasonable speech circuit under similar conditions with s.s.b. operation.

We do not yet know of a satisfactory method of producing a single-sideband signal directly,

Block schematic diagram of a two-channel single sideband transmitter using upper sideband of one audio input and the lower sideband of the other

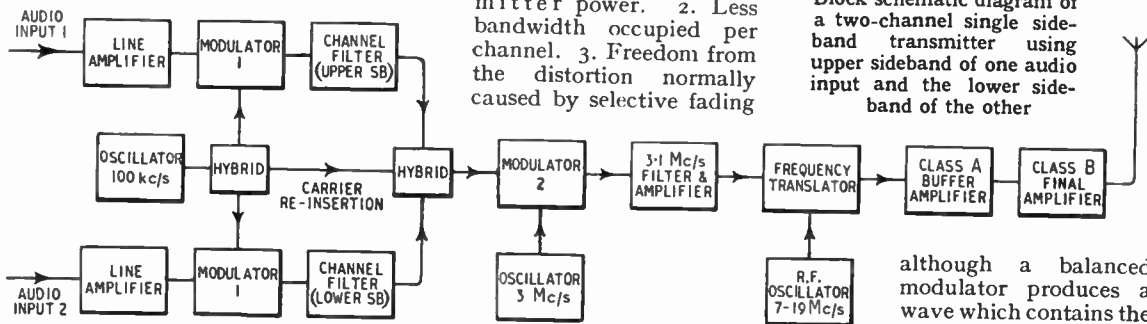

sideband will comprise a band of frequencies between  $(f_0 + 100)$  and  $(f_0 + 5,000)$  c/s and the lower sideband frequencies between  $(f_0 - 100)$  and  $(f_0 - 5,000)$  c/s.

The frequency, phase and amplitude of the carrier remain unaltered whatever the modulating signal, and it therefore contains no intelligence. Moreover, each

and multi-path propagation. What do these advantages mean in the field of marine radio-telephony?

Since the radio equipment carried on board ship is necessarily limited in size, weight and power consumption, it has been the practice in the past to attempt to improve communication between ship and shore by using more

although a balanced modulator produces a wave which contains the two sidebands without the carrier. Thus a very simple transmitter could be used to transmit such a suppressed carrier signal, but the receiver would have to be very complicated since for demodulation a locally generated carrier would be required not only of exactly the same frequency as the original carrier, but also of the same phase. Since this would

be very difficult to produce it is necessary to suppress also one of the sidebands. This is normally done by means of crystal filters.

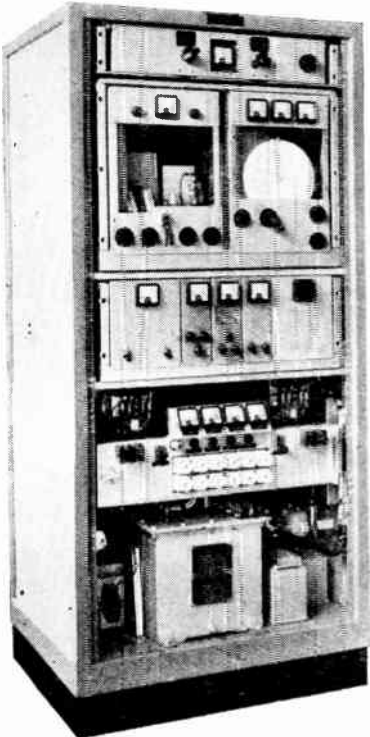

Single channel sideband transmitter rated at 300 watts as installed in the *Caronia*. It is made by Standard Telephones

The carrier frequencies normally used for long-distance telephone communication are between 2 and 30 Mc/s and the audio frequencies which must be reproduced are between 100 and 5,000 c/s. Thus it can be seen that each sideband is separated from the other by only 200 c/s and that with a carrier frequency of, say, 10 Mc/s the upper sideband filter would have to pass the band 10,005,000-10,000,100 c/s, but cut-off at 9,999,900 c/s. Since it would be practically impossible to design a filter to comply with these requirements it is necessary to generate the s.s.b. signal at a comparatively low frequency, convert it to the required frequency for transmission, and then feed it to the aerial through linear amplifiers.

The accompanying block diagram shows a low-power two-channel transmitter. Each audio input after amplification is fed to-

gether with the output of a 100-kc/s oscillator to a balanced modulator. Crystal filters select the upper sideband from the output of one modulator and the lower sideband from the output of the other. The two are then mixed, together with a very much reduced carrier, and applied to a second balanced modulator with the output of a 3-Mc/s oscillator. A 3.1-Mc/s filter selects the upper modulation product, which is then mixed with the output of a third oscillator, the frequency of which is variable between 7 and 19 Mc/s. This gives a signal frequency variable between 4 and 22 Mc/s. Three stages of linear amplification are provided at this frequency, negative envelope feedback being incorporated to increase the linearity.

A number of transmitters and receivers for single-sideband operation have been developed by Standard Telephones & Cables

during the last few years. The transmitters have output powers ranging from 300W to 40kW, and the receivers vary in complexity according to the facilities required. The 300-W transmitter shown here is self-contained, but the larger ones have separate drive units, which contain all the stages shown in the block diagram up to the 3.1-Mc/s amplifier.

For land-stations diversity reception is normally used to give the best possible quality and freedom from fading effects. Such receivers are necessarily somewhat complex. Those designed for marine use do not include facilities for diversity reception and are therefore considerably simpler and easier to operate and maintain.

REFERENCES:

- 1 "Sidebands Again," by "Cathode Ray," *Wireless World*, December, 1947.
- 2 "Modulation," etc, by "Cathode Ray," *Wireless World*, July, 1948.

## CARONIA RADIO EQUIPMENT

AMONG the other radio equipment which has been installed by the International Marine Radio Company in the *Caronia* is a double sideband high-power transmitter for r.t., c.w. or m.c.w. operation. It will be used for normal telegraph traffic and for supplementary telephone services with land stations not equipped for single sideband working.

This set, the ES<sub>4</sub>B, can operate on several spot frequencies in each of six separate pre-set channels in the band 1.76 to 22 Mc/s and delivers 300 watts to the aerial on r.t. or m.c.w. and 1 kW

on c.w. telegraphy. It is remotely controlled from the receiving room, which adjoins the transmitting room.

There is one other general-purpose transmitter, the type IMR29, which covers 3 to 17 Mc/s



Two of the receiving positions in the *Caronia*. The single sideband receiver is seen in the right rear alongside the telephone terminal equipment

**Caronia Radio Equipment**

in the h.f. band, 365 to 515 kc/s in the m.f. and 107 to 160 kc/s in the l.f. Radio-telephone facilities are available on reduced power of about 150 watts, the c.w. output being of the order of 400-500 watts.

A 400-watt h.f. telegraph transmitter covering 4 to 24 Mc/s and a complete battery-operated emergency transmitter and receiver, the former giving 50 watts output, and the single-sideband set completes the principal equip-

ment in the transmitting room.

Four main operating positions are provided in the receiving room, two are primarily for radio-telephony and two are exclusively for radio-telemetry. Each is fitted with two communications receivers which together cover all frequencies from 15 kc/s to 25 Mc/s. It is interesting to record that for long-wave reception, 14 kc/s to 500 kc/s, a t.r.f. set is used; the others are superhets.

There is some subsidiary radio

equipment on the navigating bridge. It comprises a ship-to-shore r.t. set giving about 200 miles range and operating on 10 spot frequencies, switch selected, in the band 1.5 to 4 Mc/s. Here also is a loop direction finder and two radar sets, a Metropolitan-Vickers "Seascan," giving a coverage of about 30 miles radius, and an Admiralty type 268. All the radio equipment, except the emergency and the IMR29 transmitter, operate from the ship's 220-volt 3-phase a.c. supply.

# ELECTRONIC CIRCUITRY

## Selections from a Designer's Notebook

By J. McG. SOWERBY (Cinema Television Ltd.)

A GOOD deal of interest has been shown lately in the so-called "bootstrap" circuit<sup>1</sup> for the production of a saw-tooth waveform, for use in triggered and single-stroke time bases for pulse examination and photographic recording of high-speed transients. The circuit was widely used in

American radar equipment<sup>2</sup> during the war, but has not been so much used in this country. The fundamental circuit is shown in Fig. 1.

The valve  $V_3$  is normally kept conducting by the positive bias return of  $R_g$ , and consequently the standing potential across C

is only the few volts occasioned by current flowing through the h.t. supply  $V_1$ , R and  $V_3$ . If a negative pulse (as shown) of sufficient amplitude is applied to the grid of  $V_3$ , that valve is abruptly cut off. Immediately C begins to charge up positively taking with it the grid (and hence the cathode) of the cathode follower  $V_2$ . The time constant  $C_k R$ , is very long compared with RC, and so as the cathode of  $V_2$  moves positively,  $V_1$  is cut off and the charging current is transferred from  $V_1$  to  $V_2$ . Thereafter a nearly constant potential is retained across R so that the charging current through it is also nearly constant; the potential at A is "pulled up by its own bootstrap."

In fact if  $R_C$  is very large (and preferably returned to a negative source of supply) C will appear to be charged from a source of approximately  $\mu E$  volts through a resistance of approximately  $\mu R$ , where  $\mu$  is the amplification factor of  $V_2$ .

By way of example, suppose we allow C to charge up to 100 volts; let  $E = 400$  volts and  $\mu = 50$ .

Then the apparent supply potential is about 20 kV, and the saw-tooth sweep potential across C will be linear within about 0.5 per cent.

It is obvious that the potential across C starts to rise immediately  $V_3$  is cut off. The potential at the

### The "Bootstrap" Circuit

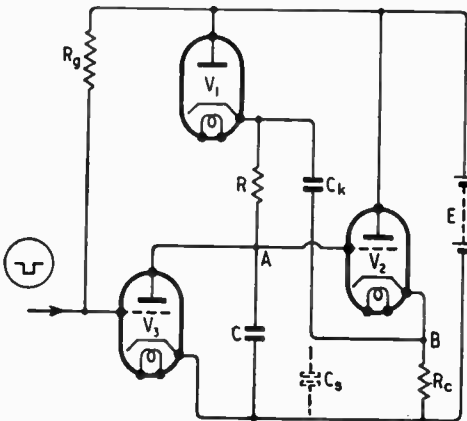

Fig. 1. Fundamental "bootstrap" circuit.

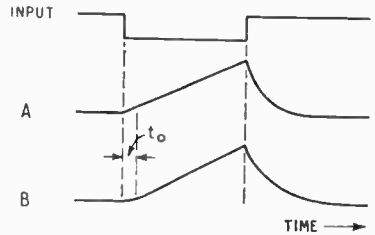

Fig. 2. Showing the potentials at A and B in Fig. 1 in response to a step input.

cathode of  $V_2$  follows only after a short time lag needed to charge up the stray capacitance,  $C_s$ , between the cathode of  $V_2$  and earth. This lag is determined by the time constant  $C_0/g_m$ , where  $g_m$  is the mutual conductance of  $V_2$ . From this, and the foregoing, we see that  $V_2$  should have both a large  $\mu$  and a high slope.

When  $V_3$  is restored to conduction, C discharges through it, and the grid potential of  $V_3$  falls, taking with it the cathode. However large  $C_k$  may be, it will have lost some charge during the sweep period, and this is restored through the diode and  $R_C$  in series.

Fig. 2 shows qualitatively the waveforms at A and B related to the input waveform.

The lag  $t_0$  is generally of the order of 0.1 microsecond if  $V_2$

<sup>1</sup> O. S. Puckle, "Time Bases." 1st Edn., p. 94. (Chapman & Hall.)  
<sup>2</sup> Solter, Starr and Valley. "C.R.T. Displays," p. 137. (McGraw Hill.)







the existing tuning capacitor.

As only a single tuned circuit is used for tuning, this must clearly have a high  $Q$  to give good selectivity. The detector valve is an r.f. pentode with a very small anode-grid capacitance, and there is thus negligible damping of the tuned circuit due to Miller effect. The coupling to the aerial should not reduce the  $Q$  appreciably nor upset the calibration; these

normally advanced until the detector nearly oscillates; the resulting improvement in selectivity is very acceptable and the improvement in voltage gain makes up

component, and some space could be saved by using a smaller modern type supported in the wiring. The output valve is operated with an anode supply of

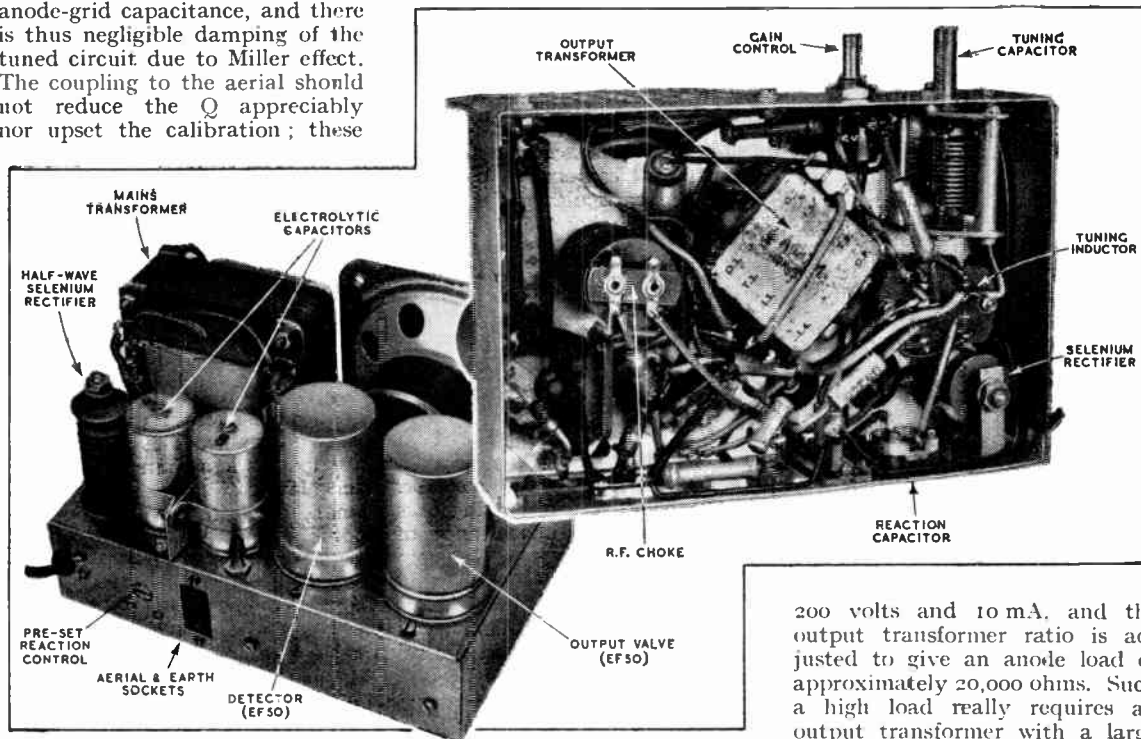

General view of the finished receiver. The overall dimensions are  $6\frac{1}{2}$  in.  $\times$   $4\frac{1}{4}$  in.  $\times$   $4\frac{1}{4}$  in. The underside of chassis shows the positions of some of the principal components.

aims are achieved by coupling the tuned circuit to the aerial by a shunt capacitor of  $0.005 \mu F$ . This gives very low voltage transfer (about  $\frac{1}{4}$  from aerial to grid) but restricts the reduction in  $Q$  due to aerial damping to less than 5 per cent., and tuning calibration is completely independent of the aerial constants. A further reason for using the shunt-capacitance aerial coupling circuit is that it gives the receiver an input impedance of only a few ohms; this low input impedance is necessary for the gain control as will be seen later.

Reaction is used to improve the  $Q$ , regeneration being controlled by a pre-set ceramic capacitor of  $30 pF$  maximum capacitance mounted on the rear of the chassis and adjusted by a screwdriver. Details of the reaction winding are given in Fig. 2. Reaction is

for the low voltage transfer of the aerial-coupling circuit.

A disadvantage of pre-set reaction is that the receiver bursts into oscillation for a few seconds shortly after switching on. This can be avoided by setting the gain control to zero, but even then faint whistles may still be heard unless the r.f. screening is good; further details about such screening are given later.

The r.f. choke in the anode circuit of the detector is essential; if it is omitted or if a resistor is used instead, it is very difficult to prevent r.f. signals being handed on to the output valve where, after amplification, they give trouble in the output transformer by upsetting the a.f. negative feedback circuit or by causing r.f. positive feedback. The particular r.f. choke used was an old-fashioned and unnecessarily bulky

200 volts and 10 mA, and the output transformer ratio is adjusted to give an anode load of approximately 20,000 ohms. Such a high load really requires an output transformer with a large primary inductance, and the inductance of the midjet component used is certainly inadequate, but the tendency to lose bass is offset by negative feedback.

The feedback voltage is obtained from the secondary of the output

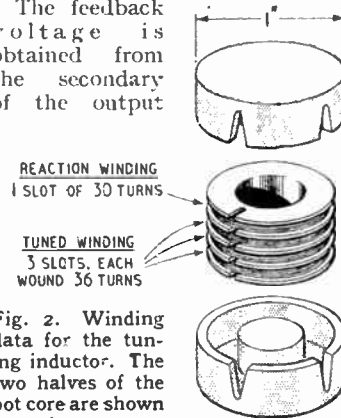

Fig. 2. Winding data for the tuning inductor. The two halves of the pot core are shown parted to expose the coil former.

transformer and is injected into the detector cathode circuit. The cathode resistor is very low (20 ohms) to avoid giving the

**Midget A.C. Mains Receiver—**

cathode a positive bias which would upset detector operation, and the grid leak is returned to h.t. negative, not cathode, so that the negative feedback can operate properly. Gain is controlled by varying the negative feedback; the gain control  $R_6$  is arranged to short-circuit the cathode resistor  $R_5$  when rotated fully clockwise. This system has the disadvantage of a limited range of control and does not reduce the output to zero when the control is rotated fully anticlockwise. To give zero output  $R_6$  is arranged to short-circuit the aerial and earth terminals at its minimum setting. To operate satisfactorily, such a system requires a low value of  $R_6$  and a low receiver input impedance; the method of obtaining the latter has already been described. The value of  $R_6$  is 150 ohms, but as maximum changes in gain occur near the maximum and minimum settings a somewhat smaller value (say 50 ohms) might give smoother control. Quality becomes shrill near the maximum gain setting due to the removal of feedback; but this can be overcome by increasing the capacitance across the primary winding of the output transformer. In regions of high field strength, signals may be picked up directly by the tuning inductor; such signals spoil the performance of the gain control by giving an output from the receiver when the control is set to zero. This effect can be avoided by fitting an earthed plate on the bottom of the chassis so as to screen all the r.f. components completely. Such a plate can be fitted to the bottom of the cabinet and bonded to the chassis.

**Positive Feedback**

It was found in the experimental stage of the design of this receiver that the gain of the a.f. amplifier without feedback is quite sufficient to cause oscillation if the grid circuit of the detector is in close proximity to the anode circuit of the output valve. Thus these circuits should be kept well apart, or, if this is impossible, the anode circuit should be screened.

The loudspeaker used is a midget type with a diaphragm 3 in. in diameter and, as would

**OUR COVER**

Some of the thirty-two operating positions at the re-equipped G.P.O. receiving centre at Burnham, Somerset, are illustrated on this month's front cover. The station's thirteen transmitters at Portishead, some twenty miles away, are remotely controlled from this centre.

be expected, the quality tends to be dominated by an extremely good upper register. The receiver has, however, been used to drive full-sized loudspeakers and its quality is extremely pleasant. With the particular midget loudspeaker used there is a tendency for bass notes to modulate high ones; this is probably due to the large excursions at low frequencies of the speech coil, which moves out of the linear part of the magnetic field in the gap. This effect may not be present to the same extent with all types of midget loudspeaker but can in any case be reduced by using a bass-cut circuit in the receiver. A convenient way of cutting bass is to reduce the capacitance of  $C_7$ . At low settings of the gain control, feedback will probably offset this bass loss but this is of no consequence as volume will then be low. As the gain control is advanced and volume increases the bass cut will become more effective.

The loudspeaker used had an impedance of 15 ohms and the output transformer, which is a midget multi-ratio type was arranged to give a ratio of 35:1. If a 3-ohm speaker is used, the ratio should be 80:1 and  $R_{11}$  should be reduced to about 50 ohms.

The power pack incorporates a half-wave 230-volt 30-mA selenium rectifier mounted vertically through a hole in the chassis behind the mains transformer, and the output from the rectifier is adequately smoothed by two RC circuits one for each valve. Two midget electrolytic capacitors are used, one containing an 8- and a 16- $\mu$ F capacitor and the other a single 32- $\mu$ F capacitor. It was originally intended to modify a small output transformer to be used as a mains transformer, employing the existing primary and secondary windings for mains and l.t. supplies respectively and adding a third winding for h.t. Experience has shown that this can be done successfully, if the

existing primary winding and the h.t. secondary are interleaved and capable of withstanding voltages of the order of 230 volts r.m.s. Alternatively a transformer can be wound to the following specification:

Primary (untapped 2530 turns 38 s.w.g. enamelled.

H.t. secondary 2300 turns 43 s.w.g. enamelled.

L.t. secondary 73 turns 24 s.w.g. enamelled.

No primary tappings are necessary as the receiver is used only on 230-volt mains. The total secondary load is less than 7 watts and the laminations can be quite small, say 2in. by 2½in. with a core section of approximately ¼ sq. in. The author was fortunate enough to obtain from a surplus store a commercial transformer which proved suitable without alteration, though it is slightly larger than strictly necessary, and the windings have a number of tappings which are not needed in this circuit. This transformer is shown in the photographs. No on-off switch was fitted to the receiver but there is room above the chassis for a small switch.

**VALVE DATA**

BEFORE the war the publication of valve data was an annual feature in *Wireless World*. Since 1940, however, it has not been practicable, for reasons beyond our control, to issue other than a reprint of the information contained in the May issue of that year.

It has now been made possible for us to resume publication, but, owing to paper restrictions, the information cannot be included in *Wireless World*, and it is therefore issued separately in book form (price 3s 6d, plus 3d postage).

"Radio Valve Data," which contains 80 pages of *Wireless World* size, gives characteristics and base connections for 1,600 British and American receiving valves, including metal rectifiers, barretters, voltage stabilizers and crystal valves. An index to all valves by type number and a list of British-made American types are also included.

# When valves are out of date **BRIMARIZE**-no need to wait!

**T**YPE 76 and its octal based equivalent type 6P5G are general purpose triodes used as oscillators and amplifiers in radio receivers and test gear.

Type 6J5G will replace type 6P5G directly with change of bias resistor if necessary, whilst replacement of type 76 will involve a change of socket.

For oscillator applications the slight differences in inter-electrode capacitancies may necessitate re-trimming. When used in push-pull amplifiers the increased gain of type 6J5G will involve re-balancing of the inputs to the push-pull valves.

**76  
6P5G**

INSTRUCTIONS: Punch holes where indicated and cut away this portion. Cut out and file them in the order in which they appear. This column will then give you a quick reference index.

PUNCH HOLES HERE

CHARACTERISTICS		TYPES 76, 6P5G		TYPE 6J5G	
Heater Voltage	6.3	6.3	volts	6.3	volts
Heater Current	0.3	0.3	amp.	0.3	amp.
Anode Voltage	250	250	volts	250	volts
Anode Current	5.0	9.0	mA.	9.0	mA.
Bias Resistor	2500	1000	ohms.	1000	ohms.
Mutual Conductance	1.5	2.6	mA/V	2.6	mA/V
Amp. Factor	14	20		20	

RESISTANCE COUPLED OPERATION			
(Supply Voltage 250 volts)			
Anode Load Resistor	0.05	0.1	0.05 0.1 meg.
Cathode Bias Resistor	3000	7500	2000 4000 ohms.
Voltage Gain	9	10	15 16

KEY  
TYPES 6J5G, 6P5G

KEY  
TYPE 76

CHANGE VALVE		CHANGE SOCKET		CHANGE CONNECTIONS		OTHER WORK NECESSARY	PERFORMANCE CHANGE
FROM	TO	FROM	TO	FROM OLD SOCKET	TO NEW SOCKET		
76	6J5G	U.X. 5 Pin	International Octal	Pin 1 .. 2 .. 3 .. 4 .. 5	Pin 2 .. 3 .. 5 .. 8 .. 7	1. Change Bias Resistor in accordance with table above. 2. Re-trim receiver if necessary.	Increased oscillation or gain depending on the application.
6P5G	6J5G	International Octal	NO CHANGE	NO CHANGE		AS ABOVE	

**BRIMAR** says..  
We will be at the  
R.C.M.F. EXHIBITION  
STAND 96

**BRIMAR**  
RADIO VALVES

STANDARD TELEPHONES AND CABLES LIMITED, FOOTSCRAY, SIDCUP, KENT.

*A sure way to far better reproduction—  
far less record wear*



**THE FINEST  
LIGHTWEIGHT**

**PICK-UP**

**Type 14.** Complete Pick-up unit with rest, matching transformer, screened lead and plugs for insertion in "Record Player" or "Pick-up" sockets of radio receiver.

Price complete £3.15.0 plus £1.1.8 (Purchase Tax).

**Type 14A.** Pick-up (identical with type 14 described above) and rest only.

Price, including rest, £2.10.0 plus £1.1.8 (Purchase Tax).

- **Minimum Record and Needle Wear.** This Marconiphone Pick-up is designed to provide the highest quality reproduction with the absolute minimum of record and needle wear. To those whose record library contains specimens that are irreplaceable this is a most important advantage.

- **Extended Frequency Response.** The frequency response has been greatly extended and by the elimination of any spurious resonances a perfect balance of tone is obtained over the musical range. It is sensibly linear over the section 50 — 8,000 c/s.

- **Adaptability.** By means of the special matching

transformer supplied, which incorporates a tone compensation circuit, the pick-up provides more than sufficient volume with almost any radio receiver to which it may be connected. The pick-up may be used without this transformer in conjunction with record reproducing equipment of individual design.

- **Pick-up-output** for average record, 6 mV.

Output at secondary of matching transformer is 1.5V.

- **Needles.** Needle changing is simple (no needle screw to operate) and up to 100 playings with steel needles and 2,000 playings with all-sapphire needles are possible. Ordinary needles must not be used with these instruments. Recommended types are the Columbia 99, Columbia Permanent sapphire or Columbia Miniature Thorn.

**MARCONIPHONE-** *the REAL thing*

The Marconiphone Company Limited, Hayes, Middlesex

M.100



**Superheterodyne Television Unit**—ponents following  $V_7$  on the other. The bracket thus provides screening between the pre- and post-limiter circuits and is necessary to prevent stray capacitance from passing interference when  $V_7$  is cut-off.

All the r.f. and i.f. coils used are of the same mechanical form and comprise a tube of  $\frac{3}{8}$ -in outside diameter and  $\frac{1}{4}$ -in inside diameter with slots in the walls at one end to carry a flat brass cross-piece for mounting. Slots at the other end permit a few turns of twine to be wound so as to engage in the thread of the o.B.A. tuning slug. Although all the coils utilize formers of the same mechanical type and are identical with those used in the straight set previously described, two different materials are used.

All coils tuned to the sound channel— $L_2, L_3, L_4, L_5, L_6, L_7, L_9$  and  $L_{11}$ —have polystyrene formers and copper slugs, whereas all coils in wideband circuits,— $T_1, T_2, T_3, T_4, T_5, L_8, L_{10}$ —have paxolin formers and brass slugs. The losses with paxolin and brass are heavier than with polystyrene and copper and their use is only permissible in circuits which require high losses for their proper

operation. If it is desired for uniformity, polystyrene formers and copper slugs can be used throughout, but the reverse is not permissible. If any difficulty is found in obtaining o.B.A. copper rod, it should be noted that  $\frac{1}{4}$ -in

copper rod can easily be threaded with a o.B.A. die. Polystyrene is also used for the oscillator-coil former  $L_1$ , but paxolin for the coils  $L_{12}, L_{13}, L_{14}$ , and  $L_{15}$ .

Except for  $T_1$  and  $T_2$  all coils are close wound. In  $T_1$  and  $T_2$

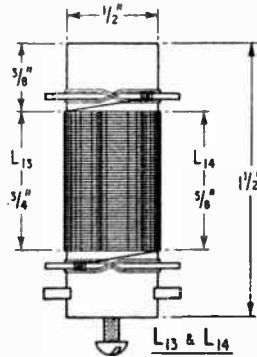
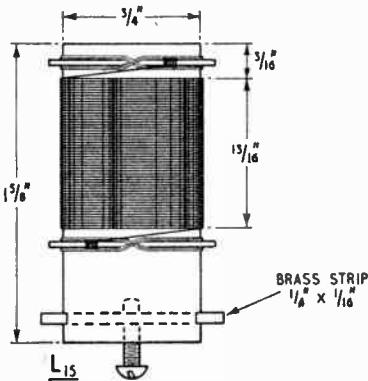
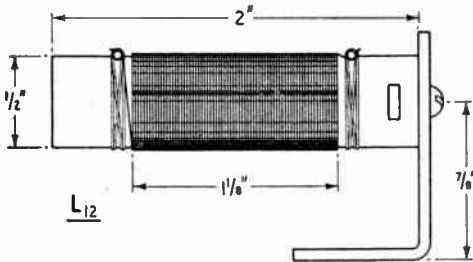
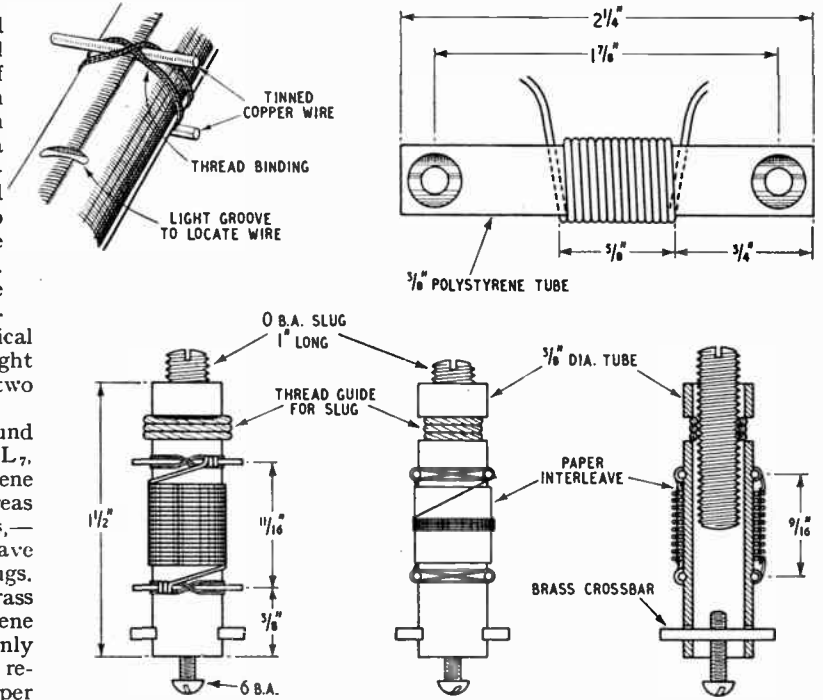

Details of the r.f., i.f. and oscillator coils are given above. On the left the drawings show the form of the filter and correction coils. The winding data appears in the Table on page 100.

the turns are spaced out to fill the winding space uniformly. After winding, the coils should be doped with shellac, in the case of those with paxolin formers, or polystyrene varnish, for the others.  $T_2, T_3, T_4$  and  $T_5$  are double-wound and should have a layer of shellacked paper between the windings to provide insulation. Primary and secondary are identical in  $T_2$  and  $T_5$  but in  $T_3$  and  $T_4$  the coupling windings have only a few turns, which should be placed in the centres of the main windings. Details of the windings are given in the table.

The set requires careful alignment and a calibrated test oscillator must be regarded as essential. The sound channel should be aligned first. Remove  $V_3$ ; set



the signal generator to 9.5 Mc/s and connect it between the chassis and the grid of  $V_5$ . Then adjust  $L_5$  and  $L_6$  for maximum output;  $L_6$  will normally be flatter than  $L_5$ . Transfer the signal generator to the grid of  $V_4$  and adjust  $L_3$  and  $L_4$ . Disconnect  $C_4$  from the secondary of  $T_2$  and connect it to the signal generator; adjust  $L_2$ . Then readjust all sound-channel trimmers with the gain control (contrast) at maximum starting with  $L_6$  and finishing with  $L_2$ .

It will be necessary progressively to reduce the signal-generator output as more circuits are brought into operation, and as they come into tune. The coupling between  $L_3$  and  $L_4$  and between  $L_5$  and  $L_6$  is adjustable by their spacing. This is normally  $\frac{3}{4}$ -in between centres but is not critical. It should be slightly sub-optimum. Now connect the signal generator to the grid of  $V_{10}$  and set it to 11.5 Mc/s. Adjust  $T_5$  for maximum response. The tuning is very flat and it is advisable to use a meter as an indicator; this should be an 0-1 millimeter connected in series with  $R_{24}$  and by-passed with an 0.001- $\mu$ F capacitor.

Transfer the signal generator to the grid of  $V_9$  and with it set to 9.5 Mc/s adjust  $L_{11}$  for minimum output. This circuit is sharp and must be set precisely. Alter frequency to 10 Mc/s and adjust  $L_{10}$  for maximum output. Then connect the signal generator to the grid of  $V_8$  and with it set to 9.5 Mc/s adjust  $L_9$  for minimum output; then adjust  $L_8$  for maximum output with the generator at 12.5 Mc/s.

Now connect the generator to  $C_4$  just as in the case of the sound-channel adjustments, and connect a 470-ohm resistor in series with each end of the inter-unit cable. Disconnect  $R_{24}$ , set the generator to 9.5 Mc/s and adjust  $L_7$  for minimum output. Then adjust  $T_4$  for maximum output with the generator at 10.3 Mc/s. Reconnect  $R_{24}$ , disconnect  $R_{13}$ , set the generator to 12 Mc/s and adjust  $T_3$ . Reconnect  $R_{13}$  and remove the 470-ohm resistors. The overall response curve should now be of the form shown in Fig. 2.

Connect the signal generator to the grid of  $V_1$ , set it to 41.5 Mc/s,

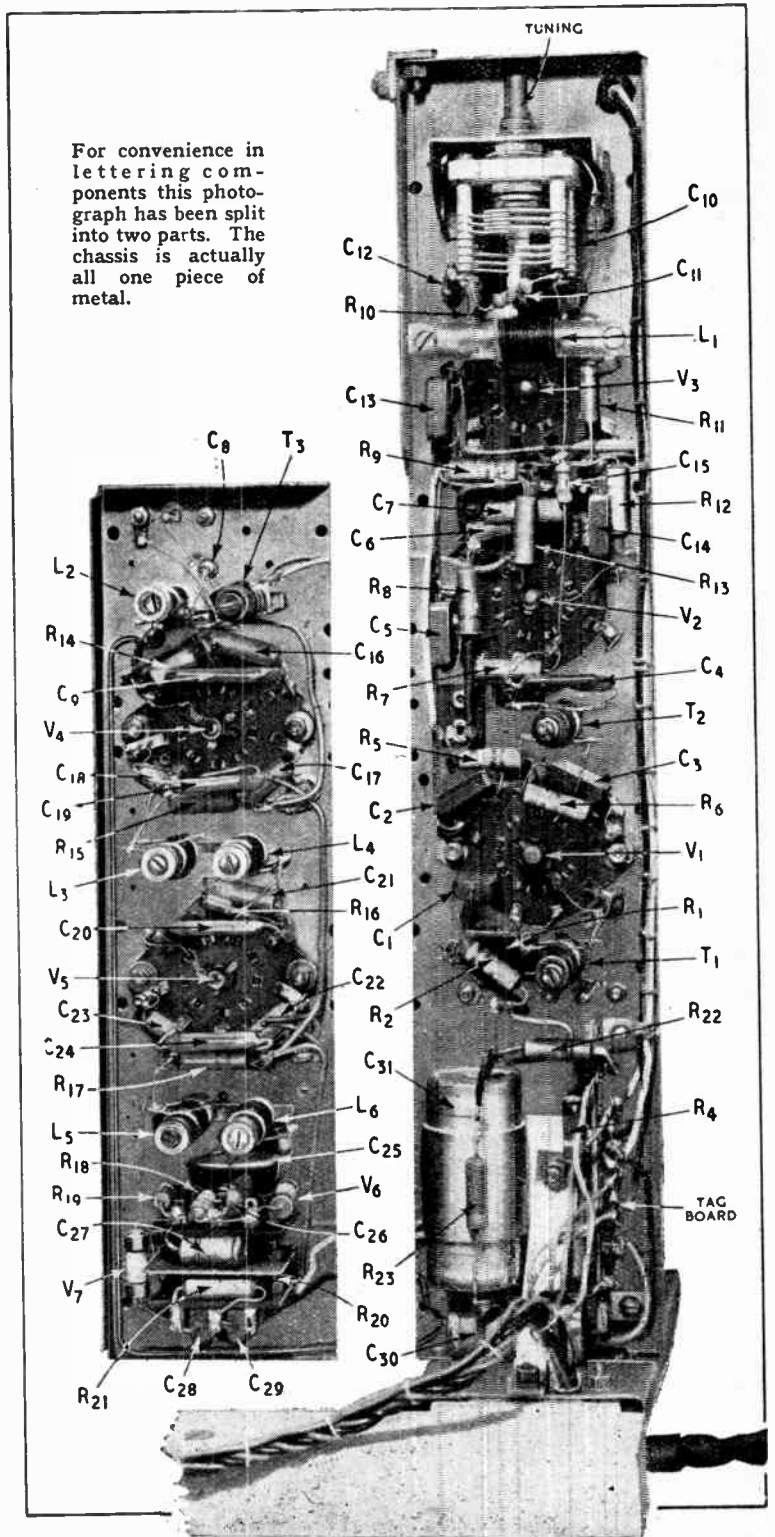

R.F., Oscillator and Sound I.F. Chassis.

**Superheterodyne Television Unit—** insert  $V_3$  and adjust  $C_{10}$  for maximum output on the sound channel. Swing the generator to a higher frequency. All output

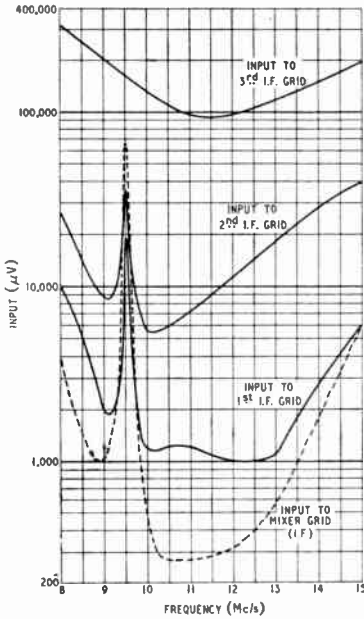

Fig. 2. These curves show the unmodulated r.m.s. signal input needed at various stages to produce a change of detector current of 0.5 mA ; i.e., a change of 1.65 V across the diode load.

from the sound channel should rapidly vanish and should appear in the vision channel. There should be a maximum around 44 Mc/s and the response should be about one-half of this at 45 Mc/s.

When satisfied that the oscillator is properly set connect the signal generator to the input socket. With it set to 43 Mc/s, adjust  $T_2$  for maximum vision-channel output, and  $T_1$  with it set to 45 Mc/s.

The adjustments on a signal are the same as with any other receiver, but tuning with  $C_{10}$  must be carried out on the sound signal only. If  $C_{10}$  is adjusted for maximum sound output, the picture signal will automatically be tuned right provided, of course, that the i.f. circuits have been properly aligned. This correct setting of  $C_{10}$  is not one giving maximum vision signal, it is one giving one-half of the maximum. Initially put the noise suppressor out of action by tuning the control so that the slider of  $R_{40}$  is at

earth. Set Brightness and Contrast for the best picture, re-adjusting Focus as necessary. If there is ignition interference adjust  $R_{40}$  until its setting just has no effect on the picture.

As this control is turned it will be found that it has no effect at all until a certain point is reached at which it suddenly takes out the brightness of the whitest parts of the picture. It should then be turned back a little so that it just has no effect on the picture quality. Any alteration to Contrast will require a re-adjustment of the noise limiter but Brightness does not affect it.

Care in the setting of this control is necessary. The aim is to adjust it so that the anode potential of  $V_{13}$  is very close to the instantaneous anode potential of

$V_{12}$  with a peak-white signal. If it is more negative than this, the limiter will not reduce interference fully ; if it is more positive, the diode will conduct on the signal and all detail in the white region will be lost.

The receiver draws a somewhat higher current than the earlier straight set and in consequence one change is desirable elsewhere. The resistor  $R_2$  of Fig. 1, Part 6 (the limiting resistor in series with the focus control), should be changed to 200  $\Omega$ , 3 W. The resistor  $R_1$ , of Fig. 1, Part 9, (+ H.T.3 feed resistor) need not be altered, however.

It is not possible to give much indication of the range of the receiver for it depends to a very large extent on local conditions. The set has been designed on the

**COIL WINDING DATA.**

Note—In all multi-winding assemblies, all windings are in the same direction, and grid windings are overwound on anode windings with one turn of shellacked paper between for insulation ; adjacent ends are grid and anode on the one hand and earth and + H.T. on the other.

Component	Wire (S.W.G.)	Winding 1-2 (turns)	Winding 3-4 (turns)	Trimming Frequency (Mc/s)	Remarks
$T_1$ ...	36 D.S.C.	12	1½	45	3-4 interwound with 1-2 at earthy end.
$T_2$ ...	36 D.S.C.	9	9	43	
$T_3$ ...	38 enam.	45	4	12	3-4 overwound in centre of 1-2 with one turn of shellacked paper between.
$T_4$ ...	38 enam.	50	4	10.3	
$T_5$ ...	38 enam.	51	51	11.5	
$L_1$ ...	20 enam.	15	—	32	Polystyrene former, air core.
$L_2, L_3, L_4, L_5, L_6, L_7,$	26 enam.	22	—	9.5	
$L_8, L_{11}$	36 enam.	30	—	12.5	
$L_{10}$ ...	36 enam.	45	—	10	
$L_{12}$ ...	40 enam.	200	—	—	
$L_{13}$ ...	38 enam.	108	—	—	Polystyrene formers and copper slugs.
$L_{11}$ ...	38 enam.	90	—	—	
$L_{15}$ ...	40 enam.	142	—	—	

basis that a signal-noise ratio of 20 db is the minimum acceptable. This being so it has not been thought worth while to go to extremes in reducing set noise. A triode first stage, for instance, would theoretically be an improvement, but would at most be 6 db better. In practice, probably no more than 3 db would be gained. In either case, the improvement is small considering the overall requirement of at least 20 db. Matters are very different in radar where signals equal to the noise can be useful; an improvement of only 1 or 2 db may then justify considerable receiver complication.

When receiving a weak signal, receiver and external noise may well be appreciable and may affect the line synchronizing as well as produce a pattern on the picture. It has been found that the 'tearing of lines' is more disturbing than the direct noise. This can be greatly reduced, if not completely eliminated, by connecting a resistor in series with  $C_1$ , Fig. 1, Part 6.

The effect of this is to form with the input capacitance of the sync separator an integrator which largely smooths out noise peaks and prevents them from tripping the timebase. If the resistor has too high a value pulling on whites may occur, but it should be made as high as possible as long as much pulling does not occur. Usually, 20 k $\Omega$  is a suitable value.

At extreme ranges when receiver noise becomes important it has been found that considerable improvement can be effected by the careful adjustment of the limiter. If it is set so that it does operate on the picture signal to some degree it removes quite a lot of the noise and although it degrades the picture to some extent the net result is an improvement. At such ranges the aerial becomes extremely important and is the place to which one must look for any major gain.

The receiver has been tested in a country district some 40 miles north-east of Alexandra Palace, but with rather a poor aerial. The aerial itself was a standard dipole and reflector but during the tests it was impracticable to mount it high enough above the roof of the house on which it was erected. The lower ends of the dipole rods

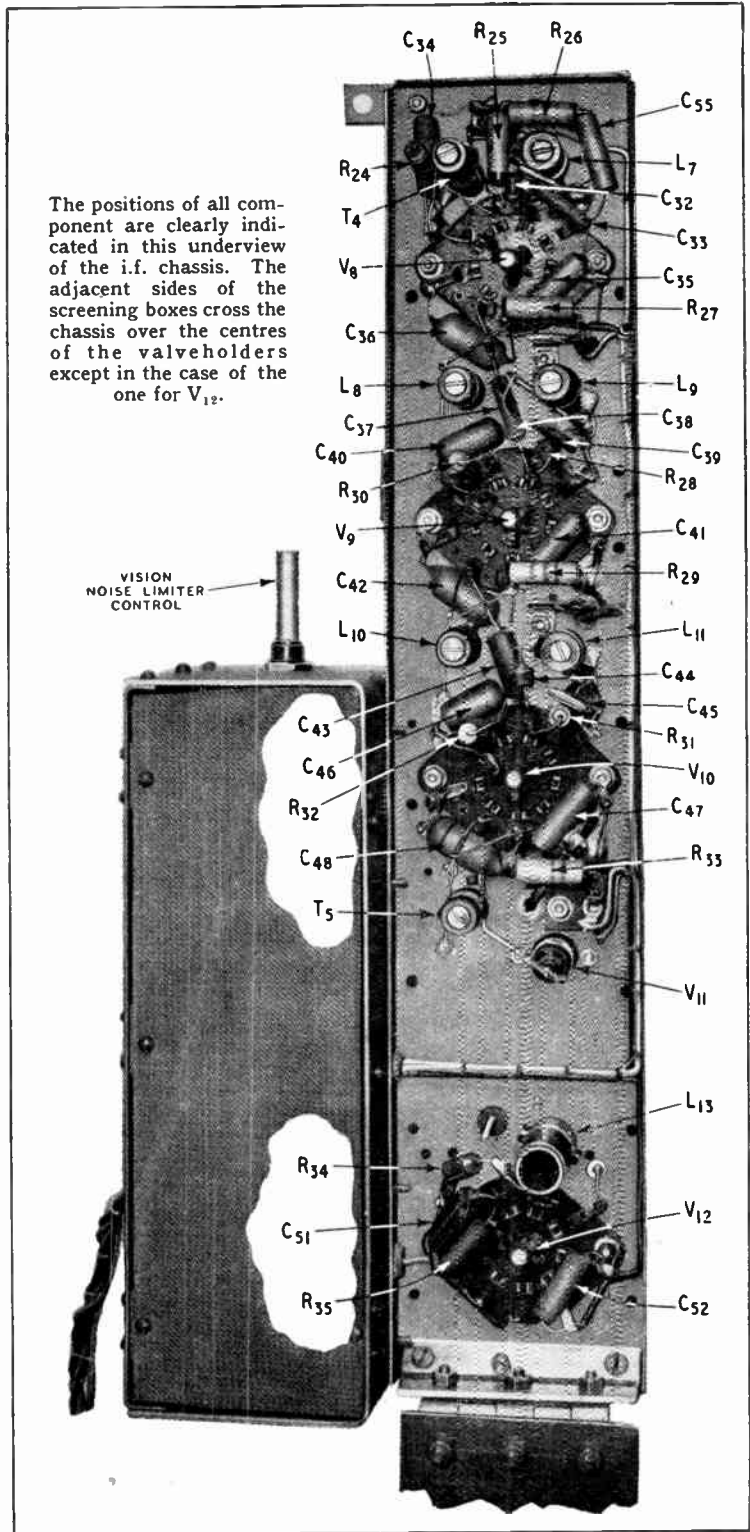

I.F. and V.F. Chassis

**Superheterodyne Television Unit—** were only a couple of inches from the tiles of the sloping roof and the centre of the aerial was no more than a couple of feet above the peak of the roof. It was estimated that at least 10 db more signal would have been obtained with a properly erected aerial.

Nevertheless, the picture obtained was indistinguishable from a local one, except of course, from

ignition interference from passing vehicles. On sound, such interference could be heard but was never obtrusive. On vision it was more noticeable, but only in the case of one or two particularly bad cars was it sufficient to mar one's enjoyment of the picture.

**Corrections**

In the list of components in the first part of this article the

rating of  $R_{40}$  was wrongly given as 3 W; it should be 1 W.

A by-pass capacitor  $C_{65}$  was also omitted from the circuit diagram and list of components. It is of the mica type and of  $0.001 \mu F$  capacitance; it is connected to earth from the 'free' end of  $R_{26}$  and is considered advisable on account of the great length of the lead to the contact control mounted in the other chassis.

## SHORT-WAVE CONDITIONS

### January in Retrospect : Forecast for March

By T. W. BENNINGTON and L. J. PRECHNER (Engineering Division, B.B.C.)

**DURING** January maximum usable frequencies for this latitude decreased by day and increased slightly at night. The day-time decrease was due to the "Mid-winter Effect," while the night-time increase was in accordance with the normal seasonal trend.

The month was again very disturbed, ionosphere storms being observed on 1st-2nd, 3rd, 8th, 13th and 24th-28th, the 25th-27th being exceptionally disturbed. Working frequencies for the whole month were, in fact, lower than had been expected, due to the storminess. So far as is known, no long-distance contacts were made on frequencies as high as 50 Mc/s, but transmissions of the order of 40 Mc/s from America, and 30 Mc/s from Australia, were fairly frequently received, while, during the night, frequencies as low as 3.5 Mc/s continued to be workable. From 24th-27th very little direct reception occurred on frequencies above 20 Mc/s. During this period there occurred great magnetic and ionospheric storms, which started almost simultaneously, as well as displays of Aurora Borealis, seen in places as far south as France and Austria. Some amateur transmissions on 28 Mc/s were received from the direction of the auroral zones, and not in the great circle direction between transmitter and receiver.

Again, an abnormally high rate of incidence of Sporadic E was recorded, this value being somewhat higher than in December. It is quite possible that the reception just mentioned of the 28-Mc/s band transmissions via the auroral zone was due to a considerable increase in the Sporadic E ionization in the auroral regions during the violent disturbance period.

Only three "Dellinger" fadeouts were recorded in January (15th,

17th and 18th), the fadeout on 18th being particularly violent.

Sunspot activity in January was slightly greater than in December. Two large groups were observed, which crossed the central meridian of the sun on 19th and 22nd. This last exceptionally large group was very probably associated with the violent disturbances mentioned.

Long-range tropospheric propagation was observed on a few occasions, particularly so during the foggy spell towards the end of the month. Thus transmissions on the 145-Mc/s band from Belgium were received by G6DH, Clacton, Essex.

**Forecast.**—During March there will probably occur in these latitudes a slight decrease in the daytime m.u.f.s, and a considerable increase for night-time. The seasonal and sunspot cycle effects taken together will tend to produce this result.

Daytime working frequencies for nearly all circuits should, therefore, remain quite high, and long-distance communication on high frequencies should often be possible in all directions for periods considerably longer than during February, due to the lengthening hours of daylight in the Northern Hemisphere. The 28-Mc/s amateur band should be regularly usable for long periods on some circuits. Frequencies lower than 11 Mc/s should seldom be necessary at any time during the night over many circuits, though on high-latitude transmission paths it is likely that frequencies of the order of 9 Mc/s will be required for limited periods.

For transmission over distances between about 600 and 1,000 miles, the E layer may sometimes control transmission during the daytime, and thus perhaps higher frequencies may be usable than would otherwise have been so. Sporadic E

ionization is not likely to be much in evidence.

Below are given, in terms of the broadcast bands, the working frequencies which should be regularly usable during March for four long-distance circuits running in different directions from this country. All times are G.M.T. The figures in brackets indicate the highest frequency likely to be usable for about 25 per cent of the time during the month for communication by way of the regular layers:—

<b>Montreal :</b>	0000	9Mc/s	(13Mc/s)
	0200	7 "	(11 " )
	0800	9 "	(12 " )
	1000	15 "	(18 " )
	1100	17 "	(23 " )
	1200	21 "	(26 " )
	2000	17 "	(23 " )
	2100	15 "	(20 " )
2200	11 "	(15 " )	
<b>Buenos Aires :</b>	0000	11Mc/s	(16Mc/s)
	0800	17 "	(22 " )
	0900	21 "	(26 " )
	1000	26 "	(32 " )
	2000	21 "	(27 " )
	2100	17 "	(22 " )
	2200	15 "	(19 " )
	2300	11 "	(16 " )
<b>Cape Town :</b>	0000	11Mc/s	(16Mc/s)
	0300	9 "	(14 " )
	0500	11 "	(17 " )
	0600	17 "	(24 " )
	0700	21 "	(30 " )
	0800	26 "	(34 " )
	1800	21 "	(27 " )
	2000	17 "	(23 " )
	2100	15 "	(19 " )
	2200	11 "	(16 " )
<b>Chungking :</b>	0000	7Mc/s	(10Mc/s)
	0300	9 "	(13 " )
	0400	11 "	(16 " )
	0600	17 "	(25 " )
	0700	21 "	(28 " )
	1000	26 "	(32 " )
	1300	21 "	(26 " )
	1400	17 "	(23 " )
	1500	15 "	(19 " )
	1600	11 "	(15 " )
2000	9 "	(13 " )	
2200	7 "	(10 " )	

As a considerable amount of ionospheric storminess often occurs during March, it may be anticipated that some serious disturbances may occur. At the time of writing it would appear that such disturbances are more likely to occur within the periods 2nd-6th, 13th-14th, 19th-21st, and 29th-31st, than on the other days of the month.

# THE "BELLING-LEE" PAGE

Providing technical information, service and advice in relation to our products and the suppression of electrical interference

## "DOOROD" INDOOR TELEVISION AERIAL

This has become very popular, and in fact we have been behind with deliveries ever since its introduction. For those who may have missed the original description, it is a fully dimensional half-wave dipole with one rigid and one flexible element. It is satisfactory for use within six or seven miles of Alexandra Palace, but its use in a steel framed building should not be encouraged. We cannot too strongly advise against exaggerated claims for any indoor aerial, even a fully dimensioned one like the "Doorod."\*1.

Any indoor aerial will be influenced by vertical metal work situated within a distance of  $\frac{1}{4}$ ,  $\frac{1}{2}$ , or  $\frac{3}{4}$  wavelength, and it should be remembered that such metal work may well be hidden in walls; i.e., conduits or gas-pipes, or even lead covered telephone cables, either in connection with your own home installation, or that of your neighbour if in a semi-detached or terrace house. "Wireless World" readers should not have to be reminded that wireless waves have no respect for bricks and mortar.

## THE LIFE OF WHITE POLYTHENE

We have received an enquiry from a wholesaler as to the position on L.336\*2 balanced feeder using Polythene insulation. A statement has been circulated to the effect that white polythene deteriorates (photages) if exposed to bright sunlight. We accept this, and have made arrangements to have future makings with the necessary admixture of carbon black which will retard the cracking and splitting which takes place. In other than seaside areas the deterioration is very slow and generally the cable would outlast the normal expectations of life of the installation, say five or more years.

## RADIATED INTERFERENCE

During January we received a letter demonstrating a particularly interesting example of interference being picked up from the mains in a house.

"I use an ordinary inverted "L" type aerial and when I use my set near the point of entrance the reception is free of interference, but I want to use the set in another

room. To do this I run my aerial for forty feet round picture rails, and in doing so I pick up so much interference (bangs, clicks, hisses, etc.) as to make listening very difficult. Would co-axial cable solve the difficulty and would I need transformers?"

The aerial having proved itself to be relatively free from interference pick-up, the answer to this very common problem is that the co-axial cable that would normally be used would have excessive capacity to earth, resulting in excessive attenuation of incoming signal. Therefore it would be desirable to use an impedance matching transformer system such as the "Eliminoise"\*3 to overcome losses of the long screened lead. If the aerial itself had been picking up interference, we would have recommended the erection of a "Skyrod."\*4

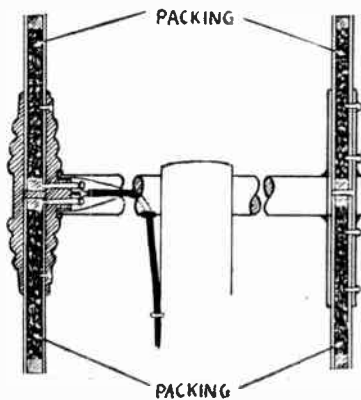

## VIBRATING AERIALS

This winter has produced its usual crop of complaints of television dipoles vibrating in the wind. "Belling-Lee" steel elements were apparently immune, there may be effect at very high wind speeds but, under such conditions, there is so much other noise that the vibrations are not unduly troublesome.

With light high tensile alloy elements, this vibration is set up at lower wind velocities and can be very troublesome, particularly where the wind is undisturbed by hills or buildings. It would take up too

much space to say how the noise is set up, but much work has gone into the cure. It has been found that if each element is filled with sawdust, close up to the cross arm, the trouble clears. Dismantling of the elements is unnecessary. First, remove the rubber plug, ram home a plug of rag, then fill with sawdust, finally replace rubber plug. Other methods may be found, but we know that this works.

It was very gratifying to hear from a dealer, near Worthing, that on the coast all makes of aerials were apt to vibrate, but that Belling-Lee "Viewrods"\*5 were the only ones that really stood up to heavy weather conditions in exposed locations.

## PERSONAL SETS IN CARS

With the growing popularity of the Personal receiver, we are receiving enquiries regarding their use in motor cars. First of all the car must be suppressed, each plug with suppressor type L.1143\*6 and distributor with L.630\*7.

Unless you can think of some way of "locking" the receiver on to the bearing of the station, the set frame aerial will not be very satisfactory. There is generally provision on the receiver for an external aerial, and this should be connected to a vertical "Carod"\*8 aerial L.582 or L.590.

\*1. "Doorod" (Regn. app. for) indoor T.V. aerial, 30/-.

\*2. L336 balanced feeder, 7 $\frac{1}{2}$ d. yard.

\*3. "Eliminoise" (Regd. trade mark) L308 plus feeder, 70/-.

\*4. "Skyrod" (Regd. trade mark) 18ft. vertical aerials from 60/-.

\*5. "Viewrod" (Regd. trade mark) T.V. aerials from 52/6.

\*6. L1143 Plug suppressor, 1/6.

\*7. L630 Distributor suppressor, 2/-.

\*8. "Carod" (Trade mark) car aerials, L590, light, 24/9; L582, heavy, 27/6.

**BELLING & LEE LTD**  
CAMBRIDGE ARTERIAL ROAD, ENFIELD, MIDD  
ENGLAND



THE SHOCKING OF DIM McCLUE.

A bunch of the boys were 'stepping it up' on transmitters south of Crewe,  
 And in charge of this bunch of technicians was Dunderhead Dim McClue;  
 As bosses go, he was rather slow, when you must be kinda slick  
 When the power is switched to them humming wires, the juice flows mighty quick.

Now Dim scorned all transformers, said they were Cissy's game,  
 And the way he fixed a circuit was surely far from tame;  
 With hand on line, Dim yelled out "Fine. O.K., now let it roar!" -  
 A mighty crack and Dim fell back - in cinders on the floor.

Now when you wire transformers, look out for those sudden shocks,  
 Vibration, moisture, heat and cold, humidity and knocks.  
 Beware of rust, and fumes, and dust; Yes, this you all should know,  
 If you want full protection - you insist on PARMKO.



**Parmeko**  
*of Leicester*

Makers of Transformers for the Electronic and Electrical Industries

★ With apologies to the late Robert Service

# 25 WATT & 50 WATT AMPLIFIERS

*New high standard of stability and reproduction. Very high degree of amplification. Simplicity of operation.*



**EXTREME SENSITIVITY.** Perhaps the most noteworthy feature of these amplifiers is their high sensitivity, which allows wide-range pick-up with low-level high fidelity microphones.

For example, the 25-watt has an overall power amplification of 133 d.b. or twenty-million-million-times. This is mainly achieved by the inclusion of a high-gain input stage completely enclosed in a rubber-mounted magnetic screening case.

**OUTPUT.** The output transformer of each amplifier is of generous size, and has an eight-sectioned primary in order that it can be included in the inverse feed-back loop. The following outputs are provided :-

- Max. undistorted voltage (R.M.S.) 100, 50, 25 volts.
- Load impedance (25-watt) - - 400, 100, 25 ohms.
- Load impedance (50-watt) - - 200, 50, 12.5 ohms.

These amplifiers are normally intended to use with the 100-volt-line system in which each loudspeaker has its own transformer. This allows simple parallel connection of the loudspeaker load, the use of long lines, and the rating of loudspeakers in terms of their actual power consumption in watts.

**MICROPHONE INPUT**  
 Input required for full drive 0.8 millivolts  
 Impedance - - 1 megohm  
**GRAMOPHONE INPUT**  
 Input required for full drive 90 millivolts  
 Impedance - - 0.25 megohm



**PHILIPS ELECTRICAL LIMITED**

AMPLIFIER DEPARTMENT,  
 CENTURY HOUSE, SHAFTESBURY AVENUE, LONDON, W.C.2

# VOIGT PERMANENT-MAGNET LOUDSPEAKER

*Performance Similar to That of Energized Models*

FOR many years the Voigt energized magnet has set a standard of performance far above the ordinary run of commercial designs, and there can be little doubt that the success of the first Voigt moving-coil loudspeaker was in no small measure due to the high flux density in the gap.

It is not easy, even in these days of anisotropic magnet alloys, to approach this standard with a permanent magnet, but as the result of several years' development work, P. G. A. H. Voigt has now succeeded in producing a magnet which gives 18,000 lines/cm<sup>2</sup> in a 1½ mm gap with an outside diameter of 40 mm and a depth of 5 mm.

The form of the magnet is similar to that of the original energized version, so that the firm's policy of continuity of design and interchangeability of parts, to provide for new developments, has been preserved. The magnetomotive force is supplied by a massive centre block of Ticonal, and the return paths are through two side limbs of generous cross-section.

In a magnet of these dimensions, accuracy of alignment at the gap presents some difficulty, and this has been overcome by making a separate unit of the pole tip assembly. The inner and outer poles, which are of specially selected material, register in a ring of non-magnetic alloy, giving a perfectly concentric air gap and a rigid assembly which will withstand the stresses incidental to magnetization. Owing to the short-circuiting effect of the side members, which are virtually in parallel with the permanent magnet during the magnetizing process, ordinary magnetizers are not big enough for the job, and a

Light coil twin diaphragm P.M. unit.

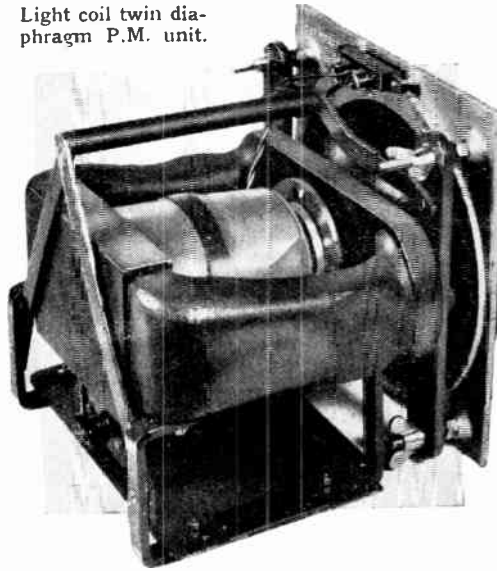

special machine had to be designed with a magnetizing force of not less than 20,000 ampere-turns.

The joints in the magnet system are so arranged that alignment is automatic, and they also give latitude for subsequent alterations in

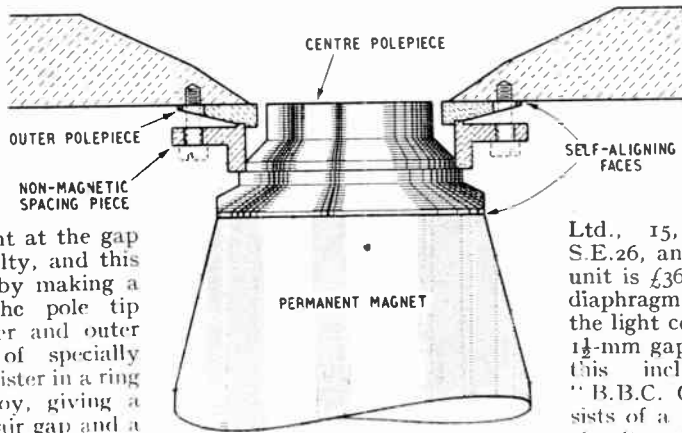

The magnet system is so designed that accurate machining is required only in the polepiece assembly.

design which may result from the discovery of even better magnetic alloys in the future. The weight of the loudspeaker with the new mag-

net system is about 30 lb.

Externally the light coil twin diaphragm has the same appearance as in previous models,\* but the speech-coil impedance is now 15Ω, and a re-calculation of mechanical and electrical impedances has resulted in better matching between the damping forces and the characteristics of the diaphragm, horn and bass chamber.

In view of the permanently high flux and the difficulties of clearing the gap of filings, export models, at least, will be fitted with dust covers, back and front.

We have had an opportunity of comparing the new P.M. model with a pre-war energized model, and we are

of opinion that it will worthily uphold the traditions of the name for high electro-acoustic efficiency and fine quality of reproduction. The redistribution of matching between the various elements has effected a noticeable improvement

on the best transmissions, and in listening to the bass response it is impossible to detect coloration from any resonant effects.

The makers are Voigt Patents, Ltd., 15, Silverdale, London, S.E.26, and the price of the new unit is £36 for the standard twin diaphragm in a 2-mm gap. With the light coil twin diaphragm in a 1½-mm gap, the price is £40, and this includes an adjustable "B.B.C. Corrector" which consists of a filter in the speech-coil circuit and controls medium high frequencies without affecting extreme top. The units are designed to work into a horn load, and two types are available, the H.C. corner horn with bass chamber at £19 10s and the domestic corner deflector at £47 10s.

\* *Wireless World*, March 9, 1939, p. 233.

## **WORLD OF WIRELESS**

### **P.M.G.'s New Powers ♦ Licences ♦ Component and Instrument Shows ♦ Faraday Medalist**

#### *W/T Act*

A MAJOR change was introduced in the Wireless Telegraphy Bill before its presentation to the House of Lords. A new section (12) has been included empowering the Postmaster General to prohibit the sale, except for export, of electrical apparatus which fails to comply with any regulations he may make as to its non-interfering properties.

Provision is made in the Act for the appointment by the P.M.G. of an advisory committee from nominees of the I.E.E. and also an appeal tribunal.

The Bill, which, when placed on the Statute Book, will be known as the Wireless Telegraphy Act, 1949, and will supersede the Acts of 1904-1926, has been published by H.M. Stationery Office, price 6d.

Prior to the third reading the R.I.C. sent to all members of Parliament a memorandum giving in non-technical language the causes of electrical interference and means of suppression.

#### *Nearly 11,500,000*

INCREASES during 1948 of 340,000 broadcast receiving licences and 60,000 television licences brought the total for Great Britain and Northern Ireland to 11,456,800.

Of this figure 92,800 were television licences.

If the monthly rate of increase in television licences (10,400) continued during the first part of this year, the 100,000 mark must have been passed in January.

#### *R.C.E.E.A. Report*

WHEN reviewing the past year's activities of the Radio Communication and Electronic Engineering Association, the chairman of this constituent body of the Radio Industry Council stated that the exports of communication equipment, navigational aids and industrial electronic gear were doubled during the year. The total value was over £3,000,000.

Broadcast transmitters accounted for some 15 per cent of the exports; communication equipment for 60 per cent, and marine and air navigational aids for 20 per cent.

#### *Physical Society's Show*

FURTHER details are now available of the 33rd annual exhibition of scientific instruments and apparatus organized by the Physical Society, which will be held at the Imperial College, South Kensington, S.W.7, from 5th to 8th April.

With the exception of the opening day, when the exhibition opens at 2.0, there will be both morning (10.0 to 1.0) and afternoon sessions—from 2.0 to 9.0 on the first two days and 2.0 to 7.0 subsequently.

The catalogue of the exhibition will be available from the Exhibition Secretary, 1, Lowther Gardens, London, S.W.7, early in March, price 6s, including postage.

Among the lectures which will be given during the exhibition are: "Some Problems of Wave Diffraction in the Ionosphere," by J. A. Ratcliffe, on 5th April, and "Some Modern Aspects of Scientific Instruments," by A. J. Philpot, on 6th April. Both lectures begin at 5.0.

#### *Components Show*

THE sixth annual private exhibition of British radio components, valves and test gear opens in the Great Hall, Grosvenor House, Park Lane, London, W.1, at 10 a.m. on March 1st. It is promoted by the Radio Component Manufacturers' Federation to acquaint radio and electronic manufacturers and engineers with the latest advances in the design and development of British components and accessories. Admission is restricted to holders of invitation cards issued by the Federation.

The show—there are to be 106 exhibitors—will be open on the 1st, 2nd and 3rd from 10 a.m. to 6 p.m.

#### *German Amateurs*

IT was erroneously stated some months ago that German amateurs were again being licensed. Although the regulations had been framed, they had not become law and the only amateurs operating in Germany since the war have been members of the occupying powers.

The German Economic Council has now made the necessary legislation for the licensing of German amateurs in the British and U.S. zones, and it is expected that the licences will be issued at the end of February. Technical and Morse examinations have already been held and a list of some 500 successful applicants has been prepared. The prefixes DL1, 3, 6, 7, 8, 9 and 0 will be used.

#### *Beam Pioneer Honoured*

THE Faraday Medal for 1949 has been awarded by the I.E.E. to C. S. Franklin for his distinguished work in radio engineering, and more particularly for his development of the beam aerial and other devices that made long-range h.f. communication a practical possibility. Of the many other innovations for which he was responsible,



**O.B. TELEVISION.**—Interior of the O.B. van equipped by Pye to B.B.C. specification. Three of the four rack-mounted tubes monitor the three Photicon cameras and the fourth the picture transmitted from the van. The image received from A.P. is shown on the upper tube.



the Marconi "multiple tuner" was among the first. His name is



C. S. Franklin.

perhaps best known as the originator of the high-stability Franklin oscillator. Mr. Franklin was one of the original band of engineers who joined the Marconi Company 50 years ago.

News in Morse

IN response to requests from readers, we have secured and give below the latest schedule of official news bulletins transmitted in morse from Post Office stations.

G.M.T.	Call	Freq. (kc/s)	Zones
0130-0315*	GBV	78	1
	GIJ	6,985	1, 2
	GPG	7,735	3
	GCX	8,920	4
	MIJ	7,447	6
0445-0545	GBI	10,865	2
	GCV	19,365	3
	GBV	78	1
0945-1045	GIM	12,975	1, 2
	GCV	19,365	3, 5
	GCF	19,005	4
1100-1200	GPA	20,100	6
	GIM	12,975	1, 2
	GBI	10,865	3, 5
1215-1315	GCF	19,005	4
	GBI	10,865	3, 5
	GCF	19,005	4
1300-1430	GPA	20,100	6
	GAG2	17,425	2
	GBV	78	1
1445-1545	GIH	10,650	1, 2
	GAH	8,065	3, 5
	GCF	19,005	4
1600-1700	GBV	78	1
	GBX	10,530	6
	GBV	78	1
1700-1800	GIH	10,650	1, 2
	GAH	8,065	3, 5
	GCF	19,005	4
1715-1815	GCX	8,920	6
	GCX	8,920	6
	GBV	78	1
1830-1930	GDI	7,780	1, 2
	GAH	8,065	3, 5
	GIB	11,980	4
1945-2045	MIJ	7,447	6
	GBV	78	1
	GBV	78	1
2100-2200	GIJ	6,985	1, 2
	GAH	8,065	3
	GCX	8,920	4
2215-2315	MIJ	7,447	6
	GBV	78	1
	GBV	78	1
2330-0100*	GIJ	6,985	1, 2
	GAH	8,065	3
	GCX	8,920	4
Midnight-0330*	MIJ	7,447	6
	GAC	6,945	7
	MIK	9,725	7
	GAF	7,308	8
	GIH	10,650	8

\* Sunday included.

In addition to the usual details of time, call sign and frequency, we give the zone of reception (1, Europe; 2, Near and Middle East; 3, N.E. Asia; 4, Africa; 5, Australia and New Zealand; 6, India and S.E. Asia; 7, N. America and Mexico; 8, Central and South America). Bulletins are radiated on week-days only unless otherwise indicated.

PERSONALITIES

Sir Ben Lockspeiser, M.A., who has held a number of scientific administrative posts in the Ministries of Production and Supply and has been Chief Scientist in the latter since 1946, has been appointed Secretary to the Committee of the Privy Council for Scientific and Industrial Research in succession to Sir Edward Appleton, who is going to Edinburgh University. Sir Ben, who was knighted in 1946 and is 57, will take up his new position in April.



Sir Ben Lockspeiser, M.A.

Sir Cyril Radcliffe, K.C., who from 1941-1945 was director-general of the Ministry of Information, has accepted the Government's invitation to be chairman of the Committee of Enquiry into the B.B.C. before the renewal of its Charter which expires at the end of 1951.

H. G. Booker, M.A., Ph.D., who has been appointed a professor of electrical engineering at Cornell University in the U.S.A., was at one time in charge of the Mathematics Section of the M.O.S. Telecommunications Research Establishment. Since the war he has been working in the Cavendish Laboratory, Cambridge. A few months ago he was appointed a member of the B.B.C. Scientific Advisory Committee and also of the I.E.E. Radio Section Committee; he has resigned both appointments.

C. W. Oatley, M.A., M.Sc., of the Engineering Laboratory, Cambridge University, has been appointed to the I.E.E. Radio Section Committee to fill the vacancy caused by Dr. Booker's resignation.

Geoffrey W. Hart, M.A., who was until recently head of the Radar Division of E.M.I. Engineering Development, Ltd., is now development officer in the Council of Industrial

Design and is in charge of the industrial survey being undertaken in preparation for the 1951 Festival of Britain. He was vice-chairman of the Technical Committee of the R.C.E.E.A. last year.

O. W. Humphreys, B.Sc., who has been on the staff of the G.E.C. Research Laboratories at Wembley since 1925, has been appointed manager of the Laboratories.

F. S. Mockford (Marconi's W/T Co.) and V. M. Roberts (B.T.H.) have been elected chairman and vice-chairman respectively of the council of the Radio Communication and Electronic Engineering Association for 1949.

J. A. Ratcliffe, O.B.E., M.A., of Cavendish Laboratory, Cambridge, has resigned from the I.E.E. Radio Section Committee to which he was elected in 1947. He is succeeded by E. C. Cherry, M.Sc. (Eng.), of the City and Guilds of London Institute.

Dudley Stretton succeeds the late Alex Moody as organizer of the National Radio Exhibition which is to be held at Olympia from September 28th to October 8th. Since his discharge from the Army he has been with the Exhibitions Division of the M.O.I.

IN BRIEF

Decca.—Lane identification, by means of which marine or air navigators coming within range of the transmissions from a Decca Chain know immediately their position, has been officially introduced in the English Chain. The Decca Navigator is now recognized as a radio navigational aid in compliance with Air Traffic Control requirements. Two additional chains, one in S.W. England and another in Scotland, have been sanctioned by the Ministry of Transport.

Combined operations by Rediffusion, G.E.C., Pye and Ekco, co-ordinated by International Aeradio, have resulted in twelve radio installations for Burmese airfields being assembled ready for export in under three months.



Sir Cyril Radcliffe, K.C. (See "Personalities")

Plessey Apprenticeships.—A revised scheme for apprentices has been drawn up by the Plessey Co. It provides for occupational training and for technical education at the South-East Essex

## World of Wireless—

Technical College throughout the whole terminates when the apprentice reaches the age of 21. Details of the scheme, which is open to juveniles between the ages of 16 and 17 without payment of a premium, are obtainable from the Plessey Co., Ilford, Essex.

**No Radio Degrees.**—At a January discussion meeting of the I.E.E. Radio Section it was agreed almost unanimously that the establishment of university degrees in radio was unnecessary, and even undesirable.

**Business Radio.**—G.E.C. radio-telephone equipment has been installed by the Midland Electricity Board to facilitate the direction of its service vans over an area of 120 square miles. F.M. is used with duplex working on two frequencies between 65 and 85 Mc/s. Both the headquarters and mobile transmitters have a 20-W output. The G.E.C. has also installed simplex equipment in the editorial office of *The Scotsman* in Edinburgh for use by reporters. Working on a fixed frequency it has no controls other than a press-to-talk switch on the telephone handset.

**Piped Television.**—The cost of 3s 6d per week, quoted in our note last month on the television aerial service to be available in certain L.C.C. flats, covers not only this service but also includes a four-programme broadcast relay service and the renewal of the £2 annual television licence.

**Vacuum Technique.**—A course of lectures on high vacuum technique has been arranged by the South-East London Technical College, Lewisham Way, London, S.E.4, for the six successive Mondays beginning on February 28th, from 7 to 9 p.m. The fee for the course, which has been prepared by J. Yarwood, M.Sc., will be £1. The syllabus includes details of pumps, de-gassing and gettering techniques, the deposition of metals *in vacuo* and the applications of vacuum technique in industry.

**P.T. on Accumulators.**—It was announced on January 18th that 2-V accumulators of a capacity not exceeding 7 Ah at the 14-hour discharge rate—except those having glass containers—will not in future be charged with purchase tax.

**Ediswan-Mazda** cathode-ray tubes are not manufactured at the company's Ponders End factory as stated on page 52 of the last issue, but at its Brimsdown Works, where the photograph was taken.

**Metallic Finishes.**—A British Standard has been issued (B.S.1448:1948) for the nomenclature of decorative metallic finishes, and is obtainable from B.S.I., 24, Victoria Street, London, S.W.1, price 2/6 post free.

**E.M.I.** has published reprints of papers on quality recording and reproduction read by members of its staff before learned societies, and they are available from the Advertising Division, E.M.I. Sales and Service, Ltd., Hayes, Middlesex, price 2/6. The titles are: "Commercial Disc Recording and Processing," B. E. G. Mittell; "The Development of Sound Recording and

Reproduction," Sir Ernest Risk; "Sound Recording and Reproduction," G. F. Dutton; and "High Quality Disc Recording," W. S. Barrell. Others will be published in due course.

**A.R.R.L. Handbook.**—A supply of the 1949 edition of the Amateur Radio Relay League's *Handbook* is being secured by Arthur F. Bird, of 66, Chandos Place, London, W.C.2, who hopes to have copies available by March; price 15s 6d plus 11d postage.

**For "B.E.E.J." read "B.E."**—With the January issue our associated journal *British Engineering Export Journal* has changed its title to *British Engineering*.

**"Ionosphere Review, 1948."**—It is regretted that contraction of the wording in paragraph four, centre column, page 56, of this article in the February issue implies that records of measurements of ionospheric ionization go back to 1749. This is obviously not the case; the records associated with this date are those of solar activity.

## INDUSTRIAL NEWS

**R.C.E.E.A. Council.**—Representatives of the following member firms of the Radio Communication and Electronic Engineering Association constitute the council for 1949: B.T.H., E.M.I., G.E.C., Henry Hughes, Marconi's, Metropolitan-Vickers, Mullard, Murphy, Plessey and Rediffusion.

**Indian Ekco.**—As a result of the recent agreement between Ekco and the National Radio and Engineering Company, Bombay, for the manufacture of radio gear in India, a new company has been formed. It will be known as the National Ekco Radio and Engineering Co. Products will be distributed by General Radio and Appliances, Ltd. (previously Fazalbhoy, Ltd.). J. A. Howie, until recently works manager at the Ekco Works, Rutherglen, Scotland, will be general manager of the new company.

**Partridge.**—The factory and offices of Partridge Transformers, Ltd., are now at Roebuck Road, Oakcroft Estate, Kingston By-pass, Tolworth, Surrey (Tel.: Elmbridge 6737/8).

**Scophony-Baird, Ltd.**, is the new name adopted by Scophony since the acquisition of John Logie Baird, Ltd.

**Mail Order Supply Co.** is opening a new retail establishment to be called the "Radio Centre" at 33, Tottenham Court Road, London, W.1.

## MEETINGS

### Institution of Electrical Engineers

**Radio Section.**—"The Analogies between the Vibrations of Elastic Membranes and Electro-Magnetic Fields in Guides and Cavities," by E. C. Cherry, M.Sc. (Eng.), at 5.30 on March 2nd.

"The Development of Q-Meter Methods of Impedance Measurement," by A. J. Biggs, Ph.D., B.Sc., and J. E. Houldin, Ph.D., B.Eng., at 5.30 on March 8th. (Joint meeting with the Measurements Section.)

Discussion on "The Planning of Business-radio Services at V.H.F.," opened by D. H. Hughes at 5.30 on March 15th.

The above meetings will be held at the I.E.E., Savoy Place, London, W.C.2.

**East Midland Centre.**—Faraday lecture on "Television" by Sir Noel Ashbridge, B.Sc. (Eng.), and H. Bishop, C.B.E., B.Sc. (Eng.), at 7.15 on March 16th at the De Montfort Hall, Leicester.

**Cambridge Radio Group.**—"Electronic Calculating Machines" by Prof. D. R. Hartree, Ph.D., M.A., M.Sc., at 8.15 on March 8th at the Cavendish Laboratory.

**North-Eastern Radio Group.**—"Induction Disc Motors for Relays and Instruments" by W. Gray at 6.15 on March 7th at King's College, Newcastle-on-Tyne.

Informal lecture on "Printed Circuits, including Miniature Components and Sub-Miniature Valves," by J. E. Rhys-Jones, M.B.E., and G. W. A. Dunmer, M.B.E., at 6.15 on March 21st at King's College, Newcastle-on-Tyne.

**Sheffield Sub-Centre.**—Faraday lecture on "Television" at 7.0 on March 23rd at the City Hall, Sheffield.

**Southern Centre.**—"Aids to Training—the Design of Radar Synthetic Training Devices for the R.A.F.," at 5.45 on March 9th at H.M.S. *Collingwood*, Fareham.

"Fixed Resistors for use in Communication Equipment, with special reference to High-Stability Resistors," by P. R. Coursey, B.Sc. (Eng.), at 6.30 on March 16th at the Wedgewood Café, Albert Road, Bournemouth.

**West Wales Sub-Centre.**—"Communication over High-Tension Networks," by W. B. Warren at 4.0 on March 10th at the Osborne Hotel, Langland, Swansea.

**Irish Branch.**—"The Application of Carrier Telephony to Coaxial Cables," by A. J. Litton, B.E., B.Sc., at 6.0 on March 24th at Trinity College, Dublin.

### Radio Society of Great Britain

"Technical Publishing," by G. Parr at 6.30 on March 25th at the I.E.E., Savoy Place, London, W.C.2.

### British Sound Recording Association

"Design of a Cutter Head for Disc Recording," by D. O'C. Roe, B.Sc., at 7.0 on March 25th at the Royal Society of Arts, John Adam Street, London, W.C.2.

### Institute of Navigation

"The Use of Radar Beacons," by K. A. B. Gillfillan, M.B.E., at 5.0 on March 18th at the Royal Geographical Society, 1, Kensington Gore, London, S.W.7.

### Television Society

**Midlands Centre.**—"A Home-built Television Receiver" by W. I. Flack at 7.0 on March 4th at the Chamber of Commerce, New Street, Birmingham.

### Junior Institution of Engineers

**Sheffield and District Section.**—"The Manufacture of Gramophone Records," by H. W. Bowen, O.B.E., at 7.30 on February 28th at the Metallurgical Club, West Street, Sheffield.

### Institution of Electronics

**N.W. England Section.**—"Photo Electric Multipliers," by S. Rodda, B.Sc., at 6.30 on March 23rd, at the Reynolds Hall, College of Technology, Manchester.

### British Institution of Radio Engineers

**London Section.**—"The Design and Characteristics of Marine Radar Equipment," by A. Levin at 6.0 on March 17th, at the London School of Hygiene and Tropical Medicine, Keppel Street, London, W.C.1.

# RANGE OF V.H.F.

## Part I.—Air to Ground Communication

By M. V. CALLENDAR, M.A. (E. K. Cole, Ltd.)

THE effect of transmitter power upon range is a particularly important question from a practical and economic point of view, since a larger power increases cost, and also increases size, weight and battery drain—factors which are very important in airborne sets.

Theoretical maximum ranges of communication will not, of course, always be obtained in any given instance owing to such factors as slight deficiencies in the equipment, unfavourable terrain or meteorological conditions, or electrical interference. Nevertheless, a great deal of useful information can be extracted from the calculated range, which depends, of course, on the following two factors:—

(a) The field at any distance  $d$  from a transmitter radiating a known power  $P$ , the ground station aerial being at height  $h_1$

available, and that local interference (e.g., from the aircraft ignition) can be neglected.

Practical ground receivers of good design (noise factor of, say, 10 db) are quite near to the maximum possible efficiency referred to, but an aircraft receiver may be well below this optimum owing to exigencies of space, weight, or battery drain; moreover, the aerial on the aircraft may be partly screened by the fuselage and a slight residuum of ignition or other interference may be unavoidable, even after careful suppression. It is therefore customary to make the

a transmitter operating on 120 Mc/s has been calculated from the available formulæ (see Appendix). From these, the distance at which the field falls to the minimum required at the receiver has been extracted, and the figures thus obtained have been plotted in Fig. 1 which shows the theoretical range for any height between 150 ft and 15,000 ft under a variety of conditions. The "efficiency" quoted is relative to maximum possible efficiency and is intended to include any loss due to interference or to an inefficient aerial system, as well as any lack of efficiency (signal/noise ratio or noise factor) in the receiver, relative to a standard of 10 db noise factor.

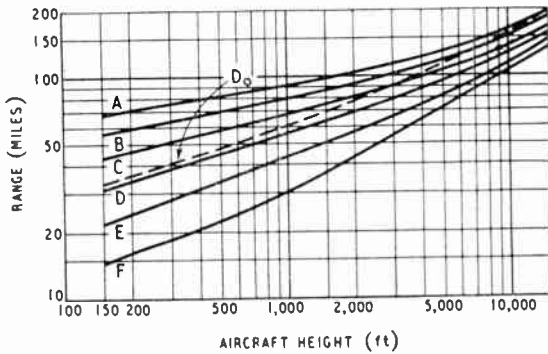

Fig. 1. Theoretical ranges of communication with aircraft for different ground transmitter powers and height of aerial. The dashed curve is the optical horizon with a ground aerial 100-ft. high.

At heights greater than 15,000 ft range will normally increase further. Fig. 2 shows a typical example, corresponding roughly to Curves E or F of Fig. 1: note the "lobes" caused by the vertical directional pattern of the aerial with earth reflection.

A curve for distance  $D_0$  to the optical horizon has been plotted in (dashed) on both Figures, since

above ground and the aircraft at height  $h_2$ .

(b) The field required for intelligible reception in the aircraft, assuming a fully efficient receiver, and no external interference.

The range will be the same in both directions if the power radiated and the receiver are the same at each end, assuming that no electrical interference is present. Half-wave dipoles, or quarter-wave aerials with ground plane are normally used.

As regards the field required at the receiver, it can be shown from the available data on cosmic noise and on internal receiver noise, that a signal field of about  $2 \mu\text{V/m}$  (equivalent to  $2 \mu\text{V}$  from a signal generator) is just sufficient to give intelligible reception, assuming that the receiver is up to the maximum efficiency now

Use Curves in Fig. 1.

First Column is Efficiency Relative to the Maximum Possible.

Efficiency	Ground Aerial	Transmitter Power				
		0.1 w.	1.0 w.	10 w.	100 w.	1 Kw
0 db	100 ft.	D	C	B	A	—
0 db	30 ft.	E	D	C	B	A
10 db	100 ft.	E	D	C	B	A
10 db	30 ft.	F	E	D	C	B
=20 db	100 ft.	F	E	D	C	B
=20 db	30 ft.	—	F	E	D	C

ground transmitter at least 10 times more powerful than the aircraft transmitter, allowing for a deficit of at least 10 db at the aircraft receiver.

A series of curves for field from

$D_0$  is often used as an approximation for range. For low heights of aircraft, it is seen that the actual range may be as much as double  $D_0$ , while at heights of the order of 20,000 ft  $D_0$  represents a

### Range of V.H.F.

maximum range only attainable with very high power.

Inspection of Fig. 1 shows that the curves are (in terms of miles) almost evenly spaced: we can, as a result, formulate the following useful simple rule; *an increase or decrease of ten times in transmitter power will alter the range by about ten miles for aircraft at any height between 150 and 15,000ft.*

This means, of course, that the only really important advantage

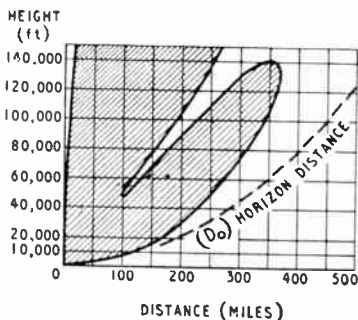

Fig. 2. Full-line curve shows calculated range for aircraft flying at great heights and a transmitting ground aerial at 50-ft. with power of 1 watt. Dashed line is approximate limit of range for higher power.

of increasing power is in respect of range to very low flying aircraft, where an extra ten miles may represent an increase of 30% to 50% in range: even here the effect, expressed as a percentage, of an increase in power above a few watts is not large unless the losses at the receiver are rather high. For sets in aircraft, therefore, quite a low power is adequate, since they are working to an efficient receiver under good conditions and this argument is, of course, reinforced in the case of light aircraft by the low battery consumption there desirable.

For aircraft at heights over 15,000ft range varies more rapidly with power, especially if the efficiency of the receiver is low. However, the use of a large power in the aircraft is particularly inadvisable under these conditions, since interference with other aircraft would then occur up to very large distances, e.g., over 500 miles at 40,000ft.

The curves of Fig. 1 may be used for practical estimates of

range in the 100- to 140-Mcs band, provided that the following points are borne in mind:—

(a) Unless actual measurement results are available, it is advisable to assume an "efficiency" of -10 db when transmitting from air to ground and -20 db when transmitting from ground to air.

(b) If the site of the ground aerial is higher than most of the surrounding country, ranges may be somewhat greater. On the other hand, range will be considerably curtailed beyond any neighbouring hills. Both these effects will be more noticeable with low-flying aircraft.

(c) Meteorological conditions will occasionally affect results (due to variation of atmospheric refractive index), especially at the longer ranges.

(d) With some installations, there may be a loss of range due to screening of the aerial by the aircraft body, and this loss may be dependent upon the heading of the aircraft.

Range at very great heights will usually lie between the full and dashed lines of Fig. 2.

Range to another aircraft is, of course, greater than to ground: it may be roughly estimated by finding the range from each aircraft to a 30ft ground aerial, and then adding together the figures obtained.

If the amplitude modulation now used were replaced by frequency modulation, the maximum range would not be much affected, but the audible noise,

background to signals, when within range might be noticeably reduced.

### APPENDIX

The figures given are mainly based on a paper on "Range of Low Power Communication" by the present writer in *Journal I.E.E.* for November, 1948, and this should be consulted for formulae and references. The figures for field at 5,000 and 10,000 feet were calculated directly from "Field Strengths over a Spherical Earth," by Domb and Pryce (*J.I.E.E.*, Sept., 1947).

The geometrical horizon [distance =  $1.2(\sqrt{h_1} + \sqrt{h_2})$  miles] has often been used as an approximation for range. The normal optical horizon distance is 15 per cent more than the geometrical (due to refraction), and this has also been sometimes used for range estimation.

At distances well beyond the horizon, the field is controlled by diffraction (with secondary effects due to atmospheric refraction) and thus exhibits a uniform rate of attenuation with distance (0.8db per mile at 120 Mc/s). When the power or efficiency is low, the range is less than the horizon distance and the field is calculated by ray formulae instead of diffraction formulae. However, the attenuation at the distances in question here never exceeds some 1.2db/mile. The rule for variation of range with power is based on these considerations and corresponds to an average attenuation of 1db per mile. For very great heights, at distances well within the horizon, the field approaches that in free space and the attenuation is much less (e.g., 0.04db per mile at 200 miles) since the field here varies inversely as the distance.

### NEWS FROM THE CLUBS

**Barnet.**—The next meeting of the Barnet Amateur Radio Society will be held at 7.30 on March 12th at 15, Station Road, New Barnet, when the subject to be discussed is audio amplifiers. Sec.: M. R. Jenkins, G3EIM, 1193A, High Road, London, N.20.

**Brighton.**—The Brighton and District Radio Club's transmitter, G3EVE, is now operating on 1.7, 3.5 and 7 Mc/s (phone) and reports will be welcomed. Meetings are held on Thursdays at 7.30 at St. Mary's Hall, Bread Street, Brighton. Sec.: R. J. Donald, G3DJD, 2, Canfield Road, Brighton.

**Derby.**—The transmitter of the Derby and District Amateur Radio Society is now operating with the call G3ERD. The club, which meets on alternate Wednesdays at 7.30 at 67B, London Road, Derby, is issuing a quarterly magazine. Sec. F. C. Ward, G2CVV, 5, Uplands Avenue, Littleover, Derby.

**Gravesend.**—Meetings of the Gravesend Amateur Radio Society are held

each Wednesday at 7.30 at 30, Darnley Road, Gravesend, Kent. Talks on receiver design and elementary radio principles are scheduled for the first two meetings in March. Sec.: R. E. Appleton, 23, Laurel Avenue, Gravesend.

**Hampton Court.**—The Thames Valley Amateur Radio Transmitters' Society is probably the first in the country to organize a regular network on two metres. It operates on Fridays at 10.30. Sec.: A. Mears, G8SM, Broadfields, East Molesey, Surrey.

**Southport.**—The recently formed Southport Radio Society meets at 38A, Forest Road, Southport, at 8.0 on the third Wednesday in each month and also holds Morse classes on Mondays at 8.0. Sec.: F. M. P. Lawson, 113, Waterloo Road, Southport.

**Wandsworth.**—The March meeting of the Wandsworth and District Radio Club will be held on the 9th at the Earlsfield Men's Institute, Waldron Road, London, S.W.18. Sec.: A. R. Dyer, 28A, Isis Street, London, S.W.18.

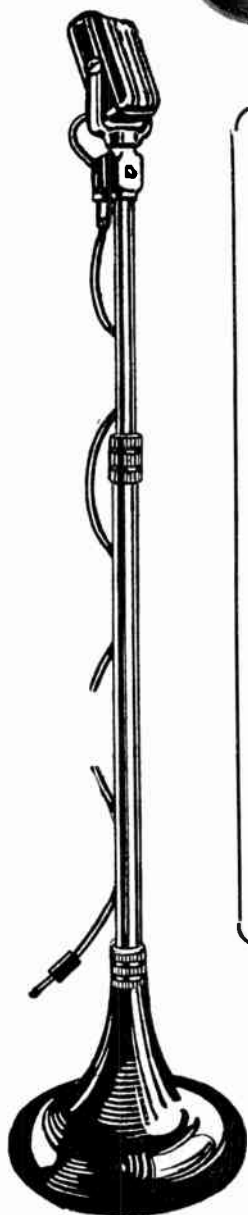

All types of  
**MICROPHONES,**  
**STANDS**  
and **SPEAKERS**  
available from  
stock including  
12 in. **GOODMAN**  
**P.M. SPEAKER**

•

**30-Watt RECORD**  
**REPRODUCER**  
in metal case  
PRICE 30½ Gns.

•

**10-Watt RECORD**  
**REPRODUCER** with  
**MICROPHONE**  
**STAGE,** in case  
PRICE 25½ Gns.

•

**CP20A AMPLIFIER**  
for A.C. Mains and  
**12-volt Battery**  
PRICE £28.0.0

## "SUPER FIFTY WATT" AMPLIFIER

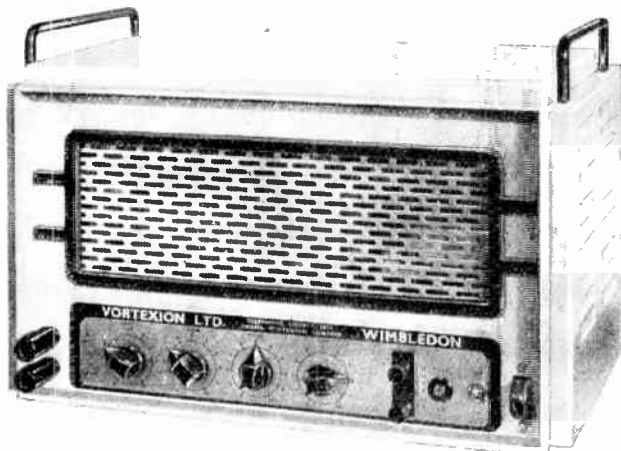

This **AMPLIFIER** has a response of 30 c/s. to 25,000 c/s. within ½db, under 2 per cent. distortion at 40 watts and 1 per cent. at 15 watts, including noise and distortion of pre-amplifier and microphone transformer. Electronic mixing for microphone and gramophone of either high or low impedance with top and bass controls. Output for 15/250 ohms with generous voice coil feedback to minimise speaker distortion. New style easy access steel case gives recessed controls, making transport safe and easy. Exceedingly well ventilated for long life. Amplifier complete in steel case, with built-in 15 ohm mu-metal shielded microphone transformer, tropical finish. As illustrated, Price **36½ Gns.**

## FOUR-WAY ELECTRONIC MIXER

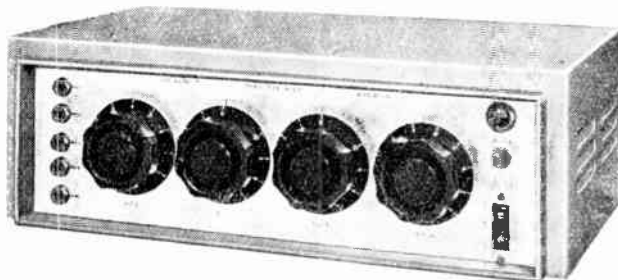

This unit with 4 built-in, balanced and screened microphone transformers, normally of 15-30 ohms impedance. Has 5 valves and selenium rectifier supplied by its own built-in screened power pack : consumption 20 watts. Suitable for recording and dubbing, or large P.A. installations since it will drive up to six of our 50 watt amplifiers, whose base dimensions it matches. The standard model has an output impedance of 20,000 ohms or less, and any impedance can be supplied to order. Price in case with valves, etc., **£24.**

**OUR FRIENDS OVERSEAS**  
are invited to write for Export Terms

*Vortexion*  
**LIMITED**

**257-261, THE BROADWAY, WIMBLEDON,  
LONDON, S.W.19, ENGLAND**

TELEPHONES : LIBerty 2814 and 6242-3.  
TELEGRAMS : "VORTEXION, WIMBLE, LONDON."

# Products renowned

for their excellence and backed by twenty years of experience—need no “superlative” advertising.

## ● Amplifiers

6 W to 50 W Output—by the pioneers of Multi-channel amplification.

*Tri-Channel, 1937—Remote Control pre-amplifier and electronically coupled Tone Control, 1945.*

## ● Transformers

from 6 W to 12 K.V.A. Single and three phase, 25 cps, 50 cps, 500 cps, 2,000 cps.

All types—L.F., Auto., Double wound. Fully vacuum impregnated by the latest methods.

. . . 1929 to 1949, and on . . . (1939 to 1945 over 1,000,000).

## ● Chokes

All types from H.F. Suppression to Arc Welding control.

. . . 1929 to 1949, and on . . .

## ● Loudspeakers

—by the pioneers of Dual Suspension 1934, *The “Speaker without a dialect,”* followed by the *Phase Inverter Speaker*—beloved by its numerous users and flattered by imitation.

## ● H.F. Tuners and Chassis

as supplied to the B.B.C.

## ● Rack and Panels

as supplied to the G.P.O. for the instigation of T.I.M. and to discerning customers ever since.

**Quality Radio in every sense from components to the amazing new 11-VALVE POLYPHONIC CONSOLE.**

NO WONDER THOSE IN THE KNOW DEPEND ON

# Sound Sales Ltd.

Office, Showrooms, Demonstrations, etc., at 57, ST. MARTIN'S LANE, LONDON, W.C.2.

Tel.: Temple Bar 4284.

(Works—West Street, Farnham, Surrey. Tel.: Farnham 6461/2/3.)

# PLAN YOUR CAREER

RADIO • TELEVISION  
and other INDUSTRIAL  
ELECTRONIC subjects

ELEMENTARY and  
ADVANCED COURSES



**WRITE NOW FOR FREE BOOKLET** summarising the careers available in Electronics and giving particulars of Training Courses offered by E.M.I. Institutes Ltd.

The booklet contains full details of **CORRESPONDENCE COURSES** in Radio, Television, Telecommunications, Mathematics and Industrial Electronics.

Daytime and Evening Attendance Courses, and Special Courses for candidates taking examinations such as those of City & Guilds, Brit.I.R.E., etc. are also available.

Payment for tuition can be made in easy instalments

## E.M.I. INSTITUTES LTD.



Dept. 16, 43 Grove Park Road, Chiswick, London, W.4. Telephone CH1swick 4417/8

E.M.I. Institutes—backed by the Electronic Organisation which includes “H.M.V.”, Marconiphone, Columbia, etc.

E.102A

# Only with CO-AX

## P.F. CABLES

AIR-SPACED ARTICULATED

Patents  
Regd Trade Mark

LOW ATTEN TYPES	IMPED OHMS	ATTEN dB/100 ft	LOADING % of 100 Mc/ft	Q.D.
A 1	74	1.7	0.11	0.36
A 2	74	1.3	0.24	0.44
A34	73	0.6	1.5	0.88

**THE LOWEST EVER CAPACITANCE OR ATTENUATION**

**IMMEDIATE DELIVERIES FOR HOME & EXPORT**

Write or cable for data sheets or deliveries to the originators of flexible air spaced Co-Ax Cables.

LOW CAPAC TYPES	CAPAC pF/ft	IMPED OHMS	ATTEN dB/100 ft	Q.D.
C 1	7.3	150	2.5	0.36
P.C.†	10.2	132	3.1	0.36
C 11	6.3	173	3.2	0.36
C 2	6.3	171	2.15	0.44
C22	5.5	184	2.8	0.44
C 3	5.4	197	1.9	0.64
C33	4.8	220	2.4	0.64
C44	4.1	252	2.1	1.03

**TRANSRADIO LTD.**  
CONTRACTORS TO H.M. GOVERNMENT  
136 CROMWELL ROAD, LONDON SW7  
Cables: TRANSRAD, LONDON

HIGH POWER FLEXIBLE  
PHOTOCELL CABLE  
VERY LOW CAPACITANCE

# THÉVENIN'S THEOREM

## Its Application in Simple Network Calculations

By "CATHODE RAY"

THE very word "theorem" has a scholastic sound that repels all but the most studious. And as for Thévenin, who is he? Something of an interloper, apparently; because it really ought to be called Helmholtz's theorem.<sup>1</sup> But the name

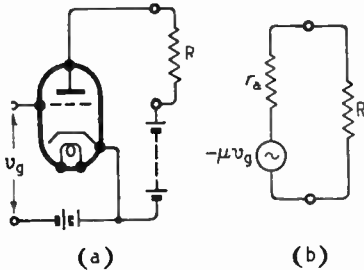

Fig. 1. (b) is the well-known "generator equivalent" of (a), and an example of the use of Thévenin's theorem.

of Thévenin is so universally attached to it that trying to change over to Helmholtz would probably just cause confusion. The only suggestion I can make for avoiding historical inaccuracy and at the same time giving a clue to what the thing is about is to call it the "Equivalent Generator Theorem." I am sure that many who look blank at the abrupt question "What is Thévenin's theorem?" would see light in that clue. For the familiar dodge of thinking of a valve as a generator with internal resistance (Fig. 1) is an example of the use of Thévenin's theorem.

Almost all useful circuits, at rock bottom, make up systems in which a generator feeds a load. Even such an elementary circuit as an electric torch (Fig. 2) is just that. The battery is the generator and the lamp filament is the load. It is the simplest application of Ohm's Law to calculate the current in the load:

$$I = \frac{E}{r + R} \quad \dots \quad (1)$$

The symbol alongside E in Fig. 2 represents a resistanceless

battery, and the resistance of the actual battery is denoted separately by  $r$ . The dotted line is a reminder that E and  $r$  can be separated only on paper or in the imagination. Together, they make up "the generator."

Another application of Ohm's Law gives the voltage obtained between the terminals of the generator:

$$V = IR = \frac{ER}{r + R} \quad \dots \quad (2)$$

This result can be arrived at in one move by considering the e.m.f. E to be shared between  $r$  and R in proportion to their resistances.

Note that E is the voltage that exists between the terminals when no load current is drawn, and that  $r$  is the resistance that a measuring instrument would indicate between those terminals if E were inoperative.

What Thévenin's theorem states is that the above results apply to

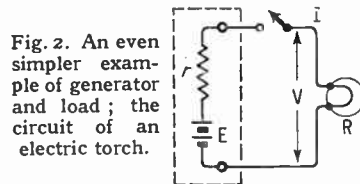

Fig. 2. An even simpler example of generator and load; the circuit of an electric torch.

any pair of terminals or points in any circuit, no matter how complicated, so long as it is linear (i.e., so long as it does not include things like rectifiers in which the current is not proportional to voltage). There is another proviso, about "steady state" conditions, which need not always apply however, and which we will come to later.

All one has to do is to measure or calculate the open-circuit voltage and the internal resistance, and substitute them for E and  $r$  respectively in the above simple equations, (1) and (2), to get the current and voltage in any load, R. The theorem is even more general than that, because it applies to a.c. and impedances of any kind,

provided of course that one uses "j" or one of the other methods of taking account of phase differences.

Strictly speaking, the linearity rule excludes all valves and iron-cored coils, because they are never quite linear. But fortunately they are often near enough, within certain limits of current or voltage to give a useful approximation, as in the well-known case of Fig. 1. But although this is a very simple basic circuit, we saw some time ago<sup>2</sup> that it is not entirely straightforward; so first let us take a simple d.c. example to bring out the idea without complications.

Fig. 3, which is a type of circuit one often comes across in practice, looks only slightly less simple than Fig. 2. How would you tackle it? Without taking any short cuts, I suppose one would find the resistance of  $R_2$  and R in parallel, add the result to  $R_1$  to get the total circuit resistance, and use Ohm's Law to calculate the main current  $I_1$ . Multiplying this by the resistance of  $R_2$  and R in parallel gives V, and dividing that by R gives I.

Thévenin is appreciably easier. With R disconnected, the terminal voltage E is obviously  $E_1 R_2 / (R_1 + R_2)$ . (Except for the symbols used, it is identical with Fig. 2, equation (2)). And the resistance  $r$  is obviously  $R_1$  and  $R_2$  in parallel,  $= R_1 R_2 / (R_1 + R_2)$ . ( $E_1$  being

Fig. 3. A slightly more complicated generator and load circuit, which can be solved very easily by Thévenin's theorem.

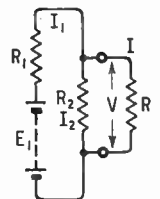

disregarded by short-circuiting it). Writing them in place of E and  $r$  in (1) we get:

$$I = \frac{E_1 R_2}{R_1 + R_2} \left/ \left( \frac{R_1 R_2}{R_1 + R_2} + R \right) \right.$$

<sup>2</sup> "Circuit Conventions (The Valve "Equivalent Generator")," *Wireless World*, April, 1947, p. 129.

<sup>1</sup> *Wireless Engineer*, July 1943, p. 320.

**Thévenin's Theorem—**

which can be simplified by multiplying above and below by  $R_1 + R_2$ :

$$I = \frac{E_1 R_2}{R_1 R_2 + R(R_1 + R_2)}$$

and of course  $V$  is  $R$  times as much.

Now for Fig. 1(a). This can be looked on as the same sort of circuit as Fig. 2 if certain assumptions or stipulations are made. When, as is often the case, the currents and voltages in question are alternating signal currents and voltages, the steady currents and voltages on which they are superimposed can be disregarded. (except, of course, in so far as they determine the valve characteristics,  $r_a$  and  $\mu$ ). One conventional method of distinguishing them is to use small letters for the alternating quantities (instantaneous values) and capitals for the steady quantities. Another method is to use plain capitals for the alternating quantities (r.m.s. values) and  $I_0$  and  $V_0$  for the steady quantities.

To bring a valve circuit within the scope of Thévenin's theorem the currents and voltages must be restricted to limits between which the valve curves can be assumed to be straight; in other words,  $r_a$  and  $\mu$  constant. Then the equivalent circuit, Fig. 1(b), may be considered to be a sufficiently close approximation.

either discover the working values of  $\mu$  and  $r_a$  in some other way, or else connect between the terminals a device (such as a choke or transformer) which passes d.c. but is virtually an open-circuit to the signal-frequency a.c. That may not be easy, especially with pentodes, which have such a high  $r_a$  that it would be impracticable to provide an impedance which by comparison would be virtually infinite. If it cannot be treated as a complete open circuit, however, it can be treated as  $R_2$  in Fig. 3, provided its value is known.

The ordinary receiver output stage, Fig. 4(a), is a typical example. An ideal output transformer would, when the loudspeaker was disconnected, have an infinite impedance at all signal frequencies; but in the equivalent circuit, Fig. 4(b), it is represented by the finite resistance  $R_p$ . Neglecting transformer leakage inductance and other imperfections, the load resistance can be represented as if directly connected, by multiplying it by the square of the transformer ratio. So it reduces to Fig. 3, which we have already solved.

Unless you are content with what mathematicians call a first approximation, you will have to take into account various complications, such as the load and transformer shunt impedances not being pure resistances, and the magnetic leakage of the transformer (which can be represented by an inductance in series with  $R$ ). It is in the solving of these more complicated circuits that the Thévenin approach is most helpful. Calculating the Thévenin equivalent of a network of internal impedances may cause a fairly extensive outbreak of algebra, it is true; but many of the radio engineers' handbooks give the impedances of the most usual parallel and series combinations all ready worked out.

There are some valve circuits, such as d.c. amplifiers and voltage stabilizers, in which it is necessary to take account of the d.c. conditions. This can generally be done by adding a battery of suitable voltage to the equivalent generator in Fig. 1(b). As this case is not so well known, let us examine it.

Fig. 5(a) shows how to arrive at the appropriate voltage. On the usual  $I_a/V_a$  curve sheet draw a straight line (shown dotted) coinciding as nearly as possible with the  $V_g = 0$  curve over the working range of anode current. Note the point  $P$ , where this line cuts the anode voltage axis, and read off the anode voltage there,  $E_0$ . (If the valve is a triode,  $P$  will generally be to the right of zero, indicating a positive voltage; if a pentode or tetrode, to the left, indicating a negative voltage.) Then  $E_0$  is the steady voltage to add to  $-\mu V_g$ , as in Fig. 5(b).

To see why this is so, remember that in accordance with the basic assumption of Thévenin's theorem the equivalent generator must be a perfectly linear device. The actual valve is not; but so long as its characteristics approximate closely to the equivalent's charac-

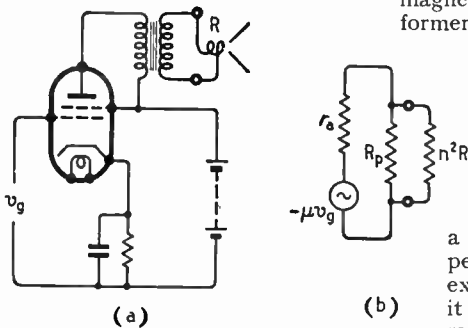

Fig. 4. A receiver output stage (a) is a practical example of the Fig. 3 circuit, in which the component values are as shown at (b).

You might object that if  $R$  is disconnected in Fig. 1(a), in order to measure  $\mu$  and  $r_a$  for use in Fig. 1(b), the valve is cut off from its h.t. supply and cannot function. True; so one must

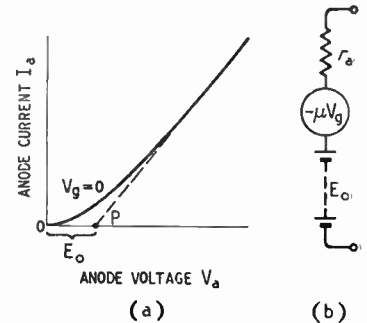

Fig. 5. Showing how to derive from the valve characteristic curves (a) the value of  $E_0$  in the d.c. generator equivalent (b).

teristics over the working range, nobody need worry if it departs widely from them in conditions under which it is not used. So far as anybody can tell from experiments restricted to the working range, the valve curve continues to follow the dotted line. That being so, at zero anode current and grid voltage the anode voltage would be  $E_0$ . Looking at Fig. 5(b), we see this condition correctly represented;  $r_a$  can be disregarded (because with zero current it drops no volts) and so can  $-\mu V_g$ ; what we have left must be  $E_0$ .

The equivalence can be checked for other conditions. If negative bias is applied,  $-\mu V_g$  adds to  $E_0$  and, if anode current is still zero, the voltage across the terminals is



greater. This corresponds with Fig. 5(a), where applying negative bias moves the valve characteristic bodily to the right. Similarly

The value of the current through the meter is then given by substituting in equation (1) the values of  $r$  and  $E$  just obtained.

I hope these examples have given some idea of how to apply Thévenin's theorem. "But what," you may ask, "about the 'steady state' proviso?" Well, "steady" here does not mean d.c. necessarily. A.c. can also be steady in this sense, if it has settled down to a regular routine after any

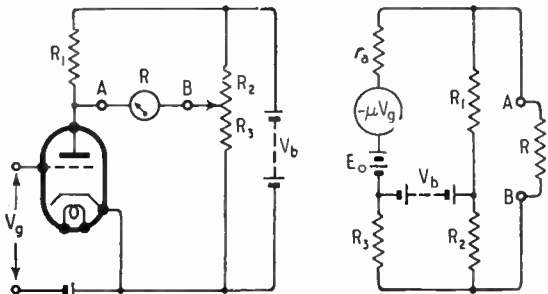

Fig. 6. A more complicated example incorporating the d.c. generator equivalent of Fig. 5.

the effect of anode current agrees in both diagrams, necessitating a higher terminal voltage.

A good example of how Thévenin's theorem can be applied in this way is the valve voltmeter circuit of Fig. 6(a), in which  $R_2$  and  $R_3$  are provided to enable the standing current to be balanced out of the meter, whose resistance is the load resistance  $R$ . Substituting the valve equivalent from Fig. 5(b), we get Fig. 6(b). To get the Thévenin internal resistance, short circuit the sources of c.m.f., leaving  $r_a$  in parallel with  $R_1$ , and  $R_3$  in parallel with  $R_2$ . So:

$$r = \frac{r_a R_1}{r_a + R_1} + \frac{R_2 R_3}{R_2 + R_3}$$

The open-circuit voltage (of A relative to B) can be got by adding the voltages across  $R_1$  and  $R_2$ , taking care to get the signs right, thus:

$$E = \frac{(E_0 - \mu V_g - V_b) R_1}{r_a + R_1} + \frac{V_b R_2}{R_2 + R_3}$$

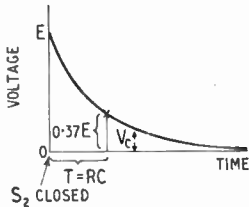
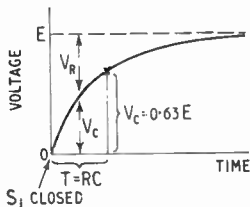
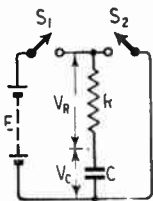

(a)

(b)

(c)

Fig. 7. Summary of how to sketch the voltage transient curves in the familiar basic RC circuit.

**NEW MODELS**

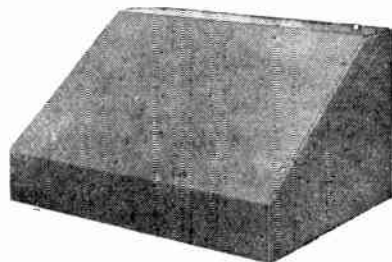

This illustration, one of the many recent additions to the Imhof standard range, shows our type 1055 instrument case. Designed for use in either the flat or upright position it has pressed feet and inverted louvres on two surfaces, giving adequate ventilation in either position. The sloping panel is detachable in three facets allowing ready withdrawal of all components. Dimensions, 15½ in. wide x 10½ in. x 8 in. Panel size 15½ in. x 2 11/16 in. x 9 11/16 in., x 2 3/16 in., available in light or dark grey from stock or other colours to special order, price 39/6.

**★ ENCLOSED RACK**

Available shortly. 6ft. and 4ft. enclosed racks, with fully radiused side panels and many interesting features. These racks are designed especially for multiple assemblies and breakdown packing. Write for details and lists of standard instrument cases, racks and handles to



**INSTRUMENT CASES**

112-116 NEW OXFORD ST., LONDON, W.C.1  
TELEPHONE MUS. 7878

**Thévenin's Theorem**—

of  $E$  falls across it, and none across  $R$ , because there is no charging current. The so-called exponential curve in Fig. 7(b) marks this shifting division of  $E$  between  $R$  and  $C$ . With practice one soon becomes able to sketch a reasonably good exponential curve, given one point on it. And it is a well-known fact that the point where  $V_C$  is 63% of  $E$  occurs at time  $T = RC$ , this quantity  $RC$  (in ohm-farads or megohm-microfarads) being called the time constant. So that provides the point.

Similarly, when  $C$  is fully charged,  $S_1$  opened, and  $S_2$  closed, it discharges as shown by the same curve inverted, Fig. 7(c). And the same curve applies to the growth of current in an inductive circuit, the time constant being  $L/R$ .

That is all familiar stuff. What may not be quite so well known is how to tell what happens in more complicated circuits such as Fig. 8(a). (In case the switching of batteries on to these circuits seems of little practical interest, may I point out that the switch plus  $R_2$  may represent a valve suddenly made to conduct by a pulse applied to the grid circuit, as for example in certain radar time-base systems?)

Assuming again that before the switch is closed the capacitor is uncharged, we know that the

that it rises exponentially, and that the time constant (as well as the value of the final voltage) can be obtained by applying Thévenin's theorem.

The open-circuit voltage (i.e. the voltage across the terminals when  $S$  is closed and  $C$  is disconnected) we have already found,

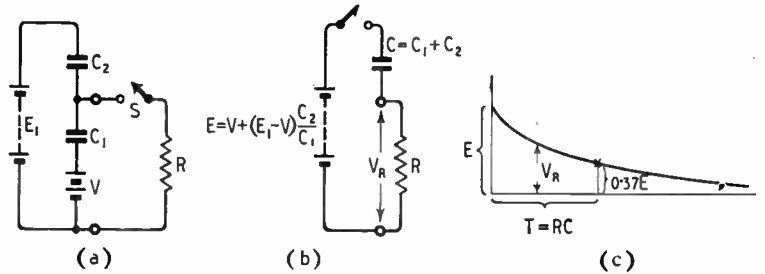

Fig. 9. Another example, in which  $C_1$  starts with an initial charge of  $V$  volts. Like Fig. 8 (a), it can be reduced by Thévenin to the basic circuit of Fig. 7.

and of course it is the same as by Thévenin. The "generator" resistance  $R$  is  $R_1$  and  $R_2$  in parallel, so the Thévenin equivalent is as shown in Fig. 8(c), reducing the problem to the familiar Fig. 7 case. The time constant  $RC$  is therefore  $R_1R_2C/(R_1 + R_2)$ , and the curve can be sketched into Fig. 8(b) as easily as before.

If there were two (or more) capacitors and one resistor, then the same principle would be followed for finding the resultant  $C$

which simplifies to  $(E_1 - V)C_2/C_1$ .  $C$ , of course, is the Thévenin capacitance, looking from the point of view of  $R$ ; so is  $C_1$  and  $C_2$  in parallel, or  $C_1 + C_2$ . The equivalent, Fig. 9(b) is just Fig. 7(a) again.  $V_R$  in Fig. 9(c) therefore varies in the same manner as in Fig. 7(b).

And so one could go on. Anybody who finds this easy and would like to pursue the matter further should go on to the alternative method, in which the resistanceless constant-voltage generator with e.m.f.  $E$  in series with  $r$  is replaced by a constant-current infinite-impedance generator in parallel with  $r^{(3)}$ , and one works in currents and admittances instead of voltages and impedances.<sup>4</sup> It will be found that in certain circumstances this approach suits some circuits better.

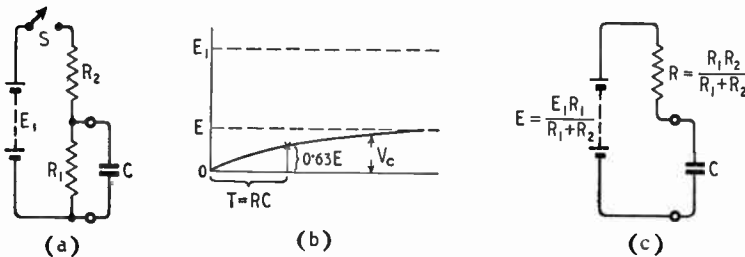

Fig. 8. The method of Fig. 7 can be extended to more difficult circuits like this by applying Thévenin's theorem.

starting condition is the same as in Fig. 7(b). And it is easy to see that in the final condition  $C$  is charged to the voltage which would exist across  $R_1$  if  $C$  were not there, namely  $E_1R_1/(R_1 + R_2)$ . So the curve rises only to the lower of the two dotted lines in Fig. 8(b). The problems are: how does it rise, and how long does it take? The answers are

to multiply by  $R$  for giving the time constant. And if there are initial charges on capacitors when the switch is closed, they can be taken care of in the Thévenin manner by inserting a battery in series with each capacitor concerned.

Take Fig. 9(a), for example. Here  $C_1$  has an initial charge of  $V$

<sup>3</sup> "Admittance," *Wireless World*, January, 1949, p. 30, Fig. 1c.  
<sup>4</sup> *Wireless Engineer*, July, 1943, p. 322.

**NEW UNIVERSAL METER**

A REVISED version of the Model 70A meter made by Taylor Electrical Instruments, 419-424, Montrose Avenue, Slough, Bucks, is announced. The modified design, which will be designated Model 70B, makes use of a 1,000 ohms/volt moving-coil meter with knife-edge pointer and mirror scale. There are 50 ranges for a.c. and d.c., including six decibel ranges. An internal buzzer is provided for quick continuity tests. The price will be £14 14s.

# CLASSIFICATION OF BROADCAST AERIALS

*Findings of the R.C.M.F.*

**H**ITHERTO the random nature of aerials used for broadcast reception has precluded any attempt at classification, but now that the vertical rod aerial, supported at the base and designed for mounting in a particular position, is becoming more popular, a broad classification based on the expected per-

formance can be formulated. Indeed, this has now been carried out by the Radio Component Manufacturers' Federation at the request of the British Radio Equipment Manufacturers' Association and the B.B.C., which organizations have accepted and endorsed the findings in principle.

Class A aerials are of from 10 to 20ft in length, class B are usually under 15ft and class C rarely exceed 10ft in length. From a number of measurements made in typical residential districts a "figure of merit" or performance factor E has been assigned to each class. This is defined as the ratio of the aerial signal output to the prevailing field strength produced by selected B.B.C. medium and long-wave transmitters.

It is pointed out that while this E factor represents the average performance for a comparatively small number of sites only, those chosen were representative of average domestic conditions. If an aerial input of 1 millivolt is taken as the minimum signal for good reception the class of aerial required for different local field strengths can be selected with reasonable certainty. For example, on the medium waves with field strengths over 13.3 millivolts per metre class A, B, or C aerials are satisfactory; with between 1.3 and 13.3 mV/M class A or B should be used and from 660 to 1,300  $\mu$ V/M only class A aerials are likely to be really effective.

On the long waves any of the three classes suffice for field strength over 40mV/M while for between 4 and 40mV/M class A or B should be used and for from 1 to 4 mV/M class A are advised for best results.

The classification of indoor aerials would seem to be impracticable owing to the widely different forms of building involved and the desire to camouflage the aerial. The R.C.M.F. panel investigating this matter strongly deprecate the use of mains aerials of any kind.

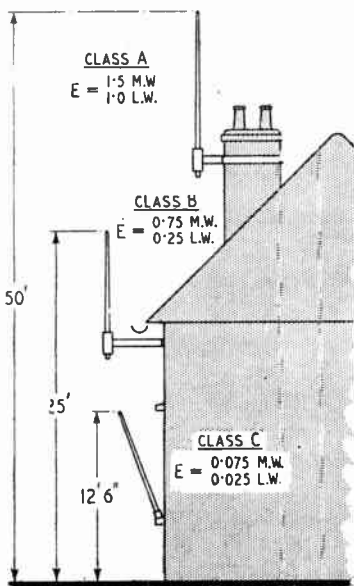

Suggested R.C.M.F. classification of vertical rod broadcast aerials based on design and mounting position. A "figure of merit" E is applied to each.

The three classes into which these are divided are shown in the accompanying illustration reproduced from the Federation's *Technical Bulletin* for December, 1948.

The  
**"COMMANDER"**  
'Double-Superhet'  
Communications  
Receiver  
of unique design  
for commercial  
and amateur use

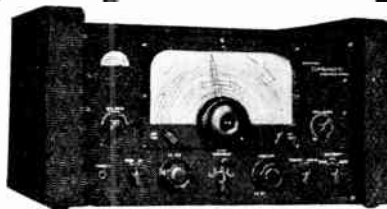

**TECHNICAL FEATURES**

**COMPLETE COVERAGE**

1.7 to 31 mcs. with separate bandspread for amateur bands.

**EXTREME SELECTIVITY**

3 Positions.  
Broad 10 times down 4 kcs.  
Medium 10 " " 2 1/2 " "  
Sharp 2 " " 1 " "

**SIGNAL-NOISE RATIO**

Better than 20 db with 10 microvolts input

**IMAGE REJECTION**

Better than 30 db at 30 mcs. Increasing to over 70 db at 2 mcs.

**A.V.C. OUTPUT**

Level within 10 db with input varying between 3 and 100.000 microvolts.

This 11 valve double Superhet Receiver fitted with all the essentials for communication purposes is available in two cabinet styles and also for rack mounting.

**PRICE**

**£48 - 10 - 0**

Illustrated Literature (Ref. CDS) sent on request.

**EXPORT AND TRADE ENQUIRIES INVITED**

**TELEVISION MAGNIFIER**

**D**ESIGNED to fit the majority of television receivers, a new television magnifier has been produced by the Dulci Co., 95/99, Villiers Road, Willesden, London, N.W.2. The size is 14in x 9in and the price is £5 5s.

**RADIOVISION (Leicester) LTD.**  
58-60, RUTLAND ST., LEICESTER  
'Phone 20167 Cables: Hamiltopap

# Unbiased

## Hats Off to Mr. Gaitskell

I AM all for this 'ere eddication and it is for this reason that I support the B.B.C.'s efforts to improve our minds. On the whole they make a good job of it; they do not at any rate drop so many bricks as the American film magnates. Those responsible for a recent film seemed to forget that ancestors who came over with Norman William in 1066 did not come as wanton invaders



"1066 and All That."

but as supporters of the rightful heir to the throne who had been so named by Edward the Confessor, the law of succession by primogeniture being by no means the universal rule in those days.

There are occasions, however, when the B.B.C. might do better. One such instance was a recent series of talks intended to instruct women in the ways in which science aids them in their homes. Now I am not going to cast doubt on the accuracy of the statements made by the learned scientists whom the B.B.C. brought to the microphone, although I cannot refrain from saying that I would rather trust the local plumber to instruct me in the niceties of adjusting a ballcock than the sanitary savant who insisted on calling it a float-operated hydrostatic valve.

When the turn of the electrical expert came to tell us how the current which operated our wireless sets reached our homes, I soon realized that my education had been seriously neglected. We were told quite rightly that two cables are used to connect our houses to Mr. Gaitskell's cut-off system, and were asked rhetorically whether we did not wonder why there were two conductors and not one as in the case of the water supply. The lecturer did

not long leave us guessing, but told us that one conductor was to enable the current to get back eventually to the generator and said that the water supply also had a return conductor; namely, the drains. Just as the same electric current goes round and round so also does the same water except that "the circuit" is a little more complicated as the water is purified, discharged, evaporated as clouds, and then returned once more to the reservoir as rain.

This seemed such an extraordinary analogy that I was lost in admiration at its daring nature. My admiration increased when the lecturer went on to tell us that, just as the water sometimes gets back not by the drains but by an unofficial route—such as when we watered the garden—so too does electricity sometimes find an earth return.

It was not, however, until the end of this talk when the lecturer, after informing us that 740 watts represented 1 h.p., proceeded to point out that our electric cookers were equal in power to a motor car that I saw the masterly hand of Mr. Gaitskell. It did not altogether surprise me, therefore, when the lecturer finally threw off the mask and gave us a stern warning to switch off our cookers.

## Whither Radio?

MARCONI'S prophetic remarks about radar made before the American Institute of Radio Engineers in 1922—to which reference was made in this journal last November—are not, of course, the only instance of an early forecast of an outstanding radio development. Another notable example was Campbell Swinton's description as long ago as 1908 of the broad outlines of our present system of television.

Thinking of this has made me cast about in my mind to see if I cannot here and now forecast some major development of radio which will not be realized for fifty or even a hundred years—long after I have embarked on what the poet calls "the Great Adventure." I do not mean simple and obvious developments like broadcast receiving sets capable of bottling any particular programme so that we can hear it at a time more convenient than that at which it is broadcast. Such a receiver could, in fact, be made today with little or no difficulty.

## By FREE GRID

Within the last quarter of a century vision has been added to aural broadcasting, and sound has been added to sight in cinema films. It cannot be very long before we think as little of going to "the smellies" as we do to "the talkies" today, while "the feelies" will be an added attraction a little later on. Once the film industry has solved the recording and reproduction of these particular sensory impressions it won't take long to work out a way of making them ether-borne. But these will hardly be major developments in the same sense as television and radar most certainly are. I shall have to think of something far more outstanding if I want a future Editor of *Wireless World* to unveil a plaque to my memory and I rather think that I have it.

My prophecy is that radio will go up and up in the frequency scale far beyond that of light and other known radiations until somewhere among the micro-angstrom units it will find itself all mixed up with sub-electrons (satellites of electrons yet to be discovered). When this has been achieved we shall probably find that the perception centres of our brains are directly responsive to these very high frequencies and are also capable of generating them. Any intermediate apparatus will be redundant, so that the radio industry, as such, will come to an end and telepathy will have really come into its own.

I have held these opinions ever since I first read the learned review of modern scientific researches into telepathy written by "Radiophare" in *Wireless World* in July, 1945. But there is a lot of ground to be covered before "Madame Estelle"



A.D. 2049.

takes her place in the *W.W.* Editorial chair; but when this does eventually happen, it is my intention that the first thing she sees is myself in spectral form.

## LETTERS TO THE EDITOR

### Legalized Interference Suppression ♦ Television Receiver Upkeep Costs ♦ Test Oscillator Modifications ♦ Broadcast Frequency Allocations

#### Compulsory Interference Suppression

ALTHOUGH it is quite natural for radio engineers to acclaim the Bill for the suppression and reduction of man-made interference to radio and radar reception, it is obvious, after some reflection, that the whole thing had better be left alone. For if it is implemented by examination of domestic appliances it will only result in an infinitesimally small reduction in noise and this in itself will cost a lot of money which the community will eventually have to find. Disturbances which seriously annoy listeners can usually be suppressed by a friendly arrangement between the offending and offended parties, without Government intervention.

As the result of some recent observations I am of the opinion that a very great deal of the disturbances annoying the broadcast listeners originate from the mains intake; i.e., the main switch and fuses. These are frequently installed in damp parts of a house and so become corroded, resulting in bad contacts and arcing and hence noises, especially under load. It is now the responsibility of the British Electricity Authority to keep them in noise-free condition.

In the discussion which preceded the launching of the Bill, great capital was made out of the fact that suppression was required in order to prevent interference to radio and radar navigational aids. I can only surmise that those responsible for the statements were ill-informed. During many hundreds of hours of radio experiments in aircraft I can call to mind no single instance in which man-made interference from the ground has caused interference to reception, and I am therefore very doubtful that a faulty domestic appliance can jam any radio or radar navigational aid. C. B. BOVILL.

Paris.

WHAT will be the position of the man who fiddles about with junk lash-ups, under the coming anti-interference laws? Unless there is either mercy or a special clause to protect them, electronic engineers fooling about in the interests of science with temporary

hook-ups made with twisted connections, to the accompaniment of the ferocious interference they cause by disturbing the gear whenever they walk across the room or by applying a soldering iron or by trying out oscillators, may find themselves obliged to choose between prison or giving up wireless. Bunyan may have written "The Pilgrim's Progress" in Bedford Gaol, but it is doubtful if a term in Pentonville will ever produce anything as good as radar.

W. H. CAZALY.

#### Seeing's Believing?

MOST of us have heard of commercial receivers being used without significant changes of valves for upwards of ten years or more, and the proud owners almost invariably boast that reproduction leaves little to be desired. In fact, until an actual breakdown occurs, renewal is nearly always postponed. Quite apart from the economic angle this is also, of course, a tribute to that very tolerant mechanism, the ear.

With the increase in popularity of television, taking into account the much larger numbers of valves involved and the fact that the eye is a very critical device, is it possible the cost of replacements is going to give the public a shock?

The manufacturers obtain their valves at very low prices and are in effect subsidized by most other users. It will be very interesting if the B.V.A. have to put the machine in reverse so that the public can afford to make the necessary replacements. L. C. IRVINE.

Seaford, Sussex.

#### Simple A.F. Oscillator

I RECENTLY built the single-valve a.f. oscillator described in the March, 1948, issue of *Wireless World*, and found it extremely difficult to obtain good waveform throughout the whole frequency range.

You may be interested in the modified circuit, given in the accompanying diagram, which finally solved the problem.

The bias developed by the voltage-doubling rectifier circuit exceeds the peak input to either half

## COMBINED "EXSTAT" AND TELEVISION AERIAL

An aerial which provides for both television and interference-free radio reception and obviates the necessity for two separate installations.

Available for London or Birmingham transmissions. Utilises 10 ft. mast and  $\frac{1}{2}$ -wave spreader as radio signal collector.

As illustrated and complete with 20 yards co-axial television cable and 20 yards screened "Exstat" cable.

LIST PRICE  
**£12. 6. 6.**  
or less feeder cables  
**£9. 8. 6.**  
Registered Design and Patents Applied for

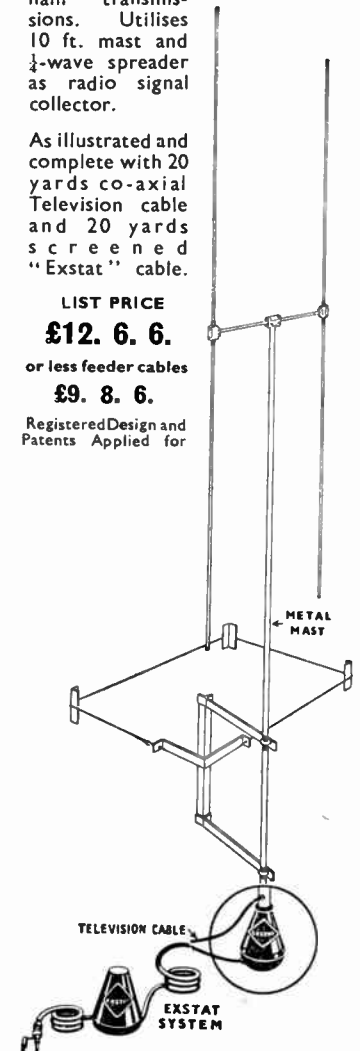

ON DISPLAY  
STAND 46 R.C.M.F. EXHIBITION  
PARK LANE, W.1 MARCH 1st-3rd

**ANTIFERRENCE**  
LIMITED  
67 BRYANSTON ST., LONDON, W.1

**Letters to the Editor—**

of the valve, thus preventing distortion due to grid current. The 250,000-ohm resistance in the input to the rectifier circuit keeps the input resistance high, thus preventing distortion when the rectifier conducts on the peaks. The left-hand half of the valve has a low anode load resistance and receives the full bias; owing to the curvature of its characteristic the gain is controlled

the right-hand valve is returned to earth, and a bias resistor (unbypassed) inserted in the cathode lead. A further improvement would probably be obtained by using a variable-mu r.f. pentode as the first valve.

comparatively compact country like Belgium are more favourable (lower in frequency) than those for the Netherlands.

On the political side Spain is not allocated a single clear channel, whilst Great Britain, considerably smaller in area, is allocated three. It is interesting to reflect that Spain was allocated two completely clear channels (589 and 997 kc/s) in the Montreux Plan which should have come into operation in March, 1940.

In addition to Great Britain, France and the U.S.S.R.—especially her Western and Baltic provinces—have been allocated particularly favourable low frequencies as clear channels.

Although not directly connected with the subject under discussion I suggest that manufacturers should standardize the frequency coverage provided by new receivers. The long-wave band should be 140-400 kc/s and the medium-wave band 515-1,650 kc/s.

These coverages are considerably greater than those provided by present-day sets, and will allow for any future expansion beyond the Copenhagen allocations.

P. BATHAM JONES.

Watford, Herts.

**Television Shocks**

SOME manufacturers of modern s.a.c./d.c. television receivers connect one side of the mains supply to the chassis and make no provision for the mains lead to be terminated in a plug that cannot be reversed in the mains socket, therefore the chassis can be alive in respect to the earthy side of the mains.

This is dangerous practice and I doubt if it conforms with the Board of Trade Regulations, for not only is the chassis alive, but the screening of the coaxial cable and one arm of the aerial are alive also.

Is there any need for this dangerous practice to continue? Perhaps someone can defend this method of connection, for in my opinion it is decidedly bad engineering.

STANLEY E. HUSON.  
Bexleyheath, Kent.

**“THE WARNING WINKER”**

**A Correction**

WE regret that there was an error in Fig. 2 of this article in our last issue. The author writes:

“I have no excuses to offer for presenting a circuit which (a) would keep the neon continuously winking, even with the switch open, since there is a return path to h.t. negative by way of the chassis and valve filaments, and (b) would burn out

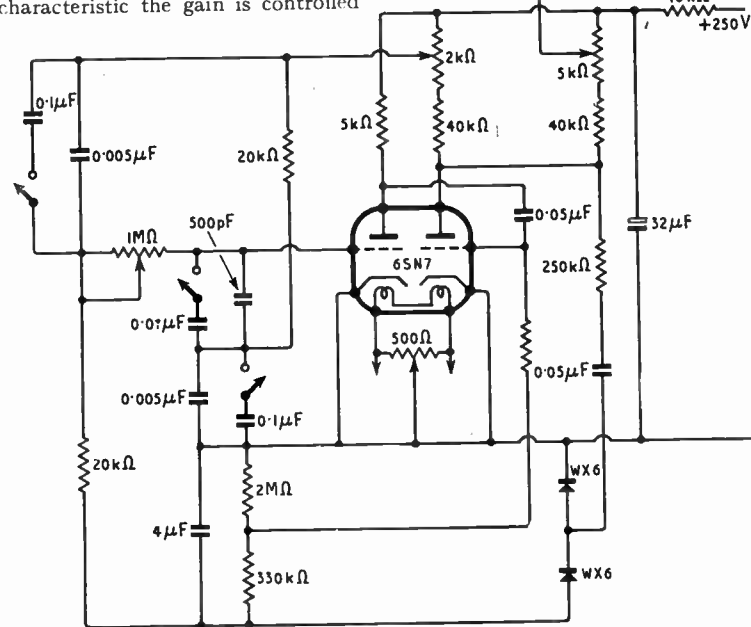

by the bias, but the input signal is small and there is very little distortion. The right-hand half of the valve has a high anode load resistance which linearizes the characteristic, and operates as a straight amplifier.

The best waveform is obtained with the gain control at the minimum setting which will sustain oscillation throughout both frequency ranges, but the setting is not at all critical. The waveform at all frequencies is then an almost perfect sine wave—just a little second harmonic, perhaps, but not the slightest sign of “sharp corners.” If oscillation does not commence shortly after switching on, momentarily earthing one of the anodes two or three times will start things moving.

Using an ex-R.A.F. valve, Type VT61A, an amplitude of about 10V r.m.s. was obtained at the second anode. Almost any other double triode should prove satisfactory; if any trouble is experienced, the anode load resistors or the bias rectifier input resistor may need to be altered. If the valve has separate cathodes, or if separate valves are used, greater stability of operation is obtained if the grid leak of

The greatest snag of this circuit is mains hum, which at low frequencies causes a periodic variation in the amplitude of oscillation. A certain amount of screening is desirable, and the hum-dinger is essential.

HOWARD BOOTH.

London, S.W.9.

**Copenhagen Comments**

MAY I offer a few belated observations concerning the Copenhagen frequency allocations published in *Wireless World* for November, 1948.

Whilst accepting as an unfortunate necessity the preservation of a 9-kc/s channel separation, I cannot help feeling that the new plan is based too much on the frequencies in use today and/or political considerations instead of an equitable scientific distribution of the limited facilities available.

An example of the first point is provided by the allocation of clear channels to Belgium and the Netherlands. Belgium is allocated 620 and 926 kc/s and the Netherlands 746 and 1,007 kc/s. Each of these frequencies is substantially a clear channel, allocated presumably for national coverage, yet those for a

all valve filaments if, with the switch open, a short occurred between h.t. positive and chassis.

There are several possible variations on the theme; but one thing essential to all is that in the 'off' position of the switch neither h.t.— nor l.t.— must be connected to chassis, either directly or through a path furnished by the filaments. May I ask any reader who made up the device to rest assured that when given a proper chance in the correct circuit the 'Warning Winker' leaves nothing to be desired as a winker and as a warner? "

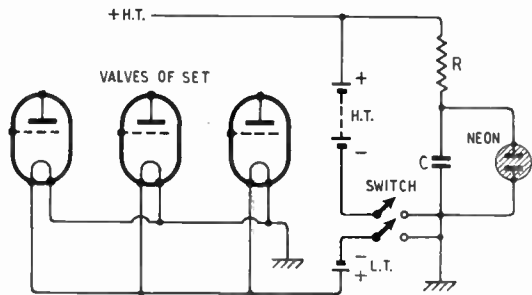

"What I meant to draw—and did in fact draw in my rough notes—was the accompanying circuit.

The correct circuit the 'Warning Winker' leaves nothing to be desired as a winker and as a warner? "

### PROPAGATION OVER COASTLINES

IN a letter to *Nature*, G. Millington, of Marconi's W.T. Co., describes an interesting phenomenon which occurs when radio waves cross a boundary between land and sea. Over land the field strength of the ground wave falls off in accordance with well-known laws but at the boundary there is a sudden rise of field strength and for a short distance it actually increases with distance. After reaching a peak of some 12 db above the normal value, the field strength falls off again, but more slowly than above land. On again reaching land, there is a sudden drop, but for some distance inland the field is stronger than if the whole path were over land.

by the solid line the theoretical variation of the field and by the circles and crosses the results of measurements at a wavelength of 3.9 m. These measurements were carried out with a Marconi 10-W transmitter across the Blackwater, Essex. The phenomenon is more fully discussed elsewhere\*.

The experimental verification of Mr. Millington's theory involved a technique not previously used in such measurements. This work was organized by G. A. Isted (also of Marconi's) and carried out by him and his assistants.

\* "Ground-Wave Propagation Over an Inhomogeneous Earth," by G. Millington. *Proc. Instn. Elect. Engns.*, January, 1949, Vol. 96, Part III, p. 53.

The accompanying graph shows

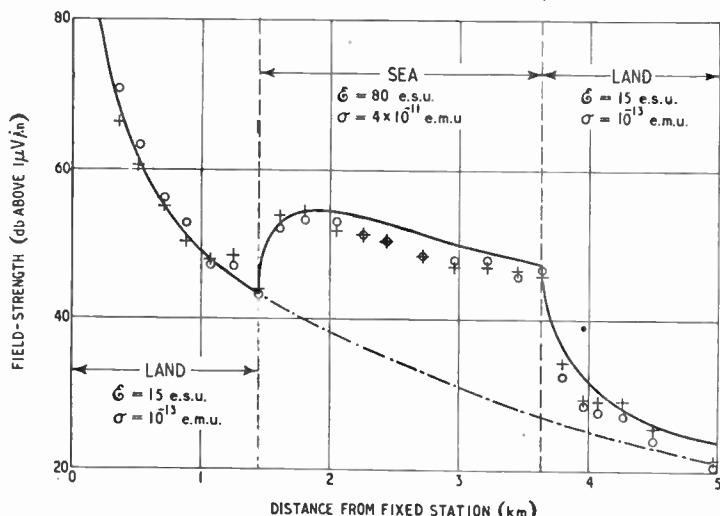

The solid and chain curves are theoretical ones indicating the field strengths respectively for a land/sea path and land only. Measured results at a fixed receiver with a mobile transmitter are indicated by crosses and those at a mobile receiver with a fixed transmitter by circles. Vertical polarization was used.

Courtesy "Nature"

**New**  
**TRIX**  
*Quality*  
**SOUND EQUIPMENT**

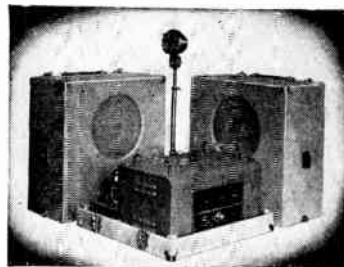

MODEL U885 P

### PORTABLE 20 watt AC/DC Equipment

This new model is designed to give a substantially larger power-output than is normally provided in Portable AC/DC outfits. It incorporates an amplifier unit with an output of 20 watts fitted into a detachable case with two 10in. loudspeakers, moving-coil microphone, folding stand and cables.

The amplifier is a 3-stage high-gain type having 4 valves in parallel push-pull in the output stage, a total of 10 valves. The control panel carries microphone, gramophone and tone controls, also mains switch and pilot lamps and special three-position switch which provides either change-over or mixer circuit for microphone or gramophone units. Its large power output and high standard of reproduction make this equipment suitable for use in the larger halls where portable, universal apparatus is needed.

Send for illustrated lists and full details of this and other equipment.

**THE TRIx ELECTRICAL CO. LTD.**  
1-5 Maple Place, Tottenham Court Road,  
London, W.1. Phone: MUSeum 5817.  
Grams & Cables: "Trixadio, Wesdo, London."

AMPLIFIERS • MICROPHONES • LOUDSPEAKERS

# RANDOM RADIATIONS

By "DIALLIST"

## Age and Loudness

AN ARTICLE in the latest issue of the *B.B.C. Quarterly* provides food for quite a bit of entertaining thought. It describes the results of tests designed to discover the sound levels at which listeners prefer to receive the broadcast programmes. I gather that the tests were originally instituted to find out whether those engaged in monitoring programmes had the same ideas about loudness as "the average listener." It soon emerged that the professionals at the transmitting end like their reproduction very much louder than did the amateurs in their own homes. With a reference to zero level of  $10^{-16}$  watt per square centimetre tests showed that for symphonic music the "pros" plumped for levels of 88db (musicians and transmitting engineers) and 90db and 87db respectively for men and women programme engineers. The levels apparently preferred by the listener, however, were 78db for both men and women. This led to a more detailed investigation of the preferences of the listening public. A large and representative section of the public is always available in the personnel of the Listener Research Panel. The results obtained here are quite remarkable. What intrigues me most is the big fall in the preferred sound level with advancing years. Take speech. At 15 years the preferred level is about 73db; at 30 years it falls to 72db; at 45 years to 70db; at 55 years to just over 68db; and at 65 years to 66db. Offhand, one might have expected rather the opposite. The young are supposed in the ordinary way to have very acute hearing and there is no doubting the falling off that takes place as people grow older. I have sometimes wondered, though, whether sounds in general convey quite so strong a stimulus to the young brain as to the older one. If they concentrate on listening, young people certainly hear better than their elders; but is this true when they are not concentrating in that special way? I doubt it. Even if they are only a few feet apart, small children invariably speak to one another at the top of their

voices. And at a rather later age a party of young folk conversing together produces a sound level many decibels above that due to a similar number of their fathers and mothers.

## Sun Spots

AS I WRITE, the rather hazy state of the atmosphere is giving all who care to cast their eyes skyward first-rate views of an outsize in sunspot groups. By the time that this appears in print the spots will have passed to the side of the sun that is then invisible; but they should reappear within a few days. If you haven't seen them already, it's worth while to take a look. Use a piece of smoked glass or the dark part of an old photographic negative if the sky is clear; but you may get an excellent naked-eye view on a misty day, particularly at sunset time. These big spots are centres of intense activity, the effects of which normally make themselves manifest on this earth of ours in two different ways. When the spots reach a position which brings them bang opposite to us electro-magnetic radiation from them is poured upon us. The spots also emit streams of particles. The radiation reaches us at the speed of light in under ten minutes; but the particles travel more slowly and don't get here until over a day later. Hence the day's delay usually observed between radio blackouts and the appearance of the Aurora Borealis.

## Trouble-savers

A COMMON FEATURE of the descriptions of new inventions nowadays is the stress laid on their trouble-saving qualities. A large proportion of the practical products of applied science promise poor toiling man emancipation from one kind of drudgery or another. You'll find illustrations of this here, there and everywhere in the advertisement sections of daily, weekly and monthly publications. This gadget enables fires to be lighted in half the time; this one does the housewife's washing-up for her while she sits and reads at her ease; a third offers her alleged lord and master

a means of getting rid of the weeds in his garden without the bother that gardeners since Adam have had of hoeing them up, digging them in or pulling them out by hand, a fourth . . . but I can do a little personal trouble-saving here by means of those dots. You can think of other trouble-savers for yourself and save me the drudgery of writing them down! Yet, for all the toil that we are told we have been saved by automatic thises or finger-tip that, it doesn't seem to me that life on the whole is easier than it was before this trouble-saving business began. I don't find that I have to do less work than I had to do twenty-five years ago. The majority of so-called trouble-saving devices are, I believe, misnamed: they should be termed "ginger-uppers," for what they do is to make it possible for you to get through far more work in the same amount of time.

## It's Up to You

Such were my thoughts when I spent a recent day in some busy research laboratories whose activities are largely devoted to the development of devices which make the electron do for us jobs that our fathers and grandfathers had to slog through by their own unaided efforts. Are we harnessing the electron?—or is it truer to say that we are busily engaged, without realizing the fact, in discovering more and more ways for it to harness us? I'm not going to offer an answer to these questions, preferring to give the reader the trouble of finding his own. Though I have the most profound respect for the almost formidable I.Q. of *Wireless World* readers, I can't resist mentioning the old Army saying: "The subaltern officer is not infrequently asked to give his reasons in writing for doing this or that. It is recognized that he has in fact no reasons; but the question provides an exercise for his otherwise sluggish brains." One electronic device which particularly interested me was a compact little apparatus for counting pills. When you plank down your one-and-fourpence, or whatever the price is nowadays, including purchase tax and entertainment tax, for a box or tube of, say, Rich Red Pellets for Pale Green Sailors you find that the tube, box or carton contains invariably twenty-five of these safeguards against sea-sickness.



Were they counted by hand into the container? They were not. The photo-electric cell and the thermionic relay did the job. Half a century ago boxes or what not would have been used which were designed to hold about twenty-five pills. Some manual counting may have been done; but you were just as likely to find twenty-three as twenty-four, twenty-five or twenty-six pellets in the container. I know that the unvarying twenty-five, electronically dished out, signify progress; but somehow I can't help wondering in my heart of hearts whether we're altogether sane in applying expensively trained physicists to developing things of this kind.

**Bigger Tuning Range Needed**

ONE RECENT BIG IMPROVEMENT made in American "TV" receivers is the introduction of a new type of tuner, which gives continuous coverage of the whole band of frequencies assigned to television broadcasting. Something of the kind is needed here, for, as I wrote a while ago, the purchaser of a television should certainly feel assured that it will work in any service area into which he may happen to move. It would be no bad thing, too, if receiving dipoles were made with telescopic end pieces. Dipoles of this kind were used in the GL1 and GL2 radar sets during the war and they enabled the receiver to be tuned to any frequency between 55 and 84 Mc/s. The idea should be useful to makers of television aerials: with telescopic end-pieces only one type of dipole and reflector array would need to be made for the whole country, instead of a separate type for each area. There's another point, too. It is quite conceivable that carrier frequencies will have to be altered from time to time, just as sound carrier frequencies are. You can cut bits off a dipole with one-piece arms if the new frequency is higher, but it's not so easy to lengthen it to suit a lower frequency. The sliding part of the GL dipoles had numbered divisions engraved on them and a table showed you just how far to push in or pull out when setting them up for any required frequency. Probably the television aerial makers had thought of that one already. If they hadn't, I make them a present of the idea.

# BULGIN PRESS SWITCHES

*Every  
Bulgin  
Product  
Guaranteed*

Push-pull operation.	Push (Biased) operation.
S.410	S.420
S.411	S.421
S.412	S.422
S.413	S.423
S.414	S.424
S.415	S.425

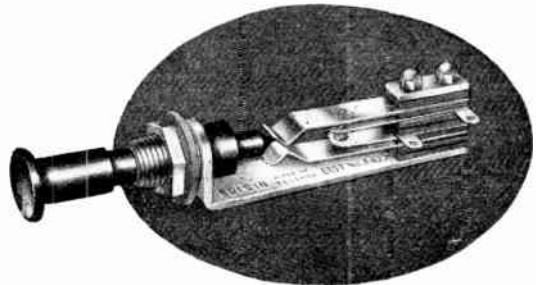

This new range of Jack type switches covers single- and double-pole switching, on-off, off-on, change-over, for push-pull or push (momentary-contact, biased plunger) operation. Fixing by one hole,  $\frac{1}{8}$ " to panels of 20 swg. —  $\frac{5}{32}$ " thickness. Rear of panel depth,  $2\frac{1}{8}$ ". Max. "panel area",  $\frac{3}{8}$ " x  $\frac{3}{8}$ ". Fitted with pure Ag. contacts, for 0.001—250v. ~, to switch loads of 25W. max., with 3A. max. current limit. Plunger displacement,  $\frac{3}{16}$ " approx. Bulgin switches are type-tested @ 15c/min for 25,000ops., = SEVENTY TIMES A DAY FOR A YEAR!

Retailers, have you obtained the new TRADE catalogue yet ?

*The Choice*



*of Critics*

A. F. BULGIN & CO., LTD., - BARKING - ESSEX

# RECENT INVENTIONS

## A Selection of the More Interesting Radio Developments

### Multi-grid Amplifiers

A SINGLE heptode valve is arranged to operate as a two-stage amplifier, the high overall gain so secured being particularly advantageous as applied to hearing-aid appliances.

As shown, the pick-up signal from a crystal microphone M is fed to the innermost grid, which is shunted by a resistance R. The next electrode is connected to the h.t. supply through load and decoupling resistances  $R_1$ ,  $R_2$ . It serves both as an anode to the first electrode, and as a control grid for the second amplifier stage, which is thereby coupled in cascade with the first. The third grid is connected to the positive side of the cathode through a resistance  $R_3$ , and is coupled through a condenser C with the screen grid, which is followed by the usual suppressor grid.

Stability is increased by applying negative feedback from the main anode to the grid anode through a resistance

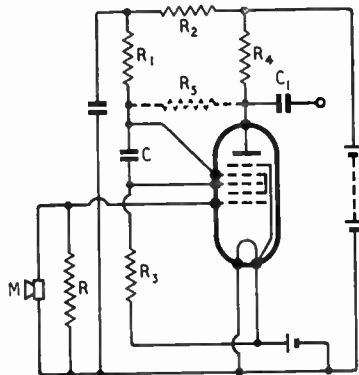

Heptode two-stage amplifier.

$R_5$ , though this is stated to reduce an average voltage gain of 400 to about half that figure.

O. B. Sneath. Application date, November 21st, 1945. No. 600884.

### Air Traffic Control

TRAFFIC or other local conditions sometimes make it necessary for the pilot of an incoming plane to circle around the aerodrome under the instructions of the Control Officer, before coming down to land.

In such circumstances the machine can be guided, either through visual signals or by the same signals applied to an "automatic pilot," in a circular course, and at a predetermined distance from the landing point by navigational equipment of the radar type. The plane carries an "interrogator" set which co-operates with a "responder" beacon at the aerodrome to develop a direct current which depends upon the time interval between the two

signals and therefore represents the distance or range of the craft. This is fed to a centre-zero meter.

A second current, calibrated to represent the flying distance allotted by the Control Officer, is taken from an independent source and is fed to the same meter, in opposition to the first current. The resulting indication not only shows when the machine is on the set course, but also how to correct for any deviation. A variable strobe is used to search for and interlock with the responder signal, thereby automatically stabilizing the first-mentioned current at its correct range-indicating value.

L. C. Barber. Application date September 5th, 1945. No. 601401.

### Pulsed Signalling Systems

ENERGY radiated in the form of short pulses can be used in various ways as a substitute for ordinary carrier-wave signalling. The modulating voltage can, for instance, be applied to vary the width, or amplitude, or relative phasing of the pulses about some mean value of these characteristics, which always represents the no-signal condition, or zero modulation. In all these known systems, the average number of pulses radiated per second remains constant.

According to the present invention, the width, height and phase position of the pulses are kept constant, and signal voltages are conveyed by varying the number of pulses above and below a given mean number transmitted in a set period of time. For instance, taking the unit of time as  $1/6,000$ th of a second, three equi-spaced pulses, sent in equi-spaced groups, correspond to the no-signal condition, leaving a possible variation of three pulses either way, i.e., from zero to six, to represent maximum modulation in the negative and positive directions respectively. The latter corresponds to a continual train of equi-spaced pulses emitted at the rate of 36,000 per second.

Marconi's Wireless Telegraph Co., Ltd. (assignees of H. O. Peterson). Convention date (U.S.A.), January 8th, 1944. No. 605178.

### Frame Aerial Couplings

A HIGH-FREQUENCY transformer of the permeability type is used to couple a frame aerial A to the first amplifier of a radio receiver; in addition, the moving core M serves to control the tuning of the input circuit without

appreciably affecting the inductance of the aerial.

To secure this result, the primary windings of the transformer are kept few in number, to reduce capacity coupling with the secondary, whilst their inductance is made equal to that of the frame-aerial turns, this balance favouring the gain factor of the coupling. In a suitable design of transformer, shown enlarged, the secondary, S, is wound on a dielectric former F, whilst the primary L is wound over a shoulder or projection on one end of the moving core, so that the primary inductance remains the same for all positions of the core. That

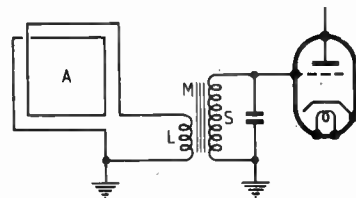

Frame aerial coupling circuit.

arrangement also ensures a constant coefficient of coupling over the whole of the tuning range.

The British Thomson-Houston, Ltd. Convention date (U.S.A.), January 19th, 1945. No. 606599.

### Range Selectivity

MODULATED pulses are used to limit and select the range of distances over which point-to-point communication can be carried out, without interference from stations at other distances. For instance, stations A and B are each provided with repeater installations which transmit pulses to and fro, so that the stations are locked together at a repetition rate which depends upon the distance separating them. Both stations are equipped with modulating and detecting circuits, which are intermittently coupled to a common aerial in known manner, for two-way signalling.

Adjustable gating circuits are also provided to enable the operator at Station A to accept messages from stations other than B, situated at selected distances varying from a quarter of a mile to 50 miles away. With sharply directive aerials a further discrimination can be made between stations at equal range but with different orientation. It is desirable to use pulses of the order of one micro-second or less, since the distance-selectivity obtainable, and the minimum working range, are both inversely proportional to the duration of the pulse.

Marconi's Wireless Telegraph Co., Ltd. (assignees of W. Hansell). Convention date (U.S.A.), September 16th, 1943. No. 604438.

The British abstracts published here are prepared with the permission of the Controller of H.M. Stationery Office, from specifications obtainable at the Patent Office, 25, Southampton Buildings, London, W.C.2, price 2/- each.

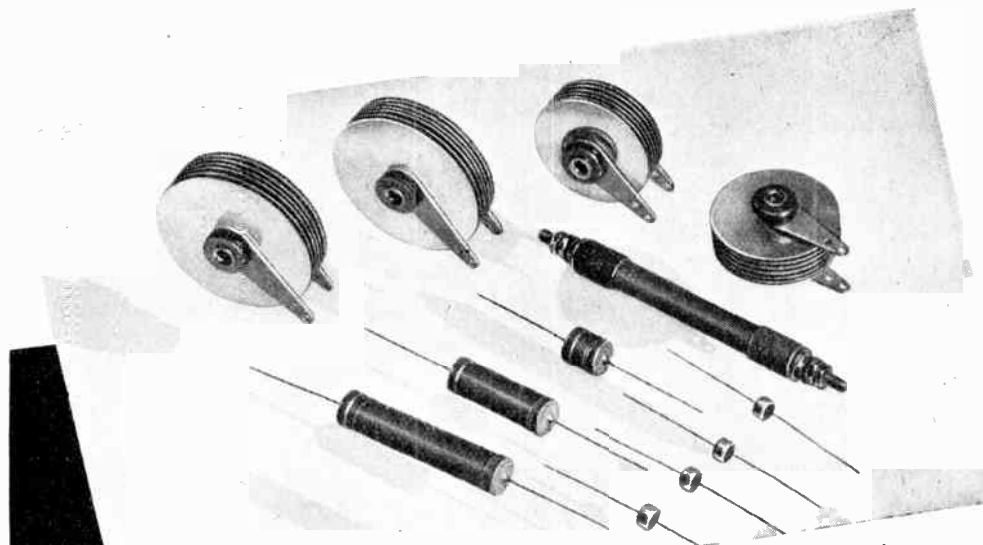

## THREE NEW TYPES OF *SenTerCel* SELENIUM RECTIFIERS FOR THE RADIO INDUSTRY

**H.T. Rectifiers**  
 Compact, easily mounted, inexpensive stacks for H.T. supplies in domestic radio receivers.  
 Inputs: 100/250V. Outputs: 60, 90 or 120 mA.

**E.H.T. Rectifiers**  
 Wire or screw ended tubular rectifiers for E.H.T. supplies to C.R. tubes, photoflash equipment, etc.  
 Outputs: 20V to 2.5 kV. 1 to 5 mA.

**Detector Rectifiers**  
 A miniature single disc assembly suitable for use as a detector at frequencies up to 5 Mc/s.  
 (Minimum H.F. input 0.5 volts r.m.s.)

## SELENIUM RECTIFIERS



Selenium rectifiers of all types including Uniplate, tubular and spindle mounted stacks. Equipments for stationary or vehicle battery charging, electrostatic precipitation, aircraft and vehicle engine starting, electro-plating and similar electrolytic processes. Power supplies for circuit breaking and other operations.

**Standard Telephones and Cables Limited**

(RECTIFIER DIVISION)

(Regd. Offices: Connaught House, Aldwych, London, W.C.2.)

WARWICK ROAD  
 Telephone: ELSTREE 2401

BOREHAM WOOD · HERTS  
 Telegrams: SENTERCEL BOREHAMWOOD

# Simon

## SOUND SERVICE

### THE COMPLETE SERVICE FOR SOUND RECORDING AND REPRODUCTION

- ★ Mobile, static and specialised recording units
- ★ Recording amplifiers, speakers, microphones, etc
- ★ Sapphire cutting and reproducing stylii
- ★ Blank recording discs from 5in. to 17in. Single and Double-sided
- ★ Groove locating and cueing devices
- ★ A comprehensive range of accessories to meet every requirement of the sound recording engineer
- ★★ A development of special interest to users of sapphire and delicate pick-ups—THE SIMITROL. This is a controlled micro-movement easily fitted for use with any type of pick-up
- ★★★ OUR CDR48A RECORDER UNIT complete and self-contained, measuring only 22in. x 14in. x 13½in., incorporating 7-valve amplifier, recorder unit, light-weight pick-up, speaker and microphone and with many exclusive features, is now ready for early delivery.

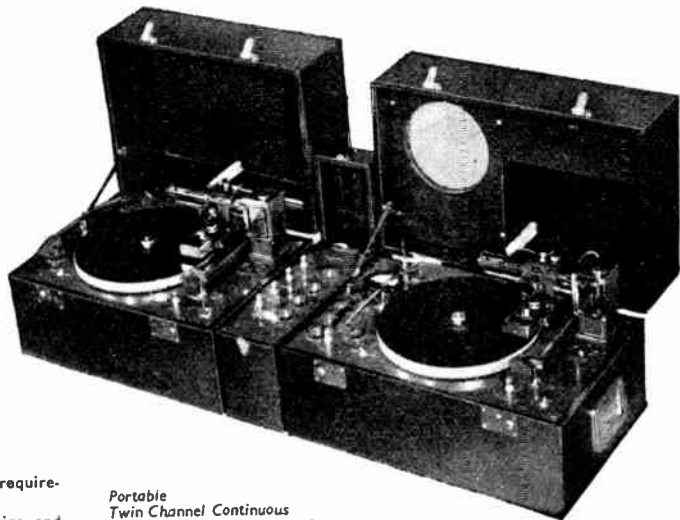

Portable  
Twin Channel Continuous  
Recording System incorporating  
CDR48A Recorder/Amplifier  
DR48A Recorder and EM48A Electronic  
4 Channel Mixer

OUR WELL-EQUIPPED WORKSHOPS ARE AVAILABLE FOR THE  
DEVELOPMENT OF EQUIPMENT TO MEET SPECIAL NEEDS.

**SIMON SOUND SERVICE, Recorder House, 48/50, George St., Portman Square, London, W.1.**

CABLES: Simsale, London.

TELEGRAMS: Simsale, Wesdo, London.

TELEPHONE: Welbeck 2371 (4 lines)

# Wharfedale

for ...

## REALISM IN REPRODUCTION

REALISM in reproduction is improved by extending the frequency response downwards. The arrangement illustrated with a W.15/CS for bass and W.10/CS for treble, gives almost lifelike results.

W.10/CS — 140/-  
W.15/CS — 230/-  
Separator — 65/-

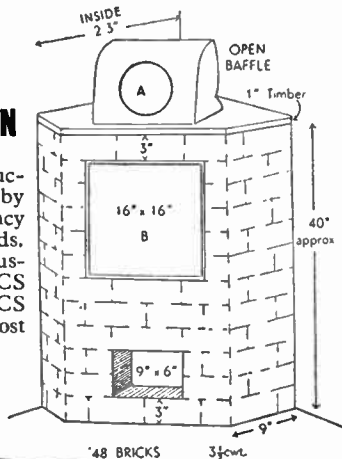

Ask your Dealer or send for book "Loudspeakers" by G. A. Briggs (5/-) in which acoustic loading is fully explored.

**WHARFEDALE WIRELESS WORKS**  
BRADFORD ROAD, IDLE, BRADFORD  
Phone: Idle 461. Grams: Wharfedel, Idle, Bradford.

## CONSISTENTLY *Accurate*

### PULLIN

#### Multi-Range Test Set Series 100

A Service Engineers' Universal Testing Set, with sensitivity of 10,000 Ohms per Volt. Strong metal case with carrying handle — complete with leads having detachable bull-dog clips and test prods. Ranges:

AC/DC Volts: 10, 25, 100, 250, 500, 1,000.

D.C. Milliamps: 2.5, 10, 25, 100, 500.  
AC/DC Microamps: 100 Microamps on the 10V range.

Resistance ranges: 0-1 Meg., (13,000 Ohms mid scale), 0/10,000 Ohms (135 Ohms mid scale).

Size 9" x 5½" x 4". Price £10-10-0



● We can give early deliveries — write for details:—



Address all enquiries to:—

**MEASURING INSTRUMENTS (PULLIN) LTD.**  
DEPT. J, ELECTRIC WORKS, WINCHESTER ST., LONDON, W.3

TELEPHONE: ACORN 4631/3 & 4995.

# The 'CINTEL' UNIVERSAL OSCILLOSCOPE

*A highly versatile laboratory instrument of outstanding performance*

Designed on the unit principle the 'Cintel' Universal Oscilloscope offers a basic instrument which is expandable at will to meet your requirements. Units now available include:

- Basic unit, comprising console, Cathode Ray Tube and power pack and calibration device.
- Simple time Base with frequency range from 5c/s to 200 Kc/s.
- Amplitude Stabilised Time Base with calibrated frequency range from 5c/s to 150 Kc/s.
- A.C. Amplifier with frequency range from 5c/s to 1.5 Mc/s.
- D.C. Amplifier with frequency range from 0c/s to 5 Mc/s.
- Double Beam Switch Unit.
- Five Beam Switch Unit.

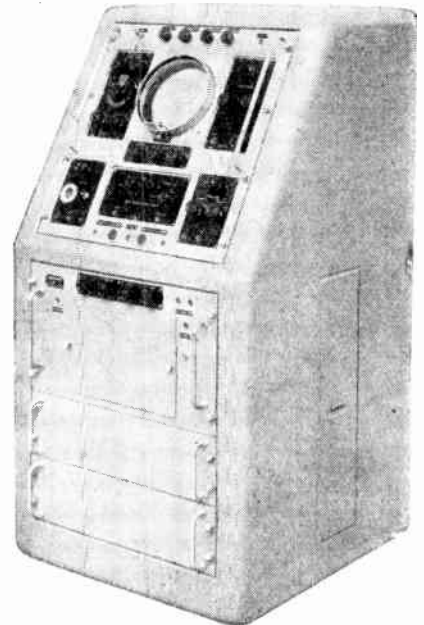

REGISTERED TRADE MARK

**CINEMA - TELEVISION Ltd.**

WORSLEY BRIDGE ROAD,  
LONDON, S.E.26

Telephone: H1Ther Green 4600

Manufacturers of Scientific Instruments and Photo-electric Cells

*The World's  
Best*

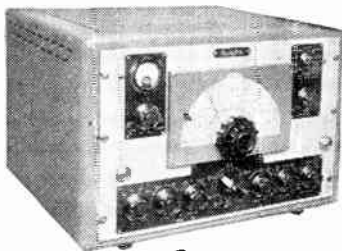

COMMUNICATIONS

**Redifon  
Radio**

Radio Communications Division

**REDIFFUSION LIMITED, BROOMHILL ROAD, WANDSWORTH, S.W.18**

DESIGNERS & MANUFACTURERS OF RADIO COMMUNICATION & INDUSTRIAL ELECTRONIC EQUIPMENT

Phone: PUTney 5691

RC 202

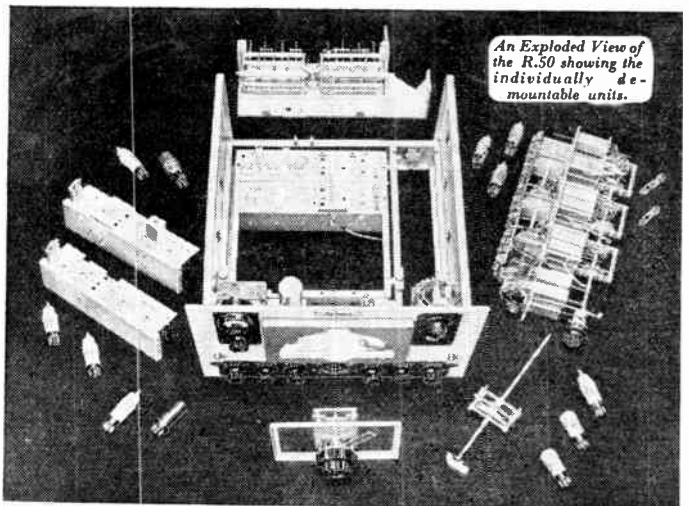

An Exploded View of the R.50 showing the individually de-mountable units.

Expertly planned and superbly executed, this all-purpose communications receiver is yet another triumph for Redifon research and development. No other receiver in the world can equal its amazing range and performance. Those services demanding the very best in radio equipment will readily admit that the higher cost of the R.50 is more than justified by its amazing

performance and reliability.

Five degrees of selectivity, including a crystal gate and crystal filter, are provided and the sensitivity is such that an input of between 1.5 microvolts gives a signal/noise ratio of at least 10 dB over the entire frequency range of 13.5 to 26 kc/s and 95 kc/s to 32 Mc/s. Separate power units for A.C. or D.C. operation are available.

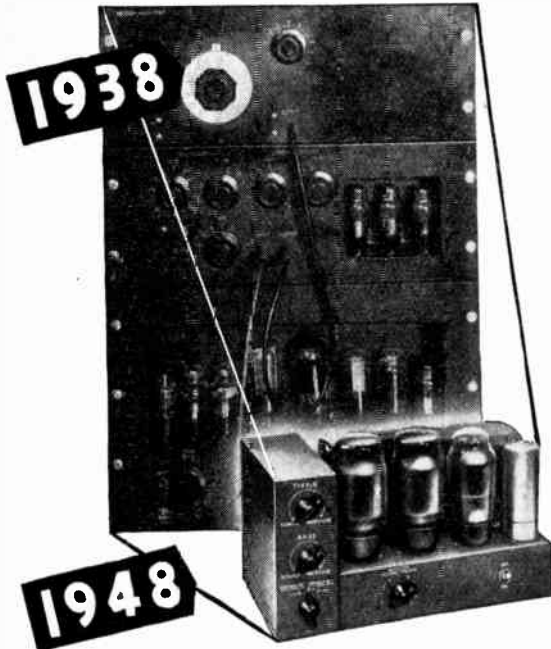

## Evidence of PROGRESS

The illustration above shows an ACOUSTICAL product of ten years ago—an amplifier designed for high quality reproduction of records and radio programmes. Using push-pull triodes throughout—RC coupled throughout—independent treble, middle and bass controls etc., it was considered about the best that could then be obtained. Indeed the circuit is often specified today for high quality reproduction. A comparison of the performance with that of the QAI2/P reveals the extent of recent developments.

	Pre-War	QAI2/P	Improvement achieved
Output deviation within 20-20,000 c.p.s. range ...	3 db	0.3 db	7 times better (% power change).
Frequency range within $\pm$ db ...	30-15,000 c.p.s.	15-30,000 c.p.s.	Increase of two octaves.
Total distortion at 10 watts (Both models rated 10-12 watts).	2%	0.1%	20 times less distortion.
Sensitivity (r.m.s. for full output) ...	0.2 v	0.0015 v	120 times more gain with no background increase.
Background noise (equivalent r.m.s. at input) ...	120 microvolts	1 microvolt	
Background for equal (low) gain ...	-65 db	-80 db	15 db lower background.
Load impedance: Internal Impedance	7	12	Better damping.
Treble and bass controls ...	variable extent of boosts and cuts.	variable slope of boosts and cuts.	Wider range of control and slopes of controls more accurately designed for small room listening conditions.
PRICE ...	£60	£30	50% less cost

**ACOUSTICAL**

Acoustical Manufacturing Co., Ltd.  
HUNTINGDON. Tele.: Huntingdon 361.

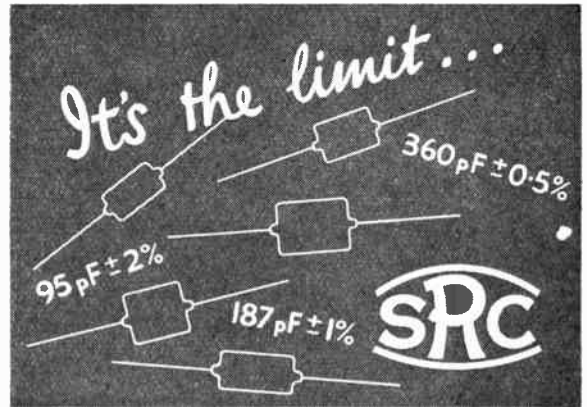

Our Silvered Mica Capacitors reach the limit of accuracy which can be achieved in a mass-produced radio component. Our recognised technical standards will satisfy those set manufacturers who wish their tuning scales to be "dead on line."

## STABILITY RADIO COMPONENTS LTD

14, NORMAN'S BUILDINGS,  
CENTRAL STREET, LONDON, E.C.1

Telephone: CLERKENWELL 5977

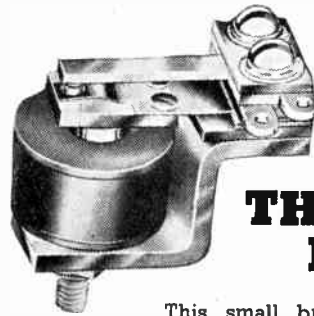

## THE TAYLOR BUZZER

This small buzzer has a number of applications, such as continuity testing, a signal for telephones and communication circuits, or as a source of interrupted supply for bridge circuits.

It operates at approximately 500 cycles per second, and the consumption at 3 volts is very approximately 100 mA. Also it will operate satisfactorily from 4 volts A.C. 50 cycles.

TAYLOR PRODUCTS INCLUDE:  
MULTIRANGE A.C. D.C. TEST METERS • SIGNAL GENERATORS • VALVE TESTERS • A.C. BRIDGES • CIRCUIT ANALYSERS • CATHODE RAY OSCILLOGRAPHS • HIGH AND LOW OHMMETERS • OUTPUT METERS • INSULATION TESTERS • MOVING COIL INSTRUMENTS



TAYLOR ELECTRICAL INSTRUMENTS LTD  
419-424 MONTROSE AVENUE, SLOUGH, BUCKS, ENGLAND  
Telephone SLOUGH 21381 (4 lines) Grams & Cables "TAYLINS" SLOUGH

# Television Aerial Downloads

**recommended  
types for use  
with these  
receivers**

CUT THIS OUT FOR REFERENCE

Cat. 339 — 1/- Yd.  
Cat. 386 — 1/6 Yd.  
Cat. 341 — 1/3 Yd.  
Cat. 387 — 6d. Yd.

**Aerialite**  
TELEVISION AERIALS AND EQUIPMENT

	TYPE OF AERIAL PLUG	CAT. NO.	TYPE OF DOWNLOAD RECOMMENDED	Impedance (OHMS)
BAIRD	2-Pin Special Standard	339 or 387	Balanced Twin	80
COSSOR	Standard Coaxial Plug	341	Coaxial	80
DENCO	Terminals only	341 or 339	Coaxial or Balanced Twin	80
EKCO	Auto Type Special	341	Coaxial	72
FERGUSON	Standard Coaxial Plug	341	Coaxial	75
FERRANTI	Octal Plug	387 or 339 or 386	Balanced Twin	80
G.E.C.	2-Pin Special	341	Coaxial	80
MARCONIPHONE	3-Pin Special	341 or 386	Coaxial	50
MCMICHAEL	Standard Coaxial Plug	341	Coaxial	80
MURPHY	Standard Coaxial Plug	341	Coaxial	80
PHILLIPS	2-Pin Screened Plug	386	Twin Screened	80
PHILCO	Auto Type Special	341	Coaxial	70
RGD	Standard Coaxial Plug	341	Coaxial	80
SOBELL	Standard	341	Coaxial	75
ULTRA	3-Pin Special	339 or 387	Twin Unscreened	80
VIDOR	Standard Coaxial Plug	341	Coaxial	80
PYE	Standard Twin Plug	339	Balanced Twin	75

MADE BY AERIALITE LIMITED AT THEIR CASTLE WORKS, STALYBRIDGE, CHESHIRE, ENGLAND.

**TWENTY-FIVE YEARS  
OF SPECIALISED  
EXPERIENCE**

**BEHIND EVERY  
*Stentorian***

"The finest proposition in radio's easiest market" is a title not easily earned: it results from a quarter of a century's association with radio. Stentorian Extension Speakers owe their pre-eminence to faithful reproduction, handsome appearance and outstanding value. Magnets in Alcomax, die-cast basins, cabinets designed to give correct acoustic balance and maximum base response, universal ratio transformer if required.

The Stentorian range comprises the Senior (£5.2.6), Junior (£4.10.6), Cadet (£4.0.0)—all as illustration, fitted with constant impedance volume control; Baby (£2.13.6), Minor (£1.19.6). Transformers extra in all cases.

**✚ REMOTE CONTROL OF RADIO**

Every Stentorian Senior, Junior and Cadet has a control button enabling the user to switch the receiver on or off from the extension speaker, no matter how far it is away from the set. This seeming miracle is performed by the "Long Arm"—a small compact unit which, fixed on or close to the radio, operates any number of speakers. Details on request.

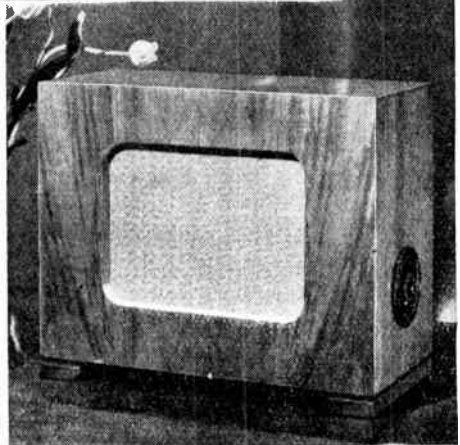

**LONG ARM REMOTE CONTROL**



**Costs 35/-**  
No Purchase Tax.



WHITELEY ELECTRICAL RADIO CO. LTD MANSFIELD NOTTS



# Get into Top Gear.

Marconi Test Gear is in the top class. This is worth remembering because the quality of your repair work is only as good as can be judged by your test gear. If you could make thorough and accurate measurements instead of comparative tests, no limitation would be imposed on your technique. You could raise it to the highest level and so give unrivalled service to your customers. You could, in fact, restore a receiver to its original performance — make it as good as new! And all you need, to get into “top gear” is the Marconi Receiver Tester — a complete laboratory in itself. Ask us to demonstrate it, or write for full particulars.

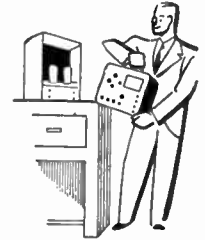

## The MARCONI PORTABLE RECEIVER TESTER TYPE TF 880

### Marconi Instruments Limited

ST. ALBANS, HERTFORDSHIRE • Telephone: St. Albans 6161/5.

Selling Agents: SIMPSON, BAKER & CO. LTD., AT BRISTOL, LONDON, BIRMINGHAM, EXETER, SWANSEA, CARDIFF, SOUTHAMPTON



## FOR THE RADIO SERVICEMAN DEALER AND OWNER

The man who enrolls for an I.C.S. Radio Course learns radio thoroughly, completely, practically. When he earns his Diploma, he will KNOW radio. We are not content merely to teach the principles of radio, we want to show our students how to apply that training in practical, every-day radio service work. We train them to be successful.

Write to the I.C.S. Advisory Dept. stating your requirements. Our advice is free.

You may use this coupon.....

**INTERNATIONAL CORRESPONDENCE SCHOOL Ltd.**  
DEPT. 38, INTERNATIONAL BUILDINGS, KINGSWAY, LONDON, W.C.2

Please explain fully about your instruction in the subject marked X.  
Complete Radio Engineering      Radio Service Engineers  
Radio Service and Sales      Advanced Short-Wave Radio  
Elementary Electronics, Radar, and Radio

And the following Radio Examinations:—  
British Institution of Radio Engineers  
P.M.G. Certificates for Wireless Operators  
City and Guilds Telecommunications  
Wireless Operators and Wireless Mechanics. R.A.F.  
I.C.S. Students for Examinations are coached till successful.

Name..... Age.....  
(BLOCK LETTERS PLEASE)

Address.....

**BC454B. (The Famous "Command" Communication Receiver)**  
Fitted 6 valves, types as follows: 3 12SK7's, 1 12KB, 1 12SR7, 1 12A6. Frequency Range 3-6mc's (50m-100m) IF value 1415kc's.  
**BC455B.** Exactly the same specification but Frequency Range 6-9.1 mc's (30m-50m) IF value 2830kc's.  
Brand new in sealed cartons. Unbeatable Value.  
each **30/-** Post 1/3  
Full Circuit Diagram 1/-  
Either set convertible to Medium Waves with our Special Coil Assembly. Price 10/- including Diagram of Connections, Special Press-In Tuning Spindle and Knob 2/6d.

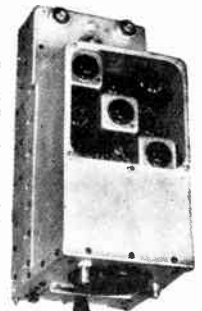

230v. A.C.  
**COMMAND POWER PACK FOR BC453, BC454, BC455**

**45/-**  
post paid

Wired and Tested. Fitted 6x5 Rectifier. Just Clip On. No Alterations to Wiring. Mains Cord fitted ready for instant use.

These units are manufactured by us exclusively to highest standard.

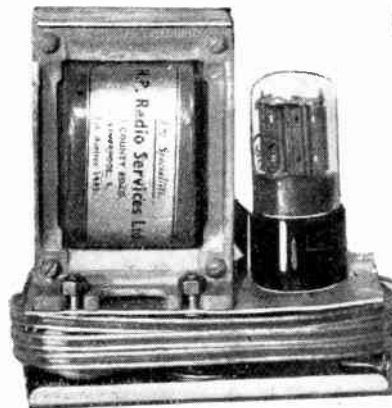

DELIVERY PER RETURN GUARANTEED.

**H. P. RADIO SERVICES LTD.**  
Britain's Leading Radio Mail Order House  
55 COUNTY ROAD, WALTON, LIVERPOOL 4  
Est. 1935. Tel.: Aintree 1445. Staff Call Signs: G3DGL, G3DLV



# QUICK ACTION TOGGLE SWITCH

AN APPROVED  
COMPONENT

*featuring*

Stainless Steel Operating Springs.  
Chromium Plated Bush and Dolly.  
Heavy Silver Clad Contacts.  
Resistance per pole approximately 0.002 ohms.  
Rating 250 volts 10 amps.  
Conforming to R.C.S.C. Tropical Specification  
for Type Approved Components.

A QUALITY  
SWITCH  
*at a*  
COMPETITIVE PRICE

PAINTON & CO LTD · KINGSTHORPE · NORTHAMPTON



*Control by*  
**PAINTON**

# A FINE INSTRUMENT

by



## VALVE VOLTMETER TYPE 712

**A. C. RANGE**

0-1.5 V, 0-5 V, 0-15 V, 0-50 V, 0-150 V.  
Balanced, Unbalanced and Differential.

**D. C. RANGE**

0-5 V, 0-50 V, 0-500 V.

**RESISTANCE RANGE**

0-1,000, 0-10,000, 0-100,000, ohms  
0-1, 0-10, 0-100, megohms.

**FREQUENCY RANGE**

30 c/s to 10 Mc/s with probe mounted.  
10 Kc/s to 100 Mc/s with probe unmounted.

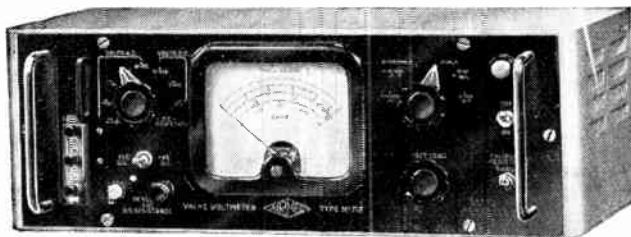

This general purpose Airmec instrument possesses a high degree of accuracy and covers a wide frequency range. Furthermore, it is designed for both bench use and for face-mounting in a standard 19" rack. An extendable low loss probe for use at high frequencies is provided. Balanced, unbalanced and differential A.C. voltages may be measured, and the circuit is arranged to measure positive and negative D.C. voltages and its usefulness increased by the incorporation of a resistance range. We should welcome the opportunity of sending you descriptive literature.

**AIRMEC LABORATORIES LTD.** Cressex, High Wycombe, Bucks.  
Telephone: High Wycombe 2060

**"BAFFLETTE"**  
EXTENSION  
SPEAKER

Regd. Design  
No. 851509

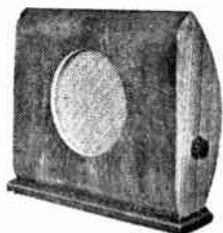

by

**Richard Allan**

£4. 4. 0. Walnut  
(Mahogany £4. 10. 0.)

**FOR BETTER REPRODUCTION**  
Fitted with precision-built 8" P.M. Unit.

Four Models

	Walnut	Mahogany
JUNIOR .. .. .	59/6	65/-
STANDARD .. .. .	£4 4 0	£4 10 0
DE LUXE .. .. .	£4 15 0	—
CONSOLE .. .. .	£6 15 0	£7 10 0

All available with Transformers, 8/6 extra.

Made and Guaranteed by

**RICHARD ALLAN RADIO LIMITED**

CALEDONIA ROAD, BATLEY, YORKS.

Tel : Batley 1123.

'Groms : Acoustics, Batley.

DRAYTON 'HYDROFLEX'  
Bellows, with tube from which  
it is made in one operation.

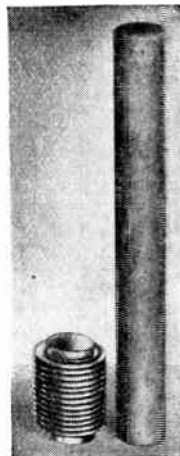

**FOR:** Automatic coolant regulation. Movement for pressure change. Packless gland to seal spindle in high vacua. Reservoir to accept liquid expansion. Dashpot or delay device. Barometric measurement or control. Pressurised couplings where vibration or movement is present. Dust seal to prevent ingress of dirt. Pressure reducing valves. Hydraulic transmission. Distance thermostatic control. Low torque flexible coupling. Pressure sealed rocking movement. Pressurised rotating shaft seals. Aircraft pressurised cabin control. Refrigeration expansion valves. Thermostatic Steam Traps. Pressure amplifiers. Differential pressure measurements. Thermostatic operation of louvre or damper.

Hydraulically formed  
"Hydroflex" METAL BELLOWS with a  
uniformity of life, performance and reliability  
in operation unobtainable by any other method

Seamless, one-piece, metal bellows combining the properties of a compression spring able to withstand repeated flexing, a packless gland and a container which can be hermetically sealed. Made by a process unique in this country; no thicker than paper (the walls range from 4/1000" to 7/1000"), they are tough, resilient and every bellows is pretested and proved during forming.

Write for List No. N 800-1

(B.7)

DRAYTON REGULATOR & INSTRUMENT CO. LTD., WEST DRAYTON, MIDD.

**TELE-RADIO (1943) LTD.**

177 EDGWARE ROAD, LONDON, W.2

Steel Chassis 17in. x 10in. x 3in. ....	12 6
" " 17in. x 10in. x 2in. ....	10 6
Aluminium Chassis 17in. x 10in. x 3in. ....	11 6
" " 17in. x 10in. x 2in. ....	11 0
" " 11in. x 6½in. x 2½in. ....	9 0
" " 8in. x 6½in. x 2in. ....	7 6
Standard chassis brackets, per pair .....	5 6
Heavy duty racks ex-W.D. 4ft. 10in. ....	57 6
Heavy duty racks ex-W.D. 6ft. ....	90 0
Carriage charge on racks .....	7 6
Chromium plated handles 3in. x ¾in. per pair .....	6 6

**DURAL PANELS FINISHED BLACK CRACKLE.**

14 SWG 19in. x 10½in. ....	9 6
" 19in. x 8½in. ....	8 6
" 19in. x 7in. ....	7 6
" 19in. x 5½in. ....	6 6
" 19in. x 3½in. ....	5 6
10 SWG 19in. x 10½in. ....	13 6
" 19in. x 8½in. ....	12 0
" 19in. x 7in. ....	10 3
" 19in. x 5½in. ....	8 3
" 19in. x 3½in. ....	6 6

Prestopunch for chassis hole punching up to 16 SWG soft steel or aluminium; complete with 1½in. punch and die 21 0

Additional punches and dies available in sizes ¾in., ¾in., ¾in., 1in., 1½in., dia. .... all 4 6 each

Please include sufficient for postage and packing

Send for 1949 catalogue—9d. post free.

'Phone : Paddington 6116 and 5606. Ambassador : 5393.

**Pushbutton?**

**Slider?**

**Rotary?**

**Band Selection?**

**Circuit Selection?**

**Tap Switching?**

Whatever it is—the answer is always OAK! Equalised pressure, double contact clips and floating rotors are exclusive features embodied in all special or standard type OAK switches

**WITHOUT QUESTION  
SPECIFY**

**OAK SWITCHES**

BRITISH N.S.F. CO. LTD., Keighley, Yorks.

Sole Licensees of OAK Manufacturing Co., Chicago

# INTRICATE PARTS

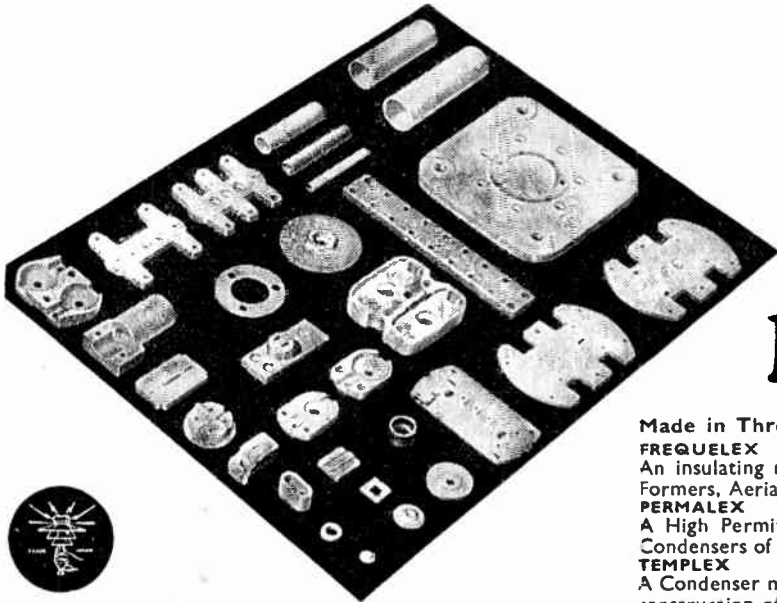

but not too intricate for **Bullers**

Made in Three Principal Materials

**FREQUELEX**

An insulating material of Low Di-electric Loss, for Coil Formers, Aerial Insulators, Valve Holders, etc.

**PERMALEX**

A High Permittivity Material. For the construction of Condensers of the smallest possible dimensions.

**TEMPLEX**

A Condenser material of medium permittivity. For the construction of Condensers having a constant capacity at all temperatures.



**BULLERS LOW LOSS CERAMICS**

**BULLERS LTD.**, 6, Laurence Pountney Hill, London, E.C.4

Phone: Mansion House 9971 (3 lines)

Telegrams: "Bullers, Cannon, London"

## "VICTORIA" at the B.I.F

Visitors to our stand will be interested in the development of Victoria instruments during the past twelve months. New, advanced instruments and their applications will be demonstrated, and technicians will be at hand for advice on any matters relating to our products.

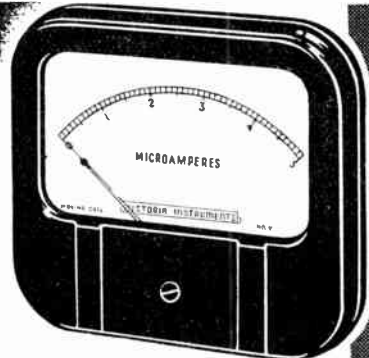

### PORTABLE TEST SETS

Robust moving iron Instruments. Suitable for the Electrical Contractor or Automobile Electrical Engineer.

Size: 3 3/4" x 3 3/4" x 2 1/2" overall complete with carrying strap

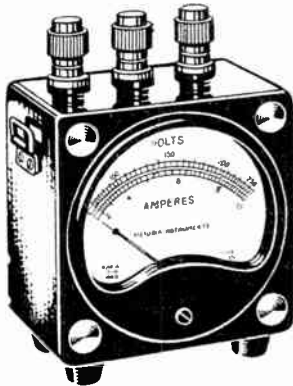

These combined instruments are made in many standard ranges. Combination examples:

- 260V A.C. or D.C.
- 15A A.C. or D.C.
- 25V A.C. or D.C.
- 25A A.C. or D.C.

Other Combinations to order.

### SQUARE FLANGE METERS

4" Large Open Scale. Mirror Scale can be supplied if required.

**RANGES:**

- A.C. From 1V-10kV
- 25uA-100 Amps.
- D.C. From 5mV-10kV
- 5uA-5000 Amps.

**B.I.F. OLYMPIA • Stand No.C.52**

## VICTORIA INSTRUMENTS

Proprietors: V.I.C. (Bournemouth) Ltd.

**MIDLAND TERRACE • LONDON • N.W.10**

Telephone: ELGar 7871/2



# A NEW B.P.L. INSTRUMENT



**THE VOLTASCOPE**—A combined valve-voltmeter and oscilloscope. **VALVE-VOLTMETER**—Infinite Input Resistance for D.C. ranges 0 to 300 volts. A.C. ranges 0 to 150 volts in 5 ranges. 3½ inch scale meter. **OSCILLOSCOPE**—3 inch screen tube provided with balanced amplifiers for Y and X plates giving a 5 times trace expansion. Maximum sensitivity 150mV/cm. Response from D.C. to 100 kcs.

Limited quantity available for early delivery.

**BRITISH PHYSICAL LABORATORIES**  
HOUSEBOAT WORKS, RADLETT, HERTS.

Tel: Radlett 5674-5-6

# ★ STARS for SALE! ★

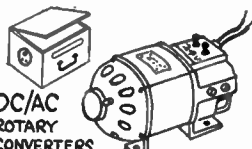

**DC/AC ROTARY CONVERTERS**

Input 24v 9a DC. Output 230v 100w 50c/AC continuous rating. Ball bearings. Brand new in stout wood carrying case 15 x 10 x 8. AM ref: 5P 24/24.

£3.15s.  
Carriage Paid.

Miniature Radio  
Altimeter C R O  
Indicator unit  
type 1-152-AM.

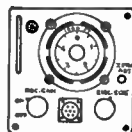

Comprising 3DP1 3" short persistence CR tube 4000/s pack, 212 HV rectifier, 3 midget 6AG5 deflection amplifiers giving circular trace. As new in black crackle case 11 x 8½ x 6½. Made in USA.

**TRUVOK 8" P.M.**



**SPEAKERS**

Receiver Manufacturers surplus 2 - 3 ohm voice coil.

**BRAND NEW 17/6**

Post 9d.

**BI Electrolytics**  
BRAND NEW  
All 500v working  
Card carton type

only **30%**  
Carriage 2/6

4mf	3/2
8mf	3/5
16 mf	4/7
8+8	4/9
8+16	6/1
16+16	6/11

Vertical Metal Cans  
8mf 4/4 16mf 5/4  
3P 8/4 8+8 5/9  
16+16 8/6  
Post 3d each  
12 assorted Post Free

Ex-Govt. **BLOCK CONDENSERS**



**Carriage 10/6**  
80 mfd 250VAC working  
Size 9x6x4. Wt 13 lbs  
Brand new in original  
packing. Ref: 42P/214

SATISFACTION GUARANTEED OR CASH REFUNDED INSTANTLY!!

**Frith**  
**RADIOCRAFT Ltd.**  
69-71 CHURCH GATE-LEICESTER  
PHONE 58927

**HIVAC**  
THE SCIENTIFIC  
BRITISH VALVE MADE

*Pioneers & Specialists in Small Valves*



Messrs. Hivac Ltd  
Greenhill, Crescent  
Harrow-on-the-Hill, Middx.

*THE address for:-  
Subminiatures-Midgets-Miniatures  
and Cold Cathode Tubes*

## Wireless Set No. 19. Supply Units No. 1.

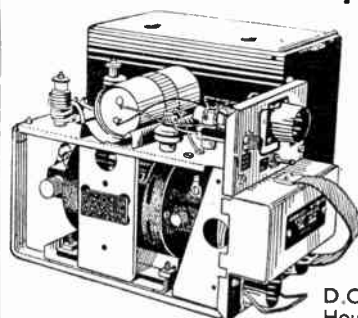

The portable power unit for the renowned "19" set. Comprises a powerful rotary transformer with associated smoothing circuits including electrolytic condensers. On-Off control switch on front panel with fuses and signal lamp. Input 12v. D.C. Outputs (a) 275v. 110 m/a D.C. (b) 500v. 50 m/a D.C. Housed in a steel carrying

case with handle. A useful supply for RX and TX. ONLY 25/- Carriage Paid.

### MODULATOR TYPE 76

A 9-valve equipment comprising 2 stages—I.F. amplification (560 Kc/s), Detector, A.V.C., separate B.F.O. and 1 stage audio output (phone). Also 4 valve push-pull modulation amplifier (1 valve used as A.F. oscillator on M.C.W.).

Complete with valves and power unit (24v. D.C. input with 2 outputs of 250v. D.C.).

Valve line-up:-2 KT33C; 2 EF36; 3 EF39; 1 EBC33; and 1 EF50.

Brand new and complete in transit case 50/-, or, less valves, 30/- Carriage and Packing 7/6.

You are cordially invited to inspect our huge range of radio and allied equipment at our new showrooms **OPENING MARCH 15th at**

**MOS THE RADIO CENTRE**  
33, TOTTENHAM COURT RD., LONDON W.1.

Telephone: MUSeum 6667-8-9  
All communications should be sent to Mail Order Supply Co., Dept. W.W., at this address.

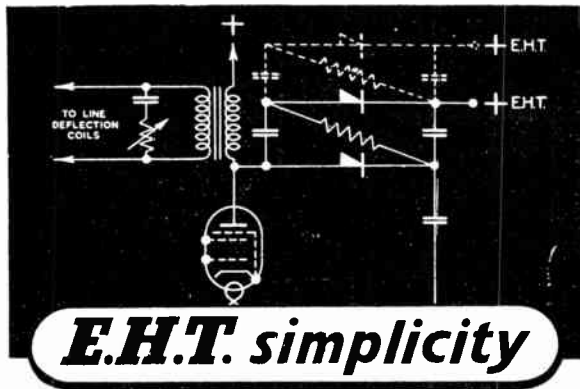

**E.H.T. simplicity**

E.H.T. may be obtained from the standard line scanning output transformer without any alteration whatever. Simply add three 36EH60 rectifiers in a tripler circuit and



Three type 36EH60 rectifiers, each only 3½" long X ¼" dia, will, from a peak pulse input of approx. 4,500V obtained from the standard line scanning output transformer, give an output of about 10kV at 100µA, used in the tripler circuit shown on the left.

you will obtain 10kV for your tube anode supply. Simple . . . . . efficient . . . . . reliable. Other sizes of rectifier available for lower or higher outputs.



**36EH METAL RECTIFIERS**

Write for data sheet No. 60, to Dept. W.W.3.

Westinghouse Brake & Signal Co., Ltd., 82, York Way, King's Cross, London, N.I.

**Design** for purpose is as important in radio servicing as in nature. The Weston Model E772 Analyser has been designed to make the detection of electrical faults as simple and speedy as possible. Its features include high sensitivity (20,000 ohms per volt on all D.C. ranges), wide range coverage and robust construction—its quality is unsurpassed. Please write for details.



**WESTON**<sup>E772</sup> *Analyser*

SANGAMO WESTON LTD. . ENFIELD . MIDDX. Telephone: Enfield 3434 & 1242

from the range of  instruments

## The TWENTY MILLION MEGOHMMETER

A new instrument for research and Industry. Covers the entire resistance range from 0.3 to 20,000,000 megohms. Two test voltages, 85v and 500v, are provided. A six-inch mirror scale enables readings to be taken accurately and quickly. Designed for testing cables, resistors, condensers and all insulating materials.

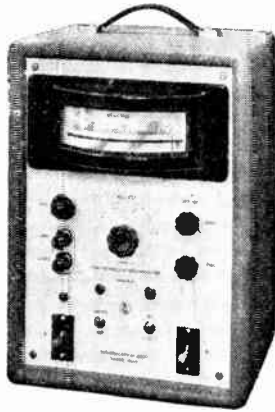

**ELECTRONIC INSTRUMENTS LTD**  
17 PARADISE ROAD • RICHMOND • SURREY



FOR  
P.A.

## THE NEW STANELECT UNIVERSAL LOUDSPEAKER

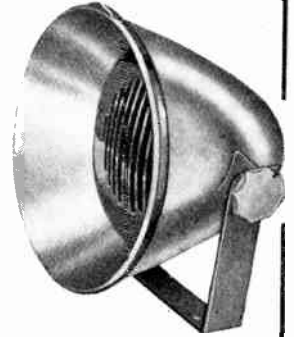

Weatherproof, Compact, Robust Die-cast case and grille in Silicon Alloy. Full Frequency Range.

High Performance  
Low Price

£7/10/0 Complete.

Subject to Usual Discounts.

### STANDARD ELECTRICAL ENGINEERING CO.

Stanelect House, 16, Heneage Lane, Leadenhall Street, London, E.C.3.

Telephone: Avenue 1633.

Cables: "Staneco," London.

**"You're CERTAIN to get it at ARTHURS!"**

BUT are you protected against BURGLARY by the amazing

### TRAVERSE BURGLAR PROOF LOCK?

The greatest security invention ever. Come to see it or send for descriptive leaflet.

★ **VALVES:** We have probably the largest Stock of valves in the Country. Send your enquiries. We will reply by return.

PICK-UPS. Decca £6 14 6. Decca head for Garrard £4 11 0. Adaptors 5/-. Connoisseur £4 11 0.

REMINGTON FOURSOME SHAVERS 210-250 v. AC/DC ..... £7 17 6

ALL AVO AND TAYLORS METERS. List on request. ALSO STOCKISTS OF ALL DOMESTIC APPLIANCES

London's Oldest Leading Radio Dealers.

**Arthur's** EST. 1919  
PROPS: ARTHUR GRAY. LTD. Terms C.O.D. or cash with order.

Our Only Address **Gray House, 150, Charing Cross Rd., London, W.C.2** TEMple Bar 5833/4  
**ELECTRICAL TELEVISION & RADIO ENGINEERS**

"Cyldon"

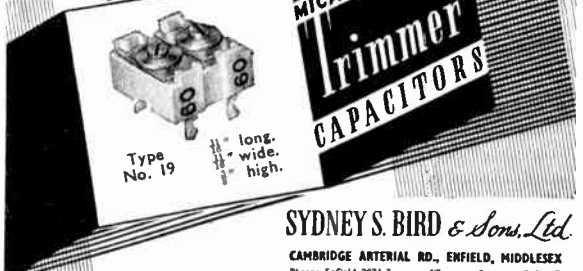

**SYDNEY S. BIRD & Sons Ltd.**

CAMBRIDGE ARTERIAL RD., ENFIELD, MIDDLESEX  
Phone: Enfield 2071-2 "Grams: "Capacity, Enfield"

## Television

FROM ANY **D.C. Mains**

Valradio Convertors will provide adequate A.C. for Television, Radiograms and the like from as low as 12v. D.C. input. We give two examples from the VALRADIO Range. Models for special inputs or outputs may be ordered.

- **MODEL 230/300** D.C. 200-250v. A.C. 200-250v., 300 watts, 50 or 75 c.p.s. **£16**
- **MODEL 230/200/110** D.C. 100-110v. A.C. 230v., 200 watts, 50 or 75 c.p.s. **£14**

## VALRADIO VIBRATOR CONVERTORS

Leaflet detailing all models from:—

**VALRADIO LTD., 57, FORTRESS RD., LONDON, N.W.5**  
Telephone: Gulliver 5165

Rate 6/- for 2 lines or less and 3/- for every additional line or part thereof, average lines 6 words. Box Numbers, 2 words plus 1/-. Press Day: April 1949 issue, first post Tuesday, March 8th. No responsibility accepted for errors.

**WARNING**

Readers are warned that Government surplus components which may be offered for sale through our columns carry no manufacturer's guarantee. Many of these components will have been designed for special purposes making them unsuitable for civilian use, or may have deteriorated as a result of the conditions under which they have been stored. We cannot undertake to deal with any complaints regarding any such components purchased.

**NEW RECEIVERS AND AMPLIFIERS**

**24** -hr. television (incl. Radar conversion) uses V.C.R.97 tube; send large s.a.e.—T.H. Products, 92 Leathwaite Rd., S.W.11. Bal 4889. (2472)

**19** 49 bandspread feeder unit with R.F. stage, n.e. wavebands, 13.5-2.000 metres; 274; stamp for illustrated brochure.—Coughpore Radio, Ormskirk, Lancs. (2528)

**L**ocal station feeder unit, £5/5; 6-watt push-pull high fidelity amplifier, £12/12; data sheets on request.—E. A. D., 18, Broad Rd., Lower Willingdon, Sussex. (2776)

**A**mplifiers new 60-watt heavy duty D.A. models, built for continuous rating and rack mounting, £40; early delivery, send for spec.—Broadcast & Acoustic Equipment Co., Ltd., Tombland, Norwich. (2905)

**A**ll types of equipment, A.M., F.M. and T.V. receivers, control and test gear designed and/or built to specification.—Write for quotation to J. Mort, B.Sc., A.M.I.E.E., BCM/HIFIDEL, London, W.C.1. (2939)

**T**he supreme small amplifier for record and radio reproduction; Felicity 5-watt response level 40-15,000 cycles not greater than 1%. Price now only £14/19/9.—F.S.R., Ltd., 87A, Upper Richmond Rd., Putney, S.W.15. (2727)

**B**.C.348 American receivers, new, £18/10; R.28 American 10-valve receivers, new, 45/-; British Navy type 76 3-valve receivers, new, in case with circuit, 30/-, all carriage paid.—G. Lawrence & Co., 3, Slater Place, Liverpool. (2872)

**J**unior version of Williamson's quality amplifier with specified output transformer, 12 watts 7 valves, £16/16; 5-valve a.c. mains, 8-watt push-pull amplifiers, with output transformers, 69; Cestation 12in. P.M. Speakers, 3-ohm voice coil, 75/-—R. T., 64, St. Leonard's Rd., London, S.W.14. (2400)

**C**ONNOISSEUR'S receiver—world-wide results on highly sensitive 10-valve communication receiver or, by change of switch, very high quality reception of local stations on non-super-cut high fidelity receiver; basis rebuilt R1155, 9-1,500 metres, P.X.4 push-pull quality amplifier, bass and treble controls (boost and cut), gram input, new panel, and other refinements; write for details, or call for demonstration; R1155 specialists, receivers repaired and realigned, also modified as above, or to your requirements; R1155 circuit and valves, 2/- post free.—R.T.S., Ltd., 5, Gladstone Rd., Wimbledon, S.W.19. Tel. Lib. 3303. (1266)

**T**HE Midget radio with the most powerful voice! Universal mains 200-250v, 3 valves plus rectifier, highly polished walnut cabinet, latest British valves and ballast tube, high Q iron-c-rd coils, wave-range 200-500 metres, 5in high-flux speaker, no earth or aerial reqd., low power consumption, no live-cord, 1-watt output; sent by return for the astonishingly low price of £6/19/9 incl. P.T. and 1 year's guarantee, c.w.o. or c.o.d., carriage 2/6; illustrated leaflet W.W. 244; also 4-watt audio amplifiers, pick-up and tuner inputs, volume, tone and feedback controls, 100-250 a.c., £5/19/6 carriage.—N.R.S., 102 Parkhill Rd., London, N.W.3. (2868)

**T**HE Spencer-West type AC/2 television pre-amplifier is designed by S. S. West, M.B.E. The first viewer to receive the Alexandra Palace transmissions outside the normal service area. A great deal of experience and modern circuit features ensure optimum performance. The AC/2 pre-amplifier is not just an additional valve stage. It is a carefully designed low noise line amplifier incorporating its own filtered power supply unit. It is completely screened electrically and mechanically. Connected in the aerial feeder, preferably as near to the aerial as is convenient, results will surpass those obtainable with a highly sensitive receiver.—Particulars from Spencer-West, Quay Works, North Quay, Gt. Yarmouth. (2868)

**U**NIVERSAL ELECTRONIC PRODUCTS, 36, Marylebone High St., W.1, Welbeck 4058. Specialists in the design and manufacture of high grade fidelity gramophone reproducers and radio units. If you are interested in obtaining the finest possible reproduction from recorded music we invite you to hear our equipment demonstrated in conjunction with the Wilkins and Wright cell pick-up and the Wharfedale corner cabinet speaker. We will gladly give you a quotation for the conversion of your existing radio gramophone into a first-class reproducing instrument, or for the design and construction of equipment to suit your own special requirements. Write for descriptive leaflets of our range of fidelity amplifiers and radio tuning units.

L 13

**Partridge News**

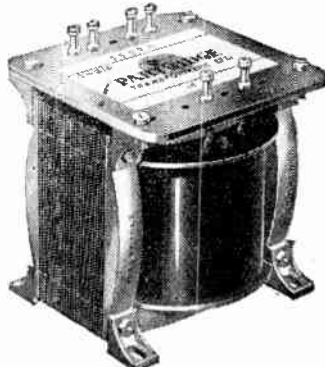

**TOLWORTH FACTORY**

Our new modern transformer factory and laboratory are now in operation and equipped with up-to-date machinery for the manufacture and testing of quality components. Increased facilities have enabled us to improve our service. As well as having 100 different types of transformers and chokes available from stock, we can wind to specification within 14-28 days depending on the quantity and types involved. Our range has been increased to cover power transformers up to 25 K.V.A. and we shall be pleased to send our catalogue and stock list upon request.



**LONDON SALES OFFICE**

Our standard components, as listed, are available from stock and can be collected from our Sales Office at King's Buildings, Dean Stanley Street, Millbank, Westminster, S.W.1. Tel. Abbey 2244 (250 yards from Big Ben). Hours 10 a.m.—1 p.m. and 2—5.30 p.m. (Mondays to Fridays only). Kindly note this address is for stock sales only.



**R.C.M.F. EXHIBITION**

We extend a cordial welcome to our friends in the trade to visit us at Stand No. 71 at the R.C.M.F. Exhibition held at Great Hall, Grosvenor House, London, W.1. on March 1st—3rd. As well as displaying a selection of all our products, we are giving a Demonstration on Harmonic Distortion in Audio Transformers. Call on us and have a chat about that transformer problem.

ELMBRIDGE 6737-8

**PARTRIDGE TRANSFORMERS LTD**

Roebuck Road, Tolworth, Surrey

**M**IDCO amplifiers 4-25 watts, 4-watt model, modern style chassis, tone and volume controls, a.c. mains, £4/10; 10-watt with p-p6V6 output stage, high gain, twin input channels, N.F.C. £10; 25-watt p-p6L6 output, bass and treble tone controls, Imhof case, very high gain, £23; stamps for catalogue of exclusive products; trade terms.—Midco Radio, 19 Newcomen Rd., Wellington, Northants. (2929)

**E**LECTRICAL & ELECTRONIC DEVELOPMENT Ltd., Hubert St., Birmingham, 6 (Aston Cross 2440), the Midlands specialist manufacturers of high fidelity equipment, for W.W. Williamson, "Electronia," and other quality amplifiers, built strictly to specification with finest components available; also tone control stages, loudspeaker cross-over units, contrast expanders and radio feeders; send 24d stamp for full details and prices. (2233)

**R**ECEIVERS for West Country amateurs: Eddystone 640, £27/10 cash, ex-stock, no tax, or terms, £5/15 down +6/- for 78 weeks; send for details; Eddystone 670, the personal receiver for marine use, 10-51 and 110-575 metres, 4 bands, a.c./d.c., 110-230v, internal speaker, £46/0/7 inc., now available for home use; Eddystone 680, the new super comm. receiver for commercial use and for discriminating amateurs, 13 valves, 10-612 metres, details on application, £85 cash, no tax, a few available for early delivery; G.E.C. BR.7400, a high quality 14 valve comm. receiver, 9.1-2,000 metres, a refined design with a considerable performance; £120 cash, early delivery, carriage paid; send for details.—G. N. Pill & Partners, 49, Coburg St., Plymouth, Tel. 2239. (3001)

**G**OODSELL, Ltd., 40, Gardner St., Brighton, 1, Sussex.—The finest range of amplifiers available to Williamson's specification, K.T.66 at £22; P.X.4 version at £17/10; and without a doubt the finest of all, the P.X.25 amplifier with two chassis and two power packs for 500 and 275 volts n.t. at £28/7, carriage extra; all on black crackle steel chassis, K.T.66 and P.X.4, 10 valves, P.X.3 P.X.25 two chassis, 12 1/2" x 8 1/2" x 2 1/2", paper condensers, fitted with ex-stock A.4, which has paper for reservoir Partridge transformers as standard, all valves B.V.A., beautifully finished with enclosed double fuse holder and recessed mains input; for use with above 0-5 any good amplifier, our tone control unit, separate 6-way treble and bass control, and cut out available by turning a switch, 2 valves, L.63s at £6, or high gain with E.F.37s at £6/6; also quality feeders, including a specially designed superhet (2-band) for fidelity reception, variable selectivity, distortionless detector, etc. Components for Williamson's Partridge mains transformer, 57/-; chokes, 2/16 and 3/16; output transformer, £5; R.T.S. output tropical finish, to specification, £3/7/6. Six useful books: The Brimar Valve Manual, 2/6; "Loudspeakers," by G. A. Briggs (Wharfedale), 5/-; Denco Bulletins, DBT 1 (Practical Design of Receivers using Max-Q coils); DBT 2 (Design and Layout for Turrets 6 & 7); DBT 3 (Design and Layout for C.T.4 Turret), 3/- each; Partridge Manual, 5/7; please add 3d postage. (2747)

**RECEIVERS, AMPLIFIERS—SECOND-HAND**

**G**. W. SMITH & Co. (RADIO), Ltd., offers the following sound and perfect TELEVISION.—Ex-R.A.F. R.3585 receivers, complete 45m/cs T/V unit with E.F.50 valves, £5/10; receiver R1143 100-125m/cs, complete with valves 4 VR 91.3, VR53 1, VT52, 25/- each; 125-150m/cs receivers 3122, IEB30, 21/6; 150-200m/cs receivers 3123, IEB31, 21/6; 200-250m/cs receivers 3124, IEB32, 21/6; 250-300m/cs receivers 3125, IEB33, 21/6; 300-350m/cs receivers 3126, IEB34, 21/6; 350-400m/cs receivers 3127, IEB35, 21/6; 400-450m/cs receivers 3128, IEB36, 21/6; 450-500m/cs receivers 3129, IEB37, 21/6; 500-550m/cs receivers 3130, IEB38, 21/6; 550-600m/cs receivers 3131, IEB39, 21/6; 600-650m/cs receivers 3132, IEB40, 21/6; 650-700m/cs receivers 3133, IEB41, 21/6; 700-750m/cs receivers 3134, IEB42, 21/6; 750-800m/cs receivers 3135, IEB43, 21/6; 800-850m/cs receivers 3136, IEB44, 21/6; 850-900m/cs receivers 3137, IEB45, 21/6; 900-950m/cs receivers 3138, IEB46, 21/6; 950-1000m/cs receivers 3139, IEB47, 21/6; 1000-1050m/cs receivers 3140, IEB48, 21/6; 1050-1100m/cs receivers 3141, IEB49, 21/6; 1100-1150m/cs receivers 3142, IEB50, 21/6; 1150-1200m/cs receivers 3143, IEB51, 21/6; 1200-1250m/cs receivers 3144, IEB52, 21/6; 1250-1300m/cs receivers 3145, IEB53, 21/6; 1300-1350m/cs receivers 3146, IEB54, 21/6; 1350-1400m/cs receivers 3147, IEB55, 21/6; 1400-1450m/cs receivers 3148, IEB56, 21/6; 1450-1500m/cs receivers 3149, IEB57, 21/6; 1500-1550m/cs receivers 3150, IEB58, 21/6; 1550-1600m/cs receivers 3151, IEB59, 21/6; 1600-1650m/cs receivers 3152, IEB60, 21/6; 1650-1700m/cs receivers 3153, IEB61, 21/6; 1700-1750m/cs receivers 3154, IEB62, 21/6; 1750-1800m/cs receivers 3155, IEB63, 21/6; 1800-1850m/cs receivers 3156, IEB64, 21/6; 1850-1900m/cs receivers 3157, IEB65, 21/6; 1900-1950m/cs receivers 3158, IEB66, 21/6; 1950-2000m/cs receivers 3159, IEB67, 21/6; 2000-2050m/cs receivers 3160, IEB68, 21/6; 2050-2100m/cs receivers 3161, IEB69, 21/6; 2100-2150m/cs receivers 3162, IEB70, 21/6; 2150-2200m/cs receivers 3163, IEB71, 21/6; 2200-2250m/cs receivers 3164, IEB72, 21/6; 2250-2300m/cs receivers 3165, IEB73, 21/6; 2300-2350m/cs receivers 3166, IEB74, 21/6; 2350-2400m/cs receivers 3167, IEB75, 21/6; 2400-2450m/cs receivers 3168, IEB76, 21/6; 2450-2500m/cs receivers 3169, IEB77, 21/6; 2500-2550m/cs receivers 3170, IEB78, 21/6; 2550-2600m/cs receivers 3171, IEB79, 21/6; 2600-2650m/cs receivers 3172, IEB80, 21/6; 2650-2700m/cs receivers 3173, IEB81, 21/6; 2700-2750m/cs receivers 3174, IEB82, 21/6; 2750-2800m/cs receivers 3175, IEB83, 21/6; 2800-2850m/cs receivers 3176, IEB84, 21/6; 2850-2900m/cs receivers 3177, IEB85, 21/6; 2900-2950m/cs receivers 3178, IEB86, 21/6; 2950-3000m/cs receivers 3179, IEB87, 21/6; 3000-3050m/cs receivers 3180, IEB88, 21/6; 3050-3100m/cs receivers 3181, IEB89, 21/6; 3100-3150m/cs receivers 3182, IEB90, 21/6; 3150-3200m/cs receivers 3183, IEB91, 21/6; 3200-3250m/cs receivers 3184, IEB92, 21/6; 3250-3300m/cs receivers 3185, IEB93, 21/6; 3300-3350m/cs receivers 3186, IEB94, 21/6; 3350-3400m/cs receivers 3187, IEB95, 21/6; 3400-3450m/cs receivers 3188, IEB96, 21/6; 3450-3500m/cs receivers 3189, IEB97, 21/6; 3500-3550m/cs receivers 3190, IEB98, 21/6; 3550-3600m/cs receivers 3191, IEB99, 21/6; 3600-3650m/cs receivers 3192, IEB100, 21/6; 3650-3700m/cs receivers 3193, IEB101, 21/6; 3700-3750m/cs receivers 3194, IEB102, 21/6; 3750-3800m/cs receivers 3195, IEB103, 21/6; 3800-3850m/cs receivers 3196, IEB104, 21/6; 3850-3900m/cs receivers 3197, IEB105, 21/6; 3900-3950m/cs receivers 3198, IEB106, 21/6; 3950-4000m/cs receivers 3199, IEB107, 21/6; 4000-4050m/cs receivers 3200, IEB108, 21/6; 4050-4100m/cs receivers 3201, IEB109, 21/6; 4100-4150m/cs receivers 3202, IEB110, 21/6; 4150-4200m/cs receivers 3203, IEB111, 21/6; 4200-4250m/cs receivers 3204, IEB112, 21/6; 4250-4300m/cs receivers 3205, IEB113, 21/6; 4300-4350m/cs receivers 3206, IEB114, 21/6; 4350-4400m/cs receivers 3207, IEB115, 21/6; 4400-4450m/cs receivers 3208, IEB116, 21/6; 4450-4500m/cs receivers 3209, IEB117, 21/6; 4500-4550m/cs receivers 3210, IEB118, 21/6; 4550-4600m/cs receivers 3211, IEB119, 21/6; 4600-4650m/cs receivers 3212, IEB120, 21/6; 4650-4700m/cs receivers 3213, IEB121, 21/6; 4700-4750m/cs receivers 3214, IEB122, 21/6; 4750-4800m/cs receivers 3215, IEB123, 21/6; 4800-4850m/cs receivers 3216, IEB124, 21/6; 4850-4900m/cs receivers 3217, IEB125, 21/6; 4900-4950m/cs receivers 3218, IEB126, 21/6; 4950-5000m/cs receivers 3219, IEB127, 21/6; 5000-5050m/cs receivers 3220, IEB128, 21/6; 5050-5100m/cs receivers 3221, IEB129, 21/6; 5100-5150m/cs receivers 3222, IEB130, 21/6; 5150-5200m/cs receivers 3223, IEB131, 21/6; 5200-5250m/cs receivers 3224, IEB132, 21/6; 5250-5300m/cs receivers 3225, IEB133, 21/6; 5300-5350m/cs receivers 3226, IEB134, 21/6; 5350-5400m/cs receivers 3227, IEB135, 21/6; 5400-5450m/cs receivers 3228, IEB136, 21/6; 5450-5500m/cs receivers 3229, IEB137, 21/6; 5500-5550m/cs receivers 3230, IEB138, 21/6; 5550-5600m/cs receivers 3231, IEB139, 21/6; 5600-5650m/cs receivers 3232, IEB140, 21/6; 5650-5700m/cs receivers 3233, IEB141, 21/6; 5700-5750m/cs receivers 3234, IEB142, 21/6; 5750-5800m/cs receivers 3235, IEB143, 21/6; 5800-5850m/cs receivers 3236, IEB144, 21/6; 5850-5900m/cs receivers 3237, IEB145, 21/6; 5900-5950m/cs receivers 3238, IEB146, 21/6; 5950-6000m/cs receivers 3239, IEB147, 21/6; 6000-6050m/cs receivers 3240, IEB148, 21/6; 6050-6100m/cs receivers 3241, IEB149, 21/6; 6100-6150m/cs receivers 3242, IEB150, 21/6; 6150-6200m/cs receivers 3243, IEB151, 21/6; 6200-6250m/cs receivers 3244, IEB152, 21/6; 6250-6300m/cs receivers 3245, IEB153, 21/6; 6300-6350m/cs receivers 3246, IEB154, 21/6; 6350-6400m/cs receivers 3247, IEB155, 21/6; 6400-6450m/cs receivers 3248, IEB156, 21/6; 6450-6500m/cs receivers 3249, IEB157, 21/6; 6500-6550m/cs receivers 3250, IEB158, 21/6; 6550-6600m/cs receivers 3251, IEB159, 21/6; 6600-6650m/cs receivers 3252, IEB160, 21/6; 6650-6700m/cs receivers 3253, IEB161, 21/6; 6700-6750m/cs receivers 3254, IEB162, 21/6; 6750-6800m/cs receivers 3255, IEB163, 21/6; 6800-6850m/cs receivers 3256, IEB164, 21/6; 6850-6900m/cs receivers 3257, IEB165, 21/6; 6900-6950m/cs receivers 3258, IEB166, 21/6; 6950-7000m/cs receivers 3259, IEB167, 21/6; 7000-7050m/cs receivers 3260, IEB168, 21/6; 7050-7100m/cs receivers 3261, IEB169, 21/6; 7100-7150m/cs receivers 3262, IEB170, 21/6; 7150-7200m/cs receivers 3263, IEB171, 21/6; 7200-7250m/cs receivers 3264, IEB172, 21/6; 7250-7300m/cs receivers 3265, IEB173, 21/6; 7300-7350m/cs receivers 3266, IEB174, 21/6; 7350-7400m/cs receivers 3267, IEB175, 21/6; 7400-7450m/cs receivers 3268, IEB176, 21/6; 7450-7500m/cs receivers 3269, IEB177, 21/6; 7500-7550m/cs receivers 3270, IEB178, 21/6; 7550-7600m/cs receivers 3271, IEB179, 21/6; 7600-7650m/cs receivers 3272, IEB180, 21/6; 7650-7700m/cs receivers 3273, IEB181, 21/6; 7700-7750m/cs receivers 3274, IEB182, 21/6; 7750-7800m/cs receivers 3275, IEB183, 21/6; 7800-7850m/cs receivers 3276, IEB184, 21/6; 7850-7900m/cs receivers 3277, IEB185, 21/6; 7900-7950m/cs receivers 3278, IEB186, 21/6; 7950-8000m/cs receivers 3279, IEB187, 21/6; 8000-8050m/cs receivers 3280, IEB188, 21/6; 8050-8100m/cs receivers 3281, IEB189, 21/6; 8100-8150m/cs receivers 3282, IEB190, 21/6; 8150-8200m/cs receivers 3283, IEB191, 21/6; 8200-8250m/cs receivers 3284, IEB192, 21/6; 8250-8300m/cs receivers 3285, IEB193, 21/6; 8300-8350m/cs receivers 3286, IEB194, 21/6; 8350-8400m/cs receivers 3287, IEB195, 21/6; 8400-8450m/cs receivers 3288, IEB196, 21/6; 8450-8500m/cs receivers 3289, IEB197, 21/6; 8500-8550m/cs receivers 3290, IEB198, 21/6; 8550-8600m/cs receivers 3291, IEB199, 21/6; 8600-8650m/cs receivers 3292, IEB200, 21/6; 8650-8700m/cs receivers 3293, IEB201, 21/6; 8700-8750m/cs receivers 3294, IEB202, 21/6; 8750-8800m/cs receivers 3295, IEB203, 21/6; 8800-8850m/cs receivers 3296, IEB204, 21/6; 8850-8900m/cs receivers 3297, IEB205, 21/6; 8900-8950m/cs receivers 3298, IEB206, 21/6; 8950-9000m/cs receivers 3299, IEB207, 21/6; 9000-9050m/cs receivers 3300, IEB208, 21/6; 9050-9100m/cs receivers 3301, IEB209, 21/6; 9100-9150m/cs receivers 3302, IEB210, 21/6; 9150-9200m/cs receivers 3303, IEB211, 21/6; 9200-9250m/cs receivers 3304, IEB212, 21/6; 9250-9300m/cs receivers 3305, IEB213, 21/6; 9300-9350m/cs receivers 3306, IEB214, 21/6; 9350-9400m/cs receivers 3307, IEB215, 21/6; 9400-9450m/cs receivers 3308, IEB216, 21/6; 9450-9500m/cs receivers 3309, IEB217, 21/6; 9500-9550m/cs receivers 3310, IEB218, 21/6; 9550-9600m/cs receivers 3311, IEB219, 21/6; 9600-9650m/cs receivers 3312, IEB220, 21/6; 9650-9700m/cs receivers 3313, IEB221, 21/6; 9700-9750m/cs receivers 3314, IEB222, 21/6; 9750-9800m/cs receivers 3315, IEB223, 21/6; 9800-9850m/cs receivers 3316, IEB224, 21/6; 9850-9900m/cs receivers 3317, IEB225, 21/6; 9900-9950m/cs receivers 3318, IEB226, 21/6; 9950-10000m/cs receivers 3319, IEB227, 21/6; 10000-10050m/cs receivers 3320, IEB228, 21/6; 10050-10100m/cs receivers 3321, IEB229, 21/6; 10100-10150m/cs receivers 3322, IEB230, 21/6; 10150-10200m/cs receivers 3323, IEB231, 21/6; 10200-10250m/cs receivers 3324, IEB232, 21/6; 10250-10300m/cs receivers 3325, IEB233, 21/6; 10300-10350m/cs receivers 3326, IEB234, 21/6; 10350-10400m/cs receivers 3327, IEB235, 21/6; 10400-10450m/cs receivers 3328, IEB236, 21/6; 10450-10500m/cs receivers 3329, IEB237, 21/6; 10500-10550m/cs receivers 3330, IEB238, 21/6; 10550-10600m/cs receivers 3331, IEB239, 21/6; 10600-10650m/cs receivers 3332, IEB240, 21/6; 10650-10700m/cs receivers 3333, IEB241, 21/6; 10700-10750m/cs receivers 3334, IEB242, 21/6; 10750-10800m/cs receivers 3335, IEB243, 21/6; 10800-10850m/cs receivers 3336, IEB244, 21/6; 10850-10900m/cs receivers 3337, IEB245, 21/6; 10900-10950m/cs receivers 3338, IEB246, 21/6; 10950-11000m/cs receivers 3339, IEB247, 21/6; 11000-11050m/cs receivers 3340, IEB248, 21/6; 11050-11100m/cs receivers 3341, IEB249, 21/6; 11100-11150m/cs receivers 3342, IEB250, 21/6; 11150-11200m/cs receivers 3343, IEB251, 21/6; 11200-11250m/cs receivers 3344, IEB252, 21/6; 11250-11300m/cs receivers 3345, IEB253, 21/6; 11300-11350m/cs receivers 3346, IEB254, 21/6; 11350-11400m/cs receivers 3347, IEB255, 21/6; 11400-11450m/cs receivers 3348, IEB256, 21/6; 11450-11500m/cs receivers 3349, IEB257, 21/6; 11500-11550m/cs receivers 3350, IEB258, 21/6; 11550-11600m/cs receivers 3351, IEB259, 21/6; 11600-11650m/cs receivers 3352, IEB260, 21/6; 11650-11700m/cs receivers 3353, IEB261, 21/6; 11700-11750m/cs receivers 3354, IEB262, 21/6; 11750-11800m/cs receivers 3355, IEB263, 21/6; 11800-11850m/cs receivers 3356, IEB264, 21/6; 11850-11900m/cs receivers 3357, IEB265, 21/6; 11900-11950m/cs receivers 3358, IEB266, 21/6; 11950-12000m/cs receivers 3359, IEB267, 21/6; 12000-12050m/cs receivers 3360, IEB268, 21/6; 12050-12100m/cs receivers 3361, IEB269, 21/6; 12100-12150m/cs receivers 3362, IEB270, 21/6; 12150-12200m/cs receivers 3363, IEB271, 21/6; 12200-12250m/cs receivers 3364, IEB272, 21/6; 12250-12300m/cs receivers 3365, IEB273, 21/6; 12300-12350m/cs receivers 3366, IEB274, 21/6; 12350-12400m/cs receivers 3367, IEB275, 21/6; 12400-12450m/cs receivers 3368, IEB276, 21/6; 12450-12500m/cs receivers 3369, IEB277, 21/6; 12500-12550m/cs receivers 3370, IEB278, 21/6; 12550-12600m/cs receivers 3371, IEB279, 21/6; 12600-12650m/cs receivers 3372, IEB280, 21/6; 12650-12700m/cs receivers 3373, IEB281, 21/6; 12700-12750m/cs receivers 3374, IEB282, 21/6; 12750-12800m/cs receivers 3375, IEB283, 21/6; 12800-12850m/cs receivers 3376, IEB284, 21/6; 12850-12900m/cs receivers 3377, IEB285, 21/6; 1290



## A NEW SYMBOL

is presented to you to associate with Hartley-Turner Highest Fidelity Reproduction. We have often been asked why we don't put our name on our speakers and we have replied that we didn't think it necessary. On a good set no one could mistake it for any other make, and on a bad set, well...

But the Hartley-Turner 215 Speaker is gradually being used in ever-increasing numbers all over the world, particularly in the U.S.A., and the time has come for us to let the world know what it is and where it comes from. So on goes the symbol.

When you see it on speakers, amplifiers, radios, or anything else in that line, you will know it indicates pride in craftsmanship and pride in performance.

You in Britain who are not as yet numbered among our customers may not realise what you are missing, or why the rest of the world is making a beaten path for "our better mousetrap." You should be doing so too, and the only thing that will ensnare you is the pride we take in our craftsman and artistic ability, added to a proper humble knowledge that we still have far to go before we or our products are perfect. But we will treat you intelligently and efficiently, and that is not so common these days.

### THREE H-T HIGHSPOTS

The 215 Speaker, £9 (Output transformer £3).

The Selected Record Catalogue, 25/-, with supplements.

New Notes in Radio, 2/6, the only guide to hi-fi.

Catalogue and literature free.

# H. A. HARTLEY CO. LTD.

152, HAMMERSMITH RD.,  
LONDON, W.6. Riverside 7387

V55R for sale, perfect; £20 or offer; owner engraving, BRS16802.—F. Burney, 17, Longfield Rd., Tring, Herts. (2848)

10 Valve Armstrongs superhet chassis, 3 speakers, 8, 9 and 10in crystal pick-up, purchased end 1947; £20.—Box 4034. (2830)

HALLICRAFTER Super Skyruder SX17. crystal 8-meter amplifier, recently overhauled.—5 Station Rd., Benton, Newcastle-on-Tyne.

WIRELESS World, R.F.F. 3 valve quality tuner for use with quality amplifier; £6/10 including valves; new and unused.—Box 1384.

BC342, with 230/110v transformer, output 2½ ohm, variable noise limiter; £30.—White Heather, Crampmoor, Romsey, Hants.

SUPERHET radiogram chassis, 3 W.B. 7-valve, CL33P.P. output, guaranteed; £11/11.25. Percy Ave., Kingsgate, Broadstairs, Kent. (2853)

3 only, as new Ferranti 12v car radio, surplus to requirements; to clear, £18, list price £36/19.—Enfields, 77, High St., Midsomer Norton. (2607)

30w amplifier, 2 12in Goodmans record player, 2mc microphones, 1,000w, spotlight, approx. 100 records; best offer over £65.—2a, Leslie Rd., Lewiston. (2882)

BUNSWICK BGA/5 R. gram, 10v P.P. output, 5-wave, 9.5-200/50 a.c., Coltraco changer, crystal pu., unpolished walnut cabinet; £48.—E. Scarlett, 6, Grantham Rd., S.W.9.

BRITISH acoustic cinema amplifiers, h.t. and field energising units, including large metal rectifiers and power transformers, in five metal rack cases, some three part sets, no valves; £15 the lot.—Young, 16, High St., Ryde, I.W. (2700)

A MATEUR, must sell, H.R.O. with coils in fitted case, £35; BC-348, adapted for mains, with 6V6 output, £15; M.C.R.I. with mains pack and all coils, fitted with slow-motion dial, £5; no offers.—Airey, 101, Thornton Rd., Morecambe.

15 mounting, twin chassis, heavy duty iron cored components; 2, PX 25 in pp with valves, £6/15; less valves £4/10, plus carriage.—Broadcast & Acoustic Equipment Co., Ltd., Tomband Norwich. (2907)

R 124D R.A.F. rec., six universal valves, complete version diagram, with gen. for television sound adaptability, bargain, 18/6, carr. pd. recs., AR38L.F., 1155, for sale; wavemeters, 160 to 260 mc/s, 35/- each; acoustical 30-watt amplifier, £14.—J. Rae, 39, Penn Rd., W. Hampton.

R C.A. AR88D, with handbook and R.C.A. phones, £45; R.C.A. 50-watt amplifier, brand new and crated, 110v, but easily adapted for 230v, £16; see also Test Equipment section.—Pickering, 32, Sherington Ave., Hatch End, Middx. Hatch End 789. (2915)

BRAND new condition R.C.A. amplifiers or 230v a.c. operation, magnificent ventilated steel case, finished grey wrinkle enamel, valve line up: 6J7-6J7-6J7-6J7-6L6-6L6-5U4G, a fine quality product; price, carr. paid, with circuits, £16, or less valves, £13/15.—Lawrences, 61, Byrom St., Liverpool. Gen. 4430. (2736)

R 1132A receivers, 11-valve, 100-126 mc/s, 2 EB34, etc., just right for television or oscilloscope, £5/17/6; type 74 indicator, 9in CRT, complete with focus and deflection coils, 3 DET19, 2 6V6, 2 EB34, etc., £4/17/6; 1 5V6t a.c./d.c. motors, ¼hp (not rotary converters), pulley fitted, £2; BS456B modulator, 1 12J5, 1 1625 (12volt 807), 1 VR150, 30, transformers, etc., with circuit for conversion to audio amplifier, brand new, Hallicrafters S27, receiver, FM-AM, 27.8 to 143 mc/s, 200kc-20mc a.c., £29; all above are carriage paid.—A. C. Steadman, 230, Chellaston Rd., Derby. (2705)

R F units, type 24 8/6 ea., 24 mod. 27 (65-85 mc/s), 8/6, plus 1/3 post; types 26 and 27 21/- ea. plus postage, all with valves; R.C.A. crystal cal. wavemeters, 200kc-20mc a.c., as new in transit case, phones and manual, £6/10 ea.; H.R.O. Senior with valves and crystal less coils, £20 ea.; AR 88, perfect, £60; R.A.P. Special, 20-130mc/s, £60; S27, £30; S27 less valves and S meter, needs clean and overhaul, £15; Marconi 52, 13 valves, crystal cal., 1.75-16mc/s, as new, £12; IF transformers, 465kc/s, 9/9, pr. 200kc/s, 8/-; 13mc/s, 7/-; 16mc/s, 7/- per pr. All types of components, etc., in stock; s.a.e. for our lists will save you pounds.—H. English, Rayleigh Rd., Hutton, Essex. (2879)

NEW LOUSPEAKERS

W H A R F E D A L E speakers, valves, at list prices, Elstone transformers and spares; requirements to Albert Innes, Ltd., 10, Wells Rd., Ilkley

W R I T E for details of the new Flexicone conversion which considerably improves reproduction of speech and music to existing speakers.—Looker's Quality Radio, 106, Davidson Rd., East Croydon. (1923)

T H E Tridem range of twin bass vented enclosure corner cabinet speakers remain unchallenged, hand made cabinets; prices complete from £12.—F.S.R., Ltd., 87a, Upper Richmond Rd., Putney, S.W.15. (2728)

B R O A D C A S T new model pm/12.12in d/c cast frames, Ticoat magnets, 15ohm, 12watts, detachable cones, 12,500 lines, standard £5/15; Hi-Fi twin cone £6/10.—Broadcast & Acoustic Equipment Co., Ltd., Tomband, Norwich. (2909)

B E S T types and makes only recommended and supplied; 5in 12/6, 6½in 16/-, 8in 18/6, 10in 26/-, transformers 4/- extra; Wharfedale Golden 10in 3 or 15 ohms coils, 75/-; Celestion P44 12in 2/3 ohms, 75/-; R. & A. £12 15 ohms, 130/-; R. & A. energised 1400 ohms field with trans., 25/-; sent by return c.w.o. or c.o.d.—N.R.S., 102, Parkhill Rd., London, N.W.3. (2958)

## ALLEN COMPONENTS LTD.

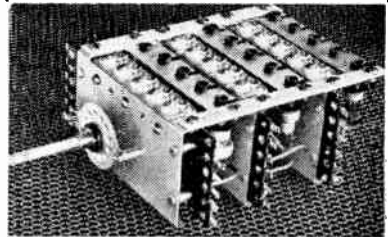

### Type 320 5-wave band coil unit.

A comprehensive pre-aligned assembly consisting of switch, complete set of aerial, H.F. and oscillator coils and all associated trimming and padding condensers for 5-wave band operation with tuned H.F. stage on all bands. All coils have dust iron cores for inductance adjustment. A six position switch is used with provision for pick up connections and H.F. muting on the sixth position. For use with any of the standard frequency changer valves (6K8, ECH35 etc.) and an I.F. frequency of 465 Kc.

Ranges: 1, 13-40. 2, 30-100. 3, 80-200. 4, 200-550. 5, 900-2000 metres.

Send for latest catalogue of our full range of components for Radio and Television.

## ALLEN COMPONENTS LTD.

Tower Road, Willesden, N.W.10

Telephone Willesden 3675

## SOLONS FOR YOUR SOLDERING JOBS!



These five models will satisfy practically every soldering demand whether for the occasional household job or continuous soldering under workshop or factory conditions. With the Solon the heat is in the bit itself... continuously... hour after hour; all connections hold at end of handle away from heat. Each model complete with 6 feet Henley 3-core flexible. Now available from stock. Write for folder Y.10.

W. T. HENLEY'S TELEGRAPH WORKS CO. LTD.  
51-53 Kington Garden, London, E.C.1



**THE** Mordant Duplex reproducer, as used in the Enock instrument, folded horn bass unit and high reflector of original design, giving exceptionally smooth response from 40-20,000cps; even distribution over a wide angle, reproduction has an atmosphere and realism hitherto unobtainable; price, ex-works, 98gns; in white wood skeleton form, £88; please send for particulars, or better still, let us demonstrate.—Joseph Enock, Ltd., 273a, High St., Brentford, Middlesex. Ealing 8103. (2899)

**LOUDSPEAKERS, SECOND-HAND**  
**G**OODMAN Axion 12 in 3 feet square mahogany cabinet, £16; another, without cabinet, £5.—Tel. Esher, 4266.

**G**OODMANS 12in. unused, in maker's cartons; a few a clear at £4/10.—Percy Bros., English St., Dumfries. (2914)

**C**ORNER H.r.n. unit, Voigt twin diaphragm, with 230v field and rectifier; complete £10, 21, Fairway, Stafford.

**B**ARKER 148, unused, £10/10, cost £15/15; Tay-ormer 70a, 50 range, 1,000 o.p.v., unused, £9.—34, Coleridge Ave., Sutton.

**A**LMOST new Hartley-Turner 215 speaker, £7; output transformer suitable for speaker, £3.—"Maryland" Components With Parts, 25, Baker Super quality 12in tripe cone speaker with Ticonal magnet, comp. etc. with infinite baffle cabinet in veneered walnut, 150hms speech coil; £7/10; new and unused, half original price.—Box 1563. (1764)

**OYNAMOS, MOTORS, ETC.**  
**B**ATTERY chargers, 4 models, 2-6-12V, 1-2-4 amps D.C.; any mains voltage; also larger types special transformers, chassis, test wear, resistor car heaters, etc.—The Banner Electric Co., Ltd., Hoddesdon, Herts. (2212)

**D**C. L. A.C. motor alternators, 200-250 v.o.t. D.C. input, 200-250 volts 50 cyc. 1 ph A.C. output at 200 watts, ball bearings, new, £12/10 each, also motor rotary converters with special smoothing equipment for television radiograms, etc., 300 watts output £23/10, 500 watts £30.—Johnson Engineering, 319, Kennington Rd., London, S.E.11, Reliance 1412-3. (2191)

**N**EW One-pair generators, 12-15v, 600w self-start air-cooled 4-stroke, volt. reg. auto cut-out, amateur components with tools, spares and instruction book, £24 p.p. curr.; Alco-Lyon 12-16v 360 watt, air-cooled 4-stroke, new or hardly used, ammeter cut-out, etc., £16/10 curr. free. Full descriptive lists free on request. One only, 24-32v 320-watt Chore Horse, new, self-start, £17/10, curr. free. Chargers; H.D. 50v 50a 3-circuit, with control panel, M.V. meter, etc., input 200/250 1 ph or 440/3,50, £20, p.p. curr.; 200/250v c.n., in 24v 25a out, in steel case with control panel, M.V. meters, rheos, fuses, etc., £12, plus curr.; another, £12a in vent. case, steel, fully metered and fused, £10, plus curr.; high output 1 and 3-phase rectifiers for plating, etc.; quotations by return.—Pearce, 66 St. Percy St., London, W.C.1. See also under Components. (2956)

**TEST EQUIPMENT**  
**T**AYLOR Model 65B, sig. gen., as new, £13/10.—Grainger, Hambleton, Nr. Selby, Yorks.

**P**L. frequency wobulator, mains, as new; £12.—7, Beaumont Terr., Bristol, 5. (2894)

**A**BGARR electronic fault tracer, with oscillator; £35.—61 Athelstan Rd., Glasgow, W.3.

**T**AYLOR Model 30 oscilloscope, new condition, bargain; £20.—Apply, 14, Brackenburo Rd., Louth, Lincs. (2826)

**A**VO oscillator, unused, 10gms; R.C. bridge buzzer-phone type, 6 range, 47, 6.—Wagesey, 58, Wakefield Ave., Hull. (2761)

**E**MISCOPE C.R.T., 12in, complete focus deflection coils, new; £13, 1224A receiver, £4/10.—Taylor, Shoemaker, Lake, I.O.W. (2726)

**V**OMETERS, valve tester and bridge, brage steel megger, various amp thers; will sacrifice; offers.—106, Old Winton Rd., Andover, Hants.

**T**AYLOR signal generator 65B universal meter 190A new and little used; also megger, R1155, to car £35; or sell separate.—Box 3578.

**S**IGNAL generator TF 140C Marconi instrument, post-war model, in perfect condition; £60 or near offer.—R.S.S., Ltd., 68A, Park Rd., N.8, Mou. 5533. (2851)

**T**AYLOR model 65A, fitted with artificial aerial, coaxial plug and socket, condition as new; offers to.—Wharton & Sillitart, Ltd., High St., Rochester, Kent. (2832)

**M**ODERN audio modulated signal generators directly calibrated frequency/metres 6 ranges, 100kc-30mc, 3,000-10m new, ideal radio servicing, £5/10 (plus 2/6.—BM/AMSP London W.C.1. (2803)

**L**ATEST type Avo valve tester, 11 gms; unused Farbridge oscilloscope transformer, 35v.—Avo meters, gen., as new, 9gms; unused constant voltage transformer, 190 250v input, stable 230 r.m.s. output, 6gms.—Box 4270.

**C**AMBRIDGE instrument test set comprising C.Ln.pivot galvanometer, thermo couples and all voltage and current shunts; max. voltage 2,400 max. current 24amp; further details on request, cost over £120; consider any reasonable offer.—Box 3611. (2701)

**S**ELLING out, best offers; radio amateur's laboratory; collection proc. IRE, 1933-1948, Cusack DB, oscillograph 339, impedance bridge, cam-ras photo-oscilloscope, Marconi 1,000c/s, inductance bridge, valve voltmeter, Muirhead decades Evershed bridge megger, Bowthorpe testometer, Philco scope, Ferranti meters, rack mounted radiogram, etc.—Box 4005. (2769)

# ELECTRADIX RADIOS

OFFER MORE BRITISH BARGAINS

**SPECIAL STOCKTAKING DYNAMO BARGAINS.** Dynamos for windmill work totally enclosed 12/15 volts, 10 amps, speed 600/1,000 r.p.m. with shaft extension at both ends, weight 24 lbs., 10 1/4 in. x 5 in. dia., C.A.V. make, £4.

12 volts 10 amp. car type dynamo, 1,400 r.p.m., as new, 30/-, 30 volt 5 amp. shunt wound machines 1,500 r.p.m., 55/-, 24 volt 30 amps., 2,000 r.p.m., 40/-, 12 volts 30 amps., 2,000 r.p.m., 25/-.

**MOTOR BLOWERS.** 24 volt D.C. series wound, 5in. inlet and 5in. outlet, by Keith Blackman, £5.

**MOTOR PUMPS.** 12 volt D.C. Lesdix, lift 2ft. throw 10ft., handle 100 g.p.h., ideal for caravan or boat, £5/15/-, 230 volt A.C. Stuart Turner motor pumps for garden fountains, etc., £6/10/-.

**FREQUENCY METERS.** 250 volt Crompton Parkinson and Naider, flush panel I/C needle type, 5in. dia., 45/60 cy., and 320/480 cy., 2in. scale, £6/10/-, Watt meters, Met. Vic. watt meter, 5-30 K.W., full circular scale, 230 volts, 6 1/2 in. dia., 3 ph, 50 cy., £5.

**RELAY AND RECTIFIER UNITS.** Comprising D.P.C.O. relay D.C. and metal Rectifier unit, 5/6.

**SWITCHBOARDS.** 500 watt in metal case, 15in. x 15in., with doors, 5 moving coil meters, 4 variable slider resistances, 3 enclosed cutouts, switches, terminals, etc., £4 ex. Battersea Stores.

**DAVENSET D.C.3 BATTERY CHARGER.** 230 volts 3 circuits, 0.8 amps., 2 amps., 5 amps., for charging 100 cells per circuit, 3ft. x 2ft. x 1ft. 6in., fitted 3 meters, 3 charging resistances, 3 D.P. switches. Terminals, etc., in ventilated metal case, £17.

**FANS.** G.E.C. 24 volt 6in. fan, table or wall fixing for caravan or boat use, white, with blade and guard, new condition, 35/-.

**HEADPHONES.** Double phones for crystal reception, bakelite caps, lightweight with cord, 5/- pr. Low resistance single phone for circuit testing, etc., 2/-.

**VARIABLE CONDENSERS.** Large lab oil type in glass cases, .0005 mfd. approx., with heavy ebonite knob and scale, 10/-, Marconi lab. condenser, enclosed in metal case, .005 mfd., heavy knob and scale, 15/-.

**MORSE INKERS.** Clockwork drive, speed 28 words per minute, records on paper, hand wind and filled on tape draw fine workmanship, £5.

**MAGNETS.** New Alni perm. steel magnets by Swift Levick, instrument type machined and drilled, useful for polarised relays, mirror galvanos., M.C. meters, electric guitar construction and many other purposes. Circular type, 1 1/2 in. dia., 1/2 in. thick, polar gap 1/4 in. drilled poles, lift 3 lbs., 3/6 each or 4 for 10/-, post free.

**TERMINAL BOXES.** Bakelite power terminal boxes 3 1/2 x 2 1/2 x 2 1/2 highly polished black with 1in. centre fillet and screwed cover 2-pole 5/16in. connection studs and nuts. Admirable terminal or branch top on large transformer, 2-pole lights, power or charging circuits 10/50 amps. Wall or ceiling fixing, 2/6 each, 20/- per dozen. (Special quotations for large quantities.)

**THE DEM. CONTINUITY-TESTER.** A self-contained portable circuit tester for all electrical circuits, almost pocket size, 6 1/2 x 3 1/2 x 2 1/2 in., a beautifully made Gov. Instrument, new, totally enclosed Polished wood case with carrying strap and contact switch. Price only 12/6, post free, including battery and single headphone with headband and cord.

**LIQUID LEVEL.** Remote indicators, Electrical type, less meter, with variable resistance operated by geared float to vary a reading on a distant dial connected by a pair of wires and a dry battery, 3/6 each, post 6d.

**SWITCHES.** Dewar Key switch, 7-way C.O. flush, 5/-, Yaxley type 8-pole 1-way, 3/-; 3-pole 3-way, 3/6, Toggle switch, S.P.C.O., 2/-, double pole C.O., 2/6, 8-way Lucas switch box 3/6; 6-way, 3/-.

Please include postage for mail orders.

# ELECTRADIX RADIOS

214, Queenstown Road, London, S.W.8.

Telephone: MACoulay 2159

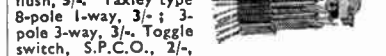
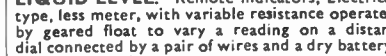
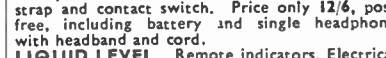
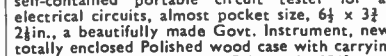

**SERVICOMETER, Model 1212,** new instrument incorporating signal tracer inductance, capacitance measurement, valve voltmeter, etc., direct calibration meter, scale 0-3/17, 6g. £12. P.P. available; stamp details.—Radio Development, Moretonhamstead, Devon. (2800)

**NUPLANS** at last present their valve-tester in plan. Tests for shorts, continuity, gas, etc., and a direct reading mutual conductance test, yet is simple to build, for battery and mains valves of all types.—Plan, 2/6, from E.N.B.—"Whinnie Knowe," Sennen, Cornwall, S.A.E.

**SULLIVAN** inductance bridge, type a.c. 1,100, with d.c. attachment, and capacity attachment, and Muirhead amplifier detector, 1,000, 1,000, this instrument is ex-laboratory, and in new condition; price, £190, or near offer.—Kaysales, Ltd., 27, Clements Lane, E.C.4. (2842)

**A** ditto, 25/6; 5in, 35/-; frequency meters, 40-60 cycles, 200-250, 4 1/2 in. dia. round frame by Crompton Parkinson, £5. A.C. ammeters and other meters in stock; send for lists.—Pike Bros., 86, Mill Lane, London, N.W.6. Hampstead 4219.

**A**VO model 7, in leather case, perfect, £14; A Siemens Halske 6in scale 0-40 mv., as new, with carrying laboratory case, £10. Led and instruments (Cough-Brengle), 20,000 o.p.v. analyser, perfect, £12; modern Evershed Bridge-Megger, in leather case, as new, £20; see also receivers second-hand section.—Pickering, 32, Sturminster Ave., Hatch End, Middx. Hatch End 785. (2916)

**ONE** Philips' oscilloscope, model GM3152, recently overhauled by makers; 1 Cosor FM signal gen. model 343, as new; 1 Weston analyser model E772, complete with carrying case, 1,000 o.p.v.; 1 Hunt's analyser; 1 Ferranti universal meter with case; offers for all, buyer collects; inspection invited.—Apply L. Cliffe, Rad o Dealer, 29, West St., Bourne Lincs, Tel. 301, after 6 p.m. (2768)

**C**OMBINATION portable valve tester and multi-range meter, by famous U.S.A. maker, ranges d.c. 0-10, 0-10, 0-50, 0-1,000, 1,000 at 10,000 v.; a.c. volts do, at 2,000v/1v; d.c. ma 0-1, 10, 50, 250, 4 resistance ranges reading 0.1 to 15meg; capacity 0.1 to 10µf; tests over 1,000 U.S.A. valves; black crackle case with carrying laboratory instrument tested and guaranteed; £17/10, carriage paid.

**FRITH RADIOFACT, Ltd.** 69-71, Churchgate, Leices. (2948)

**M**ETERS.—3.5amp, 2in T.C., 5/-; 30ma, 2in, m/c, 6/-; 4amp 2 1/2in, thermo-coupled, 7/6; double reading, 40-120ma, 2in, m/c, 8/-; 20amp, 2 1/2in, m/c, 9/6; 15v 2 1/2in, m/c, 9/6; 300v 2 1/2in, m.l., 12/6; 6,000v, 3 1/2in, m/c, 5/7/6; 3in, m/c, 20/-; 150v, 2 1/2in, m/c, 10/-; 15v/60v double reading, 2in, m/c, 8/-; 2in meter movements with magnet (500 micro-amp), 2/6; post extra; R.A. 12-volt 2-watt microphone amplifier as used in plane inter-com., in self-contained metal case, can be used to make up a deaf aid outfit, intercommunication system, or with crystal set, comp. etc. with valves 20/-, post 1/6; wooden box to hold amplifier, 2/-; extra; crystal sets, with permanent detector, 9/6, in oak case, 18/6; headphones, 5/6, 7/6, 10/6, and 12/6 pair; permanent detectors, 2/6; soldering irons, streamline 50w, 9/-, standard 60w, 9/6; heavy duty 1.0w, 12/6, all post e.t.a.; letters only new illustrated list sent on request with 10d stamp and s.a.

**HIGHSTONE UTILITIES.** 58, New Wanstead, London, E.11. (2809)

**TRANSMITTING EQUIPMENT**  
 transmitter with coils: £6.—Box 4015. (2795)

**H**AMMARLUND transmitter receiver, 18-v-a-v, comp. etc; offers.—Fitz George Adams, West Kensington, W.14. (2814)

**B**EST RX/TX, all coils, less power supply, unused, brand new in steel case; bargain, £7/10.—A. Stanshead, Aireworth Terrace, Keighley. (2752)

**R**EAL bargain.—Brand new American transmitter tuning units, TU-6B, TU-9B, TU-10B, in black crackle metal cabinets, 13/6 each, without cabinets, 10/6 each, c.p., all types contain vernier dials, 3 fixed, 3 variable condensers, traffic coils, etc., everything beautifully made.—Simcock Beechfield Rd., Grapenhall, Cheshire. (2724)

**H**ALLICRAFTER transmitters, type HT4E, complete to makers' latest specification, covering all amateur bands up to 30 mcs, with special amplifier, transformer, coils, and immediate deliveries in quantity; Hallicrafter H.T.14 50-watt marine radio telephone, complete with all tubes, crystals, and covers amateur and marine bands from 1.6-4 mcs.—Immediately available from Hallicrafter, Dial Road, Huddersfield, W.14. (2814)

**W**ANTED gift, as new, Garrard a.c. gramophone motor and separate Garrard pick-up; £5/5.—A. Maurice, 63 Dalling Rd., W.6.

**L**EXINGTON senior pick-up w'th sapphire and screened transformer, unused, perfect; £5 or offer.—Sandford, 54 Whitehill Rd., Crayford.

**L**EXINGTON Senior PU, just overhauled by makers, spare parts, head amplifier; £6 or best offer.—43, Beaumont Ave., Weymouth.

**L**. MARCUS, Ltd., 75-77, East Rd., N.1, have for d.sposal number of radio-gram cabinets, 6 valve chassis and Garrard player units, £2533 pick-up.—Tel. Cle. 2462.

**B**EST RX/TX, all coils, less power supply, unused, brand new in steel case; bargain, £7/10.—A. Stanshead, Aireworth Terrace, Keighley. (2752)

**R**EAL bargain.—Brand new American transmitter tuning units, TU-6B, TU-9B, TU-10B, in black crackle metal cabinets, 13/6 each, without cabinets, 10/6 each, c.p., all types contain vernier dials, 3 fixed, 3 variable condensers, traffic coils, etc., everything beautifully made.—Simcock Beechfield Rd., Grapenhall, Cheshire. (2724)

**H**ALLICRAFTER transmitters, type HT4E, complete to makers' latest specification, covering all amateur bands up to 30 mcs, with special amplifier, transformer, coils, and immediate deliveries in quantity; Hallicrafter H.T.14 50-watt marine radio telephone, complete with all tubes, crystals, and covers amateur and marine bands from 1.6-4 mcs.—Immediately available from Hallicrafter, Dial Road, Huddersfield, W.14. (2814)

**W**ANTED gift, as new, Garrard a.c. gramophone motor and separate Garrard pick-up; £5/5.—A. Maurice, 63 Dalling Rd., W.6.

**L**EXINGTON senior pick-up w'th sapphire and screened transformer, unused, perfect; £5 or offer.—Sandford, 54 Whitehill Rd., Crayford.

**L**EXINGTON Senior PU, just overhauled by makers, spare parts, head amplifier; £6 or best offer.—43, Beaumont Ave., Weymouth.

**L**. MARCUS, Ltd., 75-77, East Rd., N.1, have for d.sposal number of radio-gram cabinets, 6 valve chassis and Garrard player units, £2533 pick-up.—Tel. Cle. 2462.

**B**EST RX/TX, all coils, less power supply, unused, brand new in steel case; bargain, £7/10.—A. Stanshead, Aireworth Terrace, Keighley. (2752)

**R**EAL bargain.—Brand new American transmitter tuning units, TU-6B, TU-9B, TU-10B, in black crackle metal cabinets, 13/6 each, without cabinets, 10/6 each, c.p., all types contain vernier dials, 3 fixed, 3 variable condensers, traffic coils, etc., everything beautifully made.—Simcock Beechfield Rd., Grapenhall, Cheshire. (2724)

**H**ALLICRAFTER transmitters, type HT4E, complete to makers' latest specification, covering all amateur bands up to 30 mcs, with special amplifier, transformer, coils, and immediate deliveries in quantity; Hallicrafter H.T.14 50-watt marine radio telephone, complete with all tubes, crystals, and covers amateur and marine bands from 1.6-4 mcs.—Immediately available from Hallicrafter, Dial Road, Huddersfield, W.14. (2814)

**W**ANTED gift, as new, Garrard a.c. gramophone motor and separate Garrard pick-up; £5/5.—A. Maurice, 63 Dalling Rd., W.6.

**L**EXINGTON senior pick-up w'th sapphire and screened transformer, unused, perfect; £5 or offer.—Sandford, 54 Whitehill Rd., Crayford.

**L**EXINGTON Senior PU, just overhauled by makers, spare parts, head amplifier; £6 or best offer.—43, Beaumont Ave., Weymouth.

# MAINS TRANSFORMERS

15/6

Postage and Packing 1/- extra

New Goods, Fully Guaranteed, Not Surplus

- Standard Replacement Types. Drop-through chassis type with top shroud. Impregnated. Screened primaries 200/230/250 v.
- (a) 250-0-250 v. 60 mA. 6.3 v. 3 A., 5 v. 2 A. ... 15 6
  - (b) 250-0-250 v. 60 mA. 4 v. 4 A., 4 v. 2 A. ... 15 6
  - (c) 250-0-250 v. 80 mA. 0/4/6.3 v. 4 A. C.T. ... 18 0
  - 0/4/5 v. 2 A. ... 18 0
  - (d) 300-0-300 v. 80 mA. 0/4/6.3 v. 4 A. C.T. ... 18 0
  - 0/4/5 v. 2 A. ... 18 0
  - (e) 350-0-350 v. 80 mA. 0/4/6.3 v. 4 A. C.T. ... 18 0
  - 0/4/5 v. 2 A. ... 18 0
  - (f) 250-0-250 v. 100 mA. 0/4/6.3 v. 4 A. C.T. ... 21 0
  - 0/4/5 v. 2 A. ... 21 0
  - (g) 300-0-300 v. 100 mA. 0/4/6.3 v. 4 A. C.T. ... 21 0
  - 0/4/5 v. 2 A. ... 21 0
  - (h) 350-0-350 v. 100 mA. 0/4/6.3 v. 4 A. C.T. ... 21 0
  - 0/4/5 v. 2 A. ... 21 0
  - (i) 350-0-350 v. 150 mA. 0/4/6.3 v. 6 A. C.T. ... 38 0
  - 0/4/5 v. 2 A. ... 38 0
  - (j) 425-0-425 v. 180 mA. 6.3 v. 4 A. C.T., 6.3 v. 4 A. C.T., 5 v. 3 A. ... 43 6
  - (k) 425-0-425 v. 180 mA. 4 v. 8 A. C.T., 4 v. 4 A. C.T., 4 v. 4 A. ... 43 6
  - (l) 425-0-425 v. 180 mA. 6.3 v. 4 A. C.T., 4 v. 2 A. C.T., 4 v. 2 A. C.T., 5 v. 3 A. ... 46 0

## 1949 RADIO FEEDER UNITS.

Tuned R.F. Stages. High performance, appearance and workmanship. Completely aligned and ready for connection to audio amplifier. High "Q" coils throughout Model B. A de-luxe feeder unit for the connoisseur. Wave ranges 48/145, 200/650, 800/2,000 metres, plus six electrical bandspread ranges covering 13, 16, 19, 25, 30 and 41 metre bands. Colour printed glass dial 10in. x 8in. with wave range indicator and provision for magic eyes. Volume and tone controls. Switched pick-up sockets. For use with EP50, 6K8, 6K7, 6Q7, Y65 valves. £18/7/6.

## EX-GOVT. SURPLUS.

In response to many requests we have decided to stock **SELECTED EX GOVT. SURPLUS**. If interested please send extra 2d. stamp for illustrated catalogue—it will save you 2s.

Send 2d. stamp for illustrated leaflet on Feeder Units, and 52 page Catalogue.

**COULPHONE RADIO PRODUCTS**  
"The Return of Post Order Mail Service"  
**ORMSKIRK, LANCs.**

# THE HEART OF A FIRST-CLASS RADIO-GRAM

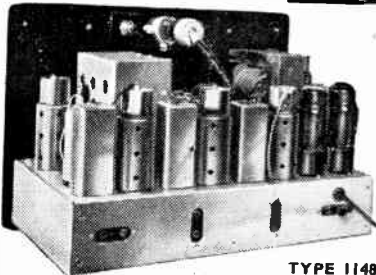

TYPE 1148 Radio-gram Chassis

Developed from the popular type 1047 this receiver will form the basis for a Radio-gram of unsurpassed performance, and at great saving in cost. Principal features include:

- 12 stage superhet circuit • 11 valves with magic eye indicator • 4 wavebands (11-2,000 metres)
- R.F. Amplifier • 2 I.F. stages • 4 stages AVC • 10 watts push-pull output • Separate treble and bass controls • Tropicalised components.

Other Peerless equipment of interest to the enthusiast includes: 16-valve Communications Receiver Type 1546 • RIF Feeder Unit (comprising RIF portion of Type 1148 Receiver) • A.I.F. Unit and Power Pack Type 1. All details on request.

**PEERLESS RADIO LIMITED**  
374 KENSINGTON HIGH STREET, LONDON W.14  
Telephone: WEStern 1221

**A**UTOMATIC recording instruments (Murday system) by Everthart & Vignoles, Ltd.—H. L. Prior, 23 Northgate St., Gt. Yarmouth.

**M**ODEL 80 Webster Chicago wire recorder. Perfect working order, magnificent reproduction complete accessories; £85.—Box 4003.

**R**ECORD p-layer unit, magnetic pick-up, auto stop, 250-volt motor, speed regulator, mtid. on 10 shod wood, good cond.; £6.—Box 4014.

**A**UTOMATIC changer type R.C.6, with G.E.C. Fidelity all-wave 8-valve receiver chassis; best offer around £20.—2, Trevor Rd., Hucclecote, Gloucester. [2789]

**1947** Rekenstone 8 record changer, 3 w/ band radio, recently overhauled, cabinet unmarked; £30 or near offer.—6, Herent Drive, Ilford, Wan. 2604. [2738]

**"SOUND** recording by the Direct Disk Method," by D. O.C. Roe. Copies available, 5/-, post paid, from Birmingham Sound Reproducers, Ltd. Old Hill Staffs. [2734]

**H** 1/10; H.M.V. radioram motor and pick-up, £3; rim-drive gram-motor and turntable, £3/15; Plessey auto-changer, £16/15.—Cook, Old Barn Rd., Christchurch, Hants. [2731]

**L**ATEST, Plessey 4-second autochange unit; £10 or 8 in. magnetic speaker, £16; Baker super quality 12in. tripe cone speaker, £12; 75/-; Williamson output transformer by Partridge to designer's specification, 55/-.—Race, 38, Chaucer Drive, Lincoln. [2702]

**M**.S.S. portable record machine, fitted connoisseur pick-up for play back scroll off mech. indicator meter, etc.; this machine has only been used for 20 recordings; £60; recording amp. model E.A.25 f r use with above, £25; seen working W. London.—Box 4178. [2860]

**T**HE C.D.P. Recorder is still the best value for money at £32. It has a built-in new micro-cut, giving ten m-nutes on a 12in. disc, especially suitable for cine work; the C.D.P. motor being synchronous, is ideal for film work.—Bourne Instruments Bourne, Lincs. [2793]

**G**RAM motors, Collaro with mag. PU and auto stop, £5/10; Garrard auto, £5/17/8; Collaro auto-changer (mixed records and crystal PU), £14/6/8; Plessey as above but with mag PU, £18/10; all new, in sealed cartons.—T. Perado, 157 Fore St., Edmonon N 18 [2793]

**L**ATEST type U.S.A. magnetic drive (capstan control speed) wire recorder, complete with amplifier, 12in. L.S. Turner mic. radio input, erase and spare spools, ideal for musical recording, microphone or radio; £95/10.—Warburton, 9 Troy Grove, Wyche Ave., King's Heath, Birmingham. [2788]

**T**HE Enock pick-up is now available from stock. Moving coil (licensed under Patent No. 538,058, others pending) with precision made polished diamond stylus; weight at needle point, 3.0oz; no resonances within the recorded range; price £29/5, inc. tax.—Full particulars from Joseph Enock, Ltd., 273a, High St., Brentford, Middlesex, Ealing 8103. [2298]

**P**ROFESSIONAL recording equipment to the trade: M.S.S. recording machines recording amplifiers, ribbon and M C microphones, blank discs, etc., etc.; gramophone motors and lightweight pick-up, radio pre-stage units and quality speakers all from stock on full trade terms; Victor 16mm talkie-projectors for immediate delivery.—Sound Discs (Suppliers) Ltd, 37, Highbury St., Southwark, Lanes. [174]

**A**MPLIFIERS, 60-70 watt rack mounting, 200-250v a.c., rated for continuous duty, various r.c. coupled throughout, inputs for P.E. cell, microphone and pick-up, bass boost control, weight 2 cwt., tested, £25; less valves, £22 ex-Lincoln; 50in. projector horns with G.E.C. 12-watt units, £5 7/6; steel racks for standard 19in. panels, 35/-; P.E. cell assembly suitable sound track, 17/6; panels, chassis, covers, etc.; send for details.—Western, 35, Portland St., Lincoln. Tel. 10211. [2889]

**T**HE wonderful New Collaro a.c. mixed auto-changer, finished in brown and chrom with super crystal pick-up—our special introductory offer—only £14 inc. tax cart. pd., leaflet 2/6d; Plessey ditto with magnetic pick-up 17/6s; Collaro AC47 induction type motor with 12in t.t., var. speed, £5; Collaro RP49 complete a.c. autostop, £5 7/6; Garrard mic. £5 18/4; Collaro AC47 radogram unit, var. speed, 12in t.t., magnetic pick-up and auto stop, a.c. model, £9, a.c./d.c., £12/18/9; all above sent by return c.w.o. or c.o.d.—N.R.S., 102, Parkhill Rd., London N.W.3. Gulliver 1453

**COMPONENTS—SECOND-HAND, SURPLUS**  
C.S.T. 300 in walnut cabinet and set of coils, in good working order.—Bry 4272 [2954]

**T**RANSFORMERS 110-230V 250-0-250 80ma. 6v. Sv. 17/6; 460:Fc M.dget iron core, 47. G3 VB.—20, West St., Haslemere. [2878]

**L**OWTHER, dual tuning unit T.R.F. and L.S.H. own power, just overhauled by makers; near £15.—4, Limes Ave., N.W.7, Mill 3322

**T**ELEVISION magnifying lenses of famous make, to fit any and every make of receiver, just in; our price from £5/19/6.—Du've & Co., 219 Ilford Lane, Ilford, Essex. [2479]

**8** with crackle covers, 1/6 pair, complete, 12/-, dozen pairs, £3/10 per 100 pairs; carriage paid.—Jack Porter, Ltd., College St., Worcester.

**3**-BANK rotary selector switches, 12/6; 0-100 microampmeters, blank scale, plug-in type, 17/6; 5 m/a. inst. rectifiers, 3-2, 4, 10, 15, 25, 50, 150 p/a. doz.—Stansfield, 13, Birchworth Terrace, Keighley. [2753]

# THE A.W.F. TRADE SERVICE is second to none.

Fast repairs to loudspeakers, Cone assemblies, field coils, and everything for L/S repairs in your own workshop. Mains transformers rewound. Transformers wound to individual requirements.

**LARGE STOCKS AND SPEEDY DESPATCH.** Tungram valves, T.C.C. condensers, Eric resistors, Egen volume controls, Less switch, S.P., and D.P.S.T., Large range of transformers, popular range of B.A. sizes in brass screws, nuts and washers. Hundreds of other lines too numerous to list here.

Send Id. for the Current Copy of the Monthly Bulletin, together with your trade card or billhead.

**A.W.F. Radio Products Ltd.**  
Borough Mills, Bradford, Yorks.

# YOU can become a first-class RADIO ENGINEER

We are specialists in Home-Study Tuition in Radio, Television and Mathematics. Post coupon now for free booklet and learn how you can qualify for well-paid employment or profitable spare-time work.

**T. & C. RADIO COLLEGE**  
King Edward Ave., Aylesbury, Bucks.

(Post in unsealed envelope, w. stamp)

Please send me free details of your Home-Study Mathematics and Radio courses

NAME .....

ADDRESS .....

w.w.81

**VCR97:** fit a Magnavista lens; will make your 5in picture 9 or larger at the staggering low price of 4 gns.; trade supplied; orders taken in strict rotation.—Duke & Co., 219, 11th Lane, Ilford, Essex. [2612]

**EHF** transformers, mains transformers and other choices for general purpose oscilloscope, as per W.W., May, 1948, delivery ex stock.—Metropolitan Radio Service Co., 1021, Finchley Rd., N.W.11. Tel. Speedwell 3000. [1265]

**PARCELS** of radio and electrical material, including many components for constructing direct current superhet post free; also service manuals, technical books.—Mawson, 11, Salisbury St., Pea-won-Tyne. [2636]

**IFTS**, 465kc iron core, 6/- pair; electrolytics, 1 new, not Govt. surp.us, 450v wkg, 8mfid, 2/3 each; 8+8mfid, 3/6 each; 16+8mfid, 4/- each, etc.; send for list.—T. G. Howell & Co., 29, McWilliam Rd., Woodingdean, Brighton 7. [2511]

**LITTLEWOODS**—Electronic Engineering television, all components in stock, 3rd edition book reprinted Oct., 1948, containing latest revisions and modifications, 2/8 post free.—G. Henson Littlewood & Co., 27, Ballard La., Finchley, N.3. Fin. 3060. Demonstrations daily. [2563]

**H.T.** eliminator and trickle charger, output 150v max (4 h.c. tapplings), 1.1, 2-volt 1/4 amp, £2/15; kit for above, complete with circuit diagram, 2/6; mains transformer, 24-watt in eliminator, 13/-; send for components list.—Radio Service (W. Tanner), East Cliff Lyme Regis Dorset. [2707]

**MAINS** transformers, output transformers and choices for d.t.n. Williamson amplifier as per "W. World," May, 1947, and for the economical 50watt amplifier. "W. World," Dec. 1948; delivery ex-stock.—Metropolitan Radio Service Company, 1021, Finchley Rd., N.W.11 Tel. Speedwell 3000. [2511]

**K** valve new materials, table models, semi-mid; our latest kit.—Wylwyn Star 1948 has connections for gramophone pick-up, extensions to loudspeakers, A.V.C., 6 hours average time for constructing; full details, diagrams with circuit diagrams.—H. H. Woodrow, Rime House, 81, Plungington Rd., Preston, Tel. 3348, Estd. 1936. [6768]

**TRANSFORMERS**, special quality, tropicalised, 6.5v x 6.5v x 7in, 230v primaries, secondary 350-0-350v at 500ma, 2x30-0-20v, 2x30-0-20v, secondary 2x30-0-350v at 200ma, 2x6.3v C.T., 2x5v, 6.3v, 55/-, carriage 5/-; primary tapped 200-250v, secondary 500-0-500v at 120ma, 3x4v C.T., 10v, 32/6; 350ma L.F. chokes, 20/-; many other items, s.a.e. list.—Cross, Skerries, Cross Lane, Grange, West Kirby, Cheshire. [2511]

**R** transit case, £6/10, carr. £1; electrolytics, 350v w, 8mfid, 2/-; 16mfid, 2/3; 32mfid, 2/6; 32+8mfid, 500v w, 3/6; for callers on ly. 1355 reevisors, 29/6; 25 units, 12/6; 62a indicator units complete with valves and on, £4/10; 62 indicator, complete, 59/6; large stocks of components and meters; send for lists;—Pike Bros., 86, Mill Lane, London, N.W.6. Hampstead 4219. [2511]

**SET** of four coils, long, medium and short, 4-pole 4-way switch, pair 465kc stand-off iron core; 2 twin gang condenser, 1000ohm field with transformer, require recentering, 7/6; m.a.s. transformer, 230-0-280v to 8cm, 1.5, 6.3v to 1 amp, 5v to 2 amp screened pr. drop thru chassis type, primary input 220 and 240 volts, 13/6; wdg. for lists.—Cohen, 67, Ralegh Ave., Hayes, Middx. [12478]

**C**ONDENSERS, speakers.—16+16mfid at 500v d.c., at 3/6; 8+16mfid at 450v d.c., at 3/6; 16mfid, at 3/-; 0.5, 0.25, 0.1, 0.0001mfid, at 6d; 0.0005 (variable), at 2/-; 0.0005 twin and tripe gangs, at 6/6; speakers, 5 in., less transformer, 3/6; 5 in., with transformer, 12/6; 6 in., less transformer, 13/-; 6 in., with transformers, 15/-; 8 in., less transformers, 16/6; 8 in., with transformers, 18/6; 10 in., less transformers, 22/-.—Duke & Co., 219, Ilford Lane, Ilford, Essex. [2670]

**A** NEW feature—The Osor glass dial assembly is now available; best ever, fitting in any position either on or above the chassis; works independently of any existing tuning arrangement, and is suitable for all purposes, really attractive 3-wave 3-colour scale, size 7in x 7in; parts manufactured for the famed G coil packs, type L.M.S. and L.M. shipping, but suits many others; ret. price complete (less pilot bulbs), 22/6; trade enquiries invited.—Osor Radio Products, Ltd., Borough Hill, Croydon, Surrey, Croydon 122. [12805]

**FREE** ELECTRIC for guaranteed goods: this 6 month special bargains which cannot be repeated; a few only, 58 Mk 1 (Canadian) wireless sets, as brand new, in sealed cartons, complete with spare and working tools, at special price of 12/6; complete carriage paid; 3170 receivers, in perfect condition, only £3/15, carriage paid (the most suitable receiver for television conversion); motor generators, new, 24v d.c. input, 115v a.c. output, 800 cycles at 10 amps, complete with automatic voltage regulator, a few only, 45/- each; 3 1/2 in p.m. speakers, well-known make, 30hms, list price 29/6, our price 17/6 each; 115v wave change selector switches 6/- each; twin feeder, 4in co-axial cable, 800hms, 7/6 doz v. 1000hms, 10/6 doz; 32 mfid 650v w, electrolytic condensers, metal case, size 5x4x1 3/4, 9/6 each; single flexible screened and insulated covered microphone cable, finest quality, 9/- doz v. 15/- 500hms, 1000hms, 12/6 each; (the 1000hms, 1000hms, 1000hms, 12/6 each; trade enquiries invited.—Gee Electric, 15, Little Newport St., London, W.C.2. Ger. 6794. [2799]

# ARMSTRONG

## Model RF103, Type 2 10-VALVE ALL-WAVE CHASSIS WITH VARIABLE SELECTIVITY

- High Performance
- Outstanding Selectivity

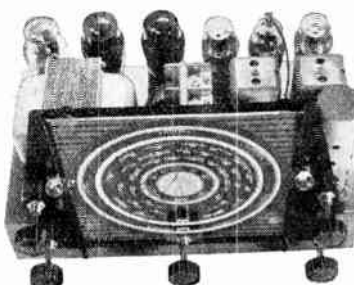

The ever-increasing difficulty in separating stations after dark is apparent to all. Our redesigned Model largely removes this serious obstacle to good listening. The two stages of I.F. amplification with variable selectivity permits of a maximum selectivity better than 6 K.c.s. On the short wavebands the actual sensitivity is 8 micro volts. It will be appreciated that this chassis has a performance of an extremely high order, and coupled with the 10 watt output makes, in our opinion, one of the most desirable musical instruments offered to the public. For 200-250 v. A.C. mains. Price 19 Gns. Plus Tax.

**SPECIAL NOTICE**  
MODELS EXP83 and UN183 briefly described hereunder now incorporate a re-modelled coil pack with permeability iron core coils giving increased selectivity and sensitivity and a new tone compensating circuit to still further increase quality of reproduction.

**Model EXP83. 8-VALVE ALL-WAVE RADIO CHASSIS** incorporating waveband expansion. Large glass scale. Treble boost control. High quality push-pull output gives 10 watts audio. For 200-250 v. A.C. mains. Price £15. 8. 8. Plus Tax.

**Model UNI-83. 8-VALVE ALL-WAVE RADIO CHASSIS** incorporating waveband expansion, e.g. the 16-50 m. band covers just over 20 inches on the large glass scale, treble boost control, high quality push-pull output giving 6 watts audio. For 200-250 v. D.C. or A.C. mains. Price £15. 8. 8. Plus Tax.

**Model EXP125. 14-VALVE ALL-WAVE RADIO CHASSIS** giving continuous waveband coverage from 11.9 m. upwards. Waveband expansion, R.F. Pre-amplifier. Two I.F. stages with variable selectivity. Electronic bass and treble lift controls. 15 watt push-pull output. For 200-250 v. A.C. mains.

Kindly write for Illustrated Catalogue Demonstrations at our Showrooms

**ARMSTRONG WIRELESS & TELEVISION CO. LTD.**  
WALTERS ROAD, MOLLWAY, LONDON, N.7  
Phone: NORth 3213

**MANUFACTURERS**—Enamel, copper wires, all gauges, laminations, all types, huge stocks radio components, 5/11, m/m, 2vt and condensers, most tolerance and high stability resistors to 1%; all goods guaranteed.—L. E. Simmonds 10, Valencia Rd., Stanmore, Middx, Grimsbury 608. [2515]

**SOMETHING** new for 1949 radio constructors. Try improved kit for 6 valves, 3 waveband a.c. superhet with R.F. and P-P output stages, contains absolutely all necessary guaranteed components, instructions; demonstration given of wireless set built from the above kit; price £8/9; limited quantity.—Day's Lane, Sidcup, Kent (bus 228 from Latham). [2723]

**EX-GOV'T.** wireless masts, telescopic, 23in cased, 8ft open, six sections, duralumin, many use, 5/11; two-valve battery amplifiers, type All354 with 210LF and Q221 in transit case, 9/11; Svydki 15amp fuse holders, 1/-; auto-trans 230/115, 50/1, 500va; shipping weight 24lb, 25/-; 1ma instrument rectifiers, 2/6.—Passingham (Dept. W.W.), North St., Keighley.

**EXHAUSTIVE** constructional manuals enabling even beginners to build fully professional radio sets: No. 1, l. & m wave 3-valve plus rec., T.R.F. (moulded bakelite cabinet), 3/-; No. 2, 5-valve all-wave superhet of exceptional power and range (figured walnut cabinet), a.c. or a.c./d.c. version, 5/-; Lee Products A.C. or D.C. 3-wave superhet kits, complete, 4in speaker, £6; Osomor G coil packs, 33/-; W.W. bargain list, 2/6d.—N.R.S., 102, Parkhill Rd., London, N.W.3. Gulliver 1453. [2960]

**TRERAD** Electronics, 70, Church Rd., Upper Stock at cheapest prices, all specified components for W.W. and E.E. televisions, sets of Coventry var./res., 1 ea., 2,000 2,500, 5,000ohms and 2 ea., 10k and 100k ohms, 40/9; wire and tested chassis etc.; Denco and Wearite stockists, 2 coils, 3/-; latest J.E. diodes, 1/6; with span driver, 25/-; G.P. trans, multi-ratio, 8 straight and 4 c.t. ratios, 9/-; State your requirements, write call or phone Liv. 4879. [2962]

**TELEVISION**—Focus coils and shrouds, I frame and line deflector coils, line output transformers, focusing oscillators, etc. forming complete focus and deflector assemblies also available, supplied correct to designer's specification for "Wireless World" television receiver. Television components of all types, valves, condensers, resistors, tube masks, mains transformers and chokes, etc., in stock at current prices.—For particulars write or phone, "Handy Parts", 226, 228, Merton Rd., Wimbledon, S.W.19. Liberty 7461. Trade enquiries invited. [1420]

**SURPLUS** equipment.—Thermostats, a further supply is available, ideal for Max. control in greenhouses, etc., 2/6 each; 0-0.5 amp thermocouple meters, brand new, made by Met-Vic, boxed, 6/- each, or 6 for 30/-; ceramic insulators, 9in high, the ideal thing for insulating that mast, power lines, etc., 2/6 each; American signal generators, accuracy better than 0.001 per cent, X-tal check points, range 8-16mc/s and 150-220mc/s, a laboratory instrument, a.c. mains, £50; micro-switches, 1/3 each; h.t. eliminators 230v a.c. input, 120v 30ma output, 10/-; pumps for fountains, spraying oil, etc., 10/-; telescopic aerials, extend to 8ft, 10/6; type-2 valve cutouts, 12/-; aerial insulators, bakelite chain type, 6d; reduction gears, 2/6; rotary transformers, 9 and 18 volts d.c. to 480 volts 50ma, convertible to a.c. motor by making two connections, 8/6. New equipment: We can supply all your television requirements; circuit diagrams in stock, etc. catalogue gives details of all items we stock; sent post free on request.—Write, call or phone Larkwood 6377. The Radio Hospital, 50, Hoe St., Walthamstow, London, E.17. [2729]

**47/6**—Roding Laboratories are so proud of their aligned tuner unit, comprising the world-famous L.T.C. model 30 three-waveband coil pack, aligned and sealed to 465kc/s, two-gang condenser (matched), pair of iron-cored, Litz wound, I.F. transformers, aligned and sealed to 465 kc/s, and three-gang condenser, that they are once again making the offer to try this unit free; if you are not absolutely satisfied you can return the unit in its original condition, when your money will be refunded; note that the price is only 47/6 for the complete aligned and sealed tuner unit, plus the extra cost of a generator required, no laborious lining up to do, just wire the unit into one of the many circuits described in our Home Constructor's Handbook; this 2/6 book for trouble-free radio which contains many circuits, hints, formulae, components, useful data, etc., etc. is given free to all purchasers of the above unit; we are, however, repeating our special offer of this famous book for 1/- to any "Wireless World" reader who has not yet had his copy; remember, this is the book for the man who wants the "know-how" of radio, not the man who wants to be sure to get a promptly; this offer is limited; the unit above is but one of the many special lines that we run for the Home Constructor; our full catalogue is included in the Handbook, terms, c.w.o. or c.o.d.—Roding Laboratories, Mail Order Dept., 10, Lord Ave., Ilford. [2992]

**MOVING COIL  
AMMETERS & VOLTMETERS**

EXGOVT., NEW, UNUSED & BOXED  
Offered at a fraction of original cost



**FINEST QUALITY PRECISION  
INSTRUMENTS**

by famous makers such as Ferranti, Pullin,  
Metropolitan Vickers, Sangamo Weston, G.E.C.

**AMMETERS**

zin. Flush, 50-0-50 amp

**VOLTMETERS**

zin. Flush, 0-40 volt      zin. Flush, 0-20 volt  
All at **3/11** each. Carriage paid.

Cash with order only.

Secure yours now—limited quantity

**H. H. LINTON & CO., LTD.**  
34 Osnaburgh St., London, N.W.1

Telephone: EUSton 8406

**Mr. A. C. BARKER'S**



**NEW  
148a  
S  
P  
E  
A  
K  
E  
R  
  
IS  
HERE**

The 148a, like its predecessor the Concert 148 is the most satisfyingly NATURAL reproducer extant, of broadcast and recorded sound. The featherweight aluminium coil former provides critical damping throughout the entire audible frequency range, and is also inductively driven by the currents in the speech coil which it supports. A pure stabilised latex insulating sleeve provides a compliance which permits controlled independent movement of the former at high frequencies, thus halving the weight of the driving component and extending its effective range into the supersonic region. The logarithmically corrugated cone forms a perfectly graded complement to this exclusive, patented dual drive.

The 148a may now be heard at many good dealers and full details are always to be had from

BCM/AADU, LONDON, W.C.1

**"YOU'LL** probably get it at Smith's, Edgware Rd.1. Everything for the constructor from a 1/10watt resistor to a radiogram cabinet; lowest prices, biggest variety.—Near Metropolitan Music Hall, Pad. 5891. (8005 TELEVISION. E.E. components, superior manufacture, branded, guaranteed, to specification. Line O.P. trans., canned wax-sealed silent operation 27/6; scanning coil assembly to match 30/3; focus coil 32/6; all beautifully made and finished; Stewart e.h.t. trans., 4.000v, £3/7/6; sound chassis complete w/holders, coil formers, etc., 18/9; vis on chassis ditto, 22/6; sync./time base chassis, 17/6; power pack chassis, 25/-; set coils. Distrene formers. wound exact specification, 11/9; all condensers, resistors; everything for E.E.; terms c.w.o.—Westmead Radio, 117, Westmead Rd., Sutton, Surrey. Vigilant 4109. (2862

**NEW** good quality output trans. section wound for 6V6, 6N6, KT33, etc., in P.P. to lines of 1 to 15 ohms; carefully planned SEC; taps provide wide choice of ratios from approx. 26 to 85/1; solid brass clamp has 4 lugs; av. wtg. over 1 1/2lb, 3in 1, 2 1/2in W, 2in D; grey clamp; silver core, black bobbins, 7 coded leads, separate 4-pin V holder letter coded with diagram to make speaker connections, 22/- ea. incl.; double bobbin O.P.T.s, av. pri. inductance 50Hs section wound to match PX4, etc., in P.P. to 2 1/2 to 3 ohms speaker; 4in H, 2 1/2 in W, 3in D incl.; tag plate, 42/- ea., incl.; 3 ratio winding multi sec., for 6.65, etc. up to 20w, 48/- incl.; these have separate 6-socket speaker strip connectors; 6.3v 2a mains trans. Normal tapped pri., tag plate for all connections, 2 1/2in H, 1 1/2in W, 2 1/2in L, 2 1/2in incl. fix. lugs.—L. H. Smith, 75, Dunlop St., Glasgow, C.1. (2765

**45/6** (plus 10/2 p.t.) brings you one of the famous Model 40 coil packs. The superbet 3-waveband coil pack with provision for R.F. stage and using 9 High Q Iron cored coils; the world renowned Model 30 coil pack is now only 23/6+5/3 p.t.; these packs are the basis of the Models 30 and 40 high fidelity feeders, units which are now available at popular prices; full details and circuit diagrams of these and of 5-valve a.c., 5-valve a.c./d.c., 6-valve a.c. and 6-valve a.c./d.c. sets and also of a 5watt amplifier and power pack are given in the Constructor's Handbook, which we can supply for only 1/- post free! This extremely useful booklet also contains details of all our other products, a catalogue of highest quality radio and television components at lowest prices, colour codes, useful information on construction and repair and many hints. (2937  
**R** RECEIVER chassis, 10x5 1/4x2 1/2in 3/-, 11x6x 5/3, 20x8x2 1/2in 6/6; vol. controls, 5 meg. with switch and standard spindle, 3/9 ea. 40/- doz; P.M. speakers, 2-3 ohms, Rola 10in 25/-, Truvox 8in 13/6, Rola 5in 14/9; Selenium rectifiers, small size, H.W. 600v 40ma 3/9, 250v 60ma 3/6, 500v 80ma 4/9 ea, 48/- doz, 120-0-120v 40ma F.W. with circuit 2/9 ea. 30/- doz, 120-0-120v 100ma F.W. with circuit 3/9 ea. 36/- doz, 12 1/2v H.W. 1/4 doz, 15/- doz, brown beige cabinets, fluted front and sides, 25/-, fully punched chassis to suit, 3/9 suitable gilt. black and red dial 1/11; can electrolytics, 8-16mfid 450v 4/6 ea, 45/- doz, 16-32mfid 350v 4/9 ea, 47/- doz; brand new ex-Govt items 22v dry batteries, 1/6 ea, 15/- doz; R.F. test buzzers with Morse key and battery, 3/9; block electrolytics, 32mfid 450v, 1/9 ea, 18/- doz; c.w.o. or c.o.d. over £1; under £2 post 1/- extra. list 2 1/2d; trade supplied.—Radio Supply Co., 15, Queen Square, Leeds 2. (2937

**H** FRANKS, 58 New Oxford St., London W.C.1 Tel. Museum 9594, one minute from Tottenham Court Road Station; performance meters type no.2, fitted standard mains 230v a.c., 50 cycle power pack 2 VR91, 1 VR137, 1 5Z4G, CV51, 1 VR92, and other useful components, £2/5 each, carriage 3/6; a.c. mains 230v 50 cycles power packs with variable output, 300v, d.c. at 10ma to 200v d.c. 25ma housed in nicely finished metal cabinet size 11inx6 1/2inx6in, complete with 5Z4G rectifier, also gives 18v a.c. 1/2amp £2/10 each, post paid; condensers, 80mfid 250v a.c. working, price 15/- each, carriage 2/6; modulator type 67, fitted standard mains 230v a.c., 50 cycle power pack, giving 345v d.c. 125ma, 6.3v 5amp, 6.3v, 25 and 12 valves, viz. 5 VR65 2 VR54, 3VR92, 1 VR116, 1 5Z4G, and various useful components, £4 each, carriage 7/6 each; indicator units type 184a, fitted 3in and 6in cathode ray tubes type acid and VCR 517B and 17 valves, viz. 6 VR92, 5 VR91, 3 VR54, 3 VR65, metal rectifiers chokes, transformers, potentiometers, resistances, condensers, etc., £3 10 each, carriage 10/-; synchronous clock units, self-starting 200-250v a.c. 50 cycle, fitted Sangamo motors, consumption 2 1/2watts, size 2 1/2in diam 2in deep geared 1 rev. 60 mins; can be reset to zero by friction drive from front or back, to run clockwise, ideal movements for making electric clocks, time switches, etc. nickel plated finish, complete with 12 to 1 dial train, set of 5in hands, 22/6 each, post paid; type 24 R.F. units, new in maker's cartons, these make excellent s.w. converters, complete with valves, 50 to 40mc/s, price 13/6 each, post paid; mins transformers, 230v a.c. outputs 250v 90ma, 2.7v, 8 amp, 5v, 2 amp, price 17/6 each, post paid; we have a large assortment of various ex-W.D. radar and radio equipment, relays, power packs, oscillogram units, gears, photographic apparatus available; s.a.e. for lists. (2895

**LASKY'S RADIO**

**BRAND NEW IN MAKER'S ORIGINAL WOUND TRANSIT CASE, UNUSED. RECEIVER TYPE 1365.** Contains 11 new valves: 8 VR65, 1 6U4G, 1 VU120, 1 VR92. Incorporated in this unit is a 7.7 Mc/s. I.F. strip. **THIS UNIT IS IDEAL FOR TELEVISION.** LASKY'S PRICE 42/8, carriage 5/- extra.

**DATA BOOK** giving full details of construction of an inexpensive television receiver from Ex. Govt. equipment. (Utilizes 1365 etc.). PRICE 1/6.

**E.H.T. TRANSFORMERS FOR THE VCR97 CATHODE RAY TUBE.** Specifications: Primary 200/250 volts 50 cycles. Secondary 2,600 volts at 4 m/a., 4 volts at 1.1 amps., and 4 volts (centre tapped) at 1.5 amps. LASKY'S PRICE 35/-, post 1/6 extra.

**E.H.T. SMOOTHING CONDENSERS.** 1 mfd, 2,500 volts working. LASKY'S PRICE 1/6 each, post 4d.

**MAINS TRANSFORMERS,** 200/250 volt, 50 cycles input. Complete with tapping screw voltage adjustment, 350-0-350 volts, 100 m/a., 6.3 volts 3 amps., 5 volts 2 amps. Semi shrouded, chassis mounting. LASKY'S PRICE 20/- each, post 1/6 extra.

**INDICATORS TYPE 62.** Complete with 20 valves and VCR97 cathode ray tube (short persistence). Still available at 59/6, carriage 7/6 extra.

**DO NOT MISS THIS AMAZING BARGAIN.** **INDICATORS E 62A.** Contains 21 valves, 117 Mc/s., crystal VCR97, 9in. cathode ray tube (short resistance) etc., etc. 12 EF50, 2 EB34, 4 8P61, 3 EA50. LASKY'S PRICE 99 6, carriage 7/6 extra.

**300 PF., FEED THROUGH CONDENSERS** (.0003 MFD). 6d. each, 5/- per doz., post extra.

**10 YARD LENGTHS, TWIN RUBBER COVERED CABLE. CIRCULAR SECTION, FINE QUALITY.** LASKY'S PRICE 2/6 per length. Post 9d. extra.

**BRAND NEW IN BOXES. MOVING COIL METERS.** F.S.D., 0-500 microamps. LASKY'S PRICE 6/11 each, post 6d. extra.

A 21d. stamp will bring you our bulletin by return. (Name and address in block letters please.) Why not pay us a visit? Our staff will be only too pleased to help you with your queries.

**LASKY'S RADIO**

**370, HARROW RD., PADDINGTON LONDON, W.9.** (Opp. Paddington Hospital)

Telephone CUNNINGHAM 1979  
Hours: Mon.—Sat. 9.30 am. to 6 pm.  
Thurs. Half-day 1 p.m.

**Specialists  
in**

**HIGH-POWER  
AMPLIFIERS**  
from  
**250W to 1kW**

**W. Bryan Savage Ltd**  
WESTMORELAND ROAD, LONDON, N.W.9

Telephone: Colindale 7131



THE "FLUXITE QUINS" AT WORK

"That's the tenth we've mended today  
Now Oi, be off on your way.  
Come on. Show some speed!  
Look out! Mind the lead! ...  
More FLUXITE needed" bawled EH.

See that FLUXITE is always by you—in the house—garage—workshop—wherever speedy soldering is needed. Used for over 40 years in Government works and by leading engineers and manufacturers. Of all Iron-mongers—in tins, 10d., 1/6 & 3/-

TO CYCLISTS! Your wheels will NOT keep round and true unless the spokes are tied with fine wire at the crossings AND SOLDERED. This makes a much stronger wheel. It's simple—with FLUXITE—but IMPORTANT.

The FLUXITE GUN puts FLUXITE where you want it by a simple pressure. Price 1/6, or filled, 2/6



ALL MECHANICS WILL HAVE  
**FLUXITE**  
IT SIMPLIFIES ALL SOLDERING

Write for Book on the ART OF "SOFT" SOLDERING and for Leaflets on CASE-HARDENING STEEL and TEMPERING TOOLS with FLUXITE. PRICE 1d. each.

FLUXITE LTD.

(Dept. W.W.), Bermondsey Street, S.E.1

**S**elenium rectifiers, charger kits, transformers, chokes. New goods not surplus material. Add 7d postage up to 12/6, 1/4 above. Latest type selenium rectifiers for L.T. packs, etc., with informative data sheet. S.T.C. Set recter 12-15v 3amp 21/-, 4amp 25/-, 5amp 27/6. 5amp half wave 22/-, 12-15v 6amp giant finned tube 32/6, 6v 10amp ditto 25/-, 12-15v 10amp ditto 39/6, 6v 4amp 23/6; smaller type, 24v 2.5amp 32/10, 24v 5amp 45/-, 12v 2amp 12/6. 12-15v 1.5amp 9/6, 6v 2amp 9/-, 2v 0.5amp 4/11, 12-15v 0.5amp 7/-; H.T. rectis., small space selenium type. 120v 20ma elim. type 7/-, 250v 60ma for a.c.-d.c. sets 7/-, 110-60ma U.S.A. midgets 7/-, 250v 100ma bridge full wave 13/6. 350-0-350v 80ma full wave for a.c. sets, 13/6; ditto with transformer with L.F. windings, 4v or 6.3v to choice 33/6; eliminator kit, 22 watt trans., h.t. rect., two 8mfds condensers, trickle charge rect. for 120v 20ma eliminator with trickle charge, 39/6; charger kits, standard kit, S.T.C. 12-15v 3amp rectifier with 50 watt interleave, impregnated transformer, ballast bulb for 2v to 12v charger, no rheo. or ammeter needed, 45/-; ditto 4amp rect. and 75 watt trans. with ballast bulb for 2v to 12v charger, 62/-; ditto but 2amp rectifier, 45 watt trans., ballast bulb 32/6; also 6v kits for 2v, 6v only, 4amp, 32/6; 4amp 42/6, 4amp 52/6, 5amp 75/-, heavy duty kit, 140 watt trans. (9bs), giant 6amp rectifier, slider res. and flush mtg., 0-6 ammeter for 6v, 12v charger, £5; or transformer and rectifier only, £3/15; specially manufactured cracked black, dourved cases for standard kits only with terminals, grommets, screws, for 2a kit 17/6, for 3amp, 4amp 20/-.

**C**HAMPION, 43, Uplands Way, London, N.21. Tel. Lab. 4457 [2986]

**N**ew S.T.C. selenium rectifiers, largest range h.t. metal rectifiers in the country. makers' current products, not surplus: from stock: H4/200 E.H.T. for W.W. televisor, 28/- each p.f.; ha.-f.wave 16v 5a 6/8, 1a 8/-, 2a 9/6, all p. 6d; 16v 3a 17/-, 4a 18/-, 5a 21/6, 6a 22/6, 10a 24/6, all p. 10d; 30v 2a 14/-, 5a 35/-, 8a 34/6, 15v 2a 21/-, 3v 2a 100v, 2a 34/6, all p. 1/4; full-wave bridge-conn., 17v 1.5a 12/1, 2a 15/5, 2.5a 20/6, 3a 21/6, 4a 25/-, 5a 27/-, all p.f.; 33v 2a 18/6, 1a 21/3, 1.5a 28/-, 2a 29/6, 3a 35/-, 4a 42/-, 5a 43/6; 100v, 1.5a, 72/-, all p. 10d; heavy duty type, 7in sq cooling fins, 17v 10a 43/-, 10v 10a 32/-, 15v 3a 32/-, 50v 64/-, 10a 71/-, 54v 6a 90/-, 65v 10a 130/-, all p. 1/4; industrial rectifiers, funnel cooled, 17v 12a 76/-, 17v 12a 76/-, 17v 50a, 188/-; 33v 6a 69/-; 100v 6a, 160/-, all p. 1/6; 100v 10a 192/-, carr. 2/6; valve chargers conversion to metal rect. from stock. Charger kits, trans. rect. and rheo. 54v 6a, incl tap switch, £11 10/6; 33v 6a, £19 6/6; 16v 10a, tapped 10v, £6/12/6; 17v 6a, tapped 10v, £4/12/6; following with fused voltage adj. for 2-6-12v bats, 16v 5a, £3/10; vent steel case 7/6 extra; 16v 4a, £3, case 7/6; 16v 2a, 58/6, case 7/6; transformers, 200/250 in, 16v 10a, 25/-, p. 1/4; 17v 6a, 47/6, p. 1/4; 15v 5a, 41/6, p. 1/-; 16v 4a, 35/-, p. 1/-; 16v 2a, 23/6, p. 10d; slider res. from 24/6, all values, p. 1/-; ammeters, 0-6a M.I., 12/6, 0-5a M.C. 15/-, both p. 6d; 0-14a, 5in dial, 32/6, p. 1/4. In stock, S.T.C. portable charger for 6-12v bats at 3-5v, fully automatic and gun, 1 yr. input 200/250 a.c., £10, carr. free; illus. leaflet on request. Chargers, 6-12v at 5-6a, from 200-250 a.c., with rheo. and ammeter in vent. steel case, £6/18/6, carr. 3/6; see others under Dynamot. Terms, c.o.d. post goods only, others c.w.o. or on terms, wholesale and retail, at Pearce 66 Gt. Percy St., London, W.C.1. Off Pentonville Rd., between King's Cross and Angel, Est. 17 years. [2955]

**A**MAZING radio surplus bargains! As brand new searchlight radar control receivers (Elsin) No. 4, nitride 6v valves, I.F. 11mc/s, freq. 200mc/s, broadband, splendid cabinet, a beautiful job for high gain T.V. or amateur conversion, 60/-; special components for receivers BC453-4-5; genuine plug-on dynamotors, 14 or 28v, output 250v, 12/6; coils BC453 and BC455 stipulate type required, 10/6; BC453 a.c. power packs, 230v, complete with 6X5, plugs on to RX, 45/-; new power relays, 230v a.c., switch 1kw, 17/6; as new U.H.F. receivers AN/CRW2 2 6SN7, 2 6SL7, 1 6J5, 1 6SG7, plug-in coils, 60mc/s, with 28v power unit, 25/-; as new 3cm radar scanning units, para. 1000, 1000, 1000, powerful motors, 25/-; Tannoy P.A. Horns, with driver units, re-entrant or exponential, 60/-; as brand new, guaranteed speakers by famous makers, 8in, 14/-; 8in and transformer, 16/3; 10in, 22/6; as new, receivers type 76, 150-500kc/s, 3 valves, in fitted cases with circuit, 30/-; receivers BCOA/429, 6 6v valves, 201-398kc/s, 2.5-7.7mc/s, plug-in HRO type coils, 37/6; new amplifiers 16129, midget 9D6, ideal for deaf aid conversion, etc., 15/-; receivers, R1125, 2 valves, 30mc/s, with circuit, 6/-; aerial tuning units type 126, rotatable inductance, R.F. ammeter, 7/-; Morse practice sets, quality key, highnote buzzer, 4/10; as brand new, 38 Walkie Talkies, compete with aerial, spare valves, 12v vibrator, and connecting cables, handbook, etc., 90/-; as new, G.P.F. tuning units, CA47155, 1.5-3mc/s, precision dials, in cabinets, 17/6; as new, RF26 units, 30/-; as new, Star identification instruments, 3/-; antenna tuning units BC306, variometer type, 11/-; new Xtals, freq. multipliers and variable units, APW996, 100 Xtals, 10/-; power units type 22, dynamotor 12v in, 250v and 6v out, may be used in reverse as d.c. charger, 11/-; terms c.w.o.; prices include carr.; no lists—Lawrences, 61, Byrom St., Liverpool, 3. Cen. 4480.

Best buy at Britain's

The illustration below depicts the R1124 Receiver which is eminently suited for conversion to the television sound channel. Frequency range 30.5 to 40.5 Mc/s, switched by 5 bank 6 way Yaxley switch; valve line-up consists of 1 10J1, 1 16D2, 3 9D2, 1 9D2, all with screening cans. Among the host of components are 30 condensers, 30 resistors and 3 pot/meters all enclosed in a robust metal case the size of which is 16in. x 10in. x 16in. BRAND NEW AND UNUSED. Astonishingly cheap at 17/6, plus 2/6 carriage and packing.

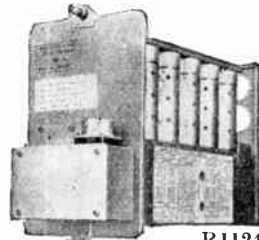

R1124

RECEIVER UNIT R1125.

Of prime interest to the experimenter, this two valve (but 9D2) apparatus contains coils, condensers, I.F. Transformers, etc. Easily convertible for television sound. At 8/6 post free this is not to be missed.

AMPLIFIER UNITS TYPE 18 OR 185.

The huge demand continues unabated. These are neat and compact units comprising 2 EF36, 1 EBC35 and 2 EL32 valves, together with microphone transformers, intervalve transformers, countleess condensers and resistors, etc. An experimenter's gold mine for 25/-, plus 2/6 carriage and packing. An unrepeatable offer.

RECEIVER UNITS TYPE 25 OR 73.

Another popular item in great demand is the Receiver Unit 25/73. Actually the receiver portion of the TR1196, they make an excellent medium wave superhet by replacing the two coils. The valves incorporated are 2 EF36, 2 EF39, 1 EK32, 1 EBC35; also included are one pair of 450 Kcs. I.F. Transformers, resistors and condensers. Suitable coils for superhet adaptation are the Wearite "P" which we have available at 6/- per pair. Moderately priced at 18/6, plus 8/- carriage and packing, it is little wonder that the Receiver Unit 25/73 is proving such a resounding success.

INDICATOR UNITS.

Solely due to the fragile nature of these instruments they are now for personal callers only. Included among our huge and diverse stocks are Types 182, 184, 183, 96, 6, 42, 62A, 95, AFN4. We would emphasize that every tube is demonstrated before purchase and competent technical staff is always in attendance to advise and suggest. Stay us a visit.

EHT TRANSFORMERS.

250v input, 2,000 v. RMS (giving 2,500 v. when fully smoothed), and 5 v. 2 amp. C.T. Specially designed for the VCR97. Of sturdy construction and pleasing finish. Only 29/6, post free.

COMPONENT MART.

All brand new and current stock:—

ELECTROLYTICS ALI-CAN

16 + 16 450 v. D.C. wkg., 5/6; 8 + 16 450 v. D.C. wkg., 4/8; 32 mid. 350 v. D.O. wkg., 2/6; 16 mid. 350 v. D.C. wkg., 1/8; 8 mid. 450 v. D.C. wkg., 2/3; 16 + 24 350 v. D.C. wkg. carboid, 3/6; 25 mid. 25 v. D.C. wkg., 1/6; 60 mid. 12 v. D.C. wkg., 1/8.

LOUDSPEAKERS.

Several famous makers are represented, and the speakers are all new and complete with pentode transformer. 5in., 12/6; 6in., 14/9; 8in., 17/6; 10in., 25/-, A deluge of orders is anticipated. Order early.

METERS.

All new and boxed. 0-1 mfs. M.C. D.C. 2 1/2 in. dia. int. res. 75 ohms, 15/-, 0-40 v. M.C. D.C. 2 1/2 in. sq., 4/8.

**SPECIAL OFFER** This month only. A portable M.C. test meter in bakelite case. Ranges: 0-1.5 v., 0-3 v., 0-60 m/a., 0-5,000 ohms. Can be rapidly modified to make a superb general purpose test meter. BRAND NEW AND BOXED. ONLY 17/6, post free. TRADE ENQUIRIES INVITED.

CHARLES BRITAIN (RADIO) LTD.  
11, UPPER SAINT MARTIN'S LANE,  
LONDON, W.C.2



Open 9 a.m. to 6 p.m. including Saturday.

**MIDLAND INSTRUMENT Co.**

BRAND NEW GOVT. SURPLUS STOCK

**AMPLIFIERS.** TYPE 1134, contains two valves, civilian type 6L6 and 6Z5, four transformers, switches, etc., operates from 2 v. L.F. and 120 v. H.F.; ideal battery amplifier for gram. pickup, microphone or two-way loud-speaking inter-com., in black enamel metal case 7in. x 5in. x 4 1/2in., also wood transit case, 15", post 1/4. **AN API INDICATOR** and amplifier units consists of an API cathode ray tube, 11-valve amplifier 5557G (7), 6X6, 6X6G1, 2X2, 916, valves, control unit, connecting cable and instructional booklet, also additional data to operate from 230 v. A.C. mains, brand new in sealed cartons, 90/-, carriage 6/-.

**CUT-OUTS,** accumulator charging type, 60 amp., in bakelite cases, two types 12 or 24 v., 7/6, post 9d. **TOOL SETS,** one of each the following: Elliot Lucas 6in. flat nose pliers, Terry's B.A. spanner sets, 8 sizes. Apollo box spanners, 9in., one end 4-B.A., the other G-B.A., ditto 4in., 4-B.A., only 3/3, post 9d. **HEADPHONES,** moving coil, 7/6, post 9d., super-sensitive balanced armature high resistance, 7/6, post 9d. **MAGNETIC COMPASSES,** TYPE P-8, alcohol fluxgate, engraved 300-deg., luminous cross-wires, in wood carrying cases, 10/-, post 1/-. **HEADPHONE LEADS,** fitted high or low impedance matching transformer with selection switch, 2/6, post 6d. **TRANSFORMERS,** input 230 v., output 50 v., 11 amp., or with little alteration 100 v. 5j amp., 25/-, carriage 5/-.

**CAMERA CONTROL UNITS** TYPE 35, 12 v., consists of a small electric motor geared to clockwork escapement, 0 to 50 sec. exposure timing device, 0-125 exposure counter, in smart metal case, also wood transit case, 20/-, post 1/-.

**CRYSTAL VALVE RECTIFIERS,** U.S.M. type, highly sensitive, for crystal sets, 2/6, post 3d. **RADIO INTERFERENCE SUPPRESSORS,** mains 6-section metal case type, dust-covered coils and conds., worth 25/-, our price 2/6, post 11d. **MAINS MOTORS,** 200/250 v. A.C./D.C. approx. 1 amp., one end fitted enclosed fan blower, the other reduction gear box, two final drives of approx. 5 and 25 r.p.m., continuous rating, 30/-, post 1/4.

**TELEPHONE SETS,** consists of two combined microphones and telephones, 25ft. twin connecting flex provides perfect two-way communication, self-energised, no battery required, can be extended to 300ft. if required, set complete, 7/6, post 9d. **ARTIFICIAL HORIZONS,** 5/-, post 1/-. Also direction indicators, 7/6, post 1/1-, both contain a 3-ply gyroscope, cost approx. £30.

Also hundreds of other items. Send for our new enlarged Jan., Feb. lists, 3d., with s.a.e. Orders over 30/- post paid, carriage orders extra in all cases. Our C.O.D. service is cancelled for the time being.

**MOORPOOL CIRCLE, BIRMINGHAM, 17**  
Telephone HA 430rne 303 or 2684

**C. A. RYALL, "Utopia,"** Mayfield Rd., Herne Bay, Kent; mail order only; postage or carriage extra, c.o.d. £1 or over; special list for the trade: U.S.A. tubular metal cases wire ended 0.1m.f. 500v 7/6 doz., 350v 5/6 doz.; U.S.A. tubular metal case wire ended 0.5m.f. 350 7/6 doz.; Mansbridge 1m.f. 500v wkg. 3-2/-; Mansbridge 4m.f. 400v wkg. 2/3 each; silver mica 10p.f. 40p., 200p.f. 50p.f., 400p.f. 50p.f. 3/6 doz.; mica 0.01m.f. 3-1/3; all condensers guaranteed.

**Amphenol type British 5-pn chassis valve holders,** 3/6 doz.; international octal chassis valve holders, paxo/in. 4/- doz.; bar type 3-gangs 5/-; bar type 4-gangs 5/-; resistors 1/2 watt and 1 watt, 100 ohms to 2 meg. level assortment 40-5/-; switches, SB, 2P 2W miniature 1/6. 3B, 2P 6W five poles total 2/3 each; SB, 9w 2/-, 2B SP 6w 1/6, SB, SP, 3w 1/-, 2B, 3P, 3w 2/-, SB, 2P, 4w 1/3; two-ve-way group boards with 9-1w and 4w resistances, etc., 2/-, all new; twenty other types in stock; octal plugs; cap and chassis socket, 3-3/-, with tags 3/6; high resistances phones with sponge earcaps, with good class microphone, all wired into p-g type 10H/10991, 10/9 pair; metal boxes, black finish with quarter inch paxo/in panel, fixing tabs and corner sockets, size 8 1/2 x 7 1/2 x 3 1/2 deep, 6/9 each new; 1000 ohm bakelite cased volume controls medium spindle 1/6; metal cases, 100mm depth 1/4meg vols., short spindle 1/6 each; special list for trade. [1613]

**COMPONENTS for West Country constructors:**  
Eddystone mains filter, £2/10; Eddystone absorption wave meter, £5/17/6; Eddystone high voltage neutralising condenser, 1.5-6 p.f., 20-5,000v, 7/6; Eddystone 145 M/Cs convert r.chassis with screens and bracket, h.o.d. 25/-; Eddystone 145 M/Cs transmitter chassis, 25/-; small 4-pn ribbed formers, 1/9 and 2/-; Westcoaters W26, unused 1/- ea., 5/6 for 6; r.tary switches, 2 wafer ea., 3 pole, 3-way, 2/3 ea., 12/2- for 6; 1-wafer 1-pole 9-way, 2/- ea., 11/6 for 6; 2-wafer 1-pole 6-way, no stop, 1/9 ea., 10/- for 6. Speakers: Celestion, 3 1/2-in. special bargain, new high quality, guaranteed, 15/6 ea.; Plessey 5in. less transformer, 16/6; ditto with trans., 9/-.

**Plugs and sockets:** Beeching Lee, 7-pin, ex-A.M., 1/6 ea., 3 for 4/-; telescopic aeral masts, 7ft 6in. to folding to 16in, 5/6 ea., p stage 9d. **Meters:** Sangamo Western 1ma, 2in rd. fl. M/C, 9/6 ea.; San. West. 1ma 2 1/2-in rd. fl., scaled 0-100, 19/6 ea.; San. West. 5ma 2in sq. fl. M/C, 12/6; 30m. 2 1/2-in. sq. fl. M/C, 12/6; San. West. 100ma 2in sq. fl. M/C, 12/6; Ferranti 300v sq. fl. M/C, compete with external resistor, 14/6; Pye plugs and sockets, 1/- pr.; Marconi plugs and sockets, 1/9 pr.; c.v. only orders under 30/- add postage, s.a.e. for lists—G. N. Pill & Partners, 49, Colston St., Plymouth, Tel. 2239, [3002]

**PREMIER RADIO Co.** offers the following surplus material, all guaranteed perfect; chokeys, 500ma, 50ohms, 15 henries, 25/-; 2v. 16amp accumulator, 7/6; type 1355 units, used, 30/-; 20 us 1/2" packing and carriage, new 45/-; R.F. units type 24 or 25 for same, used, 12/6; R.F. unit type 26, new, 27/6; supersensitive balanced armature double headphones, low resistance, 3/6; mains transformers 200/250v input, 300v, 60ma (ch.f. wave), 6.5v, 1a, 10v, 1a, output, 10/-; pieces, supersensitive, 700ohms, 1.9; meter, 8.5; radiogram cabinets, a few available to cost; half price, for callers on; Johnson petrol electric generators, output 32v, 11a, d.c., £22; electron multiplier photocell type 931A, £3; accumulator charger kits, consist of mains transformer and suitable metal rectifier to charge 2 or 6v accumulator, 1a, 22/6; 1a, 22/6; 12v accumulator, 27/6; vibrators, 12v 4-pin non sync, 5/-; transformers for same 300v, 60ma, 7/6; converters, input 24v d.c., output 230v 50c 100w £5; microph. nes. carbon, hand type, switch in handle, 2/11; transformer for same, 2/6; cab tyre cable, twin 1/4 3/6, 6/- per dozen yards, or 42/6 per 100 yard coil; twin flex, 14/36, 5/- per dozen yards, 32/6 per 100 yard coil; aeral's, aluminium, 7 section, total length 5ft 6in, make excellent d.p.o.e. 3/11; resistors, high stability plus minus 2%, 1K, 10K, 100K, 1meg, 1/- each either type; Morse code training sets consist of a good quality key and high note buzzer mounted on a base, 3/6; d.c. generators for engine drive, 12v, 500w, 30/-; Germanium crystal diodes type CV102; a super fixed detector for crystal sets 5/-; balanced armature single ear pieces, supersensitive, 700ohms, 1.9; meter, 8.5; moving coil meters 2 1/2in diam, flush mounting, scaled 15v and 600v, complete with multiplier; to read 1.5v, 15v, 60v, 150v and 600v, 10/-; 2v vibrators synchronous type complete with transformer output 15v, 30ma, 12/6 the pair; resistor parcels, 100 1/4 and 1/2 watt resistors, our assortment, 12/6; condenser parcels, 50 moulded mica, silver mica and tubular condensers, our assortment, 12/6; oil-filled condensers, with clips, 2mf, 600v, 1/9; 2mf, 1,000v, 2/6; 4mf, 1,000v, 7/6; 1mf, 1,500v, 2/6; Weston 50 microamp meters, 2 1/2in scale (undivided), 37/6; enamelled copper wire, all sizes, between 16 and 38 gauge, in 1/4 and 1/2 reels; output transformers, push-pull PX4's to 3 and 15ohms, 17/6; push-pull 6V6's to 3 or 15ohms 17/6; Circle cutters, used with ordinary hand brace cuts circles 3/4in to 3 1/2in, in aluminium or steel, up to 16g; accumulators, 2v, 16a.h., 7/6; charger kits, consist of transformer and metal rectifier, charge a 12v battery at lamp, 27/6; enamelled copper aeral wire 7/25g, 50ft, 2/-; 100ft, 4/-; 1200ft, 30/-; Caller, 1833, Fleet St., London. E.C.4 Tel. Central 2833; or 207, Edgware Rd., London, W.2. Tel. Ambassador 4033. Terms of business, cash with order or c.o.d.; all goods guaranteed perfect. [2952]

**SWITCHES.**

Double-throw. Several hundreds all at 3/6 each.  
10 amps ..... 125v. 5 amps ..... 250v.  
3 amps ..... 460v. 2 amps ..... 600v.  
Normally open. As above.

**NEW CABLE.**

Approximately 25,000 yards for disposal. Price per yard.  
5,000 yards. Unistart VIN No. 1, rubber covered, Single 57/036, in 500yd. drums. 3/-  
450 yards. Lead Covered rubber insulated 660v., single 7/06, in 50 yd. coils. 3/-  
The following are in 100 yard lengths:  
1,000 yards. Cab tyre cotton braided Twin Flex, 136/012 ..... 5/-  
1,700 yards. Rubber sheathed, 12 core, 024 ..... 1/6  
1,500 yards. Quadrage metal braided, 4 core, 3-136/012 & 1-9/012. .... 2/6  
2,000 yards. Quintoseath 4, Cab Tyre, 5 core, 9/012. .... 3/6  
500 yards. Tricomflex 4, braided cotton flexible, 3 core, 9/012. .... 1/6  
735 yards. Unilowcapmet No. 1. .... 1/6  
Coaxial H.F. 7/022. .... 1/6  
1,235 yards. Uniradio 18. Coaxial H.F. 7/022. .... 1/6  
1,600 yards. Uniradio 6. Coaxial H.F. 1/036. .... 1/-  
3,400 yards. A.P. 13806. Coaxial H.F. 1/036. .... 1/-  
3,000 yards. Duradio II. Twin Core H.F. 7/032. .... 2/-  
500 yards. Flex Cord, 3 Core ..... 1/-  
500 yards. Flex Cord, 2 Core ..... 1/-  
2,500 yards. Duradio 28. Twin Feeder H.F., 2/028 ..... 8d.  
2,000 yards. 12 Flex Met. 12 core metal braided 14/0092 ..... 2/6  
Sample Piece supplied on Request.  
24v. Relays, 4 point, approx. 2,400 at 1/6 each.

**The Motherwell Machinery & Scrap Co. Ltd.**  
INSHAW WORKS, MOTHERWELL, SCOTLAND.

**ETA**

**FOUR-STATION PRESET TUNER TYPE TS41**

A complete preset tuning unit for use in superhet circuits to select any three MW and any one LW station.  
Each coil tunes over the whole relevant band by adjustment of its dust iron core. Supplied with full instructions and a complete receiver circuit.

**Price 33/- plus 7/2 Pur. Tax.**

**I.F. TRANSFORMERS SERIES IT1**

A midget high efficiency IFT for 465 kc/s. Both sections permeability trimmed at side of can. Size: 1 1/2" dia. by 2 1/2" high. IT1 critically coupled with top grid lead. IT2 is overcoupled for diode circuits with all connections at base.

**Price 7/- each**

**PRESET TUNING COILS TYPE V**

These coils are exactly as used in the TS41 (with the addition of soldering tags) and are now available for TRF and superhet use. Coverage by permeability trimmers MW 195-530 metres, LW 850-2000 metres.

**Price 3/6 each H.F. 4/- each.**

Obtainable from your dealer or direct from **ELECTRO TECHNICAL ASSEMBLIES** West Hill, St. Leonards-on-Sea, Sussex.



W. H. SMITH & SON give special attention to the requirements of technical men and students. Books not in stock, but obtainable from publishers, are supplied within a few days. Students' needs for examinations are given priority.

**GO TO W.H. SMITH & SON**  
1500 BOOKSHOPS AND BOOKSTALLS

# GALPINS

ELECTRICAL STORES

408, HIGH ST., LEWISHAM, LONDON, S.E.13

Telephone Lee Green 0309. Near Lewisham Hospital

TERMS: CASH WITH ORDER. NO C.O.D.

**MAINS TRANSFORMERS.** Input 230 volts 50 cys., output 42 to 50 volts at 100 amps., £12/10/- each, carriage 10/-, another 200/250 volts in steps of 10 volts, output tapped 6, 12, 18, and 24 volts, at 10/12 amps., 45/- each, carriage 2/-, another 230 volts input, output 12 volts at 8½ amps., 25/- each, carriage 2/-, another 220 volts input, output tapped 12½, 25, 37½, 50, 60, 75, 87½, 100 and 110 volts at 1,100 watts, £4/15/- each, carr. 7/6. (These transformers are all double wound.)

**MAINS TRANSFORMERS.** all 200 250 v. 50 cys., 1 phase, input, output 700/0700 v., 70 m/a., 4 v., 2½ a., 12 v., 1 a., 30/- each. Another 525/525 v. 150 m/a., 6.3 v. 5 a., 5 v. 3 a., 37/- each. Another 2,350 v. at 500 m/a., 85/- each. Mains Smoothing Chokes, 10 Hy. 100 m/a., 6/-; 150 m/a., 8/6; 350 m/a., 25/-; 5 Hy., 250 m/a., 17/6.

**MAINS VARIABLE RESISTANCES** (slider type), new, ex-Govt., 14 ohms, carry 1 to 4 amps., graduated, useful as dimmers, etc., 17/6 each; another 0.4 ohms, carry 25 amps., 17/6 each, post 1/6. Ex-Govt. Moving-coil Cell Testers, 3-0-3 v. (new), 15/- each.

**MAINS TRANSFORMERS** (Auto Wound). Voltage Changers tapped 10, 20, 25, 90, 130, 150, 210 and 230 v., all at 1,000 watts, a combination of 34 voltages can be obtained from this transformer, new ex-Government. Stock, £5/10/- each, carriage 5/-; Mains Booster Transformer, tapped 0, 6, 10, 19, 175, 200, 220, 225, 240 and 250 v. at 1,500 watts (new, ex-Government), £5/5/- each, carriage 5/-; Another Auto wound, tapped 0, 110, 150, 190, 210 and 230 v. at 1,500 watts, £6/10/- each, carriage 5/-; Ditto, 2,000 watts, £7/5/- each, carriage 5/-.

**EX-R.A.F. MICROPHONE TESTERS** (new). These consist of a Ferranti 0 to 450 mamp. 2½ in. scale meter shunted to 1 m/a. incorporated Westinghouse Rectifier, the whole enclosed in polished teak case, calibrated at present 0 to 10 v., 25/- each.

**SPECIAL OFFER METERS**, all new, boxed. Moving coil, first grade instruments, 0 to 20 v., 10/- each, or 3 for 25/-; 0 to 40 v., 12/6 each; 0 to 10 amps., 15/- each, all 2in. scale. 0 to 20 v. A.C., calibrated 50 cycles, 25/- each; 0 to 40 amps., thermo-coupled, 25/- each.

**ELECTRIC LIGHT CHECK METERS** (Watt Hour). A.C. 50 cys., 200/250 v., 5 amp. load, 18/6, post 2/-; 10 amp., 21/-, post 2/-; 20 amps., 25/-, post 2/-; also a few only Pre-Payment 1½ slot type, 20 amp. load, less coil box, complete with synchronous Motor, 35/- each, carriage 3/6.

**EX-R.A.F. R.F. UNITS** (New), containing 6 valves including E.F.50s, 5U4Gs, Grounded Grid Triodes, also a 24 volt Miniature Motor with laminated Field, and approx. 60/75 Resistances and Condensers, 32/6 each, carriage 3/6.

**EX-R.A.F. I.F.F. UNITS**, 10 Valve Short Wave complete with valves, E.F.50s, S.P.41s, E.A.50s, fitted with a motor generator, 12 volts input, 450 volts at 50 m/amps. output, these units are as new, 30/- each, carriage 3/6.

**MAINS TRANSFORMERS.** 200/250 volts 50 cys. input, output 350/0350 volts at 250 m/amps. 4 v. 8 a., 4 v. 4 a., 6 v. 6 a., 6 v. 2 a., tapped at 2 volts, 65/-; Ditto, 500/0500 volts at 300 m/amps. 6.8 a., 4 v. 8 a., 5 v. 4 a., 62/6. Ditto, 350/0350 volts at 180 m/amps. 4 v. 4 a., 6.3 v. 4 a., 5 v. 3 a., 38/6, post 1/6. Ditto, 500/0500 volts at 150 m/amps. 4 v. 4 a., 6.3 v. 4 a., 5 v. 3 a., 45/-, post 1/6. Another 100/230 volts input, 12 volts at 15 amps. output, 32/6 each.

**D.C. PRE-PAYMENT 1½ SLOT METERS**, 10 amp. load, 200/250 volts, condition as new, 27/6 each, carriage 3/6.

**LARGE VARIABLE RESISTANCES** (Stud Switch-arm type), 25 studs, 50 ohms to carry 1.4 to 9 amps., 30/- each. 10 ohms to carry 9 to 14 amps., 32/6 each.

**FRITH RADIOCRAFT, Ltd.**, Leicester offer: 1) super value in bargain parcels, only 1/- each. (1) tag strips 2, 3 and 4 point, 40 each, total 120; (2) sleeving 1, 1½, and 2mm, 72yds asstd colours; (3) valve holders, 8 each B9G (EF50) 4 pin UX and 5 pin Eng. total 24; (4) ¼w resistors 10 each 1,500, 2,700, 4,700, 10k and 100k, total 50; (5) ¼w resistors, 12 each 4,700, 47k, 100k and 680k, total 48; (6) 1w resistors, 6 each 33k, 47k, 100k and 1meg, total 24; (7) 2w resistors, 6 each 3,300, 22k, 33k and 300k, total 24; (8) mica condensers, 8 each .0005, .001 and .01, total 24; (9) ceramic condensers, 9 each 6.8, 8, 50 and 75 pf, total 36; (10) component boards, 12 asstd, comprising over 100 res. and cond.; (11) RF chokes, 12 asstd.; (12) 12in lengths screwed brass rod, 3 each, 2, 4 and 6BA, total 9; (13) pr. 1F transformers 455ac/s adjustable dust iron cores (14) paper condensers, 6 each .01/1,500v (tub), .5/750 (block), 1.0/350 (tub), total 18; any parcel above 5/- p.u.s. 6d. postage; all items brand new; satisfaction guaranteed or cash refunded with out question.

**FRITH RADIOCRAFT, Ltd.**, 69-71, Churchgate, Leicester. [2949]

**JACK PORTER, Ltd.** (Radio).—New components, satisfaction guaranteed: U.S.A. oil block condensers, 4+4+4+5; 1mfds, with clips; U.S.A. electrolytic capacitors, 2,000 mfd, 15 volts, 2/6; moulded mica condensers, 0.01, 400 volts, wire ends, 3/- doz; ceramic tub. condensers for C.R. work, 0.001mfd at 9,000 volts, 2/-; Cylond-Polar type ceramic variable 0.0001 midget condensers with full ¼, shdts. 2/6; U.S.A. midget Neons, 115 volt, ¼, ½, 1, 1½; Cossor-Osram type 4-pin S.130 Neon Staos, 3/9; boxed RF 0-350 ma meters, 3/9; boxed 0-20 voltmeters, 3/9; Thorndon tropical 1½ chokes, 70ma 250 ohms 3/-; variable slider, 300 ohm bias resistors, 30 watts with clips, 1/-; standard fuseholders, black plastic tubular type, 1/-; U.S.A. crackle finished metal boxes with sliding clip fastening lids, 6X5X 4¼in, 2/6; boxed U.S.A. 24-volt ac/dc blowers, 4 shafts, 1,000rpm, complete with fan, 12/6; British 12-volt small 1/2 and ¾ shafts, 8/-; Pyrex glass ribbed Lo-Loss aerial sw. insulators, 11d; boxed U.S.A. vibrators, 7-p.n. 6-volt and 4-pin 12-volt, 2/- each; C.R. terminal blocks, 5,000 volts, black plastic, 8-way, with terminals both sides for chassis mounting, 3/6; aluminium chassis, 12X12, 6X6X2¼, for amplifiers or sets, 4/-; radio control relays, 11,000 ohms res. micro adjustment, 6/-; resistors, 50 ohms to 4 megs, ¼, ½, 1, 2 and 3 watts, assorted, per box of 50 for 7/6; condensers, 10 pf to 0.1mfd, in silver mica, mica and tubular paper, per box of 50 assorted, 10/-; U.S.A. 35mm direct embossing film for recording and playback, per box of 50ft. 1/6; double wound 230 to 115-volt transformers, 450 watts with terminals, 49/5; G.P.O. type multi key switches, 1/-; McElroy moving coil and stylus motor assembly, boxed, new, 1/-; Midget transformers, 50 ohms to 5,000 ohms, ideal for mikes or phones, 1/9; R.C.A. boxed 923 photo electric cells, 4-pin 19/6; orders over £1 carr. paid.—Jack Porter, Ltd. (Radio), 22-31, College St., Worcester, Tel. 12516

**SUPREME RADIO, 746b, Romford Rd., Manor Park, London, E.12.** Tel. If. 1260. Est. 15 years. Buy by our mail and you buy right. Satisfaction at the right components that give television and radio sets. E.H.T. 4kv or 5kv 2v fil., tested at 20kv, 55/- ea.; 2kv E.H.T., 4v fil., tapped at 2v, 26/- ea.; scanning coils, 25/6 ea.; line trans., 21/- ea.; both items matched focus coil, 30/- ea.; H.T. trans., 350-0-350, 6.5v 6 anno, 4v 8 amp, 4v 3 amp, 0-2v, 6v, 12v, 18v, 25v, 30v, 35v, 40v, 70v, 80v, 85v, 90v, 100v, 150v, 180v, 200v, 250v, 300v, 350v, 400v, 450v, 500v, 550v, 600v, 650v, 700v, 750v, 800v, 850v, 900v, 950v, 1,000v, 1,000mfd, 500v, 0.05mfd, 500v, 5/6 doz.; 0.1mfd 500v, 6/6 doz.; 0.1mfd 350v, 5/6 doz.; 0.001mfd and 0.0005mfd and 0.0003mfd midget mica condensers, 5/6 doz.; can type condensers, 8mfd 450v, 2/1 each; 16+32mfd, 30v, 4/3 each; 16+8mfd 450v, 6/3; 30+30mfd 350v, 425v, 5/6 doz.; 16+24mfd 450v, 5/6 ea.; 32mfd 350v, 3/- ea.; 32mfd cardboard drylyc condensers, 6/6 ea.; 16mfd 350v drylytic condensers, 1/9 ea.; midget 450v can condensers, 16+8mfd, 4/9 ea.; midget 16+8mfd 450v, 5/6 ea.; 2+8 mfd 450v midget type, metal, 409 ea.; 8mfd 450v midget metal can type, 2/6 ea.; 32mfd 350v midget can type, 4/9 ea.; fixed mica cond., 3ppf, 30ppf, 60ppf, 65ppf, 70ppf, 180ppf, 305ppf, 300ppf, 500ppf, 570ppf, 590ppf, 700ppf, 4,550ppf, all at 2/6 doz or assorted; 0.1mfd mica, 3kv, 3/- doz.; 0.005mfd mica, 3/- doz.; terms c.w.o., no c.o.d.; send 6d. extra for postage orders under £5; 2½d. s.a.e. all enquiries and list. [3000]



Resistances. Special offer. Parcel containing 100 popular assorted values 1-watt type, 8 6 per 100, 1-watt type, 11/6 per 100. (Trade enquiries invited.)

**M Coil Speakers.** Well-known mfrs' surplus, all 2 ½ ohms and P.M. 10in., 23/6; 8in., 17/- (15 ohm, 18/9); 6in., 16/6; 5in., 10/11 and 12/9 (with Transf., 18/6); 3in., 13/9; 2in., 14/9. Energised also available in all sizes.

**Tuning Cond.** Twin (tangs) .0015 mfd. ceramic, 7/6 (with Trm., 8/6); .0003 mfd. with Trm., 8/6. Midget .0001 mfd. 5/-; Midget .0005 mfd. with Trm., 10/6; Midget .00035 mfd. 1½ 1½in. x 2in. 10/6. 4-gang .0005 mfd., 5/9; 3-gang, .0005 mfd. 7/6.

**T.R.F. Matched pair, M. & L., 6/9.** Weymouth ditta, 8/6 pair. 8/11ct. matched, S.M. & L., 8/9, 10/6 and 11/6 pair. All Weirite "P" Coils, 3/- each, including R.F., B.F.O. and A.F.

**Vibrator Transf.** 6V in, 250-0-250 v., 100 m/a out (also available in 12 v.), 9/6.

**I.F. Transf.** 465 kc. New well-known mfrs' surplus. 1in. x 1½in. Per. Tuned, 9/- each.

**Potentiometers.** Centralab 5K, 10K, 25K, 50K 100K, 1, 1, 1 and 2 Meg. less Switch, 4/3. With Switch, 6/-; Midget with Switch, 1 and 1 Mer., 6/3. Special 75 Meg. with Switch, 4/9.

**Electrolytics.** B.E.C. Midget Can 8 mfd 450 v., 2/11; 8-mfd. 450 v. 1 dia. x 1½, 4/9; 8-mfd. 450 v., 4/11. Dubilier 8 mfd. 500 v. Card. Tub., 4/9. T.M.C. 32 mfd. 450 v., 4/9.

**Meier Rectifiers.** Westinghouse. 0.5 m/a, 4/9; 0-10 m/a, 7/6; 0-1 m/a, 10/6.

**Selenium Rectifiers.** H.T. h/wave; 250 v. 50 m/a, 5/9; 200 v. 100 m/a, 5/9; 250 v. 100 m/a, 7/6; 250 v. 300 m/a, 13/9; Bridge Rect., 6 v. 11 amp, 6/9; 12 v. 11 amp, 12/6; 12 v. 3 amp, 24/-; 8-mfd. 450 v., 37/6; 70 v. 11 a., 37/6. Also L.T. 1/12 volt 4 amp, 3/6.

**Television Transf.** E.H.T. 4,000 v. 3 m/a, 2 v. 11amp, 45/-; 500-0-500 v., 250 m/a, 4 v. 5 a., 6.3 v. 8 a., 75/-; 350-0-350 v. 250 m/a, 6.3 v. 6 a., 4 v. 8 a., 4 v. 8 a., 6.3 v. (tapped 2 v.), 2 a., 72/6; 5 K.V. 3 m/a, 2 volt 11 amp, 57/6. (also available with 4 v. or 1 amp.)

**Charger Transfs.** Each has Input 230 v., Outputs 24 v. (tapped 15, 8 and 4 v.), 3 amps., 27/6; 30 v. (tapped 15 and 9 v.), 3 amps., 25/6; 15 v. (tapped 9 v.), 8 amps., 17/6.

**Filament Trans.** Input 200-250 v., output 6.3 v., 11 amp, 8/-; Also with output 4 v. 11 amp., 9/-.

**Ex-Govt. T.M.C. Reed-type Headphones.** 70 ohms, 19 each (3 pair with leads). Single carbones, 75 ohms, with adjustable Headband, 1/6. Midget output Trans. 32-1, and Tarnafed Tfr., 4-1, both 1½ x 1½ in. x 1½ in., 3/- each. 1/2 Pull Intervalve 2.5-1 each half. Output Tfr. 60-1, both 1½ in. x 1½ in., 3/- each. Tannoy Transverse Carbon Mica inset, 2/3. Midget Intervalve Transfs. 3-1, 5-1 or 10-1, 3/9 each. Multi-ratio Matching Transfs. 4 windings (2 C.T.) for 10 ratios between 10 and 100-1, 2in. x 1½ in. x 1½ in., 3/9; 12 volt I.C. motor suitable for models, 19/6. Moving Coil Mike with 8/8 Switch, 2/6. M/Coil Headphone, 2/-; Carbon Hand Mike, with 8/8 Switch, 2/11. 1 mfd. 5,000 volt Mainbridge, 6/9; 25 mfd. 2,000 v. Mainbridge, 1/6; Throat Mikes, 3/6.

**Garrard A.C. 100/250 v. Gram. Motor** with Turntable and Pick-up, A5 18s. 6d.

**Plessey Auto Changer, A.C. 200/250 v., 8 records mixed, Mag. Pick-up, £18 6s. 8d.**

**Collaro Gram. Motor.** Auto Stop, Turntable A.C. 100/250 v., 25 18s. 4d.

**L.F. Chokes.** Midget 10 Hny. 250 ohm 60 m/a, 3/6. Standard 15/20 Hny. 250 ohm 60 m/a, 6/6. 20 Hny. 300 ohm 100 m/a, 12/9; 5 Hny. 50 ohms 250 m/a, 18 6d.

**Coil Packs.** Osorn Midget 3½in x 1½in. x 2½in. covers 2-3 meg. Wave Intervalve 3-11, 3/6. Weymouth standard, covers 8-M-11, wave, 36/6.

**Output Transf.** Wharfedale Midget 30-60 or 90-1, 6/9. Elston Multi (over 12 Ratios some C.T.), 6/7 watts, 8/-; Kingway Multi Ratio, all C.T. for 1/2 Pull, suit. 1N-4, 1N-5, etc., handle 13 watts, 24/9 (also available in 30 watt type, 30/-).

**Moving Iron A.C. Meter.** 2½in. 0-300 volt, 12/9.

**Rotary Transf.** New. Input, 230 v. A.C., output, 12 v. D.C. 65 m/a, 22/6. Also input 490 v. A.C., output 12 v. D.C. (or 230 v. in), gives 6 v. D.C. out, 6/6.

**3-Watt Amplifier Kit.** Consists of complete kit of parts, including M/Coil Speaker, to construct small Amplifier, ideal for home use on gram., price 72/6 (circuit supplied). Similar complete kits, with detailed instructions, can be supplied for Amplifiers with between 5 to 30 watts output.

★ Send 2½d. stamp for very full Stock Lists. When ordering please cover packing and postage.

**STERN RADIO LTD.**  
109 & 115, FLEET STREET, E.C.4.  
Telephone: CENTRAL 5814 and 2280.

# Pennine RADIO

## ANNOUNCE NEW LOW PRICED AUDIO SIGNAL GENERATOR

WIDE FREQUENCY RANGE  
40 CPS.-16000 CPS. WITH 3  
WATTS OUTPUT SUITABLE  
FOR CHECKING.

★ **AUDIO AMPLIFIER**  
FREQUENCY RESPONSE

★ **RADIO RECEIVERS**

★ **MODULATORS**

CAN ALSO BE USED FOR  
★ **LOUDSPEAKER BUZZ**  
**TESTS** AND PRODUCTION  
TESTING EMINENTLY SUIT-  
ABLE FOR SERVICE ENGI-  
NEERS, RADIO HAMS, RADIO  
AND RELAY ENGINEERS

PRICE £9.9.0

Write for particulars

**PENNINE AMPLIFIERS**  
SOUTHGATE, ELLAND  
YORKSHIRE, ENGLAND

## SOUTHERN RADIO'S WIRELESS BARGAINS

**BENDIX COMMAND RECEIVERS.** BC454 and BC455. Frequency 30-1 meg. m. v. controls. Ideal for conversion to car radios and AC/DC receivers. 6 valves, 12SK7 (3), 12SR7 (1) 12AG (1), and 12KS (1). Either set 35/-, post 1/6 extra.

**CONTROL BOXES FOR BC453, 454 and 455 RECEIVERS.** Comprising three slow motion dials and drives three 50,000 ohm volume controls and six rotary switches. Brand New in makers cartons. 12/6 each, post 1/- extra.

**DRIVE ADAPTORS FOR BC453/4/5** with 1 1/2 in. black knob. Easily fitted to existing shaft to give full slow motion travel. 2/6 per set, post 3d.

**COMMAND RECEIVER DRIVE CABLES.** 14 feet long. 8/6 each, post 6d.

**POWER PACKS.** input 12 v., output 250 at 30 ma. Suitable for car rack for BC453/4/5. In metal case 10 1/2 in. x 6 1/2 in. x 4 1/2 in. with switch and indicator lamp. Fully smoothed and sup. ressed. 22/- each, carriage 3/- extra.

**INERT CELLS.** 1.5 volts. Ideal for bell batteries, i.t. on small receivers, etc. Require one filling of water for long life. Large size 2/6, small size 2/-, post 6d. per battery.

**INVERTOR UNITS.** type PU16/AP, 28 volt input, 115 v. at 400 cps. output. Black crackle finish in manufacturers' sealed wooden boxes. £3.10/- plus 7/6 carriage.

**THREAT MICROPHONES.** Magnetic, low impedance, 3ft. lead and jack. 3/6, post 6d.

**HIDE FACED HAMMERS.** Ideal for panel and chassis work. Double faced, 2/6 each, post 6d.

**FIFTEEN FOOT COPPER AERIALS** in 7 interlocking sections, 4/6 each, post 6d.

**CONTACTOR TIME SWITCHES.** By Smiths and Venners. 10 hour movement giving two impulses per sec. Ideal for darkroom work. Brand New in soundproof boxes with thermostat control. 10/-, post 1/4.

**LUFFERA HOLE CUTTERS.** For use on wood, metal or plastic. Adjustable to 3/16 in. dia. 5/- each, post 6d.

**WESTCOTORS WX6** and **W12.** WX6, 36 v., at 100 micro-amps. W12, 6 volts each side at 250 micro-amps. Either Type 6/- per dozen. Post 4d.

**BATTERIES.** M.G.R.I. type. 90 v. H.T. and 7 1/2 v. L.T., 6/6, post 6d.

**SEND FOR FULL RADIO PUBLICATIONS LIST.**  
**Southern Radio Supply Ltd.**  
64, LISLE STREET, LONDON, W.C.2.  
GERrard 6653

**TELEVISION!** Television! Are you building a T.V. receiver? Complete instructions for building a long-range outfit using surplus material for only 4/5 each, free, send stamp to-day for our latest television list; all is post free to any address in Great Britain; here are a few items picked at random: aerial masts, 22ft all-steel mast in four sections, only 12/6 carr. free, extra sections which are ideal for cross booms can be supplied at only 4/5 each; each cathode ray tube bases to suit VCR.97, 2/6 each, 20/- per dozen; insulated flexible couplings, for 1/4 in dia. spindles, 1/6 each, 12/- per dozen, set of volume controls for T.V. receiver using VCR.97 tube, 10 in all, 17/6; 24ft 80 ohms co-axial cable with Pvc plug each end, 4/6; 72 ohm co-axial cable, 6d per yard, 40/- per 100 yards, sample free on request; 7ft 6in aluminium telescopic aerials, closed 11in, only 5/-; mail order dept., callers only.--Walton's Wireless Stores, 203, Staveley Rd., 48, Stafford St., Wolverhampton, [2988

**TELEVISION** branded components exact to E.E. designer's specifications; vision chassis fitted valveholders, coil forms, 22/4; sound ditto chassis, 18/6; time base ditto, 18/6; power ditto chassis, 25/-; set gantrys, clips, control panel, 10/-; complete chassis assembly with gantrys, etc., £4/4/6; Aden deflector coil assembly, 32/6; line transformer, 32/6; focus coil, Pvc set 8 coils fully wound with h.f. chokes, 15/-; television aerials; Hunts 0.1 mid tubular condenser, with clip, 7.000 v.v., 14.000 v test, 19/6; rubber mask for 9in tube, 11/-; Magnavista screen enlarger, 6gms; co-axial cable, 1.3 per yard; e.h.t. transformer, 4.000v, 2.0-2v, 60v/-; ditto 5.000v, 2.0-2v, 65v/-, S.M.L. wave horizontal drive assembly, complete with escutcheon, size of glass dial 9in x 4 1/2 in, 21/-; ditto flywheel tuning, 25/-; glass s.m.l. dial, 6 x 8in, 4/6; 8in p.m., less trans., 17/6; 5in p.m. with trans., 17/6; 5 1/2 p.m., less trans., 12/6; 3in ditto, 15/-; American throat microphones, boxed, 3/- each; condensers, dmf 450v, 2/6; 16mf 350v, 2/6; 8mf 450v, 2/-; 8 plus 16mf, 450v, 5/6; 16 plus 16mf, 450v, 7/-; choke, 150 ma. 10hy, 14/-; walnut cabinet, complete with ornamental speaker, grilled and escutcheon, size 15 1/2 in wth. X 12 1/4 in ht X 10 1/4 in, 37/6; rotary trans., in 6-12v, but 200-480v 50ma, or as motor d.c. mains, 15/-; drive cord in 20yd spools, 3/6 each; miniature 2-gang condensers, fitted trimmers, with perspex cover, for personal receivers, 10/6 each; buzzers, 2/6 each; 4-pin vibrators, 6v, 6/-; switches, Yaxley type, 3-pole 2-way, 2/-; 4-pole 3-way, 3/-; 4-pole 4-way, 3/6; 6-pole 4-way, 1/6; 12-pole 3-way, 7/6; 2-way, 3/-; enamelled copper wire, various gauges, in 1/4 lb reels; tinned copper wire, 18, 20, 22, at 1/6 per 1/4 lb reel; full list at 2/6d; postage all orders.--O. Greenlick Ltd., 265, Whitechapel Rd., London, E.1. Bis. 5079. [2950

**RADIO CLEARANCE.** Ltd., 27, Tottenham Court Rd., London, W.1.--Master osc. V.F.O. by Wilcox Gay, type M1, 19467A, uses 207 electron coupled osc., very stable, employs 2 circuits, grid 1-5mc/s in 6 bands, plate 2-10mc/s in 3 bands, grid current meter (0-10ma), supplied in original cartons, brand new, with accessories and instruction book, 25/-, carr. paid; Xtal multipliers, M1, 19468, Xtal osc., using 807, freq. 2-7mc/s, 0-10ma meter, brand new, in original cartons wth inst. book, etc., 40/-; receivers R.U.19 6-valve straight set, with 3 F. stages, using plug-in coils, H.R.O. type, valves 3-78, 2-77, 2-77, 2-77, (out; and B.F.O.), black crackle case, 15X 8X8in., provision for remote or local control, dial cal. 0-100, supplied new, complete with valves and coil packs, covering O.187/305, P.281/455, Q.524/54, R.2265/2155, G.2960/4620, H.3865/6265, M.5075/7800, 13950/res, heater w red for 26v operation, external P.P. required, £4.10, carr. paid; personal receivers, B.C. 728c, 7-valve rec. using covering 2-8mc/s, operates from 2v Acc. by 2v Vib with provision for charging 2v Acc. from 12v source by means of 12v Vib., carried slung on shoulder, supplied brand new, complete with valves, telescopic AE, accessories and inst. book, built-in L/S, £9.9, carr. paid; main trans., sec. 200ma, 210v, 15ma, 6.3v 5a, primary, 230 250v 50v 18/-, sec. 2-250v 100ma, 5v 2a, 6.3v 2a, primary 200/250v 50c/s, with 110v tapping, 15/6; sec. 275-0-275v, 120ma, 4v 2a, 4v 3a, primary 200/250v 50c/s, 13/6; smoothing chokes, 20H, 40ma, 200 3/11, 5H 120ma, 1400 5/-, 2H 150ma 750 4/-, 5H 200ma, 800 7/6, 20H 300ma, 1500 7/6, 14lb 18/6, post 1/6; electrolytics, 100mf 5v, 6d, 50mf 12v 1/-, 25mf 25v 1/6, 25mf 50v 1/9, 50mf 50v 2/-, 8mf 150v 1/6, 8mf 170v 1/9, 8mf 350v 2/3, 8mf 450v 2/6, 16mf 350v 3/-, 16mf 450v 3/6, 25mf 50v 2/6, 2.750 2/0, 4/7-, 6-16mf 450v 7/-, +16 50v 5/-, 20 4/4, 350v 4/6, 8-24mf 350v 3/6, 32mf 450v 4/6, 16-24-8mf 450v 5/9; loudspeakers, P.M., 5in less trans., 13/6, with trans. 16/11, 6 1/2 in, less trans. 16/11, 10in with trans. 32/6, all new, boxed with A11 speech coils; output trans., 2.000 2/0 3/6, 2.500 2/0 3/6, 2.750 2/0 3/6, 4.000 4/0 3/6, 6.000 2/0 4/6, 7.000 2/0 4/6, multi ratio 7.000-3.500-1.750/4 4/6; modulators B.C. 456B, wth 3 valves, 1-1625, 1-VR 150.30, 1-12J5, 13/6, brand new, S.M. dials, as found on R.F. 26v, cursor 4.11, switches small size, 2Pw, 4P3W, 2P6W, 2P6W, standard size 2P4W 5B 2/9, 1P 10w 2B 2/4, 4P 3W 2B 2/9, 2P 4W 2B 2/6; teleasonic receivers with 4 Hivac 1.4v valves, 3-XH and 1XP, 25/-.

## -towards perfection-

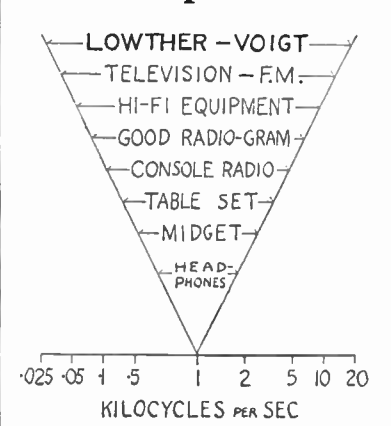

From Aerial or Pick-up to Loudspeakers, Lowther's offer you complete equipment.

**THE LOWTHER MANUFACTURING CO.**  
Lowther House, St. Mark's Road  
BROMLEY, KENT  
Rav. 5225

**MAINS TRANSFORMERS, SCREENED, FULLY INTERLEAVED AND IMPREGNATED.**

H.S.63. Input 200/250, Output 250/0/250, 60 m/A, 6.3 v. at 3 amp., 5 v. at 2 amp.	15/6 Half
H.S.40. Windings as above, 4 v. at 4 amp., 4 v. at 2 amp.	Shrouded 0-10ma
F.S.2. Input 200/250, Output 250/0/250, 80 m/A	19/6
F.S.3. Input 200/250, Output 350/0/350, 6.3-4.0 v. at 4 amp. 5-4-0 v. at 2 amp.	Fully Shrouded
H.S.2. Windings as F.S.2, 80 m/A	17/6 Half
H.S.3. Windings as F.S.3, 80 m/A	Shrouded
F.4. Filament Transformer, 200/250 Input, 4 v. at 2 amp. Output, at ...	7/6
F.6. Filament Transformer, 200/250 Input, 6.3 v. at 2 amp. Output, at ...	7/6
F.4.4. Filament Transformer, 200/250 Input, 4 v. at 4 amp. Output, at ...	13/6
F.12. Filament Transformer, 200/250 Input, 12.6 v. tapped at 6.3 v. at 3 amp., at ...	15/6
F.24. Filament Transformer, 200/250 Input, 24 v. tapped at 12v. at 3 amp., at ...	21/6
Multi-Ratio Output Transformer at 5/-	
Midget Pentode Output Transformer, at ...	per dozen 33/-
C.W.O. (add 1/- in the £ for carriage over £2).	Carriage paid.

## H. ASHWORTH

676, GREAT HORTON RD., BRADFORD, YORKS.





We are pleased to announce that a Televisor model, constructed to "Inexpensive Television" specification, may be seen working at our premises. Price of fully descriptive booklet, 1/6 only. Total cost of necessary Ex-Govt. equipment, under £20. All items can be supplied by us.

Please note that we are now able to supply Mains Transformers, for the Vision receiver. Spec. 250-0-250 v., 80 mA., 5 v. 3 a., 6.3 v. 6 A., at only 28/6. NEW COLLAR RIM-DRIVE AUTOC-CHANGER, TYPE R.C. 49. Latest release. For A.C. mains 50 cycles, 200/250 volts, complete with Crystal Pick-Up, all latest refinements, at the absurdly low figure of £14/9/-, including Purchase Tax. E.H.T. TRANSFORMERS. Output, 250 v., 5 mA. 4 v. 1.1a., 2.0-2 v., 2a. (for VCR 97) 37/6 only. Output 3250 v. 5 mA., 6.3 v. 1 a., 2.0-2 v. 2 a. (for 6CP1), 39/6. Output 4000 v., 10 mA., 2.0-2 v. 2 a., 59/6. Output 5000 v. 10 mA., 2.0-2 v. 2 a., only 65/-. All input 200/250 v. and fully guaranteed.

L.T. TRANSFORMERS. Input 200/250 v. Output 6 v. and 12 v. 3 a., only 15/-. Input 200/250 v. Output 6.3 v. 12 a., only 37/6. Input 200/250 v. Output 12 v. and 24 v. 6 a., only 42/-. N.B. Above voltages are when "on load". "OSMOR" DIAL AND DRIVE. Complete with attractive 3 wave band. Glass dial size 8 1/2 in. x 8 1/2 in. square, centre tuning, with base plate bracket supports pointer, drive, pulleys, pilot lamp holders, etc., and fitting instructions. Very effective. 22/6 complete. SUPERHET RECEIVERS TYPE 25 and 73. Ex-Govt. The receiver portion of the TH119s. Containing 1 pr. 460 kc/s IFT'S plus 2 valves EF36, 2 EF39, one EK32 and one EBC33. Easily converted to home use. Outstanding value. Only 25/- ea.-h. Plus carriage, 1/6.

ROCKET VOLTMETER. Ex-Govt. Two range 0-15 v., 0-250 v. D.C. Brand new and complete in Web carrying case, only 10/6.

MILLIAMMETERS. 0-1 mA., 2in. scale, square, moving coil, panel-mounting, only 10/- each. 15-1 mA., 2 1/2 in. scale, moving coil, panel-mounting, 10/- each. 0-5 mA., 2 1/2 in. scale, moving coil, two mounted on panel. New and unused, 12/6 pair.

DENCO COIL TURRET TYPE CT 6 v. Complete 5-wave band coil pack, tuning condenser, dial and drive assembly, attractive large vertical reading black glass dial, provision for magic eye. Polystyrene insulation throughout, silver plated contacts, and iron-cored High Q coils, ensure a very high performance 465 kc/s. Complete coverage 15 to 30 m/c. Extra switch position for gram. Supplied complete with recommended circuit. Ready for operation, £4/19/6, plus purchase tax, £11/3.

DENCO CH16 12V5s KIT. Pre-fabricated drilled chassis, for use with coil turret type CT6 v. Complete with instructions for assembly around the turret. 12/6 We have in stock, for immediate delivery, complete range of Taylor and Avo Test Equipment, including the new Avo Wide-Range Oscillator, at £25. Also at present in stock, are 12in. C.R. tubes, plus complete accessories for all popular Televisor circuits. Send stamp for Current Component List. Probably the most comprehensive in the trade.

Our reputation is your guarantee.  
5, HARROR ROAD, LONDON, W.2  
PADington 1008/9

**RADIOMENDERS LIMITED**  
FOR SPECIAL TRANSFORMERS AND REWINDS

We specialise in—  
AMATEURS' WINDINGS, TRANSFORMERS ALL TYPES, CHOKES, PICK-UP COILS, INSTRUMENT COILS, Etc.

LOUD SPEAKER SERVICE  
Highest workmanship. Good Delivery

★  
**RADIOMENDERS, LTD.**  
123-5-7 Parchmore Road,  
THORNTON HEATH, SURREY  
LIV 2261. Trade enquiries invited. Est. 16 years

**RAYMAX** television sound unit, complete kit, using 2-EF50, EBC33 and EL33, chassis punched and main components assembled; price (less valves), £2/17/6; valves supplied at current prices; push-pull intervale transformers, ratio 3:1, each; 6.3v. 6A. rfm drive gram unit, magnetic p.u. and auto-stop £5.18/6 incl. tax; inter octal moulded V/H 7/- doz; all types of components, available ex stock, including cabinets for TV. Player or auto change table radiograms; our Console TV cabinet at £19/15 is worth looking into; good photographs of certain cabinets available at 6d. returnable; stamp for lists; we welcome enquiries for cabinets to your own specification.—Raymax Elec. Co., Ltd., 126, Narwood Rd., S.24. [2841]

**WANTED EXCHANGE, ETC**  
WANTED, a few Lotus (long stem) Jack plugs. —Box 4215. [2896]

**DATA** on Admiralty G.73 wavemeter.—State terms of Kinema, Lostwithiel. [2843]

**RECORDED**, back numbers, May '48 to Jan. '49 incl.—O'Hare, 75, Castellain Rd., W.9. [2847]

**WANTED**, Williamson's amp.; cash, or exchange latest Ila Wasp enlarger.—Box 4237. [2896]

**WANTED**, Colvern iron-cored bandpass coils. —Harrison, 177, East Dulwich Grove, S.E.22. [2926]

**WANTED**, Teletype apparatus, parts and accessories of all kinds.—Terry, Strouds, Pansbourne, Berks. [2665]

**WILL** any reader consider selling or loaning current issues of W.W.; full price. [2847]

**WANTED**, telephone and telegraph carrier apparatus of all types in any condition.—Wilson, 93, Wardour St., W.1. [2665]

**WANTED**, 1,000 milliammeters, 0-1 or 0-4; please quote full details and price.—Harris & Gillow, 93, Wardour St., W.1. [2802]

**WANTED**, Voigt corner-horn, with or without speaker, condition immaterial but must be cheap.—Harman, 48, New Rd., E.1. [2762]

**WANTED**, surplus resistor, with platinum contacts, in any condition, large or small quantities; highest prices paid.—Box 4304. [2802]

**EXCHANGE** new Wharfedale separator for Hartley-Turner duode P.M., cash adjustment.—Furness, 64, Cove Rd., Bournemouth. [2802]

**WANTED**, information about Admiralty W8232 tuner amp B36, R.A.F. R.G.V.R., R.1294.—Johnson, 83, Horace St., St. Helens, Lancs. [2888]

**WANTED**, telephone and telegraph components or equipment in any condition; please give full details and prices.—Harris, 93, Wardour St., W.1. [2865]

**WANTED**, Western Electric or Standard Telephones parts, coils, transformers, condensers, any condition; please send full details and price.—Harris, 93, Wardour St., W.1. [2864]

**QUOTATIONS** for large quantities of iron lead bell wire or similar, closed circuit jacks and plugs, 10k ohm potentiometers and 4k ohm headphones in new condition.—69, Allerton Grange Way, Leeds, 7. [2977]

**REEDUNDANT** components, materials and equipment of all kinds urgently required in large quantities; immediate cash available and fair prices paid.—Radio Agencies, Ltd., 157, Wardour St., W.1. Gerrard 2640. [2208]

**MARINE Radio Suppliers**: For our suppliers' file we want catalogues, descriptive literature and samples of components and equipment for production of marine radio transmitters and receivers.—Lehmkuhl's verksteder, Radio Department, Hoffsaaleen, Skyen, Oslo, Norway. [2880]

**REPAIRS AND SERVICE**  
Mains transformers rewound, new transformers to any specification.

MOTOR rewinds and complete overhauls: first-class workmanship, fully guaranteed. F.M. ELECTRIC Co. Ltd., Potters Bldgs., Warser Gate, Nottingham, Est. 1917. Tel. 3855.

Mains transformer rewound and constructed to any specification; prompt delivery.—Brown, 3, Bede Burn Rd., Jarrow. [3460]

ELECTRIC gram motors, auto-changers repaired, rewound.—Radio & Transformer Services, Manchester Rd., Hollinwood, Lancs. Tel. Pal. 2507. [2410]

LOUDSPEAKER and transformer repairs; fields, transformers rewound, cones replaced, any make.—Dodds Radio Service, 131a Hurst St., Oxford. [2661]

REWINDS and conversions to mains and output transformers, from 4/6; pp equipment a speciality.—N.L. Rewinds, 4, Brecknock Rd., N.7. Tel. Arnold 3390. [6283]

REWIND service which duplicates or modifies as required; transformers, loudspeakers, etc.; prompt returns.—Raidel Services, 49, L. Addiscombe Rd., Croydon, Cro. 6537.

EVERY make of electrical measuring instruments repaired and standardised.—The Electrical Instrument Repair Service, 329, Kilburn Lane, London, W.9. Lad. 4168. [2527]

ADHOC MAINTENANCE SERVICE for guaranteed rewinds and repairs; armatures; F.H.P. motors vac. units, etc.; good deliveries.—139, Goldhurst Terrace, N.W.6. Mai. 6133.

"SERVICE with a Smile."—Repairers of all types of British and American receivers; coil rewinds; American valves, spares, line cord.—F.R.I. Ltd., 22, Howland St., W.1. Museum 5675. [1575]

"STURDY" rewinds, mains transformers, chokes and fields, first-class work, prompt deliveries and satisfaction guaranteed.—Sturdy Electric Co., Ltd., Dipton, Newcastle-on-Tyne. [2430]

**FOR BEST PICTURES you MUST use quality products**

A complete range of brand new components for Television always available.



9in. Cathode ray tube ..... £11/6/5  
Complete set of Chassis (Drilled or undrilled).

Line Output Transformer ... 27/6  
Line and frame scanning coil... 29/6

Focus coil ..... 35/-  
4 Kv. EHT Transformer 4 v. 2 a. 4 v. 2 a. 2 v. 2 a. .... 87/6

350-0-350 v. 250 mA. 6.3 v. 6 a., 4 v. 8 a., 0-2-6.3 v. 2 a., 4 v. 3 a. .... £5 15/6

LF Choke 5 H. 250 mA. .... 43/6  
Do., 10 H. 80 mA. .... 29/2

Aladdin Formers and Cores... 10d.  
Co-axial plug and socket ..... 3/-

B9G valve bases ..... 2/6  
Diode valve bases ..... 1/-

5-way terminal block ..... 2/6  
Welwyn vitreous and precision resistors, 500 pF. T.C.C. Micadiscs ..... 2/6

T.C.C. Electrolytics, Metalmites, Metal packs, Picopacks, etc.

**WILLIAMSONS AMPLIFIER.**  
Everything in stock from nuts and screws to Output Transformers 10,000 ohms C.T.

Secondaries 1.7 ohms per section to match all speech coils ..... 82/6

450-0-450 v. 250 mA. Mains Transformer, 6.3 v. 2 a. C.T., 6.3 v. 4 a., 5 v. 3 a. .... 82/6

30 H. 50 mA. L.F. Choke ..... 27/6  
10 H. 180 mA. do ..... 32/6

**JUST IN—T.C.C. PLUG-IN ELECTROLYTICS.**

16 mfd. 500 v. peak 600 v. surge ..... 11/-

32 mfd. 450 v. peak, 550 v. surge ..... 12/-

8-8 mfd. 500 v. peak, 600 v. surge ..... 12/6

16-16 mfd. 450 v. peak, 550 v. surge ..... 13/6

8-8-4 mfd. 500 v. peak 600 v. surge ..... 15/-

16-16-8 mfd. 450 peak, 550 v. surge ..... 15/6

PLUG INTO STANDARD BRITISH 5-PIN BASE.

"Q-MAX" CHASSIS CUTTERS in all sizes from 1/2" to 2 1/2"

**BERRY'S** (SHORT WAVE) LTD.

25, HIGH HOLBORN, LONDON, W.C.1 (Opp. Chancery Lane.) Tel. HOLborn 6231.

## THE BRITISH NATIONAL RADIO SCHOOL

ESTD. 1940

for

New World Ideas and Old World  
Ideals!

The Urge to Serve and the Know-  
ledge How!

Home Study Specialists with the  
Personal Touch.

Radio, Radar, Maths., Physics.

### The B.N.R.S. FOUR YEAR PLAN

covers the full syllabus of:

**A.M.I.E.E., A.M.Brit.I.R.E. and  
CITY and GUILDS Radio and  
Telecommunications Exams.**

Six months' trial period without  
obligation to continue.

Send for free booklet to:—

#### STUDIES DIRECTOR

**BRITISH NATIONAL RADIO SCHOOL**  
66, ADDISCOMBE ROAD, CROYDON

Phone: Addiscombe 3341

A Spencer-West Television Pre-amplifier type AC/2 is completely self contained including power supply unit. It is simply connected to any type of Television receiver and will materially improve results. Price 10gn. complete (Refunded if unit is returned within 7 days)

### SPENCER-WEST

Quay Works, Gt. Yarmouth.

## WESTERN GATEWAY HEADQUARTERS for Radio Equipment and Components

G6YA G2BAR

#### COMMUNICATIONS RECEIVERS

**"EDDYSTONE 640."** The popular priced British Communication receiver, for all interested in long-range Short-Wave reception. Has many refinements, with Crystal phasing, B.F.O. and Noise limiter. £27 10s. Very reasonable hire purchase terms available. Send P.C. for full details.

**"EDDYSTONE 670."** Marine receiver. For export only, either direct, or for use aboard a foreign-going vessel. Descriptive literature forwarded. £37 10s. CONDENSES. Govt. Surplus. New. 0.15 plus 0.15 mfd., 7 kv., oil-filled, 15", 4 plus 4 mfd., 3 kv., 25/-, 4 mid., 2 kv., 12/6 plus postage.

**CHOKES.** 10H 100 m/a 100 ohms, 7/6. 20 H 100 m/a 350 ohms, 10/6. 12 H 200 m/a super potted bob. 20/-, 15-20H 800 m/a 80 ohms, 25/-, Carriage extra. **H.T. UNIT.** Regulated 140-120 v. up to 60 m/a. 200/250 v. input. Ideal for bias supply or battery receiver. 35/-, plus 2/6 carriage.

**AMPLIFIER, 25 WATTS OUTPUT.** TG10, with valves: 2 6L6, 2 6X7, 2 6S37, 3U4G, less motor and P.E. cell. 110 v. A.C. input. £27 12/6. Auto-transformer. 21/4 extra, plus 10/- carriage.

**TUBES.** VCR138A tube. This is a super tube for 'scope work, complete with base, 30/- each, plus 1/6 postage.

Agents for "Eddystone," "Denco," "Labzarg" and "Baymart." We guarantee satisfaction with all our equipment. Write to us for all your requirements. Export Enquiries Invited.

**ARTHUR H. RADFORD A.M.I.E.E.**  
28, BEDMINSTER PARADE, BRISTOL, 3.  
Tel.: 64314.

Open Saturdays: 9-6.30 p.m.

**REWINDS.**—Mains transformers, chokes, fields, O/P transformers, etc.; prompt deliveries and satisfaction guaranteed.—Thomas Bolton & Co., 20, Heath Terrace, Leamington Spa, Tel. 13.

**ACCURATE** coil winding; tuning coils, I.F., L.F. and mains transformers rewound and wound to specifications; wave and progressive wave winding.—Rynford, Ltd., 17, Arvenack St., Falmouth. [2497]

**REPAIRS** to moving coil speakers, cones, coils fitted, field rewound or altered; speaker transformers clock coils rewound; guaranteed satisfaction, prompt service; we do not rewind mains trans.—Closed Sat.

**L.S. REPAIR SERVICE.** 49 Trinity Rd., Upper Tooting, London, S.W.17. Baltham 2359.

**SECOND** to none rewind service, reliable clean, neat, return of post, new transformers, standard or to specification, EHT 2HT, choke; stamp quotations.—R.E.F., 137A, Ashton Rd., Oldham. [2379]

**TRANSFORMER** and chokes to specification in single or quantities; finest quality work and finish; all units fully tested and guaranteed.—Millett & Holden, Ltd., Oxford Garage, Mews, Nelson St., Southend-on-Sea, Essex.

**REWINDS,** mains transformers, speaker field coil, chokes, high-grade workmanship, prompt delivery; new transformers constructed to customers' specification, singly or in quantities.—Metropolitan Radio Service Co., 1021, Finchley Rd., N.W.11, Speedwell 3000. [3719]

**24-HOUR** service, 6 months' guarantee, any type of transformer, mains outputs, pots and i.s.s. etc.; all types of new transf., etc. supplied to specification; business heading or service card for trade prices.—Majestic Winding Co., 180, Windham Rd., Bournemouth.

**L.T.P.** rewind service, all rewinds are layer by layer wound, guaranteed, and units tested at 2,000 volts and guaranteed for three months, 48-hour service.—Enquiries London Transformer Products, Ltd., L.T.P. Works, Coochold Estate, N.W.10. Tel. Willesden 6486.

**REWINDING** of all types of transformers, chokes, cloc coils, etc.; quick service; new transformers supplied to any spec. "Wireless World," transformers a speciality; bobbin replacements for all makes of trans.—Radio & Transformer Services, Manchester Rd., Hollinwood, Tel. Fal. 2507. [2409]

**REWINDS** and repairs, mains transformers, O/P trans., clock coils, field coils, pickups; vacuum and gram, motors; new transformers to any specification; guaranteed work; competitive prices; delivery 2/3 days.—W. Groves, Manufacturing Electrical Engineer, 154, Ickneld Port Rd., B'ham, 16. [1482]

**REWINDS.**—Send your "burn outs" to be re-wound; no technical data wanted; post transformer, etc., labelled with your name, address, and marked "for re-wind"; our windings are double wound, interleaved and impregnated.—Southern Trade Services, Ltd., 297-299, High St., Croydon, Tel. 4870. [9883]

**NATIONAL RADIO SERVICE & TELEVISION** Co., radio and television development engineers; high quality receivers and amplifiers built to specification and modernised, repairs to all makes of receivers, transformers, coils, armatures rewound, loudspeaker cones renewed, television aerial installations, conversion, etc.—63, High St., St. John's Wood, N.W.8. Primrose 6725. [2671]

#### WORK WANTED

**WE** make wireless and radiogram cabinets for home and export; immediate deliveries.—Radiac, Ltd., 26, Brondesbury Rd., London, N.W.6, Maids Vale 8792. [8025]

**RADIO** mfrs. can undertake development and assembly of radio or electronic equipment; winding shop with vacuum impregnation plant; ample space and labour available.—Box 685

**FIRST-CLASS** transformers and chokes manufactured, stock lines available, also special manufacturers' components made to specifications; armatures and fields wound and motors assembled.—Avis & Baggis, Ltd., 140-141, Friar St., Reading, Berks. [2715]

**INSTRUMENT** repair recalibration instrument cases, coils resistors made to order, designs prepared, prototypes, complete instrument kits, circuit details, etc.; stamp details.—Radio Development Co., Moretonhampstead, Devon.

**DRAWING** and tracing work for radio and electrical engineering, jig and tool and light engineering, photoprinting; full sets of drawings undertaken to commercial or Ministry standards.—Drawing & Tracing, Ltd., 456A, Eton Rd., Folworth, Surbiton, Middlesex, 7406.

**INDUSTRIAL** designer, extensive design and research experience on preformed ply and laminated furniture would co-operate with manufacturer desiring advanced work; conversant laboratory headaches; no rehashed sketches supplied, but first-class organic designing in association with works technicians; retaining or free.—Box 4233. [2912]

**WE** now have the capacity in our works to cope with the building of electronic gear to your specification; we are specialists in rack work, and are actual builders of test gear for the C.P.O. and our workmanship guaranteed.—For further information apply to Gem & Radio Service Co., 233, Cricklewood Broadway, London, N.W.2. Tel. Gladstone 6113. [2741]

#### MISCELLANEOUS

**LUMINUM,** 1/- sq ft; no order too small; s.a.e. for leaflets.—Bullanco, 66, Queens Rd., S.E.15. New X 1092. [2743]

# frequency calibration service

## 5/-

The frequency of any type or make of Quartz Crystal Unit will be measured, and a calibration certificate issued. Crystal Units are returned to the customer within 48 hours. For further particulars write for leaflet QC. 4812 to:—

**SALFORD ELECTRICAL INSTRUMENTS LTD.,** Peel Works, Silk Street, Salford, 3.

## The "ADCOLA" Soldering Instrument

Reg. Trade Mark.



Designed for Wireless Assembly and Maintenance.

Working temperature reached in 1 1/2 mins. consumption 25 watts, weight 2 1/2 ozs. Supplied in voltage ranges from 6.7v. to 230/250v. 3/4" diam. Copper Bit (standard model) 22/6. 1" diam. Copper Bit 25/-.

Replacement Unit Bit Elements available. British and Foreign patents.

Sole Manufacturers'

**ADCOLA PRODUCTS LIMITED**

Alliance House, Caxton Street, London S.W.1  
Write or Phone: WHI. 0030.

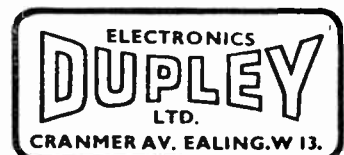

PHONE EALING 5688

## WILLIAMSON AMPLIFIER COMPONENTS

**OUTPUT TRANSFORMER £4 7 6**

TO DESIGNERS' SPECIFICATION

**MAINS TRANSFORMER £4 2 6**

**CHOKE, 20 HEN. 150 MA. £1 7 6**

**CHOKE, 35 HEN. 20 MA. 9 6**

Send for details of above and full range of standard transformers and chokes.

Manufacturers' enquiries invited

# BUILD YOUR OWN TELEVISION FROM Ex-Govt GEAR

At the cost of only a few pounds it is possible to build a Television Receiver, utilising Ex-Govt. Radar Units. The FULL CONSTRUCTIONAL DETAILS containing 26 large pages of data, photographs and wiring diagrams, can be purchased for only 7/6d., but if the undermentioned Radar Units are ordered the data is supplied gratis. Alternatively, the cost will be allowed if the units are purchased within 14 days.

UNIT 1 is a Vision Receiver IF Strip at 55/-.  
UNIT 2 is a Radar Indicator containing CR Tube etc., at 75/-.

**THE COMBINED HT AND EHT MAINS TRANSFORMER** is specially made, and costs 110/-. If this is ordered with the above units the total cost is ONLY £11/10/-, showing a saving of 10/-. Customers ordering by post are requested to add 12/6 carriage, plus 10/- deposit on a returnable packing case.

The receiver is of course designed for reception from Alexandra Palace, but for use in the Birmingham Area when transmissions start, it will only be necessary to utilise coils having slightly less turns, as the Birmingham Station is of a higher frequency. Midland Constructors are advised to purchase now, even if they do not intend to build immediately. Supplies of the Radar Units at the moment are ample, but the demand is very great. Please bear with us if there is a few days' delay in delivery as all orders are dealt with in strict rotation.

Optional items which are available are an Aerial, designed for indoor use, at only 15/-, and a Magnifying Lens which adds to the entertainment value by increasing the picture size, at 29/6d. (postage on each 1/6).

For the convenience of callers, we are two mins. from High Holborn (Chancery Lane Station), and 5 mins. from King's Cross (Buses 18b, 613, etc.). We are open from 9-6, Saturdays 9-1.

C.W.O. Please. S.A.E. for lists.

**THE RADIO CORNER**  
138 GRAY'S INN ROAD,  
LONDON, W.C.1.

(Phone: TERminus 7937)

★  
**'Radiospares'**  
**Quality Parts**  
The  
**Service Engineer's**  
**First Choice**



13CHL sending all gear, cheap; s.a.e. list.—87, Abbey Rd., Smethwick.  
W.W. June, 1942, onwards, clean cond; offers.—Kay Sorn Rd., Mauchline, Ayrshire.  
GENERAL printing, 7-day service.—Central London Press, 1a, Wood St., E.C.2, Mon. 1779.  
WARNING Winker neon and holders, 3 for 4/1.—22, Hengrove Rd., Bristol, 4.  
W.W., 1942-48 (inc.), comp. etc.; £5.—Broomhead, 69, Duxford Rd., Birmingham, 22A.  
W.W. WORLDS," Mar., 1936, to Dec., 1941; W offers.—Goodacre, Risegate, nr. Spalding.  
LONG range television with the Q5R9 aerial, folded dipole, two or multi-element; s.a.e.—Emdo, Moor Lane, Staines, [2786  
FOR sale, bound vols. 4 and 5 of "Wireless Engineer"; what offers?—Roe, 14, St. Mary's Rd., Llandudno, Caern. [2872  
WALNUT radiogram and television cabinets, a man's' samples, few only stamp details.—Watts, 501, Hale End Rd. E.4. [1763  
ROTARY beams for amateurs, 2 1/2 to 20 metres; masts, lashings, rotators, etc.; s.a.e.—Emdo, Moor Lane, Staines. [2787  
TRADE transfer, void and unack, your words, 7 days' delivery; also decorative transfers; list free.—W. W. Axon, Jersey, C.I. [2160  
FREE, receiver circuits, no obligation; send 1d. s.a.e for list to Hobbies Division, Jouglas Electronic Industries, Ltd., Brinklow, Rugby. [2755  
RADIO cabinets, 11 1/2x8 1/2x6in, manufacturer surplus, qual. timber, high gloss; 8/6, c.w.o., post 1/6.—Hughes Radio, Ltd., 194, Mill St., Liverpool, 8. [2854  
SPARKS' data sheets provide complete constructional details and full-size draughtsman-prepared prints showing drilling, assembly and wiring plans of tested and guaranteed designs by L. Ormond Sparks.  
LATEST release.—The Challenger portable, an ac/dc 5-valve (plus T.C.F. circuit having an exceptional performance on med. and long waves, the ideal set for radio in any room, no aerial or earth; 6in Stentorian speaker gives amazing power and quality; no complicated switching or adjustments; data sheet 2/9.  
COMPONENTS can now be supplied; send a stamp for list giving full details of the 34 designs available.  
SPARKS' DATA SHEETS (W.), 9, Phoebeth Rd., Brockley, S.E.4. Tel. Lee Green 0220.  
TIME switches, partly used, 14-day, 5 amp, 0 to 250 volt a.c. delivery; 22s. mercury sealed tube type, 10 amp., £2/10; cash with order.—J. Donohoe, 2, Upper Norfolk St., North Shields. [2849  
FRANCE.—Radio manufacturer offers accommodation in his home to a young Englishman on exchange for similar facilities in England for his son.—Enquiries to Cerutti, 23, Avenue Charles Saint Venant, Lille-Nord, France. [2792  
BRITISH Short-Wave League (founded 1935).  
Over 20 departments (QSL, Bureau, DX, Certificates, Technicals, Translations, etc.) for membership details send s.a.e.—H.Q. (W), 145, Uxendon Hill, Wembley Park, Middlesex.  
FLUORESCENT lighting, kit of parts, 210/- block, tube chips, adaptor, suppressor and circuit, but less the 5ft tube, 35/9, carr. free.—Malden Transformer Supplies, 200, Cambridge Rd., Norbiton, Surrey. [2919  
COPPER wires enamelled, tinned, Litz, cotton, silk covered, all gauges, E.A. screws, nuts, washers, soldering tags, eyelets; ebonite and laminated bakelite panels, tubes, coil formers; Tunfol rod; headphones, flexes, etc.; latest radio publications, full range available; list s.a.e.; trade supplied.—Post Radio Supplies, 33, Bourne Gardens, London, E.4. [1454  
RADIO cabinet, good class walnut veneered, French polished, undrilled, 12x7x7 1/4 (internal), 32/6 each, including dial; also speaker fabric, latest two colour inter-woven, cut from the roll, 14in wide 2/6 per foot, 18in 3/6 per foot; add accordingly; sound absorbing felt, 52in wide, 10/- per yard; post paid.—Burmans, 64, Reighton Rd., Clapton, London, E.5. [2874  
ALUMINIUM chassis and panels; standard sizes by return, special sizes made promptly; holes punched for valveholders, etc.; our or your items finished in black crackle or grey cellulose; estimates free; precision-built coil packs, T.R.F. 12/6, superhet 39/6, H.F. stage superhet £3; stamp for lists and data sheets; note new address.—E. A. D., 18, Broad Rd., Lower Willington, Sussex. [2775

**SITUATIONS VACANT**  
Vacancies advertised are restricted to persons or employments excepted from the provisions of the Control of Engagements Order, 1947.  
RADIO service engineer, fully qualified.—State experience and salary to Elliotts 45, Howarthgate Welwyn Gen. City, Herts. [2638  
RADIO and television service engineer; good wages and comfortable position for skilful man; Murphy, H.M.V., etc., agencies.—Write Box 4009. [2773  
TELEVISION engineers required for central service department of large chain store retail distributors.—Apply J. & F. Stone, 53, Worship St., E.C.2. [2863  
RATEFIXERS with experience of mass production of light electrical and radio equipment.—Write Box S.5715, A.K. Advg., 212a, Shaftesbury Ave., W.C.2. [2637  
VACANCY exists for scientifically minded person, preferably with experience, to undertake the processing of quartz crystals.—Write, stating wages required, to Box 3516. [2826

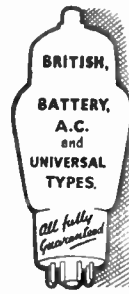

VALVES from 8/10 up. All at H.O.T. prices. You can order G.O.D. any valve type we may have if it is a rare and difficult type. Equivalents Charts, including Quick Reference Index, 1/8. BOOKS. You can order from us practically any publication required. Following titles just arrived. Foundation of Wireless, 7/6. Wireless Servicing Manual, 10/6. Television Rec. Equipment, 12/6. Radio Data Charts, 7/6. Radio Wave Interference, 2/6. Valve Application Manual, 5/-. Modern Battery Receivers, 2/6. Inductance Manual, 2/6. Frequency Modulation, 2/6. Communication Receivers, 2/6. BOOK LIST FREE

METERS. All models available, AVO, TAYLOR, etc. Easy terms on Taylor instruments.

CATALOGUES FREE  
Q-MAX 'Chassis Outlets, all sizes, at 12/6. Keys, 1-1. SOLDIER Multicores, 13 SWG, 400, 16 SWG, 3/3 POTENTIOMETERS, wire wound, 5 ohms, 1,000 ohms, 5,000 ohms, 10,000 ohms, 2/- each. 14-foot (seven sections) AERIALS, very rigid. Ex-Govt. Bargain. Post free 8/6. SERVICE SHEETS. Our best selection, 10/6 per dozen. We shall enclose you to include one sheet—your own choice—with every dozen if available. G.E.C. HOME BROADCASTER, 42/-.  
RUCCO MAINS NOISE SUPPRESSORS, 16/-.



## VIBRO TOOL

You can now ENGRAVE on anything, even the hardest Metal, Plastic, Glass, Wood, Leather, Jewellery, etc. Operates on A.C. mains. Plugs straight into any light socket. Every user enthusiastic. Pleasure to work it. Profitable, too. 26 pages illustrated Instruction Manual enclosed. Fully guaranteed. Price 12/6, plus 1/- postage. Introducing the new AE29 "SNAPPY" indoor television aerial kit. Fit your own indoor television aerial in five minutes.

In the greater number of televisions, the installation of an indoor television aerial is all that is required for adequate sensitivity. We have been experimenting with this type of aerial, and we can now supply all the necessary fittings that will enable you to install a television aerial in five minutes. Fixed in a jiffy, can be easily transported to the job in your coat pocket, as they are of the collapsible type. Simple yet efficient. Every item in the kit. All you need is a hammer and five minutes time. 15/-, plus 1/- postage.

VARIABLE CONDENSER. Midget two-gang fitted with trimmers and complete with perspex dust cover. These condensers made by 'Elioscopy' are of the type used for tuning person 1 receivers. Price 7/2 each. 5in. P.M. LOUDSPEAKER.—Plessey, less transformer—complete with dust bag. Price 12/6.

AUTO-TRANSFORMER. Biryce 100 watt 250n 110 volt out. Price 17/6.

MAINS DROPPER. Made by 'Erie,' drops approximately 130 volts at 2 amp.—tapped for rectifier anode. Vitreous enamel covered. An excellent replacement for line cord in midget receivers. Price 1/6. E.T. SMOOTHING. .03 mfd. at 5,000 volts 'Tropicalized,' 1/8 each.

MAINS TRANSFORMER. 350-0-350 @ 80 ma, 4 v. 4 amp. and 4 v. 2 amp. Price 20/3, plus 1/- postage. Mains Transformer, 260-0-260 @ 70 ma, 0.3 v. @ 3 amp., 5 v. @ 2 amp. Price 17/3, plus 1/- postage.

EX-W.D. HAND TORCH. This is quite a useful torch of very similar construction to an ordinary cycle lamp, with the exception that it is fitted with a hood and a coloured screen. Nevertheless, these items can be quickly removed when it becomes an almost standard torch to take the type 800 twin cell battery. The switch mechanism is rather better than most torches, and it is complete with bulb. Price 2/6 each. Metal case paper condenser, 01-1,000 v. working. Price 5/3 per dozen.

ELECTROLYTIC. 16 mfd. x 350 v. Dubilier drillite, 2/3. 16 mfd. x 450 v. B.E.C. can type, 3/-. 8 mfd. x 450 v. B.E.C., tag end type, 2/3. 8 mfd. x 16 mfd. x 500 v. B.E.C. can, 3/6. 16 mfd. x 16 mfd. x 450 v. T.M.C. cardboard, 4/6. 32 mfd. x 350 v. B.E.C. can type, 2/-. 50 mfd. 12 v. American can type, 1/-, 25 mfd. x 25 mfd. x 200 v. B.I. block, 5/3. 25 mfd. 25 v. midget tag end, 1/6. 10 mfd. 25 v. T.C.C. micro-pack, 1/3. 26 mfd. 50 v. B.E.C. cardboard wire ends, 1/6. P.M. LOUDSPEAKER. 5in., less output transformer (Plessey), 12/9. 5in., fitted output transformer (Plessey), 15/9. 6in., fitted output transformer, 17/6. 8in., fitted output transformer, 24/-. 10in., fitted output transformer, 33/9.  
Please address to: (W.W.)

RADIO **BULLS** VALVES  
246 HIGH ST. HARLESDEN HANTS

**L-R-S** FOR  
**PROMPT & EFFICIENT SERVICE**  
CASH or EASY TERMS

Goodman's "Axiom Twelve" Speaker Unit  
Cash price £8 8 0

Goodman's Standard 12" Speaker " £6 15 0

Barkers Natural Loudspeaker " £15 15 0

Callenders B.I. all-wave Anti-interference aerial ... £6 18 0

Avo Model 7 Meter ... £19 10 0

Avo Miner AC/OC Meter ... £8 10 0

Avo New Wide Angle Signal Generator ... £20 0 0

Avo Valve Tester, Complete ... £16 10 0

Collaro Radiogram Units—various models.

Stuart Centrifugal Electric Pumps for all pumping purposes.

Specifications of all the above on request.

Please write for our **EASY TERMS**.

**PERSONAL ATTENTION TO ALL ENQUIRIES**

**The LONDON RADIO SUPPLY CO.**  
Est. 1925  
**BALCOMBE, SUSSEX**

**ENGINEERS!**

Whatever your age or experience, you must read "ENGINEERING OPPORTUNITIES". Full details of the easiest way to pass A.M.I.Mech.E., A.M.I.E.E., A.M.I.C.E. CITY & GUILDS, MATRIC, etc. on "NO PASS—NO FEE" terms and details of Courses in all branches of Engineering—Mechanical, Electrical, Civil, Auto, Aero, Radio, etc., Building, etc. If you're earning less than £10 a week, tell us what interests you and write for your copy of "ENGINEERING OPPORTUNITIES" today—FREE!

**B.I.E.T.**  
Shaughnessy Hse.,  
17-19, Stratford Place,  
London, W.1.

**BRITISH INSTITUTE OF ENGINEERING TECHNOLOGY**

**108 PAGES Free!**

**COILS and PACKS for WEST COUNTRY CONSTRUCTORS**

ATKINS. Fully trimmed and padded.

OS.1.—Mixer Input, L. M. & S. Bands £2 9 4

OS.2.—" " M. & 2 S. " £2 9 4

HP.1.—H.F. Stage L. M. & S. " £4 0 1

HP.2.—" " M. & 2 S. " £4 0 1

COP.1.—A Six Band Communication Pack covering 5 metres to 2,000 " £8 11 10

DENCO. High efficiency tuning turrets having polystyrene coil formers and complete with tuning condensers, knobs and dials.

CT.6.—Mixer Input, 5 Ba, 10-2,000 m. " £6 0 9

CT.7.—As above with H.F. Stage " £8 13 0

Drilled Sub-Chassis for CT.6 and CT.7. " £2 12 6

CT.4.—The improved DENCO 6-band communication turret covering 5.5-1,700 metres, with band spreading on 5 amateur bands " £12 14 11

CT.4C.—As above with completely wired Sub-Chassis " £15 16 10

CT.4/SW.—As CT.4, with the broadcast band omitted " £9 6 0

WEARTE. With dust cover coils.

605B.—Mixer Input, L. M. & S. Bands. " £2 11 4

**G. N. PILL & PARTNERS**  
49, COBOURG STREET, PLYMOUTH  
Telephone: 2239

**ROYAL NAVY.**—Short service commissions in the electrical branch.

**SHORT** service commissions of five years are offered in the Electrical Branch of the Royal Navy to ex-R.N.V.R. officers under 35 years of age on 1st January, 1949, who served in the Torpedo, Special, Electrical or Air Branches and were employed on technical duties connected with radio, wireless, or radio, air electrical or ships' electrical equipments. Candidates will be entered in the substantive rank held on release, with seniority adjusted by the time out of the Service. Promotion will be in accordance with the regulations in force at the time for R.N. officers (e.g. a Lieutenant (L) is at present eligible for promotion to Lieutenant-Commander (L) at eight years' seniority). Officers who complete the full period of five years on the Active List will be eligible for a gratuity of £500 (tax free). Daily rates of pay are as follows: Sub-Lieutenant (L), 13/-; Lieutenant (L), after four years £1/4, after six years £1/6; Lieut.-Cdr. (L) on promotion, £1/12, thence in biennial increments of 2/- per day to a maximum of £2/2. Marriage allowance of £337 per annum if aged 25 or over, or £146 if under 25, is payable, and accommodation and rations are provided free, or allowances in lieu.—App'y to the Director, Naval Electrical Department, Admiralty, Queen Anne's Mansions, London, S.W.1. for fuller details and application forms. [2620]

**PROMINENT** engineering firm in North-West requires senior engineer having experience in development of centrimetric radio aerials and waveguide technique.—Rep'y Box 3515. [2623]

**TRANSFORMER** manufacturer of repute (London district) requires: chief engineer; exp. in design of audio and power transformers.—Write, stating age, exp. and salary.—Box 4255.

**EXPERIENCED** men and women required in the Cambridge area as testers on blind landing radio equipment; interesting work, profit sharing scheme; five-day week.—Box 4011. [2785]

**SERVICE** engineer, conversant: all principles makes repairs, television experience an advantage, man just released from Services, but suit; able to drive; single; East Anglia.—Box 4303. [2994]

**RADIO** tester required for radar and special electronic instruments, technical qualifications to N.C. or C.G. standard.—Write Box S.5776, A.K. Advn., 212a, Shaftesbury Ave., W.C.2. [2927]

**SALES** manager required to take full charge of the marketing of a range of domestic television equipment for a large manufacturing company having world-wide connections.—[2824] Box 4032.

**DRAUGHTSMEN** required immediately; must be experienced in electronic and electro-mechanical instrument design.—Write or call at Salford Electrical Instruments, Ltd., Chestergate Mill, Stockport. [2784]

**DRAUGHTSMAN** (senior) required in connection with electronic measuring instruments.—Apply, giving full particulars of qualifications and experience, to Marconi Instruments, Ltd., St. Albans, Herts. [2781]

**TELEVISION** and radio service engineer. [2781]

**Permanent** positions vacant on staff of large company with branches in provinces; scope for progressive men.—Full particulars, please, to Box 4152. [2945]

**FIRST-CLASS** radio engineer required for W.2 district, able to repair all makes of receivers, knowledge of television.—Write, stating age, experience, salary required, to Box 4271. Married man preferred. [2945]

**RADIO** mechanic required to make up prototype type equipment in industrial electronic laboratory; good prospects for career; manufacturing, Surrey area.—State experience, age and salary required to Box 4240. [2936]

**TESTER** required (N.W. London), experienced in production, final test ng of superhet receivers; basic theoretical knowledge of superhet; principles essential; state age, experience and salary required.—Box 4321. [2993]

**SALES** engineer required for head office staff of well-known company in Hertfordshire; applicants must possess necessary technical qualifications and experience of X-ray and electro-mechanical apparatus.—Box 4028. [2922]

**RADIO** production engineer wanted, must be fully experienced and capable of organising large production, first-class qualifications essential; factory situate South Wales.—Box GA 749.

**AIRCRAFT** radio and radar mechanics, mathematicians and instrument mechanics required.—Write full details of experience to Signals Superintendent, Lancashire Aircraft Corporation, Soyvingdon Airport, Hemel Hempstead.

**ASSISTANT** required for radio component A.A. mail order distributors, keen youth or ex-R.A.F. would suit—good prospects and opportunity to grow with firm; salary according to ability.—Write N.R.S., 102, Parkhill Rd., London, N.W.5. [2961]

**TESTERS** required experienced in receiver, transmitter or electronic instrument engineering for work in S.W. London area; commencing salary according to experience and ability.—Apply Box W.939, L.P.E., 110, St. Martin's Lane, W.C.2. [2822]

**FIRST-CLASS** mechanical designers required—men with experience in the design of domestic radio receivers and components preferred.—Applications in writing to Personnel Department, Murphy Radio, Ltd., Welwyn Garden City, Herts. [2461]

**CLYDESDALE**

For Ex-Service Electronic Bargains.

T.1154 XMTB. 4 W.B. MODEL, with valves plug/skts., and circuit (less Power pack) at £10/10- each, also 3 W.B. Model as above £7/18/6 each, carr. paid.

R.1155 RECEIVER, 5 W.B. MODEL, 13-3 mc/s., 1500-600 kc/s., 500-75 kc/s., 10 valves construction and D.P. with valves, pl./skts. and circuit (less power pack) at £12/12/- each, carriage paid.

Brand New in maker's cartons. 38 A.F.V. XMTB/RCVR., frequency 7.5-9 mc/s., 6 valves, complete with 12 v. vibrator in two units, with spares, aerial and instruction book (less junction cable) at 79/6 per set carriage paid.

A.1134A AMPLIFIER, 2 valves, 2 stages, intercom., etc. (Complete less batteries) at 110/6 each post paid.

A.1218 AMPLIFIER, 2 valves, 2 stages relay controller pre-ampl., complete (less batteries) at 12/6 each. Post paid.

SILICON CRYSTAL DIODE C.V.102 at 5/- each.

JOHNSON "JUMBO" VALVEHOLDER FOR C.V.57 etc. II.V. porcelain base, retaining clamp at 2/6 each or 25/- per doz.

Send now for 112 page list No. 5. Print name and address.

**CLYDESDALE SUPPLY CO., LTD.**  
2, Bridge St., Glasgow, G.5. Phone 800th 2706/9  
Visit our Branches in Scotland, England and Northern Ireland.

**MORSE CODE TRAINING**

There are Candler Morse Code Courses for BEGINNERS AND OPERATORS

Send for this Free "BOOK OF FACTS" It gives full details concerning all Courses.



**THE CANDLER SYSTEM CO.**  
(Room 55W), 121 Kingsway, London, W.C.2  
Candler System Co., Denver, Colorado, U.S.A.

**BULLS RUISLIP DEPOT OFFER**

**TELEVISION AERIAL**—tubular aluminium—designed for fitting in the loft, bedroom, boxroom, etc., 15' post free. Outdoor type 37/6.

**MASK** white plastic—designed to suit 6in.tube. Will put professional finish to your home-bult television. 7/6 post free.

**MAGNIFIER**—super quality—39/6, others very good from 27/6.

**SPANNER KIT**—nothing speeds up work—saves time and earns money quite like a good set of good spanners. We can offer a kit of 50 Spanners including 10 ring types, which cover Whitworth 1/16in.—1in. B.A. sizes 0-6 and American threads sizes 1/16in.—1in. With this kit you will be able to service British and American equipment—refrigerators, radios, cars, lorries, tractors, etc., etc. £7 10s. Od. carriage free.

**SPARES**—electrolytics, 450-500 v. working; 8 mfd.—1/11, 16 mfd.—2/8, 8 mfd. x 16 mfd.—3/4, 16 mfd. x 16 mfd.—3/8; 350 v. working; 8 mfd.—1/8, 16 mfd.—1/11, 32 mfd.—1/11, 200 v. working; 25 mfd. plus 25 mfd.—3/11, 32 mfd.—1/8; Cathode bias types 50—12 v.—10d., 25 v.—30 v.—1/5, 25 v.—25 v.—1/-, 10 v.—25 v.—10d., P.M. SPEAKERS, best makes Rola R. & J. Plessey, etc.—3in.—11/9, 5in.—11/9, 6in. with O.P.T.—13/9, 6in. with O.P.T.—17/6, 8in. with O.P.T.—17/9, 10in. with O.P.T.—27/9.

**MAIN TRANSFORMERS**—standard primaries, 6.3 v. 3 amps, 5 v. 2 amps, 250-0-250, 60-70 m.a. 13/9, plus 1/3 postage.

**NOTE.**—All the above parts are recently manufactured definitely not Government Surplus. Orders over £3 post free, otherwise include extra 2/- for postage.

Electron House, Windmill Hill, Ruislip Manor, Middlesex.

**ELECTRON HOUSE, WINDMILL HILL, RUISLIP MANOR, MIDDLESEX.**

# ALEC DAVIS

SUPPLIES LTD.

## Special Offer

### 14ft. AERIAL MAST

Carr. paid 4/9 complete  
Consists of two lengths of paxolin tubing 2½ in. and 3¼ in. dia. respectively, with 3/16 in. wall. The smaller tube fits tightly into the larger, both having metal ends. When fitted, the aerial has an over-all length of 14ft. Ideal for a transmitting or receiving aerial, but has many other uses also. May be fixed to a fixture such as a chimney, wall, etc. Very sturdy.

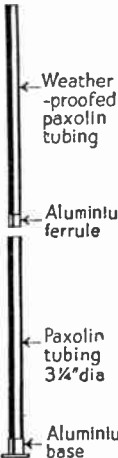

## ALEC DAVIS SUPPLIES LTD.

18 Tottenham Court Rd., London, W.1. Tel. MUS. 4539 and MUS. 2453

**E**LECTRICAL laboratory assistant required for routine measurements of magnetic and other alloys, room temperature. State experience and technical qualifications to Box 4037. [2837]  
**D**RAUGHTSMAN required for transformer division of well-known West of England manufacturers, preferably with some experience of small transformers up to 50 kVA; interview and preliminary training in London area.—Write Box 4036. [2836]

**P**HYSICISTS required by manufacturers in South-East England to carry out work on semi-conductors, phosphors, etc.; applicants should preferably have some experience of work on electronic equipment.—Apply, quoting Ref. 192, to Box 4027. [2796]

**R**.F. heating sales engineer, preferably with wide experience in industrial applications of dielectric and induction heating, required by Manchester branch of a large well-known firm of engineers; state age, experience and salary required.—Box 4030. [2820]

**D**RAUGHTSMAN, experienced, for mechanical constructional design work; National Certificate standard preferred.—Apply to the Secretary, W. Marconi's Wireless Telegraphy Co., Ltd., New St. Chelmsford, stating age, education, experience and salary required. [2891]

**S**ENIOR research engineer required with honours degree in electrical engineering or physics, for advanced work on radar, radio and electronics.—Apply, quoting Ref. 187, to Central Personnel Services, English Electric Co., Ltd., Queens House, Kingsway, W.C.2. [2629]

**A** VARIETY of positions vacant for experienced senior and junior development, research engineers and draughtsmen, for radio, electronics, television, radar, speakers, preference H.N.C., as inspectors, repairers, service engineers, etc.—Technical Employment Agency, 179, Clapham Rd., S.W.9 (Brixton 3487). [2927]

**S**ENIOR engineer required by leading firm of radio capacitor manufacturers; applicant must have sound knowledge of circuit techniques and be capable of carrying out the development of highly specialised test gear; post within 20 miles radius of London; salary according to experience and qualifications.—Box 4002. [2759]

**T**ELEVISION assembly line foreman required by expanding manufacturer in North-West London area; applicants must have ability to organise female labour and have extensive and recent experience of quality mass production of television receivers; a permanent post and good salary for a man with the right qualifications. [2866]

**R**ADIO engineers required for development work on communication equipment by large and progressive company in the East London area; applicants should have technical education to degree standard and some experience of electronic research; state full details, including age and salary required, to Box 4004. [2763]

**R**ADAR technical writer of mature technical experience, capable of writing technical descriptive matter and technical handbooks, in co-operation with the appropriate development engineer, required by large light engineering company, East London district.—Apply in writing, stating age, experience and salary required, to Box 4241. [2937]

**R**ADIO service engineers, suitable for television training and permanently resident in Warehambury and Wolverhampton, required immediately by leading radio manufacturer; clean driving licence essential and ownership of private car an advantage; good working conditions and pay; only first-class men should apply to Box 4010. [2777]

**E**NGINEER with television and radio aerial experience, to take full charge of Midlands branch dealing with aerial installations and the wholesale trade; able to direct staff and transport; partnership possible to applicant; Midlands resident preferred; possibilities to industrious, progressive technician.—Full particulars to Box 4029. [2808]

**R**ADIO service engineer required for provincial firm of high standing, must be to first-class technical standard, and have considerable practical experience, knowledge of television an advantage; wage according to ability and confirmed after one month's probation.—Apply to Messrs. Barnes & Avis, Ltd., 140/1, Friar St., Reading. [2774]

**D**EVELOPMENT engineer required for work on experimental types of cathode ray tubes; applicants should have had practical experience in the design, development and manufacture of cathode ray tubes.—Apply, giving details of qualifications, experience and salary required, to Personnel Department, C/F, E.M.I. Factories, Ltd., Blyth Rd., Hayes, Middx. [2917]

**S**ENIOR development engineers required by large firm in the Midlands engaged in the development of radio communication equipment of various types; applicants should be able to undertake the complete development to the production stage; competitive salaries are offered to engineers having the necessary qualifications and experience.—Quote age, qualifications and experience to Box 4150. [2840]

**S**ENIOR chemist required by new chemical laboratory in Essex engaged on research in the electronic field; applicant must have B.Sc. in chemistry and not less than seven years' experience of chemical research, preferably in connection with electronic engineering; a flat in the country will be available for the successful applicant.—State full details of experience also age and salary required, to Box 4183. [2870]



Denco Maxi-Q Coils have the following features:—  
High Q—Litz Windings on Polystyrene Formers—  
Adjustable Iron Dust Cores—Two types available,  
Chassis Mtg.—has Single 'B.A. fixing, or Plug-in  
type fits Standard Octal Valve Holder.  
7 Ranges available, in Aerial, H.F. and Oscillator  
coils covering:—

3.6 to 6 Metres	20-60 Metres.
6 to 10 " "	56-180 " "
9 to 30 " "	190-370 " "
560 to 1,800 Metres.	

Wiring instructions supplied with each coil.  
Price: Chassis Mtg. type, 3/9 (or with Reaction, 4/9 each).  
Plug-in type, 4/- each (or with Reaction, 5/- each).

**C.T.6 Coil Turret.** Completely assembled highly efficient Tuning Unit, designed for Superhet using Triode Hexode or similar Mixer on 465 K/C. has five ranges covering:—

10 to 50 Metres.	200-560 Metres.
25 to 75 " "	750-2000 " "
75 to 200 " "	and GRAM position.

Use of Polystyrene Insulation, Plated Contacts, and High-Q Coils with Adjustable Iron Dust Cores ensures very high performance.

Price £2/10/6 (plus 21/3 P.T.)  
Includes 2-Gang Cond., Trimmers, Padders, etc. Has attractive Glass Dial, 8 in. x 6 1/2 in., with five clear vertical scales showing Station Names and S/Motion Control Tuning, Circuit and Calibration instructions included. C.T.7 Coil Turret, similar in appearance and construction as C.T.6, having same Dial and Calibration, but has important addition of an R.F. Stage, Plywheel Tuning and a Double Pole Switch which isolates Radio Circuits when switched to GRAM and vice versa. Price £7/2/6 (plus 30/6 P.T.)

Includes circuits and detailed instructions.

**Complete Kit of Parts, comprising 5 Valves plus Metal Rectifier to build five W/Band A.C./D.C. SUPERHET.** Uses C.T.6 Coil Turret (described above) covering 10 to 2,000 Metres, the stages being Mixer (C.G.H.35) I.F. Amplifier (E.F.39) Det. A.V.C. and let A.F. (E.B.C.33) Tuning Indicator (E.M.34) Output (C.L.33). Building is made easy, the Tuning and I.F. Units being assembled and aligned at Denco factory, thus ensuring a high performance. Has four controls.—Tuning, Tone, Volume and W/Band Switch (with Gram position) and gives 4/5 Watts output, convenient size of 12 in. x 8 in. x 1 1/2 in. high. Wiring diagram and comprehensive building instructions included. Price £11/11 (plus £2/9/5 P.T.)

**Television Components.** Efficiently Screened Line Output Transf. 27/-, Scanning Coil, Assembly for 9 in. and 12 in. Tubes, 33/-, Focus Coils, Thumb Screw Adjustment, suit Electronic circuit, 25/-, Line Time Base Blocking Oscillator Unit, 25/-, I.F. Transf., Litz Wound, Ferru Tuned, gives variation of ±5% by adjustment of Core available for 465 K/C., 1.5, 3, 5 or 10 M/c. size 1 1/2 in. sq. x 8 in. Price 16/6 pr. (Also miniature type available, 1 in. sq. x 2 1/2 in., 18/- pr.)

Other available Denco Products are listed in a most comprehensive and detailed Catalogue. Price 9d. EXPORT AND TRADE ENQUIRIES INVITED.

**DENCO DISTRIBUTORS LTD.**  
115, FLEET STREET, E.C.4.  
Tele.: CENTRAL 5814 and 2280.

# TELERADIO

Radiogram Equipment

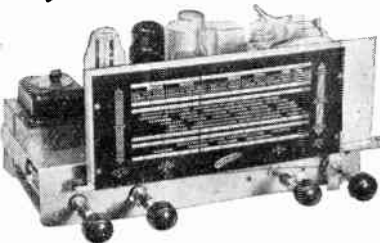

**MODEL A70.** 6 valve all wave modern superhet chassis with tuning indicator, tone control and radiogram switch. The ideal replacement chassis. £14 14 0d. plus £3 3 3d. Purchase Tax.

**MODEL 70 TU.** As above but as 3 valve tuning unit feeding model 77 amplifier £8 0 0d. plus 34/10d. Purchase Tax.

**MODEL 77.** 4 valve push pull amplifier with 2 6V6 fed by phase inverter. Approx. 8 watts output £9 5 0d.

Send for leaflet to:

**THE TELERADIO CO.,**  
157, Fore St., Edmonton, N.18  
also at 224, Chingford Mount Rd., E.4  
and 668, High Road Tottenham, N.17

**"WEYRAD"**

CRESCENT WORKS, WEYMOUTH

**3-WAVE****MIDGET****COIL PACKS**

SIZE 3" x 2 1/4" x 1 1/2".

AVAILABLE IN 4 TYPES:—

\*B5 { SHORT, MEDIUM & LONG  
B6 { WAVES.\*B7 { 12.5-37, 33-100, & 200-550  
B8 { metres.

★ Tuned with 365 pF.

PRICE **35/-** (+ 7/10 P.T.)SPECIAL TUNING SCALES AND  
DRIVES CAN BE SUPPLIED.**A.B. OAK**PATENT Nos.  
47891-  
47892.**wafer switches**The wave-change switch with silver plated  
double contacts.**A.B. METAL PRODUCTS LTD.**,  
Great South-West Road, Feltham, Middlesex.London Office:  
Ludgate House, 107, Fleet Street, E.C.4.  
Tel.: Central 5667/8.**FORREST**

(EST. 1922)

**FOR  
QUALITY**

- TRANSFORMERS
- CHOKES, ETC.
- REWINDS (all makes)

SHIRLEY, BIRMINGHAM. SHI. 2483

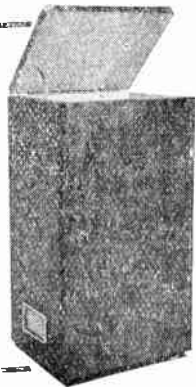
**IAN BAILEY REPRODUCER Series 2**

A horn-type speaker which supersedes the original Ian Bailey C.H., but measuring only 3ft. 2in. high by 1ft. 9in. wide, 1ft. 4in. deep, giving an actual range of 20-18,000 c.p.s. Transient response is outstanding.

In walnut (other finishes to order), complete with L.S. unit.

PRICE **£33**

Send stamp for details.

**ELMSLEIGH RADIO CO.**1102 London Rd., Leigh-on-Sea, Essex  
Leigh-on-Sea 75168

**T**ECHNICAL assistant required for prototype testing and development of radio and electronic measuring instruments.—Apply, giving full particulars of qualifications and experience, to Marconi Instruments Ltd., St. Albans, Herts.

**R**ADIO engineers required for development and design of communications equipment by prominent firm in S.W. London; experience essential.—Reply, stating qualifications, experience, salary expected, and when available, to Manning Director, Box 57, Scientific Publications, Cliffords Inn, Fleet St., E.C.4.

**L**ABORATORY assistant required to act as assistant to a senior technician engaged in the development of valves, must possess experience in measuring the characteristics of radio valves and/or have an adequate knowledge of associated circuits, age 21-25 years; salary, £250-£350 per annum; applicants should state past experience and qualifications.—H.vac. 141.

**D**RAUGHTSMEN for development and design of radio communication equipment; drawing office experience in the production of electro-mechanical apparatus essential; applicants should be of National Certificate standard.—Apply to the Secretary, Marconi's Wireless Telegraph Co., Ltd., New St., Chelmsford, stating age, education, experience and salary required. [2818]

**W**ANTED, ex-R.A.F. radar mechanics now on Senior N.C.O. rank, by the Government of India for service as civil air radar instructors in Royal Indian Air Force training schools, in India on a contract basis for 3 years.—Apply Air Adviser's Department, Office of the High Commissioner for India, in the United Kingdom, India House, Aldwych, London, W.C.2. [2810]

**E**LECTRONIC engineer or physicist required to take charge of a department engaged on the design and construction of special purpose electronic test gear; a suitable applicant must have an Honours Degree in Electrica, Engineering or Applied Physics, and previous experience of the class of work; state qualifications, experience, age and salary required, to Box 4013. [2791]

**E**LECTRONIC development engineer wanted for the Australian Division of a large aircraft organisation, minimum qualifications are engineering or physics degree, with three years' research and development experience; single men preferred due to accommodation difficulties in Australia; applications should give full details of education, experience, and salary required.—Box 4213. [2890]

**W**IREMAN required, able to wire prototype electronic apparatus, working direct from circuit diagram; accustomed to interpreting diagram and making initial cable forms and setting job on production basis; first-class opportunity for competent man to join staff; excellent prospects of early advancement for right man.—Apply, giving full particulars of experience, to Marconi Instruments Ltd., St. Albans, Herts.

**B**USH RADIO, Ltd.—Applications are invited from experienced radio engineers for the following position: (a) development work on communications and domestic radio receivers; (b) development work on test gear for quality control, television production laboratory use; apply in writing only, giving age, details of experience, qualifications, salary required, etc., to: The Labour Manager, Bush Radio, Ltd., Power Rd., Chiswick W.4. [2797]

**W**ELL-KNOWN electrical and radio company in Essex require foreman for coil winding dept. must have wide experience in test and i.f. winding, fully conversant with up-to-date methods of manufacture and good knowledge of operation layouts, material control, time study application, and be used to controlling approx. 300 female operatives; only men with first-class experience, initiative and drive need apply, stating age, experience and salary required, to Box 4330. [3002A]

**D**RAUGHTSMEN, senior and junior, are required in the research and development division of a large manufacturer in the East London area; preference will be given to draughtsman with electronic experience, but all men with good drawing office experience will be given the most careful consideration; the vacancies are in connection with a development project that holds excellent prospects for the future.—State experience, age and salary required to Box 4012. [2790]

**M**URPHY RADIO, Ltd., invite applications for the following vacancies in the electrical design laboratory: (1) Senior radio engineer, with good honours degree in physics or electrical engineering and several years' industrial experience in television or radio receiver development. (2) Radio engineer, with good academic qualifications in physics or electrical engineering, preferably with some industrial experience.—Apply to Personnel Dept., Murphy Radio, Ltd., Weyn Garden City, Herts. [2618]

**E**LECTRICAL engineers, sound electrical knowledge to Degree standard; background training in process development, including welding technique, electrical measuring control devices, H.F. measurements and electrical measurements generally; write age, details of experience, etc. also juniors, age 20 to 25 years free from Military service taking 12 week course at day or night school, for position as laboratory assistants; Enfield district, N. London.—Write Box 6360, Frost-Smith Advg., 64, Pinsbury Pavement, E.C.2. [2806]

**HILL & CHURCHILL LTD.**

BOOKSELLERS

**SWANAGE, DORSET**

Available from stock

" Vacuum Tube Amplifiers "—M.I.T. Vol. 18	... ..	60/-
" Elements of Acoustical Engineering "—Olson	... ..	42/-
" Network Analysis and Feedback Amplifier Design "—Bode	... ..	42/-
" Electromagnetic Waves "—S. A. Schell-knoff	... ..	42/-
" Field and Waves in Modern Radio "—Ramo and Whinnery	... ..	33/-
" Radio Engineering "—D. Fink	... ..	42/-
" Telephony " Volume I—J. Atkinson	... ..	35/-
" Antennae "—J. Aharoni	... ..	25/-
" Radio Engineering " Volume I—E. K. Sandeman	... ..	45/-

Postage Extra.

CATALOGUE ON APPLICATION



Time Limit fixed under Town & Country Planning Regulations 1 Work has been started on the last batch of Iomestio detector type (corner forms to be made at this address. Price in the white £47-10-0 ex-works. Future outlook "unsettled", don't miss the bus. "units sold Feb. advt.

**VOIGT PATENTS LTD.,**  
15, SILVERDALE, S.E.26

Owing to Mr. Voigt's health, demonstrations only by special arrangements.

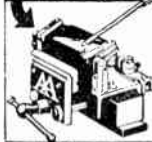
**THIS Does these**

**ACCU RATELY and QUICK LY**  
(hasis, 'rackets, 'hrouds, (ondenser and Transformer clips—  
TREPANNING Steel or Aluminium  
Five sizes—12" to 36"

Full particulars from  
**A. A. TOOLS (W),**  
197A, WHITEACRE ROAD,  
ASHTON-UNDER-LYNE

**QUARTZ  
CRYSTAL  
UNITS**

For— **AIRCRAFT, MARINE AND  
COMMERCIAL USE** are available in  
the complete range from 35 kilo-  
cycles to 15 megacycles.

Alternative mountings in standard  
two-pin A.M. pattern 10X, International  
octal, and miniature type FT243, can be  
supplied for most frequencies.

Prices are fully competitive, and  
we specialise in prompt deliveries for  
urgent requirements.

**WE WELCOME YOUR ENQUIRIES.****THE QUARTZ CRYSTAL Co., Ltd.**63-71 Kingston Road,  
NEW MALDEN, SURREY

Telephone: MALden 0334

# 3 AMPLIFIERS

that meet all needs

## 3 WATT . . . 11 Gns.

P.14.—A highly portable amplifier—t weighs only 10 lbs. and is suitable for outdoor use. Works from a low power supply of 2 amps. at 6 volts. Built into case 13in. x 6½in. x 4in. with controls and sockets at one end.

## 15 WATT . . . 66 Gns.

P.10.—A quality amplifier in which the HT supply is carefully filtered and all components conservatively rated. No electrolytic condensers are used in any part of the circuit. Switch correction is provided for Decca and HMV recordings. Mounted on polished chromium plated chassis.

## 20 WATT . . . 26 Gns.

P.16.—Designed for universal mains supply, its output of 20 watts is exceptionally high. Total harmonic distortion at full output is only 4 per cent. and hum level is unusually low. Weight, 17 lbs. Overall size 15½in. x 7½in. x 8½in.

Write for leaflets giving full details.

# M c M U R D O

INSTRUMENT CO. LTD.  
Victoria Works, Ashtead, Surrey

# MINIATURE COMPONENTS

**TUNING CONDENSERS.** Two gang 560 μf. max. 2½in. x 2in. x 1¼in., ½in. spindle, ½in. long, 8/6.

**IF TRANSFORMERS.** Permeability tuned, 1½in. x ½in. x ½in., 465 Kc., 14/6 per pair.

**VALVE HOLDERS.** Button base type. For 1R5, 3S4, etc. Paxolin, 8d. Ceramic, 1/3.

Screening cans for the above holders, complete with retaining spring and base, 1/6.

**POTENTIOMETERS.** 1 megΩ, 1in. diameter, ½in. shaft, ½in. long, 2/-.

**CONDENSERS**  
Paper tubular. .1 μf., 150 v., ½in. x ½in., 6d. .05 μf., 350 v., ½in. x ½in., 6d. each.

Ceramic tubular. ½in. x ½in., 33 μf., 40 μf., 47 μf., 50 μf., 6d. each.

Mica. ½in. x 7/16in. x 3/16in., 20 μf., 50 μf., 50 μf., 200 μf., 1,000 μf., 6d. each.

Electrolytic. 8 mfd., 350 v., ½in. diam., 1½in. long, 3/6.

**RESISTORS.** Midget ½ watt, ½in. diameter, ½in. long, 100Ω, 150Ω, 220Ω, 330Ω, 500Ω, 2,200Ω, 10,000Ω, 47,000Ω, 100,000Ω, 150,000Ω, 330,000Ω, 470,000Ω, 1.3 megΩ, 10 megΩ, 6d. each.

**OUTPUT TRANSFORMERS.** R.M., Multi ratio, 1½in. x 1½in. x 1½in., 45 ma., Primary current. Ratios 13-20-26-52 to 1, 7/11 each.

All the above components are Manufacturers' or Government surplus and are in brand new condition. All made by well-known manufacturers.

A complete list of other components is available.

Trade list issued.

# M. WATTS & Co.

8 Baker Street  
Weybridge, Surrey

Telephone: Weybridge 2642.

**S**ERVICE manager for well-known retailer; applicant should be practical radio and television engineer with pre-war experience. Resident adjacent to Pinner, Harrow or Wembley; suitable wage will be paid for ability.—Write Fox 4003. [2772]

**Q**UALIFIED testers required for Radar equipment, electronic instruments, radio transmitters and receivers; technical qualifications City and Guilds standard with practical experience on testing and alignment of the above equipment; good salary is offered to men who have the necessary qualifications and experience; works are in the London area.—Write City and Guilds, 1, Great Newport Street, London, W.C.2, to Box S/5853, A.K. Advg., 212a, Shaftesbury Ave., W.C.2. [2859]

**A**PPPLICATIONS are invited from all grades of development engineers having qualifications to degree standard or equivalent for vacancies in the development laboratory of a large firm engaged in the production of numerous fields of electronic equipment involving h.f., v.h.f., cm and television techniques; excellent prospects are offered, particularly to engineers having the necessary training.—Applicants should quote full details of qualifications, experience, age, etc., to Box 4147. [2839]

**V**ACANCIES exist in a manufacturer's service department in North London for two radio engineers and two television engineers (16 17); education to School Certificate standard and adequate technical training are essential in the former case, whilst applicants for the latter position must have School Certificate and an interest in radio.—Applications, giving full details of education, technical training, experience, age and salary required, to Box 325, c/o Era Publicity, Ltd., 7, Fitzroy Sq., London, W.1.

**M**ICHAEL RADIO, Ltd., require senior project engineers in their equipment division development laboratory at South; these appointments are of a stable and progressive nature, satisfying the keenest appetite for the expression of initiative and the acceptance of responsibility; training and experience in the field of applied electronics (including communications) and experience of working in a Government department are the chief qualifications required; salary will be commensurate with ability.—Write stating age and full details of training, qualifications and experience to the Chief Engineer, Equipment Division, McMichael Radio, Ltd., 2683 South Buckle Street, London, W.12. [2683]

**C**ONTINUED expansion of the E.M.I. Electronics College has created further vacancies for lecturers in radio communications; two lecturers whose duties will include some technical writing are required immediately; applicants should possess a good Physics or Electrical Engineering Degree and also experience in radio, television, etc.; age 22-28; commencing salary according to age, qualifications and experience, not less than appropriate Burnham scale; superannuation benefits in addition.—Apply giving fullest possible particulars to Professor H. F. Trewhman M.A. (Cantab.), M.I.E.E., M.I.Mech.E., M.Brit.I.R.E., E.M.I. Institutes, Ltd., 45, Grove Park Rd., London W.4, Tel. Chiswick 4077. [2725]

**E**. K. COLE, Ltd. (Malmesbury Division), invites applications from electronic engineers for permanent posts in development laboratories engaged on long-term projects involving the following techniques: (1) Pulse generation and transmission. (2) Servo mechanisms. (3) Geometric and V.H.F. systems. (4) Video and feedback amplifiers. There are vacancies in the Senior Engineer, Engineer and Junior Grades. Candidates should have had at least 5 years' industrial experience in the above types of work, together with educational qualifications equivalent to A.M.I.E.E. examination standard. Commencing salary and status will be commensurate with qualifications and experience. Excellent opportunities for advancement are offered, with entry into a superannuation scheme after a period of service. Forms of application may be obtained from Personnel Manager, Ekco Works, Malmesbury, Wilts. [2833]

**T**HE MINISTRY OF SUPPLY invites applications for establishments appointments as Technical Author II or Techn. Author III. Candidates, who must be of British nationality, born of British parents, must have attained a good general standard of education and be able to provide evidence of a sound technical training, a recognised apprenticeship and practical experience in aeronautical, mechanical, electrical or radio engineering; duties of the post are: preparation of technical publications, writing of descriptive notes, compilation of instructions on servicing, maintenance and repair, on aircraft and associated equipment used by the Royal Air Force and the Royal Navy; the subjects include airframes, aero engines and all associated airborne and ground equipment (armament, instruments, electrical, radar and telecommunications, electronics, propellers, hydraulics, pneumatics, general mechanical engineering, marine craft, photographic, chemistry of explosives, etc.); salary range: Technical Author II, £470-£595; Technical Author III, £380-£495; written applications stating age, name and address of present employer and full particulars of experience, in chronological order, to the London Appointments Officer, Ministry of Labour and National Service, 1-6, Tavistock Square, London, W.C.1, quoting reference No. KU275; in no circumstances should original testimonials be forwarded; only candidates selected for interview will be advised. [2846]

## THESE ARE IN STOCK

**Radio, Television and Electrical Repairs.** Ed. R. C. Norris. 10s. 6d. Postage 9d.

**Using Ex-Service Radio Apparatus.** By D. W. Thomasson. 2s. 6d. Postage 2d.

**The Amplification and Distribution of Sound.** By A. E. Greenlees. 16s. Postage 6d.

**Handbook of Industrial Electronic Circuits.** By J. Markus and V. Zeluff. 39s. Postage 9d.

**Vacuum-Tube Circuits.** By Lawrence. Baker and Arguimbau. 36s. Postage 9d.

**Radar Primer.** By J. L. Hornung. 21s. Postage 6d.

**Radio Engineering.** By F. E. Terman. 42s. Postage 9d.

**Television.** By M. G. Scroggie. 6s. Postage 4d.

**Television Receiving Equipment.** By W. T. Cocking. 12s. 6d. Postage 4d.

**Wireless Servicing Manual.** By W. T. Cocking. 10s. 6d. Postage 4d.

**Radio Tube Vade-Mecum.** 1946 Edition. By P. H. Brans. 5s. Postage 6d.

**An Introduction to the Theory and Design of Electric Wave Filters.** By F. Scowen. 15s. Postage 4d.

We have the finest stock of British and American radio books in the Country. Complete list on application.

# THE MODERN BOOK CO.

(Dept. W.3)

19-23, PRAED STREET, LONDON, W.2

# OPPORTUNITIES IN RADIO



Get this FREE Book!

"ENGINEERING OPPORTUNITIES"

reveals how you can become technically-qualified at home for a highly-paid key-appointment in the vast Radio and Television Industry. In 208 pages of intensely interesting matter, it includes full details of our up-to-the-minute home study courses in all branches of TELEVISION and RADIO, A. M. Brit. I.R.E., A.M.I.E.E., City & Guilds, Special Television, Servicing, Sound Film Projection, Short Wave, High Frequency, and General Wireless Courses.

We definitely Guarantee "NO PASS—NO FEE"

If you're earning less than £10 a week, this enlightening book is for you. Write for your copy today. It will be sent FREE and without obligation.

**BRITISH INSTITUTE OF ENGINEERING TECHNOLOGY**  
388b, Shakespeare House,  
17, 19, Stratford Place, London, W.1.

## HOT NEWS! FIRST ANNOUNCEMENT

"Sound Magnet" Tape Recording Outfit £30.

Records—playback—erase, speech and music by exclusive method for high quality. With amplifier and speaker in leather cloth case.

"Car-Announcer" Mobile P.A. Outfit £15.

For smallest car, sports events, traffic control, election campaigns.

"Hi-Low" Dual Channel Gramo Audio £12.

Separate amps, driving 10in. and 2½in. units, for quality. Also available as kit.

"Car-Pal" Dual Purpose Superhet, £15. Car-radio or portable as desired. Superhet with H.F. stage from vibrapak.

Threepence in stamps brings you data on any of above new productions.

**GENERAL LAMINATION PRODUCTS LTD., DEPT. SR., 294, BROADWAY, BEXLEYHEATH, KENT.**

## AUDIO FILTERS

Field-free, Hi-Q, Toroidal Windings. Permalloy Cores—Permanent Accuracy. Low, High, Band-pass or Cross-over. ADJUSTABLE Whistle and Scratch Extractors.

**LYNCAR LABORATORIES**

29, Camborne Road, Morden, Surrey, LTB. 3447

## BRASS, COPPER, DURAL, ALUMINIUM, BRONZE

ROD. BAR. SHEET. TUBE. STRIP. WIRE.  
3,000 STANDARD STOCK SIZES

No Quantity too Small List on application

London: **H. ROBERTS & Co., Ltd. Liverpool: 3, Chesham Place S.W.1. Kirkby Estate. SLOane 3463 SIMONSWOOD 3271/3**

## "HIGH FIDELITY" PERFORMANCE AT TRULY LOW COST.

"THE RD JUNIOR."

A new amplifier designed to meet the needs of those who require high performance at a reasonable price.

Improved production methods, ingenious circuitry and the elimination of unnecessary components, have made the production of this amplifier possible at a truly competitive price.

Main Features:  
6 valves, plus rectifier,  
8-10 watts output, two PX4s in push-pull. Independent bass and treble tone controls. High gain compensated p.u. input stage. Frequency range 30-15,000 cps. ± 1 DB. Provision for radio feeder unit.

Ample negative feedback applied over three stages, including output transformer. High grade components used throughout, including Partridge transformers and chokes. Price complete: £19/10/0.

Full details of this amplifier will be forwarded on request.

The new Barker Model 148A loudspeaker, which we consider to be the finest baffle loaded speaker available, is now being demonstrated and is available from stock.

**ROGERS DEVELOPMENTS CO.**

106, Heath Street, Hampstead, London, N.W.3. HAMPSHIRE 6901.

**B.B.C.** invites applications for a post in the recording section of the Research Department based initially at Balham, London, S.W.12, and later at Kingswood, Surrey; applicants must possess a University Degree in electrical engineering or equivalent qualifications such as graduate membership of the Institution of Electrical Engineers; the successful candidate will be employed upon research and development work on all aspects of sound recording; familiarity with low frequency electronic technique is essential. A knowledge of electronic and the design of light electrical and mechanical equipment, together with ability to guide development work in drawing office and workshops, will be an advantage; the salary is in a grade rising by annual increments of £35 to a maximum of £785 per annum.—Applications, stating age, qualifications and experience should reach the Engineering Establishment Officer, Broadcasting House, London, W.1, within 7 days of the appearance of this advertisement. (2819)

**T**he Ministry of Supply invites applications for unestablished appointments as Engineer III. Duties are to prepare official text books, handbooks and other technical publications on the following subjects from information obtained from research, design, manufacturing and other sources: (1) The application and effectiveness of Air Weapons (Ref. C.13/49A). (2) Airborne and ground centimetric radar equipment, theory and practice (Ref. D.15/49A). (3) Modern teleprinter and associated equipment (Ref. D.16/49A). (4) Modern aircraft gun, bomb and torpedo sights and navigation instruments, including electronics, theory and practice (Ref. D.17/49A). (5) Modern a.c. and d.c. airborne and ground electrical equipment for aircraft including electronics, theory and practice (Ref. D.18/49A). Candidates must be of British nationality, born of British parents (see detailed regulations, copy of which can be obtained on application to Ministry of Supply, Room 432, Adelphi, John Adam St., Strand, W.C.2), should have served an engineering apprenticeship or either be Associate Fellows of the Royal Aeronautical Society or corporate Members of one of the Institutions of Civil, Mechanical or Electrical Engineers, or have passed examinations recognised by any of these institutions as granting exemption from Sections A and B of their examinations or associate membership. Alternatively, they may have an honours degree in physics or associate-ship of the Institute of Physics and have had at least three years' experience in a factory or industrial laboratory where they should have demonstrated ability to teach scientific and technical subjects or experience in writing or editing text books or other technical publications. Preference will be given to applicants who have had several years' experience with the techniques of apparatus mentioned, either in research, design, production or operational use. Salary range £350-£470-£720 (Commencing salary will be determined in relation to age and experience.) Write to the Ministry of Labour and National Service, Technical and Scientific Register (K), York House, Kingsway, London, W.C.2, for application forms which must be completed within 10 days of the date of this advertisement. (2835)

**SITUATIONS WANTED**  
**A**DVERTISER seeks opening junior development engineer; National Certificate and 3½ yrs. practical experience. London area.—Box 4514

**YOUNG** radio engineer, recently released from Army; exp. 5 yrs. study, 2 yrs. radio mechanic in Army; anything considered.—Box 4006  
**ITALIAN** (22) seeks post: 4 yrs. experience. Acad. qualifications, radio knowledge, English, C & G., 2d to 3d operator; English/French spoken, culture enthusiasm, initiative; Brit. ref.; full details from: Box 4028. (2804)

**MAN** with over 20 years' experience in the design and development of radio receivers, components and test gear, 10 years in executive capacities, desires similar position or that of technical representative; own car.—Box 4297.

### AGENTS WANTED

**SALESMAN** wanted to call on radio and electrical retailers, two wonderful selling lines, territories available, no objection to other lines carried; write in confidence to long established radio and electronic manufacturers.—Box 4151.

**ENQUIRIES** invited from established service engineering shops with interest in high fidelity equipment to act as sole district representatives for London firm; demonstration equipment supplied free on loan and orders dealt with from London.—Please Write, Box A.C. 35509 Samson C Works, 57/61, Mortimer St., W.1

**MOTOVIA** 5, 6 and 8 valve automobile radios; the Motovia Company is now in a position to consider applications for a limited number of registered dealerships in areas not already covered; applications are invited from motor-knowledgeable dealers prepared to fully demonstrate and install.—Write, The Motovia, 12696 Timperley, Cheshire.

### BUSINESS AND PROPERTY

**PUBLIC** address undertaking.—Well-established business in S.W. England, 2 portable and 1 fixed sets equipment, excellent connection with local authorities, public and political bodies, agricultural societies, sports clubs, hunts, etc.; good opportunity for anyone wanting an interesting outdoor life unable to do manual work; good profits; price £2,000 or near offer.—Apply W. J. Rowe, F.A.L.P.A., 10, Bystock Terrace, Exeter. (2812)

## B. & H. RADIO HUNTLEY ST., DARLINGTON

**Loud Speaker Bass & Treble Separator £2 15 0**  
Enables speakers of different impedance to be used for Bass & Treble, and also gives control of the amount of treble relative to bass.

**Scratch Filter £0 15 0**  
Gives a very marked reduction of scratch level without serious effect on treble response.

**Variable Selectivity I.F. Transformer 465K/c.s.**  
Gives three degrees of selectivity per pair £1

**Circuit Diagram of Variable Selectivity 5, 3/-**  
A high fidelity receiver with ample L.F. gain for light-weight pick-ups, and correction for recording loss.

TRADE ENQUIRIES INVITED.

## "PERIMET" ELECTRODE Soldering and Brazing Tool

Operates from 4 or 0 Volt Accumulator or Transformer



15s. Post free.  
MAINS TRANSFORMER, 3 Heat. 35s. Post free.  
**HOLBOROW & CO.,**  
71, Weymouth Bay Avenue, Weymouth.

## 'LONG RANGE TELEVISION' WITH THE QSR9 HIGH PERFORMANCE AERIAL

Folded dipole, multi-rod design; erected in high duty alloy; provided wide bandwidth, high gain, low noise; and results in higher definition and long range reception.

- ★ FD2. 2 Element 5db gain, 7½lbs. weight.
- ★ FD3R. Triple reflector, minimises interference.
- ★ FD3DX. 3 Element long range, 7½ db gain.

Brochure from:  
**EMDO LIMITED, AGE WORKS, STAINES.**

## TRANSFORMERS & COILS TO SPECIFICATION.

MANUFACTURED OR REWOUND  
Filter Coils ± 1% a Speciality.

**JOHN FACTOR LTD.**

9-11 EAST STREET TOLEDO QUAY DEVON  
Phone Torquay 2162

## PHOTO-ELECTRIC CELLS

10R

Talking Picture Apparatus.

Catalogue now available

**RADIO-ELECTRONICS LTD.,**  
St. George's Works, South Norwood,  
London, S.E. 25.

## BE PREPARED

For the possibility of  
**WIRELESS INTERFERENCE LAWS**

—Simple Suppressors may be made up for a few shillings—  
Send for full Technical Particulars, of Components needed. Circuit Diagrams, etc.

2/9 Post Free

**TO HILTON**  
95a KING STREET, WALLASEY  
CHESHIRE



**SHOP** premises required in established shopping centre; willing pay premium; stock not essential.—Write Box 3612. [2703]

**LARGEST** public address contracting business in South-East England, showing profit in excess of £550 per annum (still rising) and enough spare time for other work; can be operated as one-man business with occasional operator help; generator fitted control truck, ditto trailer, and all equipment at valuation; 1949 season bookings in hand.—Box 4033. [2828]

**FINANCIAL PARTNERSHIP**  
**YOUNG** man seeks partnership in genuine radio and cycle business North London district; capital available.—Box 4216. [2900]

**PATENTS**  
**THE** proprietor of British Patent No. 573313, entitled "Multiple section electronic tube and method of making it" offers same for licence or otherwise to ensure practical working in Great Britain.—Inquiries to Singer, Ehiert, Stern & Carlberg, 28 East Jackson Blvd., Chicago 4, Illinois, U.S.A. [2591]

**TECHNICAL TRAINING**  
**R**ADIO officer? Train on Marconi's oceanspan and associated equipment at The Radio & Television Residential College, 1a, Ibrox Terrace, Glasgow, S.W.1. [2815]

**EX-R.A.F. EQUIPMENT for REBUILDING or disassembly for parts and valves.**

Type 25 VHF Receiver. Includes two EF36 two EF39, one EK32, and one EBC33 or equivalents; and lots of useful parts. 22/6, inc. postage.

Type 6C Indicator Unit. Includes two EF50 and two EB34 valves, and a VCR133 (ECR35 or equivalent), 4In. CR Tube; and lots of useful parts. 42/-, inc. postage.

Type 6A Mine Detector Amplifier. Includes three VP33 valves (or equivalents), pair of high-impedance headphones and lots of parts. 17/-, inc. postage.

(As with all ex-Govt. surplus, sold without guarantee, but all in apparent good condition.)

**WIRELESS SUPPLIES UNLIMITED**  
 (Props. Unlimitex Radio Ltd.)  
 264-266, Old Christchurch Road, BOURNEMOUTH, Hants.

**EDDYSTONE**  
 '640' . . . . £27 10s. 9d.  
 H.P. Terms available.  
 Orders now being booked in strict rotation.  
 Full range of components.  
 All C.O.D. orders promptly executed.  
 Send for Catalogue, 1/- post free.

**SPECIAL OFFER**  
 P.M. Speakers  
 Goodman's, Truvox, Rola (as available).  
 5 inch 13/-; 6 inch 14/-; 8 inch 16/-  
 including packing and postage.

**B.T.S.**  
 THE Radio firm of the South.  
 63, London Road, Brighton 1, Sussex.  
 'Phone: Brighton 1555

**TUITION**  
**R**ADIO training.—P.M.G. exams. and I.E.E. Diploma; prospectus free.—Technical College, Hull. [661]

**TRAINING** for careers in electronics; write for free booklet giving details of postal and attendance courses in radio, television, industrial electronics, mathematics, etc.; courses prepared by experts of E.M.I., manufacturers of H.M.V. and Marconi television, radio and allied products.—E.M.I. Institutes, Dept. W.W., 43, Grove Park Rd., Chiswick, London, W.4. Tel. Chiswick 4417-8. [2913]

**TELEVISION RECEIVERS SCANNING and FOCUS COILS TIME BASE COMPONENTS 7KV. EHT. RF. UNITS and TRANSFORMERS**

Publications post free

**HR HAYNES RADIO LTD.**  
 Queensway, Enfield.

**NEW! First post-war Edition**  
 Wireless World  
**RADIO VALVE DATA**  
 with characteristics of 1,600 valves.  
 Price 3/6 post 3d.  
**MODERN BOOK CO.**  
 21 Praed St., Paddington, London, W.2

**COPPER WIRE**  
 ENAMELLED, SILK, D.C.C., etc., most sizes  
**MOTORS** up to 1 H.P. a speciality.  
**STOCKIST** of all RADIO COMPONENTS.  
 Send S.A.E. for lists to  
**STAN. HOLT,**  
 349, HIGH ST., SMETHWICK, STAFFS.  
 Telephone: WOODGATE 3789

**PRECISION A.F. OSCILLATORS BY B.S.R. Type LO.50a.**  
 (Ex. Govt. Surplus)

These well-known audio-frequency oscillators covering the range 0-16,000 cycles on two dials (0-600 & 0-16,000), fitted with precision output voltmeter, mains operated 200-250v. 40/100 and BRAND NEW are offered at the very low prices as follows:

MODEL LO.50a. (Standard) £27  
 MODEL LO.50b. (Tropical) £30  
 Send for list of test equipment

**PIKE BROS.**  
 86 MILL LANE, LONDON, N.W.6  
 Telephone: HAMPSTEAD 4219

**BOOKS, INSTRUCTIONS, ETC.**  
**SOUTHERN RADIO'S** wireless bargains.

**BRITISH** Radio Publications, "Using Ex-Servicemen's Apparatus," 2/6; "Radio and Television Laboratory Manual," 2/6; "The Walkie-Talkie Construction Manual," 2/6; "Radio Calculations Manual," 3/6; "Radio Test Equipment Manual," 2/6; "Radio Anti-Interference Manual," 2/6; "Ultra Shortwave Handbook," 2/6; "Radio Hints Manual," 2/6; "Amateur Transmitters Construction Manual," 2/6; "Television Constructors' Manual," 3/6; "Radio Aerial Handbook," 2/6; "Sound Equipment Manual," 2/6; "Radio Inductance Manual," 2/6; "Modern Battery Receivers' Manual," 2/6; "The Loudspeaker Manual," 2/6; "Radio Valve Equivalents," 2/6; "Radio Valve Application Manual," 5/-; "Radio Repairs Manual," 2/6; "Car and Portable Radio Constructors' Manual," 2/6; "Communications Receivers Manual," 2/6; "Radio Valve Manual," 3/6; "Radio Amplifier Manual," 2/-.

**SOUTHERN RADIO SUPPLY, Ltd.,** 46, Lisle St., London, W.C.2. [2999]

**WEBB'S** 1948 radio map of world, new multi-colour printing, with up-to-date call signs and fresh information, on heavy art paper. 4/6. post 6d; on linen on rollers. 11/6. post 9d.—Webb's Radio. 1-4 Soho St. W.1. Gerrard 2099.

**WE OFFER**

A large range of used and new Test Equipment, Converters, Recorders, Amplifiers, Motors, Transformers, etc.

All guaranteed and at very attractive prices.

**We buy good modern used equipment of all types for spot cash.**

**UNIVERSITY RADIO LTD.**  
 22 LISLE STREET, LONDON, W.C.2.  
 Tel.: GER 4447 & 8582.

**ENGINEERING OPPORTUNITIES**

This unique handbook shows the easiest way to secure A.M.I. Mech. E., A.M. Brit. I.R.E., A.M.I.E.E., City and Guilds, etc.

**We Guarantee—**  
**"NO PASS—NO FEE."**

Details are given of over 150 Home-study Diploma courses in all branches of Civil, Mech., Elec., Motor, Aero, Radio, Television and Production Engineering, Tracing, Building, Govt. Employment, R.A.F. Maths., Matriculation, etc.

Safeguard your future; send for your copy at once—FREE.

**B.I.E.T., 387, SHAKESPEARE HOUSE**  
 17, STRATFORD PLACE, LONDON, W.1.

**WILKINSON'S OF CROYDON**

**AMPLIFIER UNIT**, type A 3678, employing 2 5U4G, 1 6X5, 1 EF50, 2 807, 1 EA50. All useful valves well worth the price of the Unit which is 45/-.

**POWER UNIT**, employing a 5Z4G and a high voltage rectifier 8U2150A, together with a 1 mf. condenser, 2.5 kV. and other components, 18/6, post free.

**TELEVISION Unit**, 2HF stages, 1 detector and 1 video amplifier, complete with 4 valves, adjustable iron cored coils, etc., brand new, only 45/-.

**CATHODE RAY tube Unit**, type 97, with 14 valves, C.R. Tube and various condensers, resistors, etc. Our price, only 65/-, carriage paid.

**CATHODE RAY Receiver Indicator Unit**. Brand new! Ex-U.S. Navy. Employing 40 useful valves 2 Cathode Ray tubes, power pack, motor blower, Milliameters, etc. The following are the valves: 13 6SN7GT, 8 6AC7, 2 6L6, 6 6L6G, 3 VR150-30, 1 2X2, 3 6U4G, 2 6XK1, 2 6H6.

**MURHEAD SLOW MOTION DRIVES, 7/6 EACH.**

**VOLTMETERS**, 0-300 volts A.C., moving iron, 2 1/2 in. dial, flush type, 17/6 EACH.

**ABK1 SPARES KIT**, including 32 valves individually boxed, 18 6SH7, 6 6H6, 8 7193. Also many useful relays, Resistors, Condensers, and a Dynamotor with extended Spindle which will work as a powerful motor on 200/250 A.C. mains without alteration. 14s Items in all, brand new, properly packed. 7/0—complete.

**CRYSTAL MULTIPLIER UNIT**, 2 to 6.67 Mc/s in 3-switch steps, 807 Oscillator and tuning control. Brand new with spars 807 valve, instruction books, etc. 65/- EACH.

**RF AMPLIFIER**, 100/124 Mc/s for 2VT62 Triodes in push, pull, standard 19in. rack mounting, easily modified for 144 Mc/s. Brand new 75/- List 24d.

**"ONAN" PETROL GENERATING SETS**, 12/15 Volts D.C. 30 amp., £25.

**"JOHNSON CHORB" HORSE**, 12 Volts D.C. 450 watts, £27/10/- Will charge batteries, supply light, drive light machinery. Brand new, full instructions.

**L. WILKINSON, 204, Lower Addiscombe Road, CROYDON.**

**POTENTIOMETERS**  
 by **RELIANCE**



Wire-wound and Composition types. Single, Ganged, Tandem Units.

Characteristics: linear, log., semi-log., non-inductive, etc. Full details on request.

**RELIANCE MFG. CO. (SOUTHWARK), LTD.**  
 Sutherland Road, Higham Hill, Walthamstow, E.17.  
 Telephone: Larkswood 3245

INDEX TO ADVERTISERS

	PAGE		PAGE		PAGE
A.A. Tools	68	Forrest, H. W.	68	Premier Radio Co.	23
A. Metal Prods. Ltd.	64	Fox P. X., Ltd.	50	Quartz Crystal Co., Ltd	68
Acoustical Mfg. Co. Ltd.	44	Frith, Radiocraft, Ltd.	50		
Acru Electric Tool Mfg. Co., Ltd. The	26	Furzehill Laboratories Ltd.	12		
Ad Auriema Inc.	22				
Adcola Products, Ltd.	64				
Advance Components Ltd.	16	Galpins	61		
Aerialite, Ltd.	45	Gardners Radio, Ltd.	31	Radford A. H.	64
Alrmec Laboratories Ltd.	47	General Electric Co., Ltd.	3	Radio-England Ltd.	70
Allan, Richard, Radio, Ltd.	48	General Lamination Products, Ltd.	70	Radiomart (B'ham), Ltd	30
Allen Components, Ltd.	54	Goodmans Industries, Ltd.	2	Radjomenders, Ltd.	63
Antiference Ltd.	115	Gray, A., Ltd.	52	Radiospares, Ltd.	65
Armstrong Wireless & Television Co., Ltd.	57			Radiospares, Ltd. (Leicester) Ltd	113
Ashworth, H.	62			Rediffusion, Ltd.	43
Automatic Coil Winder & Electrical Equip. Co., Ltd.	1			Reliance Mfg. Co. (Southwark), Ltd.	71
A.W.F. Radio Products, Ltd.	56			Reproducers & Amplifiers, Ltd	26
				Rimington van Wycke, Ltd	21
				Rogers Developments Co	70
				Rollet, H., & Co., Ltd.	70
B. & H. Radio	70				
Barker, A. C.	58	Hadley Bros., Ltd.	24	Salford Electrical Instruments, Ltd.	64
Belling & Lee, Ltd.	37	Hartley, H. A. Co., Ltd.	54	Sangamo Weston, Ltd.	51
Berger, Lewis & Sons, Ltd.	10	Haynes Radio, Ltd.	71	Savage Transformers, Ltd	20
Berry's (Short Wave), Ltd.	63	Henley's W. T., Telegraph Works Co., Ltd	54	Savage, W. Bryan, Ltd.	58
Bird, S. S., & Sons, Ltd.	52	Henry's	63	Simon Sound Service	42
Birmingham Sound Reproducers, Ltd.	32	Hill & Churchill, Ltd.	68	Smith, W. H., & Son	60
Brierley, J. H. (Gramophones & Recordings), Ltd.	12	Hilton	70	Sound Rentals, Ltd.	12
Brighton Tele-Services	71	Hivac, Ltd.	7	Sound Sales, Ltd.	40
Britain, Chas. (Radio), Ltd.	59	Holborow & Co.	70	Southern Radio Supply, Ltd.	62
British Institute of Engineering Technology	66, 69, 71	Holsun Batteries, Ltd.	4	Stability Radio Components, Ltd	44
British Insulated Callender's Cables, Ltd	Cover 11	Holt, Stan.	46	Standard Electrical Eng. Co.	52
British National Radio School	64	H.P. Radio Services Ltd.	71	Standard Telephones & Cables, Ltd	35, 41
British N.S.F. Co., Ltd.	48			Steatite & Porcelain Products Ltd	11
British Physical Laboratories	50	Imhof, A., Ltd.	111	Stern Radio, Ltd.	61
Brown, S. G., Ltd.	66, 69, 71	Industrial Electronics	36	Stewart Transformers, Ltd.	28
Bulgian, A. F., & Co., Ltd.	119	International Correspondence School, Ltd	40	Stratton & Co., Ltd.	31
Bull, J., & Sons	65				
Bull's Ex-Govt. Depot	66	Jackson Bros. (London), Ltd.	6	Taylor Electrical Instruments, Ltd	20, 44
Bullers, Ltd.	49	Kerry's (Gt. Britain), Ltd.	26	Telegraph Condenser Co., Ltd.	9
				Telegraph Construction & Maintenance Co., Ltd., The	24
Candler System Co.	66	Lasky's Radio	58	Teleradio Co.	67
Charles Amplifiers, Ltd.	14	Leak, H. J., & Co., Ltd.	17	Tele-Radio (1943), Ltd.	48
Chloride Electrical Storage Co., Ltd.	29	Linton, H. H., & Co., Ltd.	58	Thompson, W. & J. R. (Woodturners), Ltd.	39
Cinema-Television, Ltd.	43	London Central Radio Stores	19	Transradio, Ltd.	40
Clydesdale Supply Co., Ltd.	66	London Radio Supply Co.	66	Trix Electrical Co., Ltd.	117
Collaro, Ltd.	7	Lowther Mfg. Co., Ltd.	62	Truxov Eng. Co., Ltd.	5
Cosmocord, Ltd.	29	Lustraphone, Ltd.	70	T. & C. Radio College	56
Couplphone Radio	56	Lyncar Laboratories	70		
Coventry Radio	67			Universal Electrical Instruments Corp'n	65
				University Radio, Ltd.	71
Davis, Alec, Suppl'es, Ltd.	67	Mall Order Supply Co.	50		
Denco (Clacton), Ltd.	30	Marconi Instruments, Ltd.	46	Vallance & Davison, Ltd.	27
Denco Distributors, Ltd.	67	Marconiphone Co., Ltd., The	36	Valradio	52
Desouther Bros., Ltd.	25	Marconi Wireless Telegraphy Co., Ltd.	27	Valloria Instruments	39
Drayton Regulator & Instrument Co., Ltd.	48	Masteradio, Ltd.	22	Vitavox, Ltd.	14
Dublioir Condenser Co. (1925), Ltd.	15	McMurdo Instrument Co., Ltd.	69	Voigt Patents, Ltd.	68
Dupley Electronics, Ltd.	64	Measuring Instruments (Pullini), Ltd	42	Vortexion, Ltd.	39
		Metro Pex, Ltd.	8		
Edison Swan Electric Co., Ltd.	13	Midland Instrument Co.	60	Watts, M., & Co.	69
Electradix Radios	55	Modern Book Co.	69, 71	Wayne Kerr Labs., Ltd., The	22
Electric & Musical Industries, Ltd.	40	Motherwell Machinery & Scrap Co., Ltd	60	Wells & Co., Ltd	18
Electro Technical Assemblies	60	M.R. Supplies, Ltd.	14	Westinghouse Brake & Signal Co., Ltd.	51
Electronic Instruments, Ltd.	52	Mullard Recording Co., Ltd.	4	West, Spencer	64
Eimsleigh Radio Co.	68	Mullard Electronic Products, Ltd.	28, 34	Weymouth Radio Mfg. Co. Ltd., The	68
Emdo, Ltd.	70	Multicore Solders, Ltd.	Cover 14	Wharfedale Wireless Works	42
Eric Resistor, Ltd.	Cover 11			Whiteley Electrical Radio Co., Ltd.	45
Erskine Laboratories, Ltd.	2	Oliver Pell Control, Ltd.	24	Wilkins & Wright, Ltd.	76
Eta Tool Co. (Leicester), Ltd.	30	Oxley Developments Co., Ltd.	72	Wilkinson, L.	71
				Wireless Supplies Unltd.	71
Factor, J., Ltd.	70	Painton & Co., Ltd.	47	Wolsey Television, Ltd.	28
Filton, R. N., Ltd. (Ambassador Radio)	16	Parmeko, Ltd.	39	Wright & Weaire, Ltd	35
Fluxite, Ltd.	59	Partridge Transformers, Ltd	53		
		Peerless Radio, Ltd.	56		
		Pennine Amplifiers	62		
		Philips Electrical, Ltd.	38		
		Pike Bros.	71		
		Pill, G. N., & Partners	66		

TECHNICAL EXCELLENCE

—combines with beauty and soundness of DESIGN in the



**OXLEY**  
AIR DIELECTRIC TRIMMER

Type Approved Cat. A No. 464.

Width: 16.5 m/m. Length: 22 m/m. Height: 1.5 to 8pF—7.5 m/m. 1.8 to 20pF—10 m/m. 2 to 26pF—11 m/m. 2 to 32pF—12 m/m. Law: Straight line capacity. Power Factor: Less than .001. Insulation: Over 2,000 megohms. Voltage: 500 D.C.

OXLEY DEVELOPMENTS CO. LTD.  
ULVERSTON, NORTH LANCs. TELEPHONE: ULVERSTON 3306

MICROPHONE MIXER UNIT  
by LUSTRAPHONE

Permits the controlled mixing and fading of microphone and/or gramophone inputs. Is valveless, and requires no power supply. Elegantly finished in matt gold and black. Silent in action and long lasting.

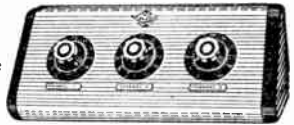

Standard Model—3 Input Channels, 4 and 5 Channel models available. Details on request from the makers.

LUSTRAPHONE LTD. 84, BELSIZE LANE, LONDON N.W.8

Printed in Great Britain for the Publishers, LEIFFE AND SONS LTD., Dorset House, Stamford Street, London, E.C.1, by THE CORNWALL PRESS LTD., Paris Garden, Stamford Street, London, S.E.1. "Wireless World" can be obtained abroad from the following—AUSTRALIA and NEW ZEALAND: Gordon & Gotch, Ltd. INDIA: A. H. Wheeler & Co. CANADA: Imperial News Co.; GORDON & GOTCH, Ltd. SOUTH AFRICA: Central News Agency, Ltd.; WILLIAM DAWSON & SONS (S.A.) LTD. UNITED STATES: The International News Co

1998

*Quality*

**ACKNOWLEDGED  
THROUGHOUT  
THE WORLD**



**ERIE**

*Radio & Electronic Components*

**RESISTORS · CERAMICONS · Hi-K CERAMICONS · POTENTIOMETERS  
SUPPRESSORS : VITREOUS ENAMELLED WIRE-WOUND RESISTORS**

Erie Resistor Ltd., The Hyde, London, N.W.9, England

Telephone: COLindale 8011-4.

Cables: RESISTOR, LONDON.

Factories: London & Gt. Yarmouth, England · Toronto, Canada · Eric, Pa., U.S.A.

