

ELECTRONIC ORGAN DESIGN

MAY 1966

Three shillings

Wireless World

ELECTRONICS • TELEVISION • RADIO • AUDIO

PICKUP TRACKING
ELECTRONICS

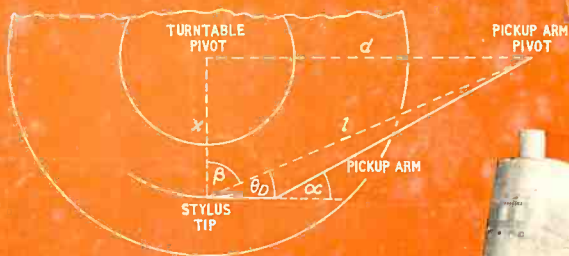

FERRANTI

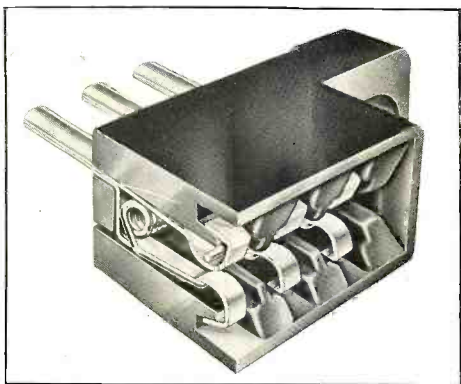

EDGE CONNECTORS

for printed
circuit boards

- Low rate floating spring.
- Controlled contact pressure.
- Unsurpassed reliability.
- Polarisng achieved without removal of contacts
- Hard gold plated to 0.0002 inch minimum.
- ✳ Gold Flashed and Silver Plated contacts supplied on request.
- Constant contact performance with different board thicknesses.

At present available in 8, 16, 24, 32, & 40 Pole sizes

FERRANTI *First into the Future*



NOW!



Avometer

Model 8 Mk.3

Thanks to greatly increased production at our new Dover factory the Model 8 Mk. 3 Avometer—renowned for its exceptional performances and reliability—is now available for prompt delivery. Why wait? There's no better moment than *now* to get in touch with one of the addresses below.

Where to get your Avometer

(or any other Avo instrument)

FARNELL INSTRUMENTS LTD.
SANDBECK WAY, WETHERBY, YORKS.
 Telephone: Wetherby 2691 2/3/4

Anglesey, Caernarvonshire, Cheshire, County Durham, Cumberland, Denbighshire, Derbyshire, Flintshire, Lancashire, Lincolnshire, Staffordshire, Westmorland, Yorkshire.

WIRELESS ELECTRIC LTD.
ST. THOMAS STREET, BRISTOL 1.
 Telephone: 9/8434

Cornwall, Devon, Dorset, Gloucestershire, Hampshire, Hertfordshire, Somerset, South Wales, Wiltshire, Worcestershire.

ELESCO ELECTRONICS LTD.
1103 ARGYLE STREET, GLASGOW, C.3.
 Telephone: CENtral 5956

All parts of Scotland.

For Avo stockists in all other counties please contact the Home Sales Department at the address below.

For details of Avo representation OVERSEAS contact the Export Sales Department at the address below.



AVO LTD

AVOCET HOUSE - 92-96 VAUXHALL BRIDGE ROAD - LONDON S.W.1 Telephone: VICtoria 3404

AS 12

WW-004 FOR FURTHER DETAILS.

M
 YOUNG & BECKETT

A

the experts'
choice

Stentorian



F. C. IUDD
*Technical Editor
Amateur Tape Recording and
Hi-Fi Magazine**



JOHN GILBERT
*Technical Editor
"Music Trades
Review"*

See and hear us
at the

**AUDIO
FAIR
STAND 46**

**Demonstration
Room 204**



DONALD ALDOUS
*Technical Editor
"Audio and
Record Reviews"*

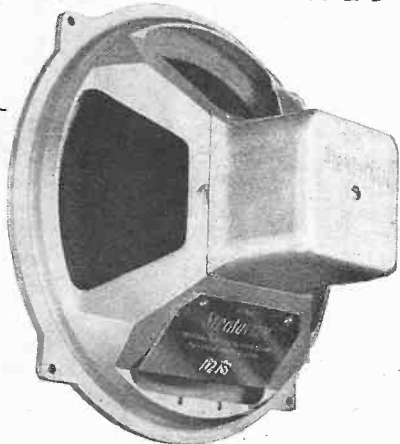

MODEL H.F. 1016 'MAJOR'

This unit makes use of the high flux density available in the magnet system of the previous H.F.1016 unit. A curved diaphragm is used with a rigid centre-section coupled to the voice coil. The rigid coupling and the design of the cone termination give a balanced response over the whole audio range. The unit is specially suitable for use in the smaller type of enclosure having a volume of approximately $1\frac{1}{2}$ cubic feet.

Specification:

Chassis—die cast aluminium; Cone—graded pulp cambric surround;
Cone dia.—10in.; Pole dia.—1in.; Flux density—16,000 gauss; Total
flux—64,000 maxwells; Impedance—15 ohms.

Price: £10 . 7 . 6 (inc. tax)

Other Stentorian Speakers ▶

CROSSOVER
NETWORKS:
CX3,000 £11/13/3
CX1,500 £2/2/-
CX500 £1/8/9

Type	Flux Density	Price	Type	Flux Density	Price
10" H.F.1012*	12,000 gauss	£5 1 3	T359 tweeter	9,000 gauss	£1 15 6
8" H.F.816*	16,000 gauss	£6 18 6	T816	16,000 gauss	£6 11 3
8" H.F.812*	12,000 gauss	£4 4 3	T12 tweeter	16,000 gauss	£15 5 6
8" H.F.810	10,000 gauss	£3 2 9	T10 tweeter	14,000 gauss	£5 2 0

*These three Speakers incorporate a universal impedance speech coil.



WHITELEY ELECTRICAL RADIO CO. LTD.

MANSFIELD · NOTTS · ENGLAND · Telephone: MANSFIELD 1762-8

London Office: 109 Kingsway, London W.C.2.

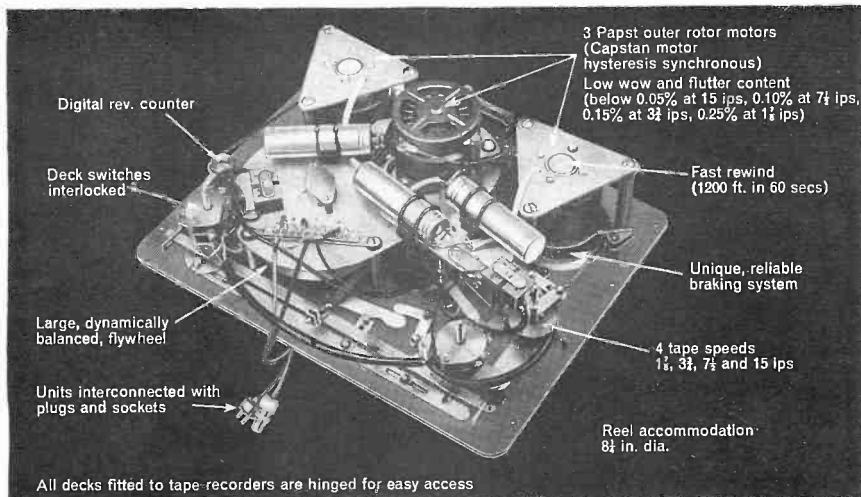

We have been accused . . .

of hiding our light under a bushel, the light being our superb 4 speed tape deck, so we have taken the hint and given you a large illustration pointing out some of its principle features. This deck is used on all Brenell models and there are versions available to take 10 1/2" NAB reels. Also we supply tape decks and matching amplifiers separately for building into your own equipment cabinet. Write for details of the Brenell range.



**MARK 5
SERIES 3**
**MONO—HALF TRACK—TWO HEADS—
MAGIC EYE**
(Available with recording level meter at extra cost.)

High quality amplifier with power output of 2½ watts r.m.s. and a frequency response of 40–20,000 c/s—can be used independently of tape recorder—narrow gapped record/playback head for extended frequency response—double-gapped ferrite erase head to minimise erase noise—headphone monitoring.



**MARK 5
TYPE M SERIES 3**
**MONO—HALF TRACK—THREE HEADS—
RECORDING LEVEL METER**
Separate record and playback heads—separate record and playback amplifiers—amplifier frequency response 25–28,000 c/s ±3dB—power output 2 watts r.m.s.—separate bass and treble controls—mixing of input signals—speaker monitoring whilst recording.



STB2
**MONO/STEREO—HALF TRACK (Record/
playback)—QUARTER TRACK (playback)
FOUR HEADS—TWO EDGEWISE METERS**
Designed for use with high fidelity stereo installations—adjustable attenuators on all input channels to ensure perfect matching with all auxiliary equipment—dual concentric recording level and playback level controls—cathodic follower output—four channel mixing on mono programme sources—twin recording and twin playback pre-amplifiers—comparison of original and recorded signal—adjustable bias level—recording facilities for 1/2 and 2/2 track—playback facilities for 1/2, 2/2, 1/4 and 2/4 tracks—sound-on-sound facilities—two edgewise meters for recording level, tape output level and bias level.
Optional extra: stereo power amplifiers and monitoring speakers.

Brenell

BRENELL ENGINEERING CO. LTD.
231/5 Liverpool Road, London, N.1.
Telephone: NORTH 8271 (5 lines)

WW—006 FOR FURTHER DETAILS.

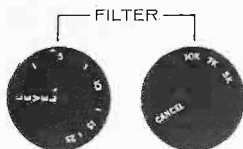

More of the music and less of the distortion!

The processing and production of discs produces a waveform in which distortion rises extremely rapidly as the upper frequency limit is approached. To obtain the best quality under such conditions the very high harmonics must be attenuated at a rate which is a function of the rate of rise of distortion.

The QUAD filters provide both switched adjustment for frequency and continuously variable adjustment for rate of attenuation. The degree of attenuation need therefore never be greater than necessary to clean up the programme but is always adequate even for very bad cases.

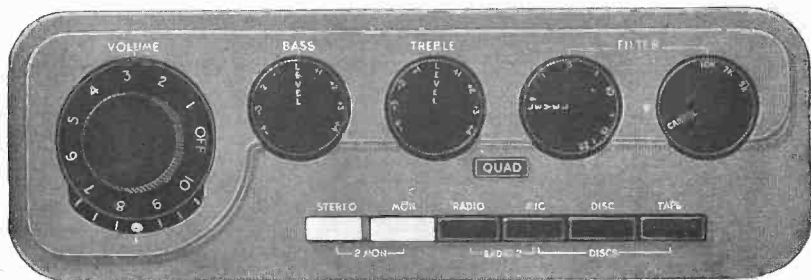

For the closest approach to the original sound

Our slogan for fifteen years and our design objective for twice that long. Ask your dealer for details of the QUAD range of high fidelity units or write direct to

**Ref. W.W. Acoustical Manufacturing Co. Ltd.,
Huntingdon. Huntingdon 361.**



WW-007 FOR FURTHER DETAILS.

The hard-to-find man is the man with advanced technical knowledge

In the field of Electronics today the greatest demand is for men to fill the positions of skilled technicians and support engineers. These are the 'hard-to-find' men for whom the way ahead to rewarding and interesting jobs lies wide open.

CREI HOME STUDY COURSES offer advanced technical education to the man who realises that technical knowledge must be current and up-to-date if progress is to be made in a world in which new ideas, new techniques and new applications develop almost overnight.

CREI COURSES ARE AVAILABLE IN :-

Electronic Engineering Technology
Automation & Industrial Electronic Engineering
Nuclear Engineering
Communications Engineering
Aeronautical & Navigational Engineering
Television Engineering
Servomechanisms & Computer Engineering
Space Data Systems
Radar & Servo Engineering
Mathematics for Electronic Engineers
City & Guilds of London Institute: Subject 49 and
Supplementary Studies Subject 300.

For further information write to:

**C.R.E.I. (London) (Dept. WW67)
WALPOLE HOUSE, 173/176 SLOANE STREET, LONDON, S.W.1
Telephone: BELgravia 8662**

(INTERNATIONAL DIVISION OF CAPITOL RADIO ENGINEERING INSTITUTE, WASHINGTON, D. C.)

PLEASE SEND ME (FOR MY INFORMATION AND ENTIRELY WITHOUT OBLIGATION) FULL DETAILS OF THE CITY & GUILDS PROGRAMME. (C. & G. SUBJECT 49)			
<input type="checkbox"/> 1st yr.	<input type="checkbox"/> 2nd yr.	<input type="checkbox"/> 3rd yr.	<input type="checkbox"/> 4th yr.
<input type="checkbox"/> SUPPLEMENTARY STUDIES (SUBJECT 300)			
NAME			
ADDRESS			
EDUCATIONAL AND TECHNICAL BACKGROUND			
C.R.E.I. (LONDON) (DEPT. WW67) WALPOLE HOUSE, 173/176 SLOANE STREET, S.W.1			

PLEASE SEND ME (FOR MY INFORMATION AND ENTIRELY WITHOUT OBLIGATION) FULL DETAILS OF THE EDUCATIONAL PROGRAMMES OFFERED BY YOUR INSTITUTE			
NAME			
ADDRESS			
ELECTRONICS EXPERIENCE			
C.R.E.I. (LONDON) (DEPT. WW67) WALPOLE HOUSE, 173/176 SLOANE STREET, S.W.1			



JUST LIKE THE OTHER 800 MILLION- UNIQUE

Erie have made approximately 800 million of the Type 9 insulated carbon composition resistor since they were first put into production as far back as the early thirties. Every one is identical, yet every one is unique.

The care and attention to detail in their manufacture, and the rigorous inspection checks at every stage, ensure that not only does every component operate efficiently, but is in itself an example of Erie's unique manufacturing skill.

The same care and attention that goes

into quality control applies throughout all the company's activities; your orders and enquiries for instance. Every order, whether it be for a million, or for a strictly limited number for a highly specialist purpose, receives the same quiet efficient attention.

Every enquiry, too, no matter how apparently simple or difficult receives the same enthusiastic attention from our technical and sales staff.

Erie take a pride in performance



Write for catalogue to:

ERIE RESISTOR LIMITED,

Great Yarmouth, Norfolk, England.

Telephone: Great Yarmouth 4911.

Cables: Resistor Great Yarmouth Telex: 97421

TAKE SIX

to measure a megacycle



STOP PRESS

- * Variable sensitivity control on A.C. input.
- * Variable display timer (0.5-5 secs).
- * Period measurement over 1, 10 & 100 cycles
- * Provision for external ref.
- * Binary coded decimal output (optional extra).

Six big digits, clear and unambiguous, to measure frequency and time up to one megacycle and down to one microsecond—clearly, without flicker.

Six into one only just goes

Not much spare space on the panel of this instrument—the digits are big and the unit is small, compact, portable. Makes for convenience and easy reading, with an adjustable support that holds firm at any convenient angle.

Smaller and smaller!

Design of the Venner TSA 3436 Mark 2 is based on solid experience of applying transistorised digital techniques to measuring instruments. Small as it is, the TSA 3436 Mark 2 will give precise readings up to a megacycle and down to a microsecond.

ONLY £215 (Price applicable to U.K. only)

Laboratories and technical colleges welcome the compactness, strength and simplicity-in-use of the TSA 3436 Mark 2. In industry, its dependability, and the clarity of its display, make it uniquely suitable for inspection and quality control applications.

Full technical details will be sent on request.

VENNER TSA 3436 MARK 2 TIME/FREQUENCY METER

VENNER ELECTRONICS LIMITED

KINGSTON BY-PASS · NEW MALDEN · SURREY, MALDEN 2442

Overseas subsidiaries

VENNER A. G. BURGERNZELWEG 16-3000 BERNE-SWITZERLAND · VENNER N. V. HELMSTRAATS DEIN HAAG · HOLLAND
WW-010 FOR FURTHER DETAILS.

RACAL Digital counters combine versatility with economy

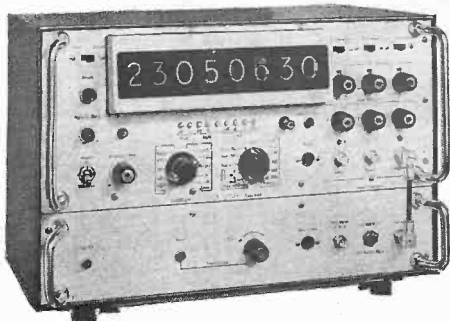

SA.550 N.A.T.O. Codification 6625-99-971-8519

Racal SA.550 100 Mc/s Digital Frequency Meter

Direct Frequency Measurements from signal levels as low as 100 mV are possible without tuning or interpolation. Measurement capability can be extended by the use of the active probe unit type SA.544.

- All Solid-State Design
- 8 Digit Inline Display
- 0-55°C. operating Ambient
- D.C. Logic Switching
- Digital Printout Facilities
- Internal or External Standard

The SA.540 Universal Counter Timer illustrated below is for time, period and frequency measurement up to 11 Mc/s.

SA.550 U.K. Price £1,100

SA.540 U.K. Price £795

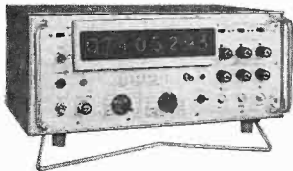

SA.540

RACAL

Write for fuller details to:
Racal Instruments Ltd.,
Dukes Ride, Crowthorne, Berks
Tel: Crowthorne 2272/3 or
Bracknell 941 Telex

LADDER

FILTERS



ADVANTAGES

Fantastic space saving
Excellent stability with time and temperature
Single or multiple resonant units

TYPICAL SPECIFICATION

Centre Frequency	300 to 600 kc/s \pm 2 kc/s
Bandwidth	2 to 45 kc/s at 6 db
Insertion Loss	1 to 15 db (dependent on B/W)
Impedance	Either 1200 or 1500 ohms in and out, dependent on B/W
Case Size	8 mm diameter 38 mm long
Operating Temperature Range	-40°C to +85°C
Shape Factor 60/5 db	1.3 : 1 to 2.6 : 1 Dependent on B/W

Curve below shows response of our ladder filter type TL 10 D 16A. Note the outstanding shape factor

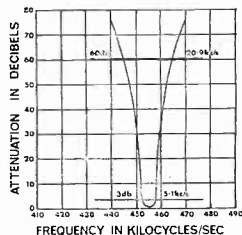

Keep your eye on Brush

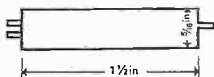

SIZE

This illustrates the typical dimensions for a ladder filter. The case is a plated brass cylinder with glass end seals and pigtail leads. A 1 1/2 inch length will provide sufficient volume to give 60 db stop band rejection.

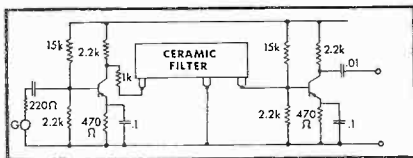

BRUSH CLEVITE COMPANY LIMITED

HYTHE SOUTHAMPTON

PHONE HYTHE 3031 GRAMS BRUDEV HYTHE SOUTHAMPTON TELEX 47687
WW-012 FOR FURTHER DETAILS.

REED

RELAYS REED UNISELECTOR

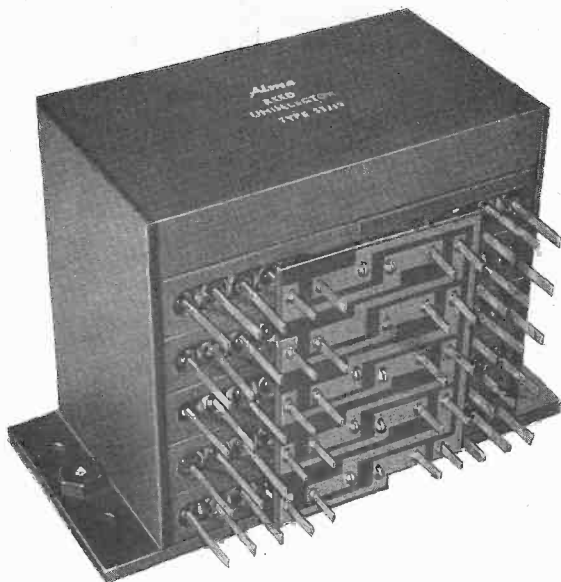

Designed for those special switching applications which are beyond the capabilities of conventional uniselectors and stepping switches. Any number of ways up to 100 can be supplied with up to 6 banks. Reverse operation can be provided and automatic homing to any pre-selected number.

Send for the provisional data sheet today.

- ★ Higher speed of operation
- ★ Fully sealed contacts requiring no adjustments or maintenance
- ★ Instantaneous re-set without going through all contacts
- ★ Changeover or normally closed contacts can be supplied if required
- ★ Independent "make" contacts are employed instead of a common wiper circuit
- ★ Low contact resistance

ALMA COMPONENTS LIMITED

Park Road • Diss • Norfolk • Telephone: Diss 2287 • Telex 18162

WW-013 FOR FURTHER DETAILS.



All Advance Transistorised Timer Counters offer more facilities than other makes at comparable prices. The current comprehensive range will be further extended during 1966 with the introduction of several new counters.

Advance Timer Counters provide frequency measurement up to 100 Mc/s, timing in micro-seconds and counting of random pulses up to 10^7 pulses per second. Accurate timing pulses variable from micro-seconds to seconds are obtainable with accuracies up to 2 parts in 10^6 , which by using optional external frequency standards can be increased to parts in 10^8 .

Frequency Measurement: 0-10 Mc/s, extended by Frequency Dividers to 100 Mc/s.

Gate Time: A wide range from 10 seconds to 1 millisecond.

Period Measurements: Multi period measurements from 10 to 10^6 periods.

Time Measurements: From micro-seconds to hundreds of hours (99999990 seconds).

Counting: 1-9999999 regular or random pulses.

ADVANCE TIMER COUNTERS

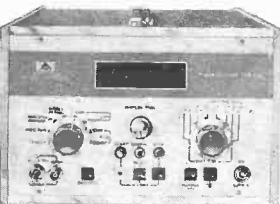

5 MC/s TIMER COUNTER TC4A

Frequency Measurement. Range: 0 to at least 5 Mc/s. **Gate Times:** 0.001, 0.01, 0.1, 1, 10S. Decimal point automatically positioned for display in Kc/s. **Sensitivity:** NORMAL input 10 c/s to 5 Mc/s, sinusoidal signal from 100 mV RMS. Maximum input 250V RMS up to 10 Kc/s and 10V RMS up to 5 Mc/s.

Period Measurement. Single and Multiple: Single period with variable time units or multiple periods up to 10^6 with μ S units.

Time Measurement. Unit time pulses: 1 μ S to 10S in decade steps. Maximum period displayed 10 6 S (approx. 28 hours).

Output Timing Pulses. Decode divisions: 10 8 pulses per second to one pulse per 10 seconds.

Counting. Range: 1 to 9999, regular or random pulses.

Frequency Standard. Internal: 1 Mc/s crystal oscillator, oven controlled at $\pm 65^\circ$ C. Accurate to 1 part 10^8 .

PRICE £205 ex Works

If you would like to know more about the Advance range of Timer Counters, please write for details or telephone for further information.



ADVANCE ELECTRONICS LIMITED

Instrument Division, Roebuck Road, Hainault, Ilford, Essex. Tel: Hainault 4444

G

NEW SHAPES OF SOUND



The Goldring-Lenco GL 68

The many proved features of Goldring-Lenco transcription units such as infinitely variable speed adjustment, pick-up lowering device, automatic idler wheel disengagement are retained on the GL 68, which is the first unit to incorporate the new G.65 arm. This is of low mass tubular construction with stylus pressure adjustment by sliding counterweight, and provision for height adjustment to suit any chosen cartridge. The interchangeable head slide (taking all cartridges with standard $\frac{1}{2}$ " fixing centres) makes use of self-cleaning wiper contacts. Swiss precision motor. Continuously variable speed adjustment. Less than 1% speed variation for 13% mains voltage variation. Adjustable click-in positions for the four standard record speeds. Pick-up raising/lowering device coupled to on/off switch. Automatic disengagement of idler wheel. Full 12" diameter turntable. Wired for stereo.
GL 68 Transcription Unit £16.16.0d. + £2.14.7 P.T.

Recommended cartridges for the GL68 are: Pickering V15 (AM1 and AME1) Pickering 380A, Goldring CS90 & CS91E.

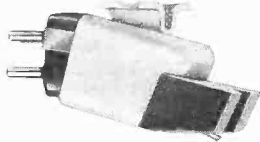

Pickering V15 AM1 and AME1 Micro-Magnetic Cartridge

Weighing only 5 gm., these high output, high compliance stereo—mono cartridges are perfect for low mass arms. 15° tracking angle gives minimum distortion. Hermetically sealed. Replaceable push-in diamond stylus assembly with retracting stylus arm for added protection to records. (0.0007" tip radius for V15/AM1 and elliptical, with even higher compliance, for V15/AME1).

V15/AM1 £9.9.0d. + £1.10.9d. P.T.
V15/AME1 £13.15.0d. + £2.4.8d. P.T.



Pickering 380A Cartridge

Moving-magnet for exceptional mono or stereo reproduction. Features the exclusive V-guard push-in diamond stylus unit which prevents damage through accidental dropping of arm on record. The Pickering 380A ensures high channel

separation and virtually eliminates needle talk, hiss or distortion. Hermetically sealed, it tracks at 2 gm., faithfully reproduces the most exacting records.
£12.12.0d. + £2.0.11d. P.T.

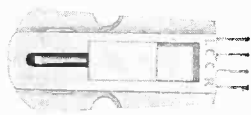

Goldring CS90 and CS91E Cartridges

These are stereo ceramic cartridges with excellent frequency response and cross-talk separation. Low tip mass, replaceable diamond stylus (CS90—0.0005" or 0.0007" tip radius; CS91E—elliptical) coupled with high compliance enables these cartridges to be played at light tracking weights. CS 90 £4.4.0d. + £0.13.8d. P.T. CS91E £6.6.0d. + £1.0.6d. P.T.

C68 Cabinet and Cover for GL68. Elegant sapele mahogany cabinet with removable, clear Perspex dust cover. Size: 14" x 17" x 7".
£8.19.6d. + £1.12.0d. P.T.

G

Goldring Manufacturing Company (G.B.) Ltd.,
486-488 High Road, Leytonstone, London, E.11
Telephone: Leytonstone 6343

WW—015 FOR FURTHER DETAILS.

Continuous Frequency Coverage from 1.5 c/s to 150 kc/s in 5 Ranges at Decade Intervals

TRANSISTOR

R. C. OSCILLATORS

TYPES TG150, TG150M

TG150D & TG150DM

SPECIFICATION:

FREQUENCY

1.5 c/s to 150 kc/s
 $\pm 3\% \pm 0.15$ c/s.

STABILITY

<0.05% drift after 30 seconds.
<0.3% drift for 30%
fall of supply voltage.
<0.05% drift per °C at 1 kc/s.

DISTORTION

<0.1% at 1 kc/s;
<0.3% from 50 c/s to 15 kc/s;
<1.5% below 50 c/s
and above 15 kc/s.

SINE WAVE OUTPUT

Variable up to 2.5V
into 600 Ω .
<1% variation with frequency.
<0.5% change for
30% fall of supply voltage.

SQUARE WAVE OUTPUT

Variable up to 2.5V.
Rise time 1% of period $\pm 0.2\mu$ s

ATTENUATOR

20dB, 40dB and 60dB; 600 Ω

SUPPLY

Self-contained PP9
batteries, life 400 hours,
or, 200/250V A.C. when Power
Supply Unit is fitted.

SIZE

10in. high x 6in. wide x 4in. deep.

WEIGHT

6 pounds.



SEE US AT THE I.E.A. SHOW
STAND N.815
FIRST FLOOR NATIONAL
GALLERY MAY 23-28

TYPE	TG150	TG150M	TG150D	TG150DM
Output Waveforms:	Sine only	Sine only	Sine and Square	Sine and Square
Output Meter:	None	0-2.5V and dB	None	0-2.5V and dB
Price with batteries:	£32	£42	£35	£45

LEVELL

PORTABLE INSTRUMENTS

Mains Power Supply Unit £7.10.0

Leather carrying case £3.10.0

Fully detailed leaflets are available on our complete range of portable instruments

LEVELL ELECTRONICS LIMITED

PARK ROAD, HIGH BARNET, HERTS ————— Telephone: BARnet 5028

WW-016 FOR FURTHER DETAILS.

SUPERIOR PERFORMANCE

Celestion Studio Series LOUDSPEAKERS

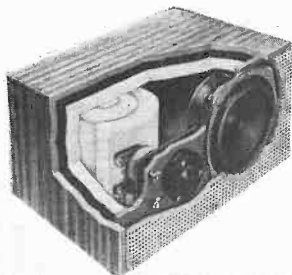

The Ditton 10

The Ditton 10 is a compact high fidelity reproducer measuring only 12 $\frac{3}{4}$ " x 6 $\frac{3}{4}$ " x 8 $\frac{1}{4}$ ". We, along with many thousands of satisfied users throughout the world, consider it to be the finest loudspeaker in its class—sales certainly substantiate this.

If you are in doubt ask your audio dealer to demonstrate the Ditton 10 against any other comparable system.

Brief Specification

Power handling capacity	10 watts R.M.S.
Overall frequency response	35-15,000 c/s
Impedance	15 ohms
Size	12 $\frac{3}{4}$ " x 6 $\frac{3}{4}$ " x 8 $\frac{1}{4}$ " (323mm x 171mm x 203mm)

Price £19.6.0. inc. P.T.

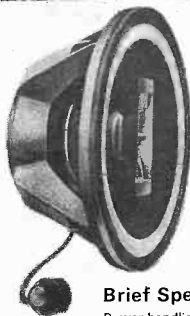

CX2012

When installed in a suitably designed enclosure the CX 2012 12" Co-axial loudspeaker provides truly professional sound quality.

A highly compliant cone surround allows maximum linear movement and minimises harmonic distortion.

Sensitivity of the co-axially mounted, horn-loaded, compression high note unit may be adjusted by means of the "Brilliance" control provided.

Brief Specification

Power handling capacity	20 watts R.M.S.
Overall frequency response	30-18,000 c/s
Impedance	15/16 ohms

Price
£17.10.0.

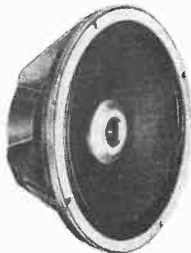

CX1512

A lower powered alternative to Model CX 2012, Model CX 1512 provides the high standards of performance demanded by professional users.

Price £12.5.0.

Brief Specification

Power handling capacity	15 watts R.M.S.
Overall frequency response	30-15,000 c/s
Impedance	15/16 ohms

SMALLER ENCLOSURES

Celestion research engineers have now evolved two new enclosure designs of only 2.5 cu. ft. to accommodate the above co-axial loudspeakers. Their external dimensions (using $\frac{3}{4}$ " timber) are only 30" x 17 $\frac{1}{2}$ " x 11 $\frac{1}{2}$ ". Full details are given on the colour brochure.

Celestion

Studio
Series

CELESTION LTD

Celestion Ltd., Ferry Works, Thames Ditton, Surrey.

Please send me full details of the Studio Series range of loudspeakers.

Name _____

Address _____

A17 _____

Ferry Works, Thames Ditton, Surrey.

Tel: EMBerbrook 3402/6

Pinnacle can assist all electronic valve users

ROUTINE

ECC83/12AX7 : 2D21/EN91 : 6AK5W/M8100 : ECF82/GU8

We supply many thousands of these and similar everyday valves to both small and large equipment manufacturers.

6AW8A : 6DK6/8136 : 5642 : 12BY7A

Users of American Instrumentation rely upon us to provide a speedy replacement service in valves not easily obtainable in this country.

DIFFICULT

SPECIAL

GV4010 : CY2578 : CV2134

The special needs of Government Establishments and Departments are regularly catered for by us. Our stocking policy ensures positive ability to supply even obscure types.

We maintain stocks of valves approved by the Air Registration Board and Ministry of Aviation making available an "off-the-shelf" service in released items for the first time.

A.R.B. : M.O.A.

UNUSUAL

OUR ORGANISATION draws upon the resources of electronic valve manufacturers all over the world. It responds immediately to your requirements. A catalogue of over 1,000 specific types is available to bona-fide users through the Wireless World reader service.

Pinnacle

PINNACLE ELECTRONICS LTD

ACHILLES STREET · NEW CROSS · LONDON S.E.14
Tel: Tideway 7285

WHARFEDALE SOUND

stereo/mono

WHARFEDALE SOUND



The DALESMAN two speaker slimline system is a big step forward in this type of enclosure. After much research an intensive listening tests the mid-range coloration usually associated with slimline cabinets is now reduced to a minimum. Designed by Wharfedale in association with consultant designer Robert Gutmann F.S.I.A., the Dalesman meets the demands of the quality conscious sound enthusiast and at the same time it occupies only a small amount of space and is a most attractive piece of sound equipment. The Dalesman features a newly developed 12" bass unit fitted

with a Flexiprene surround to handle the frequency range from 35 c/s to 1,700 c/s. The magnet assembly with a 1½" pole diameter has a flux density of 11,000 oersteds. The 5" treble unit has been specially designed for this particular enclosure. Where a free standing, compact, clean looking enclosure is required the Dalesman should certainly be heard

Frequency range 35 c/s—15,000 c/s.

Impedance 8/15 ohms.

Power Handling Capacity 15 watts (30 watts peak)

Size 25" x 20" x 6½" Weight 31½ lb.

Finish zebrano, mahogany, walnut or teak veneers.

£25.10.0

FRANK WHARFEDALE LIMITED
IDLE, BRADFORD, YORKSHIRE

Telephone Bradford 612552/3 Telegrams 'Wharfedal' Bradford

- AIRTIGHT FIBRE DOME TO ISOLATE TWEETER
- 5" HIGH EFFICIENCY TWEETER
- CROSSOVER NETWORK
- BRACING STRUT TO REDUCE PANEL RESONANCE
- BONDED ACETATE FIBRE WADDING
- 12" BASS UNIT WITH FLEXIPRENE SUSPENSION
- AIRTIGHT ENCLOSURE OF MAN MADE TIMBER

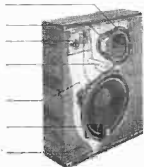

Free technical folder on the Dalesman from Dept. W5

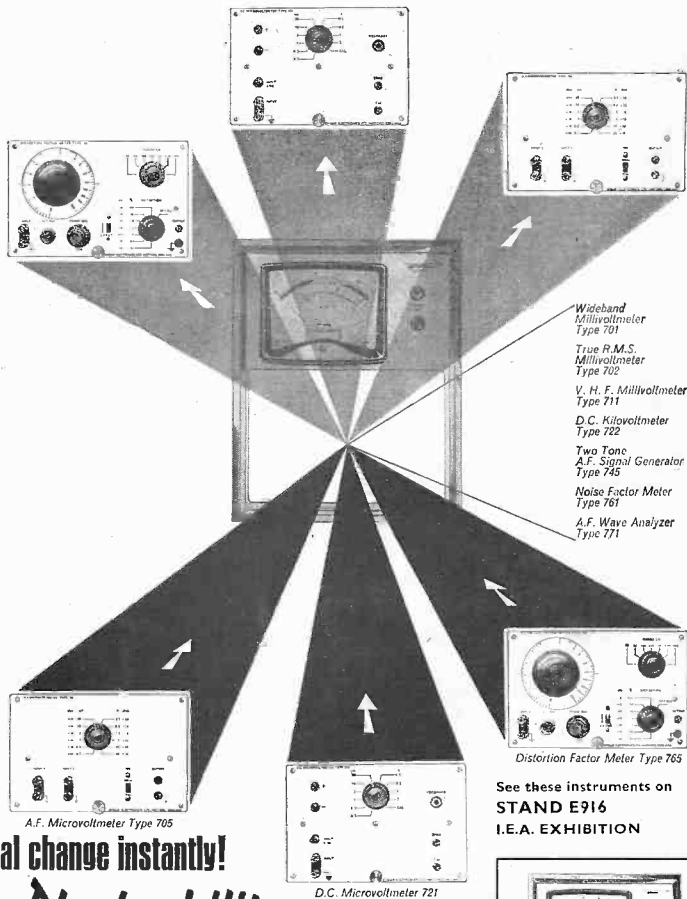
Wideband
Millivoltmeter
Type 701True R.M.S.
Millivoltmeter
Type 702V. H. F. Millivoltmeter
Type 711D.C. Kilovoltmeter
Type 722Two Tone
A.F. Signal Generator
Type 745Noise Factor Meter
Type 761A.F. Wave Analyzer
Type 771

Distortion Factor Meter Type 765

A.F. Microvoltmeter Type 705

D.C. Microvoltmeter 721

total functional change instantly!

that's *Pluginability*

—that's the Dymar System—a system of plug-in instruments offering flexibility and considerable capital saving. The basis of the system is the Type 70 Meter Unit which will accept any of a series of plug-ins. A change of function occurs with each combination because it produces a *different instrument*. Just release the retaining rod, withdraw the plug-in and insert another. It's as simple as that and 'Pluginability' sums it up in one word.

Full details from:

DYMAR ELECTRONICS LTD. REMBRANDT HOUSE WHIPPENDALL ROAD WATFORD HERTS.
Telephone: Watford 21297

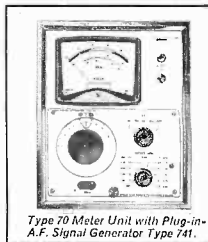
Type 70 Meter Unit with Plug-in
A.F. Signal Generator Type 741.

DYMAR

WW—022 FOR FURTHER DETAILS.

Broadway D1011

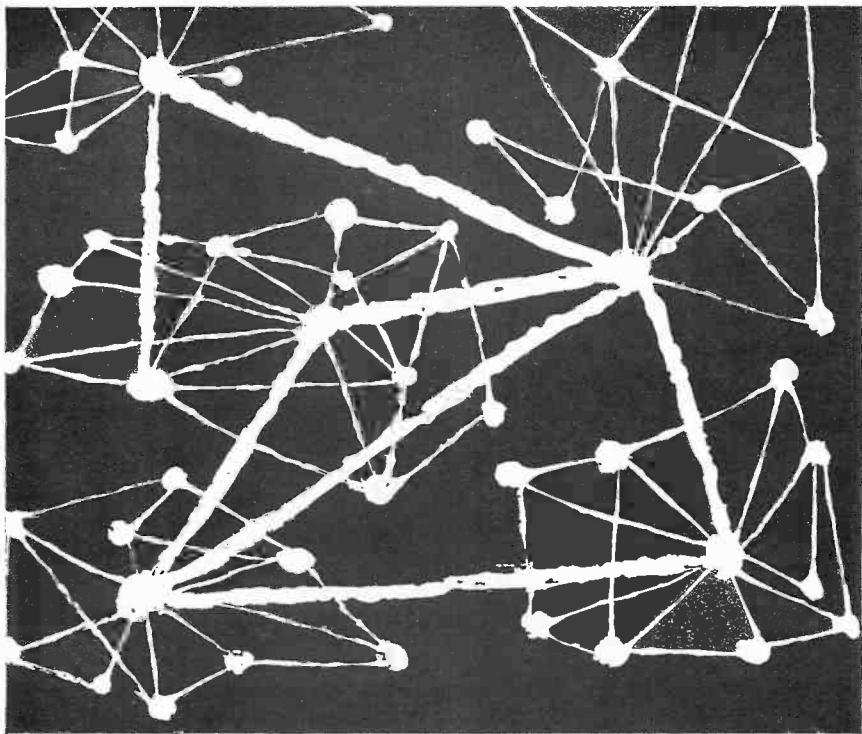

when stringing wires is hard—

It's just not economic or practical in many parts of the world to have normal wire and cable operating telephones. That's where ATE Radio Telephone Systems come in. In areas where difficulties of terrain would make the cost of installation and maintenance of telephone wires unrealistic, ATE—the pioneers of line-integrated radio telephones—can provide fully automatic systems which offer three important benefits: **LOWER INSTALLATION COSTS; LOWER MAINTENANCE COSTS; GREATER RELIABILITY.** ATE Radio Telephones cut out the costly business of constant line-checking and repair. They are designed for unattended operation under arduous conditions and they give absolute reliability in all climates.

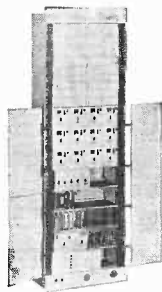

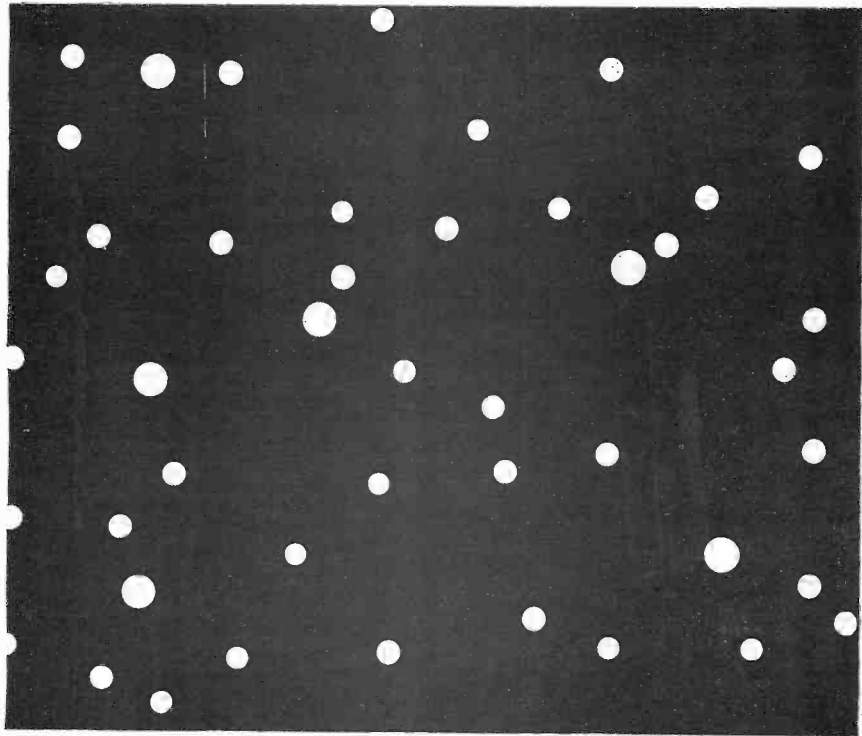

putting in ATE radio telephones is easy

Normal telephone facilities

In remote areas, ATE Radio Telephone Systems provide vital links between wire-telephone exchanges, as well as connecting remote subscribers and creating self-contained, non-public systems. Users will find that there is absolutely no difference in the use of radio telephones compared with normal wire systems. They provide the same supervisory and metering facilities that are used on manual and automatic, public or private-wire metallic circuit networks.

Wide range of ATE equipment

The range of ATE Radio Telephone Equipment covers needs from those of the remote subscriber on a battery-operated single-channel system, to a 12-channel system which is ideal for spur routes from main routes, economical relief of open-wire and cable routes, open-wire replacement, emergency service and military applications, order wire and alarm circuits for microwave applications, and short-term seasonal traffic.

Remote control and telephone facilities

ATE Radio Telephone Equipment can also provide many remote control and telegraph facilities. The equipment, which operates

completely unattended, transmits speech and enables pressures to be monitored, data telemetered, and a great variety of electronic signals transmitted in clear or in code. In combination with appropriate ATE electronic signalling units, it can activate alarms and switch power circuits on or off.

World-wide organisation

ATE has a comprehensive systems planning and surveying service. Associated companies, representatives and agents are located in 75 countries throughout the world.

Rural Radio Catalogue

For complete technical details of ATE Radio Telephone Systems and ancillary equipment, send for the fully illustrated Rural Radio Catalogue from AT & E (Bridgnorth) Limited, Bridgnorth, Shropshire, England. Telex: 33373

PLESSEY
Electronics



Ww-024 FOR FURTHER DETAILS.

PE(T)28

ADCOLA
 PRODUCTS LIMITED
 (Regd Trade Mark)

**SOLDERING
 EQUIPMENT**

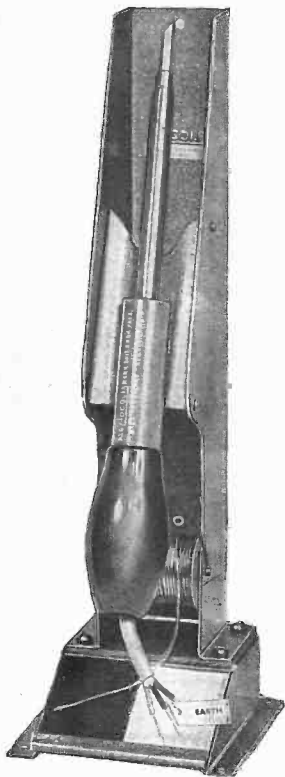

FOR FULL INFORMATION
 Apply Direct to:

ADCOLA PRODUCTS LTD.
 ADCOLA HOUSE
 GAUDEN ROAD
 LONDON, S.W.4

Telephone:
 MACaulay 0291/3
 Telegrams:
 SOLJOINT LONDON S.W.4

CLARK

LOW PRICED ELECTRICALLY OPERATED TELESCOPIC MAST

In introducing this new SUPER E Series Telescopic Mast Clark takes a stride forward. This is the equipment for which the World of Mobile VHF has been waiting. Based on the well tried QT and ST series, an entirely new concept of operation revolutionises the field of application. These telescopic masts provide the simple improvement in communication reliability for which Radio Telephone users have been searching. The power source is the vehicle battery. The control is a small panel easily attached to the dashboard. An electrical interlock makes it impossible for the mast to remain extended if the vehicle ignition is switched on—a great safety feature.



Clark SUPER E Series Masts are available with extended heights from 16 to 40 feet and head-load capacity up to 10 lb. There is, of course, also the full range of Clark Accessories. Send for more details today.



for further details write to:

A. N. CLARK (ENGINEERS) LIMITED
 BINSTED — ISLE OF WIGHT

Telephone: RYDE 3691 Telegrams: TELEMAST RYDE
 WW—025 FOR FURTHER DETAILS.



DESIGNED FOR MODERN LIVING

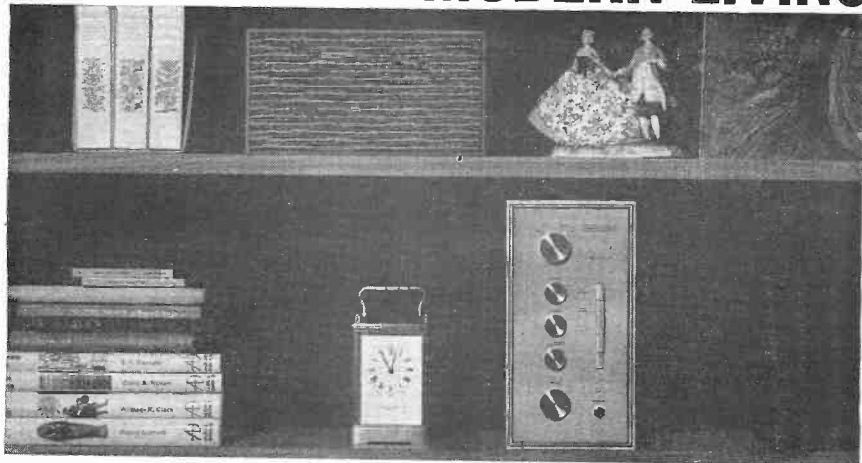

GOODMANS HIGH FIDELITY

GOODMANS HIGH FIDELITY Loudspeakers are world famous. Now GOODMANS proudly present their fully transistorised High Fidelity Amplifier—**MAXAMP 30**

To sacrifice looks for quality is no longer necessary. The smoothness in styling together with amazing compactness is obvious—the accuracy of its High Fidelity sound reproduction and ease of operation is something only a demonstration will prove.

MAXAMP 30 is a fully transistorised stereophonic High Fidelity Amplifier using Silicon Transistors throughout. It is precision engineered and fullest use is made of printed circuits. It will deliver continuously up to 15 watts of power on each channel and it looks as good as it is. Its polished wood cabinet with 'Danish Silver' scratchgrain control panel blends with any decor. **£49.10s.0d.**

MAXIM. The ORIGINAL and unequalled High Fidelity Loudspeaker mini-system. Complete full-range Hi-Fi reproduction (45-20,000 c/s) —yet within shoe-box size and handling 8 watts. Meticulously finished enclosure in hand rubbed Teak or Walnut. $10\frac{1}{2}'' \times 5\frac{1}{2}'' \times 7\frac{3}{4}''$ **£17.10s.6d.** inc. P.T.

Maxim, Mezzo or Magnum-K the **Maxamp 30** will handle them all—the choice is yours.

GOODMANS INDUSTRIES

AXIOM WORKS · WEMBLEY · MIDDLESEX Tel: WEM 1200

A Division of Radio Rentals Products Ltd.

MEZZO. The Loudspeaker to Live With. 15 watts of power yet only $10\frac{3}{4}'' \times 18\frac{1}{2}'' \times 8''$ deep—it really will go on your bookshelf. Range—a clear and clean 40-20,000 c/s. Two specially developed loudspeakers, crossover 2,200 c/s. **£26.5s.0d.** inc. P.T.

MAGNUM-K. Originally designed for professional purposes, the MAGNUM-K is the system for the connoisseur. A full 25 watt 3 way High Fidelity Loudspeaker System within only $15'' \times 24'' \times 11\frac{1}{2}''$. 12" Bass unit gives minimal distortion down to 20 c/s, the mid-range and high frequency direct radiator units are controlled by constant impedance attenuators for individual balancing. Although it will handle 25 watts, for domestic use Hi-Fi amplifiers from 6-12 watts are quite adequate. **£36.15s.0d.**

Please send MAXAMP 30 booklet and 1966 Hi-Fi Manual together with name and address of my nearest Goodman's dealer.

Name

Address

WWS

SME

The best pick-up arm in the world

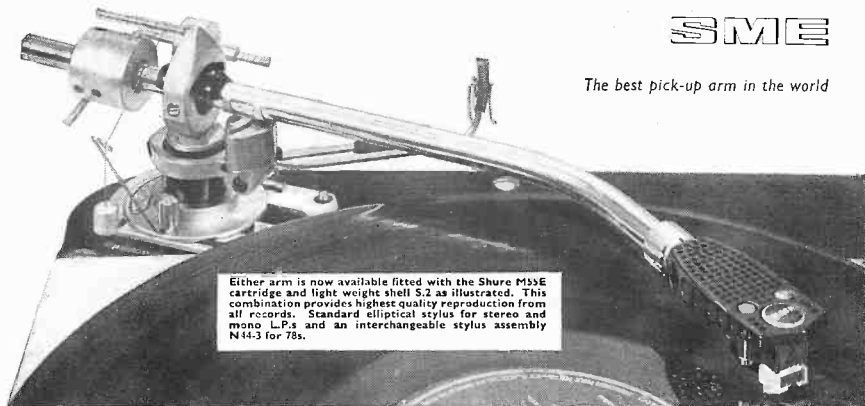

Either arm is now available fitted with the Shure M55E cartridge and light weight shell 5.2 as illustrated. This combination provides highest quality reproduction from all records. Standard elliptical stylus for stereo and mono L.P.s and an interchangeable stylus assembly N44-3 for 78s.

Only S.M.E. Precision Pick-up Arms offer all these features • Choice of arm length Model 3009 (9 in.) or Model 3012 (12 in.) for still lower tracking error—of special importance with elliptical styli • Low inertia • High precision ball races and knife-edge bearings for minimum pivot friction • Linear offset chosen for lowest distortion • Automatic slow-descent with hydraulic control • Bias adjuster calibrated for tracking force • Exact overhang adjustment with alignment protractor • Precise tracking force from 1-5 grams applied without a gauge • Shielded output socket • Low capacity 4ft. connecting cable with quality plugs • Light-weight shell • Camera finish in satin-chrome, gun-black and anodised alloy • Comprehensive instructions • Rational development—all improvements can be incorporated in any existing Series II arm.

For sales and service ring Steyning 2228.

S.M.E. LIMITED • STEYNING • SUSSEX • ENGLAND

WW—027 FOR FURTHER DETAILS.

FREE TO AMBITIOUS ENGINEERS

THE LATEST EDITION OF ENGINEERING OPPORTUNITIES

Have you sent for your copy?

ENGINEERING OPPORTUNITIES is a highly informative 156-page guide to the best paid engineering posts. It tells you how you can quickly prepare at home for a recognised engineering qualification and outlines a wonderful range of modern Home Study Courses in all branches of Engineering. This unique book also gives full details of the Practical Radio & Electronics Courses, administered by our Specialist Electronics Training Division—the *B.I.E.T. School of Electronics*, explains the benefits of our Employment Dept. and shows you how to qualify for five years' promotion in one year.

SATISFACTION OR REFUND OF FEE

Whatever your age or experience, you cannot afford to miss reading this famous book. If you are earning less than £30 a week, send for your copy of "ENGINEERING OPPORTUNITIES" today—FREE.

BRITISH INSTITUTE OF ENGINEERING TECHNOLOGY
(Dept. 303B), 29 Wright's Lane, London, W.8

THE B.I.E.T. IS THE LEADING ORGANISATION OF ITS KIND IN THE WORLD**WHICH IS YOUR PET SUBJECT?**

Mechanical Eng.,
Electrical Eng.,
Civil Engineering,
Radio Engineering,
Automobile Eng.,
Aeronautical Eng.,
Production Eng.,
Building, Plastering,
Draftsmanship,
Television, etc.

GET SOME LETTERS AFTER YOUR NAME!

A.M.I.Mech.E.
A.M.I.C.E.
A.M.I.Prod.E.
A.M.I.M.I.
A.J.O.B.
B.Sc.
A.M.I.L.R.E.
City & Guilds
Gen. Cert. of Education
Etc. etc.

PRACTICAL EQUIPMENT

Basic Practical and Theoretical Courses for beginners in Radio, T.V. Electronics, Etc.
A.M.I.E.R.E. City & Guilds Radio Amateurs Exam.
R.T.E.B. Certificate
P.H.G. Certificate
Practical Radio
Radio & Television Servicing
Practical Electronics
Electronics Engineering
Automation

INCLUDING TOOLS!

The specialist Electronics Division of *B.I.E.T.* NOW offers you a real laboratory training at home with practical equipment.

Ask for details.
B.I.E.T. SCHOOL OF ELECTRONICS

**POST COUPON NOW!**

Please send me your FREE 156-page "ENGINEERING OPPORTUNITIES"
(Write if you prefer not to cut page)

NAME

ADDRESS

.....

.....

.....

.....

.....

.....

.....

.....

.....

.....

WW—028 FOR FURTHER DETAILS.

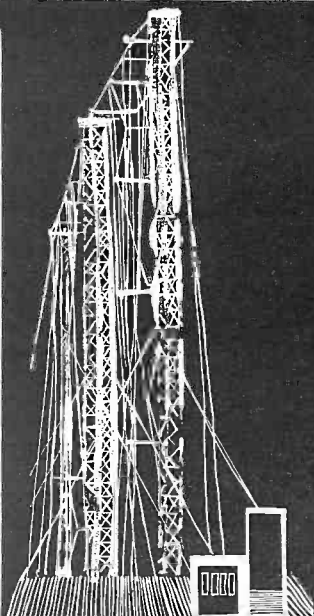

EEV Vacuum Variable Capacitors

English Electric Vacuum Variable Capacitors offer outstanding advantages over air dielectric counterparts for all transmitter applications at frequencies up to 27 Mc/s. These advantages include: ■ Compactness ■ Low self inductance and stray capacitance ■ Direct or remote control ■ Low inertia and torque for servo tuning ■ Freedom from adverse dust and moisture effects ■ Self-healing properties ■ Linear relation between shaft turns and capacitance ■ Any mounting position ■ Voltage rating maintained under adverse ambient conditions ■ Minimal maintenance costs.

The standard range employs shaft tuning but most types can be modified for axial pull tuning. EEV will also consider other special design features and alternative capacitance values to suit individual requirements not covered by the standard range. EEV capacitors, as well as being the ideal choice for new equipments, are particularly suitable for the modernisation of older transmitters. For full information on all EEV vacuum capacitors, including fixed capacitance types contact the Sales Office at the address below.

ENGLISH ELECTRIC VALVE CO LTD AGENTS THROUGHOUT THE WORLD
CHELMSFORD ENGLAND · TELEPHONE: CHELMSFORD 53491 EXTENSION: 318 TELEX: 99103
WW-029 FOR FURTHER DETAILS.

EEV
AEC

ADAMIN

Micro Soldering Instruments

- HIGH PERFORMANCE. Normal temperatures 360/375°C. Some models 450°C and 500°C.
- MINIATURE SIZE Overall lengths 6½ in. to 7½ in.
- LOW WEIGHT. From ¼ oz. to 1 oz., less flex.
- RAPID HEATING 30 seconds to 2 minutes.
- ABSOLUTE SAFETY
A & B types low voltage
C types fully earthed and flash tested.

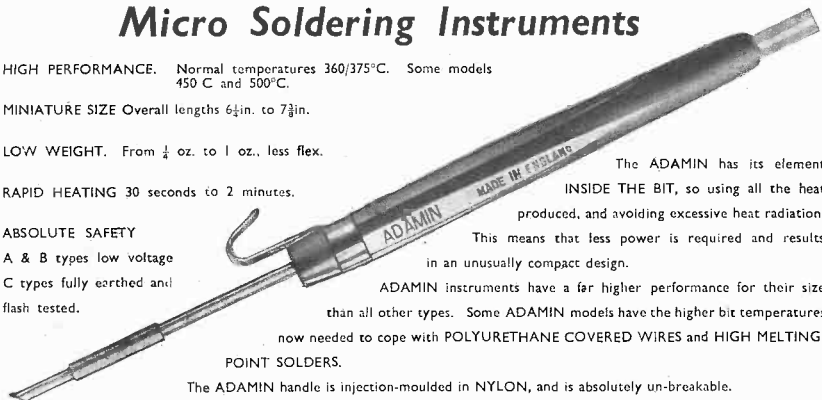

The ADAMIN has its element INSIDE THE BIT, so using all the heat produced, and avoiding excessive heat radiation.

This means that less power is required and results in an unusually compact design.

ADAMIN instruments have a far higher performance for their size than all other types. Some ADAMIN models have the higher bit temperatures now needed to cope with POLYURETHANE COVERED WIRES and HIGH MELTING-POINT SOLDERS.

The ADAMIN handle is injection-moulded in NYLON, and is absolutely un-breakable.

Free details in brochure SP.5.

LIGHT SOLDERING DEVELOPMENTS LTD.,

28, Sydenham Road, Croydon, Surrey.
Telephone: CRO 8589

WW-030 FOR FURTHER DETAILS.

this coupon
is so important
to you that we've
put it at the top.



INDUSTRIAL INSTRUMENTS LTD
STANLEY ROAD BROMLEY KENT

NAME _____
COMPANY _____
ADDRESS _____

outline requirements

V in _____
V out _____
FREQ _____
POWER _____
WAVEFORM _____

If you have a

STATIC INVERTER design problem—forget it!

TRANSIPACK®

designers have probably already solved it . . .

And if they haven't already created a static inverter to meet your specific requirements, you can be sure they'll come up with the right answer in the shortest time and in the most economical way. Sine or square wave, 5 V.A.—40 K.V.A. We also manufacture Ultrasonic Cleaning Equipment, Accumulator Eliminators, Elapsed Time Indicators.



INDUSTRIAL
INSTRUMENTS
LIMITED

STANLEY ROAD
BROMLEY · KENT
Telephone:
RA Vensbourne 9212/3.
Telegraphic Address:
TRANSIPACK BROMLEY

WW-031 FOR FURTHER DETAILS.

NOW GO BACK TO THE BEGINNING AND FILL IN THE COUPON →

PROBLEMS



SHOCK LOADS



TRANSMISSION



TROUBLE

VIBRATION



OSCILLATION



FRUSTRATION



ANSWERS



MOUNTINGS



COUPLINGS



BEARINGS



LINK ASSEMBLIES

SILENTBLOC



SILENTBLOC LIMITED • MANOR ROYAL • CRAWLEY • SUSSEX

Telephone: Crawley 27733 Telegrams: Silentbloc Crawley Telex: 87177

Silentbloc products are also manufactured by Silentbloc (Australia) Pty. Ltd., Melbourne Broadway 5507

Andre Rubber Co. Ltd. is another Silentbloc Company

WW-032 FOR FURTHER DETAILS.

'ARKLONE'

THE **CHEAP**
COSTLY **AT**
CLEANING **20**
SOLVENT **TIMES**
THE
PRICE



First things first:
 'ARKLONE' is a pure liquid,
 boiling point 47°C,
 chemical nomenclature
 1.1.2. trichlorotrifluoroethane;
 non-flammable, non-toxic.

Now for the graph. Well, there was this customer who converted his cleaning process from hand cleaning, using isopropyl alcohol and a team of girls, to a total immersion process using 'ARKLONE' ultrasonically irradiated in a suitably designed plant.

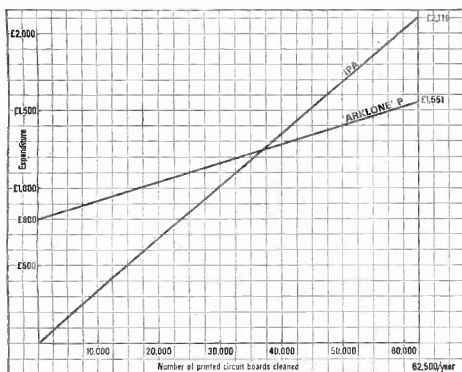

This customer saved £570 on the first year's working after deducting capital cost. And, in fact, probably rather more than this, because the number of rejects formerly produced by harsh solvent action and handling was not known, nor the cost of insurance premiums (isopropyl alcohol is highly flammable and toxic—'ARKLONE' is neither, and makes working conditions safer and more pleasant). His operations are concerned with cleaning printed circuit boards, and 'ARKLONE' is particularly good at that, because it does not attack the metals, plastics, resins and elastomers normally used in this kind of construction.

'ARKLONE' is also first-class at cleaning computer core memories, tape recording and play-back heads, and other components consisting wholly or partly of plastics materials, or containing resins or elastomers—spectacle frames, for instance.

We'll say it again: 'ARKLONE' is a costly cleaning solvent that would be cheap at twenty times the price!

If you want to work out the cost of changing your cleaning process to 'ARKLONE'—get in touch with ICI. One of our representatives will be glad to assist you.

BEFORE

Hand cleaning, by girls using alcohol:

	£	s
Capital cost and depreciation	nil	
Labour charges	2083	
Solvent consumption (4 gals. per week at 3/6 per gal.)	36	8
Services	nil	
Total/year	2119	8

AFTER

Immersion cleaning with 'ARKLONE',
 cleaning in batches in an ultrasonic plant
 operated by one man:

	£	s
Capital cost (plant written off in one year)	800	
Labour charges	500	
Solvent consumption (1 gallon/week at £4.13.9 per gallon)	234	
Services (electricity and water)	17	
Total/year	1551	

IMPERIAL CHEMICAL INDUSTRIES LIMITED, LONDON S.W.1

'ARKLONE'

'ARKLONE' is the ICI registered
 trade name for 'ARCTON' 113

AR88

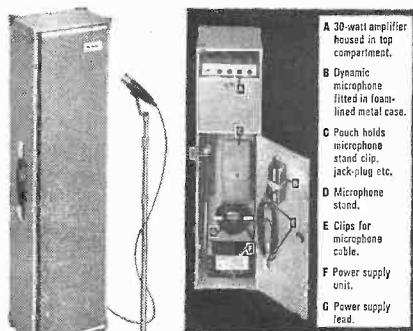

- A 30-watt amplifier housed in top compartment.
- B Dynamic microphone fitted in foam-lined metal case.
- C Pouch holds microphone stand clip, jack-plug etc.
- D Microphone stand.
- E Clips for microphone cable.
- F Power supply unit.
- G Power supply lead.

PORTABLE SOUND FOR ALL EVENTS

THE WHARFEDALE PA30 Completely self contained — pull open the amplifier compartment — open the accessory compartment — take out the microphone — plug in — switch on and speak; it's the greatest public address idea in years.

Anyone can operate the PA30 — no technical ability required.

PUBLIC ADDRESS SYSTEM

This completely portable sound system is housed in a single durable tan leatherette covered carrying case with vinyl grille cloth. A special loudspeaker system comprising six Wharfedale speakers is built in the front section of the case. The robust and powerful transistor amplifier operates from self contained batteries or mains at the turn of a switch.

Everything packs away neatly in sixty seconds — ready for use again at a moments notice.

Size $36\frac{3}{4}$ " x $7\frac{1}{2}$ " deep x $9\frac{7}{8}$ " plus $\frac{3}{8}$ " handle.

Weight 42 lb. £69.10.0.

FOR FULLY ILLUSTRATED LEAFLET AND DETAILS OF PA30 DEMONSTRATIONS WRITE TO (Dept WS)

RANK WHARFEDALE LTD
 IDELE BRADFORD - YORKSHIRE
 TELEPHONE BRADFORD 81552Z
 TELEGRAMS 'WHARFEDALE' BRADFORD

NAME _____

ADDRESS _____

TOWN _____

COUNTY _____

WHARFEDALE

WW-035 FOR FURTHER DETAILS.



Accurate components at competitive prices

produced by progressive tooling and multiform methods



JOHN SMITH LTD.

209 SPON LANE - WEST BRONWICH - STAFFS
 TELEPHONE: WVS 2516 (3 lines)
 WOODS LANE - CRADLEY HEATH - STAFFS. TELEPHONE: CR 69283 (3 lines)
 WW-036 FOR FURTHER DETAILS.

The NEW Wolec RF GENERATOR

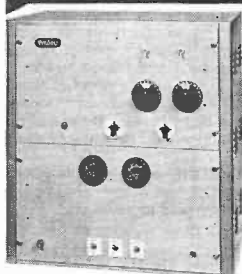

gives Variable IMPEDANCE MATCHED OUTPUT from 100-2,000Ω

This high performance, reliable and robust R.F. generator is specifically designed to meet the popular need for a lower power R.F. source with a variable output impedance. Three models are available, viz. 10-120 watts (output), 10-200 watts and 200-250 watts. The WOLEC is finding considerable application for laboratory use (to operate discharge tubes, etc.) in Industry, Nuclear Physics, Universities and Colleges. This extremely versatile unit can be coupled up to any equipment requiring an R.F. input with a low distortion sine-wave. Crystal controlled single frequency or variable frequency (with a high stability tuner) covers the bands 13-18 Mcs, 25/30 Mcs and 140/150 Mcs. The output can be modulated as required. Wolec supply (200/250V A.C.) using Silicon Rectifiers (fully smoothed). Every WOLEC is triple tested before despatch and has been designed to ensure easy maintenance. It is suitable for continuous use in temperatures up to 50°C. Circuit modification to suit customers' requirements can be incorporated.

Weight: approx. 80 lbs.

For Full Specification write to the Manufacturers, DEPT. W4.

WOLFENDELE ELECTRONICS

36A KIMBERLEY ROAD - BOURNEMOUTH - Tel: 48792

WW-037 FOR FURTHER DETAILS.

Permacon edge connectors

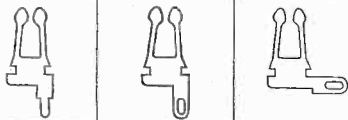
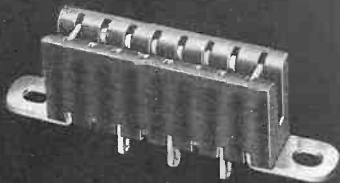

35

These inexpensive edge connectors feature polypropylene mouldings and brass or phosphor bronze contacts with a standard tinned finish. Silver plate, gold flash, or gold plate finishes are available to special order. .100" contact pitches provide a maximum of 40 positions whilst the .150" contact pitch range provides for a maximum of 26 positions. Contact tail variations (shown above) include solder slot tails projecting either vertically downwards or at 90° to the moulding, or tails for direct mounting to a "mother" printed circuit board. Mounting brackets provide "closed" or "open-ended" connectors or include contacts for direct earthing from the mating P.C. Board.

Electrical Ratings

Working voltage: 500 Volts D.C. or A.C. Peak (.150" pitch)
350 Volts D.C. or A.C. Peak (.100" pitch)

Current capacity: 5 amps max. per contact

CARR FASTENER CO LTD

the firm with the best connections

Stapleford, Nottingham. Telephone: Sandiacre 2661.

Sales Offices: Wembley, Sale.



WW-038 FOR FURTHER DETAILS.

EDDYSTONE COMMUNICATION RECEIVERS

For the professional or Amateur user who likes the Best.



840C
£66

Communication receiver at a moderate price. MANUFACTURING STANDARDS OF THE HIGHEST ORDER, 8 BSA valves Superheterodyne circuit. **FREQUENCY RANGES:**

Range 1 12.4—30 Mc/s Range 4 1.12—2.28 Mc/s
Range 2 3.2—12.9 Mc/s Range 5 450—1,150 kc/s
Range 3 2.5—6.1 Mc/s

Ranges 4 and 5 include the International Distress Frequencies.

Model No	Cash Price	Model No	Cash Price
EG10	£45 0 0	EB55	£59 7 6
240C	£65 0 0	840	£133 0 0
	EA12		£185 0 0

His Purchase Terms gladly arranged. Owing to frequent changes in the I.P. regulations we are obliged to discontinue advertising these.

Please write for current rates. A 4d stamp will bring you these and a full range of Eddystone Literature.

Carriage paid per messenger train. SATISFACTION GUARANTEED.

SEND FOR LITERATURE TO

The Eddystone

Specialists

SERVICES LTD.

49/51 COUNTY ROAD
LIVERPOOL, 4

Telephone: AIN TREE 1445

ESTAB. 1935

WW-039 FOR FURTHER DETAILS.



JONES TYPE CO-AXIAL CONNECTORS

Low cost miniature co-axial with brass shells, screw thread coupling.

Cannon Electric
(Great Britain) Ltd.,
Lister Road,
Basingstoke, Hants.
Tel: Basingstoke 3171



Registered Trademark

CANNON

WW-040 FOR FURTHER DETAILS.

**YOU CAN
NOW BUY THE
WORLD'S FINEST
SPEAKER VALUE
DIRECT FROM**

R&A

The 700 Mark V Range

Specially designed to provide outstanding range, smoothness and uniformity of frequency response with freedom from self generated forms of distortion up to levels more than adequate for domestic listening. The speakers in this range all have a highly developed dual radiating system with optimum termination of both cones — voice coil impedance 15 ohms.



Power handling capacity in appropriate enclosures:—

780 Mk. V 8 in. 6 watts r.m.s. 12 watts peak.	Price £3. 18. 6 (inc. 10/6 P.T. and P. & P.)
7100 Mk. V 10 in. 8 watts r.m.s. 15 watts peak.	Price £4. 13. 0 (inc. 12/6 P.T. and P. & P.)
7120 Mk. V 12 in. 10 watts r.m.s. 18 watts peak.	Price £4. 18. 6 (No P.T. but inc. P. & P.)

Send for full technical data sheet with suggestions for enclosures to:



REPRODUCERS AND AMPLIFIERS LTD.
Frederick Street, Wolverhampton England

Loud Speaker Manufacturers to the
Radio Industry since 1930

WW-041 FOR FURTHER DETAILS.

ROTARY SWITCHES FOR THE HOME CONSTRUCTOR

Writers of constructional articles for *Wireless World* are reminded that readers often have difficulty in obtaining rotary switches of special type and contact arrangements. Consult us before deciding upon the switches you incorporate in your designs and be assured that a switch to any desired specification will then be immediately available to your readers.

Design charts and details
(for writers and readers) from:

Specialist Switches Ltd.
23 Radnor Mews, London W.2.
Paddington 8866-7

WW-042 FOR FURTHER DETAILS.

Valradio

TRANSVERTERS

(TRANSFORMERISED D.C. CONVERTERS)

the D.C. conversion
specialists
since 1935



2 KW. Peak Starting.
750 W. Continuous.
50-60,400 cfs. or D.C.
from 12-24-50v. Battery.
Up to 93% Efficiency. Polarity Reversal Protection. Square or Sinewave. Up to 300% Instant Overload Capacity. Manually Controlled Frequency. Reed Type Indicator. Remote Control Facilities.

Applications: Static "No-Break" Standby Power Supplies; For Vital System(s) Protection, e.g. V.H.F. Transmitters; Industrial Processes; Control-Alarm-Warning Systems; Mobile Use of Counters; Sig. Gen. Recorders—UJV Sound; Oscilloscopes and Lab. Gear in Marine and Aircraft (K114).

Range of models available with prices from £11-£94.10.0 Please write to department C.10 for transverter leaflet

VALRADIO LIMITED

BROWLE LANE, FELTHAM, MIDDLESEX
ENGLAND Telephone: FELTHAM 4837-4242

Valradio and Stereoscope are the registered trade marks of Valradio Ltd.

WW-043 FOR FURTHER DETAILS.

There's
more to
Bradley's
than...

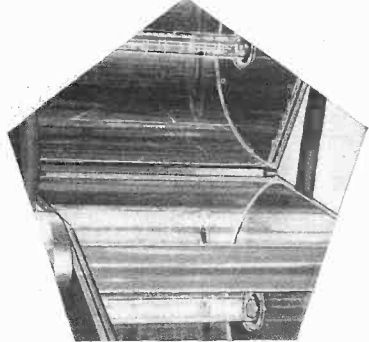
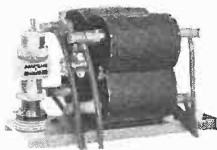

lasers. In fact we make a wide range of electronic instruments, co-axial components, solid state microwave sub-systems, as well as lasers. All combine advanced design with precision reliability and rugged construction. A continuous development programme serves both Research and Industry, seeking not only new design concepts but also more efficient manufacturing techniques. Below are just two examples from the Bradley range:

Parametric Amplifiers

A range of advanced design, developed to improve noise performance of receivers in such applications as radio astronomy, microwave link systems, U.H.F. and microwave radar systems, satellite tracking and communications. These are available for operation up to 10 Gc/s with bandwidths from 1%–10%, depending on the application.

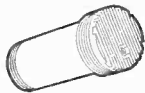

Solid State Sources and Frequency Multipliers

The Bradley range of advanced solid-state sources and frequency multiplier modules will provide output powers from 100 watts at 60 Mc/s to 10 milliwatts at 75 Gc/s.

Typical applications are:—
Solid-state microwave local oscillators.
Solid-state communication link transmitter sources.
Solid-state parametric amplifier pump courses.

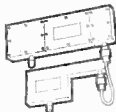

**G.&E. BRADLEY
LIMITED**

ELECTRAL HOUSE, NEASDEN LANE, LONDON, N.W.10. TELEPHONE: DOLLIS HILL 7811.
TELEGRAMS: BRADLEC LONDON N.W.10. TELEX: 25083

WW-044 FOR FURTHER DETAILS.

VARIABLE D.C. POWER UNIT WITH ACCUMULATOR PERFORMANCE FROM A.C. MAINS

EFFECTIVE
RESISTANCE
LESS THAN
-1 ohm.



TYPE
250VRU/30/20
250VRU/60/10
PRICE
£131-5-0

FEATURES

0-30 VOLTS Variable up to 20 AMPS.
0-60 VOLTS Variable up to 10 AMPS also available.
RIPPLE CONTENT negligible, IMPEDANCE and REGULATION equivalent to accumulator performance. SILICON RECTIFIERS. Insurgent "SHORT" protection.
OVERLOAD CAPACITY 200% for short periods.

APPLICATIONS

Operating and Servicing transistorised equipment. 12v. Mobile radio/telet. operation. D.C. Motors, relays, industrial power, etc., from any point of A.C. WITHOUT THE USE OF ACCUMULATORS.

12v. or 24v. FIXED OUTPUTS up to 24 Amps also available.
AVOID THE EXTRA EXPENSE OF SUPER REGULATION YOU MAY NEVER NEED. Prices £14-10-0 to £131-5-0.



LIMITED

Please write to department C 3b,
for current literature.

BROWELLS LANE,
FELTHAM, MIDDX.
ENGLAND

Tel.: FEL 4837-4342

VALRADIO and STEREOSONOSCOPE are the registered trade marks of VALRADIO LTD.

WW-045 FOR FURTHER DETAILS.

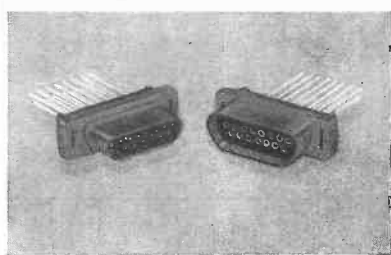

MICRO-D PLUGS

Versatile, highly reliable microminiature connectors designed for space and weight saving applications.

Cannon Electric
(Great Britain) Ltd.,
Lister Road,
Basingstoke, Hants.
Tel: Basingstoke 3171



Registered Trademark

CANNON

WW-046 FOR FURTHER DETAILS.

SEE TOMORROW'S TECHNOLOGY—TODAY

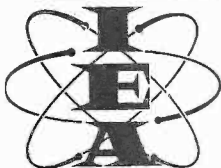

SIXTH INTERNATIONAL

INSTRUMENTS ELECTRONICS AUTOMATION

EXHIBITION
OLYMPIA LONDON

23-28 MAY 1966

The International Instruments, Electronics & Automation Exhibition is the technological show of the future—today. The most significant exhibition of the year, IEA focuses at Olympia the achievements of 800 international firms in the vanguard of scientific industrialisation.

Catholic in scope, IEA ranges the whole field of instrumentation, electronics and automation.

Times: 10 a.m.—6 p.m. daily

Admission: 5/-, Season Ticket 10/-,

or by ticket obtainable only from exhibitors.

IEA INDUSTRIAL EXHIBITIONS LIMITED 9 ARGYLL STREET LONDON W1

WW-047 FOR FURTHER DETAILS.

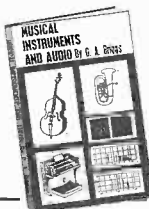

MUSICAL INSTRUMENTS AND AUDIO

A NEW BOOK BY

G. A. BRIGGS

Published October 1965
240 pages 213 illustrations. Fine art paper.
cloth bound 32/6 (34/- post free)

In this book, the sixteenth to be produced by the Briggs-Wharfedale set-up, attention has been turned to musical instruments as the basis of audio.

Chapters include:

GENERAL PRINCIPLES. VARIOUS SOUNDS—CAUSE AND EFFECT. CHARACTERISTICS OF INSTRUMENTS. FORMANTS. DISTORTION IN SOUNDS. DISTORTION IN REPRODUCTION. ORGANS. ELECTRONIC ORGANS. PIANOS. TUNING. MUSIC IN SCHOOLS.

Music Industry (Nov.) concludes its review:—"Mr. Briggs comments that this book, his sixteenth for the Wharfedale company, has taken a year and a half to complete. It is a year and a half well spent for it must surely become a standard introductory work to the sounds that result from the workings of the music industry."

W
WHARFEDALE

Sold by radio dealers and bookshops, or, in case of difficulty, direct from the publishers.

RANK WHARFEDALE LTD.
IDLE, BRADFORD, YORKS.

Telephone: 612552/3

Telegrams: "Wharfedale" Bradford.

WW-048 FOR FURTHER DETAILS.



Eddystone

SLOW MOTION DIALS

Catalogue No. 598 epicyclic dial

This full vision dial incorporates an epicyclic, ball-bearing drive mechanism of improved design

and giving a reduction ratio of approximately 10 to 1. The movement is smooth and free from backlash. Dial escutcheon measures 6" long by 4 1/2" wide, finished ripple black. Four lines are provided on the semi-circular scale for individual calibrations, the outer line being marked from 0 to 100 over 180°. Supplied complete with black instrument knob 2 1/2" diameter.



Catalogue No. 898 gear driven dial

A high grade assembly for precision instrument applications. Gear driven, flywheel-loaded mechanism, with a reduction ratio of 110 to 1, giving smooth, positive control.

instrument knob. Complete with fixing screws and mounting template.

Pointer travel is 7". A circular vernier scale, marked 0 to 100, is read in conjunction with the lowest line on the main scale, which has five lines for individual calibration. Overall dimensions 9 1/2" by 5 1/2". Diecast escutcheon finished glossy black to match 2 1/2" diameter



Eddystone Radio Limited

Eddystone Works, Alvechurch Road, Birmingham 31

Telephone Priory 2231 Cables Eddystone Birmingham Telex 33708

WW-049 FOR FURTHER DETAILS.

LTD/ED 8

100,000 REASONS WHY YOU NEED THIS CATALOGUE



Over 100,000 different types of British and American Plugs, Sockets and Connectors available.

EX-STOCK FOR IMMEDIATE EXPRESS DELIVERY

Standard Circular, Miniature Circular, Pygmy, Audio, Electrical, Miniature, Sub-miniature, Radio Frequency, Accessories: by AMPHENOL, BELLING LEE, BENDIX, BUGGIE, BULGIN, CANNON, CONTINENTAL, ELECTRO METHODS, FILMS & EQUIP., GREENPAR, HUBBELL, IGBRANC, JONES, KINGS, MAGNETIC DEVICES, MAMURDO, NIPPAN, PET, PLESSEY, PAINTON, PYLE, SUPERFLEXIT, THORN, TRANSRADIO, U.G., WINGCHESTER. Large stocks held under their INTER SERVICE reference numbers.

All are listed in this 24 page fully illustrated catalogue.

SEND FOR YOUR COPY TODAY!

LIND-AIR ELECTRONICS LTD

53 Tottenham Court Road, London, W.1.
Telephone: LANgham 3653 (10 lines) Telex: 27931

WW-050 FOR FURTHER DETAILS.

INSTRUMENTS IN THE MODERN MANNER

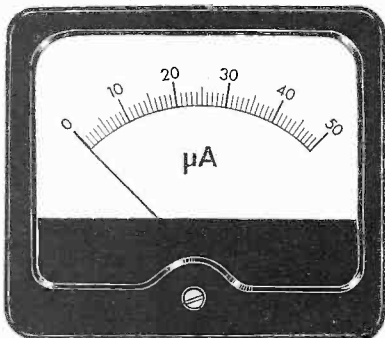

Black Moulding
and
Plastic with Black front and clear top.

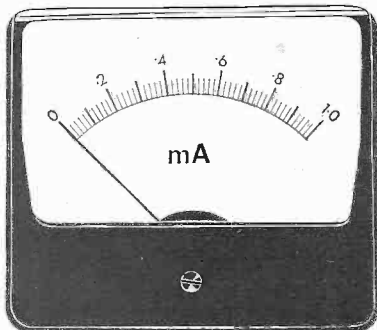

Full information on these, and other, stylings, which are all available in a wide range of Microammeters, Milliammeters, Ampmeters, and Voltmeters, both D.C. and Rectified A.C., from:

HARRIS ELECTRONICS (LONDON) LTD.

138, Gray's Inn Road, W.C.1.

'Phone Terminus 7937

WW-051 FOR FURTHER DETAILS.

accuracy + 0.1%

Price: £275

**on specification, performance and value for money
Marconi instruments challenge comparison
with any in the world**

0.1% UNIVERSAL BRIDGE **TYPE TF 1313A**

The trend is towards components of close tolerance – often better than 1%. This new version of Marconi Instruments famous TF 1313 Universal Bridge employs bridge standards of higher accuracy with closely controlled temperature co-efficients, circuits of greater refinement and new balance controls giving improved resolution. The detector sensitivity has been increased so that, on every range, 0.1% error corresponds to an unambiguous meter deflection.

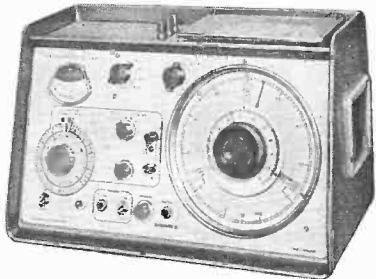

Inductance: 0.1 μ H to 110H in seven ranges
 Capacitance: 0.1 pF to 110 μ F in seven ranges
 Loss (L & C): Q 0.05 to 31 at 1 kc/s in two ranges
 D 0.0005 to 3 at 1 kc/s in two ranges,
 giving continuous Q cover from 0.05 to 2000
 Resistance: 0.003 Ω to 110 M Ω in eight ranges

Please write or telephone for full technical information

A GOOD NAME FOR GOOD MEASURE

MARCONI INSTRUMENTS

Marconi Instruments Limited
 Longacres, St. Albans, Herts, England
 Tel: St. Albans 59292 Telex 23350

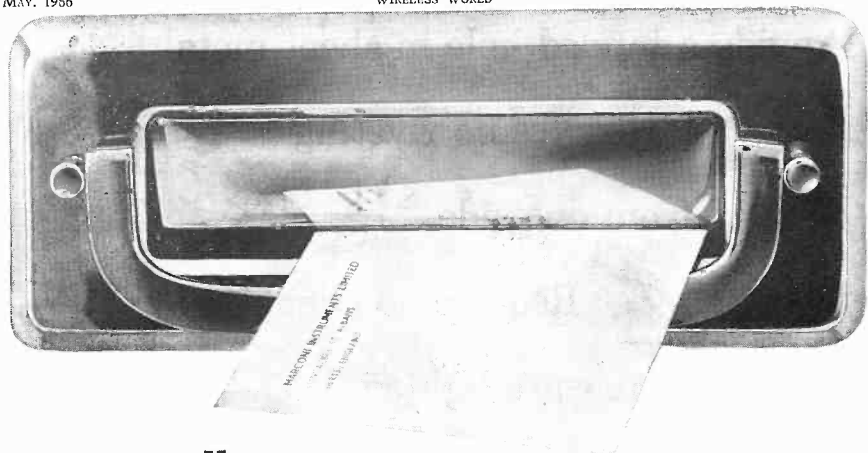

Have we got your address?

New designs are constantly added to the range of Marconi instruments and accessories. Established designs are progressively redeveloped. New measurement techniques and new instrument applications are reported by Marconi engineers in every part of the world.

We keep you up to date through journals like **Marconi Instrumentation** and **Measuretest**, regular mailings of new technical data, a whole range of new and revised technical publications (the latest is **The AF Book**) and the continuous services of our Technical Information and Applications Departments. **Have we got your address?**

Please send me the current issue of:

Marconi Instrumentation — mainly about the design and performance of electronic instruments

Measuretest — mainly about the applications of electronic instruments

I am mainly interested in:

Modulated Signal Generators and Noise Generators

Oscillators and Waveform Generators

Voltmeters and Attenuators

Oscilloscopes

Counters and Digital Systems Instruments

Impedance Bridges and Q-Meters

Response Analysers

Power Meters

Name _____

Company _____

Position or Section _____

Address _____

WW

A GOOD NAME FOR GOOD MEASURE

MARCONI INSTRUMENTS

Marconi Instruments Limited
Longacres, St. Albans, Herts, England
Tel. St. Albans 59292 Telex 23350

Provide a tapped hole in sheet metal



Require no riveting



Can

be fixed from one side



Cannot

rotate



Require no clinching



are smaller - are lighter

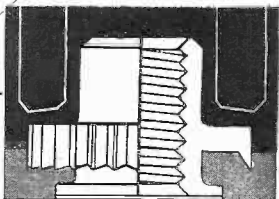

—Please send me free samples of—

ROSAN PRESS-NUTS

with threads

actual size of a 4BA nut

INSTRUMENT SCREW CO. LTD., NORTHOLT RD., SOUTH HARROW, MIDDLESEX Tel: Byren 1141

WW-054 FOR FURTHER DETAILS.

THE AUDIO FIDELITY STEREO-33

A High Fidelity, All Transistor Stereo Amplifier providing 10 watts R.M.S. on each channel

OUTPUT PER CHANNEL

10 watts R.M.S. into 16 ohm load.

16 watts R.M.S. into 3.75 ohm load.

TOTAL HARMONIC DISTORTION

0.1% at 5 watts R.M.S.

0.3% at 10 watts R.M.S.

1,000 c.p.s.

Into 16 ohm load.

DAMPING FACTOR 20

FREQUENCY RESPONSE

± 1 db. 20-20,000 c.p.s.

HUM AND NOISE

-80 db.

CROSS TALK

-42 db. to -53 db.

MAINS INPUT SELECTION

100-110-120-200-210-220-240 v.

50/60 c.p.s.

SEMI-CONDUCTORS (per channel)

AC107, OC14(3), OC312(2), OA5, OC127

AD149(2)

INPUT SENSITIVITIES

(for 10 watts R.M.S. into 16 ohms)

Pick-up Magnetic 3.5 mv. 351 r.p.m.

7 mv. 78 r.p.m.

Pick-up Crystal/Ceramic 490 mv.

Microphone 5 mv.

Tape Head 2 mv.

Aux. (Radio, Tape, Ceramic P.U. etc.) 100 mv.

(Above sensitivities will be doubled when

output load is 3-4 ohms)

BASS CONTROLS

+ 11db to - 16 db. at 40 c.p.s.

Incorporation of the very latest Mullard Transistors has made possible the really outstanding performance figures of this brilliant design. Compare them with other leading makes currently available.

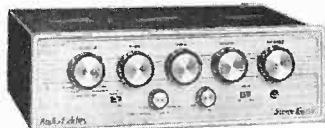

TREBLE CONTROLS

+ 15 db. to - 15 db. at 10 kcs.

EQUALISATION

Gram to standard R.I.A.A. charac'eristic.

Tape Head to standard C.C.I.R. characteristic.

SIZE 12½ x 4 x 8½ in.

WEIGHT 12½ lb.

FILTER (Steep Cut) 7 kc/s., 11kc/s., 15 kc/s.

INPUT SELECTOR

351 r.p.m., 78 r.p.m., AUX., Mic., Tape Head.

INPUT SOCKETS

Magn'ic P.U., Crystal/Ceramic Pick-up,

Aux., Tape Head/Microphone.

Designed for ease of fitting in

cabinet or for free standing use.

Tested for satisfactory operation in

temperatures of up to 50°C. (120°F.).

RETAIL PRICE **39** GNS

THE PRE-AMPLIFIER IS A COMPLETELY NEW DESIGN

IT ELIMINATES THE NECESSITY OF MATCHED INPUTS AND COMPLICATED SWITCHING ARRANGEMENTS. IT ALSO PRODUCES CONDITIONS OF MINIMUM NOISE AT HIGHEST SENSITIVITIES.

Built to highest standards employing latest materials and techniques.

PLEASE SEND S.A.E. FOR LEAFLET

EXPORT ENQUIRIES INVITED

Designed and developed by the Audio Fidelity Group of Companies.

Manufactured and Distributed by **LINEAR PRODUCTS LTD. ELECTRON WORKS, ARMLEY, LEEDS.**

WW-055 FOR FURTHER DETAILS.

two important new books
on electronics

The Electron in Electronics

Modern scientific concepts for electronic engineers

M. G. SCROGGIE B.Sc., M.I.E.E.

An introduction to a difficult subject, written in a manner that every electronic engineer will readily grasp. The author, himself an electronic engineer, appreciated the difficulties and has related the modern concepts to the things a student of electronics is likely to know already, and expresses them in familiar terms and symbols. The standard of mathematics and general physics assumed is at the most G.C.E. "A" level. Particular attention has been given to questions and difficulties that may arise; a feature that will be appreciated by home students.

Electronic Equipment in Industry

W. D. GILMOUR, B.A.(OXON.), A.M.I.E.E.

Electronic instrumentation and control equipment is finding increasing application throughout industry. To manage it well demands a broad, up-to-date understanding of the techniques and principles involved. This is what this book provides. All aspects of the subject are examined clearly, concisely and in logical order, and to illustrate the text with specific examples, a large number of typical circuits and applications have been included. This book does not replace standard textbooks, but offers a basis on which more formal treatments can be better understood and can be recommended to every scientist and technologist who needs a sound general picture of electronic control techniques and how to apply them.

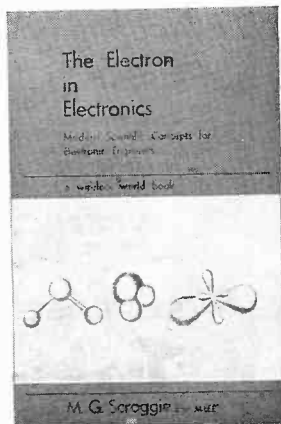

45s net by post 46s 2d
275 pp. 132 illustrations

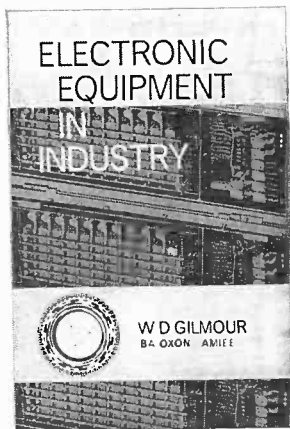

50s net by post 51s 3d
304 pp. 6 pp. plates 101 illustrations

obtainable from
leading booksellers

Published for Wireless World by

ILIFFE Books Ltd.

DORSET HOUSE STAMFORD ST. LONDON SE1
WW-056 FOR FURTHER DETAILS.

CRAFTSMAN BUILT FOR SKILLED HANDS

A brilliantly conceived combination of experience and craftsmanship, the precision-built Taylor 8 μ A Centre Pole movement is the heart of the supersensitive 101 Multi-Range Universal Meter.

The Taylor 101 is at least five times as sensitive as conventional multi-range instruments—yet costs very little more than meters of much lower sensitivity and of restricted value in the hands of the user.

This is a meter which can be trusted. More, this is a meter, craftsman-built to uncompromising standards of quality, which will give the kind of service and performance skilled hands demand. Write or telephone now for full details of the Taylor 101 and other instruments in the range.

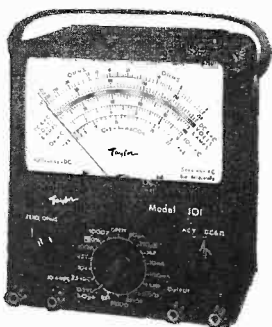

SUPERSENSITIVE

Taylor 101
100,000 OHMS PER VOLT

Three-colour 5-in scale with anti-parallax mirror. Four resistance ranges, all self-contained, lowest reading 0.5 ohms, highest 200 megohms. Seven d.c. current ranges, 10 μ A to 10 A f.s.d. Seven d.c. voltage ranges 0.5V to 1,000V f.s.d. Five a.c. voltage ranges 10V to 1,000V f.s.d. Five decibel ranges -10 db to +62 db. Accuracy $\pm 2\%$ f.s.d. on d.c., $\pm 3\%$ f.s.d. on a.c.



TAYLOR ELECTRICAL INSTRUMENTS LTD. Montrose Avenue, Slough, Bucks.
Phone: Slough 21381 - Grams: Taylins, Slough.



TAYLOR MADE TO MATCH YOUR SKILL
WW-057 FOR FURTHER DETAILS.



MICA

CERAMIC

ELECTROLYTIC

HLEMCOP

THE
CAPACITOR
SPECIALISTS

PLASTIC FILM

METALLISED

MOULDED

LONDON ELECTRICAL MANUFACTURING COMPANY LIMITED
81 Bridges Place, Parsons Green Lane, London S.W.6. Tel. Removon 7071-0

TAYLOR'S

WW-058 FOR FURTHER DETAILS.

NEW CATALOGUE

A Comprehensive, fully illustrated Catalogue of hand tools, and small machine tools, for miniature assembly and repair work.

Red plastic ring binder 5/- each
Red card back cover 2/6 each
Please send cash with order.

HENRI PICARD & FRERE LTD EST. 1877
MANUFACTURERS IMPORTERS & WORLD WIDE DISTRIBUTORS
34/35 FURNIVAL STREET LONDON E.C.4
BRANCH OFFICES IN SWITZERLAND FRANCE & GERMANY

WW-059 FOR FURTHER DETAILS.

ARE YOU DESIGNING A.F. EQUIPMENT?



EXCEPTIONALLY WIDE BAND MICROPHONE AND AUDIO LINE MATCHING TRANSFORMERS
ALL TYPES ARE NORMALLY AVAILABLE FROM STOCK

FREQUENCY RANGE
 100 K.ohm models ± 1 dB 30 c/s to 20 kc/s.
 All other models ± 0.5 dB 30 c/s to 20 kc/s.
MAXIMUM AUDIO LEVEL $+12$ dBm (16mW)
INPUT IMPEDANCE maintained to within $\pm 10\%$ ($\pm 20\%$)
 at all frequencies within the range 50 c/s to 8 kc/s (to 5 kc/s
 only for 100 K.ohm models).
MAGNETICALLY SCREENED
 — 50 dB reduction in hum pick up.

For professional recording and broadcast transmission equipment, these Octal-based plug-in transformers have a frequency response extending well beyond the audio range. The design achieves dynamic performance with minimum distortion at all levels

Type No.	Input Z Ohms	Pin Nos.	Output Z Ohms	Pin Nos.	Sec./Pri. Turns Ratio	Applications
MU.7521	3-75/15*	1-3, 2-4	600 (C.T.)	6-7-8	6-32:1/12-64:1	Low Z. Mic./Line
MU.7522	3-75/15*	1-3, 2-4	100K.	6-8	82:1/164:1	Low Z. Mic./Grid Line/Line
MU.7523	75/300*	1-3, 2-4	600 (C.T.)	6-7-8	1-41:1/2-82:1	Line/Line
MU.7524	150/600*	1-3, 2-4	600 (C.T.)	6-7-8	1:1/2:1	Mixing: Bal./Unbal.
MU.7525	600 (C.T.)	6-7-8	300/1-2K*	1-3, 2-4	1-1:1-4:1 (C.T.)	Mixing: Hybrid‡
MU.7526	600 (C.T.)	6-7-8	2-5k/10k.*	1-3, 2-4	2-04:1/4-08:1	Line/Grid.
MU.7527	150/600*	1-3, 2-4	100K.	6-8	13:1/26:1	Line/Grid.
MU.7528	7-5/30*	1-3, 2-4	600 (C.T.)	6-7-8	4-47:1/8-94:1	Low Z. Mic./Line
MU.7529	50/200*	1-3, 2-4	600 (C.T.)	6-7-8	1-73:1/1-46:1	Mic. or Line/Line
MU.7530	10K. (C.T.)	6-7-8	10K.	1-4	1 (C.T.):1	600 Ω Line Bridging
MU.7532	7-5/30*	1-3, 2-4	100K.	6-8	58:1/116:1	Low Z. Mic./Grid
MU.7534	50/200*	1-3, 2-4	100K.	6-8	22-4:1/44-8:1	Mic. or Line/Grid

*Denotes series/parallel connection.

‡Type MU.7525 may be used in "Hybrid" circuits, as shown, to establish phantom line operation in telephony. Accurate balancing of the windings enable guaranteed rejection of better than — 55 dB from 50 c/s to 10 kc/s. Up to — 75 dB may be expected for normal rejection levels.

WRITE FOR A.F. BROCHURE GT.4
 giving full details of these and other types of A.F. transformers

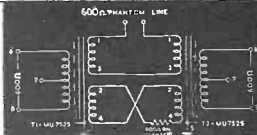
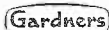

GARDNERS TRANSFORMERS LIMITED . SOMERFORD . CHRISTCHURCH . HANTS.
 TEL.: CHRISTCHURCH 1734. Telex 41276. Grams. & Cables: Radiotrans Christchurch Telex.

If lack of comprehensive continuous information is causing stoppages, production loss,

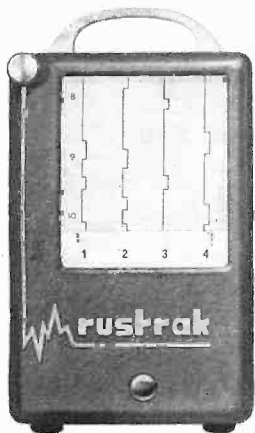

Think Rustrak!

A Rustrak Recorder has 99 different chart speed combinations available. This means it can record events of as little as 20 milli-secs. duration.

This information is recorded by means of pressure sensitive paper. No inks, no heated stylus, no voltage sensitive paper. Maintenance is almost unnecessary.

A Rustrak continues to operate with maximum accuracy in conditions of high humidity, in pressures from sea level to 100,000 ft., in temperatures from sub-zero to 160°F.

A Rustrak can have AC, DC or battery drive. Each Rustrak is a precision instrument housed in a tough die-cast aluminium case. Thousands of engineers and scientists think Rustrak. You should too. Start by contacting us:

WEST Instrument Limited

The Hyde, Brighton 7, SUSSEX BRIGHTON 66271

WW-061 FOR FURTHER DETAILS.

ELECTROLUBE* MEANS EXTRA RELIABILITY



Electrolube 2A-X is the highly efficient and completely safe electrical and mechanical lubricant which improves contact performance and inhibits tarnish and sparking. Electrolube also improves the mechanical operation of plugs and sockets, rotary and sliding switches and all types of electro-mechanical device—giving an extra reliability factor to equipment and components wherever it is used.

ONLY ELECTROLUBE 2A-X

Available—through wholesalers and agents all over the world—in the economical aerosol pack—compatible with all plastics, rubbers and paints.

For full technical details write to:—

U.K. Enquiries: Electrolube Ltd., Oxford Ave., Slough, Bucks
Telephone: Slough 25574
Telex: Electrolube Chamcom Slough 84314

Overseas Enquiries: Electrolube Ltd., 16 Berkeley Street,
London W.1
Telephone: MAYfair 7654



* Registered Trade Mark

✱

WW-062 FOR FURTHER DETAILS.

*this is all the
space you need to
mount the*

**THORN 3-COLOUR
INDICATOR**

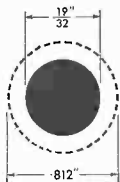

This very compact unit has an overall length of approximately 2.230" and an outside diameter of approximately .812". It can be installed into a single panel hole measuring only 19/32" using a simple fixing ring and lock nut, both of which are supplied. This makes it suitable for a variety of signalling applications where space is at a premium. The Thorn Three Colour Indicator contains three internal coloured filters optically positioned to project the selected colour through an external front lens. Both lens and filters are of glass, not plastic, and there is, therefore, no discoloration.

The unit is designed for use with a variety of Atlas Midget Panel Lamps (6, 12 or 28V) and is supplied with either a black anodised or bright chrome front nut, and solder or screw terminals. The standard filter colours are red, orange and green.

Please write for full details to:

Thorn Special Products Ltd



Great Cambridge Road, Enfield, Middlesex
(Howard 2477)

A member of the Thorn Electrical Industries Ltd
group of companies.



SINGLE SIDEBAND

RADIOTELEPHONE SSB 125T

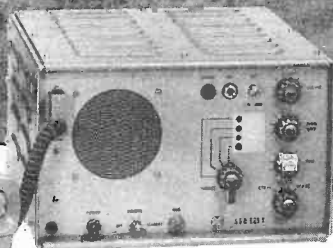

Features

- 125 watts p.e.p. output
- 4 switched channels
- Transistor receiver and power pack (AC or DC)
- Crystal filter sideband selection



Following the outstanding success of their SSB 125, Pye announce the introduction of the SSB 125T, which has a fully transistorised (silicon) receiver.

The new SSB 125T has all the outstanding features proved in many countries throughout the world. It now offers very low current consumption, low temperature rise, even higher reliability.

Automatic gain control facilities have also been added.

These improvements to an already outstanding radiotelephone put the SSB 125T in the top place in SSB equipments and at no increase in price.

PYE TELECOMMUNICATIONS LTD
CAMBRIDGE · ENGLAND

Telephone: Cambridge 61222 · Telex 81166



PIONEER

RADIOTELEPHONE

The Pye Pioneer radiotelephone, type PW-RT, is a fully transistorised equipment used to connect a subscriber to a telephone exchange. It provides telephone subscribers with a normal service in areas where the provision of overhead lines or underground cables is impracticable or too costly.

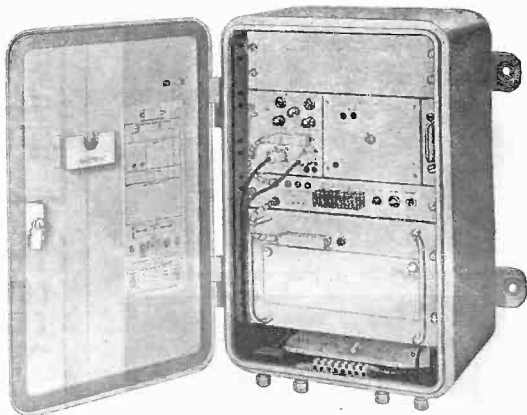

PYE TELECOMMUNICATIONS LIMITED

CAMBRIDGE · ENGLAND · Telephone: CAMBRIDGE 61222 Telex 81166

WW-065 FOR FURTHER DETAILS.

GOVERNMENTS AGREE-

on the quality of the TEONEX range of valves. Governments all over the world have ordered TEONEX valves requiring compliance to E.V.S. or M.I.L. specifications.

Up to now, TEONEX valves have been available only for Government contracts.

In response to many enquiries, the TEONEX range, incorporating the entire working range of British-produced valves or their equivalents, has now been made available for use *outside the U.K. only.*

Price lists and technical specifications may be obtained from:-

REGD. TRADE MARK

TEONEX LTD.,

2a Westbourne Grove Mews,
London, W.11, England
EXPORT ENQUIRIES ONLY PLEASE

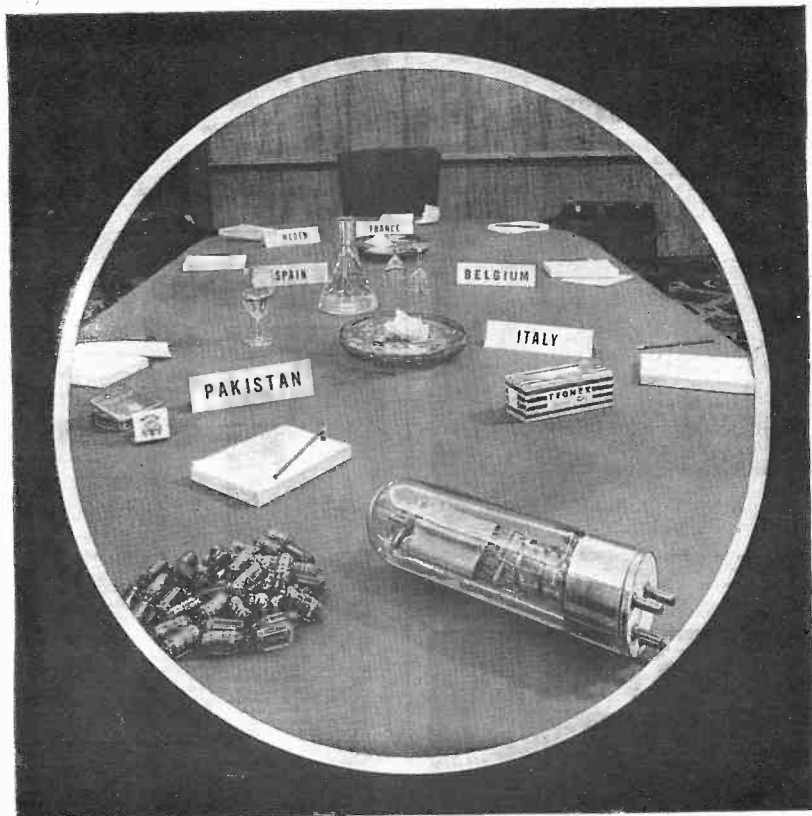

WW-069 FOR FURTHER DETAILS.

This
NEW
DIGITAL
INDICATOR
Type M22



BY

KGM

is also an
ANALOGUE CONVERTER

Type M.22 Moving Coil Indicator is in effect an analogue/digital converter which eliminates much of the wiring and circuitry generally required for multi-indicators. Compact in construction it is of special interest to Process Control engineers. Only four connecting leads are required and any one of ten letters, digits or symbols can be provided for read-out.

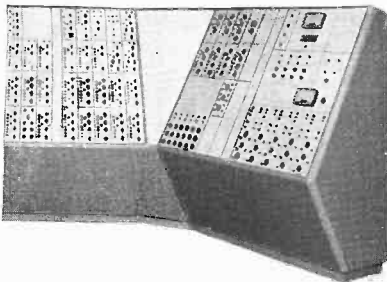

K.G.M. are specialists in INDICATIVE INSTRUMENTATION and have wide experience of Mimic Diagrams and Control Consoles. A leaflet on the subject is yours for the asking.

KGM

electronics limited
BARDOLPH RD RICHMOND
Phone: RICHmond 7171 Surrey

WW-070 FOR FURTHER DETAILS.

ORCHARD & IND LIMITED
PRESENT A SELECTION OF

**Loose
Leaf
Binders**

Write for New Catalogue to:
Head Office:
NORTHGATE · GLOUCESTER
TELEPHONE: (0612) 28111 (5 LINES)
TELEX: GLOUCESTER 43192

WW-071 FOR FURTHER DETAILS.

**a Whole World
of users
can't be
wrong!**

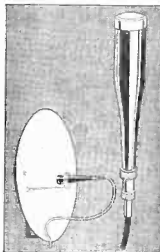

One of the really outstanding microphones in the medium-price range, the DP/4 is enjoying unparalleled success. Small wonder for the DP/4 is wonderfully reliable and sensitive to an extremely wide range of sounds. Uniform frequency response from 50 c/s. to 15 Kcs.

It is in world-wide use for high-quality broadcasting, recording and public address both by the amateur and professional. The Parabolic Reflector: its natural partner, focuses a distant sound-source onto the microphone head, greatly amplifying it without loss of realism and without unwanted side-noises. The DP/4 comes in three impedances—Low, medium and high—and is supplied complete with connector and 18ft. screened lead. The 2ft. dia. Parabolic Reflector is complete with microphone holder.

Further details from your dealer or from:—
GRAMPIAN REPRODUCERS LTD.
Hanworth Trading Estate,
Feltham, Middx. FELtham 2657

Gramplan

Sound equipment—
Integrity that you hear

WW-072 FOR FURTHER DETAILS.

THE ANTEX RANGE

-an iron for every precision need!



F
40W. Models for 20 or 24V (mains models available shortly) $\frac{5}{16}$ " bit fitted—alternative bits available. 42/6d



ES
25W. Models for 12, 24, 110, 220 or 240V supply. $\frac{1}{4}$ " bit fitted—3 alternative bits available. 35/-



E
20W. Models for 24, 110, 220 or 240V supply. $\frac{1}{4}$ " bit fitted—8 alternative bits available. 35/-



G
18W. Models for 110, 220 or 240V supply. $\frac{3}{32}$ " bit fitted — 3 alternative bits available. 32/6d



CN
15W. Models for 24, 110, 200, 220 or 240V supply. $\frac{3}{32}$ " bit fitted — 17 alternative bits available. 32/6d

HOURS of work reduced to SECONDS with the new ANTEX DE-SOLDERING TOOL

Soldered joints can now be easily, speedily and neatly unsoldered. A self-cleaning nozzle, exclusive to the ANTEX de-soldering irons, sucks up molten solder into stainless-steel catcher. Operates by compressed air from airline or standard footpump. Type ESS for 240, 220, 110 or 24 volts. Type GSS for 240, 220 or 110 volts. Price complete with connecting tube, flexible lead and adaptors £4. 4. 0.

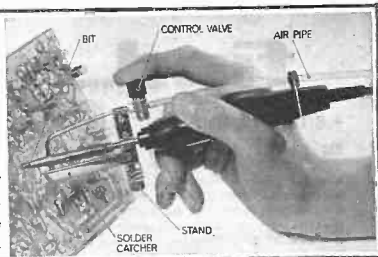

A N T E X

ANTEX LTD

Grosvenor House, Croydon,
Surrey, MUNICIPAL 2774

It's

Model 16 A
£ 2.6 0.

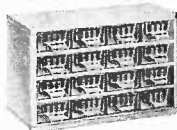

easy

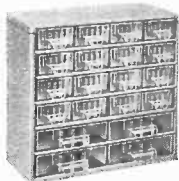

Model AB/1
£ 3.10. 0.

to

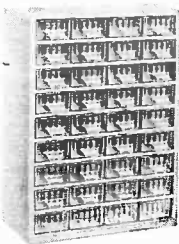

Model 36 A
£ 4.16. 0.

find...

- small components in an original **raaco** cabinet

- see at a glance, avoids searching
- transparent dividable drawers in many sizes
- rigid steel frame will carry the heaviest of loads
- hang up singularly or stacks in greater units
- range of 35 different space-saving storage cabinets

MODERN AND EFFICIENT STORAGE
OF ALL SMALL ITEMS

raaco

ask your dealer or write to
RAACO (LONDON) LTD.
for free illustrated brochure

Bath House, 57/59 Holborn Viaduct,
London, E. C. 1. - Tel: City 3-10/3122

WW-074 FOR FURTHER DETAILS.

Building Hi-Fi?

Put the best into it...
Get the best out of it!



with *Partridge*
TRANSFORMERS

There are no better output transformers for the High Fidelity constructor than Partridge. They are in fact specified for Mullard and most other leading published circuits.

PS203 for use with the Mullard S-20 Amplifier.
Also available, the TG 1073 for the Mullard 10+10 Stereo. Relevant Data Sheets available on application.

Write now for full details of the range of Hi-Fi Types

PARTRIDGE TRANSFORMERS LTD.
Roebuck Road, Chessington, Surrey. Telephone: Lower Hook 4353/4/5



WW-075 FOR FURTHER DETAILS.

Two important new ILIFFE technical books

Transistors for Technical Colleges

L. Barnes, M.Sc., Tech. A.M.I.E.E.

This book is the ideal student's guide to practical design aspects of electrical engineering. An easy-flowing text takes the reader swiftly through a whole range of devices and circuits—including the Zener diode and the thyristor—and he is encouraged to design simple circuits by a graphical approach. Separate reference and symbol sections area also included.

25s. net, by post 26s. (limp covers), 212 pp. 156 illustrations.
42s. net, by post 43s. 1d. (case bound).

Feedback Circuit Analysis

S. S. Hakim, Ph.D., B.Sc., A.M.I.E.E.

What are the real effects of feedback on the amplifier's circuit performance? The author, an experienced lecturer on feedback circuit analysis, examines the classical theory, discusses its limitations—and advances his own, more generalized explanation. He also refers to the problem of stability in detail. Electronic graduates and engineers everywhere will find this book both fascinating and factual.

95s. net, by post 96s. 6d. 400 pp. 306 illustrations.

obtainable from leading booksellers

ILIFFE Books Ltd.

DORSET HOUSE STAMFORD STREET LONDON S.E.1.

WW-076 FOR FURTHER DETAILS.

introducing...

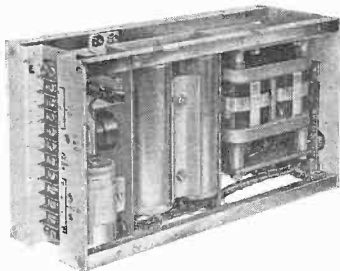

a new range of



MODULAR POWER SUPPLIES

- MODULAR CONSTRUCTION ■ FULLY TRANSISTORISED ■ ALL-SILICON SEMI-CONDUCTORS ■ AUTO RESEY OVERLOAD PROTECTION ■ C-CORE TRANSFORMERS
 ■ COMPETITIVE PRICE AND QUICK DELIVERY

Advance research engineers, applying the latest techniques to an old problem, have created a new concept in electronic design—a range of low-cost, compact and versatile modular power supplies engineered to meet the exacting requirements of many modern—and future—applications from technical education to advanced computer design.

Silicon semiconductors are used throughout to permit operation up to 60°C. All models have very low output impedance and high stability against mains changes, together with automatic reset overload protection. These power supplies offer a wide range of voltages and output currents and can be used in series or parallel for higher power requirements. They are principally intended for incorporation into customers' own equipment.

Write today for further details to:



**ADVANCE
ELECTRONICS
LIMITED**

Volstat Division, Hoebeck Rd, Hainault, Ilford, Essex. Tel: Hainault 4444

Type No.	Voltage Range	Current Rating	Price
PM1	4-15V	1 Amp	£25
PM2	15-30V	1 Amp	£28
PM3	30-50V	1 Amp	£31
PM4	4-15V	3 Amp	£31
PM5	15-30V	3 Amp	£37
PM6	30-50V	3 Amp	£43
PM7	4-15V	5 Amp	£40
PM8	15-30V	5 Amp	£50
PM9	30-50V	5 Amp	£60
PM10	4-15V	10 Amp	£52
PM11	15-30V	10 Amp	£70
PM12	30-50V	10 Amp	£88

CHASSIS and CASES

by *Smith's*
of
EDGWARE ROAD

H. L. SMITH & CO. LTD.
ELECTRONIC COMPONENT DISTRIBUTORS
287,289 EDGWARE ROAD, LONDON, W.2.
Tel: PADDINGTON 5891/7595

We shall be pleased to quote for all your component requirements

BLANK CHASSIS

SAME DAY SERVICE

Of over 20 different forms made up to **YOUR SIZE**.
(Maximum length 35 in., depth 4 in.)

SEND FOR ILLUSTRATED LEAFLETS
or order straight away, working out total area of material
required and referring to table below, which is for four-sided
chassis in 16 s.w.g. aluminium.

48 sq. in. 4/3	176 sq. in. 9/-	304 sq. in. 13/6
80 sq. in. 5/6	208 sq. in. 10/-	336 sq. in. 14/9
112 sq. in. 8/6	240 sq. in. 11/3	368 sq. in. 15/9
144 sq. in. 7/9	272 sq. in. 12/6	and pro rata.
P. & P. 2/6	P. & P. 2/9	P. & P. 3/-

Discounts for quantities. More than 20 sizes kept in stock for call-off.

FLANGES (1 in., 1/2 in.), 6d. per bend.

STRENGTHENED CORNERS 1/- each corner.

PANELS: Any size up to 3ft. at 5/3 sq. ft. 16 s.w.g.; (18 s.w.g. 4/6). Plus post and packing

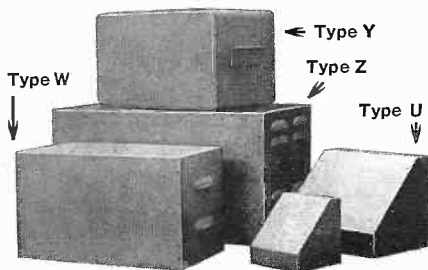

CASES

ALUMINIUM.		SILVER	HAMMERED FINISH		Price
Type	Size	Price	Type	Size	Price
U	4 x 4 x 4*	10/-	Y	8 x 6 x 6*	26/6
U	5 1/2 x 4 1/2 x 4 1/2	15/6	Y	12 x 7 x 7	41/-
U	8 x 6 x 6	21/-	Y	13 x 7 x 9	46/-
U	15 x 9 x 9	44/6	Y	15 x 9 x 7	48/6
W	8 x 6 x 6	21/-	Z	17 x 10 x 9	66/-
W	12 x 7 x 7	24/-	Z	19 x 10 x 8 1/2	71/-
W	15 x 9 x 8	44/-			

Plus post and packing

Type U has removable bottom or back, Type W removable front, Type Y all-screwed construction, Type Z removable back and front.

LIVE SOCKETS

Up to 6 at a time
Instantly!

With Lexor DIS-BOARDS. Over 1,000 combinations in all types of fittings and finishes. Available from stock.

Brochure and price list from:

LEXOR DIS-BOARDS LIMITED, ALLESLEY OLD ROAD, COVENTRY. Telephone: 72614

WW-078 FOR FURTHER DETAILS.



MICROPHONES, ACCESSORIES, TRANSISTORISED "RADIOMIC" and other EQUIPMENT

Top ranking quality
Top ranking performance

LUSTRAPHONE

St. George's Works, Regent's Park Road, London, N.W.1

WW-079 FOR FURTHER DETAILS.



SIGNAL GENERATOR MODEL 27

NOMBREX TRANSISTORISED INSTRUMENTATION

- ★ Signal Generator 27 £10 16 9
- ★ Power Supply Unit 61 £6 14 6
- ★ C.R. Bridge 62 £9 6 9
- ★ Audio Generator 63 £17 1 9
- ★ Inductance Bridge 66 £18 6 9

All prices include battery, post and packing. Prompt Delivery.

S.A.E. FOR TECHNICAL LEAFLETS

TRADE & EXPORT ENQUIRIES INVITED



AUDIO GENERATOR MODEL 63

NOMBREX LTD. ESTUARY HOUSE, CAMPERDOWN TERRACE, EXMOUTH, DEVON. Phone: 3515

WW-080 FOR FURTHER DETAILS.



- ★ BRITISH MINISTRY OF DEFENCE APPROVED TO DEF. 133 STANDARDS.
- ★ ADOPTED BY NATO AND COMMONWEALTH ARMIES.
- ★ THE SMALLEST, LIGHTEST, FULLY TRANSISTORISED ONE MAN H.F. TRANSMITTER/RECEIVER EQUIPMENT OF MORE THAN 20 WATTS OUTPUT IN PRODUCTION.
- ★ COMPACT VEHICLE INSTALLATION ALSO AVAILABLE.

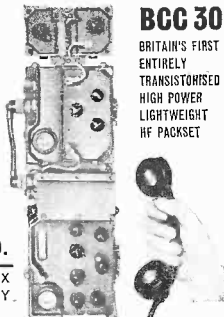

BCC 30

BRITAIN'S FIRST
ENTIRELY
TRANSISTORISED
HIGH POWER
LIGHTWEIGHT
HF PACKET

BCC

BRITISH COMMUNICATIONS CORPORATION LTD.

A MEMBER OF THE CONTROLS
AND COMMUNICATIONS GROUP

SOUTH WAY, EXHIBITION GROUND, WEMBLEY, MIDDLESEX
Telephone: Wembley 1212, Telegrams: BEECEEE WEMBLEY.

MINIATURE P.T.F.E. TUBULAR CAPACITORS

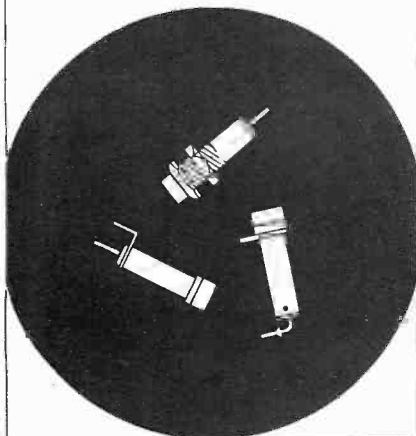

A miniature tubular capacitor of novel design utilising P.T.F.E. as the dielectric medium. Available in three types for mounting vertically on printed circuit board, horizontally on printed circuit board and for chassis mounting. In ranges up to 16 pF.

Write for technical details of Oxley Products



Longlasting Precision

OXLEY[®]

DEVELOPMENTS
COMPANY LIMITED

ULVERSTON
LANCASHIRE, ENGLAND
TELEPHONE: ULVERSTON 0267
CABLES: OXLEY ULVERSTON

WW-082 FOR FURTHER DETAILS.

TELEPRINTERS · PERFORATORS REPERFORATORS · TAPEREADERS EDITING & REPRODUCING SETS

Codes: Int. No. 2, Mercury/Pearson, Elliot 803,
Binary and special purpose Codes.



**2-5-6-7-8 TRACK AND
MULTIWIRE EQUIPMENT**



TELEGRAPH AUTOMATION AND COMPUTER PERIPHERALS A20-30 SERIES

Picture Telegraph, Desk-Fax, Morse Equipment; Pen Recorder; Switchboards; Convertors and Stabilised Rectifiers; Type Holders, Pullers and Winders; Governed, Synchronous and Phonic Motors; Teleprinter Tables and Cabinets; Silence Covers; Distortion and Relay Testers; Send/Receive Low and High Pass Filters; Teleprinter, Morse, Teletypes Paper, Tape and Ribbons; Polarised and specialised relays and Bases; Terminals V.F. and F.M. Equipment; Telephone Carriers and Repeaters; Multiplex Transmitters; Diversity, Frequency Shift, Keying Equipment; Lines, Means Transformers and Suppressors; Racks and Consoles; Plugs, Sockets; Key, Push, Miniature and other Switches; Cords, Wires, Cables and Switchboard Accessories; Teleprinter Tools; Stroboscopes and Electronic Forks, Cold Cathode Matrices; Test Equipment; Oscilloscopes; Miscellaneous Accessories and Spares.



W. BATEY & COMPANY

Gateway Works, Akeman Street, Tring, Herts.

Tel.: Tring 3478 (3 Lines) Cables: RAHNO TRING

WW-083 FOR FURTHER DETAILS.

TECHNICAL TRAINING by **ICS** IN RADIO, TELEVISION AND ELECTRONIC ENGINEERING

First-class opportunities in Radio and Electronics await the ICS trained man. Let ICS train YOU for a well-paid post in this expanding field. ICS courses offer the keen, ambitious man the opportunity to acquire, quickly and easily, the specialized training so essential to success. Diploma courses in Radio/TV Engineering and Servicing, Electronics, Computers, etc. Expert coaching for:

- INSTITUTION OF ELECTRONIC AND RADIO ENGINEERS.
- C. & G. TELECOMMUNICATION TECHNICIANS' CERTS.
- C. & G. SUPPLEMENTARY STUDIES.
- R.T.E.B. RADIO AND TV SERVICING CERTIFICATE.
- RADIO AMATEURS' EXAMINATION.
- P.M.G. CERTIFICATES IN RADIOTELEGRAPHY.

Examination Students Coached until Successful.

NEW SELF-BUILD RADIO COURSES

Build your own 5-valve receiver, transistor portable, signal generator and multi-test meter—all under expert tuition.

POST THIS COUPON TODAY and find out how ICS can help YOU in your career. Full details of ICS courses in Radio, Television and Electronics will be sent to you by return mail.

MEMBER OF THE ASSOCIATION
OF BRITISH CORRESPONDENCE COLLEGES.

INTERNATIONAL
CORRESPONDENCE
SCHOOLS

A WHOLE WORLD
OF KNOWLEDGE
AWAITS YOU!

International Correspondence Schools
(Dept. 222), Intertext House, Parkgate Road,
London, S.W.11.

NAME

ADDRESS

Block Capitals Please

5.66

WW-084 FOR FURTHER DETAILS.

voltage problems?

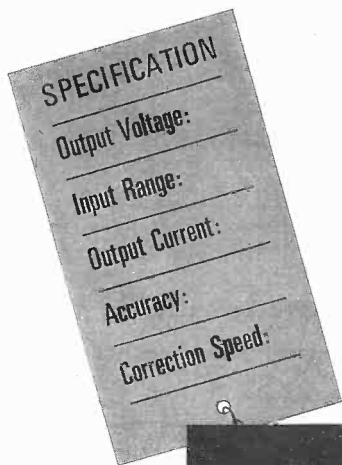

IEA
Exhibition
STAND
N456

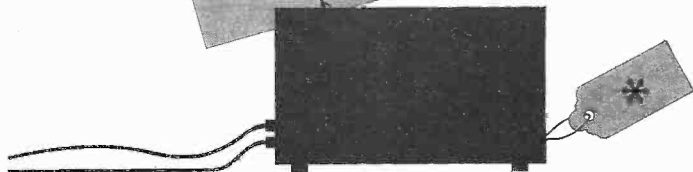

there is a standard
Claude Lyons voltage stabiliser
 already built to
***your* specification**
 * *and that includes price*

Claude Lyons make the most comprehensive range of voltage stabilisers available today. You will almost certainly find the stabiliser to suit your application in the Claude Lyons standard catalogue range. Distortionless servomechanical types from 1 to 120 kVA (and 360 kVA 3-phase). Solid-state types from 400 VA to 10 kVA. Simple tap-changing types from 600 VA to 2.4 kVA. All very high quality. All very reasonably priced. Full facts and figures from Publicity Department, Hoddesdon.

Claude Lyons Ltd ■ Valley Works, Hoddesdon, Herts. Hoddesdon 4541 Telex 22724 ■ 76 Old Hall Street, Liverpool 3. MARitime 1761 Telex 62181

CLAUDE LYONS
 LEADERS IN VOLTAGE CONTROL



WW-085 FOR FURTHER DETAILS.

AUDIO AMPLIFIER

12 Volt with 15 W. Output

Designed specially to give pleasing results on music and speech

Common emitter, class B output stages, with maximum efficiency choke coupling to 15 ohm speaker lines; temperature stabilised and direct coupled pre-amplifier stages with liberal feedback.

All output and Input terminations are fully floating, thus enabling layman or skilled engineer to be equally confident in the simple matter of coupling up for use.

FULL DETAILS OF THIS AND EQUIPMENT BY RETURN OF POST

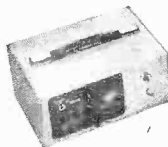

E. K. ELECTRONICS (I.A.) LTD: Brotherton, Knottingley, Yorks.

WW-086 FOR FURTHER DETAILS.

ILIFFE BOOKS

Important recent **ILIFFE** books for
electronics technologists and students

Elements of Transistor Pulse Circuits

T. D. Towers, M.B.E., M.A., B.A., B.Sc., Grad. I.E.R.E.

Provides the busy engineer with a practical review of the transistor version of the building bricks commonly used in pulse circuits.

35s net by post 35s 10d 168 pp. 107 illustrations.

Electrical Phenomena in Gases

R. Papoular

Deals with a complex subject in a style that is brief, concise and to the point and is suitable for both study and for reference purposes.

45s net by post 46s 1d 198 pp. 125 illustrations.

obtainable from leading booksellers

ILIFFE Books Ltd

DORSET HOUSE STAMFORD STREET LONDON S.E.1

WW-087 FOR FURTHER DETAILS

Network Analysis for Telecommunications

R. A. Lampitt, M.I.E.R.E.

An invaluable reference book for practising engineers and a textbook for students taking their degree course, professional examinations and equivalent diploma courses. 63s net by post 64s 2d 280 pp. 135 illustrations

Mathematical Techniques in Electronics and Engineering Analysis

J. W. Head, M.A. (Cantab.), F.Inst. P., A.M.I.E.E., F.I.M.A.

Covers the general mathematical techniques and deals with specialised applications of mathematics to problems in electrical and electronic engineering.

45s net by post 46s 1d 224 pp. 67 illustrations.

Problems in Electrical Engineering for Technical Students

B. Hamill, Grad. I.E.E., A.R.T. C.S.

Specially written for the student taking the ONC in Electrical Engineering and for those studying the Electrical Science Course, C.

25s net by post 25s 11d 195 pp. illustrated

WW-087 FOR FURTHER DETAILS

VITALITY BULBS



Tested and proven
A.I.D. and A.R.B.
Miniature and Sub-miniature
indicator bulbs, from 1 to 50v,
in sizes from 4.0 mm.

Catalogue from:—Vitality Bulbs
Ltd., Neville House, Wood Green
N. 22, MULberry 1931.

WW-088 FOR FURTHER DETAILS.

A.C. SOLENOID TYPE SCM.

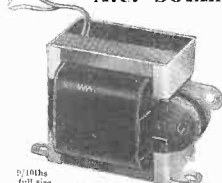

Continuous 3 oz. at $\frac{1}{2}$ in

Instantaneous to 2 lb.

Larger sizes available

Also—Transformers to
8 kVA 3 Phase

R. A. WEBBER LTD.

KNAPPS LANE, CLAY HILL, BRISTOL 5. PHONE 65-7228/9

WW-089 FOR FURTHER DETAILS.

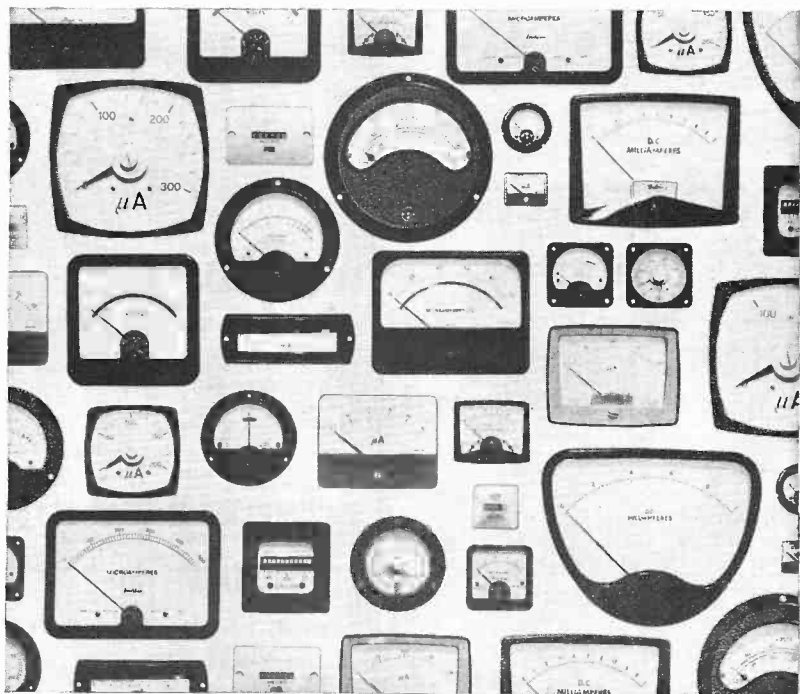

If it's a question of meters...

- Type ✓
 Size ✓
 Calibration ✓
 Delivery ✓

Here at Anders we have hundreds of meters of all types. Immediate off-the-shelf delivery from the largest stocks in the country—and a complete range of ancillaries, too. You need never be held up for a meter again. That's part of the Anders Meter Service which will meet the most urgent and unusual

demands a customer can make—fast! If you want a meter calibrated or modified to your own special requirements Anders can do it... and Anders experts will solve your metering problems in detail from just a broad outline. Whatever you want in metering—leave it to Anders.

■ Meters of all kinds from stock ■ Meter calibration/Meter modification/Ancillary equipment ■ Custom-designed meter circuitry and components □ Sole U.K. distributors of FRAHM vibrating reed frequency meters and tachometers.

ANDERS METER SERVICE

ANDERS ELECTRONICS LTD · 103 HAMPSTEAD ROAD · LONDON NW1
 TELEPHONE EUSTON 1639 · MINISTRY OF AVIATION APPROVED

WW—090 FOR FURTHER DETAILS.

RADIONIC

RADIO & ELECTRONIC CONSTRUCTION SYSTEM

ABSORBING & EXCITING!

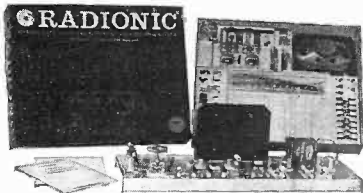

A No. 4 SET and 6-TRANSISTOR SUPERHET

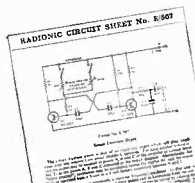

Theoretical Circuit.

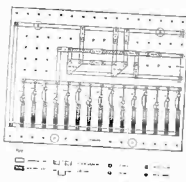

Practical Layout

Our "E" Series of basic electronic circuits is available separately.
(See Electronic Origin above)

SEND FOR DETAILS OF E/508—DUR "DO-IT-YOURSELF" COMPUTER

Unique and brilliantly simple. Hundreds of educational establishments — Universities, Technical Colleges, Schools, the Armed Forces—are already using Radionic for electronic instruction. Enthusiastic owners range from 9 to 82 years of age.

Selected by the Council of Industrial Design for all British Design Centres. Featured in Sound and Television broadcasts.

The system is beautifully engineered from top quality British components. No soldering. No mains. No prior knowledge needed. Simply arrange components on perforated transparent panel, position brass connecting strip underneath, fix with 6BA

nuts and circuit works with full efficiency. You can then dismantle and build another circuit. Your results are guaranteed by our Technical Department and News Letter Service. All parts available separately for conversion or expansion of sets.

UNIQUE! Our "No soldering" printed circuit board for superhet portable. Simply insert components and tighten nuts.

No. 1 Set £5 18 6d.
No. 2 Set £6 19 6d.
No. 3 Set £10 19 6d.
No. 4 Set £14 19 6d.

14 Circuits (Earphone)
20 Circuits (Earphone)
22 Circuits (7 x 4in. Loudspeaker output)
26 Circuits (include 6 Transistor and reflex superhets)
Prices (Post Free)

Full details from:

RADIONIC PRODUCTS LIMITED
STEPHENSON WAY, THREE BRIDGES
CRAWLEY, SUSSEX

Tel.: CRAWLEY 28700

Trade Enquiries invited.

WW—091 FOR FURTHER DETAILS.

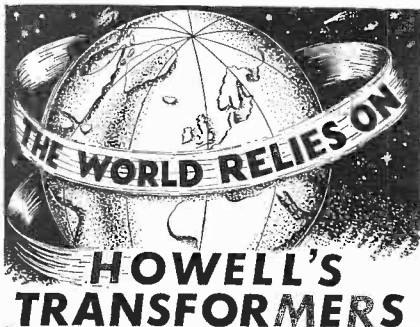

MINISTRY OF AVIATION APPROVED INSPECTION.

TRANSFORMERS

STANDARD RANGE OR TO YOUR DESIGN
TOROIDAL — 'C' CORE — PULSE — MATRIX

CHASSIS—CABINETS & PRECISION METALWORK
ELECTRONIC ASSEMBLY

HOWELLS RADIO LTD.

MULBERRY STREET, MANCHESTER, 15
MOSS SIDE 2000-2434

WW—092 FOR FURTHER DETAILS.

who supply acetal?
who does... work for?
who makes hand wheels?
who supplies coating machinery?

for quick answers to all your problems

British Plastics YEAR BOOK 1966

The recognised guide to the plastics industry—its products, suppliers, materials, leading executives—thoroughly revised and brought completely up to date.

It is bound in good quality hard covers with 11 separate sections. These sections are divided by stiff card separators each with a durable plastics-covered tab for instant reference. Materials, products, services and plant sections open with their own index and there is a general index. No one engaged in any branch of the rapidly expanding plastics industry can afford to be without this unique year book.

60s. net, by post 63s. 618 pp. 36th. edition.

obtainable from leading booksellers

Published for BRITISH PLASTICS by ILIFFE Books Ltd.,

DORSET HOUSE STAMFORD STREET LONDON S.E.1.

WW—093 FOR FURTHER DETAILS.



**one electrosil TR resistor
= 33 other types of the same value**



so why is your store so full of resistors?

Send today for a remarkable leaflet which shows how *one* TR resistor can replace thirty three other makes and types of the same value. See for yourself how relatively few Electrosil TR resistors can replace the many types and styles which you have to hold in stock. TR resistors are fully approved to DEF 5115.1: pattern RFG 5 (Multiple Rating) so you can get high stability, semiprecision and general purpose ratings in *one* resistor. Over 50 million resistors have now been produced to this standard in the UK. TR resistors can save you space, time and money. You really should investigate TR resistors — can you afford not to? Get your copy of "one for thirty three", today from

Electrosil Limited, P.O. Box No. 37, Pallion, Sunderland,
Co. Durham. Tel: Sunderland 71480 (10 lines) Telex 53273



OFFICIAL
STOCKISTS:

Townsend-Coates Ltd.,
Coleman Road,
Leicester

SASCO Ltd.,
Garwick Road,
Crowley, Sussex

Radio Resistor Co. Ltd.,
Palmerston Road,
Wealdstone, Harrow, Middlesex

Morris Warden & Co. Ltd.,
Morden House,
10 Royal Crescent, Glasgow C 3

Standard Telephones &
Cables Ltd. (Electronic Services)
Edinburgh Way, Harlow, Essex

NOW! Ranges of up to
100,000 Ω per volt with

Kelvo MULTI-RANGE TEST METERS

Measuring AC/DC volts, amps, resistance, capacitance, decibels, temperature.

A comfortable handful of high precision test equipment, covering the widest needs of electrical and electronic measurement. Built-in safeguards against overload and mechanical shock. Wide, shadowless scales, and up to 48 measuring ranges without accessories. The Kelvo range of instruments has been developed to combine reliability, precision, versatility, ease of operation and to be of a convenient and handy size. Send for literature.

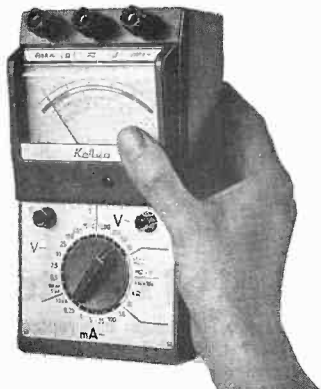

* High accuracy * Friction-free ligament suspension movement * Continental symbols
* Single selection knob * Automatic electrical cut-out * Modern styling.

See us on Stand N 404, National Hall, Olympia,
I.E.A. Exhibition—May 23rd-28th.

KELVIN

KELVIN ELECTRONICS COMPANY
A DIVISION OF SWITHS INDUSTRIES LIMITED

Kelvin House, Wembley Park Drive, Wembley, Middlesex
Telephone: Wembley 8888. Grams: Keeco, Wembley
Telex: 25366

NEC 2323

WW-095 FOR FURTHER DETAILS.

Complete portability needs



high power batteries

The TV1 HIGH POWER 12V BATTERY and the Ever Ready range of HIGH POWER 1½ VOLT unit batteries, HP2, HP11, HP7, HP16 have been designed and manufactured for applications requiring Heavy Current Drains, such applications being:

D.C. Motors, Man-Pack Transceivers,
Tape Recorders, Alarm Systems,
Flashing Beacons, Field Telephones, etc.

We shall be pleased to advise you on the most suitable battery for your application and provide Data Sheets on the above units.

IEA Stand No. G761

For further information contact:

**TECHNICAL SALES DEPARTMENT
THE EVER READY CO. (G.B.) LTD.**

Ever Ready House, 1255 High Rd., Whetstone
London N.20. Telephone: HILLside 8877

WW-096 FOR FURTHER DETAILS.

THE KNACK

"Armstrong have a happy knack of manufacturing equipment that offers exceptional value for outlay. This latest 221 Integrated stereo design proves that they still have the knack and supports their claim that it represents a breakthrough at the price of £35 15s (optional teak and vinyl hide case £3 10s.). With a sensitivity sufficient to accept the highest quality, low output pickups, it must be regarded as another step towards bringing the real hi-fi to many enthusiasts with limited budgets. A good buy on grounds of appearance, performance and price. Instruction manual supplied for installation and operation, including circuit data."

Summary of Test Report in "Audio & Record Review", November, 1965

For full details and technical specifications of this and all other models, post coupon or write mentioning reference 5WW66
Armstrong Audio Ltd., Warlters Road, London, N.7 Telephone North 3213



Armstrong

name _____

address _____

5WW66

EQUIPMENT OF THE HIGHEST ATTAINABLE PERFORMANCE

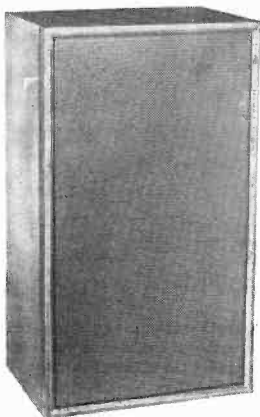

RADFORD

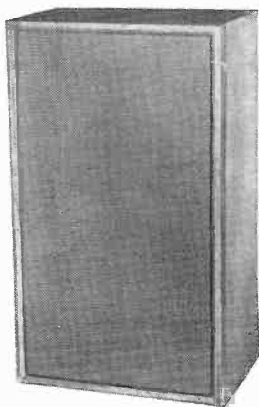
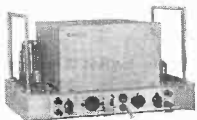

SEND FOR DESCRIPTIVE TECHNICAL LEAFLETS GIVING FULL DETAILS
RADFORD ELECTRONICS LTD., ASHTON VALE ROAD, BRISTOL 3

WW-098 FOR FURTHER DETAILS.



FABBRICA ITALIANA APPARECCHI RADIO
DIPARTIMENTO ELETTRONICA PROFESSIONALE

MILAN (Italy)-Via G. B. Grassi, 93-Telephone: 308241/306841-Telex: 31295

PRODUCTION

- | | |
|---------------------------------|------------------------------------|
| ● Closed circuit television | Radar and ancillary equipment ● |
| ● Sound diffusion installations | Electronic military equipment ● |
| ● TV transmitters | Ancillary navigational equipment ● |
| ● Radio transmitter/receivers | Antennae and accessories ● |



Transistorised television repeater P 3149



Direction unit for large sound diffusion installations



Transistorised telecamera P 4814

WW-099 FOR FURTHER DETAILS.

TELEEQUIPMENT'SCOPES

going places

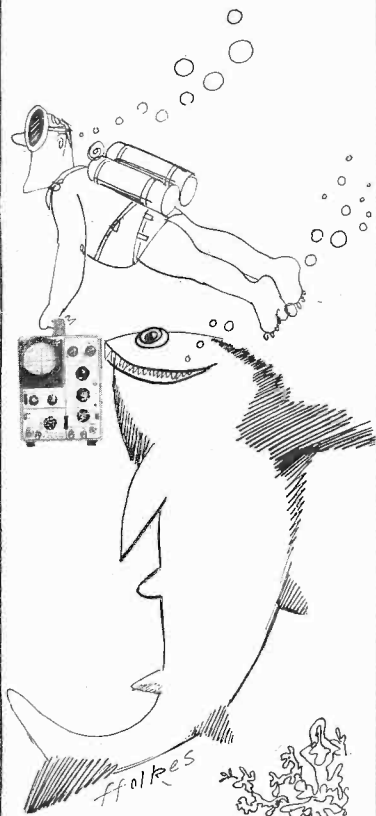

Ask for a short form catalogue of portable, light-weight 'Serviscopes' and portable, versatile laboratory 'scopes'.

TELEEQUIPMENT



* Serviscope is a registered trademark of
Teleequipment Limited, 313 Chase Road,
Southgate, London, N.14, Fox Lane 1166

WW-100 FOR FURTHER DETAILS.

take your pick!



from IR semiconductor centers

Over 100 IR semiconductor devices are available from your dealer, many with free instruction manuals and project and experiment details.

Look for the floor-standing 'Semiconductor Center', or the counter-top 'Minicenter'

EXPERIMENTER SEMICONDUCTOR KITS
MOUNTING KITS AND HEAT SINKS
SILICON BRIDGE RECTIFIERS
UNIJUNCTION TRANSISTORS
SELENIUM PHOTO CELLS
INSTRUMENT RECTIFIERS
AUTOMOTIVE RECTIFIERS
SILICON SOLAR CELLS
SILICON RECTIFIERS
GERMANIUM DIODES
THYRISTORS (S.C.R.)
ZENER DIODES
TRANSISTORS
SELENIUM STACKS

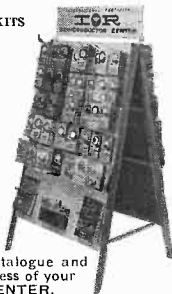

Write for the free illustrated catalogue and price-list; also the name and address of your nearest IR SEMICONDUCTOR CENTER.

INTERNATIONAL RECTIFIER
HURST GREEN · OXTED · SURREY TEL: OXTED 3215

Dealers - write for details of how you can start your own
IR SEMICONDUCTOR CENTER

IR semiconductor centers

WW-101 FOR FURTHER DETAILS.

SEE US AT THE I.E.A. EXHIBITION,
STAND E901 - - - 23-28 MAY



NEW REGAVOLT MODEL 31A

The smallest variable transformer
made in the World for 0-250v service

Nearly 30 years experience lies behind this single layer toroid capable of direct connection to a 250v A.C. supply to give reliability for industrial service.

Only 3" in diameter and 2" deep this Regavolt can control loads of up to 1 amp when heat sink mounted.

• RATED UP TO 1 AMP • TROUBLE-FREE
BRUSH GEAR • OTHER MODELS FOR 120 AND
230V INPUTS AVAILABLE • NOW IN FULL
PRODUCTION Please write for List M7/625D for full details

The British Electric Resistance Co. Ltd.



Queensway - Enfield
Middlesex Tel: HOW 2411
Grams: Vitrohm Enfield
348

WW-103 FOR FURTHER DETAILS.



STOCKISTS



MULTIMETER MK. IV

REPAIR SERVICE
7-14 DAYS

We specialise in repair, calibration and conversion of all types of instruments, industrial and precision grade to BSS.89.

Release notes and certificates of accuracy on request.



MODEL 8 MK. III

Suppliers of Elliott, Cambridge and Pyc instruments.

LEDON INSTRUMENTS LTD
76-78 DEPTFORD HIGH STREET, LONDON, S.E.8

TEL.: Tideway 2689

E.I.D. & G.P.O. APPROVED CONTRACTOR TO H.M. GOVT.
WW-103 FOR FURTHER DETAILS.

1966

Electrical & Electronic Trader YEAR BOOK

saves both time and money
every working day of the year

Have all the facts . . . figures . . . information you need at your fingertips in one compact, quick reference volume—the standard trade directory for radio and electrical dealers, service engineers. This completely up-to-date year book includes: Directory of principal trade organisations: Official addresses: Legal guide: Rates of pay: Valve data: specifications: Wholesalers: Proprietary names directory: Buyers' guides: Trade addresses, etc.

35s. net by post 36s 9d 480 pp.

obtainable from leading booksellers

Published for ELECTRICAL & ELECTRONIC TRADER by
ILIFFE Books Ltd.

DORSET HOUSE STAMFORD STREET LONDON SE1
WW-104 FOR FURTHER DETAILS.

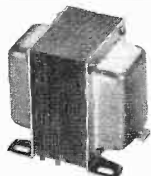

TRANSFORMERS

STANDARD RANGE
OR
TO YOUR OWN
SPECIFICATION

The following Transformers
are always in stock :-

MAINS TRANSFORMERS

INTERLEAVED & IMPREGNATED — FULLY SHROUDED
COLOUR CODED FLYING LEADS

Primarys 0-200-220-240 v. 50 c/s.

E.S.	250-250 v. 100 m/A.	6.3 v. 3 $\frac{1}{2}$ amps.	6.3 v. 1 amp.	19/-
E.S.	250-250 v. 60 m/A.	6.3 v. 3 amps.	5 v. 2 amps.	18/6
E.S.	250-250 v. 100 m/A.	6.3 v. 4 amps.	5 v. 3 amps.	25/-
E.S.	250-250 v. 70 m/A.	6.3 v. 2 amps.	5 v. 2 amps.	16/-
	250-250 v. 100 m/A.	6.3 v. 2 amps.	6.3 v. 1 amp.	19/6

CHARGER TRANSFORMERS

0-210-220-240 v. 50 c/s.

	0-3.5-9-17 v. 1A.	11/-
	0-3.5-9-17 v. 2A.	13/-
	0-3.5-9-17 v. 4A.	15/-
	0-9-17 v. 6A.	21/-

BATTERY ELIMINATOR PP.9.

Input 240V. A.C. Output 9 V. D.C. 200 mA, 2A.

Write for price list for full range of stock items. Discounts for quantities.

Terms cash with order. Packing and Postage 3/- each item.

Hours of business: Mon. to Fri. 9 to 6; Sat. 9 to 4.

OLYMPIC RADIO COMPONENTS LTD.

224 HORNSEY RD., LONDON, N.7. Tel: NOR 2914

WW-105 FOR FURTHER DETAILS.



12 good reasons for using the Wearite tape-deck

The Wearite tape-deck by Wright and Weaire is recognised for its faultless performance. Features contributing to this include:

- 1 Three motors—proved unsurpassed for reliability and fast winding.
- 2 Synchronous capstan motor—suspended on neoprene shock mounts to reduce mechanical noise to the absolute minimum. Ball race bearings give greater reliability and considerably longer maintenance-free operation.
- 3 Foolproof single knob operation is provided for linking mechanical changeovers to the electrical amplifying system.
- 4 Automatic stop switch cuts off the tape drive at the end of a reel or should the tape break.
- 5 Instantaneous mechanical stop and start of tape transit prevents slurring.
- 6 Accurate cueing indicator (turns counter) is scaled in revolutions of the take-up reel, and angled for easier viewing.
- 7 Third head position for plug-in heads, either standard or stereo, with an adjustment screw for gap alignment.
- 8 Record-lock button prevents accidental erasure of recordings.
- 9 Ability to accept 8 $\frac{1}{2}$ " reels (1750 feet of standard tape).
- 10 Ability to take a continuous loop cassette in place of standard reels.
- 11 90° hinge on head cover ensures easier tape loading.
- 12 Three tape speeds.

The Wearite tape-deck is designed for the serious recordist who would prefer to use no instrument but the best. The Wearite tape-deck has been proved in use by Science bodies, Education authorities, and in Entertainment.

For fuller details and specifications write or telephone

WRIGHT AND WEAIRE LTD

84 Blackfriars Road, London SE1. WATERLOO 1981

WW-107 FOR FURTHER DETAILS.

COIL WINDING MACHINES

for coils up to 6 $\frac{1}{2}$ " diameter to 6" long. 20-47 S.W.G.

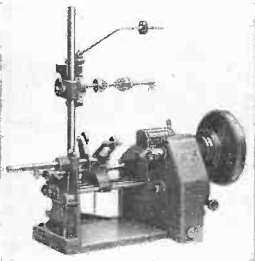

Model "Q" standard.

The feed is fully automatic and the nut is in constant contact with the lead-screw. The reversal of the carriage is obtained by reversing the lead-screw rotation. Two lead-screws are used to give the large range of feeds and a lever on the carriage nut brings either into action. This lever has a neutral position which enables the carriage to be put at any position on the lead-screws. Ball bearing feed wheels are employed. This machine may be fitted for double coil and double end drive, also for "Pyramid Winding."

Enquiries are invited.

ETA TOOL CO. (LEICESTER) LTD.

29A, WELFORD ROAD, LEICESTER. Telephone 56386

WW-106 FOR FURTHER DETAILS.

TELEQUIPMENT SERVICE

the man behind the 'scope

Wherever you may be in the U.K., there is always a Telequipment applications engineer available for consultation. Not quite on your doorstep in five minutes, but close enough to speak to on the 'phone, and to make an early appointment if a visit is necessary. It is our experience that no other oscilloscope manufacturer gives such prompt and comprehensive personal service. Only the wide range and extensive usage of Telequipment oscilloscopes makes it possible.

The telephone numbers of our applications engineers are listed here. A call to any of them, or a letter to

Southgate, will bring a copy of our new short form catalogue, which describes a dozen oscilloscopes priced from £23.10s. to £235.

London: W. T. Morison, *Fulham 0898*
 Home Counties: D. V. Simmons, *Kingston Blount 567* South West England and Wales: R. A. Watson, *Chippenham 2334* Midlands: G. W. Thomas, *Quorn 2489* Scotland: E. J. Gibbs, *Balerno 3120* North England: J. J. Leverton, *Leeds 687317*
 East England: R. A. Jonas, *Potters Bar 59524* South East England: R. J. Sawyer, *Waterlooville 52272*.

TELEQUIPMENT



Telequipment Limited · Southgate · London N14 · 'Phone Fox Lane 1166



WW-108 FOR FURTHER DETAILS.

"Wireless World"
Iliffe Electrical Publications Ltd.
Dorset House, Stamford Street,
London, S.E.1

Manager Director:

W. E. MILLER, M.A., M.I.E.E.E.

Editor-in-chief:

W. T. COCKING, M.I.E.E.

Editor:

H. W. BARNARD

Technical Editor:

T. E. IVALL

Editorial:

B. L. SEXTON, Grad. I.E.R.E.

G. B. SHORTER, B.Sc.

Drawing Office:

H. J. COOKE

Production:

D. R. BRAY

Advertisements:

G. BENTON ROWELL
(Manager)

J. R. EYTON-JONES

© Iliffe Electrical Publications Ltd., 1966. Permission in writing from the Editor must first be obtained before letterpress or illustrations are reproduced from this journal. Brief extracts or comments are allowed provided acknowledgement to the journal is given.

VOLUME 72 No. 5

PRICE: 3s.

FIFTY-SIXTH YEAR
OF PUBLICATION

Wireless World

ELECTRONICS, TELEVISION, RADIO. AUDIO

MAY 1966

213 Crisis in the Electronics Industry?

214 Pickup Arm Design—1

by J. K. Stevenson

219 Transistor Electronic Organ—

by T. D. Towers

229 Physics Exhibition 1966

234 New Techniques in Medical Electronics

235 Public Address Equipment

237 A.F. Amplification with the Cascode

by G. A. Stevens

243 Communication Theory and Colour Television

by H. O. Codon

253 Experiments and Decisions

by D. A. Bell

SHORT ITEMS

225 Aircraft Collision Avoidance System Proposed

241 Ceramic Cathode-ray Tube

252 Camera Image Stabilization

264 Flight Data Recording

REGULAR FEATURES

213 Editorial Comment

225 World of Wireless

227 Personalities

241 H.F. Predictions

242 News from Industry

248 Literature Received

249 Letters to the Editor

256 Books Received

257 New Products

262 Real and Imaginary
by "Vector"

263 May Meetings

264 Month's Conferences and Exhibitions

PUBLISHED MONTHLY (3rd Monday of preceding month). Telephone: Waterloo 3333 (70 lines).
Telegram/Telex: Wlworld Iliffe/epes 25137. London. Cables: "Ethaworld, London, S.E.1."
Annual Subscriptions: Home £2 5s 0d. Overseas: £2 15s 0d. Canada and U.S.A. \$8.00. Second-class
mail privileges authorised at New York N.Y. BRANCH OFFICES: BIRMINGHAM: 401,
Lynton House, Walsall Road, 22b. Telephone: Birchfield 4838. BRISTOL: 11, Marsh Street, 1.
Telephone: Bristol 21481/2. COVENTRY: 8-10 Corporation Street. Telephone: Coventry
25210. GLASGOW: 123 Hope Street, C.2. Telephone: Central 1205-6. MANCHESTER:
260, Deansgate, 3. Telephone: Blackfriars 4412. NEW YORK OFFICE U.S.A. 111
Broadway, 6. Telephone: Digby 9-1197

BF184 BF185

*silicon
planar*

high frequency radio transistors

Two high frequency radio transistors, the BF184 and BF185, offer low cost and first-class performance in every h.f. stage found in modern a.m. and a.m./f.m. radios. They also have closely limited spreads—a valuable design feature.

BF184 for high gain i.f. amplifiers

Outstanding features of the BF184 are its high gain and the high input impedance associated with its excellent frequency performance. These characteristics make this transistor a 'must' for all i.f. amplifier stages in car radios and both mains and battery operated a.m./f.m. receivers. It is also recommended for use in television sound i.f. amplifiers where it more than satisfies the most critical requirements.

BF185 for low noise applications up to 100 Mc/s

The very low noise figure over a wide range of source impedance makes the BF185 invaluable in all low noise applications up to 100 Mc/s. It is recommended for the self-oscillating mixer stage of f.m. receivers and the first stages of car radios and f.m. receivers. Also recommended for use in minimum cost portable receivers, where it enables far less components to be used.

In addition to these two transistors, other silicon planar devices are now becoming available. Design engineers can obtain full details from:
Mullard Ltd.,
Entertainment Markets Division,
Mullard House,
Torrington Place,
London, W.C.1.
Tel: L ANgham 6633.
Telex: 22281.

Mullard

planar

Wireless World

ELECTRONICS, TELEVISION, RADIO, AUDIO

Crisis in the Electronics Industry?

INTEGRATED circuits are said to be creating a crisis in the U.K. electronics industry. Since very large scale production is needed to make i.c.s competitive with conventional circuits, there will be room for only the handful of big companies who can make the necessary capital investment for such production, and in the West these are likely to be American. Already U.S. companies have secured over half the British market, and our own manufacturers have their backs to the wall commercially. The real danger, as stated by British industrialists, is that if we cease to make our own i.c.s the U.K. electronics industry will degenerate into little more than a collection of assembly shops, wholly dependent on outside sources, with no incentive or facilities for developing new techniques and consequently nothing to sell in world markets. Indeed the situation could be worse, for i.c.s are not just components like transistors (which we already import in large quantities) but sub-systems—and sub-systems which are getting more and more comprehensive in function. As John Pickin, manager of Ferranti's Electronics Department, said recently "the equipment design of the future will be done on a slice of silicon, and if we do not have the ability to do this we will not have an electronic equipment industry in this country."

Is there really a crisis? One could argue that the U.K. industry is already highly dependent on imported products, licensing arrangements and so on, and that everyone has accepted the fact that it could not function without them. We have to recognize that other industrial countries also have to export electronic products and know-how in order to live and that consequently Britain must import a reasonable share. Our own ability to export depends on the continuing prosperity of these nations. This is the co-operative principle underlying the European Common Market, whether you agree with it or not. Our limited resources simply do not allow us to produce good and highly competitive products in every field of electronic manufacture, and our policy must be to take full advantage of those products which other countries design better and make cheaper. Are not integrated circuits just another phase in this process?

It could also be argued that electronic engineering is gradually moving towards, or even becoming part of, systems engineering, and that consequently there is much to be gained in efficiency by having your basic "components," the sub-systems, made for you by specialist manufacturers. In systems engineering even a computer is only a component. British firms have already done excellent business in selling plants and systems abroad—and these are firms which are virtually no more than "assembly shops." What is important here is knowing how to make the hardware do the job required.

But the basic problem is to ensure that Britain gets her fair share of the available cake—the world markets in electronics. With the resources we can muster for i.c. manufacture we cannot afford to fritter away our energies over the whole field of applications, but we *could* concentrate on a carefully selected range of circuits which we knew we could produce well and competitively. This implies rationalization of products among the manufacturers. One industrialist has already admitted that the U.K. has twice as many companies as necessary in i.c.s making half as much investment as necessary. In their present fresh and belligerent state of mind these companies are not likely to go into rationalization voluntarily. But if there is, indeed, a crisis, they may eventually be forced into it in self-defence—and this would be the wrong reason.

VOL 72 NO 5
MAY 1966

PICKUP ARM DESIGN—1

DESIGN AND MOUNTING OF ARMS FOR MINIMUM DISTORTION DUE TO LATERAL TRACKING ERROR

By J. K. STEVENSON,

B.Sc., Grad. Inst. P., Grad. I.E.E.

It is possible (as shown in this article) to design and mount a pickup arm 8 in long and of conventional shape so that the maximum distortion, due to lateral tracking error, of a fairly large signal (10 cm/sec r.m.s. recorded velocity) is less than 1%. In view of the small value, any attempt to reduce the tracking error further by means of additional levers, etc., will not only have a negligible effect on the distortion, but will increase the inertia of the pickup assembly, which is undesirable. Lateral tracking error distortion for a pickup which is poorly mounted so that this value becomes 5%, say, is still small compared with that from other sources. However, these other distortions (which are much greater for stereophonic records) are slowly being reduced with improvements in pickup arms, whereas tracking error is unaffected. In fact, the distortion from tracking error increases if elliptical stylus are used.

One may argue that a 1 or 2% reduction in harmonic distortion is insufficiently large to be worth bothering with. This is true if it involves a modification to the pickup arm resulting in greater expense. If, as shown, it merely involves slightly more care in offsetting the pickup and mounting the arm, the extra effort is certainly worth while.

ANYONE who constructs a pickup arm has to choose values for the offset angle of the cantilever assembly and the overhang. Anyone mounting a pickup need only consider the overhang in order to determine the optimum distance between the pickup arm and turntable pivots. There is a general belief that a pickup arm should be mounted for minimum angular tracking error and that the longer it is, the better. However, the distortion of a given modulation becomes greater as the groove speed decreases, and a pickup arm designed and mounted for minimum tracking error will have its maximum error on the worst possible occasion, namely at the innermost grooves of the record. As the length of an arm increases, its inertia (effective mass) at the stylus tip will usually increase, and this is undesirable.

Two designs are given. The first is for a general purpose record player suitable for 7 in, 10 in and 12 in discs, and the second is for a record player restricted to 7 in discs. In both cases, a range of arm lengths is considered, and the most suitable values for the offset angle and overhang are given. Also, for the first design, values of overhang are included for offset angles varying within limits of about $\pm 0.5^\circ$ from the recommended value. Provided that the offset angle of a pickup arm lies within this range, the mounting may be considered as optimum with the smaller angle slightly favouring 45 rev/min records and the larger angle favouring long-playing records.

The importance of mounting accurately is shown graphically. An error of 0.1 in in overhang or 2° in offset angle will more than double the distortion from long-playing records. In view of this, the distances between the stylus and turntable centre, at which the tracking error should be zero, have been given. These distances are independent of the length of the pickup arm and enable the accuracy of the mounting to be checked. A mounting procedure is given for reducing these errors. If the offset angle is fixed and slightly different from the recommended value, an alternative procedure is given for adjusting the overhang for optimum mounting. Neither of these methods requires the offset angle or overhang to be accurately determined. All that is required is an alignment protractor and such a device is obtainable from most hi-fi dealers.

Distortions in reproduction from discs

The quality of reproduction from discs is limited mainly by three factors. Firstly, tracking error, which is the error in alignment between the cantilever assembly and the groove in which the stylus is located. Lateral (horizontal) tracking error is the angle, in the horizontal plane, between the groove, or direction of motion, and the cantilever, and for a conventional pickup arm the lateral tracking error varies with distance from the turntable centre. Vertical tracking error, which only affects stereophonic records, is the difference between the angle which the stylus makes with the vertical when slightly lifted (the arm remaining stationary), and the value specified for the particular record being played. The second factor limiting the quality of reproduction is groove deformation due to the plastic record material being compressed by the stylus tip. However, this distortion tends to reduce the third and most serious form of distortion, tracing distortion due to the cutter and stylus being of a different shape. The flat edge of the V-shaped cutter faces the direction of record motion, and therefore an absence of signal corresponds to a large groove width. As a result of a signal causing the

cutter to move horizontally, as in the case of a monophonic signal or two stereophonic signals approximately equal in amplitude and phase, the groove width becomes narrower causing a stylus of spherical tip to rise. This is the pinch effect. The high-frequency response of a pickup is limited by the radius of the stylus tip since the finite width in the direction of record motion limits the ability to follow groove modulations. The quality of reproduction is reduced further if the tracking mass is insufficient for the stylus to contend with large high-frequency velocities (for which a small effective tip mass is favoured) and low-frequency amplitudes (for which a large compliance is favoured).

Elliptical styli

In articles on pickup design, lateral tracking error is usually only briefly considered since the distortion is generally very much less than that resulting from other causes. However, in the last few years, these other forms of distortion have been reduced considerably. With pickups of lower effective tip mass and higher compliance, lower tracking masses have been possible. This has enabled styli of smaller radius (0.0005 in and less) to be used with a subsequent reduction in tracing distortion. Tracing distortion has been reduced further by the adoption of elliptical styli, mounted so that the major axes face the direction of record motion. The "vertical" cutting angle has been standardized in the U.S.A. at 15° and it should not be long before this value becomes universal. The result will then be a considerable reduction in vertical tracking error and subsequent distortion when the latest stereophonic records are tracked by the latest pickups, i.e. pickups designed so that a line joining the stylus tip and cantilever pivot is inclined at 15° to the record surface.

Despite their many advantages, the use of elliptical styli results in an increase in distortion from lateral tracking error by causing a time-lag effect. With a spherical tip, the points of contact with the walls of unmodulated grooves and at the crests of waves are always the same as those of the cutter, i.e. a line through these points will be perpendicular to the direction of record motion. However, if the stylus is elliptical and tracking error exists, then one point of contact will be slightly ahead of the other. In these circumstances, tracking error cannot be ignored. Even with spherical styli, it is certainly worth spending a few minutes extra in mounting a pickup arm if, as a result, the distortion due to lateral tracking error is reduced to a minimum, perhaps even halved.

Distortion due to tracking error

The main form of distortion due to tracking error is second harmonic and is given by H. G. Baerwald¹ as:—

$$\epsilon = 100 \frac{V_0 \tan \eta}{u} \approx 100 \frac{V_0 \eta}{u} \dots \dots \dots 1$$

where ϵ = % 2nd harmonic distortion, V_0 = peak recorded velocity (cm/sec), η = tracking error in radians, and u = groove speed (cm/sec).

Third and higher harmonic distortions amount to less than 10% of this value and are considered negligible. Using the expressions:—

$$V_{rms} = \frac{V_0}{\sqrt{2}} = \text{r.m.s. or effective recorded velocity (cm/sec)}$$

J. K. Stevenson, who is 26, graduated with an honours degree in physics at Birmingham University in 1952 and since then has been at the G.E.C. Hirst Research Centre, Wembley. He is senior member of a team investigating processing techniques for quartz crystals as piezoelectric resonators and determining new synthesis procedures for quartz crystal wave filters. He is a part-time teacher of physics at Willesden Technical College. This article stems from his personal interest in audio equipment.



$$\phi = \frac{360\eta}{2\pi} = \text{tracking error (degrees)}$$

x = distance between stylus tip and turntable pivot (in)

s = turntable speed (rev/min),

$$\text{then } u = (2\pi \cdot 2.54x) \frac{s}{60}$$

and equation 1 may more conveniently be put in the form

$$\epsilon = 100 \frac{\sqrt{2}}{2.54 \times 60} \cdot \frac{V_{rms} \phi}{xs} = 9.28 \frac{V_{rms} \phi}{xs}$$

A typical maximum value for V_{rms} may be considered as 10. Therefore,

$$\epsilon_{max} = 92.8 \frac{\phi}{xs}$$

The sign of ϕ (positive or negative) is ignored as it has no effect on the distortion. In order to prevent an excessive groove amplitude in the bass and to improve the signal to noise ratio, a gain of approximately 4 dB per octave with increasing frequency is applied to the recorded sound before it reaches the cutting heads. A reverse characteristic is used for replay. As a result, harmonic distortions are effectively reduced by 4 dB per octave. The effective maximum second harmonic distortion ϵ'_{max} is as follows,

$$\epsilon'_{max} = 10^{-1/20} \epsilon_{max} = 0.631 \epsilon_{max} = 58.5 \frac{\phi}{xs}$$

since the variation in pickup voltage is proportional to the recorded velocity. Hence,

$$\begin{aligned} \epsilon'_{max} &= 1.76 \frac{\phi}{x} \dots \dots \dots 33\frac{1}{2} \text{ rev/min} \\ &= 1.30 \frac{\phi}{x} \dots \dots \dots 45 \text{ rev/min} \end{aligned}$$

The values for harmonic distortion in this article are for spherical styli; other distortions due to tracking error are considered in Appendix 1 (in the next issue). The important point is that the distortions depend on ϕ/x .

Therefore, in a design ϕ/x should be minimized, and not ϕ alone.

Design procedure

Fig. 1 shows tracking errors for a straight pickup arm. By offsetting the pickup the errors are reduced considerably as shown in Fig. 2. Using the symbols in Fig. 3, we wish to determine the optimum values of θ_0 and f when x lies between given limits. We therefore require a value of θ which will remain almost constant as x varies within this range.

From Fig. 3:—

$$d^2 = x^2 + l^2 - 2xl \cos \beta = x^2 + l^2 - 2xl \sin \theta$$

¹H. G. Baerwald, *J.S.M.P.I.E.*, p.591-662, 1941.

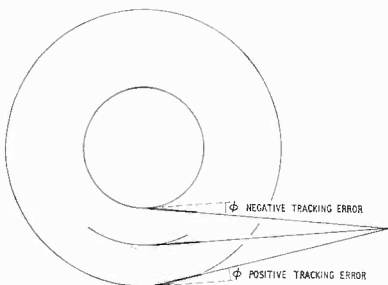

Fig. 1. Showing tracking errors for a pickup arm without offset.

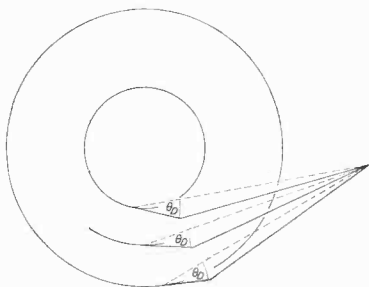

Fig. 2. Pickup arm with offset, θ_0 . By offsetting the pickup, tracking errors are reduced considerably. Note that the stylus moves very slightly in the direction of the record motion.

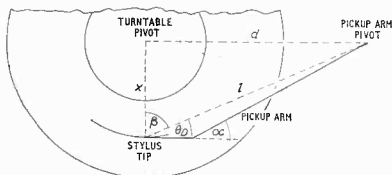
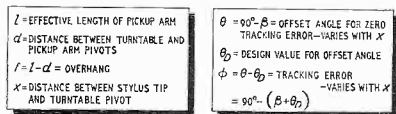

Fig. 3. Key to symbols used. The tracking error is zero when $\beta + \theta_0 = 90^\circ$. Optimum values for offset, θ_0 , and overhang f for x between giving limits are derived in the text. The offset angle of the pickup should not be confused with α , the angle through which the arm is bent.

$$\text{Rearranging, } 2l \sin \theta = x + \frac{l^2 - d^2}{x} = y \quad \dots (2)$$

where $d = l - f$.

We will consider first the determination of θ_D and f for minimum angular tracking error, and then show how these expressions are modified to reduce the maximum distortion of a given modulation, which is proportional to groove speed and therefore is inversely proportional to x .

Design for minimum angular tracking error

A value of θ is required which varies least in equation 2 when x varies between x_1 and x_2 ; l and d are constants. If we plot y against x we will obtain a curve which starts at infinity when $x=0$, reduces to a minimum value, and then increases to infinity at $x=\infty$ as in Fig. 4. The minimum at $x=x_m$ is given by differentiating equation 2 with respect to x , and equating to zero.

$$\frac{dy}{dx} = 0 = 1 - \frac{l^2 - d^2}{x^2}$$

$$\text{Hence, } x_m = \sqrt{(l^2 - d^2)}$$

Since l is given, x_m is varied by altering d . It is clear that x_m should lie between x_1 and x_2 if we wish the variation in $2l \sin \theta$ to be as small as possible for x varying between x_1 and x_2 . In particular, the variation will be a minimum if the values of y at $x = x_1$ and $x = x_2$ are equal. From equation 2,

$$x_1 + \frac{l^2 - d^2}{x_1} = x_2 + \frac{l^2 - d^2}{x_2}$$

$$\text{Hence, } x_1 x_2 = l^2 - d^2 = x_m^2 \quad \dots (3)$$

The minimum value of y then occurs at the geometric mean of x_1 and x_2 . Using equation 3,

$$d = (l^2 - x_1 x_2)^{1/2} = l - f$$

The overhang f is therefore given by:—

$$f = l - (l^2 - x_1 x_2)^{1/2}$$

The maximum and minimum values of y are given from equations 2 and 3,

$$y_{max} = x_1 + x_2 = 2/\sin \theta_{min}$$

$$y_{min} = 2(x_1 x_2)^{1/2} = 2/\sin \theta_{max}$$

The design value for θ_D is then as follows:

$$\theta_D = \frac{1}{2}(\theta_{min} + \theta_{max}) = \frac{1}{2} \left[\sin^{-1} \frac{(x_1 x_2)^{1/2}}{l} + \sin^{-1} \frac{x_1 + x_2}{2l} \right]$$

$$\text{or } \sin \theta_D \approx \frac{1}{2}(\sin \theta_{min} + \sin \theta_{max}) = \frac{(x_1^{1/2} + x_2^{1/2})^2}{4l}$$

Design for minimum tracking error distortion

In determining the pickup parameters for minimum lateral tracking error, we minimized the variation in $2l \sin \theta$ for x varying between x_1 and x_2 by including a turning point in the curve of $2l \sin \theta$ against x at $x = (x_1 x_2)^{1/2}$. $2l \sin \theta$ then has the same value at x_1 and x_2 . In this case, by minimizing the variation in $\sin \theta$ (l being constant), we automatically minimized the variation in θ , as required i.e. ϕ is as small as possible for $x_1 < x < x_2$.

Since for a given tracking error the distortion is inversely proportional to x , it is preferable for $\phi/x = (\theta - \theta_D)/x$ to be as small as possible. Most forms of distortion increase as the pickup approaches the turntable centre, so it is desirable for the distortion due to lateral tracking error to be a very small at the average minimum value of x . Let the tracking error be zero at $x = x_0$. We have mentioned Fig. 4 which gives $2l \sin \theta$ against x . Fig. 5 gives $2l \sin \theta/x$ against x and in addition $2l \sin \theta/x$ against x . The distance between these curves at a given

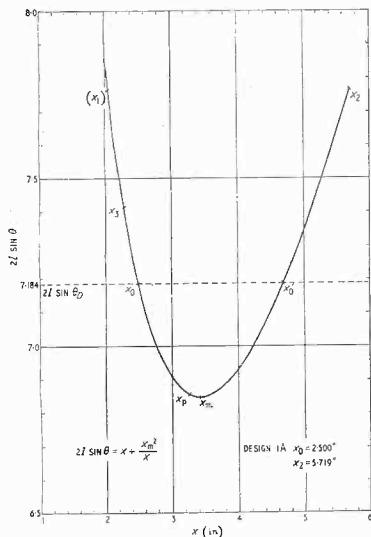

Fig. 4. Variation of $2l \sin \theta$ with x for a pickup arm designed for zero tracking error at x_0 and minimum distortion between x_0 and x_2 . As $x_0 < x < x_2$ the maximum harmonic distortion ($\propto |(\theta - \theta_0)|/x$) decreases to zero, increases to a maximum at x_0 (the same value of distortion as at x_2) and then decreases to zero at x_0 . Note that the largest negative value of $2l(\sin \theta - \sin \theta_0)$ occurs at x_m and the largest negative value of $2l(\sin \theta - \sin \theta_0)/x$ at x_p .

value of x is $2l(\sin \theta - \sin \theta_0)/x$ which we will minimize since it is approximately proportional to $(\theta - \theta_0)/x$ and allows a considerable simplification in the algebra.

Both $2l \sin \theta$ against x and $2l(\sin \theta - \sin \theta_0)$ against x have a minimum at x_m , whereas $2l(\sin \theta - \sin \theta_0)/x$ against x has a minimum at a value of x less than x_m , which we will call x_p . From equations 2 and 3:

$$2l \sin \theta = x + \frac{x_m^2}{x}$$

Hence,

$$\frac{2l(\sin \theta - \sin \theta_0)}{x} = \frac{x + \frac{x_m^2}{x} - \left(x_0 + \frac{x_m^2}{x_0}\right)}{x} = W \dots 4$$

W against x has a minimum at $x = x_p$. Hence, from Fig. 5, x_p is the value of x at which the continuous line is the furthest distance below the interrupted line. Differentiating equation 4 with respect to x and equating to zero:

$$\frac{dW}{dx} = 0 = -\frac{2x_m^2}{x^2} + \frac{x_0}{x^2} + \frac{x_m^2}{x_0 x^2} = \frac{1}{x^2} \left(x_0 + \frac{x_m^2}{x_0} - \frac{2x_m^2}{x} \right)$$

$$\therefore x_p = \frac{2x_m^2}{x_0 + \frac{x_m^2}{x_0}} = \frac{2x_0 x_m^2}{x_0^2 + x_m^2}$$

Ideally, we require $\frac{\theta_D - \theta_p}{x_p} = \frac{\theta_2 - \theta_0}{x_2} \dots 5$

$$\text{but since } \sin \theta_D - \sin \theta_p = 2 \sin \frac{\theta_D - \theta_p}{2} \cos \frac{\theta_D + \theta_p}{2}$$

$$\approx \frac{\pi}{180} (\theta_D - \theta_p) \cos \theta_D$$

$$\text{and } \sin \theta_2 - \sin \theta_0 = 2 \sin \frac{\theta_2 - \theta_0}{2} \cos \frac{\theta_2 + \theta_0}{2}$$

$$\approx \frac{\pi}{180} (\theta_2 - \theta_0) \cos \theta_0$$

we may replace equation 5 by

$$\frac{2l(\sin \theta_D - \sin \theta_p)}{x_p} = \frac{2l(\sin \theta_2 - \sin \theta_0)}{x_2}$$

This may be put in the form:

$$\begin{aligned} x_0 + \frac{x_m^2}{x_0} - \left[\frac{2x_0 x_m^2}{x_0^2 + x_m^2} + \frac{1}{2} \left(x_0 + \frac{x_m^2}{x_0} \right) \right] \\ = \frac{2x_0 x_m^2}{x_0^2 + x_m^2} \\ = x_2 + \frac{x_m^2}{x_2} - \left(x_0 + \frac{x_m^2}{x_0} \right) \end{aligned}$$

Simplifying,

$$x_m^2 \left(\frac{2x_0}{x_0^2} - \frac{2}{x_2} + \frac{1}{2x_0} \right) + x_m^2 \left(3x_0 - \frac{2x_0^2}{x_2} \right) \frac{x_0^2}{2} = 0$$

$$\text{Hence, } x_m^2 = \frac{x_0^2 x_2 (5.828x_0 - 4.828x_2)}{x_0^2 + 4x_0 x_2 - 4x_2^2}$$

This reduces to:

$$x_m^2 = \frac{x_0^2 x_2}{0.8284x_0 + 0.1716x_2} \dots \dots 6$$

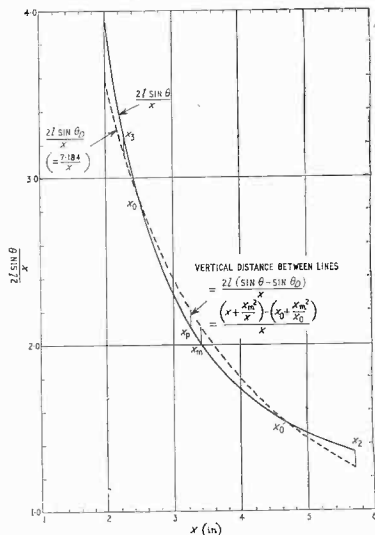

Fig. 5. Variation of $2l \sin \theta$ with x . The vertical distance between the lines is proportional to the harmonic distortion of a given modulation.

The design value θ_D for a given value of l is given from:

$$\sin \theta_D = \sin \theta_0 = \frac{1}{2l} \left(x_0 + \frac{x_m^2}{x_0} \right) = \frac{1}{l} \frac{x_m^2}{x_0} \quad \dots \quad 7$$

since $\theta_D = \theta_0$. The overhang f is given by:

$$f = l - (l^2 - x_m^2)^{1/2} \quad \dots \quad 8$$

All we require are values for x_0 and x_m . x_m^2 is then determined using equation 6 and the value substituted in equations 7 and 8 to determine θ_D and f for a given value of l .

The value of x less than x_0 at which the harmonic distortion (of a given modulation) is the same as at x_0 and x_2 we will call x_3 . This is given as follows:

$$\frac{\left(x + \frac{x_m^2}{x} \right) - \left(x_0 + \frac{x_m^2}{x_0} \right)}{x} = \frac{\left(x_2 + \frac{x_m^2}{x_2} \right) - \left(x_0 + \frac{x_m^2}{x_0} \right)}{x_2}$$

$$= \frac{\left(x_0 + \frac{x_m^2}{x_0} \right) - \left(x_p + \frac{x_m^2}{x_p} \right)}{x_p}$$

From the first two expressions,

$$\frac{1}{x_2} \left(x_0 + \frac{x_m^2}{x_0} - \frac{x_m^2}{x_2} \right) x^2 - \left(x_0 + \frac{x_m^2}{x_0} \right) x + x_m^2 = 0$$

The two solutions for x are x_2 and x_3 .

$$\therefore x_2 + x_3 = \frac{1}{x_2} \left(x_0 + \frac{x_m^2}{x_0} - \frac{x_m^2}{x_2} \right)$$

$$\text{Hence, } x_3 = \frac{\left(x_0 + \frac{x_m^2}{x_0} \right) - \frac{x_m^2}{x_2}}{x_2}$$

The tracking error changes from positive to negative between x_2 and x_p . Let it be zero at a value of x which we will call x'_0 .

$$x + \frac{x_m^2}{x} = x_0 + \frac{x_m^2}{x_0}$$

$$\text{Rearranging, } x^2 - \left(x_0 + \frac{x_m^2}{x_0} \right) x + x_m^2 = 0$$

Solutions are x_0 and x'_0 .

$$\therefore x_0 + x'_0 = x_0 + \frac{x_m^2}{x_0}$$

so $x'_0 = \frac{x_m^2}{x_0}$, as expected.

Note that whatever design method is used to obtain θ_D and f , the tracking error at a given value of x is given by:

$$\phi = \sin^{-1} \left[\frac{x + f(2l-f)}{2l} \right] - \theta_D \quad \dots \quad 9$$

i.e. $\phi = \theta - \theta_D$

where θ is given from equation 2 rewritten in the form:

$$\sin \theta = \frac{x + f(2l-f)}{2l}$$

Equation 9 was used to compare the distortion of a given modulation arising from a pickup mounted as suggested here with that obtained if Bauer's method is used. Results will be given in Appendix 11.

Summary of design formulae

As x decreases, we have shown that the tracking error changes from positive to negative and back to positive again. The tracking error per unit length is zero at x_0 and x'_0 and the maximum negative value (at x_p) is equal to the positive values at x_2 and x_3 , as indicated in Fig. 5.

The values of x are related as follows:

$$x_0 + \frac{x_m^2}{x_0} = x'_0 + \frac{x_m^2}{x'_0}$$

$$\left(x_2 + \frac{x_m^2}{x_2} \right) - \left(x_0 + \frac{x_m^2}{x_0} \right) = \left(x_3 + \frac{x_m^2}{x_3} \right) - \left(x_0 + \frac{x_m^2}{x_0} \right)$$

$$= \frac{\left(x_0 + \frac{x_m^2}{x_0} \right) - \left(x_p + \frac{x_m^2}{x_p} \right)}{x_p}$$

$$x_p = \frac{2x_m^2}{x_0 + \frac{x_m^2}{x_0}}$$

where $x'_0 > x_0, x_2 > x_3$.

We must specify two values of x to obtain a solution.

If we specify x_0 and x_2 (as in the given designs), then:

$$x'_0 = \frac{x_m^2}{x_0}$$

$$x_p = \frac{2x_0 x_m^2}{x_0^2 + x_m^2}$$

$$x_3 = \frac{\left(x_0 + \frac{x_m^2}{x_0} \right) - \frac{x_m^2}{x_2}}{x_2}$$

$$= \frac{x_0^2 x_2}{0.8284x_0 + 0.1716x_2}$$

where $x_m^2 = \frac{0.8284x_0 + 0.1716x_2}{x_0^2 + x_2^2}$

Alternatively, we can give values for x_2 and x_3 , the limits of x between which we require the tracking error per unit length to be minimized. Then it is easily shown that:

$$x_0 = \frac{x_2 x_3}{0.8536x_2 + 0.1464x_3}$$

$$x'_0 = \frac{x_m^2}{x_0} = \frac{x_2 x_3}{0.1464x_2 + 0.8536x_3}$$

$$x_p = \frac{2x_2 x_3}{x_2 + x_3}$$

where $x_m^2 = \frac{8x_2^2 x_3^2}{x_2^2 + x_3^2 + 6x_2 x_3}$

The offset angle θ_D and overhang f for minimum tracking error per unit length are then as follows:—

$$\sin \theta_D = \frac{1}{l} \cdot \frac{x_m^2}{x_p}$$

$$f = l - (l^2 - x_m^2)^{1/2}$$

To be concluded.

Acknowledgement is due to Alfred Imhof Ltd. for the use of their facilities in the production of our front cover.

Transistor Electronic Organ

1—ELECTRONIC ORGAN DESIGN TRENDS

By T. D. TOWERS, M.B.E.

THE electronic-organ-building bug is a curious one. Bitten by it, many thousands have become afflicted with *dementia organistra*. The first clinical signs displayed by the victim of the disease (now assuming epidemic proportions) is a delusion that without substantial mechanical, electronic and musical skills he can construct one of these complex mechanical, electronic, musical instruments. This article is written with compassion for those who feel the first stirring of the *dementia organistra* fever in their blood, and cannot bring themselves to accept the sage advice from the pundits (usually reserved for those contemplating marriage!) . . . "Don't." It tries to give the happy victim some helpful guidance by setting out the main design features of present day electronic organs.

WHAT AN ELECTRONIC ORGAN IS

Organs have been around for a long time now. My favourite illustration of this is the ancient organ pictured in Fig. 1(a). This appeared in a famous medieval Psalter, the "Utrecht," and different musicologists have ascribed various dates from A.D. 600 to A.D. 1000 to the instrument. It may seem a far cry from it to the modern domestic electronic organ, which nowadays often takes a form somewhat like Fig. 1(b). Yet both belong to the same organ class of instrument; i.e., they are keyboard instruments in which a note sounds when a playing key is depressed and continues to sound until the key is released.

"Electronic" v. "wind" organs.—How an electronic organ differs in fundamentals from a classical "wind" organ is illustrated schematically in Fig. 2.

In the wind organ of Fig. 2(a), a bellows or pump-type compressor, A, forces air under pressure through a pipe, B, into a high-pressure reservoir ("wind-chest"), C. By operating one of the keys in the keyboard, E, the player can let compressed air pass through ducts D and F on the start of its way to make the organ pipe, I, sound or "speak." However, the "stops," G, in their off position stop the flow of wind to the pipe, I, even though a note is depressed on the keyboard. By putting on a selected stop, the performer opens the way for air to flow to a selected set or "rank" of pipes designed to produce a certain type of sound. The organ pipe is like a large whistle blown by the wind pressure released into it when the appropriate stop and key are actuated. The stop selects a set of pipes of one timbre, and the playing key selects the pipe of the proper pitch in that set.

Some ranks of pipes are mounted in free air, but others are enclosed in a sound-insulated enclosure, J, in Fig. 2(a), known as a "swell cabinet." Sound from these enclosed pipes emerges through a sort of venetian blind, K, and its apparent loudness depends on how far the blind is opened. A foot-operated "swell" or "expression" pedal, L, controls the opening of the venetian blind, and thus the apparent volume of sound from the "swell" ranks of pipes. The player manipulates the organ from the console (shown dotted) which presents to him the keyboards (usually more than one), the stop actuators ("pistons" or "tabs") and the swell pedal.

The block schematic of an electronic organ is given in Fig. 2(b), laid out to parallel the functions of its various sections with those of the wind organ above it, so as to highlight the differences. An electrical supply,

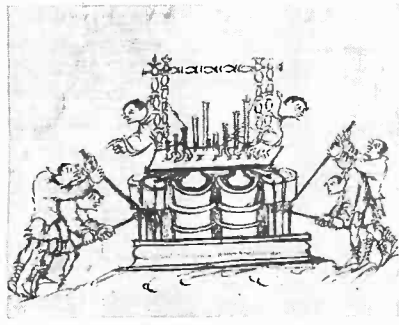
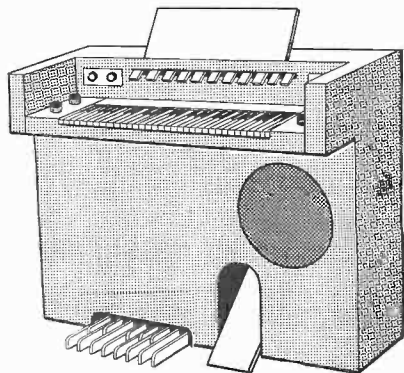

Fig. 1. The organ over the years: (a) illustration from early Psalter of pre-A.D. 1000 organ, well-known to organ antiquarians; (b) sketch of typical modern domestic electronic organ.



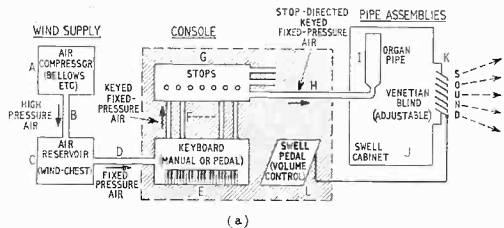

Fig. 2. Diagrammatic illustration of the essential differences between a traditional "wind" organ (a) and an electronic organ (b).

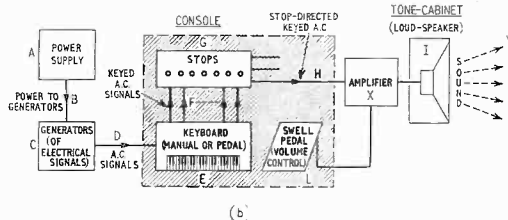

Fig. 3. Basic differences between two main classifications of electronic organs: (a) continuously-running generators and (b) switched generators.

A, provides power for the generators, C, of electrical a.c. signals of various frequencies. As with the wind organ, the console provides keyboard(s) E, stop controls, G, and a swell pedal, L.

The playing keys on the electronic organ keyboard select the appropriate frequency a.c. signals from the generator, and the stop tabs direct these selected signals into corresponding tone shaping circuits. Subsequently, these keyed, stop-directed, shaped, a.c. signals at H pass into the amplifier, X. There they are amplified and used to produce a sound output by driving a loudspeaker, I. The output level is controlled by an amplifier volume control actuated by the foot pedal, L.

The traditional organ nomenclature of keyboards ("manual" and "pedal"), "stops" (tone colours), and "swell pedal" (volume control) have been carried over into electronic organs, because they achieve the same results, even if in a vastly different way.

Distinguishing mark of the electronic organ.—In essence, while a wind organ emits sound directly from the vibrations of a column of air in a pipe, an electronic organ produces it indirectly from a.c. electrical signals by turning them into vibrations of a loudspeaker cone. (You should not, by the way, confuse the electronic organ with the electric organ in which electrical power is used to drive the mechanical movements).*

TONE GENERATION IN AN ELECTRIC ORGAN

Electronic organs fall into two main classes according to whether their a.c. signal generators run all the time, or are switched on and off by the playing keys. The distinction is illustrated diagrammatically in Fig. 3. In the continuous-generator case at Fig. 3(a), a power supply drives the generators continuously, but their outputs do not pass towards the loudspeaker until a playing key is

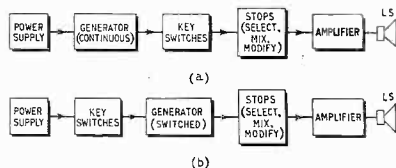

depressed; i.e., the keyboard switches come between the generators and the output busbar. In the switched-generator case at Fig. 3(b), the generators are inactive until the depressing of a playing key feeds the power supply into one of them; i.e., the keyboard this time comes between the power supply and the generators.

Generator types in common use.—Anything that will generate stable audio-frequency a.c. signals can be used as an electronic organ generator. The path of development up to date is strewn with weird relics in consequence. Fig. 4 gives a selection of some of the more common tone generator principles that have survived into current commercial organs.

At Fig. 4(a) is a sketch of the principle of the time-proved rotating disc electromagnetic generator. This has been used now for some 30 years in the Hammond organ, which is regarded by many as the "Rolls-Royce" of electronic organs. A rotating iron disc with undulating rim, set up opposite a permanent magnet, gives rise, in a coil wound round the magnet, to a.c. signals at a frequency set by the rotational speed and the number of wave cycles round the rim.

Another common generator type is the wind-blown, electrostatic pick-up, reed system illustrated in Fig. 4(b). Derived from harmonium practice, this has been widely used by such firms as Farfisa. The metal reed is continuously vibrated by a fixed-pressure air supply, and the

*What does one call a pipe organ with a semiconductor logic switching action? (See "W.W.", Jan. 1965, p. 16).—Ed.

capacitance variation between the pick-up electrode and the earthed metal reed modulates the output voltage to give an a.c. signal at the reed resonant frequency.

Fig. 4(c) illustrates a third principle, the rotary-disc, capacitor pick-up system which has been the hallmark of the Compton electronic organs for over three decades. Here the voltage on a fixed pick-up electrode is modulated by the varying capacitance between the electrode and an earthed cyclically changing pattern on the face of a rotating disc. (In the Compton version, actually, the pick-up rotates and the cyclic pattern is on a fixed stator, but the principle is the same.)

A slightly different type of generator is the key-vibrated, electro-static pick-up system illustrated at Fig. 4(d), used in "electronic pianos," such as the Wurlitzer. Strictly it is not an organ generator, because the vibration of the reed dies steadily away after the impact of the key hammer. However, it is included because the electronic piano is in many other ways very like an electronic organ.

These first four examples of organ generators given above have been all electromechanical. There is a tendency for such types to be superseded by purely electrical oscillators, of which common examples are given in Figs. 4(e) to (h). LC oscillators such as Fig. 4(e), valve, and Fig. 4(f), transistor, have their frequency set by their own LC tank circuits. By contrast, the divide-by-two circuits at Fig. 4(g), a transistor triggered blocking oscillator, and Fig. 4(h), a transistor bistable divider, merely

provide an output signal at a frequency one half of the input trigger signal frequency.

A.C. signal waveshapes.—What sort of waveshapes do the various generators produce? This is important because, if, as is sometimes desirable, the instrument has to simulate the sound of a traditional organ, it will have to feed to the loudspeakers highly complex periodic waveforms.

One way of producing such complex a.c. output signals is by Fourier synthesis, i.e., by mixing a harmonically related series of sinewaves in varying proportions. This is the working principle of the Hammond. The basic sinewave shape, as shown in Fig. 5(a), comprises only a fundamental frequency without harmonics, of course. Most electric organs nowadays, however, approach the production of a complex output waveform by taking a basic waveshape rich in harmonics and working on it to tailor the strength of the individual harmonics to give the desired tone colour.

The two commonest harmonic-rich waveforms used in organ generators are the sawtooth, Fig. 5(b), and the squarewave, Fig. 5(c). It is worth noting the harmonic content of these two types. The sawtooth of basic frequency f has material overtones in both the even ($2f, 4f, 6f, \dots$) harmonic series and the odd ($3f, 5f, 7f, \dots$) series. The squarewave has odd harmonics only. The importance of this lies in the fact that the sawtooth with

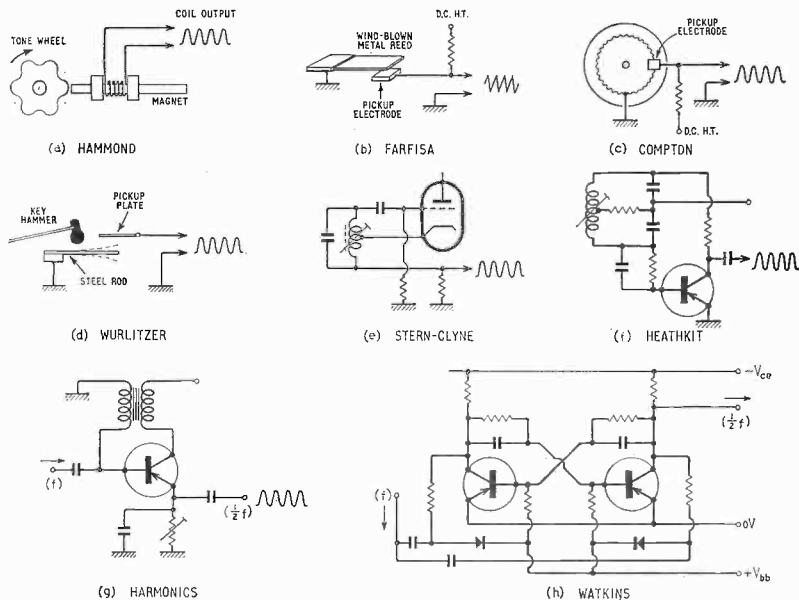

Fig. 4. A selection of some of the more common tone generator principles used in commercial electronic organs: (a) rotating disc, magnetic pick-up; (b) vibrating reed, electrostatic pick-up; (c) rotating disc, electrostatic pick-up; (d) struck rod, electrostatic pick-up; (e) sinusoidal oscillator, valve; (f) sinusoidal oscillator, transistor; (g) blocking oscillator, divide-by-two, transistor; (h) bistable multivibrator, divide-by-two, transistor.

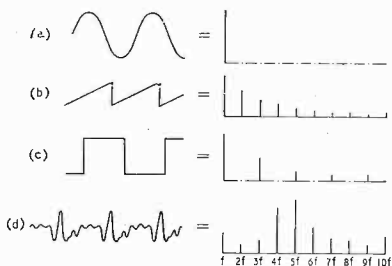

Fig. 5. Indications of the relative strength of the harmonics in basic waveshapes commonly produced by electronic organ generators compared with the complex waveshape required for a typical organ oboe stop: (a) sinewave; (b) sawtooth; (c) squarewave; (d) complex (oboe).

its full range of harmonics can be more easily reshaped to produce the normal "diapason" classical organ sound than can the squarewave. In the latter, the absence of even harmonics makes diapason tone difficult, although it has compensations in that it can more easily produce hollow tones such as the clarinet sound.

Some commercial organs use basic sawtooth and some basic squarewaves. The tendency nowadays is to adopt the squarewave because it is cheaper in production and less "temperamental" than the sawtooth. Some pundits claim that they can tell blindfolded whether an organ uses sawtooth or squarewaves, but with a well-designed instrument I personally have not found this to be so.

For the designer, the choice of sawtooth or squarewave is important, because the tone-forming filter circuits controlled by the stop tabs are substantially different for the two types. This is why any circuit for a tone filter should have on it an indication of the basic waveshape it controls.

To put point to this discussion of generator waveshapes, the complex waveshape of an oboe sound is shown in Fig. 5(d) with a spectrum of its harmonic content. This particular waveshape is characterized by a low level of fundamental and a predominance of fourth and fifth harmonics. You can see that the harmonic distribution of Fig. 4(d) can be relatively easily made up by adjusting the amplitudes of the harmonics of the sawtooth, Fig. 4(b). But, in the case of the squarewave, Fig. 4(c), even harmonics have to be produced separately and added before the desired complex oboe waveform can be achieved.

ACTION OF PLAYING KEYS

In the electronic organ each playing key operates a set of ganged switches, usually four or five in number, to produce different harmonic pitches. As mentioned earlier, these key-switches either select the appropriate outputs from certain of a set of continuously running generators or switch the actuating power to selected oscillators in a set of normally non-operating generators.

Locked- and free-phase oscillators.—The oscillators controlled by the key-switches can all be independently adjustable so that, apart from their being individually tuned as nearly as practicable to the appropriate scale-related note frequencies, they are "free-phase" oscillators working independently of each other. In such a system, initial tuning can be tedious, because anything from 60

to 600 oscillators have to be set up. It is rather like tuning a wind organ (where each pipe has to be checked).

The alternative (and nowadays by far the commonest) arrangement is the "locked-phase" oscillator system. In this there are only 12 independent tunable "master" oscillators, one for each note, (C, C♯, D, D♯, E, F, F♯, G, G♯, A, A♯, B) of the equal-tempered musical chromatic scale. All the frequencies required by the organ are octavely related to these 12 oscillator frequencies, and are produced by a string of divider oscillators phase-locked to the master oscillators (usually to subharmonics) and thus not independently adjustable.

The free-phase and locked-phase oscillator systems are illustrated diagrammatically in Fig. 6 for all the Cs to be sounded by an organ. In the locked-phase system of Fig. 6(a), the master C oscillator is tuned to C6=2,093.0 c/s; the Cs for lower octaves are produced by a string of divide-by-two circuits phase-locked to the master oscillator. This means that C1=65.4 c/s, for example, comes out coldly mathematically at an exact half of C2=130.8 c/s, and in phase with it. In the free-phase system of Fig. 6(b), each oscillator in the string of Cs is individually tuned as near as possible to the harmonic series frequencies, but each C will inevitably depart slightly from half of the frequency of the C above it. Also the individual oscillations will not now be in phase with each other.

There is no doubt that the free-phase oscillator system can more closely simulate the so-called "chorus" effect of a wind organ with all its pipes individually tuned and not in phase with each other. But you must pay for perfection, and many electronic organs now make do with the cheaper, easier-to-set-up, locked-phase divider system.

The problem of key clicks.—Whether locked- or free-phase oscillators are used has a large bearing on the keying system. Obviously in a locked-phase system the oscillators must run all the time and the keys can only switch their outputs. This means switching a.c. signals, in which it is very difficult to avoid "key-clicks" arising from the abrupt interruptions of the signal. With free-phase oscillators, on the other hand, it is possible to use the keys to switch the d.c. supply to the oscillators. The oscillator output a.c. signals then do not start and stop abruptly, and key clicks are much less of a problem. Also in this case the gradual start of oscillation stimulates the steady build-up of sound in a wind organ pipe when the playing key is pressed.

In the electronic organ, the "stops" are merely the switches for selecting the tone forming filter circuits through which the basic waveform signals are fed from the generators via the playing keys to achieve the desired final tone colour. There are three basic classes of stops: "speaking," "percussion," and "coupler."

Speaking stops are the switches that control the tone colour of the organ output. They select certain pitches of notes supplied by the playing keys, mix them and feed them to appropriate waveshape-modifying filter circuits. These stops are concerned primarily with the recurrent waveshape of the final signal to the loudspeakers, i.e., the steady, continuous, fixed-amplitude, fixed-frequency waveshapes.

Percussion stops.—Other switches, the so-called "percussion stops," are usually provided to control the envelope of the output signals. If the playing key switched the signal on and off abruptly, we should get a signal

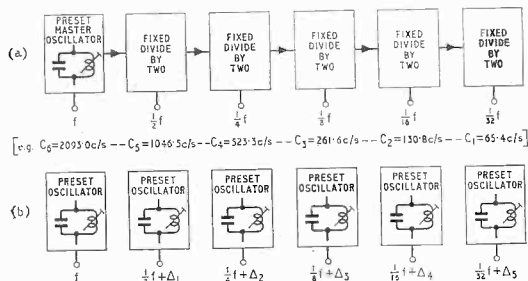

Fig. 6. Illustration of differences between locked-phase (a) and free-phase (b) oscillator systems in electronic organ. (The locked-phase system is also known as "divider" type or "synchronous" system.)

envelope like Fig. 7(a). In an attempt to simulate classical organ sound and to give variety to tonal effects, electronic organ designers use some or all of the variety of percussion (or envelope-distortion) arrangements illustrated in Figs. 7(b) to (g).

"Attack" percussion at Fig. 7(b) is the delaying of the build-up of the waveform signals on switch-on. "Decay" at Fig. 7(c) is the permitting of signals to fall off (or even cease) before the playing key is released. "Sustain" at Fig. 7(d) is letting the signal continue after key off. In all these types, the amplitude and frequency of the note are unchanged in the middle of the note sounding.

But there are other percussion stops which modify the waveshape characteristic throughout the whole note length. Of this class is the "tremolo" stop at Fig. 7(e) which varies the signal amplitude at a subsonic

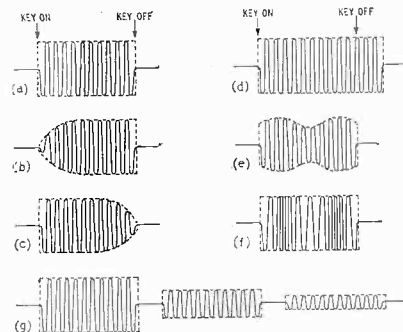

Fig. 7. Modifications of fixed-amplitude, fixed-frequency, waveshape to achieve various special "percussion" effects: (a) No percussion— instant start, instant stop, constant-amplitude, constant-frequency. (b) "Attack"—varying rate of increase of amplitude on switch on. (c) "Decay"—amplitude falling off before key off. (d) "Sustain"— signal continues after key off. (e) "Tremolo"—signal frequency constant but amplitude varied at low frequency (amplitude modulation about 6 c/s). (f) "Vibrato"—signal amplitude constant but signal frequency varies at low frequency (frequency modulation about 6 c/s). (g) "Reverberation"—signal repeated one or more times after key off, with progressively reduced amplitude.

frequency between 3 and 9 c/s to make an approximation to the "tremulant" effect in a wind organ. "Vibrato" at Fig. 7(f) frequency-modulates the signal at subsonic frequency again in an attempt to simulate the organ tremulant. But in the wind organ, the tremulant is a mixture of amplitude and frequency modulation, and electronic organ designers sometimes provide both tremolo and vibrato in consequence. (People who have difficulty in remembering which is vibrato and which tremolo may welcome my own little *aide-memoire*: Vibrato varies the Frequency, because "V" sounds not unlike "F.")

The last percussion stop is "reverberation" (also known as "echo") illustrated in Fig. 7(g). In a wind organ sited in a church or a large hall, part of the "organ" sound is due to the characteristic echoes from the walls. In effect, a tone burst is heard repeated one or more times with diminishing volume after the key is released. This is simulated in an electronic organ by feeding off part of the signal into a delay network and then releasing it back into the amplifier. The delay network can be acoustic (some people have even used a length of garden hose), mechanical (e.g. passing sound through a coiled spring), or moving-magnetic (e.g. signal recorded on a magnetic tape and picked up again later by a separate playback head).

Coupler stops.—Where an electronic organ has more than one keyboard, "coupler" stops are often provided to enable the separate keyboards to be coupled; i.e., speaking stops can be set up for one keyboard and played from another by switching in coupler stops.

COMPLETE ELECTRONIC ORGANS

If you now look back to the schematic block diagram of an electronic organ given in Fig. 2(b), you will see that we have now covered, albeit sketchily, most of the component sections of the system. But a few further remarks might not be out of place here.

The power supply is usually mains driven, but transistor models are available nowadays for battery operation. The amplifier is a little different from a standard hi-fi amplifier. Because of the possibility of sustained high level signals, its overload characteristics require careful design. Output powers range from 10 W to 100 W usually. The loudspeakers must not only have adequate wattage ratings, but must have a good response down to below 20 c/s to handle low pedal notes without distortion. The swell pedal (volume control) receives

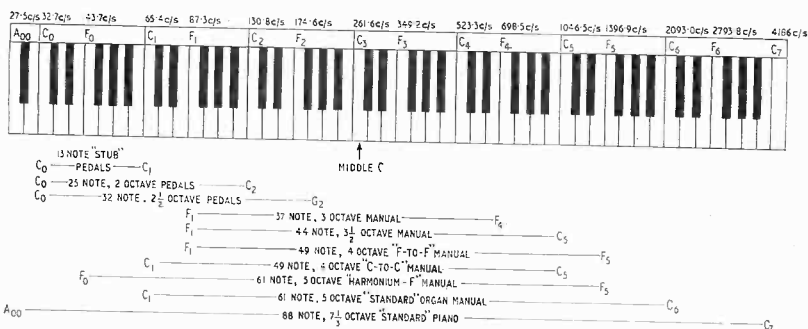

Fig. 8. Compasses of keyboards in various commercial organs compared with standard piano keyboard.

much hard wear. For this, therefore, often some arrangement of light- or voltage-dependent resistors is used to avoid using a conventional carbon or wirewound potentiometer which may soon develop contact noise.

Consoles.—A variety of layouts of the component sections of the electronic organ will be found in commercial models. The tendency nowadays is to pack everything into a single cabinet or "console." This was not always possible in earlier days, but modern miniature components make the self-contained organ the norm. The domestic electronic organ sketched at Fig. 1(b) illustrates this compactness tendency. Here you can see the stop tabs sited above the keyboard (their usual position), supplementary controls at each end, the swell pedal convenient to the player's right foot, the loud-speaker facing forward, and the pedal board at the bottom left.

Keyboards.—As to the keyboard itself, the student of the electronic organ will find a confusing variety in use. Commercial instruments will, of course, have at least one manual keyboard. More frequently they have two manuals, usually called the solo (upper) and accompaniment (lower). These are also occasionally referred to as the "swell" and "great" respectively to conform with traditional wind organ terms.

Where an electronic organ is intended to substitute for a traditional organ, three manuals are not uncommon, and these are usually given the standard organ descriptions of: "great," "swell" and "choir."

In the "pedal department," two arrangements have become fairly standard in the electronic organ. The first of these (used in the illustration of Fig. 1(b)) is the 13-note, stub-pedal common in the smaller domestic organs. The standard full 31-note classical pedal compass is not often used for electronic organs, although many models feature the second standard, a shorter two-octave, 25-note version.

When engineers first take an interest in electronic organs, they often find themselves confused by the plethora of keyboard specifications. For their benefit, Fig. 8 sets out the compasses of widely used keyboards against the spread of the familiar standard 88-note piano keyboard. The standard organ manual keyboard is the C₁-C₅, 5-octave, 61-note version, but you may come

across the alternative "harmonium, F-to-F" version with the same compass. The shorter manual keyboards listed in Fig. 8 have become very common in small domestic electronic organs, mainly because of their cheapness.

SOURCES OF FURTHER INFORMATION

By now the reader must have realized that electronic organ design is not without its complexities. If all this has not discouraged him too much, he may welcome suggestions as to where to look for further information.

For basic principles and general reading, I can heartily recommend "Electronic Musical Instrument Manual," Pittman, 1961, and "Electrical Production of Music," Macdonald, 1957, both by A. Douglas. No textbooks exist covering current practice in this rapidly changing field, but some useful information can be gleaned from such books as "Electronic Organ Handbook," H. E. Anderson, Sams, 1962, and "Servicing Electronic Organs," C. R. Pittman and E. J. Oliver, Sams, 1962.

And for the "antiquarian," interested rather in the development of the electronic organ, recommended reading "musts" are "Electronic Music and Instruments" by B. J. Miessner, *Proc.I.R.E.*, Vol. 24, No. 11, Nov., 1936, and "Electronic Musical Instruments and the Development of the Pipeless Organ" by G. T. Winch and A. M. Midgley, *Journal I.E.E.*, Vol. 86, No. 522, June, 1940.

OUR NEXT ISSUE

A 32-page supplement in our June issue will give a stand-by-stand preview of the Instruments, Electronics & Automation (I.E.A.) Exhibition to be held at Olympia from May 23rd to 28th. This supplement will be in addition to the normal quota of features and technical articles which will include the second of the series on electronic organs and a review of the latest developments in audio techniques seen at the London Audio Fair. We also plan to include a report on some of the new equipment seen at the Hanover Fair (April 30th-May 8th).

The world's most versatile 1c/s to 16Mc/s solid-state Pulse Generator



made in England

The INTERCONTINENTAL PG-2 Pulse Generator is extremely versatile, ideally suited for a wide range of measuring applications—from testing amplifiers, radar, computers, memory cores, semiconductors, and A.C. coupled logic circuits to nuclear instrumentation. Panel height is only 3½".

ADVANTAGES:

- Repetition rate 1 c/s to 16 Mc/s
- Single or double pulse
- Positive or negative and complementary pulse

- One shot pushbutton
 - Adjustable offset, delay and width
 - No duty cycle limitations
 - Linear rise and fall times variable from 12 nanoseconds to 20 milliseconds
 - DC coupled output
 - Adjustable trigger sensitivity, threshold and slope
 - All solid state
- Price £380

The Intercontinental PG-2 Pulse Generator offers a combination of advantages unobtainable hitherto in any other instrument produced in this country.

Now that it is being made in England by the Instruments Division of Claude Lyons Limited, customers will, of course, benefit in many ways—not the least of which is the elimination of tedious duty-free formalities.



CLAUDE LYONS LTD
Instruments Division, Hoddesdon, Herts.
Tel: Hoddesdon 67161 Telex: 22724.
76 Old Hall Street, Liverpool 3.
Tel: MARitime 1761. Telex: 62181.

NEW +125° C

ALUMINIUM FOIL
EXTENDED
TEMPERATURE RANGE
ELECTROLYTIC
CAPACITORS
TO MIL-C-39018 SIZES

-55° C

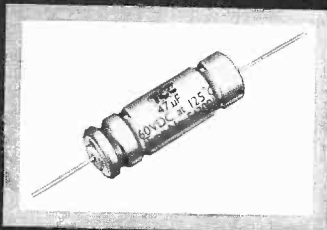

Please send me a copy of your Bulletin No. 100

NAME _____

ADDRESS _____

NEW

T.C.C. E.T.R. capacitors are about one third the weight of corresponding tantalum foil capacitors, have a larger capacitance per unit volume and in many cases will match them in performance. Available in seven sizes and from 5-200 volts working at 125°C with a capacitance range of 3.3 µF to 1000 µF. These capacitors are a big step forward in Aluminium Foil Electrolytics and are the product of T.C.C.'s continued research and development based on many years of experience in the capacitor field.

Send for the new T.C.C. Bulletin No. 100 by filling in and posting the coupon opposite, this new bulletin gives full details of the range with performance curves and complete specification.

THE TELEGRAPH CONDENSER CO. LTD

(Electronics Division) North Acton, London W.3. Telephone: Acorn 0061 (16 lines) Telex: 261383

Also at CHESSINGTON, SURREY and BATHGATE, SCOTLAND
W—11 FOR FOREIGN DETAILS.



WORLD OF WIRELESS

Aircraft Collision Avoidance System Proposed

IN 1955 the Air Transport Association of America asked the electronics industry to submit proposals for a form of collision avoidance equipment. Since then much work has been devoted to the development of a system suitable for installation in civil and military aircraft and compatible with the American air traffic control system, but to date a system has not been fully approved. However, one manufacturer, McDonnell Aircraft, of St. Louis, Missouri, has developed a system for use in specialized flight test operations with its aircraft. The system uses the time frequency, range altitude technique which entails the measurement of range, the rate of change in range (range-rate) and altitude. Each aircraft carries a computer which has a precise transmit time assigned to it; each computer also knows the transmit time of the other aircraft. All aircraft transmit their altitude on a common frequency at the allocated times and the difference in μ s, between the assigned time of transmission and the actual time of reception by the computer is used to determine distance to the transmitting aircraft. At the

receiving aircraft a frequency shift varying with the relative speeds of the two aircraft is measured to give their rate of closure. The computer divides distance by rate of closure to predict possible time of collision, advises what escape manoeuvre to use and then indicates when the potential collision has been avoided. Great precision in both timing and frequency stability is necessary. Accuracies in the order of one part in ten million are required. Each aircraft must carry an accurate frequency standard and the system requires a practical method for synchronizing the timing devices carried aboard all aircraft at appropriate intervals.

In its present form, the McDonnell system is not suitable for airline use, but the Air Traffic Control Committee of the A.T.A. has been directed to give all possible assistance to the company so that the system can be subjected to early flight evaluation by airlines.

Collision avoidance systems for aircraft are being discussed in our correspondence columns (see page 249).

Television Without Cameras

THE Canadian RCA Victor Company has developed a technique by which printed matter can be televised without the use of a camera; instead, for example, a typist operating a keyboard can type messages for direct television transmission.

The system, designated DIVCON—digital to video conversion—includes a display control logic sub-system programmed to store information from various sub-systems and to "read" the contents of a memory to a series of digital-to-video-generator sub-systems which translate the digital data into a video form synchronized with the television scanning periods. The system has all control functions normally found on an electric typewriter such as space,

shift and backspace and there are special facilities for erasing. There is also a facility to underline words or to make them flash. Stationary or travelling displays of information are also possible. Code conversion logic is provided so that the DIVCON system can work with data processing centres using different machine languages.

Data is stored in the random access core memory in an eight bit code and the actual size of the memory is dictated by the number of output video channels wanted and the amount of character symbols needed for each channel.

Readers who watched the B.B.C.'s televised results of the General Election will be interested to learn that the DIVCON system was used for these transmissions.

International Amateur Radio Conference

FROM May 23-28 at Opatjia in Yugoslavia about 70 delegates representing some 40,000 licensed radio amateurs from the national amateur radio societies of Austria, Belgium, Finland, France, Germany, Italy, Luxembourg, the Netherlands, Nigeria, Norway, Poland, the Soviet Union, Sweden, Switzerland, the United Kingdom and Yugoslavia will meet to discuss over 100 proposals and suggestions at the triennial conference of the International Amateur Radio Union, Region 1 (Europe and Africa) Division.

Subjects for discussion will include amateur teletype standards and frequencies, proposals for a European orbiting

satellite carrying amateur radio (OSCAR) and proposals by the R.S.G.B. that harmonically related frequencies should be used for s.h.f. working and authority sought for amateurs to use the amateur u.h.f. and s.h.f. bands for space communication. At present under international regulations amateur space communication activities are confined to the 144-146 Mc/s band.

The Conference is being organized by the honorary secretary of the I.A.R.U. Region 1 Division, John Claricoats, G6CL, who, until he retired at the end of 1963, had been secretary of the R.S.G.B. since 1930.

Australian Telecommunication Problems

THE Australian Telecommunication Development Association, a representative body for manufacturers of telecommunication equipment, is confronted with a major problem, for although the Post Office supports the indigenous electronics industry, the Defence Services do not. Last year, 80% of all radio transmission equipment purchased by the Commonwealth Department was imported. The Association admitted that some complex electronic devices could only be obtained abroad, but also claimed that the Australian industry could have supplied 50% of the required equipment. The prob-

lem is twofold; first, that since this industry is regarded as a major unit in the Australian economy a continued flow of orders overseas can only be detrimental to the economy; and, more seriously, A.T.D.A. maintain that with dependence on other countries for the supply of electronic defence systems, Australia could suffer if hostilities cut supply lines.

Objectives of A.T.D.A., prompted by the above problems, include (a) to encourage and maintain the growth of the industry and (b) to sustain effective co-operation with relevant Government departments and industry.

E.E.A. Annual Report

THE Electronic Engineering Association has recently issued its annual report which includes details of the general activities and work of the individual divisions during 1965.

One of the objectives of the Association has been to establish close liaison with the Ministry of Technology whose main function has been to implement the Government's programme of modernizing the economy and to maintain close collaboration with industry. However, the report indicates that the general economic inhibitions and cancellation of military aviation projects have created disturbing uncertainties for the whole of the electronic capital equipment industry.

During the year the Association has conducted a detailed

Canvas and Electronics.—Modern electronic equipment is a feature of a 300-ton topsail schooner, *Sir Winston Churchill*, which sailed recently on her maiden voyage. Equipment includes Marconi Marine "Raymarc" radar, presented by English Electric Ltd., a Marconi Marine "Kestrel II" transmitter-receiver provided with a radio goniometer and presented by The Marconi Company Ltd., a "Graphette" recording echo sounder and an octahedral radar reflector, presented by the Marconi International Marine Co. Ltd. The radar reflector has been fitted because sailing vessels are not always good radar targets; improved reflections will ensure that the schooner can be under radar observation by other vessels. The schooner is owned by the Sail Training Association.

Thirteen new relay stations will be built during the next three years by the Independent Television Authority. These stations will bring a new or improved service to over half a million people along the western side of the United Kingdom. All sites and channels have not been decided but provisional information indicates that three stations will be built along the Scottish coast to cover Central Ayrshire, Helensburgh and Rothesay and six small stations in Central Wales will cover the main towns of Abergavenny, Bala, Brecon, Ffestiniog, Llandrindod Wells and Llandoverly. Another station will cover Whitehaven (Cumberland) and, in the West of England, a station will be built between Hereford and Gloucester, another near Bath and one near Barnstaple and Bideford.

The International Publishing Corporation, of which the Iliffe group is a member, has acquired a 40% interest in Cahners Publishing Company, the Boston, Mass., publishers of 17 trade and technical journals. Among the journals published by Cahners is the monthly *Electronic Engineers' Design Magazine*, which has a controlled circulation of nearly 52,000. The latest acquisition brings the total number of trade and technical journals published by I.P.C. associated companies in this country, France, Italy, West Germany, Holland, the Far East and America to 213.

Yugoslav Post Office will issue a special 0.85 dinar stamp on May 23rd to commemorate twenty years of Yugoslav amateur radio, and the opening of the Region I (Europe and Africa) Conference of the International Amateur Radio Union in Opatija. Further publicity will be provided by the daily operation of the station YU0IARU, from the headquarters of the Yugoslav National Amateur Radio Society. Transmissions will be from 1200 to 1300 G.M.T. on 14.1 Mc/s.

Digital Instrumentation is the title of a one-day symposium to be held on May 19th at the Mid-Essex Technical College and School of Art, Victoria Road South, Chelmsford. Subjects to be covered include circuitry, displays, ergonomics, digital counters, measurement techniques and methods of digitalization. Further details are available from the Department of Electrical Engineering.

analysis regarding the expansion potential for production of radio communications, electronic control, navigational aid, aviation and broadcasting equipment. This has resulted in a document "Electronics and the Economy" which has been submitted to the Ministry of Technology and other Government departments in an attempt to show that if certain Government action were taken the total output and exports of the various analysed sectors of the industry could increase and the imports of manufactured equipment reduced. Detailed discussions with the Ministry of Technology on the document have not yet taken place but it has already provided a background to various committees and enquiries instituted by the Government.

Royal Society Awards.—Three awards of unstated value under the Royal Society and Nuffield Foundation Commonwealth Bursaries Scheme have been made. To Dr. A. R. H. Cole (University of Western Australia) to enable him to gain experience in high resolution electronic spectroscopy; to Professor E. O. Hall (University of Newcastle, New South Wales) to enable him to gain experience in the use of thin film electron microscopy and to Professor E. R. Love (University of Melbourne) to assist him to continue work on integral equations and integral transforms. An award under the Paul Instrument Fund Committee worth £3,250 has been made to Professor A. F. Gibson (University of Essex) for work on the application of infra-red lasers.

A visit of a "Spaceobile" to this country is being arranged by the British Interplanetary Society and the National Aeronautics and Space Administration of America. The "Spaceobile" is a vehicle containing models, films and other visual aid equipment for demonstrating astronautics and will be on a three-month tour of the U.K. Schools, colleges, universities, adult education centres, industrial, service establishments and other organizations who wish to be included in the tour should contact the Society at 12 Bessborough Gardens, London, S.W.1.

The second session of the **Aeronautical Radio Conference** convened by the I.T.U. commenced on March 14th for a period of eight weeks at the *Maison des Congrès* in Geneva. The main purpose of the Conference is to draw up a new world-wide plan for h.f. long-range communications for aircraft flying on national and international civil air routes. This will be considered in conjunction with the development of v.h.f. communications to reduce the use of high frequencies for short-range communication in many parts of the world.

Radio Nepal.—A gift of a 100 kW Marconi h.f. transmitter, costing with associated equipment about £145,000, is being made to the Nepalese government by the Ministry of Overseas Development as part of the £1M capital grant made by the British Government to Nepal in 1960. With the new transmitter, Radio Nepal will be receivable in all parts of Nepal.

This year's **National Mobile Rally** organized by the Radio Society of Great Britain will be held on Sunday, May 1st, at the Bedford headquarters of Texas Instruments Ltd. The talk-in stations will be GB3BS on 160 and 180 meters s.s.b. and GB2VHF on 2 and 4 metres.

An exhibition of educational equipment arranged by Educational Instruments Ltd., is being held on May 9th and 10th at the Embassy House Hotel, 31 Queens Gate, London, S.W.7. Admission to the exhibition is free to all those interested in educational equipment.

PERSONALITIES

Joseph W. King, Ph.D., 35-year-old physicist at the Radio and Space Research Station, Slough, Bucks, has received the 1965 Wolfe award for his work on "the analysis of results obtained from topside sounding satellites and their interpretation in terms of ionosphere theory; work which has enhanced his own reputation and that of the station." The £500 award is the eighth of ten annual awards to be made under the will of the late James Perrin Wolfe to the research worker who is considered to have made an outstanding contribution to the work of what was the Department of Scientific and Industrial Research, now the Science Research Council. Dr. King, who joined

Kenneth G. Budden, M.A., Ph.D., A.M.I.E.E., lecturer in physics at the Cavendish Laboratory, Cambridge, has been elected a Fellow of the Royal Society. The citation refers to Dr. Budden's "contributions to the theory of the propagation of electromagnetic waves in a non-uniform anisotropic medium, particularly of long radio waves in the ionosphere." A few years ago he was given a grant of £1,694 by the then D.S.I.R. for studying the theory of propagation of radiations from artificial satellites.

Professor James D. McGee, O.B.E., M.Sc., Ph.D., M.I.E.E., who is Professor of Applied Physics at Imperial College, London, is also among the newly elected Fellows of the Royal Society. Dr. McGee, who is 63 and a graduate of Sydney University, was a research physicist at E.M.I. Research Laboratories from 1932 until joining the academic staff at Imperial College in 1954. Reference is made in the Fellowship citation to Dr. McGee's work on the development of electron-optical instrumentation, television camera tubes, infra-red image converters and image intensifiers.

Sir Frederick White, K.B.E., chairman of the Commonwealth Scientific and Industrial Research Organization, Canberra, Australia, is also appointed an F.R.S. for his work in radio physics and radar and "for outstanding contributions to the development of Australian science."

C. H. Noton, M.Sc., Ph.D., M.I.E.E., who has been with the Plessey organization since 1959 and has latterly been resident general manager for France, has been appointed to the new post of group commercial executive of the Plessey Components Group. Dr. Noton, who studied at the Universities of Liverpool and Oxford, served at the Ministry of Economic Warfare during the second world war. He was in the chemical industry before joining Plessey.

A number of other executive appointments in the Plessey Components Group are also announced. The new group quality control manager is **E. P. Stanton, Ph.D., M.I.E.E.**, who has been with the company since 1957 and was chief inspector of Plessey-U.K. prior to his new appointment. Dr. Stanton, who is 56, previously held posts in the G.P.O. Engineering Department and was for 18 years in the Royal Signals. **R. H. Crampton**, who is 44 and has been with the company 27 years and has been regional production controller since 1964, has become production and

cost control manager. **H. P. Kavanagh**, who is 41, is appointed group data production manager. He has been with Plessey for two years. **J. A. Lee**, chief engineer of two Plessey divisions successively between 1958 and 1965, becomes group mechanisation engineer. He joined Plessey 25 years ago at the age of 20. **L. W. D. Sharp, M.I.E.E.**, who came to Plessey from E. K. Cole Ltd. in 1948 at the age of 26 and has held various divisional and group appointments, is appointed manager, new product development. He was a development engineer with E. K. Cole.

Lord Nelson of Stafford, chairman and chief executive of the English Electric Company, has been elected president of the British Electrical and Allied Manufacturers' Association. Lord Nelson, who succeeded to the barony on the death of his father in 1962, is a member of the National Electronics Research Council and of the Minister of Technology's Advisory Council on Technology and is also chancellor-designate of the new University of Aston, Birmingham.

H. S. Macadie, who in 1932 designed the Universal Avometer, has retired from the board of Avo Ltd. but is being retained by the company as a consultant. Mr. Macadie, who is 65, served his apprenticeship in mechanical engineering and then joined B.T.H., where he worked on meter production. In 1925 he started his own company to manufacture plug-in tuning coils for broadcast receivers. The coils were marketed



Dr. J. W. King

the Radio and Space Research Station in 1961, is a graduate of Rhodes University, South Africa. In 1951 he was awarded the Cornwall and York Prize by the Vice-Chancellors' Committee of the South African Universities for his first publication on ionospheric physics. He went to Emmanuel College, Cambridge, on a Rotary Foundation Fellowship for Advanced Study and was awarded the 1955 Hamilton Prize by Cambridge University for the research in ionospheric physics which he did at the Cavendish Laboratory.

C. C. Moore, who has been with the Bush organization for 35 years and for the past year has been managing director of Rank Bush Murphy Ltd., has been appointed to the newly created post of vice-chairman. The chairman is **John Davis**. Mr. Moore, who is 67, was appointed assistant managing director of Bush Radio in 1952 and held the same position in the Bush-Murphy merger. He succeeded to the managing directorship when **Dudley Saward** resigned in April last year. **J. P. Colfils**, who was named managing director designate several months ago, succeeds Mr. Moore. Mr. Colfils will continue also as managing director of Rank Audio Visual.



H. S. Macadie

by the Automatic Coil Winder & Electrical Company, which also marketed the d.c. Avometer and an automatic coil winding machine both invented by Mr. Macadie's father. In 1927 Mr. Macadie, jr., joined the Automatic Coil Winder Company; the name of which was changed in 1957 to Avo and he became a director.

Group Captain E. Fennessy, C.B.E., director of the Plessey Electronics Group, has also been appointed chairman of the reconstituted board of British Telecommunications Research Ltd. The company was established in



J. Lawton

1946 jointly by A.T. & E. and B.I.C.C. and became a subsidiary of Plessey in 1961 with the acquisition of A.T. & E. A minority interest is retained by B.I.C.C. Under the reorganization J. Lawton, M.Sc., M.I.E.E., has become director of research. Mr. Lawton, who took an honours degree at University College, London, was in the Post Office Research Department from 1939 until joining B.T.R. in 1950. He became a director in 1956 and since 1962 has been responsible for the management of the company.

G. B. B. Chaplin, M.Sc., Ph.D., M.I.E.E., chief scientist at Plessey-U.K. Ltd., has been appointed to the chair of electrical engineering science at the University of Essex. Dr. Chaplin, who is 42, graduated at Manchester University, where he subsequently served for three years as lecturer in electrical engineering. From 1955 he was for four years in the Electronics Division at A.F.R.E., Harwell. He joined Plessey in 1959 as technical manager of their Rokke Manor Research Laboratory.

Captain F. J. Wylie, director of the Chamber of Shipping's Radio Advisory Service since it was established in 1948, has retired and joined Marconi International Marine Company as a consultant. Capt. Wylie's Naval appointments included Fleet Wireless Officer Mediterranean, 1929-31; officer in charge of the experimental department of H.M. Signal School, 1935-37; deputy director, Admiralty Signal Department, 1941-43; and director of radio equipment, Admiralty, 1944-46. The Radio Advisory Service was established to give authoritative advice on all aspects of marine radio communications and navigation and to investigate and evaluate all types of marine electronic equipment for the benefit of the members of the Chamber of Shipping and of the Liverpool Steam Ship Owners' Asso-

ciation. Capt. Wylie is succeeded as director of the Chamber of Shipping's Radio Advisory Service by Captain R. G. Swallow who has been deputy director since his retirement from the Navy in 1954. Capt. Swallow, who was a communications specialist throughout his Naval career, was successively deputy director of the Admiralty's radio equipment department and of the electrical department and director of the Signal Division. From 1952 until his retirement in 1954 Capt. Swallow was director of the Tactical School, Woolwich.

J. M. C. Dukes, M.A., D.I.C., A.M.I.E.E., who six months ago joined A. C. Cossor Ltd. as technical director, has been appointed deputy managing director. Until joining Cossor last year Mr. Dukes had been for six years with the Plessey Company first as technical manager of the Telecommunications Division and since 1962 as chief engineer of the Electronic and Equipment Group. Prior to joining Plessey he was for 12 years with Standard Telephones & Cables.

G. E. Gilbert, A.M.I.E.E., who has been in charge of the B.B.C.'s engineering buying section since 1936 is retiring on April 30th. He joined the Corporation in 1935 having previously served with Marconi's and the Western Electric Company. The new engineering buyer is T. R. Boys who joined the B.B.C. in 1939 at the Daventry transmitting station. He later served in the departments concerned with research, planning and design and since 1954, has been assistant engineering buyer.

Professor Charles W. Oatley, O.B.E., M.A., M.I.E.E., who has occupied the Chair of Electrical Engineering at Cambridge University since 1960, has been appointed to the board of directors of English Electric Valve Company. For 12 years before the war he was a member of the staff of the Physics Department, King's College, London University. For some time during the war he was in charge of basic work on radar transmitters and receivers at the



Prof. C. W. Oatley

Radar Research and Development Establishment of the Ministry of Supply. Since 1945 he has been a Fellow of Trinity College, Cambridge, and was lecturer in electrical engineering prior to receiving his professorship.

Reginald J. Watson, works manager of Mullard's Southampton factory since 1957, has joined Standard Telephones & Cables (Transistors) Ltd. the newly formed subsidiary of S.T.C. and has been appointed director of operations for the E.F.T.A. area of the semi-



R. J. Watson

conductor activities of the I.T.T. group. Mr. Watson will be at the Footscray, Kent, headquarters of the new company which will co-ordinate the semiconductor operations at both Footscray and Harlow (Essex).

OBITUARY

Major-General Sir Leslie Phillips, K.B.E., C.B., M.C., director of signals at the War Office from 1943 to 1946, died on March 19th aged 74. Sir Leslie, who was knighted on his retirement in 1946, was throughout his 35 years' Army career a signals officer. He was promoted to brigadier and appointed Commandant of the Signal Training Centre in Jubbulporc, India, in 1939 but was recalled to this country in 1940 to become command signals officer, Eastern Command in London and as such he was largely responsible for the provision of communications for this country's defence. For two years prior to his War Office appointment in 1943 he was signals officer-in-command Home Forces.

Leonard A. Norman, who had been with Philips Electrical Ltd. for 37 years, died on March 17th after a long illness. After war service in the R.A.F. he rejoined the company in 1946. Six years ago he was appointed sales manager of Stella Radio and Television Company and later rejoined the parent company as a field manager, southern region.

Physics Exhibition 1966

ELECTRONIC AND MEASURING TECHNIQUES UNDER DEVELOPMENT

THE Institute of Physics and the Physical Society held this year's exhibition of scientific instruments and apparatus (the 50th) among the decaying Victorian splendours of the Alexandra Palace in North London—where at least there was plenty of room to move around. The scientific character of the event was well maintained by careful selection of exhibits, and in the following report we have picked out a number of items which will be of interest to people in electronics and communications.

MICROWAVES

Railway communications. An exhibit by the British Railways Board demonstrated the possibility of communication with a moving vehicle for the exchange of information. The exhibit comprised a length of Goubau line fed via a conical launcher at a frequency of 3 Gc/s and terminated similarly, the line supporting a travelling surface wave. A small probe attached to a cavity resonator (see illustration) is brought into the field of the surface

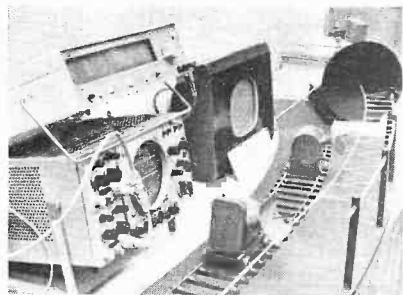

An exhibit illustrating how communication with moving trains can be achieved using guided surface waves of about 3 Gc/s.

wave (the resonant frequency incidentally being varied by a variable-capacitance diode) and it was shown that variations in resonance produced corresponding variations in the echo power at the transmitter. If the line is continuous over long distances then the wide bandwidth possibilities of the line could also be exploited for point-to-point communications.

Gunn oscillators. Semiconductor sources of microwave radiation relying on the Gunn effect have received a considerable amount of publicity recently but their development still continues.

Such devices were shown by a number of exhibitors, but the first public demonstration of their potential was given by Dr. C. Hilsam at the R.R.E. stand.

A Doppler radar system was shown in which the speed and time of travel of a model locomotive were measured. The minute Gunn oscillator replaced the usual klystron and operated at 8 Gc/s (X-band) with about 5 mW of power. The outstanding point of the exhibit was the size of the radar equipment which could be held in the hand.

The gallium arsenide device is prepared on an epitaxial layer of GaAs 10 μ m thick and of 1 Ω cm resistivity, which is grown on to a GaAs substrate 0.2 mm thick and 0.001 Ω cm in resistivity. The substrate is alloyed to a copper heat dissipator, this being the positive contact, and a small tin spot is fused on to the epitaxial layer to form the negative contact. The device operates at 12 V and 100 mA delivering about 5-20 mW of power. The frequency is stable to within 1 Mc/s per day and can be adjusted over the range $\pm 10\%$ by cavity mounting.

CIRCUIT TECHNIQUES

Circuit construction techniques of special interest included a new screen-printed film method based on thin mica wafers, introduced by Johnson Matthey. On display was a range of 0.6-in square mica wafers, some with films of resistive material fired on to one side and others with capacitor plates silvered on to both sides. Round the periphery of each wafer are 16 regularly spaced conducting tabs, to some of which the R or G elements are connected. To build up a complete passive circuit the wafers are stacked on top of each other, the complete stack is fired to fuse the layers together, and the edges of the conducting tabs at the sides of the stack are soldered together as appropriate to form required interconnections. Other passive or active elements can be soldered to the stacks, which can be encapsulated in various resins. Some prototype circuits, which were, of course, a good deal smaller than conventionally constructed circuits, were shown in operation.

A high-density method of mounting and interconnecting monolithic integrated logic circuits was displayed by I.C.T. Unencapsulated semiconductor chips, each containing one or more gate circuits, are mounted on a ceramic substrate, and this carries a thin-film multi-layer conductor network by which all connections to the chips are made. The power and earth conductor patterns are standard for a given chip. Superimposed on these, and separated by an insulating layer, is the logic "wiring," consisting of two sets of orthogonal conductors. The insulation separating the conducting strips is present only within the cross-over areas, so that interconnection between the sets of conductors can be made at any cross-over by depositing a metal link. Fifty integrated circuits can be accommodated on a 2in \times 1in substrate. The complete units are intended to be encapsulated and mounted in flat packs.

RC time-varying networks. Frequency selective networks without inductors are obviously desirable for use

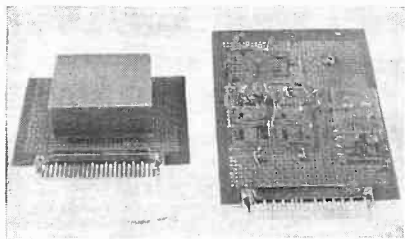

An example of frequency selective RC time-varying networks. The thin-film unit shown is a single sideband demodulator developed by A.E.I.

in integrated circuits. A type of active filter (discussed briefly in *W.W.*, March 1966, p. 129) of the time-varying variety is under investigation at the A.E.I. Research Laboratories at Blackheath. One disadvantage of these networks is the high sensitivity to changes in component values and much effort is directed in reducing this.

These networks involve the use of resistors and capacitors and time-varying elements such as modulators or sampling switches. Apart from the more usual type where low-frequency low pass filters are simulated, work is also directed at developing all-pass phase-shift networks used to produce a highly selective filter characteristic at a high frequency.

Single sideband demodulators were exhibited, one in thin film form (illustrated). In these the signal is fed to two modulators driven by carrier signals in phase-quadrature and derived from a carrier phase shift circuit. The modulator output signals are fed to a wide band 90° phase difference network and then added. The output is filtered to remove signal components and then amplified. The carrier phase shift is derived digitally from two bistable circuits thus permitting the carrier frequency to be varied and giving a filter characteristic which can be translated to any position of the frequency spectrum.

LASERS AND ELECTRO-OPTICS

Hologram reconstruction was demonstrated by the Marconi Company, who are one of the many firms investigating applications. Holography relies on a method of optical production which does not use lenses and which was described in 1948 by Dr. D. G. Gabor. The outstanding feature of holography, however, is not that lenses are not required but that three-dimensional images can be formed.

Light from an object illuminated by laser light is allowed to fall on a high quality photographic plate without the aid of a lens so that a focused image is not formed. Light directly from the laser source is also allowed to fall on the plate and as a consequence interference fringes are formed, in a similar fashion to the fringes of the classic Lloyd's mirror demonstration, which are recorded on the plate. Thus the amplitude and phase of the object light is recorded, the fringe pattern being modulated in accordance with the nature of the object. The image is viewed by looking through the plate when this is illuminated by laser light.

One of the interesting features of the hologram is that if the plate is broken, the image can be reconstructed

from only a small piece of the original, but with some loss of detail. This basic process may well find application in a wide variety of fields, much as the laser has done. Developments are still taking place and one of the latest is that it is now possible to view a coloured 3-D image with white light.

Metrology by holography has been investigated by the N.P.L. and A.W.R.E. and was demonstrated on the British National Committee for High Speed Photography stand. It is suited particularly to the detection and measurement of small changes in surface contour for rough surfaces.

A hologram is made of an object (see previous item), but instead of viewing the image with the object removed, the object is left in place, resulting in the image being superimposed on the object. If the surface of the object then moves slightly interference takes place between corresponding points on the object and its reconstruction giving rise to fringes across the object surface. The degree of distortion can be calculated from the fringe pattern.

If the plate is exposed twice, that is once with the object in its original position and the second exposure after the object has been distorted, then a permanent record of the fringe pattern is made.

The technique can be used to compare production line components for shape against a master; for determining the thermal expansion of components; and for investigating surface vibration modes.

Laser light is not necessary for image formation; the demonstration used filtered mercury light.

Radar photography allowing clear pictures to be taken, or distances of objects to be determined, through a light-scattering medium such as fog or dust was demonstrated by the Atomic Weapons Research Establishment (operating in their new "swords into ploughshares" role). The principle is to avoid reflection of light back into the camera from the scattering medium, as would occur with continuous illumination (e.g., driving a car in fog with headlights on). This is achieved by propagating a short "pulse" of light from near the camera to illuminate the object and then opening the camera shutter at the correct instant to receive only the light reflected from the object. Thus, although the scattering medium absorbs some of the incident and reflected light, the camera shutter is closed at the instant when the incident

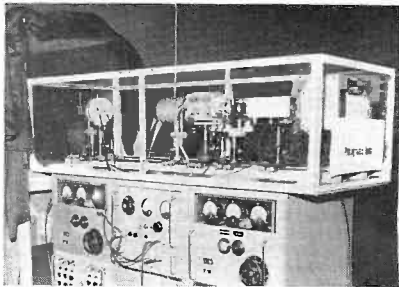

"Business end" of U.K.A.E.A. radar photography equipment—the entrance of the tunnel enclosure being visible on the left.

light pulse is temporarily causing the unwanted reflection from this medium.

Application of the principle depends on the use of electronic methods to achieve sufficiently short light pulses and rapid shuttering. In the demonstration a 20 ns high-intensity light pulse was generated by a Q-switched ruby laser and propagated down a long tunnel enclosure at the far end of which was placed the object to be photographed. The light pulse was therefore about 20 ft long, and at any instant during its travel only the section of tunnel within this 20 ft span was illuminated. Net curtains within the tunnel provided the scattering medium. The "camera" was an electronic image converter (Mullard 6929) and was pulsed from a line controlled by a spark gap to give an exposure time of 20 ns. The "camera" was correctly synchronized with the light source by triggering the spark gap from the firing of the Kerr cell in the laser unit. Suggested applications include photographing industrial processes through clouds of fumes, vapour or particles, as in furnaces.

Electronographic cathode-ray tube. To obviate the inefficient process involved in recording a photographic image from the face of a cathode-ray tube, the General Electric Company suggested a new technique. The conventional faceplate and phosphor are replaced by a thin mica window (3 μ m thick) which is bombarded by the electron beam. The beam, with an energy of about 25 keV penetrates the window thus reaching a photographic film placed directly on the window.

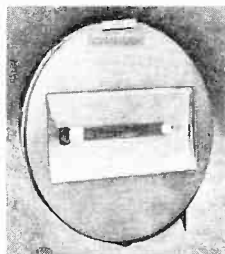

A small electronographic c.r.t. which uses a mica faceplate to enable direct photographic recording of images and eliminating the losses associated with a phosphor screen (G.E.C.)

ing good resolution and line widths of 0.0003 in are readily obtainable.

Difficulties exist in obtaining the mica screen and the exhibit showed only a small area of screen.

Contrast enhancement for automatic pattern recognition.

It is known that, due to diffraction effects, the image of a point source produced by a converging lens is surrounded by the Fourier transform of any aperture placed in the plane of the lens. If this is a transparency then the image plane contains the transform of the pattern on the transparency. The spatial components of the pattern are displaced radially about the optical axis and opaque stops can be introduced into the image or Fourier plane to suppress selected frequency components. If the low-frequency components of the Fourier transform are suppressed, areas of constant density in the pattern are eliminated and if the high-frequency components are suppressed the fine granular noise is eliminated.

Thus, this method allows contrast to be increased and

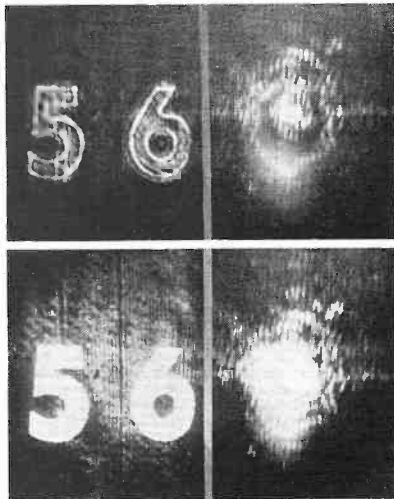

Showing enhancement of boundaries by introducing stops to suppress selected frequency components a diffraction pattern. The N.P.L. suggests that the technique may have application in automatic pattern recognition.

noise to be decreased, and may find application in automatic recognition and processing of optical patterns. An attribute of the system is that several patterns may be processed simultaneously.

Laser Doppler velocity meter has been installed in a factory for the purpose of measuring the speed of aluminium sections emerging from an extracting machine, and the developers, Decca Radar, gave a demonstration of its principles. Light from a low-power gas laser was focused on the moving surface, a rotating disc with its drive shaft inclined at an angle to the incident beam. The back-scattered energy, together with a sample of the incident laser light, was focused on to a balanced photomixer to produce a difference-frequency signal. A tracking unit followed the frequency of this signal and displayed it on an indicator as velocity in ft/min, for comparison with a similar indicator showing the disc surface velocity measured directly by a tachogenerator. Features of the system are its high sensitivity, sufficient to give good Doppler signals from a diffuse scattering surface, and reduction of local oscillator noise in the design of the homodyne balanced mixer. Other possible applications of the principle include measuring the length and vibration of surfaces and monitoring the surface finish of materials.

INFORMATION PROCESSING AND STORAGE

Correlation techniques for measurement and detection (see April 1966 issue, p. 190) appeared in a number of applications. In an "automatic "go, no-go" servo tester

introduced by Sperry, for example, the test signal is a random binary signal and the cross-correlation coefficient between the excitation and the resulting response of the servo is measured for a number of different delays to give the cross-correlation function—which is identical to the servo's impulse response if the delay parameter is considered as real time. The tester runs automatically through 11 preselected delays. At the end of each measurement a voltage representing the c-c coefficient is examined and if it is within required acceptance limits the tester passes on to the next measurement. If all 11 tests are passed the tester indicates "go." If any test is failed it can be repeated, and if the servo continues to fail it "no-go" is indicated. Acceptance limits are fed in by a programme plug.

In a cross-correlator for electroencephalograph signals shown by J. C. Shaw (M.R.C.) and K. R. McLachlan (Southampton University) simplicity is achieved by a digital mode of operation. One of the input signals is quantized into a number of levels, then the binary numbers generated from the different levels are delayed in shift registers and used to gate the second input signal. Another digital correlation technique, shown by Plessey, is intended for extracting sequences of pulses or events with fixed intervals between them from a noisy environment. Nearly all the functions required are performed by one simple circuit unit.

Elliott-Automation Radar Systems demonstrated a radar technique using correlation which achieved the effect of transmitting short pulses of high peak energy, giving good range resolution without actually requiring high peak powers. A long 210-ns pulse of r.f. energy is coded by phase reversal into the 7-bit sequence 1110010 before transmission (using a circulator with diode switches in a transmission line connected to one of its ports). On reception the reflected pulse sequence is fed into a correlator, where it is processed into a shorter pulse of 30 ns containing substantially the same energy and having, consequently, about seven times the amplitude. This would give a radar range resolution of 5 metres.

A correlation type of detector was also used at the receiving end of a system of communication using noise type signals demonstrated by Marconi. If a purely angle-modulated carrier is multiplicatively mixed with wideband noise, selection of one of the resulting sidebands gives a signal which to all normal detectors is pure noise. Thus secrecy of transmission can be obtained. At the receiver the signal is applied to one input of a correlation detector while the original noise, also transmitted separately, is applied to the other input. The original modulated carrier is then obtained at the detector output. As noise is not cyclic several channels can be transmitted by this method, the output of the noise source being delayed a different amount for each channel and separate correlation detectors being used for them. In the demonstration two speech channels were transmitted, using frequency modulated inputs and a 15 Mc/s noise source. The system is said to be reasonably immune from jamming and interference.

Non-destructive delay-line store, not requiring continuous circulation to hold the information, was demonstrated by Plessey. Intended for use as a register, the experimental device stores 20 bits, but capacities of several hundred bits are envisaged. It comprises a length of 0.0075 in diameter beryllium-copper wire plated with a thin film of magnetic material. Current signals corresponding to the binary pattern to be stored ("on" for 1, "off" for 0) are passed through the conductor, setting up

magnetic fields, while at the same time mechanical stress pulses are transmitted by a PZT transducer—the acoustic delay being 60 μ s.

The effect of the stress pulses is to "freeze" the time-varying magnetic signals into a spatial magnetic pattern on the line. Each stress pulse reduces the coercivity of the magnetic film over the small section of line occupied by the pulse during its travel. The magnetic fields set up by the current signals magnetize the film, but the value of remanence left at a particular section of line after cessation of a "1" current signal depends on the coercivity of that section, which is determined by the mechanical stress pulse. If, therefore, a "1" current passes through the conductor when the stress pulse is occupying a particular section of line, that section will be left with a higher value of remanence than the rest of the line and so will magnetically store a "1" digit. Similarly with successive stress pulses acting at other positions along the line.

Read-out is performed by transmitting another stress pulse, and the resulting changes of flux as it moves down the line induce 60 μ V pulses in the conductor. Signal/noise ratios of up to 17 dB in the read-out signals can be obtained with a digit rate of over 400 kc/s.

Memory stores by electrophoresis. The technique of electrophoresis has been well used in the past and recently the possibility of using this method for the formation of ferrite memory stores has been studied by the British Scientific Research Association and the Royal Radar Establishment. It should be possible to achieve very thin ferrite sections, allowing faster switching times and lower

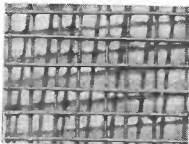

Illustrating the deposition of ferrite computer stores by electrophoretic deposition.

drive currents, by this method. Another advantage is that the laborious threading of toroids would become unnecessary.

One variety of ferrite has been used so far which has to be sintered at about 1400°C to give the requisite square-loop characteristic, and has so far restricted the conductors to platinum.

Read times of 50 ns have been achieved with 0.005 in wires with an interrogate current of 300 mA.

Because deposition can easily be controlled and the ferrite can be deposited on electrodes of almost any shape, desirable element shapes, which have previously been thought to be uneconomical, may well prove to be easily fabricated.

MEASUREMENT AND ANALYSIS

Direct measurement of transfer functions of electrical networks and mechanical devices was demonstrated with new solid-state equipment developed by Wayne Kerr from their earlier Transfer Function Computer. The new equipment is more flexible in that it allows two types of measurement—in one the system excitation is provided by a built-in signal generator and in the other it is applied separately or is already present in the system. The equipment also permits conventional frequency response

(continued on page 233)



SEE US AT THE
I.E.A. EXHIBITION
STAND E553

The TEKTRONIX 549

has a dual personality

AS A STORAGE SCOPE

Enables holding single-shot events, and low duty cycle waveforms, for detailed analysis.

features include:

High writing speed—up to 5 cm/usec, with enhancement, split-screen storage—storage on either upper or lower half of crt (with other half for conventional displays, if desired), automatic erase feature—with selectable viewing times from 0.5 seconds to 5 seconds. Storage feature adds a new dimension to sampling

PLUS ALL THESE APPLICATIONS: low-level differential-input · wide-band · sampling multi-trace · spectrum-analyzer · strain-gauge.

Type 549 Oscilloscope (without plug-ins) £981. Free of duty—subject to Treasury direction.

Tektronix U.K. Ltd.

Beverton House · Station Approach · Harpenden · Herts
Telephone: Harpenden 61251 · Telex: 25559

For overseas enquiries:—TEKTRONIX LTD · Albany House · St. Peter Port · Guernsey · C.I. · TEKTRONIX CANADA LTD · Quebec · Toronto (Willowdale) · Ontario · TEKTRONIX AUSTRALIA PTY LTD · P.O. Box 488 · Sydney · New South Wales · TEKTRONIX INTERNATIONAL A.G. P.O. Box 57 · Zug · Switzerland · TEKTRONIX INC · P.O. Box 500 · Beaverton · Oregon · U.S.A.

applications and spectrum analysis—permitting displays not possible with any other oscilloscope.

AS A CONVENTIONAL SCOPE

Accepts more than 20 plug-ins—either the Tektronix letter-series units or the newer 1-series units.

features include: calibrated sweep delay from 1 microsecond to 10 seconds, single sweep, 5X sweep magnifier, and full-passband triggering facilities. The Type 549 can handle almost any laboratory application in the DC to 30 Mhz range.



Marconi SELF-TUNING h.f. receivers

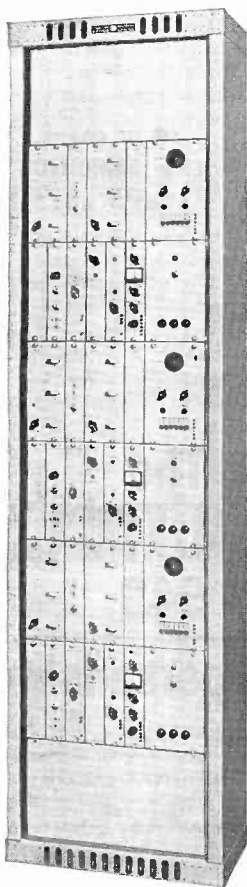

Three double-diversity
H2002 receivers

The H2002 Series of MST receivers for high grade point-to-point h.f. communication services.
H2002 double diversity f.s.k.
H2102 double diversity i.s.b. or s.s.b.
H2112 single path i.s.b. or s.s.b.

NO OSCILLATORS
NO VARIABLE CAPACITORS
NO MECHANICAL TELEGRAPH RELAYS
NO TUNING SCALES

The new range of MST transistorized receivers uses synthesizers to provide accurate selection of 250,000 frequencies.

Elimination of manual tuning by a unique self-tuning system (using servo controlled varactor diodes) allows centralized extended control.

Exceptionally good frequency stability renders a.f.c. unnecessary on stable transmissions.

One-man control of an entire receiving station.

60% space saved by much smaller equipment and back-to-back and side-by-side installation.

RECEIVER



BREAKTHROUGH

Marconi telecommunications systems

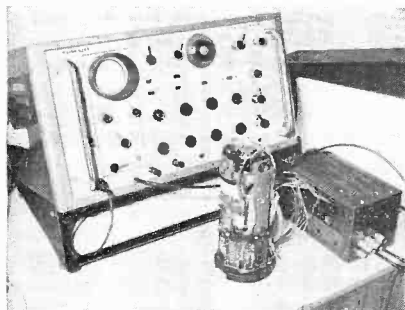

Wayne Kerr instrument for direct measurement of transfer functions, with electro-pneumatic servo unit in front.

measurements (magnitude and phase) to be made. The basic principle is to set up a model of the system using d.c. analogue computing elements (mostly integrators and potentiometers), apply a common excitation to the system and the model, connect the response signals of the system and model to a c.r.t. null indicator, then adjust the model until the null indicator shows that the model is equivalent to the system. Excitation can be a sine wave, a ramp or some other repetitive waveform, typical frequencies being from 0.01 to 500 c/s. Transducers are used where the excitation or response is mechanical.

The transfer function is presented as the ratio of the response to the excitation, derived from the linear differential equation describing the behaviour of the system and expressed in operational form. Adjustment of the model is a matter of adjusting calibrated potentiometers which vary the equation coefficients in the numerator and the denominator, and once a null balance is obtained the coefficients can be read from the dials. Demonstrations included the use of a self-contained instrument for educational purposes, measurements on an electro-pneumatic positioning servo and tests to determine the dynamic properties of elastomers. Also shown was a commercial instrument using the technique for operational performance testing of servos.

Transistor measurements by reflectometry, operating in the time domain, were demonstrated by the College of Aeronautics. The method is an extension of the technique for locating and analysing discontinuities in transmission lines by propagating impulses or step functions along them and examining the waveforms of the resulting reflections on a c.r.o. If the discontinuity takes the form of an inserted network the network elements can be determined from an analysis of the reflection waveform—and, of course, such a network can be a transistor. The function of the transmission line is then merely to separate the incident and reflected waves in the time domain so that they can be conveniently displayed.

In the demonstration the transistor was incorporated in a 50- Ω coaxial line system fed from a pulse generator, and voltage waveforms at points equidistant from the transistor network ports were recorded by a two-channel sampling c.r.o. and an x-y plotter. Five response curves were plotted—the transmitted and reflected pulses for

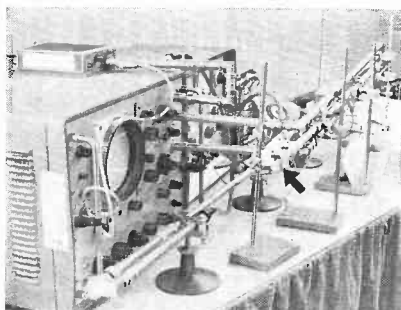

Apparatus for reflectometry transistor measurements (College of Aeronautics, with black arrow showing coaxial line link containing transistor under test.

both directions of transmission and a reference pulse obtained by substituting a direct link for the transistor under test. From these curves, which contain information characterising the transistor network over the entire frequency spectrum provided by the excitation pulse (up to 1 Gc/s), the required data are obtained by computer analysis—though this was not actually done at the exhibition.

The corresponding frequency-domain parameters can be derived, and conversion to the h , y or z parameters can be performed by standard procedures. The technique promises to be simpler and quicker than the conventional bridge method of parameter evaluation—assuming that a digital computer is available—but its full potentialities and limitations have yet to be explored.

A gallium arsenide thermometer has been developed by the International Research & Development Company. It is suited for the range 4-300°K and should find application in research cryostats and refrigeration systems, although it is not suitable for accurate calorimetric investigations at the lower end of the scale, owing to the comparatively high power required.

The instrument has an almost linear scale and relies on the temperature sensitivity of the forward voltage drop across a gallium arsenide junction (at constant current). Variation of the current through the junction alters its sensitivity and it is necessary to increase current in order to increase sensitivity.

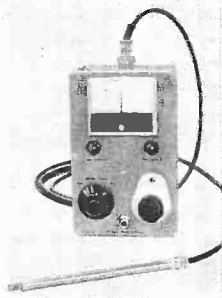

Gallium arsenide thermometer using the temperature dependence of the forward voltage drop across a GaAs junction and developed by I.R.D.C.

NEW TECHNIQUES IN MEDICAL ELECTRONICS

AS SEEN AT THE PHYSICS, AND BIOMEDICAL ENGINEERING EXHIBITIONS

As opposed to the numerous systems available for investigating man closely under highly organized circumstances (space flight, operating theatre, extreme environmental conditions, etc.), there were, until quite recently, few methods by which the physiological parameters of a normal man in normal conditions could be measured and recorded. This was simply because instruments for such research must necessarily be of very small weight and size, inconspicuous when worn, be capable of storing acquired data for long periods and be inexpensive; in fact they have to be "socially" acceptable. The biomedical engineering division of the National Institute for Medical Research has scrutinized many methods of recording such data, which were rejected for reasons such as power consumption, cost, or even size (in spite of miniaturization).

However, electro-chemical methods of data storage have been used with encouraging results. One instrument (Fig. 1) employs a commercially available electro-chemical integrator of very small size, and high charge sensitivity. Here, the use of three such devices permits division of data in time, so producing a table of results not unlike the analysis of a continuous recording. Other instruments shown were a heart beat totalizer, and a temperature excursion integrator. The size of such instruments varies, but lying between the size of a matchbox, and a packet of 20 cigarettes, they are still conveniently small, and with power consumption of the order of $400\mu\text{W}$.

A functional stimulator with myo-electric control has been developed for patients who still have some muscle control although they may have extensive muscle paralysis. Feedback of the output signal into the amplifier

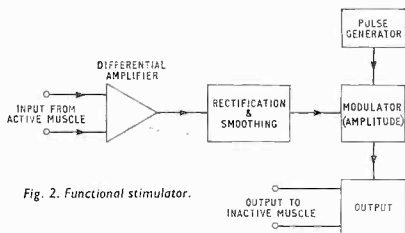

Fig. 2. Functional stimulator.

via the patient's body is inhibited by isolation transformers in the circuit and separate battery supplies. The apparatus, shown by Devices Ltd., is suitable only for conditions where paralysed muscles have not degenerated.

An ophthalmoscope that employs ultrasonics for pulse echo scanning of the interior of the eye was exhibited. It is intended to serve as a diagnostic instrument for the quick location of foreign matter, the detection of a detached retina, the measurement of its extent, and for the location of tumours. This ultrasonic examination can be carried out safely and quickly even with eye conditions such as opacity, or cataractization.

Marketed in this country by T.E.M. Sales Ltd., it has a frequency range of 3-20 Mc/s, and results are displayed on the screen of a 5-in diameter c.r.t. The output from the transmitter is controlled so that only sufficient energy is fed into any of the examination probes. Changing frequency is effected by changing the probe, no further switching being required. A reject control permits the operator to blank out the smaller echoes, thus obtaining a cleaner pattern. Enlarging of the response pattern is continuously controllable within a wide range; at minimum enlargement the range amounts to 13mm of the eye displayed on the screen, and at maximum enlargement the range is 130mm.

A correlator is being developed by the Clinical Psychiatry Research Unit at Graylingwell Hospital, Chichester, Sussex, to assist in the spatial analysis of electro-encephalogram signals. The form of e.e.g. is governed by the site on the scalp from which it is recorded, thus the topography of the e.e.g. is regarded as important. Since the cross-correlation function is a measure of the relationship between signals from two sites, this is measured over each contiguous second of a sample of e.e.g. record, thus determining the inherent variability of the record.

The design of the correlator has been simplified by using a digital method, in which one signal is quantized into six quantization levels. Time displacement of the two signals to be correlated is carried out by shift registers, and multiplication reduced to a gating process. The signals pass through the correlator, once for each time-displacement value. The output from the correlator is stored on punched paper tape, each number on the tape representing a point on the correlogram.

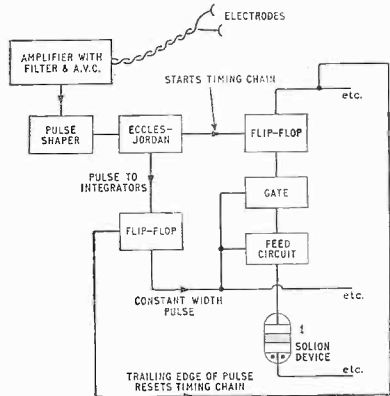

Fig. 1. Heart rate integrator.

Public Address Equipment

SOME APPARATUS SEEN AT THE ANNUAL A.P.A.E. EXHIBITION

ONE of the most outstanding demonstrations for those who visited the Association of Public Address Engineers' Exhibition at the Kings Head, Harrow, was given by one of the Association's officers, Mr. Haydon Warren. A Western Electric 618 moving-coil microphone, introduced around 1931 and forerunner of the S.T.C. 4017, fed a permanent magnet version of the 555 loudspeaker (a 1928 design) via a 250 mW transistor amplifier concealed in the microphone stand. The resulting sound level was surprising and quite usable for small halls, the secret being the loudspeaker—with an electrical to acoustic efficiency of 50%!—the most efficient loudspeaker yet produced?

Amplifiers

A number of manufacturers have introduced more transistor amplifiers this year. Wharfedale (now, incidentally, known as Rank Wharfedale) announced their new 50 W design. This four-channel amplifier has a sensitivity of 50 μ V and will provide about 50 W (75 W music power) into a 100 V line, or into a low impedance load, with 4% harmonic distortion. Three Philips transistor amplifiers were introduced by Peto Scott (10, 20 and 35 W) and the new Sound Coverage range includes 15, 30, 60 and 120 W designs with a sensitivity of 200 μ V and a distortion of 3%. Output transistors (in push-pull) are used in parallel for the high powers. The new 50 W Gramplan (type 662) amplifier uses four 2N2869 transistors in the output stage, each having a fuse in the collector leads so that in the event of failure of one transistor, operation is still possible. To protect the transistors should the accumulator supply be incorrectly connected, a diode and supply relay are included.

A 50 W amplifier design was introduced by Mullard

Protection circuit for Mullard 50W amplifier design to give protection against short circuited load. Rising current in the output stage causes the a.f. drive to be reduced by tending to cut off a transistor (OC71 on left).

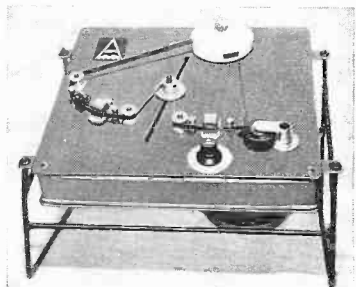
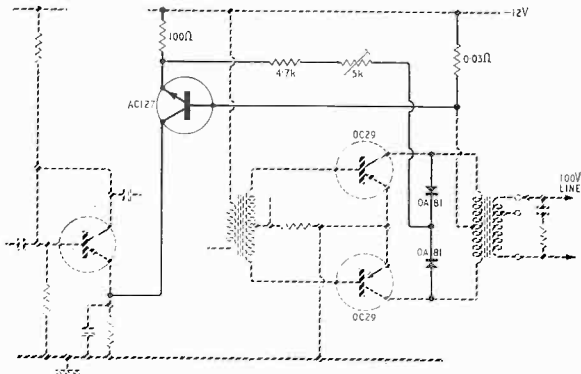

A tape transport mechanism developed by Planet Projects. This illustrates a simple method of obtaining a variable delay between recording and playback.

for operation from a 12 V battery. A single matched pair of output transistors (OC29) are used and distortion is less than 10%. To avoid destruction of the output transistors when the load is short circuited a protective circuit is included (see accompanying circuit). Should the output be short circuited the output transformer primary current rises and the AC127 turns on, tending to cut off the OC71, and thus reducing the drive. The pre-set variable resistor is adjusted at maximum output so that the OC71 collector current just starts to fall.

CTH Electronics augment their transistor amplifiers covering the range 15-1000 W with a 25 W unit which



includes the usual feature of automatic switching from mains to battery in the event of mains failure.

Armstrong have entered the p.a. field by modifying their 227 tuner-amplifier for 100 V line working. A version is available with a balanced 30 Ω input. As a high quality amplifier the distortion will be considerably less (0.5% at 8 W) than the average p.a. amplifier.

Microphones

Although a number of new types of microphone are under development (e.g. semiconductor and electret types) it is not expected that these will appear for some time in the p.a. field. Two of the new mikes shown this year were the Amplivox Telemike and the first microphone of the recently formed London Microphone Co. This last type is a low-cost moving-coil (illustrated) and forms a very neat and inexpensive microphone for various uses including transistor tape recorders—some manufacturers have been importing low cost Japanese moving-coil microphones for this purpose. Sensitivity at 500 Hz is 300 μ V/ μ bar and the frequency response is very smooth down to about 200 c/s and at 50 c/s the response is down to 10 dB. The Telemike is a two-way transducer and was briefly described in the April issue (p. 210).

Some other new microphones are the Reslo CPD pencil type†, the Shure 581 series, a number shown by Fi-Cord (including Beyer types), the A.K.G. D500 series, the Philips EL6033 and the Acos Mic 70. A Neumann condenser microphone (KTM) was exhibited by Bauch (who have, incidentally, changed their address to Holbrook House, Cockfosters, Barnet). This incorporates an f.e.t. followed by a common-emitter mode silicon transistor. A 9 V battery powers a simple built-in d.c. converter to supply the polarizing voltage.

† See *Public Address Engineers Journal*, March 1966.

The first microphone to be produced by the London Microphone Co. This moving-coil microphone is suitable for domestic tape recorder use and costs about £3 (retail).



A photograph which arrived too late for last year's display of early p.a. equipment. The transmitter-size amplifier (a W.E. No. 1 amplifier) was rated at 40 W and dates back to 1919.

Some portable equipment

Of the mixers shown, the EMT104, shown by F. W. O. Bauch, was perhaps the most interesting. This robust portable transistor mixer includes a battery cassette taking either primary or secondary cells and a charging unit. Some of its features are a peak programme meter, monitor loudspeaker, tone generator, rumble filter on each channel and a switchable limiter and compressor.

Two new portable transistor p.a. systems by the French firm of Bouyer were shown by Claude Lyons and Associates. In the smaller (5 W) version which measures about 22 x 5 x 3 in the amplifier is enclosed together with batteries and a number of loudspeakers. A stand mounting version is also available with a longer loudspeaker column.

A small sound level meter was shown by Cosmocord covering the range 60-95 dB s.p.l., with "A" weighting.

Communication Receiver Survey

Amendments

IN our survey last month Eddystone was listed under Stratton and Co. Ltd. but should, of course, have been under Eddystone Radio Ltd. which is a subsidiary of The Marconi Company Ltd.

Under K.W. Electronics Ltd. the HQ180A should read HQ170A. Details for the HQ180A which were omitted are as follows:—

Country of Origin U.S.A.

Type of Circuit Double and triple superhet.

Frequency Bands 540 kc/s-7.85 Mc/s (double conversion); 7.85-30 Mc/s (triple conversion); bandspread 3.5-30 Mc/s (calibrated for amateur bands).

Receiving Modes s.s.b., a.m., c.w.

Impedances 52-600 Ω (I/P) 3 and 500 Ω (O/P).

Sensitivity and (S+N)/N Average 1.5 μ V for 10:1 s/n on a.m. and 0.7 μ V on s.s.b. and c.w.

Selectivity Selectable sidebands, u.s.b. 1, 2 and 3 kc/s; l.s.b. 1, 2 and 3 kc/s; d.s.b. 0.5, 2, 4 and 6 kc/s at 6 dB down.

Image Rejection 55 dB.

I.F. 1st 3.035 kc/s; 2nd 455 kc/s; 3rd 60 kc/s.

Local Oscillator 1st tunable; 2nd 2,580 kc/s (xtal); 3rd 395 kc/s. The receiver also incorporates a xtal filter (on 0.5 kc/s selectivity); b.f.o.; a.n.l.; xtal calibrator; power unit.

Gain Controls n.l., r.f.

Valves 1B.

Semiconductors 2.

Additional Information Product detector, vernier tuning, aerial trimmer, calibrated "5" meter, 14 controls.

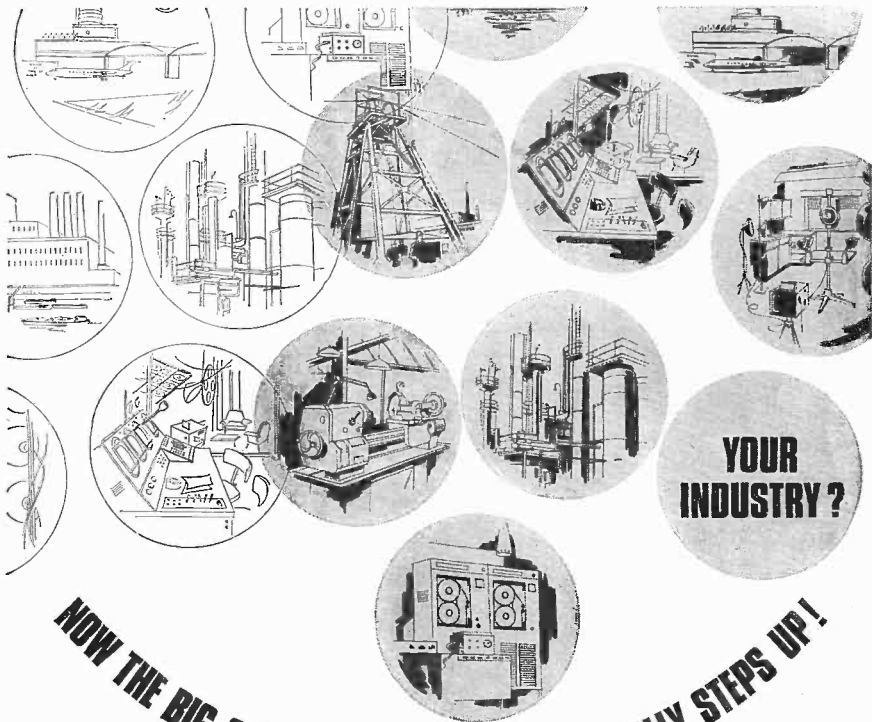

NOW THE BIG SWING TO ASTRALUX V.S.T. REALLY STEPS UP!

Everywhere Astralux Voltage Stabilising Transformers outperform and outdate conventional C.V.T. systems

HERE'S WHY ASTRALUX V.S.T. IS REPLACING C.V.T. IN INDUSTRY AFTER INDUSTRY:

Better Performance. That means improved Output Voltage Stability—output voltage maintained within $\pm 0.5\%$ for input voltage changes of $+10\% - 20\%$. Even when the voltage fluctuation is as great as $+10\%$ to -30% the V.S.T. will maintain the output voltage to within $\pm 1\%$. ● **Latest Materials.** High temperature (Class F) materials give optimum reliability and increased safety margins on operating temperatures. ● **Low external field.** The latest techniques in magnetic core design give improved performance, coupled with high efficiency, while still offering low external fields. ● **Stable Voltage—Stable Prices.**

ASTRALUX prices remain stable over long periods, so costing a job ahead is facilitated with this advanced system.

● **Over 10,000 models!** The ASTRALUX V.S.T. Standard Range consists of ten basic models with over a thousand variations on each. No other manufacturer offers such a choice, or can offer such economical prices. ● **Low Cost Specials.** You can order V.S.T. 'specials' at little more than the cost of standard units. Our design department will be happy to prepare prototypes to your specification, for incorporation into equipment under development. Free illustrated booklet giving full details of ASTRALUX V.S.T. from

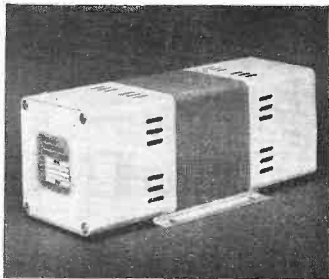

ASTRALUX dynamics limited

TRANSFORMER DIVISION • BRIGHTLINGSEA • COLCHESTER • ESSEX • TEL: BRIGHTLINGSEA 417

WW-114 FOR FURTHER DETAILS.

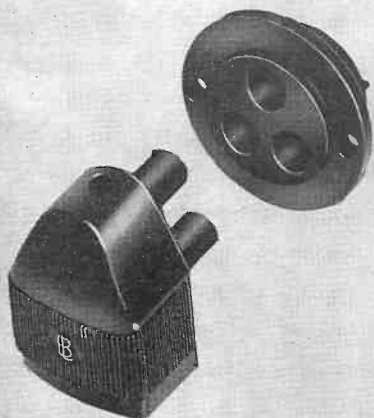

3 POLE POWER CONNECTOR L1722 P&S

*finger-proof shrouds on plug and
socket contacts. Rating 7 amp AC
5 amp DC 250 volts.*

Send for Leaflet P703

STACKING PLUGS

*4 mm. 'DZ' contacts - single L1708 double L1706.
provide fully shrouded tap-off points for cable
and plug-in connections on all types of instruments
Send for Leaflet P676*

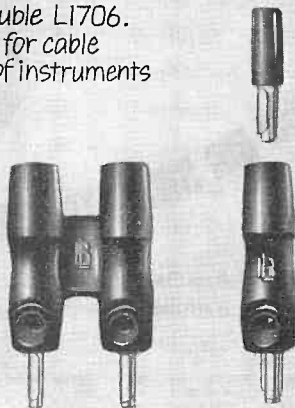

YOU SHOULD
KNOW ABOUT
THESE **NEW**

BELLING-LEE components

Write for leaflets mentioned above or telephone Miss Woolgar at Enfield 5393 Ext. 27
Belling & Lee Limited · Great Cambridge Road · Enfield · Middlesex · Telephone: Enfield 5393 · Telex: 263265

WW-115 FOR FURTHER DETAILS.

A.F. Amplification with the Cascode

AN OUTLINE OF THE ADVANTAGES OF THE TWIN-TRIODE OVER THE PENTODE FOR A.F.

By G. A. STEVENS

PRIOR to the development of Band III television tuners the cascode was very little used, its main use being in low noise r.f. stages, and it was used as a voltage amplifier in a stabilised power supply, where high gain was required.

The properties that enhance its use for r.f. amplification also indicate its suitability as an a.f. voltage amplifier. These advantages are as follows:—

1. High gain.
2. Low noise.
3. Low inter-electrode capacitances (particularly between input and output).
4. Capability of being designed with low phase shift (in feedback amplifiers).

The characteristics of the cascode that give rise to the above advantages are best illustrated by a simplified analysis of the circuit (a fuller analysis will be found in the "Radio Designers' Handbook" by Langford-Smith, Ch. 12, Sect. 9 XI).

In the basic cascode circuit as shown by Fig. 1, two halves of a double triode are connected in series, the bias for the lower valve, V1, being derived by grid current through the high value of grid resistor, the upper valves grid being held at a fixed potential V_{g2} .

Since the anode potential of V1 is held constant by the cathode follower action of V2, the change in anode current of V1 caused by an alternating voltage $V_{i,p}$ on its grid is:—

$$\delta I_a = V_{i,p} \cdot g_{m1}$$

where g_{m1} is the g_m of V1.

Providing V2 does not draw grid current, all current entering at its cathode must pass through the anode load R_L .

Hence,

$$\begin{aligned} V_{o,p} &= \delta I_a \cdot R_L \\ &= V_{i,p} \cdot g_{m1} \cdot R_L \\ G &= \frac{V_{o,p}}{V_{i,p}} = g_{m1} R_L \dots \dots \dots (1) \end{aligned}$$

Hence the circuit has the same gain as a pentode with the same g_m as the lower valve.

Also, since for any valve that has an impedance R_k in its cathode, its anode impedance is increased by a factor: $(1 + g_m R_k)$.

We can write for the cascode:—

$$r_a = r_{a2} (1 + g_{m2} r_{a1}) \dots \dots (2)$$

since the anode impedance of V1 is in series with the cathode of V2. Therefore, from equations (1) and (2) we can derive:—

$$\mu = r_a g_m = r_{a2} \cdot g_{m1} (1 + g_{m2} r_{a1}) \dots (3)$$

From equation (2) it can be seen that for a twin triode

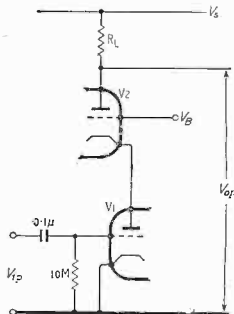

Fig. 1. Basic cascode circuit.

with $r_a = 100 \text{ k}\Omega$ and $\mu = 70$ then its composite anode impedance is:—

$$r_a = 100 (1 + 70) \text{ k}\Omega \approx 7 \text{ M}\Omega$$

i.e., much more than a similar pentode.

The similarity of characteristics to a pentode is shown even more clearly by considering the knee voltage area. As stated above all the current flowing into the cathode of V2 must pass through the load R_L providing no grid current is drawn. However, once this point is reached, increasing the input drive only produces more grid current, so producing a very sharp pentode-like knee point as V2 bottoms. So far, it can be seen that the characteristics are those of a semi-idealized pentode, certainly better than the normal amplifying pentode. There are, however, two factors which make the cascode superior to the pentode for audio amplifier use.

Firstly, since there is only one grid in a triode, this taking no current, the partition noise generated by a pentode is absent, so reducing the noise level by a factor of three or more.

Secondly, in a pentode, the g_m is dependent on the anode current, which in turn depends on the load resistor



G. A. Stevens has for the past five years been a maintenance engineer with Rediffusion Television Ltd. From 1932 until being called up for National Service in the R.A.F. in 1939 he was in the Research Laboratory of E.M.I. which he joined on leaving school at the age of 19.

SYMBOLS

$g_{m1} g_{m2} g_{m3}$	Mutual conductance of V1, V2 and combination respectively.
$F_{a1} F_{a2} F_a$	Anode impedance of V1, V2 and combination respectively
$\mu_1 \mu_2 \mu$	Amplification factor of V1, V2 and combination respectively
$G_1 G_2 G$	Voltage gain of V1, V2 and combination respectively
G	Overall gain after application of negative feedback.
$V_{i,p}$	Signal input voltage
$V_{o,p}$	Signal output voltage
R_a	Anode load
V_{c3}	The d.c. voltage at the cathode of V3
Z_a	The output impedance at the anode of V2
C_M	Effective Miller capacitance at the grid of V1
β	The fraction of the signal voltage at the cathode of V3, which is fed back to the grid of V2

and the supply voltage available. So that, for a given supply voltage, increasing the anode load decreases the g_m and a point is reached where increasing the load actually lowers the gain. In the cascode, however, the gain G is the product of the anode load of V2, and the g_m of V1.

Suppose now in Fig. 1 that a resistor was inserted between the anode of V1 (and cathode of V2) and the h.t. rail V_S . This would mean that V1 could be taking a reasonable current and so have a good g_{m1} whilst V2 could have a large value of anode load with its consequent low anode current.

This arrangement can, and does, give very high gain providing certain points are kept in mind.

1. Since V2 can now be cut-off without affecting the working conditions of V1, the bias of V2 (V_{a2}) must be derived *via* potential divider of some sort from the anode of V2.
2. The anode load for V1 is the cathode of V2 and so is equal to $1/g_{m2}$ and when the mutual conductances of both valves are equal, the gain of V1 is equal to -1 and the Miller capacity at the grid of V1 is only about 3 pF (for an ECC83). However, with the top valve drawing only a small current its g_{m1} is very low and presents a considerable load to V1. This means that the gain is shared between the two valves and the Miller capacity can be high, although the screening of input to output is still good, due to the cathode grid of V2.

Usually, a circuit with this gain would only be needed at the input of an amplifier, and should therefore be fed from a low-impedance source which swamps the effect of the Miller effect.

Since the grid of V2, and hence its cathode, is stabilised by the action of a potential divider from its anode, the effect of changes of bias on V1, due to signal level variation is, to a large part, compensated for, so allowing the use of grid current bias.

If, as is usual, the negative feedback for the whole audio amplifier in which the cascode is incorporated is applied to a small resistor in the cathode of V1 (about 100 Ω , which has little effect on the parameters of the circuit); then, the 0.1 μ F capacitor and 10 M Ω resistor in the grid circuit are outside the feedback loop, and so do not affect the phase shift over the cascode. Similarly, since V2 is drawing very low anode current the voltage

feed, V_{a2} , to its grid can be supplied by another 10 M Ω resistor and 0.1 μ F capacitor, so giving virtually no i.f. phase shift down to very low frequencies.

The bias voltage, V_{b2} , can be supplied in one of two ways:—

1. By direct potential divider from the anode of V2. This method has two disadvantages, the maximum value of resistance usually made in standard ranges is 10 M Ω , and with this value as an anode load, the potential divider has a resistance of this order which shunts the signal, and so reduces the gain.
2. The anode load and potential divider can, if the value of R_a is too high cut off V2 by reducing its anode voltage to the point where no current flows through the valve.

The above drawbacks limit the straight potential divider at high values of R_a , although when R_a is around 1 M Ω or less there is nothing to choose between this and the next bias method to be described.

If the potential divider, instead of being applied direct, is in the cathode load of a cathode follower; the grid of which is connected to the anode of V2 the above drawbacks disappear.

Usually in modern audio amplifiers the trend is to follow the input voltage amplifier with a directly coupled phase splitter, of the cathode-coupled variety, in this case the cathode resistor of the phase splitter may be replaced by two other resistors so forming the necessary bias network for V2, as illustrated by Fig. 2.

Practical cases

In order to investigate a practical case the two circuits shown in Figs. 3 and 4 (with and without the cathode follower bias network respectively) were constructed. The value of the 330 k Ω current bleed resistor was found experimentally for an anode load of 10 M Ω and on altering the load the value still seemed about optimum and so no experiments were conducted using values other than this.

S1 and R_2 were used to determine the output impedance of the circuit, R_2 being altered until closing S1 reduced the

Fig. 2. Bias arrangement of the cascode circuit to feed a cathode-coupled phase inverter.

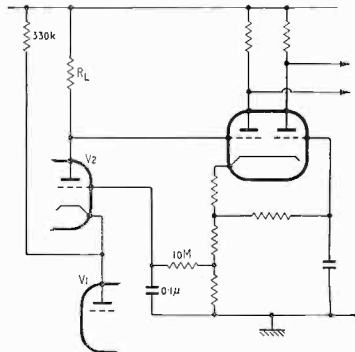

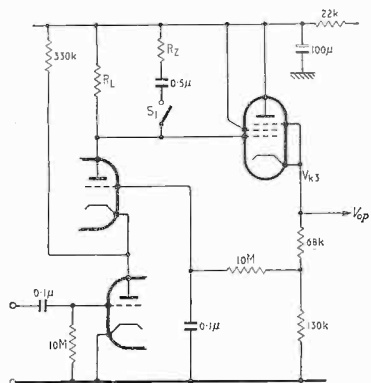

Fig. 3. Circuit used for measurements incorporating the cathode biasing method. Results are shown in Table I and Figs 6 and 8.

output signal by 6 dB, R_a then being equal to the output impedance (the series capacitor having negligible reactance).

In the experiments only the anode resistors were altered, together with slight adjustments to the stabilized power supply to give 300 V after the decoupling resistor.

The gain from the input to the anode of V1, was also measured for different loads, this giving the measure of Miller capacity on the input, and also the gain of the cascade if:—

1. The grid of V2 is not decoupled to earth; or
2. The effect of putting a frequency sensitive network between the cathode of V3 and the grid of V2 to act as an equalizer circuit.

The results are set out in Table I and in the graphs of individual parameters which follow later. The odd

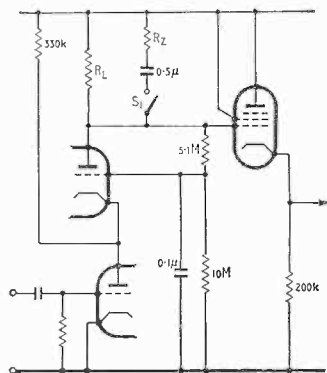

Fig. 4. Test circuit used for measurements. S_1 and R_a were used to determine the output impedance. Results are shown in Table I.

values of R_L being the measured values of standard resistors.

As can be seen, when the anode load is in the order of 10 MΩ the output impedance is 3.5 MΩ. In the test circuit 3 the stray capacity at the anode of V2 was 8 pF and so the response was 3 dB down at about 6 kc/s, the gain-bandwidth factor is given by the ratio G/Z_o , and as can be seen, increases with lower anode loads. The early roll-off associated with the highest gains can in fact be a desirable feature in feedback amplifiers, where it is necessary to reduce the loop gain below unity before the phase shift reaches 180° in order to avoid instability. When the cathode-coupled phase splitter uses a pentode in the first stage, so avoiding large values of Miller capacitance loading the anode of V2, the total stray capacitance should not exceed 16 pF and so the 3 dB upper

TABLE I

R _L	FIG. 3 Cathode follower bias							FIG. 4 Potentiometer bias					
	V _{k2}	C _M	G ₁	G	G(dB)	Z _o	G ₂	G/Z _o	G	G(dB)	Z _o	G ₂	G/Z _o
16 MΩ	153V	103pF	68	4,800	73.5	3.8 MΩ	70	1.26			Cut-off		
13 MΩ	153	103	68	4,800	73.5	3.67 MΩ	70	1.26	940	59.5	2.58 MΩ	13.8	0.365
10 MΩ	153	90	60	4,400	72.8	3.52 MΩ	73	1.25	2,350	67	2.2 MΩ	39	1.02
6 MΩ	154	75	50	3,750	71.3	2.48 MΩ	75	1.52	2,500	68	1.73 MΩ	50	1.44
3 MΩ	157	53	35.6	2,850	69.0	1.72 MΩ	80	1.64	2,100	66	1.35 MΩ	59	1.55
1.5 MΩ	161	34	22.5	1,850	65.2	1.13 MΩ	82	1.62	1,480	63.5	940 kΩ	66	1.58
1 MΩ	165	24.5	16.3	1,325	62.5	790 kΩ	81	1.67	1,130	61	693 kΩ	69	1.63
620 kΩ	173	16	10.8	900	59.0	540 kΩ	83	1.67	815	58	493 kΩ	77	1.66
400 kΩ	184	11.5	7.6	632	56.0	370 kΩ	83	1.71	610	55.5	334 kΩ	80	1.83
253 kΩ	195	8.5	5.6	423	52.5	235 kΩ	75	1.80	418	52	203 kΩ	75	2.03
137 kΩ	217	5.5	3.6	251	48.0	130 kΩ	70	1.93	250	48	125 kΩ	70	2.0
91 kΩ	232	4.4	2.9	176	45.0	87.5 kΩ	61	2.01	175	45	86 kΩ	61	2.03
52 kΩ	253	3.1	2.1	98	40.0	51.1 kΩ	47	1.92	98	40	50 kΩ	47	1.96
30 kΩ	260	2.5	1.7	56.5	35.0	28.8 kΩ	33	1.96	56.5	35	28 kΩ	33	2.02

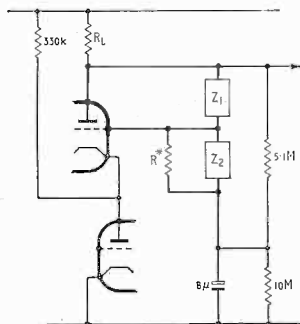

Fig. 5. Use of the cascode for equalization by frequency selective feedback. R_b is only required to provide bias if Z_2 is blocked to d.c.

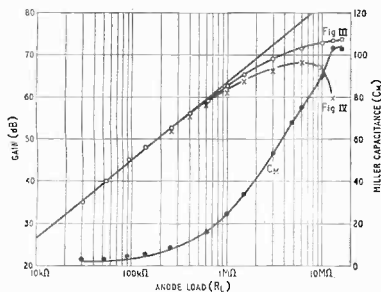

Fig. 6. Some of the results of Table 1 obtained from the circuits of Figs 3 and 4.

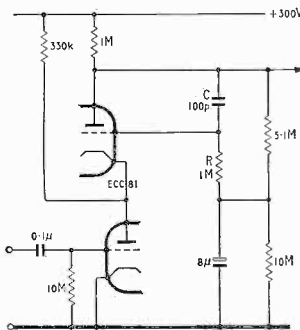

Fig. 7. Particular case of Fig. 5 for use as a tape playback equalizer.

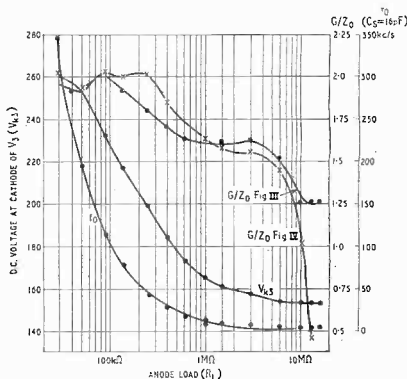

Fig. 8. Some of the results, listed in Table 1, obtained from the circuits shown in Figs 3 and 4.

frequency limit should be at about 15 kc/s with an anode load of $1\text{ M}\Omega$ giving a gain of over 60 dB. The gain-bandwidth product may be obtained from the factor G/Z_0 by multiplying it by 10^{-1} (assuming 16 pF strays).

An EF86 pentode with an anode load of $220\text{ k}\Omega$ and a following grid resistor of $1\text{ M}\Omega$ has a gain of about 200 (46 dB), the effective anode load due to the above two resistors is $180\text{ k}\Omega$, and the cascode gives a gain of 320 (50 dB) with a load of this value, while increasing the pentode load to $1\text{ M}\Omega$ and running under starvation conditions gives a gain of 400 (52 dB), the cascode giving 1,200 (62 dB), an even more marked improvement over the standard pentode circuit.

The ECC83 has a normal heater, as opposed to the bifilar type of the EF86, and so the hum introduced by the circuit could be expected to be greater than that of the pentode. With the $10\text{ M}\Omega$ load in circuit, (as with this value the hum and noise would be expected to be at their worst), and one side of the heaters earthed the total hum and noise at the output was 5 mV r.m.s., and when the heaters were on a d.c. supply the value fell to 1 mV r.m.s.—these correspond to an input level of 3.15 and $0.67\text{ }\mu\text{V}$ r.m.s. respectively over a frequency 25 c/s —6 kc/s. The measurements were taken on Fig. 3 with the input shorted, and includes hum and noise introduced by the output cathode follower.

As can be seen in Fig. 4 the gain ν load characteristic is linear up to $2\text{ M}\Omega$ (for Fig. 3) and then falls off and becomes asymptotic to the 75 dB co-ordinate. This corresponds to the value of μ at low currents as given in the published curves of the ECC83.

These results show the superiority of the cascode circuit over the conventional pentode in audio applications, and whilst the investigations were concerned only with the ECC83, the newly-developed ECC807 should show an even more marked improvement in cases where better hum or gain figures might be needed, although the excellent results obtained with the older valve type would usually make higher gain unnecessary in all but a few cases.

Finally, the effects of valve changes on the gain and d.c. level at the cathode of V_3 (V_{c3}) were investigated by

putting seven different new valves in the V1 and V2 position. The total gain variation was 10%, and the output voltage variation was over an 18V range.

APPENDIX

Equalization with the cascade

If the grid of V2 is not decoupled to earth, but is included in a frequency sensitive network as shown in Fig. 5, then the overall gain is a function of frequency.

The circuit now behaves with V1 as a pre-amplifier with gain G_1 , and V2 as a frequency-selective feedback amplifier. The gain of V2 as a feedback amplifier is given by:—

$$G'_2 = \frac{G_2}{1 + G_2 \beta} \text{ where } \beta = \frac{Z_2}{Z_1 + Z_2}$$

N.B. The application of feedback increases the input impedance of V2 and so also the gain of V1, this causes a reduction in the total lift supplied by the overall circuit, but for values of R_f greater than about 1 MΩ this effect is not serious, but in any case a little experimentation will soon determine the correct values.

Then the total gain of the circuit will be:—

$$\begin{aligned} G' &= G_1 \cdot G'_2 \\ &= \frac{G_1 \cdot G_2}{1 + G_2 \beta} \\ &= \frac{G}{1 + G_2 \beta} = \frac{G(Z_1 + Z_2)}{Z_1 + Z_2(G_2 + 1)} \end{aligned}$$

If Z_1 is not blocked to d.c. a blocking capacitor would have to be inserted to maintain the correct bias level on V2.

An example of a tape equalizer circuit is given in Fig. 7, the values of C and R given provide a time constant of 100 μs with a total top cut of about 36 dB, the i.f. gain being 60 dB, dropping to 24 dB at h.f.

Ceramic Cathode-ray Tube

Cathode-ray tubes can be a relatively unreliable part of the electronic equipment of many aircraft, space and defence systems, and in order to achieve great reliability a ceramic c.r.t. (for magnetic deflection) has been produced. The device has been developed by Elliott-Automation to meet a need for tubes which will withstand high acceleration and severe vibration in military systems.

In conventional tubes the gun assembly is supported within the tube neck by wires and in consequence the assembly can move relative to the screen. This is avoided in the ceramic tube since gun and electrode parts are integral with the tube (see illustration) and consequently greater display



Magnetically focused ceramic c.r.t. developed by Elliott-Automation.

precision is possible. Left of the exposed view is the heater-cathode-modulator assembly. The metal modulator is brazed on to the ceramic material (alumina). This is followed by separate focusing and accelerator sections. The screen is glass, but, if necessary, this can be made from sapphire—a translucent form of alumina. The tube shown has a 1 in dia. screen, but 2 in tubes are in production and it should be possible to manufacture larger diameters up to 5 in or so.

The use of ceramic material enables the tube to be baked at a higher temperature during manufacture, achieving a better vacuum and consequently longer operational life.

H. F. PREDICTIONS—MAY

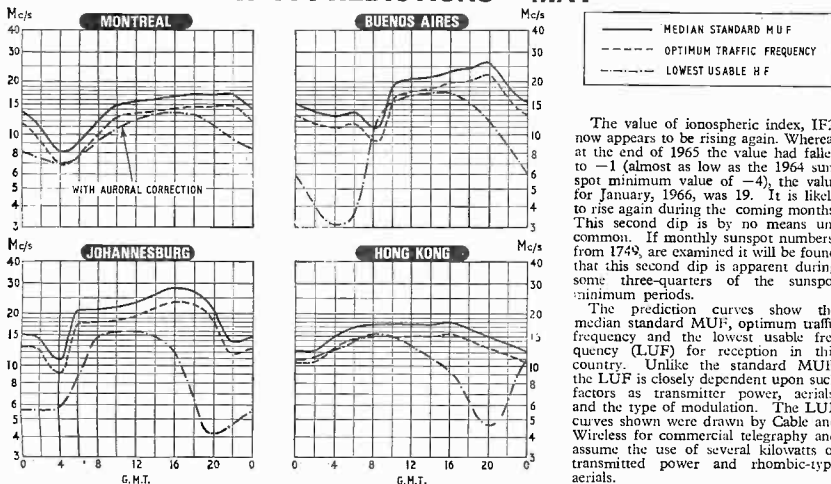

NEWS FROM INDUSTRY

IMAGE INTENSIFIERS

A JOINT £300,000 development programme by two English Electric companies, Marconi Instruments and the English Electric Valve Co., has resulted in new X-ray image intensifier equipment for medical purposes. The equipment allows medical staff to make detailed examinations of patients without exposing them to the comparatively high levels of radiation required for conventional screening; the dosage necessitated by previous methods has been reduced to about one-sixth and the resultant faint image undergoes an intensity amplification of about 40,000 times.

Basically the system entails the use of an X-ray tube whose rays, directed through the patient, form an image on a flat fluorescent screen, similar to that used for direct viewing fluoroscopy. The screen image is then optically focused on to the photo-cathode of a 4.5in image orthikon Type P825 camera tube, developed by the English Electric Valve Co. The electrical charge image produced by the tube from the optical image is then scanned and the tube output signal, in the form of a television waveform, is amplified and processed before being fed to high definition television monitors operating at 1,024 lines with triple interlaced scan. In addition to direct viewing the monitor display can be filmed or tape recorded.

The major advantage of the intensifiers is that the patient is subjected to less X-ray exposure and the medical staff can view a stronger picture and if necessary monitor a bodily process. An



A "patient" demonstrates the new Mariconette 10in X-ray image intensifier.

automatic beam control incorporated in the camera head and connected to the head amplifier stage of the image orthikon tube, adjusts the brightness of the picture so as to ensure that the best image is obtained with a wide variation of X-ray levels. The automatic beam control facility frees the operator from manually compensating for variation in fluorescent screen brightness during the scanning of a patient.

New S.T.C. Subsidiary.—The activities in the semiconductor field of the S.T.C. plants at Footscray and Harlow are now controlled by a newly formed subsidiary company, Standard Telephones and Cables (Transistors) Ltd. The range of products will include transistors, thyristors, signal diodes, silicon rectifiers, Zener diodes and integrated circuits.

Integrated Circuit Prices Down.—Due to process improvements Electrofil Ltd. have been able to effect price reductions in the Signetics range of integrated circuits. All 14-lead flat package items in the SE1000 military D.T.L. (Diodes Transistor Logic) are reduced by between 30% and 40% and those in the NE100 industrial D.T.L. range by approximately 40%. Of the other military ranges, all packages in the SE400J low-power T.T.L. (Transistor Transistor Log 16) range have been reduced by between 25% and 35% and all except the SE501 in the SE500 linear range have been reduced by between 30% and 40%.

Domestic Entertainment Equipment.

—Figures released by the British Radio Equipment Manufacturers' Association and based on net sale or return figures of deliveries by manufacturers to the home market show that sales of radio receivers (including car radios), radio-grams and television receivers fell during 1965. Figures for the last three years are listed in the table below. Radio receivers also include car radio receivers.

Year	Radio Receivers	Radio-grams	Television
1963	2,616M	0,274M	1,678M
1964	2,139M	0,282M	1,903M
1965	1,73M	0,233M	1,681M

Impetron Ltd., have formed an associated company in the United States with Ad. Auriema, whom they represent in the United Kingdom. The company, called Impetron Inc., will operate from 85 Broad Street, New York, N.Y.4. The function of the new company is to market European components in the United States.

The Electronic Industries Association of America have announced peak sales of colour, and monochrome television sets for 1965. In 1964 monochrome sales totalled 7.685 million, while in 1965 they rose to 8.028 million. Colour sets sold in 1964 totalled 1.366 million, this figure rose to 2.764 million in 1965.

The Australian Department of Civil Aviation has ordered a Solartron 24-target air traffic control simulator. It has a "playing area" of 400 miles square, with an altitude of 50,000 feet, and air speeds of up to 3,000 knots for each aircraft. It will also be used for ATC procedure evaluation, at airfields such as Tullamarine (Melbourne), Mascot (Sydney), Brisbane, Adelaide and Perth. The order is worth about £40,000.

Annual Report of B.E.A.M.A. records that exports by the British electrical industry in 1965 increased by 4½% over the previous year to £379M.

West Germany was chosen by the Electronic Valve and Semi-Conductor Manufacturers' Association (VASCA) for its first Inward Mission, organized in conjunction with the Export Council for Europe. The eleven delegates, who were with three exceptions from Government organizations, visited Ferranti (Chadderton), Joseph Lucas (Sutton Coldfield), M-O Valve (Hammersmith), English Electric Valve (Chelmsford) and S.T.C. (Paignton) during their five-day tour.

Pye of Cambridge Ltd. announce that large losses have been incurred in the radio and television side of the Group, particularly in respect of amounts due from a group of companies to which television sets have been supplied on a large scale. Other main sections of the business, however, are operating profitably.

The **Ministry of Aviation** has placed a contract, worth £230,000, with the Marconi Company for a tropospheric scatter radio system. This will be used in Malaysia to provide the Royal Air Force with 24 voice channels between Singapore and Penang. A 10kW transmitter operating at 900Mc/s will be used at either end of the 370-mile link. The tropospheric scatter terminals will be supplied by Radio Engineering Laboratories, a division of the Dynamics Corporation of America.

An agreement for an exchange of patent licenses and technology in the integrated circuits field has been signed between Westinghouse Electric International Company, N. V. Philips of the Netherlands and North American Philips Company.

Under the terms of the contract, Philips and Westinghouse will effect a complete interchange of device specifications as well as process specifications and manufacturing technologies for their lines of digital and linear integrated circuits.

Today's components Tomorrow's vision

Like architects, McMurdo design for the world of the future with today's materials. Behind McMurdo plugs, sockets and connectors lies a wealth of electronic know-how, coupled with forward-looking research and design facilities. Reliable performance, high quality construction and budget-conscious prices are the foundations on which McMurdo components have built their popularity among electronic engineers. Your best plan is to send off for our data sheets. If you're a holder of the **ELECTRONIC ENGINEERING INDEX** see Lj400 for connectors and Lj470 for Valve Holders. The McMurdo range includes: **CONNECTORS**—rack and panel, line and jumper, printed circuit and audio range. **VALVE HOLDERS**—plug-in relay sockets, Decal 10 pin valve holders. Transistor sockets, Crystal sockets. **VOLTAGE SELECTORS**.

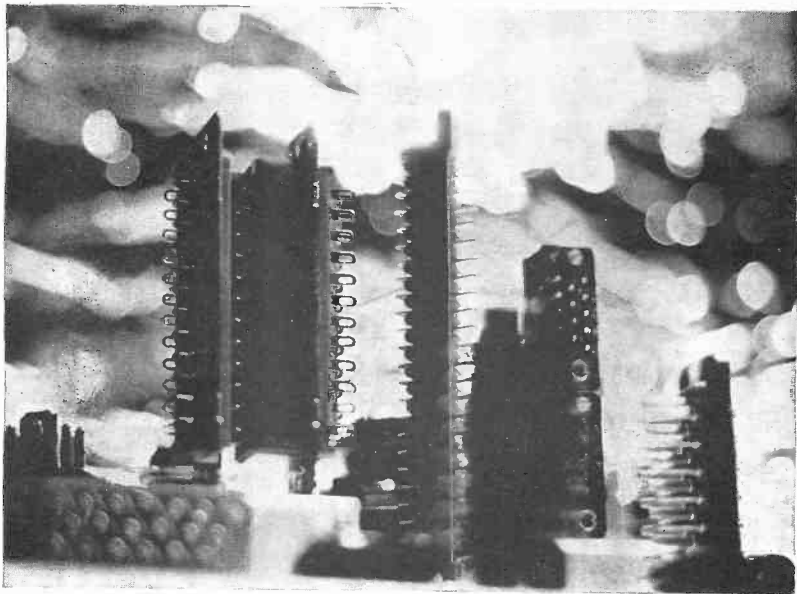

MCMURDO

ELECTRONIC COMPONENTS

THE MCMURDO INSTRUMENT COMPANY LIMITED
RODNEY ROAD · PORTSMOUTH · TEL 35361 · TELEX 86112

AGENTS—NORWAY: J. M. Feiring A/S, Lilletorvet 1, Oslo.

PERU: Estemag Peruana S.A., P.O. Box 2638, Lima.

PHILIPPINES: C&C Commercial, P.O. Box 2419, Manila.

WW-116 FOR FURTHER DETAILS.



the tube
that
makes
the
"portable"
all
picture

new
MAZDA
RIMBAND
12 inch
T.V. TUBE

The outstanding new Mazda RIMBAND 12" tube has been designed to reduce the cost, size and weight of personal portable television . . . and provide a bigger picture! RIMBAND is an entirely new method of construction. For the first time the metal band is taken back from the screen. This enables the whole screen area of 74 sq. ins. to be projected from the cabinet and utilised for the picture.

No insulated covering of the rim is required. No implosion guard is needed. The result—a really compact, lightweight and low-cost set.

The tube weighs 6 lbs. with a depth of 9" and a scanning angle of 110 degrees. It operates at an EHT voltage of 10.5 to 13.5 kV. Light transmission of 50% and the high levels of brightness obtainable on this tube, permit viewing in brightly lit surroundings.
Type No. CME 1201.

For full technical details, please write to:

**Thorn-AEI Radio Valves
& Tubes Limited**



7 Soho Square, London W1.
Telephone: GERrard 5233

TAS323

By
H. O. CODON

Communication Theory and Colour Television

Some degree of stability has been achieved in the U.K. colour television situation by the T.A.C.'s recommendation of the PAL system for Britain (and the P.M.G.'s acceptance of it), but this does not mean that the subject is now closed. In engineering the ultimate solution is never reached. This article examines the principal colour systems in the fundamental terms of communication theory, particularly from the point of view of economical utilization of the frequency spectrum, and ends with the intriguing question: what would we do if we could wipe the slate clean and start again?

TELEVISION has always demanded a wider channel than any other service, with the possible exception of high-definition radar. In broadcasting it also demands wide coverage, which implies (a) the use of the lowest possible frequency and (b) the use of frequency channels exclusively over a wide geographical area and with such high power that interference could be caused to other services using the same frequency in adjacent geographical areas. In addition, the cost of producing television programme material is so high that it is desirable to transmit programmes by landline or other networks between broadcast transmitters. The problem has been exacerbated by the demand for colour, which requires the transmission of additional information.

There have been many attempts to reduce the bandwidth occupied by the basic signal, but no scheme has been put into practical use: on the contrary, the transmission of television by pulse code modulation has been developed^{1,2,3}. This requires several times the bandwidth of the original signal, though in one case² the digits were sent through physically separate channels so that the bandwidth required for each channel was that of the original signal. The advantage gained is the regenerability of p.c.m., which allows a large number of repeaters to be used in cascade without imposing too stringent conditions on the performance of each. On the other hand, considerable ingenuity has been shown in transmitting coloured pictures within the same bandwidth as monochrome pictures.

Time analysis of the picture—It has been customary to work on the basis that the field scanning rate is a pre-assigned quantity and that the required bandwidth is then proportional to the number of "picture elements" in each field. The first assumption is justified in the absence of image storage at the receiver since the field rate is fixed from considerations of flicker. Increasing picture brightness makes flicker more noticeable, so that since modern television receivers give a much brighter picture than the early ones it is fortunate that the standards originally

adopted, 50 c/s in Europe and 60 c/s in America, allowed sufficient margin. For comparison, cinematograph flicker rates were 32 c/s on silent films and are 48 c/s on sound films. Synchronization with the power frequency was originally adopted (a) to permit the use of receivers with mechanical (mirror-drum) scanning and (b) to minimize the visibility of "hum bars" which are caused by inadequate smoothing of the power supplies of the receiver. Neither reason is now relevant, and the scanning in colour systems is *not* synchronized with the power frequency.

Since flicker results from brightness variation of a substantial part of the field of view, an immediate halving of the potential bandwidth requirement was obtained by adopting interlaced scanning so that two fields are required to build up a complete picture. Higher order line interlace has not been attempted in monochrome transmission, but there are some "dot interlace" schemes which span more than one line; and it is found that when the rate of re-painting a given spot on the picture is comparable with the response time of the eye there are objectionable stroboscopic or "crawling" effects. One would also expect that if re-painting of the whole picture took longer than the response time of the eye, then the representation of rapidly moving objects would be unacceptable.

It is then argued that if one has n scanning lines one must be able to resolve $r n$ points in each line, where r is the aspect ratio, so that if p is the picture repetition rate one must be able to transmit $p \times r n^2$ picture elements per second. It has been further argued (fallaciously) that one point or picture element can be approximated by a half sine wave so that the bandwidth required is $\frac{1}{2} p r n^2$. It is,

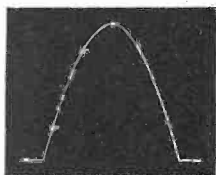

Fig. 1. A half cycle of sine wave.

however, obvious that the Fourier transform of an isolated half sine wave, Fig. 1, corresponding to an independent picture element, will include much higher frequencies as well. Gabor has pointed out⁴ that, subject to suitable definitions of effective pulse width, a Gaussian pulse gives the minimum value of $\frac{1}{2}$ for the product of time-bandwidth. A fairly close approximation to the Gaussian shape is the "raised cosine" of Fig. 2, which is the graph of $(1 + \cos x)$ from $-\pi$ to $+\pi$. Several mathematical analyses^{5,6} have confirmed that whereas the half-cycle basis allows resolution of a series of light and dark alternations, it does not suffice for an isolated change of brightness. It may be argued that in practice one is not concerned with isolated points; and empirically the

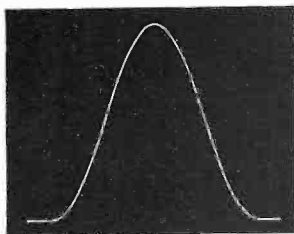

Fig. 2. A raised-cosine pulse.

required bandwidth is taken to be $(1/k) \frac{1}{2} p \cdot m^2$ where k is the "Kell factor" which is of the order of 0.7, various estimates of it ranging from 0.53 to 0.85.

Double-sideband amplitude modulation in principle involves two-fold redundancy, but true single-sideband transmission is not practicable for television because the presence of quite low frequencies and the necessity to preserve the phase of these components would make filter design an impossible task. The "vestigial-sideband" system has therefore been adopted in which one set of sidebands (usually the upper) is transmitted completely while only the lower frequencies are retained in the other. Goldman has shown⁴ that, given a limited bandwidth, it does not make too much difference to transient (step function) response where the carrier is placed, but that resolution of a repeated pattern is better if the carrier is near one end. The final decision to use the transmitter pass-band sketched in Fig. 3(a) with the complementary pass-band of Fig. 3(b) in the receiver, was influenced considerably by receiver cost.

The difference between "information" and "detail" points to the next source of redundancy in the television picture. A chequer-board pattern in which each light or dark unit occupies one picture element appears to be the most exacting test of a television system. Yet its information content is negligible, for any pre-arranged signal could have been used to turn on a pattern generator at the receiving end; or with interlaced scanning it would suffice to transmit one frequency at the edge of the video band with phase reversed on alternate frames. The latter implies square-wave phase modulation at 50 c/s, but even so the effective bandwidth is only a few hundred c/s and most of the video band remains empty. In a practical picture the detail is less regular (the example usually cited is a crowd of spectators at a football match) and the Fourier spectrum accordingly more diffuse, but usually only a part of the field of view contains fine detail.

The amount of detail can be objectively assessed by applying to the scanning waveform a voltmeter which measures the magnitude of the rate-of-change of signal voltage: *magnitude* must be used because there must be equal positive and negative slopes, so that the algebraic sum of all the changes would be zero. A "detail meter" is therefore an instrument which reads from the waveform the average amount of amplitude change in the picture, which may be expressed mathematically as

$$D = \frac{1}{T} \int_0^T \left| \frac{de}{dt} \right| dt$$

This figure occasionally reaches a few per cent of the

maximum ("chequer-board") value which it could have in the given video band.

Reduction of redundancy.—So far communication theory has taught us three things about television signals: (i) the maximum information content does not correspond merely with the highest video frequency; (ii) the transmission of an independent picture point for each half cycle of bandwidth is barely theoretically possible, and certainly unrealizable in practice; (iii) the television channel is very poorly occupied, or in the language of communication theory the signal is highly redundant. What, then, can be done to improve the utilization of the channel?

The most obvious approach in the light of the low value of D is to vary the scanning velocity in such a way that the local value of D remains approximately constant, i.e., the scanning spot must move relatively slowly where there are rapid changes in brightness and quickly over the "flat" parts of the picture. This idea was publicized in 1953^{5,6}, but has never made practical progress. The first difficulty is that the bandwidth of the control loop at the transmitter must be considerably greater than the video bandwidth. Developments in electronic components since 1953 have made this easier, but such circuits would still be costly if they had to be provided also in the receiver. The alternative is to transmit a separate velocity signal; but this would use up some of the bandwidth saved from the video signal, and still add to receiver cost. The more serious difficulty is that of ensuring synchronism of movement of the receiving scan with that at the transmitter, and this is probably an insuperable obstacle. In practice it is not permissible to allow the field repetition rate to vary with the average detail in the picture, because of problems of flicker and reproduction of motion.

A digitized substitute for variable-velocity scanning is known as "run-length coding." In this the picture amplitudes are quantized, and the number of picture elements between each successive change of level is counted. Instead of transmitting a continuous video signal, there is transmitted at each change of level a pair of signals indicating (a) how many picture elements are covered by the constant-amplitude run since the last change, and (b) what the new level is. Ideally one might transmit only the sign of the change in level (as in delta-modulation) if the resolution were good enough. But if the change from one element to the next may be more than one level, and in any case to prevent drift in level due to cumulative errors, the new level must be specified independently.

Limb and Sutherland⁷ have calculated that a bandwidth reduction of 2:1 might be obtained by run-length coding of a picture quantized into only 16 levels. (Other schemes for applying p.c.m. to television^{1,2} have suggested at least 32 levels.) The trouble is that long runs at uniform brightness are not so common: the orders of magnitude

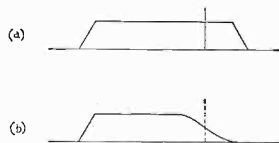

Fig. 3. (a) Transmission characteristic of vestigial-sideband transmitter; (b) transmission characteristic of vestigial-sideband receiver.

found by Limb and Sutherland for a picture of average detail were 10% of runs of length 3, 1% of length 8 and just over 0.1% of length 16. Some economy of bandwidth is obtainable if the system is made completely asynchronous, with special signals indicating end-of-line and end-of-frame¹⁰, but if the frame frequency is to be kept constant the system must be designed to meet the demands of a high-detail picture and little saving of bandwidth results. (If the system is set up for medium detail and fixed frame frequency, then a high-detail picture would not have been completely scanned by the conclusion of the frame period and the premature fly-back would leave a black space at the bottom of the picture.)

The redundancy of the television signal is most readily expressed in terms of the correlation between different parts of the same frame and between successive frames, and proposals have been made to exploit this correlation. The frame-to-frame correlation is complete for a stationary picture. It is therefore high for most pictures, in which there is a moderate amount of movement against a fixed background, though one can imagine that for a stage performance such as a Cossack dance there would be more movement than background. The engineering difficulty is that a complete frame must be stored if the correlation is to be exploited. There is also a very serious practical problem: even though the background is stationary, the picture is not constant unless the camera is fixed. This implies that all pan and zoom operations of the camera would be banned or discouraged, and sharp cuts from one scene to another would be impossible.

The fundamental difficulty is that either the communication channel must suffice for the maximum information rate of the video signal, which is the present practice, or the signal must be stored for a long enough period to allow transmission to occur at an average rate. The period needed to obtain a meaningful average is more like minutes than seconds, and though this could obviously be achieved by video-tape recording, it appears out of the question to incorporate a video-tape machine in every receiver.

The video spectrum.—A completely different approach which leads ultimately to the use of wide-band sub-carrier for colour, is via the Fourier spectrum of the video signal; and the characteristic of methods based on this is that any defect will appear as "noise" spread over the whole picture, rather than as failure to follow movement or as the complete loss of part of the picture. The nature of the picture spectrum was first analysed by Mertz and Gray¹¹, and the spectrum of television pictures has been examined by Bell and Swan^{6, 12}. The salient points are that (i) the amplitude of the Fourier components falls approximately as the inverse of the video frequency; (ii) multiples of the line repetition frequency are the dominant components; (iii) each of these line harmonics is fringed with "sidebands" spaced from each other by the frame frequency; and (iv) to the extent that there is movement in the picture, these last components spread out from lines into more diffuse components occupying to some extent the gaps between them. There are, therefore, no completely unoccupied frequencies but some parts of the spectrum are more occupied than others.

Mertz and Gray¹¹ suggested interposing other signals in the negligibly occupied parts of the spectrum of picture-telegraph signals, and this principle has been successfully used in compatible colour television. In particular, a signal exactly half-way between two frame-multiple component represents a flicker which should average out over the field period. This idea was first exploited for colour (see below) and has also been tried for bandwidth reduction¹³ according to the scheme indicated sche-

matically in Fig. 4. (The number of components in a television signal would of course be very much greater than is shown.) At (a) are shown 6 line harmonics, each accompanied by a few frame components; and at (b) the upper half of the band has been folded back into the lower half, the upper components (now shown dotted) being spaced half-way between multiples of frame frequency.

Unfortunately the eye does not remain fixed on one picture element, and wherever there is an edge in the picture the eye tends to switch from one element to the next as they change in successive frames, i.e., the observer experiences a dot-crawling effect. Consequently this scheme has not been pursued beyond the experimental stage. Dot-interlace has also been tried as a means of

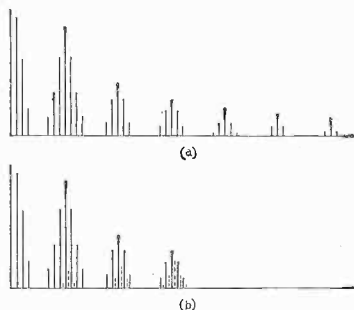

Fig. 4. (a) Schematic spectrum of television signal; (b) result of "folding" the spectrum in order to reduce bandwidth.

reducing the bandwidth required for colour¹⁴, but appears to have been abandoned.

Addition of colour.—Before considering methods of transmitting colour, it is advisable to consider what information has to be transmitted. Basically three co-ordinates must be given to specify an element of picture, and they can be represented in a three-dimensional model of which the section in the $X-Y$ plane is the colour triangle (Fig. 5) while distance parallel to the Z axis represents brightness. There are then two possible sets of co-ordinates: the brightness-hue-saturation scheme uses a kind of cylindrical polar or r, θ, z co-ordinates in which an axis parallel to Z is set up through the centre or white-point of the triangle, hue is represented by the angle θ of a radius vector to the point representing the light and saturation is represented by the length r of this vector relative to the radius to the periphery of the triangle. The alternative arrangement is to use the Z axis plus a pair of axes in the $X-Y$ plane.

It is essential in a compatible colour television system that the modulation of the main carrier should represent luminance; and it follows that the quantities transmitted on the sub-carrier must represent chromaticity (position in the colour triangle) rather than intensities of primary colours. To derive position in the colour triangle, one uses the fundamental law of colorimetry that the luminance of a "mixed" colour is equal to the sum of the luminances of its components, and normalizes the primaries having luminances say A, B and C , to chromati-

Fig. 5. Colour triangle in X-Y plane. I, Q are axes of chromaticity signals; W = white point; R, G, B = primary colours. The numbers marked round the periphery of the colour triangle are the wavelengths of the visible spectral colours, from 380 to 780 millimicrons.

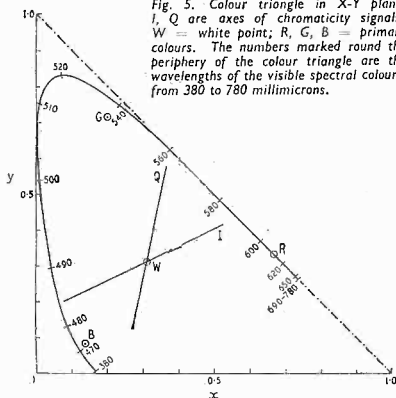

city components $a = A/(A + B + C)$, $b = B/(A + B + C)$ and $c = C/(A + B + C)$. But it is obvious that $a + b + c = 1$ so one need specify only two chromaticity components; and these can be represented by the x and y co-ordinates in Fig. 5 and may be regarded as the normalized contributions from two of a set of imaginary primaries X, Y, Z such that the triangle XYZ encloses the whole of the approximately triangular space of real colours.

The television camera and reproducing systems use three real primaries; and typical primaries for a colour picture tube are specified by:

$$\text{Red } x = 0.67, y = 0.33$$

$$\text{Green } x = 0.21, y = 0.71$$

$$\text{Blue } x = 0.14, y = 0.08$$

At the transmitter the luminance signal is made up of a weighted sum of the luminances of the primaries:

$$E'_Y = 0.30 E'_R + 0.59 E'_G + 0.11 E'_B$$

(The primes indicate that the components are gamma-corrected, i.e. are ready for direct application to the colour tube in a receiver.) The two components of modulation applied to the sub-carrier are:—

$$E'_Q = 0.41(E'_R - E'_Y) + 0.48(E'_G - E'_Y)$$

$$E'_I = -0.27(E'_R - E'_Y) + 0.74(E'_G - E'_Y)$$

These three formulae can be regarded as three simultaneous equations which can be solved in the receiver for red, green and blue luminances in terms of E'_Y, E'_Q and E'_I .

Transmission of colour by sub-carrier.—The eye has less resolving power in colour than in luminance (brightness) just as it has less sensitivity. (The loss of colour discrimination at low illumination is known as the Purkinje effect, and moonlight falls within the intensity range in which there is no colour discrimination.) An example of the eye's insensitivity to detail resolution in colour can be seen in the remarkably satisfactory impressions given by monochrome photographs which have subsequently had colour superimposed by hand; the areas of uniform colour are often much larger than would have been acceptable in a painting. The principle of "mixed highs" was proposed to take advantage of this, the colour components being separated at low frequencies

but allowed to mingle as a combined white signal at high video frequencies. In Dome's proposal¹³, using two colour sub-carriers, the basic signal to 4 Mc/s was to have been the green component while the red component extended to 1 Mc/s and the blue to 0.2 Mc/s. Since the red and blue signals were not mutually overlapping in the combined video signal, the space that could be allocated to each was strictly limited. In the N.T.S.C. system the two colour signals occupy the same band (see below) so the bandwidth limitation is not so stringent.

In all compatible transmission systems which have so far been proposed, the first step is to provide a colour sub-carrier at a frequency where it will cause least interference with monochrome reception. The three factors which are used to minimize interference are: (i) the sub-carrier is placed mid-way between frame-frequency multiples, so that its effect should average out over alternate frames; (ii) it is placed near the upper end of the video signal, where luminance components are small so that low-frequency patterns will be of low intensity and beating with the strong components at the bottom of the video band will produce fine-grained patterns; (iii) the average amplitude of the sub-carrier is kept down; and (iv) the bandwidth of the modulation of the sub-carrier is kept down.

Compression of both colour signals into one frequency band is achieved by using double modulation of one sub-carrier: the sub-carrier is regarded as a two-phase channel and the two colour components are modulated on the sine and cosine components of the sub-carrier. The two colour signals are then known as the "in-phase" (I) and "quadrature" (Q) components. (This is equivalent also to having the carrier simultaneously modulated in amplitude and phase.)

It is specified in the N.T.S.C. system that the E_I component, sometimes known as the hue component, should have a coverage of at least 1.3 Mc/s, but must be at least 20 dB down at the main vision carrier. The E_Q component must cover at least 400 kc/s but have at least a 6 dB cut-off at 600 kc/s. Since the sub-carrier is placed at approximately 3.6 Mc/s in a nominal 4 Mc/s channel, E_Q may be approximately double-sideband but E_I must be vestigial sideband.

The separation of the I and Q components in the receiver requires an accurate phase reference; and even with a burst of sub-carrier added to the synchronizing signal at the end of every line, the receiver must be set up rather carefully to avoid colour distortion. Several schemes have been devised to overcome this phase sensitivity, known as SECAM¹⁶ (from France), PAL¹⁷ (from Germany), and a scheme tentatively known as NIR or SEQUAM¹⁸ (from Russia). All make one line of colour information serve for two lines of picture, and therefore require the receiver to incorporate a delay line capable of storing one complete line of signal.

In the SECAM system the two colour signals are sent alternately, a line at a time, and each received line therefore takes one of its parameters from the current modulation of the sub-carrier and the other from the stored signal of the previous line. Since only one parameter is transmitted at a time it suffices to amplitude-modulate the sub-carrier and there are no demodulation problems. The difficulty is that this very simplicity of demodulation makes SECAM completely incompatible with N.T.S.C. The PAL system is very similar to N.T.S.C., but the same video information is used for the in-phase component on two successive lines, but with reversal of phase of modulation in alternate lines. (E_I tends to convey hue, rather than saturation, because it is based on the difference between red and blue

signals. It is E_0 which has the smaller bandwidth of the two in N.T.S.C.) It follows that E_1 vanishes from the sum of successive lines, leaving E_0 , while similarly E_0 alone is recovered from their difference. If a phase-sensitive detector is used, an error ϕ in the reference phase will only reduce the amplitude of the colour signal by $\cos \phi$.

It is one of the practical difficulties of communication theory that one has no theoretical basis for deciding the fraction of the channel capacity that should be devoted to synchronization of one sort or another; one only knows that in practice it is an appreciable fraction. With normal teleprinter machine telegraphy, for example, it is about 25%; and in monochrome television the combined line and frame synchronizing pulses (and flyback times) account for about 20% of total signal time. It appears that the Russian NIR system devotes 50% of colour sub-carrier to synchronization by the device of transmitting sub-carrier reference phase throughout the whole of alternate lines (instead of only as bursts during synchronizing pulses) and then uses the N.T.S.C. double-modulation of the sub-carrier for the other lines. A one-line delay store is thus able to bring together simultaneously the modulated sub-carrier and the reference oscillation, instead of having to rely on the "memory" of a local oscillator to provide the same phase during the line of picture signal as was indicated during the preceding synchronizing pulse.

Having once accepted the idea of storing a line of colour signal, one has only two signals to transmit simultaneously, namely luminance and one or other of the two colour signals. But two signals can be transmitted on one carrier, and the SEQUIN system¹⁶ proposes to transmit the two as in-phase and quadrature components of the main carrier. The proposal includes the use of negative modulation, and saturated colours would be represented by both amplitude and phase changes of the carrier, while unsaturated colours would differ from the corresponding saturated colours by having smaller quadrature components but the same in-phase (black-white). With negative modulation the synchronizing pulses provide maximum-power pulses of carrier, and therefore a carrier phase synchronizing reference; an automatic phase-lock circuit is suggested; and this appears desirable because the frequency of the main carrier is some twenty to a hundred times greater than that of the conventional colour sub-carrier, the phase-synchronization of which is apt to cause trouble.

On grounds of communication theory, the objection to SEQUIN is that it puts the colour information into the low-frequency end of the spectrum which is already heavily loaded: in engineering terms this means that when the carrier is subjected to double modulation there must be limits on the depth of modulation of either component. In the proposed system this is covered by the reduction in amplitude of components which involve a large angle modulation.

Other possibilities.—So far we have reviewed existing developments in the light of information theory, but if we could wipe the slate clean and start again would we make any drastic changes? The most important factor seems to be that the picture is so variable in amount of detail, in position of the centre of interest in the field of view* and in amount and speed of movement that the only alternatives are either to provide for the most severe conditions on instantaneous transmission, and so have a poorly utilized channel for most of the time, or average

*It has been suggested that only the centre of interest of the picture should be scanned in full detail: a spiral scan could be made to give fine detail in the centre of the picture and coarser coverage of the outer parts.

over such a long sequence of fields that video tape recording seems the only available means of storage.

On the choice of modulation for radio transmission, there are ample theoretical studies showing that the present vestigial-sideband system is a good compromise between the minimum redundancy of a single-sideband system and the requirements of simple receiver design. From the point of view of monochrome signals only, communication theory suggests that most of the video band should be subjected to a pre-emphasis of nearly 6 dB per octave, so that the signal transmitted should have a flat spectrum, rather than a falling one. Looked at in another way, this is approximately equivalent to differentiating the video signal before transmission, to be followed by integrating in the receiver, which (a) in the transmitted signal gives prominence to the edges and boundaries which convey most information and (b) in the receiver reduces random noise. However, this would be incompatible with present colour systems, which only work because the monochrome spectrum is of low intensity at the frequency of the sub-carrier.

There is a degree of asymmetry in present colour systems, since horizontal resolution is reduced by a factor of two or three for E_1 and about six for E_0 , but vertical resolution is unchanged for colour in N.T.S.C. or reduced by two in SECAM and PAL. Since flicker is such a powerful factor in setting frame frequency, one wonders whether whole fields could somehow be interlaced in colour. Obviously the transmission of a colour signal cannot be delayed for a whole frame, since this would lead to colour trails behind moving objects, so one then comes to the dot-interlace scheme of colour television¹⁸. Just as line interlace is normally used, so each line can be broken up into groups of say three dots, which are transmitted in only one colour at a time, red, green or blue. Thus if one used in three successive scans the sequences RGB, GBR and BRG, super-position of the three scans would give all three colours for all three points.

The main trouble is that in this form the system makes use of the wrong tolerance in colour: it reduces bandwidth by allowing the formation of colour to be extended in time, instead of by degrading the spatial resolution in colour. It is also rather inflexible in the sharing of bandwidth between the three colours; unequal allocation is possible by giving two scans of green to one each of red and blue, but only such integral proportions are possible. The practical stumbling block is that dot systems are not immediately compatible with simple monochrome reception, and the more one refines the dot system the worse is the compatibility problem. To set against the pattern which can be created by the sub-carrier in the N.T.S.C. system, there is the break-up of the picture into dots, though this is theoretically at a higher frequency.

One is forced to the conclusion that although sub-carrier colour systems have no fundamental merit, and work only by virtue of the inefficient use of the channel by monochrome signals, they have great practical merit. Whether communication theory will guide anyone to a system having sufficient advantages to justify abandoning direct compatibility with existing receivers must remain an open question.

REFERENCES

1. "Television by Pulse Code Modulation," by W. M. Goodall. *B.S.T.J.*, vol. 30, p. 37 (Jan. 1951).
2. "Video Transmission over Telephone Cable Pairs by Pulse Code Modulation," by R. L. Carberry. *Proc. I.R.E.*, vol. 48, p. 1545 (Sept. 1960).

3. "Digital Television Transmission." *Wireless World*, March 1966.
4. "Theory of Communication," by D. Gabor. *J.I.E.E.*, vol. 93, Part III, p. 429 (1946).
5. "Television Detail and Selective-sideband Transmission," by S. Goldman. *Proc.I.R.E.*, vol. 27 p. 725 (1939).
6. "Influence of Transmission Bandwidth on Television Picture Quality," by J. Schunack. *Archiv. Elektr. Übertragung*, vol. 3 p. 301 and p. 323 (1949); and vol. 4, p. 75 and p. 113 (1950).
7. "Some Possibilities for the Compression of Television Signals by Re-coding," by E. C. Chery and G. G. Gouriet. *Proc.Inst.Elect. Engrs.* vol. 100 Part III, p. 9 (1953).
8. "Information Theory and its Engineering Applications," by D. A. Bell. Pitman, London, 3rd edition, 1962.
9. "Run-length Coding of Television Signals," by J. O. Limb and I. G. Sutherland. *Proc.I.E.E.E.* vol. 53 p. 169 (Feb. 1965).
10. "Some Properties of Digital Television Systems with a Variable Number of Lines and Fields," by V. P. Mandrakiz and D. A. Novik. *Radiotekhnika (U.S.S.R.)* vol. 17 no. 10, p. 35 (Oct. 1962).
11. "A Theory of Scanning and its Relation to the Transmitted Signal in Telegraphy and Television," by P. Merz and F. Gray. *Bell Syst. Tech. J.*, vol. 13 p. 464 (1934).
12. "Spectrum of Television Signals," by D. A. Bell and G. E. D. Swann. *Wireless Engr.*, vol. 33 p. 253 (1956).
13. "Reduction of Television Bandwidth by Frequency Interlace," by E. A. Hovson and D. A. Bell. *J.Brit.Inst.Rad. Engrs.*, vol. 20, p. 127 (1960).
14. "Dot Systems of Colour," by W. Boothroyd. *Electronics*, vol. 22, no. 12, p. 88 (Dec. 1949); and vol. 23 no. 1 p. 96 (Jan. 1950).
15. "Frequency Interlace Colour Television," by R. B. Dome. *Electronics*, vol. 23 no. 9, p. 70 (Sept. 1950).
16. "Henri de France Colour Television System," by R. Chaste and P. Cassagne. *Proc.I.E.E.E.*, vol. 107B, p. 499 (1960).
17. "PAL," by M. Cox, *Wireless World*, vol. 69, p. 584 (Dec. 1963).
18. "A Single-Carrier Colour Television System," by E. J. Gargini. *Wireless World*, vol. 71 p. 210 (May 1965).
19. "From Russia with Love." *Wireless World*, Feb. 1966 p. 73.

LITERATURE RECEIVED

Two charts entitled **Oscilloscope Accessories and Mounting Arrangements for Oscilloscope Cameras**, are available from Marconi Instruments. These are intended as guides to accessories for use with Marconi scopes and, in particular, oscilloscope cameras.

WW 322 for further details

Oscilloscope input accessories is the title of another Marconi Instruments' publication (10 pages) introducing the 81 series of passive probes, and also discussing an active probe and a pre-amplifier.

WW 323 for further details

The **Lofting photomechanical process for reproducing drawings and graphic designs on flat surfaces**—all metals, laminates, plastics, and so on—is described in a 4-page leaflet available from Lee-Smith Photomechanics Ltd., of Lyon Way, Hatfield Road, St. Albans, Herts. The industrial applications of this process and details of the equipment needed for the process are included.

WW 324 for further details

"Abstracts of application notes and other Literature on Semiconductors available from General Electric Semiconductor Products Department April 1965" is the title of a publication (90.0/200.0) listing the company's semiconductor application notes, article reprints, manuals and papers. Requests should be made to the General Electric Company, Distribution Services, Building 6, Room 208, 1 River Road, Schenectady, N.Y. 12305, U.S.A.

WW 325 for further details

Newmarket Packaged Circuits ABC describes the range of packaged a.f. amplifiers and power units produced by Newmarket Transistors Ltd. Seven types of a.f. amplifier are presented, from 150 mW to 3 W, and circuits, dimensioned drawings and specifications are given for each item. A high-to-low impedance matching pre-amplifier and three power supply units are also detailed in this 12-page brochure.

WW 326 for further details

The second issue of the 312-page main catalogue of Brüel and Kjaer, of Naerum, Denmark, is divided into 14 sections, the largest covering special acoustic equipment. Others include a.f. generators, frequency analyzers, microphones and accelerometers. The final section contains abbreviated information on international standards for acoustical and mechanical measurements.

WW 327 for further details

The latest **Heathkit catalogue (86/1)** is available from Daystrom Ltd., of Gloucester. The catalogue lists available kits, including two recently introduced items—a "salamine" loud-speaker enclosure and the OS-2.3 in oscilloscope. A short leaflet listing some of the available American kits is also available.

WW 328 for further details

Crossed field amplifiers are discussed in the latest issue of *Micronotes* (vol. 3, no. 8). This American publication, intended for those interested in microwave technology, is available from Microwave Associates Ltd. at Cradock Road, Luton, Beds.

WW 329 for further details

Autospec Success is the title of publication SP149 available from the Marconi Company. The Autospec principle of automatic error correction for radio telegraph and data transmission systems is described briefly and examples of its use in various installations are given, together with some typical error-rate figures. The Autospec system was described in detail in *Wireless World* February and March 1964 issues.

WW 330 for further details

Transect Variable Ratio Transformers is the title of a 6-page folded leaflet describing a new range of transformers manufactured by Smith Hobson Ltd., Hershams Trading Estate, Walton-on-Thames, Surrey.

WW 331 for further details

British Insulated Callender's Cables Ltd., 21 Bloomsbury St., London, W.C.1, announce a new publication No. 508, **Television Distribution Cables**. Physical and electrical data of nearly forty different conductor sizes is presented in three tables. General supporting details cover cable construction, installation, screening efficiency and impedance uniformity.

WW 332 for further details

An engineering bulletin on the subject of 0.01% **A.C. Calibration Equipment** is available from Dynamco Instruments Ltd., Salisbury Grove, Mychett, Aldershot, Hampshire. The bulletin describes the general problems associated with a.c. calibration, drawing attention to the fact that there is no absolute standard for a.c. similar to the Weston Standard Cell used for d.c. calibration, and then details the method of the Dynamco system which uses the thermal transfer technique.

WW 333 for further details



NEW FROM BRIMAR
MATCHED SETS OF
TRANSISTORS
IN PACKS

Circuit diagram available for each type of pack

Pre-selected for performance to cut development and production costs!

The transistors are arranged in sets and carefully graded for performance characteristics in a range of standard audio amplifiers of different outputs. This means improved, predictable performance for amplifiers in industrial equipment—with reduced production and development time, and lower overall costs.

BRIMAR Transistor Packs offer you:

- * Audio amplifier circuit designs.
- * Balanced characteristics, giving a narrower spread of performance than could be obtained from a random selection of transistors.
- * Packaged sets for convenience of assembly.
- * Coloured sleeves for easy identification.
- * Lower production costs.

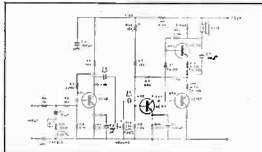

See these and other **BRIMAR** semiconductor devices at the **THORN-AEI**

STAND G109
I.E.A. OLYMPIA

WW—118 FOR FURTHER DETAILS.

Selection of Transistor Packs and Circuits available

For audio amplifiers

- LP15 0.4W Class B push-pull amplifier, 9V supply.
- LP17 1.5W complementary single-ended Class B output stage, 25V supply.
- LP19 3W Class B single-ended push-pull output stage, 25.5V supply.
- *YP56 8W Class B push-pull output stage, 25V supply.

For tape recorders

- *YP54 Educational tape recorder, microphone input—headphone output, 24V supply.

* Development packs.

Thorn-AEI Radio Valves & Tubes Limited

7 Soho Square, London W.1.
 Tel: GERrard 5233



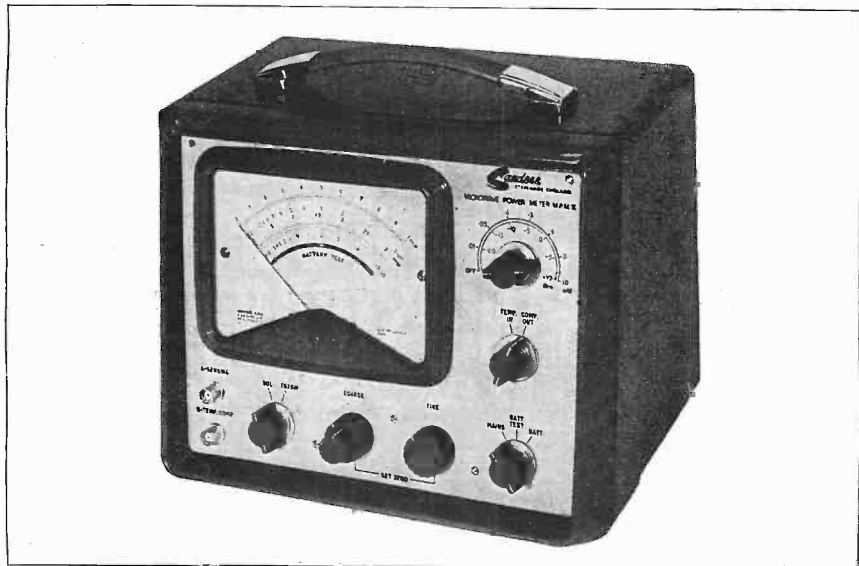

SEE THE LATEST ADDITIONS AND CURRENT RANGE OF SANDERS MICROWAVE EQUIPMENT ON **STAND N 403 I.E.A. EXHIBITION**

● Attenuators ● Bench Supports Clamps & Carriages ● Bends & Twists ● Crystal Detectors & Mixers ● Directional Couplers ● Educational Microwave Equipment ● Ferrite Isolators ● Waveguide Horns ● Junctions ● Loads ● Oscillators & Signal Generators ● Phase Shifters ● Power Meters ● Power Supplies ● Short Circuits ● Standing Wave Detectors ● Transitions ● Tuners & Variable Impedances ● Wavemeters ● Flexible Waveguides

Sanders are one of the leading European manufacturers of microwave equipment and, in the U.K., exclusive representatives for:—
Weinschel Engineering Co., INC. Gaithersburg, Maryland, Santa Monica, California, U.S.A.



MICROWAVE

W. H. SANDERS (ELECTRONICS) LTD.
A SUBSIDIARY OF MARCONI INSTRUMENTS LTD.

**GUNNELS WOOD ROAD,
STEVENAGE, ENGLAND.**

Tel: Stevenage 2311 Telex 82159
Cables Sandolect Stevenage.

LETTERS TO THE EDITOR

The Editor does not necessarily endorse opinions expressed by his correspondents

Collision Avoidance Systems

I READ with interest Mr. Gilmour's letter (April issue) about collision avoidance systems for aircraft. His theories, however, contain some serious defects:

(a) For aircraft climbing and descending (a prominent collision situation), he proposes the aircraft transponder to transmit "heights intending to be passed through." Two points here. First, the transponder has no crystal ball to foretell this, so it has to be informed of the intention by the already overworked pilot. Something else to do wrong. Second, the rate of descent is all-important, as well as the heights concerned.

(b) The successful operation of the equipment depends on complete serviceability of both units in both aircraft. Things like this go "on the blink" with monotonous regularity. One fault in either system and all is useless.

(c) Also assumed is that both aeroplanes have the equipment fitted. Some small airlines have not yet had I.L.S. installed in their aeroplanes, a system years old and widely considered vital for safe air operations. What chance is there that they will fit this new wizardry? Also, a light aeroplane can do just as much damage in collision as another airliner; yet, with the best will in the world, these do not have room to fit the proposed equipment.

(d) Aircrew cannot tell readily from a height/airspeed/heading display whether or not another aeroplane constitutes a collision risk. They want it on a yes/no basis. Given that, which implies more than the "simple modification" proposed by Mr. Gilmour, it is impossible to "discuss avoiding action" with another aeroplane owing to the diversity of frequencies in use.

A better basis for starting to look at this problem is that of simple relative velocities.

Two aeroplanes on a collision course have velocities such that their relative velocity is along the straight line joining themselves. Let me make this more clear diagrammatically.

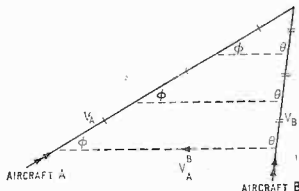

This is the old "parallel-axes" theorem; the relative velocity (represented by the intercepts) is always at a constant angle (i.e. no angular component of polar velocity) if the flight speeds are steady.

The following system therefore commends itself. A self-contained radar tracking system in the aircraft (of the gyro-based guided missile variety) picks up an aircraft within a certain range and "locks on" to it using proven missile techniques. The rest is simple. If the radar

aerial moves transversely (i.e. spherically) in following the stranger, the two aircraft are designed to miss each other. If the aerial stays geometrically stationary in following the other aeroplane the relative velocity is through the two aircraft with no angular component, and a collision course exists.

Warning of an impending collision could either be presented to the pilot or arranged to tweak the autopilot so that the relative velocity changes into one with an angular component subtended at the aerial and collision is avoided. The presentation of range and velocity information to the pilot as a bonus presents no problem, using the Doppler effect mentioned by Mr. Gilmour.

Where several aircraft are within range the locking radar would investigate each in turn, the nearest first. Once the aerial has locked on and moved while following its target it has satisfied itself that no danger exists and goes on to the next trace. This would only take a few seconds; no problem at 100 miles range even at closing velocities of 1,200 m.p.h.

This system, though idealistic, has none of the immediate snags prevalent in Mr. Gilmour's—

(i) The system is positive for all straight line flying, and takes account of rates of climb and descent.

(ii) The system is entirely self-contained. One's own careful airline has no need to trust the servicing and operating integrity of a small airline operating across the Atlantic at the "lowest fare ever."

(iii) If both aircraft have the system, one unserviceable is still a safe state of affairs.

(iv) The pilot is not bothered until something threatens, which is as it should be.

In conclusion, I am delighted to see this subject coming up in other than aeronautical circles. The evolution of the supersonic transport and proposed narrower air corridors demand the rapid development of such a device.

Officers' Mess,
R.A.F. College, Cranwell

G. L. PERRY

British Electronics Abroad

AS an electronics engineer and a resident in Hong Kong for the last six years, I wholeheartedly agree with your Editorial in the December issue and the subsequent letter from Mr. D. W. F. Milligan in the February issue.

We have just finished here in Hong Kong what is reputed to have been a very successful British Week. In conjunction with this, an eleven-day Engineering Exhibition was held to show off the cream of British products. After spending a couple of hours looking around the various displays, I concluded that British manufacturers of electronic equipment either had nothing to show, or they were just not interested. As I read most of the leading electronics journals and visit the various London exhibitions, I know that it is not the former—therefore I must assume it is the latter.

Of course, some of the larger British companies with Far East offices in Hong Kong were represented, but even they had nothing spectacular or inspiring on show.

One point in particular; although within 18 months Hong Kong is to have a broadcast television service, not one manufacturer of TV sets thought his products worthy of showing.

In the manufacturing field, Hong Kong is blessed with a large labour force and a low wage scale. This, together with a low rate of taxation, has attracted many American and Japanese manufacturers to set up their own or joint-venture plants in the Colony. In contrast, only one British company has followed suit—it is a subsidiary of a large American organization!

One American company started two years ago producing semiconductors on one floor of a small factory building. Last week they opened the doors of their own new 11-storey factory.

The general opinion of the industry here is that British manufacturers have "missed the boat"; an opinion which I am almost ready to endorse.

However, before passing judgment I decided to do a little research. I looked around this wonderful Colony of ours and concluded that one branch of electronics was still open to all. I refer to the field of industrial electronics, where none has so far ventured, though no doubt they will if left much longer.

As a start, a small group of electronics engineers have just formed a company for the design and manufacture of electronic devices for use in industry. Within ten days of advertising the fact, we have been swamped with queries from local manufacturers; so many that two of our group are permanently assigned as consultants. If the response locally is so good, then what better place to start a plant. No doubt the opportunities are as great in the other countries around us.

So, you manufacturers back home, why not take a trip out here and look over the market potential. I assure you the natives are friendly. Should manufacture be out of the question for you, there are sales to be made—but not from the sanctuary of your U.K. office.

Kowloon,
Hong Kong.

DON WEBSTER

"Flip-flop" a Misnomer?

THE letter from Mr. P. S. Pinder in your April issue can only produce my complete agreement, but what a shame that the printers let him down at a most crucial point in his argument.*

There is, however, doubt creeping into my mind. Perhaps the computing engineer uses the terms "flip" and "flop" to designate a "1" or "0" respectively being generated. In this case one can, I suppose, argue that their nomenclature is logical as this is the pattern of events occurring in a bistable, i.e., the first trigger pulse generates a "1" and the second pulse a "0." Presumably a bistable working in an "inverted mode" would then be called a "flop-flip"!

However, I will come down on Mr. Pinder's side—after all, why should the bistable be so privileged above members of its own family?

University of Keele,
Staffordshire.

E. W. FIRTH

*The fourth line from the end of Mr Pinder's letter should of course have read "a bistable a 'flip-flip' and an astable a 'flop-flip'."—Ed.

Automatic Car Parking Light

READERS may be interested in details of a circuit for an automatic car parking light which makes use of the light-sensitive properties of the OC71 when its point

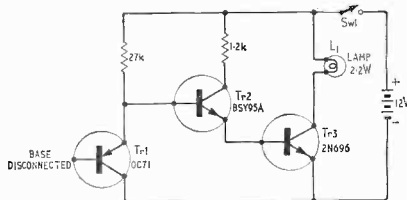

is scraped off. The base is not connected. The circuit was designed as shown in the figure and field trials carried out on different makes of cars to prove its reliability. At night maximum drain on the car battery is approx. 196mA. When the device is inoperative the maximum drain is 0.5mA unless of course a switch is incorporated to disconnect it from the battery. The lamp is automatically switched on at dusk and switched off as daylight returns. The lamp stays alight in street lighting. The components cost about £1.

The circuit analysis is as follows:—

$$\begin{aligned} &\text{maximum current taken by the 2.2W lamp} \\ &= \frac{2.2 \times 10^3}{12 - V_{SAT}} = \frac{2.2 \times 10^3}{11.7} = 188\text{mA} \\ &\text{current required to saturate Tr3} \\ &= \frac{188}{\beta(\text{min}) \text{ of Tr3}} = \frac{188}{20} = 9.4\text{mA} \end{aligned}$$

As Tr2 and Tr3 form a darlington pair and Tr2 remains saturated when circuit is in use, therefore current in Tr2 = $\frac{12 - V_{SAT} - V_{be}}{1.2} = \frac{12 - 0.3 - 0.7}{1.2} = 9.2\text{mA}$

This current is enough to saturate Tr3 which requires $\frac{9.2}{\beta(\text{min}) \text{ of Tr2}} = \frac{9.2}{30} \approx 0.3\text{mA}$.

Current of about 0.45mA is enough in the 1st stage. For Tr2 to saturate V_{b1} must rise to at least 1.6V with respect to negative earth. The impedance of Tr1 is about 3.5k in the dark. Therefore $V_{b1} = 0.45 \times 3.5 = 1.57$ volts. The values of resistors can be varied to suit requirements.

Tr1 is conveniently placed near the windscreen ensuring enough light falls on its glass covering. The paint on the glass covering is easily removed. If the car is to be used regularly S1 may be omitted as drain on the battery during daytime is negligible.

Basildon,
Essex.

S. K. CHAWLA

Temperature Control

I WAS interested in Mr. J. A. Selby's thermostatic switch unit in the February issue. Perhaps a circuit I have used in a number of versions may be of interest. It is basically an a.f. oscillator, of which the feedback is through a Wheatstone bridge with a thermistor as one of the resistors. Fig. 1 is the simplest practical version. Oscillation takes place above or below a certain temperature, depending on the way the transformer is connected, and the oscillator output is rectified and amplified to operate the relay.

Using an F type thermistor made by S.T.C., this circuit will control a water bath to $\pm 0.5^\circ\text{C}$ or better. The

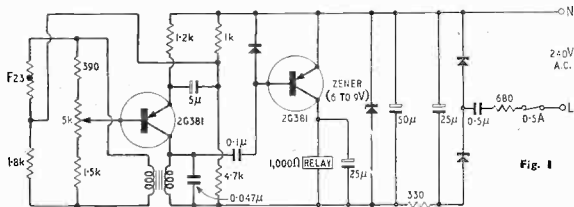

Fig. 1

resistors in the bridge should be wire-wound or metal oxide types, and their values depend on the temperature range required and the thermistor type. (The resistance of the FZ3 is $2,000\ \Omega$ at 20°C .)

There has been no trouble with the relay not switching over positively during gradual change of amplitude with temperature change.

An interesting variation is a proportional control version using a complementary monostable multivibrator as in Fig. 2. Over a small temperature range the on-off

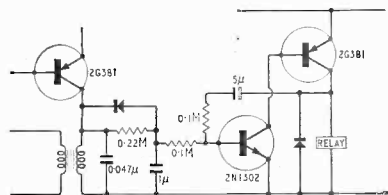

Fig. 2

ratio changes from zero to infinity. The recovery time is two or three seconds with the capacitor shown. Positive bias for the n-p-n transistor comes from the voltage drop of about 2V in the transformer winding.

The transformerless power supply shown calls for some comment on safety. The live mains wire should be connected to the capacitor, which must have an adequate rating (1,000V d.c.). The series resistor is to reduce transients, particularly when switching on. This is essentially a constant current supply and must not be open circuited (when it would become a voltage doubler), and the Zener diode must always be connected.

Bexhill-on-Sea,
Sussex.

C. Q. KEILLER

Television Sound Quality

SOME time ago I decided to improve the audio quality from my television-receiver in a similar manner to that described by Mr. T. M. George in your February, 1966, issue, but found one or two drawbacks. Most audio transformers proved unsatisfactory from the mains isolation point of view, since their insulation had not been designed to withstand 240V r.m.s. A much safer method is to isolate the receiver completely using a 1:1 mains isolating transformer*.

It is then a simple matter to bring the audio out from

* Make sure the mains supply is a.c.—ED.

the same point as used by Mr. George. If this is fed into a conventional valve pre-amplifier, and the interconnecting lead is reasonably short, there are no impedance problems to worry about. When one is using a low impedance input, or the leads are long, it is relatively simple to re-arrange the first audio stage in the television receiver to operate as a standard cathode follower. By doing this one avoids all the inherent distortions encountered

using transformers, and reveals even more clearly the quality (sic) of the transmission.

Stroud,
Glos.

JOHN WEBSTER

"Amplitude-stabilized RC Oscillator"

I WAS very interested in Mr. E. Nelson-Jones's article on the phase-retard oscillator in the November 1965 issue.

I would like to point out that a high input-impedance amplifier is not essential with such oscillators provided that an additional resistor is included in the network, as shown below.

It may be shown that if the amplifier has zero input impedance (i.e. virtual earth) the fundamental frequency of oscillation is given by

$$f = \frac{\sqrt{10}}{2\pi CR} \left\{ \text{c.f. } \frac{\sqrt{6}}{2\pi CR} \right\}$$

and the amplifier output voltage by

$$e_o = \frac{1.274e_1}{56R} R_1 \left(2 + \frac{R_1}{R_2} \right)$$

where e_1 is the sine wave peak-to-peak amplitude and e_o is the square wave peak-to-peak amplitude. This output amplitude may readily be adjusted by varying R_1 .

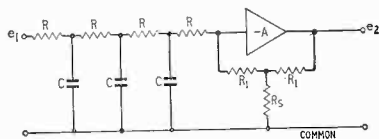

By using an operational amplifier a high open-loop gain may be achieved together with a low output impedance, thus ensuring a true virtual earth input and eliminating the need for a buffer between oscillator and load.

Basingstoke,
Hants.

J. W. HARMAN

Voltage-regulated Power Supplies

IN most published designs for voltage regulated power supplies, including that by Mr. J. S. Taylor in the April issue, the output transistor is driven by another power transistor. This method is expensive in that the driver transistor, often capable of dissipating about 30W, is only required to dissipate around 1W.

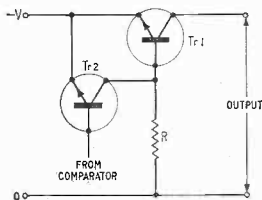

The circuit given above overcomes this objection. Tr1 is a silicon power transistor while Tr2 is a germanium device operating in the common emitter mode with a V_{CE} of about 0.7 V.

The advantages which may be claimed for the circuit are:—

- (i) Maximum power dissipation in Tr2 is normally low (usually ~ 100 mW) and is limited by R.
- (ii) A current limiter of the type described by Mr. D. Wilson in the Correspondence pages of the February issue may be readily incorporated.
- (iii) Tr2 is always operating in a region of substantial collector current. Leakage is therefore unimportant.
- (iv) The possibility of a high Tr1/Tr2 h_{FE} product is offered.

(v) The components required are inexpensive. At present a 2SO12A/2N1304 pair with a minimum h_{FE} product of 800 costs only about 15s and has very good power-handling capabilities.

The circuit's only disadvantage appears to be continuous dissipation in R but this is usually easily accommodated since no extra heat sink area is required.

Aberdeen. IAN H. HOWIE

Camera Image Stabilization

WHEN a television camera is used to take pictures of very distant objects with a telephoto lens, the optical effects of small camera movements caused by accidental shocks or vibration are greatly magnified and become noticeable as wobbling or jumping of the picture. This can be seen sometimes in outside broadcasts of sporting events. The B.B.C. are considering tackling the problem by fitting to their O.B. cameras a device which optically compensates for such movements—that is, movements more rapid than the normal panning ones. Known as the Dynalens, it comprises an adjustable prism placed in the optical path and gyrosopic displacement sensors mounted on the camera housing. A camera movement detected by the sensors produces a signal which alters the refraction angle of the prism so that the light rays are deflected in the same direction as the movement and the selected image is therefore not displaced from its original position on the camera tube target.

The prism is a lens-like structure comprising a volume of liquid enclosed between two transparent plates and a bellows. In normal operation the two plates are parallel and no deflection of the light rays occurs. When a displacement signal is received, however, the plates are moved at an angle to each other and the emerging rays are bent correspondingly. The plates are controlled about both horizontal and vertical axes so that the effects of camera movements in any direction can be compensated.

The device is marketed in the U.K. for the American

manufacturers, Dynasciences Corporation, by the Livingston Group. At present the B.B.C. are assessing its performance, which may depend to some extent on the speed of response which in turn depends on the inertia of the mechanical parts. It is thought that the stabilizer may prove particularly useful when cameras are mounted on high towers where they are likely to be buffeted by the wind.

An alternative solution to this type of problem adopted by another American firm, the Itek Corporation, is to interpose in the optical path an electronic image converter with electro-magnetic means for deflecting the electron beam (*Electronics*, September 20, 1965). This has the advantage that the electron beam deflection system has no mechanical inertia to limit the speed of response of the stabilizer.

New Aid for Renal Studies

KIDNEY function studies employing radioactive isotope tracers will be assisted by a specially developed renal function analyser with two separate channels. This equipment, made by Isotope Developments Ltd., employs two scintillation counters, which are so positioned on two vertical columns that the patient can be examined in a sitting position. The associated collimators, with special iso-count characteristics, are intended to minimize cross interference caused by the radiation emitted from each kidney. Both analogue counting channels are constructed of transistor modules, and each channel contains a high voltage unit with digital setting indication, a wideband amplifier with continuous gain control, a pulse height analyser, and a multi-range linear ratemeter. The mounting of the detectors permits other studies to be carried out, with the patient lying down or sitting up.

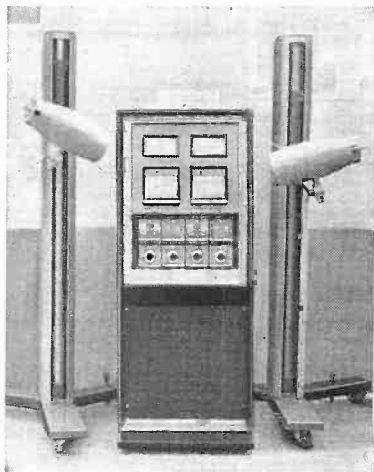

Dual channel renal function analyser.

RELAYS— Immediate Delivery

**PRINTED
CIRCUIT
RELAY**



**G & R
and
LATCHING
RELAYS**

PRINTACT miniature relays are designed solely for printed circuits. 6, 12 and 24 volts; 500 mW; 5,000,000 operations; Palladium contacts; — 30 C. to + 95 C. 3 to 7 milliseconds. $\frac{3}{4}$ in. cube; 0.8 oz.; 1000 V. insula-

tion; Bifurcated double break contacts; Balanced armature; Enclosed housing; Plug-in application; Encapsulated coil; Self-wiping contacts; Inherent snap-action, greater switching versatility—

and still the **MINI-Q** the economical 4 pole miniature plug-in relay. High Sensitivity, Twin contacts to switch 1a. at 100 V.

MINI G.P.

S1500 P.O. Miniature General Purpose relay. Miniaturised version of P.O. 600 type with identical specification. $\frac{3}{4}$ in. \times 1 $\frac{1}{2}$ in. \times 2 $\frac{1}{2}$ in. plus tags.
Ideal for printed circuits

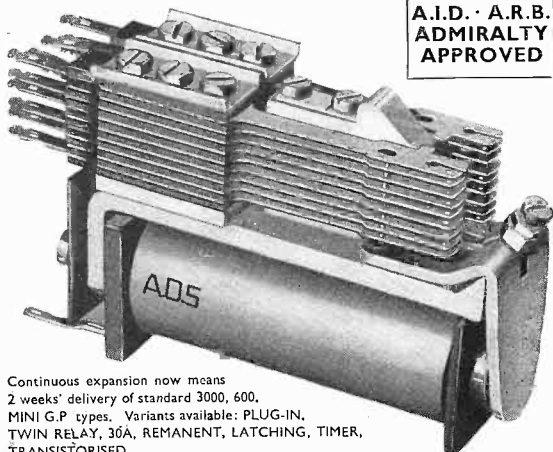
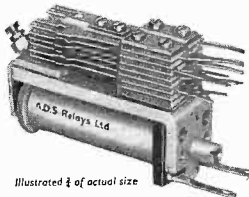

Continuous expansion now means 2 weeks' delivery of standard 3000, 600, MINI G.P. types. Variants available: PLUG-IN, TWIN RELAY, 30A, REMANENT, LATCHING, TIMER, TRANSISTORISED.

14 Days' Delivery

of 3000, 600
& MINI G.P. types

48 HOURS' PROTOTYPE SERVICE

Mark **URGENT** enquiries 'E.M.S.' for EXPRESS MANUFACTURING SERVICE

A.D.S. RELAYS LIMITED

97 ST. JOHN STREET, London, E.C.1. Phone: CLERkenwell 3393. Cables: ADSRELAYS, LONDON, E.C.1.
WW-126 FOR FURTHER DETAILS.

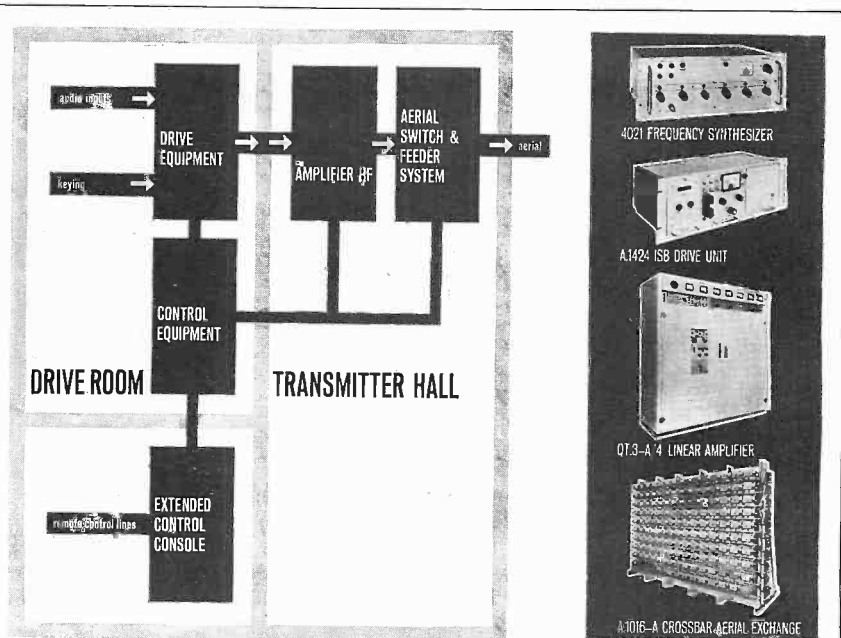

The STC HF Transmitter System

Economic considerations in the operation of modern transmitter stations call for a high degree of automation. The STC HF Transmitter System design philosophy reduces the number of technical personnel, improves equipment utilization, minimizes lost time during frequency changes and facilitates more compact system layout — all achieved at little increase in cost. The STC System is the culmination of two decades of STC experience in automatic HF communication techniques. Progressing from single unit equipments to complex multi-

block systems, the STC System now provides for complete transmitter stations from line input to aerial output. It embodies comprehensive monitoring, automatic fault location and rapid restoration of service in the event of a failure. Due to greatly improved reliability, the transmitter and drive equipment can be unattended, tuning and control functions being carried out from a remote position. System flexibility accommodates all user and site requirements. Space reduction is accomplished by the extensive use of solid state devices and logic

techniques. The transmitters are self-contained with integral cooling, front access only being required.

The STC range includes:—
 F.S.K. Telegraph Drive Unit A.1422 • Independent Sideband Drive Unit A.1424 • Frequency Synthesizer 4021 • Transmitter Amplifiers QT Series • Crossbar Aerial Exchange A.1016-A

For further details, write, phone or telex Standard Telephones and Cables Limited, Radio Division, Oakleigh Road, New Southgate, London, N.11. Telephone: ENT Enterprise 1234. Telex: 261912.

world-wide telecommunications and electronics

STC

5-Experiments and Decisions

(Concluding the series)

By D. A. BELL,* M.A., B.Sc., Ph.D., M.I.E.E., F.Inst.P.

DECISION-MAKING is an important activity in government, management and scientific activities; and from a theoretical viewpoint two of the major characteristics of decision-making are, first, that it involves loss of information and, secondly, that the task of scientific decision-making is to make logical decisions on the basis of doubtful evidence. The loss of information is inherent in the non-linear nature of decision-making, whether or not it is irreversible. Consider, for example, a criminal trial in which the evidence for the prosecution is largely circumstantial. Tens of thousands of words may be spoken about times and places, alleged recognition of persons, chemical analyses, etc., but the decision of the jury reduces all this to one binary digit's worth: "guilty" or "not guilty" (except in Scotland, where the verdict provides one ternary digit of information on the scale "guilty," "not proven" or "not guilty"). The discarding of information by decision-making is perhaps illustrated even more dramatically by the tradition in certain examinations of destroying the candidates' scripts as soon as the class list has been prepared.

It is equally true that there is a loss of information when a decision is made by a threshold circuit between the "mark" and "space" conditions of a signalling circuit. It is inherent in the philosophy of Shannon's ideal coding (as described in the geometrical model¹) that in order to preserve as much information as possible until a single decision shall be taken, identifying the received signal as a whole with some particular message, and the freedom from error which is associated with the ideal-coding theorem is lost if one decodes the signal one digit at a time. This viewpoint is also applicable to character-recognition schemes: those which divide the character area into a matrix of cells and then take a separate binary decision on each cell in turn must be inferior to those which retain all the information until a later stage.

"Doubtful" evidence means statements which can be expressed as probabilities but not as facts; an example from electronic engineering is the estimate of the magnitude of a signal or other current on which is superimposed "noise" of some kind. The decisions are described as *logical* because the use of the appropriate statistical algorithm will lead to a unique result which does not involve any subjective judgment by the observer; and this is both the strength and the weakness of statistical decision methods. The absence of subjective factors is in general desirable, but there may be anxiety lest the statistical process might ignore "imponderable" factors which would be included in a subjective judgment but which are not amenable to quantitative formulation. The answer to this objection is that diligent study will often lead to a quantitative formulation of the so-called imponderable, in which case all that was hurt by the use of statistics would be the pride of the man who would otherwise have made a subjective judgment.

Experiments and decisions have been linked together because the purpose of an experiment is often to obtain information for use in making a decision: this can usually be described formally as deciding on the best out of n number of possible hypotheses. In measuring a length of x millimetres with a metre rule, you select one out of the thousand hypotheses from $x = 1$ to $x = 1000$. However, it would usually be unrealistic to suggest that all the different values are equally probable: for example the length of a man's shoe is unlikely to be more than 35 cm or less than 20 cm. One thus has some advance estimate of the probabilities of the various hypotheses—the *a priori* distribution of probabilities—and the experiment leads to a more restricted *a posteriori* distribution of probabilities. The difference between these two sets of probabilities, when suitably expressed on a logarithmic scale, is the *information* obtained from the experiment, in the particular sense of information/communication theory. Suppose that in given circumstances there are k probabilities to consider. (We might have $k = 57$ if we were waiting for the next symbol to appear on a teleprinter page, or perhaps $k = 9$ for the number of horses in a particular race.) Then the average logarithmic probability is obtained by multiplying the logarithm of each probability by the probability of its occurring, i.e. by itself. Since probabilities are by definition less than unity, their logarithms are negative quantities; and the positive quantity obtained by reversing the sign of the average logarithmic probability is the *entropy*

$$H = - \sum_{i=1}^k p_i \log p_i$$

Thus the whole basis of information measurement is statistical.

However, the application of statistics is more obvious when a particular statistical technique is used to reach a

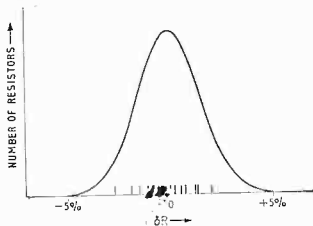

The short vertical lines indicate by their positions along the scale of R the differences from nominal value of fifteen resistors. It is reasonable to assume that the bulk quantity of resistors, from which these fifteen were drawn, have the gaussian distribution centred on the correct value, which is represented by the curve?

*University of Hull.

decision on some specific type of question. For example, a sample of 15 resistors drawn from a large batch of 5% tolerance resistors has a mean value 0.22% below the nominal value: does this mean that the whole batch is probably a little low in value? To answer this question the variances of the whole population and of the sample must be known, because such a sample could be from normal production in the way sketched in Fig. 1. The curve, a normal distribution with a standard deviation of 1.5%, represents the distribution of frequency of occurrence of various magnitudes of discrepancy in the whole population, and the small arrows indicate the individual values of the 15 samples. The samples occur more thickly towards the centre of the distribution, but being random are not quite symmetrically distributed. Are these values which could reasonably have been drawn as a random sample from the population? The parameter used by statisticians to investigate this question is known as "student's t " and is defined by the formula*.

$$t = \frac{(\bar{x} - \bar{X})}{\sigma_s} \sqrt{n} \quad \dots \quad \dots \quad \dots \quad (1)$$

where \bar{x} is the mean of the sample, \bar{X} the mean of the whole population, n the number in the sample, and σ_s is related to the variance of the sample:

$$\sigma_s = \frac{\sum(x - \bar{x})^2}{n - 1}$$

The quantity $m = n - 1$ is said to be the number of "degrees of freedom" of the sample parameter σ_s ; one degree of freedom has been lost because instead of asking about the variance of the sample, the mean being fixed by the sum of the individual values in the sample, we are asking about the variability of the sample relative to the pre-determined mean of the whole population. (The idea of "degrees of freedom" will be further discussed below.)

Returning to the specific example, $\bar{x} - \bar{X} = 0.012$, $n = 15$, and $\sigma_s = (1/14) \sum(x - \bar{x})^2$ which for the sample values indicated in Fig. 1 is 1.701. It follows that $t = 0.508$. Now look in a table of the t distribution (e.g. Table XII in *Burington and May*), take the line of the table for $m = 14$, (14 degrees of freedom): the nearest entry, 0.537, occurs in the column headed 0.60 which means that there is a nearly 60% probability that the difference is random and no change in the characteristics of the production is indicated by the sample.

Degrees of freedom

The meaning of "degrees of freedom" is most easily seen in a "contingency table" which is a means of discerning relationships, similar to correlations, when the relevant characteristics are given only qualitatively instead of as continuous variables. For example, is it more difficult to get an Ordinary National Certificate in Engineering or in Building? The numbers enrolled and numbers obtaining O.N.C. at certain colleges could be set out in a table as follows†. The non-statistician would convert these figures to percentages passing, which is quite correct as far as it goes. But when the percentages work out to 49 and 54, are we sure this is significant?

The statistician may take a different approach. The total number of enrolled students is divided in two ways, first between those who take engineering and those who

	Obtain O.N.C.	Do not succeed	Total enrolled students
Engineering Building	539 (542) 54 (51)	561 (558) 48 (51)	1100 102
Totals	593	609	1202

take building and secondly between those who obtain O.N.C. and those who do not. If there is no difference in standard of courses or quality of students, the number who obtain O.N.C. in engineering should be obtained by multiplying the number of engineering students by the number of successes amongst all students i.e. $1100 \times 593/1202 = 542$ to the nearest integer. This number is shown in brackets in the table; and it is clear that given this number and the totals of rows and columns it is immediately possible to construct the figures which would be expected in the other cells of the table.

Since the figure for one cell (in addition to the totals) suffices to fix the whole distribution, this table is said to have one degree of freedom. However, if there are several rows and several columns in the table, it is necessary to specify the content of all but one cell in each row or column, and a table having r rows and s columns has $(r - 1)(s - 1)$ degrees of freedom (e.g. 6 degrees of freedom for a 4×3 table). The statistician can then write into each cell the difference δ between the value found experimentally and the value which would follow from multiplying independent probabilities: in the top left-hand cell of the present example $\delta = 539 - 542 = -3$, and since this table has only one degree of freedom all the other three cells must have $\delta = \pm 3$. Without entering into a proof it is plausible to say that the \pm ambiguity is eliminated by squaring δ , and that in general the square of δ is likely to be proportional to the independence value m ; so we derive a measure

$$\chi^2 = \sum(\delta^2/m)$$

where the summation is taken over all cells in the table. There are tables of χ^2 showing for various degrees of freedom the probabilities of various values of χ^2 arising by chance. If the value of χ^2 is greater than could occur by chance with an acceptable degree of probability, it is suggested that the two ways of splitting the population—into rows and into columns—are not independent. In the example shown above the value of δ is the same in all cells, but of course there are different values of m , so that $\chi^2 = 9 \left(\frac{1}{542} + \frac{1}{558} + \frac{2}{51} \right) = 0.386$

Now looking in the table of χ^2 under one degree of freedom we find $\chi^2 = 0.148$ for a probability of 0.7 and 0.455 for a probability of 0.5; so there is a probability of around 0.6 that such a result could arise by chance which is an unhappy value situation. There is no ground for affirming that it is easier to obtain the O.N.C. in building than in engineering, but the idea cannot be firmly excluded.

At this point it is well to be reminded that there is no magic in statistics. Tests such as "student's t " and χ^2 are concerned with evaluating the probable effect of random fluctuations due to sampling. The statistician's ideal model would be to suppose that we had a bag containing a very large number of ball bearings, mostly steel (engineering students) but a known proportion of bronze (building students) and a fixed proportion of the whole marked with a white spot (O.N.C.); if a handful is drawn at random, what proportions of the four different kinds may be expected? Our O.N.C. data do represent a sample because (a) they refer to certain colleges instead of to all colleges, (b) they refer to a single year and (c)

*This is the form given by Yule and Kendall in "An Introduction to the Theory of Statistics," *Burington and May*, in "Handbook of Probability and Statistics, give the algebraically equivalent and apparently simpler formula $t = \frac{(\bar{x} - \bar{X})}{\sigma_s} \sqrt{n-1}$ where σ_s is the ordinary variance of the sample. It is less easy to explain the factor $n-1$, rather than n , in this form. †Based on figures given on p. 356 of the *Growth Report*, "15 to 18," H.M.S.O., 1959.

when we ask whether one course is more difficult than the other, the people who actually enrolled in the courses are only a sample out of all the people who were qualified to enroll. Of course, the sample in social problems may be biased; but unless you are prepared to regard the data as a sample, either approximately unbiased or with a specified bias, you must not apply statistical tests which are based on sampling theory.

The possibility of averaging over several years brings in again the question of the distribution being stationary. In using autocorrelation in order to obtain the power spectrum, the function was integrated over a time which tended to infinity and it was therefore necessary that the distribution of amplitudes be the same at all times, i.e. that the continuing sequence of values form a stationary time series. When the durations of individual events are very short compared with the time of observation of the whole phenomenon, as in most forms of electrical noise, the distribution function is usually exactly stationary; but this may not be so in other problems. For example, when studying congestion in telephone systems one has individual calls lasting a few minutes but the total loading varying appreciably over a period of an hour at some times of day (the G.P.O. reckon the peak period to be the two hours from 10 a.m. to noon): it follows that one cannot take any averages over a period very long compared with the duration of one call.

Decision functions

The remaining major topic is *decision functions*. The binary symmetric channel (b.s.c.) is so often assumed that one tends to assume that the chance of 0 being converted to 1 by noise should necessarily be the same as the chance of 1 being converted to 0, but this is not generally correct. One can usually distinguish between a *false-alarm risk* α and a *lost-signal risk* β , a terminology which is applicable to many situations including radar. In the b.s.c. one makes the false-alarm risk (0→1) equal to the lost-signal risk (1→0) by appropriate choice of the decision-point or threshold. In a radar system, however, one might first specify a maximum acceptable risk of lost-signal (for a defined signal fixed e.g. by radar transmitter and receiver characteristics, distance to the horizon and assumed type of target) and then adjust the system to minimize the risk of false alarm subject to the specified maximum risk of lost signal. This is known as the Neyman-Pearson criterion for setting up the decision mechanism, and its difficulty is that it implicitly assumes at least two degrees of freedom in the system, one to be adjusted for each half of the criterion. If the only available adjustment is a threshold, then setting it for the specified β necessarily fixes also the value of α . Hence the Neyman-Pearson criterion is significant only if there are also other adjustments which can be made, e.g. bandwidth, and these adjustments do not affect signal and noise equally.

One will always be balancing the change in α against the change in β when adjusting the threshold; consequently one's decision should be made in terms of the likelihood ratio L of the received signal,

$$L(y) = \frac{p(y|H_1)}{p(y|H_0)}$$

where $p(y|H_1)$ and $p(y|H_0)$ are the probability density functions of the probabilities that the observed signal y would have resulted from transmitting a mark or space respectively. L is then to be compared with some decision threshold K in likelihood and y attributed to a mark or space according as L is greater or less than K .

The *a priori* probabilities of signal and no-signal are not necessarily equal. An obvious example of this is a ballistic-missile early warning radar system (BMEWS) where it is hoped that signals will always be absent. A more subtle example is teleprinter communication in English (or any West European) language. The letter E, which is far more common than any other letter, has only one mark element and four space elements, and other common letters, T, A, O, I, N have only two mark elements out of five, so there must be fewer mark than space elements in an English-language transmission and for minimum overall errors one should make α rather less than β , i.e. set the threshold a little higher than half way between space and mark. So let π_0 and $\pi_1 = 1 - \pi_0$ be the *a priori* probabilities of space and mark, and let C_0 and C_1 be the costs of false-alarm and lost-signal errors. Multiplying π_0 (the frequency of occurrence of spaces) by α (the proportion of mistakes made on spaces) and C_0 (the cost of each such mistake) one finds $\pi_0 \alpha C_0$ as the cost arising from false-alarm errors, and $\pi_1 \beta C_1$ for lost-signal errors. The total cost $R = \pi_0 \alpha C_0 + \pi_1 \beta C_1$ is minimized if for every signal y one computes the likelihood ratio $L(y)$ and sets the dividing line in L at the value

$$K = \frac{\pi_0 C_0}{\pi_1 C_1}$$

In general terms this says that one should set the dividing line in likelihood higher in proportion jointly as "space" signals are transmitted more often, and the cost of false-alarm errors is greater, or inversely for frequency of mark signals and cost of lost signals. This test, which minimizes cost when the *a priori* probabilities are known and average cost is a linear function of the absolute error probabilities, is known as a Bayes test.

Using the Bayes test

As an example, suppose that $\pi_0 = 0.6$ and $\pi_1 = 0.4$ (compare the teleprinter mark/space ratio) and that the error costs are the same, $C_0 = C_1$. Hence in this example $K = \pi_0/\pi_1 = 1.5$. The likelihood ratio is the ratio of the slopes of the error probability curves at the value of y in question. If a signal of amplitude y' is received over a channel with Gaussian noise power N , the probability of its being due solely to noise (the transmitted condition being "space") is

$$\alpha = \frac{1}{\sqrt{2\pi N}} \int_{y'}^{\infty} \exp\left(-\frac{y^2}{2N}\right) dy$$

The probability of its being due to a "mark" transmission with received amplitude m is

$$\beta = \frac{1}{\sqrt{2\pi N}} \int_{-\infty}^{y'} \exp\left(-\frac{(y-m)^2}{2N}\right) dy$$

The slopes $d\alpha/dy$ and $d\beta/dy$ are the integrands, so the likelihood ratio is

$$\begin{aligned} L(y) &= \frac{\exp\left(-\frac{(y'-m)^2}{2N}\right)}{\exp\left(-\frac{y'^2}{2N}\right)} \\ &= \exp\left[-\frac{m}{n} \left(\frac{m-y'}{2}\right)\right] \\ &= \exp\left[-k \frac{P}{N} + \frac{m y'}{N}\right] \end{aligned}$$

where P is the signal power and k is a function of the signal waveform. The received signal is recorded as a mark if its amplitude y' is such that $x(y')$ is greater than 1.5.

One further criterion should be mentioned, though its application is beyond the scope of this article, and that is the one known as a *minimax* test. The simple Bayes test requires a knowledge of the signal parameters π_0 and π_1 , but in fact these may be uncertain. Therefore one picks out the worst-case values of π and constructs a test which will give the minimum cost in errors if this worst case occurs. This is the *minimax* criterion, but for all other values of π it will be less efficient than a Bayes test constructed for the specific value of π .

It is difficult at this stage to construct realistic examples. As in all branches of mathematics, practice in use is essential to an understanding of theorems, and the reader who is seriously concerned with decision functions is advised to work out his own cases with the aid of the specialist literature.²

REFERENCES

- (1) "Communication in the Presence of Noise," by C. E. Shannon. *Proc. I.R.E.*, vol. 37, p. 10, 1949.
- (2) "Detection Theory," by I. Selin. Princeton University Press, 1965.

BOOKS RECEIVED

Electronic Components, Tubes and Transistors, by G. W. A. Dummer. Treating the component as a building block, the author explains the characteristics and measurement theory of components treated as discrete elements and then discusses the practical application of components in equipment. Separate chapters deal comprehensively with resistors, capacitors, magnetic materials, electromagnetic components, valves and semiconductor devices. Chapters contain references to sources for further reading; also questions and answers. Pp. 166; Figs. 76. Price 21s. Pergamon Press Ltd., 4 & 5 Fitzroy Square, London, W.1.

Guide to Radio Technique Vol. 1; Fundamentals, Valves, Semi-conductors, by E. Julander. This is a book intended to provide a basis for the enthusiast or student who seriously wishes to improve his theoretical knowledge of radio rather than make a continued practical approach. The opening chapters deal with the fundamentals of electricity, complex numbers and transmission units. A complete chapter deals with the construction, theory and operation of thermionic valves; this is then followed by a similar chapter on semi-conductors in which a comparison is made with valve circuits. The final chapter deals with generation, propagation and modulation of electro-magnetic waves. A 14-page appendix contains useful data presented in the form of tables and monograms. The book is issued as part of the Philips Technical Library and is a translation of the original Swedish edition. Pp. 238; Figs. 214. Price 37s 6d. Distributed by Macmillan & Co. Ltd., Little Essex St., London, W.C.2.

British Miniature Electronic Components Data 1965-66, edited by G. W. A. Dummer and J. Mackenzie Robertson. In this, the fourth annual issue of the publication nearly 170 different types of components from nearly 140 firms are listed. For most components, the textual information is supported by photographs, line drawings and tabular matter. Comprehensive details are given of each type of component and these range from accelerometers to wires and cables. Manufacturers have made available advance details of components to provide the most up-to-date information for designers, users and buyers. Pp. 984. Price £9. Pergamon Press Ltd., 4 and 5 Fitzroy Square, London, W.1.

A new British Standard, BS3934, "Dimensions of Semiconductor Devices," has recently been published. Although international discussion is currently in progress, the need within the electronics industry for a record of the dimensions of semiconductor devices in general use necessitated publication of the Standard as soon as possible. It has, however, been published in loose leaf form to facilitate amendments. The primary object of the Standard is to provide a basis of comparison for mechanical interchangeability; electrical and thermal data is not covered. Copies of the Standard may be obtained, price £4 10s from B.S.I. Sales Branch, 2 Park St., London, W.1.

Electrical & Electronic Trader Year Book 1966.—As usual this book, compiled in collaboration with *Electrical & Electronic Trader*, is a mine of information covering most of the general important aspects of the trade. The publication is divided into eight sections—Valve base diagrams—Specifications—Technical literature—Wholesalers—Proprietary names—Buyers' guide, radio and television—Buyers' guide, domestic electrical—Trade addresses—identified by thumb index tabs which facilitate rapid reference. Additional general information contains a legal guide which includes details of aerial erection, hire purchase and credit sales, noise abatement, tenancies of business premises and the Wireless Telegraphy Act. Pp. 480. Price 35s (plus postage). Iliffe Books Ltd., Dorset House, Stamford St., London, S.E.1.

Servicing Electronic Organs, by C. R. Pittman & E. J. Oliver. The book is written as a practical guide to the theory and operation of electronic organs for the serviceman requiring basic knowledge of this application of electronic techniques. Details are given of the basic circuits encountered and include illustrations and information reproduced by courtesy of ten American organ manufacturers. Originally published in America in 1962. Pp. 191; Figs. 112. Price 30s. W. Foulsham & Co. Ltd., Yeovil Road, Slough, Bucks.

Transistor Receivers and Amplifiers, by F. G. Rayer. Treatment used in the book is essentially of a practical nature and is intended to provide guidance for the home constructor interested in the use of transistors. Basic contents include general descriptions of operating characteristics of semi-conductors, aerials and r.f. amplifiers, superhet circuitry and power supplies. Additional chapters describe printed circuits, test equipment and fault finding. Pp. 164; Figs. 129. Price 30s. Focal Press Ltd., 31 Fitzroy Square, London, W.1.

Many of the titles in the M.I.T. Radiation Laboratory Series of text books originally published by the McGraw-Hill Book Company and regarded as standard works of reference are now available in paper back form from Constable & Co. Ltd., 10-12 Orange St., London, W.C.2. They are:— **Computing Mechanisms and Linkages**, by Svoboda, 18s; **Microwave Antenna Theory and Design**, by Silver, 24s; **Microwave Transmission Circuits**, by Ragan, 24s; **Pulse Generators**, by Glasoe & Lebacoz, 24s; **Principles of Microwave Circuits**, by Montgomery, Dickie & Purcell, 18s; **Propagation of Short Radio Waves**, by Kerr, 24s; **Radar System Engineering**, by Ridenour, 24s; **Theory of Servomechanics**, by James, Nichols & Phillips, 18s; **Threshold Signals**, by Lawson & Uhlenbeck, 18s; **Vacuum Tube Amplifiers**, by Valley, Wallman & Henry, 24s; **Waveforms**, by Chance, Britton, Hughes, Vernon, MacNichol, Sayre, David & Williams, 26s; **Waveguide Handbook**, by Marcuvitz, 18s.

—Vortexion

quality equipment

12-WAY ELECTRONIC MIXER

The 12-way electronic mixer has facilities for mixing 12 balanced line microphones. Each of the 12 lines has its own potted mumetal shielded microphone transformer and input valve, each control is hermetically sealed. Muting switches are normally fitted on each channel and the unit is fed from its own mumetal shielded mains transformer and metal rectifier.

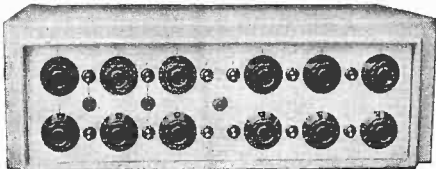

FOUR-WAY ELECTRONIC MIXER

This unit provides for 4 independent channels electronically mixed without "spurious break through," microphony hum and background noise have been reduced to a minimum by careful selection of components. The standard 15-50 ohm shielded transformers on each input are arranged for balanced line, and have screened primaries to prevent H.F. transfer when used on long lines.

The standard 5 valve unit only consumes 18.5 watts, H.T. is provided by a selenium rectifier fed by low loss, low field, transformer in screening box. The ventilated case gives negligible temperature rise with this low consumption assuring continuance of low noise figures.

20,000 ohms is the standard output impedance, but the noise pick-up on the output lines is equivalent to approximately 2,000 ohms due to the large amount of negative feedback used.

For any output impedance between 20,000 ohms and infinity half a volt output is available. Special models can be supplied for 600 ohms at equivalent voltage by an additional transformer or 1 milliwatt 600 ohms by additional transformer and valve.

The white engraved front panel permits of temporary pencil notes being made, and these may be easily erased when required. The standard input is balanced line by means of 2 point jack sockets at the front, but alternative 3 point connectors may be obtained to order at the rear.

Mixer for 200-250V AC Mains	£40 8 6
Extra for 600 ohm output model	£1 18 6
Extra for 600 ohm 1 milliwatt output	£3 0 6
Size 18½in. wide × 11½in. front to back (excluding plugs) × 6½in. high.	
Weight 22 lb.	

THREE-WAY MIXER and peak programme meter, for recording and large sound installations etc.

This is similar in dimension to the 4-Way Mixer but has an output meter indicating transient peaks by means of a valve voltmeter with a 1 second time constant in its grid circuit.

The meter is calibrated in dBs, zero dB being 1 milliwatt-600 ohm (.775V) and markings are provided for +10 dB and -26 dB. A switch is provided for checking the calibration. A valve is used for stabilising the gain of this unit. The output is 1 milliwatt on 600 ohms for zero level up to +12 dB maximum. An internal switch connects the output for balance, unbalance, or float. This output is given for an input of 40 microvolts on 15 ohm.

An additional input marked "Ext. Mxr." will accept the output of the 4-Way Mixer converting the unit into a 7-Way controlled unit. This input will also accept the output of a crystal pick-up but no control of volume is available. The standard input is balanced line by means of 3 point jack sockets at rear but alternative 2 point connectors may be obtained to order at the front or rear as desired.

The 8 valves and selenium rectifier draw a total of 25 watts.

P.P.M. for 200-250V AC Mains	Price on application.
Size 18½in. wide × 11½in. front to back (excluding plugs) × 6½in. high.	
Weight 23 lb.	

10/15 watt Amplifier with built-in mixers.

30/50 watt Amplifier with built-in mixers.

2 × 5-way stereo mixers with outputs for echo chambers, etc.

Full details and prices on request.

VORTEXION LIMITED, 257-263 The Broadway, Wimbledon, S.W.19

Telephone: LIBerty 2814 and 6242-3-4

Telegrams: "Vortexion London S.W.19"

To measure C. W. Power . . . Sideband power . . . Modulation depth

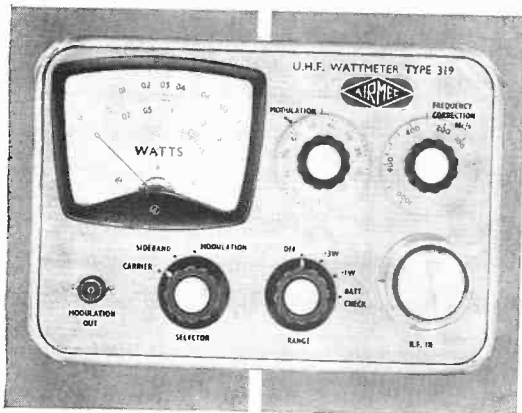

- ★ Frequency Range:
1-1000 Mc/s
- ★ Ranges:
0-100 mW
0-300 mW
3 W with Attenuator
type 321
30 W with Attenuator
type 363
- ★ Input Impedance:
50 ohms

The U.H.F. Wattmeter Type 319 is a light and compact instrument for measuring C.W. power, sideband power, and modulation depth in the frequency range 1-1000Mc/s. Carrier and sideband powers are indicated directly on a $3\frac{1}{2}$ " scale meter in two ranges. Percentage modulation depth is shown on a potentiometer scale,

For carrier measurement no additional power is necessary; internal dry batteries provide power for sideband and modulation measurement. This instrument is one of the units in the Airmec range of U.H.F. equipment which includes connectors, adaptors, attenuators, reactance lines, slotted lines etc.

**SEE US AT
THE I.E.A. EXHIBITION,
STAND NUMBER G 102
GRAND HALL, OLYMPIA
MAY 23-28**

Airmec UHF Wattmeter Type 319



Airmec

for peak performance
— CONSISTENTLY

LABORATORY INSTRUMENTS DIVISION
Oscilloscopes, Wave Analysers, Signal Generators, Phase Meters,
Valve Voltmeters, Ohmmeters, High Speed Counters, etc.

AIRMEC LIMITED, HIGH WYCOMBE, BUCKS, ENGLAND
TELEPHONE: HIGH WYCOMBE 21201 (10 lines)

WW-123 FOR FURTHER DETAILS.

AP286A

NEW PRODUCTS

equipment systems components

THYRISTOR POWER CONTROL SYSTEM MODULES

THE Mullard thyristor firing module (MY5011) has been designed for use in 1 or 3-phase power systems. It is claimed that the cost of thyristor d.c. motor speed controls has been reduced by a new series of Mullard designed control systems, incorporating the MY5011 module. These new systems have been constructed so that motor or control gear manufacturers, or users, can assemble their own control systems cheaply, employing standard components, modules and thyristor stacks. The three systems are, simple speed control, armature-voltage speed control and tachometer speed control.

Additional refinements, such as current limit, controlled acceleration, automatic protection against loss of motor field, compensation for mains variations,

phase control systems to provide automatic correction for load current variations, or short circuit conditions, and start facilities for motor control.

When this module is in a feedback system, between a current sensing device, e.g., a current transformer, and a thyristor module, the onset of the current limit occurs when the input to the MY5051 is 2.6 V r.m.s. At lower outputs, the module has little effect on the control circuit, but at higher inputs the trigger angle of the thyristor is rapidly increased. Price: £5 16s.

The cost of these power control systems varies between £24 for a d.c. motor speed control with +0, -10% regulation of set speed (for single phase 1 h.p.), to £130 for a d.c. motor speed control system with tachometer feedback offering +0, -1% regulation of set speed (for single phase 5 h.p.). There is also a three-phase version of the tachometer system at £101. Further information from Mullard Industrial Markets Division, Mullard House, Torrington Place, W.C.1.

WW 301 for further details

P.I.N. Diodes

FROM Microwave Associates Limited, comes a range of microminiature P.I.N. diodes, suitable for series mounting in strip transmission line circuits. In all-glass hermetically sealed microminiature housings, these diodes offer low total capacitance (high isolation in series switch mode) and low series resistance (low insertion loss). Typical performance of this new series is demonstrated by the MA-4732C which has a minimum breakdown voltage of 75 V, maximum total capacitance of 0.3 pF, maximum series resistance of 2 Ω , and a maximum switching speed of 10ns.

Further details from Microwave Associates Ltd., Cradock Road, Luton, Beds.

WW 302 for further details

Ultra-thin Pressure Transducers

SENSOTEC sub-miniature pressure transducers by Scientific Advances Inc., U.S.A., are available either as the SA-SA absolute, or the SA-SD differential pressure transducer. Both provide a full scale output up to 60 mV, making it possible to resolve small pressure changes. The transducer is a 0.02in thick capsule, one side of which is the active diaphragm. The sensing element is a semiconductor bonded strain gauge. The SA-SA and SA-SD are intended to be compatible with all types of standard strain gauge instrumentation. Models are available in a range of pressures from 2 p.s.i. to 2000 p.s.i. Operating temperature range is -40° to +150° F. Full details from sole U.K. agents, Wessex Electronics Ltd., Royal London Buildings, Baldwin St., Bristol 1.

WW 303 for further details

PANORAMIC MICROWAVE RECEIVER

THIS receiver, from Microwave Physics (U.S.A.), is for use in the design and testing of harmonic generators, solid state signal sources, transmitters, and other signal generators, where observation of spurious and harmonic signals is desirable. The circuit uses an electronically swept yttrium iron-garnet bandpass filter as a prescaler. The filter which has a decade tuning range, is followed by a sensitive crystal detector, and a low-noise video amplifier.

Two versions of this receiver are available; the MPR-U (0.5 to 5 Gc/s), and the MPR-X (2 to 12 Gc/s), both sets permitting continuous 'scope display of signals within the stated ranges.

The MPR-U and MPR-X are available either as plug-in modules for Tektronix scopes (£722) or with self-contained power supplies for use with other scopes (£876).

Marketed by Microwave Systems Ltd., 9-10 River Front, Enfield, Middx. WW 304 for further details

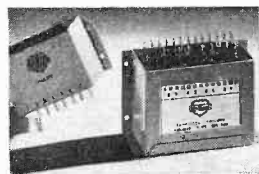

and motor field heating can be added to these basic circuits.

The MY5011 thyristor firing module will fire four 70 A thyristors connected in parallel or series, and provide continuously variable, and reliable control, over a power range of below 0.25% to above 99.9% of maximum power.

Size: 9.14 x 6.60 x 4.82 cm in an epoxy resin encapsulation.

Price: £14 18s.

Also available in the simple, single-phase module MY5000, capable of driving two 70A thyristors. Price: £5 5s.

Current limiting and surge suppression module (MY5051) is for use with existing thyristor stacks and firing modules. It will enable single-phase or three-

NICKEL BIT SOLDERING IRONS

SOLDERING irons with bits of solid nickel are now being produced by the West Germany company, Loring Werner Bittman, of Windscheid Strasse 18, Berlin 12. Nickel was chosen in

preference to copper because of its excellent resistance to corrosion by the chemicals and resins used as fluxes. It is readily "wetted" by the solder, while its thermal capacity and conductivity are satisfactory for this application.

Two models Pico Pen 15TS—(15W for small work) and Pico Post 30PL—(30W for larger work) have their heating elements and bits designed so that heating to 200 degC takes 0.7 and 1.5 minutes respectively.

WW 305 for further details

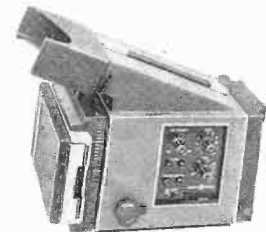
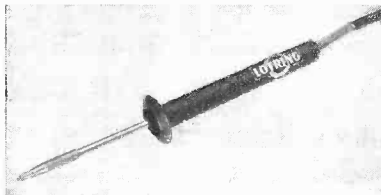

OSCILLOSCOPE CAMERA

THE Hewlett-Packard model 197A camera uses an electronically controlled shutter calibrated in nine even steps from 1/30 to 4 s. X-synchronization, particularly useful in photographing one-shot phenomena, is controlled by connections made to an external instrument panel.

Where an internal graticule is used on the oscilloscope an optional ultraviolet light source is available to illuminate the graticule. Pre-exposure for the graticule and exposure for the trace is performed automatically by the setting of a single control. The back of the camera can be rotated from a horizontal position to vertical so that two smaller photographs can be taken on a single film. Price of the camera is £184 or without the ultraviolet light facility £165.

WW 308 for further details

Capacitance Tester

FOUR-DIGIT in-line readout is utilized on the Model 1201 Digital Capacitance Tester manufactured by the American company of Micro Instrument Co. and marketed by Claude Lyons Ltd., Ware Road, Hoddesdon, Herts. The instrument has been designed for two- or three-terminal measurements and uses a 1 Mc/s, 35 mV r.m.s. test signal. A 0 to 100 V bias supply is provided for reverse biased diode and varactor capacitance measurements and for transistor C_{ob} (capacitance between base and collector with emitter o/c) and C_{cb} (capacitance between base and emitter with collector o/c) measurements. Overall accuracy is a combination of measurement accuracy, which is $\pm 3\%$, and a readout accuracy of ± 1 digit. The instrument will tolerate shunt resistances down to 10 k Ω without loss of accuracy and permits in-circuit capacitance measurements and measurements

on integrated circuits having low shunt resistance. Operation is based on the principle of frequency deviation. Two high-stability tunnel diode oscillators are used, one of which varies its frequency linearly with the applied capacitance. The difference frequency output from a mixer is applied to gating and zeroing circuitry and then to an electronic frequency counter for direct display as capacitance.

Three versions are available. Two single-range versions are models 1201 (0-99.99 pF) and 1201S (0-999.9 pF) both priced at £798 or £878 with print out, and a dual-range model 1201DS (0-99.99 and 0-999.9 pF) at £998 or £1,078 with print out. A transistor jig for TO-5 and TO-18 cans with C_{ob} and C_{cb} switch and 30 in coaxial leads is available for £40.

WW 306 for further details

Circuit Board for Module System

AN insulated board, the C.B.1, is perforated to the 0.1 in standard grid, and is suitable for mounting wire or tag-ended components. The board mounts on two tie rod supports behind individual module front panels. Each module can carry 1 or 2 boards. It is claimed that for experimental construction circuits, this system is neat, durable and versatile. Price: 4s 6d. A.P.T. Electronic Industries Ltd., Chertsey Road, Byfleet, Surrey.

WW 307 for further details

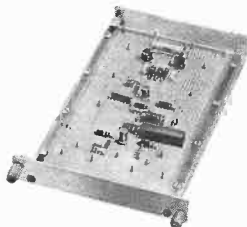

Matched Signal Divider

THE Bishop Type 080-001 matched signal divider permits a source to drive two paths, and maintains 50 ohms impedance at input and output. The ability to handle signals with fast rise time of 100 picoseconds makes it suitable for pulse as well as u.h.f. carrier wave applications. It can also be used to add signals from 50 ohm sources. Connectors are BNC (3).

Available in the U.K. from Claude Lyons Ltd., of Hoddesdon, Herts., the divider costs £10.

WW 309 for further details

Unspillable Lead Acid Cell

THE compact 2V Exide cell MRP7 which weighs 12oz filled and measures $1\frac{1}{2}$ in \times $2\frac{1}{4}$ in \times $3\frac{1}{4}$ in is unspillable, even when inverted. The plate alloy permits the cell to be maintained under floating and trickle charge conditions, and to be used where frequent discharge and recharge demands have to be met. The cell has a capacity of 4Ah at a 20 hour rate, and is suitable for intermittent, and standby use, since it is capable of standing idle for long periods.

Moulded in transparent styrene acrylonitrile, with four ribs to support the plates, and accommodate sediment, the container has red lines on it, to indicate maximum and minimum electrolyte levels. Specific gravity charging rate, and topping up instructions are also shown. Price 29s.

WW 310 for further details

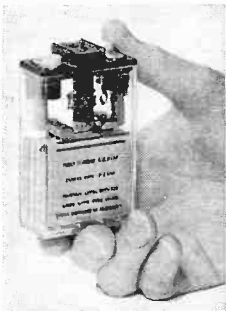

Miniature Lever Switches

THE 5000 and 5100 BECUWE series of lever key switches made in France have stainless-steel frames, levers, spindles and securing plates. The keys are from 0.78in (20mm) to 1.73in (44mm) in length, depending on contact combinations, 0.425in (10.8mm) wide, and 1.76in (44.6mm) deep (behind panel). They are identical in all characteristics, except for the method of panel mounting; the 5000 series being supplied with a central stainless-steel milled nut for 0.325in (8.2mm) diameter single hole fixing, while the 5100 series have 2 fixing screws for 2 side holes 0.09in (2.3mm) diameter.

The cam is made of the hard plastic DELRIN, and the contact springs of nickel-silver. The self cleaning twin contacts in fine silver have the following ratings (non-inductive) for a.c. operation at 48V-2A, at 110V-1A, and



at 250V-0.6A. For d.c. operation 48V-0.6A, at 110V-0.3A, and at 250V-0.2A.

Contacts are also available in Palladium or other materials to order. The maximum number of contacts per side for all types are 3 change-over, or 5 normally-opened, or 5 normally-closed.

The conical stainless-steel lever can be colour coded by means of a slip-on neoprene mantle in Black, Green, Red, Blue or White. Full information from Britec Ltd., 17 Charing Cross Road, W.C.2.

WW 312 for further details

Time Interval Measurement

THE A. G. Brown MINITIME is designed to measure the time interval between opening, and/or closing of contacts. Moulded in black plastic, and powered by two batteries, this instrument has a 3in meter with a linear scale, calibrated 0 to 10 and 0 to 3. Persistence of reading is within 1% for at least 1 minute, provided the insulation resistance of the external circuit is high enough to prevent leakage leads or contacts. The ranges cover 0 to 300 μ s, 0 to 300ms, and 1 to 10s. Readings are $\pm 2\%$ f.s.d. Controls on the front panel are: range selector, function selector, zero set, calibrate.

Amongst suggested applications for the MINITIME are, measurement of delay between closing or opening of sets of contacts on relays or contactors, measurement of velocity of moving objects by operation of trip wires, etc.,



and measurement of exposure times in photography. Size: $5\frac{1}{2}$ in (14.5cm) \times $3\frac{1}{2}$ in (9.5cm) \times $1\frac{1}{4}$ in (4.5cm). Weight 1lb 4oz (0.6kgm) unpacked. Batteries B121, U10 (1 of each).

From A. G. Brown Electronics Ltd., Lower Mills, Busby, Glasgow.

WW 313 for further details

MICRO-CIRCUIT WELDER

A COMPACT multi-purpose micro-circuit bonding system, capable of welding, brazing, parallel-gap soldering and thin film diffusion bonding, is available from Hughes International (U.K.) Limited, Heathrow House, Bath Road, Cranford, Hounslow. Occupying only 20 inches of bench space, the system includes a power supply (MCW 550), two sizes of bonding heads, micro-positioning apparatus and accessories, and a stereozoom microscope. The smaller head, designated Model VTA-90, is designed for ultra-fine materials and can be adjusted to apply bonding pressures as light as 10 grams. The larger head, VTA66, is used for parallel-gap welding or soldering of flat packs, memory plane matrices and other surface bonding applications.

WW 311 for further details

INFORMATION SERVICE FOR PROFESSIONAL READERS

To expedite requests for further information on products appearing in the editorial and advertisement pages of *Wireless World* each month, a sheet of reader service cards is included in this issue. The cards will be found between advertisement pages 16 and 19.

We invite professional readers to make use of these cards for all inquiries dealing with specific products. Many editorial items and all advertisements are coded with a number, prefixed by WW, and it is then necessary only to enter the number on the card.

Postage is free in the U.K. but cards must be stamped if posted overseas. This service will enable professional readers to obtain the additional information they require quickly and easily.

COMMUNAL AERIAL AMPLIFIERS

NEW communal aerial amplifiers for television and sound signals and combined u.h.f. and v.h.f. crystal controlled converters have been introduced by Teleng Ltd. The design of the new



amplifiers is based on the dual channel U30 amplifier to which has been added a wide band amplifier and power supply. Two models are being introduced—"Popular Four" (Type E342) priced at £16 10s and "Popular Five" (Type E343) priced at £18 6s; the gain of the E342 is 25 dB for both TV and f.m., whereas the gain of E343 is 40 dB for TV and 35 dB for f.m. The amplifier can be preset for reception of any specified channel in Band I and Band III but for Band II the tuning range covers 88-100 Mc/s. Sensitivity is 250 μ V minimum and output is 100 mV maximum.

These amplifiers are most suitable for smaller networks where the original wide-band "U" series of amplifiers has

proved to be too expensive. Also in installations where provision for the later addition of other channels is not required, the units are claimed to be most competitive.

The u.h.f. and v.h.f. converters are based on a modified design of the U166 converter, which allows BBC-2 to be "added" to existing single-channel systems. This has resulted in two versions of the U166 which are designated Type U338 (£49 15s), having a gain of 50 dB, and Type U340 (£47 4s) having a gain of 35 dB. Maximum output levels for both amplifiers is 300 mV. The combination of the new converters and amplifiers produce a distribution system for three television channels and three

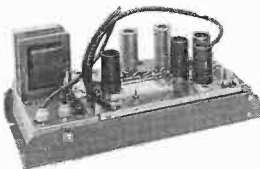

f.m. programmes which will provide high quality signals for up to 100 outlets. Available from Teleng Ltd., Teleng Works, Church Road, Harold Wood, Essex.

WW 313 for further details

R.F. Piston Attenuator

A PISTON attenuator giving an attenuation range of 100 dB at frequencies from 1 Mc/s to 2 Gc/s has been introduced by Flann Microwave Instruments (9, Old Bridge Street, Kingston-upon-Thames, Surrey) under the type number IF 100. Designed as a basic attenuation standard, it comprises a precision electroformed tube with an input-tunable launching loop and a sliding pickup loop coupled to a direct-reading

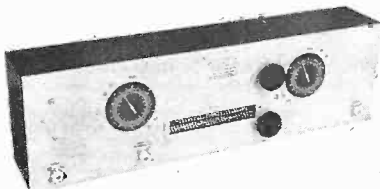

scale. The change in attenuation is indicated on dial gauges in steps of 2 dB per revolution. The upper linear scale is permanently fixed and indicates 0-100dB in 2dB steps. The lower linear scale is movable and provides an arbitrary datum when set to a cursor line anywhere within the range of the attenuator. Impedance is 50 Ω and the cut-off frequency is in the region 3-4 Gc/s. For the highest accuracy measurements - small setting corrections have to be made as the measurement frequency deviates from the design frequency (60 Mc/s), but a correction curve is supplied.

WW 315 for further details

260

Rectifier Bridges for Printed Circuits

THESE bridges by Pirelli (Milan) are single phase, resin cast units, with a body length of $\frac{1}{8}$ in. and $\frac{1}{16}$ in. diameter.

The WO2, WO4 and WO6 bridges which respectively have a p.i.v. of 200, 400 and 600 V, possess these principal ratings.—Max. average rectified output at 50°C, 1.5 A, at 100°C, 1 A; peak single-cycle surge current 50 A; max. forward voltage drop at 1 A and 25°C, 2 V; and max. leakage at rated p.i.v. and 25°C 10 μ A. The bridges have an operating temperature range of -55° to +125°C. Prices are: WO2—19s 6d; WO4—22s; and WO6—28s 6d.

Available from S.D.S. (Portsmouth) Ltd., 67-69, Commercial Road, Portsmouth, Hants.

WW 316 for further details

SUB-MINIATURE SWITCH

ALL the existing SE series of switches (with the exception of the 75E model) of Honeywell Controls Ltd., Brentford, Middlesex, is to be replaced by a recently developed miniature switch—the 91SE. The switch, designed primarily for use in the aircraft industry, incorporates a new fluoro-silicone seal, with a corrosion-resistant steel plunger which ensures protection from all oils and fuels. Basically, the switch comprises a standard 11SM1-T micro switch sealed in epoxy resin in a corrosion-resistant case 0.6 x 0.876 x 0.34 in. The cable connections are covered by an outer sheath of extruded p.t.f.e. which affords good protection against heat and abrasion. Designed to operate within a temperature range of -62 to 150°C, the 91SE can be fitted with a range of actuators from the Honeywell J.E. series. By this

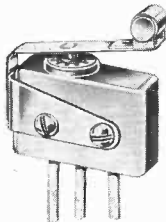

means the switch can be operated from cams, slides or other devices which are not in line with the motion of the switch plunger. The illustration shows a roller leaf actuator, JE-5, for applications involving rapid cam or slide operation.

WW 317 for further details

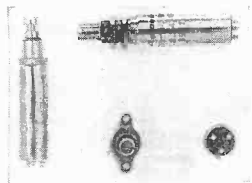

HELICAL POTENTIOMETER

A TEN turn potentiometer with a resistance range of 50 ohms to 100 k Ω is offered by Reliance Controls Ltd. A linearity of $\pm 1\%$ is available, which can be improved by selection to $\pm 0.1\%$. With a temperature range of -55°C to $+100^{\circ}\text{C}$, the unit has been tested for vibration and shock to MIL.202. The style number is HEL. 05-10, and the unit has a body diameter of $\frac{1}{2}$ in. Available in flange and bush mounted versions, as seen in the illustration, from Reliance Controls Ltd., Sutherland Road, London, E.17.

WW 318 for further details

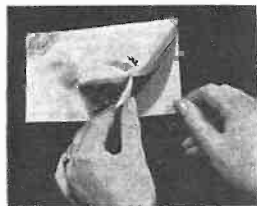

Copper Sheet for Printed Circuits

MANUFACTURED by Peak Sound (Harrow) Ltd., and marketed under the name "Cir-Kit" this adhesive copper sheet is intended for constructing prototype circuits.

The sheet (0.002 in thick) is coated on one side with a heat resistant adhesive, which, in turn, is protected by a paper backing. Offered in $\frac{1}{2}$ in wide strip (at 7s 6d for 24 feet) that can be cut to length, or in 6 in wide sheets (6s for 1 foot) permitting required dimensions to be drawn on the backing paper, and cut out with scissors or knife. The paper is stripped off, and the shape pressed firmly on a laminated board. Normal drilling and soldering may be carried out.

From Peak Sound (Harrow) Ltd., 10 Asher Drive, off Mill Ride, Ascot, Berks.

WW 319 for further details

195 CHANNEL MARINE TRANSMITTER

THE Redifon G.341 gives complete coverage of the marine bands 400 to 535 kc/s, 1.6 to 3.8 Mc/s, and 4 to 26 Mc/s, offering a choice of 195 channels between 400 kc/s and 26 Mc/s. As a ship's main transmitter, it also incorporates facilities for short, medium and long range radiotelephony on s.s.b. as well as on d.s.b. The output power of 1,200 W p.e.p. available for long distance s.s.b. h.f. radiotelephony can be reduced by preset adjustments so as to comply with particular national regulations.

Deck or bench mounted, the transmitter and power unit are in separate housings. Modular construction is used extensively, facilitating speedy interchange of units and sub-units, without realignment or soldering. Ease of access is ensured by glide-out units. Short circuiting or breaking the aerial connection will not damage the transmitter, and power supply circuits are fully protected against damage under fault conditions.

The G.341 is fully type approved by the G.P.O., complying with the 1965 Merchant Shipping (Radio) Rules, also conforming with C.C.I.R. Recommendation No. 258 (Los Angeles 1939) with respect to SSB equipment for maritime use.



Power supply: 440 V ($\pm 10\%$) 50/60 c/s 3 phase.

Power consumption: maximum 3 kVA.

Redifon Ltd., Broomhill Road, S.W.18.

WW 320 for further details

Cored Preform Washers

UNDER varying forms of vibration, printed circuit boards may show failure of contact at the eyelets. The small fluxed solder preforms from Enthoven are designed to go on to the printed circuit, and under the eyelet, which is then punched by the normal method. The preformed washer, now sandwiched between board and eyelet, can be hand or machine soldered, offering a sound mechanical joint, and minimizing this fault condition.

These preforms can be produced with diameters down to 0.047 in, and with thicknesses down to 0.01 in. The flux contained in the preforms is a non-corrosive organic type of material.

Large runs requiring solder preforms of this type, can be supplied to any specification with reference to the alloy (available with melting points from 190 deg C to 245 deg C), and dimensions. Enthoven Solders Ltd., Upper Ordnance Wharf, Rotherhithe, S.E.16.

WW 321 for further details

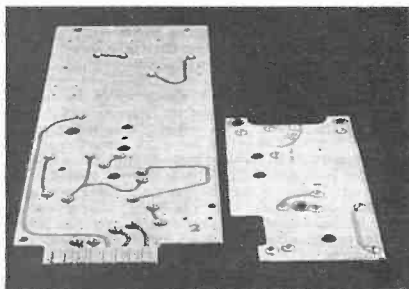

Mirror-Image

It was Alice who started it all when, in Looking Glass Land, she found that she had to run very fast indeed in order to stay in the same place. Today it has become an article of faith; a good old standby for the politician guest of honour at the electronics dinner, who never fails to remind his audience that electronics is a growth industry and therefore its economy must expand steadily if it is to survive.

The audience, mostly company chairmen, in turn never fail to applaud this sentiment because it is always safer to clap than to be obliged to argue later about something you don't understand. The politician, thus encouraged, follows up with an exhortation to one and all to double their export sales. This is received in deadly silence because experts are a chairman's recurring nightmare and he doesn't want to be reminded about them at social functions.

Eventually, the constant reiteration at such gatherings gets on the chairman's nerves to the point where the subject is put on the agenda for discussion at the next board meeting. The directors don't understand the economy-expansion bit either, but it would never do to admit it, so it is decided that vigorous action is called for. As this involves nothing more onerous than telling the general manager to pull his socks up, it is implemented forthwith.

The hapless G.M., having no wish to receive the golden handshake just yet, gets down to an analysis of the situation. He knows only too well that his export figures can only be doubled at the expense of the mighty American electronics industry, and the temptation to cast the situation in terms of David and Goliath is irresistible. But the stripling David, he reflects glumly, did not have to take the field with his hands tied behind his back by lashings of credit restrictions.

There is clearly only one possible course of action. He must build his stripling into something approaching the size of the opposition, starting with that genesis of exportable products, the research laboratories. Mass attack is henceforth the order of the day.

So, away to the universities and technical colleges and rope in anyone who has a degree and feels warm to the touch. And, in parallel with this operation, send all senior research men over to the States to get the know-how on this mass attack business.

This realistic approach brings results. The recruitment scheme donates so much new blood that there are not enough arteries at the laboratories for them to course through, so 50 Nissan huts have to be thrown up on the nearest available site, a piece of cow pasture some forty miles away. There the recruits sit like birds in the wilderness with not a multi-test set between them.

The delegation to the U.S.A. also brings in the sheaves. Seventy-two per cent of its members return to hand in their respective resignations. This is highly encouraging to the new blood because it makes for quick promotions. The overall situation is encouraging to the Board because without doubt the G.M. has succeeded in invoking the magic word "expansion," although the directors are a shade hazy as to the detail. It is also encouraging to Goliath as he goes about his lawful occasions of kicking the undercarriage from British avionics and covering every square inch of the country with microcircuits.

With the bit now firmly between his teeth the G.M. then holds an inquest on development and production, with his

senior management as chief witnesses. He enters the meeting thoroughly alarmed at the monumental ratio of clerical staff to those on the production floor and determined to enforce a ruthless streamlining. But the senior management have done their homework thoroughly and each produces statistics to prove beyond doubt that, far from being over-stuffed, his particular domain is well below skeleton level and only functions as well as it does by reason of genius at the helm.

Baffled in his attempt to beat Parkinson's Law, the G.M. in desperation invokes the most powerful ju-ju of all. He calls in a firm of Efficiency Consultants.

At zero hour the Assyrian comes down like a wolf on the fold. A small army of elegant young ladies and gentlemen disperse themselves around the territory like langorous Big Sisters and Brothers—watching. This is phase one. In phase two the meetings start. Interminable meetings, presided over by one or other of the voluble experts: meetings at which expressions like "procedures improvement," "procedures analysis," "timetable productivity," "function output" and "conversion integrals" sweep like machine gun fire over the stunned assembly. The entire organization dissolves into soviets as if all the secret societies in the world were holding their meetings in separate compartments under one roof. The telephones are all silent; no point in ringing anyone because he will be at a meeting.

At the end of a highly expensive twelvemonth the Chief Wizard pitches in his recommendations to the G.M. Shorn of its double talk it advises that several new departments should be inaugurated without delay. One of the most vital of these is the Image Promotion Dept., for it seems that the Company Image needs a face-lift which can only be achieved by a strenuous drive in prestige advertising in newspapers, journals, cinemas, television and exhibitions.

A 500% increase in time and motion study staff is considered essential, together with the institution of a Network Analysis Division. The immediate objective of the latter is to replace the old-fashioned term "work" with all its distasteful associations by the more socially acceptable word "activities," thus at last giving recognition to those who are perpetually in a high state of activity but do not work at all.

In depth, it exists to promote secret clubs, identified by such acronyms as BURP, SLUG, RANT or SQUIRT (the latter standing for System Quotient Unification in Rational Tendencies).^{*} The initiates go into hibernation with a computer for three months and then emerge with a wall-chart emblazoned with something which looks like a cross between a drunken octopus and a map of London's Underground.

In brief, a dazed G.M. adds all the efficiency-aid departments suggested. When this is done he finds himself at the head of an empire which is twice the size it was before the Efficiency Consultants got at it. The G.M. is accordingly restyled arch-comptroller; his erstwhile managers become comptrollers; section chiefs become managers and so on all down the line, with salaries increasing *pro rata* naturally.

The entire Company structure hums with new vigour. Everyone in the organization is hard at it from dawn to dusk answering internal memos and initiating their own quota. The whole outfit is now in a condition which has been aptly

^{*} The latest from the U.S.A. is PRIDE—Personal Responsibility In Daily Effort.—Ed.

described as self-oscillating, using paper-work coupling.

The Chairman can now listen with equanimity to any after-dinner politician, for his Company is now more than fulfilling the dictates of the economists and expanding like a soap bubble (if the simile is not too unfortunate).

Exports? . . . er . . . well. The full benefits of expansion will naturally not be felt for a year or so and—purely as an interim measure, you understand—the prices of end products will have to increase somewhat; a moderate 50% perhaps? After all, these foreigners should be only too glad to pay for solid British workmanship allied to 21st century efficiency.

MAY MEETINGS

Tickets are required for some meetings; readers should, therefore, communicate with the secretary of the society concerned

LONDON

2nd. I.E.E.—Colloquium on "Current topics in tropospheric propagation" at 2.30 at Savoy Pl., W.C.2.

9th. I.E.E.—Discussion on "An engineer's ideas on some of the electromagnetic fundamentals" at 5.30 at Savoy Pl., W.C.2.

10th. I.E.E.—"Automatic control in railway systems" by S. Jones at 5.30 at Savoy Pl., W.C.2.

11th. I.E.E.—"Holography" by Prof. D. Gabor at 6.0 at Savoy Pl., W.C.2.

13th. I.E.E.—Discussion on "The C.E.I., its implications on engineering courses" opened by Prof. M. G. Say at 5.30 at Savoy Pl., W.C.2.

23rd. I.E.E. & I.E.R.E.—Discussion on "Electrical aids to the handicapped" at 10 a.m. at Savoy Pl., W.C.2.

23rd. I.E.E.—Colloquium on "A new look at energy storage" at Savoy Pl., W.C.2.

BIRMINGHAM

18th. Television Soc.—"Take 625 lines" by L. Marsland Gander at 7.0 at Broadcasting House, Carpenter Rd., Edgbaston.

FARNBOROUGH

10th. I.E.E.—"Long-wavelength laser generation" by L. E. Mathias at 6.30 at the Technical College, Boundary Rd.

MANCHESTER

10th. I.E.E.—Hunter Memorial Lecture "Lasers and associated devices" by Dr. G. G. MacFarlane at 6.15 at Renold Building, the College of Science and Technology.

PAISLEY

10th. I.E.E.—Discussion on "Computers and computing in electrical engineering courses" at 6.0 at the College of Technology.

PLYMOUTH

9th. Television Soc.—"Video tape for studio inserts" by Reg Pirkin at 7.30 at the studios of Westward Television Ltd.

LATE APRIL MEETING

LONDON

26th. Soc. of Relay Engrs.—"The application of wideband transistor amplifiers to modern v.h.f. television networks" by R. J. Seacombe at 2.30 at the I.E.E., Savoy Pl., W.C.2.

WIRELESS WORLD, MAY 1966



THE HOUSE OF BULGIN AT YOUR SERVICE

OVER 15,000 COMPONENTS

MADE THROUGHOUT IN OUR FACTORY AT BARKING
(A SMALL SELECTION)



List No. D.906/M/55/2
The world's largest range of Legend Indicators to choose from.



List No. J.35
2-pole insulated Short Panel Jacks conforming to B.S.666.



List Nos. P.538-9
Chrome or Gold plated Jack Plugs for co-ax. concentric cables.



List No. D.925
Miniature push-fit neon lamp with AMP 250 series tags.



List No. C.R.48
Insulated Crocodile Clip with tags suitable for AMP-type connectors.



List Nos. F.296, 297
All phenolic moulded panel mounting fuseholders. Front Knob carrier unswivel.



List No. M.P.10
A heavy-duty panel-mounting Meter-push with screw Terminals.



List No. B.1
Panel-mounting Cell Holder accepting one Cell U.11, etc. size.



List No. B.6
Base-fixing Cell Holder accepting one Cell U.2, etc. size.



List No. K.492
One of a range of bar knobs with aluminium 'decor' inserts.



List No. K.303
A pair of concentric grub-screw fixing Instrument Control knobs.

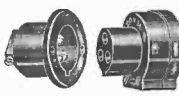

List No. P.73/S.E.
Fully insulated side-entry connectors with one-piece floating electrodes.



List No. S.M.370/P.D.
One of our full range of Double-Pole Moulded Switches.



List Nos. S.500-502
The illustration left shows a standard Rolling-spring Micro-Switch, right shows an useful Sub-miniature Micro-Switch.



List Nos. S.800, 900



List No. M.B.C./M.126
Miniature-Bayonet-Cap Lampholder with moulded base conforming to DEF.5000.

SEND FOR CATALOGUE, REF. 205/C

A. F. BULGIN & CO. LTD.
Bye Pass Rd., Barking, Essex.
Tel: RIPPleway 5588 (12 lines)

MANUFACTURERS AND SUPPLIERS OF RADIO AND ELECTRONIC COMPONENTS TO:
ADMIRALTY, MINISTRY OF DEFENCE, B.S.C., C.P.O., WAR OFFICE, MINISTRY OF AVIATION, MINISTRY OF SUPPLY, I.F.A., HOME OFFICE, RESEARCH ESTABLISHMENTS, CROWN AGENTS, U.K.A.L., N.P.L., U.S.R.

WW-124 FOR FURTHER DETAILS.

FLIGHT DATA RECORDING

DETAILS FROM THE AEROSPACE INSTRUMENTATION SYMPOSIUM AT CRANFIELD

SPONSORED by the College of Aeronautics and the Instrument Society of America, the fourth international Aerospace Instrumentation Symposium held at the College at Cranfield, Beds, at the end of March, was the best attended yet. Well over 300 delegates were present from 10 countries and 31 papers were read.

Held in conjunction with the symposium was an exhibition of aerospace instrumentation equipment. Flight data recording equipment was well to the fore and exhibited on the stand of S. Davall and Sons Ltd. was the recorder retrieved from the crash of a Vanguard at London Airport last October. Apparently the recorder suffered an impact shock equivalent to a deceleration approaching 1000g for 5ms and during the subsequent fire it was subjected to a temperature of approximately 1000°C. The recording wire however was unbroken and the data has been available for the investigation of the crash.

Details of some of the electronic equipment for the Concorde were also available. Elliott Bros. (London) Ltd. were showing the Elliott AIR-3, a high-density digital recorder accommodating 33 channels of 800 bit per inch information on one inch tape and designed by Elliott-Automation especially for the Concorde. Where necessary signals are converted from analogue to digital form and multiplexed. Information from about 300 points on the aircraft will be monitored, and in some cases the sampling rate will be five times per second. With flight recorders so much in the news it was interesting to note that a paper presented by J. J. Smith (Consolidated Electrodynamics Corporation) discussed the practical aspects of aerospace tape recorders. A point emphasized by the author was the effect of space environment on the performance of a recorder as compared to operation in laboratory conditions. An example given by the author was that where acceleration and vibration cause an increase in power consumption by the recorder due to high radial and thrust loads placed on rotating shafts. The increase in power is that drawn by the motor speed control system which ensures that adequate torque is provided to maintain the speed requirements. The solution was to orientate the drive motor so that the axis of its rotation was parallel with the axis of maximum mechanical energy input. Shock and vibration also introduce mechanical effects which cause flutter (instantaneous departure of the tape from a nominal speed) and dynamic skew (non uniform velocity of the tape across its width) and time displacement error (the integral of flutter). These errors have been minimized by the design of appropriate shock and vibration mounts which has been achieved by close co-operation of the shockmount designer, the recorder manufacturer and the ultimate user.

Looking towards the future, the author outlined new developments which would improve performance. Integrated circuitry with its advantages of reduced weight and space and the ability to incorporate the integrated circuit amplifier in the tape head would make possible better signal-to-noise ratios and a high signal level. Higher longitudinal information packing density is expected and lateral density will depend on the number of tracks per inch. Present magnetic tape limited longitudinal packing where surface magnetization at short wavelengths does not allow optimum use of the energy storage characteristic of the oxide, but new materials are expected to provide a higher figure with

thinner coatings. Problems of lateral density are the need for shielding between adjacent tracks and the guiding of the tape between record and reproduce heads where small deviations are significant. At the moment 42 tracks per inch are available. The author also discussed the possibilities of incremental recorders, fast stop-start recorders which record only the data desired. These offer good possibilities where requirements of an aerospace data recording system are for discontinuous recording or flight editing. Their advantages over continuous recorders are obvious, but at the moment these recorders are limited to the recording of digital information where the requirements of flutter and speed accuracy needed for analogue information are not important factors.

THE MONTH'S CONFERENCES AND EXHIBITIONS

Further details are obtainable from the addresses in parentheses

LONDON

- May 2-9 Olympia
Numerically Controlled Machine Tool Exhibition
(Machine Tool Trades Assoc., 25-28 Buckingham Gate, S.W.1)
May 10-20 Earls Court
Mechanical Handling Exhibition
(Mechanical Handling, Dorset House, Stamford St., S.E.1)
May 23-28 Olympia
I.E.A.-Instruments, Electronics & Automation Exhibition
(Industrial Exhibitions, 9 Argyll St., W.1)

BRIGHTON

- May 15-19 Hotel Metropole
R.T.R.A. Conference
(Radio & Television Retailers' Assoc., 19 Conway St., W.1)

EASTBOURNE

- May 3-5 Congress Theatre
British Joint Computer Conference
(Joint Conference Secretariat, I.E.E., Savoy Pl., London, W.C.2)

SALFORD

- May 5-6 Royal College of Advanced Technology
Ultrasound in Medicine
(Dr. Basil Brown, Dept. of Physics, Royal College of Advanced Technology, Salford, Lancs.)

OVERSEAS

- Apr. 29-May 15 Oslo
Britain 66
(British Overseas Fairs, 21 Tothill St., London, S.W.1)
Apr. 30-May 8 Hanover
Hanover Fair
(Schenkers Ltd., 13 Finsbury Sq., London, E.C.2)
May 2-4 Washington
Communications Satellite Systems Conference
(I.E.E.E., 345 East 47th St., New York, N.Y. 10017)
May 4-6 Washington
Electronic Components Conference
(I.E.E.E.E., 345 East 47th St., New York, N.Y. 10017)
May 10-12 Boston
National Telemetering Conference
(I.E.E.E., 345 East 47th St., New York, N.Y. 10017)
May 22-26 Sydney
Radio & Electronics Engineering Convention
(Instn. of Radio & Electronics Engrs., Box 3120 G.P.O., Sydney, N.S.W.)

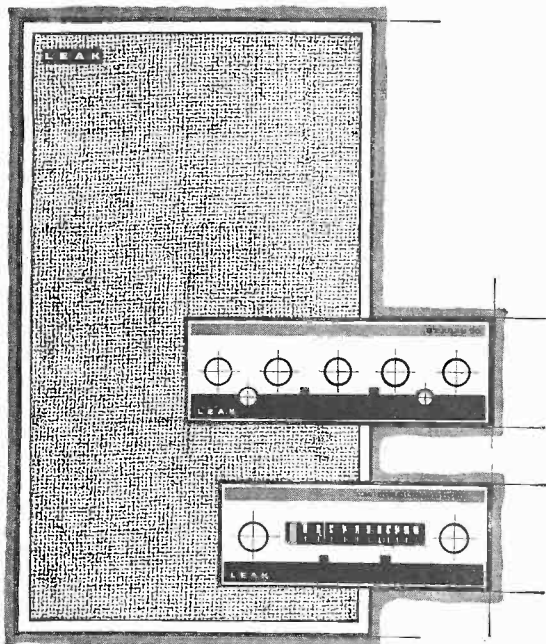

The LEAK SANDWICH

A TRIPLE FIRST FOR LEAK



A SUCCESSOR TO THE FAMOUS
"TROUGHLINE II" : FM "TROUGHLINE 3"
Price £31 : 14 : 6d.

HI-FI NEWS—"To sum up
the Leak Troughline II belongs to the very limited class of aristocrats
in the tuner world."



A MAJOR LOUDSPEAKER INVENTION
THE "SANDWICH" Price £39 : 18 : 0d.

AUDIO AND RECORD REVIEW—
"... This design must be regarded as a
breakthrough of fundamental and far-
reaching importance."

If you are interested in Hi-Fi equipment combining faultless presentation with audio engineering to impeccable standards offering studio quality reproduction at reasonable cost . . .

ANOTHER MILESTONE IN AUDIO ENGINEERING
"STEREO 30" TRANSISTORISED AMPLIFIER
Price: £49 : 10 : 0d.



WIRELESS WORLD Editorial, May
1963—"Last autumn during his presi-
dential address to the British Sound
Recording Association, H. J. Leak demonstrated a prototype high-
quality transistor amplifier which gave results indistinguishable from
those of his valve amplifiers . . ."

"People sometimes ask why there is any necessity to change to
transistors. The elimination of the output transformer is, in our view,
sufficient reason now that solutions of the problem of linearity in the
response of the rest of the transistor circuit have been found. As
additional bonuses we get smaller size, cooler running and the prospect
of longer life."

WRITE NOW FOR FULLY ILLUSTRATED AND DETAILED LITERATURE

LEAK

. . . the first name in High Fidelity since 1934

H. J. LEAK & CO. LTD., BRUNEL ROAD, WESTWAY FACTORY ESTATE. LONDON, W.3.

Telephone: SHEpherds Bush 1173 (PBX). Telegrams: Sinusoidal, London, W.3

AVO METER CALIBRATION TEST UNIT TYPE CT165.
A modern precision instrument giving 7 standard voltages from 0.1 A.C. to 250 V. A.C. or 0.1 A.C. to 250 V. D.C. from internal standard cell. Internal a.c. source simply 110-250 V. A.C. contained in portable carrying case. Size 11.8x8x2in. Bench size equipment. £12/10. P.P. 14/6.

MUIRHEAD KEY SWITCHES

Very latest type twice C/O heavy duty silver contacts. These switches were designed for normal panel mounting, complete with chrome excelsior plate and screws. Price 6/0 each. Special terms for quantities. Herby/Erskine Double Beam Counterkeys. Type 128. Perfect condition. £25.

BC211 FREQUENCY METERS

Complete with calibration book, in first-class condition. £18/10. P.P. 16/0.

HIGH POWER BLOWERS

Ideal for fume extraction, floors, etc. 240 V. A.C., continuous rating, speed 2,500 r.p.m., overall size 8x4 1/2x10in., silver running capacitor motor, this extremely efficient motor has no equal for its size. Price only £10/10. P.P. 10/6.

B.T.H. INVERTERS TYPE 350

BUR. 3500. Input 100/210 V. D.C. Output 115 V. A.C./100-150 phase at 1,200 VA + 115 V. A.C./1,500/1-phase 2,000 VA. Complete with control unit, continuous rating. £30.

GCRE FS10 AUDIO FSK TERMINAL UNITS

Completely self contained, with internal mains supply, input and output sockets. Carpenter type 500; metal case, p.c.b. units, etc. In perfect working order, condition as new. Size 9.8x9.8in. £8/10. P.P. 15/6.

MARTINDALE VIBROVERTOR TYPE XM300R

Input 24 V. D.C. Output 220 V. A.C. at 1.8 amps, contained in alloy case, waterproof, complete with mains outlet fuses in metal case, internal rating, size 12x10x8in., new condition. Price £15. P.P. 12/6.

LONDEX Aerial C/O RELAYS

Type 702P. Price 20/0. P.P. 25/0.
Matching R.C. PLUGS (GUNDERT) 3/- each.

TEST EQUIPMENT BARGAINS

Recent Circulo Watt Meter, direct reading 0-1,000 watts. 4in. scale, clear coating measurements for 240 V. A.C. £12/10. Also "Vie" Wave meter and Oscilloscope for X-band measurements, 0-500 Mc/s. Direct reading, small size. £15. TRS14C. I.P. direct generator range 500-100 Mc/s. Very latest equipment, as new condition. £25. Marconi Valve Millivoltmeter type T7000 £12. P.P. 10/6. Robinson Laboratory Amplifier type A98 51A. £25. Dynatron Scale type 1009A. £15.

Ferranti T.V. NVA M/C Constant Voltage Regulator, output constant 230 V. A.C. regardless of voltage swings in perfect working order. £25. P.P. 20/6.
Ferranti 30 KVA Combined Auto Transformer and M/C Voltage Regulator for 3-phase 50 Hz supply, oil cooled type, unused condition. P.U.I.

15kvaan Regulated and Stabilised P.S.U. variable from 200 V. to 250 V. at 150 mA. + 6.3 V. at 6 amps. Fully equipped with volt and amp meters, etc. not new but in perfect order for bench or rack mounting. £15. P.P. 17/6. A.P.T. (reconditioned and stabilised P.S.U. Variable from 50 V. to 500 V. at 500 mA. + 6.3 V. at 10 amps. meter indication, perfect condition only. £25.

POWER UNIT TYPE 234A

A square of power to operate your 100W 10K or any equipment that requires a fully smoothed output of 200 V. D.C. at 0.5 A. or 100 mA. 240 primary, wet/dry, fully filtered, fully fused tapped input 200 V. A.C. based on 5.8 V. at 100 mA. for bench or 10in. rack mount. Price £15. P.P. 10/6.

HIGH VOLTAGE TRANSFORMERS

(1) 120V-1,850 V. at 500 mA. 240 primary, weight 7.2 lbs. Price £50. P.P. 10/6.
(2) 2,400-0-2,400 V. at 500 mA. 240 primary, wet/dry, fully filtered, fully fused tapped input 200 V. A.C. (3) 1,000-0-1,000 V. at 250 mA. plus 750-0-750 V. primary 200-0-200 V. "potted" C/O form. Famous Vacuum Tube Price £24. P.P. 7/6
(4) Low voltage transformers, Woden. 50 V. and 250 V. at 2 amp. primary 200/250 V. open wound. Price £28. P.P. 3/4.

P. F. RALFE

425 GREEN LANES, HARRINGAY, LONDON, N.4.
MOUNTVIEW 6980

AN/APR4 VHF COMMUNICATIONS AND SEARCH RECEIVERS

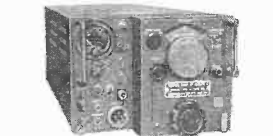

For the first time offered in a new board condition. Frequency Range 80-100 Mc/s. Average 11.5. Price 11K. Output Impedance 600 or 4,000 ohms. Power supply 110 V. A.C. (240-volt). Price complete with three tuning units. NEW £260.

COMMUNICATIONS RECEIVERS

ARRS and AIRSALP, mint condition, perfect order, from £25.
Halliforders S85A U.H.F. receiver. £35. P.P. 25/6.
Ridgeway 38X with full set of coils and PAIR. £25.
1938 Spittack signal 100 Mc/s. £37. P.P. 25/6.
Jewson Transistorised D.F. set. 15 kc/s. to 4.5 Mc/s. £25. P.P. 12/6

TEST EQUIPMENT

Marconi 373D Impedance Bridge, perfect condition. £25. P.P. 16/6.
Marconi T7340 Power Output Meter, good working order. £12. P.P. 7/6.
Frequency Measuring Equipment "A" Audio and I.F. J.P.R.L. Direct reading in the range of 1 kc/s. to 10 kc/s. small modern instruments, as new. £18.
Davis Direct reading 1 kc/s. to 10 kc/s. with internal calibrator, type 718A, small modern instrument, as new. £25.
RCA Hi-Resolution Frequency Meter and calibrator type 1H1, range 160 kc/s. to 30 Mc/s. £25.
DC211 Heterodyne Frequency Meter with correct calibration. £18/10. P.P. 16/6.
Heterodyne pH Electrodes, new, housed with leads and buffer tanks. £12.
Alcaine 10 KV. Ionisation Tester, visual and audio indication. All modern, perfect working order. £20. P.P. 12/6

BRAND NEW AM/FM (V.H.F.) RADIOGRAM CHASSIS AT £15.150 (CARRIAGE PAID)

A.C. ONLY. Chassis size 18 x 6 1/2 x 5 1/2 in. New manufacture. Dial 14 1/2 in. dia. in c.c. colour mechanism. Reception. Pick-ups. Extension. Speaker. Ac. E.C. E.C. and Dipole. See k.e. 1.9. "Piano" push buttons - J.W. M.W. R.W. F.M. and Grass. Aligned and tested with all valves and O.P. Transforms. Time Controlled. Covers 1,800-1.3m Mc/s. 200-520 Mc/s. 49-58 Mc/s. 5.1-17 Mc/s. UHF 12700 Mc/s. ECH81, 6F8, 6AR5, 6X4, 6X5, 6X6, 6X7, 6X8, 6X9, 6X10, 6X11, 6X12, 6X13, 6X14, 6X15, 6X16, 6X17, 6X18, 6X19, 6X20, 6X21, 6X22, 6X23, 6X24, 6X25, 6X26, 6X27, 6X28, 6X29, 6X30, 6X31, 6X32, 6X33, 6X34, 6X35, 6X36, 6X37, 6X38, 6X39, 6X40, 6X41, 6X42, 6X43, 6X44, 6X45, 6X46, 6X47, 6X48, 6X49, 6X50, 6X51, 6X52, 6X53, 6X54, 6X55, 6X56, 6X57, 6X58, 6X59, 6X60, 6X61, 6X62, 6X63, 6X64, 6X65, 6X66, 6X67, 6X68, 6X69, 6X70, 6X71, 6X72, 6X73, 6X74, 6X75, 6X76, 6X77, 6X78, 6X79, 6X80, 6X81, 6X82, 6X83, 6X84, 6X85, 6X86, 6X87, 6X88, 6X89, 6X90, 6X91, 6X92, 6X93, 6X94, 6X95, 6X96, 6X97, 6X98, 6X99, 6X100.

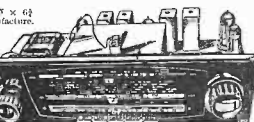

TERMS: £4/0/0 down and five monthly payments of £2/10/0. Total £10/10/0.
NEW 6 PUSHPULL STEREOGRAM CHASSIS
M.W., R.W., F.M., V.H.F. (Trans., Stereo Gram). Two separate channels for Stereo Gram, with balance control. Also operates with two speakers on 16in. Chassis size 18in. x 7in. x 5 1/2 in. high. Dial chrome and red 14 1/2 in. dia. Valve 6X5, ECH81, 6F8, 6AR5, 6X4, 6X5, 6X6, 6X7, 6X8, 6X9, 6X10, 6X11, 6X12, 6X13, 6X14, 6X15, 6X16, 6X17, 6X18, 6X19, 6X20, 6X21, 6X22, 6X23, 6X24, 6X25, 6X26, 6X27, 6X28, 6X29, 6X30, 6X31, 6X32, 6X33, 6X34, 6X35, 6X36, 6X37, 6X38, 6X39, 6X40, 6X41, 6X42, 6X43, 6X44, 6X45, 6X46, 6X47, 6X48, 6X49, 6X50, 6X51, 6X52, 6X53, 6X54, 6X55, 6X56, 6X57, 6X58, 6X59, 6X60, 6X61, 6X62, 6X63, 6X64, 6X65, 6X66, 6X67, 6X68, 6X69, 6X70, 6X71, 6X72, 6X73, 6X74, 6X75, 6X76, 6X77, 6X78, 6X79, 6X80, 6X81, 6X82, 6X83, 6X84, 6X85, 6X86, 6X87, 6X88, 6X89, 6X90, 6X91, 6X92, 6X93, 6X94, 6X95, 6X96, 6X97, 6X98, 6X99, 6X100.

8 WATT PUSHPULL O.P. AMPLIFIER

£5.50 (G.O. - CART.)



200-240 V. A.C. 50/60 cycles. Base, treble and mid, valve controls. 700W, 6X5 and 2-EL84. Chassis size 12 x 12 x 2 1/2 in. With 2-in. leads for 2-in. open speaker. Front panel (normally secured to chassis) may be removed used as "Rig panel", includes Percept control panel.

Send 6d. for 30-page illustrated catalogue. All New Goods. Delivered by return.

We regret we cannot execute overseas orders.

GLADSTONE RADIO

68 ELMs ROAD, ALDERSHOT, HANTS. Aldershot 22640. (1 min. from station and bus). Closed Wednesday afternoons.

VALVES SAME DAY SERVICE! NEW! TESTED! GUARANTEED!

SETS 18K, 18S, 17A, 284, 7V4, DA991, D931, DA91, D122, D121, Set of 4 for 17A, DA195, D936, D184, D185, 4 for 242L.

1A70T	7/6	10P1	9/6	10K91	4/6	10P27	7/6	10P21	6/6	11M50	6/6
11M17	7/6	10A7	2/6	10K92	6/6	10P28	8/6	10P22	6/6	11M51	6/6
12X01T	7/6	12A50	6/6	10K93	6/6	10P29	8/6	10P23	6/6	11M52	6/6
1B5	4/6	14A17	4/6	10K94	6/6	10P30	8/6	10P24	6/6	11M53	6/6
1B5	4/6	14A27	4/6	10K95	6/6	10P31	8/6	10P25	6/6	11M54	6/6
1B5	4/6	14A37	4/6	10K96	6/6	10P32	8/6	10P26	6/6	11M55	6/6
1B5	4/6	14A47	4/6	10K97	6/6	10P33	8/6	10P27	6/6	11M56	6/6
1B5	4/6	14A57	4/6	10K98	6/6	10P34	8/6	10P28	6/6	11M57	6/6
1B5	4/6	14A67	4/6	10K99	6/6	10P35	8/6	10P29	6/6	11M58	6/6
1B5	4/6	14A77	4/6	10K100	6/6	10P36	8/6	10P30	6/6	11M59	6/6
1B5	4/6	14A87	4/6	10K101	6/6	10P37	8/6	10P31	6/6	11M60	6/6
1B5	4/6	14A97	4/6	10K102	6/6	10P38	8/6	10P32	6/6	11M61	6/6
1B5	4/6	14A07	4/6	10K103	6/6	10P39	8/6	10P33	6/6	11M62	6/6
1B5	4/6	14A17	4/6	10K104	6/6	10P40	8/6	10P34	6/6	11M63	6/6
1B5	4/6	14A27	4/6	10K105	6/6	10P41	8/6	10P35	6/6	11M64	6/6
1B5	4/6	14A37	4/6	10K106	6/6	10P42	8/6	10P36	6/6	11M65	6/6
1B5	4/6	14A47	4/6	10K107	6/6	10P43	8/6	10P37	6/6	11M66	6/6
1B5	4/6	14A57	4/6	10K108	6/6	10P44	8/6	10P38	6/6	11M67	6/6
1B5	4/6	14A67	4/6	10K109	6/6	10P45	8/6	10P39	6/6	11M68	6/6
1B5	4/6	14A77	4/6	10K110	6/6	10P46	8/6	10P40	6/6	11M69	6/6
1B5	4/6	14A87	4/6	10K111	6/6	10P47	8/6	10P41	6/6	11M70	6/6
1B5	4/6	14A97	4/6	10K112	6/6	10P48	8/6	10P42	6/6	11M71	6/6
1B5	4/6	14A07	4/6	10K113	6/6	10P49	8/6	10P43	6/6	11M72	6/6
1B5	4/6	14A17	4/6	10K114	6/6	10P50	8/6	10P44	6/6	11M73	6/6
1B5	4/6	14A27	4/6	10K115	6/6	10P51	8/6	10P45	6/6	11M74	6/6
1B5	4/6	14A37	4/6	10K116	6/6	10P52	8/6	10P46	6/6	11M75	6/6
1B5	4/6	14A47	4/6	10K117	6/6	10P53	8/6	10P47	6/6	11M76	6/6
1B5	4/6	14A57	4/6	10K118	6/6	10P54	8/6	10P48	6/6	11M77	6/6
1B5	4/6	14A67	4/6	10K119	6/6	10P55	8/6	10P49	6/6	11M78	6/6
1B5	4/6	14A77	4/6	10K120	6/6	10P56	8/6	10P50	6/6	11M79	6/6
1B5	4/6	14A87	4/6	10K121	6/6	10P57	8/6	10P51	6/6	11M80	6/6
1B5	4/6	14A97	4/6	10K122	6/6	10P58	8/6	10P52	6/6	11M81	6/6
1B5	4/6	14A07	4/6	10K123	6/6	10P59	8/6	10P53	6/6	11M82	6/6
1B5	4/6	14A17	4/6	10K124	6/6	10P60	8/6	10P54	6/6	11M83	6/6
1B5	4/6	14A27	4/6	10K125	6/6	10P61	8/6	10P55	6/6	11M84	6/6
1B5	4/6	14A37	4/6	10K126	6/6	10P62	8/6	10P56	6/6	11M85	6/6
1B5	4/6	14A47	4/6	10K127	6/6	10P63	8/6	10P57	6/6	11M86	6/6
1B5	4/6	14A57	4/6	10K128	6/6	10P64	8/6	10P58	6/6	11M87	6/6
1B5	4/6	14A67	4/6	10K129	6/6	10P65	8/6	10P59	6/6	11M88	6/6
1B5	4/6	14A77	4/6	10K130	6/6	10P66	8/6	10P60	6/6	11M89	6/6
1B5	4/6	14A87	4/6	10K131	6/6	10P67	8/6	10P61	6/6	11M90	6/6
1B5	4/6	14A97	4/6	10K132	6/6	10P68	8/6	10P62	6/6	11M91	6/6
1B5	4/6	14A07	4/6	10K133	6/6	10P69	8/6	10P63	6/6	11M92	6/6
1B5	4/6	14A17	4/6	10K134	6/6	10P70	8/6	10P64	6/6	11M93	6/6
1B5	4/6	14A27	4/6	10K135	6/6	10P71	8/6	10P65	6/6	11M94	6/6
1B5	4/6	14A37	4/6	10K136	6/6	10P72	8/6	10P66	6/6	11M95	6/6
1B5	4/6	14A47	4/6	10K137	6/6	10P73	8/6	10P67	6/6	11M96	6/6
1B5	4/6	14A57	4/6	10K138	6/6	10P74	8/6	10P68	6/6	11M97	6/6
1B5	4/6	14A67	4/6	10K139	6/6	10P75	8/6	10P69	6/6	11M98	6/6
1B5	4/6	14A77	4/6	10K140	6/6	10P76	8/6	10P70	6/6	11M99	6/6
1B5	4/6	14A87	4/6	10K141	6/6	10P77	8/6	10P71	6/6	11M100	6/6
1B5	4/6	14A97	4/6	10K142	6/6	10P78	8/6	10P72	6/6	11M101	6/6
1B5	4/6	14A07	4/6	10K143	6/6	10P79	8/6	10P73	6/6	11M102	6/6
1B5	4/6	14A17	4/6	10K144	6/6	10P80	8/6	10P74	6/6	11M103	6/6
1B5	4/6	14A27	4/6	10K145	6/6	10P81	8/6	10P75	6/6	11M104	6/6
1B5	4/6	14A37	4/6	10K146	6/6	10P82	8/6	10P76	6/6	11M105	6/6
1B5	4/6	14A47	4/6	10K147	6/6	10P83	8/6	10P77	6/6	11M106	6/6
1B5	4/6	14A57	4/6	10K148	6/6	10P84	8/6				

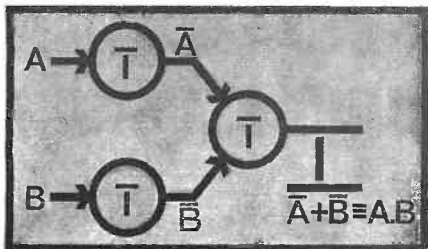

DIGITAL LOGIC

INSTRUMENTATION KITS

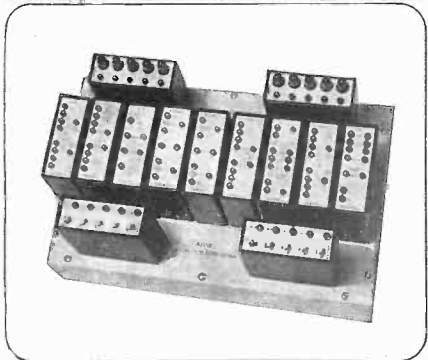

AN EDUCATIONAL SYSTEM FOR TEACHING LOGIC AND CONTROL TECHNOLOGY WITH PRACTICAL APPLICATIONS IN INDUSTRY

A modular digital system with patching lead connections designed to teach Engineers of any science or Technology the essential requirements of Logic design and digital control techniques.

The equipment is accompanied by a comprehensive instruction manual giving an introduction to logic, with terms employed, and detailing 15 of the many experiments which can be carried out. Using the input and output units, designed systems can be proved in operational form by utilising the complete equipment as a control device.

- LOGIC KIT (25 modules) £125
- NOR KIT (13 modules) £83
- POWER SUPPLY (will drive six kits) £26



FARNELL INSTRUMENTS LTD.
 Sandbeck Way,
 Wetherby, Yorkshire
 Telephone 2691 2/3/4

WW-126 FOR FURTHER DETAILS.

USED SCIENTIFIC, ELECTRONIC, LABORATORY & INDUSTRIAL EQUIPMENT

TEMPERATURE
 Recorders from £50 to £120, meters from £5, controllers £15 to £30 by Kent, Electroflo, Cambridge, Ether, Bristol, etc.

VACUUM PUMPS
 Rotary pumps from £12, diffusion pumps from £12, valves and accessories, etc. by Edwards, N.G.N., Leybold, etc.; e.g. ISP30 at £22 to Kinney GKD110 at £160 and N.G.N. OP25 at £12 to Edwards 9B3 at £100.

LABORATORY
 Flasks, pipettes, burettes, filter papers and thimbles, etc. Large quantity (list price over £400). Bargain £100 only.

PYE PANCHROMATOGRAPH
 Complete with sample injector, operating manual and the following detectors: Gas density balance and Katharometer with power supply control unit. Only 3 years old, original cost £917. Special offer, only £400.

CLOSED CIRCUIT TELEVISION
 E.M.I. (modified outside broadcast unit) 625 lines, type 10307 CPS Emitron pick-up tube. Only £500 o.n.o.
 Pye (modified under-water unit) Image Orthicon Industrial Camera 2063, C.C.U. 2327, only £250, o.n.o.

ELECTRONICS
 Universal Bridge Marconi TF868, £45
 Guard circuit Muirhead D-140-10, £45.
 Capacitance bridge Muirhead A-168-A, £45.
 Oscilloscopes ex government research type T200, £75
 KX30, £35
 E.M.I., WM2, £80

Oscilloscope cameras (without lens) of various makes, from £5. Scan generator Type T5007, £20.

PROCESS TIMERS
 Chamberlain & Hookham type P.O-10 secs., 0-30 secs., 0-30 mins, etc., each £8.

Please let us have your requirements. Catalogue available.
V. N. Barrett & Co.
 18 Sherwood Rd., Addiscombe, Croydon, Surrey
 ADDISCOMBE 6470

Build the smallest radio set in the world!

the inimitable
sinclair MICRO6



SIX-STAGE POCKET RECEIVER

Anyone can build it in an evening!

- 1 1/2" x 1 1/2" x 1 1/2"
- FANTASTIC RANGE AND POWER
- PLAYS ANYWHERE



This remarkable set has two stages of R.F. amplification, double diode detector and 3 stages of audio amplification with powerful A.G.C. to counteract fading from distant stations. Slow motion tuning makes station selection easy. Kit complete with transistors, case, dial, Hi-Fi weight earpiece and instructions manual.

59/6

See pages 86/87
 FULL SERVICE FACILITIES AVAILABLE TO SINCLAIR CUSTOMERS.



SINCLAIR RADIONICS LTD.
 22, NEWMARKET ROAD, CAMBRIDGE
 Phone - OCA3 - 32731

WW-127 FOR FURTHER DETAILS.

Build the World's most amazing FM tuner-receiver

THE SINCLAIR MICRO FM is more than an F.M. Tuner; more than an F.M. Receiver for it combines the advantages of both with many other unique features to make it the most advanced set of its kind in the world. Anyone can construct it, for unlike other FM constructional kits, the Micro FM needs no aligning and is ready to work as soon as it is finished. Pulse counting detection gives better audio quality than any other discriminator system. Excellent sensitivity assures good reception using no more than the small telescopic aerial

included in the kit in all but the worst reception areas. When built, the Sinclair Micro FM has all the appearance of a professionally engineered set both inside and out. Its distinctive, elegant exterior makes it particularly pleasing to own and to operate whether as a tuner for amplifier or tape recorder or independently as a self-contained pocket F.M. portable. Yet with all these features the Micro FM costs pounds less and enables you to enjoy F.M. reception to the full at once.

ONLY THE SINCLAIR MICRO FM HAS ALL THESE EXCLUSIVE FEATURES

- Size $2\frac{1}{4} \times 1\frac{1}{2} \times 2\frac{1}{2}$ in.
- Tuning—88 to 108 Mc/s.
- Requires no aligning
- Supply voltage—9 V. from self-contained standard battery
- Consumption—5 mA.
- Sensitivity—Typically 3 microvolts
- Signal to Noise Ratio—30 dB at 30 microvolts
- Audio frequency response—10-20,000 c/s.
- Two Audio Outputs—One for feeding to amplifier or tape recorder. One for feeding to earpiece to enable set to be used as a portable receiver.
- A.F.C.
- Black plastic case with brushed and polished aluminium front panel.
- Inserting plug of earpiece or tuner lead switches set ON

TECHNICAL DESCRIPTION

THE SINCLAIR MICRO FM is a completely self-contained double-purpose FM superhet housed within a case less than 3in. high x 1 1/2in. wide with a depth of 2in. It uses 7 transistors and 2 diodes in new circuitry. The R.F. amplifier is followed by a self-oscillating mixer and three stages of I.F. amplification which dispenses with I.F. transformers and all problems of alignment. The final I.F. amplifier produces a square wave of constant amplitude which is converted into uniform pulses so arranged that the original modulation is reproduced exactly.

A pulse-counting detector ensures absolute linearity and therefore better audio quality at the output stages. After equalisation the signal is channelled to one output for feeding to amplifier or recorder and to another in which the receiver's own audio amplifying stage enables the Micro FM to be used as an independent self-contained pocket portable. A.F.C. is used to lock the programme tuned in; the telescopic aerial included with the kit will be found sufficient for all but the worst signal areas.

sinclair MICRO FM

7 TRANSISTOR FM SUPERHET
WITH A.F.C. AND TWO AUDIO OUTPUTS

Complete kit of parts, including transistors, aerial, case, front panel, dial, earpiece and clearly presented stage-by-stage instructions manual.

£5.19.6

FULL SERVICE FACILITIES AVAILABLE TO ALL SINCLAIR CUSTOMERS

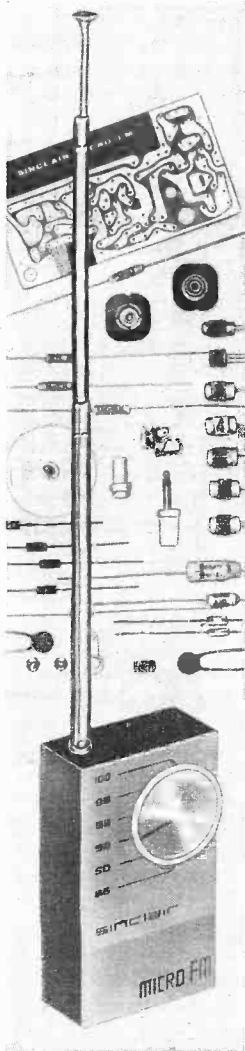

sinclair radionics Ltd.
22 newmarket road, cambridge

Telephone: OCA3—52731

WW—128 FOR FURTHER DETAILS.

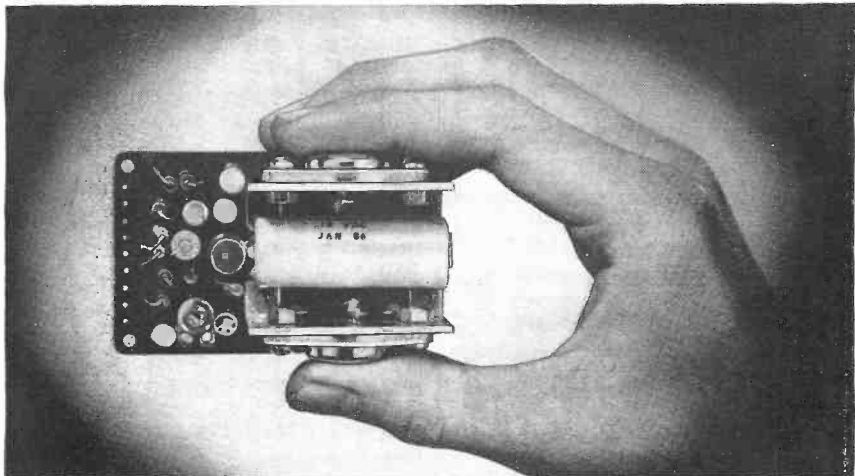

More power per square inch than any other amplifier in the world!

The Z.12 has quality. The Z.12 has power, and it is certainly marvellously compact. In fact, this wonderful unit which is complete with its own high gain pre-amplifier and ready to connect to any input will give you an output of up to **SIX WATTS PER SQUARE INCH** of its total size—a standard of performance unequalled by anything in its class. And because of its size and excellent circuitry, you can now use quality amplification in applications never before possible.

The Sinclair Z.12 uses 8 special H.F. transistors with generous negative feedback and ultralinear class B push-pull output to achieve the highest possible standards of quality. The unit can be powered from 6 to 20 v. d.c. and for those not using a battery, the new PZ.3 will be found ideal. Signal to noise ratio is better than 60dB, and the output may be fed directly into any load from 3 to 15 ohms, or two 3 ohms speakers may be used in parallel. The Manual included with the Z.12 gives full details of matching tone and volume control circuits for mono and stereo, together with multi-input switching facilities.

- ⊗ 12 WATTS R.M.S. OUTPUT
Continuous Sine Wave (24 w. Peak)
15 Watts R.M.S. Music Power (30 w. Peak)
- ⊗ SIZE 3" x 1 1/4" x 1 1/4"
- ⊗ IDEAL FOR 12 V. OPERATION
- ⊗ INPUT 2mV. INTO 2K OHMS
- ⊗ RESPONSE—15 TO 50,000 c/s ±1dB
- ⊗ SUITABLE FOR HI-FI, TUNER, GUITAR, P.A., INTERCOM, ETC.

PROMPT DELIVERY IS OFFERED TO MANUFACTURERS WISHING TO ORDER IN QUANTITY AT COMPETITIVE PRICES. ENQUIRIES INVITED FOR THIS AND AMPLIFIERS TO SPECIFICATION.

If you prefer not to cut this page, please refer to W.W.5 when writing your order.

sinclair Z.12

COMBINED 12 WATT
HI-FI AMPLIFIER AND
PRE-AMPLIFIER



A NEW POWER UNIT SINCLAIR PZ.3

The PZ.3 uses new circuitry based on advanced transistorised techniques to achieve phenomenally good smoothness, making it ideal for the Z.12, two of which it will power with ease. Example is a handy measurable 0.85 v. Output 20 v. D.C. for A.C. mains operation 200/250 v. 50-60 c/s. **79/6**

Ready-built, tested and guaranteed, with Z.12 manual.

89/6

Guarantee

Should you not be completely satisfied with your purchase when you receive it from us, your money will be refunded in full and at once without question.

ORDER FORM

To SINCLAIR RADIONICS LTD.,
22 NEWMARKET ROAD, CAMBRIDGE.

Please send.....

.....

.....

..... for which I enclose

CASH/CHEQUE/MONEY ORDER for £ s. d.

NAME

ADDRESS

..... W.W.5

SINCLAIR MICRO-6—the world's smallest radio

SEE PAGE 85

WW-129 FOR FURTHER DETAILS.

TIMERS

MICRO SWITCHES

IMMEDIATE DESPATCH



S5G

- ★ 1 MILLION OPS.
- 5 amp. c/o Sub-miniature Micro-switch.

2/3 each
per 1,000.



VAQ

- ★ 10 amp. c/o PUSH BUTTON.
- Panel mounting.
- Buttons in six colours.

5/4 each
per 500.



G-5

- ★ LOW TORQUE PRECISION ROTARY SWITCH.

★ 5 amp. c/o.
★ 1/2 milips
6/3 each
per 1,000.



VV-15-1A

- ★ 15/10 amps. c/o.
- ★ 100,000 ops.

1/8 each
per 1,000
Single Throw 1/6 each

LIMIT SWITCH WL 10 FCA2



- ★ 10 amp. 2 circuit
- ★ CASED FOR USE UNDER F.RODUOUS CONDITIONS.
- MECHANICAL HANDLING, MACHINE TOOLS, LIFT GEAR.

ROLLER LEVER AS ILLUS.
As low as 41/1 each



V-10-1B

- ★ 1 MILLION OPERATIONS.
- ★ 10 amp. c/o.

- ★ COMPARE OUR SPEC. & OUR PRICES WITH OTHER SIMILAR TYPES.

Screw Terms 2/2 each per 1,000
V-10-1A Solder Tags 1/11 each per 1,000



VV-5GW-1A44

- ★ LIGHT FORCE
- ★ 4 gms. Wire actuator.
- ★ Designed for coin-operated mechanisms.

2/4 each per 1,000.

U.L. APPROVED (Appr. No. 32667)

U.S. MIL. SPEC.

ALWAYS AVAILABLE FROM STOCK.

PROCESS TIMERS

611 T Delay Relay



- ★ 2 secs. to 25 secs. Delay.
- ★ 15 amp. c/o micro-switch fitted.

- ★ LARGE RANGE OF A.C. & D.C. OPERATIONS.

From 26/11 each.

SYT MINI-TIMER



- ★ DIAL RANGES 10 secs. to 6 hours.
- ★ Mains operation.
- ★ 5 AMPS. DOUBLE POLE, DOUBLE THROW SWITCHING INCORPORATED.
- Accuracy 1%.
- From £8.14.5 each.

STP Sub-Mini Process Timer



- ★ Plug-in Octal base.
- ★ Mains operation.
- ★ Built-in 2 amp. c/o switching.
- ★ 10 secs. to 1 hour.
- From £5.0.0 each.

PROXIMITY SWITCH—TL 2 GNA



- ★ FOR BATCHING, CONVEYORS, MACHINE TOOL CONTROL, PACKAGING, SORTING, etc.
- ★ SENSES FERROUS & NON-FERROUS OBJECTS.
- ★ NEEDS NO MECHANICAL FORCE OR PRESSURE TO OPERATE.
- ★ SOLID STATE SENSING HEAD, plus Power Pack.

From £6.14.5 each.

FLOATLESS LIQUID LEVEL CONTROLS

- ★ To control or record liquid levels.
- ★ Stainless Electrodes switching minute current to Master unit for:
- ★ Pumps, Motors, Alarms, etc.
- ★ No moving parts.
- Single and multi switching.

From £4.19.7 each

SEE US AT THE I.E.A. EXHIBITION. STAND No. G259. 23-28 MAY.

(Dept. W.W.1) **OMRON** PRECISION CONTROLS
313 Edgware Road, London, W.2

Tel.: Paddington 2370

See **DAYSTROM** Industrial Products and **HEATHKIT** models at the
International Instruments, Electronics, Automation EXHIBITION
OLYMPIA, LONDON. 23-28 MAY. Stand No. 768

MODERNISE YOUR SERVICE DEPT. OR WORKSHOP WITH THESE INSTRUMENTS

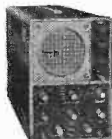

**Sin. Flat-face GENERAL PURPOSE
 OSCILLOSCOPE Model 10-12U**

An outstanding oscilloscope

"Y" sensitivity 10 mV. r.m.s. per cm. at 1 kc/s. Bandwidth 3 c/s-4.5 Mc/s. Frequency compensated input attenuator X1, X10, X100. T/B. 10 c/s-500 kc/s. in 5 steps. Two extra switch selected pre-set sweep frequencies in T/B. range. T/B. output approx. 10 v. peak to peak. Built-in IV calibrator. Facility for "Z" axis modulation. Electronically stabilised power supply. Power req. 200-250 v. A.C. 40-60 c/s. 80 watts. Fused. Front panel silver and charcoal grey. Cabinet, charcoal grey, size 8 1/2" x 14" x 17 1/2".

dep. Net weight 23lb. 56-page construction and operation manual.

Kit.....£35.17.6 Assembled £45.15.0



**Transistorised
 REGULATED POWER SUPPLY
 Model IP-20U**

Tremendous value! 0.5-50 volts D.C. output at up to 1.5A. Voltage or current monitored on easy-to-read meter. Adjustable current limiter.

Relay protected against overload. Less than 150 microvolts ripple. Regulation less than ± 15 millivolts. Output impedance less than 0.1 ohm. Compact 9 1/2" x 6 1/2" x 1 1/2". Weight 1 1/2 lb. net. Full details on request.

Kit.....£35.8.0 Assembled £47.8.0

**HARMONIC DISTORTION
 METER Model IM-12U**

Will give fast, accurate noise and distortion measurement in amplifiers, receivers, transmission lines, speakers, etc. Measurements are read directly on large meter. High input impedance, precision components and Wien bridge circuit design assure excellent sensitivity and high accuracy in all applications. Freq.: 20 cycles to 20,000 cycles. Distortion: 1, 3, 10, 30, 100% f.s.d. Voltmeter: 0, 1, 3, 10, 30 volts f.s.d. Input resistance 300kΩ Dimensions 13in. x 8 1/2in. x 7in. deep. Weight 1 1/2 lb.

Kit.....£24.15.0 Assembled £34.0.0



**TRANSISTOR TESTER
 Model IM-30U**

Unmatched for quality and performance at the price.

Provides a complete d.c. analysis of PNP and NPN transistors and diodes. D.C. gain (Beta, Alpha) is read direct on calibrated scales. Four lever switches facilitate fast, easy, test selection. Internal batteries for tests up to 9 v. Provision for connection to ext. power supply for higher voltage and current tests. Modern functional styling. Size 5 1/2in. high x 10 1/2in. deep x 10 1/2in. wide.

Kit.....£24.18.0 Assembled £35.10.0

OUTSTANDING EQUIPMENT FOR THE DISCERNING HI-FI ENTHUSIAST



**“STARMAKER 33”
 TRANSISTOR PA/GUITAR
 AMPLIFIER Model PA-2**

This is a high performance amplifier whose size and weight allows easy transportation. Ideal for vocal and instrumental groups, P.A., electronic organs, guitars, etc.

Features include: 20w. amplifier (33 watts. 1.5A.F.M.), two heavy duty speakers, 4 inputs on two channels, variable tremolo, modern elegant cabinet. Size: 18in. h. x 29in. w. x 10in. deep. Wt. 5 1/2 lb.

Casters or legs available as optional extras.

Kit.....£44.19.0 Assembled £59.10.0



**The BERKELEY Slim-line
 SPEAKER SYSTEM**

A new concept in Heathkit loudspeaker design. The cabinet shell is assembled and finished in superb Queensland walnut veneer. Two specially designed speakers, a 12in. bass unit and 4in. mid/high frequency unit and an L.C. cross-over network provide the smooth 30-17,000 c/s. frequency response. Its professional cabinet styling will blend with both traditional and contemporary decor. 15 ohm nominal impedance. Size 28" x 17" x 7 1/2" deep.

Kit.....£18.10.0 Assembled £23.0.0

MODELS FOR THE MUSIC LOVER AND FOR FAMILY ENTERTAINMENT

**A WELL DESIGNED
 F.M. TUNER Model FM-4U**

Tuning range 88-108 Mc/s. Flywheel tuning. Attractive Plastic Front Panel in two-tone grey with golden trim surround and motif. Thermometer type visual tuning indicator. Pre-aligned. I.F. transformers. Three I.F. stages. Wide-band low distortion Ratio Detector. R.F. Unit, wired, tested and power aligned. Printed circuits for I.F. amplifiers and ratio detector. Built-in power supply. Output socket for stereophonic adaptor (for stereo transmission when available).



TUNER UNIT Model FMT-4U with 10.7 Mc/s. I.F. output. £21/5/- (inc. P.T.). I.F. AMPLIFIER and power supply Model FMA-4U complete with case and valves, £13/10/-. Sold separately.

Kit Total.....£16.8.0

**“OXFORD” LUXURY
 TRANSISTOR PORTABLE
 Model UXR-2**

This superb transistor radio is the ideal domestic or personal portable Medium and Long Wave receiver. Solid leather case and handle. Easy-to-read tuning scale. Extra large loudspeaker. Push button L, MW and tone. 10 semi-conductors (7 transistors plus 3 diodes). Sockets for personal airphone, tape recorder, car aerial. Includes 9-volt battery (not supplied), lasts for months. Latest printed circuit techniques.



Comprehensive easy-to-follow, fully illustrated Instruction Manual.

Kit.....£14.18.0 incl. P. Tax.

• Prices quoted above are Mail Order prices •

• Prices include free delivery in U.K. •

DAYSTROM LTD.

DEPT. W.W.5, GLOUCESTER, ENGLAND
 FREE BROCHURE AVAILABLE ON THE BRITISH INSTRUMENT RANGE OF MODELS
 ALSO “AMATEUR” RADIO BROCHURE COVERING BRITISH & AMERICAN MODELS

WV-130 FOR FURTHER DETAILS.

So easy to build



So easy to use



TRANSISTOR MIXER

Model TM-1

"A must for the tape enthusiast"

Four channels with individual, continuously variable controls, plus a master volume control allows model to be used for recording from a wide variety of sources, e.g. dynamic and crystal microphone, radio tuners, record players, etc.

- * 7 transistor circuit and internal 9 v. battery (not supplied) allows unit to be used "in the field" as well as in the home, studio, etc.
- * Printed circuit board ensures consistent performance, easiest possible construction.
- * Professional, modern, compact, low silhouette styling.
- * Beautiful walnut veneered, fully finished cabinet.
- * Attractive anodised aluminium front panel.
- * Size: 11 1/2 in. x 7 1/2 in. x 3 1/2 in. high.

KIT £11.16.6 incl. cabinet Assembled £16.17.6 incl. cabinet
Full specification leaflet sent on request.

**The Outstanding
20+20 WATT TRANSISTOR
STEREO AMPLIFIER
Model AA-22U**



This "international Class" amplifier offers you a realism and beauty of music never before obtainable at such a competitive price.

- * Professional, elegant, compact, slim-line styling.
- * The Best of American transistor techniques in a British amplifier.
- * Beautiful walnut veneered, fully finished cabinet available as an optional extra.
- * 5 stereo inputs (five on each channel) accommodate pick-up, radio tuner, tape and two other sources.
- * 20 transistor 10 diode circuit.
- * Dimensions: 15 1/2 in. wide x 3 1/2 in. high x 12 1/2 in. deep.

Kit £39.10.0 less cabinet
Walnut cabinet for free standing use £2.5.0 extra.

COMPARE ANY HEATHKIT MODEL FOR PRICE, PERFORMANCE, QUALITY

**3+3 W HI-FI STEREO AMPLIFIER
KIT Model S-33H**

An inexpensive stereo-mono amplifier with the high sensitivities necessary for lightweight miniature ceramic pick-ups (e.g. Decca Deram). De luxe version of the S-33 with attractive two-tone grey Perspex panel.
Kit £15.17.6 Assembled £21.7.6

**5 W HI-FI MONO AMPLIFIER
KIT Model MA-5**

A low-priced general purpose Hi-Fidelity amplifier based on the popular S-33 for those who do not require a stereophonic system. Separate bass and treble controls. Gram and Radio inputs Suitable for most crystal pick-ups. A printed circuit simplifies construction.
Kit £10.19.6 Assembled £15.10.0

**HI-FI MONO POWER AMPLIFIER
KIT Model MA-12**

A compact Hi-Fidelity power amplifier (including auxiliary power supply), 12 watts output. Wide frequency range and low distortion. A variable sensitivity control is fitted enabling it to be used with an existing amplifier in a stereophonic system. Other applications include sound reinforcement systems, transmitter modulators, for use with tape recorders, also as a general purpose laboratory amplifier.
Kit £11.18.0 Assembled £15.18.0

**STEREO CONTROL UNIT KIT
Model USC-1**

Incorporates all worthwhile features for Hi-Fidelity stereo and mono. Push-button selection, accurately matched ganged controls to ±1 dB. Negative feedback rumble and variable low-pass filters. Printed circuit boards. Accepts inputs from most tape-heads and any stereo or mono pick-up.
Kit £19.10.0 Assembled £26.10.0

HEATHKIT-THOMAS (Transistorized) ELECTRONIC ORGAN KIT

(with Color-Glo) Model GD-325E Can be built with no knowledge of electronics.
Kit £205.0.0 Bench £14.10.0
(Price includes carriage and duty)



HI-FI EQUIPMENT CABINETS

A range of equipment cabinets is now available. Designed for maximum operating convenience or for where room space is an over-riding consideration, this range includes easy-to-build kits or ready-assembled cabinets in the white for finish to own requirements.

"MALVERN" (Illustrated) Kit. £18.1.0 (inc. P.T.)
Assembled (left in the white) £23.6.0

"GLOUCESTER" for Tape Deck and Record Player.
Kit £10.10.0 (inc. P.T.) Assembled £13.5.0

"CHEPSTOW" for Record Player or Tape Deck.
Kit £11.2.6 (inc. P.T.) Assembled £16.17.6

How to install Hi-Fi in YOUR home

If you are planning to install a Hi-Fi system in your home, and are uncertain of the type of equipment to use, our widely experienced technical staff will with pleasure put forward recommendations. As you have to do is state the type of installation contemplated, the price you are prepared to pay and give details of existing equipment you wish to include, if possible.

**HI-FI STEREO AMPLIFIER
KIT Model S-99**

18 w. output (9 per channel with 0.2 per cent. distortion at 9 w. per channel). It has ganged controls. Stereo/Mono gram, radio and tape recorder inputs and push-button selection. Ultra-linear push-pull output. P.C. board. Attractive Perspex front panel with golden surround and grey metal cabinets.
Kit £28.9.6 Assembled £38.9.6



INTERNATIONAL MAIL ORDER SCHEME
Covering the American Heathkit range of 250 models

Direct from U.S.A. to your U.K. address. Illustrated American catalogue and full details can be obtained from us for 1/- post paid.

Deferred Terms available on orders above £10

**MONO CONTROL UNIT KIT
Model UMC-1**

Ideal for use with MA-12 or similar amplifier. Output 0.25 v. Send for full details.
Kit £8.12.6 Assembled £13.12.6



**HI-FI SPEAKER SYSTEM KIT
Model SSU-1**

Ducted-port bass reflex cabinet "in the white". Frequency response is 40-16,000 c/s. Power rating 10 watts. Matched speaker units 8 in. high flux (2,000 lines) with hyperbolic cone and 4 in. wide angle dispersion type for higher frequencies.
Kit (with legs) £12.12.0 (less legs) £11.17.6 (inc. P.T.)



**"COTSWOLD" SPEAKER
SYSTEM KIT**

This acoustically designed enclosure measures 26 x 23 x 14 1/2 in. and houses a special 12 in. bass speaker with 2 in. speech coil, elliptical middle c/s. Power rating with a pressure unit to cover the full frequency range of 30-20,000 c/s. Its polar-distribution makes it ideal for really Hi-Fi Stereo. Delivered complete with speakers, cross-over unit, level control, grille cloth, etc. Left in the white for finish to personal taste, all parts are pre-cut and drilled for ease of assembly.
Kit £25.12.0 Assembled £33.17.0



**"COTSWOLD M.F.S."
SPEAKER SYSTEM
KIT**

This model, based on the standard Cotswold, measures only 36 in. high, 16 1/2 in. wide by 14 in. deep. Particularly recommended to those who require the best results in small rooms.
Kit £25.12.0 Assembled £33.17.0



DAYSTROM LTD.

DEPT. W.W.5, GLOUCESTER, ENGLAND

Member of the Schlumberger Group including the Heath Company.

MANUFACTURERS OF THE WORLD'S LARGEST-SELLING ELECTRONIC KIT-SETS

WW-131 FOR FURTHER DETAILS.

See **HEATHKIT** at the
International Instruments, Electronics, Automation EXHIBITION
OLYMPIA, LONDON. 23-28 MAY. Stand No. 768

AN OUTSTANDING LOW-COST 3in. OSCILLOSCOPE Model OS-2

- ★ Vertical amplifier 2 c/s to 3 Mc/s.
- ★ Modern professional styling.
- ★ Vertical sensitivity 100 mV/cm.
- ★ Compact size 5in. x 7in. x 12in.



- ★ Light weight—under 10lb.
- ★ Time base range 20 c/s to 200 kc/s.
- ★ Horizontal input 100 mV/cm.
- ★ Mm scale c.r.t. screen.

MULTIMETER KIT Model MM-1U

Provides wide voltage, current, resistance and dB ranges to cover hundreds of applications. Sensitivity 20,000 ohms/volt D.C. and 5,000 ohms volt A.C. Ranges: 0-1.5 v. to 1,500 v. A.C. and D.C.; 0-150mA to 15 A. D.C. Measures resistance from 0.212 to 20MΩ. 4in. 30A meter. A polarity reversing switch eliminates transferring test leads when alternately measuring + and - voltages.



Kit £12.18.0 Assembled £18.11.6

OSCILLOSCOPE TRACE DOUBLER KIT Model S-3U

This device will extend the use of your single-beam oscilloscope and, at a nominal cost, will give you the advantages of a double (or other multiple) beam scope.

Kit £12.18.0 Assembled £18.10.0

R.F. SIGNAL GENERATOR KIT Model RF-1U

Provides extended frequency coverage on six bands from 100 kc/s. to 100 Mc/s on fundamentals and up to 200 Mc/s on calibrated harmonics.

Kit £13.8.0 Assembled £19.18.0

DECADE RESISTANCE BOX KIT Model DR-4U. Range 1-99,999Ω in 10 steps. Ceramic switches throughout. Current rating from 500 mA, to 5 mA, according to decades in circuit. Polished wooden cabinet supplied complete.

Kit £16.8.0 Assembled £14.8.0

RESISTANCE-CAPACITANCE BRIDGE KIT Model C-3U

Measures capacitance 10pF. to 1,000pF. Power-factor and resistance 5-450 v. Safety switch provided.

Kit £10.10.0 Assembled £16

AUDIO SIGNAL GENERATOR KIT Model AG-9U

10 c/s. to 100 kc/s., switch selected. Distortion less than 0.1%. 10 v. sine wave output metered in volts and dB's.

Kit £22.10.0 Assembled £30.10.0

This compact oscilloscope offers excellent performance, is professional in appearance and is an instrument you will be proud to own. Apart from its obvious uses by radio/TV engineers, etc., it is ideal for construction, study and use by workshop apprentices and by students in schools, technical colleges and universities.

Kit £22.18.0 Assembled £30.8.0

A.M./F.M. TUNER KIT

Tuning range 88-108 Mc/s. (FM) 16-50, 200-550, 900-2,000 m. Flywheel tuning. Attractive Perspex front panel in eye-tone grey with golden trim. Thermometer type tuning indicator, pre-aligned I.F. transformers. Switched wide and narrow A.M. bandwidths.

TUNING HEART Model AFM-T1 £41/13/6 (inc. P.T.) I.F. AMPLIFIER and Power Unit Model AFM-A1. Complete with metal cabinet and valves £22/11/6. Sold separately.

Kit Total £27.5.0

DUAL-WAVE TRANSISTOR PORTABLE RADIO KIT Model UXR-1

Presented in elegant real hide case with castful gold relief. Can be assembled in 4 to 6 hours and you have a set in the top flight of transistor portables. Pre-aligned I.F. transformers, printed circuit and a 7in. x 4in. high flux speaker.

Covers both Long and Medium waves. Dimensions 9 1/2in. x 7 1/2in. x 3 1/2in.

Kit £12.11.0 (inc. P.T.)

SINE/SQUARE GENERATOR Model 1G-82U

Covers 20 c/s. - 1 Mc/s. in 5 bands. Simultaneous Sine and Square Wave outputs. Less than 0.15% rise time and on Square Wave. Less than 0.5% distortion on Sine wave. Up to 10 volts output. This attractively styled generator is designed for maximum operating convenience. Size 13in. x 8 1/2in. x 7in. deep.

Kit £24.10.0 Assembled £36/10/0

ELECTRONIC WORKSHOP KIT EW-1

20 exciting experiments can be made with this one kit. Kit £7.13.6 (incl. P.T.)

4 1/2in. VALVE VOLTMETER KIT Model V-7A

The world's most popular valve voltmeter with printed circuit and 1 per cent. precision resistors to ensure consistent laboratory performance. It has 7 voltage ranges measuring precision D.C. volts to 1,500 and A.C. to 1,500 r.m.s. and 4,000 peak to peak. Resistance measurements from 0.1 ohm to 1,000 megohms, with internal battery. D.C. input resistance is 11 megohms and dB measurement has a centre-zero scale. Complete with test probe, leads and standardising battery. Power requirements, 200-250 v. 40-60 c/s. A.C. 10 watts.

H.V. and R.F. Probes available at optional extra.

Kit £13.18.6 Assembled £19.18.6

6in. VALVE VOLTMETER Model IM-13U

Modern styling. Many extra features. Unique gimbal bracket allows bench, shelf or wall mounting. Measures A.C. and D.C. volts 0-1.5, 5, 15, 50, 150, 500, 1,500. Resistance 0.1 to 1,000MΩ. Size 5in. x 12 1/2in. x 4 1/2in. Complete with test probe and leads.

Kit £18.18.0 Assembled £26.18.0

DECADE CAPACITOR KIT Model DC-1

Capacity values 100pF to 0.11111F in 100µF steps. Precision silver-mica capacitors and minimum loss ceramic wave switches ensure high accuracy.

Kit £7.5.0 Assembled £10.8.0

TELEVISION ALIGNMENT GENERATOR KIT Model HFV-1

Offers the maximum in performance, flexibility and utility at the lowest possible cost. Several outstanding features have been incorporated in this model which are unusual in instruments in this price range. Frequency coverage 3.6 Mc/s. to 220 Mc/s. on fundamentals. Unique non-mechanical sweep oscillator system. High level output on all ranges. Sweep deviations up to 42 Mc/s. Built-in fixed and variable marker generators (5 Mc/s. crystal supplied).

Kit £37.18.0 Assembled £47.10.0

AUDIO SINE-SQUARE WAVE GENERATOR KIT, Model AO-1U

Covers 20 c/s to 150 kc/s in four ranges with choice of sine or square waves. The latter up to 25 kc/s. Output 10 v. max. and distortion less than 1%. Ideal for audio testing. Size 9 1/2 x 6 1/2 x 5in.

Kit £14.15.0 Assembled £21.5.0

OSCILLOSCOPE ACCESSORY KITS

Demodulation Probe Kit 337-C £2.7.6
 Low-cap Attenuator Probe kit PK-1 £3.2.6

● Prices quoted are Mail Order Prices. ●

● Deferred Terms available on all orders above £10. ●

● Prices include Postage U.K. ●

DAYSTROM LTD.

DEPT. W.W.S, GLOUCESTER, ENGLAND

SEND FOR FREE CATALOGUE OF INSTRUMENT RANGE

W.W.132 FOR FURTHER DETAILS.

Thoroughly



dependable

AMATEUR TRANSMITTER KIT

Model DX-40U

Covers all amateur bands from 80 to 10 metres, crystal controlled. Power input 75 watts C.W. 60 watts peak controlled carrier phone. Output 40 watts to aerial. Provision for F.F.O. Filters minimise I.V. interference. Modulator and power supplies are built-in. Single knob band switching is combined with a pi-network output circuit for complete operating convenience. A high-grade moving-coil meter indicates the final grid or anode current. Provision is made for the use of 3 crystals with access through a trap-door in the back of the cabinet. A 4-position switch selects the appropriate crystal or a jack for external VFO which can be used instead of the crystals (s).
Kit .. £39.10 Assembled .. £45.80

SINGLE SIDEBAND ADAPTER KIT Model SB-10U

May be used with most A.M. transmitters with certain provisions. Allows full use of existing equipment for SSB facilities. Band coverage: 80, 40, 20, 15, 10 m. Unwanted sideband suppression; better than 30 dB. Carrier suppression; better than 40 dB. Power requirements: 300 v. D.C. 85 mA. (average) 30 mA (standby). 140 mA (peak). Meter: 2 1/2 in. Scale edge reading, 200uA movement, indicates carrier null and relative power output. Cabinet 11 in. high x 8 in. wide x 4 1/2 in. deep.
Kit .. £39.50 Assembled .. £54.180

GENERAL COVERAGE RECEIVER KIT RG-1

An inexpensive communications type receiver specially designed for the short wave listener with many refinements found only in receivers costing much more. Freq. coverage 32 Mc/s-1.7 Mc/s in 5 ranges also 11.4 m. band.
Kit .. £39.16.0 Assembled £53.0.0
Optional extras available.

GRID-DIP METER KIT. Model GD-1U

Functions as oscillator or absorption wavemeter. With plug-in coils for continuous frequency coverage from 1.8 Mc/s. to 230 Mc/s.
Kit .. £10.19.6 Assembled .. £13.19.6

Additional Plug-in Coils Model 341-U extend coverage down to 350 kc/s. With dial correlation curve, 17/6.

TRANSISTOR INTERCOM KITS Models XI-U and XIR-U

9 v. battery operated. Up to five remote stations can be operated with each Master. The Master unit can call any one, any combination, or all five Remote stations and any Remote station can call the Master. A private call to any Model XI-U (Master) .. £16.19.6
Model XIR-U (Remote) .. £16.19.6
Kit .. £47.5. Assembled .. £5.16.0

AMERICAN MARINE MODELS

Prices include carriage, duty, import levy, etc.
DIRECTION FINDER, MR-21A
3WB transistor circuit. Kit .. £61.10.0
DEPTH SOUNDER MI-11A
Soundings to 200ft. Kit .. £38.10.0
FUEL VAPOUR DETECTOR MI-25
Transistor circuit. Kit .. £23.10.0
TACHOMETER MI-31A
6, 12, 24 or 32 v. D.C. Kit .. £14.0.0
Please send for details.

WELCOME TO OUR LONDON HEATHKIT CENTRE

See the British Heathkit range and a selection of American models etc.
233 TOTTENHAM COURT ROAD, W.1 TEL: MUSUM 7349
We open MON-SAT., 9 a.m.-5.30 p.m. THURSDAY 11 a.m.-2.30 p.m.
When you are in town we hope that you will visit us there.

DAYSTROM LTD., Dept. WWS, GLOUCESTER, ENGLAND.
WV-133 FOR FURTHER DETAILS.

"MOHICAN" GENERAL COVERAGE RECEIVER KIT

Model GC-1U

This fully transistorized receiver which includes 4 piezo-electric transmitters, is in the forefront of receiver design. It is an excellent portable or fixed station receiver. The R.F. "front-end" is supplied as a pre-assembled and pre-ignited unit. Its many features include a 10-transistor circuit, printed circuit board, telescopic whip antenna, tuning meter, and a large slide-rule dial giving a total length of approximately 70 inches. Housed in a steel cabinet and powered by two 6 volt dry batteries (not supplied), mounted internally, it gives frequency coverage from 500 kc/s. to 30 Mc/s. In five bands: thus enabling broad-wide reception. Electrical bandspread covers the amateur bands from 80 to 10 metres—each band having a scale length of approximately 8 inches. BFO tuning and Zener diode stabiliser. Size 6 1/2 x 12 in. x 10 in.
Please write for specification leaflet.
Kit .. £37.17.6 Asmbld. .. £45.17.6

STABILISED POWER PACK Models MSP-1M and MSP-1V

Specially recommended for industrial and laboratory use, meeting the need for a reliable and versatile stabilised power pack capable of a very high performance. Input 200-250 v. 40-60 c/s. A.C. Fully fused. Outputs: H.T. 200-410 v. D.C. at 0.225 mA. in 3 switched ranges. Unstabilised A.C. 6.3 v. at 4.5 A. contra-regulated. Two 3 in. "easy-to-use" meters for reading voltage and current simultaneously. Separate L.T. and H.T. supply transformers. All output circuits are isolated. Size 13 in. x 8 in. x 9 in.
MSP-1M (with meters) Kit .. £36.12.6 Asmbld. .. £43.12.6
MSP-1V (less meters) Kit .. £29.17.6 Asmbld. .. £36.17.6

BALUN COIL UNIT KIT

Model B-1U. Will match unbalanced co-axial lines to balanced lines of either 75 or 300Ω impedance. Frequency range 10-80 m. input up to 200 watts.
Kit .. £41.5.6 Asmbld. .. £58.0

TAPE PRE-AMPLIFIER KITS Models TA-1M and TA-1S

The Combined Tape Record/Play Amplifier unit is available in both monophonic and stereo-phonetic models. Model TA-1M can be modified to the stereo version with modification kit TA-1C.
TA-1M Kit £19.80 Asmbld. £28.180
TA-1S Kit £25.100 Asmbld. £35.180
TA-1C Kit .. £6.150

All prices are small order and include free delivery in the U.K.

Deferred Terms are available on all orders above £10

AMATEUR TRANSMITTER KIT

Model DX-100U

The World's most popular Amateur TX Kit

- Completely self-contained, 150 w. D.C. input. Built-in high stable VFO and all Power Supplies.
- The KT88 high-level anode and screen modulator stage gives over 100 watts of audio from less than 1.5 mV. input.
- Keying on CW is via the VFO and buffer amplifier cathodes; the other RF valves are biased beyond cut-off.
- Provision has been made for remote control operation.
- Covers all Amateur bands up to 30 Mc/s. phone or CW.

Kit .. £79.10.0 Assembled .. £104.15.0

AMATEUR BANDS RECEIVER KIT

Model RA-1 The ideal economically priced fixed station, portable or mobile receiver covering the Amateur bands from 160-10 m., each band separately calibrated on a large illuminated slide-rule dial. Features: Signal strength meter, tuned RF amplifier stage, half-lattice filter, adjustable noise limiter. Freq. coverage 160, 80, 40, 20, 15, 10 metre bands, I.F. 1620 kc/s.
Kit .. £39.6.6 Assembled .. £52.10.0

AMERICAN HEATHKIT

SINGLE SIDE BAND EQUIPMENT

Transmitters, Receivers, Transceivers. Send for details of models. Fully illustrated American Catalogue of Heathkit range sent for only 1/- post paid.

REFLECTED POWER METER KIT

Model HM-11U Indicates, reliably but inexpensively, whether the R.F. power output of your transmitter is being transferred efficiently to the radiating antenna.
Kit .. £8.5.0 Assembled .. £10.10.0

VARIABLE FREQUENCY OSCILLATOR KIT. Model VF-1U

Specially designed to meet the demand for the maximum possible flexibility from an amateur Transmitter which would otherwise be subject to certain limitations imposed by crystal control. Calibrated for all Amateur bands, 160-40 m. Ideal for Heathkit DX-40U fundamentals on 160 and 40 m. Ideal for similar transmitters.
Kit .. £10.17.6 Assembled .. £15.19.6

Q MULTIPLIER KIT. Model QPM-1

A reasonably priced Q Amplifier for the amateur and short-wave enthusiast. This self-powered unit (200-250 v. 50/60 c/s.) may be used with communications receivers to provide both additional selectivity and signal rejection.
Models QPM-1 for 470 kc/s. I.F. QPM-16 for 1.6 Mc/s. I.F. Kit, either model .. £8.10.0
Assembled .. £12.14.0

AERIAL TOWER KITS. Model HT-1, HT-1G

Height 32ft., sq. section 3ft. x 3ft. at base (no stays required). Accessories available as extras.
HT-1G Kit (galvanised) £40.15.0
HT-1 Kit (red oxide) £34.15.0

Please send me FREE CATALOGUE (Yes/No)

Full details of Model(s)

NAME

(Block Capitals)

ADDRESS

WWS

LASKY'S RADIO

LONDON'S LARGEST STOCKISTS OF HI-FI AND AUDIO EQUIPMENT

BY ALL THE WORLD'S FAMOUS MANUFACTURERS

DEMONSTRATION STUDIOS

VISIT OUR NEW HIGH FIDELITY CENTRE AT:
42 TOTTENHAM COURT ROAD, LONDON, W.1.

Tel: LANGHAM 2573

This branch is devoted exclusively to quality Hi-Fi/Audio equipment—Tape recorders, Record Reproducers, Radios, Tuners, etc. Custom built installations provide complete comparisons of the best in Hi-Fi in ideal surroundings. Open all day Thursday, early closing Saturday.

Visit our other specialist showrooms at 23 Tottenham Court Road, 207 Edgware Road or 122-3 Fleet Street, whichever is most convenient. In our Demonstration Studios you can see, examine, hear and compare the very latest products in the realm of high-quality reproduction by all the well-known makers.

If you cannot call please send us details of your choice of equipment and we shall be pleased to quote. See Complete Specimen. *Furnish best-price Plan* for certain visitors. H.P. Terms available.

RECORD PLAYERS

4-SPEED AUTOCHANGERS

B.S.R. AUTOCHANGERS AT LOWEST EVER PRICES!

All brand new and fully guaranteed complete with cartridge and stylus.

HA14 4-speed machine model	£4 9 6
HA16 4-speed machine model	£4 19 6
HA16 4-speed machine model	£4 19 6
HA29 4-speed machine model	£5 19 6
Asst. Exp. Post on extra	



GARRARD

Autumn Mono	£9 19 6	478 low cartridge	£19 19 0
ATC Mono	£8 19 0	450 low cartridge	£9 14 6
ATC Stereo	£8 9 0	13000 with GCS cartridge	£7 6 0
3000 Mono with stereo cartridge	£8 9 0	20000 with GCS cartridge	£7 6 0
4780 low cartridge	£10 19 6	Postage on all above 5/-	

SPECIAL OFFER—GARRARD AT5 AUTOCHANGERS

4-speed machine model—brand new and fully guaranteed. With Mono Crystal Cartridge. £5 19 6 Post-Exp.

TRANSCRIPTION MOTORS

GARRARD 451	£32 10 0	LENSCO GLE5	£17 1 0
GARRARD 451 with auto cart.	£32 10 0	LENSCO G16L8	£19 10 7
GARRARD 451 (stereo)	£29 19 6	LENSCO G170	£20 19 6
GARRARD 451 Mono/Stereo	£14 19 0	LENSCO G170	£20 19 6
GARRARD 451 A, 6 on plinth	£15 19 0	THORNSEN 12	£21 19 6
GARRARD SP25 Mono	£9 19 0	THORNSEN T0211	£28 9 4
GARRARD SP25 Stereo	£10 19 0	THORNSEN T0212	£28 9 4
PHILIPS AV10140	£12 12 6	SINGLE PLAYERS	£20 15 2
HELAN T111 Stereo	£8 19 6	Auto start and stop. With pick-up and crystal cartridge.	
COXSONSPEL 1		FEM with stereo cartridge	£3 19 6
Craftman 11	£17 2 11	COLLAR 12N1016 4-speed motor and model B	£3 9 6
Confession 11	£22 19 6	pick-up	
Model B	£25 4 0	Postage on all above 5/- extra.	

All other current models available. Postage on all above 5/- extra.

GREENCOAT RECORD PLAYER

2 speed model for 321 and 45 rpm. 4" battery operated. Complete with pick-up and dust with crystal cartridge. Also with auto stop and start.

LASKY'S PRICE 59/6 Post-Exp

AMPLIFIERS

STOP PRESS AM/FM TUNER/AMPLIFIER SCOOP

LOWE/OPTA L400 Spec. Valve Stereo Tuner and IF Amp. (incl. Multiplex) and VHF/FM switched AFCS. Superbly made, styling beautiful veneer cabinet. Large tuning scale—11 push button controls. Trig. list price **84/0**.

LASKY'S PRICE 59 GNS. Write for details and illustration. Limited quantities only. Carriage & Ins. 2/6 extra.

ARMSTRONG EQUIPMENT

Model 227M	£38 15 0	T-6	£17 19 0
Model 227	£38 15 0	T-6	£29 5 0
Model 226	£35 10 0	127M	£26 10 0
Model 226	£36 10 0	127	£27 10 0
Model 222 Amplifier	£27 10 0	Auto Stereo Amp	£27 10 0
Model 221	£22 10 0	P-C-U 25 Stereo Pre-amp.	£21 10 0
Model 221	£33 15 0	Stereo Multiplex Decoder	£14 10 0

MARTIN HI-FI AUDIOKITS

Using specially developed circuits, the very latest transistors and related circuits—these kits are all stock checked and tested before leaving the factory.

KIT 1	2 stage Matching Input Selector	LASKY'S PRICE £27/6
KIT 2	Pre-amplifier with volume control	LASKY'S PRICE £17/6
KIT 3	2 Channel Mixer, 4th order equaliser, 2 stage matching circuit, 2 stage matching circuit. 4-band 8 B each	LASKY'S PRICE £31/6
KIT 4	Pre-amplifier with tone-reinforcing circuit stage	LASKY'S PRICE £25/6
KIT 5	10 and 5 watt Mini Amplifier	LASKY'S PRICE £25/6
KIT 6	Power supply Converter Kit	LASKY'S PRICE £20/6
KIT 7	10 watt version of KIT 2	LASKY'S PRICE £20/6
KIT 8	Power module for KIT 2	LASKY'S PRICE £25/6

LASKY'S RADIO FOR FINEST VALUE AND COURTEOUS SERVICE

WW-134 FOR FURTHER DETAILS.

COMPLETE SYSTEMS

A Lasky's "Privilege Parcel Package Deal" allows you to purchase the complete Amlo System of your choice at a worthwhile cash saving. We shall be pleased to quote you "Privilege Parcel Package Deal" prices for any selection of equipment of your own choice. Refer to details of your requirements. H.P. Terms can be arranged on "Privilege Parcel Package Deal."

HI-FI FURNITURE

Choose from our extensive range of equipment cabinets and speaker enclosures by Decort, Hensing, Fisher, G. D. D., Hogan Furniture, etc. A full range is in stock to suit all types of equipment, furnishing style, etc. Complete installations can be made to your choice, and our expert staff will be pleased to advise you.



Shows range—Lowest equipment cabinet by Decort Hensing suitable for a wide range of equipment including space for record and tape storage.

Shows kit—'Eckert' cabinet suitable for most types of motor/turntable units.

TAPE RECORDERS

SPECIAL BARGAIN!! COSSOR CR.1604 PORTABLE TAPE RECORDERS

These recorders are extremely high quality and are brand new and unused. Many superb technical features include: slotted push button operation; auto both valves and transistors; 4 track, parallel track switching on play back; 2 speeds—1 and 2 1/2 ips.; take up, symbol, reels and gram tape—can be used with separate mount, 1st. iper; forward for foot switch, monitoring with headphones or through speaker; fast forward and rewind. Other features include a light position indicator; outputs for extra amplifier, external speaker, headphones and stereo socket; record level indicator—can be adjusted with tape stationery. Cabinet with carrying handle finished in two-tone beige-pink-stone, 2 big cut microphone, auto tape and entry 200.

Price 141.14 7/6—space for note. Supplied with new 1/2" 15" fully guaranteed. Make's List Price 39 cts.

LASKY'S SPECIAL PRICE 29 1/2 GNS. C. & P. 15/- extra.

JUST ARRIVED—THE NEW GARRARD STEREO DECK

Now available from stock—superb specification, Three 4 track stereo mono heads, 4 speeds—11, 11 1/2, 7 1/2, 4 1/2; take up, 7 1/2 speed; fast forward and rewind; tape position indicator; panic control; separate auto stop, play and erase heads—3 track; piano key controls interlocked for all functions; stop/start can be remotely controlled; auto, tape-wrap stop. Heavy duty motor, capacitor start and run, large systematically balanced flywheel. Deck finished in grey plastic over 141 x 22 1/2 x 6 1/2 in. depth below plinth line. For 141 20 p.p.s. Manual operation. Auto-tim-forward for 300/200 x 100. Included free.

LASKY'S PRICE 29 1/2 GNS.

MAGNAVOX-COLLAR 363 TAPE DECKS

The very latest 3 speed model—11, 8 1/2, 7 1/2 ips., available with either 3 track or 4 track line. Features include: 4 speed control; digital counter; fast forward and rewind, new 4 pole fully screened induction motor; interesting feature: size of tape 125 x 11 1/2 cm. deep below and plate. For 200 200 v. A.C. mains, 50 p.p.s. operation. New unused and fully guaranteed.

LASKY'S PRICE 1 track £10.10.0 Carriage and Ins. 2/6 extra. 4 track £13.6 7/6 extra.

SPECIAL FOR OVERSEAS CUSTOMERS—the new Magnavox-Collar 363 Deck for 110/125 v. 50 or 60 p.p.s. mains from available, prices as above. Post to any part of the world 25/-.

MARTIN TAPE RECORDER AMPS.

Designed for use with Collar 8000 Tape Recorder, its sub-component instructions make full assembly as simple as possible. Everything supplied including valves, etc. Monitoring facilities. 3 slow operation, speed controlling, etc. £20 0 0 A.C. mains. Price £21 10 0. 1 track £11 10 0. 4 track £12 10 0. Post 2/6. Portable carrying case—Designed to take the Collar 8000 Tape Deck and the Martin Tape Amplifier. Fitted with 2 x 20 cm. speaker. Price complete £25 6 0. Post 2/6. Note: These Amplifiers can be used with the Magnavox 363 deck by a simple alteration to the mounting of the record/play switch assembly.

**LASKY'S
RADIO**

**GREAT REBUILDING
SALE**

Due to complete rebuilding and
modernisation of our premises
at: 207 EDGWARE ROAD, W.2
we are able to offer
THOUSANDS of
unrepeatable bargains in
all departments!

Too many items to list—all at Rock Bottom Prices
PERSONAL CALLERS ONLY TO
207 EDGWARE ROAD, W.2
Open all day Sats.—early closing Thurs.
**THIS MONTH
ONLY!**

WW—137 FOR FURTHER DETAILS.

important new books for all engaged in the electronics industry

**RELIABILITY
of
ELECTRONIC COMPONENTS**
C. E. Jowett

PRINCIPLES AND APPLICATIONS OF BOOLEAN ALGEBRA FOR ELECTRONIC ENGINEERS

Salvatore A. Adelfo Jnr., and Christine E. Nolan.

This new book is one of the few available that have been written specifically for the electronic engineer. It is a readily understood textbook—each stage leads easily to the next and check problems are given at the end of each chapter to enable the student to assess his progress. An invaluable introduction to the subject which will be welcomed by all in the electronics industry.

45s. net by post 46s. 6d. 326 pp. 150 illustrations.

RELIABILITY OF ELECTRONIC COMPONENTS

C. E. Jowett.

Clarifies and presents all the relevant facts concerning the properties and stabilities of various classes of components and materials and seeks to provide each member of an electronics research team with a summary of information based on a wide experience of testing and evaluation.

42s. net by post 43s. 174 pp. illustrated.

obtainable from leading booksellers.

ILIFFE Books Ltd.

DORSET HOUSE STAMFORD STREET LONDON S.E.1

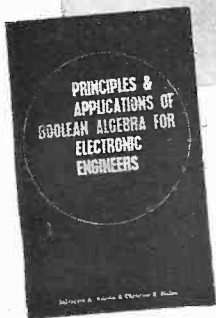

Wilkinsons FOR RELAYS

P.O. TYPE 3000 AND 600
BUILT TO YOUR REQUIREMENTS—QUICK DELIVERY
COMPETITIVE PRICES—VARIOUS CONTACTS
DUST COVERS—QUOTATIONS BY RETURN

MINIATURE SEALED RELAYS

OVER 120 TYPES IN STOCK. SEND FOR LIST

SIEMENS 1 C.O.			
2.203 + 2.212	1108A	18.6	
5082 + 5081	11061	19.5	
14543 + 14542	11060	19.5	
1.00042 + 1.00043	11061	19.5	
1.70041 + 1.70042	11062	22.6	
G.E.C. 2.50001	4CO	M1108	19.5
2.50002	1CO	M1072	15
5.00001	2CO	M1052	17.6
6.0001	2m2+HD	M1105	15
2.50001	2C2K	M1417	18.6
5.00001	3CO	M1424	17.6
2.50001	2mHD	M1458	15
4.023	2CO2K	M1462	15
2.50002	1m1HD	M1482	19.5
18093	3C2K	M1487	17.6
47011	2C2K	M1490	19.5
47011	2C2K	M1493	19.5
07003	4K	M1507	19.5
S.T.C. 45G	1mHD	4180R13	19.5
1204	1mHD	4180E13	19.5
2003	2CO2M	4190HD	19.5
2.50013	2CO	4184GE	19.5
7.50013	2CO	17.2250A21	17.6
7.50013	2CO	2.2250A21	17.6
		N2350A21	17.6

ERICSSON
 7.50013 2CO
 7.50013 2CO

RECTIFIER UNITS. Input 230/440 v. A.C. output 50 v. 60 v. 100 v. D.C. £35.

FREQUENCY METERS. 45-50 cycles per second, 230 v., 6 1/8 in. Flush Round. Brand new, £10/10/-.

ROTARY VANE VACUUM PUMPS. Rotary 1 1/2 Mark 3. Brand new 7 cu ft per min 10 p.s.f. at 1,200 r.p.m. size 6in. x 4in. splined shaft 2in. x 1/2 in. Inlet and outlet 1/2 in. dia. internally serrued 95% ea., post 5/-.

RELAYS. 24 volt D.C. 4 Make, 4 Break, 10 amp. 24 1/2 x 1 1/2 with Dust Cover, 18.6 each.

SIEMENS MINIATURE RELAYS TYPE TRLS 1544. 24 volt, 2 change-over contacts, heavy duty with transparent dustproof cover and base, 17.6

SIEMENS HIGH SPEED OPEN TYPE RELAYS with usual adjustments, 1.7000 1 change-over, 17.6 each.

FANS INDUSTRIAL TYPE. 230/240 v. 16in. blades in housing, adjustable louvers, filter, brand new, £20, carr. 15/-.

ONE HOLE FIXING SWITCHES

SINGLE POLE Double Throw, 3 amp. 230 v. A.C. can be used as ON/OFF or CHANGE-OVER switch.

12/- per dozen, 75/- per 100

VEEDER-ROOT MAGNETIC COUNTERS WITH ZERO RESET 500 COUNTS PER MINUTE. COUNTING TO 999,999. 230 volts A.C. 65/-, Post 2/6.

PRECISION SILVER MICA CAPACITORS. 0.1 mfd. 250 v. A.C. 1 p.f., 7/6; 0.2 mfd. 1.5, 100 mfd. 15% 17.6; 0.5, 0.15 mfd. 250, 7/6; 0.25 mfd. 15/-.

L. WILKINSON (CROYDON) LTD.

LONGLEY HOUSE LONGLEY RD. CROYDON SURREY

Phone: THO 0216 Grams: WILCO CROYDON

METERS GUARANTEED Complete list available

2in. Moving Coil Flush Round Microamps 0.040, 25/-

Millicamps 0.1 or 0.10. Volts 0.20 or 0.050.

Amps 0.04. All D.C. 27.6 ea.

2 1/2 in. Moving Coil Flush Round. Microamps 0.040, miscell 70/-

0.100, 40/-; 0.100, 70/-

Millicamps 0.2, 50/-; 0.20, 35/-

Amps 0.04, 42/6; 0.250, 60/-

Volts 0.2, 45/-; 0.250-0.250, 60/-

M.C. RECTIFIER A.C. METERS. 31 1/2 x 1 1/2 Milliamperes, 70/-; 30 or 100 v., 72/-; 230 volts 65/-.

MOVING IRON A.C. AMMETERS. 0.10 2 1/2 in. fr. 44/-

0.060 in. Projection Round, 50/-

DIRECT ON STARTERS by Crabtree B15, 95/-

WEE MEGGER INSULATION TESTER 500 VOLT SERIES 3. BRAND NEW in leather case, £18/10/-

AVOMETER POWER FACTOR WATTAGE UNIT, £7.

MEGGER, Series 2. 600 volt, 100 megohms, leather case, leads, keys, etc. Brand new, £37/10/-

AVOMETERS MODEL 7, £31/10/-, Post 7/-

VOLTAGE REGULATOR with Current Limiting Reactor, Input 230V., Output 230 57.5 to 230 v., 21 amps, controlled by 110 57.5 Rotary Switch "English Electric", £20.

SUBMINIATURE MICRO SWITCHES

HONEYWELL 11 SM-TN13 S.P.D.T. 6/0 ea.

NO EXCUSES! NO DELAYS! FROM STOCK!

VARIABLE VOLTAGE TRANSFORMERS

PORTABLE



Input 230 v. A.C. Output variable 0-260 v. A.C. at 2.5 amp. Fitted in beautifully finished steel case. Complete with voltmeter, pilot lamp, fuse, switch, carrying handle, £9/17/6 P. & C. 5/-.

OPEN TYPES

Designed for Panel Mounting

Input 230 v. A.C. 50/60 Hz. Output variable.

0-260 v. 1 amp. £3 3 0

1 amp. £4 17 6

2 1/2 amp. £5 12 6

1 AMP. 1 AMP.



50 AMPS.

1 AMP.

1 AMP.

1 AMP.

1 AMP.

1 AMP.

1 AMP.

1 AMP.

1 AMP.

1 AMP.

INPUT 230 v. A.C. 50/60 Hz. BRAND NEW. Carriage Paid. Buy direct from the importer, keener prices in the country. All Types (and Spares) from 1 to 50 amp. available from stock.

0-260 v. at 1 amp.	4	10 0
0-260 v. at 2.5 amps.	5	17 6
0-260 v. at 4 amps.	8	7 6
0-260 v. at 5 amps.	9	6 0
0-260 v. at 8 amps.	13	10 0
0-260 v. at 10 amps.	17	0 0
0-260 v. at 12 amps.	19	0 0
0-260 v. at 15 amps.	22	0 0
0-260 v. at 20 amps.	32	0 0
0-260 v. at 37.5 amps.	65	0 0
0-260 v. at 50 amps.	85	0 0

15 DIFFERENT TYPES AVAILABLE FOR IMMEDIATE DELIVERY.

SLIDER RESISTANCES



1 ohm, 12 amp. 17/6; 1.2 ohm, 14 amp. 27/6; 75 ohm, 2 amp. 37/6; 200 ohm, 1.25 amp. 37/6; 36 ohm, 6.5 to 2.8 amp. tapered winding, geared drive (less knob) 37/6. P. & P. 3/6

100 WATT POWER RHEOSTATS

(NEW) Ceramic construction, winding embedded in Vircous Enamel, heavy duty brush assembly designed for continuous duty. AVAILABLE FROM STOCK IN THE FOLLOWING VALUES: 10 ohm 2.5 amp. 7.5; 50 ohm 1.4; 100 ohm 1.4; 250 ohm 7.4; 500 ohm .45; 1,000 ohm .280 mA; 1,500 ohm .230 mA; 2,500 ohm .2; Diameter 3 1/2 in. Shaft length 3 1/2 in. dia. 11in. 27/6. P. & P. 1/6

Now also available in 25 WATT

10 ohm, 1.5 a.; 25 ohm, 1 a.; 50 ohm, .75 a.; 100 ohm, .5 a.; 250 ohm, .3 a.; 500 ohm, .2 a.; 1,000 ohm, .15 a.; 1,500 ohm, .12 a.; 2,500 ohm, .1 a.; all at 14/6. P. & P. 1/6.



INSULATED TERMINALS available in black, red, white, yellow, blue and green. New 15/- per doz. P. & P. 1/2.



370v. A.C. MOTOR & REDUCTION GEAR BOX

Reversible 1 1/2 h.p. 1.450 r.p.m., 3/8 in. dia. lin. long shaft. Mounted in anti-vibration cradle.

Supplied complete with precision 20-1 reduction gear box, and pulleys. Made to highest standard for computer work. Ex equip. First class condition.

Price £3/5/0 P. & P. 7/6 extra.

7 Amp. A.C./D.C. Variable Output Power Unit

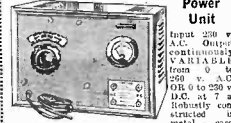

Input 230 v. A.C. Output continuously variable from 0 to 250 v. D.C. at 7 A. Industrially constructed in metal case, complete with safety fuse, on indicator and voltmeter. Size: 17 x 12 1/2 in. Weight 80 lb. Price £24/10/-, Carriage 20/-

SERVICE TRADING COMPANY

SERVICE TRADING CO

Postage and Carriage shown above are inland only. For overseas please ask for quotation. We do not issue a catalogue or list.

ULTRA VIOLET BULBS
Easy to use source of U.V. for dozens of practical and experimental uses.
12 volt 36 watts A.C./D.C. SBC. 6/6. P. & P. 1/1-1/2
12 volt 60 watts A.C./D.C. SBC. 8/6. P. & P. 1/1-1/2
Transformer to suit the above. Input 200-240 v. A.C., 12 volt 36 watts, 16/6. P. & P. 1/6
200-240 v. A.C. 12 volt 60 watt, 12/16. P. & P. 3/16
Set of 4 Colours FLUORESCENT PAINT: Red, yellow, green and cerise. In 1 oz. tins. Ideal for use with the above Ultra Violet Bulbs. 9/6, plus 1/6 P. & P.

MOVING COIL HEADPHONES
Finest quality soft chamois earmuffs. Superb reproduction. Complete with jack plug, 25/6. P. & P. 2/6.

SIEMENS SEALED HIGH SPEED RELAYS
H96A, 2.2 ohm - 2.2 ohm, H96G, 50 ohm - 50 ohm, H96C, 145 ohm - 145 ohm, 1,700 ohm - 1,700 ohm. All at 12/6 each. P. & P. 1/6 on each relay.

P.O. RELAYS, Type 3000
100 ohm, 3 c/o, 2 leads, 2 1/2 watt, 8 ohm, 6/6. 500 ohm, 1 heavy duty c/o, 600 ohm, 2 heavy duty c/o, 2000 ohm, 1 make, 1 break, 25,000 ohm, 2 make, 2 break, All at 12/6 each, 20,000 ohm, 2 heavy duty make. Plus 1/6 P. & P.

SOLENOID. Overall length 3 1/2 in., stroke 1/2 in. Maximum push 8 oz. 12-24 v. D.C. operation. D.C. resistance 25 ohms, 2 1/2 watt, P. & P. 1/6.

G.C. SEALED RELAYS
M1059 5,000 ohm, 2 c/o, M1091 180 ohm, 4 c/o, M1092 670 ohm, 4 c/o, M1095 670 ohm, 2 m, 2, 6/6. M1100 670 ohm, 2 c/o. Ex new equipment. All at 12/6 each, plus 1/6 P. & P.

14,000 OHM SEALED RELAY. High Speed single c/o. Platinum contacts. Very fast. Ideal for Transistor circuitry. Will operate on 1 milliamper, 25v., P. & P. 1/6.

CARPENTER POLARISED RELAY. Type SAF TR 2 x 1,900 turns at 55 ohms. Including Base 25/6. P. & P. 1/6.

12-18 VOLT D.C. RELAY
168 ohm coil, 3 x 5 amp. N.I. c/o contacts. New, 16/6, plus 1/6 P. & P.

"CABY" MULTI-RANGE TEST METER
Model 110. D.C. volt 0.5 v. to 2.5 v. at 10,000 ohm per volt. Ideal for testing A.C. and D.C. volt. 0 v. to 30 v. 150 v. to 300 v., 1,000 v. at 1,000 ohm per volt. Resistance, 20 ohm, 200 ohm, 2,000 ohm, 20,000 ohm. Complete range of spares available from stock. Price including Test Leads, Battery, Instruction book, Packing and 1 Year C.K. Price 89/0/0. Three additional models available. Prices from 54/- to 114/1-1. Lenses gladly sent on request.

LATEST HIGH SPEED MAGNETIC COUNTERS
4 figure 10 impulses per second. Types 100D, 41 ohm coil, 3 x 5 v. D.C. operation. Type 100A, 500 ohm coil, 18-24 v. D.C. operation. Type 100B, 2,300 ohm coil, 36-48 v. D.C. operation. Any type, 15/- each, plus 1/6 P. & P.

RESETTING HIGH SPEED COUNTER
4 figure 1,000 ohm coil, 36-48 v. D.C. operation. 43/10/-, P. & P. 1/6.

FIRST AGAIN! TYPE 3R SILICON SOLAR CELL
Four 5 v. units connected in series connected in high capacity polyethylene enclosure. Fine lead connections.

diffusing lens system to ensure maximum light pick-up. Output - up to 2 v. at 16-20 mA. in bright sunlight. Wider spectral response, and thirty times the efficiency of silicon cells. As used to power earth satellites. 37/6 and 1/1- P. & P. JUST PUBLISHED - "SOLAR CELL & PHOTO-CELL EXPERIMENTERS GUIDE". Teaches the principles of light sensitive devices and their application. 26/-, post paid.

MINIATURE IMMERSION HEATER. 6in. x 3/4 in., 240 volt, 12 watts, 6/6, plus 2/- P. & P.

ALL MAIL ORDERS. ALSO CALLERS AT: 47-49 HIGH STREET, KINGSTON-ON-THAMES
Telephone: Kingston 9450. Closed Saturdays.

230 v. A.C. RELAY. 2 c/o 2 amp. contacts, 9/6, ex new equip. P. & P. 1/6.

HIGH SPEED BLOWER UNIT
200-250 v. A.C. Powerful 2-speed motor, 11,000 and 13,000 R.P.M., 17/6, plus P. & P. 2/6.
AUTO TRANSFORMERS. Step up, step down, 110-220-220-240 v. Fully shrouded. New. 300 watt type 43 each. P. & P. 4/6. 500 watt type 44/2/6 each. P. & P. 6/6. 1,000 watt type 45/5/2 each. P. & P. 7/6.

UNIVERSAL DEMONSTRATION TRANSFORMERS
A complete complete apparatus, comprising a robustly built transformer and electro-magnetic with removable coils and pole pieces. Kit topped for 230 v., 220 v., 110 v., 115 v.; 6, 12, 24, 36, 48, 60, 72, 84, 96, 110, 120, 132, 144, 156, 168, 180, 192, 216, 228, 240, 252, 264, 276, 288, 300, 312, 324, 336, 348, 360, 372, 384, 396, 408, 420, 432, 444, 456, 468, 480, 492, 504, 516, 528, 540, 552, 564, 576, 588, 600, 612, 624, 636, 648, 660, 672, 684, 696, 708, 720, 732, 744, 756, 768, 780, 792, 804, 816, 828, 840, 852, 864, 876, 888, 900, 912, 924, 936, 948, 960, 972, 984, 996, 1,000. All at 12/6 each, plus 1/6 P. & P.



A.C. These coils are also used for D.C. experiments. Complete with all accessories as shown. 4/17, plus 10/- carr. Leaflet on request.

WIMSHURST ELECTROSTATIC GENERATORS
413/17/6, carr. U.K. (B.R.S.) 10/- Leaflet on request.

S.T.C. SILICON POWER RECTIFIERS
R530 Series. All types 1.5 amp. wire ended. R531, 100 v. P.I.V. 4/- R532, 500 v. P.I.V. 8/- R533, 100 v. P.I.V. 5/- R534, 500 v. P.I.V. 10/- R535, 400 v. P.I.V. 7/- R536, 800 v. P.I.V. 10/- 4 can be used to make 3 amp. bridge. Not Seconds. Brand New Stock, Post paid.

230 VOLT A.C. GEARED MOTOR
Type B180 1/2 h.p. 1.58h. Each 22/9/6. P. & P. 2/6. Type D180 1/2 h.p. 1.58h. Each 22/9/6. P. & P. 2/6. Type B180 80 rpm, 38h. Each 22/9/6. P. & P. 2/6.

INSULATOR
B 6 hole, 25 watt all non-bridging, full wires, plain coil, 950 ohm. Unused 43/2/6. P. & P. 4/6.

NICKEL CADMIUM BATTERY. Sintered Cadmium Type, 1.2 v., 7 AH. Size: height 3 1/2 in., width 4 1/2 in. Weight: approx. 13 oz. Ex-R.A.F., tested, 12/6. P. & P. 2/6.

LIGHT SENSITIVE SWITCHES
Kit and parts including ORP-12. Cadmium Sulphide PhotoCell, Relay, Transistor and Circuit. Now supplied with new Siemens High Speed Relay for 6 or 12 volt operations. Price 25/-, plus 2/6 P. & P. ORP-12 and Circuit 8/6, post paid.

A.C. MAINS MODEL
Incorporates main transformer, rectifier and special relay with 3 x 5 amp. mains c/o contacts. Price inc. circuit 47/6, plus 2/6 P. & P.

NEW LINE! PHOTO ELECTRONIC COUNTER
Can be set for counts up to 500 per minute. 210-250 v. A.C. powered. Kit of Components including photo cell. High speed non-resistive counter. Transformer relay, etc., together with clear circuit diagram. 43/2/6, plus 2/6 P. & P.
ELECTRIC CHECK METER (Sangamo Weston), 200-240 volt A.C., 40 amp. As new 35/- plus 3/6 P. & P.

SEMI-AUTOMATIC "BUG" SUPER SPEED MORSE KEY. 7 adjustments, precision cooled, speed adjustable 10 w.p.m. to as high as desired. 1/2 Weight 2 1/4 lb. 44/2/6, post paid. (Illustrated)
TRANSFORMERISED FULLY AUTOMATIC ELECTRONIC KEYS. 230 v. A.C. or Battery operated. Incorporates built-in monitor Oscillator, Speaker, and Keying Lever. Adjustable speeds. Keying either auto, semi-auto or manual. (Illustrated) hold 4 diodes, 7 transistors. Price 16/10/-.

TRANSFORMERISED MORGAN OSCILLATOR
Fitted 2 1/2 in. Moving Coil Speaker. Uses type PP3 or equiv. 9 v. battery. Complete with latest design Morse Key. 22/6, plus 1/6 P. & P.

PERSONAL CALLERS ONLY: 9 LITTLE NEWPORT STREET, LONDON, W.C.2. Tel: GR 0576
(OFF LEICESTER SQUARE)

Open till 1 p.m. Thursday and all day Saturday.

TRANSISTORS Brand new

OC29	18/-	OC12	12/-	AF15	18/-
OC41	7/-	OC140	19/-	AF16	10/-
OC44	6/-	OC171	9/-	AF17	9/6
OC45	6/-	AF124	10/6	BC211	10/-
OC71	5/-	Get 104	6/-		
OC72*	7/-	Get 101	6/-		
OC73	6/-	Get 103	6/-		
OC76	6/-	Get 173	12/6	OA91	3/-
OC76	6/-	25019	30/-	OX81	4/-
OC81	8/-	AC107	14/6	IS11	4/-
OC83*	8/-	AF124	11/-	ZS108	3/-

*Available in Matched Pairs.

ZENERS 5
All 1/2 watt 5% to 10% each, 4.3 v., 4.7 v., 5.1 v., 5.6 v., 6.2 v., 6.6 v., 7.5 v., 8.2 v., 9.1 v., 10 v., 12 v., 15 v., 16 v., 22 v.

L.T. TRANSFORMERS
All primaries 220-240 volts.

Type No.	Sec. Taps	Price	Car.
1	30, 32, 34, 36 v. at 5 amps	42/19/6	6/-
2	30, 40, 50 v. at 5 amps	44/15/-	6/-
3	10, 17, 18 v. at 10 amps	43/2/6	4/6
4	6, 12 v. at 20 amps	43/10/6	4/6
5	17, 18, 20 v. at 20 amps	45/2/6	6/6
6	6, 12, 20 v. at 20 amps	44/15/-	7/6
7	24 v. at 10 amps	43/9/-	3/6
8	28, 29, 30, 31 v. at 21 amps	45/15/-	10/-

A.C. AMMETERS 0-1, 0-5, 0-10, 0-15, 0-20, 0-50, 0-100, 0-200, 0-500, 0-1,000, 0-2,000, 0-5,000, 0-10,000, 0-20,000, 0-50,000, 0-100,000, 0-200,000, 0-500,000, 0-1,000,000. All at 21/- each. P. & P. extra.

A.C. VOLT METERS 0-25, 0-50, 0-150, 0-1 v. M.I. 2 1/2 in. Full round all at 21/- each. P. & P. extra.

0-300 v. A.C. Rect. M-Coil 2 1/2 in. 29/-
0-300 v. A.C. Rect. M-Coil 3 1/2 in. Type W23. 35/-

0.5 amp. D.C.M.I. 2 1/2 in. Rnd. 11/6
0-500 M.C.M.P. sub-min. 2 1/2 in. dia. Scaled 8/11/6
0-1 milliamper 2 1/2 in. Postage extra.

VAN DE GRAAF ELECTROSTATIC GENERATOR. Fitted with motor drive for 230 v. A.C. giving a potential of 50,000 volts. Supplied absolutely complete including accessories for carrying out a number of interesting experiments, and full instructions. This instrument is completely safe, and ideally suited for school demonstrations. Price 65/6, plus 4/- P. & P. 1/6 on request.

Latest type SIEMENS MINIATURE RELAY. Type 3C944, 4 pole, c/o 10 amp. contacts, 24 volt D.C. operation, 12/6 each, P. & P. 1/6

BUILD AN EFFICIENT STROBE UNIT FOR ONLY "37/6". The ideal instrument for workshop lab, or factory. This wonderful device enables you to "freeze" motion and examine moving parts stationary. We supply a simple circuit diagram as well as all electrical parts including the NSP2 Strobe tube which will enable you to easily and quickly construct your own for infinite variety. Price 37/6, plus 3/- P. & P.

SANGAMO WESTON Type S32
2 1/2 Edgewise Meter
250 Micro-amp, sealed in dB's. New 29/6, P. & P. 1/6

INSULATION TESTERS (NEW)
Test to I.E.E. Spec. Rugged metal construction, suitable for bench or field work. constant speed clutch. Size 8 1/2 in. x 4 1/2 in. H. 6 in. Weight 6 lb. 500 volt 500 megohms. Price 22/- carriage paid. 1,000 volts, 1,000 megohms, £28, carriage paid.

NEW SOUND POWER OPERATED EX-A-MINUTE TONE AND BREATH SETS
Two such sets connected up will provide perfect intercom. No batteries required. Will operate up to 1/2 mile. Price 17/6 each plus P. & P. 3/- or 32/6 per pair. P. & P. 4/-.

PERSONAL CALLERS ONLY: 9 LITTLE NEWPORT STREET, LONDON, W.C.2. Tel: GR 0576
(OFF LEICESTER SQUARE)

Open till 1 p.m. Thursday and all day Saturday.

Open till 1 p.m. Thursday and all day Saturday.

Open till 1 p.m. Thursday and all day Saturday.

Open till 1 p.m. Thursday and all day Saturday.

Open till 1 p.m. Thursday and all day Saturday.

Open till 1 p.m. Thursday and all day Saturday.

Open till 1 p.m. Thursday and all day Saturday.

Open till 1 p.m. Thursday and all day Saturday.

Open till 1 p.m. Thursday and all day Saturday.

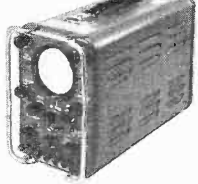

PORTABLE OSCILLOSCOPE CT-52

A compact general purpose instrument with many unusual features. Size 9in. high, 8in. wide, 16 1/2in. deep. Time base 10 c/s to 40 Kc/s. Y plate sensitivity 40V per cm. Tube 2J5. Frequency compensated amplifier up to 38 dB gain. Bandwidth up to 1 Mc/s. Single sweep facilities. Operates from A.C. mains 100-250 volts 50 c/s. Complete with all test leads, metal transit case, instruction book and circuit diagram. As used in the American version of the No. 19 set. 15/- P. & P. 1/6.

MICROAMMETERS

R.C.A. 0-500 microamps, 2 1/2in. circular flush panel mounting. Dials are engraved 0-15, 0-600 volts. As used in the American version of the No. 19 set. 15/- P. & P. 1/6.

AR-88 SPARES

R.C.A. Headphones 12/6
Escutchions (Windows) 8/6
Knobs. Medium size. Set of 6 10/-
Knobs. Large size 5/6
Block Condenser (3 x 4 mid.) 12/6

AR-8BD RECEIVERS

A good selection is available for callers at from £30. All are in good condition and are functioning perfectly. Realign.

HEAVY DUTY TRANSFORMER

Input 220 volts to 250 volts at 50 cycles tapped every 5 volts. Secondary, 50 volts at 15 amp. Very conservatively rated. Size 7 1/2 x 5 1/2 x 7in. Wt. 28 lb. Brand new. £5/17/6. Carr. 7/6.

SILICON RECTIFIER. 800 P.I.V. The Modern Marvel. 3in x 1in. Can be used to replace T.V. rectifiers up to 500 mA. (40 1/2 ballast resistor). 7/-.
TS-175 HETERODYNE FREQUENCY METER
A high frequency version of the well known BC-221. Accuracy 0.05%. Frequency range 80 to 1,000 Mc/s. As new condition with original calibration book. Tested and guaranteed. £75.

LABORATORY pH METER

Marconi type TF1093/1. Range 0-14 pH direct reading. Full temperature compensation. Scale expansion providing discrimination of 0.01 pH. A.C. mains operation. Brand new complete with electrode stand and manual. Full details on request. £35.

CINTEL OSCILLOSCOPE

A 12in. demonstration oscilloscope with all controls at rear. BRAND NEW £80.

SANGAMO WESTON VOLTMETERS

S61. Dual range 0 and 0-100 v. D.C. FSD 1 mA. 3in. scale. Recent manufacture. Ideal for schools. Complete in super quality carrying case, with test leads and leads.

BRAND NEW. Boxed 32/6. Post 2/6.

SIGNAL GENERATOR KC-218 (FM/AM)
MARCONI TF 937. Covers 85 Kc/s to 30 Mc/s in 8 switched ranges. Effective length of film scale is 50ft. Output level variable in 4 dB steps from 1uV to 100 mV (75Ω). Also 1V Outputs down to 0.1uV from an outlet at 7.5Ω. Int. mod. at 400 c/s, 1 Kc/s, 1.6 Kc/s and 3 Kc/s. FM frequencies above 394 Kc/s. Variable mod. depth and deviation. Crystal calibrator 200 Kc/s and 2 Mc/s. Monitor speaker for beat detection. Fully metered, blower cooled, Panclastic. A.C. mains 100 to 150 and up to 250 volts, 45 to 100 c/s. 17 1/2 x 20 1/2 x 17 1/2in. Weight 117 lbs. Fully tested and guaranteed. Under 10% of original price. £65. Carr. 50/-.
CINTEL EQUIPMENT ELECTROLYTIC CAPACITANCE AND INCREMENTAL INDUCTANCE BRIDGE No. 36601
A modern instrument, all solid state, which accurately measures the capacity of electrolytic condensers from 0.1uF to 1,000.0uF under operating conditions. Leakage current and polarizing voltage are separately metered. Inductances from 100 mH to 100 H can also be measured with currents up to 100 mA. A.C. mains operation. Untested with handbook. £100.
WIDE RANGE CAPACITANCE BRIDGE. No. 1864.
A matching instrument to the above. All solid state. Mains operation. Measures from 0.002pF to 100.0F. Unused with handbook. £100.

V.H.F. SIGNAL GENERATOR DIRECTLY CALIBRATED. Covers 10 to 300 Mc/s (4 bands). DIRECTLY calibrated. Int. Mod. at 400, 1,000 and 5,000 c/s. Attenuated or forced out. Guaranteed over-hauled, accurate and in perfect working order. £32,10/-, Carr. £1.
HAMMARLUND SP-600-JX
20 valve dual conversion superhet receiver covering 540 kc/s to 54 Mc/s in 6 bands. This is a professional quality receiver of recent design with stability of 0.01% or better. Second channel rejection 74 dB down and spurious responses are at least 100 dB down. Bandwidth from 200 c/s to 13 kc/s. Crystal filter with crystal phasing control. Operates directly from A.C. mains 90-260 v. 50-50 c/s. Original cost £510. Supplied overhauled and in first class working order, £100. Fuller details on request.

PCR-3 RECEIVERS
These receivers are in as new condition. They have 3 wavebands with a frequency coverage of 190-570 metres, 2.3-7.3 Mc/s, 7.0-23 Mc/s, R.F. stages, 6 valves. Output for 3 ohm speaker. Require external Power Supply or can be fitted with internal Mains Power Supply for £2 extra. Circuit simplified. Fully tested prior to dispatch. £8/19/6. Carriage 10/-. Vibrator Supply Unit for operation from 12 v. car battery for caravans or boats, 15/6. Carriage 7/6.
DISTORTION FACTOR METER
MARCONI TF-142E. This instrument measures the percentage of total harmonic distortion in the fundamental frequency range 100 to 8,000 c/s. The lowest scale engraving is 0.05%. Will handle 2 watts (continuous) and will give satisfactory readings with only 1mV input. Mains operated. Output impedance 600 ohms. Very good condition. £30. Carr. £1.
MINIATURE RELAYS. 240 v. A.C. coils. Contact assembly 2 "m" makes" and 1 C.O. 5 amps. Size 2 x 1 1/2 in. Unused and removed from brand new equipment. 8/6 post paid.
B. & R. RELAYS TYPE CO3. 230 volt A.C. coils. Very heavy duty contact assembly. 4 makes. Size 4in. x 3in. x 2 1/2 in. weight 2 lb. BRAND NEW. 27/6. P. & P. 2/6.
HICKOCK OSCILLOSCOPE OS-88/U
A high grade general purpose instrument made to exacting U.S.A. Navy specifications. Detachable cover with carrying handle. Compact (13 1/4 x 6 x 8 1/2 in.) weight 17 lbs. Green trace 3 in. tube. Bandwidth amplifier D.C. to 2 Mc/s (D.C. coupled). Sensitivity 40 mV/cm. "X" amp. can be used separately, similar spec to "Y" amp. Leads are housed in case. For A.C. mains 105 to 125 v. 50 to 1,000 c/s. BRAND NEW, tested and guaranteed. £25. Carr. 10/-. Auto transformer 15/6 extra.

STANDARD TRANSFORMERS
Vacuum impregnated, interleaved, E.S. screen, universal mounting. Size 4 x 3 1/2 x 2 1/4in. ALL BRAND NEW, 24/- each. Post 2/6.
Type 1. 250-0-250 v. 80 mA. 6.3 v. 3 a. tapped at 4 v. 4 x 6.3 v. 1 a. tapped at 4 v. and 5 v. 2 a.
Type 2. as above but 350-0-350 v. 20 mA.
Type 3. 30 v. 2 a., tapped at 12, 15, 20 and 24 v. to give 3-4-5-6-8-9-10 v., etc.
Type 5. 0-6-9-15 v. 4 a. ideal for chargers.

CHARLES BRITAIN (Radio) LTD.
11 UPPER SAINT MARTIN'S LANE LONDON, W.C.2. Telephone Bar 0545
Near Leicester Sq. Station. (Opposite Tourist House)
Shop hours: 9-6 p.m. (9-1 Thursdays). Open all day Saturday.

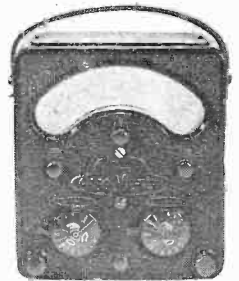

AVOMETER MODEL 7
Complete with leather carrying case, leads and batteries ready for use. Fully guaranteed. £33/13/- Post 7/-.

PHASE MONITOR ME-63/1 (AN-URM-47)
Designed to measure directly the phase angle between two applied audio frequency signals of from 20 to 20,000 c.p.s. 1%. Direct indication on a panel meter. Input can be sinusoidal or non-sinusoidal from 2 to 30 volts peak. Of recent manufacture (1957) by Control Electronics Inc. and ex-U.S.A. Air Force. In first class condition with handbook. A complex instrument with 19 valves. £40. Carr. 30/-.

T.C.C. METALPACK CONDENSERS.
0.1 mfd. 500 v. D.C. wkg. at 70°C. Brand new, polythene wrapped, 7/6 doz., or £2 per 100. T.C.C. METALMITE 350v. D.C. wkg. 0.1 mfd. (CP37N), 0.05 mfd. (CP35N), 0.01 mfd. (CP22N) all at 5/6 doz. or 32/6 per 100. SPRAGUE METALCASED CONDENSERS 0.01 mfd. 1,000 v. D.C. wkg. 5/6 doz., or 32/6 per 100.

T.C.C. VISCONAL CONDENSERS.
8 mfd. 600 v. D.C. wkg. at 71°C. CP 152 v. Size 3 1/2 x 1 1/2 in. high. BRAND NEW (boxed), 8/6 each. DUBILIER NITROGOL 8 mfd. 350 v. D.C. wkg. at 71°C. Size 1 1/2 x 1 1/2 in. high. With firing clips. BRAND NEW (boxed) 5/6 each. T.C.C. or DUBILIER. 4 mfd. 600 v. wkg. CP 130T or similar. 1 1/2 x 1 1/2 x 4 1/2 in. high. BRAND NEW (boxed), 4/6 each. All post paid.

LOW CAPACITANCE BRIDGE
MARCONI TF 1342. Range 0.002 pF to 1,111 pF. Accuracy 0.2%. Three terminal transformer ratio arm bridge allows 'in situ' measurements. Internal oscillator frequency 1,000 c/s. 12 x 17 x 8 1/2 in. Weight 13 1/2 lbs. A.C. mains 200 to 250 volts to 150 v. 40-100 c/s. With leads and handbook. ABSOLUTELY BRAND NEW. £45.

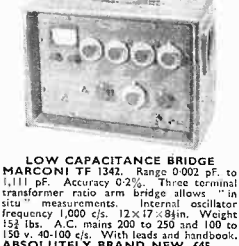

20 Amp. L.T. SUPPLY UNIT

Plus 40/- Carr. & Pkg.
G.B. (Inland)

**LATEST DESIGN
HEAVY DUTY**
12/24 VOLT D.C.
Output: Adjustable
up to 20 amps
CONTINUOUS
at 12/24 volts plus
trickle. Input: 220/
230/240 VAC 50
cycles.
FULLY FUSED.
Neon indicator, 0-20
amp. meter. Size:
16" x 12" x 20in.
high, in heavy gauge
steel cabinet. Grey
Hammer finish.
Weight: 50 lbs.

**ONLY
£29.10.**

**CONSTANT VOLTAGE TRANSFORMER
AUTOMATIC MAINS STABILISER**

Specification
Input: 240 v. A.C. $\pm 20\%$ —50 cycles.
Output: 240 v. A.C. Capacity: 250 watts.
Accuracy: $\pm 1\%$ Size: 11x6 1/2 x 6in. high.
Weight: 21 lbs. Fitted
signal lamp and switch. **£11.10.** Carr. & Pkg. 20/-.

*** CORRECTED WAVE**
Modern design in 2-tone grey hammer steel case with
handle. Complete with lead and plug.

1,000 WATT MODEL
Input 240 v. A.C. $\pm 20\%$ Output
accuracy $\pm 1\%$. Fitted signal lamp
and switch. Carr. & pkg. 25/-.

£29.10.0

**PORTABLE VARIABLE A.C. POWER
SUPPLY UNIT**

Designed for engineers
whose requirements
call for a visual indication
of volts applied.

OUTPUT:
0-260 v. 1 $\frac{1}{2}$ amps.
INPUT:
230 v. A.C. 50/60 c.p.s. Fitted
with fuses, voltmeter, safety indicator, on-off switch
and lead. Size: 8x5x5in. high.

PRICE £8.10.0 Carr. & Pkg. 10/-.

**VARIABLE VOLTAGE
TRANSFORMERS**

WORLD FAMOUS "SLIDE-TRANS" AVAILABLE ONLY FROM I.M.O.

*** RATED CURRENT CONSISTENT AT ALL POINTS ALONG THE WINDING**



Output: 0-260 V. Input: 230 V. A.C. 50/60 c.p.s.
Shrouded fully variable transformers for bench
or panel mounting.



1 Amp. **£4.10.0**
2.5 Amp. **£5.17.6**
5 Amp. **£9.0.0**
10 Amp. **£18.5.0**
20 Amp. **£32.10.0**

Carr. & Pkg. extra.

Inset shows latest type brush Gear providing 1 volt variation.

PORTABLE TRANSISTOR TESTER

SUITABLE FOR PRODUCTION & LABORATORY USE
SPECIFICATION.

Alpha 0.7 to 0.997
Beta 5-300
ICO 0.50 μ A. 5mA
Capable of measuring
GERMANIUM AND
SILICON DIODES.
DESIGNED WITH RESI-
STANCE SCALE 200
ohms to 1 Megohm as
an ADDED FEATURE.
Housed in heavy duty
plastic case, c/w in-
ternal battery.

Plus S.F. & P. Only **£7/7/-**

TRANSISTORISED MEGOHMMETER

*** PUSH
BUTTON
EQUIPMENT
USE 1966**

500 v. 1000 Megohms.
Superb portable in-
strument. Supplied
c/w batteries, probes
and carrying case.

**ONLY
£23.10.0**

Carr. & Pkg. 7/6.

**36ft. AERIAL
MASTS
NEW LATEST PATTERN
TUBULAR MAST**

Check these vital points:

* Made from 6 x 1/2in. dia. Shear-
dized steel sections, for dura-
bility and strength.
* Extra strong fitting base.
* Top cap with located pulley and
halyard.

* 2 sets (8) Rotproof Guys.
* Rustproofed Steel Picketing
Stakes.

ONLY £13.10.0 ex works

Carr. 17/6. Returnable wooden
case 20/-.

**AC/DC VALVE VOLTMETER**

Price
ONLY **£35.0.0**

* 11 megohms per volt.
* 5 mV-1,500 V. D.C.
* 100 mV-1,500 V. D.C.
* 0.1 ohm-1,000 Megohms.
* 1 Kc Oscillator Test Source.
* Complete with test probes.

IMMEDIATE DESPATCH
FULL SPARES AND SERVICE AVAILABLE

**DIELECTRIC BREAKDOWN TESTER
VARIABLE HIGH VOLTAGE UNIT**

* Range: infinitely variable up to 3,000 volts.
0.1 amp.
* Entirely suitable for continuous testing.
* Automatic safety cut-out. Input: Mains voltage.
Input and test leads with clips.
Model T30 **£32**

WALKIE TALKIE '88' SET

Made by E. K. Cole & Co. Weighs 5 1/2 lb. (approx.)
and measures 3 1/2 x 5 1/2 x 9 1/2in. Crystal controlled.
Dry battery—H.T./L.T. (i.e. Vidor L5537).
Supplied to Overseas Govts. **ONLY £10 EACH**

**5 AMP. A.C. & D.C. VARI-
ABLE SUPPLY UNIT**

Specification:
Output: 0-260 V.A.C.
0-240 V.D.C.
* Smooth stepless voltage
variation from 0-Max.
* Current consistent through-
out the controlled range.
* Ammeter and voltmeter
fitted, and Neon indicator.

* Fully fused input and output.
Strong steel case with carrying handle and rubber feet.
11in. x 7in. x 14in. high. **MADE IN ENGLAND**

PRICE £30.0.0 Carr. & p.kgs. 40/-
(Gr. Britain inland)

BUY DIRECT FROM MANUFACTURER

30 Amp. L.T. SUPPLY UNIT

0 to 18V D.C. WITH SMOOTH STEPLESS
VARIATION.

Designed for CONTINUOUS use a: max.
loading.

* Fitted voltmeter and ammeter.
* Input and output fully protected.
Input: Mains A.C. robust construction.
2 tone grey hammer finish. Steel case.

£49.10.0 Carr. & Pkg. 40/-
G.B. (Inland)

Entirely suitable for plating plants, laboratory
supplies, etc.

I.M.O.
(ELECTRONICS) LTD.

(Dept. WW4), 313 Edgware Road, London, W.2.

PADington 2233/4

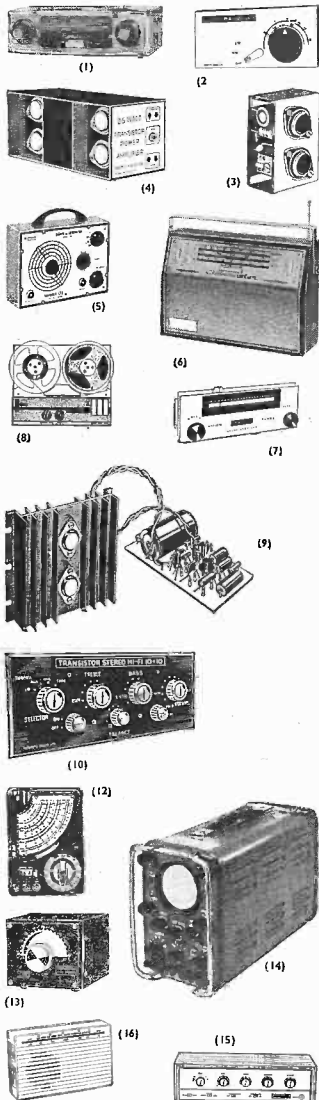

NEW 1966 CATALOGUE 150 PAGES

Fully detailed and illustrated components, equipment and Hi-Fi. All types and makes. 5000 Stock lines. 500 Transistor and Devices, 1000 Quartz Frequencies, 800 Valves and Tubes. The Finest and largest Range available. A mine of information and with FREE vouchers. Price paid.

HENRY'S RADIO LTD.
303 EDGWARE ROAD LONDON W2

Paddington 1008/9
Open Mon. to Sat. 9-6. Thurs. 1 p.m.
Open all day Saturday



(1) ROADSTER MW/LW CAR RADIO

Supplied as Pressedmetal Panels. Permeability tuned superhet. Push-button wave-changer. Push-pull output. Fits any car. 7 x 4 x 2in. 12 volt (+) earth. Assembly £6/19/6, p.p. 3/6. Total cost. (Speaker/Battle/Car Fixing Kit 2/0).

(13) VHF F.M. TUNER
Sensitive Superhet circuit. Covers 87-105 Mc. Geared tuning. 9-volt operated. Up to 1 volt output. For valve or transistor amplifiers. 4x3 1/2 x 2 1/2 in. Total cost £6/19/6, p.p. 2/6. to build. (Cabinet assembly, 20/ extra).

(6) GLOBEMASTER MW/LW/SW PORTABLE
Full tuning on 3 wavebands. Push - button wavechance. Superhet circuit. 1 Watt push-pull. Attractive cabinets with chrome fittings. 11 x 7 1/2 x 3 1/2 in. (\$W. 17-50 mm) Total cost £8/19/6, p.p. 3/6. to build.

(12) MULTI-METERS
PT34 1kΩ/volt £1 19 6
M1 2kΩ/volt £2 9 6
TP10 2 kΩ/volt £3 15 0
EP10K 10kΩ/volt £3 19 6
EP20K 20kΩ/volt £4 19 6
TI-2 20kΩ/volt (illus) £3 9 6
TP55 20kΩ/volt £5 19 6
EP30K 30kΩ/volt £4 10 0
S50 50kΩ/volt £7 17 6
EP50K 50kΩ/volt £8 15 0
EP100K 100kΩ/volt £10 0 0

(4) 25 WATT AMPLIFIER
9 transistor plus 2-recifier design. Output for 7 1/2 to 16 ohms speakers. 150mV input to 3kΩ, ohm ± 1 dB 30 c/s to 20 Kc/s. For use with valve or transistor preamplifiers for 25 watts rms output—50 watts peak (overall size 2 1/2 x 2 1/2 x 6 1/2 in.) Suitable for preamplifiers (10M) and (10) below. Built and Tested £8/19/6, p.p. 3/6. Mains Unit: 79/6, p.p. 2/6.

10 AND 20 WATT MONO AND STEREO TRANSISTOR AMPLIFIERS AND PREAMPLIFIERS

(9) POWER AMPLIFIER
10 watts R.M.S. output. For 10 watt or 25 watt amplifier Full range of controls. 8 inputs from 1 mV. Scl./Trans./Bass/Filter/Vol. Controls For use with Valve or Transistor Amplifiers. 150 mV. RMS output. Size 9x2 1/2 in. *MP2 £5/10/, p.p. 2/ (Front panel 8/6).

(14) MINIATURE OSCILLOSCOPE MODEL GT52

High sensitivity scope, fully portable with Mullard DG7/5 2 1/2 in. tube. 10 c/s to 40 Kc/s. FREE running Time Base. Single Sweep. Pulse Monitoring 50 m/sec. to 0.1 u sec. Y Plate Sensitivity 40 v. per cm. 3 dB 25 c/s. to 2 Mc/s and up to 35 dB Gain on Amplifier. Full Input Facilities and Controls. 110 to 250 volt A.C. mains operated. Complete in portable case with leads. In new condition. **£22.10.0** Carr. & Pkg.

(10) FULL HANDBOOK AND CIRCUIT

SPECIAL OFFER
DEAC Rechargeable Batteries. 9.6 volt 500 mA/H. 1 1/2, 1 1/4 in. dia. Price 12/6, p.p. 1/6. (9.6 volt 225mA/H. 2 1/2, 1 1/4 in. dia. Price 20/, p.p. 1/6. BRAND NEW STOCKS

DEAC BATTERY CHARGER
Completely assembled in moulded case. 110-250 volt mains. Fully transformer isolated, to charge 9.6 volt and 3.6 volt DEACs as above. Price 45/6, p. & P. 2/6.

MAINS ELIMINATOR
Transistorised and Zener Stabilised power supply. Output 9.6 volt 250 mA and 3.6 volt 300 mA. Fully isolated, 110-250 volt. A.C. operation. Assembled in moulded case. Price 67/6, p.p. 2/6.

(7) VHF F.M. TUNER
Supplied as 2 Pressedmetal Panels, plus metal work Superhet design, 88-108 Mc/s, 9 volt operated. Total cost £12/17/6, p.p. 2/6.

(3)-5 WATT AMPLIFIER
6 Transistor push-pull to 3 ohms. 6 mV to 1 k. input. 12/18 Hz valve operated. Size only 2 1/2 x 2 1/2 in. 25 c/s. to 16 Kc/s. Ideal general purpose sensitive amplifier with 5 watts RMS output. Built and Tested 79/6, p.p. 2/ (Optional mains unit, 54/6)

(10M) MONO PREAMPLIFIER

For 10 watt or 25 watt amplifier Full range of controls. 8 inputs from 1 mV. Scl./Trans./Bass/Filter/Vol. Controls For use with Valve or Transistor Amplifiers. 150 mV. RMS output. Size 9x2 1/2 in. *MP2 £5/10/, p.p. 2/ (Front panel 8/6).

(2) NEW MW/LW TUNER SUPERHET TO BUILD

MW/LW Superhet tuner. Output up to 5 volt peak. Full coverage with excellent sensitivity and selectivity. 9 volt operated. Complete with front panel, etc. Total cost to build 79/6, p.p. 2/.

(16) RECENT-6 MW/LW POCKET SET

6 Transistor Superhet, geared tuning. Push - pull output. Attractive cabinet 5x3x1 1/4 in. Total cost 49/6, p.p. 2/ to build.

SPECIAL PRICE LOWERS PRICE

(8) BUILD A QUALITY TAPE RECORDER

THREE-SPEED RECORDERS
Using New '363' Decks *TWO-TRACK. Deck £10/10/. Amplifier £11/10/. Cabinet and Speaker £5/5/6. Complete kits with FREE 7in. 1200c. tape, 100c. tape and Acco 40 Mic. £26, p.p. 8/6. *FOUR-TRACK. Deck £13/10/. Amplifier £12/10/. Cabinet and speaker £5/5/6. Complete kits with FREE 7in. 1200c. tape, spare spool and Acco 40 Mic. £30, p.p. 8/6.

FREE New 16-page valve transistor 1 recifier and quartz crystal catalogue on request.

QUARTZ CRYSTALS

1 Mc/s. HCGU (minerals) 20/-
100 Kc/s 3 pin. 15/-
100 Kc/s, Octal. 25/-
500 Kc/s. 15/-
100 Kc/s. 1 Mc/s. 19/6
HCGU 6/12 volt 80° C. oven 22/6

(5) NOMBREX TEST EQUIPMENT

150 Kc/s-250 Mc/s. RE Generator. £9 10 0
Resistance/Capacitance Bridge £8 5 0
Transistorised Power Supply £6 10 0
10 c/s-100 Kc/s Audio Generator £16 15 0
Sensitive Inaccuracy Bridge £18 0 0
Complete Range of Test Equipment in Stock

(10) STEREO PREAMPLIFIER

Two Channel Preamplifier for (2) 10 watt or 25 watt amplifiers 8 inputs per channel. Scl./Treble/Bass/Balance/Vol./etc. Controls. 1 1/2 mV. input. For P.U.'s, Tuner, Tape, etc. etc. Size 9 3/4 x 1 1/4 in. *SP2 £10/19/6, p.p. 3/6. (Front Panel 12/6).

ALL UNITS SUPPLIED BUILT AND TESTED WITH FULL DETAILS AND INSTRUCTIONS FULLY ILLUSTRATED AND DETAILED LABEL ON REQUEST

GARRARD DECKS-BRAND NEW-FULLY GUARANTEED-WITH CARTRIDGE UNLESS STATED

1000	1000	1000	1000	1000	1000
1000 stereo	1000 stereo	1000 stereo	1000 stereo	1000 stereo	1000 stereo
2000 mono	2000 stereo	2000 stereo	2000 stereo	2000 stereo	2000 stereo
3000 stereo	3000 stereo	3000 stereo	3000 stereo	3000 stereo	3000 stereo
4000 stereo	4000 stereo	4000 stereo	4000 stereo	4000 stereo	4000 stereo
5000 stereo	5000 stereo	5000 stereo	5000 stereo	5000 stereo	5000 stereo
6000 stereo	6000 stereo	6000 stereo	6000 stereo	6000 stereo	6000 stereo
7000 stereo	7000 stereo	7000 stereo	7000 stereo	7000 stereo	7000 stereo
8000 stereo	8000 stereo	8000 stereo	8000 stereo	8000 stereo	8000 stereo
9000 stereo	9000 stereo	9000 stereo	9000 stereo	9000 stereo	9000 stereo

SPECIAL PARCEL PRICES FOR HIGH FIDELITY EQUIPMENT—LET US QUOTE—ALL MAKES

ALL MAKES OF HIGH FIDELITY EQUIPMENT IN STOCK. VISIT OUR HI-FI ROOM. LET US QUOTE FOR YOUR REQUIREMENTS FOR EQUIPMENT AND COMPONENTS.

STERN-GLYNE ELECTRONIC CO.

MAIL ORDER & ALL ENQUIRIES TO : DEPT. WW, 3-5 EDEN GROVE, HOLLOWAY, LONDON, N.7.

Tel. NORTH 8161/5

LONDON:
18 Tottenham Court Road, W.1. MUS 5329.0095
23 Tottenham Court Road, W.1. MUSum 3451
309 Edgware Road, W.2. PADlington 6963
109 Fleet Street, E.C.4. FLEet Street 5912/3
162 Holloway Road, N.7. NORTH 7941

9 Cambwell Church Street, S.E.5. RODney 2875
291 Edgware Road, W.2. PADlington 5697
CROYDON:
100 Guildford House, George Street. MUNCipal 3250
BRISTOL:
26 Merchant Street, Bristol 1. Bristol 20.61

LIVERPOOL: 52 Lord Street. ROY 7450
MANCHESTER:
125 Withy Grove, M.4. Blackfriars 5379/5246
SHEFFIELD: 25 The Moor. Sheffield 29593
NOTTINGHAM:
Eastown House, Lincoln Street. Nottinghams 45889

Member of the Pantiya Group of Companies

★ H.P. TERMS AVAILABLE FOR ALL GOODS OVER £13-10-0

SUPERB NEW STERN-GLYNE F.M.I. VHF TUNER

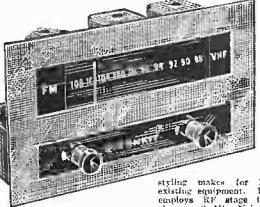

Features sparkling performance — inherent stability.

Specially designed for the Amateur builder, a sensitive tuner unit that provides a wide frequency range reception of BBC FM transmissions.

High quality output stage ensures optimum performance from any Hi-Fi audio system, superbly

styling makes for harmonious installation with existing equipment.

Includes, easily aligned circuit components in a stage tuned-modes trimmer-grid rod. 2 1/2 W. Valve Amplifier & Radio Detector. Valves are 4 x E91 plus 2 diodes. Input sees 100V m.a. for 40 dB. Dist. less than 1% at full frequency. Power req. 500 v. at 20 mA and 0.2 v. at 1.8 A. Panel black and silver-grey. Size 8 x 6 in. Case: aluminium plated, overall depth 4 1/2 in. F.M.I. kit of parts with Instruction Handbook. £7/6/6, carriage 1/6. F.M.I. Assembled and tested. £10/5/6, carriage 1/6. Optional Power Pack Type D kit of Parts. £27/5/-, carriage 2/6. Power Pack Type D, assembled and tested. £31/0/-, carriage 3/6.

Handbook only 5/6. Post free. Description in leaflet on request.

NEW ADVANCED DESIGN - Veritone Compact Communications Receiver

New, highly developed, extremely compact design. Veritone CR. 150 has perfect radio proportions and a DC performance comparable with many highly complex, professional receivers. Frequency coverage is continuous from 400 Kc to 20 Mc in 4 bands, plus bandspread on base frequency of 1.7, 7.1 and 28 Mc. Features include extra large electrolytic dial "X" meter, variable pitch 100,000 min. divider, built-in bandpass and extending rod antennas to receive all long wave distant stations.

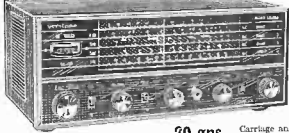

Extra include phone output Jack, standby switch, etc. Size only: 12 1/2 x 5 1/2 x 8 in. deep. Valves 12BH6, 12AV6, 12X14B and 50C5 plus silicon rect. Transformer for 230V, nearest local hotspots etc. Housed in handily finished metal case. For 230/250 volts A.C. or D.C. supplied with 128 page "Wireless World Guide to Broadcasting Stations."

20 gns. Carriage and Insurance 1/6

EXCLUSIVE OFFER OF TOP QUALITY RECORDING TAPE

New American branded tape by world renowned manufacturers and equal in quality to the best obtainable anywhere. Unmistakable edge free, red oxide coated, with full frequency response and uniform output. Resistant to moisture, heat, cold and abrasion. Available in 1/2" wide range of acetate and polyester qualities, each individually boxed and polyfoam wrapped in colour coded cartons showing recording times: 15, 20, 30 and 34 1/2 min. Compare the prices!

Ranges available: Acetate
Both types best packing 5in. 600ft. Standard 5/6
1/2" per reel, Four or more 5in. 900ft. Long Play 1/6
reels post free. 5in. 1,800ft. Long Play 1/6

TEST 7 POCKET MULTIMETER

39/6

Carriage 2/-

A really versatile instrument that makes a handy, pocket size tool. Measures A.C. or D.C. voltage in three ranges of 0.15-150-1,000 v. Resistance 0-10,000 ohms, and Current 0-100 mA. D.C. scale only 38 x 2 x 1 1/2 in., with expansion dial design providing a clear, easily read scale. Complete with battery and test leads.

DUAL CHANNEL PRE-AMPLIFIER

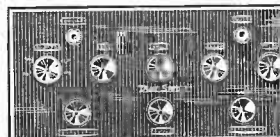

Assembled and tested Add 5/- carriage. Kit

Exceptional offer of AM/FM Radiogram Chassis



16 gns. Curr. 10/-

Superb new six valve unit covering long and medium waves on FM and all BBC VHF transmissions on FM. Highly sensitive AM circuit receives most stations through internal aerial, separate FM input employs Lamsou Gorter tuning head. Unfinished back covers with frosted area and amplifier adaptation to existing cabinets or building into contemporary bookshelf units. Extra large illuminated dial and dual concentric controls for volume, tune selection and tuning simplify operation, enhance appearance. Powerful 4 W. output includes standard 13 ohm speaker. Inputs available for external AM and FM aerials and gramophone pickup. For 200/250 v. A.C. operation. Size overall 12in. x 6 1/2 in. x 7 1/2 in. deep.

TEST 8 MULTIMETER 57/6

Post and packing 2/6.

Compact all purpose tester with 12 specially selected ranges for all home and motorcar wiring and servicing, domestic radio, T.V. stage, electronic hobby work, etc. Extremely robust construction employs rugged fibre seals meet universal and plus-in range selection to obviate wear defect and ensure trouble-free life. In tough metal backed impact resistant case. Ranges: 0.10-500-1000-1000 mA, A.C. and D.C. resist. 100 ohms per volt 0-1000 mA. D.C. current. 0-10000-100000 ohms resistance. Size only 4 1/2 x 3 1/2 in. deep. Complete with test leads and battery.



* Designs by MULLARD - Hi-Fi designs from the Mullard Applications Research Laboratory, meticulously executed by Stern and Veritone.

Interpreted by STERN. By them as hand-built and tested units, or in Stern-Glyne's famous Homebuilt Kits, they provide performance per £ unequalled anywhere. If you are working to a budget, kits offer a real saving plus real building satisfaction. Each is absolutely complete and backed by comprehensive, easy-to-follow building instructions.

TWO VALVE PRE-AMPLIFIER



Specially designed for use with the Mullard sets of 3, 19 and 20 watt amplifiers but entirely suitable for all Hi-Fi power units not requiring input of more than 200 mV for full output. Features include input for crystal and variable reluctance pickups with 21KΩ equalisation, plus radio, sensitive microphone, and tape replay direct or indirect. Controls include 6-position selector, volume and wide range bass and treble boost. Volume 2 x 120Ω, size 9 1/2 x 4 1/2 x 2 1/2 in. high. Power 10 x 2 1/2 in. Requires 300 v. at 3 mA and 0.2 v. at 0.05 amp.

Assembled and tested £9 - 10 - 0

Add 4/- carriage. Kit £6 - 6 - 0

THREE VALVE PRE-AMPLIFIER

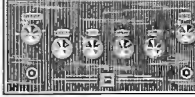

Specially recommended for use with the 40-100 amplifier, but also suitable for use with all Mullard series mono amplifiers and any high quality unit requiring an input of up to 200 mV for full output. Features include wide range bass and Treble controls, high and low pass filters, auxiliary input and record output sockets, switched inputs for crystal or reluctance pickups, radio, tape replay direct or indirect. Power required 250 v. at 0.6 mA and 0.3 v. at 1 amp. Volume 100Ω and 100KΩ, size 11 x 4 1/2 x 2 1/2 in. high. Power 12 x 4 1/2 in.

Assembled and tested £13 - 13 - 0

Add 5/- carriage. Kit £10 - 10 - 0

Actually twin Two-Valve Pre-amplifiers which together form an extremely versatile and sensitive input arrangement for the 7m plus Ten amplifier in place of the Passive Control Unit. Features include dual inputs for mono and stereo Alpacado, Variable Reintance, Crystal and Ceramic pickups, dual inputs direct and amplified, plus 100Ω and 100KΩ, plus 100Ω and 100KΩ, plus 100Ω and 100KΩ, plus 100Ω and 100KΩ.

Assembled and tested and supplied complete with Ten plus Two Amplifier. £34 - 0 - 0

Kit Add 10/8 Carriage. £27 - 0 - 0

Dual channel pre-amplifier only—Assembled and tested. £15 - 0 - 0

Kit Add 5/- Carriage. £12 - 10 - 0

'ELEGANT SEVEN' MK. II

POWER SUPPLY KIT to purchasers of Elegant Seven parts, incorporating mains-transformer, etc. A.C. mains 200-250 v. Output 9 v. 50 mA 7/6d. extra.

COMBINED PORTABLE & CAR RADIO. The Radio with the STAR features, 4in. SPEAKER.

- * 7-transistor superhet. Output 350mW.
- * Wooden cabinet fitted handle with silver coloured fittings. Size 12in. x 8in. x 3in.
- * Horizontal tuning scale, size 1 1/2in. x 2 1/2in. in silver and black lettering.
- * All stations clearly marked.
- * Ferrite rod internal aerial.
- * I.F. Neutralisation on each stage. 460 kc/s.
- * D.C. coupled output stage with separate A.C. negative feedback.
- * All components, ferrite rod and tuning assembly mounted on printed board.
- * Operated from PP9 battery.
- * Full comprehensive instructions and point-to-point wiring diagrams.
- * Printed circuit board, built with all component values.
- * Fully tunable over medium and long waveband.
- * Car aerial socket.
- * Full after-sale service.

Parts list and circuit diagram 2/6. Free with parts.

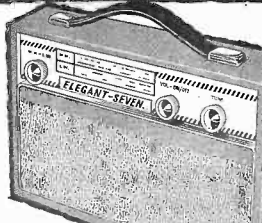

ONLY
£4.4.0 (plus 6/6 P. & P.)

'MAYFAIR' 5-Transistor TAPE RECORDER

Capstan-driven, battery operated 7 1/2 and 3 1/2 i.p.s. Precision made. Push-button controls. High quality 2 1/2in. speaker. Push-pull circuit. Output: 400 mW. Frequency response: 200-7,000 kc/s. Fast rewind. Up to 1 hour twin track playing time. Automatic erasing for re-recording. Dimensions 8in. x 11in. x 3in. Weighs only 7lb. Takes 5in. spools.



plus 7/6 P. & P.

£11.11.0

40W. FLUORESCENT LIGHT KIT

Incorporating GEC Choke size 8 1/2in. x 1 1/2in. x 1 1/2in., 2 bi-pin holders, starter and starter holder. **11/6** P. & P. 4/6.
Similar to above: 80W. Fluorescent Light Kit incorporating GEC choke size 11 1/2in. x 1 1/2in. x 1 1/2in. **17/6** P. & P. 5/6.



CYLDON A.M./F.M. PERMEABILITY TUNER FOR ALL TRANSISTOR OPERATION

Size 2 1/2in. x 2 1/2in. approx. By famous manufacturer. A.M.-I.F. 470 kc/s. F.M.-I.F. 10.7 Mc/s. A.M. coverage from 1,620 kc/s-525 kc/s. F.M. coverage 105 Mc/s-89 Mc/s. Circuit diagram 2/6. FREE with Tuner. Ist. 2nd, 3rd A.M.-I.F.'s, Ist. 2nd, 3rd and 4th F.M.-I.F.'s. V.H.F. Osc. choke A.M.-F. trap. All the above are the R.F. end of an A.M./F.M. receiver car radio, etc. **£2. 10. 0**
The above items: P. & P. 6/-.

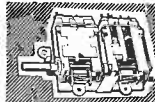

SILICON RECTIFIERS 250 v. P.I.V. 750 milliamps. Six for 7/6, post paid.

BSR MONARCH UA16 With FULL-FI HEAD

4-speed, plays 10 records, 12in., 10in. or 7in. at 16, 33, 45 or 78 r.p.m. Intermites 7in., 10in. and 12in. records of the same speed. Has manual play position; colour, brown. Dimensions: 12 1/2 x 10 1/2in. Space required above baseboard 4 1/2in., below baseboard 2 1/2in. Fitted with Full-Fi-turn-over crystal head. **£4. 19. 6** P. & P. 7/6.

CYLDON U.H.F. TUNER

Complete with PC.88 and PC.86 Valves. Full variable tuning. New and unused. Size 4 1/2in. x 5 1/2in. x 1 1/2in. Complete with circuit diagram. Plus 2/6 P. & P. **35/-**



MAGNAVOX COLLAR

Set of three Tape Deck Motors. These are made for 110 v. but suitable auto. transformer is supplied. Three motors. 3/6, P. & P. 6/-.

R & TV FIRST QUALITY PVC TAPE

5 1/2in. Std. 850ft. 9/-	5in. L.P. 850ft. 10/6
7in. Std. 1,200ft. 11/6	3in. T.P. 600ft. 10/6
3in. L.P. 2,400ft. 4/-	5in. T.P. 1,800ft. 25/6
5 1/2in. L.P. 1,200ft. 11/6	5in. T.P. 2,400ft. 32/6
7in. L.P. 1,800ft. 18/6	7in. T.P. 3,600ft. 42/6

P. & P. on each 1/6, 4 or more post free.

TRANSISTORISED SIGNAL GENERATOR

Size 5 1/2in. x 3 1/2in. x 1 1/2in. For I.F. and R.F. alignment and A.F. output. 700 kc/s frequency coverage 460 Kc/s to 2 Mc/s. In switched frequencies. Ideal for alignment to our Elegant Seven and Musette. Built and tested **39/6** P. & P. 3/6.



POWER SUPPLY KIT

In metal case, size 3 1/2in. x 2 1/2in. x 2in. incorporating mains transformer, rectifier and condensers. 230/250 A.C. Mains. Output: 9 v. 100 mA. Price 10/6 plus 3/-, P. & P.

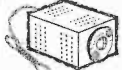

OSCILLOSCOPE

for D.C. & A.C. Applications

Push-pull X amplifier; Fly-back suppression; Internal Time-base Scan Wave form available for external use; pulse output available for checking TV line C/P Transformers, etc. Provision for external I.F. and C.R.T. Brightness Modulation. A.C. mains 200/250 v. £18/18/-, P. & P. 10/-, FULL 12 MONTHS' GUARANTEE INCLUDING VALVES and TUBE.



3 to 4 WATT AMPLIFIER KIT. Comprising chassis 8 1/2in. x 2 1/2in. x 1 1/2in. Double wound mains transformer, output transformer, Volume and tone controls, resistors, condensers, etc. 6V6, ECC81 and metal rectifier. Circuit 1/6, free with kit. 29/6 plus 4/6 P. & P.

RINGO BURGALAR ALARM A.C. Mains 200/240 volt. Fire salvage slightly tarnished. List price 7 gns. Our price complete with double pong ball, five micro switches and full instructions. **49/6** P. & P. 5/-

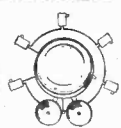

FIXED FREQUENCY SIGNAL GENERATOR

Crystal control in metal case, size 10in. x 6in. x 6in. Incorporating 2 FC13 valves, mains transformer, metal rectifier, choke, indicator lamp, crystal and numerous components. Modulated and unmodulated output sockets. Originally used for I.F.T. frequencies. Brand new, 39/6, plus 7/- P. & P. A.C. Mains 200/250 volts.



RADIO AND T.V. COMPONENTS (ACTON) LTD.

Goods not despatched outside U.K. All enquiries stamped addressed envelope. Terms C.W.O.

21A HIGH STREET, ACTON, LONDON, W.3
SHOP HOURS 9 a.m.-6 p.m. EARLY CLOSING
WEDNESDAY

BeuVision

remote
supervision ...

for **TRAFFIC CONTROL**
SECURITY · EDUCATION
PRODUCTION CONTROL
INDUSTRIAL · MEDICAL
ENTERTAINMENT...



with the

LOW COST BEULAH D.80

INDUSTRIAL **C.G.T.V. CAMERA**
TRANSISTORISED · AUTOMATIC

For DOMESTIC and COMMERCIAL USE
the **BEULAH** D.50 TRANSISTORISED T.V. CAMERA

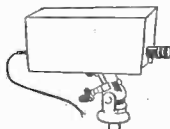

Britain's lowest priced Domestic Closed Circuit TV Camera is fully transistorised and is designed to operate in conjunction with standard VHF domestic television receivers on either 405, 525 or 625 line systems.

The performance is outstanding, and it transmits signals over 1 mile of co-axial without amplification and consumes only 15 watts. Supplied complete with a high quality 25 mm. f/1.9 Television Lens on type C mount with fully adjustable focus and iris. 2 1/2 Mc/s resolution. Operates on 200-250 volts a.c. Mains supply (or 110 volts to order). Price 79 gns.

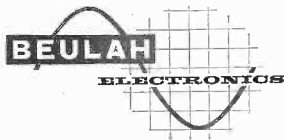

Write for leaflets fully descriptive of the models in which you are interested.

A fully transistorised Video T.V. Camera. Fitted with separate Mesh Vidicon Tube and employing a highly sensitive type of automatic photocell light control. The resolution is 5 Mc/s. Supplied complete with high quality 25 mm. f/1.9 Television Lens, type C mount with fully adjustable focus and iris. With the Beulah Model 1400 Transistorised Monitors (14in. screen), it provides the lowest priced Transistorised Industrial System available, with fully stabilised power supplies on camera and monitor. Total consumption only 45 watts. Can be operated from a 12-volt car battery, using a small inverter.

D.80 Camera Price **£140 0 0**
14in. Model 1400 Monitor Price **£93 9 0**
8 1/2 in. Model 850 Monitor Price **£89 5 0**

Suppliers to: Ministry of War, G.P.O., Government Communication Headquarters, North Thames Gas Board, B.A.C., Education Committees, Ford Motor Company and many other large industrial concerns.

Build your own T.V. Camera with the BEUKIT

Buy it and build it in easy stages with the famous BEUKITS—

- Kit No. 1. Spec. principles of vidicon tube, scanning assembly and optical system diagram. £18/17/6.
- Kit No. 2. Printed circuit board and assoc. components, circuit diagram, layout instructions and Manual. £16/10/-.
- Kit No. 3. All transistors and semiconductors. £8.
- Kit No. 4. All metal work. £6.

Plus 7/6 P. & P. for each kit. (Kits cannot be split. Instruction Manual cannot be supplied separately.)

SAVE MONEY and buy the Combination Kit comprising Kits 1-4 for only £40. P. & P. 7/6. Less Vidicon Tube (Experimenters' Tube £12) and T.V. Lens (£13/19/-).

See the complete BeuVision range on

Stand G19
I.E.A. Exhibition

Olympia, London. May 23rd to 28th

126, HAMILTON ROAD, WEST NORWOOD, LONDON, S.E.27
Telephone: GIPsy Hill 6166 (PBX), Day and Night Ansafone Service.

A PREAMPLIFIER FOR PERFECTIONISTS



PAS-3X

For years since its introduction, the Dynaco preamplifier design has been generally accepted as one in which the noise and distortion are so low, and the sound quality so high that attempts to improve it would be laboratory exercises rather than commercial enterprises.

However, our avowed philosophy of perfectionism has kept us looking for some way to improve the circuit—and this has now led to the first major change in our preamplifier design since it was initiated. This development (on which patents are pending) is applicable to all continuous tone control systems and immediately makes them superior to the far more costly switch type controls. We have kept the infinite resolution capability of the continuous control, but all frequency and phase discriminating networks are removed from the circuit when the control is rotated to its mechanical center. This new design, which combines the advantages of both step-type and continuous tone controls is now available at no increase in price. And, a conversion kit TC-3X is available at nominal cost to update any Dynaco PAS-2 or PAS-3.

Can you hear the difference? We doubt it. The preamp was amazingly good in the past. We have improved it for the sake of improvement, not because we think it needed it. It has always surpassed every other preamplifier without regard to cost. And, it is superior on more than measurements—listening tests prove that the Dynaco preamp adds no coloration to the sound and that its inclusion in the hi fi chain is undetectable. Partially diagrammed below is the performance you can expect from the PAS-3X—why you can never get better overall quality regardless of how much money you spend. Complete specifications on request.

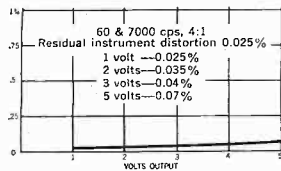

Intermodulation Distortion

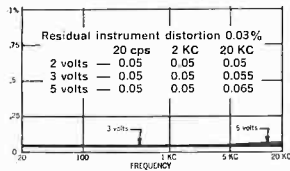

Harmonic Distortion

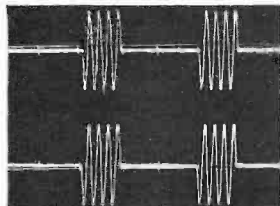

Four cycle 20KC tone burst from generator (above) matches PAS-3X (below)

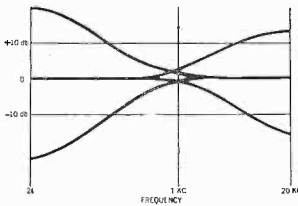

Tone Control Range



10 cps Square Wave

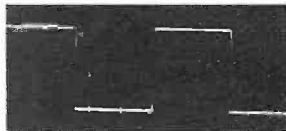

1 KC Square Wave

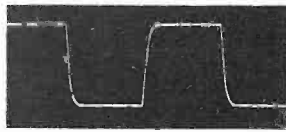

10 KC Square Wave

There are Dynakit amplifiers in all power brackets which will do justice to the perfectionist's preamplifier.

All are rated for RMS continuous power.



2 Mark III
60 watts/
channel



Stereo 70
35 watts/
channel



Stereo 35
17.5 watts/
channel

DYNACO INC. 3912 POWELTON AVENUE, PHILADELPHIA, PA., U.S.A.

WESTERN
EUROPEAN
DISTRIBUTORS

UNITED KINGDOM—Howland-West Ltd., 2 Park End, South Hill Park, London N.W. 3 ■ FRANCE—High Fidelity Services, 14 Rue Pierre Semard, Paris 9 ■ HOLLAND—Acoustical, Postbus 8, 'S-Graveland ■ BELGIUM—Dyner Audio, 20 Reyndersstraat 20, Antwerp ■ AUSTRIA—A. Weiner Ges. m. b. H., Karl Schweighofergasse 12, Vienna VII ■ SWEDEN—Elfa Radio & Television AB, Systeļomansgatan 18, Box 12086, Stockholm 12 ■ SWITZERLAND—Arnold Bopp, Limmatquai 74, Zurich 1 ■ Studio Phonovox, Gerechtigkeitsgasse 44, Berne ■ Hi Fi Studio des Bergues, 5 Rue Guillaume Tell, Geneva ■ Walter Eggenberger A. G., Steinentorstrasse 18, Basel ■ SPAIN—Alberto Llorach V. S/A, Pasaje Luis Pellicer—10, Barcelona 11 ■ GERMANY—Transonic Elektrohändelsges. m. b. H., Schmilinskystrasse 22, 2000 Hamburg, 1 ■ ITALY—Prod.El S. p. A., Via Monfalcone 12, Milan ■ DENMARK—Qual-Fi Ingenierfirma, Kristianjagade 1, Kobenhavn K ■ NORWAY—J. M. Feiring A/S, Lilletorget 1, Oslo ■ FINLAND—OY Chester AB, Uudenmaakunt 23A, Helsingfors.

EUROPEAN SALES DIVISION: Audiodyne A/S, Christian X's Vej 42, Aarhus C, Denmark.

WW-142 FOR FURTHER DETAILS.

BENTLEY ACOUSTIC CORPORATION LTD.

38 CHALGOT ROAD, CHALK FARM, LONDON, N.W.1.
THE VALVE SPECIALISTS Telephone PR1MROSE 9399
ALL GOODS LISTED BELOW IN STOCK

0A3	3/6	7H7	5/8	1H15	3/6	12B9	6/3	Q1M7	7/6	MIDGET
02A2T	5/3	7E7	12/6	DK45	15/6	EM31	7/6	R10	1/5	MIDGET
1A2	6/6	8V5	3/6	DK57	5/6	EM34	8/6	R14	3/6 11	RECEIVER
1A7U	7/6	9P7	7/6	DK59	6/6	EM37	7/6	R19	6/9	TYPE
1B2	5/6	10A5	3/6	DK61	5/6	EM40	8/6	R21	6/9	TYPE
1B6	6/6	10C3	12/6	DM70	6/6	EV1	5/6	R51	2/6	Output
1H6T	7/6	10E7	11/6	DM75	6/6	EV2	5/6	R55	2/6	Output
1L1	2/6	10F1	1/6	DY6	6/6	EV3	5/6	T41	1/6	500 v.c.k. 2
1L5	4/6	10F5	6/6	BY87	5/6	EV4	5/6	T104	7/6	100 v.c.k. 2
1L5C	4/6	10F5B	6/6	Z80F	2/6	EV5	5/6	T111	15/6	100 v.c.k. 2
1N8GT	8/6	10P13	12/6	EV8F	8/6	EV7	6/6	T123	6/6	100 v.c.k. 2
1S5	6/6	10P14	11/6	EV8G	7/6	EV8	6/6	T125	5/6	100 v.c.k. 2
1B4	5/6	12A0	5/6	EV8P	10/6	EV9	5/6	T127	5/6	100 v.c.k. 2
1S5B	6/6	12A0B	5/6	EV9	10/6	EV10	5/6	T128	5/6	100 v.c.k. 2
1F4	2/6	12A2B	6/6	EV6	6/6	EV11	5/6	T129	5/6	100 v.c.k. 2
7E4	5/6	12A2C	6/6	EV12	5/6	EV12	5/6	T130	5/6	100 v.c.k. 2
7E4B	5/6	12A2D	6/6	EV13	5/6	EV13	5/6	T131	5/6	100 v.c.k. 2
7E4C	5/6	12A2E	6/6	EV14	5/6	EV14	5/6	T132	5/6	100 v.c.k. 2
7E4D	5/6	12A2F	6/6	EV15	5/6	EV15	5/6	T133	5/6	100 v.c.k. 2
7E4E	5/6	12A2G	6/6	EV16	5/6	EV16	5/6	T134	5/6	100 v.c.k. 2
7E4F	5/6	12A2H	6/6	EV17	5/6	EV17	5/6	T135	5/6	100 v.c.k. 2
7E4G	5/6	12A2I	6/6	EV18	5/6	EV18	5/6	T136	5/6	100 v.c.k. 2
7E4H	5/6	12A2J	6/6	EV19	5/6	EV19	5/6	T137	5/6	100 v.c.k. 2
7E4I	5/6	12A2K	6/6	EV20	5/6	EV20	5/6	T138	5/6	100 v.c.k. 2
7E4J	5/6	12A2L	6/6	EV21	5/6	EV21	5/6	T139	5/6	100 v.c.k. 2
7E4K	5/6	12A2M	6/6	EV22	5/6	EV22	5/6	T140	5/6	100 v.c.k. 2
7E4L	5/6	12A2N	6/6	EV23	5/6	EV23	5/6	T141	5/6	100 v.c.k. 2
7E4M	5/6	12A2O	6/6	EV24	5/6	EV24	5/6	T142	5/6	100 v.c.k. 2
7E4N	5/6	12A2P	6/6	EV25	5/6	EV25	5/6	T143	5/6	100 v.c.k. 2
7E4O	5/6	12A2Q	6/6	EV26	5/6	EV26	5/6	T144	5/6	100 v.c.k. 2
7E4P	5/6	12A2R	6/6	EV27	5/6	EV27	5/6	T145	5/6	100 v.c.k. 2
7E4Q	5/6	12A2S	6/6	EV28	5/6	EV28	5/6	T146	5/6	100 v.c.k. 2
7E4R	5/6	12A2T	6/6	EV29	5/6	EV29	5/6	T147	5/6	100 v.c.k. 2
7E4S	5/6	12A2U	6/6	EV30	5/6	EV30	5/6	T148	5/6	100 v.c.k. 2
7E4T	5/6	12A2V	6/6	EV31	5/6	EV31	5/6	T149	5/6	100 v.c.k. 2
7E4U	5/6	12A2W	6/6	EV32	5/6	EV32	5/6	T150	5/6	100 v.c.k. 2
7E4V	5/6	12A2X	6/6	EV33	5/6	EV33	5/6	T151	5/6	100 v.c.k. 2
7E4W	5/6	12A2Y	6/6	EV34	5/6	EV34	5/6	T152	5/6	100 v.c.k. 2
7E4X	5/6	12A2Z	6/6	EV35	5/6	EV35	5/6	T153	5/6	100 v.c.k. 2
7E4Y	5/6	12A30	6/6	EV36	5/6	EV36	5/6	T154	5/6	100 v.c.k. 2
7E4Z	5/6	12A31	6/6	EV37	5/6	EV37	5/6	T155	5/6	100 v.c.k. 2
7E5	5/6	12A32	6/6	EV38	5/6	EV38	5/6	T156	5/6	100 v.c.k. 2
7E5B	5/6	12A33	6/6	EV39	5/6	EV39	5/6	T157	5/6	100 v.c.k. 2
7E5C	5/6	12A34	6/6	EV40	5/6	EV40	5/6	T158	5/6	100 v.c.k. 2
7E5D	5/6	12A35	6/6	EV41	5/6	EV41	5/6	T159	5/6	100 v.c.k. 2
7E5E	5/6	12A36	6/6	EV42	5/6	EV42	5/6	T160	5/6	100 v.c.k. 2
7E5F	5/6	12A37	6/6	EV43	5/6	EV43	5/6	T161	5/6	100 v.c.k. 2
7E5G	5/6	12A38	6/6	EV44	5/6	EV44	5/6	T162	5/6	100 v.c.k. 2
7E5H	5/6	12A39	6/6	EV45	5/6	EV45	5/6	T163	5/6	100 v.c.k. 2
7E5I	5/6	12A40	6/6	EV46	5/6	EV46	5/6	T164	5/6	100 v.c.k. 2
7E5J	5/6	12A41	6/6	EV47	5/6	EV47	5/6	T165	5/6	100 v.c.k. 2
7E5K	5/6	12A42	6/6	EV48	5/6	EV48	5/6	T166	5/6	100 v.c.k. 2
7E5L	5/6	12A43	6/6	EV49	5/6	EV49	5/6	T167	5/6	100 v.c.k. 2
7E5M	5/6	12A44	6/6	EV50	5/6	EV50	5/6	T168	5/6	100 v.c.k. 2
7E5N	5/6	12A45	6/6	EV51	5/6	EV51	5/6	T169	5/6	100 v.c.k. 2
7E5O	5/6	12A46	6/6	EV52	5/6	EV52	5/6	T170	5/6	100 v.c.k. 2
7E5P	5/6	12A47	6/6	EV53	5/6	EV53	5/6	T171	5/6	100 v.c.k. 2
7E5Q	5/6	12A48	6/6	EV54	5/6	EV54	5/6	T172	5/6	100 v.c.k. 2
7E5R	5/6	12A49	6/6	EV55	5/6	EV55	5/6	T173	5/6	100 v.c.k. 2
7E5S	5/6	12A50	6/6	EV56	5/6	EV56	5/6	T174	5/6	100 v.c.k. 2
7E5T	5/6	12A51	6/6	EV57	5/6	EV57	5/6	T175	5/6	100 v.c.k. 2
7E5U	5/6	12A52	6/6	EV58	5/6	EV58	5/6	T176	5/6	100 v.c.k. 2
7E5V	5/6	12A53	6/6	EV59	5/6	EV59	5/6	T177	5/6	100 v.c.k. 2
7E5W	5/6	12A54	6/6	EV60	5/6	EV60	5/6	T178	5/6	100 v.c.k. 2
7E5X	5/6	12A55	6/6	EV61	5/6	EV61	5/6	T179	5/6	100 v.c.k. 2
7E5Y	5/6	12A56	6/6	EV62	5/6	EV62	5/6	T180	5/6	100 v.c.k. 2
7E5Z	5/6	12A57	6/6	EV63	5/6	EV63	5/6	T181	5/6	100 v.c.k. 2
7E6	5/6	12A58	6/6	EV64	5/6	EV64	5/6	T182	5/6	100 v.c.k. 2
7E6A	5/6	12A59	6/6	EV65	5/6	EV65	5/6	T183	5/6	100 v.c.k. 2
7E6B	5/6	12A60	6/6	EV66	5/6	EV66	5/6	T184	5/6	100 v.c.k. 2
7E6C	5/6	12A61	6/6	EV67	5/6	EV67	5/6	T185	5/6	100 v.c.k. 2
7E6D	5/6	12A62	6/6	EV68	5/6	EV68	5/6	T186	5/6	100 v.c.k. 2
7E6E	5/6	12A63	6/6	EV69	5/6	EV69	5/6	T187	5/6	100 v.c.k. 2
7E6F	5/6	12A64	6/6	EV70	5/6	EV70	5/6	T188	5/6	100 v.c.k. 2
7E6G	5/6	12A65	6/6	EV71	5/6	EV71	5/6	T189	5/6	100 v.c.k. 2
7E6H	5/6	12A66	6/6	EV72	5/6	EV72	5/6	T190	5/6	100 v.c.k. 2
7E6I	5/6	12A67	6/6	EV73	5/6	EV73	5/6	T191	5/6	100 v.c.k. 2
7E6J	5/6	12A68	6/6	EV74	5/6	EV74	5/6	T192	5/6	100 v.c.k. 2
7E6K	5/6	12A69	6/6	EV75	5/6	EV75	5/6	T193	5/6	100 v.c.k. 2
7E6L	5/6	12A70	6/6	EV76	5/6	EV76	5/6	T194	5/6	100 v.c.k. 2
7E6M	5/6	12A71	6/6	EV77	5/6	EV77	5/6	T195	5/6	100 v.c.k. 2
7E6N	5/6	12A72	6/6	EV78	5/6	EV78	5/6	T196	5/6	100 v.c.k. 2
7E6O	5/6	12A73	6/6	EV79	5/6	EV79	5/6	T197	5/6	100 v.c.k. 2
7E6P	5/6	12A74	6/6	EV80	5/6	EV80	5/6	T198	5/6	100 v.c.k. 2
7E6Q	5/6	12A75	6/6	EV81	5/6	EV81	5/6	T199	5/6	100 v.c.k. 2
7E6R	5/6	12A76	6/6	EV82	5/6	EV82	5/6	T200	5/6	100 v.c.k. 2
7E6S	5/6	12A77	6/6	EV83	5/6	EV83	5/6	T201	5/6	100 v.c.k. 2
7E6T	5/6	12A78	6/6	EV84	5/6	EV84	5/6	T202	5/6	100 v.c.k. 2
7E6U	5/6	12A79	6/6	EV85	5/6	EV85	5/6	T203	5/6	100 v.c.k. 2
7E6V	5/6	12A80	6/6	EV86	5/6	EV86	5/6	T204	5/6	100 v.c.k. 2
7E6W	5/6	12A81	6/6	EV87	5/6	EV87	5/6	T205	5/6	100 v.c.k. 2
7E6X	5/6	12A82	6/6	EV88	5/6	EV88	5/6	T206	5/6	100 v.c.k. 2
7E6Y	5/6	12A83	6/6	EV89	5/6	EV89	5/6	T207	5/6	100 v.c.k. 2
7E6Z	5/6	12A84	6/6	EV90	5/6	EV90	5/6	T208	5/6	100 v.c.k. 2
7E7	5/6	12A85	6/6	EV91	5/6	EV91	5/6	T209	5/6	100 v.c.k. 2
7E7A	5/6	12A86	6/6	EV92	5/6	EV92	5/6	T210	5/6	100 v.c.k. 2
7E7B	5/6	12A87	6/6	EV93	5/6	EV93	5/6	T211	5/6	100 v.c.k. 2
7E7C	5/6	12A88	6/6	EV94	5/6	EV94	5/6	T212	5/6	100 v.c.k. 2
7E7D	5/6	12A89	6/6	EV95	5/6	EV95	5/6	T213	5/6	100 v.c.k. 2
7E7E	5/6	12A90	6/6	EV96	5/6	EV96	5/6	T214	5/6	100 v.c.k. 2
7E7F	5/6	12A91	6/6	EV97	5/6	EV97	5/6	T215	5/6	100 v.c.k. 2
7E7G	5/6	12A92	6/6	EV98	5/6	EV98	5/6	T216	5/6	100 v.c.k. 2
7E7H	5/6	12A93	6/6	EV99	5/6	EV99	5/6	T217	5/6	100 v.c.k. 2
7E7I	5/6	12A94	6/6	EV100	5/6	EV100	5/6	T218	5/6	100 v.c.k. 2
7E7J	5/6	12A95	6/6	EV101	5/6	EV101	5/6	T219	5/6	100 v.c.k. 2
7E7K	5/6	12A96	6/6	EV102	5/6	EV102	5/6	T220	5/6	100 v.c.k. 2
7E7L	5/6	12A97	6/6	EV103	5/6	EV103	5/6	T221	5/6	100 v.c.k. 2
7E7M	5/6	12A98	6/6	EV104	5/6	EV104	5/6	T222	5/6	100 v.c.k. 2
7E7N	5/6	12A99	6/6	EV105	5/6	EV105	5/6	T223	5/6	100 v.c.k. 2
7E7O	5/6	12A100	6/6	EV106	5/6	EV106	5/6	T224	5/6	100 v.c.k. 2
7E7P	5/6	12A101	6/6	EV107	5/6	EV107	5/6	T225	5/6	100 v.c.k. 2
7E7Q	5/6	12A102	6/6	EV108	5/6	EV108	5/6	T226	5/6	100 v.c.k. 2
7E7R	5/6	12A103	6/6	EV109	5/6	EV109	5/6	T227	5/6	100 v.c.k. 2
7E7S	5/6	12A104	6/6	EV110	5/6	EV110	5/6	T228	5/6	100 v.c.k. 2
7E7T	5/6	12A105	6/6	EV111	5/6	EV111	5/6	T229	5/6	100 v.c.k. 2
7E7U	5/6	12A106	6/6	EV112	5/6	EV112	5/6	T230	5/6	100 v.c.k. 2
7E7V	5/6	12A107	6/6	EV113	5/6	EV113	5/6	T231	5/6	100 v.c.k. 2
7E7W	5/6	12A108	6/6	EV114	5/6	EV114	5/6	T232	5/6	100 v.c.k. 2
7E7X	5/6	12A109	6/6	EV115	5/6	EV115	5/6	T233	5/6	100 v.c.k. 2
7E7										

C. T. SUPPLY Co.

THE CAR RADIO SPECIALISTS

10-12 HAINAULT ST. ILFORD, ESSEX. TEL: ILF 4564

OFFER THE BEST CAR RADIO BARGAIN EVER!
BRITISH QUALITY MADE FOR LEADING BRITISH
CAR MANUFACTURER

FIT ANY CAR - ALL TRANSISTOR
FULLY GUARANTEED Money refund guaranteed
 if not the best radio bargain in the country

LESS THAN 1/2 PRICE

MODEL 1. 2-Wave full coverage.

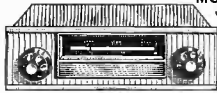

£20 **£8-0-0**

or £3. 0. 0. deposit, followed
 by 9 monthly instalments
 of 15/- (total £3. 15. 0)

More facts about Car Radio.

1. size 7" x 5 1/2" x 2" STANDARD SIZE FIT ANY CAR.
 2. 12 volt positive earth.
 3. Medium Wave (87 mm) - 550 mm)
 4. Aerial trimmed ESPECIALLY FOR PIRATE STATIONS.
 5. 3 Watt output. FRONT PLATES MAY VARY
- OPTIONAL EXTRAS 7" x 4" Matching Speaker 12/6d 3 stage telescopic aerial 28/6 18/6 POSTAGE 6/6.



MODEL 2.

£6-6-0

More facts about Car Radio.

1. Full Medium Wave coverage to get Home/Light and all Pirate Stations.
 2. size 7" x 5 1/2" x 2" STANDARD SIZE FIT ANY CAR.
 3. 12 volt positive earth.
 4. Aerial trimmed ESPECIALLY FOR PIRATE STATIONS.
 5. 3 Watt output. FRONT PLATES WILL VARY
- OPTIONAL EXTRAS 7" x 4" speaker 12/6d 3 stage telescopic aerial 18/6. POSTAGE 6/6d.



MODEL 3.

14/29NS

or Deposit
 £4. 0. 0. 8 monthly payments
 of £1. 9. 6d. (Total £17. 5. 0).

- 5—Push button. Medium/Long Wave "EASI-TUNE". British Made 4 watt output—instant station selection. Fully Transistorised and guaranteed.
- 12 volt negative or positive earth. Easy fitting to any car.
- FREE Fitting Kit 'FREE Speaker and baffle.
- FREE AERIAL FREE Insurance against Theft.

Use this coupon as your ready made Order form.
 Please send me Car Radio. I enclose cash/cheque
 /Money Order for—
 NAME Model 1. £28. 0. /
 or £3. 0. 0. deposit.
 ADDRESS Model 2. £6. 6. 0.
 Model 3. £15. 4. 6.
 or £4. 0. 0. deposit.
 18/6. Aerial.
 12/6 Speaker.

POSTAGE/PACKING 6/6d.

C. T. Supply Co., 10-12 Hainault St., Ilford, Essex. TEL: ILF 4564



All components used in our transistors may be purchased separately if desired. Parts price lists and easy build plans available separately at prices stated.

NEW TRANSONA FIVE



7 Stages—6 transistors and 2 diodes.
 Covers M. and L. Waves and Traveller Bands. Incorporating ferrite rod aerial, tuning condenser, volume control, and new type fine tone super dynamic 2 1/2" speaker, attractive case. Size 9 1/2" x 4 1/2" x 1 1/2" approx.
Total cost of all parts NOW ONLY £2/6
 Parts price list and easy build plans 2/- (Free with kit.) P. & P. 2/6.

POCKET FIVE

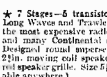

7 Stages—6 transistors and 2 diodes. Covers Medium and Long Wave and Traveller Bands. Features specially fitted to suit the most expensive radios. On test. Home, Light, Intermediate and many Continental stations were received loud and clear. Improved aerial incorporating ferrite rod aerial and fine tone 2 1/2" moving coil speaker, built into attractive black case with red speaker grille. Size 7 1/2" x 4 1/2" x 1 1/2" (with 220 battery, available any where).
Total cost of all parts NOW ONLY 42/6
 Parts price list and easy build plans 1/6 (Free with kit.) P. & P. 2/6.



Med. and Long Wave version with miniature speaker. **29/6** P. & P. 2/6.

ROAMER SIX NEW!



8 Stages—6 transistors and 2 diodes.
 8 wavebands.
 * Now with Philips micro-alloy R.F. transistors. Listen to stations half a world away with this 6 waveband portable. Tunable on Med and Long Wave, Traveller Bands and Three Short Waves. Push-pull output. Benelux ferrite rod aerial and telescopic aerial for short wave. Ten grade transistor. 2 inch speaker. Transistorised with gift fitting. Size 7 1/2" x 5 1/2" x 1 1/2". * Extra hand for easier tuning of L.W. etc.
Total cost of all parts NOW ONLY £3. 19. 6
 Parts price list and easy build plans 2/- (Free with kit.) Carrying strap 1/6 extra. P. & P. 2/6.

NEW! ROAMER SEVEN Mk. IV

7 WAVEBAND PORTABLE OR CAR RADIO
 AMAZING PERFORMANCE AND SPECIFICATION
 * NOW WITH PHILIPS MICRO-ALLOY R.F. TRANSISTORS.
 * Only tunable on all wavebands.
 8 Stages—7 transistors and 2 diodes.
 Covers M. and L. Waves, Traveller Bands and three Short Waves to approx. 18 stations. Push-pull output for room-filling volume from rock found 2 1/2" 4 ohm speaker. Air cooled general tuning condenser. Ferrite rod aerial for M. & L. Waves and telescopic aerial for 3 Short Waves. Metal leather case with gift fitting and shoulder straps and straps. Size 9 1/2" x 5 1/2" approx. The perfect portable and the ideal car radio. (Uses P.C. batteries available any where).
 * Extra hand for easier tuning of pirate stations, etc.
Total cost of all parts NOW ONLY £5. 19. 6
 P. & P. 2/6.



SUPER SEVEN

8 Stages—7 transistors and 2 diodes.
 Covers M. and L. Waves and Traveller Bands. The ideal radio for home, car or can be fitted with carrying strap for outdoor use. Completely portable—built-in ferrite rod aerial for wonderful reception. Special direct incorporating 2 I.F. stages, push-pull output, 2" speaker (will drive larger speaker). Size 7 1/2" x 5 1/2" x 1 1/2". (Uses P.C. batteries, available any where).
Total cost of all parts NOW ONLY £3. 19. 6
 Parts price list and easy build plans 2/- (Free with kit.) P. & P. 2/6.

NEW!! TRANSONA SIX

8 Stages—6 transistors and 2 diodes.
 A top performance receiver covering full M. & L. Waves and Traveller Bands. Push-pull output. High grade speaker makes listening a pleasure. Ferrite rod aerial. Many stations heard in one covering including Luxembourg, loud and clear. Attractive case in grey with red grille. Size 6 1/2" x 4 1/2" x 1 1/2". (Uses P.C. batteries, available any where).
Total cost of all parts 59/6
 Parts price list and easy build plans 2/- (Free with kit.) P. & P. 2/6.



MELODY SIX NEW!!

8 Stages—6 transistors and 2 diodes. Our latest completely portable transistor radio covering M. and L. Waves. Incorporates pre-selector, heavy duty speaker, two grade transistor, volume control, tuning condenser, wave change slide switch, sensitive fine ferrite rod aerial. Push-pull output. Waveband switching of B.B.C. Home and Light. 280 and many Continental stations. Handsome leather look pocket size case, only 6 1/2" x 3 1/2" x 1 1/2" approx. with gift speaker grille and hand and shoulder straps. **Total cost of all parts £3. 9. 6**
 P. & P. 2/6.

SEND S.A.E. for list of COMPONENT BARGAINS

RADIO EXCHANGE

61 HIGH ST., BEDFORD. 'Phone: 52320

Dealers side entrance Barratts Shoe Shop. Weekdays 9-5 p.m. Saturdays 9-12.30

Camson's

(ELECTRONICS LTD)

LONDON'S LARGEST SUPPLIERS OF
ELECTRONIC EQUIPMENT
9 & 10 CHAPEL STREET
LONDON, N.W.1
Tel. PAD 7851 AMB 5125



HOURS 9.30-6
OPEN ALL DAY
SAT.
SEND 6P. STAMP
FOR LIST

HEAVY DUTY L.T. TRANSFORMERS ALWAYS IN STOCK.

All Primaries 200-240 VOLTS. TER-
MINAL BLOCK CONNECTIONS.
*DENOTES SHROUDED TYPES.

No.	Sec. Taps.	Amps	Price	Carr.
1.	25-30-35 v.	40	£12 15 0	15/-
2.	25-30-35 v.	20	£7 19 6	9/6
3.	25-30-35 v.	10	£5 10 0	6/6
4.	25-30-35 v.*	2	£2 7 6	4/6
5.	10-17-18 v.*	10	£2 10 0	4/6
6.	24 v.	30	£9 5 0	9/6
6a.	24 v.*	30	£10 5 0	9/6
7.	20 v.	30	£7 5 0	8/6
8.	5 v.	15	£7 19 6	8/6
9.	30-40-50 v.*	5	£5 5 0	6/6
10.	24-36-48 v.*	8	£5 17 6	6/6
11.	17-18-20 v.*	20	£5 12 6	6/6
12.	6-12 v.	20	£4 19 6	6/6
12a.	6-12 v.*	20	£4 17 6	6/6
13.	24 v.*	10	£2 17 6	6/6
14.	30-32-34-36 v.*	5	£3 5 0	6/6
15.	6-12 v.	10	£2 10 0	6/6
15a.	12 v.*	5	£1 15 0	4/6
16.	12 v.*	5	£1 12 6	4/6
17.	24 v.*	10	£2 17 6	6/6
18.	24 v.*	5	£2 9 6	4/6
19.	48-56-60 v.*	1	£1 15 0	4/6
20.	12-24-36-48 v.*	2	£2 7 6	4/6
21.	6.3 v.	15	£2 2 6	4/6
22.	6.3 v. 5A & 6.3 v. 1A.	1	17 6	4/6
23.	12-24 v.*	2	19 6	3/6
24.	9-15 v.	2	19 6	3/6
25.	6-9-15 v.	4	£1 9 6	3/6
26.	12-18 v.	10	£2 2 6	5/6
27.	12-18 v.*	20	£4 9 6	6/6
27a.	12-18 v.*	20	£4 19 6	6/6
28.	48-56-60 v.*	2	£2 7 6	4/6
29.	12 v.	50	£7 5 0	8/6
30.	12-24-36-48 v.	15	£7 19 6	9/6

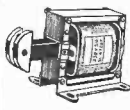

VARLEY A.C. SOLENOIDS

BRAND NEW
200-240 v. very powerful,
Base size 2 1/2 x 2 1/2 in. x 2 1/2 in.
Length pulling spindle, 2 1/2 in.
22/6. P.P. 2/6.
D.C. types 180 v. Size 1 1/2 x 1 1/2 in. Length of spindle 1 1/2 in.
6/6. P.P. 2/2. 50 v. D.C., 7/6. P.P. 2/2.

BLOCK CAPACITORS

New and Guaranteed. Send for List, over 2,000 in stock at a fraction of maker's price.

LATEST ARRIVALS

Maker	Mid.	D.C.V.	Temp	Price	Carr.
T.C.C.	10	750	60°C	10/6	2/6
T.C.C.	10	350	60°C	6/6	2/6
T.C.C.	8	1,500	60°C	17/6	3/6
T.C.C.	8	750	60°C	8/6	2/6
T.C.C.	8	600	60°C	7/6	2/6
T.C.C.	8	400	71°C	6/6	2/6
T.C.C.	2	2,000	60°C	12/6	2/6
Dubilier	8	600	60°C	7/6	2/6
Dubilier	4	800	71°C	5/6	2/6
Dubilier	1	3,000	100°C	17/6	2/6
Dubilier	0.5	5,000	60°C	17/6	2/6
Dubilier	0.1+0.1	6,000	71°C	8/6	2/6

JUST ARRIVED AMERICAN OIL FILLED CAPACITOR GUARANTEE

Mid.	D.C.V.	Price	Postage
15	1,000	22/6	3/6
12	1,000	19/6	3/6
10	1,500	19/6	3/6
8	600	8/6	2/6
7	600	6/6	2/6
10 tubular	300	6/6	2/6

SOLARTRON POWER SUPPLY SUB-UNIT

TYPE AS955.
A.C. input 100-125 v. and 200-240 v. Stabilised D.C. output continuously variable between 200 and 200 v. at 200 mA. Also two 6.3 v. A.C. at 6 a. and one at 2 a. Supplied BRAND NEW with instruction manual. Manual sent on a returnable deposit of 10/- £12/10/0. Carr. 10/0.

400 WATT AUTO TRANSFORMERS

By famous maker, fully tropicalised. Sapped 200-210-220-230-240-250, 50-75-85-100-105-110-150-160 v.
Table top connections, 49/6. Carr. 5/-.
*See P.P. 2/6.

DAVID BROWN GEARS, LTD. RADICON WORM DRIVE REDUCERS.

Reduction 25:1. Size 1 1/2 in. RHU. Drive spindle 3/8 in. dia. Reduction spindle 3/8 in. dia. Brand new in maker's carton, 65/-. Carr. 5/-.
*See P.P. 2/6.

SMITH 4 MINUTE TIMERS

Switch Contacts 15amps, 250 v. A.C. Complete with chrome bezel and knob. Brand new, 17/6. P.P. 2/6.

DRAYTON THERMOSTATS TYPE CT

Flow range 100-200 deg.F. Switch contacts 15 amp, 250 v. A.C. Make, break or change over-circuit. Complete with metal straps, flexible conduit and data sheet. 35/-. P.P. 5/-. Brand new.

TEDDINGTON AIR PRESSURE SWITCHES TYPE 13A/1A/B

Single pole 15 amp, 250 v. switch contacts. Approx. 1/6. Pressure, 12/6. P.P. 2/6. Brand new.

EAC LTD. A.C. 0-300 v. METERS

50 cycles, 6 in. flush mounting, iron case, protected. Panel hole 6 1/2 in. Supplied new, in sealed cartons at a fraction of maker's price, 75/-. Carr. 3/-.
*See P.P. 2/6.

SIEMENS MINIATURE RELAYS

Plug-in type, 9,000/62 makes, 16,000/121 makes, 5,500/24 CQ. Complete with base, all at 8/6 each. 1/6 P.P. G.P.O. 3,000 type 500/1 change over contacts 15/- P.P. 2/2.

AUTO TRANSFORMERS

240-110 v. 2,000 watts. Completely enclosed in beautifully finished case. Fitted with 2 two-pin American sockets or terminal blocks, neon indicator, on/off switch, and carrying handle. £10/9/6. Carr. 7/6. 1,500 watts, £7/10. Carr. 7/6. Also available, completely shrouded, fitted with 2-pin American sockets or terminal blocks. Please state which type required. Wattage Price Carr. 1,000 £4 19 6 7/6 500 £3 15 0 6/6 300 £2 9 6 5/6 150 £1 11 6 4/6 80 £1 12 6 4/6

A.C. SYNCHRONOUS GEARED MOTORS

200-250 v., very powerful, 40 R.P.M. Size 2 1/2 x 1 1/2 in. Easily adapted to oscillate up to half a revolution. 12/6. P.P. 2/6.

REDCLIFFE HT TRANSFORMERS

"C" core type, table top connections. PRI T 200-250 v. Sec. 3, separate windings of 130 v., 450 mA, 45/- Carr. 6/6. **GARDENERS.** Fully shrouded table top connections. PRI T 200-250 v. Sec. 250 v. 187 mA 6.3 v. 10.3 amps, 49/6. Carr. 6/6. **PARMECO.** Totally enclosed "C" core PRI T 200-250 v. sec. 415-0-415 v., 160 mA, 165 v. 155 mA, 6.3 v. 3A 6.3 v. 1.6A 6.3 v. 1.6A 5 v. 2.8A, 49/6. Carr. 6/6.

PARMECO NEPTUNE SERIES.

PRI T 200-250 v. Sec. 500-0-500 v. CT 120 mA, 6.3 v. 3A, 5 v. 3A, 39/6. P.P. 6/6. **GARDENERS.** Fully shrouded "C" core PRI T 200-250 v. Sec. 350 v. 200 mA, 250 v. 120 mA, 6.3 v. 2.8A, 6.3 v. 3.85A, 49/6. Carr. 6/6.

BRAND NEW SLIDING RESISTORS FRACTION OF MAKER'S PRICE

Ohms	Amps	Type	Price	Carr.
30	1.25	STGD	27/6	3/6
152	2	TTGD	49/6	5/6
178	1.5	TT	49/6	6/6
400	1.7-0.5	TTGD	65/6	5/6
758	0.7	TT	49/6	6/6
1,622	1	ST	57/6	6/6
1,624	1	TT	65/6	6/6
1,540	0.5	TT	75/6	6/6
12,000	0.03	TTGD	45/6	6/6
0.1	2	ST	65/6	6/6
1	16	STF	17/6	4/6
130	1	STF	7/6	2/6

ST - Single Tube TT - Twin Tube GD - Gear Drive. F = Fixed.

L.T. SUPPLY UNIT SET I.E.I.

A.C. input 200-240 v. D.C. Output 250 v. tapped to give 12 or 24 volts 8 amp continuous rating. Fitted with panel fuse. Mains on/off switch and D.C. output switch. Built in metal case 15 x 6 x 6 in. Size 15 x 6 x 6 in. An ideal general purpose L.T. supply unit for operating relays. Connections, battery charging, etc. £9/19/6. Carr. 7/6.

L.T. SUPPLY UNIT SET 2

A.C. input 200-240 v. D.C. output 50 volts 5 amps. Built in metal case 15 x 6 x 6 in. Fitted with on/off switch, panel fuse, and output socket, £9/19/6. Carr. 7/6.

MULTI-TAPPED TRANSFORMERS

All Primaries 200, 230, 250 v.

Type	Sec. Taps	Amps.
A	3-4-5-6-8-9-10-12-15-18-20-24-30 v.	2 29/6 4/-
B	3-4-5-6-8-9-10-12-15-18-20-24-30 v.	4 42/6 4/6
C	3-4-5-6-8-9-10-12-15-18-20-24-30 v.	5 49/6 5/6
D	3-4-5-6-8-9-10-12-15-18-20-24-30 v.	8 65/6 7/6
E	6-7-8-10-14-15-17-19-25-31-33-40-50 v.	3 49/6 5/6
F	6-7-8-10-14-15-17-19-25-31-33-40-50 v.	6 97/6 7/6
G	12-18-20-24-30 v.	10 77/6 7/6

EX-GOV. L.T. TRANSFORMER BY FAMAULT MAKERS GUARANTEED. ALL PRIMARIES TAPPED 200-250 v.

No. 1 50-0-50v. conservatively rated at 200-watts. Completely enclosed. £8/19/6. Carr. 7/6.
No. 2 Sec. 70 v. 5A Parmeko Neptune, 75/- Carr. 7/6.
No. 3 Sec. T. 35-38.5 v. 11.8A, enclosed in metal case, 79/6. Carr. 10/0.
No. 4 Sec. T. 32-38.4 v. 7A, 79/6. P.P. 6/6.
No. 5 Sec. 50-0-50 v. 2A, 50/-, P.P. 5/-.
No. 6 Sec. T. 53.6-55.2 v. 6A. "C" core, 75/-, Carr. 7/6.
No. 7 Sec. 6 v. 6A, suitable for projector lamps, 19/6. P.P. 3/6.
No. 8 Sec. 6-12 v. 8A, 39/6. P.P. 5/6.
No. 9 Sec. 1.25 v. 3A, Sec. 210 v. 0.1A, Sec. 3, 115 v. 0.6A, 29/6. P.P. 4/-.
No. 10 Sec. T. 65-130 v. 85 mA, Sec. 2, 6.3 v. 5A Sec. 1, 11.5 v. 0.5A.
No. 11 Sec. 1, 22.3 v. 0.9 Sec. 2, 21 v. 60 mA, 15/-. P.P. 2/6.
No. 12 Sec. 1, 45 v. 25 mA, 1 v. 1A, 15/-, P.P. 2/6

LOW RESISTANCE SMOOTHING CHOKES

Shrouded type 0.05 H 0.7/6. 2 amps 39/6. P.P. 4/-. 0.03 H 0.4/3. 4 amps, 49/6. P.P. 4/6. 0.02 H 0.2/5. 8 amps, 55/6. P.P. 6/6.

WIDEN ISOLATION TRANSFORMERS

Completely enclosed PRI 200-210-220-230-240-250 v. Sec. 230 6.3 amps., £8/15/6. Carr. 10/0.

PROPS Walk-around Store

and MAIL ORDER SERVICE

MEMBER
OF THE
PANTYA
GROUP OF
COMPANIES

52 Tottenham Court Road, London, W.1. • Open 9-6, including Sats., Thurs. 9-1 • LAngham 0141

VISIT OUR NEW BRANCHES AT: **MANCHESTER**—10 Withy Grove, Manchester 4. Tel.: Deansgate 3357 • **LONDON**, N1—162 Holloway Road. Tel.: North 7941
SHEFFIELD—Dumbarland 2, The Moor, Sheffield, Tel.: Sheffield 29983 • **GROVDOWN**—12 Suffolk House, George St., Croydon, Tel.: Municipal 3250
LIVERPOOL—52 Lord Street, Liverpool. Tel.: Royal 7450 • **BRISTOL**—26 Merchant Street, Bristol 1. Tel.: 23977.

CADMIUM SULPHIDE POWER PHOTOCELL

New American made, extremely robust, sealed-glass units. Spectral response covers entire visible light range. Suitable for 40 to 100 voltages up to 200 volts. Max. load 0.5 watts. Resistance varies from 80 ohms in bright daylight to 1 megohm in total darkness. Size 1 1/2" dia. x 1/2" thick. 10—Post Free.



STANDARD SOLENOIDS Specially made, high grade Solenoids, in four basic frame sizes and for 12 V. D.C. or 240 V. A.C. pull or push operation. State requirements.



TYPICAL UNITS TYPE 1. Max. pull 2 oz. Stroke 1/4 in. to 1/2 in. Size 1 1/2 in. long. Both dia. 1/4 in. **12 6**

TYPE 2. Max. pull 18 oz. Stroke 1/4 in. to 1/2 in. Size 2 1/2 in. Serial for Post and Parting 1/4 in. **14 6**

TYPE 3. Max. pull 25 oz. Stroke 1/4 in. to 1/2 in. after 1 1/2 in. long both dia. 1/4 in. wide x 1/2 in. high. Both dia. 1/4 in. **27 6** P. & P. 1/2

TYPE 4. Max. pull 26 oz. Stroke 1/4 in. to 1/2 in. Size 3 1/2 in. long both dia. 1/2 in. wide x 1 1/2 in. high. Both dia. 1/2 in. **32 6** P. & P. 1/2

PHOTOCELL SWITCH

Heavy metal back metal box contains a highly sensitive cadmium sulphide photocell, double-pole relay and wired-in circuitry to provide complete, light actuated switch. Designed for operation from 120 V. A.C. but very easily adapted by alteration of small resistor to operate directly from mains. It will respond so that relay operates and stays on immediately light falls on cell (small glow 1/2 in. dia. relay, no load tripping device for surge hot operation. Longer life and safety device. Size 2 1/2" x 1 1/2" overall.



22/6 P. & P. 2.

DEKATRON TYPE GS10E

By Erickson, simplified beam-tube, bottled and complete with performance and connection data. Max. operating speed: 18 kcps. Anode voltage: 440/475 v. Current: 6.5 mA. Cathode voltage: 23 v. max. Pulse Amplifier: 120 v. rate, also overall 1.2 in. dia. x 2.5 in. fitted with standard shielded base. **15/-** free



ETCH YOUR OWN PRINTED CIRCUIT KITS 21/-

Each containing over 60 sq. in. of laminated board and sufficient chemicals to make dozens of printed circuits, plus comprehensive instruction book giving advice and examples on etching those chemical circuits into layouts ready for etching. High quality materials—completely safe to handle—entirely prepared to assist fine resolution and uniform results without laboratory venting.



PROOPS MULTI-TESTER



Specially designed for Proops! This truly top-notch, all-purpose tester combines the usual needed voltage, current, and resistance measuring ranges for home and motor car wiring and servicing, motor and T.V. fans, and electronic hobby construction checking. Extremely robust construction employs rugged, large scale meter movement, hand-wiring switch controls, and fine-point rotating test leads plastic case. Ranges: 0-10-20-250-500-1000 volts A.C. or D.C. 0-100-500 ohms and —0-10 to —20 ohms. Also overall: 0-25-125 ohms. Supplied complete with red and black insulated connector leads, batteries, and full instruction. **39 6** P. & P. 2.

SEMI-CONDUCTOR MODULES

Ice cube size encapsulated circuits

Solid state semiconductor modules—fully transistorized and completely wired and tested circuits that only require a 9 V. battery and connection to input and output to provide a complete ready-made unit. Zero-potential type, no ground and almost trouble-free. Supplied with instructions.

KEYSTONE—New design driving bank suitable and visual indication over the range 20 to 240 beats per minute. Requires only 3 ohm speaker, 220 ohm pot. and torch bulb to complete. **22/6** P. & P. 1/2.

CODE PRACTICE OSCILLATOR—Advanced design giving powerful, authentic tone and visual indication if trouble-free. Uses standard 3 ohm speaker. **20/-** P. & P. 1/2.
PHONE ADDRESS AMPLIFIER—Ideal kit book for home builders. Uses 3 ohm speaker and suitable for use with common crystal or dynamic microphones. **30/-** P. & P. 1/2.
GRAMOPHONE AMPLIFIER—Can be used with magnetic crystal or ceramic pickups—full and clear information supplied. High quality output fills average living room. **30/-** P. & P. 1/2.
SEIZY MODULE—Needs only 3 ohm speaker and suitable for complete push-button to complete. Provides powerful upward accelerating note to form bell sounds for alarms, etc. **22/6** P. & P. 1/2.

important new

ILIFFE

technical books

Industrial Electronics Measurement

Edited by Alexander Schure

This book presents the theory of electronic measurement devices as used in the industrial electronics field. Though written primarily for the student at technical schools, it will also be found particularly useful to the electronics technician.

15s net by post 15s 7d 128 pp. illustrated

Electrical Interference

Rocco Ficchi

Gives the design and field engineer, programme manager and technician a broad view of the importance of interference in modern electrical systems. Shows the entire field as a unified display and makes it possible to solve the problems that would be encountered in equipments varying from a missile system to a small radio receiver.

50s net by post 51s 7d 266pp. illustrated

Design of Low-Noise Transistor Input Circuits

William A. Rheinfelder

Written for both students and circuit design engineers interested in low-noise circuit design. Throughout, the book gives a multitude of time-saving graphs and design curves for the practical circuit designer. The simple derivations of all important formulae are so presented as to enable the reader to obtain an insight into the fundamentals of practical low-noise design.

30s net by post 31s 160pp. illustrated

Simplified Modern Filter Design

Philip R. Geffe

This book brings together the various modern or network-synthesis methods of modern filter design, and enables the engineer to achieve practical designs with a minimum of engineering effort. The difficult calculations of modern filter design have already been worked out and are presented in extensive tables of numerical data.

50s net by post 51s 182pp. illustrated

obtainable from leading booksellers

ILIFFE Books Ltd.

DORSET HOUSE

STAMFORD STREET

LONDON SE1

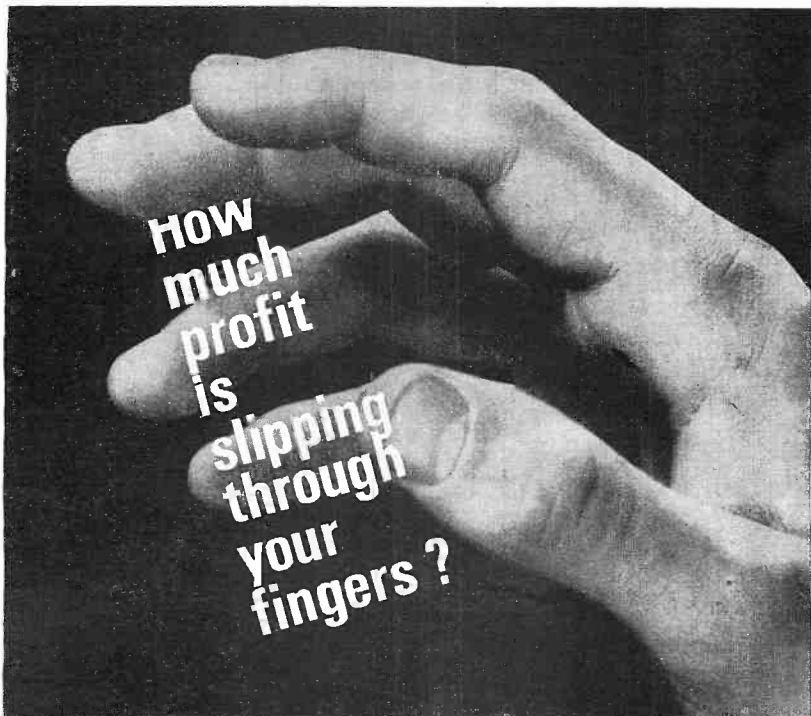

everyone can mechanize and profit .

Business may be brisk, with everyone working ; but where are all the profits? Something is robbing your company of its expected returns. Labour costs are rising 8% a year; values of factory space and production machinery are rising fantastically. Under-utilization of these high-cost productive elements through inefficient handling operations is your worst enemy, and British industry is estimated to waste £800 million yearly in this way. Even if your business is not large, don't ignore the

big savings possible with mechanized handling. Many new ideas are discovered at every Mechanical Handling Exhibition—a survey in 1964 revealed that 47% of visitors had seen something new. Mechanization is your best investment—simple low-cost devices often produce remarkable results. See thousands of new ideas from over 300 exhibitors at the Mechanical Handling Exhibition, Earls Court, 10-20 May. Don't miss this important event—mail the enquiry coupon now.

mechanical
handling exhibition

10/20 MAY, 1966, EARLS COURT, LONDON

Mail this coupon now for free tickets and further details

To the Manager, Mechanical Handling Exhibition,
Dorset House, Stamford Street, London, S.E.1

NAME (please print) _____

FIRM _____

ADDRESS _____

45C

6 VALVE AM/FM TUNER UNIT

Mod. and VHF 100m-250m., 90 Mc/103 Mc/s. 6 valves and metal prefilter. Self-contained power A.C. 200/250 v. operation. Master eye indicator, 3 position output control, auto. Mod. VHF 100m and high output antenna with gain control. Illuminated 3-color periscope dial 11 1/2 in. dia. chassis size 11 1/2 in. x 6 in. A recommended fidelity kit for use with unit. "3-3" or "5-10" Amplifiers.
Bargain Price. Complete kit parts, inc. Power Pack as illustrated. **£10/8/6.** Carr. 7/6. **10/1/6** less Power Pack. **£9/10/6.** Carr. 7/6. Circuits and Coax. Details. A/G. Free with kit.



7 VALVE AM/FM RADIOGRAM CHASSIS

Valve line-up. ECC85, ECC81, EF89, EABC80, EL84, EM81, E230.

NEW 1966 MODEL NOW AVAILABLE

Three Watford and Swedish Grid positions. Mod. 200/250 v. 1000-2000 m. VHF/FM 85-95 Mc/s. (Full) perm. illumination. Tuning eye on FM combined. AM/FM 100m transformers. Latest circuitry including AVC and Mag. Feedback. Three watt output. Readability and reproduction of very high standard. Chassis size 13 1/2 x 6 1/2 in. Height 7 1/2 in. Edge illuminated dial 11 1/2 x 6 1/2 in. Vertical rotator. Horizontal station names. Gold on brass background A.C. 200/250 v. operation. Mags. eye tuning. Circuit diagram now available.

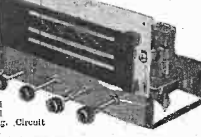

Aligned and tested ready for use **£13.19.6** Carr. & Ins. 7/6.

Complete with Tuning QIP! Rodent, cast. split. and 17U sockets, 4 knobs—waxnut or ivory to choice and 1st/2nd FM aerial 236 extra.
 3 ohm P.M. Speaker only required. Recommended Quality Speakers 10in. H.A. 27/6. 15in. H.A. 32/6. 12in. H.A. with 2 speaker. 42/6. E.M.I. 101 x 8in. 42/6. Carr. 2/6.

MULLARD "3-3" and "5-10" HI-FI AMPLIFIERS

3 OHM & 15 OHM OUTPUT
 3-3" Amp. 3-valve Hi-Fi quality at reasonable cost. Bass Boost and Treble controls, quality sectional output transformer, 40 c/s-25 kc/s ± 1 dB. 100 mV. for 3W, less than 1% distortion. Bronze escutcheon panel. Complete Kit only 7/5. Carr. 5/6. Wired and tested **£8/10/6.**
MULLARD "5-10" AMPLIFIER—5 valves 10 W. 3 and 15 ohms output. Mullard's famous circuit with heavy duty ultra-linear quality output trf. Basic amplifier kit price **£9/10/6.** Carr. 7/6. Ready built 11/1 gns.
2-VALVE PRE-AMP. UNIT. Based on Mullard's famous 2-valve (2 x EF86) circuit with full equalisation with volume, bass, treble, and 2-position selector switch. Size 9in. x 6in. x 2 1/2in. Ready built, wired and tested, **£7/19/6.** Carr. 3/6.

VOLUME CONTROL—OK—2 Meg. ohms. 3in. ARNOLDS. MORGANITE MIDGET TYPE 11in. dia. DUAL 1 year LOU or LIN. ratios. less 8/6. 2 1/2 D.P. Ser. 5/6. Twin Stereo less 8/7. 1/2in. track to 2 inches with D.I. Ser. 8/6. Same layout! Log values less 8/6.

TRANSISTOR COMPONENTS

Midget I.F. 5-65 Kc/s. 3/4in. diam first, second or third, ea. 5/6
 Osc. Coil M. & L.W. 3/4 dia. 5/6
 Midget Driver Trans. 1/2 x 1/2 5/6
 Midget Output Trans. Push Pull—3 ohms 6/6
ELEC. CONDENSERS. Midget Type 1 mid.-50 mid. ea. 1/9, 1/10 mid. 2/4, 12 v. wkg. 1/5 cheque 2/6 each
CONDENSERS. 150 working: .01 mid., .02 mid., .03 mid., .04 mid. 9d.; .05 mid., 1 mid. 1/-; .25 mid. 1/3; .5 mid. 1/6 each
MIDGET TUNING CONDENSERS. 1.5 "O.C." 208 pf. and 176 pf. 8/4; ditto with trimmers, 9/6. 16 220 pf. and 103 pf. conc. slow motion 1/10. 365 pf. single 7/6. Sub. Min. 2in. Dilemma 100 pf., 300 pf., 500 pf., 7/- each.
FERRITE AERIALS. M. & L.W. car aerial coil 9/1.
MIDGET WOLL CONTROL. with edge control knob. 3 or 10 K/ohms, with switch, 4/9. Ditto less switch 3/9.
SPEAKERS: P.M.; 2in. Plessey 7/5 2 1/2in. Plessey 12/6
 2 1/2in. Plessey 3 ohms 21/6. 2 1/2in. Conventional 8 ohms 13/6. 7 x 4in. Plessey 35 ohms 22/6.

V.H.F. MOBILE RECEIVERS by Pye 65-100 MC/S 12v. D.C. SUPPLY



These are 11 valve double Superhet receivers operating on fixed frequency. Crystal controlled. Speaker output using midget valves. Give away price, 37/6 post free.

DESK CONTROL UNIT containing speaker, switches, etc. 10/- post free.
RADIO RELAY EQUIPMENT
 2 1000 Watt Amplifiers with Receivers.
 1 x 750 Watt Amplifier. 9 x 500 Watt Amplifiers.
 7 200 Watt Amplifiers. 3 x 100 Watt Amplifiers.
 2 000 x Bin. Loudspeakers in Polished Wooden Cabinets and various other radio relay. Only reasonable prices asked as space is required.
STABILISED POWER PACKS (rack mounting). Mains input. Outputs 250 v. 100 mA.; 250 v. 200 mA.; 300 v. 400 mA.; 150 v. —150 v., 500 mA.; 300 v. 510 mA.; 24 v. 2 amp.; 1350 v. —50 v. heavy duty.
S.T. & C. POWER UNITS. Type 246/LU 3945A. 1 kw. V.H.F. Amplifiers and associated equipments.
 2 element Yagi Aerial type 468B.
 PR51H Receivers with coils. Transmitters P.T.C. 354 N.
 8in. Loudspeakers in polished wooden cabinets, 12/6 each or 22/6 pair. Post free.
 Callers only. Oscilloscopes by Cosor, Erskine, Solatron and others. AR88 Receivers, 52 Receivers, 107 Receivers.

M.A.C. (MORLEY) LTD., MACHINERY AND COMPONENTS

Head Office: Troy Rd., Morley, N.P. Leeds. Tel.: Morley 2334. Shops: 38 Market Lane, Leeds. Tel.: Leeds 26226.

AUTOMATIC VOLTAGE REGULATORS, carbon pile, by Newton Bros. (Derby) Ltd., 115 v. A.C. type 4, for alternators. Pile Resistance Range 16/250 ohms. Price £10.

CHOKES, smoothing, 50 ma. 5/-, 60 ma. 8/-, 8 henries 100 ma. 10/-, 2 henries 35 ohms 300 ma. 10/-, 12 henries 90 ohms 200 ma. 21/-.
CAPACITORS. T.C.C. Metallpack tubular .05mf and 1mf, 350v. D.C. working, 6/6 per dozen. Duplicator 1 mf, 350 v. D.C., 1/9 each. T.C.C. 2 mfds., 10,000 v. D.C., £10 each. T.C.C. .02 mfd., 11,000 v. D.C., 25/- each. T.C.C. 1mf, 11,000 v. D.C., £3 each. American 5 mfd., 7,500 v. D.C., 25/- each. B.I. Cables, 01 mfd, 5,000 v. D.C., 2/6 each. Jackson Bros., 132 pf., single variable, 5/- each. Large laboratory type variable, suitable for transmitters, etc., 30/- each.
 T.C.C. 2000mf., 25v., 10/- . T.C.C. 75pf. 5000 v. tubular, 1/9 each.
INDUCTANCES, transmitter type by Redifon, with 9 turns approx. 5in. diameter, and sliding clips. Very suitable for laboratory use. Price £3.
METERS, moving iron projecting type, A.C./D.C., approx. 4in. diameter, 0-150 v. Price £1.
RECTIFIERS, Westinghouse metal, 12 v., 3 amps. Price 12/6.
ROTARY INVERTERS, Type Ba. Input 24 v. D.C. Output 115 v. 3 phase, 400 cycles, 1.8 amps. Price £5.
SIGNAL GENERATORS. Marconi type TF517/F1, covering 18-33, 33-58, and 150-300 mcgacycles. These are offered by us brand new and as received from Government sources, at £10 each, with instruction book. Carriage and packing 25/- extra.
TELEPHONE TRANSFORMERS, types 34 and 35. Price 5/-
SIGNAL GENERATOR, Service type No. 8, 5HF, with equipment. Price £50.
TRANSFORMERS, heavy duty type in scaled container, nominal input voltage 117/234 v. Outputs 320-0-330 v. at 200 ma. 5 v. at 2 amps. 6.4 v. at 4 amps. Price 35/-
TRANSFORMER, input 230 v. Outputs 4.5 v. C.T. at 6 amps. 4.5 v. C.T. at 6 amps. 4.5 v. C.T. at 20 amps. Price £3.
 Other types available.
WINDING MUSE TRANSFORMERS, input 115 v., 400 cycles, and various L.T. outputs. Prices on request. Also pulse transformers. Postage or carriage extra. Prompt despatch.

SOTONIAN TRADING CO.

53 The Avenue, Southampton, Hants. Tel. 565337



AERO ELECTRONICS LTD

PEN RECORDERS



Efficient portable recording milliammeter.
As H.T. recorder: 1 mA. F.S.D.
Movement resistance 1200Ω.
As A.C. current or voltage recorder:
Movement resistance at 50 c/s.
150Ω. Sensitivity 1 mA. A.C.
F.S.D.
As deflection meter: source impedance
500Ω. Range 15 to 150 ΩV.
Frequency response 50 c/s to
10 kc/s.
Chart drive: 250 v. A.C. at 3 in. and
6 in. per hour. Movement is fitted
with "high" and "low" alarm
contacts which can be set for any
value of the current.
Strip chart 2 1/2 in. wide. Curvilinear
trace. PRICE £20
Packaging and carriage 15%.

RECORD PORTABLE RECORDING MILLI-AMMETERS

These are similar to the above but are somewhat smaller and lighter, and D.C. resistance of the movement is 100Ω. Other details as above. PRICE £12 10 0
Packaging and carriage 15%.

THOMSON VARLEY POTENTIAL DIVIDERS

Needs to have 4-decade potential divider with total resistance of 70,000Ω. Maximum input voltage 200 v. Built-in galvanometer 10A. F.S.D. 255.

CTS3 SIGNAL GENERATORS

Frequency range 0.5 to 300 mc. Accuracy ± 1%. Output 10V. to 100 mV. Internal impedance not sine wave modulation. 115 c/s 250 v. A.C. Range operation. Fully tested, in perfect condition, with new calibration certificates. £20, P.P. 17%.

CONSTANT VOLTAGE TRANSFORMER



Input: 110/230 v. A.C.
Output: 240 v. ± 1.3%.
Max. Current 1 A.
E11/11L. P.P. 17%.

PHILIPS FIRST-CLASS MIRROR SCALE I mA. D.C. MC METERS



Square frame 4 1/2 in. x 4 1/2 in. dial mounted. Scale length 10 in. Body 3 1/2 in. dia. x 1 1/2 in. deep. Calibrated 0 to 1 mA. Price 65/-

VARIABLE AUTO-TRANSFORMERS

Input Voltage 250 v. A.C.; output variable from 0 to 250 v.
Type H2, 2.5 amps. £5 10/0. P.P. 17%.



TYPE S810—Illustrated above, 10 amps. with protecting fuse. £18/5/0. P.P. 17%.

DOUGLAS STEP-DOWN TRANSFORMER

Type at 0.112, 0.200, 0.300, 0.500 V. Output 115 v.
M17/AT, 150 watts 30/-
M17V/AT, 500 watts

DOUGLAS POWER TRANSFORMERS

Input at 200-250 V.
M12/AT, 250 v. at 50 mA.; 6.3 at 1.75 A. 16/3
M12V/AT, 250-0-250 v. at 90 mA.; 6.3 v. at 2.5 A. 27/-
6.3 v. M.I.A.
M11/AT, 250-0-250 v. at 80 mA.; 6-4-6 v. at 4 A.; 6-4-6 v. at 2 A. 27/-
M11V/AT, 250-0-250 v. at 100 mA.; 6.3 v. at 3.5 A. 30/6
6.3 v. at 2 A.; 6.3 v. at 1 A.
M12/AT, 350-0-350 v. at 80 mA.; 6-4-6 v. at 3.5 A.; 6-4-6-3.3 v. at 2 A. 35/-

DOUGLAS CHARGER TRANSFORMERS

Input 200-250 V.
M13/AT, secondary tapped at 0-12-15-20-50-50-50 v. at 3 amps. Using intermediate taps the following voltages can be obtained: 24-45-5-8-10-15-20-24 V.
M13V/AT as M13/AT but 2 amps. capacity 30/-
M16/AT, 24 v. at 2 amps. 16/3

PLESSEY ELECTROLYTIC CAPACITORS

24μF at 27V 2/- 100-300μF at 27V 3/6
200μF at 27V 2/6 100-300μF at 100V 3/6
200μF at 45V 3/- at 250 V; 50μF at 250 V 3/6
200μF at 27V 3/- 20 V; 20μF at 20 V 3/6
All voltages are D.C. working. Leakage 7% per year.

VARIABLE A.C. POWER SUPPLY UNIT

Output 0-250 v. A.C. at 2.5 amps. £12 10/0. P.P. 17%.



Portable Power Unit fitted with 1.5 amps. Variable Transformer, switched and fused, with A.C. Voltmeter and power indicator lamp. £8/10/0. P.P. 17%.

TRANSISTOR CIRCUIT COMPONENTS

Set of three 400 hertz I.F. Coils 10/6
Variable Tune Gang Miniature Tuning Capacitor, two sections 4-16.5 pF. and 10-40 pF. with 1 1/2 pF. trimmer, complete with Broadcast Band Oscillator Coil 6/6
Driver Transformer, Impedance ratio 2:1 3/6
Output Transformer for push-pull output, 250 mA. V. 2/6
5,000Ω. 100-watt volume control with switch locking and carriage 10/- per item 4/6

S.T.C. SILICON JUNCTION 3-AMP. HALF-WAVE POWER RECTIFIERS

ES310, 140 p.i.v. 5/- ES350, 700 p.i.v. 7/6
ES230, 250 p.i.v. 5/- ES400, 410 p.i.v. 6/6
ES300, 320 p.i.v. 5/- ES270, 380 p.i.v. 5/-
ES340, 500 p.i.v. 7/- ES380, 1120 p.i.v. 10/-

MISCELLANEOUS SILICON HALF WAVE POWER RECTIFIERS

101000 (Lamin) 50 p.i.v., 500 mA. 5/-
S112A (A121) 100 p.i.v., 2.5 A. 7/6
S112B (A121) 150 p.i.v., 2.00 mA. 4/6
D4202 (Mullard) 150 p.i.v., 100 mA. 5/-
D1001 (Fenwal) 200 p.i.v., 200 mA. 2/6
BY743 (Mullard) 200 p.i.v., 65 amps. 7/6
D1000 (Fenwal) 400 p.i.v., 500 mA. 6/6
O1230 (Mullard) 400 p.i.v., 500 mA. 6/6
D1225 (Fenwal) 400 p.i.v., 1 amp. 5/-
P1252A (Fenwal) 400 p.i.v., 100 mA. 6/6
18004 (Fenwal) 500 p.i.v., 270 mA. 5/6
18004 (Fenwal) 600 p.i.v., 100 mA. 5/6
BY 100 (Mullard) 200 p.i.v., 450 mA. 7/-
P1252B (Fenwal) 400 p.i.v., 100 mA. 6/6
O1231 (Mullard) 400 p.i.v., 500 mA. 6/6
D1002 (Fenwal) 800 p.i.v., 500 mA. 10/6
P1252C (Fenwal) 600 p.i.v., 6 amps. equivalent to P1252C 10/-

MICROWAVE DIODES

1S21 (4,000 Mc/s) 4/- CV1019 (12,500 Mc/s) 37/6
1S212 (4,000 Mc/s) 4/- CV110 (6,000 Mc/s) 37/6
1S24 (3,000 Mc/s) 5/- CV102 (6,000 Mc/s) 5/-
1S25 (4,000 Mc/s) 5/- CV111 (12,000 Mc/s) 5/-
1S25B (4,000 Mc/s) 5/- CV112 (12,000 Mc/s) 5/-
1S26 (4,000 Mc/s) 5/- CV113 (12,000 Mc/s) 5/-
1S210 (3,750 Mc/s) 20/- CV215 (12,000 Mc/s) 37/6
1S211 (3,750 Mc/s) 20/- CV216 (12,000 Mc/s) 37/6
1S24 (3,000 Mc/s) 40/- CV217 (12,000 Mc/s) 37/6
1S24 (3,000 Mc/s) 40/- CV218 (12,000 Mc/s) 37/6
1S24 (3,000 Mc/s) 5/- VX319 (31,800 Mc/s) 65/-
CSA (19,000 Mc/s) 12/6

TEXAS SILICON FULL-WAVE BRIDGE RECTIFIERS

110K10 100 p.i.v., 2 amps., dimensions 1 1/4 x 1 1/4 x 3/16. 25/-
110K15 150 p.i.v., 4 amps., dimensions 1 1/4 x 1 1/4 x 3/16. 30/-
110K20 200 p.i.v., 5 amps., dimensions 2 1/2 x 2 1/2 x 3/16. 35/-
Voltage 10% per rectifier.

GERMANIUM JUNCTION STUD MOUNTED POWER RECTIFIERS

4J235, 200 p.i.v., 400 mA./1 amp. 3/6
4J236, 300 p.i.v., 200 mA./1 amp. 3/6
4J237, 450 p.i.v., 500 mA./1 amp. 3/6
4J238, 600 p.i.v., 500 mA./1 amp. 3/6
Higher ratings refer to cooling in mounting.

CATHODE RAY TUBES

3PPT 3 in. yellow trace, long persistence screen, E.H.T. 2,000 V. with P.D.A. (H144) 12/-
3PPT 3 in. green trace, long persistence screen, E.H.T. 2,000 V. (H144) 15/-
1L90 V. (H144) 10/-
3PPT 3 in. white trace, fast fade, medium persistence, E.H.T. 2,000 V. (H144) 12/-
4P14, 4 in. white trace, fast fade, medium persistence, E.H.T. 2,000 V. (H144) 16/-
2ADP16, 5 in. blue trace, short persistence, fast fade, with E.H.T. 2,000 V. E.H.T. (H144) 100/-
3PPT 3 in. yellow trace, long persistence screen, with P.D.A. 4,000 V. E.H.T. (H144) 100/-
3PPT 3 in. blue trace, long persistence screen, with MAGNETIC DEFLECTION, ultra-thin focusable, 4,000 V. E.H.T. (H144) 60/-
TRPT 3 in. yellow trace, long persistence screen, MAGNETIC DEFLECTION AND FOCUSING, 2,500 V. E.H.T. (H144) 30/-
S81, 3 in. double beam, blue trace, fast fade, short persistence, 2,000 V. E.H.T. (H144) 60/-
90P14F, 3 in., green trace, medium persistence, P.D.A. max. I.H.T. 5,000 V. (H1215) 180/-
H12-5, 2 1/2 in., green trace, medium persistence, E.H.T. 500 V. (H203) 58/-
1M150, 3 in. green trace, medium persistence, P.D.A. max. I.H.T. 5,000 V. (H144) 120/-
D1002, 3 in., 2 1/2 in., red/green screen, green trace, medium persistence, E.H.T. 5,000 V. (H144) 200/-
S82, 3 in. green trace, short persistence screen, fast fade tube, 4,000 V. E.H.T. (H1215) 200/-

TYPE 108-T MULTIMETER

2 1/2 in. range precision portable meter, 5,000 ohms I.H.T. Volt. 25-10-50-250-500-2500 v. A.C. Volt. 15-50-100-500-2500 v. D.C. current range 0-50-500-2500 mA. Resistance range 200-2000 ohms-25Ω impedance. Power output calibration for 200 ohms I.H.T. £5 5/- P.P. 17%.

POCKET MULTIMETER TYPE U-J

Scaleability 1,000Ω V. D.C. and A.C. voltage range 0-10-20-200-500-1,000 v. D.C. current range 0-10-100-500 mA. Resistance range 2,000Ω-200-2000Ω. Power output calibration for 200 ohms I.H.T. £2.2/- P.P. 17%.

Head Office: 24a WESTBOURNE GROVE, LONDON, W.2

Tel: PARK 5641/3

Cables: ZAERO LONDON

R.V.B. Approved for inspection and release of electronic valves, tubes, klystrons, etc.

Retail branch (personal callers only)

85 TOTTENHAM COURT RD.,

LONDON W.2 Tel: LANGHAM 8403



Please send all enquiries, correspondence and Mail orders to Head Office

TRANSISTORS

Table of transistor part numbers and specifications, including types like 0A16, 0A2, 0A3, etc.

ZENER DIODES

Table of zener diode part numbers and specifications, including types like 2B5W, 2B6W, 2B7W, etc.

KLYSTRONS

Table of klystron part numbers and specifications, including types like 6X125, 6X130, etc.

MAGNETRONS

Table of magnetron part numbers and specifications, including types like 6X125, 6X130, etc.

COUNTER TUBES

Table of counter tube part numbers and specifications, including types like 6X125, 6X130, etc.

Complimentary page 25657(NEN) and 25112E (NPF5 50)

Main table of electronic components including vacuum tubes, diodes, and other parts with columns for part number, description, and price.

WHEN ORDERING BY POST PLEASE ADD 2% IN £ FOR HANDLING AND POSTAGE. MINIMUM CHARGE 1/6

PLEASE OFFER US YOUR SURPLUS STOCK OF VALVES, KLYSTRONS, MAGNETRONS, ETC. WE PAY £1.00. FOR 723A/B AND 2K25 KLYSTRONS, SUBJECT TO TEST.

WW-147 FOR FURTHER DETAILS.

4-STATION INTERCOM



Our Price Only
18Gns
£7/15/0

Solve your communication problems with this new 4-Station Transistor Intercom system (1 master and 3 subs), in de-luxe plastic cabinets for desk or wall mounting. Call-hold/listen from Master to Subs and Subs to Master. Operates on one 9 V. battery. On/off Switch. Volume control. Ideally suitable to medicine Office, Factory, Workshop, Warehouse, Hospital, Shop, etc., for instant inter-departmental contacts. Complete with 3 connecting wires, each 60ft. and other accessories. Nothing else to buy. P. & P. 4/5 in U.K.

Transistor TELEPHONE AMPLIFIER



75/6

Why not increase efficiency of Office, Shop and Warehouse with this incredible De-luxe Portable Transistor TELEPHONE AMPLIFIER with Rotary Calendar and Pen-Holder which enables you to take down long telephone messages or converse without holding the handset. A status symbol? Yes, but very useful one. On/off switch. Volume Control. Operates on one 9 v. battery (supplied) which lasts for months. Ready to operate. P. & P. 4/6 in U.K.

WEST LONDON DIRECT SUPPLIES (W.W.),
6 Chignell Place, W. Ealing, London, W.13.

INTERCOM/BABY ALARM



Usually 6 Gns.

Our Price Only

59/6

This wonderful TWO-WAY TRANSISTOR INTERCOM consists of two units—Master and Sub—in de-luxe plastic cabinets with chrome trim. Operates on one inexpensive battery. Call, talk or listen from Master to Sub and Sub to Master. On/off switch. Full Volume Control. IDEAL AS A BABY ALARM. Or communicate with your neighbour or listen for telephone bell in other rooms. Hundreds of other uses. Inexpensive in Home, Shop, Nursery, Surgery and Office. A boon for spasies and disabled. Saves shouting and waiting up and down the stairs. Complete with 60ft. connecting lead and a battery. Ready to operate. P. & P. 2/6 in U.K. 5/- abroad.

DO YOU STILL USE A HAMMER AND CHISEL TO CUT A SQUARE IN SHEET METAL?

Don't any more

We have a Hand-operated Tool now to cut any straight sided shape. Square R/Angles slots for Louvers. All you do is simply mark out your shape and follow the lines. You can also convert the Tool to a Punch-Louvre Forming and Riveting Tool.

NO DISTORTION OF METAL ON EITHER SIDE OF CUT

Also a number of Bench Type folding machines

EXPORT ORDERS DESPATCHED IMMEDIATELY

AVONLEA TOOLS, WOODEND MILL, MOSSLEY, LANCASHIRE.
MOSSLEY 2687

Introduction to Laplace Transforms for radio and electronic engineers

W. D. Day, A.M.I.E.E., A.M.I.E.R.E.

Presents the theory of the Laplace transformation in easily understood language, dealing with electrical circuits from the very first paragraph to the stage when transforms are used to investigate transient conditions. The first part of the book is designed for home study while the second half is designed as an introduction to more advanced texts.

32s 6d net, by post 33s 6d

from leading booksellers

ILIFFE Books Ltd

DORSET HOUSE, STAMFORD STREET, LONDON, SE1

THE HIGH-FIDELITY MAIL ORDER SPECIALISTS

GOODS DESPATCHED BY RETURN

Carriage, Packing & Insurance (U.K.) FREE !!

AMPLIFIERS • TUNERS • SPEAKERS
MOTORS • PICK-UPS • MICROPHONES
CABINETS • TAPE RECORDERS

A.D.C. ARMSTRONG, R. & O. BRENELL, CELESTION CHAYMAN, COMMOISEUR, DECCA, DESIGN FURNITURE, EDVSTONE RADIO, F.L. FERROGRATER, IC-CORD G.K.B., GAREARD, GOLDRING, GOODRASS, GRAMMAN, K.E.F., LEAK, LOWTHER, LENO, LUSTRA-PHONE, ORTOFON, PHILIPS, PVE, QUAD, RADFORD, RECORD HOUSING, REVOX, ROBERTS, S.M.E., TANNON, TANBERG, THORNS, THUXOS, VALERADIO, VORTICON, W.B. WEARIE, WIDNETTE, ETC.
CASH OR TERMS—CALL, WRITE OR PHONE

WORLD WIDE EXPORTERS

OVERSEAS ORDERS SENT FREE OF PURCHASE TAX AND SHIPPED PROMPTLY AT MINIMUM COST

Fully Illustrated catalogue 4s. 6d. U.K. (Export 7s. 6d. or \$1.00). Refundable against first purchase value £7. 0s. 0d. or \$10.00.

C. C. GOODWIN (SALES) LTD.
(Dept. W74) 7 THE BROADWAY,
WOOD GREEN, LONDON, N.22.

Telephone: BOWas Para 00714

1 minute from Wood Green Underground
Open 9-6 Monday to Saturday (Thursday 9-1 p.m.)

BRAND NEW POLYESTER P.V.C. & MYLAR RECORDING TAPES

also

Pre-Recorded Language Courses

Both manufactured by world reputable German and British firms. They are boxed and have fitted leaders, these tapes are not to be confused with sub-standard, off-cuts, or impaired inferior tapes. This is a genuine truly genuine less than half-price offer.

S.P.	3in.	150ft.	2/-
	5in.	600ft.	6/-
	5in.	900ft.	7/-
	7in.	1,200ft.	9/-
L.P.	3in.	220ft.	2/6
	5in.	900ft.	8/-
	5in.	1,200ft.	10/6
	7in.	1,800ft.	13/-
D.P.	3in.	400ft.	4/6
	5in.	1,200ft.	12/6
	5in.	1,800ft.	16/-
	7in.	2,400ft.	21/-

Special limited offer.

Why not learn a foreign language the easy way from one of our brand new pre-recorded language courses in GERMAN—FRENCH—SPANISH and ITALIAN!

Each tape consists of 26 step-by-step lessons recorded at 31 i.p.s., supplied complete with handbook.

Price only 20/6 each. Normal retail price is 59/6 per course.

Fully guaranteed, you will be delighted with the results.

STARMAN TAPES

26 LINKS ROFT AVENUE, ASHFORD, MIDDX.

ASH 53020

Communications Equipment

H.F. TRANSMITTER RECEIVER. H.F.

series 10 Watts H.F.

Overall weight 12lbs.

Current drain on full transmit power—

1 Amps/12V

Transmit—3 switch selected crystal channels.

Receive—Continuous tuning or preset channels.

3 models available—H.F.15 for 1.6-3.5 mcs.

H.F.26 for 2.5-5.5 mcs.

H.F.41 for 4.0-9.3 mcs.

Suitable for service in extreme climatic conditions—used in antarctic expeditions.

TRANSISTORISED P.S.U. Suitable for

direct replacement of Rotary Transformer

(2W) in W.R.82.

FIELD TELEPHONES FT.1A. Branded

lightweight for point-to-point use or with out

type of manual switchboard system without

necessity for separate switching. Performance

to highest standard.

FIELD TELEPHONES FT.2A. Steel

case, extensively sealed and protected

against extreme weather conditions.

CARRIER TELEPHONE SYSTEMS. 1-1

and 1-4—all types.

FREQUENCY FILTERS. Audio and

carrier frequencies.

LINE TRANSFORMERS, COILS RE-

PEATING, INDUCTION RETARDA-

TION, PROTECTIVE DEVICES AND

ACCESSORIES for SWITCHBOARDS,

OVERHEAD AND UNDERGROUND

LINES, etc.

R. GILFILLAN & CO. LTD.,

98 Dominion Road, Worthing, Sussex.

TEL: 8719. Cables: "GILL".

CLASSIFIED ADVERTISEMENTS

DISPLAYED: £5 5s per single col. inch.

LINE ADVERTISEMENTS (run-out): 6/- per line (approx. 7 words), minimum two lines.

Where an advertisement includes a box number (count as 2 words) there is an additional charge of 1/-.

SERIES DISCOUNT: 15% is allowed on orders for twelve monthly insertions provided a contract is placed in advance.

BOX NUMBERS: Replies should be addressed to the Box number in the advertisement, c/o Wireless World, Dorset House, Stamford Street, London, S.E.1.

No responsibility accepted for errors.

Advertisements accepted up to MAY 5 for the JUNE issue, subject to space being available.

SITUATIONS VACANT

CIVILIAN Instructors Grade III Telecommunications

5 POSITIONS for men fully experienced in the maintenance of radio and/or terminal channeling equipment (including ancillary equipment such as DC telegraph machines and telephone exchanges) to teach Royal Signals technicians and trainees. Possession of appropriate O.N.C., C. & G. certificates or equivalent qualification desirable. Selection by written examination and interview.

STARTING salary £395 (at age 21)—£1,243 (at age 30 or over) rising to £1,365.

PERSPECTIVES of pensionable appointment and promotion.

OPPORTUNITIES exist for further technical study and Day Release will be granted where possible.

ACCOMMODATION may be provided for single and for unaccompanied married men on a temporary basis.

WRITERS for application form to C&G/O, Personnel Office, Caterick Camp, Yorkshire.

CLOSING date 13th May 1966. [1481]

ENGINEER Technicians, Diplomatic Wireless Service.

The Diplomatic Wireless Service have vacancies for about 22 posts in (a) Grade II, (b) Grade III.

THIS Department operates a world-wide network of radio communication stations which is in the process of being modernised and expanded and the most up-to-date techniques in radio teleprinter systems are being employed. The duties of engineers in this field involve installation, modification, maintenance and operation of radio transmitters and receivers of the most modern type, remotely tuned aerial systems, teleprinter and voice frequency telegraph equipment.

In addition several high powered broadcasting stations relative programmes in both the H.F. and M.F. bands. The transmitters involved include some of the highest powers yet produced for this purpose. The duties in this field include the installation, modification, maintenance and operation of these very high power transmitters, the most modern receiving equipment, base receivers, diesel generating plant, etc. The Department's policy is to encourage versatility and to carry out as much installation and modification work as possible with its own staff. The initial appointments will be either to (a) (b) (c) (d) (e) (f) (g) (h) (i) (j) (k) (l) (m) (n) (o) (p) (q) (r) (s) (t) (u) (v) (w) (x) (y) (z) (aa) (ab) (ac) (ad) (ae) (af) (ag) (ah) (ai) (aj) (ak) (al) (am) (an) (ao) (ap) (aq) (ar) (as) (at) (au) (av) (aw) (ax) (ay) (az) (ba) (bb) (bc) (bd) (be) (bf) (bg) (bh) (bi) (bj) (bk) (bl) (bm) (bn) (bo) (bp) (bq) (br) (bs) (bt) (bu) (bv) (bw) (bx) (by) (bz) (ca) (cb) (cc) (cd) (ce) (cf) (cg) (ch) (ci) (cj) (ck) (cl) (cm) (cn) (co) (cp) (cq) (cr) (cs) (ct) (cu) (cv) (cw) (cx) (cy) (cz) (da) (db) (dc) (dd) (de) (df) (dg) (dh) (di) (dj) (dk) (dl) (dm) (dn) (do) (dp) (dq) (dr) (ds) (dt) (du) (dv) (dw) (dx) (dy) (dz) (ea) (eb) (ec) (ed) (ee) (ef) (eg) (eh) (ei) (ej) (ek) (el) (em) (en) (eo) (ep) (eq) (er) (es) (et) (eu) (ev) (ew) (ex) (ey) (ez) (fa) (fb) (fc) (fd) (fe) (ff) (fg) (fh) (fi) (fj) (fk) (fl) (fm) (fn) (fo) (fp) (fq) (fr) (fs) (ft) (fu) (fv) (fw) (fx) (fy) (fz) (ga) (gb) (gc) (gd) (ge) (gf) (gg) (gh) (gi) (gj) (gk) (gl) (gm) (gn) (go) (gp) (gq) (gr) (gs) (gt) (gu) (gv) (gw) (gx) (gy) (gz) (ha) (hb) (hc) (hd) (he) (hf) (hg) (hh) (hi) (hj) (hk) (hl) (hm) (hn) (ho) (hp) (hq) (hr) (hs) (ht) (hu) (hv) (hw) (hx) (hy) (hz) (ia) (ib) (ic) (id) (ie) (if) (ig) (ih) (ii) (ij) (ik) (il) (im) (in) (io) (ip) (iq) (ir) (is) (it) (iu) (iv) (iw) (ix) (iy) (iz) (ja) (jb) (jc) (jd) (je) (jf) (jg) (jh) (ji) (jj) (jk) (jl) (jm) (jn) (jo) (jp) (jq) (jr) (js) (jt) (ju) (jv) (jw) (jx) (jy) (jz) (ka) (kb) (kc) (kd) (ke) (kf) (kg) (kh) (ki) (kj) (kk) (kl) (km) (kn) (ko) (kp) (kq) (kr) (ks) (kt) (ku) (kv) (kw) (kx) (ky) (kz) (la) (lb) (lc) (ld) (le) (lf) (lg) (lh) (li) (lj) (lk) (ll) (lm) (ln) (lo) (lp) (lq) (lr) (ls) (lt) (lu) (lv) (lw) (lx) (ly) (lz) (ma) (mb) (mc) (md) (me) (mf) (mg) (mh) (mi) (mj) (mk) (ml) (mn) (mo) (mp) (mq) (mr) (ms) (mt) (mu) (mv) (mw) (mx) (my) (mz) (na) (nb) (nc) (nd) (ne) (nf) (ng) (nh) (ni) (nj) (nk) (nl) (nm) (nn) (no) (np) (nq) (nr) (ns) (nt) (nu) (nv) (nw) (nx) (ny) (nz) (oa) (ob) (oc) (od) (oe) (of) (og) (oh) (oi) (oj) (ok) (ol) (om) (on) (oo) (op) (oq) (or) (os) (ot) (ou) (ov) (ow) (ox) (oy) (oz) (pa) (pb) (pc) (pd) (pe) (pf) (pg) (ph) (pi) (pj) (pk) (pl) (pm) (pn) (po) (pp) (pq) (pr) (ps) (pt) (pu) (pv) (pw) (px) (py) (pz) (qa) (qb) (qc) (qd) (qe) (qf) (qg) (qh) (qi) (qj) (qk) (ql) (qm) (qn) (qo) (qp) (qq) (qr) (qs) (qt) (qu) (qv) (qw) (qx) (qy) (qz) (ra) (rb) (rc) (rd) (re) (rf) (rg) (rh) (ri) (rj) (rk) (rl) (rm) (rn) (ro) (rp) (rq) (rr) (rs) (rt) (ru) (rv) (rw) (rx) (ry) (rz) (sa) (sb) (sc) (sd) (se) (sf) (sg) (sh) (si) (sj) (sk) (sl) (sm) (sn) (so) (sp) (sq) (sr) (ss) (st) (su) (sv) (sw) (sx) (sy) (sz) (ta) (tb) (tc) (td) (te) (tf) (tg) (th) (ti) (tj) (tk) (tl) (tm) (tn) (to) (tp) (tq) (tr) (ts) (tt) (tu) (tv) (tw) (tx) (ty) (tz) (ua) (ub) (uc) (ud) (ue) (uf) (ug) (uh) (ui) (uj) (uk) (ul) (um) (un) (uo) (up) (uq) (ur) (us) (ut) (uu) (uv) (uw) (ux) (uy) (uz) (va) (vb) (vc) (vd) (ve) (vf) (vg) (vh) (vi) (vj) (vk) (vl) (vm) (vn) (vo) (vp) (vq) (vr) (vs) (vt) (vu) (vv) (vw) (vx) (vy) (vz) (wa) (wb) (wc) (wd) (we) (wf) (wg) (wh) (wi) (wj) (wk) (wl) (wm) (wn) (wo) (wp) (wq) (wr) (ws) (wt) (wu) (wv) (ww) (wx) (wy) (wz) (xa) (xb) (xc) (xd) (xe) (xf) (xg) (xh) (xi) (xj) (xk) (xl) (xm) (xn) (xo) (xp) (xq) (xr) (xs) (xt) (xu) (xv) (xw) (xx) (xy) (xz) (ya) (yb) (yc) (yd) (ye) (yf) (yg) (yh) (yi) (yj) (yk) (yl) (ym) (yn) (yo) (yp) (yq) (yr) (ys) (yt) (yu) (yv) (yw) (yx) (yz) (za) (zb) (zc) (zd) (ze) (zf) (zg) (zh) (zi) (zj) (zk) (zl) (zm) (zn) (zo) (zp) (zq) (zr) (zs) (zt) (zu) (zv) (zw) (zx) (zy) (zz)

SALARY (national interim): (a) £1,129-£1,268; (b) £795 (at age 21), £1,009 (at 25 or over)-£1,129.

Promotion prospects. Non-contributor pension.

WRITE (preferably by postcard) to Civil Service Commission, Savile Row, London, for application forms (ending S/611/65). Closing date extending to 20th May, 1966. Candidates who have already applied need not do so again. [1486]

AN OVERSEAS CAREER with International Aeradio Limited.

TO meet the requirements of constant growth and expansion we invite applications from technicians and engineers for an overseas career in North West and East Africa, the Mediterranean area and the Arabian Gulf.

If you have recently completed service in a trade such as Ground Wireless Fitter in the R.A.F., Radio Electrical Artificer in the Royal Navy or R.E.M.E., Army, or have other experience in the maintenance of H.F. and V.H.F. communications, R.T. and navigational aids, we should be interested to hear from you. Successful candidates would normally spend six weeks at our Radio Engineering School, Southall, Middlesex, before proceeding overseas, but in some cases men with suitable qualifications and experience may be offered immediate posting. Overseas to receive a tax-free salary with married and child allowances if appropriate and accommodation. Bachelor or married is provided free; other benefits include free return U.K. leave and membership of an excellent pension and life assurance scheme.

WRITE IN applications, please, to Personnel Manager, International Aeradio Limited, Aeradio House, Hayes Rd., Southall, Middlesex. [156]

WHY STICK IN A RUT?

WHEN YOU CAN

PROGRESS... with

TRANSIPACK®

A GO-AHEAD, LIVELY COMPANY

TESTERS · DEVELOPMENT ENGINEERS
LAYOUT DESIGNERS · PROJECT PLANNERS

POWER ELECTRONICS

FOR BROMLEY OR HASTINGS

for informal chat—phone or write



**INDUSTRIAL
INSTRUMENTS
LIMITED**

Stanley Road
Bromley Kent
Ravensbourne 9212
Telegrams
Transipack Bromley

SEEKING ALTERNATIVE EMPLOYMENT?

Our dynamic organisation is geared to obtain for you the best job available in the area you require. If you are seeking employment in S.E. England and have at least two years' experience in British industry, contact Electronics Appointments Ltd., who are the foremost source of employment in Great Britain. Write or phone for details of our free and confidential service.



Electronics Appointments Ltd.,
Norman House, 105-109 Strand,
W.C.2. TEMple Bar 5557-8.

FOR
SALES AND WANTED
ADVERTISEMENT FORM
TURN TO
PAGE No. 141

MARINE SERVICE TECHNICIANS TO WORK IN CANADA

Immediate openings are available with the Canadian Marconi Company in Quebec, Ontario and the Maritime Provinces.

Starting salaries will be in the order of \$450.00 monthly depending on the qualifications of the individual candidate.

Applicants must be experienced with marine radio and radar equipment. 2nd PMG or amateur certificate as well as some sea-going experience could be useful.

Those applying must be capable of working independently with a minimum of supervision. Candidates familiar with the following types of equipment will be given first consideration: Radar: H/F, W/T and R/T; VHF, FM and R/T; M.F.D.F. and Echo Sounders.

Please write with full details, quoting reference WW2990.B to:

Technical Staff Officer, English Electric House, Strand, London, W.C.2.



MONTREAL QUEBEC

PYE CAMBRIDGE WORKS, Ltd., Hale Rd., Cambridge.
 * SINGLE sideband equipment.
 * VHF radiotelephone equipment.
 * H.F. reproduction equipment.
 WE require trained personnel for production testing and fault finding of micro equipment.
 WE have limited vacancies for more senior and experienced men with driver, who can lead small teams entrusted on this work.
 WE have also limited vacancies for persons of less experience who can be trained for such work.
 APPLY TO: The personnel Manager. (131)

SENIOR Electronics Engineers—Vacancies exist for 2 senior engineers, B.Sc. or B.Eng. or equivalent. Candidates must be first-class technicians with some practical experience and must be capable of administration and co-ordination of complete projects. Considerable periods will be spent abroad and only single men will be considered.—Box W.W. 1467, Wireless World.

GRAMPIAN REPRODUCERS, Ltd., Hanworth Trading Estate, Feltham, Middlesex, require a senior engineer for development of audio frequency transmitter equipment in public address applications. 11405

COLOUR television engineer, well versed latest techniques, required by new development company, apply in confidence, giving age, details of experience.—Box W. W. 54, c/o Wireless World.

A FULL-TIME technical experienced Salesman required for retail sales; write giving details of relevant experience, salary required to—The Manager, Henry's Radio, Ltd., 303, Edgware Rd., London, W.4
SALES engineers with good knowledge of Hi-Fi equipment and the electronic industry are offered responsible and remunerative position in various parts of the United Kingdom. Applicants are invited to write giving full details of their work to: Bridgeway, Ltd., 15-22, Great Russell St., London, W.C.1. 11644

VACANCIES FOR PRODUCTION INSPECTORS AND TECHNICAL AUTHORS MINISTRY OF DEFENCE (NAVY DEPARTMENT)

Production Inspectors and Assistant Production Inspectors are required in the Navy Department for a wide range of duties concerned with production, inspection and testing of equipment in the fields of Radio Communication, Sonar, Radar, Missile and Weapon Control, and Computers. The work includes Test and Inspection of Ladders, Testing and Tuning of Weapon systems in Ships, Calibration, Qualification Approval, preparation of Production Specifications, Technical Issues with Guidance for Research and Development Teams. There are also vacancies in the field of Calibration and Test Technicians to prepare Technical Handbooks used in maintenance of Weapon and Ship Production equipment in the Fleet.

LOCATION

Portsmouth, Bath, Cuppage, Portland, Slough and other manufacturing and shipbuilding centres. At Portland mainly concerned with production of Submarine Weapons and Sonar, at Portsmouth with Radar and Communication equipment. Portsmouth is also the normal base for mobile teams responsible for setting to work, tuning and testing of Weapon systems in ships, but work also in other main shipbuilding areas. Posts at Bath are concerned with production of surface and Underwater Weapons, at Slough with Naval Ordnance, and at Cuppage with Test, Inspection, Calibration and Condition.

Technical Author posts at Bath, Portsmouth, Portland and Slough.

QUALIFICATIONS

and apprenticeship; practical experience in the above fields; possession of an ONC (or equivalent) in Electronic or Electrical Engineering; Possession of Higher Technical qualifications an advantage.

SALARY SCALES

Salary scales are—
 Production Inspectors (Technical Class Grade 1) £1,120 per annum by four annual increments to £1,228 per annum.
 Assistant Production Inspectors (Technical Class Grade 11) £704 per annum to £1,120 per annum by four annual increments.
 (Above rates under review. Posts in London area attract an allowance)

Prospects of preferable employment and promotion to higher grade posts.

APPLICATIONS

Write to Superintendent of Production Pool (Naval), Ministry of Defence (Navy) Offices, Kingsley Road, Harlow, Essex for Application Form. 1468

ELECTRONIC Service Engineers required to service and install Airborne Navigation Equipment at London Airport, Home Counties and Overseas.—Apply The Decca Navigator Co. Ltd., Spar Road, Feltham, Middlesex. Tel. Feltham 3188.

AIRCRAFT Radio Radar Engineers and Mechanics with specific workshop experience in one of the following: X Band Radar, VHF, HF, ILS/AOR, or ADP; 40-hour week, 3 weeks holiday, pension scheme; apply—Miss J. D. Trotter, Personnel Officer (c/o) Ltd., Willow Rd., Colnbrook, Slough, Bucks. 11496

OPPORTUNITY for man to join electronics team enhanced on wide variety of applications to scientific research. Applicants should be able to read, understand and have experience in design or development of electronic equipment as well as servicing experience. Salary up to £2,250 p.a. inclusive. Application forms from Establishment Officer, University College London, Gower St., W.C.1, quoting Chem.6. 11483

PENNSYLVANIA

A well-known American Company based in the Pennsylvania area of America, at present engaged in the design, development and application of Semi-Conductor devices.

require

Qualified engineers experienced in Semi-Conductor work to join the company. Top salaries will be paid to the successful applicants, plus an excellent relocation allowance including fares for their families.

APPLY IN THE FIRST INSTANCE TO—

TEMTECH AGENCY LIMITED

7, Southampton Place, London, W.C.1.

Telephone HO1born 7033

BOROUGH POLYTECHNIC

Borough Road · London · S.E.1

Applications are invited for the following posts in the Department of Electrical and Electronic Engineering:

Chief Technician (Electronic)
 Chief Technician (Instrumental Workshop—Instrument-type)
 Senior Technician (Electrical Machines)
 Technician (Electrical Machines)
 Technician (Electronics)

A formal experience in Electrical/Instrumental workshop practice is essential in all posts, except the senior posts, although this is desirable for the senior post. Services in one of the above fields would be most appropriate.

Salary, according to age, experience and qualifications:

Chief Technician: £1,120-£1,200 per annum
 Senior Technician: £811-£1,115 per annum
 Technicians: £650-£820 per annum

Apply by writing, stating the post for which application is made, giving the address of your present or the Borough.



The Civil Service

Professional and Technical Appointments

POST OFFICE EXECUTIVE ENGINEERS

Forty-five posts in London and Provinces for mechanical, electrical and electronic engineers to develop and design communications systems and postal service equipment.

QUALIFICATIONS: Degree or Dip. Tech. in Mechanical or Electrical Engineering, Physics, or Applied Physics or, exceptionally, very high professional attainment. Final year students may apply.

SALARY (Inner London): £877—£1,806. Salary under review. Promotion prospects.

AGE: At least 21 and normally under 35 on 31.12.66. Some extensions for service in H.M. Forces or Overseas Civil Service. (Reference: S/322).

ELECTRICAL AND MECHANICAL ENGINEERS

For design and installation of Heating, Ventilating and other building services urgently required by Ministry of Public Building and Works to fill 30 posts in London and the provinces. The work is varied and will provide experience in latest techniques. A further 150 vacancies for Electrical and Mechanical Engineers exist in other Government Departments.

QUALIFICATIONS: Degree or Dip. Tech. with 1st or 2nd class honours, or have passed all examinations for A.M.I.E.E., A.M.I.Mech.E., A.M.I.E.R.E., A.M.I. Prod.E., or A.F.R.Ac.S.

SALARY (Inner London): £1,143 (at 25)—£1,718. Salary under review. Promotion prospects.

AGE: Normally at least 25 and under 35 on 31.12.66. Some extensions for service in H.M. Forces or Overseas Civil Service. (Reference: S/85).

ENGINEERING DRAUGHTSMEN

Vacancies in Ministry of Public Building and Works, Ministry of Defence, Post Office, and in other Departments for Engineering Draughtsmen in the fields of **MECHANICAL, ELECTRICAL, and HEATING AND VENTILATING ENGINEERING.**

QUALIFICATIONS: O.N.C. (or equivalent) in appropriate subject, three years' training and, in addition, at least one year's drawing office experience.

SALARY (Inner London): £718 (at 20)—£1,108 (at 28 or over)—£1,209. Salary under review. Annual leave allowance 3 weeks and 3 days rising to 6 weeks.

AGE: At least 20. Promotion prospects. Where appropriate, time off for further technical study may be given. (Reference: S/68).

The above posts are pensionable and **APPLICATION FORMS** are obtainable from the Secretary, Civil Service Commission, Savile Row, London, W.1. Please quote appropriate reference.

English Electric Leo Marconi

Computer servicing

English Electric Leo Marconi is Britain's foremost computer company. Ever increasing sales mean that we need more engineers to maintain computers on our customers' premises.

Experience in the development, testing or servicing of transistorised electronic equipment and the ability to understand the logic of advanced computers are the qualifications we are looking for.

Training, salaries and fringe benefits are all that you would expect from a leader in the computer field and prospects are limited only by ability.

Jobs exist in most parts of the country, but the greatest number of vacancies is in the London Area, the Midlands and South West Lancashire.

To obtain more information write to:—
The Personnel Officer,
Dept. W.W.M.16,
English Electric-Leo-Marconi Computers Ltd.,
24, Minerva Road,
London, N.W.10.



AN ENGLISH ELECTRIC COMPANY

Instrumentation Technicians and Mechanics

If you are a Technician or Mechanic we invite **YOU** to apply for one of the several vacancies in our Commissioning or Laboratory Section.

What do we want?

You must have experience in the operation and/or commissioning of some of the following systems

- (a) RELAY CIRCUITS, MAGNETIC AMPLIFIERS, NUCLEONIC INSTRUMENTS, PRESSURE TRANSDUCERS WITH ELECTRICAL OUTPUT, HEALTH PHYSICS INSTRUMENTS
- or (b) FLOW MEASUREMENT, TEMPERATURE MEASUREMENTS, CONTROL VALVES, PNEUMATIC AND HYDRAULIC CONTROL SYSTEMS

What qualifications must you have?

- (a) H.N.C. ELECTRICAL OR MECHANICAL
- (b) O.N.C. ELECTRICAL OR MECHANICAL
- (c) TRADE APPRENTICESHIP

What can we offer?

- (1) FOR APPLICANTS WITH H.N.C. AND CONSIDERABLE EXPERIENCE, TECHNICIAN GRADE I
- (2) FOR APPLICANTS WITH H.N.C. AND LIMITED EXPERIENCE OR O.N.C. AND CONSIDERABLE EXPERIENCE, TECHNICIANS GRADE II
- (3) IF YOU HAVE SERVED AN APPRENTICESHIP AND HAVE SOME EXPERIENCE IN INSTRUMENTATION WE WILL OFFER TO SUCCESSFUL APPLICANTS THE POST OF MECHANIC, AN HOURLY PAID JOB WITH GOOD PROMOTION PROSPECTS TO TECHNICIAN GRADE

The successful staff applicants will be required to participate in our super-annuation scheme and will be given assistance with removal expenses in appropriate cases.

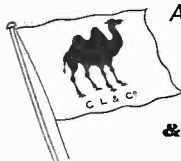

*All applications to be addressed to the Personnel Officer,
quoting reference IT/1*

CAMMELL LAIRD

& Co (Shipbuilders & Engineers) **Ltd · Birkenhead**

RACAL

Need a technical author

Racal Instruments Limited have a vacancy for a Technical author to prepare handbooks for their new range of Digital Measuring Instruments. Candidates should have formal electronic training; some experience in the application of logical techniques would be an advantage. Consideration will be given to engineers who have a desire to enter this field but have not had previous experience as Technical Authors. The work calls for personal initiative. The successful applicant will be based in the Reading area.

And a technical publications writer

To work on a range of publications dealing with HF Communications Systems and Digital Instrumentation. Ideally, candidates will have had a basic training in Electronics, or at least a background knowledge and be willing in the first instance to generally assist in the production of Commercial Technical Publications. A good educational level including 'O' or 'A' at English is essential. Candidates need not have had previous experience in this type of work and will be assisted and encouraged by experienced writers. This is an opportunity to train for a worthwhile and interesting profession.

Attractive conditions of employment are offered including entry to the Company's Superannuation Scheme, etc. Applications in writing, enclosing full personal details to:-

RACAL
THE RACAL GROUP

Personnel Manager
Racal Electronics Ltd.
Western Road, Bracknell,
Berkshire

TELECOMMUNICATIONS SUPERINTENDENT

Required by NIGERIAN RAILWAY CORPORATION on contract for two tours, each of 18 months in first instance. Salary £2,475 gross a year. Gratuity at rate of 20% of total salary drawn. Quarters provided at moderate rental. Free passages. Liberal leave.

Candidates must be experienced telecommunication engineers possessing a recognised University Degree/Diploma, or be A.M.I.E.E. or A.M.I.E.R.E. P.M.G. Certificate desirable but not essential. They should have sound experience of railway telecommunication systems, and be capable of advising the Corporation on problems arising during the installation of a complex communications system. Possibility of secondment will be considered for successful applicant.

Apply to CROWN AGENTS, M. Dept., 4 Millbank, London, S.W.1 for application form and further particulars, stating name, age, brief details of qualifications and experience, and quoting reference M2R/62781/W.F.

RADIO TECHNICIANS

A number of suitably qualified candidates will be required for training, leading to permanent and pensionable employment, normally at Cheltenham but with opportunities for service abroad or assignment to other U.K. establishments including London.

Applicants must be 19 or over and be familiar with the use of Test Gear and have had Radio/Electronic Workshop experience. They must offer at least 'O' level (GCE passes in English language, Mathematics and/or Physics or hold Intermediate Certificate or equivalent technical qualifications.

Pay according to age, e.g. at 19 £747; at 25 £902 (which pay on entry) rising by four annual increments to £1,104.

Prospects of promotion to grades in salary range £1,032-£1,691.

Annual leave allowance of 3 weeks 3 days, rising to 4 weeks 2 days.

Normal Civil Service sick leave regulations apply.

Apply:

Personnel Officer (R/T/3),

Government Communications Headquarters,

Osley, Priors Road, Cheltenham, Glos.

AIRCRAFT Radio Engineers and Mechanics with specific workshop experience in one of the following: VHF, HF, or ADF, 40-hour week, 3 weeks' holiday; Periodic Engine Director, Air Transport (Charters) (G.T.), Ltd., Willow Road, Colnbrook, Bucks. 11485

INTERNATIONAL ALLOYS LIMITED, Aylesbury, require Electronics Technician for maintenance and fault finding on direct reading spectrographic equipment; experience on this type of equipment desirable but not essential; experience on high voltage equipment advantageous; salary based on qualifications and experience; hours of work 37 per week; additional hours paid at overtime rates; company operates pensions and life insurance schemes; three weeks' holiday per year after first year; canteen facilities available—Apply to Personnel Manager. 11488

INSTITUTE OF CANCER RESEARCH: ROYAL CANCER HOSPITAL, ELECTRONICS TECHNICIAN required in the Chester Beatty Institute, Fulham Rd., S.W.3 to take charge of the servicing of equipment (e.g. spectrometers and other instruments) and the construction and development of prototype apparatus. Applicants will be required to hold Technician's Grade, M.R.C. scale, E955-£1,265 with London Allowance, depending on age, qualifications and experience. Apply with names of two referees to the Secretary, 34, Sunnier Place, S.W.7, quoting ref. 501/B/624. 11474

HYDROLOGICAL research unit: electronic engineer: An electronic engineer is required by the hydrological Research Unit, Natural Environment Research Council, Howbery Park, Wallingford, Berkshire, to assist in the development and construction of mechanical instruments for hydrological measurements. The post is at assistant experimental officer grade and applicants should have an H.N.C. in electrical engineering and some years' experience in electronic development work, examples of salary: £741 at 21, £970 at 25; a day release scheme operates for further studies.—Apply to the above address, telephone number Wallingford 2581. 11459

BOOKS, INSTRUCTIONS, ETC.

CIRCUITS for audio and tape recording 7.5 raw available at all good bookshops or 8.6 post free from Haymarket Press, Ltd., 9, Harrow Rd., London, W.2.

MANUALS, circuits of all British ex-W.D. 1919-45 wireless equipment and instruments from original R.E.M.E. instructions; sale for 15s. over 70 types—W.H. Batley, 167a, Moffat Rd., Thornton Heath, Surrey. 11479

BOOKS WANTED

MANUALS or instruction books, data, etc. on American or British Army, Navy or Air Force types of electrical equipment—H. Harris, 93, Wardour St., London, W.1. 11416

ELECTRONIC ENGINEERS

Service Engineers required for London Area and Provincial Offices of well-known Crown manufacturing Electronic Desk Calculating Machines. Applicants should possess a sound knowledge of basic electronics with experience in electronics, Radio, Radar and T.V., or similar field. Position is permanent and pensionable. Comprehensive training on full pay will be given to successful applicants. Please send full details of experience to:

Service Manager,
SUMLOCK COMPOTMETER LTD.,
102/108 Clerkenwell Road,
London, E.C.1.

Commissioning Organisation

SENIOR WEAPONS ENGINEER

An experienced electronic engineer with administrative ability is required to control the weapons section of our machinery test organisation.

Likely background would be that of a commissioning engineer on radar, radio and/or sonar equipment with some control over other engineers.

Salary will be commensurate with qualifications and experience. The successful applicant will be required to participate in our superannuation scheme. Assistance in appropriate cases will be given with removal expenses.



Applications initially to the Personnel Officer

**CAMMELL LAIRD
& CO (Shipbuilders & Engineers) LTD
BIRKENHEAD**

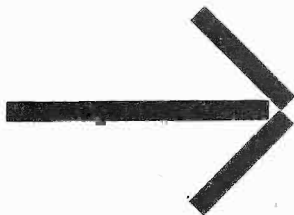

Electronics Technicians

The Job

Servicing a wide range of high quality electronic instruments—oscilloscopes, digital and valve voltmeters, power supplies, pulse generators, etc. Location will be at Farnborough, in one of the most modern and attractively situated companies in South East England.

The Men

Radio and T.V. service engineers; technicians leaving the armed forces; men with industrial experience. The real requirement is a good knowledge of electronics and experience in fault diagnosis and rectification, preferably backed up by a sound technical training (City & Guilds Telecommunications for example).

The Benefits

Good pay; first-class fringe benefits; up-to-date workshops, superbly equipped; on-the-job training; day-release for suitable candidates; prospects of career advancement and broader industrial experience within the Company; security; companionable working atmosphere; assistance for people willing to move into the area.

The Right Thing

to do now is to get yourself an interview; talk to the people in our Service Department, and find out for yourself the advantages of linking your future to SOLARTRON. Write a descriptive letter to:



C. S. J. Mardell, Personnel Officer,
THE SOLARTRON ELECTRONIC GROUP LTD.,
Victoria Road, Farnborough, Hants.

TECHNICAL CLASS VACANCY AT R.A.F. CHESSINGTON

The Ministry of Defence (Air Force Department) has a vacancy for a Civilian Technical Class Grade III officer at No. 248 Maintenance Unit, Royal Air Force Chessington.

Duties

The review of serviceable stocks of medical electronic equipment held at RAF Chessington and testing before issue, the small scale production of locally-developed equipment, and the servicing and repair of equipment at hospitals and other medical establishments.

Qualifications

Applicants must be British subjects. They should have served an apprenticeship, and hold the ONC or an equivalent qualification, but applicants with substantial experience in the electronics field with technical knowledge up to ONC standard will be considered.

Pay

£796 at age 21 increasing by annual increments to a maximum of £1,129. Age 28 and over start at £1,009. These rates are under review.

Prospects for Pension

Established appointment (for pension and gratuity) can be obtained by passing Civil Service Commission Open Competitions once the ONC or an equivalent certificate is held.

Studies for ONC, HNC, etc.

Encouraged by release from work one day a week and by payment of fees, etc., by Department.

Holidays, Sickness, etc.

Five day week, Annual leave three weeks, three days at start increasing to six weeks. Sick leave benefit.

Selection is by interview at Chessington.

Application forms from:— **Officer Commanding,**
No. 248 Maintenance Unit,
Royal Air Force Chessington,
Chessington,
Surrey.



TELECOMMUNICATIONS

We have vacancies for Fault Finders, Testers, and Inspectors to work on interesting and advanced equipment including H.F. SINGLE SIDEBAND, V.H.F. RADIO TELEPHONES, U.H.F. MINIATURE EQUIPMENT.

Transistor experience is desirable but not essential. Vacancies exist at all levels and training will be given where necessary.

Apply: **Personnel Manager,**
CAMBRIDGE WORKS LTD.,
Haig Road,
Cambridge.

BERRY'S RADIO

Require

**TECHNICAL STAFF,
ENGINEERS AND
SALES ASSISTANTS**
GOOD PROSPECTS, PERMANENCY

Write giving full details of experience, past situations, etc. in confidence to

25 HIGH HOLBORN, LONDON, W.C.1

LANCASHIRE CONSTABULARY

Wanted Radio Technicians

The Lancashire Constabulary has vacancies for Radio Technicians in the Wireless Workshops at Hutton, Preston.

Candidates should have a sound fundamental knowledge and practical experience of Frequency Modulated V.H.F. Radio Telecommunications Engineering. Salary, £820 per annum at 21, rising by eight annual increments to a present top rate of £1,104 per annum; subject to an efficiency bar at age 25.

Lancashire County Council Contributory Superannuation Scheme applies.

Application forms and Conditions of Service from **The Chief Constable, P.O. Box 77, Lancashire Constabulary, Preston.**

Science Research Council RADIO AND SPACE RESEARCH STATION Ditton Park, Slough

Physicists, Electrical Engineers and Mathematicians required for the following posts:—

(1) **Senior Scientific Officers/Scientific Officers** for work on:—

The propagation of radio waves through the ionosphere and the troposphere. Study of the upper atmosphere and ionosphere with apparatus in rockets and satellites. The use of an 80ft. radio telescope in the study of radio waves and their travel through the ionosphere and troposphere. The engineering development of specialised electronic and other apparatus for use in these investigations.

(2) **Experimental Officers/Assistant Experimental Officers** to assist the scientific staff in design and development of apparatus, in experiments and analysing results. Background in physics, electrical engineering or applied mathematics necessary. Opportunities for overseas service.

Qualifications required:—

S.O./S.S.O. 1st or 2nd Class Honours Degree (or equivalent) in appropriate subject plus (for S.S.O.) at least three years post-graduate experience.
A.E.O./E.O. Suitable Degree, Dip. Tech., H.N.C. (or equivalent), or if under age 22, two G.C.E. 'A' levels in scientific subjects.

Salaries:—

S.O./S.S.O. Between £926 and £2,155.
A.E.O./E.O. Between £508 and £1,734.

Send for details to

The Secretary, S.R.C. Radio and Space Research Station, Ditton Park, Slough, Bucks.

ELECTRONICS TEST ENGINEER

An opportunity has arisen for a capable man to fill a vacancy concerned with the testing of electronic instruments and sub-assemblies in our modern scientific instrument factory in Cambridge. Experience of electronic fault-finding, inspection and testing OR radio and television servicing is desirable. Technical qualifications at an intermediate level would be an advantage.

This appointment will carry staff status and an attractive rate of pay.

Please apply in confidence to:

The Personnel Manager,
Unicam Instruments Ltd.,
York Street, Cambridge.
Telephone: 61631.



THE RANK ORGANISATION

projects engineer

Due to the expansion of the Communication Division of Rank Relay Services a vacancy has arisen for a Projects Engineer with detailed knowledge of closed circuit television and audio techniques.

He will be required to produce work costings, prepare tenders and liaise with customers. In addition there will be work of a more practical nature in the way of surveying, commissioning and supervising installations.

The post is based at Whyteleafe, near Purley, Surrey, but considerable travelling throughout the United Kingdom will be necessary. It is desirable that applicants have some formal qualifications such as H.N.C. or City and Guilds Telecommunications although men with good practical experience should certainly apply. An attractive starting salary will be offered along with Company Car and comprehensive fringe benefits.

Please write showing how you meet the above requirements to:—

**The Personnel Officer,
Central Personnel Department,
The Rank Organisation
Limited, 439/445 Godstone
Road, WHYTELEAFE,
Surrey.**



**HOME & LEISURE
SERVICE
DIVISION**

Vacancies in Cambridge

Considerable expansion of our Radio Communications Division is planned and immediate vacancies exist for the following technical staff—

- (1) Senior Development Engineer for S.S.B. Radio Equipment. Experience with solid state circuitry essential.
- (2) Engineer familiar with micro-miniaturisation techniques.
- (3) Three Assistant Circuit Development Engineers with experience of H.F. S.S.B. equipment.
- (4) Six advanced Test Engineers and fault finders for work on sophisticated apparatus.

Really attractive salaries with ample opportunity for advancement will be offered to selected applicants. Send details of your qualifications, background and experience, which will be treated in confidence, to:—

**Personnel Manager, Labgear Limited,
Cromwell Road, Cambridge.**

ARTICLES FOR SALE

GOOD secondhand Ferragros often available—Reg. 2745 (Lon.).
2 Philips pro. 20 tape machines. 2 track stereo. £650 each, new. mint condition: offers.—Box 1469, Wireless World.

PUBLIC Address amplifiers, mains operated. 25w A output. £15; 40w £25, 70w £35, 120w £50; external re. current transformer. Es 10 each.—Harrington Suppliers, Ltd., 435, Green Lanes, London, N.4. Mou. 5241.

DISC cutter with power amplifier, equalizer amplifier, hot stents unit, pick-up and pre-amplifier, spare head, several blankets, etc. New. £150 o.n.o. Further details Malconi Disc Recordings, 592, Hesle Rd., Hull.

AMOEX series 600 professional recording tape, 1575 601, 1800; Altyar on 7in spool, complete with motor, brand new in makers box, retail price £3. Limited quantity available at 67/- for two spools, p. & Co., (for 277, Smith, p. & I. S.)—Pamsey & Co., 95, Tottenham Court Rd., London, W.1. Euston 2300.

FOR sale—1961 Decca River Radar equipment, Type 215, comprising aerial, search, receiver, display unit, motor alternator, voltage controller, hood, vision magnifier unit, pivot mast and seat. Squares, Type 2153, cover for radar mast, wind. Full brochures and address for viewing on application to County Supplies Office, County Supplies Department, Sandring Road, Nuneaton, Kent, to whom offers must be returned on or before 2nd May, 1966.

ELECTROID Voltmeter and Ohmmeter (Electronic Desizes Inc.) Gossor P.M. Receiver Alignment Generator Model 1324 Serial 450; Advance Signal Generator Type 62 Serial 321; Avo Test Bridge, 50 c/s 240V; Micron Crystal Calibrator; pair S.G. Brown Super-K headphones; Stereoephone; Permuton Gain Leverage Meter; peak level reflectograph; quantity air electric trimmer; test leads; capacitors; semi-conductors. Property of deceased electronics engineer. Reasonable offer accepted.—Apply J. W. Barber, Slough Arms, Great West Road, Slough, 141, 2385-526.

HIGH quality professional recording and reproducing equipment complete. Quad 22 stereo pre-amp and two Quad main amplifiers. Quad FM radio unit, Vortexion four-way mixer, Shure pickup and Garrard transcription turntable. Ampex 6 track 1200 series tape recorder. Equipment housed in small canvas cabinet 30 in. section long. Price 250 guineas o.n.o. Two Lockwood burst monitor enclosures complete with 100 W. Tannoy dual-cone speakers. Price 125 guineas o.n.o.—Tel. Weston 5155 or write to Prov. 30, Monkton Court, Melbury Rd., London, W.11.

SYSTEMS TEST ENGINEERS



TELECOMMUNICATIONS LTD. NEWMARKET ROAD, CAMBRIDGE

require Systems Test Engineers for testing complete electronic switching systems.

Applicants should have some experience in the field of transistor switching techniques.

Successful applicants can expect to receive a salary in accordance with their experience and qualifications.

Apply to:

**THE PERSONNEL MANAGER,
TELEPHONE:
CAMBRIDGE 61222**

TEST ENGINEERS

Due to Company expansion, The Decca Navigator Company Limited wishes to recruit the services of Test Engineers for the testing of Radio Navigation and Survey Equipment.

We are world leaders in this field and have an extensive and interesting programme planned for the future.

Applicants with a first-class background of T.V. and Radio Servicing or Telecommunication Electronic and Control Circuiting are required.

The salary paid will be commensurate with ability and experience.

Please apply for interview giving brief details of experience, qualifications and present salary to:

The Personnel Officer, The Decca Navigator Company Limited, 88 Bushey Road, Raynes Park, London, S.W.20. Telephone: WIAbledon 8011.



**ELECTRIC
CONSTRUCTION**

ELECTRONICS ENGINEERS

for work on Thyristor applications. Some experience with transistor circuits desirable.

MINIMUM QUALIFICATIONS H.N.C.

Pensions and Life Assurance and Sick Pay Schemes in operation.
Modern Restaurant and Recreational Facilities available.

Apply

**Personnel Manager,
Electric Construction (W'ton) Limited,
Bushbury Engineering Works,
WOLVERHAMPTON.**

STC INSPECTORS AND TESTERS

Owing to continued production expansion within our Radio Division we urgently require Male Inspectors and Testers. There are vacancies on day work and a night-shift is being started to cope with the additional load.

Applicants must have had at least two years broad experience of inspection or fault finding work on assembled and wired electronic units used in the Radio Communication and Aircraft Navigational Aids field or alternatively some years experience of Radio and Television servicing.

Good rates will be paid to suitable applicants who will also enjoy an excellent variety of welfare amenities, including a sickness, accident benefit and pension scheme.

Write or telephone the Male Employment Officer, ENTenterprise 1234, Extension 437, or call at the Personnel Department.

Standard Telephones and Cables Limited

Oakleigh Road, New Southgate, London, N.11, between the hours of 9-11 a.m. or 2-3.30 p.m. Monday to Friday.

BOROUGH POLYTECHNIC Borough Road, London, S.E.1.

Applications are invited for the post of:

HEAD OF THE DEPARTMENT OF ELECTRICAL AND ELECTRONIC ENGINEERING

which will become vacant on the 1st September, 1966.

The work of the Department includes a well-established Honours Degree course (C.N.A.A.) full-time and part-time courses in preparation for the Part III Examinations of the Institution of Electrical Engineers, and a wide range of special courses of post-graduate standard.

The whole of the Department is to be rehoused in a new building, on which work has recently commenced.

Candidates should possess high academic and professional qualifications in Electrical Engineering and have held a senior teaching post in this subject. Responsible research, industrial or administrative experience would be an added qualification. Salary Scale: Head of Department (Grade V) £2,900—£3,140, plus "London Allowance" of £70 per annum.

Further particulars and Application Form obtainable from the Clerk to the Governing Body, to whom completed applications should be returned within two weeks of receipt, but in any case not later than the 10th May, 1966.
28th March, 1966.

ARTICLES WANTED

WANTED. TV cameras, any type.—Weston, 11, Peartree Ave., Leeds 8. Tel. 656578. 155

GARRARD magnetic type tape decks, please send details to Smye-Burnby Engineering Co. Ltd., 2, Queen St., Dover, Kent. 1468

WANTED. all types of communications receivers and test equipment.—Details to R. T. & I. Electronics, Ltd., Ashville Old Hall, Ashville Rd., London E.11. Lev. 4935

TAPE RECORDING ETC.

SAVE on cost of hi-fi. See Audio Supply notice (advert. No. 111). 1109

TAPE to rise transfer using latest feedback disc cutters; EP's from 21" s.s.e. tested.—Derry, 52, West Bank Lane, Lutchester. 144

YOU ought to send for a copy of "Psychology and Whisper Teaching" to 3, York House, Huddersfield—5/9 most free. 135

A UNIQUE Tape Bus! Top brand, 7in. 2, 600ft. 25/-; 50ft. 1200ft. 10/-; 2 at 2/9. 3/6 at 3/6; bargain in all stars; s.a.e. for list.—E. C. Kingston Co., Ltd. 55, Tottenham Court Rd., London W.1. Euston 6500. 1113

TAPE/DISC TAPE transfer editing; duplicating; if quality and durability matter (especially with LPs from your precious tapes), consult Britain's oldest transfer service.—Fund raising records published for schools, musical societies (tax free).—Sound News Productions, 10, Clifford St., London, W.1. Reg. 2745. 1108

VALVES

VALVE cartons by return at best prices; send 1/- for all samples and list.—J. & A. Boxmeyer, 75a, Godevin St., Bradford, 1. 1116

VALVES WANTED

WE buy valves for cash, large or small quantities, old 1970s or the latest; send details, quotations by return.—Watsons Wireless Stores, 13, Church St., Wolverhampton. 131

TELEVISION SERVICE ENGINEERS

Here is a splendid opportunity for you to widen your sphere of knowledge and join an expanding Company manufacturing Television Test Equipment.

The positions available carry staff status and offer generous salaries with good prospects of advancement.

If you would like to know more about us, why not come along for an informal chat?

Apply: **Mr. D. G. Greatrex,**
Gresham Lion Electronics Limited,
Twickenham Road,
HANYORTH, Middlesex.
TWickenham Green 5511.

Eastern Electricity

CHILTERN SUB-AREA

MEASUREMENTS and COMMUNICATIONS SECTION

A vacancy exists in the Measurements and Communications Section of the Sub-Area Engineer's Department for a craftsman who has a sound knowledge of basic Electronics and preferably experience in V.H.F./U.H.F. radio-telephones installation and maintenance. The successful applicant will be based at Leighton Buzzard, Bedfordshire.

Salary is in accordance with the National Joint Industrial Council Agreement, Group "G," and a stagger pattern of working is in operation for which an additional payment will be made.

Basic rate of pay: £16 11s. 9d. per week including incidental overtime allowance.

Plus 10s. 6d. per week productivity bonus.

Plus £1 10s. 0d. per week stagger payment.

Total pay £18 12s. 3d.

Also an additional 7/8d. per week will be paid after two years' service and a further 7/8d. per week after three years' service.

Applications should be made in writing, stating age, experience and present position to the Manager, Chilterns Sub-Area, Eastern Electricity, Prebend Street, Bedford, as soon as possible.

COMMUNICATION

networks operated and maintained by International Aeradio are constantly increasing in complexity and demand and new commitments appearing. Immediate posts are available for

ENGINEERS

and technicians capable of carrying out installation and maintenance services on airports, in radio maintenance units and communication networks. If you are interested in taking up a progressive interesting career

OVERSEAS

living in free furnished accommodation with tax free salaries, married and family allowances, generous U.K. leave, air travel concessions and pension at 55, apply to

INTERNATIONAL AERADIO LIMITED

Applicants must have sound practical experience of HF and VHF communications and preferably at least Intermediate C. & G. qualifications.

Applicants are also invited from technicians with an electronic background who are prepared to undertake intensive conversion training at our open training school at Southall, the first course commencing mid April.

Write with details of age, qualifications, experience and family status to Personnel Manager, International Aeradio Limited, Hayes Road, Southall, Middlesex.

Philips Technical Library

COLOUR TELEVISION SERVICING HANDBOOK, Part I: Fundamental Principles.

W. A. M. Hartwich

Deals with the three-colour theory and with the transmission technique from the recording camera up to the complete transmitter signal, and describes the restoring and the reproduction of the colour information in the receiver. Based on N.T.S.C. but main principles apply to other systems.

216 pages. 164 illustrations. 14 colour illustrations. 50s.

COLOUR TELEVISION EXPLAINED, Second Edit.

W. A. Holm

A popular book in which Dr. Holm uses the same pictorial methods that made *How Television Works* so successful. It explains with many line and colour diagrams the fundamental features common to all the various systems.

118 pages. 68 illustrations. 21s.

FROM MICROPHONE TO EAR, Fourth Edition.

G. Slot

A widely appreciated survey of the technique of sound recording and reproduction—from microphone to loudspeaker. This is a practical book, prompted by queries that reached the author from all parts of the world not only from sound technicians but also from music-lovers without technical training.

260 pages. 144 illustrations. 27s. 6d.

APPLIED MAGNETISM

—A Study in Quantities.

Eigel Olsen

A general introduction to applied magnetism based on the fundamental terms and definitions necessary in the various branches of alternating current technique.

144 pages. 79 illustrations. 42s.

MACMILLAN

Little Essex St., London, W.C.2

design engineers

The Control Gear Division at Kidsgrove is continuously expanding its activities in the field of Industrial Control.

Vacancies exist in the development teams for experienced electronic design engineers, qualified to at least H.N.C. standard.

The successful applicants will develop semiconductor equipments which are generally associated with the control of electrical machines or process control applications.

KIDSGROVE is situated in rural surroundings on the Staffordshire/Cheshire border. Houses are readily available at attractive prices.

Write, giving full career details and quoting Reference WW0306B, to the Technical Staff Officer, English Electric House, Strand, London, WC2.

ENGLISH ELECTRIC

MEASUREMENT, CONTROL
AND AUTOMATION

DINDALE AMPLIFIER

Printed Circuits and parts for Mono and Stereo units "W.W." F.M. TUNER. Printed Circuits and all parts available, including R.F. Assembly. **MULLARD PI-MODE 10 W. AMPLIFIER.** Official Mullard Board now available, also Printed Circuit Pre-amplifier for Guitar use with two channel input and tremolo. S.A.E. for lists.

HART ELECTRONICS

321 Great Western Street, Manchester 14

WW-149 FOR FURTHER DETAILS.

TANNOY

For Sound Sense

WEST NORWOOD LONDON SE27
GIPSY HILL 1131

WW-150 FOR FURTHER DETAILS.

SPECIAL OFFER!
ALL ARMSTRONG
UNITS on NO
INTEREST terms.
12 Monthly Payments.

A. L. Stamford Ltd.
68 Weymouth Terr.,
London, E.2.
SHO 5003



NEW GRAM AND SOUND EQUIPMENT

GLASGOW.—Recorders bought, sold, exchanged; grammas, etc., exchanged for recorders or vice versa.—Victor Morris, 343, Argyll St., Glasgow, G.2.

SERVICES OFFERED

LEAVE IT to us.
FOR all electronic wiring, large or small, metal fabrication, chancing, etc., competitive prices and excellent delivery.
APPLY Contracts Manager, Shirehall Electronics, Ltd., Station Yard, Borough Green, Sevenoaks, Kent. Tel: Borough Green 2812.
JOIN Audio Supply Association, 7/6 p.a. (65-page photographic illustrated, non-advertising) hi-fi catalogue, 4/6; your best guide for safe buying.—10, Cliffield St., London, W.1.

ELECTRONICON, Ltd.—From drawing board to production with minimum delay; let us be your research development, design and prototype department. Pilot production runs a specialty.—176, Lyndell Lane, Coventry. Tel: Nuneaton 2353 or Coventry 8024. 1120

EXCHANGES

WE purchase for spot cash, modern used hi-fi equipment, quality tape recorders, communications RXs, stereo RXs, etc. etc.; call, write or telephone, best prices given.—Miller's Radio, 5th, Newport Court, West from Leicester Square Underground Station, Ger. 4638. Est. 20 years. Buyer can collect within 100 miles radius. 1157

DEIMOS LTD

TAPE RECORDERS FOR
RESEARCH, INDUSTRY AND
PROFESSIONAL AUDIO
single and multichannel

8 CORWELL LANE, HILLINGDON, MDX.

HAYes 3561

WW-151 FOR FURTHER DETAILS.

ANGLIA

Free lance and full time Sales Engineers are required by this expanding company specialising in Industrial Electronics. Applicants should have a good broad knowledge of industrial techniques and a proven sales record.

Apply to the Sales Director.

Anglia Instruments Ltd.,

61, Union Street, Stockport, Cheshire.

WW-152 FOR FURTHER DETAILS.

HAMMERITE

HAMMER PATTERN HIGH PAINT
The pattern is in the tin. All you do is brush it on.
COLOURS: White, silver, black or bronze.
Silver tin: 500 g. 1 gallon 85s. 6d. Car: up to 85. 10s. up to 10s.
1 pint 2/6. 1 gallon 85s. 6d. 10, 0/6 10s. 2/6.
1 pint 18s. *not by retail.
From compound shops or direct from the manufacturer:
FINNIGAN SPECIALTY PAINTS (W), Midgley Square, Stock-
field, Northumberland. Tel.: Stockfield 2750

WW-153 FOR FURTHER DETAILS.

"WIRELESS WORLD" TEST INSTRUMENTS

Complete sets of Metalwork, machine engraved Front Panels, Special Tag Boards and all specified 1st grade components. For professional appearance and performance.

Send 6d. in stamps for lists

MALVYN ENGINEERING WORKS

Engineers to the Radio and Electronic Industries

7 CURRIE STREET, HERTFORD, Herts.

TELEPHONE: HERTFORD 2264

40 Semiconductors commonly used in Electronic and Radio Circuits consisting of 20 Transistors OC42-45-71-81, etc.
10 Silicon Rectifiers 50-800 PIV 200-800 mA. Inc. 8Y100's plus 10 Diodes OA70-79-81 Zener and Gold Bonded.
All brand new. Valued over £5. For only 40/-, plus post and packing 1/-, to:

B-PAK SEMICONDUCTORS
8 Radnor House, 93/97 Regent Street, London, W1

WW-154 FOR FURTHER DETAILS.

NYLON · P.T.F.E.

ROD, BAR, SHEET, TUBE, STRIP, WIRE
No quantity too small. List on application.
BRASS · COPPER · BRONZE
ALUMINIUM · LIGHT ALLOYS
STAINLESS STEEL

H. ROLLET & Co. Ltd.
Howie Street, S.W.11. BATTERSEA 7872
ALSO AT LIVERPOOL, BIRMINGHAM,
MANCHESTER, LEEDS, GLASGOW

WW-155 FOR FURTHER DETAILS.

240 WATT ELECTRIC POWER ANYWHERE

ANYTIME from 12 with CAR BATTERY

THE AMERICAN DYNAMOTOR UNIT

1400 12v output 240/230v at 150 to 220 watts.
Perfect for TELEVISION, POWER TOOLS and all universal AC/DC ELECTRICAL EQUIPMENT. One-
watt rated results. Price ONLY £11.95 (incl. VAT)
Send stamped envelope for full literature details.
DYN · SCIENTIFIC PRODUCTS, CHELSEA, LONDON



WW-156 FOR FURTHER DETAILS.

Bib ACCESSORIES

NEW

Bib

INSTRUMENT CLEANER is anti-static

Surfaces stay clean longer, because they do not become statically charged and attract dust. Specially formulated for cleaning tape heads, delicate instrument panels, plastic, chrome, glass, printed surfaces and the exterior of all kinds of electronic equipment. non-flammable and does not smear.

Size A

4/6 (subject)



Bib Instrument Cleaner
Specially formulated for cleaning tape heads, delicate instrument panels, plastic, chrome, glass, printed surfaces and the exterior of all kinds of electronic equipment. non-flammable and does not smear.

Bib THE PROFESSIONAL TAPE SPLICER



All metal—beautifully plated—compact in size. Easily and permanently attached to a tape recorder. Clamps hold the magnetic or leader tapes in the precision cut channel—no damage to the edges. Right angle and oblique cutting slots.

Complete with Razor Order 18/6 (subject)

Bib WIRE STRIPPER AND CUTTER



This efficient tool strips insulation, cuts wires cleanly and splits plastic twin flex. It is adjustable to most wire thicknesses.

4/- (Subject)

If you have any difficulty in obtaining these items they will be sent post free. (U.K. only)

MULTICORE SOLDERS LTD.
HEMEL HEMPSTEAD, HERTS.
TEL: HEMEL HEMPSTEAD 3636

M16

WW-157 FOR FURTHER DETAILS.

Qualex SOUND SYSTEMS

AUDIO EQUIPMENT MANUFACTURERS
STANSTED, ESSEX
Phone: STANSTED 3032
WW-158 FOR FURTHER DETAILS.

SERVICE & REPAIRS

B.B.C. 20225. Complete conversion kits, or tubes and IF panels separately, send for free lists. Special order, manufacturer's complete UHF conversion kit, tuner, transistorised sound and vision IF panel, controls, hiimes etc., only £8.10, post 75 p. TV. Signal Booster Units, Lanchester 31 3, or CHIF 75, mainboard 105 - Perleto UHF 70 - post free. L.O.P.T.S. Philips Stella 1700 9837 etc. 30 6. Eko-Perranti 125 types 42/6, Eko-Perranti 126 and Persyx types 74 6. Ferguson 306, 205, 42, 6, 406 etc. 7 6. Subtel, T817, 38 6, 173, etc. 7 6. P.P. V.I. 1070 etc. 6 6. 6 post 7/6. Also Alba, Cosmor, Decca, G.E.C., K.B., Invinta, Pam, Philips, Melchior, G.C.D., Dynatron, Emerson, Roentgen, Ultra, H.M.V., Marconi, etc. Scan coils, frame O.P. Frame etc. Line coils, mains socket O.P. transformers, which are coils mainly, dropouts, aerial controls, etc.: Turner QUTS, Fireball incremental, turners, channel code: QUTS Mullard, motor, etc. salvaged components—large selection clean, serviceable. hi-tunes, transformers, etc. enquiring invite. C.O.D. 2 6. MANOR Suppliers, 25-27, Colliers, Manor Park, London, N.W.11. Callers, 5809, High Rd. (near Graysville Rd.), N. Finchley, N. 11. 9118 (day). Box 4032 (even.) open all week incl. Sat. 1101

SPEEDY and experts tape recorder and hi-fi repairs by Eugene's leading hi-fi specialists.—Teleonic, 141, 20, Tottenham Ct. Rd., London, W.1. Mus. 8177.

AGENCIES

MANUFACTURER'S agents, already calling on radio and electrical retailers in London, Birmingham and Manchester are required by high quality record tape producers. Reply in first instance with full details of area visited at present and other products handled, to Box WW 1481, Wireless World.

LONDON CENTRAL RADIO STORES

16-WAY PRESS-TOUCH INTER-COM TELEPHONES in double case with 16-line box. Thoroughly overhauled. Re-manufactured. £10. 10/11 incl. Complete installation 250. Wiring diagrams for 16-line 20 was an application.

ELECTRIC SLOT METERS (12 on each) in A.A. make. Free trial in your requirements. Suitable for banks, etc. 200/200, 10 A, 81/8, 15 A, 81/8, 20 A, 104/8 other capacities available. Re-manufactured in new 2 years' guarantee.

SUPERIOR TYPE DESK PHONES Black Bakelite. 16-line telephone with Hand Set, Dial Bell and Interbell. £21 7/6.

GARRARD REC.5A A.C. make. 3-speed autochanger, complete with stylus. Approx. size 2 1/2 x 1 1/2. Height approx. 4 1/2. £12 10/0.

EX EQUIPMENT COLLARO, 3-speed autochangers complete with arm and pick. Hi-Fi/Hi-Fi Model BC4 also Model 14/331. C. motor. Approx. size 2 1/2 x 1 1/2. Height 4 1/2. £10 10/0.

QUARTERLY ELECTRIC SLOT METERS. Re-manufactured in new, 200/200 x 10 A, 42/6; 15 A, 62/6; 20 A, 57/6. Other capacities available. Re-manufactured.

TWIN GUN TELEPHONE, extension bells. 21/-.

TELEPHONE TYPE HAND GENERATORS. Model 11/111/112 9 6.

20-WAY PRESS-TOUCH INTER-COM TELEPHONES in double case with 20-line box. Thoroughly overhauled. Re-manufactured. £11 10/0. Complete installation £135. Wiring diagrams for 20-line 20 was an application.

BRASS JACK STRIPS, 10 Jack Sockets. In each strip, 100 approx. 11 x 2 1/2. 12 6. Also 20 Jack Sockets in each strip. Size approx. 11 x 2 1/2. 12 6.

P.M. MOVING COIL SPEAKERS, size 9 6. 8 in. 20 10/0. 10 in. 20 10/0.

MOVING COIL HEADPHONES ohmicless leather earpiece, 250. 5-BANK UNISELECTOR SWITCHES. 25 contacts, alternate 200/200, 10 A, 81/8, 15 A, 81/8, 20 A, 104/8 other capacities 47 6.

DESK PHONES Black bakelite cases complete with hand set and interbell. 47 6.

HIGH SPEED ELECTRO-MAGNETIC COUNTERS, Es-Count 0-999, 1000, 10000, 100000. 10 A, 1 1/2. Single coil, 25,000/1. Single coil, 100,000. 10 6.

WIRELESS SET No. 35 A.E.V. Freq. range 73 to 76 Mc/s. Working range 12-20 Mc/s. Also 1011b, 8 in. x 6 1/2 in. Weight 1 1/2 lbs. Includes power supply unit and wax, valves and wiring. Also includes metal shell with tone. £6 per unit or £3 single. Callers only. All prices include carriage in United Kingdom except where otherwise stated.

23 LISLE ST. (GER. 2969) LONDON, W.C.2
Closed Thursday 1 p.m. Open all day Saturday

EXCLUSIVE OFFER

PERMANENT OR TRANSPORTABLE STEEL 60-FOOT AERIAL TOWERS

As supplied to British and other Governments
* Unique design.
* Scientific Construction.

having the following remarkable features.



- * Entirely self supporting structure on legs, stays, foundations, girders or splices, or any attachment to the ground.
- * Eited with steel ladder to the top and balcony with railings all round. (You can walk right round the top with both hands free.)
- * No feet secure at base tapering to 6 feet square at top. They are quite safe when subjected to face force winds and will support 50 square feet superficial area on top at force of 60 m.p.h. They require no ground area of 50 feet square.
- * Will support up to 2 tons of equipment on top, the whole tower can be completely dismantled to the ground by 2 men in 20 minutes and re-erected in the same time.
- * Can be completely erected and dismantled by 3 men.
- * Breaks down for transport by 3 men
- * Small loose parts easily handled by 2 men; there are no small loose parts, no nuts or bolts to get lost or damaged; all screws and adjustments are fully protected from rust and so designed to be free from damage when transported or left loose on the ground.
- * Fuel-proof—the tower cannot be erected if not assembled correctly. No skilled labour is required and no special tools are necessary.
- * Can be raised and lowered, erected and dismantled and re-erected as many times as desired.
- * Everything necessary for the complete tower to be put into use and raised and lowered is provided, full drawings and instructions.

These new Towers were made in England by H.L.C.C. and cost the astronomical £2,200 each. They are BRAND NEW and in maker's original paintwork. You can see one erected at our premises.

Cost £2,200
Price Brand New £345

10-year list of over 1,000 different items in stock available—keep one by you.

* SP-600 Hamamuland Receivers	1145 0
* E.M.I. BTR/2A Receivers	2390 0
* Marconi 5.3.R. Receivers HR-22 2/28 2/28	1240 0
* 1000 BTR/10 Whip Aerials	11 15
* R.C.A. 420 Type 5. Vari. 5.0. Beams	£2 10
* 1000 BTR/10 Whip Aerials	£25 10
* Model 14 Keltipax Tape Readers	£25 0
* Model 14 Keltipax Reproducers	£25 0
* 1 mile	£13 10
* Metro-Vickers Vacuum Pump 230 c.c.m.a.	£22 10
* Metro-Vickers B.S.500 Waveform Oscilloscope	£19 0
* Precision Beam Filter Units	£12 10
* E.M.I. Recording Drums	£12 10
* Avo Galvanometers	£7 10
* Pilioc W. 30. 43 Transmitters 30W	£75 0
* Metro-Vickers B.S.500 Waveform Oscilloscope	£19 0
* E.M.I. 5784 Waveform Monitors on rollers	145 0
* Motorola 6 v. Mobile Transmitters 100W	£12 10
* Pen-type Personal Detectors	15
* E.M.I. BTR-18 Tape Recorder	£250 0
* Waco Electric Reel Test Set 1-181	19 10
* Monitor Tape and Power Units	£7 10
* Marconi T2 1000 Wave Meters	£19 10
* AN-UPM-17 Spectrum Analysers 10/16000 Mc	£19 10
* AN-UPM-30, 10, 35, 50, 100, 200, 300, 500, 1000, 2000 Mc	£22 10
* AN-PDR-27 Radiac Sets	£17 10
* SGLA ARM and MD-3A ARM V.G.R. Test Set	£19 10

We have a large quantity of "bits and pieces" we cannot list—please send us your requirements—we can probably help all enquiries answered.

P. HARRIS ORGANFORD
WESTBOROUGH 56501

WW-159 FOR FURTHER DETAILS.

WIRELESS

EQUIPMENT CABINETS OF DISTINCTION



LOWFLEX

- Illustrated in this advertisement are two fine cabinets from the Lewis Radio Range.
- These Cabinets are just two of a really extensive range.
- Each one carefully made by British Craftsmen and soundly constructed from the best materials available.
- Fill in coupon below to obtain FREE catalogue showing this wonderful range of cabinets.



IMPERIAL

FREE THE NEW LEWIS RADIO CATALOGUE

Designed to assist your choice of cabinet. The new Lewis Radio Cabinet Catalogue is the most comprehensive ever prepared. Sent absolutely FREE!

Please send your FREE cabinet catalogue

NAME _____
 ADDRESS _____
 _____ (Dept. W.5.6)
 CAPITALS PLEASE

LEWIS radio

100 Chase Side, Southgate, London N.14. Tel: Palmers Green 3713/9666

WW-161 FOR FURTHER DETAILS.



MINY WALKIE TALKIE

The latest craze! Push-button operation; crystal control. Fully transistorised (2 transistor circuit) for perfect reception. Tremendous conversational scope. Complete with strap, battery and 8-section carrying case. Uses 9V. PP9 battery and operates up to half mile in open country. (Measures 5 1/2" x 1 1/2". Frequency 27.125 Mc/s.)

ONLY £6.19.6 pair (Post & Insurance 4/6)

A full P.O. Transmitting licence is necessary if this set is used in L.K.

SPEAKER BARGAINS

Manufactured by famous English company. 10in. 3 or 15 ohms 2W (P. & I. 4/-); 12in. 3 or 15 ohms, 10 watt, with built-in Tweeter 20015 (P. & I. 4/-); 14in. 7.5; 21in. 6/6; 24in. 10/-; 31in. 13/-; 4in. 13/-; 5in. 18/6. All 8 ohms (P. & I. 1.9 on each). 7in. 17/6-10in. 6in. 20/-; both 8 or 15 ohms (P. & I. 8/- on each). 12in. 25 Watt bass reflex amplifier speaker £5 (P. & I. 7/6).



NICKEL CADMIUM Rechargeable Cells

No corrosion, no acid, no maintenance. Why keep buying batteries when you can purchase one of the new rechargeable nickel cadmium cells. Pays for itself over and over again.

Equip. PP3 37/-; Equip. U7 18/6; Equip. PP9 £5; Equip. U2 32/6; Equip. U11 21/6. (P. & I. 2/6 on each). Charging units available.



TELEVISION AERIAL for fringe-area B.B.C-2

More and more areas are able to receive BBC-2 and here's your chance to purchase a famous-make 11 reflector lens aerial at Trade price. 2nd best roof design. Limited stocks so hurry! State channels required and area.

ONLY 52/6 (P. & I. 5/-)
 Conical cable 14/6, set of sockets 2/4.

ELECTRAMA, Dept. WW30
 Windmill Hill, Hailsham, Sussex
 Tel. Hersternaceux 3276

R & R RADIO & TV SERVICE

Dept. W.W.
 MARKET STREET, RADCLIFFE, LANCs.
 Telephone 465

SALVAGE VALVES

6F12	4/6	10P14	2/-	1P6E2	3/6	20P16	2/-
6L18	2/6	20Y7	6/6	170L1	2/4	1P70L1	4/-
12Y8	1/6	20Y7	7/-	10P1	1/6	1P123	2/-
12X2	2/6	10P18	5/-	20E2	2/6	1P131	2/4
12X2	3/6	12E13	1/-	20E14	2/6	12E13	2/4
50Y5	6/-	8P85	6/-	1P22	6/-	10P121	2/6
1P126	4/6	1P127	4/6	6E4E1	2/-	20E13	1/6
1P230	4/6	20Y7	6/-	6Y7	1/6	20P12	6/-
1P231	5/-	20Y7	6/-	1P238	4/-	1P127	2/-
1P238	5/-	1P129	4/6	20Y7	6/-	1P200	4/-
1P239	5/-	1P132	2/-				

Speakers: Ee TV 6. 4in. 3/6; 5in. round 6/- (post 2/-).
 New Valves: 6N80, 6W6, 6X1 4/6 each. 6B7, 6E6, 6E6C 3/- each.

Turret Tuners, B., Post 2/-.
 Scan Coils, etc. Quote set Model No. with all equipping and S.A.R. for prompt reply. All goods subject to satisfaction or money returned.

SPECIAL OFFER

1 watt S.T.C. 300 Mc/s. N.P.N. Silicon Planar 100% Transistors. Limited stocks. £1 for six. 3/- each. OC44, OC45, OC70, OC71, OC81, OC82, OC200, GET16, GET20.

SUN SOLAR CELL KITS

24-page booklet on Experiments, inc. 4 Sun Solar Cells, 11/- set.
 4/- each. AF114, AF115, AF116, AF117, OC170, OC171.

Send 6d for full lists :-Inc. S.C.R., Zeners, etc.
 CURSONS,
 78 BROAD STREET,
 CANTERBURY, KENT

WW-162 FOR FURTHER DETAILS.

PRICE SPECIAL RADIO CHASSIS OFFERS



Magnificent "Continental" Stereophonic Radiogram Chassis with piano key switches, built-in ferrite rod aerial. Comes complete with two 10in. elliptical loudspeakers, plus a mono/stereo 4-speed automatic record changer. Complete £29/19/6 (Units available separately if required).

Special terms available of £7/10/- deposit followed by 18 monthly payments of £19/1 (total H.P. of £33/13/6) plus 15/- P.P. Send £8-5-0 now

IMPERIAL HI-FI STEREOPHONIC RADIOGRAM CHASSIS



The Imperial stereophonic 4-waveband chassis has the most advanced specifications yet offered in this country. There is a built-in ferrite rod aerial, seven piano key buttons, controlling mono/stereo selection, Gram Long-Medium-Short-Fast ON/OFF. The units come complete with two 10in. elliptical loudspeakers plus a mono/stereo 4 speed automatic record changer. Complete £41/9/6 (Units available separately if required).

Special terms available of £10/7/6 deposit followed by 24 monthly payments of £11/18 (total H.P. £48/17/6) plus 7/6 P.P. Send £11-5-0 now

HI-FI EMPRESS RADIOGRAM CHASSIS



This fabulous "Empress" Hi-Fi radiogram chassis is offered complete with 10in. loudspeaker plus 4-speed auto-changer. At only £24/3/0 this is the bargain of the year. (Units available separately if required).

Special terms available of £6/3/0 deposit followed by 18 monthly payments of £13/4 (total H.P. £27/3/0) plus 15/- P.P. Send £6-18-0 now

All Lewis Radio equipment including valves are fully guaranteed for one year. Send your cheque or P.O. today while stocks last to Dept. W.5.

LEWIS radio

LEWIS RADIO, 100, CHASE SIDE, SOUTHGATE, LONDON, N.14. Telephone: PAL 3713/9666

WW-163 FOR FURTHER DETAILS.

TECHNICAL TRADING Co.

For value and Service visit us at—

- ★ LONDON—10 Tottenham Court Rd. Tel.: MUS 2639
 ★ PORTSMOUTH—356-352 Fratton Rd. Tel.: 22034
 ★ SOUTHAMPTON—73 East St. Tel.: 22551
 ★ BRIGHTON—Devenian Court, Park Crescent Place
 All Mail Order and 24-hour Radiophone service Brighton 860722
 BULKY AMPS OF LEVEE RADIOGRAM CHASSIS (Normally 10 Gns.) 13 Gns.
 BULKY AM STEREO RADIOGRAM CHASSIS (Normally 10 Gns.) 91 Gns.
 BUY AM DE LUKE RADIOGRAM CHASSIS (Normally 12 Gns.) 61 Gns.

Orders welcomed for all items advertised last month
 F.M. Tuners, Dole, F.M.T. Highest
 Finish Normally £21/13/5. ... 15 GNS.
 HITACHI Tape Recorders.
 Special Bulk Purchase TQ200.
 Latest Portable Battery Zapped
 capstan. 1½" x 3½in. Normally 35
 Gns. Excellent for music. ... 19 GNS.
 TRASOS 4-Track Plains. High
 quality 1½" x 3½in. Overlay. Plays
 stereo tapes. Normally 44 Gns. ... 29 GNS.

AUTOCHANGERS with cartridge.
 SRP12 £4 19 SP25 £11 19
 ATS £6 10 AT60 £7 19
 1000 £6 19 2000 £7 19
 3000 £8 19 LAB80 £27 10
 401 £39 19 TU14 £2 19
 GU7 £4 5 UA14 £4 19
 UA25 £5 10 UA2555 £5 15
 S.A.E. list of 1,000 bargains.

LAWSON BRAND NEW TELEVISION TUBES**2 YRS.' FULL GUARANTEE**

The continually increasing demand for tubes of the very highest performance and reliability is now being met by the new Lawson "Century 99" range of C.R.T.s.

"Century 99" are absolutely brand new tubes throughout, manufactured by Britain's largest C.R.T. manufacturers. They are guaranteed to give absolutely superb performance, needle sharp definition, screens of the very latest types giving maximum contrast and light output; together with high reliability and very long life.

"Century 99" are a complete range of tubes, in all sizes, for all British sets manufactured 1947-1964. Our stocks are very large and we can supply the EXACT tube you require by return.

12" — £4 : 10 : 0
 14" — £5 : 10 : 0
 17" — £5 : 19 : 0
 19"-21" — £7 : 15 : 0

LAWSON TUBES

18 CHURCH DOWN RD.
 MALVERN, WORCS.
 Tel. MAL 2100.

WW-164 FOR FURTHER DETAILS.

Today's Orders despatched today, and full fitting instructions are supplied with every tube.

Terms: C.O.D. or C.W.O.
 Carriage and insurance 8/6.

PERSONAL

HOUSE names in gold leaf on wood, 4in x 16in, post free 57/6 from Wood Lodge Studio, Hilltown, 1155

CAPACITY AVAILABLE

Coil winding and electronic assembly capacity available—Swetnam & Brindley Ltd., Breventham Works, Bristol Rd., Malmesbury, Wilt. Phone 234. 11415

RECTIFIERS, Selenium and Silicon units supplied for all applications, keen prices, good deliveries. J. K. SERVICES & DEVELOPMENTS, 231, Haverhill, Harlow, Essex, Tel. Harlow 1705. 11412

AHTONIONS Ltd., for coil winding, assembly and a writing of electronic equipment, transistorized sub-unit, sheet metal work—3a, Walerard Rd., London, S.E.13. Tel. Lee Green 1705. 11407

TRANSFORMERS: Winding and design of transformer types. "C" core and laminated patterns up to 2 KVA, power transformers 250 VA to 20 KVA, your enquiries invited; our representatives will be pleased to call upon you to discuss your application—Avalon Electronic Ltd., Manor Works, Old Town, Clapham, London, S.W.4. Tel. Mac 4226/719. 11413

RESERVE capacity available mechanical, electro-mechanical, assembly, electronic equipment, wiring. Lead time six weeks. Top quality assurance and supporting technical service. Based North Wales, Box 1466, Wireless World.

ASSEMBLY and wiring facilities available for the production of all types of electronic equipment, prototypes and production runs from your designs—Woodstock Associates Ltd., Broadway Court Offices, Brighton Rd., Lancing, Sussex. Tel. Lancing 2844. 11453

TECHNICAL TRAINING

CITY & Guilds (electrical, etc.) on "Satisfaction or Refund of Fee" terms. Thousands of passes. For details of modern courses in all branches of electrical engineering, electronics, radio, T.V., automation, etc., send for 156-page handbook—FREE—B.I.E.T. (Dept. 152K), 29, Wrights Lane, London, W.8. 11465

PM.G. Certificates, City & Guilds Examinations, L.E.R.E., also many non-examination courses in radio, TV and electronics, study at home with world famous I.C.S.—Write for free prospectus, stating subjects, to International Correspondence Schools (Dept. 443), Intercast House, Parkgate Rd., London, S.W.11. 1153

FOR ALL YOUR PANEL WORK WRITE FOR ILLUSTRATED BROCHURE OF PARALEX & LUFBRA ADJUSTABLE HOLEGUTTERS

WITH MORSE TAPER SHANK UP TO NO. 4 OR STRAIGHT SHANK ½ DIA. TO ¾ DIA.

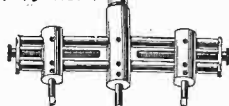

HOLES ACCURATELY BORED FROM 1in. DIA. TO 1½in. DIA.

AKURATE ENGINEERING Co. Ltd.
 CROSS LANE, LONDON, N.8
 TEL. FITZROY 2670

WW-167 FOR FURTHER DETAILS.

Quartz Crystal Units

For **ACCURACY RELIABILITY PRICE ECONOMY** you can **DEPEND** on

Write for Illustrated Brochure & Price List

THE QUARTZ CRYSTAL CO. LTD.
 Q.C.C. Works, Wellington Crescent,
 New Malden, Surrey (Malden Q334 & 2988)

WW-168 FOR FURTHER DETAILS.

YUKAN SELF-SPRAYGet this **AIR DRYING HAMMER FINISH** NOW!

So professional... the YUKAN aerosol way!



YUKAN Aerosol spraykit contains 12 ozs. the quality durable easy instant spray. No stove heating required. Available in Grey, Blue, Gold, Bronze at 16/11, or our complete 18/11, per 6oz. 6-in. self-spray can.

SPECIAL OFFER! 1 can plus optional travelable spray-on trigger bottle (value 1/3) for 3/11 each, post free. Please enclose cheque or P.O. for total amount to:

Y U K A N, Dept. WWS, 309a Edgware Road, London, W.2. (Closed Thurs. aft., open all day Sat.)
 Choice of 13 self-spray plain colours and 6 primer (Motor car finish) also available.

WW-165 FOR FURTHER DETAILS.

RadioSpares Ltd.

FOR ELECTRONIC COMPONENTS—BY RETURN

WW-166 FOR FURTHER DETAILS.



TRADE ONLY

ROTARY TRANSFORMERS. Input 12 v. D.C. Output 275 v. 110 mA. Brand New. 27/6. Carr. 4/-.

500 MICRO AMP. TRANSFORMERS. Patent miniature type. 1 1/2 in. dia. Brand New. 12/6.

VARIABLE TWIN GANG. Solid dielectric 190-210 pF. Miniature. 4/6.

IIFT WHIP AERIALS. 6 sections, copperized steel and painted. Dia. 3/16 in. Complete with mounted base 21 v. 90 each. Post. 1/6.

TELESCOPIC AERIAL MASTS. Tubular Steel copperized spray finish. Ring cam locking on each section provides full fall or any height required. Suitable for fringing and base locations. 14 ft. (6 sections), closed 6 ft. 6 in. Wgt. 20 lbs. Base dia. 1 1/2 in. 75/-.

Carr. 5/- 20ft. (4 sections) 55/-.

ALTERNATOR GENERATOR. Type 106. Coverage 5.5 Meg. to 55 Megs. Max. Sig. O/ut 100 Millivolts. Brand New. Manufacturer's Ref. Inst. £5. Carr. 10/-.

3 KVA. AUTO TRANSFORMERS. 110-250 v. Mounted in steel case with external hand voltage regulator 7 Taps. Brand New. £12. Carr. 10/-.

HEADPHONES. Balanced armature, DLR3. Brand New. 9/6 pr. Moving coil type, with ear muffs for same excluding. 12/6 pr. Same fitted with moving coil mike. 17/6 pr. Carbon hand mike. 7/6 each.

TANNY LOUDSPEAKERS. Ideal for all outdoor uses, enclosed in waterproof wooden case, complete with steel grille designed to produce directional radiation at 5 watts. 7 1/2 x 2 1/2 inch. Carr. 2/6.

R220 MH.II. RECEIVERS. Superbet complete with 3 in. ohm, built-in speaker 230-250 v. A.C. Minus power pack. Easily converted to amateur bands. Class only. Complete with valves. Less Atal. £3.15/0 Carr. 3/-.

SMALL GEARED MOTORS. Working voltage 6-12 v. D.C. Overall size 4 x 2 1/2 x 1 1/2 in. Carr. 1/6.

TRANSISTOR. IC6 625, part of 7/6. SCR. 522. Class only. Complete with valves, except 832 v. Relay. Range 100-150 Mcs. 21/- ea. Carr. U.K. 4/-.

LINEAR ACTUATOR. 14 or 12 v. D.C. Will operate 500 lbs. in either direction. 3 in. travel through motor operated gearbox. £4/10/0 each. Carr. 3/6.

38 SETS A.F.V.-6.9 Mcs. New condition. Complete with valves. Untested. 21/- ea. Carr. 3/-.

SIEMENS MINIATURE RELAYS. Size 1 1/2 x 1 1/2 in. Res. of coils 700 or 250 ohms. 2 pole 2 contacts, contact capacity up to 2 amperes. 15 v. a.c. P.F. 12.

SIEMENS HIGH SPEED RELAYS. 1/16th type 100-50 ohms. 108 ea. Type 196H. 700-1700 ohms. 148 each.

CARPENTERS TYPE RELAY. 5HM52. Operating coil triple coil. 12 ohms. 100 turns. 150 ohms. 3,000 turns. and 250 ohms. 3,000 turns. 15/- ea. G.E.C. Sealed type 670 ohms. 2 M. 2 b. 7/6 each.

POST OFFICE TYPE RELAYS. 3,000 turns. 2 g.c. 2 m. slugged coil 150 ohms. 2 g.c. 2 m. coil 1,000 ohms. 2 g.c. slugged coil 500 ohms. 14/- ea.

D.P.C.O. AERIAL CHANGE-OVER RELAY. 12 v. D.C. coil, heavy silver contacts. American Surplus. 12/6 each. Carr. 1/-.

MORSE KEYS complete with leads, terminals and cover. 6/6 each.

PRESSURE GAUGE. 2 in. round brass case. 0.160 lbs. 9/6 each.

MINIATURE PLUGS AND SOCKETS. 8 way. Length 3/8 in. 2 v. 4 pin. 12 v. 4 pin. 12 v. 7 pin. Svn. All 6/- each.

BIG WAVE CONDENSERS. Paper. 1.7-17 Mfd. 3 KV. 8/6 ea. 2 Mfd. 250 v. 4/6 ea. 8 Mfd. 600 v. 6/- ea. 10 Mfd. 350 v. 7/6 ea.

ELECTRIC PUMPS. 24 v. D.C. Overall size 7 x 2 1/2 x 2 1/2 in. G.P.H. Brand New. 37/6.

NEW COMPONENTS. Min. can. 1.64 Mfd. 15 v. 1/8 ea. 100 Mfd. 6 v. 12 v. 25 v. at 2/- 250 Mfd. 12 v. 2/- 250 Mfd. 25 v. 273. 500 Mfd. 15 v. 2/3. 1,000 Mfd. 15 v. 2/6. 200 Mfd. 25 v. 8/6. 100 Mfd. 15 v. 4/6. 500 Mfd. 15 v. 4/6. 100 Mfd. 400 v. 3/6. 16 x 8. 2/3. 4 v. 4/- 16 x 16 Mfd. 450 v. 4/6. 16 x 32 Mfd. 500 v. 5/6. 32 Mfd. 450 v. 4/6. 32 Mfd. 500 v. 6/6. 32 x 32 x 32. 5/- 100-200-200 Mfd. 9/9. 25 v. 25 v. 100 v. 25 v. 100 v. 50 v. a. at 2/- Stand Jack 2/-.

Small C.B. Switches. 2 v. or 23 v. 100 Mfd. 100 v. sockets. 2/6. V.C. 5k. 10k. 25k. 50k. 100k. 250k. 500k. 1 Meg. 2 Meg. All at 5/-. With 100 v. 500 v. 500 Ohms W/W. pre-seg. All values 1 w. var. 4d. each. Equates unvaried. No lists.

HYDRAULIC RAMS. Miniature. 200 P.S.I. W.T. 1 lb. 3 in. travel. 3 in. screwed extension. Gimbil fitting one end. 1 in. long. cylinder 2 1/2 in. Brand new. 30/- ea. incl. cart.

S.A.E. all enquiries.

Radio Electrical Stores
108 CHESTER ST., BIRKENHEAD, CHESHIRE



P. O. 3000 TYPE RELAYS
AT A PRICE YOU CAN AFFORD
Reconditioned as new. Built up to customers' requirements. Return of post delivery. Let us quote you.
CATALOGUE 2/6 POST FREE

RADIO CONTROL **ARTHUR SALLIS** **BRIGHTON**
65806 **EX-GOV'T ELECTRICAL SURPLUS**

TELEVISION

RADIO officers see the world. Sea-going and shore appointments. Trainee vacancies during 1966. Grants available. Day and boarding students. Stamp for prospectus—Wireless College, Colwyn Bay, 12/6

I.E.R.E. City & Guilds and R.T.E.E. exams, specialised I.C.S. home-study course will ensure success. For details of wide range of exams and diploma courses in radio, TV and electronics, also new practical courses with kits, write to I.C.S. (Dept. 52), Parkgate Rd., London, S.W.11.

A.M.I.Mech.E. AM.I.E.R.E. City & Guilds, G.E.E., etc. Become a technician or technologist via hands on and accurate. Thousands of passes. For details of exams and courses in all branches of engineering, building, electronics, etc. write for 150-page handbook—FREE—B.I.E.T. (Dept. 151K), 29, Wrights Lane, London, W.8. 1/47

T.V. and radio—A.M.I.E.R.E. City & Guilds, R.T.E.E. Cert. exam. Satisfaction or Refund of Fees Terms. Thousands of passes. For details of exams and home training courses (including Practical apparatus) in all branches of radio, TV and electronics, write for 150-page handbook—B.I.E.T. (Dept. 150K), 29, Wrights Lane, London, W.8. 1/46

OSMABET LTD
A NEW RANGE OF RADIOGRAM CHASSIS

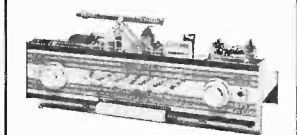

The latest "Continental" AM/FM Stereo-Phonic Radiogram Chassis. Piano Key Operation. 4 Wavebands S.M.L. plus VHF FM, provision for tape record and playback, together with many other outstanding features. A superb chassis. Model PB57.

Our price 24 Gns + 15/- p.p.

The latest "Continental" AM Stereo-Phonic Radiogram chassis. 3 wavebands S.M.L. Piano Key Operation. Internal Ferrite Rod Aerial, etc. A chassis of outstanding performance. Model PB56.

Our price 15 Gns + 15/- p.p.

The latest "Continental" HI-FI AM chassis. 3 wavebands S.M.L. Piano Key Operation. Internal Ferrite Rod Aerial, etc. Better than the best in its class. Model PB45.

Our price 13 Gns + 15/- p.p.

We offer a full range of chassis in addition to the above, full details in our catalogue, 6d. stamp please. We supply direct to user, and give the finest value for money.

(S.A.E. all enquiries) Mail Order Only
46, Kenilworth Road, Edgware, Middx.
Tel.: ST0neg.0vc.9314

NEW FROM PITMAN

Transistor Electronic Organs for the Amateur

Alan Douglas / S. Astley

This is the fourth book by Alan Douglas, who is probably the leading writer on this type of equipment. It presents not only a detailed design for a full scale organ, but a complete explanation of everything to do with transistorized organs. Written in simple style especially for the home constructor, and profusely illustrated with clear diagrams. 18s. net.

The Silicon Gate-Controlled Switch

Edited by G. H. Pridham

Aimed at H.N.C. and higher level electronic students, this short monograph was originally presented as a symposium by experts from four major electronic companies at Enfield College of Technology. The device is a transistor-type mechanism, recently developed, which has found wide applications in computer and other electronic circuitry. 12s. 6d. net.

Connectors, Relays and Switches

G. W. A. Dummer / N. E. Hyde

This is the sixth volume in the series Radio and Electronic Components, and is the first book in the world that covers the subject of electronic connections. This subject is now of extreme importance, because of the improvement in reliability of both conventional components and integrated circuits; requiring similar improvements in connection methods. 50s. net.

The Radio and Electronic Components series is designed to meet the needs of the rapidly expanding electronics industry for information about specific components. The first books of their kind in this field, they fill a wide gap in present technical literature. Titles in the series are:

- Vol. 1 Fixed Resistors 28s. net.
- Vol. 2 Variable Resistors and Potentiometers 45s. net.
- Vol. 3 Fixed Capacitors 45s. net.
- Vol. 4 Variable Capacitors and Trimmers 32s. 6d. net.
- Vol. 5 Wires and R.F. Cables 47s. 6d. net.
- Vol. 6 Connectors, Relays and Switches 50s. net.

PITMAN-PARKER ST. LONDON W.C.2

RESISTANCE WIRES

EUREKA - CONSTANTAN

Most Gauges Available

NICKEL-CHROME MANGANIN
NICKEL-SILVER

COPPER WIRE

ENAMELED, TINNED, LITZ,
COTTON AND SILK COVERED

SMALL ORDERS PROMPTLY DESPATCHED

B.A. SCREWS, NUTS, WASHERS
soldering tags, eyelets and rivets

EBONITE and BAKELITE PANELS.

TUNFOL ROD, PAXINUM TYPE COIL
FORMERS AND TUBES. ALL DIMENSIONS
SEND STAMP FOR LIST. TRADE SUPPLIED

POST RADIO SUPPLIES

33 Bourne Gardens, London, E.4
Phone: Glissod 4888

WW-170 FOR FURTHER DETAILS.

BOOKS

"BASIC Mathematics for Radio and Electronics."
By F. M. Colbrook, B.Sc., D.I.C.A.C.G.I. Revised
and enlarged by M. H. Bennett. (Gamb.)
presents in readable form a complete course in basic
mathematics from engineering students of all kinds
and leads on to the more advanced branches of
mathematics of increased importance to radio en-
gineers. In this edition the chapter covering the
application of mathematics to radio has been revised
and enlarged, while new subjects covered include
Stability, Linear Differential Equations, Elementary
Statistics, Short Cuts to Numerical Calculations and
an Introduction to Matrices. Will be invaluable to those
without previous knowledge of the subject. 17/6 net
from all booksellers. By post 19/6 from Hillo Books,
Ltd., Dorset House, Stamford St., London, S.E.1.

"WIRELESS Servicing Manual." W. T. Cocking,
M.I.E.E. This is the tenth edition of a book
which since 1936 has been known to radio servicemen
everywhere as a reliable, thorough and comprehensive
guide to solving most of the problems that arise in the
repair, maintenance and adjustment of the modern
radio receiver. By post 19/6 from Hillo Books,
Ltd. Dorset House, Stamford St., London, S.E.1.

"WIRELESS Servicing Manual." W. T. Cocking,
M.I.E.E. This is the tenth edition of a book
which since 1936 has been known to radio servicemen
everywhere as a reliable, thorough and comprehensive
guide to solving most of the problems that arise in the
repair, maintenance and adjustment of the modern
radio receiver. By post 19/6 from Hillo Books,
Ltd. Dorset House, Stamford St., London, S.E.1.

ELECTRONIC SERVICE

WE DESIGN, DEVELOP AND
PRODUCE TO YOUR
PRECISE REQUIREMENTS:

- TRANSISTORISED
AMPLIFIERS
- INSTRUMENTS
- TELEMETRY AND CALLING
SYSTEMS
- RADIO DIRECTION FINDERS
- TAPE REPLAY
PROGRAMMERS
- VHF REMOTE CONTROL RADIO
RECEIVERS AND
TRANSMITTERS



RCS ELECTRONICS
NATIONAL WORKS, BATE ROAD,
ROYDON, MID. D0. 0933

WW-171 FOR FURTHER DETAILS.

SURPLUS HANDBOOKS

19 Set Circuit and Notes	3/6	P.P. 6d.
1155 Instruction Handbook	4/6	P.P. 6d.
I.R.O. Instruction Handbook	4/6	P.P. 6d.
45 Set Walker-Talkin Circuit and Notes	3/6	P.P. 6d.
58 Set Walker-Talkin Instruction Handbook	4/6	P.P. 6d.
58 Set Instruction Handbook	3/6	P.P. 6d.
Frequency Meter BE23 Instruction Handbook	3/6	P.P. 6d.
Wavemeter Class D Instruction Handbook	3/6	P.P. 6d.
15 Set Circuit Details and Notes	3/6	P.P. 6d.
R1115 Circuit Diagram and Notes	1/6	P.P. 6d.
R1284-A Circuit Diagram and Details	1/6	P.P. 6d.
R1355 Circuit Diagram and Details	1/6	P.P. 6d.
R7 Valve 24, 25, 26, Circ. Diagram and Details	1/6	P.P. 6d.
Amplifier A1194 Circuit Diagram and Details	1/6	P.P. 6d.
Resistor Colour Code Handbook	1/6	P.P. 6d.
R.107 Instruction Handbook	1/6	P.P. 6d.
C.R.100/203 Receiver Handbook	3/6	P.P. 6d.
W1154 Circ. Diagram and Details (all models)	2/6	P.P. 6d.

MAIL ORDER ONLY TO INSTRUCTIONAL
SUPPLIES DEPT., W.W., TALBOT HOUSE, 83 TALBOT
GARDENS, BOUNDARY, LEEDS, 8

WW-172 FOR FURTHER DETAILS.

DAMAGED METER?

Have it repaired by Glaser

Reduce overheads by having your damaged Electrical
Measuring Instruments repaired by E. Glaser & Co. Ltd.

We specialise in the repair of
all types and makes of
Volts/meters, Ammeters, Micro-
ammeters, Multirange Test
Meters, Electrical Thermo-
meters, Recording Instruments,
etc.

As contractors to various Government Departments,
we are the leading Electrical Instrument Repairers in
the industry. For prompt estimate and speedy delivery
send defective instruments by registered post, or write
to Dept. W.W.-

L. GLASER & CO. LTD.

1-3 Berry Street, London, E.C.1

Tel.: Clerkenwell 5481-3

WW-173 FOR FURTHER DETAILS.

**THE ONLY
COMPREHENSIVE
RANGE OF RECORD
MAINTENANCE
EQUIPMENT
IN THE WORLD!**

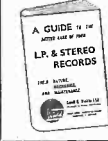

Send stamps value 9d. for 16
pages booklet and supplement-
ary data sheets Nos. 1 and 4
giving the fullest and latest
information.

GECIL E. WATTS LIMITED
Darby House
Sunbury-on-Thames, Middx.

WW-174 FOR FURTHER DETAILS.

COMPONENTS POSTAL SERVICE

- * SWITCH KIT. Includes quality 2 and 8 button
push-button Switches, Rotary Switch and
Control Knobs. 12/6
- * SLIDER SWITCHES. Professional grade
D.P.D.T. Special Silver contacts, vac. 2off 5/9
- * RESISTORS—5% Hi-Stat. Carbon film
75Ω to 1MΩ (½ watt); 10 off, one standard
value 4/-
- * CAPACITORS—Polyester Foil; 160 VDC/100
VAC.
33 off to 1µF; 5 off, one standard value . . . 3/6
150 off to 47nF; 5 off, one standard value . . . 5/-
- * ASSORTED RESISTORS—Hi-Stat.
300 off (5% or better) . . . 10/-
(P.P. 1/6 per order C.W.O.)

ELMBRIDGE INSTRUMENTS LTD.

26 Ganhall, Guildford, Surrey.

WW-175 FOR FURTHER DETAILS.

A.B.C.'S OF SILICON CONTROLLED RECTIFIERS

by Lytel, 16/, P. & P. 1/-.

Radio Amateurs Handbook 1966 ed., by
A.R.R.L., 40/, P. & P. 3/-.

Sound Mixers Building and using, by Steele,
30/, P. & P. 1/3.

How to build Proximity Detectors and
Metal Locators by Shields, 20/-. P. & P. 1/-.

Know your Signal Generators, by Middleton,
20/-. P. & P. 1/-.

Transistor Pocket Book, by Hibberd, 25/-
P. & P. 1/3.

Transistor Specifications and Substitution
Handbook, by Techrpass, 15/-. P. & P. 1/-.

Electronic Guitar Amplifier Handbook, by
Durr, 24/-. P. & P. 1/-.

Know your Test Meters (VOM-VTVM) by
Risse, 21/-. P. & P. 1/-.

Where possible 24-hour service guaranteed.

UNIVERSAL BOOK CO.

12 LITTLE NEWPORT ST., LONDON, W.C.2
(Leicester Square Tube Station)

TO ALL

Manufacturers, Wholesalers, Importers,
etc. of the Radio and Electronic Indus-
tries

We are spot cash purchasers for all types
of redundant and surplus stocks.

Phone or write **Hillside 2713**
Stonegrove 7624

Broadfields Disposals Ltd.,
8, Broadfields Avenue,
Edgware, Middx

or
Mayco Products Ltd.,
21 Lodge Lane,
N. Finchley, N.12

WW-176 FOR FURTHER DETAILS.

ELECTRIC TIME SWITCHES

MADE BY SPRENS. 200/250 A.C.
with 10 amp. Contacts. One ON one
OFF every 24 hours at any manually
preset time. Fully perfect. Fully
guaranteed. Wiring instructions supplied.
With metal case—on 141-778 extra. P.P. 5/6
10/6
100% MAN ELECTRIC TIME SWITCHES. P.P. 5/6
10/6
10 amp. Contacts. Take ON twice OFF
every 24 hours at any manually preset
times. Used best perfect. Complete with
mounting base. Metal case for above 10/6 extra.
VENNER 48-241 CLOCKWORK TIME SWITCH. 45/-
in metal case. 0.1 amp. rating. 500 cycles on every
hour hour for adjustable on/off time three to thirty 1/4 sec.
seconds. Rise 12mm. x 6mm. x 41mm. P.P. 5/6

ELECTRIC CHECK METERS

200 250 A.C.
A.C. 25
amps.

29/6
fully guaranteed.

3/6
P.P. 5/6

SANAMO WESTON 0.5 amp. model
T.P. on each time 3/9.

An Exceedingly Rugged Hand Held Beta-Du battery
required 35/- per pair. P.P. 3/6.

All meters guaranteed two years.

State voltage—QUANTITY DISCOUNTS
Send *Money advanced—send for Price List.*
Box 355, Kingswood Supplies (W.W. 8.)
4, Sals Park, London, W.2. PAD. 61/3

WW-177 FOR FURTHER DETAILS.

INDEX TO ADVERTISERS

Appointments Vacant Advertisements appear on pages 123 to 134

	PAGE		PAGE		PAGE
Acoustical Mfg. Co. Ltd.	4	Glaser, L. & Co., Ltd.	140	Proops Bros., Ltd.	116
Adco Products, Ltd.	22	Golding Mfg. Co., Ltd.	12	Pye Telecommunications, Ltd.	44, 45
A.D.S. Relays, Ltd.	79	Goodmans Industries, Ltd.	23	Quartz Crystal Co., Ltd.	138
Advance Electronics, Ltd.	11, 51	Goodwin, C. (Sales), Ltd.	122	Raco, Ltd.	50
Airmec, Ltd.	82	Grampian Reproducers, Ltd.	48	Rcal Instruments, Ltd.	8
Akurate Eng. Co., Ltd.	138	Hill Electric, Ltd.	18	Radford Electronics, Ltd.	62
Alma Components, Ltd.	10	Harris Electronics (London) Ltd.	35	Radio & T.V. Components (Acton), Ltd.	109
Anders Electronics, Ltd.	57	Harris, P.	135	Radio Component Specialists	117
Anglia Instruments	134	Hart Electronics	134	Radio Control Specialists	140
A.N.T.E.N., Ltd.	49	Haversham Supplies Co., Ltd.	136	Radio Exchange Co., The	114
Armstrong Audio, Ltd.	61	Henry's (Radio), Ltd.	107	Radionic Products	58
Astralux, Ltd.	73	Howell's Radio, Ltd.	58	Radiopares, Ltd.	138
Audix, B. B., Ltd.	135	H.P. Radio Services, Ltd.	31	Rafie, P. F.	84
Avo, Ltd.	1	Iliffe Books, Ltd.	39, 50, 56, 58, 64, 97, 116, 118	R. & R. Radio	137
Avonica Tools	123	I.M.O. (Electronics), Ltd.	106	Rank-Whitfeldale, Ltd.	16, 30, 34
Barrett, V.	85	Industrial Chemical Industries, Ltd.	28, 29	Readers Radio	84
Batey, W., & Co.	54	Industrial Exhibitions	134	Reproducers & Amplifiers, Ltd.	32
Belling & Lee, Ltd.	74	Industrial Instruments, Ltd.	36	Rohet, H. & Co., Ltd.	134
Bentley Acoustic Corp., Ltd.	112	Instructional Handbook Supplies	140	R.S.C. (Manchester), Ltd.	102, 103
Berry's Radio	130	Instrument Screw Co.	38	Sallis, A. T.	139
Beulah Electronics	110	International Correspondence Schools	63	Samsons (Electronics), Ltd.	115
Bi-Pak	134	International Rectifier Co. (G.B.), Ltd.	54	Sanders, W. H., Ltd.	78
Bradley, G. & E., Ltd.	33	K.G.M. Ltd.	48	Scientific Products	134
Brenell Engineering Co., Ltd.	3	Kingswood Supplies	140	Service Trading Co.	100, 101
Briggs, G. A.	46	Lasky's Radio, Ltd.	94, 95, 96, 97	Silentbloc, Ltd.	27
Britain, Chas. (Radio), Ltd.	105	Lawson Tubes	138	Sinclair Radionics, Ltd.	85, 86, 87
Britec, Ltd.	141	Leak, H. J. & Co. Ltd.	133	S.M.E., Ltd.	24
British Communications Corp.	53	Ledon Instruments, Ltd.	64	Smith, G. W. (Radio), Ltd.	98, 99
British Elec. Resistance Co., Ltd.	64	Leverell Electronics, Ltd.	13	Smith, H. L., Co., Ltd.	52
British Institute of Engineering Technology	24	Lewis Radio Co.	137	Smith-Kelvin, Ltd.	60
Broadway Electronics	140	Lexor Electronics, Ltd.	52	Smith, John, Ltd.	30
Broadway Electronics	141	Light Soldering Developments, Ltd.	26	Sotonian Trading Co.	119
Brush Clevis, Ltd.	9	Lim-Air, Ltd.	35, 113	Specialist Switches, Ltd.	31, 112
B.S. Radio & Electrical Store	139	Liner Products, Ltd.	38	Stamford, A. L., Ltd.	134
Butain, A. F. & Co., Ltd.	Edit. 263	Lionmount & Co., Ltd.	136	Standard Telephones & Cables, Ltd.	80, Cover III
Butlers, Ltd.	46	London Central Radio Stores	135	Sunman Tapes	122
Canon Electric, Ltd.	31, 33	London Electrical Mfg. Co.	40	Stern-Clyne, Ltd.	108
Carroll Fastener, Co., Ltd.	31	Lustraphone, Ltd.	52	Sutton Electronics	141
Celestion, Ltd.	14	Lyons, Claude, Ltd.	55, 69	Tannoy, Ltd.	134
C.R.E.I. (London)	5	M.A.C. (Morley), Ltd.	119	Taylor Elec. Insts., Ltd.	40
C.T. Supply	114	Macmillan & Co.	133	Technical Trading Co.	138
Cursons, B. W.	137	Malyen Engineering Works	134	Tekronics, Ltd.	71
Daxrom, Ltd.	90, 91, 92, 93	Marconi Company, Ltd.	72	Telegraph Condenser Co., Ltd.	70
Deimos, Ltd.	134	Marconi Instrument, Ltd.	36, 37	Tenex, Ltd.	63, 66
Drake Transformers, Ltd.	17	McMurdo Instrument Co., Ltd.	75	Thorn, A.E.I. Radio Valves & Tubes, Ltd.	76, 77
Dymar Electronics, Ltd.	19	"Mechanical Handling" Exhibition	118	Thorn Special Products, Ltd.	43
Dynaco	111	Mills, W.	88	T.R.S. Radio	119
Eddystone Radio Co., Ltd.	34	Modern Book Co.	136	Universal Book Co.	140
E.K. Electronics (IA), Ltd.	56	M. R. Supplies, Ltd.	46	Valradio, Ltd.	32, 33
Electrams	137	Mullard, Ltd.	68	Venner Electronics, Ltd.	7
Electrolab, Ltd.	42	Multicore Solders, Ltd.	135 Cover iv	Vitality Bulbs, Ltd.	56
Electronics (Croydon), Ltd.	103	Newnes, George Ltd.	112	Vortexion, Ltd.	81
Electrosil, Ltd.	59	Nonbres, Ltd.	52	Watts, Cecil E., Ltd.	140
Electro-Winds, Ltd.	46	Olympic Radio Components, Ltd.	65	Webber, R. A., Ltd.	56
Elmbridge Instruments, Ltd.	140	Omron, Ltd.	89	Wells, J. (Metals), Ltd., Hart Electronics	134
English Electric Valve Co., Ltd.	25	Orchard & Ind., Ltd.	48	West Instruments, Ltd.	42
Eric Resistor, Ltd.	6	Osmabot, Ltd.	139	West London Direct Supplies	122
ETA Tool Co., Ltd.	65	Oxley Developments Co., Ltd.	54	Whiteley Electrical Radio Co., Ltd.	2
Ever-Ready Co., Ltd.	60	Partridge Transformers, Ltd.	50	Wilkinson, I. (Croydon), Ltd.	100
Farnell Instruments, Ltd.	85	P.C. Radio, Ltd.	104	Wolfendale Electronics	30
Ferranti, Ltd.	Cover II	Picard, H. & Frere	40	Wright & Wear, Ltd.	65
F.I.A.R.	62	Pionac Electronic, Ltd.	15	Yukan	138
Finnegan Speciality Paints, Ltd.	134	Pitman, Sir Isaac & Son, Ltd.	139	Z. & I. Aero Services, Ltd.	120, 121
Gardners Transformers, Ltd.	41	Plessey Co., Ltd.	20, 21		
Gee Bros. (Radio), Ltd.	117	Post Radio Supplies	140		
Giffith, R. & Co.	122				
Glustone Radio	84				

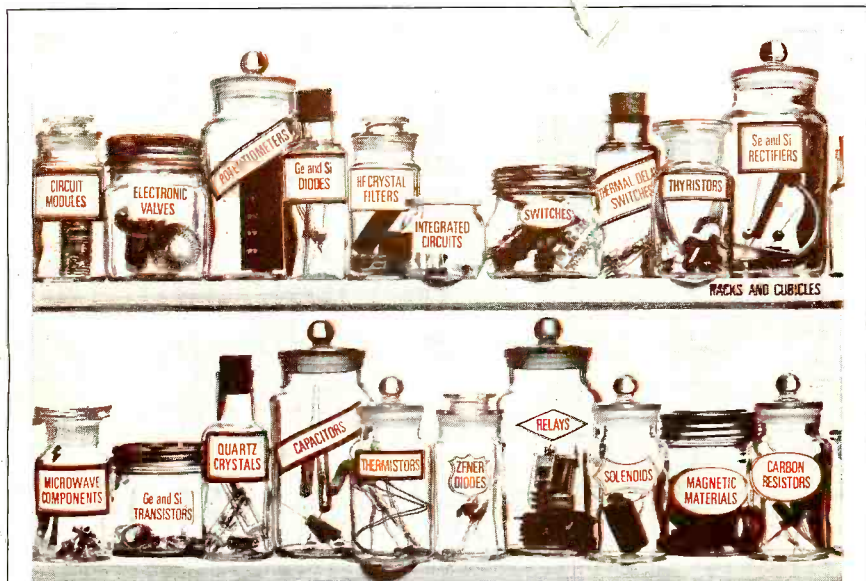

Only one-fifth of the story!

Yes, STC Components Group is able to supply you with about five times the number of different types of components shown—*off the shelf*. And the range of components is being extended all the time. If your requirements are urgent, STC Electronics Services Division offers *same day despatch*.

Each STC Division maintains an Applications Department with Engineers ready to help you choose the most suitable and most economic components and circuits for your equipments or systems.

Wherever your location on the map, STC Components Group, made up of nine successful Divisions and a single mobilized field force, can put the finest components service right on your

doorstep. The Group is represented in practically every country through ITT (International Telephone and Telegraph Corporation).

To obtain your copy of the STC 'Designers Digest' write, phone or telex STC Components Group, Footscray, Sidcup, Kent. Telephone: FOOTscray 3333. Telex: 21836.

high-grade components by

STC
COMPONENTS GROUP



**5 core solder so fine
it goes through the eye of a needle**

**ERSIN MULTICORE 5 CORE SOLDER NOW AVAILABLE IN
GAUGES DOWN TO 34 S.W.G. GIVING UP TO 4,950 FT. PER LB.**

From 16 s.w.g. — virtually the standard gauge ten years ago — the trend has been to 18 s.w.g. in the production of electronic and television equipment. Today the trend is to even finer gauges and, recently, the demand for ERSIN MULTICORE 5 CORE SOLDER in 22 s.w.g. has increased considerably.

New plant installed at our works in Hemel Hempstead now enables us to provide ERSIN MULTICORE SOLDER with five core of flux in even gauges to 34 s.w.g., effecting substantial economies in soldering

costs. The table shows the lengths as compared with 16 and 18 s.w.g.

60/40 alloy is available from stock in even gauges from 22 s.w.g. to 28 s.w.g. and can be supplied to special order in even gauges to 34 s.w.g. Other alloys can be supplied in special order in all these gauges.

22 s.w.g. which has hitherto been supplied only on 1 lb. reels, can now also be supplied on 7 lb. reels. Gauges from 24 s.w.g. upwards are wound on 1 lb. type reels, $\frac{1}{2}$ lb. of Ersin Multicore Solder per reel.

Standard Wire Gauge	Diameter in inches	Diameter in mm	Approx. No. of feet per lb. 60 Tin/40 Lead
16	.064	1.626	102
18	.048	1.219	182
22	.028	.711	536
24	.022	.558	865
26	.018	.46	1,292
28	.014	.375	1,911
30	.012	.3146	2,730
32	.0108	.274	3,585
34	.009	.233	4,950

For samples and literature please write on your company's letterheading to:

MULTICORE SOLDERS LTD., MAYLANDS AVENUE, HEMEL HEMPSTEAD, HERTS. (HEMEL HEMPSTEAD 3636)