

wireless world

AUGUST 1976 35p

The inventors

Digital clock

Australia A\$ 2.00
Canada \$1.50
Denmark Kr. 11.00
Finland Fmk. 6.20
Germany Dm. 4.50
Greece Dr. 45.00
Holland Df. 4.50
Italy L. 90C
Malaysia M\$3.25
New Zealand \$NS1.20
Norway K. 10.00 incl. moms
Portugal Esc. 40.00
South Africa R. 1.10
Spain Ptas 80.00
Sweden Kr. 6.90 Incl. moms
U.S.A. \$1.50

And now, a clever signal source.



*After nearly 50 years
we've learned a thing or two.*

The new Gould Advance SG200.

Advance Electronics were a big name in RF signal sources.

And, now we've become Gould Advance, we're coming back into the business in a major way.

Beginning with a product that costs little and offers a lot.

For the new Advance 'SIG GEN' SG200 is a bargain.

It's got an extraordinary stable frequency and output level (160 KHz –

230 MHz and $2\mu\text{V} - 200\text{mV}$).

And it's truly portable in a dual mains/battery operation. With ease of use enhanced by the panoramic linear scale.

Finally, the SG200 was built with simple, reliable circuitry to ensure that it won't let you down.

Do ask for data.

Because you'll see the SG200 is a signal achievement.

Gould Advance Limited
Roebuck Road, Hainault, Essex IG6 3UE, England.
Telephone: 01-500 1000 Telex: 263785

 **GOULD ADVANCE**
The product development company

1745

LOW COST TESTERS



LEVELL

PORTABLE INSTRUMENTS

INSULATION TESTER

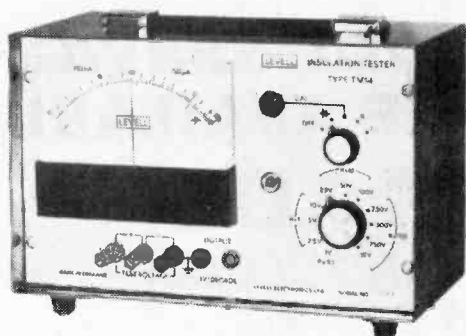

A logarithmic scale covering 6 decades is used to display either insulation resistance or leakage current at a fixed stabilised test voltage. The current available is limited to a maximum value of 3mA for safety and capacitors are automatically discharged when the instrument is switched off or to the CAL condition. The instrument operates from a 9V internal battery.

RESISTANCE RANGES

10M Ω to 10T Ω (10^{13} Ω) at 250V, 500V, 750V and 1kV.
 1M Ω to 1T Ω at 25V, 50V and 100V.
 100k Ω to 100G Ω at 2.5V, 5V and 10V.
 10k Ω to 10G Ω at 1V.

Accuracy $\pm 15\%$ +800 Ω on 6 decade logarithmic scale.
 Accuracy of test voltages $\pm 3\%$ ± 50 mV at scale centre.
 Fall of test voltages $< 2\%$ at 10 μ A and $< 20\%$ at 100 μ A.
 Short circuit current between 500 μ A and 3mA.

CURRENT RANGE

100pA to 100 μ A on 6 decade logarithmic scale.
 Accuracy of current measurement $\pm 15\%$ of indicated value.
 Input voltage drop is approximately 20mV at 100pA, 200mV at 100nA and 400mV at 100 μ A.

Maximum safe continuous overload is 50mA.

MEASUREMENT TIME

< 3 s for resistance on all ranges relative to CAL position.
 < 10 s for resistance of 10G Ω across 1 μ F on 50V to 500V.
 Discharge time to 1% is 0.1s per μ F on CAL position.

RECORDER OUTPUT

1V per decade $\pm 2\%$ with zero output at scale centre.
 Maximum output ± 3 V. Output resistance 1k Ω .

type **£98**
TM14

TRANSISTOR TESTER

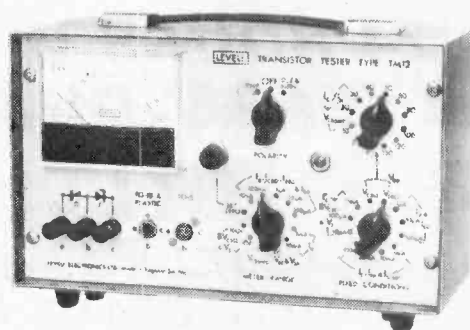

Tests bipolar transistors, diodes and zener diodes. Measures leakage down to 0.5 nA at 2V to 150V. Current gains are checked from 1 μ A to 100mA. Breakdown voltages up to 100V are measured at 10 μ A, 100 μ A and 1mA. Collector to emitter saturation voltage is measured at 1mA, 10mA, 30mA and 100mA for I_C/I_B ratios of 10, 20, 30. The instrument is powered by a 9V battery.

TRANSISTOR RANGES (PNP OR NPN)

- I_{CBO} & I_{EBO} : 10nA, 100nA, 1 μ A, 10 μ A and 100 μ A f.s.d. acc. $\pm 2\%$ f.s.d. $\pm 1\%$ at voltages of 2V, 5V, 10V, 20V, 30V, 40V, 50V, 60V, 80V, 100V, 120V, and 150V acc. $\pm 3\%$ ± 100 mV up to 10 μ A with fall at 100 μ A $< 5\%$ +250mV.
- BV_{CBO} : 10V or 100V f.s.d. acc. $\pm 2\%$ f.s.d. $\pm 1\%$ at currents of 10 μ A, 100 μ A and 1mA $\pm 20\%$.
- I_B : 10nA, 100nA, 1 μ A ... 10mA f.s.d. acc. $\pm 2\%$ f.s.d. $\pm 1\%$ at fixed I_E of 1 μ A, 10 μ A, 100 μ A, 1mA, 10mA, 30mA, and 100mA acc. $\pm 1\%$.
- h_{FE} : 3 inverse scales of 2000 to 100, 400 to 30 and 100 to 10 convert I_B into h_{FE} readings.
- V_{BE} : 1V f.s.d. acc. ± 20 mV measured at conditions on h_{FE} test.
- $V_{CE(sat)}$: 1V f.s.d. acc. ± 20 mV at collector currents of 1mA, 10mA, 30mA and 100mA with I_C/I_B selected at 10, 20 or 30 acc. $\pm 20\%$.
- DIODE & ZENER DIODE RANGES**
- I_{DR} : As I_{EBO} transistor ranges.
- V_Z : Breakdown ranges as BV_{CBO} for transistors.
- V_{DF} : 1V f.s.d. acc. ± 20 mV at I_{DF} of 1 μ A, 10 μ A, 100 μ A, 1mA, 10mA, 30mA and 100mA.

type **£95**
TM12

LEVELL ELECTRONICS LTD.

Moxon Street, High Barnet, Herts. EN5 5SD
 Tel: 01-449 5028/440 8686

Prices include batteries and U.K. delivery, V.A.T. extra.
 Optional extras are leather cases and mains power units.
 Send for data covering our range of portable instruments.

TRANSIPACK®

NO BREAK POWER SUPPLIES

NEW 2000 SERIES — FOURTH GENERATION

1KVA TO 200KVA

24 HOURS WORLDWIDE SERVICE 2 YEARS' GUARANTEE AVAILABLE

BRITISH MADE

VISIT US AT HASTINGS AND SEE OUR
STATIC INVERTER CENTRE

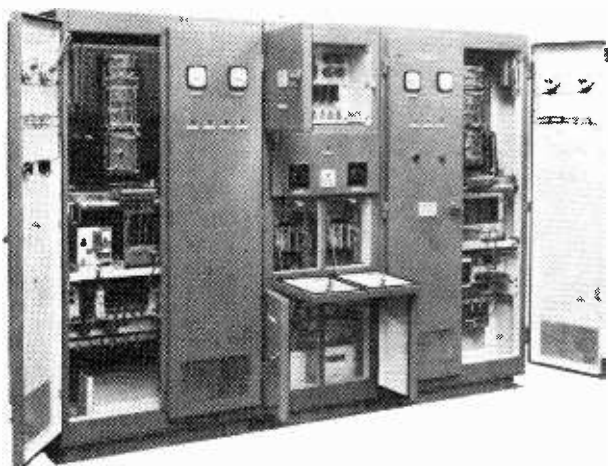

TYPICAL TRANSIPACK
NO-BREAK POWER SUPPLY
AS DELIVERED TO C.E.G.B.

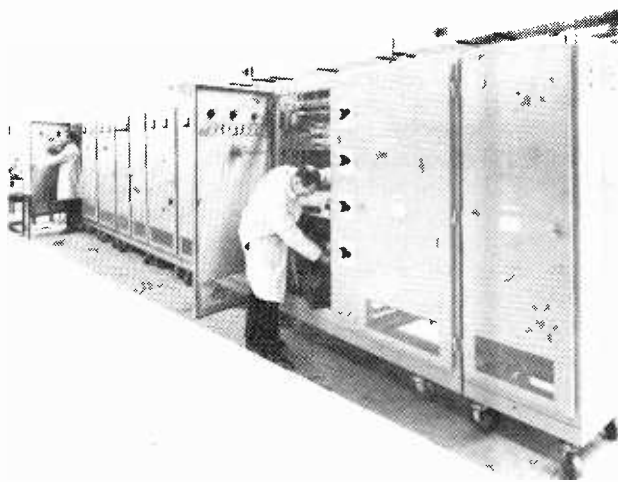

TYPICAL
TRANSIPACK U.P.S.
FOR COMPUTER
APPLICATIONS



**INDUSTRIAL
INSTRUMENTS
LIMITED**
TRANSIPACK®

Sales and Laboratories
STANLEY ROAD
BROMLEY BR2 9JF
KENT, ENGLAND
Telephone: 01-460 9861/5
Telegrams: TRANSIPACK, BROMLEY
Telex: 896071

Factory
THEAKLEN DRIVE
PONSWOOD INDUSTRIAL ESTATE
HASTINGS, SUSSÉX, ENGLAND
Telephone: Hastings 427344

ISOPHON

How do you advertise a Horn Tweeter?
 We had thought of showing a picture
 of a French Horn—aesthetically more
 pleasing than a Horn Tweeter—but
 instead decided just to proudly include
 a photograph of our
NEW HORN TWEETER

We have pleasure in
 announcing the new
ISOPHON HORN TWEETER
 Type DKT 11/C—110/8



We are excited about this new addition to the product line and feel sure that you will be too, when you examine the specification and listen to the sound.

We are confident it will not be long before this Horn Tweeter joins our other successful products like the Dome Tweeters KK7, KK8 and KK10. There are, of course, many other drive units to choose from in the Isophon range including bass units, dome mid-range units and assembly kits.

Why not send for the Isophon catalogue containing 28 pages of useful information which we will be happy to send you, free of charge, on receipt of the cut-out coupon.

Hayden Laboratories Ltd



Churchfield Road,
 Chalfont St. Peter, Bucks. SL9 9EW
 Tel: Gerrards Cross (02813) 88447
 ENGLAND



Please send a free copy of the 28-page Isophon Catalogue.

Name

Address

.....

.....

Total Capability in soldering

Litesold

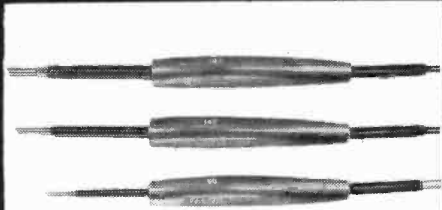

LITESOLD STANDARD MODELS
Thermally Balanced Irons 10 w to 75 w

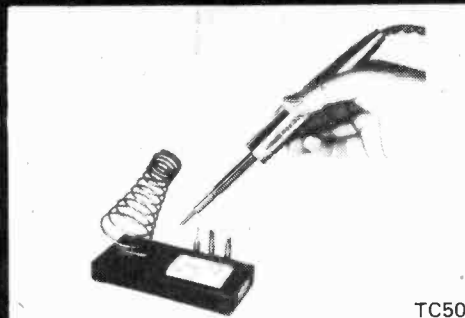

TC50
Self-Contained Adjustable Thermostatic Iron.
Mains or 24v

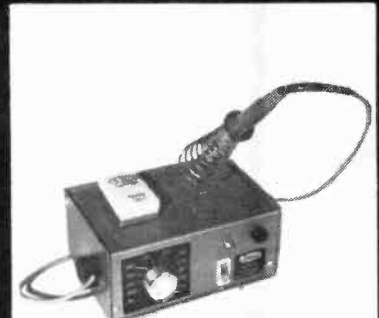

ETC/2
New Electronically Temperature
Controlled Soldering System.

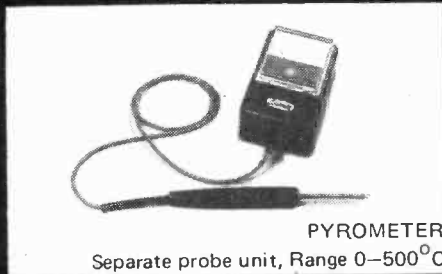

PYROMETER
Separate probe unit, Range 0-500°C

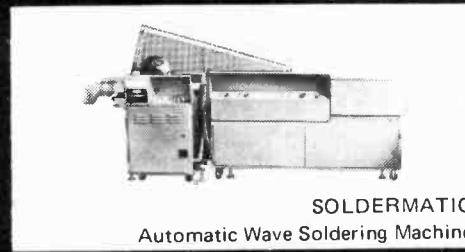

SOLDERMATIC
Automatic Wave Soldering Machine

Send TODAY for FREE
Catalogue with full details
of this and other
equipment

LIGHT SOLDERING DEVELOPMENTS LTD

97-99 Gloucester Road Croydon Surrey

Telephone 01-689 0574

WW-056 FOR FURTHER DETAILS

AMCRON POWER AMPLIFIERS

The AMCRON range of DC-coupled power amplifiers are used by Government, and University Research Departments as well as by Industry for a variety of applications ranging from Shaker, and Vibrator driving, to driving both AC and DC Motors, providing variable frequency power supply, or high voltage material testing. All models are DC-coupled throughout, with Intermodulation, and Harmonic Distortion below 0.05%, damping factor of at least 400 from DC to 1 kHz, and the ability to operate into load impedances from 1 ohm to infinity even into highly reactive loads.



M600

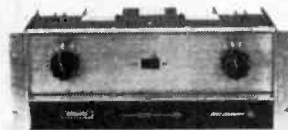

DC 300A



D150A

RMS power out

750 watts into 8 ohms
1,350 watts into 4 ohms
DC to 20 kHz + 1 db - 0 db.
+ 0' - 15' DC - 20 kHz
16 V / μ second
120 db below 600 Watts
19" std rack, 8 $\frac{3}{4}$ " H, 16 $\frac{1}{2}$ " Deep

Power bandwidth
Phase response
Slew rate
Hum & noise
Dimensions

500 watts rms into 2.5 ohms (1 chan)
DC-20kHz + 1 db - 0 db
+0, - 15' DC to 20kHz
8 volts per microsecond
At least 110db below 150 watts
19" Rackmount, 7" High, 9 $\frac{3}{4}$ "
Deep

200 watts into 2.5 ohms (1 chan)
DC-20 kHz + 1 db, - 0 db
+ 0', - 15' DC to 20 kHz
6 volts per microsecond
At least 115 db below 90 watts
19" Rackmount, 5 $\frac{1}{4}$ " H, 8 $\frac{3}{4}$ " D.



MACINNES LABORATORIES LTD.

MacInnes House, Carlton Park Industrial Estate
Saxmundham, Suffolk IP17 2NL. Tel: (0728) 2262 2615

MACINNES FRANCE

45 Rue Fessart
Paris 75019, France
Tel: 203-30-01

WW-017 FOR FURTHER DETAILS

You need a flash tube?



Get to the Point Quickly with ANTEX Model X25

Point 1

Near-perfect insulation.
Breakdown voltage 1500 A.C.
Leakage current 3.5 uA.

Point 2

Top-efficiency in heat transfer.
Element slides inside the soldering bit.
25 watts but equivalent in heat capacity to 60 watts.

Point 3

High grade phenolic handle (own moulding!)
Stainless steel shaft.
— 3 core 0.4mm.
Flexible lead.

Point 4

Iron-coated bits that do not stick to the shaft but slide on and off easily.
3 tip sizes 2.4, 3.2 and 4.7mm.

Point 5

Price with standard (3.2mm.) bit
£3.20 (P+P 0.22) each
Spare elements £1.52 each
Spare bits £0.50 each

Point 6

A well balanced tool —
length 22cm.
weight 50gr.

Prices include VAT
Postage + Packing extra as shown in brackets.

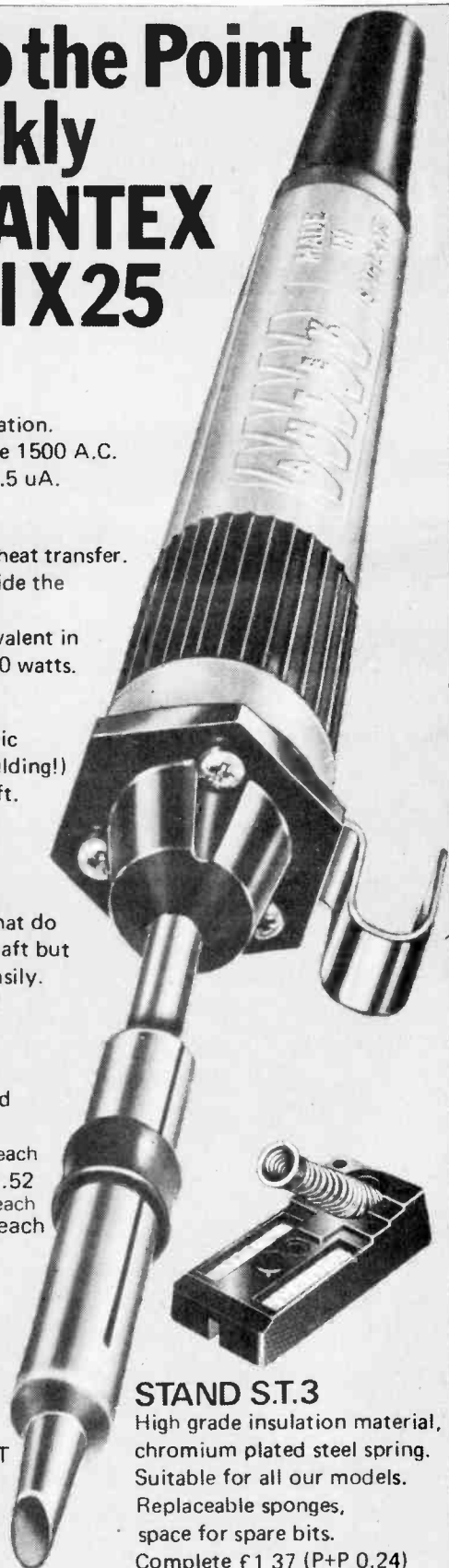

STAND S.T.3

High grade insulation material, chromium plated steel spring. Suitable for all our models. Replaceable sponges, space for spare bits. Complete £1.37 (P+P 0.24)

breadboard power source

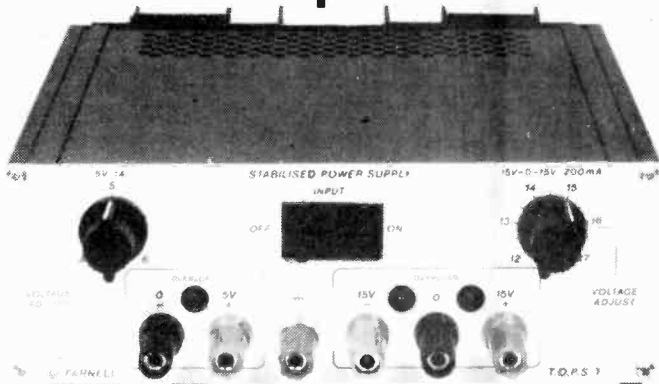

The Farnell Triple Output Power Supply - TOPS - is an ideal utility power source for 'breadboarding' IC and Op. Amp circuitry.

- 5V, 1A and 15-0-15V, 200mA
- LED indication of overload
- Adjustable outputs
- Low cost, good performance
- Output protection
- Ideal utility IC/Op. Amp power source for bench use



For details contact:

FARNELL INSTRUMENTS LIMITED · SANDBECK WAY · WETHERBY · WEST YORKSHIRE, LS22 4DH · TELEPHONE 0937 3541 or 01-864 7433 · TELEX 557294

WW - 041 FOR FURTHER DETAILS

METER PROBLEMS?

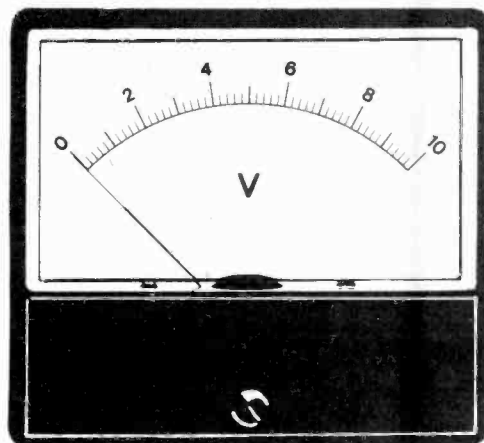

137 Standard Ranges in a variety of sizes and stylings available for 10-14 days delivery. Other Ranges and special scales can be made to order.

Full Information from:

HARRIS ELECTRONICS (London)

138 GRAYS INN ROAD, W.C.1 Phone: 01/837/7937

WW-019 FOR FURTHER DETAILS



from electrical, radio or car accessory shops or from Antex Ltd., Freepost (no stamp required) Plymouth, PL1 1BR Telephone 0752 67377/8.

Please send the following:

ANTEX colour catalogue.

I enclose cheque/P.O./Cash (Giro No. 258 1000)

Name
Address
.....
.....
.....
.....
.....

WW8

Remember to ask EEV.

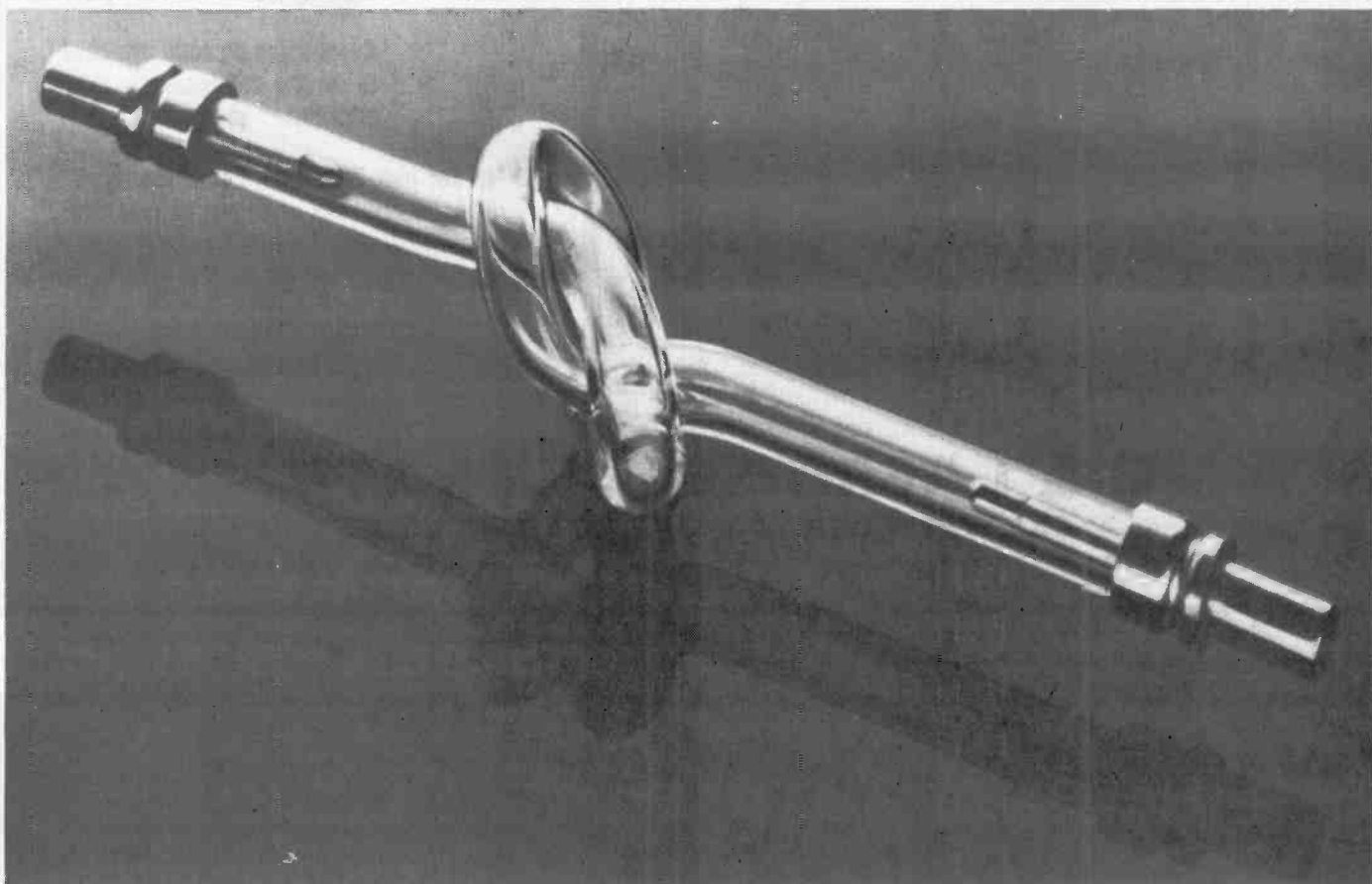

At EEV we make solder seal and bright seal flash tubes.

In linear, helical and circular shapes.

For laser pumping, photography, strobing and beacons.

We can make the exact flash tube you want - whatever the quantity, shape or application.

Since 1963 we have manufactured flash tubes to rigorous mechanical

and electrical specifications.

EEV knowhow on electrode design and production ensures reliability and longer life - up to one thousand million shots.

New Free Brochure. Send for full data and our new free brochure - in English, French and German - on what's newest in flash tubes.

Write, 'phone or telex Chelmsford for your copy.

LA 31

EEV and M-OV know how.

FAST RESPONSE STRIP CHART RECORDERS

Made in USSR

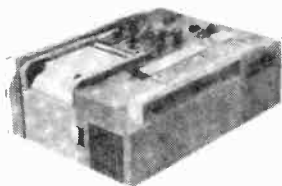

Type H3020 -1
Single pen

Specification

Basic error.....	2.5%
Sensitivity.....	8mA F.S.D.
Response.....	0.2 sec.
Width of each channel.....	80mm
Chart speeds, selected by push buttons.....	0.1-0.2-0.5-1-2.5- -5-12.5-25mm/sec.
Chart drive.....	200-250v 50Hz

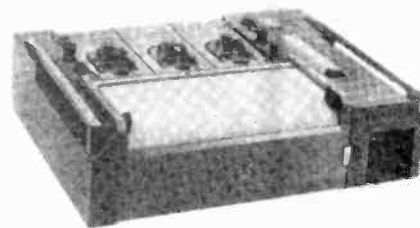

Type H3020-3
Three-pen

Recording: Syphon pen directly attached to moving coil frame, curvilinear co-ordinates

Equipment: Marker pen, Timerpen, Paper footage indicator, 10 rolls of paper, connectors, etc.

Dimensions: H320-1: 285x384x16.5mm
H320-3: 475x384x16.5mm

PRICE: H320-1 £108.00
H320-3 £160.00
Exclusive of VAT

Available for immediate delivery

Z & I AERO SERVICES LTD.

44A WESTBOURNE GROVE, LONDON W2 5SF

Tel. 01-727 5641

Telex: 261306

WW-038 FOR FURTHER DETAILS

THIS IS IT!

Fully built and tested for immediate use in ANY tuner using Vari-cap control

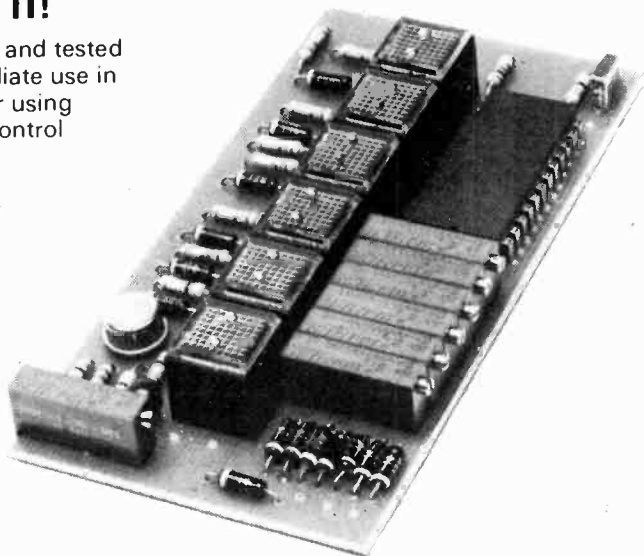

TOUCH TUNE PRE-SELECT UNIT

Shown here with meter drive components from Kit K12 mounted on same P.C.B.

Our Tuner is now fully updated and improved. If you intend to build, you must buy our new booklet fully describing our updated tuner.
(50p post free, refundable on orders over £10)



NOW IS THE TIME TO BUY!

Our prices were **reduced** in April. Now VAT has been halved. Will things ever be quite this good again? Make use of your credit card and buy now with confidence. We give full after-sales service and guarantee with all parts and kits.

6 channels plus manual.
Illuminated touch buttons.
20 volts supply.
Full instructions for use.
Fully built and tested.
Available now, post free.
Introductory price £16.71 inc. V.A.T.
See May's advertisement for full lists and prices, or write to:

Icon Design

33 Restrop View
Purton, WILTS.
SN5 9DG

A NEW DIMENSION IN SOLDERING

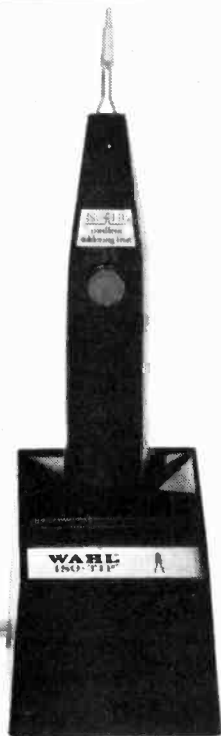

Iso-Tip Cordless Soldering Iron

Ideal for factory, field servicing, laboratory or home, the Iso-Tip Cordless offers a great advance in soldering. It is completely portable, heats in 5 seconds and recharges automatically in its own stand.

The Iso-Tip is powered by long-life nickel cadmium batteries giving tip performance up to 50 watts with a temperature of 370°C. Tips are available in five different sizes ranging from Micro to Heavy Duty to meet all soldering requirements.

Greenwood Electronics
Portman Rd, Reading RG3 1NE, England.
Telephone: Reading (0734) 595844.
Telex: 848659.

WW-024 FOR FURTHER DETAILS

FREQUENCY COUNTERS

HIGHER PERFORMANCE INSTRUMENTS FROM 1/10 Hz to 1.2 GHz. MEASURING FREQUENCY, PERIOD, TIME, FREQ./RATIO AND CALIBRATED OUTPUT FACILITY. FAST DELIVERY.

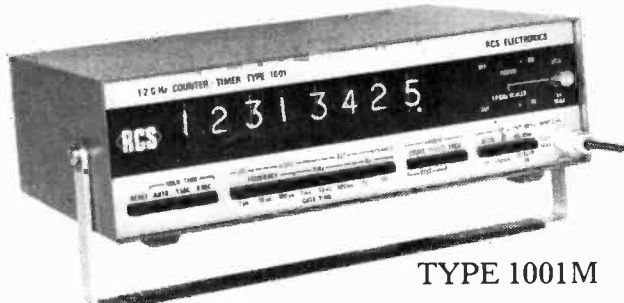

TYPE 1001M

CRYSTAL OVEN
OPERATING MANUAL
TWO TONE BLUE CASE

£670 **1.2 GHz**

Sensitivity 10mV. Stability 5 parts 10.¹⁰

301M	32MHz 5 Digit £82	401	32MHz 6 Digit £121
501	32MHz 8 Digit £178	701A	80MHz 8 Digit £195
801A/M	300MHz 8 Digit £305	901M	520MHz 8 Digit £375
801B/M	250MHz 8 Digit £262	1001M	1.2GHz 8 Digit £670

Start/Stop versions plus £12

Memory versions available if not suffixed M £25 extra

Type 101 1MHz 100KHz 10 KHz Crystal Standard £85
Type 103 Off/Air Standard £85

SUPPLIERS TO: Ministry of Defence, G.P.O., B.B.C., Government Dept., Crystal Manufacturers and Electronic Laboratories world-wide



R. C. S. ELECTRONICS
6 WOLSEY ROAD, ASHFORD
HOUNSLOW, MIDDX. TW4 7EE
Telephone: Ashford (Code 69) 53661/2

WW-029 FOR FURTHER DETAILS

The easy way to a PCB... ...the Seno 33 system!

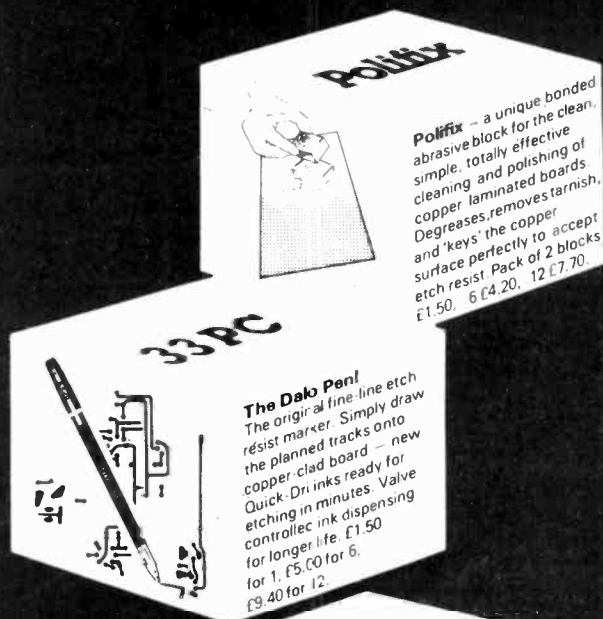

Polifix - a unique bonded abrasive block for the clean, simple, totally effective cleaning and polishing of copper laminated boards. Degreases, removes tarnish, and 'keys' the copper surface perfectly to accept etch resist. Pack of 2 blocks £1.50, 6 £4.20, 12 £7.70.

The Dako Pen
The original fine-line etch resist marker. Simply draw the planned tracks onto copper-clad board - new Quick-Dri inks ready for etching in minutes. Valve controlled ink dispensing for longer life. £1.50 for 1, £5.00 for 6, £9.40 for 12.

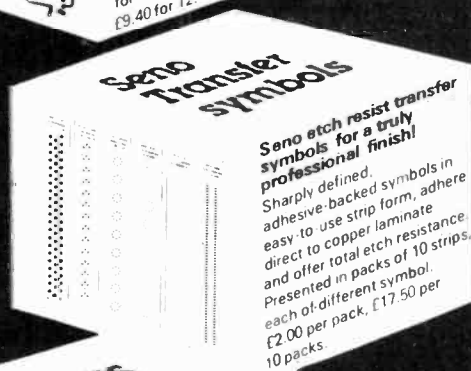

Seno etch resist transfer symbols for a truly professional finish!
Sharply defined, adhesive-backed symbols in easy-to-use strip form, adhere direct to copper laminate and offer total etch resistance. Presented in packs of 10 strips, each of different symbol. £2.00 per pack, £17.50 per 10 packs.

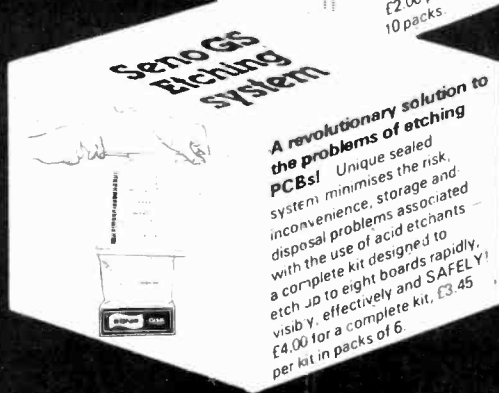

A revolutionary solution to the problems of etching PCBs! Unique sealed systems minimises the risk, inconvenience, storage and disposal problems associated with the use of acid etchants - a complete kit designed to etch up to eight boards rapidly, visibly, effectively and SAFELY! £4.00 for a complete kit, £3.45 per kit in packs of 6.

Seno 33 - The Laboratory in a box

From your usual component supplier or direct from:

DECON LABORATORIES LTD.
Ellen Street, Portslade,
Brighton BN4 1EQ
Telephone: (0273) 414371
Telex: IDACON BRIGHTON 87443

All prices post & VAT inclusive. Data sheets free of charge

WW - 053 FOR FURTHER DETAILS

LABORATORY INSTRUMENTS

G5

WIDE BAND AUDIO SIGNAL GENERATOR

a high accuracy solid state sine / square wave generator with 600 ohm attenuator output or low impedance output delivering 3 watts into a 5 ohm load.

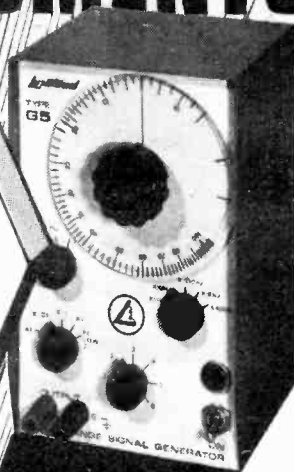

UK price

£53.70

plus VAT and P&P

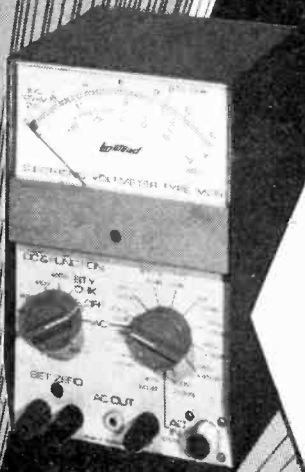

M2B

HIGH IMPEDANCE AC/DC MILLIVOLT-METER (The Modern equivalent of the Valve Voltmeter)
an AC/DC wide range meter with 20 scales covering 1.2 mV to 400 volts FSD incorporating a power scale in decibels.

UK price

£53.70

Plus VAT and P&P

LINSTEAD

MANUFACTURING CO. LTD.

ROSLYN ROAD, LONDON N15 5JB. TEL. 01-802 5144

To: Linstead Manufacturing Co. Ltd.
Roslyn Road, London N15 5JB. Tel. 01-802 5144

Please supply G5 @ £59.70 each inc. VAT and P&P
..... M2B @ £59.70 each inc. VAT and P&P

I enclose Cheque / P.O. / or Official Order for £
(Delivery 14-21 days)

Name

Address

Reg. No. 767209

WW876

WW-036 FOR FURTHER DETAILS

BULK ERASURE PROBLEMS?

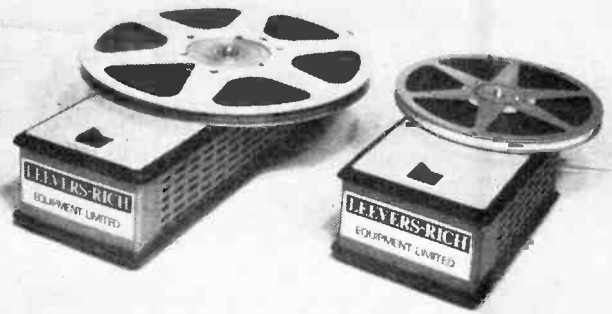

LR71

MAX REEL SIZE 11 1/2"

LR70

MAX REEL SIZE 8 1/4"

If it's personal we can only advise a diet or joining weightwatchers. If it's to do with tape, then why not consider the LR70/71 bulk tape erasers. They are simple to operate and will erase cassettes, cartridges and reels of tape up to a maximum reel size of 11 1/2" and tape width of 1" quickly and efficiently within the time it takes to read this advertisement.

The LR70/71 bulk erasers are currently used in Broadcast Companies, Recording Studios, Government Departments, Educational Establishments and the Computer Industry.

Moderately priced and available from:

LEEVERS-RICH EQUIPMENT LIMITED

INCORP. BIAS ELECTRONICS

319 Trinity Road, Wandsworth, London SW18 3SL

Telephone 01-874 9054

Cables: Leemag London SW18. Telex 923455 Wembley

WW-032 FOR FURTHER INFORMATION

servos synchronous steppers dc motors



gearboxes and control systems

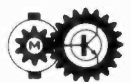

Stockists for **IMPEX** Motors

McLennan

McLENNAN ENGINEERING LIMITED

Kings Road Crowthorne Berks Telephone: Crowthorne 5757/8

WW-004 FOR FURTHER DETAILS

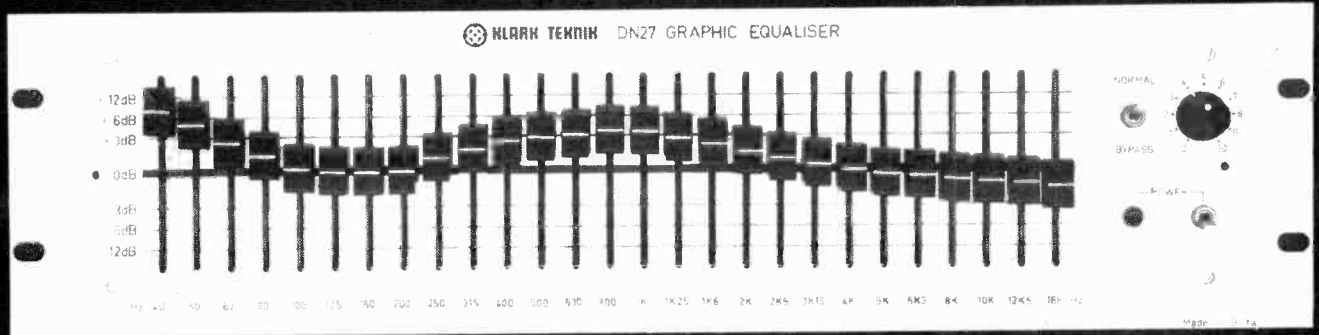
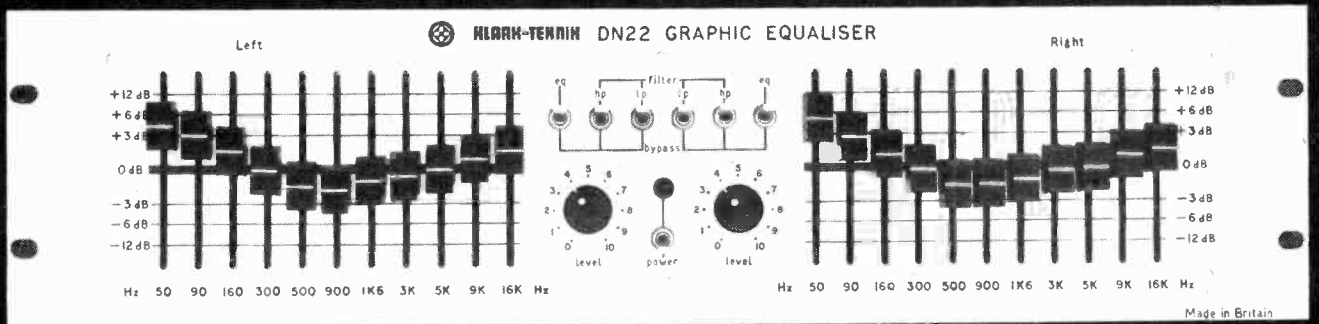

Better Performance than any Graphic Equaliser on the market

BUY BRITISH  **BUY KLARK-TEKNIK RESEARCH LIMITED**
 Summerfield Kidderminster DY11 7RE
 Tel Kidderminster 64027

WW-018 FOR FURTHER DETAILS

ESP Capacitance measuring

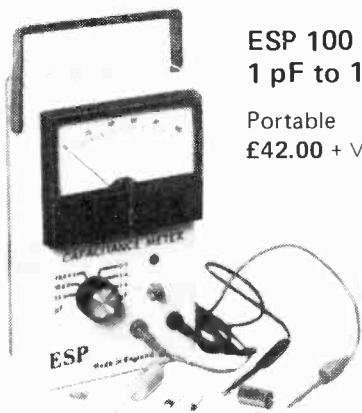

ESP 100 A
 1 pF to 10 μ F
 Portable
 £42.00 + V.A.T.

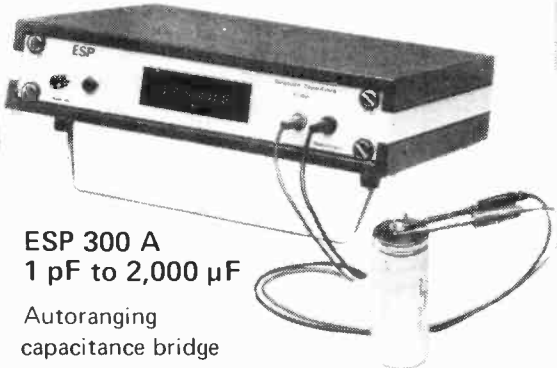

ESP 300 A
 1 pF to 2,000 μ F
 Autoranging
 capacitance bridge
 £185.00 + V.A.T.

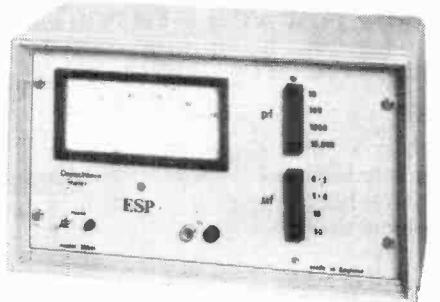

ESP 200 A
 1 pF to 50 μ F
 Wide scale
 laboratory model
 £82.00 + V.A.T.

**Now
 capacitance
 is easier to
 measure than
 resistance**

A complete range of British-made instruments designed to simplify capacitance measuring

- Accurate and sensitive
- Requires no manual balancing
- Takes less than a second to measure a capacitor
- Updates changes in capacitance automatically
- Wide range of applications



Electronic Services and Products Limited
 Cross Lane, Braunston, Near Daventry,
 Northamptonshire NN11 7HH
 Telephone: Rugby (0788) 890672

Send for technical literature and free booklet: "Modern methods of capacitance measuring"
 Suppliers to: Ministry of Defence, Post Office, B.B.C., Government departments and Electronic Laboratories world-wide.

KWP/ESP2 7619

WW - 052 FOR FURTHER DETAILS

Everyone just says . . .

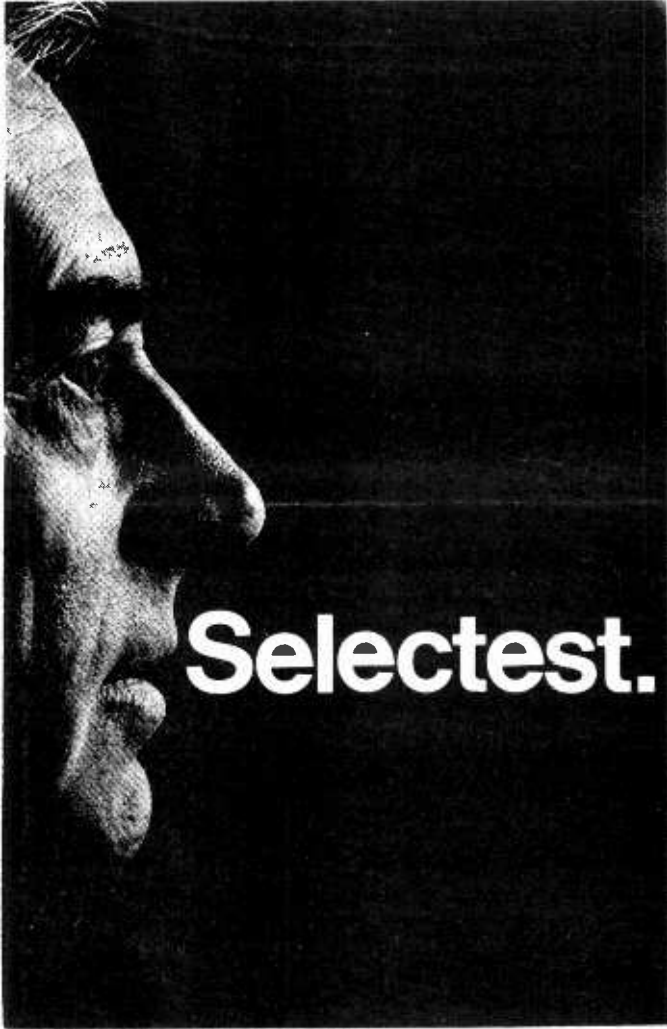

Good job we know what they mean

The MK. 3 Selectest has every facility you need built into it, accuracy, sensitivity and robustness. The case is made of wipe-clean, tough, light-weight melamine. Terminals accept 4mm push-in plugs on the front panel, enabling the Selectest to be used horizontally or vertically. The scale incorporates an inset mirror and knife-edge pointer.



SALFORD ELECTRICAL INSTRUMENTS LIMITED

Peel Works, Barton Lane, Eccles, Manchester M30 0HL
Telephone 061-789 5081 Telex 667711
A member company of GEC Electrical Components Ltd.

S&C

WW-073 FOR FURTHER DETAILS

-TURNER-

STEREO POWER AMPLIFIERS
(from 100 watts to 500 watts)

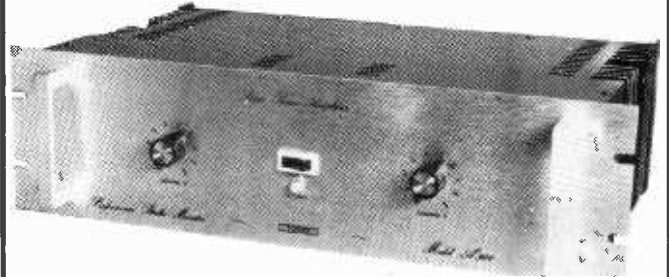

Professional Stereo Power Amplifiers designed and manufactured to the very highest standard.

TURNER POWER is setting a new standard in the studios for ultra-clean monitoring, and with bands on the road for ruggedness and reliability.

Customers include: Air Studios, Wessex Studios, Gooseberry Studios, Lansdowne Studios, Decibel Studios, Queen and leading hire companies.

TURNER ELECTRONIC INDUSTRIES LTD.
175 Uxbridge Road, London W7 3TH
Tel. 01-567 8472

WW — 068 FOR FURTHER DETAILS

Switching problems? Rely on Zettler.

Producing 30 basic types of relay and 15,000 variants with regard to contact stacks, terminals, energizing current and contact material, Zettler is among the largest manufacturers of electro-mechanical components.

Our product range comprises:
Low profile (flatrom)
Timing · Miniature · Low contact capacity · Hermetically sealed · Stepping
Mains switching · Latching
Contact stacks · Solenoids



Impulse Latching Relay AZ 340

Make contacts:
Resistive load: 10 A/240 V AC.
Lamp load: 8 A/240 V AC.
Compensated fluorescent tubes:
3.7 A/240 V AC.

Break contacts:
Resistive load: 8 A/240 V AC.
Lamp load: 5 A/240 V AC.
Compensated fluorescent tubes:
3.7 A/240 V AC.

We resolve your switching problems rapidly and expertly. Please contact us for further details.



ZETTLER Zettler
UK Division

Brember Road
Harrow, Middx. HA2 8AS. Tel. (01) 422 0061

A member of the worldwide ZETTLER electrical engineering group, est 1877

WW-007 FOR FURTHER DETAILS

nombrex

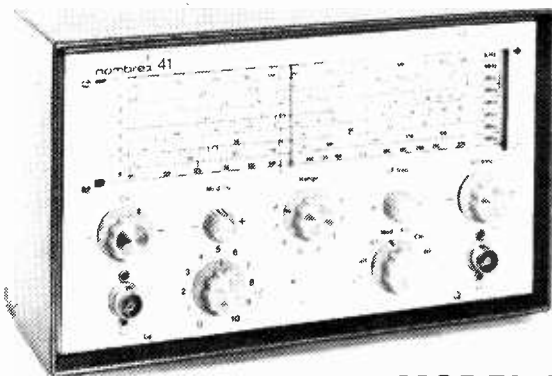

MODEL 41 R.F. SIGNAL GENERATOR Price £54.85

PLUS V.A.T.

- ★ 150 KHz — 220 MHz on fundamentals.
- ★ 8 clear scales — Total length 130mm.
- ★ Spin-Wheel Slow Motion Drive 11 — 1 ratio.
- ★ Overall Accuracy — 2½%.
- ★ Modulation, Variable depth and frequency.
- ★ Internal Crystal Oscillator providing calibration checks throughout all ranges.
- ★ Mechanical scale adjustment for accurate alignment against internal 1MHz crystal oscillator.
- ★ Powered by 9V Battery.

*Trade and Export enquiries welcome.
Send for full technical leaflets
Post and Packing £1.00 extra*

**NOMBREX LTD., POUND PLACE, WOLBOROUGH STREET,
NEWTON ABBOT, DEVON, TQ12 1NE
Tel. Newton Abbot 68297**

WW—030 FOR FURTHER DETAILS



Red & Green LED applied Logic Level Indicator MODEL 320 LOGIC PROBE

- * Wrong polarity and overload protectors provided
- * Detection of the peak value of input waveform
- * Open circuit or faulty IC can be detected
- * All logic levels are visible at a glance
- * Powered from circuit under test
- * Built-in storage circuit
- * Up to 12 MHz

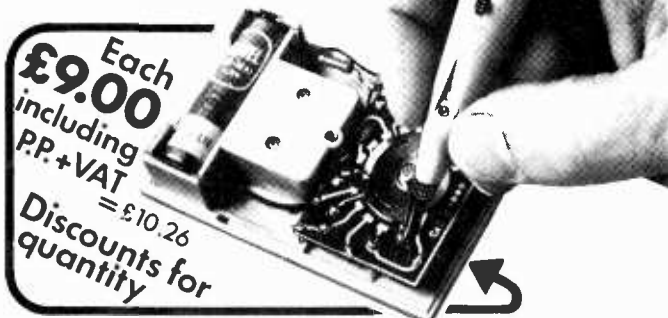

Each £9.00
including P.P. + VAT
= £10.26
Discounts for quantity

JH Associates Ltd

**Sales Office: 52 Silver Street,
Stansted, Essex. (0279) 814929**

WW—033 FOR FURTHER DETAILS

RADFORD

NOISE MEASUREMENT STANDARDS for Consumer Audio Equipment

The signal-to-noise ratio in an audio frequency system is conventionally measured by, noting the signal output voltage at a defined reference output level and comparing it with the output voltage with no signal input. In practical systems the figures obtained without bandwidth restriction may be meaningless. When it is desired to compare one system with another then the bandwidth and rolloff characteristics must be specified. Such a characteristic is defined in the DIN specification 45.500 April, 1975 — High Fidelity Standard as "Audio Band". It is a maximally flat band pass filter with 3dB points at 22Hz and 22kHz. The rolloff specified is 36dB/octave outside the pass band. This filter makes no allowance, however, for the characteristics of the ear at perceived noise levels or the irritation factor of the noise itself. The IEC/DIN curve "A" (also specified in DIN. 45.500) has a "weighted" frequency response contour to correlate the measured signal-to-noise ratio with the aural effect. Curve "A" has been in use for some time. Recently a new weighting characteristic (CCIR) has been introduced which is said to have a better correlation between the measured signal-to-noise ratio and the subjective value. It has been widely accepted and will probably become a world standard for professional use for audio noise measurement.

Meters which respond to peak, average and r.m.s. values of the waveform are in use. Dolby Laboratories published a report (see below)* in August, 1972, on noise measurement on consumer equipment. It stresses the advantage of the CCIR filter and the adequacy of an average sensing meter (ordinary millivoltmeter) and recommended its standardisation for published specifications on consumer equipment. For those who wish to use their own millivoltmeter a CCIR filter is now available in addition to the ANM1 and ANM2 complete noisemeters.

ANM1

High Sensitivity Audio Noisemeter

ANM2

High Sensitivity Audio Noisemeter, True r.m.s. reading

ANF1

Audio Noisefilter, CCIR weighting

Write or telephone for descriptive leaflet and Dolby Laboratories Bulletin 19/2 Noise Measurements on Consumer Equipment.*

RADFORD LABORATORY INSTRUMENTS LTD.

**Ashton Vale Road, Bristol BS3 2HZ, Avon
Telephone: 0272 662301**

WW—057 FOR FURTHER DETAILS

DIGITAL CLOCKS	MODULES	KITS	CALCULATORS																								
NEW PRICES		NEW MODELS																									
 <p>"DELTA" 12 hour from £8.00 4 RED 0.5" LEDs</p> <table border="1"> <tr> <td>Module Kit (excl. case)</td> <td>8.00</td> <td>10.50</td> </tr> <tr> <td>Module: Assembled (excl. case)</td> <td>8.50</td> <td>11.00</td> </tr> <tr> <td>Complete Clock Kit Incl. Case</td> <td>10.36</td> <td>12.91</td> </tr> <tr> <td>Ready built Clock Incl. Case</td> <td>14.00</td> <td>16.50</td> </tr> </table>		Module Kit (excl. case)	8.00	10.50	Module: Assembled (excl. case)	8.50	11.00	Complete Clock Kit Incl. Case	10.36	12.91	Ready built Clock Incl. Case	14.00	16.50	<p>ALARMS: Built-in alarm: Tilt operated snooze AM/PM indicator: Power failure indicator</p> <p>"ALPHA" 4 GREEN 0.5" DIGITS from £9.00 12/24 hour</p> <table border="1"> <tr> <td>Module Kit (excl. case)</td> <td>9.00</td> <td>12.00</td> </tr> <tr> <td>Module Assembled (excl. case)</td> <td>10.00</td> <td>13.00</td> </tr> <tr> <td>Complete Clock Kit Perspex Case</td> <td>11.50</td> <td>14.00</td> </tr> <tr> <td>Ready-built Clock Perspex case</td> <td>14.50</td> <td>17.00</td> </tr> </table>		Module Kit (excl. case)	9.00	12.00	Module Assembled (excl. case)	10.00	13.00	Complete Clock Kit Perspex Case	11.50	14.00	Ready-built Clock Perspex case	14.50	17.00
Module Kit (excl. case)	8.00	10.50																									
Module: Assembled (excl. case)	8.50	11.00																									
Complete Clock Kit Incl. Case	10.36	12.91																									
Ready built Clock Incl. Case	14.00	16.50																									
Module Kit (excl. case)	9.00	12.00																									
Module Assembled (excl. case)	10.00	13.00																									
Complete Clock Kit Perspex Case	11.50	14.00																									
Ready-built Clock Perspex case	14.50	17.00																									
<p>Genuine Teak Veneer Case or Perspex Case Colours: Black, White, Red, Blue, Green, Orange. Available separately £3.78</p>																											
<p>Built Alpha Units: State 12 or 24 hour 2-YEAR GUARANTEE ON READY BUILT CLOCKS</p>		<p>NOVUS CALCULATORS</p> <table border="1"> <tr> <td>650</td> <td>£5.40</td> <td rowspan="2">Send S.A.E. for complete range</td> </tr> <tr> <td>850</td> <td>£6.75</td> </tr> </table>		650	£5.40	Send S.A.E. for complete range	850	£6.75																			
650	£5.40	Send S.A.E. for complete range																									
850	£6.75																										
<p>CWO, PULSE ELECTRONICS LTD. (W2) 202 SHEFFORD ROAD, CLIFTON, SHEFFORD, BEDS. Tel. Hitchin (0462) 814477</p>																											

2-Volume RCA DATA BOOKS

The newest, most up-to-date
SOLID STATE DATABOOKS

Pre-publication Price per Set **£7.50**
(Incl. Post & Pack)
(Standard price: £8.50 per set)

ORDER NOW from:



REL Equipment & Components Limited
Croft House, Bancroft, Hitchin, Herts., SG5 1BU.
Tel: (0462) 56576 . 50551/2/3 . 52202 . 52776/7/8

SPECIAL OFFER



2 Volumes, over 1200 pages
Size: 8 1/4 in x 11 1/4 in.

* Offer closes Aug. 31st 1976

The Integrated Circuits book covers linear types, MOS/FETs, COS/MOS digital types, high-reliability types, and for the first time....memories and microprocessors.

The Power Device book covers power transistors, rf/microwave devices, thyristors (SCRs, triacs), silicon rectifiers and high-reliability types.

Both books include selection charts, cross-reference guides, terms and symbols, maximum ratings, electrical characteristics, design curves and abstracts of application notes.

Please send copy/copies of the new RCA DataBooks.
I enclose cheque/P.O./Money Order, value £
made payable to REL Equipment & Components Limited

Name: _____

Address: _____

ww876

UNIQUE STEREO ELECTRONIC CLOCK RADIO



£39.95
inc. VAT
P&P £1

THE REALTONE E4 AM/FM-FM STEREO CLOCK RADIO has a unique design. It features an accurate digitron (green) clock incorporating a dimmer control which can be used as a night light or adjusted to a pleasant soft glow. It has a stop watch facility and can be set to display HRS/MINS or MINS/SECS and can be programmed to wake you up to the alarm and/or stereo music. The radio has an FM multiplex stereo system with AFC (automatic frequency control) which allows drift free reception and incorporates two balanced high-fidelity speakers. The wake-up/ sleep control has its own memory and can be set for up to 59 mins. duration.

ALSO THESE SCIENTIFIC CALCULATORS AVAILABLE: T.I.SR56 @ £70.95. SR52 @ £224. SC6010 @ £60 (13 memories). SC60 @ £39.90. SC44 @ £27. CBM4190R @ £39.95. 4148R @ £27.95. Rockwell 44RD @ £18.95. 64RD @ £23.95. H.P.21 @ £64. 25C @ £155. 25 @ £107. S.A.E. for full details and quantity prices.

C.W.O. TO: **KRAMER & CO., 9 October Place, Holders Hill Road London NW4 1EJ 01-203 2473**
Registered Number: 1797716

OVER 2,000 ELECTRONIC COMPONENTS IN A BIG NEW FREE 100 PAGE CATALOGUE

YOURS BY POSTING TODAY



40 PAGES IN COLOUR

Please send me the 100 page Tandy catalogue

Name _____

Address _____

ww

TANDY
Nationwide supermarket of sound!

Tandy Corporation (Branch UK), Bilston Road, Wednesbury, W. Midlands WS10 7JN.

BLOCK CAPITALS PLEASE

We know of only one other Power Amplifier Module superior to our JPS 50

The JPS 150

For starters, JPS Power Amplifier Modules are designed, manufactured and tested in England, yet sold throughout the world.

Incorporating comprehensive protection circuits including, mismatch, short and open circuits, impedance and thermal protection, these Modules will ensure a high standard of both reliability and top performance.

Unlike other modules, they offer an indefinite life - span! Should they ever require any attention or repair, all components on both Modules are easily replaceable. And, what's more, they both also carry a full two year guarantee. That's confidence for you!

	JPS 50	JPS 150
Power Output	65 watts RMS 7.5 ohms	170 watts RMS 7.5 ohms
Frequency Response	10-22kHz -0.5dB	10-30kHz +0dB -0.5dB
Power Bandwidth	10-22kHz -0.5dB	10-22kHz +0dB -0.5dB
Slewing Rate	8.4 Volts per microsecond	8.2 Volts per microsecond
Total Harmonic Distortion	0.05% @ 1kHz	0.05% @ 1kHz
Hum and Noise	115dB below 60 watts	115dB below 150 watts
Damping Factor	Greater than 200 @ 1kHz	Greater than 400 @ 1kHz
*Input Sensitivity	0dB (0.775 Volts) 50 watts	0dB (0.775 volts) 150 watts
*Input Impedance	47k	47k
Power Requirements	± 35 Volts	± 55 Volts
Transistor Complement	7 transistors, 1 integrated circuit	10 transistors, 1 integrated circuit
Module Dimensions	4"H x 3"W x 1"D	6"H x 5"W x 1"D
Guarantee	Full 2 year	Full 2 year

For Industrial usage the frequency response of the amplifiers can be extended down to DC -30kHz +0dB -0.2dB.

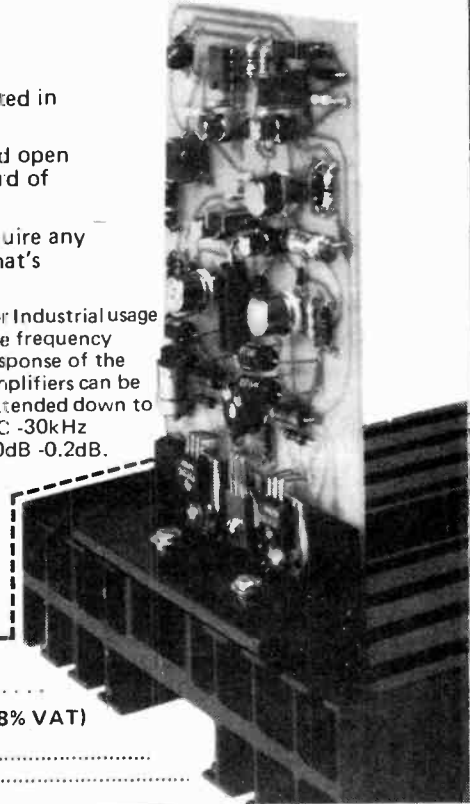

*Parameters can be changed to suit your requirements. Power Supplies are also available.

I herewith enclose Cheque/Postal Order for £..... (Made payable to JPS Associates)

PLEASE SUPPLY.....

JPS 50 @ £17.78 (+ 8% VAT) JPS 150 @ £29.65 (+ 8% VAT) LED Display @ £16.65 (+ 8% VAT)

JPS Associates NAME..... ADDRESS.....
 BELMONT HOUSE STEELE ROAD PARK ROYAL LONDON NW10 7AR TELEPHONE 01-961 1274

Test Equipment

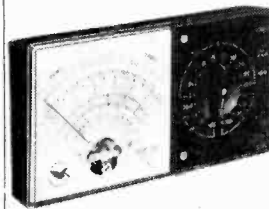

Multimeters

The Eagle range of multimeters covers every possible need of the electrical or electronic engineer. They cost from about £6 to £58 (inc V.A.T.). There's at least one which suits your job precisely.

We have a lot of other test equipment too. Send the coupon and we'll send you our complete catalogue.

Please send me details of all your test equipment

NAME

ADDRESS

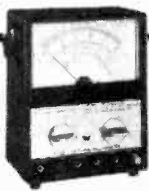

Eagle International Ltd., Precision Centre, Heather Park Drive, Wembley HA0 1SU
 Tel(01)-902 8832

Eagle

WW-027 FOR FURTHER DETAILS

ELECTRONIC INDUSTRIAL THERMOMETER

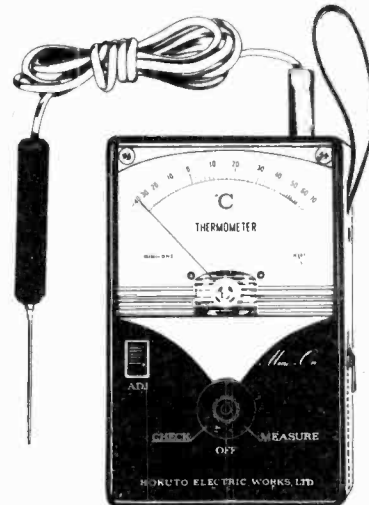

THE MODERN WAY TO MEASURE TEMPERATURE

A Thermometer designed to operate as an Electronic Test Meter. Will measure temperature of Air, Metals, Liquids, Machinery, etc., etc. Just plug-in the Probe, and read the temperature on the large open scale meter. Supplied with carrying case. Probe and internal 1 1/2 volt standard size battery.

Model "Mini-Z 1" measures from -40° C to + 70° C

Model "Mini-Z 2" measures from -5° C to + 105° C

Model "Mini-on Hi" measures from + 100° C to + 500° C

PRICE £20.00 each (VAT 8% EXTRA)

Write for further details to

HARRIS ELECTRONICS (LONDON),
 138 GRAY'S INN ROAD, LONDON. WC1X 8AX
 ('Phone 01-837 7937)

WW-020 FOR FURTHER DETAILS

BARR & STROUD MODULAR FILTERING

Barr & Stroud are pleased to announce a further advance in the continued development of their acclaimed EF3 Electronic Filter System. The new

modules 05 and 06 so extend the capabilities of the system that it could well meet all your filtering requirements.

Now 6 Modules for the EF3

Write for technical literature giving full specifications.



EF3-01 High Pass
Cut-off frequency variable from 0.01Hz to 10kHz



EF3-02 Low Pass
Cut-off frequency variable from 0.01Hz to 10kHz



EF3-03 High Pass
Cut-off frequency variable from 0.1Hz to 100kHz



London & Glasgow

Barr & Stroud Limited
1 Pall Mall East, London SW1Y 5AU
Telephone 01-930 1541 Telex 261877.



EF3-04 Low Pass
Cut-off frequency variable from 0.1Hz to 100kHz



EF3-05 High Pass
Cut-off frequency variable from 1Hz to 1MHz

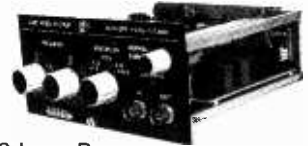

EF3-06 Low Pass
Cut-off frequency variable from 1Hz to 1MHz

WW-048 FOR FURTHER DETAILS

ELECTROTIME

SPECIALISTS IN ELECTRONIC TIMEKEEPING

ELECTRONIC DIGITAL ALARM CLOCK MODEL EC3



- ★ LARGE 4 DIGIT DISPLAY
- ★ AM/PM INDICATOR
- ★ FLASHING SECONDS INDICATOR
- ★ 5 MINUTE REPEATING SNOOZE ALARM
- ★ 24 HOUR ALARM
- ★ BRIGHTNESS CONTROL
- ★ ATTRACTIVE WHITE CASE.

COMPLETE BUILT CLOCK PRICE **£14** inc. VAT

THE "MISTRAL" I DIGITAL CLOCK



- ★ PLEASANT GREEN DISPLAY
- ★ 12/24 HOUR READOUT
- ★ FULLY ELECTRONIC
- ★ PULSATING COLON
- ★ PUSH BUTTON SETTING
- ★ BUILDING TIME 1 HOUR

COMPLETE KIT PRICE **£11.07** inc. VAT

BUILT CLOCK PRICE **£14.95**

LCD MODEL TLC4

CONTINUOUS
READOUT
UTILISING
LIQUID CRYSTAL
DISPLAY

WITH BACKLIGHT
FOR NIGHT
READING

- FEATURES—
- ★ HOURS
 - ★ MINUTES
 - ★ SECONDS
 - ★ DATE



RHODIUM **£39.95**
GOLD **£41.50** inc. VAT

LED MODEL TLE5

- FEATURES:
- ★ HOURS
 - ★ MINUTES
 - ★ SECONDS
 - ★ DATE
 - ★ DAY OF WEEK



£29.50 inc. VAT

GOLD OR
RHODIUM PLATED

We are proud to announce the opening of our new showroom in which you will find one of the Largest Ranges of Digital Electronic Clocks and Watches available in the UK so why not call in and see us?

ELECTROTIME, DEPT. 1/8, 11 SHEPLEY'S YARD
CHESTERFIELD, DERBYSHIRE. TEL. (0246) 35804

PLEASE SUPPLY
ENCLOSE CHEQUE/POSTAL ORDER

NAME

ADDRESS

TPA SERIES-D

integrated circuit power amplifier

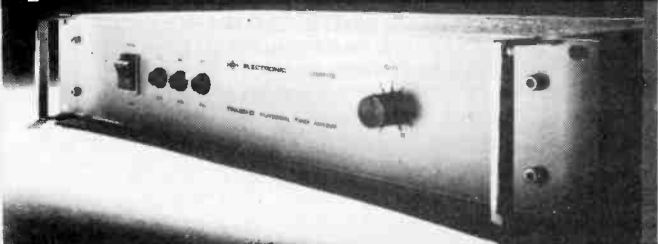

TPA 50 - D Specification

Power Output	100 watts rms into 4 ohms 65 watts rms into 15 ohms
Freq Response	± 0.1 dB 20Hz to 20KHz into 15 ohms. -1dB at 150KHz
Total harmonic distortion	Less than 0.04% at all levels up to 50 watts rms into 15 ohms
Input sensitivity	0dBm
Noise	-100dB
Rise time	2 μ seconds
Price	£77 plus V.A.T.

100V Line (C.T.) and balanced inputs available.

For full technical information contact:

HH ELECTRONIC

CAMBRIDGE ROAD, MILTON, CAMBS
TELEPHONE CAMBRIDGE 65945/6/7

WW-021 FOR FURTHER DETAILS

MOTOROLA IN-LINE WATTMETER

Measures power output from transmitter and reverse power from antenna.

Compact and light weight (approx. 1 lb)

Frequency range 2MHz to 19Hz.

Measures RF power from 1W to 1KW.

System includes a series of wide range RF elements which can be left permanently in-line in the transmission cable — measurements can then be taken without disconnecting the antenna.

MOTOROLA ELECTRONICS LTD.,
444 BATH ROAD, SLOUGH, BERKS.
TELEPHONE: BURNHAM 62427 TELEX: 847121.

WW-016 FOR FURTHER DETAILS

With our New ORYX SUPER 30

soldering iron
we have a slight
problem
at £2.95* how
do we convince
you that it is a
precision tool.

Our reputation for professional soldering equipment has been built on our precision products, so we have taken extreme care to see that our new ORYX Super 30 iron at, dare we repeat it, only £2.95, is going to be the best at its price.

* plus VAT at 8%

Here are some of the features you get as standard:

- A neon Safety Light,
- A long life element,
- Iron coated screw-on tip,
- Stainless steel shaft,
- Styled handle,
- A two-minute element change, and a Stainless steel clip-on hook.

You can have further technical information, or by ordering one now you will see why we call it the Super 30.

Illustration actual size.

Greenwood Electronics

Greenwood Electronics, Fortman Road, Reading, RG3 1NE
Telephone: 0734-595844. Telex 848659

WW-023 FOR FURTHER DETAILS

Series 7 Amplifier Equipment —sound investment



Grampian

Since Grampian introduced the Series 7 range in 1971 hundreds of satisfied customers all over the world have found it to be a sound investment. The high technical specification has set a new standard in engineering and reliability and the modular construction offers the most comprehensive and flexible system available.

Series 7 — Sound investment

GRAMPIAN REPRODUCERS LTD

Hanworth Trading Estate, Feltham, Middx.

TEL: 01-894 9141

WW — 059 FOR FURTHER DETAILS

DO YOU KNOW . . .

WHAT COUNTS UP TO 200MHz
HAS A CRYSTAL CONTROLLED CLOCK
AN INPUT SENSITIVITY OF 20mV.
HIGH INTENSITY 7 SEGMENT READOUTS.
1MHz, 100KHz and 10KHz CALIBRATION
OUTPUT SOCKETS
STABILISED PROTECTED MAINS PSU
ATTRACTIVE PROFESSIONAL STYLING
FULLY BUFFERED DISPLAY
A 12-MONTHS' GUARANTEE
COSTS ONLY £130
OR £155 WITH CRYSTAL OVEN

THE TC12

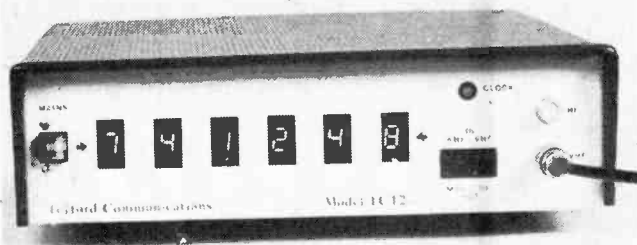

For further details contact:

TELFORD COMMUNICATIONS

78B HIGH STREET, BRIDGNORTH, SALOP WV16 4DS
TEL. 074 62 4082

NEW PEAK PROGRAMME METER

A PPM drive circuit with standard performance. Manufactured under licence from the British Broadcasting Corporation it is based on the ME12/9 but with the addition of our electronic floating input circuitry which will withstand mains or static voltages on the signal line.

Intended for use in the most critical monitoring applications it possesses excellent temperature and long term stability. Meeting BS4297, the proposed revision of BS4297 and the proposed new IEC Type 2 meter specifications, it also fulfills the requirements of the IBA, EBU and BPO.

The circuit board is designed to mount on the rear of the meter movement and it accepts balanced or unbalanced signal inputs at line level. The sensitivity may be increased by 20dB and the supply requirement is 24V at 30mA, either polarity or earth free.

ERNEST TURNER 642 and 643 meter movements stocked with 1/7 and —22/+4 scalings

Ring or write for leaflet with specifications and photographs

STABILIZER
FOR HOWL REDUCTION, BALANCED AND
UNBALANCED VERSIONS BOXED
OR RACK MOUNTING

PUBLIC ADDRESS: SOUND REINFORCEMENT



+5Hz Fixed Shift Circuit Boards for WW
July 1973 article.

Small enough to be built inside the cabinets of many amplifiers.
Complete kit and board £24 including PSU designer — DESIGNER
Board built and aligned £31 mains transformer approved. APPROVED

SURREY ELECTRONICS

The Forge, Lucks Green, Cranleigh

Surrey GU6 7BG (STD 04866) 5997

CASH WITH ORDER less 5%
UK POST FREE ADD VAT at 8%

ELECTRONORGTECHNICA

carbon film

RESISTORS

1/8 and 1/4w 70°C 5% tol. E, 12

EX-STOCK

£4.50 PER 1,000
OF ONE VALUE PLUS
V.A.T.

Contact John Gingell

Z & I

AERO SERVICES LTD.

44A Westbourne Grove

London W2 5SF

TEL: 01-727 5641 TELEX 261306

WW—045 FOR FURTHER DETAILS

Hatfield's versatile Test Team

Well established instruments from the Hatfield range include:

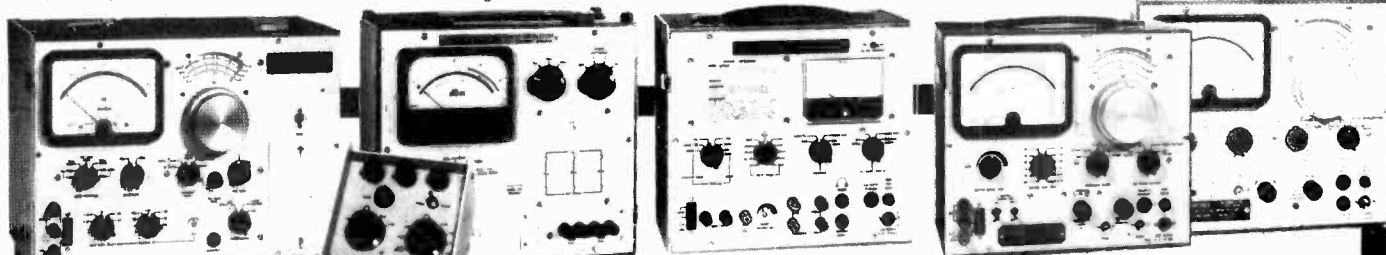

120 KHz Selective Measuring Set 1015/1016

Comprising Selective Level Meter, Type 1015 and Level Oscillator Type 1016. Frequency range: 30 Hz to 120 KHz; 140 and 600 ohm inputs and outputs. Measuring range: +25 dBm to -95 dBm. Oscillator output: +13 to -75 dBm. Synchronous tuning facility.



Hand-held Decibel Meter, 1008
20 Hz - 150 KHz; 75, 140, 600, 900 and 120 ohm inputs; range +21 dBm to -60 dBm.

Milliwatt Test Set 747
DC - 20 MHz; 75, 135/140 and 600 ohms inputs; range +1 dBm to -1 dBm.

Sponophometer Type 1000
30 Hz - 20 KHz with weighting filters; 600 ohms through and terminated and 30 Kohm inputs; range 10¹V - 300 V.

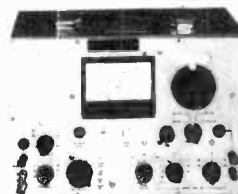

AF Selective Level Measuring Set 1001/1003
Comprising Selective Level Meter, Type 1001 and Level Oscillator, Type 1003. Frequency range: 30 Hz - 30 KHz; 140 and 600 ohm inputs and outputs. Measuring range: +21 dBm to -105 dBm. Synchronous tuning facility.

Wideband Flat Level Measuring Set 1017 20 Hz - 200 KHz; 75, 140 and 600 ohm inputs and outputs. Input range: +26 dBm to -56 dBm. Output range: +10dBm to -40 dBm.

HATFIELD TEST EQUIPMENT FOR VERSATILITY

The latest Selective Level Meters from Hatfield Instruments provide greater versatility in the 2KHz to 20MHz range. The new sets provide both level meter and oscillator, together with selective and wide band facilities in all frequency range groupings. Plug-in modules allow variations of bandwidth, upper and lower frequency limits. All instruments have a very high stability, excellent frequency discrimination and synthesised frequency generation. Basic frequency ranges covered are: 2KHz to 700KHz; 5KHz to 1.6MHz; 60KHz to 4.5MHz; and 60KHz to 12.5MHz. Further developments will extend the frequency range to 100MHz.

HATFIELD
forward thinking in electronics
HATFIELD INSTRUMENTS LIMITED

Burrington Way, Plymouth, PL5 3LZ, Devon. Telephone: Plymouth (0752) 772773 Telex: 45592. Grams: Sigjen, Plymouth.

WW - 067 FOR FURTHER DETAILS

NEW FROM STRUMECH

Electric powered winch (110 volt / 5 amp). Bolts directly onto existing towers without modification. Send for leaflet. Price £115 ex works.

VERSATOWER
Strumech Engineering Limited
Coppice Side, Brownhills, Walsall, West Midlands
Telephone: Brownhills 4321

WW-013 FOR FURTHER DETAILS

PRECISION PETITE LTD.
119A HIGH STREET, TEDDINGTON, MIDDX.
TEL. 01-977 0878

Now with the:

NEW MK. II DRILL

10,000 r.p.m., 120 cmg.

"MORE POWER - MORE TORQUE"

12v. - 14v. DC
DRILL ONLY £8.00 (P.P. 35p)
STAND £4.00 (P.P. 35p) Incl. VAT
(Together 50p P.P.)
SAE for illustrated leaflet and order form

TEAC

TEAC A3340(S)
4-CHANNEL
RECORDER



Industrial version upgraded to studio requirements, with increased signal to noise performance and improved reliability. Four totally independent channels each with sel sync, input mixing, switchable VU's and all the facilities for easy multitracking. This industrial model is in more studios than any other version.

Available only from ITA
(Semi-pro version also available)
IMMEDIATE DELIVERY

REVOX

REVOX A-700 SERIES

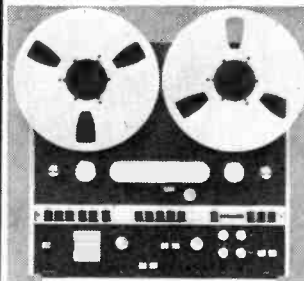

The new big Revox — ideal for all studio requirements. Highly sophisticated design features include servo tape tension, full deck logic, crystal controlled servo electronics, 3 speeds, tape footage counter.

£690 IMMEDIATE DELIVERY

The famous A77 has been consistently improved over the past 8 years and is now available in the latest Mk. 4 version.

The wide choice of specifications includes versions for duplicating and logging applications. Backed by UK's latest fastest service.

A-77 SERIES Mk4



Hire service Check our prices from £340 IMMEDIATE DELIVERY

ITA

ITA 10-4
MODULAR MIXER

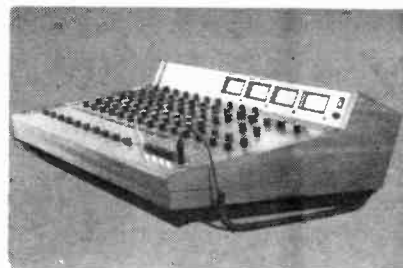

Ten balanced inputs; four output groups, 4 limiters; bass mid and treble EQ, modular construction, headphone monitoring. Extremely high quality construction only matched by mixers costing around £1,000.

10-4 £690

20-4 £1190

EIGHT OUTPUT £1260

IMMEDIATE DELIVERY

Also available for hire

PRICES EXCLUSIVE OF V.A.T.

Industrial Tape Applications



5 Pratt Street, London NW1 OAE
Telephone: 01-485 6162. Telex: 21879

Bench size ultrasonic cleaners from American Beauty

Five new Ultrasonic cleaners which will clean items and assemblies that cannot be cleaned any other way. Cleans in minutes without scrubbing, rubbing or disassembly.

For example — suitable for electronic components and assemblies, intricate glassware, camera parts, lenses and other optical items.

Cleans by means of high frequency sound waves — 50-55,000 cycles per second. Solid state circuitry. Completely self contained — NO EXTERNAL GENERATOR required. Portable — the smallest is a 5' cube.

Largest capacity is 1 gallon (US). Virtually indestructible transducer. Long life — low cost.

Catalogue of cleaners, accessories and prices from: Special Products Distributors Ltd., 81 Piccadilly, London W1V 0HL Telephone: 01-629 9556.

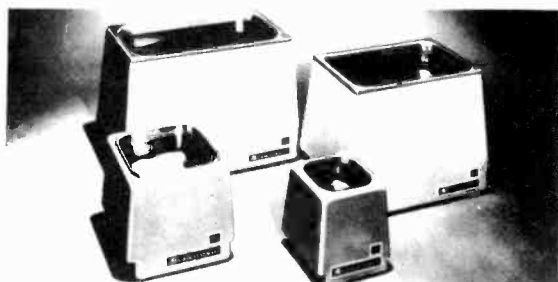

WW — 054 FOR FURTHER DETAILS

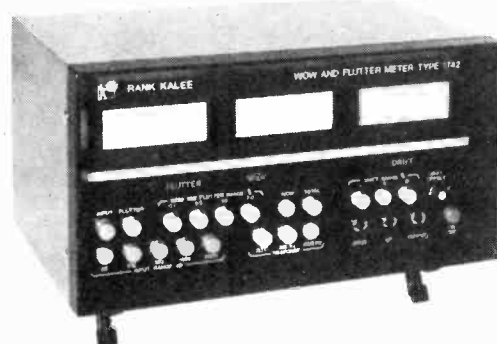

*
The new Rank

WOW & FLUTTER Meter Type 1742

Fully transistorised for high reliability

Versatile

Meets in every respect all current specifications for measurement of Wow, Flutter and Drift on Optical and Magnetic sound recording/reproduction equipment using film, tape or disc

High accuracy

with crystal controlled oscillator

Simple to use

accepts wide range of input signals with no manual tuning or adjustment

Two models available:

Type 1742 'A' BS:4847:1972 DIN 45507
CCIR 409-2 Specifications
Type 1742 'B' BS 1988:1953 Rank Kalee Specifications

For further information please address your enquiry to Mrs B. Nodwell

Rank Film Equipment, PO Box 70
Great West Road, Brentford
Middlesex TW8 9HR



RANK FILM EQUIPMENT

Tel: 01-568 9222 Telex 24408 Cables Rankaudio Brentford

WW—014 FOR FURTHER DETAILS

- P.A. SYSTEMS FOR AIRPORT, HOTEL, FACTORY.
- THEATRE AND LECTURE THEATRE AUDIO SYSTEMS
- AUDIO MIXING EQUIPMENT
- SIMULTANEOUS TRANSLATION SYSTEMS
- RADIO AND T.V. BROADCAST SOUND CONTROL EQUIPMENT
- MARINE INTERCOMMUNICATION AND ENTERTAINMENT EQUIPMENT
- *System design, manufacture and installation.*



audix

AUDIX LIMITED
 Wenden, Saffron Walden, Essex CB11 4L9
 TEL. Saffron Walden (0799) 40888: TELEX: 817444

BIMBOARD

Stop Ruining Your I.C.'s And Wasting Time Soldering
 Plug Into The Revolutionary New

BIMBOARD

The Only Professional Quality Breadboard That
 Accepts All DIL Packages With 6 To 40 Pins

Incorporates Bus Strips For Vcc And Ground

Includes A Component Support Bracket

Has Over 500 Individual Sockets

And Allows You To Use And Re-Use
 IC's, Transistors, LED's, 7 Segment Displays,
 Diodes, Resistors, Capacitors

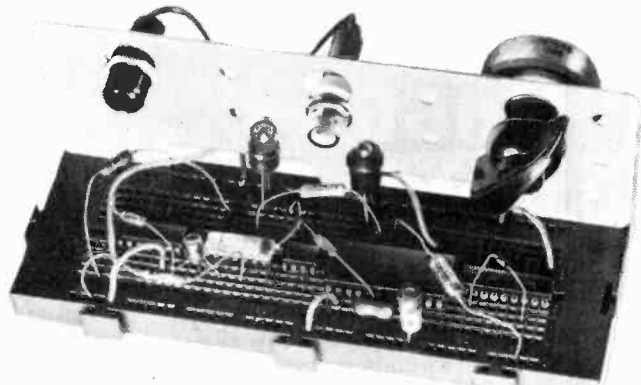

Only £9.72 (cheque with order) Including VAT and P.P.
 Special Quantity Discounts Available For
 Radio Clubs, Retail Outlets, Distributors

BOSS INDUSTRIAL MOULDINGS LTD

Higgs Industrial Estate, 2 Herne Hill Road, London, SE24 0AU, England
 Telephone 01-737 2383 Telex 919693

**DATA AND
 COMMUNICATIONS
 TERMINALS**

Teletype 28, 32, 33, 35, 40
 TermiNet 30, 300 & 1200 (30 and 120 cps)
 Teleterm 1030 & 1132 (portable 30 cps
 with integral coupler and RS 232C)
 Other page printers (by Siemens, ITT Creed, etc.)
 TermiNet 120 line printer

- ★ Spares, repairs, overhauls and maintenance
- ★ Other types and models available
- ★ Refurbished units also available
- ★ Short and long period rentals
- ★ Minicomputer interfaces
- ★ Quantity discounts
- ★ Immediate delivery

TELEPRINTER EQUIPMENT LTD.
 70-80 AKEMAN STREET,
 TRING, HERTS., U.K.

Telephone 0442-82-4011
 Cables RAHNO Tring
 Telex 82362
 A/B Batelcom Tring

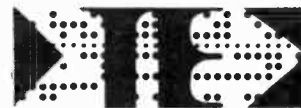

WW-010 FOR FURTHER DETAILS

**fault finding-
 no fiddle**

With the AVO TT 169 in-circuit transistor tester.
 Go/No Go tests almost any transistor, diode or
 thyristor without de-soldering, without damage.
 Find out how it can save you time, save you
 money.

You'll find the price is no fiddle either.
 Contact your local wholesaler, or us:



AVO Limited, Dover, Kent CT17 9EN.
 Telephone: Dover (0304) 202620

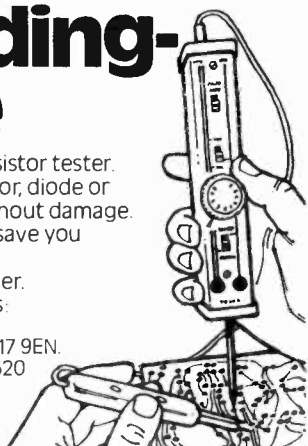

WW - 062 FOR FURTHER DETAILS

N.A.B'C' CARTRIDGE TAPE TRANSPORTS

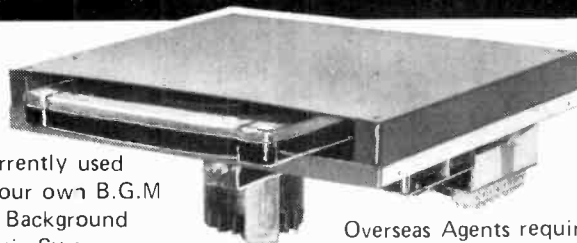

Currently used
 in our own B.G.M
 50 Background
 Music System

Overseas Agents required

For further information write or telephone :
FITCH TAPE MECHANISMS
 7a Balham Grove London SW12 01-673 1362

WW-058 FOR FURTHER DETAILS

NEW FROM COMPUTER APPRECIATION!

- PDP 11** 8k Memory Module, type MM11L, £625.00.
- PDP 8L**, 12k with Teletype, £1,300. PDP 8L, 4k without Teletype, £650.00.
- ASR 33** Teletype, with 20mA current-loop interface and reader control, £325.00.
- MELCOM** Model 84 Minicomputer with 12k fixed head disk, paper tape reader and punch, I/O typewriter and two V.D.U. units, £925.00.
- ITEL** Paper Tape golfball typewriter, ex-demo, £275.00.
- FRIDEN** Model 2305 FLEXOWRITER, ASCII coded, suitable for n/c tape prep., £575.00.
- GENERAL ELECTRIC** P112/V125 Punches and Verifiers for card orientated data-prep. Per pair, £125.00.
- EKCO** M5183 TTL Timer Counters. These units have very versatile switching, and will count frequency to 10MHz. A wide range of external control and outputs are provided. NEW, £48.00.
- PRINTEC** Model 100 High Speed (100cps) printer. Very compact unit with several alternative interfaces available, EX-DEMO, £395.00.
- FACIT** Model 4001 High Speed (capacitive) paper tape reader, £375.00.
- HONEYWELL** High Speed punched card SORTER, £195.00.
- GENERAL ELECTRIC** 7-Track Magnetic tape units. With electronics and documentation, £75.00 each, or 2 for £100.00.

**Computer Appreciation, Castle Street, Bletchingley, Surrey RH1 4NX
088 384 (Godstone) 3106**

It's the cat's whiskers!



A fascinating excursion into the past. The author has unearthed some 400 trade names from the crystal set days, along with nearly 200 manufacturers—giving the name of the set, technical description and original price. He also reviews the first days of broadcasting and looks at the difficulties experienced by crystal set users. Concise information and over 40 illustrations make this book a valuable work of reference as well as a rare piece of nostalgia for collectors.

VINTAGE CRYSTAL SETS 1922-1927

£2.50 from bookshops

£2.80 inclusive direct from Wireless World, Room 11, General Sales Dept., IPC Business Press Ltd., Dorset House, Stamford Street, London SE1 9LU.

Name

Address

wireless
world

JES AUDIO INSTRUMENTATION

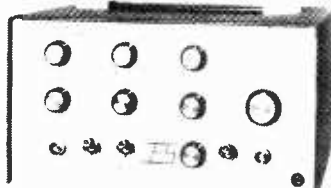

Illustrated the Si452 Distortion Measuring Unit—low cost distortion measurement down to .01% **£40.00**

Si451 **£50.00**
Comprehensive Millivoltmeter
350µ Volts 20 ranges

Si453 **£50.00**
Low distortion Oscillator
sine — square — RIAA

prices plus VAT

J. E. SUGDEN & CO. LTD. Tel. Cleckheaton (0274) 872501
CARR STREET, CLECKHEATON, W. YORKSHIRE B19 5LA

WW—034 FOR FURTHER DETAILS

AC/DC MULTIMETER TYPE U4324*

With taut band suspension movement

High sensitivity movement and full coverage of AC and DC current and voltage ranges

0.05-0.6-6.60-600mA-3 Amps DC
0.3-3-30-300mA-3 Amps AC
0.6-1.2-3-12-30-60-120-600-1200 Volts DC
3.6-15-60-150-300-600-900 Volts AC
45 to 20 000 Hz Freq Range
500Ω! 5-50-500kΩ!
25Ω-0.5-50kΩ!
5MΩ! Res. Range

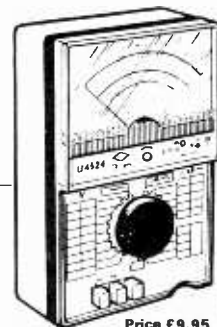

Price **£9.95**
+ 8% VAT

*** STAR OFFER**
BC 207
50 for **£2.50** + 25% VAT
Plastic BC 107

*** STAR OFFER**
2N 3055A
8 for **£2.50** + 8% VAT

*** STAR OFFER**
IN 4002
100 for **£2.50** + 8% VAT
Silicon rectifier
1 amp 100 volt

Please add VAT
and 20p P.&P.

Send Stamped Addressed Envelope for FREE Catalogue of over 2,000 Items

AMATEUR COMPONENTS
ORCHARD WORKS, CHURCH LANE, WALLINGTON, SURREY SM6 7NF

RADFORD HD250

High Definition Stereo Amplifier

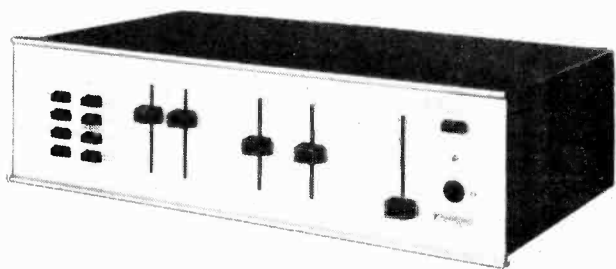

A new standard for sound reproduction in the home! We believe that no other amplifier in the world can match the overall specification of the HD250.

Rated power output: 50 watts av. continuous per channel into any impedance from 4 to 8 ohms, both channels driven.

Maximum power output: 90 watts av. per channel into 5 ohms.

Distortion, preamplifier: Virtually zero (cannot be identified or measured as it is below inherent circuit noise.)

Distortion, power amplifier: Typically 0.006% at 25 watts, less than 0.02% at rated output (Typically 0.01% at 1 KHz)

Hum and noise: Disc.—83dBV measured flat with noise band width 23 KHz (ref 5mV); —88dBV "A" weighted (ref. 5mv)

Line —85 dBV measured flat (ref 100v)
—88dBV "A" weighted (ref 100v)

Hear the HD250 at

SWIFT OF WILMSLOW

Dept. WW

5 Swan Street, Wilmslow, Cheshire (Tel. 26213)

Mail Order and Personal Export enquiries: Wilmslow Audio, Swan Works, Bank Square, Wilmslow (Tel. 29599)

Also in stock: All Radford speaker drive units and crossovers, ZD22 preamp, Low Distortion oscillator LD03 and Distortion Measuring set DMS3.

WW—011 FOR FURTHER DETAILS

A.S.P.

(Dept. WW4), SIMMONDS ROAD
WINCHEAP, CANTERBURY, KENT
Tel: (0227) 52436

CASED TRANSFORMERS

Housed in smart resin coated steel cases with 3 core power cable and outlet socket, fused primary winding, isolation types are fitted with 3-pin outlet sockets and are available with 110 volt or 240 volt output (Please state). Auto types are fitted with 2-pin flat style sockets up to 500 VA. 3 pin sockets from 750 to 3000 VA. See Auto and isolation sections for prices. Plugs extra.



TRANSFORMERS

See catalogue for full range

30 VOLTS		See catalogue for full range	
AMPS	Ref. No.	PRICE £	Post £
0.5	112	2.17	0.51

See catalogue for full range

50 VOLTS		See catalogue for full range	
AMPS	Ref. No.	PRICE £	Post £
1	103	3.67	0.76
2	104	5.57	0.85

See catalogue for full range

60 VOLTS		See catalogue for full range	
AMPS	Ref. No.	PRICE £	Post £
0.5	124	2.72	0.72
1	126	4.08	0.72
2	127	5.63	0.85

SAFETY ISOLATING

See catalogue for full range
Prim. 120/240V. Sec. 120/240V Centre Tap with screen.

VA (WATTS)	REF No.	PRICE Cased £	PRICE 2 Pin + 1 Earth £	PRICE Open £	Post £
60	149	9.46	0.98	5.02	0.72
200	151	12.87	0.98	9.07	0.97
250	152	14.47	0.98	10.81	1.18

AUTO TRANSFORMERS

See catalogue for full range

VA (Watts)	Ref. No.	PRICE Cased £	PRICE Plugs 2 & 3 pin £	PRICE Open £	Post £
1500	93	£24.37	0.95	20.13	0A

MINIATURE & EQUIPMENT

See catalogue for full range
Primary 240V with Screen

VOLTS		MILLIAMPS		REF No.	PRICE £	Post £
Sec. 1	Sec. 2	Sec. 1	Sec. 2			
3-0-3	—	200	—	238	1.75	0.34
0-6	0-6	500	500	234	1.75	0.34
0-6	0-6	1000	1000	212	2.33	0.46
0-9-9	—	100	—	13	1.75	0.34
0-9	0-9	330	330	235	1.75	0.34

12 and 24 VOLTS PRIMARY

See catalogue for full range
200-240 Volts

AMPS		REF No.	PRICE £	Post £
12V	24V			
0.3	0.15	242	1.66	0.34
0.5	0.25	111	1.60	0.46
1	0.5	213	1.90	0.61
2	1	71	2.64	0.61
4	2	18	3.17	0.62
6	3	70	4.82	0.72
8	4		5.65	0.85

2" AND 4" PANEL METERS

See catalogue for full range
2" SIZE: 60mm wide x 45mm High x 40mm Deep
4" SIZE: 110mm wide x 82mm High x 43mm Deep
VM Meters are complete with detectors. Modern wide view 25% VAT. Price £3.30
Post 10p. Price 4" £4.10. Post 10p. Lamps 60p per set. Plus 8% VAT

BRIDGE RECTIFIERS

ONE AMP	Price	FOUR AMP	Price
50 P.I.V.	0.25	100 P.I.V.	0.60
100 P.I.V.	0.30	200 P.I.V.	0.65
200 P.I.V.	0.35	400 P.I.V.	0.80
600 P.I.V.	0.40	600 P.I.V.	1.10

TWO AMP	Price	SIX AMP	Price
50 P.I.V.	0.40	50 P.I.V.	0.70
100 P.I.V.	0.45	100 P.I.V.	0.75
200 P.I.V.	0.50	200 P.I.V.	0.90
400 P.I.V.	0.55	400 P.I.V.	0.95

25% VAT on all prices

SPECIAL OFFER!

2 KVA ISOLATORS
Fully impregnated & screened.
2 primary windings 110V each
2 secondary windings 115V each
(2 matching transformers)
£29.50 plus carr. & VAT.

★ PLEASE ADD 8% VAT ON ALL TRANSFORMERS & METERS

NEW CATALOGUE 25p

EXPO DRILLS LTD.

LONDON

Illustrate—

A TITAN DRILL mounted in a MULTI PURPOSE STAND

This drill is a powerful tool running on 12v DC at approx. 9000 rpm with a torque of 350 gm. gm. Chuck capacity 3.00 m/m.

The multi-purpose stand is robustly constructed of steel and aluminium. The base and bracket are finished in hammer blue.

Also available for use in the stand is the RELIANT DRILL which is a smaller version of the Titan. Approx. speed 9000 rpm, 12v DC, torque 35 gm. cm. Capacity 2.4 m/m.

TITAN DRILL

ONLY Cat. No. 175

£9.61 + 35p p & p inc. VAT

RELIANT DRILL

ONLY Cat. No. 0150

£5.64 + 18p p & p inc. VAT.

MULTI-PURPOSE STAND

ONLY Cat. No. 0200

£11.44 + 75p p & p inc. VAT

ADAPTOR COLLAR FOR RELIANT DRILL

Cat. No. 0201

£0.43 + 11p p & p inc. VAT

These are only two examples of the extensive range of power tools designed to meet the needs of development engineers, laboratory workers, model makers and others requiring small precision production aids.

To back up the power tools Expo Ltd offer a comprehensive selection of Drills, Grinding Points and other tools.

SEND S.A.E. (foolscap) for full details to main distributors:

A. D. BAYLISS & SON LTD.

Pfefa Works, Redmarley, Glos GL19 3JU

Tel: Bromesberrow (STD 053 181) 273 and 364

Stockists: Richards Electric, Worcester and Gloucester, Hoopers of Ledbury Hobbs of Ledbury

WW — 074 FOR FURTHER DETAILS

a star is born..



ROTEX

Emmen Holland

ask for our catalogue!

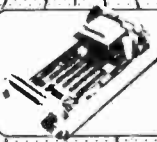

FREQ. COUNTERS
RFC 30
RFC 250

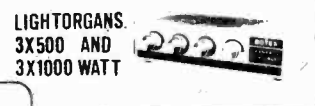

LIGHT ORGANS.
3X500 AND
3X1000 WATT



2 MTR. RECEIVER



DIN NORM

STEREO MIXERS 6 MODELS



POWER SUPPLIES
PS.2
0.30V
2 A



LIGHT DIMMERS

and a large variety of electronic modules.

sales only via wholesale dealers

RADIO ROTOR EMMEN HOLLAND

P.O. BOX 260, TELEF. 01031-5910-16810, TELEX 53910

WW—015 FOR FURTHER DETAILS

The easy to use, easy to buy, general purpose scope~the D61a

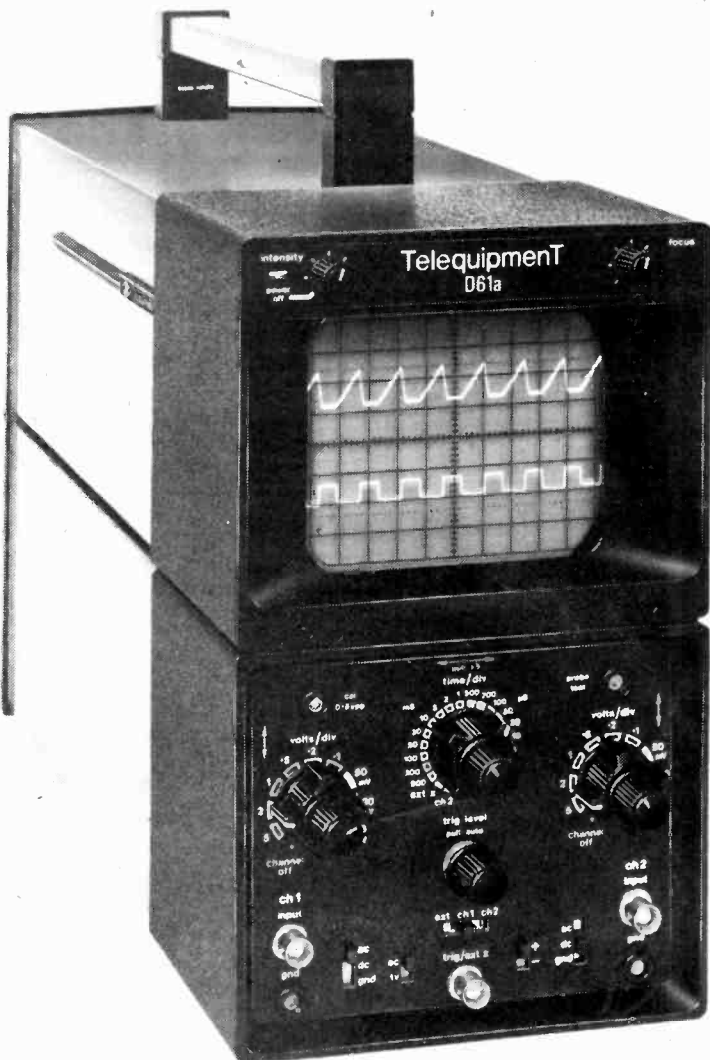

Versatile~that's our scope

D61a dual trace Lightweight Oscilloscope

The 10 MHz 'scope that makes others seem expensive at any price!

It took years of Telequipment experience and intensive design effort to arrive at that unique combination of effortless higher performance and remarkable low cost which makes the D61a so outstanding for general purpose duties in the laboratory, the classroom and the TV service department.

Who else offers an oscilloscope with two 10mV vertical channels with a full 10MHz bandwidth, PLUS automatically switched, chopped or alternate display modes, PLUS automatically switched TV line or field triggering, PLUS an 8" x 10 cm display driven at 3.5kV and the choice of single trace, dual trace or X-Y presentation?

And who will send you full details on request?

Who else but Telequipment

Tektronix U.K. Limited,
P.O. Box 69, Beaverton House, Harpenden, Herts.
Tel: Harpenden 63141 Telex: 25559

TELEQUIPMENT



wireless world

Electronics, Television, Radio, Audio

AUGUST 1976 Vol 82 No 1488

Contents

- 27 **Broadcasting from on high**
- 28 **Satellite broadcasting developments**
- 30 **Teletext at Heda. H.F. predictions**
- 31 **The inventors** by John Dwyer
- 36 **News of the month**
 - Dolby f.m. up-date
 - Mobile radio consortium formed
 - Citizens' Band radio association
- 39 **Surface acoustic wave devices** by J. Highway
- 44 **Letters to the editor**
 - Low-noise cassette deck
 - Phase — Amos and Moir
 - Communication theory
- 47 **Self-setting time-code clock** by N. C. Helsby
- 52 **Circuit ideas**
 - Tone burst generator for testing p.p.ms
 - Fast modulo 3 counter
 - Direct reading transistor tester
- 55 **Low noise, low-cost cassette deck — 3** by J. L. Linsley Hood
- 56 **Announcements. Sixty years ago**
- 57 **Surround-sound decoders — 3** by David Heller
- 60 **Electronics in measurement**
- 63 **Characteristics and load lines** by S. W. Amos
- 67 **World of amateur radio**
- 68 **Earthing, shielding and filtering problems** by R. C. Marshall
- 70 **Optical fibre communications**
- 71 **Digital colour TV via satellite**
- 72 **New products**
- 74 **APRS exhibition notes**
- 76 **Real and imaginary** by "Vector"
- 106 **APPOINTMENTS VACANT**
- 120 **INDEX TO ADVERTISERS**

Price 35p (Back numbers 50p, from Room 11, Dorset House, Stamford Street, London SE1 9LU.)
Editorial & Advertising offices: Dorset House, Stamford Street, London SE1 9LU.
Telephones: Editorial 01 261 8620; Advertising 01-261 8339.
Telegrams/Telex. Wiworld Bisnespres 25137 London. Cables. "Ethaworld, London SE1."
Subscription rates: 1 year: £7.00 UK and overseas (\$18.20 USA and Canada). Student rate: 1 year, £3.50
UK and overseas (\$9.10 USA and Canada).
Distribution: 40 Bowling Green Lane, London EC1R 0NE. Telephone 01-837 3636.
Subscriptions: Oakfield House, Perrymount Rd, Haywards Heath, Sussex RH16 3DH. Telephone
0444 59188. Subscribers are requested to notify a change of address.

© I.P.C. Business Press Ltd, 1975



Photographer Paul Brierley

Front cover this month shows part of a high voltage generating circuit for an electron microscope made by the General Electric Company.

IN OUR NEXT ISSUE

Citizens' Band radio. How CB has developed in the USA, how it is being used, and how the industry and FCC are coping with demand for equipment and channels.

Projection television. Technical survey of principles of optical systems used for projection and descriptions of equipment now on the market.

Non-linear characteristics. Circuits which need non-linearity for their action. Part 2 of series on characteristics and load lines.

SIXTY-SIXTH YEAR
OF PUBLICATION



Does your
present radio test
equipment
measure up to this?

The Solartron Schlumberger 4010A/4011

Time was when radio testing meant a clutter of space-consuming instruments, complex inter-connections, and out-of-phase calibrations.

We've changed all that. We've built a complete range of radio test equipment into a single compact unit – the Solartron/Schlumberger Manual Radio Test Set. It comes in two models: 4010A and 4011.

Features include a synthesizer covering the range 0.01 to 480MHz, depending on model, with decade manual and remote control facilities; FM, Φ M, and AM modulation; frequency counter; RF power meter; AF millivoltmeter; AF generator; and a distortion meter and filter for noise weighting.

The Solartron/Schlumberger 4010A/4011. The compact unit that measures everything in manual radio testing. Simply. Reliably. Quickly.

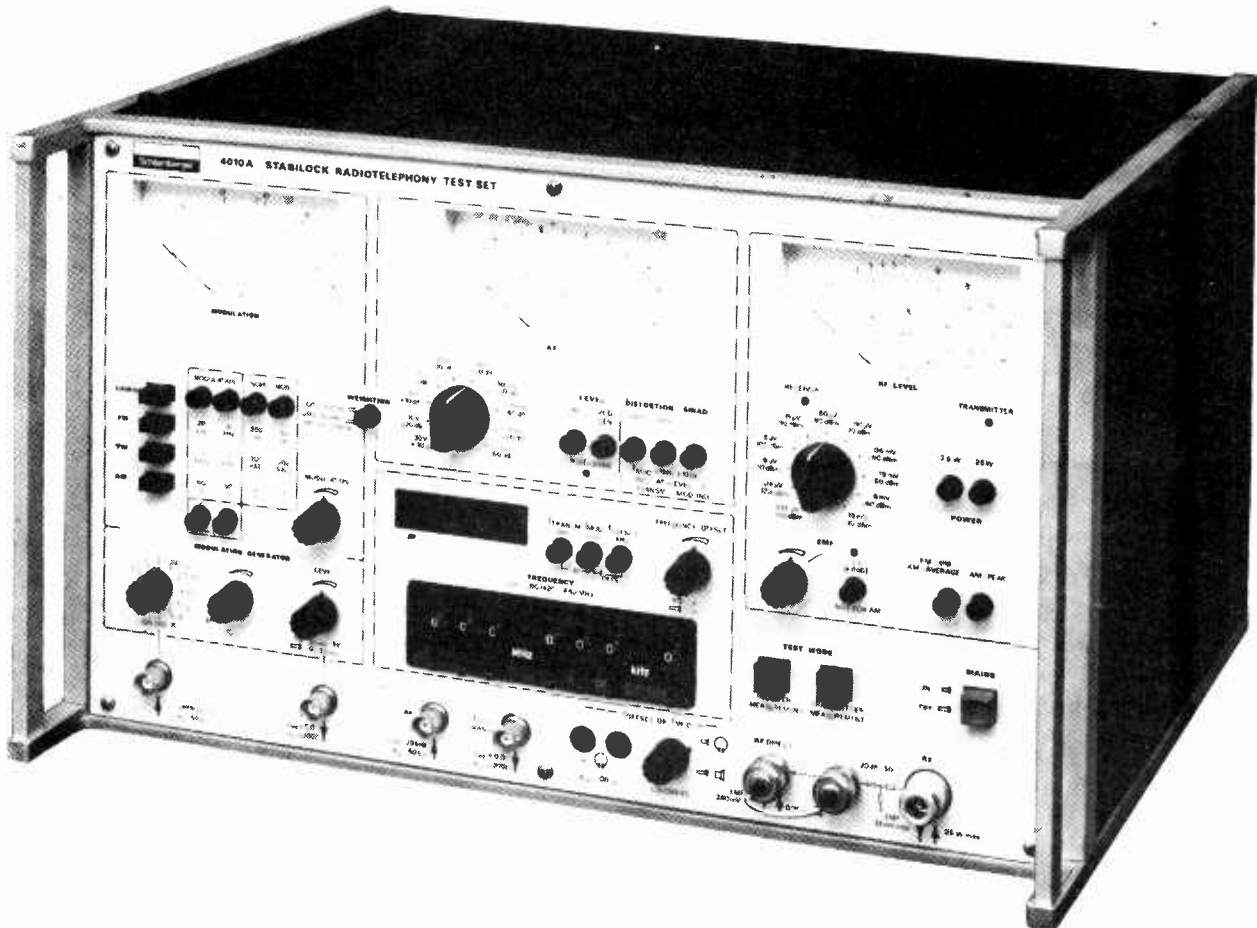

SOLARTRON

Schlumberger

The Solartron Electronic Group Ltd.,
Farnborough, Hants. England.

Telephone: (0252) 44433. Telex: 858245.

wireless world

Broadcasting from on high

Editor:

TOM IVALL, M.I.E.R.E.

Deputy Editor:

 PHILIP DARRINGTON
Phone 01-261 8435

Technical Editor:

 GEOFFREY SHORTER, B.Sc.
Phone 01-261 8443

Assistant Editors:

 MIKE SAGIN
Phone 01-261 8429

 RAY ASHMORE, B.Sc., G8KYY
Phone 01-261 8043

Production:

D. R. BRAY

Advertisements:

 G. BENTON ROWELL (*Manager*)

 NIGEL LITTERICK
Phone 01-261 8037

 LEO KEMBERY
Phone 01-261 8515

 O. BAILEY (*Classified Advertisements*)
Phone 01-261 8508 or 01-261 8423

 JOHN GIBBON (*Make-up and copy*)
Phone 01-261 8353

Publishing Director:
GORDON HENDERSON

Direct broadcasting from geo-stationary satellites — for which we are now witnessing the first experiments — will certainly be a boon to the broadcasters. In the first place it allows coverage of enormous land areas, of a million or more square miles, at low cost from a single, sun-powered r.f. source of only 100 watts or so; and this is particularly economical when the population is dotted about in small isolated communities. It eliminates reception problems for people who live in mountain valleys or other places which are in the shadows for terrestrial broadcasting. And in countries which already have highly developed systems of terrestrial broadcasting it offers the possibility of additional services. In the last-mentioned situation, of course, the satellite broadcasting stations must use frequencies which do not interfere with the established terrestrial u.h.f. or v.h.f. transmissions used for existing services, and an article in this issue mentions how the 12GHz bands allocated by the ITU for satellite broadcasting will come into play here. A great advantage of such centimetre wavelengths is that they allow very selective coverage: satellite transmitter aerials of reasonable size can send very narrow beams to illuminate small areas.

One of the interesting, and difficult, problems that has yet to be faced with broadcasting satellites is interference — both in the frequency sense and in the political/social sense. Already there is a possibility of frequency interference occurring between synchronous communications satellites stationed above the Indian Ocean. With broadcasting satellites it is theoretically possible for country A maliciously to send programme signals to a satellite belonging to country B and so attempt to broadcast the programmes to country B, but in practice, of course, this would be pointless because both country A's programmes and country B's programmes would be made unintelligible by mutual interference. But malicious jamming could take place on this principle.

More innocent, but nevertheless potentially troublesome, is the possibility of overlapping service areas. We have already seen that India's television programmes can be received via the ATS-6 satellite in Northern Europe (March 1976 issue, pp.68-70) — though this might be dismissed as a DX-ing activity. A particular problem arises where there are adjacent countries with widely differing political/social/economic systems (e.g. Western Europe and Eastern Europe), and the sustaining of the different ideologies relies partly on the control of broadcast programmes. In such a situation the overlapping of service areas of broadcasting satellites may be seen as adding something new to the techniques of propaganda, even though it is not different in principle to the overlapping that occurs in conventional broadcasting. This problem of "overspill" in satellite broadcasting has already been discussed at the United Nations. For such reasons the development of satellite broadcasting services can never remain purely in the realm of engineering.

Satellite broadcasting developments

After India, first steps by Canada, Japan, Russia and Europe

The undoubted technical success of the Indian experiment in direct television broadcasting from a satellite (see March 1976, p.68, Dec. 1975, p.549, Dec. 1973, p.609) has been a great encouragement to all engineers and administrators working in this field of direct broadcasting from synchronous satellites. The social results have yet to be assessed and the indications are that things are not as rosy as on the technical side — we have been told, for example, that the ATS-6 broadcasting experiment in 1975 for isolated communities in North America was considered a failure.

Meanwhile three more such experiments are going ahead, in Canada, Japan and the USSR. The Canadians have built a satellite, the CTS (Communications Technology Satellite) which was launched by NASA in January 1976, and among other things it is hoped to use the high power 12GHz transmitter of this to test experimental receivers for satellite broadcasting. Then in 1978 the Japanese will be broadcasting from a satellite built in the USA and also launched by NASA. The interesting point about these two experiments is that they are the first to attempt to use the 12GHz band allocated by the International Telecommunication Union for satellite broadcasting* and a new era of microwave television receiver technology is about to be ushered in. (D. B. Spencer and K. G. Freeman gave some indication of the nature of this receiver technology in their article "Television broadcasting from satellites" in our March 1974

issue.) Also, in January 1977, the International Telecommunication Union will be holding a planning conference for satellite broadcasting in the 12GHz band. A consultative group of the European Broadcasting Union for this type of service has in fact already stated that within the European broadcasting area it is possible to establish a plan for channel assignment, signal polarisations and positions of satellites in synchronous orbit that will allow each country to have a service of four television programmes and about 15 high-quality sound channels without causing unacceptable interference.

But why 12GHz? One basic reason for the choice of this allocation in the developed countries (e.g. Europe, Japan, North America) is that most of these countries already have estab-

lished terrestrial broadcasting networks working on u.h.f. and the use of the ITU's satellite broadcasting allocation at u.h.f. would cause intolerable interference with these. By contrast the undeveloped countries (e.g. India, Brazil) have no such u.h.f. terrestrial broadcasting systems. A second reason for the use of the 12GHz band is that the small wavelengths in this frequency region, a few centimetres, make possible narrow beamwidths from the satellite transmitters — about 1° — so that small countries or small regions can be separately "illuminated" without too much overlapping or interference between transmissions. Also, small receiving aerials are possible (e.g. 75cm diameter with a satellite transmitter power of about 500W).

The Canadian CTS satellite — actually Canada's eighth satellite — was built at the Communications Research Centre near Ottawa, with subcontractors Spar Aerospace for the structure and RCA for electronics. It is in synchronous orbit above the equator at 116°W longitude and is maintained in station to an accuracy of $\pm 0.2^\circ$, with comparable pointing accuracy, using

Ancient and modern materials are combined in this receiving antenna used in India for the ATS-6 satellite television broadcasting experiment. Wire mesh dish is supported in a mud and brick structure built to face the satellite

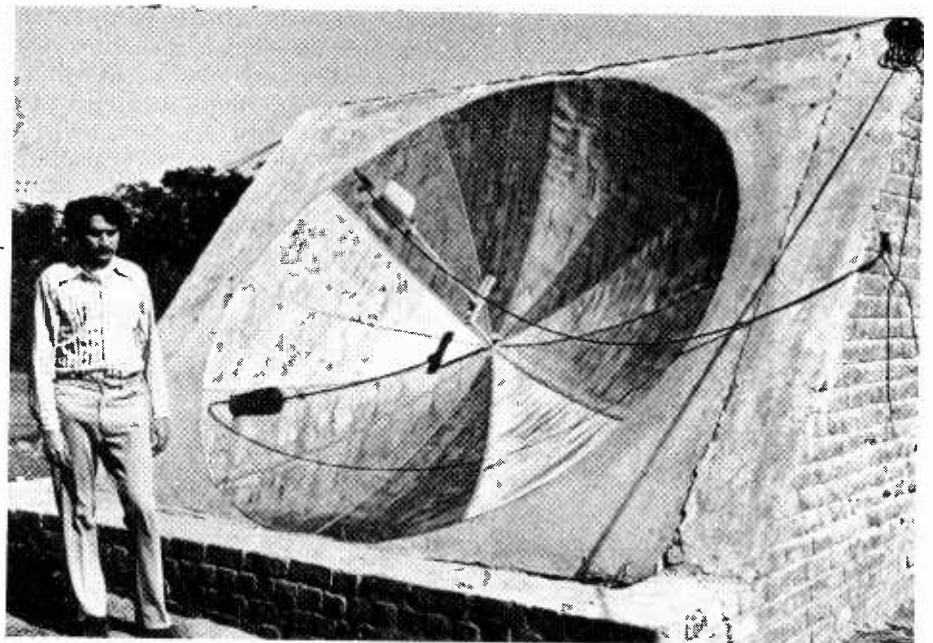

*At the 1971 World Administrative Radio Conference the ITU authorized a number of allocations for these direct broadcasting services: for Region 1, 11.7 to 12.5GHz, and for Regions 2 and 3, 11.7 to 12.2MHz, on a shared basis between satellite and terrestrial broadcasting and the fixed and mobile services (including fixed services by satellite in the case of Region 2 only); 620 to 780 MHz (u.h.f.) for f.m. television signals, provided these do not unduly interfere with existing terrestrial systems; 2.5 to 2.69 GHz on a shared basis with fixed and mobile services; and two other bands 41 and 43 GHz and 84 to 86 GHz. The Indian experiment, on 860 MHz, is not within the official u.h.f. allocation, and a permanent service in India would have to lie within the 620-780 MHz band or in a higher band.

three-axis stabilization (to which it was transferred from spin stabilization). Electrical power of about 1kW is provided by 27,000 solar cells carried on a pair of 22ft x 4ft "sails". The transmitter's maximum r.f. output of 200W at 12GHz is provided by a travelling-wave tube, supplied by NASA, but unfortunately the associated power-supply switching system developed a fault soon after launching. It is hoped nevertheless that the high-power tube can be operated satisfactorily for certain periods. Also on board is a 20 watt 12GHz travelling-wave tube, contributed by the European Space Agency, which can be directly connected to the antenna to provide a lower-power transmission. Signals are sent up to the CTS in the 14GHz communications satellite band.

There are two gimbal antennas on the spacecraft, each being used simultaneously for transmission and reception. Each antenna provides a beam coverage area corresponding to that of a 2.5° circular beam, and can be positioned by command from the ground so that the beam can be aimed at any point within a 15° cone. In the transmission bands (11.843 - 11.928 GHz and 12.038 - 12.123 GHz) the effective isotropic radiated power (e.i.r.p.) capability is 60 dBW (compared with 51 dBW for ATS-6) when using the 200-watt tube.

Although initiated by Canada, the CTS project is a co-operative Canadian/USA experiment and the satellite is being shared by the two countries on a 50-50 basis. The main purpose of the project is to try out various methods of broadcasting and communication to remote areas, and it will act as a relay for over 20 experiments, some of which will be purely engineering and some for social, administrative, scientific, educational, medical, entertainment and other such purposes. One of the broadcasting experiments, conducted by the Canadian Broadcasting Corporation will be to evaluate reception of 12GHz television signals in a metropolitan environment, using a 2-metre diameter dish antenna and a professional receiver. Another is planned to test direct satellite-to-home television broadcasting using a 1-metre dish and ordinary domestic television sets with 12GHz front ends made in Japan and Europe. A further experiment will be in sound broadcasting - sending the programme signals from studios via the CTS satellite to individual sound broadcasting stations. British made 12GHz receiving equipment has already been set up in Canada for evaluation with the transmissions.

Canada's main ground control station for the CTS is in Ottawa and uses a 9-metre diameter dish antenna. The expected life of the CTS itself is about two years.

The Japanese experimental direct broadcasting satellite, called BSE

(Broadcasting Satellite Experiment) and made by General Electric in the USA with sub-system by Toshiba, will be launched by NASA in February 1978. It will be placed into synchronous orbit over the equator at about 110°E, approximately over Borneo, and will keep in station with an accuracy of $\pm 0.1^\circ$ and have a pointing accuracy of $\pm 0.2^\circ$. The 12 GHz transmitter will have two travelling-wave tubes, each with an r.f. output power of 100W, and the shaped beam from the satellite's antenna, which has an elliptical reflector, will be adapted as closely as possible to include the Japanese outer islands but to reduce the radiation impinging on China, Korea and Siberia. The maximum e.i.r.p. will be 58dBW. Power for the electronic equipment is provided by two solar cell "sails" with nickel-cadmium secondary batteries, giving a power of about 800 watts.

This experiment will provide two frequency modulated colour television channels, each with a channel bandwidth of 25 MHz, and a number of sound channels. Again the signals will be sent up to the satellite in the 14GHz communications band. Expected life of the experimental satellite is three years.

One of the reasons why Japan needs a broadcasting satellite is that about a million households are located in mountainous areas (about 22% of the population), in remote islands, or in shadowed positions in cities, where normal terrestrial television reception is poor. Also, the Japanese expect an increasing demand for educational television channels in their country, and these could well be provided by a satellite.

As part of this Japanese experiment, four types of ground terminal will be tested. The largest will be a transportable station with a 4.5-metre dish antenna and two-way transmission of television and sound signals. Next in size will be a mobile station with 2.5m antenna and also with two-way television and sound transmission. The third type of terminal will be for reception only with antennas of 2.5m and 4.5m; while the fourth type will be for high quality community reception, using a very rigid, carefully oriented 1.6m antenna and a high quality television receiver. For s.h.f. reception a very neat 12GHz front end has been developed by NHK, the Japanese broadcasting organization, with a very low noise figure (500K noise temperature over a bandwidth of 180 MHz), only one down-conversion frequency change, and housed in a small box of about 3in x 1in. There is also a simplified f.m. to a.m. modulation converter for use with the television receiver.

The service area of the satellite is envisaged as being in two parts. There will be an inner part, including the four main islands of Japan, and for this a medium power electromagnetic flux density (-99 dBW/m^2) will be provided,

allowing the use of the 1.6m diameter receiving antennas and 500K noise-temperature receiver front ends. The outer part of the service area will extend over the remainder of the country, including the remote islands (such as the Sakishima Islands) and will receive a low power electromagnetic flux density (-110 dBW/m^2) requiring the use of the 4.5m diameter antennas. The possibility of signal attenuation due to rainfall at 12GHz has been studied, but this proves not to be too serious. Investigations made in Tokyo show attenuations of 1dB for 1% of the time and 7dB for 0.01% of the time.

In Russia a synchronous satellite called Statsionar T for television broadcasting within the territory of the USSR is being launched this year. It will be placed above the equator at 99°E longitude, above the eastern part of the Indian Ocean and will transmit in the official ITU u.h.f. satellite band at 714MHz. Signals will be sent up to it on 6.2GHz from a ground terminal at Gus-Khrustalnyi near Moscow. The first receiving stations will be community reception centres in Siberia, eastern regions beyond the Urals and places in the extreme north of the USSR. Distribution of sound and television programmes will be handled by a second Russian satellite, a synchronous communications type named Statsionar 2, which will be stationed at 35°E longitude over East Africa near to the ATS-6, and this will operate in the well established 4GHz and 6GHz communications bands.

Europe seems to be lagging behind with 12GHz broadcasting satellites, in so far as the broadcasting and other organizations are still only at the talking stage. The EBU consultative group in fact reports that an experimental, pre-operational broadcasting satellite, probably developed by the European Space Agency, could be launched in about 1980. There is less urgency in this part of the world because the European countries are already well served by terrestrial broadcasting systems. As the consultative group says: "It is becoming more and more evident that satellites will in the future form the best means for the broadcasting of national programmes to countries with relatively large surface areas, the terrestrial networks being better adapted to regional local and special programmes (for which there is an increasing need) as well as, naturally, national programmes in smaller or more-easily covered countries." The consultative group points out, however, that it may be advantageous for EBU countries to change eventually to satellite systems for national programmes, in place of the present terrestrial networks. However, even if this were to be done, conventional terrestrial transmitters are still likely to be needed to fulfil requirements for local programmes.

Teletext at Heda

The appearance at the Birmingham Home Electronics and Domestic Appliances exhibition of a large number of television receivers with teletext and Viewdata decoders built in may have deceived the casual onlooker into thinking that this type of set is almost in the shops. Conversation with the exhibitors, however, made it plain that this is not the case and that most of the equipment on view was not even of pre-production status.

Many teletext receivers shown use the Tifax decoder made by Texas Instruments, for the very good reason that it is the only one available which employs large-scale integrated circuits to achieve a small and reasonably inexpensive unit. Some manufacturers said that they were using their own design of decoder, employing t.t.l. small or medium-scale integration (around 80 packages) but were "considering" Tifax or the Mullard l.s.i. module, when it appears. Most recent or new receivers can cope with teletext, but Rank Bush Murphy have used an acoustic surface wave filter in their i.f. amplifier for improved phase response. Degradation of signal down to the point where eye height (W.W. p.59, Mar. 1976) is 15-20% can be tolerated, according to most of the set makers we questioned.

All but one of the teletext demonstrations were by means of integral decoders, many using ultrasonic keypads combined with the ordinary receiver controls in a hand-held unit, but one company — Labgear — were

Tifax 14-package teletext decoder by Texas Instruments

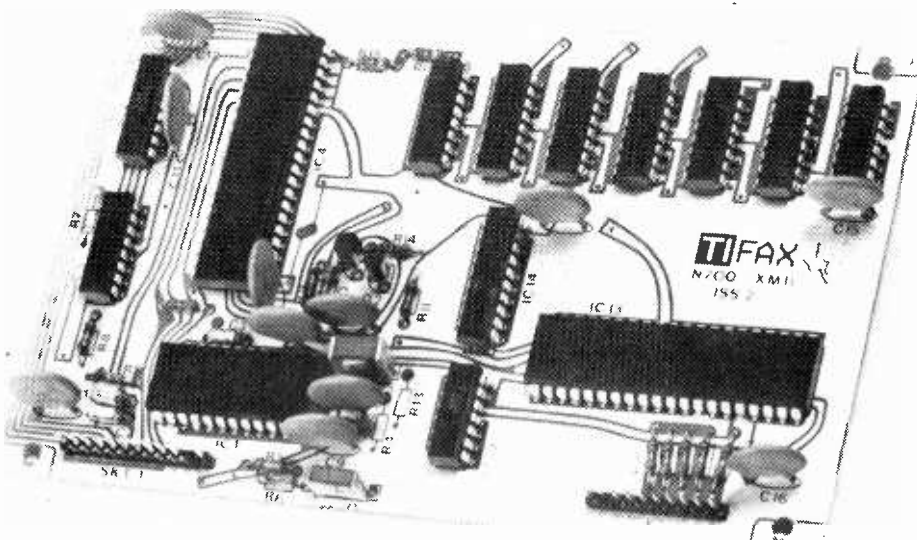

showing an "add-on" decoder which can be placed in the aerial lead. To do this, the signal is processed by low-noise u.h.f. tuner and i.f. strip, passed to a Tifax decoder and the teletext characters (not the data signal) modulated onto a u.h.f. carrier. The performance of the i.f. amplifier in this kind of system should be better than that of the amplifier in a normal receiver, since the character clocking rate is 7 Mbit/s. The data bits normally received are also at 7 Mbit/s, but are of "raised-cosine" form and in a non-return-to-zero code, which gives a bandwidth of 3.5MHz. The Labgear display was not as sharp as that normally seen and it was explained that the response of the amplifiers was such as to turn the rectangular character waveform into a rounded shape.

Decca's teletext receiver uses the Texas X887 r.o.m., which forms part of the Tifax unit, in a decoder of their own design. Facilities provided by Decca include the display of channel number, date and time when changing channels and the possibility of a doubling in height of parts of the display.

Viewdata was shown by most of the manufacturers, who use the r.a.m.s and character generators already present in teletext decoders and use a universal asynchronous receiver/transmitter (u.a.r.t.) or a Post Office modem and microprocessor for the signal-conditioning and organisation of the data. Manufacturers seemed optimistic about the future of teletext and Viewdata, although Michael Butler of Philips did think that more tests of the system in Europe were needed.

HF predictions

There is still no sign that solar activity is moving away from the low level experienced for the past two years. Comparison with previous sunspot minimum periods shows that it will be unusual if an increase has not started by the end of August. Sunspot numbers for the next six months are required to confirm that a distinct upward trend exists, but once this has been established a long-range sunspot number forecast using an increase of five per month for the following eighteen months can then be made with confidence.

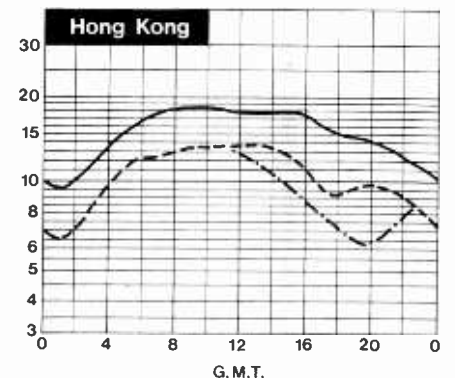
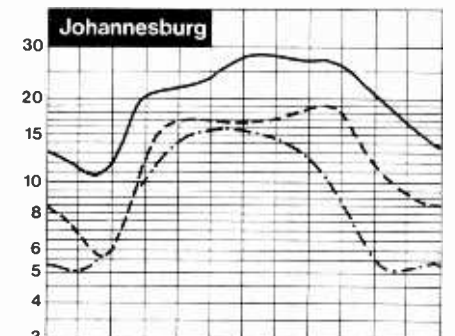
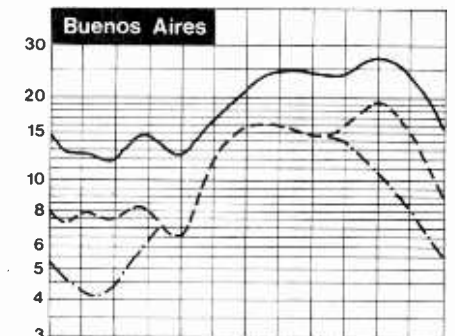
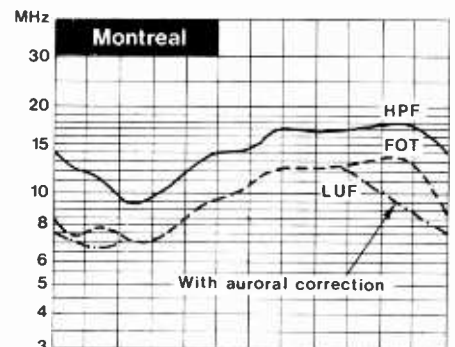

The inventors

Britain never had greater need of innovation and original ideas. Yet, when they do appear, how do we treat the innovators?

by John Dwyer

The traditional picture of the inventor is of one who is bald, bespectacled, and irredeemably dotty. However accurate that may be, it is usually true that the inventor refuses to listen to sensible advice, even that offered by those generally accepted as knowing far more about his chosen field of invention than he does.

But while his deafness may be an embarrassment to the new Royal Chartered aristocracy, the rest of us should be grateful for it. When D. E. Hughes demonstrated, with a telephone earpiece and what would now be described as a primitive copper-oxide rectifier, that he could hear the interruptions in a circuit located hundreds of yards away, the Royal Society were not impressed. He had walked up and down Great Portland Street, London, one day early in 1880 and the clicks in his earpiece could be heard 500 yards from where his "interrupter" was operating, but Sir George Stokes, president of the Royal Society, said the phenomenon was due to induction.^{1,2}

Another example of "misguided" persistence was Edwin Armstrong's advocacy of frequency modulation. In this case, Armstrong had a proven record — he had already invented the superheterodyne and had several feedback patents to his credit. He patented f.m. in 1933, but he met with opposition from the radio companies, many of whom were motivated less by any consideration of the technical merit of the system than by avarice, since they and the set manufacturers already had a stake in a.m. According to one account,³ Armstrong's idea was finally taken up by a rich friend, John Shepard, who owned the Yankee network. Shepard built a station for the new type of broadcasting and public demand did the rest. According to another⁴ Jack Hogan of Radio WQXR, which was owned by the New York Times, co-operated with Armstrong, allowing him to present the first regularly scheduled programme on f.m. radio, using music from WQXR on July 18, 1939.

The demand for static-free radio was immediate, large and lasting. By December, 1941, f.m. receivers were

being produced at the rate of 1,500 a day.

Despite the evidence available on the other side of the Atlantic it was May, 1955, before an f.m. service began in Britain. Field trials with low powered transmitters had begun ten years before, although, as Geddes⁵ puts it, "The results were encouraging, but did not yield a conclusive answer to the question 'a.m. or f.m.?' " Wrotham transmitter was built as an experimental high power transmitter broadcasting both a.m. and f.m. signals. It started that broadcast in July 1950. The official f.m. service began five years later, 22 years after Armstrong's patent.

It is easy now to be critical of the American stations and the BBC because, with hindsight, we know that f.m. was a good idea. Many ideas aren't so good. Eric Laithwaite, professor of heavy electrical engineering at Imperial College, London, and developer of the linear motor used in the Hovertrain, commented: "For every exploitable invention that is worthy there are a thousand that are not, and if you sit in the corridors of power trying to decide, how shall you decide whether there is genius when you yourself are not a genius?"

An inventive nation

As a nation we seem to have become used to the idea that we will invent the thing and the Americans will make money out of it. The Hovercraft seems a good example, but Britons invented the electric motor, the electromagnet, the telegraph, the computer, radio telegraphy, the radio valve, probably television, certainly radar and the cavity magnetron, to name just those things of direct interest to *Wireless World* readers. Others include Terylene, Rayon, polyethylene, stainless steel, foam rubber, Perspex, silicones, the electric vacuum cleaner(!), the disc brake, the carburettor, various forms of bicycle, Celluloid, the refrigerator, linoleum, the deck chair and the export-spinning miniskirt.

We don't always show inventors the door. Guglielmo Marconi had performed a series of successful experi-

ments in his native Bologna but could extract no help from the Italian Government. So he came to England, and went to see A. A. Campbell Swinton at his home in Victoria Street, London. Swinton gave him a letter of introduction to Sir William Preece, Engineer-in-Chief of the Post Office and himself an experimenter in wireless. Thereafter Marconi prospered.

The site of the house Marconi visited in Victoria Street is now occupied by the offices of the National Research and Development Corporation, a government-backed body set up in 1948 to develop and exploit inventions from universities, companies, government research establishments or private individuals. The NRDC has come in for a great deal of criticism. Its position is, in many ways, untenable; either it is accused of rejecting too many ideas, largely by inventors who have approached the NRDC with an idea and been rejected, or it is accused of spending money on projects that are not a commercial success. In answer to the first, Roland Rosser, who deals with private inventions for the NRDC, echoed what Professor Laithwaite had said. Of all the inventions dealt with by the Corporation about three per cent were those of private individuals, he estimated, and "about 2½ per cent of private inventions are worth looking at." Many good inventions were snapped up by industry for development straight away, so that they never reached the NRDC.

Perhaps the most famous, and certainly the most expensive, private invention sponsored by the NRDC was the Hovercraft, and its sister the Hovertrain. Christopher Cockerell was an electronics engineer at Marconi's for 15 years after he began his career in 1935. Twenty years later he invented the Hovercraft and in January 1959 the NRDC set up a subsidiary, Hovercraft Development Ltd, to exploit the invention. Although the original amphibious vehicle still has the aura of a missed opportunity, perhaps a worse example of official blindness was the abandonment of the Hovertrain. NRDC set up another subsidiary in 1967, Tracked

Hovercraft Ltd, to develop it, but two years after doing so they discovered that the amount of money required to make the train commercially viable was beyond its means.

The Department of Trade and Industry told the National Research and Development Corporation later that no further funds would be advanced, with the result that the Hovertrain project was wound up in 1973.⁶ Yet the amount needed was small, particularly when compared with the amounts spent on Concorde.

The NRDC does not have a free hand. It cannot supply money for the setting up of plant or machinery to make a product commercially. Their concern is to develop an invention from an embryo stage to the point at which it is ready for commercial production. Neither is it interested in the development of what it calls gadgets. The excuse is that it is spending public money and so must use the money for projects which they consider will be of public benefit.

The corporation finances itself, and pays off the money the government put in to start it off, by taking over the patents in a project, licensing them to industry and paying the inventor a royalty. The NRDC wishes that more private inventions would prove worthy of exploitation, but the apparent restrictions on the kinds of ideas that the NRDC can involve itself in make it unlikely that the number of exploitable submissions from private inventors will increase.

Backers lacking

These restrictions have another effect. Mr A. L. T. Cotterell, secretary of the Institute of Patentees and Inventors, said that the total income of his Institute, including a DTI grant of under £2,000 was £18,000 a year. Most of it came from subscriptions. "The institute would like to back inventions but we don't have enough money. The government say the NRDC is there for that."

Tomorrow's World have done a survey showing that only one in five out of 2,350 published items ever saw production at all and of those only one in five hadn't "bitten the dust". These figures also have to be seen in the light of the rejection rate before the programme goes on the air. Many of the letters asking for an appearance on the programme do not reach Michael Blakstad, the editor, and of those that do about one in ten goes on the air, though other items appear which the Tomorrow's World team search out for themselves. The individual inventor usually has preference in the choice between two comparable items. Of the organisations that exist to help inventors he said: "My feeling generally is that it's not a very well organised field and that a really slick entrepreneur could make a lot of money." He also thought too few patent holders tried the simple expedient of advertising for backers in journals.

Professor Laithwaite was in no doubt about one cause of the problem: "Industry won't take on a half-baked project. Industry wants it presented to them on a plate, because their accountants say that it has to be that way."

But Mr Cotterell of the IPI was less critical of manufacturers. "You get inventors who claim that they have something important which nobody seems to be interested in. Usually the idea has no commercial viability or it may be unsuitable for some other reason." I asked him how the IPI could help: "We can hold their hands, and this is particularly important in the beginning." He gave the example of a man who had mortgaged his house and borrowed money from the bank to meet the cost of tooling up for the production of his invention. He ran into trouble with the tooling firm and eventually ended up in the courts. "We could have advised him so that he could avoid all that."



Professor Eric Laithwaite.

A characteristic of individual, as opposed to corporate, invention has been that some highly unlikely people have been responsible for the innovating. Legend has it that the dial telephone was invented by an undertaker, the hermetically-sealed refrigerator by a French monk, and the kodachrome process by two music students. Gillette was a travelling salesman in crown corks, Mr Biro, who invented the ballpoint pen, was a painter, and Dunlop was a vet. The parking meter was invented by a journalist, and all the various type of automatic gun that have come into use over the years have come from individual inventors who were also civilians. The phenomenon has led Christopher Cockerell to remark: "I sometimes think that if some competent electronics engineers got into the treasury and challenged their conventional wisdom, we'd probably

have an end to stop-go in the economy."

Pinch or pigeonhole?

No matter how complex your idea it is little use relying on the astuteness of civil servants to perceive its value. Eric Laithwaite's comments about Whitehall would have seemed more than apt to Christopher Cockerell as he tried to persuade various government departments to promote the hovercraft. Were he dealing with anyone else, one would hardly believe the difficulties he faced: "The Admiralty, on the grounds that it was not a proper boat, shuffled the device on to the Ministry of Supply. A demonstration was held in a basement in Whitehall where the little hovercraft, belching diesel fumes, buzzed around the floor at such a speed that one anxious civil servant jumped on to a chair." The craft was put on the secret list, and Cockerell became convinced that officials were trying to pigeonhole the idea.

Sometimes officials seem to be doing rather more pinching than pigeonholing. For example, a tribunal of enquiry was appointed to look into the case of John Hargrave, who has conducted an eight year battle to win recognition for his development of a moving map navigational aid similar to that used in Concorde.

Hargrave, now 81, has documented the history of his autonavigator meticulously. On the afternoon of June 13, 1937, he was invited to Hatfield aerodrome to meet an RAF officer friend, Squadron Leader McKinley Thompson. He was appalled by the primitive way pilots were expected to navigate. The pilot had to draw a pencil line for his course and fold his maps over and over, all the time controlling the aircraft. He thought about the problem and, according to his own account, the way round it suddenly came to him one evening, seven weeks later. "I stayed up all night," he told me, "and made a model out of bits of cardboard and paper and a child's magic lantern, and it worked." When his wife appeared at breakfast the following morning, July 31, it was ready.

The purpose of the instrument, which in its later form looks rather like a CRO, was to show a map of the land over which the aircraft was flying, with the position of the plane at the centre of the display. The map moved across the screen as the plane travelled. The display rotated as the plane changed direction, and wind-drift was allowed for.

Hargrave and Williams demonstrated the model to Smiths Instruments on February 9, 1939. They wanted Smiths to produce a gyro-controlled model, but Smiths wanted to know the attitude of the Air Ministry before they would do so. At a subsequent meeting with the head of the Air Ministry's navigation department, Wing-Commander P. H. Mackworth, D.F.C. they were told the air ministry had "failed so far to solve

the problem of constructing an effective air navigation instrument in the form of a moving map . . . during the last 14 years." He was greatly interested in the instrument and asked that a written specification be submitted "so that the principals and mechanism can be carefully studied by the Air Ministry technical staff and the whole idea be thrashed out between them and my own department."

Next, the head of research department, Squadron Leader May, flight tested the Model II and reported that, in spite of the crudities of the hand-controlled, clockwork driven model the invention was, in his opinion, worth going on with. On the strength of this Hargrave applied for an air ministry development contract, but the war prevented this going further. On May 31, 1940 the device was used on a routine bomber run with the ordinary maps locked away. The pilot reported that he thought the instrument a practical form of moving map and suitable for use in his aircraft.

In October 1941, Hargrave received a letter from the director of technical development of the Ministry of Aircraft Production saying that there was no chance that the autonavibrator could be put into production as there was not enough spare production capacity. Nevertheless, Hargrave and Williams pressed ahead. They demonstrated the Model II, in the following months, to an impressive list of defence top brass including Winston Churchill, Lord Beaverbrook and Air Marshall Sir Philip Joubert. As the *Sunday Times* reported in 1973, 'Of the 27 people who were given details of the Hargrave instrument, 23 were either officers or officials of the Crown, a vital point in Hargrave's claim.'⁸

In May, 1942 Hargrave received a letter of agreement from instrument makers E. R. Watts & Son of Camberwell, London, to develop the mark III fully automatic model, and to pay a royalty of not less than 10 per cent on each one sold when the model was produced. The agreement was never carried out. According to the *Sunday Times* account, Hargrave never heard from Watts again. Four months later, however, he received a letter from a Group Captain Peter Stewart, who wrote to him from the War Office saying "I cannot too strongly urge you to continue development of this instrument. . . ." Hargrave says this is the most important of the 19 official communications in his files. By the end of the war, however, his patents lapsed owing to non-payment of the yearly renewal fees.

Over twenty years later, the cover of the February 10, 1967, edition of the *Daily Telegraph Magazine* carried a photograph of the cockpit of Concorde. The prototype of the plane had not yet fully appeared, and the first flight was not to take place until March, 1969, but the photograph showed a section of the



Michael Blakstad, editor of "Tomorrow's World".

instrument panel to which the text referred as follows: "... There is even a moving map display, which continuously indicates the aircraft's position in relation to the earth below."

There are two main pillars to his case. He realises that his legal rights to the invention ceased with the lapse of his patents in November, 1946. He claims, however, that he is entitled to an ex-gratia payment, and cites the example of Sir Frank Whittle, whose patent on the jet engine expired in 1935, but who subsequently received £100,000 from the government.

The more substantial basis of his claim, however, is contained in the Report of the Royal Commission on Awards to Inventors (Use of Inventions and Designs by Government Departments). Paragraph 117 states that "where the claimant had shown that his invention was communicated to the appropriate Government Department and where in addition it was proved or admitted that an invention similar to that suggested by the claimant had been used in the service of the crown . . . the crown was required to show that the claimant's communication had not contributed to the Crown use . . . Unless it could be shown by the Crown beyond all reasonable doubt that this subsequent development was wholly uninfluenced by the claimant's communication, this residuum of doubt should weigh in the scale in favour of the claimant."^{*}

Whose transistor?

It often happens that an inventor doesn't get the credit for an idea he has thought up, though we must allow that whenever an invention is made public a horde of innovators descends yelling "I thought of it first." In conversation with Professor Laithwaite, for example, you discover that although Wheatstone invented the concertina, he didn't invent the Wheatstone bridge. He was responsible for producing the first linear motor, the second being made by Henry

Fox Talbot, the father of modern photography, of all people, but it was Wheatstone's assistant who devised the bridge; Wheatstone merely gave the lectures.

If you asked most engineers who invented the transistor they will reply "Shockley". Shockley's own detailed account⁹ of the discovery seems to confirm that view. "On 29th December 1939 I wrote a disclosure of what in principle was a sound concept of a semiconductor amplifier . . . Research in my notebook entries show that experiment based on the 1939 disclosure were carried out before Feb 6, 1940. However, my disclosure waited nearly two months, until 27/2/40, before it was witnessed by J. A. Becker, Walter Brattain, supervisor. Two days later on leap year day of 1940, Walter Brattain and I both signed a modification of the earlier disclosure. This disclosure . . . shows a more or less standard copper oxide varistor unit with two lines of metal forming electrodes on the surface of the oxide. It would today be called a Schottky-barrier, field effect transistor. It was prophetic of developments that were to come 20 years later as parts of integrated circuits using field effect transistors."

If Shockley was aware of any previous work he doesn't acknowledge it. The fact that he details the structure of a device which he did not make, and the principles of which he had later to abandon, suggests that he thought the idea original.

So did Oskar Heil. A recent article in *Hi-Fi News*¹⁰ drew attention to the possibility that Shockley had not been first to think up a solid state device which might replace the valve. Heil took out his patent, British Patent Number 439 457 in 1935, a year after the German application. "This invention," states the second paragraph of the specification, "relates to electrical amplifiers and the like and provides novel apparatus adapted to effect alternating current amplification and to perform other functions, e.g. general control functions such as have usually been performed hitherto by thermionic valves. In general terms the present invention, which, as will be seen later, embodies a principle which is believed to be new and is based upon a discovery believed to be new - may be stated to provide a substitute for thermionic valves."

The device Heil describes is based on the theory that "if a semi-conductor be arranged as to form part of a condenser which is subjected to a varying voltage, charge the resistance thereof will vary as a function of the said varying voltage and according to this invention this phenomenon or effect is utilised for amplifying or other control purposes." The device is nothing if not an insulated gate field effect transistor. Although the production techniques needed to make the device efficient were not available when Heil devised it, he says in the

^{*}See "News of the Month"

patent that the best way to form the electrodes is by vaporising metal or by depositing metal by cathode dispersion.

The most likely explanation is that Shockley didn't know about Heil's work, and it may well be that more detailed researches would reveal pre-Heil devices which differed little from that which he patented. It is just strange that a patented device should so have been overlooked. "The things that humans are worst at doing is communicating with one another," said Professor Laithwaite. "I would not be aware of what my opposite number is doing in Newcastle. He might be doing something which is just the thing I want, I may never know . . . Our communication is our very worst feature as animals on this planet."

Laithwaite is the model of a good communicator, perhaps because he knows how important communication is. A close associate told me he was always in trouble for saying the wrong things in public, and one acquaintance said he was in danger of becoming 'a bit of a bore', but he seems to thrive on battles with the scientific establishment. "It's like the theatricals will tell you: only no publicity is bad publicity." He has less relish for personal criticisms directed at him by the press, and perhaps the wounds inflicted by the *New Scientist* after a discourse he delivered to the Royal Institution still hurt.

Jones the gyroscope

To discover what all the fuss was about you have to examine the claims of one of a most remarkable character. Laithwaite, no intellectual slouch himself, described him to me as "a rare man," and said that some of the things he had written showed "the absolute hallmark of a genius." He did admit to grave reservations about the man's experimental method, however, and added that to touch the gems of genius in his correspondence you had to wade through a lot of things which were erroneous and inconsequential.

He speaks of Alex Jones, whose background as a heating and ventilation engineer has served only to allow him the great inventor's traditional freedom from too great a knowledge of his subject. Whatever the value of his thoughts, Jones is a highly original thinker, someone who can take nothing on trust. Conversation with him is stimulating, perplexing and, at times, disturbing.

He says that what set him off was a friend's asking, "Does gravity pull or push?" From that unpropitious beginning he has formulated a theory which, if generally adopted, would turn gravitational physics on its head, and has build a machine which, he thinks, defies gravity itself.

He questions all kinds of assumptions, the most basic being the usual interpretation of Newton's laws of motion. The second law, in particular,

he says, has been misinterpreted. Newton's Latin phrase *'mutationem motus'* "is alteration of motion; it mentions nothing of momentum."

Further, he questions the usual account of the Michelson-Morley experiment, which was designed to determine the speed of the earth through the ether. The result, we are told, was null, and it was therefore concluded that the ether didn't exist and, later, that the speed of light was independent of the motion of the observer. This in turn led to the theory of relativity. Altogether the experiment is a crucial one in modern physics, but Jones says we've built the tower on sand. 'The result was very firmly other than null.' He says that the difference or displacement involved was about 0.02λ , where λ is the wavelength of light. The reason the experiment was first thought to fail was that they were using a closed system, they measured phase displacement, and they took no account of Doppler effect. The ether, he postulates, does exist: "I know the shape of it, and what its structure is, even."



Alex Jones, thinker.

The existence of the ether is crucial to his theory, which is that gravitation "is a sort of pressure created by the motion of a mass which is going in a straight line." The masses moving through the ether produce a longitudinal displacement wave, he says. Two bodies moving relative to one another experience a mutually repulsive force proportional to their relative speed.

The next step was to demonstrate the theory. "How can I make a machine which has one part of it always moving faster on one side than on the other, which brings you to the gyroscope." A gyroscope spinning on its own axis exhibits no odd effects when its axis is stationary but, when the gyroscope axis is made to precess, the conditions he outlines above, assuming the existence of an ether, are fulfilled.

He devised and built a machine which was shown on *Tomorrow's World* two years ago. It is explained in a description of the experiment which he wrote in August, 1973. An electrically driven flywheel is mounted at the end of a

pendulum hung by a universal joint from a frame which is then mounted on ball bearings. The spinning flywheel is moved to one side of the frame so that the pendulum is at an angle to the vertical. When the flywheel is released it precesses around the point of suspension but there is no reaction on the pivot. Not only that, but the frame in which the apparatus is mounted moves to follow the flywheel, not to go in the opposite direction. The experiment demonstrated, he thought, the creation of a force which could counteract gravity.

He took the experiment to Roland Rosser of the NRDC, who according to Jones saw it move across the floor in the way I've described. "I said 'Did it translate?', and he said 'Yes', and then proceeds to tell me why it didn't work." He also quotes Rosser as saying "My job is much easier if I reject everything." Rosser, naturally enough, is not prepared to discuss this or any other individual case.

Jones had arranged a meeting with Laithwaite and, in Laithwaite's private laboratory, had shown him a machine he had made, though not the one he had shown Rosser which, by this time, had gone to Hawker Siddeley.

Laithwaite has described Jones's experiments to me as "bogus". He told me the floor in his laboratory was not level, it has turned out, and so the experiment proved nothing. "He has made a number of machines and not one of them works. It is not that, his experiments are wrong, it's the interpretation he puts on it. He makes the experiment appear to do what he wants it to do . . . Alex has yet to show me the first piece of convincing evidence that an object can lose weight."

I quoted to Jones what professor Laithwaite had said. Had the floor been uneven? "Yes, but he knows damn well that we've shown the machines go uphill because we always run them both ways on his desk."

What about none of the machines working: "Ah, but he accepts the one I showed Rosser." Laithwaite had not actually seen the Rosser machine, which ended up at Hawkers, but Jones had submitted a new explanation to Laithwaite as to why the machine worked and, according to Jones, Laithwaite said "Ah, we have at last a machine which could work." Jones admitted that he hadn't understood, at the time, why the machine did what it did, "But by God I understand now."

What about the "bogus" description? "But it wasn't, you see. Eric is now coming round to this in his maths. I can see it happening now and I know that in a year's time there's going to be one very surprised Eric."

Truth to tell, he may not be far out, though Laithwaite may remain unconvinced about gravitation. "The important thing," said Laithwaite, "is that Alex communicated with me . . . I tried to isolate the effect he'd got and one day

I came across an effect which was readily reproducible which was totally unacceptable to me in terms of conventional physics. And that set me on a road from which I have never turned back."

On the evening of November 8, 1974, Laithwaite gave a discourse at the end of which he presented a machine which he said violated gravity and produced lift without any external reaction. The machine was mounted on a set of kitchen scales. It consisted of two electrically driven spinning tops. The precession of the tops would cause them to rise were it not for a track attached to the frame of the machine. The tops followed the track and caused the machine to move up and down. Laithwaite said there was more upward movement than downward. Gyroscopes of the type used in navigation and direction finding were adequately described by Newton's laws, he said, being supported through their centres of gravity. But the child's spinning top, spinning on a point on its base, was not.

He maintained that the angular momentum of precession about a vertical axis was created out of nothing, so angular momentum about the axis was not conserved about that axis as suggested in Newton's laws.

He also said that the precession was not accompanied by any centrifugal force, that no force was needed to stop the precession, and that if the precession speed were increased the tops rise without there being any corresponding downward reaction at the point of spin.

The needle on the kitchen scales "swung violently between its upper limits and 15 pounds," said the *New Scientist*. The machine weighed 20 pounds at rest, they reported, and if the weight of the apparatus had oscillated between 15 and 25 pounds, showing no average change in weight, it would not have shown on the scales because the pointer had reached the end of its travel at 20 lbs.

Laithwaite replies that if you examined any set of kitchen scales the pointer will travel one and a quarter turns before it reaches its full deflection. "There were pulses of loss of weight," he insists, and adds that he knew a great deal more about it now. The machine had been finished at three o'clock that day, with the discourse due to start six hours later. He saw then that it oscillated. "I knew at once what I'd done wrong but there was no time to change it."

But a greater controversy arose when, a few weeks later, he said more about the subject in a televised Christmas lecture for children. His words were more guarded, but they reached more people. "I'm not saying Newton's laws of motion are wrong. I am merely pointing out that they are restricted to motion in straight lines, and to motion where there is no change of acceleration, just as there is no rate of change of

current in Ohm's law . . . Gyroscopes do not exhibit a new force. They show the lack of a force where there should have been one." The force lacking, was centrifugal force.

To show this he made his eight year old son, Dennis, hold a pole, at the other end of which a flywheel rotated. Dennis stood on a turntable and, as the flywheel was speeded up, the boy turned round. The further he held the flywheel out the faster he precessed, but the flywheel did not fly out of his hands, and he had no difficulty holding the machine lightly from the very far end of the pole.

The lecture attracted sceptical comment from the *New Scientist* and 800 letters to Laithwaite himself. "They're from amateur, armchair inventors, and about a dozen of them proposed systems for loss of weight that worked . . ."

The NRDC's annual report for last year says: "... Gyroscopic anti-gravity devices have been arousing interest in the press and on television, and we have received a larger than usual number of proposals of this kind.

Roland Rosser said there were about a dozen gyroscope devices on the files which had been received during the year. "It's a very common submission. People think there's something odd about gyroscopes but they're not really peculiar. Lots of them come up to us with a gyroscope and say something strange is happening but it's all to do with the conservation of angular momentum."

Alex Jones said he could not demonstrate his machine as it was in pieces. I leave readers to sift for themselves through the snags with which his theories seem to abound, but they should note that his exploration of the gravitational mechanism has a number of historical parallels. During our conversation he made frequent references to a scientist called Le Sage, who had written a paper in 1782 which asserted that gravitation was caused by the impacts of streams of atoms.

In 1950, 20 years before Jones began to expound his beliefs, Paul G H Voigt, the inventor of the modern loudspeaker, was convalescing from an illness. He began to while the time by thinking about gravitation. As he admitted in the notes he completed three years later, he was not a physicist. He said recently that he had not heard of Le Sage even by 1957, in September of which year a speech he had recorded on tape in Canada was played to a gathering of the British Sound Recording Association. In the speech he stated what he had come to believe about gravitation.

Either again?

Voigt's idea is that all matter is penetrated by sub-atomic particles travelling at or near the speed of light. They are so small that they may pass easily through the atomic lattice of which all matter is said to be composed yet, unlike Le Sage's particles, which

were said to have a mean free path of some 10,000 miles, the Voigt particles are so numerous that they bump into atoms and into one another in a constant exchange of kinetic energy.

Gravity, he says, is the result of an imbalance of forces between those particles acting on a body from space and those that act on it having passed through the earth or another body. The gravitational effect will be proportional to the energy the particles have lost in passing through other bodies, that in turn being a function of what we have called mass. One body, in other words casts a gravitational shadow upon another.

The Voigt particles are travelling in all directions completely randomly. The gravitational shadow will vary as the distance between the bodies in accordance with the inverse square law: If the distance between two bodies is doubled the solid angle is halved and the subtended area reduced to a quarter.

These particles, if they exist, pervade all matter. They swarm through and over everything, and they are the ideal medium for the transmission of light and radio waves. Voigt's particles, in order words, suggest the stuff of which the ether is composed. All we may say with certainty is that none of us knows enough about gravitation to say that Voigt or Jones is wrong.

Almost as certain is that some day, someone will build a machine that will demonstrably defy gravity. It may even be Jones or Laithwaite. Whoever it is it will not make them rich. Sir Christopher Cockerell knows more about that side of things than most people. He received a taxable £150,000 for inventing the Hovercraft, about the amount of a modest transfer fee for a professional footballer. "Inventing," he said, "isn't a way of making money. If you want to do that it's better to be a Beagle or an ice-cream salesman."

References

- 1 W. M. Dalton, *The Story of Radio*, Vol. 1, p.83 (May, 1975)
- 2 J. G. Crowther, *Discoveries and Inventions of the Twentieth Century*, p.351 (Routledge and Keegan Paul, 1966)
- 3 John Jewkes, David Sawers, Richard Stillerman, *The Sources of Invention*, p.354. (Macmillan, 1958)
- 4 Elliott M. Sanger, *Rebel in Radio*, *The Story of the New York Times "Commercial" Radio Station*, p.50 (Focal Press, 1973)
- 5 Keith Geddes, *Broadcasting in Britain, 1922-72*, p.44 (HMSO, 1972)
- 6 P. S. Johnson, *The Economics of Invention, and Innovation*, p.149 (Martin Robertson, 1975)
- 7 Peter Grosvenor, James McMillan, *The British Genius*, p.268 (Dent, 1973)
- 8 *The Sunday Times*, February 11, 1973
- 9 William Shockley, *The Invention of the Transistor, an Example of Creative-Failure Methodology*, Proceedings of conference on the Public Need and the Role of the Inventor, Monterey 11-14 June, 1973.
- 10 *Hi-Fi News*, Vol. 20, No. 11, November 75, p.110.

News of the Month

Dolby f.m. up-date

Dolby Laboratories Inc., report that German stations have been broadcasting encoded B-type signals since mid-1975 with reportedly no adverse comments. As a result they expect full-time Dolby f.m. transmissions in Germany to start in the near future.

Last year, the Institut für Rundfunktechnik (IRT) in Hamburg carried out tests on Dolby B-encoded transmissions both in-house and on-air using the NDR transmitters in Hamburg. With a 50 μ s pre-emphasis time constant, listeners complained of a change in sound quality; when altered to 25 μ s – that recommended by Dolby Laboratories – no listener reaction was reported. Further tests, at RIAS Berlin, SR Saarbrücken and WDR Cologne, using a 25 μ s time constant and B-type encoding have not resulted in any adverse reactions, according to Dolby Laboratories. Results of a re-broadcast test from RIAS were said to be highly impressive, in which a professional receiver in Hof, 250km away, picked up the broadcast, and retransmitted it after decoding. In the WDR test transmissions the same programme (light music) was broadcast from two transmitters, one intermittently encoded and the other non-encoded, to enable direct comparisons to be made. Signal-to-noise ratio was studied in the service area and a report on these measurements is under preparation. The German broadcast authority, ARD, and IRT in Munich have also been making on-air television sound tests using B-type encoding, 25 μ s time constant and an increased modulation level.

Following FCC authorization of Dolby encoded f.m. transmissions in May 1974, there are now 130 stations using the system in the USA. In changing from 75 to 25 μ s pre-emphasis, these stations are able to increase their modulation by an average of 4dB, or reduce compression or h.f. limiting by a similar amount. In Canada, the Department of Communications gave approval for B-type transmissions in October last

year and five stations have been equipped. Mexico approved the transmissions in 1974, while Brazil have six stations equipped with encoders. Tests are under way in other countries – Australia, Denmark, Ireland, Luxembourg, Norway, Sweden and Thailand.

In the UK off-air tests were undertaken last year by the IBA and authorization for further, on-air, tests is being sought from the Home Office. One proposal is to transmit the same programme from co-sited transmitters working on different frequencies in the London area.

There are now 27 products on the market with capability for receiving and decoding Dolby f.m. transmissions with the 25 μ s time constant, and 112 products that allow decoding with the 25 μ s time constant in conjunction with conventional tuners, including the *Wireless World* noise reducer.

Sound broadcasting in Band I?

The possibility of broadcasting wide-band high quality sound programmes in Band I is suggested by the BBC in a submission to the Annan Committee on the future of broadcasting. Hitherto it has been assumed that when the present 405-line television transmissions in v.h.f. Bands I and III are closed down (now expected to be in the 1980s) both these bands would be "re-engineered" for 625-line tv with 8MHz channels, as on u.h.f. The BBC's proposal, however, published in edited form in the April 1976 issue of the *EBU Review (Technical)*, points out that Band I could provide only a limited national coverage for tv. Band III, if extended to 222MHz, could provide a comprehensive national 625-line service in six channels.

For sound broadcasting, the BBC say, Band I could accommodate 12 or more wideband channels providing national or regional coverage for three or more programme services. Modulation could be either f.m., with ± 300 kHz deviation using 650kHz channels, or a digital system – p.c.m. with four phase p.s.k. modulating the carrier and channels of 250kHz or 500kHz width. A strong point in favour of four-phase p.s.k. is that it does not require such a high field strength – actually estimated as 27dB(μ Vm) – as other possible systems to give good national coverage.

Another interesting idea put forward is that part of Band I could be made available for a "dedicated" teletext service with a channel width of 5MHz. All 625 lines would be filled with teletext data instead of just the four non-picture lines as at present. Also, the BBC recommend that extension of Band II to at least 104MHz should be considered.

TI report world semiconductor slump

The world semiconductor market has dropped by over \$900 million from the 1974 level to \$4,100 million dollars in 1975, according to the annual report of the chairman of Texas Instruments, Mark Shepherd jr. The US market had declined by \$500 million dollars in 1975, but total figures were expected to reach the former figure during 1976 and the semiconductor market would achieve \$22 billion by 1980.

Semiconductor memory stores continued to displace magnetic stores because of further reductions in cost, the fastest growing component being the 4k random-access memory, demand for which tripled in 1975 and was expected to double again this year. The leading memory component by 1980, said Mr Shepherd, in terms of bits shipped would be the 16k r.a.m., samples of which were now being delivered. "The development by TI of a new, simplified structure for a charge-coupled device (c.c.d.) has made possible a significant increase in memory cell density. This has the potential of reducing memory costs below that of m.o.s. r.a.m.s, enhancing the prospects for c.c.d.s to serve in auxiliary memory systems." Pilot production of magnetic bubble devices, which need longer access times than c.c.d.s but are non-volatile, has started at TI and samples are being evaluated for their equipment applications. A 100kbit magnetic bubble device was demonstrated last year packaged with bias magnets and drive coils.

Sales chief calls for import curbs

A call for import controls on consumer electronics has come from the sales manager of Fidelity Radio. Mr Arthur Banford, in a statement issued in May, said that if controls were not introduced on Japanese and Far Eastern imports then large sectors of the industry would go bankrupt. He pointed to the Japanese invasion of the American market, which had forced many American firms out of business. "Now US businesses are beginning to argue, unsuccessfully, that Japanese firms are using their very strong base – over 10,000,000 a year – to cut prices so as to get a stranglehold on the north American market. The irony is that Japan operates one of the most effective import control systems in the world."

Of the one and a half million colour sets and tubes exported to Europe by the Japanese last year, he said, 600,000 came to the UK, even though it was a

bad year for colour tv sales. In the year 170,000 music centres were sold in Britain and half were made in Japan. The radio market was worth £30 million last year nearly 85 per cent of which was imported. The Japanese share of the audio market had risen from £58 million out of £131 million in 1973 to £72 million out of £135 million last year. With the market picking up again and at a lower VAT rate, without controls, the Japanese share would increase further.

Post Office backs large scale integration

The Post Office have approved General Instrument Microelectronics Corporation as the first m.o.s., l.s.i. microcircuit manufacturer to supply m.o.s., l.s.i. microcircuits in their equipment. Their D400 test procedure, under which the m.t.n.s. (metal thick-oxide nitride) process at GIM's factory at Glenrothes, Fife, has been approved, requires a service life for m.o.s., l.s.i. devices of 20 years with no more than 2 per cent cumulative failures. The Post Office has approved the use of the process for telephone exchange equipment.

In a speech at the beginning of the Communications 76 exhibition Professor James Merriman, Post Office Board member for Technology and Senior director, Development, Telecommunications Headquarters, said that by 1980 the British telephone service would be one of the country's largest users of microelectronics. Use of microelectronic devices will grow from four to 12 million devices a year in the next four years, accounting for ten per cent of the country's total consumption.

● Sales of l.s.i. test equipment will be worth over \$2.25 million during the next year, according to l.s.i. Instrumentation Ltd, UK representative of the Macrodata Corporation. "Rapid growth in the use of microprocessors is making an l.s.i. test capability almost essential."

Mobile radio research: Possible solution to fading

A major advance in mobile radio system design was claimed by W. Gosling of Bath University when he presented his paper "A feasibility study for a voice plus data mobile radio system of the future", at the Communications 76 conference held at Brighton in June. Professor Gosling said that since writing his paper, they had succeeded in producing a system which greatly reduced the loss of information due to mobile fading. The system, which used

a method called sideband diversity, required two or more fixed stations transmitting the same information but with the modulations phase-shifted relative to each other, using wideband phase-difference networks. This resulted in the peaks and troughs of the upper and lower sidebands occurring in different places, enabling the mobile receiver to hunt at all times for the sideband with the heaviest peak, thus ensuring that the signal was always greater than zero. He stressed that phase-shift angles were not critical and could be as much as $\pm 30^\circ$. The system developed for the Bath University project employed three 12W v.h.f. transmitters, sited on a 15 mile triangle, operating in the s.s.b. mode for speech and the d.s.b. mode for data. Sideband diversity is claimed to reduce errors sufficiently for error correcting codes and systems to be used to increase the accuracy still further.

Professor Gosling's lecture created much interest among the conference delegates, and when R. C. French of Mullard Research Laboratories claimed similar results with error-correcting systems only, he pointed out that unlike the diversity system they did not help stationary vehicles located in bad reception areas.

Professor Gosling told *Wireless World* that Britain was certainly ahead of America and Europe in the field of mobile research, and this was a direct result of the Home Office sponsoring work at universities since 1969. "For this we are very grateful", he added (see also Mobile Radio Consortium formed).

Mobile radio consortium formed

Bath, Birmingham and Bradford universities are to spend £100,000 a year on research into better mobile radio telephones and into linking them with teleprinter machines and visual display panels. The universities, which have been co-operating since 1974, have now formed the Universities Mobile Radio Research Consortium 1976 (UMRRC) to pool information and equipment and make sure their work is not duplicated. The research is backed by the Home Office Directorate of Telecommunications, the Science Research Council, the fuel and power industries and the Ministry of Defence.

The consortium is investigating ways of reducing fading and interference. Birmingham is developing techniques by which aerials on different parts of a vehicle pick up the same signal at different parts of the pattern formed when an incident and a reflected wave cross, so that loss of reception at one place is compensated at the other. They have built an add-on unit no bigger than

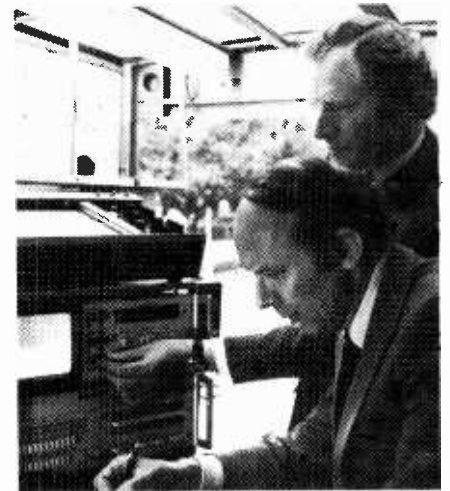

E. D. R. Shearman (foreground) and J. D. Parsons of Birmingham University engaged in on-site measurements of the effects of car ignition interference on data communication to vehicles. The work is part of joint research carried out by the Mobile Radio Consortium formed with Bath and Bradford Universities.

a small portable radio for v.h.f. amplitude-modulated equipment and a prototype u.h.f. f.m. version. Bradford is examining interference at mobile radio base stations from other co-sited transmitters and from the interference produced by radiation reflected off rusty metal structures.

UMRRC says that the number of installations has grown from 1500 in Great Britain in 1950 to 176,000 in April this year. "At this rate", it says in a statement, "there will soon be no vacant channels in our larger cities unless the consortium can succeed in compressing more channels into existing wavebands. This will be one of its prime tasks." Mobile radio presently uses 70-170MHz (v.h.f.) and 425-470MHz (u.h.f.) and with the coming of improved crystal oscillators and synthesizers the Home Office have been able to reduce the intervals between channel allocations from 25kHz to 12.5kHz. The ultimate interval could be as little as 5kHz.

Computer-aided radio surveillance

A commission placed by the British government four years ago has resulted in the development of CERES, a family of computer-enhanced radio emission surveillance systems. CERES, produced by Redifon Telecommunications Ltd, was first demonstrated at Communications 76 in June.

The operator has complete control over the equipment and, with real-time computer aid, the modular systems enable him to monitor communications

traffic with greater efficiency. A typical system could consist of six operator-controlled consoles, each with facilities for remote-manual or computer control of four receivers. Associated equipment includes antenna selection units, two four-channel tape recorders, visual tuning aids for each receiver, and audio selection and control circuits. The receivers, aerial switching, receiver memories, computer, tape recorders, time-code generator and a disc store are all located in a suitable remote environment and can be automatically controlled by the computer. A v.d.u. provides the operator with control instructions and transcribes the received information. This facility enables the equipment to be used by relatively untrained operators. Specific frequencies may be monitored either continuously or at specified times and several frequencies within a selected band may be monitored in sequence at a chosen rate. It is claimed that the main advantage of these systems are that each operator is given the freedom to monitor as many as four frequencies simultaneously, transcribing one transmission in real time and, if necessary, recording other transmissions for subsequent replay and transcription. It is envisaged that these systems will find applications in the monitoring of distress frequencies and in channel utilisation, and in particular in defence and surveillance communication systems.

Medical scanner prospects

EMI are expected to launch an improved medical scanner at the Radio Society of North America Radiological conference in Chicago at the end of November. Since EMI launched their brain scanner in 1972 with a scan time of four and a half minutes rival companies have tried hard to better the performance of the original design and some prototype scan times have now come down to 5s. Last year in Chicago EMI launched a 20s scanner and it is expected that this year they will unveil a unit with a scan time well below that.

EMI shares went up on the Stock Exchange in mid-June after a report in the *Evening Standard* claiming that EMI were about to launch a "new generation of scanners which use harmless ultra-high-frequency radio waves instead of potentially dangerous X-rays." EMI hastily issued a denial and pointed out that they and their associate companies, particularly Nuclear Enterprises, had been using ultrasonic techniques in medicine for many years now.

An EMI statement in May said it had sold £105m worth of scanners to date, 90 per cent for export. It has sold 538 systems: 384 brain and 154 body scanners. One million patients, they say,

have been scanned by the 265 scanners in hospitals and clinics throughout the world. North America is the biggest customer having ordered 400 units, Japan have installed or ordered 37 and the UK 32. EMI won a 1976 Queen's award for exports of the systems, and another for technological achievement.

Citizens' Band Association formed

A Citizens' Band Association has been formed by Mr James Bryant "to help establish a v.h.f. f.m. Citizens' Band in the UK". As Mr Bryant said in a letter in the June issue, he is opposed to the use of 27 MHz on a.m. for CB because of excessive television interference, audio breakthrough, the disruption of radio controlled models and co-channel interference during high sunspot activity.

The Home Office is still likely to adhere to the view that frequencies are so short that even a small Citizens' Band could not be contemplated. Despite the change in emphasis from 27 MHz a.m. on the part of those advocating CB, the Home Office is still worried that a flood of cheap foreign transceivers would ruin communications in that band, but it might be happier about a CB system which allowed a carefully monitored high quality home market to develop for British made equipment. All the same, potential British CB-ers face an uphill struggle. Home Office decisions will still be based on what they regard as the economic and efficient use of the existing available frequencies.

James Bryant's address is: The Citizens' Band Association, 16 Church Road, St Marks, Cheltenham GL51 7AN.

Ortofon takeover

Harman International are in the final stages of acquiring the majority of shares in Ortofon, previously jointly owned by David Hafler of Dynaco and his partner Newton Chanin. Harman's announcement at the Chicago Electronics Show on June 14 coincided with news that Ortofon would no longer make loudspeakers. Only a year ago Ortofon took over the Danish Scan-Speak loudspeaker factory, which may now close. Although Harman says there is no connection between the two events, the possible closure may have been precipitated by Harman's reluctance to take on the factory, coupled with a prospective change in the terms of a contract Scan-Speak had with ITT. Since Ortofon took over Scan-Speak in July 1975 it has produced ITT and Pioneer speakers for sale in Denmark.

The discontinuation of Ortofon speakers came as a surprise to Metro-sound, Ortofon's UK agents, who issued a statement on June 19 saying they had

just received the news from Denmark. A month earlier they and other agents had attended a launch of Ortofon speaker products in Denmark. Unaware that the new range would be dropped, Metro-sound showed it at HEDA at the end of May preparatory to launching an autumn advertising campaign.

Harman already own JBL and Tannoy and had no need of the as yet unknown Ortofon range, but for some time they have felt that the acquisition of a pickup manufacturer would be a logical extension of their list of subsidiaries. Newton Chanin was reported to have wanted to withdraw from Ortofon and Harman said they would take over his half if Hafler would surrender some, ideally all, of his shares to give them a majority holding. Some reports have said that the deal, which should be concluded well before the end of Harman's financial year on August 31, may involve a 20 per cent holding for Hafler.

Both Metro-sound and Feldon Audio, who now handle Ortofon disc-cutting equipment, have said that they will continue to market Ortofon products. Harman's marketing policy varies, though some have noticed a tendency towards their doing their own marketing. Highgate Acoustics, agents for Harman Kardon electronic products, have just signed a contract to import Altec Lansing speakers, and from August 1 Harman will begin to market Harman Kardon from Tannoy's headquarters in South London instead of through Highgate. On the other hand, last year Harman transferred the JBL agency from Feldon to Colin Hammond.

Hargrave loses on moving map display

Mr John Hargrave has lost his claim for an ex-gratia payment from the Ministry of Defence who, he said, had stolen his invention of a moving map display device eventually used in Concorde and the MRCA. The president of the tribunal of enquiry into the claim, Mr T. H. Bingham QC, said in his report that two of the necessary seven conditions for granting the payment had not been fulfilled. The two were that a causal connection had to be established between the communication of the details of the invention to the Crown and the subsequent use of the invention; and that before the invention was developed by the Crown there had to be no public disclosure of the information communicated to the Crown.

Mr Bingham added that even had all seven conditions been met the payment would have been in line with awards made by the Royal Commissions on Awards to Inventors, rather than the £1.5 million Hargrave and his colleague Cedric Williams were claiming. The case is described in "The inventors" article on p31.

Surface acoustic wave devices

Basic principles and applications as filters, delay lines and oscillators

by J. Heighway, B.Sc., Ph.D., M.Inst.P. *The Plessey Company Ltd*

The basic phenomena of the propagation of waves in materials have been understood for many years. Longitudinal sound waves and transverse waves are familiar enough, but surface wave modes are less well known except, of course, when they propagate on the sea. Surface wave modes are a combination of longitudinal and transverse particle motion and, in the context of occurrence in solids, were explained by Lord Rayleigh in 1885 in relation to earthquakes. Since then, the state of knowledge remained static for nearly eighty years until researchers in the USA achieved efficient generation of surface waves on piezoelectric solids:

This discovery produced an upsurge of interest in the research field, and, more recently, effort has been devoted to systems applications of the devices. Several properties of the devices are of interest to systems designers:

- the devices are of a planar structure and are therefore readily fabricated by establishments with i.c. production facilities
- the wave velocity is non-dispersive (independent of frequency) so linear phase devices can be readily made
- the device performance is almost entirely determined by the geometry of the electrodes, whose structures can be readily and accurately produced by computer-controlled drawing machines
- the waves are accessible over the whole length of the device, hence tapping is straightforward
- the substrates can be chosen to be stable, reproducible, and highly temperature invariant.

Surface acoustic wave (s.a.w.) devices have been under investigation at the Allen Clark Research Centre of Plessey for five years and units have been typically used as bandpass filters,

dispersive delay lines, oscillators and discriminators. This article discusses the basic operation of the devices but more particularly highlights their use in systems and their potential. To this end, a number of specific examples will be given.

Principle of operation

The basic s.a.w. device is shown schematically in Fig. 1. It comprises a carefully orientated and polished piezoelectric substrate onto which have been deposited an input electrode and

Fig. 1. Simplified schematic of the basic surface acoustic wave device. Note angled ends of substrate.

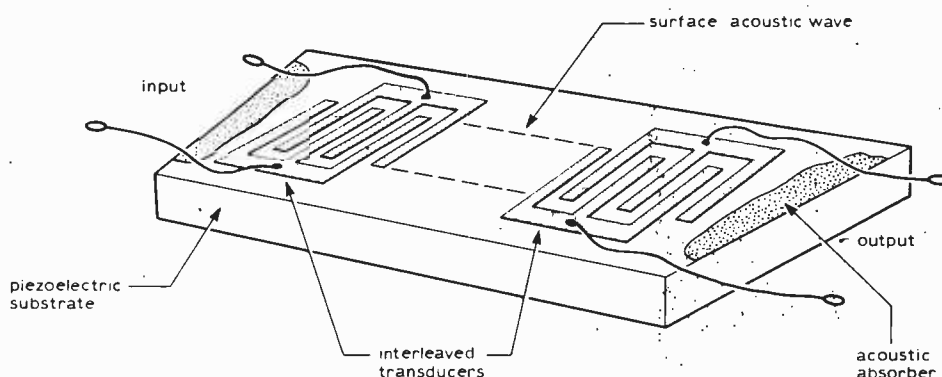

an output electrode in the form of a thin film of a good conductor (0.1µm of aluminium is standard). The ends of the crystal substrate are covered with an acoustic absorber and are "angled" slightly to prevent coherent edge reflections. The electrodes are in the form of interleaving metal fingers.

The physical operation of the device relies on efficient use of the piezoelectric effect. In piezoelectric materials the application of a positive voltage to the surface causes a physical expansion and, conversely, a negative voltage causes a contraction. Hence by applying alternately positive and negative voltages to the surface a "corrugation" of the surface is produced (Fig. 2). If the

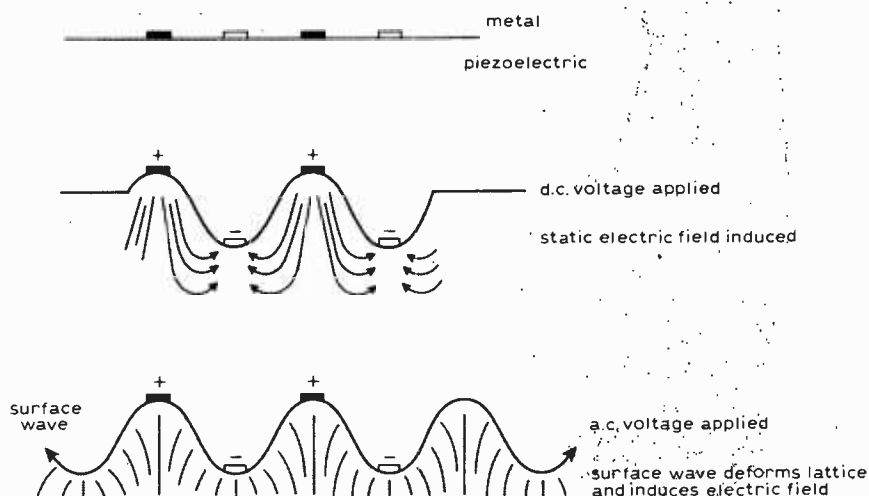

Fig. 2. Physical operation of the s.a.w. device. Voltages applied to interleaved metal electrodes (black, one set; white, other set) cause disturbances in piezoelectric material surface which travel outwards as waves.

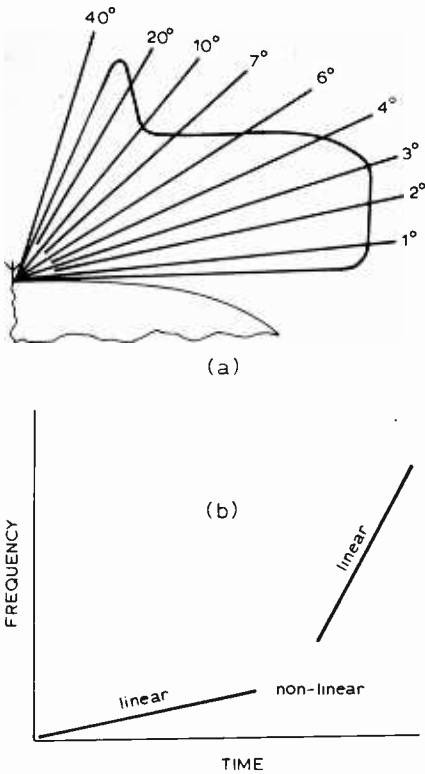

Fig. 3. (a) Vertical plane coverage of a radar equipment resulting from the frequency sweep shown in (b).

applied voltage is time varying then the physical disturbance travels both forward and backward along the surface. The acoustic absorbers remove the backward travelling wave and the forward wave is intercepted by the receiving transducer. The action of reception again relies on the piezoelectric effect. In this case the travelling physical disturbance has associated with it a travelling electric field. On passing under the interleaving metal fingers the charges induced on the surface are sensed by the fingers. A signal appears across the load that is the sum of the induced charges in the electrodes.

It is instructive to consider two of the analogous wave motions that are more familiar. For example the waves that are seen on the sea are exactly the same type of motion that is being utilised in the surface wave device. Many swimmers will have observed that gravity waves on the sea are a surface phenomenon and in fact 90% of their total energy is contained within one wavelength of the surface. A second and more sinister example was the recent earthquake damage in Europe where a distinct surface wave effect was detected. It was in fact from early studies of earthquakes by Lord Rayleigh that the wave motion got its name and it is worth emphasising that the surface of the crystal buckles and shakes (in a periodic manner) in an exactly analogous fashion to that experienced in earthquakes.

The basic design of the transducer is such that:

- the width of each finger and the gap

Table 1

Application	f_0 (MHz)	Δf (MHz)	Sidelobes (dB)	Shape	Insertion loss (dB)
TV vision carrier	39.5	1	-30	symmetric	20
TV transmission	37.5	8	-40	square	20
Radar	30	6	-25	symmetric	24
Radar	250	80	-25	flat symmetric	30
Oscillator	1000	single mode	-20	symmetric	15
Communications	23.5	0.08	-40	symmetric	15

between them is one quarter of an acoustic wavelength (typically $8\mu\text{m}$ at 100 MHz)

- the length of the fingers (overlap) is determined by the power of the source to which the device has to be connected
- the number of fingers depends on the device function.

This demonstrates the fundamental control that the device designer has over the function through its geometrical shape. It also shows clearly that not only is the device highly reproducible but that it cannot be changed once

produced — if it does not function correctly it must be redesigned.

Dispersive delay lines. The simple design procedure for a s.a.w. delay line readily lends itself to the design of a

Fig. 4. Dispersive delay line design: (a) pattern of finger spacing and overlap; (b) frequency/time characteristics of the device and amplitude/time characteristics achieved by (c) variation in finger spacing and/or overlap.

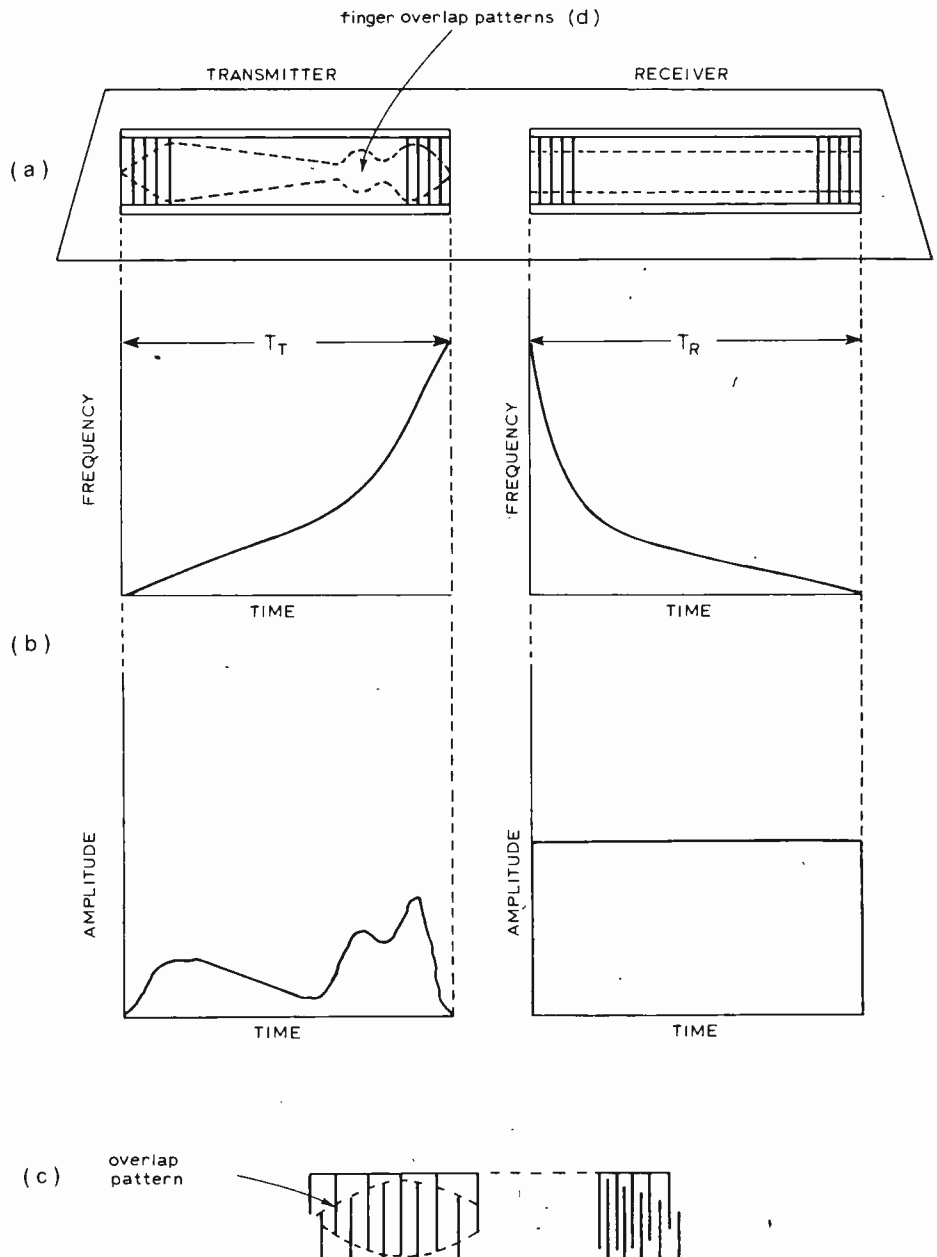

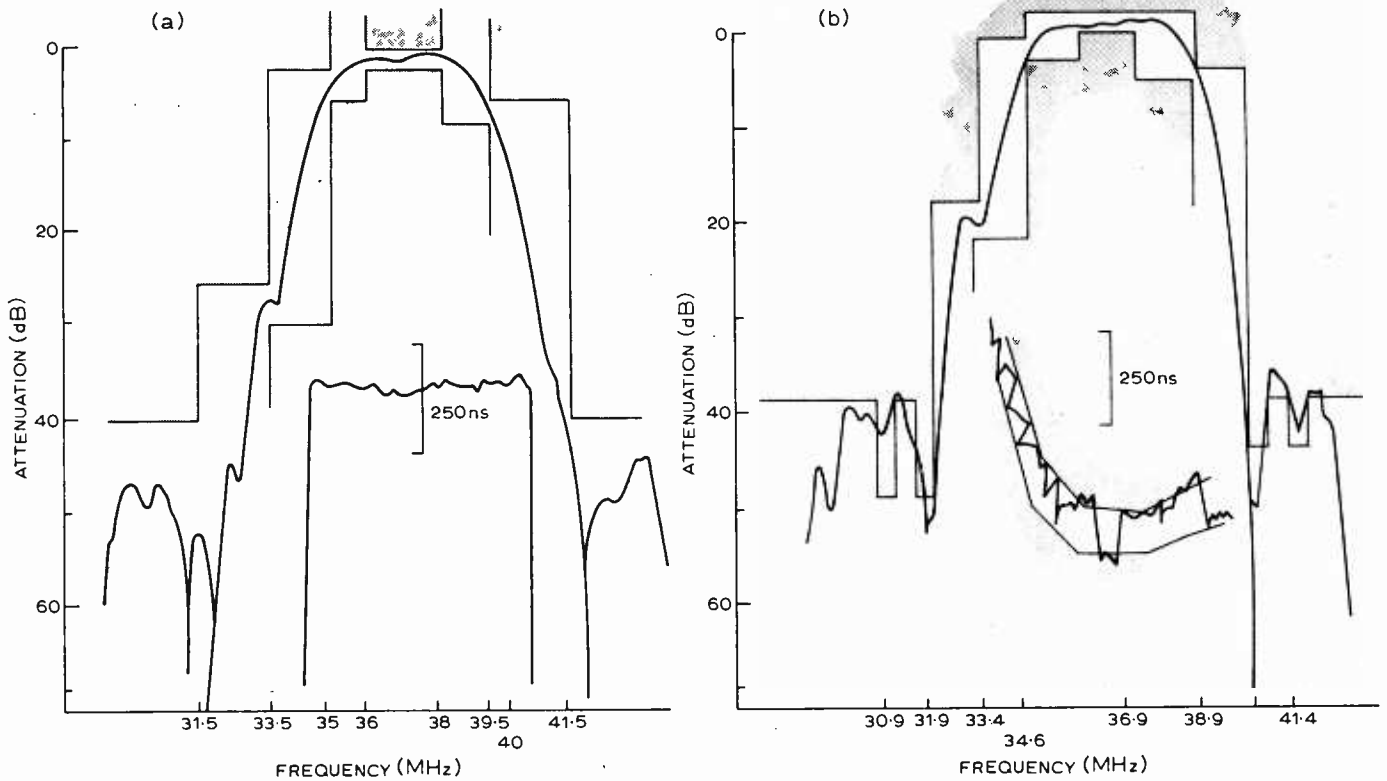

Fig. 5. (a) Band-pass responses for a UK television i.f. filter: upper curve, amplitude/frequency response; lower curve, group delay response with 250ns interval of time scale marked. (b) Band-pass responses for a PAL i.f. filter: upper curve amplitude/frequency; lower curve, group delay. In both (a) and (b) the shaded areas show tolerances.

dispersive delay line. It was soon realized at Caswell and the Radar Research Centre that the s.a.w. technology could contribute directly to the development of an advanced radar system. In a previous article¹ on the Plessey AR3D radar, mention was made of the s.a.w. equalizer application. Here the important parameters are stability, linearity of response, and the precision of the response over a relatively large bandwidth.

The s.a.w. devices are sophisticated dispersive delay lines not only because the phase/time characteristic is determined accurately by the device but because the required amplitude/frequency characteristic is provided. The characteristics of the devices for the AR3D are the conjugate of the frequency/time characteristic of the transmitter which is determined by the required coverage diagram of the radar. A typical example is given in Fig. 3 and the plots of the finger overlap weighting required for the two transducers are given in Fig. 4. It is worth noting that the dispersive delay is achieved by the transducer structure and not by the nature of the wave — pairs of fingers close together generate high frequencies, large separations generate low frequencies.

The design of devices to fit given input data is now a completely computer-oriented process. A set of programmes exists, and from inputs of the required phase law, time length, and amplitude/frequency response, the transducer design is produced on magnetic tape and in the correct format for a computer-controlled drawing machine. The programmes include correction routines for a number of second-order effects, including the highly significant diffraction correction. In addition, the basic finger geometry is chosen to minimize inter-electrode interactions and mechanical loading of the wave path.

The type of performance that can be achieved using these techniques is as follows:

Time-bandwidth product range 4 to 1000
 Time length 0.25 μ s to 50 μ s
 Bandwidth 1MHz to 50MHz
 (at 75MHz)

The control of both the amplitude and phase characteristics is sufficient to give 31dB close-in sidelobes. The use of this approach has made temperature-stable dispersive delay lines readily achievable and devices are now fully engineered.

Bandpass filters. The successful operation of a dispersive delay line — which is, in some ways, a bandpass filter with a particular phase/frequency characteristic — naturally leads to the design of more complex filter shapes. One range of filters is that comprising the television receiver i.f. filters for the UK, USA and Europe. In this application, the important parameters are:

- cost, as first and foremost the tv industry expects low-cost devices
- no tuning or adjustment — which also reduces cost
- small size
- electrical performance.

In fact, the performance requirements, can be quite stringent for such systems as cable tv and data transmission.

The electrical characteristics are best illustrated by diagram, as in Figs. 5 (a) and (b). Here the experimental responses of two devices are shown — the first is the UK tv filter which has linear phase, and the other is the European PAL filter which has a controlled non-linear phase.

The design of these devices is an extremely involved process but basically follows the scheme used for the dispersive delay line. The required input data consists of the amplitude and phase of the filter and, since cost is a parameter, the maximum time length allowed must be an input (the time length relates directly to the physical length because of the non-dispersive nature of the wave). In addition, the tolerancing on both the amplitude and phase must be inserted, and is shown in Fig. 5. In this way, for example, the 6dB point of the vision carrier and the 25dB value of the in-channel sound can be set exactly.

In general, the synthesis of a given filter shape is more difficult than for a dispersive device, but only because the time length has to be minimized. The resulting transducer structures are extremely involved and a typical example is shown in Fig. 6.

These tv filters are now marketed through the consumer division of

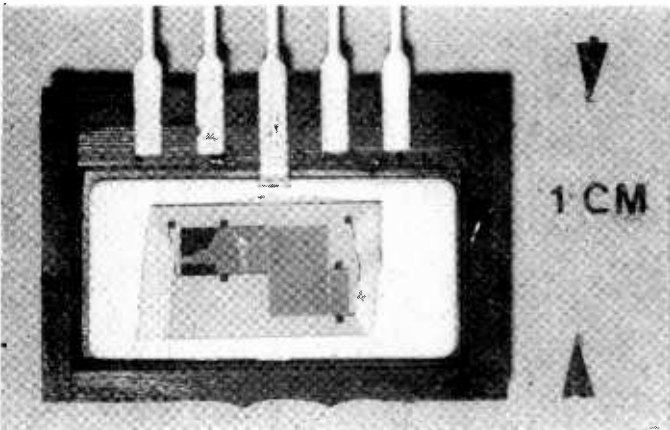

Fig. 6. Bandpass i.f. filter for television using a s.a.w. device.

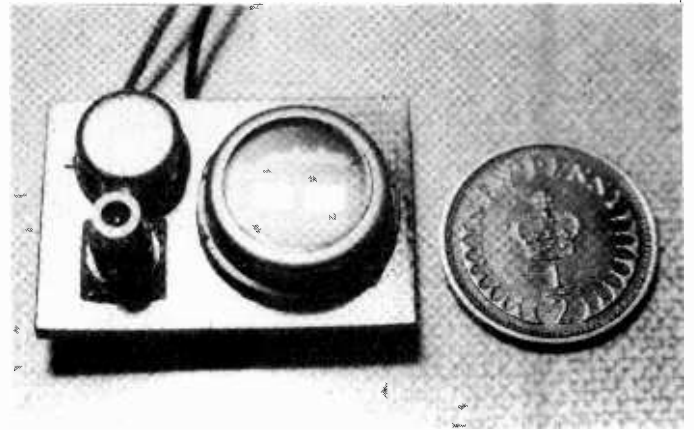

Fig. 8. Example of a 490 MHz s.a.w. oscillator.

Plessey Microsystems under the numbers SW150, SW170 and SW200. The devices can be packaged in either a standard TO8 housing or a Plessey design of plastic flat pack.

The tv filters are just one example of the type of filter that can be produced by s.a.w. techniques. A whole range of professional filters is possible and Table 1 lists some examples of typical parameters.

Oscillators. The inclusion of a simple bandpass filter in the feedback loop of an amplifier can provide a highly stable oscillator. A schematic of this arrangement is shown in Fig. 7, and Fig. 8 shows a typical device.

A number of advantages is offered to the system designer by these devices:

- high fundamental frequency operation — the device can operate at any frequency within the range of the s.a.w. delay line, namely, 10-1500MHz
- quartz short-term stability — typical figures using the Avantek GPD series amplifiers show 1 part in 10^6 over 1 second
- a frequency modulation capability that exceeds 1 per cent — which is a significant improvement over existing alternatives
- a fast warm-up time to reach an operating temperature — the device uses its package as an integral heat-sink
- small, robust and potentially cheap.

A disadvantage of the technique is its medium to long-term drift of, typically, 2 p.p.m./month. It should, however, be attractive to have the short-term stability of the s.a.w. device combined with its f.m. capability and to use this in conjunction with a locking system, either to a bulk wave crystal (normal phase lock loop) or to an atomic standard. Also, there should be a significant market application where cheap, stable oscillators are required for short-term use — for example, in sonobuoys or marine distress beacons.

S.a.w. sub-systems

The s.a.w. devices discussed above have been used mainly in retrofit applications. The wide bandwidth capability of the devices has been exploited by their

incorporation into radar systems, and their reproducibility and low production costs have been used in tv applications. But in a more general way, the devices can be incorporated into novel sub-systems to take advantage of their versatility and, of greater import, may generate new system configurations.

A few of the more significant ideas incorporating s.a.w. devices, and cur-

rently available, are briefly outlined in the following paragraphs.

Coherent pulse compression units. The block diagram of a complete unit is shown in Fig. 9. This is an example of how much can be done using s.a.w. techniques rather than of how much should be done. The shaded units in the diagram use s.a.w. devices. The incorporation of both passive generation and matched pulse compression into a small unit has the advantage of temperature tracking of the devices and ensures a good match over the whole temperature range.

Compressive receiver. For a linear frequency/time dispersive delay line the relationship between the delay of the output and the frequency of the input can be used as a fast spectrum analyzer. The relative ease of fabrication of the s.a.w. device has meant that compact units can be fabricated that enable users to identify the frequency components of an incoming pulse after mixing down. The principle is simple and is illustrated in Fig. 10.

The s.a.w. expander is continuously impinged (and therefore scans a frequency range), the start of the impulse being the reference. If two signals f_1 and

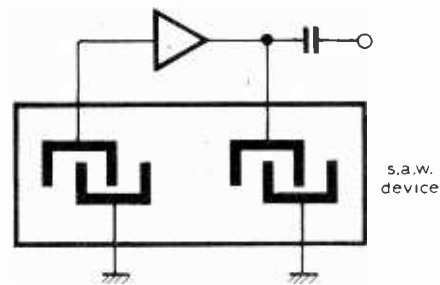
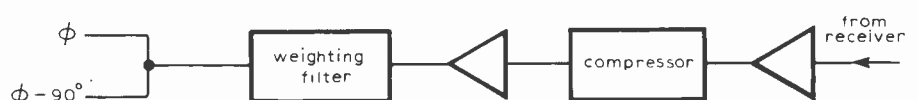
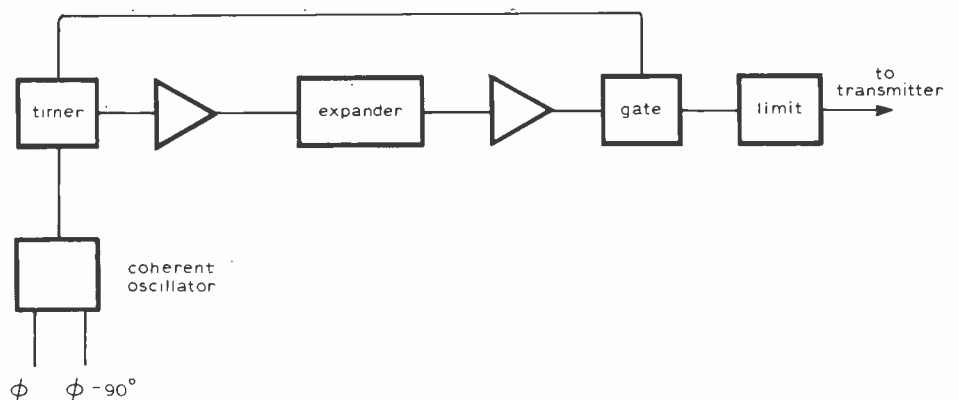

Fig. 7. Simplified schematic of a s.a.w. oscillator.

Fig. 9. Coherent pulse compression system. The blocks with shading around them use s.a.w. devices.



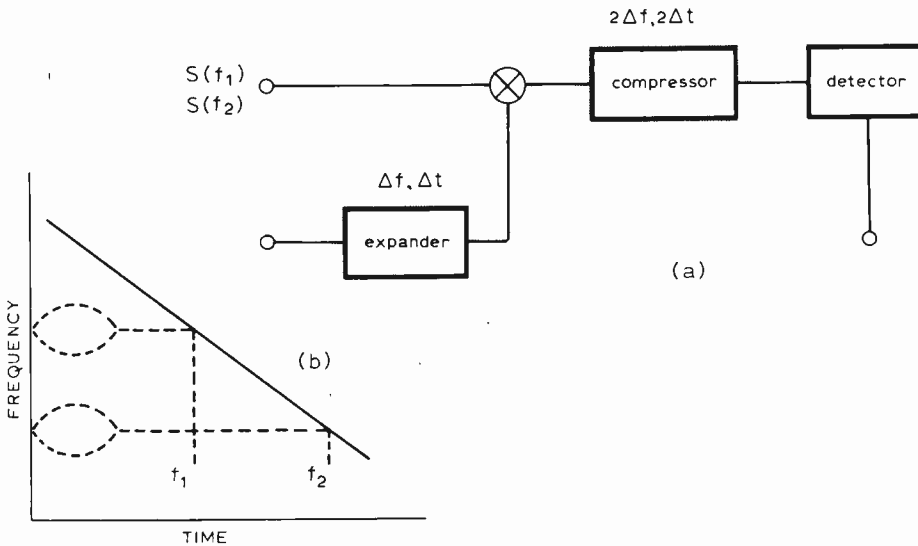

Fig. 10. (a) Schematic of compressive receiver; the shaded blocks contain s.a.w. devices. (b) Principle of operation of compressive receiver; the bulbous areas in broken line represent the pulse shape after mixing.

substitute for what is currently an expensive item. It provides the properties of short-term stability and f.m. capability inherent in a s.a.w. oscillator, outweighing any s.a.w. device disadvantages for systems such as radar where frequency agility is attractive and short-term stability is required.

Conclusion

To sum up, within the last two years surface acoustic wave technology has progressed from being an interesting research project to full system realization in various capacities:

- pulse compression units are being incorporated into advanced radar systems
- television filters are being produced in reasonable volume and gaining acceptance in the industry
- professional filters and oscillators can be designed and are available on a custom-design basis
- novel sub-systems are being developed which should impinge on system design within the next few years.

References

1. D. L. Motkin. "Three-dimensional air surveillance radar", Plessey Systems Technology, No. 21, p.29 (June 1975).
2. J. M. Deacon and J. Highway. IEEE Spring Conference 1975 (Chicago) on television receivers.
3. C. L. Grasse and D. A. Gandolfo. Ultra. Symp., Boston 1972.
4. J. M. Deacon et al. Electronics Letters, No. 10, 1973.

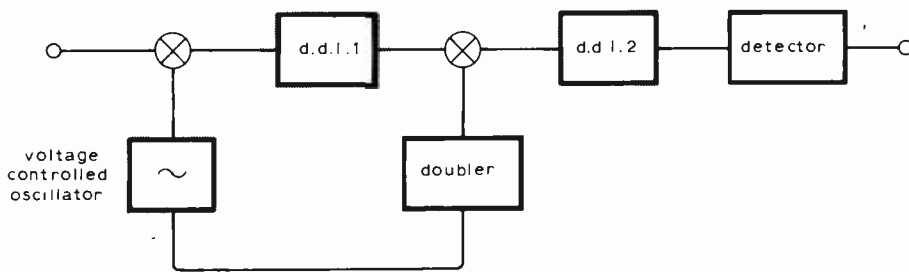

Fig. 11. Variable delay line. Shaded blocks are those containing s.a.w. devices.

f_2 come into the system at the same instant of time, the frequencies will be resolved by the system into two compressed and distinct pulses. These processes have been discussed in detail by Grasse and Gandolfo in an article³, in which they conclude that the s.a.w. implementation of the technique offers the best potential for future development.

Variable time delay. The dispersive delay line (d.d.l.) can be used very simply to provide a variable analogue delay line'. This system, outlined in Fig. 11, operates by delaying the input signal by an amount proportional to the local oscillator frequency. The output from d.d.l.1 is distorted by the phase characteristic of the delay line, but this distortion is readily removed by mixing with the doubled local oscillator output and again convolving the output with d.d.l.2.

The delay can be varied by simply varying the local oscillator frequency, and units have been made which operate over a range of 4 to 60µs, continuously variable. A neat extension of this approach is to vary rapidly the frequency of the local oscillator in such a way that the time length of the input information can be changed and hence

data rate modifications made. These techniques are currently undergoing intensive research and show promise in particular applications.

Synthesizer. The s.a.w. oscillator has been mainly used in single-mode operation but multi-mode operation has always been possible. In practice, the mode separation is the reciprocal of the time delay, and hence for a 500kHz spacing a 2µs delay is required. What has always been difficult has been the selection of the required mode, but a particularly elegant solution has been proposed and demonstrated by Maines at the Royal Radar Establishment, using a number of the s.a.w. device properties discussed above.

The basic principle is that the s.a.w. oscillator can be injected. The signal for use in this is provided by a voltage controlled oscillator and the system operates as shown in Fig. 12. This synthesizer offers a very economic

Fig. 12. Use of s.a.w. device (shaded blocks) in a frequency synthesizer.

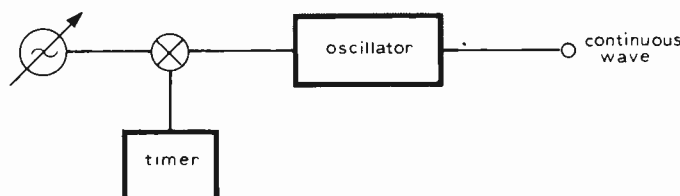

American CB boom

More than 200 stands at the recent US Consumer Electronics Show in Chicago displayed Citizens' Band radio equipment. CB is now a £300M market in the States. It is estimated that four million units were sold in 1975, which is 25% up on the previous year, and that now about half a million units are being sold each month. This volume of sales has created a licensing jam at the FCC. Sources in the US electronics industry forecast that the sales value of CB equipment will surpass all other consumer electronic products except colour television by 1980. Wireless World will be publishing an article on the CB "scene" in the States later this year.

Letters to the Editor

LOW NOISE CASSETTE DECK

We should like to take the eminent Mr J. Linsley Hood to task for advising the use of the 70 μ s equalisation characteristic for use with normal low-noise ferric cassettes. This is most misleading because one of the most serious problems with these cassettes is their lack of response to high-level, high-frequency signals; the 120 μ s post-emphasis was adopted to try to alleviate this. Even this results in a fully-saturated recorded level of about 10dB below Dolby level at 10kHz. Adopting the 70 μ s equalisation characteristic reduces the h.f. overload figure by almost another 5dB which makes an already bad situation intolerable. This would produce severe h.f. intermodulation distortion when recording typical musical material at "normal" mid-band modulation levels.

The reason that the 70 μ s equalisation is adopted for chrome cassettes is simply that they are much less susceptible to h.f. overload because of the smaller particle size and higher coercivity of the oxide formulation.

We would, however, endorse Mr Linsley Hood's suggestions for optimising bias and equalization settings. In our opinion too many manufacturers align their machines to attain the ultimate in frequency response (or "specmanship") to the detriment of other aspects of the reproduced quality. One notable exception to this is the British manufacturer NEAL, who quite deliberately align their machines to be -2dB down at 12kHz on ferric tapes. This compromise produces a similar result to that obtained using Mr Linsley Hood's square wave technique.

C. J. Evans,
J. Dawson,
A&R,
Cambridge.

The author replies:

The original Philips recommendation for the equalisation of the "Musicassette" was for time constants of 1590 and 120 μ s, of which the first was to compensate for anticipated inade-

quacies in the l.f. response and hum pick-up problems with the circuitry, and the second was to remedy the known shortcomings of recording head and tape characteristics. Improvements in system design have led to the universal adoption of the 3180 μ s low-frequency equalisation time constant, to bring the cassette system into line with other reel to reel, recording systems, and the advent of chromium dioxide cassette tapes has prompted the adoption of a 70 μ s h.f. time-constant in order to secure some of the advantages which these improved tape types can offer.

As a consequence of this, most modern cassette recorders will offer a choice of h.f. time constants, whose use is at the discretion of the user, when he is making recordings for himself.

However, the design of recording heads and cassette tape materials has not stood still in the intervening years, and it is my belief that there are many ferric tapes which will give an improved signal to noise ratio, without any significant penalty in terms of h.f. overload on typical programme material when used with the "chrome" (70 μ s) equalising time constant, and it was this belief, based on a quite substantial number of tests, which led me to make the recommendation to which Mr Evans and Mr Dawson object.

A shrewd friend once observed to me that rules were made for the guidance of the wise, and the blind obedience of fools, so, in this context I would urge, even in the light of hind-sight, which is said to be an exact science, that users try out the available options, and judge the issue for themselves.

J. L. Linsley Hood

WAS BAIRD FOOLING THE PUBLIC?

In reference to the article on John Logie Baird in the January issue, my letter in April and subsequent readers' letters in June, I would reply as follows:

D. B. Pitt. Looking back only to the 1925/1928 period there are many published references to demonstration successes. Claims were supported by unconvincing details. From the journals of the time it is clear that editors were pressed to give publication to reports in the terms of Baird associates. When the 30-line test transmissions commenced (September 1930) both Post Office and BBC disclaimed responsibility for the results. No amateur activity ensued. There were no dealer demonstrations, no receiver sales and no public reaction to the service.

Dr P. Waddell. Here is a report of an event, a 3D, 1,000-line, colour demonstration of November 1943. My letter commented only on the earlier

claims made in the Falkirk Transmitter article. Other irrelevant events are cited (1938/1939) concerning large screen colour. Much could be said in the context of what was happening at this later time, including the adoption of the Marconi system at the Alexandra Palace now mentioned.

Space was given by the original authors claiming the application of fibre optics to television. This I considered was in no way usefully related to the Baird single channel objective. To digress, therefore, optical cables, with maybe a thousand critically related separate paths, serve to produce small, high definition images over short distances. Contrary to Dr Waddell's advice the video cable is not usually associated with scanning and synchronising devices, particularly of mechanical type.

Prof G. D. Dawson. The "Televisor" test report, a single page, did not appear until 12th March 1930, a full six months after the transmissions had started. Styled for domestic use, the "Televisor" was not acceptable for home entertainment and could only be handled by an expert, to doubtful effect. With the transmissions taking place a receiver was described at length in *Wireless World* of 18th December 1929. The normal circuit of lamp and sync winding connected in series, which I believe Dr Dawson implies by his comment, was changed over to a shunt arrangement. This allowed of brightness control and so avoiding the silhouette image caused by the lamp cut-off when adjusting for synchronisation. Without this modification sync arose from random white to black picture changes. Synchronisation was not due to any intended pulse and came accidentally, in the main, from the framing barriers and depending on whether the image background was dark or light at the start or finish of a line scan. The necessary intentional gap of zero signal (blacker than black) was not provided on the completion of each line.

H. W. Barnard. My compliments to H.W.B. Baird's use of the "bits and pieces of unrelated discoveries" is apt comment from the writings of P. P. Eckersley (the BBC's first chief engineer). Those fascinating toys of a Victorian physics laboratory, the Kerr electro-optic shutter, the phonic wheel, the Nipkov disc, all developed before the turn of the century, in no way serve as the basic components for the invention of television as Baird clearly proved. To him the thermionic valve was non-existent. It is a matter of wonder that some, who by distinction might have disregarded the Baird adventure, allowed themselves to be sponsors to his plans.

F. H. Haynes,
Overleat,
Bovey Tracey,
Devon

PHASE—AMOS AND MOIR

The question of whether the end always justifies the means is one that has engaged mankind in perennial dispute. Even education in its most respectable forms, must be admitted to be "a process of diminishing deception." But, with respect, I hold that Fig. 1 in Mr Amos's article "Antiphase or 180° phase shift?" (June, p.47) is an inadmissible deception for the purpose of reaching his legitimate conclusion, viz., that a distinction should be maintained between inversion and 180° phase shift.

Fig. 1 (b) is stated to show the result of phase-shifting Fig. 1 (a) by 180°. But (a) is "a sine wave together with some second harmonic." In (b) the sine wave has truly been shifted 180°, but the harmonic has been shifted 360°! It was to avoid this kind of thing that the British Standards Institution definitions relating to phase* all took care to specify *sinusoidal waveforms, of the same frequency.*

When inversion and 180° phase shift respectively are applied, as they should be for a true comparison, to sine waves, as in Mr Amos's Fig. 2, no difference can be seen between the results. What really matters is which part of the treated waveform corresponds, as effect to cause, to the original. In the case of inversion these coincide in time; in the case of phase shift they differ in time by half a cycle.

Few of your readers are likely to have handy for reference your issues of May and June 1948, in which I went into the whole matter at considerable length, but copies of "Second thoughts on radio theory," in which a revised version appears as Chap. 9, are still to be found in some libraries.

I'm sure it would gratify our curiosity, as well perhaps as emphasizing Mr Amos's point, if he could be persuaded to disclose the nature of the equipment that failed to work because its designer did not distinguish between inversion and phase shift.
"Cathode Ray"

* BS.4727: Part 1: Group 01:1971, definitions 101 1031-1036.

Articles and correspondence about phase have appeared in the last six months issues of *Wireless World* and elsewhere. I am unable to resolve my own understanding of phase with the viewpoints put forward by James Moir and S. W. Amos. If phase is dimensionless (and all the equations I have seen have it so) then it cannot properly be a measure of time.

There is a clear error in Fig. 1(b) of Amos' article. What he describes as a 180° phase shift is, in my view, a time delay of half the period of the fundamental component of waveform (a). Such a delay might be produced by a suitably long piece of lossless transmission line. He asserts that Fig. 1(c) is not

a 180° phase shift but concedes that in the case of a symmetrical waveform the result would be indistinguishable. Since my understanding of Fourier analysis is that an unsymmetrical, but zero average, waveform can be constructed by summing symmetrical sine waves then I am sure that his distinction is incorrect.

That referring to phase in terms of time is incorrect is shown by Fig. 3 of James Moir's article in the March issue. Again, Fig. 3 has nothing to do with phase and not even really time. What he shows is the result of feeding his input signal to a dispersive propagating medium. If it were simply a time delay, as he says, then the input waveform would be reproduced exactly.

The debate about linear-phase loudspeakers will undoubtedly go on but perhaps the correspondents could clarify their ideas first.

John Newell,
Workingham,
Berks.

Mr Amos replies:

Cathode Ray will, I know, agree that phase shift in reactance-resistance networks is invariably accompanied by signal delay. There is a danger, therefore, that if the signal inversion of an amplifier is interpreted as 180° phase shift, someone will try to make use of the associated (non-existent) delay: this is what happened to my unfortunate designer. In my article I was trying to distinguish between the phase shift in networks (which gives delay) from signal inversion in amplifiers (which doesn't). To highlight the difference I used Fig. 1 to distinguish between the response of a signal-inverting amplifier (c) and the response (b) of a typical network (with 180° phase shift at the fundamental frequency and phase shift proportional to frequency). It is true that I did not mention the 360° phase shift at the second harmonic frequency. In my opinion this omission was justified because it simplified the presentation and clarified the argument e.g. by avoiding any need to introduce considerations of delay and group delay. But Cathode Ray, is of course, **entitled to his opinion.**

I cannot reply adequately to Mr Newell without introducing delay. To set up a magnetic field around an inductor or to charge a capacitor takes a finite time which is measured approximately by the time constant of the circuit. The phase shift ϕ in the circuit is also measured by the time constant and hence phase shift is inexorably associated with signal delay. There is a simple relationship between them: in fact the delay is given by ϕ/ω which has the dimensions of time. Phase shift itself, as Mr Newell says, is dimensionless. To avoid distortion of a wave passing through a network the delay must be constant for all its components and must thus be independent of frequency. Thus for distortionless

transmission phase shift must be directly proportional to frequency.

Mr Newell is quite right in his statement about Fourier analysis and it is also true that the effect of inverting each component of an asymmetrical waveform is the same as phase shifting it by 180°. It would not be possible, however, to create an inverted wave such as that of Fig. 1(c) by phase shifting each component by 180° (even if a network could be found which would do it) because the components would be subjected to different delays and therefore would not produce the required result when added. This difficulty does not arise if the components are inverted because there is no delay in this process.

Comments have also been received from Messrs Jefferies, Stancliffe, Evans, Rossiter, Bulmer and no doubt others. The points I would make in reply are all included in my answers to Cathode Ray and Mr Newell above. The fundamental issue is that it is misleading to refer to the signal inversion of an amplifier as 180° phase shift because there is no signal delay. Phase shift in networks (even phase advance) is always associated with signal delay and it is not unreasonable therefore (but quite wrong) to assume that the 180° phase shift of an amplifier is also accompanied by signal delay. Hence my deprecation of the use of the word "phase" to describe signal inversion.

I am grateful to Mr Sargent for his support and for reminding me that phase shift can occur as a result of transit-time effects.

S. W. Amos.

Mr Moir replies:

I think that it is unfortunate for communications engineers that the concept of phase was introduced by power supply engineers operating a system at a fixed frequency. As I showed in the contribution in the March issue, in the context of single frequency working a specification of phase shift between two waves can be unambiguous specification of the time difference. In communication circuits the same concept cannot meaningfully be applied. We should be thinking in terms of the differential time delay, the difference between the time of propagation at some reference frequency in the middle of the band and the time of propagation at the extremes of the audio frequency band. It is this differential time delay that produces waveform distortions.

It should be fairly clear that a circuit that has a phase shift of say 360 degrees (one complete cycle) at a frequency of 100 Hz., a phase shift of 720 degrees at 200 Hz (two complete cycles) and a phase shift that continues to increase linearly with frequency will not introduce any differential time delay and is therefore non-distorting (in phase) because all frequency components are

delayed by exactly the same time interval (10ms). In consequence waveforms are transmitted without distortion.

The tenor of my March contribution was that waveform distortions due to phase shift (propagation time differences) do not appear to be of any significance in determining the quality of sound signals, provided that the time delays are kept within the CCIF limits which in simple phase shift terms are absolutely enormous.

The waveform shown in Fig. 3 of the March issue certainly shows that the signal is delayed, the start of the 'received' signal occurring 0.0109 secs after the start of the 'sent' signal. The oscillograms were obtained by passing the signal through a simple band pass filter and not in the complicated way Mr Newell suggests. The input waveform would have been delayed and not distorted if the phase characteristics of the filter had met the requirements outlined earlier, but obtaining a linear phase characteristic for such a filter requires the addition of many more elements. The filter used exhibited the usual characteristics, minimum time delay in the middle of the pass band and a delay that increased towards both ends of the pass band. It is this characteristic that results in the amplitude variation and the final "overhang". James Moir.

THE CONSULTANTS

As one of the consultants included in John Dwyer's article "The Consultants" in the November 1975 edition of *Wireless World*, I have of course been following the subsequent comment with some interest. Whilst I have been tempted to comment upon the original article and the subsequent correspondence before, Roger Driscoll's letter in June 1976 cannot be left to pass without reply.

In my opinion there are three classes of consultants. There are the variety described by Raymond Cooke, who own "an AVO with a bent needle". There are a few of us who like myself have considerable experience in industry, and have then "gone it alone" and set up their own laboratory facilities. Thirdly there are those like Roger Driscoll who are professional academics, but do some spare time consulting work.

Clearly these three classes of consultants work in very different circumstances - just what has each class to offer? The "AVO with the bent needle" type is clearly to be avoided, but what about the others? The academic type is probably appropriate where a theoretical problem alone is involved, but just how can someone who spends his life in an academic world have experience in practical designs; that is, unless he learns at his clients' expense? I have no

disagreement with academic institutions undertaking research projects on behalf of industry on a profit making basis, but individuals making free use of instrumentation and facilities which are public property, for their own benefit is a different issue. Any reasonable laboratory will have at least £50,000 of equipment. If we look at the cost of employing this amount of capital it is at least £5,000 per annum, to which we must add the cost of replacements which allowing for inflation is at least £10,000 per annum and also add overheads at say a minimum of £2,000 per annum. This shows that in the order of £17,000 per annum is involved in purely maintaining a good laboratory - why shouldn't some of this be recovered when academic staff use the laboratory for their personal gain? After all it's the public who own the equipment.

This of course leads to the question of fees. John Dwyer suggested that £100 per day was too high a fee. Well, £17,000 per annum operating cost is about £350 per week which does not leave a £100 per day consultant all that rich!

Hugh Ford,
Sunbury-on-Thames,
Middx.

CITIZENS' BAND RADIO

In reply to Mr Webber in March "Letters", I am in complete agreement with him as to the practicality and usefulness of CB radio but as to the "Smokey Bear" messages, I fear I must take an opposite stand. Being a professional technician in the music business, I find myself travelling a great deal in America frequently travelling with private and professional CB users, and because of this familiarity I must make two relevant points. Firstly, Mr Webber says "offenders could be charged..."; to this I must say that it is "illegal" for police to listen to and act upon any of the CB channels (other than the emergency bands) and also it is common knowledge that a speed violator with a CB unit is liable to higher fines than a speed violator without (the reasoning being that an operator with CB knows about the existence of police patrols/speed traps, and travels over the limit regardless).

One further point regarding Mr Webber's letter re: "...impeding the police in the execution of their duty..." About a year ago a motorist, being very annoyed about being caught in a police radar trap, positioned himself about a mile from radar trap and posted a sign warning other motorists of its existence. He was apprehended and charged. When brought before the magistrate, the case was dismissed as the court ruled that the motorist was doing more to stop speed limit violators than the police could accomplish by ticketing the occasional offender.

W. T. Penman,
London, W.6.

COMMUNICATION THEORY

Professor D. A. Bell's excellent article concerning redundancy included an unfortunate half-truth which I feel to be misleading. I refer to the statement on page 75 of *Wireless World* May issue in which are the words "with a sub-carrier placed exactly half-way between line harmonics."

If the sub-carrier was so placed, the interference pattern would build up a vertical bar system which the eye would see. In practice the sub-carrier is placed in a carefully controlled manner, just off this exact half-way position. This results in a more complicated pattern which, while it does in fact repeat, looks like random interference as the repeating time is too long for the eye to realise it.

Another detail, yet an important one, is that the subcarrier is divided into two components, basically in quadrature, and each of these is then modulated, by the I and Q components, in balanced modulators such that only side-frequency components are left. In the absence of colour information, no sub-carrier component is present.

R. L. Hackworth,
The City University,
London

The author replies:

The point I wanted to make was that the basic picture signal has most of its energy in sidebands clustered around the line harmonics (and a bias towards the lower frequencies) so that one puts the colour information between a pair of line harmonics. When the frequency of colour sub-carrier is 4433.61875 kHz, it is clearly not exactly in the centre of the gap. But if it were exactly in the centre it would not produce a vertical bar system. Simple Fourier analysis shows that any vertical bar is represented only by exact harmonics of line frequency, the horizontal position of the bar being represented by the phase of the harmonics. Since the separation between line harmonics is a multiple of 25 Hz., the centre point between two of them must be a multiple of 12.5 Hz. The pattern (not bar) produced would be reversed on alternate frames and so minimised by persistence of vision. It would, however, be a stationary pattern and in practice it has proved advantageous to use a frequency which is not related simply to the scanning frequencies. The form of modulation is also of practical value; and if one is going into detail one should include the point that the I component in NTSC has only a vestigial upper sideband, so that the distance between colour sub-carrier and top edge of video band can be less than the maximum colour bandwidth. PAL, however, is different.

D. A. Bell.

Self-setting time code clock

Constructional design suitable for domestic use

by N. C. Helsby M.A. University of Essex

To meet the demand for a fully constructional time-code clock this article describes a modular design comprising five basic functional units. The full circuit receives a time-coded transmission from Rugby MSF and uses this to drive a six-digit display. An optional GMT/BST converter accounts for the one hour discrepancy which exists during the UK summer.

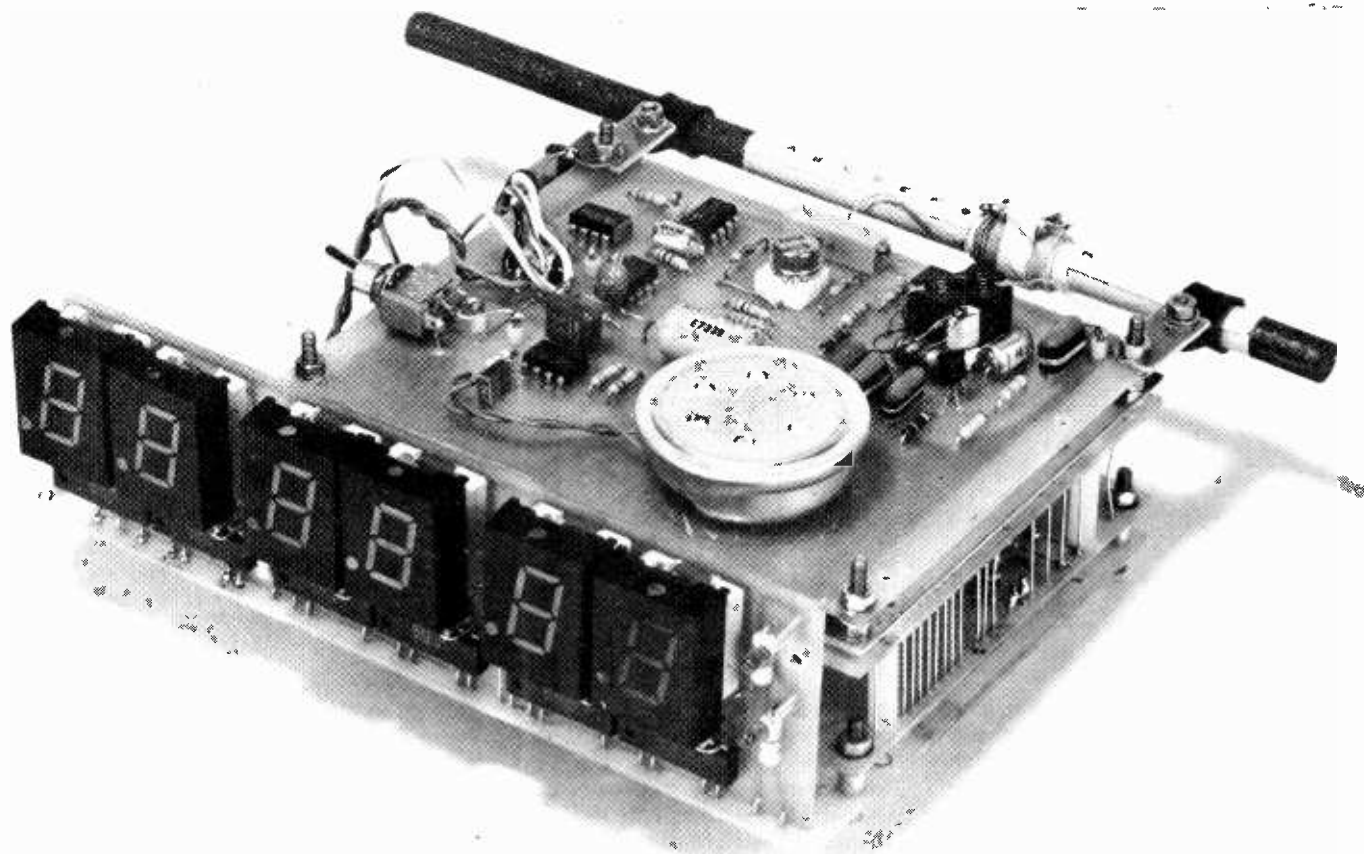

Self-setting digital clocks using coded radio signals have recently been made possible in this country by the introduction of a time-of-day code into the 60kHz transmissions from Rugby, call sign MSF. Until recently only second and minute markers were transmitted in addition to the call sign. This service is maintained as before but the transmission now carries a 13-bit b.c.d. code giving hours and minutes in the UTC time scale.

Receiver

Various receiver designs were considered including a phase-locked loop version. However, it was desired to keep the circuitry simple and a receiver with two tuned stages of amplification followed by a detector was found to work well with a pre-set gain control.

With this conventional design it was difficult to obtain more than 12dB extra gain over that required at 100 miles from the transmitter. To obtain extra sensitivity without the danger of regeneration, a low-level detection system was designed using a multiplier as shown in Fig. 1. By operating the multiplier as a frequency doubler a d.c. output is obtained in addition to the double frequency which is removed by filtering. Most of the gain is required at audio frequencies and is provided by amplifier IC₂. Using this system, no high levels of 60kHz are present in the receiver which eliminates pick up by the ferrite rod aerial. Although the signal strength has been found consistent, inclusion of a.g.c. and a precision Schmitt-trigger level detector enables best use to be made of the available

signal at any moment. The signal strength meter is a useful addition and allows optimum positioning of the aerial.

The multiplier is preceded by a common-emitter gain stage with a tuned collector load, the input of which is fed by the aerial. Current in this stage is set by the a.g.c. amplifier, and reaches a maximum of about 1mA under no signal conditions. Resistors R₁ to R₄ set the multiplier tail currents, signal and carrier input bias levels via centre tapped windings, the a.g.c. amplifier reference, and a reference for the Schmitt-trigger comparator circuit. Half a milliamp flows in each of the multiplier loads under no signal conditions. Output of IC₂ is set to 4.3V by R₅ when no signal exists (shorted aerial). When a signal is applied to the input of

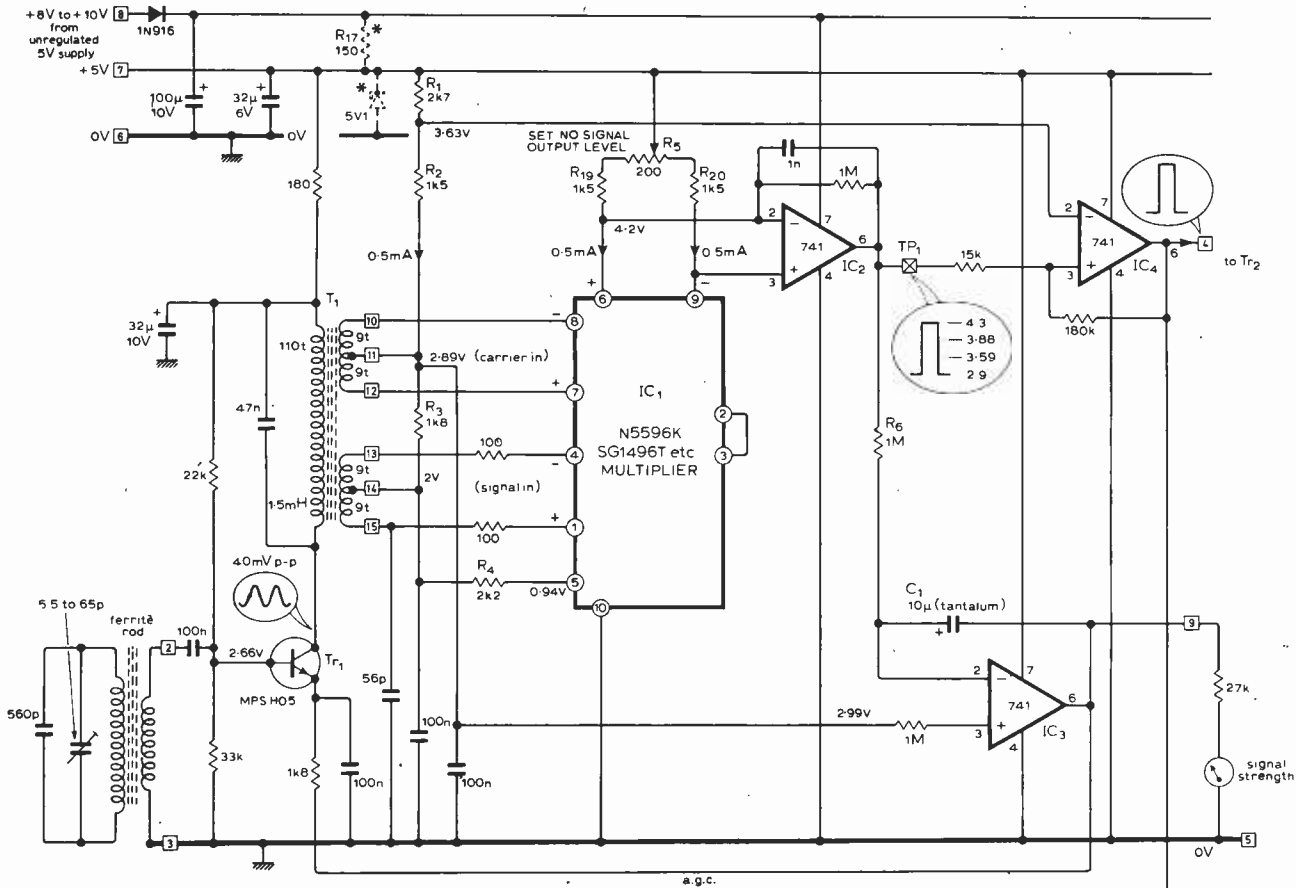

* fitted if single supply required

WINDING DATA

component	core	number of turns		wire
		primary	secondary	
aerial	7½ in x ¾ in F14	380	16	36 s.w.g. s.s.c.en.
T ₁	10 mm POT CORE LA 2936	110	(2 off) 18 centre tapped	40 s.w.g. en.
T ₁	RM6-R LA 4145	59	(2 off) 14 centre tapped	30 s.w.g. en.

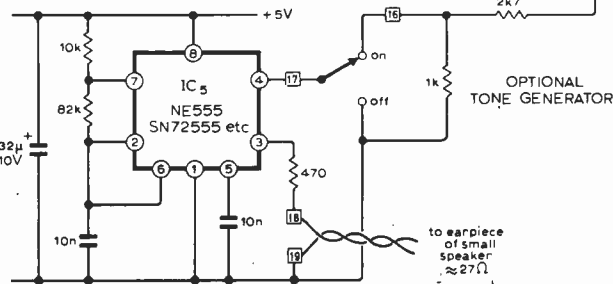
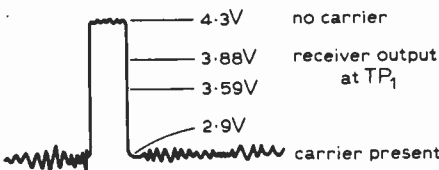

Fig. 1. Receiver using a multiplier as a frequency doubler to produce a d.c. output. Most of the gain is at a.f. which eliminates aerial interference from high levels of 60kHz.

Fig. 2. Typical break in carrier relative to the Schmitt-trigger levels.



the receiver the negative differential output of the multiplier is amplified and filtered by IC₂ (if output is not negative either of T₁ secondary windings may be reversed). The a.g.c. amplifier IC₃ produces a level of 2.9V at the output of IC₂ by controlling the gain of Tr₁. The long time constant formed by R₆ and C₁ ensures that the gain does not change much during the 0.1 to 0.5 second breaks which occur in the carrier. This slow response causes a delay after switch-on for the signal to

appear. Schmitt-trigger IC₄ has a 0.29V hysteresis and the thresholds are 3.88 and 3.59V. These levels were chosen because most of the noise appears when the carrier is present. A typical break in the carrier relative to the Schmitt-trigger levels is shown in Fig. 2.

The receiver is required to respond to a 60kHz carrier modulated by pulses, the shortest of which is 5ms. Because single tuned stages are used there is no overshoot in the response and the rise time of a stage is $0.7/B$ where B is the bandwidth in Hz between the 3dB points. This expression accounts for the two sidebands of the modulated wave occupying a frequency band that is twice the modulating frequency. If the response determining stages have similar rise times the exponential output of the receiver $V = V_0(1 - e^{-t/\tau})$ where t is the time after a step of carrier is applied, V_0 is the final output after a long period and τ is the response time constant.

Fig. 3. (a) Minimum input voltage at aerial to produce a low output from IC₄. (b) Frequency response of receiver.

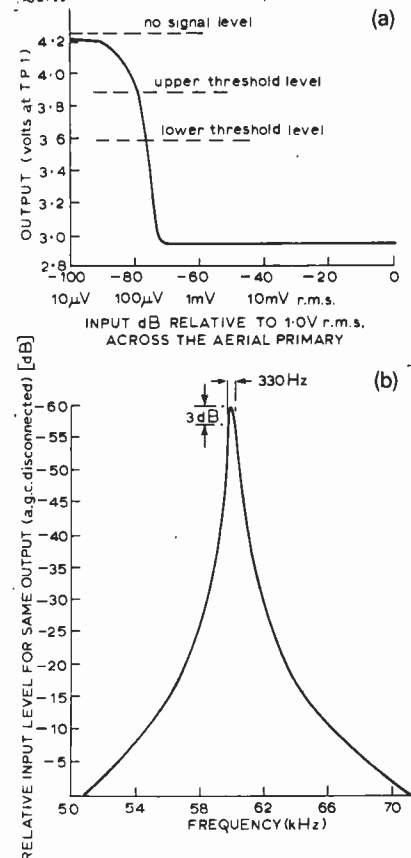

The rise time (T) is the time taken for V in this equation to rise from $0.1V_0$ to $0.9V_0$ and can be expressed as 2.2τ . Therefore, $V = V_0(1 - e^{-2.2t/RT})$. From this equation the overall rise time which will allow V to reach 99% of V_0 in a specified time t may be found; $0.99 = 1 - e^{-2.2t/RT}$ therefore $t/RT = 2.0$. Thus if $t = 5\text{ms}$ the overall time required is 2.5ms . Two tuned circuits in the receiver define RT in addition to the filtering capacitor. The transmitter rise time may also be taken into account in this approximate analysis if it is considered to have the same rise time as one of the receiver stages. The overall rise time is approximately proportional to the square root of the number of stages. For these four response determining stages to give an overall rise time of 2.5ms , each stage should have a rise time of $2.5/\sqrt{4} = 1.25\text{ms}$.

For the single tuned stage, rise time is $0.7/B$ hence B is $0.7/1.25 \times 10^{-3} = 560\text{Hz}$. The loaded Q 's of the aerial and the amplifier tuned circuits should be

adjusted to give a 3dB bandwidth of this order of magnitude, requiring a loaded Q of 110 (60,000/560) at 60kHz. Note that if two single tuned stages have bandwidths of 560Hz the overall bandwidth, which is given by $B = B_0\sqrt{2} - 1$ where B_0 is the bandwidth of each stage, is $0.64 \times 560\text{Hz} = 360\text{Hz}$.

The aerial pick-up coil design involves a compromise between Q and output voltage. Tuning is accomplished by means of a fixed capacitor and a trimmer across the primary coil. It was found that 36 s.w.g. single silk-covered wire gave a Q of about 140 with the coil spread over 2in. A signal generator connected across the aerial primary produced the results shown in Fig. 3(a). The minimum level of signal required to register as a low from the Schmitt trigger is $160\mu\text{V}$ r.m.s. across the aerial primary. The maximum signal picked up from Rugby, 100 miles from the transmitter, was equivalent to 3.5mV r.m.s. which gave about 26dB reserve gain. Inside a reinforced concrete

building the signal was 10dB lower which still left 16dB of gain. Frequency response of the receiver is shown in Fig. 3(b). The a.g.c. was removed and Tr_1 was operated at a current which would normally give the correct output level from a signal of about 1mV r.m.s. across the aerial primary. It should be noted that the step-down ratio of the aerial transformer is 380:16 or 27dB in terms of signal strength. By buffering the input stage, so that this ratio can be reduced or eliminated, greater sensitivity can be obtained.

Decoder

The receiver output detector, which appears typically as an inverted form of waveform A in Fig. 5, is fed into the buffer stage Tr_2 in Fig. 4. This is

Fig. 4. Decoder circuit, the charge and discharge action of C_2 provides heavy filtering and increases the noise immunity.

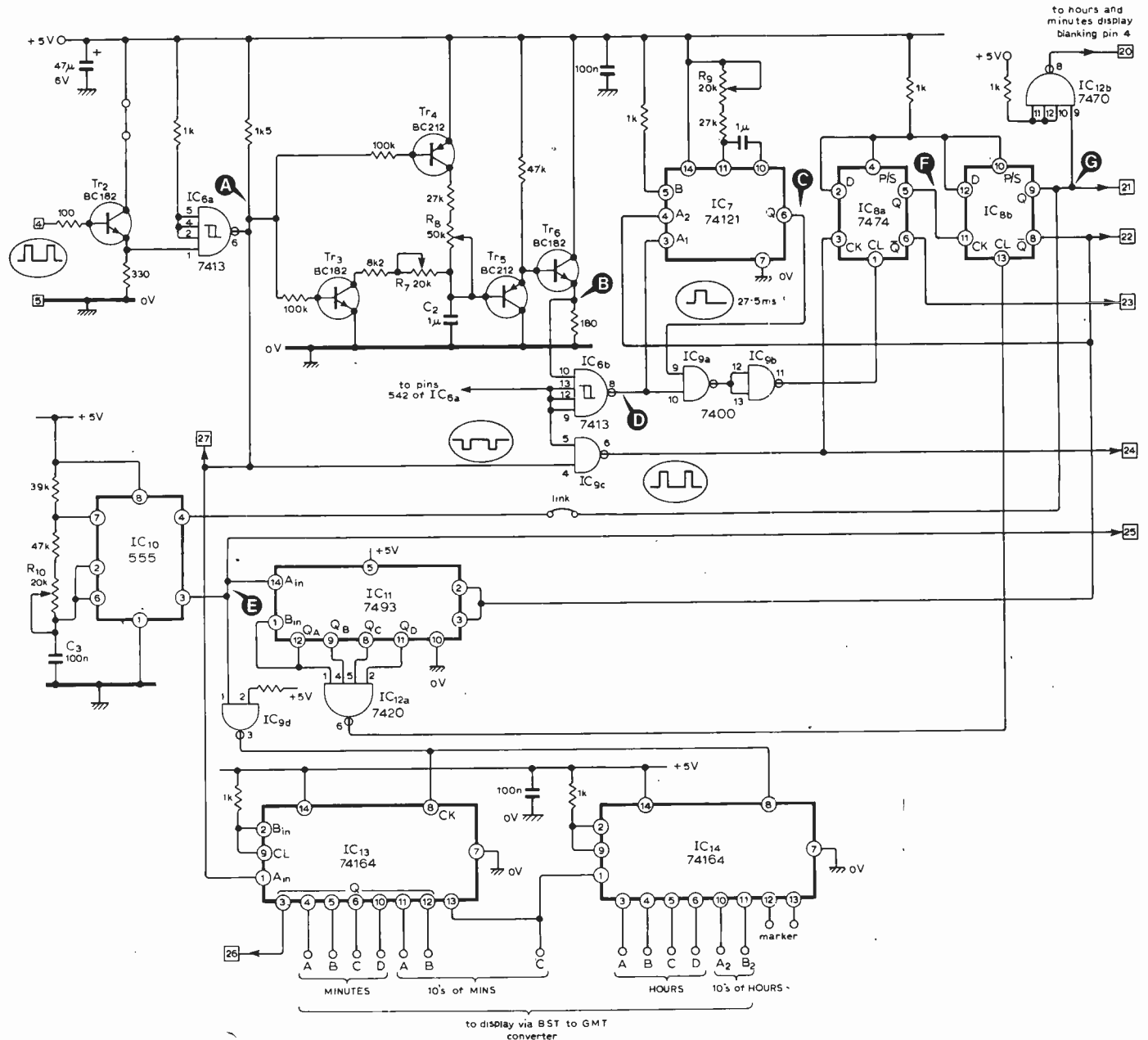

Fig. 5. Waveforms for various points throughout the decoder circuit.

followed by Schmitt trigger IC_{6a} to improve noise rejection in the conversion to t.t.l. levels. The output of this gate feeds a circuit which charges and discharges capacitor C₂ to produce waveform B in Fig. 5. Transistors Tr₅ and Tr₆ form a double emitter follower to drive Schmitt trigger IC_{6b}.

Resistor R₈ is adjusted so that if point A is low for more than 22ms, the positive threshold on the second Schmitt trigger is reached, to produce a low as shown by waveform D, Fig. 5. The output from IC_{6b} triggers monostable IC₇ which is adjusted by R₉ to give a pulse length of 27ms. Output D is required to be high with output C in

Fig. 6. Seconds counter using a phase-locked-loop tone decoder.

order to clear IC_{8a} via IC₉. These conditions leave a narrow window during which a negative going edge at A, made positive-going by IC_{9c}, can clock IC_{8a}. Resistor R₇ is adjusted so that if A is high for more than 18ms after

the initial 25ms break, C₂ is discharged to the negative threshold of IC_{6b}. The charge and discharge action of C₂ provides heavy filtering and reduces the likelihood of false triggering by noise pulses.

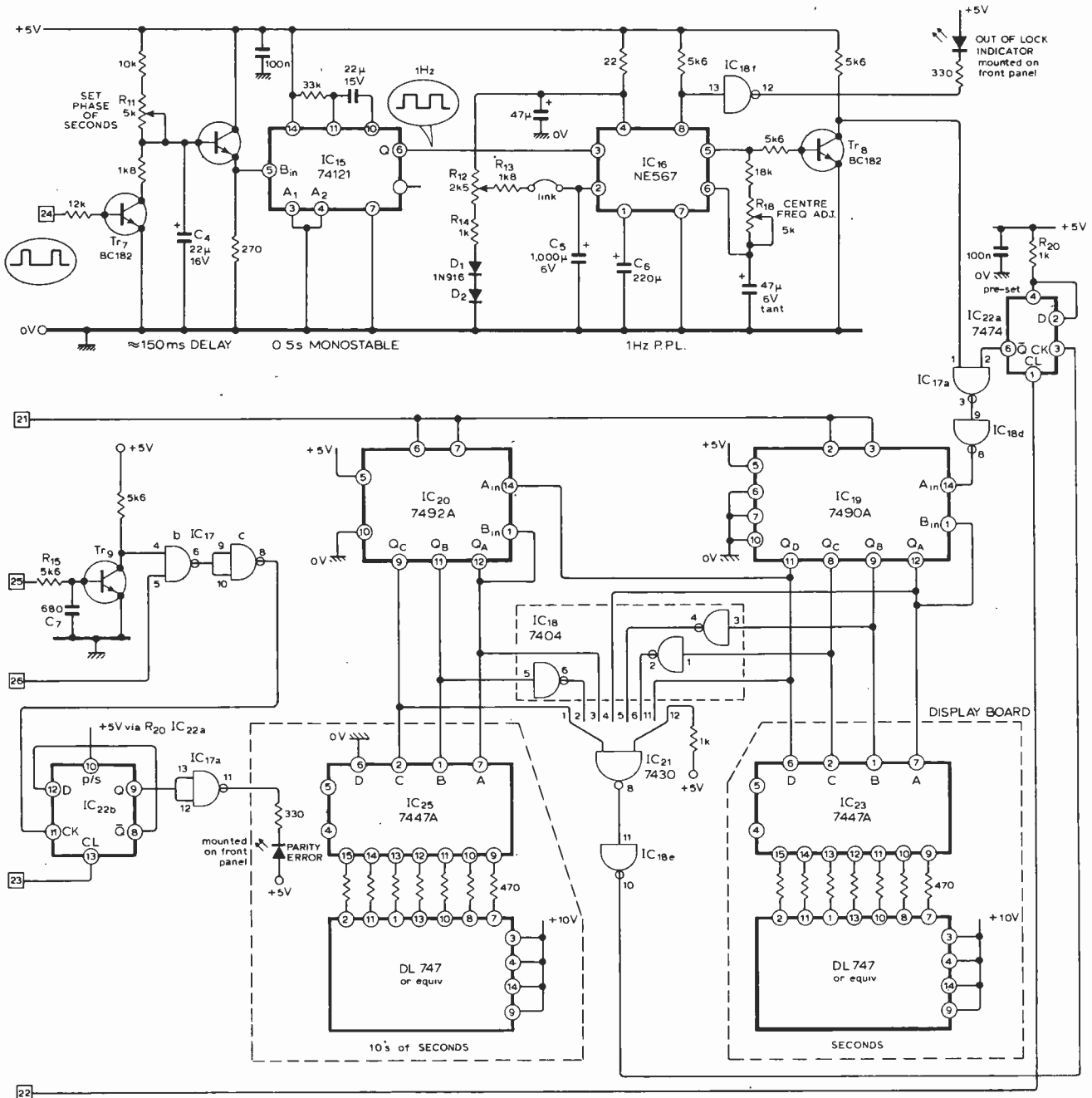
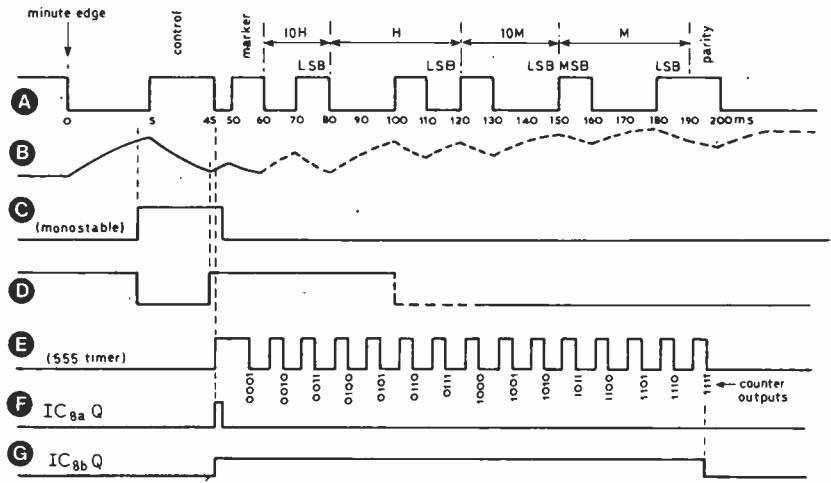

Unused inputs of gates which are required to be high are taken to +5V via 1kΩ resistors as a precaution against transient noise on the power supply. The Q output of IC_{8a} clocks IC_{8b} which in turn allows IC₁₀ to run in the astable mode with a frequency set to 100Hz by means of R₁₀. Simultaneously, the Q̄ output of IC_{8b} allows IC₁₁ to count the negative-going edges from the timer. On the 15th edge all outputs of IC₁₁ go high to give a low out from IC_{12a} which clears IC_{8b}. The last-mentioned then resets and holds the timer. The Q̄ output of IC_{8b} returning high also resets IC₁₁.

The timer capacitor C₃ normally charges to 2/3 of the supply and discharges to 1/3 by the internal action of the circuit. This gives the mark-space ratio as shown in Fig. 5 with the component values selected. When held in the reset state, C₃ becomes discharged and it is therefore required to initially charge from zero to 2/3 of the supply which produces the first wide pulse as shown. Thus, by choice of resistor values it is possible to place the negative-going edges of the timer output in the centre of the time code bits. This output is then inverted so that the time code is clocked serially into shift registers IC₁₃ and IC₁₄ at the middle of each bit; the shift registers clocking on positive-going edges. The registers are not cleared in this design, new information simply pushes out the previous pattern. Although the marker bit can be used as the first received high at the end of the shift registers, to stop the clock, the counter was used because if the marker bit were missed due to noise, the time-code might still be retained correctly.

It is possible that the time code itself contains a pattern similar to the one that indicates the start of the code because it is divided into 10ms-long bits. However, the Q̄ output of IC_{8b} is connected to the A₂ input of IC₇ and this pin therefore goes low just before the end of the monostable pulse. IC₇ cannot fire again until the complete code has been received and when this occurs A₂ returns high without firing the monostable so good noise immunity of the code recognition circuitry is maintained.

Seconds counter

Due to the transmission accuracy, reception and display of seconds is well justified. In this design the Signetics NE567 p.l.l. tone decoder has been used for the seconds counting function as shown in Fig. 6. The device operates from a 5V supply and incorporates a balanced multiplier type of phase detector which, when overdriven, also operates as exclusive-OR gating.

The maximum recommended timing resistance for the p.l.l. current-controlled oscillator (c.c.o.) is 20kΩ. The tantalum timing capacitor may increase in value by as much as 5% for a 20degC rise in temperature but, as the oscillator is not required to accurately run for

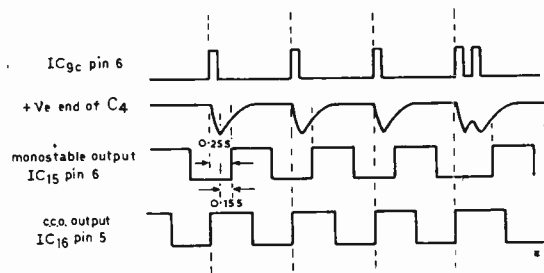

Fig. 7. Delay of 250ms is created from the positive edge on IC_{9c} by lengthening pulses via monostable IC₁₅

long periods without an input signal, the effect is not important provided the loop remains locked.

In this application the p.l.l. is required to lock to a single fixed frequency so it is desirable that the bandwidth of the loop is small. Because heavy filtering is used it is necessary to reduce the loop gain which increases damping. This is accomplished by the manufacturer's recommended method of adding R_{12,13,14}, D_{1,2}. This network reduces one of the internal multiplier collector loads and hence the loop gain. Potentiometer R₁₂ enables the correct d.c. conditions to be maintained while the diodes provide temperature compensation. The detection band is reduced from ±7% to about ±4%. Reduction in gain coupled with the value of C₅ gives the loop a damped response which prevents overshoot in phase after a disturbance. It also has the advantage of reducing the number of input cycles required before locking occurs, usually less than the maximum of twenty.

To produce the required 1:1 mark-space ratio at the input of the p.l.l., monostable IC₁₅ is used to lengthen the input pulses. By delaying the input to the monostable a phase shift brings the c.c.o. output in phase with the second markers. The total delay is 250ms from the positive-going edge, on the second, at pin 6 of IC_{9c} - see Fig. 7. By timing the delay from the negative-going edge the extra amount required is 150ms which is obtained by allowing C₄ to charge through R₁₁. This capacitor is discharged by Tr₇ when the output from IC_{9c} is high for 100ms after the second. The monostable Schmitt trigger input is used and R₁₁ adjusted until the necessary delay is achieved. The output-pulse length of the monostable is fixed at about 0.5s and any phase error can be eliminated by adjusting R₁₁.

The c.c.o. output is fed via buffer stage Tr₈ through IC_{17a} and IC_{18d} to the input of the seconds counter. The outputs of the counters IC₁₉ and IC₂₀ are inverted where necessary to present all highs to IC₂₁ at the count of 59 seconds. This causes the output to go low and clock flip-flop IC_{22a} causing its Q̄ output to go low. Further clock pulses via IC_{17a} are inhibited until the flip-flop is cleared by detection of the minute sequence. Thus, if the hours and minutes are not updated the seconds count ceases. When the sequence is correctly received the counters are reset and IC_{22a} is cleared by the output of IC_{8b}. Waveforms of this are shown in Fig. 8.

It should be noted that extra decoupling of the supply to the tone decoder is used. This is to prevent the decoder running as a locked oscillator, with no signal at pin 3, due to small 1Hz spikes on the supply rail from other parts of the circuit.

(To be continued)

Printed circuit boards

Wireless World has arranged a supply of glass fibre boards for the time code clock. The p.c.bs are available as a set which comprises three double-sided and two single-sided boards for the receiver, GMT/BST converters, decoder, seconds counter, and display. The boards mount on top of each other (see photo) to form a compact module which can be housed in a case approximately 8 x 5 x 3in. The set of boards is priced at £13.50 inclusive or £11.00 undrilled.

A set of special components is also available which comprises an aerial assembly, receiver coil assembly (LA4145) N5596K multiplier, MPS H05 transistor, two 1.5kΩ metal-film resistors, and the NE567 tone decoder. This set is priced at £7.50 inclusive. Available from M. R. Sagin at 11 Villiers Road, London NW2.

Fig. 8. Waveforms present in the seconds counter.

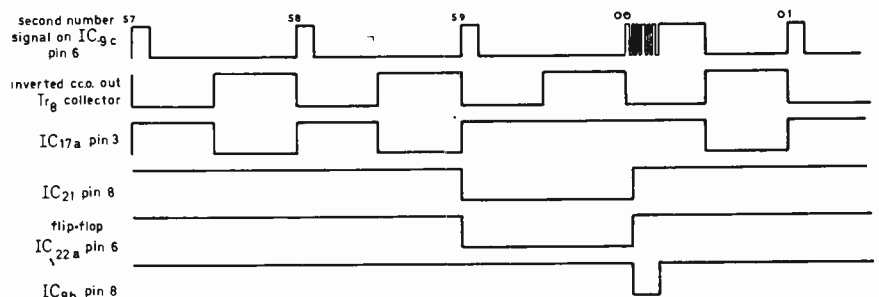

Circuit Ideas

Voltage probe

This circuit indicates the presence of direct or alternating voltages from 3 to 440V without range switching. The circuit is basically a constant current supply for the l.e.d. Transistor Tr_2 regulates the base current of Tr_1 . As the voltage across R_2 rises to V_{eb} , Tr_2 begins to conduct and reduces the base current of Tr_1 . The voltage capability of the probe is limited by the $V_{ceo(sus)}$ of Tr_1 which is 350V. This value can be increased to 450V by the addition of a suitable base emitter resistor R_{be} . If this is a fixed value of 60Ω the low voltage operation of the circuit is impaired due

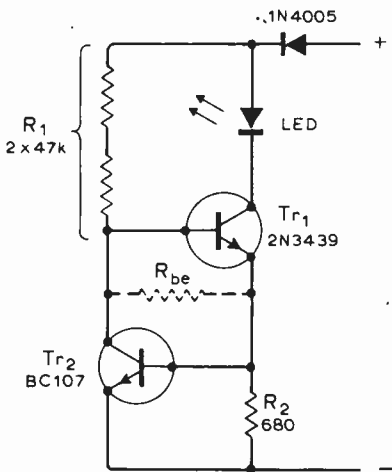

to the lack of forward bias on Tr_1 . With the correct selection of R_1 , Tr_1 can be made to act as a variable R_{be} , having high resistance at low operating voltages and low resistance at high operating voltages. The power dissipated in R_1 can be reduced by increasing its value provided that Tr_1 has a h_{FE} above 45 at 1mA. However, R_1 must not be so high that R_{be} is significantly increased due to the lower collector current in Tr_2 .

The prototype was housed in a plastic tube of internal dimensions 100mm x 10mm dia. The probe tip was made from a 4mm plug and the l.e.d. was mounted in the back end plate of the probe. For use on the mains supply a suitable varistor should be used to limit voltage transients.

Glyn Jones,
Queen Elizabeth College,
London W.8.

Direct-reading transistor tester

The op-amp provides base current for the transistor under test whose action causes equal voltages to occur at the op-amp input terminals. If V_{ref} is 5.3V, sufficient base current will flow to provide 1mA collector current. Gain of the transistor is then 1mA/base current, and the meter scale is calibrated. Thus, the $50\mu A$ point is marked $1000/50 = 20$, and so on. A gain value of 400 is marked at the $2.5\mu A$ point. Resistor R and the

diode protect the meter against overloading which could occur if a zero-gain transistor were tested. Resistance R in series with the meter should total $5k\Omega$.

For testing p-n-p devices a switch is fitted to reverse the supply polarity and the meter.

A. Rigby,
Ormskirk,
Lancs.

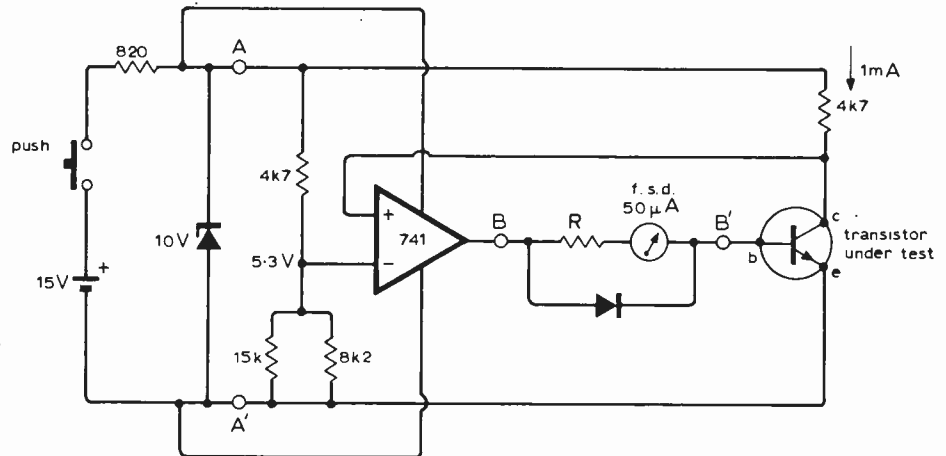

Fast modulo-3 counter

A receiver design required a local oscillator source covering 10 to 30MHz. To avoid a $3^2:1$ capacitance ratio in the oscillator tuner, and to reduce the tuning rate, a 40 to 60MHz oscillator was followed by a circuit which could divide by 2, 3 or 4. G_1 and G_4 are the input driving gate and output buffer gate respectively. When A and B are both 1, the circuit is a $\div 4$ twisted ring counter with G_2 and G_3 acting as

inverters between the J & K inputs of each bistable. When A is 0 and B is 1, both Ks go to 1, and the circuit is a synchronous $\div 3$. With both A and B at 0, FF_2 is preset, preventing it from switching, and J of FF_1 is forced to 1. Input K of FF_1 then divides by 2. With the components shown the circuit will operate up to 60MHz.

C. Attenborough,
Emsworth, Hants.

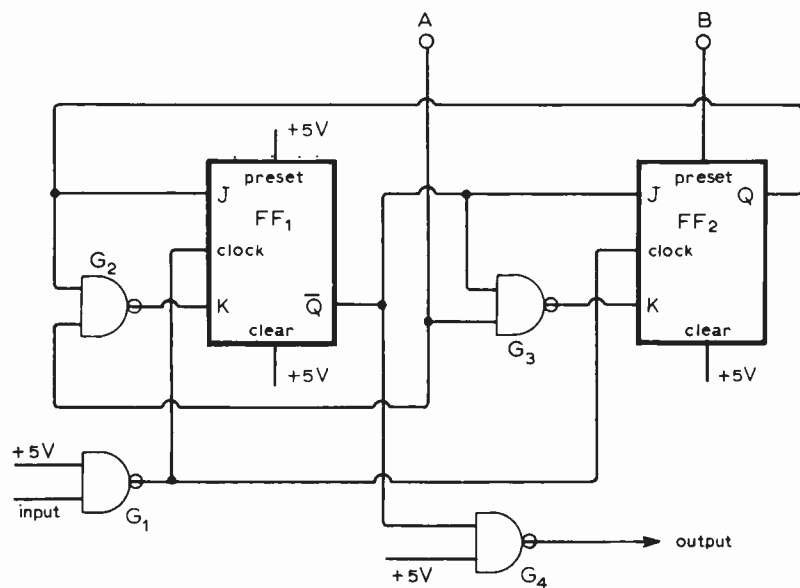

A	B	division ratio
1	1	4
0	1	3
0	0	2

$G_1 - G_4$ each $\frac{1}{4}$ 74S00N
 FF_1 & FF_2 each $\frac{1}{2}$ 74S112N

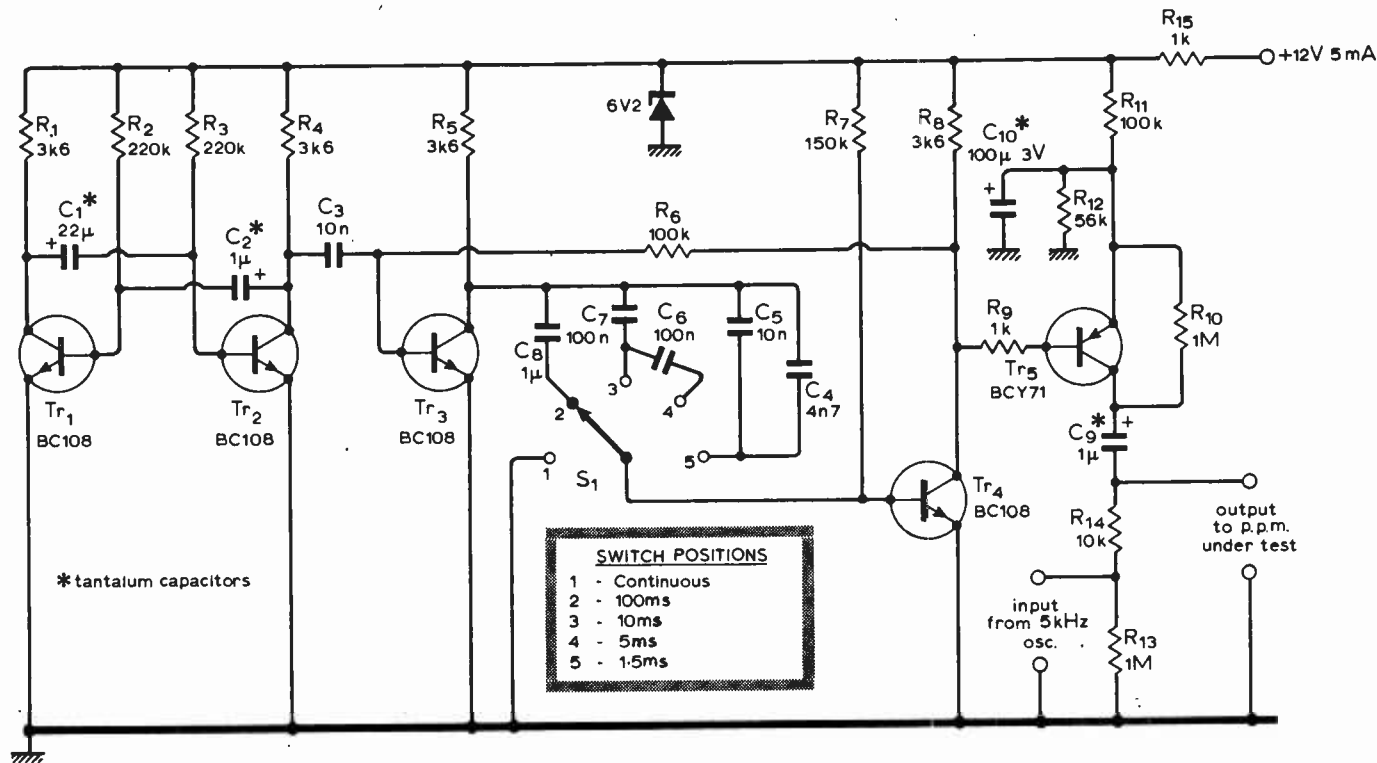

Tone burst generator for testing p.p.ms

The rise time of a peak programme meter is defined by BS4297:1968 as the deflection caused by various short duration tone bursts. This circuit can be used with an audio oscillator for producing these tone bursts. Transistors Tr₃ and Tr₄ form a monostable with switched timing capacitors. The monostable is triggered every five seconds by the astable Tr₁ and Tr₂. An audio oscillator signal is pulsed by the monostable output via the transistor switch formed by R₁₄ and Tr₅. This switch is biased to handle the required +8dB output, and is designed to avoid d.c. level changes and spurious transients which could give misleading results. The load impedance should not be lower than 10kΩ which results in a transmis-

sion loss of 6dB. If this cannot be tolerated, or the p.p.m. under test has a low input impedance, the switch should be followed by an emitter follower. The residual output in the off condition is adequately low at -26dB, and the minimum input impedance is 10kΩ. Output waveform can be checked on an oscilloscope, in which case C₁ can be temporarily reduced in value to increase the pulse repetition frequency. Power requirements are 5mA at 12V but other voltages can be used if R₁₅ is adjusted accordingly. Transistors Tr₁ to Tr₄ can be any silicon n-p-n types but a good quality device is recommended for Tr₅.

To test a p.p.m. response time the tone burst generator is connected to a 5kHz oscillator which is adjusted for a

reading of 6 on the meter with Sw₁ at continuous. On switching to the various pulse lengths the p.p.m. reading should be within the following limits.

Burst duration	Meter reading (relative to 6)
continuous	0dB
100ms	0 ± 0.5dB
10ms	-2.5 ± 0.5dB
5ms	-4.0 ± 0.75dB
1.5ms	-9.0 ± 1.0dB

E. T. Garthwaite, Carlisle.

Phase failure indicator

The circuit shown will indicate whenever any one of the three phases of a balanced supply is absent. Each phase is separately stepped down to about 9 volts and rectified. The three cathodes of the diodes are joined together and resistor R₂ is adjusted so that Tr₁ is just conducting when three phases are present. In this condition the relay will operate. If one of the phases is off the average voltage at the base of Tr₁ is reduced and the relay is released.

S. K. Sud,
Instrument Design Development Centre,
I.I.T. Delhi,
India.

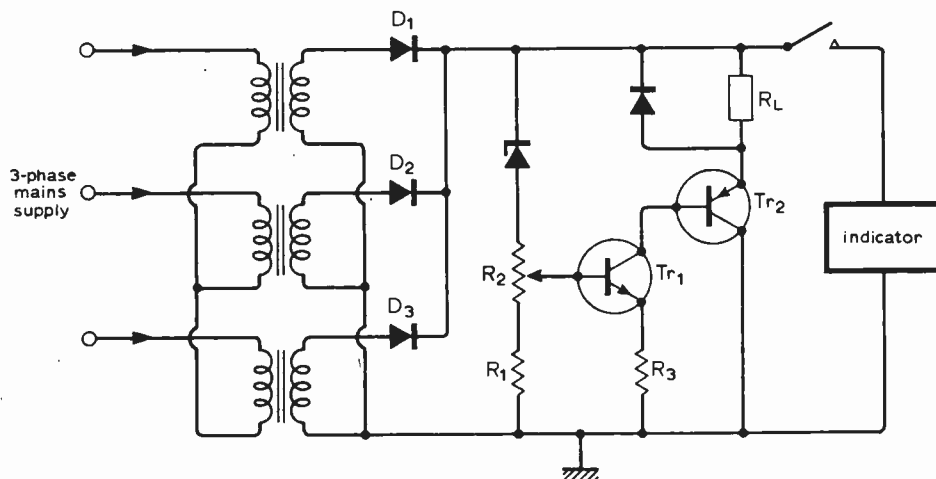

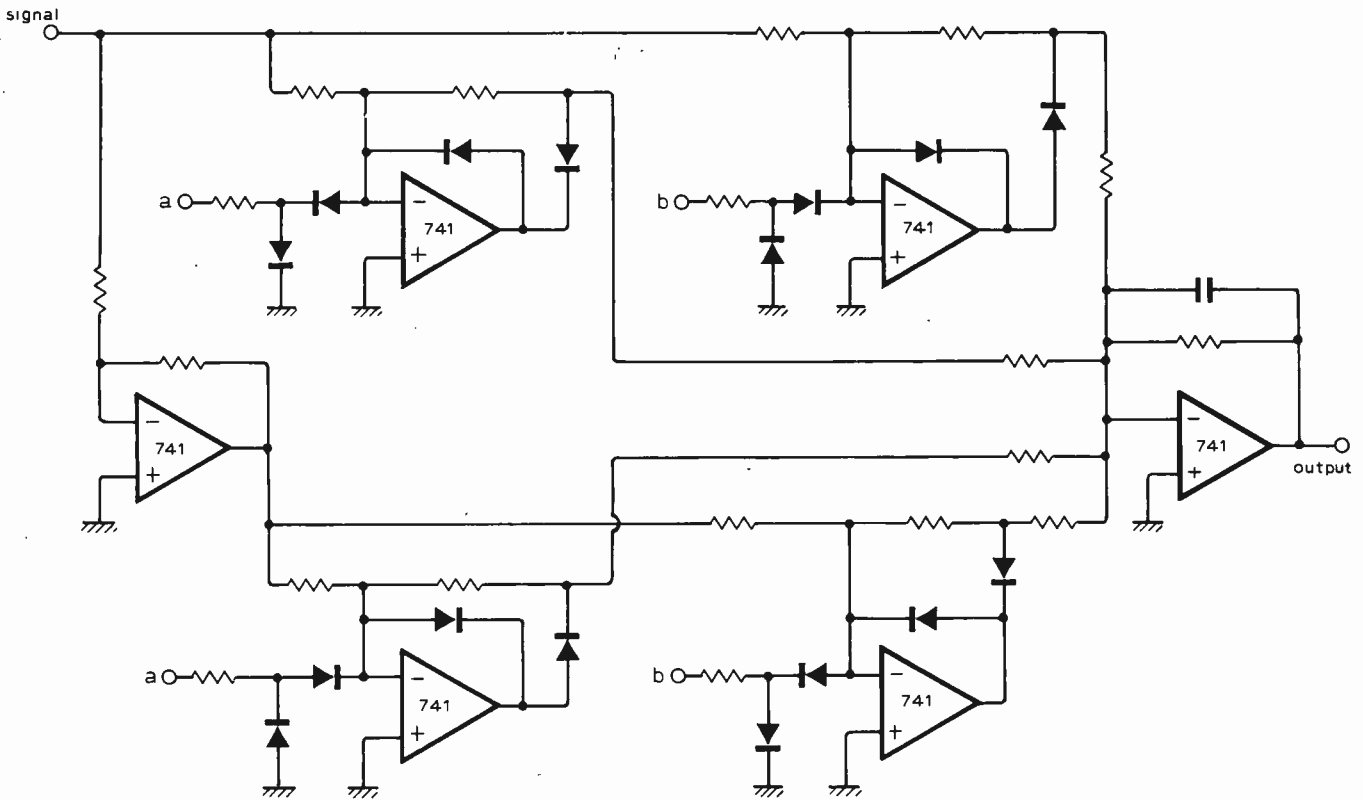

Precision phase sensitive detector

Precision phase sensitive detectors are finding an increasing application in experimental environments where a small signal has to be retrieved from background noise, often much greater than the signal itself.

The basis of this detector is four precision rectifiers operating as analogue gates. Each passes signals of one polarity and may be dis-enabled by a suitable signal. At any instant only one of the gates will be passing a signal and a d.c. output is obtained by summing and smoothing the outputs from the individual gates. The phase reference is obtained from two 180° out of phase square waves (a and b in the diagram) which should be symmetrical about zero and have an amplitude greater than the largest expected signal.

Performance of the circuit is good, and no switching transients are present at the output. Overall phase response and rejection of quadrature components in the signal are dependent on all the amplifier elements having unity gain. For the highest quality detector, selection of the gain determining resistors will be necessary.

W. Allison,
U.C.L. (Dept. of Physics),
London W.C.1.

Loudspeaker feedback circuit

Power dissipated in a loudspeaker is proportional to V^2/R where V is the voltage across the coil and R is the resistive impedance. Modern voltage amplifiers driving into moving coil loudspeakers work successfully on the assumption that the impedance is roughly constant over the entire frequency range. This, however, is not the case and, although damping factors can minimize the effect, this is one of the causes of colouration.

It is possible to obtain a loudspeaker output which is more accurately proportional to the square of the amplifier input voltage by including the speaker in the feedback path of an amplifier. In circuit (a) the resistance in series with the loudspeaker monitors the current, and a potentiometer is used to monitor the output voltage. If the feedback is now made proportional to the geometrical mean of v_1 and v_2 , i.e. $(v_1 \times v_2)^{1/2}$, then the output from the speaker will be proportional to the amplifier input and independent of variations in the speaker impedance. Very complicated circuitry would be needed to obtain such a mean, but for medium differences between v_1 and v_2 the arithmetical mean approximates closely to the geometrical mean. The simplest way of obtaining an arithmetical mean is shown in circuit (b) where the output and feedback paths of a typical amplifier are shown. Circuit (c) shows a modified arrangement but other configurations are possible and may be more suitable in different amplifier designs. The results, especially in the medium quality loudspeaker range, can be quite impressive.

Giles Hibbert,
Blackfriars, Oxford.

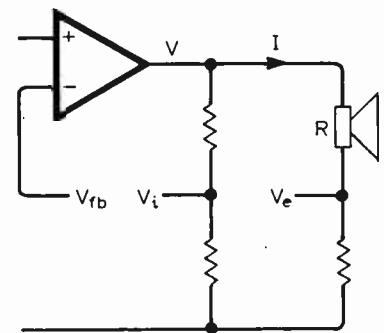

(a)

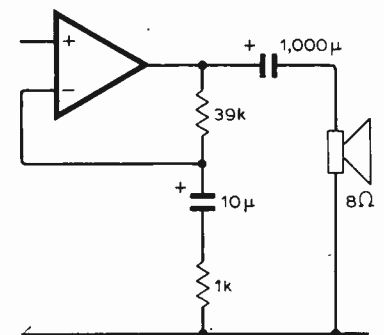

(b)

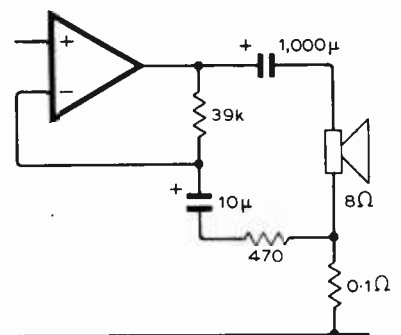

(c)

Low-noise, low-cost cassette deck — 3

Motor control and further notes

by J. L. Linsley Hood

In response to one or two queries, the following notes are offered. Several cassette decks have now been completed, using alternative designs of printed board, and have proved very successful.

Motor control

Circuitry for the control of the drive motor and solenoid is shown in Fig. 20. It is required to supply or withhold current from the cassette-retaining solenoid and to supply a constant drive to the motor in the presence of supply variations.

Solenoid control. Tr₃ normally conducts and energizes the solenoid. As the motor turns, the pulse-generating switch in the mechanism (yellow and green leads in the Goldring deck) keeps Tr₁ conducting, which cuts off Tr₂ and allows current to flow through the solenoid and Tr₃. When the motor stops, so does the switch: Tr₁ ceases to conduct and, after 3 seconds (C₂R₅) Tr₂ conducts, cutting off Tr₃ and de-energizing the solenoid. The cassette is

thereby released. If the "pause" contacts are made, the motor stops, but the cassette is retained in position.

Speed control. The motor is supplied with constant current via Tr₅. Tr₄ is conducting. Back e.m.f. developed by the motor beginning to turn is applied to Tr₄ emitter, reducing its forward bias.

This reduces the current into Tr₅ base and tends to reduce the motor speed — the effect is to stabilize the motor. Tr₅ behaves as a constant-current source by virtue of the feedback from its collector to Tr₄ base.

Record input impedance

There are, unfortunately, two conventions on the impedance levels employed for signal handling prior to tape recording. Of these, the older, and I think the

Fig. 19. Buffer amplifier to match a DIN source to the recording amplifier.

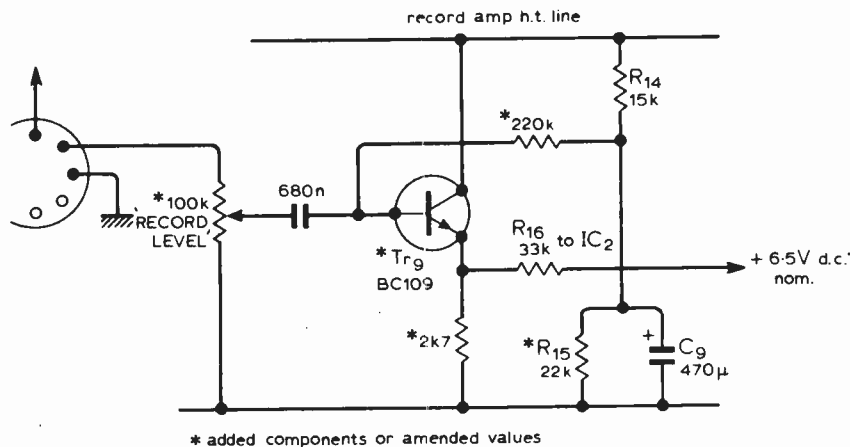
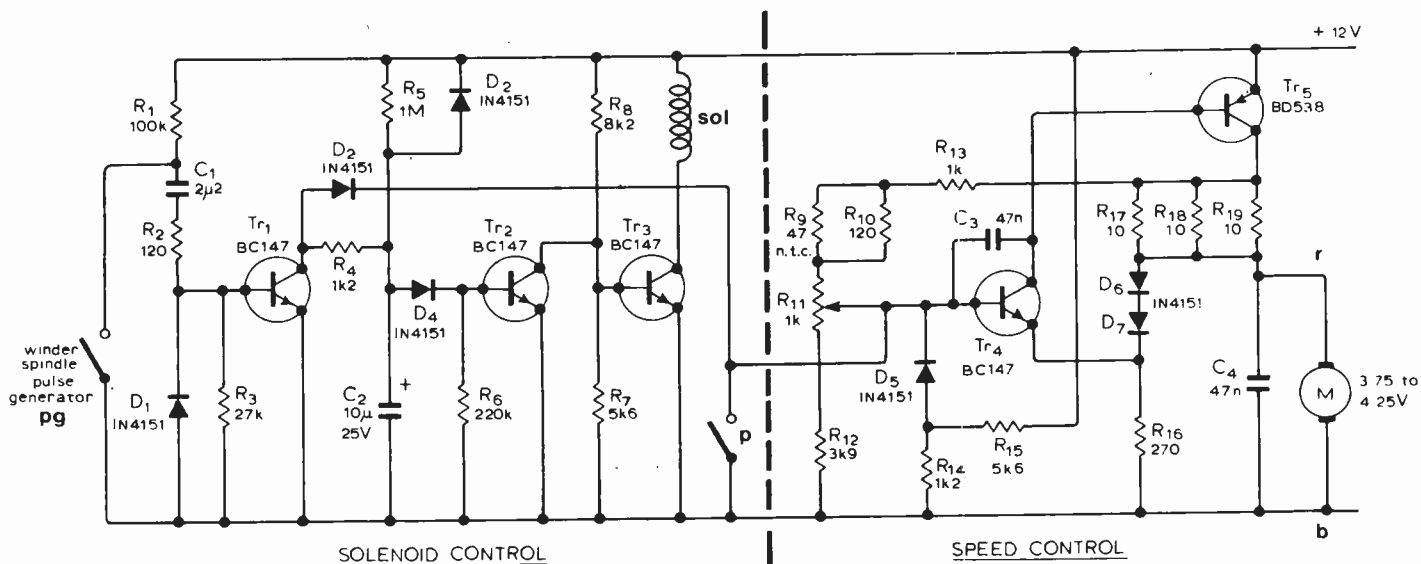

Fig. 20. Circuit diagram of the motor controller.



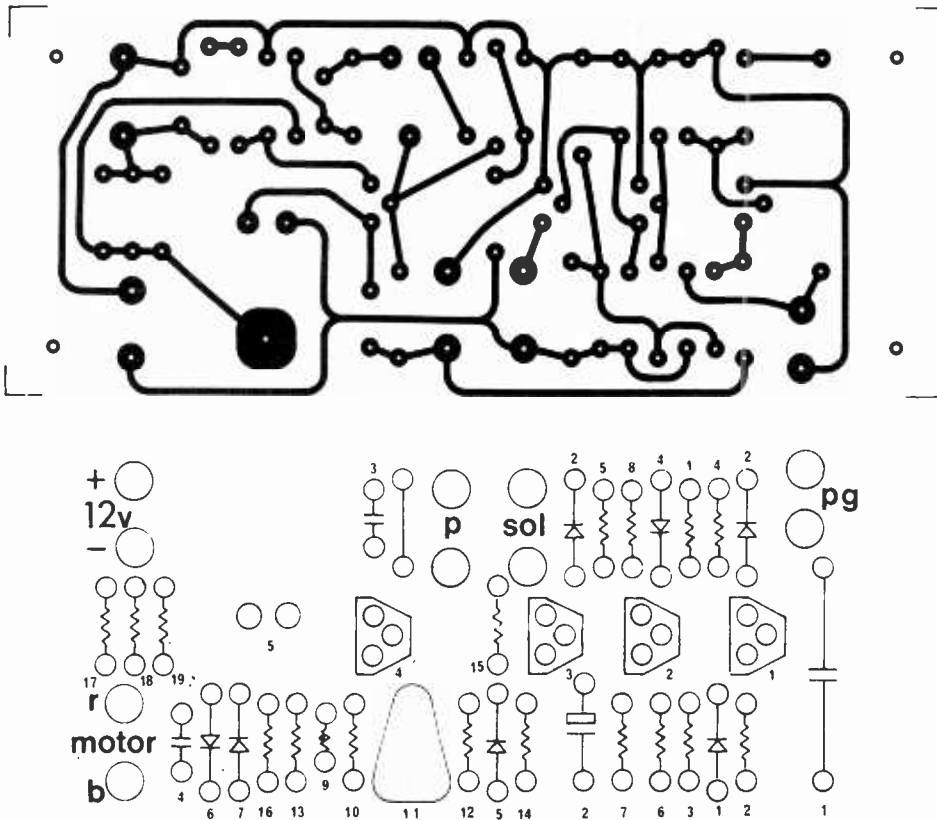

Fig. 21. A suggested, actual-size layout for the controller. The layout and modifications to the speed control circuit are due to Mr A. H. Milligan.

more sensible, is the "600 ohms, 0 VU" (+0 to -60dB, ref. 0.77 V r.m.s.), system which seems to be used by many recording studios, and gives a signal level which can be handled comfortably without problems of degradation due to noise. The other, and the one which is being used increasingly in commercial amplifier "recorder" outputs, is the DIN standard, which implies basically a constant-current source, developing a nominal lmV r.m.s. for each $1\text{k}\Omega$ of recorder input impedance. Predictably, this leads to a degradation of signal quality due to thermal noise unless fairly high value input impedance circuits are employed.

The convention for which the recorder described above was designed was the 600-ohm source impedance one although, taken in general terms, this means any range of source impedances in the range zero to a few kilohms, and the system as it stands would probably have inadequate gain if operated from a DIN source. It is, however, not practicable simply to increase the input record level potentiometer to $50\text{k}\Omega$ or $100\text{k}\Omega$ since the source impedance of IC_2 influences the Q of the h.f. pre-emphasis system (see Appendix). While the effect of the existing $10\text{k}\Omega$ potentiometer, when driven from a fairly low source impedance, is negligible, this would not be true for a higher value DIN input.

If, therefore, this is to be used with a commercial unit having this convention (as distinct from a home-constructed item, in which it is probably most convenient to take the recorder feed at the pre-amp output, in parallel with the power amplifier input), it is recommended that a small buffer circuit

should be attached to the output of the record level potentiometer, as shown in Fig. 19.

Replay h.f. stability

Proximity of output and input leads may cause instability in the replay amplifier. If this cannot be avoided due to layout constraints, a small capacitor (330pF or so) can be connected across the replay output relay terminals ($\text{RL}_1/1, \text{RL}_1/2$) - across the replay coil output in the replay position - without any adverse effect on the h.f. performance.

The author has pointed out to us that the use of a Doram 207-374 toroidal transformer greatly eases the problems of hum elimination. Doram Electronics Ltd, P.O. Box TR8, Leeds, are the suppliers. Components and metalwork for this design will be available from Hart Electronics Ltd, Penylan Mill, Oswestry, and Powertran Electronics, Portway Industrial Estate, Andover, Hants, also tell us they intend to produce a kit of components. *Wireless World* has arranged a supply of glass fibre p.c.bs based on the author's design. The board accommodates a changeover relay and four preset potentiometers for switchable bias and provision has been made for a single time constant suitable for chromium dioxide tape ($70\mu\text{s}$). The board is priced at £4.50 inclusive. Make cheques or postal orders payable to M. R. Sagin at 11 Villiers Road, London, N.W.2.

Announcements

Customs and Excise have issued a revised list of electronic components which will attract a VAT rate of 12½ per cent from July 1. The announcement supersedes one made on May 22 by the customs and the Electronic Components Board, and the list includes c.r.t.s, radio and tv tuners, delay lines, transformers, chokes and coils, valves and voltage multipliers. The full list is available from the nearest VAT office.

Computer exhibition COMPEC has been acquired by the publishers of *Wireless World*, IPC Business Press Ltd, from the original promoters Trident Conferences & Exhibitions Ltd. This year it will be held at the new Wembley Conference Centre, November 23 to 25. In May COMPEC Europe was launched in Brussels and plans are in hand for further European shows.

The European Physical Society has awarded the Hewlett Packard Europhysics prize to Professor Wolfgang Helfrich for work on liquid crystals, leading to the discovery of the twisted nematic display.

The Sira Institute, in association with Warren Spring Laboratory, is holding a two-day seminar on microprocessor applications in instrumentation and control systems at the City University, London EC1, on September 29 and 30, 1976. Application forms from the Sira Institute Ltd, South Hill, Chislehurst, Kent BR7 5EH.

Sixty Years Ago

The following, rather untypical piece was published in *Wireless World* for August 1916. Technological prophecies seem to become fact rather quicker than the prophets imagine, but this one was a little too far-seeing. The long-wave trans-Atlantic wireless telephone service was opened on January 7th, 1927.

"According to an American scientific journal, it will not be long before England and America will be able to converse with one another by means of the wireless telephone. There are certain individuals to-day who cling to the conviction that the telephone was simply the invention of a man who had a grudge against humanity. What will they now say of the wireless telephone? There is this much to say. It will be much better than those cheap wire telephones, the wires of which are so apt to snap if you don't pay up your subscriptions. With the wireless telephone it may be that you will receive a second demand note for payment, but there will be not a man with a pair of wire-cutters in his pocket to bring the third and last demand note and cut you off if you do not pay at once. It is getting to be very exciting when we get those wireless telephones in full working order. Just imagine yourself stepping into a call box in Victoria Street and asking for "45678, Broadway, New York City." While the young lady is waking up New York you just sit down and read a few chapters from your Shakespeare or Bacon - according to which school you belong. But it will test your temper when the young lady tells you that you are through, and will you please drop three hundred and sixty-five pennies in the slot and 'turn the handle after each, please'."

Surround-sound decoders — 3

Operation of QS Variomatrix decoder

by David Heller, B.Sc. (Eng.)

The Sansui Variomatrix technique allows decoding of QS records with enhanced separation but without altering the gain of the decoder outputs and consequent loss of subsidiary sounds. It permits decoding of SQ records and provides two alternative ways of reproducing stereo records through four loudspeakers.

It's well-known that in the basic Sansui QS system crosstalk is distributed symmetrically in that a left-front source, for example, produces crosstalk in the right front and left back speakers, but negligible leakage in the diagonal speaker. The QS Variomatrix (continued next folio) is a technique to increase the interchannel separation and place the reproduced signal more sharply in focus. When a predominant signal is detected, say in the left-front (L_F) direction, the Variomatrix circuit varies the L_B' matrix coefficients* as well as the R_F' matrix coefficients. If a signal of a lower level is present at the same time, it will be reproduced with maximum interchannel separation if it is located in the same direction as the dominant signal L_F . If it is located in a different direction, it will be reproduced in such a way that its directionality is more and more obscure as it moves further away in direction from the L_F signal.

Sansui claim that their experiments have shown that when a listener perceives a dominant and a secondary sound source simultaneously, the directionality of the secondary sound source is masked by the direction of the predominant sound source, which they call directional masking. This being the case, a listener would hardly be able to detect the ambiguous directionality of the secondary sound source. However for the directional masking to be efficient it is necessary that the secondary sound source should occur within a certain time after the predominant signal. For this reason the Variomatrix coefficients have to respond to primary source changes within 20ms.

Variomatrix principles in QS decoding

The QS Variomatrix decodes the coded L_T and R_T signals † as follows

$$L_F' = (1+f)(L_T - R_T) + (1+l)\sqrt{2}R_T$$

$$R_F' = -(1+f)(L_T - R_T) + (1+r)\sqrt{2}L_T$$

$$L_B' = (1+b)(L_T + R_T) - (1+l)\sqrt{2}R_T$$

$$R_B' = (1+b)(L_T + R_T) - (1+r)\sqrt{2}L_T$$

where the Variomatrix coefficients f , l , b and r vary between 0 and $\sqrt{2}$. Fig. 1 shows the relationship between the

In attempting to give a surround effect, matrix systems arrange source information into two, three or four audio channels. Differences between the various approaches arise in the coding and decoding methods used; different relative weights being given to the quality of surround, stereo and mono playback. (In two-channel systems it is not possible to give optimum playback in all three modes.) The defects of early two-channel systems were quickly recognized and widespread use was made of 90° phase difference circuits to distribute the 180° phase error. Codings for these systems, including the Sansui QS, have been detailed many times, see for example "Commercial quadraphonic systems," *Wireless World Annual 1975* pp.84-9, (for a subjective assessment see "Matrix decoding" *Hi-Fi News*, March 1975, pp. 147-57), and it is known that the maximum directivity of a two-channel system is governed by a cardioid-shaped characteristic relating signal amplitude and direction, no matter how many loudspeakers are used. The Variomatrix technique is a method developed by Sansui to improve directional effect by reducing the gains of signals prior to final decoding, according to detected phase relationships. This allows subsidiary sounds, which would otherwise be attenuated along with undesired crosstalk, to be reproduced. — Tech-ed.

direction of a sound source and the corresponding value of the Variomatrix coefficients. The centre of each circle represents 0 and the circumference $\sqrt{2}$. For example, when the sound source is located in the L_F direction the Variomatrix coefficients become $f = \sqrt{2}$, $b = 0$, $l = \sqrt{2}$ and $r = 0$. Fig. 2 shows the internal functions of the HA1328

*Primed quantities indicate playback signals.
† L_T and R_T represent signals in the two transmission channels; they are in-phase for front sources and antiphase for back sources.

decoder i.c. The input matrix derives the $L_T + R_T$, $L_T - R_T$, $\sqrt{2}R_T$ and $\sqrt{2}L_T$ signals which are then passed through four gain-controlled amplifiers.

It is here that any similarity with the SQ logic ends, because in the case of SQ logic the gains of the output amplifiers are varied in such a way that the channel containing the predominant signal is amplified, while the gains of the channels containing crosstalk are attenuated. Hence any secondary sound sources contained in the attenuated channels are largely lost and only appear as crosstalk components in the remaining channels. To quote Sansui's phrase, matrix coefficients are governed according to the "centre of gravity" of the total sound signal.

The QS Variomatrix system allows weak secondary sources to be reproduced, but with ambiguous directionality. To understand how this is achieved, readers are referred to the Appendix.

Derivation of four-speaker signals from stereo sources

The QS Variomatrix circuitry can be adapted to "synthesize" a surround sound field from a stereo source in two ways.

Surround mode. In Fig. 3 stereo signals at the input are blended in antiphase through S_1 to yield the following signals prior to entering the matrix i.c.

$$L - 0.414R$$

and

$$R - 0.414L$$

For a left-only source ($R = 0$), inputs to the matrix i.c. are L and $-0.414L$, chosen to correspond to a left-back QS-encoded signal. Similarly a right-only signal produces the equivalent of a right-back encoded signal. If the stereo inputs correspond to a phantom image defined by $L = 1.414R$ or $R = 1.414L$, this is equivalent to an encoded left-front or right-front signal respectively.

Hall mode. In this instance, the stereo signals are blended by the same amount but in-phase and fed to the matrix i.c. However, signals for the left-front and right-front speakers are taken directly from the stereo source signals, while

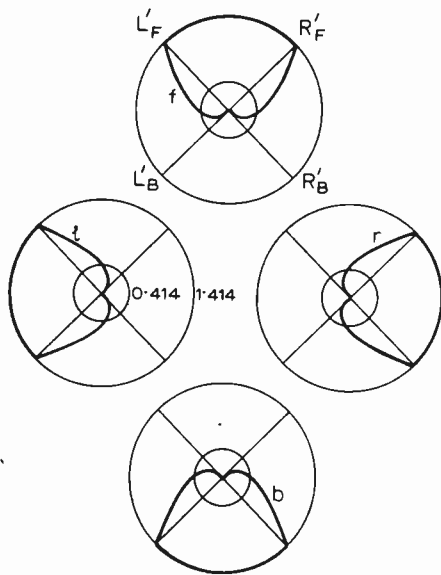

Fig. Relationship of the four Vario-matrix coefficients with encoded direction follows the laws shown.

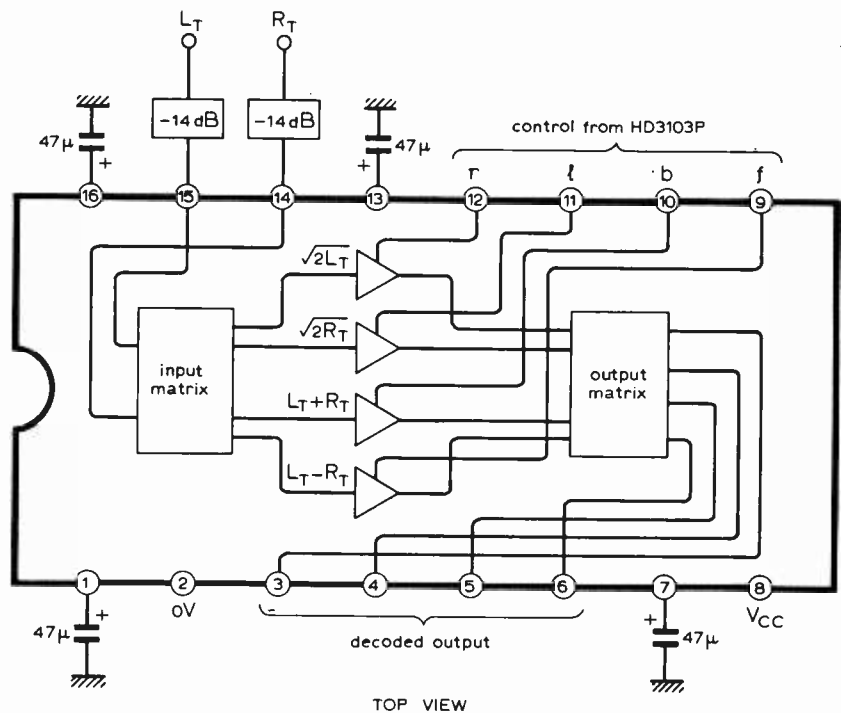

Fig. 2 Matrix i.c. includes gain-control elements before final matrix.

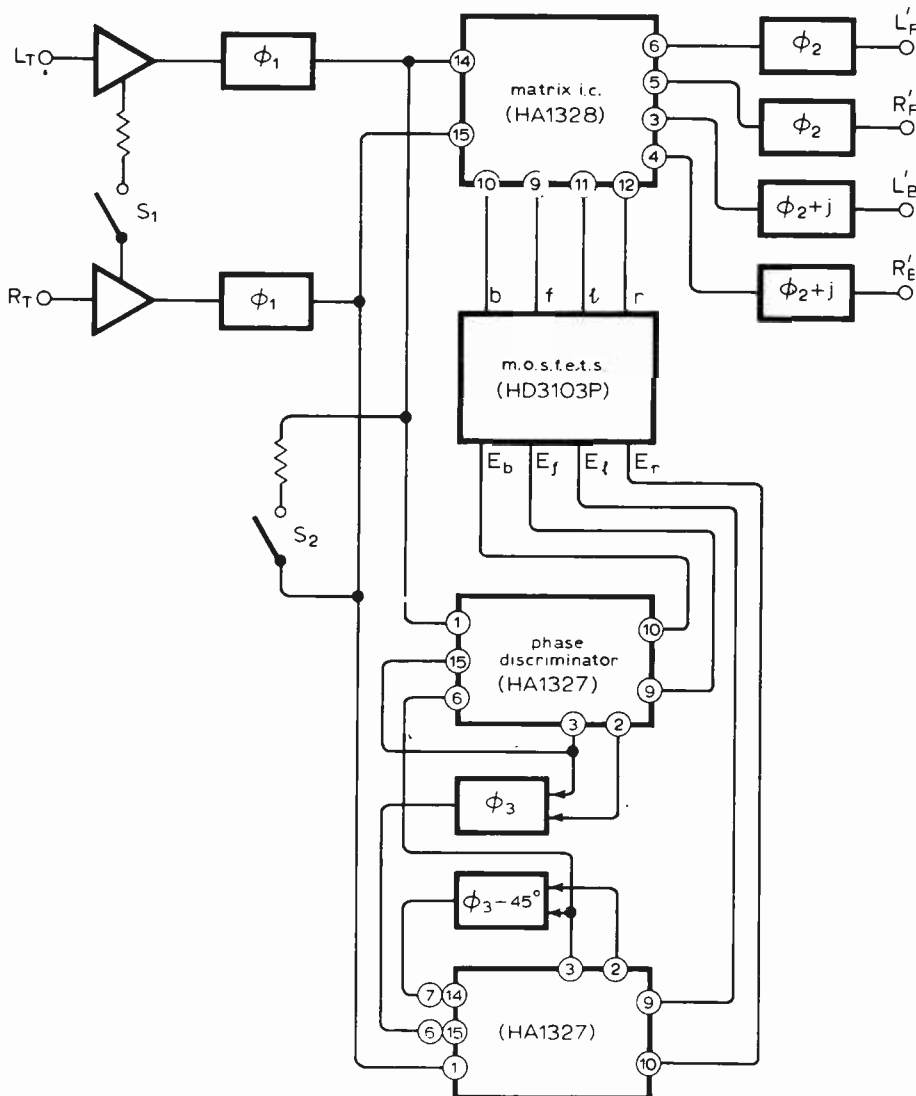

Fig. 3 Decoder arrangement includes facility for deriving four speaker sound from stereo sources using Vario-matrix technique by operating S_1 or S_2 .

signals for the rear speakers are taken from the appropriate Vario-matrix decoder outputs. Referring to the table it is evident that all in-phase stereo signals would appear in the front while antiphase signals result in rear speaker images. Therefore any antiphase information present in a stereo recording will appear from the back speakers and normal stereo from the front.

SQ decoding

It is possible to use the Vario-matrix decoder to with SQ sources. Like the QS matrix, the SQ matrix distributes the front signals in-phase to L_T and R_T , and the back signals in reverse-phase to L_T and R_T . In the case of the SQ matrix the L_B' and R_B' signals are 90° out-of-phase with each other. Separation between L_F , L_B and between R_F , R_B is limited to 6dB, but is theoretically infinite for centre front/back.

The decode equations for playback of SQ encoded signals using the Vario-matrix decoder are

$$L_F' = (1+f)(L_T - R_T) + 2R_T$$

$$R_F' = -(1+f)(L_T - R_T) + 2L_T$$

$$L_B' = (L_T + R_T) - 2R_T + jb(L_T + R_T)$$

$$-R_B' = (L_T + R_T) - 2L_T + jb(L_T + R_T)$$

with $0 \leq f, b \leq 1$. The first two terms of the above equations correspond to the original QS decode equations with $l=r=\sqrt{2}-1$, while the third and fourth equations correspond provided $l=r=\sqrt{2}-1, b=0$ and a new term $jb(L_T + R_T)$ is added. Hence, provided the signals $j(L_T + R_T)$ are derived at external circuits to be applied to the b control terminal of the matrix i.c. HA1328, it is possible to decode SQ sources.

Variomatrix processing In the block diagram, Fig. 3, of the QS Variomatrix system (without SQ option) the encoded direction of sound sources are detected by discriminating the phases of the L_T and R_T signals. Back and front sound sources are recognized by discriminating phases of L_T and R_T , while left and right sound sources are located by subjecting R_T to -45° phase shift and then phase discriminating $L_T + R_T \angle -45^\circ$ with $L_T - R_T \angle -45^\circ$. Fig. 4 shows the relationship between encoded direction of a sound source and the phase difference.

Referring again to Fig. 3 signals L_T and R_T are transmitted through buffer amplifiers and phase shifters ϕ_1 to the input of the matrix i.c. and to the two inputs of the phase discriminator i.c.s HA1327. The last-mentioned i.c.s discriminate the phases between $L_T - R_T$, and $L_T + R_T \angle -45^\circ$ and $L_T - R_T \angle -45^\circ$ respectively to obtain control signals E_f, E_b and E_l, E_r . These control signals are applied to the respective gates of four p-channel f.e.t.s on the m.o.s. i.c. HD3103P to control the resistance between drain and source of each f.e.t. The drains of the f.e.t.s are connected to control terminals 9, 10, 11 and 12 on the matrix i.c. HA1328 to control the matrix coefficients with the result that decoded outputs L_F'', R_F'', L_B'' and R_B'' appear at the output terminals. These signals are changed back to the state prior to phase shift when encoding by passing the signals through phase shifters $\phi_2, \phi_2 + j$, and $\phi_2 + j$ respectively.

The antiphase blend in the QS synthesizer surround mode is effected by closing S_1 , while in-phase blend if the hall mode is effected by closing S_2 .

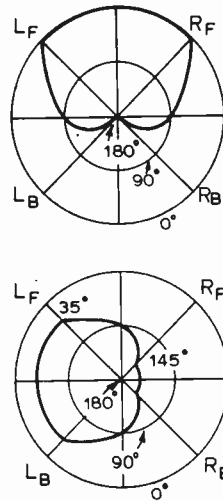

Fig. 4 Relationship between encoded direction and phase difference of L_T, R_T and $(L_T + R_T \angle -45^\circ), (L_T - R_T \angle -45^\circ)$.

Appendix

To understand how the QS Variomatrix method of decoding allows both dominant and weak signals to be reproduced simultaneously, consider the Table. Two columns show the encoder and decoder inputs while another column shows the resultant Variomatrix coefficient required to give the correct decoded output. In physical terms, this is equivalent to placing resistors, the values of which are given in the Table, at the respective i.c. pins numbered 9 to 12.

Consider a signal L_T, R_T to be present at the decoder inputs consisting predomi-

minantly a left-front signal (L_T^*, R_T^*) together with a lesser signal of right-front directionality (S_l, S_r). The L_T and R_T signals may be expressed as

$$L_T = L_T^* + S_l \quad (L^* \gg S_l)$$

$$R_T = R_T^* + S_r \quad (R^* \gg S_r)$$

where $L_T^* = 1, R_T^* = \sqrt{2}-1, S_l = (\sqrt{2}-1)x$ and $S_r = x$ and with $x \ll 1$.

The Variomatrix circuitry recognises the dominant signals L_T^* and R_T^* to be a left-front encoded signal and adjusts the Variomatrix coefficients to $f = \sqrt{2}, b = 0, l = \sqrt{2}$ and $r = 0$. The resulting decoding equations become

$$L_F' = (1 + \sqrt{2})(L_T - R_T) + (1 + \sqrt{2})\sqrt{2}R_T$$

$$R_F' = -(1 + \sqrt{2})(L_T - R_T) + \sqrt{2}L_T$$

$$L_B' = (L_T + R_T) - (1 + \sqrt{2})\sqrt{2}R_T$$

$$R_B' = (L_T + R_T) - \sqrt{2}L_T$$

Substituting $(L_T^* + S_l)$ for L_T and $(R_T^* + S_r)$, and then for L_T^*, R_T^*, S_l and S_r yields

$$L_F' = 2.83 + 2x$$

$$R_F' = 0 + 2x$$

$$L_B' = 0 - 2x$$

$$R_B' = 0 + 0.83x$$

The calculations may be redone for different combinations of primary and secondary sound sources. In all cases it can be shown that the Variomatrix decodes the dominant sound source in the correct position, while secondary sounds are reproduced with ambiguous directionality.

To be continued.

Note. Sansui ask us to point out that QS and QS Variomatrix are trade marks of Sansui Electric Co. Ltd. and SQ is a trade mark of CBS Inc. — Ed.

Matrix coefficients and control resistor values in Variomatrix decoder.

Encoder input		Encoded signal			Matrix coeff.			Control resistor			Decoded output	
L_F	R_F	L_T	R_T	phase diff (deg)	l	f	r	R_l	R_f	R_r	L_F'	R_F'
L_B	R_B				b				R_b		L_B'	R_B'
1	0				1.414	1.414	0	692	692	∞	1	0
0	0	1	0.414	0	1.414	0	0	692	∞	∞	0	0
0	1					1.414		∞	692	692	0	1
0	0	0.414	1	0	0	0	1.414	∞	∞	∞	0	0
0	0				1.414	0	0	692	∞	∞	0	0
1	0	j	$-j0.414$	180	1.414	1.414	0	692	692	1	1	0
0	0	$j0.414$	$-j$	180	0	0	1.414	∞	∞	692	0	0
0	1					1.414		692	1	692	0	1
1	1					1.414		692	692	692	1	1
0	0	1.414	1.414	0	.414	0	.414	2366	∞	2366	0	0
0	0					0		∞	∞	∞	0	0
1	1	$j1.414$	$-j1.414$	180	.414	1.414	.414	2366	692	2366	1	1
0	0					.414		2366	2366	∞	1	0
2	0	2	0	-	1.414	.414	0	692	2366	∞	1	0
0	0					.414		∞	2366	692	0	1
0	2	0	2	-	0	.414	1.414	∞	2366	692	0	1
0	0					.414		2366	2366	2366	1.08	1.08
1	1	1.414	1.414	90	.414	1.414	.414	2366	2366	2366	1.08	1.08
1	1	$+j1.414$	$-j1.414$.414			2366		1.08	1.08

Books Received

Convolution and Fourier Transforms for Communications Engineers by R. D. A. Maurice explains the mathematical process of convolution from basic concepts and gives many examples enabling the reader to compare convolution with Fourier transformation. Convolution is rather like correlation in that it is a statistical process which enables relationships between, or possible combinations of, two or more groups of things to be calculated. In communications engineering a method of calculating the effect of a network on a transient signal would be to obtain the final waveform by convolution of the original signal with the waveform of the network's response to a test signal — the unit impulse. If the functions to be convolved are in digital rather than analogue form the process becomes a simple arithmetical operation. All examples in the book are taken from real cases and chosen to show features which predominate in practice. Suitable for broadcasting and telecommunications engineers and also for undergraduate and postgraduate engineering students. Price £7.50. Pp. 198. Pentech Press, 4 Graham Lodge, Graham Road, London NW4.

Electronics in measurement

New industrial techniques revealed at 7th IMEKO congress, London

Too often electronics seems to be associated with dangling before the public a succession of new toys and trinkets — digital watches, pocket calculators, radio and television sets, video games and the like — for the main purpose of creating mass consumer markets for components and equipment. To some engineers this seems like a trivialisation of their calling. It is therefore encouraging to be able to report on a field of activity where electronics has a more direct bearing on the quality of our lives — on energy conservation, pollution control, public safety, agriculture, and the efficient utilization of raw materials. Such applications were the dominant feature of the seventh IMEKO congress held in London in May this year. Indeed, the official theme of the congress was "practical measurement for improving efficiency", and this was reflected in most of the papers delivered.

In general the electronic techniques described were used for processing in various ways the electrical signals produced by measurement transducers, thereby obtaining more refined or elaborated information, or quicker results, than would be possible by other means. One of the simplest examples, described by two Indian authors, A. S. Zadgaonkar and M. G. Tarnekar, was an instrument for estimating the ash content of coal samples. This is being used to test coal in India to decide whether it is in fact worth mining. A 1000Hz acoustic signal, produced by a signal generator, amplifier and transducer, is passed through a 5mm cube sample of coal and the received energy is picked up by a microphone, the output of which is amplified and indicated on a voltmeter directly calibrated in percentage ash content. The ash percentage is in fact proportional to $\log_{10}(V_0/V)$, where V_0 is the voltmeter reading without the sample and V the reading with the sample.

At the other end of the scale were elaborate instruments including analogue and digital computing techniques, in some cases using microprocessors. The technique of correlation computing

is now being widely used, particularly for measuring the flow rate of materials and the velocity of objects. The attraction of this method is that it can be applied to measurement signals obtained from natural features of the material itself, such as particles, grain patterns, turbulences and radiation discontinuities. In flow rate measurement, for example, two transducers are used, spaced at a known distance apart along the flowing material. They produce electrical signals $x(t)$ and $y(t)$. The output from the leading or "up-stream" transducer, $x(t)$, is delayed in time by an interval τ which can be continuously varied, giving $x(t-\tau)$. To obtain the cross-correlation function of the two signals, $x(t-\tau)$ is multiplied by $y(t)$ and the time integral of the product is continuously calculated over a fixed period of time while τ is varied. All this is done by analogue or digital electronic circuits. When delay time τ is equal to the time of travel of, say, a particle from one transducer to the other, the cross-correlation function is at a maximum. This gives the time of travel, and since the distance between transducers is known the flow rate can be electronically calculated.

One example of this method of flow measurement was concerned with pollution of the environment by fumes from steel making plant, in a paper by P. J. Webb and co-authors from the British Steel Corporation. To optimise the use of capital in the construction of steel-making plant and to monitor the conditions of service they have developed non-contacting techniques for measuring the flow rate, temperature and composition of exhaust gases. These make use of either emission or absorption of infra red radiation by the fumes. In particular the flow rate of the exhaust gases is based on cross-correlation between the electrical signals from two spaced infra-red detectors "viewing" the gas stream. By arranging these detectors in different viewing configurations it is possible to distinguish information relating to either regional flow rates or to the mean flow rate.

Correlation is also the basis of an instrument, described by G. J. Llewellyn,

of Bradford University, for measuring the velocity of jets of high temperature gas and solid material from volcanos. Expeditions have been made to the Etna and Stromboli volcanos to test it, and the applications intended are to provide early warning of volcanic activity and to improve the deployment of rescue services aiding the communities affected by the eruptions. The flow of the volcanic jet is detected by means of infra-red radiation emitted by it, received at a distance. A telescope is focused on the jet, and the infra-red radiation from two points on the jet, one above the other, is directed onto two lead sulphide cells. The output signals from the cells are amplified and tape recorded on site, after which the readings are applied to a cross-correlator, from which the jet velocity is obtained.

When solid materials are transported hydraulically or pneumatically along pipelines they have to be conveyed as slowly as possible to minimise power costs and wear on equipment and to reduce the risk of breakage. R. M. Henry (Open University) and M. S. Beck (Bradford University) presented a paper on an adaptive control system for achieving this which used cross-correlation for conveyer velocity measurement. Two conductivity transducers are placed in the pipeline about 2 pipe diameters apart and the cross-correlation, flow control, adaptive control and flow valve positioning are all done digitally by an on-line digital computer (the Argus 400). The system operates by sampling at a rate of 1300Hz, and 48 points are correlated in about 9 seconds. A modified system under development will use a microprocessor and a l.s.i. correlator.

Two cross-correlation flowmeters for use in open channels were described by R. W. Smith and co-authors of Bradford University. In one, ultrasonic sensing is used. Two transducers transmit beams of ultrasound from one side of the channel through the flowing liquid to pick-up transducers at the other side. Discontinuities in the flowing liquid modulate the received signals in amplitude and phase, and the demodulated signals are

processed in the cross-correlator. A second flowmeter works optically, using photocells, and operates on the time of travel of turbulence patterns or floating particles between two points on the liquid surface.

Speed measurement

Highly accurate measurements of vehicle speeds are often needed as a basis for improving motor vehicle efficiencies. T. Idogawa and T. Ono of Hokkaido University, Japan, described a method, using cross-correlation of random functions obtained from road surfaces, which gives a speed measurement accuracy of 1% for movement both in straight lines and in arbitrary curves. Two semiconductor photocells are mounted in the vehicle and arranged to examine the road surface, one being 20cm ahead of the other in the line of movement. The output signals of these are fed to a digital cross-correlator and the correlation function is read out every 400 μ s and indicated on analogue and digital display units.

Another method of speed measurement using cross-correlation was revealed by C. Zimmer and co-authors of Hasler Ltd, Switzerland. This uses a delay locked loop, based on a shift register, which automatically follows the delay time between the two spaced transducer signals. The system is for measuring the speed of trains without using the wheels (which introduce errors because of skidding and slipping) and it works by optically scanning the varying structure of the rail surface with two optical heads spaced 50mm apart. The rail surface is illuminated by solid state light sources and the reflected light is focused through slits onto photodiodes. The output of the leading photodiode is applied to the shift register delay line and the delayed signal is multiplied by the output of the other photodiode. The product is then integrated and, through a voltage controlled oscillator, used to control the stepping speed of the shift register. Each step of the shift register indicates a certain travelled distance, e.g. 1.25mm. The whole delay locked loop operates to automatically adjust the delay time in the shift register to equal the time of travel of a point on the rail between the spaced optical heads. Speed is then obtained by integrating the distance pulses over a given time. Measurement accuracies of better than 1% are obtained.

Correlation technique also has its use in extracting periodic signals from noise which obscures them: the periodic signal is highly correlated but the noise, being random, is not. Y. Dubnistchev and co-authors from the USSR showed how correlation technique can reduce the noise that affects the performance of a laser Doppler velocity meter used for flow measurement. Another noise problem was dealt with by Japanese authors. Flaws in wire rod being made by hot rolling are normally detected by

eddy current flaw detectors. The rod passes between search coils as it is rolled and a flaw is detected by the change it causes in the eddy current induced in the rod. A serious measurement problem, however, is introduced by noise created by vibration of the rod. K. Watanabe and co-authors from the Daido Steel Company of Japan showed how this trouble can be overcome electronically by phase discrimination between the flaw signal (at 160kHz) and the noise. This is based on the fact that the phase angle of the noise is continually changing while that of the flaw signal remains constant.

A special purpose m.o.s. integrated circuit digital correlator designed for use in correlation flowmeters was described by J. R. Jordan and B. A. Manook of Edinburgh University. The i.c. executes 12 points of polarity correlation and has a novel output circuit which interrogates only the overload state of the integrating counters summing coincidence between the two, polarity detected, analogue inputs. When used in a flowmeter, the first integrating counter to overload indicates the position of the peak of the correlation function, while a frequency inversely proportional to the peak position (i.e. proportional to flow rate) is obtained directly from the output circuit.

Thickness and layers

An optical method for measuring the deposition rate and thickness of various layers of material used in the making of microelectronic devices was described by V. N. Chernjaev and co-authors from the Moscow Aircraft Technological Institute, USSR. The principle makes use of optical interference between rays of coherent light. A beam of monochromatic light is directed on to the substrate carrying a deposited layer and the intensity of the reflected light is measured. As the thickness of the deposited layer increases there is a continuous change of phase between the light reflected from the substrate and the light reflected from the layer surface, and this causes a cosine law variation in the intensity of the measured reflected light. From this the thickness is determined electronically and used to control the deposition rate.

In optical range-finders and other stereoscopic instruments, the parallax is a measure of range or altitude. Normally such instruments depend on human perception, but F. Mesch and H. Moll of the University of Karlsruhe, Germany, showed how correlation methods could be applied to obtain parallax measurements. For electrical operation, the two stereoscopic images, which are temporarily constant, have to be transformed into time varying signals by electronic scanning methods using television cameras or cathode-ray tubes.

Examination of layers in the earth's

atmosphere associated with temperature discontinuities has been carried on for some time with powerful frequency modulated, continuous-wave microwave radar sets. A development revealed by J. H. Davies of Barringer Research, Toronto, is a small, light-weight (150 lb) f.m.-c.w. radar for this purpose which could be carried in an aircraft. Using a transmitter power of only 20 watts at 5.8GHz with a frequency excursion of 200MHz, it has a receiver sensitivity of -140dBm, a maximum range of 1km and a resolution of 3 metres.

One way of measuring the flow rate of solid granules in pipes or conveyors depends on detecting random fluctuation of the granules in transit: the greater the flow rate the greater the amplitude of the fluctuations. A method described by Y. Tomita and co-authors of Keio University, Japan, depends on the audible noise produced by the collision of the particles against each other. The noise is picked up by a microphone mounted in the pipe and the power spectrum of the noise signal is obtained by a wave analyser for bandwidths of 10 and 100Hz. The noise is pink; at lower frequencies the r.m.s. sound pressure is flat but above about 200Hz it falls sharply. Curves plotted show a relationship between particle flow velocity and r.m.s. sound pressure. Other methods, using a similar basic principle, were described by H. K. Kwan and M. S. Beck of Bradford University. One of these employed a capacitance transducer. Random variations in flow cause small changes in the instantaneous concentration of material between two capacitance electrodes and the amplitude of the resulting capacitance changes is measured electronically. The second method uses ultrasonic transducers operating at 40kHz. The granule fluctuations cause variations of ultrasound pressure at the receiving transducer and the amplitude of this modulation of the 40kHz signal is again measured electronically. With the capacitance method, R. G. Green of Bradford College showed that higher sensitivity is obtained with an f.m. transducer (the capacitance changes causing frequency variations in an oscillation) than with an a.m. transducer (the capacitance changes causing amplitude variations in the oscillation).

Speakers from Unilever Research, Netherlands, described the use of microprocessors in conjunction with a nuclear magnetic resonance spectrometer, for measuring the percentage of solid matter in partially crystallized fat, and with a dissolver/sampler for automated analysis of detergent powders. Digital techniques are also used in a system, explained by S. Kun and co-authors of Budapest, for accurately measuring the net mass of hydrocarbons passing along pipelines. The mass flow measurements taken by turbine flowmeters are automatically corrected in digital circuits by measurements of

density, pressure, viscosity, temperature and other variables to give accurate measurement of net mass. Also from Hungary, G. Várnai showed how digital computing methods are used for accurate measurement of the mass or volume of liquids stored in tanks. The basic measurements are of liquid level in the tank and of temperature differences which affect the expansion of the liquid. The digital computing operation calculates the volume or weight of liquid using these measurements and the cross-sectional area of the tank stored in a r.o.m.

A method of measuring the quality of printed characters, resulting from multiple copying or other processes, was described by R. J. Hall of Wiggins Teape Research and Development. Its principle is to compare the density distribution of a sample character with that of a master (perfect) character by means of two vidicon television cameras scanning the characters. For each line scan across the characters, the line waveform from the "master" camera is subtracted from that from the "sample" camera and the resulting difference signal represents the error in density between corresponding areas. The integral of this waveform is the total area-density product and is obtained by digitizing the difference signal. Measured results are displayed digitally. A refinement to the digital processing system enables the area due to the "master" to be removed from the "sample" field and as a result only the external dispersion error, or "blur," is measured.

It is useful to be able to monitor the flames used for heating boilers, in one case for the purpose of minimizing fuel consumption (by controlling air/fuel ratios) and in another case to prevent explosions (caused by accumulation of a mixture of unburnt fuel and air). H. C. Lord and co-authors from the Environmental Data Corporation, USA, described a flame monitor used for the first application which works on a spectroscopic principle. The intensity of light emitted from the flame is measured at two wavelengths and the ratio of these two measurements, calculated in a microprocessor, is proportional to the percentage of air in the combustion process and is used to control electronically the burner's air/fuel ratio.

B. G. Gaydon of the UK C.E.G.B. gave a review of flame monitoring techniques for large boilers, one of which was an electronic cross-correlation method now being tried out in England and Australia. Two telescopes spaced 70mm apart are aimed so that their lines of sight intersect at the edge of the flame. When the flame is present the flickering light received by one telescope is very similar to that received by the other telescope. If, however, the flame is absent, either the light level will be very low or the flickering illumination received from different areas of background sources will be dissimilar,

i.e. uncorrelated. The monitored flame is presumed to be present only when the electrical flicker signals have sufficient amplitude (determined by a "low signal" detector) and are highly correlated (determined by a cross-correlator). An advantage of this method is its sensitivity to low light levels as the correlation process gives a dimensionless criterion of flame presence, independent of flicker amplitude.

The vibration in lathes and other machine tools known as "chatter" was the subject of a paper by M. A. El Hakim, of Ain Shams University, Egypt, who described a "chatter" detector and control system. Vibration of the cutting tool is detected by an accelerometer and the output signal of this is amplified and passed through a band-pass filter tuned to the natural frequency of the chatter process, then rectified. When the rectified voltage approaches a reference voltage which represents a point just before the onset of chatter, a relay operates an audible alarm and also causes a solenoid to disengage the clutch of the machine-tool feed motion.

A new type of very thin (10 to 50µm) pressure transducer, for measuring pressure fluctuations on aerofoils, was the subject of a paper by M. Chatanier of the French Office National d'Etudes et de Recherche Aérospatiales. Being so thin, it can be attached by simple bonding and no machining of the aerofoil is necessary. It consists of a dielectric film (6 to 25µm), both surfaces of which are metallized. Pressure changes cause corresponding variations in the dielectric thickness and an electrical signal is obtained by measuring the resulting capacitance values. The transducer will operate at temperatures of a few hundred °C and at frequencies up to tens of kHz.

Aids to agriculture

Agricultural research is greatly benefiting from the use of electronics and several papers reflected this activity. For example, J. D. Lambricht of Texas Technical University and co-authors described a digital capacitance meter designed for measuring the foliage yield of plants. This is much quicker in use than the normal method of clipping, drying and weighing samples of foliage to obtain the mass per unit area. The principle is to measure the capacitance of a structure consisting of a specific volume of vegetation enclosed between electrodes. Basically the system measures moisture content, because water has a higher permittivity than other substances. The measured capacitance variations indicate either water content and its alteration with time in a constant mass or total mass in a given region of growth, or both. Essentially, a relationship between water content and foliage mass can be established.

Reducing the heating costs of glass-houses is the ultimate purpose of an electronic meter which measures and

records the total heat in joules dissipated by a hot water heating system. Described by W. R. Wignall of the UK National Institute of Agricultural Engineering, it integrates the product of water flow rate and the temperature difference between flow and return circuits. This is done by means of a train of pulses which have an amplitude proportional to the temperature difference and a mark-space ratio proportional to flow rate. The area under the pulses is integrated and the result is shown on an electromechanical counter. Also outlined by this author was an electronic instrument for measuring a rotary digger's "bite length" — or length along the ground surface between successive cuts of the rotor blade. It operates from photoelectric transducers sensing forward speed and rotor blade speed, and these produce pulses which are fed to gating and counting circuits. Forward-speed pulses are counted for a period determined by counting a pre-set number of rotor speed pulses, and from the first-mentioned a direct display of "bite length" is obtained.

The 7th IMEKO congress was organized by the Institute of Measurement and Control, and the proceedings, consisting of 163 papers in four volumes, can be obtained from the Institute at 20 Peel Street, London W8 7PD, price £20.00 including postage and packing.

Announcements

North Sea orders

Ferranti will supply £1½ million worth of telemetry and control equipment to the Central and South Platforms in the Ninian field. Each will have a dual Argus 700E computer with paper tape peripherals and an interface which includes two semi-graphic CRTs with digital and analogue inputs and outputs. All systems can be monitored on the displays and the operator will be able to route selected wells to the test separator system automatically. As well as full logging the system will provide constant monitoring for metal fatigue and corrosion in the steel platform.

Marconi has bought Comelit antennae and cable feeders from Hayden Laboratories to establish communication links between oil and gas rigs in the North Sea and the shore. Hayden says all the rigs will now be linked permanently to the mainland telecommunications system. Hayden has also supplied equipment to install on the Occidental Piper and Mobil Beryl A oil platforms 100 miles east of the Shetlands. The four antennae use either line of sight or tropospheric scatter techniques.

Tanker equipment orders

The Shell tankers Methane Princess and Methane Progress are to be fitted with a ship telex system, the new vessel Matco Thames has been fitted with radio communications and navigational equipment, and the BP fleet has been supplied with 79 multi-standard colour tv receivers, all orders for Marconi.

Characteristics and load lines

1 — Linear characteristics

by S. W. Amos, B.Sc., M.I.E.E.

To use an electronic device successfully information is required on its basic properties and these may be quoted as the input resistance, output resistance, transfer resistance (or conductance) and reverse transfer resistance. This is true whether the device is a transistor, an i.c. or a complete equipment. This article and the next one are concerned with the shape of the transfer characteristic, i.e. the form of the relationship between the input signal and the output signal. For some applications the characteristic is required to be linear, showing strict proportionality between input and output signals: such characteristics are the subject of this article. Other applications require a non-linear characteristic and these are discussed in Part 2.

For a bipolar transistor the input-output characteristic may be given in the form of a curve relating output (collector) current with input (base) current. A typical example of such a curve is given in Fig. 1(a) and this has an almost-linear section showing the output current to be nearly directly proportional to the input current. For a field-effect transistor (and a thermionic valve) the input-output characteristic is generally shown as a curve relating output (drain or anode) current and input (gate or grid) voltage. As shown in Fig. 1(b) this curve also has a near-linear section showing that the output current is proportional to the input voltage (measured from the cut-off point).

In general input-output characteristics have the form shown in Fig. 2 in which BC is the nearly-linear section. The regions of curvature at the ends of the characteristic can be explained by considering a simple single-ended amplifying stage. Linearity cannot continue as the input is decreased towards zero because the output current is cut off, causing the characteristic to become horizontal as shown by section AB. On the other hand linearity cannot continue indefinitely as the input is increased, and at a particular value of input amplitude the device is unable to increase the output current pro rata with the input and the charac-

teristic again goes horizontal as shown by section CD. This may not be due to lack of emission: it is quite likely to be due to the inclusion of a load resistor in the output circuit which limits the output current to a particular value by reducing the supply voltage across the device to zero. For example if the supply voltage is 12 and the load resistor 3 kilohms, the output current cannot exceed 4mA. Thus the curvature at one end of the characteristic arises because the active device runs out of current and at the other end because it runs out of voltage.

The linear part of the characteristic is of interest to the designer of linear or analogue equipment and in general the degree of linearity of active devices is not good enough for most purposes. The linearity must therefore be improved, and some methods of doing this are described later.

In the design of digital equipment the shape of the almost-linear part of the input-output characteristic is of little interest. For most of the time the active device is biased either well beyond point A, i.e. beyond cut off, or well beyond point D, i.e. at maximum current. These two regions are identified in Fig. 3. The device is used in fact as a switch which is either on or off. The only time the linear part of the characteristic is used is during the change from one stage to the other, and this occurs so quickly that the precise shape of section BC is of little concern. The only interest the designer of digital equipment has in this part of the characteristic is that it should be steep so that the change from one state to the other can be as rapid as possible.

Linear amplification

Let us assume that part BC of an input-output characteristic has been

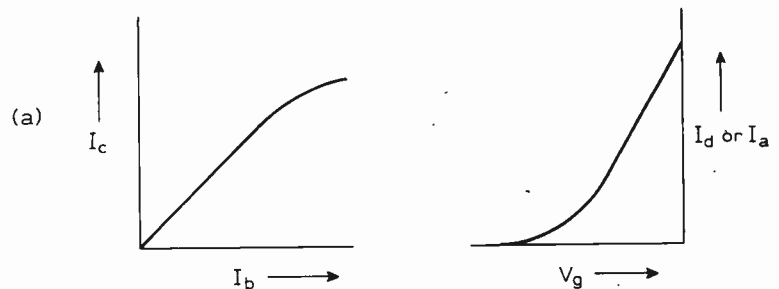

Fig. 1. Input-output characteristic for (a) a bipolar transistor and (b) a field-effect transistor or a thermionic valve.

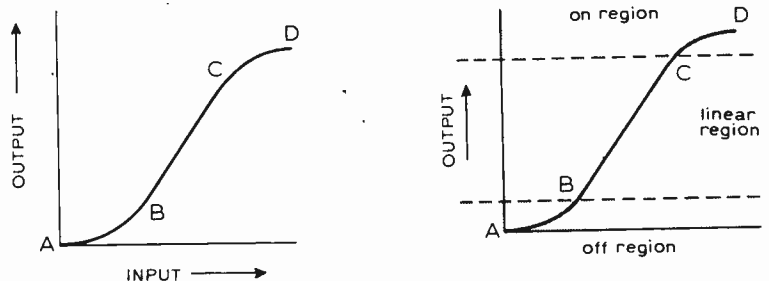

Fig. 2. General form of input-output characteristic.

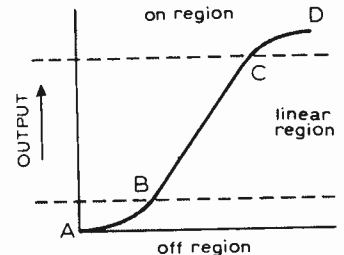

Fig. 3. Relationship between on, off and linear modes of operation.

linearised by one of the methods to be mentioned later and suppose a sinusoidal signal of say 1kHz is applied to the input of the device. To avoid using the non-linear sections of the characteristic, which would result in distortion, the amplitude of the signal must not exceed the extent of the linear section of the characteristic and the bias must be chosen to ensure that the signal is centred accurately on the linear section. Amplification is then distortion-free and, if we ignore extraneous signals such as hum and noise, the output of the device consists solely of the amplified 1-kHz signal.

Suppose now a second signal of say 10kHz is added to the input. The two signals when added give the waveform shown in Fig. 4, from which it is clear that the combined amplitude is the sum of the individual amplitudes of the two input signals. This combined amplitude must be accommodated on the linear part of the characteristic if distortion is to be minimised. Thus the individual amplitudes of the two signals must be smaller than that of the 1-kHz signal used originally. Under these conditions the two signals are amplified independently and the output of the device contains only 1-kHz and 10-kHz components: amplification is again distortion-free.

If too large a signal amplitude is used the non-linear parts AB and CD of the characteristic are involved in the amplification process and distortion results: this, of course, is overloading the amplifier and can be avoided by restricting the input-signal amplitude. But even when there is no overloading there is still some residual non-linearity in part BC of the characteristic in spite of efforts to linearise it. Amplification is not quite distortion-free and there is a slight modification to the waveform of the signal during amplification: an example is shown in exaggerated form in Fig. 5. This distortion is equivalent to the addition of new signals (harmonics) at multiples of the original frequency. When the non-linearity is such as to produce a resultant wave which is asymmetrical about the time axis, as shown in Fig. 5, the added harmonics are chiefly even, i.e. are at twice, four times, six times etc. the frequency of the input signal. If the distorted output wave is symmetrical about the time axis (e.g. both peaks equally flattened) the added harmonics are chiefly odd, i.e. at three times, five times, seven times etc. the input frequency. In general both even and odd harmonics are generated, and if the frequency of the input signal is 1kHz, the harmonics have frequencies of 2kHz, 3kHz, 4kHz etc., the amplitude of the harmonic decreasing as the frequency increases. The harmonics are evenly spaced throughout the spectrum, the common frequency difference being 1kHz — the frequency of the input signal.

If the introduction of harmonics were the only consequence of non-linearity

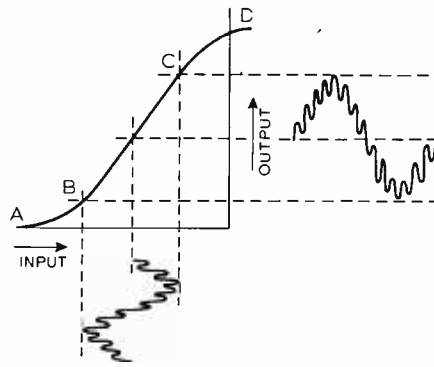

Fig. 4. Addition of 1-kHz and 10-kHz signals at the input to a device and their application to the linear part of an input-output characteristic. (Time scales are different.)

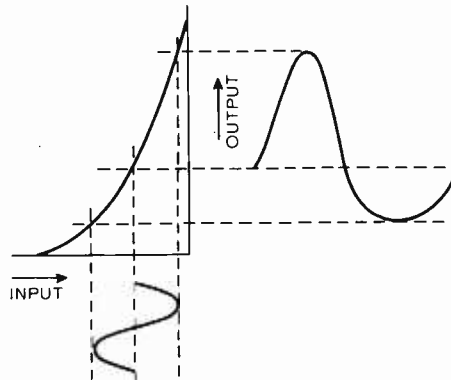

Fig. 5. Production of even-harmonic distortion by a non-linear characteristic. (Time scales are different.)

they would not be serious in an audio-frequency amplifier because:

(a) low-order harmonics blend harmoniously with the input frequency and with each other. For example 2kHz is one octave higher than 1kHz; 3kHz forms a musical fifth with 2kHz. The 7th and 9th harmonics do form discords with the original frequency but often the amplitude of these harmonics is too small to be significant.

(b) in audio amplification the input signals are not usually single tones such as 1kHz. Musical instruments and the human voice produce a wealth of harmonics and it is their number and relative amplitudes which give the source its characteristic sound quality. In practice therefore the input is likely to contain a number of harmonics: as a result of the non-linearity of the amplifier the amplitudes of the harmonics will be slightly increased.

Unfortunately non-linearity results in another effect which is far more serious than the introduction of harmonics. This effect occurs when there is more than one input frequency and this, of course, is normal for an audio-frequency amplifier. For simplicity suppose there are two inputs at frequencies of f_1 and f_2 . Each is treated as a single tone and a number of harmonics of

each are generated during amplification as just described. In addition, however, new signals are produced as a result of non-linearity with frequencies equal to the sum and difference of the two input frequencies and their harmonics. These new signals are known as sum and difference tones or intermodulation products and their frequencies can be expressed as $(mf_1 \pm nf_2)$ where m and n are 1, 2, 3 etc. Each fundamental component and each of its harmonics gives rise to sum and difference tones with every component of the other signal and thus the total number of tones now generated is very large. Some of these new tones do not blend harmoniously with the others. Discords are produced and it is these which are responsible for the harsh and unpleasant quality from an overloaded amplifier. The difference tones can be low in frequency and probably make a greater contribution to the harshness than the sum tones, many of which lie outside the frequency range of the amplifier or the ear.

The degree of distortion introduced by the use of a non-linear characteristic is measured by the amplitude of the intermodulation terms introduced and this depends on the length of the non-linear section of the characteristic used during the amplification process. In general distortion is very low for very small input-signal amplitudes, increases slowly as the amplitude is increased but increases very rapidly when the overload point is reached. Small input signals, such as those from a high-quality microphone, take up such a small length of the characteristic that its linearity is not so important as for signals of larger amplitude.

The generation of harmonics and combination tones by a device with a non-linear characteristic is not peculiar to electronic equipment. It occurs also in the human ear for sound inputs exceeding about 50dB above the threshold of hearing. It is an interesting thought that if an amplifier generates intermodulation tones we interpret the process as distortion but we do not do so when the ear itself introduces such tones. The brain is evidently able to decide whether the spurious signals are introduced externally or internally. Many of the properties of the ear, e.g. its ability to detect the fundamental frequency of a complex harmonic sound, were at one time thought to depend on the non-linearity of the ear. The theory was that the ear made an analysis of the sound and could assess the common interval between the harmonic frequencies: this interval is the fundamental frequency and determines the pitch of the sound. This explains the ability of the ear to detect the pitch of a note which has no discrete component at the fundamental frequency. However, this theory has been abandoned because of the observation that the ear is linear for very small sound inputs but can still detect pitch accurately. Moreover,

recent experiments have shown that the ear still correctly assesses pitch even when the common frequency interval is by electronic means made different from the fundamental frequency. It is now thought that the ear assesses pitch by measuring the repetition frequency of a complex sound and it does so without using the non-linearity of the characteristic.

Video-frequency amplification

We have so far confined this discussion to the effects of curvature of an input-output characteristic on audio-frequency amplification. It is instructive to consider the effects of such curvature on video-frequency amplification. As an example consider a characteristic for which the output is proportional to the square of the input as shown in Fig. 6. Such a characteristic could have a disastrous effect on audio-frequency amplification. The distortion depends on the input-signal amplitude and is small for small signals but for large-amplitude signals the distortion can reach 25 per cent. If a video signal is applied to the input of the squaring device the curvature of the characteristic causes details near one extreme of the input signal (say near white level) to be exaggerated compared with those at the other extreme (i.e. near black level), as shown in Fig. 6. The reproduced picture is still recognisable; indeed it is quite viewable and for some types of picture the effect of the characteristic could be an improvement in tonal balance. The television engineer would say that the signal has been "up-gammed" (gamma for the characteristic in question being, of course, 2). The effect of the characteristic curvature is thus quite different from that experienced in audio reproduction: in television the effect would not be described as distortion but as "white stretching" or "black stretching" depending on the polarity of the signal applied to the input.

Methods of linearising characteristics

There are a number of methods of minimising the distortion caused by the curvature of an input-output characteristic. One has already been mentioned: if the signal amplitude can be kept small, distortion can be kept to a low level. This may apply, for example, to an amplifier intended to follow a high-quality microphone. The output of such a microphone is so low that distortion due to characteristic curvature is unlikely to be troublesome. The designer is likely to be more concerned with maintaining a good signal-to-noise ratio than in obtaining a high degree of linearity.

A second method of reducing the waveform distortion caused by a device characteristic is to pass the distorted signal through another stage with a characteristic having complementary

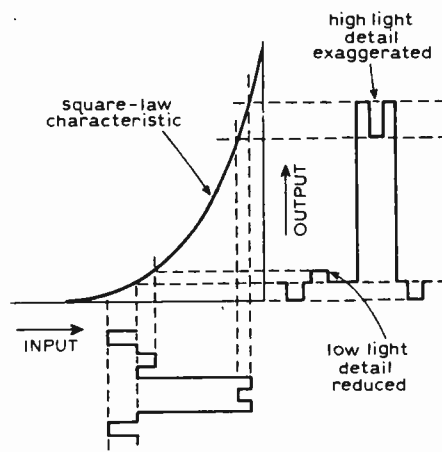

Fig. 6. Exaggeration of a highlight detail by a square-law characteristic.

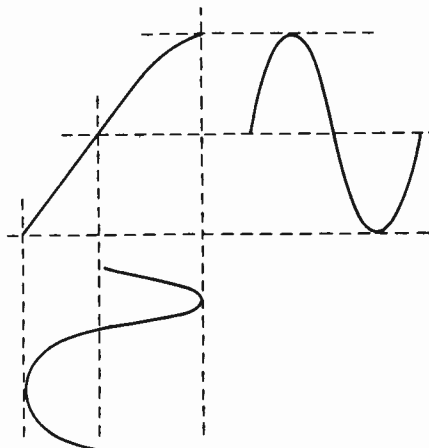

Fig. 7. Form of characteristic required to correct the waveform distortion introduced in Fig. 5. (Time scales distorted to emphasize effect.)

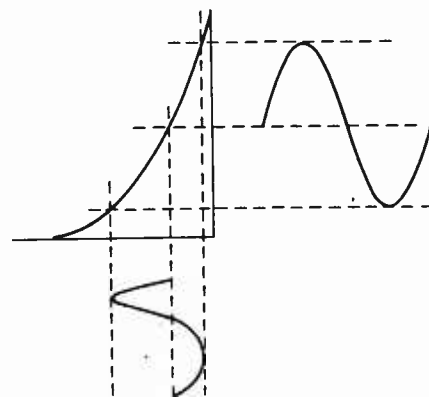

Fig. 8. Distortion reduced by inverting the input and using the same characteristic as in Fig. 5. (Time scales distorted to emphasize effect.)

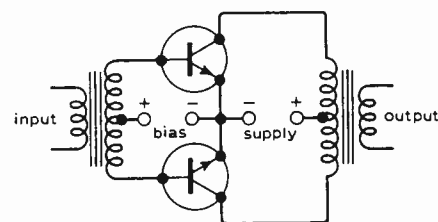

Fig. 9. Basic form of push-pull amplifier.

curvature to that of the first device. For example, if the output signal in Fig. 5 is applied to a device with a characteristic shaped as in Fig. 7 the final waveform is less distorted than that at the output of the first stage. In practice it is difficult to find two devices with accurately-complementary characteristics but fortunately this is not necessary. A considerable reduction in distortion can be achieved by using two similar devices and by inverting the signal applied to one of them. To illustrate this consider again the output signal in Fig. 5. Let us invert it and apply it to a characteristic identical to that in Fig. 5. This is illustrated in Fig. 8 which shows that a reduction in waveform distortion is possible by this means. Such a reduction in distortion occurs to a limited extent in amplifiers consisting of cascaded common-emitter or other signal-inverting stages but the cancellation is not perfect because:

- (a) a characteristic and its mirror image (which we are effectively using here) are not necessarily complementary
 - (b) the signal input to the second stage is larger than that applied to the first stage: it therefore uses a longer length of the characteristic and so produces greater distortion than the first stage.
- If it were possible to arrange that the signals applied to an amplifying stage and to the compensating stage were of equal amplitude a considerable reduction in distortion could be achieved. This can be done for example by using a transformer with a centre-tapped secondary winding to provide two identical signals, by applying these signals to closely-matched devices and by combining the outputs of the devices. The circuit deduced in this way is shown in Fig. 9 and is, of course, a push-pull amplifier.

The way in which the push-pull principle reduces distortion is shown in Fig. 10. In this diagram we have allowed for the fact that the signal applied to one device is inverted with respect to that applied to the other by assuming a common input signal and by laterally-inverting one characteristic with respect to the other. The horizontal spacing between the two characteristics is determined by the bias value which must be located at the same point on both characteristics: the bias value in Fig. 10 is chosen to give class-A operation at (a) and class-B operation at (b). The effective characteristic for the pair of devices can be obtained by simple addition of the individual characteristics and is shown in dashed lines in Fig. 10. It is a better approximation to the ideal straight line than the individual characteristics but there is still some residual curvature. This is to be expected because one characteristic is the mirror image of the other and the two are not accurately complementary. Any curvature in one characteristic on one side of the bias value is repeated in the other characteristic on the opposite side of the bias value: thus when the

characteristics are added the result is a characteristic symmetrical about the bias value. A symmetrical characteristic produces only odd-harmonic distortion: even harmonics cancel.

This advantage of the push-pull principle is one reason for its popularity: a second reason is that by biasing the devices to cut off as in class-B operation very high efficiency can be obtained.

A third method of reducing the waveform distortion caused by the non-linearity of input-output characteristics is to include the non-linear stage within a negative feedback loop. In this way distortion can be reduced to any desired extent.

There is a graphical method of demonstrating the improvement in linearity brought about by negative feedback. Fig. 11 shows in solid lines the I_d-V_{ds} characteristics for a junction-gate field-effect transistor. We will assume that voltage-derived negative feedback is to be applied to this device and, as a numerical example, we will assume that 20 per cent of the drain voltage is to be returned to the gate circuit. Consider point A: this corresponds to a drain voltage of 10 and lies on the characteristic for $V_g = -2V$. The feedback voltage is 20 per cent of 10, i.e. 2V. Thus when feedback is applied the new input (V_{fb}) must be $-2V$ to neutralise the feedback and $-2V$ to supply the gate input. Thus for this point $V_{fb} = -4V$. Similarly for point B the drain voltage is 15 and the feedback voltage therefore 3V. As B lies on the characteristic for $V_g = -1V$ the value of V_{fb} for this point is also $-4V$. Thus A and B are two points on the new characteristic for $V_{fb} = -4V$. By continuing this process it is possible to deduce the new set of characteristics shown in dashed lines in Fig. 11 which apply when 20 per cent voltage feedback is applied.

The new characteristics are more upright than the original characteristics, showing the effective reduction in a.c. drain resistance brought about by the feedback. Both sets of characteristics are drawn for 0.5-V increments in input voltage but the new characteristics are more closely spaced, this illustrating the reduction in gain due to feedback. The improvement in linearity due to feedback is best demonstrated by considering the intercepts on a load line. CD is a load line chosen to cross most of the characteristics and the intersections of this line with the solid curves are plotted in Fig. 12 in the form of an curve of input voltage against output voltage. The intersections of the load line with the dashed characteristics are also plotted on the same diagram to show the effect of the negative feedback on the input-output characteristic. The characteristic with feedback is clearly straighter than the other, showing the improvement in linearity, and also has a lower slope, showing the reduction in gain due to feedback.

(To be continued)

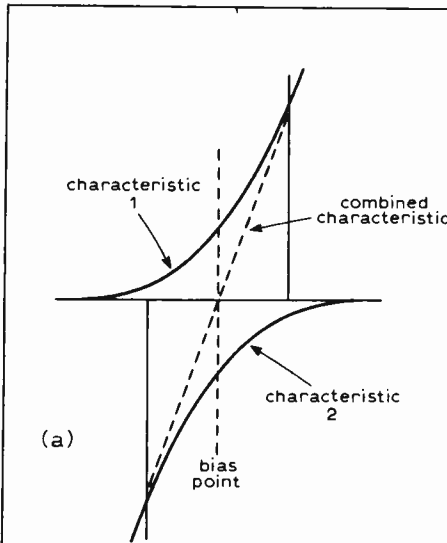

Fig. 10. Derivation of the shape of the effective input-output characteristic for a push-pull amplifier (a) class-A and (b) class-B.

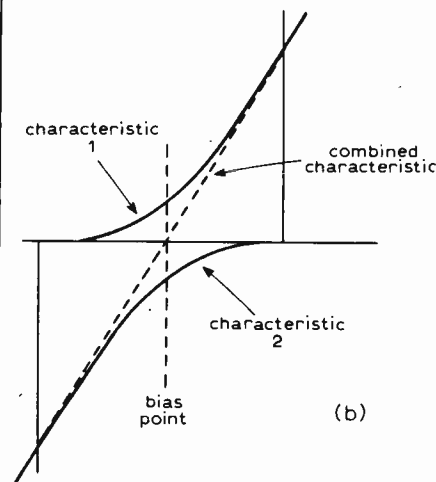

Fig. 12. Input-output characteristics of the transistor of Fig. 11 with and without negative feedback.

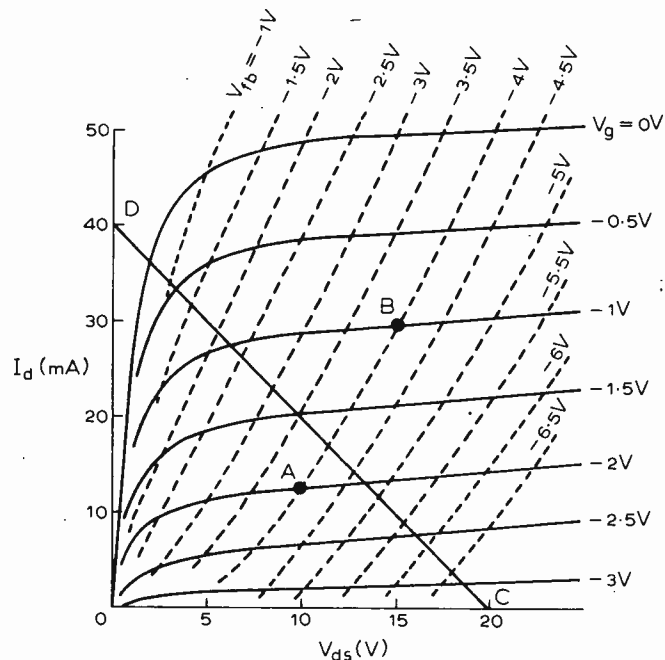
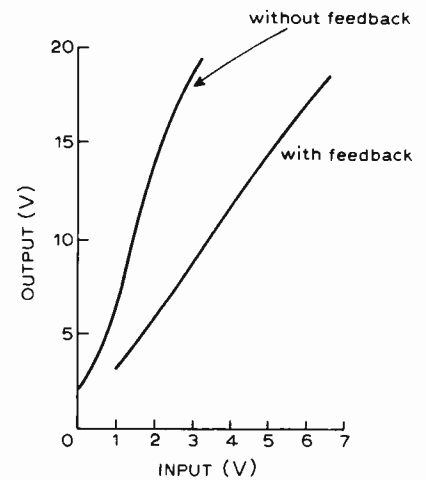

Fig. 11. I_d-V_{ds} characteristics of a junction-gate field-effect transistor in solid lines without negative feedback and in dashed lines with 20% voltage feedback.

World of Amateur Radio

In the air

The month of May brought a big change to the 21 and 28 MHz bands with many Sporadic E openings and some unexpectedly good F-layer conditions. The morning of May 15, for instance, found the 21MHz band full of Japanese signal, while the late evening of May 27 produced an opening to North America that may have been double-hop Sporadic E. On 28MHz the beacons (DL0LGI, 5B4CY, 3B8MS etc) provide very good indicators of these sunspot-minimum openings. In Australia a 28.5MHz "local net" has been organised and the additional activity on the band ensures that opportunity is taken of the long-distance openings that occur most often at the commencement and break-up of geomagnetic disturbances. Openings between Europe and Australia are rare but a few were reported during the past winter season.

A Sheffield amateur, Barry Chambers, G8AGN, has applied for permission to install the country's first 9cm (3456MHz) beacon station, GB3UOS, to the north-west of Sheffield. The 10.1GHz beacon on the Isle of Wight has been received in nine English counties and in Guernsey.

Virtually every country having a significant number of radio amateurs has a national society of its own. There is however one exception: the recognised IARU society for Canada is a division of the American Radio Relay League. The Americans seem determined to keep it that way. At the recent IARU Region 2 conference in Florida there was extensive discussion "of the problems which arise when there are competing societies in a country, and it was agreed to continue with the existing policy, which discourages official IARU contact with such societies". So presumably RSGB contact with Canada should be routed via Connecticut? A thought for the Bicentenary.

An investigation into the future of the Wireless Institute of Australia (the doyen of all national societies, having been founded in 1910) has suggested a change of name on the grounds that "Institute" is felt to be too Victorian sounding.

Touchy transmitters?

An article on "antennas" by Bill Lowe, GB3UOS, to the north-west of Sheffield. letter of the Association of Sheffield Amateur Radio Clubs makes one reflect on the limitations that we have apparently come to accept in the design of modern amateur transmitters. For he firmly advises amateurs not to attempt to use voltage-fed systems such as the 136ft long-wire that I find a most convenient multiband system (since it uses some salvaged multi-core telephone cable and is slung over a tree it cost me precisely nothing to put up).

Bill Lowe states that "if you squirt your transmitter into a high impedance you wreck your power amplifier . . . even though it can be made to look like a low impedance by the use of an antenna tuner or "Z-match". . . the slightest tweak on the controls sends the s.w.r. sky high and it is during the microsecond or so of high s.w.r. that the snap, crackle and pop takes place in the power amplifier . . . we concede that experienced operators are adept at the art of tuning up and get away with it but we cannot emphasise strongly enough that for the average chap, an inherently low impedance is essential."

Well, well. Certainly Bill Lowe, whose firm handles many of the popular transmitters using high-perveance and line-output valves in their output stages, should be in a good position to speak from experience, even if his "microseconds" are artistic licence. And one must accept that solid-state power amplifiers, unless protected, are vulnerable to high s.w.r. and that stages using line-output valves need to be tuned quickly since they are seldom intended to operate with a high duty cycle. But should we encourage designers to accept that we are never going to use voltage-fed systems or those with high s.w.r.?

The almost 20-year-old transmitter that feeds my long-wire aerial has an 813 p.a. that loafs along at 150-watts d.c. input and I suspect that if I wished I could spend all day twiddling the knobs of my a.t.u. without any snap, crackle and pop (except perhaps from the high-efficiency r.f. output). But that's progress!

Amateurs and the CIA

Little reaction has been forthcoming on the disturbing suggestion in the book "The Real Spy World" by Miles Copeland, a former CIA organiser, that amateur transmissions are sometimes used for clandestine intelligence operations. He suggests that high-speed "squirt" or "screech" signals are sometimes played in the background to ordinary "ham radio messages" since it is no longer possible to pass speeded up transmissions over international telecommunications circuits due to the presence of cut-off filters. Copeland claims that squirt recordings "are still

used to good effect on 'ham' radio transmissions". It is much to be hoped that if CIA or any other organisations have ever in the past used amateur radio in this way, the practice has long ceased.

It is of course well known that radio amateurs played a big part in both German and British clandestine radio during World War 2, in very different circumstances. Last September we noted how SOE's suitcase sets (A2, A3, B1, B2, B3 and MCR1) owed much to Major John I. Brown, G3EUR, as a member of the Inter-Services Research Bureau. John Brown has recently joined Avel-Lindberg Ltd to provide a liaison service to handle technical queries on their uninterruptible power supplies. Since considerable emphasis was placed in the SOE-ISRB work on providing novel forms of power supply for use in the field, his wartime experience should stand him in good stead.

In brief

"We must try to behave like responsible people . . . some recent happenings on 3.5MHz and 144MHz have made me ashamed to be the holder of an amateur licence. Some have been due to inexperience in new licence holders, but I'm sure that the bulk has been deliberate action by old hands who, for reasons best known to themselves, wish us to be all put off the air." — Quoted from a stern warning issued by Dr John Allaway, G3FKM, president of the RSGB. . . Radcomex 76, the revived RSGB Radio Communication Exhibition for the first time at Alexandra Palace in north London, opens at 10 a.m. on Friday, July 30 (official opening by Lord Wallace of Coslany at noon) and is open to 8 p.m. on the Friday and Saturday, closing at 4 p.m. on Sunday, August 1 . . . the recent steep increase in postage rates for sending printed papers overseas will significantly increase the cost of QSL bureaux. . . When Bill Bullivant, VK2BC, sent a large packet of QSL cards to Box 88, Moscow (address of the Russian QSL Bureau) it was returned marked "addressee unknown in Moscow, Idaho, USA — apparently the Australian Post Office had not heard of Moscow, Ayr, Scotiand or Moscow Road, Bayswater. . . The BATC is holding its next amateur television convention on Saturday, September 18 in Parkinson Court, University of Leeds, from 10 a.m. to 5.30 p.m. with demonstrations of both slow-scan and 625-line systems, trade stands and bring-and-buy stall. Further details from A. R. Watson, Somerby View, Bigby, Barnetby, South Humber-side . . . Alan Dorhoffer, K2EEK has become Editor of CQ Magazine, taking over from Richard Ross, K2MGA. . . The French society REF lists "Radio France International" as an intruder on 7085 kHz.

PAT HAWKER, G3VA

Earthing, shielding and filtering problems

1 — Unwanted resistance in earth lines

by R. C. Marshall, M.A., M.I.E.E. *Rank Xerox Ltd*

Problems resulting from ineffective or insufficient grounding, shielding or filtering are not easily anticipated or understood, yet this is one of the least-taught aspects of the electronic engineer's art. Difficulties arise from components not shown on circuit diagrams, modes or operation not contemplated by the designer and, worst of all, several such modes operating at the same time. Cure of one mode may not eliminate the symptom — only when all spurious couplings are removed at the same time will correct operation occur.

Grounding and shielding problems often occur only when systems are coupled together, and then may appear only spasmodically. This makes them difficult to locate, and underlines the importance of dealing with them at the design stage. This short series of articles considers the basic effects, setting the scene with first-order numbers, and the cures that can be achieved by changing magnitudes and circuit configurations. Situations will be dealt with in order, firstly those due to unwanted series impedance, then unwanted coupling capacitance, and then more complex situations involving both.

Unwanted series impedance almost always appears as the source of potential difference between ground point. For example one foot of 16 s.w.g. (14 a.w.g.) wire has a resistance of 2.5 milliohms. Above 3kHz the inductance (0.6 μ H) will be dominant. Printed wiring has much higher resistance¹, 0.36 Ω per

foot of 0.015in-wide 10z copper track. The significance of this depends of course on the circuit. In a small audio amplifier, 1A is a typical reservoir capacitor ripple current which will develop 2.5mV across the above-mentioned foot of thick wire. A mere one thousandth of this voltage transferred to a 1mV input will degrade the signal-to-hum ratio to 52dB!

These notes detail the effect of series resistance in an earth line that is common to both input and output of an amplifier or buffer².

Case 1

Situation: Subassembly amplifier or digital buffer with significant output

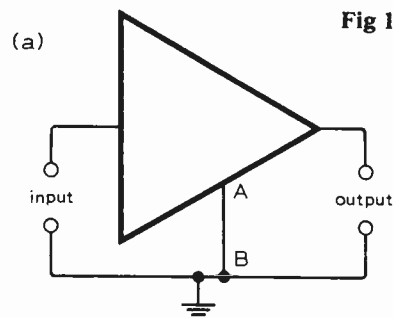
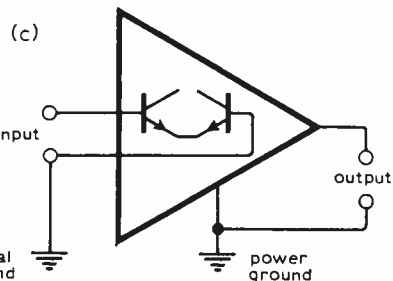
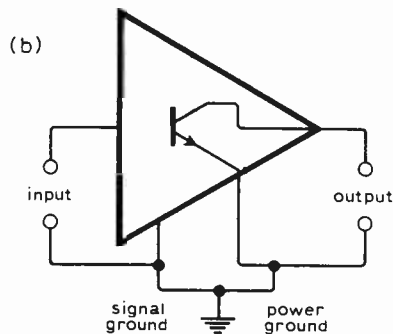

Fig 1



current as shown in Fig. 1 (a). This could be a loudspeaker amplifier, or solenoid or lamp driver.

Symptoms: Oscillation or unexpected gain characteristic. Input threshold variation with output load. Hysteresis.

Problem: Output current flows through AB, developing e.m.f. in series with input circuit.

Cures: Reduce resistance of AB.

Separate wiring of the output stage and use distinct signal and power earths, connected only at one point for the whole system, as in Fig. 1 (b).

Isolated or balanced input using transformer or long-tailed pair, as in Fig. 1 (c).

Case 2

This case is similar, except that the common earth line couples the power supply to an input circuit because of an incorrect sequence of earth connections.

Situation: Audio or instrumentation amplifier, line-powered or using a battery and inverter, as in Fig. 2 (a).

Symptom: Pulses at twice supply frequency appear in amplifier output.

Problem: Smoothing capacitor ripple current flows through wire FG and develops an e.m.f. in series with input, as the common side of the input returns to the amplifier along this wire.

Cure: Rearrange sequence of connections to earth, or isolate input circuit from earth. The arrangement of Fig. 2 (b) is one of many.

Comments: Use of directly-earthed reservoir capacitors and directly-earthed input sockets is the commonest cause of this problem. A related problem is the e.m.f. between one point of an earthed wire or chassis and another, caused by circulating currents induced by the magnetic field of a supply transformer or motor; 1mV per square inch is typical. This spurious voltage is

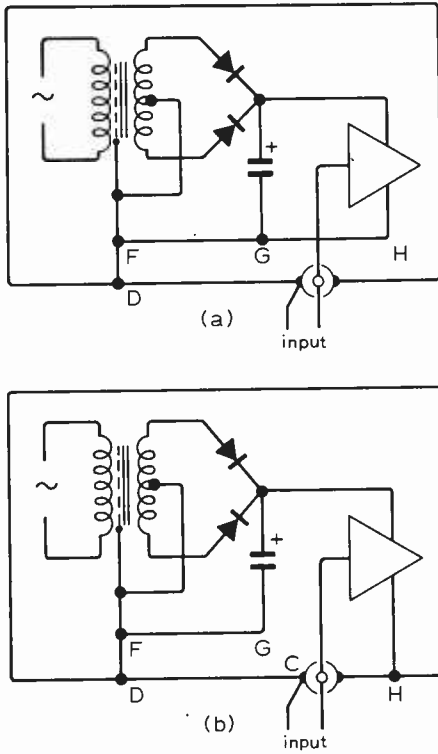

Fig 2

approximately sinusoidal, and at supply frequency. Motor sources can be identified by the change of phase when the motor is stalled.

Case 3

Next for consideration are the common-impedance effects of simple systems.

Situation: Two amplifiers in different boxes, at least one mains powered, and both grounded to same ground point. E.g. f.m. tuner and audio amplifier, or instrumentation amplifier and oscilloscope.

Symptom: Line frequency and line switching transients appear at amplifier 2 output.

Problem: Currents flow through transformer and wiring capacitance shown symbolically as C_1 and C_2 in Fig. 3 (a) to equipment 2 chassis. The current from primary to interwinding shield (or, if there is no shield, to secondary) is typically $50\mu A$ for a 240V 50Hz 60W transformer, but can be substantially less for low capacitance designs. This current returns to source via NM and NJKLM in parallel. The portion developed across JK is in series with amplifier 2 input and causes the symptom.

Cures: Break ML or MN, or add series resistance to either – but this may contravene safety regulations. Isolate amplifier 2, point J and all associated electronics and power supplies from box 2 – this may satisfy safety regulations.

Lower the resistance of JK. Use twin shielded cable to ground the input return of amplifier 2 at K not J. Isolate K from L by using a transformer T_2 , for fairly narrow bandwidth, or optoisolator, for digital systems, as in Fig. 3 (b).

Raise the signal level to swamp interference by reallocating circuits to boxes.

Eliminate the loop, perhaps by combining power and signal along one cable as in the reference oscillator of Fig. 3 (c).

Comments: The situation and cures above may be extended to cover other real-life cases. If the supply earth connections are to different distribution points, currents due to leakage elsewhere in the electricity distribution system may contribute to the voltage across JK. Such currents may also

arrive via unexpected routes such as structural steel work, or water or air pipes. In some specialized buildings a low-impedance “technical earth” is provided for electronic equipment³, but, continuing vigilance is needed to keep this distinct from the power earth. Between buildings, lightning or power faults may develop 100 to 100,000 volts of differential earth potential, and substantial earth connections, together with zener diodes, spark gaps, or gas discharge tubes, may be needed to protect equipment.⁴

Next article in this series will consider situations involving stray capacitance.

References

1. Printed Circuits Handbook, edited by C. F. Coombs McGraw Hill 1967, particularly pages 1-30 and 1-31.
2. Case and cable shielding, bonding and grounding considerations in electromagnetic interference, C. B. Pearlston, *IRE Trans. R.F.I.* October 1962. Tutorial paper with bibliography. Particularly recommended treatment of shielding and bonding.
3. Considerations in the design of a grounding System for a complex electronic facility, H. W. Denny, J. A. Woody *IEEE Electromagnetic Compatibility Symposium Record*, 1974, 75CH0803-7EMC pages. Mixed h.f. and l.f. equipments spread over a large area benefit from a grounding arrangement incorporating features of the four basic noise minimization techniques.
4. Lessening lightning's effects A. K. Guthrie *IEEE Newsletter of Vehicular Technology Group*, July 1975 pages 21 to 23. Practical methods for protection of isolated radio transmitter sites. Transient Protection Devices. Chin-Lin Chen. *IEEE EMC Symposium Record*, 1975, Paper 31a. Semiconductor devices in hostile electrical environments, K. A. T. Knox. *Electronics and power* 13 December 1973, pages 557-60, with bip. Some Effects of low frequency interference when using thermocouples for industrial temperature measurement. L. C. Towle and C. J. Burkitt. *IEE Conference on Electrical Interference in Instrumentation*, London, 1970. Discusses the environment, common mode – series mode conversion, and the effect of guarding, isolation and siting practice.

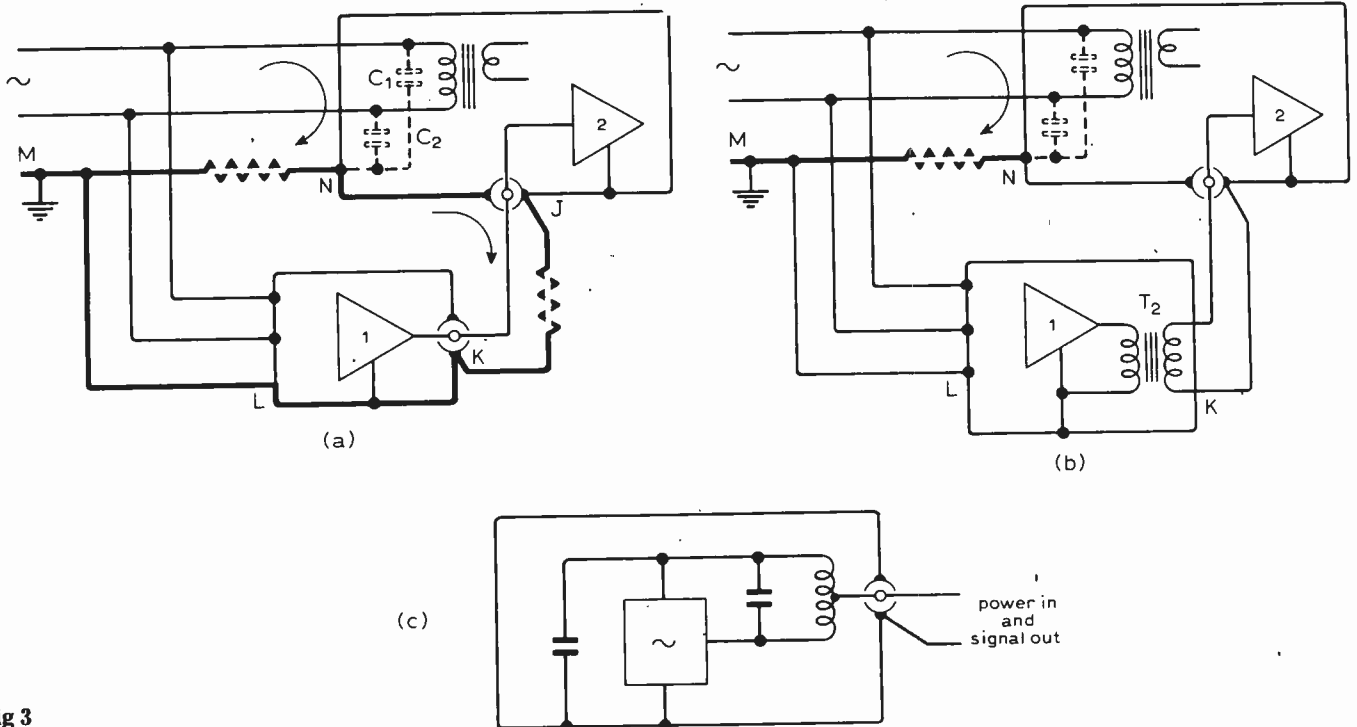

Fig 3

Progress in optical-fibre communications

A field demonstration of a 140Mbit/s digital optical fibre system for a telephone network is to be carried out on the urban route Hitchin to Stevenage in the latter half of 1977. STC, who have been manufacturing and marketing optical cables since September 1975, are to undertake the task to demonstrate, in co-operation with the Post Office, the current state-of-the-art in a non-research environment. Optical-fibre research has shown that system frequencies of between 2 and 560MHz are feasible and can be economical, depending upon the application.

A system, which will have a route length of 9km, will have repeater spacings of 3km and will be capable of handling 1920 speech channels. Some of the lessons to be learned from this demonstration will be: whether the cable can be pulled over long distances, exactly what sort of coding is necessary to control the system, and overcoming practical problems such as cable jointing in the field. Jointing by mechanical alignment is acceptable if close tolerances are met, but fusion, by melting the glass, gives far better results. Although fusion can be carried out successfully in the laboratory, many problems arise when this is attempted in the field. When producing mechanical joints, the fibre must be broken to form a flat normal face so that the joint attenuation is minimized. This can now be done repeatedly by simultaneously marking, tensioning and snapping the fibre, and it is envisaged that small machines could be produced to carry out this job in the field.

Recently, the Nippon Telegraph and Telephone Public Corporation of Japan released a report claiming that they have produced a fibre with a minimum attenuation of 0.47dB/km at a wavelength of 1.2 μ m, with an overall bandwidth loss of 1dB/km between 0.95 μ m and 1.37 μ m. The best fibre previously produced, by Bell Telephone Laboratories in the USA, had a minimum loss of 1.1dB/km at 1.02 μ m. The new fibre, consisting of a borosilicate cladding and phosphosilicate core, was fabricated using the chemical vapour deposition technique previously used by Southampton University to produce fibres with a minimum loss of 1.9dB/km. Chemical vapour deposition greatly diminishes the transition-metal-ion and OH-ion concentrations in the glass, but the Japanese have improved on this by pre-refining all the materials before fabrication to further reduce the highly absorptive OH-ion component. At present, losses as low as 1.9dB/km are only considered to be "aims" when manufacturing optical cables. In practice,



This optical cable being held has a bandwidth greater than the 4800 pair cable or the 18-core 9mm coaxial cable. The space requirement is tiny compared with the other two types of cable.

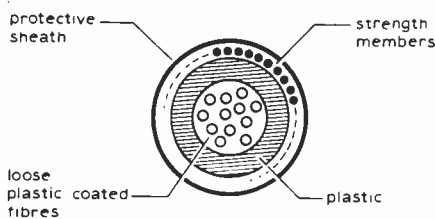

Fig. 1. Optical fibre cable construction. Note that the fibres are loose in the cable in order to reduce bending strains and radial crushing.

fibre attenuations may be in the region of 3 to 4dB/km with typical increases of about 3dB/km after plastic coating and about 1dB/km after cabling. Cables with 10dB/km attenuations can now be manufactured on a repeatable basis.

Manufacturers are primarily concerned with the practical problems associated with systems and cable construction. Glass is extremely sensitive to mechanical strains, especially during manufacture, and small strains can cause high attenuation losses. A plastic coating over the fibre increases both its tensile and radial strength; the first maintains low fibre strain; the second resists crunch stresses, periodic distortions, and improves bend performance, at the same time providing overall mechanical protection. The loose fibre cabling shown in Fig. 1 reduces strain due to bending and also reduces radial crushing within the cable. Cable manufactured in this way can stand reasonably loose knotting – at Communications 76 a representative of STC, R. E. J. Baskett, claimed that a pencil-thick cable could follow a curvature of 1cm radius.

The advantages of an optical system are numerous; the fibres take up relatively little space for a given information load compared to that of conventional systems, they are lightweight and the system does not require an earth return. The transmission line region cannot produce sparks and therefore is suitable for use in hazardous environments. With the exception of the source and receiver sections, the line is completely immune to electrical or magnetic interference of any kind. In security terms these lines are very good, it would be extremely difficult to tap off information without completely disturbing the system, at which point the communication link would be transferred to another line. Because of the saving in space, more fibres may be included in the cable, for little extra cost, for future expansion of the system or for failure replacement.

SITE solar experiment

Two solar arrays will provide electricity to run two of the television receivers in the SITE project as a result of an agreement between NASA and the Indian Space Research organisation (ISRO) to add a solar energy experiment to the project. The arrays were shipped to ISRO in May. They can produce 260 watt-hours of power each day under Indian sunlight conditions and will be used during the four hours each day that programmes are broadcast to Indian villages from satellite ATS-6. "The experiment," NASA said, "is being

conducted to demonstrate the technical and economic feasibility of using photovoltaic power to operate television sets in areas where there is no electricity available." A report on the SITE project will be published shortly.

At the end of May NASA launched a second Maritime satellite (Marisat B) for COMSAT General Corporation. The satellite will provide communications to the US Navy, commercial shipping and offshore industries, and will be in stationary orbit over the equator at 176.5 degrees west, just west of Hawaii.

Hi Fi market to stay depressed, says report

A market survey of the hi fi market in the United Kingdom predicts that rising unemployment and continuing inflation would depress the market until 1978. The report, conducted for Acoustic Research, the speaker makers, by Research Associates and supplemented for publication, says that a fall of £17.4 million on last year's figures can be expected to the end of this year, when the market will be worth £164.5 million. Small increases may be expected in the following two years, but a rise of £25.9 million on the 1978 figure may bring the 1979 figure to £200 million, and the market will be worth £226.1 million the year after that.

Research Associates also expect the tendency to improved performance and features in amplifiers and tuner amps to slow down. "There will be a move to the modular concept in the electronics and towards making the equipment easier to service." At the same time the appearance of equipment would improve. Turntables would have more complicated motors and drive mechanisms, with servo-controlled assemblies and direct drive, but they would perform better. Automatic turntables would tend to disappear, "but there would seem to be a place in the market for the more expensive automatic deck with true high fidelity specification." The greater use of four channel records would bring about improvements in pickup cartridges. "It is also expected that there will be a movement towards tape systems as against record systems since a tape system is cheaper, more convenient and produces a higher quality of sound. There has been a revival of interest in the conventional reel-to-reel recorder as a result of this trend but the main areas of benefit will be cassette systems and to a lesser extent cartridge systems."

Loudspeaker manufacturers, the report says, would try to improve the look of their product because the consumer wanted a better looking speaker and was more inclined to look behind the front panel. "Speakers which are not well finished behind the gauze are increasingly likely to be rejected by discerning consumers. Another reason for the improved appearance was the effort by manufacturers to make their product look different from that of their competitors. Speaker sales would increase as the market became more sophisticated, and the demand grew for four speakers rather than two.

The survey examines the market by geography, age, marital status, social class and knowledge of the subject. The projections were based on a study of general economic information, a review

of published information available in the UK on the development of the sound reproduction market, fourteen executive interviews with manufacturers or retailers, fifteen more extended interviews with senior shop staff, and numerous telephone inquiries.

A 48-page second volume on consumer attitudes is based on 12 group discussions in the Midlands and South with 111 respondents who had spent at least £150 on hi fi in the last three years. "Real high fidelity equipment was thought to cost a minimum of £110-£150 by most. Many would not consider paying more than £250. Beyond this level they considered the improvement in quality was too marginal to justify the extra cost."

The survey said that most buyers did not have a rigid budget but a good idea how much they would spend. "Friends were an important source of advice when choosing equipment. The high fidelity magazines were respected but several found them too technical to understand. Manufacturers' leaflets were criticised for the use of meaningless terms and the lack of standardisation of frequency responses. Price and sound quality were the most important factor (sic) in the choice of system for all income groups."

The report, which is 95 pages long and cost over £7,000 to produce, costs £140 from Research Associates, the Radfords, Stone, Staffs. Title: "High-Fidelity in the United Kingdom".

Switching component prospects

The Electrical Research Association predicts that over £1,000 million will be spent on switching components in the EEC in 1980. By that time the UK market alone will have increased by half, electromechanical components rising by 24 per cent and semiconductor devices doubling their sales. The information is contained in a £1,200 report which took 14 months to compile and analyses the markets for contractors, relays, sensing switches, timers and their solid state equivalents. The UK and European markets are covered country by country under various application headings and there is also an examination of the structure of the telecommunications market. The price includes an opportunity to discuss the findings with the compilers. ERA Ltd, Cleeve Road, Leatherhead, Surrey KT22 7SA.

Digital colour TV via satellite

Digitized PAL colour television signals on System I have been experimentally transmitted through a communications satellite. This was done in May by the BBC and the Post Office, using the Intelsat IV (Flight 1) satellite stationed over the Indian Ocean. The picture signals were sent from the BBC Designs Department, London, in analogue form to the Post Office earth station at Goonhilly Downs, Cornwall, and back over Post Office s.h.f. links.

A 60Mbit/s signal, generated in BBC equipment, was transmitted. This was split into two 30Mbit/s parallel streams plus a clock signal before being fed to a differentially encoded quadrature phase shift keying (q.p.s.k.) modulator built by the Post Office. The 70MHz i.f. output from the q.p.s.k. modulator was up-converted to s.h.f., amplified, and transmitted through Aerial 1 at Goonhilly to the Intelsat IV satellite and back again, using a transponder with a 36MHz r.f. bandwidth.

The 60Mbit/s signal comprised one video-audio "package". This consisted of a multiplex of one digital colour video signal, with a bit-rate of optionally 44.3 or 53.2 Mbit/s, and one 2048kbit/s multiplex signal for sound channels. The video channel used sub-Nyquist sampling at about 8.9MHz. After quantizing with 8 bits per sample, the bit-rate was reduced optionally to 5 or 6 bits per sample, using a type of differential pulse-code modulation. Resultant bit-rate was 53.2Mbit/s, which, after error-correction coding, was increased to 56.8Mbit/s.

To facilitate reliable recovery of the q.p.s.k. carrier signal in the demodulator (developed by Marconi Research Laboratories), in which only 36MHz r.f. bandwidth was being used for the 60Mbit/s baseband signal, the digital video bits were "scrambled".

The 15kHz bandwidth sound channels were coded using a digital companding technique to enable six such channels to be fitted into a bit-rate of 2048kbit/s (the rate of the first-order multiplex in the new Post Office digital communications network).

Elevation of the Goonhilly aerial above the horizon was necessarily small: about 5°, which is about the smallest elevation for satisfactory transmission. Consequently, careful adjustment of parameters such as group-delay equalization of filters was needed. When this was done a bit-error rate of about 1 in 10⁶ was attained. Subjective assessment of picture and sound quality suggested, according to the BBC, the long-term possibility of obtaining slightly higher quality using digital techniques rather than analogue f.m. techniques, without requiring additional r.f. bandwidth or getting unacceptable interference between channels.

New Products

Four-channel cassette recorder

A 4-channel recorder has been made available in this country by North East Audio Ltd. The recorder, designated Model 140, utilizes a 4-track, in-line, full-tape-width record/playback head and is available in standard form with Dolby noise reduction on all four channels and provisions for line or microphone inputs on each channel. This model is intended for professional and industrial applications. Versions of the Model 140 can be obtained to specification: for example, with Dolby on some channels only or with specified input and output levels to suit applications such as dual-sync plus stereo sound audio-visual. Technical specifications of the Model 140 are the same as the forerunning models 102, 103, and 104 and similarly a 3M Wollensak heavy duty mechanism provides the drive. Some of these specifications are as follows: wow and flutter less than 0.09% r.m.s., distortion less than 0.1% from the head to all outputs at 0dB level, and crosstalk better than 40dB. As with the previous models all the outputs have 10 Ω impedances, the frequency

responses are corrected to 3,180 μ sec \pm 1dB from DIN test tape 45513/6, and the signal-to-noise ratio with Dolby is better than 52dB depending upon the tape used. North East Audio Ltd, 5, Charlotte Square, Newcastle-on-Tyne. **WW 301 for further details**

Multitester

A portable solid-state multitester, the TMII made by Levell Electronics Ltd, offers 120 basic ranges and 30 optional ranges. Basic ranges have maximum f.s.d.s of 500V and 500mA for both a.c. and d.c. Minimum d.c. ranges are 150 μ V and 150pA. In addition the meter reads decibels, resistance from 0.2 Ω to 10G Ω , and d.c. nulls with lin/log scales \pm 4 decades. The meter, which has a 140mm mirror scale, has an input resistance of 100M Ω on all voltage ranges. Low test voltages on the resistance ranges allow solid-state circuits to be tested without turning on semiconductor junctions, and an i.c. operational amplifier with a m.o.s.f.e.t. balanced input stage is used to obtain a low offset current, high input resistance and wide bandwidth. A selection of optional extras are available with this multitester. Levell Electronics Ltd, Moxon Street, High Barnet, Herts. **WW 302 for further details**

Electrolytic capacitors

The 071 series of electrolytic capacitors from Mullard Ltd has been extended to cover the range 3300 μ F to 4700 μ F, 63 to 6.3V. Previously this range was provided for by externally linking capacitors in the 072 triple tag series, which is now to be phased out. Series 071 comprises etched-foil polarized capacitors having aluminium electrodes and non-solid electrolytes impregnated into paper. Mullard Ltd, Mullard House, Torrington Place, London WC1E 7HD. **WW 303 for further details**

X-band amplifiers

Gallium arsenide f.e.t.s are used in a series of wide-band amplifiers by Avantak. The AMT-11000, AMT-12000 and AMT-12400 series are available for gains of 22, 26, 31 and 35dB in frequency ranges of 7-11, 8-12 and 8-12.4GHz. The f.e.t.s are passivated with polycrystalline GaAs to reduce gain drift with time and temperature. The mean time to failure is said to be "thousands of hours", during which time performance remains constant. Gain/frequency response is within \pm 2dB over the quoted range, noise figure is less than 8dB and the balanced mode of each stage reduces even-order distortion. Walmore Electronics Ltd, 11-15 Betterton Street, London W.C.2. **WW 304 for further details**

R.f. shielding paste

A low-cost, silver-filled adhesive paste by Dage Intersem, Ablebond 26-2 is designed as both bonding agent and r.f. shield. It takes the form of a room-temperature curing adhesive, which can be applied by brushing. The shielding properties are said to be better than those of mesh gaskets. Volume resistivity is 0.005 Ω -cm, remaining constant after 100 hours at 85 $^{\circ}$ C and in 85% relative humidity. Dage Intersem Ltd, Haywood House, 64 High St, Pinner, Middlesex.

WW 305 for further details

Electronically tuned magnetrons

Magnetrons which can be tuned electronically are announced by the English Electric Valve Company. Tuning over 100MHz in the X-band at 50kW and over 30MHz in the S-band at 200kW

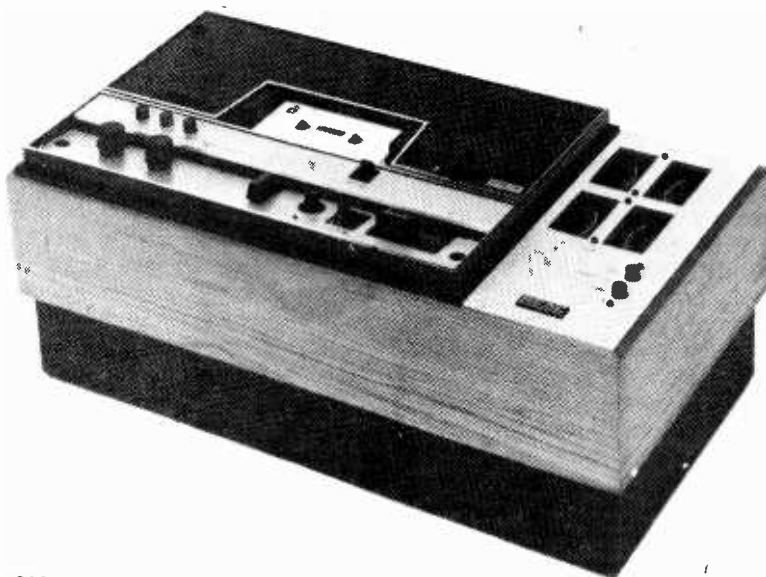

WW 301

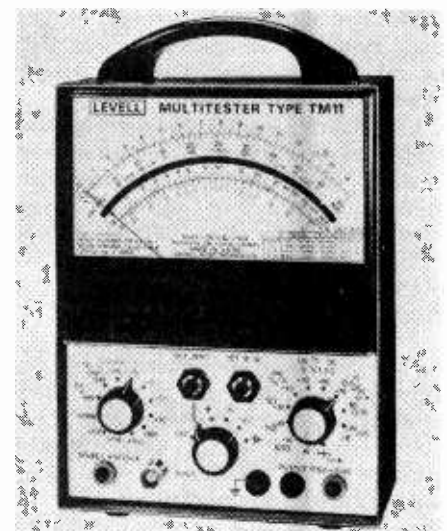

WW 302

peak power output is claimed. This is achieved in a few nanoseconds by applying a control voltage of 1 to 3 kV to the multipactor cavity electrode. An auxiliary resonant cavity, coupled to the main magnetron anode, is designed so that when an r.f. voltage is applied between its electrodes there is a controlled electron multipactor discharge; this causes a resonance shift and so changes the magnetron frequency. Several of these cavities can be fitted to the same anode to increase the total frequency shift or to give a selection of frequencies. English Electric Valve Company Ltd, Chelmsford, Essex CM1 2QU.

WW 306 for further details

Quartz-crystal filter

A 21.4MHz, 25kHz-channel-spacing filter has been designed within a volume of one and a half cubic centimetres. This quartz-crystal filter, which is the result of studies carried out by Hirst Research Centre of GEC, is claimed to offer performance equal to larger devices previously available. The stopband attenuation is greater than 90dB beyond ± 25 kHz, providing a ± 7.5 kHz 3dB bandwidth and ± 1 dB ripple within the passband. The filter, designed for 1.6k Ω termination, maintains its specified performance from -20 to $+70^\circ\text{C}$ and can be provided with impedance matching coils for lower resistances or to include a reactive impedance component. Salford Electrical Instruments Ltd, Times Mill, Heywood, Lancs.

WW 307 for further details

Rotary switch for p.c.bs

A small rotary switch for mounting on p.c.bs has a roller type of indexing mechanism with a pressure spring. It

can be made in up to three sections, axially connected. Each section has a stator bearing, linearly placed in two rows, the connecting terminals and a rotor bearing the movable contacts. A sliding type of contact system is claimed to give long life by reducing contact wear. A standard version, suitable for switching currents up to 0.2A at 150V, has silver gilded contacts, while another model, intended for frequent switching of microampere currents, has gold plated contacts. Special versions can be supplied. AB Electronic Components, Abercynon, Glamorgan, CF45 4SF.

WW 308 for further details

Coaxial attenuator

The FA2015 coaxial attenuator covers the range 0 to 2GHz and has a power handling capability of 50W average, 5kW peak. Attenuation is 10 ± 0.5 dB and is flat within ± 0.1 dB. Excluding the connectors the FA2015, which has a maximum v.s.w.r. of 1.2:1, measures only $2 \times 1\frac{1}{4} \times 1$ in. Each unit is suitable for mounting on the customer's heatsink, or can be supplied with a radiator for cooling in ambient air. REL Equipment and Components Ltd, Croft House, Bancroft, Hitchin, Herts SG5 1BU.

WW 309 for further details

Liquid-crystal multimeter

On display at the Leeds Electronics Exhibition was the Beta 3 $\frac{1}{2}$ -digit portable digital multimeter. This multimeter, introduced for the first time in the UK by Gould Advance Ltd, has a high-contrast liquid-crystal display and is battery operated. Voltage ranges are from 200mV to 1kV d.c. and 200mV to 750V a.c. and current ranges are from 200 μA to 10A on both a.c. and d.c. The meter also measures resistances from 200 Ω up

to 20M Ω and offers optional temperature, r.f., and h.v. probes, a battery eliminator and a carrying case. Gould Advance Ltd, Roebuck Road, Hainault, Essex.

WW 310 for further details

200MHz square-wave synthesizer

Syntest SI-200 is a frequency synthesizer with, the makers claim, features only found on higher-priced instruments. Output is variable between 1Hz and 200MHz with a stability of 1 in 10^6 . A 6 $\frac{1}{2}$ -digit thumbwheel selection switch sets a divider in the phase-locked loop, whose reference is a 1MHz crystal oscillator. Output attenuator is calibrated in both μV and dBm and covers 0.1 μV to 10mV in two ranges. Two fixed-level outputs are provided at -6 dBm and at t.t.l. level into 50 Ω (usable to 50MHz). Rise and fall times are 2ns. Manufacturer is Syntest Corporation, 169 Millham Street, Marlboro, Mass. 01752. UK agents: Lyons Instruments Ltd, Hoddesdon, Herts. UK price $\pounds 1,370$.

WW 311 for further details

Logic checker

An audible logic checker is now available for testing 0 to 5MHz pulse-rate-frequency logic systems. The LC1, from Lawtronics Ltd, produces a high tone on logic 1 or V_{cc} voltages and a low tone on logic 0 or ground potential. Changes of logic level are indicated by an alternating high-low tone. The presence of a single-shot transient of 200ns or more is shown by a short high tone. This unit, which is not limited by type of logic or size of i.c. package, has a typical input resistance of 1M Ω and can be used on logic voltages from 3 to 18V. Lawtronics Ltd, 139 High Street, Edenbridge, Kent TN8 5AX.

WW 312 for further details

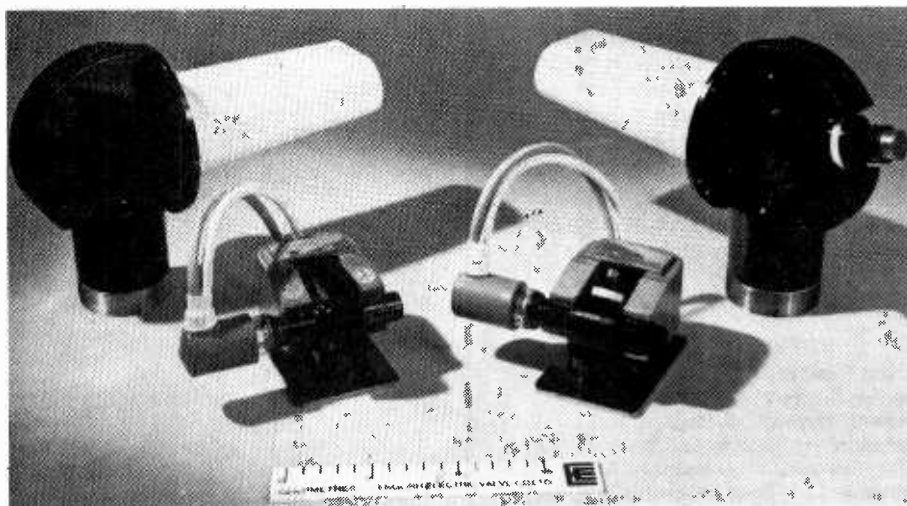

WW 306

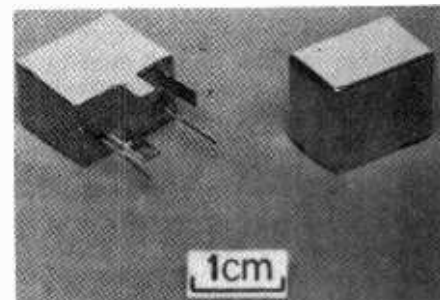

WW 307

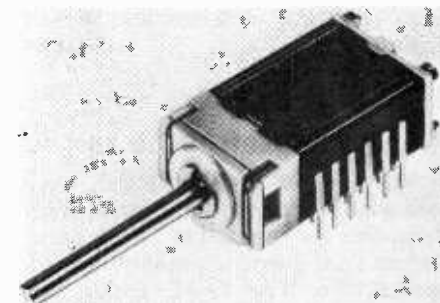

WW 308

Solid State Devices

Names of suppliers of devices in this section are given in abbreviation after each entry and in full at the end of the section.

Low-noise r.f. transistor

A 5GHz silicon p-n-p transistor, the BFT95, has a noise characteristic of 2dB at 1GHz. The device is constructed using planox-silicon-nitride technology to minimise parasitic capacitances, and is mounted in the common-emitter configuration in a T-plastic package. An improved cross-modulation level is obtained using a copper-alloy frame to withstand high currents. The transistor, which has a forward transmission gain of 10dB at 1GHz and an intermodulation intercept point for optimum bias of +23dBm, is intended for high-volume r.f. applications such as antenna amplifiers, cable TV and up-converter tuners.

SGS-ATES

Voltage comparators

A family of monolithic comparators which combine 200V/mV gain, for low-level signal detection, with 50mA or 35V high-level output drive compatibility, has been announced by Analog Devices Ltd. The units, AD111, AD211 and AD311 are suitable for use with t.t.l., r.t.l. or d.t.l. loads, lamps, relays, in window or threshold detectors, or free-running multivibrators. Two additional external components facilitate t.t.l. strobing on the AD111. Each comparator is packaged in a TO-99 can. AD311 is also available in an 8-pin dual-in-line package. Analog Devices

High current rectifiers

The Impac series 3S1015-16 miniature high-current silicon rectifiers are cylindrical in design, have insulated cases and axial leads. These general purpose rectifiers, introduced by Semtech, are characterized within the following ranges: p.i.v.s from 50 to 600V, r.m.s. voltages from 35 to 420V, and direct blocking voltages from 50 to 600V. Average rectified currents are 3A at 55°C and 2A at 100°C, and surge current limits are 30A if recurrent and 300A if single cycle. Bourns

Radio frequency f.e.t.s

Two f.e.t.s, the BF244 and BF256L, have been added to the Siliconix range. Both transistors are supplied in TO-92 packages and are intended primarily for r.f. applications. The f.e.t.s, which are available in categories to define perfor-

mances more accurately, feature typical C_{rss} values of 0.85pF and have high y_{fs}/C_{iss} ratios. Type BF244 is in three categories, A, B and C, corresponding to i_{dss} spreads from 2 to 6.5mA, 6 to 15mA and 12 to 25mA respectively when operating at $V_{ds} = 15V$ and $V_{gs} = 0$. Similarly BF256LA, B and C correspond to i_{dss} spreads from 3 to 7mA, 6 to 13mA and 11 to 18mA respectively under the same conditions. Siliconix

Bi-m.o.s. op-amp

The CA3140 operational amplifier uses a technique called bi-m.o.s., combining a p.m.o.s. input stage with a wide-voltage-range bipolar output stage. It is claimed that this amplifier is suitable for virtually all applications of the 741 series and most applications of other op-amps ranging from the 107 series to the LF356. The p.m.o.s. stage is similar to that used in the CA3130 op-amp but with the added features of internal compensation and a 44V supply-rail capability. Bipolar diodes protect the input so that there is no need for any special handling procedures. The output stage may be strobed, allowing the output to be driven to a low-level independently of the input signal. An output swing to within 0.2V of the negative supply voltage allows power transistors to be driven directly, thus eliminating the need for level-shifting circuitry. The CA3140 has an input impedance of 1.5TΩ, a 10pA input current (at ±15V) and a 5mV input offset voltage. The amplifier, which has an input swing -0.5V below the negative rail, has a 9V/μs slew rate, a 4.5MHz gain-bandwidth product and a settling time of 1.4μs. RCA

High speed analogue gate

A high-speed four-channel analogue switch designed for use in high-speed store-and-hold and general purpose analogue gate applications, is made by Crystalonics Inc. The 16-pin dual-in-line package has a maximum turn-on time of 20ns and maximum turn-off time of 30ns. The typical on resistance is 35Ω, off leakage current is 1nA, and operating voltages and temperatures range from +5 to -15V and from -55 to +125°C respectively. GE

Analog Devices Ltd, Central Avenue, East Moseley, Surrey.

Bourns (Trimpot) Ltd, Hodford House, 17/27 High Street, Hounslow, Middlesex TW3 1TE.

G.E. Electronics (London) Ltd, 182/4 Campden Hill Road, Kensington, London W.8.

RCA Ltd, Solid State-Europe, Sunbury-on-Thames, Middlesex.

SGS-ATES (UK) Ltd, Planar House, Walton Street, Aylesbury, Bucks.

Siliconix Ltd, 30A High Street, Thatcham, Newbury, Berks RG13 4JG.

APRS

The ninth exhibition shows increases in foreign interest and British confidence

The number of visitors at this year's Association of Professional Recording Studios exhibition was up by 11% to 1,926. Foreign visitors from 36 countries accounted for 14% of the total, 270 compared with 148 last year. The exhibition drew visitors from Jordan, Iran, Iceland and Indonesia as well as the European countries to see the 82 exhibitors, 15 per cent up on last year.

These figures coincide with a welcome upsurge in the number of British manufacturers anxious to compete in one of the fussiest yet most whimsical markets there is. Two reasons for their increased confidence are the fall in the pound and the necessity for buyers to look a little further down the market than their resources would have required a couple of years ago.

A good example is Leavers Bias, who introduced their Proline Professional tape machine for the first time at APRS. For under £2,000 they make a machine which has a good chance of attracting those buyers who are unable to afford the established stereo and two track machines at more than twice the price. The Proline supersedes the Bias B1000 and is the result, say Leavers Bias, of analysing faults and spares orders over the past four years. The design has a toroidal mains transformer and plug in capstan and spool motors. All the adjustments are accessible from underneath except for the record and replay electronics.



The Ampex ATR100 recorder, which is available in 1, 2 or 4 channel table top, floor standing or rack mounted versions. It has servo controlled tape handling and a new matrix control panel. Ampex also showed the MM1200 multitrack machine.

Another British firm launched a new **tape machine** at APRS. Brenell's Mk 7S deck offers stereo half or quarter track to add to their range of stereo and multitrack tape transports. Brenell has also changed ownership, having joined Allen & Heath in the Batiste group of companies a little while ago. Neither company has designs on the money-no-object end of the market but Allen & Heath seems to have a solid group of adherents in the sound reinforcement and small studio fields. A & H launched a ten-channel **production mixer** S6-2 consisting of two stereo gram, two stereo tape, and two mic input channels and a master stereo output channel with VU metering. The unit is intended "for the production of tape collages for radio, television and film broadcast."

Raindirk is a fairly new British firm which seems to be doing well in foreign markets. It is competing in the high cost **mixer** market but produces a range of smaller modular units, such as the Mini Mixer, as well as the bigger custom built models. The latest addition to the Raindirk range is the Quantum system. Each channel has circuits normally associated with separate input, output and monitor modules, and sections of the circuitry are used for more than one function. A master status module is provided to determine whether the channel modules are being used in the record, overdub, remix or track jump modes. This reflects a tendency noted elsewhere, such as on the Harrison console shown by Scenic Sounds Equipment, for even the biggest desks to become smaller. It is evident that the prestige afforded by being able to show customers acres of knob-speckled console has been tempered by the reduction in studio budgets and the unchanging length of engineers' arms. The Quantum comes in three frame sizes, for 24, 32 and 40 channels. Further modules can be added as needed. The 24 channel frame with 24 channel costs about £15,475. The 40 channel frame with 32 channels costs £19,355.

Audix says Thames Television has already ordered five or six of its new MXT 1000 audio mixers aimed at the small radio and recording studio, mobile and theatre market. Customers may build up a two or four group system from a pre-designed range of channel modules. "Technical features," says Audix, "include a compressor in the microphone/line channels and the talkback module, two auxiliary outputs from each channel and stereo monitoring facilities." It also offers a choice of VUs or p.p.m.s and a selection of faders. The preliminary specification lists 12 modules, including two and four group mic/line channels, two and four group line input amplifiers, two and four group input monitors, talkback module, meter panel in two or four groups, and an oscillator.

3M (UK) is marketing a new **autolocator** and a tape timer made by a British firm better known, perhaps, for making

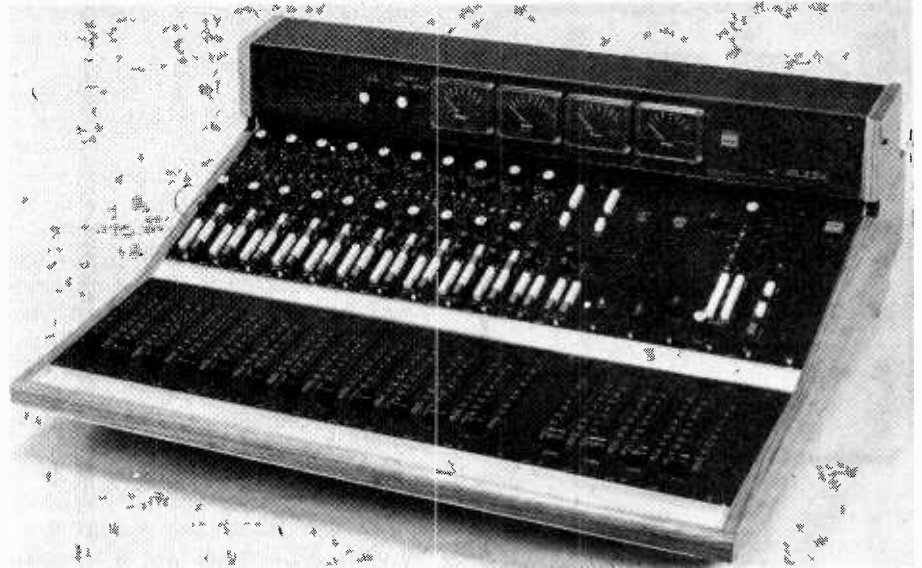

Audix MXT1000 four group p.p.m. metered mixer with ten mic/line and 2 stereo line inputs. See text.

acoustic screens. Sonaplan designed the XT14 autolocator for 3M's M79 machines. It consists of a display and control unit and a logic unit normally hidden inside the tape machine. The counter operates in minutes and seconds and accuracy, says 3M, is better than plus or minus two seconds over 30 minutes playing time at 15 i.p.s., with no overshoot. The unit, which can be hand held, also has a full tape machine remote control unit on the same panel. Among its 11 functions, including a memory, the most basic is to find the point on the tape at the elapsed time set on the preset counter. The unit can also make the machine go to zero, which is normally set automatically when the tape is loaded.

The tape timer is a real time **digital timer** for use with all the 3M professional range and derives its drive pulses from two sensors mounted below the reversing idler at the front of the 3M tape transport. The accuracy is as quoted for the autolocator.

F.W.O. Bauch was showing a new **wow and flutter meter** by EMT. The unit has a frequency deviation sensitivity of 0.1% f.s.d., and works to linear, DIN/IEC, low pass, high pass or band pass curves, with provision for an external filter. Three lamps indicate the performance of a given unit under test. A green lamp shows that the wow and flutter is well within limits, the amber that it is adequate and the red that it is outside limits. The limits are set by a programme plug in the front of the unit which is supplied along with a dummy plug for making up individual programmes. At the moment the price is £453 based on an exchange rate of 4.5DM to the pound. Bauch also showed a new micro-ohmmeter from EMT with suppressed zero facility, at £507.

Ferrograph, part of the reorganized

Wilmot Breeden Electronics group, showed their professional **audio response analyzer** ARA1. The oscillator provides automatic, continuous and single sweep modes in the ranges 20Hz to 30kHz or 200Hz to 200kHz. The long persistence c.r.t. displays a gain v frequency plot, and a permanent record of the response can be obtained by connecting an X-Y plotter to the machine. "The receiver frequency display is derived from the incoming signal and not from the oscillator," says Ferrograph, so the unit can be used to test systems with time delay, such as tape recorders, systems using separate sources, such as test records or tapes or where there is a distance between oscillator and receiver, as in telephone line checks. The graticule has a log frequency scale from 20Hz to 20kHz with a $\times 10$ range. Vertical ranges are 10, 25 and 50dB.

The Digital Audio special effects unit provides simple delay and echo effects, phasing, frequency shift and octave up and down signals mixed with the main signal. The unit uses a 40kbit r.a.m. store to hold up to 200ms of audio information which is released to the output under the control of an arithmetic processor. All functions can be remote controlled. There is a line and a low level input and all terminations are on XLR connectors. The unit can be rack mounted or free standing. The sole agents are Philip Drake Electronics.

Lockwood showed a new range of three professional **disc turntables**. The PDR1 has a Russco turntable, PDR2 a Garrard 401 and PDR3 a Thorens TD125. The last two have Ortofon F15E arms, but the Russco has a Grays 12in arm and Stanton cartridge. Alternatives can be provided for all three. Each has a 12 transistor amplifier offering a maximum output of 18dB into 600 ohms with a distortion of not greater than 0.3%. At OdBm and 1kHz the distortion is 0.1%. The output is on two XLR connectors and there is a headphone jack at the front. PDR1 costs £750, PDR2 £530 and PDR3 £575 plus VAT.

Real and Imaginary

by "Vector"

ELECTRONICS CAN BE FUN

Just in case any reader, on scanning the heading, is wondering whether his subscription has been transferred to *Reader's Digest*, a hasty glance at the front cover will reassure him. His second natural assumption, namely that Vector is mentally deranged, is equally invalid. (*I wouldn't put money on that!* — Ed.)

What I really wanted to talk about is "do-gooders" of various kinds. Do-gooding covers a wide spectrum, from the flamboyant gift of a hundred thousand or so to a hospital, with the Press fully alerted beforehand, to those earnest souls who rouse us from our Sunday afternoon nap to press a tract upon us and to assure us that their particular brand of dogma washes whitest of all. There is a great variety of do-gooders and it has been said that you can always tell the people who are being done good to by the hunted expressions on their faces.

But do-gooding, even when performed with the highest of motives in view, does not always work out in the way intended. I have in mind a certain electronics factory whose employees included two brothers by the name of Miller. One was chief of Goods Inward and the other chief of Finished Components Store. Now, if you happened to be in Goods Inward, its chief would be referred to as "Dusty" and the chief of Finished Comps as "Dusty's Brother". So far so good, except that the personnel of Finished Comps, to a man, regarded their chief as the only genuine Dusty and the Goods Inward usurper as "Dusty's Brother". I daresay you find that confusing and so did new arrivals in the factory, but they either contracted a nervous breakdown or got the hang of it after a while.

There was a young and enthusiastic curate in the area who conceived the idea (basically a good one) that he could best get to grips with the problems of his parishioners by working alongside

some of them, and to this end he bludgeoned the management into allowing him to work in the factory for three days a week. (I don't know how the union aspect was overcome, but it evidently was.)

News of the impending arrival swept through the factory grapevine at the speed of light and on the works floor a book was made as to which department would be selected to take the curate under its wing. "Goods Inward" was firm favourite, for that particular Dusty Miller, being a thorough-going Plymouth Brother, was considered a natural for the honour; in fact, a supplementary book was envisaged as to who would convert who. The Dusty Miller of Finished Comps, on the other hand, was at the tail-end of the field at astronomical odds; for although he was a chap with a heart as big as a barn door he subscribed only to one of those churches run by the Licensed Victuallers Association and was, moreover, possessed of a lurid vocabulary, with every other word an adjective of four-letter derivation.

Now, some say it was malice aforethought on the part of the management, while the more charitable hold that the hierarchy were genuinely confused as to which Dusty was which. Be that as it may, when the news broke that the cleric had been assigned to Finished Comps, the Works was in a ferment. The bookmaker, in particular, was contemplating suicide until a providential last look at his list showed that not a single client had backed the winner.

Not the least surprising aspect of the affair was the seriousness with which Dusty Miller of Finished Comps took his assignment. The clergyman was due to start on Tuesday; on Monday afternoon Dusty paraded his workforce before him.

"Now look here, you bleepers," he began. "As you may know, the bleeping management have wished a bleeping sky-pilot on me. And I want to say, right here and now, that I want some bleeping respect for the cloth from you lot. The first of you bleepers who says a bleeping word out of place, gets his bleeping cards! Savvy?"

It would be pleasant to conclude by saying that in the fullness of time Dusty might have been seen taking up the collection on Sundays. Life, however, is not always what we would wish it to be. Truth compels me to say that the alliance foundered after three weeks when the curate resigned, being distressed to find that he was acquiring the habit of uttering certain undesirable expletives in moments of trial. By doing so, he saved Dusty from certain apoplexy, for the discipline of saying, "Sorry, mate, we're out of stock" in place of his erstwhile "Wot the 'ell d'you bleeping fink this is — bleeping Marks and Spencers?" had become all but intolerable. Honours, it was generally agreed, were just about even.

But I would particularly like to recall to you a little-known category among those who do good — and, furthermore, do it by stealth. I'm thinking of those anonymous Works humorists who put a little leaven into the flour-and-water of everyday existence. You are walking along the corridor, let us say, feeling Monday-morningish and with a particularly dull chore ahead. You pause at a notice-board and one sheet sticks out from the rest. It's typed on official Head Office paper and runs as follows:

NOTICE TO ALL EMPLOYEES

It has come to the attention of the Management that personnel are becoming increasingly in the habit of dying in the company's time. This practice must cease forthwith.

*(Signed) F. M. Tuner,
Managing Director*

Another that I recall was handwritten at the foot of a Samaritan's poster. It stated simply: "My mother made me a homosexual." Underneath, in (apparently) another hand, was the comment: "If I send her the wool, will she make one for me?"

You read, and all of a sudden the prospect of the chore doesn't seem nearly so grim. Why do they do it, these chaps? It's an interesting problem in psychology. It can't be for public acclaim, because, by the way nature of things, the author must remain anonymous. The cynic may say that it's for kicks; the thrill of filching Head Office notepaper and pinning it up unseen in a busy corridor. I prefer to think it's done in the hope of relaxing a few taut faces, but perhaps I'm being naive.

Sometimes, however, these efforts come unstuck. Some years ago — in the same Works I spoke of earlier — an "official" document was circulated to the technical staff. It purported to be a description of two new types of radar equipment, one a transmitter and the other a receiver. The tone of the document was that of a preamble to a technical handbook; the uninitiated could easily read the first couple of paragraphs — or, as it transpired the whole of it — without realising that the "new radar system" was in fact a description of that biological process which, initiated by Adam and Eve, has enjoyed universal popularity ever since. The author as usual, was our old friend Anon.

His offering brought joy to the staff, and then someone decided to push the joke a stage farther and sent a copy to a well-known journal (not, I hasten to add, *W.W.!*) which promptly took it at face value and published it. On the morning of publication somebody must have rung the editor, for the edition was whistled off the book-stands at high speed.

Make it with MAPLIN!

ELECTRONIC COMPONENTS
WIDE RANGE • HIGH QUALITY • FAST SERVICE

The 4600 SYNTHESISER

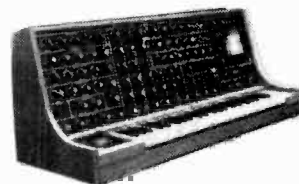

We stock all the parts for this brilliantly designed synthesiser, including all the PCB's, metalwork and a drilled and printed front panel, giving a superb professional finish. Opinions of authority agree the ETI International Synthesiser is technically superior to most of today's models. Complete construction details in our booklet now available price £1.50, or send SAE for specification.

ELECTRONIC ORGAN

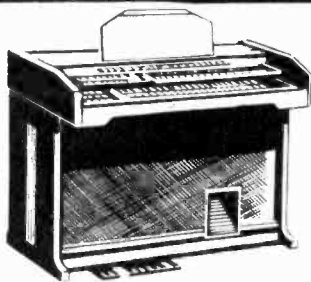

BUILD IT YOURSELF . . . IN STAGES

Get started with a 49 note instrument — features tremulant and reverberation. Ideal to learn on. Leaflet MES 51. Price 15p gives full details to build this complete instrument. Extend the range of MES 51 by adding another keyboard and several new tone colours. Leaflet MES 52. Price 15p also shows how to use 61 note keyboards.

Fully controllable attack and delay controls (normally found only on the most expensive organs), up to seven footages on each keyboard, up to 70 controls including drawbars, and a 13 note pedalboard, make up the additions described in the step-by-step 32 page instruction leaflet MES 53. Price 35p.

GRAPHIC EQUALIZER

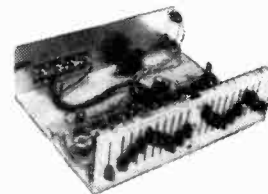

A really superior high quality stereo graphic equalizer featuring 9 octaves per channel. We stock all the parts (except woodwork) including the metalwork drilled and printed. 15p brings you a reprint of the article.

DIGITAL CLOCK KITS

ONLY **£8.60** INC. VAT
E P I P

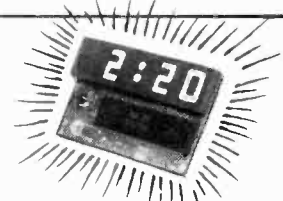

This is a fully constructed and tested electronic clock module as illustrated. Data sheet supplied. Simple to connect to alarm and your battery/mains radio. Smart case available shortly. Data sheet available separately. Please send SAE.

- ★ Bright 4 Digit 0.5" Display
- ★ Flashing Colon (1Hz)
- ★ Switch for Display Seconds
- ★ Alarm Set Indicator
- ★ P.M. Indicator
- ★ Power Failure Indicator
- ★ Sleep Timer
- ★ Snooze Timer
- ★ Time can be set accurately to within one second
- ★ Leading Zero Blanking

SIMPLE ALARM KIT — £9.38 **ALARM CLOCK KIT — £10.99**
ALARM CLOCK & RADIO CONTROLLER KIT — £11.51
SMART PLASTIC CASE with fully punched chassis — £2.49
Please send SAE for our Clock data sheet

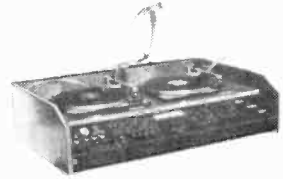

100 W PER CHANNEL STEREO DISCO

- ★ Automatic voice operated fader.
- ★ Belt drive turntables
- ★ Monitor facilities (Headphones and VU meter)
- ★ Sound operated light show — plus many other advantages.

Full construction details to be published in "Electronics Today International" on sale August.

Send for our leaflet MES 41, giving full details for construction. Price 20p. Soon you'll be the Deejay everyone wants at their party!

Get our FABULOUS NEW 1977/78 CATALOGUE

PUBLICATION DATE OCT. 28, 1976 ON APPROVAL

All new • Completely re-written • Hundreds of new lines.
Lots of exciting new projects to build — PRICE 50p
SEND NO MONEY NOW Overseas send 8 International reply coupons.

JOIN OUR MAILING LIST NOW!

Published every two months our Newsletter gives full details of our latest guaranteed prices.

Send just 30p towards cost of postage and we'll send you the next six issues as they are published. (A 5p voucher is sent with each newsletter which may be used on purchases.)

★ SAVE ££'s ON SPECIAL OFFERS! ★ DETAILS OF NEW PROJECTS AND NEW LINES

Please rush me a copy of your brand new 1977/78 catalogue the instant it is printed (Oct. 28th, 1976). Only if I am completely satisfied that it is worth every penny will I send 50p within 14 days of receipt. If I am not satisfied I may return the catalogue to you within 14 days without obligation. I understand that I need not purchase anything from your catalogue should I choose to keep it.

NAME
ADDRESS



MAPLIN ELECTRONIC SUPPLIES
All mail to P.O. Box 3, Rayleigh, Essex SS6 8LR
Shop 284 London Road, Westcliff-on-Sea Essex
(Closed on Monday). Tel: Southend (0702) 44101

If you do not wish to cut magazine, write your request for catalogue on separate sheet
1975/76 GREEN COVER CATALOGUE STILL
AVAILABLE PRICE 40p

VALVE MAIL ORDER CO.

Climax House, 159 Fallsbrook Rd., Streatham
London SW16 6ED
Tel: 01-677 2424 Telex: 946 708

VALVES			INDUSTRIAL VALVES		
AZ31	1.50	ECH35	6060	CV131	CV3986
AZ41	1.00	ECH42	6061	CV132	CV3988
CL31	1.40	ECH84	6062	CV133	CV3991
CL33	1.50	ECH90	6063	CV134	CV3998
CY31	1.00	ECL82	6064	CV136	CV4001
DAF91	0.40	ECL86	6065	CV137	CV4002
DAF96	0.60	ECL80	6067	CV138	CV4003
DCC90	1.35	ECL86	6072	CV140	CV4004
DF51	0.40	EF37A	6073	CV144	CV4005
DF96	0.60	EF39	6074	CV160	CV4006
DK91	1.50	EF41	6075	CV173	CV4007
DK92	0.50	EF55	6080	CV187	CV4008
DK96	0.75	EF80	6081	CV188	CV4009
DL92	0.50	EF86	6082	CV190	CV4010
DL94	0.44	EF86	6083	CV220	CV4011
DL96	0.50	EF89	6084	CV261	CV4012
DM70	0.75	EF91	6085	CV273	CV4013
DM78	0.45	EF92	6086	CV284	CV4014
DY702	0.45	EF98	6087	CV286	CV4015
EABC80	0.36	EF184	6088	CV287	CV4016
EAF42	0.75	EH90	6089	CV329	CV4017
EAF801	0.75	EL33	6090	CV337	CV4019
EBC31	1.00	EL34	6091	CV342	CV4020
EBC41	1.00	EL37	6092	CV345	CV4022
EBC81	0.40	EL42	6093	CV347	CV4023
EBC80	0.40	EL44	6094	CV359	CV4024
EBP83	0.40	EL91	6095	CV428	CV4028
EBP89	0.32	EL95	6096	CV432	CV4033
EBL31	0.20	EM30	6097	CV434	CV4035
ECC40	0.45	EM80	6098	CV435	CV4038
ECC81	0.45	EM81	6099	CV436	CV4039
ECC82	0.38	EY51	6100	CV437	CV4040
ECC83	0.38	EY51	6101	CV438	CV4041
ECC85	0.45	EY86	6102	CV439	CV4042
ECC88	0.45	EZ40	6103	CV447	CV4062
ECC89	0.45	EZ41	6104	CV449	CV4064
ECC82	0.45	EZ41	6105	CV451	CV4066
			6106	CV452	CV4068
			6107	CV453	CV4069
			6108	CV454	CV4070
			6109	CV455	CV4071
			6110	CV456	CV4072
			6111	CV457	CV4073
			6112	CV458	CV4074
			6113	CV459	CV4075
			6114	CV460	CV4076
			6115	CV461	CV4077
			6116	CV462	CV4078
			6117	CV463	CV4079
			6118	CV464	CV4080
			6119	CV465	CV4081
			6120	CV466	CV4082
			6121	CV467	CV4083
			6122	CV468	CV4084
			6123	CV469	CV4085
			6124	CV470	CV4086
			6125	CV471	CV4087
			6126	CV472	CV4088
			6127	CV473	CV4089
			6128	CV474	CV4090
			6129	CV475	CV4091
			6130	CV476	CV4092
			6131	CV477	CV4093
			6132	CV478	CV4094
			6133	CV479	CV4095
			6134	CV480	CV4096
			6135	CV481	CV4097
			6136	CV482	CV4098
			6137	CV483	CV4099
			6138	CV484	CV4100
			6139	CV485	CV4101
			6140	CV486	CV4102
			6141	CV487	CV4103
			6142	CV488	CV4104
			6143	CV489	CV4105
			6144	CV490	CV4106
			6145	CV491	CV4107
			6146	CV492	CV4108
			6147	CV493	CV4109
			6148	CV494	CV4110
			6149	CV495	CV4111
			6150	CV496	CV4112
			6151	CV497	CV4113
			6152	CV498	CV4114
			6153	CV499	CV4115
			6154	CV500	CV4116
			6155	CV501	CV4117
			6156	CV502	CV4118
			6157	CV503	CV4119
			6158	CV504	CV4120
			6159	CV505	CV4121
			6160	CV506	CV4122
			6161	CV507	CV4123
			6162	CV508	CV4124
			6163	CV509	CV4125
			6164	CV510	CV4126
			6165	CV511	CV4127
			6166	CV512	CV4128
			6167	CV513	CV4129
			6168	CV514	CV4130
			6169	CV515	CV4131
			6170	CV516	CV4132
			6171	CV517	CV4133
			6172	CV518	CV4134
			6173	CV519	CV4135
			6174	CV520	CV4136
			6175	CV521	CV4137
			6176	CV522	CV4138
			6177	CV523	CV4139
			6178	CV524	CV4140
			6179	CV525	CV4141
			6180	CV526	CV4142
			6181	CV527	CV4143
			6182	CV528	CV4144
			6183	CV529	CV4145
			6184	CV530	CV4146
			6185	CV531	CV4147
			6186	CV532	CV4148
			6187	CV533	CV4149
			6188	CV534	CV4150
			6189	CV535	CV4151
			6190	CV536	CV4152
			6191	CV537	CV4153
			6192	CV538	CV4154
			6193	CV539	CV4155
			6194	CV540	CV4156
			6195	CV541	CV4157
			6196	CV542	CV4158
			6197	CV543	CV4159
			6198	CV544	CV4160
			6199	CV545	CV4161
			6200	CV546	CV4162
			6201	CV547	CV4163
			6202	CV548	CV4164
			6203	CV549	CV4165
			6204	CV550	CV4166
			6205	CV551	CV4167
			6206	CV552	CV4168
			6207	CV553	CV4169
			6208	CV554	CV4170
			6209	CV555	CV4171
			6210	CV556	CV4172
			6211	CV557	CV4173
			6212	CV558	CV4174
			6213	CV559	CV4175
			6214	CV560	CV4176
			6215	CV561	CV4177
			6216	CV562	CV4178
			6217	CV563	CV4179
			6218	CV564	CV4180
			6219	CV565	CV4181
			6220	CV566	CV4182
			6221	CV567	CV4183
			6222	CV568	CV4184
			6223	CV569	CV4185
			6224	CV570	CV4186
			6225	CV571	CV4187
			6226	CV572	CV4188
			6227	CV573	CV4189
			6228	CV574	CV4190
			6229	CV575	CV4191
			6230	CV576	CV4192
			6231	CV577	CV4193
			6232	CV578	CV4194
			6233	CV579	CV4195
			6234	CV580	CV4196
			6235	CV581	CV4197
			6236	CV582	CV4198
			6237	CV583	CV4199
			6238	CV584	CV4200
			6239	CV585	CV4201
			6240	CV586	CV4202
			6241	CV587	CV4203
			6242	CV588	CV4204
			6243	CV589	CV4205
			6244	CV590	CV4206
			6245	CV591	CV4207
			6246	CV592	CV4208
			6247	CV593	CV4209
			6248	CV594	CV4210
			6249	CV595	CV4211
			6250	CV596	CV4212
			6251	CV597	CV4213
			6252	CV598	CV4214
			6253	CV599	CV4215
			6254	CV600	CV4216
			6255	CV601	CV4217
			6256	CV602	CV4218
			6257	CV603	CV4219
			6258	CV604	CV4220
			6259	CV605	CV4221
			6260	CV606	CV4222
			6261	CV607	CV4223
			6262	CV608	CV4224
			6263	CV609	CV4225
			6264	CV610	CV4226
			6265	CV611	CV4227
			6266	CV612	CV4228
			6267	CV613	CV4229
			6268	CV614	CV4230
			6269	CV615	CV4231
			6270	CV616	CV4232
			6271	CV617	CV4233
			6272	CV618	CV4234
			6273	CV619	CV4235
			6274	CV620	CV4236
			6275	CV621	CV4237
			6276	CV622	CV4238
			6277	CV623	CV4239
			6278	CV624	CV4240
			6279	CV625	CV4241
			6280	CV626	CV4242
			6281	CV627	CV4243
			6282	CV628	CV4244
			6283	CV629	CV4245
			6284	CV630	CV4246
			6285	CV631	CV4247
			6286	CV632	CV4248
			6287	CV633	CV4249
			6288	CV634	CV4250
			6289	CV635	CV4251
			6290	CV636	CV4252
			6291	CV637	CV4253
			6292	CV638	CV4254
			6293	CV639	CV4255
			6294	CV640	CV4256
			6295	CV641	CV4257
			6296	CV642	CV4258
			6297	CV643	CV4259
			6298	CV644	CV4260
			6299	CV645	CV4261
			6300	CV646	CV4262
			6301	CV647	CV4263
			6302	CV648	CV4264
			6303	CV649	CV4265
			6304	CV650	CV4266
			6305	CV651	CV4267

BI-PRE-PAK

Bargains in Semi-Conductors, components, modules & equipment.

B-P-P Packs



Originated in 1959 by the Company's managing director, his were the first semi-conductor and component packs to be marketed in this country, and indeed, the company's name grew out of "British Industrial Pre-Packed Components". Today, Bi-Pre-Pak continues to occupy a position of pre-eminence in the supply of packs as well as a vastly extended range of products detailed in our latest 24-page A.4 size free catalogue. Send 10p stamped large addressed envelope for your copy, together with our special summer bargains list, by return.

IT'S ALL IN OUR FREE CATALOGUE

Component Packs

- CP1 150 Capacitors, mixed bag of paper, silver mica, electrolytics etc. Approx. quantity counted by weight. **60p**
- CP2 200 Resistors, mixed bag of different types, values, wattages etc. Approx. quantity counted by weight. **60p**
- CP3 40 Wirewound resistors, mixed types, values and wattages. **60p**
- CP4 12 Potentiometers, pre-sets, w/wound, carbon etc. Mixed types and values. **60p**
- CP5 5 Earphones, single low impedance for transistor radios, cassettes etc. Less plugs. For suitable plugs see PAKs CP9 and CP10. **60p**
- CP6 50 TO 5 mounting pads, fits between transistor and board for that pro finish. **60p**
- CP8 500 Cathie clips for G.P.O. 1/2" dia. cable. Nylon with hardened steel pin (probably tungsten) per sealed box of 500. **60p**
- CP9 5 3.5mm plugs, miniature jack, to fit earphones in PAK CP5. **60p**
- CP10 5 2.5mm sub miniature jack plugs, to fit earphones in PAK CP5. **60p**
- CP11 6 Screwdrivers, 1 x mains neon tester, 5 x grub screwdrivers. **60p**
- CP12 10 Reed relay inserts, 1 1/2" long 1/8" dia. These will operate from an external magnet or coil. For magnets see PAK CP13. **60p**
- CP13 10 Magnets of various sizes for operating reed switches on PAK CP12. Ideal for burglar alarms on doors and windows etc. **60p**
- CP14 40 Potentiometers, pre-sets, wirewounds, carbons, dual gangs, with and without switches etc. Mixed values and wattages. **£1.20**
- CP15 12 Standard crocodile clips, screw fixing, good quality. **60p**
- CP16 5 P.C. boards, each containing a BF180 UHF amplifier transistor. A good basis for building a T.V. aerial pre-amp as various parts inc. **60p**
- CP17 25 Electrolytic Capacitors, various values and voltages, many useful types from T.V. to transistor radio and Hi-Fi. **60p**
- CP18 1 Light activated SCR 50 volts 1.6 amps type 19F. Ready mounted on P.C. board with gate resistor and leads fitted. Full data and circuit diagrams for 14 projects, includes slave photo flash unit, burglar alarm, etc. **60p**
- CP19 3 Micro switches 1 pole change over, standard model 1 1/2" x 1/2". **60p**
- CP20 10 Relays, assorted types, Ex-G.P.O. and others, mixed voltages. **£1.20**
- CP21 200 Square inches of copper laminate P.C. board in approx. 8 pieces. **60p**
- CP22 3 Fibreglass plain printed circuit boards, approx. 2 1/2" x 14". **60p**
- CP23 4 Switches, miniature push to make, single pole. **60p**

YOUR SUPPLIERS FOR:

Semi-conductors — all popular types. Opto-electronic devices inc. Nixie Tubes, Solder Tools, Terminals, Switches, Knobs, Ex-G.P.O. items, Aluminium Boxes, Triacs, Thyristors, Zener Diodes and much more in our catalogue and shop.

Semi-Conductors

TESTED AND GUARANTEED PACKS

- TP4 3 SN7490 integrated circuits, 14 pin dual in line TTL type decade counter. Get one FREE, these are 60p each in singles. **£1.20p**
- ALL THE FOLLOWING ARE AT 60p EACH PACK
- TP9* 5 SN7400 integrated circuits, 14 pin dual in line TTL type Quad 2-input NAND gate. Get one FREE, these are 15p each.
- TP10 2 Light dependant resistors, 400 ohms light, 1 megohm dark, 1/4" dia.
- TP11 10 Transistors XB102 and XB112 equivalent to AC126 AC156, OC81/2 OC72, etc.
- TP12* 4 BY127 Silicon rectifiers, 1000 piv 1 amp Plastic T.V. rectifier.
- TP13* 5 OCP71 Light sensitive transistors.
- TP14 20 OC71 Germanium PNP audio pre amp transistor, black glass type.
- TP15 20 OC81 Germanium PNP audio output transistor, white glass type.
- TP16 20 OC200/1/2/3 transistors, PNP silicon TO-5 unmarked.
- TP17 20 1 watt zener diodes, mixed voltages, 6.8 to 43 volts.
- TP18 20 2N3707/8/9/10 transistors, NPN silicon plastic unmarked.
- TP19 100 Diodes, mixture of germanium, gold bonded, silicon, etc. a useful selection of many types, marked and unmarked.
- TP20 10 Mullard OC45 transistors, 1 F amp, PNP germanium.
- TP23 20 BFY50/1/2, 2N696/7, 2N1613, etc. NPN silicon IO-5 uncodced COMPLEMENTARY TO PAK TP24.
- TP24 20 BFY64, 2N2904/5, etc. PNP silicon TO-5 uncodced COMPLEMENTARY TO PAK TP23.
- TP30 20 NPN silicon planar transistors, TO-18 similar to BC108 etc. uncodced.
- TP31 20 PNP silicon planar transistors, TO-18 similar to BC178 etc. uncodced.
- TP32 20 2N2926 silicon plastic transistors, uncodced and ungraded for colours.

UNTESTED PACKS — 60p each Specially for keen bargain hunters

- UT1 50 PNP germanium transistors, AF and RF. Very good yield.
- UT2 150 Germanium diodes, miniature glass type.
- UT5 40 Zener diodes, 250 mW OAZ240 range, average 50% good.
- UT6 25 Zener diodes, 1.1 1/2 watt top hat type, mixed voltages.
- UT9 40 NPN silicon planar transistors, of the 2N3707-11 range, low noise amp.
- UT10 15 Power transistors, PNP germanium and NPN silicon mostly TO-3 but some plastic and some marked.
- UT13 15 Integrated circuits, experimenters pak, dual in line, TO-5 TTL, DTL, marked and unmarked, some definitely good but old types.

FOR FULL RANGES — SEE CATALOGUE

POWER TRANSISTORS

	Vce	Watts	Amps	Price
40P1	15	20	3	30p
40N2	40	40	4	30p
40P2	40	40	4	30p
90N1	15	45	4	25p
90P1	15	45	4	25p
90N2	40	90	8	35p
90P2	40	90	8	35p

Many other types available from 3 to 115 watts

INTEGRATED CIRCUITS

- MM5314 Dual in line clock chip **£3**
- LM380/SI60745 Dual in line 2w. audio amp, with data, etc. **75p**
- Dual in line I.C. sockets 8 pin **14p**; 14 pin **15p**; 16 pin **16p**.

FETs	18p	UNI-JUNCTION TRANSISTORS	65p
2N3819	20p	2N2160	48p
2N4416		2N2646	31p
MOS F.E.T.s	50p	T1543	
3N141/MEM616			

PUTs	50p	LEDs	18p
2N26027		TIL209—Red	33p
		TIL211—Green	

Also Power Diodes, Thyristors, Triacs, Diacs-Zener Diodes, Opto-Electronics, etc.

WHEN ORDERING

- Write your own name and address clearly in block capital letters.
- Check that your order is correct for description, quantity and price.
- Don't forget VAT at 12 1/2% of total value of order unless otherwise marked * or (8%).
- MAKE SURE YOU GET OUR NAME AND ADDRESS RIGHT WHEN ORDERING.
- Mention this journal when ordering if you don't want to cut out the coupon.

TERMS OF BUSINESS:

VAT at 12 1/2% must be added to total value of order, except for items marked * or (8%), when VAT is to be added at 8%. No VAT on overseas orders. **POST & PACKING** add 30p for UK orders except where shown otherwise. Minimum mail order acceptable—£1. Overseas orders add £1 for postage. And difference will be credited or charged. **PRICES** Subject to alteration without notice. **AVAILABILITY** All items are available at time of going to press when every effort is made to ensure correctness of information. Cash with order please. Cheques or money orders should be crossed and made payable to Bi-Pre-Pak Ltd.

Singles BRIDGE RECTIFIERS Plastic encapsulated

P.I.V.	50v	100v	400v
1 amp	35p*	35p*	45p*
2 amp	35p*	45p*	55p*
4 amp	45p*	50p*	80p*
6 amp	50p*	60p*	90p*

BY164 equiv. SKB2/02 400v 1.5 amp 450*

Sundry

SIGNAL GENERATOR

For MW and IF Covers 550 KHz to 1.6 MHz for MW and 400 to 550KHz for IF. Fully portable. Invaluable in AM repair and alignment jobs (p/p 40p). **£4.25***

POCKET SIGNAL INJECTOR

Fountain-pen type. Invaluable for fault tracing in radio sets, amplifiers, TVs, tape recorders, etc. Takes one HP7 battery. **£2.00***

EX-G.P.O. 6" LONG NOSE PLIERS

Not new, but in perfect order, per pair **60p***

MAINS TRANSFORMERS

M16	6v 0.6v 100mA	£1.22*
MT12	12v 0.12v 50mA	£1.22*
SST9/1	9v 1amp	£1.67*
SST12/1	12v 1amp	£2.05*
SST18/1	18v 1amp	£2.50*
SST25/2	25v 2amp	£3.00*
SST30/2	30v 2amp	£4.25*
SST35/4	35v 4amp	£5.50*

(P/P 50p any one)

PC EDGE CONNECTORS

Type	Sizes	Pitch	
SSEC 6-way	1 1/2"	156"	32p*
SSEC 10	1 1/2"	156"	50p*
SSEC 12	2"	156"	60p*
SSEC 16	2 1/2"	156"	75p*
SSEC 18	3"	156"	85p*
SSEC 22	3 1/2"	156"	£1.00*

UHF TUNER UNITS

Brand new by famous manufacturer. 625 lines Channels 21-65. Ideal for use as TV sound receiver. With data. **£2.50**

BOOKS

All free of VAT. We carry very large stocks of technical books by Baban & Bernard Publishers, by Newnes & Butterworth as well as reference books from the Common Market in English/German/Italian. All detailed in our catalogue.

MONEY SAVER FOR CAR OWNERS

The "Super Spark" Mk.5 Capacity Discharge Ignition Unit, developed out of our original ETI model (of which we have sold well over 9,000) enables you to enjoy this system at a truly economic price. Facilities include simple adaption to pos. or neg. earth, immediate switch back to conventional ignition, anti-burglar immobilisation with all parts in totally enclosed strong metal case. Very easy to fit and install. With full instructions. (P/P add 75p).

"A very good investment indeed" (Practical Wireless, May '76).

KIT £7.95* READY-BUILT £10.50*

X-44 R.F. CROSS HATCH GENERATOR

Improved version of our famous Mk. 2 model, of which thousands are in regular use. Size 150x75x50mm, strong plastic case with handle/stand, 4 push button operation, 4 patterns. Self-contained line and frame generator and synchro pulse. Pre-set adjust for RF output and line/frame sync. Uses 4 alkaline type 1600 batts. Blank raster facility. **FOR COLOUR AND MONO (P/P add 50p)**

£27.50 * Built & tested

TV SIGNAL STRENGTH METER

As described originally in "Television", Dec. 74/Jan. 75. Gives direct reading of strength of signal received on UHF aerial, complete kit and reprints of articles. (P/P 50p.) **£19.50***

SOME SPECIAL SUMMER OFFERS

FM STEREO DECODERS	
I.C. unit, for negative earth, with data.	£1.95
Transistorised version for positive earth.	£1.75
RADIO SET CHASSIS	
On P.C.B.s., unsorted, useful for experimenting etc. Various kinds (cannot be exchanged) AM/FM	£1.00
AM types, each.	75p

BI-PRE-PAK LTD

Co. Reg. No. B21919

220 224 WEST ROAD, WESTCLIFF-ON-SEA, ESSEX SS0 9DF.

TELEPHONE: SOUTHEM (0702) 46344.

Get a great deal from Marshall's

A Marshall (London) Ltd Dept: WW
 40/42 Cricklewood Broadway, London NW2 3ET
 Tel: 01-452 0161/2 Telex: 21492
 & 85 West Regent St Glasgow G2 2QD Tel: 041-332 4133
 & 1 Straits Parade Fishponds Bristol BS16 2LX Tel: 0272 654201/2
 & 27 Rue Danton Issy Les Moulineaux Paris 92
 Call in and see us 9-5.30 Mon-Fri 9-5.00 Sat
 Trade and export enquiries welcome.
Catalogue price 35p (30p to callers)

OUR RANGE COVERS OVER 7,000 ITEMS THE LARGEST SELECTION IN BRITAIN TOP 200 IC'S, TTL, CMOS & LINEARS

CA3020A 1.45	CD4511 1.70	SL610C 2.35	SN7470 0.32	SN74174 1.06	TBA800 0.89
CA3028A 0.85	CD4516 1.54	SL611C 2.35	SN7472 0.26	SN74175 0.94	TBA810 0.98
CA3035 1.35	CD4518 1.38	SL612C 2.35	SN7473 0.30	SN74176 0.86	TBA820 0.85
CA3046 6.13	CD4520 1.38	SL620C 3.50	SN7474 0.30	SN74180 1.23	TBA920 1.79
CA3048 2.75	LM301AH 0.47	SL621C 3.50	SN7475 0.40	SN74181 2.58	TBA990Q 3.00
CA3052 1.62	LM308N 1.17	SL623C 4.75	SN7476 0.36	SN74190 1.33	TCA160C 1.85
CA3089 2.00	LM309K 1.80	SL640C 5.00	SN7480 0.45	SN74191 1.33	TCA420A 1.90
CA3090Q 4.25	LM380-B 0.98	SN7400 0.16	SN7481 1.10	SN74192 1.18	TCA720 3.40
CD4000 0.20	LM391AM 2.07	SN7401 0.16	SN7482 0.67	SN74193 1.13	TCA750 2.45
CD4001 2.00	LM702C 0.75	SN7402 0.16	SN7483 0.92	SN74196 1.81	TCA800 3.25
CD4002 0.20	LM709 0.98	SN7403 0.16	SN7484 0.85	SN74197 1.81	UAA-170 1.50
CD4006 1.16	TO5 0.38	SN7404 0.18	SN7485 1.25	SN74198 2.04	UAA180 1.50
CD4007 0.20	8DIL 0.40	SN7405 0.18	SN7486 0.29	SN74199 2.04	BDLSKT 0.12
CD4008 0.97	14DIL 0.40	SN7406 0.51	SN7490 0.43	SN76003N 2.36	14DILSKT 0.14
CD4009 0.57	LM710 0.45	SN7407 0.51	SN7491 0.68	SN76013N 1.50	16DILSKT 0.16
CD4010 0.57	LM723C 0.60	SN7408 0.18	SN7492 0.43	SN76023N1 5.50	
CD4011 0.20	LM741C 1.00	SN7409 0.18	SN7493 0.43	SN76033N2 5.50	
CD4012 0.20	TO5 0.38	SN7410 0.16	SN7494 0.74	TAA263 1.25	
CD4013 0.59	8DIL 0.38	SN7412 0.25	SN7495 0.59	TAA300 2.67	
CD4014 1.01	14DIL 0.40	SN7413 0.40	SN7496 0.78	TAA310A 1.50	
CD4015 1.01	LM7470N 0.78	SN7416 0.43	SN74100 1.15	TAA320A 1.15	
CD4016 0.56	LM748 1.99	SN7417 0.43	SN74107 0.30	TAA350A 2.48	
CD4017 1.01	8DIL 0.44	SN7420 0.16	SN74118 0.90	TAA550 0.60	
CD4018 1.01	14DIL 0.41	SN7423 0.26	SN74119 1.80	TAA560 1.60	
CD4019 0.57	LM3900N 0.55	SN7425 0.27	SN74121 0.34	TAA570 2.30	
CD4020 1.12	LM7805P 1.99	SN7427 0.27	SN74122 0.45	TAA611C 2.25	
CD4021 1.01	LM7812P 1.99	SN7430 0.16	SN74123 0.40	TAA621 2.15	
CD4022 0.97	LM7815P 1.99	SN7432 0.27	SN74141 0.72	TAA661A 1.32	
CD4023 2.00	LM7824P 1.99	SN7437 0.35	SN74145 0.74	TAA661B 1.85	
CD4024 0.79	MC1303L 1.44	SN7438 0.35	SN74150 1.20	TAA661C 1.32	
CD4025 0.20	MC1310P 1.91	SN7440 0.16	SN74151 0.77	TAA700 3.91	
CD4027 0.56	MC1330P 1.35	SN7441 0.76	SN74153 0.73	TAA930A 1.00	
CD4028 0.91	MC1351P 0.87	SN7442 0.55	SN74154 1.28	TAA930B 1.05	
CD4029 1.17	MC1466L 3.95	SN7445 0.94	SN74155 1.20	TAA661B 1.32	
CD4030 0.57	MC1469P 2.50	SN7446 0.88	SN74157 0.68	TAD100 1.95	
CD4031 2.26	MC14553 4.07	SN7447 3.81	SN74160 1.20	TBA120 1.65	
CD4037 0.97	NE555V 0.48	SN7448 0.85	SN74161 1.20	TBA510Q 2.30	
CD4041 0.83	NE556 1.30	SN7450 0.16	SN74162 1.20	TBA520Q 2.30	
CD4042 0.83	NE560 4.48	SN7451 0.18	SN74163 1.20	TBA530Q 2.07	
CD4049 0.56	NE561 3.48	SN7452 0.18	SN74164 0.93	TBA540Q 2.30	
CD4050 0.86	NE565 1.30	SN7454 0.16	SN74165 0.93	TBA641B 2.50	
CD4510 1.54	SL1414A 2.35	SN7460 0.16	SN74167 3.70	TBA651 1.80	

POPULAR SEMICONDUCTORS

2N696 0.25	2N3820 0.29	AF117 0.65	BC477 0.35	BRF79 0.24	TIP42A 0.90
2N697 0.16	2N3904 0.21	AF118 0.65	BC478 0.35	BRF29 0.38	TIP2955 1.00
2N699 0.55	2N3906 0.22	AF124 0.65	BC479 0.35	BFX30 0.38	TIP3055 0.50
2N706 0.12	2N4058 0.20	AF139 0.69	BC547 0.12	BFX84 0.38	TIS43 0.30
2N708 0.21	2N4067 0.18	AF239 0.74	BC548 0.10	BFX85 0.41	ZTX300 0.15
2N916 0.43	2N4921 0.60	AF279 0.80	BC549 0.13	BFX88 0.32	ZTX301 0.15
2N918 0.34	2N4923 0.70	AF280 0.61	BC549B 0.16	BFY50 0.30	ZTX500 0.15
2N1302 0.37	2N5245 0.29	AL102 1.50	BC549C 0.14	BFY51 0.38	ZTX501 0.15
2N1306 0.45	2N5294 0.35	BC107 0.14	BC557 0.13	BFY52 0.36	ZTX502 0.18
2N1308 0.60	2N5296 0.36	BC109 0.15	BC558 0.12	BRY39 0.50	IN914 0.07
2N1711 0.27	2N5458 0.26	BC147B 0.10	BC559 0.14	ME0402 0.20	IN4007 0.18
2N2102 0.67	2N5459 0.29	BC149B 0.13	BCY70 0.25	ME0412 0.20	IN4148 0.07
2N2148 1.55	2N6027 0.45	BC157A 0.12	BCY71 0.26	ME102 0.10	IN4504 0.18
2N2184 0.40	3N125 0.80	BC158A 0.11	BCY72 0.24	ML480 1.05	IN5409 0.40
2N219A 0.52	3N140 1.00	BC167B 0.12	BD115 1.20	MJ481 1.30	AA119 0.14
2N2220 0.35	3N141 0.85	BC168B 0.12	BD121 2.00	MJ490 1.05	BA102 0.15
2N2221 0.22	3N200 2.60	BC169B 0.12	BD123 2.00	MJ491 1.85	BA145 0.19
2N2222 0.25	40361 0.45	BC182 0.11	BD124 2.00	MJ2955 1.00	BA154 0.10
2N2669 0.25	40362 0.48	BC182L 0.14	BD131 0.51	MJE340 0.58	BA155 0.12
2N2646 0.55	40406 0.48	BC183 0.11	BD132 0.54	MJE370 0.68	BB103B 0.20
2N2905 0.37	40407 0.38	BC183L 0.14	BD135 0.34	MJE371 0.81	BB104B 0.34
2N2906 0.28	40408 0.50	BC184 0.12	BD136 0.36	MJE520 0.65	BY126 0.27
2N2907 0.21	40409 0.55	BC184L 0.14	BD137 0.36	MJE521 0.75	BY127 0.29
2N2926G 0.13	40410 0.55	BC212 0.14	BD138 0.39	MJE2955 1.25	BY211 0.70
2N3053 0.25	40411 2.30	BC212L 0.17	BD139 0.42	MJE3055 0.75	BY212 0.70
2N3054 0.50	40594 0.75	BC213L 0.16	BD159 0.50	MPE113 0.45	OA47 0.10
2N3055 0.65	40595 0.88	BC214L 0.17	BD181 1.10	MPE102 3.00	OAS0 0.06
2N3391 0.29	40636 1.15	BC237B 0.14	BD236 0.40	MPSA05 0.20	OA91 0.06
2N3392 0.14	40673 0.73	BC239C 0.16	BD438 0.76	MPSA06 0.20	OA200 0.08
2N3393 0.15	AC126 0.37	BC257A 0.17	BF115 0.35	MPSA06 0.20	BY164 0.57
2N3440 0.57	AC127 0.44	BC259B 0.18	BF117 0.70	MPSA55 0.20	S72 dnc 0.20
2N3442 1.20	AC128 0.57	BC301 0.45	BF154 0.25	MPSA56 0.20	40669 1.00
2N3638 0.16	AC151 0.35	BC307B 0.20	BF180 0.36	OC28 2.00	TIC47 0.15
2N3702 0.17	AC152 0.50	BC308A 0.18	BF181 0.36	OC42 0.50	CI06D 0.65
2N3703 0.15	AC153 0.40	BC309C 0.25	BF184 0.35	OC45 0.75	OPR12 0.70
2N3704 0.15	AC176 0.40	BC327 0.20	BF194 0.12	TIP29A 0.50	
2N3706 0.14	AC187K 0.40	BC328 0.19	BF196 0.13	TIP29C 0.75	
2N3708 0.14	AC188K 0.45	BC407 0.25	BF197 0.14	TIP31A 0.62	
2N3714 2.45	AD161 1.23	BC408 0.25	BF198 0.15	TIP32A 1.75	
2N3716 2.60	AD162 1.23	BC409 0.25	BF244 0.35	TIP33A 1.00	
2N3771 1.60	AF106 0.45	BC440 0.45	BF258 0.49	TIP34A 1.20	
2N3773 2.65	AF109 0.45	BC442 0.45	BF259 0.49	TIP35A 2.50	
2N3815 0.65	AF115 0.65	BC460 0.55	BF398 0.27	TIP36A 3.85	
2N3819 0.26	AF116 0.65	BC461 0.55	BRF39 0.24	TIP41A 0.70	

Prices correct at July 1976, but all exclusive of V.A.T. Post & Packing 30p

LONDON, GLASGOW, PARIS — AND NOW BRISTOL
IT'S OUR SERVICE THAT MAKES US GROW

- MUIRHEAD D-658 18" MUFAX CHART TRANSMITTERS** (Model GA). Further details on request. For 110/250v a.c. operation £325.00
- MEGGER (Record)**: 500 volts £20.00 £1.00 post
- MEGGER (Evershed Vignoles)**: 250 volts £17.50 £1.00 post
- R216 Receiver MANUAL** (photostat copy): £1.50 inc. post
- RACAL I.S.B. ADAPTOR RA-95A**: £65. Carr. £2.
- MUIRHEAD ATTENUATORS**: 75 ohms 0-8 Mc/s 3V MAK 3 ranges 0-5, 0-25, 0-50 dB £3.00 + 75p post.
- CREED MODEL 75 TELEPRINTER**: Receiver only £30.00. Carr. £3.
- EDDYSTONE TELEPRINTER ADAPTOR TYPE 937**: £45. Carr. £1
- WILD BARFIELD ELECTRIC FURNACE MODEL CCI.22X**: With ether indicating temperature controllers Model 990. 0-1400° C. £250. Carr. £5.
- METROVAC IONIZATION GAUGE MODEL V.C.3**: £55. Carr. £3.
- AVO VALVE TESTER CT.160**: (Portable) similar to Avo Mk. 3 Characteristic meter. Good condition. £45.00. Carr. £2.00.
- REDIFON TELEPRINTER RELAY UNIT No. 12**: ZA-41196 and power supply 200-250V a.c. Polarised relay type 3SEITR. 80-0V 25mA. Two stabilised valves C.V 286. Centre Zero Meter 10-0-10."Size 8in. x 8in. x 8in. New condition. £10. Carr. 75p.
- SOLARTRON PULSE GENERATOR TYPE G1101-2**: £75.00 each. Carr. £2.00.
- TELEPRINTER TYPE 7B**: Pageprinter 24V d.c. power supply, speed 50 bauds per min. second hand cond. (excellent order) no parts broken. £20 each. Carriage £3.
- AUTO TRANSFORMER**: 230V 50c/s, 1000 watts. Mounted in strong steel case 5" x 6 1/2" x 7". Bitumen impregnated. £12.00. Carr. £1.50.
- CRYSTAL TEST SET TYPE 193**: used for checking crystals in freq. range 3000-10,000KHz. Mains 230V 50Hz. Measures crystal current under oscillatory conditions and the equivalent resistance. Crystal freq. can be tested in conjunction with a freq. meter. £25. Carr. £1.50.
- SOLARTRON VARIABLE POWER UNIT S.R.S. 1535**: 0-500 volts at 100 mA and 6.3 volts C.T. 3 amps d.c. 110/250 volts a.c. input. £18.50. Carr. £1.50.
- ADVANCE A.F. SIGNAL GENERATOR HIE**: Sinesoidal or square wave output. 15-50KHz. Adjustable level between 200uv and 20v. Overall distortion less than 1%. Output adjustable 1.4mV to 140V. Waveform ratio 50:50 up to 25KHz. Standard A.C. mains input. As new condition £40.00. Carr. £2.00.
- ADVANCE A.F. SIGNAL GENERATOR H.I.I.**: Same frequency and characteristics as above. Earlier model. Secondhand condition. £25.00. Carr. £2.00.
- PULSE GENERATOR PG21**: Pulse width variable 15nS to 200msec in 7 ranges. Delay variable 40nS to 200msec with respect to sync pulse output in 7 ranges. Jitter less than 1%. Repetition rate 1Hz to 10MHz in 7 decade ranges. 20MHz available in double pulse mode. Pulse mode: normal, square wave and double pulse. 240v a.c. As new condition. £125.00. Carr. £2.00.
- CLASS 'D' WAVEMETER NO. 1**: Crystal controlled heterodyne frequency meter covering 2-8 MHz. Power supply 6V d.c. Good secondhand condition. £8.50. Carr. £1.50.

- PRECISION PHASE DETECTOR TYPE 205**: Freq. 0.1-15MHz in 5 ranges. Variable time delay microseconds 0-0.1c. 115v input. £55 each. Carr. £1
- RING TOROIDAL DUST CORES**: Size 2 1/2" outside 1 3/4" inside 5/16" thick. Box of two £1.00. Post 30p.
- MUIRHEAD PHASEMETER TYPE D729**: A.M. £95.00. Carr. £3.00.
- CT.420 SIGNAL GENERATOR**: 200-8000c/s Variable tuning. Two fixed frequencies 9000 and 10,000. Internal calibrator 100 & 500 c/s. £75 each Carr. £2.
- NOISE GENERATOR TF-1106**: Frequency 1 to 200 Mc/s Direct noise factor calibration. Output impedance 70 ohms £65 each. Carr. £1.50.
- MW-59 UNIVERSAL KLYSTRON POWER SUPPLY**: £85. Carr. £3.
- TF-1278/1 TRAVELLING TUBE WAVE AMPLIFIER**: £125. Carr. £2.
- BPL A.C. MILLIVOLTMETER TYPE VM.348-D Mk. 3**: 2 millivolts-2 volts, 6 ranges. £30. Carr. £1.
- CAWKELL REMSCOPE TYPE 741**: Memory scope, 'as new' cond. £150.00.
- MANSON SYNTHESISER Q115-URC**: 2-30 mc/s. £175.00.
- FIREPROOF TELEPHONES**: £25.00 each. carr. £1.50.
- POWER UNIT**: 110/230 volts a.c. input. 28 volts d.c. at 40 amps output. £30.00 each. carr. £3.00.
- SMOOTHING UNIT** (for the above): £10.00 each. carr. £2.00.
- X-BAND MODULATOR CALIBRATOR TYPE MC-4420-X**: Mnfr. James Scott. £125 each. Carr. £1.
- BACKWARD WAVE OSCILLATOR TYPE SE-125**: 6.3 heater, 105V Anode, 7.9mA. Mnfr. Watkins & Johnson. £85 each. Carr. £1.
- ROTARY INVERTERS: TYPE PE.218E** — input 24-28V d.c. 80 Amps, 4,800 rpm. Output 115V a.c. 13 Amp 400 c/s. 1Ph. P.F.9. £20.00 each. Carr. £2.50.
- FREQUENCY METER BC-221**: 125-20,000 Kc/s complete with original calibration charts. Checked out. working order £20 + £1.50 carr.
- SORENSEN VOLTAGE REGULATOR**: Input 190/260 volts a.c. Output 220/240 volts a.c. 1000 watts. £40.00, carr. £3.00.
- EVERSHED SAFETY OHM. METER**: Max 10Ma. Test pressure 30v. Complete leather case. £25.00 each. post £1.00.
- FYLED AMPLIFIERS TYPE 154 BDM**: Rack mounted 3v d.c. and power supply FE.500.TP. £65.00. carr. £2.00.
- AUTOMATIC VOLTAGE STABILIZERS**: Input 207-242v a.c. Output 230v a.c. at 2.80 amps. £17.50, carriage £1.50.
- ANTENNA MAST 36ft.**: Aluminium, diameter at base 3" tapering to 2" at top, complete with red hazard lights, stays, guys, etc. Normally used with direction finding equipment. Approx. weight 3cwt. £95.00 each, carriage rates on request. With rotating Antenna suitable for 200-400 mHz, £15.00 extra.
- BURGLAR ALARM BELL**: 6-8v. d.c. £3.00. £1.00 post.

Carriage quotes given are for 50-mile radius of London

If wishing to call at stores, please telephone for appointment

W. MILLS

3 & 3a BALDOCK STREET, WARE, HERTS. SG12 9DT
 WARE 66312 (STD 0920)
 and at ELSTOW STORAGE DEPOT. Phone: Bedford 740605 (STD 0234)

MULTIMETER F4313 *(Made in USSR)*

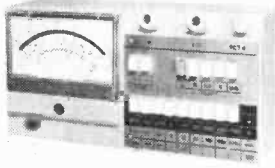

SENSITIVITY:
 1200V DC range: 10,000 Ω/V
 Other DC ranges: 20,000 Ω/V
 1200 AC range: 6,000 Ω/V
 600V AC range: 15,000 Ω/V
 300V AC range: 15,000 Ω/V
 Other AC ranges: 20,000 Ω/V

AC/DC current ranges: 60-120-600 μA-3-12-300mA-1.2-6A
 AC/DC voltage ranges: 60-300mV-1.2-6-30-120-300-600-1200V
 Resistance ranges: 300Ω-10-100-1000K
 Accuracy: 1.5% DC, 2.5% AC (of full scale deflection)

Mirror scale and knife edge pointer. Taut suspension of movement. Transistor amplifier is used for all AC ranges thus achieving a common linear scale for both AC and DC ranges.

Meter is fully protected for a transistorised cut-out relay circuit. Range selection is achieved by clearly marked piano keys. Power source: 5 1.5V dry cells. Dimensions: 95 x 225 x 120mm.

PRICE £37.50 plus VAT
 Packaging and postage £1.10

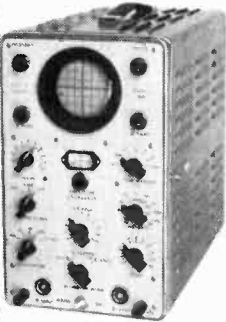

OSCILLOSCOPE CI-5 *Made in USSR*

Extremely simple and easy to use single beam oscilloscope. Well proved design based on standard octal valves makes servicing and maintenance straightforward and inexpensive. Because of its bandwidth of 10 MHz the instrument is suitable for general electronic applications and educational purposes where a sophisticated instrument would be both too expensive and delicate. 3-in. tube giving a 50 x 50mm clear display. Amplitude and time base calibrations. Sensitivity 30mm/v max. Triggered and free-running time base, suitable for displaying pulses from 0.1 μsec. to 3 m sec. A.C. mains operation.

Price £55.00 ex. works
 Packing and carriage (U.K. only £2.50)

FULLY GUARANTEED



0A2	0.45	6SN7GT	0.55	ECC83	0.38	EF86	0.40	KT66	3.40	PL508	0.90
0A3	0.55	12AT7	0.45	ECC84	0.35	EF183	0.35	KT88	3.65	PL509	1.30
0B2	0.45	12AU7	0.31	ECC85	0.45	EF184	0.40	PC66	0.65	PL802	1.40
0C3	0.45	12AX7	0.31	ECC86	1.25	EFL200	0.75	PC88	0.65	PY31	0.50
003	0.45	12BA6	0.81	ECC88	0.60	EL34	0.70	PC900	0.55	PY33	0.63
5RAGY	1.00	12B6A	0.60	ECC89	0.60	EL36	0.60	PCC84	0.45	PY81	0.45
5U4G	0.55	12BE6	0.61	ECC189	0.80	EL41	0.80	PCC85	0.45	PY82	0.45
5Z4G	0.55	12BH7	0.61	ECC189	0.80	EL41	0.80	PCC88	0.65	PY88	0.50
5Y3GT	0.65	12K4	0.50	ECC80	0.45	EL81	0.60	PCC89	0.55	PY500A	1.10
6AB4	0.50	19A05	0.75	ECC80	0.45	EL81	0.60	PCC189	0.65	PY800	0.50
6AJ5	0.65	30A5	0.70	ECC83	0.38	EF86	0.40	PCF80	0.40	TT21	5.90
6AK5	0.45	35A3	0.70	ECC84	0.35	EF183	0.35	PCF82	0.40	TT22	5.90
6AL5	0.30	35A5	0.80	ECC85	0.45	EF184	0.40	PCF86	0.65	WAB800	0.50
6AQ5	0.50	35B5	0.70	ECC86	1.25	EFL200	0.75	PCF200	0.80	UAF42	0.70
6AT6	0.60	35C5	0.70	ECC88	0.60	EL34	0.70	PCF201	0.85	UBC41	0.50
6AV6	0.50	35A5	0.80	ECC89	0.60	EL36	0.60	PCF801	0.55	UBC81	0.50
6AW8A	0.75	35WA	0.60	ECC189	0.80	EL41	0.80	PCF802	0.55	UBF80	0.50
6AU6	0.40	50A5	1.00	ECC80	0.45	EL81	0.60	PCL81	0.55	UCB84	0.75
6BA6	0.38	50B5	0.85	ECC82	0.45	EL82	0.60	PCL82	0.40	UCB85	0.50
6BE6	0.45	50C5	0.70	ECC86	0.75	EL83	0.60	PCL83	0.70	UCF80	0.75
6BN6	0.75	57G3	1.50	ECC801	0.75	EL84	0.35	PCL84	0.80	UCH42	0.80
6BJ6	0.75	EABCB0	0.40	ECC802	0.75	EL90	0.50	PCL85	0.60	UCH81	0.50
6BN6	0.80	EAC91	0.55	ECH42	0.65	EL95	0.70	PCL86	0.60	UCL82	0.40
6BN6	0.65	EAF42	0.70	ECH81	0.50	EL500	0.80	PCL86	0.60	UCL82	0.40
6BZ6	0.55	EAF801	0.65	ECH83	0.50	EM80	0.55	PCL200	0.75	UCL83	0.70
6BZ7	0.70	EBC41	0.75	ECH84	0.50	EM81	0.60	P0500	1.70	UF41	0.75
6CA	0.40	EBC81	0.50	ECL80	0.40	EM84	0.40	PFL200	0.70	UF42	0.75
6CB6	0.50	EBF80	0.50	ECL81	0.75	ET51	0.45	PL35	0.40	UF80	0.40
6EAB	0.75	EBF83	0.50	ECL82	0.42	ET51	0.45	PL36	0.60	UF85	0.50
6GK5	0.70	EBF89	0.40	ECL83	0.75	EY87	0.50	PL38	0.65	UF89	0.50
6K6	0.65	ECB6	0.75	ECL84	0.60	EY88	0.50	PL81	0.55	UL41	0.70
6L4	0.75	ECB8	0.75	ECL85	0.65	EZ40	0.60	PL82	0.50	UL84	0.50
6L5GT	0.55	EC91	2.60	ECL86	0.55	EZ41	0.75	PL83	0.50	UY41	0.55
6J6	0.35	ECC40	0.80	ECL80	4.50	EZ80	0.30	PL84	0.50	UY42	0.55
6L6GT	0.60	ECC81	0.45	EF80	0.35	EZ81	0.35	PL95	0.70	UY82	0.60
6SL7GT	0.55	ECC82	0.38	EF85	0.45	GZ34	0.75	PL504	0.90	UY85	0.50

HIGH GAIN DARLINGTON PAIRS

Plastic 3-Lead Case Darlington Pairs. Typical current gain 30,000. Max. collector voltage V_{CB0} 40V. Max. collector current 400mA. IC_{BO}-10mA.

BC516 PNP	£0.80
BC517 NPN	£0.80

TRANSISTORS FOR T.V.

R2008B	0.95
R2010B	1.65
BU126	1.55
BU133	1.55
BU208	2.00

Z & IAERO SERVICES LTD.

Head Office: 44A WESTBOURNE GROVE, LONDON W2 5SF
 Tel.: 727 5641 Telex: 261306

Retail Branch:
 85 Tottenham Court Road
 London W1. Tel: 580 8403

WW-039 FOR FURTHER DETAILS

THE RADIO SHOP

16 CHERRY LANE
 BRISTOL BS1 3NG



TELEPHONE
 0272-421196

OFFICIAL ORDERS WELCOMED GOVT./EDUCATIONAL DEPTS., ETC.

TRIACS

1.6 AMP PLASTIC ●	6 AMP ISOLATED TAB	10 AMP ISOLATED TAB
NAS 0161w 100V .31	NAS 0651w 100V .68	NAS 1001w 100V .80
NAS 0161x 100V .31	NAS 0651x 100V .68	NAS 1001x 100V .80
NAS 0162w 200V .34	NAS 0652w 200V .72	NAS 1002w 200V .86
NAS 0162x 200V .32	NAS 0652x 200V .72	NAS 1002x 200V .84
NAS 0164w 400V .45	NAS 0654w 400V .80	NAS 1004w 400V £1.19
NAS 0164x 400V .43	NAS 0654x 400V .78	NAS 1004x 400V £1.14
NAS 0166w 600V .56	NAS 0656w 600V .97	NAS 1006w 600V £1.49
NAS 0166x 600V .53	NAS 0656x 600V .86	NAS 1006x 600V £1.47

3.5 AMP CLIPPED TAB	8 AMP ISOLATED TAB	15 AMP ISOLATED TAB
NAS 0351w 100V .58	NAS 0851w 100V .76	NAS 1501w 100V £1.15
NAS 0351x 100V .57	NAS 0851x 100V .75	NAS 1501x 100V £1.05
NAS 0352w 200V .64	NAS 0852w 200V .86	NAS 1502w 200V £1.14
NAS 0352x 200V .61	NAS 0852x 200V .84	NAS 1502x 200V £1.12
NAS 0354w 400V .75	NAS 0854w 400V .97	NAS 1504w 400V £1.66
NAS 0354x 400V .74	NAS 0854x 400V .94	NAS 1504x 400V £1.63
NAS 0356w 600V .95	NAS 0856w 600V £1.21	NAS 1506w 600V £2.07
NAS 0356x 600V .92	NAS 0856x 600V £1.16	NAS 1506x 600V £2.02

Devices with internal trigger have 'W' suffix, 'X' Denotes Standard Triac.

THYRISTORS

1.6 AMP TO5 ●	4 AMP ISOLATED TAB	6 AMP ISOLATED TAB
NAS 006p 50piv .28	NAS 106p 50piv .29	NAS 206p 50piv .40
NAS 006q 100piv .31	NAS 106q 100piv .33	NAS 206q 100piv .46
NAS 006r 200piv .34	NAS 106r 200piv .40	NAS 206r 200piv .55
NAS 006s 400piv .44	NAS 106s 400piv .43	NAS 206s 400piv .85
NAS 006t 600piv .57	NAS 106t 600piv .99	

8 AMP ISOLATED TAB	16 AMP TO 48
NAS 306p 50piv .45	16A 50V .60
NAS 306q 100piv .52	16A 100V .64
NAS 306r 200piv .65	16A 200V .70
NAS 306s 400piv .93	16A 400V .85
	16A 600V £1.17

Quantity Prices on Application SAE

TRANSISTOR SPEAKERS ●

2 1/2" 0.3 watt	8 ohms	40p
2 1/4" 0.1 watt	75 ohms	40p
707 LED 3" Common Anode Display		.90
704 LED 3" Common Cathode Display		1.00
747 LED 6" Common Anode Display		1.65

● Please add 12 1/2% VAT. Remainder 8% P&P 20p

Phone in your Access or Barclaycard order. Catalogue 20p. Callers welcome

ELECTROVALUE

Wise buyer's first choice

CATALOGUE 8

ISSUE No. 2

- 144 pages
- UP-DATED PRODUCT & PRICE INFORMATION
- 40p POST PAID + 40p REFUND VOUCHER

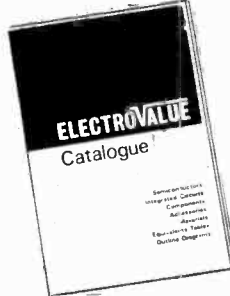

We have made it just about as comprehensive and up-to-the-minute as possible. Thousands of items from vast ranges of semi-conductors including I.C.s to components, tools, accessories, technical information and diagrams are included as well as a refund voucher worth 40p for spending on orders list value £5 or more. SEND NOW FOR YOUR COPY OF CATALOGUE 8, ISSUE No. 2 BY RETURN. It's an investment in practical money-saving and reliability!

+ E.V. PRICE STABILIZATION POLICY

This is one of reviewing prices every 3 months rather than trying to keep up with day by day changes as they occur. We have on the whole held prices better than anticipated in following this plan. Next review period starts July 1st

+ E.V. DISCOUNT PLAN

Applies to all items except the few where prices are shown NETT 5% on orders from £5 to £14.99 10% on orders value £15 or more

+ FREE POST & PACKING

In UK for pre-paid mail orders over £2. If under there is an additional handling charge of 15p.

+ QUALITY GUARANTEE

All goods are sold on the understanding that they conform to makers' specifications. No rejects, seconds or sub-standard merchandise.

ELECTROVALUE LTD

All communications to Dept. 4/6
 28 ST. JUDES ROAD, ENGLEFIELD GREEN, EGHAM, SURREY TW20 0HB
 Telephone Egham 3603. Telex 264475. Shop hours: 9-5.30 daily, 9-1 p.m. Sats.
 NORTHERN BRANCH: 680 Burnage Lane, Burnage, Manchester M19 1NA
 Telephone 061 432 4945. Shop hours: Daily 9-5.30 p.m., 9-1 p.m. Sats.
 In U.S.A. you are invited to contact ELECTROVALUE AMERICA, P.O. 337 Peterborough NH03458

ELECTRONIC DIGITAL CLOCK with alarm and snooze features

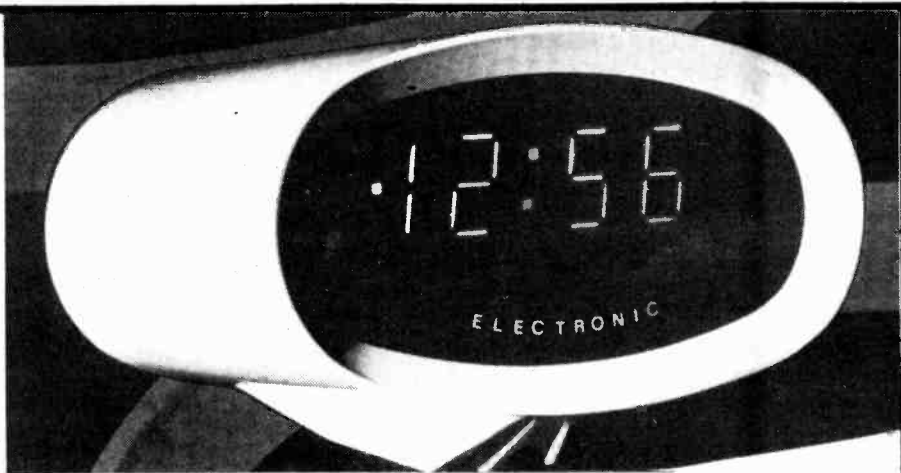

FEATURES: ● 0.7-inch high digits ● Variable intensity ● 24-hour alarm ● 5-minute repeating, snooze alarm ● Alarm set indicator ● Snooze indicator ● Pulsing second indicator ● Power interrupt indicator ● Alarm cancel features -- tilt operation ● Alarm tone output ● AM, PM, Indicator.

Size 130mm x 90mm x 95mm
 Weight 10oz
 Power Supply 230 VAC ± 10% 50Hz

Manufactured to high standards by a major American electronics corporation this superbly styled solid-state timepiece is made available to all readers fully guaranteed. Mail Order only.

SPECIAL OFFER

£18.95

inc. VAT and Post & Packing

FREE TRIAL IN YOUR HOME. Try out the clock in your home. If digital time is not for you return it in original condition within ten days and we'll refund your money without question. Allow 21 days for delivery.



TIME MICROELECTRONICS
 P.O. BOX 29
 BRIGHTON HILL PARADE, BASINGSTOKE
 HANTS RG22 4EH

Please send electronic clocks as illustrated.

I enclose cheque postal order money order

Name

Address

Signature

LYNX ELECTRONICS (LONDON) LTD.

AC126 0.15	BC301 0.32	BY206 0.15	1N4003 0.06*
AC127 0.16	BC323 0.60	BY207 0.20*	1N4004 0.07*
AC128 0.13	BC327 0.18*	BYX36-300 0.12*	1N4005 0.08*
AC128K 0.25	BC328 0.16*	BYX36-600 0.15*	1N4006 0.09*
AC141 0.18	BC337 0.17*	BYX36-900 0.18*	1N4007 0.10*
AC141K 0.28	BC338 0.17*	BYX36-1200 0.21*	2N696 0.14
AC142 0.18	BCY70 0.12	BYX38-300 0.50	2N697 0.12
AC142K 0.28	BCY71 0.18	BYX38-600 0.55	2N706 0.10
AC176 0.16	BCY72 0.12	BYX38-900 0.60	2N930 0.14
AC176K 0.25	BD115 0.55	BYX38-1200 0.65	2N1131 0.15
AC187 0.18	BD131 0.36	BZX61 Series	2N1132 0.16
AC187K 0.25	BD132 0.40	Zeners 0.20	2N1304 0.20
AC188 0.18	BD135 0.36	BZX83 or BZX88	2N1305 0.20
AC188K 0.25	BD136 0.39	Series	2N1711 0.15
AD140 0.50	BD137 0.40	Zeners 0.11	2N2102 0.44
AD142 0.50	BD138 0.48	C106A 0.40	2N2369 0.14
AD143 0.46	BD139 0.58	C106B 0.45	2N2484 0.18
AD149 0.45	BD181 0.86	C106D 0.50	2N2648 0.50
AD161 0.35	BD182 0.92	C106F 0.35	2N2905A 0.22
AD162 0.35	BD197 0.97	CRS1 0.25	2N2926G 0.10*
AL102 0.95	BD232 0.60*	CRS1 1.0 0.25	2N2926G 0.09*
AD103 0.93	BD233 0.48*	CRS1 20 0.35	2N3053 0.15
AF114 0.20	BD237 0.55*	CRS1 40 0.40	2N3054 0.40
AF115 0.20	BD238 0.60*	CRS1 60 0.65	2N3055 0.50
AF116 0.20	BD184 1.20	CRS3 0.05 0.34	2N3440 0.56
AF117 0.20	BDV20 0.80	CRS3 1.0 0.45	2N3442 1.20
AF118 0.50	BDV38 0.60	CRS3 20 0.50	2N3525 0.75
AF139 0.33	BDV60 0.60	CRS3 40 0.60	2N3570 0.80
AF239 0.37	BDY61 0.65	CRS3 60 0.85	2N3702 0.10*
BC107 0.14	BDY62 0.55	MJ480 0.80	2N3703 0.10*
BC107B 0.16	BF178 0.28	MJ481 1.05	2N3704 0.10*
BC108 0.13	BF179 0.30	MJ490 0.90	2N3705 0.10*
BC109 0.14	BF194 0.10*	MJ491 1.15	2N3706 0.10*
BC109C 0.16	BF195 0.10*	MJE340 0.40*	2N3707 0.10*
BC117 0.19*	BF196 0.12*	MJE371 0.60	2N3714 1.05
BC125 0.18*	BF197 0.12*	MJE520 0.45	2N3715 1.15
BC126 0.20*	BF224J 0.18*	MJE521 0.55	2N3716 1.25
BC141 0.28	BF241 0.17*	OAS 0.50	2N3771 1.60
BC142 0.23	BF257 0.30*	OAS 0.08	2N3772 1.60
BC143 0.23	BF258 0.35	OAS 0.08	2N3773 2.10
BC144 0.30	BF337 0.32	OAS 0.15	2N3819 2.80
BC147 0.09*	BRW60 0.17*	OC42 0.15	2N3904 0.16*
BC148 0.09*	BFX29 0.26	OC44 0.12	2N3906 0.16*
BC149 0.09*	BFX30 0.30	OC45 0.10	2N4124 0.14*
BC152 0.25*	BFX84 0.23	OC70 0.10	2N4290 0.12*
BC153 0.18*	BFX85 0.25	OC71 0.10	2N4348 1.20
BC157 0.09*	BFX88 0.20	OC72 0.22	2N4870 0.35
BC158 0.09*	BFY50 0.20	OC84 0.14	2N4871 0.35
BC159 0.09*	BFY51 0.18	SC40A 0.73	2N4872 0.35
BC160 0.32	BFY52 0.19	SC40B 0.81	2N4919 0.70*
BC161 0.38	BFY64 0.35	SC40D 0.98	2N4920 0.50*
BC168B 0.09*	BFY90 0.65	SC40F 0.65	2N4922 0.58*
BC182 0.11*	BR100 0.20	SC41A 0.65	2N4923 0.64*
BC182L 0.11*	BRV39 0.40	SC41B 0.70	2N5060 0.20*
BC183 0.10*	BSX19 0.16	SC41D 0.85	2N5061 0.25*
BC183L 0.10*	BSX20 0.18	SC41F 0.60	2N5062 0.27*
BC184 0.11*	BSX21 0.20	ST2 0.20	2N5064 0.30*
BC184L 0.11*	BSY95A 0.12	TIP29A 0.44	2N5496 0.65
BC207B 0.12*	BT106 1.00	TIP30A 0.52	
BC212 0.11*	BT107 1.60	TIP31A 0.54	
BC212L 0.11*	BT108 1.60	TIP32A 0.64	
BC213 0.12*	BT109 1.00	TIP34 1.05	
BC213L 0.12*	BT116 1.00	TIP43A 0.68	
BC214 0.14*	BU105 1.80*	TIP42A 0.72	
BC214L 0.14*	BU105/02 1.90*	IN2069 0.14	
BC237 0.16*	BU126 1.60*	IN2070 0.16	
BC238 0.16*		1N4001 0.04*	
BC300 0.34		1N4002 0.05*	

DIGITAL DISPLAYS & LED'S

DL704	99p	DL747	£1.75	2 RED LED ONLY	13p
DL707	99p	DL750	£1.75	GREEN CLEAR	15p

THYRISTORS

	8A (TO92)	1A (TO5)	3A (C106 type)	6A (TO220)	8A (TO220)	10A
50	20	25	35	41	42	47
100	25	25	40	47	48	54
200	27	35	45	58	60	68
400	30	40	50	87	88	98
600		65	70	1.09	1.19	1.26

TRIACS (PLASTIC TO-220 PKGE. ISOLATED TAB)

	4A		6 5A		8 5A		10A		15A	
	(a)	(b)	(a)	(b)	(a)	(b)	(a)	(b)	(a)	(b)
100V	0.60	0.60	0.70	0.70	0.78	0.78	0.83	0.83	1.01	1.01
200V	0.64	0.64	0.75	0.75	0.87	0.87	0.87	0.87	1.17	1.17
400V	0.77	0.78	0.80	0.83	0.97	1.01	1.13	1.19	1.70	1.74
600V	0.96	0.99	0.87	1.01	1.21	1.26	1.42	1.50	2.11	2.17

N.B. Triacs without internal trigger diac are priced under column (a) Triacs with internal trigger diac are priced under column (b) When ordering please indicate clearly the type required

74 TTL mixed prices

	1.24	25.99	100+		1.24	25.99	100+		1.24	25.99	100+
7400	14p	12p	10p	7445	85p	71p	57p	7493	45p	40p	32p
7401	14p	12p	10p	7447	81p	75p	65p	7495	67p	55p	45p
7402	14p	12p	10p	7448	75p	62p	50p	74100	£1.08	89p	72p
7403	15p	12 1/2p	10p	7447A	95p	83p	67p	74107	35p	28p	22p
7404	16p	13p	11p	7470	30p	25p	20p	74121	34p	28p	23p
7408	16p	13p	11p	7472	25p	21p	17p	74122	47p	39p	31p
7409	16p	13p	11p	7473	30p	25p	20p	74141	78p	63p	53p
7410	16p	13p	11p	7474	32p	26p	21p	74145	68p	58p	48p
7413	25p	20p	20p	7475	47p	39p	31p	74154	£1.62	£1.48	86p
7417	27p	22 1/2p	20p	7476	32p	26p	21p	74174	£1.00	83p	67p
7420	16p	13p	11p	7482	75p	62p	50p	74180	£1.06	89p	71p
7427	27p	22 1/2p	18p		£1.30	£1.09	87p	74181	£3.20	£2.50	£1.90
7430	16p	13p	11p	7486	32p	26p	21	74192	£1.35	£1.14	90p
7432	27p	22 1/2p	18p	7489	£2.92	£2.80	£2.10	74193	£1.35	£1.14	90p
7437	27p	22 1/2p	18p	7490	49p	40p	32p	74196	£1.64	£1.34	99p
7441	75p	62p	50	7491	65p	55p	45p				
7442	65p	55p	43p	7492	57p	46p	36p				

LINEAR IC'S

301A 8 pin DIL	35p*	3900 14 pin DIL	70p*	565 14 pin DIL	£2.00*
307	55p*	709 8/14 pin DIL	35p*	566 8 pin DIL	£1.50*
309K	£1.60	741 8 pin DIL	28p*	567 8 pin DIL	£2.00*
380 14 pin DIL	90p	741 14 pin DIL		CA3046 14 pin DIL	50p*
381 14 pin DIL	£1.60*	748 8 pin DIL		CA3045	85p*
		7491 65p	55p		
		555 8 pin DIL	45p		

HIGHAM MEED, CRESHAM, BUCKS. Tel. (02405) 75154

VAT — Please add 8% except items marked * which are 12 1/2 %

P&P 20p. Overseas 80p

<p>SINCLAIR. CBM AND NOVUS CALCULATORS* Sinclair: Cambridge Scientific £11.45. Oxford 300 £13.30. Programmable Scientific £24.95. Mains adaptors for all models £3.20. CMB: SR7919D 8 digit/memory/trig/log/pi/powers/sci. notation £11.90. 796MD 8 digit/%/memory £5.98. Mains adaptors £3.20. Novus: 750 6 digit £5.45. 835 8 digit/%/const/sq root/4 funct mem £7.60. Mains unit £4.20.</p>	<p>SINCLAIR BLACK WATCH* Fully assembled with black strap £20.95. Bracelet £2.00.</p>
<p>BATTERY ELIMINATORS STABILIZED POWER UNITS Millennia series. Switched 1 to 30V in 0.1V steps. 1A output. Kit £7.95. Kit + case £9.95. Built £12.95. 2A output. Kit £9.95. Kit + case £11.95. Built £14.95.</p>	<p>SINCLAIR IC20 IC20 10W+10W stereo amp kit with printed circuit £4.95. PZ20 Power supply for above £3.95 - VP20 Control and preamp kit £7.50.</p>
<p>6-WAY SPECIAL Switched output of 3, 4½, 6, 7½, 9, 12V at 500mA £5.20.</p>	<p>SINCLAIR PROJECT 80 FM tuner £13.25. Q16 £9.50. PZ5 £3.95. PZ6 £8.70. PZ8 £9.10. Trans for PZ8 £5.60. Z40 £5.75. Stereo 80 £11.95. Project 805Q £18.95.</p>
<p>6-WAY DOUBLE RADIO MODEL Switched output 3+3, 4½+4½, 6+6, 7½+7½, 9+9, 12+12V at 250mA. Also 15, 18, 24V single £6.20.</p>	<p>JC12 AMPLIFIER 6W IC audio amp with free data and printed circuit £1.95*. DELUXE KIT FOR JC12 Volume and tone controls and extra parts for the pcb. Mono £2.16. Stereo £4.66. JC12 POWER KIT Supplies 25V 1Amp £3.25. SEND SAE FOR FREE LEAFLET</p>
<p>3-WAY MODEL* Switched output of 6, 7½ and 9V at 250mA with 4-way multi-jack connector and free matching socket £2.95. RADIO MODELS 50mA with press-stud battery connectors for radios etc. 6V £3.45. 9V £3.25. 4½+4½V £4.45. 6+6V £4.45. 9+9V £4.45. Also 9V 300mA £3.95. CASSETTE MAINS UNITS 7½V output with 5 pin DIN plug. 50mA model £3.45. 300mA model £3.95. CAR CONVERTERS Input 12V DC. Output 6, 7½, 9V DC 1A regulated £4.75*.</p>	<p>S-DECS AND T-DECS S DeC £2.24 T DeC £4.05 u-DeCa £4.45 u-DeCb £7.85 16 diode IC carriers with sockets £2.21</p>
<p>PRINTED CIRCUIT KIT* Make your own printed circuits. Contains etching dish, 100 sq ins of copper clad board, 1lb ferric chloride, etch resist pen, drill bit and laminate cutter. £3.95.</p>	<p>BATTERY ELIMINATOR KITS Send sae for free leaflet on range. 100mA radio type: with press stud terminals. 4½V, 6V or 9V £1.95. 100mA double radio type: with press stud terminals. 4½+4½V, 6+6 or 9+9V £2.60. 100mA cassette type: 7½V din plug. £1.95. Stabilized 8-way types: transistor stabilized to give low hum. 3 / 4½ / 6 / 7½ / 9 / 12 / 15 / 18V 100mA model £3.15. 500mA model £4.65. Heavy duty 13-way types: 4½ / 6 / 7 / 8½ / 11 / 13 / 14 / 17 / 21 / 25 / 28 / 34 / 42V 1A £4.10. 2A £6.80. Car converter kit: input 12V DC. Output 6 / 7½ / 9V DC 1A regulated £2.95.</p>

SWANLEY ELECTRONICS

DEPT. WW, PO BOX 68, SWANLEY, KENT BR8 8TQ

Post 30p on orders under £2, otherwise free. Prices include VAT (Overseas customers deduct 7% on items marked*, otherwise 11%). Official orders welcome

HART ELECTRONICS

Audio Kit Specialists since 1961

J. L. Linsley-Hood High Quality Cassette Recorder

Full kits of parts for this outstanding design, including metalwork, cabinet, low humfield mains transformer and all other parts. Please send SAE for full data.

Cassette Mechanism only complete with Erase and Record/Playback head, £19.10 + 12½% VAT.

FURTHER INFORMATION ON ALL KITS FREE if you send us a 9 in. x 4 in. S.A.E.

REPRINTS Post free, no VAT

BAILEY 30W 18p.

STUART TAPE RECORDER. All 3 articles under one cover 30p.

BAILEY/BURROWS/QUILTER Preamp circuits, layouts and assembly notes 15p.

All prices exclude VAT @ 12½ per cent except for reprints which are exempt.

Penylan Mill, Oswestry, Salop

Personal callers are always welcome, but please note we are closed all day Saturday

For Toshiba say Erie

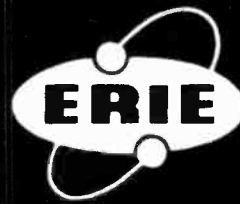

If you're looking for ex-stock, competitively priced solid-state devices, look no further! Because at Erie, we are offering the comprehensive Toshiba range. It includes signal and power transistors, FETs, diodes, ICs, and LEDs (single and 7-segment).

Here's a selection of Toshiba devices, with prices for quantities from 1 to 24 inclusive.

15% discount applies to all orders for quantities of 25 to 99. If you want 100 or more of any one item, special prices apply—send for price list direct from Erie, or complete the reader service card.

Data sheets for devices ordered are supplied free on request, but if you want data sheets only, please send 10p for each set of device data, to cover costs.

P & P of 30p is applicable on all orders up to 100 devices (any mix of types).

VAT Please add 12½% for VAT to all prices, except those marked with an asterisk (*) which are rated at 8% VAT.

TRANSISTORS

Small Signal (2-5B)		BD 139 NPN	40p
2SA 561 PNP	13p	BD 140 PNP	44p
2SA 562 "	12p	(TO-220AB)	
2SA 493 "	17p	*2SA 473 PNP	40p
2SA 495 "	12p	*2SA 489 "	75p
2SC 372 NPN	9.5p	*2SC 790 NPN	50.5p
2SC 373 "	9.5p	*2SC 1173 "	35.5p
2SC 382 "	26p	*2SC 1447 "	50.5p
2SC 383 "	24.5p	*2N 5296 "	59p
2SC 388A "	22.5p	Metal Power	
2SC 733 "	6p	(TO-66)	
2SC 734 "	11.5p	2SC 515A NPN	48.5p
2SC 735 "	11p	2SC 782 "	£1.08
2SC 1000 "	16p	(TO-3)	
2SC 1681 "	16p	*2SC 643A "	£2.05
(TO-92)		2SC 1434 "	£14.30
BC 451 NPN	11p	*2SC 1576 "	£2.43
BC 452 "	11p	2SC 1617 "	£1.29
BC 453 "	11p	*2N 3055 "	£0.86
BC 454 PNP	11.5p	*S 2530A "	£3.48
BC 455 "	11.5p	S 1299 "	£4.09
BC 456 "	11.5p	Integrated Circuits	
Plastic Power (2-7)		TA 7093P	£1.49
S1234 NPN	33.5p	TA 7109AP	£1.57
(TO-126)		TA 7117P	£2.36
BD 135 NPN	33.5p	TA 7205P	£1.55
BD 137 "	36.5p	F.E.T.	
BD 138 PNP	40p	(2-5J)	
		*2SK12	£1.04
		2SK30A	27p
		*3SK35	£1.45

DIODES

Zener		Vari Cap		Light Emitting Diodes	
05Z5.6	14p	1S1658	25p	TLR 102	21.5p
05Z6.2	12p	Switching		TLR 103	21.5p
05Z6.8	13p	1S1554	4p	TLR 104	21.5p
05Z7.5	13p	Pulse Rectifier		TLR 105	21.5p
05Z8.5	13p	1S2755	23.5p	TLR 106	21.5p
05Z9.1	13p	Diac		TLR 114	30p
05Z10	13p	1S2093	25p	TLG 102	35.5p
05Z11	13p	Thyristors		TLG 103	35.5p
05Z12	13p	SF0R 2B41	52.5p	TLG 105	35.5p
05Z13	13p	Triac		Seven Segments	
05Z15	13p	*SM6G14	£1.61	TLR 301	£1.08
General Purpose		Uni Junction		TLR 302	£2.22
S5089A	7.5p	*2SH21	57p	TLR 306	£3.08
(IN4001)				TLR 307	£3.08
S5089B	8p				
(IN4002)					
S5089F	11p				
(IN4006)					

ERIE ELECTRONICS LIMITED
 South Denes, Great Yarmouth, Norfolk.
 Tel: 0493 56122 Telex: 97421



RETURN OF POST MAIL ORDER SERVICE

BSR HI-FI AUTOCHANGER STEREO AND MONO
 Plays 12", 10" or 7" records. Auto or Manual. A high quality unit backed by BSR reliability with 12 months' guarantee. A.C. 200/250V.
 Size 13 1/2" x 11 1/4". 3 speeds. Above motor board 3 3/4". Below motor board 2 1/2". with STEREO and MONO CARTRIDGE **£10.25** Post 75p
 B.S.R. SINGLE PLAYER similar to MP60 with stereo cartridge and cueing device **£15.50**
PORTABLE PLAYER CABINET
 Modern design. Rexine covered. Vinylair front grille. Chrome fittings. Size 17 x 15 x 8in. approx. Motor board cut for BSR or Garrard deck **£4.50** Post 50p



HEAVY METAL PLINTHS
 With P.V.C. Cover. Cut out for most B.S.R. or Garrard decks. Silver grey finish. Model "A" Size 12 1/2 x 14 3/4 x 7 1/2in. **£5.50** Post 75p.
 Model "B" Size 16 x 13 3/4 x 7in. **£6.50**

COMPLETE STEREO SYSTEM
 Two full size loudspeakers 13 3/4 x 10 x 3 3/4in. Player unit clips to loudspeakers making it extremely compact. Overall size only 13 3/4 x 10 x 8 1/2in. 3 watts per channel. plays all records 33 r.p.m., 45 r.p.m. Separate volume and tone controls **£22.50**
 Attractive Teak finish 240V a.c. mains. **£1** carriage



SPECIAL OFFER! SMITH'S CLOCKWORK 15 AMP TIME SWITCH
 0-60 MINUTES **£2.95** Post 35p
 Single pole two-way. Surface mounting with fixing screws. Will replace existing wall switch to give light for return home, garage, automatic anti-burglar lights, etc. Variable knob. Turn on or off at full or intermediate settings. Brand new and fully guaranteed



TEAKWOOD LOUSPEAKER GRILLES will easily fit to baffle board. Size 10 1/2 x 7 1/2in—**45p**.

WEYRAD P50 TYPE TRANSISTOR COILS
 RA2W Ferrite Aerial 85p Driver Trans. LF0T4 65p
 I.F. P50/2CC 470 kc/s 40p Printed Circuit, PCA1 65p
 3rd I.F. P50/3CC 40p J.B. Tuning Gang £2.00
 P50/1AC 60p OPT1 65p
 Ferrite Rod 7in. x 3/16in. 20p. 6 x 5/16in. 20p. 3 x 3/8in. 10p

VOLUME CONTROLS
 5kΩ to 2MΩ. LOG or LIN. L/S 25p. D.P. 40p. STEREO L/S 55p. D.P. 75p. Edge 5K. S.P. Transistor 30p.

80ohm Coax 8p yd.
 STANDARD TYPE VHF FRINGE LOW LOSS 15p yd.
 Ideal 625 and colour PLUGS 10p. SOCKETS 10p. LINE SOCKETS 18p. OUTLET BOXES 50p.

ELAC HI-FI SPEAKER
 8in. or 10 x 6in.
 Dual cone plasticised roll surround. Large ceramic magnet 50-16,000 c/s. Bass resonance 55 c/s. B ohm impedance. 10 watts. music power. **£3.95** Post 35p



E.M.I. 13 1/2 x 8in. SPEAKER SALE!
 With tweeter and crossover. 10 watt. State 3 or 8 ohm. As illustrated. **£5.25** Post 35p
 Bass Woofer. 15 watts. 8 or 15 ohm. **£6.60** Post 45p



With tweeter and crossover. 20 watt. Bass res. 25 c.p.s. Flux = 11,000 gauss. 8 or 15 ohm. 20 to 20,000 c.p.s. **£8.95** Post 45p

Bookshelf Cabinet
 Teak finish 16 x 10 x 9in. For EMI 13 x 8 speakers. **£6.95** Post 75p

THE "INSTANT" BULK TAPE ERASER AND HEAD DEMAGNETISER. Suitable for cassettes, and all sizes of tape reels A.C. mains 200/250V. Leaflet S.A.E. Will also demagnetise small tools. **£4.35** Post 30p



BLANK ALUMINIUM CHASSIS. 6 x 4—70p; 8 x 6—90p; 10 x 7—£1.15; 12 x 8—£1.35; 14 x 9—£1.50; 16 x 6—£1.45; 16 x 10—£1.70.
ALUMINIUM PANELS. 6 x 4—17p; 8 x 6—24p; 14 x 3—25p; 10 x 7—35p; 12 x 8—43p; 12 x 5—30p; 16 x 6—43p; 14 x 9—52p; 12 x 12—68p; 16 x 10—78p.

ELAC 9 x 5in HI-FI SPEAKER
£3.45 Post 35p
 This famous unit now available. 10 watts. B ohm.

RCS LOW VOLTAGE STABILISED POWER PACK KITS
£2.95 Post 45p
 All parts and instructions with Zener diode, printed circuit rectifiers and double wound mains transformer. Input 200/240V a.c. Output voltages available, 6 or 7.5 or 9 or 12V d.c. up to 100mA or less. Size 3 x 2 1/2 x 1 1/2in. Please state voltage required.

RCS POWER PACK KIT
£3.35 Post 30p
 12 VOLT. 750mA. Complete with printed circuit board and assembly instructions.
 12 VOLT 300mA KIT. **£3.15.** 9 VOLT 1 AMP KIT. **£3.35.**

R.C.S. GENERAL PURPOSE TRANSISTOR PRE-AMPLIFIER — BRITISH MADE
 Ideal for Mike, Tape, P.U., Guitar, etc. Can be used with Battery 9-12V or H.T. line 200-300V d.c. operation. Size: 1 3/4 x 1 1/4 x 3/4in. Response 25 c/s to 25 kc/s. 26 dB gain. For use with valve or transistor equipment. **£1.45** Post 30p
 Full instructions supplied. Details S.A.E.

ELECTRO MAGNETIC PENDULUM MECHANISM
 1.5V d.c. operation over 300 hours continuous on SP2 battery, fully adjustable swing and speed. Ideal displays, teaching electro magnetism or for metronome, strobe, etc. **95p** Post 30p

R.C.S. "MINOR" 10 watt AMPLIFIER KIT
 This kit is suitable for record players, guitars, tape playback, electronic instruments or small P.A. systems. Two versions available. Mono. **£11.25;** Stereo. **£18.** Post 45p. Specification 10W per channel; input 100mV; size 9 1/2 x 3 x 2in. approx S.A.E. details. Full instructions supplied. AC mains powered.

MAINS TRANSFORMERS ALL POST. 50p
 250-0-250V 70mA. 6.5V. 2A **£3.45**
 250-0-250 80mA. 6.3V 3.5A. 6.3V 1A or 5V 2A **£4.60**
 350-0-350 80mA. 6.3V 3.5A. 6.3V 1A or 5V 2A **£5.80**
 300-0-300V 120mA. 6.3V 4A C.T.: 6.3V 2A **£7.00**
 MIDGET 220V 45mA. 6.3V 2A **£1.40**
 HEATED TRANS. 6.3V 1/2 amp **£1;** 3 amp **£1.40**
 GENERAL PURPOSE LOW VOLTAGE. Tapped outputs at 2 amp 3, 4, 5, 6, 8, 9, 10, 12, 15, 18, 25 and 30V **£4.60**
 1 amp 6, 8, 10, 12, 16, 18, 20, 24, 30, 36, 40, 48, 60 **£4.60**
 2 amp 6, 8, 10, 12, 16, 18, 20, 24, 30, 36, 40, 48, 60 **£7.00**
 3 amp 6, 8, 10, 12, 16, 18, 20, 24, 30, 36, 40, 48, 60 **£8.70**
 5 amp 6, 8, 10, 12, 16, 18, 20, 24, 30, 36, 40, 48, 60 **£11.25**
 6.06V 500mA **£1.9V**
 1 amp **£1;** 12V 300mA **£1.12V** 500mA **£1.12V** 750mA **£1.10V**
 30V. 40V. 2 amp. **£2.75;** 20V. 3 amp. **£2.45;** 40V. 2 amp. **£2.95;** 30V 5A and 34V 2ACT **£3.45.** 16V. 1/2 amp. **£1.15V.** 2 amp. **£2.20.** 0, 5, 8, 10, 16V. 1/2 amp. **£1.95.** 20V 1/2 amp. **£1.75.** 20V. 1 amp. **£2.20.**
 AUTO TRANSFORMERS. 115V to 230V or 230V to 115V 150W **£5;** 250W **£8;** 400W **£7;** 500W **£8.**
 FULL WAVE BRIDGE CHARGER RECTIFIERS. 6 or 12V outputs. 1 1/2 amp **40p;** 2 amp **55p;** 4 amp **85p.**
 CHARGER TRANSFORMERS. 1 1/2 amp **£2.75;** 4 amp **£4.60.** 12V. 1/2A HALF WAVE Selenium Rectifier. **25p.**

R.C.S. ROSEWOOD SPEAKERS
 Size 12 1/2in. x 9 3/4in. x 5 1/2in. Response 50 to 14,000 cps B watts rms. 3, or 8, or 16 ohms **£12 pair** Post 75p



NEW ELECTROLYTIC CONDENSERS

2/350V	20p	250/25V	20p	50+50/300V	50p
4/350V	20p	500/25V	25p	30,000/25V	95p
8/350V	28p	100+100/275V	85p	32+32/250V	20p
16/350V	35p	150+200/275V	70p	32+32/450V	80p
32/500V	60p	8+8/350V	50p	330+50/325V	95p
25/25V	15p	8+16/350V	50p	100+50+50/350V	95p
50/50V	15p	16+16/350V	80p	32+32+32/350V	95p
100/25V	15p	32+32/350V	80p	400V/63V	95p

LOW VOLTAGE ELECTROLYTICS
 1, 2, 4, 5, 8, 16, 25, 30, 50, 100, 200mF 15V 10p.
 500mF 12V 15p; 25V 20p; 50V 30p.
 1000mF 12V 17p; 25V 35p; 50V 47p; 100V 70p.
 2000mF 6V 25p; 25V 42p; 50V 57p.
 2500mF 50V 62p; 3000mF 25V 47p; 50V 65p.
 5000mF 6V 25p; 12V 42p; 25V 75p; 35V 85p; 50V 95p.

SHORT WAVE 100pF air spaced gangable tuner. **95p.**
TRIMMERS 10pF. 30pF. 50pF. 5p. 100pF. 150pF. 15p.
CERAMIC, 1pF to 0.01mF. 5p. Silver Mica 2 to 5000pF. 5p.
PAPER 350V-0.1 7p; 0.5 13p; 1mF 150V 15p; 2mF 150V 15p; 500V-0.001 to 0.05 5p; 0.1 10p; 0.25 13p; 0.47 25p.
MICRO SWITCH SINGLE POLE CHANGEVER 20p.
SUB-MIN MICRO SWITCH, 25p. Single pole change over
TWIN GANG, "0-0" 208pF + 176pF **£2.00;** 500pF standard **75p;** 365 + 365 + 25 + 25pF. Slow motion drive **65p.**
 120pF **TWIN GANG**, 50p; 365pF **TWIN GANG**, 50p.
NEON PANEL INDICATORS 250V AC/DC. Amber or red 30p.
RESISTORS. 1/4W, 1/2W, 1W, 20% 2p; 2W, 10p; 10Ω to 10M **HIGH STABILITY.** 1/2W 2% 10 ohms to 6 meg., **12p.**
 Ditto 5%. Preferred values 10 ohms to 10 meg. **5p.**
WIRE-WOUND RESISTORS 5 watt. 10 watt. 15 watt. 10 ohms to 100K 12p each
TAPE OSCILLATOR COIL. Valve type. **35p.**
BRIDGE RECTIFIER 200V PIV 1/2 amp **50p.**
TOGGLE SWITCHES S.P. 20p. D.P.S.T. 25p. D.P.D.T. 30p..

BAKER MAJOR 12" £10.35
 30-14,500 c/s. 12in. double cone, woofer and tweeter cone together with a BAKER ceramic magnet assembly having a flux density of 14,000 gauss and a total flux of 145,000 Maxwells. Bass resonance 40 c/s. Rated 25W. NOTE 3 or 8 or 15 ohms must be stated.



Module kit, 30-17,000 c/s with tweeter, crossover, baffle and instructions. **£13** Post 60p each
 Please state 3 or 8 or 15 ohms

BAKER "BIG-SOUND" SPEAKERS. Post 50p each
 'Group 25' 12in 30W **£8.95** 3 or 8 or 15 ohm
 'Group 35' 12in 40W **£10.50** 3 or 8 or 15 ohm
 'Group 50/15' 15in 80W **£19.50** 8 or 15 ohm

NEW MODEL BAKER LOUSPEAKER, 12IN 60 WATT GROUP 50/12, 8 OR 15 OHM HIGH POWER FULL RANGE PROFESSIONAL QUALITY. £14.50
 30-16,000 CPS MASSIVE CERAMIC MAGNET. Post 80p
 WITH ALUMINIUM PRESENCE CENTRE DOME.

TEAK VENEERED HI-FI SPEAKERS AND CABINETS
 For 12in. or 10in. speaker 20x13x12in. **£12.50** Post 95p
 For 13x8in. or 8in. speaker 16x10x7in. **£6.95** Post 75p
 For 8x5in. speaker 12x8x6in. **£4.95** Post 50p
LOUSPEAKER CABINET WADDING 18in. wide... **20p** ft

R.C.S. 100 watt VALVE AMPLIFIER CHASSIS
 Four inputs. Four way mixing, master volume, treble and bass controls. Suits all speakers. This professional quality amplifier chassis is suitable for all groups, disco, P.A., where high quality power is required. 5 speaker outputs A/C mains operated. Slave output. Produced by demand for a quality valve amplifier. Send for leaflet
 Suitable carrying cab **£14.** Price **£85** carr **£2** 50



SPEAKER COVERING MATERIALS. Samples Large S.A.E. Horn Tweeters 2-16kc/s. 10W 8 ohm or 15 ohm **£3.60**
 De Luxe Horn Tweeters 3-18kc/s. 30W, 8 ohm. **£7.50**
CROSSOVERS. TWO-WAY 3000 c/s 3 or 8 or 15 ohm **£1.90.** 3-way 950 cps/3000 cps. **£2.20.**
LOUSPEAKERS P.M. 3 OHMS. 7x4in **£1.50;** 6 1/2in. **£1.80;** 8x5in. **£1.90;** 8in. **£1.95.**
SPECIAL OFFER: 80 ohm 2 1/2in., 2 1/2in., 35 ohm, 3in., 25 ohm, 2 1/2in. dia., 3in. dia., 5x3in 8 ohm, 2 1/2in., 3in., 3 1/2in., 5in., 15 ohm, 3 1/2in. dia., 6x4in., 7x4in., 5x3in., 3ohm, 2 1/2in., 2 1/2in., 3 1/2in., 5in. dia **£1.25** each.
PHILIPS LOUSPEAKER, 8in. 4 ohms, 4 watts, **£1.95**
RICHARD ALLAN TWIN CONE LOUSPEAKERS
 8in diameter 4W **£2.50.** 10in diameter 5W **£2.95;** 12in diameter 6W **£3.50.** 3/8" / 15 ohms. please state.
VALVE OUTPUT TRANS. 40p; **MIKE TRANS.** 50 1. **40p.** Mike trans mu metal 100 1 **£1.25.**

Loudspeaker Volume Control 15 ohms 10W with one inch long threaded bush for wood panel mounting. 1/2in. spindle. **65p**.

BAKER 150 WATT ALL PURPOSE MIXER AMPLIFIER
 All purpose transistorised. Ideal for Groups, Disco and P.A. 4 inputs speech and music. 4 way mixing. Output 8/15 ohm a.c. Mains. Separate treble and bass controls. **£68** Carr **£1** 00 each
 Guaranteed. Details S.A.E. NEW MODEL MAJOR—50 watt, 4 input, 2 vol Treble and bass. Ideal disco amplifier **£49.95**



100 WATT DISCO AMPLIFIER CHASSIS
 volume, treble, bass controls. 500 M V or 1 volt input. Four loudspeaker outputs 4 to 16 ohm. **£52**

BARGAIN 4 CHANNEL TRANSISTOR MONO MIXER
 Add musical highlights and sound effects to recordings. Will mix Microphone, records, tape and tuner with separate controls into single output. 9V **£5.20**
TWO STEREO CHANNEL VERSION **£6.85**
BARGAIN 3 WATT AMPLIFIER. 4 Transistor. Push-Pull Ready Built, with volume, Treble and bass controls 18 volt d.c. Mains Power Pack **£3.45**

BALANCED TWIN RIBBON FEEDER 300 ohms. 7p yd. JACK SOCKET Std. open-circuit 20p, closed circuit 25p; Chrome Lead-Socket 45p. Mono or Stereo. Phono Plug 8p. Phono Socket 8p.
JACK PLUGS Std. Chrome 30p; Plastic 25p; 3.5mm 15p.
STEREO JACK PLUG 30p. SOCKET 25p.
DIN SOCKETS Chassis 3-pin 10p. 5-pin 10p.
DIN SOCKETS FREE 3-pin 25p. 5-pin 25p. **DIN PLUGS** 3-pin 25p; 5-pin 25p. **VALVE HOLDERS, 10p; CANS 10p.**

R.C.S. SOUND TO LIGHT KIT
 Kit of parts to build a 3 channel sound to light unit 1,000 watts per channel **£12.50.** Post 35p
 Easy to build. Full instructions supplied Cabinet **£3.**
 As featured in December Practical Wireless

E.M.I. TAPE MOTORS. 240V a.c. 1,200 r.p.m. 4 pole 185mA Spindle 0.18x0.75in. Size 3 3/4 x 2 1/2 x 2 1/4in. **£2.** Post 40p
120V Model, £1
 Collard gram motor 240V **£1.50.**





TRAMPUS

ELECTRONICS LTD. WINDSOR

58-60 GROVE RD.
WINDSOR, BERKS. SL4 1HS.

ADD 8% VAT TO PRICES MARKED *
 ADD 12% VAT TO ALL OTHER PRICES.
 SEND CWO (EXCEPT GOVT. DEPTS.)
 POST & PACKING 20p FOR THE UK.

NEW FAST SERVICE, LOW PRICES
 MONEY BACK IF NOT SATISFIED.
 ALL BRAND NEW TOP GRADE FULL
 SPEC DEVICES. CALLERS WELCOME
 NEW CATALOGUE LIST FREE SAE.
 BARCLAYCARD & ACCESS BY POST
 OR TELEPHONE ON £5 MINIMUM

FAST SERVICE



ALL FULL SPEC.
 DL707 COM. ANODE &
 DL704 COM. CATHODE
 0.3" 0-9DP 89p. ea.

747 JUMBO 0.6" CA
 LED DISPLAY £1.75.
 3015F 0-9DP £1.25.

DISCO etc STROBE
 ZENON TUBE £5 ea.

LEDS red 12P.

209 STYLE OR 0.2" NO CLIP 11p*
 TIL209 or 0.2" RED & CLIP 13p*
 GREEN LARGE/SMALL & CLIP 22p*
 ORANGE LARGE/SMALL & CLIP 22p*
 ORP12 57p* 2N5777 33p* TEC12 50p*
 DIGITAL CLOCKS MM5316 £5*
 MM5314 £3.39* MM5311 £5*
 AY51224 £3.49* PCB £1*

CAPACITORS

CERAMIC 22pf-0.1uf 50v 5p.
 ELECTROLYTIC: 10/50/100 uf 10 or
 25V 7P. 50V 9P. 2uf/10V 6p.
 1000uf 25V 18p. 200/500uf 9p.
 POTENTIOMETERS LIM/LOG 16p ea
 PRESETS 6p. RESISTORS 1 P ea

HEATSINKS T05/18 7p. T03 15p.
 SWITCHES: SPST 19p. DPDT 24p.*
 DIN PLUGS ALL 12p. SOCKETS 9p.
 ALI CASES: A35/A47 50p AB13 65p
 TRANSFORMERS .100mA 89p ea*
 1A/1A 6/12 or 12/24 £2 each.

NEW AUDIBLE WARNING BLEEPER £1

TRAMPUS FULL SPEC PAKS ALL £1 ea

PAK A 10 RED LEDS our choice £1*
 PAK B 5 741C OP AMP 8 PIN £1*
 PAK C 4 2N3055 £1*. D 12 BC109C £1*
 PAK E 10 BC182 £1. F 11 2N3704 £1
 PAK G 8 BFY51 £1*. H 9 2N3819 £1
 PAK J 9 2N3053 £1*. K 40 1N914 £1
 NEW PAK M 4 PLASTIC 3055 90W £1*

IC's LOW PRICES

703 RF/IF	26p	MC1303	£1.47
709 T099	22p*	MC1310	£2.09
709 DIL 14	28p*	MC1312 SQ	£1.50
710 DIL 14	31p*	MC1318	£2.50
723 Regul'r	45p*	MC1330	75p
741 DIL 8	20p*	MC1339	£1.49
741 DIL 14	31p*	MC1350/1/2	75p
741 T099	31p*	MC1466 /9	£3
747 2x741	67p*	MFC4000 1W	59p
748 DIL 8	27p*	NE536 FETOPA	£2*
7805 5V	£1.39*	NE540	£1.10*
7812 12V	£1.39*	NE550 2VR	£1*
7815 15V	£1.39*	NE555 TIMER	41p*
7900 Series	£3*	NE556 2x	84p*
76013 6W AF	75p	NE560 PLL	£4.00
CA3046	59p	NE561 PLL	£4.00
CA3048	£2.20	NE562 PLL	£4.00
CA3054	£2	NE563	£2.25
ICL803R	£2.69*	NE565	£2.50
LM300	£1.50*	NE566	£1.55
LM301 OPA	41p*	NE567	£2.20
LM304 0-40V	£3*	SN72741 741	20p*
LM308 HI Po	95p*	SN76860 IF	75p
LM309K 5V	£1.75*	SN76811 IF	£1
LM372 IF	£2.00	TAD100 & IF	£2
LM377 2x2W	£3	TBA800	89p
LM380 00745	89p	TBA810 7WAF	80p
LM381	£2	TBA820	£1.49
LM3900 40PA	63p*	ZN414 RX	99p

7400 TTL

FULL SPEC. 5% off 100MIX

7400	9p*	7474	27p*
7401	10p*	7476	27p*
7402/3	11p*	7490	37p*
7404	13p*	7491	60p*
7405/6/7	25p*	7492/93	43p*
7408/9/10	9p*	7494	43p*
7413	26p*	7496	68p*
7420/30	12p*	74100	£1
7440	12p*	74121	26p*
7441	64p*	74123	58p*
7447	67p*	74141	64p*
7470	25p*	74174	£1*
7472	22p*	74175	95p*
7473	26p*	74196	£1*

CMOS LOGIC

NEW MOTOROLA

CD4000	15p*	CD14533	£2.35*
CD4001	16p*	CD4028	73p*
CD4002	16p*	CD4746	£1*
CD4009	45p*	CD4047	73p*
CD4011	17p*	CD4049	45p*
CD4013	45p*	CD4054	94p*
CD4016	45p*	CD4055	£1*
CD4017	82p*	CD4060	90p*
CD4018	82p*	CD4071	17p*
CD4022	77p*	CD4081	17p*
CD4023	16p*	CD4510	£1.19*
CD4024	63p*	CD4511	£1.90*
CD4027	45p*	CD4528	£1.10*
		CD4558	£2.35*

TRANSISTORS

PRICE EACH:-

AC127 & 128	10p*	MATCHING	20p*
AC176	15p*	INS. BUSH SET	6p*
AC187 & 188	18p*	TIP29 & 30	43p*
AD149	45p*	TIP31 & 32	54p*
AD161 & 162	33p*	TIP41	63p*
BC107	8p*	TIP42	67p*
BC107B	12p*	TIP2955	99p*
BC108	7p*	TIP3055	67p*
BC108B	12p*	TIS43 UJCT	26p*
BC109	8p*	ZTK107/8/9	11p
BC109C	12p*	ZTK300 & 304	20p
BC147/8/9	9p	ZTK500 & 504	42p
BC157/8/9	12p	2N706 & 708	11p
BC167/8/9	12p	2N2646 UJT	38p*
BC177/8/9	18p	2N2904 & 5	20p*
BC182/3/4/44L12p		2N2926b nryg	9p
BC212/3/4/44L12p		2N3053	16p*
BCY70/1/2	16p*	2N3054	42p*
BD131 & 132	39p*	2N3055 115W	37p*
BFR88 250V	35p	2N3055 RCA	60p*
BFY50	14p*	2N3702/3/4/5	8p
BFY51	14p*	2N3706/7/8/9	8p
BFY52 & 53	14p*	2N3710 & 11	8p
BSX19/20/21	16p*	2N3819F FET	12p
MJ2955 TO3	75p*	2N3820 FET	40p
MJE2955	89p*	2N3823E FET	16p
MJE3055	64p*	2N3904/5/6	15p
MPU131 PUT	49p	2N4289 mini	31p
		2N5457 FET	45p

TELEPHONE 54525

DIODES

OAB1 & OA91 GERMANIUM	5p.
1N4001 1A50V & 1N4002	5p*
1N4004 6p* 1N4007	9p*
1N4148 & 1N914 SILICON	4p.
ZENERS RZY88 400mW	9p.
ZENERS 1 1/2W 17P. 21J noise	£1
BRIDGE RECTIFIER 1A50	18p
1A400V 25p. 4A100V	45p

SCR's TRIACS

SCR's TAG1/400 1A400V 50p*
 1A50V 38p* 1A 600V 70p*
 C106D 4A400V SCR ONLY 47p*
 TRIAC SC146D 10A400V £1*
 TRIAC DISCO 16A400V £1.75*
 DIACS: ST2 20p. BR100 25p

vero

36PINS 28p* FACE CUTTER 49p*
 COPPERCLAD 0.1 PITCH VERO
 2 1/2"x5" 32p* 2 1/2"x3 1/2" 29p*
 3 1/2"x5" 37p* 3 1/2"x3 1/2" 32p*
 3 1/2"x17" £1.70*
 3 1/2"x17" PLAIN 0.1" £1.06*
 DIL BREADBOARD 6x4" £2*

DALO 69P pen

DALO ETCH RESIST PEN 69p*
 FEC ETCH PAK 500gm 89p*
 6x4" COPPER BOARD 50p*
 PCB KIT 3 ITEMS £2*
 CASSETTE MECHANISM £9 & ASC12
 TGS GAS DETECTORS 308 etct £2*

Oil sockets

TOP QUALITY NYLON
 SOCKETS 8PIN 12p*
 14PIN 12p* 16PIN 12p*
 SOLDERCON PINS:
 100 65p* 1000 £3.50*

WW-009 FOR FURTHER DETAILS

Rub down lettering...

This product is ideally suitable for many applications in addition to art work, fascia panels, etc.

... FOR THE PROFESSIONAL LOOK

A boon to industry, students and enthusiasts, this is a totally new system of graphic lettering.

- (1) Eliminating pencil marks on art work
- (2) Built-in straight edge
- (3) Guaranteed correct spacing of letters
- (4) Ensures all letters upright

SO SIMPLE TO USE

No experience in graphics is required as simplicity is the keynote. A neat and professional job is assured under guarantee.

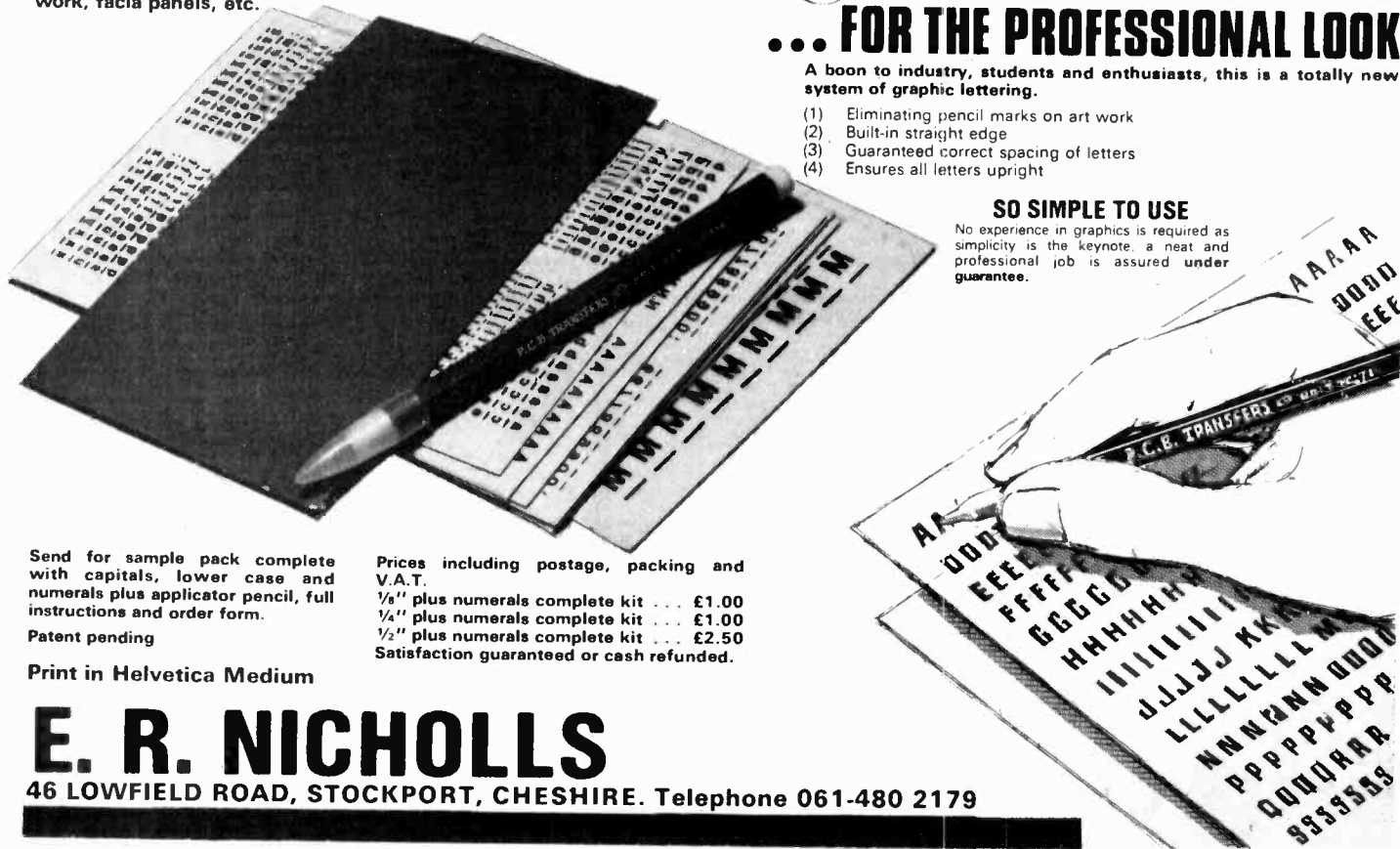

Send for sample pack complete with capitals, lower case and numerals plus applicator pencil, full instructions and order form.

Patent pending

Print in Helvetica Medium

Prices including postage, packing and V.A.T.

1/8" plus numerals complete kit ... £1.00

1/4" plus numerals complete kit ... £1.00

1/2" plus numerals complete kit ... £2.50

Satisfaction guaranteed or cash refunded.

E. R. NICHOLLS

46 LOWFIELD ROAD, STOCKPORT, CHESHIRE. Telephone 061-480 2179

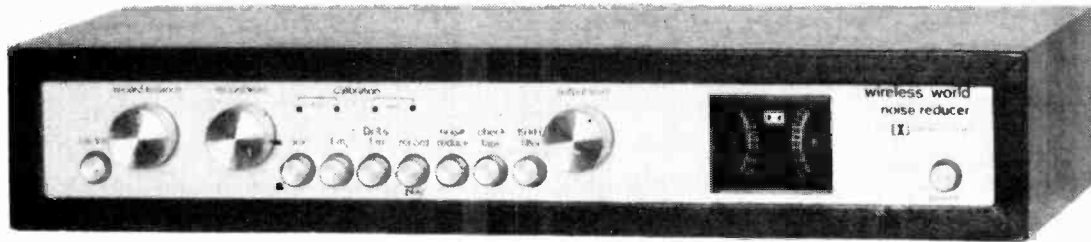

Wireless World DolbyTM noise reducer

Trademark of Dolby Laboratories Inc.

We are proud to announce the latest addition to our range of matching high fidelity units.

Featuring:

- switching for both encoding (low-level h.f. compression) and decoding
- a switchable f.m. stereo multiplex and bias filter
- provision for decoding Dolby f.m. radio transmissions (as in USA)
- no equipment needed for alignment
- suitability for both open-reel and cassette tape machines
- check tape switch for encoded monitoring in three-head machines

The kit includes:

- complete set of components for stereo processor
- regulated power supply components
- board-mounted DIN sockets and push-button switches
- fibreglass board designed for minimum wiring
- solid mahogany cabinet, chassis, twin meters, front panel, knobs, mounting screws and nuts

Typical performance

Noise reduction: better than 9dB weighted

Clipping level: 16.5dB above Dolby level (measured at 1% third harmonic content)

Harmonic distortion 0.1% at Dolby level typically 0.05% over most of band, rising to a maximum of 0.12%.

Signal-to-noise ratio: 75dB (20Hz to 20kHz, signal at Dolby level) at Monitor output.

Dynamic Range > 90dB

30mV sensitivity.

PRICE: £37.90 + VAT

Also available ready built and tested **Price £52.00 + VAT**

Calibration tapes are available for open-reel use and for cassette (specify which) **Price £2.00 + VAT***

Single channel plug-in DolbyTM PROCESSOR BOARDS (92 x 87mm) with gold plated contacts are available with all components **Price £7.20 + VAT**

Single channel board with selected fet **Price £2.20 + VAT**

Gold plated edge connector **Price £1.40 + VAT***

Selected FET's. **60p** each + VAT, **100p** + VAT for two, **£1.90** + VAT for four

Please add VAT at 12½% unless marked thus* when 8% applies
We guarantee full after-sales technical and servicing facilities on all our kits



INTEGREX LTD.

Please send SAE for complete lists and specifications
**Portwood Industrial Estate, Church Gresley,
Burton-on-Trent, Staffs DE11 9PT
Burton-on-Trent (0283) 215432 Telex 377106**

INTEGREX

S-2020TA STEREO TUNER / AMPLIFIER KIT

SOLID MAHOGANY CABINET

A high-quality push-button FM Varicap Stereo Tuner combined with a 24W r.m.s. per channel Stereo Amplifier.

Brief Spec. Amplifier: Low field Toroidal transformer, Mag. input, Tape In/Out facility (for noise reduction unit, etc), THD less than 0.1% at 20W into 8 ohms. All sockets, fuses, etc., are PC mounted for ease of assembly. Tuner section: uses Mullard LP1186 module requiring no RF alignment, ceramic IF, INTERSTATION MUTE, and phase-locked IC stereo decoder. LED tuning and stereo indicators. Tuning range 88–104MHz. 30dB mono S/N @ 1.8µV. THD typ. 0.4%

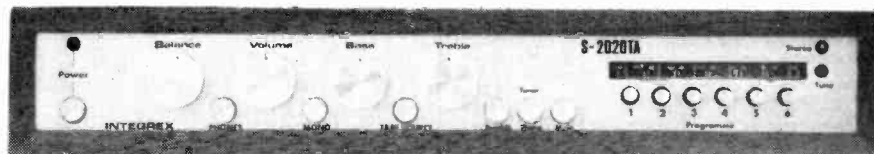

PRICE: £53.95 + VAT

NELSON-JONES STEREO FM TUNER KIT

A very high performance tuner with dual gate MOSFET RF and Mixer front end, triple gang varicap tuning, and dual ceramic filter / dual IC IF amp.

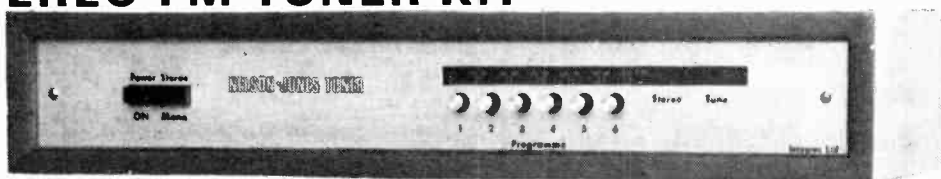

Brief Spec. Tuning range 88–104MHz. 20dB mono quieting @ 0.75µV. Image rejection — 70dB. IF rejection—85dB. THD typically 0.4% IC stabilized PSU and LED tuning indicators. Push-button tuning and AFC unit. Choice of either mono or stereo with a choice of stereo decoders.

Compare this spec. with tuners costing twice the price

Mono £29.15 + VAT

With ICPL Decoder £33.42 + VAT

**With Portus-Haywood Decoder
£35.95 + VAT**

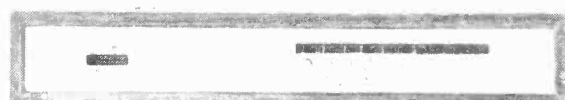

Sens. 30dB S/N mono @ 1.8µV
THD typically 0.4%
Tuning range 88–104MHz
LED sig. strength and stereo indicator

STEREO MODULE TUNER KIT

A low-cost Stereo Tuner based on the Mullard LP1186 RF module requiring no alignment. The IF comprises a ceramic filter and high-performance IC Variable INTERSTATION MUTE. PLL stereo decoder IC

**PRICE: Mono £26.85 + VAT,
Stereo £29.95 + VAT**

S-2020A AMPLIFIER KIT

Developed in our laboratories from the highly successful "TEXAN" design. PC mounting potentiometers, switches, sockets and fuses are used for ease of assembly and to minimize wiring

Type Spec. 24+24W r.m.s into 8-ohm load at less than 0.1% THD. Mag. PU input S/N 60dB. Radio input S/N 72dB. Headphone output. Tape In/Out facility (for noise reduction unit, etc.). Toroidal mains transformer.

PRICE: £31.95 + VAT



ALL THE ABOVE KITS ARE SUPPLIED COMPLETE WITH ALL METALWORK, SOCKETS, FUSES, NUTS AND BOLTS, KNOBS, FRONT PANELS, SOLID MAHOGANY CABINETS AND COMPREHENSIVE INSTRUCTIONS

BASIC NELSON-JONES TUNER KIT . . . £14.28 + VAT
BASIC MODULE TUNER KIT (Mono) . . . £14.75 + VAT
BASIC MODULE TUNER KIT (stereo) . . . £16.75 + VAT

PHASE-LOCKED IC DECODER KIT . . . £4.47 + VAT
PUSH-BUTTON UNIT . . . £4.50 + VAT

PORTUS-HAYWOOD PHASE-LOCKED STEREO DECODER KIT . . . £8.00 + VAT

MOTOROLA BOOKS

Diodes Transistors, etc., over 3500 Pages £10.50
 CMOS over 400 Pages £1.50
 Linear i.b. over 800 Pages £2.00
 Motorola M6800 Programming Manual £3.50
 Motorola M6800 Applications Manual £7.00
 From Minicomputers to Microprocessors £1.00

SIGNETICS

Data/Applications book, over 1600 Pages £4.00
 DMOS; 74LS; Consumer; shift registers; RAM's; PROM's
 20p each

FERRANTI

E-Line Applications 50p
 Complete range of data and applications notes available

NO VAT THIS SECTION

LINEAR ICs

LM301A Ext. comp. operational amplifier 36p
 LM307V Int. comp. operational amplifier 45p
 MC1458V Dual comp. operational amplifier 80p
 NE510A Video amplifier £1.58
 NE540L Audio power driver £1.17
 NE555V Timer 44p
 NE556A Dual 555 14 pin 95p
 NE516B Phase locked loop with A.M. demode £2.70
 NE562B Phase locked loop with V.C.O. £2.70
 NE566V Phase locked loop function gen. £1.50
 PA239A Dual low noise stereo pre-amp. 95p
 A741CV Op. amp. 42p
 A747CA Dual op. amp. 90p
 MC1306P Dual Stereo pre-amp. £1.47
 MC1306P 1/2W audio amp. 64p
 MC1304P F.M. multiplex stereo demodulator £1.12
 MC1301P Stereo demodulator £1.92
 MC1312P £1.94
 MC1314P Quadrophonic decoder kit £3.31
 MC1315P £3.59
 MC1330P Low level video detector 67p
 MC1496G Double balanced mixer

MOS I.C.s

AY-5-1224 12/24 24 hour digital clock circuit £4.25
 AY-5-3510 3 1/2 digit DVM circuit £6.10
 AY-1-0212 Master tone generator £5.55
 AY-1-5051 4 stage divider £1.20
 AY-1-6721 5/5 stage divider £1.45
 AY-1-6721 1/6 stage divider £1.45
 AY-1-5050 7 stage divider £1.75
 C550 8 digit calculator chip £6.50
 C500 8 digit calculator chip £3.25
 2102B MOS 1024 bit static RAM £3.00

FERRANTI I.C.s

ZN1040E Universal counter/display CCT £12.00
 ZN1034E Precision timer CCT £2.99
 ZN114 A.M. radio circuit £1.00
 Data and Circuits on ZN414 5p

SPECIAL OFFERS

IN4148 Diodes 12 for 50p
 30 for £1.00
 1000 for £25.00
 35p
 0 127" Display (MAN3M) 5% Discount orders over £5.00
 10% Discount orders over £10.00
 Discount not applicable to kit or special offers

I.C. SOCKETS

14 pin 12p 28 pin 27p
 16 pin 15p 40 pin 30p
 24 pin 26p

CAPACITORS

Electrolytic; paper; Non polar Tant. Pack of 25 Mixed our choice 50p

Metal Tant 6v — 1, 3, 3.3, 4.7, 56; 68, 180; 10v — 150; 15v — 47
 20v — 0.1, 1, 39; 68 35v — 0.47, 0.56; 0.68; 0.82; 1 18; 2.7; 3.3; 4.7; 10; 15; 33 50v — 3.3; 3.9; 10; 15; 22; 27; 50

Plastic Tant 6v — 47
 Tubular 20v — 15 35v — 2, 2.2; 3.3; 4.7, 6.8

All values microfarads Your choice 10p each Pack of 20 mixed our choice £1.00 Polystyrene — Pack of 25 mixed 50p

RESISTORS

1/2 Watt Carbon. Mullard CR37 10 for 20p
 1/2 Watt Metal Film Welwyn MR5 10 for 50p
 8 Watt Wirewound Welwyn W22 37p
 12 Watt Wirewound Welwyn W23 39p
 20 Watt Wirewound Welwyn W24 41p
 CR37 and MR5 min. quantity any one value 10 pcs. E12 Series available to 1 MO except W23 and W24 up to 27K only.

POTENTIOMETERS

Moulded Track — Panel Mounting
 Lin — 1w — 250k; 2M
 Log — 1/2w — 10k; 500k
 Min. Moulded Track Linear — Panel Mtg. 1/2w — 22k; 100k; 20k; 2M2
 Open Min. Preset 1/4w Linear
 100R; 220R; 250R; 330R; 470R; 500R; 1k; 10k; 25k; 100k; 500k; 500k; 1M
 Sealed Min. Preset 1/4w Linear
 33R; 100R; 220R; 330R; 500R; 4k7; 5k; 8k; 22k; 25k; 50k; 100k; 500k
 Your Choice 10p each—panel mtg. 5p each—preset Pack of 10 (inc. 2 panel mtg.) 30p Wirewound helical pots (10 turn) 5k, 50p each

Mullard BD232 £1.10 BRY39 50p BY128 95p
 Transistors BD233 68p BRV50 52p BY164 59p
 — 12 1/2% VAT BD234 70p BSW67 96p BY182 £1.30
 AC176/128 61p BD235 68p BSX19 32p BY184 41p
 AD161/162 £1.20p BD237 70p BSX20 42p BY206 19p
 AC126 32p BF115 21p BT102 £1.40p BX10 23p
 AC127 26p BF126 21p BU126 £2.20p BX36-150 12p
 AC128 19p BF167 27p BU205 £2.50p BX36-600 17p
 AC176 25p BF173 29p BU206 £2.50p BX38-600 41p
 AC187/188 01 95p BF178 47p BU208 £4.00p BX38-600R 59p
 AC188 47p BF179 54p GET103 6p BYX48-600R 43p
 ACY19 43p BF180 44p GET187 6p OA95 7p
 ACY20 23p BF181 42p OC28 £1.00p OA200 13p
 ACY220 10p BF182 44p OC70 6p OA202 9p
 AD140 50p BF183 48p OC75 6p OA223 69p
 AD149 69p BF185 26p OC171 6p
 AF114 35p BF194 9p
 AF115 30p BF194B 14p MULLARD 13p
 AF116 26p BF195 12p
 AF117 25p BF196 13p
 AF121 13p BF197 7p
 AF125 32p BF200 30p
 AF126 30p BF240 20p AA119 11p BZV10 59p
 AF139 42p BF241 27p AA215 13p BZV15CR12 75p
 AF178 60p BF262 56p AA213 10p BZV61C27 13p
 AF239 90p BF263 56p AA217 22p BZV61C27 25p
 BAT10 £1.00 BF263 56p AA217 22p BZV70C11 33p
 BAV10 11p BF337 42p BA154 10p BZX70C30 33p
 BC107 18p BF338 47p BA155 11p BZX79 7p
 BC107A 19p BF390 43p BA156 11p 4.7V-75V 10p
 BC107B 15p BF390 43p BA182 23p BZY88C6V8 12p
 BC108 16p BF394 41p BA182 23p BZY88C13 12p
 BC108A 17p BF394 41p BA182 23p BZY91C15 £5.20
 BC108B 13p BF395 40p BA217 19p BZY93C18 74p
 BC108C 21p BF501 48p BB105B 33p BZY93C20 74p
 BC109B 21p BF501 48p BB105G 29p BZY93C24 74p
 BC109C 28p BF522 36p BR100 33p BZY95C15 68p
 BC147 9p BF900 £1.70 BR100-1 33p BR101 62p BZY95C18 68p
 BC148 7p BR100 33p BY126 15p BZY95C24 68p
 BC148B 12p BR101 60p BY127 13p BZY95C68 68p
 BC149 7p
 BC158 10p
 BC159 14p
 BC327 27p
 BC328 25p
 BC337 26p
 BCY72 24p
 BD115 31p
 BD124 80p
 BD131 50p
 BD132 72p
 BD133 68p
 BD135 42p
 BD136 44p
 BD138 52p
 BD139 56p
 BD140 68p
 BD144 £1.80
 BD160 £1.00
 BD181 £1.00
 BD182 £1.00
 BD183 £1.00
 BD201 £1.30
 BD203 £1.30

AUDIO AND RADIO MODULES

LP1400 Stereo Decoder Module £8.02
 LP1162 Audio Amp. £5.46
 LP1173 10W Audio Amp. £7.54
 LP1182/2 Stereo Pre-amp. £4.00
 LP1183/2 Stereo Pre-amp. £4.92
 LP1184/2 Low distortion stereo pre-amp. £8.18
 LP1185 FM IF Amplifier £7.78
 LP1185 FM Tuner Module £8.10
 LP1194 40 Voltage Multiplier (EHT gen) £8.10

SPECIAL OFFER

(1) 10 Watt stereo amplifier comprising —
 1 x LP1182/2 and 2 x LP1173
 Normal price £19.08 Offer price £15.00

(2) FM tuner comprising —
 1 x LP1185 1 x LP1186 1 x LP1400
 Normal price £22.08 Offer price £18.00



Dept. WW, Wellington Road
 London Colney, St. Albans
 Herts

WW—012 FOR FURTHER DETAILS

All prices exclusive of VAT which must be added
 VAT 8% except items 12 1/2% or specified. Cash with order
 Add 30p P&P UK. £1.00 EEC Countries. no other export orders acceptable
 Callers by arrangement only

VALVES

A1065	1.25	EF36	0.65	G234	0.80
AR8	0.60	EF37A	1.10	G237	1.00
ARP3	0.60	EF40	0.70	KT66	3.00
ATP4	0.50	EF41	0.75	KT88	4.00
B12H	3.00	EF80	0.35	MH4	1.00
DAF96	0.80	EF83	1.25	ML6	0.75
DF96	0.80	EF85	0.40	OA2	0.45
DK96	0.75	EF86	0.40	OB2	0.45
DL92	0.50	EF89	0.35	PABCO80	0.40
DL96	0.70	EF91	0.60	PC86	0.65
DY86/87	0.45	EF92	0.50	PC88	0.65
DY802	0.45	EF95	0.45	PC97	0.55
EB8CC/01130	0.45	EF183	0.40	PC900	0.55
E180CC	1.00	EF184	0.40	PC84A	0.45
E182CC	3.00	EF1200	0.75	PC89	0.60
EAS0	0.40	EL34	0.70	PC1189	0.65
EABCO80	0.40	EL35	0.70	PC180	0.65
EAFA2	0.70	EL37	2.20	PCF82	0.40
EB91	0.30	EL41	0.80	PCF84	0.65
EB33	1.00	EL81	0.60	PCF86	0.65
EB34	0.75	EL84	0.35	PCF200	0.90
EBF80	0.40	EL85	0.60	PCF201	0.90
EBF83	0.48	EL86	0.50	PCF801	0.55
EBF89	0.40	EL90	0.50	PCF802	0.55
EC52	0.40	EL91	1.00	PCF806	0.90
ECC81	0.45	EL95	0.70	PCH200	0.80
ECC82	0.35	EL504	0.80	PCL81	0.60
ECC83	0.35	EL821	1.80	PCL82	0.40
ECC84	0.35	EA31	0.70	PCL83	0.70
ECC95	0.45	EM80	0.55	PCL84	0.50
ECC96	1.25	EM81	0.60	PCL86	0.60
ECC98	0.55	EM84	0.40	PCL805/85	0.60
ECC189	0.80	EM87	1.00	PF200	0.60
ECF80	0.45	EY51	0.45	PF201	0.70
ECF82	0.45	EY81	0.45	PL36	0.50
ECF901	0.75	EY86/B	0.45	PL81	0.55
ECF804	2.50	EY88	0.50	PL82	0.50
EC42	0.85	EZ40	0.70	PL83	0.50
ECH81	0.40	EZ41	0.75	PL84	0.50
ECH84	0.60	EZ80	0.30	PL504	0.85
ECL80	0.60	EZ81	0.35	PL508	0.95
ECL82	0.40	GT11C	0.50	PL509	1.35
ECL83	0.75	GY501	0.60	PL802	1.85
ECL86	0.60	GZ32	0.65	PY33	0.60

A lot of these valves are imported and prices vary for each delivery so we reserve the right to change prices for new stock when unavoidable

PLUMBICON TUBES TYPE XO 1071 Mullard £150.00

PY80	0.60	U25	1.00	UCL83	0.70	Z900T	1.50	5R4GY	1.00	6A05	0.55
PY81/800	0.45	U26	0.80	UF41	0.70	1A3	0.55	5U4G	0.60	6A05W	0.70
PY82	0.50	U27	1.00	UF80	0.40	1L4	0.30	5V4G	0.65	6AS6	0.80
PY83	0.50	U28	0.75	UF85	0.50	1R5	0.50	5Y3GT	0.60	6AS7G	1.00
PY88	0.50	U29	0.80	UF89	0.50	1S4	0.35	5Z3	1.20	6AT6	0.60
PY500	1.10	UAF42	0.45	UL41	0.70	1S5	0.35	5Z4G	0.60	6A06	0.40
PY801	0.55	UAF44	0.70	UL84	0.50	1T4	0.35	5Z4GT	0.65	6A08	0.50
PY003	101.70	UBF80	0.50	UY41	0.50	1X2B	0.75	6A27	0.60	6AX4GT	0.75
QV006	40A	UBF89	0.50	VR105/30	2.25	2D21	0.50	6AC7	0.50	6AX5GT	1.00
QV003	1.70	UBL1	1.00	0.45	3A4	0.60	6AK5	0.45	6BA6	0.40	
QV03-12	1.70	UBL2	1.75	VR150/30	3.06	4A4	0.60	6AK8	0.40	6BE6	0.40
SCI/400	3.60	UCC85	0.50	0.45	354	0.50	6AL5	0.30	6BG6G	1.00	
SCI/600	5.50	UCF80	0.80	X81M	1.50	3V4	0.85	6AL5W	0.60	6BQ7A	0.60
SP61	8.00	UCH42	0.80	X86	0.75	5B/254M	5.00	6AM5	1.00	6BR7	1.30
TT21	6.00	UCH81	0.50	Z800U	3.00	5B/255M	5.00	6AM6	0.60	6BR7	1.30
		UCL82	0.45	Z801U	3.00	5B/258M	5.00	6AN8	0.70	6BW6	1.10

VIDECON TUBE TYPE P 863 B English Electric £20.00

TRANSISTORS 12 1/2% Please add VAT 12 1/2% for valves, etc.

Please write or phone for current price of any of the transistors

AZ12-BAV10	AF186	BCY72	GET116	OC35	OC204	2N3638A
AC113	AF239	BF115	GEX66	OC36	OC206	2N3730
AC126	AF212	BF167	NKT222	OC42	ZR11	2N3819
AC127	ASV26	BF173	NKT304	OC44	ZR21	2N4038
AC128	ASV27	BF185	NKT404	OC45	ZR22	2N4058
AC176	ASV28	BFY51	OA5	OC70	2N456A	2N4061
ACY17	BC107	BFY52	OA47	OC73	2N525	2N4172
ACY19	BC108	BSY27	OP70	OC75	2N596	2N5295
ACY20	BC109	BSY38	OA71	OC78	2N708	3N126
ACY39	BC113	BSY95A	OA73	OC78B	2N818	3N128
ACY40	BC116	BY100	OA91	OC81	2N1305	3N154
AD149	BC118	BY216	OA92	OC82	2N1307	3N159
AD161	BC136	CRS1/20	OA200	OC83	2N1309	3N159
AD162	BC137	CRS1/30	OA202	OC83M	2N12062	3N159
AD211	BC148A	CRS3/10	OA2200	OC838	2N2411	T12082
AD212	BC172A	CRS3/20	OC22	OC139	2N2989	4D235
AF114	BC212A	CRS3/30	OC25	OC140	2N3053	4D250
AF115	BCY31	CRS4/20	OC26	OC170	2N3054	4D251
AF116	BCY32	CRS25/025	OC28	OC172	2N3055	IN23A
AF118	BCY33	GET115	OC29	OC200	2N3391	IN25
AF124					IN38A	
AF125					IN43	
AF126					IN677	
AF127					IN4148	
AF129					IN4785	

OTHERS IN STOCK inc. integrated circuits, CRT & special valves Min Mail Order £1. UK POSTAGE £1. £2 20p. £2-£3 retail £3 £5 40p Over £25 Free Casual callers welcome

VALVES AND TRANSISTORS

Telephone enquiries for valves, transistors, etc. retail 749 3934. trade and export 743 0899

COLOMOR THE VALVE WITH A GUARANTEE

6B9V7	1.00	12E1	3.75	955	0.50
6C4	0.40	12K6	1.50	956	0.50
6C6	0.50	12K7GT	0.55	957	0.50
6C8	0.60	12K8GT	0.75	1629	0.70
6C8H	1.50	12O7GT	0.50	2051	1.00
6C9	0.75	12SA7GT	0.80	5763	1.70
6D6	0.45	12SG7	0.55	5933	3.00
6E8	0.75	12T7	0.35	6017	0.80
6E8A	0.75	12Y4	0.40	6080	0.70
6F7	1.10	14S7	1.00	6084	0.60
6F8	0.75	19A05	0.70	6065	1.00
6F12	0.60	19G3	8.00	6067	8.00
6F17	1.00	19G6	6.50	6080	3.50
6F33	3.50	19H5	15.00	6146	3.35
6H6	0.45	19Q3	0.60	6148	5.00
6J4WA	1.25	20P4	1.10	6360	1.70
6J5	0.65	25L6GT	0.70	8020	5.00
6J5GT	0.65	30C15	1.00	9001	0.40
6K7	0.55	30C17	1.10	9002	0.55
6K7G	0.35	30F5	1.00	9003	0.70
6K8GT	0.55	30FL1	1.10	9004	0.40
6L6M	1.90	30FL2	1.10	9006	0.40
6L7G	0.40	30L15	1.00		
6S7	0.75	30L17	1.00		
6S7GT	0.60	30P12	1.00		
6S7J					

SUMMERTIME SAIL-AWAY



WITH OUR **SIZZLING PRICES!!**

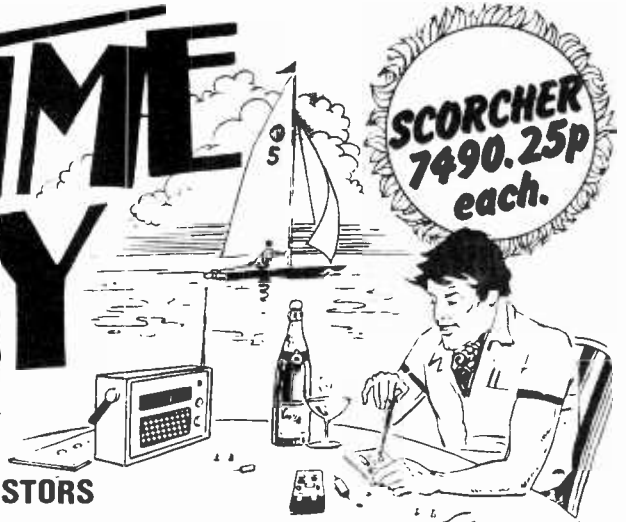

PAK OFFERS

ALL U PAKS, UIC PAKS, *ULIC PAKS, AS SEEN IN OUR PREVIOUS ADVERTS. AVAILABLE AT 40p PER PAK

ZENER PAKS

400mW
PAK No
1 containing 20 3v-10v
2 containing 20 11v-33v
£1.00 PER PAK*

RESISTOR PAKS

R1 50 1/2w 100 ohm-820 ohm
R2 50 1/2w 1K-8.2K
R3 50 1/2w 10K-82K
R4 50 1/2w 100K-1M

BUY ONE OF EACH

SPECIAL PRICE:
£1.60 the 4*

R5 30 1/2w 100 ohm-820 ohm
R6 30 1/2w 1K-8.2K
R7 30 1/2w 10K-82K
R8 30 1/2w 100K-1M

BUY ONE OF EACH

SPECIAL PRICE
£1.60 the 4*

CAPACITOR PAKS

E1 18 ELECTROLYTICS 47uF-10uF
E2 18 ELECTROLYTICS 10uF-100uF
E3 18 ELECTROLYTICS 100uF-680uF

BUY ONE OF EACH

SPECIAL PRICE
£1.20 the 3*

MC1 24 CERAMIC CAPS 22pf-82pf
MC2 24 CERAMIC CAPS 100pf-390pf
MC3 24 CERAMIC CAPS

470pf-3300pf
MC4 21 CERAMIC CAPS 4700pf-0.047uF

BUY ONE OF EACH

SPECIAL PRICE
£1.60 the 4*

OPTOELECTRONICS

L.E.D. DISPLAYS
DL707 0.3" .70p
DL747 0.6" £1.50
DL727 0.5"

DOUBLE DIGIT
0.0-9.9 £1.80

I.T.T. NIXIE TUBES
5870 ST. 1"

FIGURES
LOWEST EVER
PRICE

5 for £2.00
PHOTO CELLS
ORP12/NSL4931
38p ea.

PHOTO TRANSISTORS
DCP71 5 for £1.00

L.E.D.'s
RED TIL209 0.125" or FLV117 0.2" 5 of EITHER 50p
GREEN TIL211 0.125" FLV 0.2" 5 of EITHER 75p
YELLOW 0.125" SIZE 0.2" SIZE 5 of EITHER 75p
CLIPS FOR LED's. 0.125" ONLY. AVAIL-
ABLE AT

10 for 20p

IC's

NE555 TIMER 38p
NE556 Dual Timer 80p
709P 8-PIN DIL 15p
741P 8-PIN DIL 18p
747 14-PIN DIL 36p
748P 8-PIN DIL 25p
uA711 Dual Comparator 25p
*72301 op. amp. T099 25p
*72770 op. amp T099 50p

IC SOCKETS

BPS8 09p
BPS14 10p
BPS16 11p

TRIACS

2A/400PIV 50p
6A/400PIV 55p
10A/400PIV 75p

DIACS

BR100 15p
D32 15p

THYRISTORS

T05 15p
1A/50PIV 25p
1A/400PIV 30p
1A/600PIV 30p
T066 25p
5A/50PIV 40p
5A/400PIV 50p
5A/600PIV 50p
T048 30p
16A/50PIV 60p
16A/400PIV 60p

BRIDGE RECTIFIERS

2A/50 volt 25p
2A/100 volt 30p
2A/200 volt 35p
2A/400 volt 40p
2A/1000 volt 50p

F.E.T.'s

2N3819 12p
2N5458 (MPF104) 15p

DIY PRINTED CIRCUIT KIT

Normal Price **£7.80**

SALE PRICE £5.50

TRANSISTORS

AC127	10p	*BF199	12p
AC128	10p	BF257	18p
AC141K	20p	BF258	19p
AC142K	18p	BF259	20p
OC71	09p	BFX29	18p
BC107	06p	BFX84	15p
BC108	06p	BFY50	15p
BC109	06p	BFY51	15p
*BC147	08p	BFY52	15p
*BC148	08p	2N696	10p
*BC149	09p	2N697	11p
*BC157	11p	2N698	11p
*BC158	10p	2N706	06p
*BC159	10p	2N708	08p
*BC169C	07p	2N1613	15p
*BC170	05p	2N1711	15p
*BC171	05p	2N2219A	15p
*BC172	05p	2N2369	12p
BC178	12p	2N2369A	12p
*BC182	10p	2N2905A	13p
*BC182L	10p	*2N2926g	09p
*BC183	10p	*2N2926y	08p
*BC183L	10p	*2N2926008	08p
*BC184	11p	2N3053	15p
*BC184L	11p	2N3055	36p
*BC212	10p	*2N3702	08p
*BC212L	10p	*2N3703	08p
*BC213	10p	*2N3704	09p
*BC213L	10p	*2N3705	08p
*BC214	11p	*2N3706	08p
*BC214L	11p	*2N3903	08p
BC327	12p	*2N3904	08p
BC328	12p	*2N3905	09p
BC337	11p	*2N3906	08p
BC338	11p	*2N4058	08p
BD116	50p	*2N4060	09p
BF167	10p	*2N5172	09p
BF173	10p	*ZTX300	05p
*BF194	09p	*ZTX500	08p
*BF195	09p	*ZTX107	05p
*BF196	10p	*ZTX108	05p
*BF197	10p	*ZTX109	05p
*BF198	12p		

I.C. INSERTION EXTRACTOR TOOL

32p!

DIODES

OA10	15p	IN4002	3p
OA47	5p	IN4003	3 1/2p
OA81	5p	IN4004	4p
OA91	5p	IN4005	4 1/2p
OA200/		IN4006	5p
BAX13	5p	IN4007	6p
OA202/			
BAX16	5p	3 AMP	
IN914	4p	IN5400	11p
IN4148	4p	IN5401	12p
IS44	4p	IN5402	13p
IS920	5p	IN5403	14p
IS923	5p	IN5404	15p
IS970	5p	IN5405	16p
BA100	6p	IN5406	17p
BA148	10p	IN5407	18p
IN4001	2 1/2p	IN5408	20p

VAT CHAT

Please add 12 1/2% to prices marked *. Remainder add 8%.

UNI-JUNCTION TRANSISTORS
UT46/TIS43 18p

VOLTAGE REGS
L129/uA7805 85p
L130/uA7812 85p
L131/uA7815 85p

DYNAMIC CASSETTE MIKE
With 2.5mm and 3.5mm Jack Plugs.
£1.50*

P&P

Postage & Packing add 25p.
Overseas add extra for airmail.



BI-PAK

P.O. BOX 6, WARE, HERTS.

Samson's

(ELECTRONICS) LTD.

9 & 10 CHAPEL ST., LONDON, N.W.1
01-723 7851 01-262 5125

ADJACENT TO EDGWARE ROAD MET. LINE STATION
PLEASE ADD 8% TO ALL ORDERS INC. CARR.

AUGUST 1976

CURRENT RANGE OF NEW L.T. TRANSFORMERS OPEN TYPE TAG CONNECTIONS ALL PRIMARIES 220-240V

Type	Sec Taps	Amps	Price	Carr
1	24.30-40-48-60	12	£20.25	£2 00
2	24.30-40-48-60	10	£19.40	£2 00
3	24.30-40-48-60	8	£15.75	£1 50
4	24.30-40-48-60	5	£10.24	£1 00
5	24.30-40-48-60	3	£7.90	75p
6	24.30-40-48-60	2	£5.53	75p

6-8 10-12 16 18 20 24 36 40 60V

CAN BE OBTAINED FROM THE ABOVE RANGE

7	19.25-33-40-50v	10	£17.75	£2 00
8	19.25-33-40-50v	6	£12.00	£1 25
9	19.25-33-40-50v	3	£6.00	75p
10	19.25-33-40-50v	2	£4.95	75p

5-7-8-10-13-15-17-20-25-30-40-50v

OR 25.0 25v or 20.0-20v CAN BE

OBTAINED FROM THE ABOVE RANGE

11	12.15-20-25-30v	10	£10.35	£1 25
12	12.15-20-25-30v	5	£6.70	£1 00
13	12.15-20-25-30v	2	£3.75	75p

3.4-5-6-8-9-10-12-15-18-20-24-20v

or 12.0-12v or 15.0-15v CAN BE

OBTAINED FROM THE ABOVE RANGE

14	12-24v	12v 60A 24v 30A	£17.50	£2 00
15	12-24v	12v 30A 24v 15A	£14.25	£1 50
16	12-24v	12v 20A 24v 10A	£10.75	£1 25
17	12-24v	12v 10A 24v 5A	£5.50	75p
18	12-24v	12v 4A 24v 2A	£2.95	60p

FULLY SHROUDED TYPE TERMINAL CONNECTIONS

19	4-16-24-32v	4	£6.95	75p
20	4-16-24-32v	2	£4.65	65p
21	12-20-24-30v	10	£9.50	£1 00
22	12-20-24-30v	5	£6.50	75p
23	24-30-36v	10	£12.00	£1 25
24	24-30-36v	5	£9.50	£1 00
25	24-30-36v	2	£4.50	65p

CENTRE TAPPED L.T. TRANSFORMERS

Fully shrouded terminal block connections Pri. 220-240v Scr. sec. tapped 30:25:0 25:30:0 2amps **£5.95**, p.p. 75p
36:25:0 25:36:5amps **£11.95**, p.p. £1. Open frame type tag connections Pri. 240v. Sec. 18.0-18v 12.5A Core tabletop connections **£10.00**, carr. £2.

WOODEN AUTO TRANSFORMERS

3000 watts tapped 105-115-125-135-200-215-230-245-260v open type terminal block connections **£19.50**, carr. £2.00 in metal case with twin American 2.3 pin flush mounted sockets 3 core 240v mains lead. Carrying handle **£35**, carr. £3.

AUTO TRANSFORMERS FOR AMERICAN EQUIPMENT

240/110v 80-3000 watts, fitted with 2-3 pin sockets, and 3 core mains lead. Send Sae for price list. We have England's largest selection of American electrical accessories. 2.3 pin plugs, recessed and surface type 2.3 sockets, multi-way adaptors 2.3 pin grounding adaptors. Cable type sockets. Extension cords 240v Edison screw type light bulbs. Industrial plugs and sockets. Let us know your requirements.

HT TRANSFORMERS BY FAMOUS MAKER, ALL PRIMARIES 240V OPEN TYPE TAG CONNECTIONS

Sec. 350.0-350v 120 m/a 6.3v CT 4A, 5v 2A **£3.75**, pp 85p 300.0-300v 150 m/a 6.3CT 4A, 5v 6.3v 2A **£3.75**, pp 85p 300.0-300v 100 m/a 6.3v 3.5A 5v 2A **£3.00**, pp 85p 250.0-250v 120 m/a 6.3v 20A 5v 2A **£3.00**, pp 85p C core type 250.0-250v 50 m/a 6.3v 1A 6.3v 0.7A 6.3v 250.0-250v 50 m/a 6.3v 1A 6.3v 0.7A 6.3v Shrouded types: 500.0-500 200 m/a **£4.50**, carr. £1 250v, 20 m/a 6.3v 1A **£1**, pp 40p.

ISOLATION TRANSFORMERS BY FAMOUS MAKERS

Pri. 200-220-240v Scr. sec. 240v 13 amps conservatively rated. Open type, terminal block connections **£35.00**, carr. £4. Pri. 200-220-240v Scr. sec. 240v 700 watts. Open type. Cable lead connections **£8.50**, carr. £2. Pri. 115-220-240-240v Scr. sec. 115v 13.5 amps. Shrouded type table type connections, conservatively rated **£32.50**, carr. £3. Pri. 200-220-240v. Sec. tapped 90:110-120v 7.5 amps. Conservatively rated. Shrouded type. Table top connections **£19.50**, carr. £2.

POTTED H.T. TRANSFORMERS BY FAMOUS MAKERS

No. 1 Pri. 110-220-240v Scr. Sec. tapped 408-200.0-200.408v. High taps 165M/A. Low taps 500M/A **£5.50**, carr. £1. No. 2 Pri. 115-220-240A Scr. Sec. 400.0-400v 400M/A **£5.75**, carr. £1. No. 3 Pri. 115-220-240v Scr. Sec. 350.0-350v 200M/A, 6.3v 6A 5v 3A **£4.50**, carr. £1. No. 4 Pri. 115-220-240v Scr. Sec. 330.0-330v 200M/A, 6.3v 6A 5v 3A **£4.00**, carr. £1. No. 5 Pri. 220-240v Scr. Sec. 250.0-250v 320M/A, 6.3v 10A **£4.50**, carr. £1. No. 6 Pri. 110-220-240v Scr. Sec. 167v 60M/A and 500v 31M/A **£5.00**, carr. £1. No. 7 Pri. 110-220-240v Scr. Sec. 230v 200M/A, 6.3v 7A **£3.00**, carr. 75p. No. 8 Pri. 220-240v Scr. Sec. 250.0-250v 75M/A, 6.3v 2A 6.3v 1A **£3.00**, carr. 75p. No. 9 Pri. 220-240v Scr. Sec. tapped 170-180-190-200-210-220-230-240v, 175M/A, 6.3v 3A, 6.3v 2A **£3.75**, carr. 75p. No. 10 Pri. 220-240v Scr. Sec. 250.0-250v 100M/A, 6.3v 3A, 5v 2A **£3.00**, carr. 75p.

L.T. TRANSFORMERS BY FAMOUS MAKERS, ALL PRIMARIES 240V

Sec. 6-12v 20 amps open type table top connections **£8.50**, carr. £2. 20v 20amps **£10**, carr. £2. 12v 30amps twice **£17.50**, carr. £3.

3 PHASE ISOLATION TRANSFORMERS BY FAMOUS MAKER

Input tapped 380-440-415-430 volts RMS. Line Line 3 phase 4 wire 50Hz output 415 volts NMS 3 phase 4 wire at 2.15kVA. Regulation 2% secondary fully screened open type construction. Terminal board connections size 16x7/8x1/2. Weight 90lbs. Brand new. Fraction of makers price **£27.50** plus VAT carriage charges at cost.

RELAYS

Keyswitch Kmk3 230v AC 3 CO 75p, Kmk3 12v AC 3 CO 75p, Kmk1 230v AC 1 CO 60p, Omron Mk 2P 12v DC 2 CO plug in type 75p, bases 10p, Mk 2 24v AC 12v DC 2 CO 60p, pp all types 15p. Siemens miniature types 230V! 4 CO 75p, 185V! 4 CO 75p, 250V! 4 CO 60p, pp all types 15p. American miniature type 6v DC 1 CO 35p, pp 15p. Siemens open type AC 230v 1 make 40p, pp 15p. Cutler and Hammer 230v AC contacts: One NO or NC 16 amp 600v AC contacts, in metal cast **£1.50**, pp 35p.

OIL FILLED BLOCK CAPACITORS BY FAMOUS MAKERS

4+4+4+4+2+1mfd 600v Wkg OC **£1.50**, pp 50p. 8mfd 2500v OC Wkg **£3.75**, pp £1.25. 8mfd 400v OC Wkg **65p**, pp 25p. 8mfd 350v DC Wkg **60p**, pp 25p. 25mfd 1000v DC Wkg **75p**, pp 25p. 25mfd 1100v DC Wkg **65p**, pp 25p. 4mfd 1000v DC Wkg **75p**, pp 25p. 4mfd 350v OC Wkg **40p**, pp 25p. 2mfd 2000v OC Wkg **65p**, pp 25p. 2mfd 500v OC Wkg **30p**, pp 15p. 1mfd 2000v OC Wkg **50p**, pp 25p. 1mfd 600v DC Wkg **25p**, pp 15p. 0.25mfd 7500v DC Wkg **£1.00**, pp 25p. 0.1mfd 3000v OC Wkg **30p**, pp 15p. 0.001mfd Mica 6000v DC Wkg **75p**, pp 25p. Electrolytics 100.000mfd (-10+50%) **35p**, pp 15p. TCC dry electrolytics block type 2000mfd (-20+50%) 50v DC wkg **75p**, pp 25p.

HIGH VOLTAGE ISOLATION TRANSFORMER

Pri. 200-220-240v SEC tapped 4-5-6-3v 12 amps and 2-5v 35 amps. One only **£20.00**, carr. £3.

AC WKG BLOCK CAPACITORS

Dubliler 15mfd 330v AC Wkg **£1.25**, P.P. 25p. 10mfd 350v AC Wkg **£1.00**, P.P. 25p. 5mfd 300v AC Wkg **75p**, P.P. 25p. 4mfd 650v AC Wkg **£1.00**, P.P. 25p. 4mfd 500v AC Wkg **75p**, P.P. 25p. T.C.C. 4mfd 250v AC Wkg **50p**, P.P. 20p. 2mfd 300v AC Wkg **75p**, P.P. 20p. 1mfd 400v AC Wkg **75p**, P.P. 20p. 0.4mfd 440v AC Wkg **50p**, P.P. 20p. 8mfd 1mfd 800v AC **£1.00**, P.P. 20p.

H.T. SMOOTHING CHOKES

Paramek potted types 10H 180 M/A **£2.00**, P.P. 50p. 10H 75 M/A **£1.00**, P.P. 35p. 50H 75 M/A **£1.00**, P.P. 35p. Svinging type: 5H 0.04A 4H 0.05A **£1.75**, P.P. 50p. Gardners 100H 20 M/A **£1.25**, P.P. 35p. 20H 120 M/A **£1.25**, P.P. 35p. 20H 80 M/A **£1.00**, P.P. 35p. C core type 10H 350 M/A **£3.50**, P.P. 1.00.

L.T. TRANSFORMERS BY FAMOUS MAKERS

Open types No 1 Pri. 240 Sec. 26v 10A and 12v 0.1A **£5.50**, No 2 Pri. 220-240v Sec. Tapped 51-61-65-67-69-10A, **£10.00**, No 1150 No 3 Pri. 220-240v Sec. Tapped 58-53-69 74V 3A **£4.75**, carr. £1. No 4 Pri. 115-230v Sec. 6.3v 5.7A Twice and 26v 600 M/A C core **£3.75**, P.P. 75p. No 5 Pri. 115-230v Sec. 33v 6A and 18.0-18v 1A, **£3.00**, P.P. 75p. No 6 Pri. 110-200-220-240v Sec. 14v 5A 14v 2.5A 12v 10A 8v 10A 24v 750 M/A 200v 500 M/A Separate windings **£10.00**, carr. £1.50. No 7 Pri. 200-220-240v Sec. 4v 6A 4v 3A **£3.50**, P.P. 75p. No 8 Pri. 110-220-235v Sec. 12v 2.2A and 12v 1A 110-220-240v Sec. 12v 2.2A and 12v 1A Pri. 200-220-240v Sec. 37v 5.5A and 37v 2A and 21v 11A **£8.50**, carr. £1.50. No 10 Pri. 200-220-240v Sec. 31v 7A 26v 5A 16v 4A 25v 2A Separate windings **£8.50**, carr. £2.00. No 11 C core types: Pri. 220-240v Sec. 18.0-18v 21A, **£10.00**, No 12 Pri. 220v Sec. 1.25:0.1 25v 10A **£2.00**, P.P. 50p. No 13 Potted types: Pri. 200-220-240v Sec. 70v 1A and 30v 1A, **£3.50**, carr. £1.

AC 240v BLOWERS

Ex computer equipment. Perfect condition. Robustly housed on metal frame. Overall size 11 x 7 x 7in. Air outlet size 4 x 3in. Motor speed 1300 r.p.m. cont. rated. Cap start included with motor. Quiet running **£3.50**, carr. £1.

A.E.I. 240v AC CONTACTORS 20AMP CONTACTS

Type	Contacts	Price
0656	6M 2B	£1.50
0658	2M 2B	£1.25
0651	AC 1B types	£1.25
0654	2M 2B	£1.25
0653	4M	£1.25

Band new and boxed offered at a fraction of maker's price. P.P. all types 25p.

L.T. SMOOTHING CHOKES

C core type 10 M/H 25 amps **£8.75**, carr. £1.25. Paramek potted types, 100 M/H 2 amps **£3.50**, P.P. 75p. 13 M/H 1.5 amp **£1.00**, P.P. 50p. 150 M/H 3A open type **£3.50**, P.P. 75p. C core swinging types 7.5 M/H 6A 7.5 M/H 0.5A **£3.95**, P.P. 75p. 10 M/H 4A 100 M/H 0.5A **£3.00**, P.P. 50p. 50 M/H 5A 100 M/H 0.5A **£3.00**, P.P. 50p. 50 M/H 5A 100 M/H 0.5A **£3.00**, P.P. 50p.

HOWELL'S "C" CORE TRANSFORMERS

Pri. 200-220v, screen. Sec. 70.0-70v 10 amp table top connections, size 7 x 7 x 7 inches. **£15.00**, carr. £2.00. Pri. 220-240v. Sec. 18.0-18v 21A **£15.00**, carr. £2.00. Sec. 12v 2.2A conservatively rated. Table top connections **£10.00**, carr. £2.00.

SINTEL for MEMORIES-CMOS-DISPLAYS-MODULES-BOOKS

FAST SERVICE

We guarantee that telephone orders, for goods in stock, received by 4.30 p.m. (Mon.-Fri.) will be despatched the same day. First Class Post — and our stocking is good. Telephone orders. Private customers, quote Access or Barclaycard card no. (min. tel. order £5). Official orders, no minimum.

CMOS from Top Manufacturers — mainly RCA & Motorola			
CMOS	CD4026 1.50	CD4051 0.81	CD4082 0.18
	CD4027 0.48	CD4052 0.81	CD4085 0.62
CD4000 0.15	CD4028 0.78	CD4053 0.81	CD4086 0.62
CD4001 0.15	CD4029 0.99	CD4054 1.01	CD4089 1.34
CD4002 0.15	CD4030 0.48	CD4055 1.14	CD4093 0.69
CD4006	CD4031 1.92	CD4056 1.14	MK50253 5.60
CD4007 0.16	CD4032 0.92	CD4057 21.56	CD4095 0.91
	CD4033 1.21	CD4059 4.77	CD4096 0.91
CD4008 0.83	CD4034 1.65	CD4060 0.97	A51202 3.50
CD4009 0.48	CD4035 1.02	CD4061 18.92	AY5224 3.50
CD4010 0.48	CD4036 2.23	CD4062 7.77	
CD4011 0.16	CD4037 0.83	CD4063 0.97	FLAT CABLE
CD4012 0.48	CD4038 0.93	CD4066 0.61	20w 1m 1.00
CD4013 0.48	CD4039 2.23	CD4067 3.12	10m 10v 8.00
CD4014 0.87	CD4040 0.92	CD4068 0.18	
CD4015 0.87	CD4041 0.73	CD4069 0.18	VEROCASES
CD4016 0.48	CD4042 0.73	CD4070 0.48	751410J 2.60
CD4017 0.87	CD4043 0.87	CD4071 0.18	751411H 3.04
CD4018 0.87	CD4044 0.81	CD4072 0.18	CD4073 1.08
CD4019 0.48	CD4045 1.22	CD4073 0.18	CD4074 1.72
CD4020 0.97	CD4046 1.16	CD4074 0.18	CD4075 2.15
CD4021 0.87	CD4047 0.78	CD4075 0.18	
CD4022 0.83	CD4048 0.48	CD4076 1.34	SUNDRY
CD4023 0.16	CD4049 0.48	CD4077 0.48	CA3130 0.88
CD4025 0.16	CD4050 0.48	CD4078 0.18	78L2W 0.60
		CD4081 0.18	75491 0.96
			MC14553 6.07
			MC14553 7.02

SOLDERCON IC SOCKET PINS
Excellent contact low-cost sockets used by R&D depts. of Univs. Hospitals. Computer manufacturers and thousands of others. Simply cut off lengths you need, solder into board and snap off the connecting carrier. Send a Sae for free sample. Strip of 100 pins for **50p**, 1,000 for **£4**, 3,000 for **£10.50**.

MEMORY IC'S
Intel P2102A-6 (new version of 2102-2) 16 pin IC, TTL compatible, Single +5v supply, 650nsec, 1024 x 1-bit Static CMOS RAM **£3.35**
Intel P2112-2 650nsec 256 x 4-bit Static CMOS RAM **£4.76**
Intel IM6508BCE CMOS 1024 x 1-bit Static RAM **£8.05**

DISPLAYS These Jumbo LED displays take no more current than 0.3" types. All our Common Cathode (C.C.) digits can be used in place of any other C.C. display (DL704, DL750, MAN3640, etc.) as they are all electrically identical (but may have different pin-outs). Similarly our Common Anode digits may be used in place of any other C.A. types (DL707, DL747, RS-Doram 586/699, etc.)

FND500 C.C. Red 0.5" £1.02	TIL321 C.A. Red 0.5" £1.30	XAN652 C.A. Green 0.6" £1.75
---	---	---

Display-holding PCBs are available for multi-plexed arrays using our LED digits. PCBs also available for displays with TTL and CMOS Count/Latch/Decoder drivers. See our catalogue for more details (free on request — send Sae).

USING DISPLAYS WITH CMOS OR TTL? Send Sae, asking for free application note "SN1", which gives simple circuits with component values.

ADD VAT at 8%, 25p P&P on all orders. Price List sent with orders or free on request. Access and Barclaycard welcome, by post or phone. Export orders very welcome. No VAT but add 10% (Europe), 15% (Overseas) for Air Mail P&P (for export postage rates on books, contact us first).

CATRONICS WW

TELETEXT DECODER



Our kit contains all the printed circuit boards and components necessary to build the complete decoder. The power supply and video switching circuitry are normally installed within the television cabinet and the main decoding control and memory circuitry in a separate cabinet positioned on top of the television.

PRICES ARE AS FOLLOWS:

- Set of 5 PCBs (incl. PSU & Video Switching) £16.00 + VAT = £18.00
- Component Kit (incl. PCBs) £96.02 + VAT = £104.10
- Add-on Unit for Lower Case: PCB only £2.00 + VAT = £2.25
- Component Kit (incl. PCB) £12.65 + VAT = £13.75
- Cabinet £12.00 + VAT = £13.50
- READY BUILT AND TESTED £158.00 + VAT = £173.80
- for Lower Case add £16.00 + VAT = £17.50

Post & Packing: PCBs are post free but add £1 for component kit and 50p for cabinet

Components are also available separately with Special Prices for Semiconductor kits. SAE for price list

MOBILE AERIALS

A 'must' for all users of Commercial Radio

BIG ECONOMY NEWS!

Catronics stock a wide range of whip type aerials and a variety of bases, including types that do not require a fixing hole on the car. We can, therefore, supply virtually ANY frequency aerial for mounting on ANY car! These aerials are particularly suitable for MINICABS, Breakdown Trucks and other radio-controlled service vehicles.

The range of frequencies extends from 50MHz to 476 MHz ALL AT THE MOST COMPETITIVE PRICES

Write for illustrated leaflet

CATRONICS LTD. (Dept. 628)



39 Pound Street
Carshalton, Surrey
Tel: 01-669 6700

WW - 628 FOR FURTHER DETAILS

STEREO IC DECODER

HIGH PERFORMANCE PHASE LOCKED LOOP
(as in 'W.W.' July '72)

MOTOROLA MC1310P EX STOCK
DELIVERY SPECIFICATION

Separation: 40dB 50Hz-15kHz Distortion: 0.3%
I/P level: 560mV rms O/P level: 485mV rms per channel
Input impedance: 50kΩ Power requirements: 8-14V at 16mA
Will drive up to 75mA stereo 'on' lamp or LED.

KIT COMPRISES FIBREGLASS PCB (Roller tinned), Resistors, I.C., Capacitors, Preset Potm. & Comprehensive Instructions
LIGHT EMITTING DIODE Suitable as stereo 'on' indicator for above

ONLY **£3.98** WHY PAY MORE? post free 29p 59p
RED GREEN

MC1310P only £2.15 plus p.p. 10p

NOTE
As the supplier of the first MC1310P decoder kit, of which we have sold literally thousands, our customers can benefit from our wide experience.

V.A.T.
Please add V.A.T. to all prices
FI-COMP ELECTRONICS
PORTWOOD INDUSTRIAL ESTATE, CHURCH GRESLEY
BURTON-ON-TRENT, STAFFS. DE11 9PT

WORKSHOP TEST EQUIPMENT

Designed by Mr. J. L. Linsley Hood

1. AUDIO OSCILLATOR

Simple design. Very low distortion. 10HZ-100KHZ. Sine/Square output.

Kit Form £14

Made and tested £18 Tax 8% PP75p



His famous 30-75 watt **HI-FI AMPLIFIER £65** (tax 12 1/2%)
Distortion is below normal measurement. Available in pack form or made in units.

P.L.L. F.M. STEREO TUNER

Requires no adjustments. **Kit £40** (Tax 12 1/2%)



We can also supply REG P.S.V. 0-60v. 0-1A £17.30 Tax 8% F.M. SIG/GEN Wobbulator £12. TH.D. Analyser £18.50 MVM £15.25
Detailed leaflets available. Send f'cap s.a.e.

TELERADIO ELECTRONICS
(Annual holidays July 12-26)

325 FORE STREET, EDMONTON, LONDON N.9. 01-807 3719

TRANSFORMERS

ALL EX-STOCK - SAME-DAY DESPATCH

MAINS ISOLATING VAT 8% 12 and/or 24-VOLT

Primary 220-240 Volts
Centre Tapped and Screened

Ref.	VA (Watts)	£	P&P	AMPS			
				12v	24v	£	
07	20	£3.10	.66	0.5	0.25	1.54	36
149	60	4.69	.80	1.0	0.5	1.86	65
150	100	5.33	.95	2	1	2.41	80
151	200	8.54	1.25	4	2	2.97	80
152	250	10.32	1.53	6	3	4.43	95
153	350	12.47	1.53	8	4	5.09	95
154	500	14.33	1.79	10	5	5.50	1.10
155	750	21.94	BRS	12	6	5.80	1.10
156	1000	30.51	BRS	16	8	7.48	1.73
157	1500	34.89	BRS	20	10	10.91	1.73
158	2000	38.92	BRS	30	15	14.20	1.41
159	3000	41.48	BRS	60	30	17.67	BRS

50 VOLT RANGE

SEC. TAPS 0-19-25-33-40-50V

Ref.	Amps.	£	P&P
102	0.5	2.71	.65
103	1.0	3.55	.80
104	2.0	4.95	.95
105	3.0	5.10	1.0
106	4.0	7.98	.25
107	6.0	12.71	.37
118	8.0	13.63	.73
119	10.0	17.75	BRS

30 VOLT RANGE

SEC. TAPS 0-12-15-20-25-30V

Ref.	Amps	£	P&P
112	0.5	1.90	.65
79	1.0	2.52	.80
3	2.0	3.77	.80
20	3.0	4.70	.85
21	4.0	5.56	.95
51	5.0	6.73	1.10
17	6.0	7.52	1.25
88	8.0	10.20	1.37
89	10.0	10.36	1.53

60 VOLT RANGE

SEC. TAPS 0-24-30-40-48-60V

Ref.	Amps	£	P&P
124	0.5	2.48	.80
126	1.0	3.68	80
127	2.0	5.33	95
125	3.0	7.90	1.10
123	4.0	9.19	1.53
40	5.0	10.24	1.37
120	6.0	12.07	1.53
121	8.0	15.75	BRS
122	10.0	19.40	BRS
189	12.0	20.25	BRS

AUTO TRANSFORMERS

Ref.	VA (Watts)	AUTO TAPS	P&P
113	20	0-115-210-240V	1.75 59
64	75	0-115-210-240V	3.05 80
4	150	0-115-210-220-240V	4.33 80
66	300	6.11 95
67	500	9.36 1.37
84	1000	14.36 1.73
93	1500	19.02 BRS
95	2000	25.41 BRS
73	3000	36.84 BRS

HIGH VOLTAGE

MAINS ISOLATING
Pri 200/220 or 400/440
Sec 100/120 or 200/240

VA	Ref.	£	P&P
110	243	4.37	97
153	247	10.93	1.41
1000	250	26.31	BRS
2000	252	44.12	BRS

SCREENED MINIATURES

Ref.	mA	Volts	£	P&P
238	200	3-0-3	1.62	46
212	1A, 1A	0-6-0-6	1.93	58
13	330, 330	9-0-9	1.56	32
235	500, 500	0-9-0-9	1.64	32
207	1A, 1A	0-8-9-0-8-9	2.02	59
208	200, 200	0-8-9-0-8-9	3.07	65
236	300, 300	0-15-0-15	1.56	32
214	1A, 1A	0-20-0-20	2.03	65
221	500, 500	20-12-0-12-20	2.38	65
206	1A, 1A	0-15-20-0-15-20	3.63	80
203	500, 500	0-15-27-0-15-27	3.15	80
204	1A 1A	0-15-27-0-15-27	4.14	80
S172	500	12-15-20-24-30	1.97	65

COMPONENT PAKS

P1 200 app. Mixed Resistors.
P2 150 app. Mixed Capacitors.
P3 15 Ass. pots. & pre-sets.
P4 10 Reed switches.
P5 3 Micro switches.
P6 5 Ferrite rods & slabs
65p per pak, p&p 20p
VAT 12 1/2%

BRIDGE RECTIFIERS

50v	2A	35p
100v	2A	40p
100v	6A	80p
200v	1A	35p
200v	2A	45p
400v	2A	50p
400v	4A	85p
600v	2A	55p
500v	10A	PM746
		£2.35
		P&P 15p VAT 12 1/2%

METERS

AVOB	£61.09
AVO72	£24.07
AVOMM5	£20.94
AVO TT169	£24.52
V4315	£12.00

(USSR) inc. steel carrying case - Avo Cases and Accessories
P&P £1.25 VAT 8%

STEREO F.M. TUNER

4 Pre-selected stations
Switched AFC
Supply 20 35v 90Ma Max
£19.95. P&P 25p VAT 12 1/2%

MAGNETIC TO CERAMIC CARTRIDGE CONVERTER

Operating Voltage 20/45v.
ONLY £2.65 P&P 18p
Vat 12 1/2%

BSR MINI-DECK

4-speed autochanger £6.00.
Garrard SP25 Mk. IV (Chassis)
£17.20
P&P 80p VAT 12 1/2%

CASED AUTO. TRANSFORMERS

240v mains lead input and USA 2-pin outlets
20VA £3.29. P&P 80p Ref. 113W
150VA £6.37. P&P 95p Ref. 4W
500VA £10.97. P&P £1.37. Ref. 67W
1000VA £18.39 BRS Ref. 84W
2000VA £28.71 BRS Ref. 95W

HIGH QUALITY MODULES

3 watt RMS Amplifier	£2.30
5 watt RMS Amplifier	£2.65
10 watt RMS Amplifier	£2.95
25 watt RMS Amplifier	£3.95
Pre-Amp for 3-5-10w (new)	£6.50
Pre-Amp for 25w	£13.87
Power Supplies for 3-5-10w	£1.20
Power Supplies for 25w	£3.00
Transformer for 3w	£1.90
Transformer for 5-10w	£2.30
Transformer for 25w	£2.60
P&P Amps / Pre-Amps / Power Supplies	18p
P&P Transformers	58p

NEW STEREO 30

Complete chassis, inc. 7+7w rms amps, pre-amp, power supply, front panel, knobs (needs mains trans.) £15.75. Mains trans. £2.45. Teak veneered cab. £3.65. P&P 88p. VAT 12 1/2%.

POWER UNITS

CC12-05. Output switched
3. 4.5v. 6v. 7.5v. 9v. 12v at 500mA
£4.08. P&P 48p. VAT 12 1/2%

ANTEX SOLDERING IRONS

15W £2.90. 18W £2.75. 25W £2.45
Soldering iron kit £3.90
Stand for above £1.13. P&P 25p VAT 8%

PLEASE ADD VAT AFTER P&P

ELECTROSIL AND SEMICONDUCTOR STOCKISTS AUDIO ACCESSORIES & BARGAIN PAKS CALLERS WELCOME (MON-FRI) OR SEND STAMP FOR LISTS

Barrie Electronics Ltd.

3, THE MINORIES, LONDON EC3N 1BJ

TELEPHONE: 01-488 3316/8

NEAREST TUBE STATIONS: ALDGATE & LIVERPOOL ST.

Bahrain Singapore Thailand Iceland Brazil Sweden Germany Iran Jamaica St. Kitts Tunisia
 Yugoslavia
 Zambia Ghana Turkey
 South West Africa
 South
 Guernsey
 United States
 Norway
 Oman
 Muscat
 Hungary
 Eire
 Cyprus
 Angola
 Portugal
 Mozambique
 Belgium
 Sumatra
 Switzerland

POWERTRAN ELECTRONICS

INCORPORATING

AMBIENTACOUSTICS

HI-FI NEWS 75W/CHANNEL AMPLIFIER

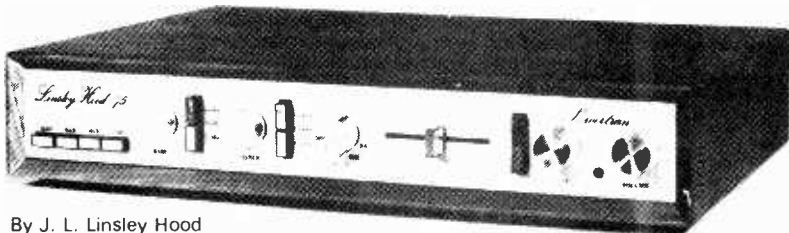

By J. L. Linsley Hood

- | | | | |
|---|--------------|--|--------------|
| Pack | Price | Pack | Price |
| 1. Fibreglass printed-circuit board for power amp | £1.15 | 11. Fibreglass printed-circuit board for power supply | £0.85 |
| 2. Set of resistors, capacitors, pre-sets for power amp | £2.15 | 12. Set of resistors, capacitors, secondary fuses, semi-conductors for power supply | £4.60 |
| 3. Set of semiconductors for power amp | £6.50 | 13. Set of miscellaneous parts including DIN sockets, mains input socket, fuse holder, inter-connecting cable, control knobs | £5.35 |
| 4. Pair of 2 drilled, flanged heat sinks | £1.10 | 14. Set of metalwork parts including silk screen printed fascia panel and all brackets, fixing parts, etc. | £7.30 |
| 5. Fibreglass printed-circuit board for pre-amp | £1.75 | 15. Handbook | £0.30 |
| 6. Set of low noise resistors, capacitors, pre-sets for pre-amp | £3.40 | 16. Teak cabinet 18.3" x 12.7" x 3.1" | £9.85 |
| 7. Set of low noise, high gain semiconductors for pre-amp | £2.40 | | |
| 8. Set of potentiometers (including mains switch) | £3.15 | | |
| 9. Set of 4 push-button switches, rotary mode switch | £4.50 | | |
| 10. Toroidal transformer complete with magnetic screens/housing primary: 0-117-234 V; secondaries: 33-0-33 V, 25-0-25 V | £10.95 | | |
- 2 each of packs 1-7 inclusive are required for complete stereo system. Total cost of individually purchased packs £83.75

In Hi-Fi News there was published by Mr. Linsley-Hood a series of four articles (November 1972-February 1973) and a subsequent follow-up article (April, 1974) on a design for an amplifier of exceptional performance which has as its principal feature an ability to supply from a direct coupled fully protected output stage, power in excess of 75 watts whilst maintaining distortion at less than 0.01% even at very low power levels. The power amplifier is complemented by a pre-amplifier based on a discrete component operational amplifier referred to as the Lincac which is employed in the two most critical points of the system namely the equalization stage and tone control stage, positions where most conventional designs run out of gain at the extremes of the frequency spectrum. Unusual features of the design are the variable transition frequencies of the tone controls and the variable slope of the scratch filter. There is a choice of four inputs, two equalized and two linear, each having independently adjustable signal level. The attractive streamline unit pictured has been made practical by highly compact PCBs and a specially designed Toroidal transformer.

FREE TEAK CASE WITH FULL KITS
£73.90
 KIT PRICE ONLY

WIRELESS WORLD FM TUNER

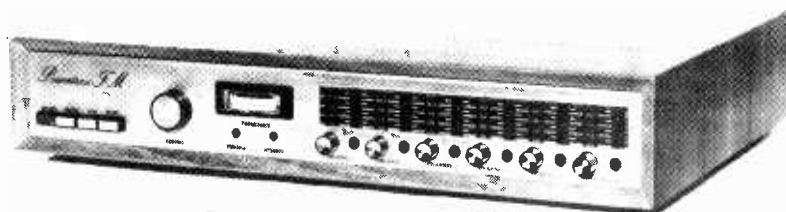

Designed in response to demand for a tuner to complement the world-wide acclaimed Linsley Hood 75W Amplifier, this kit provides the perfect match. The Wireless World published original circuit has been developed further for inclusion into this outstanding streamline unit and features a pre-aligned front end module, excellent a.m. rejection and temperature compensated varicap tuning, which may be controlled either continuously or by push button pre-selection. Frequencies are indicated by a frequency meter and sliding LED indicators, attached to each channel selector pre-set. The PLL stereo decoder incorporates active filters for "birdy" suppression and power is supplied via a toroidal transformer and integrated regulator. For long term stability metal oxide resistors are used throughout.

- | | | | |
|---|--------------|--|--------------|
| Pack | Price | Pack | Price |
| 1. Fibreglass printed board for front end IF strip, demodulator, AFC and mute circuits | £2.15 | 9. Function switch, 10 turn tuning potentiometer, knobs | £5.30 |
| 2. Set of metal oxide resistors, thermistor, capacitors, ceramic preset for mounting on pack 1 | £4.30 | 10. Frequency meter, meter drive components, fibreglass printed circuit board | £9.45 |
| 3. Set of transistors, diodes, LED, integrated circuits for mounting on pack 1 | £5.25 | 11. Toroidal transformer with electrostatic screen, Primary: 0-117V-234V | £4.45 |
| 4. Pre-aligned front end module, coil assembly, three section ceramic filter | £8.50 | 12. Set of capacitors, rectifiers, voltage regulator for power supply | £2.95 |
| 5. Fibreglass printed circuit board for stereo decoder | £1.10 | 13. Set of miscellaneous parts, including sockets, fuse holder, fuses, inter-connecting wire, etc. | £1.50 |
| 6. Set of metal oxide resistors, capacitors, ceramic preset for decoder | £2.60 | 14. Set of metal work parts including silk screen printed fascia panel, acrylic silk screen printed tuning indicator panel insert, internal screen, fixing parts, etc. | £7.50 |
| 7. Set of transistors LED, integrated circuit for decoder | £2.90 | 15. Construction notes (free with complete kit) | £0.25 |
| 8. Set of components for channel selector switch module including fibreglass printed circuit board, push-button switches, knobs, LEDs, preset adjusters, etc. | £8.80 | 16. Teak cabinet 18.3" x 12.7" x 3.1" | £9.85 |
- One each of packs 1-16 inclusive are required for complete stereo FM tuner. Total cost of individually purchased packs £76.85

NEW KIT! LINSLEY-HOOD CASSETTE DECK



Low-noise, low-cost cassette deck

A full kit has been prepared for this excellent new design. The above illustration is of Mr. Linsley-Hood's own unit but the Powertran kit is, though not identical, very similar and of course in the same cabinet (that used for the outstandingly successful 75W Linsley-Hood Amplifier design).

- | | |
|---|--------|
| Goldring-Lenco mechanism, as specified | £19.10 |
| Stereo P.C.B. (accommodates 2 rep. amps, 2 rec. amps, 2 meter amps, bias/erase osc. relay), 7.3" x 3.7" | £3.35 |
| Stereo set of capacitors, M.O. resistors, potentiometers for above | £9.80 |
| Stereo set of semiconductors for above | £8.90 |

Further details of above and additional packs given in our FREE LIST

FREE TEAK CASE WITH FULL KITS
£66.75
 KIT PRICE ONLY

PRICE STABILITY!

Order with confidence! Irrespective of any price changes we will honour all prices in this advertisement for two months from issue date provided that this advertisement is quoted with your order. E&OE VAT rate changes excluded. All components are brand new first grade full specification devices. All resistors (except where stated) are low noise carbon film types. All printed circuit boards are fibre-glass, drilled, roller tinned and supplied with circuit diagrams and construction layouts.

U.K. Orders. Subject to 12½% Surcharge for VAT. Carriage free MAIL ORDER ONLY (*or at current rate if changed)
 Securicor Delivery. For this optional service (Mainland only) add £2.50 VAT inc per kit
 Overseas Orders. No VAT. Postage charged at actual cost plus 50p packing and handling.

DEPT. WW08

POWERTRAN ELECTRONICS
 PORTWAY INDUSTRIAL ESTATE
 ANDOVER, HANTS SP10 3NN

Hong Kong Jersey Australia St. Lucia India Barbados Antigua Jordan Spain Israel Mauritius St. Vincent Uganda Ascension Island Malta Sierra Leone Somalia New Guinea Italy Kuwait Netherlands Canada Trinidad Malaysia Austria

AUDIO KIT SUPPLIERS TO THE WORLD

T20 + 20 and our new T30 + 30 20W, 30W AMPLIFIERS

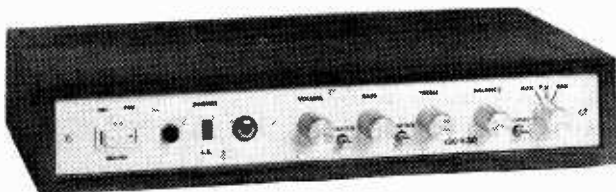

Designed by Texas engineers and described in Practical Wireless the Texan was an immediate success. Now developed further in our laboratories to include a Toroidal transformer and additional improvements, the slimline T20 + 20 delivers 20W per channel of true Hi-Fi at exceptionally low cost. The design is based on a single F/Glass PCB and features all the normal facilities found on quality amplifiers, including scratch and rumble filters, adaptable input selector and head phones socket. In a follow up article in Practical Wireless further modifications were suggested and these have been incorporated into the T30 + 30. These include RF interference filters and a tape monitor facility. Power output of this new model is 30W per channel.

Pack	T20	T30	Pack	T20	T30
1. Set of low noise resistors	1.40	1.50	8. Toroidal transformer - 240V prim. u.s. screen	4.95	6.80
2. Set of small capacitors	2.20	2.80	9. Fibreglass PCB	3.20	3.60
3. Set of power supply capacitors	1.90	2.30	10. Set of metalwork, fixing parts	4.20	4.80
4. Set of miscellaneous parts	3.20	3.20	11. Set of cables, mains lead	0.40	0.40
5. Set of slide, mains, P.B. switches	1.20	1.20	12. Handbook (free with complete kit)	0.25	0.25
6. Set of pots, selector switch	2.80	2.80	13. Teak cabinet 15.4" x 6.7" x 2.8"	4.50	4.50
7. Set of semiconductors, I.Cs, slts.	7.25	7.75			

SPECIAL PRICES

FOR COMPLETE KITS!

T20+20
KIT PRICE only **£28.25**

T30+30
KIT PRICE only **£32.95**

2 NEW TUNERS!

WW SFMT II

Following the success of our Wireless World FM Tuner kit we are now pleased to introduce our new cost reduced model, designed to complement the T20 and T30 amplifiers. The frequency meter of the more advanced model has been omitted and the mechanics simplified, however the circuitry is identical and this new kit offers most exceptional value for money. Facilities included are switchable afc, adjustable, switchable muting, channel selection by slider or readily adjustable pre-set push-button controls and LED tuning indication. Individual pack prices in our free list

KIT PRICE
£45.50

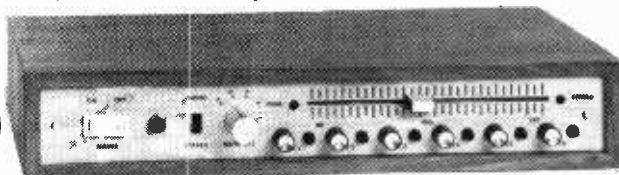

POWERTRAN SFMT

This easy to construct tuner using our own circuit design includes a pre-aligned front end module, PLL stereo decoder, adjustable, switchable muting, switchable afc and push-button channel selection. As with all our kits, all components down to the last nut and bolt are supplied together with full constructional details.

KIT PRICE
£32.60

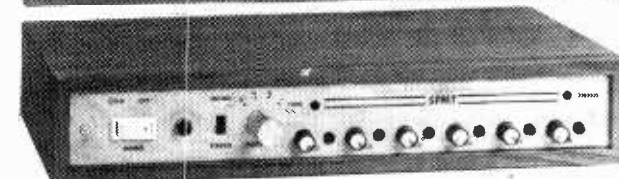

CONVERT NOW TO QUADRAPHONICS!

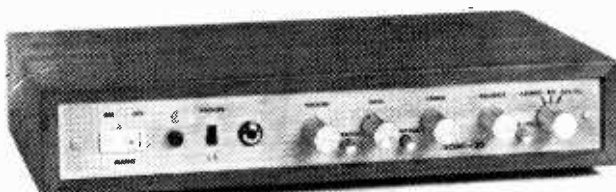

SQM1 - 30 KIT PRICE **£37.15**

With 100s of titles now available no longer is there any problem over suitable software. No problems with hardware either. Our new unit the SQM1-30 simply plugs into the tape monitor socket of your existing amplifier and drives two additional speakers at 30W per channel. A full complement of controls including volume, bass, treble and balance are provided as are comprehensive switching facilities enabling the unit to be used for either front or rear channels, by-passing the decoder for stereo-only use and exchanging left and right channels. The SQ matrix decoder is based upon a single integrated circuit and was designed by CBS whilst the power and tone control sections are identical to those used in our T30 + 30 amplifier which the SQM1-30 matches perfectly. Kit price includes CBS licence fee.

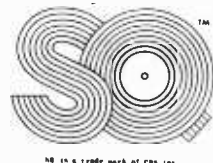

Special offer to T20 + 20 and Texan owners!
Owners of T20 + 20 and Texan amplifiers, which have no tape monitor outlet, purchasing an SQM 1-30 will be supplied on request, a free conversion kit to fit a tape monitoring facility to the existing amplifier. This makes simple the connection to the highly adaptable SQM 1-30 quadraphonic decoder/rear channel amplifier.

Wireless World Amplifier Designs. Full kits are not available for these projects but component packs and PCBs are stocked for the highly regarded Bailey and 20W class AB Linsley Hood designs, together with an efficient regulated power supply of our own design. Suitable for driving these amplifiers is the Bailey Burrows pre-amplifier and our circuit board, for the stereo version of it features 6 inputs, scratch and rumble filters and wide range tone controls which may be either rotary or slider operating. For those intending to get the best out of their speakers, we also offer an active filter system, described by D. C. Read, which splits the output of each channel from the pre-amplifier into three channels each of which is fed to the appropriate speaker by its own power amplifier. The Read/Texas 20W, or any of our other kits are suitable for these. For tape systems a set of three PCBs have been prepared for the integrated circuit based, high performance stereo Stuart design. Details of component packs are in our free list

30W Bailey Amplifier	
BAIL Pk 1 F/Glass PCB	£1.00
BAIL Pk 2 Resistors, Capacitors, Potentiometer set	£2.35
BAIL Pk 3 Semiconductor set	£4.70
20W Linsley Hood Class AB	
LHAB Pk 1 F/Glass PCB	£1.05
LHAB Pk 2 Resistor, Capacitor, Potentiometer set	£3.20
LHAB Pk 3 Semiconductor set	£3.35
Regulator Power Supply	
60VS Pk 1 F/Glass PCB	£0.85
60VS Pk 2 Resistor, Capacitor set	£2.20
60VS Pk 3 Semiconductor set	£3.10
60VS Pk 6A Toroidal transformer (for use with Bailey)	£8.80
60VS Pk 6B Toroidal transformer (for use with 20W LH)	£7.25
Bailey Burrows Stereo Pre-Amp	
BBPA Pk 1 F/Glass PCB	£2.80
BBPA Pk 2 Resistor, capacitor semiconductor set	£6.70
BBPA Pk 3R Rotary Potentiometer set	£2.85
BBPA Pk 3S Slider Potentiometer set with knobs	£3.10
Active Filter	
FILT Pk 1 F/Glass PCB	£1.40
FILT Pk 2 Resistor, Capacitor set (metal oxide 2%, polystyrene 2½%)	£4.20
FILT Pk 3 Semiconductor set	£2.25
2 off Pks 1, 2, 3 reqd for stereo active filter system	
Read/Texas 20W Amp	
READ Pk 1 F/Glass PCB	£1.00
READ Pk 2 Resistor, Capacitor set	£1.20
READ Pk 3 Semiconductor set	£2.30
6 off pks 1, 2, 3 required for stereo active filter system	£2.30
Stuart Tape Recorder	
TRRP Pk 1 Reply Amp F/Glass PCB	£1.30
TRRC Pk 1 Record Amp F/Glass PCB	£1.70
TROS Pk 1 Bas/Erase/Stallizer F/Glass PCB	£1.20
Further details of above and additional packs given in our FREE LIST	

SQ QUADRAPHONIC DECODERS

Feed 2 channels (200-1000mV as obtainable from most pre-amplifiers or amplifier tape monitor outlets) into any one of our 3 decoders and take 4 channels out with no overall signal level reduction. On the logic enhanced decoders Volume, Front-Back, LF-RF balance, LB-RB balance and Dimension controls can all be implemented by simple single gang potentiometers. These state-of-the-art circuits used under licence from CBS are offered in kits of superior quality with close tolerance capacitors, metal oxide resistors and fibre-glass PCBs designed for edge connector insertion. All kit prices include CBS licence fee.

M1. Basic matrix decoder with fixed 10-40 blend. All components, PCB	£5.90
L1. Full logic controlled decoder with "wave matching" and "front back logic" for enhanced channel separation. All components PCB	£17.20
L2A. More advanced full logic decoder with "variable blend" for increased front back separation. All components, PCB	£22.60
L3A. Decoder similar to L2A but with discreet component front end with high precision 6-pole phase shift networks for increased frequency response. All components (carbon film resistors), PCB	£25.90
Also available with M.O. resistors, cermet pre-set - add	£4.20

SEMICONDUCTORS as used in our range of quality audio equipment.

2N699	£0.20	40361	£0.40	8D529	£0.55	MJE521	£0.60	TIP29C	£0.55
2N1613	£0.20	40362	£0.45	8D530	£0.55	MPSA05	£0.25	TIP30C	£0.60
2N1711	£0.25	BC107	£0.10	BDY56	£1.60	MPSA12	£0.35	TIP41A	£0.70
2N2926G	£0.10	BC108	£0.10	BF257	£0.40	MPSA14	£0.30	TIP42A	£0.80
2N3055	£0.45	BC109	£0.10	BF259	£0.47	MPSA55	£0.25	TIP41B	£0.75
2N3442	£1.20	BC109C	£0.12	BFR39	£0.30	MPSA65	£0.35	TIP42B	£0.80
2N3711	£0.09	BC125	£0.15	BFR79	£0.30	MPSA66	£0.40	1N914	£0.07
2N3904	£0.17	BC126	£0.15	BFY51	£0.20	MPSU05	£0.50	1N916	£0.07
2N3906	£0.20	BC182	£0.10	BFY52	£0.20	MPSU55	£0.50	1S920	£0.10
2N4062	£0.11	BC212	£0.12	CA3046	£0.70	SBA750A	£1.90		
2N4302	£0.60	BC182K	£0.10	LF1186	£6.50	SL301	£1.30		
2N5087	£0.25	BC121K	£0.12	MC1310	£2.20	SL3045	£1.20		
2N5210	£0.25	BC182L	£0.10	MC1351	£1.05	SN72741P	£0.40		
2N5457	£0.45	BC184L	£0.11	MC1741CG	£0.85	SN72748P	£0.40		
2N5459	£0.45	BC212L	£0.12	MC04010	£0.95	TIL209	£0.20		
2N5461	£0.50	BC214L	£0.14	MJ481	£1.20	TIP29A	£0.40		
2N5830	£0.35	BCY72	£0.13	MJ491	£1.45	TIP30A	£0.45		

EXPORT NO PROBLEM

Our Export Department will be pleased to advise on postal costs to any country in the world. Some of the countries to which we sent kits in 1975 are shown surrounding this advertisement.

Kenya France St. Martin, Java New Zealand Borneo South Africa Denmark Nigeria Anguilla Finland

Sierra Leone
Somalia
New Guinea
Italy
Kuwait
Netherlands
Canada
Trinidad
Malaysia
Austria

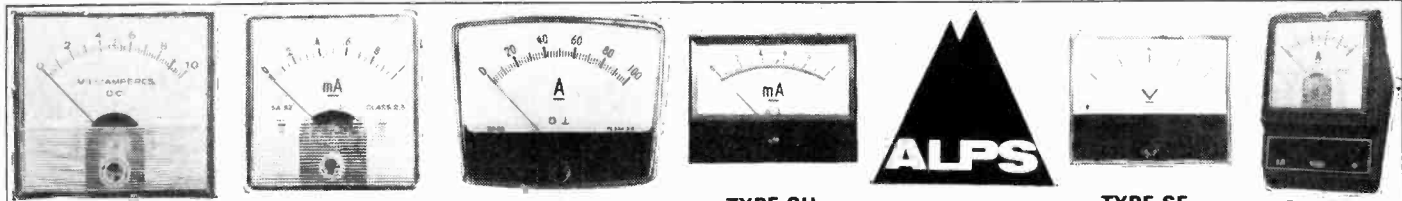

ALPS INSTRUMENT CO. PANEL METERS are available in production quantities at extremely competitive prices. The meters are of high quality and attractive appearance. **FOR YOUR NEW INSTRUMENTS SPECIFY ALPS METERS. PROTOTYPES AT SHORT NOTICE.** Our range includes 240° in instruments and TRUE VU METERS. Personalised Scales and Special movements manufactured to customers' requirements. For one off prices see the May WW

SPECIALIST STOCKISTS OF SERVOMOTORS, SYNCHROS, TEST EQUIPMENT, METERS AND CONNECTORS

Servo and Electronic Sales Ltd
 (Established 1953)
 24 HIGH ST., LYDD, KENT TN29 9AJ. Tel. Lydd 20252 (STD 0679)
 VAT No. 201-1296-23. TELEX 965265

UNIVERSAL AVOMETERS Ranges: DC Voits. 2.5, 10, 50, 100, 1000 (10kV/v) DC current: 1mA, 2.5mA, 10mA, 50mA, 100mA, 500mA, 1A, AC Voits: 10, 100, 1000 (1kV/v). Resistance: 100kΩ (mid scale 1k); 1M (m.s. 10k), 10M (m.s. 100k). Fitted as usual with AVO reverse movement button and cut-out. £29.50 (inc. P&P & VAT). (Good condition with test certificate all normal ranges).

FULL SERVICING AND SPARES SERVICE NOW IN OPERATION AT LYDD, KENT

sanwa
 electronic test instruments

QUALITY DISCOUNTS AVAILABLE TO TRADE, PROFESSIONAL AND OEM USERS! For details contact: Ann Reynolds
QUALITY ELECTRONICS LTD.
 24 High Street, Lydd, Kent TN29 9AJ
 Tel. Lydd (0679) 20252
 (opposite the Guildhall)
 Telex: 965265 (A/B Servolydd)

FOLLOW THE COURSE MANY THOUSANDS IN BRITAIN

HAVE ALREADY TAKEN AND ORDER

sanwa
 MULTITESTERS

FROM QUALITY ELECTRONICS LTD.
 Full catalogue and prices on request

TABAL
ENVIRONMENTAL TEST EQUIPMENT
 A Standard Range offering the following facilities:
 High temperatures to 500° C
 Low temperatures to -75° C
 Humidity Cycling
 Thermal Shock
 Vibration
 Pressure Cycling
 Sand and Dust exposure
 Corrosive Gas exposure
 Explosion Test

REED SWITCH INSERTS

Overall length 1.85in (Body length 1.1in). Diameter 0.14in. to switch up to 500mA or 250VDC. Gold clad contacts £4.25 per 100 (min. qty.) £29.65 per 1,000. All carriage paid U.K.
Operating Coils for 12v supply to accept up to four standard reeds £2.65 per doz. £12.50 per 100. All carriage paid U.K.
Heavy duty type. (Body length 2in.) Diameter 0.22in. to switch up to 1A at up to 250vAC. Gold clad contacts £1.75 per doz. £8.95 per 100.
£82.00 per 1,000. Changeover Heavy Duty type £3.00 per doz. All carriage paid U.K.
Magnets for HD reeds £1.60 per doz. A few coils available for HD reeds.

OSCILLATOR/DISTORTION METER For masts on amplifiers and transmitters. Consists of a **Generator** 17Hz to 170KHz (±1% ±1Hz) -82 to +22dB W.R.T. 1mW in 600 ohms (100mW max). 700µV to 10V across 600 ohms. Uncalibrated outputs of 1.50µV and up to 40V at higher distortion levels also available. Output impedances 600, 300, 25, 100, 75 ohms. A **Distortion Meter** 20Hz to 20KHz. Continuously variable rejection filter for input range 500mV to 130V at impedance of 500ohms and a **Valve Voltmeter** 100mV to 100V in 7 ranges £55 inc. carr. (England) & VAT

U - V RECORDERS. N.E.P. type 1000. 6" chart width. 12 channel + event marker. Speed 0.2, 0.6, 2.0, 6.0 in/sec with footage counter. 19" rack mtg. x 16" high. 240V 50Hz supply £50 inc. P&P. carr. (England) & VAT.

OVER 300,000 RF AND MULTIWAY CONNECTORS IN STOCK

WW - 060 FOR FURTHER DETAILS

TOYA

High quality competitively priced Knobs in production quantities only. Min. order 1000 Pcs fancy one of 266 types.

The SECOND-USER Computer Specialists
 Peripherals and Systems for Data Processing
 Systems, Equipment and Components

COMPUTER SALES AND SERVICES

Mini-Computer Exchange

- PDP8E 24K** System complete with industry-compatible magnetic tape unit, VDU and Teletype.
- PDP8I** Rack-mounted 8K Processor with Teletype control module
- PDP11/20 20K** Processor with Dual DECtape and Control, 64K Disk Drive and Control, Real Time Clock, Line Printer
- NOVA 840** Rack-mounted 24K System complete with 128K Novadisc, VDU and Real Time Clock
- PDP11** Interface Boards: UK11 Parallel Interface, DC11-AC Serial Line System Unit, DC11-DA Full Duplex Serial Module Set.
- PDP8E** Option Modules: KDBE Databreak, KP8E Power Fail/Auto Restart, M8E Bootstrap Loader
- PDP8, PDP8I** - many spares in stock
- HEWLETT PACKARD 9830A** Programmable Calculator
- DEC** Power Supplies 728A +10/-150V 50Hz

TERMINALS - LARGE STOCKS AVAILABLE
 ASR33 Teletype from £445.00
 KSR33 Teletype from £250.00
 ASR35 Teletype from £750.00
 IBM73 1/0 Golfball Typewriter from £275.00
 Lessor: DIDS 401 2 Visual Display Units 13 lines x 40 characters (8 1/2 x 4 1/2" screen) 64 character repertoire with detachable ASCII keyboard (Control device required) £195.00

Add 8% VAT to all prices shown. Carriage extra - details on request.

Peripheral Equipment

- DEC DF32** Disk Drive & Control
- DEC TU60** Dual Disk Drive & Control
- DEC RT02** Single-line Alphanumeric Display & Control (All above supplied complete with control module for PDP8E/F/M series and all connecting cables) CALCOMP 565 Digital Incremental Plotter
- ICL 2802** 8 Meg. Disk Drives (= CDC 9450) Control Units available with multiple options only. From £450.00
- MDS** 9-track Key-to-Tape Encoders IBM coded £450.00
- ELLIOTT 803** Film Handlers Bargain price to clear
- SANDERS 720** Data Display System: 6 ASCII-coded visual display units linked via control unit to communications buffer. Complete with all connecting cables, technical manuals, etc. Suitable for use with IBM 360/370 and many other mainframes.
- TELETYPE BRPE** 110 cps Synchronous Punch 5/7/8 channel. Self-contained, mains-operated unit consisting of punch-unit, base-motor and tape supply spool. Price £145.00. Sound reducing cabinet available at £25.00
- FACIT 4060** rack-mounting heavy-duty punch 5/8 channel, maximum operating speed 150 cps. Complete with supply and take-up spools, tape low/out sensor and large built-in chad box. £595.00, Control unit also available.
- TALLY P120** panel-mounted perforator. Asynchronous operation up to 120 cps. Integral tape supply and take-up spools. Price £160.00
- TALLY 420** Rack-mounting perforator. Asynchronous operation up to 60 cps. Integral supply and take-up spools. Complete with Model 5088 transistorised drive package. £495.00
- WELMEC LOW-SPEED PUNCH** Magnetically driven up to 17 cps ideal for data logging. Large chad box £45.00
- WELMEC RB2** solenoid-operated mechanical reader. Low cost low-speed reader for speeds up to 17 cps. Compact free-standing unit £45.00
- ELLIOTT** high-speed photo-electric paper tape readers. 200/250 cps. Compact, table-top unit From £145.00

New Economy 80 Column Hand Punch

Completely redesigned with many important new features - send for brochure from **£85.00**

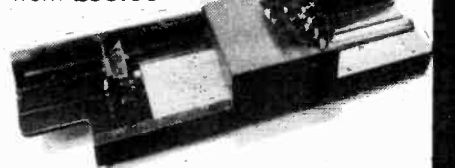

Keyboards

16-Key Japanese Keyboard, BRAND NEW SURPLUS! Magnetically operated reed relay switches mounted on PCB 9 white keys: 4 black, 2 yellow, 1 red. Dimensions 3 1/2" x 3" x 1 1/2". Price £3.50 (P&P 30p).

REED-SWITCH 4-BANK ALPHANUMERIC KEYBOARD mounted on printed circuit board with ASCII coded output, 43 character keys + 21 shift keys and 12 instructional keys. Ideal for data displays, computer programming, etc. (a) Ex-equipment, housed in metal case £30.00 + £3.00 P&P.

MINIATURE MATRIX PROGRAMME BOARDS. X,Y matrix board with 3mm grating, BRAND NEW by Ghelmetti of Switzerland. 20x30 positions (4 1/2" x 3 1/2") £15.00; 12x10 (2 3/4" x 2 1/4") £8.00; 3x10 (1 3/4" x 1 1/2") £4.00. P&P 40p. Diode pins available to special order from 40p each.

MAGNETIC TAPES

Manufacturer's surplus stocks just received. Brand new in original sealed packs 1/2" x 2,400 ft. £4 per reel, 3/4" x 2,400 ft. £4.50 per reel. P&P extra

COMPUTER SALES & SERVICES (EQUIPMENT) LIMITED
 49/53 Pancras Road, London NW1 2QB. Tel. 01-278 5571

Callers welcome Monday to Friday 9 a.m. to 5 p.m.

WW-070 FOR FURTHER DETAILS

Collect wireless world Circards. And build a valuable dossier on circuit design.

Circards is a unique and comprehensive system, launched by Wireless World, to provide professional engineers and enthusiasts with valuable and up-to-the-minute data on circuit design — data not available from any other single source.

Each Circard is 8" x 5" and usually shows a specific tested circuit, a description of the circuit operation; component values and ranges; circuit limitations and modifications; performance data and graphs.

The double-sided format enables the Circard to be filed in standard boxes for easy reference. And the plastic wallet provided keeps the cards well protected.

Circard sets (10 cards) come in wallets and cost £2.00. A subscription for 10 consecutive sets costs £18.

Start your personal dossier on circuit design by completing and returning the coupon below.

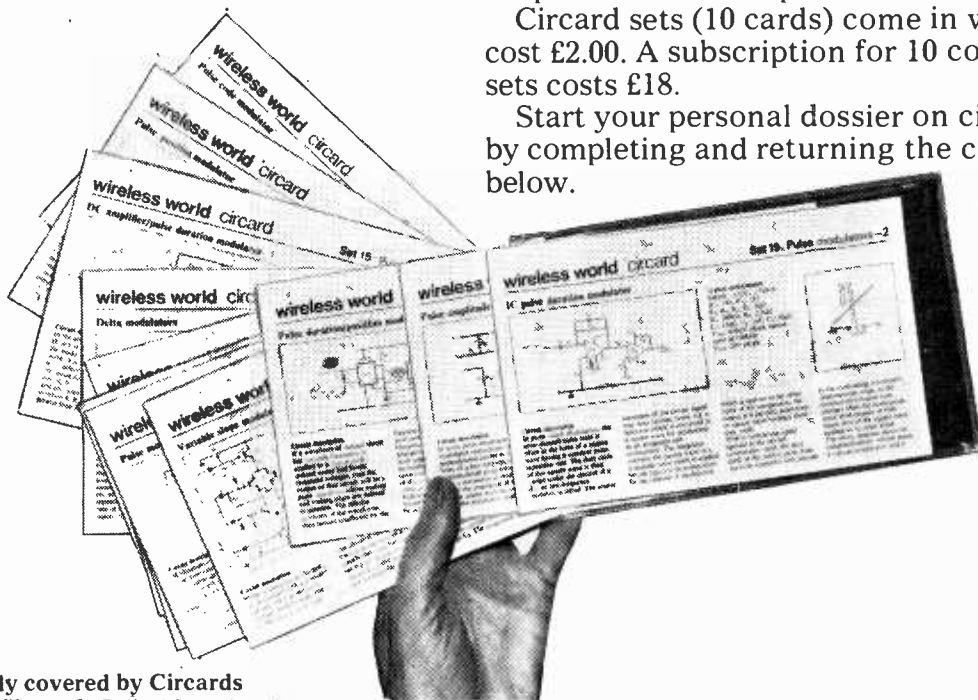

Subjects already covered by Circards

1. Basic active filters. 2. Switching circuits comparators and schmitts.
3. Waveform generators. 4. AC measurements.
5. Audio circuits: preamplifiers, mixers, filters and tone controls.
6. Constant current circuits. 7. Power amplifiers.
8. Astables. 9. Opto-electronics.
10. Micropower circuits. 11. Basic logic gates.
12. Wideband amplifiers. 13. Alarm circuits.
14. Digital counters. 15. Pulse modulators.
16. Current differencing amplifiers — signal processing.
17. Current differencing amplifiers — generation.
18. Current differencing amplifiers — measurement and detection.
19. Monostable circuits. 20. Transistor pairs.
21. Voltage to frequency converters.
22. Amplitude modulators. 23. Reference circuits.
24. Voltage regulators
25. RC oscillators — I. 26. RC oscillators — II.
27. Linear C.M.O.S.—I.
28. Linear C.M.O.S.—II.
29. Analogue multipliers
30. Non-linear functions

To: General Sales Dept., IPC Business Press Ltd., Room 11
Dorset House, Stamford Street, London SE1 9LU

Please send me set no(s) @ £2.00 each *
@ £18.00 *

I wish to subscribe, starting with no

I enclose cheque/money order for £
*Tick as required/Cheques to be made payable to IPC Business Press Ltd.

Name

Address

Company registered in England. Registered address, Dorset House
Stamford Street, SE1 9LU, England. Registered Number 677128

“Amplex and WHAT?...”

The JAMES SCOTT Alignment Units for D.R. and F.M. Multi-Channel Tape Recorders.



The F.M. Alignment Unit Type FMU/1 illustrated was designed at the Royal Radar Establishment, Malvern, to suit Amplex Recorders working on the IRIG intermediate band specification (using ES 100 Electronics) e.g. Model Numbers FR 1200, FR 1260, FR 1300, FR 1800L, FB 400, PR 500

If you have a sophisticated Amplex Recorder—Align it to the Manufacturers specification using our Alignment Units for D.R. & F.M. Systems.

Speedy and inexpensive

For Further information and Technical Literature Write or telephone.

JAMES SCOTT
(Electronic Engineering) Ltd
CARNTYNE INDUSTRIAL ESTATE
GLASGOW G32 6AB
Tel: 041 778 4206

Join the Digital Revolution

Understand the latest developments in calculators, computers, watches, telephones, television, automotive instrumentation . . .

Each of the 6 volumes of this self-instruction course measures 11¼" x 8¼" and contains 60 pages packed with information, diagrams and questions designed to lead you step-by-step through number systems and Boolean algebra, to memories, counters and simple arithmetic circuits, and on to a complete understanding of the design and operation of calculators and computers.

Design of Digital Systems.



£6.20

plus 80p packing and surface post anywhere in the world.

Payments may be made in foreign currencies.

Quantity discounts available on request.

VAT zero rated

Also available — a more elementary course assuming no prior knowledge except simple arithmetic.

Digital Computer Logic and Electronics

In 4 volumes.

1. Basic Computer Logic
2. Logical Circuit Elements
3. Designing Circuits to Carry Out Logical Functions
4. Flipflops and Registers

£4.20

plus 80p P. & P.

Offer Order both courses for the bargain price £9.70, plus 80p P. & P.

**Designer
Manager
Enthusiast
Scientist
Engineer
Student**

These courses were written so that you could teach yourself the theory and application of digital logic. Learning by self instruction has the advantages of being quicker and more thorough than classroom learning. You work at your own speed and must respond by answering questions on each new piece of information before proceeding to the next.

Guarantee—no risk to you

If you are not entirely satisfied with Design of Digital Systems or Digital Computer Logic and Electronics, you may return them to us and your money will be refunded in full, no questions asked.

To: Cambridge Learning Enterprises, Dept COM
FREEPOST, St Ives, Huntingdon, Cambs PE17 4BR

*Please send me . . . set(s) of Design of Digital Systems at £7.00 each, p & p included

*or . . . set(s) of Digital Computer Logic and Electronics at £5.00 each, p & p included

*or . . . combined set(s) at £10.50 each, p & p included

Name

Address

delete as applicable

No need to use a stamp — just print FREEPOST on the envelope.

WW8

TELETYPE 35RO ASC11 CODE

HEAVY DUTY CONTINUOUS OPERATION with 240Volt Power Supply and Paper Feed. Circuits, Diagrams, Information supplied with all purchases. A MUST AT £50 each

A Re-BUILDABLE KEYBOARD. In addition to the conventional keyboard layout there are 21 separate push-button function switches. Circuits of the internal logic and core system are provided. £10 each.
As above but requiring push buttons etc. to be replaced. All parts provided for you to fit. £6 each.

MARCONI TF1094 SPECTRUM ANALYSER

Late Model, 3MHZ to 30 MHZ. Resolution down to 6 HZ. Nice condition with copy of manual. Cost new in excess of £2,000. **Our Price £75.** Carr. £2.50. **SPECIAL OFFER TO FIRST TEN PURCHASERS** a FREE L.F. Adaptor extending the range down to 100HZ. Further purchases of the L.F. Adaptor enables us to continue our free offer.

SOLARTRON OSCILLOSCOPE

type CT316. DC-6MHZ. Size 8½" x 11" x 20". With Circuit Diagram.

THE LATE MODEL MARCONI OSCILLATOR TF855A/1

in superb condition covering 25HZ to 12MHZ sine wave in 3 ranges and 50HZ to 150KHZ square wave. High output 31.6V. Meter scaled in volts and dbs.

SOLARTRON AC MILLIVOLT METER VF252

1.5MV to 150V full scale in 10 ranges. 6" meter ±1%. Good Condition.

AVO RF SIGNAL GENERATOR

AM Modulation. Freq. range 2 to 250MHZ. 240V operation. Suitcase style. Size approx. 15" wide x 10" high x 6" deep.

ALL ITEMS **£22.50** ea.
SPECIAL OFFER — pick 3 different items of the 5 for
£60.
Carriage £2.50 each or £5 for 3.

AVO VALVE TESTED CT160

"The Suitcase". Size approx. 15" wide x 10" high x 11" deep.

R.F. WATTMETER TS118A

FREQ. RANGE 20MHZ TO 1400MHZ. POWER 2 WATTS TO 300 WATTS 4 RANGES IMPEDANCE 50 OHMS. Designed also to be used as a Dummy Load. Small portable instrument. In Superb Condition supplied in transit case with MANUAL AND SPARES.

£75 each

Ex-Min SCOPES CT436 DB 6 meg £95 ea. SOLARTRON CD1212 SB 40meg £85. OB 24 Meg twice £120.

Many other types available

ONLY £10 EACH STABILISED POWER SUPPLY. 240V 50HZ input. Outputs — 15V @ 10A, +15V @ 4A, -4.5V @ 12A, -21.5V @ 1.5A. Size 16 x 20 x 9". Auto overload trips on each voltage rail with push-button resets. Many OTHER POWER SUPPLIES — call and see

TELEPHONES. Post Office style 746. Black or two-tone grey £8.50 ea. Modern style 706. Black or two-tone grey £4.80 ea. P&P 75p ea.

TELEPHONE EXCHANGES. eg. 15-way automatic (exchange only) from £95.

MUFFIN FANS. 115V Size 5 x 5 x 1½". Superbly quiet and reliable. Ex-eq. but tested. £1.50 ea. P&P 75p.

Also 230V @ £2.50 ea. P&P 75p.

PHOTOMULTIPLIER type 931A £4 ea. P&P 75p. Other types available, also suitable Power Supplies.

POTENTIOMETERS — All 5p ea. P&P extra. Metal bodied AB Linear. PCB Mount. Brand New. 10K, 100K ganged, 250K ganged, 100K ganged concentric shafts.

BEEHIVE TRIMMERS 3.30p. Brand New. 10 off 40p P&P 15p. 100 off £3.50 P&P 75p. 500 off £15.

P&P £1.25. 1,000 off £25. P&P £1.50.

LARGE RANGE ELECTROSTATIC VOLTMETERS. From 0-300V 2" £3 to 20KV Max. General grade 5KV 3½" £5. Thereafter £1 per KV. P&P 75p.

VARIACS 240V input 0-270V output £18 ea.; 20A £30 ea. Carr. £2.50

4-43MHZ CB Crystal 25p ea. P&P 15p. 50KHZ Crystal 87/Octal base £2.50 ea. P&P 50p

E.H.T. TRANSFORMERS 20KV 2KVA £85 ea. 26KV AC 10MA 240V 50HZ Single phase input £50 ea. Many other EHT transformers and EHT Capacitors available

TRANSFORMERS — All 240V 50HZ inputs. Type A. 17-0-17V 250MA; 7.5-0-7.5V 250MA; 0-20V 5A; 0-4V 5A; 0-1-1.5V 5A. £2 ea. P&P £1.25. Type B. 17-0-17V 250MA; 8-0-8V 250MA; 0-12.5-13.5V 5A; 0-1.5-2V £1.50 ea. P&P £1. Type C. 19-0-19V 250MA; 8-0-8V 250MA; 0-7.5V 5A; 0-1.4V 5A. £1.25 ea. P&P £1.25. Type D. 34V 4A; 13V 4A; 17V 4A £3 ea. P&P £1.25. Type E. 3V 1A 25p ea. P&P 50p. Type F. 17V 1A 85p ea. P&P 50p. Type G. 20-0-20V 200MA; 0-6V 100MA 75p ea. P&P 75p.

ALL BRAND NEW (APT surplus types A, B, C & D; Honeywell surplus type E; Recordacall surplus type F; Parmeko Atlantic series type G)

TUBES. All Brand New Boxed. Electrostatic deflection. Type 408A 1½ dia 7½ long Blue Trace £2.50 ea. P&P 75p. Type CV 1526 (3EG1) 3" dia. £4 ea. P&P 1.1. Type DG 7/38 3" dia. (Replacement for Telegon 5311)

£15 ea. P&P £1.50. Magnetic Deflection. 12DP7 12" round Blue with yellow after glow. £1 ea. AND FOR THE

VDU BUILDER. M38-111GH Rectangular 30x20cm. Green trace. Superb value. £12, or Economy type CME 1220 24 x 18cm. White Trace. £9 ea.

DONT FORGET YOUR MANUALS. SAE with requirements.

*10,000 TRANSISTORS Type 25C733 by Toshiba (BC108) £250 the Lot (2½p each)

20HZ TO 200KHZ SINE AND SQUARE WAVE GENERATOR

In four ranges. Wien bridge oscillator thermistor stabilised. Separate independent sine and square wave amplitude controls. 3V max sine, 6V max square outputs. Completely assembled P.C. Board, ready to use. 9 to 12V supply required. £8.85 each P&P 35p. Sine Wave only £6.85 each. P&P 35p.

WIDE RANGE WOBBULATOR

5MHZ to 150MHZ (useful harmonics up to 1.5GHZ) up to 15MHZ sweep width. Only 3 controls present RF level sweep width and frequency. Ideal for 10.7 or TV IF alignment filters, receivers. Can be used with any general purpose scope. Full instruction supplied. Connect 6.3V AC and use within minutes of receiving. All this for only £6.75. P&P 35p (Not cased, not calibrated).

RHODE & SCHWARZ
POLYSCOPE SWOB 1.500KHZ to 400MHZ. Very fine condition £850.
GENERATOR BN41022 300-1000MHZ £220.
DIAGRAPH AND GENERATOR 3MHZ to 300MHZ. Very nice condition £750 pair.
ADMITTANCE METER BN3511. As new £75 ea.
RECEIVER ES180 BN15073/2 30 to 180MHZ £285.
LARGE Benson-Layner X-Y PLOTTER. Approx 4 x 3 ft. table £400.
MARCONI Wide Range Oscillator TF1370. Freq. range 10HZ to 10MHZ Sine Wave: 10HZ to 100KHZ Square Wave: High outputs up to 31.6V. Fantastic Value at £95 ea.
MARCONI Generator TF801D. Very fine condition £190.
MARCONI Generator TF867. 15KHZ to 30MHZ £65 ea.

ROYAL INVERTORS manufactured USA. 28V DC Input. Output 115V AC 400HZ up to 2KVA. Brand New. Catod. £22.50 each.

POLARAD Receiver Model FIM-B2 Complete 1-10GHZ £750.
12-CHANNEL CHART RECORDER FSD 5V 20MA per channel £29.
MARCONI ADAPTOR TM6113 for TF2700; TF1313; TF868B £35.
AIRMEC 4 trace scope type 279. Large screen £130.
TELEONIC SWEEPER 2000-1 with LA-1M 20HZ-20KHZ £130.
MARCONI OSCILLATOR TF1101 20HZ-20KHZ. Nice condition. Special price £65.
SOLARTRON VF252 AC Millivoltmeter 1.5mv-150V full scale in 10 ranges 6" meter ±1%. These have been refurbished by Solartron/Schlumberger and are as new £45.
WAYNE KERR Autobalance Adaptor type AA221 £60 ea.
FLANN SIGNAL GENERATOR type 501. 800MHZ to 3GHZ. Superb condition £150.

Just In — E & H EQUIPMENT

1 off Ward Generator Model 1623
1 off Cabinet complete with 3 Dual Ramp Units Model 1033
4 off Timing Units Model 1221

COME AND LOOK ON OUR SHELVES — HUNDREDS OF OTHER ITEMS TO INTEREST YOU. TOO FAR AWAY? THEN SEND FOR LISTS

Our Prices too high — then make us an offer we can consider

Minimum Mail Order £2. Excess postage refunded Unless stated — please add £2.50 carriage to all units
VALUE ADDED TAX not included in prices — Goods marked with ★ 12½% VAT, otherwise 8%
Official Orders Welcomed. Gov./Educational Depts., Authorities, etc., otherwise Cash with Order
Open 9 a.m. to 5.30 p.m., Mon. to Sat.



CHILTMHEAD LTD



7/9 ARTHUR ROAD, READING, BERKS. (rear Tech. College, King's Road). Tel. Reading 582605

DISPLAYS

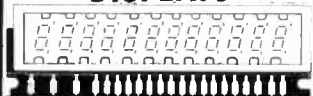

Segmented Multiple Cold Cathode Gas-filled Indicator Tube Type 2M1500/12 made by Mullard - unused. 12 Decades. Character height 7.6mm. Striking voltage 160. Ideal for Display Applications requiring a large No. of digits to be displayed, e.g. Desk Top Calculator. Overall width 86.2mm. Overall height 26mm. **£3.75 + P&P 30p + VAT 8%**

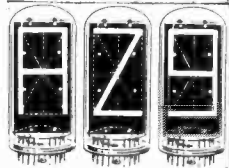

Numeric Tube B.5853 0-9 Digit 1.4 height. Brand New. **£1.00.** Also Alpha Numeric Nixie Tube B.7971. Displays alphabet & 0-9 numerals. **99p**

SELF SCAN
Panel Display Model SSD 1000-0030 Direct Visual Presentation of Alpha-Numeric Data. Each panel is a self-contained package, providing 16 to 18 display positions, each of which may be instructed by a 6-bit coded signal to display one of 64 pre-programmed characters as a 5 x 7 dot-matrix, formed by special gas-discharge units. Each character is 0.4 inches high providing a bright image, visible over a wide viewing angle. Full applications data is available giving all necessary information. Price **£60**

SIGNAL SOURCES

ADVANCE
V.H.F. Square Wave Generator SG21 10 KHz-100MHz Max. o/p 2V. **£35**

GENERAL RADIO
Unit Oscillator 1209C Freq. 250-920MHz Accuracy 1% Drift. 0.2% O/pin to 500ohms - 150mW supplied with Power Supply Type 1201-CQ18 as illustrated. **£215**
Unit Oscillator 1218A 900-2000MHz. Power output of 200mW across band. **£140**

HEWLETT PACKARD
F.M./A.M. Signal Generator 202H F.M. A.M. CW & pulse coverage 54 to 216 MHz R.F. o/p 0.1µV-0.2V 50ohms impedance. **£450**
V.H.F. Signal Generator 608E 10-480MHz (5 band). Accuracy ±0.5% o/p 0.1µV-1V (variable) 50ohms. Int. A.M. 400 & 1000Hz. Ext. A.M. 20Hz-20KHz. Superb condition. **£895**
S.H.F. Signal Generator 618C 2.8-7.6GHz ±1% 50ohms. **£550**
U.H.F. Signal Generator 616A 1.8-4.2GHz. **£475**

MARCONI INSTRS.
F.M./A.M. Signal Generator TF 995A/3S Ministry Type No. CT402 1.5MHz-220MHz R.F. o/p 2µV-200mV. Internal & External Mod. Facilities. V. good condition. **£385**

F.M./A.M. Signal Generator TF 995A/51 1.5-220MHz in 5 bands. 0.1µV-200mV. F.M. up to ±20KHz from 50Hz-15KHz. A.M. up to 50% from 100Hz-10KHz. 0.1µV-200mV (2) with terminating unit 1µV-100mV. Int. mod. freqs. 400Hz, 1KHz & 1.5KHz. Distortion (1) on internal F.M. ±25Hz. (2) on internal A.M. 5% at 30% mod. **£300 to £450**
A.M. Signal Generator TF801D/1 Freq. range 10-470MHz. R.F. output 0.1µV-1V. Piston attenuator: 50ohms Impedance Modulation Int. A.M. 1KHz. Ext. A.M. 30Hz-20KHz. Low spurious F.M. & drift. V.S.W.R. 1.2 or less. **£400-£800**
A.M. Signal Generator TF801D/1S Military Version 10-485MHz. **£450-£800**
R.C. Oscillator TF1370A 10Hz-10MHz. Square Wave up to 100KHz High Outputs up to 31.6V. **£285**
Phase/A.M. Signal Generator TF 2003 0.4-12MHz. **£150**

A.M. Signal Generator TF 801B/3S 12.485MHz. 0.1µV-1V. **£195**
R.C. Oscillator TF1101 Frequency range 20Hz-200KHz. Output Direct into 600Ω-20V variable Attenuator 0-6dB in 10dB steps. Impedance 600Ω. Distortion Via 1KHz Filter less than 0.1%. Direct or via Attenuator. Less than 0.5%. 50Hz-20KHz. Less than 1%. 20Hz-200KHz. Superb condition. **£175**
U.H.F. & S.H.F. Signal Generator TF1058 1600-4000MHz 0.1µV-445mV. 50ohms Impedance. **£295**

F.M./A.M. Signal Generator TF937/1 CT320 35KHz-18.3MHz. As seen condition. **£80**
Portable Receiver Tester TF888/3 Freq. 70KHz-70MHz Xtal check 500KHz & 5MHz. Output V.H.F. TF1064B/5M. **£300**
Signal Generator TF144H/4 Late models in superb condition. **£500 to £650**
AM/FM Generator TF995B/5 (Brand new - unused). **£750**

MARCONI
U.H.F. F.M. Signal Generator TF 2012 400-520MHz. Low Noise & freq. drift. For narrow band f.m. receiver measurements. Price new ca. **£1,300** - OUR PRICE **£840**

MURHEAD
L.F. Decade Oscillator D880A 2 phase. 0.01Hz-11.2KHz. **£295**
Decade Oscillator D890A 1Hz-11.2KHz. **£335**

RHODE & SCHWARTZ
S.H.F. Generator SMG5-BN 41042 1700-5000MHz. **P.O.A.**

HEWLETT PACKARD
Audio Signal Generator 206A 20Hz-20KHz ±2% accuracy. Distortion < 1%. **£90**

Electronic Brokers Ltd. are one of the leading electronic instrumentation companies in the UK, providing a full range of services to Universities, Industry, Colleges and Governments both at home and overseas.

We have the largest stocks of secondhand test equipment in Europe as well as a selected range of new products. These are on display at our London showrooms where customers can examine the equipment of their choice and see it working.

Electronic Brokers Ltd. have fully equipped workshops on the premises to test and report on the majority of equipment we sell.



Electronic Brokers Ltd

RADIOMETER

Stereo signal generator SMG1C. Full spec. on request. Superb condition. **£350**
AM/FM Generator Type MS27G. **£315**
WAYNE KERR
Video Oscillator 0.222 7KHz-8MHz in 6 ranges. **£75**
Video Oscillator 0.222 10 KHz-10MHz. **£ 50**
WANDEL & GOLTERMAN
U.H.F. Power Oscillator LMS-68 c/w Plug in Oscillators.
Type LO-4 4. 41MHz
Type LO 40 40.108MHz
Type LO-170 170.330MHz
Type LO-610 610-960MHz. **P.O.A.**

OSCILLOSCOPES

COSSOR
Type 3100 DC to 35 MHz. **£410**
C/D U. 150. **P.C.A.**

HAMEG

Transistorised compact single beam portable scope bandwidth of 8MHz. Compensated Y - attenuator 12 ranges 50mV/cm to 30V/cm. Timebase sweep range of 10Hz to 500kHz and can be triggered from +ve or -ve externally or internally. Y input can be AC or DC coupled. Display area 6cm x 4cm. Rise time 44ns. Dimensions 203mm x 160mm x 240mm. Wt. 5Kg. BRAND NEW. Type No. HM207. **£85**

MARCONI T.V. Scope TF 2700A/1 c/w TV Diff plug in TM 6457A DC-30MHz. **£190**
Portable Scope TF2203 15MHz Bandwidth DC coupled. 50mV/cm sensitivity. **£125**

SOLARTRON
Portable Scope DC 6MHz Double Beam CT436. **£95**
CD 1014.3 DC-5MHz. **£90**
Portable Scope CD 1400 DC-15MHz Plug ins available CX1441, 1443, 1444, 1448, 1571. **£180**
Wide Band General Purpose Scope CD 1212 (Min spec. CT484) Plug ins CX1251 & CX1252 (collection only). **£143.50**
Portable transistorised CD 1642. Dual trace. DC - 15MHz 10mV/cm Sensitivity triggering to 25MHz. Screen 10 x 6cm. **£195**

HEATHKIT
10-12 µ Scope Single Beam 50MV/cm AC coupled.

8/W 4 5MHz 5" Tube. Assembled Refurbished 90 Day Warranty. Our price. **£49.50**

TEKTRONIX
Sampling Scope 661 c/w plug ins. **£450**
453 DC 50MHz Solid state & portable. **£650**
545 c/w C.A. Plug in. **£275**
TV Waveform Monitor 525. Freq. response: Flat - within 1% between 60Hz & 5MHz. Low Pass - Passes stair steps, eliminates H.F. High Pass - Passes H.F. eliminates stair steps. IRE - meets IRE standards for level measurements. Sensitivity - Deflection factor of the vertical amplifier is 0.015V/cm. Vert. Atten. 1x, 2x, 5x. Keyed Clamp-type DC. Restorer Gain stability within 1%. **£175**
DC to 15MHz Scope 515A. Bandwidth DC-15MHz. Rise time > 24ns. 50mV/cm-20V/cm. Timebase 0.2µs/cm-2.5/cm. **£160**
Differential Unit 10A1 Used on 647 Series. **£300**
585 c/w. Type 82 Plug-in. Dual Trace 60MHz B/width. Sweep Delay. **£675**. Other plug-ins available 80 and 36.
475 Oscilloscope. 200MHz D/trace Transistorised. 2mV/DIV. 8 x 10cm Display SUPERB CONDITION. **£1,800**

HEWLETT PACKARD
1707A. Portable 75MHz Scope. Dual Channel 10mV/DIV. Sweep Delay timebase. **£670**

TEKTRONIX-SONY
323 Single Channel, solid state, portable battery or mains 1mV/DIV to 20V/DIV 4MHz weighing ca. 7lbs. **P.O.A.**

MULTIMETERS

AVO
Avometer Test Set No. 1 (Panclimatic Version of Model 9). **£44**
Avometer Model 8X (same spec. as Model 8). **£40**
Avometer Model 7. All above refurbished, calibrated and guaranteed test leads. NEW. For above Models. **£4**
Ever-Ready cases. **£6.50**
Multimeter Mk. 4 c/w carrying case & leads. **£17.50**
250V Megger. **£1.80**

RUSSIA
AC Clamp Volt-ammeter. U.91 Brand New. **£13.75**
Spec. Current 10-25-100-250-500 Amps. Voltage 300. 600V Accuracy 4%. Used for measurements of AC Voltages and currents without breaking the circuits. Ranges are selected by means of a Rotary Selector Switch.
Megohmmeter. Type M4100/3 Brand New. **£37**
Nominal o/p Voltage (open cct.) 500V High measurements Range (at 500V) 500MΩ (Mid Scale 5MΩ) Low measurements Range 1000KΩ. Portable (7lbs) and Hand operated c/w carrying case. SEE ALSO INSIDE BACK PAGE.

POWER SUPPLIES

SCOOP PURCHASE - E's to be saved!!!
We have taken into stock a very large quantity of varying types and makes, ex-computers. These devices are fixed and/or presettable with 115V I/P or 230V I/P. Let us have your requirements in the form of voltage and current O/P's quoting also your I/P voltage preference, and we will quote you.
Just Received -
ICL Power Supplies (ex-computer) 6V/25A (variable from 4.5V to 8V) 28V/20A (variable from 25-30V)

BRIDGES

SULLIVAN
Contact Resistance Bridge AC 6000. Range 0.99 ohms ±2% Freq. 1KHz. **£90**
WAYNE KERR
Radio Freq. Bridge B601. **£95**
Universal Bridge B221 c/w Low Impedance Adapter Q221A. **£115**
V.H.F. Admittance Bridge B701. **£85**
Component Bridge B521. **£100**

POWER METERS

BIRD
Terminal Loads Type 884 1000W. Z=50 ohms. As used by USAF Uncalibrated. **£150**

ELECTRONIC

the test

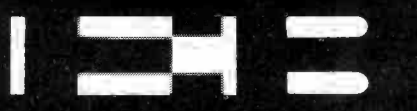

ELECTRONIC

49-53 Pancras Road
London NW1 2QB
Tel: 01-837 7781

ADD 8% VAT TO ALL PRICES

BROKERS LTD
equipment people

On these pages you will find just the briefest selection from the vast range which we hold in stock at any one time.

If you are seeking a specific item and it is not listed, it will pay you to ring us first — we believe we offer the best prices and the best service.

WORLD WIDE EXPORT

Enquiries and tenders welcome from any part of the world.
HOW TO REACH US . . .

We are easy to reach, no matter where you live. Minutes away from Kings Cross or St. Pancras main-line stations, and a bus ride from Euston; only just over half an hour from Heathrow Airport. Parking is easy too.

49-53
 Pancras Rd
 London
 NW1 2QB
 Telephone:
 01-8377781



MISCELLANEOUS

- ADVANCE**
Recorder Calibrator HC20 £15
- AVO**
AC/DC Breakdown & Ionisation Tester RM215L1 P.O.A.
- AIRMEC/RACAL**
Wave Analyser 248A 5-300MHz £195-£300
Wave Analyser 853 30KHz-30MHz Sensitivity 1µV to 1V up to 20 MHz, 4µV to 4V up to 30MHz £95
Wave Analyser 248. Freq. Range 5MHz-300MHz £110
- AIRMEC**
Modulation Meter 210 £75 to £100
- AMPEX**
F.M./Direct Recorder/Reproducer SP.300 4 Channels. Speed 1½, 3¼, 7½, 15 ips. Freq. response. Instrumentation. 50Hz-40Hz at 15 ips. Audio. 50Hz-18KHz at 15 ips. **SPECIAL OFFER £850**
- BECKMAN**
Transfer Oscillator 75B0H DC-15GHz with counter. 7.5MHz-15GHz without counter. Sensitivity 100mV (R.M.S.) **SPECIAL OFFER £250**
- BELL**
Gaussmeter Type 120, complete with Probes P.O.A.
- B & K**
Deviation Bndge 1505, 1504, 1503 P.O.A.
- B.P.L.**
Component Comparator C2457/5 P.O.A.
- COHU**
DC Voltage Standard Mod. 321 6 Decade. Volt. Ranges 10V, 100V, 1000V P.O.A.
- DECCA**
Power Supply for Noise Source. MW.61 P.O.A.
- EDDYSTONE**
Receiver Type 7705 Freq. 500-10000MHz P.O.A.
- GENERAL RADIO**
Inmittance Bridge 1607A Immaculate Condition in Wooden Transit Case £1000
Unit Null Detector 1212A. 20Hz-5MHz. Log Response with 120dB scale P.O.A.
- HEWLETT PACKARD**
Distortion Analyser 331A £210
Digital Recorder 560A £110
Digital Recorder 561B £140
- HEWLETT PACKARD**
Directional detector 787D 1.9-4.1GHz £90
Directional detector 788C 3.7-8.3GHz £95
- MARCONI INSTRS.**
Attenuator TF.1073A/2S £85

- MARCONI**
R.F. Power Meter TF1152/1 £75
R.F. Power Meter TF1152A/1 £80
50 ohms DC 500MHz, 10 watt & 25 watt F.S.D.
A.F. Power Meter TF 893A 20-4z-35 KHz 20w-10W £175

TELEPHONE TEST EQUIPMENT

- SIEMENS**
Level Meter 3D 332 0.3-1200KHz £250
Level Meter 3D.335 10KHz-17MHz £300
Level Oscillator 3W29 0.3-1200KHz £250
Level Oscillator 3W518 £300
- WANDEL & GOLTERMAN**
Level Transmitter TFPS 42 10KHz-14MHz £375
Level Meter TFPM 43 10KHz-14MHz £375
Wandel & Golterman VZM 2. Distortion measuring set for phase and amplitude mod. For multichannel FM Radio Systems up to 12MHz base bands £350

SWEEP GENERATORS

- HEWLETT PACKARD**
Sweep Oscillator 592D 2.4GHz: Sweeps from "start" to "stop" freq. **SPECIAL OFFER £300**
Sweep Oscillator 693B 4.8GHz £325
Sweep Oscillator 693D 4.8GHz: **SPECIAL OFFER £325**
- JERROLD**
Sweep Signal Generator 900B Central Freqs. 500KHz-1200MHz Sweep widths narrow as 10KHz to 400MHz wide. 50ohms o/p impedance £400
- M.E.S.L.**
Sweep Signal Source MH883 1-12.5GHz £480

- Out of Limits Indicator TF 2404/3M1 Checks readings from electronic counters and other digital tests. Local and remote visual and electrical indication suitable for use by unskilled personnel and with A.T.E. P.O.A. £90
- Blank & Sync. Mixer TF.2908 P.O.A. £90
- Quantization Distortion Tester TF 2343 P.O.A. £90
- Probe kit TMB £20/1 X1 for use with valve voltmeter TF2600. Brand new £20
- '0' Meter TF.329G £200
- PYE**
Thermocouple test set 7556 £95
- RHODE & SCHWARTZ**
Polyscop Swob 6 £1250
Attenuator type SPR Z-60 ohms EN 1E04Z P.O.A. £20
- Frequency Indicator FKM-BN 47051 P.O.A.
- SIGN ELECTRONICS**
D.F.M. Type DN.344A £T15
- TELONIC**
Band Pass Filter TBA 140-60-5CC. 5 Section TNC to INC connector. ¼" tubular 60MHz bandwidth 140MHz centre freq. Brand new £20
- Sweep Generator SM 2000 c/w Plug Ins E 3M, S 6 & S4M P.O.A.
- TEKTRONIX**
Sq Wave Gen. 105. Rise time — 13m secs. Freq. range — 25Hz-1MHz continuous variable. Freq. Meter — Direct reading. O/P Amplitude 0-100V max £30
- TEKTRONIX**
Constant Amplitude Generator 190A. 350KHz-500MHz. O/P 40mV 10V pk-pk £30
- WAYNE KERR**
Current Ratio Transformer T102C P.O.A.

VOLTMETERS

- ADVANCE**
Differential Voltmeter M500 ±w AC/DC Converter M501 P.O.A. £80
- AC Millivoltmeter 77B**
- HEWLETT PACKARD**
DC Vacuum Tube Voltmeter 412A 1mV-1000V 1% Accuracy. Can also be used as Ohmmeter & Ammeter £90
- VITVM. 4000 1mV to 300V FSD. 12 ranges 10Hz to 4MHz. 2% accuracy. Input Impedance 10Mohms £35
- VITVM. 400L Logarithmic version of 400D Feeds RMS value of sine wave. Log. voltage scale 0.3 to 1 & 0.8 to 3. Linear dB scale. Input Impedance 10Mohms £90
- Vacuum Tube Voltmeter 4108. Freq. Range 20Hz-700MHz. AC1-600V (6 ranges). DC 1V-12V ohmmeter 0.2 ohms to 500Mohms (7 ranges). Accuracy ± 3% £35
- Vacuum Tube Voltmeter 400H. Freq. Range 10Hz-4MHz. Vc's 1.0mV-300V F.S. (13 ranges). Accuracy ± 1% (50Hz-500KHz) ± 2% (20Hz-1MHz) P.O.A.
- AV Voltmeter 4CDE Solid state AC volts. mV-300V FS (12 ranges). Freq. 10Hz-0MMHz. Accuracy: 1% P.O.A.
- R.M.S. Voltmeter 3400A P.O.A. £285
- AC Voltmeter 40DF P.O.A. £285
- MARCONI**
Sensitive Valve Voltmeter TF.1100 100µV-300V AC Freq. coverage 10Hz-10MHz. Meter has dB scale facility £85
- Valve Voltmeter TF.1041B. General Spec. C-300V AC 0-1KV DC Resistance up to 50.2Mohms £60/£85
- Voltmeter No. 3 CT.208 TF.95B AC 100mV-15CV.

- multiplier extends AC range to 1.5KV. DC 50mV-100V. Freq. Range 20Hz-100MHz £55
- Valve Voltmeter TF2600. AC 25mV-300V (7 ranges). DC 10mV-1000V (8 ranges). Ohms 0.2 to 59M (7 ranges). 20Hz to 15000MHz. Brand new condition £175
- PHILIPS**
L.F. Millivoltmeter GM.6012. 12 ranges-1mV-300V. dB scale on meter. Accuracy 2Hz 5% 5Hz-100KHz 2.5% 100KHz-1MHz 0.5% Amplification available 50-70 £65
- H.F. Millivoltmeter GM 6014. Measuring Ranges 1mV-300mV in 6 ranges. Accuracy at 30KHz. 3% of FSD = Amplitude Char. 1KHz-30KHz flat within ± 5% £55
- DC Microvoltmeter GM602C. 10µV-1KV Current 10pA-10µA. Accuracy 5% (FSD) 0-100µV. 3% (FSD) AU other ranges. Recorder o/p facility £65

NEW PRODUCTS DIVISION

E.B. import and distribute high-grade products from World-renowned manufacturers including:

STROBOSCOPIC TACHOMETER
 Two units in one

STROBOSCOPIC FLASH RATE — 200 to 6,000 flashes per minute
 TACHOMETER
 SPEED RATE — As above. ACCURACY — 3% better
 FLASH DURATION — Approx. 10 to 25 µ sec. HIGH IMPACT CASE
 WEIGHT — 27 oz. 22 Volts.
£49.50

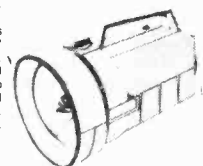

"TOUCHLESS" RETRO-REFLECTIVE TACHOMETER

Reads RPM from as far as 24 in. away! Four ranges 0-1,000, 3,000, 10,000, 30,000 RPM. Battery powered. Mirror Scale. Accuracy 1½% of full scale. Push-button reading.
£89.50
 Carrying Case . . . £12.50 extra. Send for full literature.



The New 'TAK-ETTE' Digital Hand-Held Tachometer

Batteries 4 HP7 cells. £98.50. P&P £1 Complete with leather carrying case.



RUSSIAN
 AC Clamp Volt-ammeter. U 91 Brand New £13.75. Spec. Current 10-25-100-250-500 Amps. Voltage 300-600V. Accuracy 4%. Used for measurements of AC Voltages and currents without breaking the circuits. Ranges are selected by means of a Rotary Selector Switch.
 Megohmmeter Type M4100/3 Brand New £37. Nominal o/p Voltage (open ckt.) 500V. High measurements Range (at 500V) 500MΩ (Mid Scale 5MΩ). Low measurements Range 1000KΩ. Portable (7lbs) and Hand operated c/w carrying case.

SEE INSIDE BACK COVER FOR DETAILS OF ICE SUPER RANGE OF MULTIMETERS!

Shown on these pages are just a few samples of our huge stock. If the item you require is not shown please give us a ring.



BROKERS LTD

Carriage and packing charge extra on all items unless otherwise stated

Please note: All instruments offered are secondhand and tested and guaranteed 12 months unless otherwise stated

TTLs by TEXAS		C-MOS I.C.s		OP. AMPS		TRANSISTORS		DIODES	
7400 16p	7486 34p	CD4000AE 18p	1458 Dual Op. Amp. Int. Comp. 8 pin DIL 70p	301A Ext. Comp. 8 pin DIL 36p	AC125 18p	BFY50 16p	2N3439 67p	SIGNAL+	
7400 28p	7489 270p	CD4001AE 18p	3130 COSMOS/B-Polar MosFet 8 pin DIL 100p	3900 Quad Op. Amp. 14 pin DIL 70p	AC126 16p	BFY51 15p	2N3442 140p		
74500 39p	7490 40p	CD4002AE 18p	3900 Quad Op. Amp. 14 pin DIL 70p	536T FET Op. Amp. TO-99 275p	AC127 16p	BFY52 16p	*2N3702 12p	0A47 7p	
74LS00 25p	7491 75p	CD4006AE 104p	709 Ext. Comp. 8/14 pin DIL 30p	536T FET Op. Amp. TO-99 275p	AC128 14p	*BU105 140p	*2N3703 12p	0A70 9p	
7401 17p	7492 48p	CD4007AE 18p	741 Int. Comp. 8/14 pin DIL 30p	747 Dual 741 14 pin DIL 70p	AC141 18p	BU108 250p	*2N3704 12p	0A81 15p	
7402 17p	7493 40p	CD4009AE 67p	747 Dual 741 14 pin DIL 70p	748 Ext. Comp. 8/14 pin DIL 36p	AD142 18p	*MUJES340 45p	*2N3706 12p	0A85 15p	
7403 18p	7494 80p	CD4011AE 18p	776 Programmable Op. Amp. TO-5 140p		AD161 36p	*MUJ2955 100p	*2N3707 12p	0A90 7p	
7404 21p	7495 70p	CD4012AE 18p			AD162 36p	*MUJ2955 99p	*2N3708 12p	*DA91 7p	
74H04 28p	7496 84p	CD4013AE 55p			AD187 18p	*MUJES3055 65p	*2N3709 12p	0A95 7p	
7405 23p	7497 270p	CD4015AE 90p			AC188 18p	*MPS6534 25p	*2N3773 250p	0A200 8p	
7406 43p	74100 120p	CD4016AE 50p			AC188K 25p	*MPSA06 30p	2N3866 90p	0A202 10p	
7407 36p	74104 55p	CD4017AE 120p			AD149 49p	*MPSA12 50p	2N3886 90p	IN914 4p	
7408 20p	74105 55p	CD4018AE 175p			AD161 36p	*MPSU06 32p	*2N3904 18p	IN916 9p	
7409 20p	74107 32p	CD4019AE 52p			AD162 36p	*MPSU06 78p	*2N3905 20p	IN4148 4p	
7410 17p	74110 45p	CD4020AE 250p			AD162 36p	*MPSU56 90p	*2N4058 15p		
74H10 28p	74118 84p	CD4022AE 170p			AD162 36p	*MPSU56 90p	*2N4059 10p		
7411 25p	74121 30p	CD4023AE 19p			AD162 36p	*MPSU56 90p	*2N4060 13p		
7412 25p	74122 46p	CD4024AE 120p			AD162 36p	*MPSU56 90p	*2N4123 22p		
7413 36p	74123 68p	CD4025AE 19p			AD162 36p	*MPSU56 90p	*2N4124 22p		
7414 75p	74126 70p	CD4026AE 196p			AD162 36p	*MPSU56 90p	*2N4225 22p		
7416 33p	74132 70p	CD4027AE 75p			AD162 36p	*MPSU56 90p	*2N4289 20p		
7417 36p	74136 75p	CD4028AE 140p			AD162 36p	*MPSU56 90p	*2N4347 13p		
7420 17p	74141 75p	CD4029AE 175p			AD162 36p	*MPSU56 90p	*2N4348 18p		
7421 40p	74145 85p	CD4030AE 55p			AD162 36p	*MPSU56 90p	*2N4401 27p		
7422 22p	74148 160p	CD4042AE 137p			AD162 36p	*MPSU56 90p	*2N4403 27p		
7423 37p	74150 140p	CD4043AE 202p			AD162 36p	*MPSU56 90p	*2N4509 27p		
7425 30p	74151 72p	CD4046AE 140p			AD162 36p	*MPSU56 90p	*2N5296 60p		
7427 37p	74153 84p	CD4047AE 154p			AD162 36p	*MPSU56 90p	*2N5401 50p		
7428 36p	74154 150p	CD4049AE 63p			AD162 36p	*MPSU56 90p	*2N6034 160p		
7430 17p	74155 90p	CD4050AE 52p			AD162 36p	*MPSU56 90p	*2N6107 70p		
7432 27p	74156 90p	CD4054AE 196p			AD162 36p	*MPSU56 90p	*2N6247 20p		
7437 28p	74157 90p	CD4055AE 196p			AD162 36p	*MPSU56 90p	(Comp. to 2N3055)		
7438 30p	74159 190p	CD4056AE 135p			AD162 36p	*MPSU56 90p	40360 40p		
7440 17p	74160 104p	CD4060AE 229p			AD162 36p	*MPSU56 90p	40361 70p		
7441 75p	74161 104p	CD4069AE 37p			AD162 36p	*MPSU56 90p	40362 45p		
7442 70p	74162 104p	CD4071AE 27p			AD162 36p	*MPSU56 90p	40364 120p		
7443 140p	74163 104p	CD4072AE 27p			AD162 36p	*MPSU56 90p	40409 65p		
7444 140p	74164 120p	CD4081AE 19p			AD162 36p	*MPSU56 90p	40410 65p		
7445 90p	74166 126p	CD4082AE 27p			AD162 36p	*MPSU56 90p	40411 225p		
7446 95p	74173 120p	CD4510AE 130p			AD162 36p	*MPSU56 90p	40594 81p		
7447 75p	74174 120p	CD4511AE 200p			AD162 36p	*MPSU56 90p	*ZTX100 10p		
7448 80p	74175 85p	CD4516AE 112p			AD162 36p	*MPSU56 90p	*ZTX130 13p		
7450 17p	74176 120p	CD4518AE 100p			AD162 36p	*MPSU56 90p	*ZTX500 15p		
7451 18p	74177 100p	CD4528AE 120p			AD162 36p	*MPSU56 90p	*ZTX502 18p		
7453 18p	74180 110p				AD162 36p	*MPSU56 90p	2N457A 190p		
7454 18p	74181 298p				AD162 36p	*MPSU56 90p	2N697 22p		
7460 18p	74182 82p				AD162 36p	*MPSU56 90p	2N698 30p		
7470 30p	74185 150p				AD162 36p	*MPSU56 90p	2N706 20p		
7472 28p	74190 165p				AD162 36p	*MPSU56 90p	2N708 20p		
7473 30p	74191 165p				AD162 36p	*MPSU56 90p	2N918 18p		
7474 34p	74192 120p				AD162 36p	*MPSU56 90p	2N1132 18p		
7475 45p	74193 120p				AD162 36p	*MPSU56 90p	2N1134 18p		
7476 32p	74194 120p				AD162 36p	*MPSU56 90p	2N1302 36p		
7480 50p	74195 95p				AD162 36p	*MPSU56 90p	2N1306 36p		
7481 95p	74196 120p				AD162 36p	*MPSU56 90p	2N1307 40p		
7482 80p	74197 120p				AD162 36p	*MPSU56 90p	2N1308 40p		
7483 90p	74198 210p				AD162 36p	*MPSU56 90p	2N1309 28p		
7484 95p	74199 210p				AD162 36p	*MPSU56 90p	2N1613 25p		
7485 120p					AD162 36p	*MPSU56 90p	2N1711 25p		
					AD162 36p	*MPSU56 90p	2N1893 30p		
					AD162 36p	*MPSU56 90p	2N2219 20p		
					AD162 36p	*MPSU56 90p	2N2222 20p		
					AD162 36p	*MPSU56 90p	2N2369 14p		
					AD162 36p	*MPSU56 90p	2N2484 30p		
					AD162 36p	*MPSU56 90p	2N2904/A 25p		
					AD162 36p	*MPSU56 90p	2N2905/A 25p		
					AD162 36p	*MPSU56 90p	2N2906/A 24p		
					AD162 36p	*MPSU56 90p	*2N2926R 7p		
					AD162 36p	*MPSU56 90p	*2N2926G 9p		
					AD162 36p	*MPSU56 90p	*2N2926Y 9p		
					AD162 36p	*MPSU56 90p	*2N2926Z 7p		
					AD162 36p	*MPSU56 90p	*2N2926G 9p		
					AD162 36p	*MPSU56 90p	*2N2926Y 9p		
					AD162 36p	*MPSU56 90p	*2N2926G 9p		
					AD162 36p	*MPSU56 90p	2N3053 18p		
					AD162 36p	*MPSU56 90p	2N3054 50p		
					AD162 36p	*MPSU56 90p	2N3055 50p		
					AD162 36p	*MPSU56 90p	8A/30V 20p		
					AD162 36p	*MPSU56 90p	8A/100V 20p		
					AD162 36p	*MPSU56 90p	8A/200V 20p		

TEXAS 75 SERIES

TEXAS DTLs

MEMORIES
2602B 1024 bit RAM £2.50
2513(UC) Character Generator £8.50
2513(LC) Character Generator £8.50

LOW PROFILE DIL SOCKETS BY TEXAS
8 pin 13p, 14 pin 14p, 16 pin 15p, 24 pin 50p, 40 pin 75p, 28 pin 60p

VOLTAGE REGULATORS - FIXED - PLASTIC
1 Amp Positive 5V 7805 140p 5V 7905 200p
12V 7812 140p 12V 7912 200p
15V 7815 140p 15V 7915 200p
18V 7818 140p 18V 7918 200p
24V 7824 140p 24V 7924 200p
LM309K 1 Amp 5V TO3 140p
LM323K 3 Amp 5V TO3 700p
DUAL VOLTAGE REGULATOR
1468 ±15V 100mA 16 pin DIL 300p.
(Adjustable by resistors from ± 8V min. to ± 20V max.)
VARIABLE VOLTAGE REGULATOR
723 2V to 37V 150mA 14 pin DIL 45p
LM305H 4.5V to 30V 20mA TO5 120p
Basic Data Sheets on Vol. Regs. at 10p each + SAE

SEVEN SEGMENT DISPLAYS
3015F Minitor 0.3 in 160p
DL704 Com. Cathode 0.3 in 140p
DL707 Com. Anode 0.3 in 140p
DL747 Com. Anode 0.6 in 225p

OPTO-ISOLATORS
Phototransistor: TTL 112 (IL 12) 6 pin DIL 140p
Photodarlington: ICA-55 6 pin DIL 250p

DRIVERS
75491 Quad Segment Driver 14 pin DIL 78p
75492 Hex Digit Driver 14 pin DIL 90p

SCR-THYRISTORS
1A 50V TO5 40p
1A100V TO5 42p
1A400V TO5 45p
1A600V TO5 70p
3A100V Stud 65p
3A400V Stud 75p
7A100V TO5+HS 84p
7A400V TO5+HS 90p
8A 50V Plastic 130p
12A400V Plastic 160p
16A100V Plastic 160p
16A400V Plastic 180p
16A600V Plastic 220p

FETs
*BF244 25p
*MPF102 34p
*MPF103 34p
*MPF104 34p
*MPF105 34p
*2N3819 22p
*2N3820 63p
*2N3822 57p
*2N4100 35p
*2N4548 34p
*2N5459 34p
MOSFETs
3N128 85p
3N140 85p
3N141 85p
3N187 180p
3N202 58p
40603 58p
40673 58p

TRIACS
Amp Volts 3 400 120p
6 400 150p
6 500 180p
10 400 185p
10 500 195p
15 400 210p
15 500 250p
40A30 99p
40A69 99p
DIAC BR100 25p

BRIDGE RECTIFIERS
*1A 50V 22p
*1A 100V 24p
*1A 200V 26p
*1A 400V 27p
*1A 600V 30p
*2A 50V 30p
*2A 100V 35p
*2A 200V 40p
*2A 400V 45p
*4A 100V 60p
6A 50V 65p
6A 100V 72p
6A 200V 78p
6A 400V 84p

TELETEXT DECODER
Complete Semiconductor kit for the above "WW" Project available (includes all I.C.s, Trs, etc for U.C., L.C. and P.S. unit).
£61.00 inc V.A.T. and P&P
Please send S.A.E. for details.
VAT RATES: All items at 8% EXCEPT where marked * which are at 12½%.

Fully branded devices by Texas, RCA Motorola, National, Mullard, etc.

Minimum Order £2 P&P 20p Please add VAT to total

Mail Order Only Govt., Colleges, etc., orders accepted. TECHNOMATIC LTD. 54 SANDHURST ROAD, LONDON, NW9 Tel: 01-204 4333

Crimson Elektrik

HIGH POWER AUDIO AMPLIFIER MODULES THE ONLY TRUE HI-FI MODULES AVAILABLE

UNCOLOURED SOUND FROM CRIMSON

In the design and production attention has been paid to the transient response. With a response rise-time of 8µs, an exponential slew rate of 46V/µs, and only 40dB of feedback from an intermodulation distortion minimum, a two-pole Zobel network gives excellent control and low-tone loads resulting in a settling time of 15µs for 8V, 0.2p.

Send cheque/PO to:
S.A.E. for literature
Overseas enquiries welcome
tel: 0533-386211

CRIMSON ELEKTRIK
74 STATION ROAD
RATBY
LEICESTER

- CE 60 60Wrms/8Ω £14.55
- CE 100 100Wrms/4Ω £17.55
- T.H.D. 0.3% typical up to rated power, 1kHz
- Frequency response 12Hz-35kHz, -3dB
- Unconditionally stable
- Signal to noise ratio >110dB
- Sensitivity 250mv into 56kΩ
- 14 transistors 4 diodes.
- Fully protected - load line sensing.
- D.C. coupled, suitable for ±15 to 35V
- Small size - only 80 x 120 x 25mm.
- Fully tested and guaranteed.

WW-066 FOR FURTHER DETAILS

W.H.M. FLUTTERMETER

Model 3 Mk II 1972
To B.S. 1988

£150.00 inc



POWER AMPLIFIER (Jan. 1974)
Abridged Spec.
T.H.D. < 0.05%, predominantly 2nd harmonic, maintained at any frequency or signal level and into any speaker load, without overshoot, crossover effects, intermodulation distortion or extended rise-time.
£22.00 per pair inc.

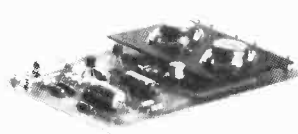

Sydney House, 35 Villiers Road, Watford WD1 4AL Tel: 38757

Solid State Colour Television Circuits

G. R. WILDING

The book contains, firstly, a clear and concise explanation of how the various semiconductor devices used in solid-state receivers function, and how they are utilized in the complicated and often highly ingenious arrangements of modern designs. Secondly, concentrating on the most modern c.t.v. designs, explanations are given of how these circuits operate, providing excellent back-up material to the manufacturers' service manuals, which can contain only the minimum of 'circuit notes' to aid fault diagnosis.

The information covering the most up-to-date innovations in c.t.v. design in major British, European and Japanese receivers will be useful to service engineers, technicians and students and to amateur enthusiasts as a lucid exposition of the modern design of colour television receiver.

CONTENTS: Devices and Principles. Power Supplies. Time-base Circuits. Sync Separators. Convergence and Degaussing. Tuners and I.F. Amplifiers. Luminance Circuits. Chrominance Circuits. Burst Gates and Reference Oscillators. Demodulator and PAL Switch Circuitry. Signal Amplifying and Output Stages. Beam Limiters. Index.

1976 208 pages 252 x 160mm 0 408 00228 X £5.75

Order from your bookseller or, in case of difficulty, from

NEWNES-BUTTERWORTHS
Borough Green, Sevenoaks, Kent, TN15 8PH
Telephone 0732 884567

HEPWORTH ELECTRONICS

Worcester Road, Kidderminster, Worcs.

Direct Mail: Tel. 0562-2212
Contact Mrs Moore

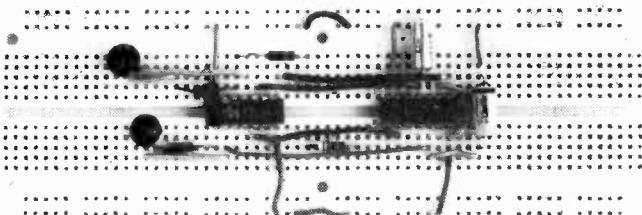

The **original** concept in breadboarding
Solderless long life contacts
Takes up to **40 pin** D.I.P.'s, just **push in**

THE FIRST — THE BEST
— THE ONLY
SK10 Socket £13.33

— includes VAT, Postage & Packing —

WW — 076 FOR FURTHER DETAILS

ambit international

WIRELESS SPECIALISTS

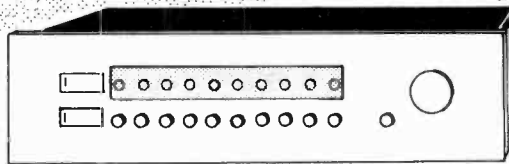

fm tuner number two

The New FM Tuner from Ambit.

1.2uV for 30dB SN, adjustable output voltage, ultrasonic suppression better than 70dB. 6 presets, geared manual drive. Double IC stabilizers. Supplied with prealigned Larholt RF/IF and decoder module. Complete with black woodgrain cabinet, and solid aluminium front panel.

Kit £55.50 (£62.43 inc. VAT)
Built and tested £79.75 (£89.71 inc. VAT)
(Carriage £3.00 extra)

modules for rf, if, mpx: (12v) audio and general components

- NEW 7020** Dual ceramic filters, 2 stage preamp into the improved CA3089E (HA1137W), with mute, AFC to suit ANY varactor tunerhead, meter output and edge terminations. kit £5.25 built £6.55
- NEW 92310** The MC1310 mpx decoder, with twin audio preamps, and BLR3107 ultrasonic block filter. kit £5.35 built £6.65
- NEW 71197** A new varicap tuner for MW/LW, with ceramic filter, 80dB AGC, low noise and distortion. kit with ferrite rod £9.65 built £11.35
- NEW 5800** The state of the art in FM tunerheads. 6 double varicap tuned circuits, 2 MOSFET AGC controllable RF stages, double tuned IF output stage. kit £11.35 built £14.00
- TDA2020 kit** A stereo power amp, with the TDA2020 15W RMS 0.1% THD IC from SGS. £7.85. (Special extruded heatsinks 75p each).

LINEAR ICs		(* at 8%)	DISCRETE DEVICES		
CA3089E	1.94	LS8038	3.10*	ZTX107/8/9n	0.14
CA3090AQ	3.75	NE560	2.50	ZTX212/3/4p	0.16
MC1310	2.20	NE561	2.50	ZTX551/451pn	0.18
SN76660	0.75	NE562	2.50	BF256	0.34
TBA120AS	1.00	NE565	2.50	40673/MEM616	0.50
TBA651	1.81	NE566	2.55*	40822/MEM615	0.38
uA720	1.40	7805UC	1.55*	BD535n(60v-50w)	0.52
LM380	1.00	TDA1412	0.95*	BD536p(60v-50w)	0.53
LM381	1.81	78M20UC	1.20*	BD609n(80v-90w)	0.70
TBA810	1.09	uA723	0.80*	BD610p(80v-90w)	1.20
TCA940	1.80	NE550	0.80*	n = NPN type	
TDA2020	2.99	NE567	2.50*	p = PNP type	
VARACTORS		FOIL TRIMMERS		POTS	
MVAM2	1.05	3-12pF	0.18	100k+100k LIN	0.60
MV104/8B104	0.45	4-30pF	0.23	100k+100k with...	
BA102	0.30	6-45pF	0.26	50% tap	0.65
BA121	0.30	(7.5 diameter types)		20 turn 100k	
				diode law	0.35

TOKO COILS, FILTERS, TUNERS FOR AM/FM AND MPX.
Full details of standard types in lists:

- 10mm IFTs for 455.470kHz 27p Linear Phase filter for 10.7MHz 2.25
- 10mm IFTs for 10.7MHz 30p MFH41/71T mechanicals for 455 1.65
- Ceramic filters for 10.7MHz 50p SFD470 new Murata ceramic block 0.75
- Ceramic filters for 6.0MHz 80p BLR3107 19/38kHz notch (stereo) 1.60
- Ceramic 455kHz type CFX104 1.50 Variable chokes 11, 23 & 36mH .30
- CFT455B/C, CFT470C ceramic 60p EC3302 low cost varicap FM tuner 5.50
- CFU050D 470kHz ceramic 65p EF5600 5 stage varicap FM head 12.50

Send an SAE for a free price list and stock list. There is a new Larholt Signalmaster FM tuner and more details on our range of wireless products. PP 22p per order, VAT is generally at 12½% - and the min. CWO charge is £1. Min. invoice £7.50, Catalogue 40p. (* 8% VAT).

37 HIGH STREET,
BRENTWOOD, ESSEX.
CM14 4RH tel 216029

low cost ~ top quality COMPONENTS



DISTRIBUTORS OF TOSHIBA COMPONENTS

VALVES

Type	Price (p)	Type	Price (p)
DY87	37.0	PCF802	52.0
DY802	37.0	PCL82	54.0
ECC82	37.0	PCL84	55.0
EF80	34.0	PCL85	52.0
EF183	39.0	PCL86	50.0
EF184	39.0	PFL200	65.0
EH90	40.0	PL36	63.0
PC86	58.0	PL84	30.0
PC88	58.0	PL504	90.0
PC900	30.0	PL508	78.0
PCC89	46.0	PL509	£1.35
PCC189	47.0	PY88	43.0
PCF80	38.0	PY500A	£1.25
PCF86	44.0	PY800	42.0
PCF801	46.0		

SEMI CONDUCTORS

Type	Price (p)	Type	Price (p)
* AC127	20	* BC137	20
* AC128	15	BC138	30
AC141K	25	* BC142	20
AC142K	25	BC143	25
* AC151	20	* BC147	8
* AC154	18	* BC147A	11
* AC155	18	* BC148	9
* AC156	20	* BC149	10
AC176	22	* BC153	20
* AC187	20	* BC154	20
AC187K	30	* BC157	11
* AC188	18	* BC158	10
AC188K	30	* BC159	11
AD142	62	* BC173	15
AD149	45	* BC178B	20
AD161	38	* BC182L	12
AD162	38	* BC183L	12
AF114	25	BC187	25
AF115	22	* BC214L	15
AF116	22	* BC327	13
* AF117	20	* BC328	13
AF118	45	* BC337	12
AF139	35	* BC338	12
AF178	45	BD124	75
AF180	40	BD131	35
AF181	40	BD132	39
AF239	45	BD135	29
* AF240	20	BD136	30
* BC107	10	BD137	30
* BC108	10	BD138	33
* BC109	12	BD139	37
* BC109C	14	BD140	39
* BC113	15	BD160	£1.65
BC116A	25	BD233	43
* BC117	14	BD234	49
* BC125B	18	BD235	49
* BC132	15	BD236	53
* BC135	15	BD237	49

Type	Price (p)	Type	Price (p)
BD238	55	BU108	£1.80
BDX32	£2.40	BU126	£1.49
BF115	24	BU205	£1.67
BF160	35	BU208	£2.20
BF167	24	BU208/02	
BF173	25		£2.75
BF178	33	BUY69B	£2.50
BF179	38	BUY69A	£2.65
BF180	31	E1222	38
BF181	32	MJE340	45
BF184	29	2N3055	55
BF185	30	* OC71	18
* BF194	8	* OC72	18
* BF195	8	R2008B	£1.90
* BF196	10	R2010B	£1.90
* BF197	11	RCA16334	80
BF198	23	RCA16335	80
BF200	25	S2802	£2.99
BF218	40	S6080 A KIT	
* BF224	20		£4.90
BF258	26	* BC546	13
BF336	27	* BC547	12
BF337	35	* BC548	12
BF355	50	* BC549	13
BF457	37	* BC550	14
BF458	37	* BC556	14
BF459	38	* BC557	13
BFX86	28	* BC558	12
* BFY50	19	* BC559	14
* BFY52	20	TIP31A	52
BSY52	30	TIP32A	62
BT106	£1.20	TIP41A	60
BU105/02	£1.60	TIP42A	75

*20p or less. Minimum 5 items.

DIODES

Type	Price (p)	Type	Price (p)
* BA115	7	* BY206	17
* BA145	16	BY238	25
* BA148	16	* OA90	6
* BA154/201	12	* OA202	8
* BY126	11	* IN60/OA91	7
* BY127	10	* IN914	6
* BY199	25	* IN4002	5

*20p or less. Minimum 5 items.

INTEGRATED CIRCUITS

Type	Price (p)	Type	Price (p)
ETTR6016	£2.00	SN76023N	£1.43
MC1351P	70	SN76203ND	£1.20
SN76003N		SN76033N	£2.15
SN76013N	£2.35	SN76227N	£1.45
SN76013ND	£1.43	SN76532N	£1.45
	£1.25		

Type	Price (p)	Type	Price (p)
SN76660N	60	TBA540Q	
SN76666N	90		£1.25
TAA550	32	TBA550Q	£2.30
TAA700	£3.80	TBA560CQ	
TBA120AS	60		£2.40
TBA120SQ		TBA800	£1.10
	£1.00	TBA920Q	
TBA480Q			£2.90
	£1.40	TBA990Q	
TBA520Q			£2.50
	£1.75	TCA270Q	
TBA530Q			£2.90
	£1.75		

EHT MULTIPLIERS MONOCHROME B.R.C.

Type	Price (p)
2DAK 1500 (17" x 19")	£1.85
2TQ 950MK2 1400	£2.05
2TAK 1500 (23" x 24")	£2.05

EHT MULTIPLIERS COLOUR

Type	Price each
11 TAQ ITT CVC 1, 2 & 3	£5.10
ITN GEC Sobell	£4.50
IITAZ GEC 2110	£4.50
IITAM Philips G5	£4.50
IITBD Philips 58	£4.65
3TCW Pye 691/693	£3.49
ITH Decca 30 Series	£4.60
3TCU Thorn 3000/3500	£5.00
11HAA Thorn 8000	£1.99
11HAB Thorn 8500	£4.31
IITCP Bush 823	£5.50
TVKI Korting	£4.39

NEW BLACK AND WHITE TUBES

Type	Price each
20" CME 2013	£13.90
24" CME 2413	£15.95

NEW COLOUR TUBES

19" A49-191X equivalents	
A49-192 and A49-120X	£52.00
20" 510DJ822 equivalent	
A51-110X	£54.30
22" A56/120X	£55.40

* All goods subject to settlement discount of 5% 7 days and 2% monthly.

* Prices subject to 12 1/2% VAT w.e.f April 12th '76

* No Postal Charges

* C.P.C. - Price - Quality - Service



COMBINED PRECISION COMPONENTS LTD.

DISTRIBUTORS:

LANCASHIRE — G. TAYLOR, 70 Moorside Ave., Smithills, Bolton. Tel. 0204 40918

SOUTH LONDON — PAUL ELECTRICAL LTD., 250/252 Grand Dr., Raynes Park, London SW20

Tel. 01-542 6546

SOUTH WEST — D. B. COMPONENTS, 20 Russell Close, Saltash, Cornwall. Tel. Saltash 4135

NORTHERN IRELAND — NORTHERN IRELAND ELECTRONIC SALES (ULSTER) LTD., 4 Tates

Ave., Lisburn Rd., Belfast BT9 7BY. Tel. 0232 668718

Distributors now required for other areas

C.P.C., Dept. W, 194-200 NORTH ROAD, PRESTON, LANCASHIRE, ENGLAND.

Phone: Preston (STD 0772) 55034. Telex 677122

New price list 12.5 '76

Good people to deal with

For all who want to know about electronic circuits

Here's a book of very special appeal to all concerned with designing, using or understanding electronic circuits. It comprises information previously included in the first ten sets of Wireless World's highly successful Circards – regularly published cards giving *selected* and *tested* circuits, descriptions of circuit operation, component values and ranges, circuit limitations, modifications, performance data and graphs. Each of the ten sets – including additional circuits – in this magazine size hard cover book has been updated where necessary, and is preceded by an explanatory introduction. Circuit designs (1) is the first collection of its kind.

Circuits covered are:

- Basic active filters**
- Switching circuits**
- Waveform generators**
- AC measurements**
- Audio circuits**
- Constant-current circuits**
- Power amplifiers**
- Astable circuits**
- Optoelectronics**
- Micropower circuits**

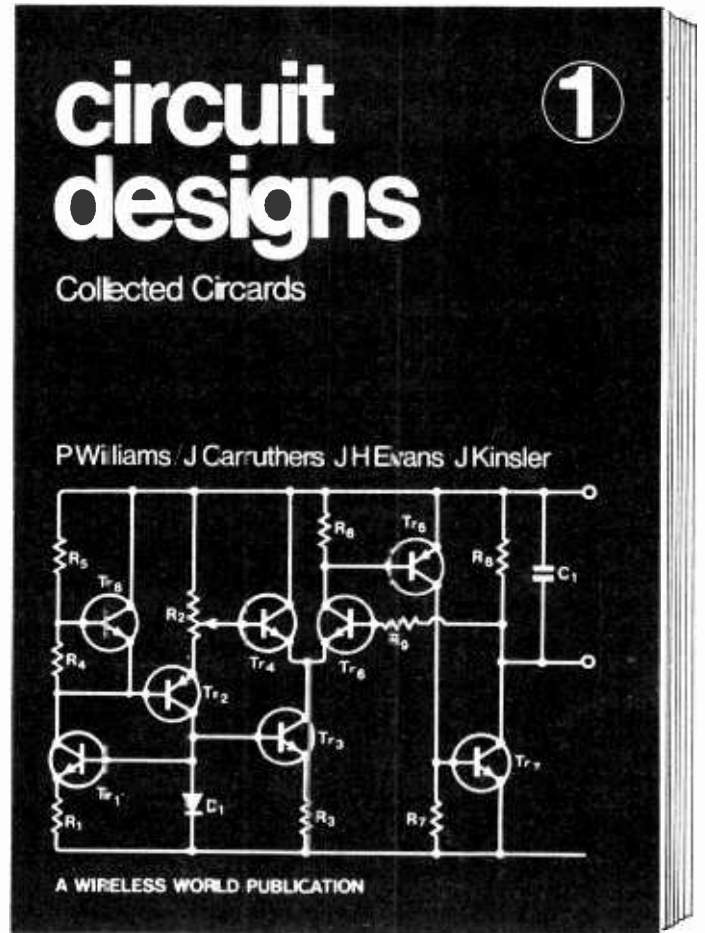

A new book from Wireless World

ORDER FORM

To: General Sales Department,
IPC Business Press Limited,
Room 11, Dorset House,
Stamford Street, London SE1 9LU.

Please send me copy/copies of
Circuit Designs – Number 1 at £10.40
each inclusive. I enclose remittance
value £. (cheques payable to
IPC Business Press Ltd.)

NAME (please print)

ADDRESS

Company registered in England and a subsidiary of Reed
International Limited Registered No 677128 Regd. office
Dorset House, Stamford Street, London SE1 9LU.

You've asked for it!

Time and again we are asked for reprints of Wireless World constructional projects: tape, disc, radio, amplifiers, speakers, headphones. Demand continues long after copies are out of print. To meet the situation we have collected fifteen of the most sought after designs and put them in one inexpensive book. And we've updated specifications where necessary to include new components which have become available. A complete range of instruments is presented, from the Stuart tape recorder and Nelson-Jones f.m. tuner, through the Bailey, Blomley and Linsley Hood amplifiers, to the Bailey and Baxandall loudspeakers – some of which have been accepted as standard in the industry.

high fidelity designs

£1 from newsagents and bookshops
or £1.35 (inclusive) by post from the publishers.

A book from

Wireless World



To: General Sales Department, Room 11, Dorset House,
Stamford Street, London, SE1 9LU

Please send me _____ copy copies of High Fidelity Designs
at £1.35 inclusive. I enclose remittance value £
(cheques payable to IPC Business Press Ltd.).

NAME
(please print)
ADDRESS

Company registered in England No. 677128
Regd. office, Dorset House, Stamford Street, London SE1 9LU

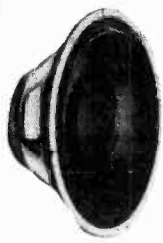

WILMSLOW AUDIO

THE Firm for speakers!

SPEAKERS

BAKER

Group 25 3, 8 or 15 ohm	£8.64
Group 35 3, 8 or 15 ohm	£10.25
Group 50/12 8 or 15 ohm	£14.00
Group 50/15 8 or 15 ohm	£18.62
Deluxe 12" 8 or 15 ohm	£12.38
Major 12" 3, 8 or 15 ohm	£10.69
Superb 12" 8 or 15 ohm	£16.31
Regent 12" 8 or 15 ohm	£9.00
Auditorium 12" 8 or 15 ohm	£14.65
Auditorium 15" 8 or 15 ohm	£19.41

CASTLE

8RS/DD 6 or 8 ohm	£9.28
-------------------	-------

CELESTION

HF1300 8 or 15 ohm	£6.98
HF2000 8 ohm	£8.55
MH1000 8 or 15 ohm	£13.50
G12M 8 or 15 ohm	£12.95
G12H 8 or 15 ohm	£15.95
G12/50TC 2245 d/cone	£18.00
G12/50 2236 single/cone	£16.50
G12/50 2239 s/cone aluminium dome	£17.00
G12/50 2242 s/cone cambric	£16.50
G15C 8 or 15 ohm	£26.95
G18C 8 or 15 ohm	£34.50
C03K 3 kHz crossover	£4.46

DECCA

London Ribbon Horn	£28.80
London X/over CO/1000/8	£6.75
DK30 Ribbon Horn	£17.25
DK30 X/over CO/1/8	£4.50

EMI

14" x 9" bass 14A/770 8 ohm	£11.92
8" roll surround, bass 8 ohm	£5.73
8" x 5" d/cone roll surround 4 or 8 ohm	£3.56
6 1/2" d/cone roll surround 8 or 15 ohm	£3.93

ELAC

59RM109, 59RM114 8 ohm	£3.38
6 1/2" d/cone roll/s 6RM171 8 ohm	£3.83
10" 10RM239 8 ohm	£3.83

EAGLE

CT5	£1.95
CT10	£2.75
DT33	£5.68
FF5	£3.26
FF22	£8.50
FF23	£10.68
FF24	£11.70
FF25	£10.13
FF26	£7.60
FF27	£6.18
FF28	£8.10
FF30	£8.43
FR4	£5.51
FR65	£8.66
FR8	£11.08

FR10	£14.06
HT21	£6.13
HT15	£3.96
MHT10	£4.00

FANE

Pop 15 8 or 15 ohm	£5.25
Pop 33T 8 or 15 ohm	£9.25
Pop 50 8 or 15 ohm	£12.50
Pop 55 8 or 15 ohm	£15.50
Pop 60 8 or 15 ohm	£17.95
Pop 70 8 or 15 ohm	£18.75
Pop 100 8 or 15 ohm	£27.95
Crescendo 12A 8 or 15 ohm	£37.95
Crescendo 12BL 8 or 15 ohm	£39.95
Crescendo 15/100 8 or 15 ohm	£49.95
Crescendo 15/125 8 or 15 ohm	£59.95
Crescendo 18 8 or 15 ohm	£67.95
910 Mk II horn	£15.75
920 Mk II horn	£36.95
PH50 High power tweeter 50 watt	£6.50
HPX1 X/over, 200 watt	£2.50
138/10T 13x8 d/cone 8 or 15 ohm	£5.50
801T d/c roll surround	£8.96

GOODMANS

Axent 100	£7.60
Audiom 200	£13.44
Axiom 402	£19.80
Twinaxiom 8, 8 or 15 ohm	£9.50
Twinaxiom 10, 8 or 15 ohm	£9.86
8P 8 or 15 ohm	£5.95
10P 8 or 15 ohm	£6.25
12P 8 or 15 ohm	£14.95
12PG 8 or 15 ohm	£16.50
12PD 8 or 15 ohm	£16.95
12AX 8 or 15 ohm	£39.00
15P 8 or 15 ohm	£22.50
15AX 8 or 15 ohm	£45.00
18P 8 or 15 ohm	£39.00
Hifax 750	£16.00
5" midrange 8 ohm	£4.05

GAUSS

12"	£84.00
15"	£96.00
18"	£129.00

JORDAN WATTS

Jordan Watts Module	£15.36
Jordan Watts Treble Kit	£7.00

KEF

T27	£5.18
T15	£6.25
B110	£6.75
B200	£7.85
B139	£15.08
DN12	£5.39
DN13 SP1015 or SP1017	£4.05
DN8	£2.08

LOWTHER

PM6	£30.60
IPM6 Mk 1	£32.85
PM7	£48.60

PEERLESS

1060	pr	£50.40
1070	ea	£41.40
1120	ea	£45.00
2050	pr	£39.50
2060	pr	£53.00
MT25HFC		£2.95
MT225HFC		£2.95

RADFORD

Filter network	£13.00
TD3 tweeter	£7.25
MD9 midrange	£10.50
MD6 dome midrange	£12.50
BD25 Mk II bass unit	£22.00

STC

4001G Super tweeter 15 ohm	£5.90
4001K Super tweeter 8 ohm	£5.90

TANNOY

10" Monitor HPD	£78.00
12" Monitor HPD	£86.00
15" Monitor HPD	£99.95

WHARFEDALE

Super 10RS/DD	£13.50
---------------	--------

SPEAKER KITS

Baker Major Module 3, 8 or 15 ohm	ea	£13.28
Fane Mode One Mk II 15 watt	ea	£10.35
Fane D40 Disco Kit	ea	£19.95
Goodmans DIN 20 4 or 8 ohm	ea	£13.28
Mezzo Twinkit	pr	£46.50

HELME

XLK 20	pr	£13.50
XLK 30	pr	£17.10
XLK 35	pr	£21.60
XLK 40	pr	£31.50
XLK 50	pr	£50.40

KEFKIT

I	pr	£51.00
III	ea	£46.00

LOWTHER

PM6	pr	£62.10
PM6 Mk I kit	pr	£65.70

PEERLESS

20-2	ea	£15.70
30-2	ea	£21.95
20-3	ea	£23.90
50-4	ea	£34.45
1060	pr	£50.40
1070	ea	£41.40
1120	ea	£45.00

RICHARD ALLAN

Twin Assembly	ea	£13.46
Triple 8	ea	£20.25
Triple 12	ea	£25.16
Super Triple	ea	£29.25
RA8	pr	£37.80
RA82	pr	£59.40
RA82L	pr	£65.70

WHARFEDALE

Linton II kit	pr	£21.50
Glendale 3XP kit	pr	£47.70
Dovedale III kit	pr	£59.40

HI-FI ON DEMONSTRATION IN OUR SHOWROOMS

AIWA, AKAI, ARMSTRONG, BOWERS & WILKINS, CASTLE, CELESTION, DUAL, GOODMANS, KEF, LEAK, MONITOR AUDIO, PIONEER, RADFORD, RICHARD ALLAN, ROTEL, TANDBERG, TANNOY, TRIO, VIDEOTONE, WHARFEDALE, ETC.

Ask for our Hi-Fi discount price list

THIS MONTH'S SPECIALS

Pioneer PL12D	£43.00	
Pioneer SX434	£98.95	
Videotone Minimax II	pr	£39.00
Pioneer CT 2121	£115.00	
Videotone Saphir	1 pr	£52.00

All prices include V.A.T. (Prices correct at 12/5/76)

Send stamp for free 32-page booklet 'CHOOSING A SPEAKER'

All units guaranteed new and perfect

Carriage and Insurance: SPEAKERS 50p each 12" and up 75p each

Kits 80p each (£1.60 per pair) Tweeters and crossovers 30p each

WILMSLOW AUDIO

Dept. HFA

Loudspeakers, mail order and export: Swan Works, Bank Square, Wilmslow

Hi-Fi, Radio & TV: Swift of Wilmslow 5 Swan Street Wilmslow, Cheshire

PA, Hi-Fi & Accessories: Wilmslow Audio 10 Swan Street Wilmslow, Cheshire

Telephone: Loudspeakers, Mail Order & Export. Wilmslow 29599

Hi-Fi, Radio, etc: Wilmslow 26213

We stock the complete Radford range of amplifiers, pre-amplifiers, power amplifiers, tuners, etc., and also Radford Audio Laboratory equipment, low distortion oscillator, distortion-measuring set, audio noise meter, etc.

Complete kits in stock for:

Radford Studio 90, Radford Monitor 180, Radford Studio 270, Radford Studio 360, Hi-Fi Answers Monitor (Rogers), Hi-Fi News No Compromise (Frisby), Hi-Fi News (State of the Art), Wireless World Transmission Line (Bailey), Practical Hi-Fi & Audio Monitor (Giles), Practical Hi-Fi & Audio Triangle (Giles), Popular Hi-Fi (Colloms) etc.

Construction leaflets for Radford, Kef, Jordan Watts, Tannoy, Hi-Fi Answers Monitor. Free on request

PA Amplifiers, microphones, etc., by Shure, Linear, Eagle, Beyer, AKG, etc.

FREE WITH ORDERS OVER £10:
'HI-FI LOUDSPEAKER ENCLOSURES' BOOK

Appointments

Advertisements accepted up to 12 noon Monday, July 26, for the September issue, subject to space being available.

DISPLAYED APPOINTMENTS VACANT: £6.50 per single col. centimetre (min. 3cm),
LINE advertisements (run on): £1 per line, minimum three lines.

BOX NUMBERS: 45p extra. (Replies should be addressed to the Box Number in the advertisement, c/o Wireless World, Dorset House, Stamford Street, London SE1 9LU.)
PHONE: Owen Bailey on 01-261 8508 or 01-261 8423.

Classified Advertisement Rates are currently zero rated for the purpose of V.A.T.

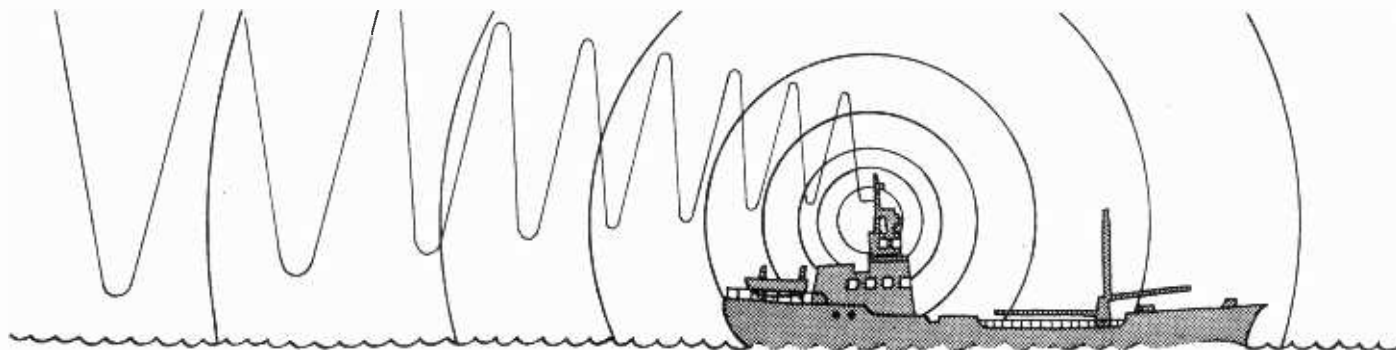

Radio Officers—now you can enjoy the comforts of home.

Working for the Post Office Maritime Services really makes sense. You still do the work that interests you, but with all the advantages of a shore-based job: more time to enjoy home life, job security and good money. To qualify, you need a United Kingdom Maritime Radiocommunication Operator's General Certificate or First Class Certificate of competence in Radiotelegraphy, or an equivalent certificate issued by a Commonwealth Administration or the Irish Republic.

Starting salaries, at 25 or over, are £2905 rising to £3704 after three years service. Between 19 and 24, the starting salary varies from £2234 to £2627 according to age. In addition, a supplement of £312

p.a. is payable. You'll also receive an allowance for shift duties which at the maximum of the scale averages £900 a year and there are opportunities to earn overtime. There's a good pension scheme, sick pay benefits and prospects of promotion to senior management.

Right now we have a few vacancies at some of our coastal radio stations, so if you're 19 or over, preferably with sea-going experience, write to: ETE Maritime Radio Services Division (L690), ET 17.1.1.2., Room 643, Union House, St. Martins-le-Grand, London EC1A 1AR.

Post Office Telecommunications

EASTERN ELECTRICITY

ENGINEERING ASSISTANT (TELECOMMUNICATIONS)

Salary £3042 to £4692

A vacancy exists at our Stowmarket depot for an Engineer to assist with the installation, maintenance, repair and future development of internal private data and PAX telephone systems. Previous experience in this type of work is desirable and a working knowledge of Strowger types of telephone equipment is essential.

Applicants should have appropriate experience and should preferably possess a recognised technical qualification in Telecommunications work.

Applicants should apply in writing giving qualifications and previous experience to: The Group Secretary and Accountant, Eastern Electricity, East Anglian Group, Finborough Hall, Stowmarket, Suffolk IP14 3DN, by 19th July, 1976

(6030)

Aural and Visual Aids Technician

£3,963-£4,299 p.a.

An experienced technician is required by the Croydon Education Service to maintain and repair a range of Audio and Video equipment including TV Receivers in schools.

Commencing salary in the scale will be according to qualification and experience.

In appropriate cases assistance toward removal and lodging expenses will be paid.

CROYDON

Apply in writing, giving details of age, qualifications, present post and relevant work experience to the Superintendent, Education Service Centre, Princess Road, Croydon, CRO 2QZ, or telephone the Superintendent, Mr. A. Bevan (tel: 01-684 9393) for further details.

(6070)

THE HATFIELD POLYTECHNIC SCHOOL OF NATURAL SCIENCES PSYCHOLOGY

TECHNICIAN

to assist with the maintenance and construction of a variety of electronic and other equipment. The person appointed will work with the Senior Technician and he/she should preferably hold an appropriate intermediate or National Certificate, or City and Guilds qualifications — but this is not essential. The work centres on the development of research equipment and calls for initiative and resourcefulness.

Salary scale Technical 1 rising to £2529 per annum plus £120 local weighting.

Application form and further details from: **The Staffing Officer, The Hatfield Polytechnic, PO Box 109, Hatfield, Herts AL10 9AB.**

Quote ref. 789. Closing date 9th July, 1976 1



YAMAHA

require an

AUDIO ENGINEER

We require an Engineer to service Yamaha Hi Fi products. Applicants must be used to working on current sophisticated audio products and should be able to repair these without assistance to the highest standards. Salary up to £3,500 negotiable.

Please telephone the Service Manager, Mr. T. Finn, on 01-904 0141.

Natural Sound Systems

Ltd.

Strathcona Road, North Wembley, Middlesex HA9 8QL

LINK



ELECTRONIC ENGINEERS

TELEVISION

We need an engineer to augment the staff of our Test Department. The job entails test and commissioning of our full range of TV studio broadcast equipment including our colour cameras.

The most up-to-date semiconductor techniques are employed and this is reflected in the required experience. You should either have HND / Degree or possess very relevant experience of similar equipment. Someone with less than two years in industry is unlikely to have the necessary depth of knowledge.

Link Electronics is situated in Hampshire within easy reach of London and many major towns in the South. There is a wide choice of housing in the town and surrounding villages. Relocation assistance will be given where necessary.

There is a pleasant working environment and benefits include free life and health assurance.

Please write or telephone Mic Comber (at Andover 61345 — reverse charges if you wish) Brief details only at this stage please as we shall be asking you to complete an application form

LINK
ELECTRONICS

Walworth Industrial Estate, Andover, Hampshire, England Telephone Andover (0264) 61345

(6046)

*Looking
for
a
new
job?*

Perhaps we can help!

We have regular contact with hundreds of electronics and electrical companies needing qualified electronics engineers and technicians and TV service engineers.

We can, therefore, help you to find an interesting and well paid job. All you need to do is to return the coupon below or give us a ring. Our service is confidential and costs you nothing.

**TJB Electrotechnical Personnel Services
12 Mount Ephraim
Tunbridge Wells, Kent**

Tunbridge Wells (0892) 39388

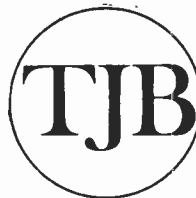

TJB Electrotechnical Personnel Services is a division of Technical & Executive Personnel Ltd. and is solely concerned with job placement in the Electronics and Electrical Industries

Please note that this service is available only for engineers who are (or will be) available in the U.K. for interview.

Please send me an "Application for Registration" form

NAME

ADDRESS

.....

..... (90)



INTERNATIONAL CIVIL AVIATION ORGANIZATION

A Specialised Agency of the United Nations

Invites applications for Technical Assistance Programme assignments in South America, Africa, Middle East and Asia.

ELECTRONICS ENGINEERS

Duties: Vary with assignment; in general, to assist and advise Governments in the standards and procedures of systems planning, installation, modification and maintenance of air navigation, air traffic control and aeronautical communications facilities.

Qualifications: University degree, or equivalent, with ten years or more experience at a responsible level in the management of installation and maintenance programmes relative to telecommunications, VOR, ILS, DME, NDB and/or Radar. Training experience highly desirable.

Salary: Min. U.S. \$21,324 Tax Free.

ELECTRONICS TECHNICAL OFFICERS

Duties: To advise and assist Governments in the installation and maintenance of electronic equipment such as VOR, ILS, DME, NDB and Radar; and/or to conduct formal and on-the-job training of personnel involved in the use of the above-mentioned equipment, point-to-point communications, teletype and automatic data processing equipment.

Qualifications: Ten years or more experience in the installation, maintenance, repair and overhaul of electronic and electrical communications and navigation equipment; certification or licensing in accordance with requirements of the applicant's home country; knowledge of pertinent international standards. Experience as instructor or supervisor, or as an operator or airborne flight calibration consoles desirable.

Salary: Min. U.S. \$15,853 Tax Free.

AVIONICS INSTRUCTORS

Duties: To provide instruction at basic and advanced levels in one or more of the following: Aircraft Electrical, Instrument, Radio or Radar Systems.

Qualifications: Adequate technical or academic background with previous instructional experience; must have worked with relevant equipment for at least ten years.

Salary: Min. U.S. \$17,532 Tax Free.

Dependency, Assignment Allowance and Post Adjustments are payable in accordance with current United Nations scales depending on location.

Apply in writing, giving details of qualifications, experience and equipment knowledge to:

**Director, Technical Assistance Bureau
International Civil Aviation Organization
P.O. Box 400
International Aviation Square
1000 Sherbrooke Street West
Montreal, Quebec
Canada H3A 2R2**

TELEVISION ENGINEERS

Doric Radio is a fast growing member of the Rediffusion group of companies, selling monochrome and colour T.V. receivers to the retail trade through an increasing network of dealers. A small but effective team is being established to provide a technical service to our customers at home and overseas. This team provides service back up facilities by direct contact with our Doric dealers, helping to solve their problems and completing the link back to our factories where necessary.

Attitude, ability, thoroughness, tact and a willingness to get involved are essential requirements for these positions. This is a challenging opportunity for experienced engineers who wish to become important members of a small successful team working on the latest receivers employing advanced electronic techniques. Prospects for promotion are excellent. Formal qualifications, whilst desirable, are not essential where adequate practical experience on modern colour television receivers can be demonstrated.

Successful applicants will be based at our Chessington laboratories, with their excellent facilities and equipment, but occasional visits to our factories in the North of England and to our dealers' premises, both at home and abroad, may be necessary.

Salaries will depend on ability and experience, but will reflect the importance of these new posts. Assistance with relocation expenses will be given where appropriate.

Interested? then write to:-

H. Brearley,
Head of Technical Services,
Doric Radio Ltd.,
Fullers Way South,
Chessington,
Surrey, KT9 1HJ.

Telephone 01-397-5411



DORIC RADIO

(6049)

Opportunities in the ELECTRONICS FIELD

We have selected from many vacancies those which offer exceptional career prospects and job interest. If you have experience in design, test, sales or service and wish to progress your career, please telephone Mike Gernat B.Sc. who is advising on these opportunities.

E.M.A. Management Personnel Ltd.
Burne House, 88/89 High Holborn
London WC1V 6LR
01-242 7773

TECHNICIAN

required in the Computer Centre for construction, testing and maintenance of electronic equipment, mainly in the area of data transmission. HNC or equivalent. Knowledge of digital devices an advantage. Salary sale £2,751-£3,207 p.a. Ref. 660/C/143.

Applications from: Assistant Secretary, Personnel Office, University of Birmingham, P.O. Box 363, Birmingham B15 2TT.

(6034)

SOUND SYSTEM ENGINEERS

Join the APAE, the only official Association representing the P.A. Industry — further details:

**The Secretariat
The Association of Public
Address Engineers**

47 Windsor Road, Slough,
Berks., SL1 2EE

(6039)



**CAPITAL
APPOINTMENTS LTD.**

FIELD SERVICE ENGINEERS (ELECTRONICS)

If you're not earning over £3,500 p.a. plus a car — then you had better contact us! (5540)

34 Percy Street, London, W.1
01-436 9659 (day) or
550 0836 (evening)

AVIONICS IN EDINBURGH

With contracts for a variety of advanced avionic projects in the Tornado (MRCA), Sea Harrier, Nimrod Mk2, Mitsubishi FS-T2, Jaguar and the naval Lynx helicopter, Ferranti in Edinburgh are in a position to offer career conscious engineers a wealth of technological experience. Planned expansion through this year and next now requires the appointment of engineers with experience in the following areas:

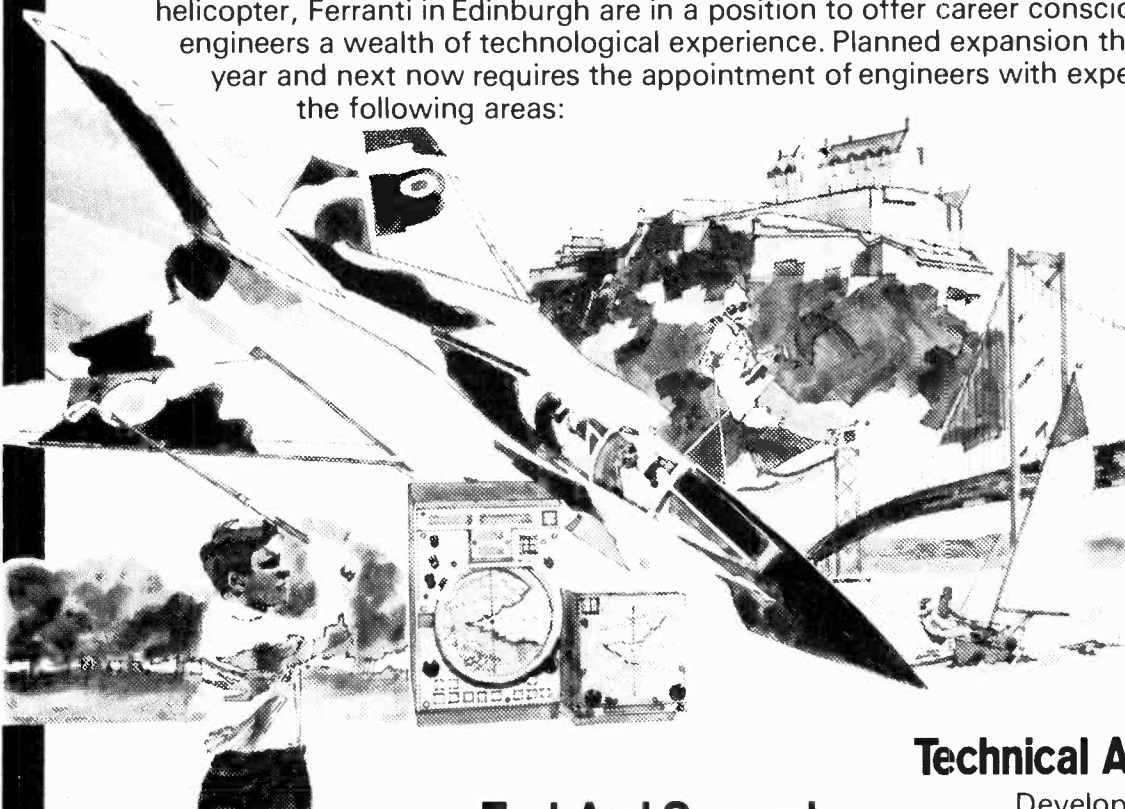

Design/Development

Opportunities exist for electronic and mechanical engineers with qualifications ranging from HND to Honours degree to join our design teams involved in airborne radars, laser range finding and target seeking equipments, inertial navigation systems and their associated test gear.

Test And Support

To support our design teams we need engineers with qualifications from C & G to HNC, preferably with Test and Quality Assurance experience.

They will become involved in a range of work covering automatic test equipment, fault diagnosis and building special-to-type test equipment.

Technical Authors

Development across all our projects requires parallel expansion in our Technical Publications Group.

Experienced technical authors will find the close association with project design particularly stimulating and for engineers keen to embark on such a career this is an opportunity to train in one of the most authoritative technical writing teams in the country.

Salaries are negotiable. The Company operates a contributory pension and life assurance scheme and incoming employees will qualify for housing under the Scottish Special Housing Association scheme.

Apply in writing, quoting reference WW/1, with particulars of qualifications and experience to:

Staff Appointments Officer,
Ferranti Limited, Ferry Road,
Edinburgh EH5 2XS.

FERRANTI

mi

Careers in Professional Electronics

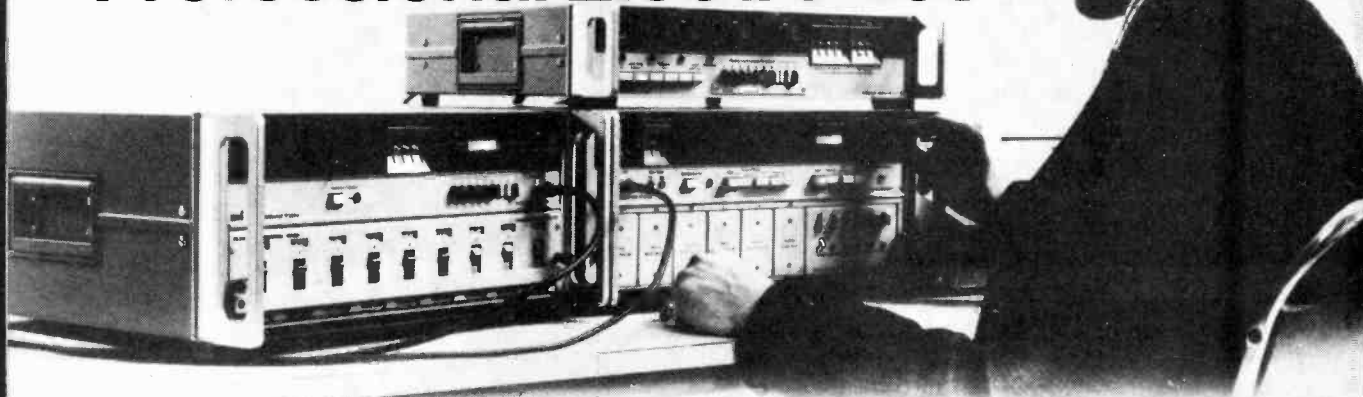

Your experience could open the door to a range of interesting and rewarding opportunities in the Design, Production or Service departments of a Company whose products complement the most advanced modern electronic techniques.

For more information apply in confidence to :- John Prodger,
MARCONI INSTRUMENTS LIMITED
Longacres, St. Albans, Herts. Tel : St. Albans 59292

A GEC-Marconi Electronics Company

(6053)

Sales Engineers

Later this year we shall be adding to our sales programme a range of Hi-Fi and Semi-Professional products by one of the worlds best known manufacturers of Audio Equipment.

We are therefore presently interviewing sales engineers with experience in the Hi-Fi Market for both in-house and travelling positions.

Applicants should enclose a brief CV. and indicate the area of occupation in which they are interested.

Service Engineers

Due to the expansion outlined above and the recent completion of our new extended laboratories, we are seeking service engineers for our entire range of audio products. A good understanding of tape recorders and audio equipment is essential.

Applications in writing please to:-

**The Managing Director,
F.W.O. Bauch Limited**

49 Theobald Street, Boreham Wood,
Hertfordshire, WD6 4RZ

**It's the
Engineers
on the
ground
who
keep the
aircraft
flying**

**MARCONI
ELLIOTT
AVIONICS**

A GEC-Marconi Electronics Company

With the increasing sophistication of today's aircraft, the role of the Service and Test Engineer on the ground is of the utmost importance if the electronic systems and equipment are to be kept at a high level of efficiency.

We are engaged in an expanding programme of work covering the provision of spares and the repair, maintenance and overhaul of airborne electronic equipment, and we need Engineers to service and test a variety of British and American equipment, both in the aircraft and in the workshop.

The work calls for a sound knowledge of radio and electronics theory, preferably coupled with a recognised qualification and at least two years' experience in servicing or maintaining complex electronics equipment, including complete fault diagnosis using sophisticated test gear. Training will be given to suitable less experienced engineers.

The Company offers excellent salaries together with all the benefits of working for a highly progressive company within a major electronics group. The Unit provides first-class working conditions and is conveniently located in pleasant surroundings with close easy access to the M1.

Write with details of experience to Mrs. L. J. Elborn, Marconi-Elliott Avionic Systems Limited, 22-26 Dalston Gardens, Stanmore, Middlesex HA7 1BZ. Tel: 01-204 3322.

(6032)

**CITY OF LONDON
POLYTECHNIC
LIBRARY AND LEARNING
RESOURCES SERVICE**

**TECHNICAL MANAGER
(MEDIA SERVICES)
TECHNICIAN GRADE 7**

Applications are invited from qualified and experienced electronics engineers for the post of TECHNICAL MANAGER (Media Services) in the Library and Learning Resources Service.

This is a new post to meet the continuing development in the Polytechnic's Media Services.

The successful applicant will have had at least 10 years' experience as an electronics engineer (preferably in the education field) and will be familiar with all types of TV and audio visual equipment. Proven management ability is desirable as well as flair and imagination. A genuine desire to contribute to this developing area is essential.

Salary £3,666 - £4,122 per annum plus £465 p.a. London Allowance.

Application forms and further details from the Assistant Secretary, City of London Polytechnic, 119 Houndsditch, London EC3A 7BU.

(6053)

TECHNICAL OFFICER

An Electronics Engineer with B.Sc. or equivalent qualification is required to assist in the design and construction of an automated system for recording isopotential electrocardiographic surface maps. The project will be conducted jointly with the Engineering in Medicine Laboratory at Imperial College and the appointment is for three years and is available immediately. Salary according to qualifications and experience on scale up to £3,699 per annum.

Applications to the Personnel Officer, RPMS, 150 Du Cane Road, London W12 0HS (01-743 2030, Ext. 93), quoting ref. no. 2/WW.

(6026)

**CIRCUIT DESIGN ENGINEERS
SYSTEMS TEST ENGINEERS
SALES AND CONTRACTS
ENGINEERS**



**MALLA
TECHNICAL STAFF**

334 Euston Road
London NW1 3BG
01-387 1043 (5243)

AGENTS REQUIRED to sell quality electric soldering instruments and ancillary equipment to industry. Commission only basis. Suit persons selling allied products who require additional income. Good potential. Box No. WW 5600.

**ELECTRONICS
TECHNICIAN**

required in Department of Engineering Production, University of Birmingham. Analogue and digital circuit development, computer interfacing, instrumentation, machine-tool control. Do you have substantial experience of two or more of these plus initiative and self-motivation? Do you enjoy varied work in a small team?

Salary scale £2,751 - £3,207 p.a.

Ref. 713/C/176.

Application forms from:

**Assistant Secretary
Personnel Office
University of Birmingham
P.O. Box 363
Birmingham B15 2TT**

**INTERNATIONAL FIELD
SERVICE ENGINEER**

Required for our International Mass Spectrometer Service Division based in the U.K. A sound knowledge of modern electronics is essential and a working knowledge of high vacuum systems would be an advantage, although training will be given. Applicants should possess City and Guilds or equivalent qualifications. Due to the extensive travel involved, the position is probably more suitable for a single person aged between 20 and 30 years.

The Company is internationally renowned for the quality of its products and offers excellent working conditions, including company car, pension scheme, superannuation and profit sharing bonus scheme.

Write or telephone for an application form.

Service Manager
G Division
LKB Instruments Limited
232 Addington Road
Selsdon, South Croydon, Surrey CR2 8YD

01-657 8822

(5587)

University of Reading

**ELECTRONICS
TECHNICIAN**

required in the Department of Chemistry. Duties include the maintenance of a very wide range of electronic instruments and help with the design and construction of electronic devices. Salary in scale £2,751-£3,207 p.a. (Grade 5) Apply in writing, quoting Ref. TZZ 288, with full details and names of two referees, to Assistant Bursar (Personnel), University of Reading, Whiteknights, Reading RG6 2AH.

(6052)

**Electronic
Engineers**



Energetic engineers required to help design, test and commission systems using our range of automatic weighing and logic control equipment. The positions offer an opportunity to join an expanding company currently enjoying a high rate of export growth. Applicants should be prepared to travel, have a current driving licence, and experience with Load Cell Weighing, Digital systems using CMOS or TTL or Industrial Logic Control.

Please write for an application form or telephone for more details.

IscA Electronics Limited,

Newtown Industrial Estate,
Crosskeys, Newport, Gwent.
NP1 7PX Great Britain.
Tel: Crosskeys (0495) 270671
Telex: 497437

TEST OR COMMISSIONING

DIGITAL INSTRUMENTS

Vacancies exist for Senior and Junior Engineers in our Test and Service department.

Necessary qualifications are HNC, ONC or C&G and experience with sophisticated digital and analogue circuitry is required.

We are a small well established company producing high standard signal processing equipment.

Salary up to £4,500

Please write with brief particulars to

Chief Test Engineer
DATA LABORATORIES LTD.
28 Wates Way
Mitcham
Surrey CR4 4HR
Tel: 01-640 5321

datalab 

UNIVERSITY OF EDINBURGH ELECTRONICS TECHNICIAN

Required for the DEPT. OF RESTORATIVE DENTISTRY. The work is mainly concerned with medical electronics and electromyography. The successful candidate will be concerned with maintenance and modification of a wide range of medical electronic and allied equipment, and with research and development in electronics as related to dentistry. The post offers challenging and rewarding work in a new and expanding field. Applicants should hold HNC or equivalent in appropriate subjects. Salary will be on scale £2751-£3207 p.a. Assistance with relocation expenses is available if necessary. Applications, quoting post reference No. A188, and giving full details of age and qualifications, together with the names and addresses of two referees, should be submitted by 23rd August, 1976, to the Personnel Office, University of Edinburgh, 63 South Bridge, Edinburgh EH1 1LS. Telephone 031-667 1011, ext. 4510-3. (6021)

Radio Society of Gt. Britain ASSISTANT GENERAL MANAGER

A vacancy will arise in the near future at the Society's London headquarters for an Assistant General Manager with a view to becoming General Manager.

The candidate should ideally possess the following qualifications:

At least five years' executive experience.
Working knowledge of accountancy.

Hold an amateur radio transmitting licence

Salary will be commensurate with qualifications.

Applications should be made before 30 September 1976 to Mr C. H. Parsons, 90 Maesycod Road, Heath, Cardiff, Glamorgan. (6062)

A leading Radio Manufacturer in JOHANNESBURG, SOUTH AFRICA

requires an experienced

DEVELOPMENT ENGINEER

Responsible to the Chief Engineer, but able to work on his own initiative, on radio development work.

Applicants should be qualified to at least HNC/HND, and are unlikely to have less than five years' production experience in the domestic radio field, including a close association with design and manufacturing activities.

The requirement above else is for a practical engineer with both the ability and experience to make a genuine contribution to the engineering team.

Salary: £6000 with additional benefits including pension and sickness scheme together with full assistance with relocation.

Apply now with full details of your qualifications and experience to Mr. T. Willis

P.O. Box 43121
INDUSTRIA
2042
S.A.

(5592)

ELECTROSONIC S.E. LONDON

PROJECT ENGINEERS

AUDIO, LIGHTING, AUDIO VISUAL SYSTEMS SALARY NEGOTIABLE

The work involves handling a project from the receipt of an order and specification, to its final installation and commissioning. Duties will include the integration of the company's standard products into systems, the design of special equipment as part of the system, and the close liaison with the customer to ensure equipment meets their specification.

Applications should be qualified to H.N.C. standard and have experience in system engineering in the relevant fields.

Electrosonic Limited is a rapidly expanding company manufacturing equipment for theatres, hotels, Conference Centres, Discotheques, and all areas of the entertainments and promotion industry.

If you have the right qualifications and experience and are prepared to travel in the UK and Overseas, apply in confidence to: R. J. Owen, Projects Manager, Electrosonic Limited, 815 Woolwich Road, London SE7. Tel: 855 1101.

BURY AREA HEALTH AUTHORITY. We need an ASSISTANT IN THE INSTRUMENT SURVEILLANCE DEPARTMENT at Bury General Hospital. Salary scale £1,635-£2,226 p.a. Junior Medical Physics Technician or £2,346-£3,267 p.a. Medical Physics Technician IV — according to qualifications and experience +£312 non-enhanceable supplement on each scale. For further information please contact Mr Brian Taylor at Bury General Hospital, phone 061 764 0511. Applications in writing giving full details of age, qualifications and previous employment together with the names and addresses of two referees to the Area Personnel Officer, Bury Area Health Authority, 22a Union Arcade, Bury, Lancashire, BL9 0QF. Closing date for receipt for applications 22 July, 1976.

Electronic Engineers with marketable ideas or inventions to join well established company with development laboratory and production facilities on salary and profit sharing basis. Preference given to high quality instruments, avionics or telecommunications. Excellent opportunity for right man to build a future with a share in well established electronics company just south of London Airport. Write Box WW 6051.

U.S.A. OPPORTUNITY. Marine Electronics Field Service technician. Must be experienced in all phases of Marine Communications. Autopilots and radar. Work on world's largest luxury yachts. Please submit resumé and photograph to Electronics for Yachting, 1525 S. E. 16th Street, Ft. Lauderdale, Fla. 33316 U.S.A. (6054)

TESTING & SERVICE ENGINEER

Due to expansion of our manufacturing department, we are looking for a young and progressive Electronic Technician to test and service our multi-track tape recorders. Knowledge of electro-mechanical tape decks will be an advantage. Salary negotiable. Excellent prospects.

Ring: 01-485 6162 (6017)

Technical Writer

Required for ELECTRICAL AND RADIO TRADING, the Trade's top-selling weekly journal.

Applicants for this position should be familiar with servicing data and have practical experience in the TV / Audio and Electrical industry together with the ability to write about repairs and servicing.

Please apply to the Editor, Electrical and Radio Trading, Dorset House, Stamford St. London SE1 9LU Tel. 01-261 8523

(6011)

APPOINTMENTS

MEDICAL PHYSICS TECHNICIAN GRADE 3

Electronic Technician required to organise maintenance service of equipment in the Physics Department Intensive Care Unit and Operating Theatre.

Good opportunities for development work and this will continue to increase depending on the candidate's initiative. Starting salary £3555 per annum inclusive.

Further details from the Principal Physicist (01-807 3071 Extn. 581).

Applications to the Sector Administrator, North Middlesex Hospital, Sterling Way, Edmonton, London N18 1QX. Closing date 2nd August, 1976.

(6078)

MEDICAL PHYSICS TECHNICIAN GRADE II for Guy's Hospital Department of Clinical Physics & Bloengineering. He/She will be a member of a team of Physicists and Technicians engaged in a variety of clinical instrumentation projects. ONC/HNC or higher qualification required, plus 2 years electronics experience in NHS Technicians Grade III. Salary scale £3,558-£4,581 plus £312 London Weighting plus £6 per week. Apply to Personnel Department, Guy's Hospital, St. Thomas Street, London SE1 9RT. Tel. 01-407 7600. Ext 3462. (5578)

ELECTRONICS SERVICE ENGINEER

Interesting and varied work with organs, hi-fi and amplification. Apply in writing, giving full details of experience to: WHITWAM'S, 70 High Street, Winchester, Hants.

(6072)

IMPERIAL WAR MUSEUM. Department of Sound Records. Applicants are invited for a post which involves a variety of both technical and library-type duties. The Department of Sound Records has a wide range of professional equipment and facilities and the post would suit a young person interested in working in the audio field. Full training will be provided by an experienced Audio Technician. Candidates must have a strong technical aptitude and be capable of careful and systematic work. The post is graded Library Assistant 2 and the starting salary is from £28.15 at age 16 to £45.21 at age 23 and over rising to £50.91. A Pay Supplement ranging from £4 pw at age 16 to £6 pw at age 18 and over is payable in addition. Leave is 3 weeks 3 days per year, rising to 4 weeks after 7 years' Service. There are prospects of permanent and pensionable employment. Please apply in writing to the Establishment Officer, Imperial War Museum Lambeth Road, London SE1 6HZ. (5578)

Royal Holloway College (University of London) Egham Hill, Egham, Surrey EXPERIENCED ELECTRONICS TECHNICIAN (GRADE 5)

required in the Physics Department for three years, preferably with experience in digital and computer electronics. Salary on the scale £2,751 - £3,207 plus £275 London Allowance.

Applications together with the names and addresses of two referees should be sent to the Personnel Officer (WW) as soon as possible.

(6069)

CAPITAL APPOINTMENTS LTD.

101 TOP JOBS

for DEVELOPMENT ENGINEERS Phone for free lists

(5075)

34 Percy Street, London, W.1 01-636 9659 (day) or 550 0836 (evening)

ARTICLES FOR SALE

PRECISION POLYCARBONATE CAPACITORS

All High Stability - Extremely Low Leakage

Table with columns: VALUE, RANGE, DIMENSIONS, PRICE. Lists capacitor specifications and prices.

TANTALUM BRAD CAPACITORS - Values available 0.1 0.22 0.47 1.0 2.2 4.8 6µp at 15V 25V or 35V 10µ at 16V 20V or 25V 22 0µ at 16V or 18V 33 0µ at 6V or 10V 47 0µ at 10V or 6V 100 0µ at 3V ALL at 10p each 10 for 95p 30 for £4.

Table with columns: TRANSISTORS & ICs, listing various transistor and IC models and their prices.

POPULAR DIODES - 1N914 5p, 8 for 45p, 18 for 80p, 1N916 5p, 6 for 45p, 14 for 80p, 1N54 5p, 11 for 50p, 24 for £1.00, 1N4148 5p, 6 for 27p, 12 for 48p, 1N4001 3p, 002 6p, 003 8p, 004 7p, 006 6p, 400 5p.

LOW PRICE ZENER DIODES - 400MW Tol ± 5% at 5mA Values available 3V 3.3V 3.6V 4.7V 5.1V 5.6V 6.2V 6.8V 7.5V 8.2V 9.1V 10V 11V 12V 13V 13.5V 15V 16V 18V 20V 22V 24V 27V 30V. All at 7p each 5 for 35p, 10 for 65p. SPI-CL-14 CETERA 100 Zeners for £8.00.

RESISTORS - High stability low noise carbon film 5% ±W at 40°C ±W at 70°C 1/2 series only - from 2.2Ω to 2.2MΩ A1, L at 1p each, 8p for 10 of any one value 70p for 100 of any one value. SPECIAL PACKS: 10 of each value 2.2Ω to 2.2MΩ (30 resistors) £5.

SILICON PLASTIC RESISTORS - 1.5amp brand new wire ended DO27 - 100 P1V 7p (4 for 26p), 400 P1V 8p (4 for 30p).

BRIDGE RESISTORS - 2½ amp 200V 80p, 350V 45p, 600V 55p.

SUBMINIATURE VERTICAL PRINTS - 61W only ALL at 3p each, 5012 100Ω 220Ω 470Ω 680Ω; 1KΩ 2.2KΩ 4.7KΩ 6.8KΩ 10KΩ 15KΩ 22KΩ 47KΩ 68KΩ 100K 250K 680K 1MΩ 2.5MΩ 5MΩ.

PLEASE ADD 8% VAT to all items except those marked with * which are 25%.

Send SAE for lists of additional ex-stock items. Wholesale price lists available to bona fide companies.

MARCO TRADING (Dept. D1) The Old School, Eastdorton, Nr. Wem Shropshire Tel. Whixall (Shropshire) (STD) 094872 464/5 (Proprs. Mincost Trading Ltd.)

ARTICLES FOR SALE

GREENBANK ELECTRONICS

(ESTABLISHED 1970)

DIGITAL CLOCK MODULES, KITS

Further details free on request

Table listing digital clock modules, kits, clock chips, OP-AMPS, CMOS with discounts, and soldercon pins with prices.

PUSH BUTTON SWITCHES Type SW9 Min. Push to make 15p

Table listing CMOS with discounts (Any mix disc 10% 25+ 25% 100+) and push button switches with prices.

Terms: C.W.O. Add VAT at all prices at 8% Post etc. U.K. 10p per order. All orders processed same day Official Govt. Varsity, Poly etc orders welcomed

GREENBANK ELECTRONICS (Dept. W8W) 94 New Chester Road, New Ferry, Wirral, Merseyside L62 5AG, England. Tel: 051-645 3391



THE QUARTZ CRYSTAL CO. LTD. QCC WORKS, WELLINGTON CRESCENT NEW MALDEN, SURREY 442 0334 x 2986

THE ELECTRONIC MUSICAL INSTRUMENT MANUAL

by A. Douglas Price £8.00 PROBLEMS & SOLUTIONS IN LOGIC DESIGN by D. Zissos PRICE £2.10 IC OP-AMP COOKBOOK by W. G Jung PRICE £8.75 COLOUR TV WITH PARTICULAR REFERENCE TO THE PAL SYSTEM by G. N. Patchett PRICE £5.40

DESIGNING WITH TTL INTEGRATED CIRCUITS by Texas Instruments PRICE £7.60 TRANSISTOR ELECTRONIC ORGANS FOR THE AMATEUR by A Douglas PRICE £4.85 TRANSISTOR POCKET BOOK by R G Hibberd PRICE £4.25 SOLID STATE COLOUR TV CIRCUITS by G R Wilding PRICE £6.25

MICROPROCESSORS & MICROCOMPUTERS by B Soucek PRICE £16.00 RADIO VALVE & SEMICONDUCTOR DATA by A M. Ball PRICE £2.50 VHF - UHF MANUAL by D S Evans PRICE £5.65

PRICES INCLUDE POSTAGE (44)

OSCILLOSCOPE / ELECTROMYOGRAPH, low noise, high gain 4 channel instrument. This is a brand new instrument for sale by the manufacturers as an end of line offer, due to cessation of production of this model. Full guarantee and all circuits, service and instruction manuals provided. Maximum gain 5 microvolts per centimeter. Noise less than 5 microvolts peak to peak at 5kHz bandwidth. Camera recording on separate CRT, fully electrically controlled, and complete with motor driven camera. Also includes a synchronised stimulator for medical use and many other facilities. Time calibration displayed on screen. Leaflet available on enquiry. Price, at below manufacturing cost 1990 plus VAT. - Phone Waddesdon (029665) 220. (6018)

RECLAIMED COMPONENTS. Guaranteed full spec CA3089E £1.25, 1310 decoders 95p, TRA 651 95p post free. Box No. W 6045.

THE MODERN BOOK CO SPECIALISTS IN SCIENTIFIC & TECHNICAL BOOKS 19-21 PRAED STREET LONDON W2 1NP Phone 723 4185 Closed Sat 1 p m

ARTICLES FOR SALE

EXCLUSIVE OFFER

WORLD-WIDE RANGE NEVER BEFORE OFFERED
PHILCO HC-150 POINT-TO-POINT STRIP RADIO HF RECEIVERS 2/30 m/cs Ten fully tuneable channels to 0.5 kcs with synthesisers. Single and diversity reception on ISB, DSB, SSB with 4 sub-bands to each channel. Full details and prices on application.

HIGHEST QUALITY 19" RACK MOUNTING CABINETS & RACKS
ENQUIRIES INVITED AND SEE NEXT MONTH'S ISSUE FOR NEW STOCK

AUDIO AND INSTRUMENTATION-TAPE RECORDER-REPRODUCERS

- * Plessey ID33 Digital Units, 7 track
- * Plessey M5500 Digital Unit, 7 tracks
- * Ampex FR-1100, 6 speeds, stereo 1/2"
- * Ampex FR600, 4 speeds, 7 tracks 1/2"
- * Ampex FR600, 4 speeds, 14 tracks 1"
- * D.R.I. RMI, 4 speeds, 4 tracks 1/2"
- * EMI TR90 2 speeds, 1 track 1/2"
- * EMI BTR1, 1 speed, 1 track 1/2"
- * EMI R301G, 2 speeds, 2 tracks 1/2"
- * EMI RE321 1/2" 7 1/2" 1 track
- * Ficord IA 1/2", 1 1/2", 7 1/2", 1 track
- * Mincom CMP-100, 6 speeds, 7 tracks 1/2", 1"
- * Leavers Rich DA-2P, 2 speeds, 2 tracks 1/2"

Prices of above £70 to £400

Also Transport Decks only available

We have a large quantity of "bits and pieces" we cannot list - please send us your requirements, we can probably help - all enquiries answered.

- * Rohm 95ft masts lattice 12" sides P.U.R.
- * 30ft Lattice Masts, 14" sides £55.00
- * 15ft Lattice Masts, 14" sides £35.00
- * 120ft Lattice Masts, 15" sides P.U.R.
- * 75/90ft Sky Towers, self-supporting £475
- * Heavy Aerial Rotators P.U.R.
- * Rascal SA 504 Voltage converters £25.00
- * Elliot Recording M/A Meters £75.00
- * Halcraftier 152/174 M/cs tuneable Receivers £65.00
- * Tequipment Servicoscopes £25.00
- * 75ft Aluminium Lattice Masts, 20ft sides £400.00
- * Plessey peak distortion meters £35.00
- * Polarad Microwave power meters £55.00
- * Rhode & Schwarz SBR sig gen, 1.6/2.4 gmc £70.00
- * Airmec 702 sig gen 30 cyc 30 kcs £26.00
- * Muirhead D689 Analysers £70.00
- * S.E. 4000 System Units P.U.R.
- * Large Aerial Turning Units P.U.R.
- * Muirhead Hydraulic Ship controls P.U.R.
- * Lavote OS-62 Oscilloscopes 115v 15 m/cs £65.00
- * S.T.C. Rx 5 Receivers 0.5/25.0 m/cs Dual Diversity £90.00
- * 45 feet Uniradio 4 Co-ax 50 ohms £2.00
- * Steima RTT Scopes £20.00
- * Baluns Professional 500/75 Ohms £5.00
- * Telegraph Distortion Test Sets £30.00
- * 25ft Telescopic Aerial Masts £24.00
- * Advance LI Signal Generator 300/1000 m/cs £70.00
- * Addo 5/8 Track Tape Punches £48.00
- * Digital Cassette Recorders 1/2" 1000 bps £250.00
- * 1600ft 16 m/m Film Spools ally (unused) 10 for £1.00
- * Quality Weather Vans 8 contacts (unused) £4.00
- * B.N.C. Connectors 200 for £42.00
- * Video Cross Hatch TV Generators £17.00
- * Rascal MA-175 L.S.B. Modulators (new) £45.00
- * Collins KW7-6 SSB Transceivers 500 watts 2/30 m/cs £1250.00
- * Inside Cabinet Shelf Sliders £3.00
- * DG-7/32 or DG7/5 C.R.T.s £3.00
- * M.V.R. Action Replay 20 sec. Videocisc Unit P.U.R.
- * Advance HI Signal Generators, 15/50Kcs £18.00
- * Varian V175A Backward Wave Oscillators P.U.R.
- * Tally 5/8 Track Tape Readers 60 cps £48.00
- * Tally 5/8 Track Tape Readers Track Spooling £65.00
- * 2 KVA Auto-Transformers £22.00
- * Cimet 2 KV Power Supply £35.00
- * Cawwell FU 4 Band Pass Filter Testers £60.00
- * Avo Geiger Counters (new) £7.50

We have a quantity of Power Transformers 250 watts to 15KVA at voltages up to 40KV. Best quality at low prices. Lists available.

- * Rascal RA-63 SSB Adaptors, new £70.00
- * Rascal RA-237 L-W Converters, new £70.00
- * 19" Blank Rack Panels 8x1in high, new £1.00
- * Apco Dial a Copy Photo Copier Electrostatic £35.00
- * Hewlett Packard 524C Digital Counter P.U.R.
- * Portable Mains Battery Hospital Lights £24.00
- * 400 channel Pulse Height Spectrum Analysers £600.00

We have a varied assortment of industrial and professional Cathode Ray Tubes available. List on request.

COMPUTER HARDWARE

- * LINE PRINTER, High speed 1000 lines c.p.m.
- * TAPE READER, High-speed 5/8 track 800 c.p.m.
- * CARD READER 80 col. 600 c.p.m.

Prices on Application
 PLEASE ADD CARRIAGE AND V.A.T.

AT APPROPRIATE RATE TO ABOVE
P. HARRIS
ORGANFORD - DORSET

BH16 6BR

BOURNEMOUTH (0202) 765051

(6013)

COLOUR, UHF AND TV SPARES. Lists on request. "Wireless World" TV Tuner and FM Tuner Projects by D. C. Read. Kits of parts available. **JAPANESE SOLID STATE COLOUR CHASSIS** for the experimenter. Includes IF Decoder CDA, Timebases, Output stages, etc incl. circuit. Brand new £20 p/p £1.50. New Cross Hatch kit Aerial input type. No other connections. Battery operated portable. Incl. Sync & UHF Modulator units £11* Add-on Grey Scale kit, £2.90* p/p 45p. CRT Reactivator kit for colour and mono £17.48* p/p 80p. Signal Strength Meter kit £18* p/p 70p. 625 TV IF Unit, for Hi-Fi amps or tape recording £6.80 p/p 65p. Decca Colour TV Thyristor Power Supply Unit, incl. H.T., L.T., etc. Incl. circuits £3.80 p/p 95p. Bush CTV 25 Power Supply Unit, incl. H.T., L.T., etc. £3.20 p/p £1.20. Bush CTV 25 Convergence panel plus yoke, blue lateral £3.60 p/p 80p. Philips single stand convergence units complete, incl 16 controls, £3.75 p/p 75p. Colour Scan Coils, Mullard or Plessey £6 p/p 80p. Mullard AT1023/05 or Plessey Converg. Yoke £2.50 p/p 55p. Mullard or Plessey Blue Laterals 75p p/p 30p. BRC 3000 type scan coils £2 p/p 80p. Bush CTV 25 Scan Coils £2.50 p/p 80p. Delay Lines: DL20 £3.50 DL40 £1.50 DL1E, DL1 85p p/p 40p. Lum. delay lines 50p p/p 30p. Bush/Murphy CTV 25 3/174 EHT quadrupler £8.50 p/p 75p. Special offer colour triplers, ITT TH25 1TH £2 GEC 2040 £1.75 p/p 50p. Philips G8 Panels, part complete, surplus/salvaged: Decoder £2.50, IF incl. 5 modules £2.25, T. Base £1 p/p 70p. CRT Base 75p p/p 30p. GEC 2040 Decoder panel for spares £3.50 p/p 70p. VARICAP TUNERS, UHF: ELC 1043 £4.20, ELC 1043/05 £5, VHF: ELC 1042 £5.50, Philips VHF £3.30. Salvaged UHF & VHF Varicaps £1.50 p/p 35p. **SPECIAL OFFER:** RBM 6 psn. Varicap control unit £1 p/p 35p. UHF Tuners transd. incl. slow motion drive £3.80, 4 Psn. and 6 Psn. push button transd. £4.20 p/p 70p. Philips, Bush, Decca integrated UHF/VHF transd. tuners £4.50 p/p 80p. Thorn 850 dual stand, time base panels 50p. Philips 625 IF panel incl. cct. 50p. p/p 65p. VHF Turret tuners AT 7650 for KB Featherlight. Philips 19TG170, GEC 2010, etc. £2.50. Pye miniature incremental tuners £1. Fireball tuners, Ferguson, HMV, Marconi 80p p/p all tuners 70p. Mullard Mono scan coils for Philips, Stella, Pye, Ekco, Ferranti, Invicta £2 p/p 70p. Large selection LOPTs, FOPTs available for most popular makes **MANOR SUPPLIES**, 172 West End Lane, London, N.W.6. Shop premises. Callers welcome. (Nos. 28, 159 buses or West Hampstead-Bakerloo Line and British Rail). Mail Order: 64 Golders Manor Drive, London, N.W.11. Tel: 01-794 8751. V.A.T. Please ADD 12 1/2% TO ALL PRICES (EXCEPT WHERE MARKED * VAT 8%). (60)

SAVE IT! BARGAIN
500 WATT DIMMER SWITCH
 (not suitable for fluorescent lights)
 Basic Module with 1" Knob £2 00
 Complete on MK switch plate £2 50
 Large 2" knob (BULGIN) 25p extra P&P 25p
 Please add 8% VAT to all orders inc P&P
FRASER-MANNING LTD.
40 TUDDENHAM ROAD, IPSWICH IP4 2SL (35)

CRYSTALS
 Fast delivery of prototype and production quantities to your specifications. EG:
 100 KHz 0.005%, NC13/0 £2.50 each £1,900 per 1,000
 1 MHz 0.005%, NC6/0 £2.50 each £1,600 per 1,000
 2.097152 MHz 0.0025%, NC6/0 £3.05 each £1,350 per 1,000
 3.2768 MHz 0.0025%, NC6/0 £2.70 each £1,300 per 1,000
 10 MHz 0.002%, HC1E/0 £2.00 each £1,100 per 1,000
 Also Stalek LF Crystals in FO-5 package many stock frequencies in the range 10-240 KHz e.g., 10 12 8 16 384 32 768 & 100 KHz prices from £2.55 each £1,400 per 1,000
 Please send for further details
INTERFACE QUARTZ DEVICES LTD., 29 Market Street, Crewkerne, Somerset. Telephone: (046031) 2578 Telex: 46283

OPPORTUNITY SALE
 Do you use equipment. Wire, solder sleeve, etc. All sizes in stock, full list sent on application.
 Example price (less than half price)
7/0076 PVC EQUIPMENT WIRE
£8/1,000 yds
RESIN CORED SOLDER
£1.30/1Kg REEL
INTEGRATED SUPPLIES
 Electrographic House
 Printinghouse Lane
 Hayes, Middx UB3 1AP
 Tel: 01-573 1826 (6063)

DIGITAL CLOCK CHIP, AY-51224, with data and circuit diagram, £3.66 plus VAT. 'Jumbo' LED digits (16mm high) type economy DL/747 only £2.04 each plus VAT, post free. Greenbank Electronics, 94 New Chester Road, Wirral, Merseyside L62 5AG. (83)

C.R.T. REGUNNING PLANT. New and secondhand reconditioned training, demonstration, colour or B/W. Barretts, Mayo Road, Croydon, Surrey, CRO 2QP. (36)

VACUUM is our speciality, new and secondhand rotary pumps, diffusion outfits, accessories, coaters, etc. Silicone rubber or varnish overplating equipment from £40. V. N. Barrett (Sales) Ltd., 1 Mayo Road, Croydon. 01-684 9917. (24)

16MM B & H 631 Sound projectors c/w speaker and transformers £135. - Hilton Cine, 9 West Hill, Dartford T. 20009. (15)

SALE UHF/VHF C.A.T. Equipment. New half price coaxial cables, spurs, tees sockets. Send S.A.E. for full list. Stone, Fernfield, Birch Platt, West End, Woking Surrey. (6060)

VARISPEED 98 conversion kit for Philips mono cassette recorders gives you second track for stereo, cine synchronization, etc. plus variable speed control only £9.95 (p&p 30p). A.M.P.C., 115 York Street, Cambridge. Trade enquiries welcomed. (6056)

YOUR TAPES TO DISC. Mono or Stereo Cutting. Vinylite Pressings. Sleeves/labels. Top professional quality. S.A.E. for photo leaflet. DEROY Records, Eastwood, Cove Dunbartonshire, Scotland. (82)

60KHz MSF Rugby Receiver, BCD TIME OF DAY OUTPUT. High performance, phase locked loop radio receiver. 5V operation with 1 second LED indication. Kit complete with tuned ferrite rod aerial £14.08 (including postage and VAT). Assembled circuit and cased-up version also available. Send for details Toolex, Sherborne (4359), Dorset. (21)

OSCILLOSCOPE Tektronix mode; 564B storage with plug in 2B67 timebase and 3A6 dual trace amplifier. Manuals. Little used. £550. - Tel. Erith (Kent) 30556. (6020)

ANTIQUÉ WIRELESS: receivers, valves, components, service sheets, books and magazines, 1920-1950. S.A.E. with enquiries or 50p for full catalogue. - Tudor Rees, 64 Broad Street, Staple Hill, Bristol BS16 5NL. Tel. Bristol 565472.

Language Laboratory. Complete equipment with furniture—32 student positions with Telefunken Recorders, Microphones and headsets Tutors console with individual or oral communication. Mr Wright, 061-764 2931 (6047)

INVERTERS
 To operate mains equipment from 12v to 24v DC on automatic stand-by



Sine wave. Square wave. Self driven or Frequency controlled. Suitable for maintaining mains supply during power failure, running equipment where the mains is not available, or insulation from the mains. **Controlled battery charging incorporated.**
MAINS-STORE
 Send for information to
Interport Mains-Store Ltd.
 30 Old Bond Street, London W1
 Tel. 01-727 7042 or (0225) 310916 (6035)

SOWTER TRANSFORMERS
 FOR SOUND RECORDING AND REPRODUCING EQUIPMENT
 We are suppliers to many well-known companies, studios and broadcasting authorities and were established in 1941. Early deliveries. Competitive prices. Large or small quantities. List on request.
 A former release: **SOWTER TYPE 3678 MULTITAP MICROPHONE TRANSFORMER**
 Primary windings for 300 ohm, 200 ohm and 60 ohm with secondary loadings from 2k ohm to 10 k ohm. Frequency response plus minus +/-20 Hz to 25 KHz. Contained in well finished metal box, 33mm diameter by 22mm high, with colour coded and built low distortion. DELIVERY JANUARY 2000. FULL DETAILS ON REQUEST.
E. A. SOWTER LTD.
 Transformer Manufacturers and Designers
 7 Durham Place, Fore Street
 Ipswich IP4 1JP. Tel. 0473 52784 6042

BURGLAR ALARMS
 Supplies and Equipment
 * **SPECIAL OFFER - LARGE SIZE**
PRESSURE MATS £1.20 *
MAGNETIC CONTACTS with magnet Only 75p
 Bells, Sirens, Alarm Units, Bell covers Window Foil, Cable, Vibration contacts
S.A.E. FOR FREE CATALOGUE
 Complete kit, fantastic value, everything you need, only £40 00
 Add VAT at 12 1/2% to all orders
A.D. ELECTRONICS, Warbeck Moor
Aintree, Liverpool, L9 0HU
051-525 3440 (6043)

QUARTZ CRYSTAL UNITS from
 ● 1.8-30.0 MHz
 ● FAST DELIVERY
 ● HIGH STABILITY
 ● TO DEF 6271-A



WRITE FOR LEAFLET AT 1
MCKNIGHT CRYSTAL Co. Ltd.
 HARLEY INDUSTRIAL ESTATE, WYTHE, SOUTHAMPTON SO4 6ZY
 TEL. HYTHE 848961
 STD CODE 0703 (6044)

CREED 54/N4 TELEPRINTERS in good condition, enquiries to—D. M. Hogan, 7 Valley View, Landey, Barnstable, Devon. Tel. Swinbridge 489. (5553)

VALVE OUTPUT transformers sectionalised silcor laminations, Kw 15 watts (Two) 4Kk 20 watts (Two), 15 OHM Secondaries. Offers. (5558)

PRINTED CIRCUIT BOARDS. High quality, fast deliveries. - Phototechniques, 11 Old Witney Road, Eynsham, Oxford. Tel. Oxford (0865) 8X0645. (5525)

SERVICES

and NOW

from ONE source

SEEN/SEE

If you are an Engineer or Buyer in any of the following, write for our Catalogues

Manufacturing,
Public Authorities
Laboratories,
Universities,
Contracting,
Maintenance.

SERVICE, you can obtain many other Technical Products including **Electrical, Mechanical and Tools** in addition to the **Electronic** components that we have been distributing to Industry for over 30 years.

Large duplicate stocks are kept in **LONDON** and **SCOTLAND** to give you quick service.

**CABLES & COMPONENTS LTD**

Park Avenue, London NW10 7XN

ARTICLES FOR SALE

Instrument case problems?
We have
OVER 300 SOLUTIONS

See last month's or next month's issue or telephone us

WEST HYDE DEVELOPMENTS LTD.
Ryefield Crescent, Northwood Hills
Northwood, Middx, HA6 1NN
Tel. Northwood 24941/26732
Telex: 923321 (6029)

VALVES RADIO TV TRANSMITTING INDUSTRIAL 1936 to 1975, many obsolete types. List 20p s.a.c. for quotation. Postal export service. We wish to buy all types of valves new and boxed. Wholesalers, Dealers, etc. stocks purchased. Cox Radio (Sussex) Ltd., The Parade, East Wittering, Sussex, West Wittering 202J. (5392)

Burglar Alarm equipment — safes — D.I.Y. — S.A.E. price list. — Astro Alarms 25 Stockton Road, Sunderland, Tyne & Wear. Telephone 77825. (6067)

Wireless World, 1943 to 1975, less three copies. 29 volumes with index. unbound. — Offers Telephone Sudbury, Suffolk 75692. (6068)

Dual Beam Oscilloscopes C116, £60; CD71152, £25; Nombrex 40 Audio Signal Generator, £20; Sinclair Programmable Calculator, £20. — Private Sale, Stuart Gordon, 794 4124. (6071)

COMPARASCOPE (By Vision Engineering) Type 51. In excellent hardly used condition. £350. Romford 44473. (6076)

VIBRATOR / TRANSDUCER (By Goodmans) 100w. £100. Romford 44473. (6076)

ENAMELLED COPPER WIRE

S.W.G.	1 lb reel	1/2 lb reel
10 to 19	2 40	1 35
20 to 29	2 45	1 40
30 to 34	2 60	1 50
35 to 40	2 85	1 60

All the above prices are inclusive of postage and packing in UK

COPPER SUPPLIES

102 Parrwood Road, Withington,
Manchester 20
Telephone 061-445 8753

RECEIVERS AND AMPLIFIERS

HRO RX5s, etc., AR8N, CR100, BRT400, G209, S640, etc. etc. in stock R. T. & J. Electronics, Ltd., Ashville Old Hall, Ashville Rd., London, E11. Ley 4986. (605)

SIGNAL Generators, Oscilloscopes, Output Meters, Wave Voltmeters, Frequency Meters, Multi-range Meters, etc. etc. in stock R. T. & J. Electronics, Ltd., Ashville Old Hall, Ashville Rd., London, E11. Ley 4986. (604)

SITUATIONS WANTED

ELECTRONIC ENGINEER wishes to obtain work in S.W. England, 15 years' experience all aspects including Medical Electronics. Would represent company (service) in S.W. or accept part time work. B. Jones, 4 Sycamore Close, Broadclyst, Near Exeter, Devon. (6058)

BUSINESS OPPORTUNITIES

TO ALL PRODUCERS of Hi-Fi equipment, complete systems or components, who are developing new techniques and are looking for a distribution outlet in Switzerland. We can offer our expertise in this field to help you place your products strategically on the lucrative Swiss market. Our young organisation is endeavoured to enable to you optimum distribution with maximum returns. Interested manufacturers apply to Box No. 6073.

EQUIPMENT WANTED

BROADFIELDS AND MAYCO DISPOSALS

21 Lodge Lane, N. Finchley
London, N12 8JG
Telephone:
01-445 2713

01-445 0749

01-958 7624

WE ARE INTERESTED IN PURCHASING ALL KINDS OF RADIO, T.V. AND ELECTRONIC COMPONENTS AND EQUIPMENT IN BULK QUANTITIES.

WE PAY PROMPT CASH AND CLEAR MATERIAL BY RETURN. (46)

PRINTED CIRCUITS and HARDWARE

Readily available supplies of Constructors hardware. Aluminium sheet and sections. Printed circuit board, top quality for individual or published designs

Prompt service

Send 15p for catalogue

RAMAR CONSTRUCTOR SERVICES

Masons Road, Stratford-on-Avon
Warwick. Tel: 4879

EURO CIRCUITS

Printed Circuit Boards — Master layouts — Photography — Legend printing — Roller tinning — Gold plating — Flexible films — Conventional fibre glass — No order too large or too small — Fast turnaround on prototypes. All or part service available NOW

EURO CIRCUITS TD.

Highfield House
West Kingsdown
Nr. Sevenoaks, Kent. WK2344

SERVICE AND REPAIRS

AUDIOMASTER . . . service; sales. Tape programmes. P. J. Equipments. 3 Onslow Street, Guildford 4801. (12)

LABELS, NAMEPLATES, FASCIAS on aluminium or plastic. Speedy delivery G.S.M. Graphic Arts Ltd., 1-5 Rectory Lane, Guisborough (02873-4443), Yorks, U.K. (5305)

TUBE POLISHING, scratched faces on your tubes can be repaired for £6.55 total cost. V.A.T. and return carriage included. — Retube Ltd., North Somercotes, Louth, Lincs. — Phone N/S 300 (Std. 050785).

COURSES

Strathclyde Regional Council —
Department of Education
GLASGOW COLLEGE OF TECHNOLOGY

PART-TIME COURSE

leading to the CNAA DEGREE OF

B.Sc. in ELECTRICAL ENGINEERING

ENTRY QUALIFICATIONS: A good HNC or HND in an appropriate subject, or equivalent qualification.
DURATION: 4 years or 3 years for some HND holders.
ATTENDANCE: 9 a.m.-8 p.m., one day per week, 40 weeks per year, plus one full week in each of the third and fourth years. The course commences each August.

FURTHER DETAILS FROM:

The Academic Registrar
Glasgow College of Technology
North Hanover Place
GLASGOW G4 0BA
TEL. 041-332 7090

(6019)

RADIO and Radar M.P.T. and C.G.L.I. Courses. Write: Principal, Nautical College, Fleetwood, FY7 8JZ. (25)

RADIO AMATEURS EXAMINATION, City & Guilds. Pass this important examination and obtain your G8 licence, with an RRC Home Study Course. For details of this, and other courses (GCE, Professional Examinations, etc), write or phone The Rapid Results College, Dept. JW1 Tuition House, London, SW19 4DS. Tel. 01-947 7272 (Careers Advisory Service), or for a prospectus only ring 01-946 1102 (24-hour recording service). (6040)

TAPE RECEIVERS

RECORDS MADE TO ORDER

DEMO DISCS MASTERS FOR RECORD COMPANIES	VINYLLITE PRESSINGS
---	------------------------

Single disc. 1.20. Mono or Stereo, delivery 4 days from your tapes. Quantity runs 25 to 1,000 records PRESSED IN VINYLITE IN OUR OWN PLANT. Delivery 3-4 weeks. Sleeves/Labels. Finest quality NEUMANN STEREO/Mono Lathes. We cut for many studios UK/OVERSEAS. SAE list.

DEROY RECORDS

Eastwood Cove, Dunbartonshire
Scotland

ARTICLES WANTED

WANTED!

all types of scrap and
**REDUNDANT
ELECTRONIC &
COMPUTER
MATERIALS**
with precious metal content

TRANSISTORS & PRINTED CIRCUIT BOARDS TO COMPLETE COMPUTERS

The **COMMERCIAL
SMELTING &
REFINING Co. Ltd.**
171 FARRINGTON ROAD
LONDON EC1R 3AL
Tel. 01-837 1475
Cables: COMSMELT, EC1

Works: FLECKNEY, nr. LEICESTER (6050)

★ MINICOMPUTERS ★ PERIPHERALS ★ INSTRUMENTATION

For fastest, best CASH offer, phone

COMPUTER APPRECIATION
Godstone (088 384) 3106

WANTED, all types of communications receivers and test equipment. Details to R. T. & I. Electronics Ltd., Ashville Old Hall, Ashville Rd., London, E.11, Ley 4986. (63)

SURPLUS COMPONENTS, Equipment and Computer panels wanted for cash. Ring Southampton 772501. (16)

B-D ELECTRONICS offer prompt settlement for your surplus components. Our main field of interest is consumer electronics. Please telephone our Miss Hughes, Sandy (0767) 81616. (22)

WE BUY new valves, transistors and clean new components, large or small quantities, all details, quotations by return. — Walton's, 55 Worcester St., Wolverhampton. (62)

ANNOUNCEMENT

The Voice of Iran change frequency

The English Programme of Iran Radio will be broadcast for Europe on 11770 KHZ (25 metre band) as from June 20, 1976, from 20.00 to 23.00 GMT. (6025)

VALVES WANTED

VALVES. Good prices. Types CV2797, CV2798, CV2792, CV2130, CV2131, CV345, CV450. Phone 021-373 4357. (5522)

SYMPOSIUM

The Society of Electronic & Radio Technicians

MICROPROCESSORS AT WORK

A residential symposium to be held at Sussex University from 26th to 29th September, 1976.

The technical sessions will cover the devices and technology on the market, the selection, prototyping and testing of microprocessors, programming and software, and a look at a wide variety of applications which will shed light on some of the problems which arise and the methods of solution.

There will also be a small scale exhibition of microprocessors and peripheral equipment, allowing further access to microprocessor expertise.

The symposium is directed towards the practical aspects of MPUs and is intended to aid those considering, or embarking upon, the use of microprocessors.

COMPETITION FOR THE MOST INGENUOUS APPLICATION OF AN MPU

During the symposium the result will be announced of a competition for an application of MPUs by the home constructor which is simple, economic, original and useful or entertaining.

First prize £150, and the working system will be displayed in the exhibition associated with the symposium. Closing date for full submission, 19th September, 1976.

Further information about the symposium *Microprocessors At Work* or the competition may be obtained from the MPU Secretariat, SERT.



SERT
society of electronic
and radio technicians

Faraday House, 8-10 Charing Cross Road, London WC2H 0HP
Telephone: 01-240 1152

(6023)

CAPACITY AVAILABLE

From drawings to completed product

For quality, service and a
keen price,
contact Mr Price-Smith

**Multiform
Electronics
Limited**

22 Portugal Road Woking Surrey GU215JE
Telephone Woking (04862) 70248 (6036)

PRINTED CIRCUIT BOARDS. High quality, fast deliveries. Phototechniques, 11 Old Witney Road, Eynsham, Oxford. Tel. Oxford (0865) 880645. (6077)

PRINTED CIRCUIT BOARDS — Quick deliveries, competitive prices, quotations on request, roller tinning, drilling, etc., speciality small batches, larger quantities available Jamiesons Automatics Ltd., 1-5 Westgate, Bridlington, N. Humberside, for the attention of Mr. J. Harrison. Tel: (0262) 4738/77877. (18)

CAPACITY available to the Electronic Industry. Precision turned parts, engraving, milling and grinding both in metals and plastics. Limited capacity available on Mathey SP33 jig borer. Write for lists of full plant capacity to C.B. Industrial Engineering Ltd., 1 Mackintosh Lane, E9 6AB. Tel: 01-985 7057. (14)

BATCH Production Wiring and Assembly to sample or drawings. Deane Electricals, 19B Station Parade, Ealing Common, London, W.5. Tel: 01-992 8976. (23)

DESIGN, development, repair, test and small production of electronic equipment. Specialist in production of printed circuit assemblies. **YOUNG ELECTRONICS LTD.**, 184 Royal College Street, London NW1 9NN. 01-267 0201. (20)

AIRTRONICS LTD., for Coil Winding — large or small production runs. Also PC Boards Assemblies. Suppliers to P.O., M.O.D., etc. Export enquiries welcomed, 3a Walerand Road, London SE13 7PE. Tel: 01-852 1706. (61)

FINE SPOT WELDING, coil winding, soldering, mechanical and electrical assembly, light sheet metal and presswork. Contact — **Webson (Manchester) Ltd.**, Shentonfield Road, Sharston, Industrial Estate, Manchester 22. (5376)

COIL WINDING and transformer Manufacturer. Quick deliveries, competitive prices. **Raven Transformers Ltd.**, 587 High Road, Leyton, E10. 01-556 9467. (6028)

Small batch production wiring, assembly to sample or drawings. Specialists in printed circuit assembly. **Rock Electronics**, 41 Silver Street, Stansted, Essex. Tel. Stansted (0279) 33108. S14006. (19)

LICENCE OFFERED

ACOUSTICALLY ADJUSTABLE LOUDSPEAKERS. We wish to appoint licensees to manufacture the world's first Monitor Loudspeaker with acoustic adjustability; the revolutionary Omal Ambionic TL6. It has no competition and its many unique features include a variable transmission line (patented) giving uncoloured sound reproduction of outstanding quality. For full details (Principals only) write to:— Managing Director, Omal Group Ltd., Omal House, North Circular Road, London, NW10 7UF, England.

ELECTRONIC Petrol consumption meter. Manufacturer required to produce under licence a miles per gallon meter for cars. For details write to Paston Electronics, 35 Wolseley Road, London, N8. (6059)

BOOKS

"WIRELESS WORLD" 1945 to July 1973. Eleven copies missing. Offers. Buyer collects. Hargreaves, Wynn House, Rawcliffe, Goole, Tel: Goole 83276. (6027)

WANTED receivers and books on microwave, U.H.F. receivers. Books for sale on communications, Electronics. List available. Hughes, 11 Henley Road, Ludlow, Salop. (6057)

NEW GRAM AND SOUND EQUIPMENT

GLASGOW. Hi Fi, Cassette Decks, Tape Recorders, Video Equipment, always available we buy, sell and exchange for Hi Fi sets and photographic equipment. **VICTOR MORRIS** Audio Visual Ltd., 340 Argyle Street, Glasgow, G1, 8/10 Glassford Street, Glasgow, G1, 8/10 Sauchiehall Street. Tele: 041-221 8958. (11)

IBM.GOLFBALL 735 1/0 TYPEWRITERS

coding similar to EBCDIC. Will accept normal or sprocketed paper supplied in working order with photocopy of IBM interface manual. Each machine serviced and tested. £100 + 8% VAT. As above but modified to take office range of golfballs (10 pitch) £125 + 8% VAT (inc. new golfball) UK delivery by Securicor + packing £7.50 + VAT. Overseas air freight or surface at cost.

+ ELECTROLYTICS
10,000 µF 63v £1 (30p), 2800µF 70p (28p), 4000µ 70v 80p (25p), 4000µ 35v 50p (20p), 5000µ 60v 75p (25p), 10,000µ 15v 50p (15p), 2000µ 63v 38p (14p), 2500µ + 2500µ 30v 40p (15p), 40µ 275v RMS Motor start cap. 60p (20p).

+ SMALL ELECTROLYTICS
2.2µ 10v, 10µ 35v, 50µ 40v, 100µ 40v, 100µ 4v, 150µ 10v, 64µ 10v, 300µ 10v, 200µ 10v 12 for 45p (12p).

+ PIHER PRESETS 100mw
200, 470, 1K, 4K7, 10k, 47k, 100k, 220K 12 for 50p (12p). + other presets available in valves 3K (large type) £1/100 470 cermet 10 for 50p (12p)

TRANSFORMERS
31v 330mA 80p (30p), 12v 2A £1.80 (50p), 17v 5A C Core EX Equip £2.25 (65p) TOROID 20v 0.6A £2.

VARIOUS
Humidity switches 80p (13p)
Mains latching relays 6A contacts 80p (13p)
Relays variety VP4/5A 2500ohm 80p (13p)
4p c/o 65p (12p)
3M plastic self-adhesive magnetic strip 30p/foot (20p)

3" WIDE
U2 size 1.25v NICAD rechargeable cells £1.50 ea (20p)
+ 250 mixed capacitors 60p (18p)
OH Lamps 12v 53µ 60p (10p)
12v 100w 90p (10p)
250v 500w £2.50 (13p)
Light activated SCR 19F 50v 1.6A 35p (10p)
FX2243 Pot core Ex. Equip with clamp 70p (32p)
(Suitable scorpion ignition)
+ Ge DIODES GEX00 £15/1000 £2.50/100 (25p)

TEXAS CALCULATOR KEYBOARDS P.C. Type new 75p (10p). No buttons.

PAPST FANS (or similar) EX. Equip Reconditioned 4½ x 4½ x 2in 100 CFM 50/60 c/s £3.80 (65p) (25p)

+ REED INSERTS 70 mm 1/d contacts 10 for £1 (12p)
+ REED INSERTS 45 mm 20 for £1 (12p)
Add 12.5% VAT to items marked + others 8%.

KEYTRONICS

Shop open Monday to Saturday
9.30 a.m. - 2 p.m.
332 LEY STREET, ILFORD
ESSEX. 01-553 1863

(6012)

DIRECT COMMUNICATIONS

Division of Direct Electronics Ltd

INTERCOMMS & TELEPHONES

- New Italian Designed 2-Way Telephone Intercomm Wall/Desk with 30 metres cable. £19.95 (£1). Operates on 6 to 9v batt or power supply
- As above, 2- to 6-way Wall Model, £10.65 Desk model inc. term block. £12.65 per inst. 2- to 11-way wall model, £11.50. Desk inc. term block, £13.45 per inst (50p) Colours, ivory and grey blue.
- Superior 2- to 6-way Siemens & Halske Wall Intercomm with desk conversion kit. term block and cord. Per instrument, £10 (packing and carriage 50p).
- Push-button Intercomms from 2- to 21-way with multi-channel and conference facilities. New: 6-way £24, 11-way £27, 16-way £30, 21-way £35. Refurbished at half the above prices. (£1 each unit)
- Entrance Phones. Single unit + Internal Phone + Electric lock release + Twin Power Supply. £39.95 (£3). Add £7 for each additional button and Internal Phone up to 20-way (+ 50p per way).
- Transistorised 2-way Intercomm with 6v Power Supply and 50ft cable. £11.75 (£1)
- Transistorised batt-op 3-way Intercomm (Master — 2 subs), £23.95 (£1). 4-way (Master — 3 subs), £28.50 (£1).
- Wireless Intercomm (just plug 2 or more into mains — no wires required). £20 pair (£1) ideal for baby alarm.
- Automatic Instruments. Strowger-compatible or PAX working. New P.O. Types 706 and 746. £15.722 (Trimphone), £41.65 Refurbished from £5.00 (£1) Also Special and Foreign types.
- Ultra Modern Types. Gondola (dial in hand set). £39.95. Charleston (Candlestick), moulded black £34.75. Leather covered red, green or brown. £50.95 Electronic-button styles from £88. 100 other superb Reproduction and Modern styles available in wood, acrylic, leather, onyx, etc. Come and see.
- Plan and Key phones for Home and Export. New or refurbished
- Telephone amplifier (1-way) £5.95 (35p) Hands-Free Tele Amp (two-way conversation) £9.50 (50p). With recording facility £12.50 (50p)
- Telephone terminal blocks: 3-way 45p, 4-way 75p, 6-way £1.25, 24-way £2.75, 48-way £3.75 (20p).
- 95a Jack Sockets £1.50 (20p), 420 plugs £1.50 (20p) Less 10% per dozen
- Telephone cords: 4-way to 9-way, 6ft 75p, 10ft £1.15, 16ft £1.65 (15p)
- Telephone cable Per metre, 4-way 18p, 6-way 20p, 10-way 50p, 13-way 56p (Add 10%). Paired cable also available up to 50 pair
- Intruder Alarm. Microwave space protector Power Supply. £25 (£1)
- Mains Adaptors. 6/7.5/9vdc, switched, £3.75 (50p), 3/4.5/6/7.5/9/12v, £5 (50p) Suit Transistor Radios, Cassette Recorders, Intercomms, etc
- Auto Exchange: 10 extension + 1 circuit. Power supply incorporated. £175 (carr free)
- New Transformers. Extensive range in stock or quick delivery. Auto. Isolating. H.V. Charger. Equipment, Output, etc. 1.2 va to 6000 va (6Kva) from £1.70 Please enquire
- Ball point stretch pens, self-adhesive, attach to anything, anywhere. 95p (20p).
- Telephone locks with 2 keys. 95p (20).

Add VAT ● = 8% * = 25% on post paid price

TRADE ENQUIRIES WELCOMED

Many surplus bargains still available at exceptionally low prices. All must be cleared.

34 LISLE STREET, LONDON, WC2H 7BD - Tel: 01-437 2524

(5583)

CLASSIFIED ADVERTISEMENTS

Use this Form for your Sales and Wants

To "Wireless World" Classified Advertisement Dept., Dorset House, Stamford Street, London, SE1 9LU

PLEASE INSERT THE ADVERTISEMENT INDICATED ON FORM BELOW

- Rate 81p PER LINE. Average seven words per line. Minimum THREE lines.
- Name and address to be included in charge if used in advertisement.
- Box No. Allow two words plus 45p.
- Cheques, etc., payable to "Wireless World" and crossed "& Co."

NAME.....

ADDRESS

.....

.....

REMITTANCE VALUE..... ENCLOSED

PLEASE WRITE IN BLOCK LETTERS. CLASSIFICATION..... NUMBER OF INSERTIONS.....

SPECIAL LOW PRICE ARRANGEMENTS FOR VISITING OVERSEAS TRADE FAIRS

wireless
world



IPC Electrical-Electronic Press Ltd., the world's largest publishers of computer, electrical and electronic journals, have made special arrangements for readers wishing to visit important overseas trade fairs. The cost, in most cases, is little more than the normal air fare but includes – travel by scheduled airline from Heathrow and Manchester * first-class hotel accommodation * arrival and departure transfers * admission to the trade fair * services of an experienced tour manager. The current programme comprises the following tours.

To obtain a brochure and booking form, tick the box against the tours in which you are interested, complete the coupon and post to the exclusively appointed travel agent, Commercial Trade Travel Ltd., Carlisle House, 8 Southampton Row, London WC1. Telephone 01-405-8666 or 01-405-5469.

International Radio and Television Exhibition – FIRATO – Amsterdam, August 27-29 1976. Two nights at the first-class American Hotel. Fully inclusive price £89.00

Western Electronic Show and Convention – WESCON – Los Angeles – September 14-17, 1976. 10 nights at the de luxe Downtown Hilton Hotel. Fully inclusive price – £399.00.

International Exhibition of Data Processing, Communication and Office Organisation – SICOB Paris, September 23 – October 1 1976. Two nights at the de luxe Meridien Hotel. Fully inclusive price £86.50, extra nights as required.

Hifi International Exhibition and Festival – Dusseldorf – September 24-29, 1976. 2 nights at the first class Quality Inn Hotel. – Ratingen (8 km from the Fair Ground). Fully inclusive price – £99.90.

International Industrial Electronics Trade Fair – FAIREX – Amsterdam, October 18-20 1976. Two nights at the first-class American Hotel. Fully inclusive price £89.00

International Trade Fair for Production in the Electronics Industry – ELECTRONICA – Munich, November 25-December 1, 1976. Two nights at the first class Hotel Der Konigshof. Fully inclusive price £118.00, extra nights as required.

Please send details of the tours indicated above.

NAME

COMPANY

ADDRESS

Telephone

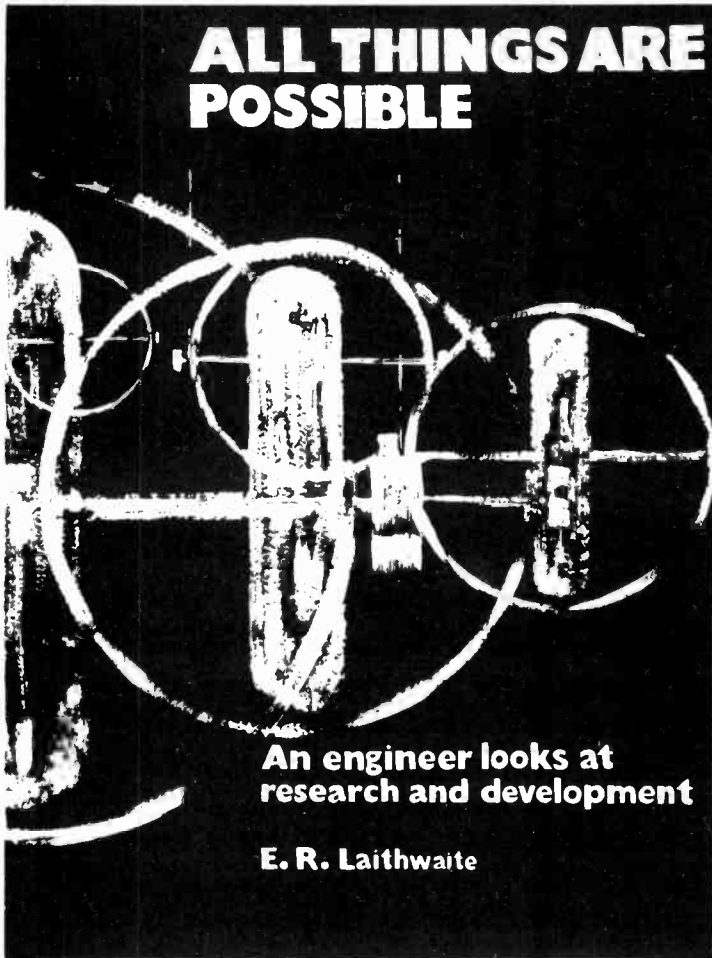

All Things are Possible

In this, Professor Laithwaite's seventh book, he again offers us a rich mixture of controversial and always thought provoking articles. In the manner that we have learned to expect, he conveys through his writings and experiments the excitement of engineering and invention, and the ways in which man in his laboured progress has so often merely mimicked nature's own engineering achievements.

The author, famous in the academic world and for numerous television appearances, presents us with two series of articles, 44 in all, which will appeal to the engineer, scientist and all interested readers equally. The price of the book is £2.85.

From leading newsagents and bookshops, or can be ordered direct by using the coupon below.

Order Form

To General Sales Dept., Room 11, Dorset House, Stamford St., London SE1 9LU.
 Please send me..... copy/copies of "All Things are Possible" at
 £2.85 each post free.
 I enclose remittance value £.....
 IPC Business Press Ltd.)

Name (Please Print).....
 Address.....

(Cheques made payable to.....)
 Company regd. in England No. 677128
 Regd. office Dorset House, Stamford St., London SE1 9LU

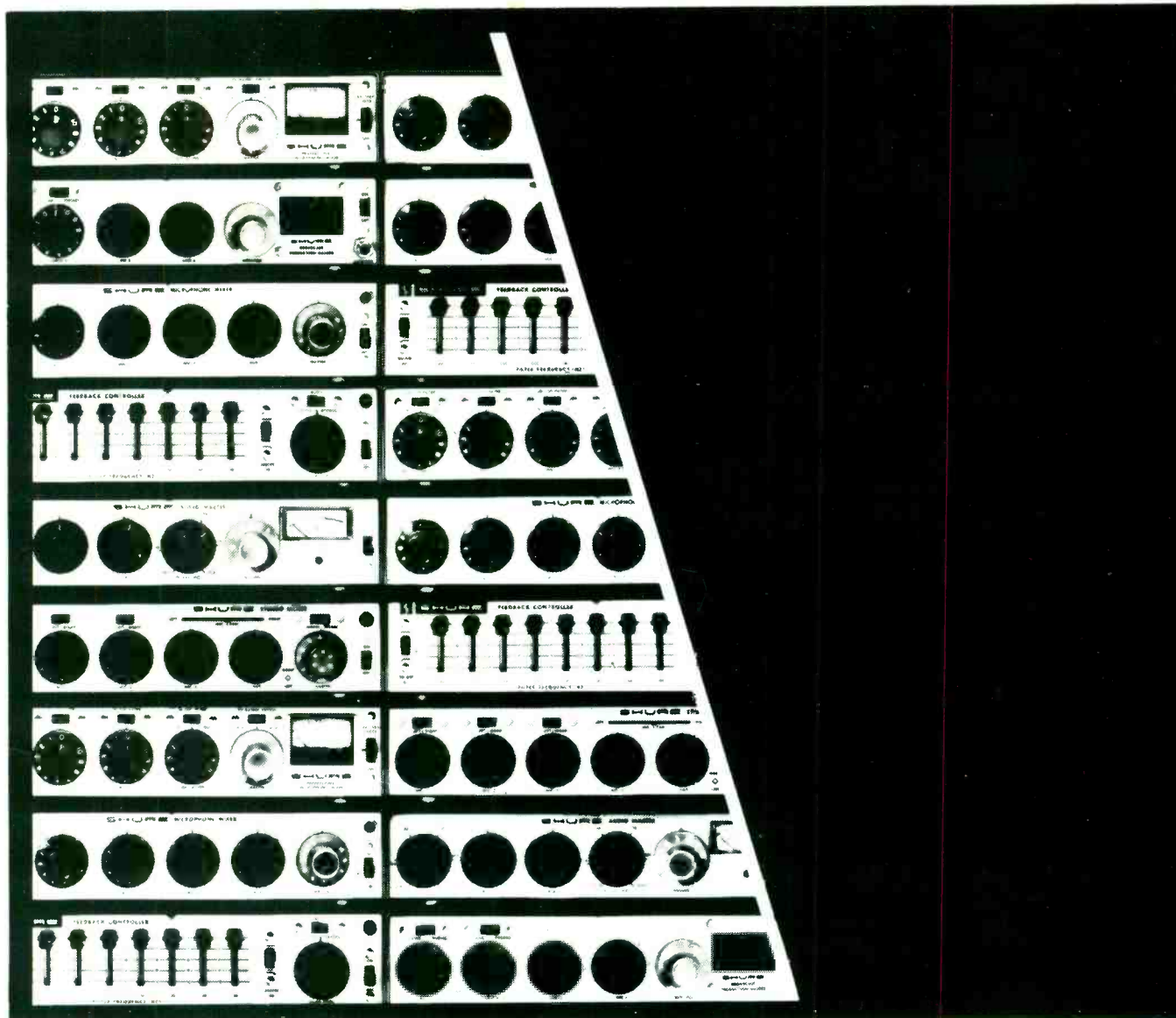

It's a mod. mod. modular world.



Simplify, simplify! Instead of paying more for bigger, bulkier audio control components, pay less for compact Shure modular components that— singly or in combination—handle critical functions flawlessly. Cases in point: (1) the *M67 and M68 Microphone Mixers*, the original high-performance, low-cost mixers; (2) the *M610 Feedback Controller*, the compact component that permits dramatically increased gain before feedback; (3) the *M63 Audio Master*, that gives almost unlimited response-shaping characteristics; (4) the *M688 Stereo Mixer*, for stereo recording and multi-source audio-visual work; (5) the *M675 Broadcast Production Master*, that works with our M67 to create a complete production console (with cuing!) for a fraction of the cost of conventional consoles; and (6) the *SE30 Gated Compressor/Mixer*, (not shown above) with the memory circuit that eliminates "pumping." For more on how to "go modular," write for the Shure Microphone Circuitry Catalogue.

Shure Electronics Limited
Eccleston Road, Maidstone ME15 6AU
Telephone: Maidstone (0622) 598&1



Multicore- the complete answer for printed circuit soldering.

Most printed circuit soldering problems can be avoided by using quality products and seeking quality advice. Naturally, we suggest ours. First, let's talk about quality products.

Extrusol and Multipure.

EXTRUSOL Extruded Bars and MULTI-PURE Cast Bars are made from specially processed ultra high purity solder. EXTRUSOL bars and pellets are protected by plastic film from the moment they are made to the moment they are used. And MULTI-PURE bars are probably the smoothest and brightest solder bars you will ever see.



Ersin Multicore Savbit.

This cored solder has countless uses. For instance, it avoids erosion of copper plating and wires as well as prolonging the life of soldering iron bits.



For full information on these or any other Multicore products, please write on your company's letterhead direct to:
Multicore Solders Limited, Maylands Avenue, Hemel Hempstead, Hertfordshire HP2 7EP.
Tel: Hemel Hempstead 3636. Telex: 82363.

Liquid Fluxes.

We have a whole family of them, so you're bound to find the right one for your job. One of our latest is PC 26, exceptionally fast but non-corrosive and non-conductive. Eliminates "icicles" and "bridging."

Right, those are the products. Now for the advice. And we can't really say any more than: if you've a soldering problem or question, call us. We really do have all the answers and the widest range of problem solving test equipment.

ROSIN BASE

ERSIN Flux No.	Type	Solids Content w/w	Specifications
0360	non-activated	38%	MIL-F-14256D Type R; DTD 599A DIN 8527 F-SW 31
5381	mildly activated Chloride and Bromide free	25%	MIL-F-14256D Type RMA; DTD 599A
304D } 304W }	mildly activated Halide Free	10% } 25% }	DIN 8527 Type F-SW 32 DTD 599A
PC.21A	activated	38%	DTD 599A; DIN 8527; F-SW 26
PC.26	activated (extra fast)	15%	DTD 599A; DIN 8527; F-SW 26
366	activated (extra fast)	38%	Meet DIN 8511 Type F-SW 26 and pass DTD 599A Corrosion Test
366A-25	activated (extra fast)	25%	
ORGANIC ACID			
PC.101	water base	12%	Water soluble residues must be removed after soldering.
PC.112	solvent base, fast drying	9.5%	
INORGANIC ACID			
ARAX	water base extremely active	40%	Used with most "very difficult to solder" metals. Not for electronics assembly joints.

Solderability Test Instrument.

Already used by major electronic companies throughout the world, this novel instrument saves production costs by controlling solderability of component leads which, unlike a printed circuit, cannot be assessed by a simple "immersion and inspection" test.



Multicore Soldering Chemicals.

We make a complete, compatible range to assist in soldering processes. They clean, protect and preserve.

Shall have