

ELECTRONICS & Wireless World

JULY 1985 85p

Video displays surveyed

Telephone charge indicator

Enlarger lamp power controller

Electronics for young people

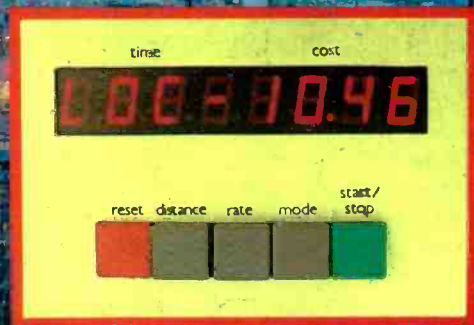

Australia	AS	3.30	Italy	L	4200
Denmark	DKr	38.00	Spain	Pts.	370.00
Germany	DM	7.00	Switzerland	SFr.	8.00
Greece	Dra	24.00	Singapore	MS	7.00
Holland	DFL	9.00	U.S.A.	\$	4.00

If you need assistance in HiFi/audio service:



Here's all the help you need

Philips versatile PM5109 LF generator and unique combined distortion meter/oscillator, the PM6309, give you all the help you need for HiFi and audio service applications. They're easy to operate – and economically priced.

PM5109 brings together all the high technology features you require from a test instrument. It offers symmetrical or asymmetrical outputs; pure sine wave signals; a wide 10 Hz – 100 kHz frequency range and switchable output impedances. A high 30 Vpp amplitude in the asymmetrical mode, with stepped and continuous attenuation; a 10 Vpp floating output in the symmetrical mode, and useful TTL or DIN loudspeaker outputs are

further benefits. In addition, there is a choice of low-distortion or fast-settling modes.

PM6309 is a simple-to-operate distortion meter that can handle all types of audio equipment. It has been specially designed to provide appropriate signal generation plus an accurate distortion measuring capability within a single instrument.

It offers a built-in RC oscillator, total harmonic distortion (THD), 3rd harmonic distortion and rms measuring facilities. It not only measures distortion according to DIN45500 – but also determines the distortion figure accurately when unstable audio signals are being applied.

Fully automatic operation means that all you do is connect the input, select the test frequency – and then read-out the distortion. Separate two-channel testing is also possible for stereo equipment.

Use the inquiry service to obtain further information.

	Inquiry No.
PM 5109 LF generator	198
PM 6309 distortion meter	199

Philips Test and Measuring
Pye Unicam Ltd
York Street, Cambridge CB1 2PX
Tel (0223) 358866 Telex 817331

GN13



Test & Measuring
Instruments

PHILIPS

WIRELESS WORLD

ELECTRONICS &

over 70 years in independent electronics publishing

CONTENTS

July 1985

Volume 91 number 1593

Editor
PHILIP DARRINGTON

Deputy Editor
GEOFFREY SHORTER, B.Sc.
01-661 8639

Technical Editor
MARTIN ECCLES
01-661 8638

Projects Editor
RICHARD LAMBLEY
01-661 3039 OR 8637

News Editor
DAVID SCOBIE
01-661 8632

Drawing Office
ROGER GOODMAN
01-661 8690

BETTY PALMER

Advertisement Manager
BOB NIBBS, A.C.I.I.
01-661 3130

MICHAEL DOWNING
01-661 8640

ASHLEY WALLIS
01-661 8641

Northern and Midland Sales
BASIL MCGOWAN
021-356 4838

Classified Manager
BRIAN DURRANT
01-661 3106

IAN FAUX
01-661 3033

Production
BRIAN BANNISTER
(Make-up and copy)
01-661 8648

Current issue price 85p, back issues (if available) £1.06, at Retail and Trade Counter, Units 1 & 2, Bankside Industrial Centre, Hopton Street, London SE1. Available on microfilm; please contact editor.

By post, current issue £1.30, back issues (if available) £1.40, order and payments to EEP Sundry Sales Dept., Quadrant House, The Quadrant, Sutton, Surrey SM2 5AS. Tel.: 01-661 3378.

Editorial & Advertising offices:
Quadrant House, The Quadrant, Sutton, Surrey SM2 5AD.

Telephones: Editorial 01-661 3614. Advertising 01-661 3130. See leader page.

Telex: 892084 BISPRSG (EEP)
Subscription rates: 1 year £15 UK and £21 outside UK.

Student rates: 1 year £10 UK and £14 outside UK.

Distribution: Quadrant House, The Quadrant, Sutton, Surrey SM2 5AS. Telephone 01-661 3248.

Subscriptions: Oakfield House, Perrymount Road, Haywards Heath, Sussex RH16 3DH. telephone: 04444 459188. Please notify a change of address. USA: \$102.70 airmail. Business Press International (USA). Subscriptions Office, 205 E. 42nd Street, NY 10017.

USA mailing agents: Expeditors of the Printed World Ltd, 527 Madison Avenue, Suite 1217, New York, NY 10022, 2nd class postage paid at New York.

© Business Press International Ltd 1983. ISBN 0043 6062.

FEATURES

Video displays An overview of current practice in c.r.t. displays	17	Call-cost calculator by S.A. Cameron Keep a check on telephone bills with this Z80-based design.	50
Domestic tv to monitor by J.A. Grubb	27	A.C. mains power controller by J.L. Linsley Hood Stabilizing power in a resistive load by triac control	53
RGB conversion for Philips G8 by D.J. Dining Two methods of converting a television receiver to a computer monitor		63rd NAB, Las Vegas by Nigel S. Cawthorne A report from the National Association of Broadcasters' annual convention and exhibition	57
Recharging system for NiCd cells by Rod Cooper Practical method of recharging, avoiding the common pitfalls	32	Sampled-data servos by D.M. Taub Calculating open and closed-loop gains as functions of time	59
Printer buffer by Mike Catherwood Software, construction and operation of this 6803-based, 64K byte character store	37	Social electronics for youth by K.L. Smith There is a need, says Ken Smith, for educating some young people away from the school atmosphere. He describes his experiences as not so much a teacher — more a leader	62
Developments in tv components by Richard Lambley New range of high-performance i.cs for television receivers from Mullard	41	Big-system automation and telemetry by R.E. Young's series on British invention	69
Eprom programmer software for the BBC microcomputer Norman Sargent Using John Adams' eprom programmer with the BBC micro. Manipulation of eprom data on disc gives added flexibility	45		

REGULARS

News commentary Trouble for d. b. s. Pirate satellites Voice (and ears) of Alvey Don't commercialize the BBC	6	Feedback Logic symbols Valve disc preamplifier Energy transfer	79
Circuit ideas Multicode combination lock Accurate transducer interface Measuring rupture current Battery-saving relay switch	66	New products Circuit diagrams on the BBC micro (p.47) Quick, dry photos Design you own l.c.d. Coded keys Graphics colour controller	86
Communications Ptarmigan Software crisis ICAP 85 Microwave dangers	75		

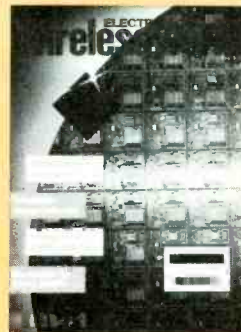

Front cover illustrates our feature on video display units, which starts on page 17. Insert at lower right is the call-cost calculator on page 50. Cover design by Philip Brooker.

CONQUIN SOFTWARE

Low Cost IBM PC Based CAD Systems

smARTWORK

An Electronic LIGHT-BOX allowing layout of component pads with auto or interactive tracking. Artwork can be printed on Epson dot matrix printer or plotted on Houston Instrument or Hewlett Packard plotters.

smARTWORK Software only **£895**
Complete systems from **£3500**

CEDS

A full PCB design system allowing the design of boards from schematic diagrams. System expandable from basic manual placing and routing to auto-tracking and schematic capture. Also available with technical drawing facilities and auto dimensioning.

Software from **£1200**
High resolution colour systems from **£6000**

PSPICE

Circuit simulation package allowing simulation of upto 120 transistors with unlimited number of nodes. Performs AC, DC and transient analysis. Can use CEDS schematic capture as input.

Software from **£950**

AUTOCAD

General 2D drafting package with auto-dimensioning. Will support a variety of graphic displays and output devices.

Software from **£1000**
Systems from **£3495**

SAM 2001 - XY

An IBM compatible with 10Mbyte hard disk, will run all IBM software. Can be upgraded to run as fast as an AT.

From **£1995**



Note: All prices exclude VAT and are subject to change without notice.

Terms: Strictly CASH WITH ORDER

Conquin Software, Freepost, Lancaster LA1 1BR.
Phone: 0524 381423

CIRCLE 64 FOR FURTHER DETAILS.

★★ NI-CAD BARGAINS ★★

Ex-equipment but little used, re-chargeable Nickel cadmium batteries at fraction of L.P.
DEAC Type 1000DK 6 Cell Button-stack (7.2V)
Measures 2 1/2" x 2" Diam. Capacity 1AH. Price each **£3** inc vat (pp 25p)
DEAC Type 600DK 3 Cell Button-stack (3.6V)
Measures 1 1/2" x 1" Diam. Capacity 600mAh. Price each **£1.50** inc vat (pp 25p)



DRYFIT BATTERIES

Brand-new, un-used, Sonnenschein Dryfit A300 sealed lead-acid re-chargeable batteries at a surplus price. 12V 1.8AH (RS No. 591-966 £17) **OUR PRICE £8.50** inc vat. (pp£1)

Also available small quantity of automatic standby units incorporating the above battery. Inbuilt mains-failure change-over, charger, ideal for burglar alarm systems etc. **£25** each (pp£2)

!!! NEW STOCK !!! ★ STEPPER MOTORS ★

In stock — used but excellent condition, 4-phase steppers. 50 steps/rev motor with (removable) gearbox giving a 300:1 reduction. 6V DC operated. Complete with a driver board requiring just a single 6V rail and pulse input. Motor measures 1" x 2" diameter, gearbox 1/2" x 2 1/2" output shaft 3/16". Sold complete with connections CCT diagram of motor CCT details of hall stepping etc. And pulse generator. Complete **£8.50** inc vat (pp 50p)

ESCAP DC MOTORS.

Swiss-made precision 6V DC motor with 70:1 reduction gearbox giving final drive speed of 16rpm @ 6V. Diameter 2.1 cms x 4cms long. **PRICE INC. VAT & CARRIAGE £5.25** (Ex-equip tested & guaranteed)

DATRON Model 1051 DIGITAL VM



1051 Multi-function digital voltmeter (DC) with Options fitted for AC Volts and Resistance. Total list is over £2200. Little used condition. **£750**

★★ CROSS-HATCH GENERATORS ★★

LABGEAR COLOURMATCH CM6004PG
UHF television pattern generators giving cross-hatch, dot and gray scale patterns. Fully tested and guaranteed.
NOW JUST £20 inc VAT & p&g

UNAQHM E0684 PAL Colour-bar & pattern gen **£275**

KORTING B2512 PAL/NTSC Colour & pattern gen **275**
Main Order customers please add £2.50 postage each item.

RALFE · ELECTRONICS

10 CHAPEL STREET, LONDON, NW1 TEL: 01-723 8753

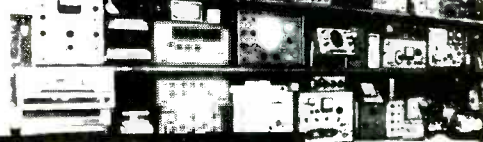

OSCILLOSCOPES

TELEQUIPMENT D75 Dual-trace 50MHz Delay	£400
TELEQUIPMENT D63 15MHz Dual & Differential	£300
TELEQUIPMENT D63 as above + STORAGE	£500
TELEQUIPMENT D83 50MHz Dual-trace	£450
COSSARCDU150 DC-35MHz dual-trace sweep delay	£200
DYNAMCO D7100 DC-30MHz dual-trace sweep delay	£200
AIRMEC 279 four-trace display scope for education	£200
TEKTRONIX 515A single-beam DC-15MHz	£75

1000 WATT AUDIO AMPLIFIERS

H & H PROFESSIONAL AUDIO POWER AMPLIFIER MODEL S500-0 available ex-stock in superb, little-used condition at vastly reduced price. Specification includes: Dual-Channel 500-500W, THD 0.005%, IMD 0.02%, Output impedance 2.5-16ohms. Frequency response: ±1db 10Hz-20KHz (NB For industrial applications these amps' can be configured to DC response). Forced air cooled dissipators for reliability and cool operation. Size 19" Rack mount x 3 5/8" Ht. **PRICE JUST £275** inc vat & handbook. Carriage + £5 (NB: List price over £700.)

★ 125W MAINS INVERTERS ★

12V DC Battery Input to 230V AC. Output @ 125 watts crystal-controlled 50Hz time-base oscillator. Fully enclosed in blue-steel cases with integral 13A socket. Dimensions approx. 4x6x10" BRAND NEW. **£60** inc VAT & Carriage.

MAINS CONDITIONERS

GOULD TCVN 220V 1500W **£95** + vat.
REGUVOLT 220V 3000W **£300** + vat
TRANSVERTER 50Hz in to 60Hz out 110/230 in or out 250W. **£350** + vat.

MARCONI TEST EQUIPMENT

Fully re-conditioned test equipment, 90-day guaranteed.
TF905/5 AM/FM SIGNAL GENERATOR 0.2-220MHz **£500**
TF1245 0-METER WITH OSCILLATORS 1246 & 7 **£**
TF2002 AM/FM SIGNAL GENERATOR 01-72MHz **£550**
TF893A AUDIO POWER METERS TO 10W **£85**
TF2905 SINE SQUARED PULSE & BAR GENERATOR **£250**
TF260A ELECTRONIC VOLTMETER **£150**

EDDYSTONE Communications receivers
770R/1 Covering 19-165MHz **£200**
770R/2 Covering 150-500MHz **£225**

COMPANIES PLEASE NOTE That we would be very pleased to receive your invitation to tender for your surplus or redundant equipment. Contracts offered for factory contents removals on regular basis

★ COMPUTER PERIPHERALS ★

1.6MB 8" FLOPPY DISC DRIVES — New Stock

BRAND NEW At a surplus price. Fully Shugart compatible 'MFE CORPORATION' Model M-700 DOUBLE-SIDED industry standard 8" floppy disc drives. Double-density, up to 1.5Mbytes. Power requirements ±5V and ±24V @ 1.1A. 240V AC 50Hz. LOWEST PRICE EVER. **£160** — INC. VAT. CARRIAGE & HANDBOOK

DRE 4000A DRIVES

Data Recording Equipment Model 4000A 5 + 5 MB Top-loading disc drives in stock. Brand new including full technical manual. Few remaining **£250** each + VAT. SHUGART 8" Flexible disc drives model SA800. Condition as new **£150** + VAT (Including postage and handbook copy).

★ MULTI-RAIL LINEAR PSU's ★

Recent stock of brand new COULTANT ESM-Series Power Supplies at surplus prices. Model ESM15 2 gving regulated, stabilised DC outputs 5V @ 1.5A and ±12V to ±15V @ 1.5A each and an un-stabilised 24V @ 2A. 240V AC input. Measures 5x8x11". Fully enclosed. In original cartons with handbooks. **£45** each + VAT (+ carriage £5)

COULTANT LINEAR POWER UNITS
MODEL ASA2000 5V DC @ 20A **£30** inc vat (pp£4)
MODEL ASC3000 24V DC @ 2A **£20** inc vat (pp£2)

★ PHILLIPS TEST EQUIPMENT ★

Brand new, surplus to requirement stock NOT to be repeated. One-offs only.
PM2554 MILLI-VOLTMETER
PM6661 FREQUENCY COUNTER
PM6307 WOW & FLUTTER METER.

★ CENTRIFUGAL BLOWERS ★

'TORIN' Type U62B1 230V Cap Start (supplied), very powerful (200W, 3,000 rpm) centrifugal fans for large rack cooling or enclosure extraction applications. Overall dimensions 20x12 cms, outlet 6x4 cms. BRAND NEW. Surplus stock. **£15** each inc. VAT, pp£2.50.

★ INSTRUMENT COOLING FANS ★

All fans available ex-stock and GUARANTEED
230V 10W 5-Blade 3x3x1" NEW **£7**
115V 13W 5-Blade 3x3x1" NEW **£6**
115V 4x4x1 1/2" 5-Blade NEW **£5**
115V 7W 4 1/2" 3-Blade WHISPER **£5**
230V 40W Papsit 350M/Hr. Ex-equip. **£13**
All prices include VAT (pp - 50p)

CIRCLE 67 FOR FURTHER DETAILS.

RADIOCODE CLOCKS LTD

SPECIALISTS IN ATOMIC TIME, FREQUENCY AND SYNCHRONISATION EQUIPMENT



NEW PRODUCTS

- **MINIATURE RUBIDIUM OSCILLATOR MODULE**
Lower power, fast warm up, optional output frequencies, programmable frequency offsets.
- **RUBIDIUM FREQUENCY STANDARD**
High performance, compact and rugged instrument. 2U rack or 1/4 ATR case options.
- **INTELLIGENT OFF-AIR FREQUENCY STANDARDS**
Microcomputer controlled instruments, directly traceable to N.P.L., precision ovened local oscillator, comprehensive monitoring and status information, real time synchronisation.
- **LOW COST MSF FREQUENCY STANDARD**
Instant operation, directly traceable to N.P.L., self-contained portable unit, no scheduled frequency changes, 24 hr transmission, real time synchronisation.

- Off-air frequency standards
- Intelligent time systems
- Caesium/Rubidium based clocks & oscillators
- Master/slave systems

- Time code generators/readers
- Record/replay systems
- Intelligent display systems
- Precision ovened oscillators
- Time/frequency distribution systems

Radiocode Clocks Ltd*

Unit 19, Parkengue,
Kernick Road Industrial Estate, Penryn,
Falmouth, Cornwall. Tel: Falmouth (0326) 76007

(*A Circuit Services Associate Co.)

CIRCLE 46 FOR FURTHER DETAILS.

MICRO-TEL

Universal Microtelemetry System

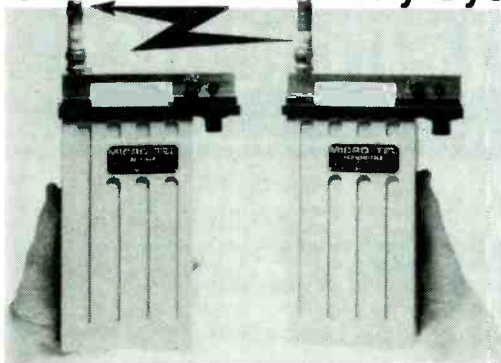

Micro-tel is a system of integrated UHF radio/modems ruggedly constructed and suitable for a wide range of 'line of sight' data communications applications.

Features:

- UHF Home Office type approved radio (MPT 1309)
- 5 Radio Channels
- 1200 BAUD INTERNAL MODEM
- 12 Volts/250 m Amps Power
- RS232 Data Input/Output
- Small size 145 x 210 x 60 mm
- SPECIALS TO CUSTOMER SPEC. ALSO AVAILABLE

Micro-tel offers a simple and reliable solution for:

- Building to building computer comms
- Instrument to computer data links
- Industrial systems data links

Dealer and OEM enquiries welcome.

MIDL

MEASUREMENT DEVICES LIMITED
Silverburn Crescent, Bridge of Don Industrial Estate, Aberdeen,
AB2 8EW Telephone: (0224) 824141 Telex: 739506 (MDLAB)

CIRCLE 56 FOR FURTHER DETAILS.

ELECTRONICS & WIRELESS WORLD JULY 1985

FIELD ELECTRIC LTD

3 SHENLEY RD, BOREHAMWOOD, HERTS. TELEPHONE 01-953-6009

☐/OFFICIAL ORDERS/OVERSEAS ENQUIRIES WELCOME

OPEN 6 DAY'S A WEEK 9.00am/5.00pm THUR.9.00am/1.00pm

12" BLACK & WHITE 75Ω COMPOSITE VIDEO, HIGH RESOLO: 80 CHARACTER IN BRUSHED ALI CASE. TESTED	£23.00
SPECIAL OFFER 12" BLACK & WHITE 75Ω COMPOSITE VIDEO, HIGH RESOLO 80 CHARACTER. IN CASE. NEW TUBES FITTED. TESTED	16.95
9" HITACHI BLACK & WHITE 75Ω COMPOSITE VIDEO. HIGH RESOLO: 80 CHARACTER. IN CASE. TESTED	45.00
12" GREEN PHOS: 75Ω COMPOSITE VIDEO. HIGH RESOLO: 80 CHARACTER IN BRUSHED ALI CASE. TESTED.	25.00
SPECIAL OFFER 24" 75Ω COMPOSITE VIDEO. HIGH RESOLO: GREEN PHOS: IN CASE. TESTED.	15.95
ALL MONITORS 230 V. A.C. RING FOR CARRIAGE DETAILS	
T ONLY K.S.R. 33 230 V. A.C. RS232 TELETYPE. BRAND NEW. C/P 7.00	69.00
M.P.I. 1/2 HEIGHT DISK DRIVE. SINGLE SIDED. 40 TRACK. 5 1/4" NEW & BOXED. C/P 2.50	65.00
T ONLY LAMBDA 3 PHASE 0-36V 72 AMP 208 V. A.C. C/P 16.00	60.00
TEAC DATA CASSETTE MEC'S EX-EQUIP.	10.00
NRZ DATA CASSETTE MEC'S EX-EQUIP. C/P 2.00	10.00
PLESSEY 2/4 MEGABYTE (MAX) GENERAL PURPOSE RANDOM ACCESS MEMORY SYSTEM. CAN BE USED FOR MAINFRAME/MINI MICROPROCESSOR'S NEW & BOXED WITH DATA P.O.A.	
AURALITE LIGHT WEIGHT HEADSET & MIC. IDEAL FOR COMMUNICATIONS EX-EQUIP. TESTED. C/P 2.00	20.00
ALL P.S.U. 200-250 V.A.C. INPUTS	
SWITCH MODE P.S.U. C/P 2.00 UNLESS STATED	
3.5V 10AMP D.C.	£12.50
ADVANCE 5V 20AMP D.C.	18.50
5V 30AMP	19.95
5V 40AMP D.C.	40.00
5V 60AMP D.C.	20.00
FARNELL 6V 5AMP D.C. 145x87x32 M/M	20.00
FARNELL 5V 20AMP D.C.	20.00
6V 40AMP D.C.	40.00
FARNELL 24V 5AMP	35.00
FARNELL 12V 10AMP	35.00
FARNELL FAN COOLED MULTI-RAIL SWITCH MODE +15V AT 15AMP -5V AT 1AMP + 12V AT 4AMP - 12V AT 1AMP	28.00
GOULD MULTI-RAIL SWITCH MODE NEW	
5V 40AMP - 12V 4AMP + 15V 11 AMP C/P 6.00	75.00
GOULD NEW & BOXED 6V 40AMP	60.00
COUTANT 0-7V 7AMP D.C. LINEAR NEW & BOXED	19.95
GOULD PMA 47 12V 3AMP LINEAR	16.95
COUTANT ESM LINEAR MULTI-RAIL	
5V 13AMP D.C. ±12V 1.5AMP OR ±15V 1.5AMP	
12V OR 24V 2AMP UNREGULATED COMPLETE BOOK CIRCUIT DIA. NEW BOXED C/P 6.00	40.00
VOLTEX LINEAR MULTI-RAIL + 12V 600M/A + 5V 1AMP D.C.	11.25
P.C. SUPPLY +5V 1AMP D.C. TOROIDAL T/X REGULATED	6.95

WE ALSO BUY EQUIPMENT SURPLUS TO REQUIREMENT.

SEND LIST OR PHONE

ALL PRICES INC VAT 15% UNLESS STATED

CIRCLE 30 FOR FURTHER DETAILS.

The Archer Z80 SBC

The **SDS ARCHER** — The Z80 based single board computer chosen by professionals and OEM users.

- ★ High quality double sided plated through PCB
- ★ 4 Byte-wide memory sockets — upto 64k
- ★ Power-fail and watchdog timer circuits
- ★ 2 Serial ports with full flow control
- ★ 4 Parallel ports with handshaking
- ★ Bus expansion connector
- ★ CMOS battery back-up
- ★ Counter-timer chip
- ★ 4 MHz. Z80A

OPTIONS:

- ★ SDS BASIC with ROMable autostarting user code
- ★ The powerful 8k byte SDS DEBUG MONITOR
- ★ On board 120 / 240 volt MAINS POWER SUPPLY
- ★ Attractive INSTRUMENT CASE — see photo.
- ★ 64k / 128k byte DYNAMIC RAM card ★ NEW ★
- ★ 4 socket RAM — ROM EXPANSION card ★ NEW ★
- ★ DISC INTERFACE card ★ NEW ★

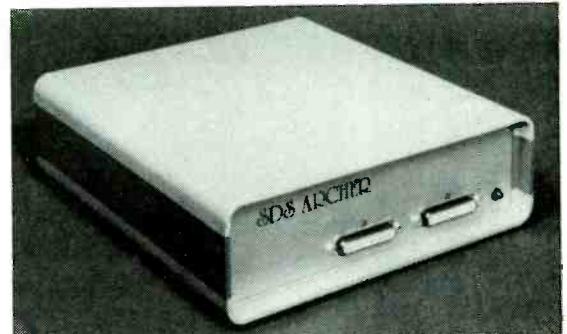
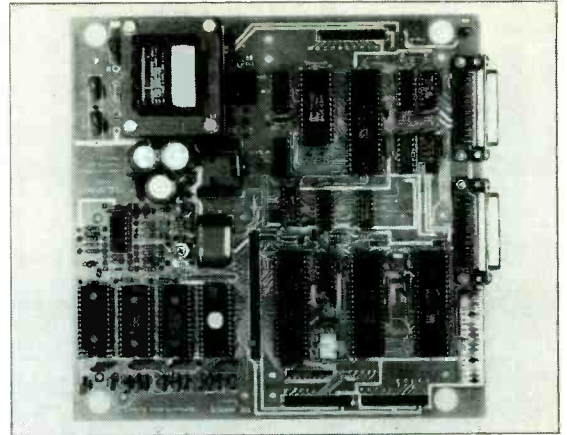

Sherwood Data Systems Ltd

Sherwood House, The Avenue, Farnham Common, Slough SL2 3JX. Tel. 02814-5067

CIRCLE 47 FOR FURTHER DETAILS.

DEWSBURY



ELECTRONICS

POCOMTOR AFR 2000 RTTY ALL MODE



SPECIAL FEATURES:

- Fully automatic recognizing of ARO, FEC-Collective and FEC-Selective (SITOR/AMTOR)
- Fully automatic searching and synchronizing in Baudot mode according to Baud rate and phase, indication of baud rate and phase
- Manual preselecting of all Baudot and ASCII speeds
- Optimum microprocessor controlled signal reception with 16 000 (sixteen thousand) samples per second and steady re-phasing on forward and backward run of signal

- Special narrow band quadrature discriminator for all used LF shifts from 50 to 1000 Hz
- Simple and quick tuning with 16 line LED bar indication
- Extremely simple operating
- Current-saving 8 bit C-Mos microprocessor
- Development and manufactured in Switzerland

FEATURES AND APPLICATION:

The POCOMTOR AFR-2000 RTTY ALL MODE DECODER allows the simple and easy writing of the usual teletype codes as BAUDOT, ASCII (including 200 baud press service), ARO, FEC-Collective, FEC-Selective (SITOR/AMTOR) and the FEC procedure used for secret services, which differs from the usual CCIR recommendation 476-2. The POCOMTOR AFR-2000 is a complete teletype decoder with built-in new quadrature discriminator for automatic adapting and processing of the normal shift offsets of 50 Hz to 1000 Hz. The POCOMTOR AFR-2000 is the first RTTY reception device on the consumer area that fully automatically determines the received baud rate and synchronizes thereon, without being necessary as yet usual to test the baud rates and phase (Normal/Reverse) in question in a troublesome way. It is now only required to call up the automatic routine and after a short time for the signal reception of about 10 to 15 seconds the synchronization is reached and the text can be written.

In the mode ARO/FEC, i.e. during synchronous character transfer (without start and stop bit) the built-in intelligence finds out by itself whether it is an ARO or FEC signal, whereby it is additionally differentiated between FEC-Collective and FEC-Selective. To balance signal phase moves there is a steady adaption of the microprocessor controlled sampling, as to pre-running characters and to after-running characters.

The technology of the POCOMTOR AFR-2000 RTTY ALL MODE DECODER corresponds to the highest requirements. Its extraordinary price/performance ratio will not be reached in near future on the easy way. Choosing the POCOMTOR AFR-2000 you take the most modern receiving device on the market. Its for that you receive more and have to tune less. It has never been thus easy to receive radio teletype.

Dewsbury Electronics offer a full range of Trio Equipment always in stock.

We are also stockists of DAIWA-WELTZ-DAVTREND-TASCO TELEREADERS-MICROWAVE MODULES
ICS AMTOR-AEA PRODUCTS-DRAE-BNOS



Dewsbury Electronics, 176 Lower High Street, Stourbridge, West Midlands.
Telephone: Stourbridge (0384) 390063 / 371228. Open Monday thru Saturday.
Instant H.P. subject to status, Access, Barclaycard and real money.



CIRCLE 85 FOR FURTHER DETAILS.

ELECTRONICS & WIRELESS WORLD JULY 1985

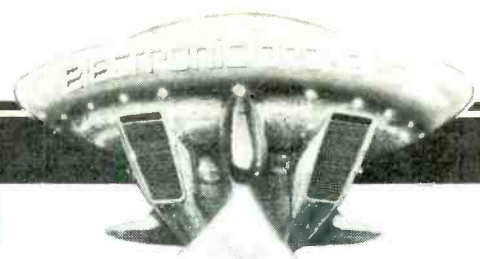

THE SOURCE OF ALL GOOD USED TEST EQUIPMENT

SAVE up to 50%

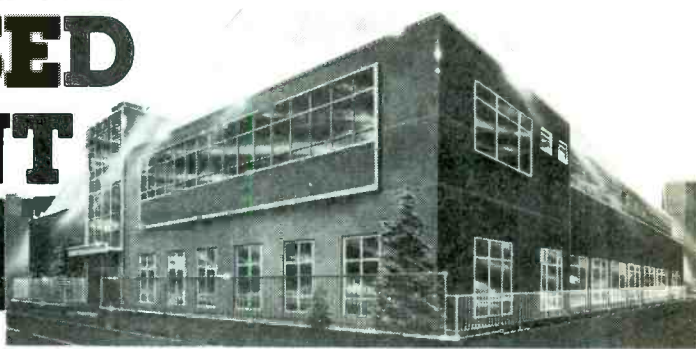

OSCILLOSCOPES

Hewlett Packard		
1332A	Display (As new)	£950
1809A	4 channel p/in for 180	£1250
1821A	Timebase p/in for 180	£750
Philips		
PM3266	Storage Scope 100MHz	£3650
Tektronix		
212	Portable Scope 500KHz	£650
2213	Scope	£675
475	Scope	£2750
475A	Scope	£4000
485	Scope	£6800
634/1/20	Monitor (As New)	£950
465B	Scope 100MHz	£1650
466	Storage Scope 100MHz	£3500
466DM44	Storage Scope + DMM 100MHz	£4500
434	25MHz Storage Scope	from £1950

TEKTRONIX 7000 SERIES

7600	Scope Mainframe	£1950
7613	Scope M/F Storage	£3950
7854	Waveform Processing Scope	£12500
7904	Scope M/F 500MHz	£6950
7A11	D T P/In	£1600
7A18	D T Amp	£800
7A19	600MHz Amp	£1600
7A24	D T P/In	£1950
7A26	D T P/In	£1650
7B50A	Timebase	£575
7B53A	Timebase	£585-£985
7B85	Timebase	£925
7B87	Timebase	£1435
7D11	Digital Delay	£1400
7D14	525MHz Digital Counter	£850
7M11	Delay Line	£750
7S11	Sampling Plug In	£1850
7S14	TDR Sampler	£4500
7T11	Sampling Timebase	£4000
S1	Sampling Head	£950
S54	Pulse Generator Head	£600

ANALYSERS

Hewlett Packard		
332A	Distortion Analyser	£850
3580A	Spectrum Analyser	£3250
8555A	18GHz Spectrum Analyser P/In	£6500
1615A	Logic Analyser	£2500
Marconi		
TF2300A	Modulation Meter	£795
TF2330A	Wave Analyser	£1095
TF2331	Distortion Factor Meter	£695
TF2337A	Automatic Distortion Meter	£295
Tektronix		
308/01	Data Analyser	£2500
308	Data Analyser	£2250
7D01/DF2	Logic Analyser	£1900
491 opt 02	Spectrum Analyser 1.5GHz + from	£3000
TR502	Tracking Generator	£3500
TR503	Tracking Generator	£4250
7D02 opt 01	Logic Analyser	£3000
7D02	Logic Analyser	£2000
PM101	Personality Module	£500
PM102	Personality Module	£500
PM108	Personality Module	£850
PM111	Personality Module	£750

RF SIGNAL GENERATORS

EH Labs		
139B	Pulse Generator 50MHz 10V	£750
Hewlett Packard		
214A	Pulse Generator 100V	£750
612A	UHF Generator 450-1230MHz	£950
8011A	Pulse Generator	£625
8007B	Pulse Generator 100MHz	£1650
8015A	Pulse Generator Dual 50MHz	£1950
8018A	Serial Word Generator	£2000
8601A	Sweep Generator	£1950
8600A	Digital Marker	£950
8616A	Signal Generator 1.8-4.5GHz	£4000
Marconi		
6058B	Signal Source 8-12.5GHz	£850
TF2002AS	AM/FM Signal Generator	£950
TF2002B	AM/FM Signal Generator	£950
TF2016A +	AM/FM Signal Generator +	
TF2173	Synchroniser 120MHz	£1350

AF SOURCES

Hewlett Packard		
4204A	Decade Osc (New)	£760
Marconi		
TF2000	Signal Source 20Hz-20KHz	£450
TF2120	Waveform Generator	£650
Wavetek		
185	Sweep Generator	£650
184	Sweep/Function Generator 5MHz	£750
166	Pulse/Function Generator 50MHz	£1950

TEKTRONIX GPT & M EQUIPMENT

AM501	Op Amp	£300
DC508A	Counter 1.3GHz	£995
DC509	Counter/Timer 135MHz	£995
DD501	Digital Delay	£500
DM 501/02	DMM	£200
FG501	1MHz Function Generator	£325
FG502	11MHz Function Generator	£565
FG503	3MHz Function Generator	£395
FG504	40MHz Function Generator	£1650
MR501	X-Y Display	£200
PG501	Pulse Generator	£330
PG502	pulse Generator	£1650
PG505	pulse Generator	£450
PG506	Calibration Generator	£1950
PG508	Pulse Generator	£1250
RG501	Ramp Generator	£250
SC501	Scope	£500
SC502	Scope	£900
SC504	Scope	£995
SG502	Signal Generator	£525
SG504	Signal Generator 245-1050MHz	£2100
SW503	Sweep Generator 1-400MHz	£950
TG101	Time Mark Generator	£1750
TM501	Mainframe	£275
TM504	Mainframe	£375
TM515	Mainframe	£400

COUNTERS & TIMERS

Fluke		
7220A	Communications Counter 1.3GHz (Quantities available)	£595
1900A	Counter 80MHz	£150
Hewlett Packard		
5341A	Microwave Counter 10Hz-4.5GHz	£1500

5300B +		
5305B	Counter 1.3GHz	£650
Marconi		
2431A	200MHz Counter	£295
2437A	100MHz Counter/Timer	£395
2438	520MHz Counter/Timer	£650
Racal		
9514	100MHz IEEE Counter/Timer	£750

BRIDGES

Gen Rad		
1615A	Capacitance Bridge	£1950
Hewlett Packard		
4271B	Digital LCR Meter	£3950
4342A	'Q' Meter	£2100
Marconi		
TF1245A	'Q' Meter	£1200
TF1246	Oscillator	£650
TF1247	Oscillator	£650
TF1313A	LCR Bridge	£775
TF2700	Bridge	£350
TF2702	Inductor Analyser	£1500

GENERAL PURPOSE T & M

Avo		
	Multimeters model 8's & 9's	£60-£85
Fluke		
760A	Calibrator	£1950
731B	Std Cal	£750
931B	Diff Voltmeter	£850
Hewlett Packard		
3406A	Sampling Voltmeter	£1500
8405A	Vector Voltmeter	£2000
467A	Amplifier	£725
11692D	Direct Coupler	£1500
Marconi		
6460/1	RF Power Meter	£1500
TF2603	RF Millivoltmeter	£650
TF2905/8	TV Pulse Generator	£750
TF2333	Trans Test Set	£850
TF2356 +		
TF2357A		
TF2807A	S.L.M.S	£3600
TF2904	PCM Tester	£1350
TF2950/5	Colour Gain Test Set	£495
TF2809	Radio Test Set	£1550
TF2828	Data Line Analyser	£950
TF2829	Simulator	£1250
TF2829	Digital Analyser	£1250
TF2915	Data Monitor	£1200
Tektronix		
576	Curve Tracer	£9000
178	Fixture	£1500
A6901	Ground Isolation Monitor	£275

HEWLETT PACKARD COMPUTERS

2631B	Printer	£1450
7221B	Plotter	£1200
85A	Processor	£1250
82160A	Interface	£55
82161A	Digital Cassette	£250
82903A	16K Mod	£100
82936A	ROM Drawer	£25
82937A	HPIB Interface	£200
9825A	Desktop	£2950
9862A	Plotter	£750
9872C	Plotter	£750
9885C	Disk Drive	£950

Electronic Brokers are Europe's largest specialists in quality second user test equipment. Established 17 years ago, we have pioneered the second user concept in Britain, and many overseas territories. To support our growth we have a skilled team. This includes trained sales staff, whose role is not only to sell, but provide a helpful information service to our many customers. Backing this team is our own service laboratory where technicians monitor each item of equipment we sell. Our maxim is service, and those who have dealt with us will know that we endeavour to always live up to our reputation.

Electronic Brokers Guarantee

Unless otherwise stated, all test equipment sold by us carries a 12 month warranty. When you buy from Electronic Brokers you know the equipment is in 'top notch' condition. It is refurbished in our own service laboratories and checked to meet the original manufacturer's sales specifications. And it's serviced by our own highly qualified technicians.

All prices exclusive of VAT. Carriage and packing charges extra on all items unless otherwise stated.

A copy of our trading conditions is available on request.

Electronic Brokers Ltd
140-146 Camden Street London NW1 9PB
Electronic Brokers Telephone 01-267 7070 Telex 298694

CIRCLE 201 FOR FURTHER DETAILS.

Another good use has been found for a cordless 'phone. This one is carried around by the warden of sheltered housing for the elderly. The handset is linked to a system that provides immediate alarm calls, can act as a vandal-proof door entry phone and offers speech communication wherever the warden may happen to be at the time. This one comes from Wolsey Electronics, in Pontypridd.



Pirate satellites?

Luxembourg may tire of the dithering over satellite broadcasting in Western Europe and launch a 'pirate' d.b.s. tv service covering several countries and financed by advertising. This comes from a report by a US firm of market researchers, International Resource Development Inc.

IRD has analysed the European d.b.s. scene. They reject two 'pirate' possibilities but feel that a third is likely. Those rejected are that an individual satellite owner capable of offering a form of d.b.s. could start transmissions or an entrepreneur could buy a satellite and launch it for the purpose. IRD's view is that a country ready to start national

coverage or even a wider service may jump the gun on overspill and copyright arguments. It could then, they say, argue from a strong position and it could, if forced to withdraw, simply re-focus on a tighter beam to stay within its own borders or, alternatively, avoid contentious programming. IRD sees Luxembourg as the most likely contender. One consequence of the 'he who dares, wins' scenario not covered by IRD is the possible effect on technical standards. It could be the end of MAC, catering for future improvements in picture quality, so opponents of MAC might well covertly back a pirate.

Hitech at the union

It seemed inappropriate for a high technology training scheme, organized by a trades union, to be launched by a Tory minister. However this is what happened when Norman Tebbit, Secretary for Trade and Industry, launched two systems for training members of the Electrical, Electronic, Telecommunications and Plumbing Union (EETPU) in microelectronics and robotics. Development of the training package was supported by grants from his Department.

Much of the training is carried out through the use of an interactive videodisc learning package. Mr Tebbit pointed out that the system was developed from a programme begun by his Department; "to stimulate development and growth of a

UK interactive video disc industry. The EETPU project is a clear example of cooperation at its best; between a forward looking trade union, an enterprising and expanding small British firm, Epic; and the Government."

He went on to praise the union's involvement with advanced technology and its contribution to the forthcoming report of the National Economic Development Office on advances manufacturing systems.

"We all depend for our well-being ultimately on the performance of British industry. Two vital ingredients of that performance are the skills of our workpeople and the new technology being put at their fingertips."

New Beeb

Without much advance publicity Acorn have launched the BBC B+ computer. Externally this is exactly the same as its predecessor. Internally it uses a completely redesigned circuit board, developed for the Acorn Business Computer. This incorporates 32K more ram, making the B+ a 64K computer. The extra memory is divided between 20K screen memory, freeing that amount for program development, and 12K of 'sideways' ram. This occupies the same area in the memory map as roms and may be used to download rom utilities. The other major difference is the provision of six sockets for roms which can now be up to 32K each. One 32K rom is installed. It combines the operating system with BBC Basic. The computer is fitted with a disc interface as standard

and as a departure from their stubborn adherence to the outdated 8271 single-density, limited file-number system, they have now opted for the 1770, but in order to keep as compatible as possible with the old system the DFS incorporates all the same restrictions! Acorn see the computer as a continuation of their role in education and 'serious' home computing and it costs £499 inclusive. This compares unfavourably with many other 64K computers and general opinion is that it is overpriced and unlikely to sell well. One would have thought that it could have been possible for Acorn to reduce the price of the BBC B to about £300 and then sell the B+, with its enhancements, for the same £400 of its predecessor.

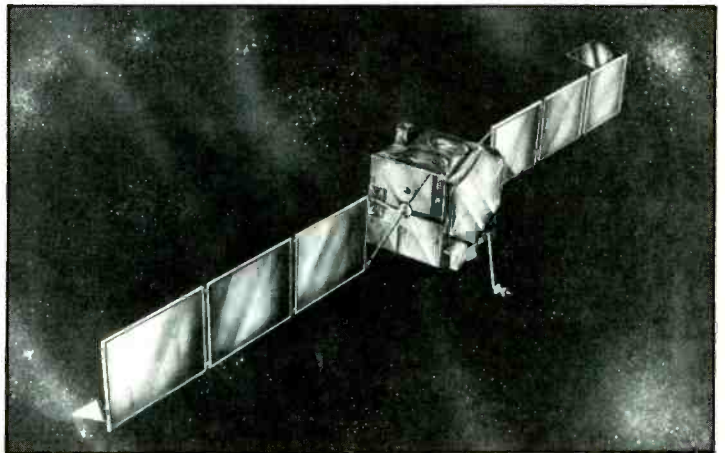

British Aerospace have been given a \$150M contract to build three new Inmarsat-2 satellites, expected to go into service during 1988/89. The satellites will be the first to be owned and operated by Inmarsat themselves; all the previous ones have been

leased. There are now 3300 vessels equipped to operate with the Inmarsat system and 10 countries operate a total of 13 earth stations. Services are to include aeronautical communications including a telephone service for airline passengers!

Substitute satellite

Meteosat-1, the ESA weather satellite, five years older than its original planned mission, is drifting out of orbit and has come to the end of its useful life. However, the USA is to lend a spare, standby, satellite already in orbit which is to be repositioned from its present position of 140°W, over the Pacific to 10°W by being moved

by 4° a day. The GOES-4 satellite, launched in 1980, lost its imaging capability in 1982 and has been used as a standby transponder, relaying meteorological data. After its temporary service in Europe, it will be boosted up, out of the geostationary orbit to make room for other spacecraft.



CLAUDIVS (Calling Line Announcer Using Digitally Integrated Voice Synthesis), enables Beattie Brooks, who lost her voice after a throat operation, to 'speak' on the Telephone. Words and phrases are selected by the push button keyboard. A total of 64 phrases are chosen by the customer and then coded into a rom. Developed by BT.

America and China have teleconference

The successful exchange of slow-scan video images between the USA and the Peoples' Republic of China opened a new channel of communications between these countries. The exchange took place between two medical facilities; the University of Cincinnati Medical Centre and Zhejiang Medical university in Hangzhou. Two separate test periods were used at the end of 1984 and in April this year. Pictures of people, charts,

graphs, printed matter and the local skyline were sent. The picture quality of the transmissions, which spanned half the globe, was considered to be good to excellent. Further tests were carried out between China and Boulder, Colorado where Colorado Video manufactured the teleconferencing equipment. Test are to continue throughout the year.

Satellite docking system

A precision navigational system for the automatic docking of spacecraft and load carriers is being developed by a Swedish Electronics company and the Saab Space corporation, which may be used on the European and American orbiting space stations now being planned.

The system is based on the invention of Dr Lars-Erik Lindholm, who developed an optical system for detecting the reflexes and movements in handicapped people. The detector used in the system was refined until an accuracy of 0.01% could be achieved, the

standard required by NASA for precise navigation in space. Dr Lindholm has also developed a photodetector process using electronic pulses from an l.e.d. The photodetector has proved to have a wide range of applications including guidance for robots and in the manufacturing industries. It's success has led to Dr Lindholm setting up his own company, SiTek. Saab Space is evaluating how the system could be used in the ESA Columbus space platform project, scheduled for 1990 to 1995, and NASA are said to be very interested.

During the All-Electronic/ECIF Show, at the ECIF banquet at the Grosvenor House Hotel, Tony Wilson, of Electronics for Peace was given the Tobie Award as Electronic Personality of the Year. The Award was for his efforts in promoting Electronics for Peace and for drawing attention to the issues of the domination of the electronics and computing industries by military research, procurement, secrecy and waste.

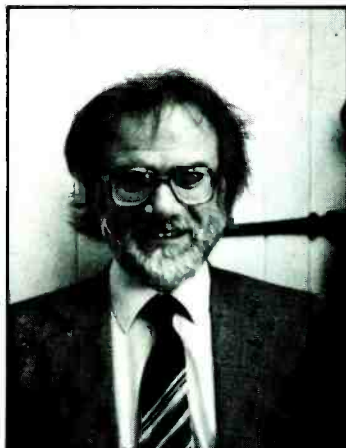

Pocket phones on the way

A low-cost, lightweight, portable telephone, the size of a pocket diary, will be commonplace by the end of the century, according to John Carrington of BT Mobile Systems. He was speaking at the Asia Telecom Forum in Singapore. The biggest stumbling-block is the need for high-capacity small batteries and Mr Carrington believes that a 'major breakthrough' in battery technology is needed. The development of low-cost large-scale i.c.s will speed the fall in prices for mobile phones as will the adoption of international standards for cellular systems.

In brief

The BBC has brought into use a system, developed by them, to protect headphone users against excessive levels. The device is smaller than a matchbox and needs no external power supply, being driven by the signal that it is monitoring and may be incorporated into the headphone lead. It offers no distortion to the sound until the limiting level is reached. That level is preset on manufacture to a value between 95 and 110dB. An averaging network prevents the protector from operation on short-term peaks. Similarly another network prevents the limiter from acting on less-harmful low-frequency sounds. The circuit is available to UK firms to manufacture and market under licence.

• British Telecom's CARE system is to be expanded. It provides continuous alarm monitoring of a customer's premises using signals transmitted over the telephone lines with interrupting telephone usage. The second phase of the scheme is to cover one hundred telephone exchange areas in London. This follows a pilot scheme of ten exchanges last September. The equipment, manufactured by Base Ten includes local exchange scanners which are connected to the BT host computer. The subscriber terminal unit is microprocessor

based and is available through Ademco-Sontrix in Reading. The system offers high security, and low cost as no extra exchange lines are required and the subscribers receive full line monitoring through the central station, with continuous interrogation and verification of the alarm system. Signalling is encrypted and modulated whether the phone is on or off the cradle.

• *Morsum Magnificat* is the magnificent title of a quarterly magazine devoted to Morse telegraphy. The first international edition (in English) is a compilation from the two years of its existence in Holland and has nostalgic tales written by professional and amateur operators as well as photos of all kinds of telegraph equipment. Copies may be obtained for £1 inclusive from the Editor; M. Hellemons, PA0 BFNBFN, Hollweg 187, 4623-XD, Bergen op Zoom, The Netherlands.

• *VHF Communications* is the English language edition of *UKW-Berichte*, a prominent German quarterly for the radio amateur.

The magazine specializes in advanced construction projects for the v.h.f., u.h.f. and microwave bands: recent issues describe a 10GHz f.m. transceiver with dielectrically-stabilized oscillator, a solid-state linear amplifier for 1.3GHz, an r.f. power meter and a receiver for the standard frequency and time signals of DCF77. Printed circuit boards and parts kits are available for most designs.

Other articles have covered coherent c.w. telegraphy, spread-spectrum techniques, weather satellites and the use of Smith charts.

Through the loss of its British distributors the magazine is less easy for U.K. radio amateurs to find; however, it remains available direct from publishers in West Germany. An annual subscription now costs DM24.00, but back issues are offered at reduced prices. The publishers prefer a signed order quoting Visa card number and expiry date. Their address is Verlag UKW-Berichte, Postfach 80, Jahnstrasse 14, D-8523 Baiersdorf, F.R. Germany.

Trouble for d.b.s.

Will direct satellite broadcasting ever come? All the signs are that the starting dates, for the home-grown variety at least, will have to carry the huge cost of a spacecraft which is already looking outdated. Receivers for 12GHz have improved so much that it is doubtful whether Unisat's expensive high-power transponders are still needed.

The BBC cannot afford d.b.s. and has the more pressing matter of its own future to worry about. The independent broadcasters, if they go ahead, will have to carry the huge cost of a spacecraft which is already looking outdated. Receivers for 12GHz have improved so much that it is doubtful whether Unisat's expensive high-power transponders are still needed.

Direct reception of existing satellite channels is already possible with dishes only a little

larger than were promised for Unisat. The Government has at last announced, after much pressure from the industry, that blocks of flats and even individuals will now be allowed to receive these programmes. But this change of policy, long overdue though it is, is certain to spoil Unisat's prospects still further.

The 11GHz band, in which Sky Channel and the others are to be found, is a broadcast band in all but name. Any individual with £1500 to spend on it can now receive six extra English-language programmes, most of them in plain ordinary PAL, plus a growing number of

foreign stations.

Yet as more stations arrive on the scene, so their value to the viewer, now spoiled for choice, inevitably diminishes. So how will the viewer feel about true high-power d.b.s. tv when it arrives?

Already it can be argued that western Europe has some of the least fertile soil in the world for d.b.s. tv. Viewers can enjoy a great diversity of programmes from national broadcasters and in many cases from private stations too. New d.b.s. channels could undoubtedly fill gaps in the present services.

But to receive them, it will be necessary to have a special

decoder for C-MAC, plus as many of its variants as may eventually be adopted. As engineers, whether amateur or professional, we may well relish the prospect of more 12GHz plumbing and more boxes full of black plastic beetles. For most people, though, the decision to buy the new equipment will depend, as such decisions always have, on the programmes it will bring. And the programmes provided by d.b.s. will need to be outstandingly attractive if they are to interest a public already reaching saturation point with other satellite or cable-borne material.

The voice (and ears) of Alvey

The latest announcement from the Alvey Directorate is about the backing of several inter-related projects on voice synthesis and voice recognition by computers. This is part of the Man-Machine Interface aspect of the Alvey programme which is looking into alternatives to the keyboard.

Central to the scheme is to be a large scale demonstration of a Machine Assisted Speech Transcription (MAST) project, also called a speech-operated word processor. This is to be undertaken by Plessey, with assistance from Shell (UK), Edinburgh University, Loughborough University and Imperial College. The problem is not so much the ability to hear and transliterate spoken words, but to put them into context so that the computer will be able to distinguish between 'eight' and 'ate' by reference to the words on either side. This involves the use of expert systems and artificial intelligence and another project between STL and Cambridge University is working on this. They expect to produce a system that can recognise over 25,000 words.

Other projects include intonation in synthesized speech so that stress may be added as well as regional accent and male

and female voices.

Sindex, a company who have developed a Chinese word editor are working on Chinese speech input/output along with the School of Oriental and African Studies, University College and the RSRE.

One project which it is hoped to reach fruition early is the use of a voice-operated enquiry systems. British Telecom, Logica and Cambridge University are working on such

a system and as a demonstration, developing a railway timetable enquiry service. Much work will go into the study of algorithms for the analysis of speech and phonetics as a path to better reproduction by the synthesized voice.

All participating bodies and other interested parties will get together in one of the interest 'clubs' which form an integral part of the whole project.

This touch sensitive robot from Cybernetic Applications, in Andover, can be guided into position by fingertip control and then programmed to find the same spot again. Sequences of movements can be easily programmed by this method although the arm uses a powerful hydraulic system.

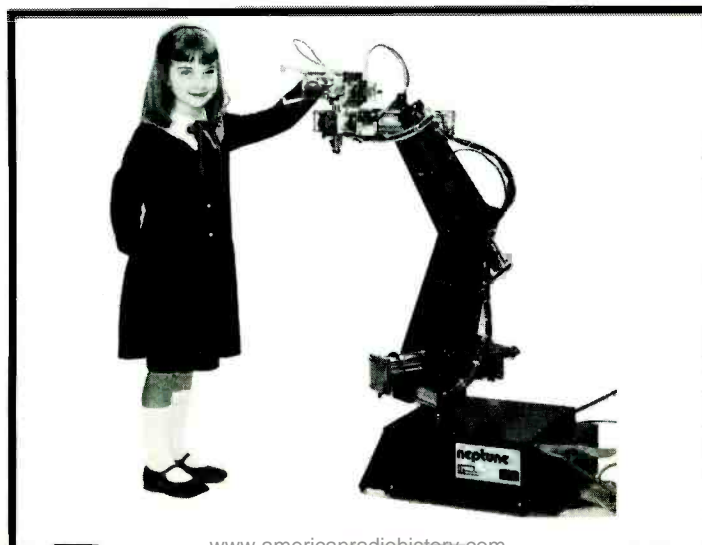

'Don't commercialize the BBC'

Lord Hill, who has been in turn Chairman of both ITA and the BBC, warns that the idea of advertising on BBC tv "spells disaster to programme standards."

"Today British broadcasting is undeniably the best in the world. But that supremacy of standard is now in danger." Lord Hill, writing in the IBA journal *Airwaves*, pointed out that the IBA has had to offer equal service as the BBC and the BBC responded to greater effort to give the public what it wanted as well as what it ought to want. The conversion of the BBC to a commercial service would "injure both and do irreparable damage..."

Lord Hill referred specifically to the committee to be chaired by Professor Alan Peacock which is to assess the effects of the BBC taking advertising. He urges all those who believe that the British system, of a public service competing with a commercial service, is best should "raise their voices; and prepare their evidence; to persuade Peacock to accept the basic truth."

TURN YOUR BBC MICRO INTO A PROFESSIONAL MICROPROCESSOR DEVELOPMENT SYSTEM

THE OPERATING SYSTEM

- FLEX—The Professional Operating System
- Versatile, Flexible & Powerful, the ideal operating system for industrial control
- Provides the power, sophistication and ease of development, previously only offered by larger, more expensive systems

THE HARDWARE

- 6809 Advanced 16 Bit Processor
- Choice of Industrial Interfaces for Target Applications:
 - High Resolution Colour Graphics
 - Industrial input/output boards
 - IEEE communications
 - and many more

THE TOOLS

- PL9—A fast, efficient control language
- CMS FORTH Interpreter & Compiler
- Cross Assemblers for most 8 bit & 16 bit micro's
- "C", BCPL, PASCAL

THE SUPPORT

- Top rate after sales technical support
- Systems / Hardware Design

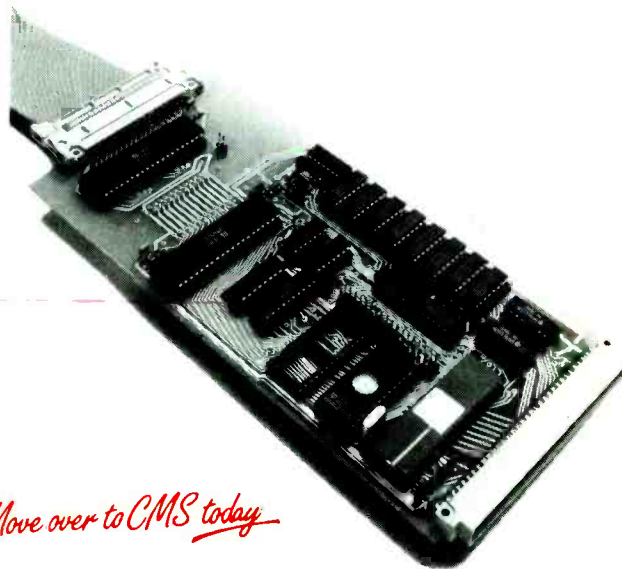

Move over to CMS today



44a Hobson Street
Cambridge CB1 1NL
(0223) 324141

Cambridge
Microprocessor
Systems Limited

CIRCLE 52 FOR FURTHER DETAILS.

OSCILLOSCOPES

TEKTRONIX 465 Dual Trace 100MHZ Delay Sweep	£1000
HEWLETT PACKARD 1707B Dual Trace 75MHZ Delay Sweep, Mains/Battery	£750
TELEQUIPMENT D75 Dual Trace 50MHZ Delay Sweep	£350
COSSOR CDU150 Dual Trace 35MHZ Delay Sweep	£200
S. E. LABS SM111 Dual Trace 18MHZ AC or external DC operation	£150
TELEQUIPMENT S54A, Single Trace 10MHZ Solid State	£110
TELEQUIPMENT D43 Dual Trace 25MHZ	£110
TELEQUIPMENTS43, Single Trace 25MHZ	£75

SIGNAL GENERATORS

MARCONI TF2088 AM/FM 10MHZ-510MHZ	£1200
MARCONI TF1066B/1 AM/FM 10MHZ-470MHZ	£375
MARCONI TF995A/2 AM/FM 1.5 - 220MHZ	£200
MARCONI TF144H/4 10KHZ - 72MHZ	£65
ADVANCE type SG63E AM/FM 4 - 230MHZ	£150
ADVANCE type SG63A AM/FM 7.5 - 230MHZ	£75
ADVANCE type SG62B AM 150KHZ - 220MHZ	£70
ADVANCE type 62AM 150KHZ - 220MHZ	£35

MULTIMETERS

UNBELIEVABLE — AVO 8 Mk IV and AVO 9 Mk IV. Complete with batteries and leads for only £65
 AVO TEST SET No. 1. (Similar to AVO 8 Mk3). Complete with Batteries, leads & carrying case. £90
 AVO Model 73. Pocket Multimeter (Analogue) 30 ranges. Complete with batteries & leads £25
 AVO 72 — Similar to above but no AC Current range. with Batteries & Leads £18

PHILIPS DIGITAL MULTIMETERS

4 digit. Auto ranging. Un-used, complete with batteries and leads (P&P £5)
 Type PM 2517E (L.E.D.) £75
 Type PM 2517X (L.C.D.) £95

All above instruments in Working Order and Supplied with Manual

NEW EQUIPMENT

HAMEG OSCILLOSCOPE 605, Dual Trace 60MHZ Delay Sweep, Component Tester	£515
HAMEG OSCILLOSCOPE 203.5, Dual Trace 20MHZ Component Tester	£270

BLACK STAR FREQUENCY COUNTERS, P&P £4	
Meteor 100 — 100 MHZ	£99
Meteor 600 — 600 MHZ	£126
Meteor 1000 — 1GHZ	£175
BLACK STAR JUPITOR 500 FUNCTION GENERATOR Sine/Square/Triangle 0.1HZ — 500KHZ, P&P £4	£110

HUNG CHANG DMM 6010, 3 1/2 digit, Hand held 28 ranges including 10 Amp AC/DC. Complete with batteries & leads. P&P £4 £16

OSCILLOSCOPES PROBES, Switched X1, X10, P&P £2 £11

5 1/4" FLOPPY DISK DRIVES

TANDON 1/2 Height, Brand New Single Sided Double Density	£70
Double Sided Double Density	£100
SHUGART type SA460 Double Sided Double Density, 80 Track, Ex-eq £75 P&P all drives £5	

HEWLETT PACKARD LOGIC ANALYSER

1600S — 32 bits £450
 (Consisting of HP1600A and HP1607A — can be sold separately). Specification on request.
 This IS A VERY SMALL SAMPLE OF STOCK, SAE Or Telephone for LISTS
 Please check availability before ordering. Carriage all units £12
 VAT to be added to Total of Goods & Carriage

This IS A VERY SMALL SAMPLE OF STOCK, SAE Or Telephone for LISTS
 Please check availability before ordering. Carriage all units £12
 VAT to be added to Total of Goods & Carriage

STEWART OF READING

110 WYKEHAM ROAD, READING, BERKS RG6 1PL

Telephone: 0734 68041

Callers welcome 9 a.m. to 5.30 p.m. Monday to Saturday inclusive

CIRCLE 88 FOR FURTHER DETAILS.

FORTH = TOTAL CONTROL

FORTH programs are instantly portable across the most popular microprocessors.

Application Development Systems include FORTH with virtual memory, multi-tasking, assembler, full-screen editor, decompiler, utilities, and full documentation.

FORTH is interactive and very fast.

FORTH programs are structured, modular, and easy to maintain.

FORTH gives control of all interrupts, memory locations, and i/o ports.

FORTH gives full access to DOS files and functions.

FORTH application programs can be converted to turnkey programs.

FORTH Cross Compilers can generate ROMmable code for: 6502, 6809, 68000, 8080, Z80, 8086, 6800, 6801/3, 1802, Z8, 8070, Z8000, 99xxx, LSI-11

We are the FORTH specialists, we also stock a large range of books, listings, and implementations for machines ranging from Spectrums to Macintosh to VAX.

mpe MicroProcessor Engineering Ltd

21 Hanley Road, Shirley
Southampton SO1 5AP
Tel: 0703 780084



CIRCLE 75 FOR FURTHER DETAILS.

Multi-Function Calibrator 9822



- 0-1000V AC/DC VOLTAGE
- 0-10 AMPS AC/DC CURRENT
- 10 ohm-10M ohm RESISTANCE
- BI-POLAR OUTPUT
- 50 ppm ACCURACY (20 ppm optional)
- IEEE-488 INTERFACE
- SELF-TEST FEATURE
- AUTOCAL
- 5 ppm RESOLUTION
- 6 AC WAVEFORMS
- 25% OVER RANGE ON DC
- ZERO OFFSET MODE



TIME ELECTRONICS

Botany Ind. Est., Tonbridge, Kent, England
 DIRECT SALES ☎ (0732) 355993 Telex: 95481

CIRCLE 18 FOR FURTHER DETAILS.

FYLDE

TRANSDUCER and RECORDER AMPLIFIERS and SYSTEMS

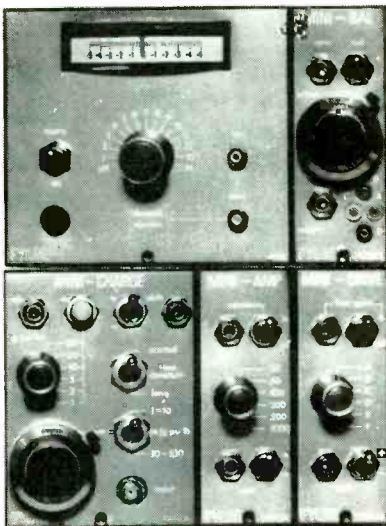

reliable high performance & practical controls. individually powered modules—mains or dc option single cases and up to 17 modules in standard 19" crates small size—low weight—realistic prices.

FYLDE

Fylde Electronic Laboratories Limited.

49/51 Fylde Road Preston
 PR1 2XQ
 Telephone 0772 57560

CIRCLE 4 FOR FURTHER DETAILS.

Lynwood GD1 VDUs: Intelligent Green micro controlled, RS232, printer port, 101 key k/b. Full Video enhancements. ONLY £149 + £15 P&P (S/H)

Burroughs MT686/7/TD710: Intelligent Green 12" VDU with 3 micros and 64K store. RS232. Programmable. ... Only £199 new or £149 S/H + £15 P&P

Open Chassis Video Monitors from above VDUs £40+7.00 p&p

Multirail Switching PSUs from above 5v 4A 12v +24v £25 + £1.50

Data General 6012 VDU's very attractive display working RS232 with integral 73 key k/b either dumb terminal mode or page buffered. Only £120.00 + £15.00 p&p

Centronics 306 Line printers: Professional fast (120 cps), superb quality 80 column printer. Parallel i/f. ONLY £99 + £15.00 P&P

Osborne Executive Portable CP/M system with oodles of software. Twin floppy drives £900 + £15 p&p

Diablo 630 Daisywheel printer. OEM i/f. NEW £599 + £15 P&P

Calcomp 565 Drum Plotter, 10thou steps. ONLY £450 + £10 P&P



BECKENHAM PERIPHERALS LTD

Callers welcome by appointment

01-486 5582
 34 Rodway Road, Bromley
 Kent BR1 3JL

We also buy redundant peripherals

CIRCLE 95 FOR FURTHER DETAILS.



AEL AT SPEED

TO BE CRYSTAL CLEAR

Tel. 029-34-5353 Telex 87116 Aero G
 MOD approved CAA approved

CIRCLE 86 FOR FURTHER DETAILS.

ELECTRONICS & WIRELESS WORLD JULY 1985

Valradio

DC-AC Inverters



STANDBY



INVERTER

Valradio Transvertors are being used all over the world to provide alternative AC Power for Standby purposes, Vital Services, Mobile, Field, Marine, Laboratory, Computer, Alarm, Communications, Medical, Control and Industrial applications including Video, TV, Camera, Hi-Fi etc.

SINE/SQUARE WAVE INVERTERS 30 to 1000 VA, 50(or 60) HZ, 115/230V, single phase AC. From 12, 24, 50, 110 or 220 Volts DC.

Standby Power Supplies
(60, 120, 200, 300, 500 or 1000VA)

Uninterruptible Power Supplies
(60, 120, 200, 300, 500 or 1000VA)

Constant voltage battery chargers 12 or 24V

VALRADIO POWER LIMITED

AK INTERNATIONAL BUILDING, LAWRENCE ESTATE, GREEN LANE, HOUNSLOW, MIDDXTW4 6DU, ENGLAND. Tel: 01-570 5622
TACKLING POWER SUPPLY PROBLEMS SINCE 1937

CIRCLE 62 FOR FURTHER DETAILS.

PINEAPPLE SOFTWARE

Programs for the BBC model 'B' with disc drive with FREE updating service on all software

DIAGRAM

● A program which allows you to store very large diagrams - up to 39 mode 0 screens - and view or edit them by SCROLLING the computer screen around over any part of the diagram.

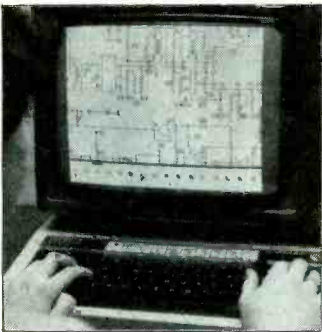

FEATURES

- Draw diagrams, schematics, plans etc., in any aspect ratio, e.g. 10*3, 2*12 screens.
- Access any part of the diagram rapidly by entering an index name, e.g. TR6, R5 etc., to display a specific section of the diagram, and then scroll around to any other part of the diagram using the cursor keys.
- Up to 128 icons may be predefined for each diagram, e.g. Transistors, resistors etc., in full mode 0 definition, up to 32 pixels horizontally by 24 vertically.

£28.75
all inclusive

Supplied only on disc - 40T/80T compatible

All orders sent by return of post.

- Hard copy printouts in varying print sizes up to 9 mode 0 screens on an A4 size sheet, compatible with most dot matrix printers.
- Many other features including, selectable display colours, comprehensive line drawing facilities, TAB settings, etc.
- Disc contains sample diagrams and two versions of the program, one of which will work from a 16k sideways RAM.
- Comprehensive instruction manual.

PINEAPPLE SOFTWARE, 39 Brownlea Gdns. Seven Kings, Ilford, Essex IG3 9NL

CIRCLE 21 FOR FURTHER DETAILS.

Keithley's 130A & 136.



Another pair of hands.

Ready and willing to give you the accuracy and flexibility you've come to expect from all handheld DMM's.

Or the one hand, the new 130A has the design and performance of our most popular 130 model but with greater basic DC accuracy - 0.25% and the need to calibrate only once every two years - all this at no increase in price.

Or the other, there is the new unbeatable value 136, a high performance full autorange 4½ digit DMM permitting precise measurements in 22 ranges of AC/DC voltage, resistance AC/DC current including 10A capability.

If you could use an extra pair of hands, or would just like to find out about our complete range of DMM's - phone 0734 861287 or contact a Keithley distributor now. Prices start at £69.00

KEITHLEY

Keithley Instruments Limited
1 Boulton Road
Reading Berkshire RG2 0NL
Telex 847047

Berkshire	(0734) 861287	Glasgow	(02367) 28170
Essex	(0279) 29522	London	(01) 639 0155
Gwen.	(0633) 280536	Cleveland	(0287) 32397
Eire	(0001) 984147	Hertfordshire	(07073) 38623

CIRCLE 29 FOR FURTHER DETAILS.

From Shure, a microphone system that mixes automatically.

Presenting a remarkable breakthrough from Shure — microphones, mixer and logic technology all combined in one totally integrated system of quite astounding aural quality.

Each microphone has complete independence within the system, eliminating all unwanted sounds

AMS 24

outside a specially tailored 120 acceptance window. And continuously analysing its own local acoustic environment, allowing each channel to adapt itself autonomously as audio conditions change.

In fact, the AMS (Automatic Microphone System) is so simple to use that an operator's only

concern is pre-setting the individual volume levels.

Its mixers (4- and 8-channel available) can easily be linked to control over 200 separate microphones.

Which makes the AMS absolutely ideal for conferences and symposiums (though it performs equally impressively in churches, courtrooms, teleconferencing and broadcasting).

And advanced logic terminals provide unprecedented flexibility for including

privacy buttons, free discussion or single speaking facilities — and many other important capabilities.

The AMS offers a choice of four effective types of microphone for all purposes: the unimposing Low-Profile AMS22; the AMS28 Lavalier for wearing round the neck; the adaptable AMS26 Probe for table, floor stand or gooseneck mounting; and the AMS24

Condenser specifically designed for the gooseneck unit.

In short, the AMS represents a major advance in sound technology. For further information or a demonstration, simply contact Shure at the address below.

AMS 28



AMS 26

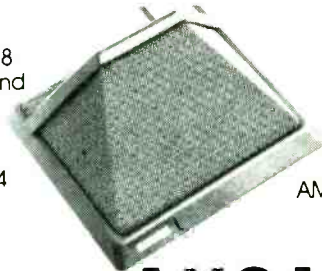

AMS 22

AMS by SHURE

HW International 3-5 Eden Grove London N7 8EQ Tel 01-607 2717

CIRCLE 73 FOR FURTHER DETAILS.

The CM1600 Measurement and Control Interface from IMS Electronics

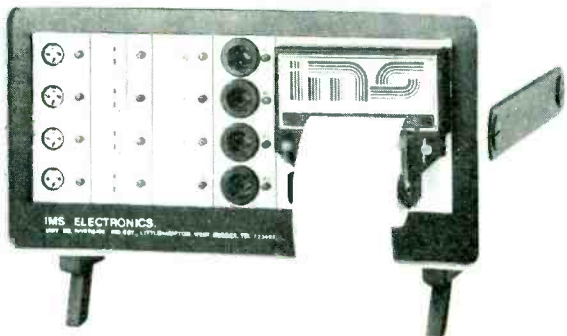

Unique construction allows flexibility
Four module positions, each with four channels

Each module may be selected from an ever increasing list including:

- ± 10 volt outputs, 16 bit resolution
- $\pm 10V, 1V, 100$ mV (Software Selectable) inputs, 16 bit resolution
- Thermocouple inputs (linearised)
- Single pole change over relays (mains rated)

CHOICE OF IEEE-488 or RS 232C INTERFACE
Z80 MICROPROCESSOR BASED

Optional extras include:

- Dot matrix panel printer (as illustrated)
- 32K RAM for assistance in data acquisition



IMS Electronics

Unit R6, Riverside Industrial Estate, Bridge Road, Littlehampton, West Sussex BN17 5DF

SALES TELEPHONE (0903) 723492

CIRCLE 6 FOR FURTHER DETAILS.

A PERSONAL LOGIC ANALYSER FOR YOUR SPECTRUM

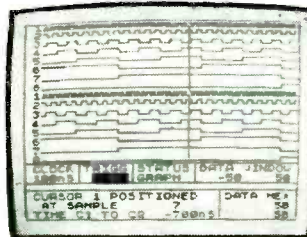

Clip this high performance tool onto your circuit to really see and understand exactly what it is doing.

- Displays oscilloscope type traces of the voltage levels (0 or 5v) of 16 points in a digital circuit.

£149

- Captures 1999 samples up to 10 MHz on 16 lines.

- Ideal for micro-processor work.

- Ready to plug into your Spectrum



Cheques and requests for information to **Seal Electronics** 1 Hagbourne Close Woodcote, Reading RG8 0RZ

CIRCLE 25 FOR FURTHER DETAILS.

ELECTRONICS & WIRELESS WORLD JULY 1985



Application other than Cable T.V. includes C.C.T.V. (up to 26 Channels 8MHz wide on V.H.F. Repeaters, and up to 65 Channels 8MHz wide on U.H.F./V.H.F. Repeaters). Suitable for outdoor mounting.

TYPE	FREQUENCY RANGE MHz	GAIN dB ADJUSTABLE	MAXIMUM OUTPUT dBmV	FREQ. RESPONSE FLATNESS	INTERNAL SLOPE ADJUSTMENT	POWER REQUIREMENT
TSC3060	40-300	10-30	60dB (1000mV)	+ or - 5dB	5dB	27-42V 10VA-
TSC3060SM	40-300	10-30	60dB (1000mV)	+ or - 5dB	5dB	25-45V 7VA-
TSC3660	40-300 470-860	10-30VHF 16-36UHF	60dB (1000mV)	+ or - 5dB	5dB VHF — UHF	27-42V 18VA-
TSC3660SM	40-300 470-860	10-30VHF 16-36UHF	60dB (1000mV)	+ or - 5dB	5dB VHF — UHF	25-45V 13VA-
TSC3665	40-300 470-860	10-30VHF 16-36UHF	60dB (1000mV) VHF 65dB (1800mV) UHF	+ or - 5dB	5dB VHF — UHF	24-42V 24VA-
TSC3665SM	40-300 470-860	10-30VHF 16-36UHF	60dB (1000mV) VHF 65dB (1800mV) UHF	+ or - 5dB	5dB VHF — UHF	25-45V 18VA-

Variations of the above are available on request. i.e. 240V mains powered; 54-84V line powered; trunk distribution amplifier with one trunk line and one distribution line out

INTERNAL PLUG IN EQUALISERS (OPTIONAL)

TYPE	FREQUENCY RANGE MHz	ATTENUATION 40MHz	ATTENUATION 300MHz	TYPE	FREQUENCY RANGE MHz	ATTENUATION 470MHz	ATTENUATION 860MHz
EZV6	40-300	6dB	1dB	EZU6	470-860	6dB	1dB
EZV9	40-300	9dB	1dB	EZU9	470-860	9dB	1dB
EZV12	40-300	12dB	1dB	EZU12	470-860	12dB	1dB

TYPE	COAXIAL CABLE CONNECTORS
A	SCP14 Screw-on coaxial plug for 14mm Outside Diameter cable
B	SCP10 Screw-on coaxial plug for 10mm Outside Diameter cable
C	SCP Screw-on coaxial plug for 5.9mm Outside Diameter cable
D	SAC Screw-on right angled connector
E	SFC Screw-on female line connector
F	SMC Screw-on male line connector
HS1/4	Heat shrink sleeve for SCP14
HS1/10	Heat shrink sleeve for SCP10

TAYLOR BROS (OLDHAM) LTD
 BISLEY STREET WORKS, LEE STREET,
 OLDHAM, ENGLAND.
 TELEPHONE: 061 652 3221 TELEX: 669911

CIRCLE 59 FOR FURTHER DETAILS.

There are better ways of measuring hum, ripple and other small signals

The Waugh Instruments Micro Amplifier extends the measurement capabilities of your oscilloscope to 100µV/div from DC—2MHz differential or single ended input. For details of this and other amplifiers contact:-

Peter Waugh at Waugh Instruments, Otter House
 Weston Underwood, Olney, Bucks. MK46 5JS
 (0234) 712445.

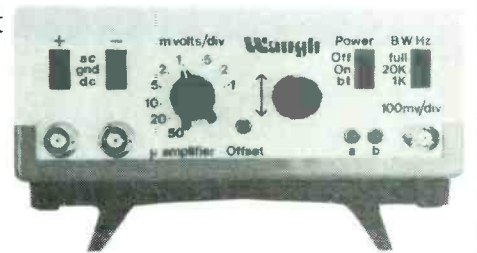

CIRCLE 97 FOR FURTHER DETAILS.

BAKER LOUDSPEAKERS	Post C2 each				
MODEL	INCHES	OHMS	WATTS	TYPE	PRICE
Disco/Group	10	8-16	50	PA	£18
Midrange	10	8	100	MID	£25
Major	12	4-8-16	30	HI-FI	£18
Supers	12	8-16	30	HI-FI	£26
Wooler	12	8	80	HI-FI	£25
Auditorium	12	8-16	60	Bass	£37
Disco/Group	12	4-8-16	45	PA	£18
Disco/Group	12	4-8-16	75	PA	£22
Disco/Group	12	8-16	100	PA	£28
Disco/Group	15	8-16	100	PA	£25

PA 150 Watt MICROPHONE VOCAL and GROUP AMPLIFIER £129
 4 channel mixing, 8 inputs, dual impedance, 50K-600 ohm, volume, treble, bass. Presence controls on each channel. Master volume control, echo, send return socket. Slave Sockets. Post C3

150 Watt MIXER AMPLIFIER 4 Inputs £99
 Discotheque, Vocal, Public Address. Speaker outlets for 4, 8 or 16 ohms. Four inputs, 20mV, 50K ohm individual volume controls. Four channel mixing. Slave output 16"X8"X5". WI-14lb. Master volume control. 240V A.C. Post C2

100 Volt Line Model, 150 watt £114. MONO SLAVE. 150 watt £80.
 Baker Stereo Slave 150 + 150 watt per channel (300 watt Mono) Heavy Duty Model £125. Post £4.

BAKER MOBILE PA AMPLIFIER. All transistor. 60 watt RMS. 12V DC & 240V AC. 4 inputs 50k Aux + 2 mics + 1 phono loudspeaker. Output 4-8-15 ohms + 100 volt line £89 Post £2

PA systems - amplifier, mike + two spkrs Carr. £20
 Mobile 60w, 240v AC + battery 12v £179
 MkII 150w, 240v AC, complete £249

150 WATT DISCO twin deck system £360 carr. £30		
120 WATT DISCO twin speakers £300 carr. £30		
Console only, £145. 120 watt, £199, carr. £10		
PA CABINET SPEAKERS. 4 or 8 or 16 ohm 75 watt 20X15X9in 90 watt 32X15X11in. £73. 150 watt £82. Carr. £10. Black vinyl covered with handles.		
RCS SOUND LIGHT Ready built Deluxe 4 channel 4,000 watt with chaser - speed - programme controls £69. Post £2		
New Model MkII with special 16 programmes. 4 channel 4,000 watt. £89 post £2		
DELUXE STEREO DISCO MIXER/EQUALISER as above but L.E.D. V.U. displays 5 band graphic equaliser, left/right fader, switchable inputs for phono/line, mike/line. Recording Output. £129		
PROJECT CASES Black vinyl top and sides		
6X6X1; £3.60	8X5X2in £4	11X6X5 £9
9X5X2in £4.80	11X6X3 £5.50	13X8X4; £11
ALUMINIUM BOXES. 4x4x1; £1.20 4x2; £1.20; 3x2x1 £1.20; 6x4x2 £1.90; 7x5x2; £2.90; 8x6x3 £3; 10x7x3 £3.60; 12x5x3 £3.60; 12x8x3 £4.30; 9x4x4 £2.20; 4x4x2; £1.60. p.p. 65p ea		
"STOP PRESS"		
1000w mono, 500 w stereo quality amplifiers. £275 p.p. £5		
S500D, reconditioned, guaranteed		
RADIO COMPONENT SPECIALISTS		
337 WHITEHOUSE ROAD		
CROYDON, SURREY, U.K.		
TEL: 01-884 1665		
Same Day Despatch. Closed Wed. Lists 34p		

CIRCLE 68 FOR FURTHER DETAILS.

VIDEO TERMINAL BOARD

★ 80 characters × 24 lines ★

Requires ASCII encoded keyboard and monitor to make fully configurable intelligent terminal. Uses 6802 micro and 6845 controller. Program and character generator (7 × 9 matrix with descenders) in two 2716 EPROMs. Full scrolling at 9600 baud with 8 switch selectable rates. RS232 interface.

Bare board with 2 EPROMs and program listing — £48 plus VAT. Assembled and tested — £118 Send for details or CWO to:



AM Electronics
 Wood Farm, Leiston, Suffolk IP16 4HT
 Tel: 0728 831131

CIRCLE 40 FOR FURTHER DETAILS.

MIDSUMMER MADNESS

POPULAR I.C.'S AT INCREDIBLE PRICES!!!

CPU'S

6502	£3.49	Z80A	£1.99
6502A	£4.99	Z80B	£6.49
6800	£1.99		

SUPPORT DEVICES

6522	£3.49	Z80APIO	£1.99
68B54	£8.99	Z80ASIO-O	£6.49
Z80ACTC	£1.99	8271	£52.50

MEMORIES

4116-15	£1.20	6116-LP3	£3.20
4164-15	£1.75	8118	£2.50

EPROMS

2764-25	£3.20	27128-25	£6.00
2764-30	£3.00	27128-30	£5.50

TTL

7437	£0.45	74LS123	£0.75
74LS00	£0.20	74LS163	£0.70
74LS04	£0.20	74LS244	£0.70
74LS08	£0.20	74LS245	£0.90
74LS10	£0.20	74LS393	£0.90

4000 SERIES

4013	£0.30	4020	£0.60
------	-------	------	-------

1. All prices exclude VAT and carriage
2. Carriage charge £1.00 (orders up to £100.00)
FREE (above £100.00)
3. Strictly cash with order or credit card
(Access or VISA)
4. Delivery by return post.

**RING NOW BEFORE
WE CHANGE OUR MINDS**

**HI-TECH
COMPONENTS**

**PHONE
0379 4131
FOR FAST DELIVERY**

GILARY ROAD, DISS
NORFOLK IP22 3EU

CIRCLE 69 FOR FURTHER DETAILS.

**THAME
COMPONENTS
LTD.**

THAME
COMPONENTS
LTD.
No.1
AMD Distributor
of the Year 1985

No.1

AMD Distributor

For the exciting NEW
CRT Display and Graphics Chip
Set solutions
and ALL your Advanced Micro
Devices requirements

THAME 084 421 4561

CIRCLE 71 FOR FURTHER DETAILS.

CARACAL ^{NEW} SINE WAVE INVERTERS 200 to 1000 VA



CARACAL'S new range of pulse width modulated inverters are now even better than ever compared to older tuned-type inverters — with even higher efficiency, lower standby current and lower weight than before.

CARACAL inverters have been in use around the world for many years wherever a reliable and stable source of backup or standby AC power is needed for computers, communications, instrumentation, and for mobile, field or marine applications.

ASK ABOUT OUR CUSTOM/OEM
SERVICE — THE U.K.'s BEST
INVERTERS TO SUIT YOUR DESIGN —
FROM 50 TO 1000 VA

CARACAL POWER PRODUCTS LTD.
42-44 SHORTMEAD ST., BIGGLESWADE, BEDS.
Tel: 0767 — 260997

CIRCLE 87 FOR FURTHER DETAILS.

ELECTRONICS & WIRELESS WORLD JULY 1985

Versatower:

A range of telescopic towers in static and mobile models from 7.5 to 36 metres with tilt-over facility enabling all maintenance to be at ground level.

Designed in accordance with CP3 Chapter V, part 2; 1972 for a minimum wind speed of 140 kph in conditions of maximum exposure and specified by professionals world-wide where hostile environments demand the ultimate in design, quality and reliability.

Suitable for mounting equipment in the fields of:
 Communications
 Security surveillance - CCTV
 Meteorology
 Environmental monitoring
 Geographical survey
 Defence range-finding
 Marine and aero navigation
 Floodlighting
 Airport approach lighting
 Further details available on request.



STRUMECH ENGINEERING LIMITED
 Portland House, Coppice Side, Brownhills
 Walsall, West Midlands WS8 7EX, England
 Telephone: Brownhills (05433) 4321
 Telex: 335243 SEL.G



CIRCLE 7 FOR FURTHER DETAILS.

Happy Memories

Part type	1 off	25-99	100 up
4116 200ns.....	1.25	1.15	1.10
4164 150ns Not Texas.....	1.45	1.30	1.20
2114 200ns Low Power.....	1.75	1.60	1.55
2016 150ns.....	2.45	2.30	2.20
6264 150ns Low power.....	6.75	6.25	5.95
2716 450ns 5 volt.....	3.85	3.45	3.30
2732 450ns Intel type.....	4.75	4.25	4.10
2732A 350ns.....	5.25	4.69	4.50
2532 450ns Texas type.....	3.85	3.45	3.30
2764 300ns Suit BBC.....	4.20	3.80	3.60
27128 300ns Suit BBC.....	5.60	5.00	4.80

Low profile IC sockets: Pins 814 16 18 20 24 28 40
 Pence 12 13 14 16 18 24 27 38

Available now - The ROAM BOARD for the BBC Micro. Reads Roms via a Low Insertion Force Socket and saves their contents as files, then reloads a file into its sideways Ram as required. Full details on request.

74LS series TTL, wide stocks at low prices with DIY discounts starting at a mix of just 25 pieces. Write or 'phone for list.

Please add 50p post & packing to orders under £15 and VAT to total. Access orders by 'phone or mail welcome. Non-Military Government & Educational orders welcome., £15 minimum.

HAPPY MEMORIES (WW),
 Newchurch, Kington,
 Herefordshire HR5 3QR.
 Tel: (054 422) 618

CIRCLE 57 FOR FURTHER DETAILS.
 ELECTRONICS & WIRELESS WORLD JULY 1985

VISIT OR
 PHONE
 OPEN 6 DAYS
 A WEEK
 ALL STOCKS
 ON DISPLAY

HENRY'S AUDIO ELECTRONICS



Equipment • Communications • Computers • Components

INSTRUMENTS STOCKED

SCOPES (UK C/P £6.50)

- *HAMEG
 - HM203/5 Dual 20MHZ £270.00
 - HM204 Dual 20MHZ £365.00
 - HM605 Dual 60MHZ £515.00
- *CROTECH
 - 3030 15MHZ Portable £188.00
 - 3035 15MHZ Bench £208.00
 - 3132 Dual 20MHZ £312.00

(*HAMEG/CROTECH INCLUDE COMPONENT TESTERS)

HITACHI

- Y212 Dual 20MHZ £329.00
- Y222 Dual 20MHZ* £295.00
- Y223 Dual 20MHZ* £450.00
- Y23 Dual 40MHZ* £650.00
- Y660 Dual 60MHZ* £880.00

*with probes

THANOR SC110A 10MHZ battery/mains £175.00

SCOPE PROBES XI-X10 £10.00

GENERATORS (UK C/P £1.00)

(F) Function (P) Pulse (A) Audio (R) RF

- 500 0.1HZ-500KHZ (F) £110.00
- TG101 0.02HZ-200KHZ (F) £110.00
- TG102 0.2HZ-2MHZ (F) £160.00
- TG601 0.005HZ-5MHZ (F) £295.00
- TG105 5HZ-5MHZ (P) £105.00
- AG202A 20HZ-200KHZ (A) £98.00
- LAG27 10HZ-1MHZ (A) £115.00
- SG402 100HZ-30MHZ (R) £79.00
- LSG17 100HZ-150MHZ (R) £115.00
- AG203 10HZ-1MHZ (A) £155.00

POWER SUPPLIES (UK C/P £2.00)

- *Twin meter • Single meter (switched) + Digital
- *241 0/30v 0/1AMP £33.00
- *242 0/30v 0/3AMP £52.13
- *154 5/15v 0/4AMP £43.43
- *2302 0/30v 0/2AMP + 5v 1A AND PULSE GEN £230.00
- + PL320 0/30v 2AMP £145.00

COUNTERS (UK C/P £1.00)

- + LED • LCD All 8 digit
- + 100 100MHZ £99.00
- + 600 600MHZ £126.00
- + 1000 1000MHZ £175.00
- + TF600 600MHZ £132.50
- + TF040 40MHZ £120.00
- + TF200 200MHZ £175.00

TV EQUIPMENT (UK C/P £1.00)

- TC40 VHF/UHF F/S meter £215.00
- LTC910A Tube Tester £199.00
- MC321 PAL(UK) Colour gen. £252.00
- MC328 PAL(B) Colour gen. £252.00
- LHM80A 40Kv meter £30.00

STOCK SELECTION
 (*UK C/P 65p *UK C/P £1.50)

- *LP1 10MHZ Logic Probe £24.95
- *DP70 30MHZ Logic Probe £29.00
- *DP71 50MHZ Logic Probe £57.00
- *ST300 AC Clamp Meter £30.87
- *YF501 Elec. Ins. Tester £59.13
- *DM6013 Digital Cap Meter £60.43
- *KDm6 200MHZ TR DIP Meter £48.70
- *LCR740 LCR Bridge £230.00
- *OM358 Scope Multiplexer £169.00
- *HZ65 Scope Comp. Tester £24.00
- *TC1 Transistor Tester £24.30
- *CM200 Bench Dig. Cap. Tester £89.00

HAND DMM'S 3 1/2 digit (UK C/P 65p)

(R) Rotary (PB) Push-Button • With case

- *3500 10A AC/DC (R) £41.48
- *3510 Plus Hle & Buzzer (R) £47.78
- ME540 10A AC/DC Auto/Man (R) £41.50
- DM73 Auto-range probe + buzzer £39.75
- *KD615 10A DC Hle Tester (R) £34.75
- 6010 10A AC/DC (PB) £37.83
- 7030 10A AC/DC 0.1% (PB) £46.91
- *KD55C 10A AC/DC (R) £38.70
- *DM528T Miniature with Hle test £29.52
- DM20 10A AC/DC Hle + conductance (R) £47.00
- DM77 10A AC/DC Auto + buzzer (R) £46.00
- *3530 10A AC/DC Hle + Cap. + buzzer (R) £57.29

BENCH DMM'S (UK C/P £1.00)

- TM355 3 1/2 digit LED 0.25% £85.00
- TM356 3 1/2 digit LCD 0.25% £95.00
- TM351 3 1/2 digit LCD 0.1% £115.00
- 5025 3 1/2 digit Auto-manual comparator £210.00
- 5030 3 1/2 digit Auto-manual comparator £137.00
- 15034 4 1/2 digit LCD 0.05% £169.00
- 15034a 4 1/2 digit LCD 0.03% £185.00
- 1504 4 1/2 digit LCD True RMS £199.00

SWITCH MODE AND LINEAR POWER SUPPLIES

Gold and ITT/STC
 (UK C/P & Ins. £1.00 each)

- A a. 24/30 V 500mA linear £6.91
- C. 5V 2 amp Eurocard linear £7.78
- D. 5V 10 amp SW mode £15.61
- E. 5V 20 amp SW mode £19.96
- F. + 5V 5A. - 23V 0.25A. - 12V 0.1A. + 12V 0.5A. SW mode £17.35
- G. + 5V 2A. - 30V 0.025A. - 12V 0.1A. + 12V 0.35A. SW mode £17.35
- H. 24V DC Input 12 volt 1.2A SW mode converter £5.17

SOFTWARE

(Please state format required and machine)

GATEWAY/PATHWAY Relational database for all CP/m £100.00

MDIS Intelligent Disassembler for all CP/m based £50.00

IVC HI-RES Provides Pseudo high resolution graphics £15.00

DISKPEN (V03) Low cost word processor for multiboard based overlays for diskpen £50.00

MAXIFILE £20.00

SPOOLER £15.00

HENRY'S CP/m UTILITIES £15.00

41 Programs

ALL DISC Variable disc format for GEMINI/NASCUM CP/m's £150.00

PREZTEL 2 Interface Galaxy or Nascom to Modem for use with BT Prestel service £26.04

ASC11 KEYBOARDS

69S D5 Compact 64 key + 5 function keys. Half effect keyboard with reprogrammable (2716) 

ASC11 output decoder EPROM. Steel key frame for good rigidity. Negative going strobe. Requires + 5 volt + 12 volt supplies (UK C/P £1.00) £21.70

2070 COMPACT 58 KEY KEYBOARD

Contactless capacitive high reliability keys. Full 128 ASC11 codes. Steel key frame for positive rigidity. 1mS strobe, single + 5 volt supply. Repeat key, control and caps. lock. (UK C/P £1.00) £28.26

COMPUTER POWER SUPPLY

Switch mode. Stabilised. Self protecting S/C protected, etc. 220/240V AC + 5V 3.3A - 12V 2.4A, 40% cycle - 5V 0.5A - 12V 0.5A. Suitable Apple replacement (UK C/P £1.50) £57.00

ITT 2020 CABINET

Professional computer case with keyboard cutout. 

18 x 15.5 x 4.5 (front slopes) Ideal for single board computers like the Nascom or Gemini Multi-board (3 cards etc) Very heavy gauge (.25) plastic with metal base. Attractive silver grey finish (UK C/P £1.78) £19.95

COMPUTER FANS

(UK C/P 60p each. £1.00 per pair)

- 4 1/2" 220/230V AC Brand new £6.52
- 4 1/2" 220/240V AC Ex-units £4.78
- 4 1/2" 110/115V AC Ex-units £4.35



CASSETTE MECHANISMS

Fitted counter. Motor. Stereo record and erase heads. 

Autostop, solenoid. Brand new available 6V DC or 12V DC (state which) (UK C/P 65p) £5.17

ALSO miniature stereo cassette replay mechanism 12v. 105 x 100 x 40mm. (UK C/P 65p) £4.78

TELETEXT BOARD

Mullard VM6101/5 board. Complete and brand new. £10.87 (UK C/P £1.00) (Thorn TX9)

TOROIDAL TRANSFORMER

250 watt isolating trans. Plus 22v 1A, 6.3v 1A, 4 1/2 dia x 1 1/2" £4.50 (UK C/P 85p)



ALSO IN STOCK Large range of analogue multimeters, breadboards.

SUPPLIERS OF ELECTRONICS FOR EVERY PURPOSE (Official Orders Welcome (subject to confirmation))

ORDER BY POST OR PHONE

301 Edgware Road, London W2
 Test Equipment • Audio 01-724 3564

404 Edgware Road, London W2
 Computers 01-402 6822
 Equipment 01-724 0323
 Components 01-723 1008

Up to £1000 instant credit Available through Lombard Tricity Finance

CALL IN AND SEE FOR YOURSELF

ASK HENRY'S FIRST

ALL PRICES EXCLUDE VAT

CIRCLE 27 FOR FURTHER DETAILS.

BETTER BETTER

BEST

CD 351

A first-class range of colour graphic displays which not only adapt to your system but make sense of your budget.

Versatile, Barco proven reliability. Flexible scanning frequencies make them compatible with a multitude of computers and systems (with a special Hewlett Packard option).

Barco gives you the performance you want — at the right price.

With years of experience behind them Barco are maintaining their leadership in colour graphic displays whether you're working to a budget or demanding the best.

The specifications speak for themselves.
THE CD AND CDCT 20" (51cm) RANGE CAN NOW BE SUPPLIED WITH AN INFRA-RED TOUCH SCREEN.

CDCT 5000

When only the best is good enough, it has to be Barco. This range of high resolution colour displays provide you with the perfect partner for today's powerful graphic systems.

When uninterrupted system operation allied to hairline picture detail are of the utmost importance the Barco CDCT 5000 comes into its own with unbeatable reliability. (Mean Time Between Failure 16,000 hours).

CD 351 SPECIFICATION

Video Bandwidth 20 MHz
Horizontal Frequency 15-37.5 KHz
Vertical Frequency 45-60 Hz 70-80 Hz
H-P Open 24.8 Hz
Tube Self Convergent,
0.31mm pitch (MRA)
0.47mm pitch (MRA)
Resolution 1024 x 870 (H x V)
Convergence Errors Max 1.0mm
Inputs RGB Sep Comp SYNC
RGB SYNC on Green, RGB
Sep, H and V SYNC
BNC Connectors
Normal or Long Persistence/Short Blue, Auto/
Manual Degaussing, Modular Construction.

CDCT 5000 SPECIFICATION

- | | |
|---|--|
| 1. Video Bandwidth 50 MHz | 6. Resolution 1280 x 1024 (H x V) |
| 2. Horizontal Frequency 15-37.5 KHz | 7. Horizontal Retrace Time Down to 4.6 μ Sec |
| 3. Vertical Frequency 38-120 Hz | 8. Normal Persistence or Long Persistence/Short Blue |
| 4. Self Convergent, 0.31 Pitch S.S.T Tube | 9. Modular Construction |
| 5. Convergence Error Max 0.6 mm | |



Cameron Communications

A division of CW Cameron Ltd.
Burnfield Road, Glasgow G46 7TH
Tel: 041-633 0077 Telex: 779469
FAX 041-633 2879

Sales Service and Distribution Centre — Reading.

CD 351:
Photograph courtesy of Kent Process Control
CDCT 5351:
Photograph courtesy of Gresham Lion (PPL)

Tick and attach your business card and send to the above address.

CD Series of Displays
 CDCT Series of Displays
 Infra-Red Touch Screens

Video displays

Low cost per character will ensure that the cathode ray tube remains the dominant display technology this decade, despite advances in flat-panel displays.

Way back in the early seventies, nearly all data display units were hardwired. The main functions of computer intercommunication, screen display and editing, and print handling were organised by fixed logic elements that couldn't do anything else, which meant the user was stuck with a rigid set of protocols, editing facilities and formatting rules. Next came the independent-maker ascii terminal of the mid-seventies that were programmable only to a limited extent but could emulate the earlier hard types, as well as handling peripheral devices. Then Televideo introduced the microprocessor to the terminal, which then became 'smart' and reduced costs as well as increased flexibility.

But nowadays, the difference between smart and dumb terminals is fast disappearing as it now becomes difficult to find them without microprocessors: characteristics are more and more determined by firmware rather than hardware.

Nevertheless, what might be called a classically-intelligent terminal is one that communicates with a mini or mainframe or other multiuser computer and can be used as an editing terminal to download, modify and possibly upload data. At the top end of this bracket is the multiple-emulation graphics terminal that can serve as a stand-alone workstation with bit-mapped graphics, modem and word processor.

More humble are the standard terminal displays that have come to feature 12 or 14in screens, holding 24 lines of 80 or 132 characters, line and character editing, smooth scrolling, a basic set of attributes plus variants, a matrix of 7 by 9 dots (being displaced by 7 by 14, 8 by 16, 9 by 12, 10 by 12, or most recently 13 by 18 dots), together with a gradual trend to the more visible amber phosphor, now standard in Sweden. Ergonomic design is almost mandatory, with swivel,

tilt and the low-profile keyboard being the most obvious elements.

There are so many models on the market (over 400 in the US alone) that we leave the market researchers to collate and classify (e.g. SRI* in the US and *Systems International* here).

Visual display unit, the term more often used in Europe, has taken on a rather different meaning for users of microcomputers. Screen actions of character and window generation, editing, attribute and cursor handling are all done within the microcomputer and do not have to be separately generated. So the term v.d.u. has also come to mean simply a monitor screen, with its power supply and deflection circuitry, contrasting with the word 'terminals', which implies keyboard editing or entry.

Current demand for c.r.t. monitors with higher bandwidth, increased colour options, and higher resolution is a reflection of the host-equipment manufacturer's demands for sharper and flicker-free monitors with improved text and graphics presentation features, according to a recent survey of the c.r.t. monitor market. But the main impetus for technical improvements and innovation, the report says, has and will come from the graphics terminal manufacturers.

The survey*, published earlier this year by Stanford Resources Inc, says that though flat-panel display technologies will make

their presence known in the marketplace in the next few years, the c.r.t. will continue to be the dominant display device because of its low cost per picture element. SRI forecast that the (US) flat panel market value will increase from nearly 50 million this year to \$340 million in five years time, while the non-tv c.r.t. market for 2,000-character tubes or more will increase from 800 million to \$2 billion over the same period.

The high resolution 1,280 by 1,024 colour format will evolve to higher resolution, stretching the capability of the shadow-mask tube to its limits, and monochrome picture element count will increase to 8-10 million elements with a resolution in the range 350 to 400 elements per inch by 1992.

'Virtual micros'

People at Rank Xerox have recently centralized the intelligence in a new network for communicating with about a thousand terminals. Instead of using PCs at around £3000 each they have substituted dumb terminals, and collected together the processors, with hardware and software specially developed for the system. In this 'virtual PC' or 'virtual micro' method, both processors and disc drives are taken away from the terminals and centralized in such a way that as network users log on each is allocated the use of a microprocessor housed in central rack-mounted module. An initial study estimated that the average information user requires much less than 30 minutes microcomputer time a day, and that only 10 to 15 centralized microprocessors are required for every 100 dumb terminals printers reduced with to one per floor.

The project started three years ago when Stephen Shiu, manager of information technology at Rank Xerox (UK), was asked to find a way of speeding informa-

Worldwide display market

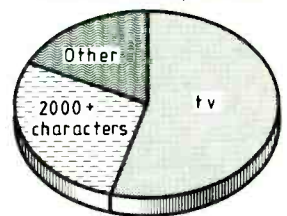

Total: \$11 billion by 1990

Though the flat-panel display market will grow from \$48 million worldwide this year to \$340 in 1990, the c.r.t. monitor market will grow from \$800 million to over \$2 billion in the same period. Source: SRI.

*The SRI study, which analyses market by application, details product specifications, assesses technology trends and profiles major suppliers, costs \$1950 in Europe from International Planning Information, Nodre Ringvej 201, 2600 Glostrup, Copenhagen. It forecasts an average annual growth in 'shipments' of non-tv c.r.t. monitors of 23% — from 3.7 million in 1983 to 16 million by 1990. Another report, from Venture Development Corp. in Wellesley, Ma, gives a rate of 17%, from 8 to 25 million units over the same period, but VDC wouldn't let us see their \$7500 report so there's a bit of a mystery in this large disparity.

Display price per character

For displays with more than 2000 characters:

Monochrome c.r.t.	2
Monochrome flat c.r.t.	3
Colour c.r.t.	8
Multiplexed fluid crystal	8
Active matrix fluid crystal	17
Electroluminescent	20
Plasma	20
Vacuum fluorescent	30

Price per character in 1984 cents projected to 1990. Source: Monitor Market Trends, SRI.

To meet the competitive demands of today's markets, 'state-of-the-art' terminals require a multiplicity of facilities — flexible attribute handling, proportional spacing, split screens and multiple windows with soft scrolling of windows, variable height and width, and full-page 132 by 60 screen format — all featured in AMD's 8052, the subject of this issue's front cover. Of 1983 vintage, it was the first to support flicker-free unrestricted (split-screen) smooth scrolling by using three row buffers. The 8052/8152 set can handle the Japanese Kanji character set by using two 12 by 24 characters side by side and redefining one of the attribute bits. Normally only four of the 12 attribute bits are user-redefinable but by programming a special register eight of the attributes can be redefined — especially useful for the Kanji set, which requires 2500 to 4000 unique characters or 12 bits of addressing.

tion to the company's UK front-line managers. His initial approach was the development of a conventional multi-function micro with mainframe link, electronic mail and file transfer capabilities that would have cost £4 million for the thousand users envisaged. But Shiu wanted terminals at £1,000: "It seemed illogical to install £3000 PCs simply for much of the time to talk to the mainframes and minis." It was then that he saw a better solution was to use a dumb terminal that would not only communicate with IBMs, DEC's and Xerox 8000 Network Systems but also with the modular micros. One then virtually has a PC, he says, but with the advantage that maintenance and up-grading become easier because all the processors are in one location, and data back-up can be carried out automatically. The disciplined 'housekeeping' and big savings on software licences were also important to Rank Xerox.

CRT controllers

There were only a handful of c.r.t. controllers on the market at the time of our last review of v.d.us*. Designed to replace the t.t.l. control gates and counters, these l.s.i. chips were of two kinds — the early fixed screen format type and the programmable type that can run at non-standard scan rates, such as Motorola's 6845. Then, there was a firm upward trend in scan rates. Horizontally, a frequency of at least 17kHz was needed before line whistle was inaudible, whilst a frame rate in excess of 55Hz

* 'Introduction to v.d.us' by Colin Carson, October and December 1982, and by James Tully, January 1983.

was desirable to reduce flicker. With the need to adequately display 25 rows of 80 characters, a resolution of at least 720 by 300 picture elements was considered necessary. This combination of resolution and higher scan rates pushed up monitor bandwidth; open-frame monochrome monitors meeting this specification sold in small quantities for over a hundred pounds.

Massive sales of home computers created a new, large market for tv line-rate monitors, particularly where parents wanted their television set back! The IBM PC emerged, it too driving a tv line-rate colour monitor, and went on to be sold in huge quantities. The price of both monochrome and colour low frequency monitors fell, and in turn became more attractive to other product designers. Furthermore, the IBM PC standard graphics offered a resolution at best of 640 by 200 pixels, with many of the business applications using the 320 by 200 mode. Suddenly lower resolution, lower frequency monitors were acceptable for business use, with many of the IBM PC look-alikes adopting the same standard. Despite this, there are still many business and c.a.d. machines which do use high frequency monitors, and IBM themselves may soon be setting new standards with the introduction of two new graphics cards.

Memory architecture. The architecture has not changed over the last three years. Four options exist:

1. Video ram, dual-ported between the system and the video controller.

2. Video ram dedicated to the video controller so that system

access to the ram is via the controller.

3. Video ram residing inside the controller.

In these three cases, it is important that the ram can be accessed at any time, with minimal delay, and without affecting the picture.

4. Character information is stored in system ram and via d.m.a. into row buffers inside the video controller.

Low-end video controllers.

There are some applications, such as cash dispensers or window advertising, where only a simple display is required. One of the first devices was the General Instruments AY-3-9025 (later 9035 and second-sourced by Plessey), designed as part of a viewdata chip set to display text and "chunky" graphics. Another is the Motorola 6847 which supports text and a number of colour graphics modes up to a maximum resolution of 256 by 192 elements. Unfortunately both devices still require external ram and logic (option 1). Fujitsu's MB88303 is a truly self-contained monochrome video controller that can connect directly onto an eight-bit multiplexed address and data bus to provide access to its internal ram (option 3). Nine rows, each of 20 characters may be displayed from an internal character set of 58 different rounded characters. The device can be synchronized to a television or video source, allowing text superposition. The single-chip microprocessor with built-in simple video controller must now be imminent: its introduction would help the development of many 'single-chip' products.

Mid-range controllers. The ubiquitous 6845, sourced from Hitachi and others as well as Motorola, is still as popular as it was in 1982. Pop the lid off any year-old business type computer and the chances are there will be a 6845 resident. Although it does little more than generate memory addresses and sync information (option 1) it still seems to be used in new designs in preference to more sophisticated and expensive controllers. One reason may be the adoption of the IBM PC as a de-facto standard. The normal graphics card basically supports four video formats: 80 by 25 and 40 by 25 colour text, 640 by 200 graphics and 320 by 200 colour graphics with a limited palette,

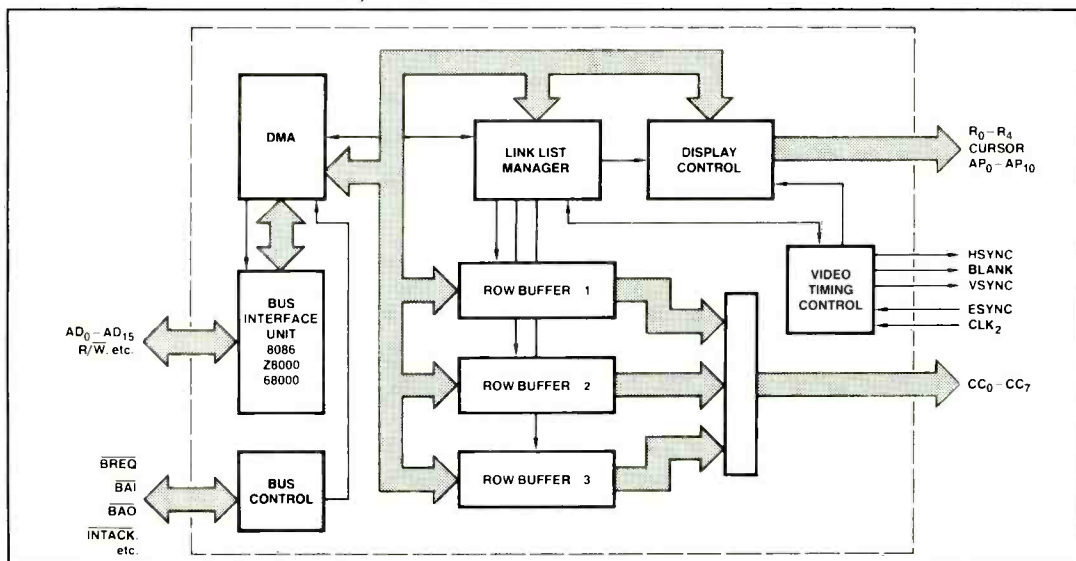

Rock steady vision at a rock bottom price



The only thing that seems to stand still on some colour monitors is the price. But at Opus we've now made our RGB High Resolution colour monitor even more affordable – it's down to just £199.95, and the picture quality is as rock steady as ever.

What's more we deliver within 48-hours and give you an unrivalled warranty plan to guarantee your peace of mind for the next two years. And if that's not enough our price includes carriage, VAT and connection leads.

Our JVC monitor (580x470 pixels) has received ample praise from the computer press. Acorn User said:

"... gave steadier pictures than the Microvitec Cub, and the colours were rather better."

Personal Computer News added:

" There is no doubt that the JVC range of ECM colour monitors is excellent value for money... there is no loss in quality of picture after long periods... "

The unit has a 14" screen and is suitable for use with the BBC Micro, Electron, Sinclair QL, Lynx, Oric, Apple, IBM, Amstrad and RML 480Z and most other leading micros.

Simply post the coupon below to: Opus Supplies Limited, or telephone us quoting your credit card number.

To: Opus Supplies Ltd,
55 Ormside Way, Holmethorpe Industrial Estate, Redhill, Surrey.

Please rush me the following:
(PRICES INCLUDE VAT AND CARRIAGE)

_____ High Resolution colour monitor(s) at £199.95 each (inc. VAT)

I enclose a cheque for £_____ or please debit my

credit card account with the amount of £_____

My Access Barclaycard (please tick) no. is: _____

My computer is _____

Name _____

Address _____

Telephone _____

Opus.
Opus Supplies Ltd.

55 Ormside Way,
Holmethorpe Industrial
Estate, Redhill, Surrey.
TELEPHONE: 0737-65080

CIRCLE 61 FOR FURTHER DETAILS.

Power for
industry

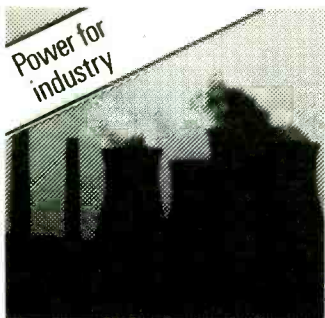

Power for
telecommunications



Power for
the oil industry



The power behind the power ERSKINE

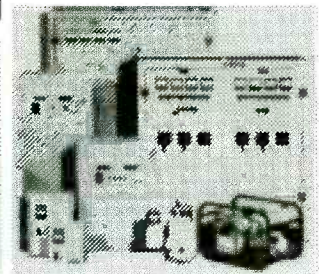

ERSKINE HAS POWERFUL SOLUTIONS

- AC and DC Uninterruptible Power Supplies • Battery Chargers
 - Rectifiers • Inverters
 - No-Break Supplies • Emergency Lighting • Switch Trippers
- Standard Products or Custom Built Power — where you need it — when you need it.

ERSKINE®

Erskine Systems Limited
 Lee De Forest House, Eastfield, Scarborough,
 Yorkshire YO11 3DU, England
 Tel: (0723) 583511 Telex: 52562.
 Facsimile: 0723 581231.

A member of the Dale Group of Companies

CIRCLE 70 FOR FURTHER DETAILS.

pantechnic

- design manufacture and supply

**POWER AMPLIFIERS
 HIGH POWER ASSEMBLIES
 CONTROL CIRCUITRY**

- for application in

**INDUSTRY
 PUBLIC ADDRESS
 HI-FI**

- available

**OFF THE SHELF
 CUSTOMISED
 C A D DESIGNED**

tel. 01.361.8715 132 High Road
 telex 266 873 New Southgate
 PANTEC G LONDON N11 1PG.

CIRCLE 74 FOR FURTHER DETAILS.

Newrad

NEWRAD INSTRUMENT CASES LTD
 Unit 19, Industrial Estate, Gore Road
 New Milton, Hants BH25 6SJ
 Tel: New Milton 0425 621195



Beautifully made 19 inch Rack Mounting enclosures complete with heavy gauge chassis and top and bottom covers. Front, Side and Rear panels are aluminium and flat for easy machining. These panels are located with heavy duty aluminium extrusions. Front and Rear panels are satin anodised. Covers are finished in cream.

HEIGHT	DEPTH	PRICE
1U	250	£18.84
1U	300	21.35
2U	250	22.05
2U	300	24.69
3U	250	25.22
3U	300	27.99

PRICES ARE EXCLUSIVE OF VAT. P&P £3.00

CIRCLE 78 FOR FURTHER DETAILS.

RADFORD

Audio Measuring Instruments,
 Audio Amplifiers, Loudspeakers and
 Loudspeaker Components for the
 professional and enthusiast

RADFORD AUDIO LTD.

10 BEACH ROAD
 WESTON-S-MARE, AVON BS23 1AU

TEL. 0934 416033

CIRCLE 39 FOR FURTHER DETAILS.

We are Cash Purchasers of large and small parcels of Surplus I/C, Transistors, Capacitors, Connectors and related electronic stock.

We also welcome the opportunity to quote for complete Factory Clearance incl. Production Machines & Tools.

We would appreciate a telephone call or a list available. We pay top prices and collect.

Enquiries also welcomed from Europe.

LANCO LTD.
 10 LABURNUM HOUSE
 LORDSHIP TERRACE, LONDON N16 0JB
 TELEPHONE: 01-249 5373

achieved using more than 60 i.c.s.

Manufacturers attempting to emulate this product, as several dozen have, may find it hard work to design equivalent graphics circuitry without using a 6845. Equally, the use of a more advanced controller might be regarded as over-the-top, and not cost-effective. There must be a possibility that a manufacturer will produce a video controller more suitable for this application. The 6845 still requires a number of logic or 'glue' chips to make it function: the trend is toward complete chip sets that require little or no glue. Mullard's 2670, 2674 and 2675 are one well-known set. The 2670 is a character generator, the 2674 the timing controller and 2675 or 2677 adds the video attributes.

Advanced video controllers. As with the mid-range controllers, there are so many different advanced controllers, that it is not feasible to detail them all. Most boast greater resolution that is normally required. The secret to choosing a controller is to obtain detailed specifications and decide which device best meets hardware, software and cost requirements. It is perhaps a shame that more manufacturers have not got together to produce similar or second-sourced devices; some components are so expensive that there must be a real risk they will be left on the shelf.

Intel's 82730 is an advanced text controller (option 4). It will support rows with up to 200 characters, and a total of 2048 scan lines. Its specification includes proportional spacing, subscript and superscripts, and smooth scrolling. The device is connected directly to the system bus with a second chip, the 82731, producing a serial data stream. The 82730 has two internal row buffers. Whilst one is being used to generate the display, the other is filled by d.m.a. This sophisticated device is controlled by blocks of data and pointers residing in system memory, and is ideal for high-performance word processors.

NEC's 7220 graphics display controller (option 2) supports a pixel map of 4 Mbits, or four planes each of 1024 by 1024 picture elements. The chip offers zooming, drawing of arcs, circles and rectangles, as well as limited text facilities.

AMD manufacture a range of integrated text and graphics chips

including the 8052 text controller which is similar in principle to Intel's 82730, but has three internal row buffers to provide flicker-free smooth scrolling of split-screen displays (page 18).

Colour palettes comprise a look-up table and high-speed d-to-a converters. Consider a graphics system having four planes of display. Each element is defined by four bits, one in each plane. Those four bits could be used to drive R, G, B and I directly, alternatively they could form an address into a look-up table. The look-up table is no more than a small block of high-speed static ram. With four bits, the look-up table needs to be 16 addresses deep. The data outputs of the look-up table feed high-speed d-to-a converters. If three 4-bit converters are used, then the table must be 12 bits wide. Each of the 12-bit combinations will display one of 2^{12} colours, and the four planes allow simultaneous selection of any 16 of those 2^{12} colours. Until recently colour palettes were generally in hybrid form, but AMD have introduced the 8151 single-channel eight-bit palette, and Thomson the 9369 three-channel four-bit palette.

Thomson's other products — 9365/6/7 graphic display processors and the single-chip 9345 semi-graphic processor — will be joined shortly by a 16-bit controller. Last April, when Mostek and Thomson announced an exchange agreement for second-sourcing Motorola's 68000 products, Thomson said they would include a graphics controller. Though not yet finalized, the device (designated 68483) will be a 68-pin advanced graphics chip to interface with most 8 or 16bit processors with programmable video timing to allow its use in a wide range of terminal or computer designs.

Some other recently introduced devices that we do not have space to describe in detail are Motorola's 'raster memory system', a two-chip 'virtual screen' graphics generator whose quality 'rests on the driving processor and its software rather than on RMS itself'. . . TI's AVDP, intended particularly for US videotex terminals and home computers, with 32-sprite control features and sound generator (type 9228). . . National Semiconductor's 'terminal management processor' designed for test and measurement instrumentation

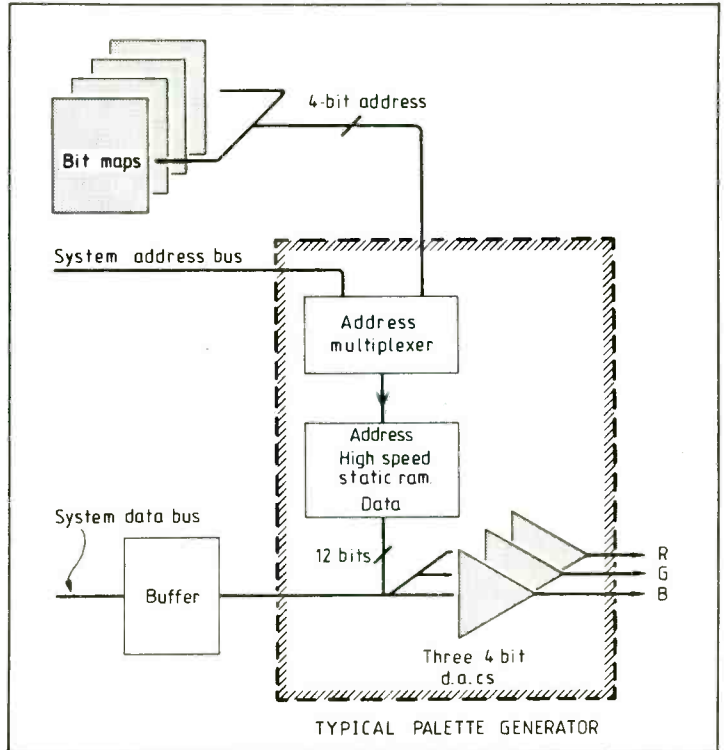

(an application note describes a logic analyser) as well as terminals (NS455). . . Xtar Electronics, 16bit 'graphics microprocessor' and video shift register that claims to draw polygon segments of 64 or more elements much faster than for 7220 systems (5ns/pe!). . . NCR's 7300 colour graphics controller integrating as many as 100,000 transistors onto one chip. . . Hitachi's advanced controller HD63484, using a multiprocessor architecture to allow parallel processing of drawing, display and timing parameters, and with 38 high-level commands. . . Philips Eurom for level 3 videotex terminals with its 40 alphabet capability, 12 by 10 matrix and 32 from 4096 colours

Colour palettes enhance low-end graphics applications in allowing economical display of up to 16 colours chosen from a universe of 4096 values (Thomson 9369) with a colour look-up table and three d-to-a converters.

Hitachi's HD63484 has a multiprocessor architecture that enables simultaneous processing of high-level commands, display functions and timing parameters. Picture shows target filled-in using pattern command, with window copied and moved within screen.

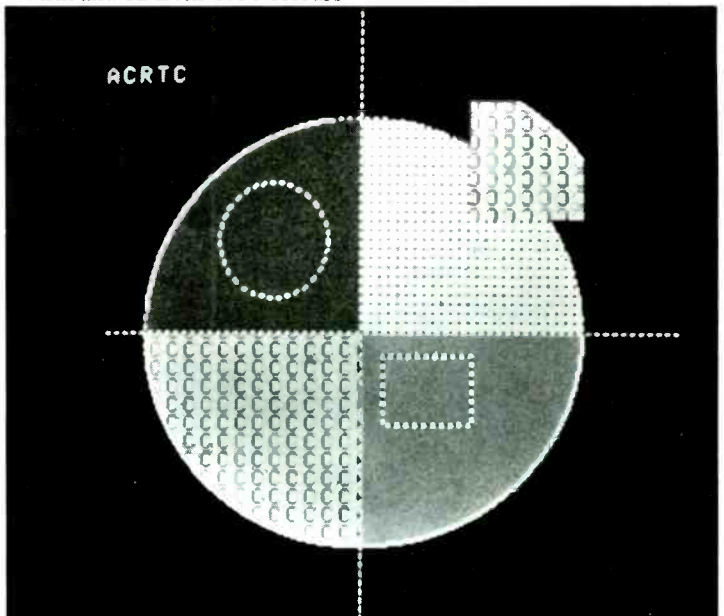

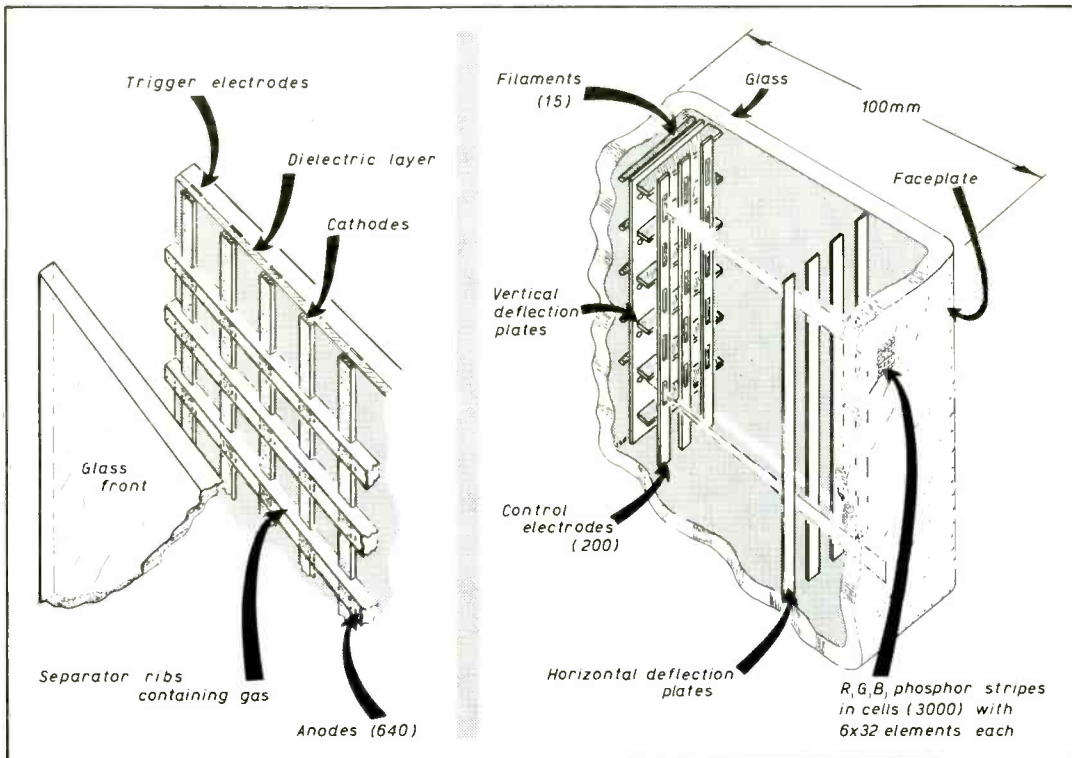

Dixy's prototype A4-size 640 by 800 plasma panel uses a trigger electrode beneath the cathode to 'keep alive' the discharge and reduce switching voltage. (left and far right).

Constructions of Matsushita's vacuum fluorescent display panel may be likened to an array of 3000 small colour cathode ray tubes, but without yoke, shadow mask and e.h.t. (middle diagram). Filament consumption is said to be only seven watts.

Densitron's 600 by 400 plasma display requires 5 and 200-volt supplies and can be driven from conventional c.r.t. controllers. This view of the display drive circuits has the front panel removed.

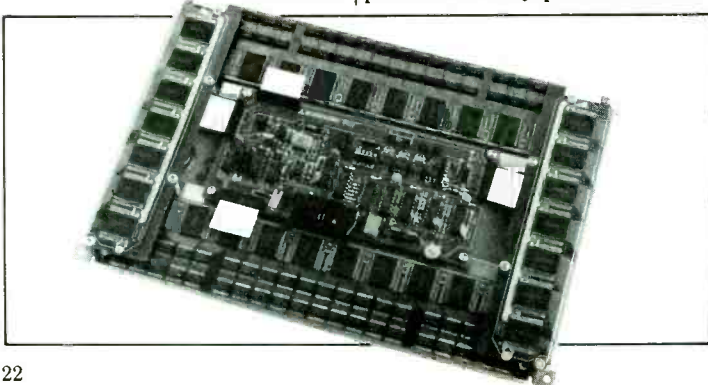

(type 5350)... And STC's CRT9007, a second-sourced Standard Microsystems' video processor and controller, with row-table-driven or sequential addressing modes... Almost all of which were introduced last year. Which must make 1984 the year of the c.r.t. controller. Hot news: Just announced is Inmos' colour palette (256 colours from 256k) containing three 6-bit converters — see page 87.

Flat panels

The number of flat panels appearing with a 640 by 200 resolution (à la IBM PC?) conjures up thoughts of portable IBM-compatible business computers. There are even some panels that are plug-in replacements for c.r.t.s, using the syncs, data and an extra signal, the dot clock (pin 7 on the 9-way connector?)

Because of low production cost and power consumption liquid crystal panels are expected to take the lion's share of the flat panel market. Japanese devices

dominate, the largest from Densitron, Epson, Hitachi, Panasonic, Seiko, Sharp, Terenix, and Toshiba, though many of the 640 by 200-element units appear very similar and may well have common sources. But most of the liquid crystal's limitations — grey scale, temperature range, field of view, contrast ratio, response time, limited resolution — are still prevalent.

Despite some big names dropping out of the field over the years, developments continue in plasma panels. Engineers have left Sony, Zenith and most recently Burroughs when their plasma projects were terminated and set up their own companies — Dixy, Lucitron, Plasma Graphics — though usually when this happens the originating company takes a stake in the new venture. The prototype Dixy panel's are the d.c. kind in which a gas mixture is sandwiched between two glass plates in such a way that pockets of gas are isolated from one another — unlike the a.c. kind where there is no isolation — and located at the intersection or vertical and horizontal anodes and cathodes deposited on the glass plates. One of the difficulties with this kind of display is in switching the high voltage needed to break down the gas, necessitating some kind of 'keep alive' arrangement; and even then of keeping the trigger potential low enough to use low-cost transistors. Yoshifumi Amano, founder of Dixy, over-



came the triggering problem with a capacitatively-coupled trigger electrode deposited on the rear glass plate, together with a dielectric layer situated underneath the cathode, using a thick-film printing process (illustrated above). The technique of positively charging the cathode using this structure not only reduces the initial discharge potential but also reduces anode-cathode switching voltage, making integrated-circuit driving possible.

In driving the 640 by 400 panel, data for the 640 lines of vertical electrodes are grouped into eight-bit packages and shifted onto the display by shift register in 80 right-to-left transfers per clock pulse. Data for all 640 lines are transferred simultaneously to latches and then to the anodes. The 400-line horizontal electrodes are sequentially driven from top to bottom and because critical flicker frequency is 60Hz the scan dwells on each cathode for 40µs or less. Luminances of this 0.3mm dot-spaced panel is 120 cd/m² pk with a viewing angle of 140° up/down and 45° left, 70° right, consuming 8 watts at 12, 65 and 175V. A prototype 640 by 800 A4 panel is being readied for trial production (see photo). (Craft Data Ltd of 92 Broad Street, Chesham, Bucks are importers for Dixy.)

Another d.c. panel with a similarly small dot size (0.25mm with a pitch of 0.33mm) and a 400 by 640-dot array is sold by Densitron. Its construction appears to be similar to Dixy's and its method of driving, though there are differences of detail in performance and in drive electronics.

Densitron claim a luminance of 50cd/m², a contrast ratio of 10:1 and a 120° viewing angle, while the circuitry uses 5 and 200V supplies a double four-bit serial format, and a t.t.l.-level interface for operation from a c.r.t.

LEVELL

OFFER AN EVEN BETTER DEAL

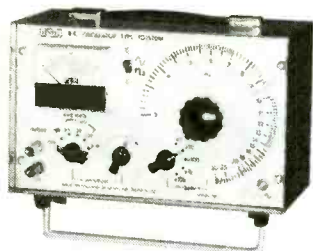

LEVELL OSCILLATORS, FUNCTION GENERATORS, AC/DC VOLTMETERS, FREQUENCY COUNTERS, DECADE R/C BOXES, TRANSISTOR and INSULATION TESTERS.

CROTECH OSCILLOSCOPES
HAMEG OSCILLOSCOPES
HITACHI OSCILLOSCOPES

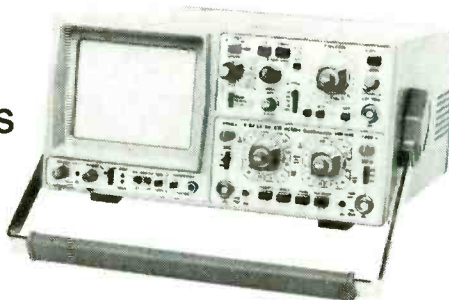

THURLBY POWER SUPPLIES, MULTIPLEXERS, DIGITAL MULTIMETERS, CAPACITANCE METERS and LOGIC ANALYSERS.

LEVELL DELIVER FREE IN THE UK.
CATALOGUE, PRICE LIST and QUANTITY DISCOUNTS ON REQUEST

LEVELL ELECTRONICS LTD. Moxon Street, Barnet, Herts., EN5 5SD, England
Telephone: 01-440 8686 & 01-449 5028

CIRCLE 81 FOR FURTHER DETAILS.

New From
POWERTRAN
CYBERNETICS LIMITED

IVAX SCARA

IVAX is the new SCARA robot designed for training and education. Available with workcell and host computer interface (options include BBC and Apple), IVAX can be programmed with complex decision making sequences. Host computer BASIC software gives complete access to the Z80 based controller and allows user programs to be run or downloaded quickly and easily. IVAX has four digital closed loop servo axes with optical encoder feedback, which accurately position a pneumatic gripper. Modelled on industrial robots, but at a fraction of the price, IVAX is available ready built or in kit form.

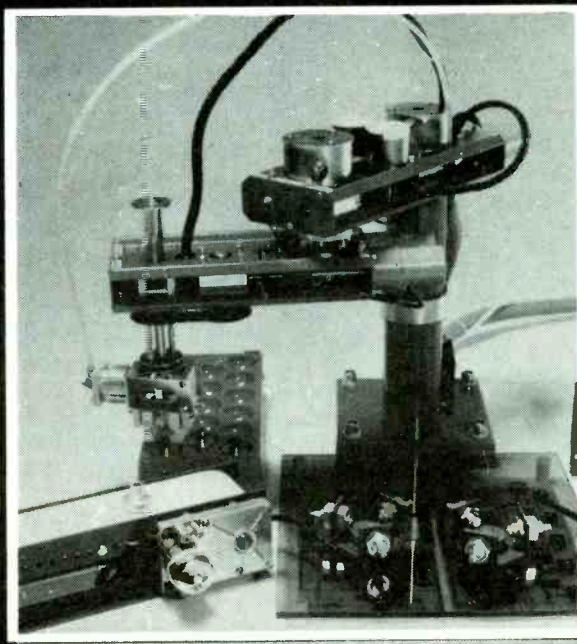

To Powertran Cybernetics Limited, Portway Industrial Estate, Andover, Hampshire SP10 3WW
Telephone: (0264) 64455

Please send me your Colour Brochure and Price List

Name _____ Address _____

EAWW



CIRCLE 82 FOR FURTHER DETAILS.

nombrex

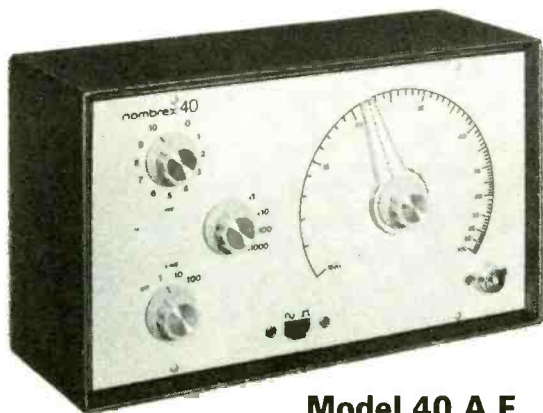

- ★ 10Hz – 100KHz
- ★ Sine and Square Wave
- ★ Calibrated Output level, stabilised
- ★ Switched & variable attenuators
- ★ Distortion < 0.2%
- ★ Battery powered

Model 40 A.F. Generator
£64.85 + VAT
+ £3 p&p

Designed and made in Devon by
ALTAIR ELECTRONICS
 Bridford
 Exeter
 Devon EX6 7HT
 Tel: 0647 52594

Send for details of the full range of Nombrex battery powered test equipment
 Export enquiries invited.

CIRCLE 79 FOR FURTHER DETAILS.

ELECTRONICS & Wireless world

EDITORIAL FEATURES 1985/86

ISSUE DATE	PUBLICATION DATE	FEATURE
Sept. 1985	Aug. 16th	Communications Receivers
Nov. 1985	Oct. 16th	Modems
Jan. 1986	Dec. 19th	A to D & D to A Converters
Mar. 1985	Feb. 20th	Computer Aided Design Equipment
May 1986	April 17th	Fibre Optics

For more details regarding advertising
 Contact Bob Nibbs
 01-661 3130

It's easy to complain about an advertisement. Once you know how.

One of the ways we keep a check on the advertising that appears in the press, on posters and in the cinema is by responding to consumers' complaints.

Any complaint sent to us is considered carefully and, if there's a case to answer, a full investigation is made.

If you think you've got good reason to complain about an advertisement, send off for a copy of our free leaflet.

It will tell you all you need to know to help us process your complaint as quickly as possible.

The Advertising Standards Authority. ✓
If an advertisement is wrong, we're here to put it right.

ASA Ltd, Dept 1 Brook House, Torrington Place, London WC1E 7HN

This space is donated in the interests of high standards of advertising.

ELECTRONICS & WIRELESS WORLD JULY 1985

controller.

The vacuum fluorescent panel — a kind of multiple cathode ray tube — has until recently been restricted to small sizes of display, though work in Japan is aimed at increasing the size to compete with the plasma — panel sizes. Earlier this year Matsushita announced construction of a prototype panel with a 25cm diagonal screen and a depth of 10cm. Called a 'matrix drive and deflection' scheme, the panel is the equivalent of 3000 electron guns — 200 horizontally and 15 vertically — that excite phosphors. Using sets of primary phosphors, this device clearly has colour potential; in fact each of the electron beams can excite two sets of red, green and blue phosphors horizontally by 32 steps vertical, to form images comprising 192,000 elements. The panel has a contrast ratio of 50 and a resolution of 270 lines (0.5mm element pitch).

It effectively removes the shadow mask from colour c.r.t.s, the high e.h.t., and the bulk, whilst retaining its luminance. The electrode structure had to be optimized by computer simulation to create a beam fine enough. But the secret to its construction is the cementing technology, which is required to "evenly and alternately cement 0.1mm grid electrodes with insulating plates".

Signal processing and drive for the panel is digital, brightness being controlled by pulse duration modulation to give 64 grey scale steps, while colour reproduction is achieved by sequentially activating the phosphors.

Hacking the vdu

Almost everyone has experienced the radio interference given off by the clocked logic circuits of present-day domestic electronic equipment, first brought to public attention by a CAA ban on the use of calculators in commercial airliners. The UK has never really had regulations that parallel those of the FCC in controlling levels of product radiation, but a recent publication from British Standards Institution lays down limits for spurious signals from data processing and electronic office equipment in the absence of agreed international limits. The Standard, BS 6527:1984, specifies two 'protection' distances, one of 30m for offices and factories, and the other of 10m for homes, at which

distances the field strength limits in the range 150kHz to 1GHz are 30dB($\mu\text{V}/\text{m}$) below 230MHz and 37dB above. (The committee members that drafted this standard obviously live in detached houses.)

These figures of course were not designed to prevent *interception* by anyone intent on decoding the radiated signals. Last February, a Tomorrow's World programme showed how easy it is to eavesdrop on a v.d.u. terminal. A van contained equipment to receive and decode signals radiated from a word processor within a nearby office block and demonstrated that usable information could be obtained from many buildings around London, including a well-known merchant bank. Not surprising, you might think, considering the power of surveillance techniques nowadays; but the tv programme brought to light just how cheaply it could be done, a fact that has not been widely appreciated hitherto.

Surveying the subsequent press coverage, we noticed that one journal thought that plasma panel displays are immune from screen eavesdropping because they do not radiate outside the visible spectrum: "... and so unlike c.r.t.s cannot be remotely read." The fact is that the easiest way to get at the displayed information is to pick up *circuit* radiation and not screen radiation.

The video drive in monitors is rich in harmonics of the dot rate, usually around 15 to 20MHz. Jonathan Drori, assistant producer of the Tomorrow's World team, explained his finding to us that certain circuit elements e.g. p.c. loops can resonate at v.h.f. and radiate a strengthened harmonic of the video signal. The actual frequency may be unpredictable if a cable loom or other wiring variable is involved, but a typical monitor will radiate at Band III — inviting the use of a v.h.f. tv receiver. Close up, you can't get rid of the signal, Drori says, (suggesting that the harmonics are spaced at less than 5.5MHz intervals) and he has had results over 300m and others have worked v.d.us at a kilometre and beyond.

Of course the sync pulses do not propagate anywhere near as effectively because of their lower frequency, but can be picked up

Acknowledgement. — Special thanks to Colin Carson and Jonathan Drori for valuable contributions.

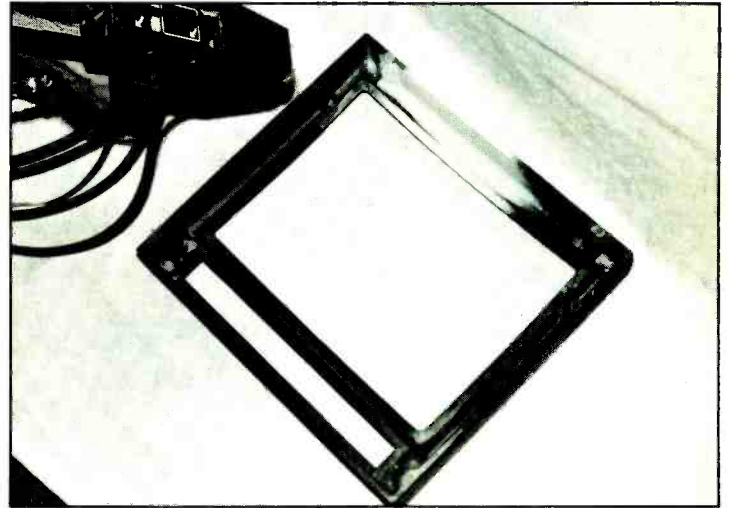

Metal spraying at the assembly stage is probably the most cost-effective way of reducing radiation from video display housings from three viewpoints — possibly hazardous emissions, radio interference, and data security now that the Data Protection Act is in force. Picture shows Tafa electric arc spray gun being marketed by Mining and Chemical Products of Stone, Staffs.

by an inductive loop, or failing that, regenerated by sync pulses from a simple t.t.l. or c-mos digital oscillator inserted into the adapted tv set. The only other item needed in the eavesdropper's armoury is a directional aerial.

The significance of all this, Drori points out, is that far more installations are at risk than previously realised, and what's more, last year's Data Protection Act requires that "appropriate security measures shall be taken against unauthorized access to personal data"; company directors not taking such measures are liable to prosecution.

Now, Philips Business Systems are introducing a new range of terminals, initially for such security-conscious areas as banking, with features designed to "increase the difficulty of interception". This is achieved by using the higher scan rate of 70Hz and a high-resolution character box of 13 by 18, designed to put the terminals outside the norm of low-cost 'hacking' equipment, according to product manager John Williams.

Researchers at Philips, Apeldorn, have come up with the idea of randomizing the raster scan for a more secure approach, using a software key to the randomizing. Prototype chips have already been developed but while trials continue no timescale has been set for their introduction.

So lots of interest in e-m screening can be expected. One study has demonstrated dramatic reductions in field intensity by screening with copper foil after installation. With a cost of only £10 to £30, this is probably not as cost-effective as spraying at the manufacturing stage (see photo).

Barco's latest range of computer graphics displays, available from Cameron Communications of Glasgow, is designed around Matsushita's overlapping-field-gun c.r.t. and is aimed at the CAD/CAM market, with 120MHz video amplifier and 64kHz scan frequency. A brief survey of monitors will appear in next month's issue.

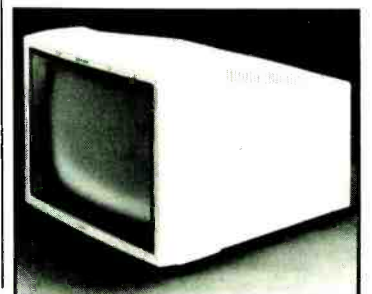

RESEARCH COMMUNICATIONS LTD.

UNIT 3, DANE JOHN WORKS, GORDON ROAD, CANTERBURY, KENT CT1 3PP
TELEPHONE: CANTERBURY (0227) 456489



TYPE 9002

TYPE 9002 Two stage Gasfet preamplifier. N.F. 0.7dB. Gain 25dB. High Q filter. Tuned to your specified channels in bands IV or V £85 + £2 p&p
TYPE 9004 UHF two stage Gasfet preamplifier. N.F. 0.6dB. Gain 25dB. High Q filter. Aligned to your specified frequency in the range 250-550MHz £85 + £2 p&p
TYPE 9012 Gasfet preamplifier mains power supply unit £24.50 + £3 p&p
TYPE 9010 Masthead weatherproof unit £9.50 + £2 p&p



TYPE 9152



TYPE 9159

TELEVISION LINEAR POWER AMPLIFIERS Tuned to you specified channels in bands IV or V. (or 400-900 MHz).
TYPE 9061 150mV. input, 10mW. output £140 + £10 p&p
TYPE 9152 10mW. input, 500mW. output £180 + £10 p&p
TYPE 9159 500mW. input, 5 watts output £210 + £10 p&p



TYPE 9006



TYPE 9035

GASFET RF PREAMPLIFIERS. Aligned to your specified frequency in the range 30-250 MHz. Masthead or local use.
TYPE 9006 N.F. 0.6dB. Gain 10-40DB. variable £65 + £2 p&p
TYPE 9006FM As above. Band II 88-108 MHz £65 + £2 p&p
TYPE 9035 Mains power supply unit for above types £24.50 + £3 p&p



TYPE 9051



TYPE 9046

TMS WIDEBAND POWER AMPLIFIERS 4/10/20 watts RF output. Without tuning. Power gain 10dB. 24V. + supply.
TYPE 9046 100KHz. - 100MHz. 4 watts £84.50 + £3.50 p&p
TYPE 9051 15MHz. - 200MHz. 4 watts £140 + £20 p&p
TYPE 9171 15MHz. - 200MHz. 10 watts £140 + £20 p&p
TYPE 9172 As above with integral mains power supply unit £200 + £30 p&p
TYPE 9174 15MHz - 200 MHz. 20 watts £180 + £20 p&p
TYPE 9175 As above with integral mains power supply unit £240 + £30 p&p



TYPE 8034



TYPE 9105

TYPE 8034 PHASE LOCKED SIGNAL SOURCE using low frequency reference crystal. Specify output in the range 1-600MHz. Output 10mW. +10dBm £84.50 + £2 p&p
TYPE 9086 FM TRANSMITTER 88-108 MHz. 50 watts RF output. 24V. + supply. Complete modular system £480 + £30 p&p
TYPE 9087 As above with integral mains power supply unit £540 + £40 p&p

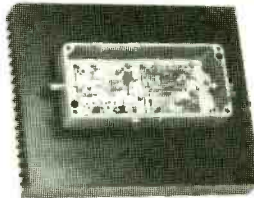

TYPE 9155



TYPE 9157

TMS RF LINEAR POWER AMPLIFIERS. Tuned to your specified frequency in the range 10-250MHz.
TYPE 9105 10mW. input, 3 watts output. 24V. + supply £160 + £15 p&p
TYPE 9155 3 watts input, 30 watts output. 24V. + supply £240 + £25 p&p
TYPE 9156 As above with integral mains power supply unit £320 + £25 p&p
TYPE 9157 As above with integral mains power supply unit £400 + £30 p&p

PLEASE ADD 15% V.A.T. ON TOTAL

CIRCLE 65 FOR FURTHER DETAILS.

ALL-TIME CP/M MICROCOMPUTER SYSTEM BARGAIN!

Fantastic bulk purchase of a major European manufacturer's entire stock of this top-quality machine enables us to retail it at far below its manufacturing cost. ALL FEATURES LISTED are INCLUDED as STANDARD:

- COMPLETE with EITHER single or double (as illustrated) TEAC half-height 5 1/4" double-sided, double-density floppy disc drives. Formatted capacity: 320Kb per drive.
- 4 MHz Z80A CPU
- 64Kb RAM (in 4164 chips)
- 28Kb EPROM containing monitor & MICROSOFT BASIC
- CP/M Version 3.01
- 80 x 24 display with colour block-mode graphics
- Exceptionally high quality styled keyboard with numeric keypad & 6 function keys
- Centronics parallel interface
- RS232/24 serial interface selectable 300-9600 Baud
- UHF Modulator for TV & composite video output
- ROM port. (A Word-Processor ROM is available at extra cost)
- 6 month full guarantee & option to return within 14 days if not absolutely delighted



PRICES (monitor not included):
With DUAL floppy: £347.00 (£399.05 incl. VAT)
With SINGLE floppy: £250.00 (£287.50 incl. VAT)
CARRIAGE: £9.50 (incl. VAT) Visa & Barclaycard accepted

Available ONLY from: **COMPUTER APPRECIATION**, 16 Walton Street, Oxford OX1 2HQ. (0865) 55163 TELEX: 838750
MATMOS Ltd., 1 Church Street, Cuckfield, W. Sussex RH17 5JZ. (0444) 414484 454377 (0444) 73830

CIRCLE 58 FOR FURTHER DETAILS.

IN VIEW OF THE EXTREMELY RAPID CHANGE TAKING PLACE IN THE ELECTRONICS INDUSTRY, LARGE QUANTITIES OF COMPONENTS BECOME REDUNDANT. WE ARE CASH PURCHASERS OF SUCH MATERIALS AND WOULD APPRECIATE A TELEPHONE CALL OR A LIST IF AVAILABLE. WE PAY TOP PRICES AND COLLECT.

R. Henson Ltd.

21 Lodge Lane, N. Finchley, London, N.12. 5 mins. from Tally Ho corner

Telephone 01445 2713/0749

CIRCLE 42 FOR FURTHER DETAILS.

BRAND NEW ELECTRONIC COMPONENTS

QUALITY .25W CARBON FILM RESISTORS

Qty	1-9K	10-24K	25-49K	50-99K	100K+
Price	4-25	3-95	3-70	3-45	3-25

Price per 1000. Sold in multiples of 1000.
Small quantity prices available.

LEAD-FORMING SERVICE AVAILABLE

Save assembly time and money with pre-formed leads.
Size setting £2-00 plus £1-50 per 1000.

Write or Phone for full Details

HARRISON ELECTRONICS

22 MILTON ROAD, WESTCLIFF-ON-SEA, ESSEX SS0 7JX Tel: (0702) 332338

Domestic tv to monitor

by J.A. Grubb
M.I.E.E.

If you can't afford a colour monitor, here's how to avoid the bandwidth limitation and spectrum interleaving of the colour tv set.

Modern colour sets have most of their signal processing performed by a set of integrated circuits, one of which takes care of the colour decoding. This chip also has to cope with the demands of teletext, which is decoded by a different circuit but is still switched into the picture signal by the colour chip. This switching is performed electronically after the colour decoder but before the tube drive amplifiers. The TDA3561 and equivalents have data insertion inputs which require a one-volt input level and a switch pin which, when taken high, connects these inputs into the signal path. Synchronization can be effected by inserting a switch into the circuit at a suitable point to connect the computer sync. signal to the deflection unit in place of the sync. separator output. As a final refinement where the computer has a direct voltage output on the monitor connector, this can be used to control the switching automatically so that the tv set operates normally until the computer is switched on.

Most modern sets incorporate a switch-mode power supply which operates at a high frequency using a small ferrite-core transformer. You may find (as I did) that this transformer is arranged so as to provide complete isolation from the mains. Note that there is a rectifier and other circuitry feeding the transformer primary from the mains, but there must be no connection between this and the tv signal circuits.

If the internal power supply does not provide isolation, there are two alternative strategies: put isolators in all the signal lines or use an isolating transformer in the mains supply. The first method can be implemented with four opto-isolators, which would be smaller than a transformer.

However, they must be rated for 240V a.c. and high-speed operation. Such devices are expensive (over £5 each), and extra circuitry would be needed to interface the isolators to the tv circuits, and possibly to the computer as well. The use of a transformer in the supply line is simpler and probably cheaper. It means that the chassis can be solidly earthed, which makes for safer adjustment and gives scope for further modifications e.g. a feed for a hi-fi sound system. It is preferable from a safety point of view that the chassis should be earthed via a three-core mains lead rather than relying on the connection to the computer.

The colour and sync. signals from the computer are at t.t.l. levels, i.e. 0 to +5V. The PAL decoder chip TDA3561 requires

inputs of 0 to about +1V for data and switching, while the TDA1950 horizontal deflection i.c. is a little more awkward: it requires a negative-going sync. pulse of 0.3V amplitude on a +1.3V baseline. Other deflection i.c.s may require different voltages, which will be specified in the manufacturer's data sheet. As the deflection system has only one input, a switching circuit must be provided to switch this between tv tuner and the computer. The easiest and cheapest way to do this is to use a c-mos analogue switch type 4053, which contains three separate change-over switches.

A 12-15V supply must be derived from the television: the current required is minimal and should not present any problems. The three colour inputs are

Interface between computer and television receivers which use TDA 3561 single-chip PAL decoders or equivalents.

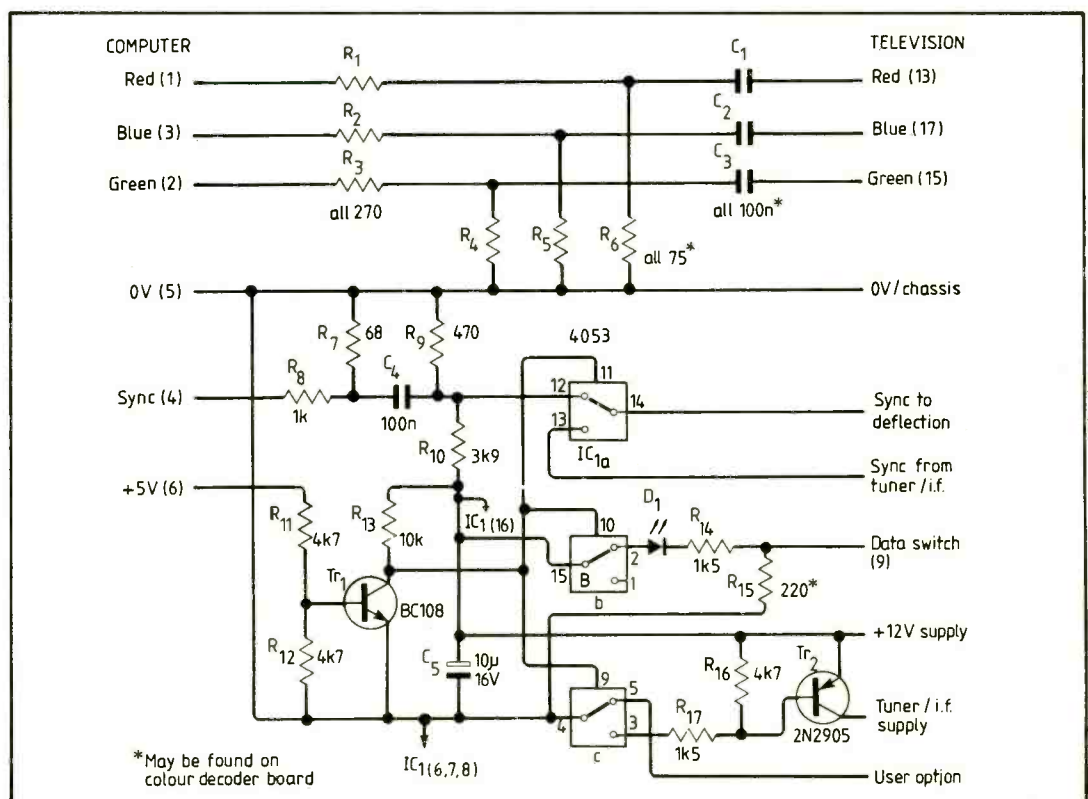

simply divided down to the correct level by resistor chains and a.c.-coupled to the i.c. inputs. Components marked with an asterisk may be present already, as they were in my set (a Grundig CUC120). Transistor Tr_1 is switched on by the +5V line from the computer and drives the i.c. control inputs. If your computer does not have a d.c. output, arrange a switch to connect R_{11} to the +12V supply in the tv. The network formed by R_7 to R_{10} and C_4 reduce the amplitude of the computer sync. pulses and shift the d.c. level. The resistor values should be changed if your tv deflection system requires different voltage levels. The feed from the tuner i.f. unit

to the deflection system must be cut (in my case, there was a wire link to un-solder) and re-connected via IC_{1a} which provides the sync. switching function. Switch IC_{1b} is used to drive the switch input of the colour i.c. via the voltage divider R_{14} and R_{15} . The led indicates that the set is in monitor mode and may be mounted in a convenient position or replaced by a link if not required.

When the circuit was tested, patterning was visible in monitor mode which was traced to breakthrough from the normal tv signal. This was eliminated by switching off the d.c. supply to the tuner-i.f. unit by Tr_2 , chosen to switch the required current

with a low voltage drop to avoid upsetting the tuner-i.f. alignment. Substituters beware! Pin 5 of IC_1 is connected to 0V when in monitor mode and is available to the user for other functions. e.g. audio muting. It is brought out to a pin with provision for a diode.

The prototype was made on double-sided board with an earth plane on the component side. This is a common technique for high-frequency circuits: the top of the board is left un-etched apart from small areas around non-earthed component leads. These areas are easily cleared using a drill bit. Earthed leads are soldered to both sides of the board.

When the installation is

completed and checked, switch on the tv without the computer connected. The set should behave normally, although the tuning may need slight adjustment to compensate for the voltage drop across Tr_2 . Plug in the computer lead and switch on. The screen should now display the computer start-up message. If the picture is unstable, the sync. signal is probably incorrect: try changing the values of the sync. network R_7 to R_{10} . If your tv deflection circuit requires positive sync. pulses, these may be provided by changing over link 31 within the BBC Micro. You may find that optimum sharpness is obtained with the brightness control turned down a little.

by D.J. Dinning

RGB conversion for Philips G8 uses opto-isolators

The Philips G8 series of sets, like most of their marque, used a 'live' chassis, i.e. the chassis of the set was connected to one pole of the mains, making direct connection of the computer a potentially hazardous operation. Other approaches overcome this problem with the use of mains isolating transformers, but these items are both bulky and costly and, if housed within the receiver cabinet, their magnetic field may affect the convergence and purity of the picture. Additionally,

unless a low-capacitance isolation transformer is used, transients can still be fed through from the mains and either damage the computer or corrupt data.

The interface uses high-speed optocouplers with 2.5kV isolation and low feed-through capacitance (0.6 pF) and is housed on a small p.c.b. fitted into the tv set, connection to the computer being via a six-core cable. The unit can be powered from the tv set itself or via a small (10VA) transformer. The unit features automatic changeover from 'off-air' to RGB drive when the computer is switched on, and was used with a BBC model B computer, but will work equally well with any computer that has RGB and sync. outputs.

RGB outputs from three identical emitter followers are fed via a six-pin DIN plug and socket to multicore cable, whose length should not exceed about three metres. The signals are terminated in high-speed opto-isolators type 6N137 (RS 304-273) Fig. 1. Resistors 1-3 are the terminating resistors with C_{1-3} as speed-up capacitors.

Leds (RS 586-475) balance the line in the reverse direction and provide a discharge path of C_{1-3} . These techniques are essential if a bandwidth of up to 10MHz is to be achieved. The optocouplers are capable of operating at up to 20MHz and require careful bypassing to avoid instability; $C_4 - C_6$ MUST be mounted across the chip, within 5mm of the pins. Components D_1, D_4, R_{10} form a modified version of the 'standard' t.t.l.-to-transistor interface, with C_7 as a speed-up capacitor.

The sync. circuit, Fig. 2, is fed from a gate in the computer via pin 4 on the RGB socket to a circuit similar to those used for the RGB drives. A level shifting circuit D_7, R_{23}, R_{26} feeds the output of the opto-gate to the sync. driver transistor, Tr_7 . C_{12} and C_{13} are speed-up capacitors. The sync. drive required by the tv circuits is negative-going and referenced to about -2volts.

The negative emitter supply is obtained by rectifying the 6.3-volt tube heater supply with D_9 and regulating it with R_{27} and D_8 .

The actual level is set by the 1k preset during the setting up procedure.

Fig. 3. Power circuit.

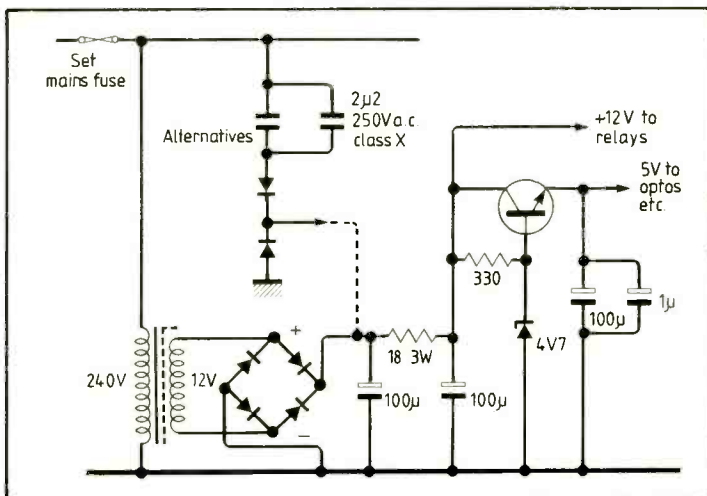

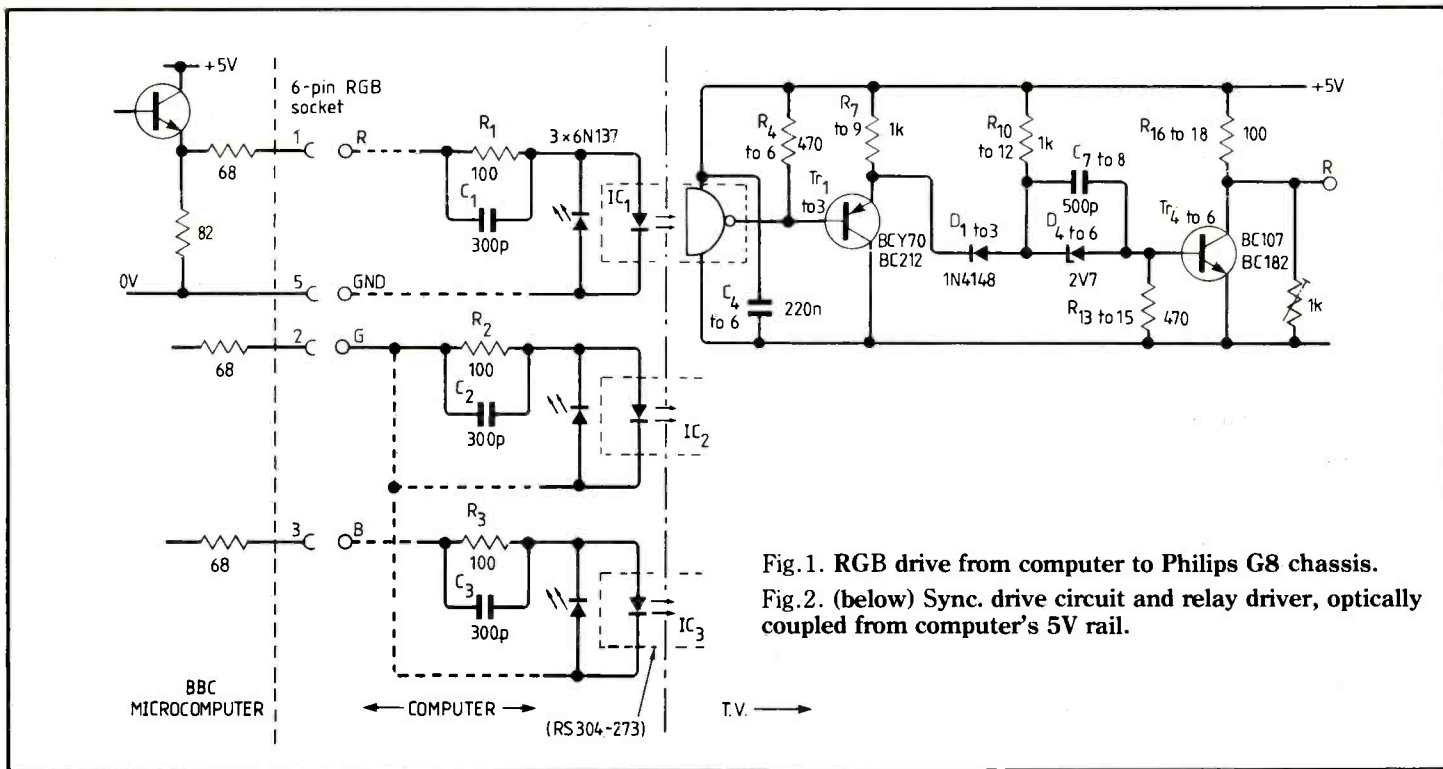

Fig. 1. RGB drive from computer to Philips G8 chassis.

Fig. 2. (below) Sync. drive circuit and relay driver, optically coupled from computer's 5V rail.

The interface can be left plugged into the computer if desired; the circuit then switches over automatically when the computer is 'powered up'. Optoisolator, IC₅ is supplied from the computer 5V rail via pin 6 of the DIN plug. This causes Tr₃ to turn on and operate the changeover relays RL1 - RL3, small p.c.b.-mounting relays (RS348-655) or similar. These relays are mounted on the top of the delay

line (RGB relays) and on top of the sound selectivity module (sync. relay), by means of double-sided adhesive pads.

The interface card draws about 130mA at 12 volts, without relay coil currents. This was thought to be too much of an additional burden for the receiver.

A small mains transformer can be used, but this should be mounted well away from the tube to prevent convergence prob-

lems; alternatively a capacitive 'dropper', using class X capacitors, can be used, as in Fig. 3.

A transistor regulator is shown, but a chip regulator such as the 7805 could equally well be used. Smoothing electrolytic capacitors are paralleled with 1μF paper capacitors for h.f. bypassing. The negative supply is derived from the tube heater pin 14 (pin 1 is earthed).

The G8 was produced with several p.c.b. versions, early sets having separate tuner i.f. and chroma boards, later sets having one large board. Thus the mounting position and number of relays used is left to the constructor.

The RGB output transistor circuitry is fed from either the RGB driver, IC₅₇₀, or the interface unit, via the changeover relays, and the sync. signal is either taken from the sound selectivity module (off air) or from the interface unit and is fed via the changeover relay into IC₀₀₁ pin 10.

Illustrations showing the location of the necessary track cuts together with associated circuit diagrams are available from the editorial office in return for an s.a.e.: mark envelopes 'G8'.)

With the unit checked out and connected to the tv sets, plug in the computer and switch on. Set the RGB pre-sets to max. resistance and adjust the 'level' preset for -2volts on the emitter of Tr₇ with respect to ground. Adjust the 'amplitude' preset until the picture just locks, then a further 10°. If the picture jumps in and out of lock, but slowly, increase the smoothing on the -2volt line, or adjust 'level' to give, say -2.5 volts. A colour bar pattern program* can be run on the micro and the RGB levels adjusted until the appropriate colours are just coming out of saturation.

* Television, January 1985, page 185.

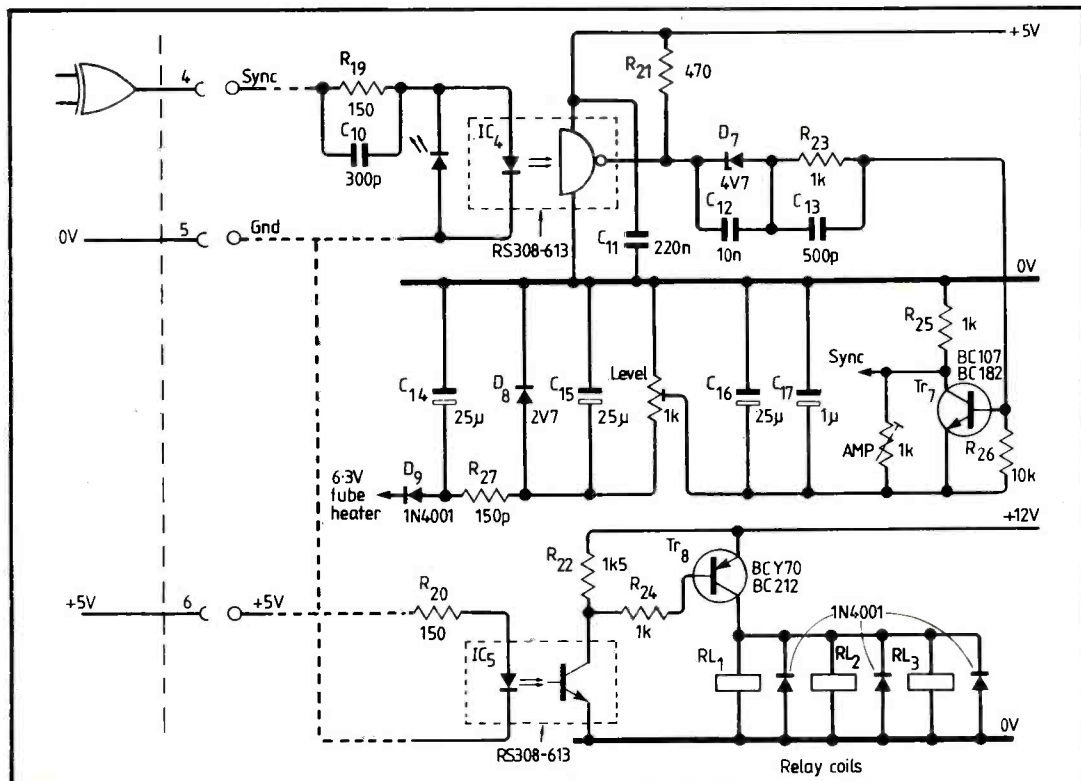



PHONE
0474 813225
AND AFTER 1.7.85
0474 60521

P. M. COMPONENTS LTD
SELECTRON HOUSE, SPRINGHEAD, ENTERPRISE PARK
SPRINGHEAD RD, GRAVESEND, KENT DA11 8HD

TELEX
966371
TOS-PM

INTEGRATED CIRCUITS

AN124	2.50	MC1310P	1.50
AN214Q	2.50	MC1322	0.95
AN240P	2.80	MC1370	0.95
AN612	2.15	MC1349P	1.20
AN7140	3.50	MC1351P	1.50
AN7145	3.50	MC1357	2.35
AN7150	2.95	MC1358	1.58
BA521	1.35	MC1495	3.00
CA1352E	1.45	MC1496	1.25
CA3086	4.66	MC145106P	9.95
CA3123E	1.50	MC1723	0.50
ETT6016	2.50	MC3357	2.75
HA1377	3.50	ML231B	1.75
HA1156W	1.95	ML232B	2.50
HA1339A	2.95	MSM5807	6.75
HA 1398	3.50	PN7101	7.95
HA1551	2.95	SAA500A	3.50
LA1230	1.95	SAA1025	7.25
LA4031P	1.95	SAS560S	1.75
LA4102	2.95	SAS570S	1.75
LA4140	2.95	SAS580A	2.85
LA440	1.95	SL901B	6.65
LA4420	1.95	SL93	6.65
LA4422	2.50	SL1310	1.80
LA4430	2.50	SL1327	1.10
LA4461	3.95	SL1327A	1.10
LC7120	3.25	SN76030N	3.95
LC7130	1.50	SN76032N	3.95
LC7131	5.50	SN76033N	3.95
LC7137	5.50	SN76033N	3.95
LM324N	0.45	SN76110N	0.89
LM3808N	1.50	SN76115N	1.25
LM3808N14	1.75	SN76131N	1.30
LM383T	2.95	SN76270N	2.95
LM3900N	3.50	SN76272N	1.05
MS1513L	2.30	SN76533N	1.65
MS1515L	2.95	SN76544N	2.65
MS1521L	2.50	SN76570N	1.00
MB3712	1.00	SN76680N	1.15
MC1307P	2.00	SN76680N	1.15

STK014	7.95	TBA530	1.10
STK015	5.95	TBA530A	1.10
STK043	5.95	TBA540	1.25
STK415	7.95	TBA540A	1.35
STK433	5.95	TBA550	1.95
STK435	7.95	TBA550A	1.95
STK437	7.95	TBA560C	1.45
STK439	7.95	TBA560C	1.45
STK461	11.50	TBA570	1.00
TA7081AP	3.95	TBA61A12	3.50
TA7108P	2.95	TBA651R	2.50
TA7120P	1.95	TBA720A	2.45
TA7130P	1.50	TBA7500	2.65
TA7176AP	2.95	TBA800	0.89
TA7203	2.95	TBA810AS	1.65
TA7204P	2.15	TBA810P	0.75
TA7205AP	1.15	TBA820M	0.65
TA7222AP	1.90	TBA820Q	1.45
TA7227P	4.25	TBA890	2.50
TA7310P	1.80	TBA950/2K	3.50
TA7313AP	2.95	TBA990	1.49
TA7321P	2.25	TCA270	1.50
TA7609P	3.95	TCA270S0	1.50
TA7611AP	2.95	TCA622	3.50
TA7612AP	1.70	TCA940	1.65
TA7613AP	1.95	TDA440	2.20
TA7614AP	1.95	TDA1001	1.95
TA7615AP	1.95	TDA1004A	5.95
TA7616AP	1.95	TDA1006A	2.50
TA7617AP	1.95	TDA1035	1.95
TA7618AP	1.95	TDA1037	1.95
TA7619AP	1.95	TDA1170	1.95
TA7620AP	1.95	TDA1190	2.95
TA7621AP	1.95	TDA12700	3.95
TA7622AP	1.95	TDA1327	1.70
TA7623AP	1.95	TDA2002	1.95
TA7624AP	1.95	TDA2020	2.95
TA7625AP	1.95	TDA2030	2.80
TA7626AP	1.95	TDA2190	3.95
TA7627AP	1.95	TDA2522	2.95
TA7628AP	1.95	TDA2523	2.95

TDA2524	1.95	TDA2530	1.95
TDA2530	1.95	TDA2532	1.95
TDA2532	1.95	TDA2540	1.95
TDA2540	1.95	TDA2541	2.15
TDA2541	2.15	TDA2560	2.15
TDA2560	2.15	TDA2571	3.50
TDA2571	3.50	TDA2581	2.95
TDA2581	2.95	TDA2593	2.95
TDA2593	2.95	TDA2600	5.50
TDA2600	5.50	TDA2610	2.50
TDA2610	2.50	TDA2611A	1.95
TDA2611A	1.95	TDA2640	3.50
TDA2640	3.50	TDA2680A	2.50
TDA2680A	2.50	TDA2690	2.45
TDA2690	2.45	TDA3310	2.95
TDA3310	2.95	TDA3560	5.50
TDA3560	5.50	UPC566H	2.95
UPC566H	2.95	UPC575C2	2.75
UPC575C2	2.75	UPC1025H	1.95
UPC1025H	1.95	UPC1028H	1.95
UPC1028H	1.95	UPC1032H	1.50
UPC1032H	1.50	UPC1156H	0.75
UPC1156H	0.75	UPC1157C2	1.95
UPC1157C2	1.95	UPC1181H	1.25
UPC1181H	1.25	UPC182H	2.95
UPC182H	2.95	UPC185H	3.95
UPC185H	3.95	UPC191V	1.50
UPC191V	1.50	UPC1350C	2.95
UPC1350C	2.95	UPC1353C	2.45
UPC1353C	2.45	UPC1355C	2.95
UPC1355C	2.95	UPC2002H	1.95
UPC2002H	1.95	555	0.35
555	0.35	556	0.60
556	0.60	723	0.50
723	0.50	741	0.35
741	0.35	747	0.50
747	0.50	748	0.35
748	0.35	7805	0.65
7805	0.65	7808	0.65
7808	0.65	7815	0.65

BFR88	0.30	RCA16335	0.80
BFR90	1.50	SKE5F	1.45
BFR91	1.75	TIP29	0.40
BFT42	0.35	TIP29C	0.43
BFT43	0.95	TIP30C	0.42
BFW92	0.85	TIP31C	0.55
BFX29	0.30	TIP32C	0.42
BFX84	0.26	TIP33C	0.95
BFX85	0.32	TIP34B	0.95
BFX86	0.30	TIP41A	0.45
BFX88	0.25	TIP41C	0.45
BFY50	0.21	TIP42C	0.47
BFY51	0.21	TIP47	0.65
BFY52	0.25	TIP120	0.60
BFY90	0.77	TIP125	0.65
BLY48	1.75	TIP142	1.75
BRV39	0.45	TIP161	2.95
BR100	0.26	TIP295S	0.50
BR101	0.49	TIP305S	0.85
BR103	0.95	TIS91	1.50
BR4443	1.15	TV106/2	1.20
BT100A/02	0.65	2N1308	1.35
BT106	1.49	2N2219	0.28
BT116	1.20	2N2905	0.40
BT119	3.15	2N3053	0.50
BT120	1.65	2N3054	0.49
BU105	1.95	2N3055	0.52
BU108	1.65	2N3070	0.12
BU124	1.29	2N3703	0.12
BU125	1.25	2N3704	0.12
BU126	1.65	2N3705	0.20
BU129	1.55	2N3706	0.12
BU205	1.30	2N3708	0.12
BU208	1.39	2M3709	0.12
BU208A	1.52	2N3733	2.65
BU208D	1.85	2N3737	2.75
BU236	1.20	2N3792	1.35
BU407	1.24	2N4427	1.95
BU500	2.25	2N4444	1.15
BU508A	1.95	2N5294	0.42
BU526	1.90	2N5296	0.48
BU80Y	2.25	2N5485	0.45
BUV698	1.70	2N5496	0.95
MJ3000	1.98	2SA715	0.80
MJE340	0.48	2SC495	0.80
MJE500	0.48	2SC496	0.80
MPSA13	0.29	2SC1096	0.80
MPSA92	0.30	2SC1106	2.50
MRF237	0.95	2SC1172	2.20
MRF450A	13.50	2SC1173	1.15
MRF453	17.50	2SC1306	1.00
MRF455	17.50	2SC1364	5.50
MRF475	2.50	2SC1449	0.80
MRF477	10.00	2SC1478	1.25
OC16W	2.50	2SC1909	1.45
OC2	15.00	2N5298	0.60
OC2	0.75	2SC1953	0.95
OC4	0.75	2SC1957	0.80
OC45	0.55	2SC1969	1.95
OC70	0.45	2SC2028	1.15
OC71	0.55	2SC2029	1.95
OC72	0.85	2SC2078	1.45
OC81	0.50	2SC2091	8.85
OC171	3.50	2SC2098	2.95
R2008B	1.45	2SC2166	1.95
R2108B	1.45	2SC2314	0.80
R2322	0.58	2SC2371	0.36
R2323	0.65	2SD234	0.50
R2540	2.48	3N211	1.95
RCA16334	0.90	3SK88	0.95

CME822W	19.00	DG7-5	55.00
CME822GH	25.00	D87-36	35.00
CME1428GH	45.00	D87-36	55.00
CME1428W	39.00	DG7-32	45.00
CME1523W	39.00	DG13.2	45.00
CME1431GH	39.00	DH3-91	55.00
CME1431W	39.00	DH7-91	45.00
CME202GH	45.00	DP7-5	35.00
CME202W	45.00	DP7-6	35.00
CME2024W	45.00	DN13.78	35.00
CME2325W	45.00	F16-101GM	75.00
CME3128W	45.00	F16-101LD	75.00
CME3132GH	45.00	F21-130GLR	75.00
CME3155W	45.00	F21-130LC	75.00
CR1400	25.00	F31-10GM	75.00
CV429	89.00	F31-10GR	75.00
CV1450	35.00	F31-10LC	75.00
CV1526	19.00	F31-10LD	75.00
CV2185	15.00	F31-12LC	75.00
CV2193	15.00	F31-12LD	75.00
CV2195	15.00	F31-13GR	75.00
CV5119	85.00	F31-13GR	75.00
CV5320	85.00	F31-13LG	75.00
CVX389	55.00	F41-123LC	185.00
DV9-110GH	39.50	F41-141LC	185.00
D10-210GH	45.00	M7-120W	19.00
D10-210GH68B	65.00	M31-102GR	55.00
D10-230GH	35.00	M4-100LC	45.00
D10-230GM	35.00	M17-151GVR	175.00
D10-293GY/90	55.00	M17-151GR	175.00
D13-30GH	49.50	M19-100W	45.00
D13-33GM	45.00	M19-103W	55.00
D13-47GH/26	55.00	M23-110GH	55.00
D13-51GL/26	85.00	M23-111LD	55.00
D13-51GL/26	85.00	M23-112GM	55.00
D13-450GH/01	55.00	M23-112GV	55.00
D13-471GH/26	55.00	M23-112GW	55.00
D13-600GM	59.00	M23-112KA	55.00
D13-610GH	59.00	M24-120GM	59.00
D13-611GH	59.00	M24-120LC	59.00
D13-611GM	59.00	M24-120VAR	59.00
D13-630GH	59.00	M24-121GH	55.00
D14-150GH	75.00	M28-12GH	45.00
D14-150GM	75.00	M28-13LC	45.00
D14-172GH/84	59.00	M28-13LC	49.00
D14-172GR	55.00	M28-13GR	49.00
D14-173GM	55.00	M28-131GR	55.00
D14-173GR	55.00	M28-133GM	55.00
D14-181GH/98	85.00	M31-101GH	55.00
D14-181G	55.00	M31-102GR	55.00
D14-181GM	53.00	M31-182GV	65.00
D14-181GM50	59.00	M31-184W	55.00
D14-182GH	59.00	M31-184GM	65.00
D14-200BE	89.00	M31-188W	69.00
D14-200GA/50	85.00	M31-190GH	55.00
D14-200GM	75.00	M31-190GR	55.00
D14-210GH/50	75.00	M31-190LA	55.00
D14-270GH/50	75.00	M31-191GV	55.00
D14-310W	110.00	M31-220W	59.00
D14-320GH/82	85.00	M31-270GY	65.00
D14-340GH/KM	45.00	M31-271P31	65.00
D14-340KA	45.00	M31-271W	65.00
D16-100GH	65.00	M31-271W	65.00
D16-100GH/65	69.00	M36-141W	75.00
D16-100GH/67	65.00	M36-170LG	75.00
D16-100GH/79	65.00	M38-101GH	65.00
D16-100GH/97	65.00	M38-103GR	65.00
D18-160GH	69.00	M38-120W	65.00
D21-10GH	65.00	M38-120WA	65.00
D21-10GH	65.00	M38-121GHR	65.00

SEMICONDUCTORS

AA172	0.25	BC178	0.15
AC125	0.20	BC182	0.10
AC126	0.45	BC182LB	0.10

PHONE
0474 813225
AND AFTER 1.7.85
0474 60521

P. M. COMPONENTS LTD
SELECTRON HOUSE, SPRINGHEAD, ENTERPRISE PARK
SPRINGHEAD RD, GRAVESEND, KENT DA11 8HD

TELEX
966371
TOS-PM



A SELECTION FROM OUR STOCK OF BRANDED VALVES

A1714 24.50	ELB22 12.95	M8223 4.50	Q51202 3.95	UL84 0.85	3AT2 3.35	6BC8 1.00	6JUB 2.50	12S5J7 1.50	833A 95.00
A1834 7.50	EM1 9.00	M8224 2.00	Q51203 4.15	U05 3.50	3B2 3.00	6BD4 1.50	6J56C 4.95	12SQ7GT 1.95	866A 4.50
A1998 11.50	EM4 9.00	M8240 29.50	Q51205 3.95	U07 8.00	3B4 7.00	6BD6 2.50	6J7G 4.15	12SR7 2.50	872A 27.50
A2087 11.50	EM8 0.70	ME1402 29.50	Q51206 4.05	U08 9.00	3B7 4.50	6BE6 0.72	6K2G 2.00	12SQGT 1.50	874 8.00
A2134 14.95	EM81 0.70	ME1501 14.00	Q51207 0.90	U09 3.50	3B24 10.00		6K6V/G 3.00	1303 3.20	884 5.50
A2293 6.50	EM85 3.95	MH4 3.50	Q51208 0.90	U085 0.70	3B26 24.00		6K7G 6.50	1307 3.20	930 9.95
A2599 37.50	EM87 2.50	MHL06 4.00	Q51209 3.15	V235A/1K 25.00	3B28 12.00		6KM8 2.50	1309 3.20	931A 13.95
A2792 27.50	EM88 0.70	MS4B 5.50	Q51210 1.50	V238A/1K 295.00	3B4 7.00		6K78 2.95	130E7 2.50	954 1.00
A2900 11.50	EM89 0.70	MU14 3.50	Q51211 1.50	V240C/2K 225.00	3C 3.00		6L1 2.50	130R7 2.95	955 1.00
A3042 24.00	EM91 1.10	MZ1-100 125.00	Q51212 5.20	V241C/1K 195.00	3C24 19.00		6L15 3.15	131E1 145.00	956A 1.00
A3043 24.00	EN2 0.85	N37 12.50	Q51215 2.10	V246A/2K 315.00	3C45 24.00		6L19 3.95	13EM7 3.50	962 1.00
AC/CD 4.50	EN22 0.75	N78 9.85	Q51218 5.00	V339 3.50	3CB6 1.50		6L6G 2.95	14S7 1.95	1619 2.50
AC/THI 4.00	EN27 4.50	OA2 0.85	QV03-7 9.50	V453 12.00	3CB8 1.50		6LGGC 4.50	14S7GT 2.95	1625 3.00
AC/T22 59.75	EN29 1.10	OA2WA 2.50	QV09-1 1.75	V464A/2K 225.00	3CB9 2.50		6LGGT 1.95	14WZ 0.95	1626 3.00
AH221 39.00	EN3 0.85	OA3 2.50	QV06-20 29.50	V464A/2K 295.00	3CBX 2.50		6LDD20 1.15	17E28 4.50	2050W 4.50
AH238 39.00	EN32 1.50	OB2 0.85	QV08-00 145.00	V464A/2K 315.00	3C33 1.50		6LFF6 7.50	1803 6.00	3545 4.00
AL60 8.00	EN37 1.10	OC2 2.50	QV2-2500A5.00	V464A/2K 315.00	3C36 1.50		6LJ8 2.50	19AAU4GT 2.50	40A4 10.95
AL70 14.00	EN38 1.50	OC3 1.50	QV3-12 85.00	V464A/2K 315.00	3C37 1.50		6LJ8 2.50	19G3 17.00	927 15.00
ARP12 0.70	EN39 1.50	OC3 1.50	QV4-2500 70.00	V464A/2K 315.00	3C38 1.50		6LJ8 2.50	19H5 33.50	1927 25.00
ARP34 1.25	EN40 1.50	OC3 1.50	QV4-480 78.00	V464A/2K 315.00	3C39 1.50		6LJ8 2.50	19O6 1.00	4212E 250.00
ARP35 2.00	EN41 1.50	OC3 1.50	R10 4.00	V464A/2K 315.00	3C40 1.50		6LJ8 2.50	20A2 10.50	4313C 4.00
AX50 5.50	EN42 1.50	OC3 1.50	R12 12.00	V464A/2K 315.00	3C41 1.50		6LJ8 2.50	20D1 0.70	4328D 9.00
AZ11 4.50	EN43 1.50	OC3 1.50	R17 1.50	V464A/2K 315.00	3C42 1.50		6LJ8 2.50	20LF6 3.50	5642 9.50
BL63 2.00	EN44 1.50	OC3 1.50	R18 2.50	V464A/2K 315.00	3C43 1.50		6LJ8 2.50	20L 0.95	5651 2.50
BS450 87.00	EN45 1.50	OC3 1.50	R19 2.50	V464A/2K 315.00	3C44 1.50		6LJ8 2.50	20P1 1.00	5652 3.50
BS810 55.00	EN46 1.50	OC3 1.50	R20 12.00	V464A/2K 315.00	3C45 24.00		6LJ8 2.50	20P3 0.80	5662 1.95
BS814 55.00	EN47 1.50	OC3 1.50	R21 12.00	V464A/2K 315.00	3C46 1.50		6LJ8 2.50	20P4 1.95	5670 3.25
CIK 19.00	EN48 1.50	OC3 1.50	R22 12.00	V464A/2K 315.00	3C47 1.50		6LJ8 2.50	20P5 1.15	5672 4.50
C3JA 9.50	EN49 1.50	OC3 1.50	R23 12.00	V464A/2K 315.00	3C48 1.50		6LJ8 2.50	21LUB 2.50	5687 4.50
C6A 9.00	EN50 1.50	OC3 1.50	R24 12.00	V464A/2K 315.00	3C49 1.50		6LJ8 2.50	24B1 39.50	5692 3.50
CI108 65.00	EN51 1.50	OC3 1.50	R25 12.00	V464A/2K 315.00	3C50 1.50		6LJ8 2.50	25L6GT 1.75	5704 3.50
C1134 32.00	EN52 1.50	OC3 1.50	R26 12.00	V464A/2K 315.00	3C51 1.50		6LJ8 2.50	25M06 1.75	5718 6.15
C1148A 115.00	EN53 1.50	OC3 1.50	R27 12.00	V464A/2K 315.00	3C52 1.50		6LJ8 2.50	29C1 19.50	5725 2.50
C1149/1 195.00	EN54 1.50	OC3 1.50	R28 12.00	V464A/2K 315.00	3C53 1.50		6LJ8 2.50	29K06 6.50	5726 1.50
C1150/1 135.00	EN55 1.50	OC3 1.50	R29 12.00	V464A/2K 315.00	3C54 1.50		6LJ8 2.50	30C17 0.40	5727 1.95
C1534 32.00	EN56 1.50	OC3 1.50	R30 12.00	V464A/2K 315.00	3C55 1.50		6LJ8 2.50	30C18 1.48	5732 1.95
CCA 2.50	EN57 1.50	OC3 1.50	R31 12.00	V464A/2K 315.00	3C56 1.50		6LJ8 2.50	30F5 0.95	5750 1.85
CC3L 2.90	EN58 1.50	OC3 1.50	R32 12.00	V464A/2K 315.00	3C57 1.50		6LJ8 2.50	30F7 1.35	5751 2.95
CL33 2.00	EN59 1.50	OC3 1.50	R33 12.00	V464A/2K 315.00	3C58 1.50		6LJ8 2.50	30F12 0.95	5752 4.95
Cv Nos Prices on request	EN60 1.50	OC3 1.50	R34 12.00	V464A/2K 315.00	3C59 1.50		6LJ8 2.50	30F13 1.10	5814A 3.25
D63 1.20	EN61 1.50	OC3 1.50	R35 12.00	V464A/2K 315.00	3C60 1.50		6LJ8 2.50	30F14 1.25	5829WA 6.50
DA41 22.50	EN62 1.50	OC3 1.50	R36 12.00	V464A/2K 315.00	3C61 1.50		6LJ8 2.50	30L1 0.45	5636 5.50
DA42 4.50	EN63 1.50	OC3 1.50	R37 12.00	V464A/2K 315.00	3C62 1.50		6LJ8 2.50	30L1 1.00	5637 7.50
DA90 0 17.50	EN64 1.50	OC3 1.50	R38 12.00	V464A/2K 315.00	3C63 1.50		6LJ8 2.50	30L1 1.00	5840 3.50
DA100 125.00	EN65 1.50	OC3 1.50	R39 12.00	V464A/2K 315.00	3C64 1.50		6LJ8 2.50	30M4R 1.00	5842 11.00
DAF91 0.70	EN66 1.50	OC3 1.50	R40 12.00	V464A/2K 315.00	3C65 1.50		6LJ8 2.50	30P12 1.00	5847 10.95
DAF96 0.85	EN67 1.50	OC3 1.50	R41 12.00	V464A/2K 315.00	3C66 1.50		6LJ8 2.50	30P19 1.00	5879 8.50
DC70 1.75	EN68 1.50	OC3 1.50	R42 12.00	V464A/2K 315.00	3C67 1.50		6LJ8 2.50	30P21 0.50	5886 13.95
DC90 1.25	EN69 1.50	OC3 1.50	R43 12.00	V464A/2K 315.00	3C68 1.50		6LJ8 2.50	30P23 0.60	5894 39.50
DCX4-1000 12.00	EN70 1.50	OC3 1.50	R44 12.00	V464A/2K 315.00	3C69 1.50		6LJ8 2.50	30P24 1.75	5899 4.50
DCX4-5000 28.50	EN71 1.50	OC3 1.50	R45 12.00	V464A/2K 315.00	3C70 1.50		6LJ8 2.50	30P25 0.60	5963 1.25
DE16 28.50	EN72 1.50	OC3 1.50	R46 12.00	V464A/2K 315.00	3C71 1.50		6LJ8 2.50	30P26 0.60	5965 2.75
DE18 28.50	EN73 1.50	OC3 1.50	R47 12.00	V464A/2K 315.00	3C72 1.50		6LJ8 2.50	30P27 0.60	5967 1.85
DE23 35.00	EN74 1.50	OC3 1.50	R48 12.00	V464A/2K 315.00	3C73 1.50		6LJ8 2.50	30P28 0.60	6002 1.85
DE24 39.00	EN75 1.50	OC3 1.50	R49 12.00	V464A/2K 315.00	3C74 1.50		6LJ8 2.50	30P29 0.60	6021 3.65
DE25 22.00	EN76 1.50	OC3 1.50	R50 12.00	V464A/2K 315.00	3C75 1.50		6LJ8 2.50	30P30 0.60	6057 2.50
DE29 32.00	EN77 1.50	OC3 1.50	R51 12.00	V464A/2K 315.00	3C76 1.50		6LJ8 2.50	30P31 0.60	6058 3.95
DE30 32.00	EN78 1.50	OC3 1.50	R52 12.00	V464A/2K 315.00	3C77 1.50		6LJ8 2.50	30P32 0.60	6059 3.75
DF72 0.60	EN79 1.50	OC3 1.50	R53 12.00	V464A/2K 315.00	3C78 1.50		6LJ8 2.50	30P33 0.60	6060 2.25
DF96 0.65	EN80 1.50	OC3 1.50	R54 12.00	V464A/2K 315.00	3C79 1.50		6LJ8 2.50	30P34 0.60	6062 4.50
DF97 1.00	EN81 1.50	OC3 1.50	R55 12.00	V464A/2K 315.00	3C80 1.50		6LJ8 2.50	30P35 0.60	6063 2.00
DH63 1.20	EN82 1.50	OC3 1.50	R56 12.00	V464A/2K 315.00	3C81 1.50		6LJ8 2.50	30P36 0.60	6064 3.25
DH77 0.90	EN83 1.50	OC3 1.50	R57 12.00	V464A/2K 315.00	3C82 1.50		6LJ8 2.50	30P37 0.60	6065 1.95
DH99 2.00	EN84 1.50	OC3 1.50	R58 12.00	V464A/2K 315.00	3C83 1.50		6LJ8 2.50	30P38 0.60	6066 1.85
DK91 0.90	EN85 1.50	OC3 1.50	R59 12.00	V464A/2K 315.00	3C84 1.50		6LJ8 2.50	30P39 0.60	6067 4.20
DK92 1.20	EN86 1.50	OC3 1.50	R60 12.00	V464A/2K 315.00	3C85 1.50		6LJ8 2.50	30P40 0.60	6068 8.50
DL35 2.50	EN87 1.50	OC3 1.50	R61 12.00	V464A/2K 315.00	3C86 1.50		6LJ8 2.50	30P41 1.75	6080 11.00
DL63 1.00	EN88 1.50	OC3 1.50	R62 12.00	V464A/2K 315.00	3C87 1.50		6LJ8 2.50	30P42 1.75	6132 10.00
DL70 2.50	EN89 1.50	OC3 1.50	R63 12.00	V464A/2K 315.00	3C88 1.50		6LJ8 2.50	30P43 0.60	6136 2.50
DL73 2.50	EN90 1.50	OC3 1.50	R64 12.00	V464A/2K 315.00	3C89 1.50		6LJ8 2.50	30P44 0.60	6146B 9.95
DL91 1.50	EN91 1.50	OC3 1.50	R65 12.00	V464A/2K 315.00	3C90 1.50		6LJ8 2.50	30P45 0.60	6157 2.50
DL92 0.95	EN92 1.50	OC3 1.50	R66 12.00	V464A/2K 315.00	3C91 1.50		6LJ8 2.50	30P46 0.60	6158 3.20
DL93 1.10	EN93 1.50	OC3 1.50	R67 12.00	V464A/2K 315.00	3C92 1.50		6LJ8 2.50	30P47 0.60	6205 6.95
DL94 0.95	EN94 1.50	OC3 1.50	R68 12.00	V464A/2K 315.00	3C93 1.50		6LJ8 2.50	30P48 0.60	6211 2.50
DL96 2.50	EN95 1.50	OC3 1.50	R69 12.00	V464A/2K 315.00	3C94 1.50		6LJ8 2.50	30P49 0.60	6267 2.25
DL97 1.50	EN96 1.50	OC3 1.50	R70 12.00	V464A/2K 315.00	3C95 1.50		6LJ8 2.50	30P50 0.60	6350 3.50
DL98 0.95	EN97 1.50	OC3 1.50	R71 12.00	V464A/2K 315.00	3C96 1.50		6LJ8 2.50	30P51 0.60	6360 4.50
DL99 1.50	EN98 1.50	OC3 1.50	R72 12.00	V464A/2K 315.00	3C97 1.50		6LJ8 2.50	30P52 0.60	6386 14.50
DL99 1.50	EN99 1.50	OC3 1.50	R73 12.00	V464A/2K 315.00	3C98 1.50		6LJ8 2.50	30P53 0.60	6455 8.50
DL99 1.50	EN100 1.50	OC3 1.50	R74 12.00	V464A/2K 315.00	3C99 1.50		6LJ8 2.50	30P54 0.60	6550A 10.95
DL99 1.50	EN101 1.50	OC3 1.50	R75 12.00	V46					

by Rod Cooper

Recharging system for NiCd cells

Recharging sealed NiCd cells can be very unsatisfactory if it is done with d.c., at too low a temperature, at too high a rate, if it is prolonged, or if it is done with cells in series. Part 3 of this series of articles describes a practical method of recharging which not only avoids some of the pitfalls, but gives the best possible performance from NiCd cells, and is at the same time cost-effective, giving pay-back time of about two years.

In the recent two-part article on the failure modes of nickel-cadmium cells, mention was made of the damage done to cells by incorrect charging techniques. The recharging system (I call it this because it is more than just a battery charger) described here was devised to show that it is possible to recharge cells both efficiently and without premature failure or falling-off in performance. Moreover, in practical terms this system is far more pleasant to operate than simple conventional chargers since there are none of the irritating problems of having to ensure that cells are matched in capacity, are not over or under-charged, do not lose capacity on standing, or that the temperature is correct.

In this radical approach the NiCd cells are intended to remain in the charger until required. Once placed in the charger, the cell is taken care of until removed for use.

The design features are:

- cells are charged individually to reduce the effects of any disparity in capacity.
- dendrite-suppression charging circuit prevents premature failure due to dendrites forming between the plates.
- automatic turn-off prevents over-charging.
- automatic turn-on minimizes the effects of self-discharge.
- low-temperature cut-out prevents damage due to

charging below 5°C.

- inherent NiCd fault-diagnosis capability.

These features are examined in turn as follows.

Cells charged individually

In the article on failure modes it was explained how charging a battery of cells could lead to more fault modes developing due to initial slight variations in the capacity of neighbouring cells. A common method of trying to even out the charge given to each cell in the battery is to thoroughly over-charge the whole battery in the hope that each cell is driven into the oxygen-recombination phase. The attendant long-term danger of this method is separator deterioration. Another factor which detracts from the method is the possible presence of cells in the battery that have dendrites. These cells may become "stuck" short of full charge regardless of how much the rest of the battery is over-charged, but the symptoms will usually go undetected, thus storing up trouble for the future. There seems to be no easy way round this problem if the cells are charged together as a battery.

In this new approach the cells are disassembled for charging and treated as individuals. Clearly this technique can only be used for equipment where separate cells are held in a battery

compartment and cannot be used where batteries consist of cells spot-welded together. However, much commercial gear like radios, cassette players etc. employs numbers of separate cells in an accessible compartment, so it is expected that this recharging system will suit most applications, and in particular it is highly suitable for those using a single cells coupled to d.c.-d.c. converters like the Texas TL496 or Verkon V9-a to step up to 9V.

Indeed, in the case of single-cell d.c.-d.c. converter combinations it is obviously nonsense to connect such a cell in series with another for the recharging process.

There are therefore definite advantages in recharging each cell according to its needs. Firstly, it will not be persistently overcharged in the interests of charge-uniformity so it is unlikely to suffer separator degradation. Secondly each cell is assured of a full charge regardless of whether this takes longer to achieve in some cells than in others, and this is more likely to result in an even charge throughout the battery than any other method, the benefits of which have already been dealt with. Thirdly, with this method it is very easy to spot the cell that has gone wrong, which can then be removed from service instead of being left to cause trouble in the battery. This aspect is dealt with later.

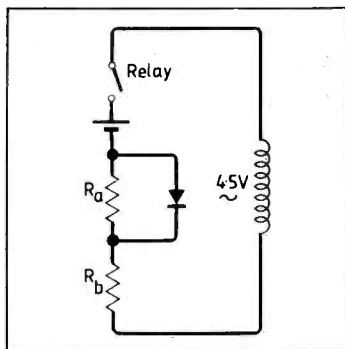

Fig. 1. Simple circuit, based on electro-plating principles, but without precise current definition, can employ a.c. mains.

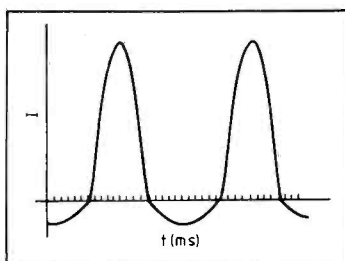

Fig. 2. Typical current waveform in circuit of Fig. 1.

Dendrite-suppression charging circuit

Charging cells with d.c. can result in the formation of cadmium dendrites, leading to the early failure or falling-off in performance that was detailed in the earlier article. Dendrite formation is not exclusive to the charging of nickel-cadmium cells. It is a problem experienced in the electroplating industry when copper, zinc and silver are electroplated. These metals are the close neighbours of cadmium in the periodic table of the elements and share some common characteristics, such as dendrite formation. However, the electroplating industry has had a remedy for very many years in the form of periodic current reversal (p.c.r. for short). This technique consists of applying a short pulse of current in the opposite direction to the main plating current at regular intervals. The result is a smooth, hard, dendrite-free metal deposit quite unlike that produced by d.c. A magnified cross-section of p.c.r. deposit shows that it is not homogeneous but distinctly laminar in nature.

Now, the charging of a NiCd cell can be regarded as a special case of electroplating, and it should therefore be possible to eliminate dendrites by using a charging current based on p.c.r. When electroplating it is necessary to define accurately the forward and reverse currents to obtain satisfactory results, but when charging a NiCd cell the requirement is not so strict, the intention being not to produce a smooth hard deposit of cadmium but merely to suppress dendrite formation. A simpler circuit should be possible, and in this design the a.c. mains is used to supply both forward and reverse currents and to define the timing. The circuit is shown in Fig. 1 and a typical current waveform in Fig. 2. Note that $R_a > R_b$. If a bank of, say, four cells were charged together using four of the circuits shown it would lead to unbalanced operation of the transformer, which would need to be up-rated to cope, so in this design the cells are charged in balanced pairs, as shown in Fig. 3. Although this detracts slightly from the concept simplicity, it does keep the transformer size (and cost) down. It was considered essential to have a basic charging circuit that was as simple as possible because the

circuit is repeated many times, i.e. by as many cells as there are in the charger. The prototype, for example, held eight.

Note from Fig. 2 that the ratio of forward coulombs to reverse coulombs is approximately 5:1. With p.c.r. it is the coulomb ratio which is important, not just the current ratio.

It is not the first time that cells have been charged using p.c.r. In 1955 R. Hallows reported in *Wireless World* on a device name the Electrophoor which was designed to recharge ordinary zinc-carbon dry cells, and which used the mains to produce p.c.r. Hallows described the hard deposits of zinc in cells that had been recharged in the Electrophoor, and contrasted them with the soft and spongy (i.e. dendritic) deposit of zinc that he found in cells recharged using d.c., although at that time he did not know of the reasons for this phenomenon. The indications that p.c.r. does the same for cadmium are therefore strong.

It would be a fair deduction that using d.c. is probably the worst possible way of recharging NiCd cells, yet there are nevertheless plenty of published designs for NiCd chargers which go to the trouble of providing smoothing for the d.c. applied to the cells!

Periodic current reversal is intended as a preventive measure, not as a cure for dendrites which are already in place.

Automatic turn-off

Although the nominal charge rate is set at C/10, which a standard NiCd cell can tolerate within the limitations explained in part 2, this design incorporates a cut-out that stops the charging shortly after full charge has been reached. The cell does not therefore remain in the oxygen-recombination phase for long.

A cut-out is necessary, bearing in mind the design philosophy of leaving cells in the charger until required, in order to avoid the ill effects of normal overcharging (at C/10) for prolonged periods.

There is available a choice of detection methods for determining the end-of-charge point for NiCd cells, and for this design the temperature-rise method was chosen because it was the least expensive consistent with reliability; cost is important when many cells are being individually monitored. The circuit design is shown in Fig. 4 and consists of a

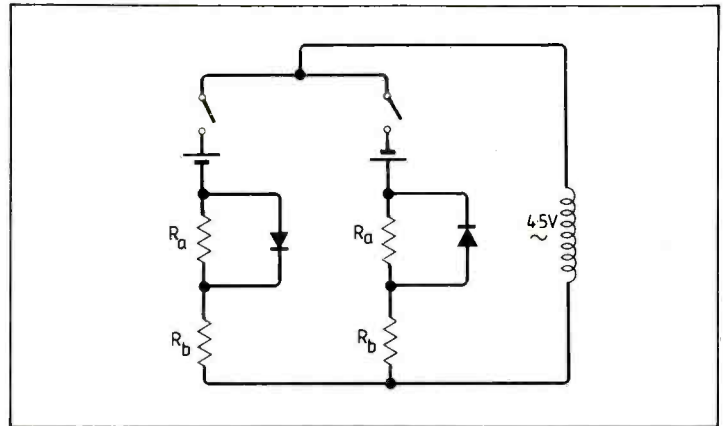
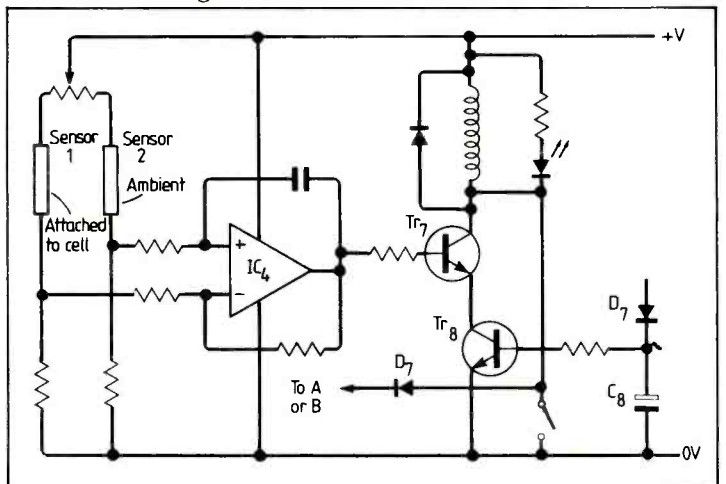

Fig. 3. Charging cells in balanced pairs saves on transformer cost, halving its size.

simple i.c. comparator driven directly by the differential temperature sensor comprising Sensor 1 and Sensor 2. The operating point is set by R_{29} . Originally, the temperature-sensitive devices used were thermistors of the VA1066 type, but in the interests of cost-effectiveness these were substituted by a string of four forward-biased 1N4148 silicon diodes. These diodes are available at only 2p each, a worthwhile saving on the prototype charger, which housed eight cells.

The voltage drop across a forward-biased silicon diode decreases by about 2mV per 1 deg C rise in temperature. A string of four will thus give 8mV per deg C. The likely temperature rise in a D-cell at C/10 charge rate during the oxygen-recombination phase is around 5°C, so this will produce a drop of 40mV, which is ample to drive a comparator directly. A CA3140 i.c., for example, will work happily with a 5mV differential in the circuit shown. The 1N4148 diode varies in its temperature characteristics from manufacturer to manufacturer and also between individual specimens from one source, but there is no need for close matching in this circuit, as the differences average out over

Fig. 4. Sensor bridge and op-amp comparator determine temperature rise and therefore end-of-charge.



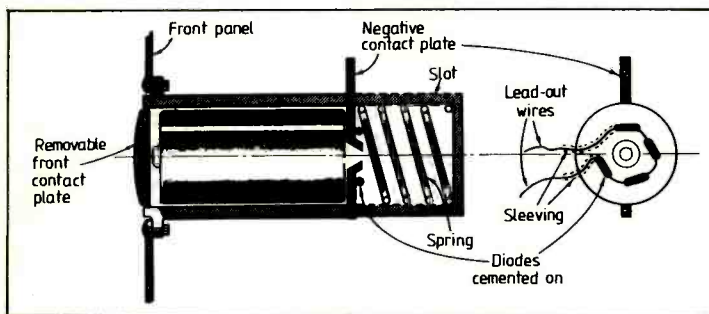

Fig. 5. Cell holder from RS Components.

eight diodes provided they are from the same source. The thermal coupling of Sensor 1 to the cell is important. Attachment direct to the cell, as described in other designs featuring thermal detection, is out of the question in this charger, where ease of use in putting cells into and taking them out of the cell holders is required. Of the other options available it was finally decided to fix Sensor 1 to the metal contact of the cell holder as it was easiest from the construction point of view. Of the single-cell holders on the market, only one has been found suitable for sensor attachment, this being distributed by RS Components. The RS reference numbers are given at the end of this article.

This range of holders has good thermal properties, an important point considering that in the case of a standard D cell only about half a watt of power is being dissipated over a surface area of some 23cm². The recommended holder has a tubular plastic body (Fig. 5) which tends to insulate the outside of the cell, which is beneficial for temperature-rise detection, and metal contact plates at each end. The negative contact plate is large enough to attach the string of four diodes and has reasonable thermal contact with the end of the cell. This contact plate is spring loaded and slides in two slots cut in the body of the holder; the slots allow air at ambient temperature to circulate over the contact plate. This is an important point, because with such a small temperature rise to detect, some insulation from the surroundings is necessary, but it is also necessary to avoid over-insulation or a separate micro-climate will be set up inside the holder and the differential action will be upset.

A compromise is required and I have found by experiment that a 1/8in thick plastic foam disc glued onto the back of the contact plate

and covering the diodes strikes about the right balance between sensitive detection of the cell temperature rise and equilibrium with the ambient temperature. It is also necessary to insulate the metal spring from the contact plate by slipping a piece of plastic sleeving over it, otherwise it acts as a heat-sink.

There are some other interesting features to this type of cell holder. For example, being panel-mounted makes design and construction of the housing for the charger easier, from the point of view of cell access. When the front cap (F) is unscrewed, the cell is partly pushed out by the rear spring — no grappling with plastic side grips to get the cell out. Also, it is polarity-protected; if a cell is inserted the wrong way round, no contact is made.

The more familiar plastic open-frame cell holders are unsatisfactory from most aspects for this design and are not recommended.

Before leaving the subject of temperature, it is worth discussing the cells themselves. It is desirable to produce a sharp rise in temperature during normal overcharge, both in the interests of end-of-charge detection and in assisting the oxygen-recombination process, which works better at higher temperatures. In the last article it was suggested that the plastic sleeve usually found on NiCd cells was removed and possibly replaced with 50mm adhesive tape. This is a good idea because the covering will accentuate the temperature rise at the ends of the cell; this will not be the case if the cell is left bare.

Note that there is a time-lag between the onset of oxygen-recombination as denoted by a rise in internal pressure and the rise in temperature at the surface of the cell, but this is not long — about an hour or so for a D-cell — and may even help dendrite suppression (see article by K.C. Johnson, *WW*, Feb., 1977) The

temperature rise for standard D-cells is around 5°C, but is appreciably less for smaller cells. With standard AA size cells the rise is so small that it is not sufficient for reliable operation of this design. In this case, fast charge AA cells should be used instead of standard cells even though their fast-charge capability may not actually be needed, and the charge rate increased to C/3 to produce a usable temperature rise. The extra cost in this size of cell is very small.

Regarding circuit operation, in the charging mode the output of IC₄ is high and Tr₇ is turned on. However, the relay RL2 cannot close until energised manually by closing push-button switch Sw₂ or automatically by a clamping pulse applied via D₇ from the auto turn-on circuit (see next section), and even then the relay cannot remain closed unless Tr₈ is also turned on. The function of Tr₈ is to prevent the relay from latching unless a cell is present in the cell holder. If the relay were to remain closed without a cell being present it would stay in this state because there would be no mechanism for turning it off. The Tr₈ circuit also ensures that the charging circuit is turned off if a cell is removed during charging.

The sequence of operation is therefore this; a pulse is applied to the relay as described; the a.c. line is connected to the NiCd cell and via D₉ charges C₈ and turns Tr₈ on, latching the relay RL2 when charging is completed, IC₄ clamps the base of Tr₇ to ground, turning it off and de-energising the relay. The a.c. is disconnected, C₈ discharges and Tr₈ turns off. As the cell cools down, IC₄ turns Tr₇ back on and the circuit is then ready for the next command pulse.

A command pulse applied before cooling-off has taken place cannot initiate more charging because Tr₇ will remain off until comparator IC₄ returns to the high state and this prevents prolonged overcharging whether intentional or not.

A relay was chosen for the switching element because it offers complete isolation of the NiCd cell when not being charged, and avoids the need to take into account leakage currents and "brown out" associated with semiconductors over long periods of use. Leakage is a significant factor bearing in mind the intention of leaving cells in the charger.

To set this circuit up, it is necessary to have a warm, freshly charged cell and a cell at room temperature, or alternatively a d.c. millivoltmeter. With the warm cell method, preset pot R₂₉ is set to that relay RL2 just switches off when the warm cell is inserted in the holder. The cold cell is then inserted in its place, and it should be possible to reset the charger with S₂. This process has to be repeated to ensure reliable results, and because the thermal time-constants are lengthy — a couple of minutes for each check — this scheme can be tedious if there are many circuits to set up. A much quicker method is to set the differential voltage between Tr₁ and Tr₂ at about 20mV using a d.c. millivoltmeter. This makes sure that a warm cell will turn off the relay but at the same time will be reasonably immune to spurious temperature fluctuations. A suitable millivoltmeter can readily be constructed from a m.c. meter and a chopper amp like the ICL7650 — see *WW*, June 1983.

It is difficult to tell when a cell is in the warm, charged state without resorting to accurate temperature measurement, and as this is essential to the first method this practical tip may help, having the advantage of needing no equipment. The difference between a warm cell taken from a charger and a cold cell which has been standing at room temperature cannot be readily detected by holding them in the hand, but if they are held simultaneously to the face, the difference is instantly apparent, the face being suprisingly sensitive to temperature difference. A strange but useful tip! Note that there is virtually no temperature rise in a NiCd cell during charging until the oxygen-recombination is reached.

Automatic turn-on

One of the most annoying features of sintered cells is their ability to discharge themselves when left standing. This feature is inherent in the design and is not a failure mode, although it is a failing in practical terms. Typically a brand-new D-cell will discharge itself to about 60% of

Fig. 6. Complete circuit diagram of cell recharger. Devices are standard 0.2in devices.

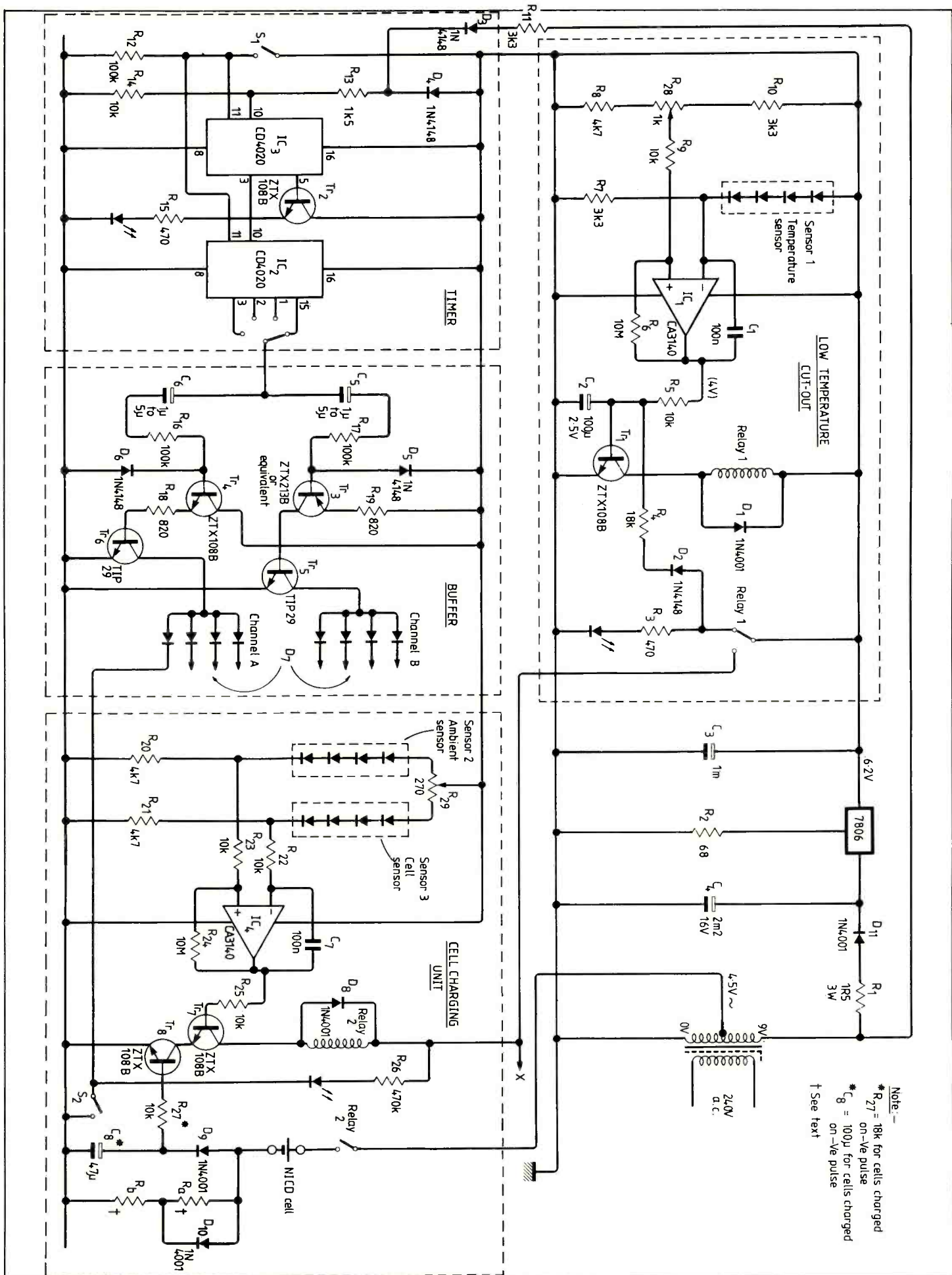

Note:—
 * R₂₇ = 18k for cells charged on -Ve pulse
 * C₈ = 100µ for cells charged on -Ve pulse
 † See text

capacity in only 40 days — a relatively short period when compared to the shelf life of other types of cell. This figure is for a temperature of 20°C, and the performance improves at lower temperatures but deteriorates at higher temperatures. The self-discharge phenomenon is due to the unstable nature of the active materials and, of course, is not irreversible — a recharge will restore the status quo.

To overcome this problem a timer has been added to the charger so that it turns itself on periodically to give the cells a topping-up charge. The time period selected can be 62, 31, 15½ or 7½ days depending on the user's requirements. I personally prefer 15½ days, giving a guaranteed minimum state of charge of any cell taken from the charger of about 80%.

The timer itself is shown bottom left of Fig. 6 and consists of two CD4020 c-mos i.cs. connected in cascade. Each CD4020 is a 14-stage binary counter with stage 1 and then stages 4 to 14 brought out to buffered outputs, stage 14 providing a total frequency division of 16,384. If two devices are cascaded and the input fed with a 50Hz input, the output from stage 14 of the second i.c. will give a change of state every 31 days 1 hour and forty minutes. The signal input is not critical since the i.c. contains waveform-shaping circuitry at the input stage, so a mains-derived signal is a very attractive source, helping to keep the cost down.

The output to the cell charging circuit is buffered by transistors Tr₃ and Tr₅ for negative-going changes of state and by Tr₄ and Tr₆ for positive-going changes. By splitting the output like this, where one buffer responds only to negative changes and the other buffer to positive changes, the maximum timing period is effectively doubled. Each buffer feeds a bank of cells, so banks of cells will be turned on at alternate times. This system makes the best use of the equipment; it is clearly not efficient to have the charger idling for up to 62 days and then turning on to charge all the cells at once.

The buffers apply a sufficiently long pulse to the relay coil RL2 to charge C₅ and turn on Tr₈, locking the circuit on. A pulse length of 2 or 3 seconds is required to ensure reliable latching. A value for C₅ and C₆ of between 1 and 5 µF is generally satisfactory, but it is

necessary to experiment with various values to achieve equal pulse lengths for both channel A and B, due to differences in H_{fe} of the transistors and their asymmetric configuration. Each charging circuit is isolated from the other by D₇, so individual cells can be charged if required by pressing pushbutton S₂, independently of the timer.

Switch S₁ is a momentary push-button type used for setting the start of the timing period and only needs to be pressed once when the charger is commissioned or if the charger is disconnected from the mains supply for any reason.

Transistor Tr₂ and the led form a flashing light indicator. On the first models I used an ordinary mains neon as the pilot light but found this to be very unsatisfactory because it did not show that anything was actually working and there was always a nagging doubt about whether or not the charger was going to switch itself on after the stipulated period. Sixty two days is a long time to have to wait to discover a simple fault!

This addition puts one's mind to rest as it shows that at least the secondary side of the transformer is working, that the a.c. signal is reaching the counters, that the first stage of the counters is working and that the stabilised line is on. The flash signal is taken from stage 5 of the first counter and has a duration of a third of a second.

Low-temperature cut-out

The dangers of charging below about 5°C are avoided by using a latching cut-out which switches the 6.2V power line away from the relay coils RL2, thus preventing them from turning on, and diverts it to a led warning light. The cut-out can only be reset by unplugging the unit and moving it somewhere warmer.

The circuit (top left of Fig. 6) is similar to that used for the end-of-charge detector, except that only one string of temperature-sensing diodes is used. The drop in temperature from 20°C to 5°C produces a voltage rise of 120mV across the diodes. The pre-set resistor is set so that the comparator switches high at 5°C, energising relay RL1 via Tr₁. Latching is achieved via D₂.

The circuit can either be set up by putting the unit in an ordinary domestic refrigerator for an hour or so (these are usually about

4°C) and then setting R₂₈ so that the relay RL1 closes.

NiCd fault-diagnosis capability

It is easy to spot a bad cell with individual charging. A cell that is suffering dendrite problems and has become stuck will stand out like a sore thumb in a bank of, say, four cells on charge, as the faulty cell will continue charging long after the others have turned themselves off.

Also, it is not difficult to sort out the cells that have "dried out" because their impedance will be higher than usual. Cells charged via the positive side of the a.c. charging circuit need an internal impedance of less than 25ohms to latch the relay, so a quick test by pushing switch S₂ will reveal faulty cells. Cells charged from the negative a.c. line need an impedance of less than 60ohms to latch.

This is not a very stringent test, but it is possible to improve it if required by modifying the base drive to Tr₈. A few diodes or even a zener in series with the base drive resistor will make it more difficult for Tr₈ to turn on with these high-impedance cells.

Practical construction details

A metal case is recommended for housing the unit as it gives good temperature equalisation with the surroundings. The cases I used had no vents but this did not present a problem since the temperature rise with bank of four D-cells on charge is not large.

During development, I found that transients introduced from the mains supply caused IC₁ and IC₄ to turn off and terminate charging before due time. A mains interference filter cured this. Other causes of erratic operation arise from placing the unit in a draught, near a heating source or in a place suffering from water condensation.

The mains transformer used for charging two banks of four D-cells was a 20VA type with two 4.5V secondaries rated at 2.2 amp each (RS 207-122). One 4.5V secondary was used to power the cell-charging circuits and the other was used in series to provide a nominal 9V from which the 6.2V stabilized line was derived. For other cells there are other transformers available from the RS range to suit.

Several methods were tried for attaching the four 1N4148 diodes which form Sensor 1 to the back of the cell contact plate. The easiest method consisted of cutting the diode leads to give an overall length of just over 1cm and then soldering the diodes together in a straight line. They can then be bent into the circular shape shown in Fig. 5. The diode body must be protected from stress damage when doing this by holding the lead at a point near the body with pliers. The contact plate must be removed from the holder for the next step. A small amount of Araldite is put on the plate where the diodes are to be fixed and the diodes held hard against the plate with small crocodile clips until the Araldite is set (heating to about 80°C hastens setting). The lead-out wires can then be soldered on. Some sleeving is recommended over the lead-out wires at the soldered connection to reduce the possibility of breakage due to flexing, as the contact plates moves 1 to 2 cm when cells are put in and out. The diodes can then be covered with a layer of Araldite for protection. Note that when the contact plate is returned to the holder, the raised part of the centre must face to the rear as shown in Fig. 5 otherwise thermal contact will be impaired. The lead-out wires are best led through an exit hole drilled in the rear of the holder.

It is a good idea to test the timer circuit before commissioning the charger. This can be done by omitting IC₃ for the time being and connecting C₅ and C₆ to terminal 3 of IC₂. The buffers Tr₃ to Tr₆ should then close a relay every 2 minutes 44 seconds, and the flashing should give 100 flashes every 64 seconds. The circuit should then be rearranged so that IC₂ is omitted and a jumper lead taken from terminal 10 of IC₂ to terminal 10 of IC₃, which is now in place. Capacitors C₅ and C₆ should be connected to terminal 3 of IC₃, and the RL2 relays should again close every 2 minutes 44 seconds. This assumes two banks of relays, one connected to point A and one to point B. If the timing sequences are not correct, the most probable fault is a damaged i.c.

The internal layout is not critical but the heat-evolving components such as R₆ and the transformer should be kept away from the heat-sensitive components.

Printer buffer

by
Mike Catherwood

Essentially a small microcomputer board with large memory, this printer buffer holds enough text for around twenty A4 pages and has serial and parallel ports. Its hardware was detailed in the May issue — this article discusses software, construction and operation.

Mike Catherwood is Systems Engineering Manager for single-chip microcontroller products with Motorola.

Incoming data is stored sequentially in a type of data structure known as a circular queue or more commonly, circular buffer. It uses two address pointers, one for data input, the other for data output. The input address pointer points to the next free space in the buffer and the output pointer points to the last space vacated.

If the buffer overflows, the input pointer is reset to the first entry point and data continues to be accepted until the input pointer is equal to the output pointer, at which time the buffer is deemed full. In other words, all buffer space relinquished by the output pointer after removing data is available for immediate use. The buffer is considered empty when the output pointer plus one equals the input pointer, Fig. 1.

should it be necessary.

Interrupt handling software for parallel data input is entered following a positive edge on the host data-strobe signal, DS. Similarly, the data-output handler is entered following a positive edge on the printer acknowledge signal, ACK.

To get the ball rolling, the first printer data strobe (output) is forced by executing a software interrupt instruction, SWI. This instruction's entry in the vector jump table will have been set to point to the parallel output service routine during initialization. Although the SWI instruction is essentially intended for use by in-circuit emulators, for example in break-point generation, it is an elegant way to force an interrupt. Note that SWI is not maskable.

Further printer data-strobe pulses are generated automatically as the subsequent printer-acknowledge signal causes the data-output handler to be reentered. The next byte to be sent is then written into the p.i.a. and a further data-strobe pulse is generated by the on-board hand-shake logic.

Similarly, acknowledge pulses to the host are also generated automatically whenever the input p.i.a. port is read.

If the buffer becomes full, the BUSY line is asserted and the buffer-full led lights. Acknowledgement for the last character strobed is not sent until space has become available for the data. The BUSY line is cleared before sending this acknowledgement.

Serial data transfer is performed in a similar way to parallel data transfer apart from the hand-shaking and buffer status differences described in the May issue. Also, the serial-to-serial

mode is unique in as much as the absence of a second serial interface precludes concurrent reception and transmission of characters.

Simple code

Much of the buffer software is straightforward, as can be seen from the sample listing. The two address pointers are BUFIN and BUFOUT. After checking that the buffer is not already full, the program reads the p.i.a., which causes an acknowledge strobe, and stores the acquired data. After being incremented, input pointer BUFIN is checked to

Fig. 1. Circular queue principle, as applied in the printer buffer. All buffer space relinquished by the output pointer after removing data is available for immediate use.

Modular software

The software is interrupt driven and consists of six modules

- initialization
- parallel data in
- parallel data out
- serial data in
- serial data out
- d-ram refresh.

During initialization, a vector jump table is set up in scratch-pad ram for interrupt request, IRQ, and software interrupt, SWI, instructions. The jump address inserted depends on the operating mode. Interrupt vectors for IRQ and SWI point to the jump table and can therefore indirectly enter the appropriate handling routine without the need to poll the interrupt sources. A sign-on message is placed into the buffer by the initialization routine primarily to help with debugging,

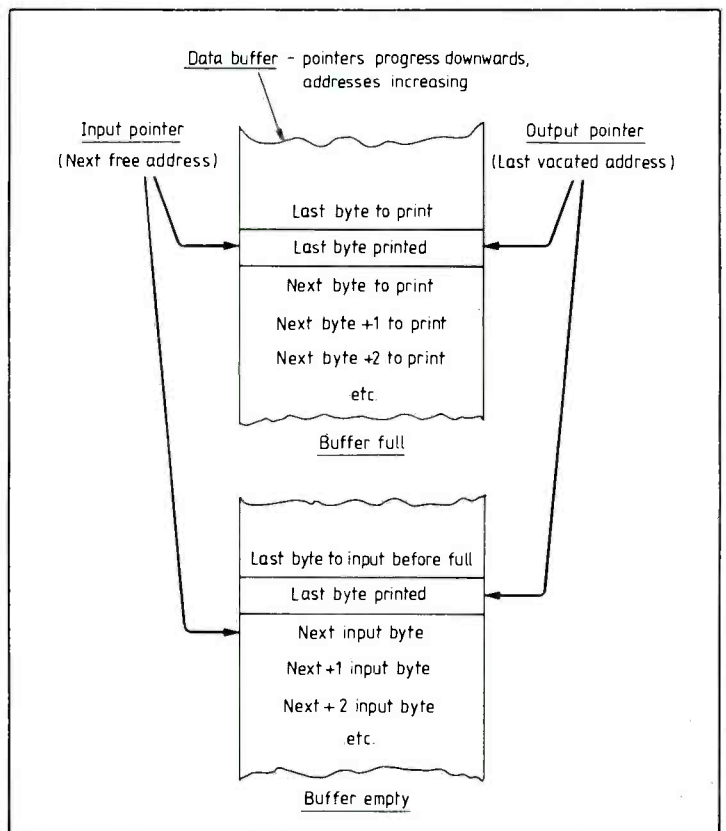

Specification

Two Centronics parallel ports and one serial

Modes

Parallel-to-parallel
Parallel-to-serial
Serial-to-serial
Serial-to-parallel
Serial RS232 port
Transmit/receive using XON/XOFF protocols
300 or 9600 baud
One start, one stop and eight data bits

Parallel Centronics interfaces
Eight-bit parallel
DS/ACK handshaking
Busy and prime lines supported

64K-byte circular buffer
6803 microprocessor/6821 p.i.a.

Abort and multiple copy functions
Error and busy indicators

ensure that it remains within the circular-buffer address range by calling subroutine LIMIT, as shown in the sample listing.

Buffer status byte FLAG is now tested to check whether or not the buffer was previously empty. If the buffer was previously empty then FLAG is cleared and, provided that the buffer is not operating in serial-to-serial mode, the program forces execution of the printer interface interrupt handler through an SWI instruction. This restarts the DS/ACK handshake after the buffer becomes empty.

Hidden benefits

A large part of the code is common to both serial and parallel communication. For example you will find that while the buffer is in parallel-to-serial mode, the parallel printer port is also active although the acknowledge handshake signal is disregarded. Consequently, parallel-to-serial and parallel-to-parallel transfers may be performed simultaneously provided that the parallel printer can receive characters at least as fast as the serial port is sending them to its printer.

Also worthy of a mention is the ability to change the baud setting between reception and transmission of serial data in serial-to-serial mode. This allows you to transfer a file to the buffer at 9600 baud, then leave the buffer to send it to the printer at the much slower rate of 300 baud.

Refreshing of the dynamic ram is carried out by software executing a string of no-operation

instructions (NOP) every 2ms. This increments the address bus 128 times which ensures that every column is refreshed through a RAS-only refresh at least once in 2ms.

An output-compare feature on the MC6803 processor is used to generate the periodic 2ms interrupt. The on-chip timer is a free-running incrementing counter which has an associated output-compare register. When the content of this compare register is equal to that of the timer, an interrupt can occur and/or a port line state can be altered (P21).

In this system, during execution of each d-ram refresh module, the output-compare register is loaded with the value of the timer plus 2ms. Port P21 is set up to fall when this time elapses, pulling the non-maskable interrupt, NMI, low and causing the d-ram refresh handler to be reentered.

Interrupt priority of the normal output-compare function was considered too low for the d-ram refresh module. Using port P21 to activate NMI effectively moved this interrupt priority to the highest position, apart from RESET. Software execution overhead is about 12% for this technique, but that is of no real consequence in this application.

Components and construction

None of the components is critical, but note that the external-clock version of the processor, the MC6803E, is not suitable for this design. A regulated 5V supply capable of delivering 1A is

needed; typical current requirement is around 450mA.

Although construction is straightforward, using a p.c.b. is recommended. High-quality i.c. sockets should be used for the processor, p.i.a., and ideally the d-ram. These few components should be inserted last. To avoid damage to the more expensive components in the kit, and wasting a lot of time tracing faults resulting from the damage, it is advisable to perform continuity, oscillator and supply-rail tests before inserting the processor, p.i.a. or memory devices. Note that on the p.c.b. the 2716 is the other way round in relation to the 6803 and 6821.

Should you decide not to use a p.c.b., remember to keep the 4MHz clock circuit compact and close to the processor. Be generous with supply decoupling, especially around the d-rams.

Finally, be conscious that you are handling mos devices, so at least earth yourself and don't wear a Nylon shirt! To help with any debugging, a sign-on message is sent to the printer immediately after a reset, but not following abort/repeat operations.

There are four operating modes on the printer buffer, determined by the state of Mode 0 and Mode 1 switches S_{3,4} immediately after power-up. These switches, shown on the circuit in the May issue, act as follows.

S ₄	S ₃	Operation
0	0	Serial-to-serial
0	1	Serial-to-parallel
1	0	Parallel-to-serial
1	1	Parallel-to-parallel

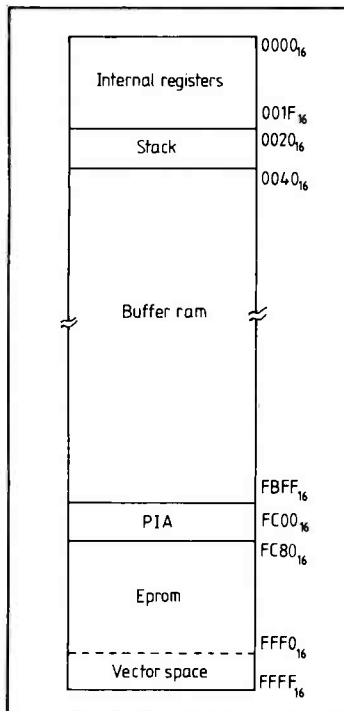

Memory map of the printer buffer, which will be of use if the hardware is to be used in other applications as a microcomputer board with serial and parallel i/o.

```

395 A .....
396 A *
397 A *
398 A *
399 A *
400 A *
401 A .....
402 A FE5B DE2A   IRQ1 LDX   BUFIN      CHECK IF FULL
403 A FE5D 9C26   CPX   BUFOUT
404 A FE5F 260D   BNE   NOTFUL
405 A .....
406 A FE61 9602   LDAA  PORT1      SET BUFFER FULL LED + BUSY LINE
407 A FE63 8A10   ORAA  EBFULL1
408 A FE65 9702   STAA  PORT1
409 A FE67 862E   LDAA  E200101110 DISABLE IRQA
410 A FE69 B7FC01 STAA  CONA
411 A FE6C 2015   BRA   QUIT
412 A .....
413 A FE6E B6FC00 NOTFUL LDAA  REGA      GET DATA,GENERATE ACK -VE EDGE,CLEAR IRQA
414 A FE71 A700   STAA  X
415 A FE73 8D83   BSR   LIMIT     CHECK POINTER
416 A FE75 DF2A   STX   BUFIN     & STORE CORRECTED VALUE
417 A .....
418 A FE77 962E   EMPTYTST LDAA  FLAG      IF PRINTER WAITING FOR NEXT DATA
419 A FE79 2708   BEQ   QUIT      TO BE SENT
420 A FE7B 7F002E CLR   FLAG      THEN CLEAR EMPTY FLAG (BIT7=0)
421 A FE7E 962F   LDAA  MODE      ENSURE NO SWI FOR S-S OPERATION TO PREVENT 1ST
422 A FE80 2701   BEQ   QUIT      CHAR SENT BEING TX IMMEDIATELY.
423 A .....
424 A FE82 3F     SWI
425 A .....
426 A FE83 3B     QUIT RTI
427 A .....

```

Important section of the printer buffer software in assembly language.

Select the mode, connect the necessary cables and power up. The sign-on message should be printed. If not, refer to the Fault-finding section described later. Note that the mode switches are only read once, just after power up.

The abort/repeat key allows you to terminate printing of the current file or reprint the content of the buffer from the first address to the current output pointer, excluding the sign-on message. Momentary operation of the abort key terminates printing of the buffer content, however, for serial printers and printers without a PRIME line, any buffer inside the printer will have to empty before printing can cease.

Multiple copies

Keeping the abort/repeat key pressed for more than a second or so causes printing to abort, provided that it is not already completed, and resets the BUFIN pointer to the start of the user data. The error led lights to indicate this. Subsequent releasing of the key initiates printing of a further copy after a short delay. This may be performed *ad infinitum*.

Serial-to-serial transfer

For serial-to-serial operation, the following procedure must be followed. Set the Rx/Tx switch, S_1 , to Rx, i.e., off. Connect the interface to the host and send the data file. If the file does not fill the buffer, then the XON/XOFF protocol will not need to be implemented in the host.

When the transfer is complete or the buffer-full led is lit, disconnect the host and connect the printer. Change the data rate if necessary and then ensure that the printer is selected and set S_1 to its Tx position. After a short delay, the file will be sent to the printer.

If the buffer-full led was lit, then it will be extinguished when 256 bytes of data have been transmitted. In this case, the rest of the file can be transmitted to the buffer by reconnecting the buffer to the host and changing S_1 back to Rx. Each time that this switch is changed to the Rx state, an XON character is transmitted, to which the host should respond by sending more data.

During the reception of serial data, the error led is used to indicate a communication error,

i.e. a framing or overrun error, or a protocol failure. A communication error is for information only and will not inhibit buffer operation. However, the printer output may have some characters missing since data received incorrectly is not stored by the buffer ram.

A protocol failure can occur as follows. If the buffer ram becomes full, i.e. less than 64 bytes left, the buffer-full led lights and an XOFF character is sent to the host. However, if it is ignored and the host continues to send data, the error led is lit. Subsequent data sent to the buffer will be ignored until the buffer status changes to not full.

Fault finding

These hints should be useful if any debugging proves necessary. Using an oscilloscope, recheck the oscillator and switch off immediately if it is not running. You probably have a short-circuit somewhere around the microprocessor. If the clock is running, check that the E clock and AS are functioning properly. For this, refer to Fig. 3 on page 22 of the May issue.

Check that there is 'sensible' activity on the data and address buses. If not, check the mode-select circuit around P20-22, and the RESET line. Try pulling the RESET line low momentarily and

examine the printer port for activity. Looking at the various chip-enable signals is also a good guide as to what is happening.

A negative-going pulse of about $34\mu\text{s}$ width and 2ms period should be present on pins four and nine of the microprocessor. The falling edge of this pulse is used to initiate the d-ram refresh interrupt module. Common causes of problems in designs like this are solder bridges and/or static damage to devices, so careful construction is essential.

Conclusion

This design is a typical example of an application which can benefit from using a microprocessor. Had this buffer been destined for volume production, then the manufacturer would have taken advantage of the internal rom available in the MC6801 to reduce overall cost and physical size with the bonus of increased reliability. Field trials using an eeprom version of the processor, the MC68701, may have been performed before committing the code to a mask.

Even though a rom version is not available for the printer buffer, I hope that this project has given an insight into the features and capabilities of a typical single-chip processor, and provided a useful computer peripheral.

Kit and expandable p.c.b. under £100

Printer buffer kits, excluding p.c.b. and case but including D connector and programmed eeprom are £70.74 each (postage and packing £1.50), excluding v.a.t., from Technomatic Ltd., 17 Burnley Road, London NW10 1ED.

Silk-screened plated-through p.c.bs for the buffer are £14 each including vat and UK postage or overseas postage from Combe Martin Electronics, King Street, Combe Martin, North Devon EX34 0AD. These Euro-card size boards include holes for tapping essential processor lines so that the hardware design may be used in other applications. Hexadecimal listings of the software can be obtained by sending an A4 sized s.a.e. to our editorial offices at Quadrant House, The Quadrant, Sutton, Surrey, SM2 5AS. If you require the assembly-language list, please include a cheque or postal order for £2 to cover part of the copying cost.

The eeprom shown in the May issue printer-buffer circuit diagram is 250ns or faster.

The complete printer buffer, shown here, can be built for under £100.

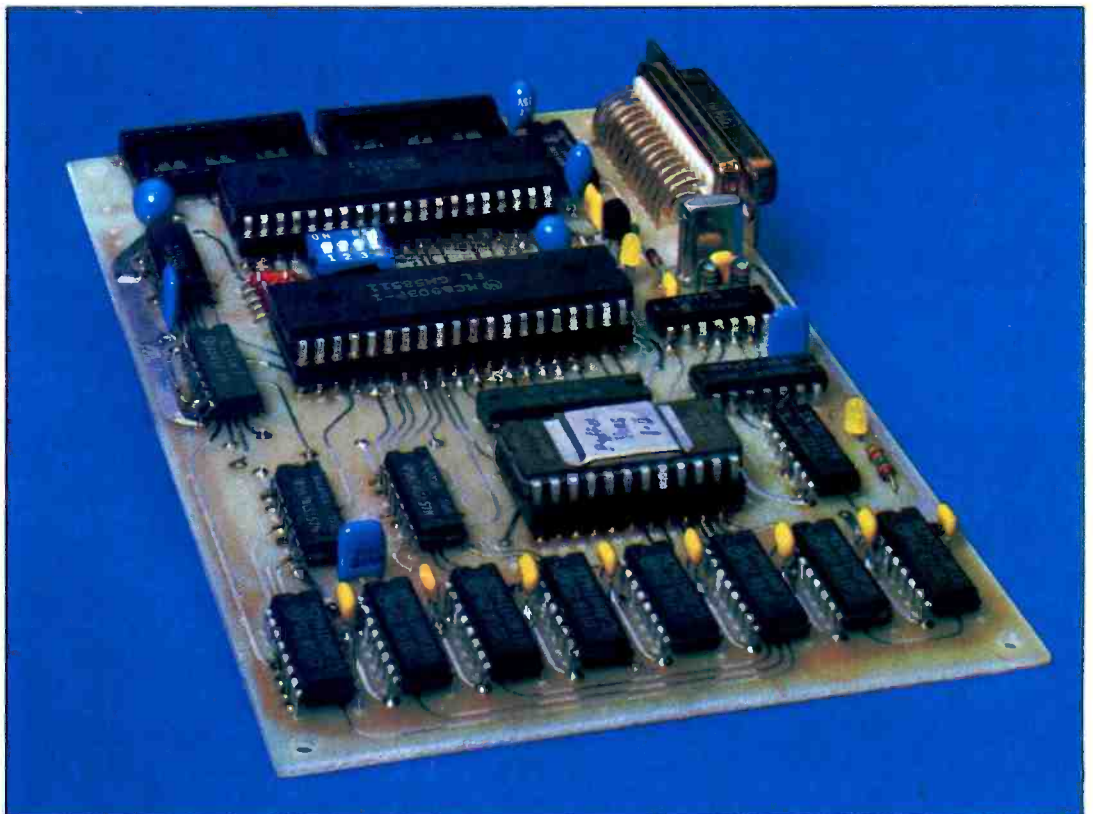

IQD- The world shrinkers

IQD

IQD Limited
North Street, Crewkerne
Somerset TA18 7AR, England

Telephone: (0460) 74433
Facsimile (0460) 72578
Telex: 46283

IQD's state-of-the-art DTMF signalling technology now brings you Smartpatch 5700, which allows you to dial direct into the telephone network while you are on the move, and to accept incoming calls regardless of your location.

Smartpatch 5700 is the only intelligent telecommunications interconnect system with British Telecom approval.

Smartpatch 5700 complements IQD's extensive range of DTMF products, which includes the Codepad, Micropad and Selcall devices.

IQD keeps you in touch.

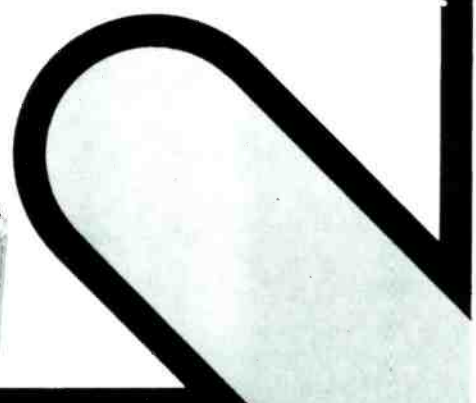
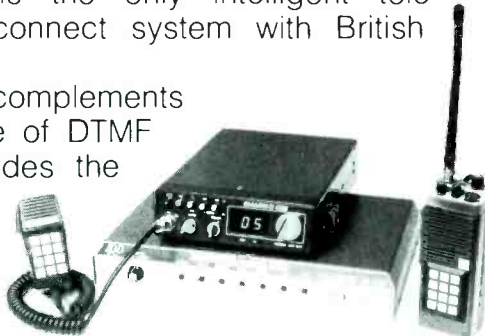

IQD COMMUNICATION DEVICES

CIRCLE 14 FOR FURTHER DETAILS.

**AFFORDABLE ACCURACY
QUALITY MULTIMETERS FROM ARMON**

ANALOGUE

HM-102BZ
10ADC Range, 20KΩ/VDC, Buzzer, Battery Test Scale **£13.00**
19 measuring ranges

HM-102R
Low end voltage & current ranges, Jack for Audio o/p Voltages **£11.00**
20 measuring ranges

HM-1015
Rugged, Pocket sized meter, for general purpose use **£7.50**
16 measuring ranges
Battery, Test Leads and Manual included with each model.

DIGITAL

HC-6010 0.15% Accuracy, Standard Model **£33.50**
HC-5010T 0.125% Accuracy, TR Test Facility **£39.50**

All models have full functions and ranges and feature:

- 3 1/2 digit 0.5" LED display
- Low battery indication
- Auto zero & Auto polarity
- ABS Plastic Casing & Triit Stand
- DC AC 10amp Range
- Overload Protection on all ranges.
- Battery, Spare Fuse, Test Leads and Manual

FULL DETAILS ON APPLICATION FROM:-
ARMON ELECTRONICS LTD
DEPT A HERON HOUSE, 109 WEMBLEY HILL ROAD, WEMBLEY, MIDDLESEX HA9 8AG
TELEPHONE 01-902 4321 TELEX 923965
PLEASE ADD 15% to your order for VAT, P.P Free of charge. Payment by cheque with order
Offer applicable to mainland UK only

Trade enquiries invited Please allow 28 days for delivery

HM 102 BZ
£13.00

HM 1015
£7.50

HC 5010
0.125% accuracy
£36.50
rotary

HC 7030
0.1% accuracy
£39.50
push button

CIRCLE 44 FOR FURTHER DETAILS.

10 OUTLET DISTRIBUTION AMPLIFIER 3

A compact mains-powered unit with one balanced input and ten a.c. and d.c. isolated floating line outputs.

- ★ Exemplary R.F. breakthrough specifications giving trouble-free operation in close proximity to radio telephones and links
- ★ Excellent figures for noise, THD, static and dynamic IMD
- ★ Any desired number of outlets may be provided at microphone level to suit certain video and audio recorders used at press conferences
- ★ Meets IEC65-2, BS415 safety and I.B.A. 'signal path' requirements

Also available as a kit of parts less the case and all XLR connectors for one or ten outlets.

Broadcast: Monitor Receiver 150KHz-30MHz ★ Stereo Disc Amplifier 3 and 4 ★ Moving Coil Preamplifier ★ Illuminated PPM Boxes ★ PPM Drive Boards and Ernest Turner Movements ★ Stabilizer and Frequency Shifter Boards ★ Peak Deviation Meter ★ Programme and Deviation Chart Recorders ★ PPM5 20 pin DIL hybrid ★ Stereo Microphone Amplifier ★ Advanced Active Aerial

SURREY ELECTRONICS LIMITED
The Forge, Lucks Green
Cranleigh, Surrey GU6 7BG
Tel: 0483 275997

METER PROBLEMS?

137 Standard Ranges in a variety of sizes and stylings available for 10-14 days delivery. Other Ranges and special scales can be made to order.

Full information from:
HARRIS ELECTRONICS (London)
138 GRAY'S INN ROAD, W.C.1 Phone: 01-837 7937
Telex: 892301

CIRCLE 5 FOR FURTHER DETAILS.

ELECTRONICS & WIRELESS WORLD JULY 1985

Developments in tv components

High-performance i.cs and new circuit techniques promise better performance and extra features. Richard Lambley reports on a big range of new devices from Mullard.

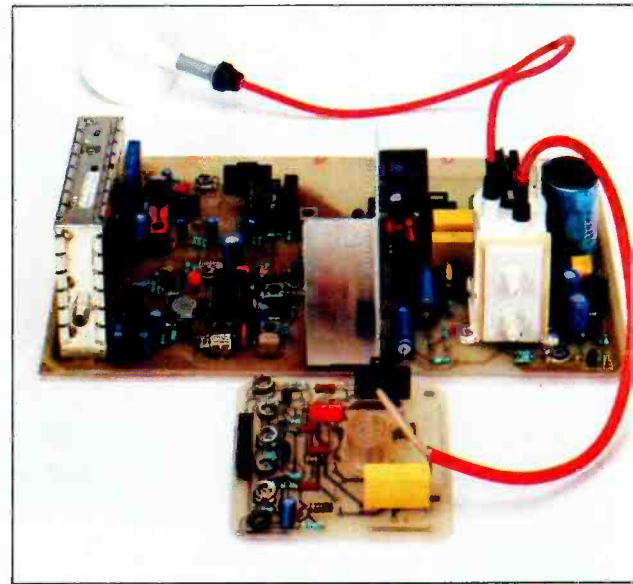

Shed a tear for the glass delay-line: soon it may be as obsolete in colour tv sets as the top-cap pentode.

Almost two decades have passed since the start of regular colour broadcasts in Britain and in that time colour receiver design has changed radically. First came the all-solid-state chassis, then the integrated circuit and the pre-aligned picture tube with built-in deflection coils. Now one of the last familiar landmarks of the early sets is likely to disappear with the introduction by Mullard of a delay-line on a chip.

The conventional ultrasonic delay-line is the bulkiest component in present-day colour decoders and one of the most expensive. At one time it was considered so difficult to mass-produce that it almost prevented the Pal system from being adopted.

Mullard's replacement for it, now being prepared in sample quantities at Southampton, is an analogue charge-coupled delay-line in an 18-pin d.i.l. package. The TDA8450 incorporates all the delay lines and filters for a Pal colour decoder. With the addition of some integrated gyrator filters it can also improve performance of Secam decoders. It has no a-to-d or d-to-a converters, need not be shielded from interference from clock signals and it consumes little power.

The new chip is one of a series of developments by Mullard aimed at keeping pace with changes in the market for tv sets.

In their view, with the advent of new video sources such as cable and satellite tv, video players and home computers, the

market is demanding an increasing diversity of tv receivers. Although the demand for basic low-cost sets is certain to continue, today's top-of-the-market receiver chassis may soon give way to a 'features tv' — an expandable system built around a basic display unit to which the designer can add extras such as multi-standard colour decoding, synthesized tuning, video memory, high-performance sound and teletext, or interfaces for peripheral devices such as microcomputers and modems.

Besides providing the improved performance now demanded by set-makers (and by

some of their customers) Mullard's new i.cs are intended to help hold manufacturing costs down; and not just through being shrunk on to ever-smaller pieces of silicon.

A typical modern colour tv has about 30 internal controls needing adjustment on the production line. The horizontal and vertical timebases, the vision i.f. and sound modules, the colour decoder and the picture geometry all take time to set up — and can account for up to a fifth of the total manufacturing time.

Many of these costly adjustments can be eliminated simply by integration on a larger scale.

Complete economy tv chassis.

A Pal decoder with integrated filters and analogue delay-lines. The delay-lines handle colour-difference information as baseband signals and not as 4.43MHz chrominance sidebands.

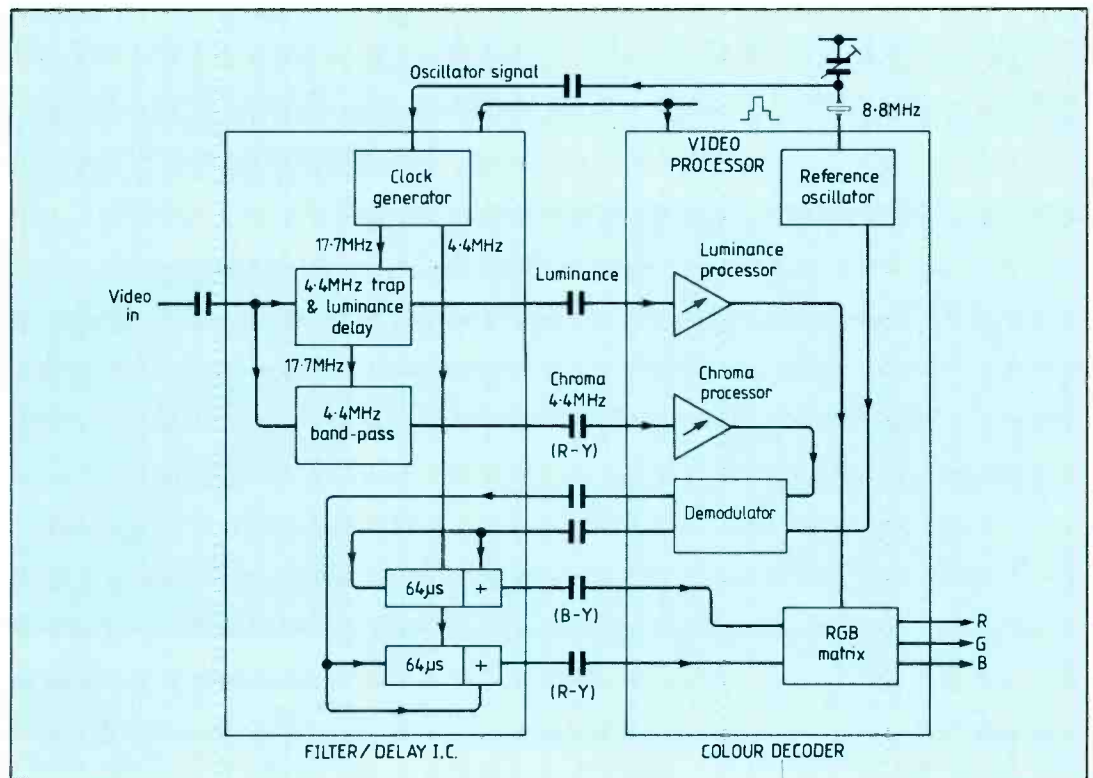

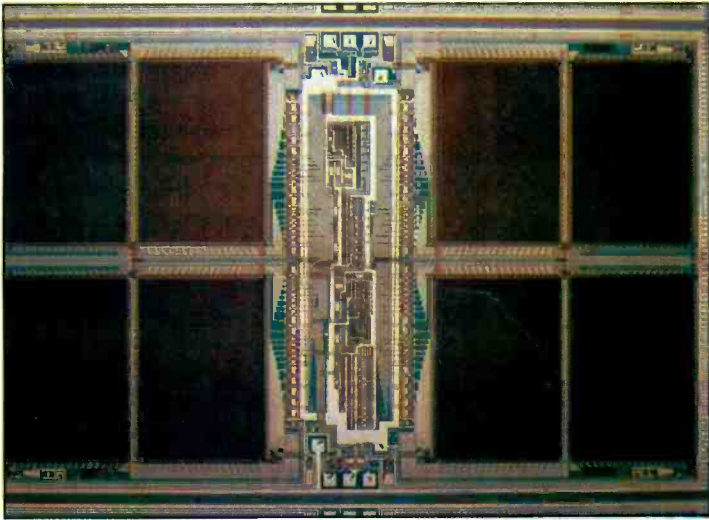

Digital c.c.d. memory i.c., 320K by 1 bit, for Mullard's 'features tv'. The eight 40K sections run at one-eighth of the input data rate; multiplexing and demultiplexing elements can be seen in the middle. A bank of seven such chips makes up a complete field memory (see diagrams opposite).

Others Mullard plan to deal with by basing the design of future sets on computer techniques.

Some headway has already been made in this direction by the introduction of digital tuning, which at little cost to the manufacturer has given the set buyer better pictures and improved reliability plus the possibility of remote control.

But with the new i.c. designs it will be possible to cut the number of adjustments to just seven. (This figure is for a receiver fitted with a stereo/dual sound option for the German market: for a British set the total will be lower still.)

In addition, the use of computer techniques brings the possibility of automatic alignment and quality monitoring — without recourse to devices such as automatic screwdrivers.

Automatic alignment

Automation in tv factories has so far been confined mainly to the automatic assembly of components on the p.c.b. Mullard propose to take it a stage further through the concept of a computer-controlled tv.

The idea behind this is an internal communications link within the set — the inter-i.c. bus or I²C. This data bus acts as the set's spinal cord, linking the various analogue processing blocks and carrying control signals and data from one to another.

The bus saves some p.c.b. space by reducing the number of interconnections and the amount of wiring. But it does much more: it makes it possible to digitize most preset adjustments, transforming them into data values to be inserted on the production line

The Philips I²C bus

The inter-i.c. bus (I²C bus) is one of two bus structures designed by Philips to meet the growing need to interconnect electronic equipment.

In the hierarchy of computer networks I³C is about as local as local can be. Intended for exchanging control signals and data between different integrated circuits within the same box, it has a bidirectional serial data format and a two-wire structure.

Maximum possible length of the bus depends on the drive capability of bus devices, which is about 400pF: in practice this means a limit of 4m. A bus can support more than one master

device (a master is a device which can initiate a data transfer) and its protocols settle any contention between masters which start simultaneously.

Each unit on the bus has an open-drain or open-collector output to both the clock wire (SCL) and the data wire (SDA). A pull-up resistor connects each wire to the positive supply voltage, creating a wired-and arrangement. When a device pulls the line low it will override any 'high' outputs from the others. All devices have input buffers connected to their outputs and so can read the status of the bus. Signal levels are t.t.l. and cmos compatible.

There is no fixed data rate, but speeds of up to 100kbit/s are possible. Data is sent in 8-bit bytes, each one answered by an acknowledgement from the receiving device, which pulls down the data wire during the ninth bit period.

Peripheral devices available for the bus include ram, non-volatile ram, l.c.d. drivers, a-to-d and I²C-to-parallel converters as well as many dedicated tv i.c.s. To drive the bus, Mullard offer two families of microcontrollers with serial i/o.

Philips' other bus structure, the digital data bus (or D²B) is for linking physically separate items of equipment — home entertain-

ment units for example. Thus a user might be able to command a video recorder, a tv and an audio system through a single remote control unit.

In contrast to the I²C, where the designer must decide in advance what devices will be connected to the bus, the D²B allows the set-up to be altered freely. It can handle up to 50 units spread over a distance of 150m.

The D² bus is essentially a single-wire system, but it is implemented in the form of a balanced pair to overcome possible noise problems on long wiring runs. Maximum data transfer rate is 8000 characters per second.

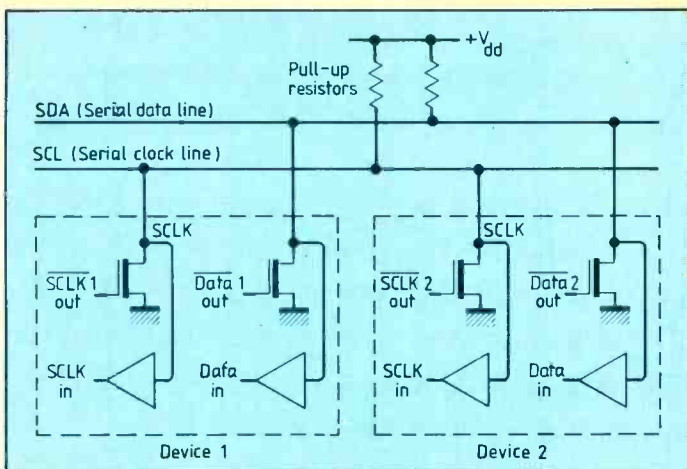

Open drain configuration of inter-i.c. bus circuits. The bus has a bidirectional two-wire structure; maximum possible length is about 4m. Multiple data rates are allowed.

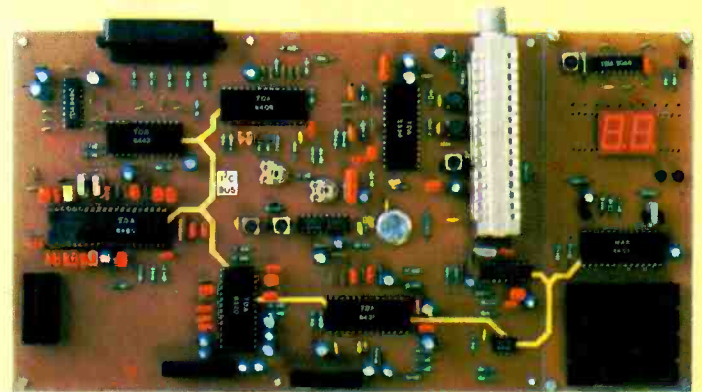

Full-specification tv circuit: the course of the inter-i.c. bus is marked by yellow tape. In place of the familiar glass delay-line is the TDA8450 i.c. (top left), an analogue c.c.d. i.c. which embodies all the filters and delay lines needed in a Pal decoder.

and held in non-volatile memory. And it allows automatic analysis and fault testing of individual modules or complete receivers.

Mullard have shown one such set, an experimental one which has fully automatic control of picture geometry and colour balance. The equipment needed to adjust it consists of a microcomputer, a GPIB-compatible signal generator and a grid of light sensors.

The grid is fitted over the screen, and the equipment transmits sequence of video waveforms, making software adjustments to the tv set until the response detected by the sensors is the correct one. The white-point is programmed in by a similar procedure and the corresponding data is stored in the set's internal memory.

This test set-up is relatively low in cost: an important point, since a similar rig with editing software would be needed in the service technician's workshop. Receivers under scrutiny there could be switched into their service mode by a special infra-red command not available from the customer's remote control unit.

Why have Mullard not followed the all-digital trail blazed by IIT with their Digivision sets? "Analogue is very difficult to beat", replies Rob Green of Mullard. He points out that the tv signal arrives from the aerial in analogue form and must be presented as analogue signals to the picture tube and loudspeaker. Any digital processing in between is likely to introduce quality impairments and must be justified by other benefits.

Memory features

One area where digital processing can help is in the introduction of memory-based features. Adding a digital frame store to the basic set can provide the manufacturer with many new selling points.

A simple example might be the set which, at the touch of a button, could freeze the current screen to enable the viewer to copy down an address or a recipe. Another idea might be to offer a split-screen display, for the viewer who cannot decide which football match to watch.

But one most effective use of memory is in improving the apparent quality of sub-standard programme sources. Many home video recorders give noisy pictures; but if the incoming picture

is recirculated through a digital field-store and the delayed signal combined with the direct signal in suitable proportions, the picture itself is reinforced while the noise (being random) tends to cancel out. The degree of mixing needs to be controlled dynamically, since with rapidly-changing pictures the result would otherwise be a blur. But an experimental system demonstrated by Mullard using programme material from a video disc showed a very worthwhile improvement in signal-to-noise ratio. It also gave a noticeable reduction in the cross-colour interference caused by poor separation of luminance and chrominance components.

BBC television engineers have used the same principle for some years to enhance their network pictures. But the new delay-line technology will offer the same facility to the home user, at a fraction of the price professionals have been paying.

In the teletext mode, the memory can store up to 250 pages, to which the user has immediate access. Mullard's demonstration system can recall any page within a second.

Teletext enhancements

The UK teletext system (now widely known as World System Teletext) is a hierarchy of five downwards-compatible standards. The present broadcast service is the basic Level 1 version.

The higher levels promise advanced features such as dynamically re-definable character sets, high resolution graphics, transmission of still colour photographs and so on.

But such developments are unlikely to render today's receivers obsolete yet, since they carry a heavy cost in transmission time and require capacity which might be used more effectively by Level 1 pages. Mullard have already announced a Level 3 decoder; nevertheless, they believe that the present Level 1 standard still has plenty of untapped potential.

Sales of tv sets in Britain are running at about 2.4 million per year. But despite a steady fall in the price of teletext components — a teletext card adds only £60 or so to the retail price of a set — deliveries of teletext sets amount to only 700 000 per year. And the growth in teletext sales seems to have levelled out.

One explanation for this might be that a sizable proportion of

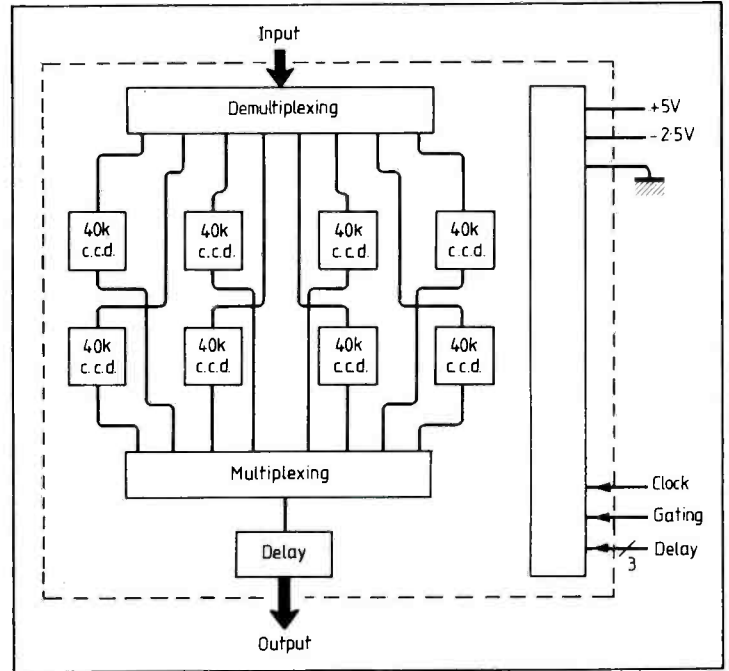

viewing public prefers to avoid information in written form. It is certainly true, though, that many find the broadcast teletext services slow and awkward to use.

Page access time is the biggest problem: it can take up to 15s for a chosen page to appear and viewers undoubtedly find the delay frustrating. But another difficulty for users is in finding their way about within the teletext magazines: teletext lacks the tree structure of viewdata systems such as Prestel, where each page displays a choice of escape-routes to other pages.

To deal with this omission, Mullard have proposed a simple improvement which they are hoping the broadcasters will want to adopt.

The idea is to add to each teletext page an extra line which would provide such routing information. This line would carry up to four brief labels indicating pages the user might want next:

For the tv set with memory features: this 320K-bit delay-line chip is organized internally as eight parallel charge-coupled delay sections. Each runs at one-eighth of the data input frequency, reducing significantly both clock-rate and power dissipation.

The complete digital field memory consists of seven c.c.d. chips working in parallel. The baseband input signal (in YUV form) is scanned sequentially by a multiplexer: four samples of the luminance (Y) signal emerge for every pair of colour difference (U and V) samples.

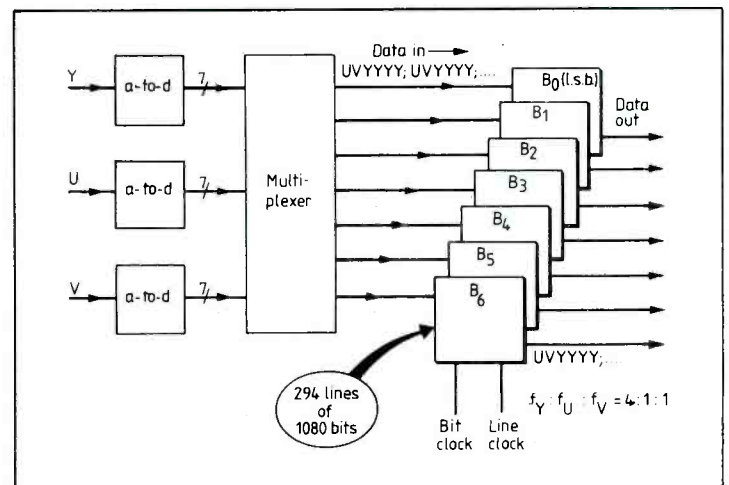

'News headlines', 'Weather', 'TV' and 'Sport', for example. Each label would be colour-coded to match a corresponding button on the user's hand-held control unit — which through a single key-press would give immediate access to those pages.

This page-linking feature is made possible by 'ghost rows', spare lines in the existing teletext transmission format. Each line (or packet) of transmitted teletext data carries an address specifying the region of the screen where it is to be displayed — blank rows do not have to be transmitted. Up to 32 different addresses are possible, though the teletext page consists of only 24 lines. So eight spare row-addresses are available for other purposes.

Mullard suggest using packet 25 to carry the new page labels and packet 27 for the numbers of the corresponding pages. Then, when the user calls for, say, page 102, the decoder receives advance warning as that page comes in of pages he is likely to want next. And if the decoder has a multi-page teletext memory, it can grab those pages while the user is still reading page 102 and

will have them ready for immediate display when one of the coloured buttons is pressed.

Page linking is one of the features incorporated in the company's Euro-CCT decoder design, which is based on two new special-function chips plus an eight-page memory. Direct page selection in the normal way is still available. But the page number can now include 'don't care' digits, a feature which, among other things, can help overcome the problem of finding an index. For reasons which only the broadcasters understand, the four British teletext services have been unable to harmonize their choice of page for their basic indexes: to the bafflement of many viewers, these appear on pages 100, 200, 100 and 400 respectively. Yet with the new decoder, pressing -00 would find any of them — and the various sub-indexes too.

Other features of the Euro-CCT decoder include a mask-programmed character generator, which can display text in up to three different languages. The correct one is selected automatically by control bits in the page header. This might be attractive to the viewer when reception of foreign services by cable and satellite becomes more common.

Each character in the display is built up on a 12 dots by 10 grid, giving a major improvement in appearance over earlier 5×9 types.

Another detail of interest to potential cable subscribers is that the data acquisition period can be controlled in software: the cable operator can select either the normal field flyback period (lines 6 to 22) or the entire field, enabling him to offer high-capacity full-field teletext services.

Control of the decoder is via the inter-i.c. bus (I²C).

Other features

Improved sync processing: the TDA2579 includes a circuit which measures the noise at the middle of the horizontal sync pulses and so can recognise whether the programme is coming from a tv transmitter or a home video recorder. Domestic v.c.r.s have poor speed stability and can give jittery pictures: the new chip copes by altering automatically the time-constant of the horizontal phase detector. The same i.c. provides automatic selection of 50Hz or 60Hz field rate, eliminat-

ing the need for manual adjustment.

Better colour: the TDA4560, already fitted to some sets for the West German market, helps to eliminate picture defects at the boundaries between areas of different colour. The i.c. has a delay-line which it switches in and out to increase the slope of colour transients. To compensate for the resulting variations in chrominance delay, it includes a luminance delay-line constructed with gyrator cells.

Improved sound: the familiar intercarrier sound demodulator, which derives the sound from the video detector as an f.m. subcarrier on 5.5MHz or 6MHz, has several shortcomings. Its performance is inevitably compromised by the conflicting requirements of picture and sound; consequently defects such as intercarrier buzz can arise and the audio signal-to-noise ratio has to be sacrificed. An alternative approach, the quasi-split sound system (QSS), offers the promise of real hi-fi performance by providing separate i.f. channels for vision and sound. The intercarrier technique is still used in the sound channel, but the filters can now be optimized for it: abandoning intercarrier altogether, say Mullard, would cause problems in the tuner.

Multi-standard reception: in Europe languages often spread across frontiers even though tv transmission standards do not. And in many countries there is a brisk demand for multi-standard sets. Mullard offer a colour decoder i.c., TDA4555, which automatically selects the standard from Pal, Secam, NTSC-3.58MHz or NTSC-4.43MHz by sequentially scanning the input signal. Another i.c., TDA3568, is an high-performance NTSC decoder which uses comb filtering to separate the chrominance and luminance signals and to suppress the colour subcarrier. The luminance channel has a hi-peaker controlled by an external potentiometer.

In the sound department, Mullard have a three-chip processor which can handle all current European transmission standards, including the German dual-subcarrier stereo sound system. The sound i.f. chip TDA8401 also has a synchronous demodulator for the French a.m. sound standard.



This automatic alignment system cuts out costly factory adjustments. A grid of light sensors over the screen responds to a sequence of test waveforms generated by a microcomputer system. The equipment handles picture-geometry and white-point adjustments and it programmes the appropriate control settings into the tv set's internal microcomputer.

Eprom programmer software for the BBC microcomputer

by Norman Sargent

On its own, John Adams' eprom programmer copies many different types of eprom but with software such as this for the BBC model B microcomputer, eproms can also be written from or read to a disc file with ease. Eprom data on disc can be manipulated in ram, which gives a lot more scope for experimentation.

The SC84 eprom programmer* and a BBC model B microcomputer form a versatile system for reading, writing and experimenting with most current eproms. Interfacing is easy; the programmer connects to the BBC microcomputer through the RS232/423 serial port.

This control software greatly simplifies driving of the eprom programmer by presenting two menus, one to select eprom type and the second to select the required function. These functions include reading from either programmer socket to disc, transferring data between memory and disc, programming from disc or master, erasure verifying and printing. Data check sums are displayed and drive-select and catalogue facilities are menu selectable.

Although the computer only accepts 2764 and 27128 eproms in its sideways rom sockets, the programming system will read, write and commit to file the larger 32 and 64Kbyte eproms accommodated in the programmer design. Microprocessors in the 8080 series with built-in eprom are allowed for and special flags and messages are included for user guidance.

* John Adams' eprom copier/programmer for 2716, 32, 64, 128, 256 and 512 eproms and 8741/42/48/49 single-chip microprocessors was described in the November, December 1984 and February 1985 issues.

Details of the adaptor for programming these microprocessors were given in the second article describing the programmer.

Data read from all eproms up to 16Kbyte can be transferred to memory for inspection and/or editing using memory manipulation routines in utility roms like Disk-Doctor or Toolstar, and re-saved to a disc file for programming when necessary. An MDUMP function is included in the command list to allow running of Toolstar's memory dump routine. This command can be changed to suit your needs.

I have based my software on John Adams' original suggestions for computer control on page 51 of the December 1984 issue. Most of the program is written in Basic, with machine code calls to access the RS423 serial port and extract the eight-byte check-sum code sent back from the programmer. Using Basic is no real handicap, since the BBC microcomputer is very fast, and it has the advantage that the program can be easily modified.

Notorious GOTOs are used only inside procedures in conjunction with steering flags, and in the generally accepted ON GOTO used for menu selection, to help keep the coding compact. Character string (CHR\$) colour control codes are set as variables for readability and again, to save

memory.

Initially, the display prompts you to enter a letter to select an eprom from the 'Eprom list'; this selection remains in force during all subsequent command selections until the eprom list is reentered or the program is terminated. The top two thirds of the second menu display is dedicated to the 'Command list'. A selected command is highlighted during execution. The remaining display area consists of seven lines.

— Elapsed time in minutes and seconds (and adaptor message)

- Message line (including error address on error)
- Master sum check
- Slave sum check
- File name input and counter
- Counter limit
- 'New command' prompt

A typical time for programming a 2764 eprom from a master eprom with a data sumcheck of DCC7B and the programmer in stand-alone mode was 1min 35s. With computer control using an identical disc file, time taken was 2min 8s. As the programming cycle is data dependent, these figures are only a rough guide.



```

10 REM BBC Basic program to drive
20 REM SCB4 eeprom programmer
30 REM 19-5-1985 * (C) NRWS G4XWK
40 REM
50 MODE7:HIMEM=&3AFF:CLOSE#0:NZ=7
60 DIM code% 110:oscli=&FFF7
70 DIM epsave 20,fnm NZ,drv 6
80 A$="ABCDEFGHIJKL":C$="USE WITH 40
pin ADAPTOR IN SLAVE SKT":D$="2":E$="NOT
POSSIBLE"
90 PROCdrive_no(-1):sp$=STRING$(34,"
")
100 r$=CHR$129:g$=CHR$130:y$=CHR$131
110 b$=CHR$132:c$=CHR$134:w$=CHR$135
120 f$=CHR$136:uf$=CHR$137:bg$=CHR$157
130 B$=y$+"Sumcheck being computed"
140 REM Disable cursor, auto-repeat
150 *FX4,1
160 *FX11,0
170 ON ERROR CLS:VDU7:REPORT:PRINT r$
Any key to continue":IFGET:RUN
180 REM 9600 baud; escape disabled
190 *FX7,7
200 *FX8,7
210 *FX200,1
220 *KEY10 OLD:MRUN:M
230 REM program start
240 VDU28,0,24,39,0:*FX202,32
250 PROCheading(c$+"E&W&W EFROM PROGRAM
MER")
260 PRINTTAB(14,4)"EFROM LIST"
270 RESTORE 500:FOR I%=65 TO 76:READ Z
$,Z$:PRINTTAB(13)y$CHR$I%w$="-c$Z$:NEXT
280 PRINTTAB(0,24)b$bg$c$Select EFROM
type "":REPEAT Z$=GET$:UNTIL INSTR(A$,
Z$)
290 IF Z$="L" PROCrestore:END
300 MZ=0:RESTORE 500:FOR Y%=1 TO ASCZ$
-64:READ type$,MZ:NEXT
310 b%=0:y%=y%-2:IF y%>8 y%=y%+1:IF y%
>9 b%=-1
320 PROCmcode:PROCheading(type$)
330 VDU28,0,24,39,2:PRINTTAB(0,0)SPC11
7TAB(13,1)"COMMAND LIST"
340 RESTORE 510:PROCmenu
350 flag=0:PRINTz$;:PROCchngcol:PRINT
TAB(7,z+2)w$
360 ON z% GOT0240,370,380,390,400,410,
420,430,440,450,460,470
370 PROCeprom_comp(2):G0T0330
380 PROCeprom_comp(3):G0T0330
390 PROCmem_disc:G0T0330
400 PROCdisc_mem:G0T0330
410 PROCcomp_slave:G0T0330
420 PROCmaster_slave:G0T0330
430 PROCsumcheck:G0T0330
440 PROClist:G0T0330
450 PROCdrive_no(0):G0T0330
460 PROCcat:G0T0330
470 PROCrestore:PRINTTAB(0,21)b$bg$c$
ESCAPE to edit"TAB(0,22)b$bg$c$BREAK
to exit":VDU28,0,21,39,2
480 *MDUMF3B00
490 END
500 DATA2716,2047,2732,4095,2732A,4095
,2764,8191,2764A,8191,27128,16383,27128A
,16383,27256,32767,27512,65535,8741/8,10
23,8742/9,2047,Basic,0
510 DATA Eprom select (and exit),Read m
aster to disc,Read slave to disc,Save m
emory to disc,Read disc to memory,Progra
m slave from disc
520 DATA Program slave from master,Sum
check/erase verify,List to printer from
master,Data drive no.,*CAT ...
,*MDUMF 3B00
530 :
540 DEF PROCrestore
550 CLS:*FX12
560 *FX4
570 *FX200
580 *DRIVE 0
590 ENDPROC
600 :
610 DEF PROCdrive_no(flag)
620 IF flag=-1 G0T0640
630 VDU28,0,24,39,18:CLS:PRINTTAB(0,2)
y$"Data storage drive no (0/1/2/3)":;:RE
PEAT D$=GET$:UNTIL INSTR("0123",D$)
640 *drv="DRIVE"+D$
650 X%=drv MOD256:Y%=drv DIV256:CALLos
cli
660 CLS:ENDPROC
670 :
680 DEF PROCchngcol
690 FOR I%=3 TO 14:PRINTTAB(7,I%)CHR$I
33:NEXT:ENDPROC
700 :
710 DEF PROCheading(z$)
720 CLS:FOR I%=0 TO 1:PRINTTAB(7,I%)CHR$I
16:SPC(16-LEN(z$)/2):z$:NEXT:ENDPROC
730 :
740 DEF PROCmenu
750 FOR I%=65 TO 76:READ Z$:PRINTTAB(3
)y$CHR$I%;w$="-c$Z$SPC(31-LENZ$):NEXT:PR
INTTAB(23,12)"(D$)"
760 PRINTTAB(0,15)CHR$14BSTRING$(39,"
"):IF b%<0 PRINTTAB(3,16)C$
770 PRINTTAB(0,22)b$bg$c$COMMAND:"y$;
:REPEAT:z$=GET$
780 UNTIL INSTR(A$,z$):z%=ASCZ$-64
790 ENDPROC
800 :
810 DEF PROCeprom_comp(t%)
820 VDU28,0,23,39,18:IF b%<0 AND t%=2:
VDU7:PRINTTAB(13,1)r$E$:G0T0890 ELSE PRO
Cskt(t%)
830 PROCinput("W"):IF Z=-1 THEN CLS:E
NDPROC
840 VDU23,1,0;0;0;0:PRINTTAB(20,4)SPC
(19)TAB(25,4)w$Count:"g$TAB(20,5)"(End
count):"c$:M%
850 ?%I%=OPENOUT($fnm):PROCsetEP(y%,t%
)
860 LZ=0:FORI%=0 TOM%:CALLget1:PTRW?%I
Z=I%:BPUT?%I%,?%7A:LZ=LZ+?%7A:PRINT TAB
(33,4):I%:NEXT
870 PRINTTAB(23,3)"Sumcheck:"g$;~LZ
880 CLOSE#0:VDU23,1,1;0;0;0;
890 PROCprompt:ENDPROC
900 :
910 DEF PROCdisc_mem
920 VDU28,0,24,39,18:PRINTTAB(0,6)b$bg
$TAB(3,6)sp$;
930 IF M%>16383 VDU7:PRINT TAB(7,1)r$
NOT ENOUGH MEMORY-16k MAX":G0T0970
940 PROCinput("R"):IF Z=-1 CLS:ENDPROC
950 PROCdiscacs("LOAD ",$fnm,"")
960 PROCmemsmck
970 PROCprompt:ENDPROC
980 :
990 DEF PROCmem_disc
1000 VDU28,0,24,39,18:PRINTTAB(0,6)b$bg
$TAB(3,6)sp$;
1010 IF M%>16383 VDU7:PRINTTAB(9,1)r$W
RONG EPROM SELECTED":G0T0 1040
1020 PROCinput("W"):IF Z=-1 CLS:ENDPROC
1030 PROCdiscacs("SAVE ",$fnm,""+5TR$~
(MZ+1))
1040 PROCprompt:ENDPROC
1050 :
1060 DEF PROCdiscacs(z1$,z2$,b1$)
1070 *epsave=z1$+z2$+" 3B00"+b1$
1080 X%=epsave MOD256:Y%=epsave DIV256:
CALLoscli
1090 ENDPROC
1100 :
1110 DEF PROCskt(a%)
1120 IF a%=2 PRINTTAB(1,1)y$Insert "ty
pe$" into"w$MASTER"y$for reading":ENDP
ROC
1130 IF a%=3 PRINTTAB(2,1)y$Insert "ty
pe$" into"w$SLAVE"y$for reading":ENDP
ROC
1140 IF a%=4 PRINTTAB(7,1)y$Insert bot
h "type$" eproms":ENDPROC
1150 IF a%=5 PRINTTAB(5,1)y$Insert bla
nk "type$" into"w$SLAVE":ENDPROC
1160 :
1170 DEF PROCmaster_slave
1180 flag=-1:VDU28,0,24,39,18:IF b%<0 V
DU7:PRINTTAB(13,1)r$E$:PROCprompt:ENDP
ROC ELSE PROCskt(4)
1190 PRINTTAB(0,6)b$bg$sp$TAB(3,6)y$P"
c$"to program "":REPEAT:Z=GET:UNTIL Z=B
0 OR Z=13:IF Z=13 CLS:ENDPROC
1200 PRINTTAB(8,1)y$PROGRAMMING RUNN1
NG "":PROCsetEP(y%,4)
1210 PROCsumcheck:ENDPROC
1220 :
1230 DEF PROCcomp_slave
1240 flag=-1:VDU28,0,23,39,18:PROCskt(5
)
1250 PROCinput("R"):IF Z=-1 CLS:ENDP
ROC
1260 PROCsetEP(y%,5):?%I%=OPENIN($fnm)
1270 VDU23,1,0;0;0;0;0:PRINTTAB(25,4)w$
Count:"g$TAB(20,5)"(End count):"c$:M%
1280 FORI%=0TOM%:PTRW?%I%=I%:?%7A=BGEI#
?%I%:CALLsend1:PRINTTAB(33,4):I%:NEXT
1290 CLOSE#0:PROCtime
1300 VDU23,1,1;0;0;0;0:PROCsumcheck
1310 ENDPROC
1320 :
1330 DEF PROCtime
1340 T=TIME DIV100:PRINTTAB(2,0)SPC37TA
B(2,0)"Programming time:"y$;T DIV60;"min
";T MOD60"sec":ENDPROC
1350 :
1360 DEF PROCsumcheck
1370 VDU28,0,23,39,18
1380 IF flag=0 PROCsetEP(y%,1):PRINTTA
B(7,1)B$;
1390 CALLsmchk:PRINTTAB(1,1)sp$
1400 chk1=?%70*256+?%71:IF chk1>0 chk1=
chk1-1
1410 chk2=?%75*(2^16)+?%76*(2^8)+?%77
1420 chk3=?%72*(2^16)+?%73*(2^8)+?%74
1430 IF flag=0 AND chk2<>chk3 VDU7:PRIN
TTAB(3,1)f$R$"ERROR"uf$y$=- Sumchecks di
fferent"
1440 IF flag=-1 AND chk2<>chk3 VDU7:PRI
NTTAB(0,1)f$R$"ERROR"uf$y$@ address:"y$
"&";~chk1;TAB(30)"(;chk1;)"
1450 IF b%<0 AND flag=0 AND chk2=(MZ+1)
*255 PRINTTAB(0,1)sp$TAB(13,1)"ERASE VER
IFIED":G0T01490
1460 IF b%<0 AND flag=0 AND chk3=0 PRIN
TTAB(0,1)sp$TAB(13,1)"ERASE VERIFIED":G0
T01490
1470 PRINTTAB(3,2)"Master sumcheck:"g$
"&";~chk2;TAB(27)"(;chk2;)"
1480 PRINTTAB(3,3)"Copy sumcheck "g$
"&";~chk3;TAB(27)"(;chk3;)"
1490 IF flag=-1 PROCtime
1500 PROCprompt:ENDPROC
1510 :
1520 DEF PROCmemsmck
1530 PRINTTAB(7,1)B$;
1540 LZ=0:FORI%=3B00T01Z+MZ:LZ=LZ+?%I%:
NEXT:PRINTTAB(20,4)w$Sumcheck:"g$;~LZTA
B(8,1)sp$:ENDPROC
1550 :
1560 DEF PROCprompt
1570 VDU28,0,24,39,18:PRINTTAB(0,6)b$bg
$sp$TAB(3,6)y$N"c$"for new command "":;
REPEAT UNTIL GET=78
1580 CLS:ENDPROC
1590 :
1600 DEF PROClist
1610 VDU28,0,24,39,18,2,32,32,3;IF A
DVAL(-4)<63:VDU7:PRINTTAB(8,2)f$R$Put p
rinter ON LINE"
1620 IFb%<OPROCskt(3) ELSE PROCskt(2)
1630 PRINTTAB(0,6)b$bg$sp$TAB(4,6)y$P"
c$"to print "y$BRK"~c$"to exit "":;REP
EAT Z=GET:UNTIL Z=B0 OR Z=69 OR Z=13:IF
Z=13 G0T01650
1640 IF Z=B0 THENVDU2,21:PROCsetEP(y%,0
):REPEAT CALLget1:VDU?%7A:UNTIL?%7A=0:VD
U6,3
1650 CLS:ENDPROC
1660 :
1670 DEF PROCinput(rw$)
1680 Z=0:PRINTTAB(2,4)"Filename:"g$STRI
NG$(NZ,"*")
1690 VDU28,12,22,13+NZ,22:INFUTTAB(12,4
)Z$
1700 IF LENZ$>NZ VDU28,0,24,39,18:G0T0
680
1710 VDU28,0,24,39,18
1720 IF LENZ$<1 Z=-1:ENDPROC
1730 PRINTTAB(11,4)SPCBTAB(11,4)c$Z$;
1740 $fnm=Z$:?%I%=OPENUP($fnm)
1750 IF rw$="W" AND ?%I%>0 VDU7:PRINTTA
B(21,4)r$OK to overwrite?":REPEAT Z=GE
T:UNTIL Z=B9 OR Z=78:VDU2:IF Z=78 Z=-1
1760 IF rw$="R" AND ?%I%=0 VDU7:PRINTTA
B(22,4)r$Not on file":PROCprompt:Z=-1
1770 CLOSE#0:ENDPROC
1780 :
1790 DEF PROCsetEP(y%,v%)
1800 YZ=166:CALLsend
1810 YZ=y%:CALLsend
1820 YZ=v%:CALLsend
1830 REM Clear buffers
1840 *FX15,0
1850 TIME=0:ENDPROC
1860 :
1870 DEF PROCcat
1880 CLS:*INFO **
1890 PROCprompt:ENDPROC
1900 :
1910 DEF PROCmcode
1920 osbyte=&FFF4:~I%=&79
1930 memloc%=&70:counter%=&78
1940 FOR S=0 TO 2 STEP 2:P%=code%
1950 LOPT S
1960 \ Sends control codes to EP
1970 .send LDA #&97 \ Write to RS423
1980 LDX #9 \ port transmit
1990 JSR osbyte \ register.
2000 RTS
2010 \
2020 .smchk LDA #8 \ Gets 8-byte sum
2030 STA counter% \ sum check and
2040 .get \ stores in page
2050 LDA #2 \ zero at &70-&77.
2060 LDX #1
2070 JSR osbyte \ Enable RS423,
2080 .loop1 LDA #&91 \ then
2090 LDX #1 \ loop until
2100 JSR osbyte \ Y contains byte
2110 BCS loop1 \ from programmer:
2120 LDA counter% \ store
2130 TAX \ sum check;
2140 STY memloc%-1,X \
2150 DEC counter% \
2160 CPX #1 \ finished?
2170 BNE get
2180 LDA #2
2190 LDX #2 \ Disable RS423.

```

Duplicated disc file names are reported to prevent accidental overwriting, and the program asks whether or not you want to overwrite the existing file. Displayed information and cross checking using information from the programmer led and error/end-of-command beeps should result in problem-free eprom programming.

Connection of the serial lead is discussed in Richard Lambley's article on page 46 of the December 1984 issue of *E&WW* describing the multi-standard modem. Note that it is possible to enter the 5 pin DIN plug into the BBC computer incorrectly; the keyway slot in the metal skirt must face downwards.

Because of cost and availability, I was unable to confirm programming of 64Kbyte eproms, and single-chip microprocessors, but I cannot foresee any problems. I may write additional code for loading segments of 32 and 64Kbyte eproms into memory if demand is forthcoming. Code for committing Basic programs to eprom and sideways ram could also be considered.

This software for driving the SC84 eprom programmer is written in BBC Basic with embedded machine code.

Data passes between intelligent programmer and computer through an RS232 serial link. If you send a disc and a £1.50 copying charge to Norman Sargent at 171 Monega Road, Forest Gate, London E7 8EP, he will copy this software for you.

```

2200 JSR osbyte
2210 RTS
2220
2230 .get1 LDA #2 \ Gets byte from
\ programmer and
2240 LDX #1 \ stores in &7A.
2250 JSR osbyte \ Enable serial,
2260 .loop2 LDA #&91 \ loop until Y
\ contains byte
2270 LDX #1 \ from programmer.
2280 JSR osbyte
2290 BCS loop2
2300 STY &7A
2310 LDA #2
2320 LDX #2 \ Disable RS423.
2330 JSR osbyte
2340 RTS
2350
2360 .send1 LDA #&96 \ Sends byte to
\ programmer.
2370 LDX #8 \ Read serial con-
2380 JSR osbyte \ trol register,
2390 TYA \ loop until tx
2400 AND #&A \ reg. is empty
2410 BEQ send1 \ (bits 1 and 3
2420 CMP #8 \ set).
2430 BEQ send1
2440 LDA &7A \ Get byte from
2450 TAY \ &7A and
2460 LDA #&97 \ write it to
2470 LDX #9 \ RS423 transmit
2480 JSR osbyte \ register.
2490 RTS
2500 J
2510 NEXT S
2520 ENDPROC

```

Creating diagrams on the BBC microcomputer

Without spending vast amounts of money, it is impossible to display all of a large detailed drawing developed on a microcomputer. In many draughting programs this problem is solved by building up a diagram in segments and stepping between them, but then drawing becomes difficult at the intersections.

The best compromise is to use the computer screen as a window to any area of the drawing, which is what Pineapple Software's Diagram program does, given a BBC model B microcomputer and disc drive*.

Although the drawing is seen as fixed rectangular segments as far as the computer is concerned, the user need not be aware of this while drawing. When the cursor meets the edge of an on-screen drawing segment, the segment moves over a little and the empty edge of the screen is filled immediately, to create the effect of a microfiche viewer. The number of segments used for a drawing may be changed at any time and is limited only by capacity of the disc; an empty 80-track disc holds up to 39 screen segments.

A second problem with computer drawing, that of accurately positioning the cursor to allow neat line joints, is overcome by building up the diagram using predetermined icons. These icons are defined using a special routine which is just as easy to use as the main drawing program. Even line drawing uses these predetermined elements so joints are always perfect.

Each icon is built up of between one and twelve 8x8 matrixes, each the size of one character element in 80-column, 30-line mode. Screen resolution is therefore around 640 by 250 pixels (mode zero), but the cursor moves in steps of 1/80 of a screen horizontally or 1/30 vertically, so positioning is easy.

There is room for 128 basic 8x8 icons, excluding text of course, which may be positioned anywhere on the drawing. Text and icons may not be superimposed though. Once an icon is used on the drawing, it may not be redefined without affecting the drawing; all spaces used by the original icon are changed to represent the new icon.

Drawing is further simplified by using tabs and the program has an indexing feature which allows you to mark items which may later be located on screen by simply typing in

the index reference. All attributes associated with the diagram are stored on the diagram's disc file, including the current screen background and foreground colours.

Various printing modes are possible and the hard-copy section of the program is written with modification in mind so screen limitations need not be passed on to the printer. One of the two sample drawings is three screens wide by two high and it is still legible when printed in full across an A4 sheet.

The penalty for this ease of drawing is that all fine details must be predefined. To illustrate, the smallest rectangle that can be drawn using line-drawing mode is the size of a character matrix on an 80-column screen.

The end product is a reliable piece of software which, with a little practice, actually allows circuit diagrams and schematics to be produced faster than can be drawn by hand, especially if one reuses predefined characters. This cannot be said of all similar products, although some of them are more suited to engineering drawing. The £28.75 package consists of a disc with two sets of programs, one for use in sideways ram and the other for main memory, and documentation. The authors are currently working on plotter-driving routines.

*Diagram accesses the disc catalogue and will not necessarily run with non-Acorn disc interfaces. It has been tried in single density with the Microware interface.

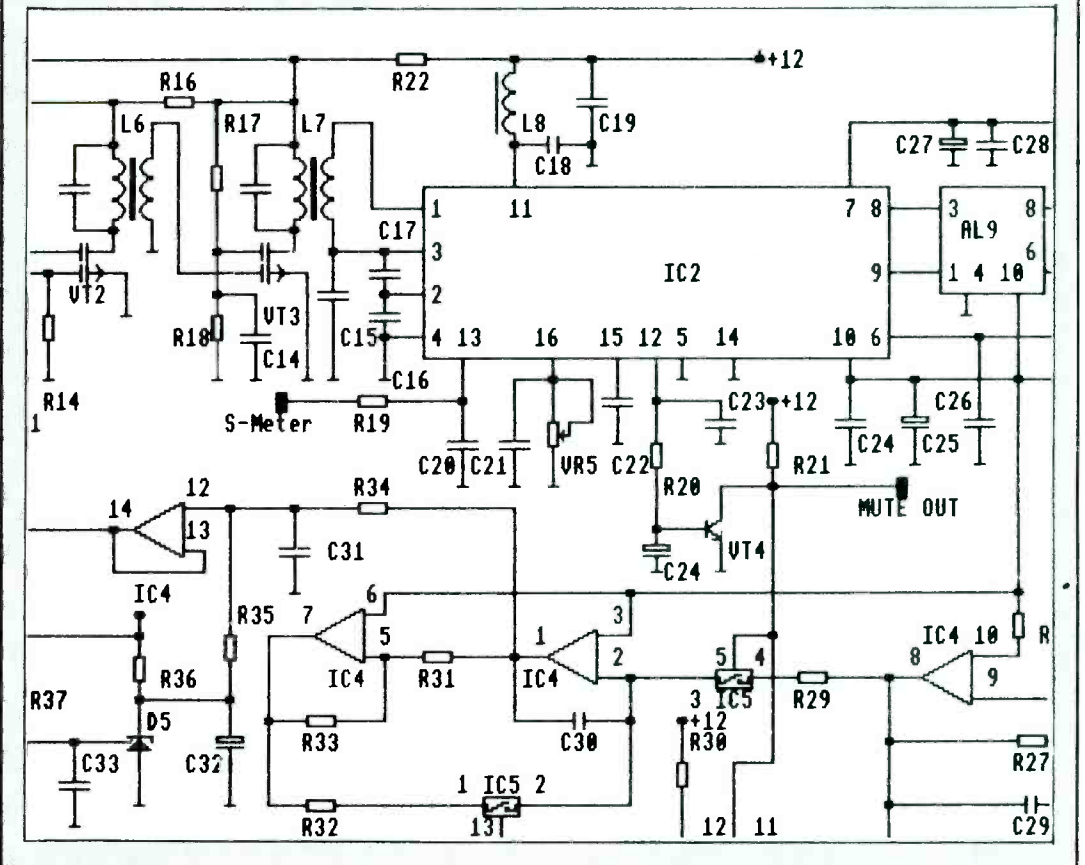

TOROIDALS

The toroidal transformer is now accepted as the standard in industry, overtaking the obsolete laminated type. Industry has been quick to recognise the advantages toroidals offer in size, weight, lower radiated field and, thanks to I.L.P., PRICE.

Our large standard range is complemented by our SPECIAL DESIGN section which can offer a prototype service within 14 DAYS together with a short lead time on quantity orders which can be programmed to your requirements with no price penalty.

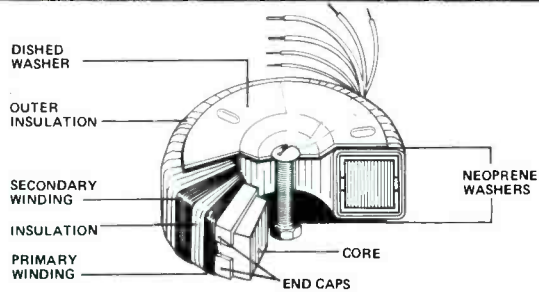

15 VA 62 x 34mm Regulation 19%			50 VA 80 x 35mm Regulation 13%			120 VA 90 x 40mm Regulation 11%			225 VA 110 x 45mm Regulation 7%			500 VA 140 x 60mm Regulation 4%		
SERIES	SECONDARY	RMS	2x010	6+6	4.16	4x010	6+6	10.00	6x012	12+12	9.38	8x016	25+25	10.00
No	Volts	Current	2x011	9+9	2.77	4x011	9+9	6.66	6x013	15+15	7.50	8x017	30+30	8.33
0x010	6+6	1.25	2x012	12+12	2.08	4x012	12+12	5.00	6x014	18+18	6.25	8x018	35+35	7.14
0x011	9+9	0.83	2x013	15+15	1.66	4x013	15+15	4.00	6x015	22+22	5.11	8x026	40+40	6.25
0x012	12+12	0.63	2x014	18+18	1.38	4x014	18+18	3.33	6x016	25+25	4.50	8x025	45+45	5.55
0x013	15+15	0.50	2x015	22+22	1.13	4x015	22+22	2.72	6x017	30+30	3.75	8x033	50+50	5.00
0x014	18+18	0.42	2x016	25+25	1.00	4x016	25+25	2.40	6x018	35+35	3.21	8x042	55+55	4.54
0x015	22+22	0.34	2x017	30+30	0.83	4x017	30+30	2.00	6x026	40+40	2.81	8x028	110	4.54
0x016	25+25	0.30	2x028	110	0.45	4x018	35+35	1.71	6x025	45+45	2.50	8x029	220	2.27
0x017	30+30	0.25	2x029	220	0.22	4x028	110	1.09	6x033	50+50	2.25	8x030	240	2.08
(encased in ABS plastic)			2x030	240	0.20	4x029	220	0.54	6x028	110	2.04			
			2x030	240	0.20	4x030	240	0.50	6x029	220	1.02			
			2x030	240	0.20	4x030	240	0.50	6x030	240	0.93			
30 VA 70 x 30mm Regulation 18%			80 VA 90 x 30mm Regulation 12%			160 VA 110 x 40mm Regulation 8%			300 VA 110 x 50mm Regulation 6%			625 VA 140 x 75mm Regulation 4%		
1x010	6+6	2.50	3x010	6+6	6.64	5x011	9+9	8.89	7x013	15+15	10.00	9x017	30+30	10.41
1x011	9+9	1.66	3x011	9+9	4.44	5x012	12+12	6.66	7x014	18+18	8.33	9x026	35+35	8.92
1x012	12+12	1.25	3x012	12+12	3.33	5x013	15+15	5.33	7x015	22+22	6.82	9x025	40+40	7.92
1x013	15+15	1.00	3x013	15+15	2.66	5x014	18+18	4.44	7x016	25+25	6.00	9x033	45+45	6.94
1x014	18+18	0.83	3x014	18+18	2.22	5x015	22+22	3.63	7x017	30+30	5.00	9x042	50+50	5.68
1x015	22+22	0.68	3x015	22+22	1.81	5x016	25+25	3.20	7x018	35+35	4.28	9x028	55+55	5.68
1x016	25+25	0.60	3x016	25+25	1.60	5x017	30+30	2.66	7x026	40+40	3.75	9x029	110	5.68
1x017	30+30	0.50	3x017	30+30	1.33	5x018	35+35	2.28	7x025	45+45	3.33	9x030	220	2.84
			3x028	110	0.72	5x026	40+40	2.00	7x033	50+50	3.00			
			3x029	220	0.36	5x028	110	1.45	7x028	110	2.72			
			3x030	240	0.33	5x029	220	0.72	7x029	220	1.36			
			3x030	240	0.33	5x030	240	0.66	7x030	240	1.25			

Why a Toroid?

- * Smaller size & weight to meet modern 'slimline' requirements.
- * Low electrically induced noise demanded by compact equipment.
- * High efficiency enabling conservative rating whilst maintaining size advantages.
- * Lower operating temperature.

Why ILP?

- * Ex stock delivery for standard 240V range
- * Fast prototype service available
- * 3 weeks despatch for special orders
- * 2 year no quibble guarantee
- * No price penalty for call-off order

Prices including P & P and VAT

VA	Size	£	VA	Size	£
15	0	7.06	160	5	12.17
30	1	7.67	225	6	13.75
50	2	8.90	300	7	14.97
80	3	10.06	500	8	19.60
120	4	10.65	625	9	22.30

For 110V primary insert "0" in place of "X" in type number.
For 220V primary (Europe) insert "1" in place of "X" in type number.
For 240V primary (UK) insert "2" in place of "X" in type number.
IMPORTANT: Regulation — All voltages quoted are FULL LOAD.
Please add regulation figure to secondary voltage to obtain off load voltage.

Mail Order — Please make your crossed cheques or postal orders payable to ILP Electronics Ltd.

Trade — We will open your credit account immediately upon receipt of your first order.

Post to: ILP Electronics Ltd., Dept. 3
Graham Bell House, Roper Close,
Canterbury, Kent. CT2 7EP
Tel: (0227) 454778 Telex: 965780

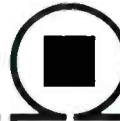

ILP ELECTRONICS LTD.

CIRCLE 54 FOR FURTHER DETAILS.

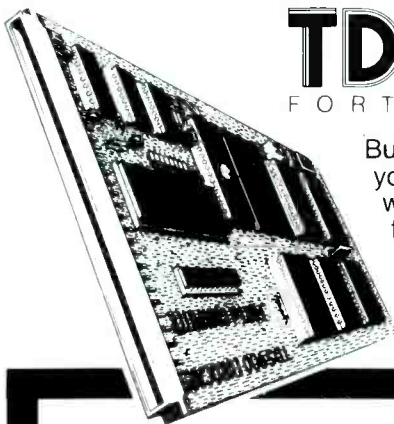

TDS900

FORTH COMPUTER

Build the TDS 900 into your products, program it with a VDU and your forecasts become fact.

NOW FROM £99

- ☆ Single board computer. 12k RAM and 8k ROM (expandable).
- ☆ All C-MOS for lower power. FORTH language. Compiled and fast. On-board screen-editor, compiler and debug facilities.
- ☆ Easy connection with serial and parallel channels, A/D, D/A converters, triacs, printers, keyboards and displays.



Triangle Digital Services Limited
100a Wood St., Walthamstow, London E17, England
Telephone: 01-520 0442 Telex: 262284 (Ref. 775)

Agents in USA, France, Switzerland, Netherlands, S.Africa, Australia.

CIRCLE 53 FOR FURTHER DETAILS.

CHOICE OF PROFESSIONALS

COMPACT LATTICE TOWERS and SLIMLINE TUBULAR MASTS

TELESCOPIC—TILT-OVER, FIXED—MOBILE FROM 6m UP TO 36m

Suitable for a wide range of civil and military applications such as:

RADIO COMMUNICATION
SURVEILLANCE & CCTV
METEOROLOGICAL MONITORING
AMATEUR RADIO
AERO & MARINE NAV AIDS
FLOODLIGHTING, ETC.

Purpose designed using 4.5m and 3m section modules for low retracted heights and cost effective shipment. Engineered to B.S.I. Standards and hot dip galvanized to BS729 for protection. Wind loads are based on B.S.C.P.3. Chap V. PT2, 1972 for wind speeds up to 100 mph/160 kph.

RELIABILITY QUALITY KNOW HOW

WE DESIGN, WE MAKE, WE SELL DIRECT

PRICES RANGE FROM £253.00 incl. VAT. & UK DELIVERY SAE FOR MORE DETAILS, PLEASE

Allwell Engineering
Factory 6, 232 Selsdon Road,
South Croydon, Surrey, CR2 6PL, G.B.
Tel: 01-680 2995 (24 hr) 01-681 6734.

Normally despatched within 7 days

CIRCLE 28 FOR FURTHER DETAILS.



Take home a world champion.

£ 72,— gets you a technical knockout.

The Fluke 70 Series.

Winners of the digital vs. analog battle.

Since their debut, they've become the worldwide champions of the industry.

Never before have such tough meters offered so many professional features at such unbeatable prices.

Each comes with a 3-year warranty, 2,000+ hour battery life, and instant autoranging.

You also get the extra resolution of a 3200-count LCD display, plus a responsive analog bar graph for quick visual checks of continuity, peaking, nulling and trends.

Choose from the Fluke 73, the ultimate in simplicity. The feature-packed Fluke 75. Or the deluxe Fluke 77, with its own protective holster and unique "Touch Hold" function* that captures and hold readings, then beeps to alert you.

So don't settle for just a contender. Take home a world champion.

For your nearest distributor or a free brochure, please call or write.

FROM THE WORLD LEADER
IN DIGITAL MULTIMETERS.



Fluke 73

£ 72
Analog/digital display
Volts, ohms, 10 A,
diode test
Autorange
0.7% basic dc accuracy
2000+ hour battery life
3-year warranty

Fluke 75

£ 88
Analog/digital display
Volts, ohms, 10 A, mA,
diode test
Audible continuity
Autorange/range hold
0.5% basic dc accuracy
2000+ hour battery life
3-year warranty

Fluke 77

£ 110
Analog/digital display
Volts, ohms, 10 A, mA,
diode test
Audible continuity
"Touch Hold" function
Autorange/range hold
0.3% basic dc accuracy
2000+ hour battery life
3-year warranty
Multi-purpose holster

* Patent pending.
Prices are exclusive V.A.T. at current rate.

Fluke (G.B.) Ltd.
Colonial Way
WATFORD Herts WD2 4TT
United Kingdom
Tel.: (0923) 25067
Telex: 93 4583



CIRCLE 15 FOR FURTHER DETAILS.

by S.A. Cameron



Stephen Cameron, who is 23, is reading for a B.Sc. in electrical and electronic engineering at Brunel University, Uxbridge. An industry-sponsored student, he has worked for the past four years on broadcast equipment, radio and line development and computing systems.

He qualified as an instructor in Cadet Force signals while at the Duke of York's Royal Military School, Dover. Spare-time interests include music, tennis and writing poetry. He is publicity manager of the Brunel University Industrial Society.

Call cost calculator

Control your telephone bills with this full-feature Z80-based design, which can save its cost in a matter of months.

This call cost calculator is a very effective aid to saving money whilst making private telephone calls. It is suitable for use in any country and can cost any chargeable service on the telephone system. In price (about £70) it compares favourably to the few commercially-made instruments on the market; in performance it far outstrips them.

There are two basic types of instrument for calculating call charges: automatic devices which count charging pulses sent by the exchange at the end of each call unit and manual devices which rely on the user to enter the details of each call correctly.

Automatic devices have the drawback that British Telecom levies an additional rental for sending the charging pulses and makes a connection charge for the instrument itself. So the extra costs may wipe out some of the potential saving. Furthermore, some such instruments do no more than count pulse units and are not even automatic, since they require the user to start the pulse detection facility.

Manual instruments need no BAPT approval because they have no connection to the line. However, when call tariffs are changed, reprogramming is necessary. One system on the market uses a 'credit card' which slots into the machine. When charges are revised, a new card is available to the user at extra cost.

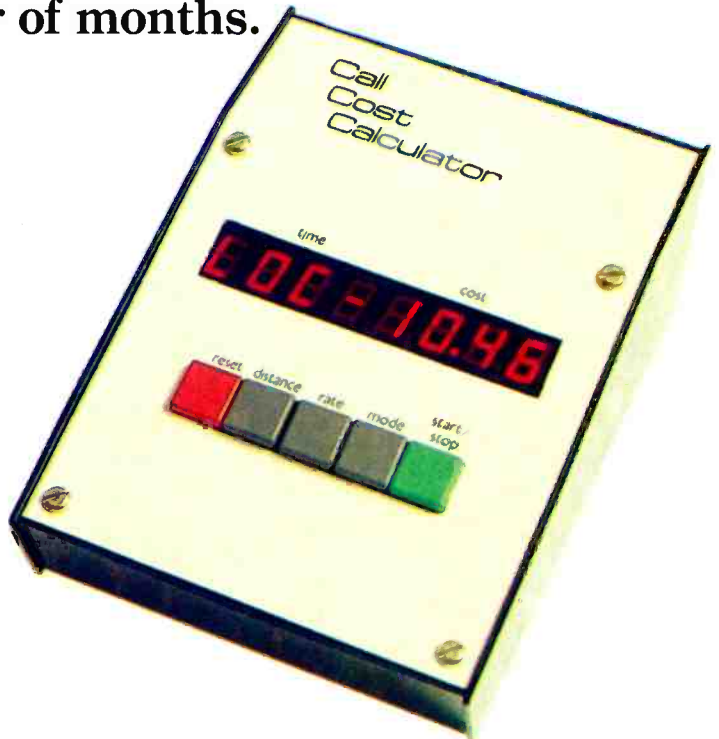

Others are just specialized stop-watches.

In this design, call charges are stored in a battery-backed cmos memory which the user can re-program without incurring any replacement costs.

The unit will cost not only direct-dialled calls but operator-controlled calls too. It takes account of normal and lower charges and can include the cost of any special services offered by the operator. This facility is unique to this instrument: on automatic machines it is not available since operator-connected calls are charged separately and by-pass the exchange's costing mechanism.

Furthermore, some units neglect certain types of inland calls: those to Ireland and over low-cost routes. This unit provides for these and in addition will cost any international call at any charge rate, whether dialled direct or connected by the operator.

Software

To cost a telephone call, the cost of and duration of each unit must be known.

Charging systems differ from country to country, but one factor is normally fixed while the other varies. For example, British Telecom at present charge a fixed unit cost of 5.41p, but the time bought for that sum ranges from eight minutes to 3.1 seconds. With calls connected by the operator, the unit time is fixed at 60s, while the unit cost varies from 2.33p to 179.4p.

The format I have chosen for storing all this information (Fig.3) is such that the software can handle any country's charging scheme. Twelve bytes are allocated for each call-type combination: three bytes for the unit cost, three bytes for the duration of the initial unit, plus three bytes each for the unit cost and unit time of any subsequent call units.

These numbers are stored in b.c.d. form, which means that the maximum unit cost is 9999.99 pence and the maximum unit time 59 minutes 59.99 seconds. The unit cost is stored in floating-point form for convenience when handling currencies with small base units such as the Italian lira.

Resolution of the software

Distances: Local (L0L) Under 35 miles (L35) Over 35 miles (O35) Over 35 miles, low-cost routes (L35) Channel Islands (L15) Irish Republic, Isle of Man, calls to cellular radio subscribers (IRE) International charge band A (CbA) International charge band B (CbB) International charge band C (CbC) International charge band D (CbD) International charge band E (CbE) International charge band F (CbF) International charge band G (CbG)	Rates: Cheap/economy (CHP) Standard (Std) Peak (PER)
	Modes: Direct-dialled (df) Operator-controlled, lower charge (OL) Operator-controlled, normal charge (ON)
	Special services: None selected (NU) Advice of duration and charge (Adw) Fixed time call (F.td) Credit-card call (C.Fd) Personal call (PER.S)

Fig. 1. A variety of factors can affect the cost of a telephone call and this design takes account of all of them.

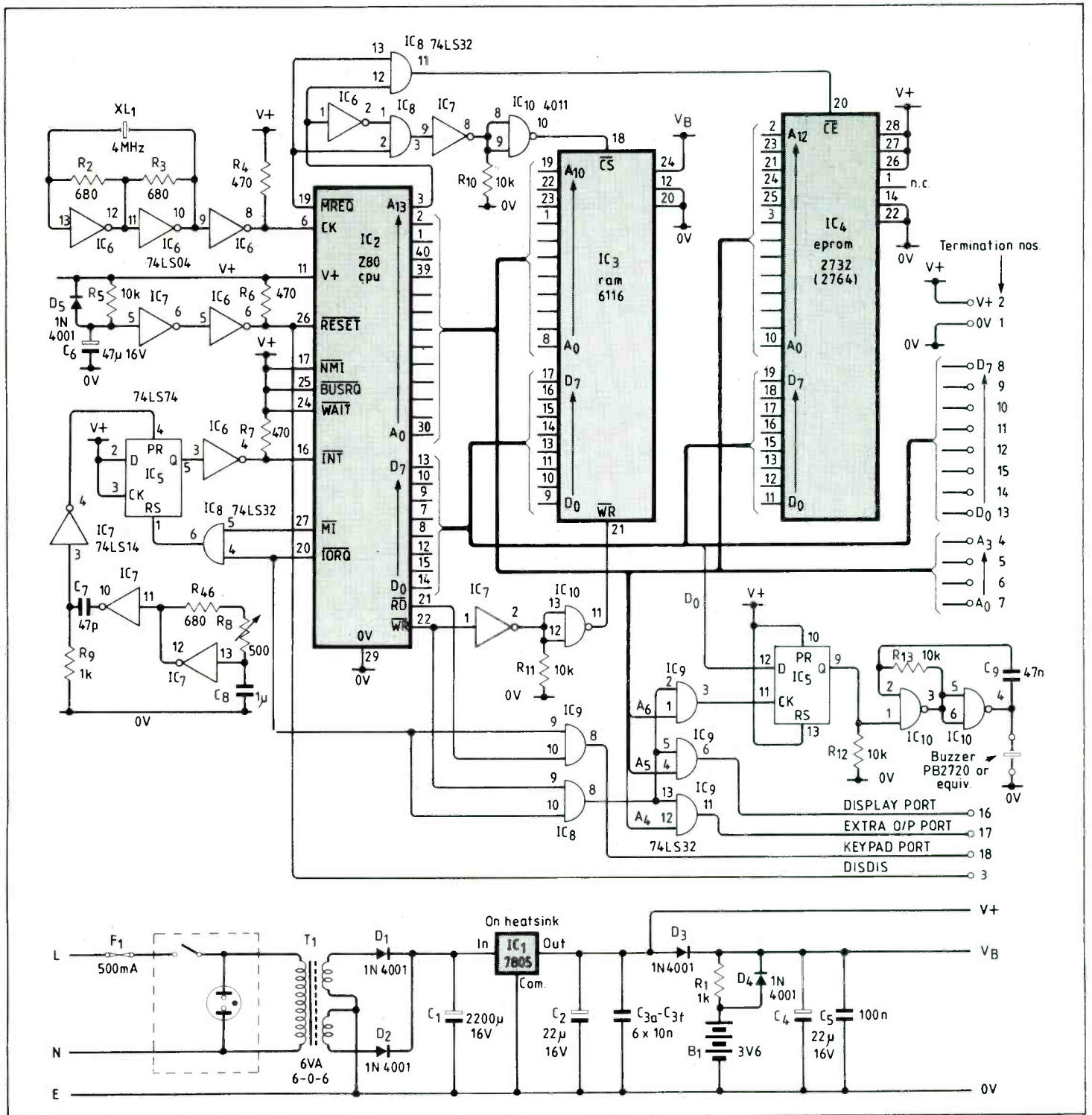

counters is 10ms, but as British Telecom (like the PTT authorities in other countries) specify their timings down to 50ms, the counters are set to increment in 0.05s steps. The cost can be set to the nearest hundredth of a penny, which is adequate for dealing with awkward v.a.t.-inclusive charges.

Operating system

The system memory map is shown in Fig.2. There is a small

fixed text data area carrying mostly the messages for the display; its contents can be altered to suit the user.

Hardware configuration information and indicators used by the system are stored in eeprom, from which they are transferred to ram on starting up (if the ram has not previously been battery-backed). The eeprom bootstrap loader saves time when the system is first commissioned, but can be disabled to avoid over-writing on subsequent power-ups any changes written into ram.

The operating system includes an interrupt service routine which updates the timers and the display. The top eight bytes of ram form the display interface between the interrupt routine and the main program. When the latter writes to any one of these bytes, the interrupt routine will output that byte to the corresponding position in the display. This method of communicating between two software modules is known as a virtual interface.

For the processor I selected the Z80 because of its compre-

Circuit diagram of the processor board. The design uses easily available, low-cost components throughout. The display board diagram will appear in the next article.

The call cost calculator's five unique facilities:

- it simultaneously displays the elapsed time and cost of a call as it progresses
- it gives warning when a new charge unit is about to begin
- it can display the unit cost, unit time or special service cost during the call
- it keeps a running total of cost and (for dialled calls) call units with full editing facilities
- it holds call tariffs in a battery-backed memory, which can be updated readily by the user

Component sources

A kit of parts including the box but excluding p.c.bs and eprom is obtainable at the special price of £38.25 (add £1 for inland postage; v.a.t. is payable on the total) from T. Powell Electronic Components, 16 Paddington Green, London W2 1LG.

Software in eprom can be supplied by the author at £8.50 including postage. The listing is available separately at £3. The address to write to is 7 Donnington Court, Worthy Road, Winchester, Hampshire SO23 7BJ.

A set of two printed circuit boards, silk-screened and double-sided with plated-through holes is available from Combe Martin Electronics, King Street, Combe Martin, Devon EX34 0AD. The price is £23 inclusive for customers inland or abroad.

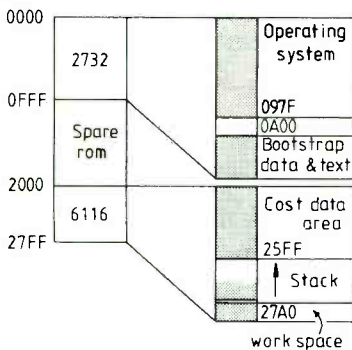

Fig. 2. Memory map of the system. With different software, the board could be used as a general-purpose i/o controller for applications such as driving central heating systems.

Fig. 3. Whatever the combination of charging factors (see Fig. 1) the instrument stores the charging information in twelve bytes using the format shown here.

1	pounds	} unit cost	} initial unit
2	pence		
3	hundredths of pence		
4	minutes	} unit time	
5	seconds		
6	hundredths of seconds		
7	pounds	} unit cost	} subsequent units
8	pence		
9	hundredths of pence		
10	minutes	} unit time	
11	seconds		
12	hundredths of seconds		

A7	A6	A5	A4	A3	A2	A1	A0	
X	0	1	1	X	X	X	X	Write to piezo latch
X	1	0	1	0	D	D	D	Clear display digit DDD
X	1	0	1	1	D	D	D	Write data to display digit DDD
X	1	1	0	X	X	X	X	Write data to extra output port

DDD - Binary no.
X — Don't care

Fig. 4. Output port address table

states). On the interrupt acknowledge cycle, when \overline{MI} and \overline{IORQ} are both active, the latch is reset and the interrupt serviced. I have avoided using the edge-triggered interrupt \overline{NMI} since it could not have been disabled while the software down-counters were being refreshed.

In the memory map of the system, the first 8K of address space is assigned to rom and the remainder to ram. The chip-select inputs of the memory devices are decoded from MREQ and A13 to give this 8K block addressing. At the input of the cmos gate which drives the \overline{CS} terminal of the ram, a pull-down resistor ensures that the address and data buses are isolated when mains power is absent. A similar arrangement protects the $\overline{W/R}$ pin. The device's \overline{OE} pin is permanently enabled, since its function can be controlled indirectly through the \overline{CE} decoder.

A bit-mapped port decoder using or-gates addresses the instrument's peripheral functions.

The piezo-sounder circuit is made up of two gates and a D-type latch. Writing logic 1 to the latch sounds the buzzer, a logic 0 silences it. This makes full control possible through an inter-

rupt-based software monostable. On the display board three octal latches interface the data bus to the outside world. One drives the display with the help of an LS259 addressable latch, which points to the active digit.

The display devices are 0.4 in. common-anode leds with right-hand decimal points. The software can also be made to drive displays with left-hand decimal points; the p.c.b. will accept either type.

Debounce, auto-repeat and multiple key discrimination for the keypad are provided by software. The keypad can be changed to a matrix type by use of the extra output and input port — up to 40 keys can be interpreted. The software can already support this mode and so allows easy expansion or reprogramming of the system. Connection to a serial printer and an auto-dialler would also be possible.

The same hardware could be used to implement a general i/o controller, in a security system or central heating installation for example.

In the next article, Stephen Cameron will describe construction and programming of the instrument.

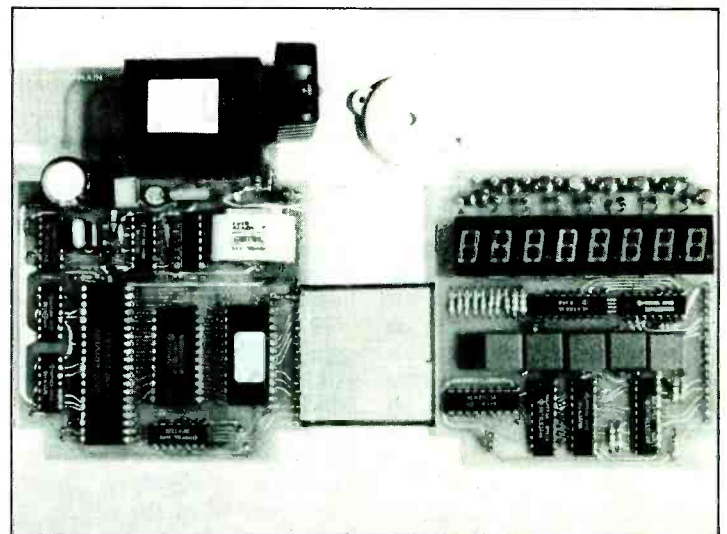

A short length of ribbon cable links the two boards, which fold together and fit neatly into a standard plastics box.

A.c. mains power controller

by J.L. Linsley Hood

A simple circuit to stabilize the power into a resistive load by means of a triac control element. Intended for use with a photographic enlarger, it can be used for other purposes in which the 'notched' output waveform is no detriment.

The control of the illumination of an enlarger, particularly with reference to the voltage applied to, and the consequent colour temperature of the enlarger lamp bulb, is a matter of some concern to photographers using colour printing papers, especially if the local a.c. mains supply is subject to voltage fluctuations, either short- or medium-term.

This arises particularly between the time at which a test strip is printed, to determine correct filtration and colour balance, and the subsequent printing of an enlargement. Any variation of mains supply voltage between these two events can lead to unwanted errors in the characteristics of the final print.

A.c. mains voltage controllers have been available for many years, and while they can give a reasonably sinusoidal output waveform, when based on a saturable reactor system, the price paid for this is the considerable weight, bulk and cost of the unit.

An alternative approach is to use a triac power controller, whereby the effective output power is regulated by varying the time of switch-on of the triac at the beginning of each half-cycle, as shown in Figs 1 and 2. Such a system is light in weight, does not dissipate much energy as heat, and is entirely satisfactory as a control method for lamp bulbs or heaters where the actual waveform is not particularly important. It does, however, have the snag that the switching waveform of the triac generates a certain amount of electrical interference, so the unit should be electrically screened, and also fitted with

output/input 'snubber' networks (R_9/C_5 in Fig.4).

A simplification of the construction of the triac control element is given by the use of one of the proprietary 3-terminal power-control i.c.s, of the type shown in Fig. 3, in which the switching phase-angle can be controlled, simply, by a variable

resistance between pins 1 and 2 of the i.c.

In the final circuit of the instrument, shown in Fig.4, this variable control resistance was replaced by a photo-conductive cell, PC_1 , so that the output of the control amplifier could be isolated from the a.c. power circuit by the use of a led-photocell link.

The method of regulation is based on the use of a small filament lamp bulb, whose brightness is determined by the effective input voltage/current waveform applied to the primary of the input power transformer, Tr_1 , across the secondary of which the bulb is connected. This is useful since it mimics the action of the larger power bulb for which this unit is intended to act as a brightness control, and also because a lamp bulb acts as a reasonably satisfactory and inexpensive 'true r.m.s.' converter.

The input transformer, a 12V/3VA unit, is also used to provide a 15V d.c. supply for an op-amp, IC_2 , for which a stable 5V d.c. reference is generated by an i.c. voltage regulator, IC_3 .

A supplementary d.c. power supply, having a fast response time ($D_3/D_4, C_4$), provides a suitable energizing voltage for a voltage divider chain, consisting of the photoconductive cell R_{11} , and the variable resistor R_{10} . This provides an output voltage which can be compared with the very stable voltage reference derived from IC_3 , and used, when amplified, to power the light-emitting diode D_5 , which, in turn, controls the power regulator i.c.

Because the 'dark' resistance of R_9 must be fairly high in order not to turn on the i.c. when not required, a fairly high sensitivity photoconductive cell was employed (an NSL-382 cadmium-selenide unit). Also, for the servo control loop to be stable, it is essential that the time delay elements within the feedback loop shall have as fast a response as practicable, and this is helped by the choice of cadmium selenide devices for R_9 and R_{11} .

This leaves the lamp bulb, LP_1 , as the main slow-response component, but the system is stable, as a second-order control loop, with the component values shown, provided that the reservoir capacitor, C_4 , is not made too large.

Because R_{11} is a fairly low-resistance unit, mounted in close

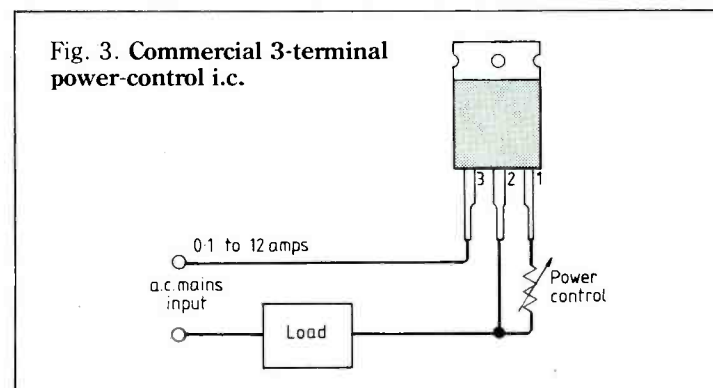
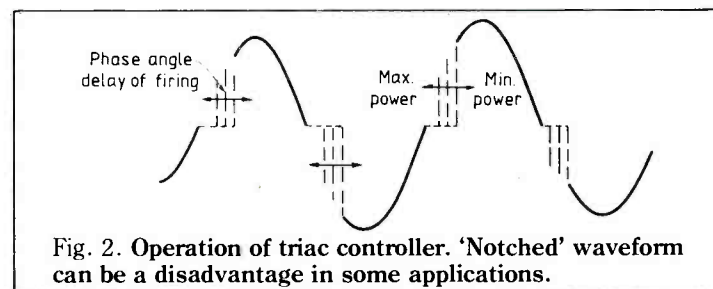
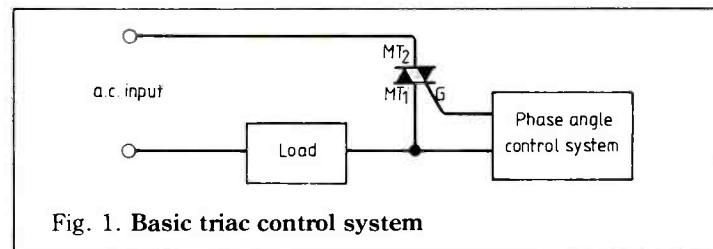

A.C. MAINS POWER

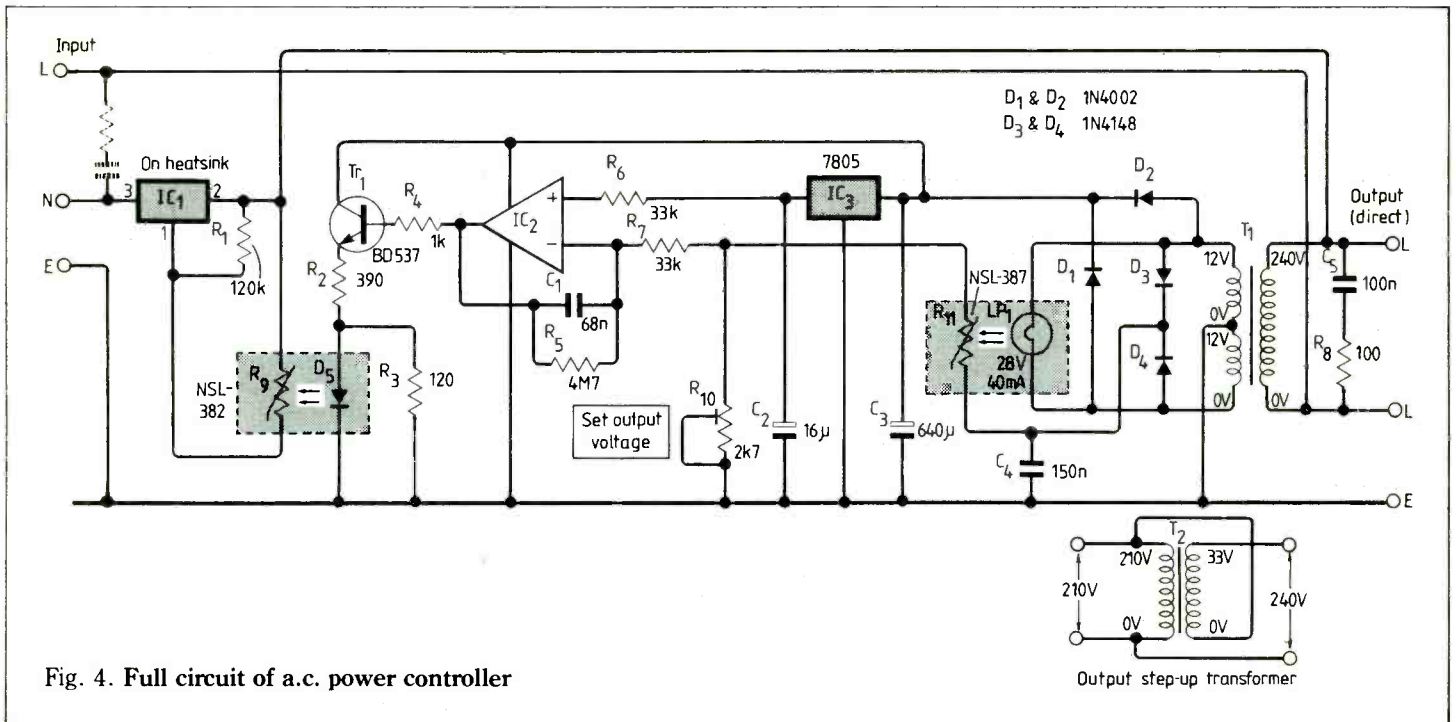

Fig. 4. Full circuit of a.c. power controller

Fig. 5. Housing for led/photocell opto-coupler, made from 35mm cassette container. Conventional led/phototransistor opto-coupler would not be usable here.

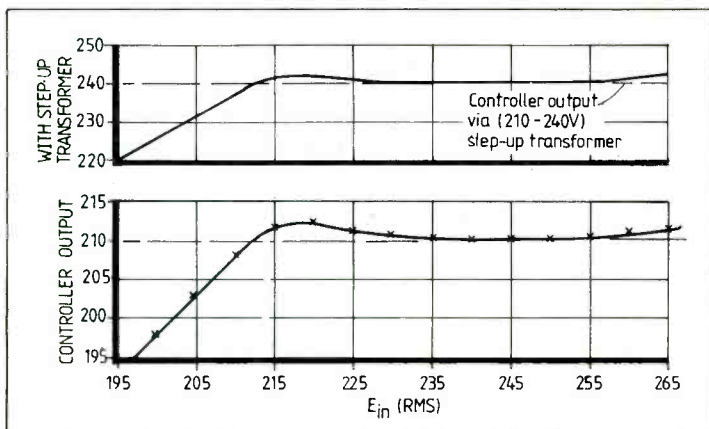
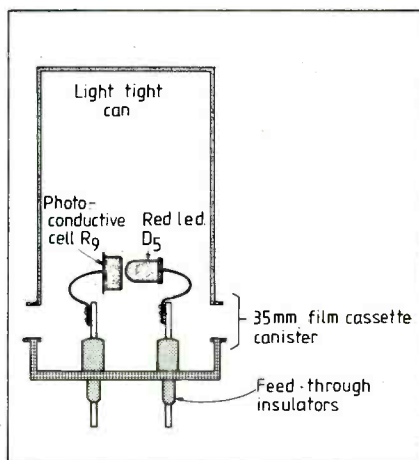

Fig. 6. Performance of power controller, with output set to 210V at an input of 240V.

proximity to the lamp bulb, LP₁, the problem of stray light isn't a particularly serious one in this instance, though it is prudent to ensure that there is little ambient light present at this point in that it will affect the output 'control voltage' setting.

However, much greater care is essential in respect of R₉/D₅, and the light-proof housing used for this is shown in Fig. 5. After some experimentation with the prototype, the construction adopted was based on a light-tight container used for 35mm film cassettes, into the cap of which four lead-through insulators were fitted. The led and photocell could then be soldered on to the internal pins. The whole unit would then be adequately light-tight when the can was fitted on to the cap.

The preset potentiometer, R₁₀, mounted on the printed circuit board, is used to control the power output of the regulator unit. The actual output voltage setting chosen will depend on the anticipated range of input voltage variation, bearing in mind that there will be a minimum of 10-12 volts drop across the control device for proper operation.

So, if it is thought that the possible input voltage range may lie between 225V and 255V r.m.s., an output setting of, say, 210V would be appropriate.

The performance of the control unit, with the output voltage measured by a true r.m.s. reading a.c. voltmeter, is shown in Fig. 6, with a 100V lamp bulb as a load.

Method of operation

A small resistor, R₁, connected across the regulator i.c. control pins, ensures that there is some

power transmitted through this i.c. on start-up, and that the amplifier i.c., IC₂, and the voltage regulator i.c., IC₃, are powered. Because the illumination of LP₁ will be low, at switch on, the resistance of R₁₁ will be high, and the d.c. voltage present at the inverting input of IC₂ will be lower than that at the non-inverting input, derived from IC₃.

The output of IC₂ will then be, initially, close to the potential of the internal d.c. supply line, and D₅ will be illuminated. This causes the conductivity of R₉ to decrease, which increases the output voltage from the controller, and consequently the voltage applied across LP₁.

This reduces the resistance of R₁₁, which lowers the illumination of R₉, until a stable output voltage is reached, which will depend on the setting of R₁₀.

The unit requires an output load, preferably resistive such as a small power lamp bulb, for correct operation, in that transformer T₁ and its snubber network are not sufficient as a load for IC₁. The output voltage from the control unit can be transformed up, say to 240V r.m.s. equivalent, for use with a nominal 240V lamp bulb, or down to some lower voltage, as the case may be, though some caution should be exercised in rating such transformers, in that the 'notched' waveform will somewhat increase the internal transformer power losses, and this should be taken into account.

Sowter Transformers

With 45 years' experience in the design and manufacture of several hundred thousand transformers we can supply

AUDIO FREQUENCY TRANSFORMERS OF EVERY TYPE

YOU NAME IT! WE MAKE IT!

OUR RANGE INCLUDES:

Microphone transformers (all types), Microphone Splitter/Combiner transformers, Input and Output transformers, Direct Injection transformers for Guitars, Multi-Secondary output transformers, Bridging transformers, Line transformers, Line transformers to B.T. Isolating Test Specification, Tapped impedance matching transformers, Gramophone Pickup transformers, Audio Mixing Desk transformers (all types), Miniature transformers, Microminiature transformers for PCB mounting, Experimental transformers, Ultra low frequency transformers, Ultra linear and other transformers for Transistor and Valve Amplifiers up to 500 watts, Inductive Loop transformers, Smoothing Chokes, Filter, Inductors, Amplifier to 100 volt line transformers (from a few watts up to 1,000 watts), 100 volt line transformers to speakers, Speaker matching

transformers (all powers), Column Loudspeaker transformers up to 300 watts or more.

We can design for RECORDING QUALITY, STUDIO QUALITY, HI-FI QUALITY OR P.A. QUALITY. OUR PRICES ARE HIGHLY COMPETITIVE AND WE SUPPLY LARGE OR SMALL QUANTITIES AND EVEN SINGLE TRANSFORMERS. Many standard types are in stock and normal despatch times are short and sensible.

OUR CLIENTS COVER A LARGE NUMBER OF BROADCASTING AUTHORITIES, MIXING DESK MANUFACTURERS, RECORDING STUDIOS, HI-FI ENTHUSIASTS, BAND GROUPS AND PUBLIC ADDRESS FIRMS. Export is a speciality and we have overseas clients in the COMMONWEALTH, EEC, USA, MIDDLE EAST, etc. Send for our questionnaire which, when completed, enables us to post quotations by return.

E. A. Sowter Ltd.

Manufacturers and Designers

E. A. SOWTER LTD. (Established 1941), Reg. No. England 303990

The Boat Yard, Cullingham Road, Ipswich, IP1 2EG, Suffolk, P.O. Box 36, Ipswich, IP1 2EL, England

Phone: 0473 52794 & 0473 219390 - Telex: 987703G SOWTER

CIRCLE 49 FOR FURTHER DETAILS.

BE FIRST WITH THE NEW SYMBOLOGY!

A Practical Introduction to the New Logic Symbols

Ian Kempel, CEng, MIERE

- ★ The new internationally agreed style of documentation
- ★ Destined to become a subject in its own right
- ★ Clear, concise and accessible
- ★ The first available practical guide

Digital engineers need to learn how to use and interpret the new logic symbology in order to stay at the top of their profession – soon the new symbols will be commonplace.

A Practical Introduction to the New Logic Symbols has been prepared with the collaboration of the International Electro-technical Commission.

Full details of the use of the new logic symbols are given in plain language in a book that will be retained as a constant source of reference.

0 408 01461 X Hardcover 216 x 138 mm
176 pages May 1985 Illustrated £11.50

Order from your local bookseller or in case of difficulty from

 **Butterworths**
Borough Green, Sevenoaks, Kent TN15 8PH

CIRCLE 26 FOR FURTHER DETAILS.

Softlife

LOGIC ANALYSER

Used with the BBC Micro and Disc Drive for test and repair, development, education etc, etc, etc.

- 8 MHz 8 channel
- Selectable trigger and trigger position
- Diagnostic capabilities
- TTL or CMOS inputs
- Complete with operating software probes and comprehensive documentation
- High-quality equipment with full specification at under £300.00



For technical information contact:

Alastair Francis B.A.

Softlife Ltd 7 Rose Crescent

Cambridge CB2 3LL Tel: (0223) 62117

CIRCLE 60 FOR FURTHER DETAILS.

PICK A CARD ...ANY CARD

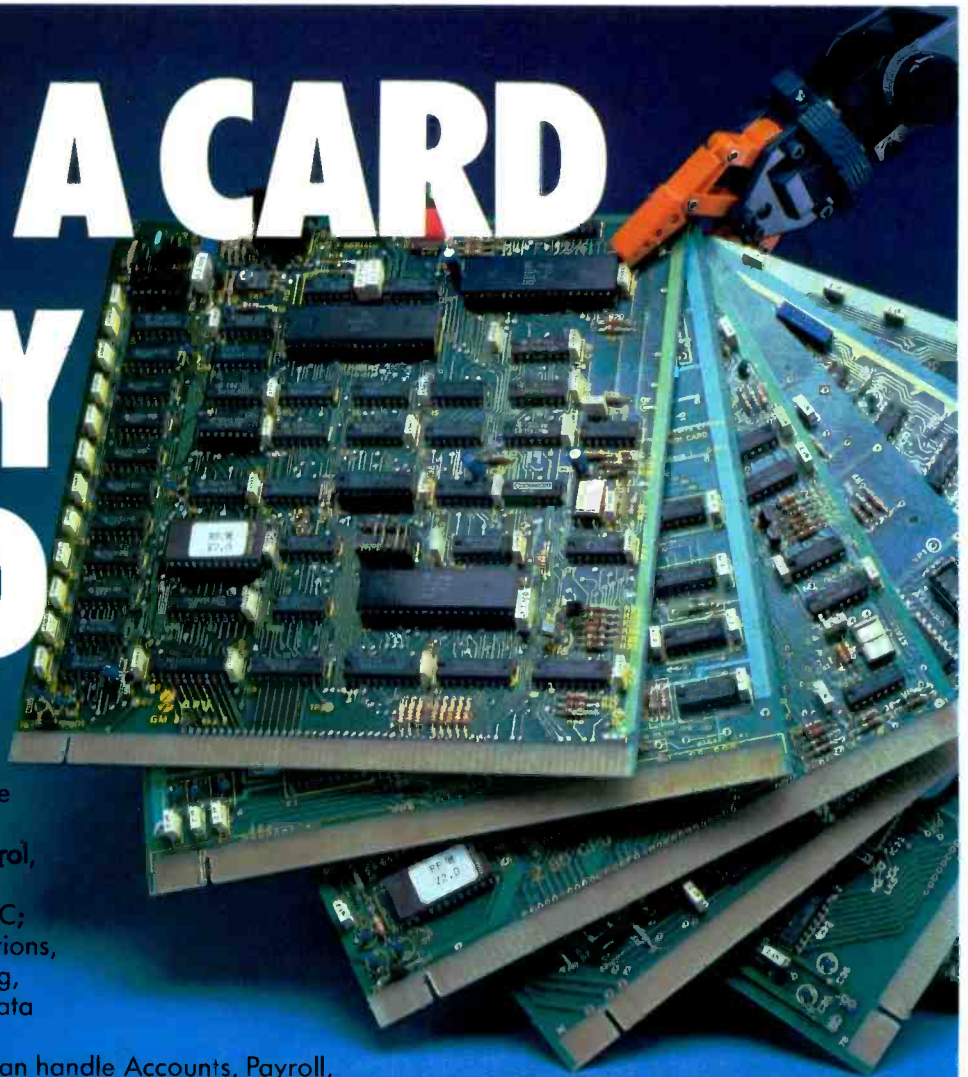

Every card's a winner. The versatile 80-Bus system can be used for a host of applications: Process Control, Batch Counting, Robotics, Colour Graphic Displays, CAD/CAM, CNC; In Manufacturing, Telecommunications, Instrumentation, Laboratory Testing, Security Systems, Plant Control, Data Collection and Distribution.

Also, in smaller companies it can handle Accounts, Payroll, Wordprocessing, Stock Control, Program Compilation and Data Base Management . . . whilst still being able to run specialist applications.

And because there is no wasted capacity with a Gemini, a system can cost a good deal less than you might think.

With Gemini you can buy a complete system, upgrade your existing 80-Bus system, or build your own.

So when you've had a look at the pack of cards below, plug yourself into our dealer network to discover how opening a new pack of cards with Gemini will help you pick a winner.



These represent just a small selection from our extensive range of cards.

GM811 Z80 CPU board with serial and parallel I/O

GM813 Z80 CPU board with 64K dynamic RAM, serial and parallel I/O

EV814 IEEE 488 interface board

GM816 Multiple parallel I/O board

GM824 8 bit A-D board

IO828 High resolution colour graphics board

GM832 Video controller board

GM833 512K RAM-DISK board

GM836 RS422 network interface

GM837 Medium resolution colour graphics board

GM839 Prototyping board

GM841 Extender board

GM842 Trackerball interface

GM844 8-way Backplane assembly

GM845 6-way Backplane assembly

GM846 3-way Backplane assembly

GM848 Multiple serial I/O board

GM849 Floppy disk controller/SCSI board

GM853 Byte-wide Eprom board

GM862 256K dynamic RAM board

GM863 Static RAM board

GM870 Modem board

GM888 8088 co-processor board



Gemini Microcomputers Ltd., 18 Woodside Road, Amersham, Bucks, England HP6 0BH. Tel: (02403) 28321. Telex: 837788

CIRCLE 66 FOR FURTHER DETAILS.

63rd NAB — Las Vegas

by Nigel S. Cawthorne,
M.I.E.E.

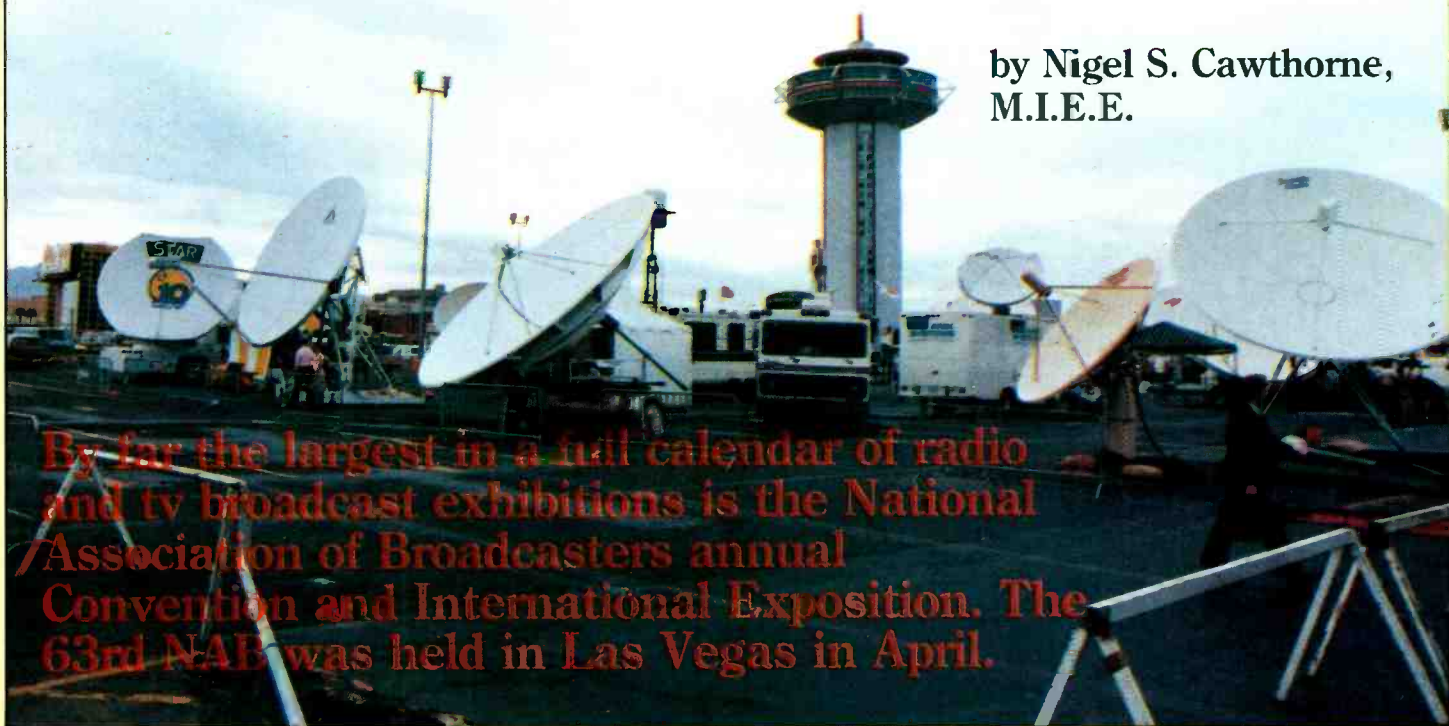

By far the largest in a full calendar of radio and tv broadcast exhibitions is the National Association of Broadcasters annual Convention and International Exposition. The 63rd NAB was held in Las Vegas in April.

North American radio and tv broadcasting is big business. The maximization of advertising revenues and the minimization of operating costs are the major consideration of broadcasting managers in the USA. Ratings are all important. The higher your audience rating the more you can charge for advertising air-time.

Understanding that business profit is the driving force behind broadcasting in the US, makes it easier to follow the development or lack of development of some of the new techniques of broadcasting in the US.

Stereo-sound tv

Stereo-sound tv has been slow to catch on in the US. A US standard for Multichannel Television Sound (MTS) was approved by the FCC in March 1984. Since then only about 25 tv stations across the US are regularly transmitting with stereo sound, although this figure is expected to increase as viewers become more aware of stereo-sound tv.

The US system, which is referred to by the initials of the Broadcast Television Systems

Committee (BTSC), provides two additional sound channels as well as the stereo programme channel. A stereo a.m.-d.s.b. suppressed-carrier subchannel is centred on a frequency corresponding to twice the horizontal line frequency ($2f_H$) within the audio baseband. This carries the (L-R) information in a similar way to stereo radio transmissions.

A monaural f.m. channel is centred at $5f_H$ further along the audio baseband. This second audio programme channel (s.a.p.) can be used for bilingual programming. In parts of the US with large second language populations, the s.a.p. facility will be attractive to both programme producers and advertisers. By the use of the second language channel, advertisers will be able to reach audiences that up until now have not taken too much notice of their advertisements, because of language difficulties. The s.a.p. can also be used for transmitting the original sound track of a foreign film, the dubbed sound-track of which is being transmitted on the main audio channel.

The third channel provided

within the audio baseband of the US stereo-sound tv system is called the Pro channel. This 3.4kHz wide channel can be used for data or voice: talk-back facilities would be one possible use for this relatively narrow-band communications facility.

The total base-bandwidth required for the multiplexed stereo sound signal in the BTSC system is about 120kHz. One of the main technical topics of discussion among television transmitter engineers at NAB was the question of stereo-sound operation and how existing equipments may have to be modified in order to access this new market. The increased audio bandwidth required imposes constraints on the transmitter driver stages. Also, in transmitter configurations which combine the sound and vision signals at the output of the transmitters before feeding the combined signal into the antenna, some modifications to the combiner may also be necessary.

Typical sound-vision combiners use a single resonator for the "sound notch". Because the multiplexed stereo audio requires

As satellites play an ever more important role in broadcasting, broadcast exhibition is complete without a large outside satellite terminal park. Outside satellite equipment exhibitors sat in temperatures approaching 100°F during this year's NAB in Las Vegas.

more bandwidth at r.f. as well as at baseband, the sound notch has to be widened, by the addition of a further sound-notch filter.

A major part of the technical discussion programme was given over to lectures on how to modify transmitting equipment, both at the low-level signal-processing stages as well as at the output combiner, to handle the demands of stereo-sound tv programming.

Tv stations that are using stereo-sound transmission currently make most use of the facility for their own in-house productions and outside broadcasts. Much of the bought-in material used by tv stations is not recorded in stereo.

Viewers in the US are being encouraged to trade-in their



NAB, the World's largest radio and tv broadcast exhibition, held this year in Las Vegas attracted 40,000 visitors from all sectors of the broadcast industry.

existing tv sets for stereo receivers. The familiar chicken and egg situation arises: tv viewers in the US will not be easily tempted to trade-in their existing perfectly functioning tv receiver for a new one until there is adequate programming available to make it worth their while. On the other hand, the businessmen running broadcast stations will not be too excited about investing in new equipment to convert their stations for stereo sound unless there is a ready audience. However, by next year's NAB, stereo-sound tv in the US is likely to be more common than it is today, only one year after the FCC approved a common standard.

U.h.f. tv under pressure

Whereas in the UK it is now some months since the last of the v.h.f. tv transmitters were finally turned off, liberating in excess of 70MHz of prime spectrum for other users, including predominately land mobile radio, in the US tv broadcast spectrum things are quite different. For US tv broadcasters the v.h.f. bands are still the major programme carriers. Rather than expanding services in the u.h.f. band, US

broad-casters are under attack from other users, particularly the land mobile services for more access to u.h.f. channels. US tv broad-casters have already lost access to the highest u.h.f. tv channels of 70 to 83 (807-890). These higher tv channels have been taken over by different types of mobile services, including the US cellular networks, which currently operate in the ranges 825-845MHz and 870-890MHz. Other parts of this spectrum at 800MHz are used for both conventional and trunked land mobile services in the US. There is also a provisional allocation at 821-825MHz and 866-870MHz for a future land mobile satellite service. US broadcasters have lost some u.h.f. tv channels for ever. It doesn't stop there.

U.h.f. tv broadcasters are now facing up to the idea of having to share u.h.f. frequencies with land mobile services on other u.h.f. tv channels. The FCC are proposing that certain u.h.f. tv channels be used by land mobile radio services in the US in cities distant from tv broadcasters using the same channel. The mobile radio industry in the US is a powerful lobby and they have been successful in squeezing broadcasters out of some of their exclusive allocations as well as encroaching on other broadcast channels. During a u.h.f. conference session at NAB, u.h.f. broadcasters were told by FCC Commissioner Rivera that "the land mobile community (in the US) are well organised and they smell blood and are being aggressive (in their attack on u.h.f. tv

frequencies)". "Broadcasters", concluded Rivera "must make their views known".

The take-over of some u.h.f. broadcast frequencies in the US by land mobile services is the exact opposite of the situation in the UK where the u.h.f. tv channels are still the exclusive reserve of tv broadcasters, but where land mobile services have taken over or will eventually take over most of what until recently were Broadcast tv Bands I and III.

Transistors move to high-power

Two of the last remaining bastions of the thermionic valve are in the front ends of e.m.p. proof receivers and in the back end of high power broadcast transmitters. Everywhere else the ever more powerful and robust transistor is taking over.

The Nautel Ampfet 50kW medium-wave broadcast transmitter being shown at NAB was an example of the transistor's ever continuing advance into the area of high-power transmitters. By using 48 power blocks, each consisting of a solid-state 1.25kW amplifier, this Canadian designed nominally 50kW a.m. transmitter is able to operate with 55kW of output power at 125% positive modulation. Old-time broadcast transmitter engineers, brought up perhaps in the days of bright emitter valves were noticeably shaking at the idea of using about 200 transistors in parallel to produce 50kW of a.m. on the medium wave! How far away now is the solid-state megawatt broadcast transmitter?

The output stages of high-power u.h.f. television transmitters are unlikely to go solid-state for many years. In the meantime klystron designers and u.h.f. tv transmitter manufacturers continue to strive to increase the d.c. - to-r.f. efficiency of transmitter output stages.

A new record in klystron efficiency was being claimed at NAB by US transmitter manufacturers Comark. Using an "S" series Comark 60kW u.h.f. transmitter fitted with a Marconi B7500 drive, an Amperex YK1265 klystron and a high energy CTM-20 pulser, klystron beam efficiencies in excess of 77% had been measured during tests made at the Columbus Ohio tv station WTTE. Cost-conscious tv transmitter station operators are always striving to reduce their energy costs. Increasing beam efficiency of the klystron amplifier can lead to significant reductions in operating costs. The Chief Engineer of WTTE was being quoted at NAB as saying that if the equipment used for the tests were permanently installed at his station, then he would expect "a 25-33% reduction in the power bill for the transmitter plant."

NAB 1986

Next year's NAB will be held in Dallas. Before then radio and tv broadcasters have both Montreux in Switzerland and InterBEE in Tokyo to attend, but for broadcasters on the transmission side of the business, there is only one exhibition and that is NAB!

Sampled-data servos — a new analysis

June's article explained how to calculate open and closed-loop gains as functions of frequency. This section, presented in two parts, extends the working of part 4 to give the response as a function of time. The first part, below, shows how to calculate the various sampled-data signals in the loop, while the second part, next month, shows how to calculate the continuous signals.

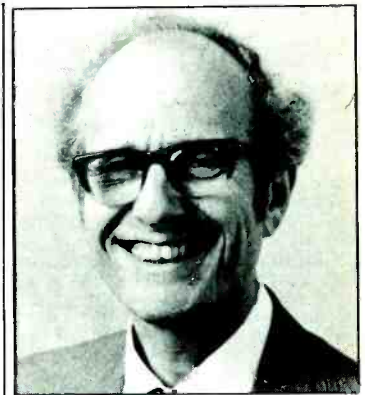

by D.M. Taub, M.Sc., Ph.D.

The servo system in Fig. 21 (June) receives a sequence of input samples at U, and produces a sequence of output samples at Y. To compute the relationship between the two, we have to obtain an expression for the closed-loop gain, H_{UY} , as a function of z — the expression will have the same form as the expression for $H_{VX}(z)$ on page 35 of the June issue — and then write down the corresponding recurrence formula to give an expression analogous to the one at the top of the same column. The first step is to develop an expression for $H_{XY}(z)$. This can be multiplied by $H_{VX}(z)$ to give the open-loop gain $H_{VY}(z)$, which is then used in the expression

$$H_{UY}(z) = \frac{H_{VY}(z)}{1 + H_{VY}(z)}$$

This is the same as expression 4.5 except that the gains are expressed as functions of z instead of $j\omega$.

Term $H_{XY}(z)$ will be expressed, like $H_{VX}(z)$ in part 4, as the ratio of two polynomials. There is a relationship between this function and $H_{XD}(s)$, the gain through the continuous-signal part of the loop, which gives us a straightforward way of finding the denominator polynomial. H_{XY} is already known in terms of real frequency (June issue, page 35),

and so the problem reduces to that of finding a numerator polynomial which, taken in conjunction with this denominator polynomial, gives us the correct form of $H_{XY}(j\omega)$. How this is done is explained on page 60.

Relationship between $H_{XY}(s)$ and $H_{XD}(s)$

Assume a unit impulse applied at X, — Fig. 21. This produces a response $d(t)$ at D, whose Laplace transform represents the gain between X and D in terms of s [ref.5, section 7.2.3]. Thus

$$H_{XD}(s) = \int_0^{\infty} d(t) e^{-st} dt \quad \dots 5.1$$

The response at Y, $y(t)$, is the result of multiplying $d(t)$ by the sampling waveform (equation 2.3). This gives

$$y(t) = d(t) \sum_{n=-\infty}^{\infty} e^{jn\omega_s t}$$

and taking its Laplace transform,

$$H_{XY}(s) = \int_0^{\infty} d(t) \left[\sum_{n=-\infty}^{\infty} e^{jn\omega_s t} \right] e^{-st} dt$$

The significance of this expression is made clear by expanding it in the following way:

$$H_{XY}(s) = \dots + \int_0^{\infty} d(t) e^{-j\omega_s t} e^{-st} dt + \int_0^{\infty} d(t) e^{-st} dt + \dots + \int_0^{\infty} d(t) e^{j\omega_s t} e^{-st} dt + \dots$$

$$H_{XY}(s) = \dots + \int_0^{\infty} d(t) e^{-(s + j\omega_s)t} dt + \int_0^{\infty} d(t) e^{-st} dt + \int_0^{\infty} d(t) e^{-(s - j\omega_s)t} dt + \dots$$

The middle term in this expression is seen to be $H_{XD}(s)$ from (5.1). The term immediately preceding it represents H_{XD} at $s + j\omega_s$, i.e. when the real part, σ , of s is unchanged but the imaginary part $j\omega$ is increased to $j(\omega + \omega_s)$. This is written $H_{XD}(s + j\omega_s)$. Similarly, the last term shown represents H_{XD} at $s - j\omega_s$, i.e. $H_{XD}(s - j\omega_s)$. The terms preceding the ones shown represent $H_{XD}(s + j2\omega_s)$, $H_{XD}(s + j3\omega_s)$, and so on, while those following represent $H_{XD}(s - j2\omega_s)$, $H_{XD}(s - j3\omega_s)$ etc. Stated formally,

$$H_{XY}(s) = \sum_{m=-\infty}^{\infty} H_{XD}(s + jm\omega_s) \quad \dots 5.2$$

The meaning of this expression is that if we draw a line on the s -plane parallel to the $j\omega$ axis, Fig. 27, and take an infinite series of points along it, ... P_{-1} , P_0 , P_1 , ... pitched $j\omega_s$ apart, the value of H_{XY} at every one of them is the sum of H_{XD} at all of them. This is a generalisation of what was found earlier (June, page 35): the only difference is that there, the real part of s was zero.

Fig. 27. s -plane diagram illustrating the relationship between H_{XY} and H_{XD} as function of s .

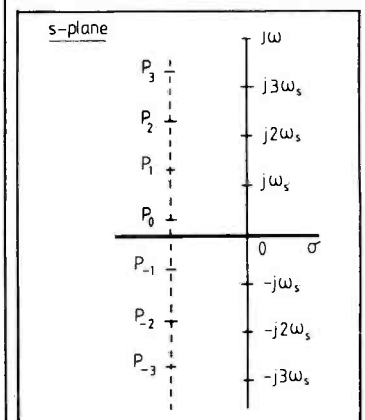

REFERENCES

- J.J. Distefano, A.R. Stubberud and I.J. Williams. 'Feedback and Control Systems' (Schaum's Outline Series, McGraw-Hill, New York, 1976).
- M. Healey. 'Principles of automatic control', (Hodder and Stoughton, London, 1975).
- M.K. Haynes. 'Magnetic recording techniques for buried servos'. *IEEE Transactions on Magnetics*, Vol. MAG 17, 1981 pp 2730-4.
- N.H. Hansen. 'Head-positioning system using buried servo', *ibid* pp 2735-8.
- P.A. Lynn. 'Introduction to the analysis and processing of signals' (Macmillan, London, 1973).
- B.C. Kuo. 'Analysis and synthesis of sampled-data control systems' (Prentice-Hall, Englewood Cliffs, NJ, 1963)
- A.M. Tropper. 'Matrix theory for electrical engineering students' (Harlap, London, 1962).
- S. Goldman. 'Transformation calculus and electrical transients'. (Prentice-Hall, New York, 1949).
- D.M. Taub. 'Programs for computing sampled-data servo performance'. IBM Technical Report no.12.199, (IBM United Kingdom Laboratories, Hursley, May 1982).

Fig. 28. Sampled-data signals in response to a step-function input. Top: plant output, $y(n)$, middle: error signal, $v(n)$, bottom: compensator output, $x(n)$.

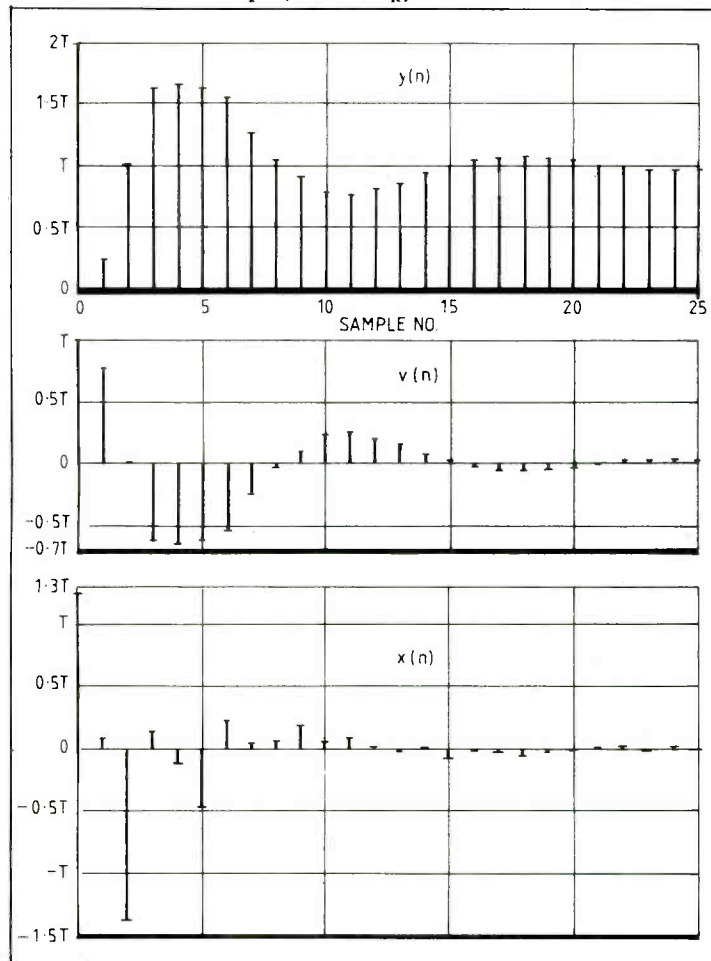

Denominator polynomial of $H_{XY}(z)$

The expression for $H_{XD}(s)$ will generally be the ratio of two polynomials in s , analogously with the $H_{XY}(z)$ expression mentioned earlier, or in terms of their factors, i.e.

$$H_{XD}(s) = K_{XD} \frac{(s - \lambda_1)(s - \lambda_2) \dots}{(s - \mu_1)(s - \mu_2) \dots}$$

λ_1, λ_2 etc are the roots of the numerator polynomial, i.e. the values of s at which H_{XD} is zero, and μ_1, μ_2 etc are the roots of the denominator polynomial, the values of s at which H_{XD} becomes infinite. They are known respectively as the zeros and poles of H_{XD} .

Referring to Fig. 27, suppose that one of the points shown, say P_1 , represents a pole of H_{XD} , i.e. a point where H_{XD} is infinite. Then from the argument given above, H_{XY} will be infinite at all of them; in other words, all of them will be poles of H_{XY} . This infinite set of poles maps into a single pole in the z -plane through the equation $z = e^{Ts}$.

Thus for each pole of $H_{XD}(s)$ there will be a corresponding pole of $H_{XY}(z)$. If these poles are at $\psi_1, \psi_2, \dots, \psi_m$ the denominator of $H_{XY}(z)$ can be expressed as

$$(z - \psi_1)(z - \psi_2) \dots (z - \psi_m)$$

and these factors multiplied together to give the denominator polynomial

$$z^m + \xi_{m-1}z^{m-1} + \dots + \xi_1z + \xi_0 \quad \dots 5.3$$

Generally speaking, the number of poles needed to represent the gain of the plant and any continuous-signal compensation is finite, but the number needed for an exact representation of the time delay and hold-circuit is infinite (see equations 3.1 and 4.1)*. The poles associated with the time delay and hold circuit will be ignored for the moment, and the necessary correction introduced later.

Numerator polynomial of $H_{XY}(z)$

The numerator polynomial of $H_{XY}(z)$ cannot be of higher order than the denominator polynomial, otherwise the function would be unrealisable (see ref.5, section 9.4.2). It could conceivably be lower, but no generality is lost by assuming the order of the two polynomials to be the same. If in fact the numerator polynomial turns out to be of lower order, the computation described in this section will cause the coefficients of the superfluous higher powers of z to be zero. $H_{XY}(z)$ can therefore be expressed as

$$H_{XY}(z) = \frac{v_m z^m + v_{m-1} z^{m-1} + \dots + v_1 z + v_0}{z^m + \xi_{m-1} z^{m-1} + \dots + \xi_1 z + \xi_0} \quad \dots 5.4$$

Writing the denominator in a more compact form, and cross-multiplying,

$$H_{XY}(z) \sum_{k=0}^m \xi_k z^k = v_m z^m + v_{m-1} z^{m-1} + \dots + v_0$$

At real frequencies z reduces to $e^{jT\omega}$ giving

$$H_{XY}(j\omega) \sum_{k=0}^m \xi_k e^{jkT\omega} = v_m e^{jmT\omega} + \dots + v_{m-1} e^{j(m-1)T\omega} + \dots + v_0$$

We already have the means of finding values for ξ_k and $H_{XY}(j\omega)$; therefore we can choose $m+1$ values of ω , ω_0 to ω_m , and compute $m+1$ corresponding values for the left-hand side of this equation. Calling these values L_0 to L_m , now write the following set of equations:

$$L_0 = e^{jmT\omega_0} v_m + e^{j(m-1)T\omega_0} v_{m-1} + \dots + v_0$$

$$L_1 = e^{jmT\omega_1} v_m + e^{j(m-1)T\omega_1} v_{m-1} + \dots + v_0$$

$$L_m = e^{jmT\omega_m} v_m + e^{j(m-1)T\omega_m} v_{m-1} + \dots + v_0$$

* There is a way of representing the zero-order hold and first-order hold with $\alpha = 1$ exactly (ref. 6, section 3.5), but it adds complication and gives no advantage in practice.

This is a straightforward set of linear simultaneous equations in which v_0 to v_m are the unknowns and the exponential terms are the coefficients. They can be solved by any of the standard methods e.g. determinants or matrices. In matrix notation they become

$$\begin{bmatrix} L_0 \\ L_1 \\ \vdots \\ L_m \end{bmatrix} = \begin{bmatrix} e^{jmT\omega_0} & e^{j(m-1)T\omega_0} & \dots & 1 \\ e^{jmT\omega_1} & e^{j(m-1)T\omega_1} & \dots & 1 \\ \vdots & \vdots & \ddots & \vdots \\ e^{jmT\omega_m} & e^{j(m-1)T\omega_m} & \dots & 1 \end{bmatrix} \begin{bmatrix} v_m \\ v_{m-1} \\ \vdots \\ v_0 \end{bmatrix}$$

or, more compactly,

$$L = E \times v$$

The solution is found by inverting the matrix of exponential terms E and forming its product with the column vector L (see, for example, ref. 7 section 1.11):

$$v = E^{-1} \times L$$

Increasing the accuracy

At the end of the denominator polynomial section it was suggested that the poles associated with the time delay and hold circuits should be left out of the calculation for the time being. This means that equation 5.4 will not give H_{XY} exactly, except at the $m+1$ chosen frequencies. The way to increase the accuracy is to increase the order of the polynomials in (5.4). The procedure is as follows.

- The denominator polynomial is found as described, (see heading)
- The numerator coefficients v_0 to v_m are found as described (see heading).
- A pole is added at the origin of the z -plane. This is done by multiplying the denominator polynomial (5.3) by z , so that it is now one order higher than before, viz:

$$z^{m+1} + \xi_{m-1} z^m + \dots + \xi_0 z$$

- The procedure described above is repeated, giving a new set of coefficients for the numerator polynomial. The new numerator polynomial, also one order higher than before, can be written

$$v_{m+1} z^{m+1} + v_m z^m + \dots + v_1 z + v_0$$

Now if the earlier numerator polynomial had been exact, then coefficients v_{m+1}, v_m, \dots, v_1 will turn out to be exactly equal to v_m, v_{m-1}, \dots, v_0 respectively, and

v_0 will be zero. This is equivalent to saying that the effect of adding the extra pole at the z-plane origin has been to add an extra zero in the same position, the two cancelling one another. Therefore, having found the new numerator coefficients, they are compared with the old ones as described above. If the comparison shows the difference to be insignificant, the last pole added, and its cancelling zero, are removed by dividing the numerator and denominator by z, and the procedure is terminated. If not, steps (c) and (d) are repeated.

In the cases studied so far it was found that at most one pole and zero had to be added to give good accuracy.

Sample-time response

Having found H_{XY} in terms of z, we are now in a position to find the sample-time response at various points in the loop, V, X and Y (Fig. 21), for any sequence of input samples at U.

The open-loop gain is

$$H_{VY}(z) = H_{VX}(z) \cdot H_{XY}(z) \quad \dots 5.5$$

and, from the first expression in this article the closed-loop gain is

$$H_{VY}(z) = \frac{H_{VY}(z) \cdot H_{XY}(z)}{1 + H_{VX}(z) \cdot H_{XY}(z)}$$

Expressing the right-hand side of this equation in terms of the relevant numerator and denominator polynomials obtained from (5.4) and the expression for $H_{VX}(z)$

$$\frac{\left[\sum \beta_k z^k \right] \left[\sum \gamma_k z^k \right]}{\left[\sum \gamma_k z^k \right] \left[\sum \xi_k z^k \right] + \left[\sum \beta_k z^k \right] \left[\sum \nu_k z^k \right]} \quad \dots 5.6$$

The gain between U and V, is

$$H_{UV}(z) = \frac{H_{VY}(z)}{H_{XY}(z)} = \frac{1}{1 + H_{VX}(z) \cdot H_{XY}(z)}$$

and in terms of the polynomials $H_{UV}(z) =$

$$\frac{\left[\sum \gamma_k z^k \right] \left[\sum \xi_k z^k \right]}{\left[\sum \gamma_k z^k \right] \left[\sum \xi_k z^k \right] + \left[\sum \beta_k z^k \right] \left[\sum \nu_k z^k \right]} \quad \dots 5.7$$

The gain between U and X is

$$H_{UX}(z) = H_{UV}(z) \cdot H_{VX}(z)$$

which, in terms of the polynomials, becomes $H_{UX}(z) =$

$$\frac{\left[\sum \beta_k z^k \right] \left[\sum \xi_k z^k \right]}{\left[\sum \gamma_k z^k \right] \left[\sum \xi_k z^k \right] + \left[\sum \beta_k z^k \right] \left[\sum \nu_k z^k \right]} \quad \dots 5.8$$

All these expressions for the various gains can be arranged as the ratio of two polynomials, and we take $H_{UV}(z)$ as being typical. Expressed in this way

$$H_{UV}(z) = \frac{Y(z)}{U(z)} = \frac{\xi_M z^M + \xi_{M-1} z^{M-1} + \dots + \xi_0}{z^M + \eta_{M-1} z^{M-1} + \dots + \eta_0}$$

and dividing numerator and denominator by z^M ,

$$\frac{Y(z)}{U(z)} = \frac{\xi_M + \xi_{M-1} z^{-1} + \dots + \xi_0 z^{-M}}{1 + \eta_{M-1} z^{-1} + \dots + \eta_0 z^{-M}}$$

The relationship between the sample values at U and Y is found by writing down the recurrence formula that corresponds to this expression, i.e. by carrying out the reverse of the process used on page 35, June issue. This gives

$$y(n) = \xi_M v(n) + \xi_{M-1} v(n-1) + \dots + \xi_0 v(n-M) - [\eta_{M-1} y(n-1) + \dots + \eta_0 y(n-M)]$$

The sample values at V and X can be found in a corresponding manner.

Example

The procedure explained in the preceding sections has been applied to the system used in the example on page 36, June issue. The coefficients of the polynomials in the expressions for $H_{XY}(z)$, $H_{UV}(z)$, $H_{UY}(z)$ and $H_{UX}(z)$ were found to be as follows. They are given in order of decreasing powers of z, the last one being the constant term in each case. Note from equations 5.6, 5.7 and 5.8 that $H_{UV}(z)$, $H_{UY}(z)$ and $H_{UX}(z)$ all have the same denominator.

$H_{XY}(z)$ numerator:
 8.479×10^{-7} 0.1836 0.6489
 0.7117 0.3565 0.003985

$H_{XY}(z)$ denominator:
 1 -0.7656 -0.7079
 -0.2875 0.7609 0

$H_{UV}(z)$ numerator:
 1 -0.03119 -1.559 -1.555
 1.035 1.669 0.3937 -0.5964
 -0.3473 -0.008918 0

$H_{UY}(z)$ numerator:
 1.067×10^{-6} 0.231 0.822
 0.6015 -0.646 -1.12
 -0.2673 0.3838 0.2018
 0.002257

$H_{UX}(z)$ numerator:
 1.258 -0.9319 -2.625
 0.891 2.753 0.1069 -1.693
 -0.1896 0.431 0

$H_{UV}(z)$, $H_{UY}(z)$ and $H_{UX}(z)$ denominator:
 1 0.1998 -0.7372 -0.9533
 0.3892 0.5484 0.1265
 -0.2126 -0.1456
 -0.006661

The sample values at V, X and Y,

denoted by $v(n)$, $x(n)$ and $y(n)$ respectively, have been computed for an input at U consisting of a sampled step function in which each of the samples is of weight T; this corresponds to a unit step function input at R (April). The results, plotted in Fig. 28, show that not until sample no. 14 does the output settle to within 10% of the input. The programs used for these computations are given in ref 9.

Stability criterion

At the beginning of the sample-time response section an expression was given for the open-loop gain as a function of z, i.e. $H_{VY}(z)$ (equation 5.5). Using this, apply the Nyquist stability criterion to check that the loop is stable.

The procedure is to follow a path in the z-plane that encloses the whole area falling outside the unit circle, steering just clear of any points lying on the unit circle itself. The path to be followed is shown in Fig. 29(a) by ABCDEFGHA. At every point along this path there will be a corresponding value of magnitude and

phase for $H_{VY}(z)$; around the unit circle itself these will correspond to $H_{VY}(j\omega)$ (page 36, June). The magnitude is plotted against phase on polar co-ordinates to give the familiar Nyquist diagram (ref, 1, chapter 11). This takes the form of a closed contour, and the criterion for stability is that the net number of clockwise encirclements of the point (-1, 0) must not exceed 0.

A Nyquist plot for the system used in the examples is sketched in Fig. 29(b), points A', B' etc representing H_{VY} at A, B etc respectively. The contour traced out is seen to make one clockwise and one anticlockwise encirclement of (-1, 0), confirming that the system is stable. The stability margins can be read from the diagram as an alternative to the Bode plot in Fig. 25.

To be continued.

Appendix

Relationship between $H_{XY}(s)$ and $H_{XD}(s)$:

$$H_{XY}(s) = \frac{1}{T} \sum_{k=-\infty}^{\infty} H_{XD}(s + jm\omega_s) \quad \dots U 5.2$$

Fig. 29.

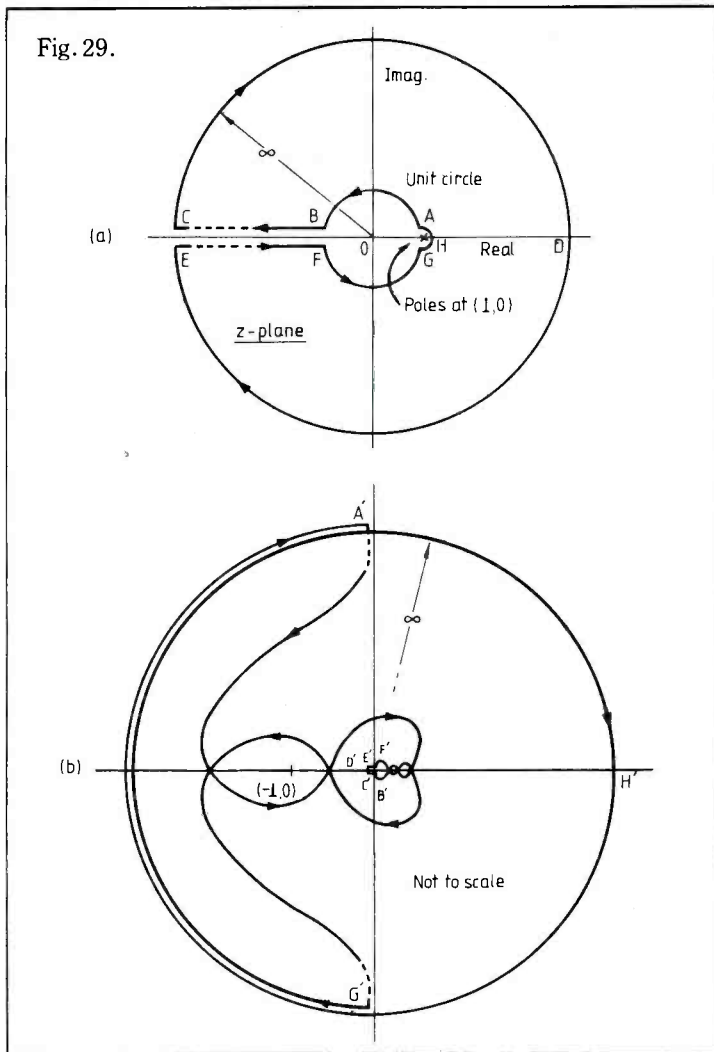

Social electronics for youth

by K.L. Smith,
Ph.D.

University of Kent at Canterbury

Ken Smith describes his work with young people. Facilities are there, components need not be expensive — where are the teachers?

In the recent past, *Wireless World* has carried commentary about the social implications of technology and electronics in particular. There is one aspect of this debate upon which I can make a few observations from a fairly wide experience that could very well have a practical outcome.

This aspect is appropriate from the point of view of individuals and 'human-scale' values relating to technology. Such a view would, of course, link with that offered by the late Fritz Schumacher¹. I realise that underlying these comments is the old question, "Where are we going, what do we want to achieve?" Therefore with a general view across most of technology, but from an unusual starting point, I ask the question: why is "grass roots" technical activity in voluntary youth work at a negligible level? All the evidence I have is that once it was much more likely to be seen, at least within certain social classes. It now seems that hardly any engineers or scientists in Britain take up voluntary 'hands-on' work with girls and boys. The prevailing attitude in technology and engineering is remarkably conservative (with a little c. . .).

But science, especially physics and chemistry, was once radical, as ecology is now. And radical activity is activity for change — especially with youth. Even if engineers as a breed tend to be 'uptight', as we used to say², yet there are hardly any scientists either that enter the rural or inner-city Youth Clubs offering science-technology activities. The occasional talk might be given perhaps, or "High-tech" careers may get a mention — even if it shows careers most youth probably *won't* attain in the meagre job situation. . .

Small, but high-status projects

occasionally surface and the odd lecturer or research boss sits on a committee 'advising' about the purchase of a dozen micros for some municipal youth centre or another. Or someone may appear on a tv channel talking about what ought to be done. The youth themselves end up becoming labelled as a noisy, disorganized rabble — "Can't you keep those kids out of here, they might damage the computers. . .". Is this the 'sanitary' theory of projects?

There is another tendency, which appears to be the growth of social engineering and systematization of everything. If the work is not professional and does not fit the youth into some kind of peg-in-a-hole trade — or if it does not possess the right image and help induce consumption of the products — and unquestioning conformity, then it is labelled useless. Or worse, it might tend to radicalize the youth, and we don't appear to want that.

Many young people are critical of such things (except certain privileged ones) when they discover the manipulation. They (the failures) get enough of that in the schools. Mind you, this ethos of what has been called "closetted oppression" (or in schooling circles, the 'hidden curriculum'), is often discussed, but little is done about it. Its continuance wears down most of the young people in the end and many become docile consumers. Yet we do have, to a considerable extent, a violent State and society, lots of fiddling, unfeeling and anti-social behaviour. The economic system being what it is there is even a lot of vested interest profit in illogical uses — some would say misuses — of resources. There are of course, many other generous actions with a silver lining, but I ask again, where are the engineers contributing this good-

will and gift of their time and moral values through their subject?

Considering these observations, we might look at a few things that could be developed concerning the Technological Society, which would involve many of our youth in new activities. But first a few more observations: visits to four youth clubs showed one or two games going on; a blaring disco, a coffee bar, general (unabating) guffawing, yelling, horseplay — bashing and spitting. One had a pottery kiln, some painting, enamelling, etc: excellent. But most had very little practical activity to offer. Whenever I mentioned electronics as a possible activity, a silence fell on the proceedings nearly everywhere.

Where in these clubs is the

photographic lab.
model engineering-metalwork shop
carpentry shop
physics-chemistry lab.
electronics club
radio shack

Even, nowadays

"computer arcade". . . (sic)
astronomy observatory
biology and ecology group
motor mechanics workshop
boat-building yard
building construction going on. . .

etc.

I tried to arouse the interest of one person via a local radio club (with a membership of about 60) to help one evening per week in something for youth from the above list — but there were no takers at all. Is this apathy also a kind of decadence?

I have not exaggerated — there appears to be few youth clubs in Britain with any of the activities I have listed. I believe much more occurs in Japan and, although patchy, in the USA. Thousands of youth in our country at the present time never meet an expert 'skills model' to emul-

Fig. 1. Nicky, aged nine, enjoying the construction of his 555 timer switching project on the benches built by the boys of an earlier generation.



ate. Young teenagers in my group shock me every time they say, "You are the only person that's ever bothered about us, — we've never had anyone to talk to about all these technical things before." In other words, they've had no mature friend from the technically literate middle class to lead them in projects.

I am not talking about paid, full-time professionals who service a sub-group of young people (the selected few, mainly middle class) as clients, but spontaneous networking which is not socially engineered. The lack of this freedom is rather sad. The point is an important one, as even in voluntary — or what the Youth Service calls part-time — leadership, systematic professional-like training towards some kind of standardized norms and assumptions, are imposed. In some respects we should be critical of this developments³).

The Thanet electronics club

Exerting a little effort, this situation can be overcome. With very little in the way of resources, other than a tiny room (with thanks to the Centre Management Committee in Margate), a small subscription and scrap electronic junk, very good results have been achieved.

The development of this electronics group for youth links back to a much earlier pilot project called the Roding Boys' Society, which was set up in Wanstead, Essex, back in the 1960s. A few years ago, Mr Stevens, then Youth and Community Officer for Kent County Council, visited me at the University and I mentioned this early work. He asked me for a short contribution to a group of Youth Leaders at a weekend training course in Broadstairs. One Centre Leader, Tony Kearney, was fired with enthusiasm after hearing the lecture, and invited me to try to form a club in a small store room at the Quarter Deck, Margate. The result has been a successful group for a few years now. This is a pattern that could very well be repeated elsewhere. To this end, you might offer a short talk to a Youth Workers' Conference in your locality.

Many projects, from low-frequency multivibrators and switching circuits, to sensitive short-wave radios, stabilized power supplies and similar devices are continually produced by a flow of young members: each project can be made for a couple

of pounds or so. A useful standard assembly system has been evolved with very good educational results indeed. Experiments in play-rehearsing small-business experiences, both via the usual hierarchical "other ownership" capitalist models, and through co-operative methods of production, have been much enjoyed.

Visits to the Model Engineering Exhibition and Science Museum are highlights. I have found it is important to socialize like this — the club must be a social group as well as technical. Going cycling on Youth Hostel tours is also a good experience for the young people and is very educational. The last holiday on which I took them was around the Isle of Wight, which enabled us to visit the excellent Wireless Museum at Arreton Manor.

Recently, a number of members requested and then organized a "study group" for mathematics and physics to "O" Level. The youth are all "non-selective"(!) young people — but enjoyed their maths (differential calculus included!) enormously. One member entered for the GCE "O" Level Electronics exam and his project, a sound and light operated counter/timer, gained 47 marks out of a possible 50.

The group is registered as Volunteers for the Talking Book for the Blind repair scheme. The whole activities programme is regularly exhibited — usually with an "Alternative Technology" special club project — at large local fairs and events (e.g. QUEXPO, Birchington). Of course, all this kind of activity is ideal for the Duke of Edinburgh's Award Scheme.

Springing from this electronics club experience has been the offshoot consisting of a programme of lectures for children at the University of Kent. This work, organized by a local committee, is known as the Canterbury Young Technologists scheme. It is much more middle-class in flavour, attracting young people from prep. schools, etc. and professors' children. In this, inspiring and useful work has also been achieved, with great fun for all concerned.

Regarding the Thanet Club work, it is not universally cheered on. There are sometimes a few inhibited reactions from one or two professionals — I wonder why? But I would like publicly to thank many of my colleagues at UKC who have helped with opti-

mistic interest and in little practical ways, who are not like this.

Spreading the work

The work of processing and engineering people into state-determined slots already figures prominently and, in spite of squeals to the contrary, mobilizes enormous private and public wealth. So I am *not* discussing that system, which often seems to claim to be the only valid one when powerful knowledge is involved.

But if you are interested in alternatives, then it is important to see that professionals involved (engineers, scientists, teachers) must act in a *voluntary capacity* and suspend the expectation of normal "fees"-level income recommended by their professional associations. But the essential thing to remember is that the given time is nevertheless worth a considerable, even if unstated, value. This means that a difficult theoretical question arises. Would such contributions amount to self-exploitation by the volunteer who carries such marketable knowledge? Would more entrenched interests take the 'profit', and laugh all the way to the (ideological) bank?

Be that as it may, it remains essential for society to provide the minimum facilities, even in so-called economically difficult times. A room and small capita-tion grants are important from the statutory bodies and from private sources⁴. The volunteer offering the valuable skills and time cannot even start without these. The apparent difficulty many statutory services experience in providing the basic requirements probably helps to account for the dearth of competent leaders in technical activities working with youth. Technology as an activity is sufficiently out of the tradition to end up different in quality than most youth work (certainly true at the present time, but many authors claim Britain never has been pro-technology as a cultural or popular activity — ever), hence the prejudice, as well as the trend for large numbers of people to be "deskilled" by the ethos of the modern State.

Young people who find, for example, *Tomorrow's World* not as interesting as one might expect, say to me that there is nothing they can see relevant to their hobbies and so on. In other words, everything is so professional — and middle-class. I can see their point. But I admit a size-

able problem. Busy engineers and scientists find it nearly impossible to generate anything for television, say, without media-people advice. Unfortunately media people are usually non-technical and have a discouraging "whizz-bang-wow" attitude to material, as well as a lot of status-mindedness. It is a problem, and a response from that quarter is needed.

The youth respect *real* skill and knowledge, but are unimpressed by ego-trippers — those qualified people who wear their status on their sleeve. The young people are incisive, genuine and spontaneous. Their respect for your Ph.D lasts no longer than the time you try to cover up the fact that you can't solder, but claim you can — or show you are a status-bore. (Huh! he's just like a teacher after all); probably the worst epithet you will receive and they will vote with their feet.

But if you get your bottom on a bike seat and take them on a YHA tour, visiting an Engineerium, or wireless station, or technical museum en route, then you *are* a bit of a hero.

The youth require *results* — and fast. They certainly are more demanding than most rather inhibited research students I have known. Because of the direct nature of this kind of work, the peculiar dehumanization ethos that is creeping across a vast area of our social/professional life, is, perhaps somewhat offset. And the lie is put to the belief that technology and its implementation is the path to human happiness. It certainly isn't to many, but democratizing it certainly can be; to us at least.

REFERENCES

1. See "Small is Beautiful". . . Economics as if People Mattered E.F. Schumacher. ABACUS 1974.
2. "Contrary Imaginations" Liam Hudson. Penguin 1972. Liam Hudson show the "convergent personality" likely to be shown in people who take up engineering, Law etc. They like things and systems more than people — who they tend to find messy. A salutary read for most engineers. . .
3. "Disabling Professions" Ivan Illich et al. Marion Boyars 1977. Much in "professionalism" might be oppressive, so argue these authors. Such a view is like 'swearing at the altar', but I have found some evidence for some of this — even in our own profession. A healthy bit of scepticism and some democratic accountability regarding professional pomposity would do a power of good.
4. I would like to record thanks to those Companies and individuals who have helped us with gifts of equipment etc. I can especially mention Messrs Avo of Dover and Sendz Components of Southend-on-Sea.

Popular CPU

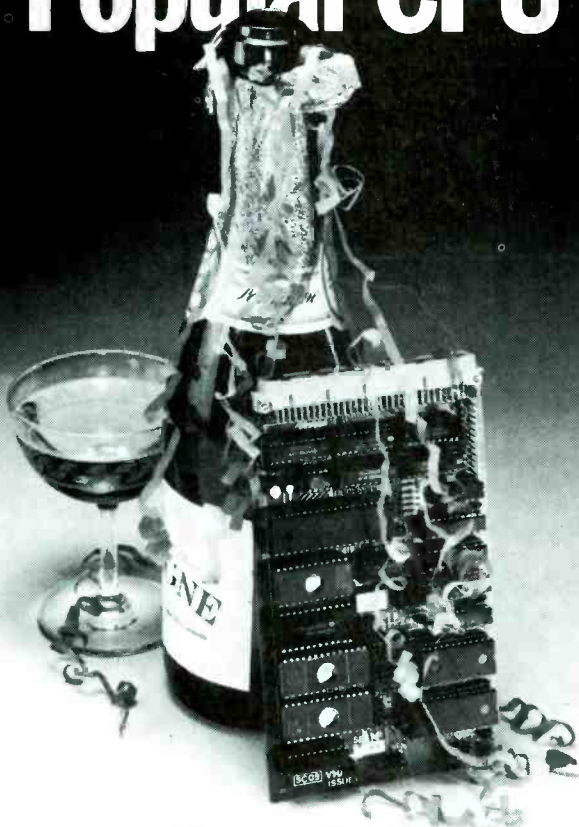

on the standard bus

The 6809 processor's exceptional power and software flexibility has won the admiration of many designers.

Now it comes with four memory sockets, serial I/O, counter-timers and software including the OS/9 operating system and a machine code monitor, on a £182 board interfacing to the STE bus, the new IEEE P1000 standard for 8-bit systems designers. STE is a modern alternative to buses like G64, but with many advanced features: processor-independence, 1 Mbyte memory addressing, 4 kbytes of I/O space, and multiprocessor facilities.

It's equally cost-effective in single-processor designs or high-performance systems that many would consider VME for.

Call for details:

Arcom

CONTROL SYSTEMS LTD

Arcom Control Systems Limited
Unit 8, Clifton Road, Cambridge, CB1 4WH
Phone (0223) 242224

Distributors:
Dage (0296) 33200, **New-Tek** (0223) 211211

CIRCLE 23 FOR FURTHER DETAILS.

E.M.S. POWER SYSTEMS



Solve all your Power Problems by contacting E.M.S.

E.M.S. specialise in systems to eliminate your power problems.

Products range from 35VA switched square wave Power Packs to 1KVA fully uninterruptible sine wave systems.

E.M.S. also manufacture chargers which range up to 60 amps.

For further details please contact:

E.M.S. Manufacturing Limited
Chairborough Road
High Wycombe
Bucks
Tel: (0494) 448484

CIRCLE 45 FOR FURTHER DETAILS.

CRICKLEWOOD ELECTRONICS LTD

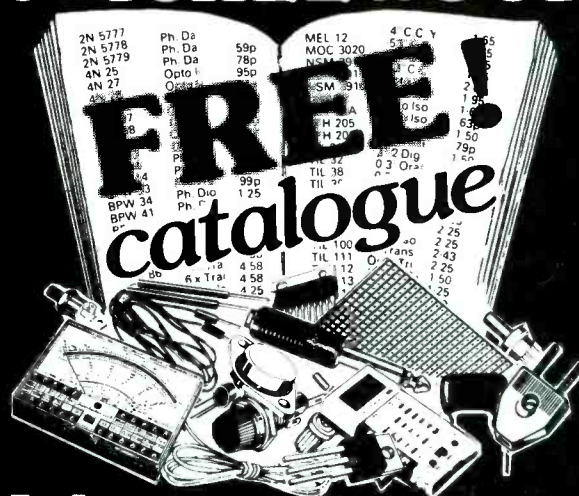

It's no secret...

... that there is a real difference at Cricklewood Electronics. That's why you should never be without the FREE CRICKLEWOOD ELECTRONICS COMPONENTS CATALOGUE, for sheer variety, competitive prices and service from the U.K.'s number one 100% component shop. No gimmicks, no gadgets or computers, just components, millions of them, all easily available by mail order, calling or credit card telephone orders. Just pick up the phone (or a pen) to get your FREE copy now (no SAE required). You have nothing to lose.

CRICKLEWOOD ELECTRONICS LIMITED

40 Cricklewood Broadway, London NW2 3ET

Tel: 01-450 0995/01-452 0161
Telex: 91 4977



EWV

CIRCLE 34 FOR FURTHER DETAILS.

Not only in height is the range of Clark Masts wide but also in the field of application. Every model, mechanical or air-operated, has been created in response to customer requirement and proved in service; for over 25 years.

Major users in the Communications Industry, Broadcasting, Civil Authorities and Military Commands worldwide, have all contributed and benefited from Clark Masts' reliability and ceaseless engineering improvement.

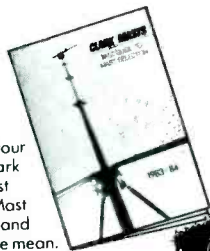

Write for your copy of Clark Masts' "Fast Guide to Mast Selection" and see what we mean.

FROM 3 METRES TO 40 METRES

CLARK MASTS

UK CLARK MASTS Ltd. (WV), Binstead, Isle of Wight, England. Tel. (0983) 63691. Telex: 86686.

EUROPE GENK TECHNICAL PRODUCTS N.V. (WV), Woudstraat 21, 3600 Genk, Belgium. Tel: 011/38.08.31. Telex: 39354.

CIRCLE 12 FOR FURTHER DETAILS.

FREQUENCY COUNTERS

**HIGH PERFORMANCE
HIGH RELIABILITY
LOW COST**

The brand new Meteor series of 8-digit Frequency Counters offer the lowest cost professional performance available anywhere.

- ★ Measuring typically 2Hz – 1.2GHz
- ★ Sensitivity < 50mV at 1GHz
- ★ Setability 0.5ppm
- ★ High Accuracy
- ★ 3 Gate Times
- ★ Low Pass Filter
- ★ Battery or Mains
- ★ Factory Calibrated
- ★ 1-Year Guarantee
- ★ 0.5" easy to read L.E.D. Display

PRICES (Inc. adaptor/charger, P & P and VAT)

METEOR 100	(100MHz)	£116.72
METEOR 600	(600MHz)	£147.77
METEOR 1000	(1GHz)	£204.12

NOW AVAILABLE WITH T.C.X.O. OPTION

Illustrated colour brochure with technical specification and prices available on request.

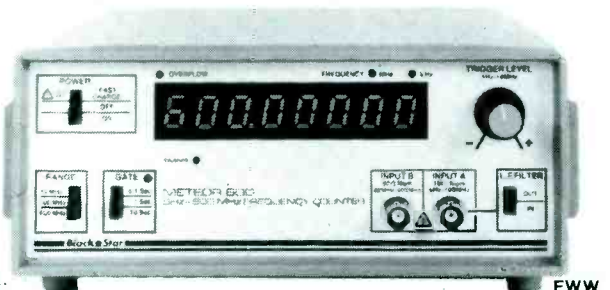

Designed and manufactured in Britain

Black Star

BLACK STAR LTD, Dept WV, 4 Stephenson Road, St Ives, Huntingdon, Cambs PE17 4WJ, England. Tel: (0480) 62440 Telex: 32339

CIRCLE 11 FOR FURTHER DETAILS.

TIME WRONG?

MSF CLOCK is EXACT

- 8 DIGIT** display of Date, Hours, Minutes and Seconds.
- SELF SETTING** at switch-on, never gains or loses, automatic GMT/ BST and leap year, and leap seconds.
- EXPANDABLE** to Years, Months, Weekday and Milliseconds and use as a STOPCLOCK to show an event time.
- COMPUTER** or **ALARM** output also, parallel BCD (including Week-day) and audio to record and show time on playback.
- DECODES** Rugby 60KHz atomic time signals, superhet receiver (available separately), built-in antenna, 1000Km range.
- LOW COST**, fun-to-build kit only £79-70 (ready-made to order) includes ALL parts, 5X8X15 cm case, pcb, by-return postage and list of other kits. TIME RIGHT.

CAMBRIDGE KITS

45(WU) Old School Lane, Milton, Cambridge, Tel 860150.

RF POWER

U.S. supplier of RF POWER DEVICES.
Prices LOWER than current domestic prices.
Query us for immediate needs.

A quality source for a complete range of RF POWER devices — From 2-30MHz, SSB 12.5V 7 28V transistors — 14-30 MHz CB/AMATEUR 27-50 MHz, low band FM — 66 — 88MHz, mid band FM — 66 — 88MHz, mid band FM — 156 — 162MHz VHF MARINE RADIO FM — 130 — 175MHz HI-BAND VHF FM — 108-152MHz VHF AIRCRAFT AM — 225 40MHZ UHF 28V — 407 — 512 UHF CATV/MATV CLASS A linear transistors — A SMALL indication of types are listed below. SEND FOR OUR FREE BROCHURE AND/OR CONTACT FOR IMMEDIATE QUOTES.

MRF450 MRF453 MRF646 BLY88A BLY90 BLY93A
.2N3553 .2N4933 .2N5109 .2N3375 .2N5016 .2N5589
.2N4128 .2N5070 .2N5591 .2N6080 .2N4427 .2N5090
.2N5634 .2N6083 .2N4431 .2N5102 .2N5918 .2N6084

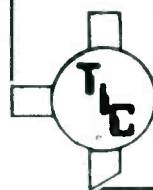

TIC Semiconductor Inc.

18 WEST 21st STREET NEW YORK, N.Y. 10010 U.S.A.
TEL: (212) - 675 6722 TELEX: 284564 TICS UR

CIRCLE 50 FOR FURTHER DETAILS.

Battery-saving relay switch

During a period of testing, the need arose for a multi-channel coaxial relay with remote control through optical fibre. Battery power was essential and the relay had to perform well at above 500MHz*. The relay chosen had a 330Ω coil, 27mA holding current and 20 and 9V minimum hold and drop voltages respectively.

Current requirement during the first 50ms after energizing the coil is shown in the graph. Using a 24V supply, the relay draws 73mA. After 30ms, the current could safely be reduced to 36mA without any effect on the relay but with a 50% saving

in battery drain, which is what this circuit does.

Initially, the capacitor is uncharged and both transistors are off. When the input goes high, both transistors conduct; this puts around 22V across the relay coil and its contacts switch. Current flowing through the coil causes the capacitor to charge which gradually reduces voltage over the coil. After 50ms, the zener diode conducts (10V) and holds the current at 36mA.

Derek Walton
Preston
Lancashire

* Mr Walton tells us that the relay chosen — an SR-4MIN-D — actually works up to 18GHz and is from RLC Electronics, Mount Kisco, New York, Ed.

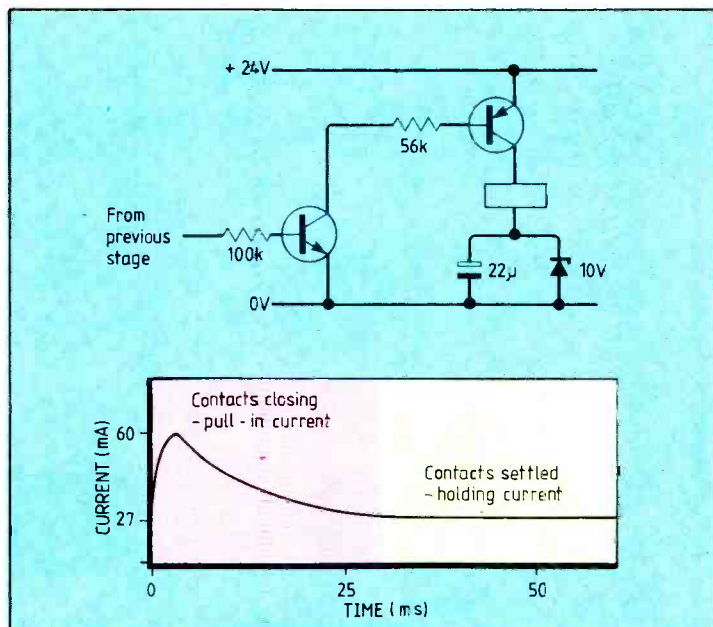

Accurate digital measurement of remote transducers

A remote resistive transducer can be accurately measured using a Wheatstone bridge, provided that a three-wire connection is made to compensate for lead resistance as illustrated. For precise lead resistance compensation, R_1 must equal R_2 .

Accurate measurement of

such a transducer using a microcomputer-controlled analogue-to-digital converter or d.v.m. chip is a different matter though. My solution to this problem is shown in the second diagram.

The op-amp and Darlington transistor automatically balance the bridge so that

$$(R_x + R_1)/R_1 = (R_1 + R_1)/R_2$$

Resistor $R_1 = R_2$, $R_1/R_1 = R_1/R_2$ and $R_x/R_1 = R_1/R_2$. The a-to-d converter measures the value of R_1/R_2 and hence indicates the value of R_x/R_1 .

Accuracy limitations are

introduced by the op-amp offset voltage and the small amount of current injected into the Darlington transistor base. Using the 7650 chopper-stabilized op-amp, maximum offset voltage is less than 1µV. With a bridge supply of about 5V, and R_x having a minimum value of $R_1/10$, error introduced by the offset voltage will be less than 3 p.p.m. Current gain of the Darlington transistor is about 10 000 so the error introduced will be of the order of 1 in 10 000 (R_1/R_x).

Measurement accuracy thus depends on the accuracy and

stability of R_1 and R_2 and resolution of the a-to-d converter. Unless the resistors are more accurate than 0.01% and the converter can resolve to better than 1 part in 10 000, op-amp offset or Darlington-transistor base current will not have any real effect on measurement accuracy.

With 0.01% accuracy resistors and, for example a 4½-digit d.v.m. i.c., R_x can be measured to an accuracy of 1/10 000 of R_1 .

A.J. Ewins
North Harrow
Middlesex

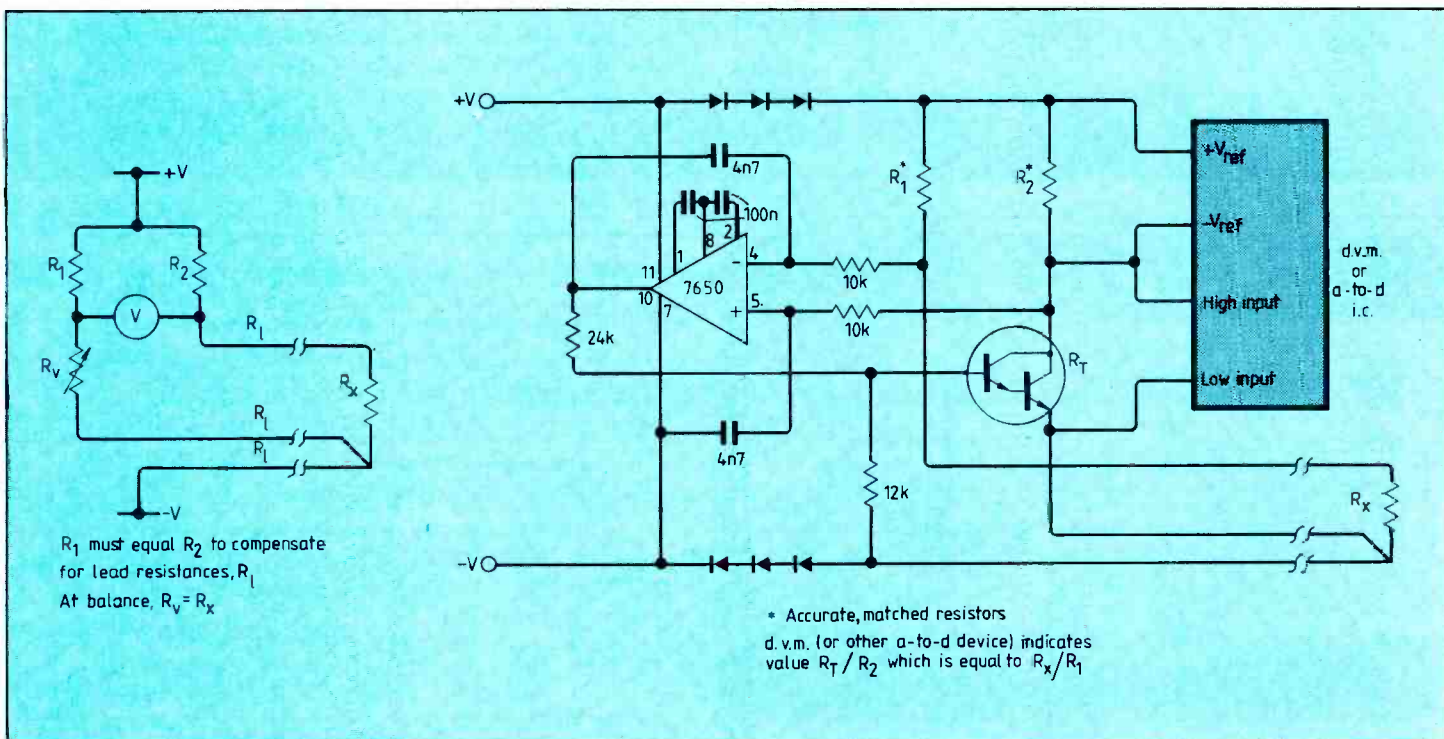

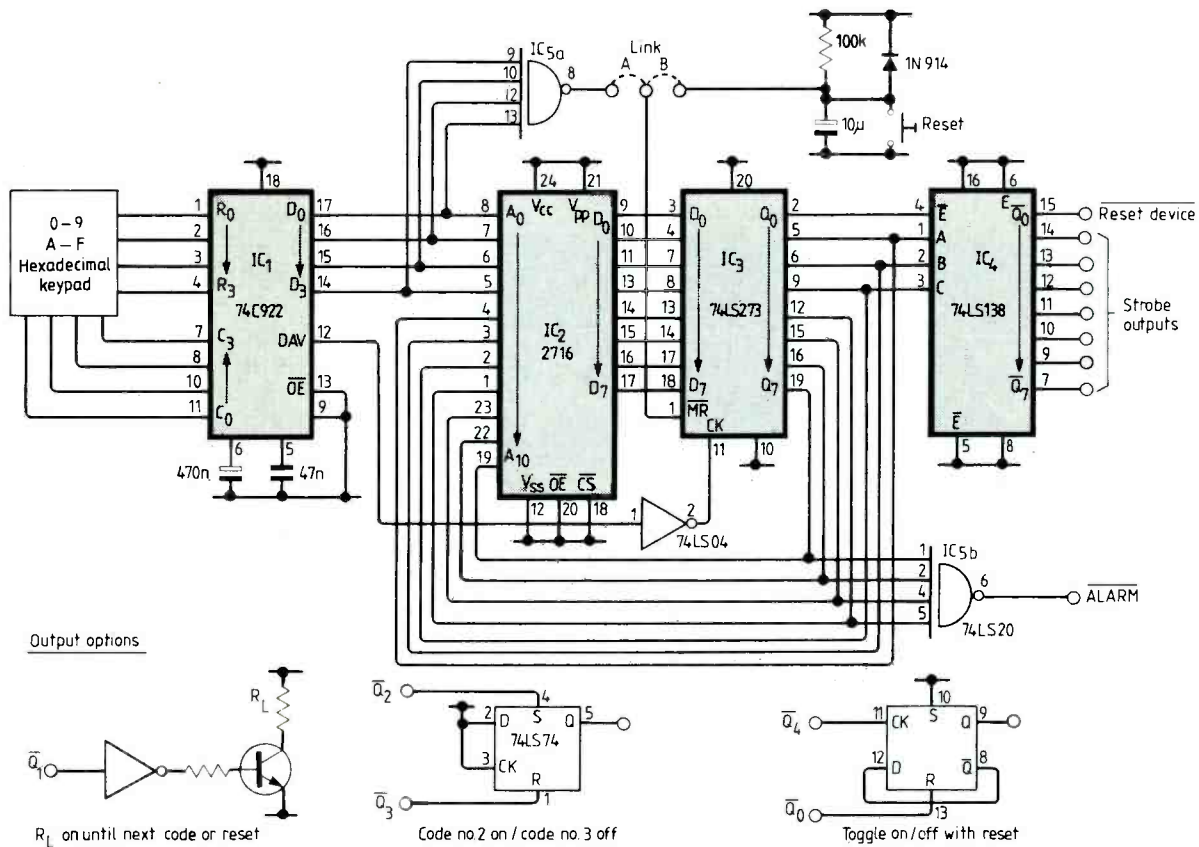

Versatile combination lock

Many limitations of the usual electronic combination lock are overcome by this relatively simple design in which codes are programmable and can vary in length. Up to seven devices can be independently controlled from the same keypad. Several output options are given for use in different applications.

Expressions shown below, for calculating addresses and data, could easily be incorporated into a computer program for programming an eeprom with any desired combination and device-select code.

Resetting of the circuit is carried out either by pressing F on the keypad (link A made) or on power up (link B). This resets bistable device IC₃ and output Q₀ of the decoder IC₄ goes low. The decoder reset output can be used to reset switches, alarms, etc.

On pressing the first key in the sequence (C₀), code for the key is presented as an address. Data for that location is clocked into IC₃ on the falling edge of DAV from IC₁ on releasing the key. This data forms part of the address that will be combined

with the next key press.

The process continues unless an incorrect key is pressed, in which case an unprogrammed eeprom location is accessed and decoding by IC_{5b} causes an alarm signal. When the final key code is reached, output Q₀ of IC₃ goes low, enabling the LS138 decoder and allowing the appropriate device to be switched. The system is now ready to receive the next code.

In these expressions, d is the device code, i.e. decoder output Q_d is enabled at code end, N+1 is the number of digits in the code (2 ≤ N ≤ 14), n is the key press counter and C_n is the nth element in the code. Desired code is C₀, C₁, C₂, ... C_n.

For n is zero and values of r from zero to seven, the address is C₀+16r and data is 1+2d+16. This is required to ensure restarting at the correct place after a previous code has been entered. For values of n from zero to N-1, the address is C_n+16d+128n and data is 1+2d+16(n+1). For n=N, the address is C_N+16d+128N and data is 2d.

Codes with the same initial few digits can be accommodated by making d zero for the common digits.

P.M. Glover
N. Humberside

Measuring rupture current

When instant rupture current needs to be determined while supply voltage and load resistance are unknown or are too remote to be measured, this hold circuit may be of use. It works for a.c. or d.c. supplies.

A resistance of known value, R_k, is inserted in the line. If current is very high, a portion of the bus bar may be used for R_k provided that its resistance can be accurately measured. For a current of around 10A, a 5W resistor of 500mΩ is used.

At the moment that the current ruptures the fuse, the diode doesn't conduct. Charge representing the current is held

by the capacitor for quite some time as the op-amp has a fet input. Output voltage of the op-amp can now be measured at leisure.

The relationship between rupture current and output is given by

$$I_R = (V_o + 0.6) / R_k$$

for d.c. and

$$I_R = (V_o + 0.6) / 0.45R_k$$

for a.c., assuming negligible offset voltage. Note that once the fuse has blown, the common line of the test jig is not connected to the return line of the unknown supply.

T.S. Doraiswamy
Shikrewadi
India

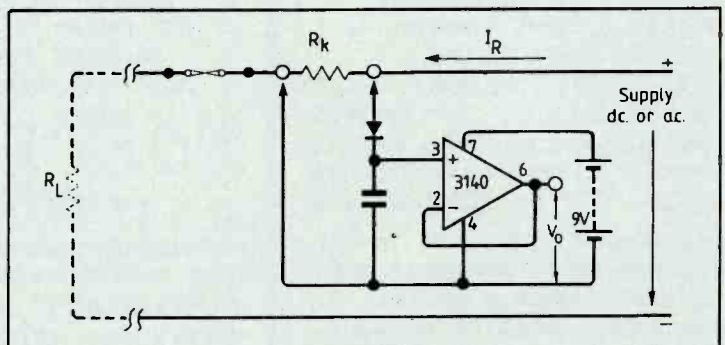

tools
for

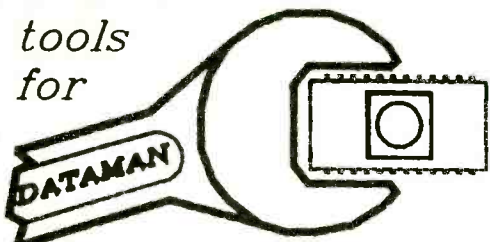

micro engineering

CIRCLE 22 FOR FURTHER DETAILS.

DATAMAN

Lombard House, Cornwall Road,
DORCHESTER, Dorset DT1 1RX

phone 0305 68066 telex 418442



FAST EPROM PROGRAMMER

Copies eight EPROMS at a pass
all 25 and 27 series up to 27256
EPROM type is set by switches
erasure is checked automatically
control is simple - two keys
Alpha liquid crystal display
checksum facility 6 hex digits
FAST or NORMAL programming
PLUS VERSION also has:

serial RS232 program & check
CTS or DSR handshake
ASCII, SIMPLE HEX, INTELHEX
MOTOROLA S or TEKHEX

GANG-OF-EIGHT £395
GANG-OF-EIGHT plus £445

AFFORDABLE ATE

Diagnoses bus troubles
Helps mend micro boards
Z80, 6502, 6800, 8085
All covered by one product
Disassemblers included
Plugs into micro socket
Hand-held probe identifies
ADDRESS, DATA and CONTROL
lines at a touch.

Prints a memory map
of an unknown system
showing ROM, RAM, I/O
and EMPTY ADDRESSING SPACE



LOGS all tests and responses
on PRINTER and ALPHA LCD
Non-volatile memory
retains test sequences
CHECKSUMS, RAMTESTS,
READS/Writes MEMORY & I/O
Reports location of SHORTS
on ADDRESS and DATA busses
Prints out memory contents
in ASCII, HEX or SOURCE CODE

You cannot expect to mend
microprocessor products with
a meter and a scope.
How many repairs would
pay for your SuperDOC?

SuperDOC.. £395

EPROM EDITOR

Displays HEX on standard TV
with text-editing facilities
inserts and deletes
shifts and copies
bytes and blocks of code
EMULATES EPROM in circuit
using romulator lead supplied



Uploads and downloads
using serial and parallel
routines - RS232, Centronics
PROGRAMS & EMULATES
2716 2732 2532

Useful for development
particularly for piggy-back
single-chip micros

Adaptor is available
to program 2764 & 27128

"Our expensive equipment
stays on the shelf
for weeks - but SOFTY
is used every day"
- says big-budget customer

SOFTY.. £195
ADAPTOR... £25

less postal expenses, if goods returned intact within 14 days
PRODUCT IS USUALLY IN STOCK
TODAY DESPATCH IS POSSIBLE
PHONE FOR A LITERATURE PACK
VAT must be added to prices

Z80 TUTOR

Designed for Schools Council
to teach Z80 machine code
MENTA uses TV for display
shows STACK & PROGRAM in HEX

Editing facility includes
direct keyboard ASSEMBLER
RS232-output DISASSEMBLER

Used to write & debug
short machine-code routines
MENTA is a complete
controller with 24 bits of I/O
used for ROBOTICS

TEACHER'S GUIDE, PUPIL READER
MODULES (e.g. A to D) available

MENTA .. £99

COMPUTER BARGAINS

-ring for our BEST OFFER

OLIVETTI M21, M24
with 10MB hard disk if req.
AUTO-CAD & M24 created this AD
also **EPSON PX8**

EPROM ERASERS from £39

BUY IT AND TRY IT
REFUND GUARANTEED

VISA

Big-system automation and telemetry

Using public utilities as examples, R.E. Young continues his series on British innovation with a discussion of the philosophy of big-system automation, with an eye to telemetry and crisis control.

In 1984, details were published of the new national control centre of the British Central Electricity Generating Board in advance of full trials in the Spring of 1985 and final commissioning in 1988¹.

This account, centred on "... a new information (monitoring) system for use by the Board's system control engineers", is of particular interest in this instance because of the R & D and associated aspects shown to be involved. Thus the evolution of the system has been the responsibility of a CEGB research team with technico-economic targets in view. One of these main targets was to provide 'more efficient monitoring of the network' with the dual objectives of achieving more economic power generation and transmission, and of improving 'security'.

One example of the possibilities offered is that the manual calculation of consumer demand, especially for immediate load forecasting, will be computer assisted and will be in terms of continuously updated information from the monitoring system.

Inevitably the question will be asked "Why manual calculation in this day and age?"

From work on comparable big systems, it is safe to assume that the CEGB engineers — with full user experience being brought in — are doing everything possible to ensure the soundness of the information needed to set up the extremely complex software which will be required for the final scheme.

As planned, the national control centre will receive comprehensive operational data from the whole of the Grid network through six regional control centres, will analyse this measurement data, 'separate-out the factors', and then issue instructions (optimized every 5 minutes) for

system loading back to the individual centres on the continuously updated basis noted earlier. In addition to carrying out these multiple supervisory control functions, the national control centre will also cover 'fine tuning' of power output which will be effected largely by virtue of the near-instantaneous response of the CEGB's Dinorwig pumped-storage station to sudden power demands (stated as 1800 MW available within 10 seconds).

Also, of special relevance in this connection, it is proposed to employ the overall monitoring system to determine whether Dinorwig would provide the most economic means of controlling Grid frequency, a technical possibility which was a feature of its original design concept.

From this brief summary it will be apparent that even to cover these *interacting* control functions purely on a routine basis demands an extremely large assembly of software. Therefore, to attempt not only to forecast demand a day ahead but also to warn the operator of potential problems make it imperative to determine trends accurately as part of 'separating-out the factors'. This situation is paralleled in building-up the engineering details of a large automation scheme where a number of interests are involved; or with any R & D project, working with experimental data coming from a number of sources when it is not really known whether these are interacting or independent, as part of the initial — and over-riding — task of finding the 'unknowns'.

These last considerations are almost certainly the key to "Why manual calculation?". Phrased equally colloquially, the answer to this original question is "Leave it in the computer and you lose (never find) trends and variations

from the expected". In more conventional terms this means that the CEGB engineers themselves would appear to be providing the flexibility needed for dealing with such widely varying experimental data, a flexibility which cannot be approached by ordinary computer programming.

This does not mean that the Board's policy is directed away from full computer working; on the contrary, certain elements of these remarkably far-reaching proposals for computer-based working have already been brought to the stage of field testing and evaluation. Fully engineered terminals with touch-sensitive screens and self-explanatory keys have been installed at two of the regional control centres, so that full continuity will be maintained over the whole project, from initial planning to final operational use.

The pivotal years from 1960 and the innovative lead-up

In the introductory article of this series, it was noted that the first issue of *Industrial Electronics*, in October 1962, not only showed that 'the Chip' was well understood in Britain at that time; but also marked the firm establishment of 'Big-System' control in the UK by then, with a main-frame process-control type computer as the cover picture.

Within the year, the first International Telemetry Conference was being held in London (September 1963); and from the report in *Wireless World*² it will be seen that while the intensive development characteristic of aerospace telemetry could be expected to continue indefinitely, public utility systems had already been produced which were mature when they were brought into use. It will be realised that

by R.E. Young,
B.Sc.(Eng.),
F.I.E.E., M.R.Ae.S.

the implications of the word 'mature' are considerable. The early part of the Conference had, in fact, been largely devoted to the question of "Has telemetry reached maturity?"; and it was in his paper "Thirty Years of 'Grid' Telemetry"³ that P.F. Gunning made the point that over those years (1932-1963), CEGB equipment gave the performance demanded of it and did not have to be replaced by new systems until fresh operational requirements arose. Again, the implications of this last statement are considerable. Apart from anything else, it indicates that development was not carried out in a vacuum — system engineering and the operational side were closely interlocked throughout, something which is evident in the 1984 CEGB approach as outlined at the beginning of this article.

The overall continuity that this represents is, of course, vital, particularly with work carried out on such a scale, not least in helping to establish a climate of confidence. Further evidence of the existence of this climate of confidence, certainly over the period up to 1963, can be deduced from Gunning's paper, with his record of achievement with equipment (usually electro-mechanical in nature) which was, in principle, the same as the 'electronic' equivalents such as analogue-digital converters which followed them much later.

Before giving a brief list of these precursors, it may help in establishing background to recall the reactions of delegates, particularly from overseas, when visiting the Conference exhibition where these original pieces of equipment were being demonstrated. Almost invariably, the ensuing remarks were ones of astonishment finishing with "It (modern digital technology) is all

BIG SYSTEM AUTOMATION

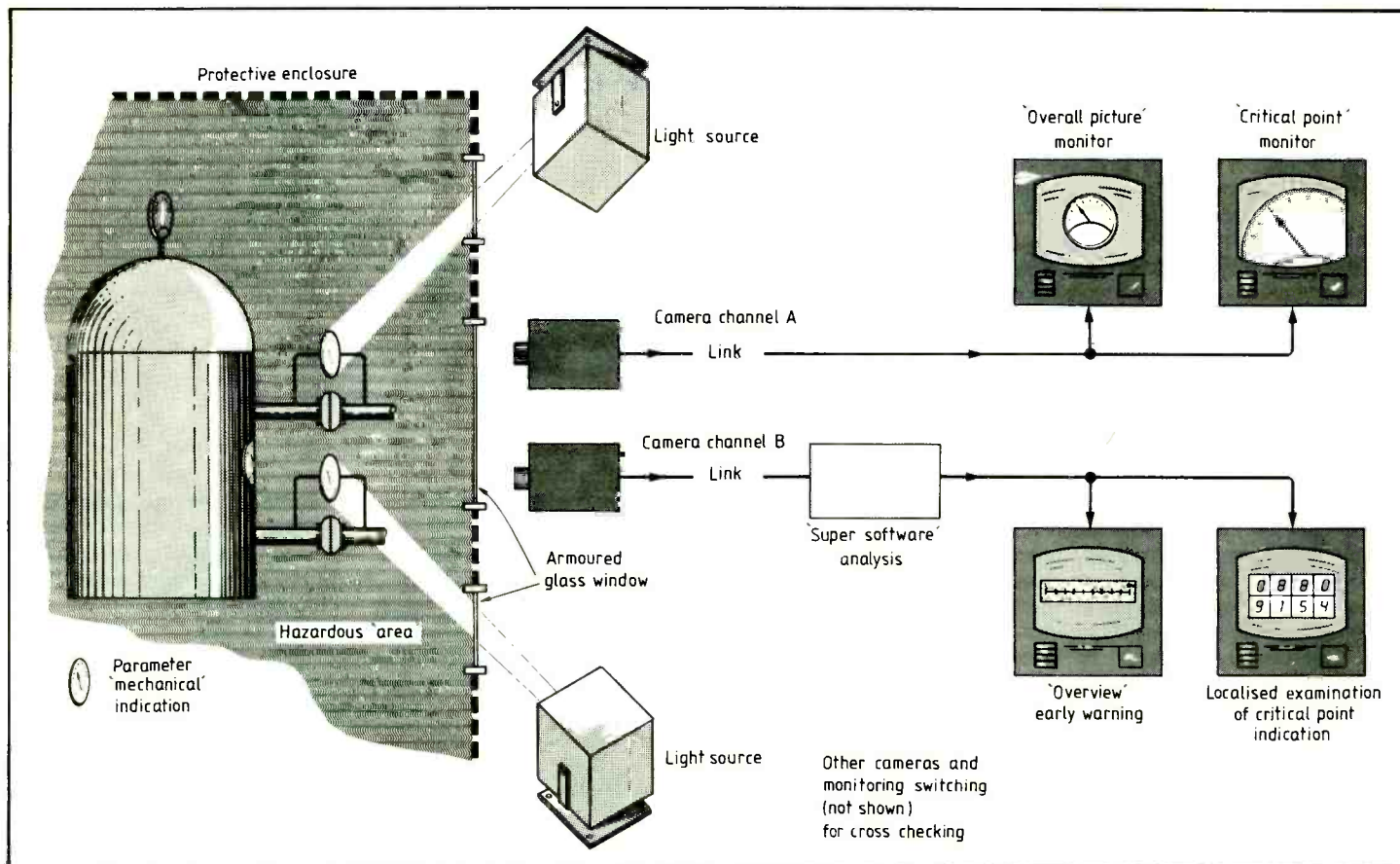

C.c.t.v. and super-software used to provide independently checked early warning and detection of mechanical malfunction.

REFERENCES

1. C.E.G.B. Keeps Up To Date, *IEE News*, August 1984, The Institution of Electrical Engineers, London.
2. 'First international telemetering conference', *Wireless World*, Vol. 69, No. 11, November, 1963.
3. Gunning, P.F.: 'Thirty years of Grid telemetering', International Telemetering Conference, IEE, London, 1963.
4. 'Telemetry', Encyclopaedia Britannica, Inc. Chicago, U.S.A., 1974.
5. Young, R.E.: Control in Hazardous Environments, Peter Peregrinus, Stevenage, 1982.
6. 'Strathfarrar hydroelectric scheme, *Elec. Review*, 172, No. 21, London, 24 May, 1963.
7. Copp, D.L.: 'The Methane Pipeline Scheme for the United Kingdom', Second International Pipes, Pipelines, Pumps and Valves Convention, London (13-27) April 1964.
8. Young, R.E.: Supervisory Remote Control Systems, Peter Peregrinus, Stevenage, 1977.
9. Young, R.E.: 'Crisis control — the background', *Nuclear Engineer*, Vol. 24, No. 4, July/August 1983.
10. Young, R.E.: 'Crisis Control', *Wireless World*, June and July 1982.

there already, and has been there for some time."

Given in date order, salient developments are outlined below: 1932-1935 'on-demand' operation, the equivalent of digital 'address-reply' (interrogation) working introduced, and employing various forms of electro-mechanical analogue-digital converters. 1935-1945 pulse-duration modulation and frequency-modulation techniques adopted, together with pulse-count methods, in 1937. 1945-1952 multiplexing with simple coded pulse-trains brought into service at the beginning of this period with address decoding for eight measurement channels. Techniques included 'cup-and-bucket' data (signal) handling with high-gain amplifier/cathode follower feedback; while on the system side, a close approach to real-time working was achieved with standard teleprinter-code multiplexing for the cup-and-bucket equipment. This, incidentally, was an all-electronic system; and, although it was largely superseded in 1952, was reported as still being in service in 1963.

Now it will be appreciated that there are a number of reasons, such as the depth of the factual information which can be quoted, which make this C.E.G.B. work

uniquely suitable for this article. Seen purely as a multi-aspect R & D project, its scale is perhaps best illustrated by the statement made in 1963 that at the end of 30 years of development (from 1933), the C.E.G.B. control complex had become the biggest and most comprehensive of its kind in world.

At this point, however, it is necessary to bring in telemetry as an overall concept⁴ with two divisions aerospace and supervisory, where in the latter the telemetering function is combined with that of remote control within the one supervisory system. Even in 1963, however, control in the C.E.G.B. case was exercised by supervisory engineers largely by passing instructions to the remote stations by telephone. As will be shown in the last section, in connection with crisis control there are times when human intervention in control becomes (literally) vital; and the facility of direct intervention becomes equally vital. Consequently it may be assumed that provision for intervention will always be a feature of supervisory schemes, although direct communication may not necessarily always be by (speech) control line⁵.

However, by the end of the 1950s, full development design was being carried out on supervi-

sory systems offering what was, in effect, computer-based automation; and embodying the solid-state equipment and digital techniques which have since become virtually standard for this work. Thus 1960 saw the beginning of a new era in supervisory remote control where a multiplicity of functions — both for telemetering and for control — were handled by the one set of master station equipment using the same 'address/reply' format for the two groups of (digital) signals.

Typical of such telemetry complexes installed in the UK in the early 1960s was the Strathfarrar hydroelectric scheme⁶, which incorporated two major automation techniques in its extremely comprehensive operational facilities. The first of these was for the remote monitoring and control of four unattended generating stations, together with two compensation stations and an area switching centre. This North of Scotland Hydro-Electric Board network, with a total capacity of 102 MW, also demanded 'hydraulic' monitoring. By this means, water storage and flow down the river system, effectively from one generating station to the next, could be controlled as part of the energy management of the complex, seen overall.

The other technique — of

local-loop operation — is of particular interest in the automation context. In this instance, two virtually self-contained control functions were covered, with master-station supervisory monitoring, viz. 'machine loading' and 'start-up' in each of the unattended stations.

Another example of these original big-systems is afforded by the UK National Methane Grid Control Scheme^{7,8}. Designed to distribute imported methane gas from the tanker terminal in the Thames Estuary to eight Area Boards, this pipeline 'Grid' was made relatively simple in operating as a free-flow system. This meant that after initial pressurization at the dispatching end, no additional pump boosting was needed along the line; and, with no intermediate compressor stages, the requirement for remote control as such was made relatively small. Specific remote control was, in fact, restricted to four gas-flow valves, which, in conjunction with automatic shut-off valves, gave all the real-time control facilities required.

From the system point of view, it is of interest that the development of a leak resulted in the local automatic valve moving to shut-off as determined by rate of pressure drop across it; while with the movement giving a 'transducer' indication of this condition at the master station, action could be taken to isolate the faulty section of the line by closing the adjacent upstream remote control valve. Measurement of gas flow was made in terms of corrected volume relative to standard (atmospheric) pressure and temperature (16° C). Of special interest here is the fact that this correction was effected by an instrument computer local to the primary measuring unit, a practice which was still being followed in comparable oil-well supervisory control systems some ten years after its establishment in the first half of the 1960s.

Crisis control — the two basic requirements

To borrow from another world, it is a 'crashing glimpse of the obvious' to state that as the size of modern industrial complexes has increased, so the risk of a large-scale disaster has grown with it. Such near-catastrophic accidents — fortunately small in number — have been experienced in many industrialized countries of the world, with a range extending

from chemical processing to nuclear power generation as exemplified by Three Mile Island⁹.

However, it was not until this last incident had occurred that the international public became fully aware of the threats posed to safety by high-risk centrally-controlled complexes when a completely unforeseen failure develops. Three Mile Island had a special significance for nuclear safety; but it had an equal significance in regard to the picture it gave of crisis control under operational conditions¹⁰ as deduced from the excellent, detailed, reporting given to it by the US authorities.

The importance of this reporting and of the analysis that lies behind it cannot be stressed too highly. The incident at Three Mile Island took place in 1979, and international action followed almost immediately in the examination of safety precautions and in re-drafting standards. In this general connection, it is worthy to note that somewhat earlier — in 1974 — Flixborough in the north of England was the scene of an explosion type of accident which, among its consequences, included serious loss of life. In this instance, a 40 tonne cloud of cyclohexane vapour escaped from a broken pipe to form "a highly flammable bubble" which exploded to "flatten" the Flixborough chemical factory. It has been indicated that this incident weighed heavily in the production of recommendations by the (UK) Health and Safety Commission aimed at the prevention of such destructive accidents. In turn it should be added that the Health and Safety Executive maintains a service in which quarterly statements are issued of incidents which have occurred at UK nuclear installations and have been reported to the Nuclear Installations Inspectorate.

As stated earlier, these accidents — often becoming utterly catastrophic in their 'aftermath' effects — have been small in number; and it says much for the various national agencies concerned that this number has been kept so low, particularly bearing in mind the spread of the technologies, both nuclear and non-nuclear, encountered. Thus, citing the article in the *Nuclear Engineer* on crisis control⁹, the statistics are that with Flixborough being the first accident if its kind in Britain during a 40 year period, at least 24 accidents had reached comparable levels in other coun-

tries over the same period.

Clearly, and as discussed in that article, a wide-ranging approach to control-system design has to be adopted if every kind of emergency, however unlikely, is to be covered.

In terms of crisis control, this approach has two main phases. The first is, in effect, an extension of conventional supervisory control system design^{5,8}, where full account is taken of potential sources of trouble, and which, initially at least, comprise known hazards, such as the risk of explosion in coal mines or at oil well-heads. With sufficient engineering resources available, it is possible to extend this process by taking advantage of experience in analogous fields and take precautions in design to cover the fault conditions which can be envisaged.

However, although these 'total-system' design procedures have to be undertaken in order to provide the foundation for any crisis-control scheme, the design approach has to take on an entirely new character; and it is for this second phase that completely fresh concepts and techniques have to be introduced. This stems from the very nature and purpose of crisis control: to deal with the emergency conditions of an incident which is completely unforeseen.

Because of their unpredictability, 'incident' failures threatening the whole operation of the plant must be countered by human intervention, i.e. an operator must take over-riding control. Thus it becomes evident that if an incident of this magnitude is to be contained and brought under control, several pre-requisites have to be fulfilled: the maximum possible early warning must be given of 'onset'; operational information (essentially measurement data) must have complete integrity; this information must be presented to the control engineer in such a way that it is assimilated almost subconsciously, so that delay and error, particularly ambiguity, are kept to an absolute minimum.

It should be added that, as an ideal, wrong information should be detected and its source located.

Requirements

Now, these pre-requisites represent a formidable total; but it can be stated that if they are brought under two 'requirement' head-

ings, it is possible to arrive at a general picture of the present position with the suggestions that have been put forward and the way development should go.

These headings are derived in terms of a 'fully developed crisis'¹⁰: the control staff are being given wrong information *some-where*, and, as a rider, they have no possible means of finding out where; the control staff are completely out of contact with the plant under their control because of the misleading and unsuccessful way in which control information is presented to them.

Integrity of data

This requirement is essentially one of failure of equipment (principally transducers) or of an element in the main installation which results in the indication coming, say, from a transducer being totally erroneous. There is no need to stress the dangers of relying on a reading which is utterly wrong. The extreme case develops when, for example, a transducer indicates mechanical movement that has not actually taken place because of a break in an actuator shaft with the (position) transducer being on the drive side of the break. Such a failure apparently occurred in practice⁹ with the break of the operating shaft of a vital control valve.

There are various ways of reducing these risks^{5,9}, one being to make the transducer, in effect, part of the operating mechanism itself. As quoted earlier in this article, this was done with the automatic shut-off valves of the UK Methane Grid where, mechanically, valve and transducer actuation were one and the same.

Another method of improving integrity is covered by the general principle of the Independent Check where, in its basic form the measurement indication of one instrumentation chain is checked by an entirely separate chain. This principle can be applied to comparison of accuracy as well as to detection of the break type of indication fault; and it will be appreciated that the former can be just as dangerous a failure as the complete break.

Various approaches can be adopted to apply this principle, ranging from suitable positioning of adjacent transducers, to c.c.t.v. telemetering⁸. This last system is of interest on several counts. The first is in the context

of transducer fundamental design where television 'transfer' obviates certain 'hyper-interface' problems; and also ensures that once the data has been 'encoded' (in pictorial form), no further degradation in its accuracy can take place through the system.

At the other end of the scale, it is suggested that c.c.t.v. could be used in conjunction with 'super-software' to provide computer-based facilities including early warning and the possibility of detecting physical (mechanical) changes, for example 'breaks' both visually and more indirectly by computer⁵.

Transfer of information

Two distinct, but closely interlinked, areas come into this requirement. The first, the presentation of information, is largely a matter of system design in the

full sense of the word; while the second is perhaps best described as being concerned with analysis/interpretation of incoming information and the implementation of the conclusions as a control action.

The underlying principle which enters into both of these areas is that of 'data marshalling'. Defined as the 'separation, streaming and systematic presentation' of masses of data, this concept helps to reduce the intangibility which is inseparable from the complex design considerations associated with crisis control and its entirely new technological approach. This applies particularly to the actual control aspect where, from the overall design point of view, some understanding of the mode of thinking of the engineer and of his general behaviour under stress is of paramount importance. This

aspect has been discussed in the *Wireless World* article already quoted¹⁰ and forms one of the main elements in the penultimate article of this series that on Human Communications. It will be realised that data marshalling is required in this mode of thinking, both for the appreciation of the incoming multi-channel information, and for the selection (as a decision) of the correct action to take, and its implementation.

It is sometimes found useful for system design, especially for full crisis control, and to consider the man-machine interface which exists between the operating engineer and the plant under his control. Two-way transfer of information takes place at this interface; and it is worth noting that under full crisis conditions, the outward transfer will usually involve 'voice command' being employed to its maximum capac-

ity. It is also worth noting that transfer in each direction should be as smooth as possible, i.e. distortion and obstruction should be eliminated. One practical example of this is the change from spread-panel display to individual control console layout. This introduces a form of data marshalling which helps to smooth the flow of information in the transfer across to the control engineer, and also assists in the other direction by facilitating actual operation.

Finally, in relation to engineering R & D, it can be said that in the circumstances of a full crisis, the control engineer is engaged in an R & D project, with all its implications and difficulties, which has to be brought to a successful conclusion, not within months, but as nearly as possible instantaneously, certainly in a matter of minutes.

Automatic enlarger timer

Regrettably, one or two errors appeared in Mr Linsley Hood's timer circuit in the May issue. In Fig.3. on page 46, the diodes D₁ to D₃, D₅ to D₇ were reversed. The input and output of stabilizer IC₂ were reversed and a 100 μF, 16V electrolytic should be connected between +15V and 0V. The diagram is reproduced here in corrected form. Apologies for the mistakes.

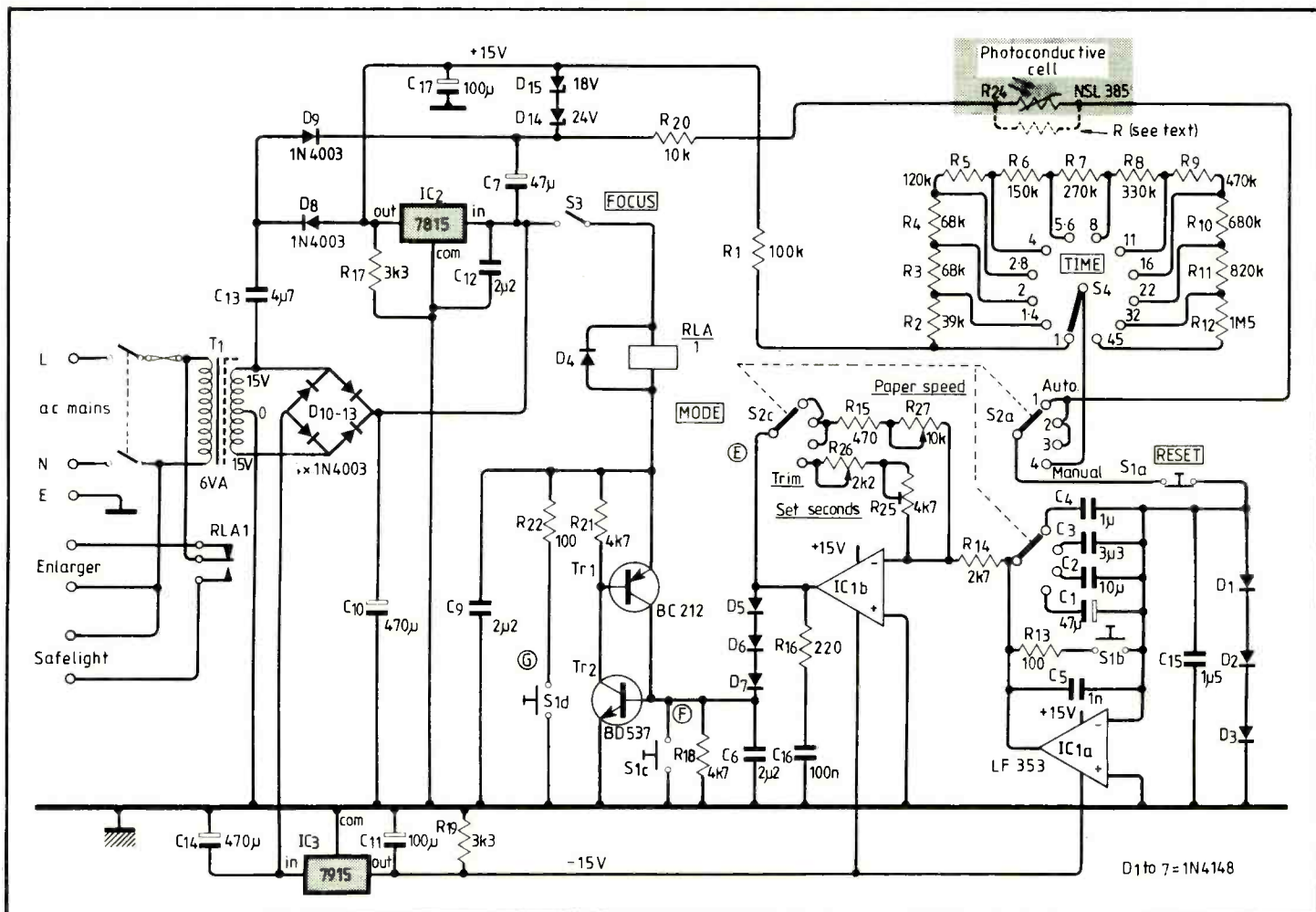

New Forth Microcard system



The Essex Forth Microcard measures only 10cm x 8cm but it is equipped to take on ambitious control tasks using the powerful FORTH Programming Language.

You can use the Essex Forthwriter disk to turn a BBC 'B' computer into a flexible workstation during program development but from then on the Microcard stands on its own.

The Essex Module Driver disk between mains level input/output and the Forth Microcard to provide easy power control.

- RS2F-12 Processor with on chip Kernel
- Interactive Extended Fig FORTH Programming and 6502 Macro Assembler with FRI Development ROM
- 40 Input/Output Lines and two programmable timers
- RS232 Interface and Autostart Operation
- BBC Compatible Development Tools

SEND TODAY FOR OUR INFORMATION PACKAGE ON THIS REVOLUTIONARY SYSTEM

Essex Electronic Centre
UNIVERSITY OF ESSEX
COLCHESTER
(0206) 865089

Also supplied by: R.C.S. MICROSYSTEMS LIMITED 01-979 2204

CIRCLE 24 FOR FURTHER DETAILS.

EXTRACTOR FANS — MAINS OPERATED

- Woods extractor.
- 5" — £5.75, Post £1.25.
- 6" — £6.95, Post £1.25.
- 5" Plannair extractor
- £6.50, Post £1.25.
- 4" x 4" Muffin 115v.
- £4.50, 230v.
- £5.75, Post 75p.
- All the above ex-computer, those below are unused.
- 4" x 4" £8.50, Post 75p.
- 9" American made £11.50, Post £2.00.
- Tangential Blower 10 x 3 air outlet, dual speed £4.60, Post £1.50.

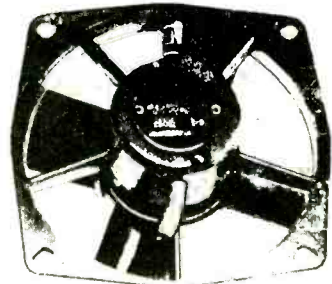

MICRO SWITCHES V3 type all 250V 10 amp SpST 15p 1000 — £1.00 Spdt 20p 1000 — £1.50, very low torque Spdt 30p 1000 for £2.00

ROCKER SWITCHES Standard size fit 11.5 x 28 mm cut out. Single pole on/off — 10p each 1000 for £75. Single pole changeover 20p each — 1000 for £100. Single pole changeover with centre off — 25p each — 1000 for £125. Single pole on/off with neon — 36p — 1000 for £180.



MINIATURE WAFER SWITCHES
2 pole, 2 way — 4 pole, 2 way — 3 pole, 3 way — 4 pole, 3 way — 2 pole, 4 way — 3 pole, 4 way — 2 pole, 6 way — 1 pole, 12 way.
All at 25p each or 100 for £20.

12 volt MOTOR BY SMITHS
Made for use in cars, etc. these are very powerful and easily reversible. Size 3 1/2" long by 3" dia. They have a good length of 1/4" spindle —
Price £3.45 or 100 for £250.

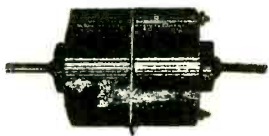

■ **N.B. ELECTRONIC SUPPLIES** ■
34 America Lane, Haywards Heath, Sussex RH16 3QU
Phone 0444 454563 for Access or B.C.
Please add £1 if order under £20.

CIRCLE 76 FOR FURTHER DETAILS.



Here is the complete range of ICOM marine radio-telephone equipment, from left to right: the M700 HF SSB transceiver offers long-range capability at a sensible price. The M5 VHF hand-portable, quick channel access with its push-button keyboard. M12 and M2 VHF hand-portables, 12 and 56 channels respectively using knobs or thumb-wheels. Finally the M80 VHF radio-telephone, a wide range of options are available for this and all other ICOM marine radios. ICOM radios are versatile, rugged, water-resistant and most important of all — reliable. More detailed information is readily available from your local ICOM dealer or direct from Thanet Electronics Ltd.

Thanet Electronics Ltd
Suppliers of Radio Communication Equipment to the Ministry of Defence.
143 Reculver Road, Herne Bay, Kent, England. Tel (0227) 363859/363850

CIRCLE 96 FOR FURTHER DETAILS.

Ptarmigan at last

Ptarmigan, the secure tactical communications system linking static and mobile battlefield units in a digital cellular-type network, is now fully operational with British service units in West Germany. As a "second generation" tactical command, control and information system it is claimed to be in advance of anything previously fielded by NATO services. Although greedy of radio spectrum, Ptarmigan is designed to "degrade gracefully" if the network sustains damage.

But, for those with long memories, Ptarmigan might better be named Phoenix, having risen from the ashes of the Hobart plan of the early 1960s, and the aborted Project Mallard proposed later as a joint American, Australian, Canadian, British plan for tactical communications. Hobart led to the Clansman single-channel radios, but its elaborate digital switching and trunking system was temporarily put aside in favour of Bruin as a secure area system.

Ptarmigan comprises a fully transportable, distributed trunk network containing switching nodes via which brigade, division and corps subscribers have dialled access, much as outlined in the Defence White Paper of 1963. Anyone with access to the radio switching nodes, and this includes single-channel radio access from vehicle and packets, can be connected to the line and radio multichannel trunking system. The act of lifting the handset automatically transmits a "calling line identity" to a 12-channel central. The system depends on the Plessey System 250 stored-program processor for switching, routing, signalling, multiplexing, interfacing and supervisory functions, with four-wire 16Kb/s time division multiplexed channels. The original Ptarmigan concept has been enhanced to provide a packet switched network, using the X.25 protocol, for the Wavell automatic data processing system.

As foreseen in the Hobart Plan the whole battlefield area is provided with a high-capacity and flexible communications

grid in which static and mobile users can be brought into contact via the lorry-mounted digital switching nodes. It has been 22 years in the making, but has been warmly welcomed by the Royal Signals — though, as noted below, not everyone is convinced that the necessary software expertise to keep it going is available.

Software crisis

The Spring 1985 issue of *The Journal of the Royal Signals Institution* follows a description of the Ptarmigan system, perhaps coincidentally, with a warning by Colonel A.J. Sammes of a "crisis in software support". He foresees the possibility of entire area networks failing at critical moments due to lack of skilled software support. In particular he is concerned that software errors or deficiencies cannot readily be put right in the field without skilled personnel and full access to all the original documents, plans, notes, charts, schedules, magnetic tapes and discs, as well as to the stored program itself.

Unlike hardware maintenance and modification, a change to software requires all the facilities and information used by the software designers to be available to the maintainers and enhancers: "A level of specialized expertise and equipment is now needed that we cannot reasonably expect to find deployed in the field. . . finding a permanent solution to a critical error may take weeks of effort and is more difficult and more error-prone than the original development of the software."

Col. Sammes sees the need for the creation of far more software and hardware support, including quick-reaction teams, in-house and contract software maintenance staff, software integrity and security teams. MoD have recently established a new Directorate of Communications and Information Systems (Army) one of whose tasks is to consider the need for an integrated support organization for CIS. But if it took Hobart 22 years to come finally to fruition, how long will it take to provide the sort of support needed to prevent Ptarmigan and similar

systems from failing when they are most needed? I recall the story of an American "European" switching centre in Paris which, due to an unsuspected software error, shut itself down for 24 hours during a crisis.

High and wide

It often seems that the only point on which members of international and national television standards committees can all agree is to disagree. The current attempts to establish an entirely new "world standard" for high-definition television are still making only slow progress, despite the impact made by demonstrations of the Japanese 1125-line, 60Hz, 5:3 aspect-ratio system, using very high-cost projection displays.

Having seen not only that system but also more recently the new wide-screen enhanced C-MAC pictures demonstrated by IBA, I am far from convinced that there is any need to create at this stage an entirely new plus-1000 line standard for broadcasting, although justifiable for electronic cinematography. With digital processing in receivers, the basic 625-line 50Hz system (and according to RCA even the 525-line 60Hz standard) can produce extremely impressive pictures using progressive (sequential) scanning for the display. Keeping the luminance and chrominance components separate, as with the MAC systems, also noticeably cleans up pictures and helps give an illusion of higher definition even without digital processing.

As someone who in the past has often complained of the flicker on 50Hz interlaced systems, it comes as something of a revelation to discover how much of this is in fact 25Hz interline flicker and how little large-area flicker remains with 50Hz progressive systems.

RCA engineers are also drawing attention to the effect of the mechanical jitter on film displayed in the cinema and argue that even well-maintained modern cinema projectors provide dynamic picture resolution of not much more than 750 lines, a resolution that can be achieved with digital processing from both 525- and 625-line pictures.

ICAP 85

A more application-orientated approach than at some of the earlier International Conferences on Antennas and Propagation is reflected in the 130 or so papers delivered at the IEE/URSI ICAP 85, which attracted almost 300 delegates to the University of Warwick during April.

Nevertheless, with some 130 papers and up to three simultaneous sessions, and a conference book (IEE Conference Publication No 248) running to 584 double-column pages, it would be surprising if all delegates came away with any clear idea of what was and was not truly significant.

Much of ICAP 85 was concerned with microwave and millimetric propagation, rain attenuation and rain scatter; electronic steering of antenna arrays, including the possible use of adaptive antennas on satellites; h.f. over-the-horizon and sea-state radar, seemingly now attracting increasing attention in the UK; direction-finding and null-steering for electronic counter-counter measures; a clutch of BBC papers on h.f., v.h.f. and microwave antenna and coverage-prediction techniques for broadcast applications; satellite antennas and propagation; broadband antennas for frequency-hopping and surveillance; millimetric radio telescopes; u.h.f. propagation for mobile cellular radio; anomalous v.h.f. and u.h.f. propagation including ducting. Many of the papers reflected university research including a number funded with a view to new defence systems.

A joint BBC/Royal Military College of Science (which was 'privatized' in 1984 as part of the Cranfield Institute of Technology) paper on a cost-constrained 'flat-plate' antenna for the reception of 12GHz d.b.s. television underlined the advantages of having a steerable 'flat' antenna that could be affixed to the side of a building. But it seemed less than certain that the proposed antennas, constructed from a microstrip comb-line sandwich structure and using lightweight foam material, will prove as practical as the conventional parabolic dish reflector, at least until further progress has been

made. A problem appears to be the inevitable loss of gain when the antenna is mounted so that considerable steering is needed, reducing the effective aperture.

With papers from Canada, China, Germany, Sweden, South Africa, Israel, Belgium, USA, Japan, India, U.S.S.R., Italy, France, Denmark, Holland, Taiwan, Poland, Spain, ICAP 85 retained its international flavour.

Aerostats

About ten years ago there was considerable interest in the idea of using load-carrying balloons, called aerostats, bearing aloft v.h.f. television transmitters to provide wide-area coverage from a single site. A Westinghouse subsidiary (TCOM) announced orders to supply such systems in the Caribbean, Iran and Nigeria. The BBC looked in some detail at the use of such a system for v.h.f. when 405-line transmissions ended. The schemes seem to have come to nothing, though I believe one was implemented in the Caribbean. Earlier, u.h.f. television broadcasting from aircraft was used operationally for an educational service in the USA and also by the Americans in Vietnam.

The 20,000ft balloon sky-hook, much cheaper than d.b.s., appeared an attractive system (though possibly not to airline pilots) and I have never understood why it apparently never caught on, or what the practical, financial or technical problems proved to be. From just two aerostats you could cover the UK nationwide. It was therefore interesting to note that Westinghouse are currently demonstrating an L-band surveillance radar (AN/TPS-63) to the Saudi Air Force, lifted by a 365,000 cubic-foot aerostat, as a supplement to early-warning aircraft.

Holiday rigs

"Have rig — will travel" is a concept that is growing apace among both h.f. and v.h.f. enthusiasts. During the summer months many amateurs can be heard operating from unfamiliar locations, particularly those that have a rare prefix or even an unusual "square" designation. Monaco, Liechtenstein,

Luxembourg, Andorra, Aland Islands suddenly become centres of amateur radio activity.

With rare prefixes it is easy to get answers to CQ calls even if your signals are relatively weak, but rather more of a problem exists for visitors to countries having considerable indigenous radio activity.

Compact, self-contained h.f. or v.h.f. transceivers are readily transportable. On v.h.f. it is also relatively easy to devise an antenna array that dismantles and fits into a portable carrying case. At a pinch even a foil quad loop stuck on a window pane can be reasonably effective.

For h.f. the problem is more tricky, although a throw-out random length of wire can be surprisingly effective provided the traveller has brought along a flexible antenna tuning unit. Increasingly popular are mobile-type whip antennas mounted on a balcony, using monopoles but also occasionally end-fed loaded dipoles. But I was surprised recently to contact on 7MHz an Austrian amateur putting out a remarkably good signal from a hotel in Germany from a rod antenna only about a metre in length. Admittedly his transmitter was about 100 watts. It has always seemed to me that while there is a lot of interest in very-low-power operation (under 5 watts) with good antennas, more could be done to improve the efficiency of miniature, easily portable, h.f. antennas regardless of the transmitter power.

Microwave danger?

Questions surrounding health hazards posed by non-ionizing microwave radiation never seem to go away. Recent claims from Poland that military personnel exposed to relatively low levels of microwave radiation are from three to seven times more likely to suffer from certain forms of cancer compared with those not so exposed have again highlighted the continued reluctance by British authorities to act on the 1982 recommendations of the National Radiological Protection Board to lower the safety limits of v.h.f. and microwave radiation. Moreover the Polish findings appear to put in

question even the proposed NRPB limit of 0.4W/kg of body weight (current British safety standard is 1W/kg).

Safety limits not only affect people working near to radar and radio transmitters and industrial r.f. generators but also microwave leakage from damaged or inadequate microwave-oven doors. The Polish investigations suggest that exposure increases the risk of cancer of the lymphatic system and blood forming organs and also, to a lesser extent, thyroid, stomach and skin cancers.

British safety standards have always been based on the premise that the only proven hazard of non-ionizing radiation is the heat generated by absorption, with particular reference to eyes.

Diamond jubilees

This recent 60th anniversary of the formation of the International Amateur Radio Union in which the American Radio Relay League were prime movers in Paris in May 1925 is only one of several "diamond jubilees" in the amateur radio field this year. It was in February 1925 that a change of ownership of *The Wireless World*, previously carrying the official notices of the Radio Society of Great Britain, led first to *Experimental Wireless* becoming the official journal in its stead, and then quickly to the launch in July 1925 of the *T & R Bulletin* by the more active Transmitter & Relay Section of the RSGB. This was the first British publication devoted entirely to amateur radio, surviving 720 monthly issues later as *Radio Communication*.

It was also in 1925 that Gerald Marcuse, G2NM, began a series of telephony broadcasts to New Zealand that quickly led to his pioneering, in advance of the BBC, and with Post Office permission, the first regular h.f. broadcasting from the UK intended for reception by listeners in all parts of the then widespread British Empire. He used a 1.5kW transmitter on 32.5 metres and a 100ft high antenna at his home in Caterham, Surrey, later setting up a studio and control panel in the nearby home of Percy Valentine.

Here and there

The RSGB and City & Guilds of London Institute have been invited by the DTI to tender for taking over responsibility for the Amateur Radio Morse Test. British Telecom, who inherited the running of the morse test from the Post Office, is expected to relinquish this responsibility in 1986.

DTI are to introduce a new form of abbreviated licence certificate with full licence conditions to be available separately in book form.

About 70 British special-call stations were licensed for operation for use over the "40th anniversary of VE Day" period using for the first time the prefix "GV".

Rajiv Gandhi who became Prime Minister of India following the assassination of his mother, Mrs Indira Gandhi, last October has held and used on h.f. and v.h.f. the amateur callsign VU2RG since January 1975. In that year he built his own h.f. s.s.b./c.w. transceiver (which he used until 1982) and a two-element quad antenna. His wife, Mrs Sonia Gandhi, has held and used the callsign VU2SON also since 1975 and his teenage son and daughter are reported to be studying to take the examination.

In brief

The British Amateur Teleprinter Group is holding a rally at Sandown Park, Esher, Surrey on Sunday, August 25. The Group is also offering to provide local clubs with speakers on r.t.t.y., Amtor and "packet radio" (Ian Wade, G3NRW, 7 Daubeney Close, Harlington, Dunstable (daytime telephone 0582 429141)). . . As an entry in a 40th anniversary "suitcase radio" event organized by the G-QRP Club, S. Garner, G3WSL has built a miniature 7MHz transceiver inside a standard, battery-powered bicycle lamp — which still functions as a lamp. Using four transistors plus an MD108 double-balanced mixer as the active devices, his rig comprises a two-stage one-watt crystal-controlled transmitter and associated fixed-channel direct-conversion receiver. . . Pat Hawker, G3VA.

Introducing...

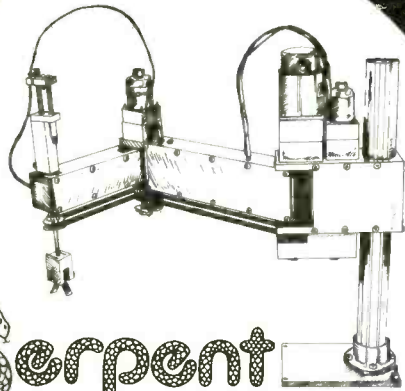

Serpent
under £2000!

Serpent SCARA assembly robot

On show at
Training & Development NEC 9-11th July



AND To be featured as a
constructional project in
Practical Electronics
September issue.

CIRCLE 19 FOR FURTHER DETAILS.

You can depend on

ELECTROVALUE

to supply the fine
range of test &
measurement
gear by

thandar

Made
in
U.K.

**FREE 44 PAGE
PRICED AND
ILLUSTRATED
CATALOGUE ON
REQUEST**

● Over 6000 items stocked

- counters
- multimeters
- scopes
- signal generators etc.

ELECTROVALUE LTD 28 St. Jude's Road, Englefield Green, Egham,
Surrey TW20 0HB Phone Egham (0784) 33603. Telex 264475
North Branch, 680 Burnage Lane, Manchester M19 1NA
Telephone 061 432 4945
Please mention this publication when replying

BRITAINS FOREMOST QUALITY COMPONENT SUPPLIERS
CIRCLE 8 FOR FURTHER DETAILS.



MITSUBISHI

MGF-1402
MGF-1403
MGF-1412
MGF-1801

GaAs FETs

FROM STOCK

Aspen Electronics Limited

UK representative for Mitsubishi Electric

2/3 Kildare Close, Eastcote, Ruislip
Middlesex HA4 9UR
Tel: 01-868 1188 Tlx: 8812727

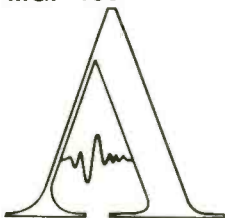

CIRCLE 16 FOR FURTHER DETAILS.

ELECTRONICS C.A.D.
"ANALYSER"

PERFORMANCE ANALYSIS OF LINEAR CIRCUITS using the BBC MODEL B AND SINCLAIR SPECTRUM 48K-MICRO'S.

Simulates Resistors, Capacitors, Inductors, Transformers, Bipolar and Field effect Transistors, and Operational Amplifiers in any circuit configuration.

Performs FREQUENCY RESPONSE ANALYSIS on Circuits with up to 30 Nodes and 100 Components, for Phase and Gain/Loss, Input Impedance and Output Impedance.

Ideal for the analysis of ACTIVE and PASSIVE FILTERS, AUDIO, WIDEBAND and R.F. AMPLIFIERS, LINEAR INTEGRATED CIRCUITS etc., etc.

"ANALYSER" can greatly reduce or even eliminate the need to breadboard new designs.

USED BY INDUSTRIAL AND UNIVERSITY R&D DEPARTMENTS WORLD WIDE.

VERY EASY TO USE. PRICES FROM £20 ACCESS OR AMERICAN EXPRESS WELCOME...

For further details write or phone NUMBER ONE SYSTEMS

DEPARTMENT WW
9A CROWN STREET, ST IVES
HUNTINGDON
CAMBS. UK. PE17 4EB
TEL: 0480 61778 TELEX: 32339

CIRCLE 33 FOR FURTHER DETAILS.

ROBOTS
For Education,
Training and Industry

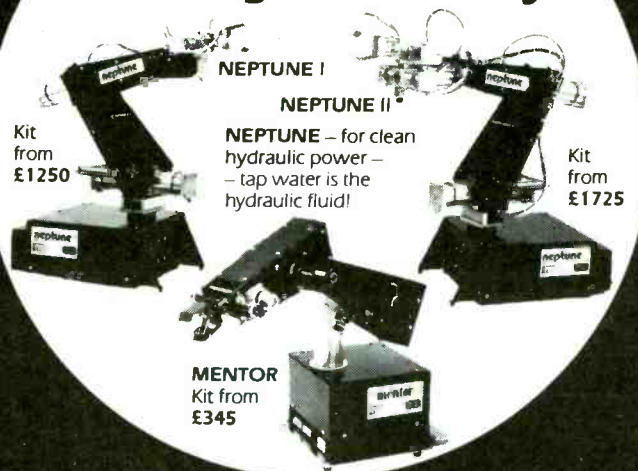

Kit
from
£1250

NEPTUNE I

NEPTUNE II

NEPTUNE - for clean
hydraulic power -
- tap water is the
hydraulic fluid!

Kit
from
£1725

MENTOR
Kit from
£345

NEPTUNE I 6 axes; 8 bit control system; 2.5Kg capacity; 1120mm reach.

NEPTUNE II 7 axes; 12 bit control system; 2.5Kg capacity; 1120mm reach.

MENTOR DC servo desktop robot; 8 bit control system; 300gm capacity; 420mm reach.

Robots programmed from keyboard or hand-held simulator (model robot).

Robots may also be taught by 'lead by the nose' method.

Extensive software is supplied free with each robot.

Leads available for connection to BBC, ZX Spectrum, Apple IIe, Commodore 64 and VIC 20.

Most other micros are also easily usable with these robots.

Robots also available ready built.



Please phone for brochure: 0264 50093.

West Portway Industrial Estate, Andover SP10 3WW.

A private and independent company giving prompt, personal service.

CIRCLE 43 FOR FURTHER DETAILS.

HART

This month we feature some fantastic bargains. Our standard range of professional quality kits and cassette decks is still expanding, along with new lines in Video heads and power supplies. Our FREE list gives details of these and many other lines.

ALL BARGAIN ITEMS INCLUDE VAT & POST.

EX PO DIGITAL TIMER TRT 340

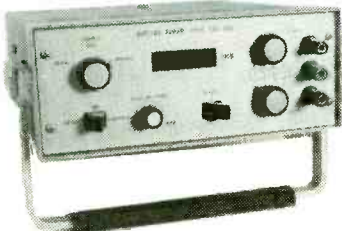

Mains/12v DC powered precision timer with full 4-digit display. 3 ranges up to 9999 mS. Sharp LED display holds until reset or cancels after user variable display time. Timing start and stop independently controllable by any of 4 types of input. Display test button on rear. Complete unit is housed in an elegant case with carrying handle/stand. These cost the PO many hundreds of pounds, our price to you only £29.78

LIQUID CRYSTAL DISPLAY WATCH MODULE
With LCD display, 2 pieces of Polarisng material, backlight diffuser, micro lamp, precision crystal, trimmer, battery contacts and open microcircuit. Untested. 5 for £1

PLESSEY MAINS INTERFERENCE SUPPRESSORS
Filter unit for mains borne interference. Max current 1.5A. Our Price, brand new only £2.27
Same item, Store soiled only £1.61

10W POWER AMPLIFIER MODULE
Mullard LP1173 Amplifier module. Needs 24v DC Supply to gives 10 watts into 4 ohm speaker. Size 112 X 70 X 29mm. Complete with heat sink. Only £2.40 complete with Data.

ALPS FF317U FM FRONT END
Beautiful, precision made High Quality variable capacitor tuned FM Front End with Dual-gate MosFet. Covers full FM range of 87 to 109 MHz. 12v supply. ONLY £5.15 Circuit if required 35p.

CAR RADIO FM IF AND STEREO DECODER
Miniature PCB with 10.7MHz ceramic filters, 2-transformer ratio detector, AX10 noise suppression IC and TCA4500A advanced stereo decoder IC. Only needs front end to make FM tuner or car radio. Complete with circuit. Incredible value at Only £1.99

TOP LOADING STEREO CASSETTE MODULES
Limited quantity of brand new stereo cassette units, as used in hi-fi music centres etc. All have auto stop.

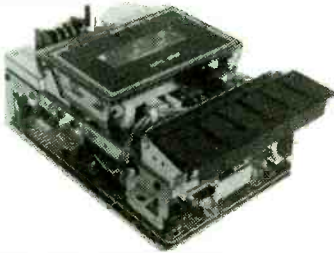

Deck type 858B. 12v DC motor. 3-digit counter. £29.32
Deck type 811C. As above but with Dolby noise reduction. Fully wired with twin VU meter, level controls, pilot lights and DIN socket. £44.73
Deck type 825A. Deck mechanism only as used in both above, produced by one of Japan's top manufacturers. Fitted high quality stereo R/P head and Ferrite erase. 12v DC electronically governed motor. £11.27
Cassette Door to fit any above. £4.02
Deck type 111D. Complete module with record and play electronics, 3-digit counter, AC drive motor and cassette door. £21.73

COMPLETE STEREO TUNER MODULE
3 Band, LW/MW/FM Stereo Tuner fully assembled on PCB 165 x 85mm. Supplied with Ferrite Rod Aerial, stereo LED and band switch fully wired. 12v DC Supply. TU560 - Tuner. Price Only £7.99
Drive accessories with 2 knobs, tuning drum, window and scale. £2.99
Special price for both items bought together. £9.70

PANEL METERS
Special front design that can be mounted on, or behind a front plate. Front 60mm X 45mm. Two types, FSD 50v DC & 1 AC ideal for power supply. Both the same price £6.21 each.

CLOCK/TIMER/FREQUENCY/METER PARTS
Special offer of the fabulous MSM5524 clock, timer and frequency meter chip. MSL2318 prescaler chip and 6LT09 5-Digit fluorescent display. These are the 3 primary components for a complete timing and frequency display system covering the long, medium, short and FM wavebands. Total cost of these parts is normally over £25. OUR SPECIAL OFFER PRICE ONLY £13.68
INF230 Data on MSM5524 and MSL2318. 70p
INF260 Application Circuit 20p
Crystal 3276.8 KHz £2.18

VIDEO HEADS
Heads to suit all VHS, BETA and PHILIPS video cassette recorders. Do not take chances with 'near equivalents' there are nine different VHS heads and seven BETAMAX. Write or ring with the make and model number of your recorder for quotation. Prices start at £47.25 for VHS and £57.75 for Beta. Plus Vat

HIGH QUALITY REPLACEMENT CASSETTE HEADS



Do your tapes lack treble? A worn head could be the problem. Fitting one of our replacement heads could restore performance to better than new! Standard mountings make fitting easy and our TC1 Test Cassette helps you set the azimuth spot-on. We are the actual importers which means you get the benefit of lower prices for prime parts. Compare us with other suppliers and see! The following is a list of our most popular heads, all are suitable for use on Dolby machines and are ex-stock.
HC20 Permalloy Stereo Head. This is the standard head fitted as original equipment on most decks £5.11
HM90 High Beta Permalloy Head. A hard-wearing, higher performance head with metal capability £8.06
HS16 Sendust Alloy Super Head. the best head we can find. Longer life than Permalloy, higher output than Ferrite, fantastic frequency response £9.91
HQ551 4-Track Head for auto-reverse or quadrophonic use. Full specification record and playback head £9.73
Please consult our list for technical data on these and other Special Purpose Heads.
MA481 Latest version Double Mono (2/2) Record/Play head. Replaces R484 £8.90
SM166 Standard Mounting 2/2 Erase head. Compatible with above or HQ551 4 Track head. £5.90
H524 Standard Erase Head. Semi double gap, high efficiency £1.50
H561 Metal Tape Erase Head. Full double gap £4.90

HART TRIPLE-PURPOSE TEST CASSETTE TC1

One inexpensive test cassette enables you to set up VU level, head azimuth and tape speed. Invaluable when fitting new heads. Only £4.66 plus VAT and 50p postage.
Tape Head De-magnetiser. Handy size mains operated unit prevents build up of residual head magnetisation causing noise on playback £4.54
Curved Pole Type for inaccessible heads £4.85

Send for your free copy of our LISTS. Overseas please send 2 IRCs to cover surface Post or 5 IRCs for Airmail.
Please add part cost of post, packing and insurance as follows:

INLAND Orders up to £10 - 50p
Orders £10 to £49 - £1
Orders over £50 - £1.50
OVERSEAS Please send sufficient to cover Surface or Air Post as required.

Personal callers are always very welcome but please note that we are closed all day Saturday

24hr SALES LINE
(0691) 652894

ALL PRICES EXCLUDE VAT UNLESS STATED

HART
HART ELECTRONIC KITS LTD
PENYLAN HILL
OSWESTRY, SHROPSHIRE
SY10 3AF

Parthia
Beckhampton,
Nr. Marlborough,
Wilts.
Tel. Avebury (067 23) 219

MARTIN ASSOCIATES sales

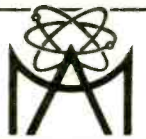

ANALYSERS			
Airmec	248A	Wave Analyser 5-300MHz	£50.00
Airmec	853	Wave Analyser 30kHz-30MHz	£70.00
Solartron	1250	Frequency response Analyser 10uHz-65kHz i/p 1uV-300V RS232C/IEEE 1yr Old	£4950.00
BRIDGES			
Marconi	TF868B	Universal LCR Bridge 1%	£150.00
Marconi	TF 2700	Universal LCR Bridge 1% Battery powered.	£225.00
GENERATORS			
Philips	PM 5770	Pulse Generator 1Hz-100MHz o/p 10V into 50 ohms	£200.00
Tektronix	148	Television Insertion Test Generator	£3500.00
OSCILLOSCOPES			
Coscor	CDU 150	Dual Trace DC-30MHz 10mV/div	£150.00
Solartron	A 100	Dual Trace DC-100MHz 10mV/div	£250.00

USED ELECTRONIC EQUIPMENT			
METERS			
H-P	3406A	R.F. Voltmeter 10kHz-1.2GHz Sample Holding	£995.00
Keithley	135	4 1/2 digit handheld DMM Almost New	£145.00
Marconi	TF 2604	Electronic Voltmeter 20Hz-1.5GHz	£160.00
MISCELLANEOUS			
Disa	55D05	Digital Constant Temperature Anenometer for fluid measurement etc.	£120.00
Coulter	550/551	Digital Air Contamination Monitor & Probe for determining dirt particles in environment	£250.00
Laminair	Laminarflo	Clean Air Workbench to keep work area dust free.	£200.00

MICROPROCESSOR & COMPUTING			
Elan	E2	EPROM Programmer 1 copy socket	£625.00
Elan	E9	EPROM Programmer & Editing 8 Sockets 1 yr Old	£995.00
DEC	RK05-AB	Digital Disk Cleaner for Disk Cartridges	£125.00
DEC	Pr/s 01	Tape Reader	£125.00
Fluke	9010A/001	Microprocessor Trouble Shooter c/w 8065 & 280 Pods New RS232	£4895.00
Dranetz	626	Universal Mains Disturbance Analyser c/w P 6001-01 & PA6003 Plug Ins 8 months Old	£6200.00
Racal Dana	488	GIPB Analyser RS232 6 months Old	£525.00
Shaffner	NSG 200 E	Line Interference Simulator c/w 223A High energy Module 6 months Old	£2200.00
H-P	7470A/002	Two Pen Graphic Recorder IEEE 1 Months Use	£495.00

THE ABOVE IS A SAMPLE OF OUR STOCK SEND S.A.E. FOR CURRENT LIST ALL ITEMS SUBJECT TO AVAILABILITY, CARRIAGE & V.A.T. CIRCLE 80 FOR FURTHER DETAILS.



4 + 11GHz SATELLITE TV RECEIVING EQUIPMENT
LNA's LNC's RECEIVERS, FEED HORNS ETC.

For further details contact
HARRISON ELECTRONICS
22 MILTON ROAD, WESTCLIFF-ON-SEA, ESSEX SS0 7JX Tel: (0702) 332338

PRINTED CIRCUIT BOARDS FOR ELECTRONICS & WIRELESS WORLD PROJECTS

PROJECT	DATE	No. of Boards	PRICE
NiCd FAST CHARGER	(NOV 83 ISSUE)	1 - ●	£7.00
R.F GENERATOR	(JAN 84 ISSUE)	2 - ●●	£6.00
SC84 COMPUTER	(MAY 84 ISSUE)	3 - ★★★	£39.00
MODEM	(JUN 84 ISSUE)	1 - ★	£16.00
SC84 POWER SUPPLY	(SEP 84 ISSUE)	1 - ●	£5.00
EPROM PROGRAMMER	(NOV 84 ISSUE)	2 - ●●	£17.00
MICRO PROG. ADAPTOR	(DEC 84 ISSUE)	1 - ●	£4.00
PRINTER BUFFER	(MAY 85 ISSUE)	1 - ★	£14.00

BOARD CODE: ★ PLATED THROUGH HOLE ● SINGLE SIDED

All P.C.B.'s are supplied with component insertion diagrams. Prices are inclusive of Inland and Overseas Postage, Packing and V.A.T. C.W.O. TO:-

Combe Martin ELECTRONICS

KING STREET, COMBE MARTIN, NORTH DEVON EX34 0AD. TEL: 0271 88 2346

CIRCLE 20 FOR FURTHER DETAILS.

ELECTRONICS & WIRELESS WORLD JULY 1985

VALVE DISC PREAMPLIFIER

I read with interest the article by Richard Brice on a valve disc pre-amplifier. I agree with his basic assumptions and design philosophy but he has made some errors of calculation.

The 10nF capacitor in conjunction with R_1 ($1M\Omega$) will not produce the $7950\mu s$ IEC bass roll-off. The Thevenin impedance seen by the 10nF capacitor is more of the order of $18M\Omega$ due to the bootstrapping effect of the cathode follower. There is no need to change this — the IEC roll-off may be implemented elsewhere. His equalization is, unfortunately, incorrect. He has assumed that the equalization network sees only the $250k\Omega$ series resistor, (where do you get $250k\Omega$ resistors)? In fact, it sees the Thévenin equivalent circuit which is the $250k\Omega$ resistor in parallel with the $1M\Omega$ resistor. An easy mistake — I did the same for months in blissful ignorance.

If we re-calculate the values of components in the equalization network we can also add the IEC roll-off. This has the added advantage that we can replace the $1\mu F$ electrolytic capacitor with a better-quality component such as a polycarbonate. See diagram 1.

The only other changes I would make are of detail, the $1\mu F$ capacitor feeding the $250k\Omega$ potentiometer could be replaced by a $0.22\mu F$ polycarbonate. The $1\mu F$ capacitor following could be replaced by a $10nF$ as used in the earlier stage.

The $100\mu F$ output coupling capacitor must surely be a bulky and suspect component; is it really necessary? The output stage should not be loaded by less than $10k\Omega$, so if we accept that as the minimum input impedance of the power amplifier, we find that $4.7\mu F$ would be an adequate value. It may be possible to use a non-polarised component here, but it would be expensive.

A word of warning, some transistor power amplifiers have coupling capacitors on their inputs with the laudable aim of preventing damage due to d.c. being applied at the input. Valve equipment always has an output capacitor to protect the following stage. Therefore connecting a valve pre-amplifier to a transistor amplifier should be safe. Occasionally this is not so; diagram 2 shows why.

The capacitors charge to equal values of charge: by applying $Q = CV$, we find that the small input capacitor of the amplifier has a large reverse voltage across it. It will fail quickly.

The solution is to add a

resistor, shown dotted, or to remove one of the capacitors. M. Jones
Shirley Warren
Southampton

RELATIVELY BORING?

Is it not possible to stem the flow of letters and articles on relativity, energy transfer and the other recondite subjects that appear to have taken over the pages of *Wireless World*? I realise that these are important, but why do they have to take up space in this particular magazine, which is supposed to be for engineers?

One could not object to the occasional page or two of exotica, but the continuous welter of statement and counter-statement, argument and bad-tempered knocking is becoming boring. It does seem a pity that all these, no doubt very clever people can't iron out their differences in some less public and less space-consuming place and then present us, once and for all, with the outcome.

Surely, Einstein, Maxwell, Michelson and Morley, Catt, Jones and all the rest are either right or they are wrong. Please try to find the most respected scientific figure in the world and get him to say which. Then, maybe, we can all get back to something useful.

H. Morgan
Tonbridge
Kent
Who would Mr Morgan suggest? — Ed.

LOGIC SYMBOLS

I can sympathise with the views expressed by Mr Hayward (Feedback, May 1985) regarding the new logic symbols. As an amateur enthusiast, I certainly hope the amateur magazines do not adopt this standard for their circuit diagrams, but the style used at the moment does not escape criticism either. Many magazines (not *Wireless World*) use unidentified blocks for complex i.c.s and provide a legend elsewhere on the diagram (IC_1 is 74LS193, IC_2 is . . .) which makes it quite difficult to understand at a glance.

With my other hat on, as a

professional engineer, I do not think Mr Hayward has the right attitude. He may well, as most of us do, operate his own personal or in-house standard for logic diagrams with complete self consistency, and very successfully too. The trouble is that the standard used is probably different from the way anyone else does it. As such the new BS will unite. I must confess though, that I dread to think how a Z80 or 6502, or for that matter a 68020, will be represented in the new scheme.

One point that Mr Hayward seems to have missed, is that it doesn't matter a jot which logic representation is used. The designer (of a complicated circuit typical of industry) invariably understands his design, while no one else does without considerable effort. If nothing else, then the BS provides the mechanism for fully documented top down design, and can lead the observer gently into the intimate details of a fiendish design.

I wish to close by taking (a minor) issue with the BS. The qualifiers used to designate the function of a combinatorial box seem based on mathematical principles, eg Or " ≥ 1 ", XOr " $= 1$ ", and presumably a three-input, majority-voting circuit would be " ≥ 2 ". Why then is the And function given by the non-mathematical symbol "&"? Surely, a two-input And gate ought to be " $= 2$ ", a three-input one " $= 3$ ", etc. While I admit the use of the ampersand means that you don't have to count the inputs, I contest that this concession to the old standards breaks the symmetry of the new.

Ken Wood
Ipswich
Suffolk

While I have a certain sympathy with Mr Hayward and his views about the new logic symbols I may have them presented to me and have no option but to learn them and use them. What I should really like to know is what are the policies of the major manufacturers with regard to this standard.

Mr Kampel's statement, in his first article, that: 'France, Germany, Netherlands, Japan, the UK and USA and many more now intend to bring their

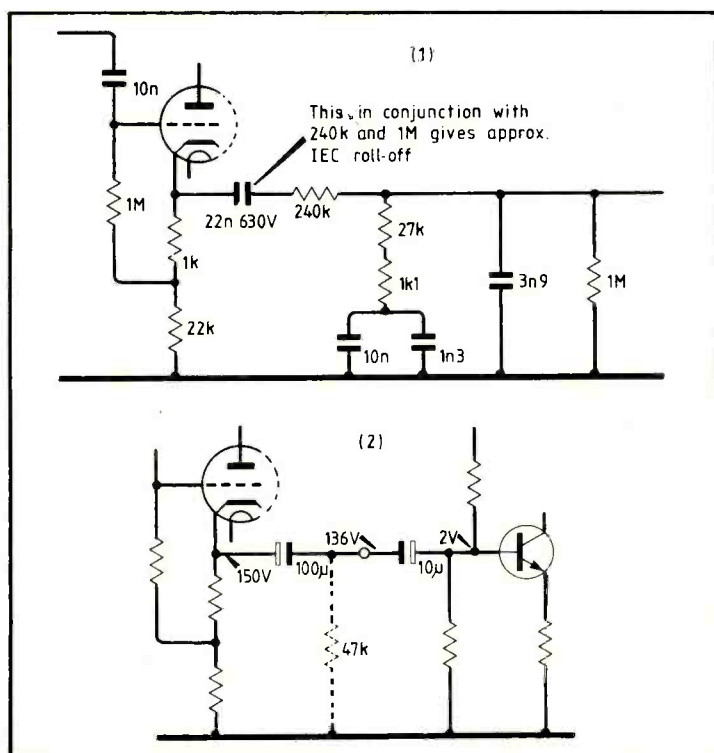

own national standards fully or broadly in line. . . implies, to me, that manufacturers are all set to follow suit. This is not at all sure. We are all aware of the impact that BS 3939: Section 21 (published in 1977) had — very little, and Section 21 was very similar to IEC Publication 117-15 which was certainly not a home-grown standard.

I am aware that publications for the armed services written to the Joint Services Publications (JSP) standards require symbols to be drawn to BS 3939 but I think I am right in suggesting that the use is selective. How many publications contractors make full use of, for example, the common control block notation?

The Texas TTL Data Book 5th Edition 1982 has as a supplement: 'Explanation of the New Logic Symbols'. The introduction mentions that work first began in the mid 1960s. IEEE/ANSI Standard Y32.14-1973 proposed the introduction of rectangular symbols for gates. I cannot remember ever having seen a 'square gate' on an American circuit diagram. A brief 'phone call to Texas suggested that they were not aware of any impending changes and a similar position seems to be current amongst a number of other manufacturers to whom I spoke.

The First Quarter 1985 issue of the *Journal of the Society for Technical Communication* states: 'IEEE Std 91-84 Graphic Symbols for Logic Diagrams. Dated 9th July 1984. This standard has been accepted by the Department of Defense for logic symbols.' Does this mean that manufacturers in the USA will now be obliged to change? If they do then very soon we shall all have to comply.

One need look no further, however, then page 23 of the May issue of this journal to see some very old-fashioned symbols; even I draw the line at 'wiggly resistors'!

My concern is with technical publications and training and I have to deal with equipment and handbooks from different sources and prepare material for use by students from many different countries. It is important that both the technical author and the lecturer be aware of impending change. Mr Kampel, in his interesting articles, has

forewarned me but need I pay any real attention if this latest attempt at standardisation is largely to be ignored as was BS 3939?

L.P. Best, F.I.S.T.C.
Aldershot
Hampshire

FUNDAMENTALS OF ENERGY TRANSFER

P.L. Taylor (Letters, June 1985) is unfair to me, probably because he has not read much of my writings. The whole thrust of "The Catt Anomaly" (*WW* Sept 1984, p.48) is that the conventional theory (which I call Theory N) contains logical inconsistency when it tries to explain the TEM wave, because electrons are involved. I base the case for my own theory, Theory C (*WW* Dec 1982 and Oct 1984) on the point Taylor is making. Does he really expect me to defend the conventional theory, which I habitually attack, for his benefit?

N.C. Hawkes (Letters, June 1985) misunderstood my February letter. He discusses the force between charged conductors and the force between conductors carrying current, whereas I am discussing the force between two conductors between which a TEM wave is travelling. I only mentioned charged conductors and current-carrying conductors in passing, in order to prove that the force between conductors between which a TEM wave is travelling is zero. Having established that the force is zero, I then proceeded to superpose two TEM waves. Hawkes has put the cart before the horse and turned them round and upside down.

I congratulate C.B.V. Francksen (*WW* May 85) on the first two and last three paragraphs of his letter.

My own position is that "modern physics", as the Establishment developments in our field during this century are termed, is a collage of layer upon layer of muddle, misconception and confusion. We do not just have a problem of one or two errors in the structure. The whole is riddled with error, and a false philosophy of science has

developed to buttress it. When it collapses, the effect will be devastating. I do not believe we shall save much fundamental theory from the mess of the twentieth century.

What we *can* do is try to get more study going on the politics, the sociology and the self-seeking contained within the science of this century, so as to learn the lessons we shall need in order to stop a similar mess from engulfing the science of the twenty-first century. We must learn why apparently clever men succumb to such a welter of arrant nonsense; what part of their action stems from self-interest; what part from lack of mental agility and what part from the very narrow education that scientists are subjected to.

Ivor Catt
St Albans
Hertfordshire

It is quite easy by pejorative writing to attack, as D.H. Potter does in *WW* April, 1985, Ivor Catt and myself. If will need somewhat more skill and persistence to attack the ideas put forward. Mr Potter says in his letter that I assume the lines initially quiescent, but I am not aware of having said that, any more than I am of unwinding reels to infinity. I simply assumed, as the SI definition of the ampere requires, that a current of 1 A is established in the conductors. How that current is set up is of no concern, since the measurement is done *after* the current is established. There was a slight error in the diagrams reproduced in *WW* that may have caused some confusion although the text was reasonably complete without the diagrams. I will give a numerical example that will, I hope, illustrate my point.

It has been long established, and I take no issue with it, that if we have a transmission line passing through a partition, no measurement that is done at the sending end can determine whether the line beyond the

partition extends to infinity or is terminated in its characteristic impedance. A practical man of course would have doubts and put his head round the partition to see. The diagram shows such a line terminated in Z_0 . Force may be measured on a metre length on the left hand side of the partition and the results will apply to the infinite line.

Consider a line that is not too different from that of the SI definition. The conductors could be 4mm diameter spaced 1m. It is easy to calculate that $Z_0 = 745\Omega$ and the capacitance per metre is 4.747 pF. Thus the value of E necessary to establish a current of 1 A is 745 V and that p.d. produces a charge per metre of 3.36 nC. The force between two such charges at a distance of 1 m is 2×10^{-7} N, which is the same as the magnetic force between the conductors when carrying 1 A, and in the opposite sense so that the net force is zero. Ivor Catt reaches the same conclusion, but by a different method.

I had not intended to enter into a prolonged discussion on this matter for I have taken it up before in *Physics Education*, a journal of the Institute of Physics. The issues concerned are Nov 1981, Mar 1982, Nov 1982, May 1983 and July 1983. Indeed if Mr Potter cares to consult the July 1983 issue of *Physics Education* he will find Professor R.G. Chambers stating my case rather more strongly than I did myself.

The question not unnaturally rises, if the ampere is always realised with an Ayrton-Jones balance, then why not define it in terms of that apparatus? It is as easy to specify circular conductors as straight ones, and clearly the manufacturing tolerances are as good in one case as the other.

One point on which I do agree with Mr Potter is the slovenly use of the term *impedance of free space*. The word *impedance* is a bad choice and *impedivity* or *specific impedance* would be better for it is an impedance measured in a specified way. What is referred to is a superficial resistivity of $377\Omega/\text{square}$. Space card is paper loaded with conducting particles such that if we cut a square from it with arbitrary length of side, the resistance between two

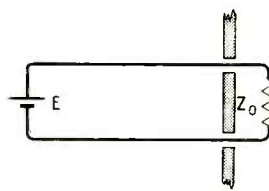

opposite edges is 377Ω . Any air-spaced transmission line passing through snugly fitting holes in the space card will have all its energy absorbed by the card and there will be no reflections.

I have said snugly fitting holes since I feel that the card should make good electrical contact with the conductors. However that may not be necessary. Heaviside, Poynting, and Ivor Catt all believe that transmission line energy is carried by the dielectric and only guided by the conductors. Space card may offer a way of testing that hypothesis. If the conductors are varnished where they pass through the card so that there is no electrical contact, it should make no difference if the energy is indeed only guided by the conductors, but all the difference if the conductors carry the energy. I do not have the facilities to test for reflection in the varnished and unvarnished cases, but if anyone does I would be glad to know the result.

Chris Parton
Uddingston
Glasgow

May I offer a few thoughts on that part of Chris Parton's letter (*E&WW*, Dec. 1984, p66) relating to the NPL definition of the ampere involving infinitely long parallel conductors? It seems to me that electric current is defined simply by the differential equation

$$i = dq/dt \quad (1)$$

When the unit of charge is the coulomb (a physical quantity) and the unit of time is the second (a physical quantity) we obtain the unit of current called the ampere (a mathematical concept).

The NPL definition of the ampere seems at first sight to involve forethoughts that the ampere has to be subsequently realised by a physical system because of its practical utility and that the definition is "superior" to the c.g.s. "circle of wire" definition. When we try to define it apart from Eq. (1), we always run into difficulties over concepts such as "conductors of infinite length" and so on which are not allowed in real life physical systems.

The c.g.s. "circle of wire" definition also involves difficulties: Does a unit pole exist? How does the current enter and leave the coil? What is meant by force? etc.

What the NPL is doing is defining the ampere in an "absolute type" of way. The term "absolute" was introduced by Gauss, meaning independent of the size of any particular instrument, or the value of gravity at any particular place, or of any other arbitrary quantities than the three standards of length, mass and time. But with concepts such as electric current I do not see how the difficulties I have mentioned can be avoided. Mechanical quantities can be defined in Gauss's absolute way but it is better, I think, to refer to "the NPL definition of the ampere" and to realize that it is an "absolute type" of concept from which any practicality has been removed. When the NPL has to realise the ampere practically then, of course, all thoughts of infinite conductors, unit poles, etc. vanish from their minds and they turn to the realities of forces and torques on mutually magnetically coupled coils, masses and levers.

May I draw readers' attention to part of a comment¹ by Dr A.T. Starr (whom I knew at Callender's Research Laboratories in 1939 and for whom I have the utmost respect)? "The development of electromagnetism adopted in this chapter is regarded with disfavour by many teachers of the subject and international committees. A few words in defence of the method will therefore be given. . . we are told that the idea of a magnetic pole is very deluding and that we are likely to find ourselves 'floundering in a world of make-believe'. This need not alarm us, as anything abstract is 'make-believe' and may be indulged in, provided it is self-consistent and useful. . . the fact that a north pole is associated with an equal south pole is not sufficient to make the idea of a single pole useless or misleading, just as the fact that every action is associated with an equal and opposite reaction does not prevent the idea of force from being useful." The whole of this reference is very worth-while reading.

In conclusion, I feel that the 'wisdom of our forefathers' was in the c.g.s. definition and that the NPL has erred in adopting the infinitely long wire definition. Chris Parton isto be congratulated on explaining the absurdity of introducing infinity into any 'absolute type' of definition. May I gently remind him, however, that parallel infinite wires never occurred originally in any c.g.s. definition?

Philip John Drake
Whickham
Newcastle-on-Tyne

Reference

A.T. Starr "Electric circuits and wave filters". (Pitman. 2ND Ed. 1944, pp.63-65).

CORRESPONDENCE, PROBLEM OR PARADOX?

In computer vision, we are led to believe that by finding corresponding objects in stereo images we can extract 3D information. In the correspondence technique, an object is found in one image and its *corresponding* object is found in the other stereo image; then using triangulation we find the range of the object. The method seems obvious but has never been implemented in practice because the rules for working out which objects correspond has never been found and hence we get the 'correspondence problem'.

However, presented now is proof that the correspondence problem was never a problem but an insoluble paradox. To start off, we say that our overall objective is not solving the correspondence problem but general object recognition with no 'a priori' knowledge of the scene. On examining the image we may find several objects but we cannot decipher the size of the objects because a small object will have the same size when imaged as a similar but large object further away. To resolve this we take a second and stereo image with the intent of finding the *same* object in both images and use triangulation to calculate object distance. In practice, finding the same object in both images is difficult and hence we get the

correspondence problem. In truth, however, finding the *same* object in both images is impossible because to find the *same* object in both images we must *recognise each object* and to do that we *must* know how far each object is away from the camera! That is, we must know how far each object is before we can try to find the corresponding object.

We clearly have a paradox. We need stereo images to range objects. To solve the correspondence problem we need to know in advance how far each object is away from the camera. To find out how far each object is away from the camera, we need stereo images. . . ad infinitum. Hence we conclude that the correspondence problem is not a problem but an insoluble paradox.

J. Michael
London N.4.

Letters

Letters for publication are always welcome, but the shorter and pithier, the better. I try not to edit original letters, but sometimes they are far too long, and therefore cut, and the writers upset. Please keep your letters short.

CORRECTIONS

Fast camera interface

In the timing circuit of this design for interfacing a video camera to a microcomputer, (June issue) the v.c.o. timing capacitor is 5pF. We apologize for this omission.

Helical antennas for 435MHz

This reference list was accidentally omitted from James Miller's article in the June issue.

References

1. Kraus, J.D. Antennas, Chap.7, McGraw-Hill, 1950.
2. King, H.E. and Wong, J.L. Characteristics of 1 to 8 wavelength uniform helical antennas, *IEEE Trans. Ant. & Prop.* vol. AP-28 No.2, March, 1980.
3. Tilson W.V., On evaluating the performance of communications antennas, *IEEE Communications Magazine* September, 1981.

BBC Micro Computer System BBC Computer & Econet Referral Centre BBC Computers:

Model B: £299 (a) B+DFS: £346 (a)
Model B+Econet: £335 (a) B+Econet+DFS £399 (a)
ACORN 10 Mbyte Hard Disc £1300 (a)
ACORN 2nd Processors: 6502: £175 (a) Z80: £348 (a)
TORCH UNICORN: Z80 Card: £275 (a) Z80 Disc Pack: £550 (a)
TORCH Graduate G800/2 £925 (a)
20 Mbyte Hard Disc+400K Floppy: £1950 (a)

We stock the full range of ACORN hardware and firmware and a very wide range of other peripherals and firmware for the BBC. For detailed specifications and pricing please send for our leaflet.

PRINTERS

EPSON: RX80T £210 (a); RX80FT £220 (a); RX100 £345 (a);
FX80 £315 (a); FX100 £430 (a); JX80 Full Colour Printer £525 (a)
KAGA TAXAN: KP810 £255 (a); KP910 £359 (a)
BROTHER: HR15 £340 (a); JUKI 6100 £340 (a).
GRAPHICS PLOTTER WORKSTATION Complete £490 (a)
Basic Plotter £270 (a); HI-Plotter £399 (a)

ACCESSORIES

EPSON Serial Interface: 8143 £28 (b); 8148 with 2K buffer £57 (b).
EPSON Paper Roll Holder £17 (b); FX80 Tractor Attach £37 (b); RX/FX80 Dust Cover £4.50 (d).
BUFFALO 32K Buffer for Epson printers £99 (d).
EPSON Ribbons: MX/RX/FX80 £5.00; MX/RX/FX100 £10 (d).
JUKI: Serial Interface £65 (c); Tractor Attach, £99 (a); Sheet Feeder £182 (a); Ribbon £2.50 (a).
BROTHER HR15: Sheet Feeder £199; Ribbons — Carbonor Nylon £4.50; Multistrike £5.50 (d); 2000 Sheets Fanfold with extra fine perf. 9.5in. — £13.50; 14.5in. £18.50 (b).
BBC Parallel Lead £8; Serial Lead £7 (d).

BT Approved Modems

MIRACLE WS2000:
The ultimate world standard BT approved modem covering all common BELL and CCITT standards up to 1200 Baud. Allows communication with virtually any computer system in the world. The optional AUTO DIAL and AUTO ANSWER boards enhance the considerable facilities already provided on the modem. Mains powered. £129 (c) Auto Dial Board/ Auto Answer Board £30 (d) each (awaiting BABT approval). Software lead £4.50
BUZZBOX:
This pocket sized modem complies with V21 300/300 Baud and provides an ideal solution for communications between users, with main frame computers and bulletin boards at a very economic cost. Battery or mains operated. £62 (c) Mains Adaptor £8 (d) BBC to Modem data lead £7

SOFTY II

This low cost intelligent eeprom programmer can program 2716, 2516, 2532, 2732, and with an adaptor, 2564 and 2764. Displays 512 byte page on TV — has a serial and parallel I/O routines. Can be used as an emulator, cassette interface.
Softy II £195.00(b)
Adaptor for 2764/2564 £25.00

ATTENTION

All prices in this double page advertisement are subject to change without notice.

ALL PRICES EXCLUDE VAT
Please add carriage 50p unless indicated as follows:
(a) £8 (b) £2.50 (c) £1.50 (d) £1.00

ACORN IEEE INTERFACE

A full implementation of the IEEE-488 standard, providing computer control of compatible scientific & technical equipment, at a lower price than other systems. Typical applications are in experimental work in academic and industrial laboratories. The interface can support a network of up to 14 other compatible devices, and would typically link several items of test equipment allowing them to run with the optimum of efficiency. The IEEE Filing System ROM is supplied £282.

INDUSTRIAL PROGRAMMER

EP8000.
This CPU controlled Emulator Programmer is a powerful tool for both Eeprom programming and development work. EP8000 can emulate and program all eeproms up to 8Kx8 bytes, can be used as stand alone unit for editing and duplicating EPROMS, as a slave programmer or as an eeprom emulator £695(a)

I.D. CONNECTORS	EDGE CONNECTORS	AMPHENOL CONNECTORS	TELEPHONE CONNECTORS																																																																																																																																																				
<p>(Speedblock Type)</p> <table border="1" style="width: 100%; border-collapse: collapse;"> <tr> <th>No of ways</th> <th>Header</th> <th>Recep.</th> <th>Edge Conn.</th> </tr> <tr> <td>10</td> <td>90p</td> <td>85p</td> <td>120p</td> </tr> <tr> <td>20</td> <td>145p</td> <td>125p</td> <td>195p</td> </tr> <tr> <td>26</td> <td>175p</td> <td>150p</td> <td>240p</td> </tr> <tr> <td>34</td> <td>200p</td> <td>160p</td> <td>320p</td> </tr> <tr> <td>40</td> <td>220p</td> <td>190p</td> <td>340p</td> </tr> <tr> <td>50</td> <td>235p</td> <td>200p</td> <td>390p</td> </tr> </table>	No of ways	Header	Recep.	Edge Conn.	10	90p	85p	120p	20	145p	125p	195p	26	175p	150p	240p	34	200p	160p	320p	40	220p	190p	340p	50	235p	200p	390p	<table border="1" style="width: 100%; border-collapse: collapse;"> <tr> <td>2 x 6-way (commodore)</td> <td>0.1" 0.156</td> <td>—</td> <td>300p</td> </tr> <tr> <td>2 x 10-way</td> <td>—</td> <td>150p</td> <td>—</td> </tr> <tr> <td>2 x 12-way (vic 20)</td> <td>—</td> <td>—</td> <td>350p</td> </tr> <tr> <td>2 x 18-way</td> <td>—</td> <td>—</td> <td>140p</td> </tr> <tr> <td>2 x 23-way (ZX81)</td> <td>—</td> <td>175p</td> <td>220p</td> </tr> <tr> <td>2 x 25-way</td> <td>—</td> <td>225p</td> <td>220p</td> </tr> <tr> <td>2 x 28-way (Spectrum)</td> <td>—</td> <td>200p</td> <td>—</td> </tr> <tr> <td>2 x 36-way</td> <td>—</td> <td>250p</td> <td>—</td> </tr> <tr> <td>1 x 43-way</td> <td>—</td> <td>260p</td> <td>—</td> </tr> <tr> <td>2 x 42-way</td> <td>—</td> <td>190p</td> <td>—</td> </tr> <tr> <td>2 x 43-way</td> <td>—</td> <td>395p</td> <td>—</td> </tr> <tr> <td>1 x 77-way</td> <td>—</td> <td>400p</td> <td>500p</td> </tr> <tr> <td>2 x 50-way (\$100conn)</td> <td>—</td> <td>600p</td> <td>—</td> </tr> </table>	2 x 6-way (commodore)	0.1" 0.156	—	300p	2 x 10-way	—	150p	—	2 x 12-way (vic 20)	—	—	350p	2 x 18-way	—	—	140p	2 x 23-way (ZX81)	—	175p	220p	2 x 25-way	—	225p	220p	2 x 28-way (Spectrum)	—	200p	—	2 x 36-way	—	250p	—	1 x 43-way	—	260p	—	2 x 42-way	—	190p	—	2 x 43-way	—	395p	—	1 x 77-way	—	400p	500p	2 x 50-way (\$100conn)	—	600p	—	<p>36 way plug Centronics (solder) 500p (IDC) 475p 36 way skt Centronics (solder) 550p (IDC) 500p 24 way plug IEEE (solder) 475p (IDC) 475p 24 way skt IEEE (solder) 500p (IDC) 500p PCB Mtg Skt Ang Pin 24 way 700p 36 way 750p</p> <p>GENDER CHANGERS 25 way D type</p> <table border="1" style="width: 100%; border-collapse: collapse;"> <tr> <td>Male to Male</td> <td>£10</td> </tr> <tr> <td>Male to Female</td> <td>£10</td> </tr> <tr> <td>Female to Female</td> <td>£10</td> </tr> </table> <p>RS 232 JUMPERS (25 way D)</p> <table border="1" style="width: 100%; border-collapse: collapse;"> <tr> <td>24" Single end Male</td> <td>£5.00</td> </tr> <tr> <td>24" Single end Female</td> <td>£5.25</td> </tr> <tr> <td>24" Female Female</td> <td>£10.00</td> </tr> <tr> <td>24" Male Male</td> <td>£9.50</td> </tr> <tr> <td>24" Male Female</td> <td>£9.50</td> </tr> </table>	Male to Male	£10	Male to Female	£10	Female to Female	£10	24" Single end Male	£5.00	24" Single end Female	£5.25	24" Female Female	£10.00	24" Male Male	£9.50	24" Male Female	£9.50	<table border="1" style="width: 100%; border-collapse: collapse;"> <tr> <td>4-way plug</td> <td>110p</td> </tr> <tr> <td>6-way plug</td> <td>180p</td> </tr> <tr> <td>6-way rt ang skt</td> <td>160p</td> </tr> <tr> <td>Flexible cable</td> <td></td> </tr> <tr> <td>4-way</td> <td>50p/m</td> </tr> <tr> <td>6-way</td> <td>72p/m</td> </tr> </table> <p>RIBBON CABLE (grey/metre)</p> <table border="1" style="width: 100%; border-collapse: collapse;"> <tr> <td>10-way</td> <td>40p</td> <td>34-way</td> <td>160p</td> </tr> <tr> <td>16-way</td> <td>60p</td> <td>40-way</td> <td>180p</td> </tr> <tr> <td>20-way</td> <td>85p</td> <td>50-way</td> <td>200p</td> </tr> <tr> <td>26-way</td> <td>120p</td> <td>64-way</td> <td>280p</td> </tr> </table> <p>DIL HEADERS</p> <table border="1" style="width: 100%; border-collapse: collapse;"> <tr> <td></td> <td>Solder</td> <td>IDC</td> </tr> <tr> <td>14 pin</td> <td>40p</td> <td>100p</td> </tr> <tr> <td>16 pin</td> <td>50p</td> <td>110p</td> </tr> <tr> <td>18 pin</td> <td>60p</td> <td>—</td> </tr> <tr> <td>20 pin</td> <td>75p</td> <td>—</td> </tr> <tr> <td>24 pin</td> <td>100p</td> <td>150p</td> </tr> <tr> <td>28 pin</td> <td>160p</td> <td>200p</td> </tr> <tr> <td>40 pin</td> <td>200p</td> <td>225p</td> </tr> </table>	4-way plug	110p	6-way plug	180p	6-way rt ang skt	160p	Flexible cable		4-way	50p/m	6-way	72p/m	10-way	40p	34-way	160p	16-way	60p	40-way	180p	20-way	85p	50-way	200p	26-way	120p	64-way	280p		Solder	IDC	14 pin	40p	100p	16 pin	50p	110p	18 pin	60p	—	20 pin	75p	—	24 pin	100p	150p	28 pin	160p	200p	40 pin	200p	225p
No of ways	Header	Recep.	Edge Conn.																																																																																																																																																				
10	90p	85p	120p																																																																																																																																																				
20	145p	125p	195p																																																																																																																																																				
26	175p	150p	240p																																																																																																																																																				
34	200p	160p	320p																																																																																																																																																				
40	220p	190p	340p																																																																																																																																																				
50	235p	200p	390p																																																																																																																																																				
2 x 6-way (commodore)	0.1" 0.156	—	300p																																																																																																																																																				
2 x 10-way	—	150p	—																																																																																																																																																				
2 x 12-way (vic 20)	—	—	350p																																																																																																																																																				
2 x 18-way	—	—	140p																																																																																																																																																				
2 x 23-way (ZX81)	—	175p	220p																																																																																																																																																				
2 x 25-way	—	225p	220p																																																																																																																																																				
2 x 28-way (Spectrum)	—	200p	—																																																																																																																																																				
2 x 36-way	—	250p	—																																																																																																																																																				
1 x 43-way	—	260p	—																																																																																																																																																				
2 x 42-way	—	190p	—																																																																																																																																																				
2 x 43-way	—	395p	—																																																																																																																																																				
1 x 77-way	—	400p	500p																																																																																																																																																				
2 x 50-way (\$100conn)	—	600p	—																																																																																																																																																				
Male to Male	£10																																																																																																																																																						
Male to Female	£10																																																																																																																																																						
Female to Female	£10																																																																																																																																																						
24" Single end Male	£5.00																																																																																																																																																						
24" Single end Female	£5.25																																																																																																																																																						
24" Female Female	£10.00																																																																																																																																																						
24" Male Male	£9.50																																																																																																																																																						
24" Male Female	£9.50																																																																																																																																																						
4-way plug	110p																																																																																																																																																						
6-way plug	180p																																																																																																																																																						
6-way rt ang skt	160p																																																																																																																																																						
Flexible cable																																																																																																																																																							
4-way	50p/m																																																																																																																																																						
6-way	72p/m																																																																																																																																																						
10-way	40p	34-way	160p																																																																																																																																																				
16-way	60p	40-way	180p																																																																																																																																																				
20-way	85p	50-way	200p																																																																																																																																																				
26-way	120p	64-way	280p																																																																																																																																																				
	Solder	IDC																																																																																																																																																					
14 pin	40p	100p																																																																																																																																																					
16 pin	50p	110p																																																																																																																																																					
18 pin	60p	—																																																																																																																																																					
20 pin	75p	—																																																																																																																																																					
24 pin	100p	150p																																																																																																																																																					
28 pin	160p	200p																																																																																																																																																					
40 pin	200p	225p																																																																																																																																																					
<p>D CONNECTORS</p> <table border="1" style="width: 100%; border-collapse: collapse;"> <tr> <th>No of Ways</th> <th>9</th> <th>15</th> <th>25</th> <th>37</th> </tr> <tr> <td>MALE:</td> <td></td> <td></td> <td></td> <td></td> </tr> <tr> <td>Ang Pins</td> <td>120</td> <td>180</td> <td>230</td> <td>350</td> </tr> <tr> <td>Solder</td> <td>60</td> <td>85</td> <td>125</td> <td>170</td> </tr> <tr> <td>IDC</td> <td>175</td> <td>275</td> <td>325</td> <td>—</td> </tr> <tr> <td>FEMALE:</td> <td></td> <td></td> <td></td> <td></td> </tr> <tr> <td>St Pin</td> <td>100</td> <td>140</td> <td>210</td> <td>380</td> </tr> <tr> <td>Ang Pins</td> <td>160</td> <td>210</td> <td>275</td> <td>440</td> </tr> <tr> <td>Solder</td> <td>90</td> <td>130</td> <td>195</td> <td>290</td> </tr> <tr> <td>IDC</td> <td>195</td> <td>325</td> <td>375</td> <td>—</td> </tr> <tr> <td>St Hood</td> <td>90</td> <td>95</td> <td>100</td> <td>120</td> </tr> <tr> <td>Screw</td> <td>130</td> <td>150</td> <td>175</td> <td>—</td> </tr> <tr> <td>Lock</td> <td>—</td> <td>—</td> <td>—</td> <td>—</td> </tr> </table>	No of Ways	9	15	25	37	MALE:					Ang Pins	120	180	230	350	Solder	60	85	125	170	IDC	175	275	325	—	FEMALE:					St Pin	100	140	210	380	Ang Pins	160	210	275	440	Solder	90	130	195	290	IDC	195	325	375	—	St Hood	90	95	100	120	Screw	130	150	175	—	Lock	—	—	—	—	<p>EURO CONNECTORS</p> <table border="1" style="width: 100%; border-collapse: collapse;"> <tr> <td>DIN 41612</td> <td>Plug</td> <td>Skt</td> </tr> <tr> <td>2 x 32 way St Pin</td> <td>230p</td> <td>275p</td> </tr> <tr> <td>2 x 32 way Ang Pin</td> <td>275p</td> <td>320p</td> </tr> <tr> <td>3 x 32 way St Pin</td> <td>260p</td> <td>300p</td> </tr> <tr> <td>3 x 32 way Ang Pin</td> <td>375p</td> <td>400p</td> </tr> <tr> <td>IDC Skt A + B</td> <td>400p</td> <td>—</td> </tr> <tr> <td>IDC Skt A + C</td> <td>400p</td> <td>—</td> </tr> </table> <p>For 2 x 32 way please specify spacing (A + B, A + C).</p>	DIN 41612	Plug	Skt	2 x 32 way St Pin	230p	275p	2 x 32 way Ang Pin	275p	320p	3 x 32 way St Pin	260p	300p	3 x 32 way Ang Pin	375p	400p	IDC Skt A + B	400p	—	IDC Skt A + C	400p	—	<p>DIL SWITCHES</p> <table border="1" style="width: 100%; border-collapse: collapse;"> <tr> <td>4-way</td> <td>90p</td> <td>6-way</td> <td>105p</td> </tr> <tr> <td>8-way</td> <td>120p</td> <td>10-way</td> <td>150p</td> </tr> </table>	4-way	90p	6-way	105p	8-way	120p	10-way	150p	<p>MISC CONNL</p> <table border="1" style="width: 100%; border-collapse: collapse;"> <tr> <td>21 pin Scart Connector</td> <td>200p</td> </tr> <tr> <td>8 pin Video Connector</td> <td>200p</td> </tr> </table>	21 pin Scart Connector	200p	8 pin Video Connector	200p																																																		
No of Ways	9	15	25	37																																																																																																																																																			
MALE:																																																																																																																																																							
Ang Pins	120	180	230	350																																																																																																																																																			
Solder	60	85	125	170																																																																																																																																																			
IDC	175	275	325	—																																																																																																																																																			
FEMALE:																																																																																																																																																							
St Pin	100	140	210	380																																																																																																																																																			
Ang Pins	160	210	275	440																																																																																																																																																			
Solder	90	130	195	290																																																																																																																																																			
IDC	195	325	375	—																																																																																																																																																			
St Hood	90	95	100	120																																																																																																																																																			
Screw	130	150	175	—																																																																																																																																																			
Lock	—	—	—	—																																																																																																																																																			
DIN 41612	Plug	Skt																																																																																																																																																					
2 x 32 way St Pin	230p	275p																																																																																																																																																					
2 x 32 way Ang Pin	275p	320p																																																																																																																																																					
3 x 32 way St Pin	260p	300p																																																																																																																																																					
3 x 32 way Ang Pin	375p	400p																																																																																																																																																					
IDC Skt A + B	400p	—																																																																																																																																																					
IDC Skt A + C	400p	—																																																																																																																																																					
4-way	90p	6-way	105p																																																																																																																																																				
8-way	120p	10-way	150p																																																																																																																																																				
21 pin Scart Connector	200p																																																																																																																																																						
8 pin Video Connector	200p																																																																																																																																																						
<p>TEXTPOOL ZIF</p> <table border="1" style="width: 100%; border-collapse: collapse;"> <tr> <td>SOCKETS</td> <td></td> </tr> <tr> <td>28-pin £9.00</td> <td>40-pin £12.00</td> </tr> </table>	SOCKETS		28-pin £9.00	40-pin £12.00																																																																																																																																																			
SOCKETS																																																																																																																																																							
28-pin £9.00	40-pin £12.00																																																																																																																																																						

DISC DRIVES

TECHNOMATIC drives are fitted with high quality slimline Mitsubishi mechanisms and are available with or without integral mains power supply. The dual drive power supplies are switch mode type and are generously rated. All drives with integral power supply are fitted with a mains indicator.

All drives are supplied with all the necessary cables, manual and a formatting disc. All drives are capable of operating in single or double density modes.

Single Drives:

1x100K 40T SS: TS100 £85 (b); PS100 with psu £125 (b)
1x400K 80/40T DS: TS400 £125 (b); PS400 with psu £149 (b)

Dual Drives

Stacked Version:
2x100K 40T SS: TD200 £175 (a); PD200 with psu £200 (a)
2x400K 80/40 DS: TD800 £250 (a); PD800 with psu £290 (a)

Plinth Version:

2x100K 40T SS: TD200P £195 (a); PD200P with psu £220 (a)
2x400K (80/40) DS: TD800P £265 (a); PD800P with psu £305 (a)

Authorised Distributor Data Recording Products



3M FLOPPY DISCS

Industry Standard floppy discs with a lifetime guarantee Discs in packs of 10
40 Track SS DD £13 (c) 40 Track DS DD £18 (c)
80 Track SS DD £22 (c) 80 Track DS DD £24 (c)

FLOPPICLENE DRIVEHEAD CLEANING KIT

FLOPPICLENE Disc Head Cleaning Kit with 28 disposable cleaning discs ensures continued optimum performance of the drives. £14.50 (b)

DRIVE ACCESSORIES

Single Disc Cable £6 (d) Dual Disc Cable £8.50 (d)
10 Disc Library Case £1.80 (d) 30 Disc Storage Box £6 (c)
30/40 Disc Lockable Box £14 (c) 100 Disc Lockable Box £19 (c)

MONITORS

MICROVITEC 14in. & 20in RGB

1431 Std Res £185 (a); 1431 Ap std Res PAL/Audio £205 (a);
1451 Med Res £240 (a); 1441 Hi Res £389 (a);
Swivel Base for Plastic 14in Microvitecs £20 (c)
2030CS Std Res £380 (a); 2040CS Hi Res £685 (a)
Plinth for 14in. Monitors £8.50.

Microvitec Monitors with TTL/Linear Inputs also available.

KAGA TAXAN 12in. RGB

Vision II Hi Res £225 (a); Vision III Super Hi Res £325 (a)
Green Screens; KAGA 12G £99 (a); SANYO DM811 112CX £90 (a);
Swivel Stand for Kaga Green £21 (c)
BBC Leads: KAGA RGB £5 Microvitec £3.50; Monochrome £3.50 (d)
SANYO CD 3125 NB 14in. RGB Std Res £169 (a)

UV ERASERS

UV1T Eraser with built-in timer and mains indicator. Built-in safety interlock to avoid accidental exposure to the harmful UV rays.
It can handle up to 5 eeproms at a time with an average erasing time of about 20 mins. £59 + £2 p&p.
UV1 as above but without the timer. £47 + £2 p&p.
For Industrial Users, we offer UV140 & UV141 erasers with handling capacity of 14 eeproms. UV141 has a built in timer. Both offer full built in safety features
UV140 £61, UV141 £79, p&p £2.50.

PRINTER BUFFER

This printer sharer/buffer provides a simple way to upgrade a multiple computer system by providing greater utilisation of available resources. The buffer offers a storage of 64K. Data from three computers can be loaded into the buffer which will continue accepting data until it is full. The buffer will automatically switch from one computer to next as soon as that computer has dumped all its data. The computer then is available for other uses. LED bargraph indicates memory usage. Simple push button control provides. REPEAT, PAUSE and RESET functions. Integral power supply. £205 (a).
Cable set £30.

CONNECTOR SYSTEMS

74 SERIES			74LS266 0.60			74C SERIES			4502 0.55			LINEAR ICs			COMPUTER COMPONENTS			
7400 0.30	74273 2.00	74LS266 0.60	74LS273 1.25	74C00 0.70	4502 0.55	AD7581 15.00	LM709 0.35	7400 0.70	4504 0.36	AD7581 15.00	LM709 0.35	7400 0.70	AD7581 15.00	LM709 0.35	7400 0.70	AD7581 15.00	LM709 0.35	
7401 0.30	74274 1.70	74LS273 1.25	74LS279 1.05	74C04 0.50	4506 0.36	AD7581 15.00	LM709 0.35	7401 0.70	4506 0.36	AD7581 15.00	LM709 0.35	7401 0.70	AD7581 15.00	LM709 0.35	7401 0.70	AD7581 15.00	LM709 0.35	
7402 0.30	74275 0.90	74LS279 1.05	74LS280 1.90	74C08 0.70	4507 0.36	AD7581 15.00	LM709 0.35	7402 0.70	4507 0.36	AD7581 15.00	LM709 0.35	7402 0.70	AD7581 15.00	LM709 0.35	7402 0.70	AD7581 15.00	LM709 0.35	
7403 0.30	74283 1.05	74LS280 1.90	74LS290 0.80	74C10 0.70	4510 0.55	AD7581 15.00	LM709 0.35	7403 0.70	4510 0.55	AD7581 15.00	LM709 0.35	7403 0.70	AD7581 15.00	LM709 0.35	7403 0.70	AD7581 15.00	LM709 0.35	
7404 0.36	74284 3.20	74LS290 0.80	74LS292 0.80	74C12 0.70	4511 0.55	AD7581 15.00	LM709 0.35	7404 0.70	4511 0.55	AD7581 15.00	LM709 0.35	7404 0.70	AD7581 15.00	LM709 0.35	7404 0.70	AD7581 15.00	LM709 0.35	
7405 0.30	74293 0.90	74LS292 0.80	74LS293 0.80	74C14 0.50	4512 0.80	AD7581 15.00	LM709 0.35	7405 0.70	4512 0.80	AD7581 15.00	LM709 0.35	7405 0.70	AD7581 15.00	LM709 0.35	7405 0.70	AD7581 15.00	LM709 0.35	
7406 0.40	74298 1.80	74LS293 0.80	74LS295 1.40	40106 4584	4513 1.50	AD7581 15.00	LM709 0.35	7406 0.70	4513 1.50	AD7581 15.00	LM709 0.35	7406 0.70	AD7581 15.00	LM709 0.35	7406 0.70	AD7581 15.00	LM709 0.35	
7407 0.40	74351 2.00	74LS295 1.40	74LS297 0.90	74C20 0.70	4514 1.50	AD7581 15.00	LM709 0.35	7407 0.70	4514 1.50	AD7581 15.00	LM709 0.35	7407 0.70	AD7581 15.00	LM709 0.35	7407 0.70	AD7581 15.00	LM709 0.35	
7408 0.30	74365A 0.80	74LS297 0.90	74LS298 1.00	74C32 1.50	4515 0.55	AD7581 15.00	LM709 0.35	7408 0.70	4515 0.55	AD7581 15.00	LM709 0.35	7408 0.70	AD7581 15.00	LM709 0.35	7408 0.70	AD7581 15.00	LM709 0.35	
7409 0.30	74366A 0.80	74LS298 1.00	74LS301 3.70	74C42 1.50	4517 2.20	AD7581 15.00	LM709 0.35	7409 0.70	4517 2.20	AD7581 15.00	LM709 0.35	7409 0.70	AD7581 15.00	LM709 0.35	7409 0.70	AD7581 15.00	LM709 0.35	
7410 0.30	74367A 0.80	74LS301 3.70	74LS322A 3.00	74C48 1.50	4519 0.32	AD7581 15.00	LM709 0.35	7410 0.70	4519 0.32	AD7581 15.00	LM709 0.35	7410 0.70	AD7581 15.00	LM709 0.35	7410 0.70	AD7581 15.00	LM709 0.35	
7411 0.30	74376 1.60	74LS322A 3.00	74LS323 3.00	74C73 1.00	4520 0.60	AD7581 15.00	LM709 0.35	7411 0.70	4520 0.60	AD7581 15.00	LM709 0.35	7411 0.70	AD7581 15.00	LM709 0.35	7411 0.70	AD7581 15.00	LM709 0.35	
7412 0.30	74390 1.10	74LS323 3.00	74LS324 3.00	74C75 1.00	4521 1.15	AD7581 15.00	LM709 0.35	7412 0.70	4521 1.15	AD7581 15.00	LM709 0.35	7412 0.70	AD7581 15.00	LM709 0.35	7412 0.70	AD7581 15.00	LM709 0.35	
7413 0.50	74393 1.20	74LS324 3.00	74LS348 2.20	74C86 2.00	4522 0.80	AD7581 15.00	LM709 0.35	7413 0.70	4522 0.80	AD7581 15.00	LM709 0.35	7413 0.70	AD7581 15.00	LM709 0.35	7413 0.70	AD7581 15.00	LM709 0.35	
7414 0.70	74490 1.40	74LS348 2.20	74LS352 1.20	74C87 2.00	4523 0.80	AD7581 15.00	LM709 0.35	7414 0.70	4523 0.80	AD7581 15.00	LM709 0.35	7414 0.70	AD7581 15.00	LM709 0.35	7414 0.70	AD7581 15.00	LM709 0.35	
7415 0.36	74490 1.40	74LS352 1.20	74LS353 1.20	74C88 2.00	4524 0.80	AD7581 15.00	LM709 0.35	7415 0.36	74490 1.40	74LS352 1.20	74LS353 1.20	74C88 2.00	4524 0.80	AD7581 15.00	LM709 0.35	7415 0.36	74490 1.40	74LS352 1.20
7420 0.30	74500 0.24	74LS353 1.20	74LS356 2.10	74C89 2.00	4525 0.80	AD7581 15.00	LM709 0.35	7420 0.30	74500 0.24	74LS353 1.20	74LS356 2.10	74C89 2.00	4525 0.80	AD7581 15.00	LM709 0.35	7420 0.30	74500 0.24	74LS353 1.20
7421 0.60	74500 0.24	74LS356 2.10	74LS364 1.80	74C93 1.50	4534 3.80	AD7581 15.00	LM709 0.35	7421 0.60	74500 0.24	74LS356 2.10	74LS364 1.80	74C93 1.50	4534 3.80	AD7581 15.00	LM709 0.35	7421 0.60	74500 0.24	74LS356 2.10
7422 0.36	74501 0.24	74LS364 1.80	74LS365 0.50	74C95 1.60	4536 2.50	AD7581 15.00	LM709 0.35	7422 0.36	74501 0.24	74LS364 1.80	74LS365 0.50	74C95 1.60	4536 2.50	AD7581 15.00	LM709 0.35	7422 0.36	74501 0.24	74LS364 1.80
7423 0.36	74502 0.24	74LS365 0.50	74LS367 0.52	74C107 1.50	4539 0.75	AD7581 15.00	LM709 0.35	7423 0.36	74502 0.24	74LS365 0.50	74LS367 0.52	74C107 1.50	4539 0.75	AD7581 15.00	LM709 0.35	7423 0.36	74502 0.24	74LS365 0.50
7425 0.40	74504 0.24	74LS367 0.52	74LS368 0.50	74C151 2.00	4541 0.70	AD7581 15.00	LM709 0.35	7425 0.40	74504 0.24	74LS367 0.52	74LS368 0.50	74C151 2.00	4541 0.70	AD7581 15.00	LM709 0.35	7425 0.40	74504 0.24	74LS367 0.52
7427 0.32	74505 0.24	74LS368 0.50	74LS373 0.90	74C160 1.80	4551 1.00	AD7581 15.00	LM709 0.35	7427 0.32	74505 0.24	74LS368 0.50	74LS373 0.90	74C160 1.80	4551 1.00	AD7581 15.00	LM709 0.35	7427 0.32	74505 0.24	74LS368 0.50
7428 0.43	74508 0.24	74LS373 0.90	74LS374 0.90	74C161 1.80	4553 2.40	AD7581 15.00	LM709 0.35	7428 0.43	74508 0.24	74LS373 0.90	74LS374 0.90	74C161 1.80	4553 2.40	AD7581 15.00	LM709 0.35	7428 0.43	74508 0.24	74LS373 0.90
7430 0.30	74509 0.24	74LS374 0.90	74LS375 0.75	74C162 1.80	4556 1.40	AD7581 15.00	LM709 0.35	7430 0.30	74509 0.24	74LS374 0.90	74LS375 0.75	74C162 1.80	4556 1.40	AD7581 15.00	LM709 0.35	7430 0.30	74509 0.24	74LS374 0.90
7432 0.36	74510 0.24	74LS375 0.75	74LS377 1.40	74C163 1.80	4557 2.40	AD7581 15.00	LM709 0.35	7432 0.36	74510 0.24	74LS375 0.75	74LS377 1.40	74C163 1.80	4557 2.40	AD7581 15.00	LM709 0.35	7432 0.36	74510 0.24	74LS375 0.75
7433 0.30	74511 0.24	74LS377 1.40	74LS381 1.40	74C164 1.80	4560 1.40	AD7581 15.00	LM709 0.35	7433 0.30	74511 0.24	74LS377 1.40	74LS381 1.40	74C164 1.80	4560 1.40	AD7581 15.00	LM709 0.35	7433 0.30	74511 0.24	74LS377 1.40
7434 0.30	74512 0.24	74LS381 1.40	74LS382 1.40	74C165 1.80	4562 1.40	AD7581 15.00	LM709 0.35	7434 0.30	74512 0.24	74LS381 1.40	74LS382 1.40	74C165 1.80	4562 1.40	AD7581 15.00	LM709 0.35	7434 0.30	74512 0.24	74LS381 1.40
7438 0.40	74513 0.34	74LS382 1.40	74LS383 0.60	74C173 1.00	4076	AD7581 15.00	LM709 0.35	7438 0.40	74513 0.34	74LS382 1.40	74LS383 0.60	74C173 1.00	4076	AD7581 15.00	LM709 0.35	7438 0.40	74513 0.34	74LS382 1.40
7439 0.40	74514 0.50	74LS383 0.60	74LS391 4.50	74C174 1.00	4077	AD7581 15.00	LM709 0.35	7439 0.40	74514 0.50	74LS383 0.60	74LS391 4.50	74C174 1.00	4077	AD7581 15.00	LM709 0.35	7439 0.40	74514 0.50	74LS383 0.60
7440 0.40	74515 0.50	74LS391 4.50	74LS393 0.95	74C175 1.50	4583	AD7581 15.00	LM709 0.35	7440 0.40	74515 0.50	74LS391 4.50	74LS393 0.95	74C175 1.50	4583	AD7581 15.00	LM709 0.35	7440 0.40	74515 0.50	74LS391 4.50
7441 0.90	74520 0.24	74LS393 0.95	74LS395A 0.60	74C192 1.50	4584	AD7581 15.00	LM709 0.35	7441 0.90	74520 0.24	74LS393 0.95	74LS395A 0.60	74C192 1.50	4584	AD7581 15.00	LM709 0.35	7441 0.90	74520 0.24	74LS393 0.95
7442A 1.00	74521 0.24	74LS395A 0.60	74LS399 1.00	74C193 1.50	4585	AD7581 15.00	LM709 0.35	7442A 1.00	74521 0.24	74LS395A 0.60	74LS399 1.00	74C193 1.50	4585	AD7581 15.00	LM709 0.35	7442A 1.00	74521 0.24	74LS395A 0.60
7443A 1.00	74522 0.24	74LS399 1.00	74LS405 1.80	74C194 1.50	4586	AD7581 15.00	LM709 0.35	7443A 1.00	74522 0.24	74LS399 1.00	74LS405 1.80	74C194 1.50	4586	AD7581 15.00	LM709 0.35	7443A 1.00	74522 0.24	74LS399 1.00
7444 1.10	74524 0.50	74LS405 1.80	74LS465 1.20	74C195 1.50	4587	AD7581 15.00	LM709 0.35	7444 1.10	74524 0.50	74LS405 1.80	74LS465 1.20	74C195 1.50	4587	AD7581 15.00	LM709 0.35	7444 1.10	74524 0.50	74LS405 1.80
7445 1.00	74526 0.24	74LS465 1.20	74LS467 1.20	74C196 1.50	4588	AD7581 15.00	LM709 0.35	7445 1.00	74526 0.24	74LS465 1.20	74LS467 1.20	74C196 1.50	4588	AD7581 15.00	LM709 0.35	7445 1.00	74526 0.24	74LS465 1.20
7446A 1.00	74527 0.24	74LS467 1.20	74LS490 1.50	74C244 1.00	4590	AD7581 15.00	LM709 0.35	7446A 1.00	74527 0.24	74LS467 1.20	74LS490 1.50	74C244 1.00	4590	AD7581 15.00	LM709 0.35	7446A 1.00	74527 0.24	74LS467 1.20
7447A 1.00	74528 0.24	74LS490 1.50	74LS540 1.20	74C245 1.00	4591	AD7581 15.00	LM709 0.35	7447A 1.00	74528 0.24	74LS490 1.50	74LS540 1.20	74C245 1.00	4591	AD7581 15.00	LM709 0.35	7447A 1.00	74528 0.24	74LS490 1.50
7448 1.00	74529 0.24	74LS540 1.20	74LS541 1.00	74C246 2.25	4592	AD7581 15.00	LM709 0.35	7448 1.00	74529 0.24	74LS540 1.20	74LS541 1.00	74C246 2.25	4592	AD7581 15.00	LM709 0.35	7448 1.00	74529 0.24	74LS540 1.20
7449 0.36	74530 0.24	74LS541 1.00	74LS542 1.00	74C247 2.25	4593	AD7581 15.00	LM709 0.35	7449 0.36	74530 0.24	74LS541 1.00	74LS542 1.00	74C247 2.25	4593	AD7581 15.00	LM709 0.35	7449 0.36	74530 0.24	74LS541 1.00
7450 0.36	74531 0.24	74LS542 1.00	74LS543 0.95	74C248 2.25	4594	AD7581 15.00	LM709 0.35	7450 0.36	74531 0.24	74LS542 1.00	74LS543 0.95	74C248 2.25	4594	AD7581 15.00	LM709 0.35	7450 0.36	74531 0.24	74LS542 1.00
7451 0.36	74532 0.24	74LS543 0.95	74LS544 1.00	74C249 2.25	4595	AD7581 15.00	LM709 0.35	7451 0.36	74532 0.24	74LS543 0								

Richardson Electronics (Europe) Ltd.

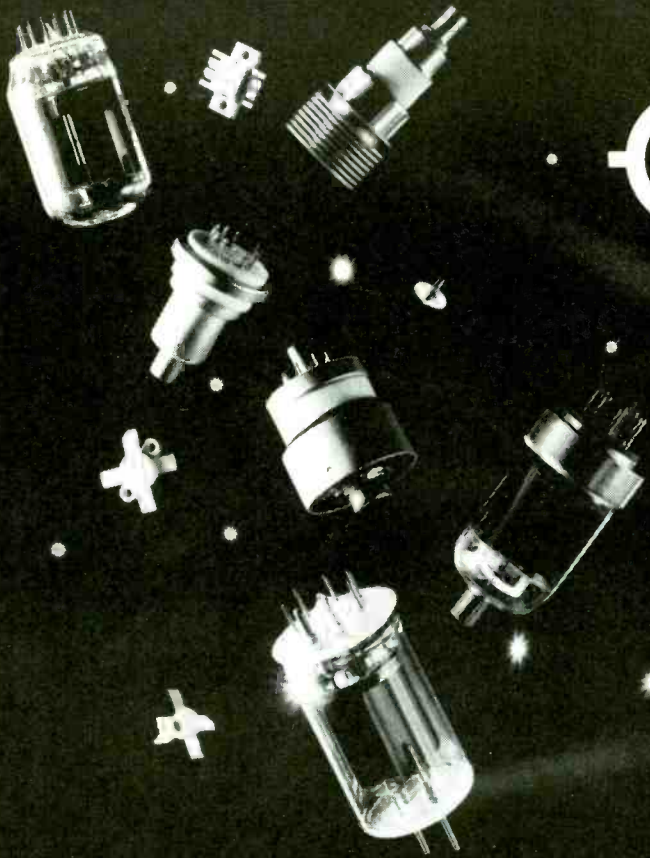

We are the leading suppliers of R.F. Power Transistors and Electronic Tubes for the communications and industrial markets. With our parent company we represent all the major manufacturers and from our nine million pounds worth of stock we can supply virtually any form of tube or R.F. Transistor of American manufacture or its European equivalent. We can normally dispatch your requirements on a same day service.

Send for further information to

Dean Road, Outer Circle Road Industrial Estate Lincoln, England LN2 4DV
Tel: 0522-42631 Telex: 56175 REEL UK

CIRCLE 10 FOR FURTHER DETAILS.

CHUM ONE A Industrial Computer

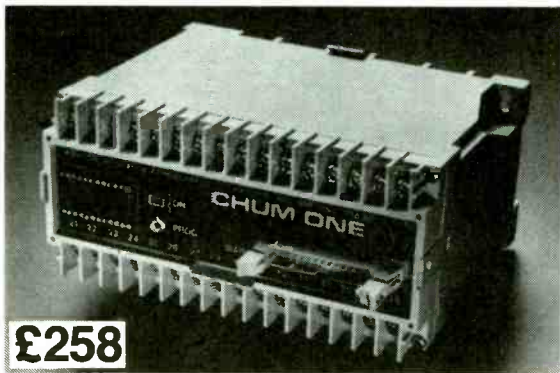

£258

- ★ Control BASIC and Z80 Assembler Language
- ★ On Board EPROM Programmer
- ★ Detachable Hand-Held Keyboard and Display
- ★ 4K Bytes of Battery Backed Memory
- ★ Up to 64 Relay Outputs
- ★ Up to 64 Opto-Coupled Inputs
- ★ 4 Analogue Inputs
- ★ 1 Analogue Output
- ★ RS232 Interface
- ★ Cassette Back-Up Memory
- ★ Real Time Clock

The Chum One A offers the complete solution to all measurement and control problems. Programs can be written, tested and modified in RAM then at a touch of a switch blown into an EPROM.

WARWICK DESIGN GROUP, 12 ST. GEORGE'S ROAD
LEAMINGTON SPA CV31 3AY (0926) 34311

CIRCLE 55 FOR FURTHER DETAILS.

EXTRA EXTRA

GRAPHICS CONTROLLERS

RING

NOW

FOR

TECHNICAL DATA AND AVAILABILITY

KUDOS ELECTRONICS LTD.
CALL 0734 794515

CIRCLE 72 FOR FURTHER DETAILS.

AUDIO · VIDEO · DATA

A superb range of innovative loading
and duplicating technology
· Worldwide ·



the leaders

Tape Automation Ltd, Unit 2, River Way, Harlow, Essex CM20 2DN.
Telephone (0279) 442946, Telex 265871 MONREF G quoting Ref: 84: AUL001.

EUROPE · USA · JAPAN · UK · INDIA



CIRCLE 51 FOR FURTHER DETAILS.

ALL-TIME CP/M MICROCOMPUTER SYSTEM BARGAIN!

Fantastic bulk purchase of a major European manufacturer's entire stock of this top-quality machine enables us to retail it at far below its manufacturing cost. **ALL FEATURES LISTED are INCLUDED as STANDARD:**

- COMPLETE with EITHER single or double (as illustrated) TEAC half-height 5¼" double-sided, double-density floppy disc drives. Formatted capacity: 320Kb per drive.
- 4 MHz Z80A CPU
- 64Kb RAM (in 4164 chips)
- 28Kb EPROM containing monitor & MICROSOFT BASIC
- CP/M Version 3.01
- 80 × 24 display with colour block-mode graphics
- Exceptionally high quality styled keyboard with numeric keypad & 6 function keys
- Centronics parallel interface
- RS232/V24 serial interface selectable 300-9600 Baud
- UHF Modulator for TV & composite video output
- ROM port. (A Word-Processor ROM is available at extra cost)
- 6 month full guarantee & option to return within 14 days if not absolutely delighted



PRICES (monitor not included):
With DUAL floppy: **£347.00 (£399.05 incl. VAT)**
With SINGLE floppy: **£250.00 (£287.50 incl. VAT)**
CARRIAGE: **£9.50** (incl. VAT) Visa & Barclaycard accepted

Available ONLY from: **COMPUTER APPRECIATION**, 16 Walton Street, Oxford OX1 2HQ. (0865) 55163 TELEX: 838750
MATMOS Ltd., 1 Church Street, Cuckfield, W. Sussex RH17 5JZ. (0444) 414484 454377 (0444) 73830

CIRCLE 58 FOR FURTHER DETAILS.

Z80A MICRO-CONTROLLERS



- 4MHz Z80A CPU
- 4K EPROM — 2K supplied with MCV2.0
- 4K Battery backed RAM — 2K supplied
- 4 × Z80A PIO's (64 I/O lines)
- Z80A CTC
- Standard 100mm × 160mm Eurocard
- Cost effective prices (£34.04-10 off) includes all connectors, manual etc.

Designed to meet the power and flexibility of today's stand — alone micro-controllers, the GNC CUB makes full use of the powerful Z80 family IC's. Micro-controllers are available with up to 64K RAM, 8K EPROM, RS232 etc. Manuals include circuit diagrams and assembly language listings. No ULA's, PAL's or other fannies. Write, phone or circle to find out more about our powerful range of Z80A micro-controllers and multi — tasking software.

PRICES
CUB (built & tested) **£103.44**
Bare board **£20.00**
Manual (free with CUB/board) **£3.50**
Please add £1.00 for P&P plus V.A.T.

GNC ELECTRONICS
Little Lodge, Hopton Road,
Theinetham, Diss, Norfolk. IP22 1JN.
Tel: Diss (0379) 898313.

CIRCLE 17 FOR FURTHER DETAILS.

Toroidal Transformers

as manufacturers we are able to offer a range of quality Toroidal Transformers at highly competitive prices and fast delivery.

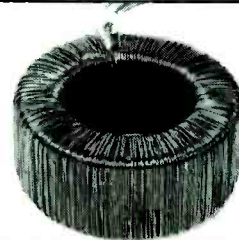

Mail Order Price List

15VA 6.92 30VA 7.18 50VA 8.86 80VA 9.92 120VA 10.59 160VA 12.10 225VA 13.69
300VA 14.77 500VA 19.20 625VA 22.09 750VA 26.17 1KVA 38.82 1.2KVA 44.06
price includes p+p & vat.

Available from stock in the following voltages: —6-0-6,9-0-9,12-0-12,15-0-15,18-0-18,22-0-22,25-0-25,30-0-30,35-0-35,40-0-40,45-0-45,50-0-50,110,220,240(max.10 amp). Primary 240 volt.

Quantity Prices and delivery on request
(we also manufacture conventional E1 type transformers)



Airlink Transformers.

Unit 6, The Maltings, Station Road,
Sawbridgeworth, Herts. Tel: 0279-724425.

CIRCLE 41 FOR FURTHER DETAILS.

British Electronics Week

Two halls at London's Olympia were used to house a combination of the All Electronics Show, The Electronic Product Design Show and the Fibre Optics Exhibition. Despite its title, this great

extravaganza lasted only three days, and with over 800 exhibitors it was found to be impossible to cover everything. We offer here details of some of the products which particularly attracted our attention.

Programme-once-only micro

Zero turn-around is the title invented by Hitachi for their processor which has on-chip prom that is not erasable, so that is programmed once and the operating system is retained from then on. This gives the equivalent of a masked device without the cost and the delay time usual for such devices.

The ZTAT principle is to be extended from the present 63701 to other processors. Hitachi were also proudly displaying their HM65265 pseudo-static ram which, they claim, offers the best of the static and dynamic memories combined together, i.e. high speed and low power. Hitachi Electronic Components (UK) Ltd., 221 Station Road, Harrow, Middlesex HA1 2XL. EWW208

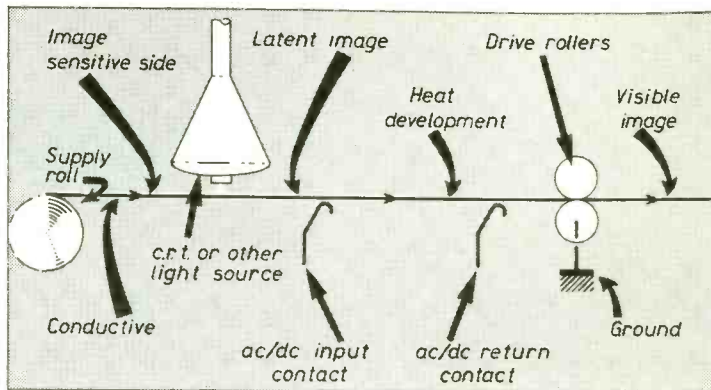
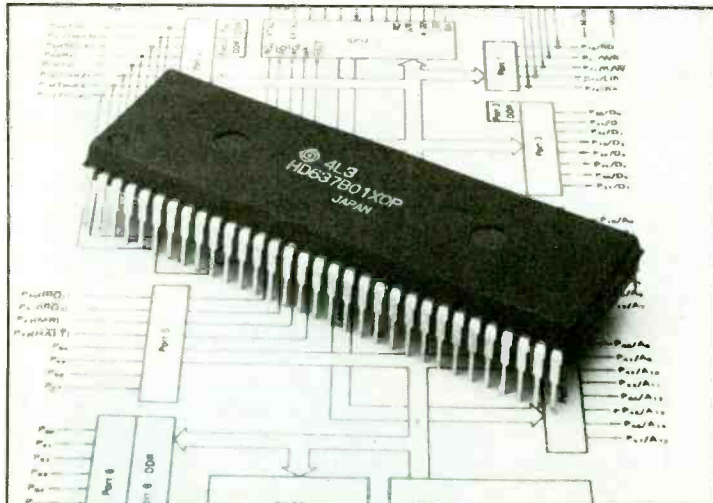

Quick, dry photos

Using a film or paper similar to that used in photography, the 3M Dry Silver process can convert electronically originated images into permanent black-and-white prints. As the light from a c.r.t. or other source strikes the silver material it forms a stable latent image. When the material is heated, the exposed silver halides act as a catalyst on other silver salts and the image automatically appears. The process is totally dry; it uses less silver than photography; it may be processed at high speed and offers high-resolution images.

The material may be used in 3M's Imager which draws the material past a c.r.t. for exposure and then heats it for development, all in one process. One version of the material has a conductive backing and, if a current is passed through it, it heats itself

without the need for any external heat source. Finished prints are available in 11 seconds, compared with 45s for a Polaroid print. The materials cost much less than the equivalent Polaroids.

Designed for use in medical imaging such as ultrasonic scanning and fluoroscopy, the Imager is self contained and may be used in aseptic environments. The system has been used to print electron microscope images. Other applications include facsimile printing of satellite or laser images, computer printing and graphics hard copy, and instrumentation logging. Different papers and films are available for various applications and others including u-v sensitive film and colour images are in course of development. 3M United Kingdom plc, PO Box 1, Bracknell, Berks RG12 1JU. EWW204

Development system with Concurrent CP/M-86

The STE bus standard is used in the ARC88 computer system. The 80188-based computer runs Concurrent CP/M-86 and provides facilities for the development of 80188 software for use in real-time target application or as an expandable system for general-purpose laboratory computing. The minimum configuration consists of two boards, a floppy disc controller and the processor with its twin d.m.a. channels, three counter-timers and interrupt vectoring priority. It also has 256Kbytes of dynamic ram, two programmable serial i.o. channels, STE bus clock, reset and arbiter circuit. The disc controller supports either 3 or 3.5in drives with up to

1.6Mbytes total capacity. Eight card slots are left free for expansion and the user may choose from a wide variety of modules, including an eprom programmer, v.d.u. drivers, a real-time clock with up to 48K extra memory, and a range of industrial cards such as a-to-d and d-to-a converters. Concurrent CP/M-86 is a multi-tasking, multi-user system that is event driven and holds all current programs in memory for fast response. The system comes with an integral power supply large enough to handle fully populated racks. Prices start at under £3000. Arcom Control Systems Ltd., Unit 8, Clifton Road, Cambridge CB1 4WH. EWW206



Design your own l.c.d.

...and EEV will make it for you. On their stand at the show, EEV were demonstrating their computer-aided l.c.d. design system. They can supply Lucid displays in many shapes and sizes with direct or multiplexed drive and a selection of viewing modes. They have also expanded their range of ready-built displays and these included an 8-digit,

7mm character height display and a 9mm character display, both requiring multiplexed drives. Two new static drive displays offered 20.6mm-high characters with six, seven-segment digits. Another new device was the 16-character display of 6mm character height, intended for use with telecommunications equipment. Lucid Liquid Crystal Displays, EEV, Waterhouse Lane, Chelmsford, Essex CM1 2QU. EWW207

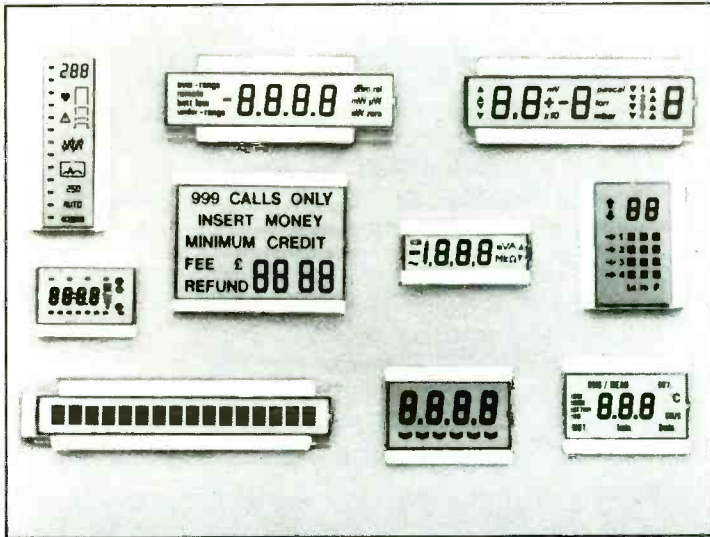

Graphics colour controller

Combining the functions of a colour palette and video memory, the IMS 170 from Immos is capable of generating 256K different colours, of which any 256 may be displayed on a screen at one time. The 28-pin chip incorporates a colour look-up table, three (RGB) 6-bit d-

to-a converters, video memory and microprocessor interface. Colour change is enabled by a pixel word mask which allows colours to be altered in one clock cycle. With a pixel rate of up to 50MHz, very fast graphics and animation may be achieved. The integrated circuit was on demonstration at the Show but details are not yet final. Immos Ltd., Whitefriars, Lewins Mead, Bristol BS1 2NP. EWW201

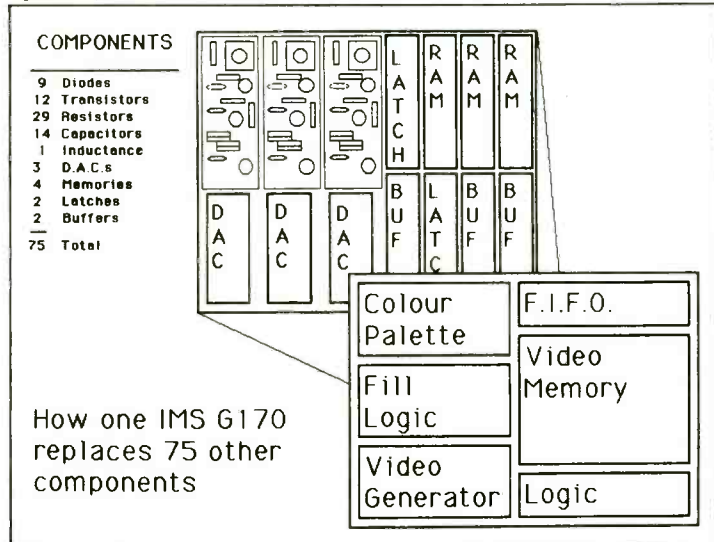

Coded key

A thick film matrix is used to store a number, which can be used for identification and in security systems. The idea is not new; pins and a matrix of copper tracks on a p.c.b. have previously provided such coding. The new system, 'Pre-programmed Memory' from Welwyn, has miniaturized this onto a 16-by-16 matrix on a ceramic substrate, the device being 10mm square.

A layer of tracks 0.25mm wide and the same distance apart are printed onto the substrate in the 'x' direction. These are coated with a thick film dielectric material. A laser is used to punch neat holes in the dielectric so that when the 'y' conductors are printed on top, they make contact with the

x layer through the holes. The laser can also print the code onto the device so that it may be visually identified. The manufacturing system is highly automated with automatic testing. The matrix may be incorporated into a thick-film circuit or mounted on a p.c.b., using surface-mounting techniques. Dynamic addressing of the matrix enables the retrieval of the code in bit serial form and provides a much greater range of codes than when using simple static coding.

Applications include the identification of animals in a herd, objects on a production line, electronic locks and identification tags for personal use. Welwyn Microelectronics, Bedlington, Northumberland NE22 7AA. EWW203

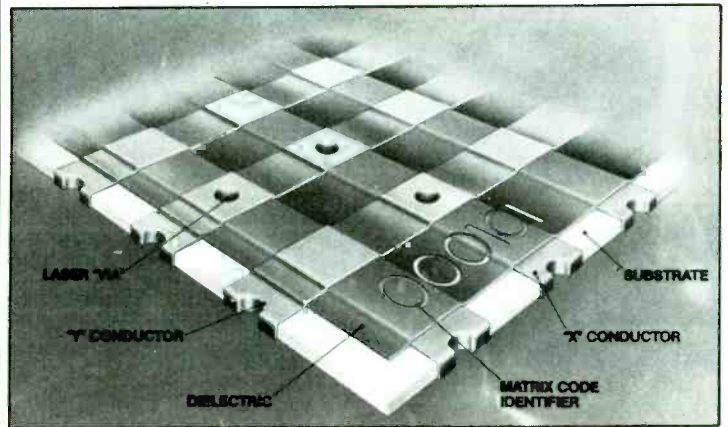

Power back-up

A range of uninterruptible power supplies is to be marketed by A.F. Bulgin, following the signing, at the Show, of an agreement between them and Power Equipment Ltd. The Power Bank range, rated at 120, 250 and 500VA, offers no-break performance and can maintain power for 15 to 20 minutes at full load.

Output frequency and voltage are stabilized and the units also act as a buffer against spikes, surges and dropouts in the mains supply. They are fully protected against overload. The u.p.s. range complements Bulgin's growing range of power products which includes switch-mode power supplies. A.F. Bulgin & Co. plc, Bypass Road, Barking, Essex IG11 0AZ. EWW202



Now Thurlby makes logic analysis affordable ! from the new Thurlby LA-160 £395 + vat



- 16 channels, expands to 32
- Clock rates up to 20MHz
- State and timing displays
- Selectable display formats
- 2K word acquisition memory
- Non-volatile reference memory
- Search and compare facilities
- Hard-copy data print-out

An oscilloscope and logic probe are not enough to unravel the complexities of today's electronic equipment. A logic analyser is as essential for observing digital signals as an oscilloscope is for observing analogue signals, and now Thurlby puts one within every engineer's reach. Contact us now and get the full technical data.



Thurlby Electronics Ltd
New Road, St.Ives, Huntingdon,
Cambs. PE17 4BG, England. Tel: (0480) 63570

CIRCLE 35 FOR FURTHER DETAILS.

The world's most advanced low-cost bench multimeter!



Thurlby 1905a £325 + VAT

A complete high performance bench DMM

- 5½ digits; 0.015% acc; 1µV, 1mΩ, 1nA.
- Full ac and current functions as standard

A sophisticated computing and logging DMM

- Linear scaling with offset; null/relative
- Percentage deviation; running average
- dBV, dBm general logarithmic calculations
- Limits comparison; min and max storage
- 100 reading timed data logging
- RS232 and IEEE-488 interface options

Thurlby Electronics Ltd
New Road, St.Ives, Cambs. PE17 4BG
Tel: (0480) 63570



CIRCLE 36 FOR FURTHER DETAILS.

Add 8 channels to your 'scope

New Thurlby OM358 multiplexer £169 +vat

The Thurlby OM358 gives any oscilloscope an 8 channel display. Observing many waveforms simultaneously can be essential when analysing sophisticated equipment. Application areas include microprocessor based products, data transmission systems, A to D converters, frequency synthesizers etc.

The OM358 is ideal for digital equipment (it can often solve problems that would otherwise need a fast logic analyser) but, unlike dedicated logic test instruments, it is equally suited to analogue waveforms.

The OM358 has a bandwidth of 35MHz and 3% calibration accuracy. Each input has an impedance of 1MΩ - 20pF and accepts signals up to ±6V. An 8 channel, 4 channel, or single channel display can be selected with triggering from any channel. *Colour data sheet with full specifications available.*



Thurlby Electronics Ltd
New Road, St.Ives, Cambs.
PE17 4BG Tel: (0480) 63570

OM358 with two BNC cables £197.80
(inc P & P and VAT)



CIRCLE 37 FOR FURTHER DETAILS.



Hitachi Oscilloscopes performance, reliability, value and immediate delivery!

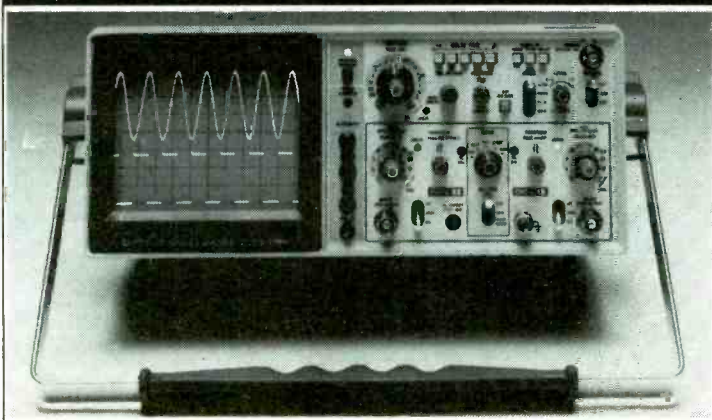

Hitachi Oscilloscopes provide the quality and performance that you'd expect from such a famous name, with a newly-extended 14 model range that represents the best value for money available anywhere.

V-212/222	20MHz Dual Trace	V-650	60MHz Dual Timebase
V-223	20MHz Sweep Delay	V-1050	100MHz Quad Trace
	(illustrated)	V-1070	100MHz Four Channel
V-209	20MHz Mini-Portable	V-1100	100MHz DMM/Counter
V-422	40MHz Dual Trace	V-134	10MHz Tube Storage
V-423	40MHz Sweep Delay	VC-6015	10MHz Digital Storage
V-509	50MHz Mini-Portable	VC-6041	40MHz Digital Storage

Prices start at just over £300 plus vat and that includes a full 2 year warranty. We hold the range in stock for immediate delivery.

For colour brochure giving specifications and prices ring (0480) 63570
Thurlby-Reltech, 46 High Street, Solihull, W. Midlands, B91 3TB.

CIRCLE 38 FOR FURTHER DETAILS.

SOME IDEAS NEVER SELL... but our new innovations do!

Crotech 'scopes are chosen for use throughout the electronics industry and in education for their reliability and ease of use.

... and they're affordable too!!

LIKE THE 3132 DUAL TRACE 'SCOPE

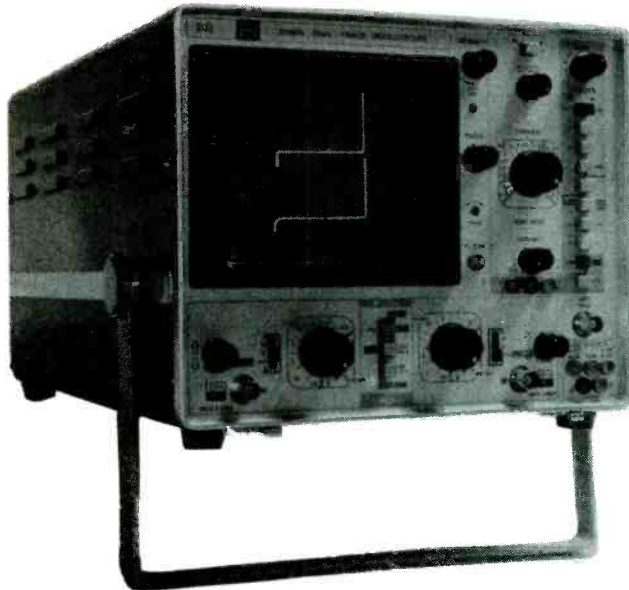

32/10/4/1



The innovations...

- * Component Comparator
- * Triple Output DC Source

plus...

- * 20MHz Bandwidth
- * 2mV/div Sensitivity
- * 40ns/div Timebase
- * TV Frame and Line Trigger
- * Add and Subtract
- * X - Y mode

... and very affordable at £312.00*



For free details call:

*(exc. VAT)

Crotech Instruments Limited

2 Stephenson Road, St. Ives, Huntingdon, Cambs. PE17 4WJ
Telephone: (0480) 301818

CIRCLE 13 FOR FURTHER DETAILS.

PC/XT - PERIPHERALS

MAINBOARD B-103 4-Layer PC/
XT £295
MEGA Mainboard PC/XT £249
SUPER Mainboard PC/XT £249
256K M/FUNCT. 1 par, 1 ser, cl/cal, OK £169
384K M/FUNCT. 6-WAY (SEE ILL),
OK £289
512K RAM EXPAND (2 DIP SWITCH),
OK £95
PARALLEL Printer Card £39
PARALLEL with 64K buffer (OK) £109
MONOCHROME (text) display card. £119

COLOUR/GRAPHICS Card (2 layer)
640 X 200 b/w + 320 X 200 4 colour
160 X 100 16 colour + light pen I/F
text: 80 X 25 & 40 X 25 will drive TTL
MONO / COMPOSITE MONO
COMPOSITE COLOUR / RGB
Monitors £149
SUPER COLOUR/GRAPHICS Card (4
layer) 64K Display Memory - TTL mono
spec:
640 X 350 b/w with 2 pages 640 X 350
single colour 16 intensities 80 col X 25
rows with 32 pages.
COLOUR / GRAPHICS specifications:
640 X 400 mono with 2 pages
640 X 200 16 colour 2 pages
640 X 400 16 colour
TEXT 40col X 50 row
40col X 50 row with 32 pages mono
PC, PC-XT, PC-AT COMPATIBLE... £399
MONOCHROME GRAPHIC CARD
VERSION II 720 X 348 graphic display, 2K
static RAM buffer eliminates scroll flicker
single parallel port standard £229

MULTI I/O CARD - & WAY!!!
Dual floppy controller interface
Asynchronous RS232 serial comms port
Parallel printer port, games adapter Clock/
Cal with battery backup £249

EPROM WRITER CARD up to 128K. £175
MODEM CARD V21/V23 CCITT AA/
AD £169
FLOPPY DRIVE CONTROLLER (4
DRIVES) £75
TEAC FD-55B half ht 320K floppy dr £175
RS232 SERIAL I/Face, 1 port 50-9600. £49
SERIAL Async RS232C, 2 port 50-9600 £69
GAMES ADAPTER £39
AD/DA 12bit 16ch-A/D, 1ch-D/A £139

TRANS-NET NETWORKING
BOARD £450
NetMAIL Software £550
NetSPOOL Software £250
NetDISK Disk Server Software £150
NetDMS Data Management Software £175
NET BOOT ROM for floppyless ops . £50
NET STARTER KIT £975

DX45 lockable 100pc DISKETTE
BOX £17
DX50 lockable 50pc DISKETTE BOX. £15

(NOTE: We can supply most of the
above as UNPOPULATED boards for
constructors.)

384K MULTIFUNCTION CARD - SIX WAY!!

- 64K to 384K RAM Memory
 - RS232C Serial Port
 - Real Time Clock / Calendar with
Battery Backup
 - RAMDISK & PSPOOL Software
 - Optional games port
- Built & Tested £289.00

4-LAYER PC/XT MAINBOARD

- 64K to 1MB ON BOARD
 - 8 Fully Compatible Slots
- Built & Tested £295.00

RAM CHIP SALE!!!

- 4164 64K DRAMS 150ns £1.99
(upgrade PC/XT and compatibles)
- 41256 2566K RAMS 150ns £5.99
each
(upgrade OLIVETTI M24, COMPAQ
DESKPRO etc)

PC/XT CASE

- 8 - Slot
 - Hinged lid
 - Includes hardware
- £99.00

PC to XT CONVERSION KITS FOR IBM AND COMPATIBLES

- NEW FAST CONTROLLER!!!
WESTERN DIGITAL 1002 SWX-2
SEGATE ST-506 STANDARD... £249.00
- 10 MEGABYTE MR-521 5 1/4"
WINCHESTER HARD DRIVE, 2-
HEADS, AVERAGE ACCESS 85ms
£399.00
- 20 MEGABYTE MR522 5 1/4"
WINCHESTER HARD DRIVE, 4-
HEADS, AVERAGE ACCESS
85ms £579.00
- HARD DRIVE CABLE SET... £25.00
- UPGRADE 130WATT POWER
SUPPLY £149.00

Prices exclude VAT and DELIVERY
- for terms see our other advertisements.

DIGITAL (0342) 313427 / 24631 tlx: 957547

Business Systems Ltd, 56 Maple Drive, East Grinstead, W.
Sussex RH19 3UR. UK

CIRCLE 89 FOR FURTHER DETAILS.

Oscilloscopes and logic analysers

A number of new instruments from Gould were launched at the All Electronics/ECIF show. Pride of place goes to the 1425 oscilloscope which can function as a conventional real-time oscilloscope but can also be used as a digital storage instrument. It incorporates a high degree of 'intelligence' combined with features such as repetitive sampling for storage to 20MHz, automatic measurement for voltage, time and frequency as well as RS232/423 interfaces for use with personal computers. The interface also allows stored waveforms to be copied out on a digital plotter; different traces can be plotted in different colours and scaling parameters and graticule lines can be printed automatically. An analogue output can be used to provide low-cost printouts through a potentiometric pen recorder.

An optional addition to the oscilloscope is the 125 waveform processor. This is a

small keypad unit that allows waveforms to be stored, recalled for comparison or analysis, magnified, attenuated, transferred between channels, manipulated arithmetically, averaged, filtered, shifted or compared with datum points indicated by cursors on the screen. The oscilloscope can store reference waveforms for comparative testing. The oscilloscope costs £2090.

Also featured was the K205 logic analyser with many enhancements over previous models. It now has a user-defineable disassembler and a number of processor analysis packages for the disassembly of all the popular 8 and 16-bit microprocessors. The analyser can test up to 48 channels at 100MHz bandwidth and combines these with circuit analysis and variable triggering. It may be used for the analysis and trouble shooting on the very fast bit-slice processors, e.c.l. circuits, gate arrays, and discrete logic systems. Gould Electronics Ltd., Instrument Systems, Roebuck Road, Hainault, Ilford, Essex IG6 3UE. EWW210

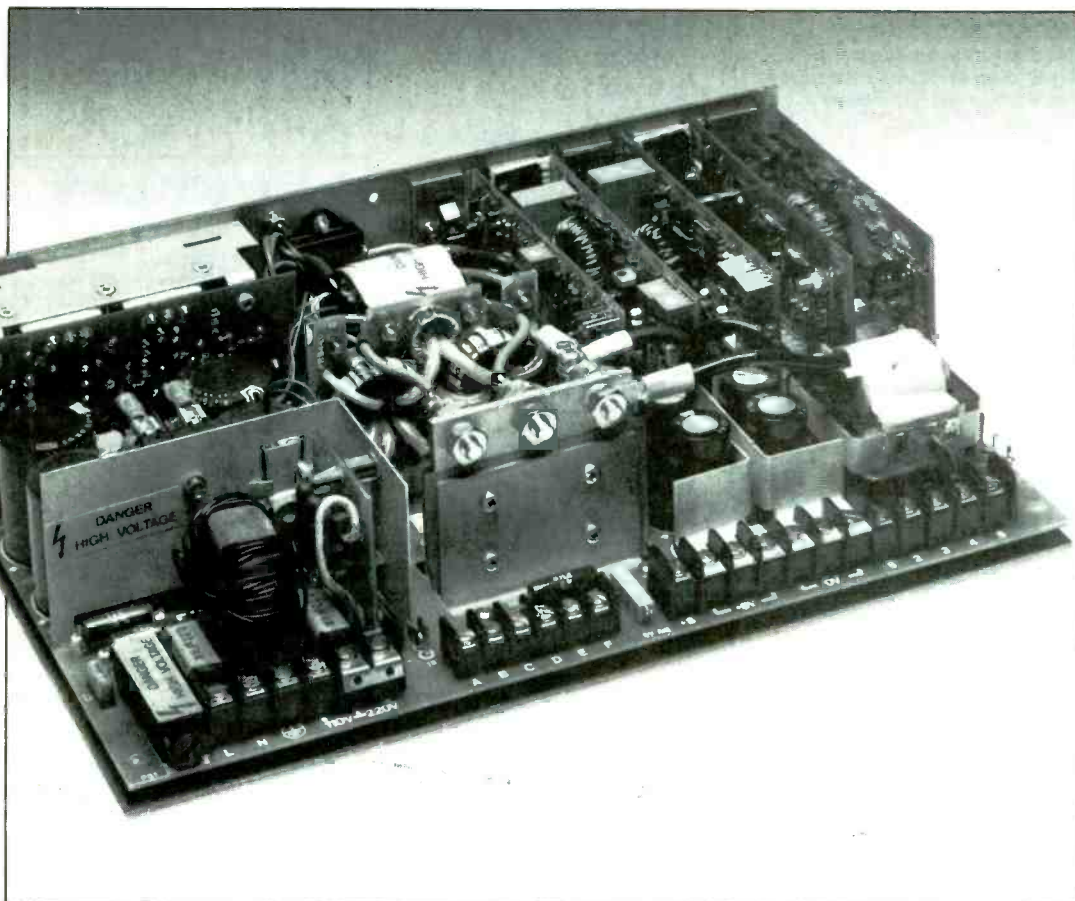

New power supplies

Following a management buy-out by Advance Power Supplies from their former masters, Gould, Advance were celebrating by launching a number of new products at the Show. They were particularly proud of higher power versions of existing ranges. For example, the Hiflex modular multi-output system has a 1kW version with a redesigned, fan-cooled input module. It is suitable for powering digital systems. Also featured were several new variants in the Powerflex P-350 system, an open frame unit with plug-in cards to give up to five separate outputs; fixed or variable 5V, 10 to 15V, and 24V. The 350W unit now includes a signals board which can give a mains-failure alarm signal and remote shut-down. Advance Power Supplies Ltd, Raynham Road, Bishop's Stortford, Herts CM23 5PF. EWW 214.

I. c. design made easy

A program for running on the IBM PC, Sceptre II/M, may be used to develop i.c.s using the AMI 3-micron single and double metal cell libraries. A recent enhancement also allows it to be used for gate array design, allowing schematic entry, functional simulation and net list generation. As AMI, a USA/Austrian joint company with a design and marketing centre in Swindon, are keen to offer their services as silicon manufacturers, they are offering the software and licences at knock-down prices. Sceptre also runs on a Sirius.

AMI have also been working on the Mentor Graphics workstation and have come up with an adaption which allows the design of large-scale gate arrays ranging from 1000 to 4000 gates. System users can have complete control over all stages in the design process, including physical layout and interconnection. The design tasks can be automatic or interactive and it is possible to place manually and route sections of a circuit, or macros, where automatic placement

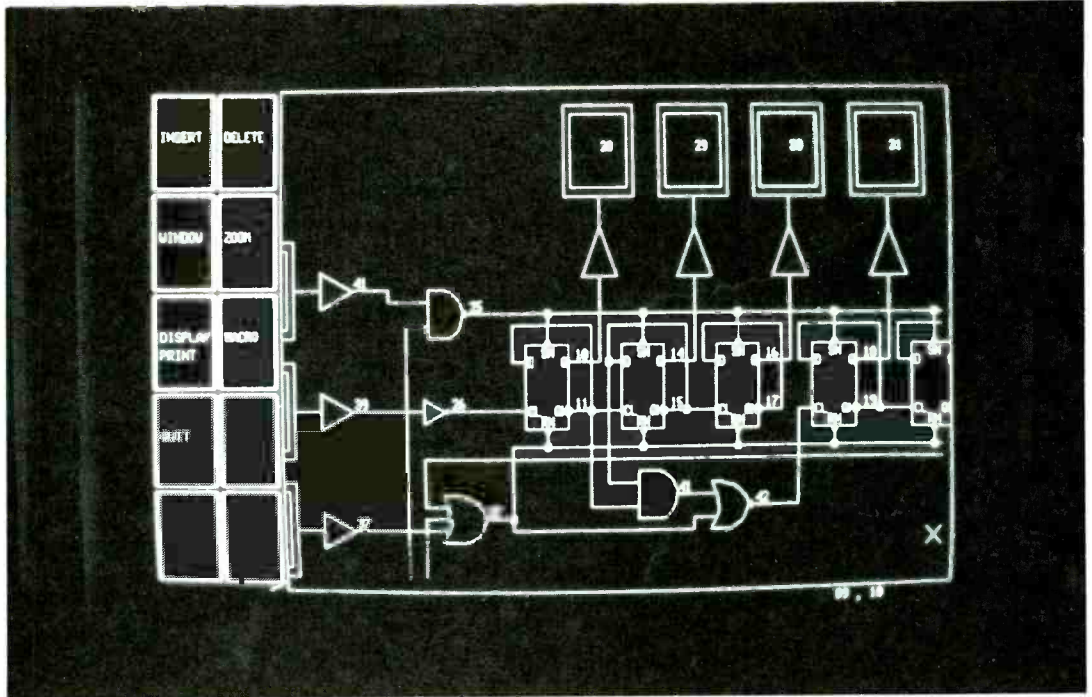

might not put them in quite the right place. The logical operation of the circuit can be simulated and examined at specific nodes. Timing analysis, together with voltage, capacitance and temperature figures are all provided automatically and the circuit may be altered to change these parameters where they may be critical. The process up to the

point of submitting masks to the manufacturer may be carried out entirely by the customer or, at any stage in the design, may be passed over to AMI for completion.

This is all part of the service which AMI can provide from complete design of a circuit to the manufacture of the silicon circuits. They claim that they can make a rom from a

programmed eeprom within two weeks. Specializing in custom circuits, they also manufacture some standard products, especially telecommunications i.c.s. and are currently reducing their circuit geometry from three microns to two and eventually less. AMI Microsystems Ltd, Prospect Place, Swindon, Wilts SN1 3JZ. EWW 211.

Instrumentation on a PC

A number of hardware modules and a software package to link them all together constitute a complete instrumentation package for the IBM Personal computer. The Hewlett-Packard instruments include a 50MHz digital storage oscilloscope, a 4.5-digit multimeter, a 100MHz counter/timer, a relay multiplexer, 5MHz function generator, 12-bit digital-to-analogue converter, 16-bit digital input output module and an 8-channel relay actuator. The modules are powered independently from an isolated power supply. Up to eight units may be connected to a PC bus and each PC can cope with two bus lines. The units fit together rather like a stacked hi-fi system. All the instruments use the computer screen for readout and simulate the discrete versions of the instruments. The software is menu-driven and offers easy control through

a mouse on any of the IBM personal computers or by touching the screen when combined with H-P's own 150 or 160 personal computer. Hewlett-Packard have devised a

new bus protocol for the system, PCIB, which includes both analogue and digital components. This interconnection bus is lower cost than IEEE-488 although the

system as a whole can also communicate over the IEEE-488 bus. Hewlett-Packard Ltd, Miller House, The Ring, Bracknell, Berks RG12 1XN. EWW 213.



COMPUTER WAREHOUSE

1000's OF BARGAINS FOR CALLERS

THE 'ALADDIN'S' CAVE OF COMPUTER AND ELECTRONIC EQUIPMENT

RECHARGEABLE BATTERIES

Dry Fit Maintenance FREE by Sonnenschein.
A300 07191315 12v 3 AH same as RS 591-770 NEW £13.95 A300 07191202 6-0-6 1.8 AH same as RS 591-382 EX EQUIP £4.99 Miniature PCB mount 3.6v 100 Mah as RS 591-477 NEW £1.00 SAFT VR2C 1.2v "C" size NICADS in 18 cell ex equipment pack. Good condition - easily split to single cells £10.50 + pp £1.90

EX-STOCK INTEGRATED CIRCUITS

2732 ex equip £3.25, 27128 - 250ns NEW £12.00.
6116-200 £4.50, 6116-250 £3.95.
6264LP-150 £22.00, 4164-200 £3.50, 4864-150 £4.00.
4116-300, £1.20, 2114 £1.75, 6800 £2.50, 6821 £1.00, 68A09 £8.00, 68B09 £10.00, 68B09E £14.50, DB085AH-2 £12.00, DB086 £20.00, Z80A £2.99.

COOLING FANS

Keep your hot parts COOL and RELIABLE with our range of BRAND NEW professional cooling fans.
ETRI 80XU01 Dim. 92 x 92 x 25 mm. Miniature 240 v equipment fan complete with finger guard £9.95.
GOULD JB-3AR Dim. 3" x 3" x 2.5" compact very quiet running 240 v operation. NEW £6.95
BUHLER 69.11.22 8-16 v DC micro miniature reversible fan. Uses a brushless servo motor for extremely high air flow, almost silent running and guaranteed 10,000 hr life. Measures only 62 x 62 x 22 mm. Current cost £32.00. OUR PRICE ONLY £12.95 complete with data.
MUFFIN-CENTAUUR standard 4" x 4" x 1 25" fan supplied tested EX EQUIPMENT 240 v at £6.25 or 110 v at £4.95 or BRAND NEW 240 v at £10.50. 1000's of other fans Ex Stock. Call for Details. Post & Packing on all fans £1.60

BUDGET RANGE VIDEO MONITORS

At a price YOU can afford, our range of EX EQUIPMENT video monitors defy competition! All are for 240v working with standard composite video input. Units are pre tested and set for up to 80 col use on BBC micro. Even where MINOR screen burns MAY exist - normal data displays are unaffected.

1000's SOLD TO DATE

12" KGM 320-321, high bandwidth input, will display up to 132 columns x 25 lines. Housed in attractive fully enclosed brushed alloy case B/W only £32.95
24" KGM large screen black & white monitor fully enclosed in light alloy case. Ideal schools, shops, clubs etc
ONLY £55.00 Carriage £10.00

DATA MODEMS

Join the communications revolution with our super range of DATA MODEMS with prices and types to suit all applications and budgets!
Most modems are EX BRITISH TELECOM and are made to the highest standard for continuous use and reliability. RS232 interfaces are standard to all our modems, so will connect to ANY micro etc. with an RS232 serial interface.

DATTEL 2B see SPECIAL OFFER centre of this ad
MODEM 13A, 300 baud. Compact unit only 2" high and same size as telephone base. Standard CCITT tones. CALL mode only. Tested with data **ONLY £45.00 + PP £4.50**.
MODEM 20-1, 75-1200 baud. Compact unit for use as subscriber end to PRESTEL. MICRONET or TELECOM GOLD. Tested with data **£39.95 + PP £6.50**.
MODEM 20-2, same as 20-1 but 1200-75 baud **£99.00**.
TRANSDATA 307A, 300 baud acoustic coupler. Brand new with RS232 interface. **ONLY £49.95**
DACOM DSL2123 Multi Standard Modem, switchable CCITT or USA BELL 103 standard. V21 300-300, V23 75-1200, V23 1200-75 or 1200-1200 half duplex.
Auto answer via MODEM or CPU CALL or ANSWER modes plus LED status indication. Dim 2 5" x 8 5" x 3" **BRAND NEW** fully guaranteed **ONLY £268.00 + PP £4.50**.
DATTEL 2412 Made by SE LABS for BT this two part unit is for synchronous data links at 1200 or 2400 baud using 2780/3780 protocol. Many features include Auto answer, 2 or 4 wire working etc. etc. **COST OVER £800. OUR PRICE £185.00**.
DATTEL 4800, RACAL MPS4800 high speed good condition **£285.00 CARR £10.00**

HOT LINE DATA BASE

DISTEL ©

THE ORIGINAL FREE OF CHARGE dial up data base 1000's of stock items and one off bargains.
ON LINE NOW - 300 baud, full duplex CCITT tones, 8 bit word, no parity
01-679 1888

MAINS FILTERS

Cure those unnerwing hang ups and data glitches caused by mains interference.
SDSA As recommended by ZX81 news letter. matchbox size up to 1000 watt load **£5.95**
L2127 compact completely cased unit with 3 pin fitted socket Up to 750 watts **£9.99**

Anderson Jacobson

AJ810 VIDEO DISPLAY TERMINAL

Made by one of the USA's largest peripheral manufacturers the AJ510 Professional VDU terminal has too many features to include in space available - just a few are: internal Z80 cpu control, very readable 15" non glare green screen, 24 lines by 80 characters, 128 ASCII character set with lower case and graphics, standard RS232 interface, Cursor addressing, numeric key pad etc. Supplied in good **TESTED** second hand condition with full manual **£225.00 + carr £10.00**. Data sheet on request.

A Major company's over production problems, and a special BULK PURCHASE enable TWO outstanding offers.

COLOUR MONITOR SPECIALS

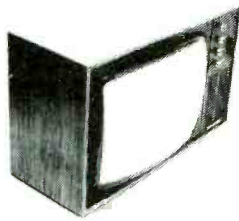
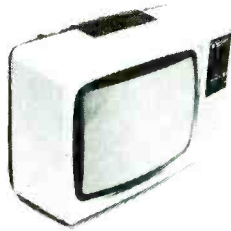

'SYSTEM ALPHA' 14" Multi Input Monitor.

Made in the UK by the famous REDIFFUSION Co. for their own professional computer system this monitor has all the features to suit your immediate and future monitor requirements. Two types of video input, RGB and PAL Composite Video, allow direct connection to most makes of micro computers and VCR's. An internal speaker and audio amplifier may be connected to your system's output or direct to a VCR machine, giving superior colour and sound quality. Many other features include PIL tube, Matching BBC case colour, Major controls on front panel, Separate Contrast and Brightness - even in RGB mode, Two types of audio input, Separate Colour and audio controls for Composite Video input, BNC plug for composite input, 15 way 'D' plug for RGB input, modular construction etc. etc.

This must be ONE OF THE YEAR'S BEST BUYS!!!

Supplied BRAND NEW and BOXED, complete with DATA and 90 day guarantee. **SUPPLIED BELOW ACTUAL COST - ONLY £149.00 + Carr.**

DECCA RGB 80-100 Monitor.

Little or hardly used manufacturer's surplus enables us to offer this special converted DECCA RGB Colour Video TV Monitor at a super low price of only **£99.00**, a price for a colour monitor as yet unheard of! Our own interface, safety modification and special 16" high definition PIL tube, combine with the tried and tested DECCA 80/100 series chassis to give 80 column definition and picture quality found only on monitors costing 3 TIMES OUR PRICE. In fact, WE GUARANTEE you will be delighted with this product, the quality for the price has to be seen to be believed. Supplied complete and ready to plug direct to a BBC MICRO computer or any other system with a TTL RGB output. Other features include internal audio amp and speaker, Modular construction, auto degaussing 34 H x 24 D, 90 day guarantee. Supplied in EXCELLENT condition, **ONLY £99.00 + Carr.** Also available UN-MODIFIED but complete with MOD DATA. Only £75.00.

Carriage and Insurance on monitors £10.00

SPECIAL 300 BAUD MODEM OFFER

Another GIGANTIC purchase of these EX BRITISH TELECOM, BRAND NEW or little used 2B data modems allows US to make the FINAL REDUCTION, and for YOU to join the exciting world of data communications at an UNHEARD OF PRICE OF ONLY £29.95. Made to the highest POST OFFICE APPROVED spec at a cost of hundreds of pounds each, the 2B has all the standard requirements for data base, business or hobby communications. All this and more!!

- 300 baud full duplex
- Full remote control
- CCITT tone standards
- Supplied with full data
- Modular construction
- Direct isolated connection
- CALL, ANSWER and AUTO modes
- Standard RS232 serial interface
- Built in test switching
- 240v Mains operation
- 1 year full guarantee
- Just 2 wires to comms line

NOW ONLY £29.95

Order now - while stocks last. Carriage and Ins. £10.00

SAVE £250 SUPER PRINTER SCOOP
BRAND NEW CENTRONICS 739-2
The "Do Everything Printer": at a price that will NEVER be repeated. Standard CENTRONICS parallel interface for direct connection to BBC, ORIC, DRAGON etc. Superb print quality with full pin addressable graphics and 4 type fonts plus HIGH DEFINITION internal PROPORTIONAL SPACED MODE for WORD PROCESSOR applications. 80-132 columns, single sheet, sprocket or roll paper handling plus much more. Available ONLY from DISPLAY ELECTRONICS at the ridiculous price of **ONLY £199.00 + VAT** Complete with full manual etc. Limited quantity - Hurry while stocks last.
Options: Interface cable (specify) for BBC, ORIC, DRAGON or CENTRONICS 36 way pig £12.50 Spare ribbon £3.50 each BBC graphics screen dump utility program £8.60 Carriage and Ins £10.00 + VAT

HUNDREDS OF PRINTERS

EX STOCK FROM £49.00. Call Sales Office for Details.

1 only large CALCOMP 1036 AO 3 pen drum plotter and offline 915 magtape controller. Good working order. **ADD VAT TO ALL PRICES £2500.00.**

EX STOCK

DEC CORNER

PDP 1140 System comprising of CPU, 124K memory + MMU 16 line RS232 interface, RP02 40 MB hard disk drive, TU10 9 track 800 BPI Mag tape drive, dual rack system, VT52 VDU etc. etc. Tested and running **£3750.00**

BA11-MB 3.5" Box, PSU, LTC £385.00
DH11-AD 16 x RS232 DMA interface £2100.00
DLV11-J 4 x EIA interface £310.00
DLVII-E Serial. Modem support £200.00
DUP11 Sych. Serial data i/o £650.00
DQ200 Dialog - multi RK controller £495.00

DZ11-B 8 line RS232 mux board £650.00
KDF11-B M8189 PDP 1123+ £1100.00
LA36 Decriver EIA or 20 ma loop £270.00
LAX34-AL LA34 tractor feed £85.00
MS11-JP Unibus 32 kb Ram £80.00
MS11-LB Unibus 128 kb Ram £450.00
MS11-LD Unibus 256 kb Ram £850.00
MSC4804 Obus (Equip MSV11-L) 256 kb £499.00

PDP11/05 Cpu, Ram, i/o, etc. £450.00
PDP11/40 Cpu, 124k MMU £1850.00
RT11 ver. 3B documentation kit £70.00
RK05-J 2.5 Mb disk drives £650.00
KL8JA PDP 8 async i/o £175.00
MIB8 PDP 8 Bootstrap option £75.00
VT50 VDU and Keyboard - current loop £175.00
VT52 VDU with RS232 interface £250.00

1000's of EX STOCK spares for DEC PDP8, PDP8A, PDP11 systems & peripherals. Call for details. All types of Computer equipment and spares wanted for PROMPT CASH PAYMENT.

DISPLAY ELECTRONICS

All prices quoted are for U.K. Mainland, paid cash with order in Pounds Sterling PLUS VAT. Minimum order value **£2.00**. Minimum Credit Card order **£10.00**. Minimum BONA FIDE account orders from Government Depts., Schools, Universities and established companies **£20.00**. Where post and packing not indicated please ADD £1.00 + VAT. Warehouse open Mon-Fri 9.30-5.30, Sat 10.30-5.30. We reserve the right to change prices and specifications without notice. Trade, Bulk and Export

32 Biggin Way, Upper Norwood, London SE19 3XF

Telephone 01-679 4414 Telex 894502 Data 01-679 1888



Appointments

Advertisements accepted
up to 12 noon July 3 for
August issue

DISPLAYED APPOINTMENTS VACANT: £19 per single col. centimetre (min. 3cm).
LINE advertisements (run on): £4.00 per line, minimum £25 (prepayable).
BOX NUMBERS: £5 extra. (Replies should be addressed to the Box Number in the advertisement, c/o Quadrant House, The Quadrant, Sutton, Surrey SM2 4AS).
PHONE: IAN FAUX, 01 661 3033 (DIRECT LINE)
15% VALUE ADDED TAX NOT INCLUDED
Cheques and Postal Orders payable to BUSINESSPRESS INTERNATIONAL LTD. and crossed.



THE BEST APPROACH

£7,000-£30,000 + CAR

- ★ **Where does your interest lie:** Graphics; CAD; Robotics; Simulation; Image and Signal Processing; Medical; Automation; Avionics; Acoustics; Weapons; Comms; Radar; Opto and Laser?
- ★ **Experienced in:** VLSI; Microprocessor Hardware or Software; Digital and Analogue circuitry; RF and Microwave techniques?
- ★ **There are hundreds of opportunities in:** Design; Test; Sales and Service for Engineers and Managers
- ★ **For free professional guidance:** Call: 0638 742244 (till 8pm most evenings) or write (no stamp needed) to

ELECTRONIC COMPUTER AND MANAGEMENT APPOINTMENTS LIMITED
FREEPOST, The Maltings, Burwell, Cambridge, CB5 8BR.

(1926)

Haringey Health Authority North Middlesex Hospital MEDICAL PHYSICS TECHNICIAN III/IV

To assist in the provision of an electronic maintenance service for Haringey Health Authority, including equipment maintenance for Intensive Care Unit, Theatres, Labour Wards etc. Preference will be given to candidates with experience in electronic maintenance and design work but newly qualified applicants will be considered. Qualification: ONC/HNC or equivalent. Salary: Grade IV £6052 - £7752 per annum inclusive of London Weighting. Grade III £7056 - £8931 per annum inclusive of London Weighting (entry to this grade requires three years relevant experience). Further information from Mr. D. Bailey, 01 807 3071 ext. 678. Application forms and job descriptions from the Personnel Department, North Middlesex Hospital, Sterling Way, Edmonton, N18 1QX. Telephone 01 807 3071 ext. 571. Closing date 5th July 1985.

(2603)

UNIVERSITY OF LEEDS ELECTRONICS TECHNICIAN

required to assist in the construction and maintenance of electronic equipment associated with research and teaching of biological studies (under the supervision of the Electronics Engineer). Must be capable of working from circuit diagrams and sketches. Applicants should hold ONC or equivalent qualification and have 3-5 years relevant experience (including training period). Further education possible. Salary will be Grade 3 £5,399 - £6,325 p.a. (under review). Applications stating age, qualifications and full experience, together with the names and addresses of two referees should be addressed to Mr. S. Stainthorpe, Department of Physiology, Medical and Dental Building, University of Leeds, Leeds LS2 9NQ.

(2623)

TECHNICIAN ENGINEERS COMMUNICATIONS AND ELECTRONICS

A Planned Career in Technology in the Cotswolds
Salaries up to £11,445

- **VACANCIES** at both **TECHNICIAN ENGINEER** and **ENGINEERING TECHNICIAN** level.
- **CHALLENGING WORK** in the development and support of highly sophisticated communications and computer systems.
- **OPPORTUNITIES** for gaining experience in a wide variety of technical roles.
- **EXTENSIVE ENGINEERING FACILITIES**
- **CAREER PLANNING** aided by regular assessments of performance.
- **ADVANCEMENT** opportunities on the basis of proven ability.
- **OVERSEAS** service (voluntary).
- **FLEXIBLE** working hours with up to six weeks leave.
- **RELOCATION EXPENSES** in most cases.

Applicants for the higher grade of **TECHNICIAN ENGINEER** should normally possess a BTEC Higher National Certificate/Diploma in electronics or other relevant subject; or a City and Guilds Full Technological Certificate, or an equivalent qualification. An aggregate of at least 8 years relevant training and experience is required. Registration as a Technician Engineer (TEng) would be an advantage.

Salary Scale: £9,113 - £11,445

Applicants with BTEC ONC or equivalent and at least 4 years relevant training and experience are eligible for posts at the **ENGINEERING TECHNICIAN** level for which a structured training programme is provided.

Salary Scale: £6,599 - £9,135

INTERESTED? Then for either post send for full details and application form to the address below, quoting Ref: T/6523/85



THE RECRUITMENT OFFICE, GCHQ, ROOM A/1108
OAKLEY, PRIORS ROAD, CHELTENHAM, GLOS GL52 5AJ
OR TELEPHONE (0242) 32912/3

2599

NOTTINGHAM HEALTH AUTHORITY
MEDICAL PHYSICS/ELECTRONIC TECHNICIAN GRADE III

Hearing Services Centre
 General Hospital
 Nottingham

The Hearing Services Centre is a friendly department of 19 staff. It has links with the Medical Physics Department also at the General Hospital, and the Institute of Hearing Research, Clinical Outstation.

The successful applicant will be based at the General Hospital but will be expected to undertake peripatetic work in schools in Nottinghamshire. They will be concerned with development, repair and maintenance of a wide range of Audiological and Hearing Aid equipment for both Health and Education.

A car would be desirable.

Applications are invited for the post from candidates with 'B' TEC in Electronics Engineering ('H' TEC of equivalent) and at least 3 years' related experience).

The Salary Scale is **£6,408-8,283**.

For further details contact

Mr. G. Armstrong-Bednall
 Senior Chief Technician
 Hearing Services Centre
 General Hospital
 Nottingham

Tel: Nottingham 476161 ext 437

For Job Description and Application Form contact

Personnel Department
 General Hospital
 Nottingham

Tel: Nottingham 476161 ext 489

Closing date: 3rd July 1985

(2608)

**ELECTRONICS
 RESEARCH AT
 THE OPEN UNIVERSITY**

Applications are invited from candidates with a good degree or equivalent qualification in an appropriate subject to study for a full-time research degree in the Electronics Discipline at The Open University.

Research projects are available in a range of subjects including: Telecommunications (Digital Systems, LAN's, Conference TV, Satellite TV), Man-Machine Interface, Robotics, Computer Vision and Graphics, Ultrasonics and Acoustics, Computer Design, Microprocessor Systems, Instrumentation, Signal Processing and Filters, and Computer-Aided-Design, Learning and Manufacture.

The Electronics Discipline has good laboratory facilities and many industrial contacts, and is based in the OU campus in the new city of Milton Keynes. Suitably qualified candidates may be eligible for an SERC studentship.

For further particulars and application forms send a POST-CARD to the Higher Degrees Office, The Open University, P.O. Box 49, Milton Keynes, MK7 6AD or telephone Milton Keynes 0908 653361 or 653806. Please quote reference TE/4 Applications should be submitted as soon as possible.

(2607)

**College of Technology,
 Yarmouk University, Jordan.**

Faculty and technical staff positions in EE Technology available Sep 85 and Feb 86. Relevant educational qualifications and demonstrated teaching/industrial abilities required. Areas of interest include, but are not restricted to Power & Machines, Communications, Electronics, Computers, Controls, Instrumentation, and Manufacturing. Responsibilities include teaching and advisory duties in a quality undergraduate EE Technology program, as well as assisting in the overall development of the College. Rank and Salary commensurate with qualifications and experience. An excellent benefits package. Positions open until filled. Letters of application, detailed resumes, copies of official transcripts, and at least three professional letters of reference should be sent to Faculty Affairs Division, Yarmouk University, Irbid, Jordan.

(2574)

Opportunities in Broadcast Engineering

SONY BROADCAST LTD is well established as one of the world leaders in the professional broadcast television industry, with branches throughout Europe, the Middle East and Africa. Our wide range of sophisticated products includes Cameras, VTRs/VCRs, Camcorders, Editors and the new High Definition Video System. Applications are now invited from experienced engineers for the following career opportunities located at our international headquarters in North Hampshire.

Senior Base Service Engineer

Reporting to the Head of Base Service, the successful candidate will be expected to lead and contribute to a team of engineers and technicians engaged in the service and repair of our range of products. In addition to an electronics qualification, applicants should have a significant track record in the broadcast industry. Previous supervisory experience would be an advantage.

Senior Engineer – Customer Acceptance

The successful candidate will be responsible for the technical support of complex video products, such as Betacam and the new Sony studio camera. Key activities will include the optimisation of performance, and the conducting of customer acceptance tests for both new and established products. A minimum of 3 years broadcast experience and the ability to effectively maintain the customer interface is essential.

Full product training will be provided for all the above positions and generous relocation assistance offered where appropriate. In addition, we offer attractive salaries and first class conditions of employment, including Free Private Medical Cover and Company Pension/Life Assurance Scheme.

If you are interested please contact David Parry, Personnel Officer.

QA Support Engineer

To provide engineering support to the inspection and customer acceptance activities. Responsibilities will be varied and will include: conducting customer acceptance tests to recognised performance standards, preparation of test procedures, the maintenance of test facilities (including ATE) and the resolving of technical problems encountered by the QA inspectorate. Previous engineering experience with broadcast equipment is essential.

QA Technician

The successful candidate will assist in the provision of technical support to the QA and customer acceptance functions. Duties will include product alignment, the maintenance and construction of test facilities, and the control of fixed assets, repair and recalibration schedules. Applicants should possess a formal electronics qualifications – a minimum of Higher TEC (or equivalent). Previous experience would be an advantage.

SONY
 Broadcast



Sony Broadcast Ltd.

Belgrave House
 Basing View, Basingstoke
 Hampshire RG21 2LA
 United Kingdom
 Telephone (0256) 55 0 11

2602

Appointments

Telecommunications Technicians

The posts available are varied, but broadly they fall into 2 groups at.

HANSLOPE PARK (MILTON KEYNES) and CENTRAL LONDON

for installations, maintenance and other work associated with HF communications equipment, VHF, UHF and microwave links and associated test equipment; teleprinters, telephone subscribers' apparatus, PMBXs, PAXs, PABXs and ancillary equipment including that using analogue and digital techniques and voice frequency telegraph.

Applicants should have at least 4 years' relevant experience, and must hold one of the following qualifications:

- ★ ONC in Engineering (with pass in Electrical Engineering 'A')
- ★ BTEC/SCOTEC certificate in relevant discipline
- ★ City and Guilds Telecommunications Technicians Certificate Part II (Course No 271) or Part I plus Maths 'B', Telecommunications Principles 'B' and one other subject
- ★ a pass in the Council of Engineering Institutions Part I examination
- ★ an equivalent or higher relevant qualification

Ex-Service personnel who have had suitable technical training, and with at least 3 years' in an approved senior technical capacity will also be considered.

Salary: £6512 — £9009; London £1300 more, starting salary may be above minimum for those with additional relevant experience. Promotion prospects are good. Relocation assistance may be available.

For an application form write to:

Foreign & Commonwealth Office, Hanslope Park, Hanslope, Milton Keynes, MK19 7BH, or telephone Milton Keynes (0908) 510444 Ext 232. Please quote reference TT/02/85.

Closing date for applications 31 July 1985.

FOREIGN AND COMMONWEALTH OFFICE

(2617)

Analogue Engineer

Berks Commercial Company c£17,000

Our client a major privately owned group of companies, due to continued expansion, are seeking a top calibre analogue engineer to become involved with their successful product development programme based around tape and cartridge systems for commercial markets.

Involvement will cover the design testing and releasing to production products and product sub assemblies. Ideally you should have experience in the following:

- Several years design experience
- Design of Servos motor/tacho systems
- Low level signal amplifiers and data recovery circuits
- Digital ability in TTL, CMOS, Pals, and Mpus (preferably Motorola).

In return you will receive all the benefits expected from joining an expanding and commercially aware company (excellent salary, superior working conditions, the use of the latest "kit", genuine career prospects) and many other advantages associated with working for a company operating at the very forefront of technology.

For further information please telephone Stephen Salt, or write enclosing a full CV.

2605

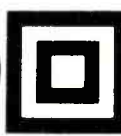

Management Personnel

Recruitment Selection & Search

2 Eton Court, Eton, Windsor, Berkshire.

Telephone: (07535) 54256 (out of hours 0344 761 870)

Professional Career Opportunities



The Easy Way to look for your new job from the comfort of your own armchair. Our well qualified consultants will carefully match your requirements against appropriate vacancies.

We have many clients seeking Engineers and Technicians at all levels and we are particularly interested in hearing from you if you have experience in the following:-

- Signal Processing
- Technical Sales
- ATE Programming
- Radar Systems
- RF Development
- Real Time Software

Your next step is to complete and return the attached coupon or telephone **John Prodder** on 0442 47311 or one of our duty consultants on 0442 212650 during evenings or weekends.



Executive Recruitment Services

THE INTERNATIONAL SPECIALISTS IN RECRUITMENT FOR THE ELECTRONICS, COMPUTING AND DEFENCE INDUSTRIES

Maylands Avenue, Hemel Hempstead, Herts HP2 7LD



NAME.....(Mr/Miss/Mrs)

ADDRESS.....

POST CODE.....

TEL NO:.....

QUALIFICATIONS..... AGE.....

NONE CG/HNC DEGREE OTHER

SALARY
 0-£6000 £6-10000 £10-15000 £15000+

JOB.....

WW2
(2618)

COMMUNICATIONS MAINTENANCE SUPERVISOR

TELEVISION OUTSIDE BROADCASTS

Salary: £11,907 - £14,542 p.a.

Depending on experience and qualifications

Responsibility for supervising the Communications Test Area which specialises in maintaining all the Sound and Vision Radio Links and line testing equipment associated with Television Outside Broadcasts. This involves a high level of diagnostic skill, both for system and unit maintenance and the ability to manage support staff. Development work and liaison with other BBC Engineering Departments and outside organisations is also included.

Applicants should have a proven ability to supervise a modern technical area, understanding of maintenance techniques and hold a HNC, B.TEC Higher Diploma or degree in Electronic Engineering or equivalent.

For further information and an application form write to or telephone, quoting ref. 85.E.4026/WW: J.W. Boden, BBC Television Outside Broadcasts, Kendal Avenue, Westfields Road, Acton, London W3 0RP. 01-992 5344 Extension 272.



We are an equal opportunities employer. (2604)

Bloomsbury Health Authority
Department of Medical Physics and Bioengineering
University College Hospital, London.

EQUIPMENT MANAGEMENT TECHNICIAN (MPT IV)

Ref RT28

To work for the Department's Electromedical Equipment Unit. The Unit is involved in the provision of an equipment management service for the Bloomsbury District. The task is to keep a wide range of patient connected equipment. Serviced, cleaned, calibrated and ready for immediate use. Duties include visits to wards to service equipment. Some knowledge of electronics and a practical aptitude are essential.

Appointment, according to qualifications and experience.

MEDICAL PHYSICS TECHNICIAN IV

Ref RT35

£6,087-£8,188 pa inc London Weighting

Further details available from Mr R. Blackwell, on 01 636 5152.

For application forms and job descriptions please contact the Personnel Department, on 01 387 2374 (24 hour service) quoting the appropriate reference number.

Closing date

AN EQUAL OPPORTUNITIES EMPLOYER

(2601)

RECORDING STUDIO MAINTENANCE MANAGER

Required for major North London Studio complex. Applicants should have a minimum of 3 years experience in this field. Knowledge of Studer tape machines, SSL desks an advantage.

Phone: Chris Dunn
01-459 8899

(2595)

YOU ARE UNDER STARTERS ORDERS

For the biggest Mobile Rally in the South Of England on July 14th 10 a.m. to 5 p.m. at the Brighton Race Ground. Huge "Bring & Buy Stall", 20,000 sq. ft under cover exhibition area, plus attractions for the XYL and children, restaurant facilities. The Rally which caters for the whole family. Talk In S22 and 3.5 Mhz. Admission £1 children free if accompanied by an adult. For further details ring 07918-5103.

(2593)

SOUTH OF SCOTLAND ELECTRICITY BOARD
ENGINEERING OPPORTUNITIES AT

TORNESSE POWER STATIONS (AGR)

IN ELECTRICAL, INSTRUMENT AND
COMPUTER MAINTENANCE

SECOND/THIRD ENGINEERS

SALARY (Currently under review):-

SECOND ENGINEER £10575/£14031

THIRD ENGINEER £8086/£11882

(plus £325 responsibility per Grade)

Torness Nuclear Power Station is currently under construction near Dunbar, East Lothian, approximately 30 miles South East of Edinburgh.

Successful candidates will assist in all aspects of maintenance in one or more of the following areas, viz:- large high voltage electrical plant, light current control systems, conventional instrumentation systems, computers and associated peripherals. Initially work will be concentrated on important activities associated with the establishment of the Section and may include some involvement in plant commissioning. Applicants should preferably have a HNC or equivalent qualification.



Applications quoting reference no. 67/G188/85, should be submitted on the standard form obtainable from and returnable to the Station Manager, Torness Power Station, Dunbar, East Lothian, EH42 1QS (Tel. No. 0368 63500) not later than 20 July, 1985. (2619)

CUT THIS OUT!

Clip this advert and you can stop hunting for your next appointment. We have a wide selection of the best appointments in Digital, Analogue, RF, Microwave, Micro-processor, Computer, Data Comms and Medical Electronics and we're here to serve *your* interests.

Call us now for posts in Design, Test, Sales or Field Service, at all levels from £6,000-£16,000.



11 Westbourne Grove, London W2. Tel: 01-229 9239. (1935)

CAPITAL APPOINTMENTS LTD THE UK'S No. 1 ELECTRONICS AGENCY

If you have HNC/TEC or higher qualifications and are looking for a job in design, test, customer service, technical sales or similar fields:

Telephone now for our free jobs list
We have vacancies in all areas of the UK
Salaries to £15,000 pa

01 808 3050
(24 hours)

CAPITAL APPOINTMENTS LTD
76 WILLOUGHBY LANE, LONDON N17 0SF

(291)



Appointments

More Hi-Tech Jobs

£8000 - £20,000

As a leading recruitment consultancy we have a wide selection of opportunities for high calibre Design, Development, Systems and supporting staff throughout the UK.

If you have experience in any of the following then you should be talking to us for your next career move.

- ARTIFICIAL INTELLIGENCE • IMAGE PROCESSING
- MICRO HARDWARE & SOFTWARE • GUIDED WEAPONS
- OPERATIONAL RESEARCH • RF & MICROWAVE • OPTICS
- MATHEMATICAL MODELLING • SIMULATION • C³
- HIGH LEVEL PROGRAMMING • SYSTEMS ENGINEERING
- ACOUSTICS & SONAR • FLUID DYNAMICS • RADAR
- SATELLITES • AVIONICS • CONTROL • ANTENNA

Opportunities exist with National, International and consultancy companies offering excellent salaries and career advancement.

For Free and Confidential career guidance call John Spencer or send a detailed C.V.. Please quote reference WW/3.



Skyquip Technical Services

85 High Street, Winchester, Hampshire, SO23 9AP
Tel: Winchester (0962) 69478 (24 hours) (2579)

Specialist recruitment for Aerospace, Defence & Communications Industries

TV BROADCAST ENGINEERING

Avitel is a small, well established and rapidly growing company, designing and manufacturing an expanding range of equipment for the Professional Broadcast Television Industry.

We have a modern purpose-built factory, offering excellent working conditions, some 10 miles south of London in Kent. As part of our programme of expansion, we have a senior engineering vacancy for which we require an enthusiastic individual, keen to grow with the Company.

TEST DEPARTMENT MANAGER

This post involves the training and supervision of test staff, planning of resources to meet production workload and specification of equipment for the department.

Close liaison with our Development, Projects, Production and Sales departments is necessary to ensure the smooth progress of equipment from the design stage through to final production. A good appreciation of modern analogue and digital circuit operation is required, including microprocessor systems. A knowledge of modern ATE techniques is also required.

Familiarity with Broadcast Video equipment is an advantage. Qualification to degree level or equivalent is desirable, and at least five years' relevant industrial experience is required.

Please write for an application form, and detailed job description, enclosing your C.V. and quoting reference TM.

(2606)

Avitel Electronics Ltd.,

Unit 6, Croydon Road
Industrial Estate,
Tannery Close, Beckenham,
Kent, BR3 4BY.
Telephone: 01-656
7027 Telex: 894360
AVITEL-G



ELECTRONICS ENGINEER

Required by fast growing company. An electronics engineer, competent in digital and analogue systems. Must be capable of working without supervision in the production, testing and trouble shooting of our range of instruments. While a practical approach is essential, the successful candidate will be qualified to at least HNC standard. Salary level will not be a problem for the suitable candidate.

Write in the first instance detailing age, qualifications and salary expected to:

Mr. B.E. Stevens, Managing Director,
Hounsfeld Test Equipment, 37 Fulleton Road, Croydon, Surrey.
CR0 6OR

(2575)

Philip Drake Electronics is a successful and growing company that has now established itself as the leading U.K. supplier of studio communications equipment and programme quality sound distribution modules to the Broadcasting industry.

An increasing workload has lead to a requirement for the following personnel:

PROJECT AND TEST ENGINEERS

Project and test engineers are required to work in the Systems Engineering Group which primarily deals with the custom design, manufacture and test of studio talkback and intercom systems.

Project Engineers should have a suitable engineering qualification and at least two years experience of system/project engineering with professional analogue equipment. The work includes detailed system design, liaison with customers, and technical support for production and test.

Test Engineers should have analogue experience but have the ability to adapt to digital technology. The job entails testing custom built equipment from prototype circuit boards to complete studio systems and providing after sales service and support. The post is one which provides excellent opportunities for advancement within the systems group.

TECHNICIAN/JUNIOR ENGINEER

An opportunity exists for a Technician/Junior Engineer to join our product development team. The successful candidate will be involved in all aspects of design from concept to production. He/she will work primarily with analogue circuits although there will be involvement with digital circuits. An ability to work with minimum supervision is essential and it is expected that the successful candidate will be qualified to TEC or degree level although ability is more important. Experience of the professional audio industry would be an advantage.

SOFTWARE ENGINEER

We are currently looking for two suitably qualified software engineers to strengthen our development team. The successful candidates would be required to write software in PASCAL and ASSEMBLER for the MC68000 family and must be able to work on their own initiative with minimal supervision. The ability to communicate ideas clearly is essential.

In addition to attractive salaries, the company offers a non-contributory pension scheme, BUPA membership and a pleasant working environment in newly constructed premises in Welwyn Garden City.

If any of the above positions appeal to you please apply in writing including your current CV or phone Jenni McCoy on Welwyn Garden City (0707) 333866 for an application form.

Philip Drake Electronics Ltd.,
37 Broadwater Road,
Welwyn Garden City,
Herts AL7 3AX.

(2589)



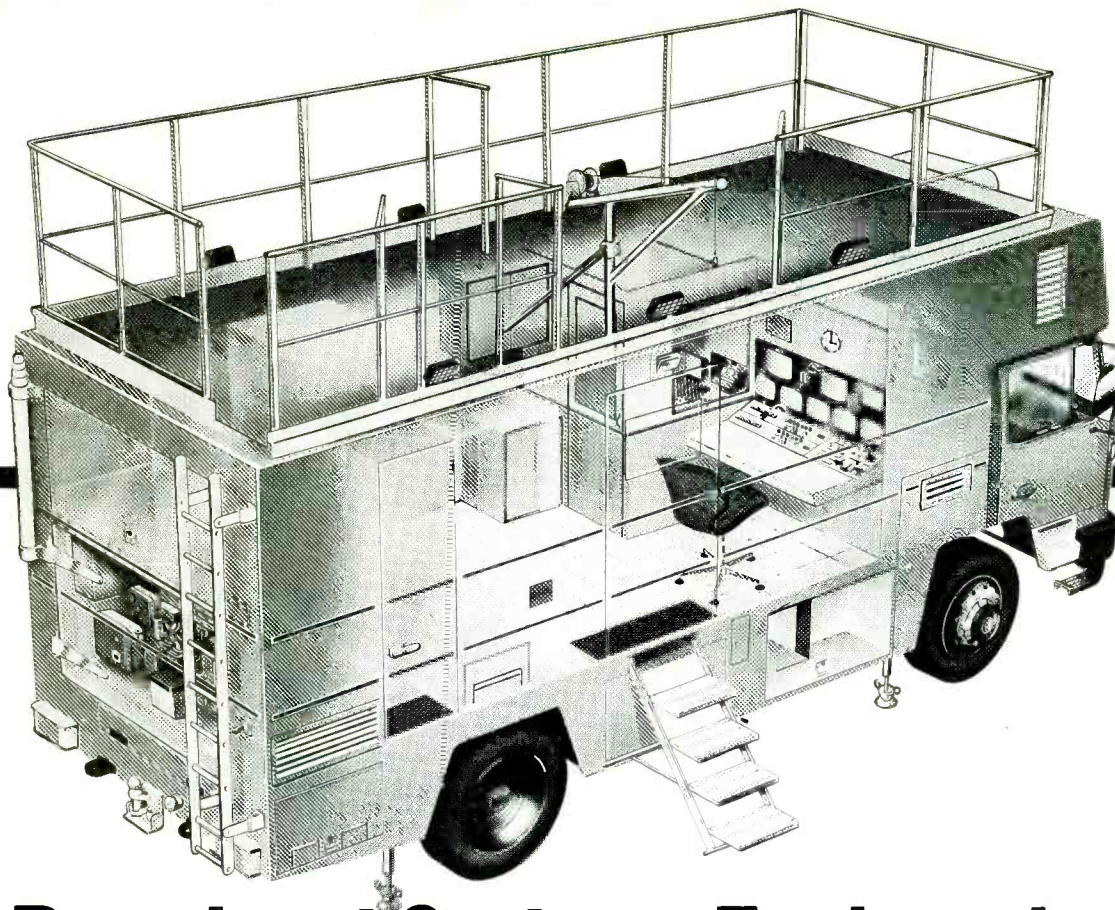

Broadcast Systems Engineering

Turning top products into total Systems.

Established in 1978, to specialise in the high technology field of professional broadcast television equipment, Sony Broadcast now has 10 overseas branches providing sales and other specialist engineering support to our customers, in a marketing area that covers Europe, the Middle East and Africa. We now employ 400 staff and enjoy a prominent position as a market leader with a wide range of state-of-the-art broadcast video and audio products.

The Systems Engineering Division plays a key role in the success of the Company, designing and equipping complete sound and vision broadcast and recording facilities. These facilities may comprise an entire television studio complex or a single mobile outside broadcast unit, often forming part of an existing, highly sophisticated national broadcast network, or representing a pioneering thrust into one of the world's remoter areas. Applications are now invited for the following challenging opportunities in the Systems Group:

Project Engineer

You will be expected to make a significant contribution to a project team which will turn a design concept into reality. This will involve the in-depth design, building and commissioning of facilities that will satisfy our customers' diverse needs. To assist, you will be supported by a Systems Production Department comprising Materials Acquisition, Mechanical Engineering, Installation and Drawing Office skills. Project time-scales of 4-12 months will offer you a stimulating challenge, and the satisfaction of seeing your contributions in action fast.

Applicants should possess a formal electronics/electrical engineering qualification (a minimum of a Higher TEC) together with experience gained in the electronic manufacturing industry. A television broadcast background would be particularly relevant. The ability to interface confidently with technical customers is essential. Both positions will involve some overseas travel, and full product training will be provided.

First class conditions of employment are offered, and generous relocation assistance will be given where appropriate. Our salaries reflect the importance we place upon attracting the best highly skilled engineering staff and keeping them.

*Please apply in the first instance to David Parry,
Personnel Officer with details of your career to date.*

Marketing Engineer

As a member of a Specialist Systems Marketing Team, you will be engaged in the conceptual design and costing of broadcast Systems. You must have an ability to analyse operational and technical requirements and turn them into practical solutions.

You can expect to meet a wide range of customers from Professional Broadcasters and Production Companies through to National Government Officials in order to discuss their project and offer expert advice. To assist in the preparation of detailed proposals you will have the use of modern computer based graphic design and information processing equipment.

SONY
Broadcast



Sony Broadcast Ltd.

City Wall House
Basing View, Basingstoke
Hampshire RG21 2LA
United Kingdom
Telephone (0256) 59 5 83

(2590)

LINK

ELECTRONIC ENGINEERS

We are in the forefront of providing state-of-the-art broadcast tv equipment to the BBC and independent companies in this country and similar organisations throughout the world. Our new type 130 micro-processor based colour camera is in production in addition to which we have a world-wide market for outside broadcast and studio installations.

To help us broaden our product range and continue our success we urgently need to recruit well qualified electronic engineers (some at senior level) who are looking for the opportunity to develop their talents in a close knit team. Current requirements include:

DESIGN AND DEVELOPMENT — HARDWARE/SOFTWARE ENGINEERS

SALES ENGINEERS TEST ENGINEERS

Salaries offered will reflect the high standard of engineer we are looking for and are accompanied by 25 days holiday per year, free health and life assurance. A pension scheme and, where appropriate, generous assistance in relocating to this pleasant part of Hampshire.

Please phone Jean Smith on Andover (0264) 61345 for an application form or further details of the vacancies. Alternatively you might like to let us have a full cv with details of your background and experience.

LINK

ELECTRONICS

Walworth Industrial Estate, Andover, Hampshire, England
Telephone: Andover (0264) 61345

(2597)

MEDICAL RESEARCH COUNCIL
INSTITUTE OF HEARING RESEARCH
SOUTHAMPTON CLINICAL OUTSTATION

RESEARCH OFFICER IN ELECTRONICS (RO/SRO)

A vacancy exists for a research officer with experience in electronics at IHR Southampton. The post will be based at the Institute of Sound and Vibration Research at the University, but will also relate to the other half of the team's activities, at the Royal South Hants Hospital.

The research is on clinically applicable aspects of hearing and deafness, advanced testing techniques, and the use of signal averaging equipment by computer for which a very high level of technical support is required. The appointee will be required, with minimal supervision to design and construct new equipment involving transducers and interfaces. There will also be a little general technical support for the research team including calibration, repair and servicing work. A general electronics background is needed and a knowledge of Z80 CP/M systems and of digital interface techniques would be advantageous. For further information about the post please contact Dr. A.R.D. Thornton (Tel: 0703 37946).

The appointment will be made on the Research Officer grade (£6483-8492) or Senior Research Officer grade (£8574-10,938). The MRC has a pension scheme and generous leave allowances.

(2566)

CALIBRATION/ SERVICE ENGINEERS

c £8,250 + Overtime + July Review

Bradley Electronics is one of the leading organisations in the electronics industry. We provide a range of advanced electronic equipment and engineering services to MoD, Industry and the Health Care market.

Our Repair and Calibration laboratory, the largest of its type in the UK, provides a comprehensive service for commercial and military organisations, with its full facilities for maintaining and calibrating all types of electronic equipment.

Opportunities exist for Engineers to work with a wide variety of equipment, including Multimeters, Oscilloscopes, Navigation Systems and Electronic Counter Measure Systems. Ability to trace, diagnose and rectify faults in these complex equipments is essential. Education to a minimum of C&G/TEC or equivalent is required, together with considerable practical knowledge and experience in electronic testing, servicing of radar, and telecommunications equipment. Experience of this nature gained in the Services will be of particular value.

The Company is located close to the underground, bus routes and the North Circular Road/M1. The salary and conditions package available is consistent with the Company's membership of a large, successful Group with considerable resources.

For full details please call our Personnel Manager, Roger Loughney, on 01-450 7811. Or write to him at Bradley Electronics Limited, Electral House, Neasden Lane, London NW10 1RR.

Bradley Electronics

(2560)



THE START OF SOMETHING NEW

If you are leaving College and planning a career in modern communications or if your present job lacks interest and challenge why not join us in GCHQ?

We are recruiting

RADIO OFFICERS

who are after initial training will become members of an organisation that is in the forefront of communications technology. Government Communications Headquarters can offer you a satisfying and rewarding career in the wide field of communications. Training involves a 32 week course (38 weeks if you come straight from Nautical College) which will fit you for appointment to RADIO OFFICER.

Not only will you find the work as an R O extremely interesting but there are also good prospects for promotion opportunities for overseas travel and a good salary. Add to this the security of working for an important Government Department and you could really have the start of something new.

The basic requirement for the job is 2 years radio operating experience or hold a PMG, MPT or MRGC or be about to obtain a MRGC. Registered disabled people are welcome to apply.

Salaries start at £4,762 at age 19 to £5,755 at age 25 and over during training and then £6,399 at 19 to £8,510 at 25 and over as a Radio Officer. Increments then follow annually to £11,741 inclusive of shift and weekend working allowances.

For full details and application form phone 0242 32912/3 or write to:



The Recruitment Office A/1108
Priors Road
CHELTENHAM
Glos GL52 5AJ

(2806)

CLIVEDEN

TEST ENGINEERS

For full systems test on datacommunications networks.

£8,000 + Wokingham

FIELD SERVICE ENGINEERS

USA training on ATE systems.

Suit experienced repair technician.

£10,000 + car Woking

TECHNICIAN ENGINEER

To maintain VAX PDP11 & flight simulation systems.

to £11,000 Middlesex.

TEST ENGINEER

Fault-find data-processing equipment to component level.

Some systems involvement.

c£10,500 Herts

SERVICE ENGINEER

Mobile radiocommunications equipment.

£8,000 + car Hants & Central London.

TEST/SERVICE ENGINEER

Repair & fault-find microprocessor based broadcast systems.

£9,000 + Reading

Phone/write/call Roger Howard C.Eng

MIEE, Cliveden Technical Recruitment

Consultants, 92 The Broadway,

Bracknell, Berks RG12 1AR. Tel:

Bracknell (0355) 489489 (six lines)

(2598)

ARTICLES FOR SALE

Apollo Sciibmaster X-Y, micrometer calibrated, table £89. Metals Research Macrotome, diamond cutters, accessories etc., £275. Stanton Electronic Balance single pan £150. Advance Twin Stabilised Power Supplies £59. Wayne-Kerr Universal Bridge £98. Ignition Analyser Unit/Diagnostic manual £39. Low-voltage Electroplater for rust prevention/rectification £39. Microscope with micrometer table £89. Miscellaneous stabilised power supplies £18-£45. Avo In-Circuit transistor, diode, thyristor tester £25. Philips RM/AM/Sweep generator £89. Creed Teleprinter £75. High Intensity Fibre-Optic Light Supply, twin lamps, twin outputs each £35. Hughes Micro-Spot Welding Head £69, ditto-Sippicam £35. Chart Recorders. Audio Generator Audio Analyser. Wow/Flutter Meter. Digital Calibration Voltmeter, five digits, DC/AC plug-ins £85. Infra-Red Analyser Heads £30. Four-Phase Signal Generator £85. Pulse generators. Sweep Generators, etc. etc.

(2016)

040 376236

SERVICES

DESIGN AND DEVELOPMENT SERVICE. RF transmitters and receivers. Telemetry U.H.F. V.H.F. Analogue and digital circuits, control systems. Full manufacturing facilities. RCS Electronics. Wolsey Road, Ashford, Middx. Phone Dr. Eric Falkner on 53661. (2637)

CIRCOLEC

THE COMPLETE ELECTRONIC SERVICE

Artwork, Circuit Design, PCB Assembly, Test & Repair Service, Q.A. Consultancy, Prototypes, Final Assembly. Full PCB Flow Soldering Service.

Quality workmanship by professionals at economic prices.

Please telephone 01-646 5686 for advice or further details.

TAMWORTH MANOR

302-310 COMMONSIDE EAST, MITCHAM

(1391)

It's easy to complain about an advertisement. Once you know how.

One of the ways we keep a check on the advertising that appears in the press, on posters and in the cinema is by responding to consumers' complaints.

Any complaint sent to us is considered carefully and, if there's a case to answer, a full investigation is made.

If you think you've got good reason to complain about an advertisement, send off for a copy of our free leaflet.

It will tell you all you need to know to help us process your complaint as quickly as possible.

The Advertising Standards Authority. ✓
If an advertisement is wrong, we're here to put it right.

ASA Ltd, Dept 1 Brook House, Torrington Place, London WC1E 7HN

This space is donated in the interests of high standards of advertising.

**SMALL SELECTION ONLY LISTED
RING US FOR YOUR
REQUIREMENTS WHICH MAY BE
IN STOCK**



Portable Battery or Mains Oscilloscope. SE Laboratories 111 Oscilloscope — Solid State — General purpose — Bandwidth DC to 18/20MC/S at 20MV/CM — Dual Channel — Rise time 19NS — Calibrated Sweep — Calibrator — Display 10CMSx8CMS — Power AC — 95 Volts to 100-190 Volts to 260 or 24 Volt DC battery — Size: W25.5 CM — H25.5 CMS — 56CMS Deep — WT11.4KGS — Carrying handle — Tested in fair condition with operating instructions £120.00

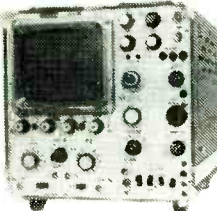

Latest Bulk Government Release — Cossor Oscilloscope CDU150 (CT531/3) £150 only. Solid state general purpose bandwidth DC to 35MHz at 5MV/CM — Dual Channel — High brightness display (8x10cm) Full delayed time base with gated mode — Risetime 10NS — Illuminated graticule — Beam finder — Calibrator 1KHz squarewave — Power 100 — 120V 200V — 250 volts AC — Size W26CM — 41CM deep — WT 12.5 K.G. carrying handle — colour blue — protection cover front containing polarized viewer and camera adaptor plate — probe (1) — Mains lead. Tested in fair condition with operating instructions — £150.00.

Communication Receivers. Rascal 500KC/S to 30MC/S in 30 bands 1MC/SWIDE — RA17 MK11 £125, RA17L £150, RA17E £200. New Metal Louvered Cases for above £25. All receivers are air tested and calibrated in our workshop — supplied with dust cover — operation instructions — circuit — in fair used condition. Rascal Synthesizers (Decade frequency generators) MA350B Solid State for use with — MA79 — RA217 — RA121B Etc £100 to £150. MA250 — 16MC/S to 31.6 MC/S £100. MA1350 for use with RA17 receiver £100. MA259G Precision frequency standard 5MC/S — 1MC/S — 100KHz £100 to £150. Panoramic Adaptor RA66 £150. RA137 and RA37 £40 to £75 LF converters 10 to 980KC/S. RA218 Independent SSB unit £50 RA98 SSB-ISM Converter £50. RA121 SSB-ISM converter £75. EC964/7K Solid state — single channel — SBB — mains or battery — 1.6 to 27.5 MC/S and 400 to 535KHz £100 with manual Plessey PR155G Solid State 60KC/S — 30MC/S £400. Creed 75 Teleprinters — Fitted tape punch and gearbox for 50 and 75 bauds — 110volts AC supply — in original transport tray sealed in polythene — like new £15EA. Redifon TT11 Audio Teleprinter converter receiver solid state — supply 110 or 240AC — Made for use with above teleprinter enabling print-out of messages received from audio input of communication receiver £15 with circuit tested. Redifon TT10 Converter as above but includes transmit facilities £20. Oscilloscopes — stocks always changing Tektronix 465 — 100MC/S £750. FM Recorder Sangmid Sabre 111 14 channels £350. Translet Matrix printers — AF11R — 5level Baudot Code — up to 300 Bauds — for print out on plain teleprinter paper £50 to £100. Translet AH11R — As above but also 8 level ASCII (CCITT No 2 and CCITT No 5) Like new £100. Army field telephones sets. Type F — L and J — Large quantity in stock £6 to £15 depending on type and quantity P.O.R. Don 10 Telephone Cable — half mile canvas containers £20. Night viewing infra-red AFV Periscopes — Twin Eyepiece — 24 volt dc supply £100ea. Original cost to government over £11,000ea. Static inverters — 12 or 24 volt input — 240 volt AC sine wave output — various wattages P.O.R. XY Plotters and pen recorders various — P.O.R. Ferrograph series 7 Tape recorders mono £100. stereo £150. Signal Generators various — TF995/A3 £60. TF801D/BS — 10MC/S to 485MC/S £90 TF144H/A4 £90. TF1060/2 £60. HP606A — £90 £140 HP608 £50 HP614A £100 HP618B £100 HP620A £100. Marconi TF1064B/5 £100 TF791 Deviation meter £100 TF893A Power meter £50 Aerial mast assembly 30ft high complete with 16ft whip aerial to mount on top-guyropes — insulators — Base and Spikes etc. in heavy duty carrying bag — new £30. Rascal frequency counter Type 836 £50 Tektronix plugs-ins — 1A1 £50, 1A2 £40, 1A4 £100 M£50. All items are bought direct from H.M. Government being surplus equipment. Price is Ex works. S.A.E. for enquiries. Phone for appointment for demonstration of any items. Also availability or price change. V.A.T. and carriage extra.

EXPORT TRADE AND QUANTITY DISCOUNTS GIVEN
JOHNS RADIO (0274) 684007
WHITEHALL WORKS,
84 WHITEHALL ROAD,
EAST BIRKENSHAW, BRADFORD
BD11 2ER

WANTED: REDUNDANT TEST EQUIPMENT — RECEIVING AND TRANSMITTING EQUIPMENT — VALVES — PLUGS — SOCKETS SYNCHROS ETC. (2734)

ARTICLES FOR SALE

**MARTIN ASSOCIATES
(ELECTRONICS) LTD.
Parthia, Beckhampton, Nr.
Marlborough, Wilts.
Tel: Avebury (067 23) 219**

CURRENT MANUFACTURED EQUIPMENT LESS THAN 18 MONTHS OLD UP TO 40% SAVINGS

APLAB	115/230/500SOLID STATE FREQUENCY CONVERTER	£150
DRANETZ	626 + P46001/01 MAINS DISTURBANCE ANALYSER plus single phase plug in EPROM PROGRAMMER suits 2508, 2716, 2532, 2564, 2764, 27125, 2815, 2816, 48016	£400 £595
ELAN	E2 EPROM PROGRAMMER & EDITOR as E2 with 8 copy sockets	£850
EP500N	HX-20 PORTABLE COMPUTER with printer VDU & cassette storage	£300
FLUKE	9011A/001 MICROPROCESSOR TROUBLE SHOOTER supplied with 8085 & Z80 pods	£4300
H-P	7470A/002 TWO PEN GRAPHIC RECORDER IEEE	£425
KIKUSUI	225 8 DIGIT MULTI-COUNTER DC-150MHz	£175
LEADER	PA32-3 VARIABLE P.S.U. 0-32V 3amp	£120
LHM80A	HIGH VOLTAGE METERED PROBE 0-40kV DC NEW	£4
RASCAL-DANA	488 GPIB ANALYSER with RS232 interface cable	£425
SOLATRON	1250 FREQUENCY RESPONSE ANALYSER 10uHZ-65kHz 1uV-300V	£5250
SCHAFFNER	200E-223A SIMULATOR GENERATOR M/F & high frequency plug in	£1850
CLARE H.P.	Q103A INSULATION TESTER DC-2.5kV	£95
	3500 ATTENUATOR DC-1MHz 600 ohm 500W	£25
	3405A R.F. SAMPLE VOLTMEETER 10kHz-1.2GHz	£850
	7100B TWO PEN STRIP CHART RECORDER	£175
KEITHLEY	135 HANDHELD OMM 4; digit Shop Soiled	£125
LAMINAIR	LAMINAIR CLEAN AIR WORK BENCH	£200
MARCONI	TF2002B AM/FM SIGNAL GENERATOR 60MHz	£450
MARCONI	TF2604 ELECTRONIC VOLTMEETER 20Hz-1.5GHz	£170
	TF868B UNIVERSAL LCR BRIDGE 1% Test Freq 1 & 10kHz	£150
	TF995A/3 AM/FM SIGNAL GENERATOR 220MHz	£175 (2610)

FOR SALE

- 1) Tektronix 526 Vectorscope £500.
 - 2) Tektronix 1485 multi standard vectorscope £2950.
 - 3) Versatec VS10 Electro static printer-plotter £3950.
 - 4) Info-fan electro static printer plotter £45 (in need of repair).
 - 5) Perkin-Elmer model later measurement £2900. System for use with NC machines P.O.A.
 - 6) Clarke Hess digital ESR metre P.O.A.
 - 7) Dec LA 36 KSR Printer £100.
 - 8) Facit tape punch model 5070 £100.
 - 9) HP 8746 BS Parom Test Set £1250.
- Tel: Cambridge (0223) 68990 (2609)**

**FLUKE 8060A DIGITAL MULTIME-
TER** for sale, complete with all accessories. Also a number of fluke high current probes, temperature probes, shunts, etc. All as new will separate. Details Mr I. Robinson, Moorcroft, Fiermbach Road, Llandudno, Gwynedd. (2612)

INTEL iPDS 100 14 months old plus 771 Printer. Software inc: ISIS, 80/85 assembler Relms Z80 cross-assembler. As new condition £3,000. Tel: 0429-78099 (2613)

**TO MANUFACTURERS, WHOLESALERS
BULK BUYERS, ETC.**
**LARGE QUANTITIES OF RADIO, TV AND
ELECTRONIC COMPONENTS FOR DISPOSAL**
SEMICONDUCTORS, all types, INTEGRATED CIRCUITS, TRANSISTORS, DIODES, RECTIFIERS, THYRISTORS, etc. RESISTORS, C/F, M/F, W/W, etc. CAPACITORS, SILVER MICA, POLYSTYRENE, C280, C296, DISC CERAMICS, PLATE CERAMICS, etc.
ELECTROLYTIC CONDENSERS, SPEAKERS, CONNECTING WIRE, CABLES, SCREENED WIRE, SCREWS, NUTS, CHOKES, TRANSFORMERS, etc.
ALL AT KNOCKOUT PRICES — Come and pay us a visit ALADDIN'S CAVE
TELEPHONE: 445 0749/445 2713
R. HENSON LTD.
21 Lodge Lane, North Finchley, London, N.12
(5 minutes from Tally Ho Corner) (1613)

Airlastener, Spatnails, rapid, custom-built, laboratory furniture, cabinet construction, boat building, fencing etc., £98. Unimatic Laboratory Balance, single pan £159. Marconi UHF Signal Generator, 450MHz-1.25 GHz. £75. Microtorque guage £12. Macrotope 2 multi diamond blade cutter, adjustable pitch, micrometer controlled head, variable speed, adjustable table, variable number of blades etc. £285. Philips 2c/s-1MHz AF Millivoltmeter, 0dB-1mW600 ohms. £35. Marconi Voltmeter TF 1041.B. 1.5GH. £59. Philips 10microvolt-1000 V. DC voltmeter. £35. LCR Bridge. Sweep generator, FM/AM Generator. Data Logger. Oxygen Analyser. Chart Recorder. X-Y Recorder. Thermocouple Millivoltmeter. General Radio Variable Calibrated Air Capacitor £25 (1607-P3). In-Circuit Transistor Tester. Heavy Duty Spot Welder 200A. MIG Welder. Valve Tester. Leak Detector. Pulse Generator. Photo-Tachometer (measures rotational speed). Multiple Battery Replacement PSU. Colour Distortion Analyser. Thermocouples. Ridsdale Dieter Permeability Meter £50 Hygrometer Compressor Ignition Analyser. £39. LV Zinc Plater £39. Stabilised PSU's etc. etc. 010-376236 (2614)

FREE P.T.H. PROTOTYPE of the finest quality with EVERY P.C.B. artwork designed by us. Competitive hourly rates, and high standard of work. Halstead Designs Limited, 31, High St., Halstead, Essex. Tel. (0787) 477408/474554. (2126)

EQUIPMENT FOR SALE:

- 1) PRINTER, PLOTTER, VERSATEC MODEL V-80 SE/ PAR I/P UP TO 1 MB/SEC, 1000 LINES/MIN OR 1/5 SEC PLOT SPEED, HI RES. 40K POINTS/SQ INCH £3950
- 2) CENTRONICS PRINTER MODEL 701 £250
- 3) DEC LA36 £100
- 4) IBM 3715 (AS IS) £75
- 5) ASR 33 (AS NEW) £70
- 6) FACIT TAPE PUNCH MODEL 4070 £250
- 7) KENT CHROMOLOG-2 INTEGRATOR £175
- 8) ESR METER CLARKE HESS MODEL 273A £1250
- 9) GAUGE METER RFL INDUSTRIES MODEL 3265 0.1 TO 1K GAUGES, A/B + DIFFERENTIAL I/P INCL PROBES £350
- 10) SOUND LEVEL METER B-K MODEL 2209 £150
- 11) OCTAVE FILTER FOR ABOVE MODEL 1613 £150
- 12) HP 3420 RATIO-METRIC VOLTMEETER P.O.A.
- 13) HP 8764B S PARAMETER TEST SET £2500
- 14) TEKTRONIC 1485 R WAVE FORM MONITOR PAL/ NTSC £2950

**FOR FURTHER INFORMATION
PHONE 0223 68990 (2609)**

Pascall ball-mill with motor driven rollers £50. pH and temperature control electrodes £25 pair. Fluoride-ion electrodes £20. Hydraulically operated steel table on wheels £39. Gearboxes £4.50 ea. Micrometer set 1-2-3-4", three calibrators, cased £35. Compressed hot-air gun, up to 450 C, 50psi, hose & cable £35. Pressure paint-pot, gauge, regulator, valves, immediate whole coat, no stopping to re-fill or polish out £48. 200 A, MIG welding transformer/rectifier £98. MIG wire-feed unit £98 (BOC). Spot welding head. EHT meter. Ignition Analyser £39. Film processor £45. Tek plug-ins £25ea. Sweep generator. Valve tester. General Radio Twin-T, Impedance Measuring Circuit £45. Stabilised PSU's. General Radio Variable Calibrated capacitor, plug-in, type 1607-P3 £25. Vibration Analyser. LCR Bridge. Pys Megohmmeter. Data Logger. Variacs etc. etc. 040-376236. (2615)

SERVICES

SMALL BATCH PCBs, produced from your artwork, also DIALS, PANELS, LAB-ELLS. Camera work undertaken. **FAST TURNAROUND.** Details: Orbi-technic Circuits, 38 Torquay Gardens, Redbridge, Essex. IG4 5PT. Tel: 01-550 3610.

TEST AND REPAIR of p.c.b.'s — Any quantity from one upwards, fast efficient service, analogue or digital, high quality repairs — Low prices. Contact — Mr Fell, Centraltrone Limited, Reading, 0734 697700 ext 296 or Ascot 0990 27357 (2621)

DESIGN AND MANUFACTURE. ANALOGUE, DIGITAL, RF AND MICRO-WAVE CIRCUIT AND SYSTEM DESIGN. Also PCB design, mechanical design and prototype/small batch production. — Adenmore Limited, 27 Longshot Estate, Bracknell, Berks. Tel: Bracknell (0344) 52023. (656)

DESIGN, DEVELOPMENT AND PROTOTYPES. Digital and microprocessor based equipment our speciality. Prototypes and small batch production undertaken to the highest quality and with fast turnaround. For details of our hardware and software services please contact: IB Electronics, 11 Broomshaw Road, Maidstone, Kent. (2611)

ARTICLES FOR SALE

DOLCH LOGIC ANALYZER LAM3250, 50MHz, 48 channel; 32 data, 2 external clocks, 6 clock qualifiers and 8 trigger qualifiers. TTL & ECL thresholds. 5ns Glitch capture. Including 6ALP88 active logic pods. £2,500 Tel: Bordon (04203) 7194. (2582)

HALF PRICE ENCLOSURES

Manufacturers Brand New Surplus and Seconds at almost Half Price. 19" Rack Mounting and smaller Free Standing Enclosures. No damage and only blemishes on the finish at the very worst. Send S.A.E. for List. C. Phillips 'The Laurels' Tiptoe Road, Wootton, New Milton, Hants BH25 5SJ. Mail Order Only. (2592)

QUARTZ CRYSTALS OSCILLATORS AND FILTERS of all types. Large stocks of standard items. Specials supplied to order. Personal and export orders welcomed — SAE for lists please. OEM support thru — design advice, prototype quantities, production schedules. Gollidge Electronics, Merritt, Somerset TA16 5NS. Tel: 0160 73718 (2472)

SHEETMETAL FOLDERS vice or bench model. 24" x 16G £45. Leaflet 01-890 7838 anytime (2558)

WAVEGUIDE, Flanges and dishes. All standard sizes and alloys (new material only) from stock. Special sizes to order. Earth Stations, 01-228 7876, 22 Howie Street, London SW11 4AR. (2099)

The Publishers take all reasonable care to ensure that classified advertisements are genuine, but readers must satisfy themselves that they will be obtaining what they require before entering into transactions, particularly if they involve large sums of money. (2519)

COMPUTER APPRECIATION

16 Walton Street, Oxford OX1 2HQ
Tel: Oxford (0865) 55163 Telex: 838750

TEKTRONIX Model 8540 Integration Unit. Less than 2 years old and AS NEW (MLP £8880)	£3500	PERTEC Model FD514 8" floppy disc drives. AS NEW	£50
INTEL Model MDS 741R 10 Mbyte hard disc (Hawk) for MDS. Without controller	£1500	SHUGART SA400 5 1/4" floppy disc drives	£50
INTEL UNIVERSAL PROM PROGRAMMER FOR MDS. With personality cards for 8748 and 2716 (with adaptor for 2764)	£650	CDC Model MMD (mini Module Drive) type B29 A1B. 160 Mbyte fixed disc drive with SMD INTERFACE. Manufactured in 1983 (MLP £929)	£2500
INTEL ICE 85B in circuit emulator for 8085. Head only	£250	ITT Model 3510 Telefax Facsimile transmitter/receiver Micro processor controlled (8085) CCIT/Group 2 machine for transmitting documents over an ordinary phone line. BRAND NEW & BOXED	£275
UNITRON Model 2200 microcomputer, APPLE 11/e & CP/M compatible machine with 6502 & 280 processors, 64 Kbyte memory, detached keyboard with numeric pad and floppy disc interface. BRAND NEW & BOXED	£250	TEKTRONIX Model 611 graphics storage display. For use with any DAC output	£75
ROCKWELL AIM 65/40 single board 6502 development system with display, keyboard, power supply and cassette recorder	£950	FACIT Model 4020 high speed paper tape reader. Parallel TTL interface	£195
MANNESMANN/TALLY Model M80MC matrix printer, with microprocessor control, 200 cps bidirectional Printing with U/L case, self test. Compact but heavy duty machine. BRAND NEW & BOXED	£95	CALCOMP Model 563 A0 drum plotter. 0.1mm step size	£425
CENTRONICS Model 702 matrix printer, 132 col., 165 cps bidirectional printing with self test. In good ex-demo condition	£95	CALCOMP Model 763 A0 plotter. As above, but high speed	P.O.A.
CENTRONICS Model 150-2 printer, NEW	£325	CALCOMP Model 1036 A0 graph plotter. High speed 3 colour plotter with Type 915 magnetic tape unit for optional off-line use, & selectable for 7/9 track, 800/1600 b.p.i. etc	P.O.A.
DIABLO Hytype II daisy wheel printer (45 cps)	£95	HEWLETT-PACKARD Model 75C portable computer with card reader	£250
OLYMPIA Scripta, Daisy wheel printer with Centronics interface. Two available, both less processor chip and PROM but otherwise complete. The Pair	£120	GENERAL DATACOMM (IAL) Model LDM-1 private line modem	£150
MOTOROLA EXOR disk. Dual 1" floppy disc drives (PERTEC FD 400) for EXORCISER	£400	GENERAL DATACOMM Model TDM 1240 4 line statistical multiplexer as used with above modem. 280 controlled Manufactured 1981	£150
		NEC Model 5510 SPINWRITER, 55 cps daisy-wheel printer with RS232 interface. As new, and sold with tractor unit, manual and complete set of mechanical spares	£490

Please note: * VAT & CARRIAGE extra on all items
* Visitors by appointment, please
* We currently have many items of high quality test equipment in stock

CIRCLE 63 FOR FURTHER DETAILS.

Wireless world

ELECTRONICS &

INDEX TO ADVERTISERS

Appointments Vacant Advertisements appear on pages 94 - 103

PAGE		PAGE	PAGE
AEL Crystals	10	Field Electric Ltd	3
Airlink Transformers Ltd	85	Fluke (GB) Ltd	49
Allweld Engineering	48	Fylde Electrical Laboratories	10
AM Electronics	12		
Arcom Control Systems	64	Gemini Micro Computer	56
Armon Products Ltd	40	GNC Design	85
Aspen Electronics	77		
		Happy Memories	15
Beckenham Peripherals	10	Harris Electronics	40
Black Star Ltd	65	Harrison Electronics	26/78
Bull J	74	Hart Electronics	78
Butterworths	55	Henrys Audio Electronics	15
		HW International	12
Cambridge Kits	65	Henson Ltd (R)	26
Cambridge Microprocessor Systems	9		
Carcal Power Products	14	ILP Electronics	48
Clark Masts Ltd	65	IMS Electronics	12
Combe Martin	78	Interface Quartz Devices	40
Computer Appreciation	26, 85, 104		
Conquin Software	2	J. Bull (Electrical) Ltd	74
Cricklewood Electronics	64		
Crotech Instruments	89	Keithley Instruments Ltd	11
CW Cameron's	16	Kudos Electronic Ltd	84
Cybernetic Application	77		
		Lanco Ltd	20
Dataman Design	68	Langrex Supplies/RST Valves	73
Dewsbury Electronics	4	Levell Electronics	23
Digitask Business Systems	89		
Display Electronics	92/93	Martin Associates (Electrical) Ltd	78
		Measurement Devices Ltd	3
Electronic Brokes	5	Memex (Hitech Computers)	14
Electrovalue Ltd	77	Micro Processor Engineering	9
EMS Mfg Ltd	64		
Erskine Systems	20	Newrad Instrument Cases	20
Essex Electronic Centre	74	Nombrex	24
European Electronics Systems	Back cover	Number One Systems	77
Electronics & Wireless World	24		
		Opus Supplies	19
		Pantechinc	20
		Pinapple Software	11
		PM Components	30/31
		Powertran Cybernetics Ltd	23
		Pye Unican	Inside front cover
		Radford Electronics	20
		Radiocode Clocks Ltd	3
		Radio Components Specialists	12
		Research Communications	26
		Richardson Electronics	84
		Ralfe Electronics (PF)	2
		Seal Electronics	13
		Sherwood Data Systems	4
		Soft Life	55
		Souter E.A.	95
		Stewart of Reading	9
		Strumech Engineering Ltd	15
		Surrey Electronics Ltd	40
		Tape Automation	85
		Taylor Bros (Oldham) Ltd	13
		Technomatic	82/83
		Tektronic's (UK) Ltd	Inside back cover
		Thame Components	14
		Thonet Electronics Ltd	74
		Thurby Electronics	88
		TIC Semiconductor	65
		Time Electronics	10
		Triangle Digital Service	48
		Warwick Design Group	84
		Waugh Instruments	13
		Valradio Power Ltd	11

OVERSEAS ADVERTISEMENT AGENTS

France and Belgium: Pierre Mussard, 18 - 20 Place de la Madeleine, Paris 75008.

Hungary: Ms Edit, Bajusz, Hungexpo Advertising Agency, Budapest XIV, Varosliget.
Telephone: 225 008 - Telex: Budapest 22-4525
INTFOIRE

Italy: Sig C. Epis, Etas-Kompass, S.p.a. - Servizio Estero, Via Mantegna 6, 20154 Milan.
Telephone: 347051 - Telex: 37342 Kompass.

Japan: Mr Inatsuki, Trade Media - IBPA (Japan), B.212. Azabu Heights, 1-5-10 Roppongi, Minato-ku 106.
Telephone: (03) 585 0581.

United States of America: Jay Feinnan, Business Press International Ltd, 205 East 42nd Street, New York, NY 10017 -
Telephone (212) 867-2080 - Telex: 23827.
Jack Farley Jr., The Farley Coi, Suite 1584, 35 East Walker Drive, Chicago, Illinois 60601 - Telephone (312) 63074.
Victor A. Jauch, Elmatex International, P.O. Box 34607, Los Angeles, Calif. 90034, USA - Telephone (213) 821-8581 -
Telex: 18-1059.

Jack Mantel, The Farley Co., Suite 650, Ranna Building, Cleveland, Ohio 4415 - Telephone (216) 621 1919.
Ray Rickles, Ray Rickles & Co., P.O. Box 2028, Miami Beach, Florida 33140 - Telephone (305) 532 7301.
Tim Parks, Ray Rickles & Co., 3116 Maple Drive N.E., Atlanta, Georgia 30305. Telephone (404) 237 7432.
Mike Loughlin Business Press International, 15055, memorial Ste 119, Houston, Texas - Telephone (713) 783 8673.

Canada: Colin H. MacCulloch, International Advertising Consultants Ltd., 915 Carlton Tower, 2 Carlton Street, Toronto 2 -
Telephone (416) 364 2269.
*Also subscription agents.

Printed in Great Britain by Index Printers Ltd., Oldhill, Dunstable, and typeset by Legendary Characters, South Street, Lancing, for the proprietors. Business Press International, Quadrant House, The Quadrant, Sutton, Surrey SM2 5AS. © Business Press International 1984. Wireless World can be obtained abroad from the following: AUSTRALIA and NEW ZEALAND: Gordon & Gotch Ltd. INDIA: A. H. Wheeler & Co. CANADA: The Wm. Dawson Subscription Service Ltd., Gordon & Gotch Ltd. SOUTH AFRICA: Central News Agency Ltd. William Dawson & Sons (S.A.) Ltd. UNITED STATES: Eastern News Distribution Inc., 14th Floor, 111 Eighth Avenue, New York, N.Y. 10011.

**Now! Tek quality
and expert advice
are just a free
phone call away...**



Our National Order Desk line gets you fast delivery of the industry's leading value/performance portables... and technical advice from experts!

The 60MHz 2213A, 2215A and the 100MHz 2235 and 2236 offer unprecedented reliability and affordability, plus the industry's first 3 year warranty on labour and parts, CRT included.

All 2200 series scopes have the bandwidth for digital circuits and sensitivity for low signal analogue measurement. The sweep speeds for fast logic families, and delayed sweep for fast, accurate timing measurement. The top of the range 2236 combines a counter/timer/DMM with the scope to provide fast, easy measurements for voltage, resistance and temperature.

These UK manufactured scopes are obtainable through the National Order Desk. Call us to order or obtain literature, or to talk to our expert on scope applications.



**...talk
to Pete**

**Dial 100 and ask for
Freefone Tek-scope**

Tektronix UK Ltd
Fourth Avenue, Globe Park,
Marlow, Bucks SL7 1YD
Tel: (06284) 6000
Telex: 847277 & 847378

The Company reserves the right to modify designs, specifications and change prices without notice.

CIRCLE 2 FOR FURTHER INFORMATION

Tektronix
COMMITTED TO EXCELLENCE

Spot On!

Time has been our business since 1974.
Precision has been our aim.
We have experience in display,
code generation, off air time,
off air frequency and
frequency standards.
Single units to the largest system.

Our time is at your disposal.



**European Electronic
Systems Limited,**
Woocham Mortimer Place,
Maldon, Essex. CM9 6SW.
Telephone: 024541-5911.
Telex: 995917

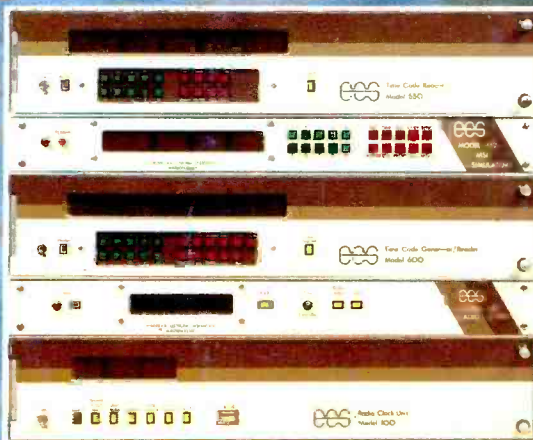

Time Code Reader.

MSF Rugby Simulator.

Tape Search System.

Radio Clock (5 mSec)

Radio Clock (500 μ Sec)