

## *Antygomonas oreas* sp.n., a new deep sea kinorhynch from the Pacific Ocean

(Kinorhyncha: Cyclorhagida)

M. Bauer-Nebelsick\*

### Abstract

A new species of *Antygomonas* NEBELSICK, 1990 (Kinorhyncha: Cyclorhagida) is described by means of light and scanning electron microscopical techniques from Fieberling Guyot in the Pacific Ocean. *Antygomonas* is characterized by following features: introvert with 7 rings of scalids (from anterior to posterior 10, 10, 10, 15, 15, 15, 14); neck with 16 placids and 32 interstitial placids; midventral placid is the widest; 1st trunk zonite as a complete ring; 2nd to 11th trunk zonite with midventral articulation; 11th trunk zonite additionally with incomplete lateral articulations; lateral acicular and cuspidate spines; mid-dorsal spines; lateral terminal spine shorter than lateral terminal accessory spine; midterminal spine; sensory spots and modified sensory spots; oral styles with 3 elements. *Antygomonas oreas* sp.n. is distinguished from *Antygomonas incomitata* NEBELSICK, 1990, by the number and arrangement of the lateral and mid-dorsal spines, sensory spots, and modified sensory spots.

**Key words:** Kinorhyncha, Cyclorhagida, *Antygomonas*, new species, deep sea, Pacific.

### Zusammenfassung

Eine neue Art von *Antygomonas* NEBELSICK, 1990 (Kinorhyncha: Cyclorhagida) aus der Tiefsee des Pazifiks (Fieberling Guyot) wird mit Hilfe von licht- und rasterelektronenmikroskopischen Techniken beschrieben. Die Gattung *Antygomonas* wird durch folgende Merkmale charakterisiert: Introvert mit sieben Skalidringen (von anterior nach posterior 10, 10, 10, 15, 15, 15, 14); Hals mit 16 Plakiden und 32 interstitiellen Plakiden; zweites bis elftes Rumpfzonit mit mittventraler Artikulation; elftes Rumpfzonit zusätzlich mit unvollständigen, lateralen Artikulationen; laterale "acicular" und "cuspidate" Stacheln, mittdorsale Stacheln, lateraler terminaler Stachel, lateraler terminaler akzessorischer Stachel und mitterterminaler Stachel; "sensory spots" und "modified sensory spots"; Oralstyli aus drei Elementen bestehend. *Antygomonas oreas* sp.n. unterscheidet sich von *Antygomonas incomitata* NEBELSICK, 1990, durch die Anzahl und Verteilung der lateralen und mittdorsalen Stachel, der "sensory spots" und "modified sensory spots".

### Introduction

Only a few Kinorhyncha have been reported from the Pacific shores of America. *Pycnophyes sanjuanensis* HIGGINS, 1961, *Kinorhynchus cataphractus* (HIGGINS, 1961), and *K. ilyocryptus* (HIGGINS, 1961) are described from the San Juan Islands (Washington, USA) of North America (HIGGINS 1961a). *Pycnophyes chilensis* LANG, 1953, and *K. anomalus* (LANG, 1953) and an unidentified cyclorhagid have been found in the Gulf of Ancud (Chile) (LANG 1953), and *Cateria styx* GERLACH, 1956, has been

\* Monika Bauer-Nebelsick, Institut für Zoologie, Universität Wien, Althanstraße 14, A-1090 Vienna, Austria.

reported from the Cachagua Beach and Renaca Beach, north of Valparaiso (Chile) of South America (see BROWN & HIGGINS 1983). *Echinoderes pacificus* SCHMIDT, 1974, and an unidentified Semnoderidae have been found in shallow waters of Galapagos (SCHMIDT 1974).

The new species is found in the deep sea of the Pacific Ocean of North America while *Antygomonas incommitata* NEBELSICK, 1990, inhabits shallow subtidal sands of the Mediterranean Sea (NEBELSICK 1990). Both species of the genus *Antygomonas* NEBELSICK, 1990, live interstitially in sandy habitats.

The description of the new representative is carried out by means of light and scanning electron microscopy. Additionally, introvert and mouth cone appendages are studied for the first time in this genus. The finding of this second species allows a reconsideration of the genus diagnosis.

#### Acknowledgements

I would like to thank Prof. Dr. L.A. Levin and Prof. Dr. H. Felbeck for providing the material. Dr. Safar from the Naturhistorisches Museum Wien was extremely helpful with Russian translations. I am especially grateful to Prof. Dr. J.A. Ott and Prof. Dr. W. Klepal (Universität Wien) for providing all equipment and material necessary for such a study. I also would like to thank Dr. B. Neuhaus for correcting the manuscript and for his valuable comments and suggestions.

#### Abbreviations used in figures

b	cuticular bristles	mva	midventral articulation
d	mid-dorsal spine (followed by trunk zonite number)	ne	neck
f	fringe	o	oral style
go	gonopore	p	pharyngeal style (followed by ring number)
i	introvert	pa	pachycyclus
ip	interstitial placid	pb	pharyngeal bulb
la	lateral acicular spine (followed by trunk zonite number)	pf	pectinate fringe
lc	lateral cuspidate spine (followed by trunk zonite number)	pl	placid
ltas	lateral terminal accessory spine	r	cuticular ribs
lts	lateral terminal spine	s1	spinoscalid type 1
mc	mouth cone	s2	spinoscalid type 2
mo	mouth opening	ssp	sensory spot
mssp	modified sensory spot	t	trunk
mts	midterminal spine	te	testis
		ts	trichoscalid
		z	trunk zonite (followed by number)

#### Material and methods

Sediment samples were collected by the submersible Alvin with an Ekman-style box corer (area 15 x 15 or 16.2 x 16.2 cm) at the summit plain of Fieberling Guyot in about 500 to 700 m depth, a seamount in the Pacific Ocean, during three cruises in October 1990, December 1990, and June 1991 (Fig. 1; see LEVIN & al. 1994 for detailed description). Two different locations were chosen: White Sand Swale (WSS) with moderately sorted, calcareous sand (32° 27.581' N, 127° 47.839' W) and Sea Pen Rim (SPR) with

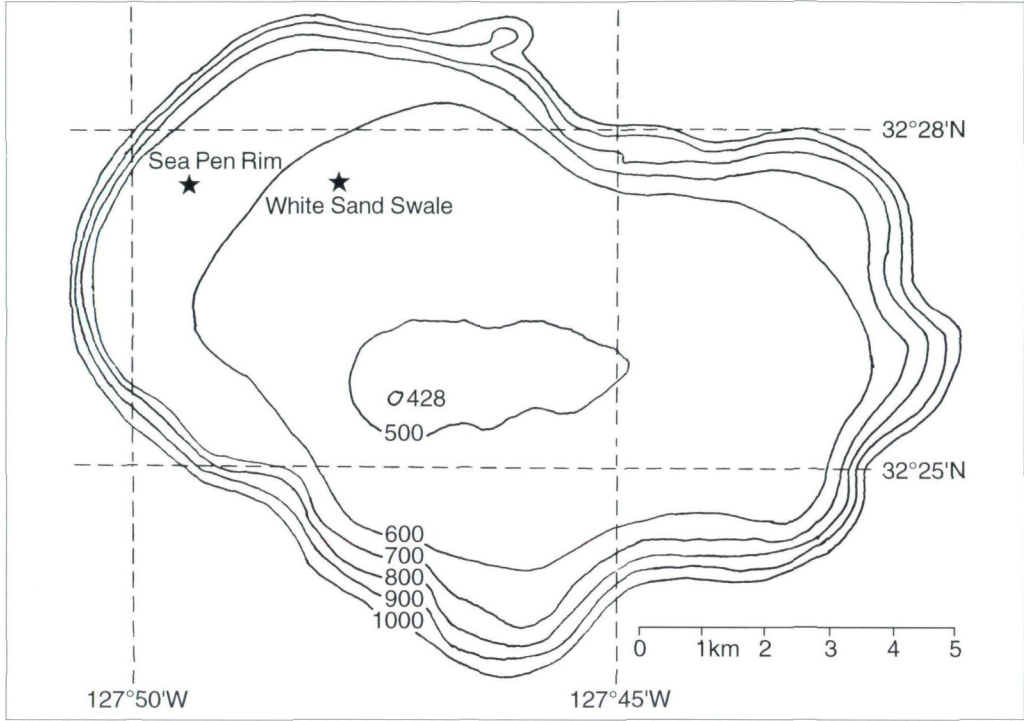

Fig. 1: Geographical map showing type locality at Fieberling Guyot; depth in meters (after LEVIN & al. 1994).

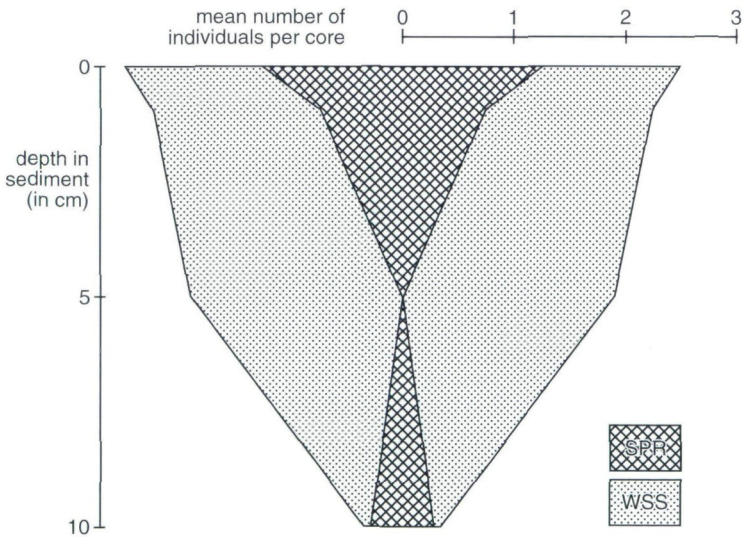

Fig. 2: Depth distribution (mean number of individuals per core) of *Antygomonas oreas* sp.n. from White Sand Swale (WSS) and Sea Pen Rim (SPR).

poorly sorted, basaltic sand (32° 27.631' N, 127° 49.489' W). Core samples were subdivided vertically into 0 - 1, 1 - 2, 2 - 5, 5 - 10 cm depth fractions, fixed and stored in 10 % buffered formalin. Later the sediment was sieved, sorted, and transferred into 70 % ethanol. In this condition the material (of 6 cores taken at WSS and 2 cores taken at SPR) was sent to the author.

For light microscopy (LM), whole mounts in polyvinylalcohol (Figs. 6 - 9; 26 - 29) and glycerin (Figs. 24, 25) were made of the entire material except for 12 specimens kept for SEM. Drawings and measurements were made with a camera lucida and a scaled eyepiece on a Leitz Diaplan. Photographs were taken with Nomarski interference contrast on a Reichert Polyvar.

For scanning electron microscopy (SEM; Figs. 10 - 13, 18 - 23), 12 adult specimens from both locations were hydrated in a series of ethanol, postfixed in 2 % osmium tetroxide in 0.1 M cacodylate buffer at pH 7.4 for two hours, rinsed in the same buffer, dehydrated in a series of ethanol, critical point dried, coated with gold, and examined in a JEOL JSM - 35 CF.

### *Antygomonas* NEBELSICK, 1990

**Included species:** *Antygomonas incomitata* NEBELSICK, 1990; *Antygomonas oreas* sp.n.

**Diagnosis:** Introvert with 7 rings of scalids (from anterior to posterior 10, 10, 10, 15, 15, 15, 14); neck with 16 placids and 32 interstitial placids, midventral placid is the widest; 1st trunk zonite as a complete ring; 2nd to 11th trunk zonite with midventral articulation; 11th trunk zonite additionally with incomplete lateral articulations; lateral acicular and cuspidate spines; middorsal spines; lateral terminal spine shorter than lateral terminal accessory spine; midterminal spine; sensory spots and modified sensory spots; oral styles with 3 elements.

### *Antygomonas incomitata* NEBELSICK, 1990

**Diagnosis:** Lateral acicular spines on trunk zonites 2 - 10; lateral cuspidate spines on trunk zonites 2, 5, 6, 8, 9; on the 8th zonite one acicular spine between two cuspidate spines, on the 9th zonite cuspidate spine only on one side; middorsal spines on trunk zonites 1 - 9, two middorsal spines, one after the other, on 11th trunk zonite; paired sensory spots ventrally on the trunk zonites 1, 3, 4, 6, 7, single sensory spot ventrally on one side of the 10th trunk zonite, dorsolaterally on the trunk zonites 1 - 4, and dorsally on the trunk zonites 1 - 9, single sensory spot ventrally on one side of the 10th trunk zonite; 4 pairs of modified sensory spots on the 11 trunk zonite, adjacent each middorsal spines d11/1, d11/2, midterminal spine, and lateral terminal spine; subdorsal sculpture present on 10th trunk zonite.

### *Antygomonas oreas* sp.n.

(Tab. 1, 2; Figs. 1 - 29)

**Material examined.** Holotype, adult male (Vertebrata Varia Collection, Naturhistorisches Museum Wien no. 3444, Figs. 14, 15); allotype, adult female (no. 3445, Figs. 16, 17, 26); 4 paratypes, adult males (no.

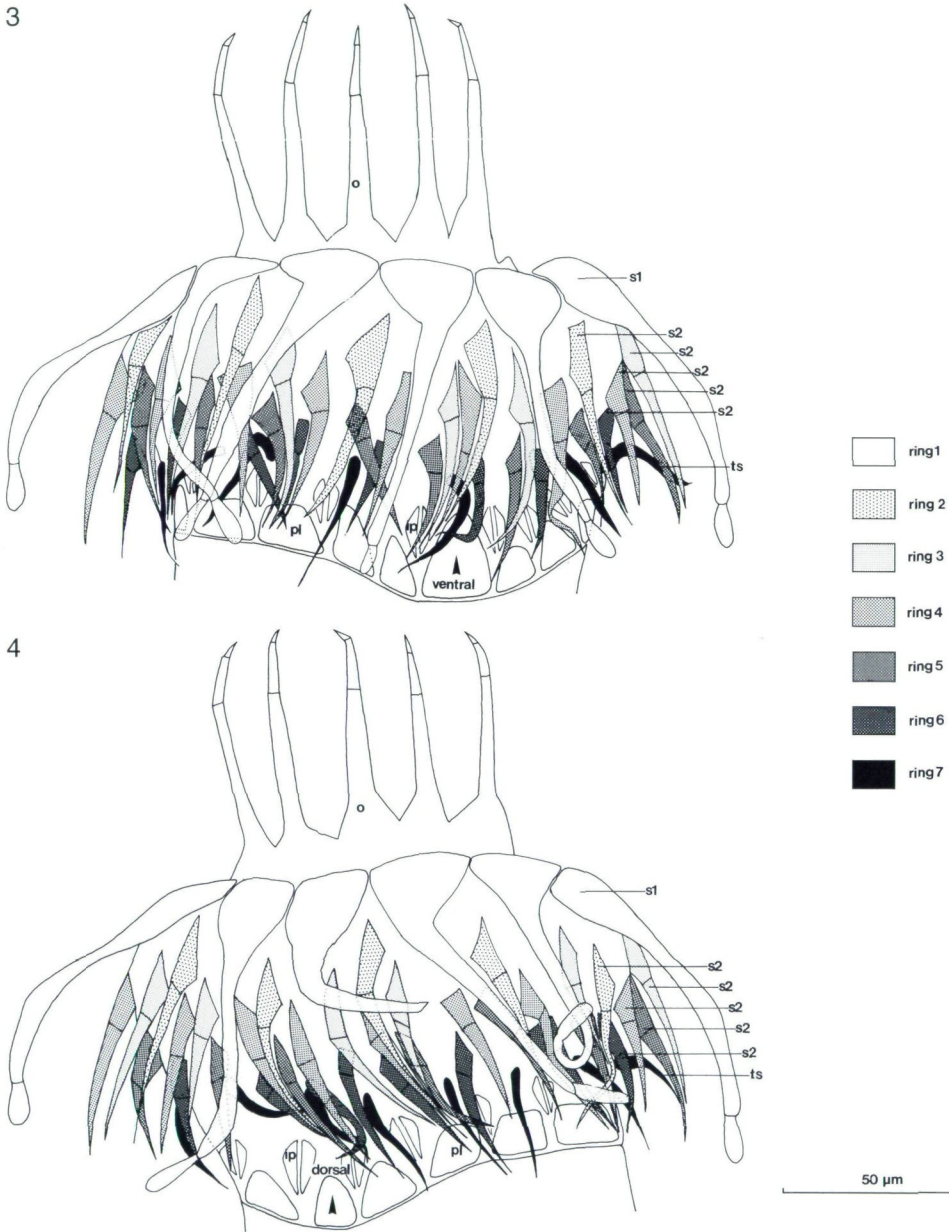

Figs. 3 - 4: *Antygomonas oreas* sp.n. Camera lucida drawing of introvert, mouth cone, and neck of paratyptic female. (3) Ventral view. (4) Dorsal view.

3446 - 3449), and 3 paratypes, adult females (no. 3450 - 3452, Figs. 3, 4, 6, 7, 9); about 50 additional specimens are in the author's collection (Figs. 8, 24, 25, 27 - 29); 12 adult specimens for SEM studies (Figs. 10 - 13, 18 - 23).

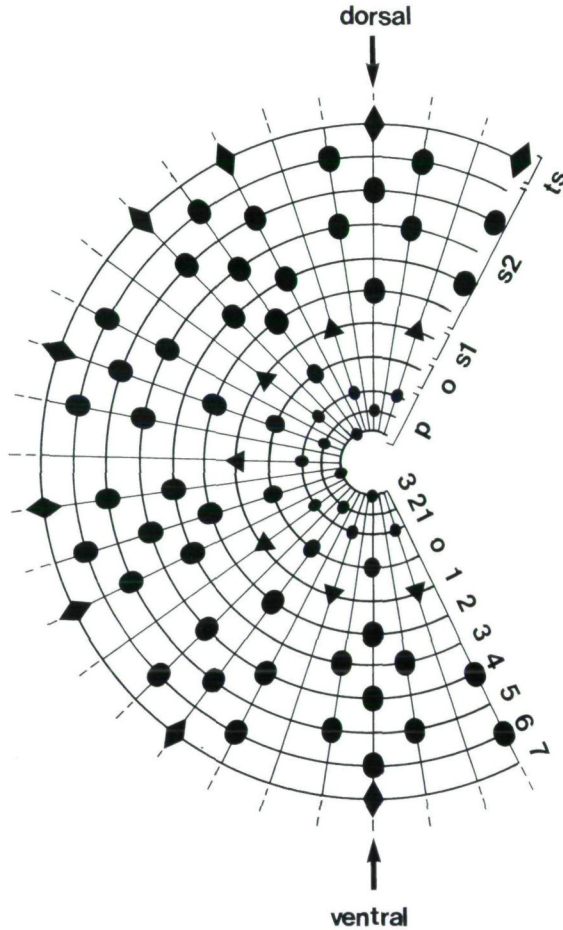

Fig. 5: *Antygomonas oreas* sp.n. Schematic diagram (after HIGGINS 1990) of number and arrangement of scalids, oral styles, and pharyngeal styles.

**Type Locality.** Fieberling Guyot, White Sand Swale (32° 27.581' N, 127° 47.839' W), Pacific Ocean; Oct. 7 - 27 1990, Dec. 2 -19 1990, and June 20 - 27 1991; coll. Lisa A. Levin (Figs. 1, 2).

**Etymology.** From Latin *oreas* meaning mountain-nymph, for the location site at an underwater seamount.

**Diagnosis:** Lateral acicular spines on trunk zonites 2 - 10; lateral cuspidate spines on trunk zonites 2, 5, 6, 8, 9; only about 50 % of the specimens exhibit a cuspidate spine on 6th trunk zonite; middorsal spines on trunk zonites 1 - 11; paired sensory spots ventrally on the trunk zonites 1, 6, 8, dorsolaterally on the trunk zonites 1, 9, and dorsally on the trunk zonites 1 - 9; 3 pairs of modified sensory spots on the 11th trunk zonite, adjacent to the middorsal spine d11, midterminal spine, and lateral terminal spine.



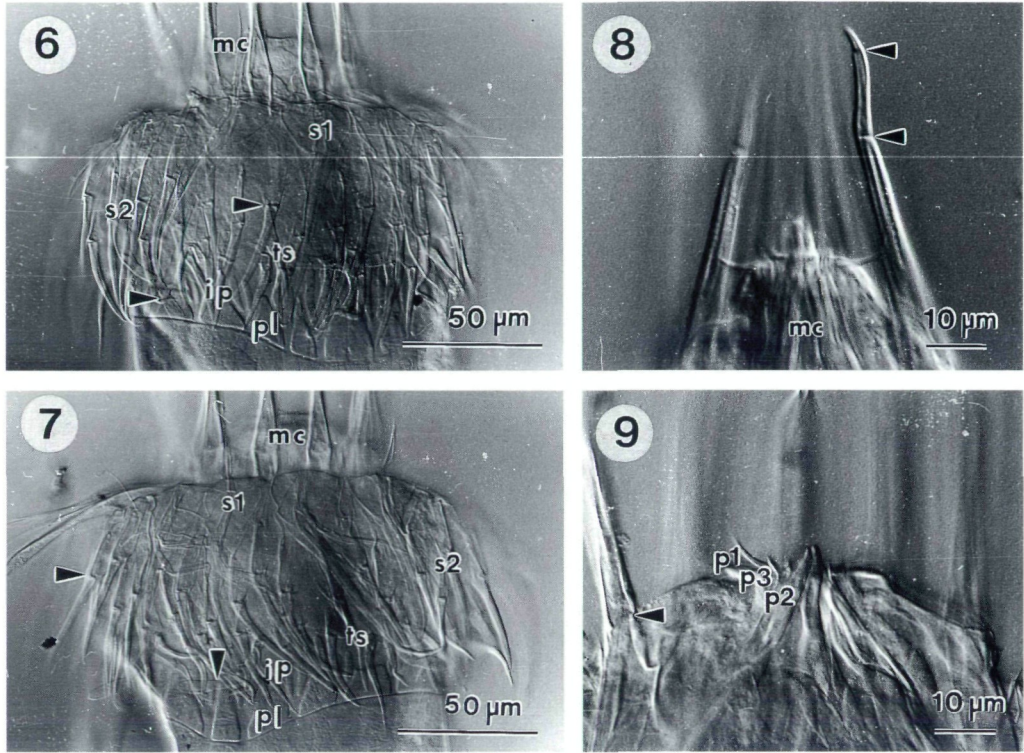

Figs. 6 - 9: *Antygomonas oreas* sp.n. Light microscopical photographs with interference contrast of whole mounts. (6) Ventral view of introvert, mouth cone and neck; note spinoscalids with articulations (arrowheads). (7) Dorsal view of introvert, mouth cone and neck; note spinoscalids with articulations (arrowheads). (8) Mouth cone; note oral styles with articulations (arrowheads). (9) Mouth cone, note oral styles with articulations (arrowhead).

### Description:

**Introvert (i).** The eversible introvert bears 89 scalids, arranged in 7 rings, from anterior to posterior 10, 10, 10, 15, 15, 15, 14 scalids per ring. The first anteriormost ring consists of s1 spinoscalids, the second to the sixth ring of s2 spinoscalids, and the seventh ring of trichoscalids (Figs. 3 - 7, 10, 11). Both types of spinoscalids arise as elevation of the head cuticle characterized by a pectinate fringe (Fig. 12). They are divided by a distinct articulation which is simple in s1 and provided with a second pectinate fringe in s2. Additionally, an oval field of cuticular hooks and bristles lies on the basal part of the latter, while this area is smooth in the former. S1 end with a round tip; s2 end with a sharp tip giving the scalid a scythe-like appearance especially distinct in light microscope. The trichoscalids lack distinct articulation. They are covered with cuticular bristles (Figs. 6, 7, 12).

**Neck (ne).** The neck is composed of 16 placids and 32 interstitial placids with two of the latter placed between the former. This closing apparatus is bilaterally symmetric



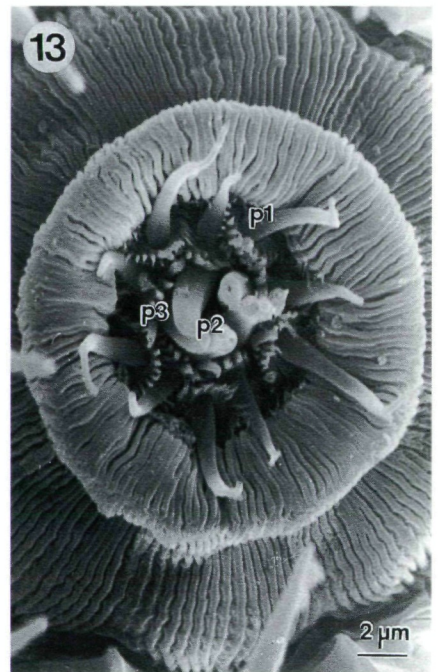
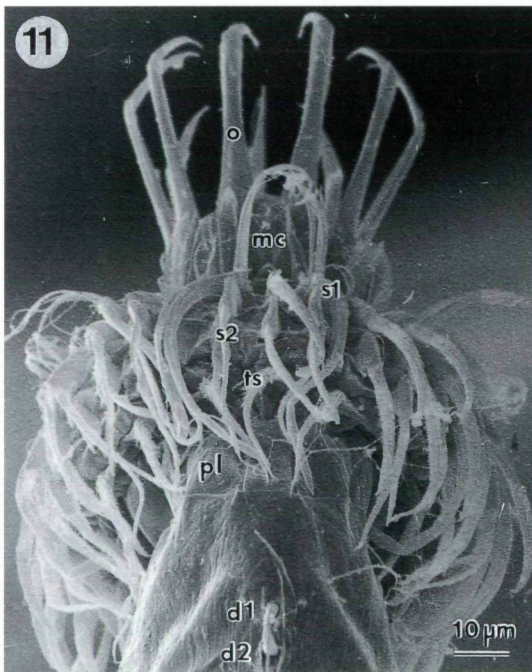
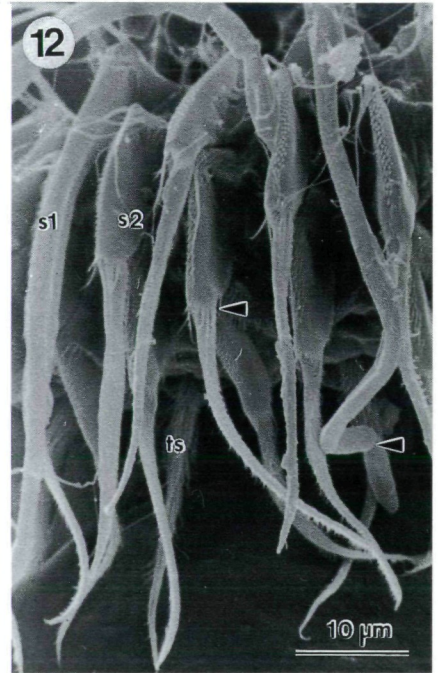
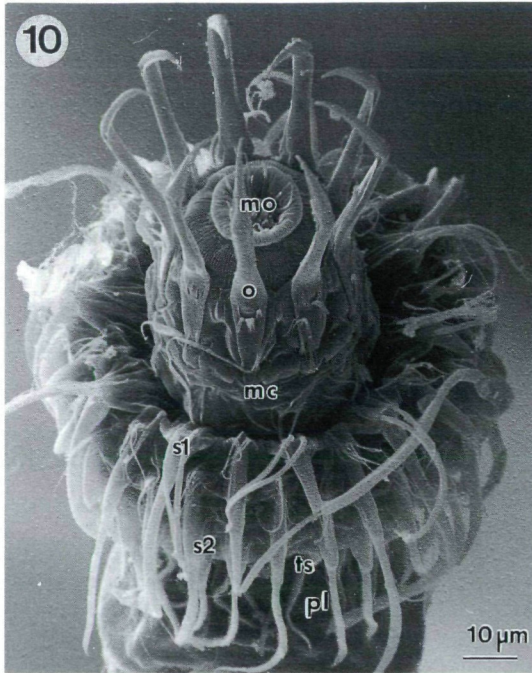

Figs. 10 - 13: *Antygomonas oreas* sp.n. Scanning electron microscopical photographs. (10) Ventral view of introvert, mouth cone and neck. (11) Dorsal view of introvert, mouth cone and neck. (12) Type 1 and type 2 spinoscalids with articulations (arrowheads) and trichoscalids. (13) Type 1 to 3 pharyngeal styles.



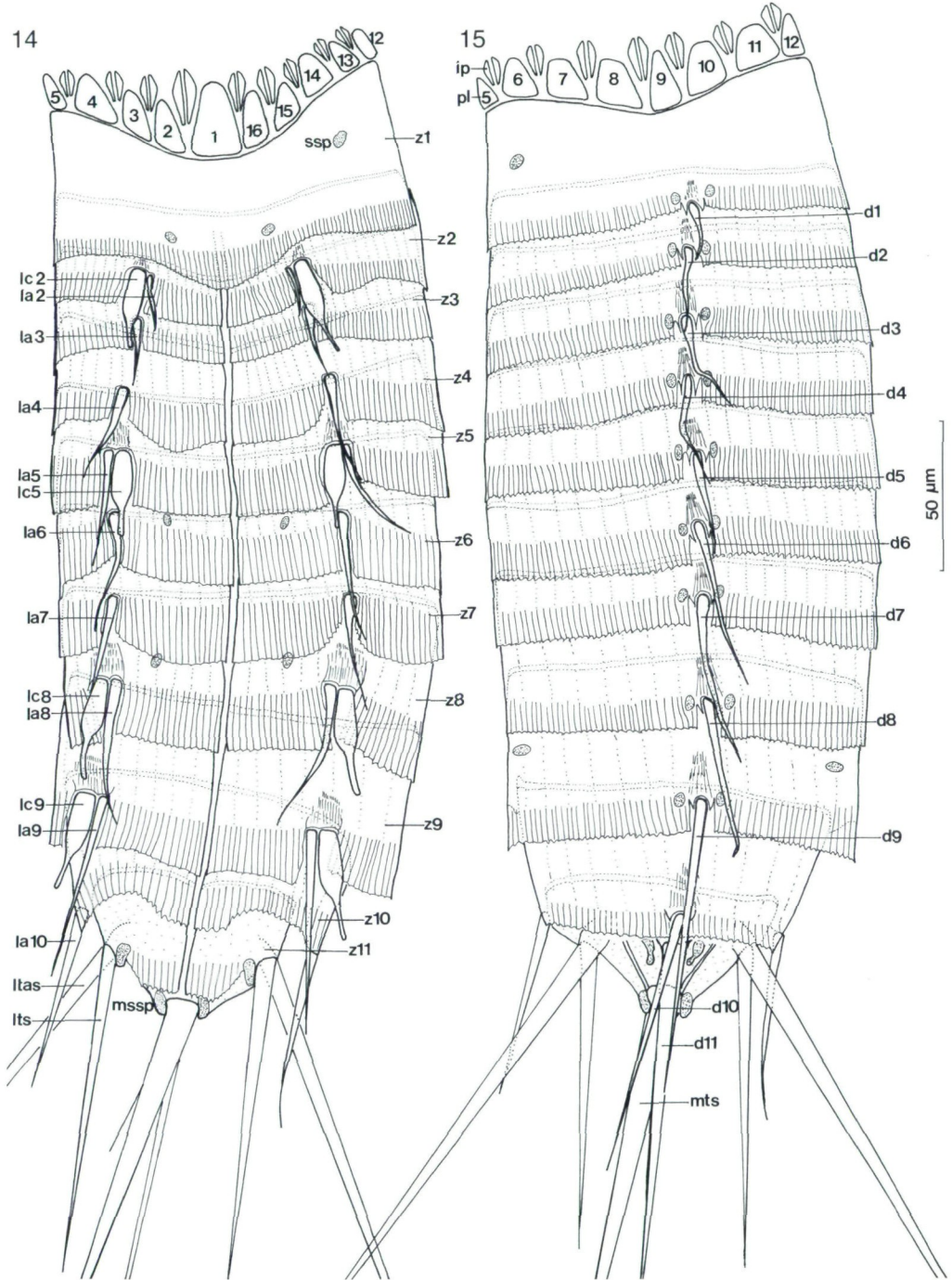

Figs. 14 - 15: *Antygomonas oreas* sp.n. Camera lucida drawing. (14) Holotypic male, ventral view (no. 3444) (introvert and mouth cone are not drawn). (15) Holotypic male, dorsal view (no. 3444) (introvert and mouth cone are not drawn).

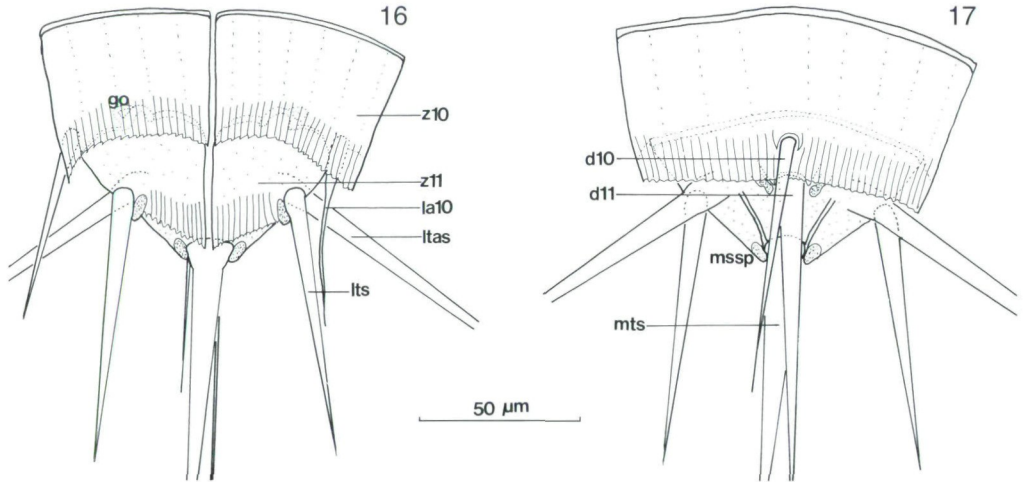

Figs. 16 -17: *Antygomonas oreas* sp.n. Camera lucida drawing. (16) Allotypic female, ventral view of tenth and eleventh trunk zonite (no. 3445). (17) Allotypic female, dorsal view of tenth and eleventh trunk zonite (no. 3445).

(Figs. 3, 4, 14, 15). The widest midventral placid (Fig. 6) and the middorsal placid (Fig. 7) are unpaired, all others are paired. The distal parts of the placids and the interstitial placids are thinner and end almost indistinctly from the neck cuticle while the proximal parts are thicker and clearly separated from the first trunk zonite (Figs. 6, 7).

**Trunk (first to eleventh trunk zonite, z).** The trunk is divided longitudinally into eleven zonites (Figs. 14, 15, 18, 19). The first anteriormost zonite is a ring; the second to the tenth zonite have midventral articulation; the eleventh terminal zonite additionally has lateral articulations. They appear incomplete reaching only from the lateral terminal accessory spines to the posterior end (Fig. 14 - 17, 23, 29). Each zonite, except for the first, has a simple cuticular thickening extending into the interior of the animal (pachycyclus) on its anterior end (Fig. 25). The posterior border ends in a short pectinate fringe only interrupted by the midventral articulation and the spines (Figs. 20, 23, 29). A long pectinate fringe is only developed ventrally in the eleventh zonite (Fig. 23, 27, 29). The surface of the trunk is characteristically sculptured: the anterior part of each zonite except for the first and the eleventh, has longitudinal rows of cuticular bristles; the posterior part has longitudinal ribs which appear as long pectinate fringe in light microscope (Figs. 20, 26 - 29). The first trunk zonite lacks the cuticular bristles and is smooth in this anterior area. The eleventh trunk zonite is irregularly covered with bristles; the longitudinal ribs are only developed ventrally (Figs. 23, 26 - 29).

**Lateral spines (la, lc).** A species-specific, bilateral symmetric pattern of hirsute, acicular and cuspidate spines is present on each ventrolateral side of the trunk (Figs. 14, 15). Acicular spines occur from the second to the tenth zonite; cuspidate spines occur on the second, fifth, eighth, ninth, and in about 50 % of the specimens additionally on the sixth zonite. The holotype (no. 3444) and the paratypes no. 3447 and 3449 exhibit the cuspidate spine on the 6th zonite; the allotype (no. 3445; Fig. 14) and the paratypes no. 3446, 3450 - 3452 lack this spine. The paratype no. 3448 shows the cuspidate spine only on

Tab. 1. *Antygomonas oreas* sp.n. Mean ( $\bar{x}$ ) and standard deviation (d) of length measurements (in  $\mu\text{m}$ ) of various morphological characters of the type material (four females and five males). The total length is measured ventrally from the beginning of the first trunk zonite to the end of the terminal trunk zonite.

character	total (n = 9)		females (n = 4)		males (n = 5)	
	$\bar{x}$	d	$\bar{x}$	d	$\bar{x}$	d
total length	254.1	18.3	256.5	17.0	252.2	19.1
z1 length	52.3	5.5	55.4	2.1	49.9	6.1
z2 length	37.1	2.6	36.8	2.3	37.3	2.7
z3 length	40.9	5.6	38.1	2.3	43.1	6.4
z4 length	42.0	3.6	40.1	2.5	43.4	3.7
z5 length	45.3	3.1	45.0	1.0	45.5	4.1
z6 length	49.1	1.5	48.1	0.4	49.9	1.7
z7 length	50.7	2.6	50.7	1.1	50.6	3.4
z8 length	53.0	4.5	53.4	3.4	52.7	5.2
z9 length	56.2	4.2	56.7	3.8	55.8	4.5
z10 length	50.4	4.9	49.6	4.0	51.0	5.5
z11 length	34.4	3.5	34.5	4.9	34.3	1.7
z1 width	117.2	6.0	120.9	4.7	114.2	3.4
z2 width	103.2	6.0	120.1	2.7	99.8	3.3
z3 width	107.2	7.5	123.1	2.7	99.8	3.4
z4 width	109.9	8.0	128.4	7.5	117.9	6.0
z5 width	125.4	8.0	131.3	7.5	120.1	7.5
z6 width	128.4	10.7	137.3	9.7	120.1	7.4
z7 width	126.9	13.4	134.3	15.4	120.1	7.4
z8 width	122.4	14.2	130.6	10.7	115.7	10.7
z9 width	115.7	9.4	123.8	6.7	109.7	7.4
z10 width	100.0	7.4	100.5	4.7	100.8	7.5
z11 width	77.6	7.5	83.6	3.4	73.1	6.7
la2	17.2	1.9	16.2	1.6	18.1	1.8
la3	29.2	3.8	21.3	12.8	30.0	3.2
la4	34.8	2.4	33.8	3.2	35.7	1.0
la5	38.6	3.3	37.9	3.3	39.1	3.3
la6	42.1	4.9	41.6	3.7	42.5	5.6
la7	43.6	4.2	43.1	3.7	46.1	5.1
la8	50.8	2.8	48.9	2.0	52.4	2.3
la9	63.7	4.6	61.8	4.8	65.7	2.5
la10	60.9	3.4	60.6	2.9	61.2	3.7
lc2	29.9	3.9	29.5	1.9	30.3	4.9
lc5	31.0	2.3	32.3	1.7	30.8	3.0
lc6	33.0	1.1	32.1	0.0	34.3	0.0
lc8	33.9	2.9	33.2	2.7	35.3	2.6
lc9	34.3	2.4	33.2	2.1	35.8	1.6
lts	107.7	6.1	106.9	3.1	108.4	7.6
ltas	168.4	13.0	170.9	13.6	166.4	12.2
d1	22.9	3.8	20.2	2.7	25.6	0.1
d2	30.6	4.0	30.1	5.8	31.0	1.7
d3	36.8	3.8	37.3	2.4	36.4	4.6
d4	41.9	2.6	40.5	2.5	42.9	2.2
d5	44.5	5.9	49.1	2.4	43.7	6.6
d6	51.6	5.3	51.9	6.4	50.0	3.6
d7	56.3	3.4	56.0	2.2	59.1	3.9
d8	57.6	6.1	55.8	6.5	60.1	4.0
d9	76.1	9.5	73.7	4.8	72.3	13.6
d10	82.8	4.4	80.6	4.0	85.7	2.9
d11	197.7	18.3	206.9	15.7	185.3	13.7
mts	472.8	41.9	485.1	46.0	456.5	28.3



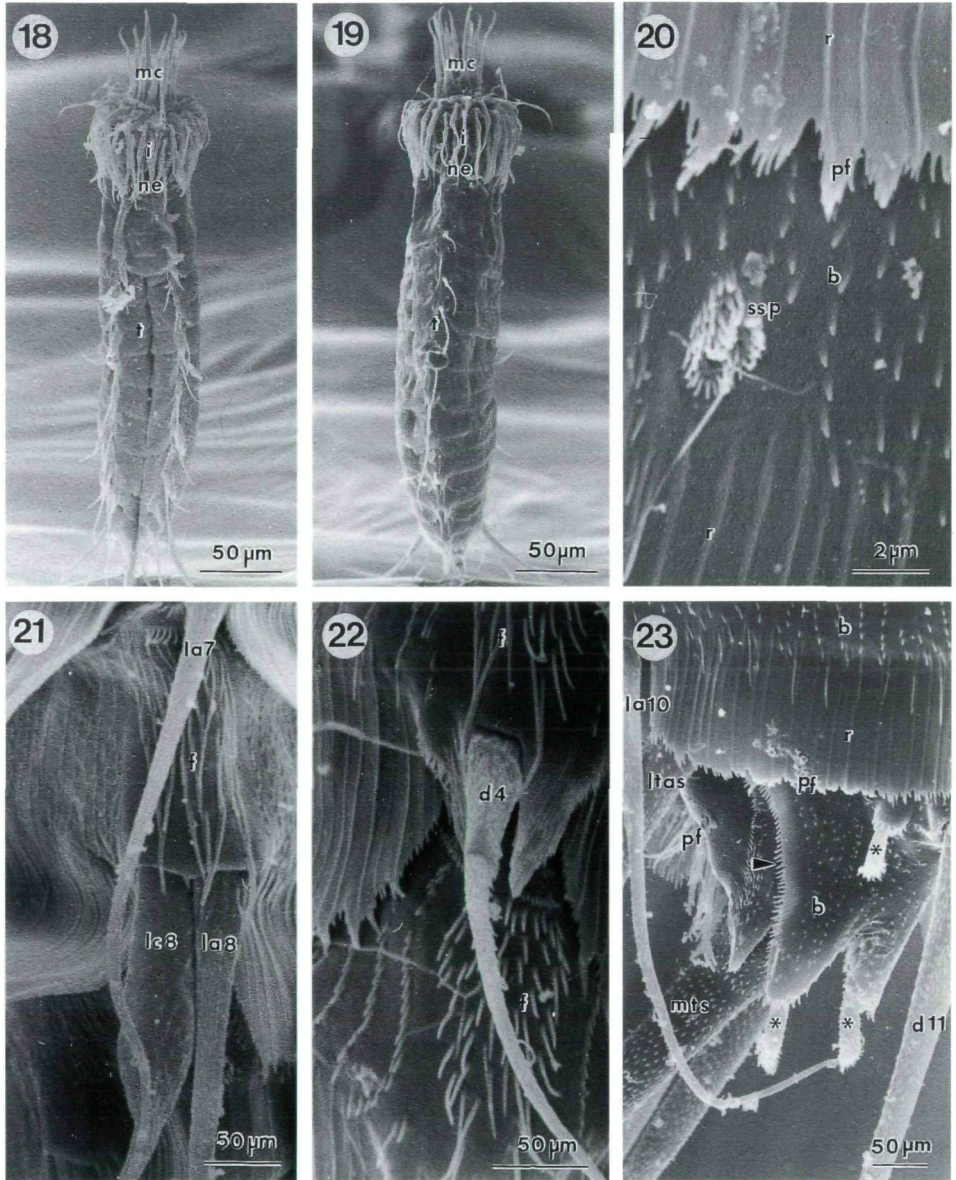

Figs. 18 - 23: *Antygomonas oreas* sp.n. Scanning electron microscopical photographs. (18) Total ventral view of specimen with body subdivision into mouth cone, introvert, neck, and trunk. (19) Total dorsal view of specimen with body subdivision into mouth cone, introvert, neck, and trunk. (20) Detail of seventh and eighth trunk zonite with pectinate fringe, cuticular ribs, cuticular bristles, and sensory spot. (21) Lateral acicular spine of seventh trunk zonite and lateral acicular spine and cuspidate spine of eighth trunk zonite with fringe. (22) Middorsal spine of fourth trunk zonite with fringe. (23) Lateral view of posterior end with lateral acicular spine, cuticular bristles, cuticular ribs, and pectinate fringe of tenth trunk zonite and middorsal spine, midterminal spine, lateral terminal accessory spine, cuticular bristles, and pectinate fringe of eleventh trunk zonite; arrowhead points to lateral articulation of eleventh trunk zonite; asterisks point to modified sensory spots.



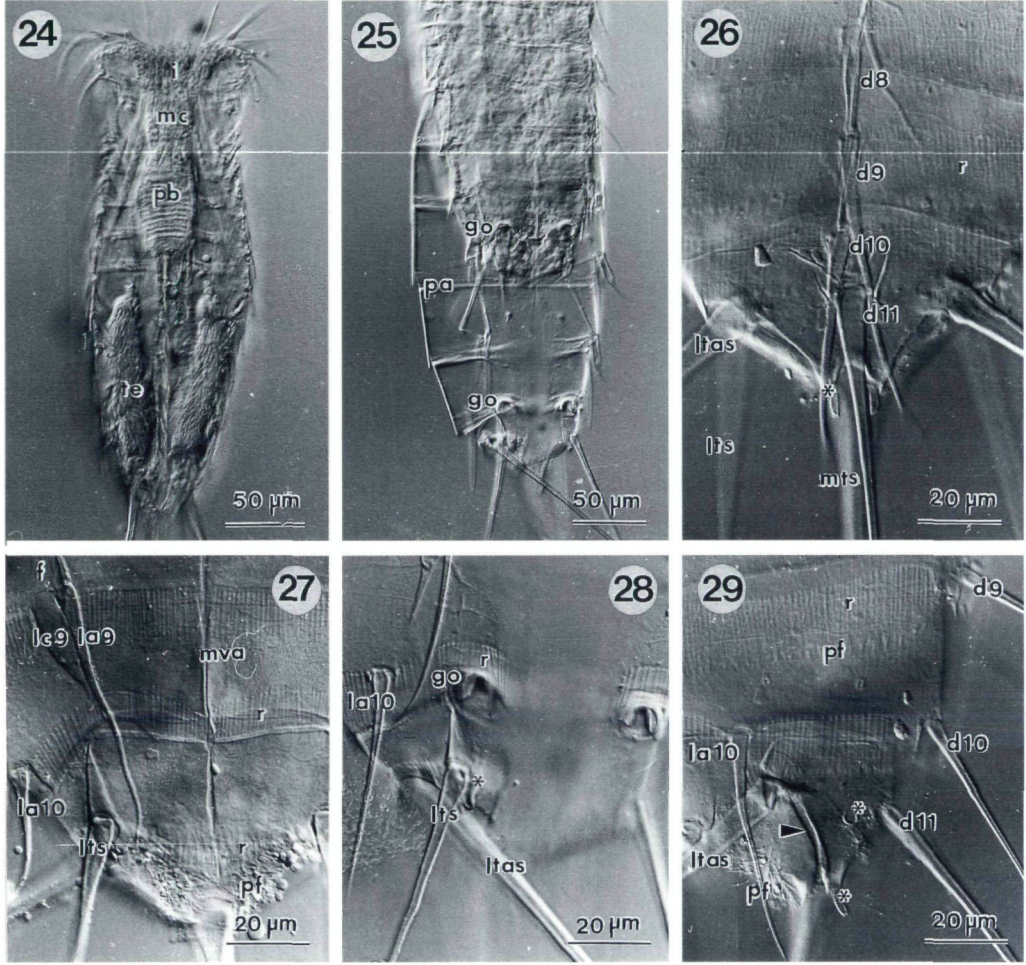

Figs. 24 - 29: *Antygomonas oreas* sp.n. Light microscopical photographs with interference contrast of whole mounts. (24) Total view of male with testes, partly inverted introvert, mouth cone, and oval-shaped pharyngeal bulb. (25) Molting female; note the gonopores in exuvia as well as molted animal. (26) Dorsal view of posterior end of female; middorsal spines d8 - d11, midterminal spine, lateral terminal spine, and lateral terminal accessory spine; asterisk points to modified sensory spot. (27) Ventral view of posterior end of male; lateral acicular spines la9 and la10, lateral cuspidate spine lc9, lateral terminal spine, midventral articulation, cuticular ribs, and pectinate fringe. (28) Ventral view of posterior end of female; lateral acicular spine la10, lateral terminal spine, lateral terminal accessory spine, cuticular ribs, and gonopore; asterisk points to modified sensory spot. (29) Lateral view of posterior end with prominent lateral articulation of eleventh trunk zonite (arrowhead); middorsal spines d9 - d11, lateral acicular spine la10, and lateral terminal accessory spine; asterisks point to modified sensory spots.

one side. On the second, sixth, eighth, and ninth zonite, the acicular spine lies more mesially adjoining the cuspidate spine, whereas it is more laterally on the fifth zonite. The acicular and cuspidate spines increase in length from anterior to posterior except for

the ninth acicular spine which is longer than the tenth (Tab. 1). Each cuspidate spine is accompanied by an anteriorly positioned fringe (Figs. 21, 27).

**Middorsal spines (d).** Middorsal spines are present on all trunk zonites increasing in length from anterior to posterior (Figs. 14, 15; Tab. 1). They are hirsute, bordered by small indentations on each side, and accompanied by anteriorly positioned fringes (Fig. 22). They lie at the posterior edge of each zonite except for the eleventh. This spine lacks the fringe and is positioned more anteriorly due to the presence of the midterminal spine (Fig. 26).

**Terminal spines (lts, ltas, mts).** The shorter lateral terminal spines lie more mesioventrally to the longer lateral terminal accessory spines (Figs. 14 - 17, 23, 26 - 29). The midterminal spine is the longest exhibiting about double length of the trunk (Tab. 1; Figs. 26 - 29). All terminal spines are hirsute similar to the lateral acicular and cuspidate spines and the middorsal spines (Fig. 23).

**Sensory spots (ssp, mssp).** All sensory spots of this species are paired and arranged bilaterally symmetrical (Figs. 14, 15). They are found ventrally on the first, sixth, and eighth zonite, dorsolaterally on the first and the ninth zonite, and dorsally from the first to the ninth zonite. These sensory spots are characterized by two or three pores surrounded by few cuticular bristles arranged more or less regularly in one or two rings around the pores (Fig. 20). Three pairs of modified sensory spots are present on the eleventh zonite, adjacent each to the middorsal spine, the midterminal spine, and the lateral terminal spines (Figs. 23, 26, 28, 29).

**Foregut.** Nine decamerously arranged oral styles (the tenth, dorsal one is missing) surround the terminal mouth opening on the mouth cone (Figs. 3 - 7, 10, 11). They consist of four elements separated by flexible articulations (Figs. 8, 9). The basal part is elevated from the mouth cone and bears a pectinate fringe (Fig. 10). Three rings of pharyngeal styles (from anterior to posterior 10, 5, and 5 styles) are present on the buccal epithelium of the mouth cone (Fig. 5). The first ring consists of five pairs with a basal pectinate fringe and a smooth, flexible style. Five large styles probably from the second ring are followed by five small styles from the third ring (Figs. 9, 13). All pharyngeal styles have a pore on their tips. The pharyngeal bulb, posterior to the buccal epithelium, is oval-shaped (Fig. 24).

**Sexual dimorphic characters.** Females of this species are distinguished from males by strongly cuticularized paired gonopores as mesioventral differentiations of the anterior border on the eleventh trunk zonite (Figs. 16, 28). One female specimen has been found in molting stage, exhibiting gonopores on the exuvia as well as on the cuticle of the molted animal (Fig. 25). The gonopores are indistinct in males (Figs. 14, 27).

Tab. 2. Distribution of *Antygomonas oreas* sp.n., *Echinoderes* sp., and *Semnoderes* sp. from White Sand Swale (WSS, total of 6 cores) and Sea Pen Rim (SPR, total of 2 cores).

	WSS	SPR	total
<i>Antygomonas oreas</i> sp. n.	84	9	93
<i>Echinoderes</i> sp.	4	1	5
<i>Semnoderes</i> sp.	2	1	3

### Distribution and accompanying kinorhynch fauna

*Antygomonas oreas* was found evenly distributed from 0 - 5 cm depth. Only a few specimens were found in the deeper 5 - 10 cm fraction. The majority was collected at the White Sand Swale (WSS) with moderately sorted, calcareous sand; only a few specimens were found at Sea Pen Rim (SPR) with poorly sorted, basaltic sand (Fig. 2). Besides *A. oreas*, a few specimens of *Echinoderes* sp., and *Semnoderes* sp. were collected from both locations (Tab. 2).

### Discussion

*Antygomonas oreas* can be distinguished from *A. incommitata* by the occurrence of only one cuspidate spine on the 8th trunk zonite instead of two, one middorsal spine on the 10th and the 11th trunk zonite each instead of two on the 11th and none on the 10th trunk zonite, and the occurrence and distribution of the sensory spots and modified sensory spots. The anterior margin of each trunk zonite shows one pachycyclus in *A. oreas* while there are two cuticular thickenings, one after the other, in *A. incommitata*. The lateral articulations of the terminal trunk zonite are less pronounced in *A. incommitata* [not mentioned in species description (NEBELSICK 1990)]. The pharynx is pear-shaped in *A. incommitata* and oval-shaped in *A. oreas*, but since the former species description is based on a single specimen this difference may be due to a special contraction during fixation. Otherwise these two species are amazingly similar in both morphological characteristics and morphometric data.

At the moment, it still seems impossible to determine the closer relationship of *Antygomonas* to other kinorhynchs. Following characters are found in *Antygomonas* and are considered autapomorphies of the Kinorhyncha: neck with 16 placids; trunk with 11 zonites; three types of scalids, anteriormost ring of scalids with ten type 1 spinoscalids, posteriormost ring of scalids with 14 trichoscalids, and rings between the anteriormost and posteriormost with type 2 spinoscalids; mouth cone with 9 decamerously arranged oral styles and 3 rings of pharyngeal styles, with, from anterior to posterior, 10, 5, and 5 styles, with quincunxial arrangement (NEBELSICK 1993; see also NEUHAUS 1994). According to HIGGINS (1990), *Antygomonas* can be placed within the Cyclorhagida due to the presence of middorsal spines. The lacking lateral articulations in the trunk region are shared with representatives of *Zelinkaderes* HIGGINS, 1990 (HIGGINS 1990, NEUHAUS 1994, BAUER-NEBELSICK 1995). Future electron microscopic investigations in *Antygomonas* will show if the midventral articulation is mainly built by intracuticle similar to *Zelinkaderes klepali* BAUER-NEBELSICK, 1995, or by fibrillar procuticle similar to all armoured kinorhynchs investigated to date (see BAUER-NEBELSICK 1995). Otherwise there are no similarities between these two taxa: the introvert has 7 rings of scalids (total number 89) in *Antygomonas oreas* instead of 5 rings (total number 69) in *Z. klepali* or 4 rings (total number 54, see NEUHAUS 1995) in *Z. floridensis* HIGGINS, 1990; the neck placids are well defined and separated from the trunk in *Antygomonas* while they are poorly defined and not separated from the trunk in *Zelinkaderes*.

Recently, ADRIANOV & MALAKHOV (1994) proposed a classification of Kinorhyncha which is based on systematic considerations of ZELINKA (1928), LANG (1949), and HIGGINS (1990). External cuticular characters, like differentiations of the neck and the

trunk as well as appendages of the trunk are used to distinguish different taxa. A new suborder Protorhagae ADRIANOV & MALAKHOV, 1994, includes the families Zelinkaderidae HIGGINS, 1990, and a new family Antigomonidae ADRIANOV & MALAKHOV, 1994.

This classification is not followed here due to several reasons: 1) According to the scheme of phylogenetic relationships and the text of the legend, published in the same monograph (ADRIANOV & MALAKHOV 1994) the Protorhagae are not monophyletic. 2) The family Antigomonidae with the single genus *Antygomonas* (wrongly spelled *Antigomonas* in ADRIANOV & MALAKHOV 1994) is characterized by the same features as the genus diagnosis in NEBELSICK (1990). The habit of creating superordinated kinorhynch taxa with only a single subordinated taxon is not followed here. Five out of nine families would be monogeneric and two out of five suborders would consist only of one family. This procedure does not bring more information. Still, there are no reasonable hypotheses about the phylogentic relationships between the different genera, especially of the Cyclorhagida. 3) It is proposed that the "Antigomonidae" are characterized by the autapomorphic character "trunk segments (except for first trunk segment) with single midventral articulation" (ADRIANOV & MALAKHOV 1994: 175), although there is no evidence at all that this midventral articulation has developed independently from midventral articulations of other kinorhynchs.

A radially symmetrical neck with thin, unsclerotized placids, fused with the first trunk zonite, is proposed for the stem species of Kinorhyncha (ADRIANOV & MALAKHOV 1994). Except for representatives of *Cateria* GERLACH, 1956, where it is not as yet understood what exactly is the neck, all Kinorhyncha are bilaterally symmetric in the neck region (see NEBELSICK 1990). In *Cateria styx* and *C. gerlachi* HIGGINS, 1968, punctuated, longitudinal thickenings of the cuticle are anterior of the ring of trichoscalids; posterior of the trichoscalids is an undifferentiated region. If a posterior displacement of the trichoscalid ring occurred, these thickenings would represent the placids of the neck. The neck then would be bilateral in *C. styx* (note the broader midventral thickening in HIGGINS 1968, Fig. 3) or radially symmetrical in *C. gerlachi* (thickenings of similar width in HIGGINS 1968, Fig. 11). The other possibility favored by this author, would be that the thickenings represent large basal plates of the trichoscalids and the neck region would appear undifferentiated in the light microscope, similar to all representatives of *Zelinkaderes* HIGGINS, 1990 (HIGGINS 1990, BAUER-NEBELSICK 1995). The broader midventral placid is not only found in the Centroderidae (ADRIANOV & MALAKHOV 1994), but, as far as it is known, in all Cyclorhagida excepting *Cateria* and probably also in all Homalorhagida (see NEBELSICK 1990).

In both species of *Antygomonas*, the males differ from the females only in the lack of cuticularized, ring-like gonopores (NEBELSICK 1990, present publication), unlike the males of *Echinoderes* CLAPARÈDE, 1863, *Dracoderes* HIGGINS & SHIRAYAMA, 1990, and the Homalorhagida who exhibit cuticular appendages ('penile spines') on the terminal trunk zonite (HIGGINS & SHIRAYAMA 1990, KRISTENSEN & HIGGINS 1991) or males of *Zelinkaderes* where the middorsal and the lateral acicular spines of the 10th trunk zonite are distinctly curved (HIGGINS 1990, BAUER-NEBELSICK 1995). This female characteristic is shared with representatives of *Centroderes* ZELINKA, 1896, *Zelinkaderes*, and the Semnoderidae (HIGGINS 1969, 1990). The postembryonic life history of all species studied to date shows a development via 6 juvenile stages and a continuous maturation of



the gonads (see KRISTENSEN & HIGGINS 1991, NEUHAUS 1993, 1995). Sexual dimorphic characters, like 'penile spines' and/or gonopores generally occur only in the adult stage. A direct development from the last juvenile stage with already well established sexual dimorphic features to the adult without molt has been found in *Pycnophyes beaufortensis* HIGGINS, 1964 (HIGGINS 1961b). The same hypothesis has been proposed for *Zelinkaderes floridensis* due to the small overall size of some specimens (HIGGINS 1990). In *Paracentrophyes praedictus* HIGGINS, 1983, five animals with penile spines and longer lateral terminal spines than the adult males have been considered juvenile (HIGGINS 1983). Later, NEUHAUS (1995) could demonstrate clearly that this species exhibits 6 juvenile stages.

One female specimen of *Antygomonas oreas* was found in the molting stage with both the exuvia and the newly molted individual showing gonopores. The same phenomenon has also been described for one female and three males of *Zelinkaderes floridensis* and has been explained as the occurrence of molting adults - in this species six juvenile stages are known. The last juvenile stage, J6, can be distinguished from the J5 stage by a stronger developed midventral articulation and the larger size; the adults are again larger and have the typical female gonopores and curved spines in males (HIGGINS 1990). Since much less is known about *A. oreas* it cannot be determined whether the adult has the ability to molt, or the last juvenile stage already exhibits gonopores, or this is a case of paedomorphosis (sensu GOULD 1977) whereby only 5 juvenile stages could exist.

### References

- ADRIANOV, A.V. & MALAKHOV, V.V. 1994: Kinorhyncha: structure, development, phylogeny and taxonomy. – Moscow, Nauka Publishing, 260 pp. (Russian).
- BAUER-NEBELSICK, M. 1995: *Zelinkaderes klepali* sp.n., from shallow water sands of the Red Sea. – Annalen des Naturhistorischen Museums in Wien 97B: 57-74.
- BROWN, R. & HIGGINS, R.P. 1983: A New Species of *Kinorhynchus* (Homalorhagida, Pycnophyidae) from Australia with a redescription and range extension of other Kinorhyncha from the south Pacific. – Zoologica Scripta 12: 161-169.
- GERLACH, S.A. 1956: Über einen aberranten Vertreter der Kinorhynchen aus dem Küstengrundwasser. – Kieler Meeresforschungen 12: 120-124.
- GOULD, S.J. 1977: Ontogeny and phylogeny. – Cambridge, Mass., The Belknap Press of Harvard University Press, 501 pp.
- HIGGINS, R.P. 1961a: Three new homalorhage Kinorhynchs from the San Juan Archipelago, Washington. – Journal of the Elisha Mitchell Scientific Society 77: 81-88.
- HIGGINS, R.P. 1961b: Morphological, larval, and systematic studies of the Kinorhyncha. Ph.D. dissertation, Duke University, Durham, NC.
- HIGGINS, R.P. 1968: Taxonomy and postembryonic development of the Cryptorhagae, a new suborder for the mesopsammic kinorhynch genus *Cateria*. – Transactions of the American Microscopical Society 78: 21-39.
- HIGGINS, R.P. 1969: Indian Ocean Kinorhyncha: 1, *Condyloderes* and *Sphenoderes*, new cyclorhagid genera. – Smithsonian Contributions to Zoology 14: 1-13.
- HIGGINS, R.P. 1983: The Atlantic barrier reef ecosystem at Carrie Bow Cay, Belize: Kinorhyncha. – Smithsonian Contributions to Marine Sciences 18: 1-131.

- HIGGINS, R.P. 1990: Zelinkaderidae, a new family of cyclorhagid Kinorhyncha. – *Smithsonian Contributions to Zoology* 500: 1-26.
- HIGGINS, R.P. & Y. SHIRAYAMA 1990: Dracoderidae, a new family of the cyclorhagid Kinorhyncha from the inland Sea of Japan. – *Zoological Science* 7: 939-946.
- KRISTENSEN, R.M. & R.P. HIGGINS 1991: Kinorhyncha. In: HARRISON F.W. (ed.): *Microscopic Anatomy of Invertebrates* Vol. 4: Aschelminthes. – New York, Wiley-Liss, pp. 377-404.
- LANG, K. 1949: Echinoderida. In: ODHNER N.HJ. (ed.): *Further zoological results of the Swedish Antarctic Expedition 1901-1903*, Vol. 4, No. 2., pp.1-22.
- LANG, K. 1953: Reports of the Lund University Chile Expedition 1948-49: Echinoderida. – *Kungliga Fysiografiska Sällskapet i Lund, Förhandlingar* 64: 1-8.
- LEVIN, L.A., LEITHOLD, E.L., GROSS, T.F., HUGGETT, C.L. & DIBACCO, C. 1994: Contrasting effects of substrate mobility on infaunal assemblages inhabiting two high-energy settings on Fieberling Guyot. – *Journal of Marine Research* 52: 489-522.
- NEBELSICK, M. 1990: *Antygomonas incommitata* gen. et sp.n. (Cyclorhagida, Kinorhyncha) and its phylogenetic relationships. – *Zoologica Scripta* 19/2: 143-152.
- NEBELSICK, M. 1993: Introvert, mouth cone, and nervous system of *Echinoderes capitatus* (Kinorhyncha, Cyclorhagida) and implications for the phylogenetic relationships of Kinorhyncha. – *Zoomorphology* 113: 211-232.
- NEUHAUS, B. 1993: Postembryonic development of *Pycnophyes kielenensis* and *P. dentatus* (Kinorhyncha) from the North Sea. – *Microfauna Marina* 8: 163-193.
- NEUHAUS, B. 1994: Ultrastructure of alimentary canal and body cavity, ground pattern, and phylogenetic relationships of the Kinorhyncha. – *Microfauna Marina* 9: 61-156.
- NEUHAUS, B. 1995: Postembryonic development of *Paracentrophyes praedictus* (Homalorhagida): neoteny questionable among the Kinorhyncha. – *Zoologica Scripta* 24: 179-192.
- SCHMIDT, P. 1974: Interstitielle Fauna von Galapagos X. Kinorhyncha. – *Mikrofauna Meeresboden* 43: 1-15.
- ZELINKA, C. 1928: *Monographie der Echinodera*. – Leipzig, Wilhelm Engelmann, 396 pp.

# ZOBODAT - [www.zobodat.at](http://www.zobodat.at)

Zoologisch-Botanische Datenbank/Zoological-Botanical Database

Digitale Literatur/Digital Literature

Zeitschrift/Journal: [Annalen des Naturhistorischen Museums in Wien](#)

Jahr/Year: 1996

Band/Volume: [98B](#)

Autor(en)/Author(s): Bauer-Nebelsick Monika

Artikel/Article: [Antygomonas oreas sp.n., a new deep sea kinorhynch from the Pacific Ocean \(Kinorhyncha: Cyclorhagida\). 5-22](#)