

Morphology of the first instar larva of *Tenomerga mucida* (Chevrolat, 1829) (Coleoptera: Archostemata: Cupedidae)

MARGARITA I. YAVORSKAYA^{1,2}, KAZUKI KOJIMA³, RYUICHIRO MACHIDA³ & ROLF G. BEUTEL^{*,1}

¹ Institut für Spezielle Zoologie und Evolutionsbiologie, FSU Jena, 07743 Jena, Germany; Rolf G. Beutel* [rolf.beutel@uni-jena.de] — ² Department of Entomology, Biological Faculty, Lomonosov Moscow State University, Leninskie gory 1–12, Moscow, Russia — ³ Sugadaira Montane Research Center, University of Tsukuba, Sugadaira Kogen, Ueda, Nagano 386-2204, Japan — * Corresponding author

Accepted 05.vi.2015.

Published online at www.senckenberg.de/arthropod-systematics on 07.viii.2015.

Abstract

External and internal structures of 1st instar larvae of *Tenomerga mucida* are described and illustrated in detail. The larvae display previously identified archostematan autapomorphies such as the posterodorsal and posteroventral cephalic emarginations, the median endocarina, a distinctly reduced epicranial suture, the lateral cardinal sclerite, the loss of *M. craniocardinalis*, a sclerotized prominent ligula, a distinctly reduced tentorium, the transverse muscle of the posterior head capsule, tergal and sternal ampullae, and the strongly muscularized loop of the hind gut. Unusual plesiomorphies are the presence of a well-developed *M. frontolabralis* (M8) and a tentoriomandibular muscle. The presence of two extrinsic premental muscles and a subdivided postlabium are also plesiomorphic features. A derived character state described for the first time in an archostematan larva is the presence of glands in the anterior and posterior abdomen. The postcephalic musculature is similar to the condition found in *Micromalthus* and *Rhipsideigma*. The neck musculature is strongly developed, and also the dorsal and ventral longitudinal muscles, probably in correlation with wood-boring habits. The leg muscles are only moderately sized. Well-developed muscles of the eversible lobes of segment IX are an apomorphy of Cupedidae. The cephalic central nervous system of the 1st instars is affected by the small size: the brain and suboesophageal ganglion are shifted to the prothorax. The postcephalic part is plesiomorphic, with three and eight distinctly separated ganglia in the thorax and abdomen, respectively. The phylogenetic results tentatively suggest a placement of Archostemata as sister taxon of the other three beetle suborders. The monophyly of Archostemata is strongly supported but the interrelationships of the families are largely unresolved. Micromalthidae are placed as sister group of Crowsoniellidae in analyses of larval and adult morphological characters. Potential larval synapomorphies of Micromalthidae and Cupedidae are the transverse and laterally rounded head, the absence of stemmata, the shortened distal part of the mandibles, the presence of sternal asperities, the eversible lobes of segment IX and the caudal process of tergum IX. Cupedidae excl. *Priacma* and *Paracupes* are monophyletic. A cupedid subgroup well supported by larval features comprises the genera *Tenomerga* and *Rhipsideigma*, and possibly also *Cupes* (larval features unknown). The reconstruction of the phylogeny and character evolution of Archostemata is still greatly impeded by the scarcity of data, especially the lacking information on internal features and larval characters.

Key words

Archostemata, Cupedidae, *Tenomerga*, larva, morphology, phylogeny.

1. Introduction

Species of Cupedidae and the closely related Ommatidae are the beetles with the maximum of preserved plesiomorphic features in the adult stage, with corresponding derived conditions in all non-archostematan

coleopteran groups (BEUTEL & HAAS 2000; BEUTEL et al. 2008; FRIEDRICH et al. 2009). The very small relict group Archostemata (ca. 40 spp.) also comprises Micromalthidae and Crowsoniellidae, and probably also Jurod-

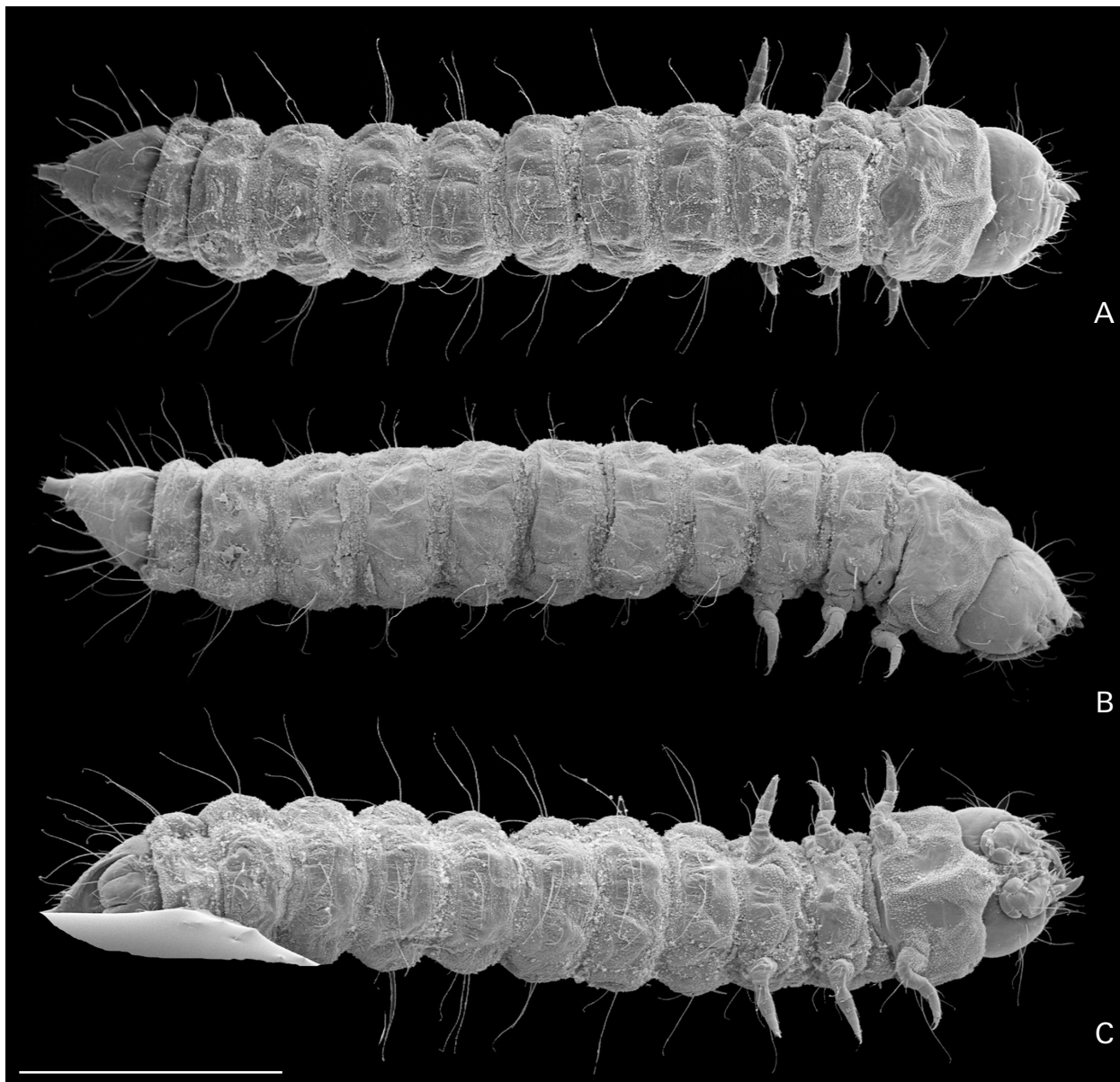

Fig. 1. SEM micrographs, 1st instar larva of *Tenomerga mucida*. **A:** dorsal view; **B:** lateral view; **C:** ventral view. Scale bar = 500 μ m.

idae (HÖRNSCHEMEYER 2005; BEUTEL et al. 2008). Micro-malthidae is monospecific and characterized by miniaturization and a highly complicated life cycle (POLLOCK & NORMARK 2002). The single described species of Crowsoniellidae (PACE 1975; CROWSON 1975) is only known by the type series and the type locality in central Italy is debated (M. Ivie, pers. comm.). Only the holotype of the single extant species of Jurodidae is known. The female specimen of *Sikhotealinia shiltsovae* was found at the edge of a river in the Sikhotealin Mountains in the Russian Far East (LAFER 1996; KIREJTSHUK 1999).

Archostemata is strongly supported as a clade by larval features (e.g., BEUTEL et al. 2008). However, despite of considerable efforts to solve the problem, the position of the suborder Archostemata remains controversial. A basal placement among the four extant suborders of Coleoptera was suggested by CROWSON (1955, 1981), and

this was supported in analyses of extensive morphological data sets (BEUTEL & HAAS 2000; BEUTEL et al. 2008; FRIEDRICH et al. 2009). In contrast to this, based on characters of the wing base and wing venation, KULAVOVÁ-PECK & LAWRENCE (1993, 2004) placed Polyphaga as the sistergroup of the remaining suborders, and Archostemata as sistergroup of a clade Myxophaga + Adephaga. The placement of Archostemata varies in molecular studies. Analyses of HUNT et al. (2007) (*16S* and *18S* rRNA, *cox1*) yielded Archostemata as sistergroup of Myxophaga, and Adephaga as sistergroup of Polyphaga. Analyses of two nuclear and two mitochondrial genes (*18S* and *28S* rRNA, *cox1*, *rrnL*) with a very extensive taxon sampling in the two large suborders resulted in basal Archostemata, and Myxophaga was placed as sistergroup of Adephaga + Polyphaga (BOČAK et al. 2014: *18S* and *28S* rRNA of ca. 8.000 spp., without outgroups). HUGHES et al. (2006),

based on analyses of transcriptomes with a dense sampling in Adephaga and Polyphaga, but only *Micromalthus debilis* LeConte and *Sphaerius* sp. (Sphaeriusidae) as representatives of the two small suborders, suggested a pattern with basal Archostemata (without outgroup), followed by paraphyletic Adephaga, and a clade comprising the myxophagan genus *Sphaerius* and Polyphaga. The phylogeny of Archostemata and the family Cupedidae were analysed by BEUTEL et al. (2008) and HÖRNSCHEMEYER (2009). In the latter study the genera *Priacma* and *Paracupes* were placed basally in Cupedidae and the genus *Tenomerga* was rendered polyphyletic.

The knowledge of the morphology of Archostemata has distinctly improved recently (e.g., HÖRNSCHEMEYER et al. 2002, 2006; BEUTEL et al. 2008; FRIEDRICH et al. 2009). However, the available information on immature stages is still very fragmentary (BÖVING & CRAIGHEAD 1931; FUKUDA 1938, 1941; ROSS & POTHECARY 1970; LAWRENCE 1991, 1999; GREBENNIKOV 2004), even though a detailed knowledge of larval features, especially of 1st instars, is apparently very important for understanding the early evolution of beetles. Only two studies on the larval anatomy are presently known. The skeletomuscular system of larvae of *Micromalthus debilis* (1st instar and cerambycoid larva) was described by BEUTEL & HÖRNSCHEMEYER (2002a) and external and internal features of mature larvae of the cupetid species *Rhipsideigma raffreyi* by BEUTEL & HÖRNSCHEMEYER (2002b).

The very limited number of larval studies is largely due to the enormous difficulty of finding suitable material. The recent collection and successful breeding of immatures of the Japanese species *Tenomerga mucida* (Chevrolat, 1829) (Fig. 1) has stimulated us to carry out a detailed anatomical study of the 1st instar larvae. The detailed documentation of external and internal features is the primary aim of this study. However, the findings are also evaluated phylogenetically largely based on data sets published earlier (BEUTEL & HÖRNSCHEMEYER 2002a,b; BEUTEL et al. 2008) and discussed with respect to their implications for the early evolution of Coleoptera, and the evolution in Archostemata and Cupedidae.

2. Material and methods

2.1. List of larvae examined

Cupedidae: *Rhipsideigma raffrayi* Neboiss (last instar, Pampel's fluid, ethanol), *Tenomerga concolor* (Westwood, 1830) (1st [ca. 20 specimens] and last instar [1 specimen], FAE).

Micromalthidae: *Micromalthus debilis* (Bouin) (from decaying wood, collected in Madison, Wisconsin by D.K. Young).

Ommatidae: *Omma* Newman sp. (ethanol; examined at the Australian National Insect Collection, Canberra = ANIC).

In late April of 2014 brown-rotted logs of a willow (*Salix chaenomeloides*) were collected at the riverbed of Edogawa river, Yoshikawa, Saitama, Japan. The material was taken back to the laboratory of the Sugadaira Montane Research Center (Sugadaira, Nagano). In June many adults of *Tenomerga mucida* emerged from the logs incubated at 28°C. They were fed on diluted honey and mated after a short while. The females deposited many eggs afterwards, and after about 10 days the first instar larvae hatched. They were fixed in Bouin or alternatively in alcoholic Bouin's fixative.

2.2. Anatomy

Microtome sectioning and scanning electron microscopy (SEM) were applied. Transverse semithin sections were made of the entire body. The specimens were embedded in araldite CY 212® (Agar Scientific, Stansted/Essex, England) and cut at 1 µm using a microtome HM 360 (Microm, Walldorf, Germany) equipped with a diamond knife. Sections were stained with toluidine blue and pyronin G (Waldeck GmbH and Co.KG/Division Chroma, Münster, Germany). Pictures were taken of every second section using a light microscope (Zeiss Axioplan, Germany) equipped with a camera (PixaLink Capture OEM). The images were aligned using Amira 5.3.1 software (Visage Imaging, Berlin, Germany). Based on the aligned image stacks the arrangement of internal structures each element was traced manually to reconstruct three-dimensional images. MAYA7 (Alias Wavefront, Toronto/Ontario, Canada) was used for smoothing and coloring.

Scanning electron microscopy (SEM, Philips XL 30 ESEM) was used to document surface structures. Larvae were dried at the critical point (Emitech K850 critical point dryer), sputter-coated with gold (Emitech K500) and mounted on the tip of a fine needle and fixed on a rotatable specimen holder (POHL 2010).

2.3. Cladistic analyses

Features of 1st instars of *T. mucida* were coded and entered in a data matrix (see Electronic Supplement File 1) of 103 morphological characters (66 characters of adults from BEUTEL et al. 2008; see Electronic Supplement File 2). The larval part of the data set was also based on earlier studies (BEUTEL & HÖRNSCHEMEYER 2002a,b; BEUTEL et al. 2008) but modified. The parsimony analysis was carried out with NONA (ratchet, 1000 replicates) and TNT (traditional search) (GOLOBOFF 1995; GOLOBOFF et al. 2000). Bremer support values (BREMER 1994) were calculated with NONA.

2.4. Terminology

The terminology for cephalic muscles is based on v. KÉLER (1963), whereas that of LARSÉN (1963) is used for

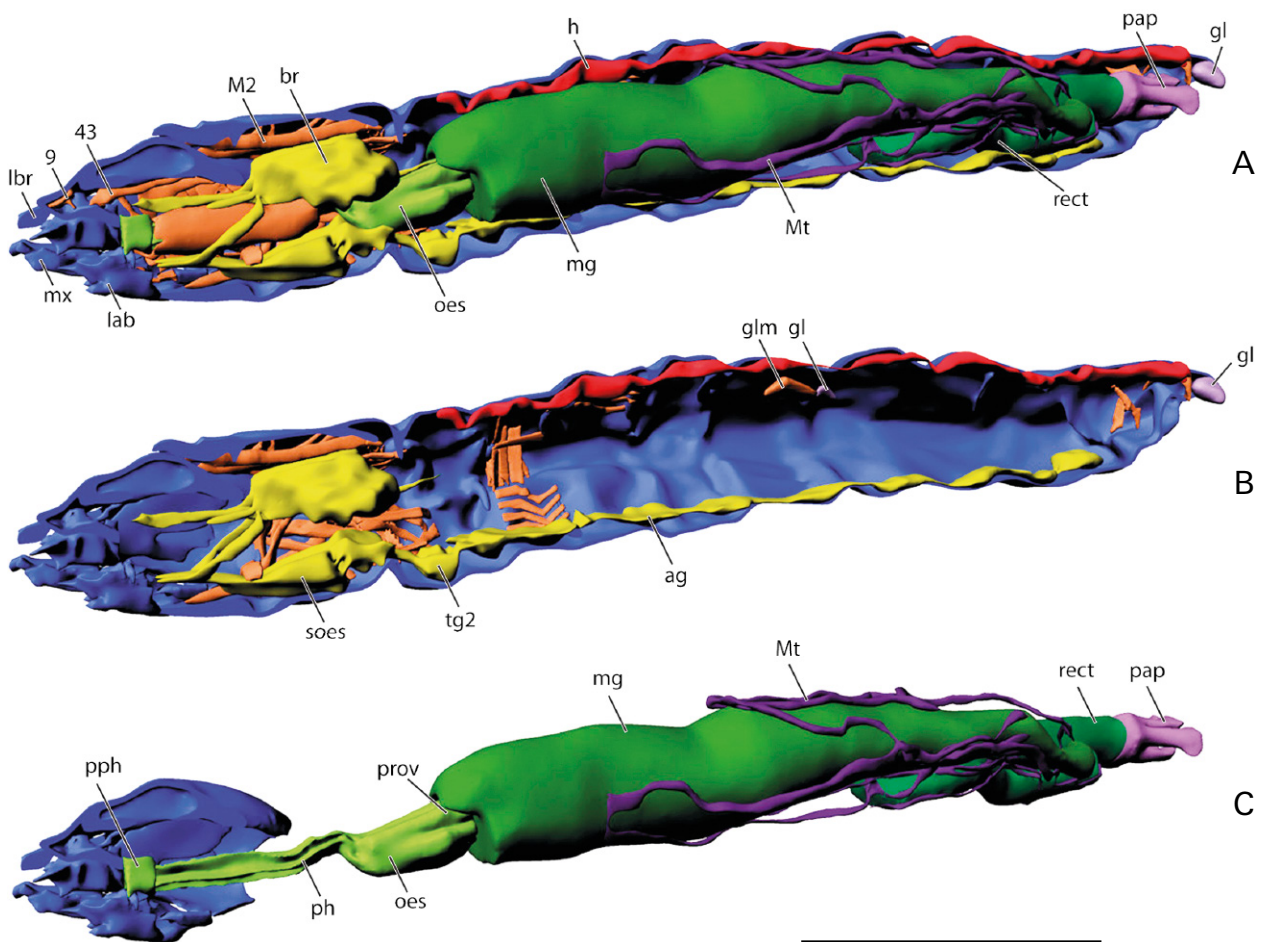

Fig. 2. Three-dimensional reconstruction, 1st instar of *T. mucida*, anterolateral view, sagittally sectioned. **A:** with complete interior structures; **B:** digestive tract removed; **C:** head and digestive tract with Malpighian tubules, pharyngeal ring muscle layer removed. – **Abbreviations:** ag – abdominal ganglion, br – brain, gl – gland, glm – muscle associated with gland, h – heart, lab – labium, lbr – labrum, mg – midgut, Mt – Malpighian tubules, mx – maxilla, oes – oesophagus, pap – rectal papillae, ph – pharynx, pph – prepharynx, prov – proventriculus, rect – rectum, tg2 – metathoracic ganglion, 9 – M. frontoepipharyngalis, 43 – M. clypeopalatalis. Scale bar = 500 μ m.

thoracic muscles. To avoid confusion only numbers are used for head muscles in illustrations, whereas an “M” (e.g., M9) is added in the case of muscles of the thorax.

3. Morphological results

3.1. General appearance

The larvae are usually slender (Figs. 1, 2) but some specimens appear distinctly more compact, probably depending on the food uptake after hatching from the egg. Most larvae are ca. 1.8 mm long. The head is strongly sclerotized (Figs. 3–7), whereas the postecephalic body is largely semimembranous, with the exception of some prothoracic areas, the legs, and the terminal abdominal segment IX (Fig. 1). The postecephalic body is only slightly flattened dorsoventrally. Fairly indistinct tergal

ampullae are present on most postcephalic segments and also sternal counterparts on the ventral side (Figs. 1, 8). Large parts of the unsclerotized surface of the thorax and abdomen are covered with minute spine-like asperities. The abdominal apex is formed by a tapering apically truncate process of the sclerotized tergite IX (Fig. 8B).

3.2. Head capsule

Figs. 3–7

The prognathous head is strongly sclerotized. Its posteriormost region is slightly retracted into the prothorax. It is not wedge-shaped in lateral view (Figs. 5, 7), but slightly convex dorsally and bearing rather prominent maxillae on the ventral side. The head capsule is about twice as broad as long. It is distinctly rounded laterally, narrowing anteriorly, and reaching the greatest width shortly before it reaches the anterior prothoracic margin (Fig. 4).



Fig. 3. SEM micrographs, 1st instar of *T. mucida*, head and prothorax. **A:** dorsal view; **B:** ventral view. Scale bar = 100 μ m.

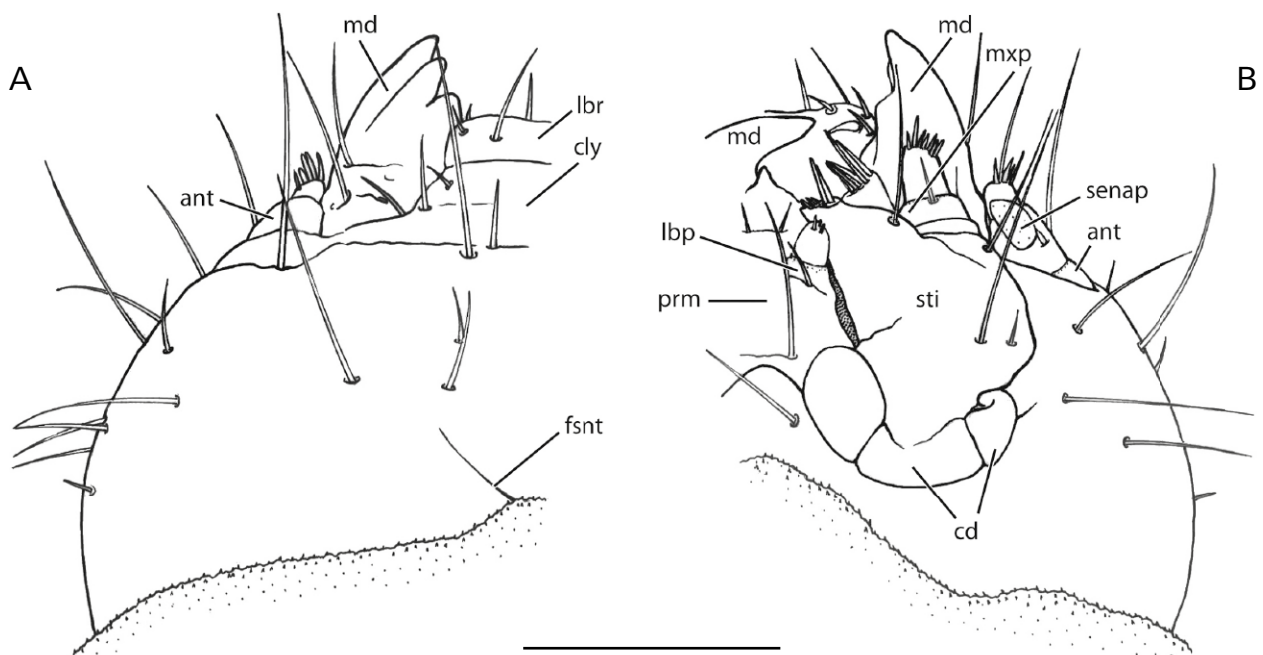

Fig. 4. First instar larva of *T. mucida*, head. **A:** dorsal view; **B:** ventral view. — **Abbreviations:** ant – antenna, cd – cardo, cly – clypeus, fsnt – frontal suture, labr – labrum, lbp – labial palp, md – mandible, mxp – maxillary palp, prm – prementum, senap – sensorial appendage, sti – stipes. Scale bar = 0.1 mm.

A defined cephalic neck region is absent. Posteromedian emarginations are present on the dorsal and ventral sides, the former rather shallow, whereas the latter is deep and triangular (Fig. 4). A vestiture of long, medium sized and very short setae is present. The distribution is shown in Figs. 4 and 7. Stemmata are absent. The labrum is movably connected with the anterior clypeal margin by an internal membranous fold (Figs. 4, 5). The uniformly sclerotized clypeus is very wide posteriorly but distinctly narrowed and trapezoid anteriorly. It is separated from the frons by a transverse external furrow, which is distinct laterally but obliterated medially (Fig. 4). The frons is largely fused with the adjacent parts of the head capsule, but remnants of a V-shaped epicranial suture are present on the posterodorsal cephalic region, anterad the dorsal emargination. The short and strongly diverging vestiges

of the frontal sutures are recognisable as distinct furrows (Fig. 7). The coronal suture is missing. Dorsomedially the head is divided by a strongly developed, unpaired and unforked median endocarina (Fig. 5). The extensive sclerotized structure reaches the posterior clypeal margin anteriorly. The anterolateral cephalic region bearing the antennal insertion area is sclerotized and slightly protruding. An externally exposed articulatory membrane of the antenna is not present. The ventral side of the head is as long as the dorsal side. The maxillary grooves are very deep and separated from each other by the posterior labium and the posteriorly adjacent sclerotized regions (Fig. 4B). Very faintly visible oblique impressions are present posterior to the insertion of the cardo, but hypostomal and ventral epicranial ridges are missing. The ventromedian closure of the posterior head is formed by a para-

bolic sclerotization with unclear homology (Fig. 4B). It is either a product of fusion of the postlabium and gula or only the former element. The extensive ventral triangular emargination of the head capsule is filled out with the ventromedian cervical membrane.

3.3. Internal skeletal structures

Figs. 5, 6

The tentorium is distinctly reduced. Well-developed cylindrical anterior arms are present but end in the anterior third of the head capsule. They are widely separated from the robust ridge-like posterior arms. Dorsal arms and the tentorial bridge are missing and gular ridges are also absent.

Musculature: a strongly developed transverse muscle connects both halves of the head capsule at the postero-ventral edges (Fig. 5). The homology is unclear.

3.4. Labrum

Figs. 3A, 4A, 5

The sclerotized transverse labrum articulates with the anterior clypeal margin. The anterior margin is nearly straight and the anterolateral corners rounded. Two pairs of setae are present on the dorsal side, the ones closer to the midline ca. 3 times as long as the lateral ones. Three pairs of strong and moderately long setae are inserted on the anterior and anterolateral margin, and one pair of broad, almost claw-like setae on the ventral side, close to the anterolateral edge.

Musculature (Figs. 5, 6A): M7 (*M. labroepipharyngalis*): absent; M8 (*M. frontolabralis*): moderately sized muscle, distinctly narrowing towards its origin, O: anterior edge of dorsal endocarina, I: upper posterior labral margin; M9 (*M. frontoepipharyngalis*): moderately sized, also narrowing towards the origin, converging with M8, anterior edge of dorsal endocarina, together with M8, I: laterally on the surface of the ventral wall of the labrum (epipharynx), but distinctly separated from the lateral edge.

3.5. Antenna

Figs. 4, 7

The very short two-segmented antenna is inserted on the anterolateral prominence without an externally exposed articulatory membrane. It is anteriorly directed and slightly inclined towards the median line. The stout basal antennomere is wider (maximum diameter) than long and slightly compressed dorsoventrally. It is rounded along its apical edge and longer mesally than laterally. The cylindrical distal antennomere is only ca. half as long and half as wide as the basal one. On its rounded apical part it bears several short, stiff setae. A large hyalinous senso-

rial appendage is inserted on the basal antennomere below and posterior to antennomere 2.

Musculature (Fig. 5): *M. tentorioscapalis* (M1, 2 or 4): only one muscle is attached to the dorsal antennal base, O: anterior frontal region, I: dorsally on the base of antennomere I.

3.6. Mandible

Figs. 4–7

The mandibles are strongly developed, with three very strong triangular teeth arranged in an oblique row and a prominent basal molar area. The apical and subapical teeth are longer than wide and apically acuminate, whereas the proximal one is broader and less pointed. Two long setae are inserted in deep articulatory pores on the dorsolateral area. A penicillum is not present and a lacinia mobilis is also missing.

Musculature (Figs. 5, 6B,C): M11 (*M. craniomandibularis internus*): largest muscle of the head, O: extensive parts of the dorsal, dorsolateral, lateral and ventrolateral areas of the head capsule, I: adductor tendon; M12 (*M. craniomandibularis externus*): moderately large, O: laterally from the head capsule, between bundles of M11, I: abductor tendon. M13 (*M. tentoriomandibularis*): thin, accompanied by a very thin nerve; O: anterior tentorial arm, I: dorsally on the base of the mandible, close to the mesal margin.

3.7. Maxilla

Figs. 3B, 4B, 6

The maxilla is inserted in a very deep fossa maxillaris. It is composed of cardo, stipes, galea, lacinia and a three-segmented palp. An exposed articulatory membrane is not present but a large, ovoid pad-shaped sclerite is inserted between the cardo and basal stipes and the posterior labium. The cardo is divided into a short and curved main sclerite and a smaller rounded lateral piece. Setae are missing. The stipito-cardinal hinge is indistinct but a deep notch is present between the slightly convex lateral stipital edge and the lateral cardinal sclerite. The large stipes is not subdivided into a proximal basistipes and a distal mediostipes. It bears a short and a very long seta on its proximal region. The palpifer is recognisable but very indistinctly demarcated from the lateral stipital area. Anteriorly the stipes is completely fused with the large lacinia, which is straight along its glabrous mesal edge and bears a group of short, stiff setae on the mesal part of the narrowed, obliquely truncated apical part and two stiff setae of medium length laterally. The well-sclerotized mesal apex of the lacinia is pointed and a long seta is inserted close to the curved lateral edge. The well-developed galea is inserted between the lacinia and palp. Mesally it is very short and its lateral margin is straight.

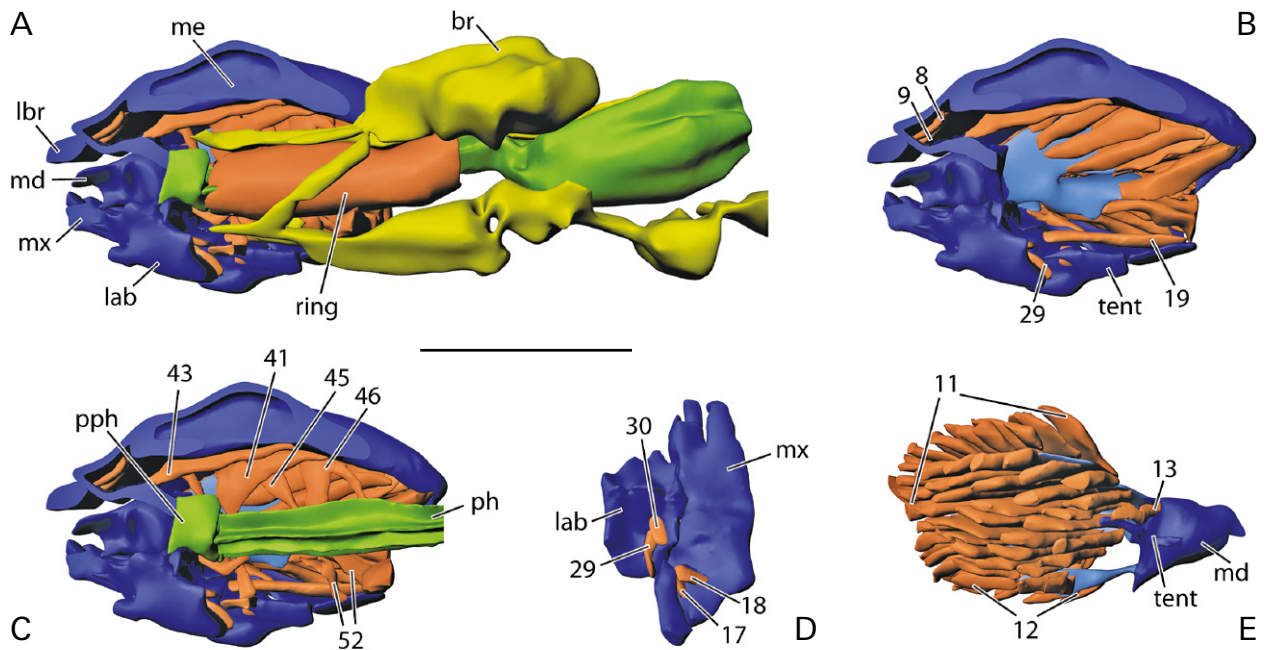

Fig. 5. Three-dimensional reconstruction, 1st instar of *T. mucida*, head, sagittally sectioned. **A:** head, sagittally sectioned, with complete interior structures; **B:** brain and pharynx removed; **C:** pharynx without ring muscle layer; **D:** maxilla and labium, dorsal views; **E:** mandible with muscles. – **Abbreviations:** br – brain, lab – labium, lbr – labrum, md – mandible, me – median endocarina, mx – maxilla, ph – pharynx, pph – prepharynx, ring – pharyngeal ring musculature, tent – tentorium, 8 – M. frontolabralis, 9 – M. frontoepipharyngalis, 11/12 – Mm. craniomandibularis internus/externus, 13 – M. tentoriomandibularis, 17/18 – Mm. tentoriocardinalis/-stipitalis, 19 – M. craniolacinalis, 29/30 – Mm. tentoriopraementalis inferior/superior, 41 – M. frontohypopharyngalis, 43 – M. clypeopalatalis, 45/46 – Mm. frontopharyngalis anterior/posterior, 52 – M. tentoriopharyngalis. Scale bar = 100 μ m.

On its nearly straight apical edge it bears several medium sized stiff setae. The short palp is composed of a broad and very short basal palpomere, a slightly longer and broad intermediate segment, and an apical palpomere, which is distinctly longer, slightly narrower and cylindrical. Its slightly rounded apex bears a group of short stiff setae. Two medium sized setae are inserted ventrally and laterally on palpomere 2, close to its anterior edge.

Musculature (Figs. 5B,D, 6B,C): M15 (M. craniocardinalis), absent; M17 (M. tentoriocardinalis), short cone-shaped muscle, O: basal part of the posterior tentorial arm, I: ventral surface of the cardo; M18 (M. tentoriostipitalis), short, similar to M17, posterior tentorial arm, close to M17, I: ventral stipital surface; M19 (M. craniolacinalis), O: ventrally on the posterior margin of the head capsule, I: base of lacinia, without a tendon; M22, 23 (M. stipitopalpalis externus and internus), the palp muscles could not be clearly identified on the available sections.

3.8. Labium

Figs. 3B, 4B, 6

The interpretation of the posterior elements is difficult. The proximal parabolic sclerite is likely the submentum, possibly fused with a gula. A very short area anterior to it possibly represents the mentum but is only indistinct-

ly separated from the prementum and immovably connected with it. At its anterior edge it bears a pair of long setae. The prementum is large. Anteromedially it bears a strongly sclerotized triangular and apically pointed ligula with irregular edges. A transverse line and a pair of medium-sized setae are present on its basal region. The short two-segmented palps are inserted laterally, distinctly proximad the apex of the lacinia. A palpiger is not present. Several short sensilla are inserted on the rounded apex of palpomere 2, which is relatively long, but distinctly smaller than the apical maxillary palpomere.

Musculature (Figs. 5, 6B): M28 (M. submentopraementalis), absent; M29 (M. tentoriopraementalis inferior), relatively short muscle, O: ventral wall of head capsule, area of origin adjacent to posterior labial margin, I: laterally at the premental edge; M30 (M. tentoriopraementalis superior), short muscle, O: not visible on available microtome section series, probably immediately posterior to the hind margin of the prementum, I: dorsolaterally on the premental edge; M34 (M. praementopalpalis ext.), absent.

3.9. Epipharynx

Figs. 5, 6B; see also labrum

The anterior part including the ventral wall of the labrum is semimembranous and glabrous. It is reinforced

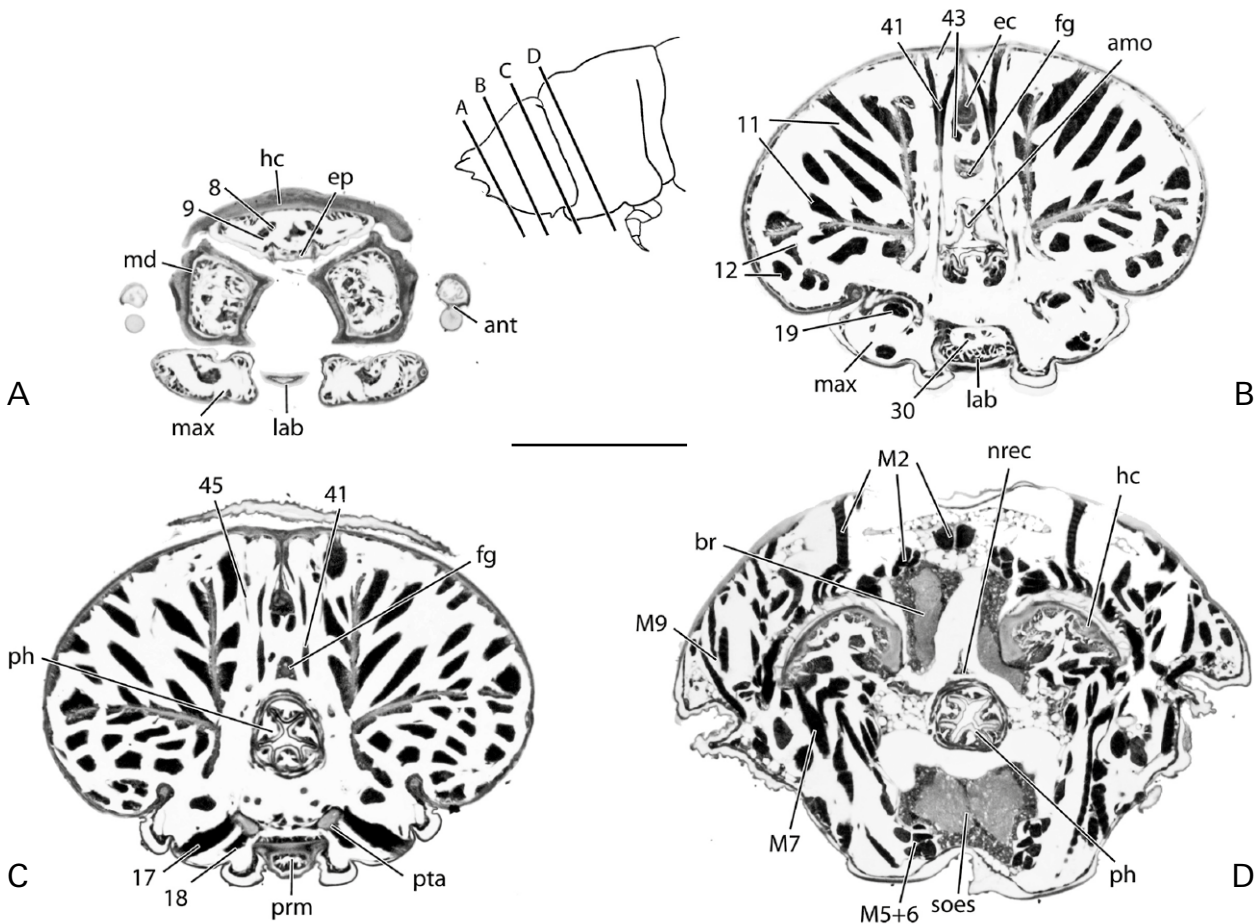

Fig. 6. Cross sections of head and prothorax, position of sections indicated in drawing. – **Abbreviations:** amo – anatomical mouth, ant – antenna, br – brain, ec – endocarina, ep – epipharynx, fg – frontal ganglion, hc – head capsule, lab – labium, md – mandible, max – maxilla, ph – pharynx, nrec – nervus recurrens, prm – prementum, pta – posterior tentorial arms, soes – suboesophageal complex; for 8, 9, 11, 12, 17–19, 30, 41, 43, 45, and M2, M5, M6, M7, M9 (cervical muscles), see text. Scale bar = 100 μ m.

by paired longitudinal paramedian ridges. The middle epipharyngeal region is laterally fused with the mandibular bases and forms the dorsal wall of a short and wide preoral chamber, which is ventrally delimited by the hypopharynx but open ventrolaterally. The posteriormost epipharyngeal part forms a short prepharyngeal tube together with a short posteriormost hypopharyngeal section. The unsclerotized cuticle of the preoral chamber and prepharynx is unusually thick.

Musculature (Figs. 5C, 6B): M43 (*M. clypeopalatalis*): a fan-shaped muscle with two areas of origin, O: anterior end of the median endocarina and dorsal wall of head capsule, I: dorsally on the roof of the anterior epipharynx. Transverse epipharyngeal muscles are absent.

3.10. Hypopharynx

Figs. 5, 6

The anterior part is fused with the anterior part of the labium. The hypopharyngeal surface is devoid of setae or microtrichia. It is flat anteriorly and more convex posteriorly. Laterally it is enclosed by distinct sclerotized ridges.

The posterior part is laterally fused with the posterior part of the epipharynx (Fig. 6; see above).

Musculature (Figs. 5, 6): M41 (*M. frontohypopharyngalis*): an unusually large muscle with several areas of origin, O: frons laterad of the dorsal endocarina, laterally on the dorsal endocarina, posterior part of the ventral edge of the endocarina; I: posterolateral edge of the hypopharyngeal tube with a strong tendon, laterad the anatomical mouth; M42 (*M. tentoriohypopharyngalis*): absent. A muscle with unclear homology connects the ventral wall of the prepharyngeal tube with the ventral wall of the anterior pharynx (Fig. 5).

3.11. Pharynx

Figs. 5, 6

The pharynx is moderately wide, with distinct folds for muscle attachment dorsally, laterally and ventrolaterally. The dorsal folds are closely adjacent.

Musculature (Figs. 5, 6): M44, a well-developed bundle; O: anterior frons; I: dorsally on the prepharyngeal tube, immediately anterior to the anatomical mouth; M45

(*M. frontobuccalis anterior*), a well-developed bundle, O: frons, laterad the endocarina and laterad the anterior components of M41; I: dorsolaterally on the anterior pharynx, but distinctly posterior to the anatomical mouth; M46 (*M. frontobuccalis posterior*): composed of four bundles with a common origin, O: laterally on the dorsal endocarina; I: with four insertion areas on the dorsal fold of the pharynx, posterior to M45. M51 (*M. verticopharyngalis*): absent; M52 (*M. tentoriopharyngalis*): composed of two bundles, M52a, O: posteroventrally from the head capsule, I: two separate areas of insertion on the ventral folds of the posterior pharynx; M52b, O: posteroventral edge of the head capsule, I: lateral fold of the posterior pharynx. A well-developed ring muscle layer encloses the pharynx.

3.12. Brain and suboesophageal complex

Figs. 5, 6

The elongate, pear-shaped brain is entirely located in the prothorax. The protocerebral hemispheres are only connected by a very narrow bridge. Optic lobes and optic nerves are missing. A pair of well-developed nerve stems arises from the narrow anteriormost part of the brain. They are likely the bases of antennal nerves but their distal parts could not be traced on the available sections. The circumoesophageal connectives are long and moderately wide. A separate tritocerebral commissure below the pharynx is missing. The suboesophageal complex is completely shifted to the prothorax, elongate, triangular and narrowing anteriorly like the brain. The frontal ganglion is unusually narrow and located in the anterior head region above the anatomical mouth. The nervus recurrens below the cerebral hemispheres is well developed. It is visible on the sections up to the middle region of the mesothorax.

3.13. Cephalic glands

Tube-like ventral glands or glands associated with the antennae or mouthparts are missing.

3.14. Prothorax

Figs. 6, 7, 9A, 10A,B

The prothorax is distinctly longer than the meso- or metathorax. Like on the following segments few very long and thin setae are inserted dorsally and dorsolaterally. The prothorax is connected with the head by a broad and thick cervical membrane densely covered with microspines. A dorsomedian rounded projection of this flexible collar fills out the dorsomedian emargination of the head capsule and a larger counterpart is present



Fig. 7. SEM micrograph, 1st instar of *T. mucida*, head and anterior thorax, lateral view. Scale bar = 100 μ m.

ventromedially. The anterior and posterior corners of the prothorax are rounded and the lateral margins approximately parallel. A well-defined dorsolateral edge and a clearly delimited pronotum are not present (Fig. 7), but considerable parts of the pronotal area are sclerotized and smooth (Fig. 3A). The anterior region is continuous with the cervical collar and like the central pronotal part semimembranous and covered with microspines. A rounded, smooth and sclerotized projection is present at the posterior margin. This structure resembling a scutellum reaches into the unsclerotized anterior part of the mesothorax (Figs. 1A, 3A). The ventral side of the prothorax is also largely semimembranous. The microspines are absent on two sclerotized rounded plaques laterad a large median projection, which is wide anteriorly and tapering towards the posterior margin of the segment (Fig. 3B). The vestiture of microspines is very dense on the projection but distinctly less so on two regions posterior to the smooth plaques, which bear two short setae each. The hind margin of the main ventral part of the sclerite between the hind coxal margins is almost straight and smooth. It is followed by a very short smooth area on a slightly deeper level (Fig. 3B). A division of the sternal region into well-defined regions is not recognisable and the furca and spina are also absent. Defined pleural elements are not recognisable. The well-developed six-segmented legs are inserted posterolaterally, quite close to the lateral margins of the segment (Figs. 1B,C, 3B, 7). A raised semimembranous element of semilunar shape is recognisable anteromesad the coxa. The coxae are very widely separated, moderately sized, and only slightly tapering towards their apical margin. They bear three

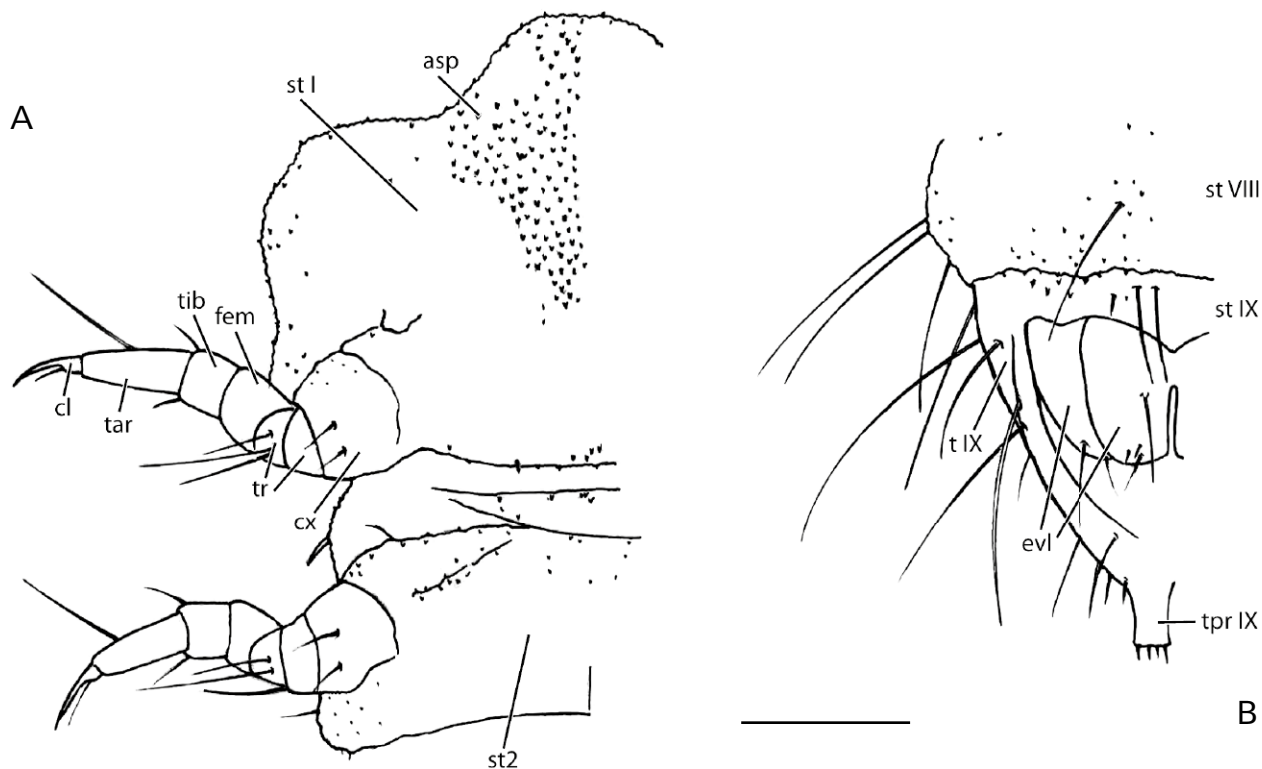

Fig. 8. First instar of *T. mucida*, ventral view. **A:** pro- and mesothorax; **B:** abdominal segment IX. – **Abbreviations:** asp – asperities, cl – claw, cx – coxa, evl – eversible lobes of abdominal segment IX, fem – femur, st1/2 – pro-, mesosternum, stVIII/IX – abdominal sternites VIII/IX, tIX – tergum IX, tar – tarsus, tib – tibia, tprIX – tergal process IX. Scale bar = 0.1 mm.

relatively short setae and the anterior surface is covered with short spines. The trochanter is almost half as large as the coxa and distinctly subdivided into a proximal and distal part, the latter bearing two setae of medium length and a very long one. The distal part is connected with the femur, which is about as long as the coxa, with parallel sides and an oblique distal margin. The cylindrical tibia is slightly shorter than the femur. Several medium sized setae insert close to its straight distal margin. The tarsus is about twice as long as the tibia and tapering towards its apex. A very long seta is inserted on its dorsal side and it also bears several shorter and thin setae. Apically a long single claw is inserted. It is slightly curved and slender in its distal region but extended basally where it bears a single fine claw seta.

Musculature (Figs. 2B,C, 6, 9A): The homologization of the thoracic and abdominal muscles is impeded by the weak sclerotization of the postecephalic body and the almost complete lack of well-defined sclerites. Due to the small size the precise location of the insertions of some muscles could not be identified.

Dorsal muscles. M2, *M. pronoti secundus* (LARSÉN 1966; M55, v. KÉLER 1963), a very large fan-shaped muscle; O: seven separate areas on the posteriormost pronotal region, with the very strong mesal bundle arising on the strongly developed phragma separating the pronotum from the mesonotum, I: two adjacent but separate areas of insertion in the dorsal emargination of the head capsule.

Ventral muscles. M5, *M. prosterni primus* (LARSÉN 1966; M58, v. KÉLER 1963), a strongly developed bundle; O: two separate areas on the posterior prosternal region; I: ventrally on the thick cervical membrane, close to the median line. M6, *M. prosterni secundus* (LARSÉN 1966), two strongly developed bundles with completely separate areas of origin; O: widely separated areas, posterior prosternal region and middle region of the metasternum; I: ventrolaterally on the cervical membrane, adjacent with the posterior edge of the head capsule. *M. prosterni tertius*, a short muscle; O: anterior prosternal region; I: ventrally on the cervical membrane, mesad and below of the insertion of *M. prosterni secundus*.

Dorsoventral muscles. M7, *M. dorsoventralis primus* (LARSÉN 1966); O: posterior pronotal region, anterior edge of the phragma; I: ventrolaterally on the cervical membrane, together with M6. M8, *M. dorsoventralis secundus* (LARSÉN 1966), a bipartite muscle; O: separate areas of origin on the posterior pronotal and posterior pleural region; I: ventral cervical membrane together with M5. M9, *M. dorsoventralis tertius* (LARSÉN 1966), a bipartite muscle; O: two widely separated areas of origin, from the phragma and from the posterior pleural region; I: laterally on the cervical membrane.

Lateral muscles. M13, *M. pronoto-episternalis* (LARSÉN 1966), a bifurcated muscle with widely separated areas of insertion; O: laterally on the posterior edge of the pronotal area, adjacent with the anterior mesonotal

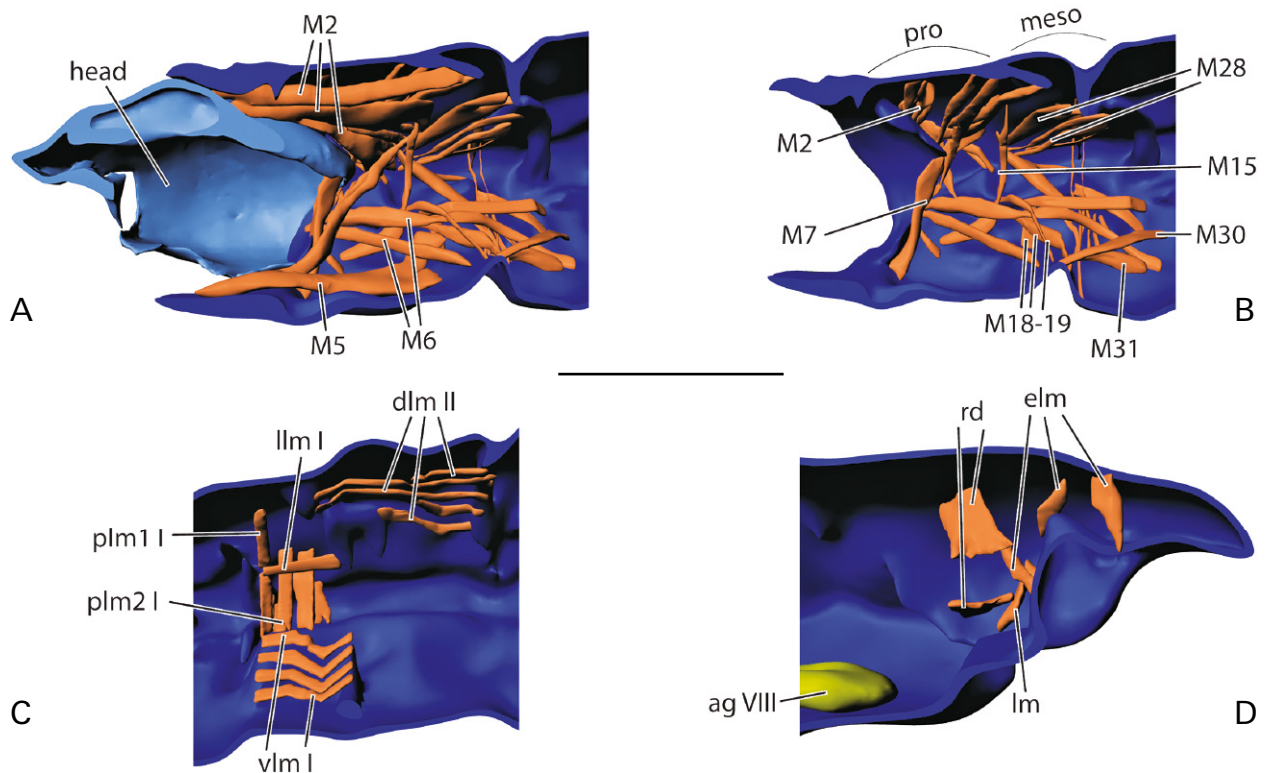

Fig. 9. Three-dimensional reconstruction, 1st instar larva of *T. mucida*, postcephalic body sagittally sectioned. **A:** thorax; **B:** anterior abdomen; **C:** posterior abdomen. – **Abbreviations:** ag VIII – ganglionic mass of abdominal segment VIII, dlm II – dorsal longitudinal muscle of abdominal segment II, elm – muscles of the eversible lobes, lm – lateral muscle of segment IX, pro – prothorax, meso – mesothorax, llm I – lateral longitudinal muscle of abdominal segment I, plm1/2 I – vertical pleural muscles of abdominal segment I, M2 – M. pronoti secundus, M5 – M. prosterni primus, M6 – M. prosterni secundus, M7 – M. dorsoventralis primus, M9 – M. dorsoventralis tertius, M15 – M. noto-coxalis, Mm. 18, 19 – Mm. sterno-coxalis / furca-coxales, M28 – M. mesonoti primus, M30 – M. mesosterni primus, M31 – M. mesosterni secundus, rd – dilators of rectum. Scale bar = 100 μ m.

border; I: the shorter bundle on the mesopleural region, the larger and much longer bundle on the anterior mesosternum. M. pleuro-pleuralis (plpl): the homology of this strongly developed lateral muscle is unclear. It connects the posterolateral prothoracic border with the posterolateral border of the mesothorax.

Leg muscles. M15, M. noto-coxalis (LARSÉN 1966); O: posterolateral notal region; I: anterior coxal margin. M18, M. sterno-coxalis, M19, Mm. furca-coxales (LARSÉN 1966), three bundles with sternal origin due to the complete reduction of the furca; O: posteriormost sternal region, one lateral and one close to the median line; I: coxal base, two posteriorly and one anteriorly.

Intrinsic legs muscles. not examined, largely constant in insects and larvae with well-developed legs.

3.15. Mesothorax

Figs. 1, 8A, 9B, 10

The mesothorax is distinctly shorter than the prothorax and most of its surface is unsclerotized and covered with microspines. A relatively short unsclerotized anterior part

of the segment shows a rather irregular pattern of folds and the typical spiny surface structure. The main part of the tergal region is subdivided by two pairs of longitudinal folds. The largest part in the middle region of the segment is elevated, thus forming a fairly inconspicuous but recognizable tergal ampulla. On the ventral side a short, laterally narrowing semimembranous bulge is present anteriorly, followed by the main part of the sternal region, which is also semimembranous and covered with microspines anteriorly and laterally. In the anterior part of the central region of the segment a distinctly raised bulging area forms the ventral ampulla, which is semimembranous and covered with posteriorly directed microspines. Two pairs of short setae are inserted at the posterior margin. Deep curved furrows separate the anterolateral part of the ampulla from the adjacent anterior sternal region. The transverse area posterior to the ampulla is smooth, sclerotized, and medially divided by a short longitudinal furrow. A distinct round spiracle is present laterally, posterior to the posterolateral margin of the sclerotized pronotal region. It is enclosed by a distinctly raised and sclerotized socket and this in turn by a small smooth and sclerotized pleural area. The legs are very similar to the prolegs.

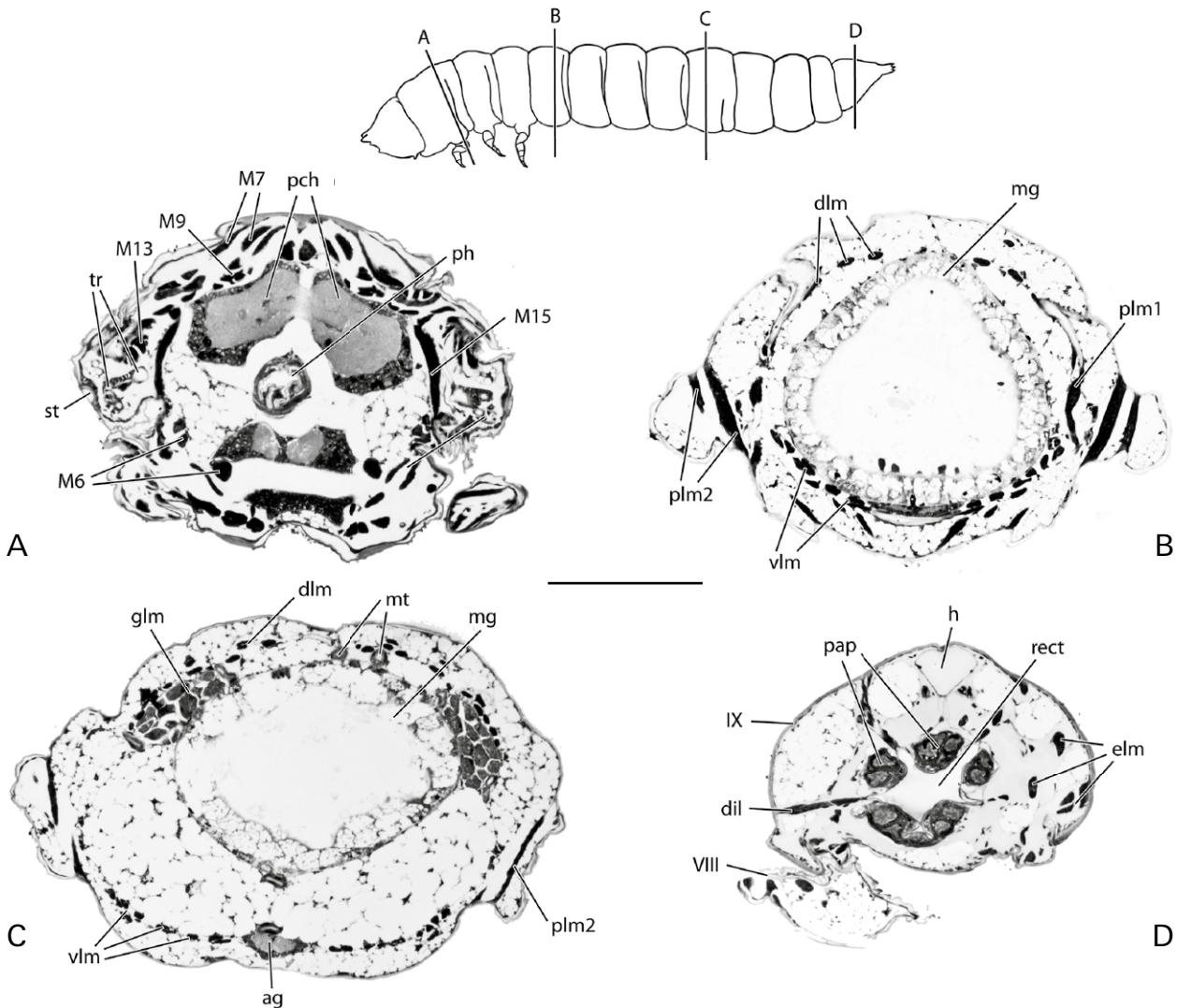

Fig. 10. Cross sections of postcephalic body, position of sections indicated in habitus drawing. – **Abbreviations:** ag – abdominal ganglion, dil – dilator, elm – muscles of eversible lobes, glm – muscle associated with gland, h – heart, mg – midgut, Mt – Malpighian tubules, pap – rectal papillae, pcer – protocerebrum, ph – pharynx, ph-oes – pharyngeal-oesophageal transition area, plm1/2 – vertical pleural muscles 1/2, rect – rectum, st – spiracle, tr – trachea, vlm – ventral longitudinal muscles, VIII/IX – abdominal segments VIII/IX, M2 – M. pronoti secundus, M6 – M. prosterni secundus, M7 – M. dorsoventralis primus, M9 – M. dorsoventralis tertius, M15 – M. noto-coxalis, Mm. 18, 19 – Mm. sterno-coxalis / furca-coxales, M28 – M. mesonoti primus, M30 – M. mesosterni primus, M31 – M. mesosterni secundus. Scale bar = 100 μ m.

Musculature (Figs. 2B,C, 9B, 10): **Dorsal muscles.** M28, M. mesonoti primus (LARSÉN 1966), a strongly developed bundle; O: dorsomedially on the second phragma, I: laterally on the intersegmental membrane connecting the prothorax and mesothorax. M29, M. mesonoti secundus (Larsén 1966), two bundles; O: from an extensive lateral fold of the metanotum; I: laterally on the intersegmental membrane connecting the prothorax and mesothorax, below M28.

Ventral muscles. M30, M. mesosterni primus (LARSÉN 1966), a well-developed muscle; O: laterally on the intersegmental fold between the meso- and metathorax, I: on the intersegmental fold between the pro- and mesothorax, close to the median line. M31, M. mesosterni secundus (LARSÉN 1966), composed of two parallel bundles; O: laterad M30, I: laterad M30.

Lateral muscles. M43, M. noto-pleuralis (LARSÉN 1966), one longer and one relatively short bundle; O: posterolateral mesonotal region, I: posterior pleural region.

Leg muscles. M40, M. noto-coxalis, M47, M. noto-trochanteralis (LARSÉN 1966), two parallel bundles with two separate insertion areas; O: posterolateral edge of the mesonotal area, I: not exactly identified, probably on the coxal base and trochanter, respectively. M46, M. furca-coxalis posterior (LARSÉN 1966), a well-developed flat muscle; O: anterior part of lateral fold of mesothorax, I: posterior coxal base. Three moderately sized parallel bundles originate on the lower pleural region and insert on the basal part of the leg. The precise points of insertion could not be identified on the microtome sections. They likely comprise M. furca-coxalis anterior (M44?), M. fur-

ca-coxalis lateralis (M45?), and *M. furca-trochanteralis* (M52?).

3.16. Metathorax

Figs. 1, 8A, 9A, 10

Similar to the mesothorax. The spiracle in the dorsolateral region of the anteriormost part of the segment is much smaller than the mesothoracic one.

Musculature: similar to that of the mesothorax.

3.17. Abdominal segments I–VIII

Figs. 1, 9C, 10

The abdomen is about 2.5 times longer than the thorax. Segments I–VII are slightly longer than the meso- and metathorax and similar in their general shape, but more rounded along the lateral edge and with moderately distinct lateral bulges. Segment VIII is distinctly shorter. As in the thoracic segments the tergal region is indistinctly delimited and a sparse vestiture of very long and thin setae is present dorsally and dorsolaterally. Dorsal and ventral ampullae are present, similar to those of the meso- and metathorax. Rather indistinct longitudinal furrows are recognizable dorsally and ventrally. Small annular spiracles are present dorsolaterally, close to the anterolateral edge of the tergal regions.

Musculature (Figs. 2B,C, 9C, 10). **Dorsal muscles.** Several well developed bundles (dlm), some of them connecting the anterior and posterior dorsal intersegmental fold. A mesal bundle inserts on the middle region of the segment and a lateral one on a lateral fold distinctly posterior to the anterior segmental border.

Ventral muscles. Several well developed bundles (vlm) connecting the anterior and posterior ventral intersegmental fold.

Lateral muscles. *M. notopleuralis* (plm1): one vertical bundle originates on the lateral notal region and is inserted on a longitudinal pleural fold. Several well developed longer and shorter vertical bundles (plm2) connect the upper and lower edges of the longitudinal pleural bulge. A lateral longitudinal muscle (llm) connects anterolateral and posterolateral apodemes of the abdominal segments. A well-developed muscle is present in abdominal segment V close to a gland (glm). Its position suggests that it is involved in releasing gland secretions but the precise function remains unclear.

3.18. Abdominal segments IX and X

Figs. 1, 8B, 9D, 10D

Segment IX is about as long as the prothorax and slightly narrower than the anterior abdominal segments at its an-

terior margin. It is a largely sclerotized and undivided structure and bears a vestiture of long and thin setae. It is distinctly tapering posteriorly. Its apex is formed by a parallel-sided and apically truncated tergal process. The tergal part including the lateral and ventrolateral areas is sclerotized and the surface is smooth. A short sternal region is semimembranous and bears scattered microspines and two pairs of long setae. It forms a short triangular posteromedian process. The greatly reduced segment X is inserted on the ventral side posterior to sternum IX. It is represented by two pairs of flattened, sclerotized anal flaps. The larger lateral flap bears two long setae, the smaller ventromesal flap one long seta and several short ones along its rounded posterior edge. The latter are fused basally but divided by a deep median cleft.

Musculature (Figs. 2B, 9D, 10): **Lateral muscles.** One well-developed almost vertical muscle is present in the posterolateral region of segment IX. **Muscles of the eversible lobes.** Three muscles originate from the wall of segment IX and insert on the base of the eversible lobes ventrally, dorsally and posteriorly. **Muscles of the rectum.** Five dilators are present. They originate dorsally, laterally and ventrally on the external wall of segment IX and insert on the rectum between the papillae.

3.19. Postcephalic central nervous system

Figs. 2, 5

The thoracic ganglia are comparatively large and distinctly connected by connectives. The abdominal ganglia are flattened. All of them including the glanglionic mass of segment VIII are distinctly separated from each other.

3.20. Postcephalic gut

Figs. 2A,C, 10

The pharyngeal-oesophageal transition area lies in the anterior prothoracic region. In contrast to the pharynx the oesophagus has a very wide lumen, the dorsal lateral and ventral folds are short and very narrow, and a ring-muscle layer is lacking. A well-developed proventriculus is present in the region of the meso and metathorax, with a strongly developed muscle layer around it and six folds with thickened cuticle and a rather irregular surface structure. The anterior end of the long and straight mid gut lies in the metathorax and its posterior end in the posterior abdomen. Caeca are absent. The mid gut wall is formed by moderately high cells, partly appearing almost cylindrical but mostly more or less quadratic in cross section. The epithelium appears rather loose and contains numerous glandular elements. Some crypt-like cell aggregations are present in the basal part of the midgut epithelial layer (Fig. 10C). Active apocrine secretion is recognizable on microtome sections, especially in the anterior part. The border between the mid gut and hindgut is marked by a

sharp bend in segment VIII which conceals the origin of the Malpighian tubules. The hind gut first turns forward and then again backward in segment VI. The fairly long loop is characterized by a very strongly developed muscular envelope. The hindgut itself is strongly folded longitudinally in this region and the intima is distinct. It ends in segment IX with the rectum with well-developed rectal papillae and a strongly developed apparatus of radially arranged dilator muscles.

3.21. Malpighian tubules

Fig. 2A,C

The Malpighian tubules form a complicated network around the gut. Two pairs of branches extend forwards and connect pairwise, with the joint flattened terminal part attached to the midgut wall dorsally and ventrally in the region of segment II. The area of origin in the loop at the midgut-hindgut border is not distinctly visible. A cryptonephric complex is not present.

3.22. Postcephalic glands

Figs. 2C, 9B,C

One postcephalic gland is present in the dorsal region of segment VI and a distinctly asymmetrical one in the apical region of segment IX.

3.23. Circulatory system

Fig. 2A

A well-developed dorsal vessel extends almost through the entire postcephalic body.

3.24. Fat body

The postcephalic body is largely filled with very loose fat body tissue.

4. Characters and character states

(matrix see Electronic Supplement File 1)

Larval features were mainly taken from BEUTEL & HÖRNSCHEMEYER (2002a,b). Modified characters are marked with one asterisk and added characters with two. Features of adults (chars 38–103 in the matrix: see Electronic Supplement File 2) were taken from BEUTEL et al. (2008).

1. *Head shape of 2nd and later instars*: (0) parallel-sided or very slightly rounded or narrowing anteriorly; (1) transverse, strongly rounded laterally, greatest width near hind margin; (2) transverse, with distinctly protruding eye region. Like in other cupedid larvae the head of *Tenomerga mucida* (also in 1st instar) is shortened, distinctly broader than long and strongly rounded laterally, with the greatest width close to the foramen occipitale (Figs. 3, 4; BEUTEL & HÖRNSCHEMEYER 2002a,b; LAWRENCE 1991: fig. 34.67a–c; ROSS & POTHECARY 1970) (coded as inapplicable [-] for 1st instar larvae).
2. *Posteromedian emarginations of head capsule*: (0) absent; (1) present. Dorsal and ventral posteromedian emarginations are present in 1st instars of *T. mucida* like in all known other larvae of Archostemata (Figs. 3, 4; BEUTEL & HÖRNSCHEMEYER 2002a,b; BÖVING & CRAIGHEAD 1931; ROSS & POTHECARY 1970; LAWRENCE 1991, 1999).
3. *Endocarina*: (0) absent; (1) present, unforked; (2) present, forked. A distinct dorsal endocarina is present in 1st instars of *T. mucida* like in all other known larvae of Archostemata (Figs. 5, 6; BEUTEL & HÖRNSCHEMEYER 2002a,b; BÖVING & CRAIGHEAD 1931; LAWRENCE 1991, 1999). In contrast to the forked endocarina of *Omma* it is undivided and extensive like in larvae of *Micromalthus*, *Rhypsodeigma* and *Distocupes*.
- *4. *Frontal suture*: (0) distinct and complete; (1) strongly shortened or absent. The frontal suture, which is absent from mature larvae of Archostemata (Figs. 3A, 4A; LAWRENCE 1999; BEUTEL & HÖRNSCHEMEYER 2002a,b) and 1st instars of *Priacma serrata* (ROSS & POTHECARY 1970: fig. 3), is partly retained (coded a 1) in 1st instars of *T. mucida* (Figs. 3, 4, 7).
5. *Stemmata*: (0) more than one pair of stemmata; (1) one eyespot or eyeless. Eyes are absent (Fig. 4) like in Micromalthidae and other known larvae of Cupedidae (ROSS & POTHECARY 1970; LAWRENCE 1991; BEUTEL & HÖRNSCHEMEYER 2002a,b). Four pairs of stemmata are present in *Omma* (LAWRENCE 1999).
6. *Endoskeleton*: (0) well-developed, with tentorial bridge and connected anterior and posterior arms; (1) tentorial bridge absent, anterior and posterior arms disconnected (Figs. 5, 6). The tentorium of 1st instars of *T. mucida* is distinctly reduced like in other archostematan larvae (BEUTEL & HÖRNSCHEMEYER 2002a,b).
7. *Length of antenna*: (0) at least 20% of greatest width of head capsule; (1) less than 20% of greatest width of head capsule. The antenna of cupedid larvae are generally shorter than 20% of the head width. They are extremely shortened in 1st instars of *T. mucida* and *P. serrata* and also in larvae of *Micromalthus* (Figs. 3, 4, 7; BÖVING & CRAIGHEAD 1931; ROSS & POTHECARY 1970; LAWRENCE 1991;

- BEUTEL & HÖRNSCHEMEYER 2002a,b). The antennal length distinctly exceeds 20% of the head width in *Omma* (BEUTEL & HÖRNSCHEMEYER 2002a: fig. 11).
- **8. *Number of antennomeres*: (0) 4 or more; (1) 3 or less. Four antennomeres are present in larvae of *Omma* and four or more in mature larvae of Cupedidae (LAWRENCE 1999; BEUTEL & HÖRNSCHEMEYER 2002b). The antennae are only three-segmented in primary larvae of *Micromalthus* and *P. serrata* (ROSS & POTHECARY 1970), and only two antennomeres are present in 1st instars of *T. mucida* (Figs. 3A, 4A, 7).
9. *Antennal muscles in mature larvae*: (0) more than one; (1) one. Only one extrinsic antennal muscle is present in larvae of *Micromalthus* and 1st instars of *T. mucida* (Fig. 5) (coded as -). Three muscles are present in mature larvae of *Rhipsideigma* and *Distocupes* (BEUTEL & HÖRNSCHEMEYER 2002a,b).
10. *Shape of distal part of larval mandible*: (0) less than 3 apices; (1) 3 apices or more. Three well developed mandibular apices are present in 1st instars of *T. mucida* like in all other known larvae of Archostemata (BÖVING & CRAIGHEAD 1931; LAWRENCE 1991, 1999; BEUTEL & HÖRNSCHEMEYER 2002a,b). The apical part is less slender than in larvae of *Omma* (BEUTEL & HÖRNSCHEMEYER 2002a: fig. 11A).
11. *Retinaculum*: (0) present; (1) absent. A distinct, hook-like retinaculum is absent like in other groups of Cupedidae and *Micromalthus* (BÖVING & CRAIGHEAD 1931; BEUTEL & HÖRNSCHEMEYER 2002a,b).
12. *Shape of mola*: (0) not quadrangular, not delimited by a distinct margin; (1) quadrangular and delimited by a distinct margin. The margin of the mola of 1st instars of *T. mucida* is less distinct than in 1st instars of *P. serrata* (ROSS & POTHECARY 1970), in mature cupedid larvae, and in larvae of *Micromalthus* (BÖVING & CRAIGHEAD 1931; LAWRENCE 1991; BEUTEL & HÖRNSCHEMEYER 2002a,b).
13. *Cardo*: (0) undivided; (1) divided, with separate lateral semimembranous piece. A subdivided cardo as it is typical for archostematan larvae (BEUTEL & HÖRNSCHEMEYER 2002a,b) is also present in 1st instars of *T. mucida* (Figs. 3, 4).
14. *Ligula*: (0) unsclerotized; (1) sclerotized, enlarged and wedge-shaped. Like in all other known larvae of Archostemata (BÖVING & CRAIGHEAD 1931; LAWRENCE 1991, 1999; BEUTEL & HÖRNSCHEMEYER 2002a,b) the ligula is strongly sclerotized and wedge shaped. In contrast to the typical condition it is apically pointed in 1st instars of *T. mucida* (Figs. 3, 4).
15. *Mentum and submentum*: (0) not fused; (1) fused and narrowed between maxillary grooves. The mentum and submentum of the 1st instar larva of *T. mucida* appear indistinctly separated from each other (Figs. 3, 4), but the homology of the anterior part remains uncertain (coded as ?). A completely undivided postmentum is present in the other known larvae of Archostemata.
16. *Labial muscles*: (0) present; (1) absent. Two pairs of extrinsic labial muscles are present in 1st instar larva of *T. mucida* (Fig. 5). They are absent in all other archostematan larvae examined (BEUTEL & HÖRNSCHEMEYER 2002a,b).
- *17. *Transverse ventral muscle between posterior halves of head capsule*: (0) absent; (1) present. This unusual muscle with unclear homology is present in 1st instar larvae of *T. mucida* (Figs. 5, 7) like in other archostematan larvae examined (BEUTEL & HÖRNSCHEMEYER 2002a,b).
18. *Proventriculus*: (0) absent; (1) present. A proventriculus is present in 1st instars of *T. mucida* and also in larvae of *Micromalthus*, *Rhipsideigma* and *Distocupes* (BEUTEL & HÖRNSCHEMEYER 2002a,b). It is equipped with distinct cuticular teeth in the cupedid larvae examined.
19. *Width of prothorax of 2nd and later instars*: (0) not broader than following segments; (1) broader than following segments. The prothorax is broader than the following segments in 1st instars (coded as -) and mature larvae of *Tenomerga*, and the same condition occurs in mature larvae of *Rhipsideigma* (BÖVING & CRAIGHEAD 1931; FUKUDA 1938; BEUTEL & HÖRNSCHEMEYER 2002b). It is equally broad in larvae of *Distocupes* and also in larvae of *Priacma* (ROSS & POTHECARY 1970), *Micromalthus* and *Omma* (LAWRENCE 1991, 1999; BEUTEL & HÖRNSCHEMEYER 2002a,b).
- **20. *Pronotal pseudoscutellum*: (0) absent; (1) present. A distinct triangular posteromedian projection of the pronotum is present in 1st instars of *T. mucida* (Figs. 3A, 7) and also in larvae of *Rhipsideigma* (BÖVING & CRAIGHEAD 1931; FUKUDA 1938; BEUTEL & HÖRNSCHEMEYER 2002b). They are absent in primary larvae of *Micromalthus* (BEUTEL & HÖRNSCHEMEYER 2002a) and probably also in 1st instars of *Priacma* (ROSS & POTHECARY 1970: fig. 3).
- **21. *Prosternal glabrous patches*: (0) absent; (1) present. Distinctly delimited glabrous, shiny patches are present anterad to the prosternal field of asperities in 1st instars of *T. mucida* (Fig. 3B) and also in later instar larvae of Cupedidae. They are absent in primary larvae of *Micromalthus* (BEUTEL & HÖRNSCHEMEYER 2002a). The condition in 1st instars of *Priacma* is unclear (ROSS & POTHECARY 1970: fig. 4; coded as -).
22. *Legs of 2nd and following instars*: (0) present; (1) absent. The absence of legs in secondary larvae is apparently an autapomorphy of *Micromalthus* (coded as - for 1st instars of *T. mucida*).
23. *Number of leg segments*: (0) 6; (1) 5. 6-segmented legs are present in 1st instars of *T. mucida* (Figs. 1, 3B, 7, 8A) like in larvae of other groups of Archostemata (present in 1st instars of *Micromalthus*, coded as 0).

24. *Claws*: (0) double; (1) single. Single claws are present in 1st instar larvae of *T. mucida* (Fig. 3A, 8) and *Priacma* (ROSS & POTHECARY 1970). Double claws occur in primary larvae of *Micromalthus* (BEUTEL & HÖRNSCHEMEYER 2002a,b) and in mature larvae of *Tenomerga* and *Omma* (LAWRENCE 1999).
25. *Tergal ampullae of 2nd and later instars*: (0) absent; (1) present. Tergal ampullae, which probably facilitate boring in fungus-infested wood (CROWSON 1981; LAWRENCE 1991), are present in later instars of all archostematan larvae (LAWRENCE 1999; BEUTEL & HÖRNSCHEMEYER 2002a,b). They are possibly absent in 1st instars of *P. serrata* (ROSS & POTHECARY 1970: fig. 3), but recognizable in the 1st instars of *T. mucida* (Fig. 1; coded as – for 1st instars).
26. *Abdominal segments I–III of 2nd and later instars*: (0) shorter than thorax; (1) longer than thorax. The abdomen is cylindrical and unusually elongate in later instars of Archostemata (BÖVING & CRAIGHEAD 1931; FUKUDA 1938; VULCANO & PEREIRA 1975: fig. 47; LAWRENCE 1991; LAWRENCE 1999: fig. 12). Segments I–III combined are longer than the thorax. They are slightly shorter than the thorax in the 1st instar larvae of *T. mucida* (Fig. 1; coded as – for 1st instars).
27. *Sternal asperities*: (0) absent; (1) present. A prosternal field of asperities is present in larvae of Cupedidae including 1st instars of *T. mucida* (Fig. 3B). It is not recorded for 1st instar larvae of *Priacma* (ROSS & POTHECARY 1970) but this may be due to the lack of SEM micrographs (coded as ?). They are present on all sternites in larvae of *Micromalthus* (BEUTEL & HÖRNSCHEMEYER 2002a: fig. 4C) but absent in the larva of *Omma* (LAWRENCE 1999).
28. *Lateral longitudinal bulge of abdominal segments I–VIII*: (0) absent; (1) present. A semi-membranous longitudinal bulge is present on segments I–VIII of larvae of *Tenomerga* (Fig. 10; BÖVING & CRAIGHEAD 1931) and also in larvae of *Rhipsideigma*.
29. *Sclerotized process of tergum IX*: (0) absent; (1) present. A median posteriorly directed appendage of tergum IX is present in 1st instars of *T. mucida* (Figs. 1, 8B) and also in other cupedidae larvae and larvae of *Micromalthus* (LAWRENCE 1991; BEUTEL & HÖRNSCHEMEYER 2002a,b). It is absent in the larva of *Omma* (LAWRENCE 1999).
30. *Asperities on segment IX of mature larvae*: (0) absent; (1) present. Asperities are present on abdominal segment IX of cerambycoid larvae of *Micromalthus* and also in examined mature larvae of Cupedidae. They are largely absent in 1st instar larvae of *T. mucida* (Fig. 8B) and probably also in *Priacma* (ROSS & POTHECARY 1970: fig. 4) (coded as – for 1st instars).
31. *Eversible lobes of segment IX*: (0) absent; (1) present. Eversible ventral lobes of segment X are present (Figs. 1C, 8B) like in larvae of *Micromalthus* and larvae of other groups of Cupedidae (LAWRENCE 1991: fig. 34.67e; BEUTEL & HÖRNSCHEMEYER 2002a,b). In contrast to the usual condition the lobes are sclerotized in the 1st instar of *T. mucida* (Figs. 1C, 8B). Specific information on this features is not given in the description of the 1st instar larva of *P. serrata* (ROSS & POTHECARY 1970) (coded as ?).
32. *Urogomphi*: (0) absent; (1) present, fixed or articulated. Urogomphi are absent from tergum IX like in all other larvae of Archostemata (Figs. 1, 8B).
33. *Toothed process of sternum IX*: (0) absent; (1) present. A sclerotized, toothed process of sternum IX is present in larvae *Micromalthus* but absent in 1st instar larvae of *T. mucida* (Figs. 1, 8B) like in larvae of all other groups of Archostemata.
- *34. *Segment X*: (0) exposed, pygopod-like; (1) not visible externally or extremely modified. Segment X is not visible externally like in larvae of all other groups of Archostemata (Figs. 1, 8B). It cannot be excluded that the eversible lobes (char. 31) represent a strongly modified segment X, which is probably developed as a pygopod with terminal eversible membranous vesicles in the groundplan of Coleoptera (BEUTEL 1997).
35. *Distal ends of Malpighian tubules*: (0) not attached to hind gut; (1) attached to hind gut. The distal ends of the Malpighian tubules are not attached to the hindgut in primary larvae of *T. mucida* (Fig. 2C), like in the mature larvae of *Rhipsideigma* and *Distocupes* (BEUTEL & HÖRNSCHEMEYER 2002a,b).
36. *Habitat*: (0) not associated with wood; (1) associated with wood. First instar larvae of *T. mucida* are associated with wood like other archostematan larvae with the possible exception of Ommatidae (LAWRENCE 1999) (coded as ?).
37. *Life cycle with hypermetamorphosis, parthenogenesis and viviparous larvae*: (0) absent; (1) present. The unique complicated life cycle of *Micromalthus* (POLLOCK & NORMARK 2002) is obviously autapomorphic.

5. Results of the cladistic analyses

The analyses with NONA and TNT yielded 15 and nine minimum length trees, respectively, in both cases with 185 steps (consistency index: 0.67, retention index: 0.82). The branching pattern of the strict consensus trees was identical (Fig. 11). Archostemata were placed as sistergroup of the three included non-archostematan terminals representing Adephaga (*Trachypachus*), Myxophaga (*Torridincola*), and Polyphaga (*Helophorus*). The monophyly of Archostemata, Ommatidae, and Cupedidae was confirmed and a clade comprising the monospecific families Crowsoniellidae and Micromalthidae.

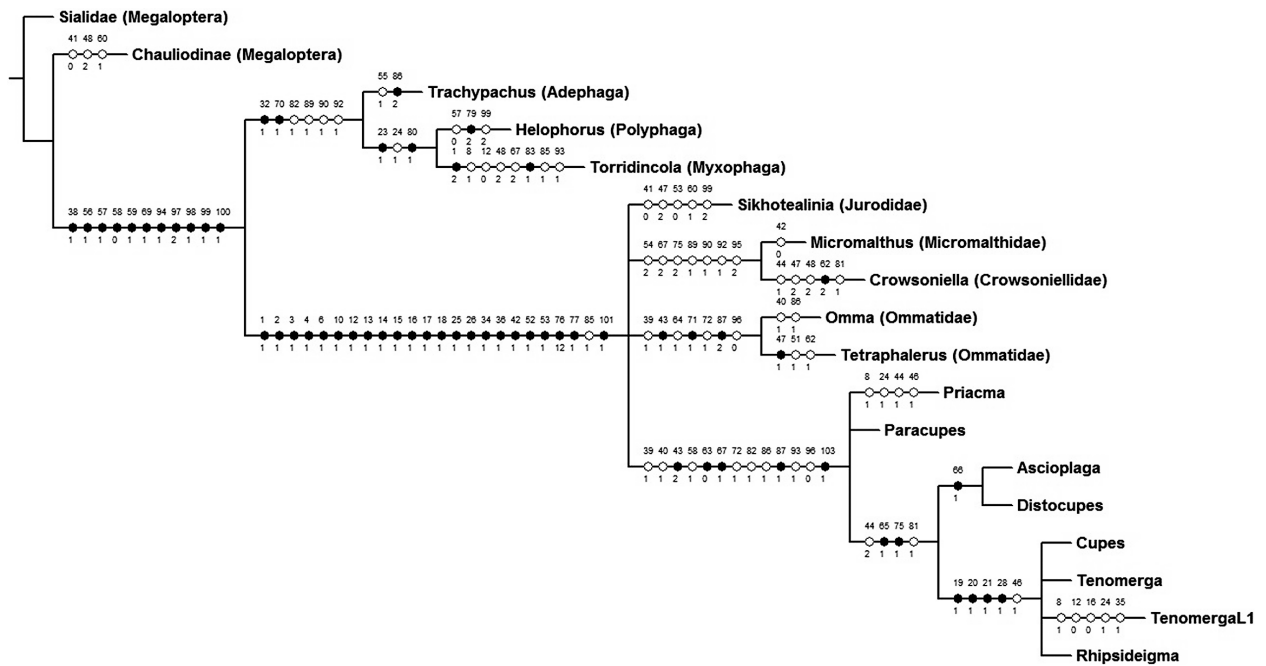

Fig. 11. Cladogram based on 37 larval character (1–37, see list in text) and 66 characters of adults (from BEUTEL et al. 2008, see Electronic Supplement File 2 herein), strict consensus of 12 minimum length trees with 185 steps (consistency index: 0.67, retention index: 0.82), apomorphies mapped on tree, ambiguous characters in italics, Bremer support (BREMER 1994) below branches: Archostemata, 1.1 head of 2nd and later instars transverse, strongly rounded laterally, greatest width near hind margin; 2.1 posteromedian emarginations of head capsule present; 3.1 endocarina present, unforked; 4.1 frontal suture strongly shortened or absent; 6.1 tentorial bridge absent, anterior and posterior arms disconnected; 9.1 one extrinsic antennal muscle; 10.1 distal part of mandible with 3 apices or more; 13.1 cardo divided, with separate lateral semimembranous piece; 14.1 ligula sclerotized, enlarged and wedge-shaped; 15.1 mentum and submentum not distinctly separated (unclear in *T. mucida*); 16.1 labial muscles absent (reversal in 1st instar of *T. mucida*); 17.1 transverse ventral muscle between posterior halves of head capsule present; 18.1 proventriculus present; 25.1 tergal ampullae of 2nd and later instars present; 26.1 abdominal segments I–III of 2nd and later instars longer than thorax; 34.1 segment X not visible externally or extremely modified; 36.1 associated with wood.

6. Discussion

Almost the complete set of previously identified archostematan larval autapomorphies (BEUTEL & HÖRNSCHEMEYER 2002a,b) is already manifest in the 1st instar larvae of *Tenomerga mucida*. The posterodorsal and posteroventral emarginations of the head capsule are present (Figs. 3, 4) even though the one on the dorsal side is rather shallow. The dorsal endocarina, a groundplan apomorphy of Archostemata, is strongly developed (Fig. 5). It is unforked as in *Micromalthus* and other cupetid species examined (BEUTEL & HÖRNSCHEMEYER 2002a,b), in contrast to the forked endocarina of Ommatidae (LAWRENCE 1999; BEUTEL & HÖRNSCHEMEYER 2002a: fig. 11A). Another autapomorphy of Archostemata is the far-reaching reduction or complete loss of the epicranial (frontal and coronal) suture. In contrast to mature larvae (BEUTEL & HÖRNSCHEMEYER (2002b) short frontal sutures are preserved in the 1st instar of *T. mucida* (Figs. 3A, 4A). Like in other archostematan larvae several strong mandibular teeth are present and a distinct mola, whereas a penicillum or lacinia mobilis are absent (Figs. 4, 5). The typical lateral cardinal sclerite is distinct and additionally a sclerotized, pad-like articulatory piece is present

(Figs. 3B, 4B). The labium is strongly modified like in other archostematan larvae. The sclerotized prominent ligula is another autapomorphy of Archostemata. It is not apically truncate in 1st instars of *Tenomerga* but sharply pointed (Figs. 3B, 4B), possibly an autapomorphy of the genus, but the condition in almost all 1st instar larvae is unknown. Another archostematan apomorphy is the presence of tergal and sternal ampullae on the postecephalic segments. They are not very prominent but recognizable in the 1st instar larvae of *Tenomerga* (Fig. 1), whereas they are apparently absent in 1st instars of *Priacma* (ROSS & POTHECARY 1970: figs. 3, 4). Other potential autapomorphies of Archostemata are the distinctly reduced tentorium, the transverse muscle of the posterior head capsule, the proventriculus, and the strongly muscularized loop of the hind gut (Fig. 2). As internal structures of larvae of Ommatidae are still unknown and any information on immature stages of *Tetraphalerus* (Ommatidae), *Crowsoniella* (Crowsoniellidae), and *Sikhotealinia* (Jurodidae) is lacking completely, the phylogenetic interpretation of these features remains very uncertain. Information on the digestive tract of immature beetles is presently extremely scarce (e.g., KORSCHULT 1923). It cannot be excluded that both above mentioned features belong to the groundplan of the order.

The 1st instar larvae of *T. mucida* display some unusual plesiomorphies. The presence of a well-developed *M. frontolabralis* (M8) is a unique feature in the entire Coleoptera (e.g., BEUTEL & HAAS 2000). Similarly, a tentoriomandibular muscle was identified for the first time in a coleopteran larva (e.g., BEUTEL 1993; BEUTEL & HAAS 1998; BEUTEL & HÖRNSCHEMEYER 2002a,b; BEUTEL & FRIEDRICH 2005). In contrast to all other archostematan larvae with available anatomical data (BEUTEL & HÖRNSCHEMEYER 2002a,b), the submentum and mentum appear still separated and two extrinsic labial muscles are preserved. A seemingly plesiomorphic feature, arguably due to reversal, is the lack of a distinct margin of the mandibular mola. It is present in 1st instars of *Micromalthus* and *Priacma* and also in mature larvae of other genera of Cupedidae (BEUTEL & HÖRNSCHEMEYER 2002a,b). Another feature described here for the first time is the presence of glands in the anterior and posterior abdomen (Fig. 2). The function is presently unknown and the phylogenetic significance unclear.

The musculature of 1st instars of *T. mucida* is similar to what was described previously for larvae of *Micromalthus* and *Rhipsideigma* (BEUTEL & HÖRNSCHEMEYER 2002a,b). Only minor reductions occur in the well-developed and strongly sclerotized head. This includes the presence of only one extrinsic antennal muscle (like in *Micromalthus debilis*; BEUTEL & HÖRNSCHEMEYER 2002a), the absence of the maxillary extensor, and the absence of intrinsic labial muscles (all archostematan larvae with available anatomical data). The neck musculature responsible for movements of the head is strongly developed. In correlation with wood-boring habits and a cylindrical and largely unsclerotized postcephalic body the dorsal and ventral longitudinal muscles are also well-developed, and some muscles associated with the body wall extend over more than one segment (Fig. 9) like in *Rhipsideigma* (BEUTEL & HÖRNSCHEMEYER 2002b). The leg muscles are rather weakly developed (Fig. 9A) compared to more active larvae as for instance those of *Dytiscus* or *Tenebrio* (KORSCHOLT 1923: figs. 11, 14; JÖSTING 1942). Well-developed muscles of the eversible lobes of segment IX (Fig. 8B) are probably a derived feature of Cupedidae. The strongly developed muscle associated with the gland in the anterior abdomen (Fig. 2B) was not described previously.

The cephalic central nervous system of the 1st instar larva is obviously affected by the small size like in the primary larvae of *Micromalthus*: the brain and suboesophageal ganglion are completely shifted to the prothorax and the hemispheres of the former are pear-shaped and distinctly elongated (Figs. 2A, 5). The postcephalic part is plesiomorphic, with three distinctly separated ganglia in the thorax and eight in the abdomen (Fig. 2B). The presence of a fully developed dorsal vessel, which extends through almost the entire postcephalic body is also obviously a plesiomorphic feature.

Like in some other studies based on morphology (e.g., BEUTEL et al. 2008; FRIEDRICH et al. 2009) Archostemata were placed as sistergroup to the terminal taxa represent-

ing the other three suborders. However, this result should be taken with caution as the non-archostematan sampling is very limited. Moreover, the available morphological information on Crowsoniellidae and Jurodidae is very scarce and larvae of all families except for Cupedidae and Micromalthidae are unknown or insufficiently documented. The monophyly of Archostemata is very strongly supported (Fig. 11) but the interrelationships of the families are largely unresolved, mainly due to missing data. Like in HÖRNSCHEMEYER (2009: figs. 1A, 2) and BEUTEL et al. (2008) Micromalthidae + Crowsoniellidae were placed as sistergroup of Crowsoniellidae, but this result is weakened by missing data for the latter family. Several presumably apomorphic larval features are shared by Micromalthidae and Cupedidae. This includes the strongly transverse and laterally rounded head capsule, the complete reduction of stemmata, the distinctly shortened distal part of the mandibles, the loss of the retinaculum (Figs. 3–5), the presence of sternal asperities and asperities on segment IX, and the presence of eversible lobes of segment IX and of a caudal sclerotized process of tergum IX (Fig. 1). Antennae shortened compared to the well-developed four-segmented antennae of *Omma* are also a derived feature found in both families, but this mainly applies to the 1st instars. The monophyly of Ommatidae is well supported by adult features (FRIEDRICH et al. 2009) (larvae of *Tetraphalerus* are unknown). The monophyly of Cupedidae is strongly supported, but like in the case of Ommatidae exclusively by apomorphies of adults. Like in HÖRNSCHEMEYER (2009: figs. 1A, 2) and BEUTEL et al. (2008) Cupedidae excl. *Priacma* and *Paracupes* (larvae unknown) are monophyletic, but again this is only supported by apomorphies in the adult stage (later instars of *Priacma* and larvae of *Paracupes* are unknown). A cupedid subgroup well supported by larval features comprises the genera *Tenomerga* and *Rhipsideigma*, and possibly also *Cupes* (larval features unknown). Shared apomorphies are the presence of glabrous prosternal patches (Fig. 3B; not described for 1st instars of *P. serrata*; ROSS & POTHECARY 1970), a widened prothorax (less strongly but still distinct in 1st instars of *T. mucida*; Fig. 1), the pronotal pseudoscutellum (Fig. 7), and the presence of lateral longitudinal bulge of abdominal segments I–VIII with specifically developed lateral muscles (Fig. 10).

Several characters are apparently related to the instar. A specific feature of 1st instar larvae is the extremely shortened antenna with a reduced number of antennomeres (Fig. 3A; ROSS & POTHECARY 1970; BEUTEL & HÖRNSCHEMEYER 2002a). Another feature is the presence of well-developed and moderately long legs (Figs. 1, 7, 8A; ROSS & POTHECARY 1970: figs. 3, 4), in contrast to strongly shortened or reduced legs in later larval stages (BEUTEL & HÖRNSCHEMEYER 2002a: fig. 3a,b; BEUTEL & HÖRNSCHEMEYER 2002a: figs. 3, 28).

Reconstruction of the phylogeny and character evolution of Archostemata is still greatly impeded by the scarcity of data, especially the lacking information on internal features and larval characters. The search for additional and unequivocally identified larvae of Ommatidae

should have high priority. However, considering the rarity of adults and the presumably cryptic habits of the immature stages, this is obviously a great challenge. In the case of *Crowsoniellidae* (only type series known) and *Sikhotealinia* (only holotype known) this is definitely unrealistic, at least in the nearer future, and this applies also to tissue of these taxa for DNA extraction. Consequently, the phylogeny and evolution of the most mysterious and archaic group of beetles will remain enigmatic to a considerable extent.

7. Acknowledgements

Stimulating discussions on the anatomical data and phylogenetic evaluation with Dr. F. Friedrich (Zoologisches Institut und Zoologisches Museum, Universität Hamburg) were very helpful. This is gratefully acknowledged as well as the kind help of the insect photographer Mr. T. Suzuki in collecting *Tenomerga mucida*. We are also grateful for financial supports by the Grant-in-Aid from the JSPS (Scientific Research C: 2544020) to RM and for a DAAD grant (91531383) to MY.

8. References

- BEUTEL R.G. 1993. Phylogenetic analysis of Adephaga (Coleoptera) based on characters of the larval head. – *Systematic Entomology* **18**: 127–147.
- BEUTEL R.G. 1997. Über Phylogenese und Evolution der Coleoptera (Insecta), insbesondere der Adephaga. – *Verhandlungen des Naturwissenschaftlichen Vereins in Hamburg NF* **31**: 1–164.
- BEUTEL R.G., FRIEDRICH F. 2005. Comparative study of larvae of Tenebrionoidea (Cucujiformia, Coleoptera). – *European Journal of Entomology* **102**(2): 241–264.
- BEUTEL R.G., HAAS A. 1998. Larval head morphology of *Hydroscapha natans* LeConte, 1874 (Coleoptera, Myxophaga, Hydroscaphidae) with special reference to miniaturization. – *Zoomorphology* **18**: 103–116.
- BEUTEL R.G., HAAS F. 2000. Phylogenetic relationships of the suborders of Coleoptera (Insecta). – *Cladistics* **16**: 1–39.
- BEUTEL R.G., HÖRNSCHEMEYER T. 2002a. Larval morphology and phylogenetic position of *Micromalthus debilis* LeConte (Coleoptera: Micromalthidae). – *Systematic Entomology* **27**(2): 169–190.
- BEUTEL R.G., HÖRNSCHEMEYER T. 2002b. Description of the larva of *Rhipsideigma raffrayi* (Coleoptera, Archostemata), with phylogenetic and functional implications. – *European Journal of Entomology* **99**: 53–66.
- BEUTEL R.G., GE S.-Q., HÖRNSCHEMEYER T. 2008. On the head morphology *Tetraphalerus*, the phylogeny of Archostemata and the basal branching events in Coleoptera. – *Cladistics* **23**: 1–29.
- BOCAK L., BARTON C., CRAMPTON-PLATT A., CHESTERS D., AHRENS D., VOGLER A.P. 2014. Building the Coleoptera tree-of-life for > 8000 species: composition of public DNA data and fit with Linnaean classification. – *Systematic Entomology* **39**(1): 97–110.
- BÖVING A.G., CRAIGHEAD F.C. 1931. An illustrated synopsis of the principal larval forms of the order Coleoptera. – *Entomologica Americana* **11**: 1–351.
- BREMER K. 1994. Branch support and tree stability. – *Cladistics* **10**: 295–304.
- CROWSON R.A. 1955. The Natural Classification of the Families of Coleoptera. – Nathaniel Lloyd and Co., LTD, London.
- CROWSON R.A. 1975. The systematic position and implications of *Crowsoniella*. *Atti X. – Bollettino del Museo Civico di Storia Naturale di Verona* **2**: 459–463.
- CROWSON R.A. 1981. The Biology of Coleoptera. – John Murray, London.
- FRIEDRICH F., FARRELL B.D., BEUTEL R.G. 2009. The thoracic morphology of Archostemata and the relationships of the extant suborders of Coleoptera (Hexapoda). – *Cladistics* **25**: 1–37.
- FUKUDA A. 1938. Descriptions of the larva and pupa of *Cupes clathratus* Solsky. – *Transactions of the Natural History Society of Formosa* **28**: 390–393.
- FUKUDA A. 1941. Some ecological studies of *Cupes clathratus* Solsky from Japan (Cupedidae, Coleoptera). – *Transactions of the Natural History Society of Formosa* **31**: 394–399.
- GOLOBOFF P. 1995. NONA Version 1.5. – Tucuman: Fundación e Instituto Miguel Lillo.
- GOLOBOFF P.A., FARRIS J., NIXON K.C. 2008. TNT, a free program for phylogenetic analysis. – *Cladistics* **24**: 774–786.
- GREBENNIKOV V.V. 2004. Review of larval morphology of the beetle suborder Archostemata (Insecta: Coleoptera), including first-instar chaetotaxy. – *European Journal of Entomology* **101**: 273–292.
- HÖRNSCHEMEYER T. 2005. Archostemata Kolbe, 1908. Pp. 157–182 in: KRISTENSEN N.P., BEUTEL R.G. (eds), BEUTEL R.G., LESCHEN R.A.B. (vol. eds), *Coleoptera, Vol. I. Morphology and Systematics (Archostemata, Adephaga, Myxophaga, Polyphaga partim)*. *Handbook of Zoology Vol. IV, Arthropoda: Insecta*. – Walter De Gruyter, Berlin, New York.
- HÖRNSCHEMEYER T. 2009. The species-level phylogeny of archostematan beetles – where do *Micromalthus debilis* and *Crowsoniella relicta* belong? – *Systematic Entomology* **34**(3): 533–558.
- HÖRNSCHEMEYER T., BEUTEL R.G., PASOP F. 2002. Head structures of *Priacma serrata* LeConte (Coleoptera, Archostemata) inferred from x-ray tomography. – *Journal of Morphology* **252**(3): 298–314.
- HÖRNSCHEMEYER T., GOEBBELS J., WEIDEMANN G., FABER C., HAASE A. 2006. The head of *Ascioplaga mimeta* (Coleoptera: Archostemata) and the phylogeny of Archostemata. – *European Journal of Entomology* **103**: 409–423.
- HUGHES J., LONGHORN S.J., PAPADOPOULOU A., THEODORIDES K., DE RIVA A., MEJIA-CHANG M., FOSTER P.G., VOGLER A.P. 2006. Dense taxonomic EST sampling and its applications for molecular systematics of the Coleoptera (beetles). – *Molecular Biology and Evolution* **23**: 268–278.
- HUNT T., BERGSTEN J., LEVKANICOVA Z., PAPADOPOULOU A., JOHN O.S., WILD R., HAMMOND P.M., AHRENS D., BALKE M., CATERINO M.S., GÓMEZ-ZURITA J., RIBERA I., BARRACLOUGH T.G., BOCAKOVA M., BOCAK L., VOGLER A.P. 2007. A comprehensive phylogeny of beetles reveals the evolutionary origins of a superradiation. – *Science* **318**: 1913–1916.

- JÖSTING E.A. 1942. Die Innervierung des Skelettmuskelsystems des Mehlwurms (*Tenebrio molitor* L., Larve). – Unpubl. PhD thesis.
- KÉLER S. VON 1963. Entomologisches Wörterbuch. – Akademie Verlag, Berlin.
- KIREJTSHUK A.G. 1999. *Sikhotealinia zhiltzovae* (Lafer, 1966) – Recent representative of the Jurassic Coleopterous fauna (Coleoptera, Archostemata, Jurodidae). – Proceedings of the Zoological Institute of the Russian Academy of Sciences **281**: 21–26.
- KORSCHULT E. 1923, 1924. Bearbeitung einheimischer Tiere. Erste Monographie: Der Gelbrand *Dytiscus marginalis* L. Bd. 1 (1923), Bd. 2 (1924). – W. Engelmann, Leipzig.
- KUKALOVÁ-PECK J., LAWRENCE J.F. 1993. Evolution of the hind wing in Coleoptera. – Canadian Entomologist **125**: 181–258.
- KUKALOVÁ-PECK J., LAWRENCE J.F. 2004. Use of hind wing characters in assessing relationships among coleopteran suborders and major endoneopteran lineages. – European Journal of Entomology **101**: 95–144.
- LAFER G.S. 1996. Fam. Sikhotealiniidae. Pp. 298–302 in: LAFER P.A. (ed.), Key to the Insects of the Russian Far East. Vol. III, part 3. – Dal'nauka, Vladivostok.
- LARSÉN O. 1966. On the morphology and function of locomotor organs of the Gyrinidae and other Coleoptera. – Opuscula Entomologica (Supplementum) **30**: 1–241.
- LAWRENCE J.F. 1991. Ommatidae (Archostemata) (= Ommadidae, including Tetraphaleridae), Cupedidae (Archostemata) (= Cupesidae), Micromalthidae (Archostemata), Buprestidae (Buprestoidea) (incl. Schizopodidae), Zopheridae (Tenebrionidea) (including Merycidae), Cerambycidae (Chrysomeloidea) (including Disteniidae, Hypocephalidae, Oxypeltidae, Parandridae, Spondylidae, Vesperiidae). Pp. 298–302, 386–388, 518–519 & 556–561 in: STEHR F.W. (ed.), Immature Insects, Vol. 2. – Kendall/Hunt Publishing Company, Dubuque, Iowa.
- LAWRENCE J.F. 1999. The Australian Ommatidae (Coleoptera: Archostemata): new species, larva and discussion of relationships. – Invertebrate Taxonomy **13**: 369–390.
- PACE R. 1975. An exceptional endogeous beetle: *Crowsoniella relicta* n. gen. n. sp. of Archostemata Tetraphaleridae from Central Italy. – Bolletino del Museo Civico di Storia Naturale di Verona **2**: 445–458.
- POHL H. 2010. A scanning electron microscopy specimen holder for viewing different angles of a single specimen. – Microscopy Research and Technique **73**: 1073–1076.
- POLLOCK D.A., NORMARK B.B. 2002. The life cycle of *Micromalthus debilis* LeConte (Coleoptera: Archostemata: Micromalthidae): historical review and evolutionary perspective. – Journal of Zoological Systematics and Evolutionary Research **40**(2): 105–112.
- ROSS D.A., POTHECARY D.D. 1970. Notes on adults, eggs, and first-instar larvae of *Priacma serrata* (Coleoptera: Cupedidae). – Canadian Entomologist **102**: 346–348.
- VULCANO M.A., PEREIRA F.S. 1975. Cupesidae (Coleoptera). – Arquivos do Instituto Biológico, São Paulo **42**: 31–68.

Electronic Supplement Files

at <http://www.senckenberg.de/arthropod-systematics>
 (“Contents”)

File 1: yavorskaya&al-tenomergalarva-asp2015-electronicsupplement-1.nex. – Character state matrix.

File 2: yavorskaya&al-tenomergalarva-asp2015-electronicsupplement-2.docx. – Characters of adults (38–103 in matrix).

Electronic Supplement 2. Characters of adults, see BEUTEL et al. (2008) for a detailed character discussion.

38. (1 in BEUTEL et al. 2008) Externally visible membranes: (0) present; (1) absent.
39. Tubercles: (0) absent or very indistinct; (1) present.
40. Scale-like setae: (0) absent; (1) present.
41. Ocelli: (0) three; (1) absent.
42. Constricted neck and postocular extensions: (0) absent or indistinct; (1) present.
43. Supraantennal protuberance (P1): (0) absent; (1) present as moderately distinct bulge; (2) present as strongly pronounced protuberance.
44. Supraocular protuberance (P2): (0) absent; (1) present as moderately distinct bulge; (2) present as strongly pronounced protuberance.
45. Posteromesal protuberance (P3): (0) absent; (1) present, moderately convex; (2) conspicuous, strongly convex.
46. Posterolateral protuberance (P4): (0) absent; (1) present.
47. Antennal groove on head: (0) absent; (1) below compound eye; (2) above compound eye.
48. Gular sutures: (0) complete, reaching hind margin of head capsule; (1) incomplete, not reaching hind margin of head capsule; (2) absent.
49. Shape of gula: (0) not converging posteriorly; (1) converging posteriorly.
50. Tentorial bridge: (0) present; (1) absent.
51. Posterior tentorial grooves: (0) externally visible; (1) not visible externally.
52. Anterior tentorial arms: (0) well developed; (1) strongly reduced or absent, not connected with posterior tentorium.
53. Frontoclypeal suture: (0) present; (1) absent.
54. Labrum: (0) free, connected with clypeus by membrane; (1) indistinctly separated from clypeus, largely or completely immobilised; (2) fused with head capsule.
55. *M. labroepipharyngalis* (M.7): (0) present; (1) absent.
56. *M. frontolabralis* (M.8): (0) present; (1) absent.
57. *M. frontoepipharyngalis* (M.9): (0) present; (1) absent.
58. Length of antenna: (0) not reaching mesothorax posteriorly; (1) strongly elongated, reaching middle region of body.
59. Number of antennomeres: (0) 13 or more; (1) 11 or less.
60. Location of antennal insertion on head capsule: (0) laterally; (1) dorsally.
61. Extrinsic antennal muscles: (0) four; (1) three; (2) two.
62. Shape of mandible: (0) short or moderately long, largely covered by labrum in repose, (1) strongly elongated and protruding in resting position, (3) vestigial.
63. Ventromesal margin of sculptured mandibular surface: (0) not reaching position of mandibular condyle; (1) reaching mandibular condyle.
64. Cutting edge of mandible: (0) horizontal, (1) with three vertically arranged teeth.
65. Separate areas with different surfaces on ventral side of mandible: (0) absent; (1) present.
66. Deep pit in cranio-lateral area of ventral surface of mandible: (0) absent; (1) present.
67. Galea: (0) not with globular distal galeomere and slender basal galeomere; (1) stalk-like basal galeomere and globular distal galeomere; (2) absent.
68. Lacinia: (0) present; (1) absent.
69. Apical segment of maxillary palp: (0) with only one apical field of sensilla (campaniform sensilla), (1) with an apical and a dorsolateral field of sensilla.
70. Digitiform sensilla on apical maxillary palpomere: (0) absent, (1) present.
71. Pit containing sensilla of dorsolateral field of apical maxillary palpomere: (0) absent; (1) present.
72. Deep basal cavity of prementum: (0) absent, (1) present.
73. Lid-like ventral premental plate: (0) absent, (1) present.
74. Transverse ridge of prementum: (0) absent; (1) present.
75. Anterior appendages of prementum: (0) paired ligula; (1) ligula subdivided into many digitiform appendages; (2) absent.
76. Mentum: (0) distinctly developed; (1) vestigial but recognisable as a transverse sclerite between the submentum and the premental plate; (2) absent.

77. *M. tentoriopharyngalis* posterior (M.52): (0) moderately sized, not distinctly subdivided into individual bundles; (1) complex, composed of series of bundles, origin from the gular ridges or lateral gular region.
78. Propleural suture (0) present; (1) absent.
79. Exposure of propleura: (0) fully exposed, propleura reaches anterior margin of prothorax; (1) exposed, not reaching anterior margin of prothorax; (2) internalized.
80. Fusion of propleura and protrochantinus: (0) absent; (1) present.
81. Prosternal grooves for tarsomeres: (0) absent; (1) present.
82. Length of prosternal process: (0) not reaching beyond hind margin of procoxae, very short or absent; (1) reaching hind margin of procoxae.
83. Shape of prosternal process: (0) not broadened apically; (1) apically broadened and truncate.
84. Broad prothoracic postcoxal bridge: (0) absent; (1) present.
85. Mesocoxal cavities: (0) not bordered by metanepisternum; (1) bordered by metanepisternum.
86. Anteromedian pit of mesoventrite for reception of prosternal process: (0) absent or only very shallow concavity; (1) distinct, rounded groove; (2) large hexagonal groove.
87. Propleuro-mesepisternal locking mechanism: (0) absent; (1) propleural condyle and mesepisternal socket; (2) mesepisternal condyle and propleural socket.
88. Connection of meso- and metaventrite: (0) sclerites distinctly separated, connected by a membrane; (1) articulated but not firmly connected; (2) firmly connected between and within mesocoxal cavities.
89. Transverse suture of mesoventrite: (0) present; (1) absent.
90. Mesal coxal joints of mesoventrite: (0) present; (1) absent.
91. Shape of mesocoxae: (0) globular or conical; (1) with deep lateral excavation and triangular lateral extension.
92. Exposed metatrochantin: (0) present, distinctly developed; (1) indistinct or absent.
93. Shape of penultimate tarsomere: (0) not distinctly bilobed; (1) distinctly bilobed.
94. Fore wings: (0) membranous; (1) transformed into sclerotized elytra.
95. Venation of fore wings: (0) not arranged in parallel rows; (1) parallel arrangement of longitudinal veins; (2) longitudinal veins absent.
96. Elytral sclerotization pattern: (0) with a pattern of unsclerotized window punctures; (1) entirely sclerotized.
97. Elytral apex: (0) distinctly reaching beyond abdominal apex posteriorly; (1) slightly reaching beyond abdominal apex posteriorly; (2) reaching abdominal apex or shorter.
98. Transverse folding mechanism of hind wings: (0) absent; (1) present.
99. Oblongum cell of hind wing: (0) closed cell not differentiated as oblongum cell; (1) oblongum present; (2) open or absent.
100. Abdominal sternite I: exposed; (1) concealed under metacoxae, largely or completely reduced.
101. Median ridge on ventrite 1: (0) absent; (1) present.
102. Number of exposed abdominal ventrites (excluding sternite I): (0) > 6; (1) 6; (2) 5.
103. Arrangement of abdominal sterna: (0) abutting, not overlapping; (1) tegular or overlapping.

ZOBODAT - www.zobodat.at

Zoologisch-Botanische Datenbank/Zoological-Botanical Database

Digitale Literatur/Digital Literature

Zeitschrift/Journal: [Arthropod Systematics and Phylogeny](#)

Jahr/Year: 2015

Band/Volume: [73](#)

Autor(en)/Author(s): Beutel Rolf Georg, Yavorskaya Margarita I., Kojima Kazuki,
Machida Ryuichiro

Artikel/Article: [Morphology of the first instar larva of *Tenomerga mucida*\(Chevrolat, 1829\) \(Coleoptera: Archostemata: Cupedidae\) 239-258](#)