

Phylogeny of the taxon *Paralaophontodes* Lang (Copepoda, Harpacticoida, Laophontodinae), including species descriptions, chorological remarks, and a key to species

Kai Horst George¹

¹ *Senckenberg am Meer, Abt. Deutsches Zentrum für Marine Biodiversitätsforschung DZMB, Südstrand 44, D-26382 Wilhelmshaven, Germany*

<http://zoobank.org/32051770-28D6-4A10-8321-BF82758AA0D6>

Corresponding author: *Kai Horst George* (kgeorge@senckenberg.de)

Abstract

Received 24 November 2016

Accepted 8 March 2017

Published 22 March 2017

Academic editor:

Michael Ohl

Key Words

Crustacea

Meiofauna

Ancorabolidae

systematics

taxonomy

geographical distribution

A detailed phylogenetic analysis of the taxon *Paralaophontodes* Lang (Copepoda, Harpacticoida, Laophontodinae Lang) based on morphological characters is presented. The monophylum *Paralaophontodes* is supported by 16 unambiguous autapomorphies such as the presence of characteristic dorsal processes on cephalothorax and body somites, a 5-segmented male antennule, the loss of the syncoxal seta on the maxilliped, and the endopodal strengthening of the first swimming leg. The corresponding extensive phylogenetic evaluation includes the description of *Paralaophontodes anjae* sp. n. from a beach on Chiloé Island (Chile), the re-description of *Laophontodes armatus* Lang, and the re-establishment of *Paralaophontodes robustus* (Bözić), the displacement of *Laophontodes armatus*, *L. hedgpethi* Lang and *L. psammophilus* Soyer to *Paralaophontodes*, a discussion on relationships within that taxon, remarks on its geographical distribution, and a key to the species.

Introduction

Lang (1936) erroneously synonymized *Laophonte echinata* Willey, 1930 (Laophontidae T. Scott, 1905) with *Laophontodes armatus* Lang, 1936 (Laophontodinae Lang, 1944 in the paraphylum Ancorabolidae Sars, 1909), owing to peculiar shared derived features such as two lateral extensions and moderately long hairy elements mid-dorsally on the cephalothorax, and a particular dorsal armature of the body somites (Lang 1936). Obvious differences between *L. echinata* and *L. armatus* were according to Lang (1936) due to misinterpretations by Willey (1930). Particularly noticeable differences include: the P1 exp being 2-segmented in *L. echinata* and 3-segmented in *L. armatus*, and; the P1 enp-2 carrying 1 terminal claw in *L. echinata*, but a terminal claw and an additional long seta in *L. armatus*. Twenty-nine years later Lang (1965) himself recognized his error and established the taxon *Paralaophontodes* Lang, 1965 within

Laophontodinae, relocating *L. echinata* into the new genus as *Paralaophontodes echinatus* (Willey, 1930) while retaining *L. armatus* within *Laophontodes* T. Scott, 1894.

Lang (1965) transferred *Laophontodes robustus* Bözić, 1964 from the Island La Reunión, Indian Ocean, to his newly created genus *Paralaophontodes*. However, Lang (1965) doubted the distinct specific status of *P. robustus*, pointing to its strong similarity with *P. echinatus*. Wells and Rao (1987) formally synonymized *P. robustus* with *P. echinatus*. At present the taxon *Paralaophontodes* contains three species, namely *P. echinatus*, *P. elegans* Baldari and Cottarelli, 1986, and *P. exopoditus* Mielke, 1981.

When describing *Laophontodes hedgpethi* Lang, 1965, Lang (1965) noted a strong similarity of that species with *L. armatus* and *Paralaophontodes echinatus*. However, he did not carry out the consequent step by unifying all corresponding species, which remain therefore in the laophontodin genera *Laophontodes* and *Paralaophontodes*, respectively. The objective of this contribution is

to update the systematics of *Paralaophontodes* by the inclusion of all respective species hitherto assigned to *Laophontodes*. To support this synonymisation, a detailed phylogenetic analysis based on all available morphological characters is presented. In that context, a re-description of *Laophontodes armatus* is given, along with the description of a new *Paralaophontodes* species, *P. anjae* sp. n., from Chiloé Island (Chile). Moreover, *P. robustus* is re-established, new records of known *Paralaophontodes* species are documented, and a key to the known species of *Paralaophontodes* is provided.

Material and methods

Paralaophontodes anjae sp. n.: one single female was collected by the author on 27.03.1994 in Puente Quilo (Gulf of Quetalmahue), Chiloé Island, Chile. The material was sampled at low tide at station #Q4 directly at the waterline (Fig. 1). The substrate consists of medium-sized sand, the measured temperature was 12°C, and the salinity was 32.3. Material was immediately fixed with 4% non-buffered formalin and later on sorted under a binocular in the laboratories of the Instituto de Biología Marina “Dr Jürgen Winter” at the Universidad Austral de Chile, Valdivia, Chile.

Additional *Paralaophontodes* material

Paralaophontodes echinatus (Willey, 1930): two females and one male were collected by Mr Johannes Dürbaum (Jülich, Germany) from an intertidal mangrove-mudflat at Bering Point village, south-east of Andros Island, Bahamas, in July 1993 (cf. Seifried and Dürbaum 2000) and kindly put to the author’s disposal. The material is kept in the collection of Senckenberg Forschungsinstitut und Naturmuseum Frankfurt, Germany, coll. nos. SMF 37104/1, SMF 37105/1, and SMF 37106/1. One male and one CI copepodid was sampled by the author on June 29th, 2008 at the port of Golfito (Pacific coast of Costa Rica). The material is kept in the collection of Senckenberg Forschungsinstitut und Naturmuseum Frankfurt, Germany, coll. nos. SMF 37107/1 (male), SMF 37108/1 (CI).

Paralaophontodes exopoditus Mielke, 1981: one female collected by Dr Gritta Veit-Köhler (Wilhelmshaven, Germany) at the coastline of Dahab (28°29.0’N, 34°30.0’E, Gulf of Akaba, Egypt) in summer 1995. The specimen was kindly put to the author’s disposal and is kept in the collection of Senckenberg Forschungsinstitut und Naturmuseum Frankfurt, Germany, coll. no. SMF 37109/1. One male collected by Prof. Dr Horst Kurt Schminke (Oldenburg, Germany) at station PNG M4, Ednago Island, near Kavieng (2°35’S, 150°5’E, New Ireland, Papua New Guinea, cf. Seifried 2003), on 11.11.1984, and kindly provided to the author. The individual is kept in the collection of Senckenberg Forschungsinstitut und Naturmuseum Frankfurt, Germany, coll. no. SMF 37110/1.

Laophontodes armatus Lang, 1936: The type material (coll. no. Type SMNH 2158) was kindly put to the author’s

disposal by Mrs Karin Sindemark Kronstedt, Swedish Museum of Natural History, Department of Invertebrate Zoology, Stockholm, Sweden. It consists of eight individuals: six females and two males are complete and of moderate condition but covered with compact detritus. Moreover, four fragments are included: SMNH 2158(a): one female cephalothorax and thorax (until swimming leg P3); SMNH 2158(b): one female thorax (P2–P4); SMNH 2158(c): two female urosomes. As neither a holotype nor any paratypes have been designated, the above named specimens are henceforth declared as syntypes. Additional material was collected in the Magellan Straits, Chile; one female (coll. no. SMF 37111/1) was sampled by the author on 27.05.1996 from Bahía Catalina in the north of Punta Arenas (Chile) (53°7.008’S, 70°52.323’W, 0m depth), and one female and one male (coll. nos. SMF 37112/1 and SMF 37113/1–7, respectively) were kindly provided by Dr Matthias Gorny (Santiago de Chile, Chile) from sampling at Punta Yartou, Canal Whiteside, Tierra del Fuego (53°53.723’S, 70°09.132’W, 15m depth) on 15.02.2003. The Patagonian specimens are kept in the collection of Senckenberg Forschungsinstitut und Naturmuseum Frankfurt, Germany.

Species identification and drawings were made with the use of a camera lucida on a Leica DMR compound microscope equipped with differential interference contrast. General terminology follows Lang (1948) and Huys and Boxshall (1991). Terminology referring to phylogenetic aspects follows Ax (1984); the terms “telson” and “furca” are adopted from Schminke (1976).

Abbreviations used in the text: A1 = antennule, A2 = antenna, aes = aesthetasc, benp = baseoendopod, cphth = cephalothorax, DP I–DP IX = dorsal processes I–IX, enp = endopod, enp-1–enp-3 = endopodal segments 1–3, exp = exopod, exp-1–exp-3 = exopodal segments 1–3, FR = furcal rami, GF = genital field, P1–P6 = swimming legs 1–6, R = rostrum, T = telson.

Results

Phylum Arthropoda

Subphylum Crustacea Brünnich, 1772

Superclass Multicrustacea Regier et al., 2010

Class Hexanauplia Oakley et al., 2013

Subclass Copepoda Milne-Edwards, 1840

Order Harpacticoida Sars, 1903

Family “Ancorabolidae” Sars, 1909

Subfamily Laophontodinae Lang, 1944

Genus *Paralaophontodes* Lang, 1944

Type species. *P. echinatus* (Willey, 1930). Additional species: *P. anjae* sp. n., *P. armatus* (Lang, 1936) comb. n., *P. elegans* Baldari and Cottarelli, 1986, *P. exopoditus* Mielke, 1981, *P. hedgpethi* (Lang, 1965) comb. n., *P. psammophilus* (Soyer, 1974) comb. n., *P. robustus* (Bözić, 1964).

Amended generic diagnosis. Laophontodinae. Body slender and cylindrical. Cphth with triangular extensions

medio- and postero-laterally (not clearly pronounced in *P. elegans*). Cphth with dorso-median ridge extended into 2 posteriorly directed blunt, conical elevations and covered by tuft of hair-like setules in anterior half. P2–P5-bearing thoracic somites dorsally with sclerotized processes bearing sensilla at their tips. First to penultimate abdominal somites with pair of dorsal processes that are transversely connected, appearing H- or even A-shaped. Telson narrowest body somite, rectangular, with anal operculum dorsally. Furcal rami approximately 3–5 times longer than broad, with 7 setae; setae I and II close together, V longest seta. A1 4-segmented in female; 5-segmented and chirocer in male, with fourth segment strongly swollen and bearing a strong spine. A2 lacking exp, or if present small and knob-like, with 1 small, bare apical seta. Md palp unilobate, exp represented by 1 seta, enp represented by 3 setae. Mx with 2 elongate and slender endites bearing 2–3 apical setae. Mxp without syncoxal seta. P1 exp 2- to 3-segmented; P1 enp-2 distinctly elongate, reaching at least half the length of enp-1, equipped with strong claw accompanied by 1 minute seta, an additional long geniculate seta may be present. P2–P4 with laterally elongate

bases. Exopods 3-segmented (fused to 1 long segment in P2 and P3 in *P. robustus*); P2 lacking endopod, P3 with or without small knob-like endopod carrying 1 small bare seta, P4 with or without 2-segmented endopod. P5 with outer seta arising from long setophore; benp completely reduced; in female represented by 2 setae, in male represented by 1 seta; with 1–3 long tube pores. Exp fused with baseopod, long and slender, laterally with 2 setae; subapically with 1 inner and 1 outer seta; apically with 1 long seta; tube pores present or absent. Female P6 small, located in front of gonopore, consisting of small segment separated from or fused with somite, with 0–2 small setae. The taxon is justified as a monophylum due to 16 unambiguous autapomorphies (see Discussion).

***Paralaophontodes anjae* sp. n.**

<http://zoobank.org/1482E119-BA97-4D1F-A516-D9417C6DDBA7>

Locus typicus. Puente Quilo, Canal de Quetalmahue, Chiloé Island, Chile, 41°51.671'S, 73°58.926'W, 0m (Fig. 1).

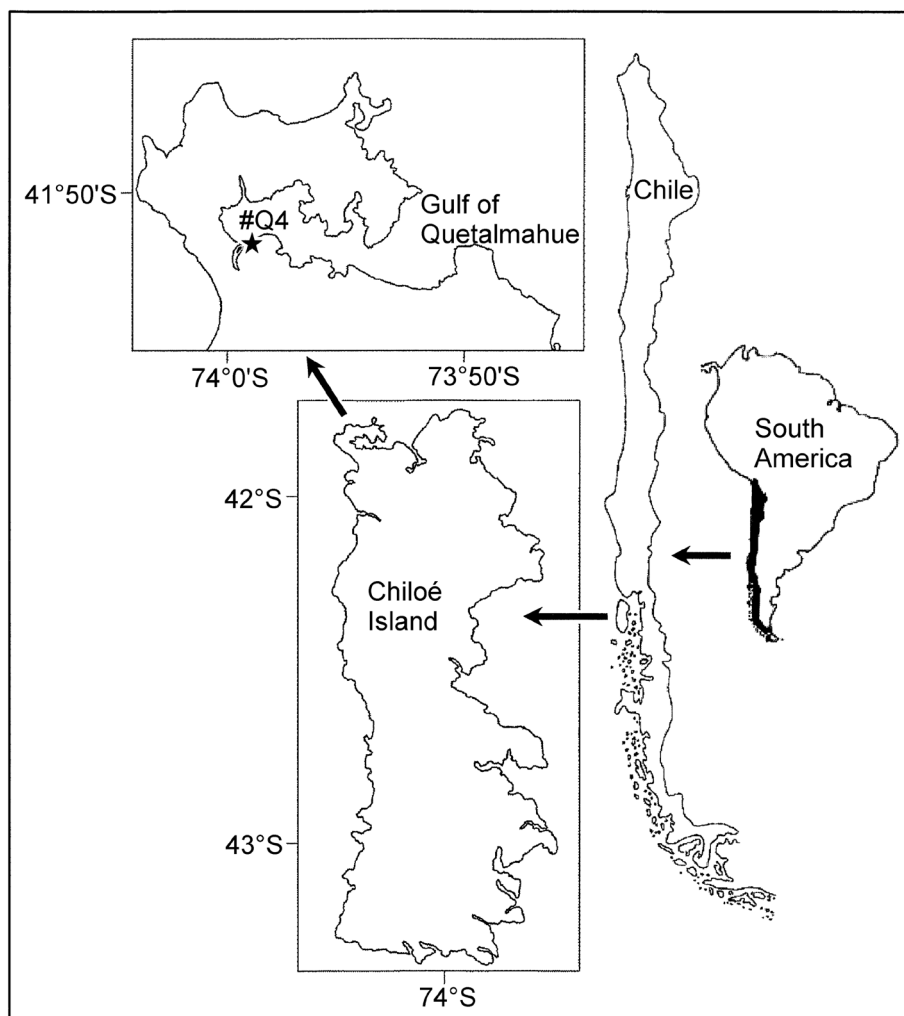

Figure 1. Map showing the locus typicus (black star) of *Paralaophontodes anjae* sp. n. in Puente Quilo, Gulf of Quetalmahue, Chiloé Island, Chile.

Material examined. Female holotype, distributed over 10 slides, coll. no. 37103/1–10.

Etymology. The specific epitheton “*anjae*” is given in fondly dedication to the author’s sister Mrs Anja George (Osorno, Chile); gender: feminine.

Description of female. Habitus (Fig. 2A) slender, cylindrical, slightly tapering backwardly, length from rostral tip to end of FR 746 μm . R (Figs 2A, 3A) fused to cphth, triangular in shape, rostral tip distinct, small, accompanied by pair of pinnate sensilla and paired hyaline protuberances. Subapically on dorsal side with small tube pore. All body somites except telson dorsally with paired cuticular processes (labelled as DP [Dorsal Processes] I–IX). Cphth with medio- and postero-lateral extensions of moderate triangular shape. Dorsally with cuticular ridge bearing 3 pairs of sclerotized processes (joined to DP I in Fig. 2A), the first of which carrying pinnate sensilla, the latter accompanied by paired bare sensilla at their bases. Between the middle pair of processes tuft of hair-like setules. Thoracic body somites laterally extended. Abdominal processes (DP VII–IX) “H”-like, partly ornamented with small cuticular “teeth” (Fig. 2A, A’). Last thoracic and first abdominal somite fused to form genital double somite; original boundary still visible from dorsal side. Telson smallest body somite, almost square. Anal operculum with small spinules at its apical margin, accompanied by pair of sensilla. FR (Figs 2A, 3B) long and slender, approximately 7x longer than broad, with 7 setae: I and II standing close together, of almost same length; III subapically, slightly longer than I and II; IV basally fused with V; V longest seta, inserting apically; VI as long as I–II, arising apically at inner margin; VII subapically at dorsal side, tri-articulate.

A1 (Fig. 3A) 4-segmented, all segments of approximately the same length. First segment apically with 1 unipinnate seta; second segment with eight bare setae; on posterior margin produced into moderate “bump” that carries several long spinules; third segment with 7 bare setae, two of which arising from pedestal together with aes; fourth segment laterally with 3 bare setae, subapically with 5 bare setae, four of which bi-articulated at base (1 seta broken in Fig. 3A); apically an aes plus 2 bare setae.

Setal formula: 1/1; 2/8; 3/7+ aes; 4/10+ aes.

A2 (Fig. 4A) with allobasis carrying a row of spinules and 1 small bare seta on abexopodal seta. Exp lost. Enp as long as allobasis, with 2 spines and tiny seta anteriorly; apically with row of spinules and with 2 spines, one of which unipinnate, and 3 geniculate setae, the outermost fused with 1 minute bare seta.

Md (Fig. 4B, B’) with small gnathobase bearing 4 teeth and 1 bare seta (Fig. 3B’); md palp 1-segmented, with 5 bare lateral setae and with 1 terminal bipinnate seta.

Mxl (Fig. 4C) praecoxal arthrite armed with 5 strong spines and with 3 bare setae; additionally with 1 lateral and 2 surface setae. Coxa without spinules, terminally with 2 setae (one seta broken in Fig. 4C). Basis without spinules,

terminally with 2 bare setae, and 2 juxtaposed subterminal bare setae; exp and enp each represented by 1 seta.

Mx (Fig. 4D) with 2 slender endites, both carrying 3 apical setae. Basis elongate, broken in Fig. 4D. Enp small, with 2 bare setae.

Mxp (Fig. 4E) with unarmed syncoxa. Basis without ornamentation (but damaged apically), enp turned into long claw accompanied by small bare seta.

P1 (Fig. 5A, A’) with longitudinally elongated praecoxa, coxa and basis; praecoxa as long as coxa. Basis with 1 outer and 1 inner bare seta, which has moved towards the anterior surface. Exp 2-segmented, exp-1 with 1 unipinnate outer spine; exp-2 nearly twice as long as exp-1, laterally with 2, subapically with 1, and apically with 2 setae; all setae bare and geniculate. Enp 2-segmented, enp-1 massive, more than 3x longer than broad, without ornamentation; enp-2 half as long as enp-1, apically with strong claw, subapically on inner margin with 1 minute bare seta.

P2–P4 (Fig. 5B–D). Intercoxal sclerites strongly reduced, triangular, not linking the counterparts. Bases transversely elongated, with 3-segmented exopods but lacking endopods. Bases with 1 outer seta and 1 tube pore on proximal margin. Exopods P2 and P3 as long as basis, exopod P4 slightly longer than basis; all exopodal segments except P4 exp-1 with outer spinules; exp-1 and exp-2 each with 1 outer bipinnate spine, exp-3 with 3 outer bipinnate spines, apically with 1 spine (comparatively short in P4) and 1 small seta. Setal formula of P2–P4 is given in Table 1.

P5 (Fig. 2B) with completely reduced benp, being represented by 2 bipinnate setae, the longer of which reaching insertion site of inner exopodal seta; baseoendopodal setae accompanied by 2 tube pores. Outer basal seta arising from long setophore, which is escorted by few long spinules and 1 long tube pore. Exp distinct, with 3 outer setae, 2 of which being bipinnate; subapically with inner bipinnate seta neighboured by tube pore; apically with bare seta reaching length of whole P5.

GF/P6 (Fig. 2C) small, P6 fused to somite, consisting of 2 small bipinnate setae arising from slightly protruded lobes.

Male unknown.

Genus *Laophontodes* T. Scott, 1894

Type species. *Laophontodes typicus* T. Scott, 1894. Additional species: According to George and Gheerardyn (2015, p. 62, Table 1), *Laophontodes* currently encloses 16 species plus 1 species *incertae sedis*.

Table 1. *Paralaophontodes anjae* sp. n., setation of P2–P4. Roman numerals indicate outer spines.

	Exp-1	Exp-2	Exp-3	Enp-1	Enp-2
P2	I-0	I-0	III-I-0	.	.
P3	I-0	I-0	III-I-0	.	.
P4	I-0	I-0	III-I-0	.	.

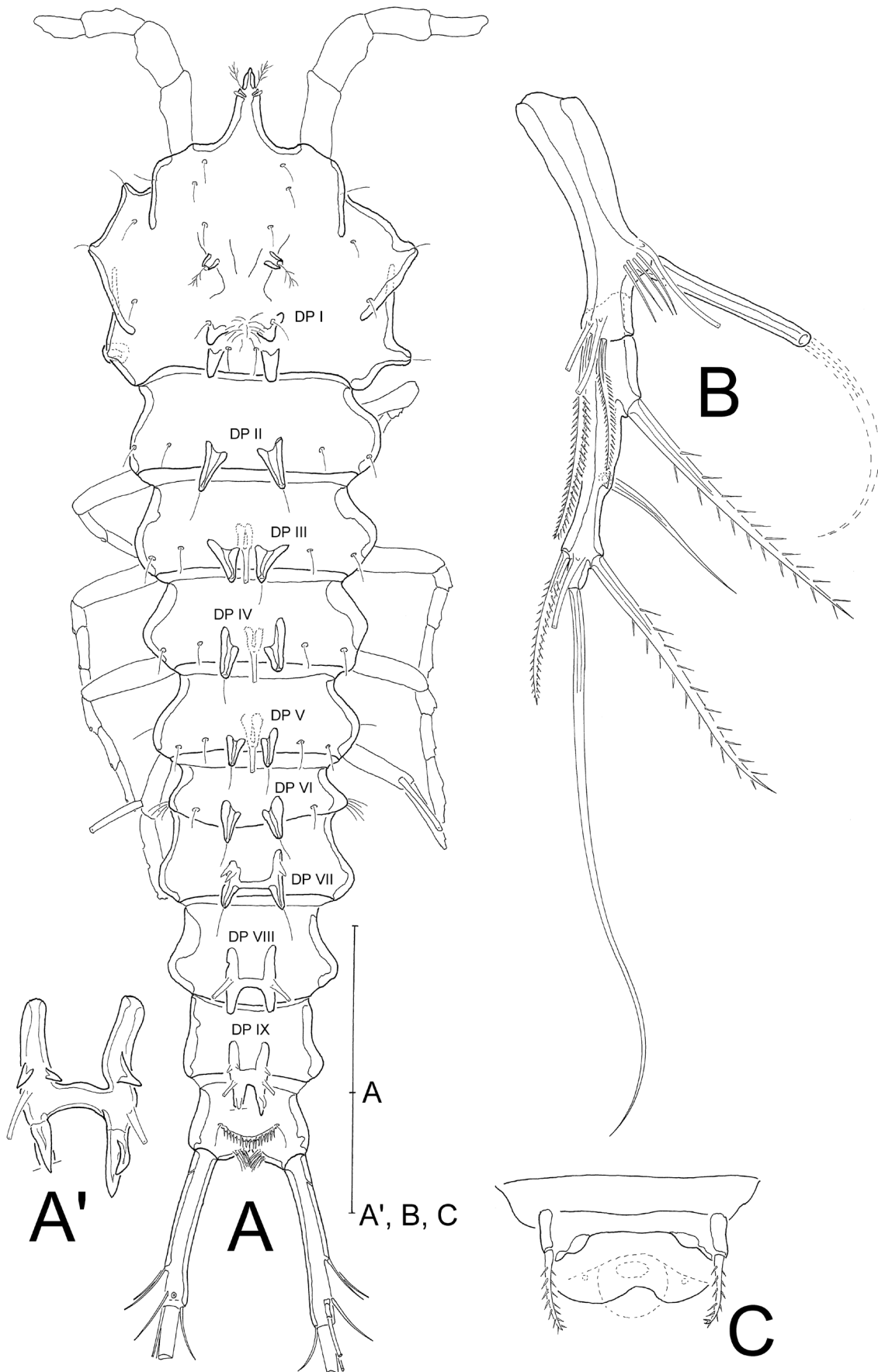

Figure 2. *Paralaophontodes anjae* sp. n., female. (A) habitus, dorsal view; (A') dorsal process IX; (B) P5; (C) genital field. Scale bars: (A) 100µm; (A', B, C) 50µm.

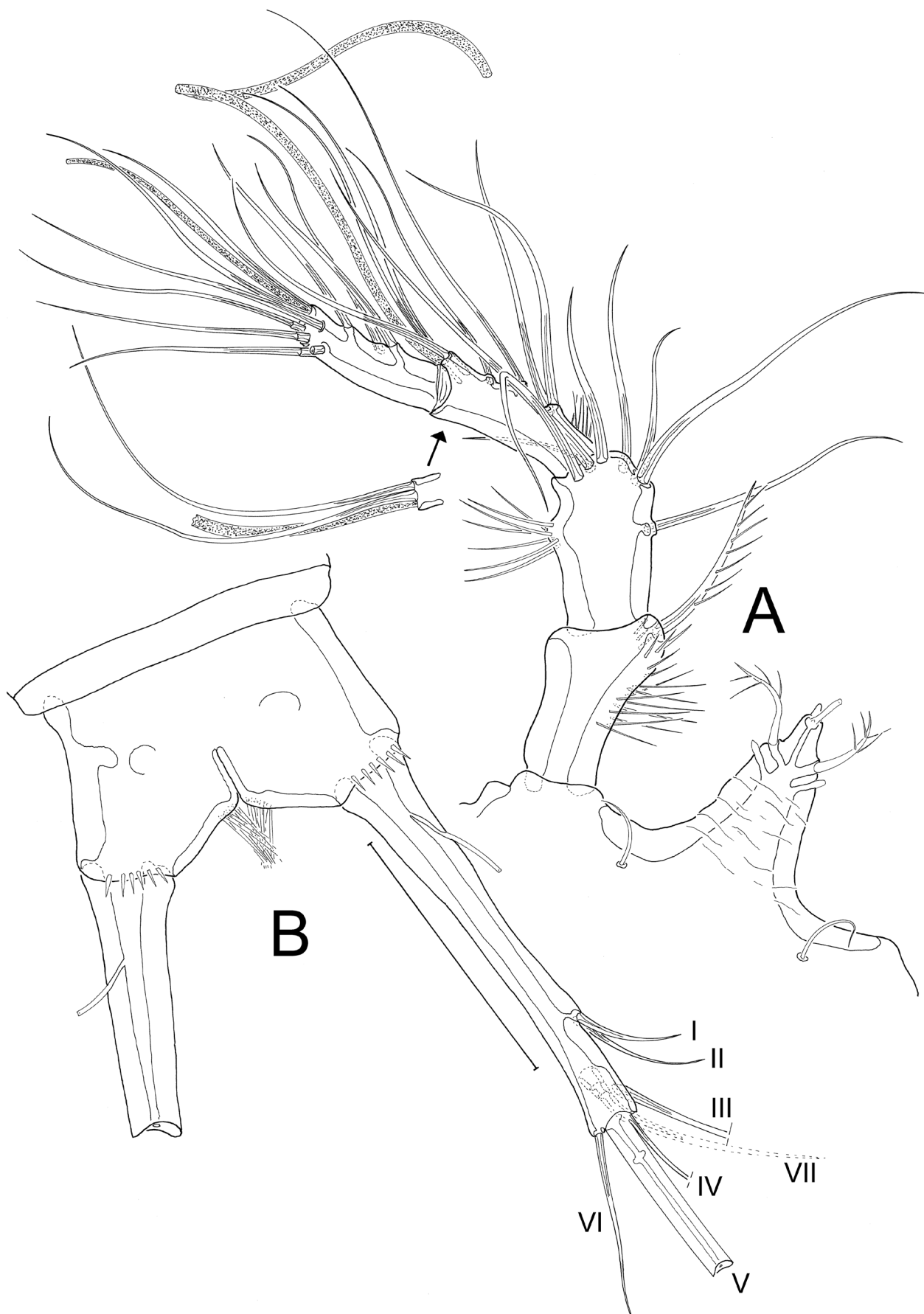

Figure 3. *Paralaophontodes anjae* sp. n., female. (A) A1 and rostrum, arrow showing insertion of aes and accompanying setae of counterpart; (B) telson and FR, ventral view, Roman numerals indicating furcal setae. Scale bar: 50 μ m.

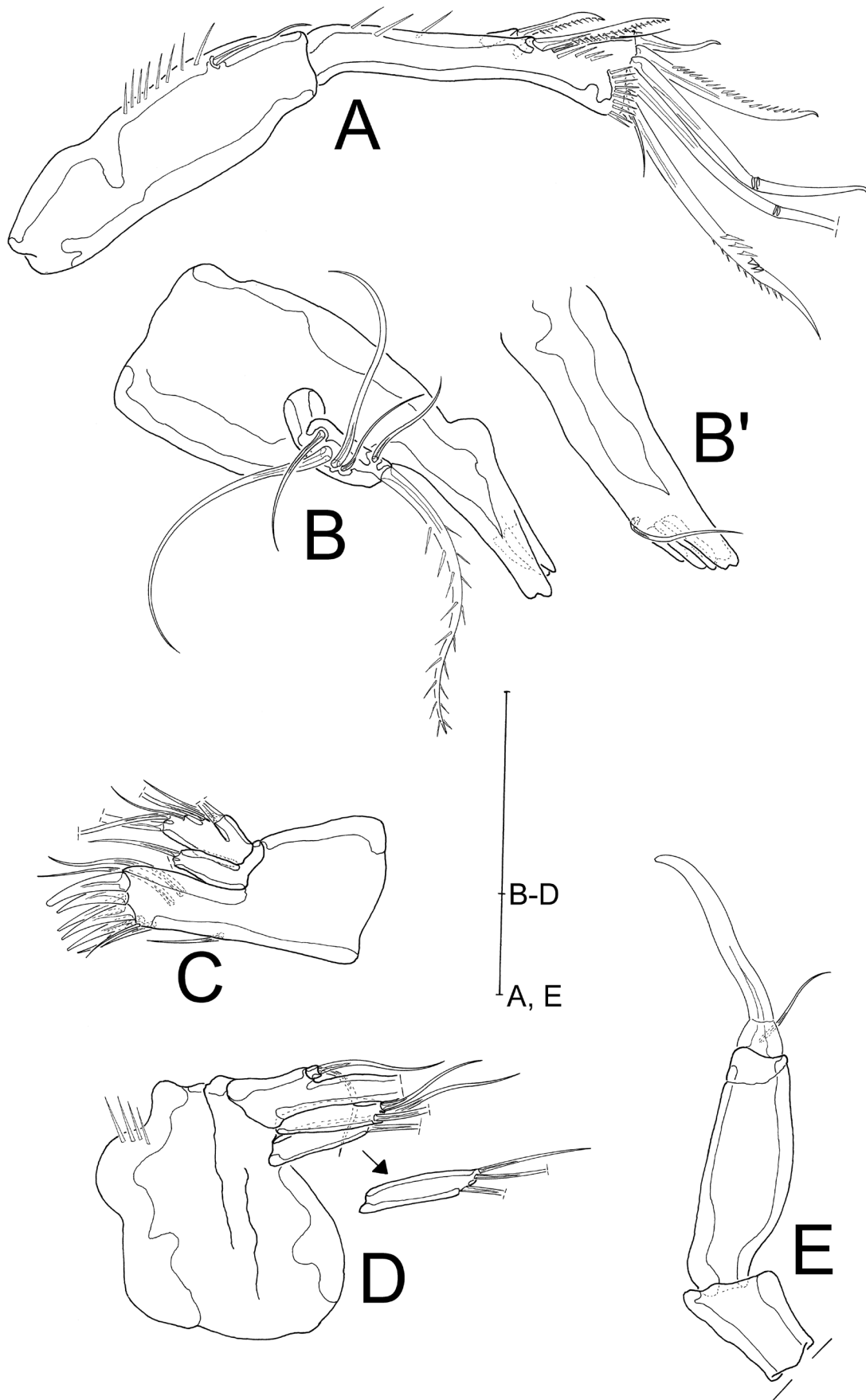

Figure 4. *Paralaophontodes anjae* sp. n., female. (A) A2; (B) md; (B') mandibular palp of counterpart; (C) mxl; (D) mx, proximal endite separated (arrow); (E) mxp. Scale bars: (A, E) 50µm; (B, B'-D) 20µm.

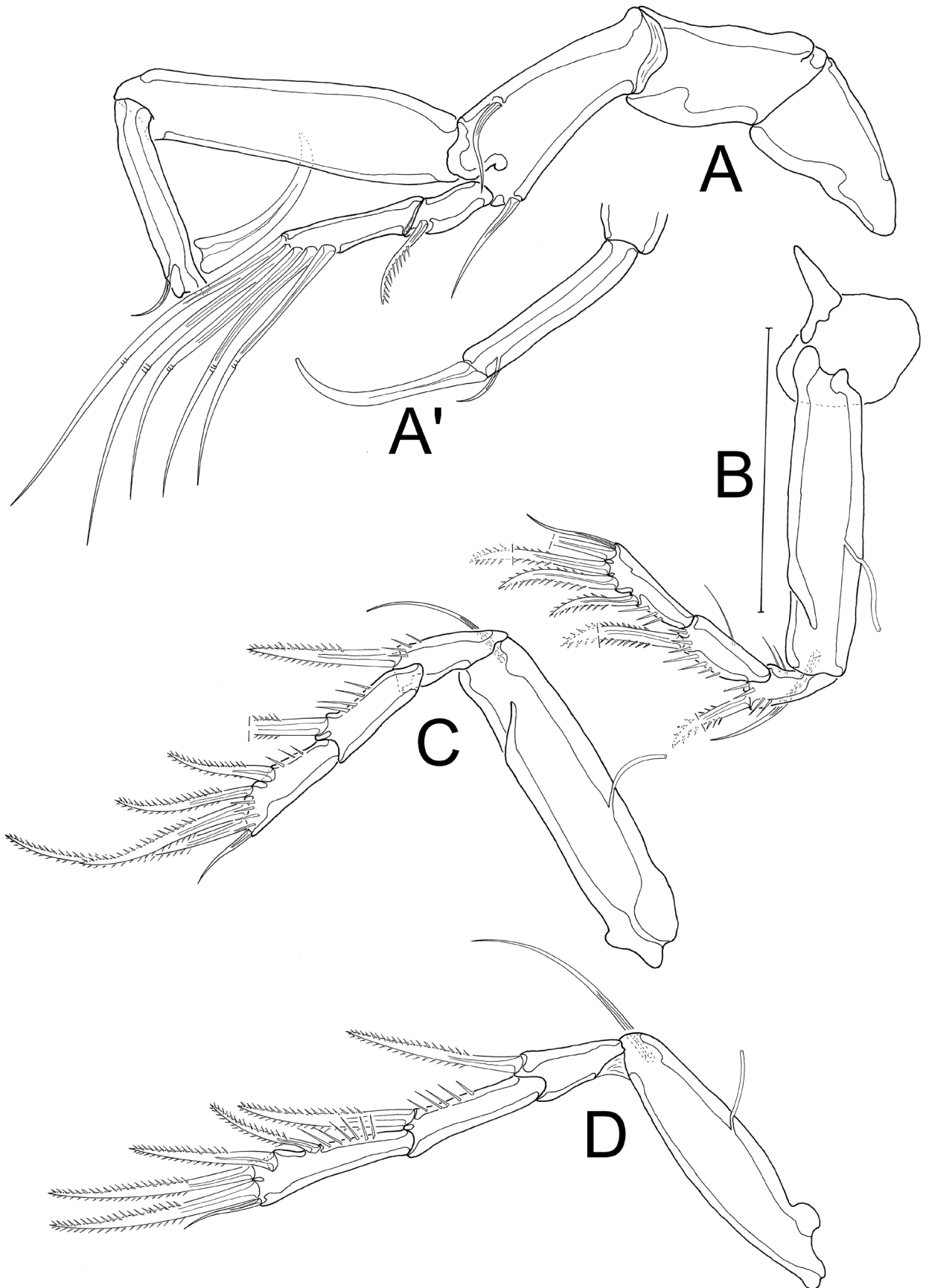

Figure 5. *Paralaophontodes anjae* sp. n., female. (A) P1, claw broken; (A') P1 enp-2 of counterpart; (B) P2 showing rudimental intercoxal sclerite; (C) P3; (D) P4. Scale bar: 50µm.

***Laophontodes armatus* Lang, 1936**

Note. The re-description is based on one female (habitus) and the fragments of the type series, in order to destroy as few complete individuals as possible, and because of the compact detritus coverage on most complete specimens. Types SMNH 2158(a) (female) and SMNH 2158(b) (female) were dissected and distributed over 7 and 4 slides, respectively. Both urosomes of Type SMNH 2158(c) (females) were put on 1 slide, 1 urosome in ventral view, the other one in dorsal view.

In addition, the female and the male of the Magellan material were included to complete the re-description (additional female habitus, male habitus, mouthparts, sexual dimorphic parts of male).

Re-description of female. Habitus (Figs 6A, 7A) cylindrical and slender, tapering, no clear distinction between pro- and urosoma. Body length (from rostral tip to end of FR) about 770µm (Fig. 6A) (Magellan female (Fig. 7A) about 730µm). Cphth laterally running out into two triangular processes, each carrying a sensillum at its tip. Cphth dorsally with several sensilla and with sclerotized ridge that is densely covered with fine hair-like elements and splits into 2 backwardly directed processes posteriorly. R protruding, fused to cphth, triangular, subapically with pair of sensilla. All body somites except telson dorsally with paired cuticular processes (labelled as DP [Dorsal Processes] I–IX in Figs 6 and 7). DP VII and/or DP VIII–IX basally with long tube-pores and small cuticular projections. DP I–VIII with sensilla at their tips. Comparison of different females revealed a variability regarding shape, ornamentation, size and number of those projections (Figs 6A–C, 7B, B'), as well as with respect to the number of apical sensilla (Fig. 7B). Posterior margins of body somites generally naked but P2–P6-bearing somites apically with sensilla. Telson square, slightly broader than long; dorsally with anal operculum apically with fine spinules. FR (Figs 6A, 7A, C, 8D) approximately 3.5x longer than broad, equipped with seven setae: I and II of almost same length, standing close together subapically on the outer margin; III, IV, V, and VI arising apically, II and VI of same length, V being the longest seta; VII tri-articulate, arising subapically on dorsal side.

A1 (Fig. 8A) 4-segmented, aes on third segment. First to third segments of almost same length; first segment with 1 bipinnate seta, remaining antennular setae naked; second segment with long spinules on bump along outer margin, 2 of its setae arising from projection surrounded by small spinules at its base; third segment slightly protruded apically, with 2 setae accompanying aes; fourth segment carrying a second, small aes. Setal formula: 1/1; 2/7; 3/6 + aes; 4/10 + aes.

A2 (Fig. 8B) with allobasis carrying 1 abexopodal seta on distal third. Exp absent. Enp with subapical row of spinules, and with 2 unipinnate and 1 bare seta distally on inner margin; apically with 6 setae, three of which geniculate, outermost seta very small.

Md, mxl, and mx described from male.

Mxp (Fig. 8C) with syncoxa lacking a terminal seta, but with rounded row of spinules; basis with 2 rows of spinules; enp turned into claw as long as basis and accompanied by small seta.

P1 (Fig. 9A) with longitudinally prolonged coxa and basis, the latter carrying 1 outer bipinnate and 1 inner bare seta, the latter being displaced on anterior surface. Exp 3-segmented, slightly surpassing half of length of enp-1. Exp-1 with 1 outer bipinnate spine; exp-2 with 1 outer bare geniculate seta; exp-3 smallest, bearing 4 bare geniculate setae.

P2–P4 (Figs 10A–C, 12A–C, E) intercoxal sclerites (Fig. 12F, G) very slender, bow-like; bases transversely elongate bearing 1 tube pore anteriorly, and with 1 outer seta. Exps 3-segmented, exp-1 and exp-2 with 1 outer bipinnate spine; exp-3 with 3 outer bipinnate spines; apically with 1 spine and 1 plumose seta; P3 exp-3 additionally with 1 tube pore apically. P2 without enp (Figs 9A, 12A–C, E), former insertion still detectable (triangular arrows in Figs 9A, 12A–C, E); P3 and P4 carrying 2-segmented enps, enp-1 very small, without armature, enp-2 with few spinules and carrying 2 apical setae, the inner one of which being shorter than the outer one. Setal formula of P2–P4 is given in Table 2.

P5 (Fig. 9B) with outer seta arising from long spinulose setophore; benp completely reduced, represented by 2 setae, one of which of fishbone pattern, the other seta bare. Additionally with 3 tube pores. Exp fused with baseoendopodal part, long and slender, laterally with 2 bare setae; subapically with 2 bipinnate setae and 1 tube pore; apically with 1 long bipinnate seta.

P6/GF (Fig. 8E). P6 small, forming bilobate sclerotized structure in front of gonopore, each leg carrying 1 small bipinnate seta.

Redescription of male. The male differs from the female in the following features: body size, shape of A1, shape of P3 and P4 endopods, ornamentation of P5, complete loss of P6.

Habitus (Fig. 7C) slender, slightly smaller than female with a body length of about 560µm. Ornamentation of cphth and body somites very similar to that in female, with slight variation regarding DP I–DP IX.

A1 (Fig. 11A) 5-segmented, chirocer, aes at fourth and fifth segment. First segment apically with 1 bipinnate seta at anterior margin, accompanied by several long spinules; second segment as long as first, with 7 bare setae; third

Table 2. *Laophontodes armatus* Lang, 1936, setation of P2–P4. Roman numerals indicate outer spines.

	Exp-1	Exp-2	Exp-3	Enp-1	Enp-2	Enp-3
P2	I-0	I-0	III-I1-0	.	.	.
P3	I-0	I-0	III-I1-0	0	0-2-0	.
P3 male	I-0	I-0	III-I1-0	0	apophysis	0-2-0
P4	I-0	I-0	III-I1-0	0	0-2-0	.

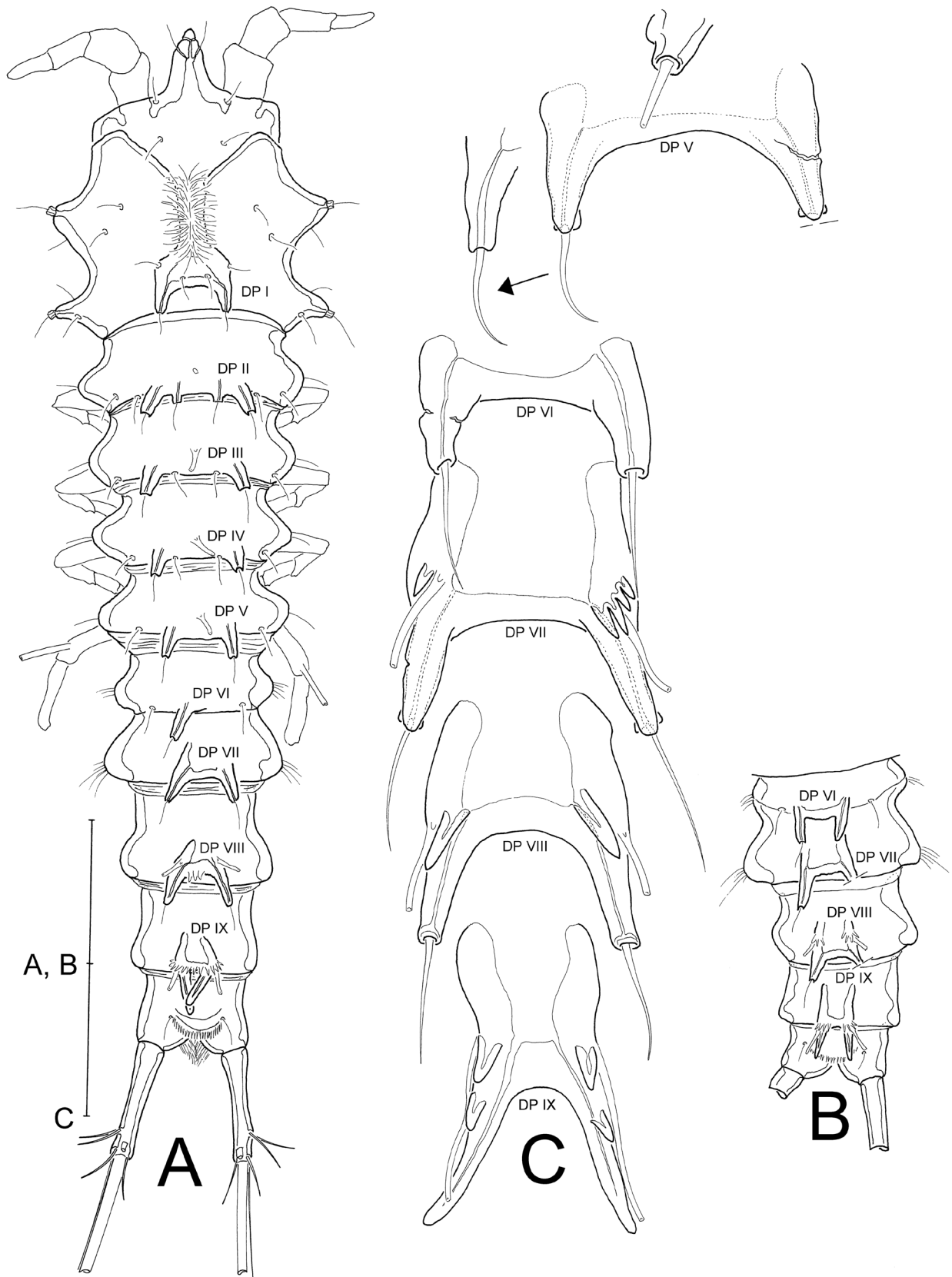

Figure 6. *Paralaophontodes armatus* (Lang, 1936) comb. n., female from the type series. (A) habitus, dorsal view, dorsal processes labelled DP I–DP IX; (B) urosome of second female; (C) dorsal processes DP V–DP IX, detail, of third female. Arrow points to cuticular overlap of sensillum-bearing tip. Scale bars: (A, B) 100 μ m; (C) 50 μ m.

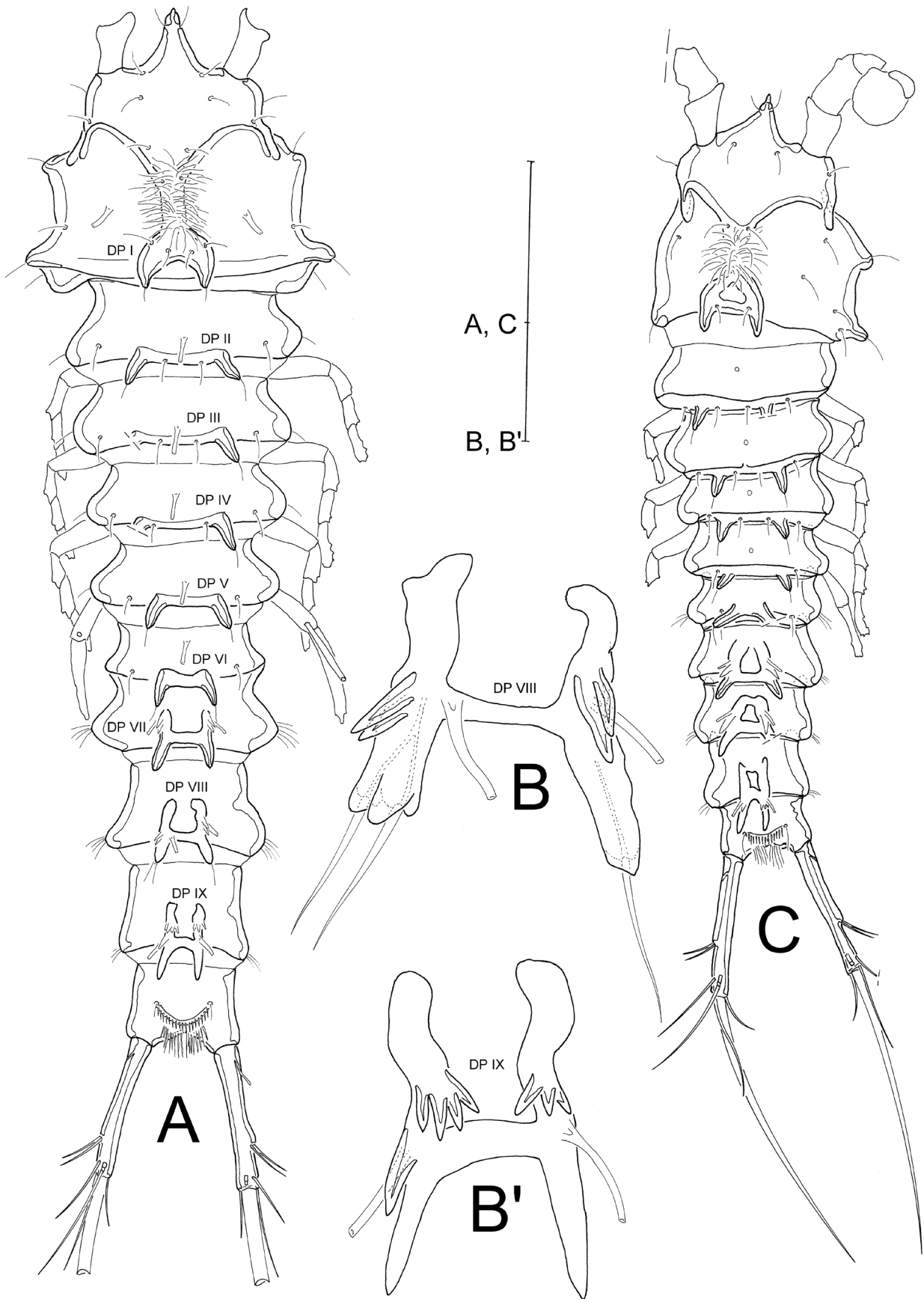

Figure 7. *Paralaophontodes armatus* (Lang, 1936) comb. n., (A) female from the Magellan material (Punta Arenas), habitus dorsal; (B, B') dorsal Processes DP VIII and DP IX of A.; (C) male from the Magellan Material (Punta Yartou), habitus dorsal. Scale bars: (A, C) 100µm; (B, B') 50µm.

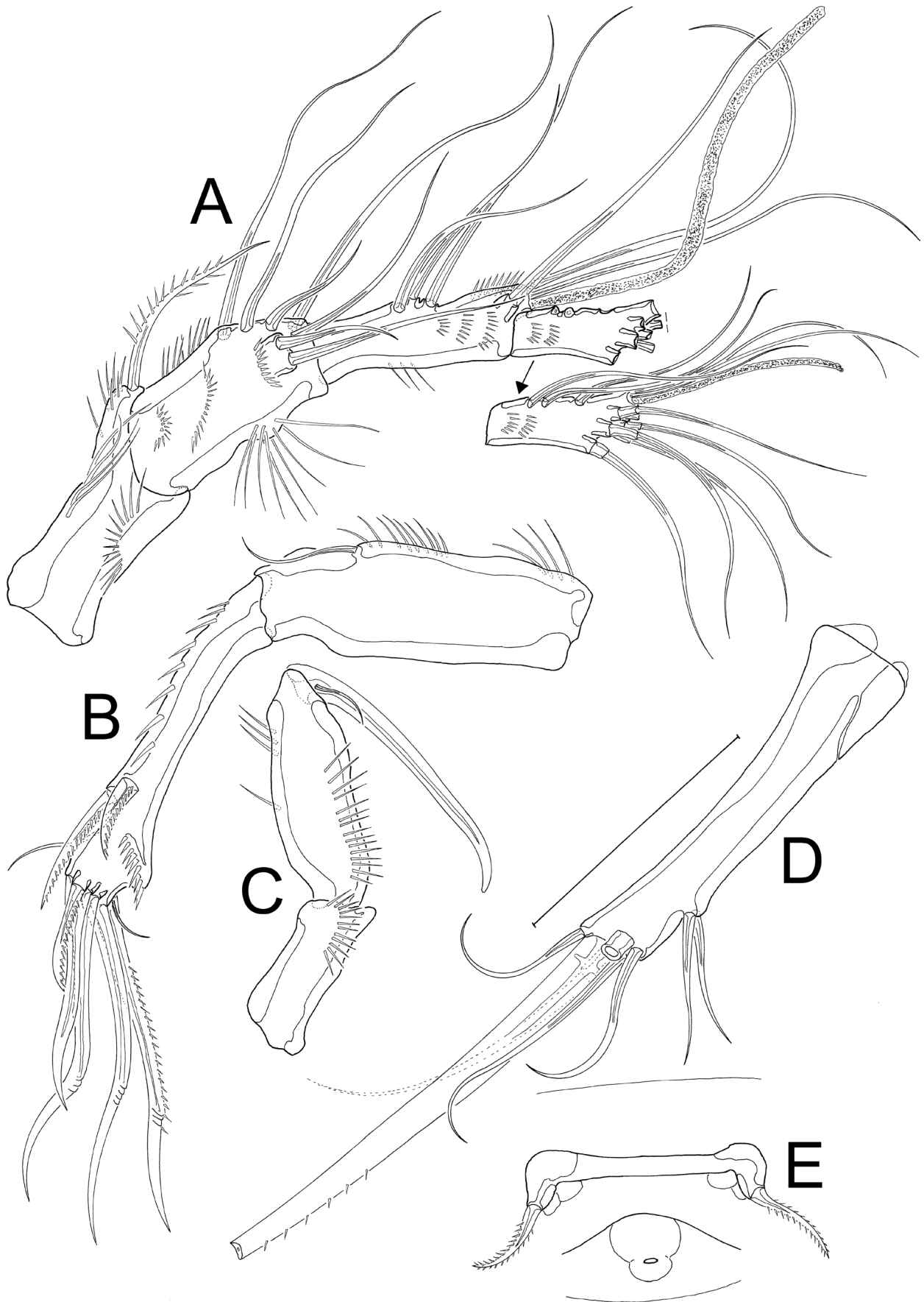

Figure 8. *Paralaophontodes armatus* (Lang, 1936) comb. n., female from the type series. (A) A1; (B) A2; (C) mxp; (D) FR, dorsal view; (E) genital field. Scale bar: 50 μ m.

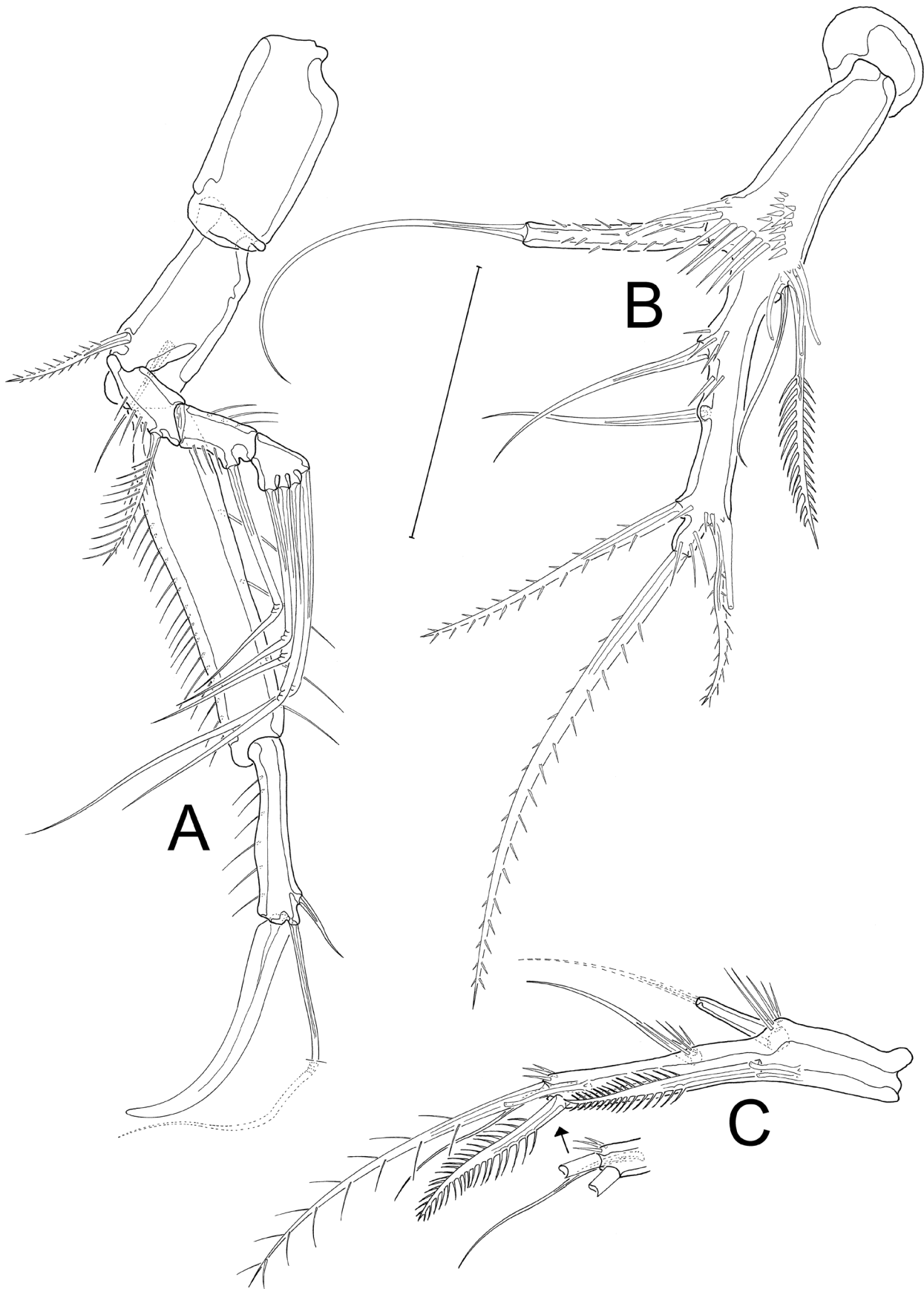

Figure 9. *Paralaophontodes armatus* (Lang, 1936) comb. n., (A, B) female from the type series; (A) P1; (B) P5; (C) male from the Magellan material (Punta Yartou), P5. Scale bar: 50 μ m.

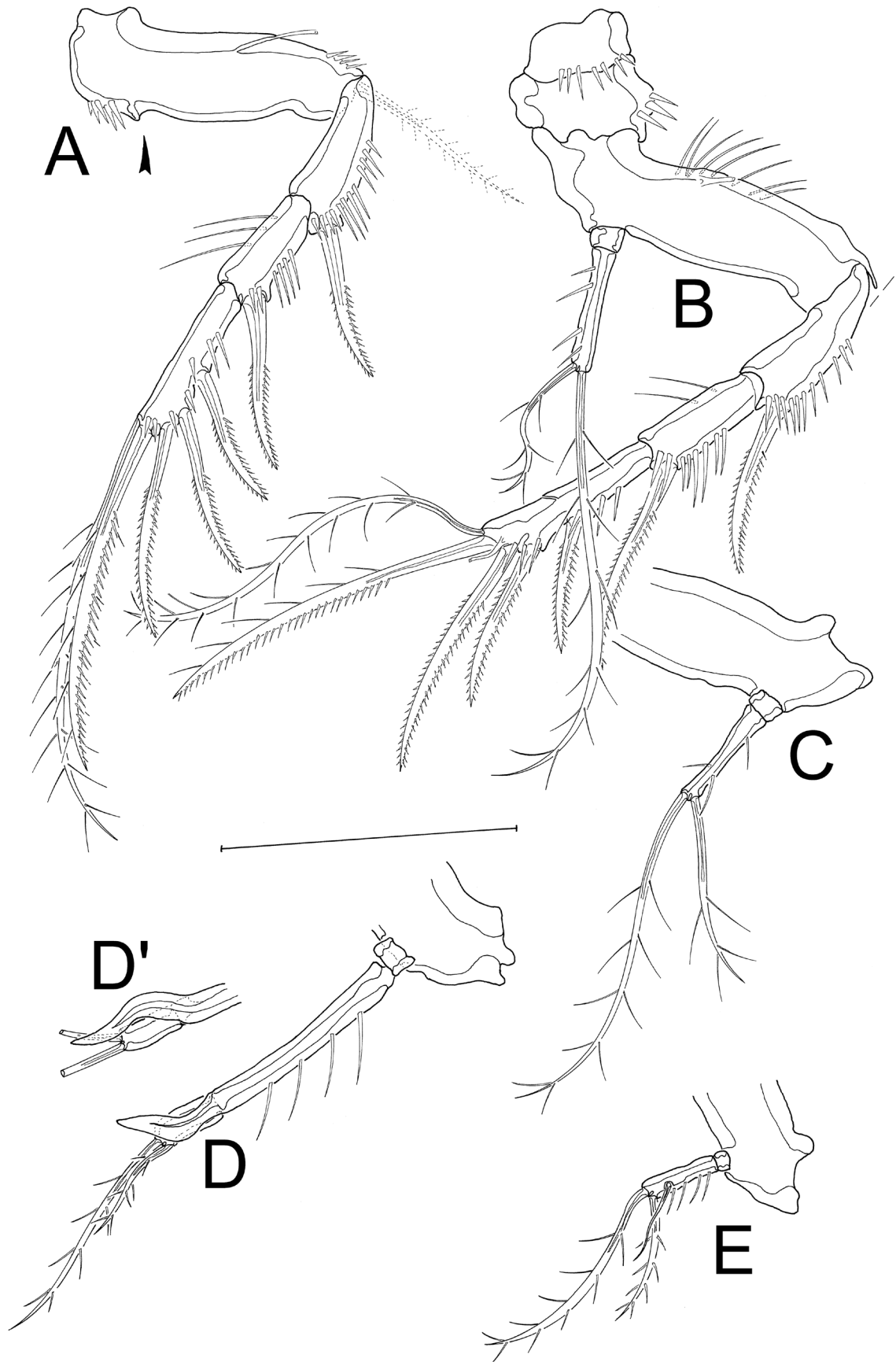

Figure 10. *Paralaophontodes armatus* (Lang, 1936) comb. n., (A–C) female from the type series; (A) P2, triangular arrow indicates insertion of the ancestral endopod; (B) P3; (C) P4 endopod; (D, E) male from the Magellan material (Punta Yartou); (D) P3 endopod; (D') P3 apophysis of counterpart; (E) P4 endopod. Scale bar: 50 μ m.

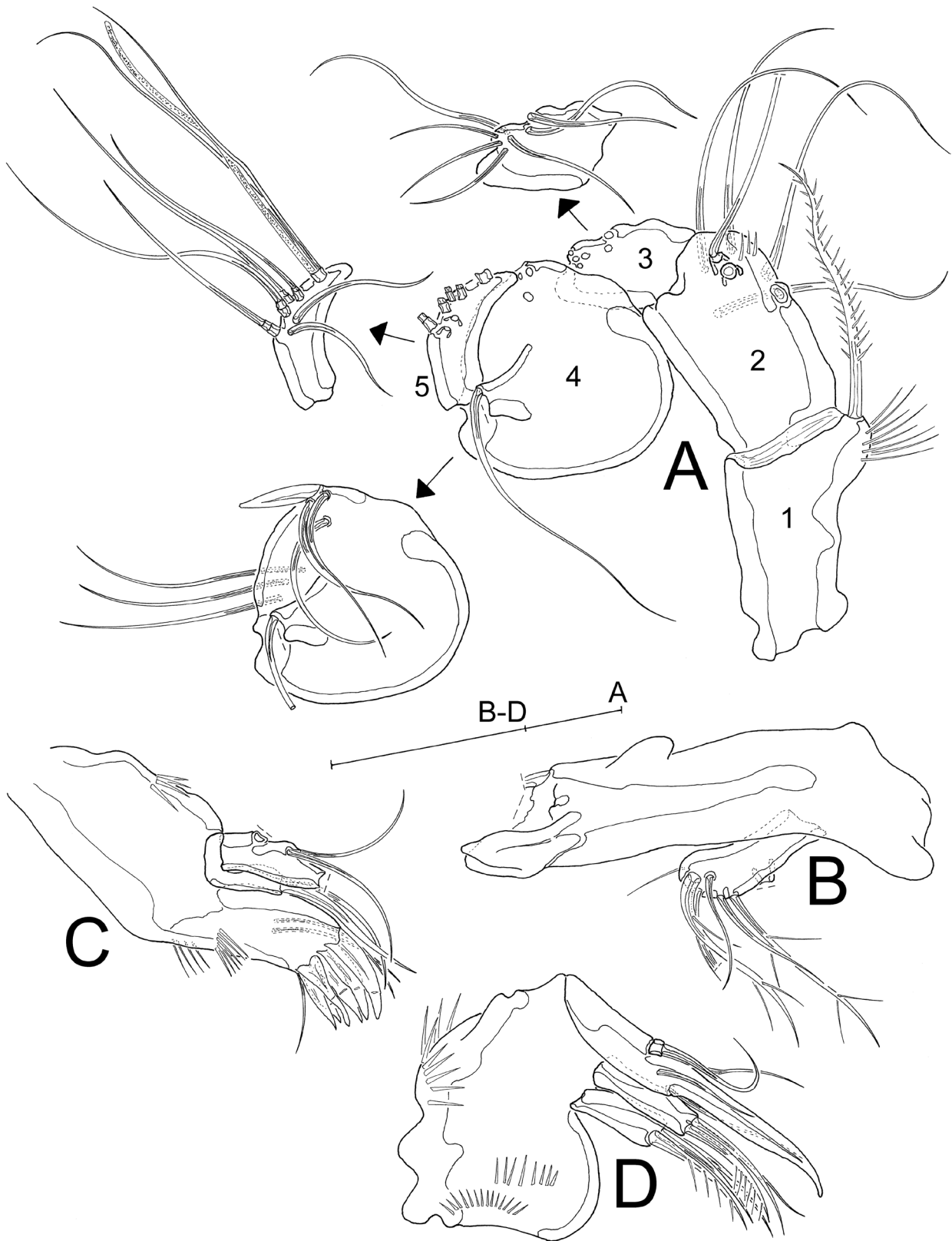

Figure 11. *Paralaophontodes armatus* (Lang, 1936) comb. n., male from the Magellan material (Punta Yartou); (A) A1, setation of segments 3–5 shown separately; (B) md; (C) mxl; (D) mx. Scale bars: (A) 50µm; (B–D) 20µm.

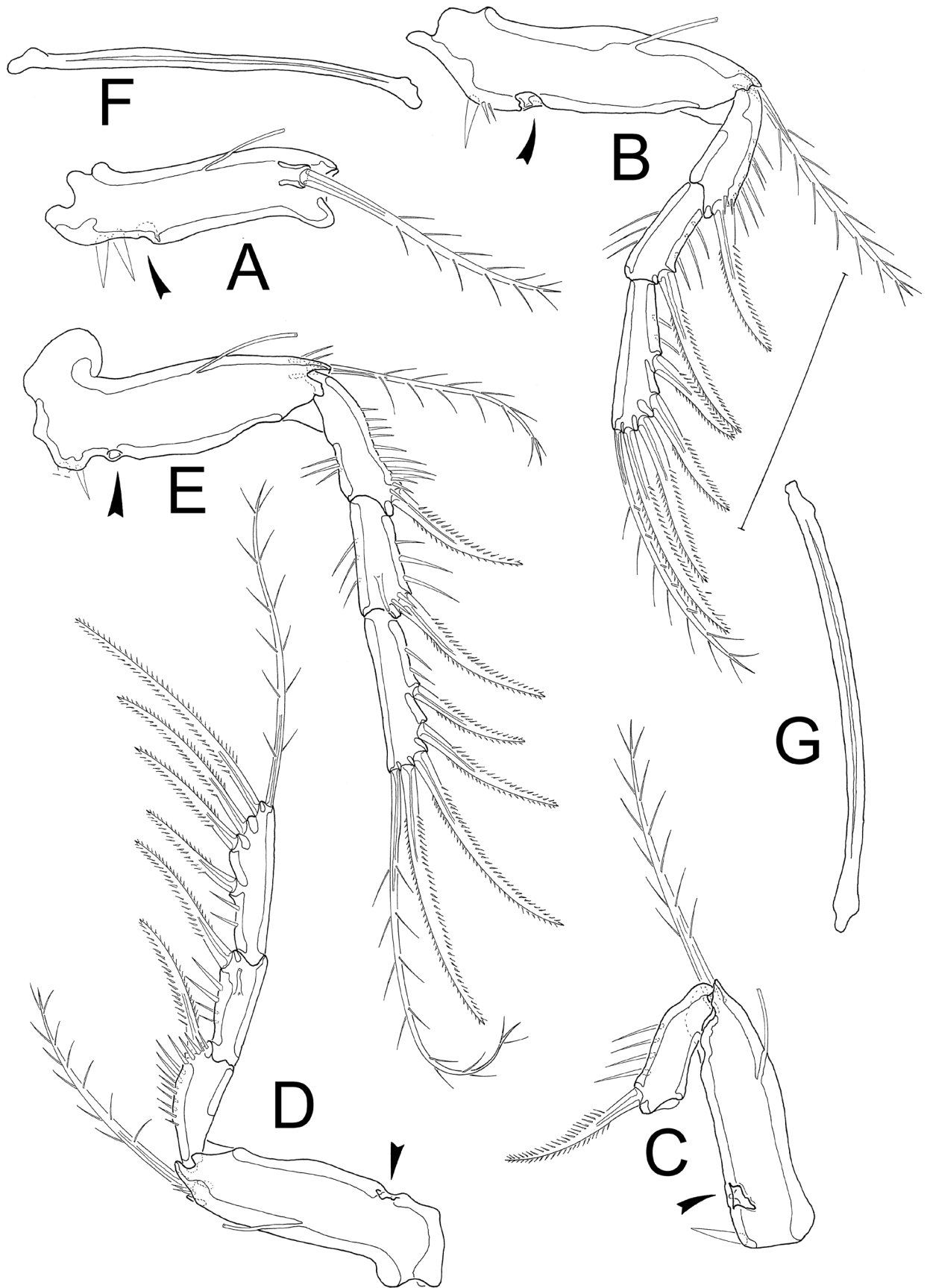

Figure 12. *Paralaophontodes armatus* (Lang, 1936) comb. n., (A–C) P2 (bases) of different females of the type series; (D) P2 of male from the Magellan material (Punta Yartou); (E) P2 of female from the Magellan material (Punta Arenas); triangular arrows pointing to insertion of the ancestral endopod; (F) intercoxal sclerite of A; (G) intercoxal sclerite of C. Scale bar: 50µm.

segment small, with 7 bare setae; fourth segment swollen, almost circular in shape, with 6 bare setae, and with strong, tooth-like spine at anterior margin; in addition with pedestal carrying at least 1 bare seta and aes (broken in Fig. 11A); fifth segment as small as third, tapering distally and bearing 8 bare setae, two of which arising subapically together with small aes forming a trithec. Setal formula: 1/1; 2/7; 3/7; 4/7(–8–9?) + aes; 5/8 + aes.

Md (Fig. 11B) gnathobase broken in Fig. 10B, only 1 massive tooth and basal part of seta discernible; palp 1-segmented, equipped with 6 setae, two of which biplumose, the others bare; lateral seta (broken in Fig. 11B) arising from small protrusion.

Mxl (Fig. 11C) praecoxal arthrite bearing 6 apical spines and 1 bare seta; additionally with 2 bare surfaces setae and 2 rows of spinules laterally; coxa with 2 bare setae apically; basis carrying 4 setae (2 broken in Fig. 11C).

Mx (Fig. 11D) syncoxa with 3 rows of spinules and with 2 slender endites, carrying each 1 uniplumose and 2 bare apical setae. Basis elongate, produced into strong claw accompanied by 1 bare seta anteriorly and posteriorly at its base. Enp small, with 2 bare setae.

P3 (Fig. 10D) exopod resembling that of female. Endopod 3-segmented, first segment very small and unarmed; enp-2 long and slender, with row of long spinules at inner margin, and apically produced into outwardly curved apophysis; enp-3 not reaching length of apophysis, bearing 2 apical biplumose setae, the innermost half as long as the outer one.

P4 (Fig. 10E) exopod resembling that of female. Endopod 2-segmented, first segment very small and unarmed; enp-2 slender, not reaching length of exp-1, with row of long spinules at inner margin. At distal half with 1 bare inner seta, additionally with 2 biplumose apical setae.

P5 (Fig. 9C) with outer seta arising from long spinulose setophore; benp completely reduced and being represented by 1 seta of fishbone pattern. Additionally with 2 tube pores. Exp fused with baseoendopodal part, long and slender, laterally with 1 bare seta; subapically with 1 bare seta and 1 tube pore; apically with 2 setae, the innermost fishbone-like, the outermost biplumose.

Remarks. *Laophontodes armatus* causes remarkable confusion. Comparison of Lang's (1936) original description (material from the Falklands) with that of Pallares (1968a) (material from Argentina) reveals some considerable differences; for instance, in the dorsal body processes (DP) of the Argentinian specimens (Pallares 1968a) the DP I seems to consist of 2 separated pairs of processes, an anterior pair antrorse and a posterior pair backward (Pallares 1968a, Fig. XXXIII/1). In contrast, the DP I in Lang's (1936, 1965) Falkland descriptions corresponds to that documented in the present contribution (Figs 6A, 7A, C), showing 1 pair of backwardly-directed processes and a median antrorse sclerotized ridge carrying hair-like setules which splits into 2 sclerotized clips. Furthermore, in the Argentinian specimens the dorsal processes of the remaining body somites are very small and set widely apart, while in the Falklands'

specimens they have the characteristic, typical shape. A third discrepancy is found in the female P5: the endopod bears 1 seta according to Pallares (1968a) but 2 setae according to Lang (1936). Two setae are also recorded here in the re-description (Fig. 9B). Unfortunately, due to the unavailability of the Argentinian material it has not been possible to re-examine it and confirm these discrepancies. However, the Chilean material is almost identical to that of the Falklands (Fig. 7), therefore supporting the assumption that the Chilean and the Falklands' material represent the same species. The examination of new records of *L. armatus* from Argentina is pending.

A further discrepancy concerns the descriptions of both Lang (1936) and Pallares (1968a) when compared to the present re-description of *L. armatus*. Both Lang (1936) and Pallares (1968a) described the endopod of the second swimming leg bearing 2 segments with 2 apical setae. However, in the present re-description of *L. armatus*, the author noted that the P2 lacks an endopod (Figs 10A, 12A–E). This re-description is based on Lang's own Falkland material and four different females were examined revealing a consistent lack of a P2 enp (Figs 10A, 12A–C).

The remaining swimming legs, P3 and P4, of the Falkland females do present endopods. Both the single male and the female specimens from the new Chilean material also lack a P2 endopod (Fig. 12D, E). Thus, although damage only to the P2 might be plausible for one specimen, it is less so for all individuals, suggesting that Lang (1936) erred, probably by confusing another swimming leg for the P2. The loss of a P2 endopod in *L. armatus* presents a derived state. Regarding the description of the P2 provided by Pallares (1968a), the apparent presence of a P2 endopod in the Argentinian specimens might represent another discrepancy between the two original records, but this needs to be confirmed with new material.

Discussion

Phylogenetic analysis

The taxon *Paralaophontodes* reconsidered

Paralaophontodes was assigned to Laophontodinae by Lang (1965), which has never been questioned in the past decades. Nevertheless, the systematic status of Laophontodinae remains unclear, as that taxon is mainly characterized by plesiomorphic character states when compared with its putative sister group Ancorabolinae Sars, 1911 (e.g. Conroy-Dalton 2004, George 2006, Gheerardyn and George 2010, Gheerardyn and Lee 2012). Yet, Gheerardyn and George (2010) detected three derived features, namely (i) a spinulose outer "bump" on the second antennular segment, (ii) the lengthways elongation of the P1 coxa, and (iii) the transformation of the P1 exp-2 outer element from a bipinnate spine into a bare, geniculate seta (cf. George and Müller 2013). These features may constitute autapomorphies of Laophontodinae, condition that still has to be verified in detail for all laophontodin repre-

sentatives. However, the taxon *Paralaophontodes* fits all named derived features. Thus, its allocation to Laophontodinae persists undoubted; future studies may elucidate the systematic status of and within Laophontodinae.

When erecting *Paralaophontodes*, Lang (1965) already noted a strong similarity of the then assigned species *P. echinatus* and *P. robustus* with *Laophontodes armatus* and *L. hedgpethi*, based mainly on the “armature of the body” (Lang 1965, p. 538). He chose not to place all four species in one genus because *L. armatus* and *L. hedgpethi* retain a 3-segmented P1 exp, a long apical seta in addition to the apical claw on the P1 enp-2 and endopods on the swimming legs P2–P4 (but see remarks on the re-description of *L. armatus* above), whilst *P. echinatus* and *P. robustus* present a 2-segmented P1 exp, no apical long seta on P1 enp-2, and at least the swimming legs P2 and P4 lack an endopod. Mielke (1981) first recognized that all these characters were synapomorphic for the then known *Paralaophontodes* species (*P. echinatus*, *P. exopoditus*, and *P. robustus*). Five years later, the status of *Paralaophontodes* was again addressed, independently by Baldari and Cottarelli (1986) and Fiers (1986). Baldari and Cottarelli (1986) described *P. elegans* from a Philippine island and provided a then updated generic diagnosis (but excluding Fiers’ (1986) work). Fiers (1986) provided an excellent re-description of *P. echinatus* (as *P. echinata*) and made a brief comparison of *Paralaophontodes* with other laophontodin species, stating that within the genus *Laophontodes* an “armatus-group” enclosing *Laophontodes armatus*, *L. hedgpethi* and *L. psammophilus* might be the sister-group of *Paralaophontodes*. Although this pointed to paraphyletic states for both genera, Fiers (1986) did not present any further phylogenetic argument, so a sound hypothesis could not be made. Later, Fiers (1988) re-stated his assumption of a sister-group relationship between *Laophontodes* [part.] and *Paralaophontodes*, but he again did not provide enough detail. It was George (1993) who first suggested a monophylum *Paralaophontodes* to include not only the then valid species *P. echinatus*, *P. elegans*, *P. exopoditus*, and *P. robustus* [George (1993) overlooked that Wells and Rao (1987) had synonymized *P. robustus* with *P. echinatus*] but also *Laophontodes armatus*, *L. hedgpethi* and *L. psammophilus* Soyer, 1974. The species described here is the first new species since the work by Baldari and Cottarelli (1986) and Fiers (1986).

Based on the summary given above, it is concluded that a monophylum *Paralaophontodes* is, according to Mielke (1981), phylogenetically justified by the following autapomorphies [plesiomorphic states in square brackets]:

- A. P1 exp 2-segmented [P1 exp 3-segmented];
- B. P2 lacking endopod [P2 with at least 1-segmented endopod];
- C. P4 lacking endopod [P4 with at least 1-segmented endopod].

All known *Paralaophontodes* species share these apomorphies, whilst they are missing from the *Laophontodes*

species treated here (Fiers’ [1986] “armatus-group”; but see the remarks in the description of *L. armatus*). Nevertheless, apomorphies A–C are to some extent weak, being widely scattered not only in Laophontodinae but also in most Ancorabolinae, its supposed sister-group, and other harpacticoid taxa. More precisely, a 2-segmented P1 exopod (apomorphy A) resembling that of *Paralaophontodes* in shape and ornamentation is also present in *Ancorabolina* George, 2006, and in all genera of the *Ancorabolus*-lineage *sensu* Conroy-Dalton and Huys, 2000. In fact, most other members of Ancorabolinae also show this kind of P1 exopod: *Arthuricornua* Conroy-Dalton, 2001, *Ceratonotus* Sars, 1909, *Dendropsyllus* Conroy-Dalton, 2003, *Dorsiceratus* Drzycimski, 1967 [part.], *Polyascophorus* George, 1998, *Pseudechinopsyllus* George, 2006, and *Touphapleura* Conroy-Dalton, 2001. Yet, each of these taxa present numerous autapomorphies (cf. George 1998, Conroy-Dalton and Huys 2000, Conroy-Dalton 2001, 2003a, George 2006a, b, c, Gheerardyn and George 2010, Gheerardyn and Lee 2012, George and Müller 2013, George and Gheerardyn 2015) absent from *Paralaophontodes*, so it is likely they are not closely related. It must be supposed that the reduction (in a phylogenetic, not an ontogenetic, sense) of a 3-segmented to a 2-segmented P1 exopod has convergently occurred more than once. This is also noted for apomorphy B: apart from many laophontodin taxa (*Algeniella* Cottarelli and Baldari, 1987, *Laophontodes multispinatus* Kornev and Chertoprud, 2008, *Lobopleura ambiducti* Conroy-Dalton, 2004, *Probosciphontodes* Fiers, 1988, *Tapholaophontodes* Soyer, 1974) (Pallares 1968b, Soyer 1974, Cottarelli and Baldari 1987, Fiers 1988, Conroy-Dalton 2004, Kornev and Chertoprud 2008), the P2 endopod is also absent in several ancorabolin taxa (*Arthuricornua anendopodia* Conroy-Dalton, 2001, *Ceratonotus steiningeri* George, 2006, *Dendropsyllus*, *Echinopsyllus* Sars, 1909, *Polyascophorus martinezi* (George, 1998), *P. monoceratus* George, Wandeness and Santos, 2013, *Pseudechinopsyllus*) (Conroy-Dalton 2001, 2003a, b, George 1998, 2006a, b, George et al. 2013). Even apomorphy C is also present in other laophontodin species (e.g. *Patagoniaella* Pallares, 1968, *Probosciphontodes*, *Tapholaophontodes*). Thus, none of the autapomorphies so far assigned to *Paralaophontodes* are unambiguous, particularly because a reduction of segments or elements is quite common in Copepoda (Huys and Boxshall 1991), explaining its heterogeneous distribution across the copepod taxa.

To evaluate phylogenetic relationships, synapomorphies, i.e. unique derived characters of the treated taxa must be recognized (Hennig 1982, Ax 1984, Sudhaus and Rehfeld 1992, Wägele 2001). In the case of *Paralaophontodes*, it seems somewhat peculiar that for many years the rather crude apomorphies A–C above have been used to justify a monophylum *Paralaophontodes* whilst complex and unique features such as the two transverse triangular elongations on cphth, the tuft of “hairy” setules dorsally on cphth, and the characteristic dorsal or-

namentation of the body somites have been neglected. Even authors who noted the strong similarity between *Paralaophontodes* and corresponding *Laophontodes* species (e.g. Lang 1965, Fiers 1986, 1988) did not recognize or consider them to be of phylogenetic relevance. Here a justification for a monophylum *Paralaophontodes* is presented based on a combination of unambiguous autapomorphies, demonstrating that *Laophontodes armatus*, *L. hedgpethi* and *L. psammophilus* must be displaced into *Paralaophontodes*.

All species treated in the present contribution (Fig. 13) share 16 distinct and exclusive apomorphies (Table 3), which are therefore supposed to have evolved in a common ancestor. For outgroup comparison, remaining Laophontodinae was chosen (Table 3, “outgr.”) and, where being appropriate, even taxa of the further phylogenetic surroundings (Ancorabolinae, Cletodidae [part.]) were included.

Character 1 – Rostral tip distinct, knob-like: Compared with other Laophontodinae, those species considered here exhibit a protruded rostrum as do *Lobopleura* and *Probosciphontodes*, and also several Ancorabolinae (e.g. *Ancorabolina*, *Ancorabolus*, *Dorsiceratus*, *Echinopsyllus*, *Pseudechinopsyllus*). Moreover, many other harpacticoid taxa show a (more or less) strongly protruded rostrum (c.f. Lang 1948, Boxshall and Halsey 2004). This suggests a convergent rostral elongation/diminution across the Harpacticoida even where close phylogenetic relationships are lacking. However, *Paralaophontodes* and *Laophontodes armatus*, *L. hedgpethi* and *L. psammophilus* carry a rostrum of a particular shape: it is triangular with a broad base (Fig. 13, but note Fig. 13F) and a distinct tip that is small and knob-like. This rostrum type is unique not only within Laophontodinae but also within Harpacticoida. It is assumed to have originated in a common ancestor and is therefore regarded as a shared apomorphy.

Character 2 – Cphth with dorso-median ridge extended into 2 posteriorly directed blunt conical elevations: The formation of dorsal sclerotized structures on cphth and body somites has been considered to be one of the characteristic features of the (paraphyletic, cf. George and Müller 2013) family Ancorabolidae Sars, 1909, but similar cuticular processes are also recorded in other harpacticoid taxa (e.g. Argestidae Por, 1986 [part.], Cerviniinae Sars, 1903 [part.], Idyanthidae Lang, 1944 [part.], Laophontidae T. Scott, 1905 [part.]). However, *Paralaophontodes* and *Laophontodes armatus*, *L. hedgpethi* and *L. psammophilus* share a unique structure dorsally on the cphth. It consists of a strongly sclerotized ridge running medially along the cephalic longitudinal axis. Its posterior half splits into 2 backwardly directed branches that each terminate in a blunt, more or less conical process, carrying a sensillum apically. Although these ridges/processes vary in shape between species, their general appearance is identical, leading to the conclusion that they evolved in a common ancestor, and supporting the hypothesis of a common evolution. This character is considered as autapomorphy of *Paralaophontodes*.

Character 3 – Cephalic dorso-median ridge covered with tuft of hair-like setules in anterior half: A tuft of hair-like setules covers the anterior part of the cephalic ridge. Lang (1965) noted a similar tuft of “hairy” setules in the genus *Echinolaophonte* Nicholls, 1941, but this without doubt belongs to Laophontidae. Thus it has evolved independently in *Echinolaophonte*, while being considered here as synapomorphic for *Paralaophontodes*, *Laophontodes armatus*, *L. hedgpethi* and *L. psammophilus*. Although Mielke (1981) did not mention this “hairy” tuft in *Paralaophontodes exopoditus*, examination of individuals from Ednago Island (Papua New Guinea) and from Dahab (Egypt, Red Sea) similarly reveals the presence of small and fine hair-like setules, resembling those described by Fiers (1986) for *P. echinatus*. Thus, this character can be interpreted as autapomorphic for *Paralaophontodes*.

Characters 4–8 – P2–P6-bearing thoracic somites with dorsal pair of processes: The presence of dorsal (and often also dorso-lateral and/or lateral) cuticular processes is considered characteristic for Ancorabolinae. In Laophontodinae, however, only *Paralaophontodes* has dorsal sensilla-bearing processes at the thoracic somites (Fig. 13), all other laophontodin taxa instead may or may not carry small socles (Fig. 14). The dorsal processes in *Paralaophontodes* are weakest in *Laophontodes hedgpethi* and in *P. robustus*, being most apparent in *P. elegans* and *P. exopoditus*. Nevertheless, the general development of dorsal processes on the thoracic somites is considered autapomorphic for *Paralaophontodes*.

Characters 9–11 – First to penultimate abdominal somites with pair of A- or H-shaped processes dorsally: Similar to the circumstances regarding the thoracic somites, *Paralaophontodes* and *Laophontodes armatus*, *L. hedgpethi* and *L. psammophilus* are exceptions within Laophontodinae in carrying very characteristic processes on the three abdominal somites, but not the telson. The processes are paired, strongly sclerotized, and close together at the dorsal posterior margin of each abdominal somite. These processes are (not always) connected by a transverse cuticular ridge (Fig. 13), forming an “H”-shape (“H-förmige Chitinvorsprünge”, Mielke 1981, p. 92); whilst in *P. elegans* they are additionally fused at their bases, the “H” therefore becoming a squarish “A” (Fig. 13F). Although the shape and ornamentation of these processes varies between species, and even between individuals of the same species (cf. Figs 2A, A', 6, 7), the similarity of their general appearance suggests that they evolved in a common ancestor and therefore constitute autapomorphies of *Paralaophontodes*.

Character 12 – Male antennule 5-segmented: Whereas in Ancorabolinae the subchirocer male antennule retains eight segments (Fig. 15A), it shows only seven segments in Laophontodinae (Fig. 15B) due to the loss of the original penultimate segment. This is therefore being considered apomorphic. Within Laophontodinae, however, this state has been retained in *Laophontodes* only (Fig. 15B) with further successive segment fusions in other genera. In a first step, segments 6 and 7 are fused, leading to a chi-

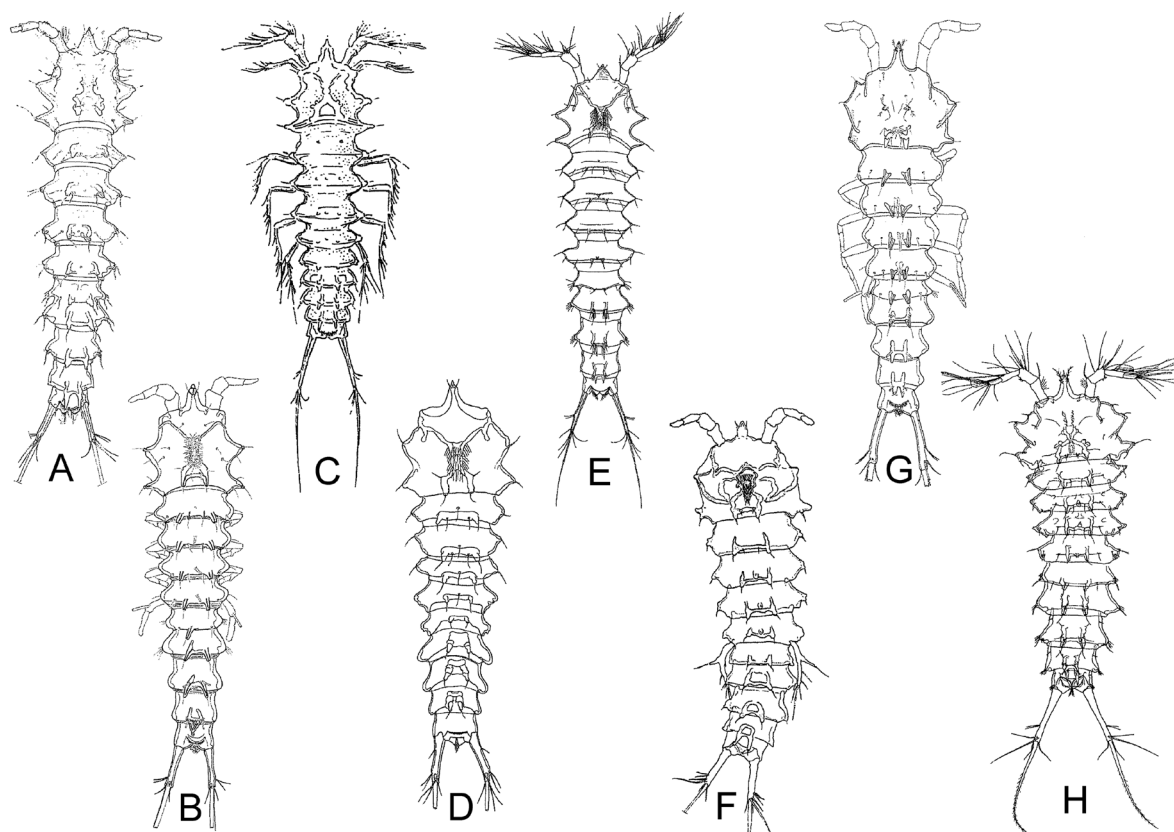

Figure 13. Habitus views of the representatives of *Paralaophontodes* reviewed for the present contribution. (A) *P. echinatus* (Wiley, 1930); (B) *P. armatus* (Lang, 1936) comb. n.; (C) *P. robustus* (Bözić, 1964); (D) *P. psammophilus* (Soyer, 1975) comb. n.; (E) *P. hedgpethi* (Lang, 1965) comb. n.; (F) *P. elegans* Baldari and Cottarelli, 1986; (G) *P. anjae* sp. n.; (H) *P. exopoditus* Mielke, 1981. (A, C–F, H) modified after different authors; (B, G) originals; no scales.

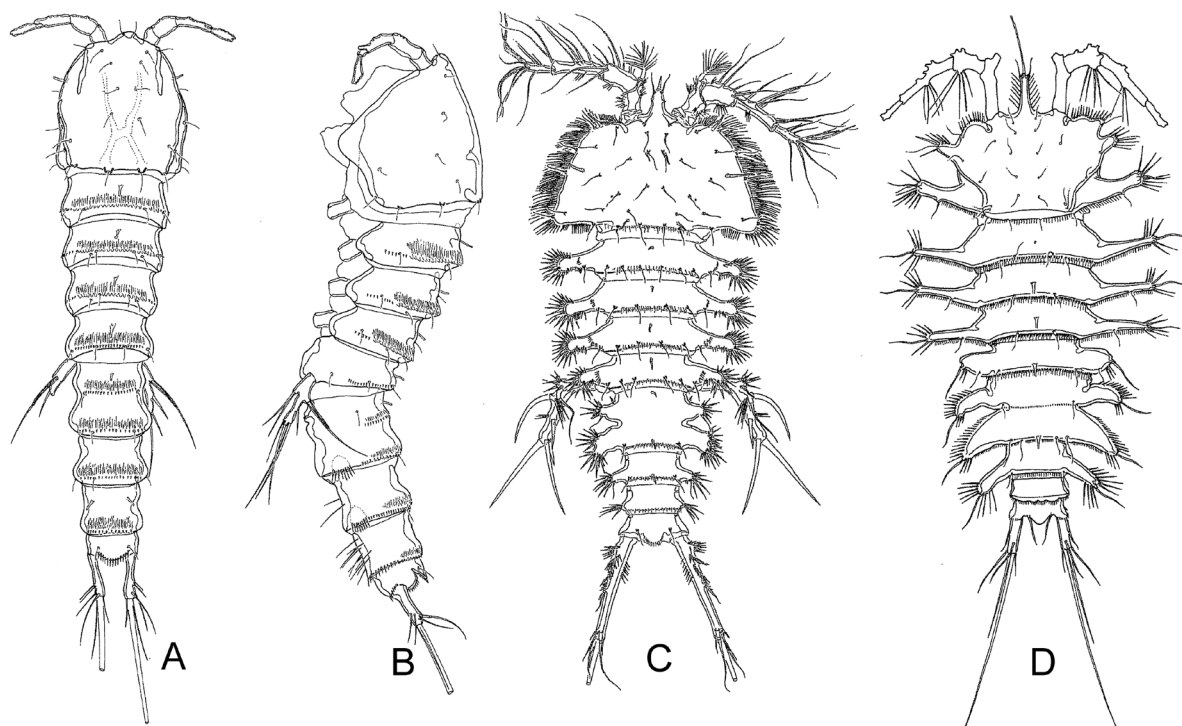

Figure 14. Habitus views of (A, B) *Laophontodes whitsoni* T. Scott, 1912; (C) *Lobopleura ambiducti* Conroy-Dalton, 2004; (D) *Probosciphontodes stellata* Fiers, 1988. (A, B) from George and Gheerardyn (2015); (C) from Conroy-Dalton (2004); (D) from Fiers (1988); no scales.

Table 3. Character list used for the phylogenetic analysis of the monophylum *Paralaophontodes*. Apomorphies are marked with 1, plesiomorphies with 0, question mark means no data available. Abbreviations: Outgr. = remaining Laophontodinae, *P. ro.* = *Paralaophontodes robustus*, *P. ec.* = *P. echinatus*, *P. el.* = *P. elegans*, *P. ex.* = *P. exopoditus*, *P. an.* = *P. anjae* sp. n., *P. ar.* = *P. armatus* comb. n., *P. ps.* = *P. psammophilus* comb. n., *P. he.* = *P. hedgpethi* comb. n.

No	Character/species [plesiomorphic states in square brackets]	Outgr.	<i>P. ro.</i>	<i>P. ec.</i>	<i>P. el.</i>	<i>P. ex.</i>	<i>P. an.</i>	<i>P. ar.</i>	<i>P. ps.</i>	<i>P. he.</i>
1	Rostral tip distinct [no distinct rostral tip]	0	1	1	1	1	1	1	1	1
2	Cphth with dorso-median ridge extend into 2 backwardly directed blunt conical processes [neither dorsal ridge nor processes developed]	0	1	1	1	1	1	1	1	1
3	Cphth dorso-median ridge with hairy tuft [no hairy tuft present]	0	?	1	1	1	1	1	1	1
4	P2-bearing thoracic somite with dorsal pair of processes [no processes]	0	1	1	1	1	1	1	1	1
5	P3-bearing thoracic somite with dorsal pair of processes [no processes]	0	1	1	1	1	1	1	1	1
6	P4-bearing thoracic somite with dorsal pair of processes [no processes]	0	1	1	1	1	1	1	1	1
7	P5-bearing thoracic somite with dorsal pair of processes [no processes]	0	1	1	1	1	1	1	1	1
8	P6-bearing thoracic somite with dorsal pair of processes [no processes]	0	1	1	1	1	1	1	1	1
9	1st abdominal somite dorsally with pair of A- or H-like processes [no processes]	0	1	1	1	1	1	1	1	1
10	2nd abdominal somite dorsally with pair of A- or H-like processes [no processes]	0	1	1	1	1	1	1	1	1
11	3rd abdominal somite dorsally with pair of A- or H-like processes [no processes]	0	1	1	1	1	1	1	1	1
12	Male A1 5-segmented [at least 6-segmented]	0	?	1	?	1	?	1	?	1
13	Male antennular swollen segment with strongly developed, tooth-like spine [no such spine present]	0	?	1	?	1	?	1	?	1
14	Mxp without syncoxal seta [syncoxa retaining 1 apical seta]	0	1	1	1	1	1	1	1	1
15	P1 enp strongly strengthened, transformed into mighty appendage [P1 slender, gracile]	0	1	1	1	1	1	1	1	1
16	P1 enp-2 distinctly elongated, reaching at least half the length of enp-1 [P1 enp small]	0	1	1	1	1	1	1	1	1
17	P2 exp-2 without inner seta [inner seta present]	0	1	1	1	1	1	1	1	0
18	P3 exp-2 without inner seta [inner seta present]	0	1	1	1	1	1	1	1	0
19	P4 exp-2 without inner seta [inner seta present]	0	1	1	1	1	1	1	1	0
20	P2 exp-3 without inner seta [inner seta present]	0	1	1	1	1	1	1	1	0
21	Abdominal dorsal processes with long and flexible setules [no such setules present]	0	0	0	0	0	0	0	0	1
22	P2 enp completely lost [enp 2-segmented]	0	1	1	1	1	1	1	0	0
23	P3 exp-3 without inner seta [inner seta present]	0	1	1	1	1	1	1	0	0
24	P4 exp-3 without inner seta [inner seta present]	0	1	1	1	1	1	1	0	0
25	P1 basis laterally extended = base for exp [no lateral extension of P1 basis]	0	0	0	0	0	0	0	1	0
26	P1 enp-2 geniculated apical seta lost [apical geniculated seta present]	0	1	1	1	1	1	0	0	0
27	P1 exp 2-segmented [P1 exp 3-segmented]	0	1	1	1	1	1	0	0	0
28	P2 exp-3 inner apical seta minute [seta long, flexible]	0	1	1	1	1	1	0	0	0
29	P3 exp-3 inner apical seta minute [seta long, flexible]	0	1	1	1	1	1	0	0	0
30	P4 exp-3 inner apical seta minute [seta long, flexible]	0	1	1	1	1	1	0	0	0
31	P3 enp female at most 1-segmented [enp 2-segmented]	0	1	1	1	1	1	0	0	0
32	P3 female enp with 1 seta only [with 2 setae]	0	1	1	1	1	1	0	0	0
33	P4 enp completely lost [enp 2-segmented]	0	1	1	1	1	1	0	0	0
34	P5 with fishbone-like setae [seta of regular bipinnate shape]	0	0	0	0	0	0	1	0	0
35	P1 exp-2 with 4 setae [with 5 setae]	0	1	1	1	0	0	0	0	0
36	A2 abexopodal seta lost [abexopodal seta present]	0	1	1	1	0	0	0	0	1
37	A2 without exp [with 1-segmented exp]	0	1	1	1	0	1	1	0	1
38	P2-bearing thoracic somite dorsal processes H-like [without transverse connection]	0	0	0	1	1	0	0	0	0
39	P3-bearing thoracic somite dorsal processes H-like [without transverse connection]	0	0	0	1	1	0	0	0	0
40	P4-bearing thoracic somite dorsal processes H-like [without transverse connection]	0	0	0	1	1	0	0	0	0
41	P5-bearing thoracic somite dorsal processes H-like [without transverse connection]	0	0	0	1	1	0	0	0	0
42	P6-bearing thoracic somite dorsal processes H-like [without transverse connection]	0	0	0	1	1	0	0	0	0
43	P3 female enp represented by single seta [exp 1-segmented]	0	0	0	0	1	0	0	0	0
44	P2 exps 1-3 fused [exps 1-3 separated]	0	1	0	0	0	0	0	0	0
45	P3 exps 1-3 fused [exps 1-3 separated]	0	1	0	0	0	0	0	0	0
46	Rostrum constricted [rostrum broad at ist base, tapering anteriorly]	0	0	0	1	0	0	0	0	0
47	P5 benp setae minute [setae reaching at least half of exopodal length]	0	0	0	1	0	0	0	0	0
48	Mxl coxa with 1 seta [coxa with 2 setae]	0	?	0	1	0	0	0	?	0
49	P3 enp female completely lost [enp at least 1-segmented]	0	1	0	0	0	1	0	0	0
50	Mx enp with 1 seta [enp with 2 setae]	0	?	1	1	0	0	0	?	1

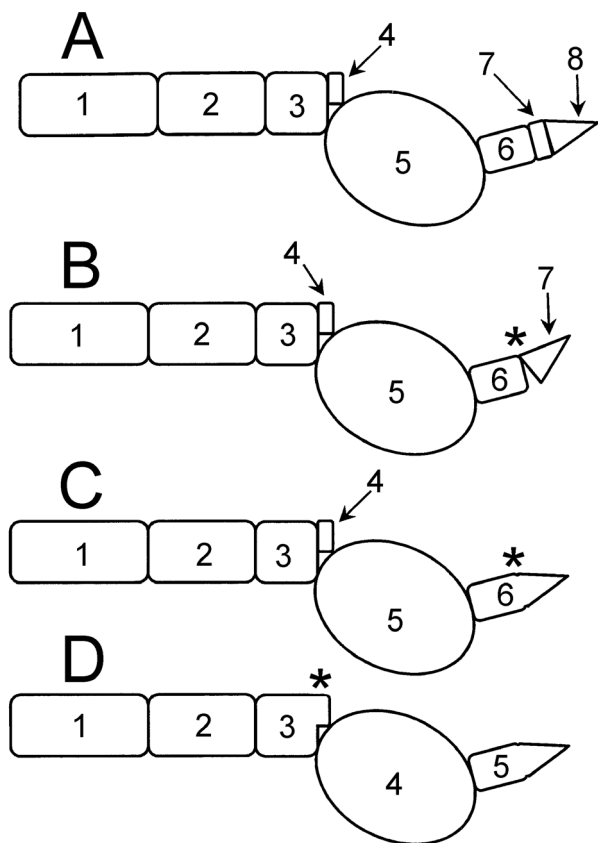

Figure 15. Schematic illustration of the different male antennules, showing from (A–D) the successive reduction of segments (*). Explanation in the text.

rocer male A1 (*Algeniella*, *Calypsophontodes* Gheerardyn and Lee, 2012, *Lobopleura*, *Paralaophontodes*, *Patagoniaella*, *Probosciphontodes*, *Tapholaophontodes*) (Fig. 15C). In a second step, segments 4 and 3 are fused (Fig. 15D), as seen in *Paralaophontodes* (Mielke 1981, Fiers, 1986, and e.g. in *Laophontodes armatus*, see Fig. 11A present contribution). Furthermore, male descriptions of *Algeniella boitani* Cottarelli and Baldari, 1987, *A. laurenceae* (Bodiou and Colomines, 1988), *Patagoniaella vervoorti* Pallares, 1968 and *Tapholaophontodes rollandi* Soyer, 1974 (Cottarelli and Baldari 1987, Bodiou and Colomines 1988, Pallares 1968b and Soyer 1974, respectively, and Mielke 1985) include the same type of A1. Thus, the fusion of segments 3 and 4 may constitute a common deviation of all these taxa. Nevertheless, certain caution appears to be advisable, segment 4 is quite minute and may have been overlooked in the original descriptions of the above listed males (e.g. Fiers (1988) in his otherwise excellent description of *Probosciphontodes stellata* Fiers, 1988 noted a 5-segmented male A1, but this was later revealed to be 6-segmented (Conroy-Dalton 2004) with a minute segment 4). Thus, before interpreting character 12 as synapomorphic for a group of laophontodin taxa, detailed revision of *Algeniella*, *Patagoniaella* and *Tapholaophontodes* is urgently needed. In the meantime, it is regarded as an autapomorphy of *Paralaophontodes*.

Character 13 – Male antennular swollen segment with strongly developed, tooth-like spine: All known males of *Paralaophontodes* present a characteristic strong and tooth-like spine situated proximally at the anterior margin of the swollen antennular segment 4 (cf. Fig. 11A). This feature is unique in Laophontodinae and its' presumed closest relatives (Ancorabolinae, *Ancorabolina*, Cletodidae), which bear a normal-shaped seta, if at all. Therefore this strong spine is regarded as a derived character and interpreted as an autapomorphy for *Paralaophontodes*.

Character 14 – Mxp without syncoxal seta: Character 14 poses a certain degree of incertitude. Firstly, in older descriptions of Laophontodinae (mainly *Laophontodes* species), the maxilliped has been illustrated and described rather roughly, and therefore potentially not observing existing rows of spinules, the typical minute seta that accompanies the maxillipedal claw, and the syncoxal apical seta. Such an assumption seems to be justified when considering the differences between the original descriptions of e.g. *Laophontodes bicornis* A. Scott, 1896 or *L. whitsoni* T. Scott, 1902 with recent re-descriptions: In their original descriptions both species lack all of the above mentioned features, but all were observed on re-examination (George and Gheerardyn 2015).

Within the supposed sister-group of Laophontodinae, Ancorabolinae, the loss of the syncoxal seta has occurred in the whole *Ancorabolus*-lineage, as well as in some genera of the *Ceratonotus*-group (*Echinopsyllus* and *Pseudechinopsyllus*). This points towards a convergent loss of the syncoxal seta in both supposed monophyla. In *Ancorabolina* and in most Laophontodinae (*Calypsophontodes*, *Laophontodes*, *Lobopleura*, *Probosciphontodes*) the syncoxal seta is present (but keep in mind the comparison “old vs. recent descriptions”). Apart from the species treated here, the Laophontodinae *Algeniella*, *Patagoniaella* and *Tapholaophontodes* also lack the syncoxal seta on mxp, but it seems unlikely that they are closely related to *Paralaophontodes* and *Laophontodes armatus*, *L. hedgpethi* and *L. psammophilus* since they each lack the other apomorphies listed above. It is therefore hypothesized that in both Ancorabolinae and Laophontodinae the loss of the syncoxal seta of the mxp occurred independently (at least) twice. Considering the other apomorphies shared by the species treated here, however, it appears probable and plausible that this reduction took place in a common ancestor of *Paralaophontodes* and must therefore be considered as an autapomorphy for that genus.

Character 15 – P1 enp considerably strengthened, transformed into powerful appendage: Laophontodinae and part of Ancorabolinae share a “laophontoidean-like” P1 that is characterized by a 2- to 3-segmented exp of rather small size and slender shape and a 2-segmented, elongated, prehensile enp (cf. George 2006c for detailed discussion). However, *Paralaophontodes* and the *Laophontodes* “*armatus*-group” differ from the remaining Laophontodinae (and also from Ancorabolinae) in a remarkable strengthening of the P1 enp. Such strengthening is characterized by a broadening of the endopodal seg-

ments and the apical claw in enp-2, transforming the P1 enp from a slender, rather delicate appendage into a quite robust prehensile medium. This is considered to be autapomorphic for *Paralaophontodes*.

Character 16 – P1 Enp-2 distinctly elongate, reaching at least half the length of enp-1: As assumed by George (2006c), the basic morphology of ancorabolin and laophontodin P1 includes a P1 enp being about twice as long as the exp, with enp-1 being 4–5 times longer than enp-2. P1 enp-2 carries 3 elements: 1 inner subapical tiny seta, 1 apical claw of increasing strength within Laophontodinae, and 1 apical seta, often being geniculate (George 2006c). Within Laophontodinae, the *Paralaophontodes* and the three *Laophontodes* species, *L. armatus*, *L. hedgpethi* and *L. psammophilus*, exhibit a secondary elongation of the P1 enp-2, so that it is at least half the length of enp-1. It is regarded as a shared apomorphy of these species.

Compared to apomorphy A discussed above (see section, ‘The taxon *Paralaophontodes* reconsidered’: P1 exp 2-segmented), characters 15 and 16 are of greater phylogenetic relevance, as they are not simple reductions of a segment (which occurs quite often within Harpacticoida, i.e. an incongruent character). Characters 15 and 16 are instead diagnostic transformations of particular parts of a swimming leg, and are therefore congruent, detectable exclusively in the *Paralaophontodes* and the *Laophontodes* “*armatus*-group” species.

Additional remarks: As described for *Paralaophontodes anjae* sp. n., the intercoxal sclerites P2–P4 are strongly reduced. They are of a triangular, thorn-like shape and do not connect the legs. Apart from *P. anjae* sp. n., this condition mentioned by Mielke (1981, p. 97) only: *P. exopoditus* shows a hooked process (“hakenartiger Fortsatz”) on the inner coxal margin. Other *Paralaophontodes* descriptions neither refer to such a process nor mention the loss of the intercoxal sclerites. However, at least Lang’s (1965) illustrations of P2–P4 on *Laophontodes hedgpethi* do show sclerotized parts in the respective coxal area, suggesting that they correspond to the relicts of former intercoxal sclerites. Also, the re-description of *L. armatus* reveals a clearly reduced and very narrow, but still bow-like intercoxal sclerite (Fig. 12F, G) connecting both legs. Thus, it is supposed that the intercoxal sclerites in *Paralaophontodes* are reduced, a condition that would constitute a valuable autapomorphy of that taxon. However, the legs are not separated in all the species treated in the present contribution and, since most descriptions do not specifically refer to the intercoxal sclerites, this feature requires further investigation before an autapomorphy can be definitively established.

Re-establishment of *Paralaophontodes robustus*

The description of *Paralaophontodes robustus* provided by Bözić (1964; as *Laophontodes robustus*) may perhaps not fulfil completely the current high standard of harpacticoid species descriptions; nevertheless, it is of a sufficient quality to characterize that species unambiguously.

It is therefore somewhat surprising that Bözić’s (1964) description and the validity of *L. robustus* (subsequently displaced to *Paralaophontodes* by Lang [1965]) have been consistently doubted (Lang 1965), resulting in its synonymisation with *Paralaophontodes echinatus* (Wells and Rao 1987) and the transfer of all associated material (La Réunion, Bözić 1964; Mediterranean, Bodin 1964, 1968, Dinet 1971, 1972).

Bözić (1964) names (among others) three particular features characterizing the single specimen he described: (i) the fusion of P2 and P3 exs 1–3, (ii) the complete absence of a P3 endopod in the female, and (iii) pronounced dorsal cuticular processes are restricted to the first three abdominal somites. These features are not found in *P. echinatus*, where (i) the P2 and P3 exs 1–3 are clearly separated, (ii) the female P3 bears a small, knob-like endopod carrying 1 seta, and (iii) pronounced cuticular processes also on all pedigerous somites (Fiers 1986). Based on these strong differences between Bözić’s (1964) specimen and *P. echinatus*, a synonymy of *P. robustus* and *P. echinatus* must be refuted categorically. Such rejection is supported by comparing the female genital field: the P6 is developed as a distinct small segment bearing 2 setae in *P. echinatus* (Fiers 1986) whilst in *P. robustus* it is fused to the body and lacks any setation (Bözić 1964). Thus the species *Paralaophontodes robustus* (Bözić, 1964) is re-established.

Uncertainty persists with respect to the reports of *P. robustus* in the Mediterranean. Bodin (1964) re-described “*Laophontodes armatus(?)*” from Lagune du Brusac (south of Sanary-sur-Mer, France) and from Plateau des Chèvres (south of Marseille, France) but transferred it later (Bodin 1968) to *Paralaophontodes robustus*. Also Dinet (1971, 1972) reported *P. robustus* from the same region (Ile de Riou, Bay of Marseille, France). However, both authors remark that despite a general strong similarity of their specimens with that from Bözić (1964) (e.g., the absence of an endopod even at P3), the Mediterranean individuals present separated exopods on P2 and P3. Assuming that Bözić (1964) was not wrong, the fused P2 and P3 exopods constitute a highly valuable apomorphic character for *Paralaophontodes robustus*. Even the fact that Bözić’s (1964) description is based on only one female does not justify rejecting the validity of the species, since this is not uncommon when describing rare Harpacticoida. Bözić (1964) undoubtedly described an adult female, so the fusion of the exopods cannot be interpreted as an ontogenetic stage (i.e., not yet separated). Thus, trusting in Branko Bözić’s power of observation, two possibilities must hitherto be considered:

The specimen described by Bözić (1964) presented malformations in both the P2 and P3. This is possible, harpacticoid specimens do present malformations relatively frequent (George, pers. obs.). The fact that both Bodin (1964, 1968) and Dinet (1971, 1974) explicitly stress the strong resemblance of their Mediterranean material with Bözić’s (1964) specimen from La Réunion, particularly with respect to the lost P3 enp, makes the assumption of a

malformation in P2 and P3 exopods in Bőzic's specimen somewhat plausible. It might therefore be concluded that the specimens of La Réunion and the Mediterranean belong to the same species, i.e. *Paralaophontodes robustus*.

P. robustus does present fused P2 and P3 exopods as autapomorphic specific character. This would mean that both Bodin's (1964, 1968) and Dinet's (1971, 1974) identifications were not correct and the Mediterranean specimens do not represent *P. robustus*.

Unfortunately, the original material is not available, and therefore additional material from both La Réunion and the French locations is needed for further comparison to determine the correct status of these records.

Establishment of *Paralaophontodes anjae* sp. n.

Paralaophontodes anjae sp. n. shares all the mentioned generic autapomorphies 1–16 of *Paralaophontodes*. It differs from already known species, primarily by the derived condition of the complete loss of a female P3 endopod. That endopodal loss separates *P. anjae* sp. n. from all other *Paralaophontodes* and *Laophontodes* “*armatus*-group” species, *L. armatus*, *L. hedgpethi* and *L. psammophilus*, with one exception: *P. robustus* also lacks a P3 enp in female (see previous section). Nevertheless, *P. anjae* sp. n. and *P. robustus* differ regarding the following features: (i) cephalic lateral extensions strongly triangular in *P. robustus*, but only moderately triangular in *P. anjae* sp. n.; (ii) pedigerous somites bearing P2–P5 dorsally with tiny socles in *P. robustus*, while bearing strong sclerotized processes in *P. anjae* sp. n.; (iii) P1 exp-2 with 4 bare geniculate setae in *P. robustus* but with 5 bare geniculate setae in *P. anjae* sp. n.; (iv) P2 and P3 exopodal segments fused in *P. robustus*, but separated in *P. anjae* sp. n. Therefore, the erection of a new species to assign the Chilean specimen is well-justified.

Transfer of *Laophontodes armatus*, *L. hedgpethi*, and *L. psammophilus* to *Paralaophontodes*

Based on the comprehensive phylogenetic discussion given above, it is established that the species *Laophontodes armatus*, *L. hedgpethi* and *L. psammophilus* share apomorphic characters 1–16 (characters 12 and 13 unknown for *L. psammophilus*) with the currently accepted *Paralaophontodes* species and are therefore considered to be their close relatives. Fiers (1986) pooled these species into a so-called “*armatus*-group” and considered it a sister-group of *Paralaophontodes*, but distinguished them by apomorphic characters A–C. However, retaining the “*armatus*-group” within *Laophontodes* overlooks the necessity for characters 1–16 to have evolved twice, convergently, within Laophontodinae: once in the taxon *Paralaophontodes* and once in the taxon *Laophontodes*. Given the high phylogenetic relevance of all 16 apomorphies (see Character discussion above) their interpretation instead as shared apomorphies is much more plausible. The assumption of convergent evolution should be therefore applied to the apomorphies A–C previously assigned to *Paralaophontodes*. Consequently, the reassignment of *L.*

armatus, *L. hedgpethi* and *L. psammophilus* from *Laophontodes* into *Paralaophontodes* is undertaken, re-naming the corresponding species *Paralaophontodes armatus* (Lang, 1936) comb. n., *P. hedgpethi* (Lang, 1965) comb. n., and *P. psammophilus* (Soyer, 1974) comb. n.

The above presented discussion confirms that the taxon *Laophontodes* is actually quite a heterogeneous collection of species (George and Gheerardyn 2015) that urgently needs to be re-examined. In addition to previous revisionary work (Lang 1965, Conroy-Dalton 2004, Gheerardyn and Lee 2012), the reassignment of the “*armatus*-group” into *Paralaophontodes* is another important step towards an elucidation of the systematics of *Laophontodes* and even Laophontodinae.

Concerning the differences that led to the “*armatus*-group” previously being retained in *Laophontodes* (i.e. the 3-segmented P1 exp, the retention of an apical seta in P1 enp-2, and the presence of endopods in P2 and P4), these are rejected here according to the detailed character discussion presented above. With the transfer of the “*armatus*-group” into *Paralaophontodes*, these characters are assumed to have evolved within *Paralaophontodes*, a condition that is commonplace in Harpacticoida.

Phylogenetic relations within *Paralaophontodes*

While the monophylum *Paralaophontodes* is in the author's opinion well-founded, unambiguously supported by autapomorphies 1–16 (see above), the relationships within *Paralaophontodes* are difficult to discern. Thirty-four additional morphological characters (17–50, Tab. 3) were included in the phylogenetic analysis. Possible phylogenetic relationships inside *Paralaophontodes* are discussed in detail below and summarized in Figure 16.

A supposed basal position within the genus may correspond to *P. hedgpethi* comb. n. It is the only species to show the assumed plesiomorphic state in characters 17–19 (the retention of an inner seta in the second exopodal segment of P2–P4) and in character 20 (the retention of an inner seta also in P2 exp-3). It can be justified as a distinct species due to character 21 (the exclusive possession of long and flexible setules on the abdominal dorsal processes: Lang 1965). Outgroup comparison (Ancorabolinae, Cletodidae) confirms the uniqueness of such setules, so they are interpreted as a derived state for *P. hedgpethi* comb. n.

P. hedgpethi comb. n. is followed by *P. psammophilus* comb. n., as both species retain a P2 endopod (character 22) as well as an inner seta on P3 and P4 exp-3 (characters 23, 24). In contrast, all remaining *Paralaophontodes* species share the derived condition that is the complete loss of a P2 endopod, and the loss of inner setae on P3 and P4 exp-3. Nonetheless, *P. psammophilus* comb. n. can be characterized by an autapomorphy, namely the transverse extension of the P1 basis (character 25) to which the P1 exopod is connected. Such transverse extension is virtually absent within Laophontodinae (exception: *Laophontodes gracilipes* Lang, 1936) but expressed in *Ancorabolina* and showing its strongest development in Ancorabolinae.

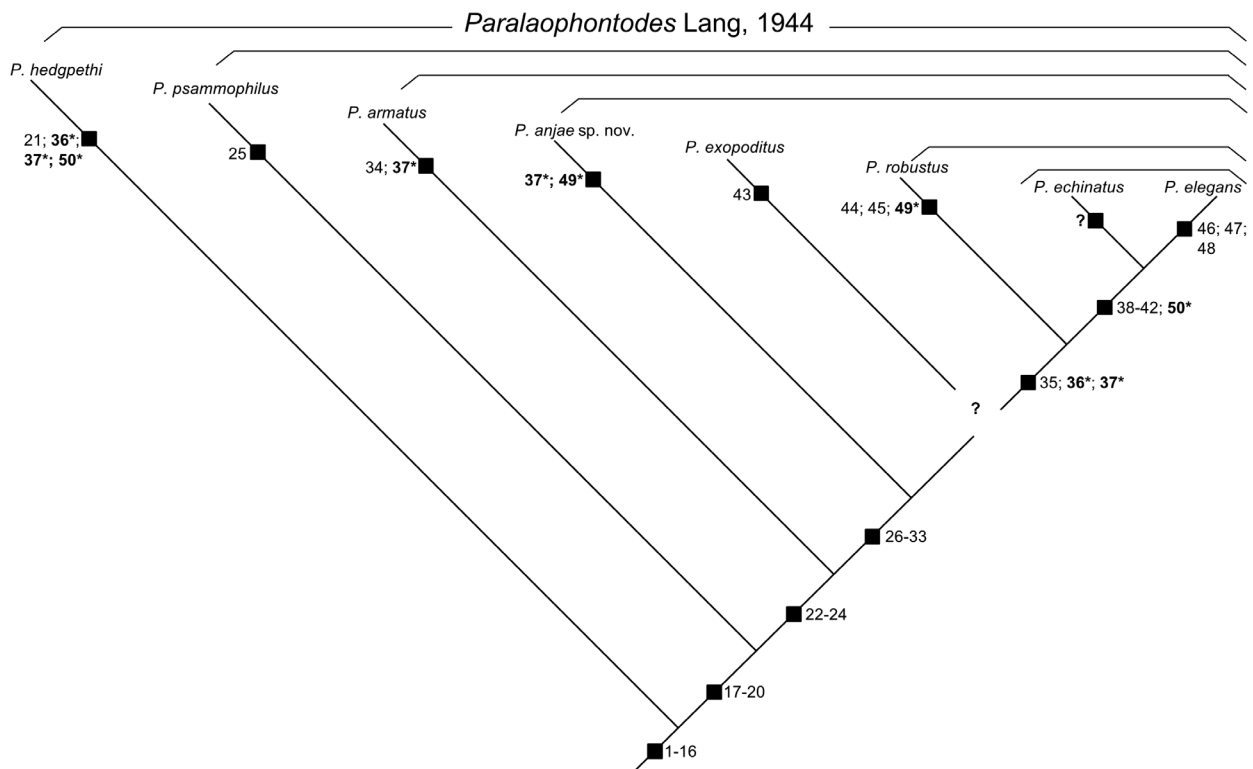

Figure 16. Cladogram summarising the results of the phylogenetic analysis presented in the text. Enumeration of apomorphies according to the text.

Next in the systematic hierarchy might be *P. armatus* comb. n. which, together with *P. hedgpethi* comb. n. and *P. psammophilus* comb. n., holds the ancestral states of a series of characters: possession of a geniculated seta on P1 exp-2 (Character 26), P1 exopod still 3-segmented (character 27), P2–P4 exp-3 inner apical seta long and flexible (characters 28–30), P3 female endopod 2-segmented (character 31) and carrying 2 setae (character 32), and P4 still bearing an endopod (character 33). Otherwise, *Paralaophontodes armatus* comb. n. may be characterized by the presence of 1 (female) or 2 (male) fishbone-like setae at the P5 (character 34). The corresponding setae in the remaining *Paralaophontodes* species and in the Laophontodinae in general are usually bipinnate. In *P. armatus* comb. n. these setae show strongly developed pinnae which are fused to the seta, giving a fishbone-like appearance. These fishbone-like setae are considered as an autapomorphy of *P. armatus* comb. n.

The remaining clade [*P. anjae* sp. n.—*P. echinatus*—*P. elegans*—*P. exopoditus*—*P. robustus*] is characterized by the derived states of characters 26–33 (see Table 3, Fig. 16). The relationships within that clade are, however, somewhat ambiguous. While some species may be characterized by unambiguous autapomorphies (*P. exopoditus*: character 43; *P. robustus* comb. n.: characters 44, 45; *P. elegans*: characters 46–48; cf. Table 3), *P. anjae* sp. n. shares its specific deviation (character 49) with *P. robustus*, whilst *P. echinatus*, as yet cannot be characterized by an autapomorphy. Similar incongru-

ence is observed if ascending further in the cladogram (Fig. 16). *Paralaophontodes echinatus*, *P. elegans*, and *P. robustus* appear more closely related, sharing 3 deviations: loss of 1 geniculated seta in P1 exp-2 (Character 35), loss of the abexopodal seta in A2 (character 36), and loss of the antennary exopod (character 37). Furthermore, *Paralaophontodes elegans* and *P. echinatus* also appear closely related, showing greatest similarity in the derived shape of their thoracic dorsal processes, which are H-like only in these two species (characters 38–42). In contrast, the allocation of *P. exopoditus* is difficult. It shares any synapomorphy neither with *P. anjae* sp. n. nor with any of the other three species (Table 3, Fig. 16).

With respect to characters 36 and 37, it has to be conceded that both characters are somewhat weak. The loss of the abexopodal seta in A2 (36) is also described for the presumed most primitive *P. hedgpethi* comb. n., and loss of the A2 exopod (37) is also recorded in *P. anjae* sp. n., *P. armatus* comb. n. and *P. hedgpethi* comb. n. (cf. Table 3, Fig. 16). In particular the here supposed convergent loss of the A2 exp (37) in four clades – (1) [*P. hedgpethi*], (2) [*P. armatus*], (3) [*P. anjae* sp. n.], and (4) [*P. robustus*—*P. echinatus*—*P. elegans*] – contradicts the principle of parsimony. It would be more parsimonious assuming that the loss of the A2 exp occurred once in the *Paralaophontodes* groundpattern, while reversing subsequently in *P. robustus* and *P. exopoditus*. Nonetheless, also the latter implies certain problems. The reduction of appendages is a comparatively common occasion within

Copepoda, described as principle of oligomerization (e.g. Huys and Boxhall 1991), whereas the formation of new armature elements happens only quite sporadically in Harpacticoida (Huys 1996), and the secondary development of previously lost segments has not been documented for Copepoda so far. Therefore, manifold convergent loss of the A2 exp within *Paralaophontodes* sounds more plausible and probable than its secondary and independent re-formation.

The resulting partly unsatisfactory systematic resolution within *Paralaophontodes* may be an effect from limitations in information available on morphological

characters, and therefore genetic comparison should be considered in future studies (but see below). Nevertheless, this lack of resolution undoubtedly also results from insufficient and incomplete species descriptions that can and should be resolved in the future. As an example Table 3 includes characters 48 and 50 that, despite their presumed high phylogenetic value, have not been described for *P. psammophilus* comb. n. and *P. robustus*. Similarly, other mouthparts that might provide important additional phylogenetic information are not described for all species. This clearly demonstrates the importance of species re-descriptions in the context of phylogenetic analyses.

Key to species of *Paralaophontodes* (females)

- 1 All free body somites with strongly developed dorsal cuticular processes 2
- Strongly developed cuticular processes restricted to abdominal somites only..... 3
- 2 P1 exp 3-segmented; at least P4 with endopod..... 4
- P1 exp 2-segmented; P2 and P4 without endopods..... 5
- 3 P1 exp 3-segmented; P1 enp-2 with claw, 1 tiny seta and 1 additional long seta; P2 and P3 with 3-segmented exps; P2 and P4 with enps *P. hedgpethi* Lang, 1965
- P1 exp 2-segmented; P1 enp-2 with claw and 1 small seta only; P2 and P3 exopodal segments not separate, 1-segmented; P2–P4 lacking enps *P. robustus* (Bözić, 1964)
- 4 Cephalic lateral extensions moderately triangular; A2 with 1-segmented small exp bearing 1 bare seta; P2 with enp
..... *P. psammophilus* (Soyer, 1974)
- Cephalic lateral extensions strongly triangular; A2 without exp; P2 without enp..... *P. armatus* (Lang, 1936)
- 5 Rostrum narrowed; cephalic lateral extensions only weakly developed; P5 baseoendopodal setae small, not reaching insertion of first outer exopodal seta..... *P. elegans* Baldari and Cottarelli, 1986
- Rostrum triangular; cephalic lateral extensions strongly triangular; P5 baseoendopodal setae long, surpassing insertion of second outer exopodal seta 6
- 6 P1 exp-2 with 5 geniculate setae; female P6 fused to body somite, represented by 1 small bipinnate seta..... 7
- P1 exp-2 with 4 geniculate setae; female P6 distinct, small segment carrying 2 bare setae; P3 endopod a small, knob-like segment with 1 small bare seta; A2 without exp *P. echinatus* (Willey, 1930)
- 7 A2 with minute knob-like exp carrying 1 small seta; female P3 enp represented by small bare seta
..... *P. exopoditus* Mielke, 1981
- A2 without exp; female P3 enp completely los *P. anjae* sp. n.

Distribution of the taxon *Paralaophontodes*

Figure 17 shows the updated distribution patterns of *Paralaophontodes*, including data from both the literature and new records. From published data, most species have been reported from single locations: *Paralaophontodes exopoditus*, Galápagos Islands (Ecuador; Mielke 1981); *P. elegans*, Mindoro Island (The Philippines; Baldari and Cottarelli, 1986); *P. hedgpethi*, Dillon Beach, California (U.S.A.; Lang 1965); *P. psammophilus*, Courbet Peninsula (Kerguelen Islands; Soyer 1974); and *P. robustus*, whose situation has been discussed in detail above. *Paralaophontodes armatus* shows a somewhat wider, but nonetheless regionally restricted distribution, seeming to be confined to the “Magellan Subregion” *sensu* De Broyer et al. (2014) (Lang 1936: Falklands; Pallares 1968a: Ría Deseado, Argentina, cf. also George 2014). In contrast, *Paralaophontodes echinatus* was collected in the Caribbean (Willey 1930, 1935: Bermuda; Fiers 1986: Yucatán Peninsula, México) as well as in the Indian Ocean (Wells and Rao 1987: Aberdeen, Port Blair, South Andaman).

Additional *Paralaophontodes* material kindly given to the author provides further chorological information for some of the *Paralaophontodes* species (Fig. 17). Thus, the records of *Paralaophontodes armatus* near Punta Arenas and Punta Yartou in the Chilean Magellan Straits (present contribution) support its distribution in the Magellan Subregion. Similarly, the Caribbean distribution of *Paralaophontodes echinatus* is corroborated by the records from Andros Island (Bahamas; present contribution). Moreover, its discovery at Golfito Harbour (Costa Rica; present contribution) extends its distribution range into the Pacific Ocean, a condition that has already been observed for several other harpacticoid species (e.g. Mielke 1990, 1994, 1995) and which may indicate a link between the Caribbean and Indian Ocean (Wells and Rao 1987). The widest distribution range is seen in *Paralaophontodes exopoditus*. It was first reported from the Galápagos Islands (Mielke 1981) and seems to show a Pacific-wide distribution, also being recorded at Ednago Island (Papua New Guinea, present contribution). Moreover, its record in Dahab (Egypt, Red Sea, present contri-

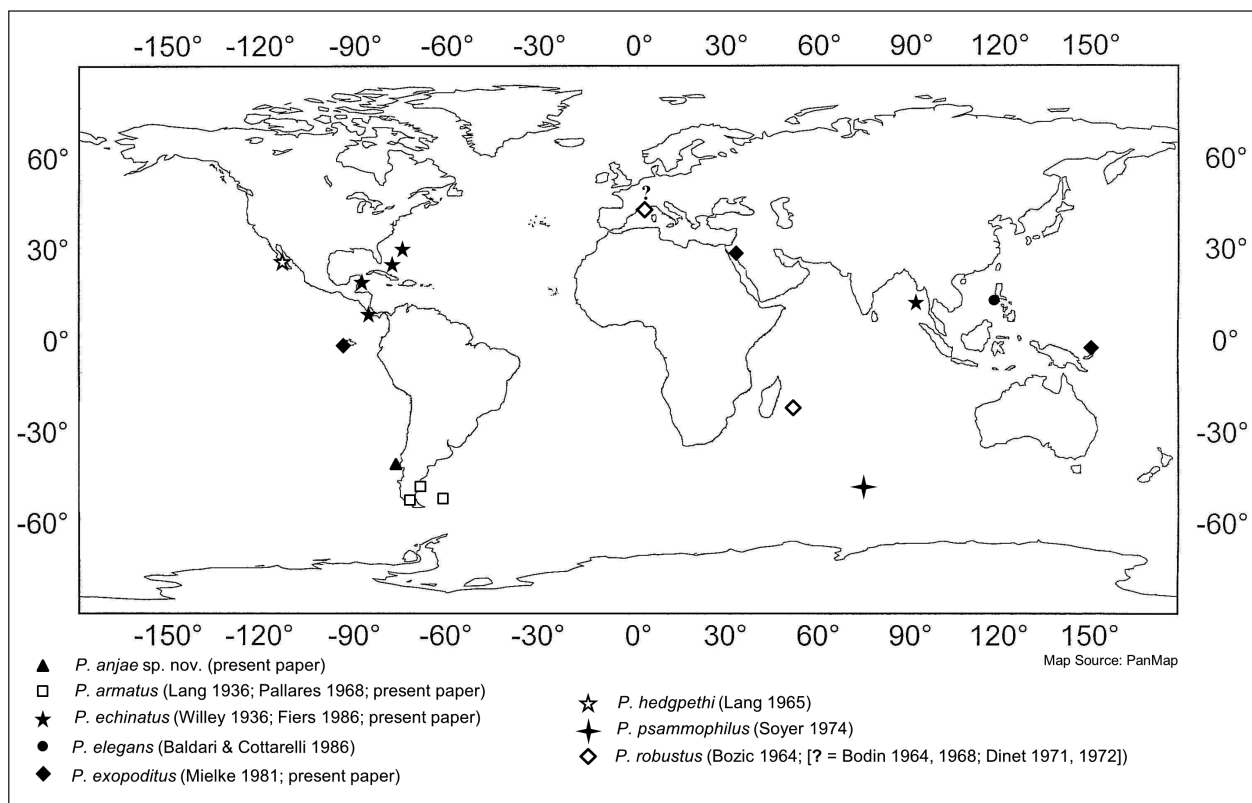

Figure 17. Map showing the world-wide distribution of *Paralaophontodes* Lang, 1965; including the distribution patterns of the respective species.

bution) even suggests its distribution crossing the Indian Ocean. Therefore, from the eight species shown in Fig. 16 only *Paralaophontodes hedgpethi*, *P. psammophilus*, *P. robustus* (?) and *P. anjae* sp. n. continue to retain a single-record locality.

Summarizing the above compiled records, the taxon *Paralaophontodes* shows an almost world-wide distribution, so far remaining absent only from the Central Atlantic, the High Antarctic and the Arctic. However, with the Falklands' records of *P. armatus* in mind, it might be assumed that *Paralaophontodes* may be also distributed northwards into the Atlantic Ocean as well as southwards into high Antarctic regions. The latter may be supported by the record of *P. psammophilus* from Kerguelen (Soyer 1974).

It is noteworthy that all findings of *Paralaophontodes* are restricted to the littoral, with the deepest record at 15 m (*P. armatus*, Punta Yartou, Magellan Straits, Chile). Even in the vastness of the oceans, records of *Paralaophontodes* have only been documented from the shores of oceanic islands, while extensive sampling in the deep sea (e.g. George et al. 2014 [Atlantic Ocean], Mahatma 2009 [Pacific Ocean]) and on seamounts (George 2013) has not revealed *Paralaophontodes*. It is therefore concluded that *Paralaophontodes* constitutes a truly littoral taxon, and so supports the hypothesis of a “meiofauna paradox” (Giere 2009), whereby meiobenthic taxa, particularly those inhabiting only littoral biotopes, present a wide to cosmopolitan distribution despite their apparent inability to traverse large distances and deep-sea areas (cf. Packmor et al. 2015).

One might expect that *Paralaophontodes* would be present on Atlantic islands, as it is in the Indian and Pacific Ocean. However, despite extensive qualitative sampling in Madeira and Porto Santo Island (Packmor and George 2016) and the Azores (Chapman and Santler 1955, Kunz 1983) *Paralaophontodes* has not been recorded. Future additional sampling on other Atlantic islands is needed to determine if it is present in the Atlantic. It must be stated that the methods and conditions required for *Paralaophontodes* species dispersal remain elusive.

Whereas statements on wide meiofaunal distribution ranges usually remain unquestioned at the genus level (e.g. George and Tiltack 2009, Handschuhmacher et al. 2010, Menzel et al. 2011), they often cause certain scepticism if looking at the species level. In particular, since molecular methods have been employed for taxonomic, systematic and biogeographic (= phylogeographic) research (e.g. Hebert et al. 2003, Tautz et al. 2003, Kieneke et al. 2012, Janssen et al. 2015, Mohrbeck et al. 2015, Raupach et al. 2015), morphological approaches have been increasingly renounced. For instance, genetic investigations of some meiobenthic polychaetes, the gastrotrich *Xenotrichula intermedia* Remane, 1934, the calanoid copepod *Eurytemora affinis* (Poppe, 1880) and the harpacticoid copepod *Cletocamptus deitersi* (Richard, 1897) suggest that their apparent broad geographic distribution ranges, originally based on morphological studies, actually represent sibling species complexes (Westheide and Schmidt 2003, Todaro et al. 1996, Lee 2000, and Rocha-Olivares et al. 2001,

respectively; see also Guil 2011 for further taxa). Against that background it may sound somewhat careless stating that *Paralaophontodes echinatus* and *P. exopoditus* perhaps show a world-wide distribution (Fig. 17). Both were objects of morphological comparison only, as no molecular data are yet available. This is also true for *P. armatus*, whose distribution appears to extend into the whole Magellan Subregion (Fig. 17) but which presents some morphological uncertainties (see remarks on that species above).

Additional molecular studies might sharpen the so far observed distribution patterns, and admittedly it is imaginable that the named *Paralaophontodes* species may constitute complexes of more than one species. One should keep in mind, however, that although genetic studies are without doubt important and provide valuable contributions in chorological and biogeographic research, their results should not be overzealously followed to the neglect or even rejection of morphological approaches. Jörger et al. (2012, p.1), for example, suggests the presence of “extensive, morphologically cryptic diversity among meiofauna“, implying the need for molecular methods in meiobenthic studies. Yet several taxa (e.g., Harpacticoida, Halacarida, Loricifera, Nematoda [part.], Tardigrada) provide distinct and clear-cut morphological and/or anatomic characters useful for species differentiation (which sometimes have been simply overlooked during species description or determination, leading this to the formation of species complexes). This is demonstrated by a number of molecular studies that have simply confirmed morphological data (e.g. Westheide and Schmidt 2003, Leese et al. 2010, Nikula et al. 2010, Brix et al. 2011, Gollner et al. 2011, Kieneke et al. 2012, Brix et al. 2014), including species with wide geographic distributions. Jörger et al. (2014) has in fact found that molecular approaches are not always able to address all uncertainties regarding species delineation. Thus, an adequate approach may be the so-called “integrative taxonomy” that has become a more and more accepted way of combining both morphology and genetics (e.g. Kieneke et al. 2012, Brix et al. 2014, Janssen et al. 2015), since morphological characters are not always indisputable and molecular data not always precise. One has to keep in mind, however, that molecular studies of meiobenthos remain rare (Guil 2011) and this is true for the here treated taxon *Paralaophontodes*. Future morphological and molecular investigation may elucidate taxonomic uncertainties and doubts, as well as emerging distribution patterns.

Acknowledgments

I am exceptionally indebted to my wife, Mrs Ilva George (Germany) for her essential and extensive help in meiofauna sampling, sample treatment and sorting during our stay in Valdivia (Chile) from 1993–1995. Thanks are given to Mr Johannes Dürbaum (Germany), Dr Gritta Veit-Köhler (Germany), Prof Dr Horst Kurt Schminke (Germany) and Dr Matthias Gorny (Chile) for ceding

material of several *Paralaophontodes* specimens. Mrs Karin Sindemark-Kronestedt (Sweden) kindly provided the type material of *Laophontodes armatus* Lang, 1936. Special thanks go to Dr Natalie Barnes (United Kingdom) for reviewing the English text of the manuscript and providing helpful comments. I am indebted to two anonymous reviewers for their very helpful and constructive comments and recommendations; two further anonymous reviewers provided helpful and constructive comments on a former version of the manuscript. The author’s stay in Chile (1993–1995) was financially supported by the German Academic Exchange Service DAAD (code no. 565/504/500/4); his stay in Punta Arenas (Chile) in the frame of the research cruise ANTARKTIS XIII/4–5 of German RV “Polarstern” in 1996 as well as his stay in Golfito (Costa Rica) in 2008 was financially supported by the Deutsche Forschungsgemeinschaft DFG (SCHM 352/18-1 and GE 1086/7-1, respectively).

References

- Ax P (1984) *Das Phylogenetische System*. Gustav Fischer Verlag, Stuttgart.
- Baldari F, Cottarelli V (1986) A new species of the genus *Paralaophontodes* (Crustacea, Copepoda, Harpacticoida) from interstitial waters of Mindoro Island (The Philippines). *Publications of the Seto Marine Biological Laboratory* 31: 163–168.
- Bodin P (1964) Recherches sur la systématique et la distribution des copépodes harpacticoides des substrats meubles des environs de Marseille. *Bulletin Recueil des travaux de la station marine d’Endoume* 33: 107–183.
- Bodin P (1968) Recherches sur la systématique et la distribution des copépodes harpacticoides des substrats meubles des environs de Marseille. Note complémentaire. *Bulletin Recueil des travaux de la station marine d’Endoume* 43: 271–277.
- Bodiu JY, Colomines JC (1988) Harpacticoides (copépodes) des îles Crozet. II Description d’une espèce nouvelle du genre *Tapholaophontodes* Soyer, 1974. *Crustaceana* 55: 104–110. <https://doi.org/10.1163/156854088X00285>
- Boxshall GA, Halsey SH (2004) *An Introduction to Copepod Diversity*. The Ray Society 166, London.
- Bözić B (1964) Copépodes harpacticoides et cyclopoïdes de La Réunion. II. Plage St. Pierre. *Bulletin du Muséum National d’Histoire Naturelle Serie 2*, 36: 481–499.
- Brix S, Riehl T, Leese F (2011) First genetic data for species of the genus *Haploniscus* Richardson, 1908 (Isopoda: Asellota: Haploniscidae) from neighbouring deep-sea basins in the South Atlantic. *Zootaxa* 2832: 79–84.
- Brix S, Leese F, Riehl T, Kihara TC (2014) A new genus and new species of Desmosomatidae Sars, 1897 (Isopoda) from the eastern South Atlantic abyss described by means of integrative taxonomy. *Marine Biodiversity* 45: 7–61. <https://doi.org/10.1007/s12526-014-0218-3>
- Chapman G, Santler JE (1955) Aspects of the Fauna and Flora of the Azores. V. Crustacea. *Journal of Natural History, Series 12* 8: 371–376. <https://doi.org/10.1080/00222935508655652>
- Conroy-Dalton S (2001) Systematics and phylogeny of the Ancorabolidae (Copepoda: Harpacticoida). II. Polyphyly of *Polyascophorus*

- and description of *Arthuricornua*, new genus. *Journal of Crustacean Biology* 21: 170–191. <https://doi.org/10.1163/20021975-99990115>
- Conroy-Dalton S (2003a) Systematics and phylogeny of the Ancorabolidae (Copepoda: Harpacticoida). III. Description of two new species of *Ceratonotus* Sars and *Dendropsyllus*, new genus. *Journal of Crustacean Biology* 23: 69–93. <https://doi.org/10.1163/20021975-99990319>
- Conroy-Dalton S (2003b) Systematics and phylogeny of the Ancorabolidae (Copepoda: Harpacticoida). IV. Redescription, ontogeny and position of *Echinopsyllus normani*. *Cahiers de Biologie Marine* 44: 153–169.
- Conroy-Dalton S (2004) Systematics and phylogeny of the Ancorabolidae (Copepoda: Harpacticoida). V. Description of *Lobopleura*, new genus, with notes on *Probosciphontodes* Fiers. *Journal of Crustacean Biology* 24: 17–36. <https://doi.org/10.1651/C-2439>
- Conroy-Dalton S, Huys R (2000) Systematics and phylogeny of the Ancorabolidae (Copepoda: Harpacticoida). I. The *Ancorabolus*-lineage, with the description of three new genera. *Cahiers de Biologie Marine* 41: 343–397.
- Cottarelli V, Baldari F (1987) Interstitial Ancorabolidae (Copepoda, Harpacticoida) from Macquarie Island: *Tapholaophontodes remotus* and *Algensiella boitani* n.gen. n.sp. *Crustaceana* 53: 67–77. <https://doi.org/10.1163/156854087X00637>
- De Broyer C, Koubbi P, Griffiths HJ, Raymond B, Udekem d’Acoz C d’, Van de Putte AP, Danis B, David B, Grant S, Gutt J, Held C, Hosie G, Huettmann F, Post A, Ropert-Coudert Y (Eds) (2014) Biogeographic Atlas of the Southern Ocean. Scientific Committee on Antarctic Research, Cambridge.
- Dinet A (1971) Copépodes Harpacticoides d’un sable fin organogène des environs de Marseille. *Tethys* 2: 747–762.
- Dinet A (1972) Etude écologique des variations quantitatives annuelles d’un peuplement de copépodes harpacticoides psammiques. *Tethys* 4: 95–112.
- Fiers F (1986) A new record and redescription of *Paralaophontodes echinatus* (Willey) (Copepoda, Harpacticoida, Ancorabolidae). *Annales de la Société royale zoologique de Belgique* 116: 137–144.
- Fiers F (1988) *Probosciphontodes* n. gen., a new genus of the family Ancorabolidae, with the description of two new species (Copepoda, Harpacticoida). *Bulletin de l’Institut Royal des Sciences Naturelles de Belgique* 58: 75–83.
- George KH (1993) Harpacticoida (Crustacea, Copepoda) aus Chile und der Antarktis, unter besonderer Berücksichtigung der Ancorabolidae. Diploma Thesis, Carl von Ossietzky-Universität, Oldenburg, Germany.
- George KH (1998) *Polyascophorus*, a new genus of Ancorabolidae (Crustacea, Copepoda), including the description of two new species and the re-allocation of *Ceratonotus gorbunovi*. *Vie et Milieu* 48: 141–155.
- George KH (2006a) New Ancorabolinae Sars, 1909 (Copepoda: Harpacticoida: Ancorabolidae) of the Atlantic and the Pacific Ocean. The taxa *Ceratonotus* Sars, and *Dendropsyllus* Conroy-Dalton. *Meiofauna Marina* 15: 87–122.
- George KH (2006b) New Ancorabolinae Sars, 1909 (Copepoda: Harpacticoida: Ancorabolidae) of the Atlantic Ocean. Description of *Pseudechinopsyllus sindemarkae* gen. et sp. n. and *Dorsiceratus ursulae* sp. n. from the Great Meteor Seamount, and redescription of *D. octocornis* Drzycimski, 1967, and *D. trarticulatus* Coull, 1973 (part.). *Meiofauna Marina* 15: 123–156.
- George KH (2006c) Ancorabolinae Sars (Copepoda: Harpacticoida: Ancorabolidae) of the deep Atlantic Ocean. *Ancorabolina chimaera* gen. et sp. n. including remarks to ancorabolid phylogeny and to the evolution of the first natatorial leg in comparison with Laophontoida T. Scott. *Meiofauna Marina* 15: 157–176.
- George KH (2013) Faunistic research on metazoan meiofauna from seamounts – a review. *Meiofauna Marina* 20: 1–32.
- George KH (2014) Southern Ocean Harpacticoida (Crustacea: Copepoda). In: De Broyer C, Koubbi P, Griffiths HJ, Raymond B, Udekem d’Acoz C d’, Van de Putte AP, Danis B, David B, Grant S, Gutt J, Held C, Hosie G, Huettmann F, Post A, Ropert-Coudert Y (Eds) *Biogeographic Atlas of the Southern Ocean*. Scientific Committee on Antarctic Research, Cambridge 88–93.
- George KH, Gheerardyn H (2015) Remarks on the genus *Laophontodes* T. Scott, 1894 (Copepoda, Harpacticoida, Ancorabolidae, Laophontodinae), including the (re-) description of four species. *Zoologischer Anzeiger* 259: 61–96. <https://doi.org/10.1016/j.jcz.2015.02.009>
- George KH, Müller F (2013) Characterization of a monophylum *Echinocletodes*, its exclusion from Ancorabolinae (Copepoda, Harpacticoida), and displacement of *E. bodini* and *E. walvisi* to *Cletodes*, including the description of two new species. *Zootaxa* 3666: 101–136. <https://doi.org/10.11646/zootaxa.3666.2.1>
- George KH, Tiltack A (2009) A new species of *Ancorabolina* (Copepoda, Harpacticoida, Ancorabolinae) from a Mediterranean cave, with a key to species. *Vie et Milieu* 59: 287–300.
- George KH, Veit-Köhler G, Martínez Arbizu P, Seifried S, Rose A, Willen E, Bröhlidick K, Corgosinho PH, Drewes J, Menzel L, Moura G, Schminke HK (2014) Community structure and species diversity of Harpacticoida (Crustacea: Copepoda) at two sites in the deep sea of the Angola Basin (Southeast Atlantic). *Organisms, Diversity and Evolution* 14: 57–73. <https://doi.org/10.1007/s13127-013-0154-2>
- George KH, Santos PJP, Wandeness AP (2013) A new species of Ancorabolidae (Crustacea: Copepoda: Harpacticoida) from the Campos Basin, Brazil, including a phylogenetic review of the taxon *Polyascophorus* George, 1998, and a key to the species. *Zoologischer Anzeiger* 252: 20–33. <https://doi.org/10.1016/j.jcz.2012.02.002>
- Gheerardyn H, George KH (2010) New representatives of the genus *Ancorabolina* George, 2006 (Copepoda, Harpacticoida, Ancorabolidae) including remarks on ancorabolid phylogeny. *Zoological Journal of the Linnean Society* 158: 16–55. <https://doi.org/10.1111/j.1096-3642.2009.00567.x>
- Gheerardyn H, Lee W (2012) *Calypsophontodes* gen. nov. (Copepoda: Harpacticoida: Ancorabolidae), a new genus of Laophontodinae, including remarks on ancorabolid phylogeny. *Journal of Crustacean Biology* 32: 263–280. <https://doi.org/10.1163/193724011X615613>
- Giere O (2009) *Meiobenthology*. The microscopic motile fauna of aquatic sediments. Springer Verlag, Berlin.
- Gollner S, Fontaneto D, Martínez Arbizu P (2011) Molecular taxonomy confirms morphological classification of deep-sea hydrothermal vent copepods (Dirivultidae) and suggests broad physiological tolerance of species and frequent dispersal along ridges. *Marine Biology* 158: 221–231. <https://doi.org/10.1007/s00227-010-1553-y>
- Guil N (2011) Molecular approach to micrometazoans. Are they here, there and everywhere? In: Fontaneto D (Ed.) *Biogeography of microscopic organisms. Is everything everywhere?* The Systematics Association Special Volume 79. Cambridge University Press, New York 285–306. <https://doi.org/10.1017/CBO9780511974878.015>
- Handschuhmacher L, Steinarsdóttir MB, Edmands S, Ingólfsson A (2010) Phylogeography of the rock-pool copepod *Tigriopus brevicornis* (Harpacticoida) in the northern North Atlantic, and its relationship to

- other species of the genus. *Marine Biology* 157: 1357–1366. <https://doi.org/10.1007/s00227-010-1415-7>
- Hebert PDN, Cywinska A, Ball SL, de Waard JR (2003) Biological identifications through DNA barcodes. *Proceedings of the Royal Society of London B*: 02PB0653. <https://doi.org/10.1098/rspb.2002.2218>
- Hennig W (1982) *Phylogenetische Systematik*. Paul Parey-Verlag, Hamburg, Berlin.
- Huys R (1996) Superornatiremididae fam.nov. (Copepoda: Harpacticoida): An enigmatic family from North Atlantic anchialine caves. *Scientia Marina* 60: 497–542.
- Huys R, Boxshall GA (1991) *Copepod Evolution*. The Ray Society 159, London.
- Janssen A, Kaiser S, Meißner K, Brenke N, Menot L, Martínez Arbizu P (2015) A reverse taxonomic approach to assess macrofaunal distribution patterns in abyssal Pacific polymetallic nodule fields. *PLoS One* 10: e0117790; <https://doi.org/10.1371/journal.pone.0117790>
- Jörger KM, Norenburg JL, Wilson NG, Schrödl M (2012) Barcoding against a paradox? Combined molecular species delineations reveal multiple cryptic lineages in elusive meiofaunal sea slugs. *BMC Evolutionary Biology* 12: 245 (1–18).
- Kieneke A, Martínez Arbizu P, Fontaneto D (2012) Spatially structured populations with a low level of cryptic diversity in European marine Gastrotricha. *Molecular Ecology* 21: 1239–1254. <https://doi.org/10.1111/j.1365-294X.2011.05421.x>
- Kornev PN, Chertoprud ES (2008) Harpacticoid copepods from the White Sea: Morphology, Systematics, Ecology. KMK Scientific Press, Moscow. [In Russian]
- Kunz H (1983) Harpacticoiden (Crustacea: Copepoda) aus dem Litoral der Azoren. *Arquipélago* 4: 117–208.
- Lang K (1936) Copepoda Harpacticoida. Further Zoological Results of the Swedish Antarctic Expedition 1901–1903 3: 3–68.
- Lang K (1948) *Monographie der Harpacticiden*. Otto Koeltz Science Publishers, Koenigstein.
- Lang K (1965) Copepoda Harpacticoida from the Californian pacific coast. *Kungl. Svenska Vetenskapsakademiens Handlingar* 10: 1–566.
- Lee CE (2000) Global phylogeography of a cryptic copepod species complex and reproductive isolation between genetically proximate „populations“. *Evolution* 54: 2014–2027. <https://doi.org/10.1111/j.0014-3820.2000.tb01245.x>
- Leese F, Agrawal S, Held C (2010) Long-distance island hopping without dispersal stages: transportation across major zoogeographic barriers in a Southern Ocean isopod. *Naturwissenschaften*. <https://doi.org/10.1007/100114-010-0674-y>
- Mahatma R (2009) Meiofauna communities of the Pacific Nodule Province: abundance, diversity and community structure. Doctoral thesis, Fakultät für Mathematik und Naturwissenschaften, Carl von Ossietzky-Universität: 1–143.
- Menzel L, George KH, Martínez Arbizu P (2011) Submarine ridges do not prevent large-scale dispersal of abyssal fauna: A case study of *Mesocletodes* Crustacea, Copepoda, Harpacticoida). *Deep-Sea Research I* 58: 839–864. <https://doi.org/10.1016/j.dsr.2011.05.008>
- Mielke W (1981) Interstitielle Fauna von Galapagos XXVIII. Laophontidae, Ancorabolidae (Harpacticoida). *Mikrofauna Meeresboden* 84: 1–106.
- Mielke W (1985) Interstitielle Copepoda aus dem zentralen Landesteil von Chile: Cyliandrocypridae, Laophontidae, Ancorabolidae. *Microfauna marina* 2: 181–270.
- Mielke W (1990) *Zausodes septimus* Lang, 1965 und *Enhydrosoma pericoense* nov. spec., zwei benthische Ruderfußkrebse (Crustacea, Copepoda) aus dem Eulitoral von Panamá. *Microfauna Marina* 6: 139–156.
- Mielke W (1994) New record of two copepod species (Crustacea) from the Pacific coast of Costa Rica. *Microfauna Marina* 9: 55–60.
- Mielke W (1995) Interstitial copepods (Crustacea) from the Caribbean coast of Venezuela. *Microfauna Marina* 10: 41–65.
- Mohrbeck I, Raupach MJ, Martínez Arbizu P, Kneibelsberger T, Laakmann S (2015) High-throughput sequencing—The key to rapid biodiversity assessment of marine metazoa? *PLoS One* 10: e0140342. <https://doi.org/10.1371/journal.pone.0140342>
- Nikula R, Fraser CI, Spencer HG, Waters JM (2010) Circumpolar dispersal by rafting in two subantarctic kelp-dwelling crustaceans. *Marine Ecology Progress Series* 405: 221–230. <https://doi.org/10.3354/meps08523>
- Packmor J, George KH (2016) Littoral Harpacticoida (Crustacea: Copepoda) of Madeira and Porto Santo (Portugal), with remarks on harpacticoid dispersal along the “Madeira Hot Spot Track” (NE Atlantic Ocean). *Journal of the Marine Biological Association of the UK*, 1–12, doi:10.1017/S0025315416001168
- Packmor J, Müller F, George KH (2015) Oceanic islands and seamounts as staging posts for Copepoda Harpacticoida (Crustacea) – Shallow-water Paramesochridae Lang, 1944 from the North-East Atlantic Ocean, including the (re-)description of three species and one subspecies from the Madeiran Archipelago. *Progress in Oceanography* 131: 59–81. <https://doi.org/10.1016/j.pocean.2014.11.012>
- Pallares RE (1968a) Copépodos marinos de la Ria Deseado (Sta. Cruz, Argentina). *Contribución sistemática-ecológica. Contribuciones Científicas CIBIMA* 27: 1–125.
- Pallares RE (1968b) *Patagoniaella*, nuevo género de la familia Ancorabolidae Sars, 1909 (Copepoda, Harpacticoida). *Physis* 27: 461–469.
- Raupach MJ, Amann R, Wheeler QD, Roos C (2015) The application of “omics”-technologies for the classification and identification of animals. *Organisms, Diversity and Evolution* 16: 1–12, <https://doi.org/10.1007/s13127-015-0234-6>
- Rocha-Olivares A, Fleegeer JW, Foltz DW (2001) Decoupling of molecular and morphological evolution in deep lineages of a meiobenthic harpacticoid copepod. *Molecular Biology and Evolution* 18: 1088–1102. <https://doi.org/10.1093/oxfordjournals.molbev.a003880>
- Schminke HK (1976) The ubiquitous telson and the deceptive furca. *Crustaceana* 30: 292–299. <https://doi.org/10.1163/156854076X00657>
- Seifried S, Dürbaum J (2000) First clear case of carnivory in marine Copepoda Harpacticoida. *Journal of Natural History* 34: 1595–1618.
- Seifried S (2003) *Phylogeny of Harpacticoida (Copepoda): Revision of ‘Maxillipedasphalea’ and Exanechechtera*. Cuvillier Verlag, Göttingen.
- Soyer J (1974) Harpacticoides (Crustacés, Copépodes) de l’archipel de Kerguelen. 1. Quelques formes mésopsammiques. *Bulletin du Muséum National d’Histoire Naturelle de Paris* 168: 1169–1223.
- Sudhaus W, Rehfeld K (1992) *Einführung in die Phylogenetik und Systematik*. Gustav Fischer-Verlag, Stuttgart, Jena.
- Tautz D, Arctander P, Minelli A, Thomas RH, Vogler AP (2002) DNA points the way ahead in taxonomy. *Nature* 418: 479. <https://doi.org/10.1038/418479a>

- Todaro MA, Fleeger JW, Hu YP, Hrincevich AW, Foltz DW (1996) Are meiofaunal species cosmopolitan? Morphological and molecular analysis of *Xenotrichula intermedia* (Gastrotricha: Chaetonotida). *Marine Biology* 125: 735–742. <https://doi.org/10.1007/BF00349256>
- Wägele JW (2001) *Grundlagen der Phylogenetischen Systematik*. Verlag Dr. Friedrich Pfeil, München.
- Wells JBJ, Rao GC (1987) Littoral Harpacticoida (Crustacea: Copepoda) from Andaman and Nicobar Islands. *Memoirs of the Zoological Survey of India* 16: 1–385.
- Westheide W, Schmidt H (2003) Cosmopolitan versus cryptic meiofaunal polychaete species: an approach to a molecular taxonomy. *Helgoland Marine Research* 57: 1–6.
- Willey A (1930) Harpacticoid Copepoda from Bermuda, Part I. *Annals and Magazine of Natural History Ser. 10*, 6: 81–114.
- Willey A (1935) Harpacticoid Copepoda from Bermuda, Part II. *Annals and Magazine of Natural History Ser. 10*, 15: 50–52. <https://doi.org/10.1080/00222933508654944>
-

ZOBODAT - www.zobodat.at

Zoologisch-Botanische Datenbank/Zoological-Botanical Database

Digitale Literatur/Digital Literature

Zeitschrift/Journal: [Zoosystematics and Evolution](#)

Jahr/Year: 2017

Band/Volume: [93](#)

Autor(en)/Author(s): George Kai Horst

Artikel/Article: [Phylogeny of the taxon Paralaophontodes Lang \(Copepoda, Harpacticoida, Laophontodinae\), including species descriptions, chorological remarks, and a key to species 211-241](#)