



www.weldoninstruments.com

PROVEEDOR EXCLUSIVO:



Scalpels & Knives

Probes

Scissors

Forceps

1 - 116

General Instruments

General Instruments
Instrumentos Generales
Allgemeines Instrumentarium

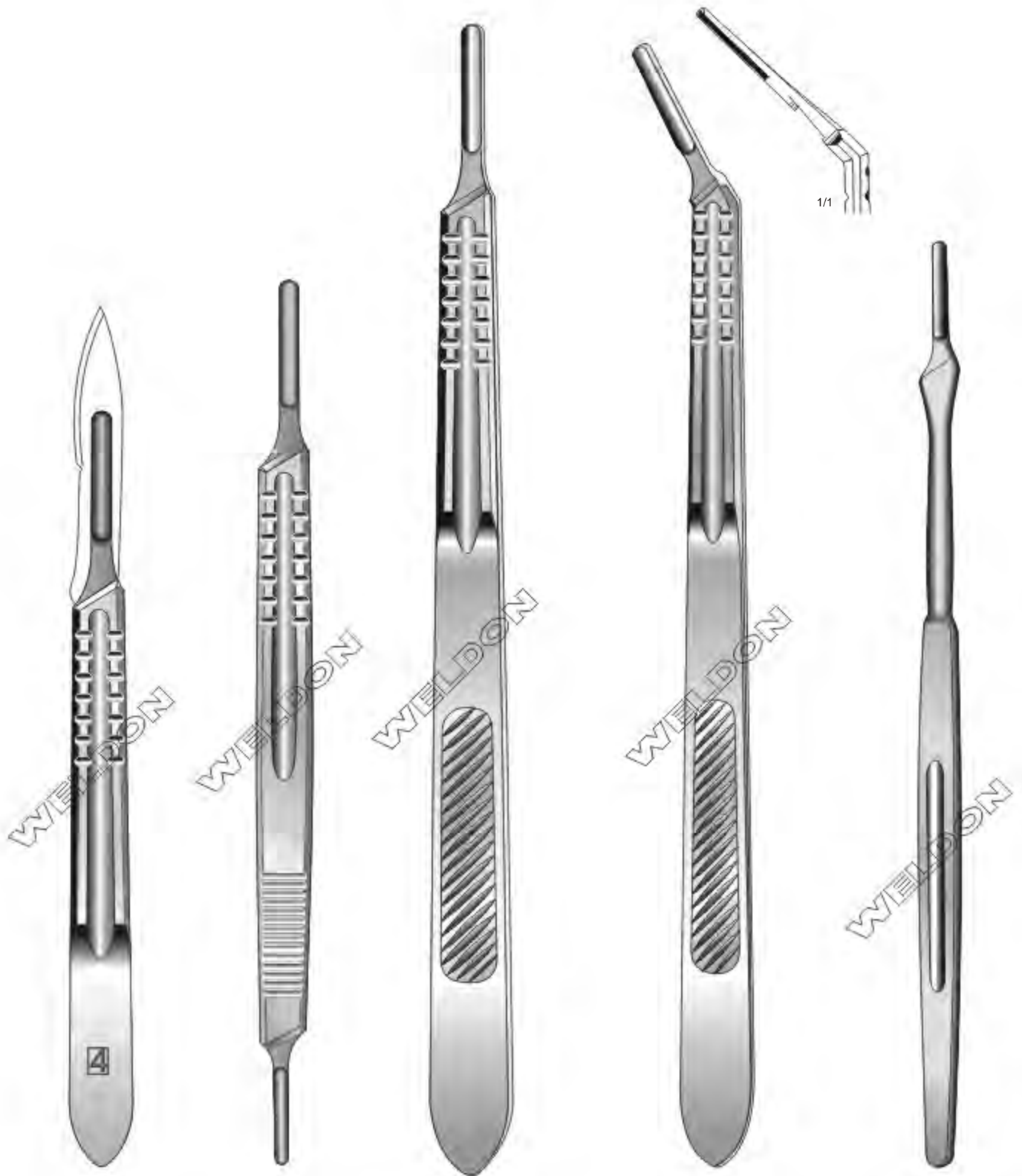

WS-001-001
13.5 cm / 5 1/4"
No.4, Solid

WS-001-002
16 cm / 6 1/4"
Double Handle
No.4 / No.3, Solid

WS-001-003
21 cm / 8 1/4"
No. 4L, Solid

WS-001-004
21 cm / 8 1/4"
No. 4L, Solid Angled

WS-001-005
16.5 cm / 6 1/2"
No.7

Scalpel Handles | Mangos De Bisturi | Skalpellgriffe

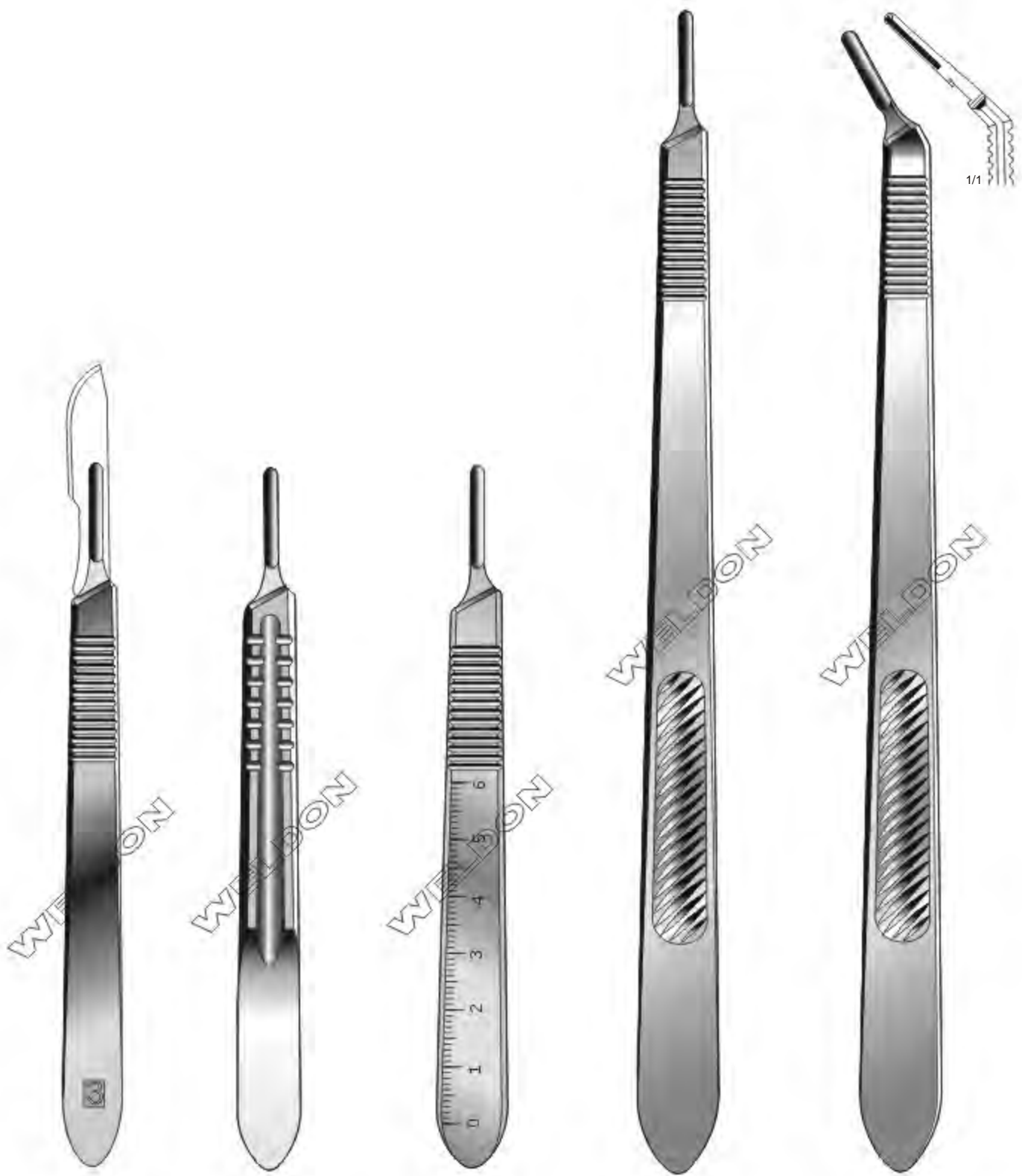

1/1

Standard
WS-002-006
12 cm / 4¾"
No. 3, Solid

WS-002-007
12 cm / 4¾"
No. 3, Solid

WS-002-008
12 cm / 4¾"
No. 3, Solid
With cm Graduation

WS-002-009
21.5 cm / 8½"
No. 3L, Solid, Straight

WS-002-010
21.5 cm / 8½"
No. 3L, Solid, Angled



WS-003-011
Fig. 62



WS-003-012
Fig. 64



WS-003-013
Fig. 65



WS-003-014
Fig. 67

Packing Unit 12 Pieces, Sterile



Landolt
WS-003-015
21 cm / 8 1/4"



Landolt
WS-003-016
25 cm / 10"



WS-003-017
13 cm / 5 1/8"



WS-003-018
15.5 cm / 6 1/8"

Delicate Scalples | Bisturies Delicados | Feine Skalpelle



13 cm / 5 1/8"

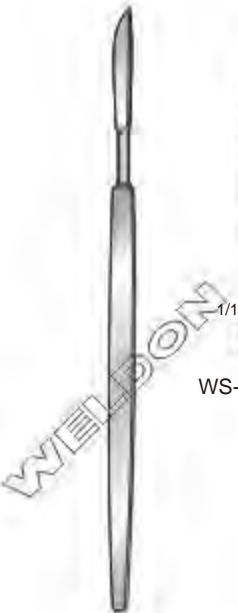
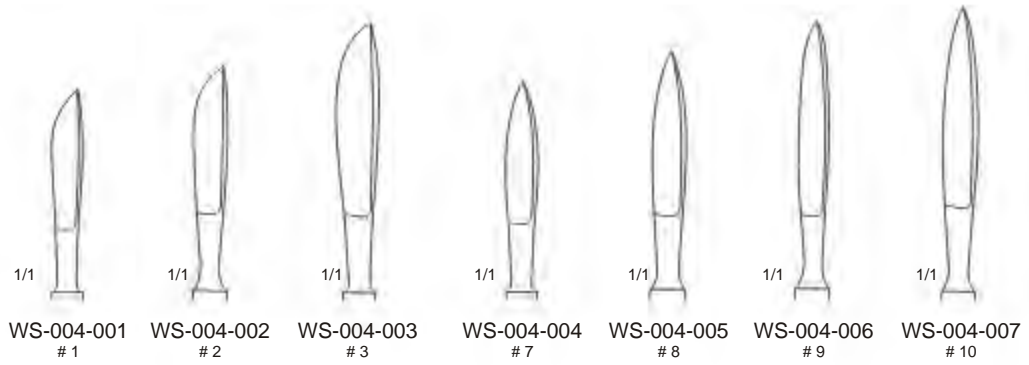

Adams
15 cm / 6"

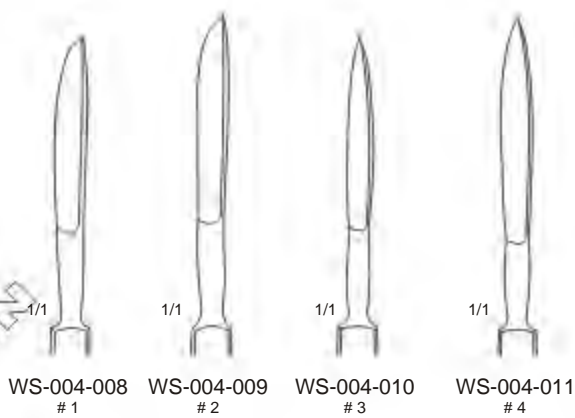

Parker
14 cm / 5 1/2"

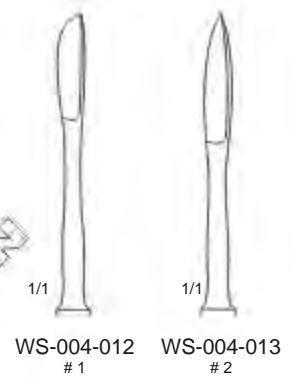

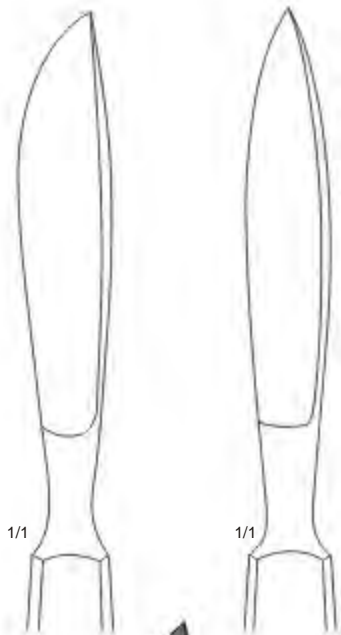

WS-005-014
1

WS-005-015
2



Langenbeck
18 cm / 7¹/₈"



Langenbeck
WS-005-016
24 cm / 9¹/₂"
Blade Size 12 cm / 4³/₄"



Liston
WS-005-017
23 cm / 9"
Blade Size 10.5 cm / 4¹/₈"



Liston
WS-005-018
34 cm / 13³/₈"
Blade Size 20 cm / 8"

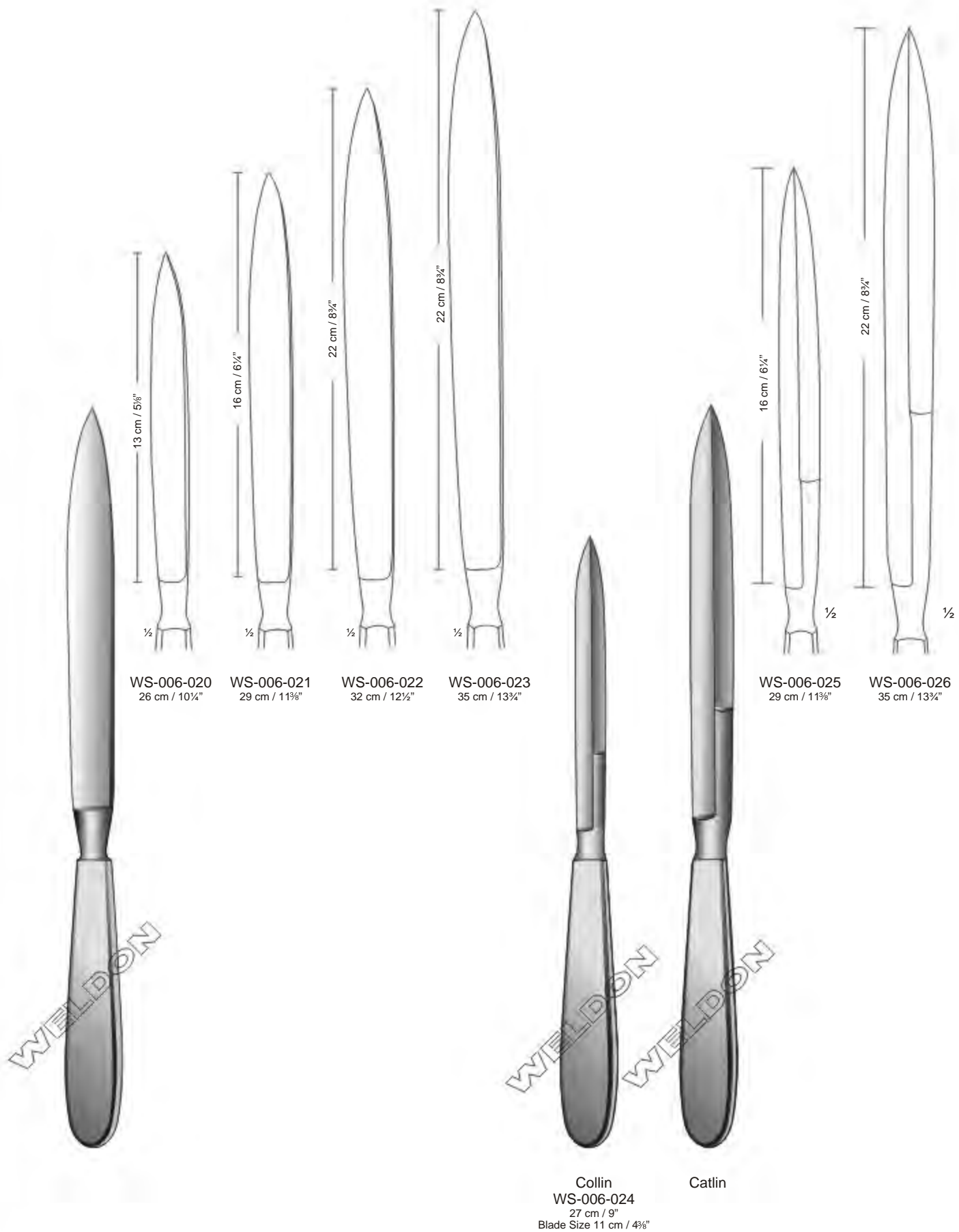

Collin
WS-005-019
27 cm / 10³/₄"
Blade Size 15 cm / 6"

Amputation Knives | Cuchillos Para Amputación | Amputationsmesser



Humby
WS-007-001
32 cm / 13"
Complete With Blade



Humby
WS-007-002
Spare Blade

Complete
With 2 Skin Fixing
Plates And One Blade



Schink
WS-007-003
31 cm / 12¼"
Adjustable From 0.1 To 2.0 mm



Schink
WS-007-004
Spare Blade



WS-008-001 11.5 cm / 4½"
 WS-008-002 13 cm / 5"
 WS-008-003 14 cm / 5½"
 WS-008-004 16 cm / 6¼"
 WS-008-005 18 cm / 7"
 WS-008-006 20 cm / 8"
 WS-008-007 25 cm / 10"
 2 mm Ø

WS-008-008 11.5 cm / 4½"
 WS-008-009 13 cm / 5"
 WS-008-010 14.5 cm / 5½"
 WS-008-011 16 cm / 6¼"
 WS-008-012 18 cm / 7"
 WS-008-013 20 cm / 8"
 1 mm Ø

WS-008-014 14 cm / 5½"
 WS-008-015 16 cm / 6¼"
 1 mm Ø

WS-008-016 14 cm / 5½"
 WS-008-017 16 cm / 6¼"
 2 mm Ø



WS-008-018 13 cm / 5"
 WS-008-019 14 cm / 5½"
 WS-008-020 16 cm / 6¼"
 WS-008-021 18 cm / 7"
 WS-008-022 20 cm / 8"
 WS-008-023 25 cm / 10"
 2 mm Ø

Fish
 WS-008-024 14 cm / 5½"
 WS-008-025 18 cm / 7"
 2 mm Ø

WS-008-025A 12 cm / 4¾"
 WS-008-025B 14 cm / 5½"
 WS-008-025C 16 cm / 6¼"
 WS-008-025D 18 cm / 7½"

Andrews
 WS-008-025E 15 cm / 6"
 WS-008-025F 18 cm / 7½"

WS-008-025G
 28 cm / 11"

WS-008-025H
 28 cm / 11"

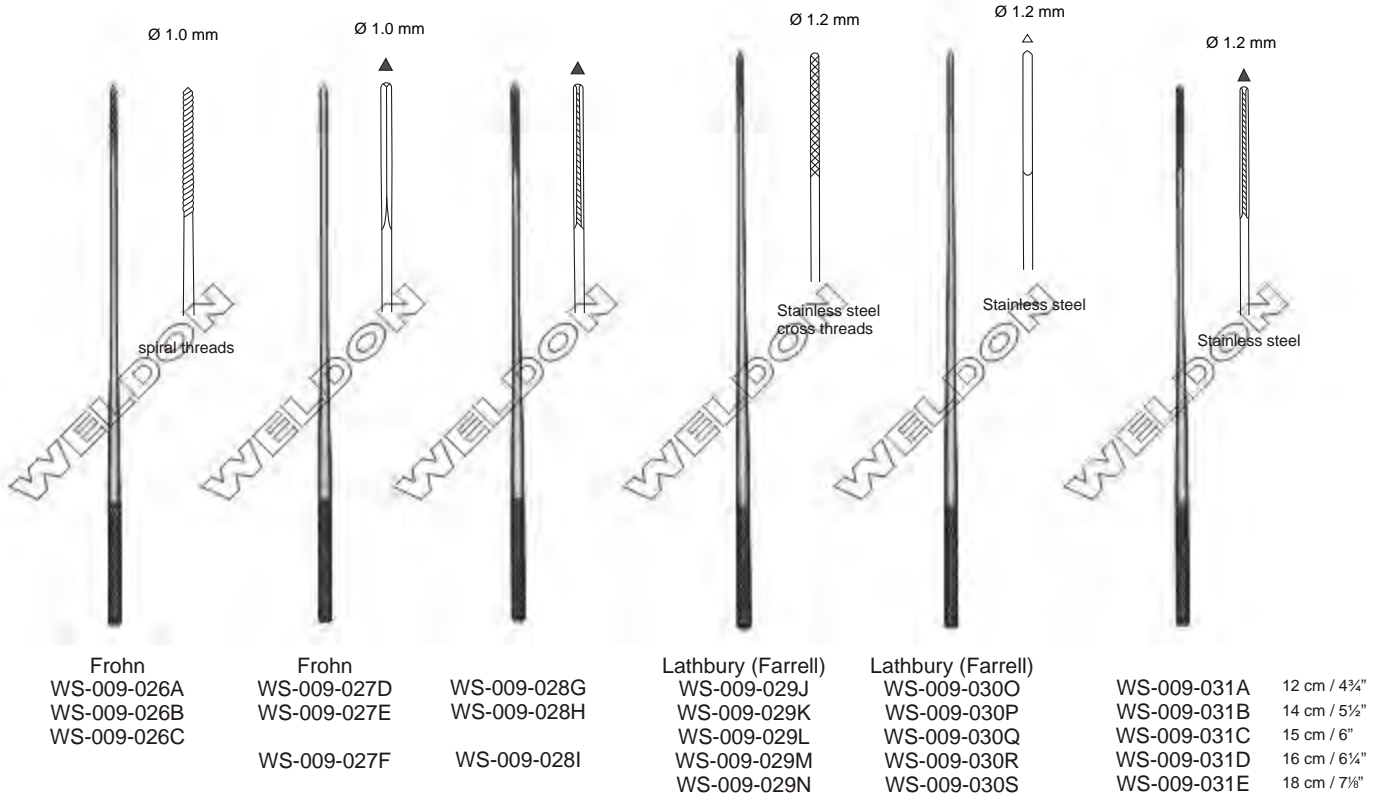



Nabatoff
WS-010-001
 138 x 100 x 25 mm

Varicose Vein Probe Set
 Complete - Containing

- WS-010-002 Traction Cable
- WS-010-003 Plastic Probe Tip
- WS-010-004 Handle Only
- WS-010-005 3 mm Ø
- WS-010-006 Olive, 6 mm Ø
- WS-010-007 Olive, 9 mm Ø
- WS-010-008 Olive, 12 mm Ø
- WS-010-009 Olive, 15 mm Ø

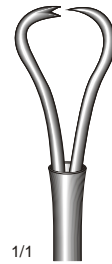

1/1



1/1
WS-010-006
 6 mm Ø

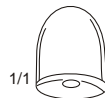

1/1
WS-010-007
 9 mm Ø

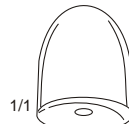

1/1
WS-010-008
 12 mm Ø

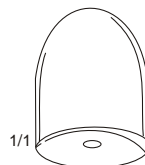

1/1
WS-010-009
 15 mm Ø



WS-010-003
 Plastic Probe Tip



WS-010-004
 T Shape Handle



1/1
WS-010-005
 3 mm Ø

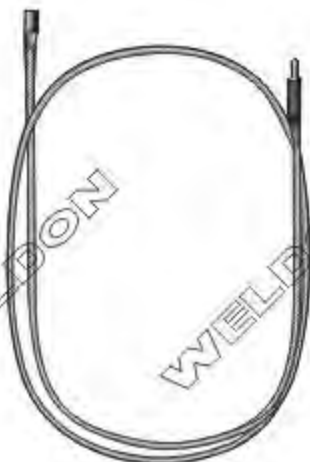

WS-010-002
 Flexible Traction Cable

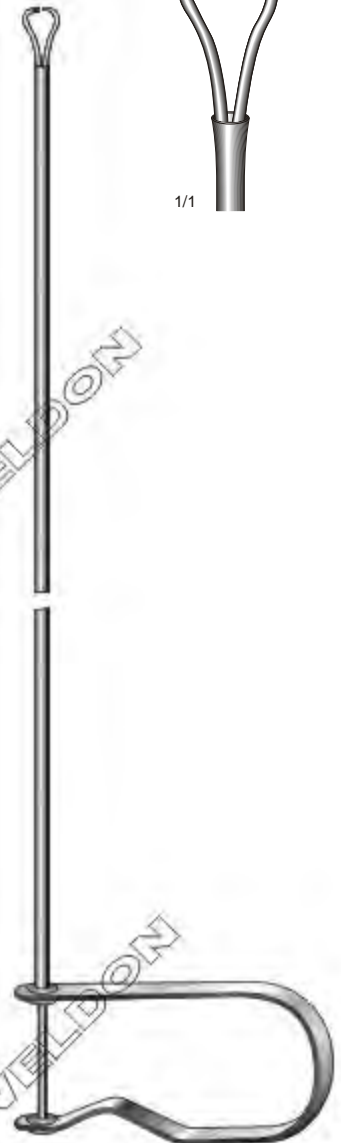

WS-010-010
 45 cm / 17¾"
 Sponge Holder

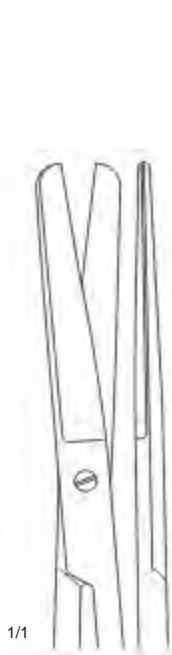

WS-011-001
10.5 cm / 4 1/4"

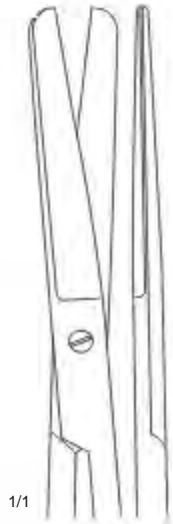

WS-011-002
11.5 cm / 4 1/2"



WS-011-003
13 cm / 5"

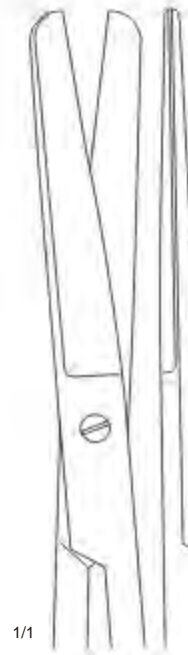

WS-011-004
14 cm / 5 1/2"

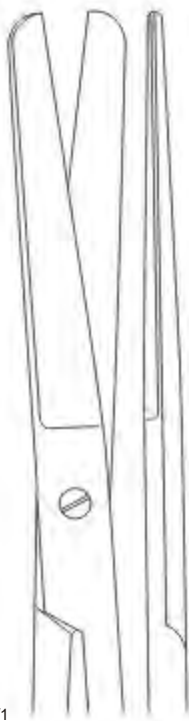

WS-011-005
15.5 cm / 6"

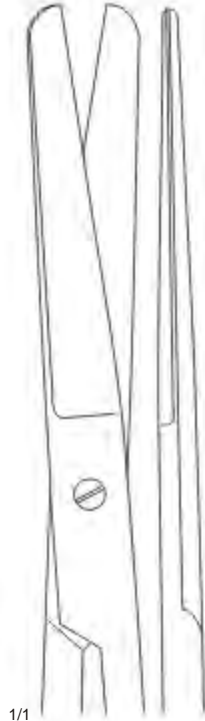

WS-011-006
16.5 cm / 6 1/2"

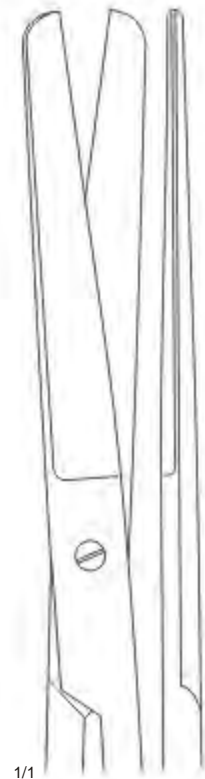

WS-011-007
18.5 cm / 7 1/4"

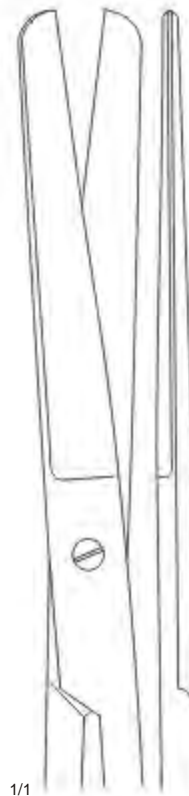

WS-011-008
20.5 cm / 8"



Operating
Blunt / Blunt
Straight

Operating Scissors | Tijeras Quirúrgicas | Chirurgische Scheren

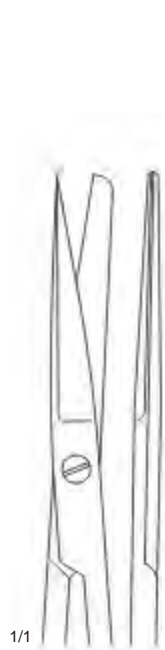

1/1

WS-012-009
10.5 cm / 4 1/4"



1/1

WS-012-010
11.5 cm / 4 1/2"



1/1

WS-012-011
13 cm / 5"



1/1

WS-012-012
14 cm / 5 1/2"



Operating
Sharp / Blunt
Straight



1/1

WS-012-013
15.5 cm / 6"



1/1

WS-012-014
16.5 cm / 6 1/2"

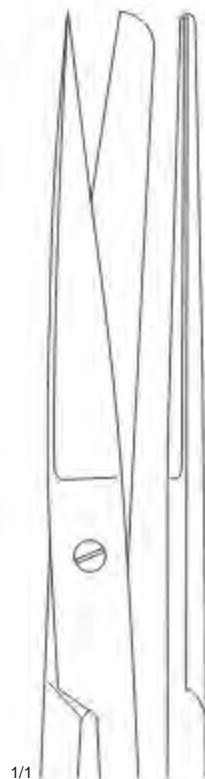

1/1

WS-012-015
18.5 cm / 7 1/4"

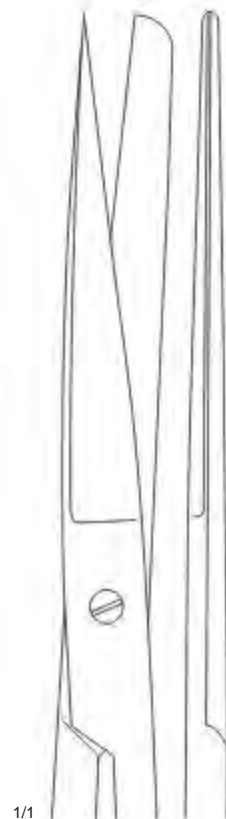

1/1

WS-012-016
20.5 cm / 8"

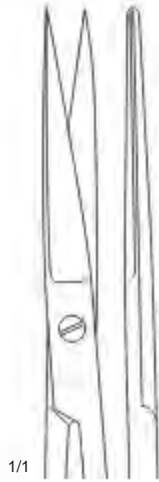

WS-013-017
10.5 cm / 4 1/4"

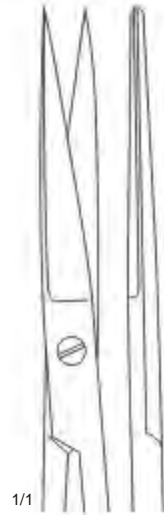

WS-013-018
11.5 cm / 4 1/2"



WS-013-019
13 cm / 5"

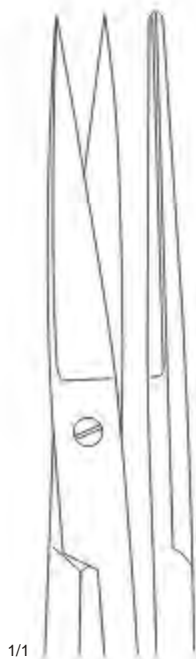

WS-013-020
14 cm / 5 1/2"



WS-013-021
15.5 cm / 6"

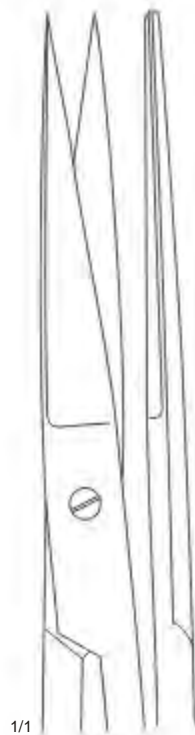

WS-013-022
16.5 cm / 6 1/2"

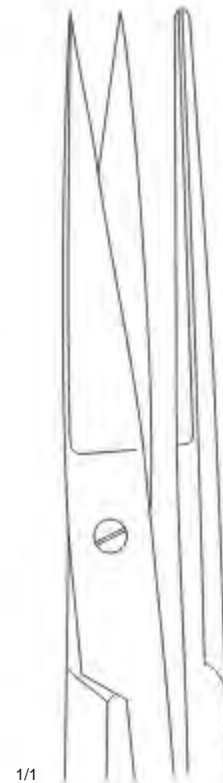

WS-013-023
18.5 cm / 7 1/4"



Operating
Sharp / Sharp
Straight

Operating Scissors | Tijeras Quirúrgicas | Chirurgische Scheren

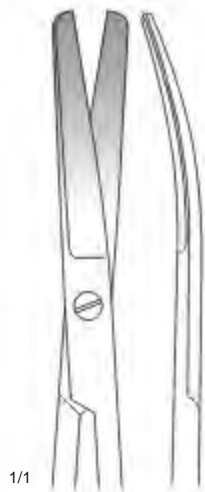

WS-014-024
11.5 cm / 4½"

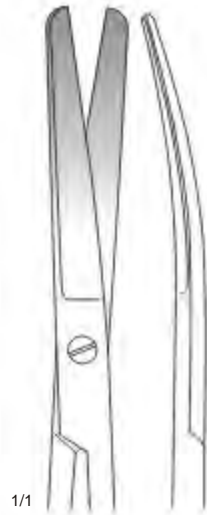

WS-014-025
13 cm / 5"

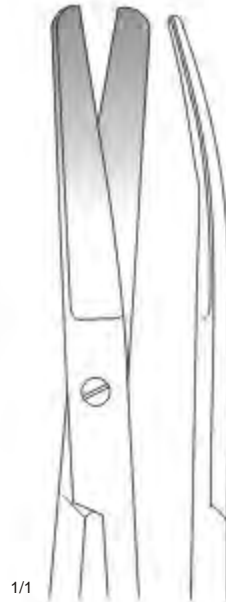

WS-014-026
14 cm / 5½"

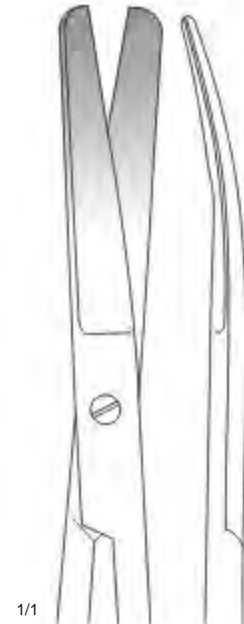

WS-014-027
15.5 cm / 6"



Operating
Blunt / Blunt
Curved

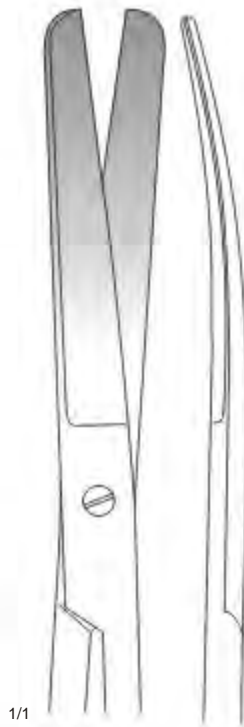

WS-014-028
16.5 cm / 6½"

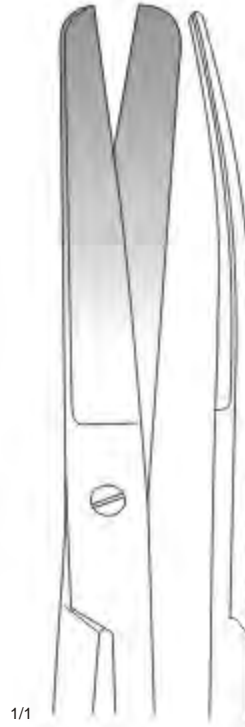

WS-014-029
18.5 cm / 7¼"

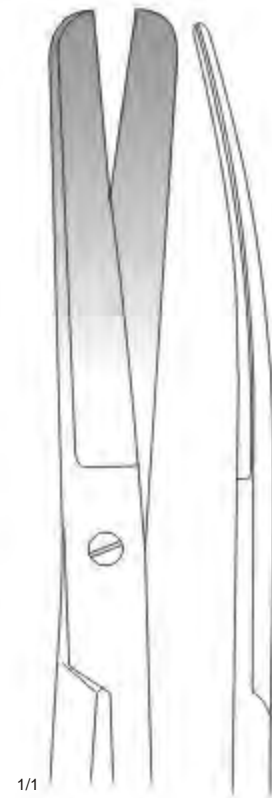

WS-014-030
20.5 cm / 8"



1/1

WS-015-031
11.5 cm / 4½"

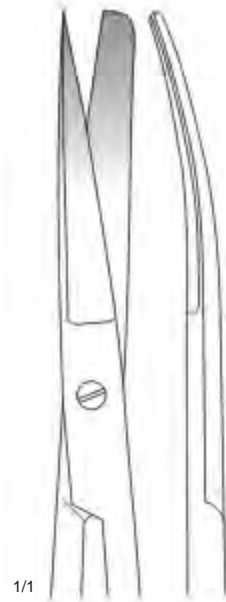

1/1

WS-015-032
13 cm / 5"

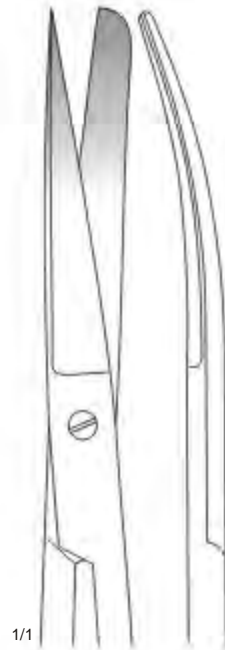

1/1

WS-015-033
14 cm / 5½"

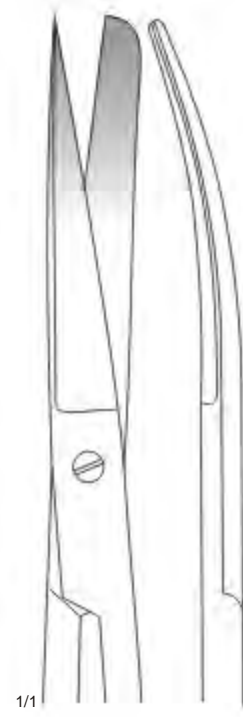

1/1

WS-015-034
15.5 cm / 6"

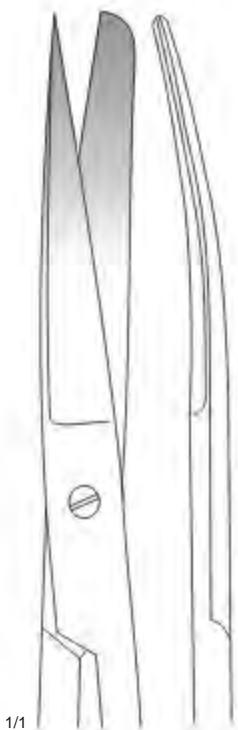

1/1

WS-015-035
16.5 cm / 6½"



1/1

WS-015-036
18.5 cm / 7½"

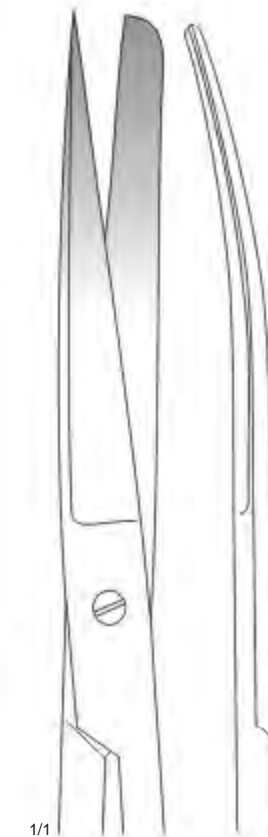

1/1

WS-015-037
20.5 cm / 8"



Operating
Sharp / Blunt
Curved

Operating Scissors | Tijeras Quirúrgicas | Chirurgische Scheren

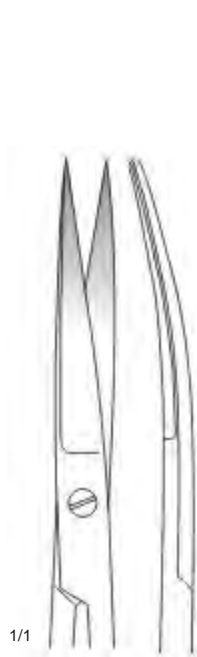

WS-016-038
11.5 cm / 4½"



WS-016-039
13 cm / 5"

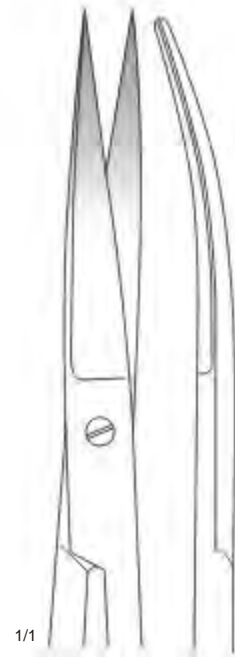

WS-016-040
14 cm / 5½"



Operating
Sharp / Sharp
Curved



WS-016-041
15.5 cm / 6"

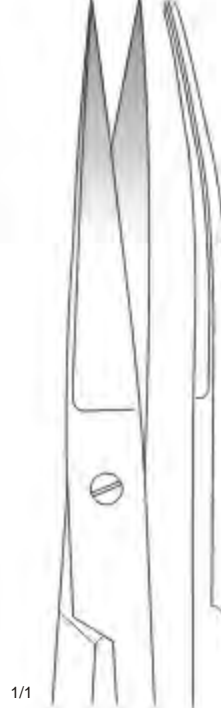

WS-016-042
16.5 cm / 6½"

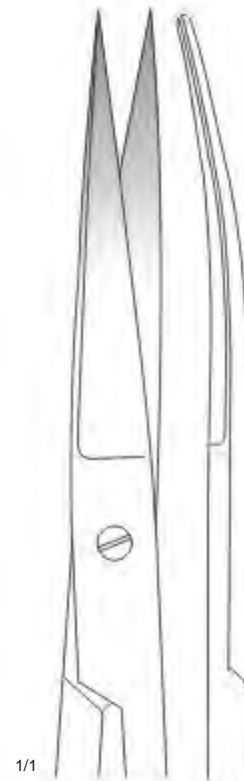

WS-016-043
18.5 cm / 7¼"

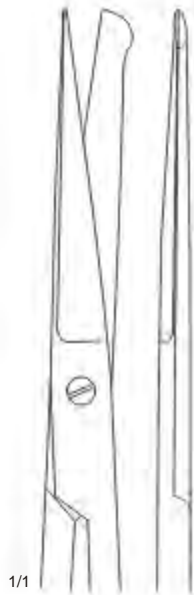

WS-017-044
13 cm / 5"

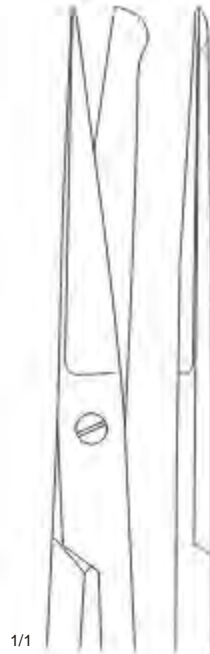

WS-017-045
14 cm / 5½"



Incision Scissors



WS-017-046
14 cm / 5½"
Straight



WS-017-047
14 cm / 5½"
Curved

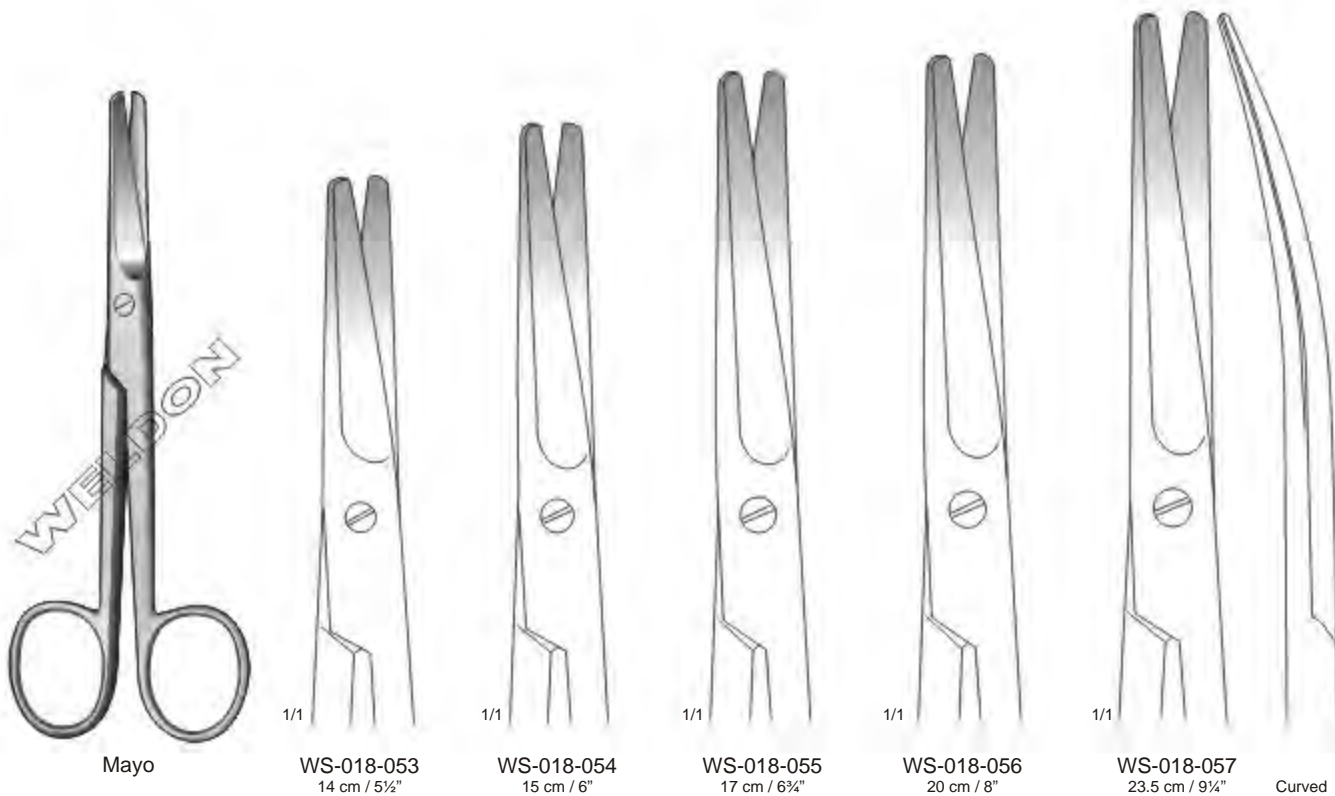
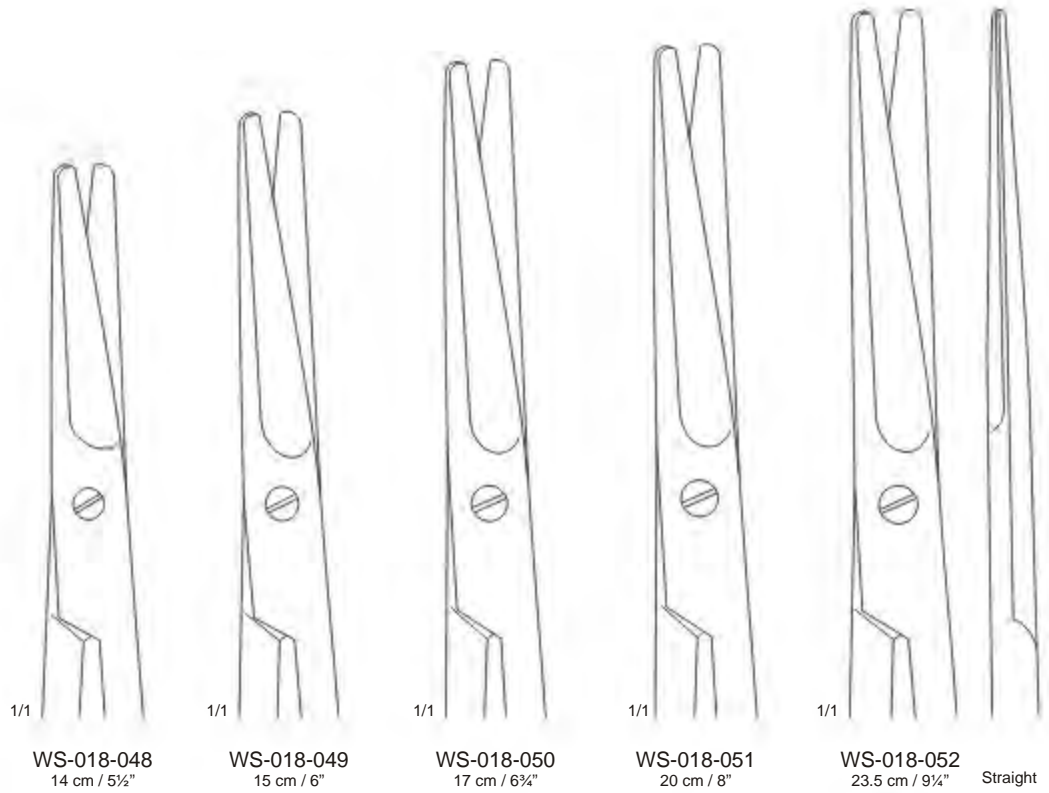

Deaver

Operating Scissors | Tijeras Quirúrgicas | Chirurgische Scheren

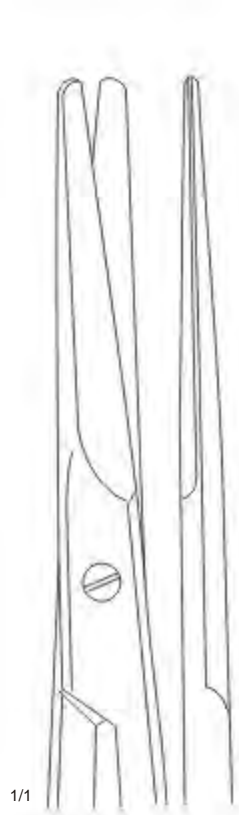

1/1

WS-019-058
22.5 cm / 9"
Straight

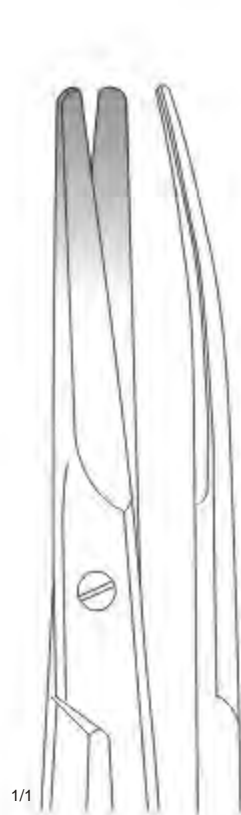

1/1

WS-019-059
22.5 cm / 9"
Curved

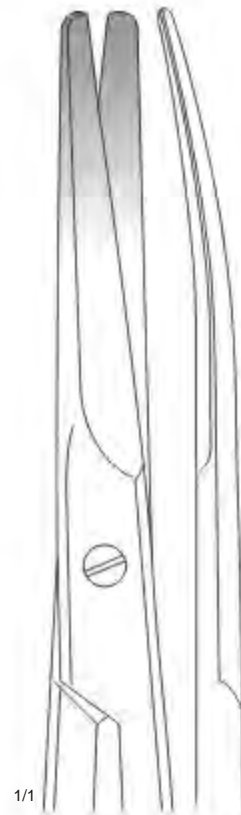

1/1

WS-019-060
25 cm / 11"
Curved



Mayo-Harrington



1/1

WS-019-061
15 cm / 6"
Straight



1/1

WS-019-062
17 cm / 6 3/4"
Straight



1/1

WS-019-063
15 cm / 6"
Curved



1/1

WS-019-064
17 cm / 6 3/4"
Curved



Mayo-Stille

Dissecting Scissors | Tijeras Quirúrgicas | Präparierscheren

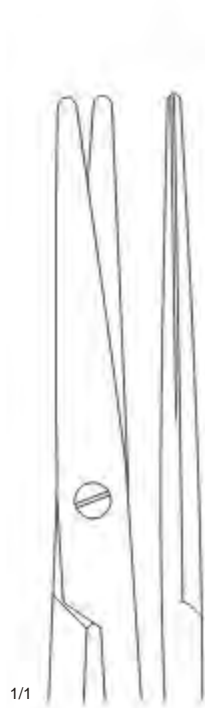

1/1
Straight
WS-020-065
16 cm / 6¼"

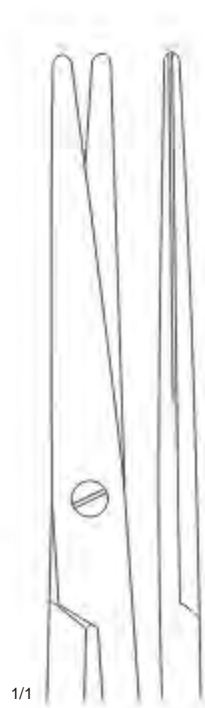

1/1
WS-020-066
19 cm / 7½"



1/1
WS-020-067
21.5 cm / 8½"



Mayo-Style

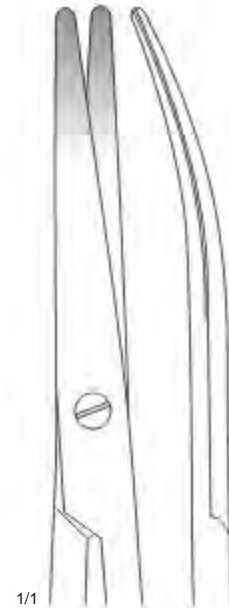

1/1
Curved
WS-020-068
16 cm / 6¼"

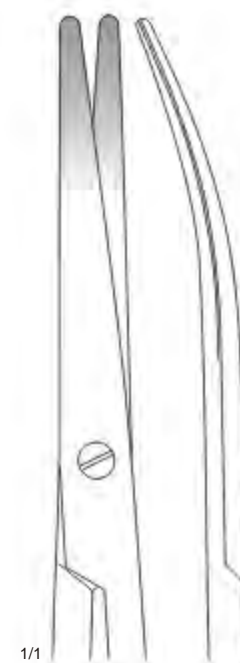

1/1
WS-020-069
19 cm / 7½"



1/1
WS-020-070
21 cm / 8¼"



Metzenbaum
11.5 cm / 4½"



1/1
WS-021-071
Straight



1/1
WS-021-072
Curved



Metzenbaum
15 cm / 6"



1/1
WS-021-073
Straight



1/1
WS-021-074
Curved

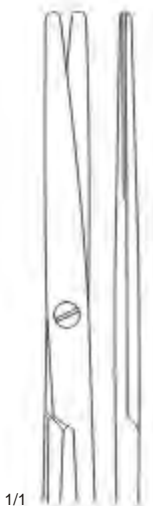

1/1
WS-021-075
Blunt / Blunt
Straight

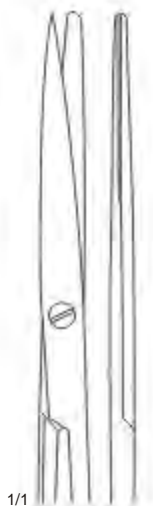

1/1
WS-021-076
Sharp / Blunt
Straight

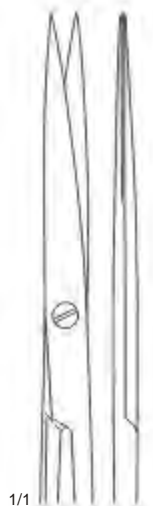

1/1
WS-021-077
Sharp / Sharp
Straight



1/1
WS-021-078
Blunt / Blunt
Curved



1/1
WS-021-079
Sharp / Blunt
Curved



1/1
WS-021-080
Sharp / Sharp
Curved



Metzenbaum
14 cm / 5½"

Dissecting Scissors | Tijeras Quirúrgicas | Präparierscheren

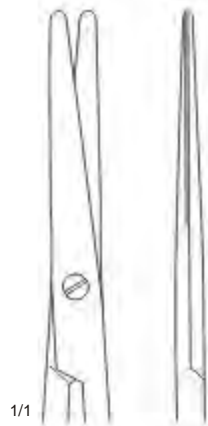

WS-022-081
18 cm / 7"



WS-022-082
20 cm / 8"

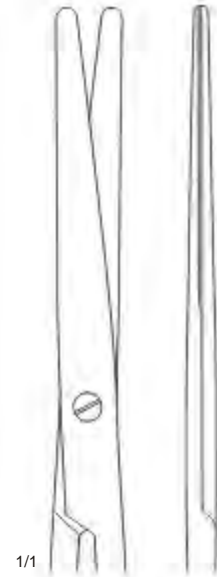

WS-022-083
23 cm / 9"



Metzenbaum-Nelson
Blunt / Blunt
Straight

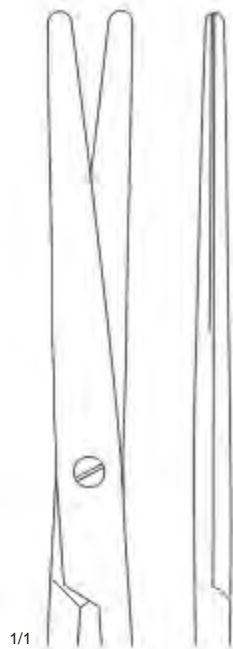

WS-022-084
25 cm / 10"

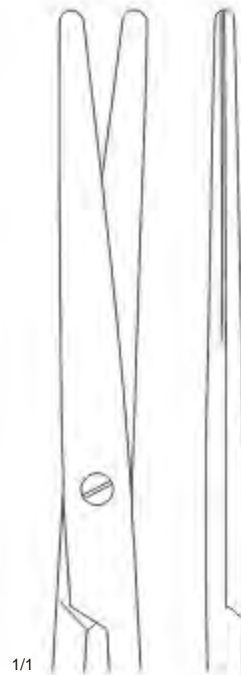

WS-022-085
28 cm / 11"

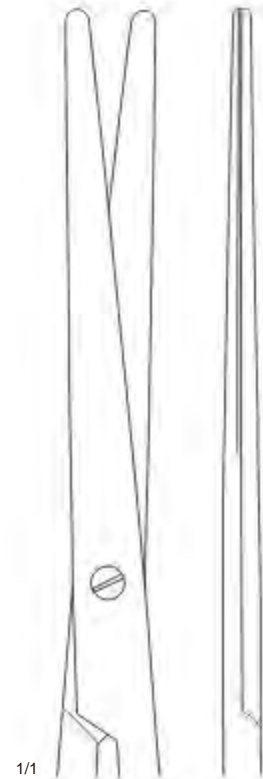

WS-022-086
30 cm / 12"

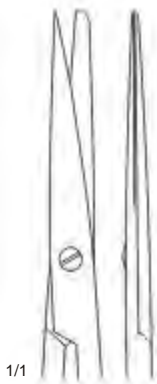

1/1
WS-023-087
18 cm / 7"

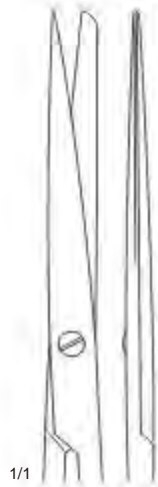

1/1
WS-023-088
20 cm / 8"

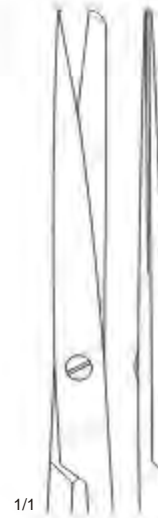

1/1
WS-023-089
23 cm / 9"



1/1
WS-023-090
25 cm / 10"

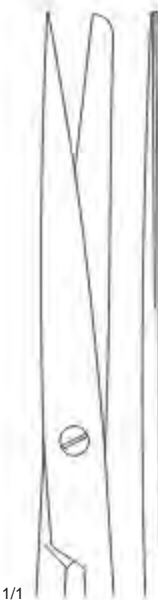

1/1
WS-023-091
28 cm / 11"



1/1
WS-023-092
30 cm / 12"



Metzenbaum-Nelson
Sharp / Blunt
Straight

Dissecting Scissors | Tijeras Quirúrgicas | Präparierscheren

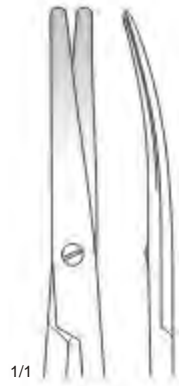

WS-024-093
18 cm / 7"



WS-024-094
20 cm / 8"



WS-024-095
23 cm / 9"



Metzenbaum-Nelson
Blunt / Blunt
Curved

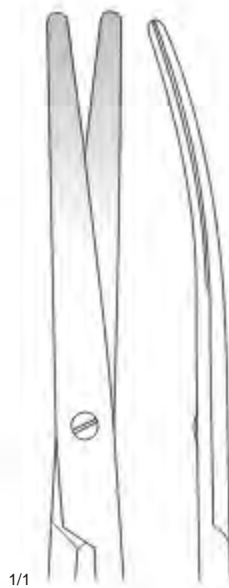

WS-024-096
25 cm / 10"

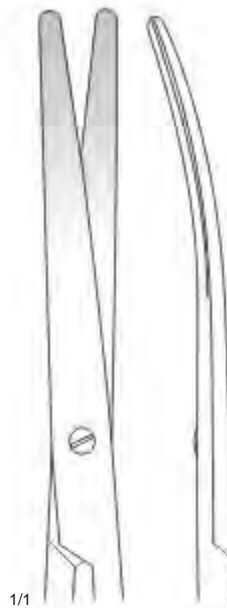

WS-024-097
28 cm / 11"



WS-024-098
30 cm / 12"

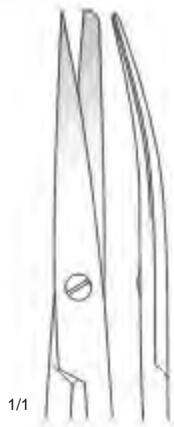

1/1

WS-025-099
18 cm / 7"

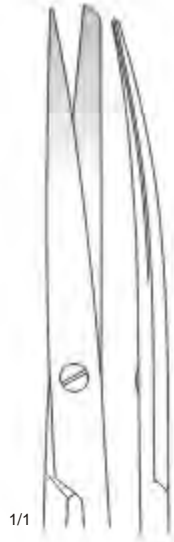

1/1

WS-025-100
20 cm / 8"



1/1

WS-025-101
23 cm / 9"

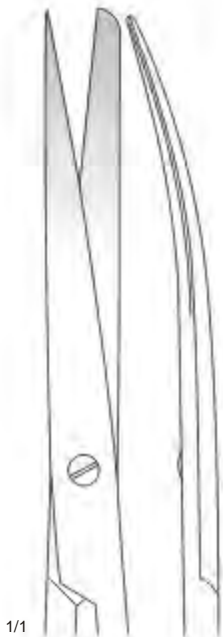

1/1

WS-025-102
25 cm / 10"

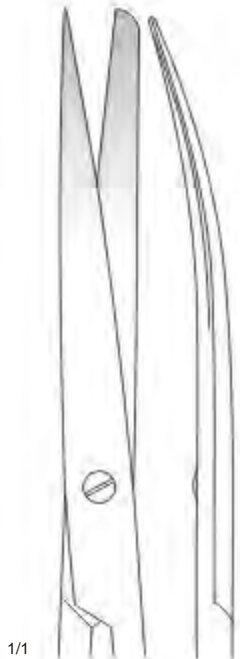

1/1

WS-025-103
28 cm / 11"

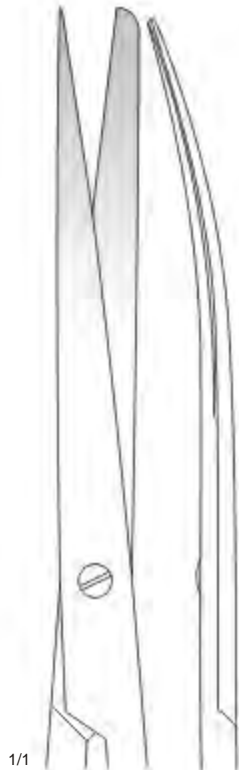

1/1

WS-025-104
30 cm / 12"



Metzenbaum-Nelson
Sharp / Blunt
Curved

Dissecting Scissors | Tijeras Quirúrgicas | Präparierscheren

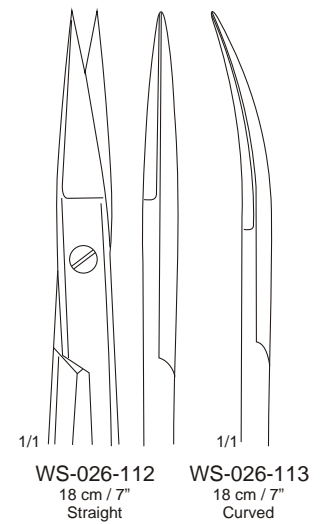
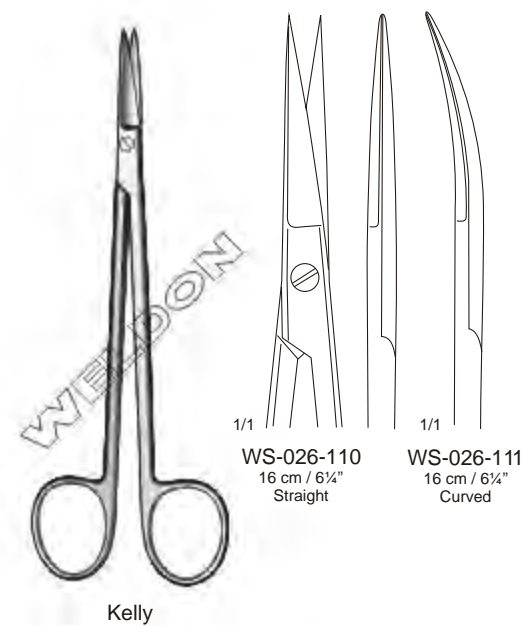
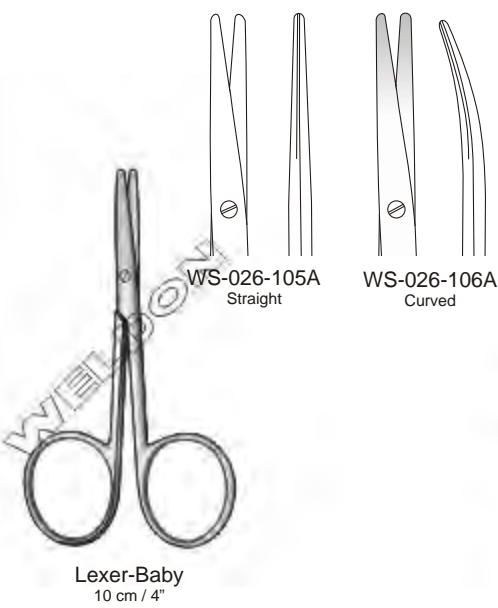
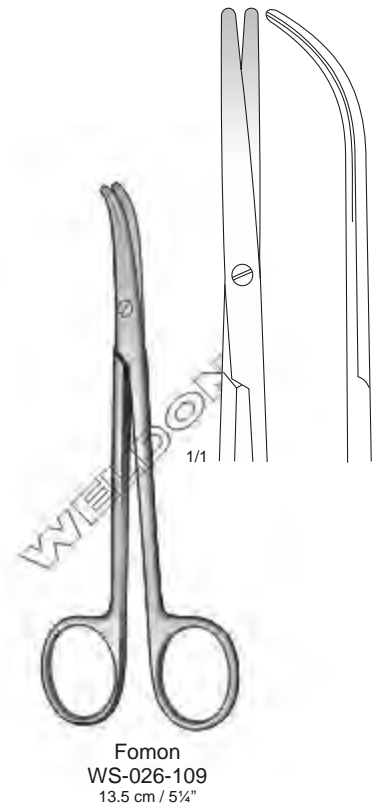
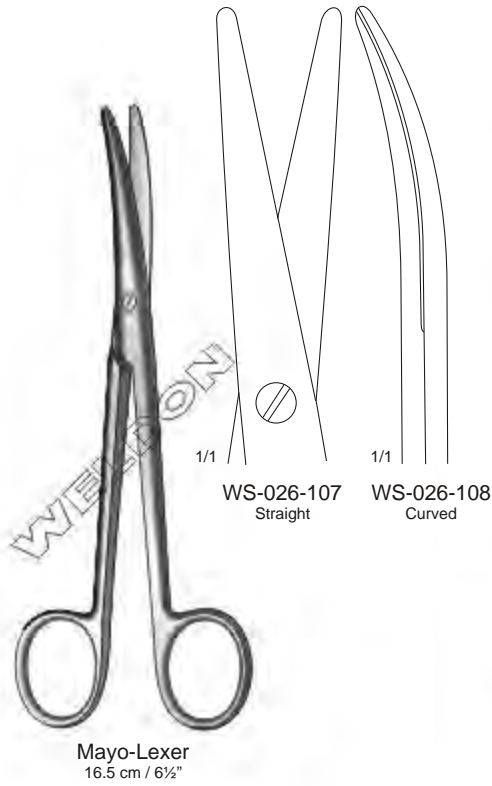
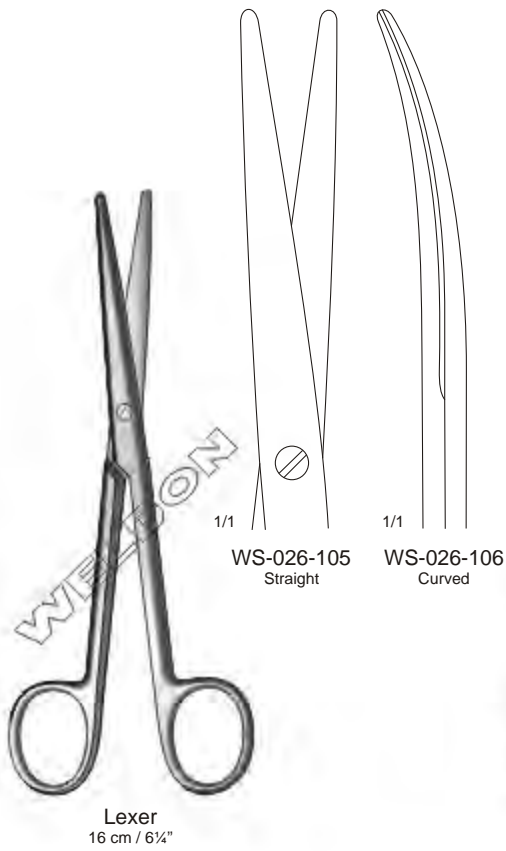



Joseph
WS-027-001
14.5 cm / 5 3/4"
Straight

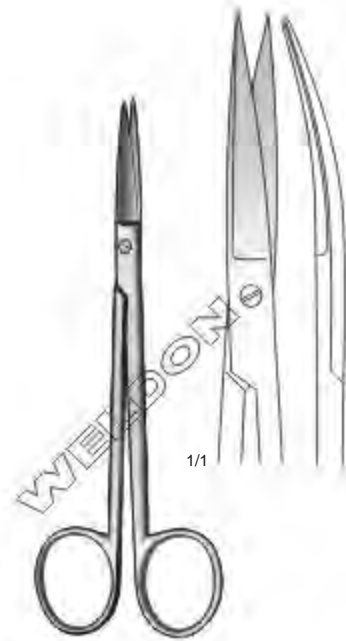

Joseph
WS-027-002
14.5 cm / 5 3/4"
Curved

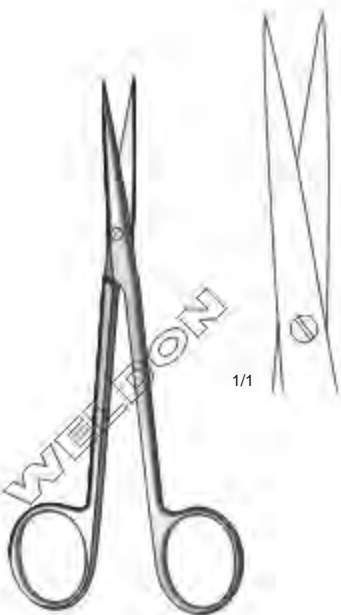

Brophy (Sullivan)
WS-027-003
14 cm / 5 1/2"
Straight

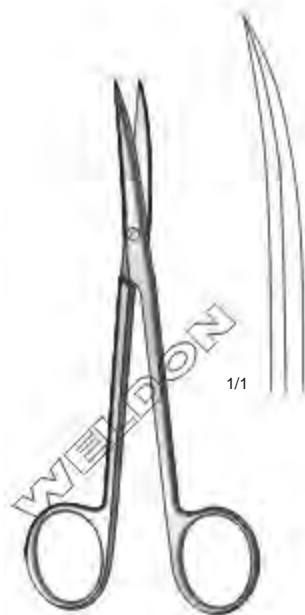

Brophy (Sullivan)
WS-027-004
14 cm / 5 1/2"
Curved

Delicate Dissecting Scissors | Tijeras Finas Para Disección | Feine Präparierscheren



Kilner



1/1

WS-028-005
12 cm / 4 3/4"



1/1

WS-028-006
15 cm / 6"

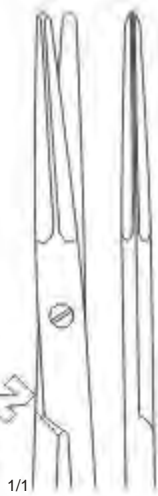

1/1

WS-028-007
Straight



1/1

WS-028-008
Curved

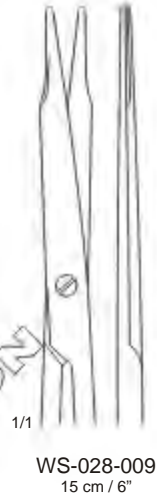

1/1

WS-028-009
15 cm / 6"

WS-028-010
18 cm / 7"
Straight



1/1

WS-028-011
15 cm / 6"

WS-028-012
18 cm / 7"
Curved

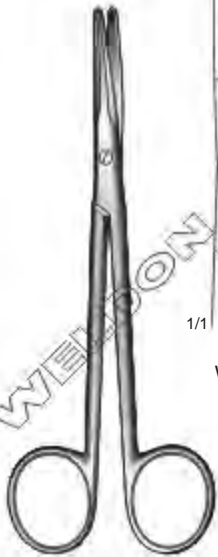

14 cm / 5 1/2"



Reynolds

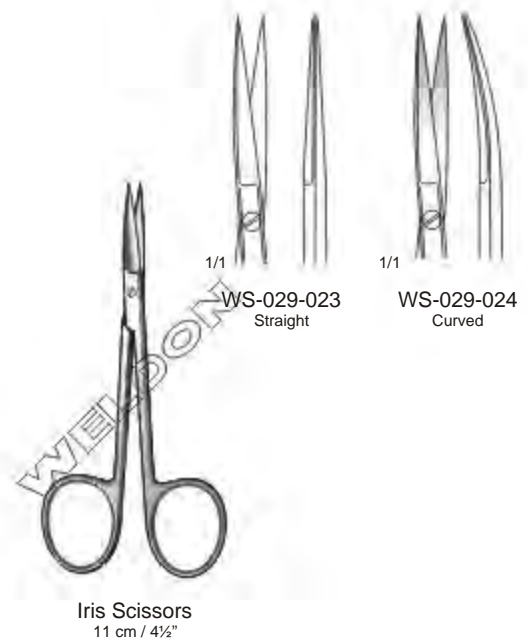
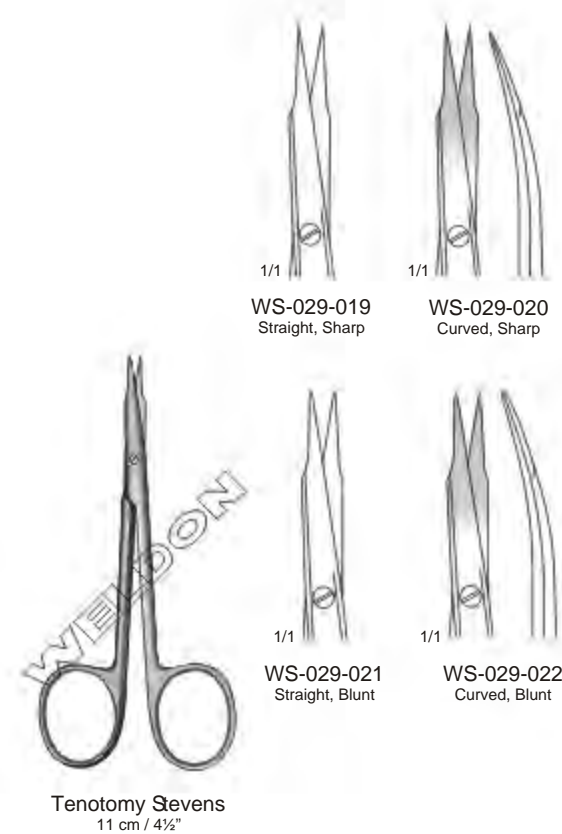

Operating And Gum Scissors | Tijeras Quirúrgicas Y Para Encías | Zahnfleischscheren



Locklin
WS-030-025
16 cm / 6¼"

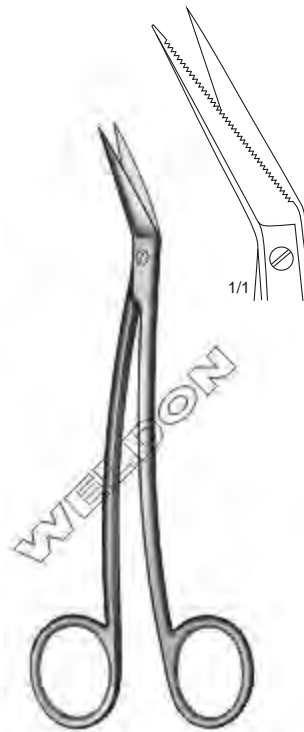

Locklin
WS-030-026
16 cm / 6¼"

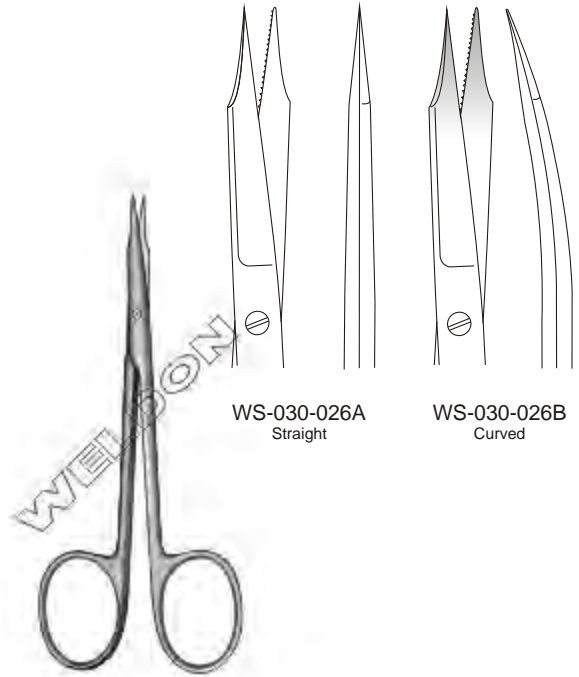

WS-030-026A
Straight

WS-030-026B
Curved

Goldman-Fox
13 cm / 5"
One Blade, Toothed

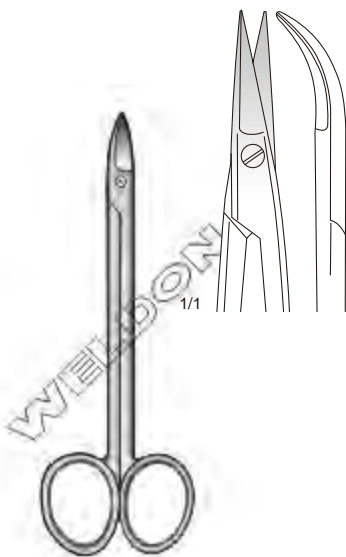

Quinby
WS-030-027
12.5 cm / 5"

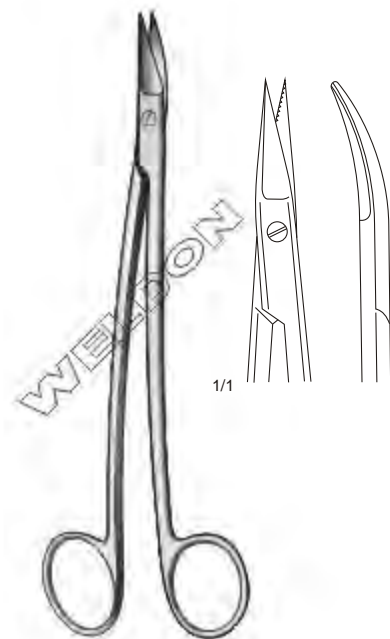

Neumann
WS-030-028
12 cm / 4¾"



Spencer
WS-031-029
9 cm / 3½"



Spencer
WS-031-030
13 cm / 5"



Littauer
WS-031-031
14 cm / 5½"

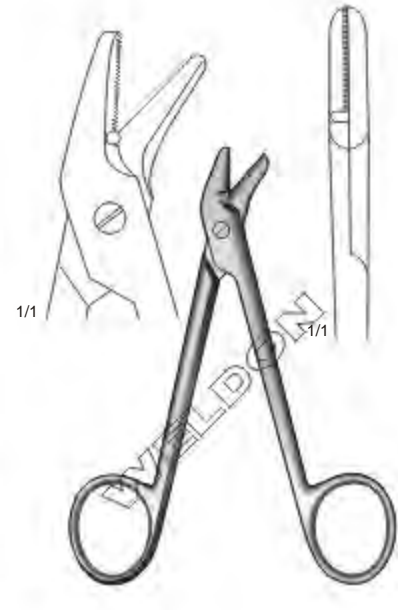

Universal
WS-031-032
12 cm / 4¾"
Wire Cutting Scissors



Heath-Stitch
WS-031-033 16 cm / 6¼"
WS-031-034 18 cm / 7"
Suture Removal Scissors



Bee Bee
Wire Cutting Scissors



WS-031-035
10 cm / 4"
Straight



WS-031-036
10 cm / 4"
Curved

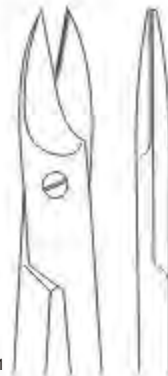

WS-031-037
12 cm / 4¾"
1 Blade Saw Edge
Straight



WS-031-038
12 cm / 4¾"
1 Blade Saw Edge
Curved

Tonsil & Nasal Scissors | Tijeras Para Amígdalas Y Nasales | Tonsillenscheren, Nasenscheren



Fomon
WS-032-039
15 cm / 6"

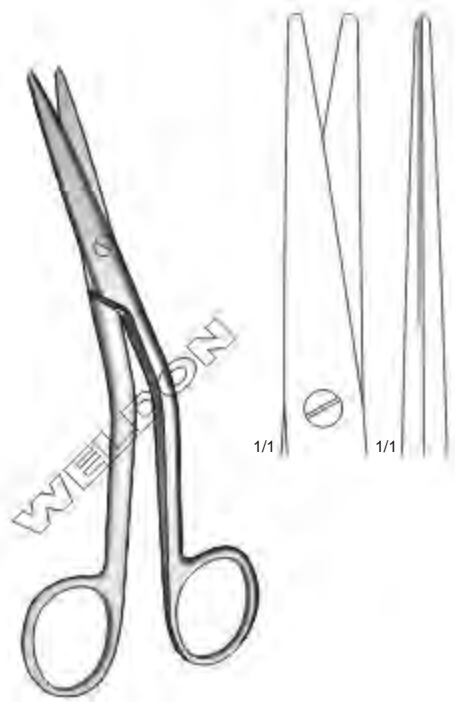

Cottle
WS-032-040
16 cm / 6½"

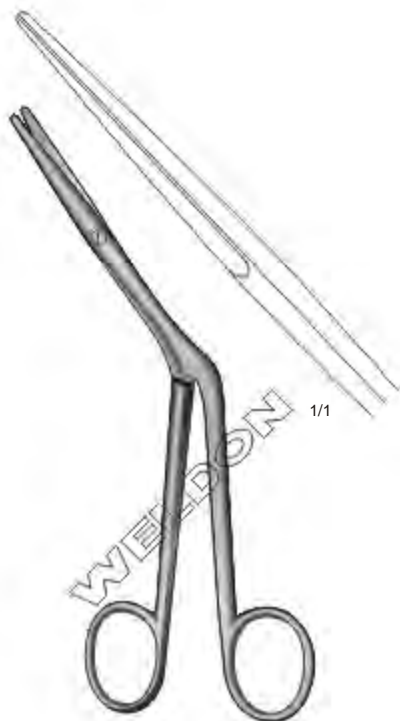

Cottle
WS-032-041
18 cm / 7"

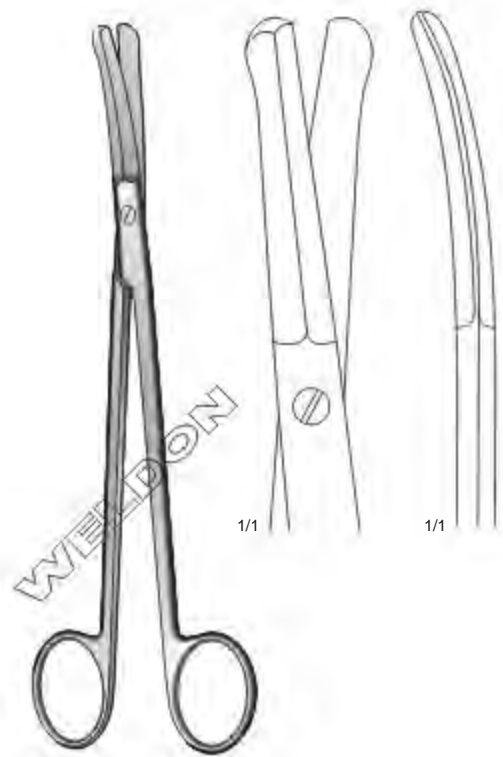

Good
WS-032-042
19 cm / 7½"

Episiotomy Scissors, Umbilical Scissors | Tijeras Para Episiotomia Y Umbilicales
Episiotomiescheren, Nabelschnurscheren

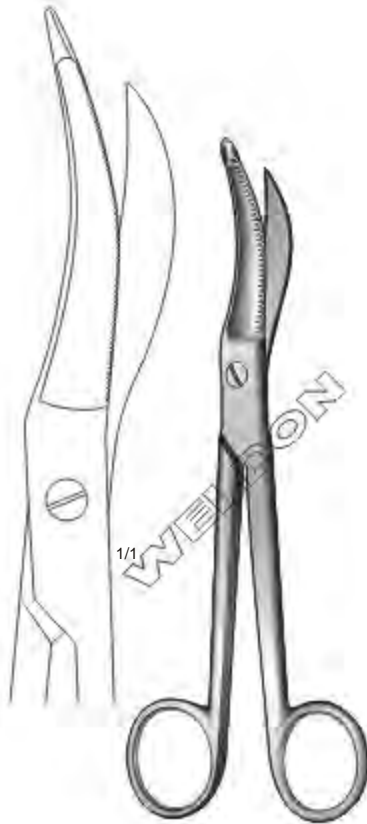

Waldmann
WS-033-043
18 cm / 7"

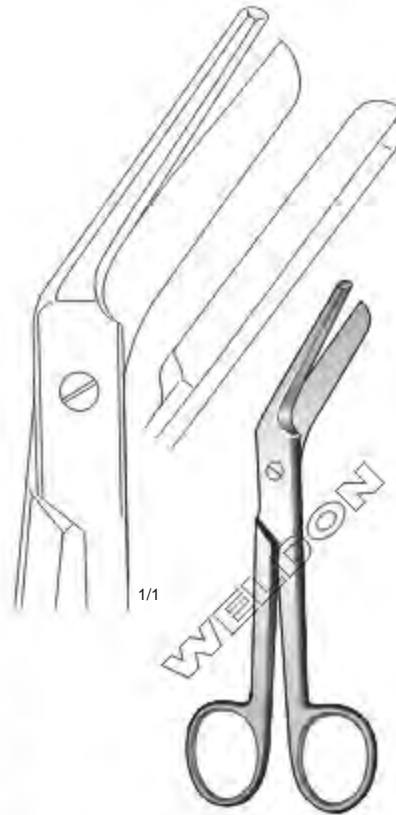

Braun-Stadler
WS-033-044
14 cm / 5½"



Braun-Stadler
WS-033-045
22 cm / 8¾"



Mod. USA
WS-033-046
10.5 cm / 4¼"

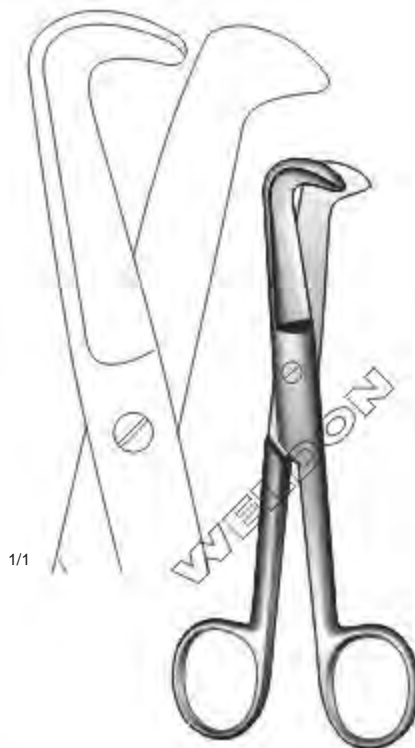

Schuhmacher
WS-033-047
15 cm / 6"

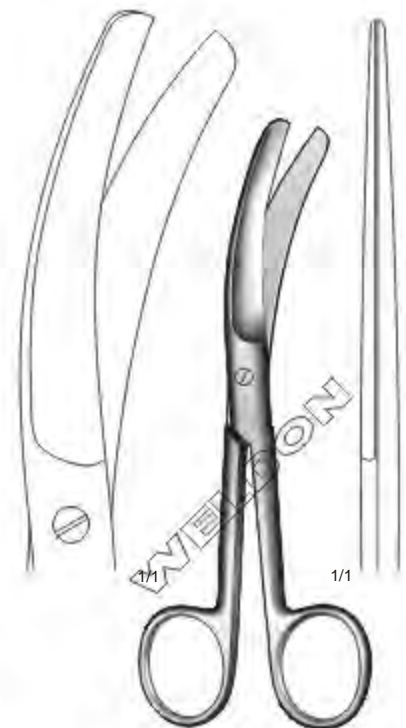

Busch
WS-033-048
16 cm / 6¼"

Dissecting Scissors, Gynecological Scissors | Tijeras Quirúrgicas, Tijeras Para Ginecología
Chirurgische Scheren, Gynäkologische Scheren

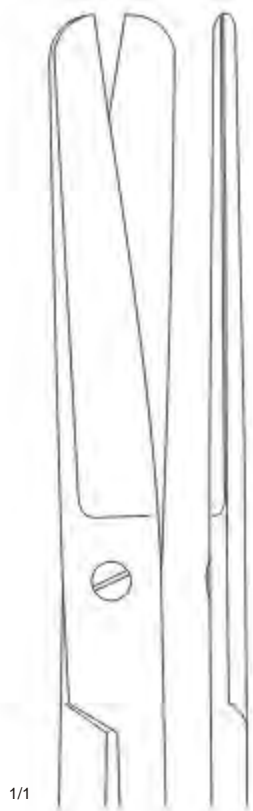

1/1

WS-034-049
Straight

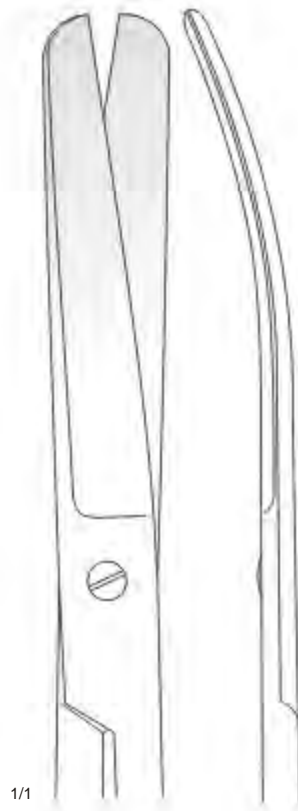

1/1

WS-034-050
Curved



Doyen
18.5 cm / 7 1/4"

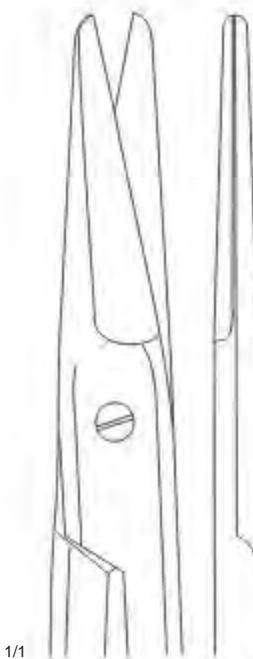

1/1

WS-034-051
Straight

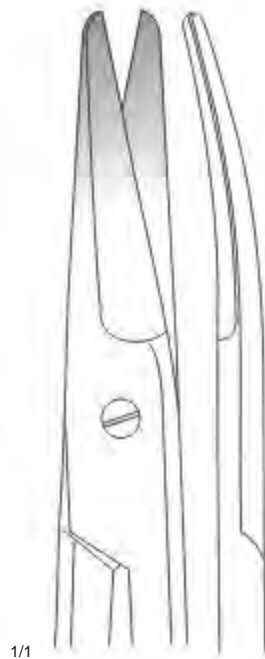

1/1

WS-034-052
Curved



Mayo-Noble
17 cm / 6 3/4"



Wertheim

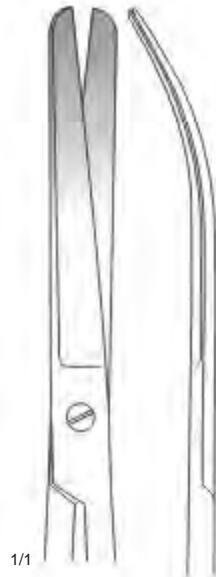

1/1

WS-035-053
14.5 cm / 5½"

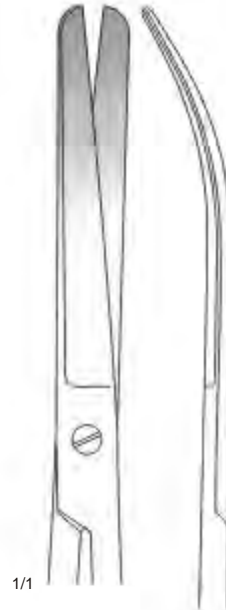

1/1

WS-035-054
19.5 cm / 7¾"

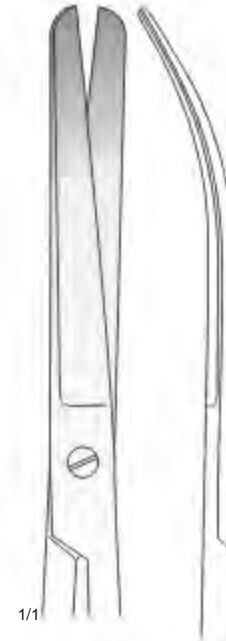

1/1

WS-035-055
22.5 cm / 9"



Sims
Blunt / Blunt

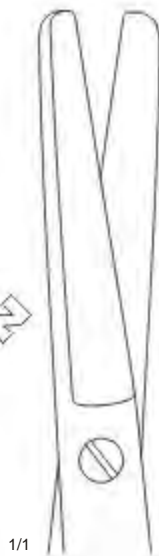

1/1

WS-035-056 20 cm / 8"
WS-035-057 23 cm / 9"
Straight



1/1

WS-035-058
WS-035-059
Curved



Sims
Sharp / Blunt

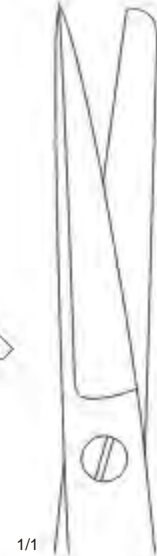

1/1

WS-035-060 20 cm / 8"
WS-035-061 23 cm / 9"
Straight



1/1

WS-035-062
WS-035-063
Curved

Vascular Scissors | Tijeras Vasculares | Gefäßscheren



WS-036-064

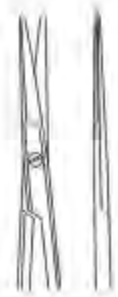

WS-036-065

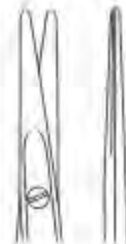

WS-036-066
Straight



WS-036-067
Curved



Bonn
9 cm / 3½"
Straight



Strabismus Scissors
11.5 cm / 4½"



Enucleation Scissors
WS-036-068
11 cm / 4½"



WS-036-069
Straight

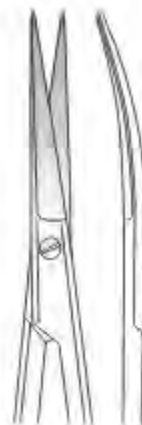

WS-036-070
Curved



Dissecting Scissors
11 cm / 4½"
Post Mortem Scissors

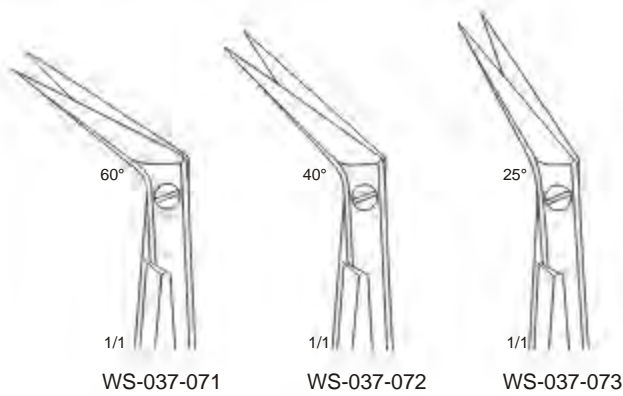

Potts-Smiths
19 cm / 7½"

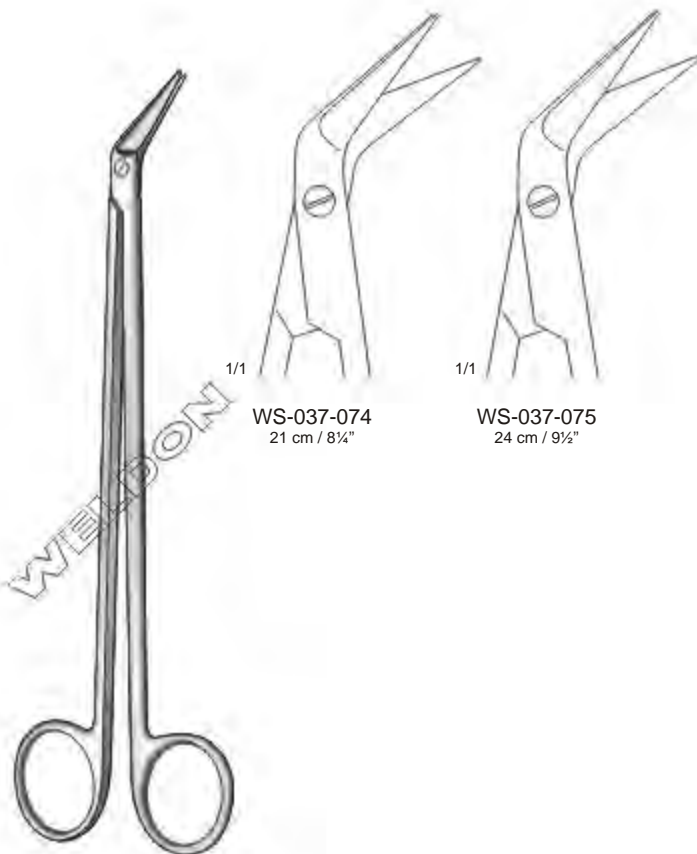

Potts de Martel

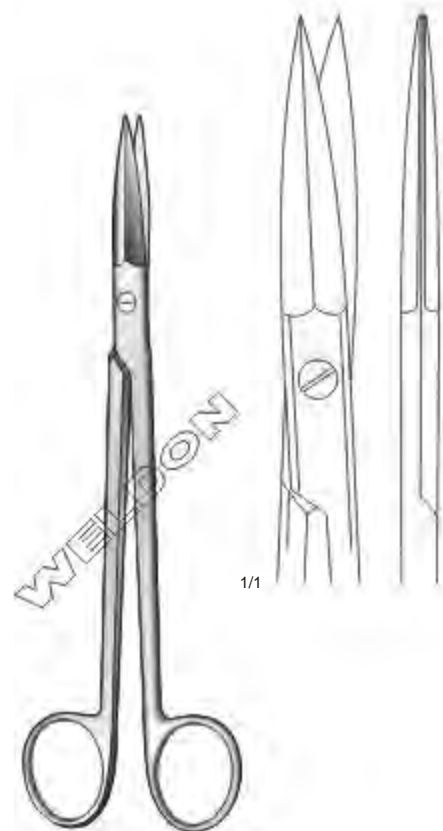

McIndoe
WS-037-076
19 cm / 7½"

Vascular Scissors | Tijeras Vasculares | Gefäßscheren



Diethrich

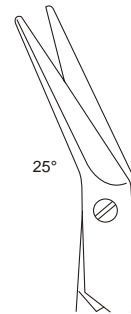
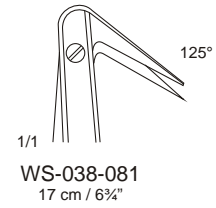
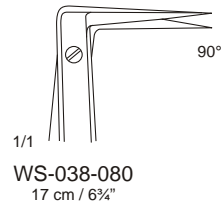
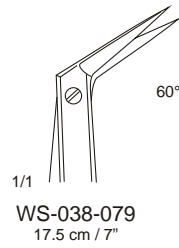
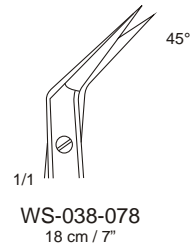
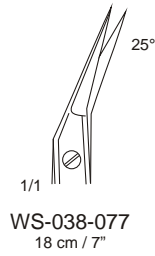

Diethrich
WS-038-082
17 cm / 6 3/4"

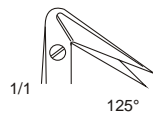

DeBakey

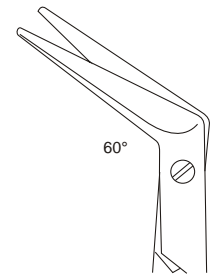
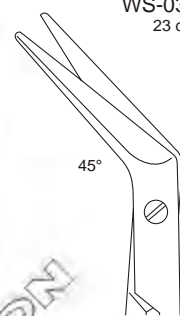

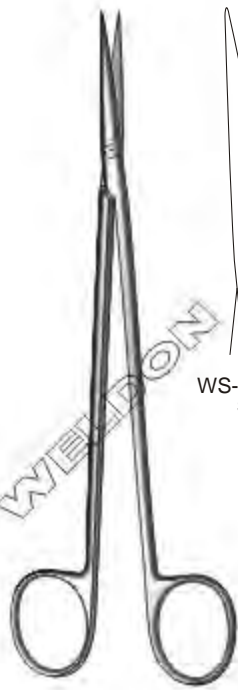

DeMartel
18 cm / 7"



WS-039-086A
Straight



WS-039-086B
Curved

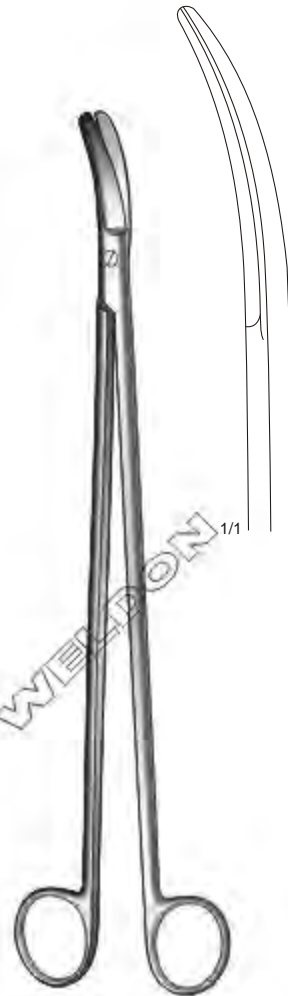

Crafoord
WS-039-087
30 cm / 12"



1/1

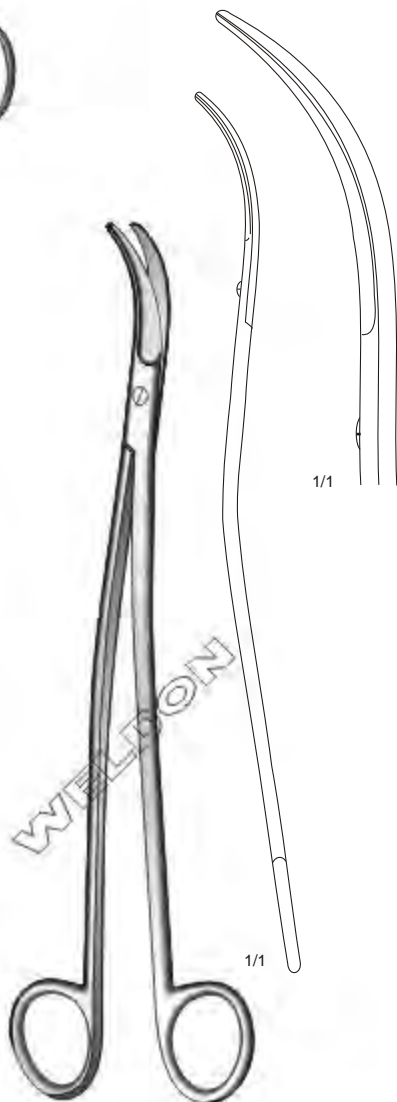

Satinsky
WS-039-086
24.5 cm / 10"

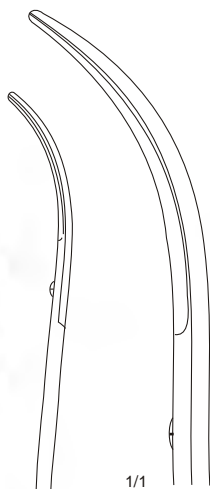

1/1

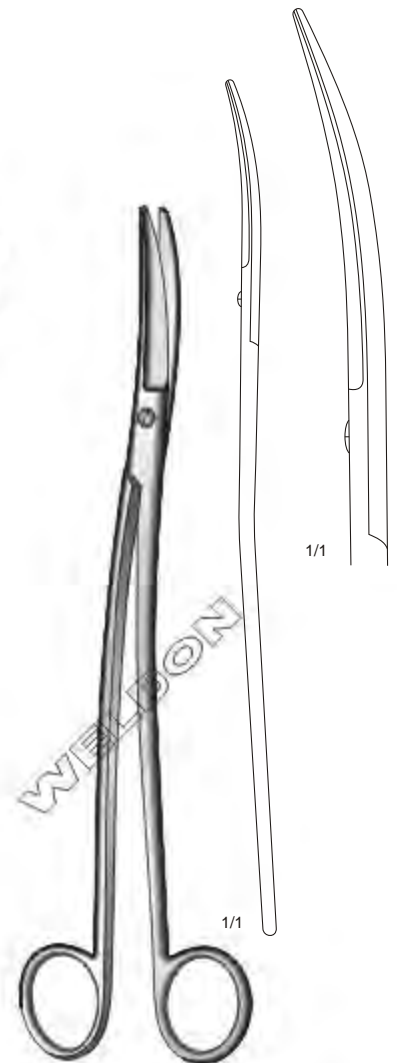

Klinkenbergh
WS-039-088
23 cm / 9"

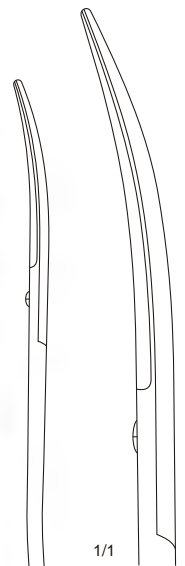

1/1

Vascular Scissors | Tijeras Vasculares | Gefäßscheren

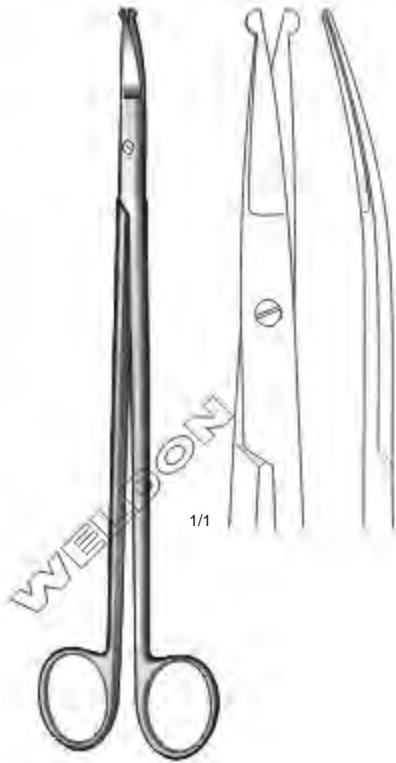

Strully
WS-040-089
22 cm / 8½"
Neurosurgical Scissors

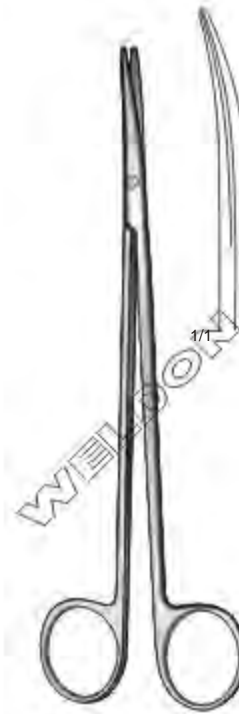

Toennis-Adson
WS-040-090
17.5 cm / 7"
Dissecting Scissors

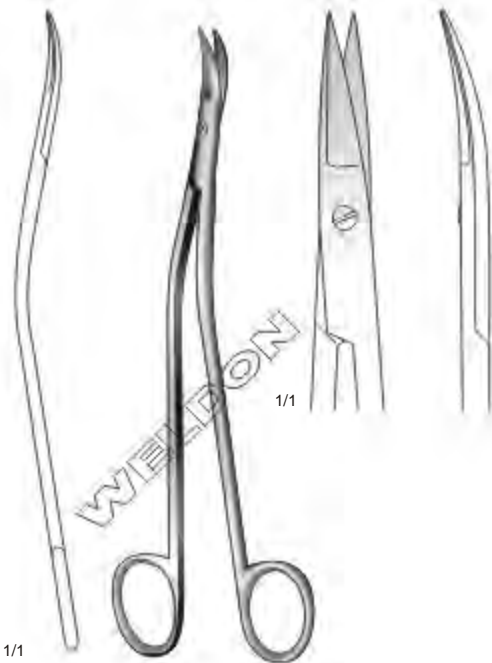

Dandy
WS-040-091
17 cm / 6¾"
Neurosurgical Scissors

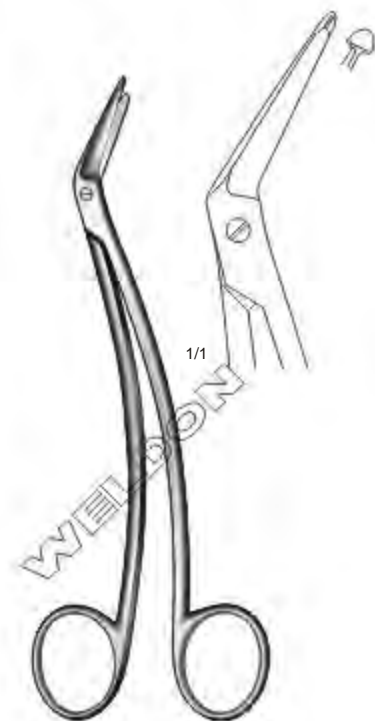

Schmieden-Taylor
WS-040-092
17 cm / 6¾"
Dura Scissors

Scissors With Tungsten Carbide Inserts | Tijeras Con Filos De Carburo De Tungsteno
Scheren Mit Hartmetalleinlagen

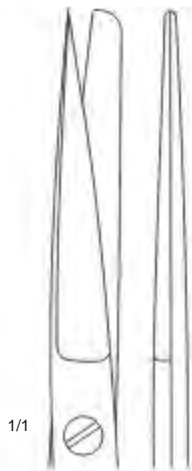

1/1

WS-041-001
14.5 cm / 6"

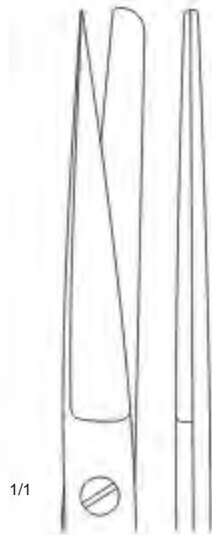

1/1

WS-041-002
16.5 cm / 6½"

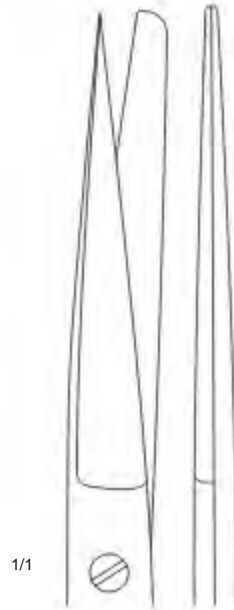

1/1

WS-041-003
18.5 cm / 7¼"



Operating
Sharp / Blunt
Straight

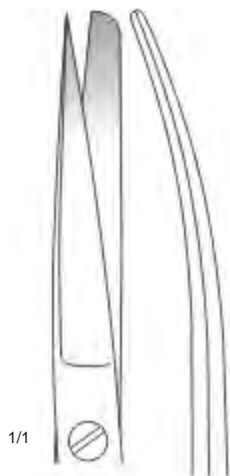

1/1

WS-041-004
14.5 cm / 5¾"

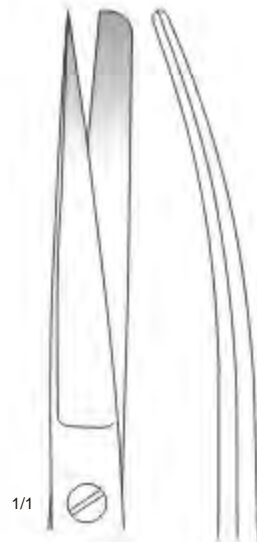

1/1

WS-041-005
16.5 cm / 6½"

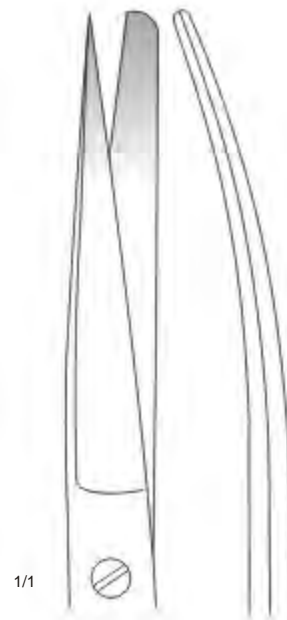

1/1

WS-041-006
18.5 cm / 7¼"



Operating
Sharp / Blunt
Curved

**Scissors With Tungsten Carbide Inserts | Tijeras Con Filos De Carburo De Tungsteno
Scheren Mit Hartmetalleinlagen**

Operating
 WS-042-007 14.5 cm / 5 3/4"
 WS-042-008 16.5 cm / 6 1/2"
 WS-042-009 18.5 cm / 7 1/4"
 Straight, Sharp / Sharp



Operating
 WS-042-007A 14.5 cm / 5 3/4"
 WS-042-008A 16.5 cm / 6 1/2"
 WS-042-009A 18.5 cm / 7 1/4"
 Straight, Blunt / Blunt



Operating
 WS-042-010 14.5 cm / 5 3/4"
 WS-042-011 16.5 cm / 6 1/2"
 WS-042-012 18.5 cm / 7 1/4"
 Curved, Sharp / Sharp



Operating
 WS-042-010A 14.5 cm / 5 3/4"
 WS-042-011A 16.5 cm / 6 1/2"
 WS-042-012A 18.5 cm / 7 1/4"
 Curved, Blunt / Blunt

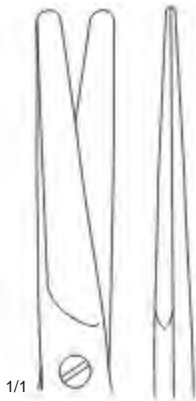

WS-043-013
14.5 cm / 5¾"

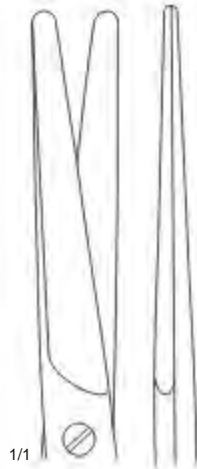

WS-043-014
17 cm / 6¾"

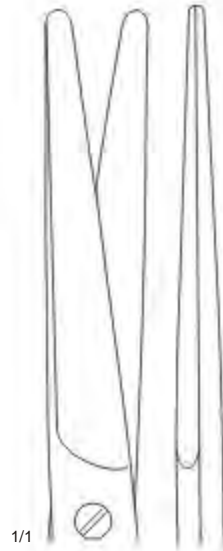

WS-043-015
23 cm / 9"



Mayo
Straight



WS-043-016
14.5 cm / 5¾"

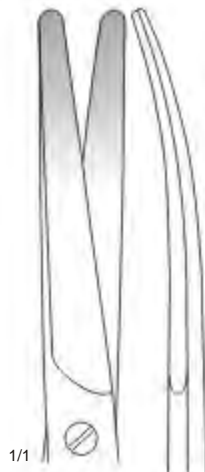

WS-043-017
17 cm / 6¾"

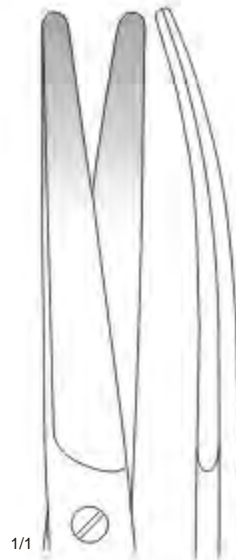

WS-043-018
23 cm / 9"



Mayo
Curved

Scissors With Tungsten Carbide Inserts | Tijeras Con Filos De Carburo De Tungsteno
 Scheren Mit Hartmetalleinlagen



Mayo-Style
Straight



Mayo-Style
Curved



Metzenbaum
Straight



Metzenbaum
Curved

Scissors With Tungsten Carbide Inserts | Tijeras Con Filos De Carburo De Tungsteno
Scheren Mit Hartmetalleinlagen

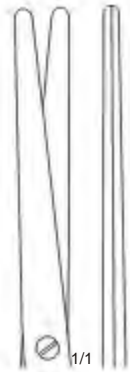

WS-045-027
18 cm / 7"

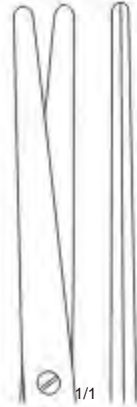

WS-045-028
20 cm / 8"

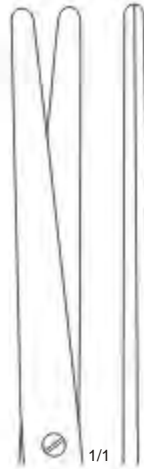

WS-045-029
23 cm / 9"

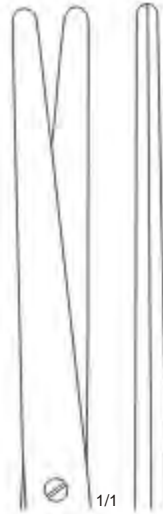

WS-045-030
25 cm / 10"

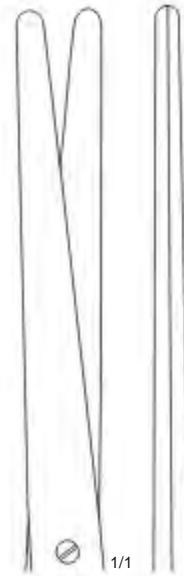

WS-045-031
28 cm / 11"

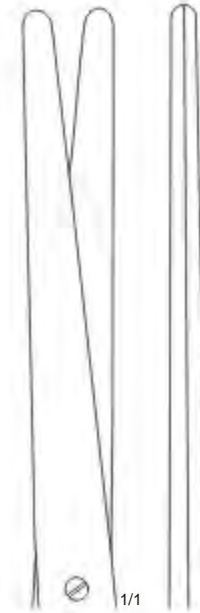

WS-045-032
30 cm / 12"



Metzenbaum
Straight



WS-045-033
18 cm / 7"

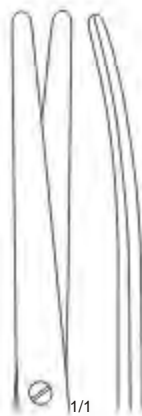

WS-045-034
20 cm / 8"

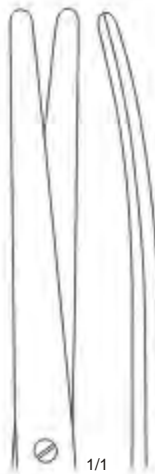

WS-045-035
23 cm / 9"

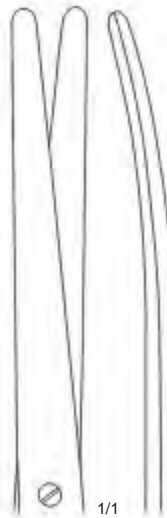

WS-045-036
25 cm / 10"



WS-045-037
28 cm / 11"

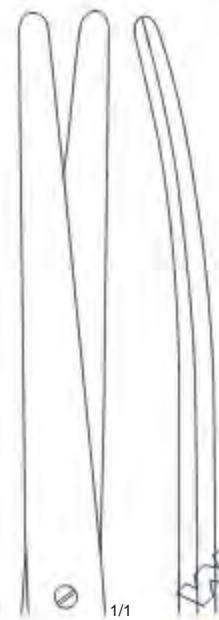

WS-045-038
30 cm / 12"



Metzenbaum
Curved

Scissors With Tungsten Carbide Inserts | Tijeras Con Filos De Carburo De Tungsteno
 Scheren Mit Hartmetalleinlagen

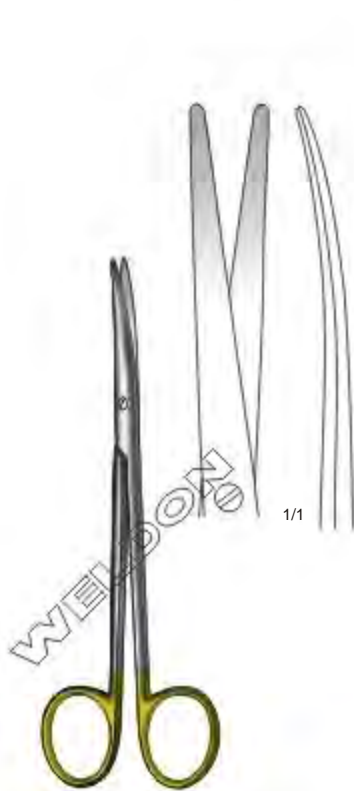

Metzenbaum-Lahey
 WS-046-039
 14 cm / 5 1/2"



WS-046-040
 20 cm / 8"

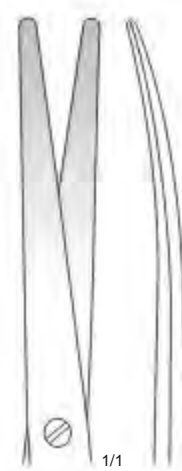

WS-046-041
 23 cm / 9"

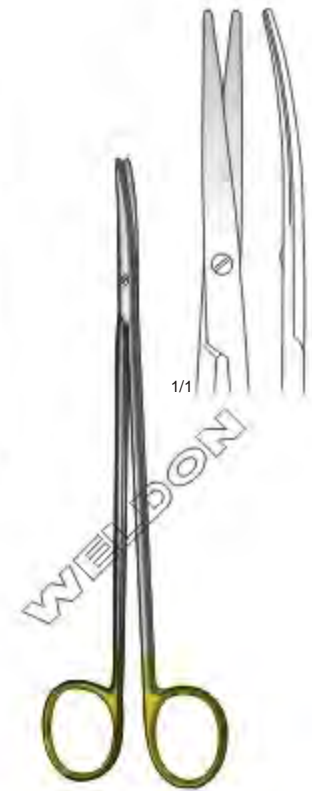

Toennis-Adson
 WS-046-042
 17 cm / 7"



WS-046-043
 14.5 cm / 5 3/4"
 Straight

Metzenbaum-Fino



WS-046-044
 14.5 cm / 5 3/4"
 Curved



WS-046-045
 18 cm / 7"

Metzenbaum-Fino

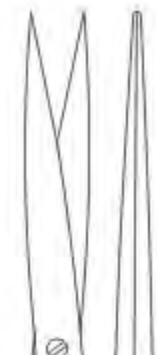

WS-046-046
 20 cm / 8"

Scissors With Tungsten Carbide Inserts | Tijeras Con Filos De Carburo De Tungsteno
Scheren Mit Hartmetalleinlagen



Ragnell
WS-047-047
12.5 cm / 5"

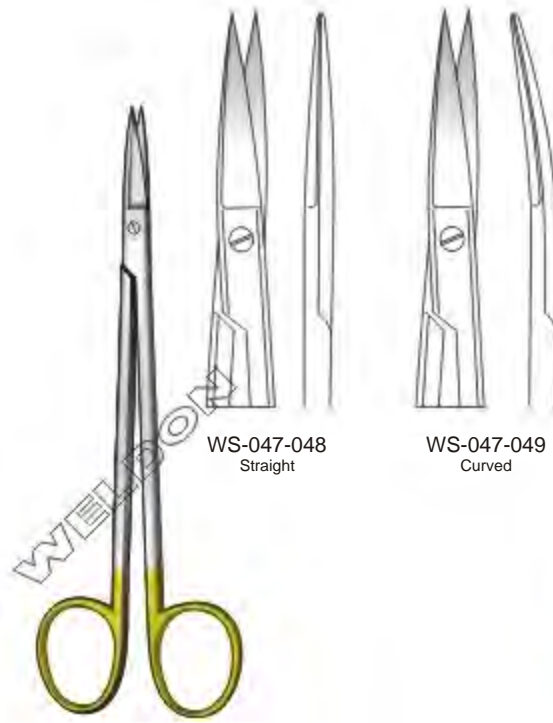

WS-047-048
Straight

WS-047-049
Curved

Kelly
16 cm / 6 1/4"



Universal
WS-047-050
12.5 cm / 5"

Wire Cutting Scissors
One Toothed Cutting Edge



Dean
WS-047-051
17.5 cm / 7"

One Toothed Cutting Edge
S-Shaped

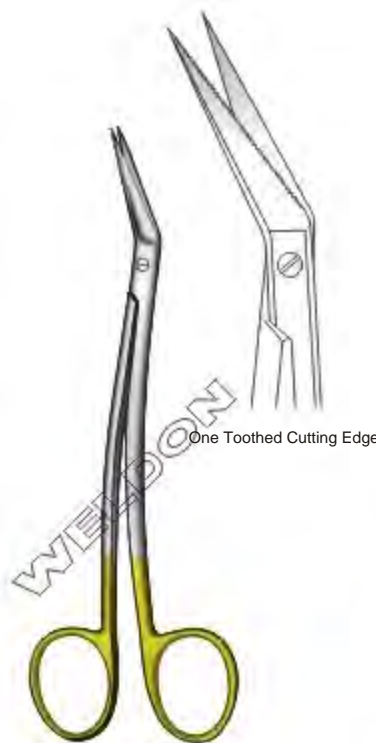

Locklin
WS-047-052
16 cm / 6 1/4"

One Toothed Cutting Edge



Locklin
WS-047-053
16 cm / 6 1/4"

One Toothed Cutting Edge

Scissors With Tungsten Carbide Inserts | Tijeras Con Filos De Carburo De Tungsteno
 Scheren Mit Hartmetalleinlagen



Mayo-Harrington
 WS-048-054 22.5 cm / 9", Curved
 WS-048-055 23 cm / 9", Straight
 WS-048-056 28 cm / 11", Curved



Sims
 WS-048-057 20 cm / 8" WS-048-058
 WS-048-059 23 cm / 9" WS-048-060
 Straight Curved



Goldman-Fox
WS-049-061
13 cm / 5"



Goldman-Fox
WS-049-062
13 cm / 5"

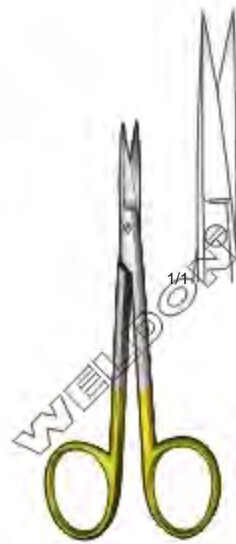

Iris
WS-049-063
11.5 cm / 4 1/2"



Iris
WS-049-064
11.5 cm / 4 1/2"



WS-049-065
19 cm / 7 1/2"
25°

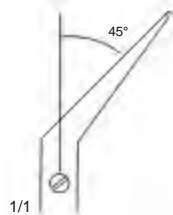

WS-049-066
19 cm / 7 1/2"
45°

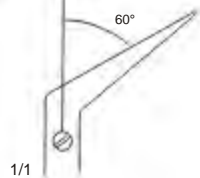

WS-049-067
19 cm / 7 1/2"
60°



WS-049-068
23 cm / 9"
25°

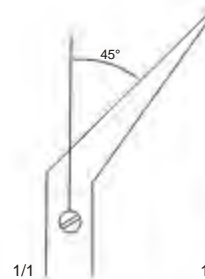

WS-049-069
23 cm / 9"
45°

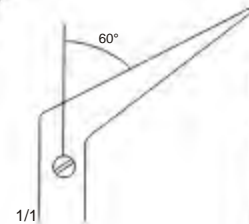

WS-049-070
23 cm / 9"
60°



DeBakey
(Potts-Smith)

Supercut Scissors With Tungsten Carbide | Tijeras Super-Cut Con Filos De Carburo De Tungsteno
 Scheren Super-Cut Mit Hartmetalleinlagen



Ligature
 For Synthetic Suture Material
 One Toothed Cutting Edge

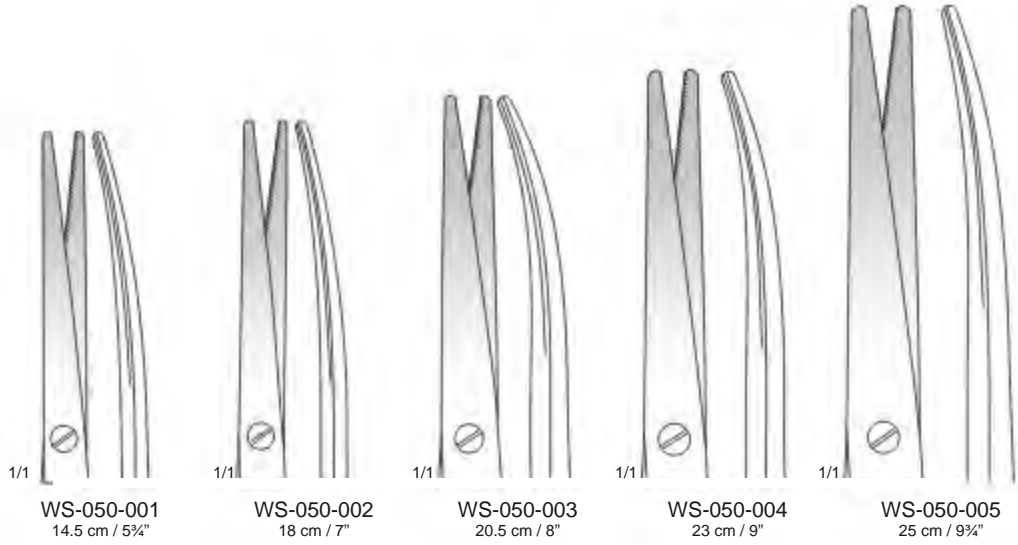

Mayo

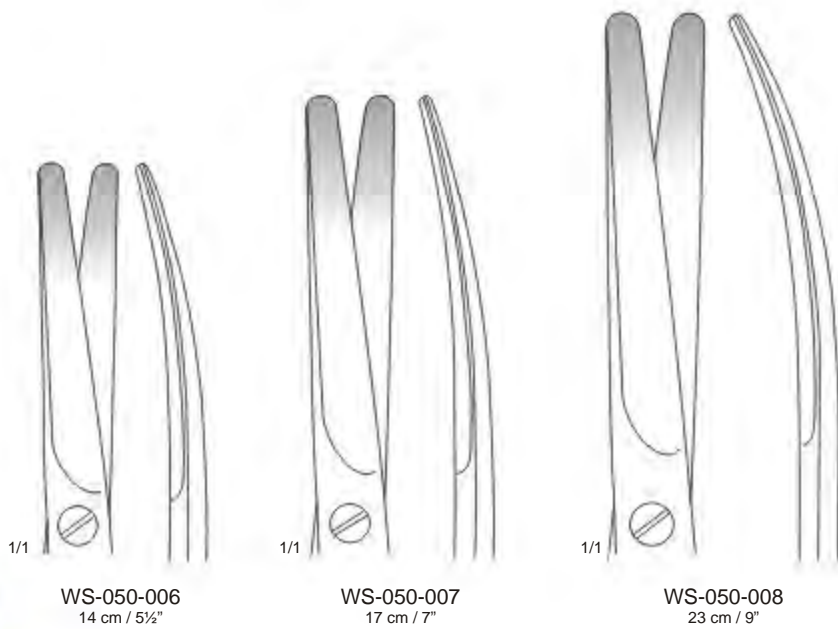

Supercut Scissors Plastic And Reconstructive | Tijeras Super-Cut Para Reconstructivo
Super-Cut Scheren Wieder Bauend



Mayo

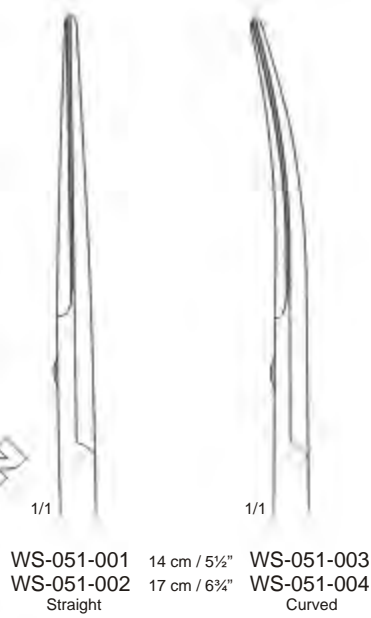

Mayo
23 cm / 9"

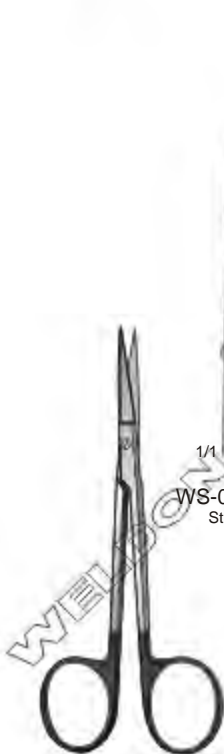

Iris
11.5 cm / 4½"

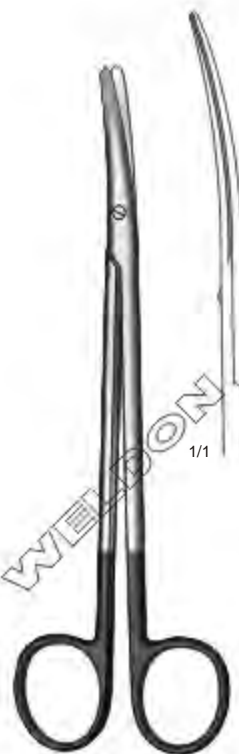

Metzenbaum
WS-051-009 18 cm / 7"
WS-051-010 23 cm / 9"
Curved



Metzenbaum (Lahey)
14.6 cm / 5¾"

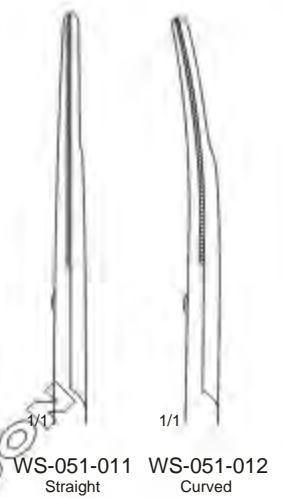

Supercut Scissors Plastic And Reconstructive | Tijeras Super-Cut Para Reconstructivo
 Super-Cut Scheren Wieder Bauend

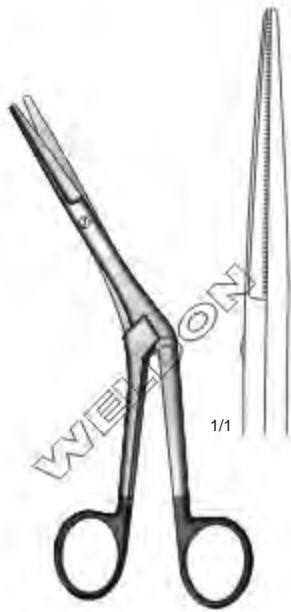

Knight Nasal
 WS-052-013
 17 cm / 6¾"

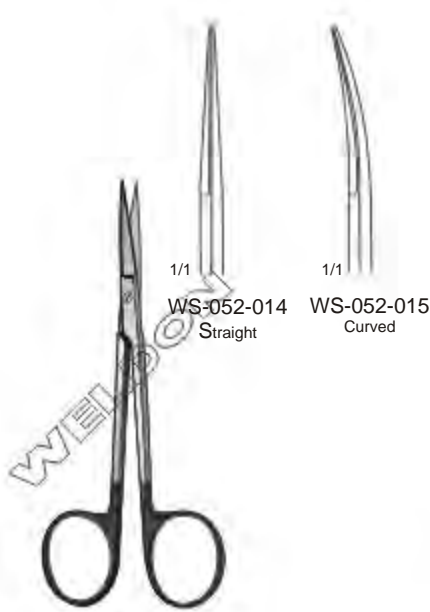

Plastic Surgery
 12 cm / 4¾"



Castanares
 WS-052-016
 16 cm / 6¼"
 Face Lift Scissors, Straight



Gorney
 18.5 cm / 7¼"

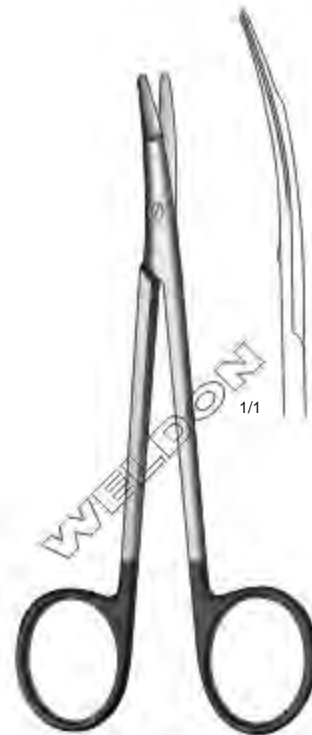

Freeman-Rhytidectomy
 WS-052-019
 18 cm / 7"
 Curved With Flat Tips

Supercut Scissors Plastic And Reconstructive | Tijeras Super-Cut Para Reconstructivo
Super-Cut Scheren Wieder Bauend

Beveled Blades Have Semi-Sharp Outer Edges And Flat, Tapered Tips.



Supercut Scissors Plastic And Reconstructive | Tijeras Super-Cut Para Reconstructivo
 Super-Cut Scheren Wieder Bauend



Fomon Lateral Scissors
 WS-054-028
 13 cm / 5"
 Full Curved

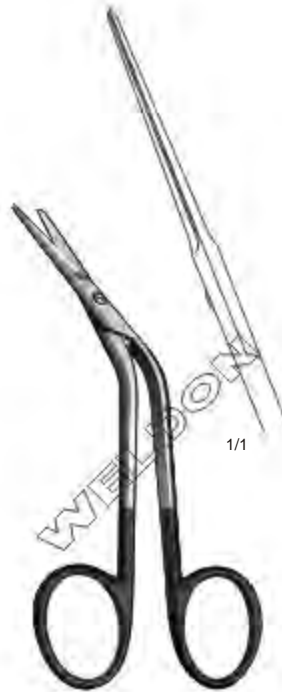

Fomon Dorsal Scissors
 WS-054-029
 14.6 cm / 5¾"
 Angled On Flat



Cottle Dorsal Scissors
 WS-054-030
 16.5 cm / 6½"
 Angled On Flat



Petit-Point Reynolds Scissors
 WS-054-031
 13 cm / 5"
 Curved

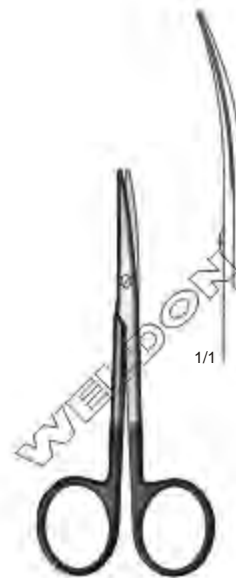

Plastic & Reconstructive Scissors
 WS-054-032 11.4 cm / 4½"
 WS-054-033 14.6 cm / 5¾"
 Curved

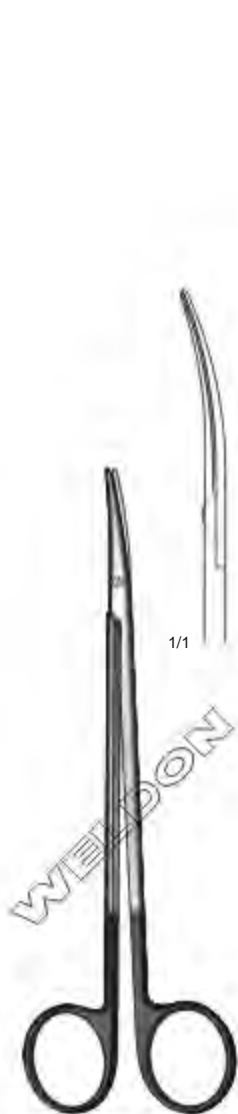

Endarterectomy Scissors
WS-055-034
17 cm / 6 3/4"
Curved

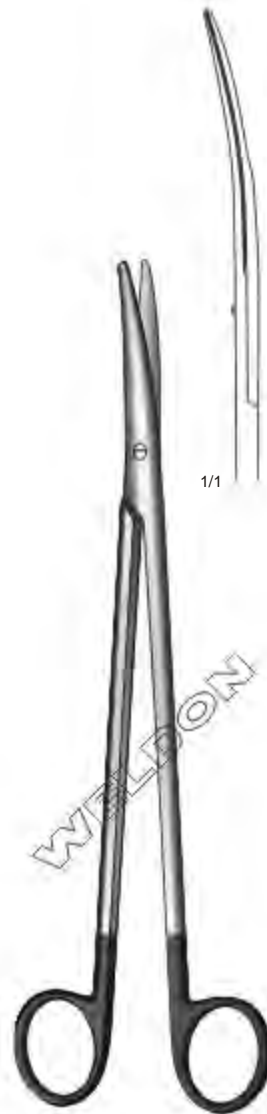

Metzenbaum Scissors
WS-055-035
18 cm / 7"
Curved, Delicate



Jamison Scissors
WS-055-036 14 cm / 5 1/2"
WS-055-037 18 cm / 7"
Curved

Supercut Scissors Cardiovascular | Tijeras Super-Cut Cardiovasculares
 Super-Cut Scheren Kardiovaskulares

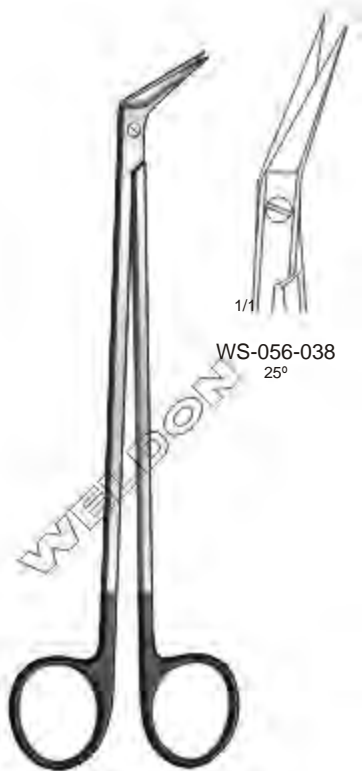

WS-056-038
25°

Potts-Smith
18 cm / 7"

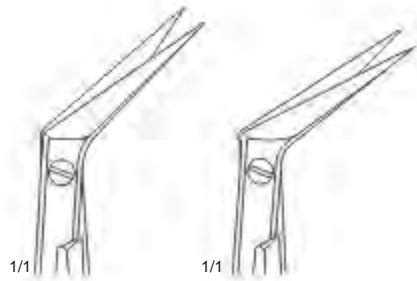

WS-056-039
45°

WS-056-040
60°



Diethrich Coronary
WS-056-041
18 cm / 7", 130°
Shanks Are Stabilized
To Keep Blades In Alignment



WS-056-042
25°

Diethrich Coronary
18 cm / 7"

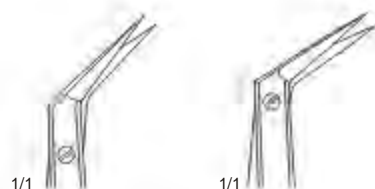

WS-056-043
45°

WS-056-044
60°

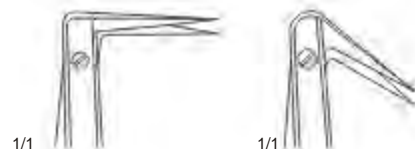

WS-056-045
90°

WS-056-046
25°

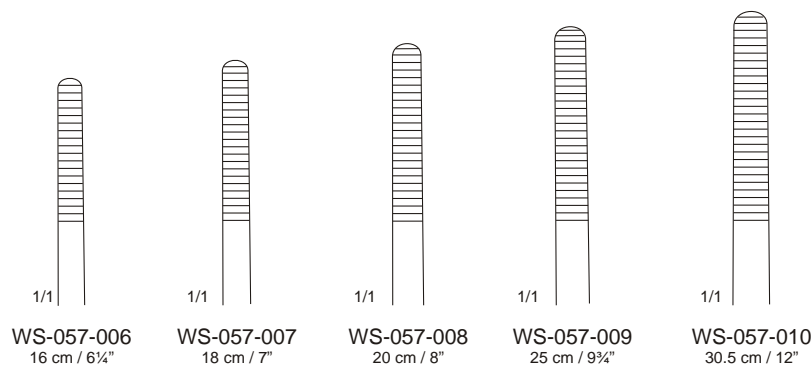
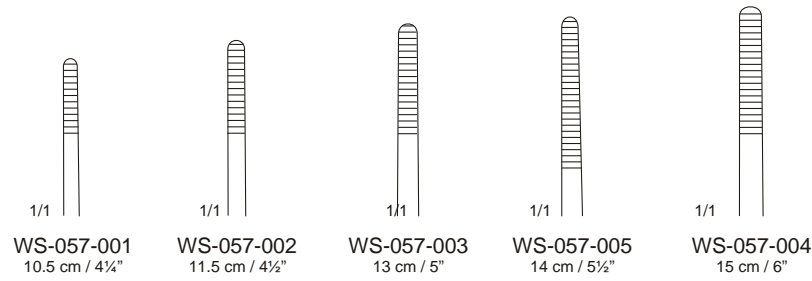

Dressing

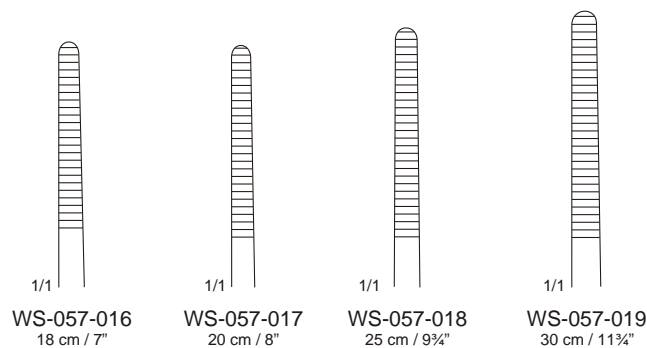
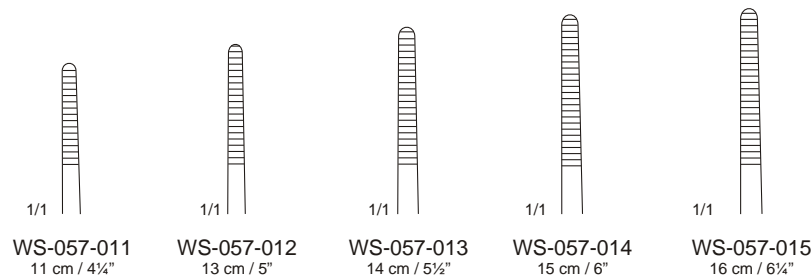

Dressing
Narrow

Dressing Forceps | Pinzas De Disección/Anatomica | Anatomische Pinzetten

Dressing

WS-058-020
12 cm / 4¾"

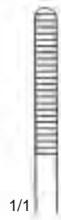
WS-058-021
13 cm / 5"

WS-058-022
14 cm / 5½"

WS-058-023
15 cm / 6"

WS-058-024
18 cm / 7"

WS-058-025
21 cm / 8¼"

WS-058-026
25 cm / 10"

WS-058-027
31 cm / 12¼"

WS-058-028
12 cm / 4¾"

WS-058-029
13 cm / 5"

WS-058-030
14.5 cm / ½"

WS-058-031
15.5 cm / 6"

**Dressing
Narrow**

Adson

WS-058-032
12 cm / 4¾"

WS-058-033
15 cm / 6"



McIndoe
WS-059-034
15 cm / 6"



Semken

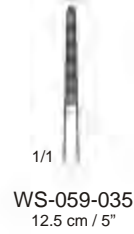

1/1
WS-059-035
12.5 cm / 5"



1/1
WS-059-036
15 cm / 6"



Taylor
WS-059-037
17 cm / 6 3/4"



Taylor
WS-059-038
18.5 cm / 7 1/4"

Micro Dressing Forceps | Micro Pinzas De Disección | Anatomische Mikropinzetten

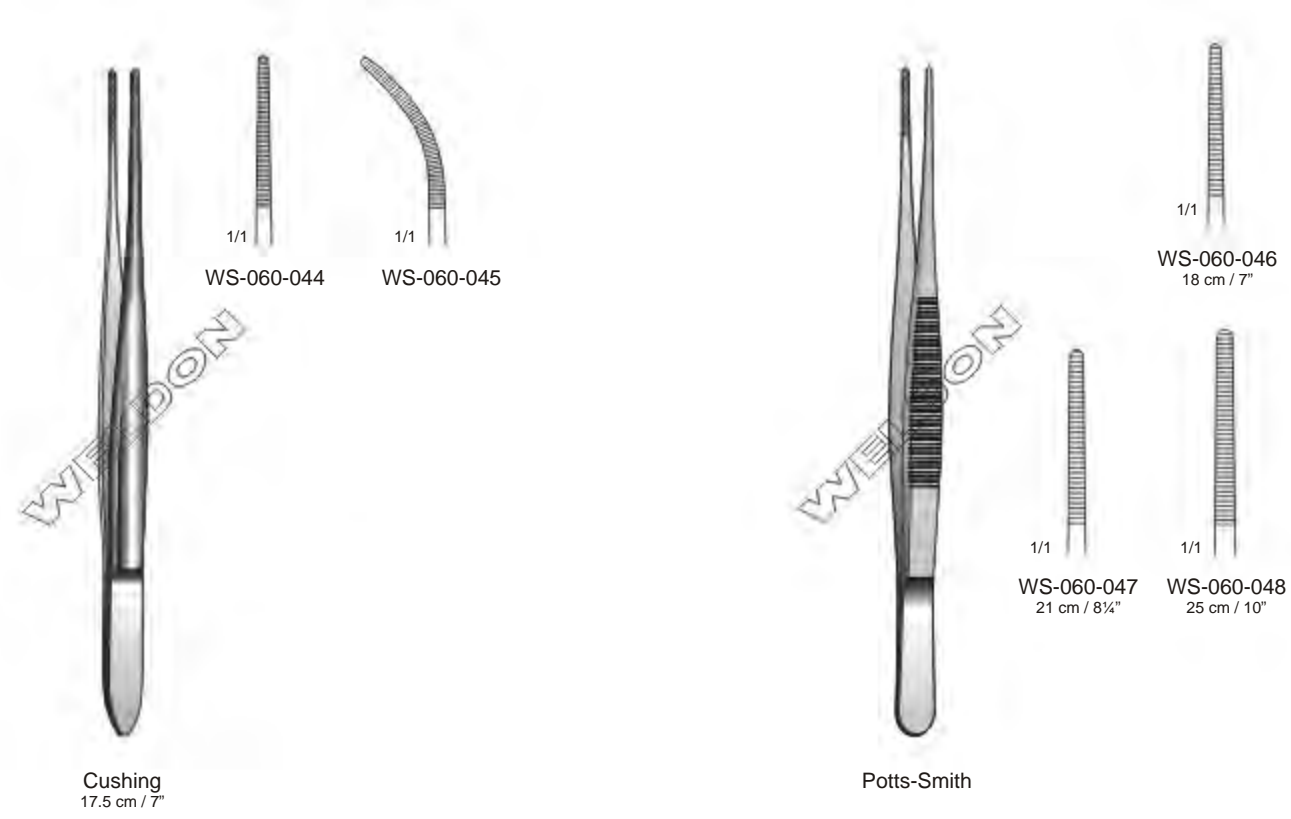
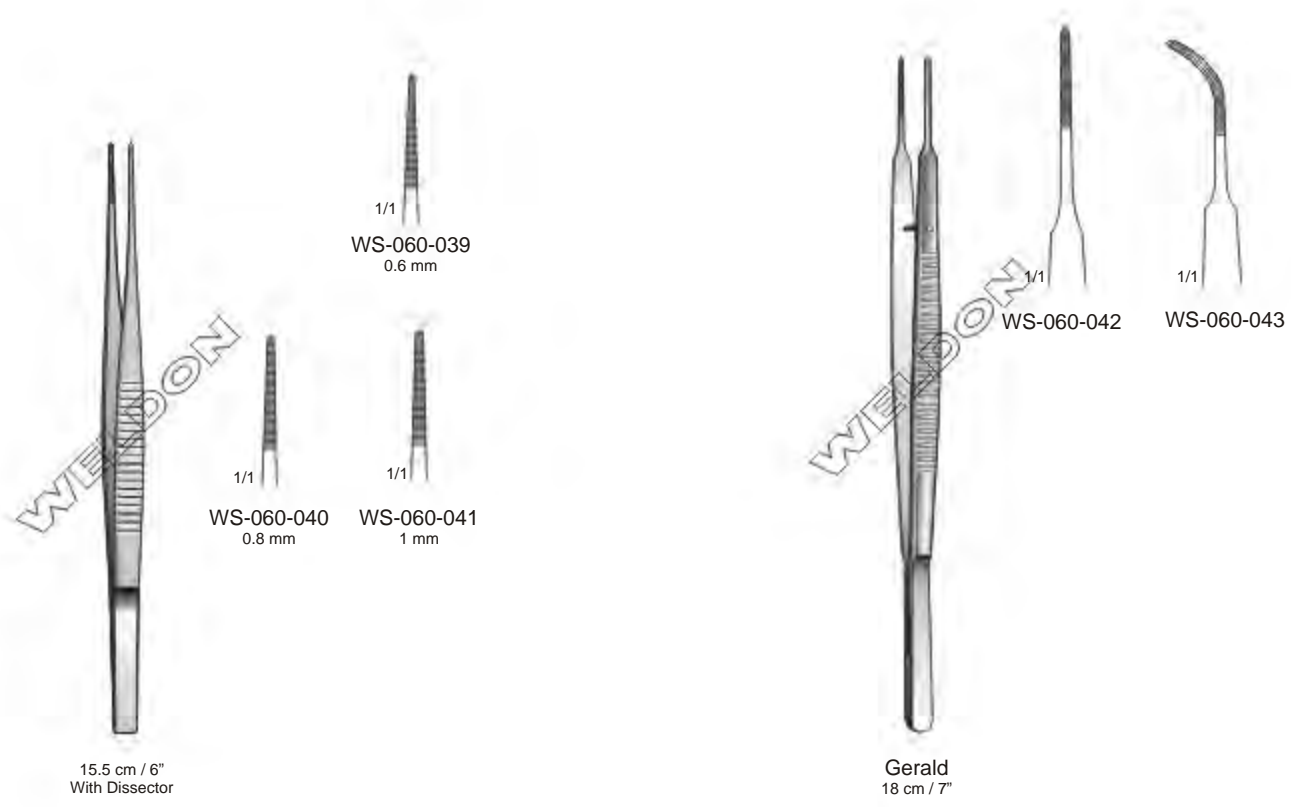

Tissue Forceps | Pinzas De Disección Con Dientes | Chirurgische Pinzetten

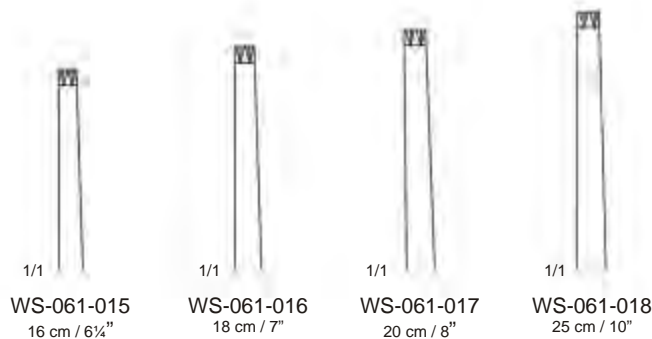
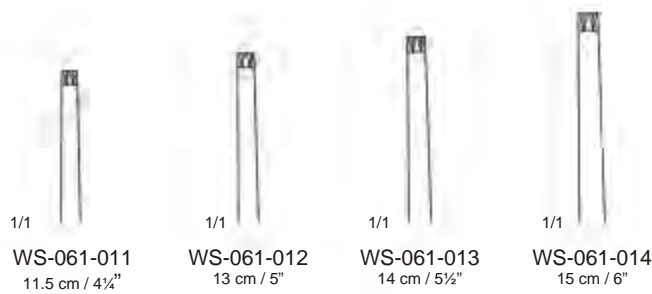
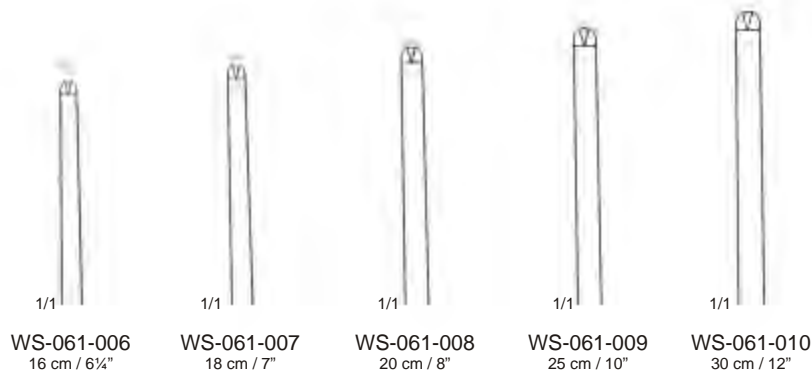
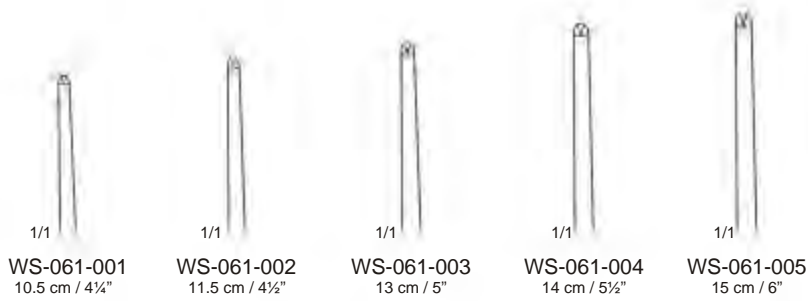

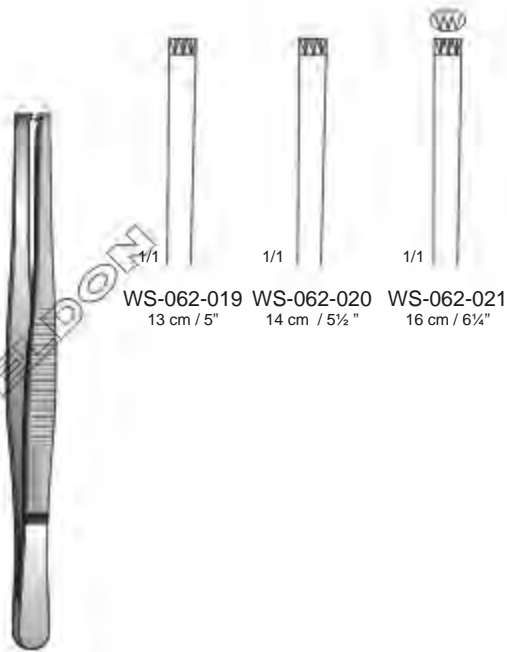
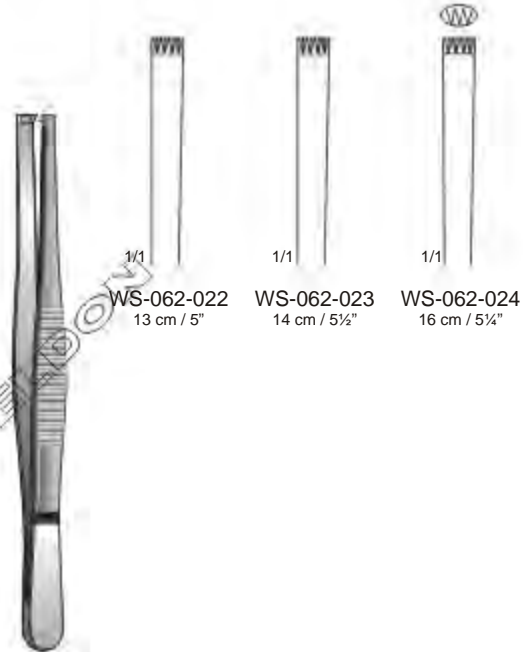
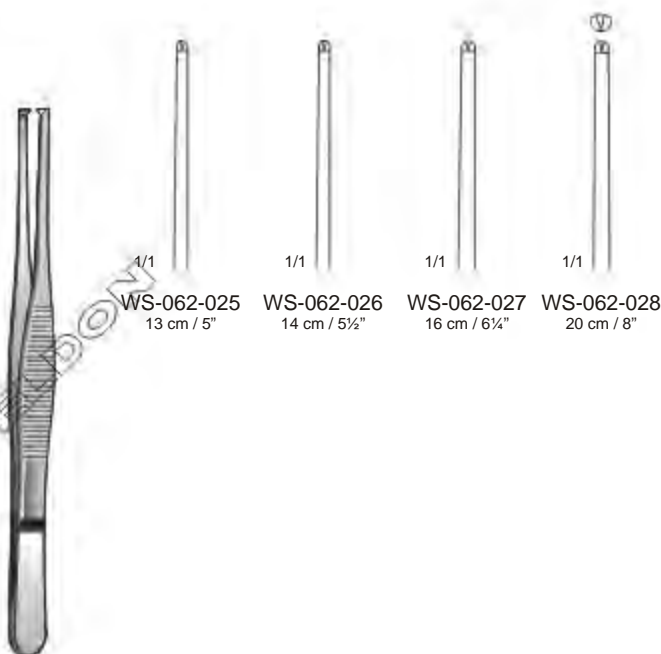
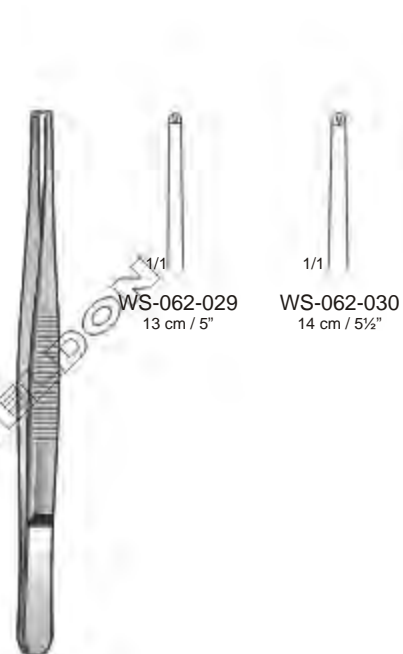
Tissue Forceps | Pinzas De Disección Con Dientes | Chirurgische Pinzetten

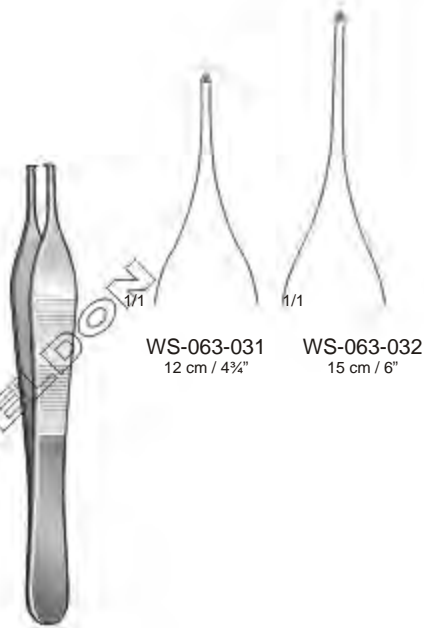
3 x 4 Teeth

4 x 5 Teeth

**1 x 2 Teeth
Fine**

**1 x 2 Teeth
Delicate**

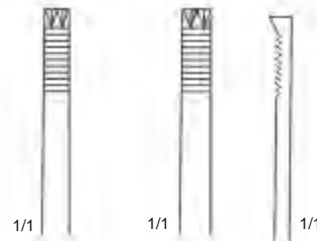

Adson
1 x 2 Teeth

WS-063-031
12 cm / 4¾"

WS-063-032
15 cm / 6"



WS-063-033
15 cm / 6"
2 x 3 Teeth

WS-063-034
20 cm / 8"
2 x 3 Teeth

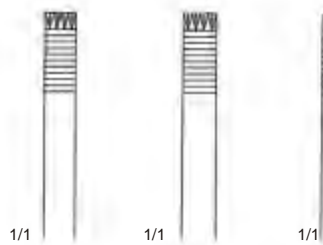

WS-063-035
15 cm / 6"
4 x 5 Teeth

WS-063-036
20 cm / 8"
4 x 5 Teeth

WS-063-037
25 cm / 10"
4 x 5 Teeth



Adlerkreuz

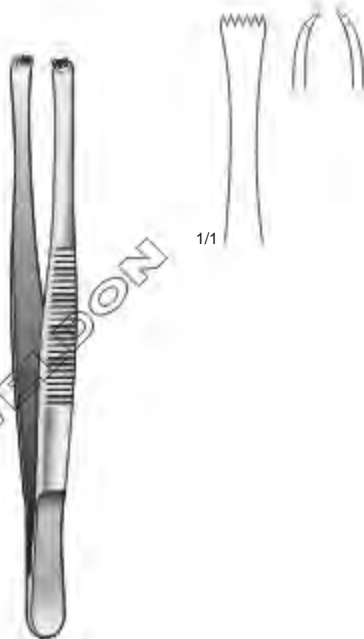

Lerche
WS-063-038
15 cm / 6"
5 x 6 Teeth

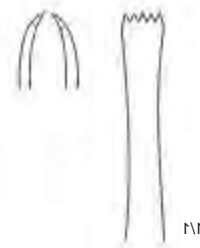

Stone
WS-063-039
15 cm / 6"
4 x 5 Teeth

Tissue Forceps | Pinzas De Disección Con Dientes | Chirurgische Pinzetten



Taylor
WS-064-040
17.5 cm / 7"
1 x 2 Teeth



Taylor
WS-064-041
17.5 cm / 7"
1 x 2 Teeth



Semken
1 x 2 Teeth



Gillies
WS-064-044
15 cm / 6"
1 x 2 Teeth



Duval
WS-064-045
14 cm / 5½"

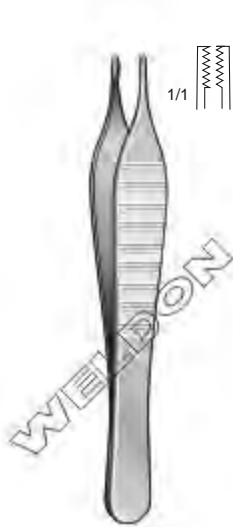

Adson-Brown
 WS-065-046
 12 cm / 4¾"
 WS-065-046A
 15 cm / 6"
 WS-065-046B
 20 cm / 8"
 WS-065-046C
 25 cm / 10"

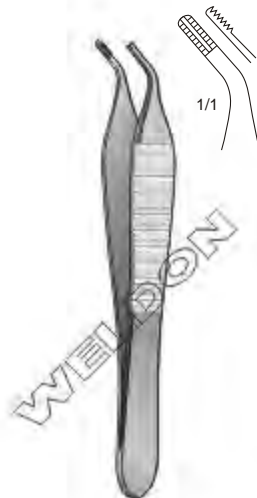

Adson-Brown
 WS-065-047
 12 cm / 4¾"
 WS-065-047A
 15 cm / 6"
 Angled

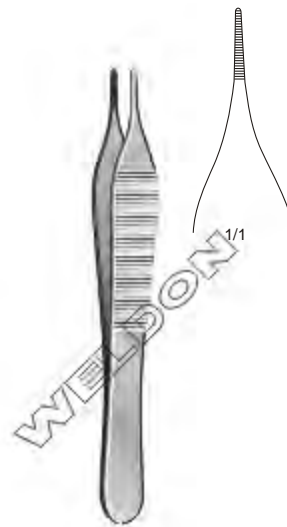

Micro-Adson
 WS-065-048 12 cm / 4¾"
 WS-065-049 15 cm / 6"
 Dressing

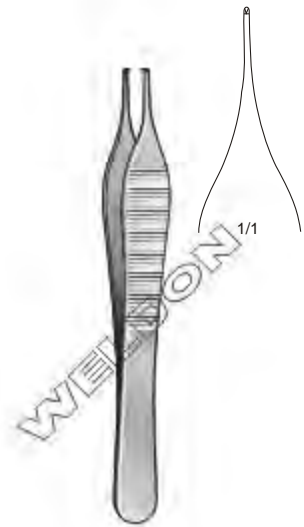

Micro-Adson
 WS-065-050 12 cm / 4¾"
 WS-065-051 15 cm / 6"
 1 x 2 Teeth



WS-065-052
 15 cm / 6"



WS-065-053
 20 cm / 8"



WS-065-054
 25 cm / 10"



Russ-Modell



Nelson Forceps
 WS-065-054A
 22.8 cm / 9"
 5 x 6 Teeth

Tissue Forceps | Pinzas De Diseccion Con Dientes | Chirurgische Pinzetten



Bonney
18 cm / 7"



WS-066-055
1 x 2 Teeth



WS-066-056
2 x 3 Teeth



Ferris-Smith
18 cm / 7"



WS-066-057
1 x 2 Teeth



WS-066-058
2 x 3 Teeth

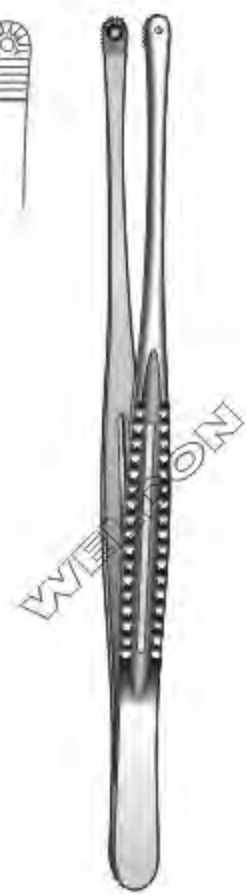

Mayo-Russ
WS-066-059 15 cm / 6"
WS-066-060 20 cm / 8"
WS-066-061 23 cm / 9"



WS-067-001
0.6 mm



WS-067-002
0.8 mm



WS-067-003
1.0 mm



15 cm / 6"
1 x 2 Teeth



WS-067-004



Gerald
17 cm / 6 3/4"
1 x 2 Teeth



WS-067-005



Cushing
WS-067-006
17 cm / 6 3/4"
1 x 2 Teeth



Cushing (Taylor)
WS-067-006A
18 cm / 7"
WS-067-006B
20 cm / 8"



WS-067-007
17.5 cm / 7"



Potts-Smith
1 x 2 Teeth

WS-067-008
21 cm / 8 1/4"



WS-067-009
25 cm / 10"



Brophy
WS-067-010
20 cm / 8"
1 x 2 Teeth



Delicate Forceps, Dressing And Tissue | Pinzas Finas, Anatómicas Y Quirúrgicas
 Feine Pinzetten, Anatomische Und Chirurgische



Waugh
 WS-068-011
 15 cm / 6"



Waugh
 WS-068-012
 15 cm / 6"
 1 x 2 Teeth



Waugh
 WS-068-013
 20 cm / 8"



Waugh
 WS-068-014
 20 cm / 8"
 1 x 2 Teeth



WS-069-015
12.5 cm / 5"
Serrated Jaw

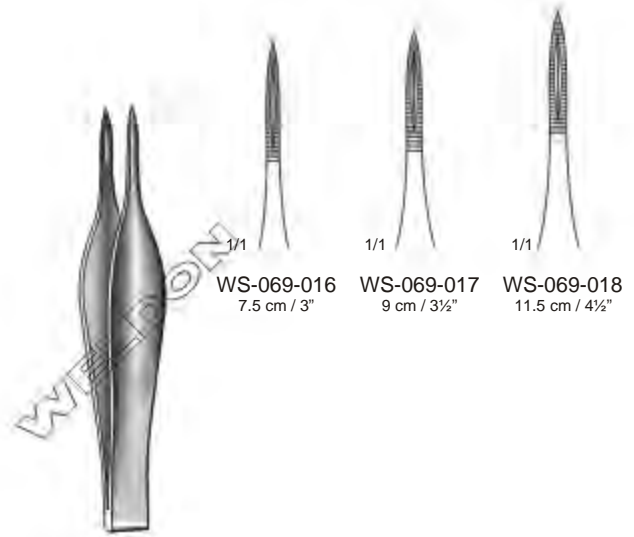

Feilchenfeld

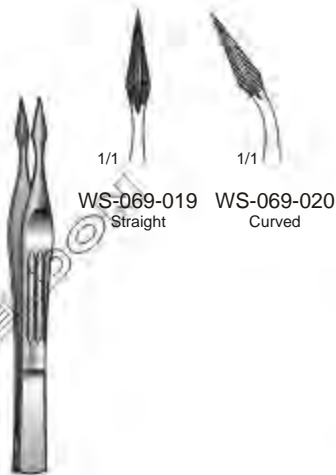

Walter-Carmalt
10.5 cm / 4 1/4"



Hunter
10.5 cm / 4 1/4"



Hunter
WS-069-023
12 cm / 4 3/4"
With Magnifying Glass

Cilia Forceps | Pinzas Depilatorias | Cilienpinzetten



Littauer
WS-070-024
8.5 cm / 3 1/2"



Littauer
WS-070-025
9 cm / 3 1/2"



Douglas
WS-070-026
9 cm / 3 1/2"



Douglas
WS-070-027
9 cm / 3 1/2"

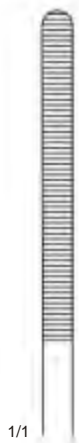

Miller
WS-071-001
15 cm / 6"



Miller
WS-071-002
15 cm / 6"

Dressing Forceps With Tungsten Carbide Inserts | Pinzas De Diseccion Con Carbure De Tangsteno
Pinzetten Mit Hartmetlleinlagen

Ferris-Smith
WS-072-001
 17 cm / 6 3/4"
 Normal Profile



Bonney
 17 cm / 6 3/4"



Gerald
 17 cm / 6 3/4"



Gillies
WS-072-006
 15 cm / 6"
 Mini Profile



McIndoe
WS-072-007
 15 cm / 6"
 Mini Profile



Semken



Adson
Normal Profile

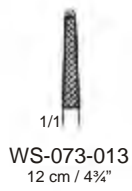

Micro Adson
12 cm / 4 3/4"
Mini Profile

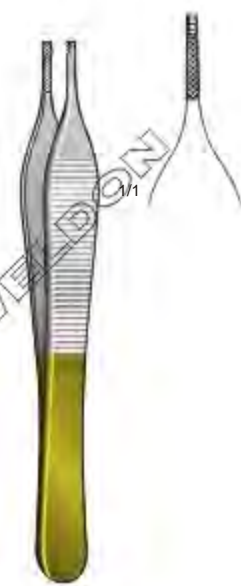

Adson-Brown
WS-073-018
12 cm / 4 3/4"
Normal Profile



Cushing
WS-073-019
17.5 cm / 7"
Normal Profile



Cushing
WS-073-020
18 cm / 7"
Normal Profile



Cushing-Taylor
WS-073-021
18 cm / 7"
Normal Profile

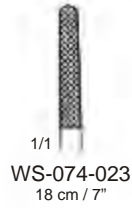
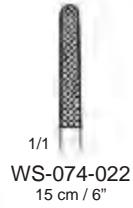

**Dressing Forceps With Tungsten Carbide Inserts | Pinzas De Diseccion Con Carbure De Tungsteno
Pinzetten Mit Hartmetalleinlagen**

Potts-Smith
Normal Profile

Oehler
1 x 2 Teeth
Normal Profile

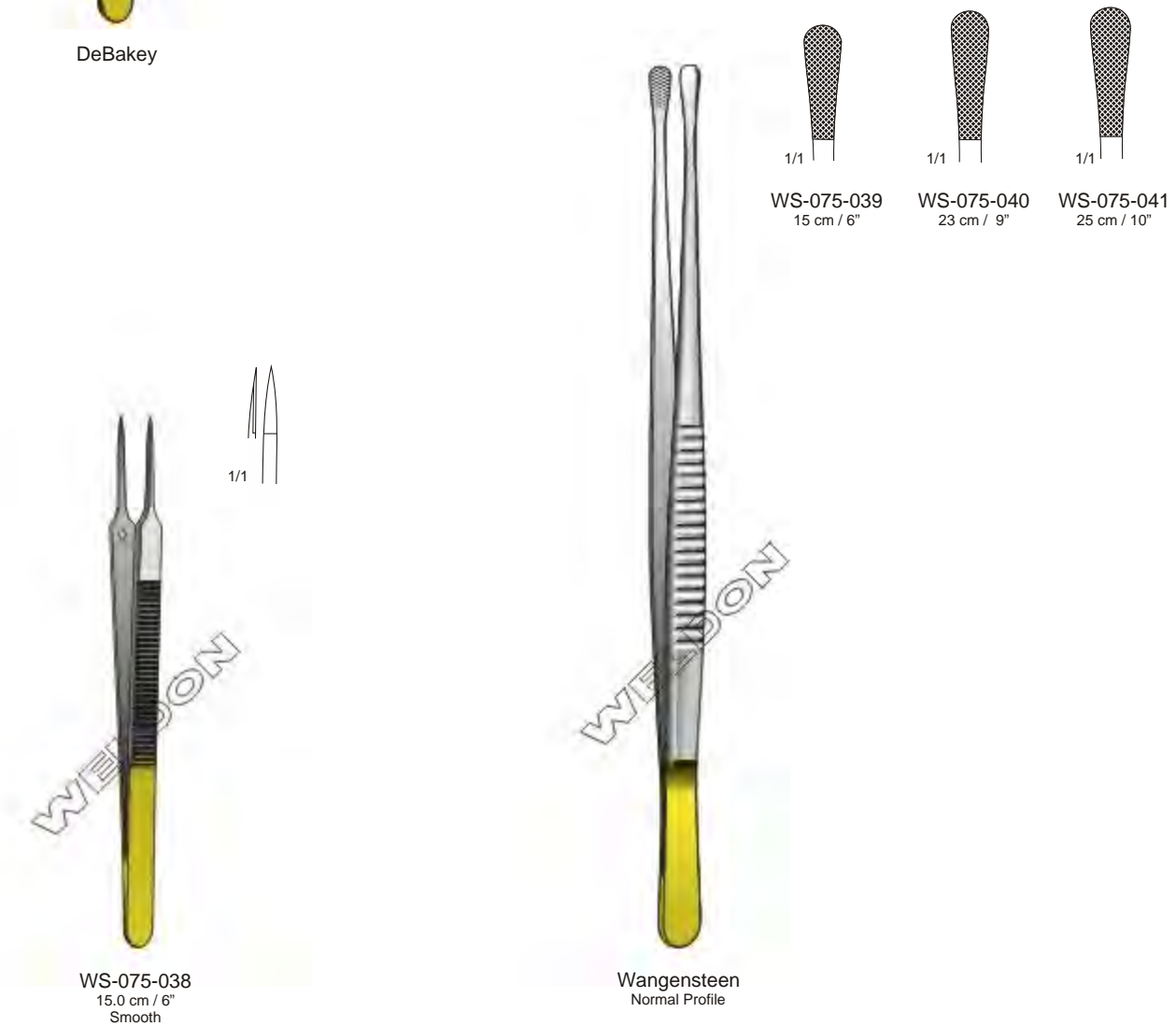
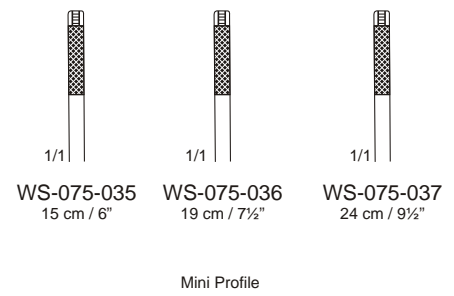
Dressing Forceps With Tungsten Carbide Inserts | Pinzas De Diseccion Con Carbure De Tungsteno
Pinzetten Mit Hartmetalleinlagen

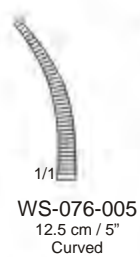
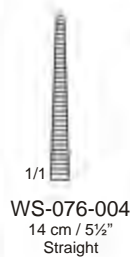
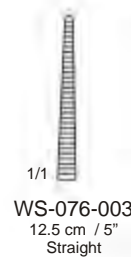

Haemostatic Forceps | Pinzas Hemostáticas | Arterienklemmen

Hartmann
10 cm / 4"



Halsted-Mosquito

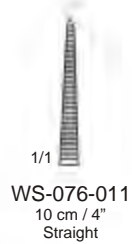

Micro-Mosquito

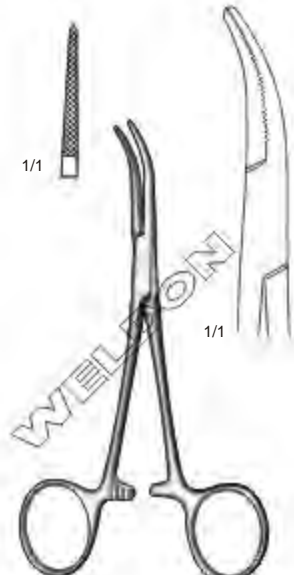
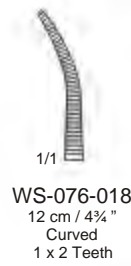
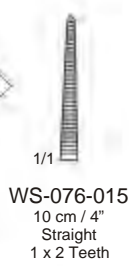

Mosquito-Dandy
WS-076-019
12 cm / 4¾"

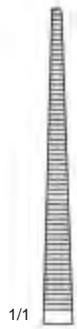

WS-077-020
18 cm / 7"
Straight



WS-077-021
18 cm / 7"
Curved



WS-077-022
18 cm / 7"
Straight
1 x 2 Teeth



WS-077-023
18 cm / 7"
Curved
1 x 2 Teeth



WS-077-024
21 cm / 8 1/2"
Straight



WS-077-025
21 cm / 8 1/2"
Curved

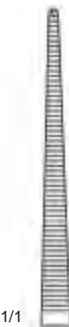

WS-077-026
21 cm / 8 1/2"
Straight
1 x 2 Teeth



WS-077-027
21 cm / 8 1/2"
Curved
1 x 2 Teeth



Halsted-Mosquito

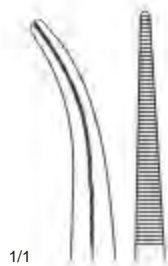

WS-077-028



WS-077-029
1 x 2 Teeth

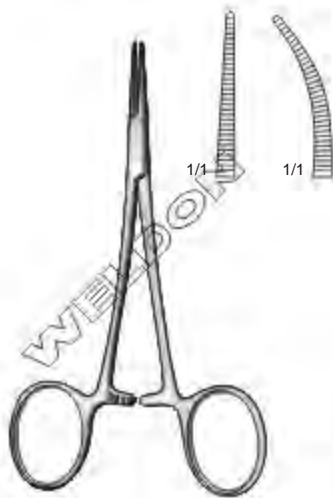

Dandy

Haemostatic Forceps | Pinzas Hemostáticas | Arterienklemmen

**Petit-Point
Jacobson Mosquito Forceps**
WS-078-030 Straight
WS-078-031 Curved
13 cm / 5"



**Petit-Point
Mosquito Forceps**
WS-078-032 Straight
WS-078-033 Curved
9.8 cm / 3⁷/₈"
WS-078-034 Straight
WS-078-035 Curved
12 cm / 4³/₄"

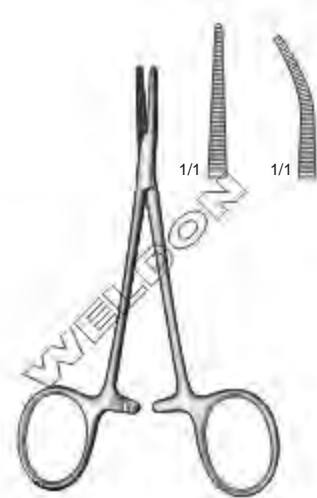

**Petit-Point
Mosquito Forceps**
WS-078-036 Straight
WS-078-037 Curved
15 cm / 6"



**Petit-Point
Mosquito Forceps**
WS-078-038 Straight
WS-078-039 Curved
18.1 cm / 7¹/₈"



**Petit-Point
Crile Forceps**
WS-078-040 Straight
WS-078-041 Curved
14 cm / 5¹/₂"

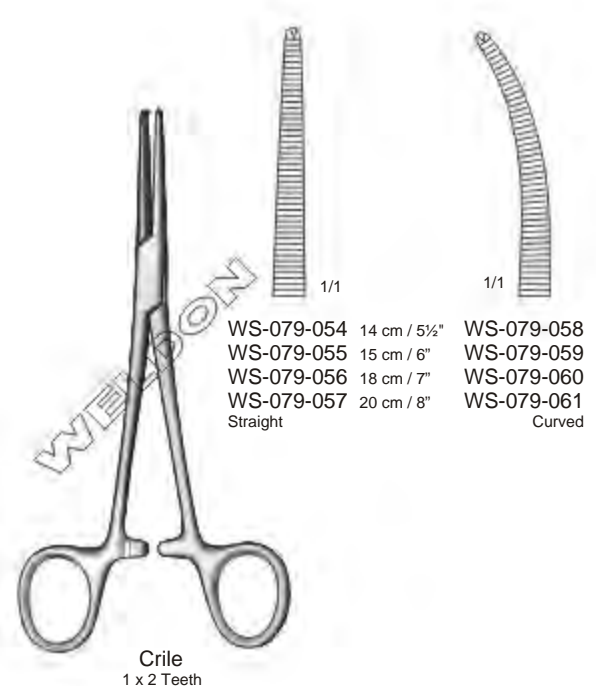
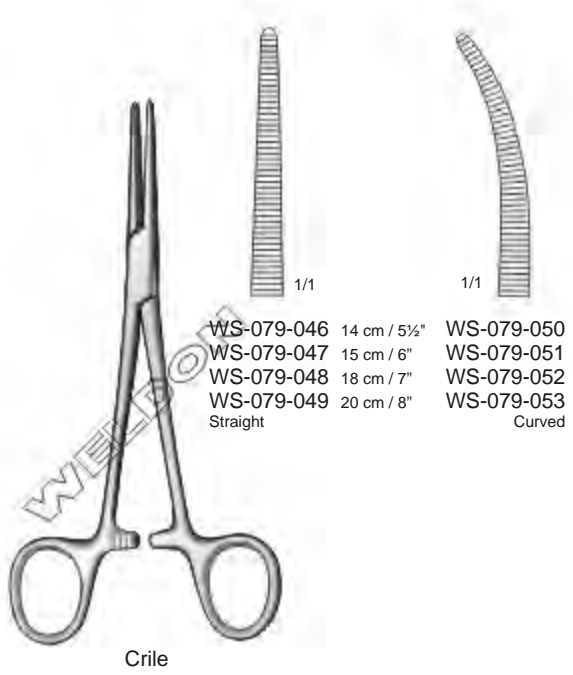
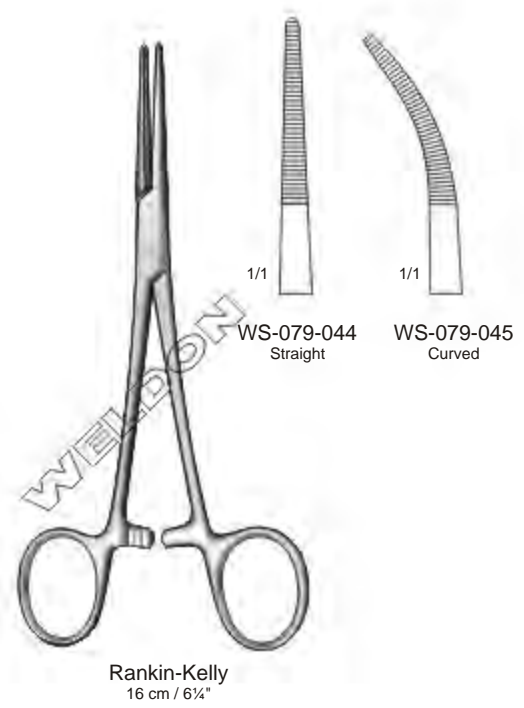
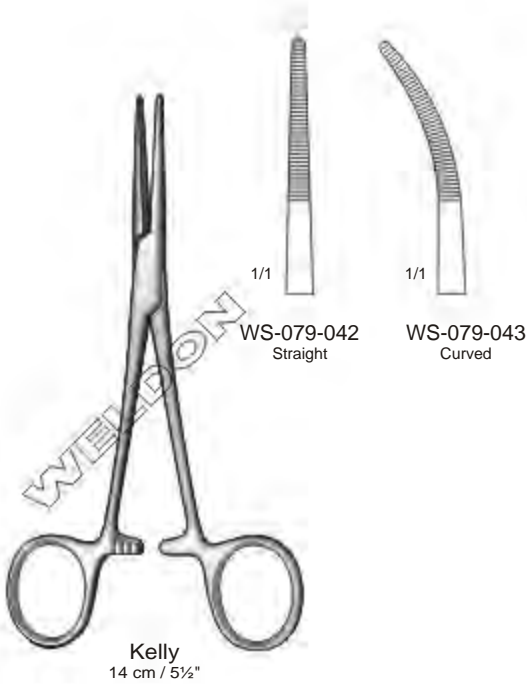

Haemostatic Forceps | Pinzas Hemostáticas | Arterienklemmen

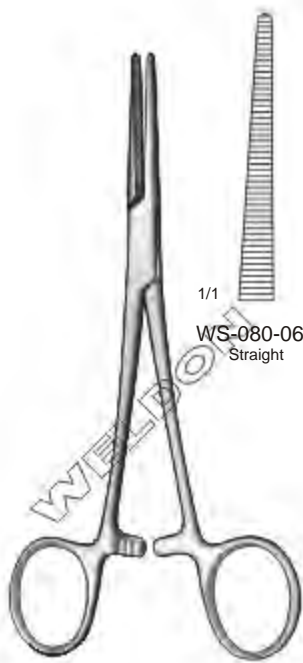

Rankin-Crile
16 cm / 6¼"

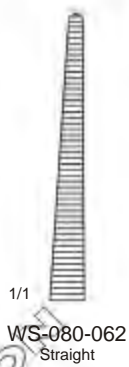

Providence-Hospital
14 cm / 5½"

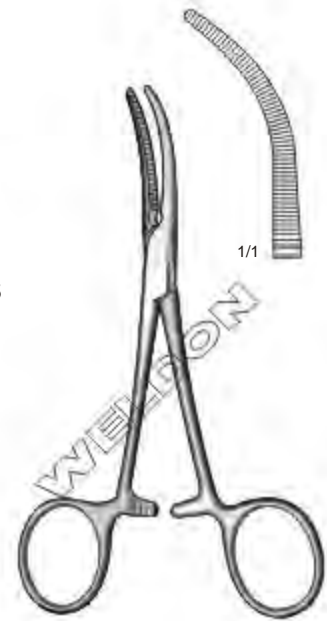
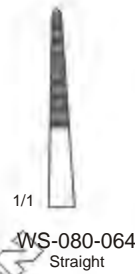

Baby-Overholt
WS-080-066
13.5 cm / 5¼"



Leriche
15 cm / 6"

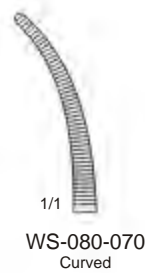
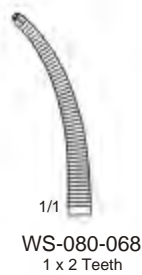
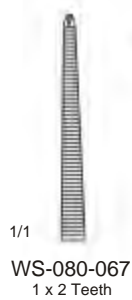

Hoen
WS-080-071
12.5 cm / 5"

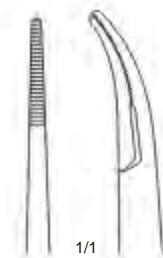

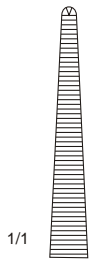

WS-081-072
Straight

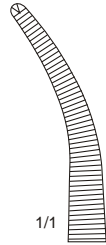

WS-081-073
Curved



Adson
18.5 cm / 7 1/4"
1 x 2 Teeth



WS-081-074



WS-081-075
1 x 2 Teeth



Lovelace
15 cm / 6"

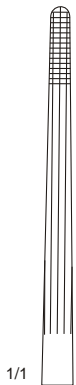

WS-081-076
16 cm / 6 1/4"
Straight



WS-081-077
20.5 cm / 8"
Straight



WS-081-078
16 cm / 6 1/4"
Curved



WS-081-079
20 cm / 8"
Curved



Rochester-Carmalt

Haemostatic Forceps | Pinzas Hemostáticas | Arterienklemmen

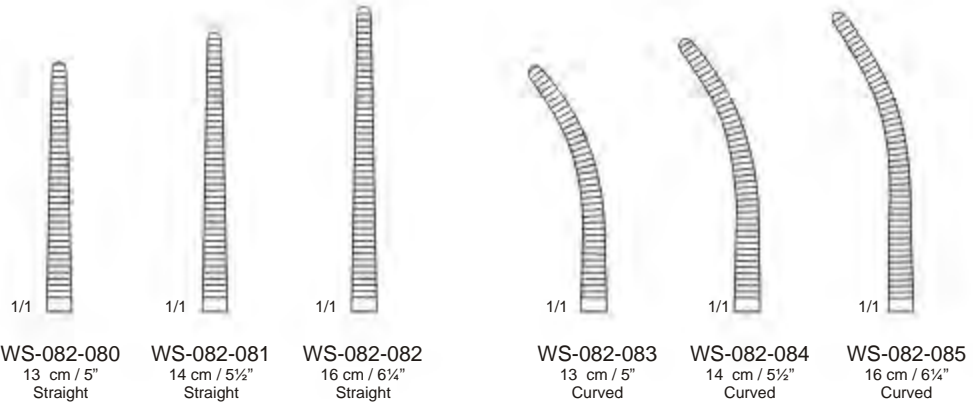

Pean
Delicate Pattern

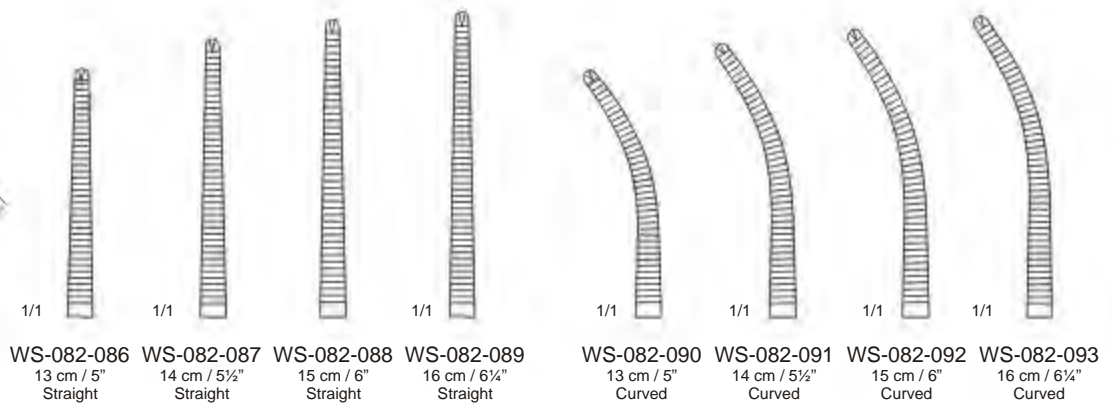

Kocher
Delicate Pattern
1 x 2 Teeth

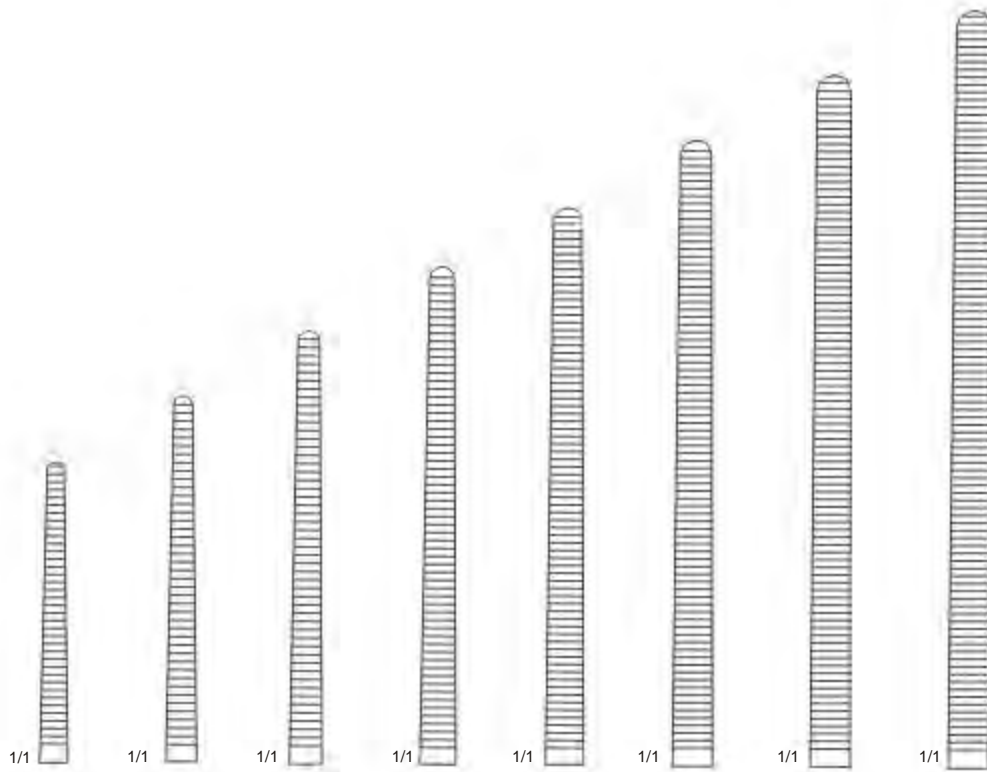

Haemostatic Forceps | Pinzas Hemostáticas | Arterienklemmen



WS-083-094	WS-083-095	WS-083-096	WS-083-097	WS-083-098	WS-083-099	WS-083-100	WS-083-101
14 cm / 5½"	16 cm / 6¼"	18 cm / 7"	20 cm / 8"	22 cm / 8¾"	24 cm / 9½"	26 cm / 10¼"	30 cm / 12"
Straight	Straight	Straight	Straight	Straight	Straight	Straight	Straight

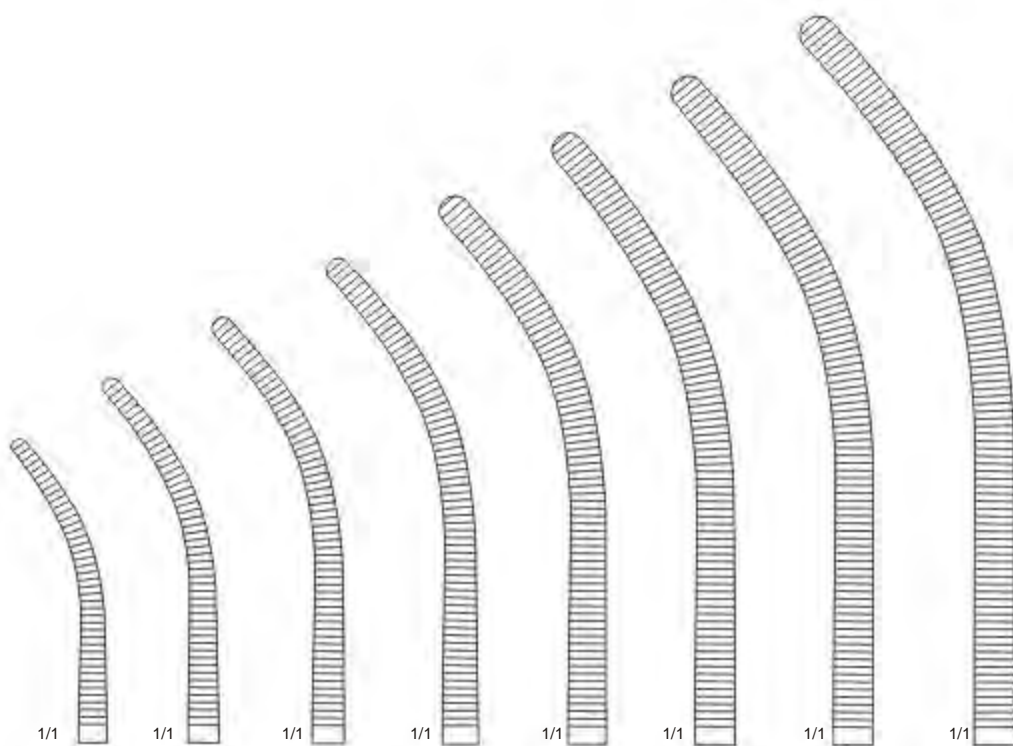

WS-083-102	WS-083-103	WS-083-104	WS-083-105	WS-083-106	WS-083-107	WS-083-108	WS-083-109
14 cm / 5½"	16 cm / 6¼"	18 cm / 7"	20 cm / 8"	22 cm / 8¾"	24 cm / 9½"	26 cm / 10¼"	30 cm / 12"
Curved	Curved	Curved	Curved	Curved	Curved	Curved	Curved

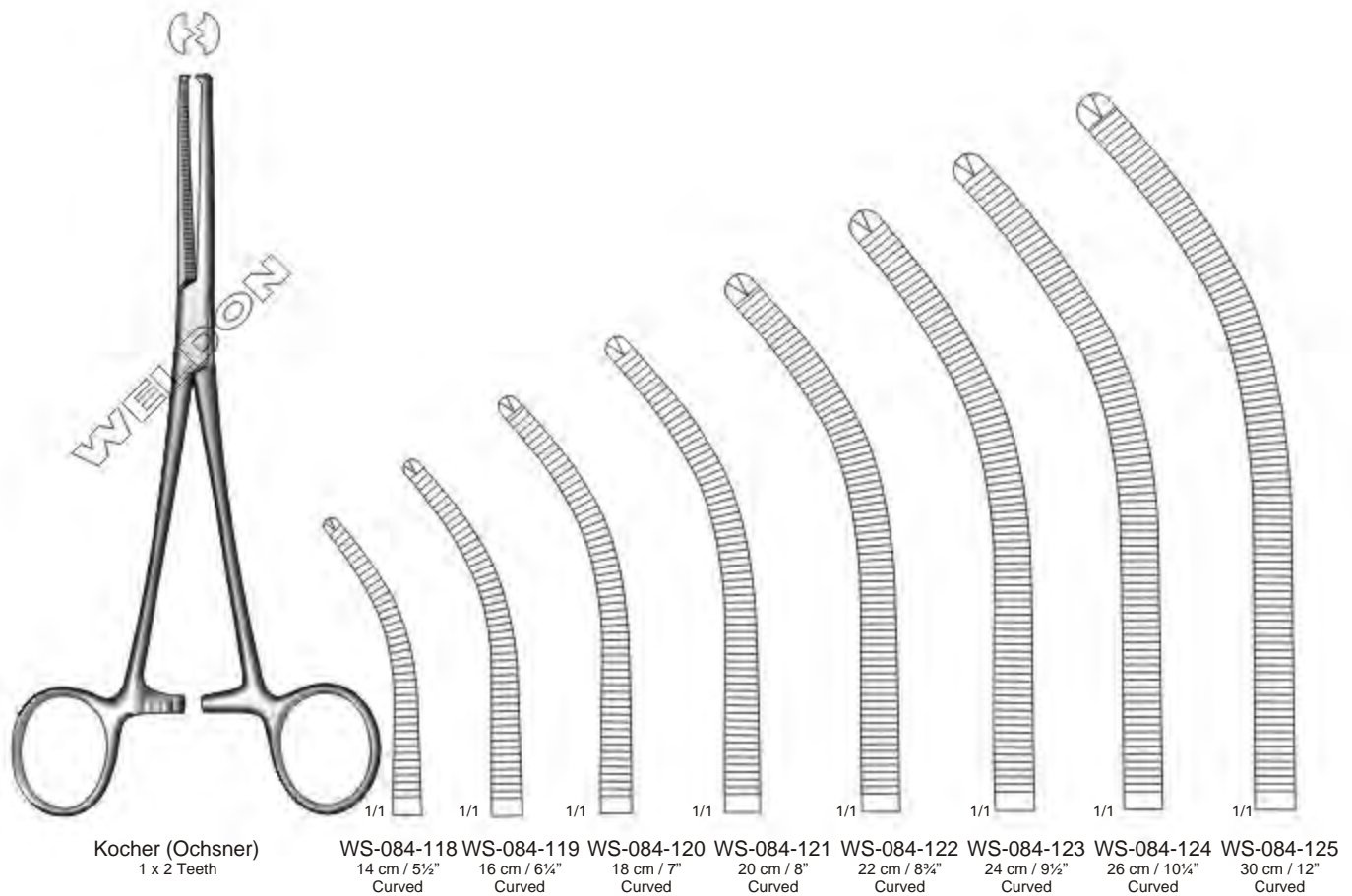
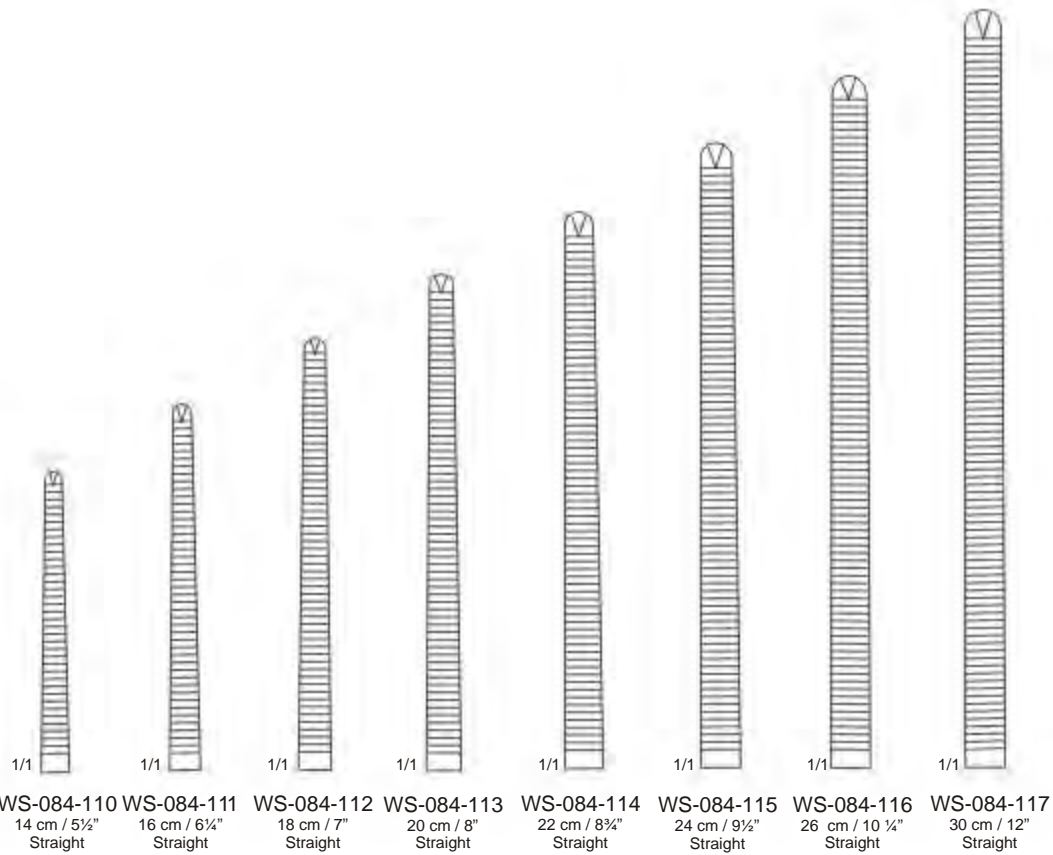

Rochester-Pean

Haemostatic Forceps | Pinzas Hemostáticas | Arterienklemmen

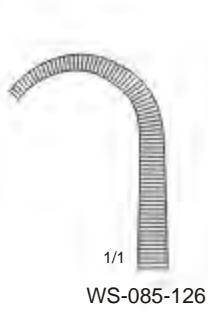

Negus
19 cm / 7½"



Birkett
19 cm / 7½"



Heiss
21 cm / 8¼"



Bridge
28 cm / 11"

Haemostatic Forceps | Pinzas Hemostáticas | Arterienklemmen



WS-086-134

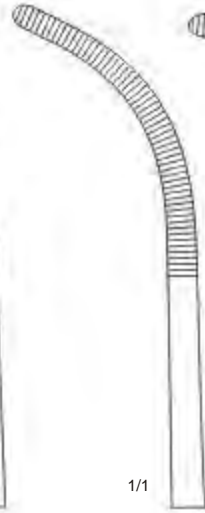

WS-086-135

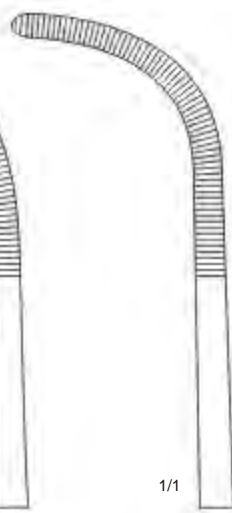

WS-086-136

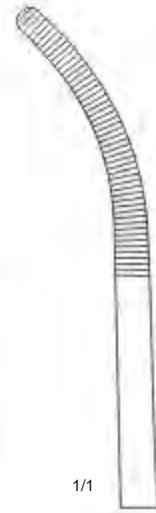

WS-086-137

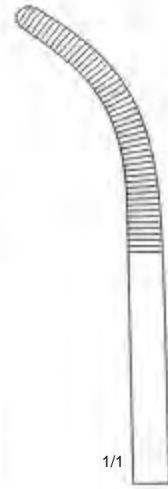

WS-086-138

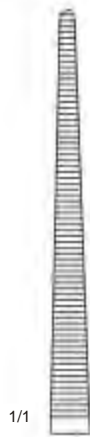

WS-086-139



WS-086-140



WS-086-141

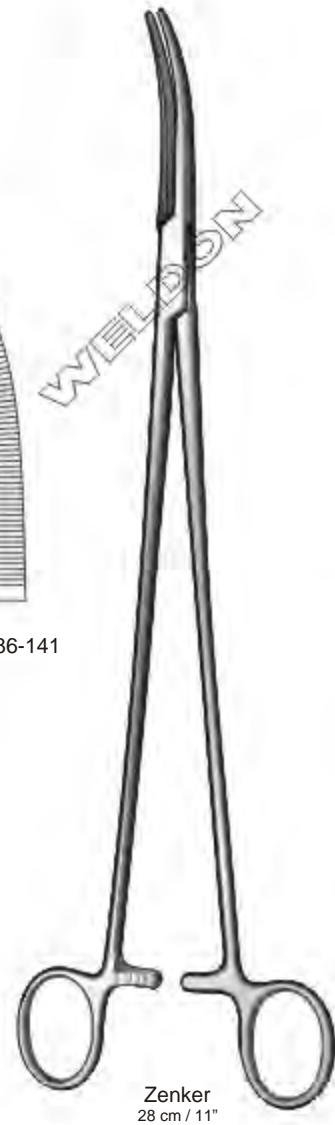

Haemostatic Forceps | Pinzas Hemostáticas | Arterienklemmen

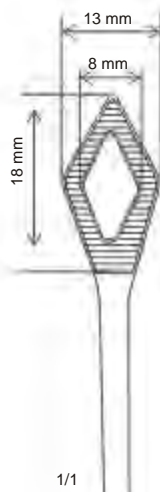
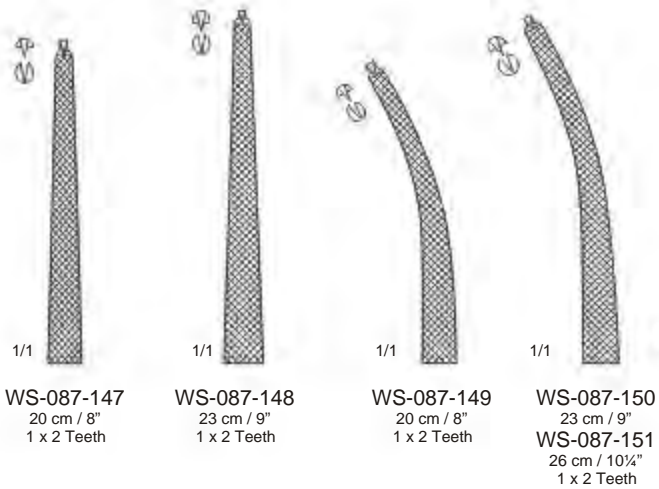
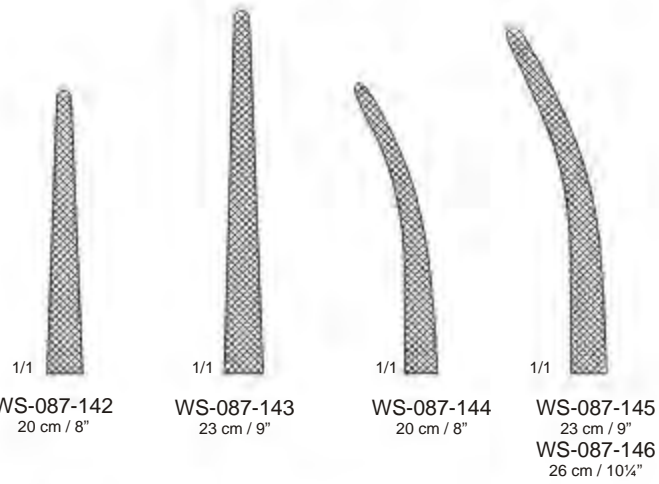

Gregoire
WS-087-152 16 cm / 6¼"
WS-087-153 20 cm / 8"
WS-087-154 25 cm / 10"



Bengolea

Haemostatic Forceps | Pinzas Hemostáticas | Arterienklemmen

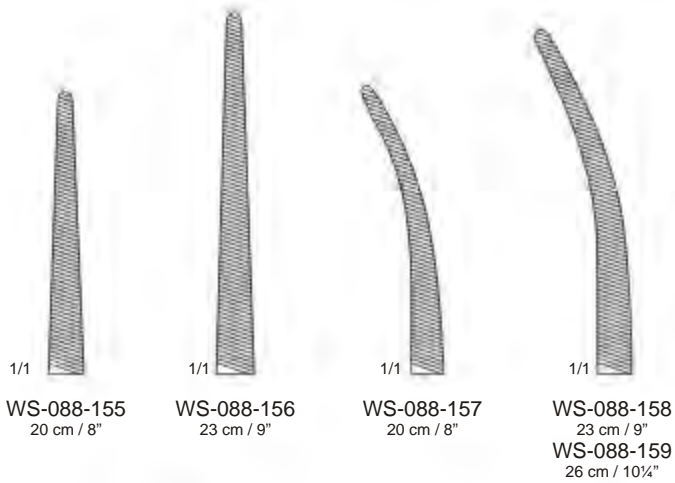
Bengolea

WS-088-155
20 cm / 8"

WS-088-156
23 cm / 9"

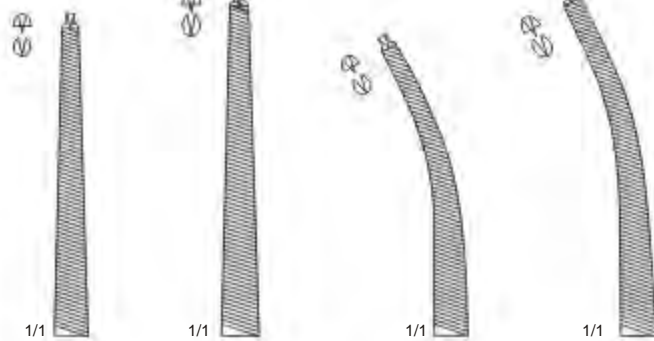
WS-088-157
20 cm / 8"

WS-088-158
23 cm / 9"
WS-088-159
26 cm / 10¼"

WS-088-160
20 cm / 8"
1 x 2 Teeth

WS-088-161
23 cm / 9"
1 x 2 Teeth

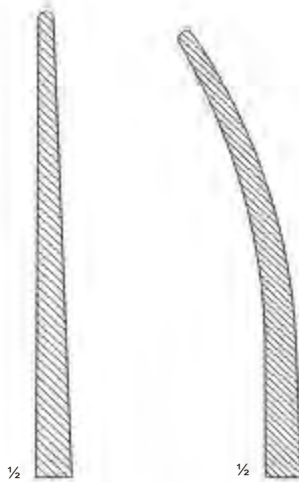
WS-088-162
20 cm / 8"
1 x 2 Teeth

WS-088-163
23 cm / 9"
WS-088-164
26 cm / 10¼"
1 x 2 Teeth

WS-088-165 18 cm / 7"
WS-088-166 21 cm / 8½"
WS-088-167 24 cm / 9½"
WS-088-168 30 cm / 12"
Straight

WS-088-169
WS-088-170
WS-088-171
WS-088-172
Curved

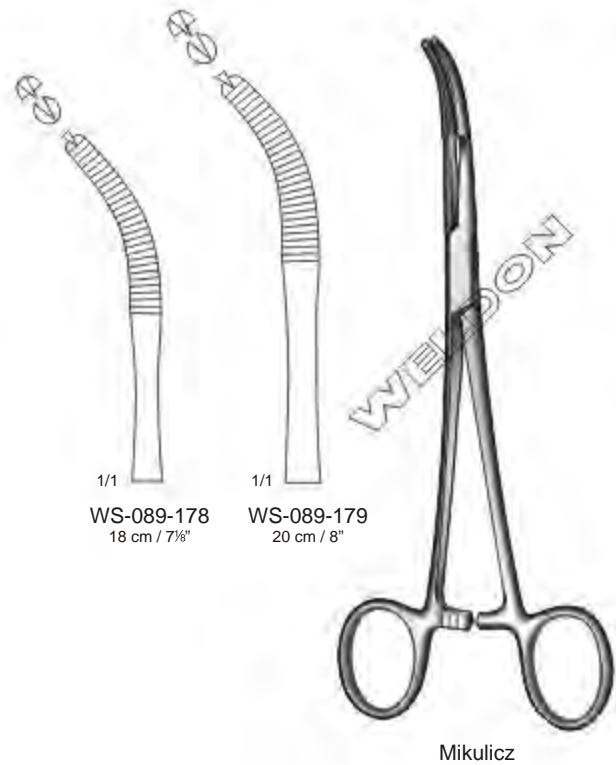
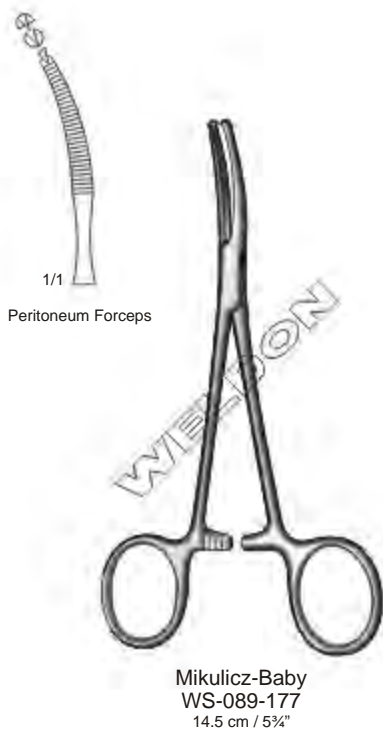
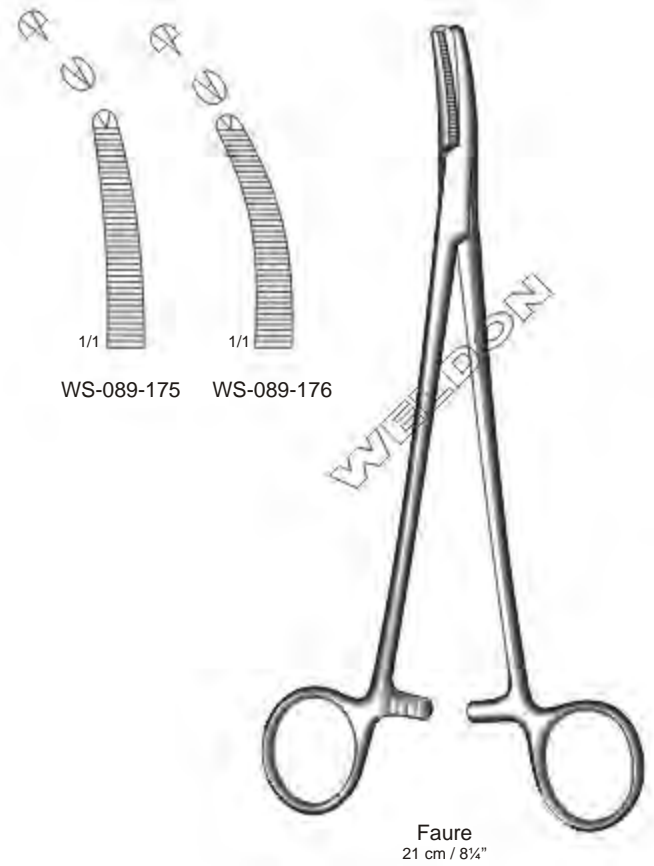
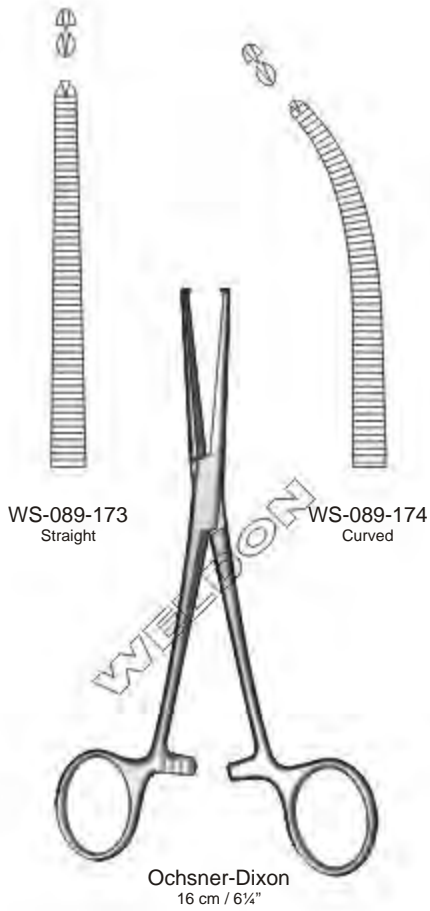
Bertola Forceps

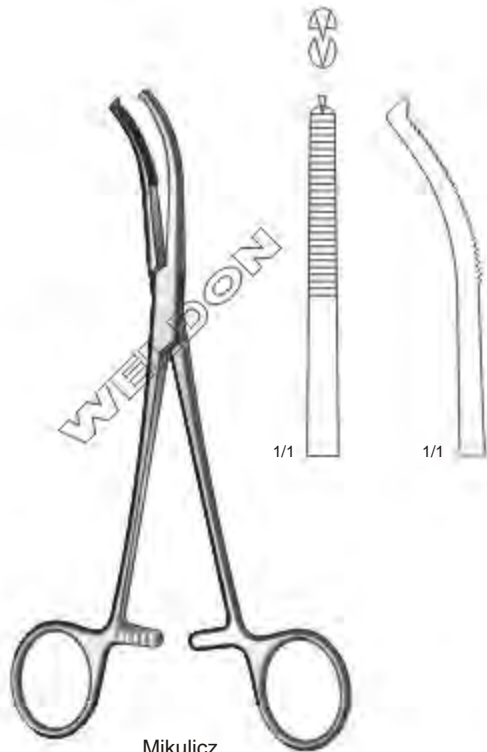

Haemostatic Forceps | Pinzas Hemostáticas | Arterienklemmen



Mikulicz
WS-090-180
18.5 cm / 7¼"
Peritoneum Forceps

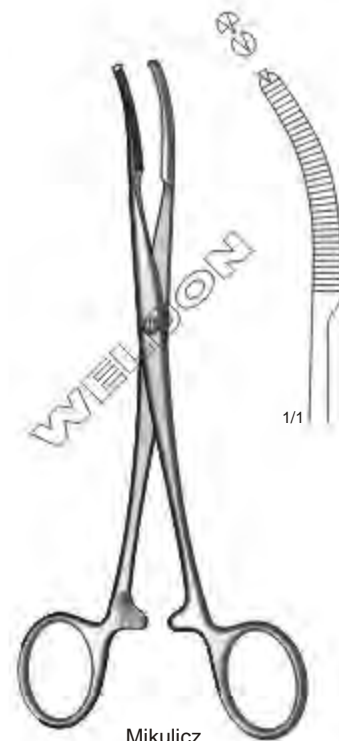

Mikulicz
WS-090-181
18 cm / 7⅙"
Peritoneum Forceps

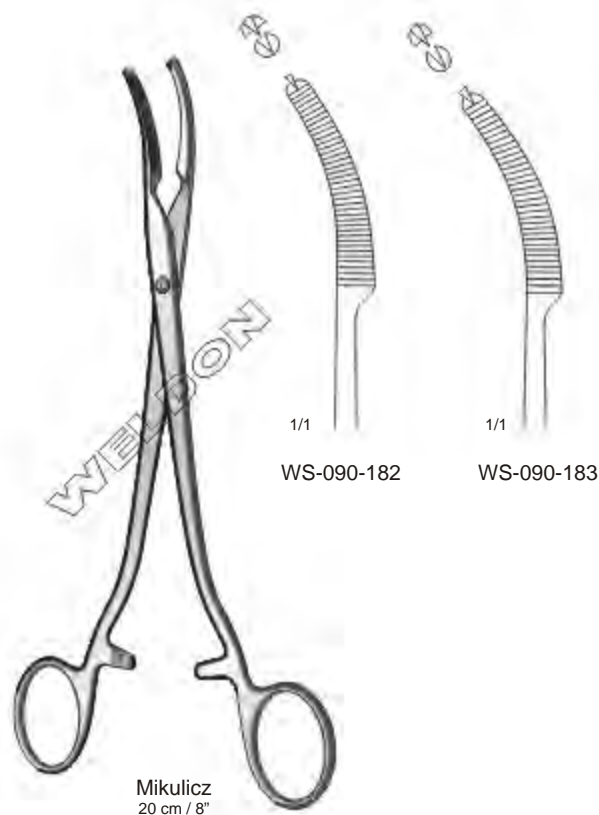

Mikulicz
20 cm / 8"

WS-090-182

WS-090-183

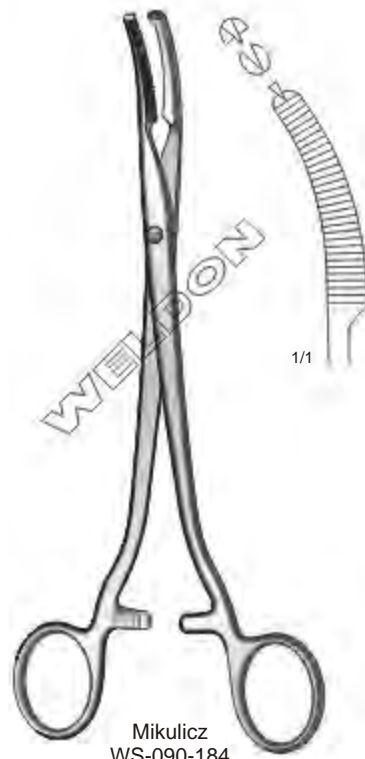

Mikulicz
WS-090-184
20 cm / 8"

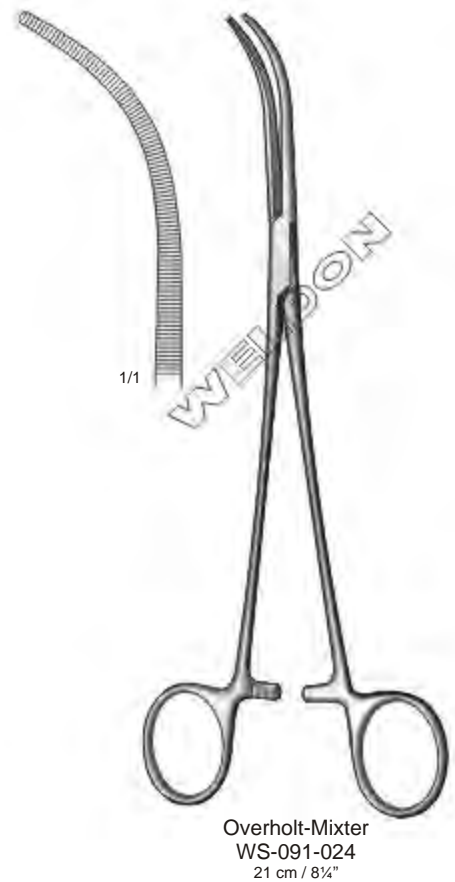
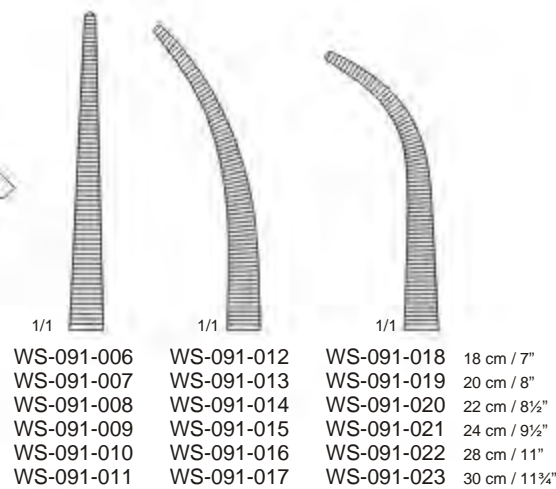
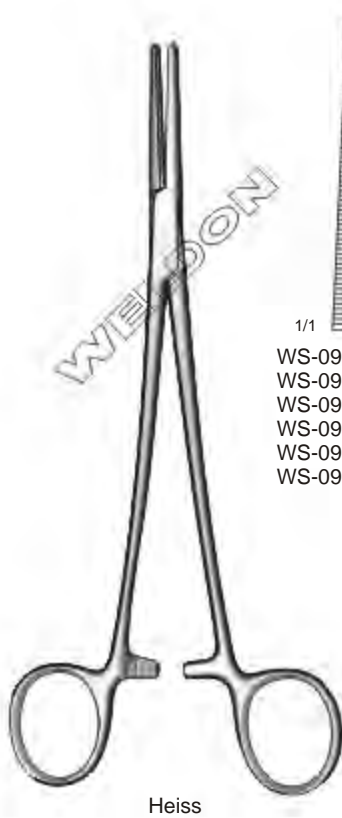
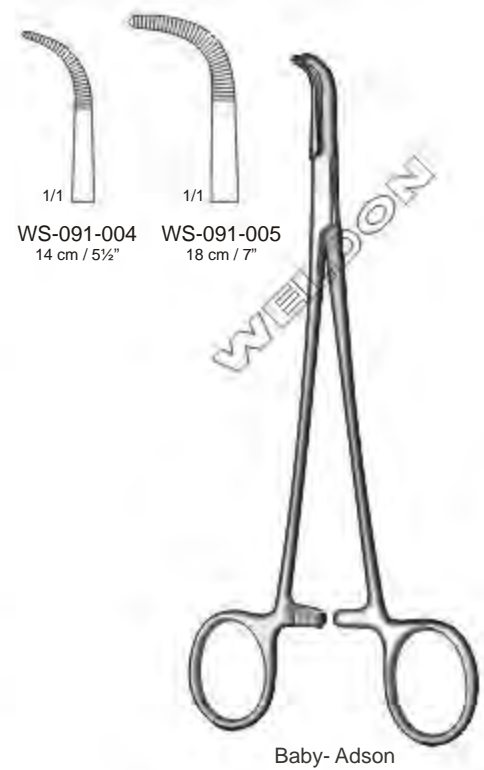
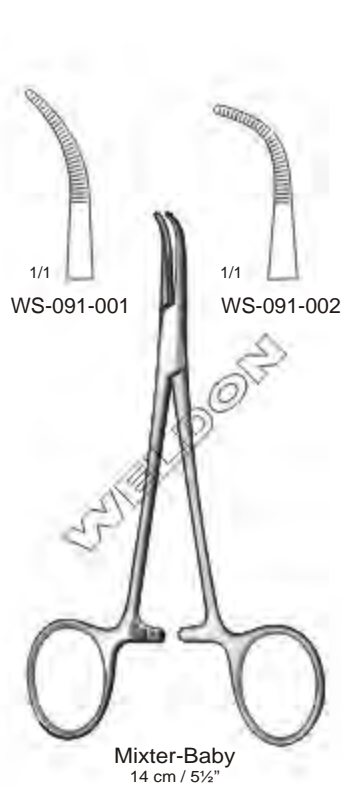

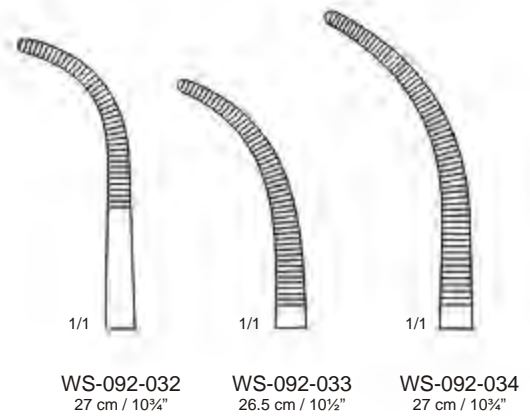
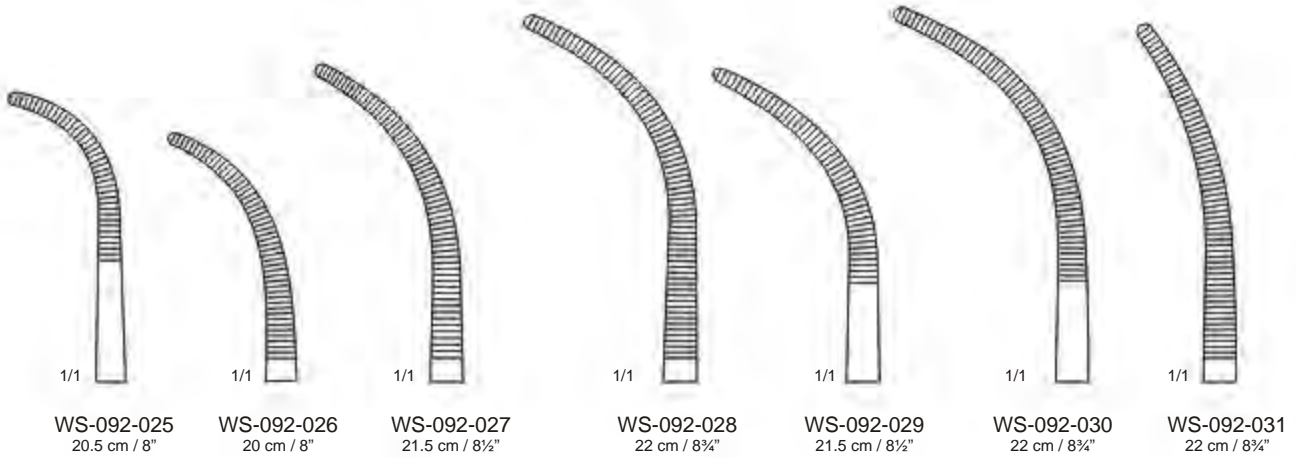
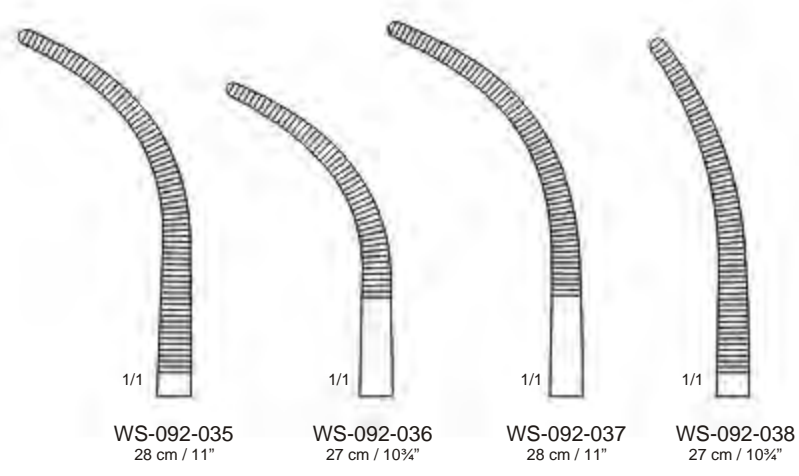
Dissecting And Ligature Forceps | Pinzas Para Preparación Y Ligadura | Präparierklemmen

Overholt-Geissendoerfer



WS-093-039
18 cm / 7"

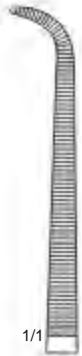

WS-093-040
22 cm / 8 1/2"



WS-093-041
25 cm / 10"



WS-093-042
28 cm / 11"



Mini-Gemini



WS-093-043
13 cm / 5"



WS-093-044
16 cm / 6 1/4"



WS-093-045
18 cm / 7"



WS-093-046
20 cm / 8"



WS-093-047
23 cm / 9"



WS-093-048
25 cm / 10"



WS-093-049
28 cm / 11"



Gemini

Dissecting And Ligature Forceps | Pinzas Para Preparación Y Ligadura
Präparierklemmen

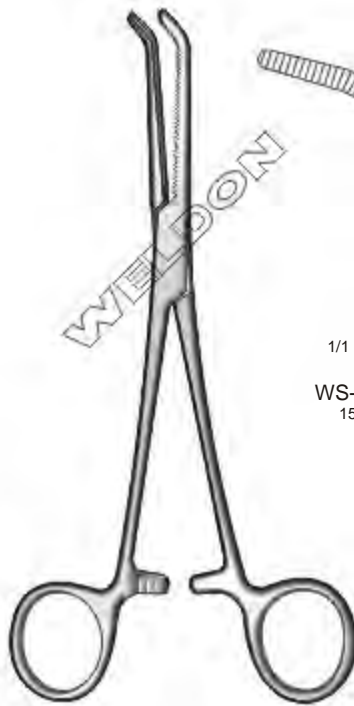

Mixer

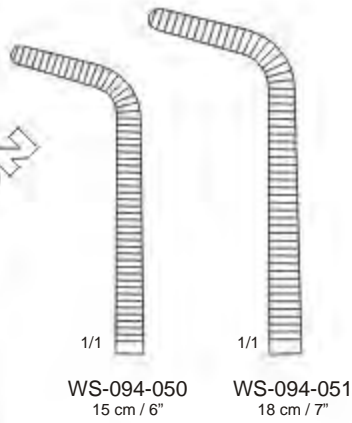

WS-094-050
15 cm / 6"

WS-094-051
18 cm / 7"

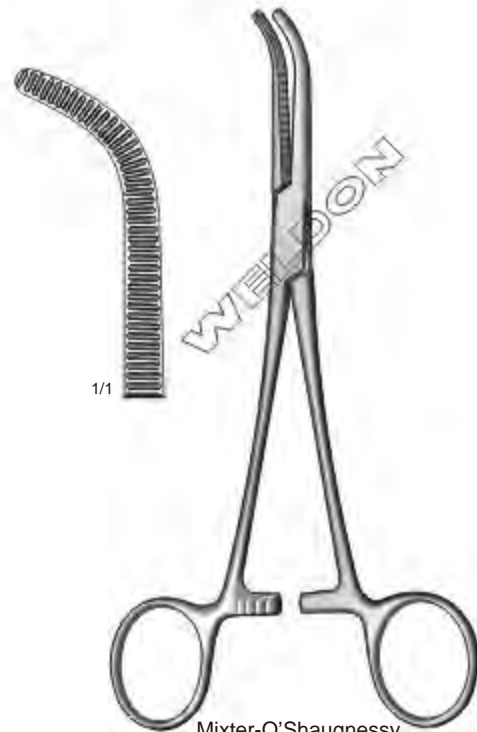

Mixer-O'Shaughnessy
WS-094-052
18 cm / 7"

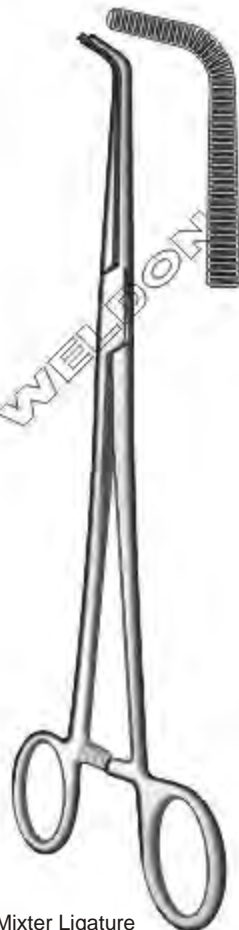

Mixer Ligature
WS-094-053 15 cm / 6"
WS-094-054 20 cm / 8"
WS-094-055 25.5 cm / 10"
Right Angled Forceps

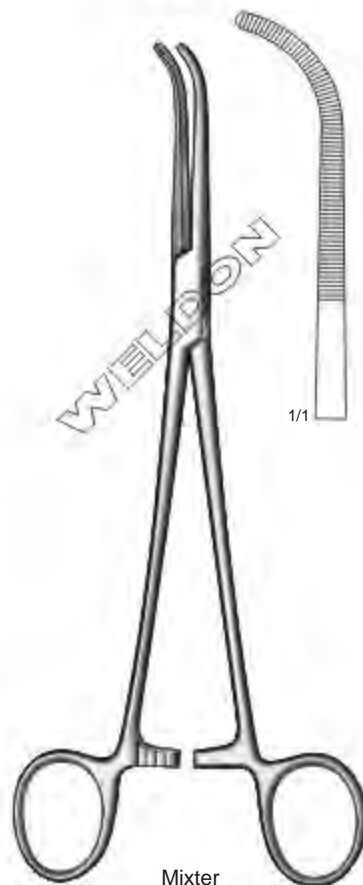

Mixer
WS-094-056
22 cm / 8¾"

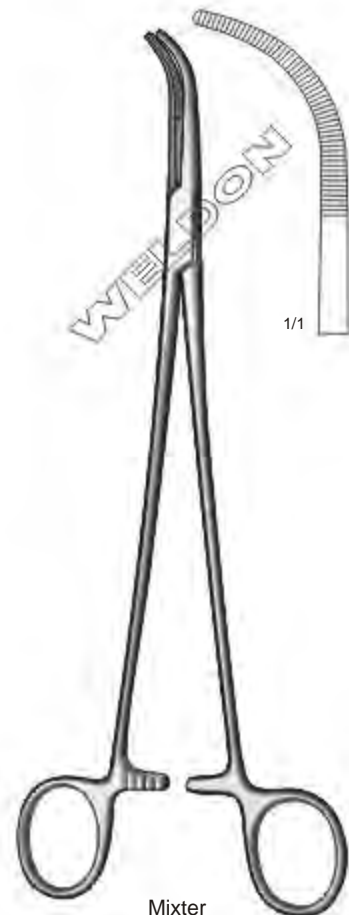

Mixer
WS-094-057
23 cm / 9"



1/1
WS-095-058
22 cm / 8 3/4"

1/1
WS-095-059
25 cm / 10"

1/1
WS-095-060
28 cm / 11"



Mixer

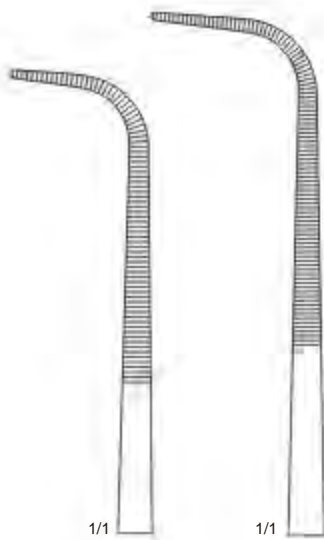

1/1
WS-095-061
21 cm / 8 1/4"

1/1
WS-095-062
24 cm / 9 1/2"



Wickström



1/1
Cross Serrated Jaw



Ligature
WS-095-063
12 cm / 4 3/4"

Dissecting & Ligature Forceps, Kidney Pedicle Clamps | Pinzas Para Preparación Y Ligadura, Pinzas Para Pediculo Renal | Präparierklemmen, Nierenstielklemmen

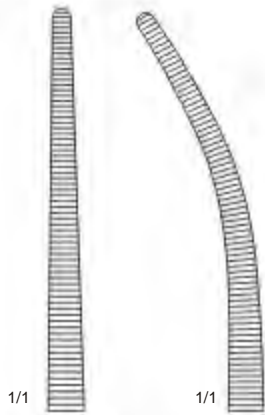

WS-096-064

WS-096-065

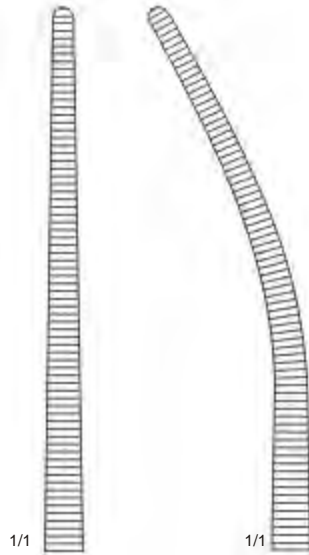

WS-096-066

WS-096-067

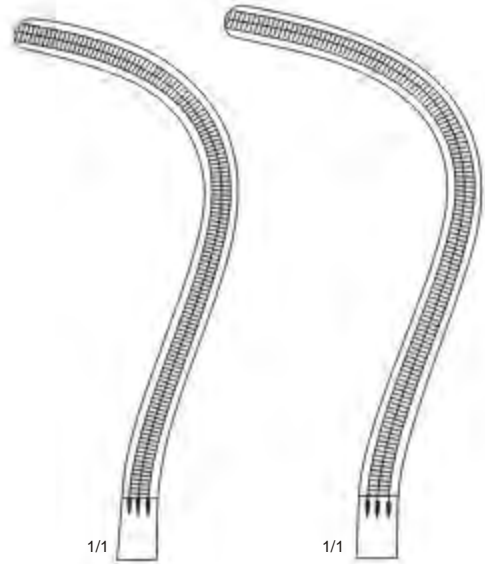

WS-096-068
23 cm / 9"

WS-096-069
24 cm / 9½"



Roberts
22 cm / 8¾"



Sarot
24 cm / 9½"



Guyon

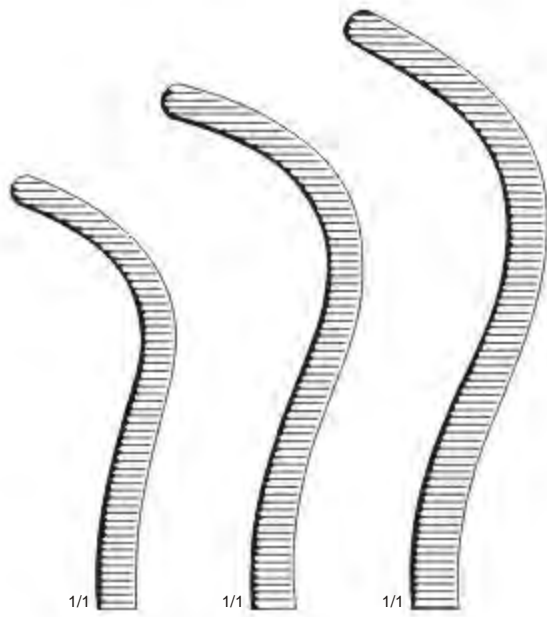

WS-097-070
20 cm / 8"

WS-097-071
22 cm / 8 3/4"

WS-097-072
24 cm / 9 1/2"



Guyon



Guyon
WS-097-073
23 cm / 9"



Desjardins
WS-097-074
21 cm / 8 1/4"

Bile Duct Clamps | Pinzas Para Conducto Biliar | Gallenkanalklemmen



Lower
WS-098-075
18.5 cm / 7 1/4"



Finochietto
WS-098-076 18 cm / 7"
WS-098-077 20 cm / 8"
WS-098-078 24 cm / 9 1/2"
WS-098-079 30 cm / 12"



WS-098-080
19 cm / 7 1/2"

WS-098-081
23 cm / 9"

Lahey

Hysterectomy Forceps | Pinzas Para Histerectomia | Hysterektomieklemmen



Meeker
WS-100-090
27 cm / 10 $\frac{3}{4}$ "



Faure
WS-100-091
25 cm / 10"



Wertheim-Cullen
WS-100-092
21.5 cm / 8 $\frac{1}{2}$ "



Wertheim
WS-101-093
24 cm / 9 1/2"
Extra Strong



Wertheim
WS-101-094
25 cm / 10"
Heavy Pattern



Wertheim
WS-101-095
25 cm / 10"

Hysterectomy Forceps | Pinzas Para Histerectomia | Hysterektomieklemmen

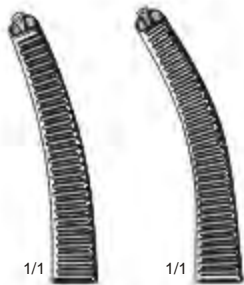

1/1

1/1

WS-102-096
22 cm / 8 3/4"
Slightly Curved

WS-102-097
23 cm / 9"
Curved

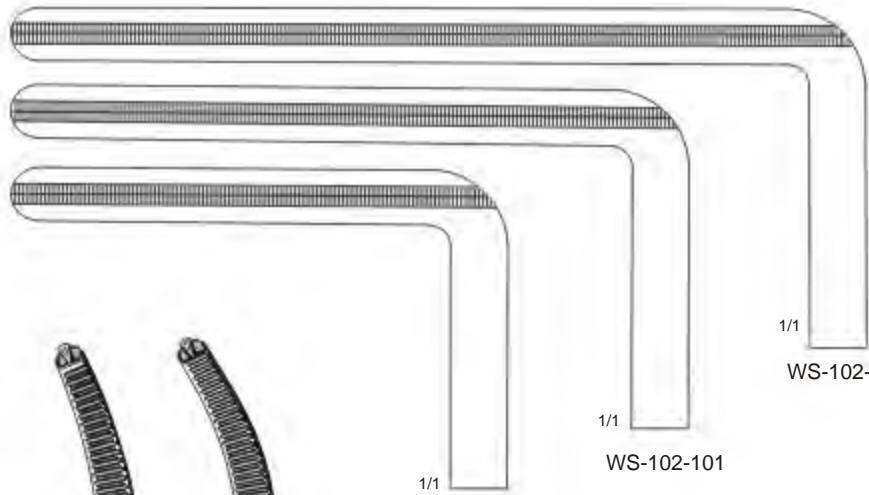

1/1
WS-102-100

1/1
WS-102-101

1/1
WS-102-102



1/1

1/1

WS-102-098
22 cm / 8 3/4"
Slightly Curved

WS-102-099
23 cm / 9"
Curved



Wertheim
1 x 2 Teeth



Wertheim
1 x 2 Teeth



Wertheim
24 cm / 9 1/2"

Sponge Forceps | Pinzas Para Tapones | Schwammzangen



Foerster



WS-103-103 18 cm / 7"
 WS-103-104 20 cm / 8"
 WS-103-105 25 cm / 10"
 Smooth Straight



WS-103-106
 WS-103-107
 WS-103-108
 Serrated



WS-103-109 18 cm / 7"
 WS-103-110 20 cm / 8"
 WS-103-111 25 cm / 10"
 Smooth Curved



WS-103-112
 WS-103-113
 WS-103-114
 Serrated

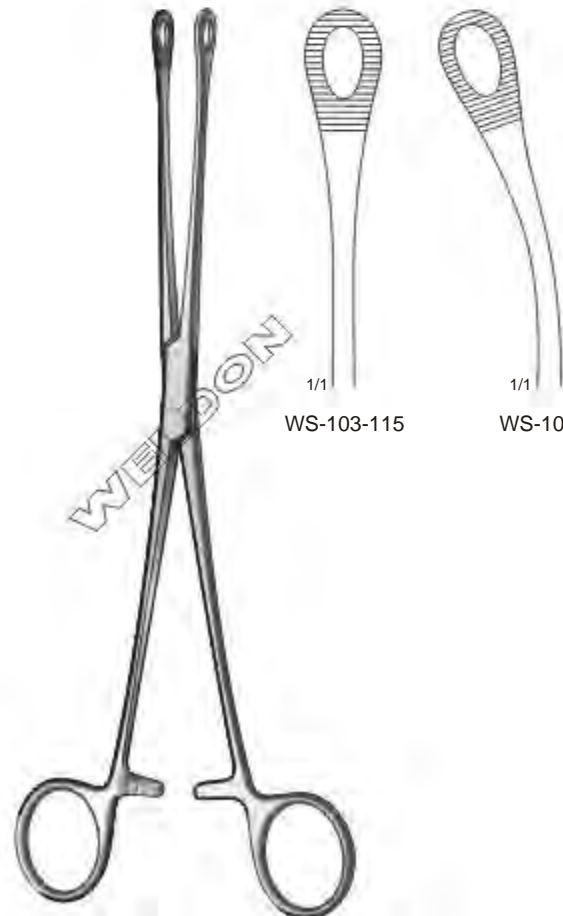

Bergmann-Foerster
 24 cm / 9½"



WS-103-115



WS-103-116

Sponge Forceps | Pinzas Para Tapones | Schwammzangen



WS-104-117
Straight

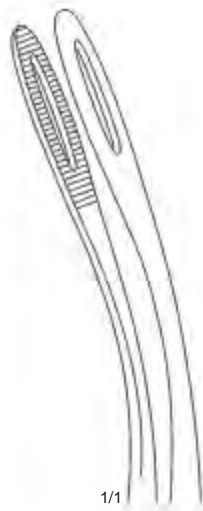

WS-104-118
Curved



Foerster
25 cm / 10"



Rampley
WS-104-119
25 cm / 10"

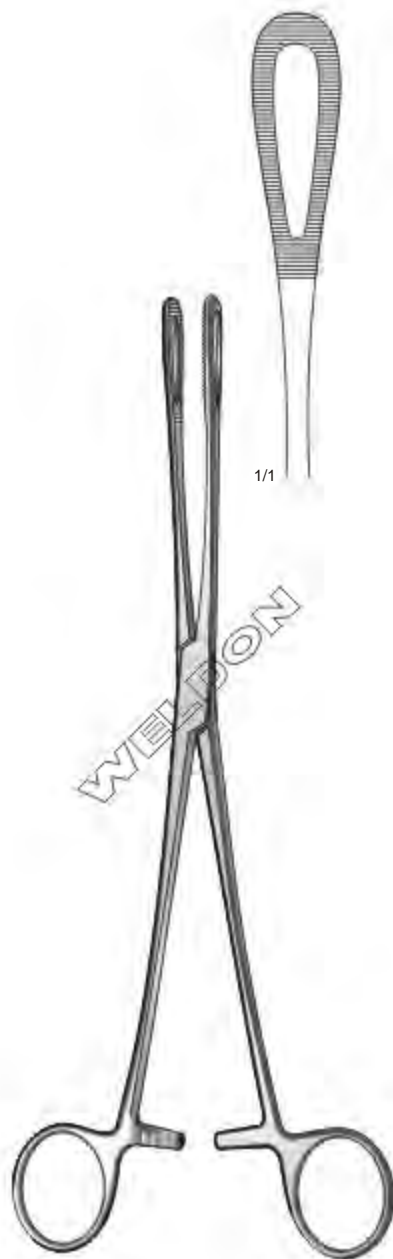

Rampley
WS-105-120 18.5 cm / 7¼"
WS-105-121 25 cm / 10"

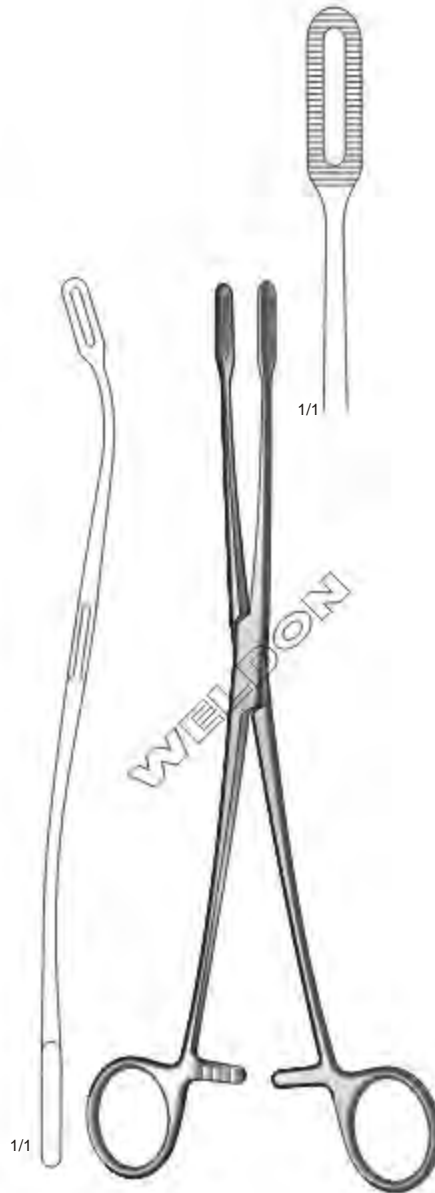

Fletcher (Javerts)
WS-105-122
24 cm / 9½"

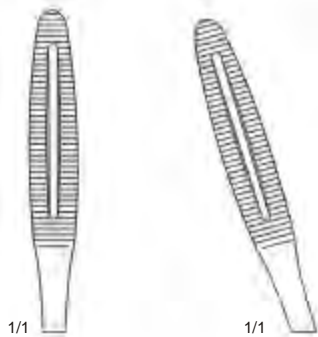

Fletcher (Javerts)
WS-105-123
24 cm / 9½"

Dressing Forceps | Pinzas Para Vendajes | Kornzangen

WS-106-124	20 cm / 8"	WS-106-127
WS-106-125	22 cm / 8¾"	WS-106-128
WS-106-126	25 cm / 10"	WS-106-129

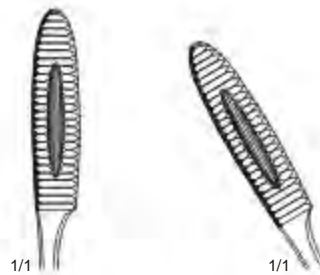

WS-106-130	20 cm / 8"	WS-106-134
WS-106-131	22 cm / 8¾"	WS-106-135
WS-106-132	25 cm / 10"	WS-106-136
WS-106-133	27 cm / 10½"	WS-106-137

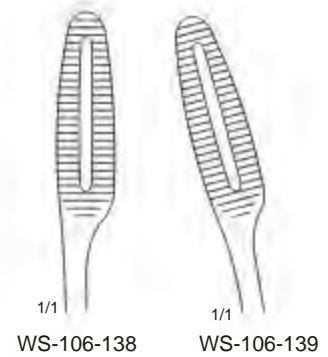

1/1	WS-106-138	1/1	WS-106-139
-----	------------	-----	------------

Gross-Maier

Gross-Maier

Sims-Maier
28 cm / 11"

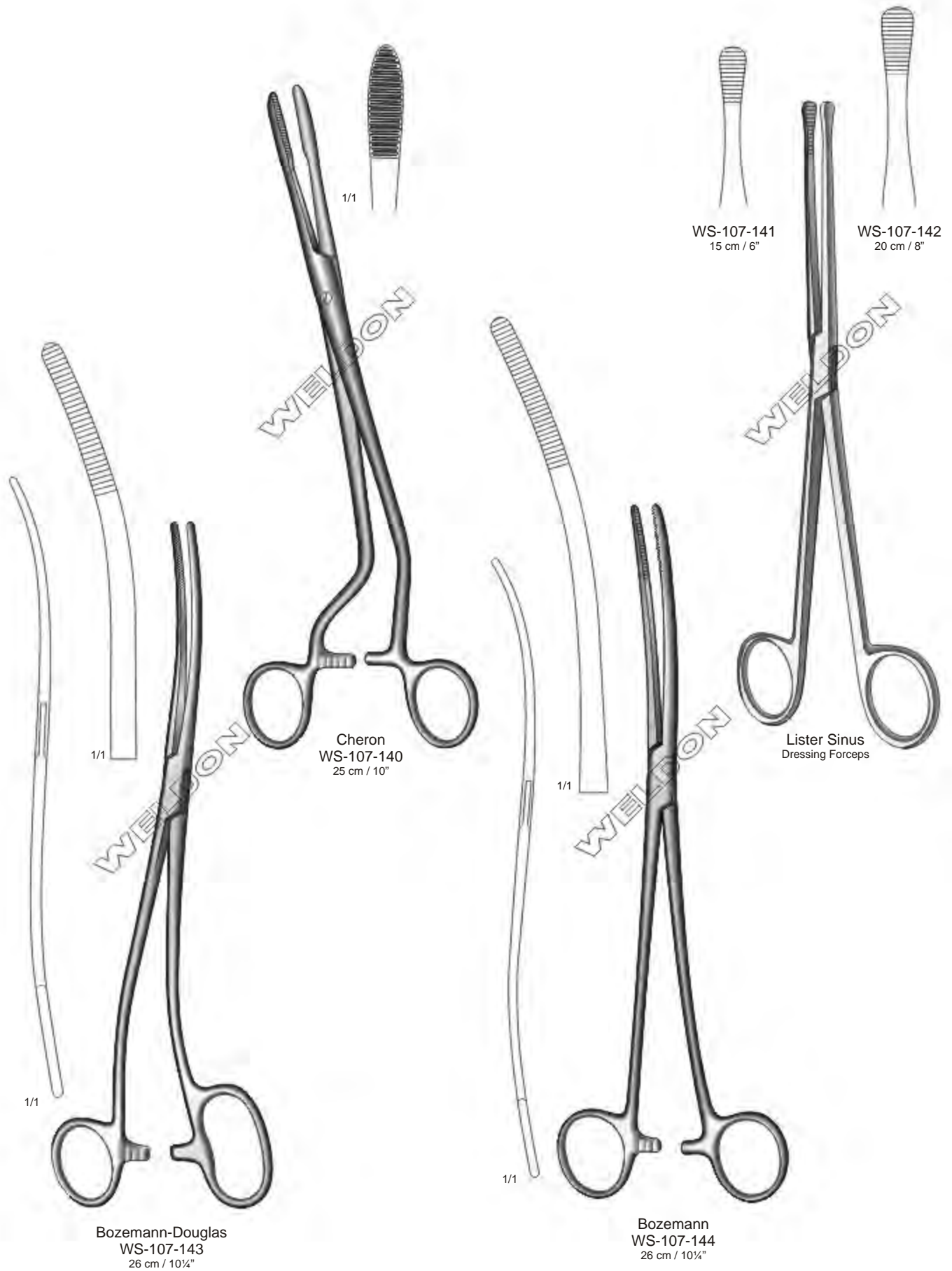

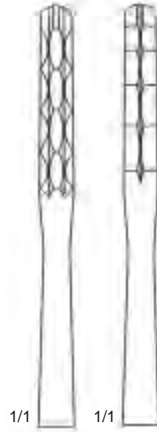

WS-108-145
18 cm / 7¹/₈"

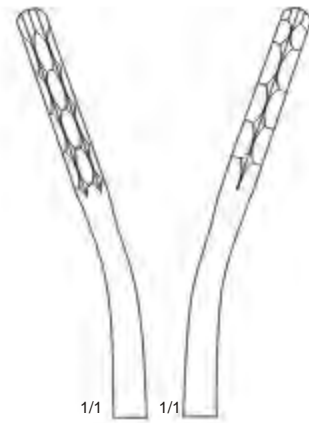

WS-108-146
18 cm / 7¹/₈"



WS-108-147 20 cm / 8"
WS-108-148 22 cm / 8³/₄"
WS-108-149 26 cm / 10¹/₄"

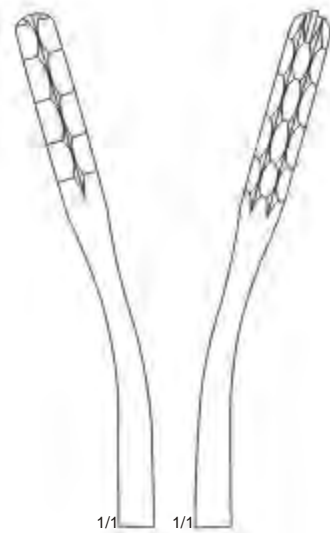

WS-108-150 20 cm / 8"
WS-108-151 22 cm / 8³/₄"
WS-108-152 26 cm / 10¹/₄"

Dressing And Haemostatic Forceps | Pinzas Hemostáticas | Arterienklemmen



Spencer-Wells

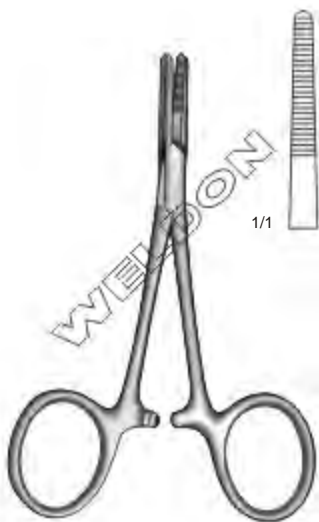
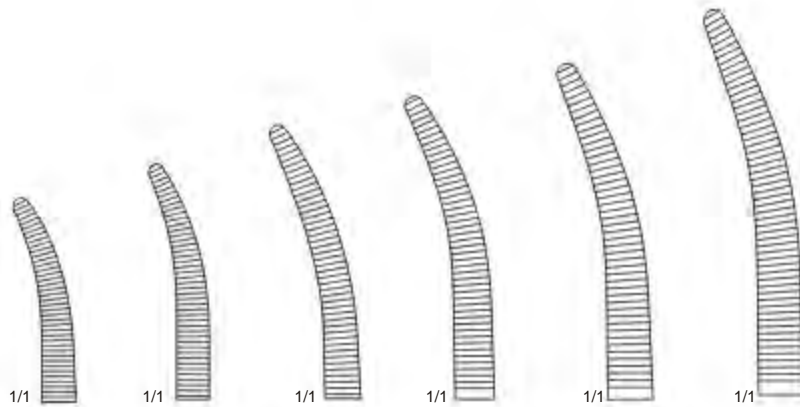
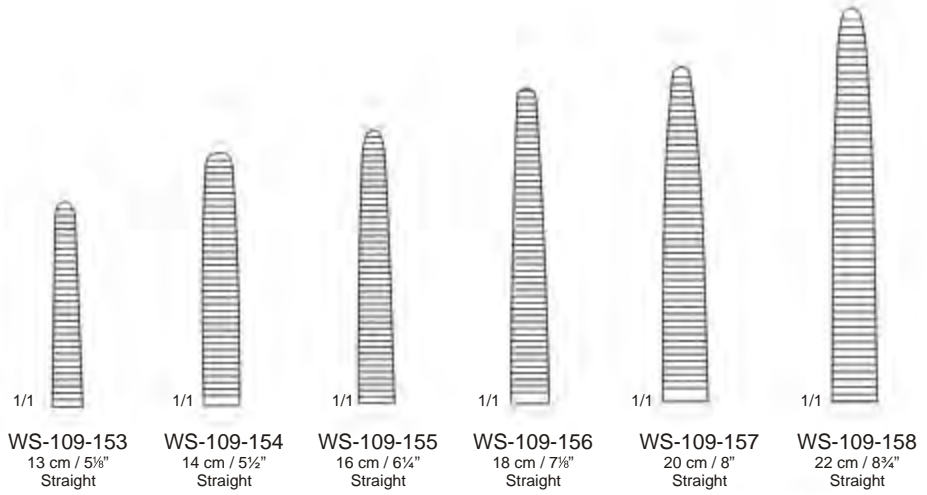

Terrier
WS-109-165
13 cm / 5 $\frac{1}{8}$ "



Pean
WS-109-166 14 cm / 5 $\frac{1}{2}$ "
WS-109-167 16 cm / 6 $\frac{1}{4}$ "

Tubing Clamps | Pinzas Para Tubos | Schlauchklemmen



Standard



WS-110-001
15 cm / 6"



WS-110-002
18 cm / 7"



WS-110-003
20 cm / 8"



With Safety Guard



WS-110-004
15 cm / 6"



WS-110-005
18 cm / 7"



WS-110-006
20 cm / 8"





Collin
 WS-111-007 16 cm / 6½"
 WS-111-008 17 cm / 6¾"



Pennington

WS-111-009
 15 cm / 6"

WS-111-010
 20 cm / 8"

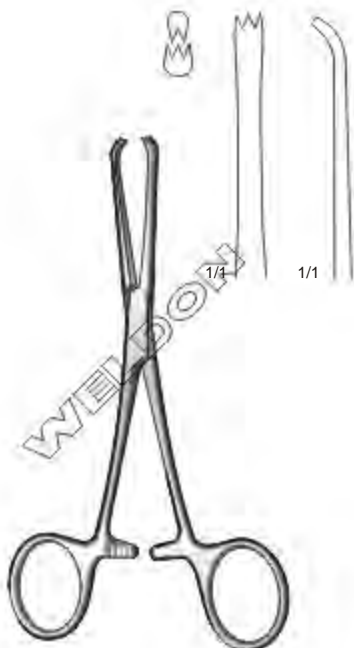

Chaput
 WS-111-011
 14 cm / 5½"

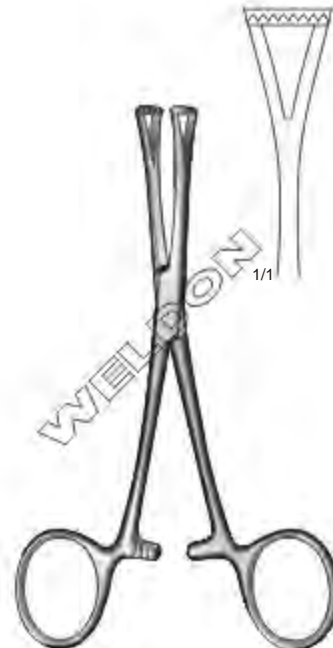

Collin
 WS-111-012
 14 cm / 5½"



Surgical Haemostatic Forceps
WS-112-013
14.5 cm / 5½"

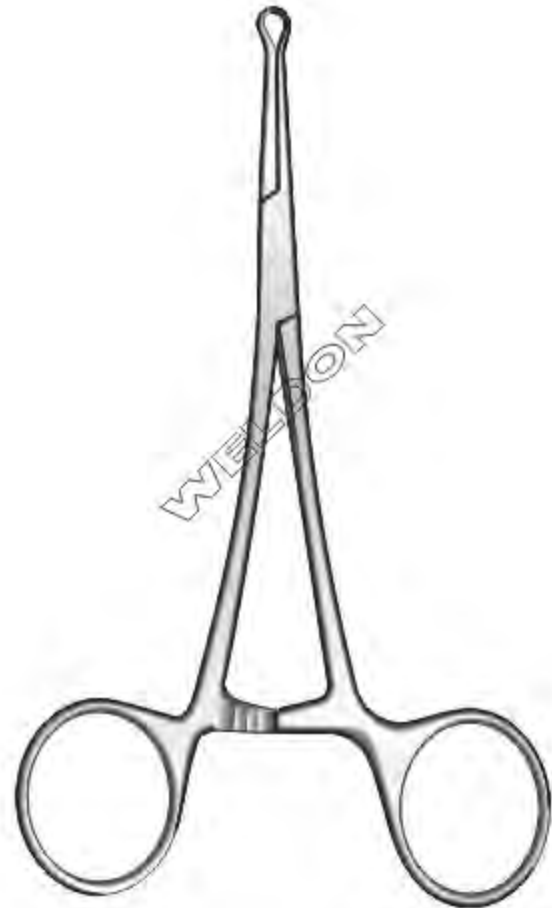

Ring Forceps
WS-112-014
14.5 cm / 5½"



Schädel
WS-113-015
9 cm / 3½"



Jones
WS-113-016 5 cm / 2"
WS-113-017 9 cm / 3½"



Backhaus
WS-113-018 11 cm / 4½"
WS-113-019 13 cm / 5"
Delicate Pattern

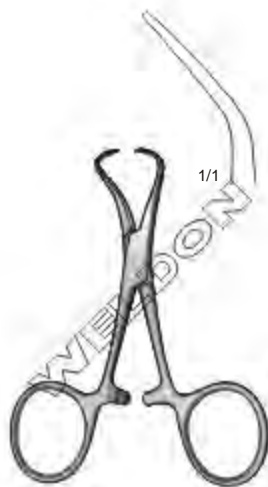

Backhaus
WS-113-020 8 cm / 3½"
WS-113-021 11 cm / 4½"
WS-113-022 13 cm / 5"
WS-113-023 15 cm / 6"



Röeder
WS-113-024 13 cm / 5"
WS-113-025 15 cm / 6"



Lorna
WS-113-026 10 cm / 4"
WS-113-027 13 cm / 5"



Doyen
WS-113-028
18 cm / 7½"

Bulldog Clamps | Clamps Bulldog | Bulldog-Klemmen

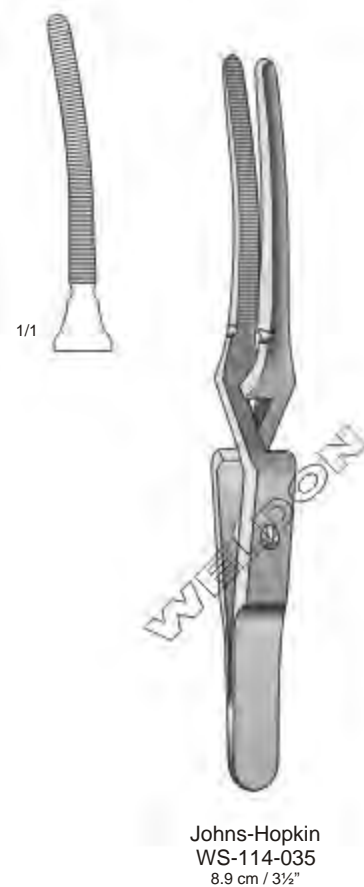
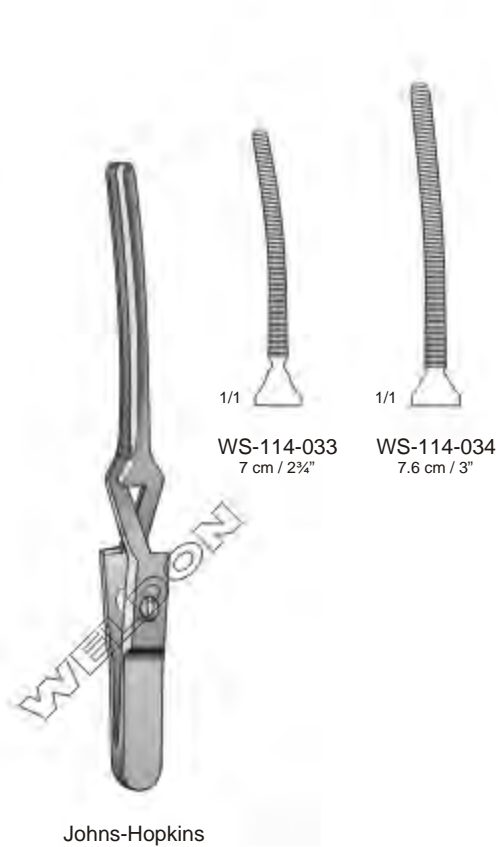
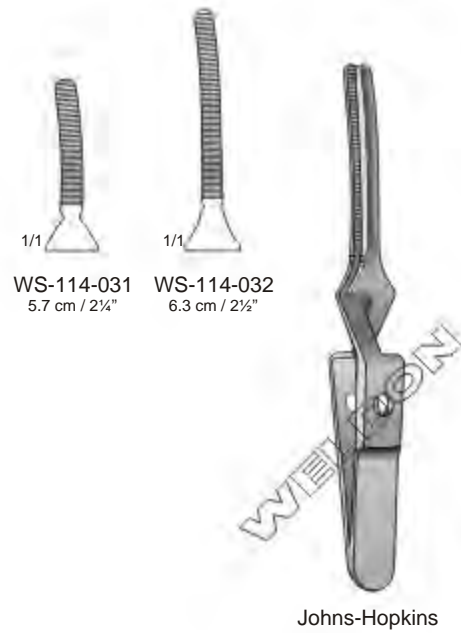



WS-115-036 4.5 cm / 1 3/4" WS-115-037 5 cm / 2" WS-115-038 5.5 cm / 2 1/8"

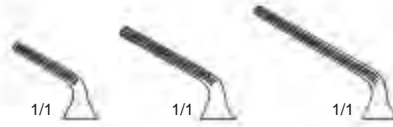

WS-115-039 4.5 cm / 1 3/4" WS-115-040 5 cm / 2" WS-115-041 5.5 cm / 2 1/8"



Diethrich
Straight



Diethrich
Curved

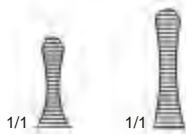

WS-115-042 3.8 cm / 1 1/2" WS-115-043 5.1 cm / 2"



WS-115-044 3.8 cm / 1 1/2" WS-115-045 5.1 cm / 2"

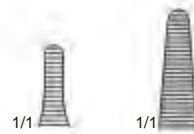

WS-115-046 3.5 cm / 1 3/8" WS-115-047 5.5 cm / 2 1/8"

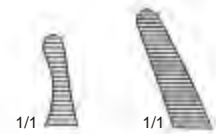

WS-115-048 3.5 cm / 1 3/8" WS-115-049 5.5 cm / 2 1/8"



Dieffenbach
Straight



Dieffenbach
Curved



Dieffenbach
Straight



Dieffenbach
Curved

Atraumatic Bulldog Clamps | Clamps Bulldog Atraumáticas | Atraumatische Bulldog-Klemmen

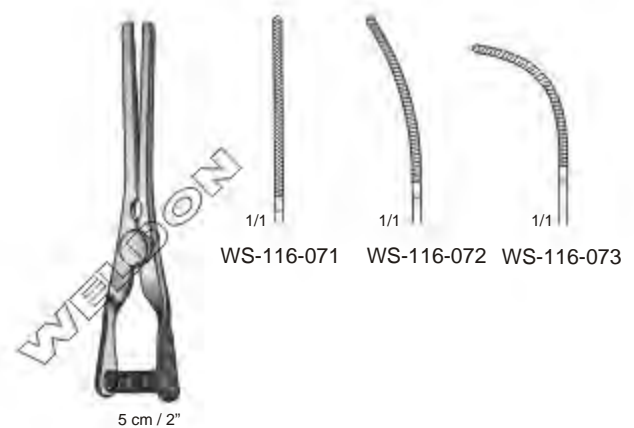
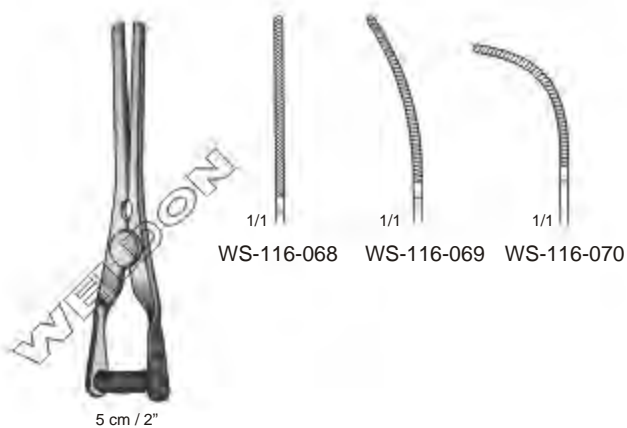
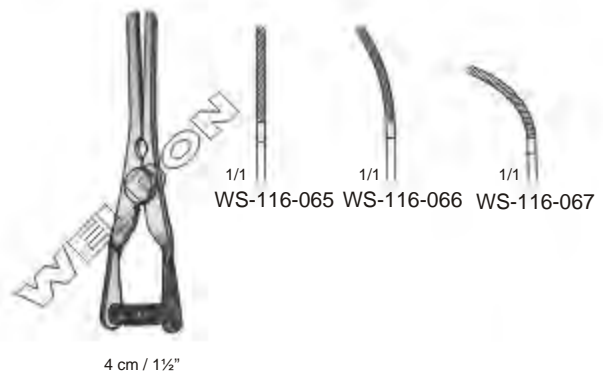
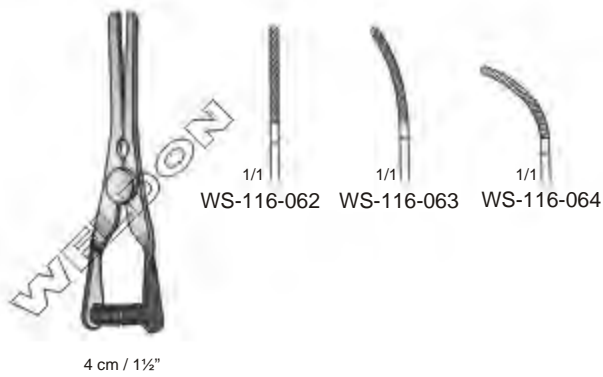
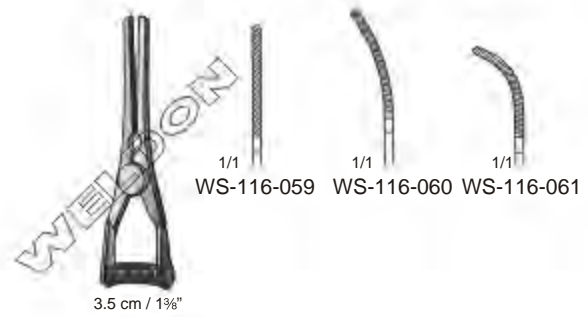
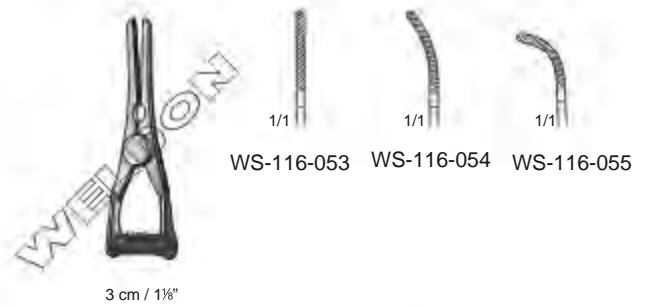



www.weldoninstruments.com

PROVEEDOR EXCLUSIVO:



Needle Holders

Needle Holders with TC inserts

Reverdin Needles

Ligature Needles

117 - 136

Suture

Suture

Sutura

Naht

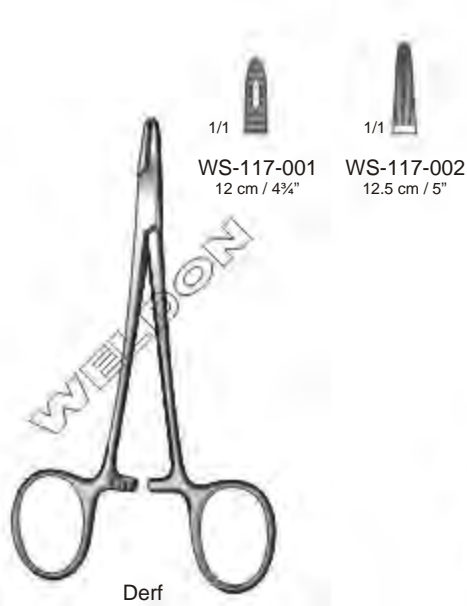

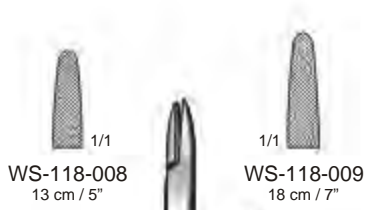
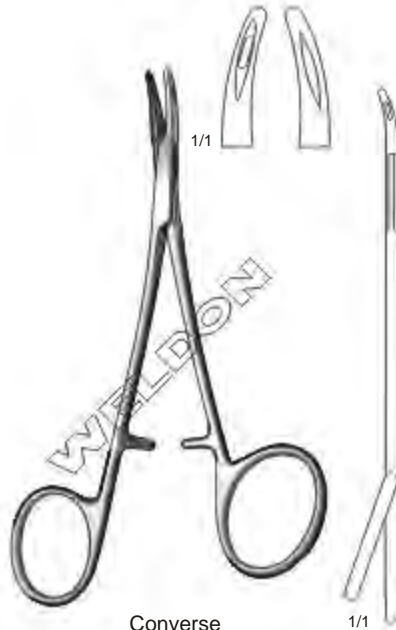
Needle Holders | Porta Agujas | Nadelhalter

Brown

Converse
WS-118-010
 15 cm / 6"

Crile-Murray
WS-118-011
 15 cm / 6"

Crile-Wood
WS-118-012 15 cm / 6"
WS-118-013 18 cm / 7"
WS-118-014 20 cm / 8"

Adson
WS-118-015
 18 cm / 7"

Metzenbaum
WS-118-016
 18 cm / 7"



Mini-Ryder "French"

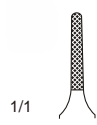

1/1

WS-119-017
13 cm / 5 $\frac{1}{8}$ "



1/1

WS-119-018
15 cm / 6"



1/1

WS-119-019
18 cm / 7 $\frac{1}{8}$ "



1/1

WS-119-020
20 cm / 8"

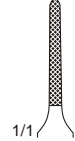

1/1

WS-119-021
22.5 cm / 9"



1/1

M.G.H (Mass-General-Hospital)
WS-119-022
17 cm / 6 $\frac{3}{4}$ "



1/1

WS-119-023
13 cm / 5"



1/1

WS-119-024
14 cm / 5 $\frac{1}{2}$ "



1/1

WS-119-025
15 cm / 6"



1/1

WS-119-026
16 cm / 6 $\frac{1}{4}$ "



Senning
WS-119-022A
15 cm / 6"
WS-119-022B
17 cm / 6 $\frac{3}{4}$ "



1/1

WS-119-027
18 cm / 7"



1/1

WS-119-028
20 cm / 8"



1/1

WS-119-029
24 cm / 9 $\frac{1}{2}$ "



1/1

WS-119-030
26 cm / 10 $\frac{1}{4}$ "



1/1

WS-119-031
30 cm / 12"



1/1

WS-119-023A
13 cm / 5"



1/1

WS-119-024A
14 cm / 5 $\frac{1}{2}$ "



1/1

WS-119-025A
15 cm / 6"



1/1

WS-119-026A
16 cm / 6 $\frac{1}{4}$ "



1/1

WS-119-027A
18 cm / 7"



1/1

WS-119-028A
20 cm / 8"



1/1

WS-119-029A
24 cm / 9 $\frac{1}{2}$ "



1/1

WS-119-030A
26 cm / 10 $\frac{1}{4}$ "



1/1

WS-119-031A
30 cm / 12"



Mayo-Hegar

Needle Holders | Porta Agujas | Nadelhalter

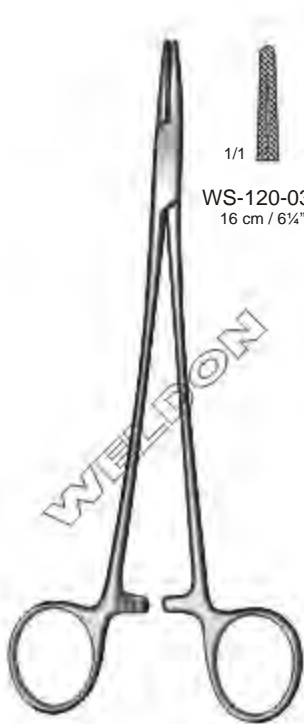

Mayo-Hegar
Delicate

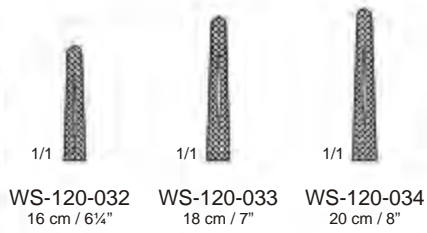

DeBakey

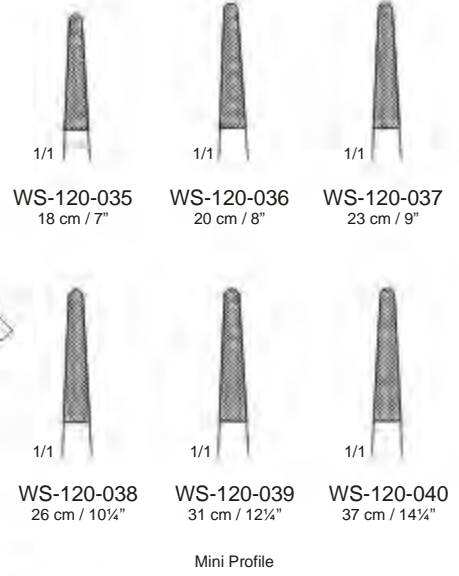

Jamison
WS-120-041
23.5 cm / 9¼"



Masson
WS-120-042
27 cm / 10½"



Finochietto
WS-121-043
27 cm / 10½"



Wangenstein
WS-121-044
27 cm / 10½"



Johnson
WS-121-045
27 cm / 10½"



Stratte
WS-121-046
23 cm / 9"

Needle Holders | Porta Agujas | Nadelhalter

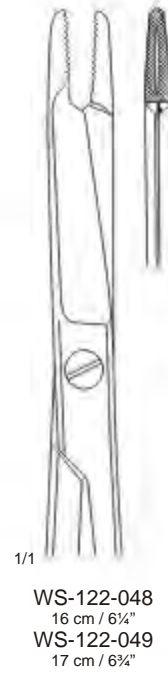
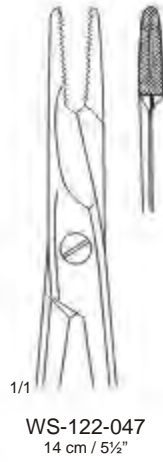

Olsen-Hegar
WS-122-050 14 cm / 5½"
WS-122-051 16 cm / 6¼"
WS-122-052 18 cm / 7"

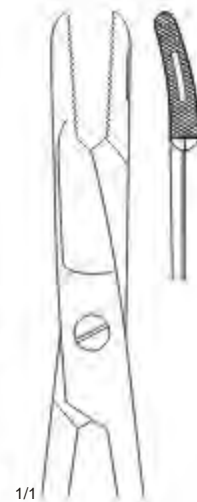
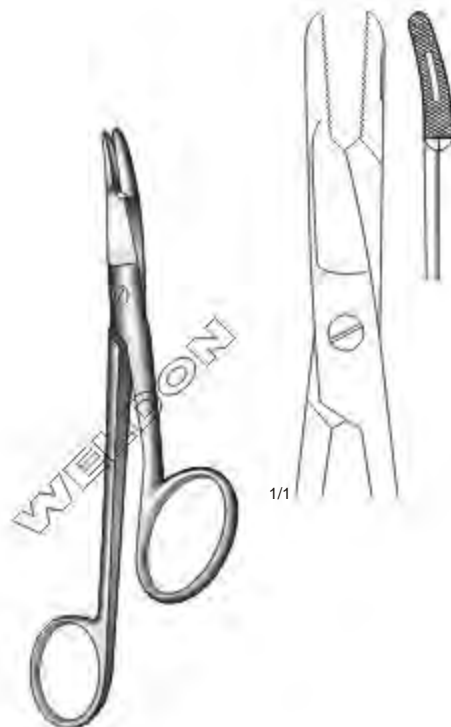



Gillies
WS-122-053
16 cm / 6¼"



Crile
WS-123-054
15 cm / 6"





Mathieu

- 
 WS-123-055
 14 cm / 5½"
- 
 WS-123-056
 17 cm / 6¾"
- 
 WS-123-057
 20 cm / 8"





Mathieu
Slender Jaws

- 
 WS-123-058
 14 cm / 5½"
- 
 WS-123-059
 17 cm / 6¾"



Mathieu

- 
 WS-123-060
 17 cm / 6¾"
- 
 WS-123-061
 20 cm / 8"



Toennis
WS-123-062
18 cm / 7"

Needle Holders With Tungsten Carbide Inserts | Porta Agujas Con Carburo De Tungsteno
Nadelhalter Mit Hartmetalleinlagen

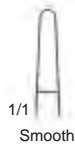

Webster
WS-124-001
13 cm / 5"



Webster
12 cm / 4 3/4"



WS-124-003



WS-124-004
13 cm / 5"



WS-124-005
14 cm / 5 1/2"

Mini Profile

Hegar-Baumgartner



WS-124-006
Smooth



WS-124-007
Mini Profile

Halsey
13 cm / 5"

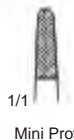

Derf
WS-124-008
12 cm / 4 3/4"



Mini Profile

Crile-wood
WS-124-009
15 cm / 6"
WS-124-010
16 cm / 6 1/4"

Needle Holders With Tungsten Carbide Inserts | Porta Agujas Con Carburo De Tungsteno
Nadelhalter Mit Hartmetalleinlagen

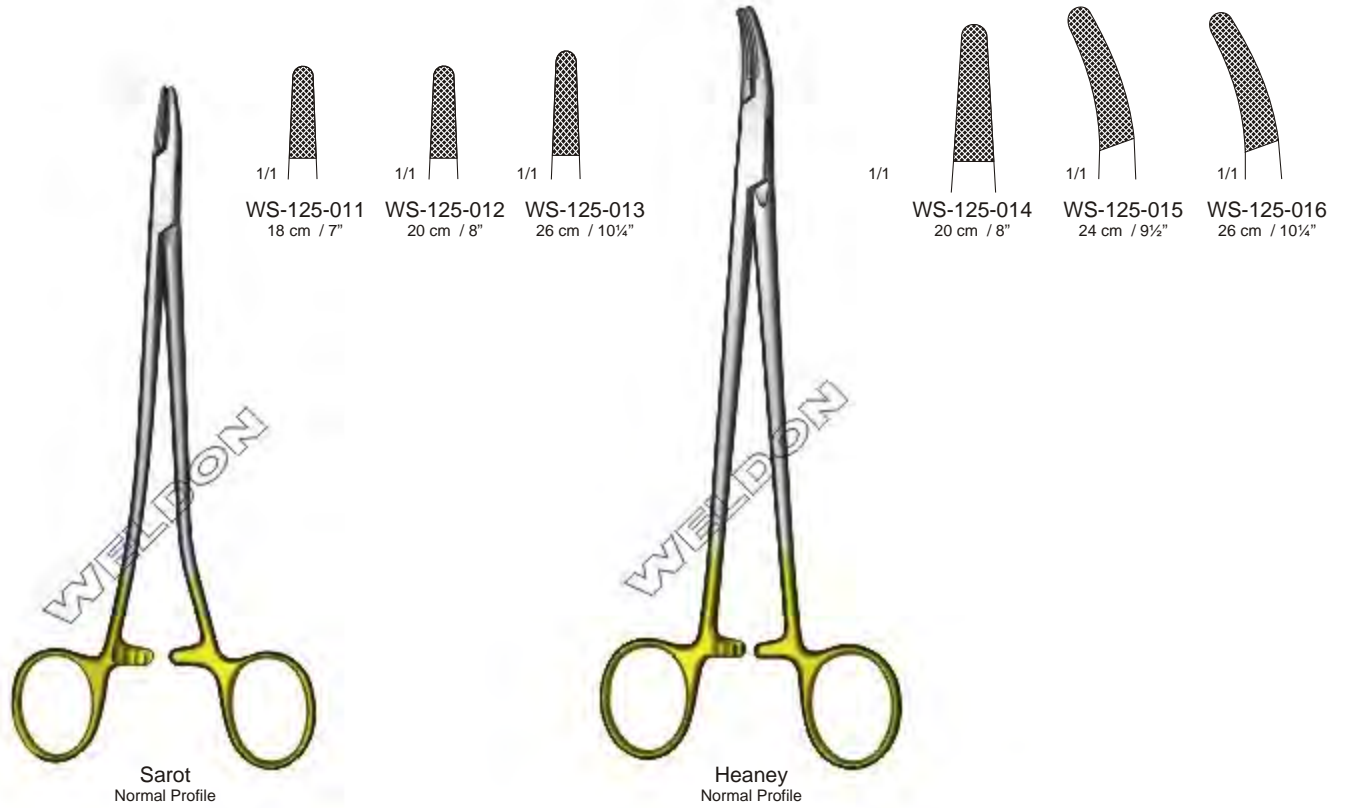

Needle Holders With Tungsten Carbide Inserts | Porta Agujas Con Carburo De Tungsteno
Nadelhalter Mit Hartmetalleinlagen



Masson
WS-126-025
27 cm / 10½"



DeBakey

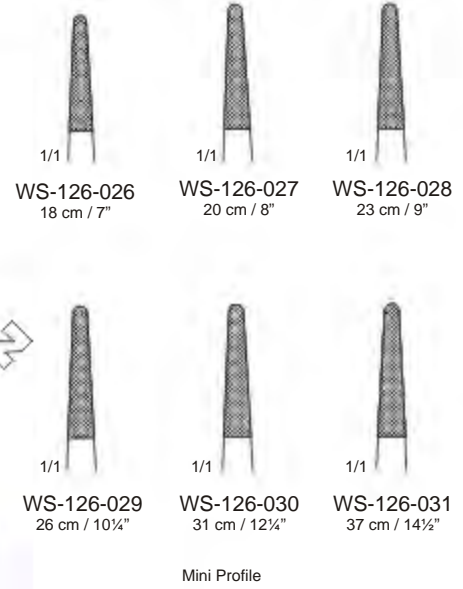

Martin
Mini Profile
Elastic Type

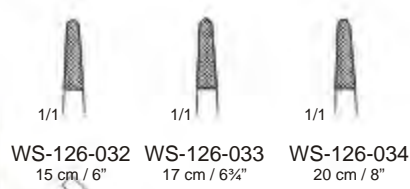

Converse
WS-126-035
15 cm / 6"

Needle Holders With Tungsten Carbide Inserts | Porta Agujas Con Carburo De Tungsteno
Nadelhalter Mit Hartmetalleinlagen



WS-127-036
13 cm / 5 1/8"



WS-127-037
15 cm / 6"

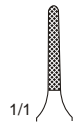

WS-127-038
18 cm / 7 1/8"

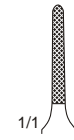

WS-127-039
20 cm / 8"

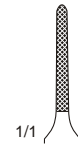

WS-127-040
23 cm / 9"

Mini Profile



Ryder "French"



WS-127-041
13 cm / 5 1/8"

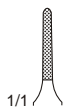

WS-127-042
15 cm / 6"

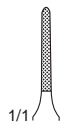

WS-127-043
18 cm / 7 1/8"

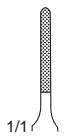

WS-127-044
20 cm / 8"

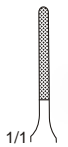

WS-127-045
23 cm / 9"

Micro Profile



Ryder-Vascular

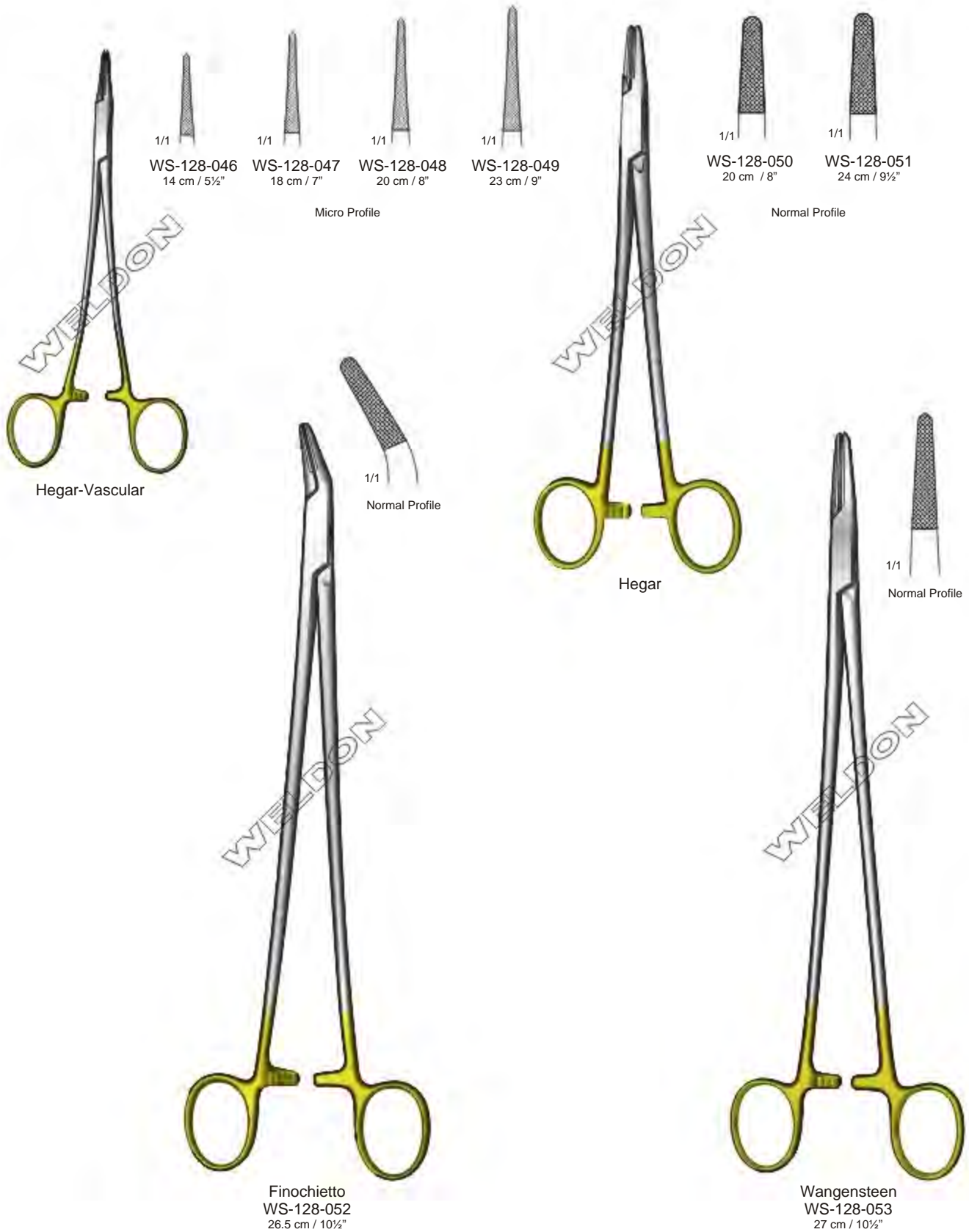

Senning
WS-127-045A
15 cm / 6"
WS-127-045B
17 cm / 6 3/4"

**Needle Holders With Tungsten Carbide Inserts | Porta Agujas Con Carburo De Tungsteno
Nadelhalter Mit Hartmetalleinlagen**

Needle Holders With Tungsten Carbide Inserts | Porta Agujas Con Carburo De Tungsteno
Nadelhalter Mit Hartmetalleinlagen

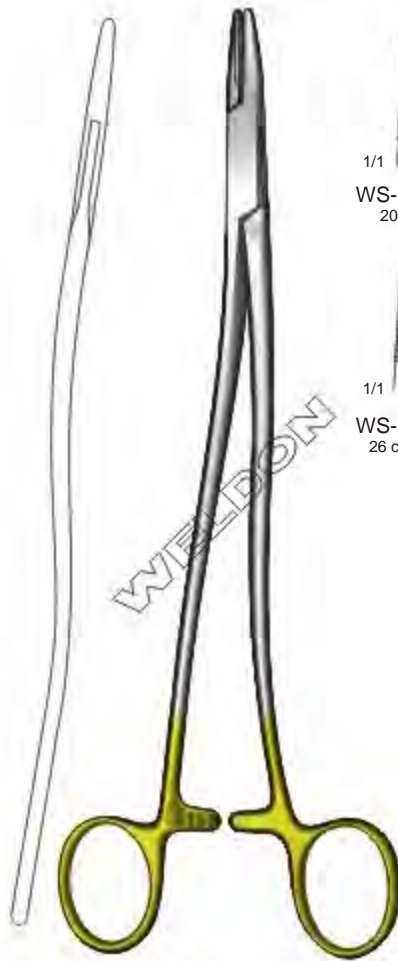

Bozemann

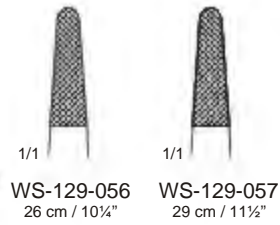
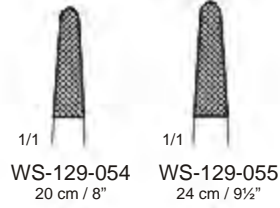

Normal Profile



Stratte

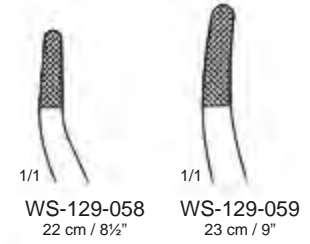

Normal Profile



Olsen-Hegar

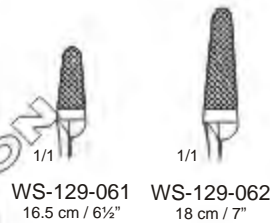

Normal Profile



Gillies
WS-129-063
16 cm / 6¼"

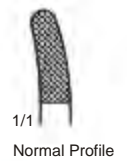

**Needle Holders With Tungsten Carbide Inserts | Porta Agujas Con Carburo De Tungsteno
Nadelhalter Mit Hartmetalleinlagen**

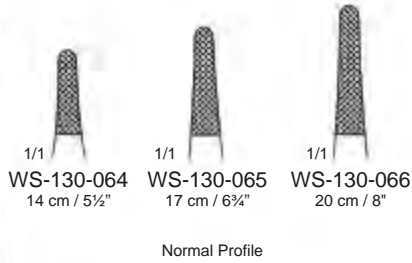
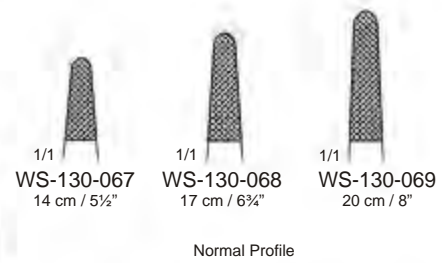
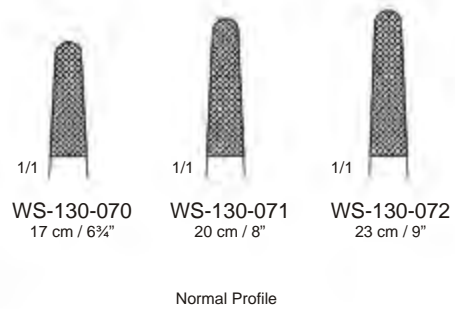
Mathieu-Kocher

Mathieu

Mathieu

Needle Holders With Tungsten Carbide Inserts | Porta Agujas Con Carburo De Tungsteno
Nadelhalter Mit Hartmetalleinlagen



1/1
Normal Profile

Toennis
WS-131-073
18 cm / 7"



1/1
Normal Profile

Lichtenberg
WS-131-074
20 cm / 8"



1/1
WS-131-075
18 cm / 7"

1/1
WS-131-076
20.5 cm / 8"

1/1
WS-131-077
23 cm / 9"

Normal Profile

Langenbeck



1/1
WS-131-078
20.5 cm / 8"

1/1
WS-131-079
23 cm / 9"

Normal Profile

Zweifel

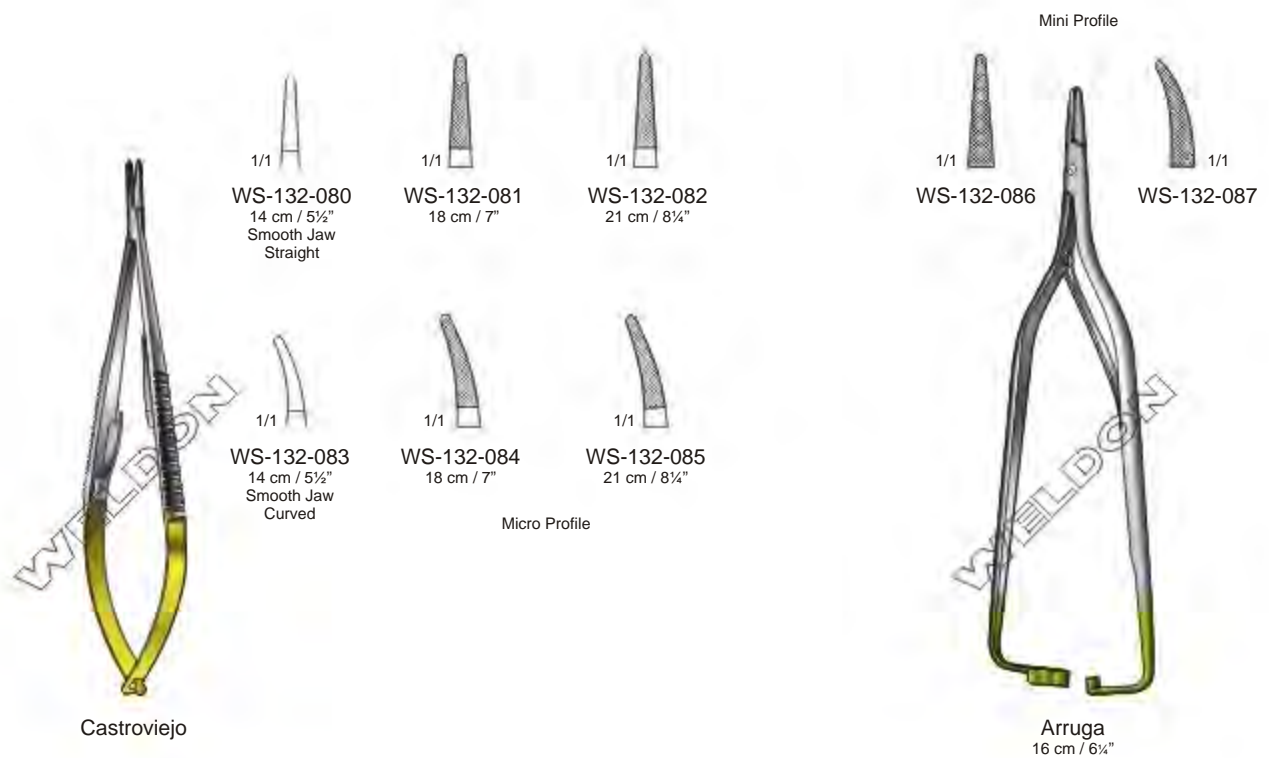
**Needle Holders With Tungsten Carbide Inserts | Porta Agujas Con Carburo De Tungsteno
Nadelhalter Mit Hartmetalleinlagen**

Needle Holders With Tungsten Carbide Inserts | Porta Agujas Con Carburo De Tungsteno
Nadelhalter Mit Hartmetalleinlagen



Vascular
18 cm / 7"



1/1
WS-133-091
With Lock



1/1
WS-133-092
With Lock



1/1
WS-133-093
Without Lock



1/1
WS-133-094
Without Lock

Micro Profile



Diethrich



1/1
WS-133-095
16 cm / 6¼"



1/1
WS-133-096
18 cm / 7"



1/1
WS-133-097
20 cm / 8"



1/1
WS-133-098
23 cm / 9"



1/1
WS-133-099
26 cm / 10¼"

Micro Profile



Reverdin
14 cm / 5½"
Small



1/1
WS-134-001
Fig. 1



1/1
WS-134-002
Fig. 2



1/1
WS-134-003
Fig. 3



1/1
WS-134-004
Fig. 4



Reverdin
19.5 cm / 7¾"
Medium



1/1
WS-134-005
WS-134-006
Fig. 1



1/1
WS-134-007
WS-134-008
Fig. 2



1/1
WS-134-009
WS-134-010
Fig. 3



1/1
WS-134-011
WS-134-012
Fig. 4



Reverdin
23 cm / 9"
Large

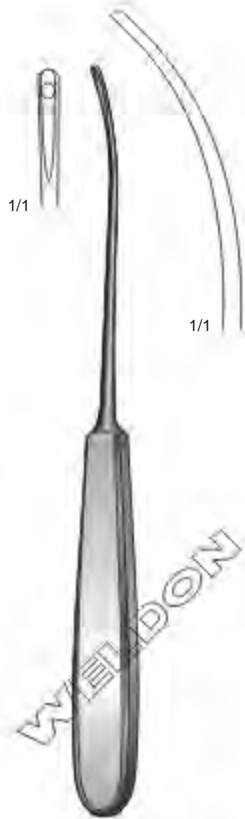

Malleable
WS-135-013
20 cm / 8"



Cooper
WS-135-014
18.5 cm / 7 1/4"

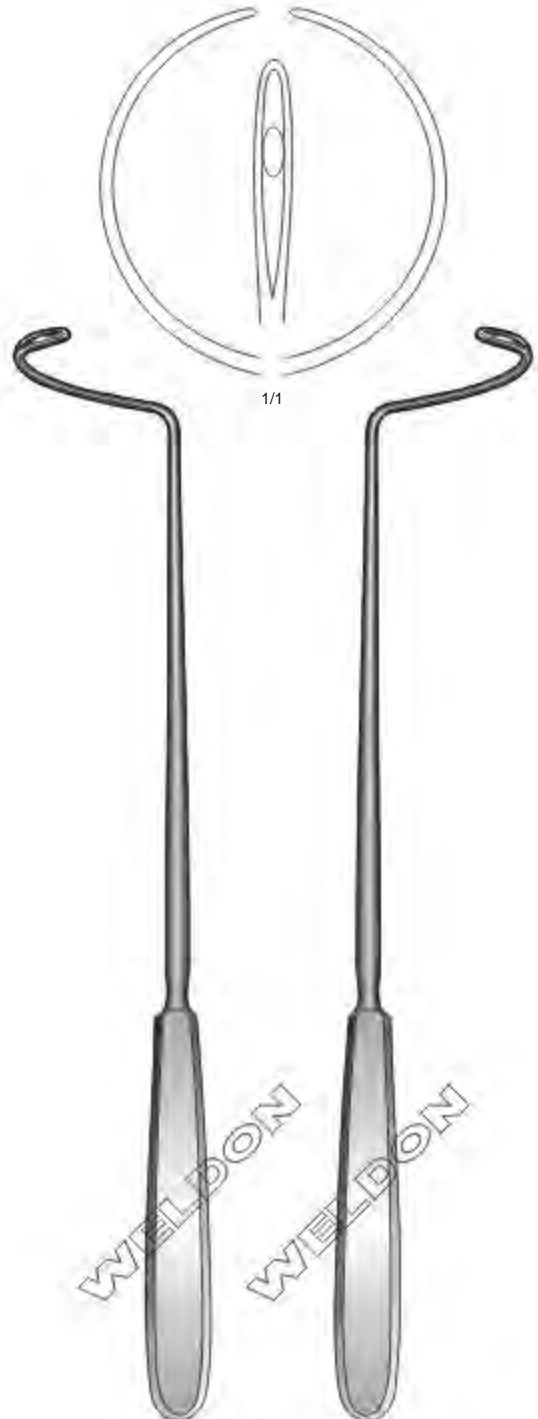

Deschamps
WS-135-017
24 cm / 9 1/2"

Deschamps
WS-135-018
24 cm / 9 1/2"



Kronecker
WS-135-015
13 cm / 5"

Kronecker
WS-135-016
13 cm / 5"

Ligature Needles | Aguja Para Ligaduras | Unterbindungsnadeln

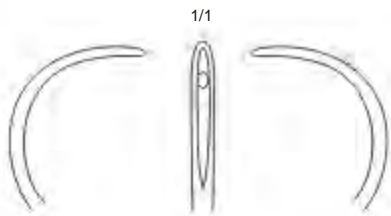

WS-136-019
Blunt
For Right Hand

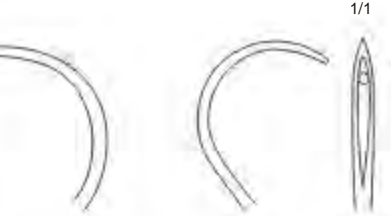

WS-136-020
Blunt
For Left Hand

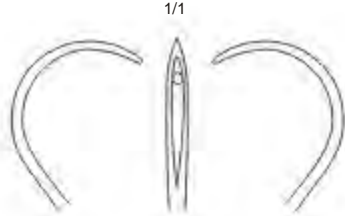

WS-136-021
Sharp
For Right Hand



WS-136-022
Sharp
For Left Hand

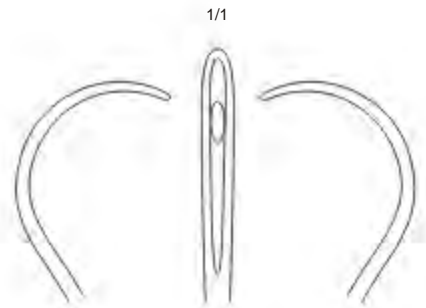

WS-136-023
Blunt
For Right Hand

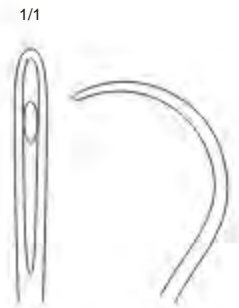

WS-136-024
Blunt
For Left Hand

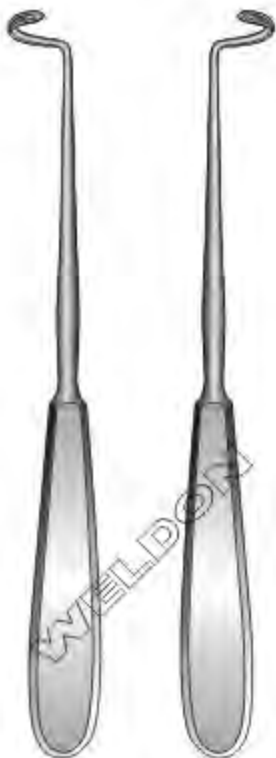

Deschamps
20 cm / 8"



Deschamps
20 cm / 8"

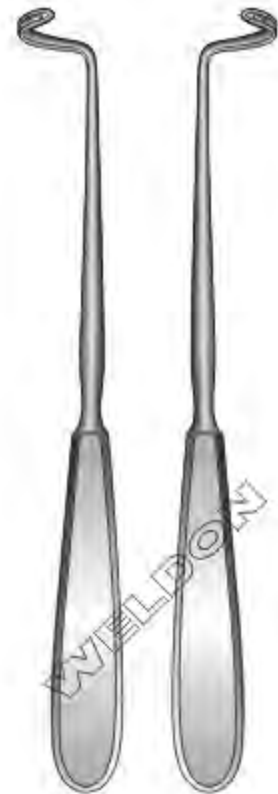

Deschamps
20 cm / 8"



www.weldoninstruments.com

PROVEEDOR EXCLUSIVO:



Percussion Hammers & Stethoscopes

Otoscopes & Ophthalmoscopes

Vaccination & Puncture

Dressing

137 - 160

Diagnostic

Diagnostic
Diagnostico
Diagnostik



Babinsky
WS-137-002
23 cm / 9"
40 mm Ø



Troemner
WS-137-004
24 cm / 9½"



Buck
WS-137-001
18 cm / 7"



Buck
WS-137-003
18 cm / 7"
Telescopic Handle



Special Model
WS-137-005
19 cm / 7½"



1/1

Neuro-Duoflex
Mod. Déjerine
WS-138-006
22 cm / 8 1/4"



Déjerine
WS-138-007
20 cm / 8"



1/1

Déjerine
WS-138-008
21 cm / 8 1/4"



Taylor
Mod. USA
WS-138-009
20 cm / 8"



Berliner
WS-138-010
20 cm / 8"



Wartenberg
WS-139-011
19 cm / 7½"



Pinard
WS-139-012
Wooden
18 cm / 7"



Pinard
WS-139-013
Aluminium, Detachable
15 cm / 6"



Pinard Stethoscope
WS-139-014 15 cm / 6"
WS-139-015 18 cm / 7"
Aluminium



Weldon
Mini Otoscopes



Oto Xk1
Otoscopes Handles



Oto Xk2
Otoscopes Handles



Megna 100



Megna 200



Megna 300



Color Options



Zeta 100



Zeta 200



Zeta 300
(Only F/O)



NS- 100
Spreadable Nasal Speculum



Reusable Oto Tips
For Weldon Mini Otoscopes
Mega 100, 200, 300



Zulu 100



Zulu 200



Zulu 300



Zulu 400



Weldon Mini
Clip Lamp 500



Weldon Mini Tongue
Blade Holder 600



BD 100
Blade



Weldon Diagnostic Set
Xena 100



Weldon Diagnostic Set
Xena 200



Dermatoscope
Mantra 300



Zen 100

Zen 200

Zen 300



Universal
 WS-143-001 Set of 3 Pieces
 WS-143-002 Set of 4 Pieces
 14 cm / 5½"



Standard
 WS-143-003 3 mm Ø
 WS-143-004 4 mm Ø
 WS-143-005 5 mm Ø
 WS-143-006 6 mm Ø
 11 cm / 4½"



Duke
 WS-143-007
 11 cm / 4½"
 5.5 mm Ø



Nelson
 21 cm / 8¼"

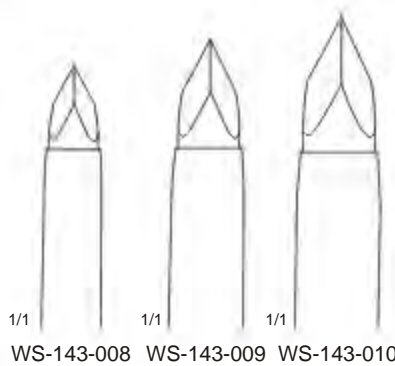

WS-143-008 WS-143-009 WS-143-010

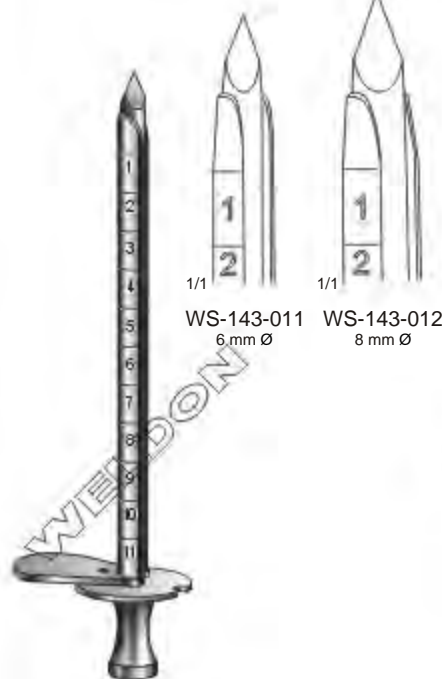

WS-143-011 6 mm Ø
 WS-143-012 8 mm Ø

Campbell
 16 cm / 6½"



Ochsner
 WS-143-013 4 mm Ø
 WS-143-014 5.5 mm Ø
 WS-143-015 6.5 mm Ø
 14 cm / 5½"



Adson
WS-144-016
21 cm / 8¼"
4 mm Ø



Frazier
WS-144-017 Fr. 6
WS-144-018 Fr. 8
WS-144-019 Fr. 10
WS-144-020 Fr. 12
12.5 cm / 4¾"



Frazier
WS-144-021 Fr. 6
WS-144-022 Fr. 8
WS-144-023 Fr. 10
WS-144-024 Fr. 12
19 cm / 7½"



Frazier
WS-144-025 Fr. 6
WS-144-026 Fr. 8
19 cm / 7½"
With Fiber Optics



Poppen
WS-144-027 Fr. 6
WS-144-028 Fr. 8
WS-144-029 Fr. 10
WS-144-030 Fr. 12
13 cm / 5"



Poppen
WS-144-031 Fr. 6
WS-144-032 Fr. 8
13 cm / 5"
With Fiber Optics



Schuhknecht
13 cm / 5 1/8", Ø 8 mm
WS-145-033 Ø 20 swg, Ø 0.9 mm
WS-145-034 Ø 24 swg, Ø 0.6 mm
Suction Cannula



Bellucci
WS-145-035 Suction Set Complete, Consisting Of:
WS-145-036 Suction Tube With Finger Cut-off And Stylet,
12.7 cm / 5", Ø 8 mm
WS-145-037 Ø 20 swg, Ø 0.9 mm
WS-145-038 Ø 22 swg, Ø 0.7 mm
WS-145-039 Ø 24 swg, Ø 0.6 mm
Detachable End



Wullstein
14 cm / 5 1/2", Ø 6-10 mm
WS-145-040 Micro-Suction Set, Complete, Consisting Of:
WS-145-041 Suction Tube With LUER Hub
WS-145-042 Ø 0.4 mm
WS-145-043 Ø 0.6 mm
WS-145-044 Ø 0.8 mm
Micro Suction Cannula



Wullstein
WS-145-045 Ø 1.5 mm
WS-145-046 Ø 2.0 mm
Suction Tube, Cylindrical
Silver With Stylet, Olive With LUER Hub
16 cm / 6 1/4"



Wullstein
WS-145-047
Suction Tube, Conical
Silver, Olive With LUER Hub
16 cm / 6 1/4"



Barron
 WS-146-048 Ø 1.3 mm
 WS-146-049 Ø 2.0 mm
 With Finger Cut-Off And Stylet,
 16 cm / 6 1/4"



Plester
 WS-146-050 Ø 1.5 mm
 WS-146-051 Ø 2.0 mm
 WS-146-052 Ø 2.5 mm
 WS-146-053 Ø 3.0 mm
 Suction Cannula With Finger Cut-Off And Stylet,
 Thumb Piece Parallel To Curve, With LUER Hub
 19.5 cm / 7 3/4"



Lempert
 WS-146-054 Ø 2.0 mm
 WS-146-055 Ø 3.0 mm
 With Finger Cut-Off And Stylet
 20 cm / 8"

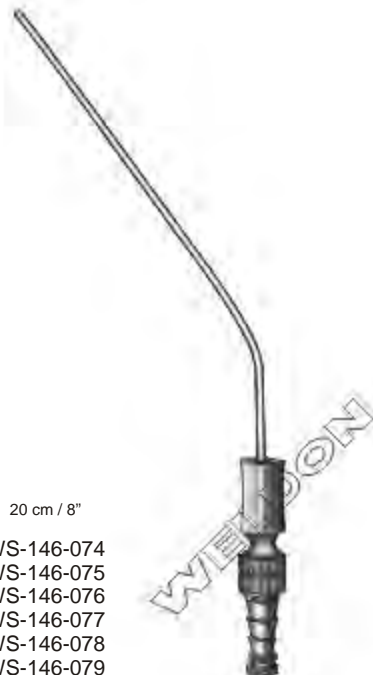

Fergusson
 Ø 6-9 mm Olive

Ø	11 cm / 4 1/4"	13 cm / 5"	16 cm / 6 1/4"	20 cm / 8"
1.5 mm	WS-146-056	WS-146-062	WS-146-068	WS-146-074
2.0 mm	WS-146-057	WS-146-063	WS-146-069	WS-146-075
2.5 mm	WS-146-058	WS-146-064	WS-146-070	WS-146-076
3.0 mm	WS-146-059	WS-146-065	WS-146-071	WS-146-077
4.0 mm	WS-146-060	WS-146-066	WS-146-072	WS-146-078
5.0 mm	WS-146-061	WS-146-067	WS-146-073	WS-146-079



Zoellner
WS-147-080
Suction Cannula Only With Stylet
, Fitting To The Detachable Ends
18 cm / 7", Ø 8 mm Olive



Zoellner
WS-147-081 Ø 18 swg, Ø 1.2 mm
WS-147-082 Ø 20 swg, Ø 0.9 mm
WS-147-083 Ø 22 swg, Ø 0.7 mm
WS-147-084 Ø 24 swg, Ø 0.6 mm
WS-147-085 Ø 26 swg, Ø 0.4 mm
Fitting To The Detachable Ends
5.5 cm / 2 1/8"
Sales unit: PZ = Package of 10 Pieces



Olive-House
WS-147-086
Suction Adapter With Finger Cut-off
5.5 cm / 2 1/8", Ø 7 mm Olive

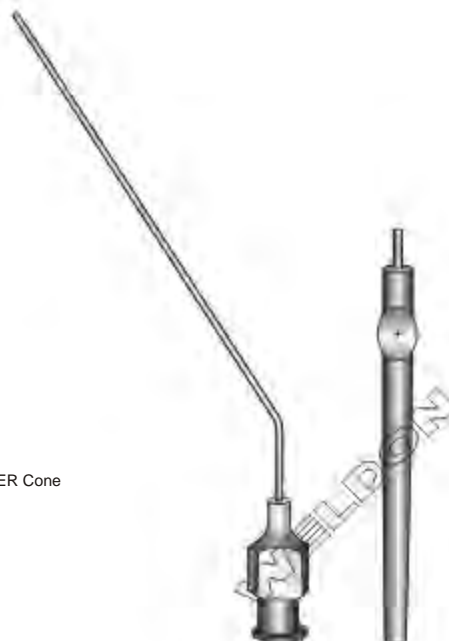

Suction Canula
WS-147-087
Ø 6-9 mm Olive
Suction Set Complete, Consisting Of:
WS-147-088 Suction Handle, With Finger Cut-off, With LUER Cone
WS-147-089 Ø 0.5 mm With LUER Cone
WS-147-090 Ø 0.7 mm With LUER Cone
WS-147-091 Ø 1.0 mm With LUER Cone
WS-147-092 Ø 1.3 mm With LUER Cone



Stiller-Luer
 WS-148-093
 Charr. 6
 Working Length 12.5 cm / 5"



Luer
 WS-148-094 Charr. 5
 WS-148-095 Charr. 6
 WS-148-096 Charr. 8
 WS-148-097 Charr. 9
 Working Length 12.5 cm / 5"

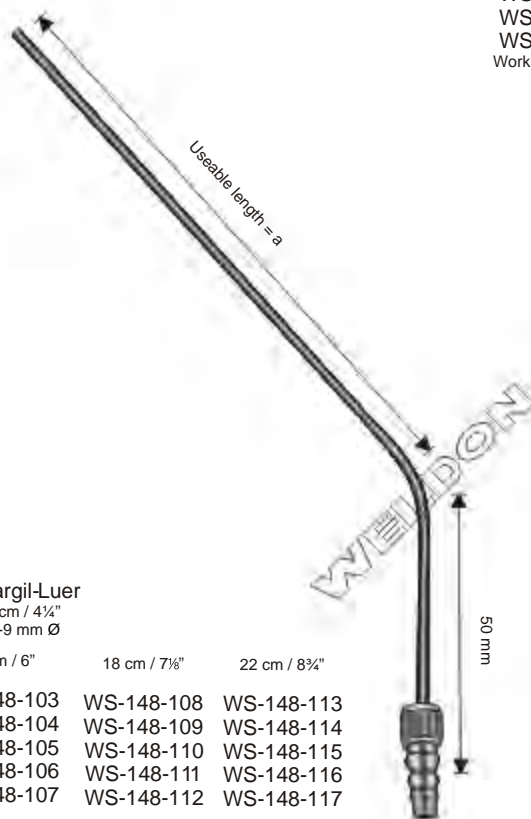

Yasargil-Luer
 11 cm / 4 1/4"
 6.5-9 mm Ø

Ø	13 cm / 5 1/8"	15 cm / 6"	18 cm / 7 1/8"	22 cm / 8 3/4"
1.5 mm	WS-148-098	WS-148-103	WS-148-108	WS-148-113
2.0 mm	WS-148-099	WS-148-104	WS-148-109	WS-148-114
2.5 mm	WS-148-100	WS-148-105	WS-148-110	WS-148-115
3.5 mm	WS-148-101	WS-148-106	WS-148-111	WS-148-116
4.5 mm	WS-148-102	WS-148-107	WS-148-112	WS-148-117

50 mm



Yankauer
WS-149-118
28 cm / 11"



WS-149-119
Suction Tip Only



WS-149-120
Tubing Connector Only For



Yankauer
WS-149-121
31 cm / 12 1/8"



Nuboer
WS-150-122
 21 cm / 8¼"
 6 mm, Round Tip



Nuboer
WS-150-123
 21 cm / 8¼"
 6 mm, Oval Tip



WS-150-124 1.5 cm Ø
WS-150-125 2.0 cm Ø
WS-150-126 2.5 cm Ø
WS-150-127 3.5 cm Ø



WS-150-128 1.5 cm Ø
WS-150-129 2.0 cm Ø
WS-150-130 2.5 cm Ø
WS-150-131 3.5 cm Ø
 With Additional Side Holes



Coupland
 17 cm / 6¾"

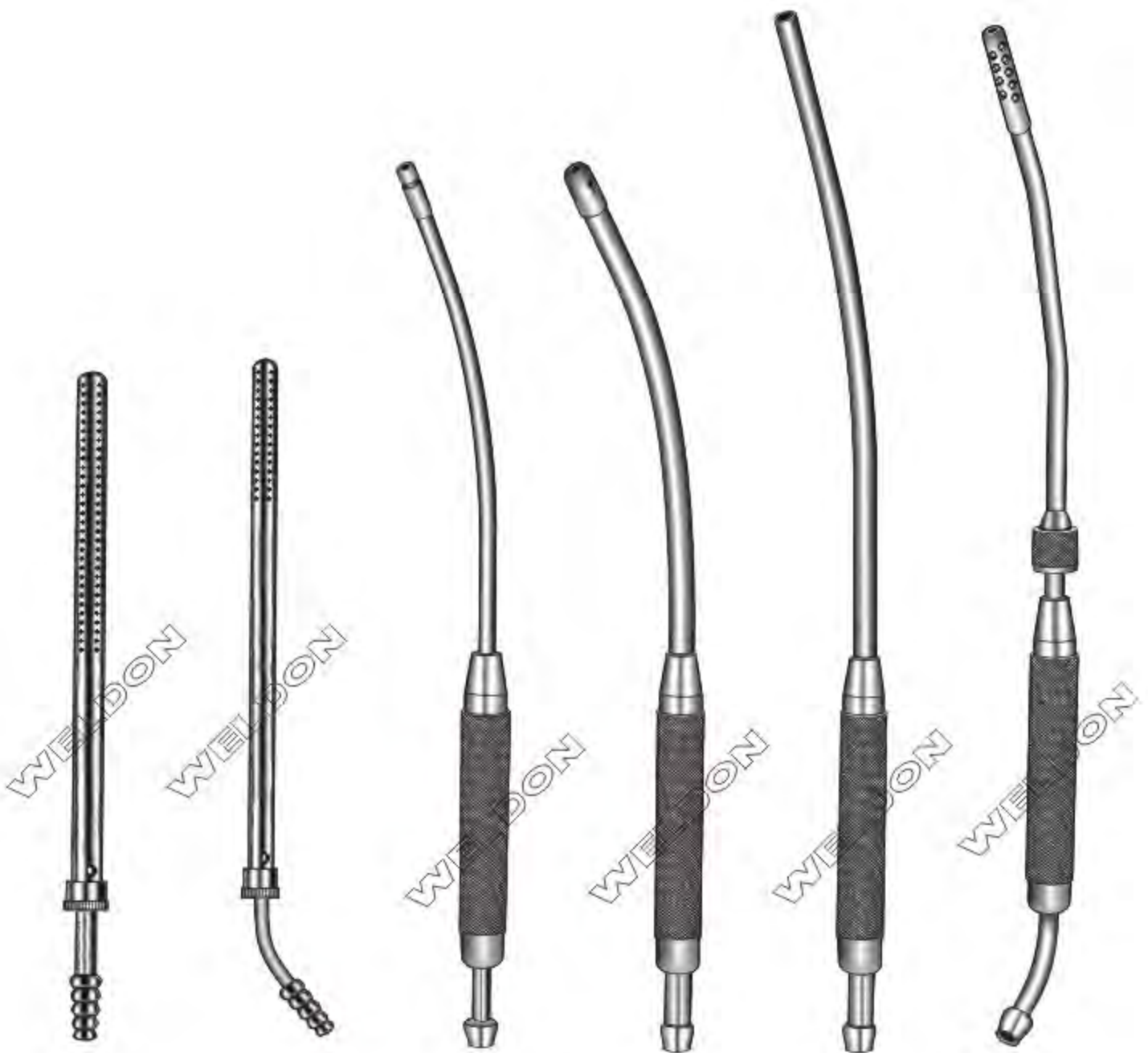

Poole
WS-151-132
22 cm / 8 3/4"
10 mm Ø
(Fr. 30)

Poole
WS-151-133
22 cm / 8 3/4"
8 mm Ø
(Fr. 23)

Cooley
WS-151-134
31 cm / 12 1/2"

Cooley
WS-151-135
31 cm / 12 1/2"

Cooley
WS-151-136
36 cm / 14 1/4"

Cooley
WS-151-137
36 cm / 14 1/4"

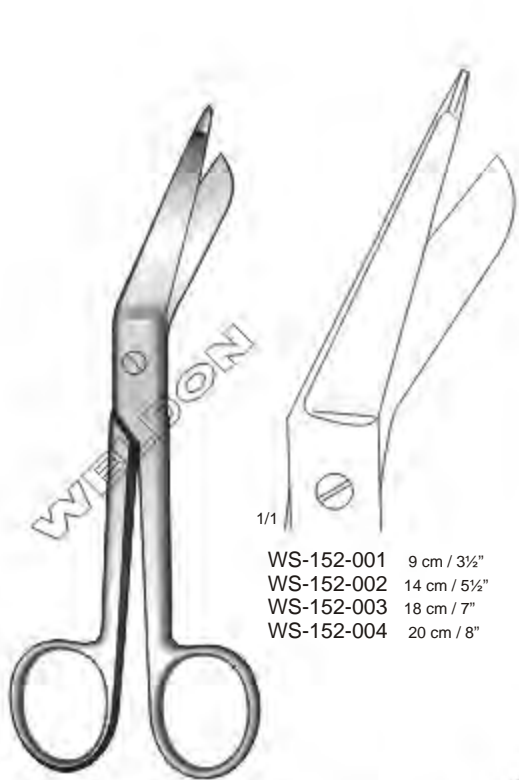

1/1

WS-152-001 9 cm / 3½"
 WS-152-002 14 cm / 5½"
 WS-152-003 18 cm / 7"
 WS-152-004 20 cm / 8"

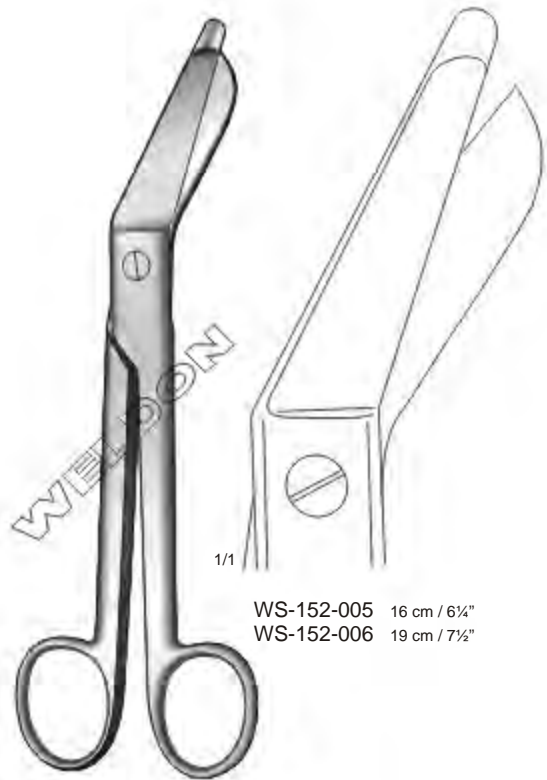
Lister

1/1

WS-152-005 16 cm / 6¼"
 WS-152-006 19 cm / 7½"

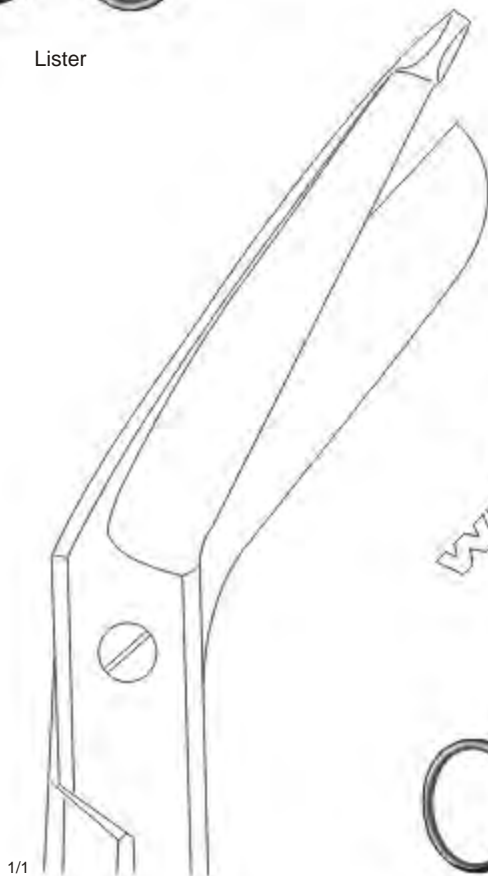
Lister-Excentric

1/1



Bergmann
 WS-152-007
 23.5 cm / 9¼"
 Heavy Pattern

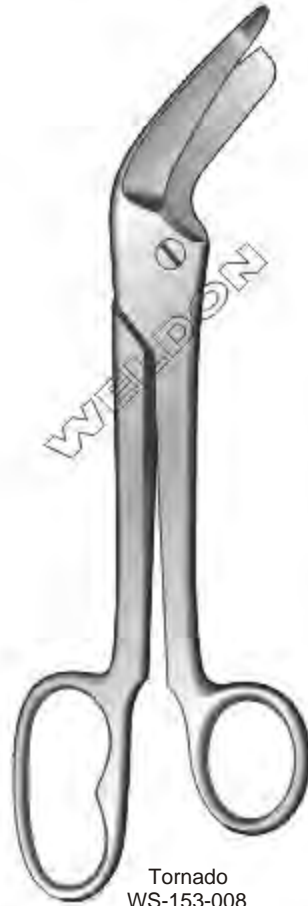

1/1

Tornado
WS-153-008
24 cm / 9½"



1/1



Knowles
WS-153-009
14 cm / 5½"
Straight



1/1

Knowles
WS-153-010
14 cm / 5½"
Curved



Bandage Scissors,Plaster Shears | Tijeras Para Vándajes Y Yeso
Verbandscheren,Gipsscheren

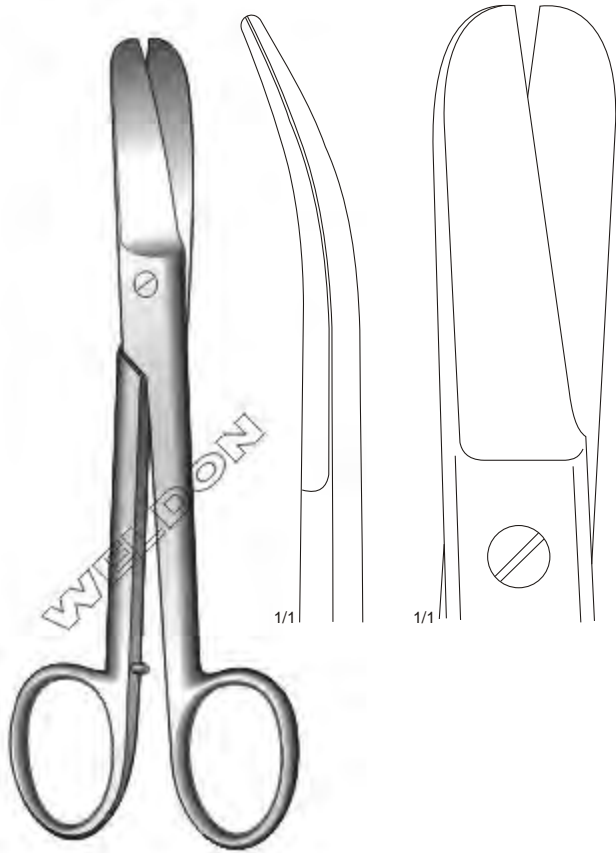

Lorenz
WS-154-011
23 cm / 9"

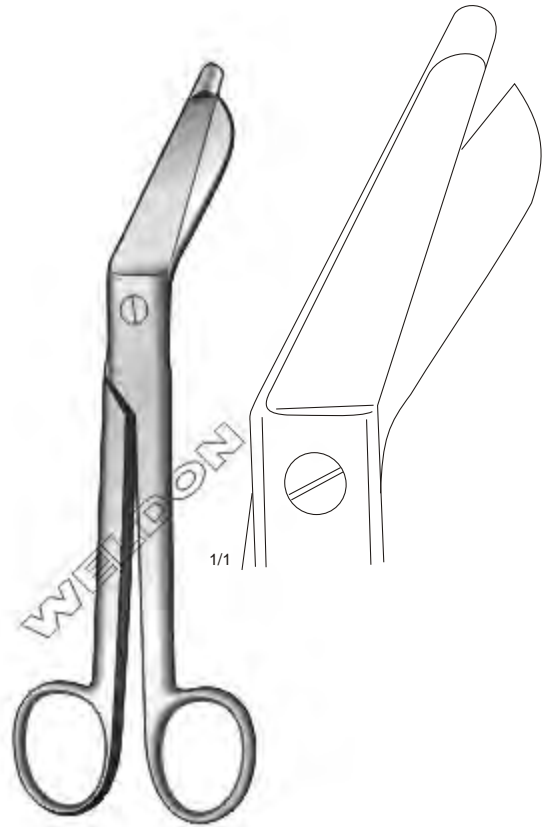

Esmarch
WS-154-012 20 cm / 8"
WS-154-013 22 cm / 8¾"



Universal
WS-154-014 15 cm / 6"
WS-154-015 17 cm 7"

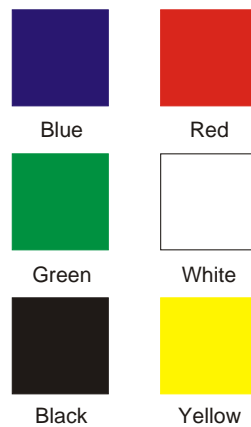

Universal Scissors
are available in
above colors

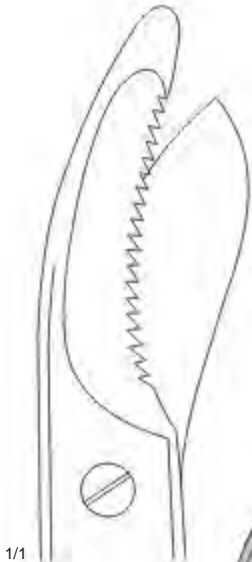
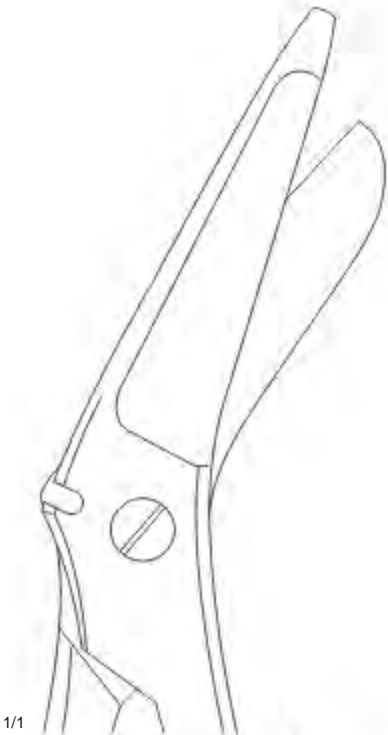

WS-155-016
20 cm / 8"

Bruns
WS-155-017
24 cm / 9½"
One Serrated Cutting Edge

Clothing Scissors | Tijeras Para Ropas | Gipscheren



WS-156-018
15 cm / 6"

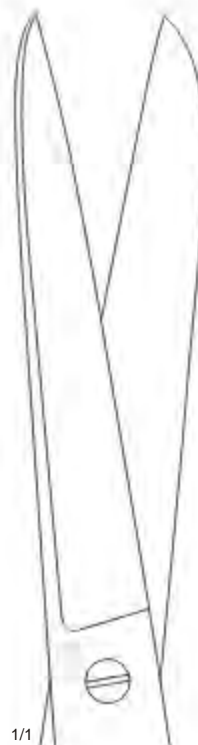

Smith
WS-156-019
20 cm / 8"
With One Big Ring

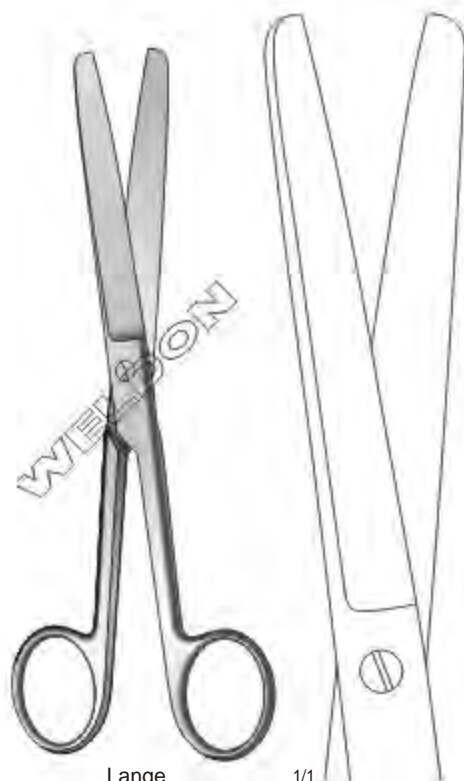

Lange
WS-156-020
18 cm / 7 1/8"

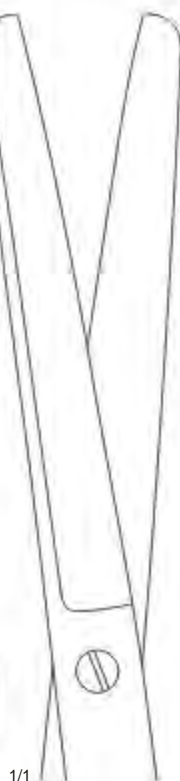



Hopkins
WS-157-001
20 cm / 8"



Esmarch
WS-157-002
18 cm / 7"



Reiner
WS-157-003
18.5 cm / 7 1/4"



Special Mod. Weldon
WS-157-004
21 cm / 8 1/4"



Engel
WS-157-005
15.5 cm / 6"

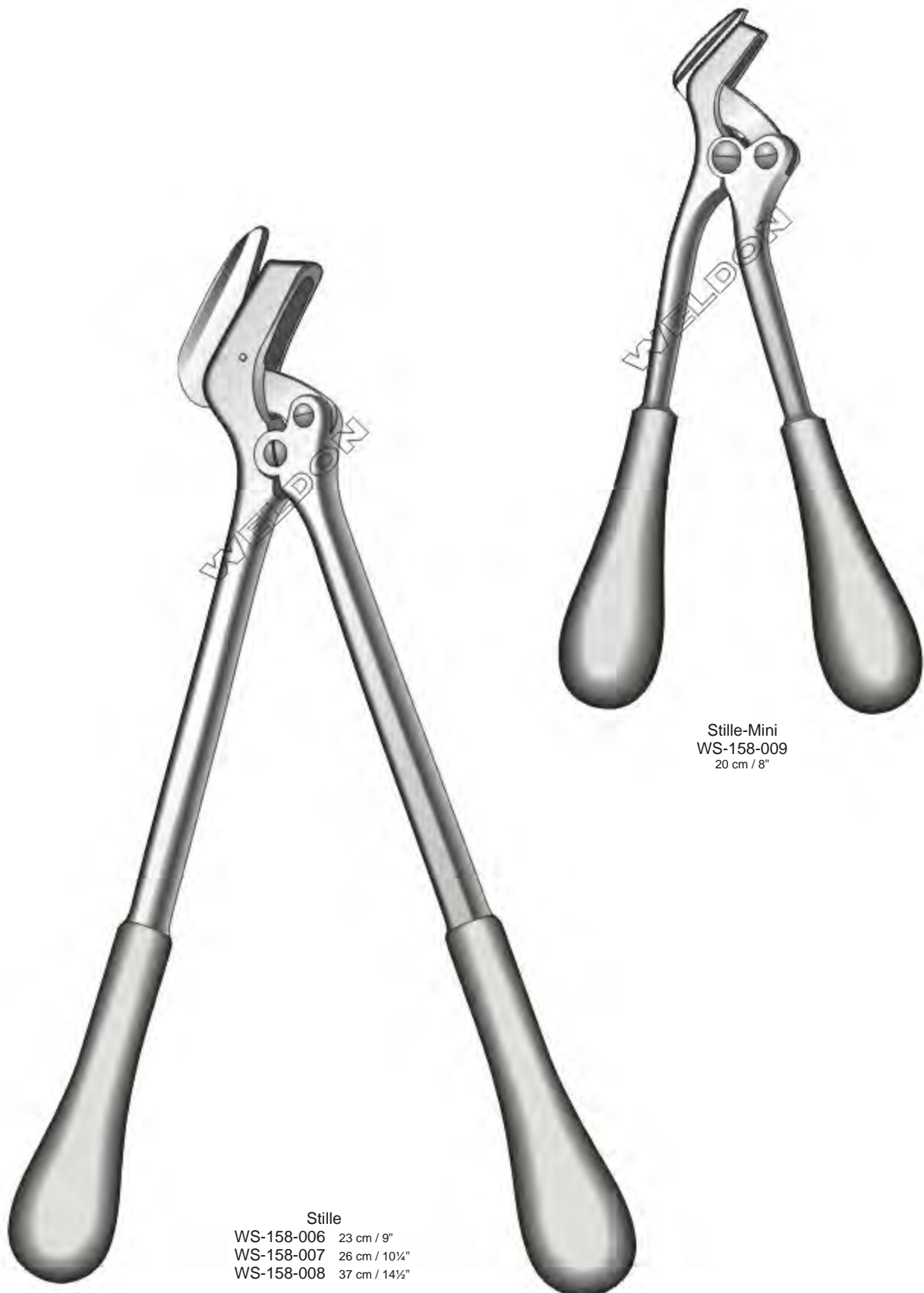

Stille
WS-158-006 23 cm / 9"
WS-158-007 26 cm / 10¼"
WS-158-008 37 cm / 14½"

Stille-Mini
WS-158-009
20 cm / 8"



Mod. USA
WS-159-010
23 cm / 9"

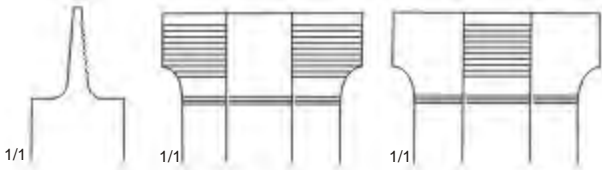

Beeson
WS-159-011
30 cm / 12"



Wolff



WS-160-012
18 cm / 7"
WS-160-013
20 cm / 8"



WS-160-014
24 cm / 9½"



1/1



Henning
WS-160-015
28 cm / 11"



www.weldoninstruments.com

PROVEEDOR EXCLUSIVO:



Pliers & Hammers

Osteotomes, Chisels & Gouges

Bone Currettes & Periosteal Elevators

Bone Holding Forceps & Rongeurs

161 - 260

Orthopedic

Orthopedic

Ortopedia

Knochenchirurgie



Niro
WS-161-001
14 cm / 6"



Niro
WS-161-002
14 cm / 6"



WS-161-003
17 cm / 6 3/4"



WS-161-004
17 cm / 6 3/4"



WS-161-005
17 cm / 6 3/4"

Wire Twisting Forceps, Flat Nose Pliers | Pinzas Tensoras De Alambre, Alicates Planos
 Drahtspannzangen, Flachzangen



Ultra Grip
 WS-162-006
 17 cm / 6¾"

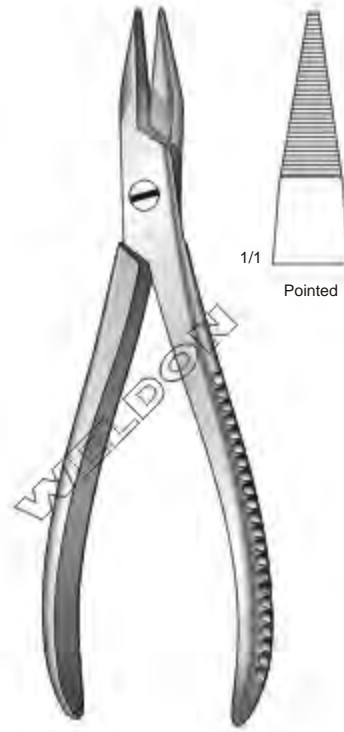

Needle Nose Pliers
 WS-162-007 14 cm / 5½"
 WS-162-008 19 cm / 7½"
 Grooved Jaws, Tip Taper To 1 mm



17 cm / 6¾"
 With Cross Wire Groove



1/1
 WS-162-009
 With Cross

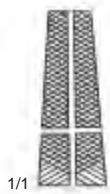

1/1
 WS-162-010
 Wire Groove



18 cm / 7¼"
 Parallel Grip Plier

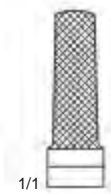

1/1
 WS-162-011



1/1
 WS-162-012



1/1
 WS-162-013

Wire Twisting Forceps, Flat Nose Pliers | Pinzas Tensoras De Alambre, Alicates Planos
Drahtspannzangen, Flachzangen



WS-163-014
16.5 cm / 6½"



WS-163-015
16 cm / 6¼"

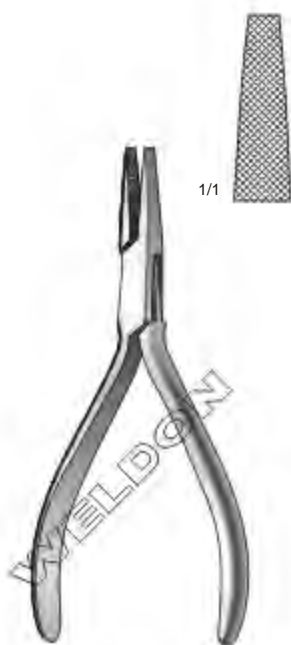

WS-163-016
14 cm / 5½"



Universal
WS-163-017
15 cm / 6"
For Bending & Cutting

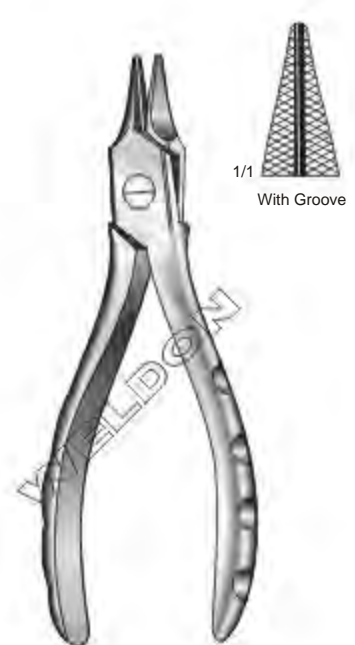

WS-163-018
16 cm / 6¼"

Flat Nose Pliers | Alicates De Pico Plano | Flachzangen

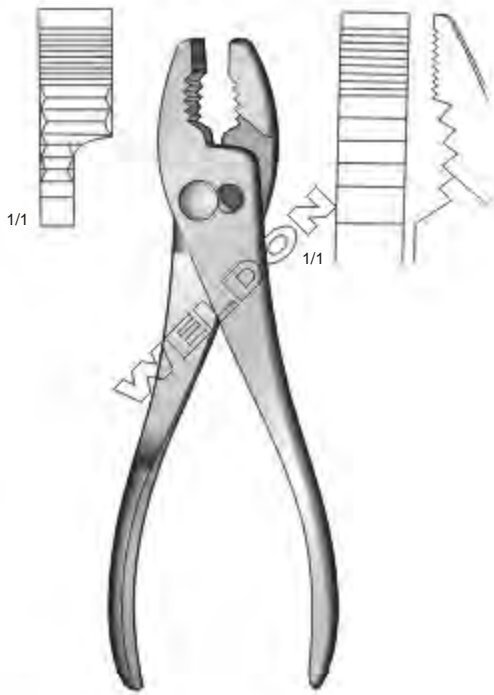

Slip Joint Adjustable Pliers
WS-164-019
19.7 cm / 7¾"

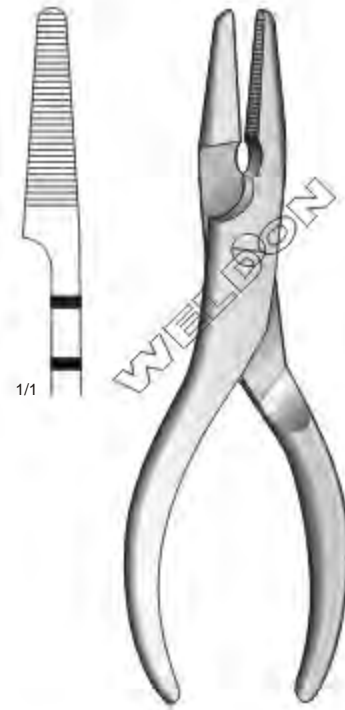

Flat Nose Plier
WS-164-020
15 cm / 6"
Side Cutting Blades
Tips Taper To 3.5 mm

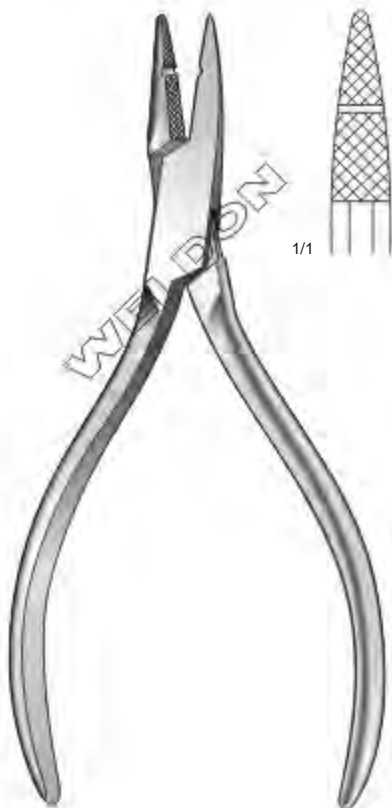

Needle Nose Plier
WS-164-021
14 cm / 5 ½"
Grooved Jaws Tips

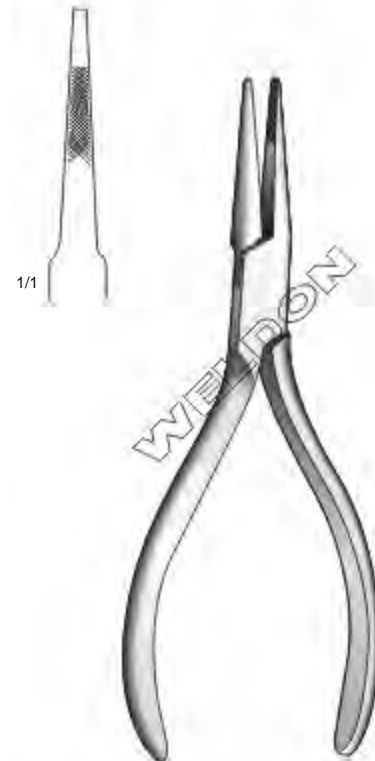

Flat Nose Plier
WS-164-022
15 cm / 6"

Flat Nose Pliers, Vise Grip | Alicates De Pico Plano | Flachzangen, Tonnenzange

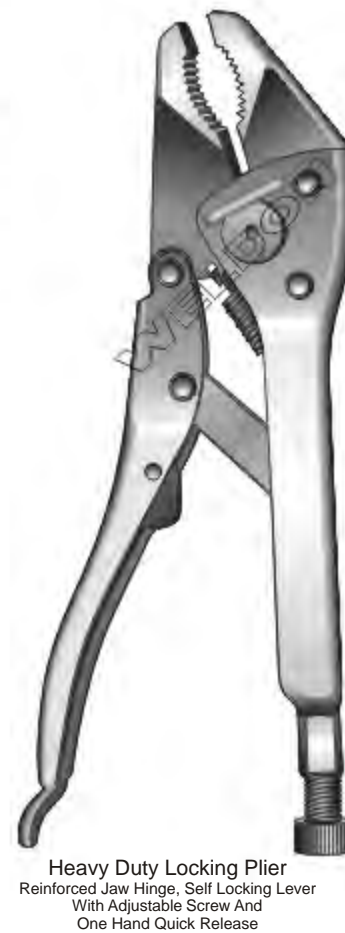
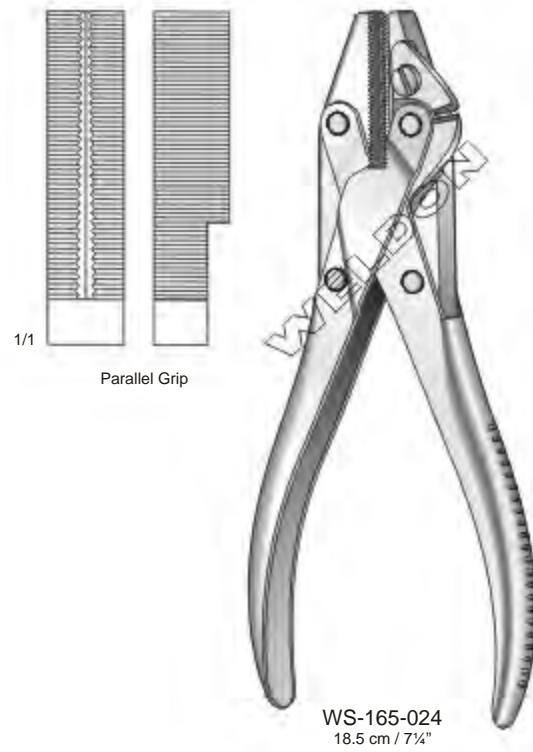
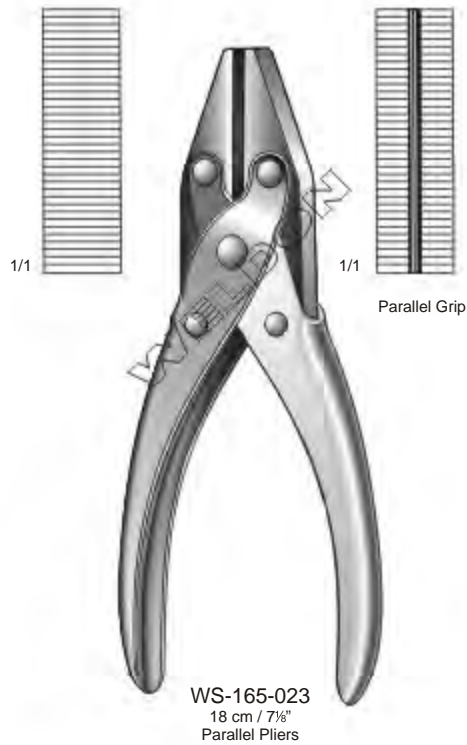

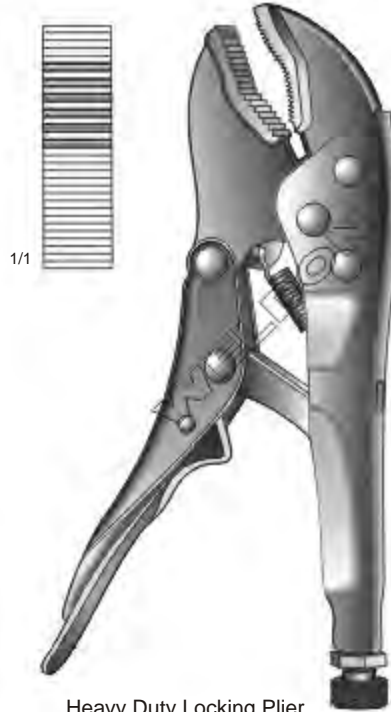

1/1

Heavy Duty Locking Plier
WS-166-028
 20 cm / 8", 9 mm Wide Tip
 Reinforced Jaw Hinge, Self Locking Lever
 With Adjustable Screw And
 One Hand Quick Release



Heavy Duty Locking Plier
 Reinforced Jaw Hinge, Self Locking Lever
 With Adjustable Screw And
 One Hand Quick Release

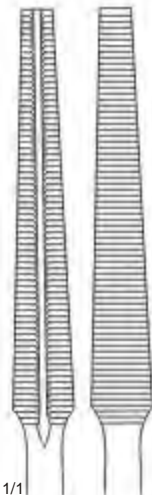

1/1

WS-166-029
 22 cm / 8 3/4"

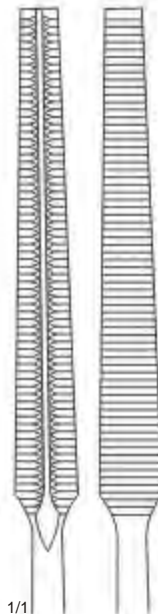

1/1

WS-166-030
 25 cm / 10"

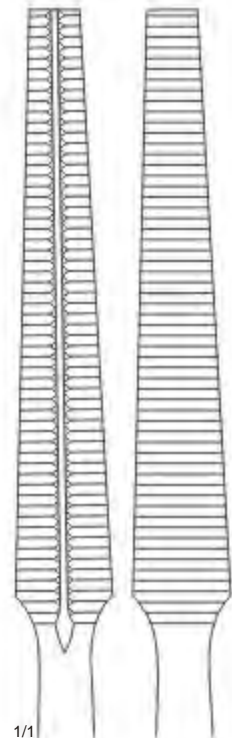

1/1

WS-166-031
 30 cm / 11 1/2"



Buck-Gramcko
WS-167-001
11 cm / 4½"



Buck-Gramcko
WS-167-002
11 cm / 4½"



Buck-Gramcko
WS-167-003
10 cm / 4"



Buck-Gramcko
WS-167-004
10 cm / 4"



Buckley
16 cm / 6¼"
Octagonal Handle

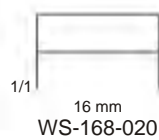
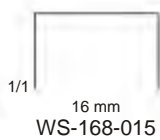
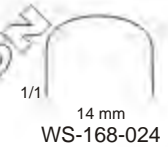
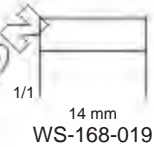
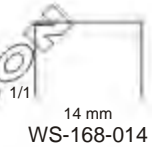
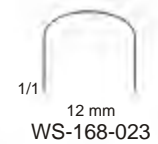
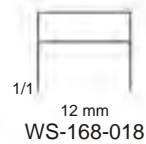
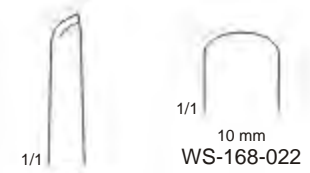
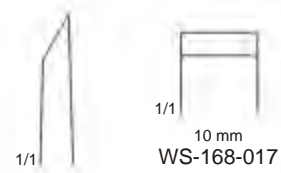
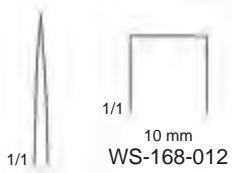
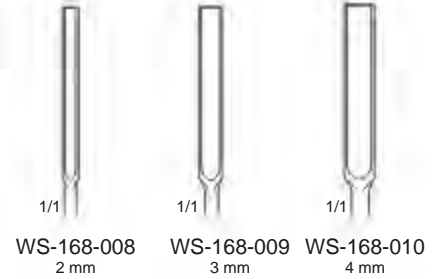
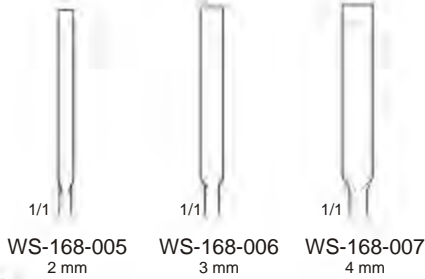

13.5 cm / 5¼"

13.5 cm / 5¼"

13.5 cm / 5¼"

1/1
2 mm
WS-169-026
13.5 cm / 5 1/4"

1/1
2 mm
WS-169-031
17 cm / 6 3/4"

1/1
2 mm
WS-169-036
13.5 cm / 5 1/4"

1/1
2 mm
WS-169-041
17 cm / 6 3/4"

1/1
4 mm
WS-169-046

1/1
4 mm
WS-169-052

1/1
3 mm
WS-169-027
13.5 cm / 5 1/4"

1/1
3 mm
WS-169-032
17 cm / 6 3/4"

1/1
3 mm
WS-169-037
13.5 cm / 5 1/4"

1/1
3 mm
WS-169-042
17 cm / 6 3/4"

1/1
6 mm
WS-169-047

1/1
6 mm
WS-169-053

1/1
4 mm
WS-169-028
13.5 cm / 5 1/4"

1/1
4 mm
WS-169-033
17 cm / 6 3/4"

1/1
4 mm
WS-169-038
13.5 cm / 5 1/4"

1/1
4 mm
WS-169-043
17 cm / 6 3/4"

1/1
8 mm
WS-169-048

1/1
8 mm
WS-169-054

1/1
5 mm
WS-169-029
13.5 cm / 5 1/4"

1/1
5 mm
WS-169-034
17 cm / 6 3/4"

1/1
5 mm
WS-169-039
13.5 cm / 5 1/4"

1/1
5 mm
WS-169-044
17 cm / 6 3/4"

1/1
10 mm
WS-169-049

1/1
10 mm
WS-169-055

1/1
6 mm
WS-169-030
13.5 cm / 5 1/4"

1/1
6 mm
WS-169-035
17 cm / 6 3/4"

1/1
6 mm
WS-169-040
13.5 cm / 5 1/4"

1/1
6 mm
WS-169-045
17 cm / 6 3/4"

1/1
12 mm
WS-169-050

1/1
12 mm
WS-169-056

1/1
14 mm
WS-169-051

1/1
14 mm
WS-169-057



Partsch



Partsch



Alexander
18 cm / 7"
Solid

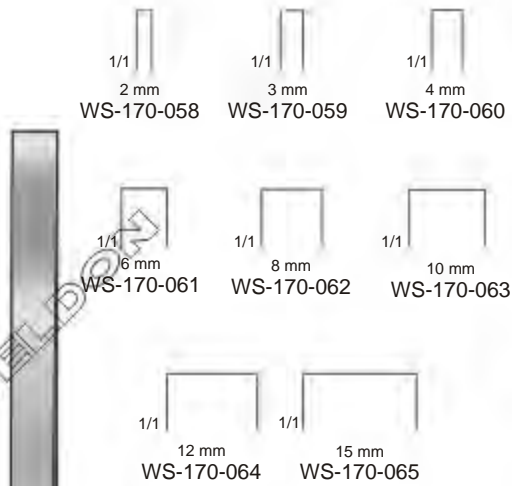
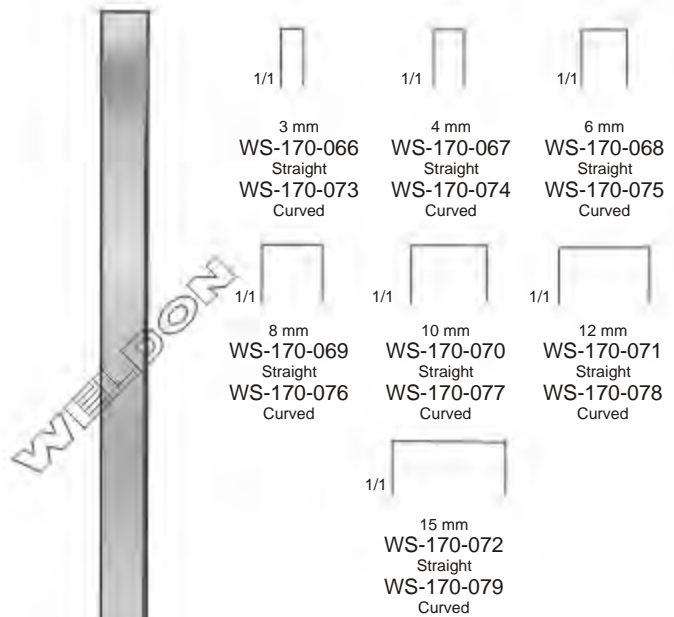
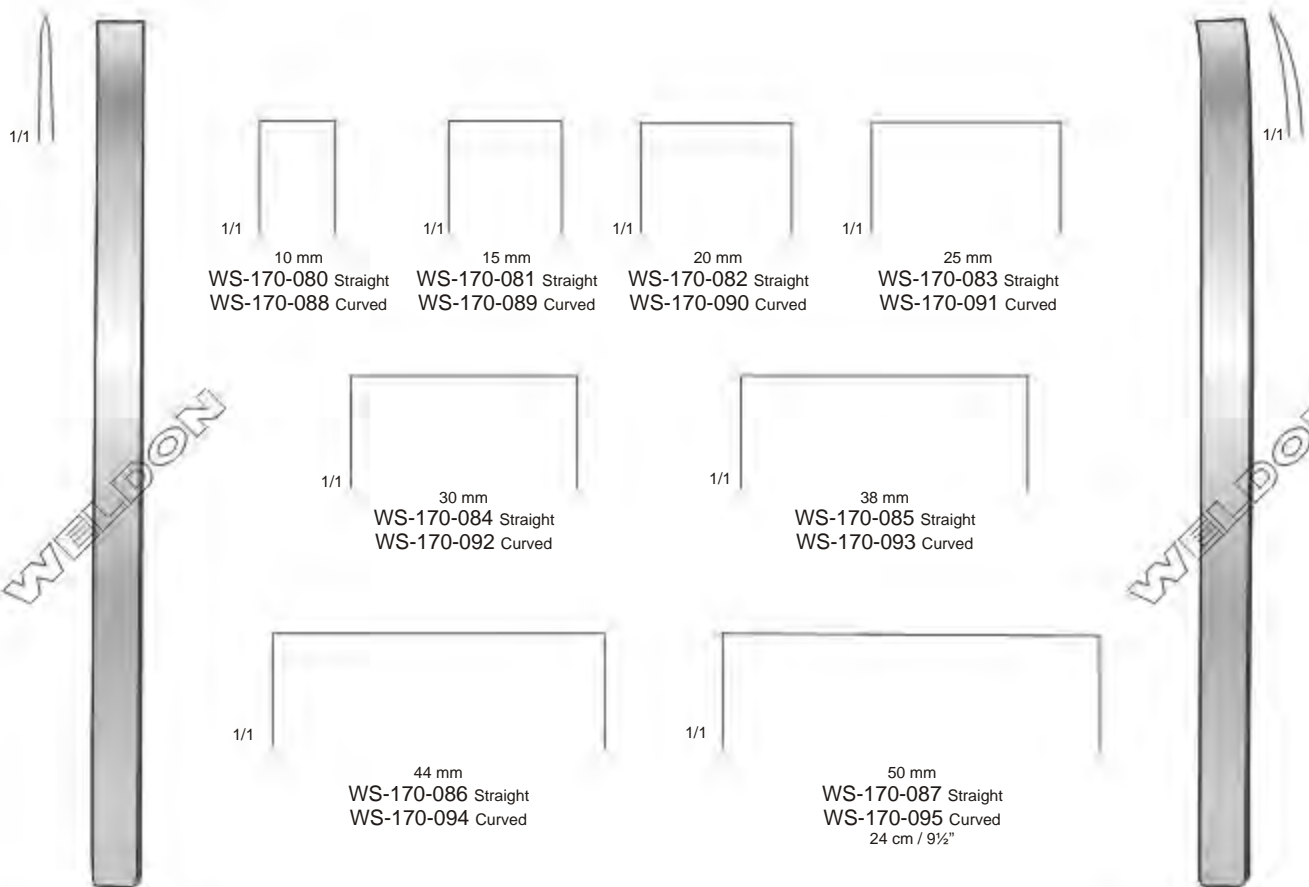

Alexander
18 cm / 7"

Chisels And Gouges | Cinceles, Gubias | Flachmeißel, Hohlmeißel

Lambotte, Mini
12.5 cm / 5"

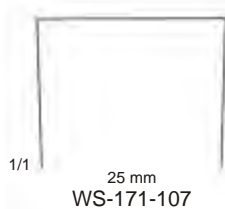
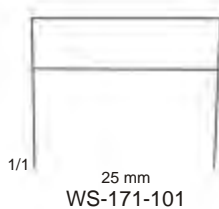
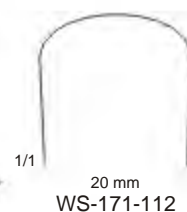
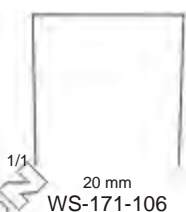
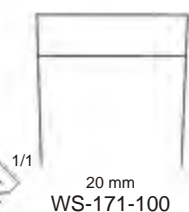
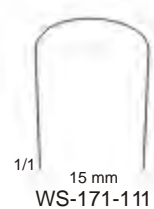
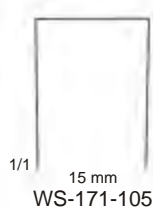
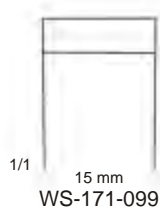
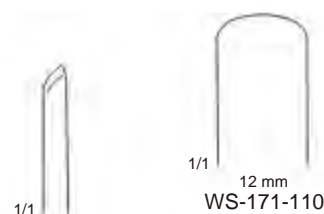
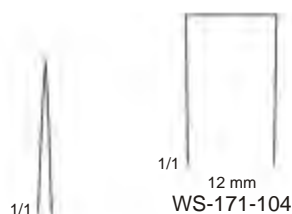
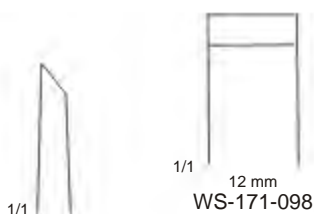
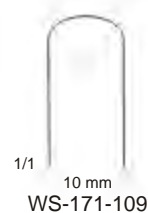
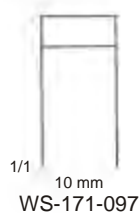
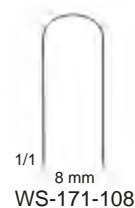
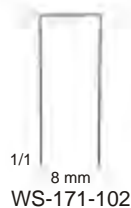
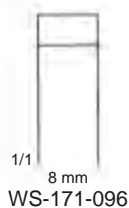
Lambotte, Mini
17 cm / 6 3/4"

Lambotte
24 cm / 9 1/2"
Straight

Lambotte
24 cm / 9 1/2"
Curved



Stille
20 cm / 8"

Stille
20 cm / 8"

Stille
20 cm / 8"



1/1
6 mm
WS-172-114



1/1
6 mm
WS-172-119



1/1
6 mm
WS-172-124



1/1
13 mm
WS-172-115



1/1
13 mm
WS-172-120



1/1
13 mm
WS-172-125

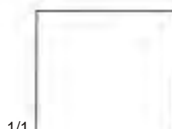

1/1
19 mm
WS-172-116



1/1
19 mm
WS-172-121

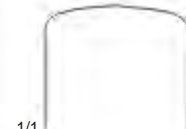

1/1
19 mm
WS-172-126



1/1
25 mm
WS-172-117



1/1
25 mm
WS-172-122



1/1
25 mm
WS-172-127



1/1
32 mm
WS-172-118



1/1
32 mm
WS-172-123



1/1
32 mm
WS-172-128



Hibbs
24 cm / 9½"



Hibbs
24 cm / 9½"



Hibbs
24 cm / 9½"

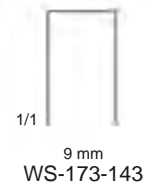
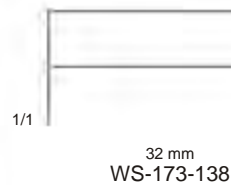
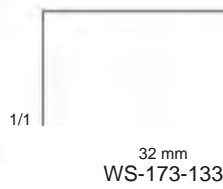
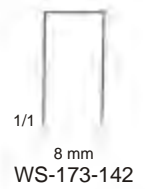
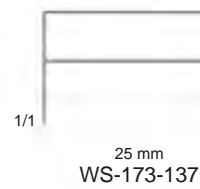
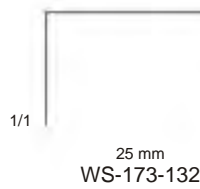
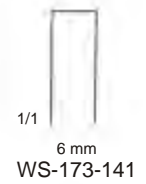
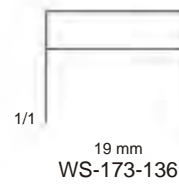
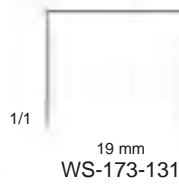
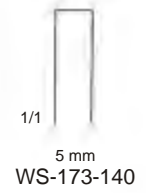
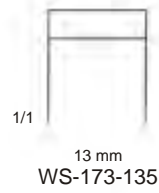
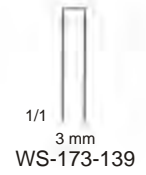
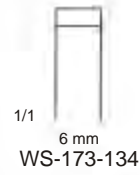

Hibbs
24.5 cm / 9 3/4"



Hibbs
24.5 cm / 9 3/4"



Hoke
17 cm / 6 3/4"

Chisels And Gouges | Cinceles, Gubias | Flachmeißel, Hohlmeißel

1/1
6 mm
WS-174-144

1/1
6 mm
WS-174-151

1/1
9 mm
WS-174-145

1/1
9 mm
WS-174-152

1/1
13 mm
WS-174-146

1/1
13 mm
WS-174-153

1/1
16 mm
WS-174-147

1/1
16 mm
WS-174-154

1/1
9 mm
WS-174-158

1/1
9 mm
WS-174-162

1/1
19 mm
WS-174-148

1/1
19 mm
WS-174-155

1/1
14 mm
WS-174-159

1/1
14 mm
WS-174-163

1/1
25 mm
WS-174-149

1/1
25 mm
WS-174-156

1/1
19 mm
WS-174-160

1/1
19 mm
WS-174-164

1/1
32 mm
WS-174-150

1/1
32 mm
WS-174-157

1/1
25 mm
WS-174-161

1/1
25 mm
WS-174-165



Smith-Petersen
20.5 cm / 8"



Smith-Petersen
20.5 cm / 8"



Smith-Petersen
20.5 cm / 8"



Smith-Petersen
20.5 cm / 8"



- WS-175-166 2 mm
- WS-175-167 4 mm
- WS-175-168 6 mm
- WS-175-169 8 mm
- WS-175-170 10 mm
- WS-175-171 12 mm
- WS-175-172 15 mm
- WS-175-173 20 mm

Mini-Lexer
18 cm / 7¹/₈"

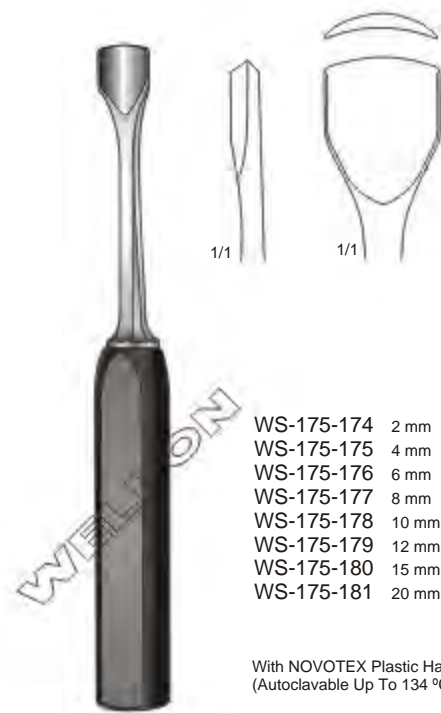

- WS-175-174 2 mm
- WS-175-175 4 mm
- WS-175-176 6 mm
- WS-175-177 8 mm
- WS-175-178 10 mm
- WS-175-179 12 mm
- WS-175-180 15 mm
- WS-175-181 20 mm

With NOVOTEX Plastic Handle
(Autoclavable Up To 134 °C at Bar)

Mini-Lexer
18 cm / 7¹/₈"

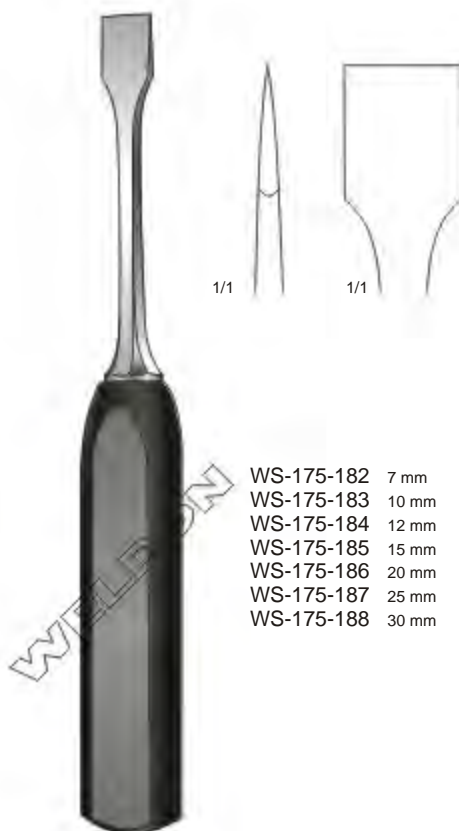

- WS-175-182 7 mm
- WS-175-183 10 mm
- WS-175-184 12 mm
- WS-175-185 15 mm
- WS-175-186 20 mm
- WS-175-187 25 mm
- WS-175-188 30 mm

Lexer
22 cm / 8³/₄"

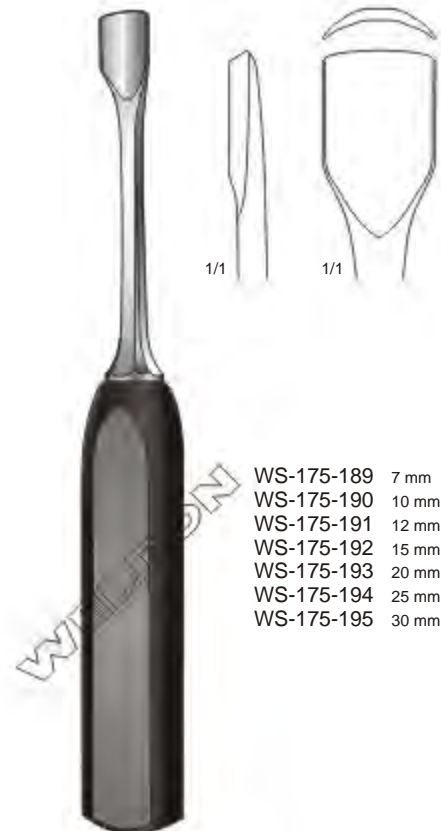

- WS-175-189 7 mm
- WS-175-190 10 mm
- WS-175-191 12 mm
- WS-175-192 15 mm
- WS-175-193 20 mm
- WS-175-194 25 mm
- WS-175-195 30 mm

Lexer
22 cm / 8³/₄"

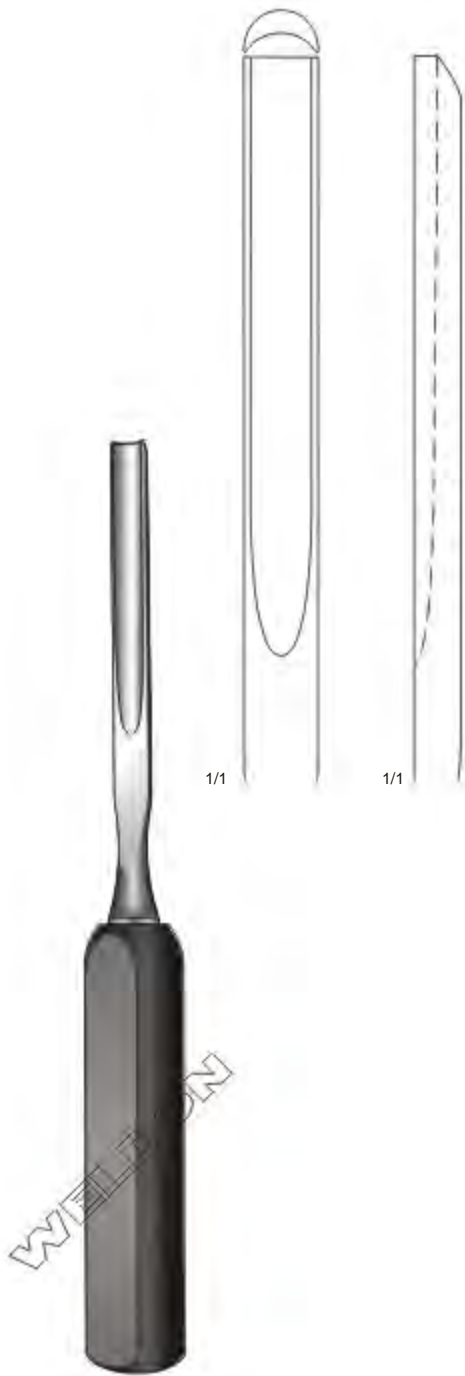

Lexer
 WS-176-196 5 mm
 WS-176-197 10 mm
 WS-176-198 15 mm
 25 cm / 10"

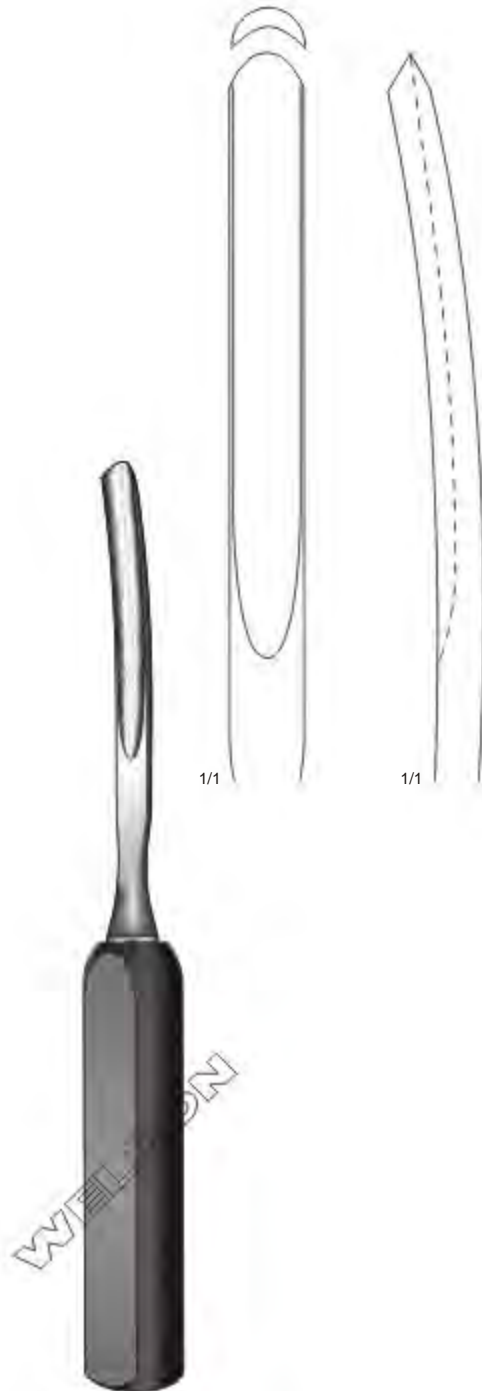

Lexer
 WS-176-199 5 mm
 WS-176-200 10 mm
 WS-176-201 15 mm
 25 cm / 10"

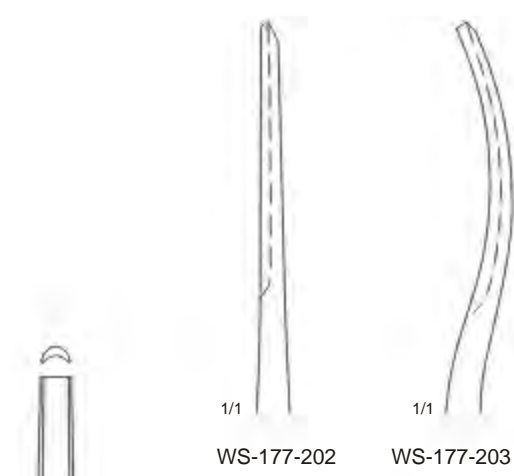

WS-177-202

WS-177-203

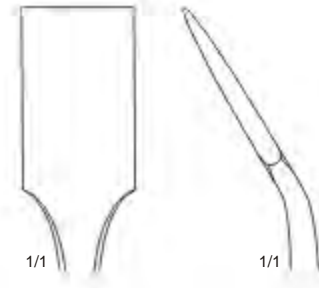

- WS-177-206 4 mm
- WS-177-207 5 mm
- WS-177-208 6 mm
- WS-177-209 8 mm
- WS-177-210 10 mm
- WS-177-211 12 mm
- WS-177-212 15 mm
- WS-177-213 20 mm
- WS-177-214 22 mm
- WS-177-215 25 mm

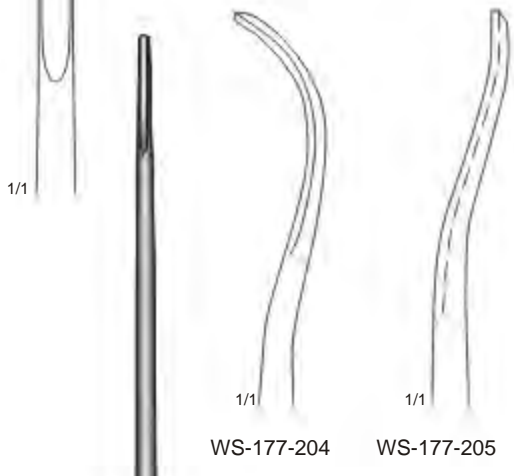

WS-177-204

WS-177-205

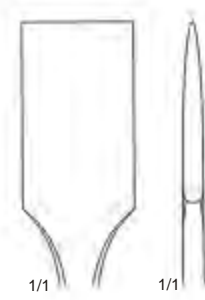

- WS-177-216 4 mm
- WS-177-217 5 mm
- WS-177-218 6 mm
- WS-177-219 8 mm
- WS-177-220 10 mm
- WS-177-221 12 mm
- WS-177-222 15 mm
- WS-177-223 20 mm
- WS-177-224 22 mm
- WS-177-225 25 mm



Cobb
28 cm / 11"



Dahmen
30 cm / 11¾"



Dahmen
30 cm / 11¾"

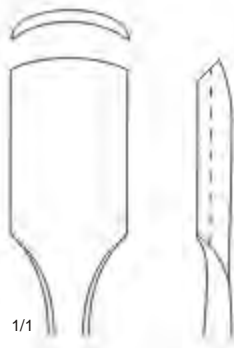

WS-178-226	4 mm
WS-178-227	5 mm
WS-178-228	6 mm
WS-178-229	8 mm
WS-178-230	10 mm
WS-178-231	12 mm
WS-178-232	15 mm
WS-178-233	20 mm
WS-178-234	22 mm
WS-178-235	25 mm

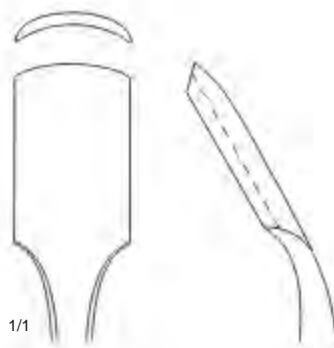

WS-178-236	4 mm
WS-178-237	5 mm
WS-178-238	6 mm
WS-178-239	8 mm
WS-178-240	10 mm
WS-178-241	12 mm
WS-178-242	15 mm
WS-178-243	20 mm
WS-178-244	22 mm
WS-178-245	25 mm

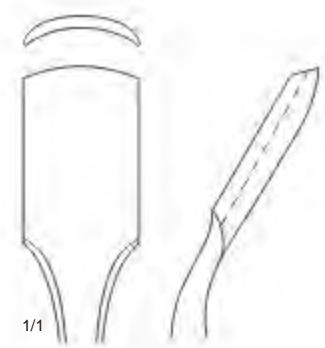

WS-178-246	4 mm
WS-178-247	5 mm
WS-178-248	6 mm
WS-178-249	8 mm
WS-178-250	10 mm
WS-178-251	12 mm
WS-178-252	15 mm
WS-178-253	20 mm
WS-178-254	22 mm
WS-178-255	25 mm

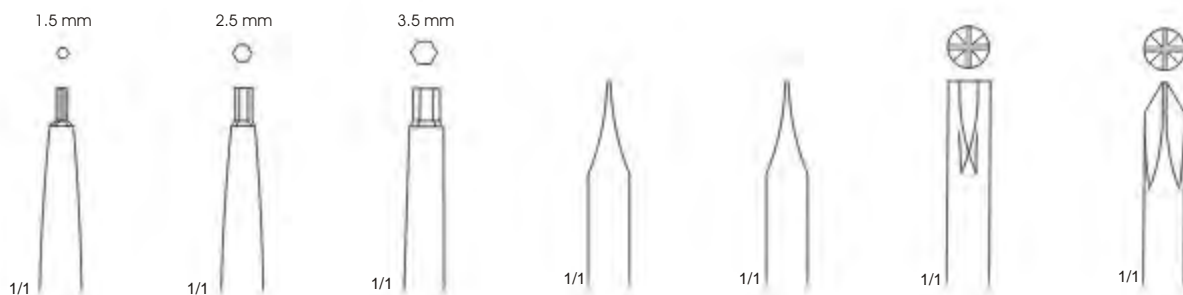

WS-179-256
25 cm / 10"

WS-179-257
25 cm / 10"

WS-179-258
25 cm / 10"

WS-179-259
17 cm / 6 3/4"

Lane
WS-179-260
25 cm / 10"

WS-179-261
25 cm / 10"

Philips
WS-179-262
25 cm / 10"



Putti
WS-180-263
 30 cm / 11¾"
 Round / Semi Round





Putti
WS-180-264
 27 cm / 10¾"
 Curved / Straight



Tampers
 15.5 cm / 6"

1/1 
 1 mm Ø
WS-180-265

1/1 
 2 mm Ø
WS-180-266

1/1 
 3 mm Ø
WS-180-267

1/1 
 4 mm Ø
WS-180-268

1/1 
 5 mm Ø
WS-180-269

1/1 
 6 mm Ø
WS-180-270

1/1 
 7 mm Ø
WS-180-271

1/1 
 8 mm Ø
WS-180-272

1/1 
 10 mm Ø
WS-180-273



Williger
24 cm / 9½"
Lead Filled



WS-181-001
Head Ø 26 mm
Weight 300 gr.



WS-181-002
Head Ø 28 mm
Weight 340 gr.



WS-181-003
Head Ø 30 mm
Weight 400 gr.

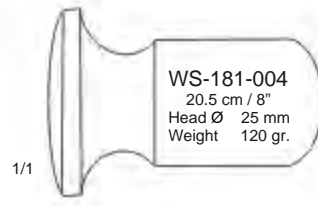

WS-181-004
20.5 cm / 8"
Head Ø 25 mm
Weight 120 gr.

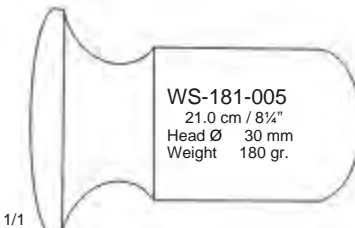

WS-181-005
21.0 cm / 8¼"
Head Ø 30 mm
Weight 180 gr.

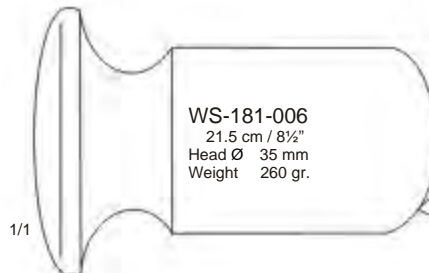

WS-181-006
21.5 cm / 8½"
Head Ø 35 mm
Weight 260 gr.



Doyen



Lucae
19.5 cm / 7¾"



Collin
WS-181-009
20 cm / 8"



Williger
WS-181-010
16.5 cm / 6½"



WS-181-007
Head Ø 19 mm
Weight 230 gr.



WS-181-008
Head Ø 25 mm
Weight 260 gr.

Mallets | Martillos | Hämmer

Gerzog
WS-182-011A
 19 cm / 7½"
 Weight 10 oz. / 285 gr.
 Head Weight 7 oz. / 200 gr.
 Head Diameter 25 mm



Head Diameter 27 mm
 Weight 320 gr.

WD-182-012-R
 Ferrozell Disks Only
 In Pairs

Mead
WS-182-012
 19 cm / 7½"
 With Interchangeable
 Ferrozell Disks



Heath
WS-182-012A
 19 cm / 7½"
 Stainless Steel, Solid
 Weight 2 lbs / 900 gr.
 Head Weight 1 lb / 570 gr.
 Head Diameter 40 mm



Head Diameter 22 mm
 Weight 200 gr.

Partsch
WS-182-014
 19 cm / 7½"
 With Hollow Handle



Head Diameter 30 mm
 Weight 510 gr.

WS-182-011
 26 cm / 10¼"
 Plastic Handle



Head Diameter 45 mm
 Weight 290 gr.

WS-182-013
 23 cm / 9"
 Hard Wood, Lead Filled



Bergmann-(Hibbs)
WS-182-013A
 22.5 cm / 9"
 Weight 570 gr., Head Diameter 40 mm



Head Ø 42/30 mm
Weight 530 gr.

WS-183-015
26 cm / 10 1/4"
Plastic Handle



Head Ø 37 mm
Weight 370 gr.

WS-183-017
24 cm / 9 1/2"
Disks and Handle Of Plastic

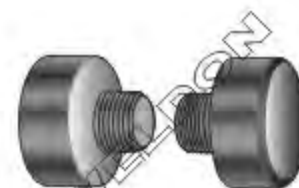

WS-183-018
Spare Facings (Pair)
Plastic



Head Ø 30 mm
Weight 480 gr.

WS-183-016
24 cm / 9 1/2"
Plastic Handle



Head Ø 30 mm
Weight 125 gr.

WS-183-019
22 cm / 8 3/4"
Made Of Plastic

Mallets | Martillos | Hämmer

Head Ø 80 x 60 mm
Weight 400 gr.



Steinbach
WS-184-020
24 cm / 9½"
Ferrozell, Solid

Head Ø 42 mm
Weight 400 gr.



WS-184-023
26 cm / 10¼"
Made Of Plastic
With Lead Filling

Head Ø 30 mm
Weight 675 gr.



WS-184-024
26.5 cm / 10½"
Plain (Nylon) Convex
(Steel) Plastic Handle

WS-184-021
26 cm / 10¼"
Made Of Plastic
With Lead Filling
Head Ø 42 mm
Weight 400 gr.



WS-184-022
26 cm / 10¼"
Made Of Plastic
Without Lead
Head Ø 42 mm
Weight 250 gr.

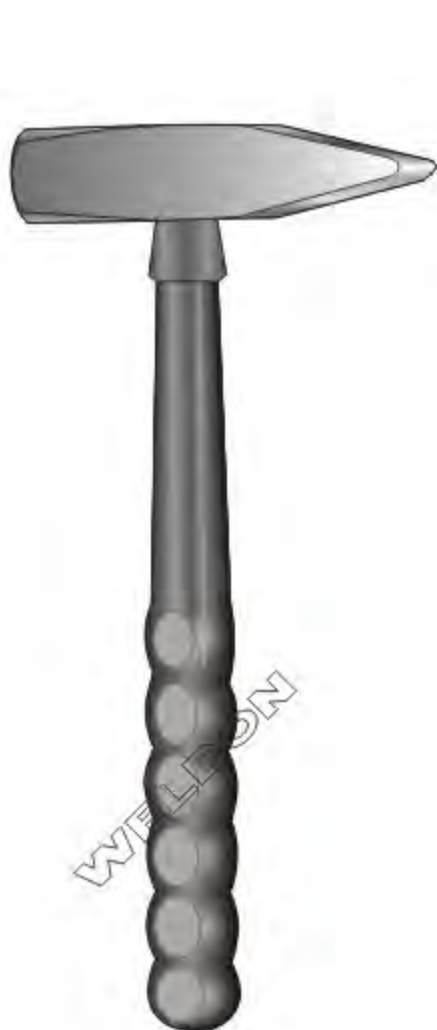

WS-185-025
24 cm / 9½"
Steel, Sold
With Plastic Handle



Head Ø 30 mm
Weight 450 gr.

WS-185-026
26.5 cm / 10½"
Plastic Handle



Head Ø 50 mm
Weight 900 gr.

WS-185-027
26.5 cm / 10½"
Plastic Handle

Bone Currettes | Cucharillas Cortantes | Scharfe Löffel

1/1
Fig. 0000
WS-186-001

1/1
Fig. 2
WS-186-006

1/1
Fig. 0
WS-186-011

1/1
Fig. 000
WS-186-002

1/1
Fig. 3
WS-186-007

1/1
Fig. 1
WS-186-012

1/1
Fig. 00
WS-186-003

1/1
Fig. 4
WS-186-008

1/1
Fig. 2
WS-186-013

1/1
Fig. 0
WS-186-004

1/1
Fig. 5
WS-186-009

1/1
Fig. 3
WS-186-014

1/1
Fig. 1
WS-186-005

1/1
Fig. 6
WS-186-010

1/1
Fig. 4
WS-186-015



Volkman
19 cm / 7½"
Oval, With Plastic Handle



Volkman
27.5 cm / 10¾"
Oval, With Plastic Handle

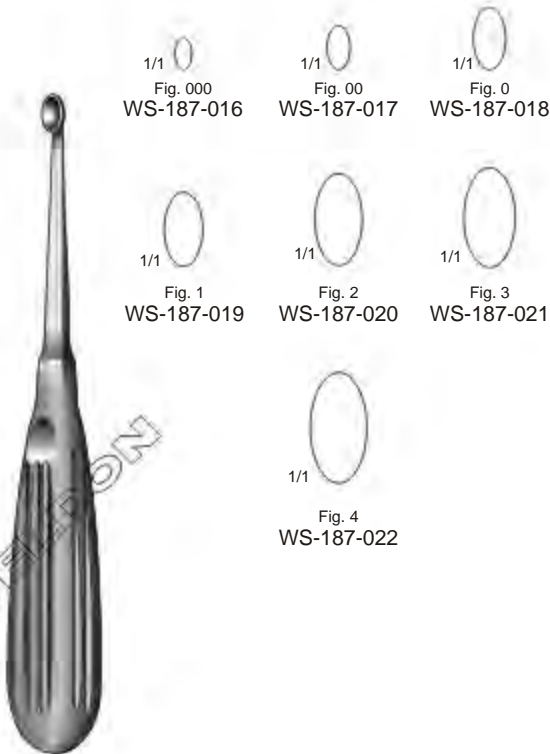

- 1/1 Fig. 000 WS-187-016
- 1/1 Fig. 00 WS-187-017
- 1/1 Fig. 0 WS-187-018
- 1/1 Fig. 1 WS-187-019
- 1/1 Fig. 2 WS-187-020
- 1/1 Fig. 3 WS-187-021
- 1/1 Fig. 4 WS-187-022

Schede
17 cm / 6¾"
Oval, With Hollow Handle

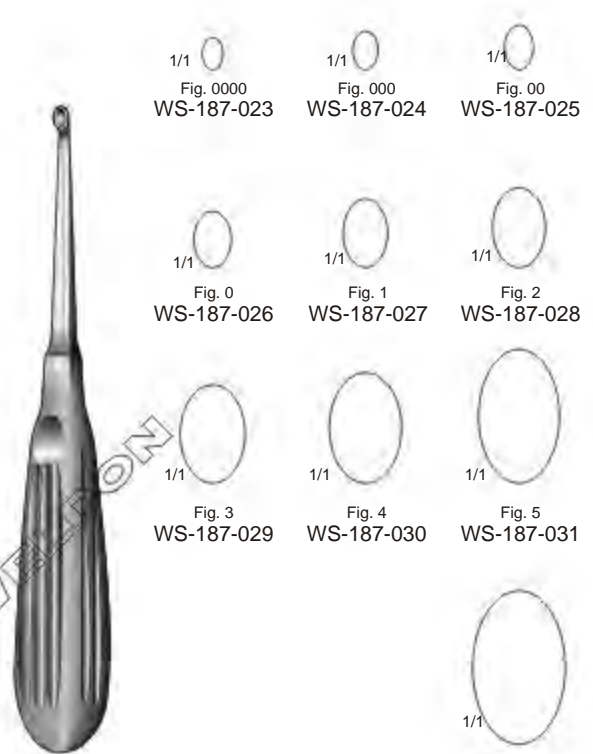

- 1/1 Fig. 0000 WS-187-023
- 1/1 Fig. 000 WS-187-024
- 1/1 Fig. 00 WS-187-025
- 1/1 Fig. 0 WS-187-026
- 1/1 Fig. 1 WS-187-027
- 1/1 Fig. 2 WS-187-028
- 1/1 Fig. 3 WS-187-029
- 1/1 Fig. 4 WS-187-030
- 1/1 Fig. 5 WS-187-031
- 1/1 Fig. 6 WS-187-032

Volkmann
17 cm / 6¾"
Oval, With Hollow Handle

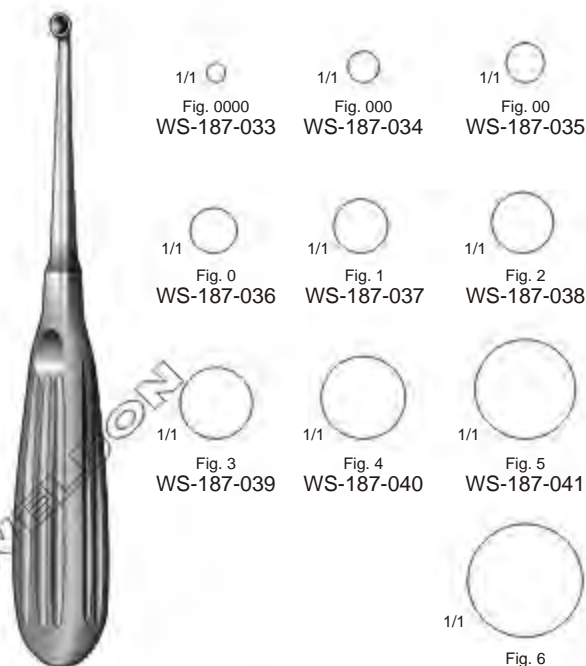

- 1/1 Fig. 0000 WS-187-033
- 1/1 Fig. 000 WS-187-034
- 1/1 Fig. 00 WS-187-035
- 1/1 Fig. 0 WS-187-036
- 1/1 Fig. 1 WS-187-037
- 1/1 Fig. 2 WS-187-038
- 1/1 Fig. 3 WS-187-039
- 1/1 Fig. 4 WS-187-040
- 1/1 Fig. 5 WS-187-041
- 1/1 Fig. 6 WS-187-042

Bruns
17 cm / 6¾"
Round, With Hollow Handle

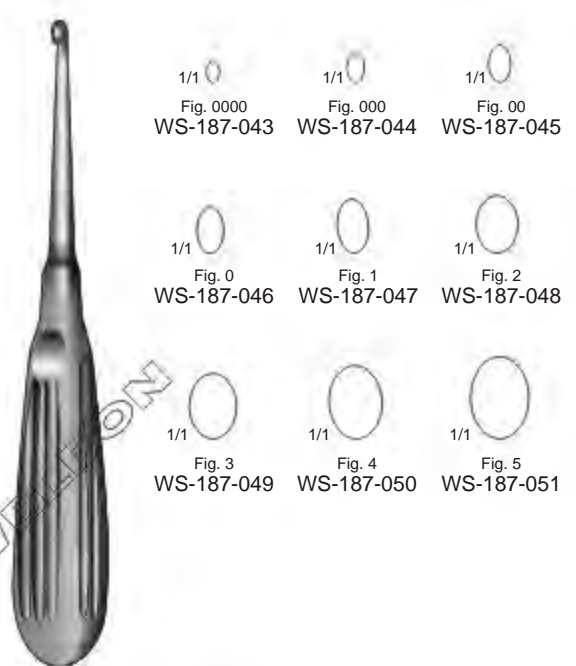

- 1/1 Fig. 0000 WS-187-043
- 1/1 Fig. 000 WS-187-044
- 1/1 Fig. 00 WS-187-045
- 1/1 Fig. 0 WS-187-046
- 1/1 Fig. 1 WS-187-047
- 1/1 Fig. 2 WS-187-048
- 1/1 Fig. 3 WS-187-049
- 1/1 Fig. 4 WS-187-050
- 1/1 Fig. 5 WS-187-051

Spratt
17 cm / 6¾"
Oval, With Hollow Handle

Bone Curettes | Cucharillas Cortantes | Scharfe Löffel

1/1
Fig. 1
WS-188-052

1/1
Fig. 2
WS-188-053

1/1
Fig. 3
WS-188-054

1/1
Fig. 4
WS-188-055

1/1
Fig. 5
WS-188-056

1/1
Fig. 6
WS-188-057



1/1
Fig. 1
WS-188-058

1/1
Fig. 2
WS-188-059

1/1
Fig. 3
WS-188-060

1/1
Fig. 4
WS-188-061

1/1
Fig. 5
WS-188-062

1/1
Fig. 6
WS-188-063



1/1
Fig. 1
WS-188-064

1/1
Fig. 2
WS-188-065

1/1
Fig. 3
WS-188-066

1/1
Fig. 4
WS-188-067

1/1
Fig. 5
WS-188-068

1/1
Fig. 6
WS-188-069



1/1
Fig. 1
WS-188-070

1/1
Fig. 2
WS-188-071

1/1
Fig. 3
WS-188-072

1/1
Fig. 4
WS-188-073

1/1
Fig. 5
WS-188-074

1/1
Fig. 6
WS-188-075

1/1
Fig. 1
WS-188-076

1/1
Fig. 2
WS-188-077

1/1
Fig. 3
WS-188-078



Simon
25 cm / 9 3/4"
Oval, With Hollow Handle



Modell USA
15.5 cm / 6"
Oval, With Hollow Handle



Halle
21 cm / 8 1/4"
Oval, Malleable Shaft,
With Hollow Handle

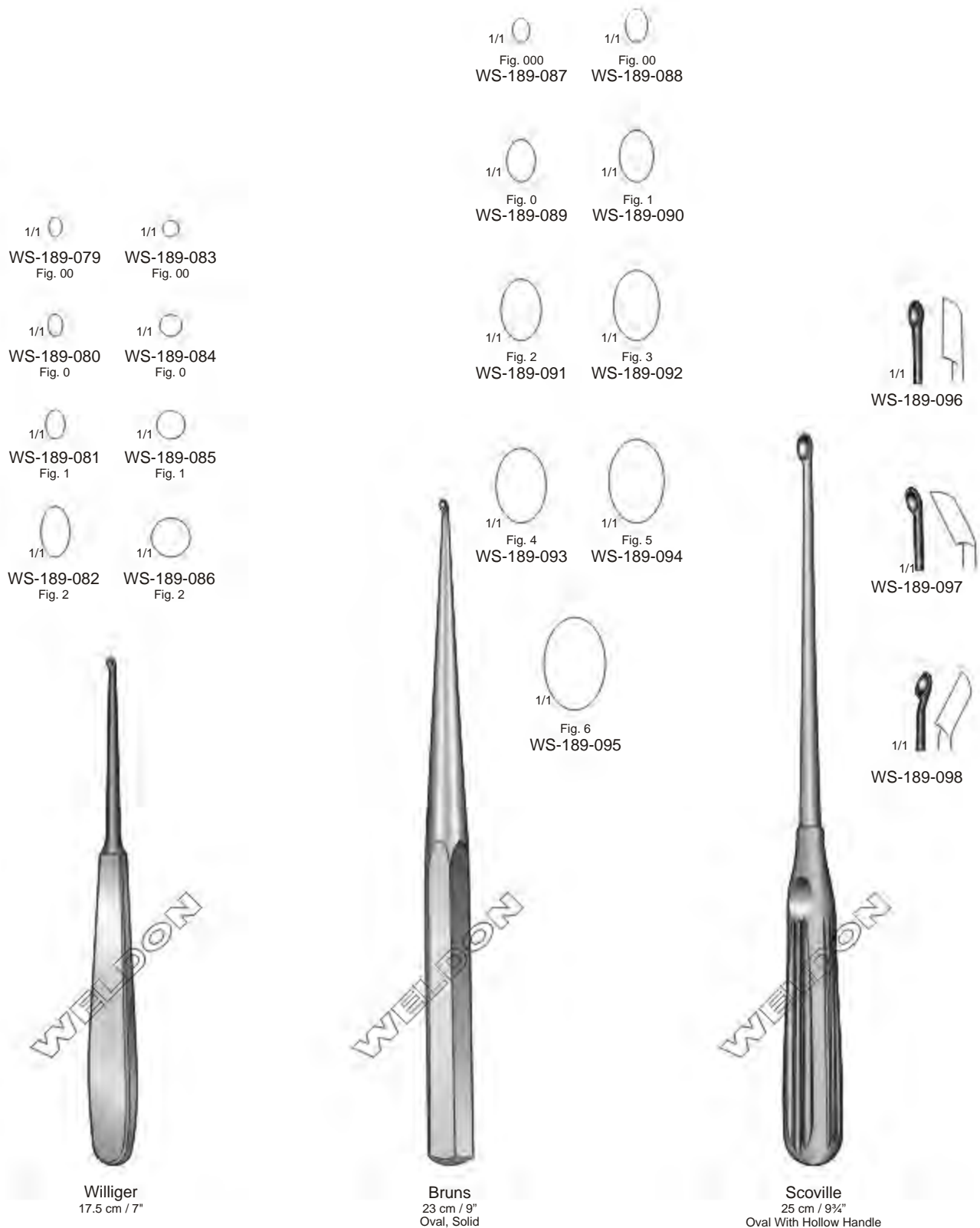

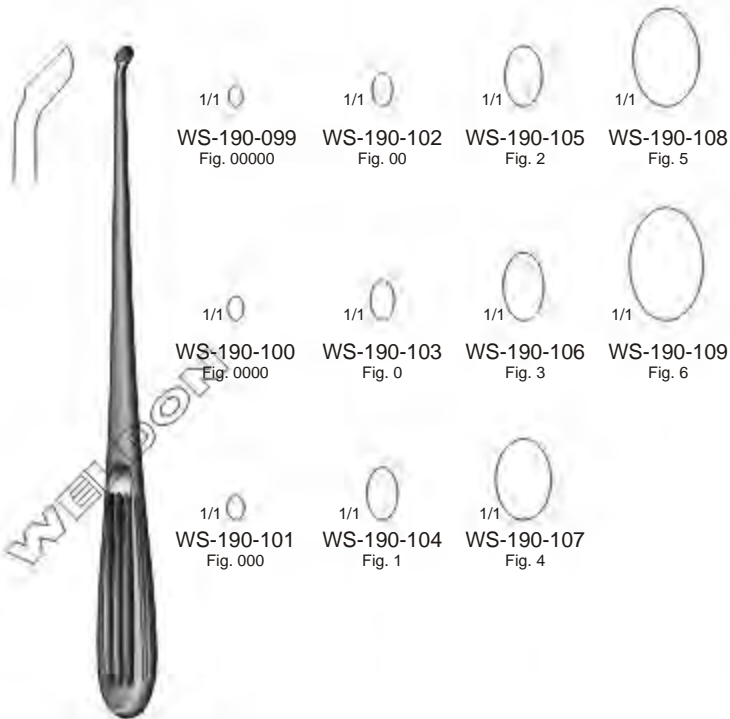
Bone Curettes | Cucharillas Cortantes | Scharfe Löffel

Spinal Fusion Curettes
23 cm / 9"
Reverse Angle

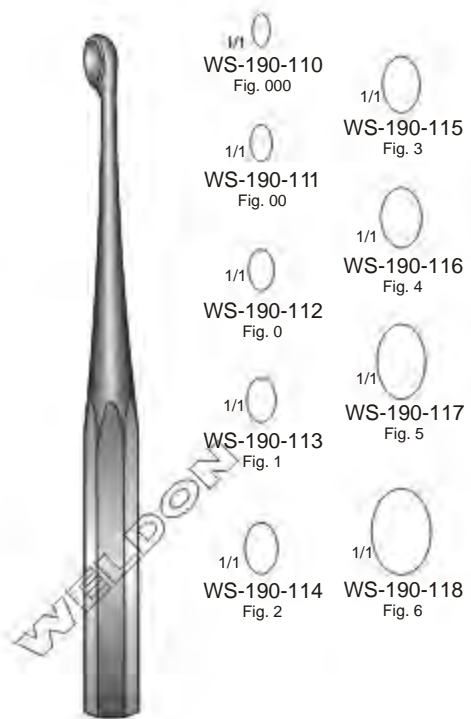

Bruns Oval Cup Cruettes
23 cm / 9"
Solid Hexagonal Handle
Straight

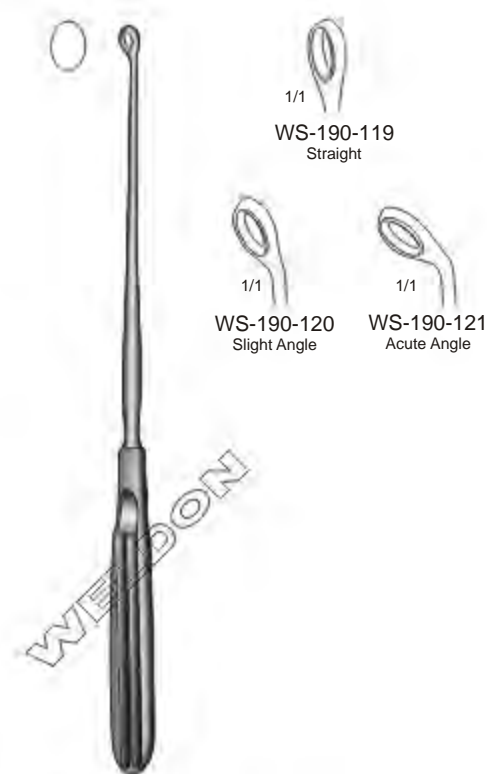

Semmes (Howard) Spinal Curettes
23 cm / 9", 4 x 7 mm Cup

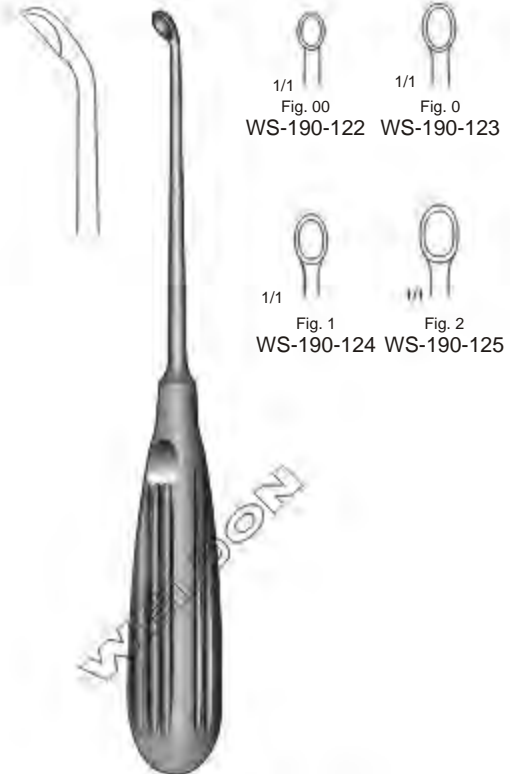

Daubenspeck
20 cm / 8"

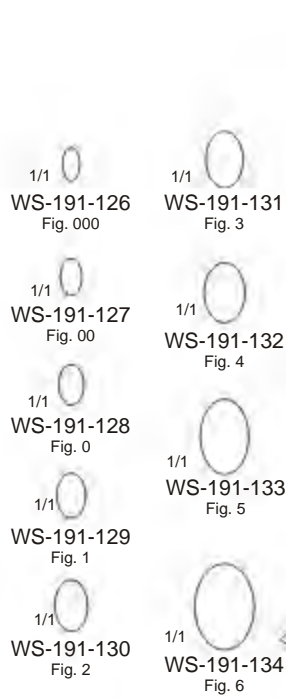

Cobb - Type Oval Cup Currettes
 27.9 cm / 11"
 Hollow, Knurled Handle
 Angled

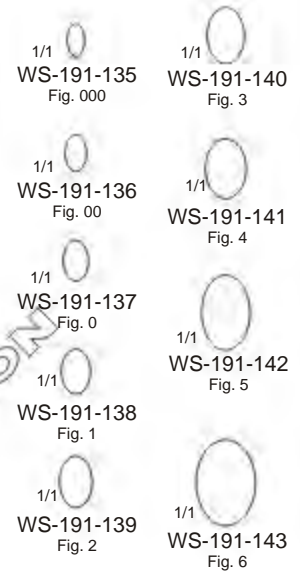

Cobb - Type Oval Cup Currettes
 27.9 cm / 11"
 Hollow, Knurled Handle
 Straight



Siebenmann
 WS-191-144
 16 cm / 6 1/4"

Siebenmann
 WS-191-145
 16 cm / 6 1/4"





Uffendorde
 WS-191-146
 17 cm / 6 3/4"





Uffendorde
 WS-191-147
 17 cm / 6 3/4"



Bone Currettes | Cucharillas Cortantes | Scharfe Löffel

- 1/1  WS-192-148 Straight
- WS-192-149 Angular
- 8 mm
- 1/1  WS-192-150 Straight
- WS-192-151 Angular
- 6 mm
- 1/1  WS-192-152 Straight
- WS-192-153 Angular
- 3 mm

Cone Ring Currettes
23 cm / 9"

- 1/1  WS-192-154 Angle
- 1/1  WS-192-155 Angle





Cone Ring Currettes
23 cm / 9"

- 1/1  WS-192-156 Straight
- 1/1  WS-192-157 Reverse Angled
- WS-192-158 Angled

Scoville Disc Currettes
25 cm / 10"
Cup Size 4 x 10 mm



- 1/1  WS-192-159 Size 3-0
- 1/1  WS-192-160 Size 2-0
- 1/1  WS-192-161 Size 0

Epstein Spinal Currettes
20 cm / 8"
Reverse Angle

- 1/1  Fig 0 WS-192-162 Ø 2.0 mm
- 1/1  Fig 1 WS-192-163 Ø 2.5 mm
- 1/1  Fig 2 WS-192-164 Ø 3.0 mm
- 1/1  Fig 3 WS-192-165 Ø 3.5 mm
- 1/1  Fig 4 WS-192-166 Ø 5.0 mm

Meyhoefer
14 cm / 5½"

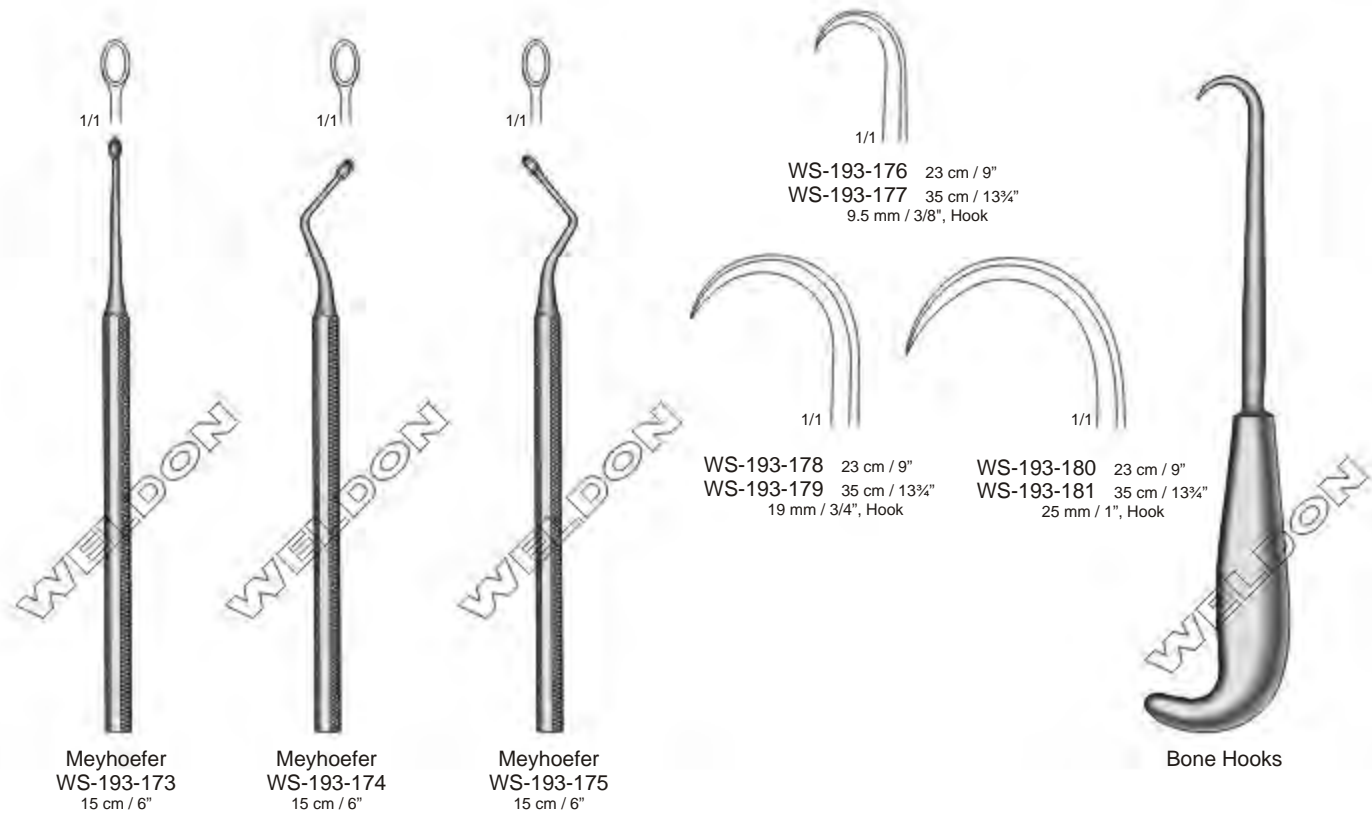
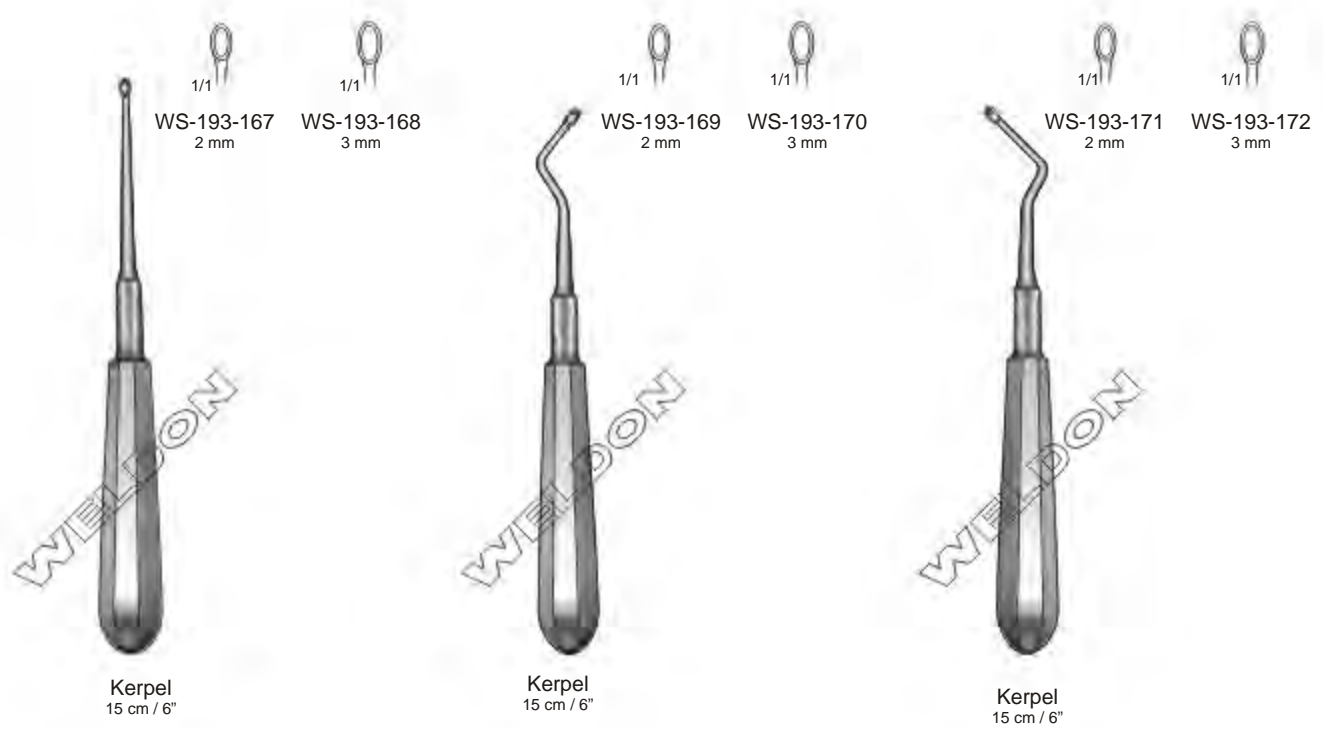
Bone Currettes And Hooks | Cucharllias Cortantes Y Ganchos | Scharfe Löffel, Knochenhaken

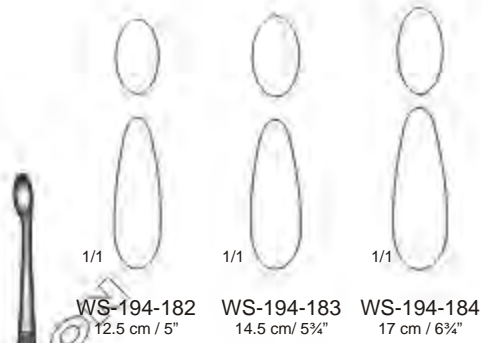
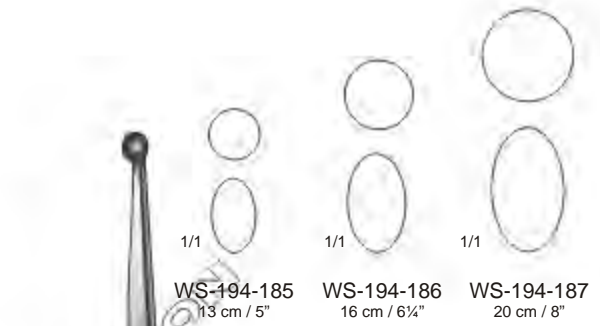
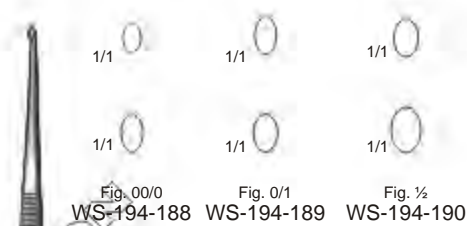
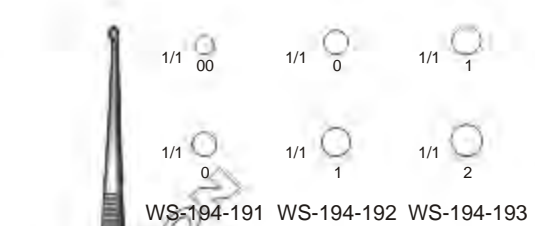

Bone Curettes Double Ended | Cucharillas De Doble Extremo | Scharfe Doppellöfel

Volkman

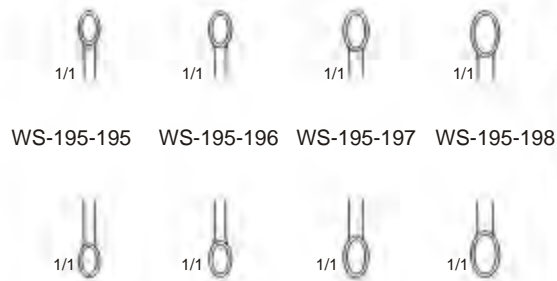
Volkman

Williger
13.5 cm / 5 1/4"

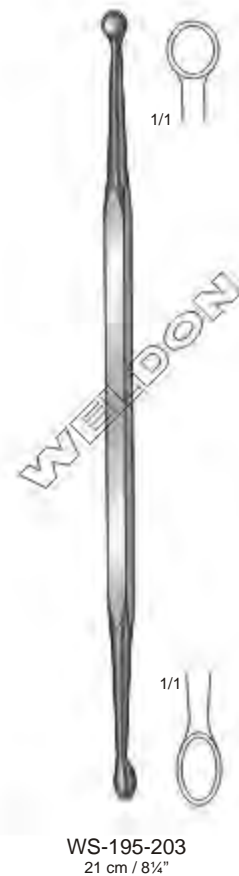
Martini
13.5 cm / 5 1/4"

Bone Curettes Double Ended | Cucharillas De Doble Extremo | Scharfe Doppellöfel



- WS-195-199 13 cm / 5", One Round And One Oval Cup, 10.5 mm And 6.3 x 6.8 mm
- WS-195-200 16.5 cm / 6 1/2", Two Oval Cups, 7.5 x 14 mm and 9 x 22 mm
- WS-195-201 16.5 cm / 6 1/2", One Round And One Oval Cup, 14 mm And 7 x 9 mm
- WS-195-202 20 cm / 8", One Round And One Oval Cup, 17.5 mm And 9 x 11 mm



Periosteal Elevators | Periostotómos | Raspatorien



Cushing



1/1
4 mm
WS-196-204
17 cm / 6¾"

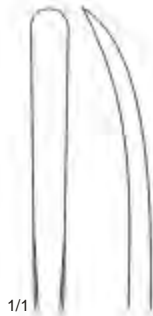

1/1
6 mm
WS-196-205
17 cm / 6¾"

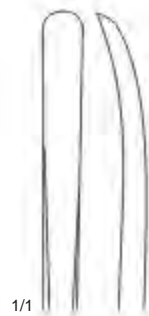

1/1
5 mm
WS-196-206
19.5 cm / 7¾"



1/1
7 mm
WS-196-207
19.5 cm / 7¾"

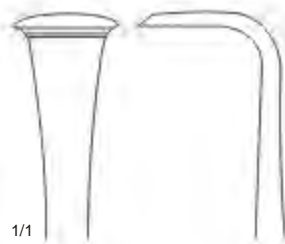

1/1
Langenbeck
WS-196-208
18 cm / 7"



1/1
Langenbeck
WS-196-209
19 cm / 7½"



Langenbeck
Solid

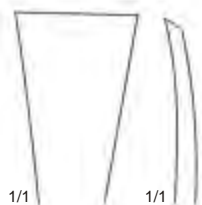

16 mm
WS-197-210
19 cm / 7½"

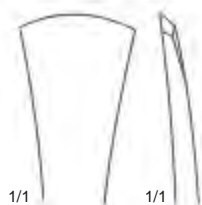

16 mm
WS-197-211
19 cm / 7½"



12 mm
WS-197-212
18.5 cm / 7¼"



12 mm
WS-197-213
18 cm / 7"



7 mm
WS-197-214
16 cm / 6¼"



15 mm
WS-197-215
18.5 cm / 7¼"

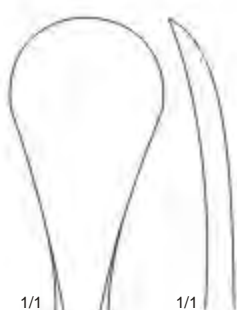

20 mm
WS-197-216
19 cm / 7½"

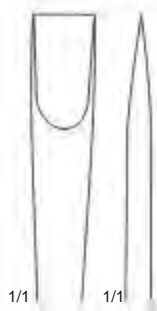

8 mm
WS-197-217
17 cm / 6¾"



Hoehn
Solid



Cushing
Solid

Periosteal Elevators | Periostótomos | Raspatorien

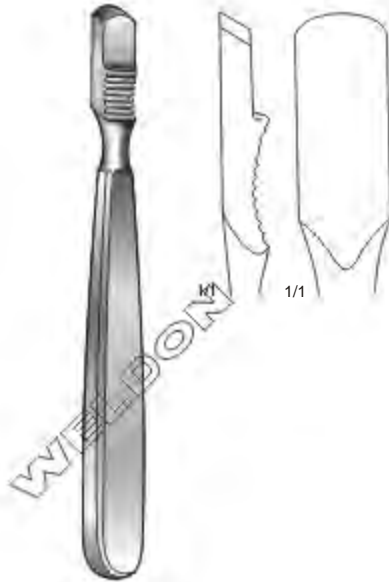

Farabeuf
WS-198-218
15 cm / 6"



Farabeuf
WS-198-219
15 cm / 6"



16 cm / 6 1/4"
Delicate, Solid

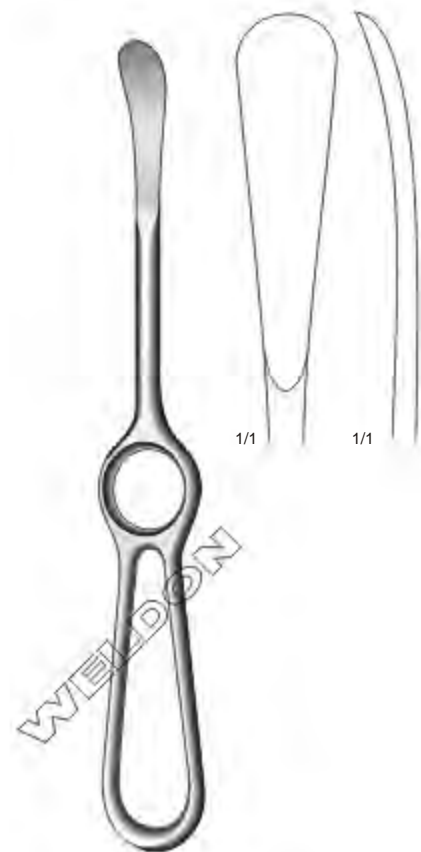

Sedillot
WS-198-223
21 cm / 8 1/4"

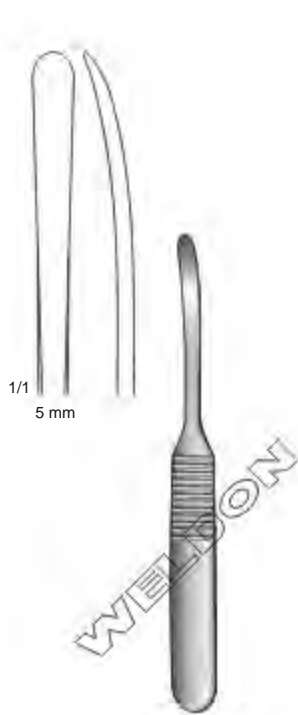

Williger
WS-199-224
 12.5 cm / 5"
 Solid

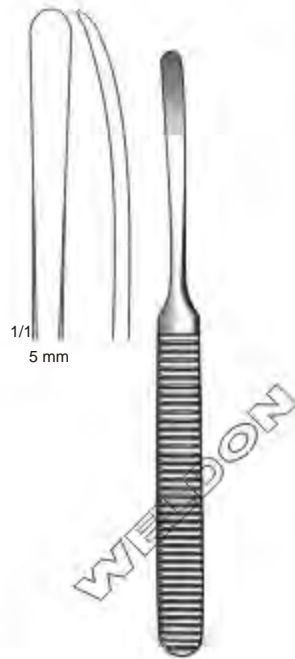

Williger
WS-199-225
 16 cm / 6¼"
 Solid

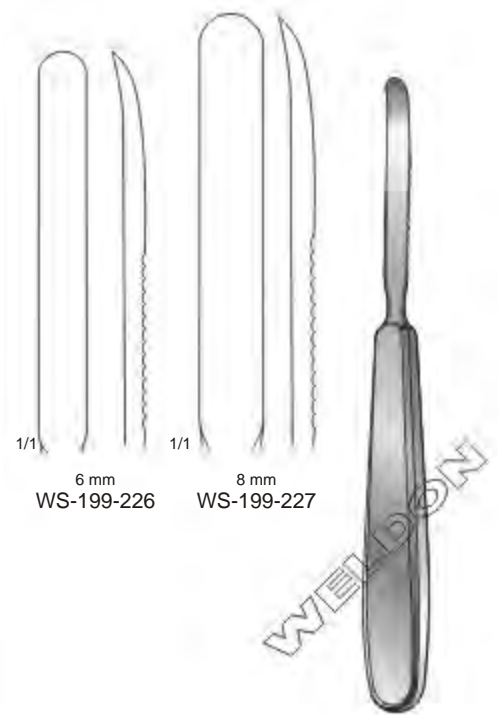

6 mm
WS-199-226 8 mm
WS-199-227

With Hollow Handle
 17 cm / 6¾"



WS-199-228
 Right Curved For Adults

WS-199-229
 Left Curved

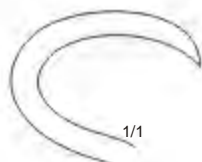

WS-199-230
 Right Curved For Children



WS-199-231
 Left Curved



Doyen
 17.5 cm / 7"
 Rib Raspatories
 With Hollow Handle

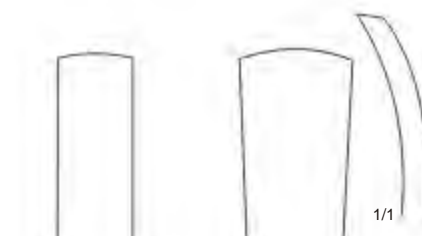

10 mm
WS-199-232 15 mm
WS-199-233

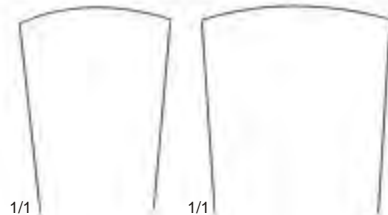

20 mm
WS-199-234 25 mm
WS-199-235



Lambotte
 21.5 cm / 8½"

Elevators | Elevadores | Elevatorien



WS-200-236

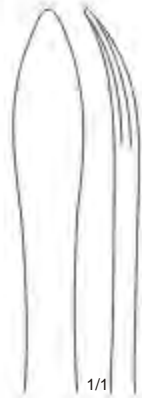

WS-200-237

Langenbeck
20 cm / 8"



5 mm
WS-200-238
17 cm / 6 3/4"



7 mm
WS-200-239
17 cm / 6 3/4"



8 mm
WS-200-240
20 cm / 8"



10 mm
WS-200-241
20 cm / 8"

Langenbeck



1/1
7 mm



1/1
5.5 mm

Williger
WS-200-242
17 cm / 6 3/4"

Williger
WS-200-243
16 cm / 6 3/4"



1/1

WS-200-244
17.5 cm / 6 3/4"
Extremely Lightweight

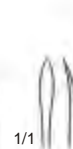

1/1

Micro Elevator
WS-200-245
16 cm / 6 3/4"



Key
19 cm / 7½"



6 mm
WS-201-246



12 mm
WS-201-247

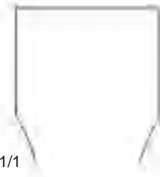

19 mm
WS-201-248



25 mm
WS-201-249

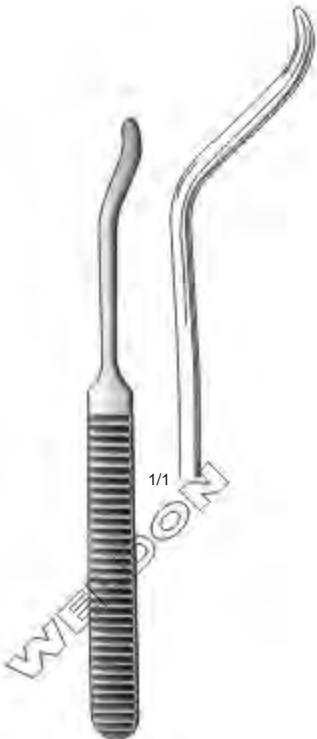

Phalangeal
WS-201-250
16 cm / 6¼"



Alderdyce
WS-201-251
21 cm / 8¼"



McDonald
WS-201-252
19 cm / 7½"

Raspatories | Legras | Raspatorien



Semb
WS-202-253
17.5 cm / 7"

Semb
WS-202-254
21 cm / 8 1/4"

Semb
WS-202-255
17.5 cm / 7"

Semb
WS-202-256
21 cm / 8 1/4"

Semb
WS-202-257
20.5 / cm 8"



WS-203-258



WS-203-259



WS-203-260



WS-203-261



Adson
17 cm / 6 3/4"

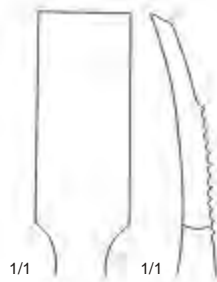

Alexander
WS-203-262
20 cm / 8"



Matson
WS-203-263
22 cm / 8 3/4"



Raspatories | Legras | Raspatorien



WS-204-001
20 cm / 8"

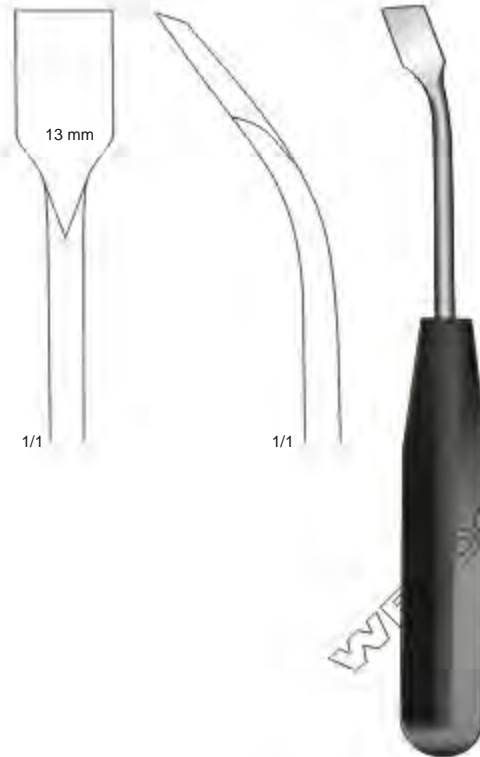

WS-204-002
20 cm / 8"



WS-204-003
20 cm / 8"



WS-204-004
20 cm / 8"

Plastic Handle - Autoclavable Up To 134°C

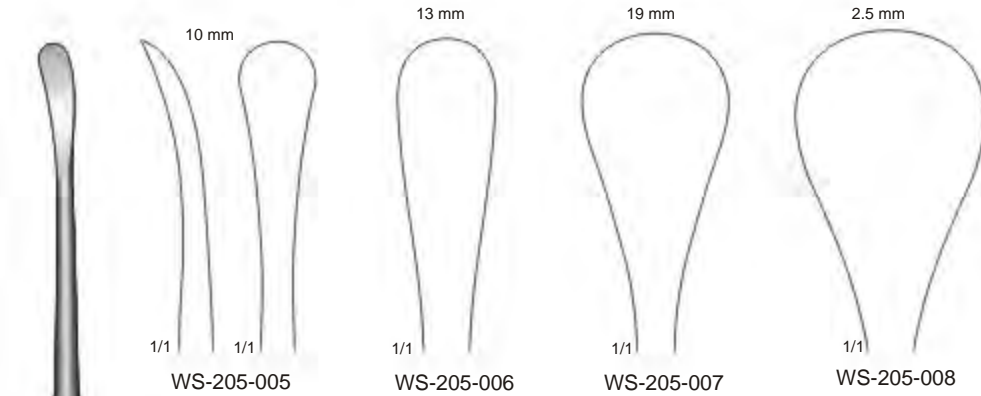

Cobb
25 cm / 10"

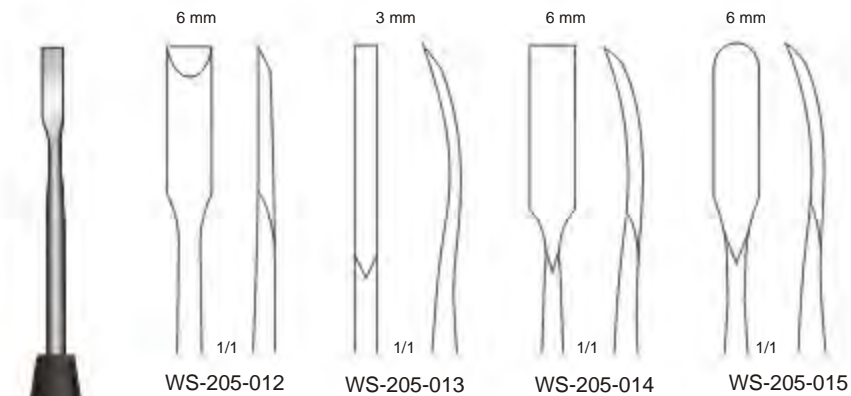
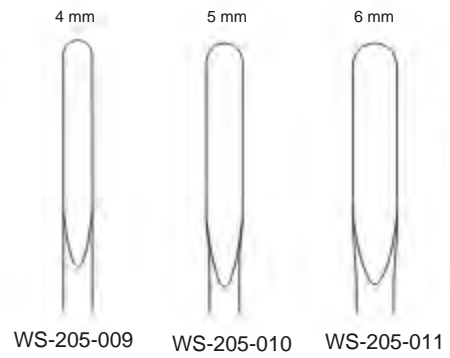

18.5 cm / 7 1/4"

Plastic Handle - Autoclavable Up To 134°C



30 cm / 11 1/4"

Raspatories | Legras | Raspatorien

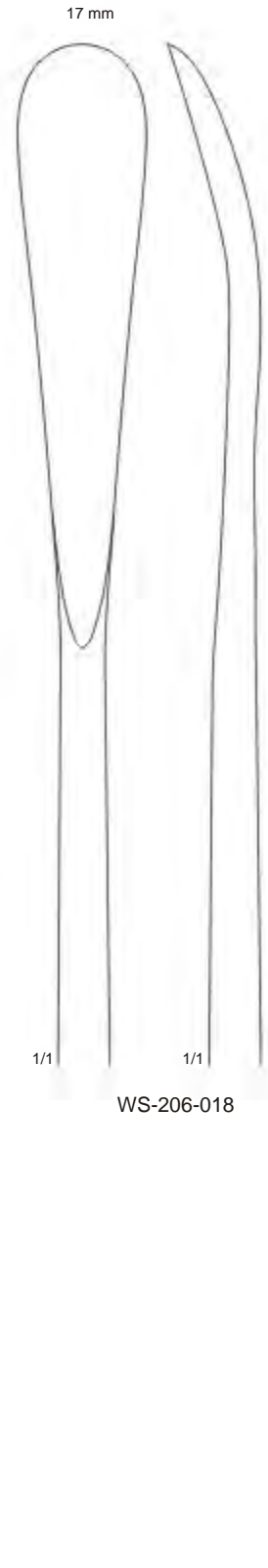
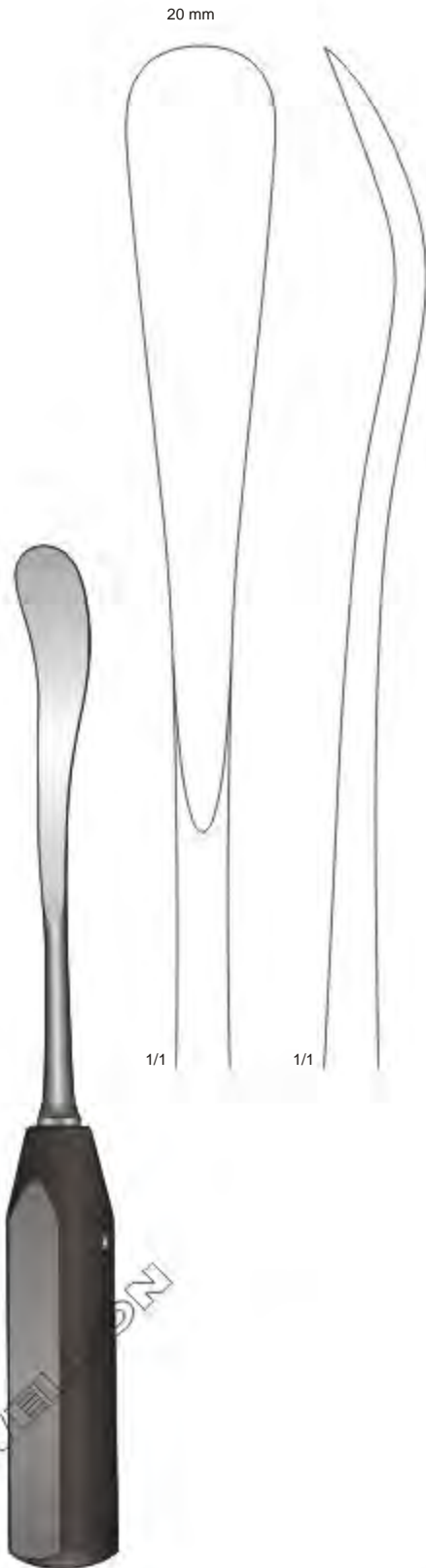

WS-206-016
28 cm / 11"

Wagner
33 cm / 13"

Plastic Handle - Autoclavable Up To 134°C

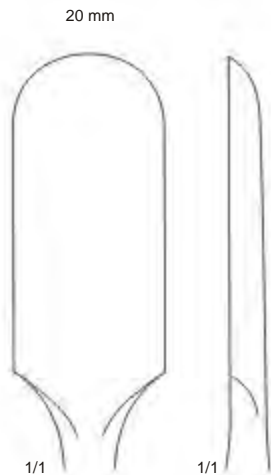

WS-207-019

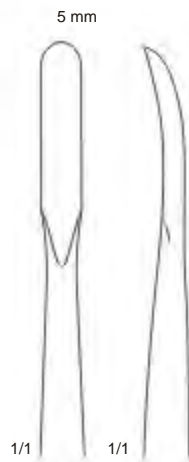

WS-207-020

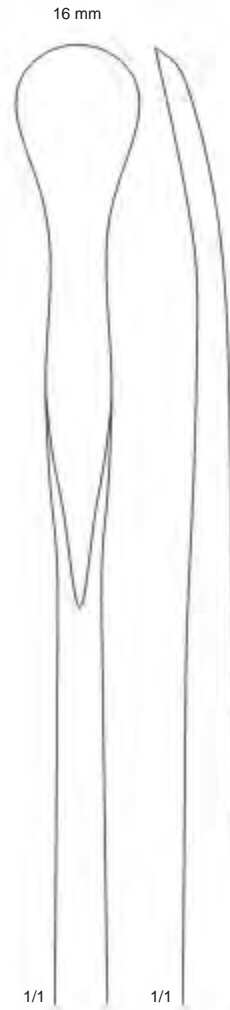

WS-207-021

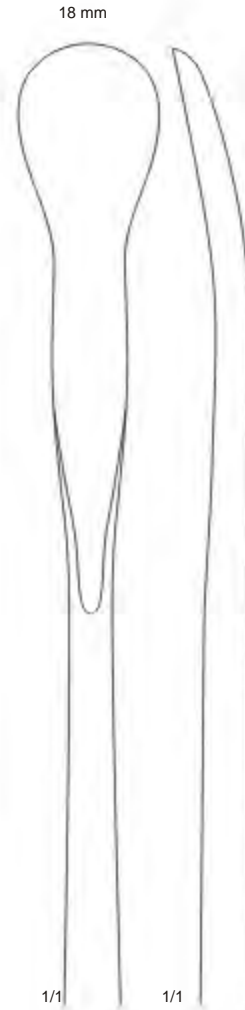

WS-207-022



20 cm / 8"



30 cm / 11 3/4"

Plastic Handle - Autoclavable Up To 134°C

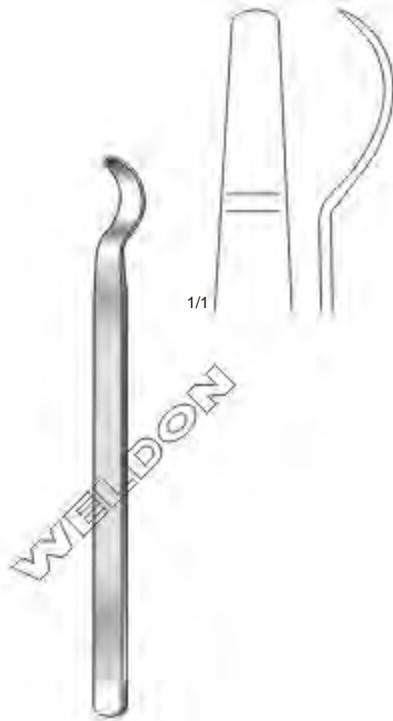

WS-208-001
14 cm / 5½"

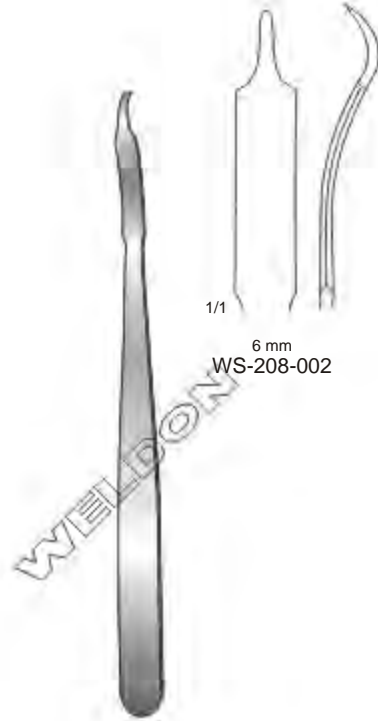

6 mm
WS-208-002



8 mm
WS-208-003

Hohmann-Mini
16 cm / 6¼"

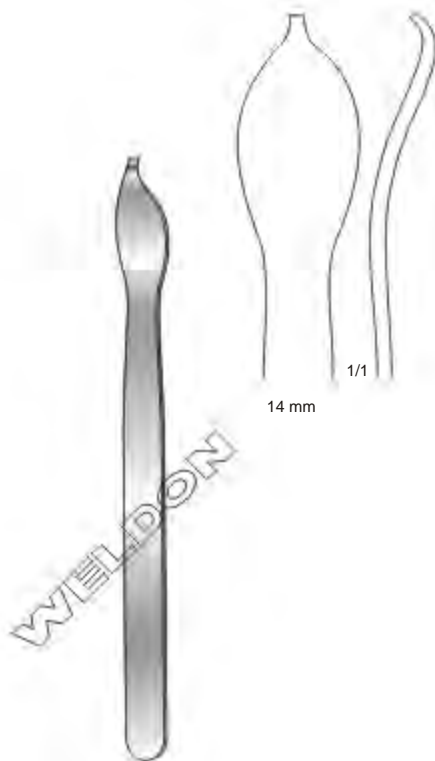

WS-208-004
16 cm / 6¼"

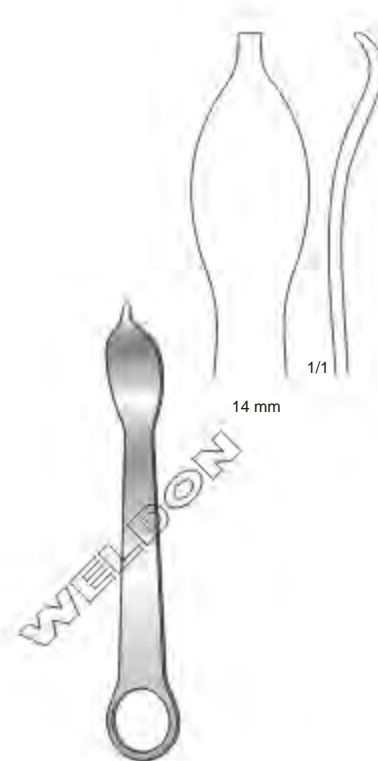

WS-208-005
12 cm / 4¾"



Hohmann
WS-209-006
22 cm / 8 3/4"



Hohmann
WS-209-007
23.5 cm / 9 1/4"

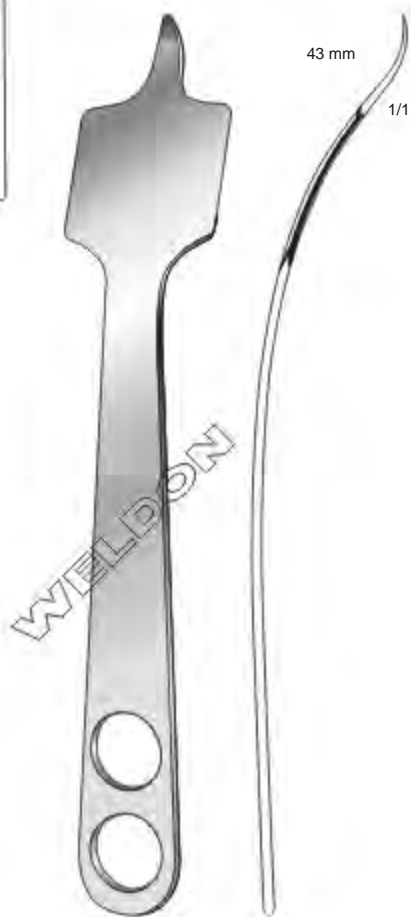

Hohmann
WS-209-008 38 mm
WS-209-009 43 mm
23.5 cm / 9 1/4"



Hohmann
WS-209-010
25 cm / 9 3/4"

Bone Levers | Elevadores Para Hueso | Knochenheber





Bennett
 WS-211-016 43 mm
 WS-211-017 60 mm
 24 cm / 9½"



Blount
 WS-211-018
 26 cm / 10¼"



Blount
 WS-211-019
 26 cm / 10¼"



Hibbs
 WS-211-019A 23 x 25 mm
 WS-211-019B 20 x 50 mm
 WS-211-019C 25 x 75 mm
 23.5 cm / 9½"

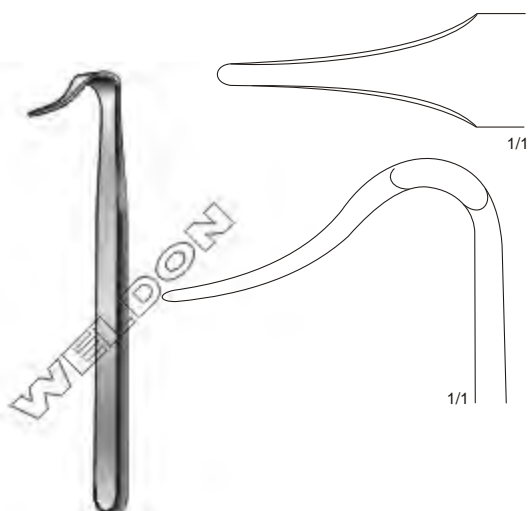

Blount
 WS-211-020
 17.5 cm / 7"
 Knee Retractors



Taylor
 Pointed End Retractors
 16.5 cm / 6½"

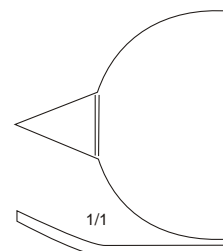

WS-211-021
 100 x 30 mm

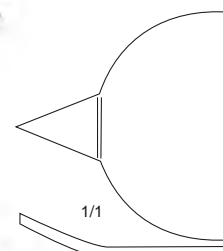

WS-211-022
 75 x 30 mm

Cartilage Seizing Forceps | Pinzas Para Cartilago | Knorpelfasszangen

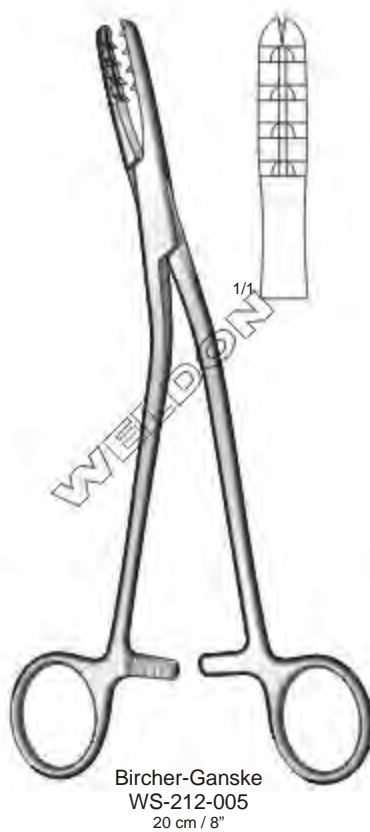
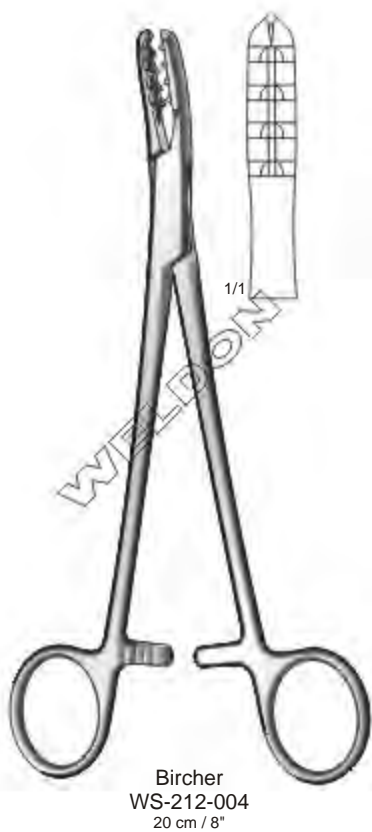
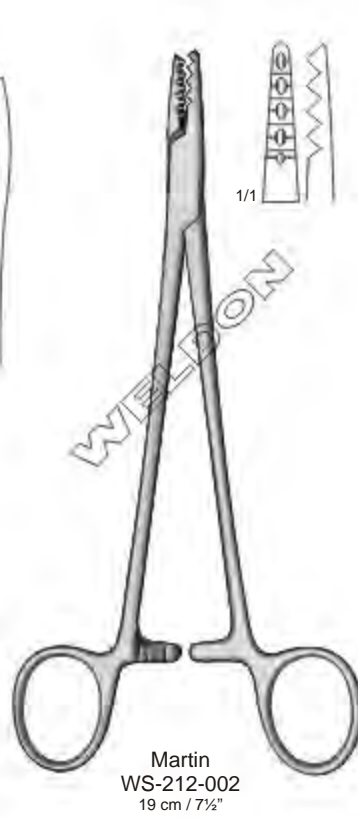
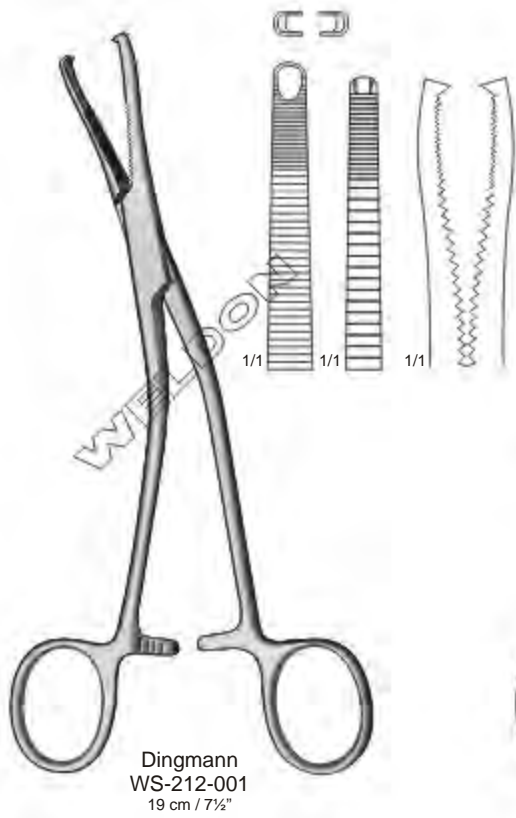

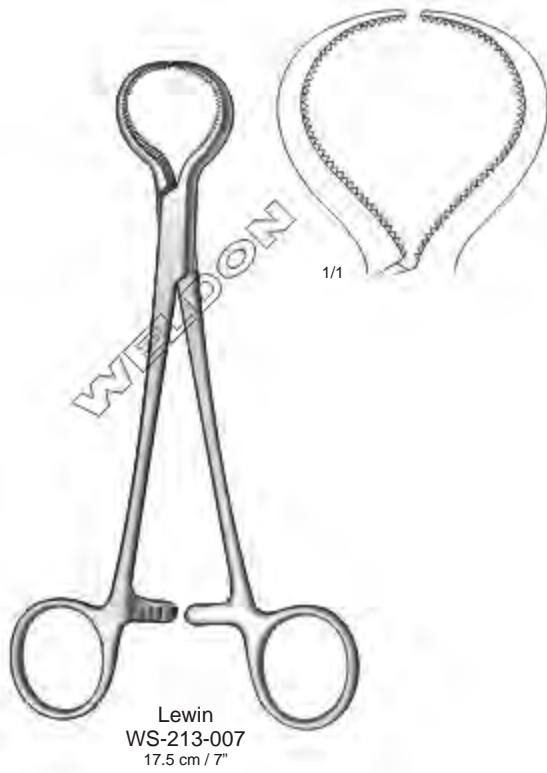

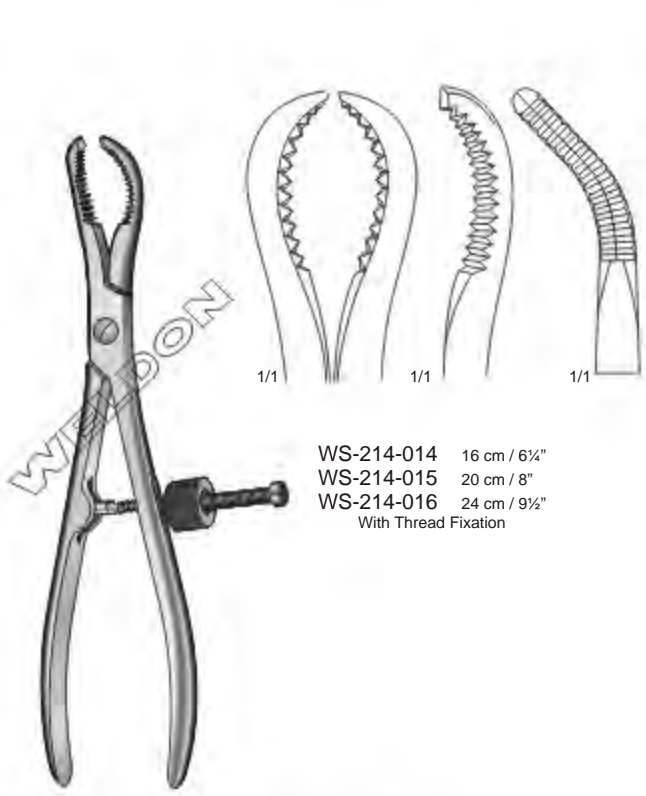
Bone Holding Forceps | Pinzas Para Hueso | Knochenhaltezangen

WS-214-014 16 cm / 6¼"
 WS-214-015 20 cm / 8"
 WS-214-016 24 cm / 9½"
 With Thread Fixation



Langenbeck
 WS-214-017
 21 cm / 8¼"

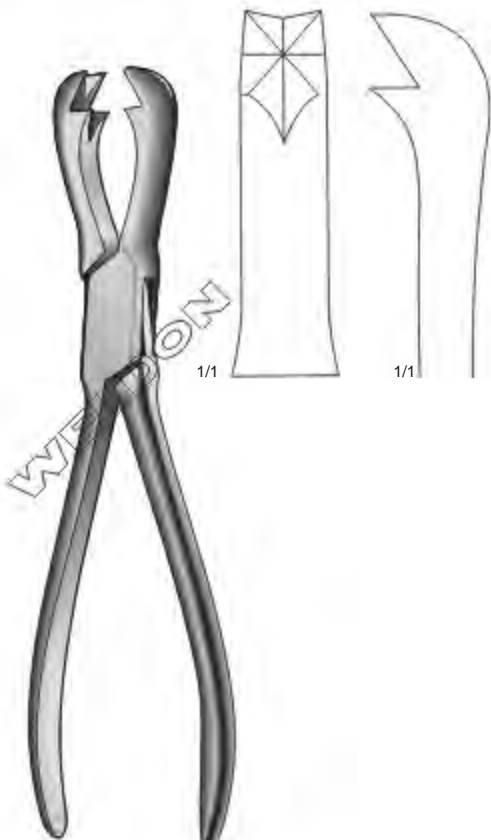

Fergusson
 WS-214-018
 21 cm / 8¼"
 Heavy Pattern



Frosch
 WS-214-019
 18 cm / 7"



WS-214-020
 20 cm / 8"

Bone Holding Forceps | Pinzas Para Hueso | Knochenhaltezangen

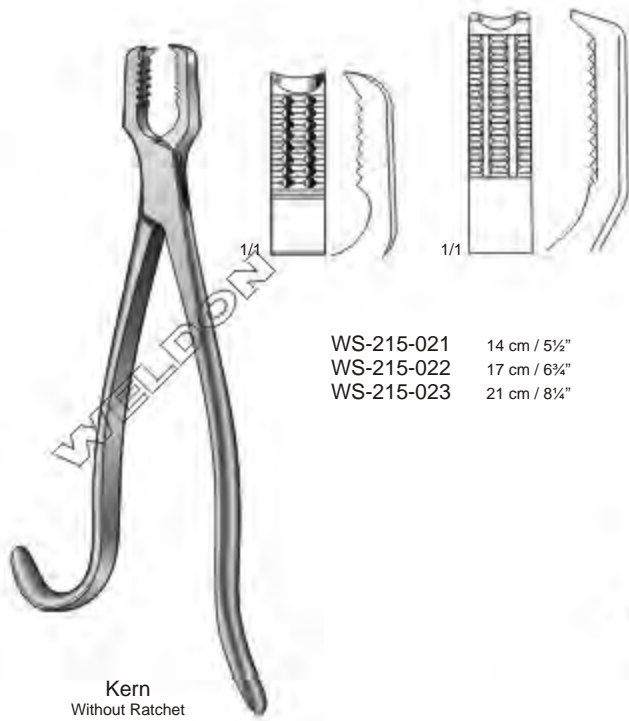

WS-215-021	14 cm / 5½"
WS-215-022	17 cm / 6¾"
WS-215-023	21 cm / 8¼"

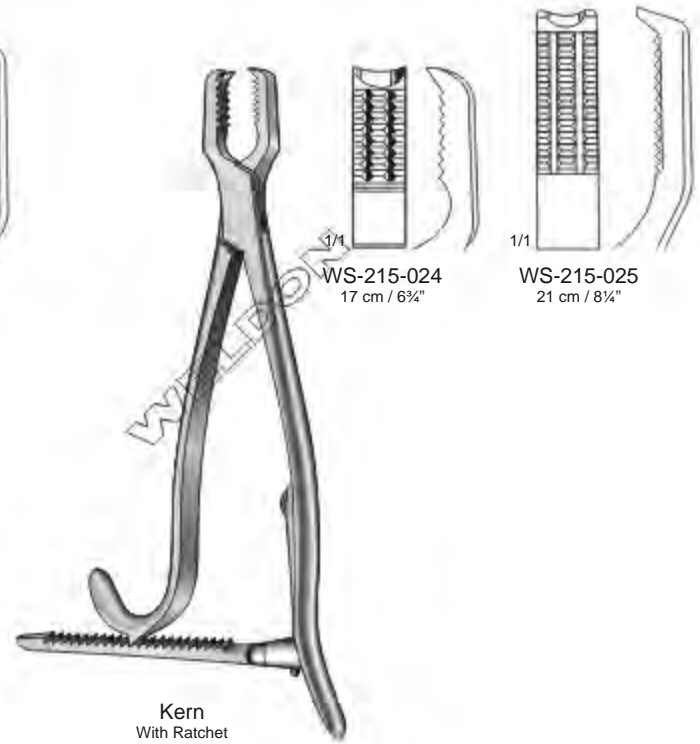

WS-215-024
17 cm / 6¾"

WS-215-025
21 cm / 8¼"

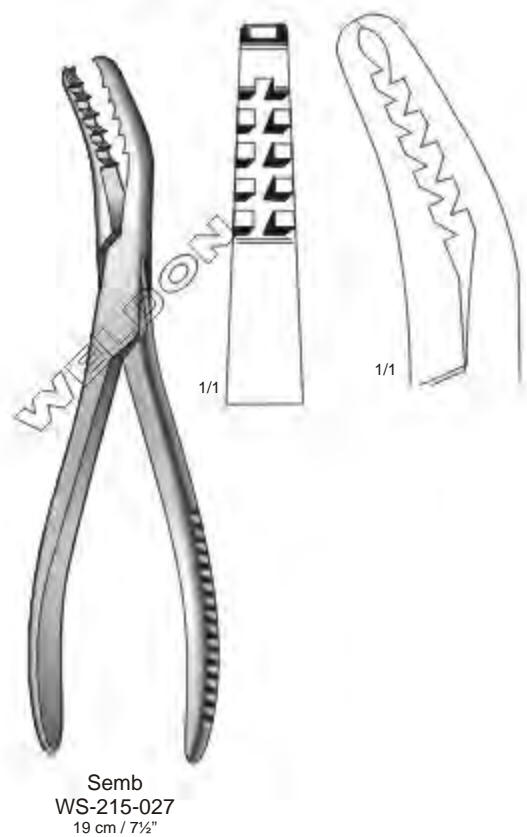
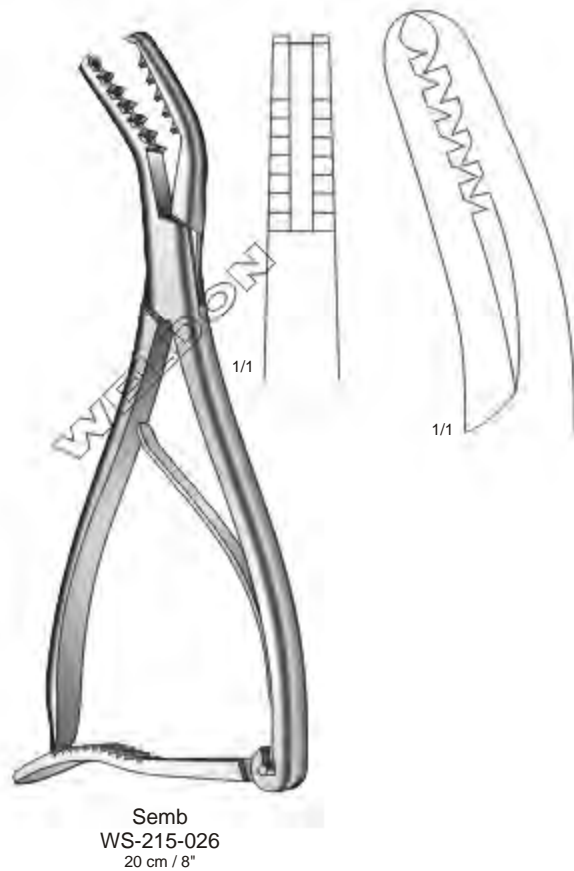

Bone Holding Forceps | Pinzas Para Hueso | Knochenhaltezangen

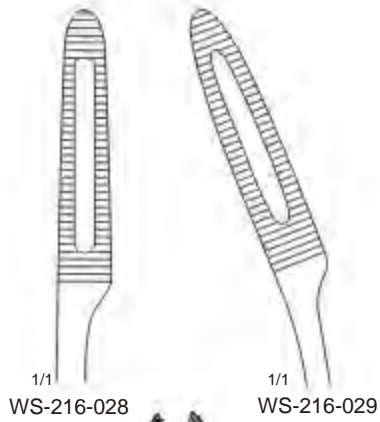

Sequestrum Forceps
20 cm / 8"



Van Buren
WS-216-030
Sequestrum Forceps
23 cm / 9"

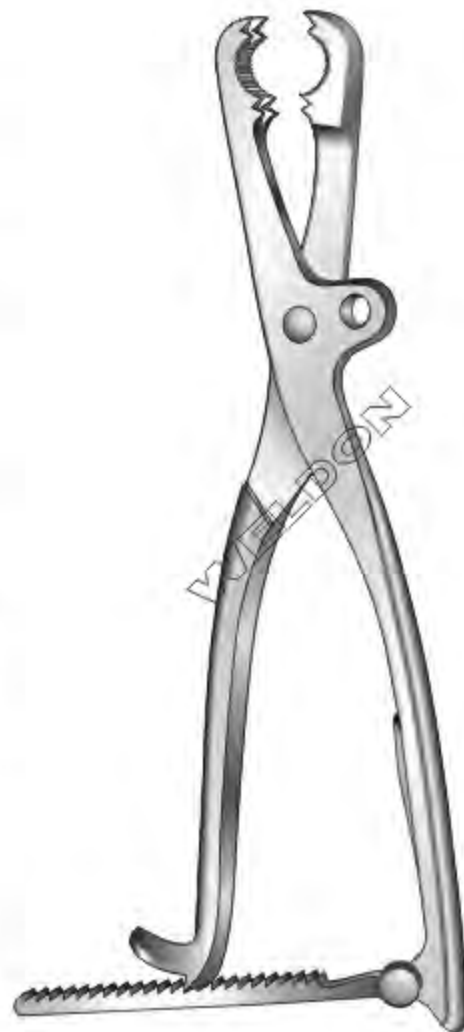
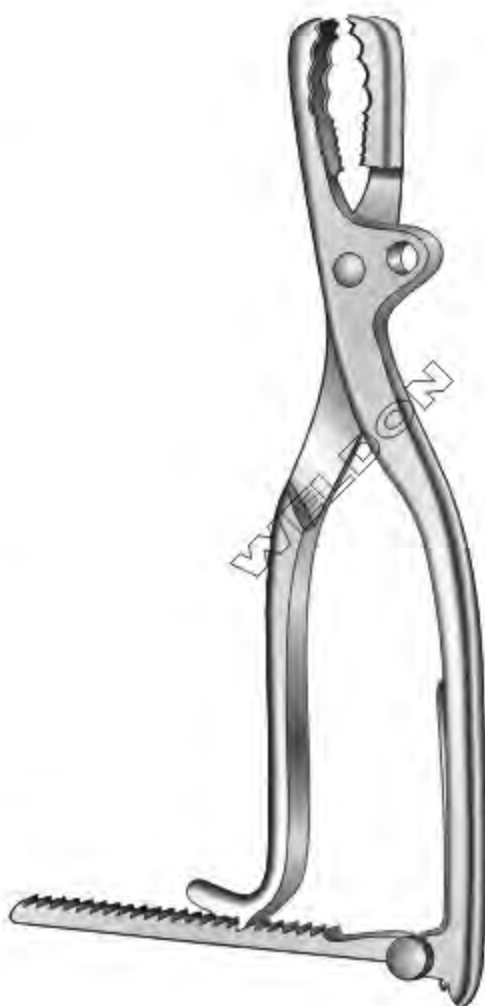
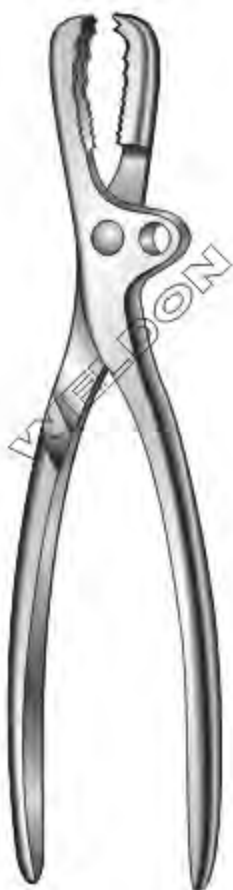
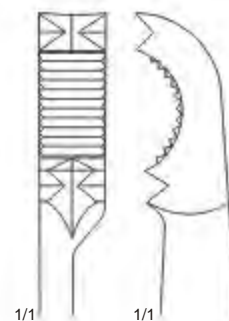
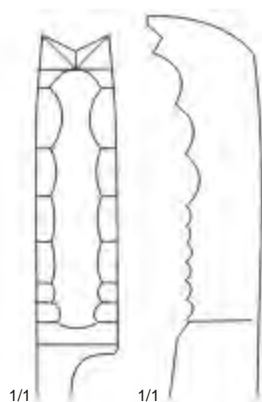
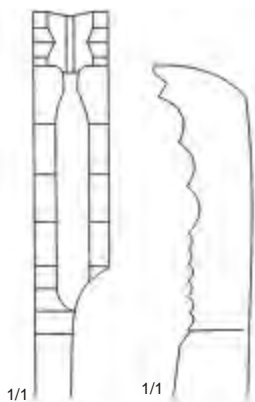

Farabeuf
 WS-217-031 23 cm / 9"
 WS-217-032 26 cm / 10¼"

Farabeuf-Lambotte
 WS-217-033
 26 cm / 10¼"

Tuffier
 WS-217-034
 27 cm / 10½"

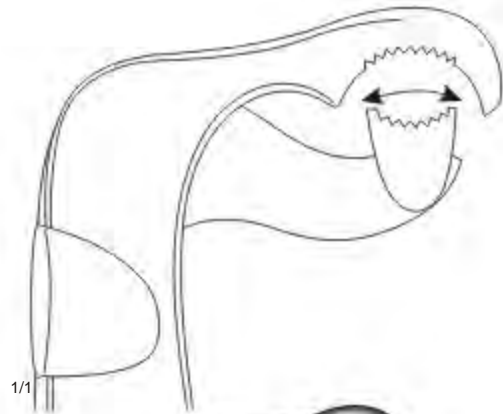
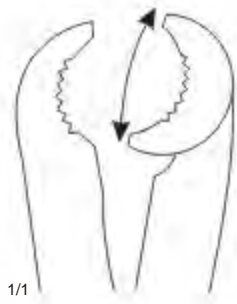
Bone Holding Forceps | Pinzas Para Hueso | Knochenhaltezangen

Lambotte
 WS-218-035 22 cm / 8¾"
 WS-218-036 27 cm / 10½"
 WS-218-037 30 cm / 12"
 One Jaw Movable



Lambotte
 WS-218-038 22 cm / 8¾"
 WS-218-039 26 cm / 10¼"
 WS-218-040 33 cm / 13"
 One Jaw Movable



Lambotte
 WS-218-041 19 cm / 7½"
 WS-218-042 23 cm / 9"
 WS-218-043 26 cm / 10¼"
 One Jaw Movable

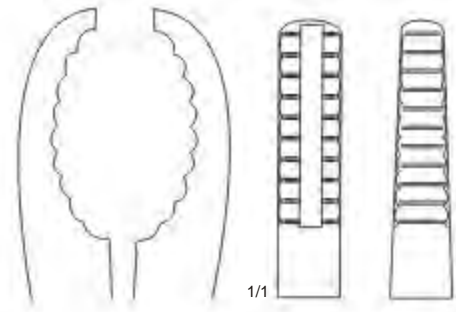
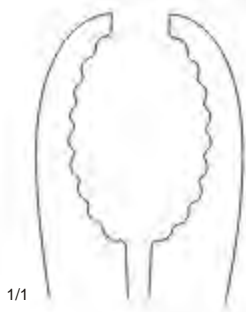

Ulrich
With Thread Fixation
Straight

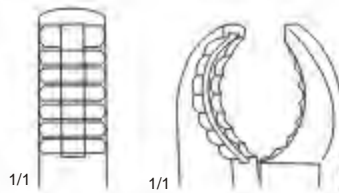

WS-219-044
23 cm / 9"

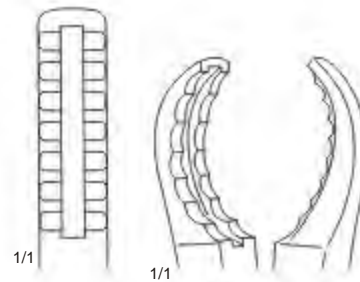

WS-219-045
25 cm / 10"

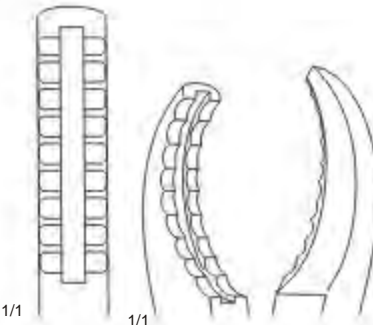

WS-219-046
28 cm / 11"



Ulrich
WS-219-047
28 cm / 11"
With Thread Fixation
Angled

Bone Holding Forceps | Pinzas Para Hueso | Knochenhaltezangen



1/1
WS-220-050
24 cm / 9½"



1/1
WS-220-051
26 cm / 10¼"

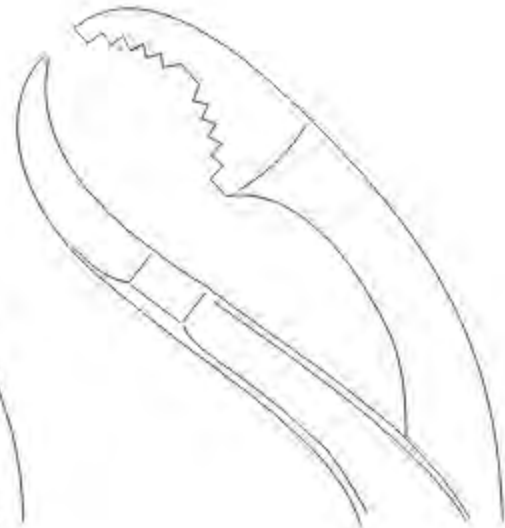

1/1
WS-220-052
28 cm / 11"



1/1
WS-220-048
15 cm / 6"



1/1
WS-220-049
19 cm / 7½"



1/1



Self-Centering
With Thread Fixation

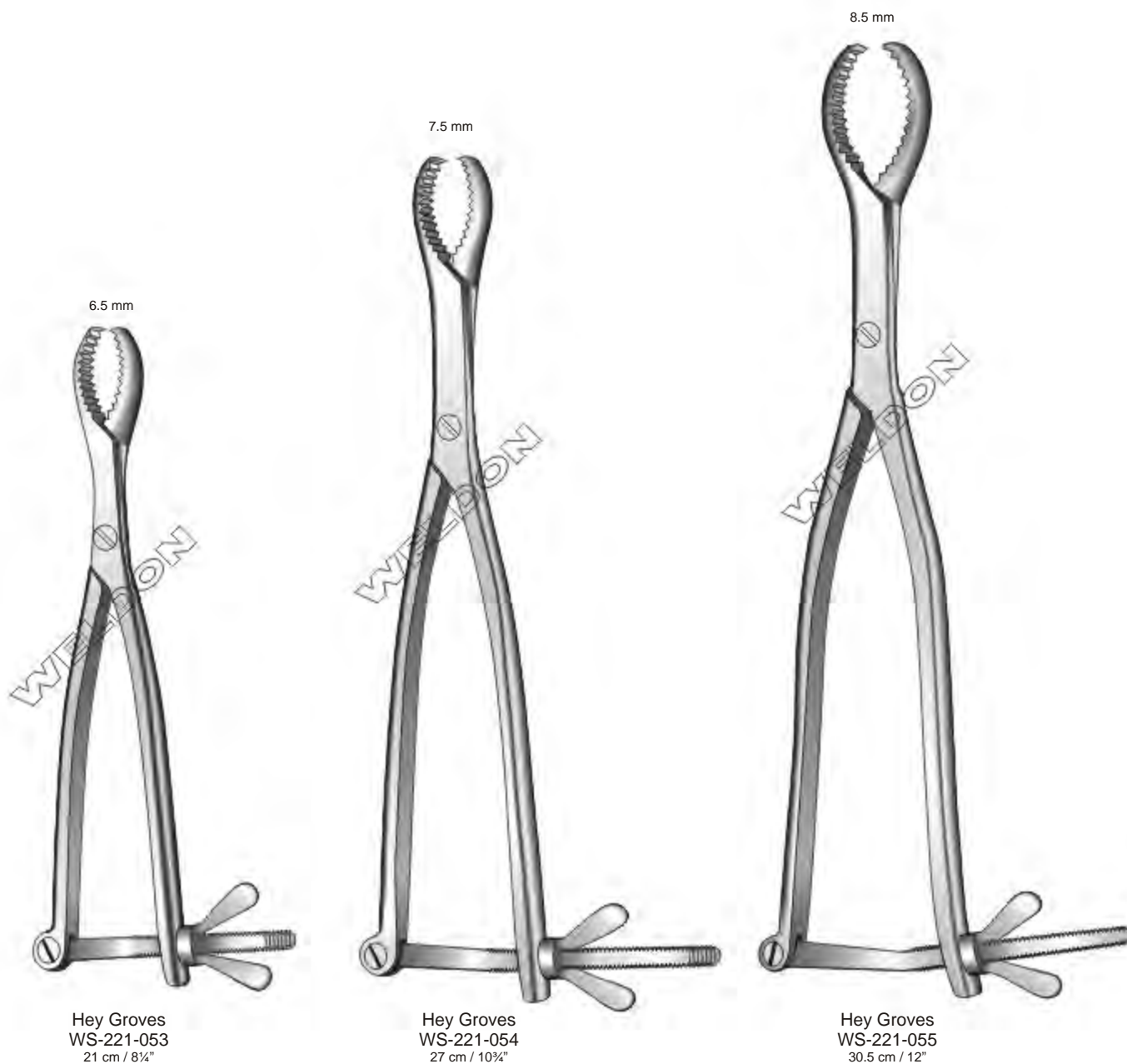

Bone Holding Forceps | Pinzas Para Hueso | Knochenhaltezangen

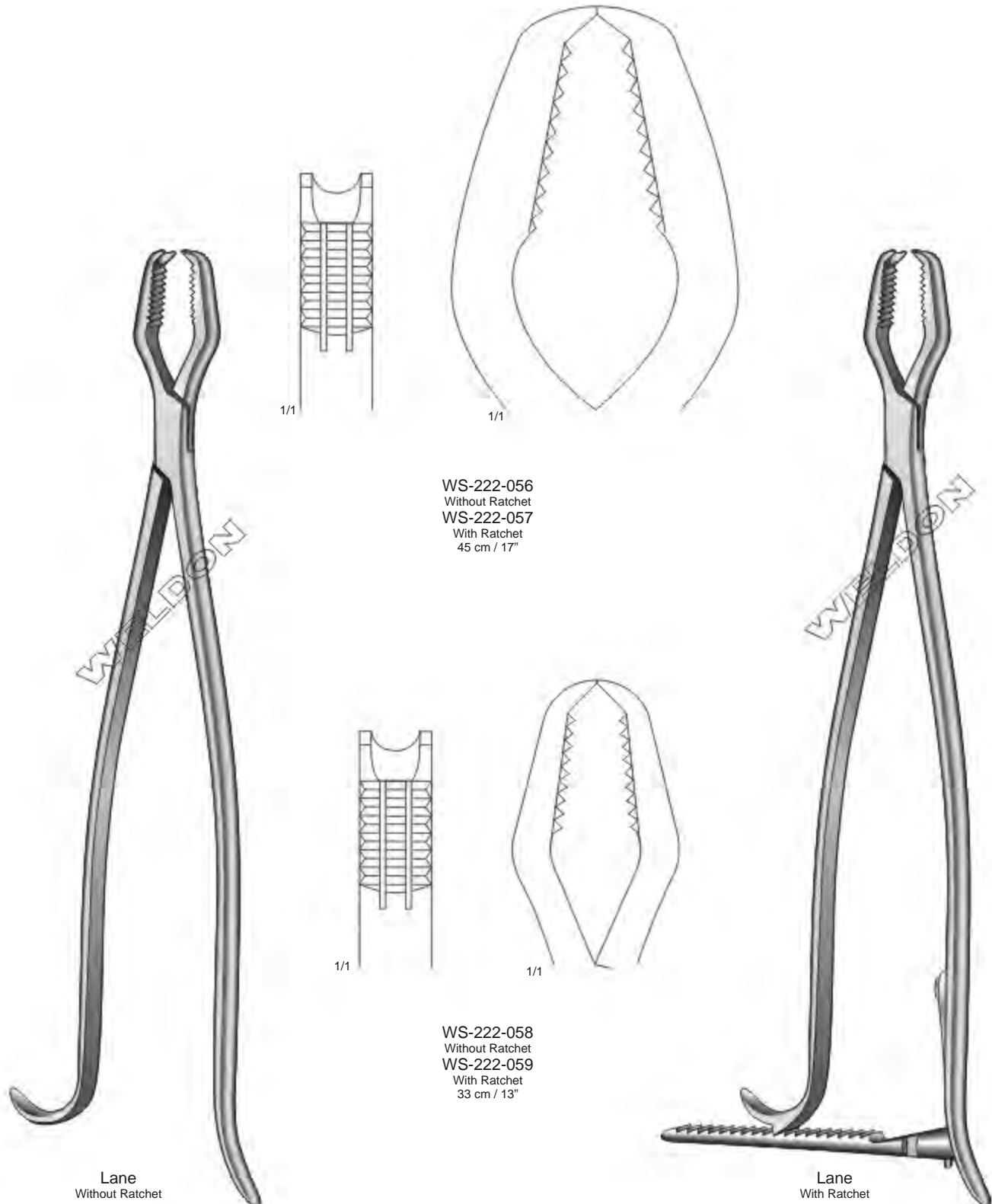

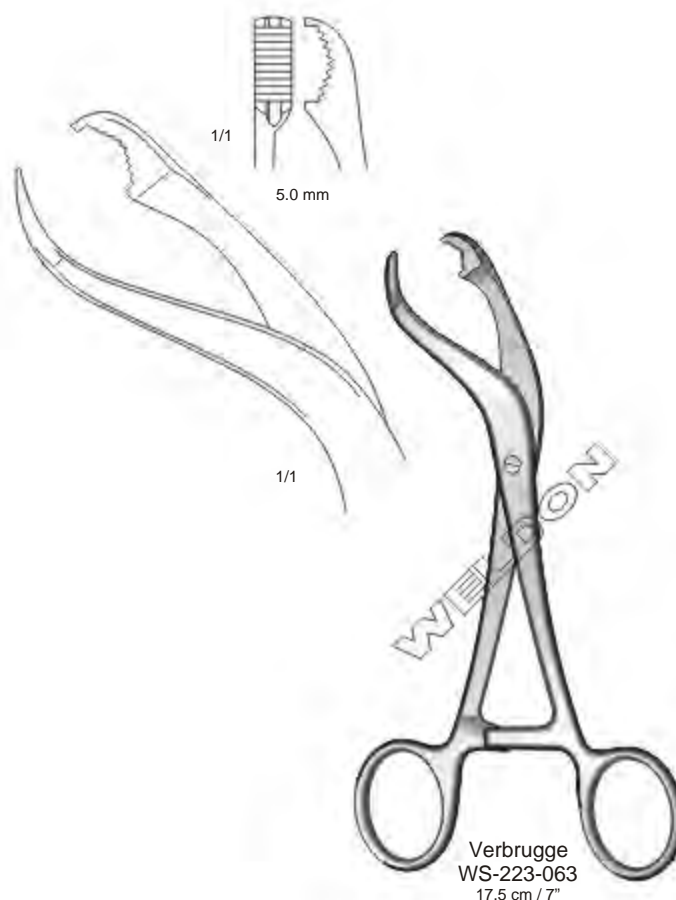
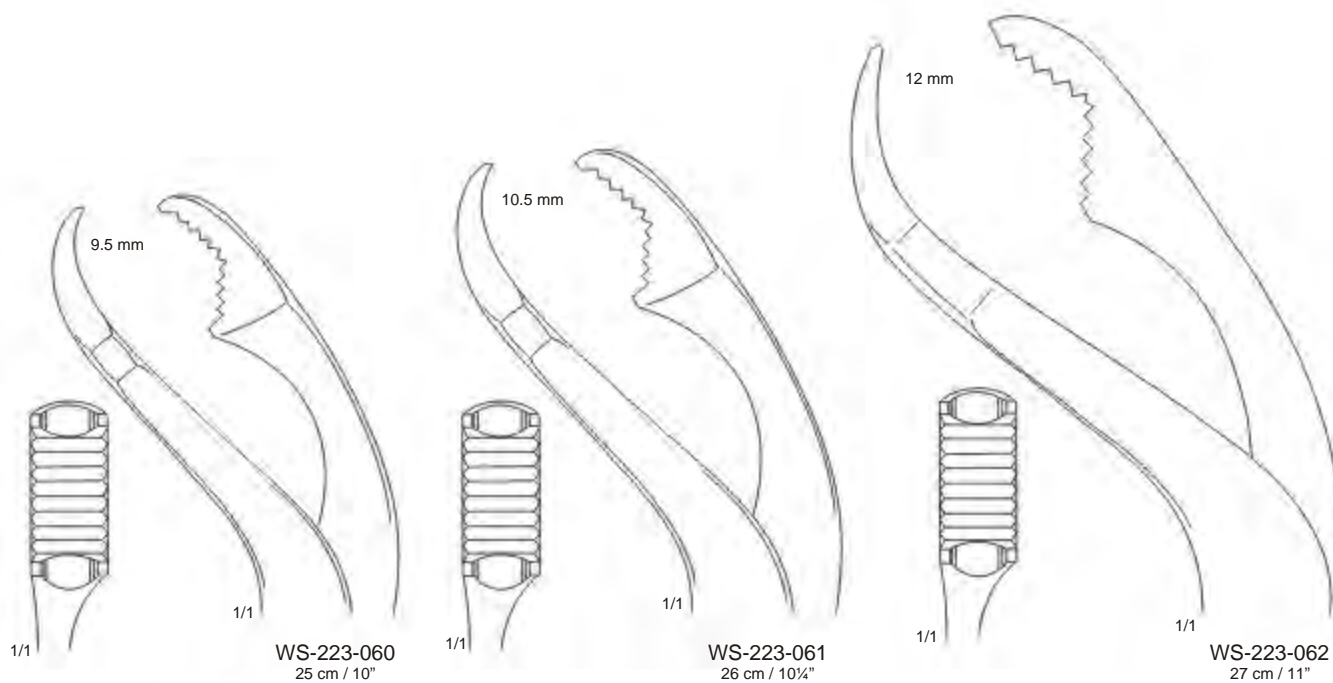

Bone Holding Clamps | Grapas Porta-Huesos | Knochenhaltezangen

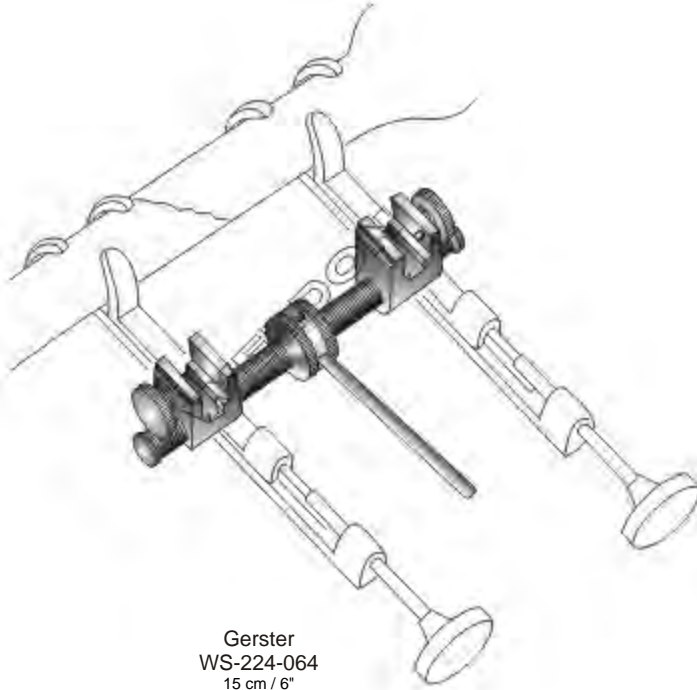

Gerster
WS-224-064
15 cm / 6"

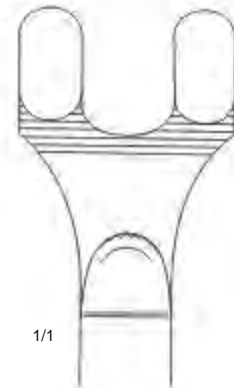

1/1

WS-224-068
18 cm / 7"

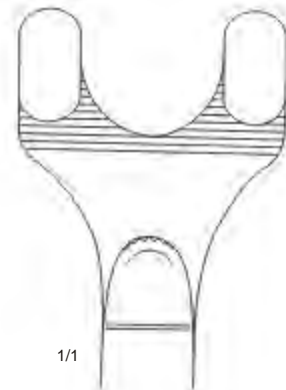

1/1

WS-224-069
20 cm / 8"



1/1

Lowmann
WS-224-065 9 cm / 3½"
WS-224-066 13.5 cm / 5¼"
WS-224-067 15 cm / 6"

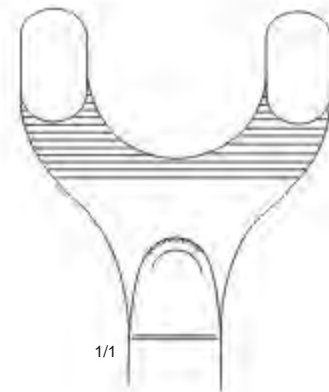

1/1

WS-224-070
22 cm / 8¾"

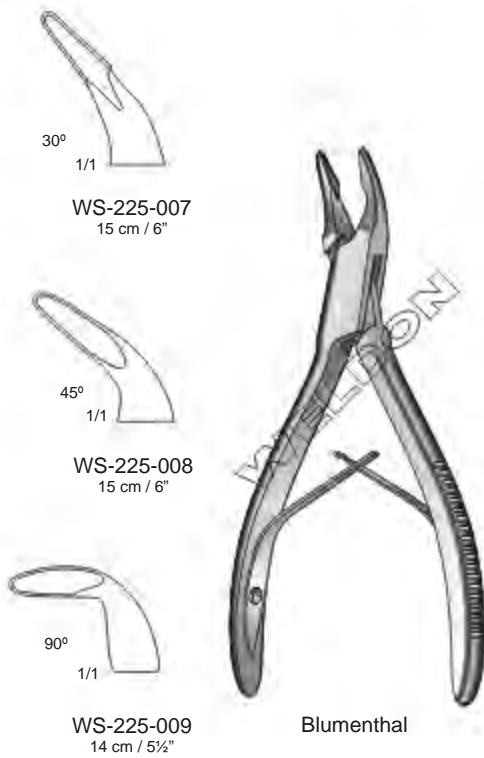
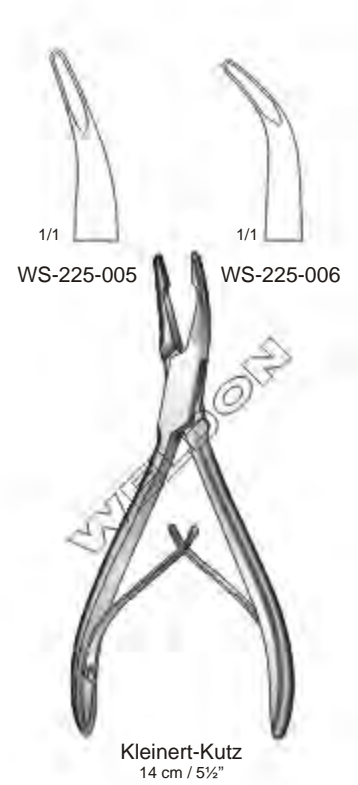
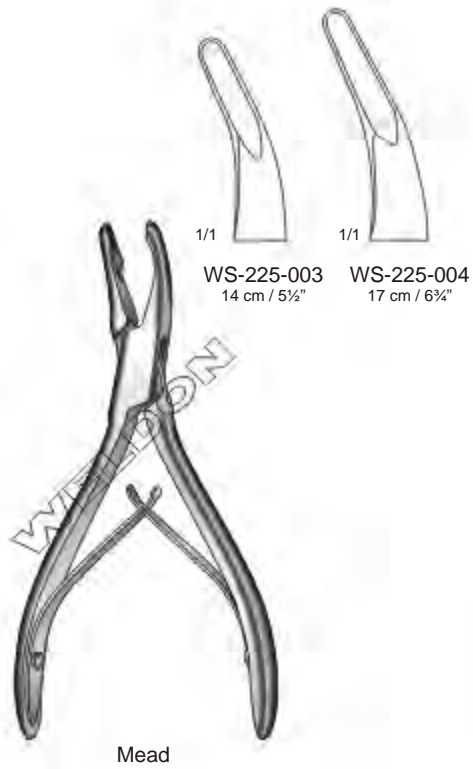
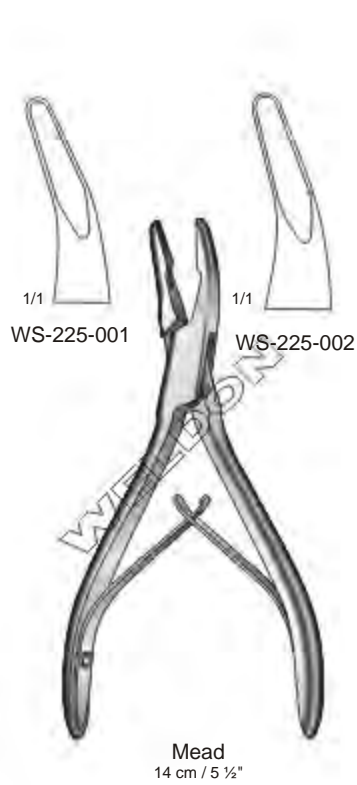

Bone Rongeurs | Pinzas Gubias | Hohlmeißelzangen

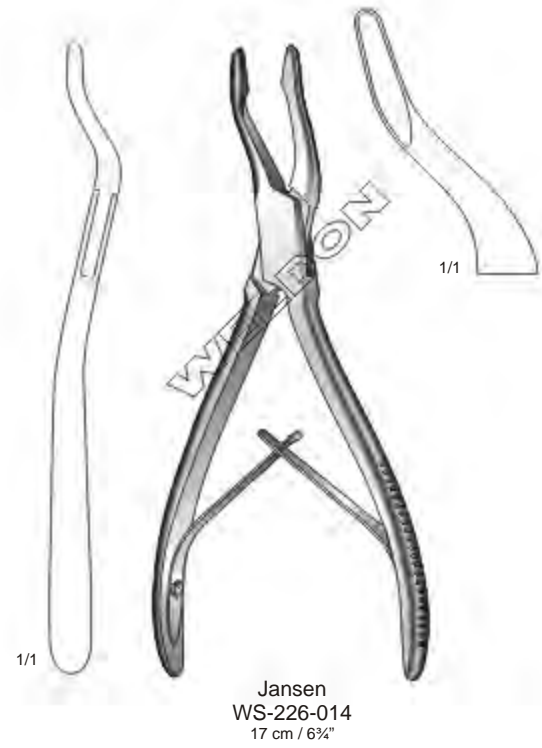
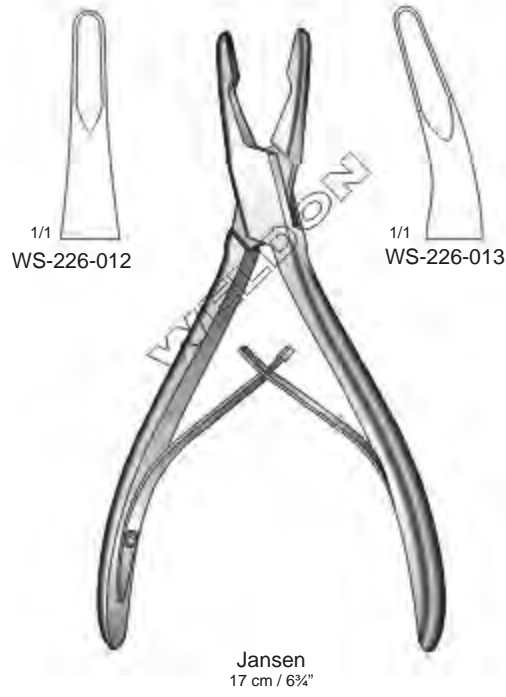

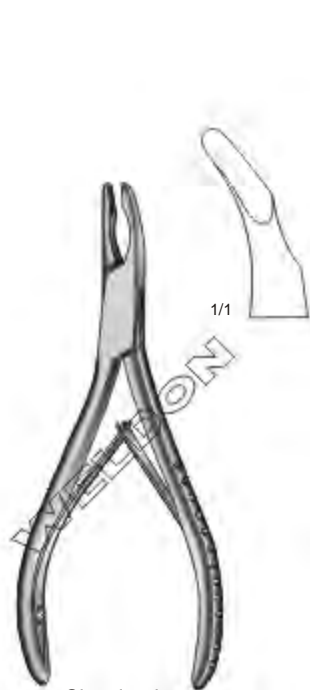

Cleveland
WS-227-017
14 cm / 5½"

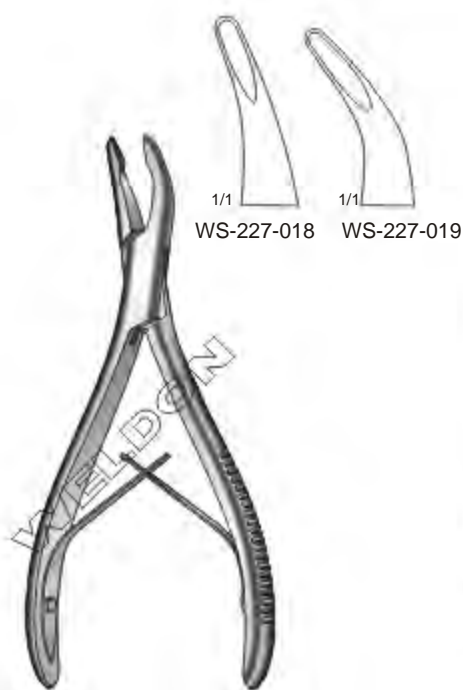

1/1 1/1
WS-227-018 WS-227-019

14 cm / 5½"

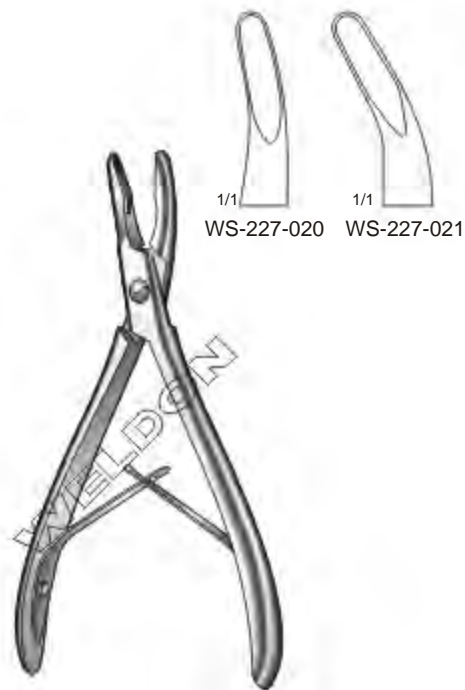

1/1 1/1
WS-227-020 WS-227-021

Luer
15 cm / 6"

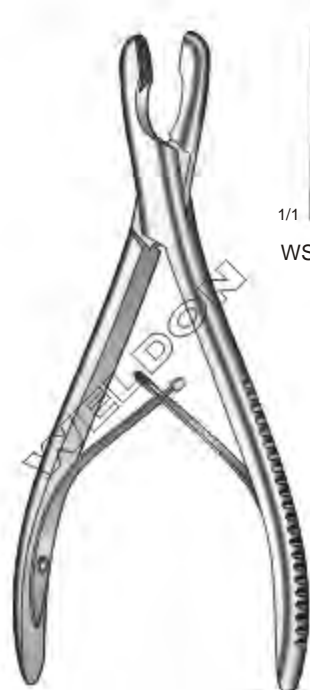

Luer
17 cm / 6¾"

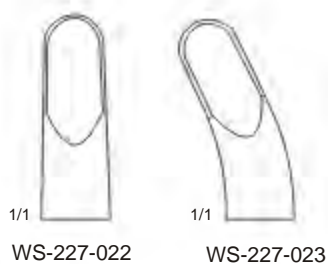

1/1 1/1
WS-227-022 WS-227-023

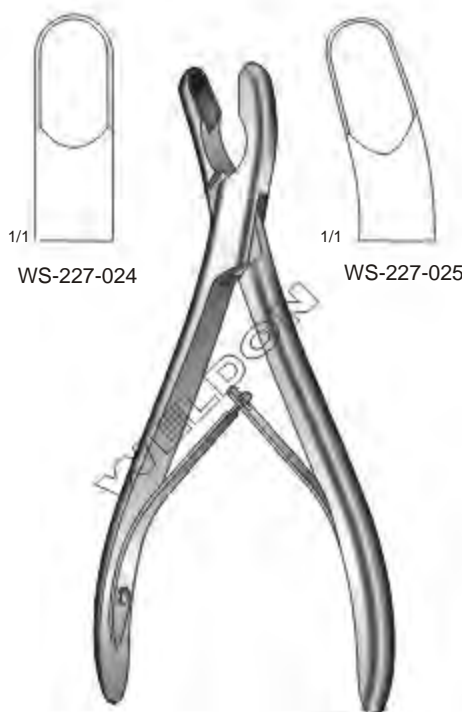

Luer
18 cm / 7¼"

1/1 1/1
WS-227-024 WS-227-025

Bone Rongeurs | Pinzas Gubias | Hohlmeißelzangen

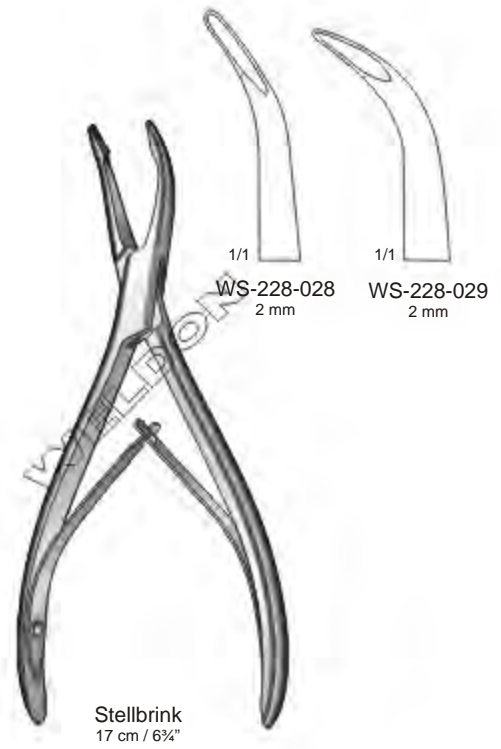
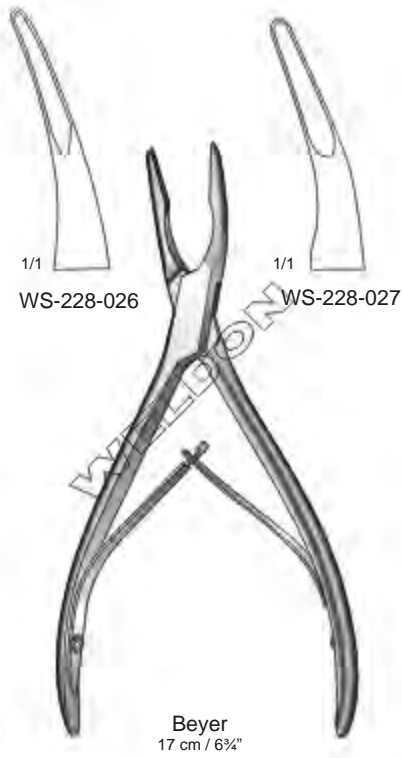

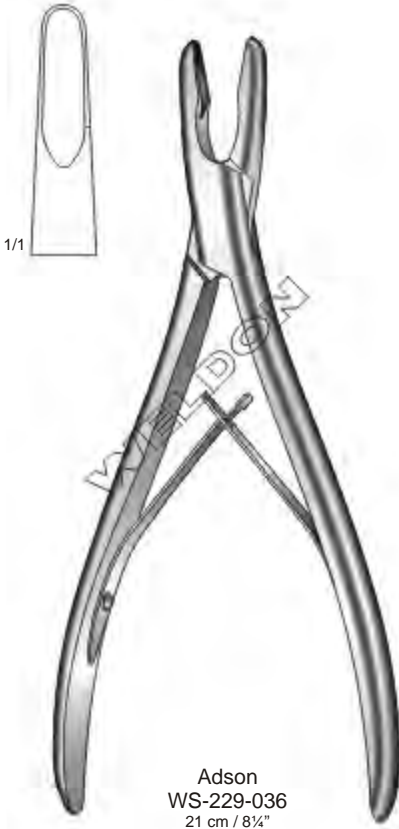
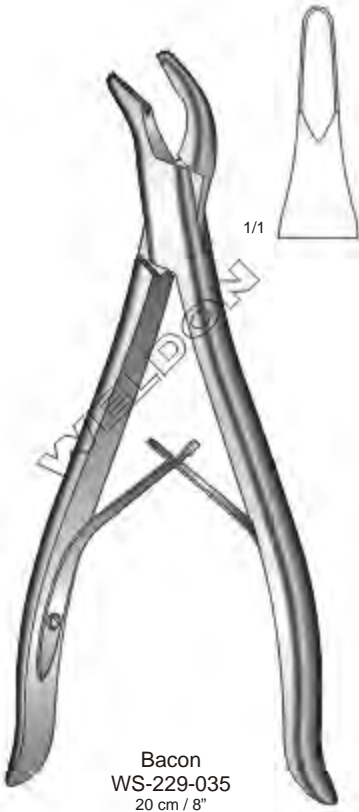
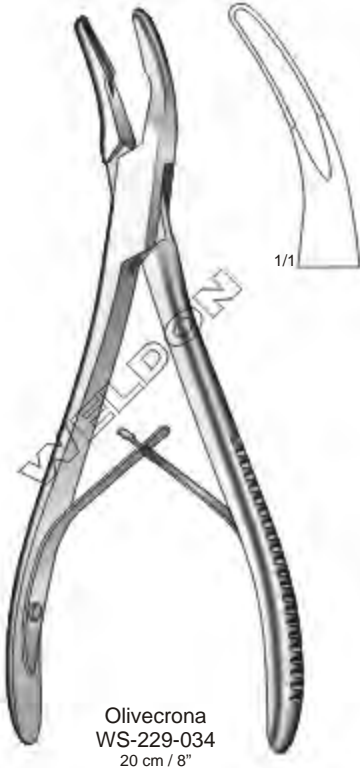

Bone Rongeurs | Pinzas Gubias | Hohlmeißelzangen

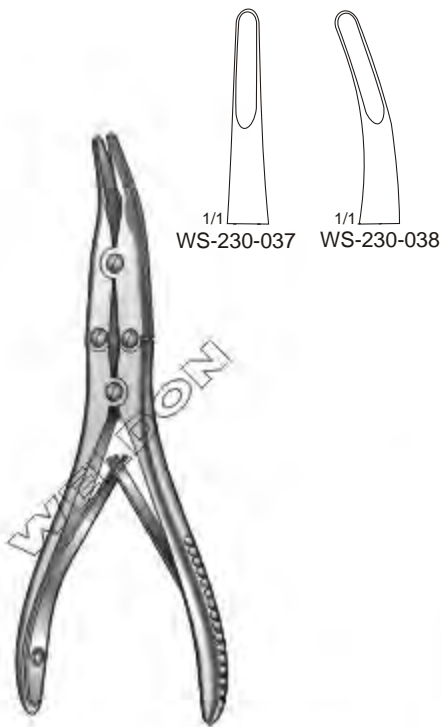

Böhler
15.5 cm / 6"

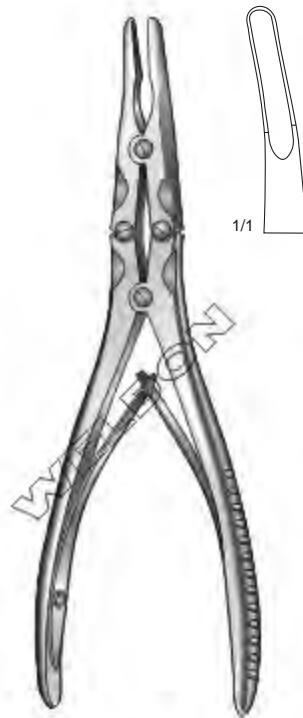

Beyer
WS-230-039
18 cm / 7"



Zaufal-Jansen
WS-230-040
18 cm / 7"



Mayfield
WS-230-041
17 cm / 6 3/4"



Marquardt
WS-230-042
20 cm / 8"

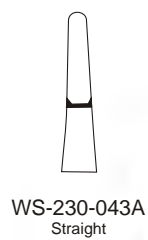

WS-230-043A
Straight

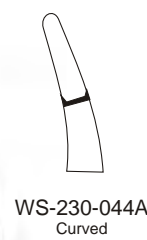

WS-230-044A
Curved



Mini-Ruskin
15.5 cm / 6"



WS-230-043
Straight

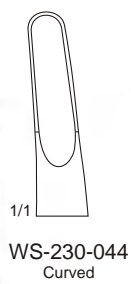

WS-230-044
Curved



Ruskin
18 cm / 7"

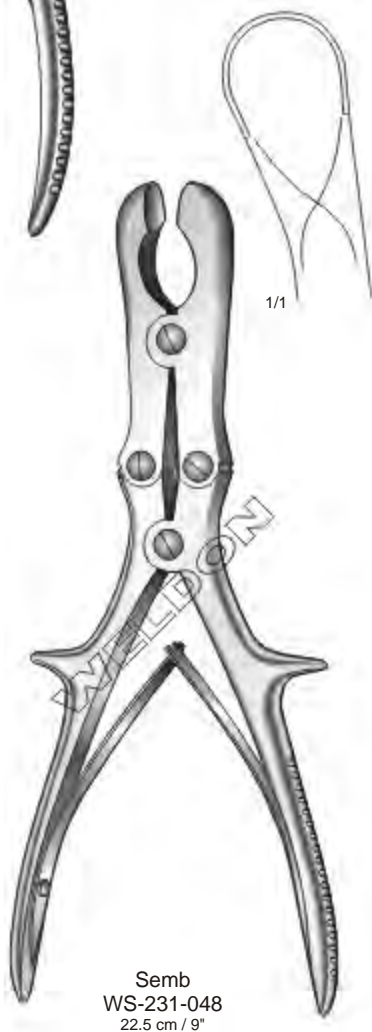
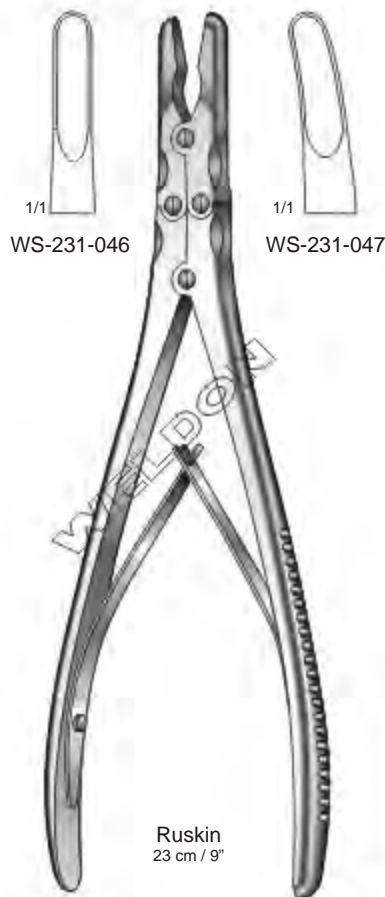

Bone Rongeurs | Pinzas Gubias | Hohlmeißelzangen



Leksell
36 cm / 14 1/8"



1/1
WS-232-050



1/1
WS-232-051



1/1
WS-232-052



Frykholm
WS-232-053
24 cm / 9 1/2"



1/1

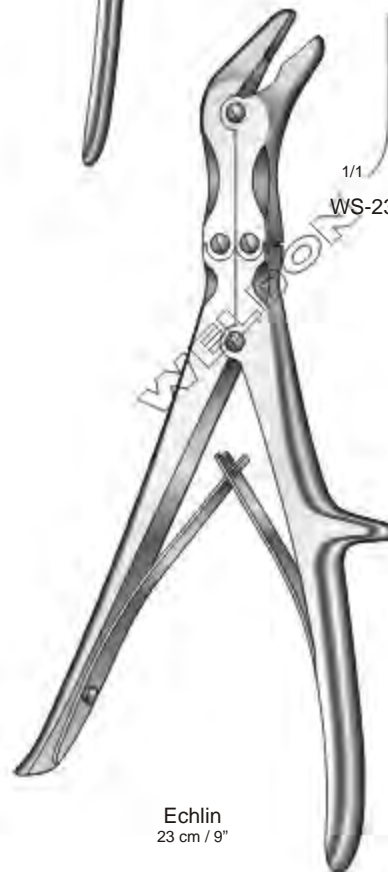

Echlin
23 cm / 9"



1/1
WS-232-054



1/1
WS-232-055



1/1
WS-232-056

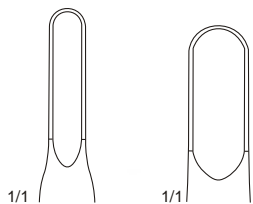

1/1
WS-233-057

1/1
WS-233-058



Smith - Peterson
WS-233-057A
23 cm / 9"
4 mm bite

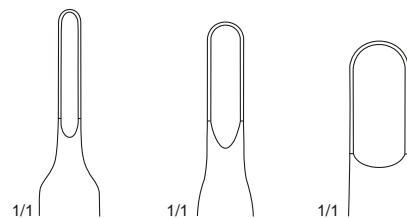

1/1
WS-233-059

1/1
WS-233-060

1/1
WS-233-061



Leksell
23 cm / 9"



Leksell
23 cm / 9"

Bone Rongeurs | Pinzas Gubias | Hohlmeißelzangen

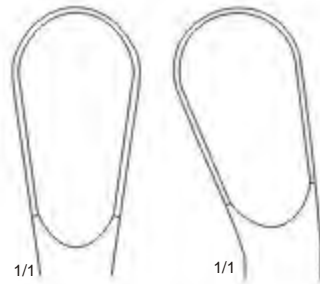

WS-234-064 23 cm / 9" WS-234-066
 WS-234-065 27 cm / 10½"

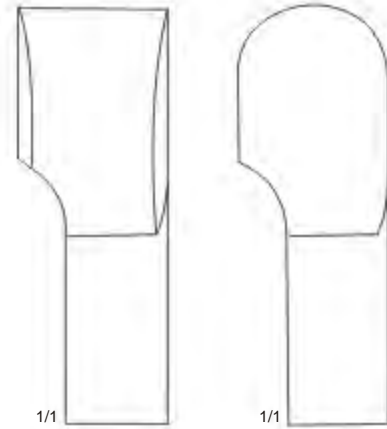

WS-234-068 WS-234-069

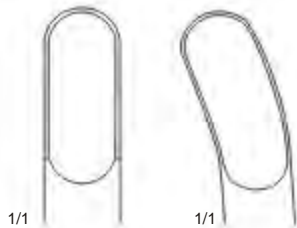

WS-234-062 WS-234-063



Stille-Luer
 22 cm / 8¾"



Stille-Luer

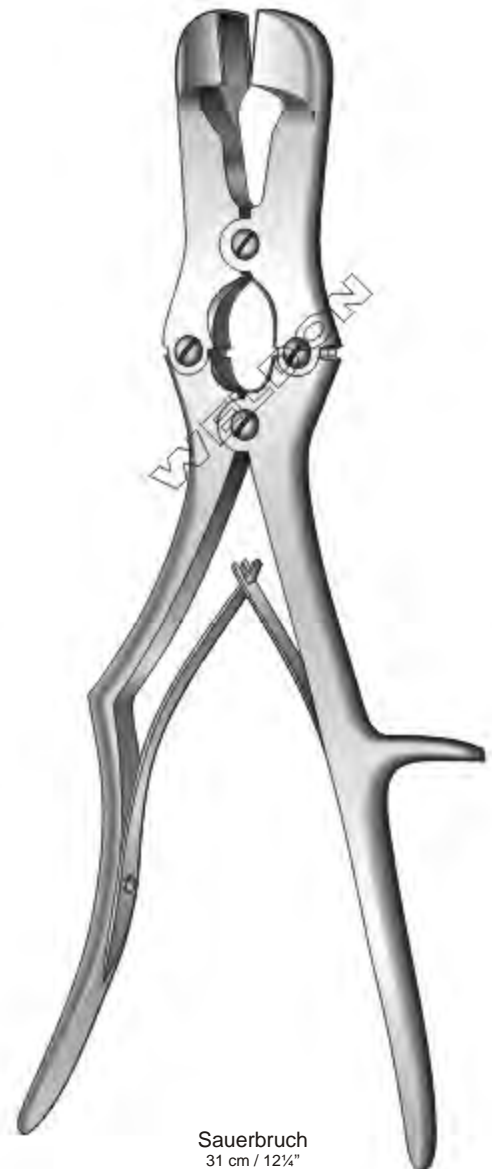

Sauerbruch
 31 cm / 12¼"

Bone Cutting Forceps | Pinzas Cortantes Para Hueso | Knochensplitterzangen

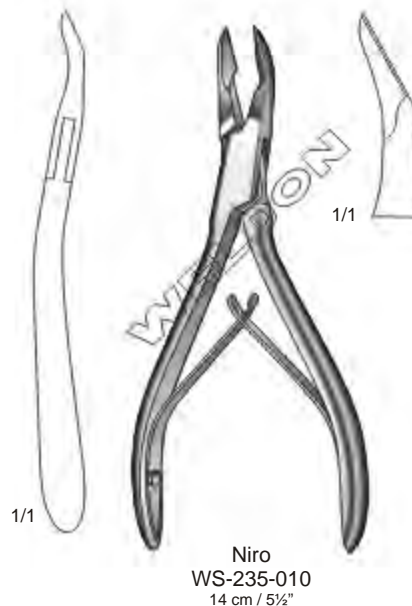
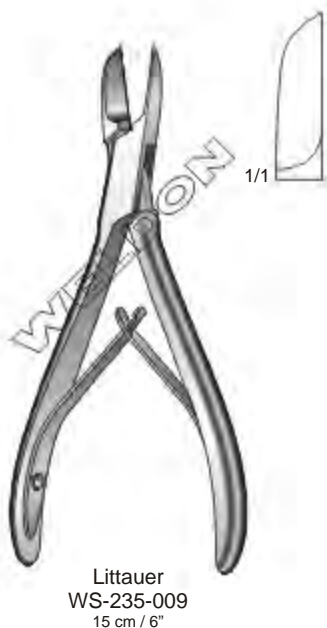
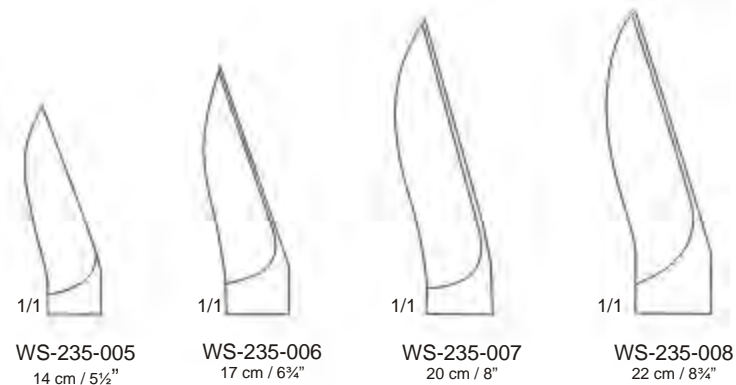
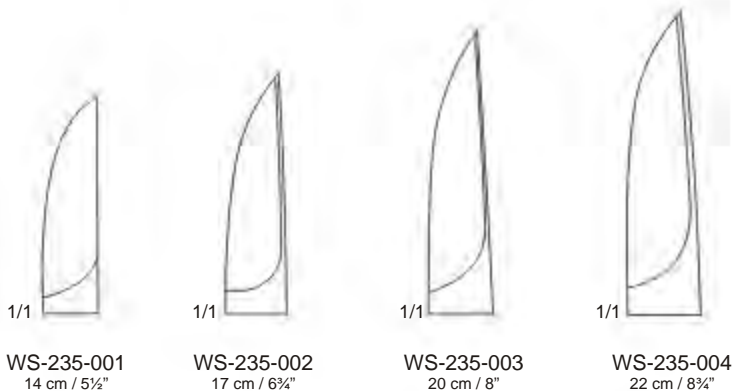

Bone Cutting Forceps | Pinzas Cortantes Para Hueso | Knochensplitterzangen



Cottle-Kazanjan
WS-236-011
19 cm / 7½"



Cleveland
WS-236-012
17 cm / 6¾"



Cleveland
WS-236-013
15 cm / 6"



Cleveland
WS-236-014
12 cm / 4¾"



Cleveland
WS-236-015
16 cm / 6½"

Bone Cutting Forceps | Pinzas Cortantes Para Hueso | Knochensplitterzangen



Böhler
15 cm / 6"

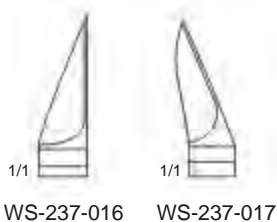

Böhler
WS-237-018
15 cm / 6"



Ruskin-Liston

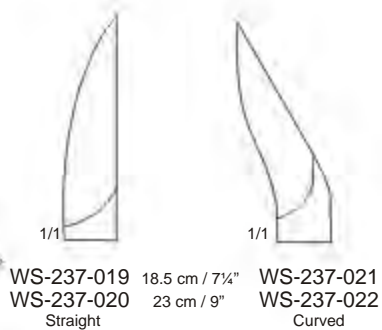

WS-237-019 18.5 cm / 7 1/4"
WS-237-020 23 cm / 9"
Straight

WS-237-021
WS-237-022
Curved

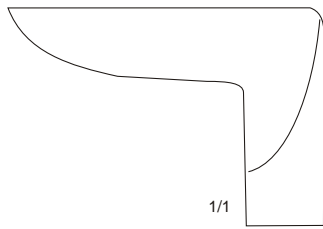

1/1

WS-238-023



1/1

WS-238-024

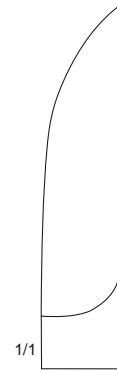

1/1

WS-238-025
23 cm / 9 1/4"
WS-238-025A
27 cm / 10 1/2"
Straight

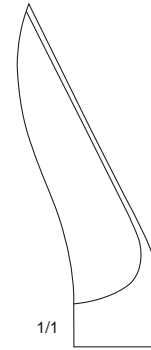

1/1

WS-238-026
27 cm / 10 1/2"
WS-238-026A
23 cm / 9 1/4"
Angled

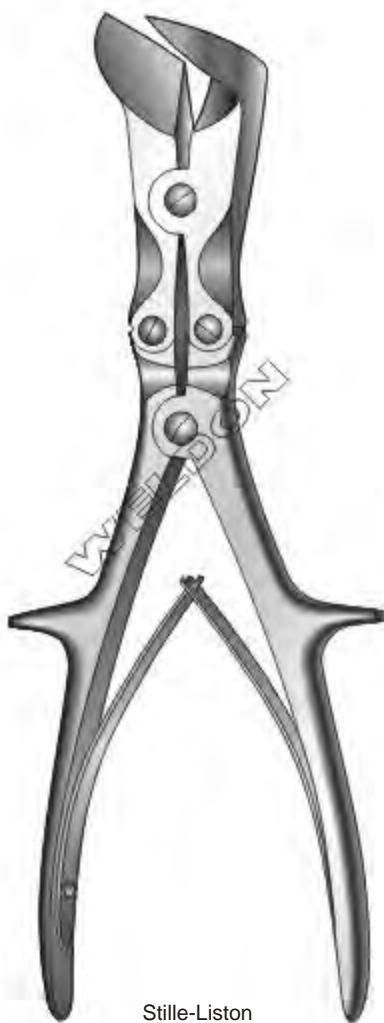

Stille-Liston
27 cm / 10 1/2"

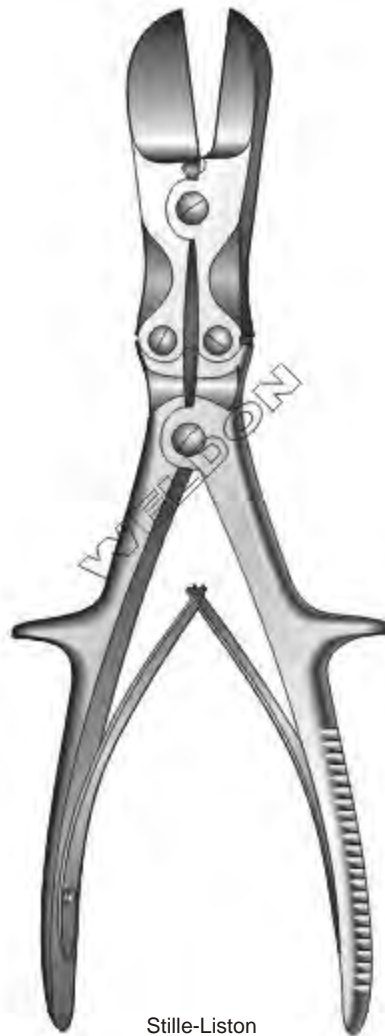

Stille-Liston
27 cm / 10 1/2"

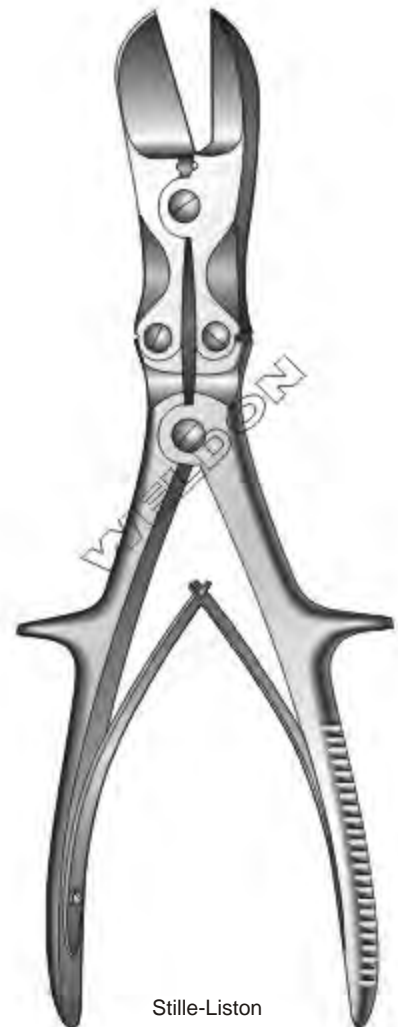

Stille-Liston

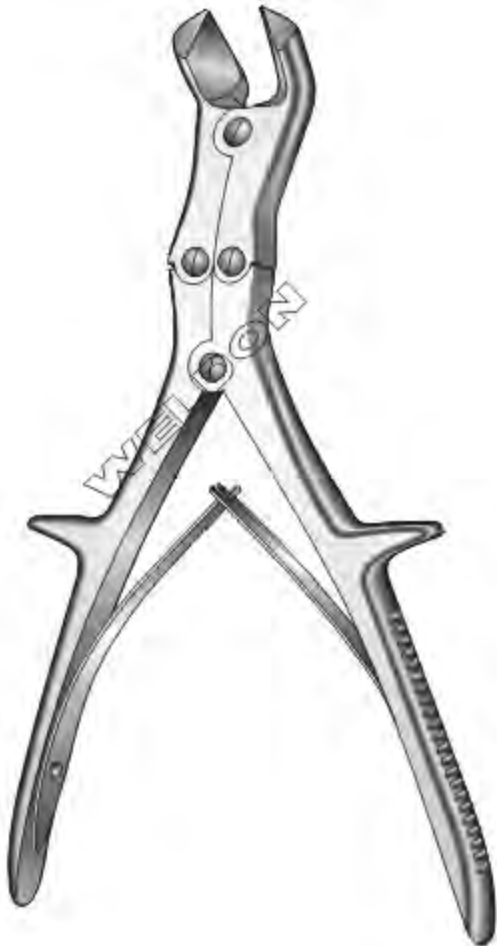
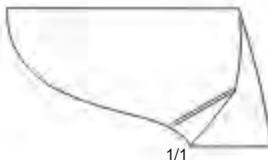
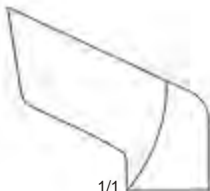

Liston-Key
WS-239-027
27 cm / 10½"

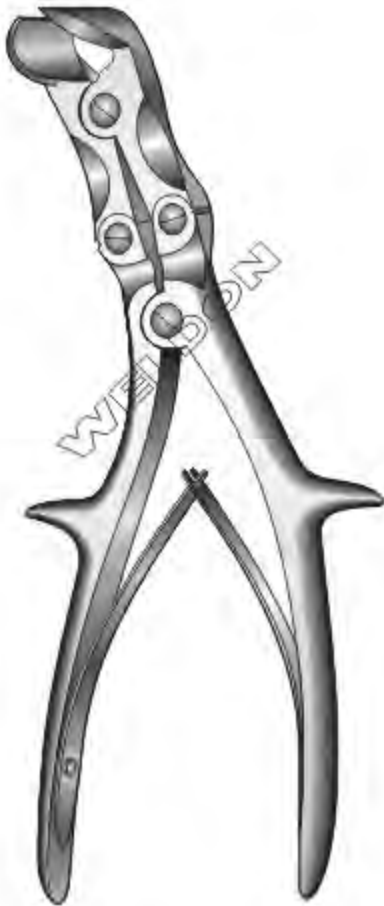

Semb
WS-239-028
24 cm / 9½"

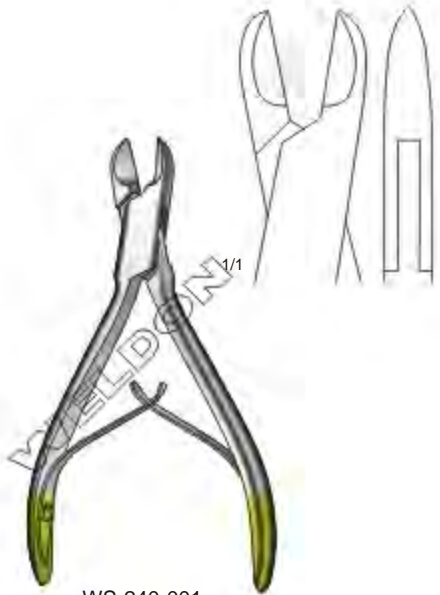
Wire Cutting Pliers | Alicates Para Cortar Alambre | Drahtkneifzangen

WS-240-001
 12 cm / 4 3/4"
 Cut Soft Wire Up To 1.2 mm
 Cut Hard Wire Up To 1.0 mm

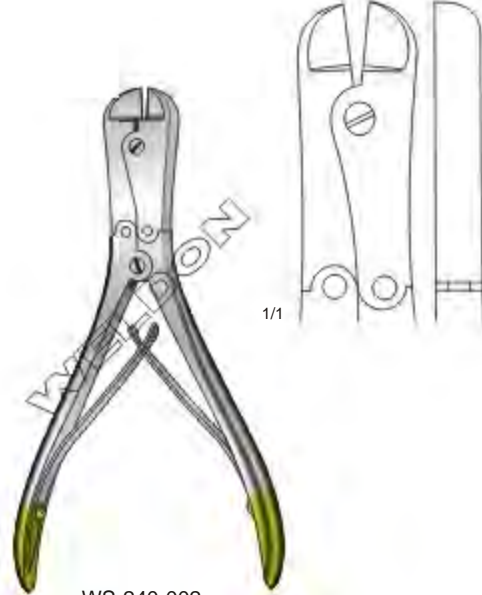

WS-240-002
 13 cm / 5 1/8"
 Cut Soft Wire Up To 2.0 mm
 Cut Hard Wire Up To 1.5 mm

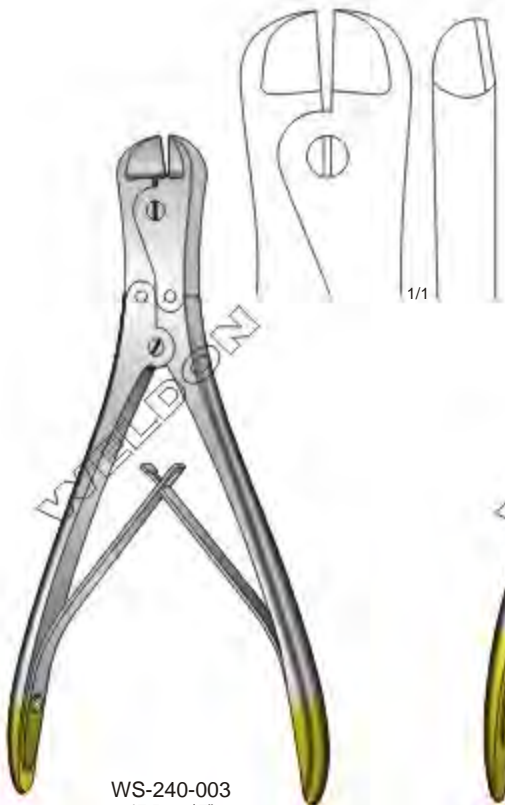

WS-240-003
 17.5 cm / 7"
 Cut Soft Wire Up To 3.5 mm
 Cut Hard Wire Up To 2.5 mm

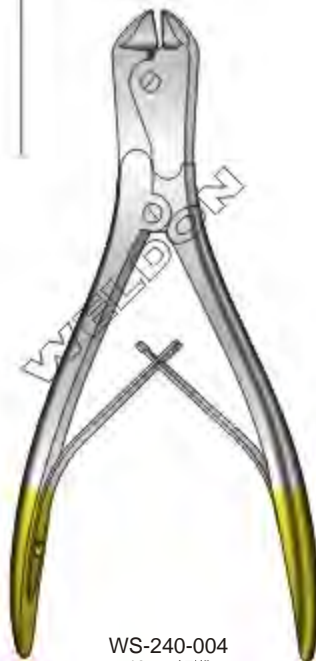

WS-240-004
 18 cm / 7 1/8"
 Cut Soft Wire Up To 2.6 mm
 Cut Hard Wire Up To 1.7 mm



WS-240-005
 18 cm / 7 1/8"

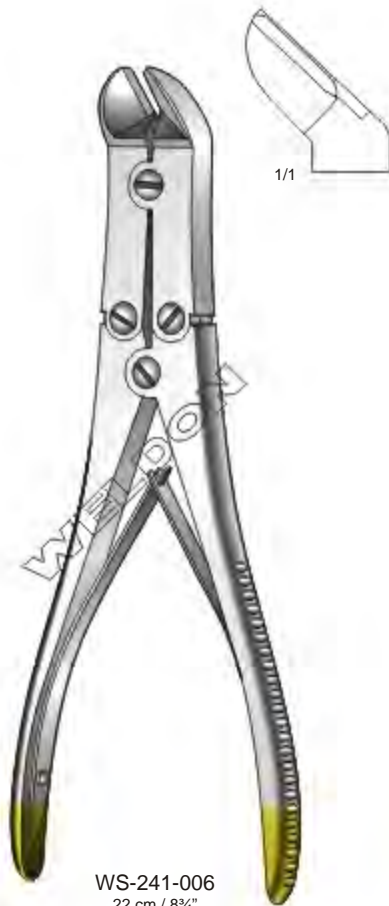

WS-241-006
22 cm / 8 3/4"
Cut Soft Wire Up To 3.0 mm
Cut Hard Wire Up To 2.5 mm



WS-241-007
23 cm / 9"
Cut Soft Wire Up To 3.5 mm
Cut Hard Wire Up To 2.5 mm

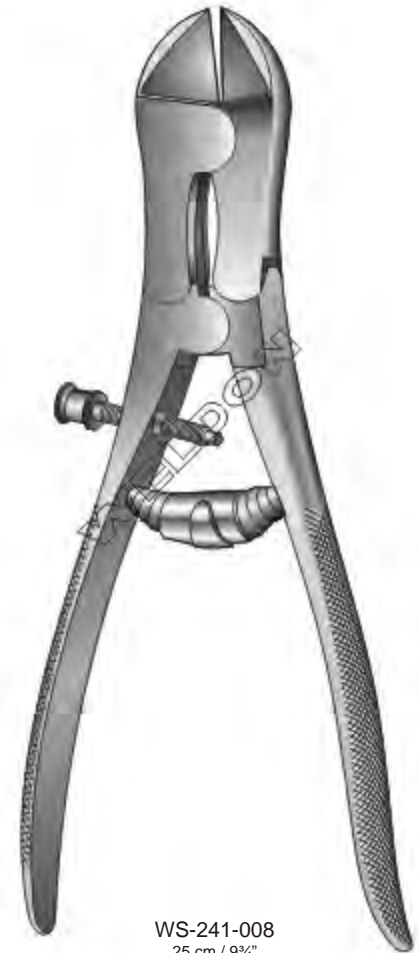

WS-241-008
25 cm / 9 1/2"
Cut Soft Wire Up To 4.5 mm
Cut Hard Wire Up To 3.0 mm



WS-241-009 16 cm / 6 1/4"
WS-241-010 18 cm / 7"
Cut Soft Wire Up To 2.0 mm
Cut Hard Wire Up To 1.6 mm



WS-241-011
15 cm / 6"
Cut Soft Wire Up To 3.0 mm
Cut Hard Wire Up To 2.5 mm

Wire Cutting Pliers | Pinzas Para Cortar Alambre | Drahtkneifzangen

Diamant
WS-242-012
 16 cm / 6¼"
 Cut Soft Wire Up To 2.0 mm
 Cut Hard Wire Up To 1.5 mm



WS-242-013
 16 cm / 6¼"
 Cut Soft Wire Up To 2.5 mm
 Cut Hard Wire Up To 2.0 mm



WS-242-014
 23 cm / 9"
 Cut Soft Wire Up To 3.5 mm
 Cut Hard Wire Up To 2.5 mm



WS-242-015
 24 cm / 9½"
 Cut Soft Wire Up To 4.5 mm
 Cut Hard Wire Up To 3.0 mm

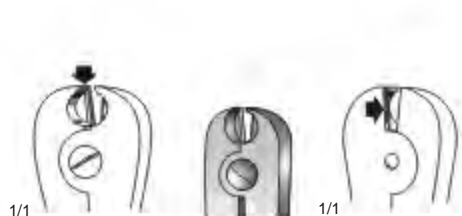

WS-243-016
17.5 cm / 7"
Cut Soft Wire Up To 2.0 mm
Cut Hard Wire Up To 1.5 mm

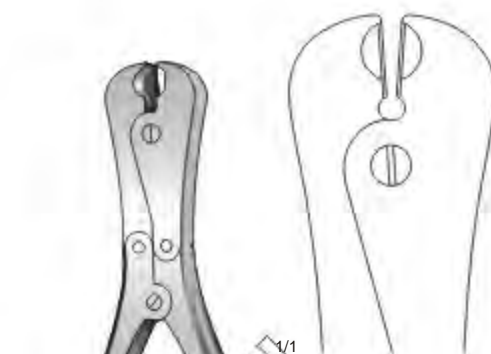

WS-243-017
19 cm / 7½"
Cut Soft Wire Up To 2.0 mm
Cut Hard Wire Up To 1.5 mm

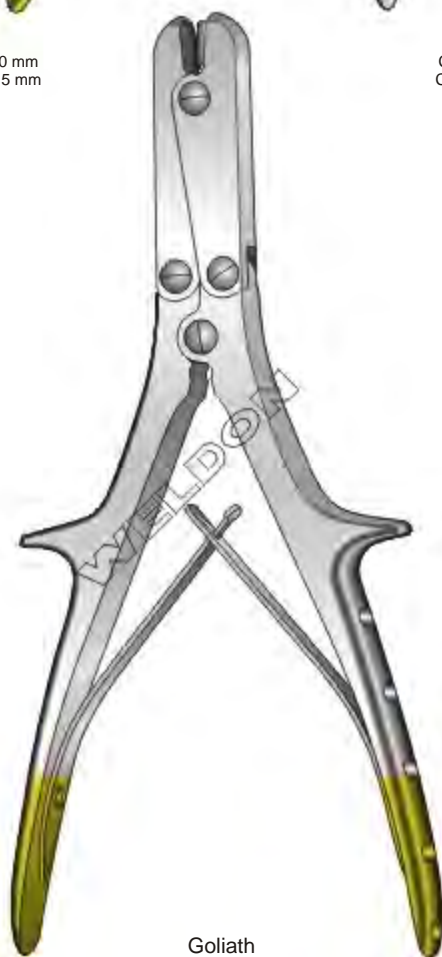

Goliath
WS-243-018 2.5 mm
WS-243-019 2.0 mm
25 cm / 10"



Easy Cut
WS-243-020
20 cm / 8"

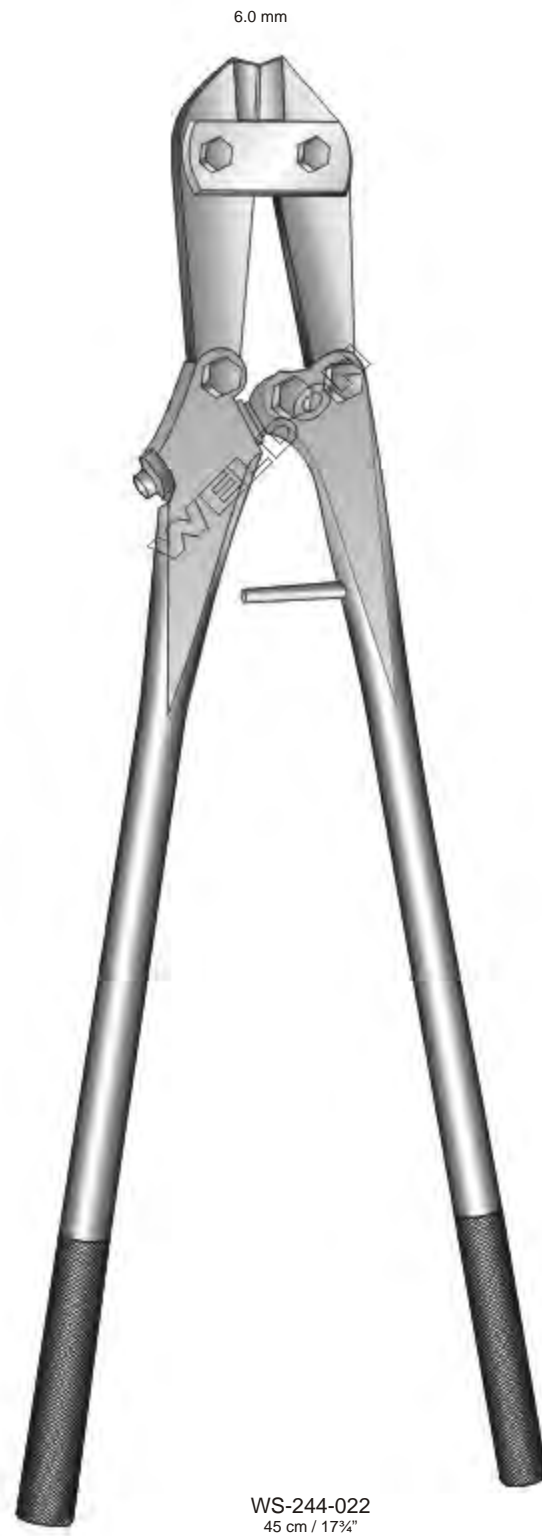
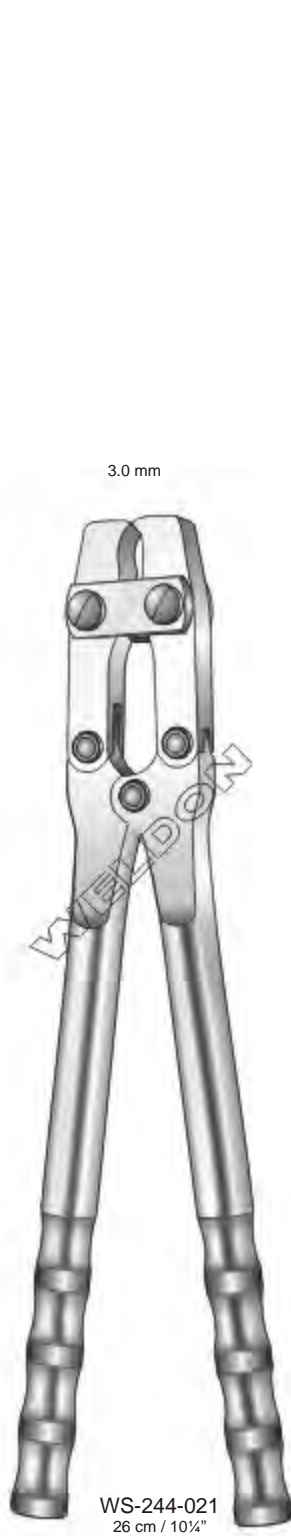

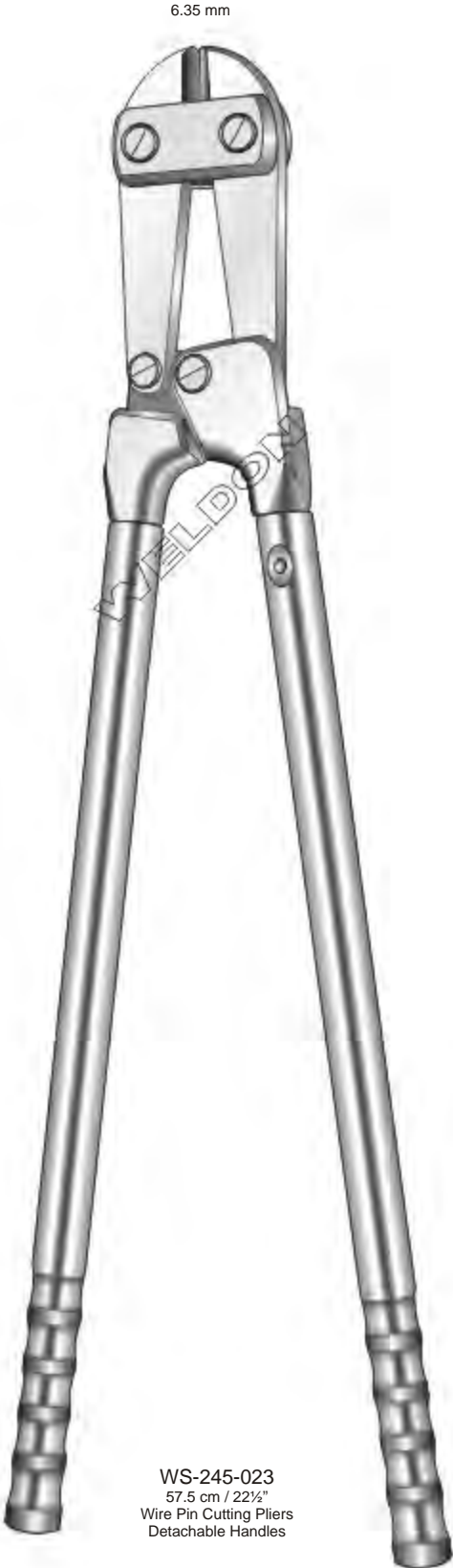

6.35 mm

WS-245-023
57.5 cm / 22½"
Wire Pin Cutting Pliers
Detachable Handles



WS-246-001 For Children
16 cm / 6"
WS-246-002 For Adults
22.5 cm / 9"



Walton
WS-247-003
16 cm / 6¼"



WS-247-004
17 cm / 6¾"
Finger Ring Saw

Amputation Saws | Sierras de Amputación | Amputationssägen

Charriere
WS-248-005
35 cm / 14"



Spare Saw Blades
WS-248-006 12 mm
WS-248-007 15 mm
WS-248-008 18 mm



Spare Saw Blades
WS-248-009 4 mm
WS-248-010 6 mm
WS-248-011 8 mm



Bier
WS-248-012
39 cm / 15½"



Lindemann
WS-248-013
20 cm / 8"



Langenbeck
WS-248-014
24.5 cm / 9¾"



Charriere
WS-248-015A 15 cm / 6"
WS-248-015B 20 cm / 8"
WS-248-015 27 cm / 10½"
WS-248-016 30 cm / 12"



Satterlee
WS-248-017
29 cm / 11½"



Percy
WS-249-018 18 cm / 7"
WS-249-019 23 cm / 9"
WS-249-020 25 cm / 10"
Detachable
Amputating Retractor

Reamers | Escariadores | Reibahlen

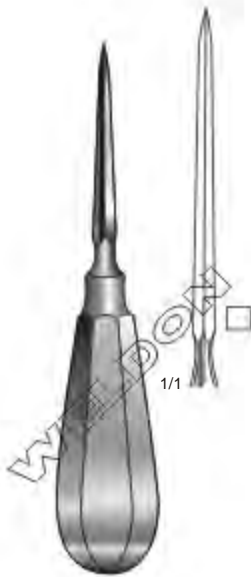

WS-250-001
14 cm / 5½"



Perthes
WS-250-002 18 cm / 7"
WS-250-003 21 cm / 8¼"



WS-250-004
14 cm / 5½"

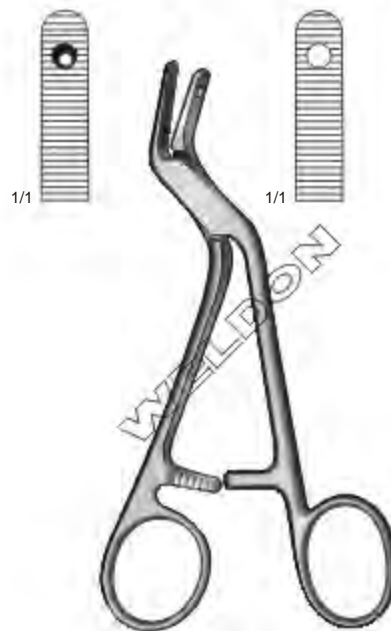

Adson
WS-250-005
15 cm / 6"



WS-251-007
Extension Piece



WS-251-008
9 mm Ø
Conical Burr



WS-251-009
14 mm Ø
Conical Burr



WS-251-010
16 mm Ø
Spherical Burr



WS-251-011
22 mm Ø
Spherical Burr



WS-251-012
14 mm Ø
Flat Trepphine



WS-251-013
2 mm Ø
Twist Drill



Mckenzie
WS-251-014
13 mm Ø
Burr



Errico
WS-251-015
16 mm Ø
Burr



Hudson
WS-251-006
27 cm / 10½"

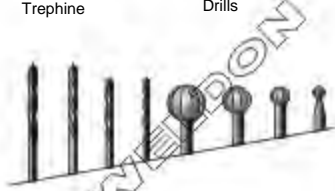

WS-252-025
 Set Consisting of Fig.1 - Fig.9



Stille
WS-252-026
 Brace Only

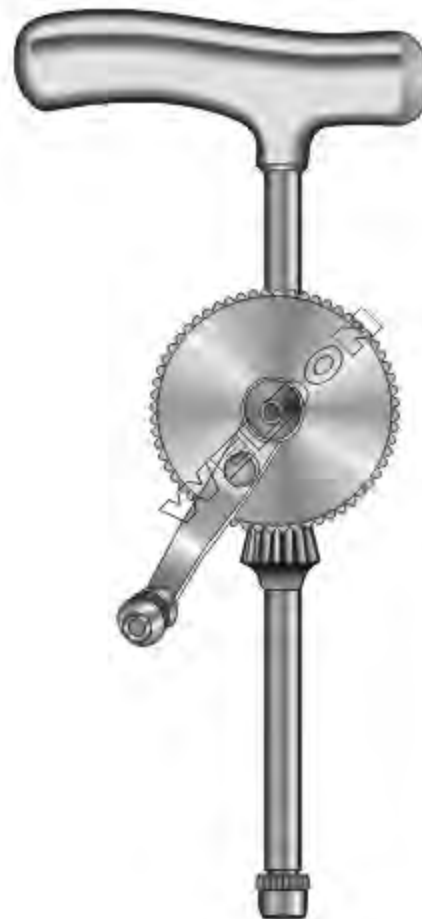

Stille-Sherman
WS-252-027 Brace Only
WS-252-028 Complete Set With 4 Drills

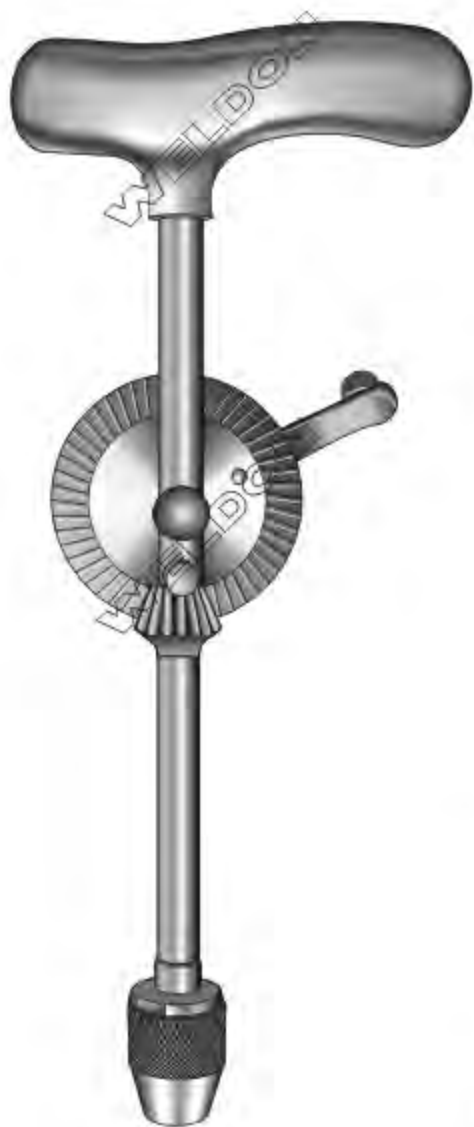

Moore
 WS-253-029 Brace Only
 WS-253-030 Complete Set With 2 Twist Drills



3.2 mm
 WS-253-031
 7 cm / 2¾"
 WS-253-032
 9 cm / 3½"
 Twist Drills

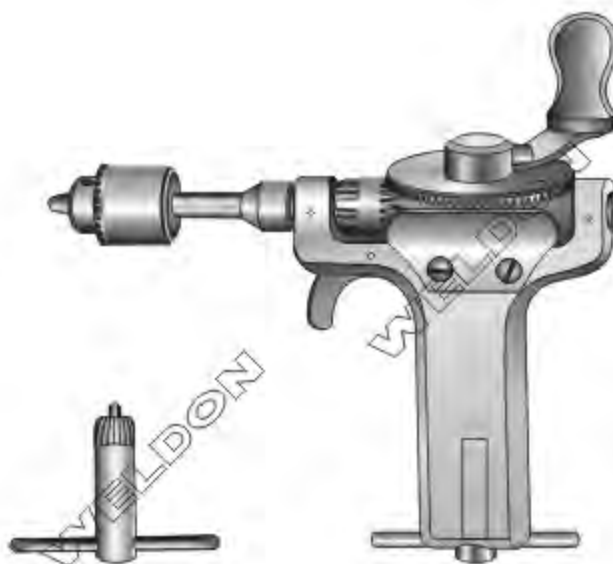

WS-253-033
 Tightening Wrech Only

Bunnell
 WS-253-034
 For Kirschner Wires Up To 3 mm Ø

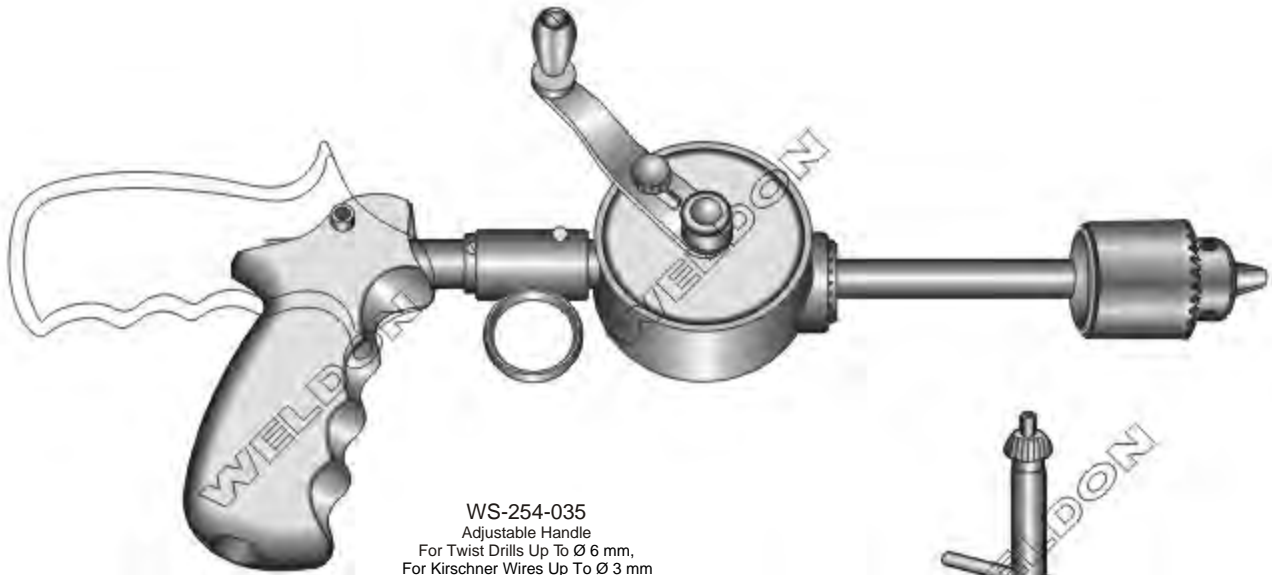

WS-254-035
Adjustable Handle
For Twist Drills Up To Ø 6 mm,
For Kirschner Wires Up To Ø 3 mm



WS-254-036
Tightening Wrench Only

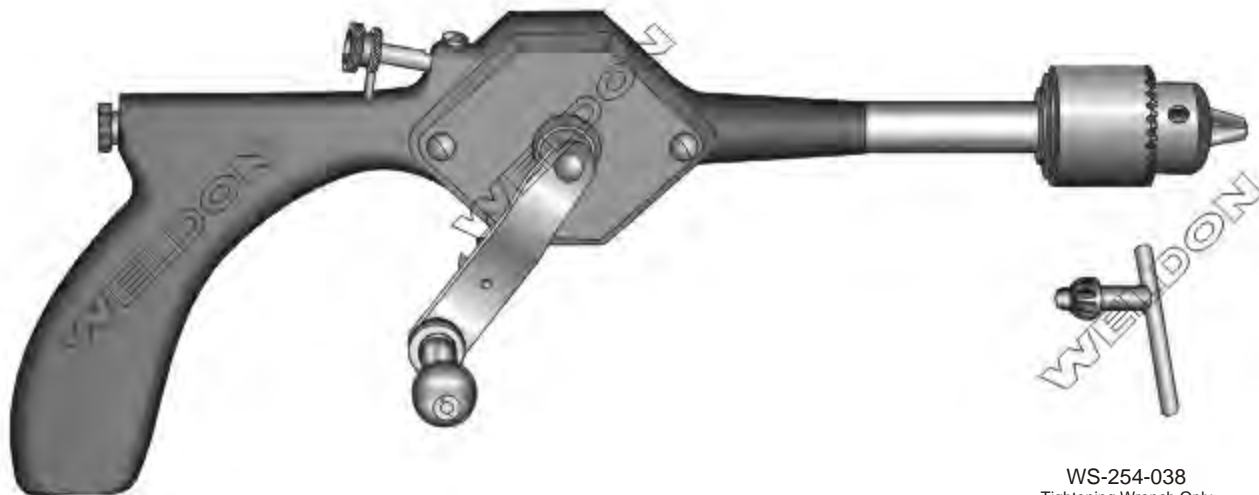

Smedberg
WS-254-037

For Twist Drills Up To Ø 6.5 mm
For Kirschner Wires Up To Ø 4 mm
With Jacobs Three-jaw Chuck And Wrench
With Axial Channel For Passing Kirschner Wires

WS-254-038
Tightening Wrench Only



Ralk
 WS-255-039
 For Twist Drills Up To Ø 7 mm
 For Kirschner Wires Up To Ø 4 mm



WS-255-040
 Tightening Wrench Only
 Twist Drills

With Three-jaw Chuck And Wrench
 With Axial Channel For Passing Kirschner Wires

WS-255-041	Ø 1.5 mm	7 cm / 2¾"
WS-255-042	Ø 2.0 mm	8.5 cm / 3⅜"
WS-255-043	Ø 2.5 mm	9.5 cm / 3¾"
WS-255-044	Ø 3.0 mm	10 cm / 4"
WS-255-045	Ø 3.2 mm	10 cm / 4"
WS-255-046	Ø 3.5 mm	11 cm / 4⅞"
WS-255-047	Ø 4.0 mm	12 cm / 4¾"
WS-255-048	Ø 4.5 mm	13 cm / 5⅞"
WS-255-049	Ø 5.0 mm	13 cm / 5⅞"
WS-255-050	Ø 6.0 mm	14 cm / 5½"

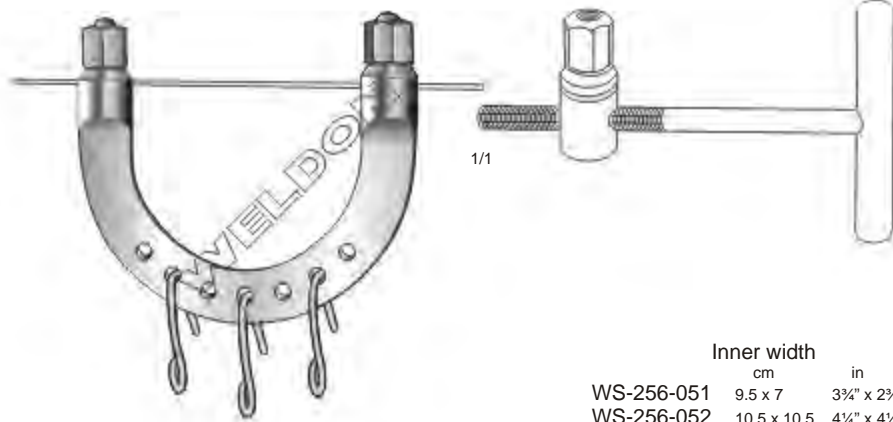
Extension Bows | Estribos Para Extensión | Extensionsbügel

Kirschner
With 3 Traction Hooks

	Inner width		
	cm	in	
WS-256-051	9.5 x 7	3 7/8" x 2 3/4"	For Children
WS-256-052	10.5 x 10.5	4 1/4" x 4 1/4"	For Wrist Ankle
WS-256-053	12 x 12	4 3/4" x 4 3/4"	For Elbow
WS-256-054	15.5 x 15.5	6" x 6"	For Knee
WS-256-055	20 x 15.5	8" x 8"	For Femur

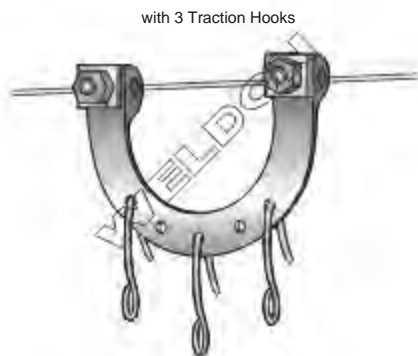

with 3 Traction Hooks

Kirschner
WS-256-056
6 x 6 cm / 2 1/2" x 2"



With 3 Traction Hooks

Kirschner
WS-256-057 0-40 mm Small Pattern
18 cm / 7 1/4"
WS-256-058 35-200 mm Large Pattern
27 cm / 10 1/2"

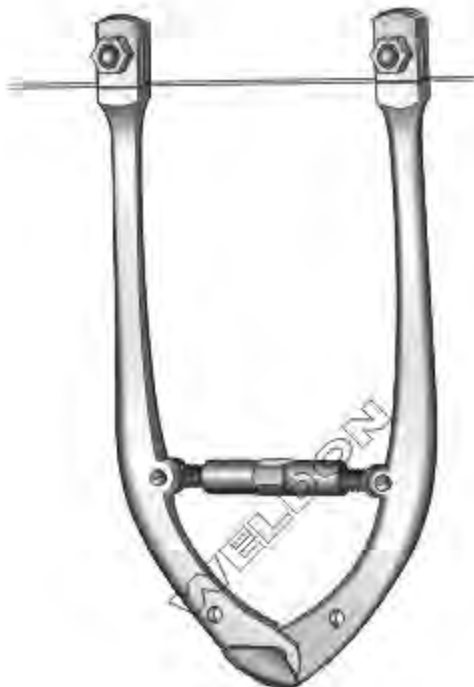

WS-257-059 180 x 100 mm
7" x 4"
Inner Width
WS-257-060 270 x 160 mm
10½" x 6¾"
Inner Width

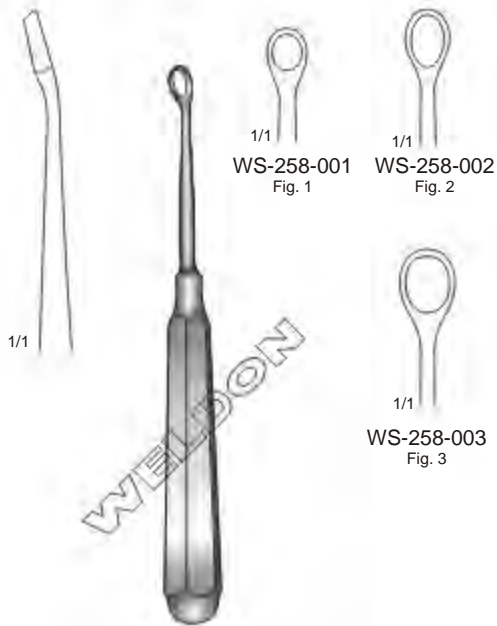

WS-257-061 Small
WS-257-062 Medium
WS-257-063 Large
Wire Mesh, Autoclavable

Lupus Currettes, Lupus Scrapers | Curettas Para Lupus, Legra Para Lupus | Lupusküretten, Lupusschaber

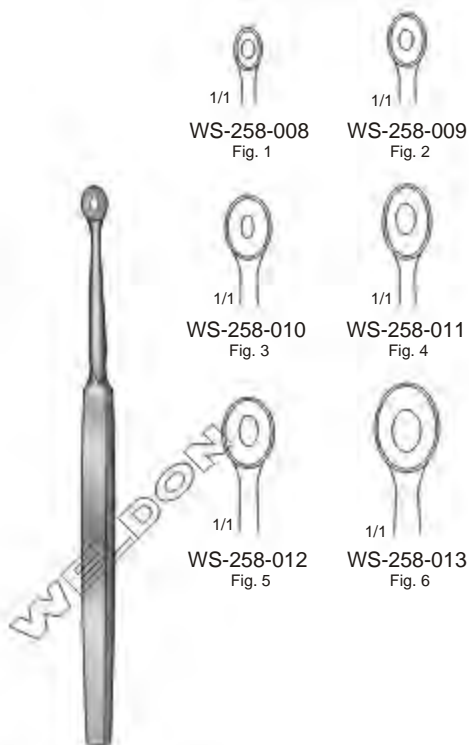
Piffard
 14.5 cm / 5¾"

Fox
 14.5 cm / 5¾"

Wolff
 14.5 cm / 5¾"

Vidal
 WS-258-014
 13.5 cm / 5⅝"

Schweden
 17 cm / 6¾"

Meniscus Knives, And Dermal Punches | Cuchillos Para Menisco, y Trépanos Para Piel
Meniskotome, Hauttrephinen



Keys
10 cm / 4"

1/1
WS-259-017
Ø 2 mm

1/1
WS-259-018
Ø 3 mm

1/1
WS-259-020
Ø 5 mm

1/1
WS-259-022
Ø 7 mm

1/1
WS-259-019
Ø 4 mm

1/1
WS-259-021
Ø 6 mm

1/1
WS-259-023
Ø 8 mm

5.5 cm / 2 1/4"
1/1
WS-259-024
1.8 mm Ø

1/1
WS-259-025
2.3 mm Ø

1/1
WS-259-026
2.7 mm Ø

1/1
WS-259-027
4 mm Ø

1/1
WS-259-028
6 mm Ø

1/1
WS-259-029
5.5 cm / 2 1/4"
2 mm Ø

1/1
WS-259-030
5.5 cm / 2 1/4"
8 mm Ø

1/1
WS-259-031
5.5 cm / 2 1/4"
10 mm Ø

1/1
WS-259-032
5.5 cm / 2 1/4"
12 mm Ø

1/1
WS-259-033

1/1
WS-259-034

1/1
WS-259-035

1/1
WS-259-036

1/1
WS-259-037

1/1
WS-259-038
Slightly Curved

1/1
WS-259-039
Slightly Curved

Bircher
19 cm / 7 1/2"

Smillie
17 cm / 6 3/4"

Stryker-Scholl
19 cm / 7 1/2"

WS-259-040
Spare Blades Sterile

Acne Knife, Comedone Expressors | Cuchillo Para Acné, Sacacomedones
Aknesser, Komedonenquetscher

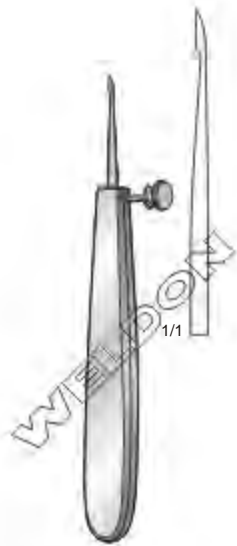

Monocorps
WS-260-041
14 cm / 5½"



Saalfeld
WS-260-042
10.5 cm / 4¼"

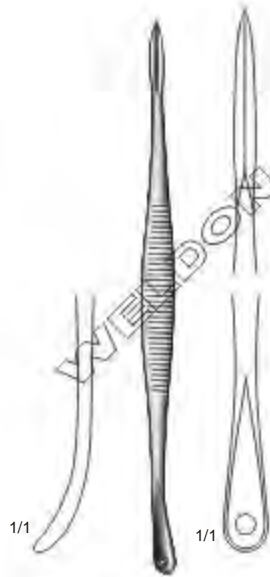

Saalfeld
WS-260-043
15 cm / 6"



WS-260-044
16.5 cm / 6½"
Child

WS-260-045
19 cm / 7½"
Adult

Jobson
Horne Probes

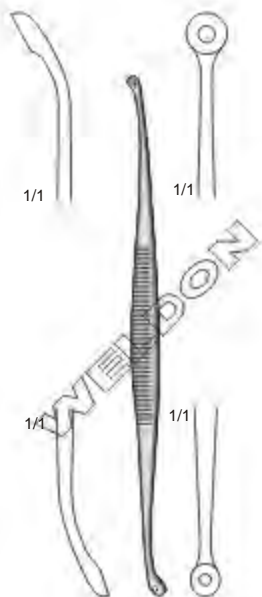

Unna
WS-260-046
14 cm / 5½"

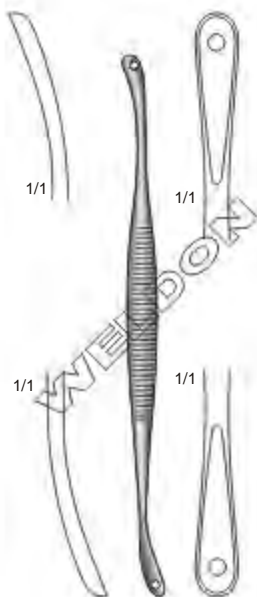

Unna
WS-260-047
14 cm / 5½"



Hebra
WS-260-048
18 cm / 7⅞"



Schamberg
WS-260-049
10 cm / 4"

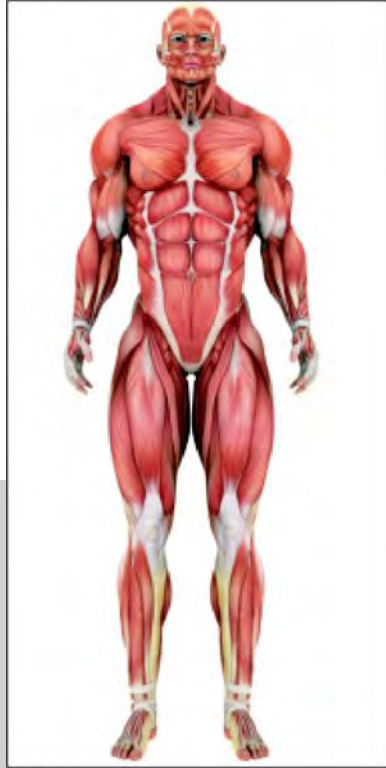

www.weldoninstruments.com

PROVEEDOR EXCLUSIVO:



Hooklets

Retractors

&

Self Retaining Retractors

261 - 312

Retractors

Retractors
Separadores
Wundhaken

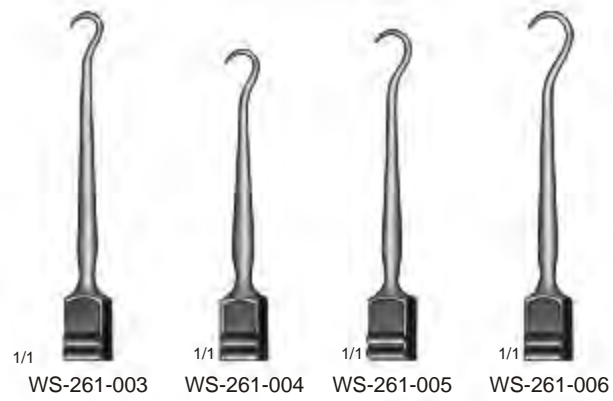

Graefe
16 cm / 6¼"

Graefe
16 cm / 6¼"
Sharp



O'Connor
WS-261-007
16 cm / 6¼"
Sharp



Guthrie
WS-261-008 Sharp
WS-261-009 Blunt
15.5 cm / 6"

Retractors, Hooklets | Separadores, Ganchos | Wundhaken, Wundhäkchen



WS-262-010



WS-262-011

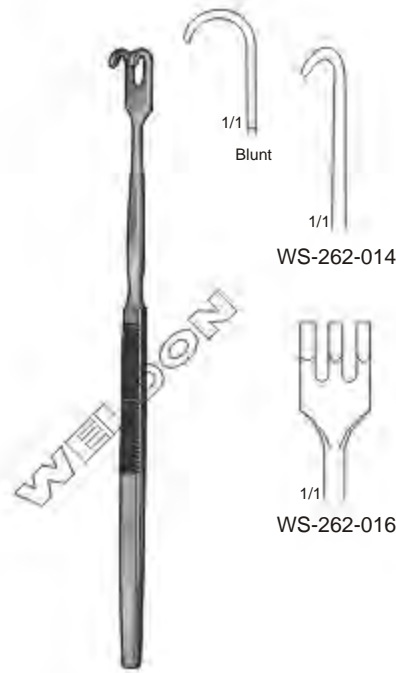

WS-262-014

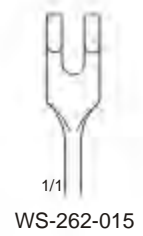

WS-262-015



WS-262-012



WS-262-013

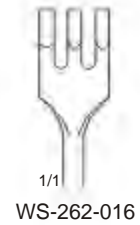

WS-262-016

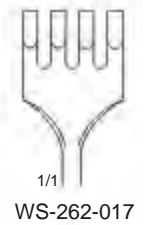

WS-262-017

16 cm / 6 1/4"

16 cm / 6 1/4"



WS-262-018

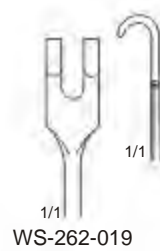

WS-262-019



WS-262-020



WS-262-021

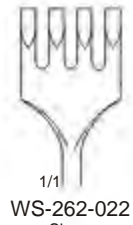

WS-262-022 Sharp

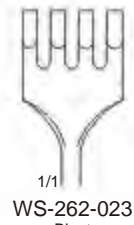

WS-262-023 Blunt



WS-262-024 Sharp



WS-262-025 Blunt

 Flexible
16 cm / 6 1/4"

16 cm / 6 1/4"



Retractors, Hooklets | Separadores, Ganchos | Wundhaken, Wundhäkchen

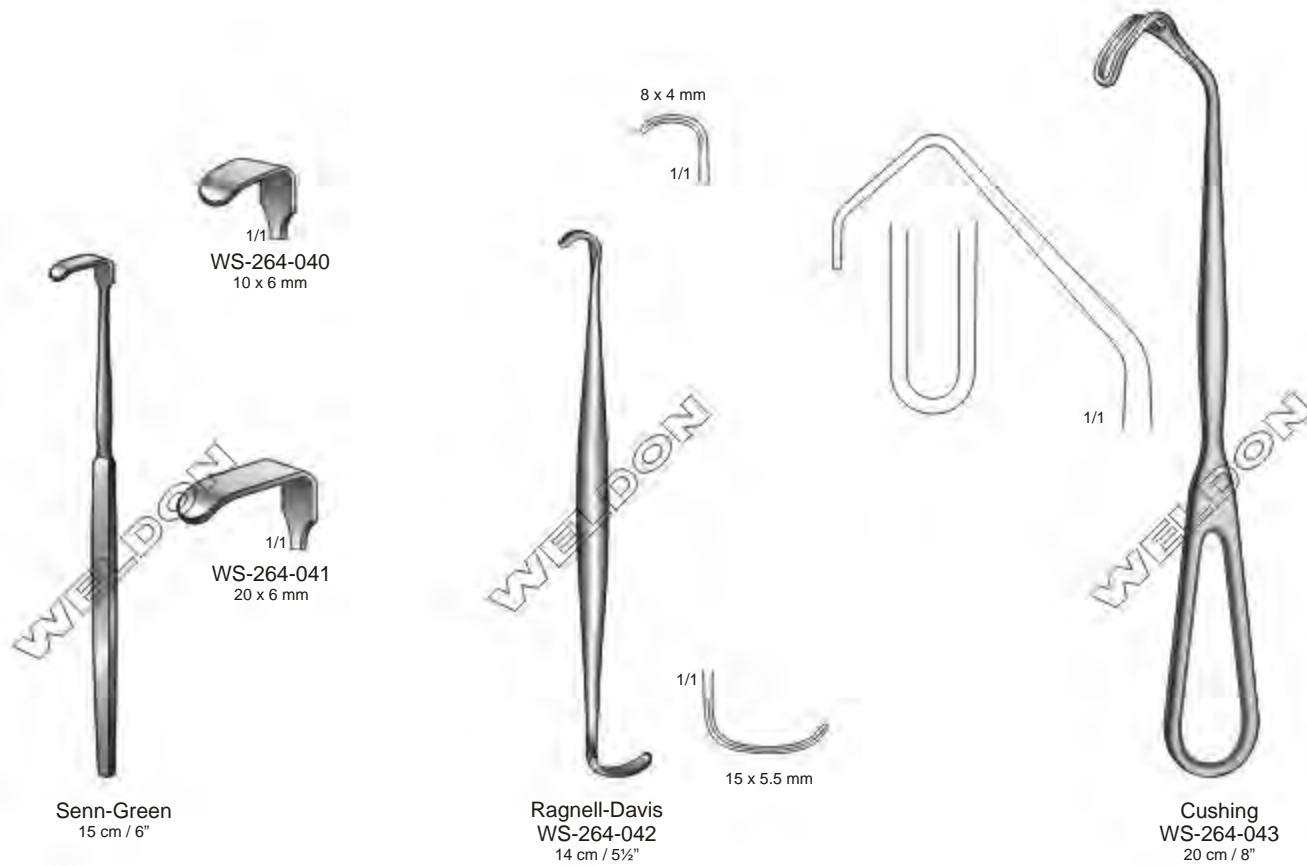



WS-265-050
12 cm / 4 1/2"



WS-265-051
16 cm / 6 1/4"



WS-265-052
8 mm



WS-265-055
10 mm



WS-265-053
12 mm



WS-265-056
14 mm



WS-265-054
16 mm

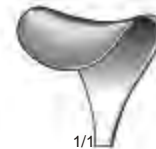

WS-265-057
18 mm



Desmarres
16 cm / 6 1/4"



Desmarres
16 cm / 6 1/4"



WS-265-058
12 mm



WS-265-060
14 mm



WS-265-059
16 mm



WS-265-061
18 mm



WS-265-062
10 x 6 mm



WS-265-064
17 x 5 mm



WS-265-063
20 x 6 mm



WS-265-065
22 x 8 mm



Mini-Langenbeck
16 cm / 6 1/4"

Saddle Hooks | Ganchos en Forma De Silla | Sattelhäkchen

1/1
WS-266-066
8 mm



1/1
WS-266-069
10 mm



1/1
WS-266-072
8 mm



1/1
WS-266-075
10 mm



1/1
WS-266-067
12 mm



1/1
WS-266-070
14 mm



1/1
WS-266-073
12 mm



1/1
WS-266-076
14 mm



1/1
WS-266-068
16 mm



1/1
WS-266-071
18 mm



1/1
WS-266-074
16 mm



1/1
WS-266-077
18 mm



Cushing
20 cm / 8"



Cushing
24 cm / 9½"

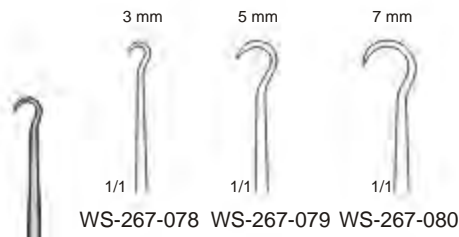

Kleinert-Kutz
13 cm / 5 1/8"

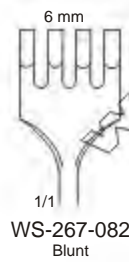
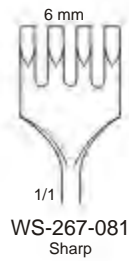

Knapp
16 cm / 6 1/4"

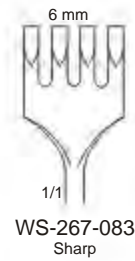

Knapp
16 cm / 6 1/4"
With Flexible Shaft

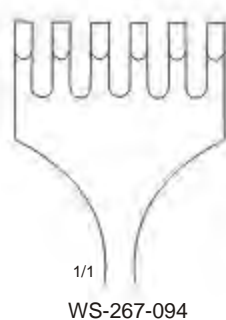
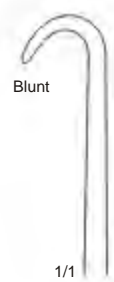
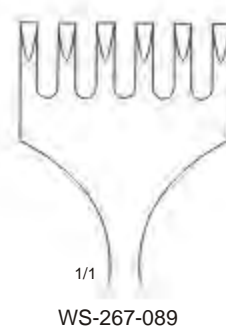

Volkmann
21.5 cm / 8 1/2"



Volkman
21.5 cm / 8½"

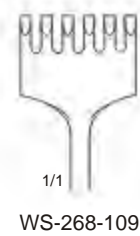
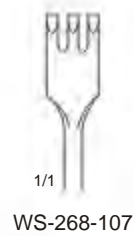
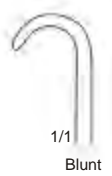
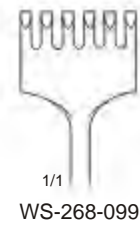
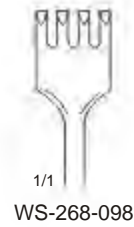
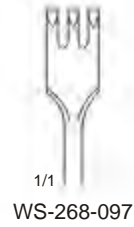



1/1

WS-269-110



1/1

WS-269-111



1/1

WS-269-112



1/1

WS-269-113



1/1

WS-269-114

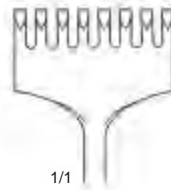

1/1

WS-269-115



1/1

Sharp



1/1

WS-269-116



1/1

WS-269-117



1/1

WS-269-118



1/1

WS-269-119



1/1

WS-269-120

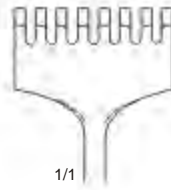

1/1

WS-269-121

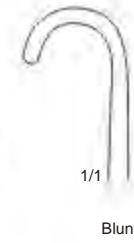

1/1

Blunt



1/1

WS-269-122



1/1

WS-269-123



1/1

WS-269-124



1/1

WS-269-125



1/1

WS-269-126

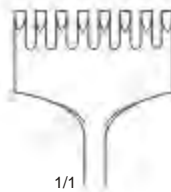

1/1

WS-269-127



1/1

Semi-Sharp



Kocher
22 cm / 8 3/4"



Murphy
19.5 cm / 7 3/4"
Sharp



1/1



1/1

WS-270-128



1/1

WS-270-129



1/1

WS-270-130



1/1

WS-270-131



Murphy
19.5 cm / 7 3/4"
Blunt



1/1



1/1

WS-270-132



1/1

WS-270-133



1/1

WS-270-134



1/1

WS-270-135



Wassmund
WS-270-136
20 cm / 8"
33 x 20 mm



Ollier
WS-271-137
22.5 cm / 9"
36 x 30 mm

Ollier
WS-271-138
22.5 cm / 9"
36 x 60 mm

Koerte
WS-271-139
23.5 cm / 9¼"
40 x 30 mm
Sharp

Koerte
WS-271-140
23.5 cm / 9¼"
40 x 30 mm
Blunt

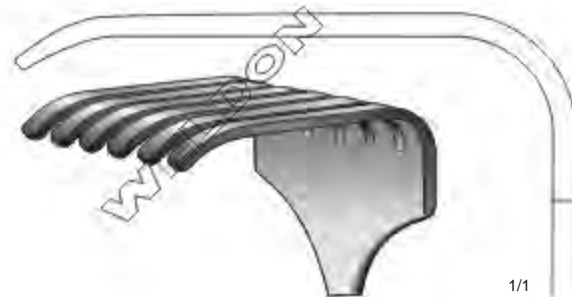
WS-272-141
40 x 40 mmWS-272-142
45 x 50 mmWS-272-143
50 x 60 mmWS-272-144
70 x 70 mmIsrael
25 cm / 10"
Blunt



Langenbeck
WS-273-145
22 cm / 8½"

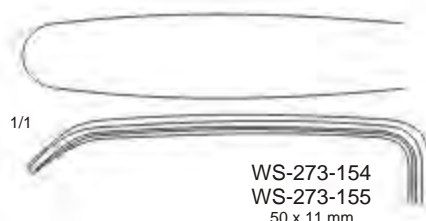
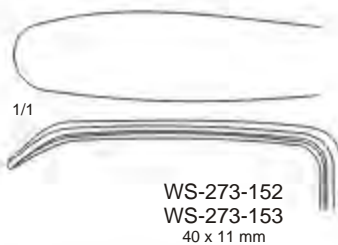
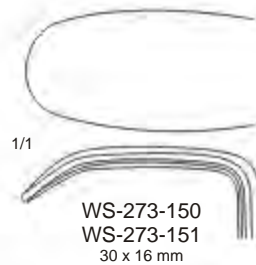
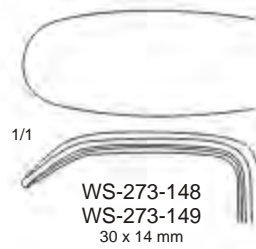
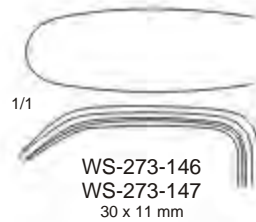

Langenbeck
21 cm / 8¼"

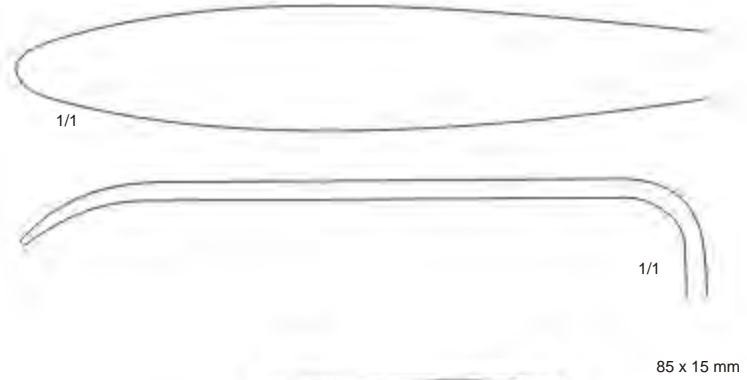
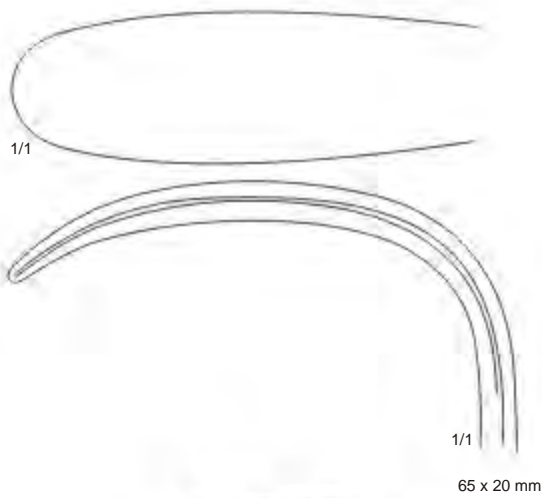

Langenbeck
WS-274-156
21 cm / 8¼"



Langenbeck
WS-274-157
22.5 cm / 8¾"

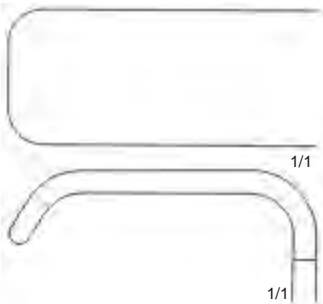

WS-275-158
43 x 18 mm



WS-275-159
53 x 20 mm



WS-275-160
63 x 25 mm



WS-275-161
77 x 30 mm



WS-275-162
78 x 40 mm



Kocher
23 cm / 9"



Sauerbruch
23 cm / 9"

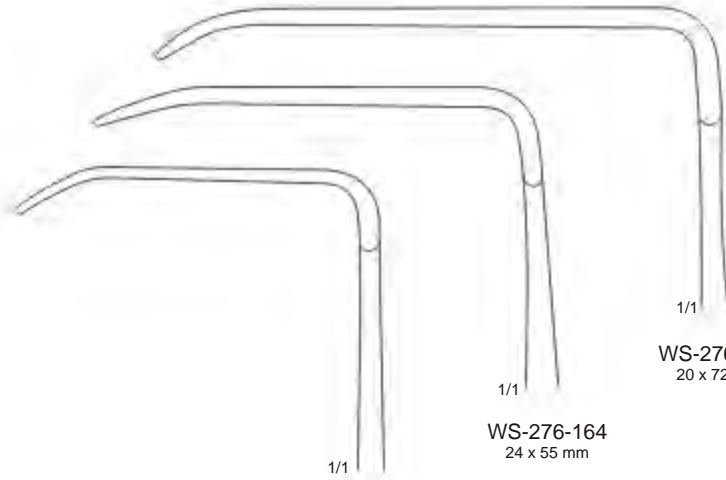

WS-276-163
18 x 45 mm

WS-276-164
24 x 55 mm

WS-276-165
20 x 72 mm

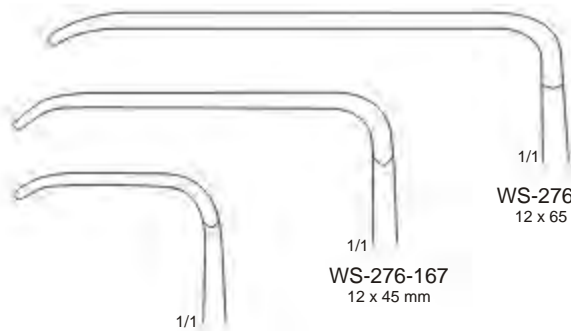

WS-276-166
8 x 25 mm

WS-276-167
12 x 45 mm

WS-276-168
12 x 65 mm



Kocher
21 cm / 8¼"

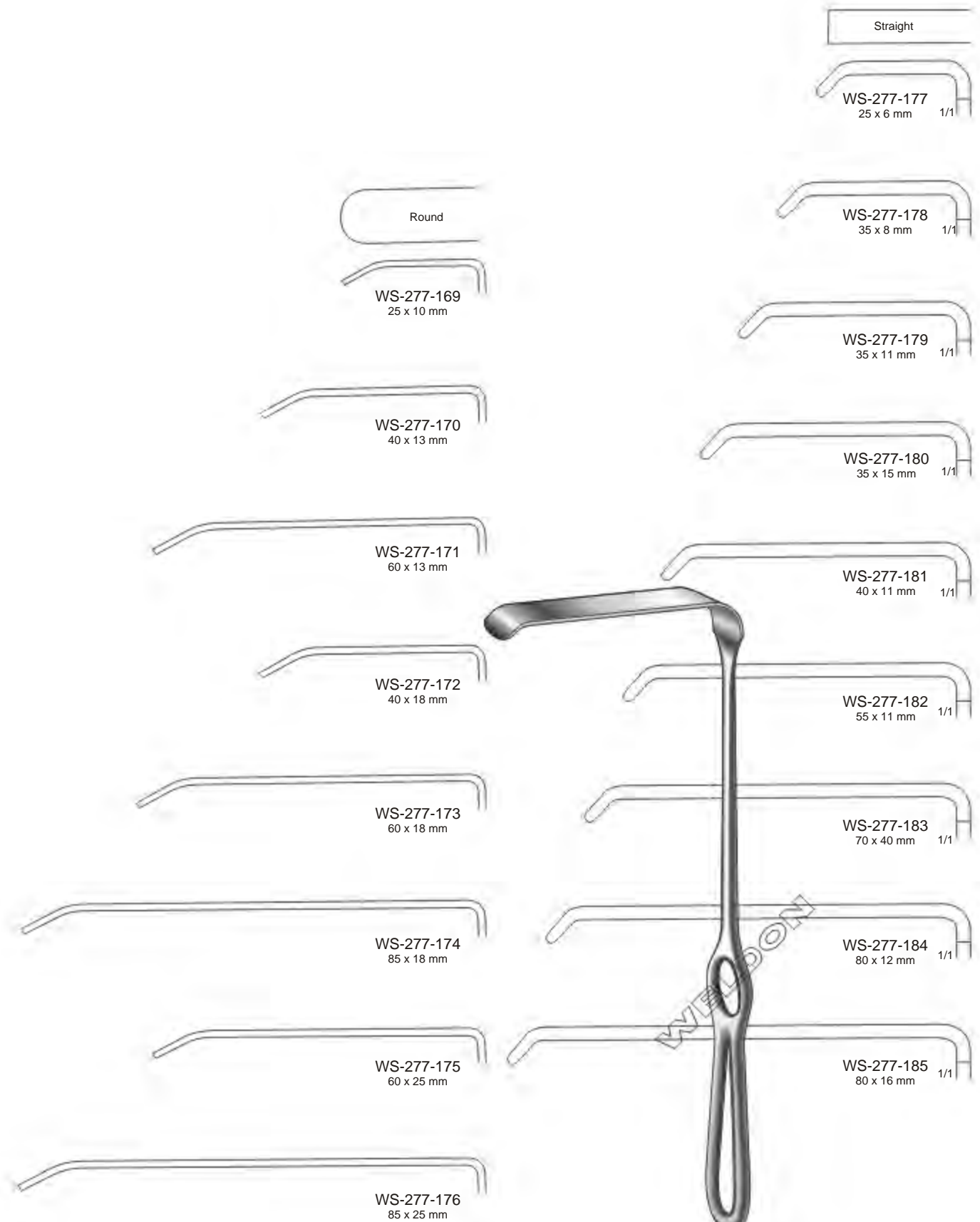

Straight

WS-277-177
25 x 6 mm 1/1

Round

WS-277-169
25 x 10 mm

WS-277-178
35 x 8 mm 1/1

WS-277-179
35 x 11 mm 1/1

WS-277-170
40 x 13 mm

WS-277-180
35 x 15 mm 1/1

WS-277-171
60 x 13 mm

WS-277-181
40 x 11 mm 1/1

WS-277-172
40 x 18 mm

WS-277-182
55 x 11 mm 1/1

WS-277-173
60 x 18 mm

WS-277-183
70 x 40 mm 1/1

WS-277-174
85 x 18 mm

WS-277-184
80 x 12 mm 1/1

WS-277-175
60 x 25 mm

WS-277-185
80 x 16 mm 1/1

WS-277-176
85 x 25 mm

Kocher-Langebeck
21.5 cm / 8½"

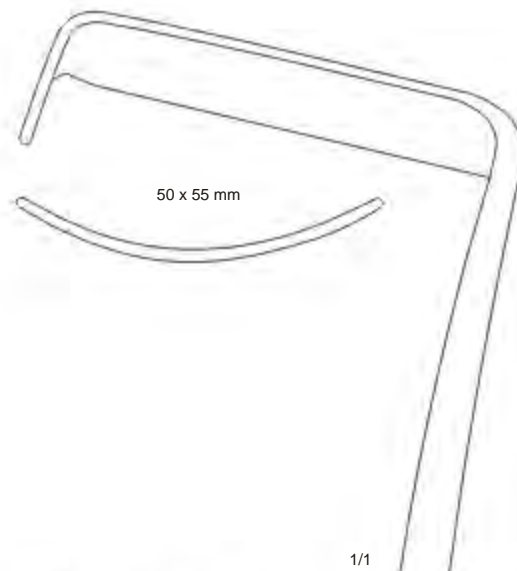
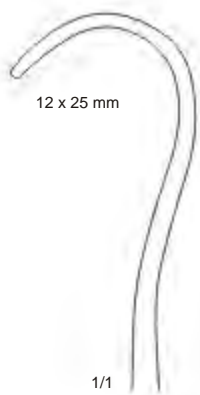

Green
WS-278-186
23 cm / 9"



Morris
WS-278-187
22.5 cm / 9"



Goelet
WS-278-188 32 x 40 mm
WS-278-189 40 x 40 mm
19 cm / 7½"

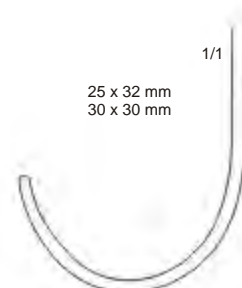
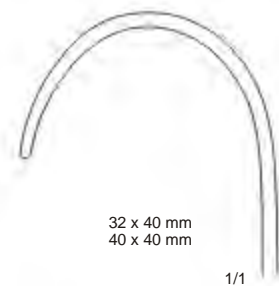

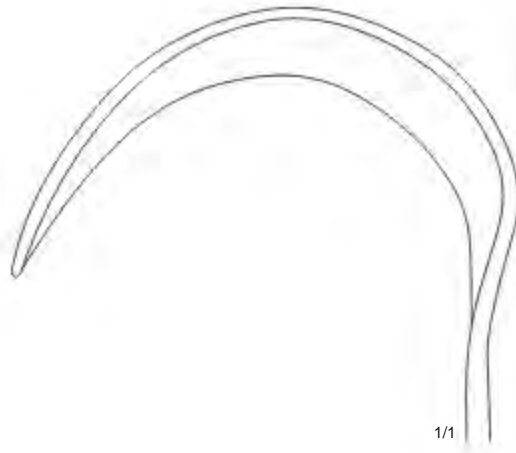

WS-279-190
80 x 60 mm



Fritsch (Kocher)
25.5 cm / 10"



- WS-279-191 40 x 40 mm
- WS-279-192 50 x 40 mm
- WS-279-193 60 x 40 mm
- WS-279-194 70 x 40 mm
- WS-279-195 80 x 40 mm



- WS-279-196 10 x 30 mm
- WS-279-197 15 x 30 mm
- WS-279-198 20 x 30 mm
- WS-279-199 30 x 30 mm

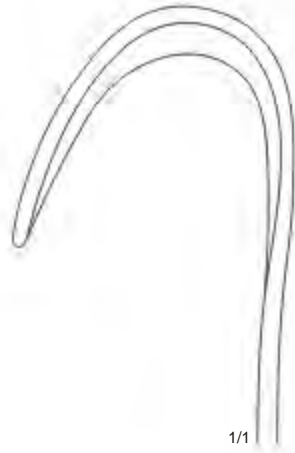

WS-280-200
40 x 30 mm

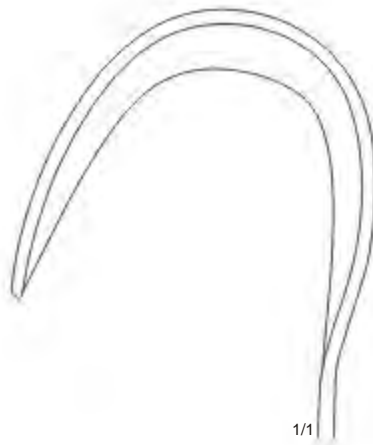

WS-280-201
40 x 40 mm



Fritsch
25.5 cm / 10"



WS-280-202
75 x 45 mm



1/1

WS-281-203
27 cm / 10 $\frac{3}{4}$ "
45 x 45 mm

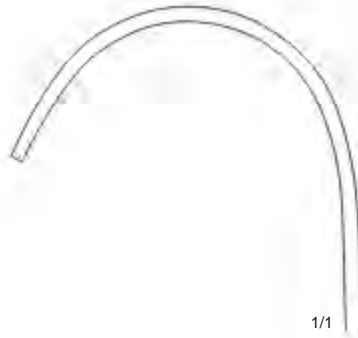

1/1



1/1

WS-281-204
27 cm / 10 $\frac{3}{4}$ "
50 x 45 mm



1/1



1/1

WS-281-205
28 cm / 11"
70 x 55 mm



1/1



Middeldorpf

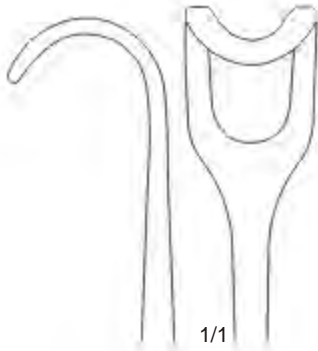

Fig 1
16 x 16 mm

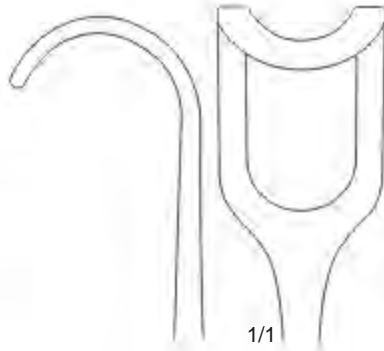

Fig 2
22 x 22 mm

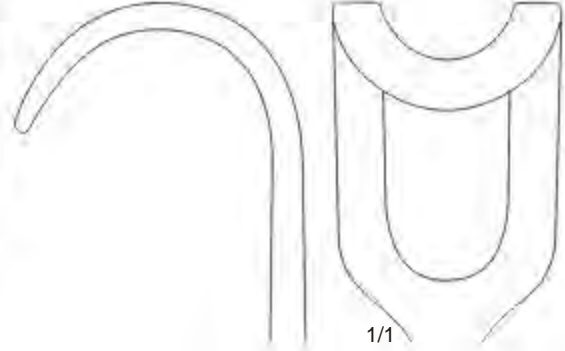

Fig 3
30 x 30 mm



Middelдорpf
 WS-282-206 Fig 1 19.5 cm / 7¾"
 WS-282-207 Fig 2 20.5 cm / 8"
 WS-282-208 Fig 3 23.0 cm / 9"



Middelдорpf
 WS-282-209 Fig 1 20.5 cm / 8"
 WS-282-210 Fig 2 22.5 cm / 9"
 WS-282-211 Fig 3 23.5 cm / 9¼"



Brunner
25 cm / 10"

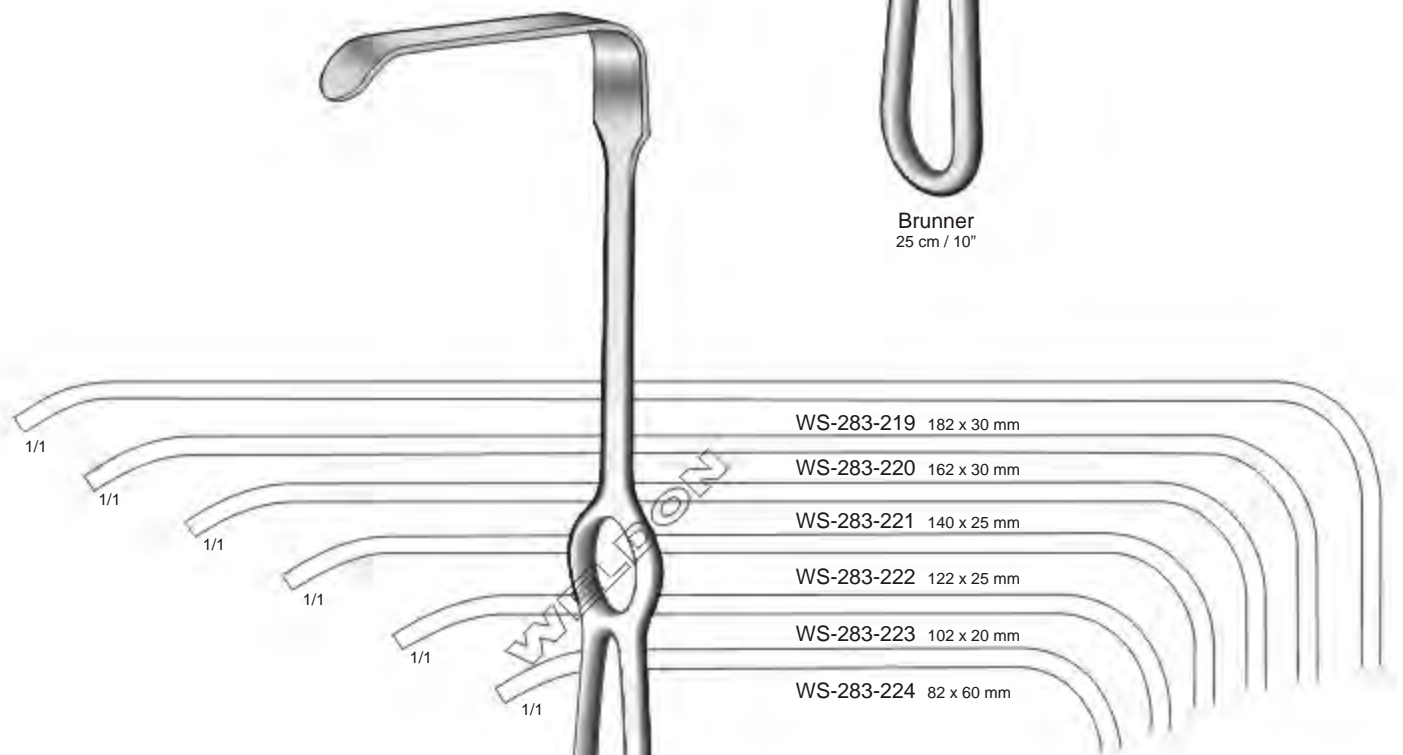

Brunner
25 cm / 10"



Kader
27 cm / 10 $\frac{3}{4}$ "



1/1
WS-284-225
30 mm



1/1
WS-284-226
40 mm

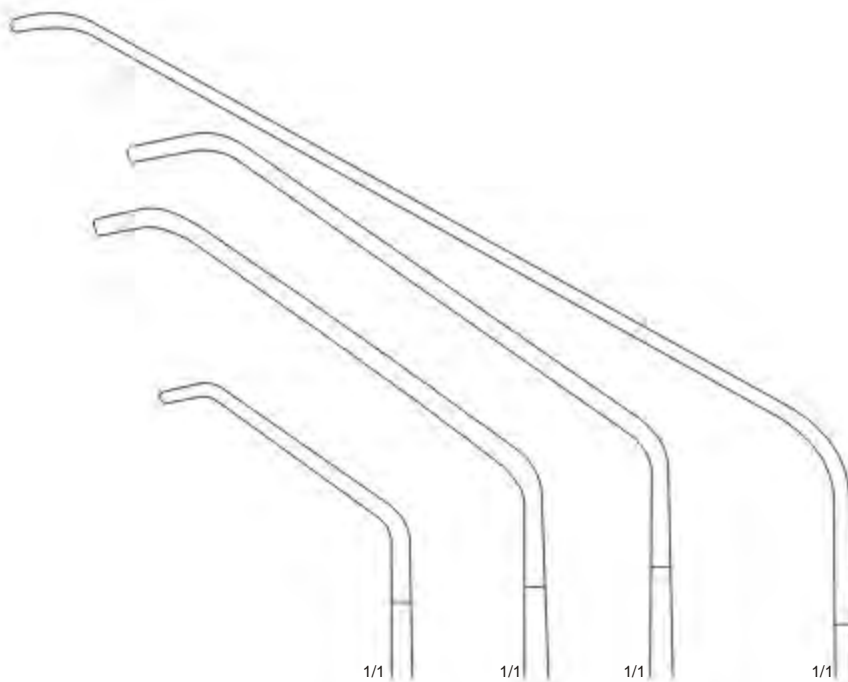

1/1
WS-284-227
25 cm / 10"

1/1
WS-284-228
26 cm / 10 $\frac{1}{4}$ "

1/1
WS-284-229
27.5 cm / 10 $\frac{3}{4}$ "

1/1
WS-284-230
29 cm / 11 $\frac{3}{8}$ "



Zenker

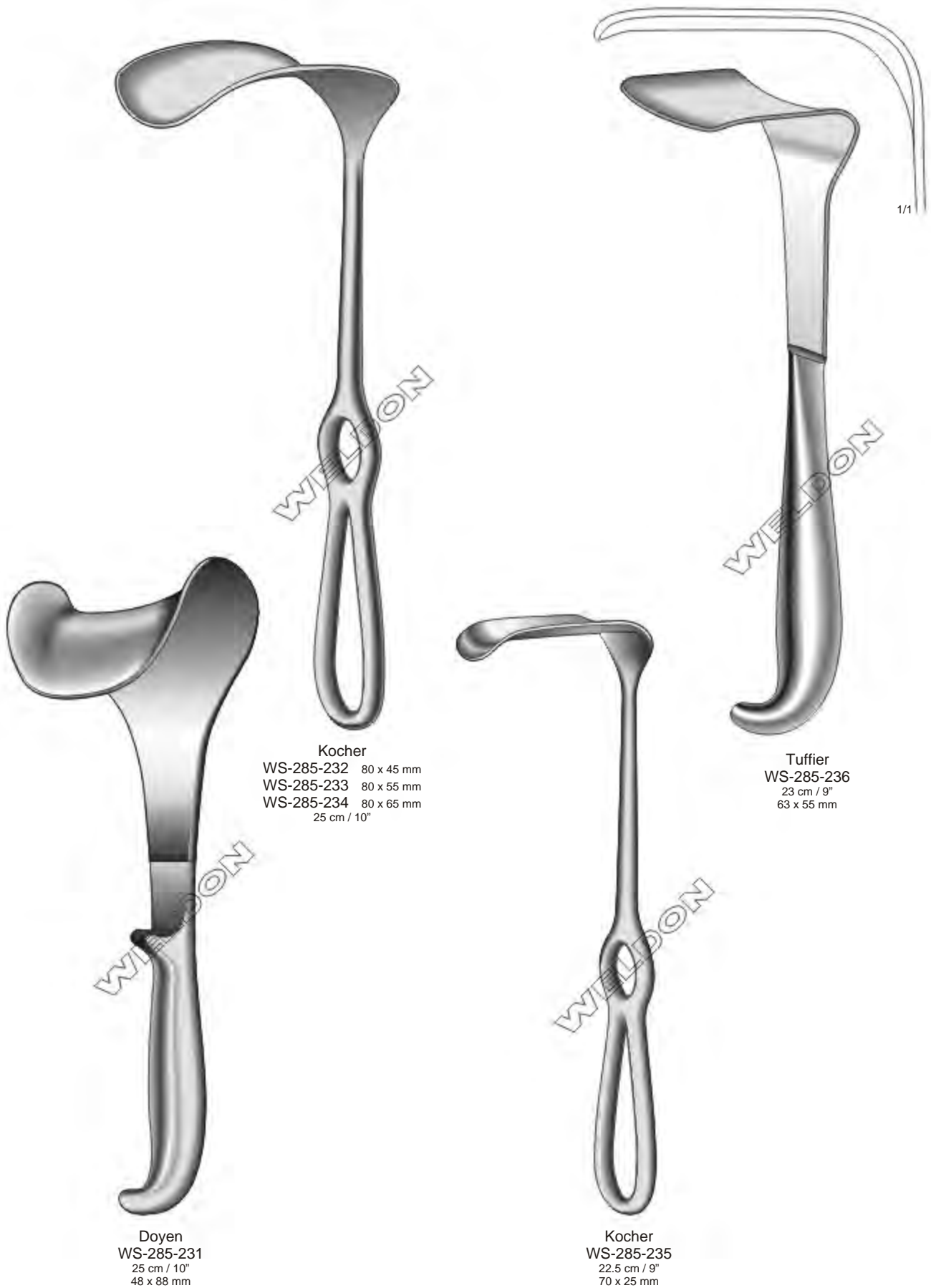

Kocher
 WS-285-232 80 x 45 mm
 WS-285-233 80 x 55 mm
 WS-285-234 80 x 65 mm
 25 cm / 10"

Tuffier
 WS-285-236
 23 cm / 9"
 63 x 55 mm

Doyen
 WS-285-231
 25 cm / 10"
 48 x 88 mm

Kocher
 WS-285-235
 22.5 cm / 9"
 70 x 25 mm

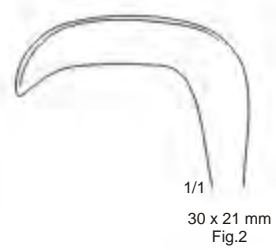
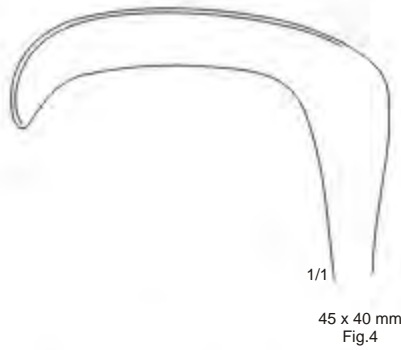

Richardson-Eastmann
 WS-286-001 Set of Two (2+3)
 WS-286-002 Fig. 1 26 cm / 10 1/4"
 WS-286-003 Fig. 2 28 cm / 11"

Richardson
 WS-286-004 Fig.1 53 x 22 mm
 WS-286-005 Fig.2 30 x 21 mm
 WS-286-006 Fig.3 37 x 29 mm
 WS-286-007 Fig.4 45 x 40 mm
 24 cm / 9 1/2"

Kelly
 WS-286-008
 26 cm / 10 1/4"

Richardson
 WS-286-009
 24 cm / 9 1/2"

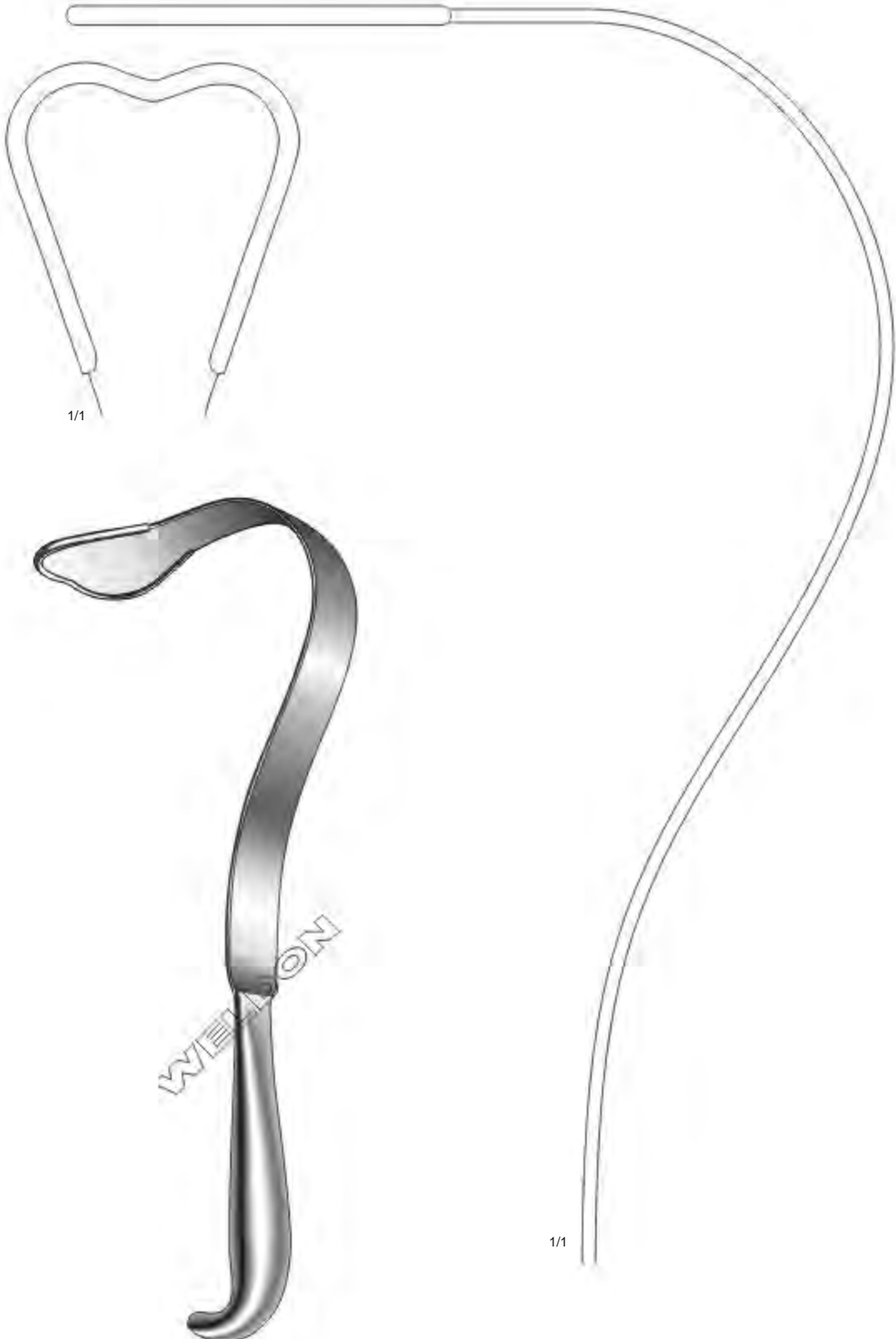

Harrington
WS-287-010 127 x 40 mm
WS-287-011 127 x 62 mm
32 cm / 12½"



Deaver
WS-288-012
18 cm / 7"
19 mm

Deaver
WS-288-013
21.5 cm / 8½"
22 mm

Deaver
WS-288-014
23 cm / 9"
25 mm

Deaver
WS-288-015
30 cm / 12"
25 mm

Deaver
WS-288-016
33 cm / 13"
25 mm

Deaver
WS-288-017
36 cm / 14"
25 mm



Deaver
WS-289-018
30 cm / 12"
38 mm



Deaver
WS-289-019
30 cm / 12"
50 mm



Deaver
WS-289-020
30 cm / 12"
75 mm



Deaver
31 cm / 12¼"

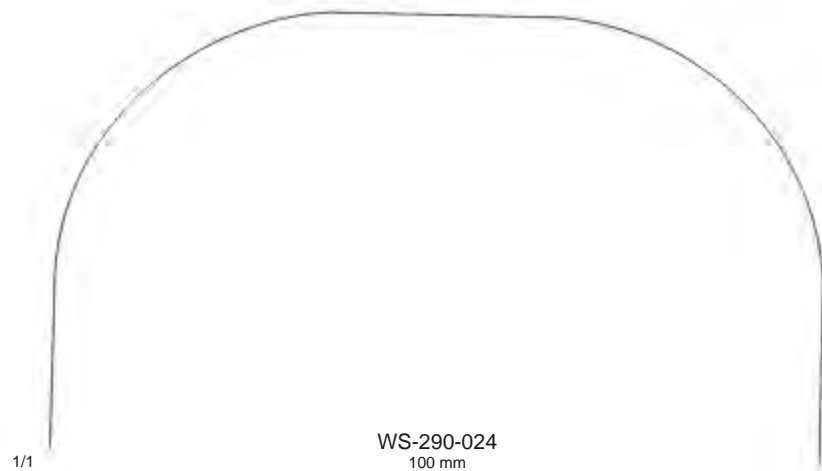
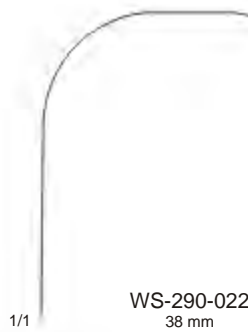



Davidson
WS-291-025
19 cm / 7½"
80 x 54 mm



Davidson
WS-291-026
18.5 cm / 7¼"
80 x 95 mm

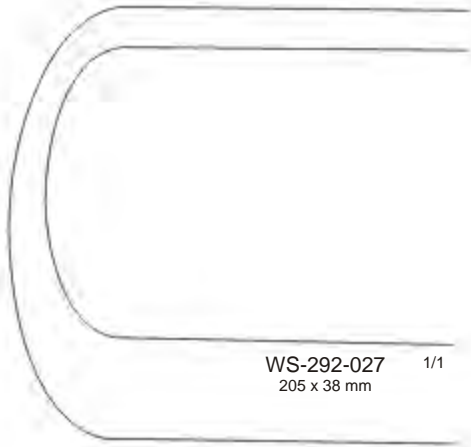

WS-292-027 1/1
205 x 38 mm

WS-292-028 1/1
205 x 57 mm

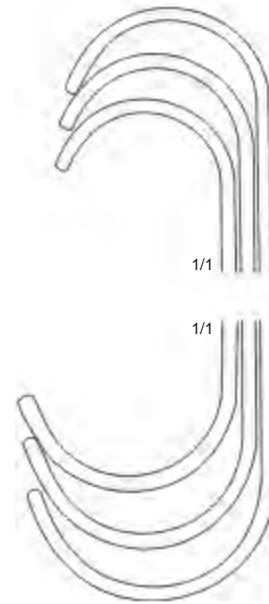

1/1

1/1



Kelly
27 cm / 10½"



Roux
WS-292-029 Set of Three (Fig. 1 - 3)
WS-292-030 Fig. 1 14 cm / 5½"
WS-292-031 Fig. 2 15 cm / 6"
WS-292-032 Fig. 3 17 cm / 6¾"

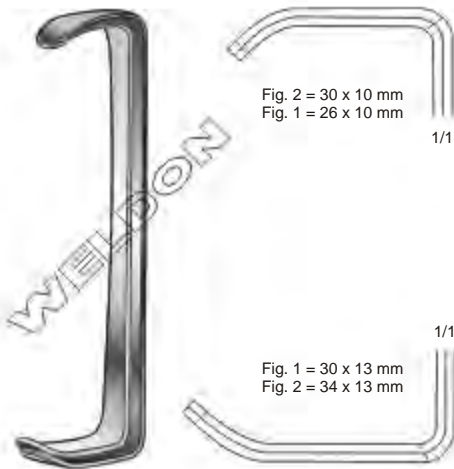

Farabeuf
 WS-293-033 8 cm / 3¼"
 WS-293-034 12 cm / 4¾"
 Set of Two

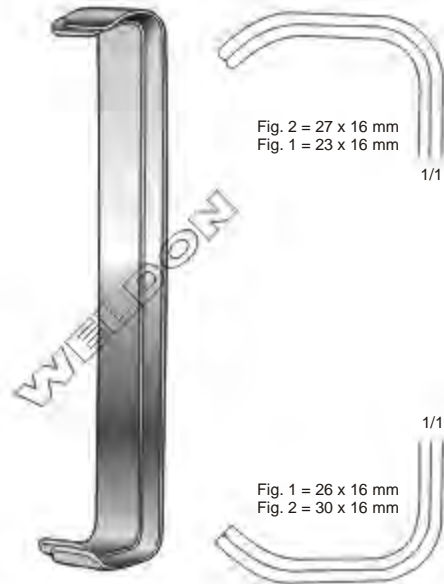

Farabeuf
 WS-293-035
 15 cm / 6"
 Set of Two



Roux-Mini
 WS-293-036
 14 cm / 5½"

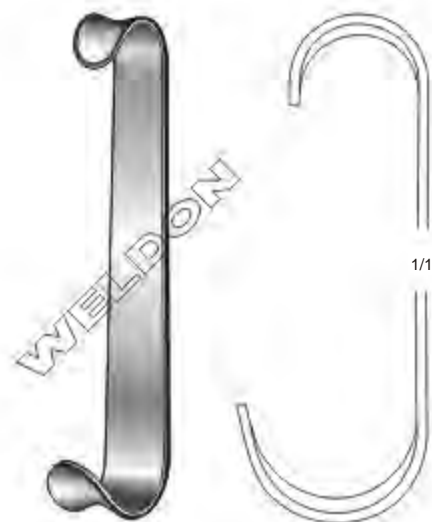

Roux-Baby
 WS-293-037
 13 cm / 5¼"



Parker
WS-294-038
13.5 cm / 5¼"
Set of Two

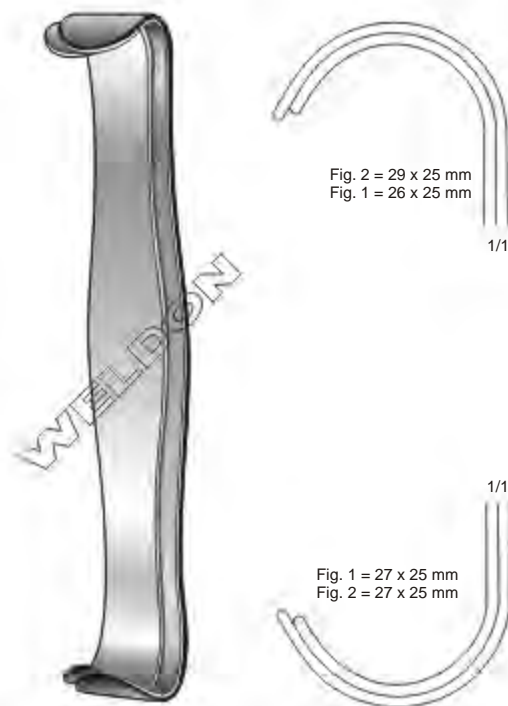

Parker
WS-294-039
17.5 cm / 7"
Set of Two



Parker-Mott
WS-294-040
16 cm / 6¼"
Set of Two

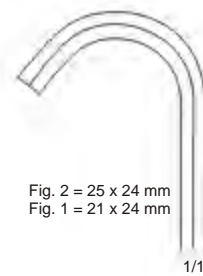
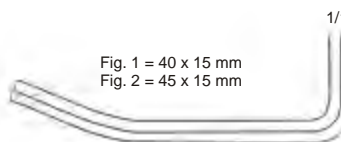
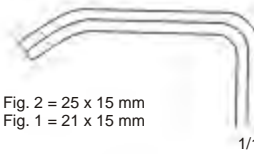
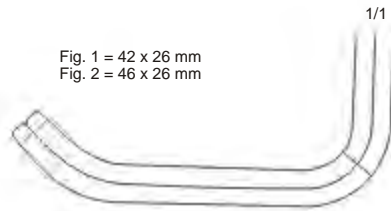
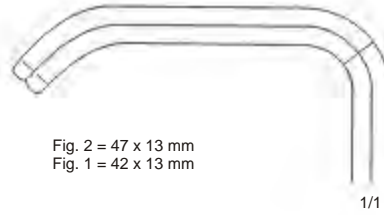

Fig. 2 = 25 x 24 mm
Fig. 1 = 21 x 24 mm

Fig. 1 = 68 x 24 mm
Fig. 2 = 72 x 24 mm



Mathieu
WS-295-041
20 cm / 8"
Set of Two



Parker-Langenbeck
WS-295-042
21 cm / 8¼"
Set of Two

Self-Retaining Retractors | Separadores Autoestáticos | Wundspreizer



Finsen
5 cm / 2"



WS-296-001
Sharp

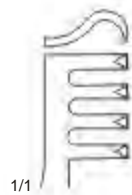

WS-296-002
Blunt



WS-296-003
Sharp

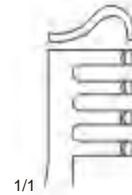

WS-296-004
Blunt



Finsen
7 cm / 2 3/4"
With Adjusting Screw



WS-296-005
Sharp



WS-296-006
Blunt



Finsen
WS-296-007 Sharp
WS-296-008 Blunt
5 cm / 2"

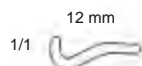

Finsen
WS-296-009 Sharp
WS-296-010 Blunt
7 cm / 2 3/4"

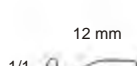

Finsen
WS-296-011 Sharp
WS-296-012 Blunt
7 cm / 2 3/4"



WS-296-013 Sharp
WS-296-014 Blunt
10 cm / 4"



Alm
7 cm / 2¾"



1/1

WS-297-015
Sharp



4 x 4



1/1

WS-297-016
Blunt



4 x 4



Logan
WS-297-017
4 cm / 1½"
With Adjusting Screw



Alm
10 cm / 4"
With Adjusting Screw



1/1

WS-297-018
Sharp



4 x 4



1/1

WS-297-019
Blunt



4 x 4



Stevenson
WS-297-020
7.5 cm / 3"
Sharp



WS-297-021 8.5 cm / 3⅜"
WS-297-022 11.5 cm / 4½"
Fat Spreaders
For Coronary Surgeries
Sharp



WS-297-023 8.5 cm / 3⅜"
WS-297-024 11.5 cm / 4½"
Fat Spreaders
For Coronary Surgeries
3 x 3 Teeth

Self-Retaining Retractors | Separadores Autoestáticos | Wundspreizer

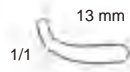

Jansen
WS-298-025
10 cm / 4"
Sharp

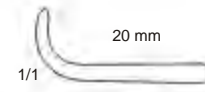

Jansen
WS-298-026
10 cm / 4"
Blunt

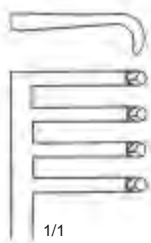

Jansen
WS-298-027
12 cm / 4 1/2"
Blunt



WS-298-028
Blunt



Scalp-Contour
13.5 cm / 5 1/4"
With Ratchet

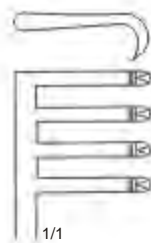

WS-298-029
Sharp



Contour
WS-298-030
14 cm / 5 1/2"
Blunt

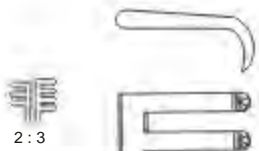

2 : 3

1/1

WS-299-031
2 x 3 Teeth
Sharp

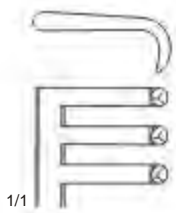

1/1

WS-299-032
2 x 3 Teeth
Blunt



Weitlaner
10.5 cm / 4 1/4"

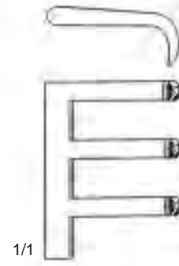

1/1

WS-299-033
Sharp

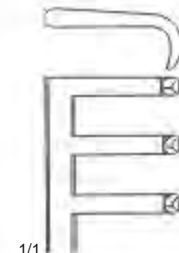

1/1

WS-299-034
Blunt



3 : 3



Weitlaner-Wullstein
13 cm / 5"



1/1

WS-299-035
13 cm / 5"
3 x 4 Teeth
Sharp



1/1

WS-299-036
16.5 cm / 6 1/2"
3 x 4 Teeth
Sharp

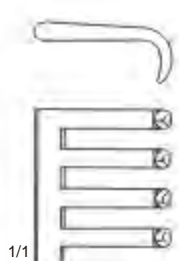

1/1

WS-299-037
13 cm / 5"
3 x 4 Teeth
Blunt

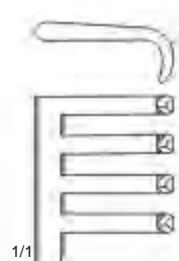

1/1

WS-299-038
16.5 cm / 6 1/2"
3 x 4 Teeth
Blunt



3 : 4



Weitlaner

Self-Retaining Retractors | Separadores Autoestáticos | Wundspreizer

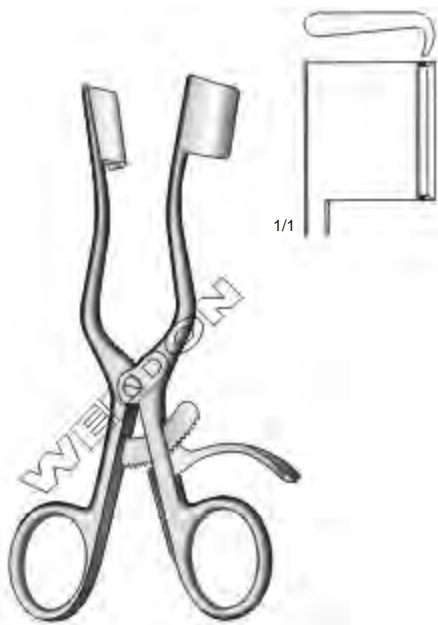

Weitlaner-Baby
WS-300-039
13 cm / 5"

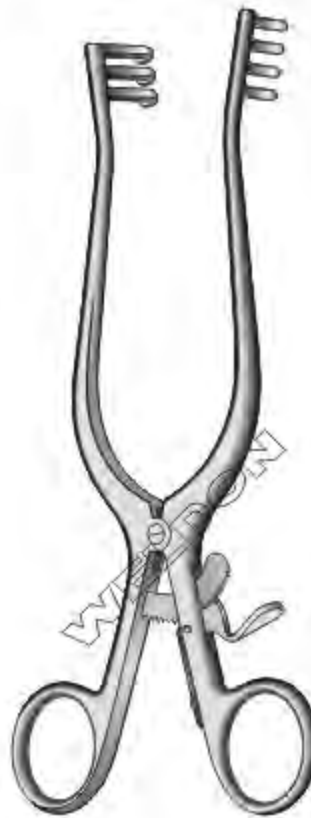

Weitlaner
20 cm / 8"

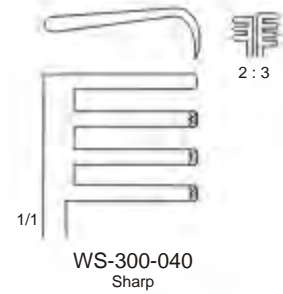

WS-300-040
Sharp



WS-300-041
Blunt



Plester
WS-300-042
11 cm / 4 1/8"



Plester
WS-300-043
12 cm / 4 3/4"



Plester
13 cm / 5"
2 x 2 Teeth



WS-300-044
Blunt

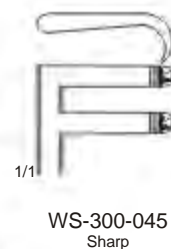

WS-300-045
Sharp

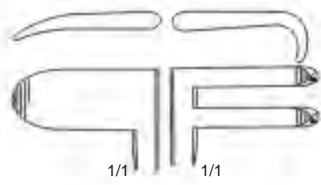

Plester
WS-301-046
11 cm / 4 1/4"
2 Teeth
Blunt

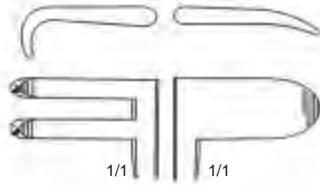

Plester
WS-301-047
11 cm / 4 1/4"
2 Teeth
Blunt

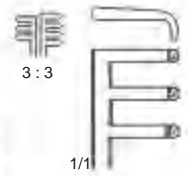

Milligan
WS-301-048
13 cm / 5"

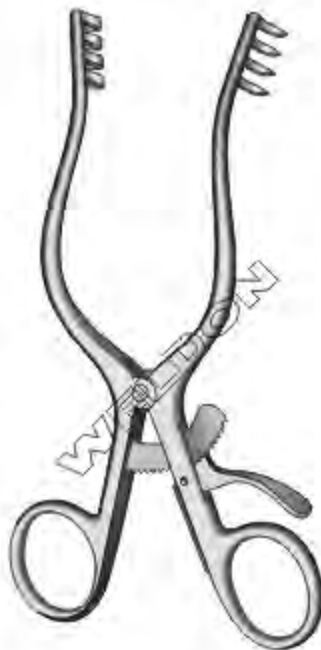

Mollison
WS-301-049 15 cm / 6"
WS-301-050 17 cm / 6 3/4"

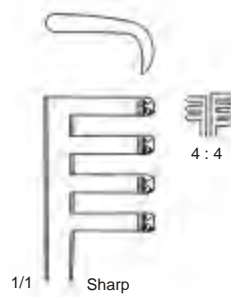

1/1 Sharp

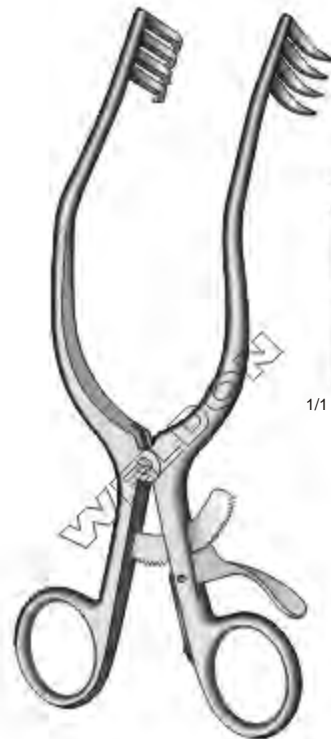

Anderson-Adson
WS-301-051
19.5 cm / 7 3/4"
4 x 4 Teeth
Sharp

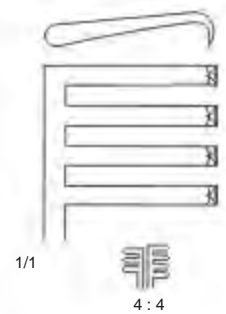

1/1 4:4

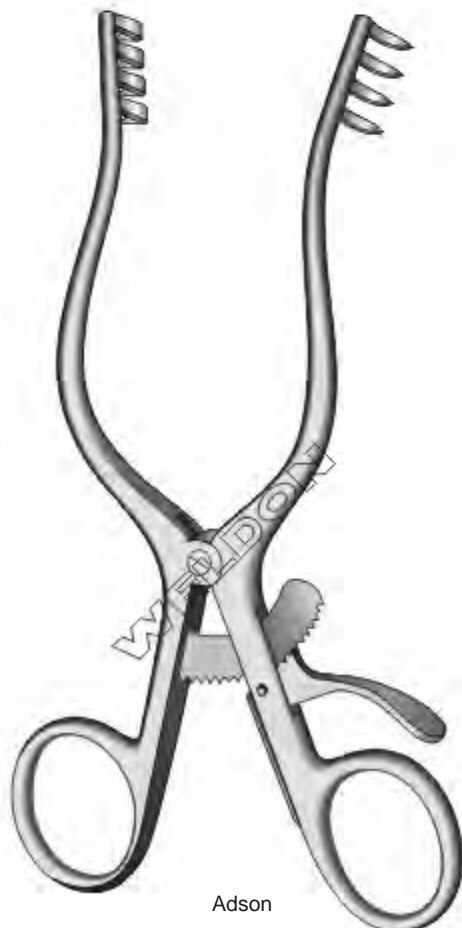
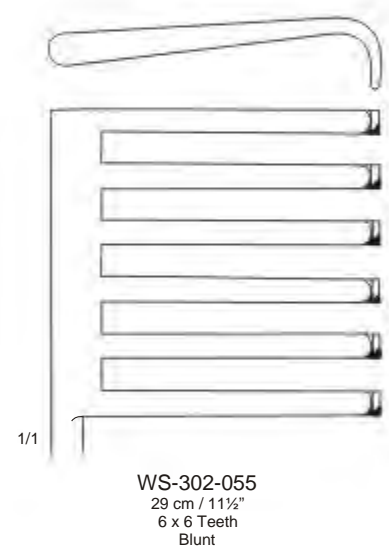
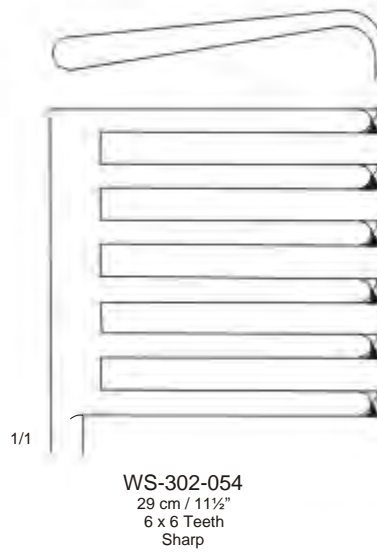
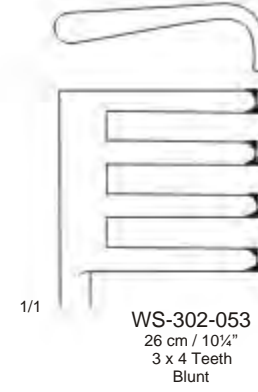
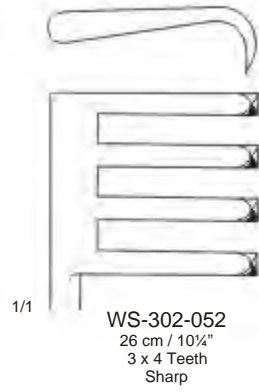



Gelpi-Baby
WS-303-056
13 cm / 5"

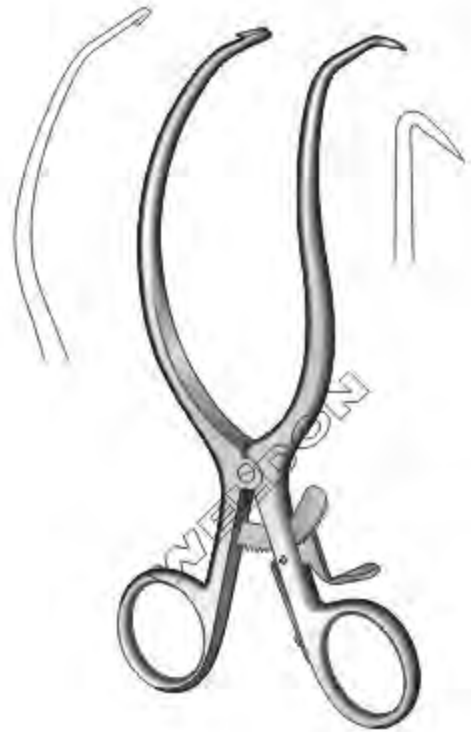

Gelpi
WS-303-057
18 cm / 7"



Gelpi
WS-303-058
18 cm / 7"

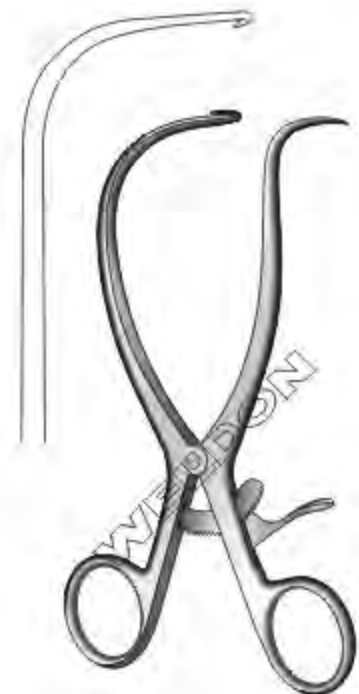

Gelpi-Seiletz
WS-303-059
15 cm / 6"

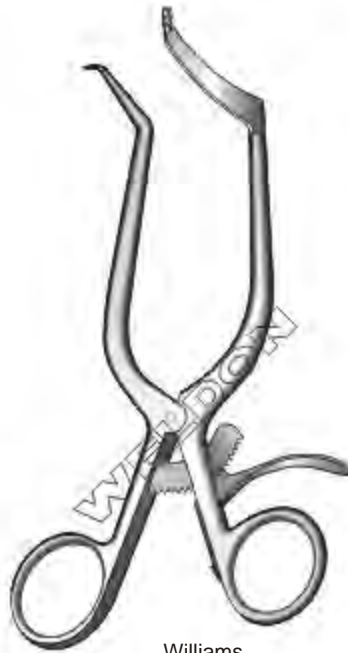
Williams

Blade Size - Width x Length

WS-304-060 1 cm x 5 cm

WS-304-061 2 cm x 5 cm

WS-304-062 1 cm x 7 cm

WS-304-063 2 cm x 7 cm

17.5 cm / 7"



1/1

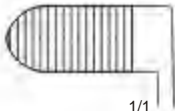

1/1



1/1

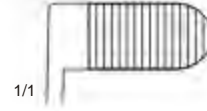

1/1

Perkins
 WS-304-064
 13 cm / 5 1/8"

Perkins
 WS-304-065
 13 cm / 5 1/8"



Casper Retractor
WS-305-071
16.5 cm / 6 3/4"
Complete Set With 5 Blade

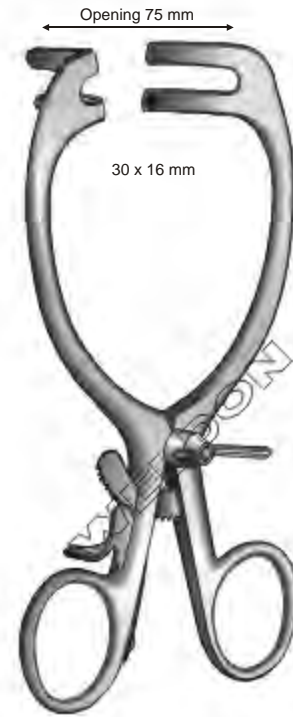
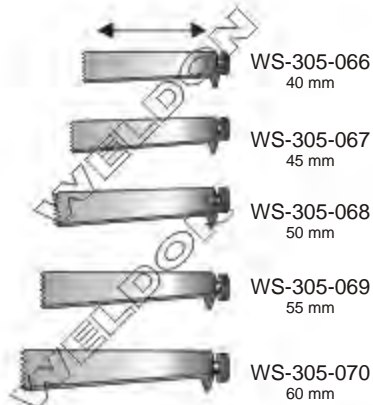

Mayo-Adams
WS-305-072
17 cm / 6 3/4"



Markham-Meyerding
WS-305-073
18 cm / 7 1/8"
Left

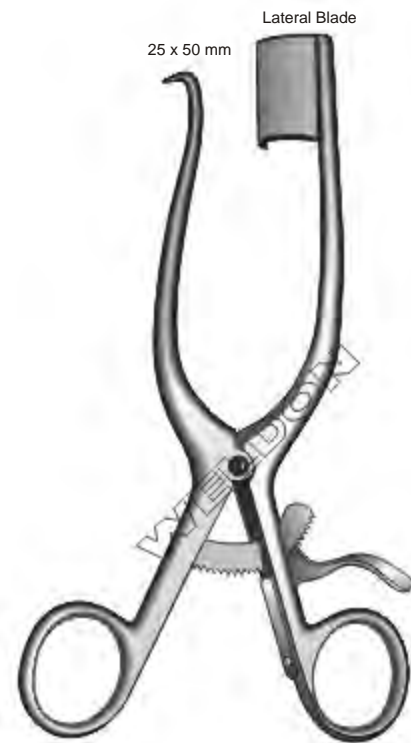

Markham-Meyerding
WS-305-074
18 cm / 7 1/8"
Right

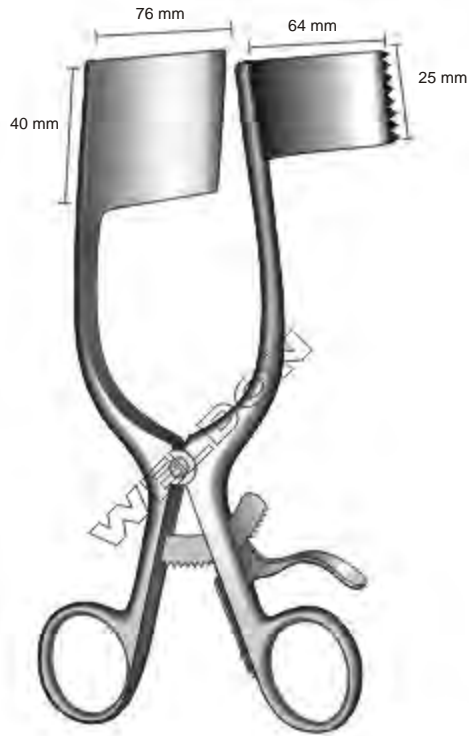

Darling
WS-306-075
18 cm / 7"
(Poplitea)

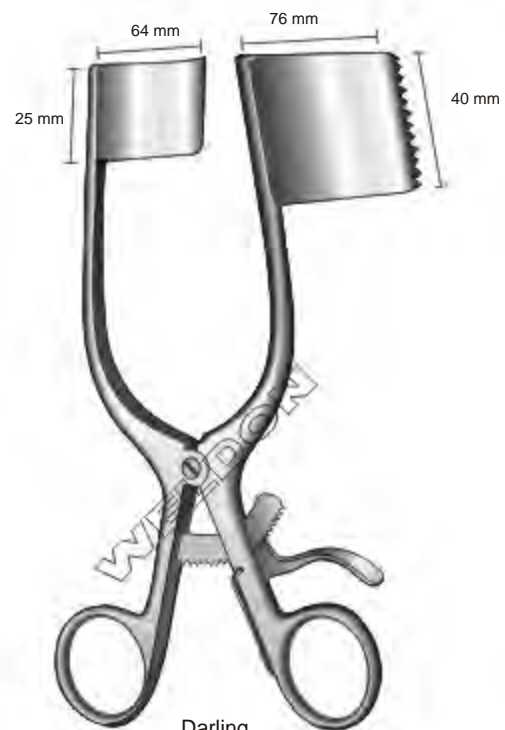

Darling
WS-306-076
18 cm / 7"
(Poplitea)

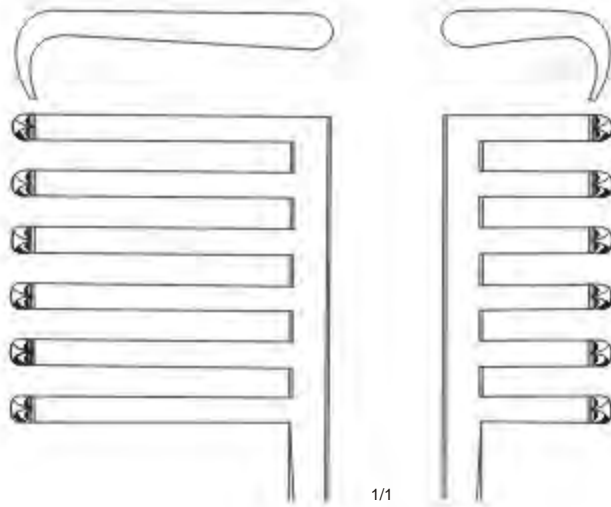

WS-307-077
Long Teeth On Left Side

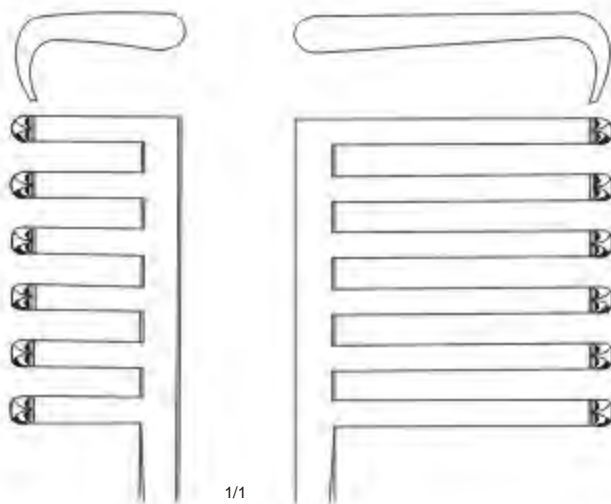

WS-307-078
Long Teeth On Right Side



Martin
28.5 cm / 11 1/4"
6 x 6 Teeth

Self-Retaining Retractors | Separadores Autoestáticos | Wundspreizer



WS-308-079
13 cm / 5"



WS-308-084
13 cm / 5"



WS-308-080
16 cm / 6 1/4"

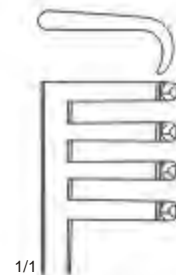

WS-308-085
16 cm / 6 1/4"

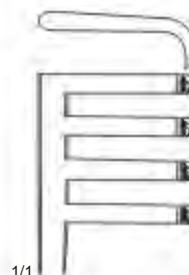

WS-308-081
20 cm / 8"

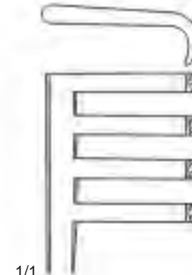

WS-308-086
20 cm / 8"

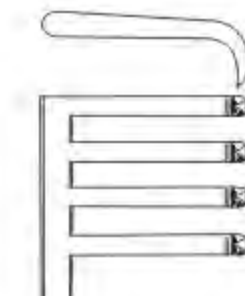

WS-308-082
26 cm / 10 1/4"
WS-308-083
31 cm / 12 1/4"
Sharp

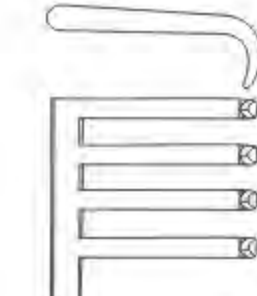

WS-308-087
26 cm / 10 1/4"
WS-308-088
31 cm / 12 1/4"
Blunt



Beckmann
WS-309-089
31 cm / 12¼"
4 x 4 Teeth
Sharp

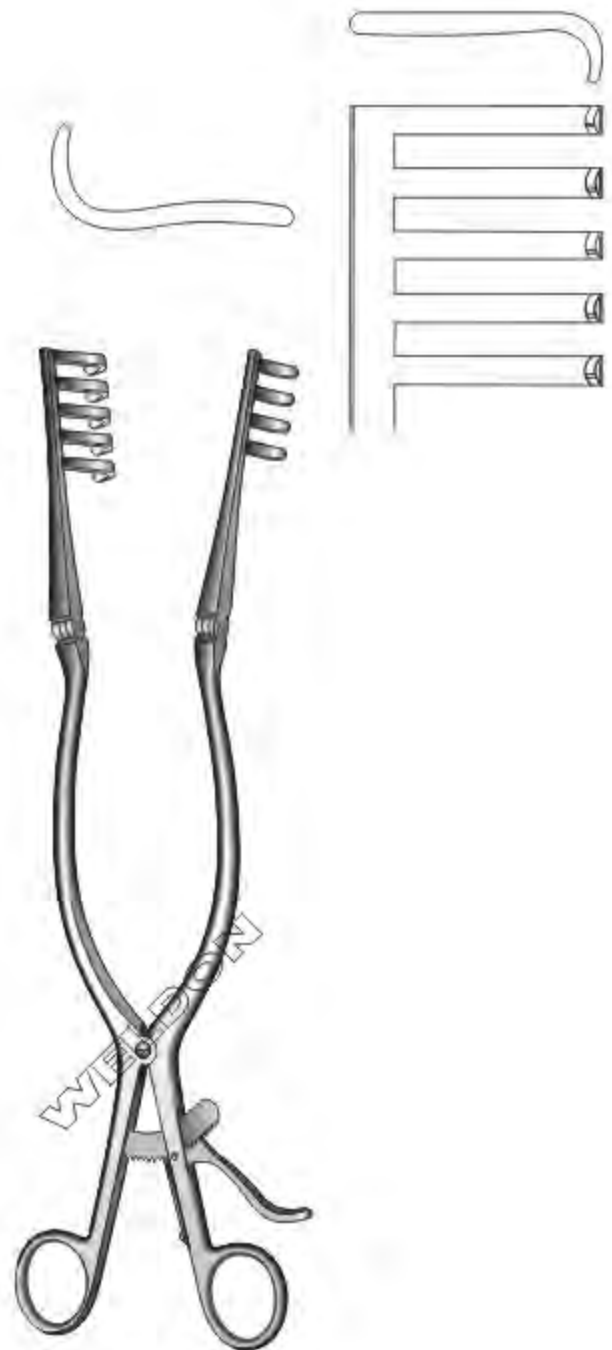

Adson
WS-309-090
32 cm / 12½"
4 x 5 Teeth
Blunt

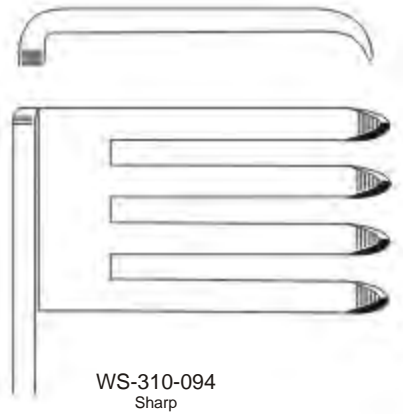
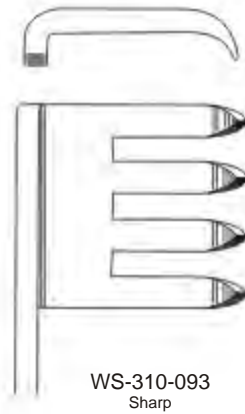
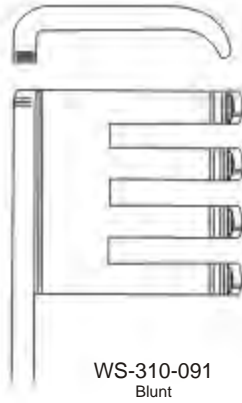
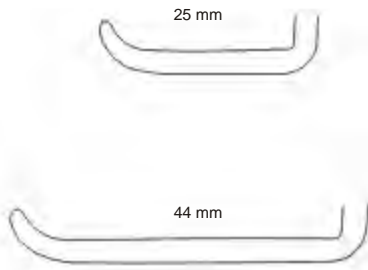

Beckmann-Adson
31 cm / 12 1/8"
4 x 4 Teeth



Beckmann-Eaton
WS-311-095
32 cm / 12½"
Sharp

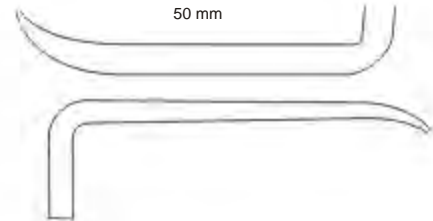
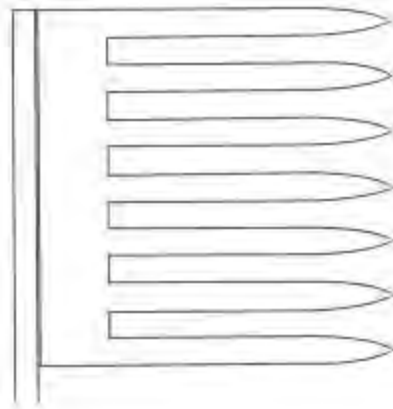

Cloward
WS-311-096
25 cm / 10"
Retractor Without Blades
WS-311-097
25 cm / 10"
Complete With 2 Each Plug-In Blades

Self-Retaining Retractors | Separadores Autoestáticos | Wundspreizer



WS-312-103
16 mm x 19 mm
5/8" x 3/4"
Central Blade



WS-312-104
16 mm x 25 mm
5/8" x 1"
Central Blade



WS-312-105
16 mm x 32 mm
5/8" x 1 1/4"
Central Blade



Henley
16.5 cm / 6 1/2"
3 x 4 Teeth

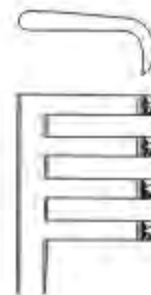

WS-312-106
Sharp

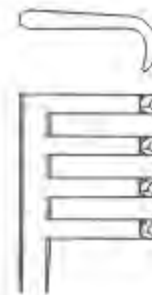

WS-312-107
Blunt

WS-312-108
Complete Set With 3 Central Blades & WS-312-106
WS-312-109
Complete Set With 3 Central Blades & WS-312-107



www.weldoninstruments.com

PROVEEDOR EXCLUSIVO:



Intestine

Stomach

&

Rectum

313 - 340

Stomach & Intestines

Intestines & Stomach
Intestinos y Estomago
Darm und Magen



Allis-Baby
WS-313-001
12 cm / 4 3/4"
4 x 5 Teeth

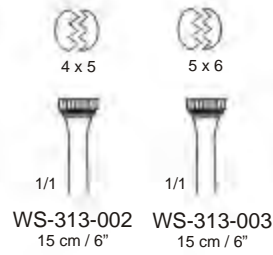

WS-313-002 WS-313-003
15 cm / 6" 15 cm / 6"

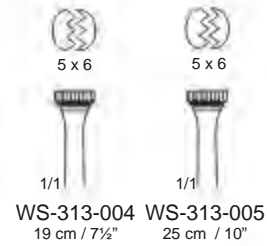

WS-313-004 WS-313-005
19 cm / 7 1/2" 25 cm / 10"



Allis



Allis-Atrauma

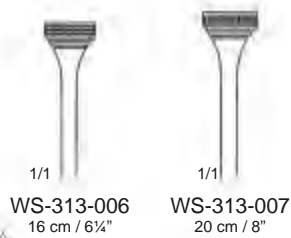

WS-313-006 WS-313-007
16 cm / 6 1/4" 20 cm / 8"

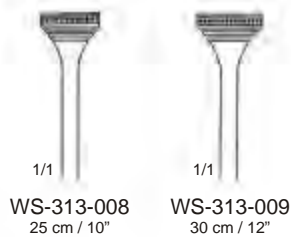

WS-313-008 WS-313-009
25 cm / 10" 30 cm / 12"



Allis-Adair
WS-313-010
16 cm / 6 1/4"
10 x 11 Teeth



Boys-Allis
WS-313-011
15 cm / 6"
5 x 6 Teeth

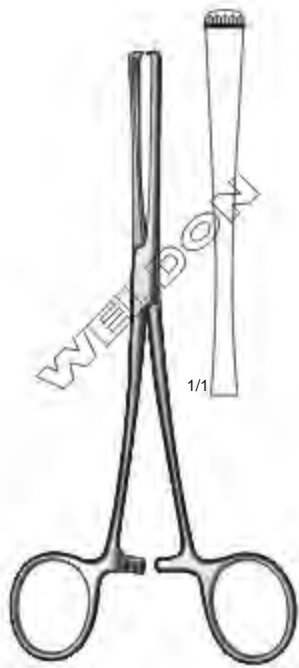

Lockwood
 WS-314-012 16 cm / 6 1/4"
 WS-314-013 20 cm / 8"



Judd-Allis
 WS-314-014 15 cm / 6"
 WS-314-015 19 cm / 7 1/2"

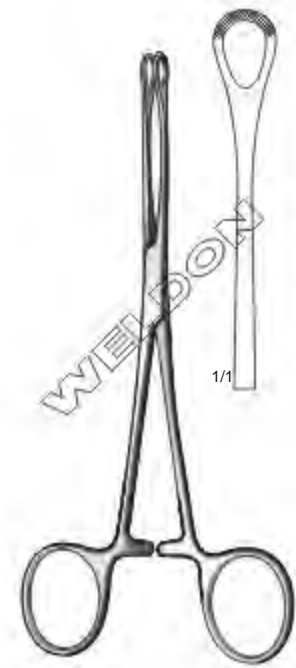

Williams
 WS-314-016
 16 cm / 6 1/4"



Thoms-Allis
 WS-314-017
 20.5 cm / 8"



Allis
 WS-314-018
 20 cm / 8"



Lockwood
 WS-314-019
 20 cm / 8"

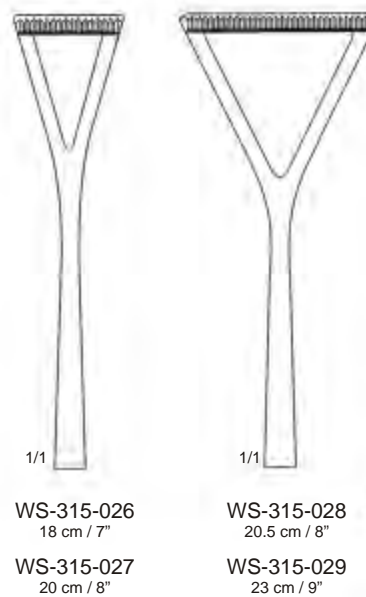
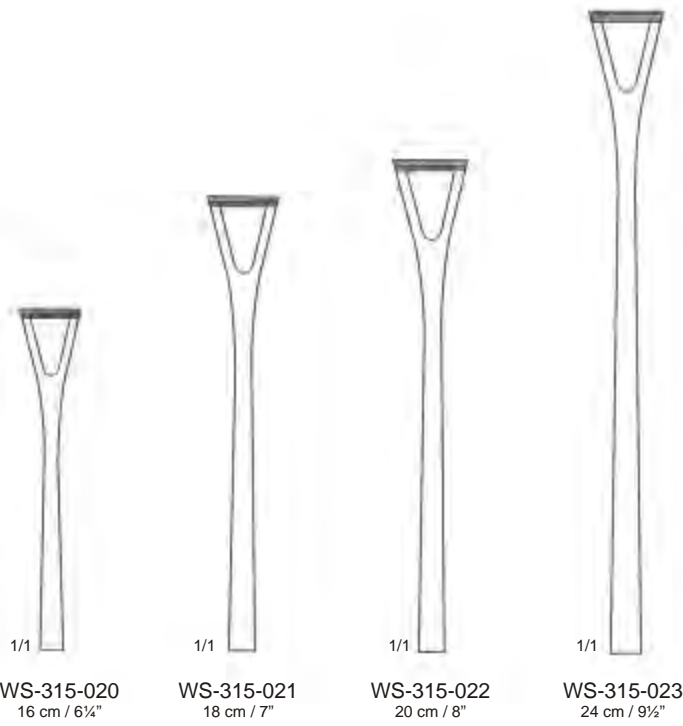

Intestinal Clamps | Pinzas Intestinales | Darmklemmen

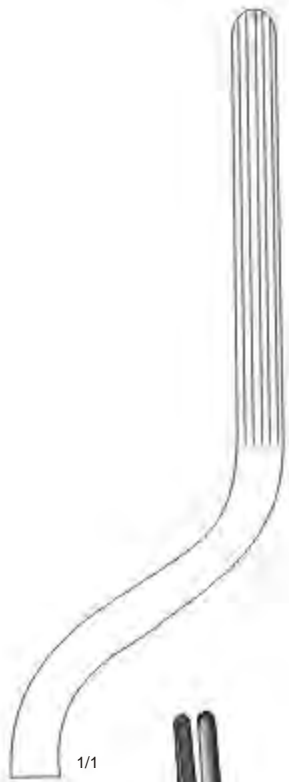

1/1



Brunner
WS-316-030
24 cm / 9½"



1/1

WS-316-031
21 cm / 8¼"

WS-316-032
23 cm / 9"



1/1

WS-316-033
21 cm / 8¼"

WS-316-034
23 cm / 9"



Doyen



1/1

WS-316-035
18 cm / 7"

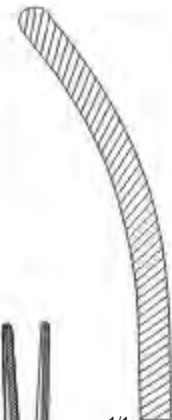

1/1

WS-316-036
18 cm / 7"



Doyen-Baby



WS-317-037
21 cm / 8 1/2"

WS-317-038
23.5 cm / 9 1/4"



WS-317-039
21 cm / 8 1/4"

WS-317-040
23 cm / 9"



WS-317-041
25 cm / 10"

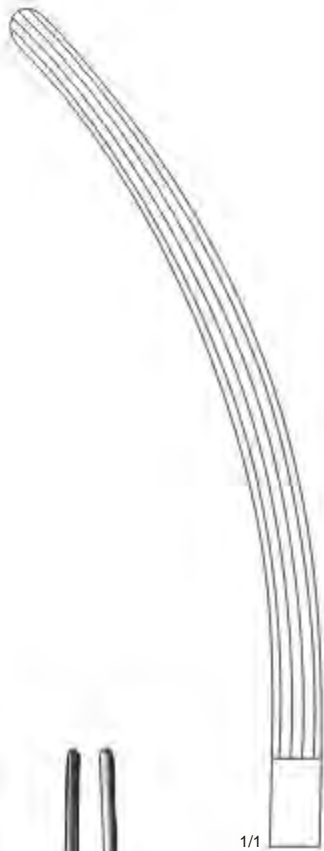

WS-317-042
24.5 cm / 9 3/4"



Mayo-Robson

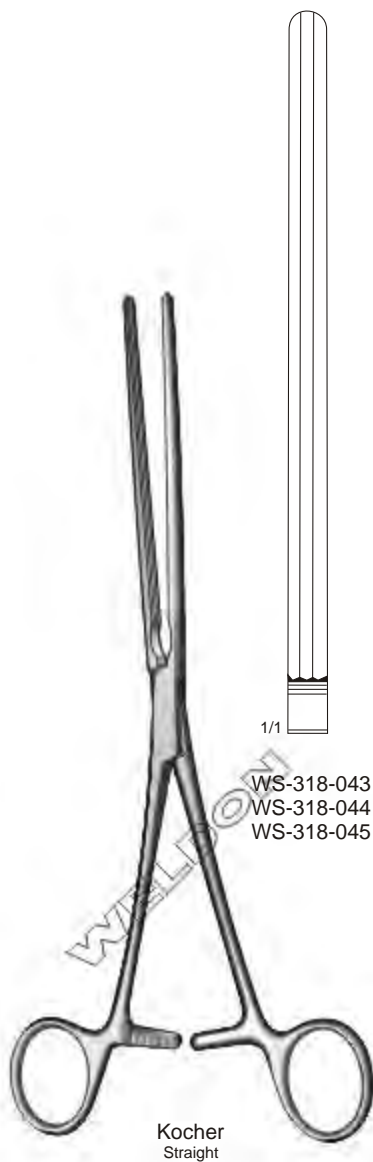

Mayo-Robson

Intestinal Clamps | Pinzas Intestinales | Darmklemmen

WS-318-043	22 cm / 8¾"	WS-318-043A
WS-318-044	25 cm / 10"	WS-318-044A
WS-318-045	28 cm / 11"	WS-318-045A
		Atraumatic

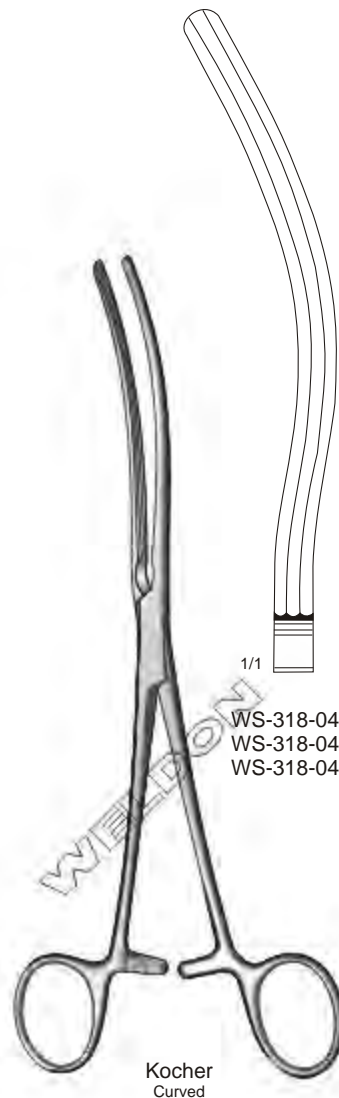
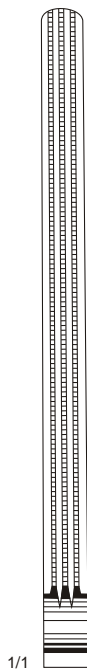

WS-318-046	22 cm / 8¾"	WS-318-046A
WS-318-047	25 cm / 10"	WS-318-047A
WS-318-048	28 cm / 11"	WS-318-048A
		Atraumatic

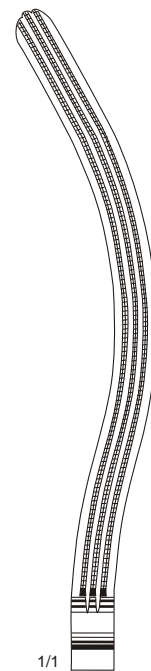

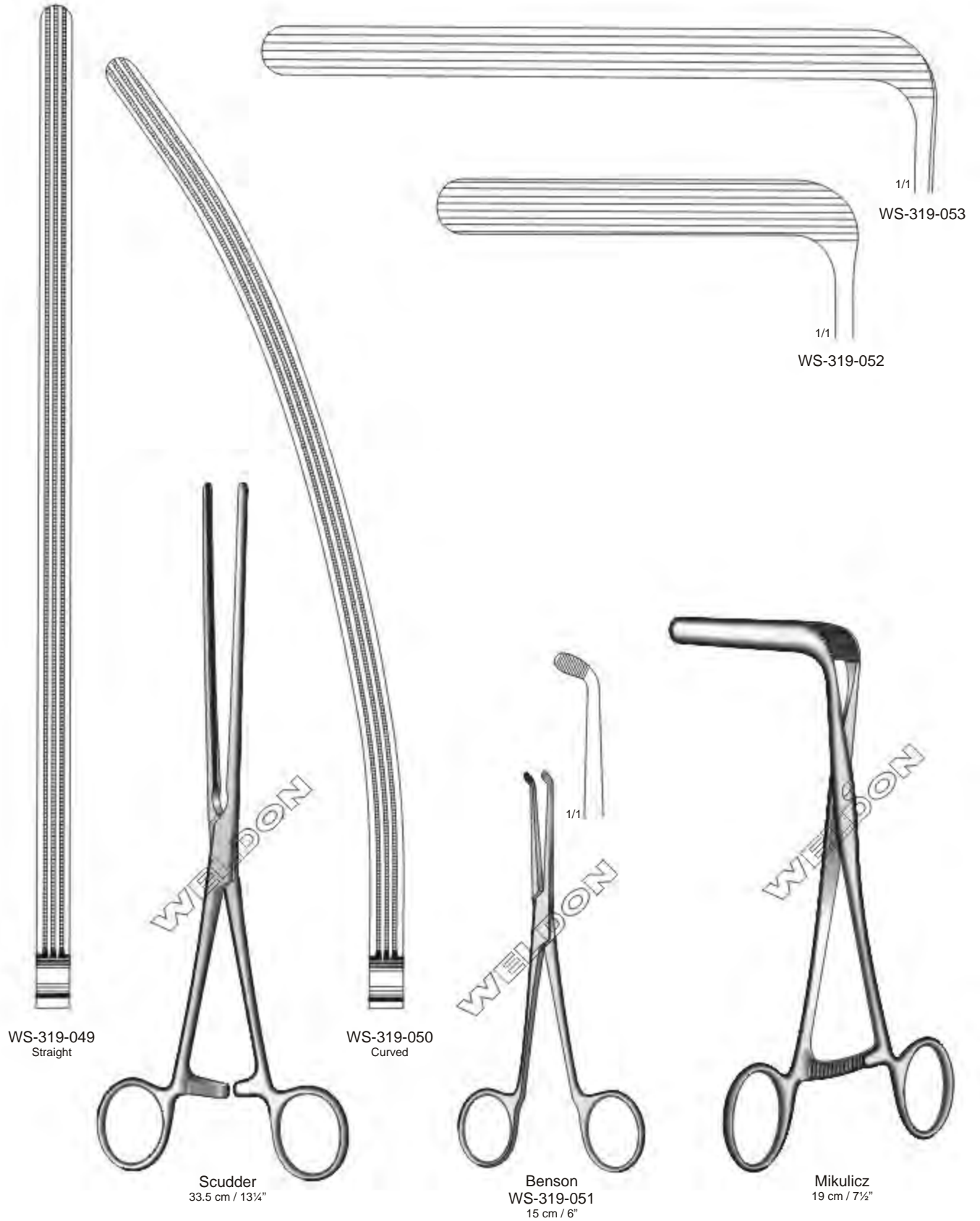

Intestinal Clamps | Pinzas Intestinales | Darmklemmen



Doyen-Baby
Straight



WS-320-054
16 cm / 6 1/4"



WS-320-055
18.5 cm / 7 1/4"



WS-320-056
21 cm / 8 1/4"

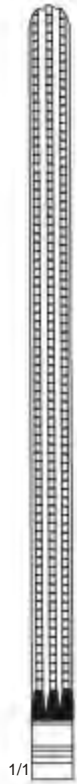

WS-320-057
23 cm / 9"



Doyen-Baby
Curved



WS-320-058
16 cm / 6 1/4"



WS-320-059
18 cm / 7"



WS-320-060
21 cm / 8 1/4"



WS-320-061
23 cm / 9"



1/1
WS-321-064
35 cm / 13 3/4"
With Pin

WS-321-065
35 cm / 13 3/4"
Without Pin



1/1
WS-321-066
29 cm / 11 1/2"
With Pin

WS-321-067
29 cm / 11 1/2"
Without Pin



1/1
WS-321-068
21 cm / 8 1/4"
With Pin

WS-321-069
21 cm / 8 1/4"
Without Pin



1/1
WS-321-062
With Pin
WS-321-063
Without Pin



Payr-Baby
15 cm / 6"

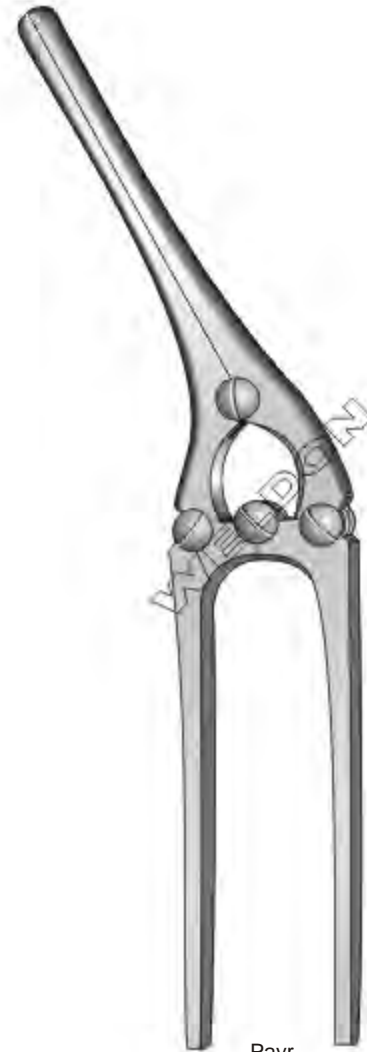

Payr

Abdominal Retractors | Separadores Abdominales | Bauchdeckenhalter

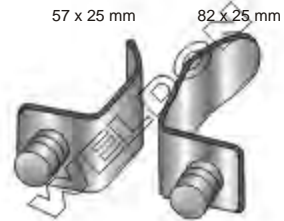

Millin
WS-322-001
21 cm / 8¼"
Center Blade 120 x 45 mm
100 mm Opening

Max Spread 80 mm



Collin-Baby
WS-322-002
18 cm / 7½"
Complete With 2 Pair of Blades 24 x 42 mm

Max Spread 110 mm



Collin
WS-322-003
23.5 cm / 9¼"
Complete With 1 Pair of Blades 38 X 60 mm

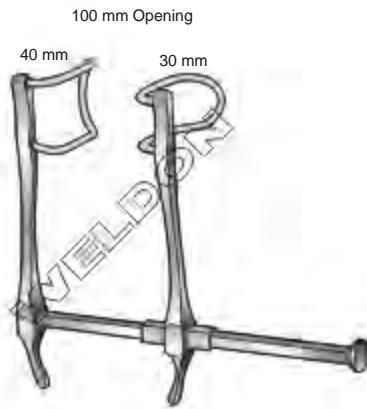

Gosset-Baby
WS-323-004
12.5 cm / 5"
100 mm Opening

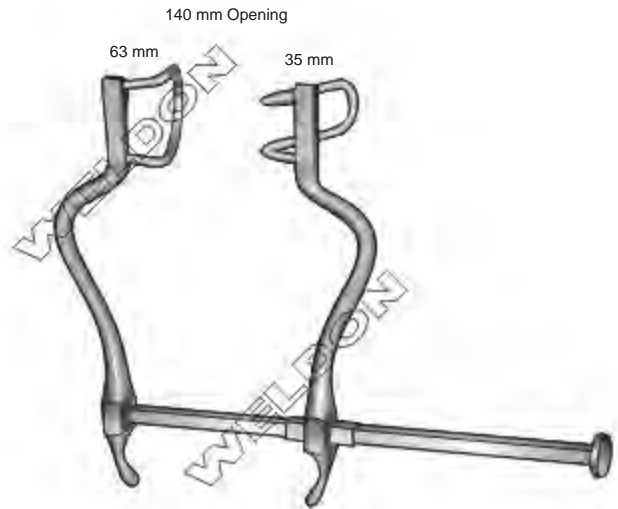

Gosset
WS-323-005
18.5 cm / 7 1/4"
140 mm Opening

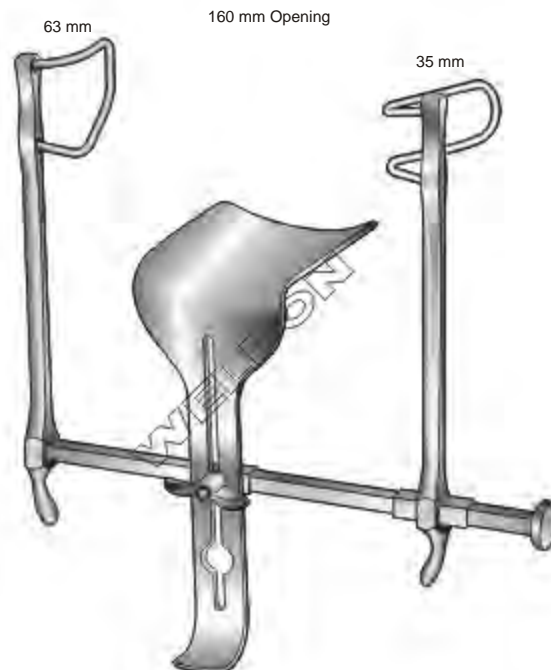

Gosset
WS-323-006
16.5 cm / 6 1/2"
160 mm Opening

Abdominal Retractors | Separadores Abdominales | Bauchdeckenhalter

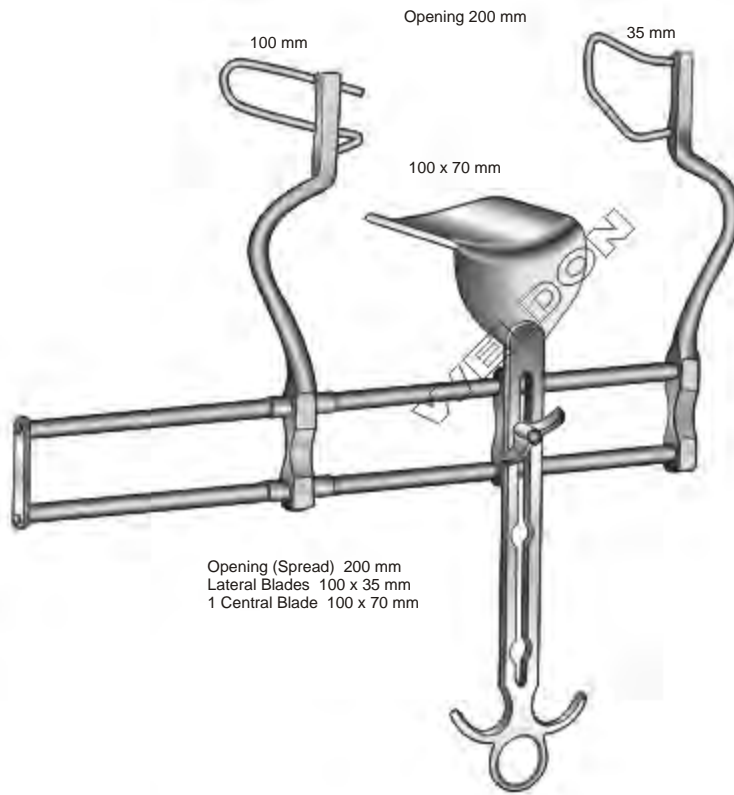

Opening (Spread) 200 mm
Lateral Blades 100 x 35 mm
1 Central Blade 100 x 70 mm

Balfour
WS-324-007
20 cm / 8"

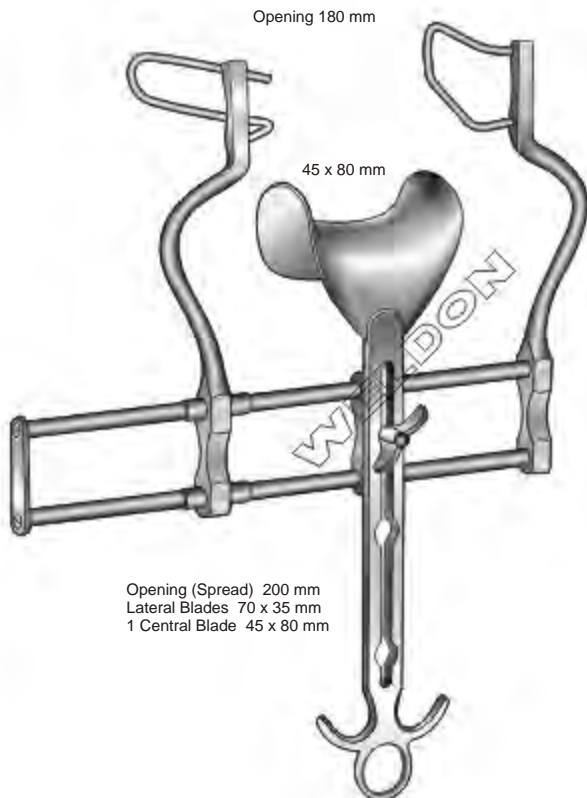

Opening (Spread) 200 mm
Lateral Blades 70 x 35 mm
1 Central Blade 45 x 80 mm

Balfour
WS-324-008
20 cm / 8"

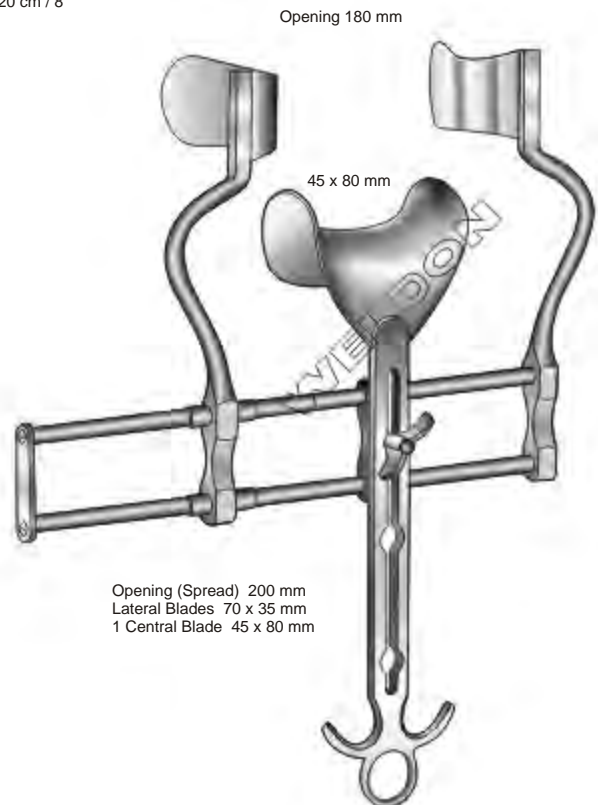

Opening (Spread) 200 mm
Lateral Blades 70 x 35 mm
1 Central Blade 45 x 80 mm

Balfour
WS-324-009
20 cm / 8"

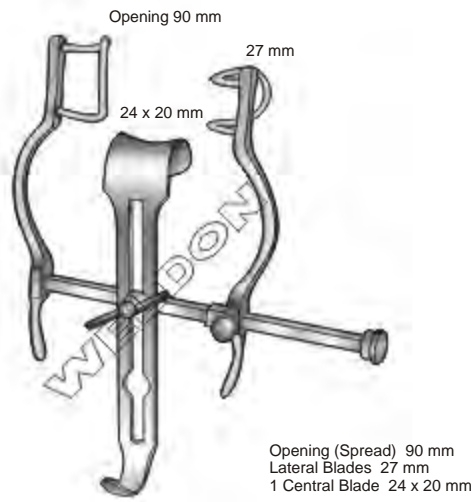

Balfour-Baby
WS-325-010
12.5 cm / 5"



Balfour
Central Blade
WS-325-011
45 x 80 mm
WS-325-012
70 x 85 mm

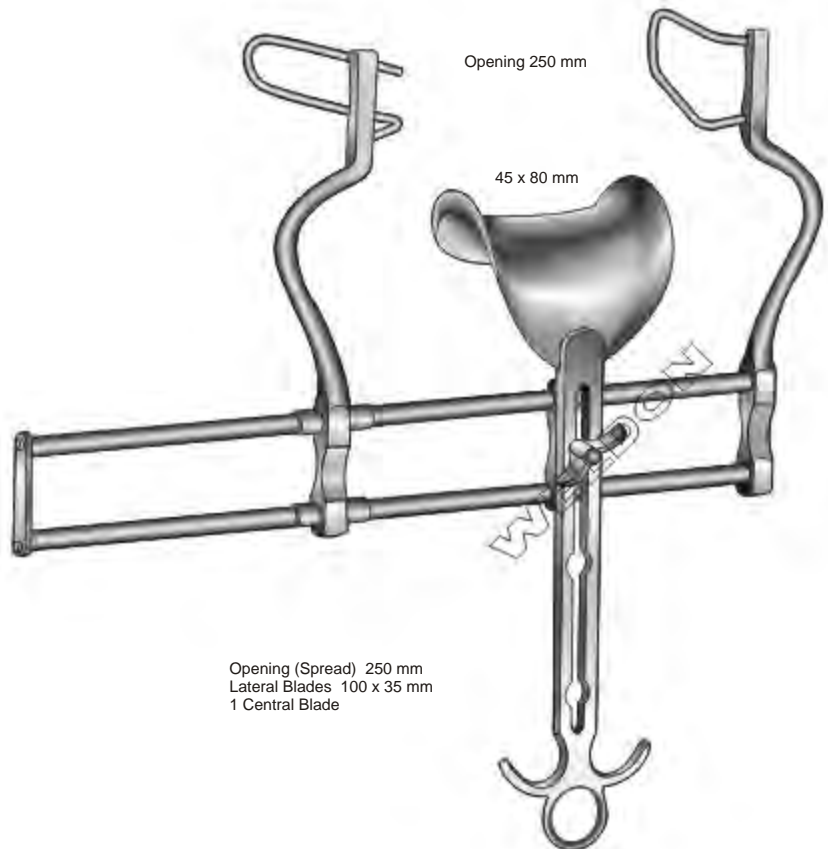

Balfour
WS-325-013
20 cm / 8"

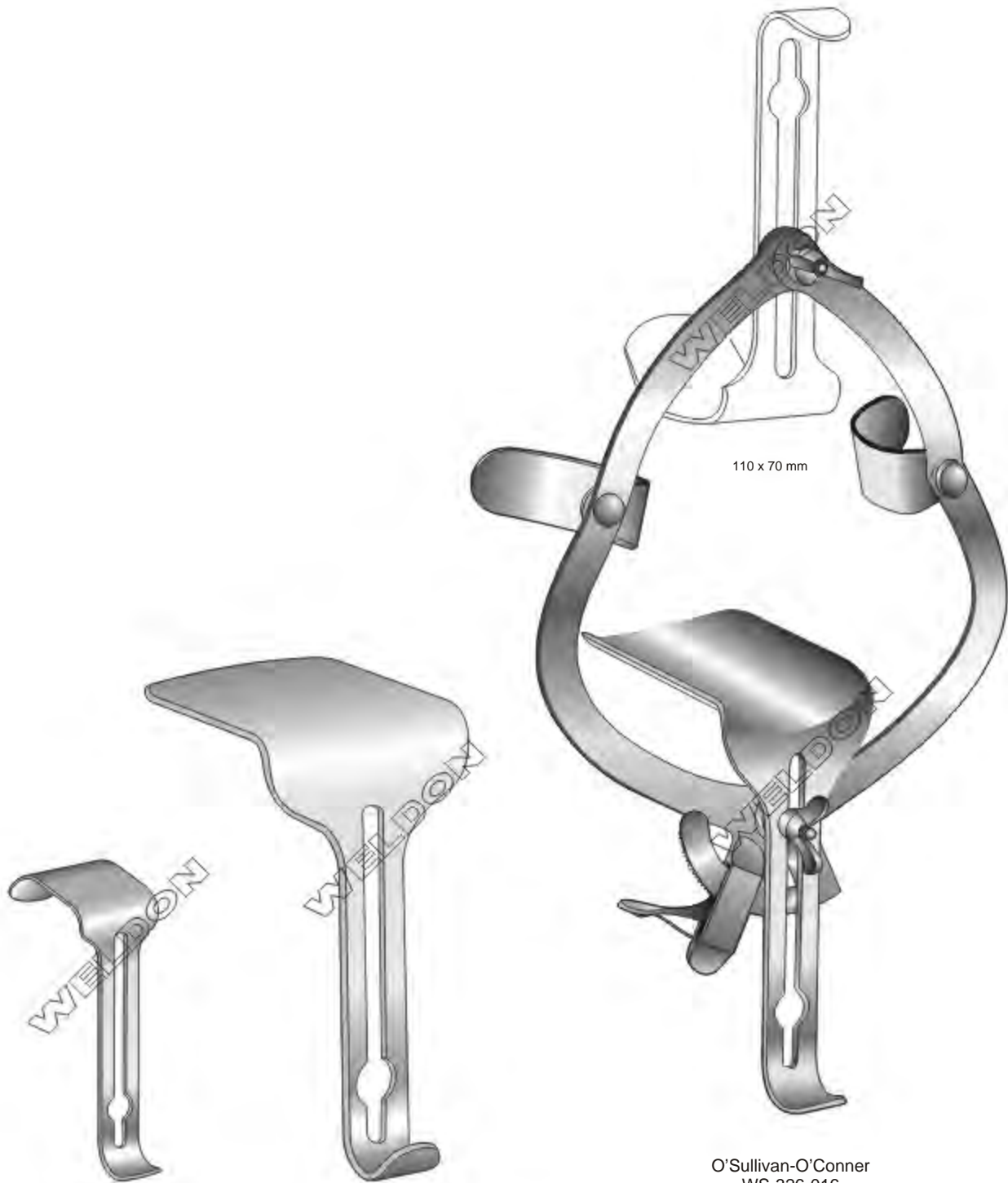

WS-326-014
Blade only
45 x 85 mm

WS-326-015
Blade only
70 x 105 mm

O'Sullivan-O'Conner
WS-326-016
27 cm / 10¾" x 27 cm / 10¾"
Frame Only
WS-326-017
Complete Set - One Frame & Two Rotatable Blades

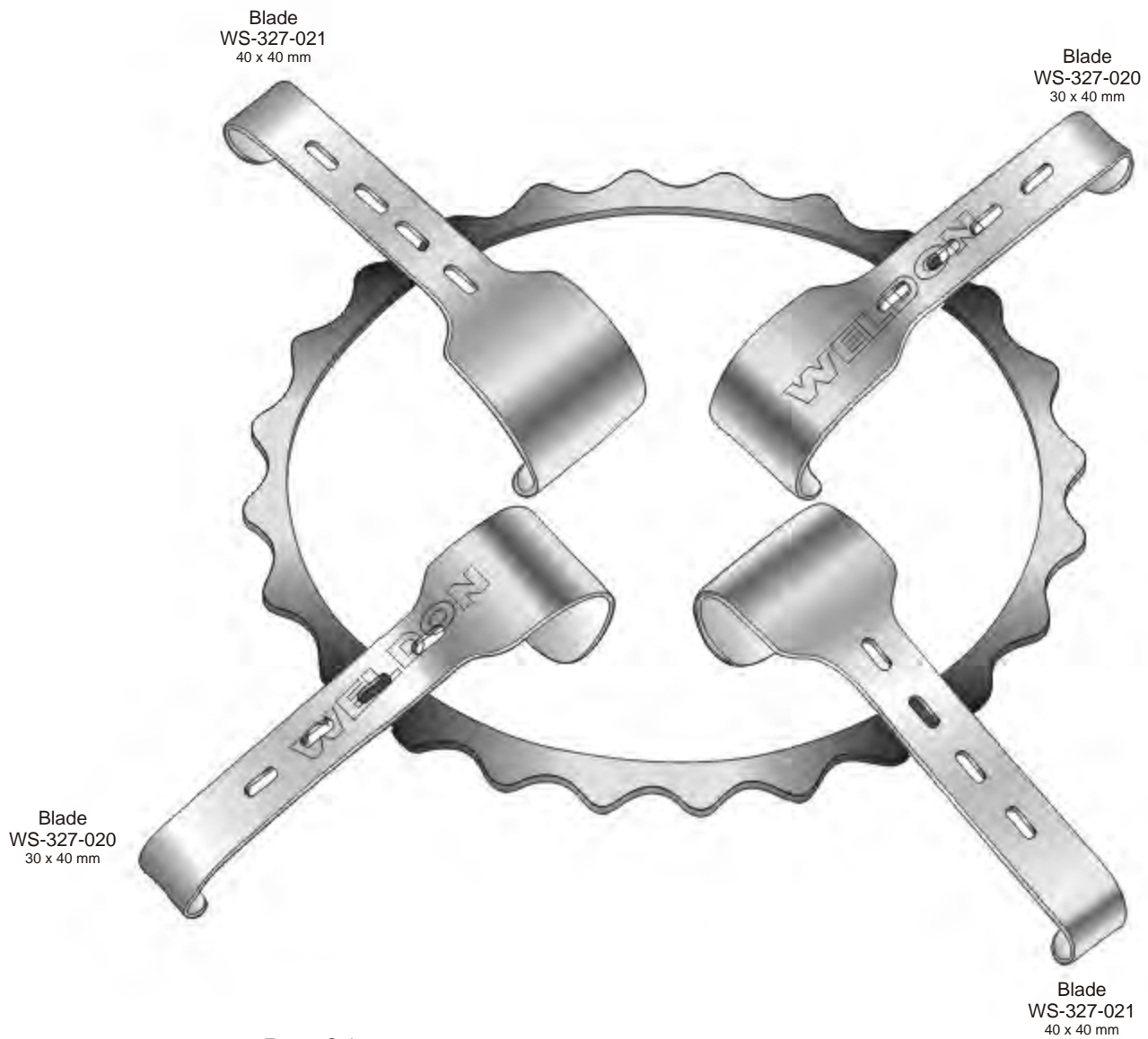

Blade
WS-327-021
40 x 40 mm

Blade
WS-327-020
30 x 40 mm

Blade
WS-327-020
30 x 40 mm

Blade
WS-327-021
40 x 40 mm

Frame Only
WS-327-018 180 x 150 mm
WS-327-019 255 x 180 mm
Blade Only
WS-327-020 30 x 40 mm
WS-327-021 40 x 40 mm

Denis Browne
Complete Set
WS-327-022
WS-327-018 One Frame
WS-327-020 Two Blades
WS-327-021 Two Blades

Denis Browne
Complete Set
WS-327-023
WS-327-019 One Frame
WS-327-020 Two Blades
WS-327-021 Two Blades

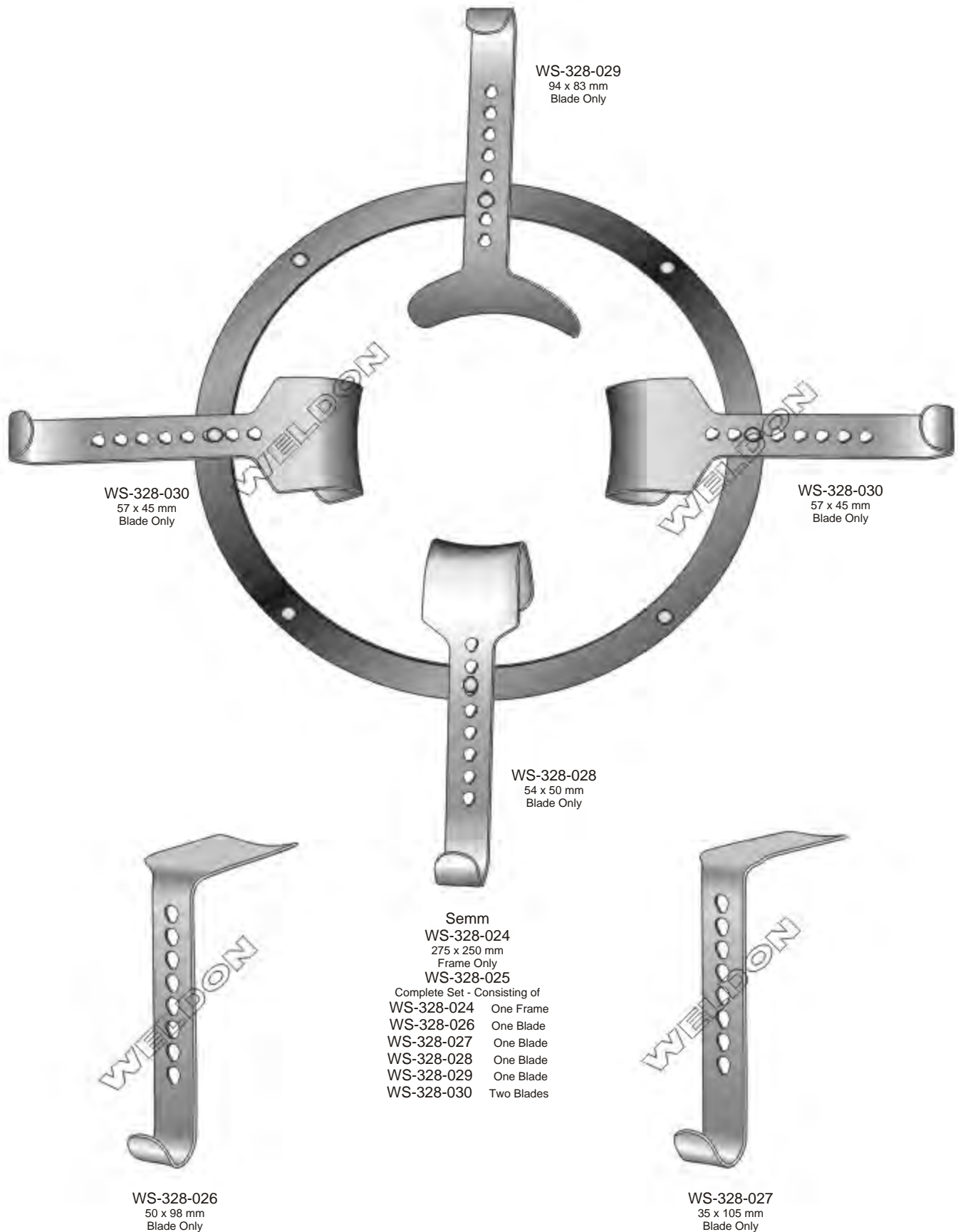

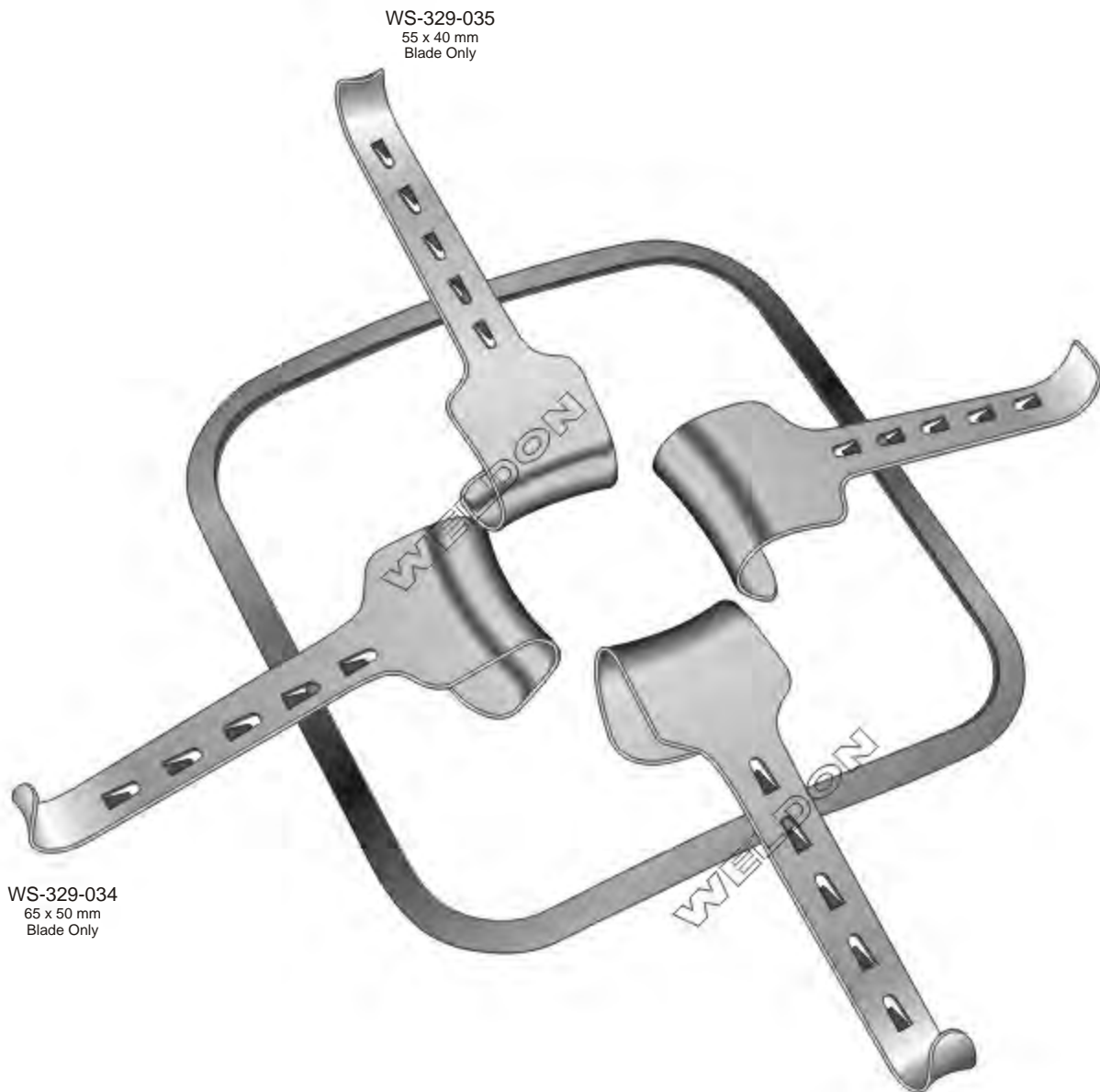

WS-329-035
55 x 40 mm
Blade Only

WS-329-034
65 x 50 mm
Blade Only

Kirschner
Frame Only
WS-329-031 270 x 270 mm
WS-329-032 300 x 380 mm
WS-329-033 380 x 380 mm

Kirschner
WS-329-036
Complete Set
WS-329-031 One Frame
WS-329-034 Two Blades
WS-329-035 Two Blades

Kirschner
WS-329-037
Complete Set
WS-329-033 One Frame
WS-329-034 Two Blades
WS-329-035 Two Blades



Reverdin
 WS-330-038
 28 cm / 11"
 Bent
 WS-330-039
 29 cm / 11½"
 Straight



Ribbon
 WS-330-040 30 mm
 WS-330-041 40 mm
 WS-330-042 50 mm
 33 cm / 13"



Heberer
 WS-330-043 20 cm / 8", 17 - 25 mm
 WS-330-044 28 cm / 11", 25 - 30 mm
 WS-330-045 30 cm / 11¾", 37 - 45 mm
 Tapered

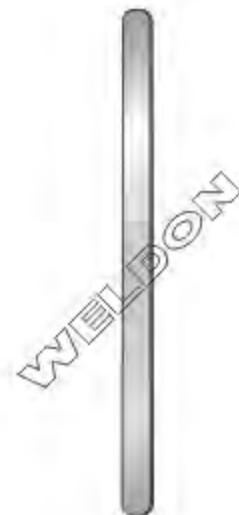

Weldon
 WS-330-046 6.5 mm
 WS-330-047 9.5 mm
 WS-330-048 13 mm
 WS-330-049 16 mm
 WS-330-050 19 mm
 WS-330-051 25 mm
 20 cm / 8"
 Malleable, Very Soft



Hirschmann

- WS-331-001 16 mm x 65 mm
- WS-331-002 19 mm x 70 mm
- WS-331-003 22 mm x 90 mm



Newmann

- WS-331-004 16 mm Ø x 63 mm
- WS-331-005 19 mm Ø x 63 mm
- WS-331-006 23 mm Ø x 63 mm



Bensaude

- WS-331-007 Ø 19 x 70 mm
- WS-331-008 Ø 22 x 70 mm

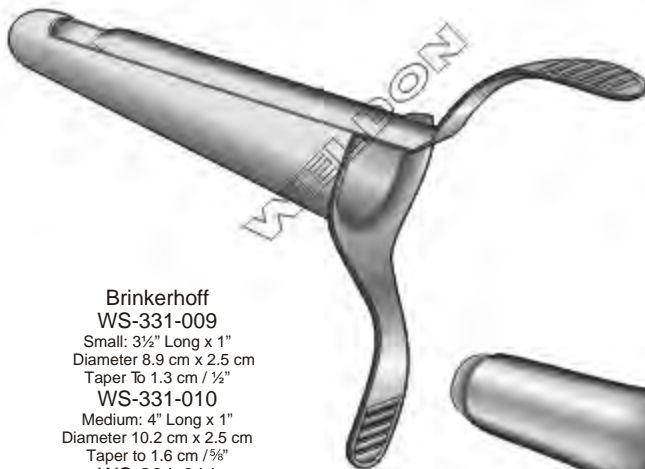

Brinkerhoff

- WS-331-009
- Small: 3½" Long x 1"
- Diameter 8.9 cm x 2.5 cm
- Taper To 1.3 cm / ½"
- WS-331-010
- Medium: 4" Long x 1"
- Diameter 10.2 cm x 2.5 cm
- Taper to 1.6 cm / ⅝"
- WS-331-011
- Large: 4¾" Long x 1¼"
- Diameter 12.1 cm x 3.2 cm
- Taper to 1.9 cm / ¾"



Kelly

- WS-331-012 Small: 5.1 cm / 2" Long
- WS-331-013 Medium: 10.2 cm / 4" Long
- WS-331-014 Large: 14 cm / 5½" Long
- 2.2 cm / ⅞" Diameter



Kelly

- WS-331-015 Ø 25 X 75 mm
- WS-331-016 Ø 21 X 50 mm
- Taper To 2.1 cm / ⅝"

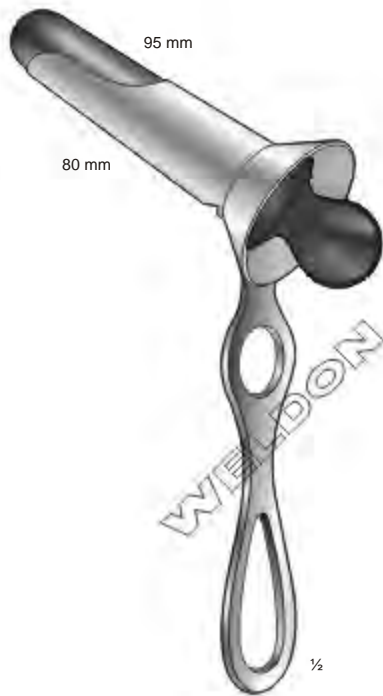

Ives Fansler
WS-332-017
22 mm Ø



Ives Fansler
WS-332-018
22 mm Ø
With Fiber Optic



Fansler Operating Speculum
WS-332-019
Slotted Tube, 2³/₈" Long x 1¹/₄"
Diameter (6 cm x 3.2 cm)



Chelsea Eaton Anal Speculum
WS-332-020
Small - 2¹/₂" Long x ⁷/₈"
Diameter (6.4 cm x 2.2 cm)
WS-332-021
Large - 2¹/₂" Long x ¹³/₁₆"
Diameter (6.4 cm x 3.1 cm)



Pratt
WS-333-022
Blade Depth = 8.9 cm / 3½"
Blade Width = 1" / 2.5 cm
Diameter At Opening = 4.4 cm / 1¾"
21 cm / 8¼"



Bodenhammer
WS-333-023
Blade Depth = 8.9 cm / 3½"
Blade Width = ¾" / 1.9 cm
Diameter At Opening = 2.2 cm / ⅞"
16 cm / 6¼"



Sims
WS-333-024
Fenestrated
Blade Depth = 8.9 cm / 3½"
Blade Width = ⅞" / 2.2 cm
Diameter At Opening = 1.6 cm / ⅕"
16 cm / 6¼"



Sims
WS-334-025
15 cm / 6"

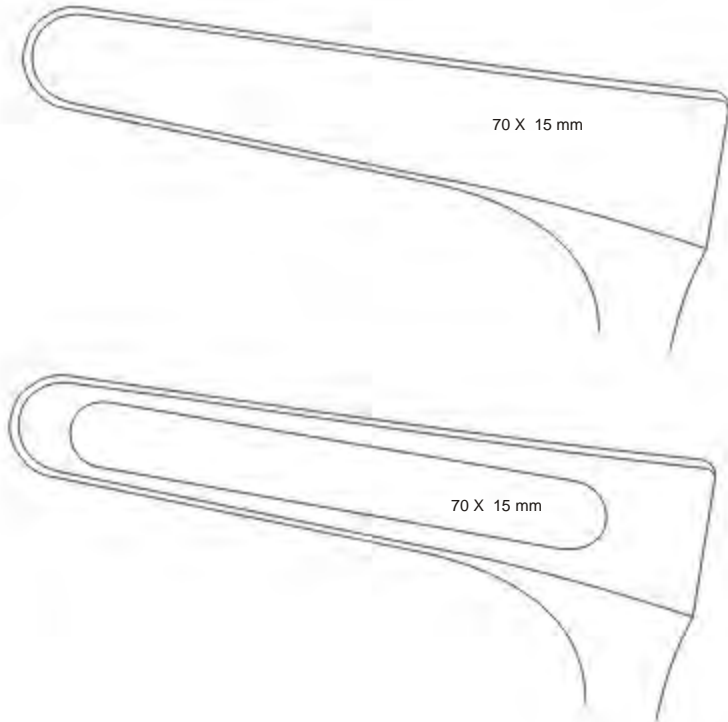

Mathieu
WS-334-026
21 cm / 8 1/4"
Working Length 90 mm



Czerny
WS-335-027
22 cm / 8 $\frac{3}{4}$ "



Sawyer Rectal

- WS-335-028 Small : Blade Size (6.4 cm / 2 $\frac{1}{2}$ ") x (2.2 cm / $\frac{7}{8}$ ")
- WS-335-029 Medium : Blade Size (7.6 cm / 3") x (2.9 cm / 1 $\frac{1}{8}$ ")
- WS-335-030 Large : Blade Size (8.9 cm / 3 $\frac{1}{2}$ ") x (3.8 cm / 1 $\frac{1}{2}$ ")
25.4 cm / 10"



Hill-Ferguson

- WS-335-031 Small : Blade Size (6.4 cm / 2 $\frac{1}{2}$ ") x (2.2 cm / $\frac{7}{8}$ ")
21.5 cm / 8 $\frac{1}{2}$ "
- WS-335-032 Medium : Blade Size (7.6 cm / 3") x (3.0 cm / 1 $\frac{1}{8}$ ")
22 cm / 8 $\frac{3}{4}$ "
- WS-335-033 Large : Blade Size (7.6 cm / 3") x (3.6 cm / 1 $\frac{7}{16}$ ")
22 cm / 8 $\frac{3}{4}$ "

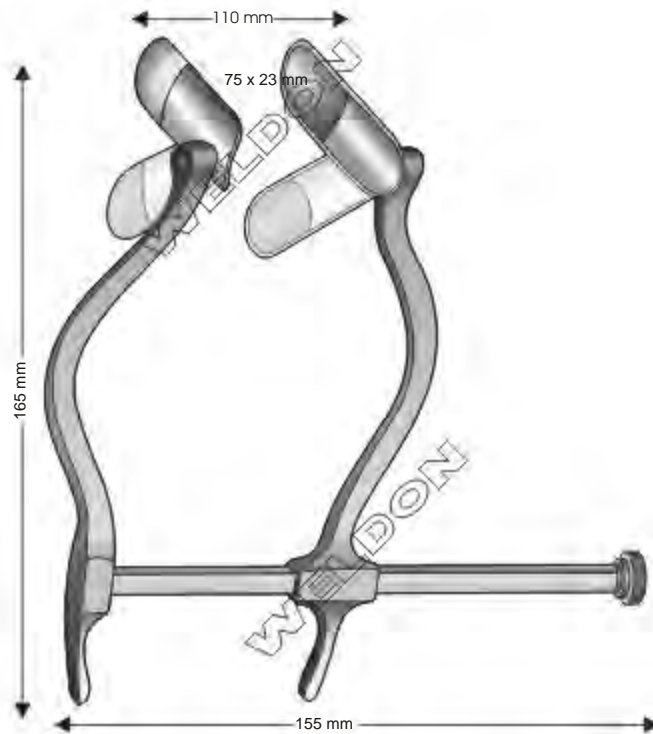

Smith-Buie
 WS-336-034
 Maximum Opening 10.2 cm / 4"
 Swivel Blades 7 cm / 2¾" Deep x 2.2 cm / ⅞" Wide



Barr
 WS-336-035
 20 cm / 8", Self-Retaining
 Blades 7 cm / 2¾" Deep x 2.2 cm / ⅞" Wide

WS-337-037
22 x 75 mm
Lateral Blades Only (Pair)

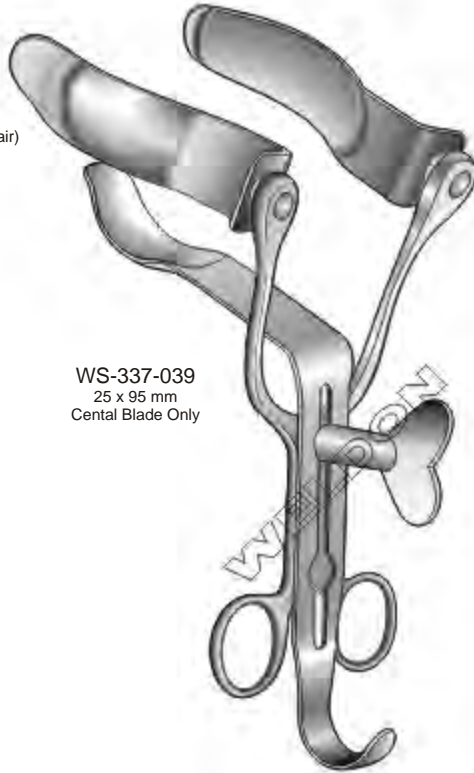

WS-337-039
25 x 95 mm
Central Blade Only



WS-337-038
22 x 95 mm
Lateral Blades Only (Pair)

Alan- Parks
WS-337-036
Frame Only

- WS-337-037 One Pair of Lateral Blades
- WS-337-038 One Pair of Lateral Blades
- WS-337-039 One Central Blade
- WS-337-040 Complete Set
- With 2 Lateral Blades & 1 Central Blade



Park
WS-337-041 Complete Set
WS-337-042 Frame Only
WS-337-043 Lateral Blades Only (Pair) Size 22 x 72 mm

Haemorrhoidal Grasping Forceps, Fistula Probes | Pinza Para Agarrar Hemorroides, Sondas Para Fistulas
 Hämorrhoidenfasszange, Fistelsonden



McGivney
 WS-338-044
 19 cm / 7½"

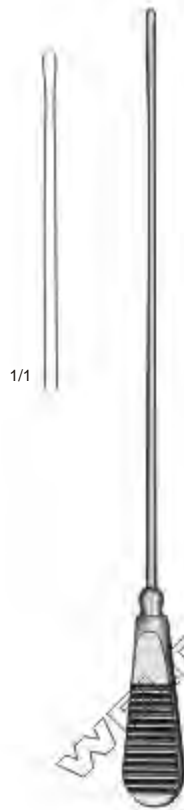

Buie
 WS-338-045
 21.5 cm / 8½"
 Malleable

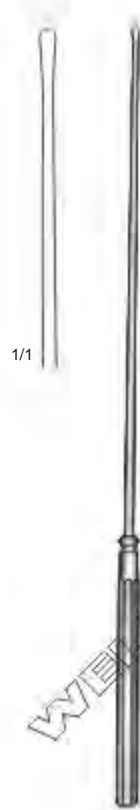

Pratt
 WS-338-046
 28 cm / 11"
 Malleable



Brodie
 WS-338-047
 18 cm / 7½"

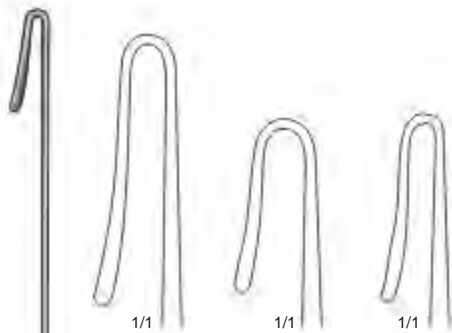

WS-338-048 WS-338-049 WS-338-050

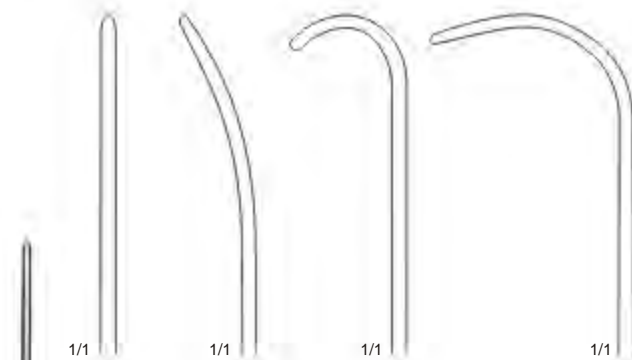

WS-338-051 Fig. 1 WS-338-052 Fig. 2 WS-338-053 Fig. 3 WS-338-054 Fig. 4



Pratt
 21 cm / 8¼"



Lockhart Mummery
 16 cm / 6¼"

Rectal Biopsy Forceps | Pinzas Para Biopsia Rectal | Rektum-Biopsiefasszangen

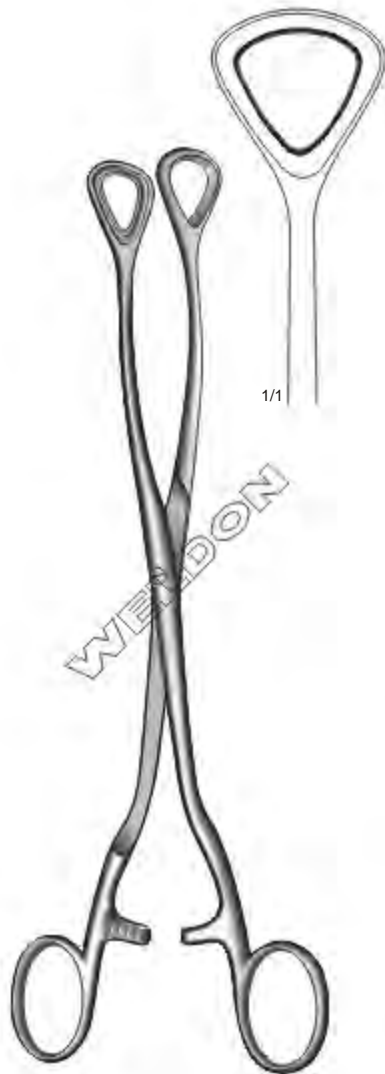
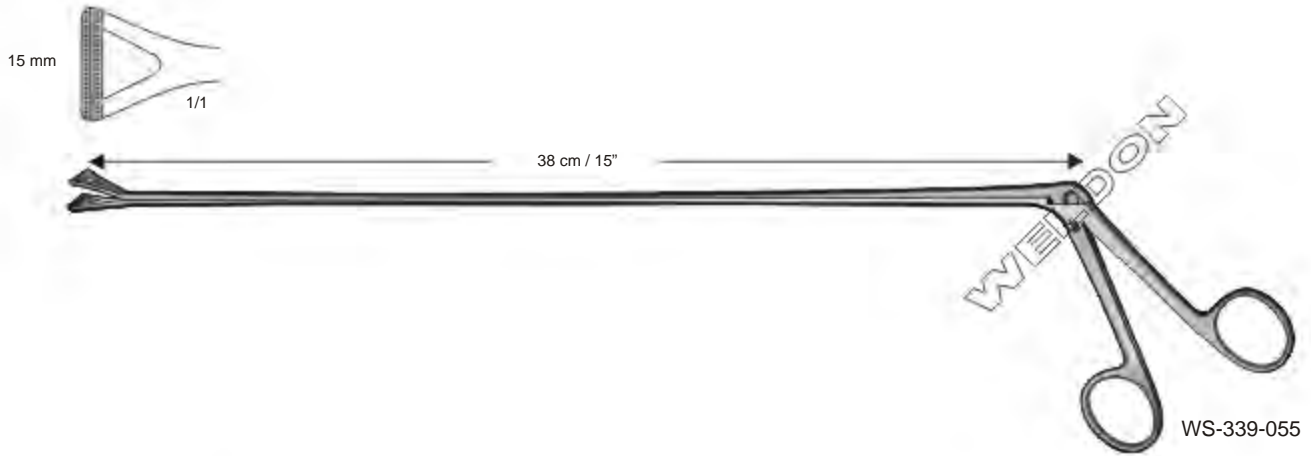

Luer
WS-339-056
24.5 cm / 9 3/4"



Heywood-Smith
WS-339-057
20 cm / 8"

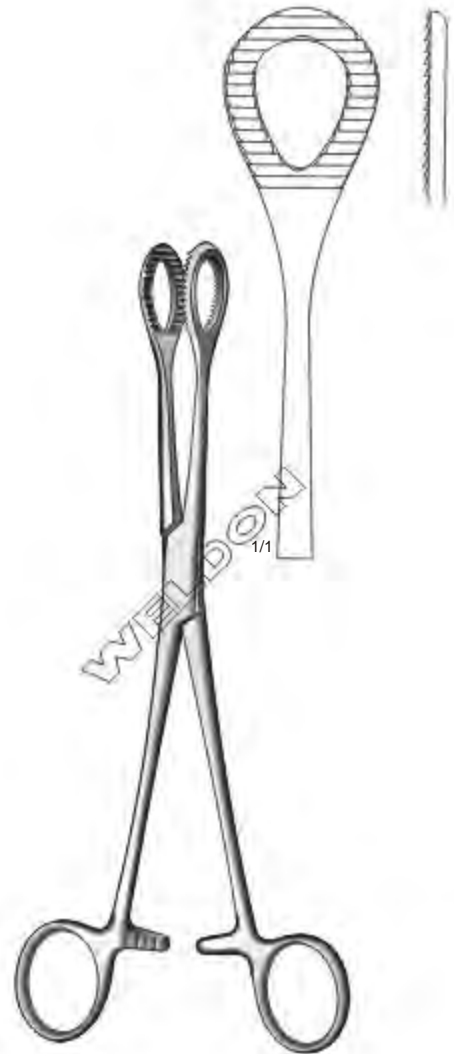

Heywood-Smith
WS-339-058
21 cm / 8 1/4"

Rectal Biopsy Forceps | Pinzas Para Biopsia Rectal | Rektum-Biopsiefasszangen

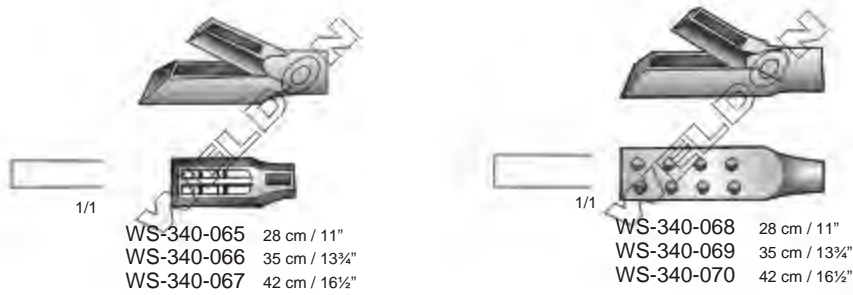
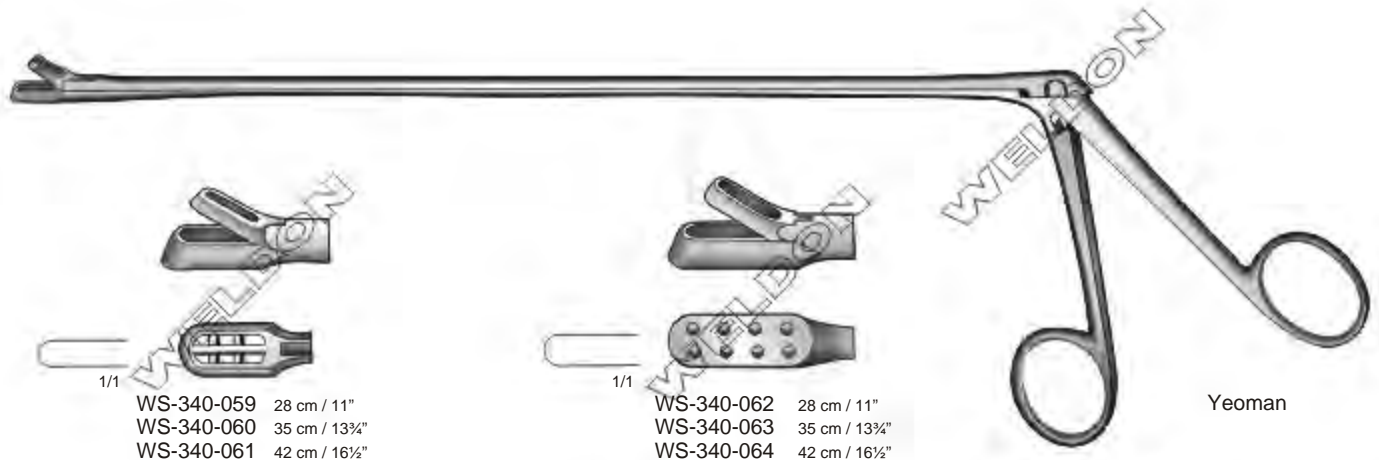



www.weldoninstruments.com

PROVEEDOR EXCLUSIVO:



Bulldog Clamps

Rib Shears

Rib Spreaders

Cardiovascular Forceps

341 - 384

Cardiovascular

Cardiovascular
Cardiovascular
GefaBchirurgie

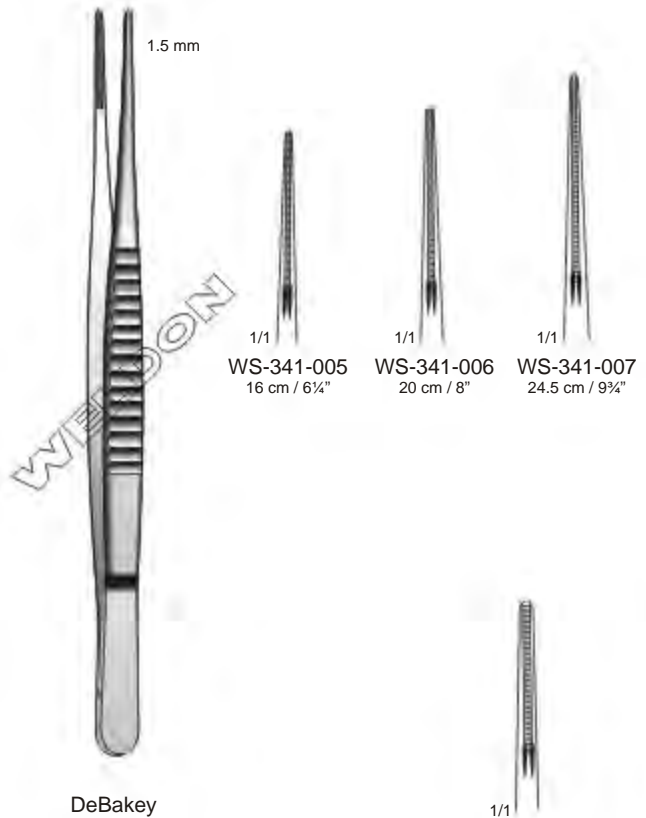
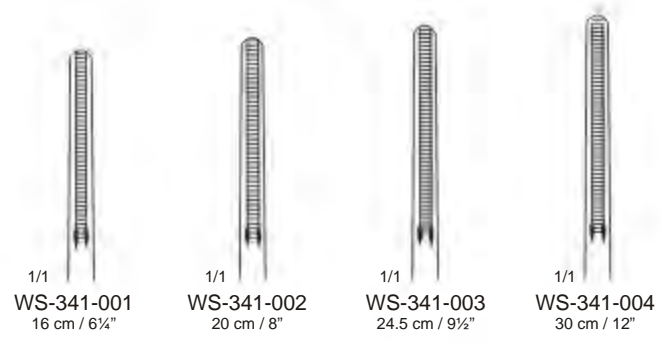

Vascular Forceps | Pinzas de Disección Vascolar | Gefäßpinzetten

2 mm



DeBakey



1/1
WS-342-012
16 cm / 6 1/4"



1/1
WS-342-013
20 cm / 8"



1/1
WS-342-014
24 cm / 9 1/2"



1/1
WS-342-015
30 cm / 12"



1/1
WS-342-016
16 cm / 6 1/2"

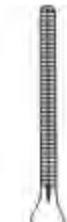

1/1
WS-342-017
20 cm / 8"

3.5 mm



DeBakey



1/1
WS-342-018
16 cm / 6 1/4"



1/1
WS-342-019
20 cm / 8"



1/1
WS-342-020
24 cm / 9 1/2"



1/1
WS-342-021
30 cm / 12"

2 mm



Cooley



Diethrich
 WS-343-022A 20 cm / 8"
 WS-343-022B 24 cm / 9½"
 WS-343-022C 30 cm / 12"
 1.0 mm Tip



Diethrich
 WS-343-022D 14 cm / 5½"
 WS-343-022E 16 cm / 6¼"
 WS-343-022F 18 cm / 7"
 WS-343-022G 20 cm / 8"
 WS-343-022H 24 cm / 9½"
 WS-343-022K 30 cm / 12"
 1.3 mm Tip

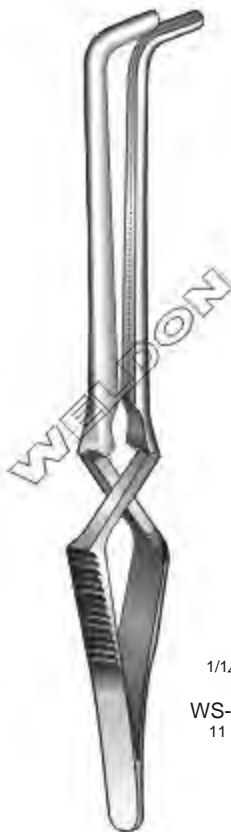

WS-343-022 11 cm / 4 7/8"
 WS-343-023 12 cm / 4 3/4"

Gregory

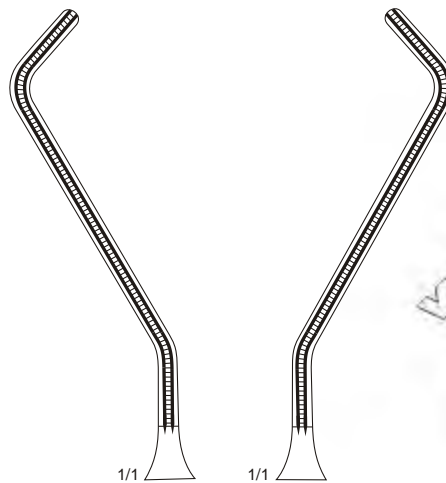

WS-343-024 WS-343-025



Gregory
 11 cm / 4 7/8"

Bulldog Clamps | Clamps Bulldog | Bulldogklemmen

DeBakey
 WS-344-026 7.5 cm / 3"
 WS-344-027 8.5 cm / 3³/₈"
 WS-344-028 10.5 cm / 4¹/₈"
 WS-344-029 12 cm / 4³/₄"



DeBakey
 WS-344-030 7 cm / 2³/₄"
 WS-344-031 8 cm / 3¹/₈"
 WS-344-032 10 cm / 4"
 WS-344-033 11.5 cm / 4¹/₂"



Glover
 WS-344-034 7 cm / 2³/₄"
 WS-344-035 8 cm / 3¹/₈"
 WS-344-036 9 cm / 3¹/₂"
 WS-344-037 11 cm / 4³/₈"



Glover
 WS-344-038 6.5 cm / 2¹/₂"
 WS-344-039 7.5 cm / 3"
 WS-344-040 8.5 cm / 3³/₈"
 WS-344-041 10.5 cm / 4¹/₈"



Glover
 WS-344-042 5 cm / 2"

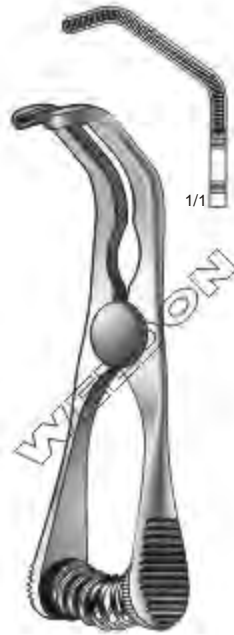

DeBakey
WS-345-043
6 cm / 2 3/8"

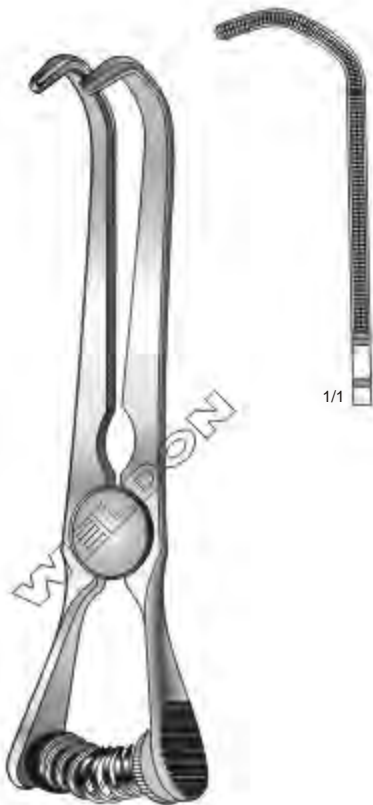

DeBakey
WS-345-044
11.5 cm / 4 1/2"

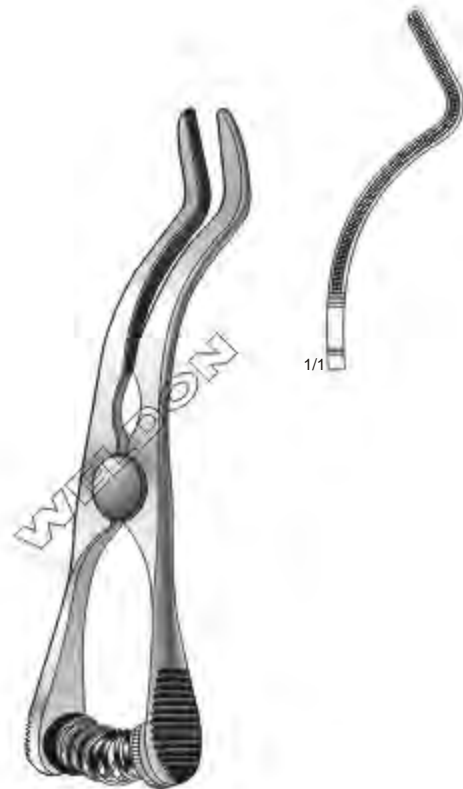

DeBakey
WS-345-045
8 cm / 3 1/8"

Cardiovascular Forceps | Pinzas Cardiovasculares | Gefäßklemmen



WS-346-001
Straight

DeBakey-Mosquito
12.5 cm / 5"



WS-346-002
Curved



WS-346-003
Straight

WS-346-004
Curved

DeBakey-Mosquito
15 cm / 6"



DeBakey-Rankin
16 cm / 6¼"
Haemosatic Forceps



WS-346-005 WS-346-006



1/1
WS-347-007
14 cm / 5½"

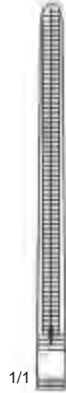

1/1
WS-347-008
16 cm / 6¼"

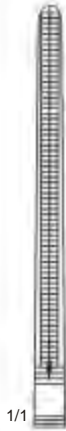

1/1
WS-347-009
18 cm / 7"

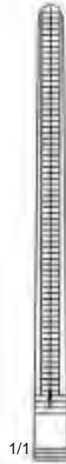

1/1
WS-347-010
20 cm / 8"



DeBakey-Pean
Straight
Haemostatic Forceps



1/1
WS-347-011
14 cm / 5½"



1/1
WS-347-012
16 cm / 6¼"



1/1
WS-347-013
18 cm / 7"



1/1
WS-347-014
20 cm / 8"



DeBakey-Pean
Curved
Haemostatic Forceps

Cardiovascular Forceps | Pinzas Cardiovasculares | Gefäßklemmen



WS-348-015
21 cm / 8 1/4"

Potts
Coarctation Clamps



WS-348-016
22.5 cm / 8 3/4"



WS-348-017
20.5 cm / 8"



WS-348-018
22 cm / 8 3/4"

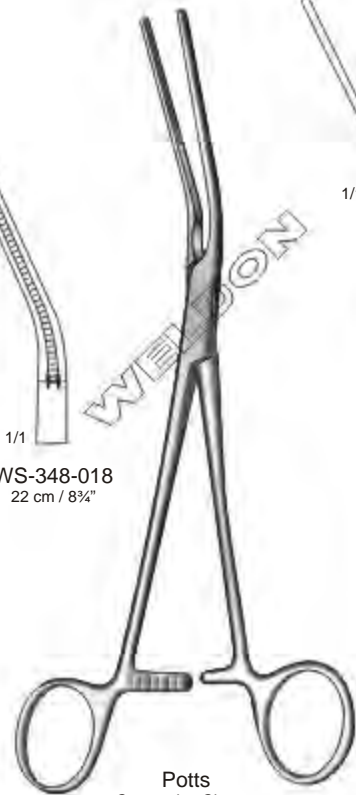

Potts
Coarctation Clamps



WS-348-019
20.5 cm / 8"

Potts
Coarctation Forceps

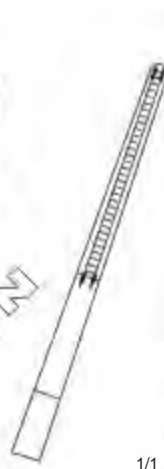

WS-348-020
22 cm / 8 3/4"

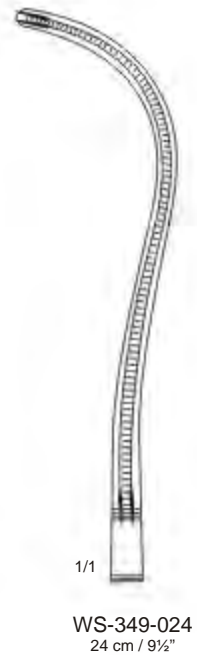

Cardiovascular Forceps | Pinzas Cardiovasculares | Gefäßklemmen

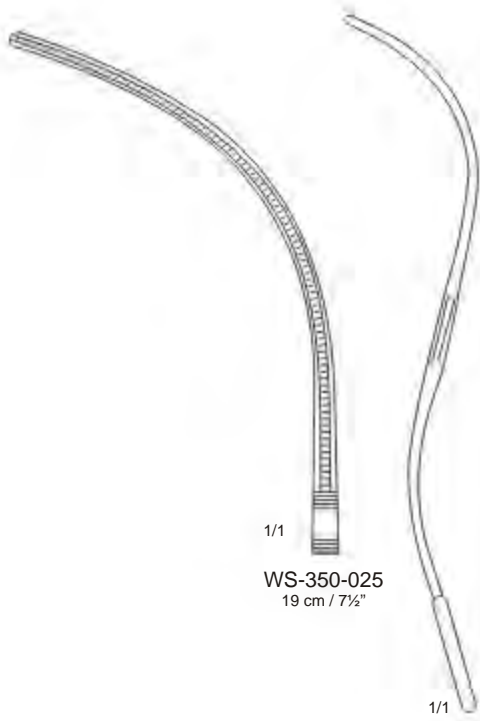

WS-350-025
19 cm / 7½"

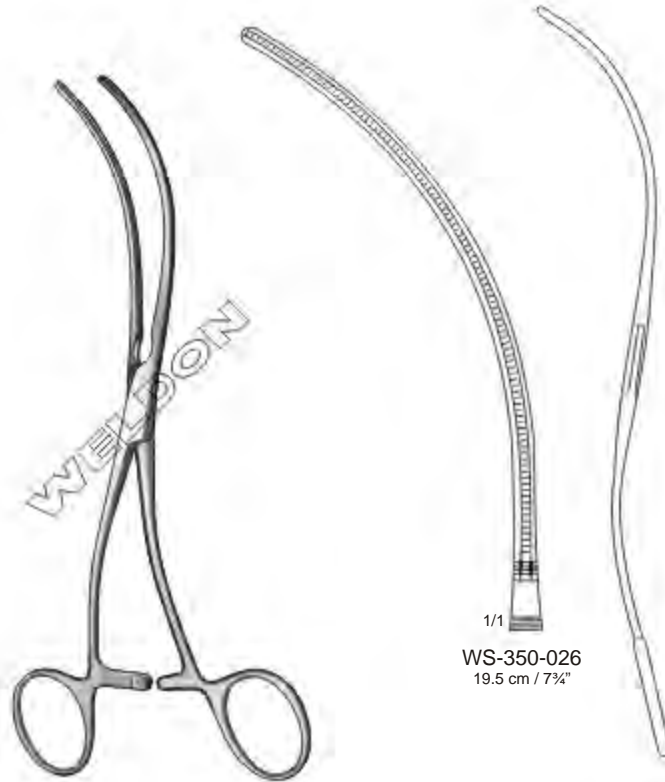

WS-350-026
19.5 cm / 7¾"

DeBakey
Peripheral Vascular Clamps

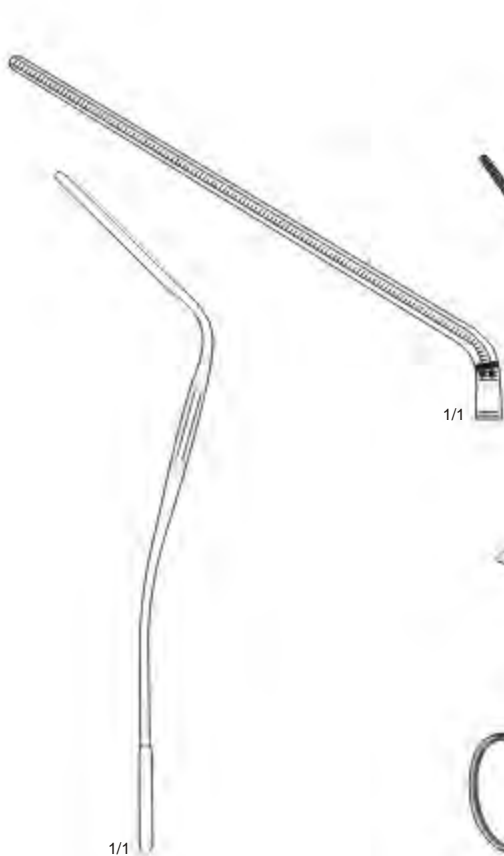

WS-350-027
18 cm / 7"



WS-350-028
18.5 cm / 7¼"

Leland-Jones
Peripheral Vascular Clamps

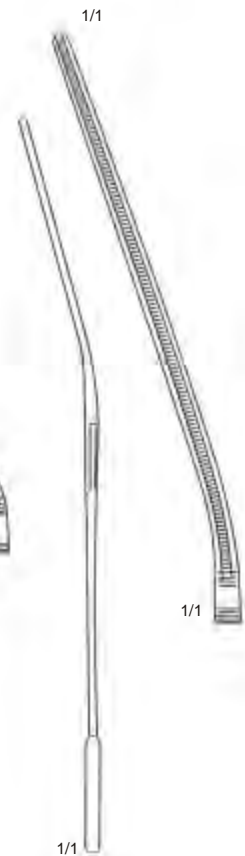

WS-350-029
19.5 cm / 7¾"

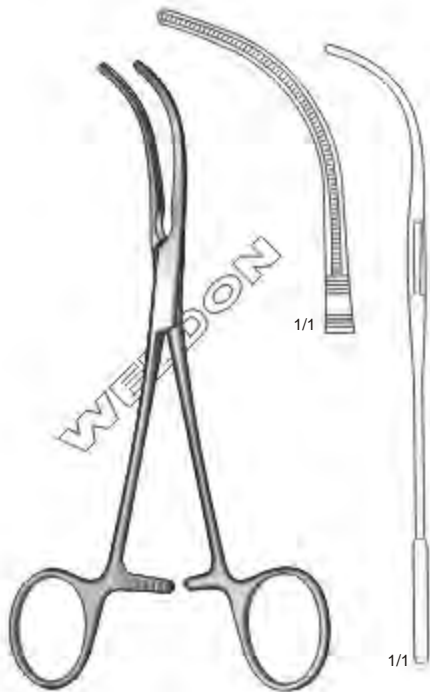

DeBakey
WS-351-030
 16 cm / 6 1/4"
 Peripheral Vascular Clamps



Brainbridge
 Multi Purpose Vascular Clamps

WS-351-031
 15 cm / 6"

WS-351-032
 18.5 cm / 7 1/4"

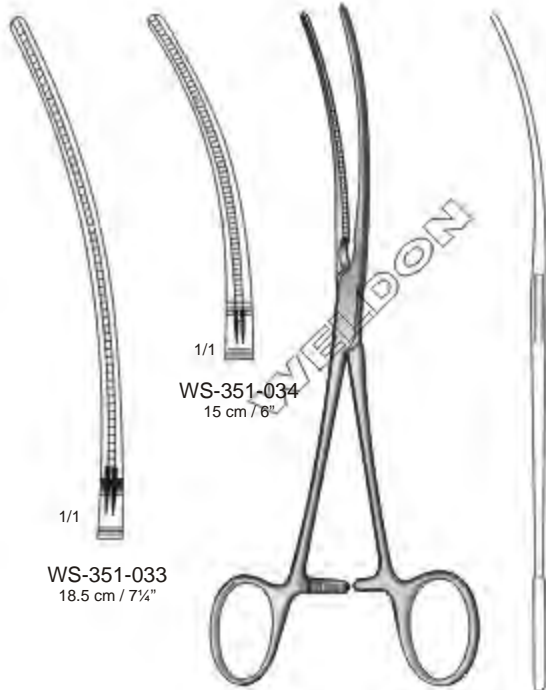

WS-351-034
 15 cm / 6"

WS-351-033
 18.5 cm / 7 1/4"

Brainbridge
 Multi Purpose Vascular Clamps

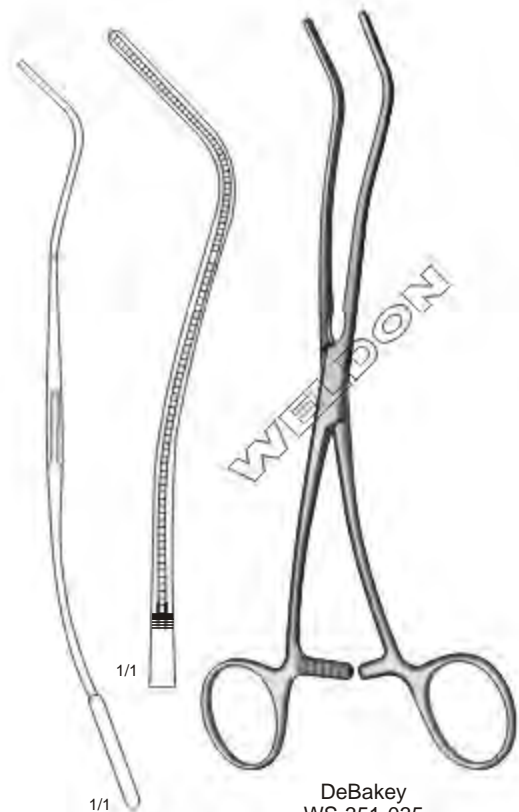

DeBakey
WS-351-035
 20 cm / 8"
 Multi Purpose Vascular Clamps

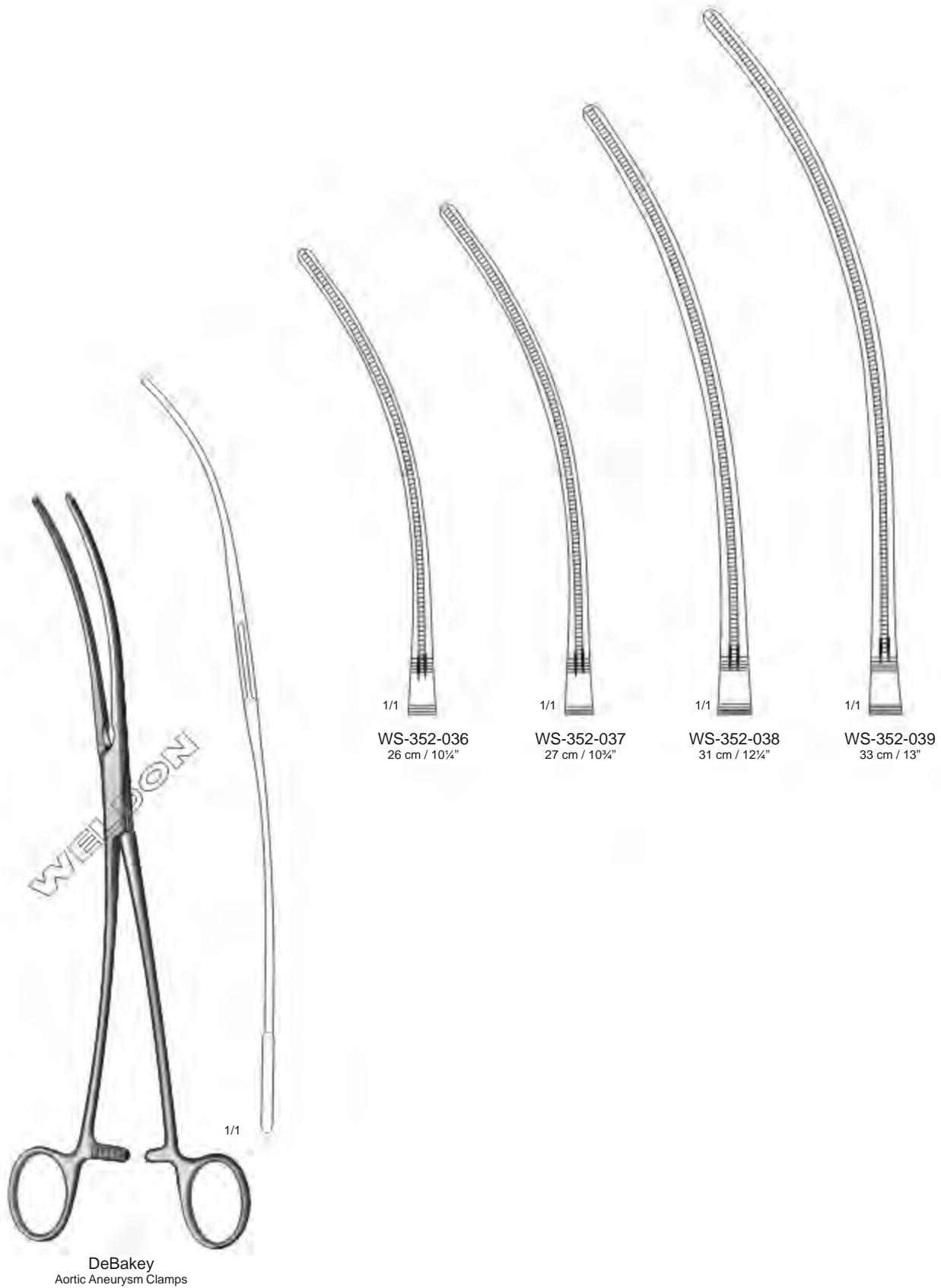



DeBakey
WS-353-040
28 cm / 11"
Aortic Aneurysm Clamps

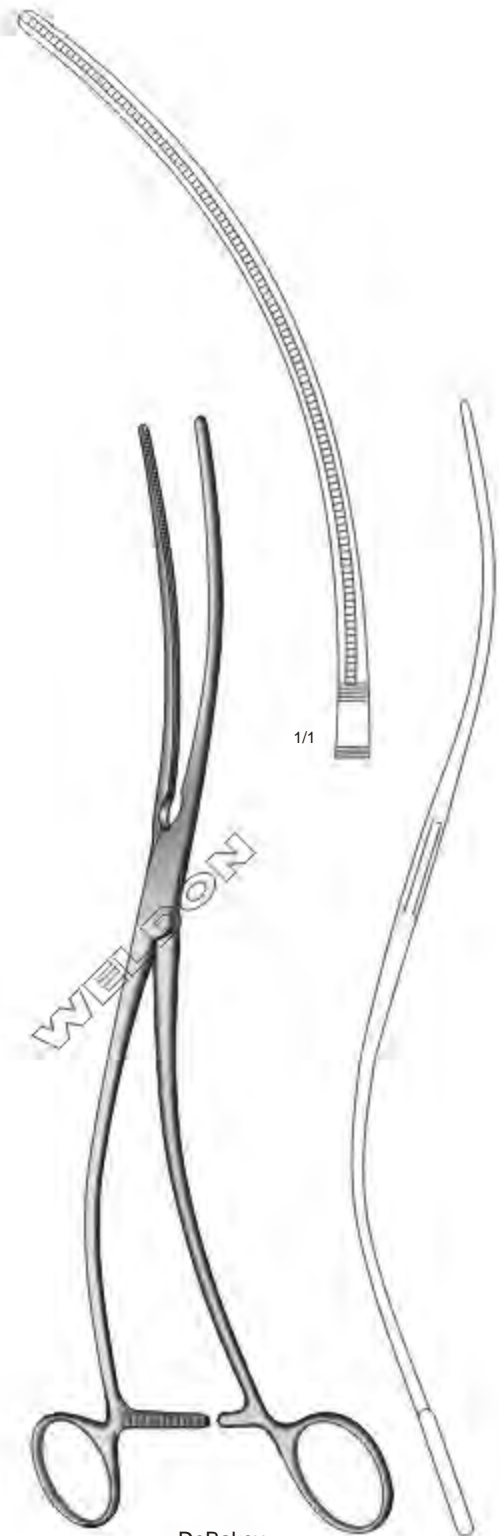

DeBakey
WS-353-041
30 cm / 11½"
Aortic Aneurysm Clamps

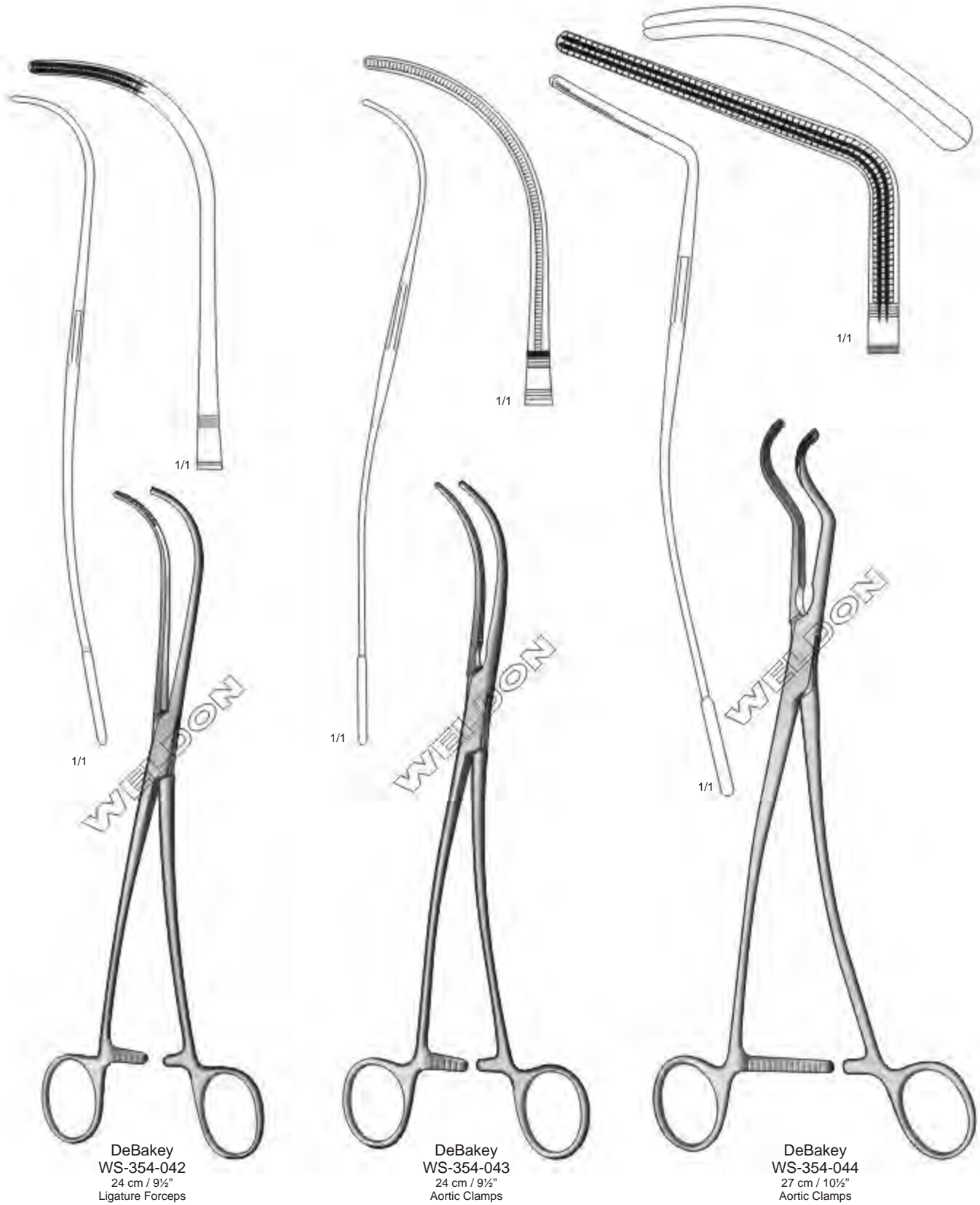

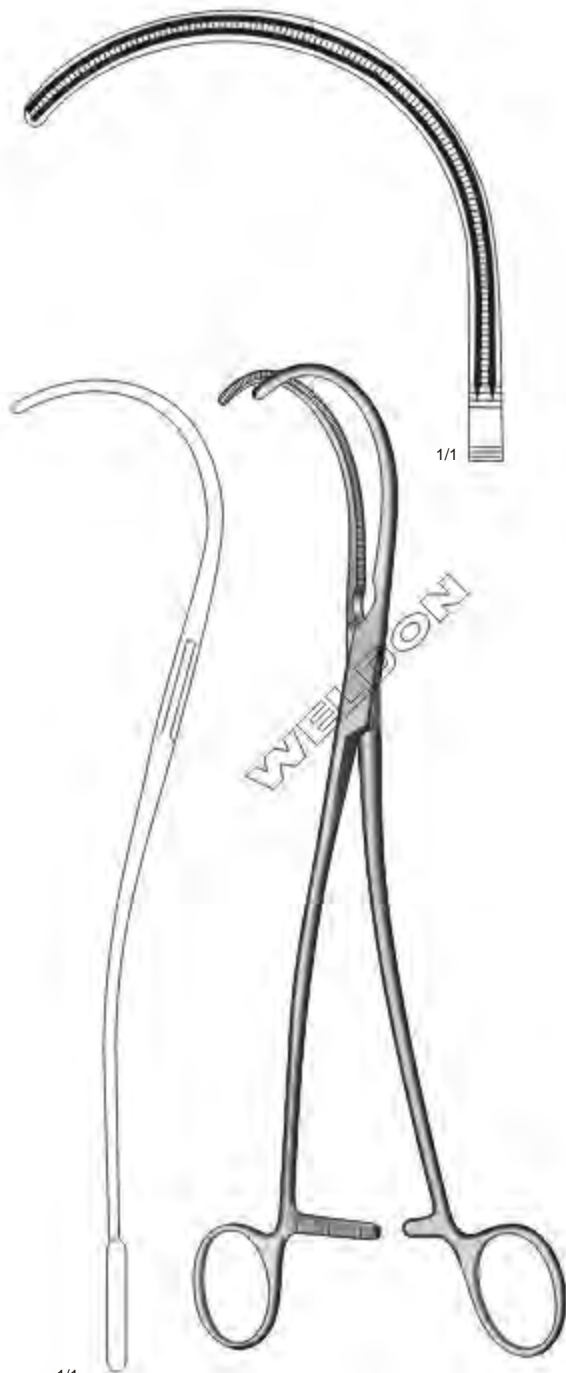

DeBakey
WS-355-045
27 cm / 10½"
Aortic Clamps



DeBakey
WS-355-046
27 cm / 10½"
Ligature Forceps

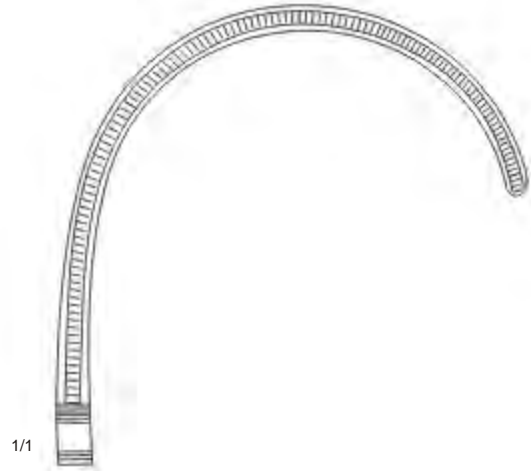
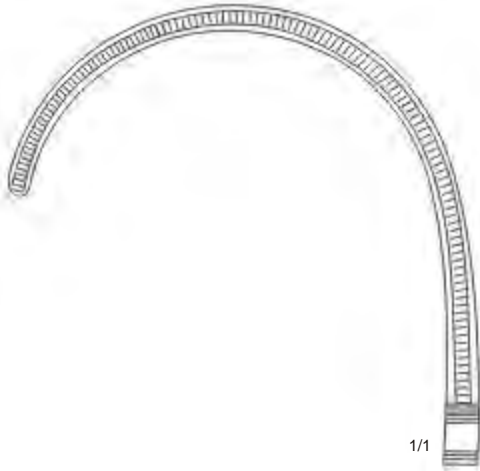

Weber
WS-356-047
24 cm / 9½"
Aortic Clamps
Left



Weber
WS-356-048
24 cm / 9½"
Aortic Clamps
Right



1/1
WS-357-050
26 cm / 10¼"

1/1
WS-357-049
22 cm / 8¾"



1/1
WS-357-051
26.5 cm / 10½"

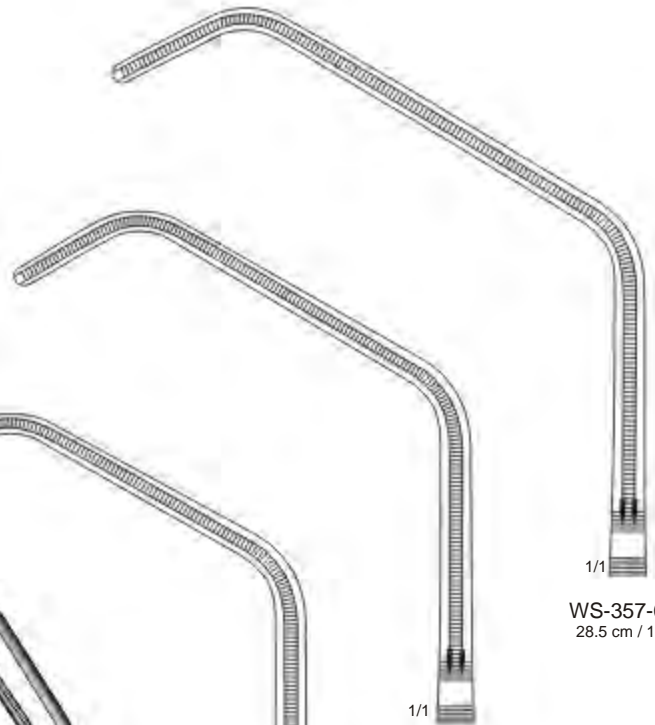

1/1
WS-357-052
27.5 cm / 10¾"

1/1
WS-357-053
28.5 cm / 11¼"



1/1



WELDON

Satinsky
Tangential Occlusion Clamps

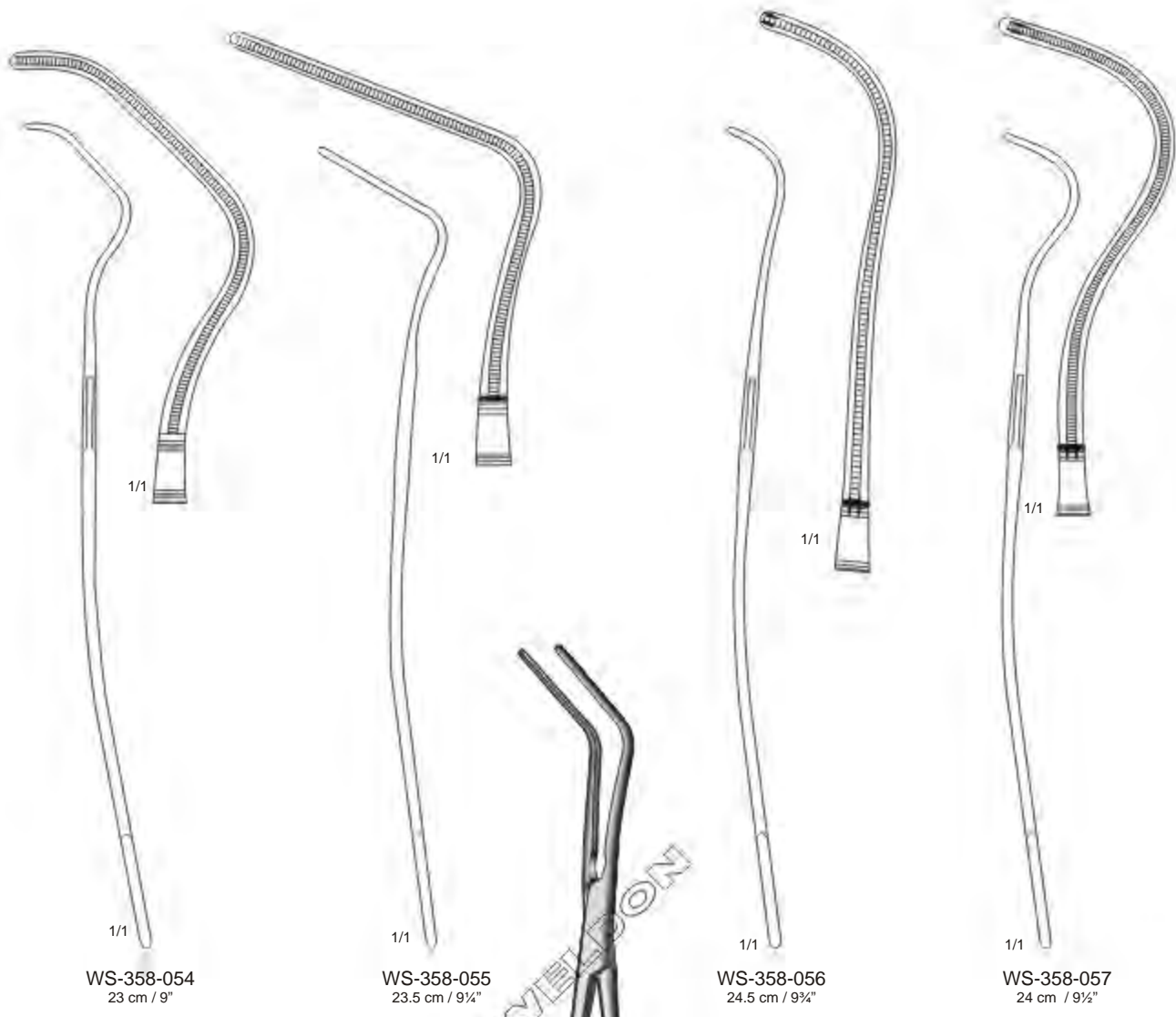

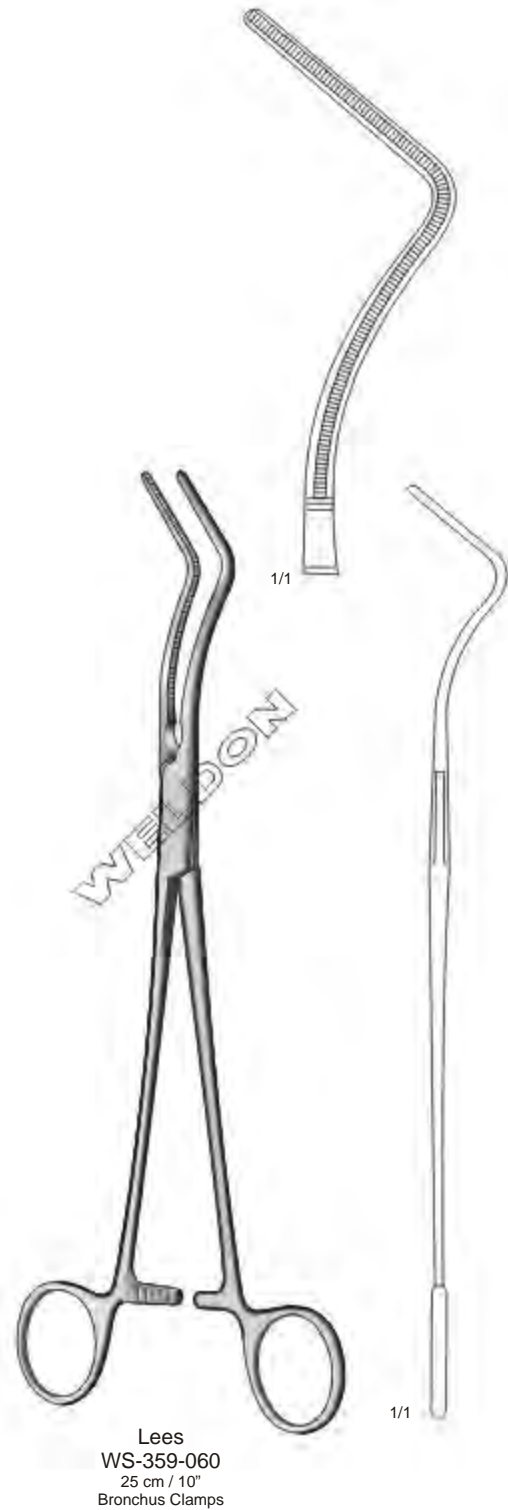
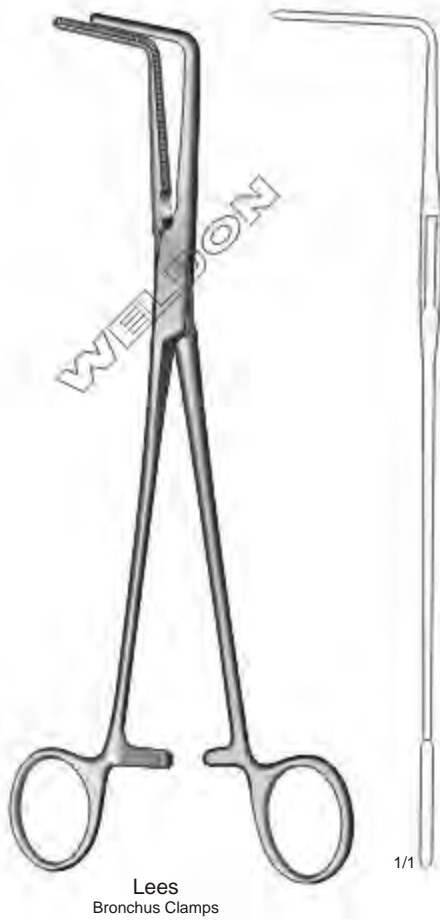
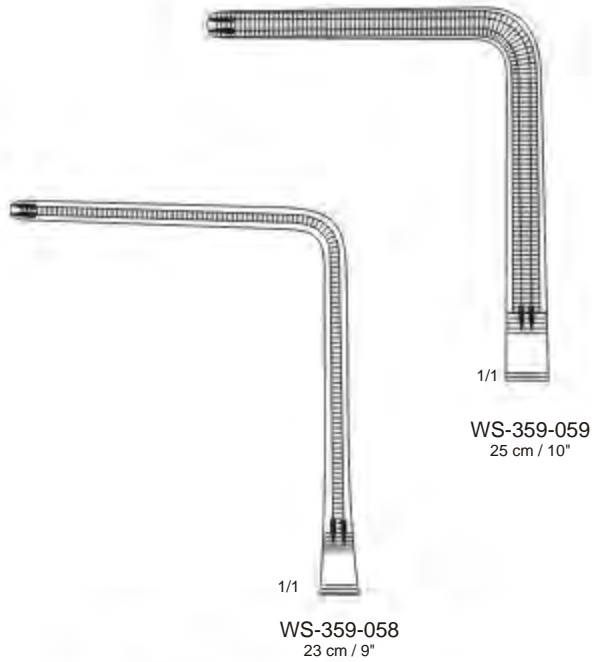

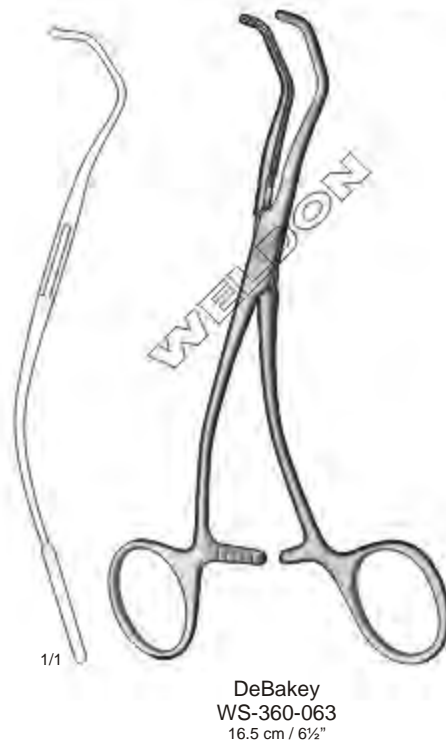
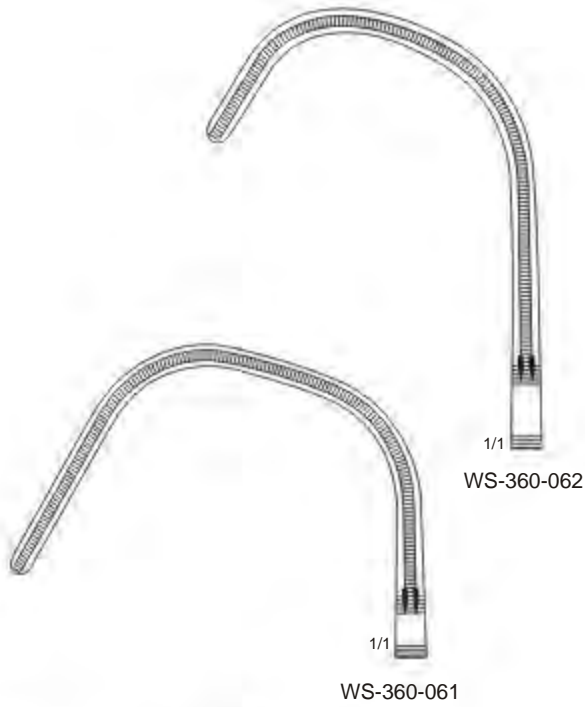

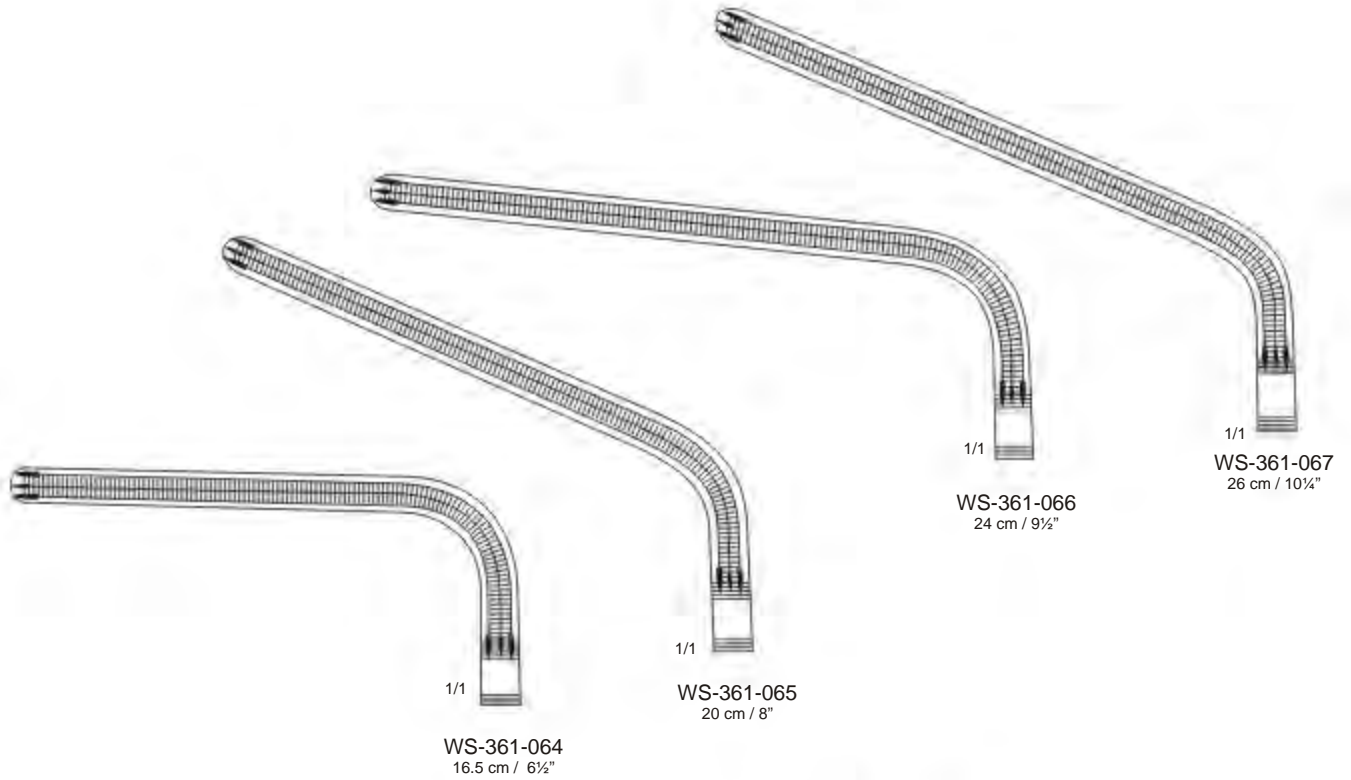

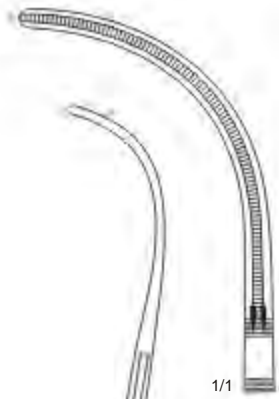

1/1
WS-362-068
23.5 cm / 9"



1/1
WS-362-069
24 cm / 9½"

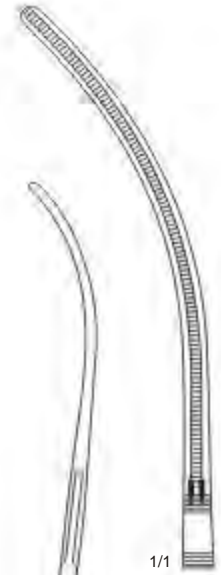

1/1
WS-362-070
25.5 cm / 10"



DeBakey-Bahnon
Aneurysm Clamps

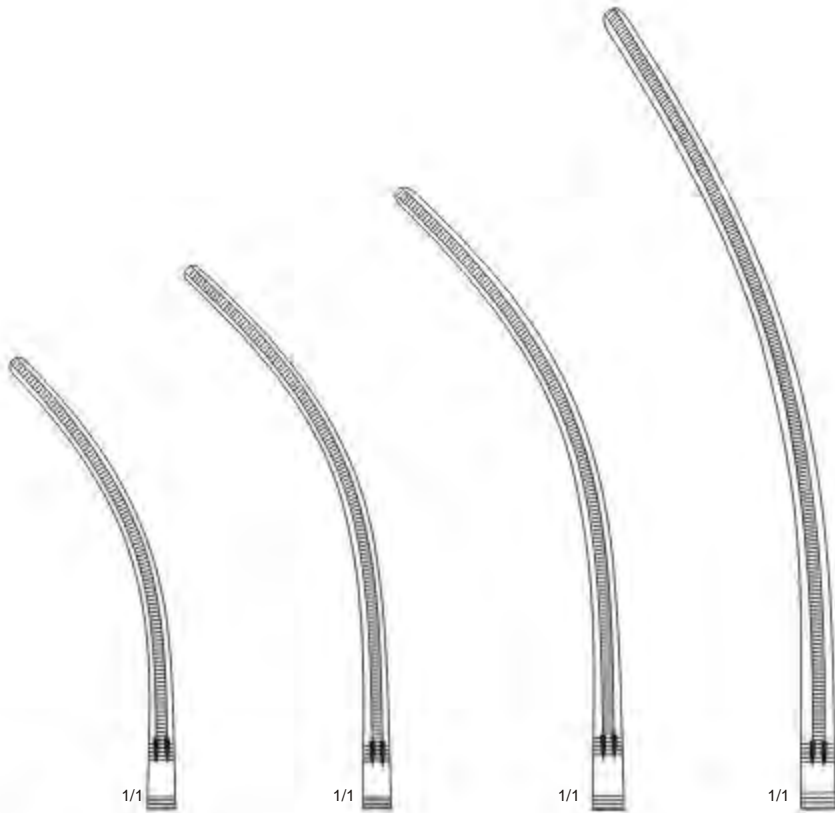

1/1
WS-363-071
21.5 cm / 8½"

1/1
WS-363-072
23 cm / 9"

1/1
WS-363-073
26 cm / 10¼"

1/1
WS-363-074
31.5 cm / 12½"



Potts
Multi Purpose Vascular Clamps

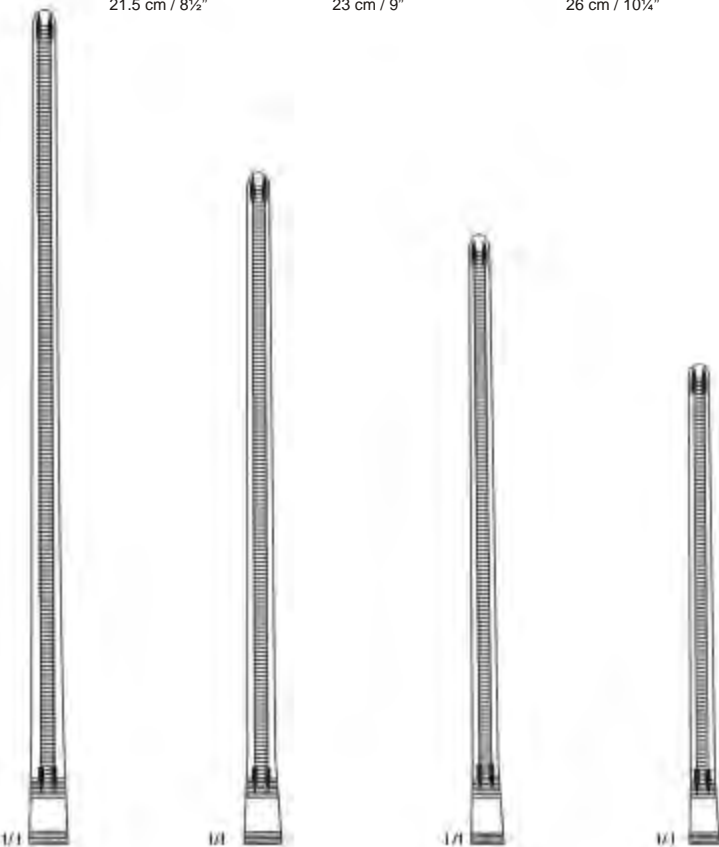

1/1
WS-363-075
31.5 cm / 12½"

1/1
WS-363-076
27 cm / 10½"

1/1
WS-363-077
23.5 cm / 9"

1/1
WS-363-078
21.5 cm / 8½"



Potts
Multi Purpose Vascular Clamps

Cardiovascular Forceps | Pinzas Cardiovasculares | Gefäßklemmen

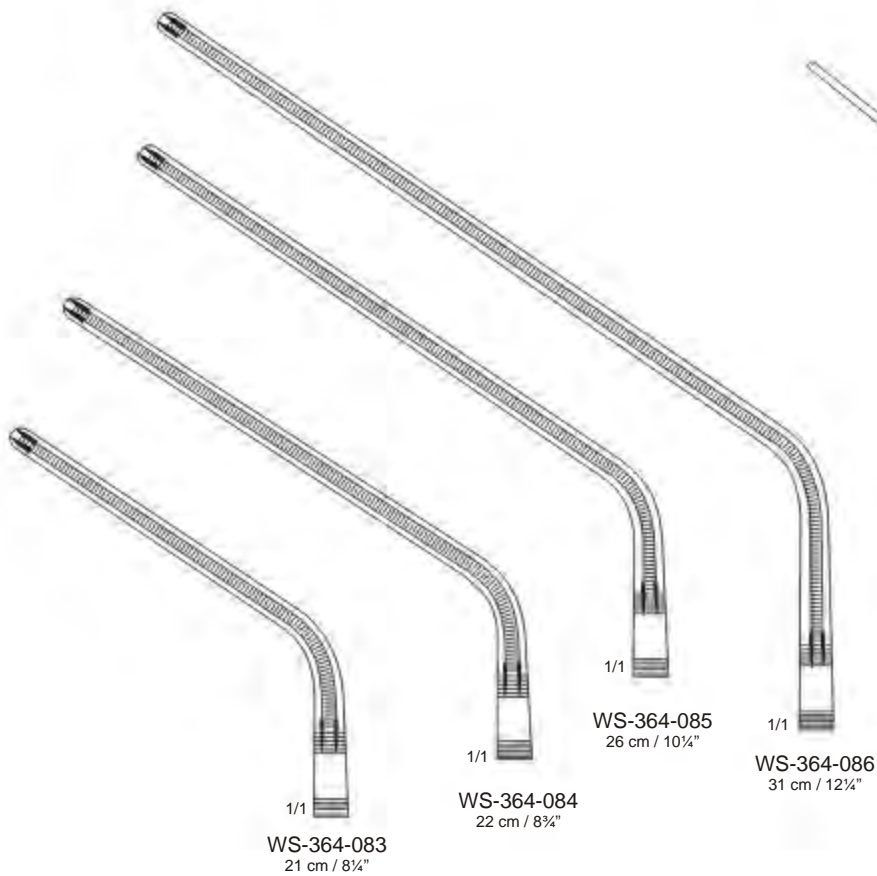
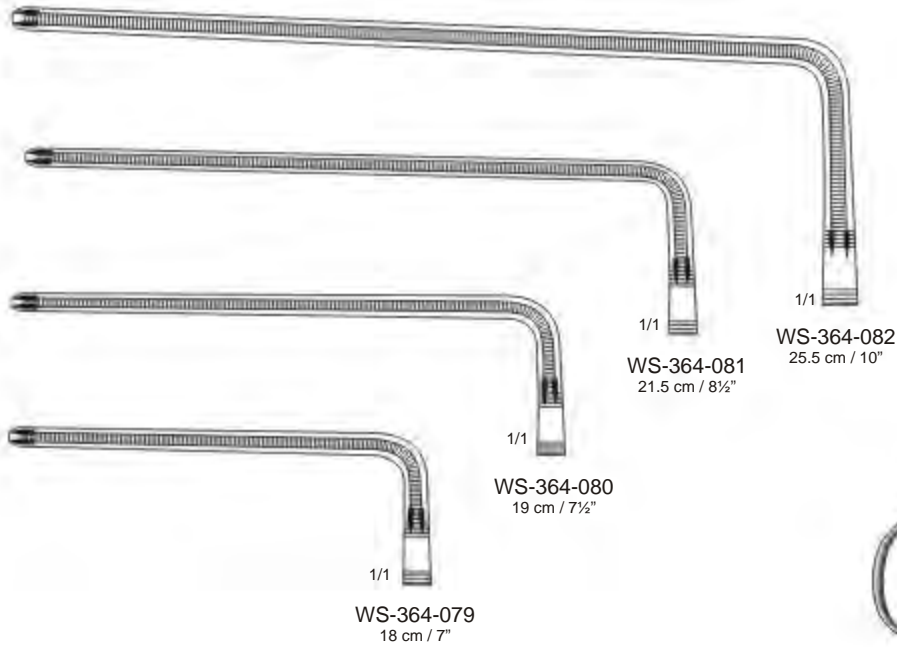

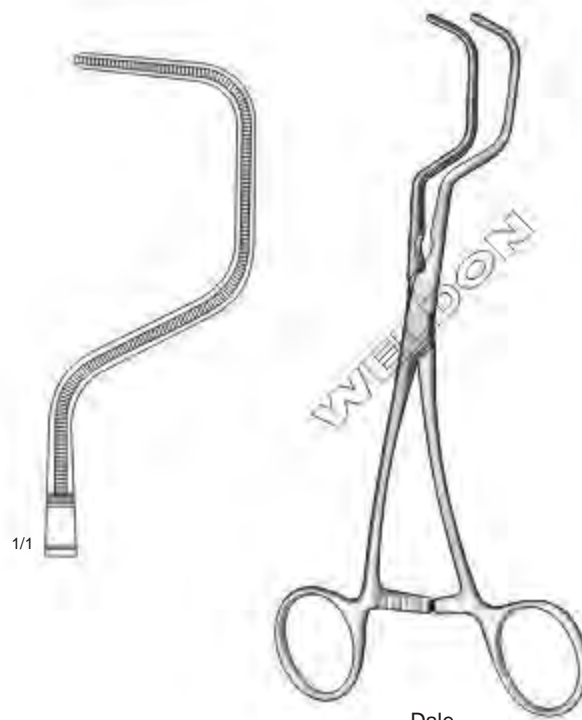

Dale
WS-365-087
18.5 cm / 7 1/4"
Peripheral Vascular Clamps

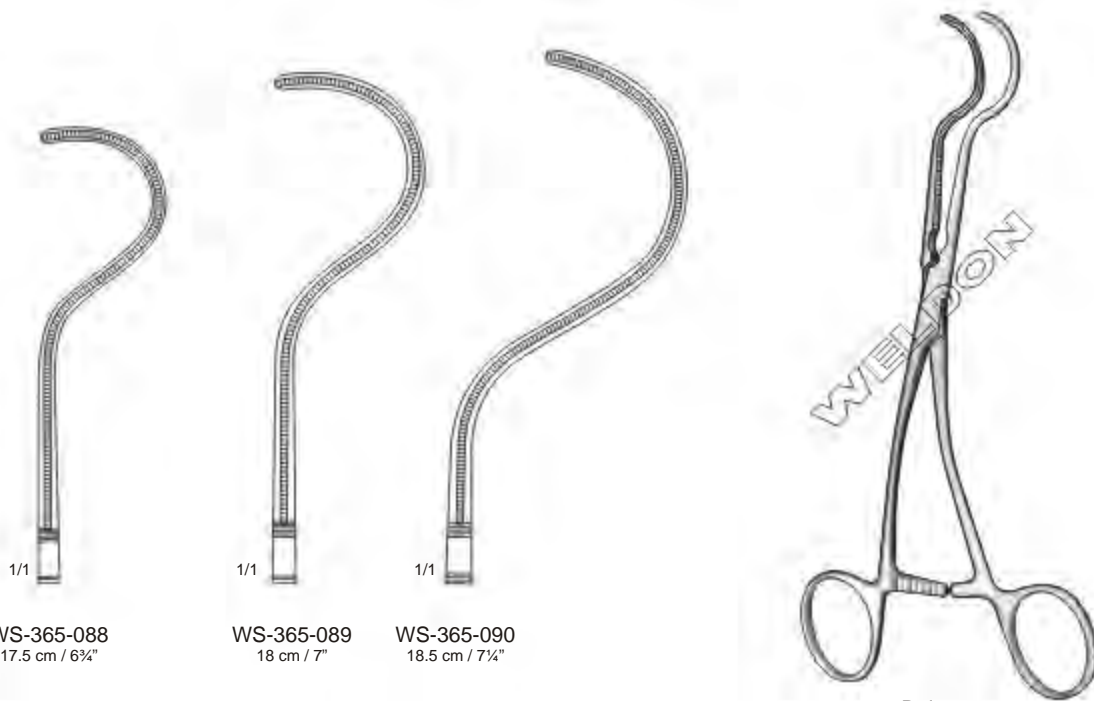

WS-365-088
17.5 cm / 6 3/4"

WS-365-089
18 cm / 7"

WS-365-090
18.5 cm / 7 1/4"

Dale
Peripheral Vascular Clamps



DeBakey
WS-366-091
16 cm / 6 1/4"
Multi Purpose Vascular Clamps



DeBakey
WS-366-092
14.5 cm / 5 3/4"
Multi Purpose Vascular Clamps



DeBakey
WS-366-093
16.5 cm / 6 1/2"
Multi Purpose Vascular Clamps

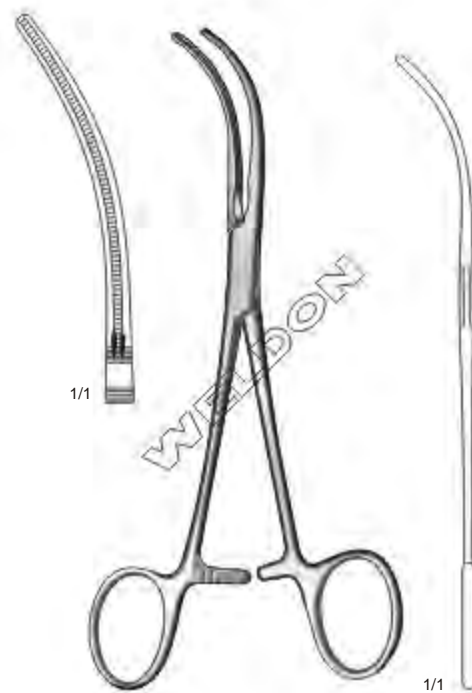

Glover
WS-366-094
17 cm / 6 3/4"
Multi Purpose Vascular Clamps

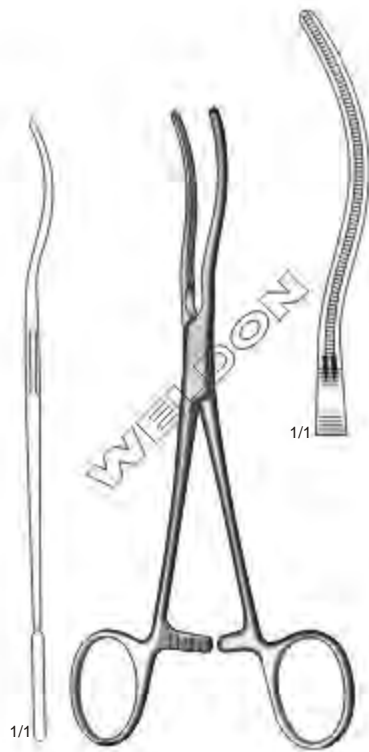

Glover
WS-367-095
17 cm / 6 3/4"
Multi Purpose Vascular Clamps

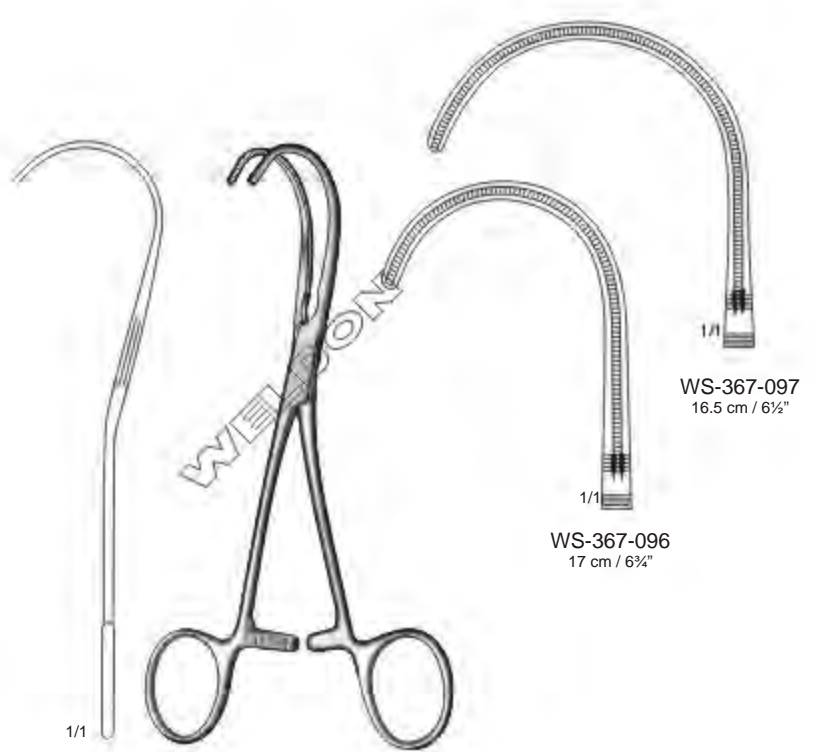

DeBakey
Multi Purpose Vascular Clamps

WS-367-097
16.5 cm / 6 1/2"

WS-367-096
17 cm / 6 3/4"



Beck
WS-367-098
17 cm / 6 3/4"
Anastomosis Clamps

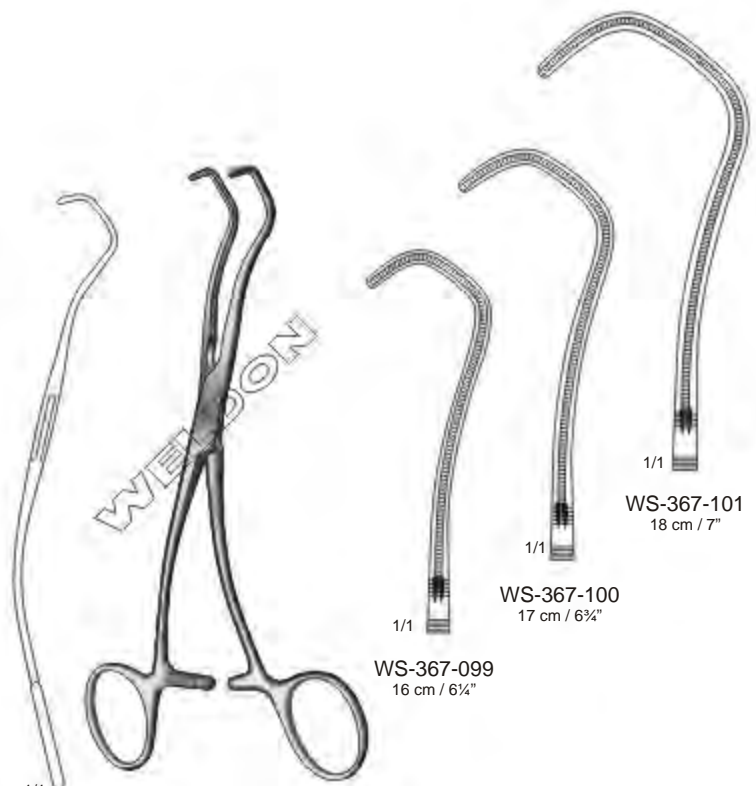

Derra
Anastomosis Clamps

WS-367-099
16 cm / 6 1/4"

WS-367-100
17 cm / 6 3/4"

WS-367-101
18 cm / 7"



DeBakey
WS-368-102
10 cm / 4"
Pediatric Vascular Clamps



DeBakey
WS-368-103
12.5 cm / 5"
Pediatric Vascular Clamps



DeBakey
WS-368-104
12.5 cm / 5"
Pediatric Vascular Clamps

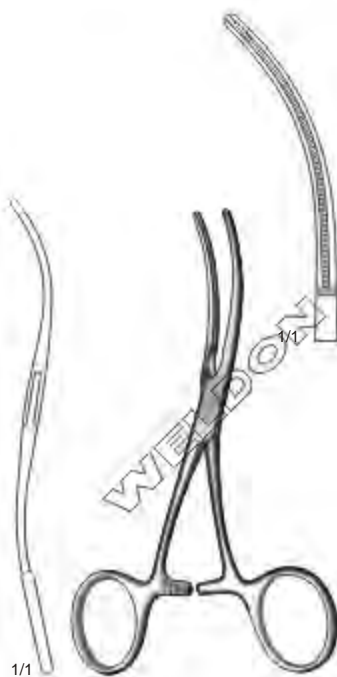

DeBakey
WS-368-105
12.5 cm / 5"
Pediatric Vascular Clamps



DeBakey
WS-368-106
12.5 cm / 5"
Pediatric Vascular Clamps

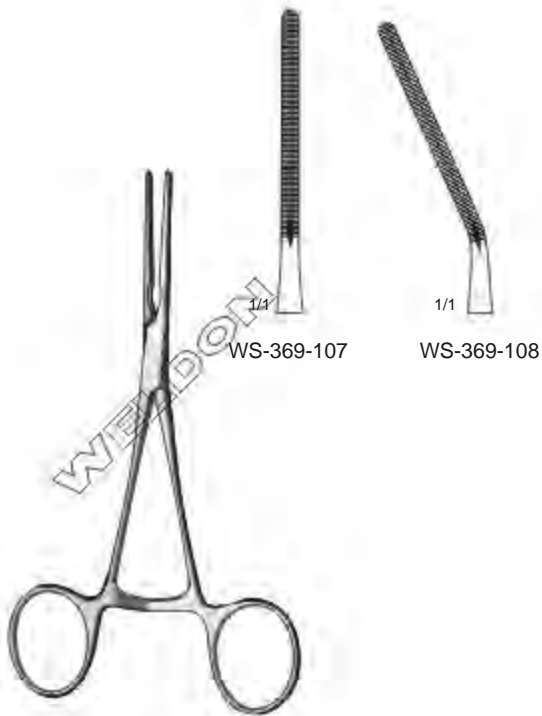

Cooley
14.5 cm / 5 3/4"
Pediatric Vascular Clamps



Cooley
14 cm / 5 1/2"
Pediatric Vascular Clamps



Cooley
14 cm / 5 1/2"
Pediatric Vascular Clamps



Cooley
14 cm / 5 1/2"
Pediatric Vascular Clamps

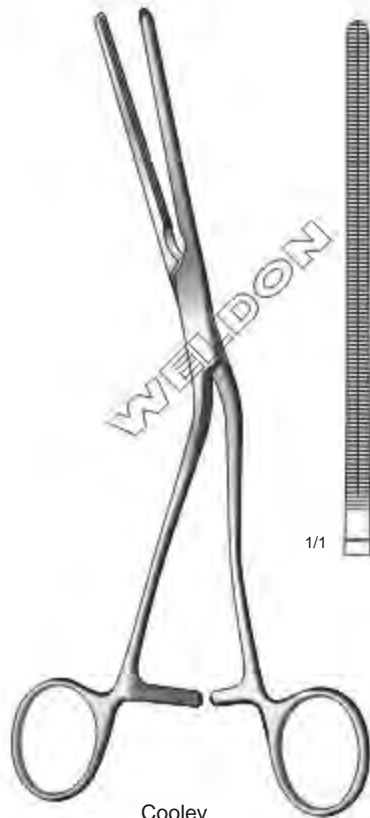

Cooley
WS-370-112
22 cm / 8 3/4"
Iliac Clamps



Cooley
WS-370-113
20 cm / 8"
Carotid Clamps



DeBakey
WS-370-114 20 cm / 8"
WS-370-115 22 cm / 9"
Hysterectomy Clamps



DeBakey
WS-370-116
17 cm / 6 3/4"

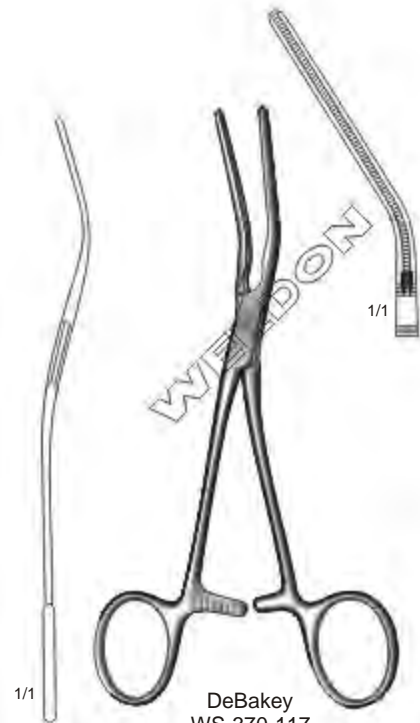

DeBakey
WS-370-117
16 cm / 6 1/4"

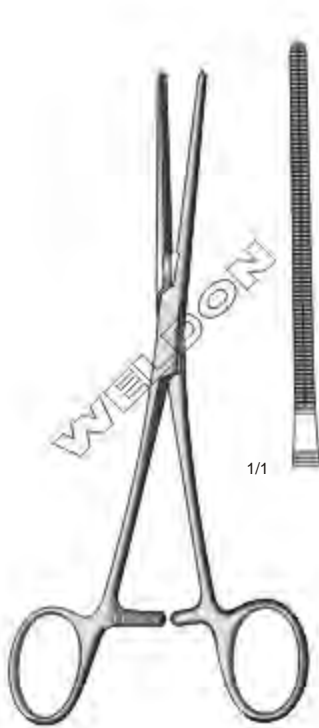

Cooley
WS-371-118
17 cm / 6 3/4"
Anastomosis Clamps

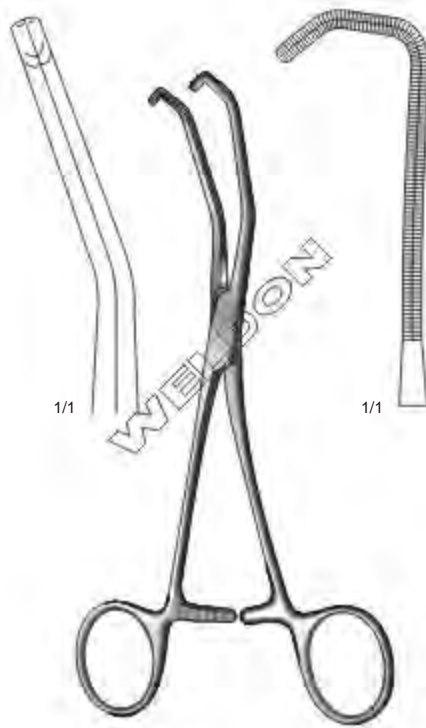

Cooley
WS-371-119
17 cm / 6 3/4"
Anastomosis Clamps

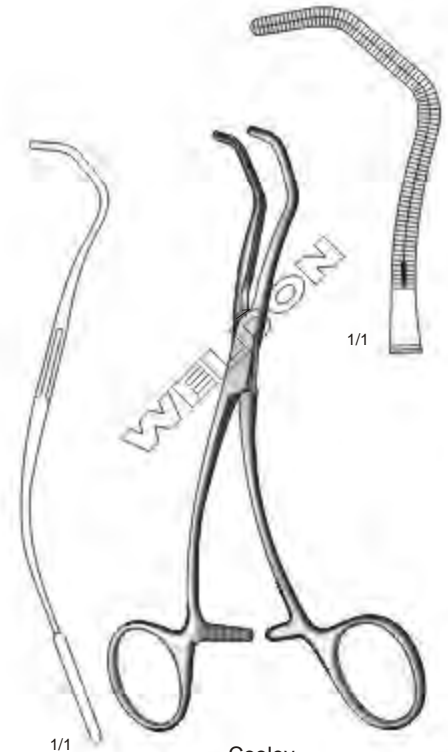

Cooley
WS-371-120
16 cm / 6 1/4"
Anastomosis Clamps



Cooley
WS-371-121
14 cm / 5 1/2"
Multi Purpose Vascular Clamps

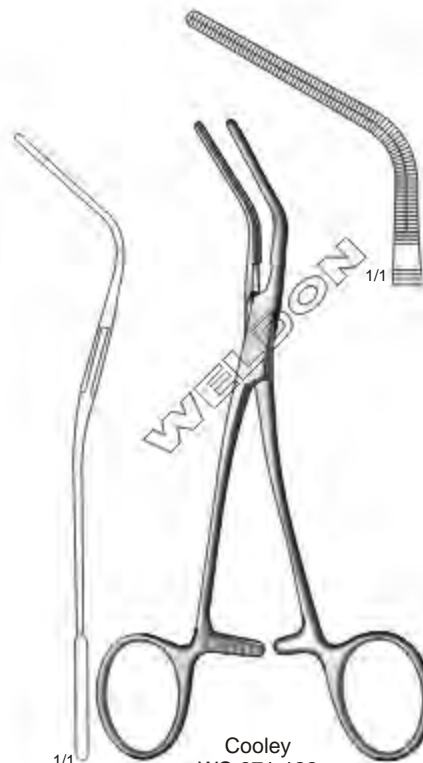

Cooley
WS-371-122
15.5 cm / 6 1/8"
Multi Purpose Vascular Clamps

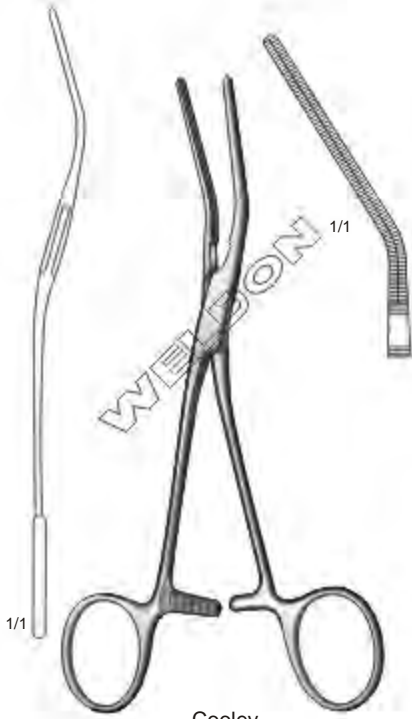

Cooley
WS-372-123
17 cm / 6 3/4"
Multi Purpose Vascular Clamps



Cooley
WS-372-124
17 cm / 6 3/4"
Multi Purpose Vascular Clamps

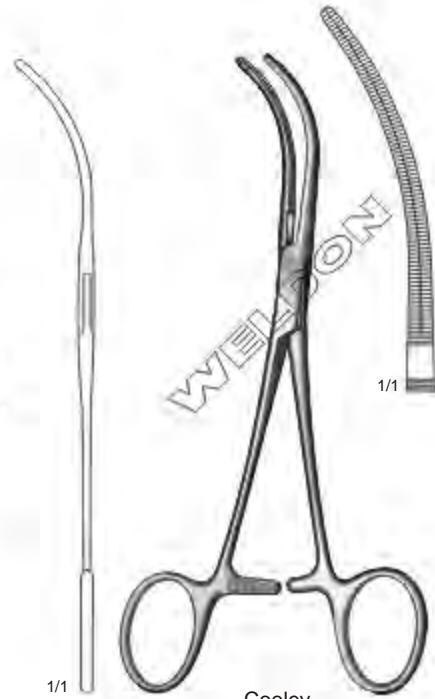

Cooley
WS-372-125
17 cm / 6 3/4"
Multi Purpose Vascular Clamps

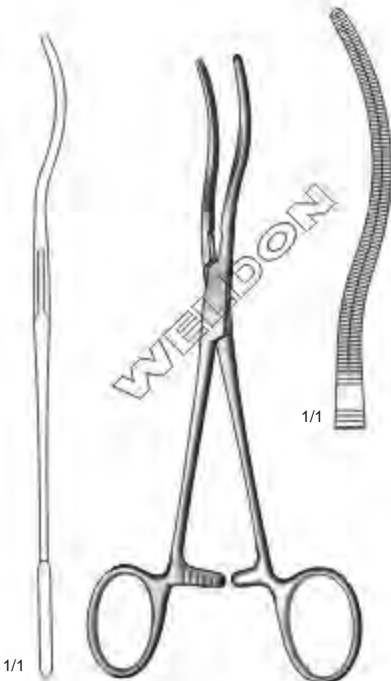

Cooley
WS-372-126
17.5 cm / 7"
Multi Purpose Vascular Clamps



Cooley
WS-372-127
16 cm / 6 1/4"

WS-372-128
17 cm / 6 3/4"

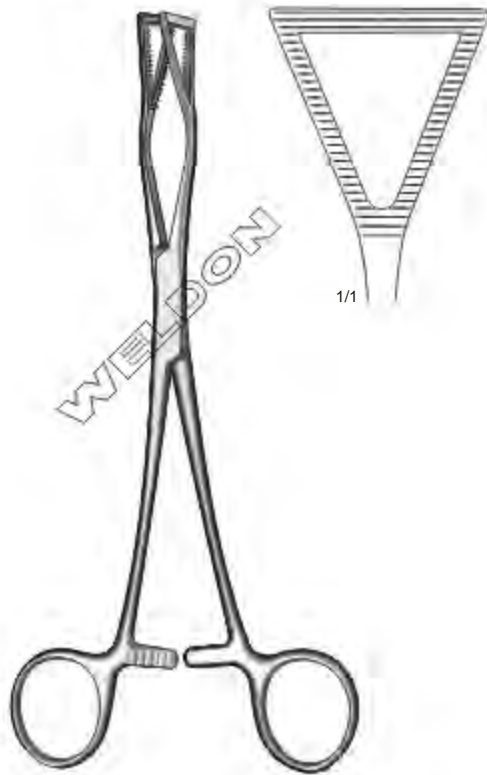

Lovelace
WS-373-129
20.5 cm / 8"

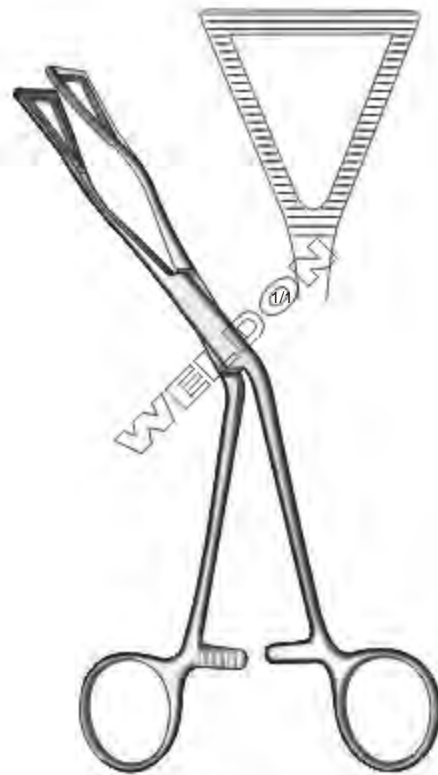

Lovelace
WS-373-130
19 cm / 7½"
Laterally Curved

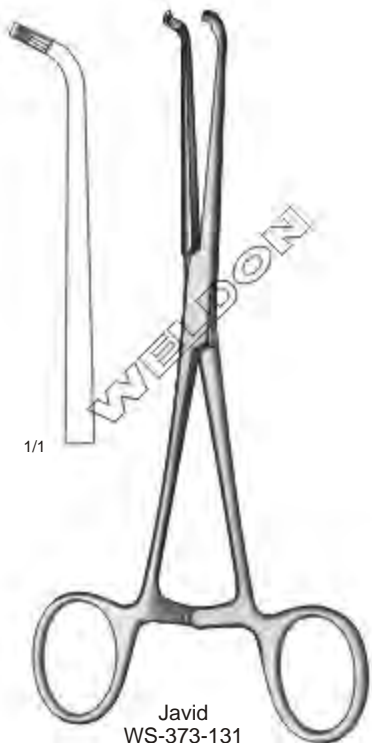

Javid
WS-373-131
17.5 cm / 7"
Carotid Shunt Clamps

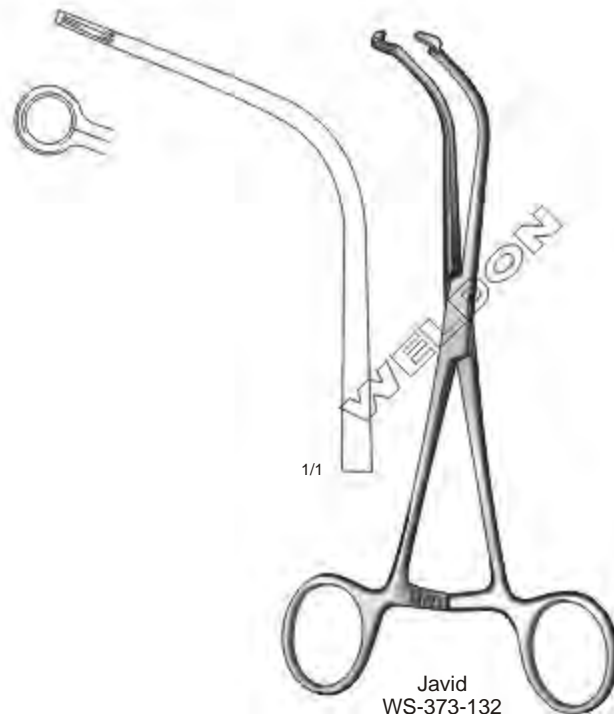

Javid
WS-373-132
18 cm / 7"
Carotid Shunt Clamps

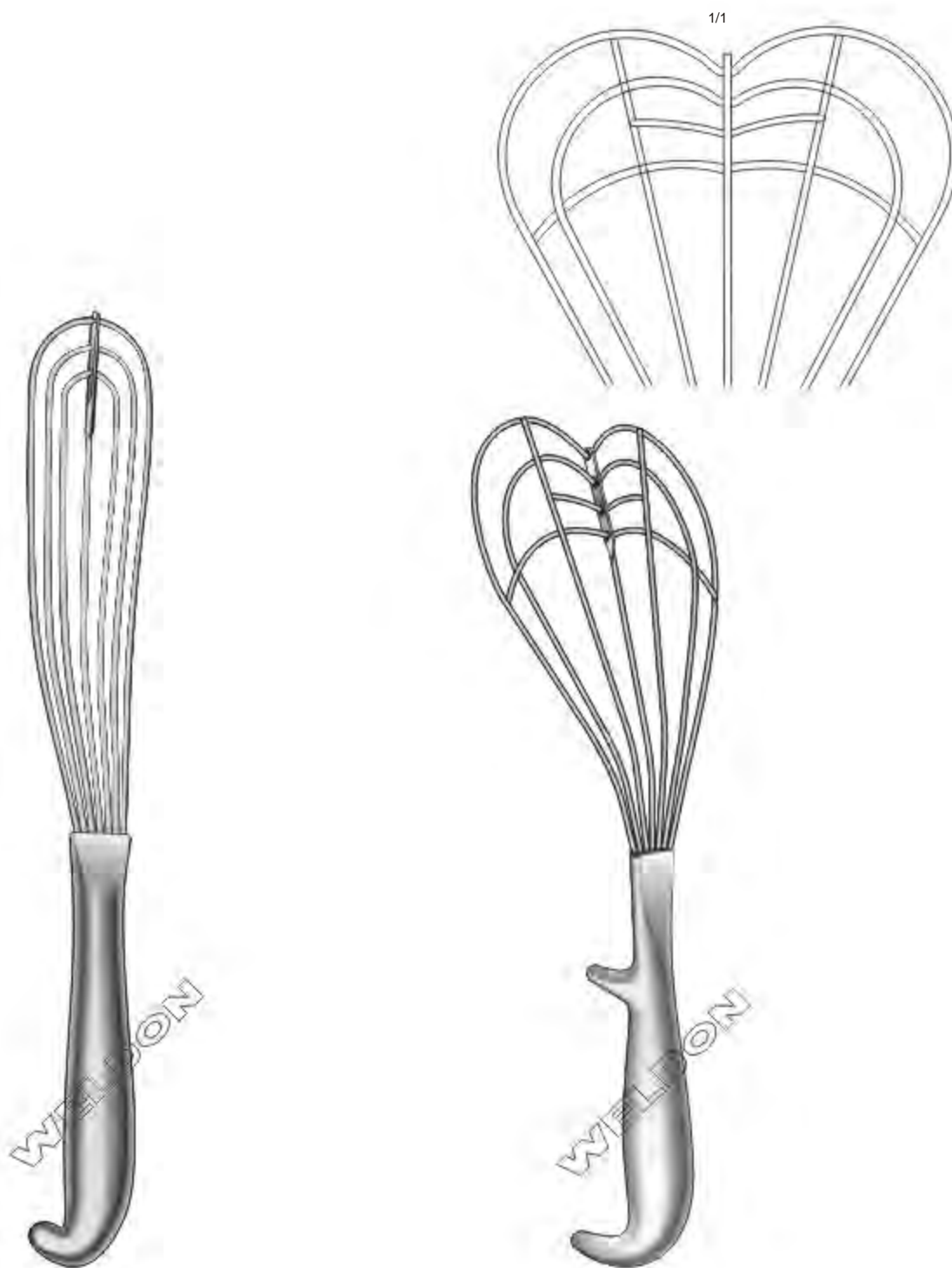

Allison
WS-374-133 29.5 cm / 11½"
WS-374-134 32.5 cm / 12¾"

Allison
WS-374-135
26 cm / 10¼"

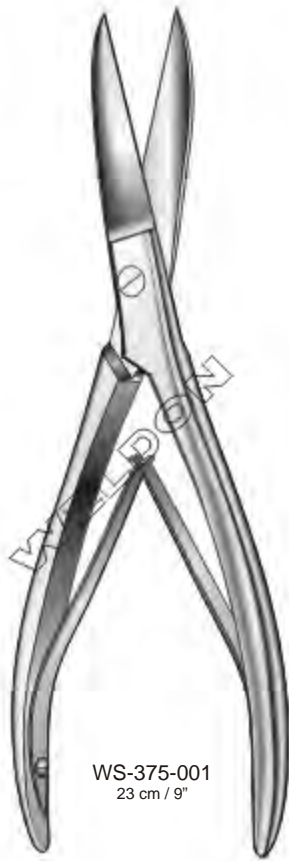

WS-375-001
23 cm / 9"



WS-375-002
22 cm / 8 3/4"



Sauerbruch
WS-375-003 23 cm / 9"
WS-375-004 26 cm / 10 1/4"



Gluck
WS-375-005
22 cm / 8 3/4"



Stille
WS-375-006
21 cm / 8 1/4"

Rib Shears, Sternum Chisel | Costótomos, Cinceles | Rippenscheren, Sternummeißel



Giertz-Stille
WS-376-007
24.5 cm / 9 3/4"



Sauerbruch Frey
WS-376-008
36 cm / 14"



Lebsche
WS-376-009
25 cm / 10"



Brunner
WS-376-010 For Left Hand
WS-376-011 For Right Hand
32 cm / 12 1/2"



Lebsche
WS-376-012
24.5 cm / 9 3/4"



Bailey-Baby
WS-377-001
15.5 cm / 6"



Bailey
WS-377-002
20 cm / 8"
Short Claws

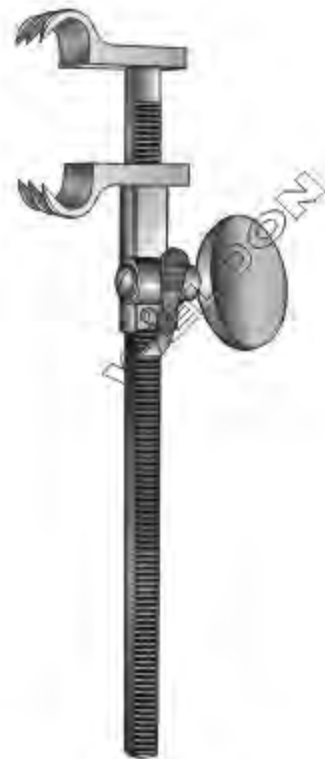

Bailey-Gibbon
WS-377-003
20 cm / 8"
Long Claws

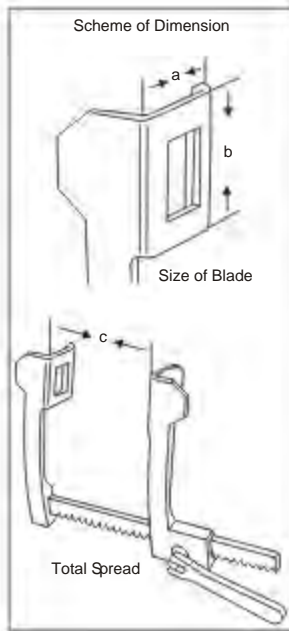

Cooley
WS-378-004
 a = 12 mm, b = 16 mm, c = 95 mm
 For New Born

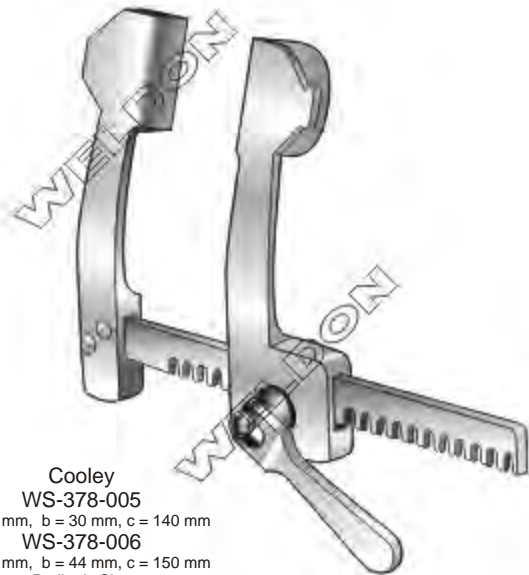

Cooley
WS-378-005
 a = 15 mm, b = 30 mm, c = 140 mm
WS-378-006
 a = 21 mm, b = 44 mm, c = 150 mm
 Pediatric Size

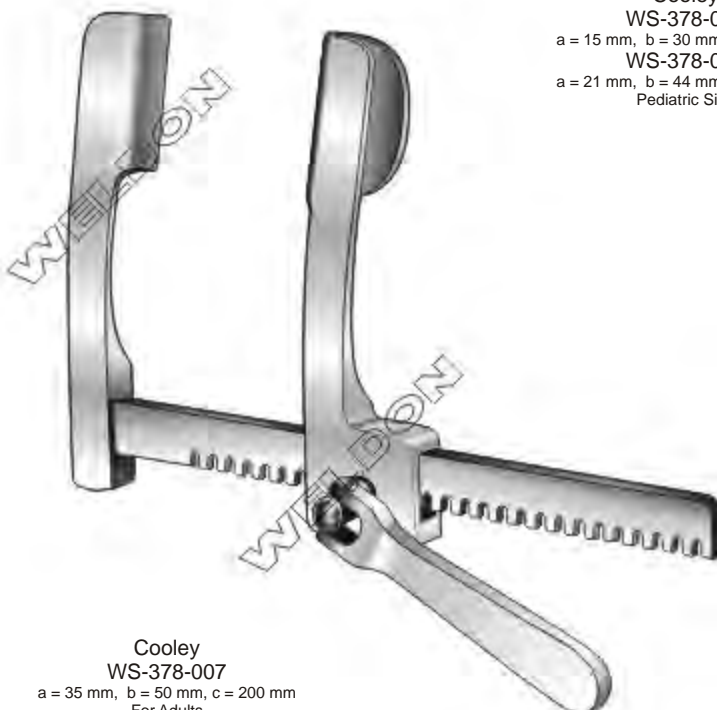

Cooley
WS-378-007
 a = 35 mm, b = 50 mm, c = 200 mm
 For Adults

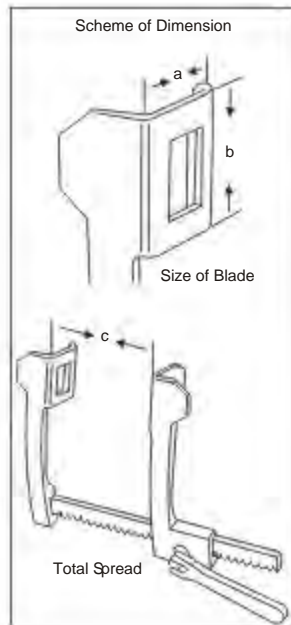

Finochietto
WS-379-008
 a = 15 mm, b = 15 mm, c = 75 mm
 For Infants

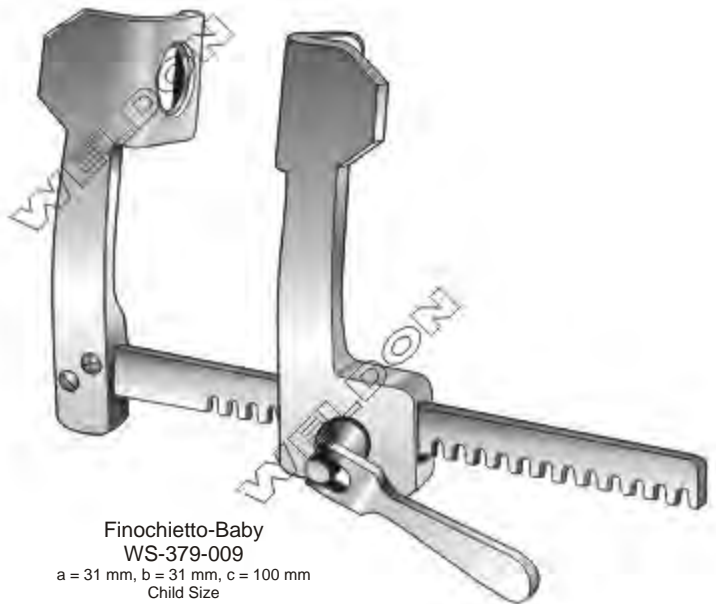

Finochietto-Baby
WS-379-009
 a = 31 mm, b = 31 mm, c = 100 mm
 Child Size

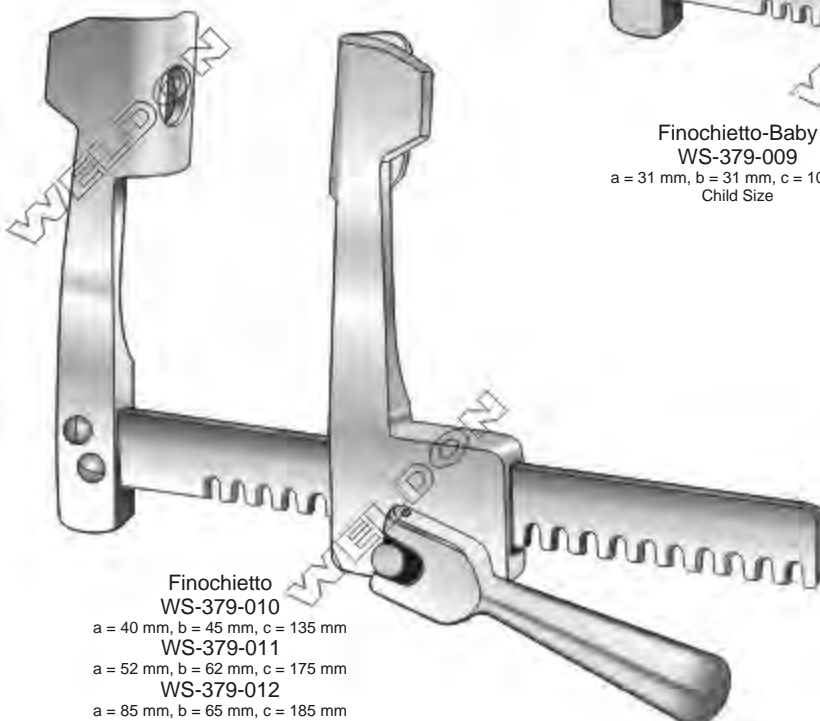

Finochietto
WS-379-010
 a = 40 mm, b = 45 mm, c = 135 mm
WS-379-011
 a = 52 mm, b = 62 mm, c = 175 mm
WS-379-012
 a = 85 mm, b = 65 mm, c = 185 mm

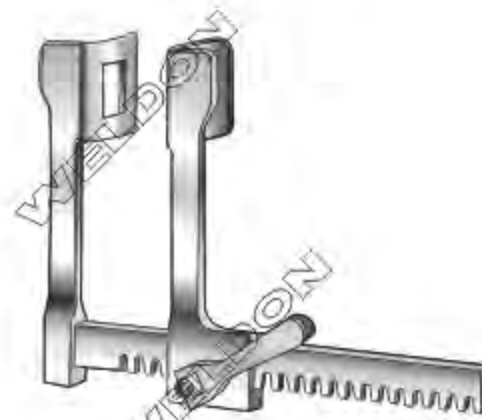
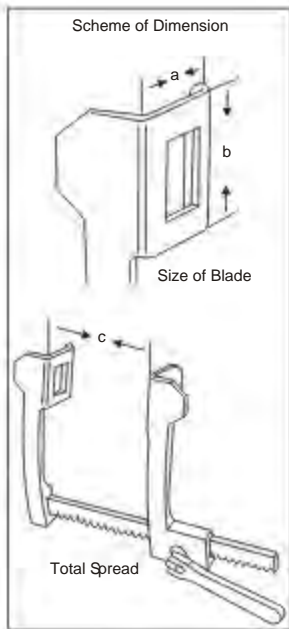

Finochietto
WS-380-013
a = 14 mm, b = 15 mm, c = 75 mm
Baby

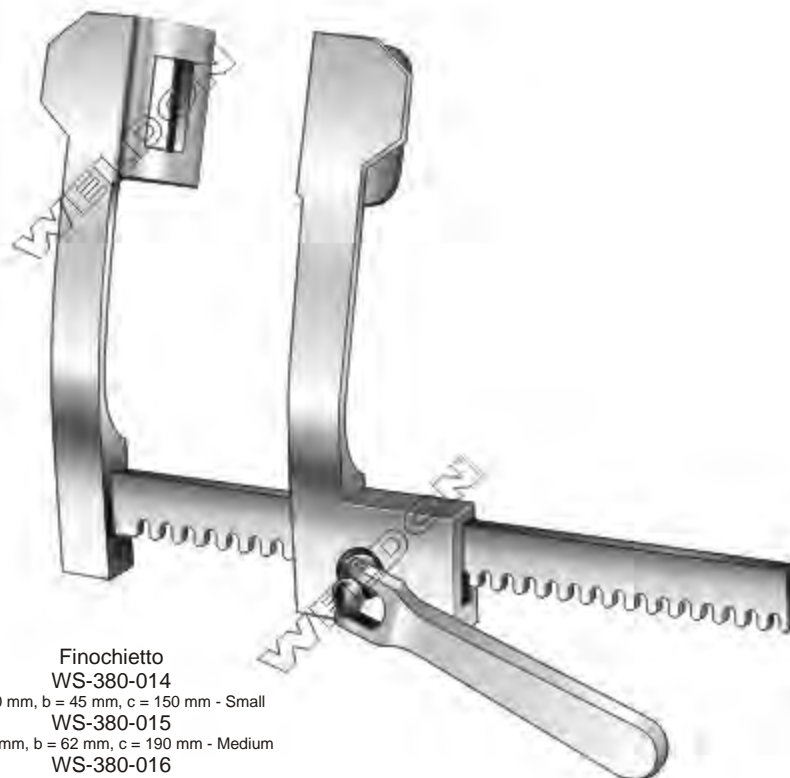

Finochietto
WS-380-014
a = 30 mm, b = 45 mm, c = 150 mm - Small
WS-380-015
a = 46 mm, b = 62 mm, c = 190 mm - Medium
WS-380-016
a = 80 mm, b = 65 mm, c = 250 mm - Large

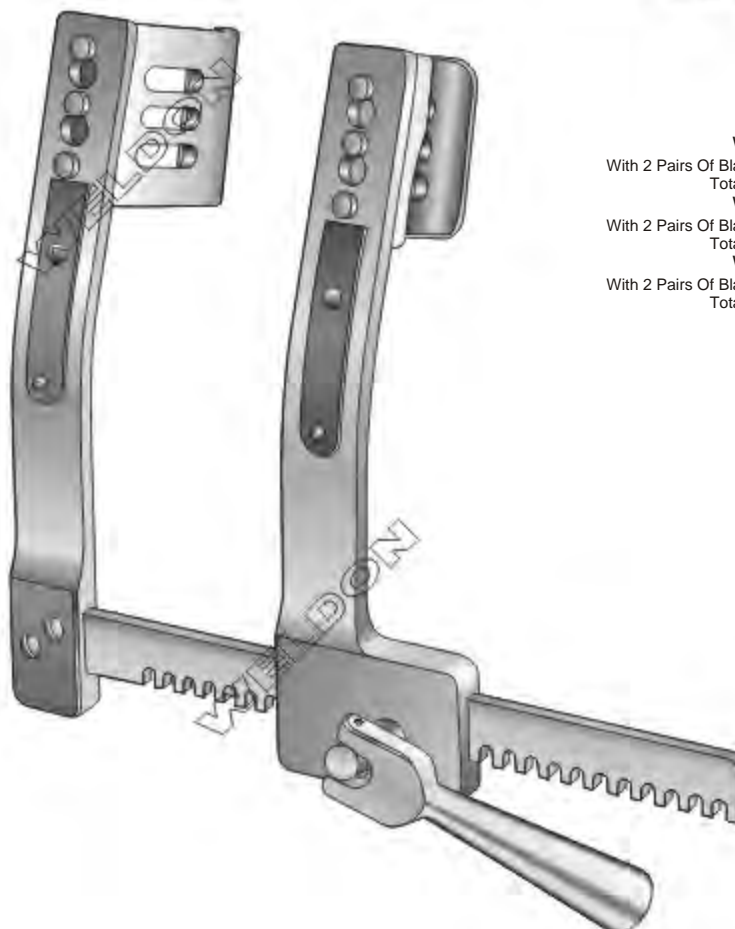
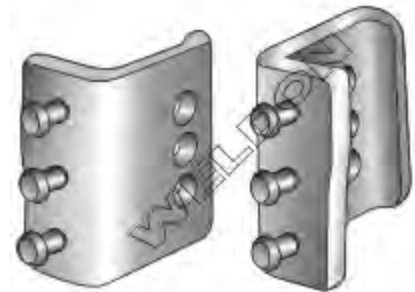
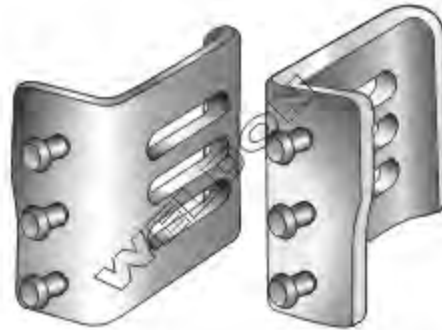
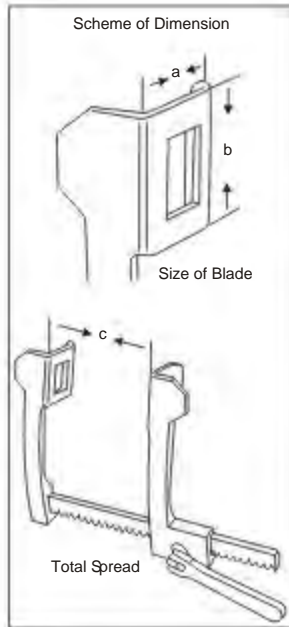

- Burford**
WS-381-017
 With 2 Pairs Of Blades = 47 X 62 mm & 65 X 62 mm
 Total Spread = 200 mm
WS-381-018
 With 2 Pairs Of Blades = 47 X 62 mm & 65 X 62 mm
 Total Spread = 260 mm
WS-381-019
 With 2 Pairs Of Blades = 47 X 62 mm & 65 X 62 mm
 Total Spread = 300 mm

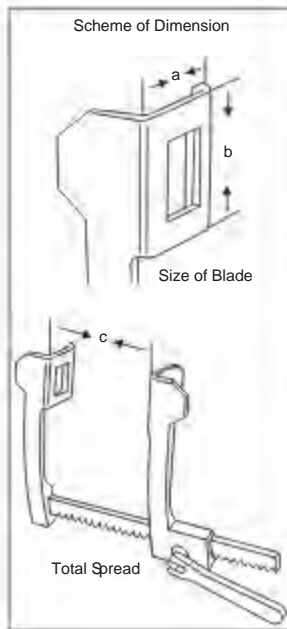

Castañeda
WS-382-020
 Laterals Blades = 10.5 x 32 mm
 Total Spread = 65 mm
 For Babies



Castañeda
WS-382-021
 Laterals Blades = 12 x 45 mm
 Total Spread = 70 mm
 For Infants



Castañeda
WS-382-022
 Lateral Blades = 15 x 60 mm
 Total Spread = 120 mm
 For Infants

Scheme of Dimension

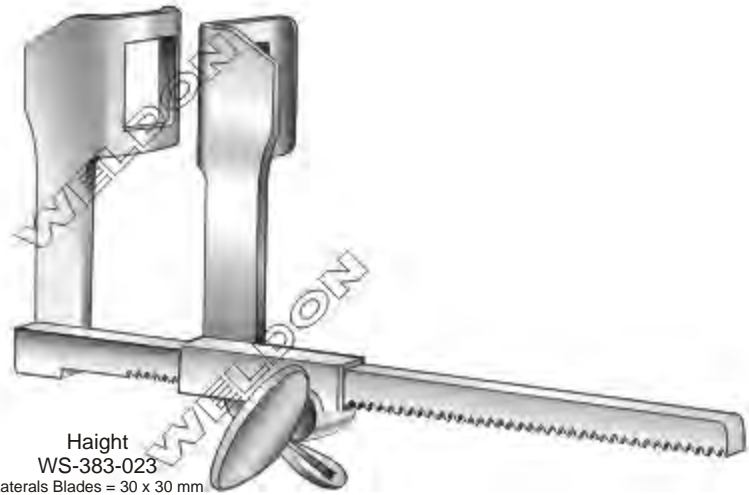
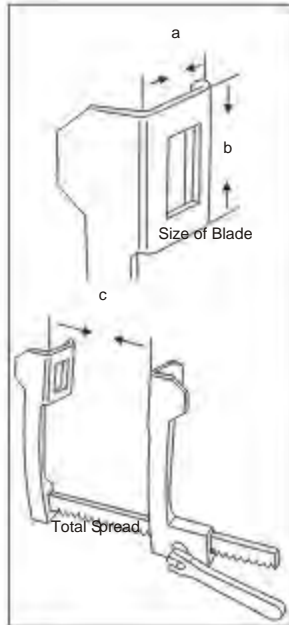

Haight
WS-383-023
Lateral Blades = 30 x 30 mm
Total Spread = 120 mm

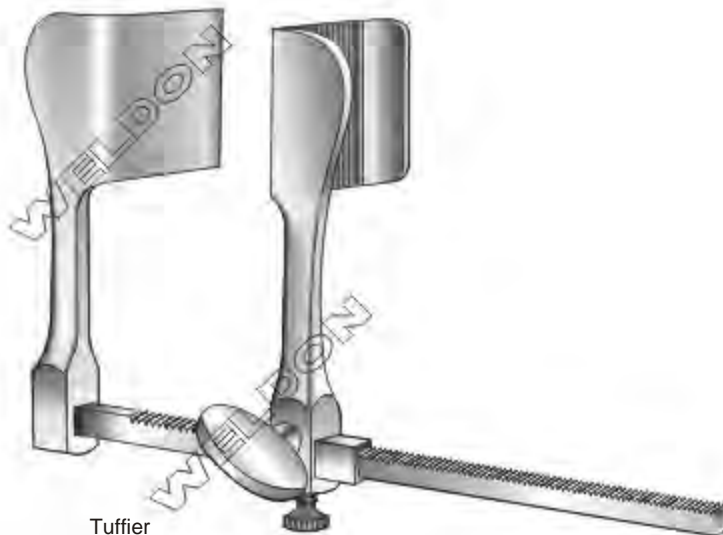

Tuffier
WS-383-024
Lateral Blades = 45 x 45 mm
Total Spread = 160 mm

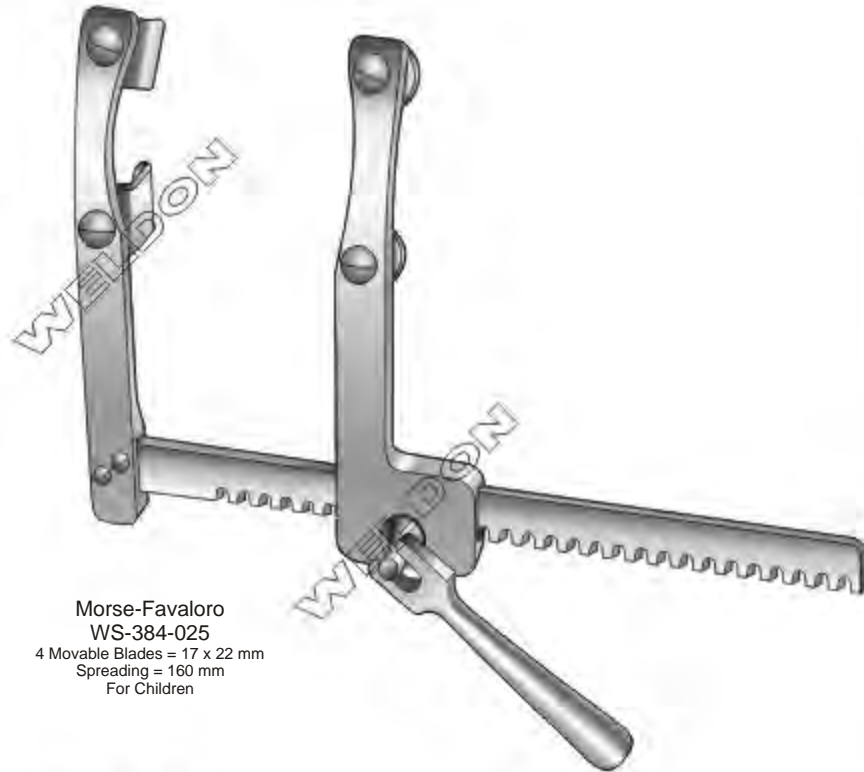

Morse-Favaloro
WS-384-025
4 Movable Blades = 17 x 22 mm
Spreading = 160 mm
For Children

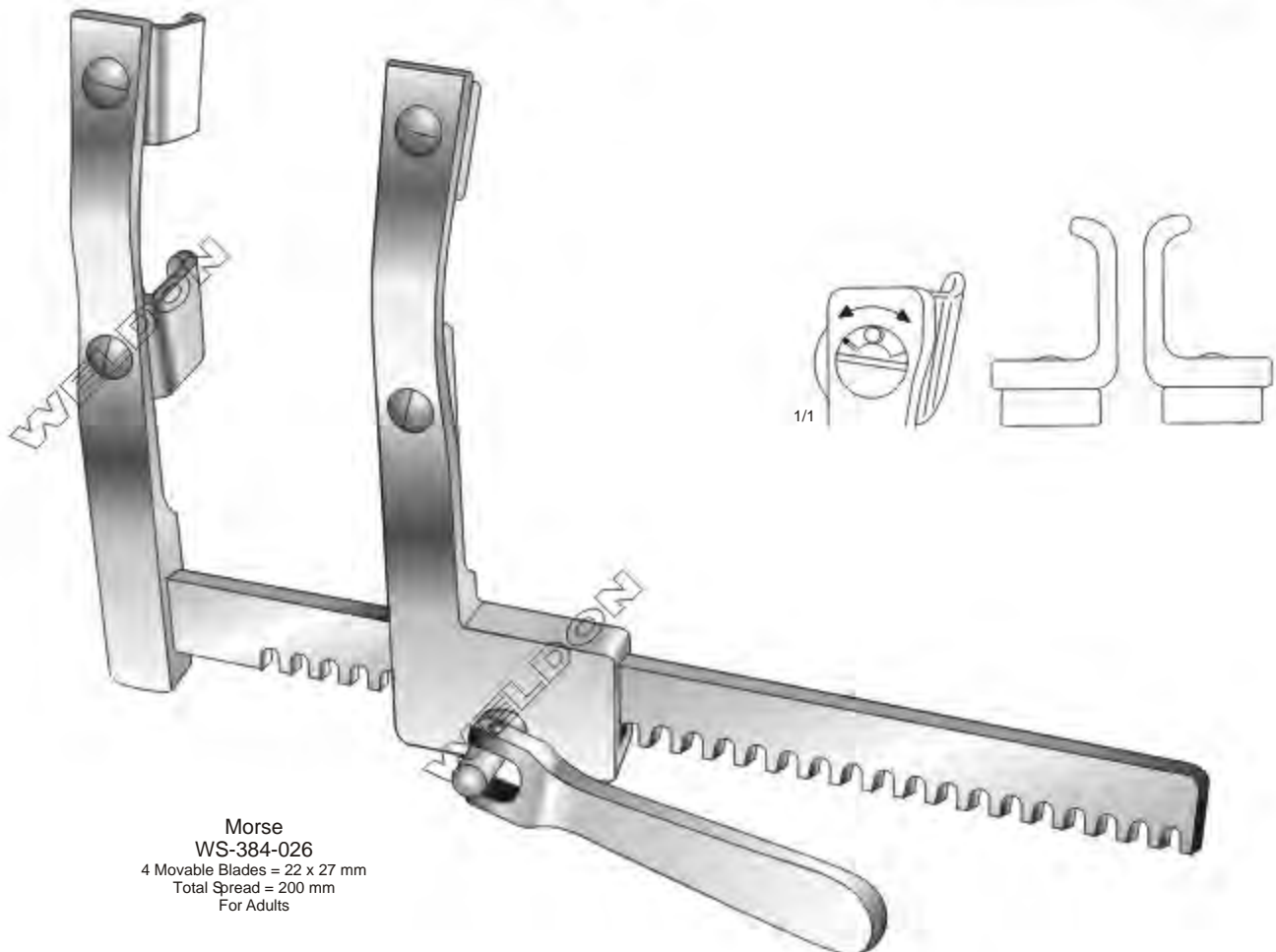
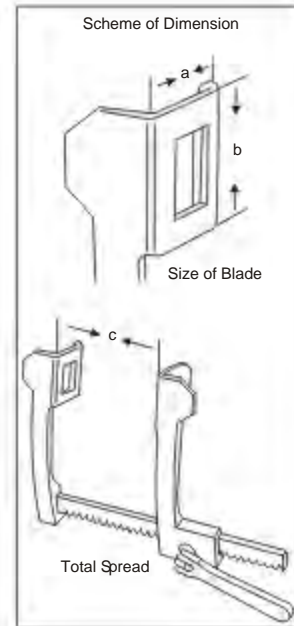

Morse
WS-384-026
4 Movable Blades = 22 x 27 mm
Total Spread = 200 mm
For Adults

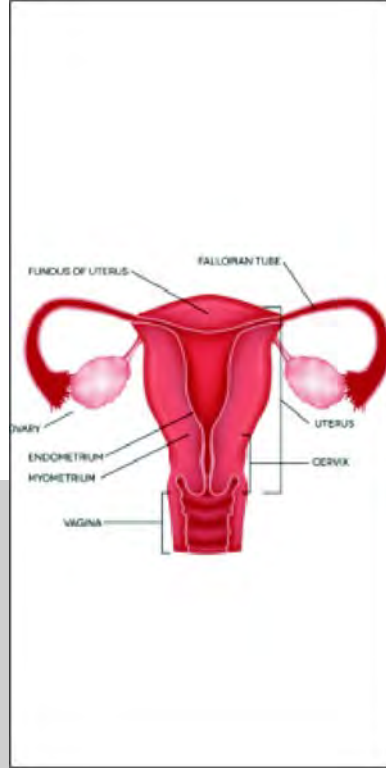

www.weldoninstruments.com

PROVEEDOR EXCLUSIVO:



Vaginal Specula

Vaginal Retractors

Uterine Curette & Scoops

Obstetrical Forceps

385 - 424

Gynecology

Gynecology

Ginecologia

Gynakologie



WS-385-001 \varnothing 25 mm
 WS-385-002 \varnothing 30 mm
 WS-385-003 \varnothing 35 mm

Fergusson
 Metal Specula
 Tubular Shape

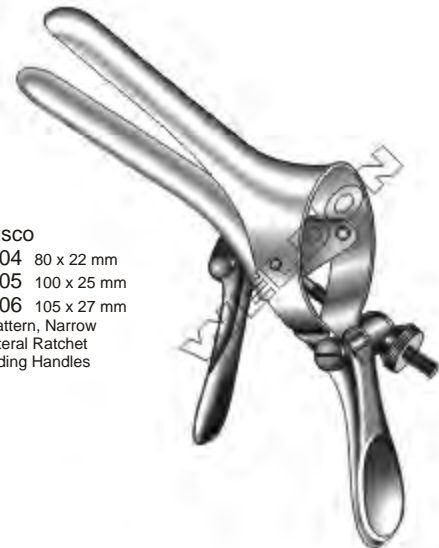

Cusco
 WS-385-004 80 x 22 mm
 WS-385-005 100 x 25 mm
 WS-385-006 105 x 27 mm
 Swiss Pattern, Narrow
 With Lateral Ratchet
 With Folding Handles



Cusco
 WS-385-007
 75 x 17 mm
 Conical Shape, Virgin Size



Cusco
 WS-385-008 75 x 32 mm
 WS-385-009 85 x 35 mm
 WS-385-010 100 x 35 mm
 Vaginal Specula With Lateral
 Ratchet, With Folding Handles

WS-385-011 85 x 35 mm
 With Interchangeable Fiber Optic Light Carrier

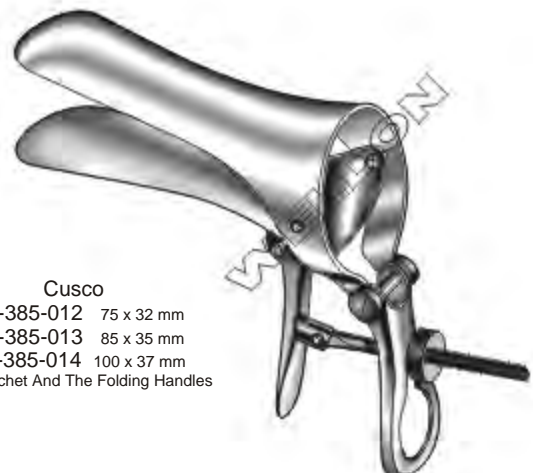

Cusco
 WS-385-012 75 x 32 mm
 WS-385-013 85 x 35 mm
 WS-385-014 100 x 37 mm
 With Ratchet And The Folding Handles

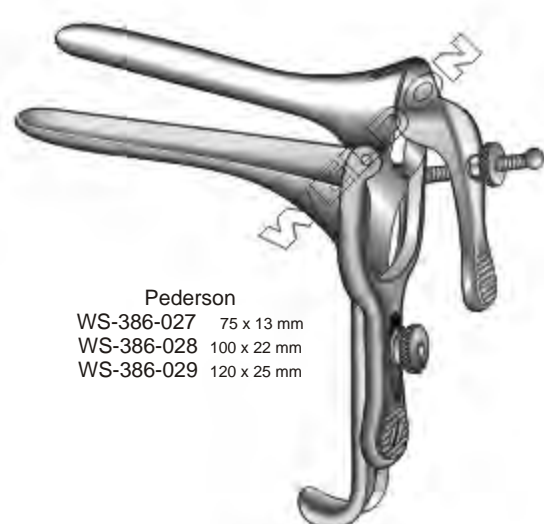
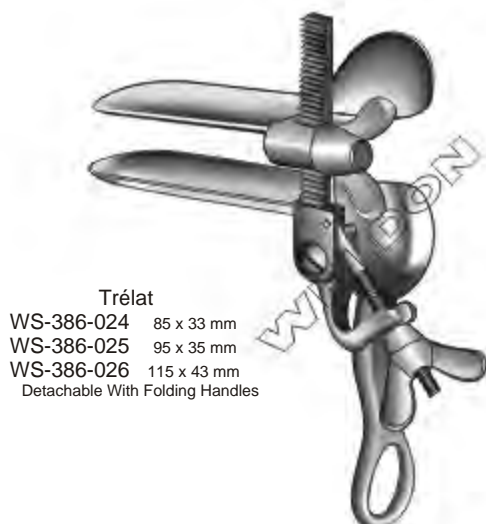
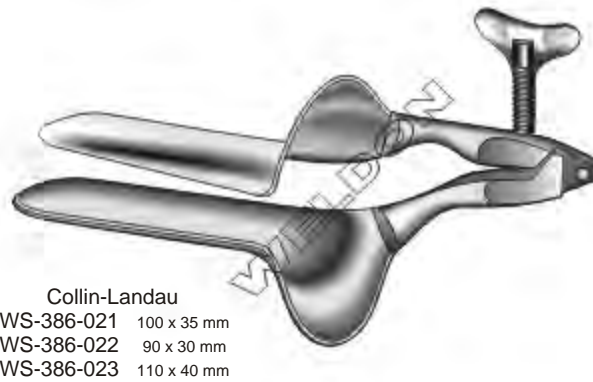
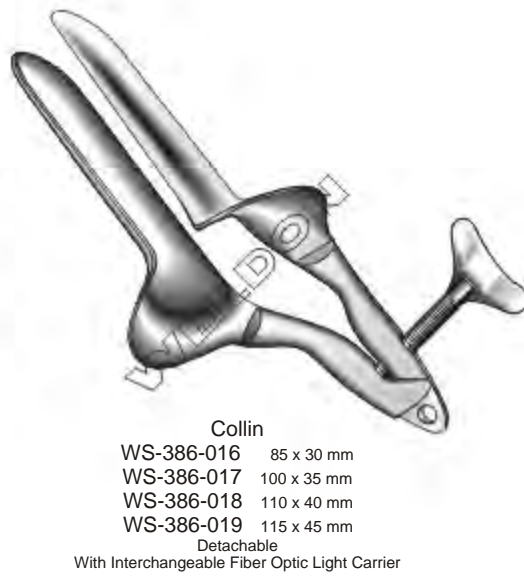
Vaginal Specula | Espéculos Vaginales | Vaginalspekula

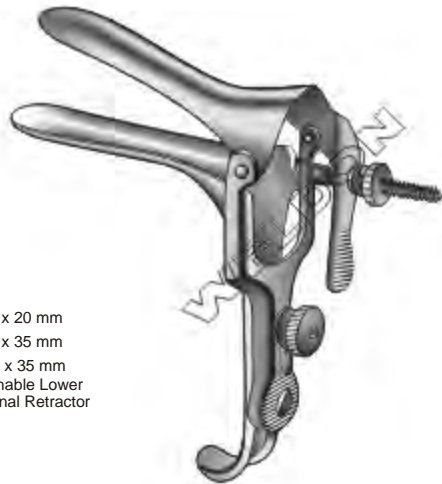

Grave
 WS-387-030 75 x 20 mm
 WS-387-031 95 x 35 mm
 WS-387-032 115 x 35 mm
 With Lateral Ratchet, Detachable Lower Blade, Convertible Into Vaginal Retractor

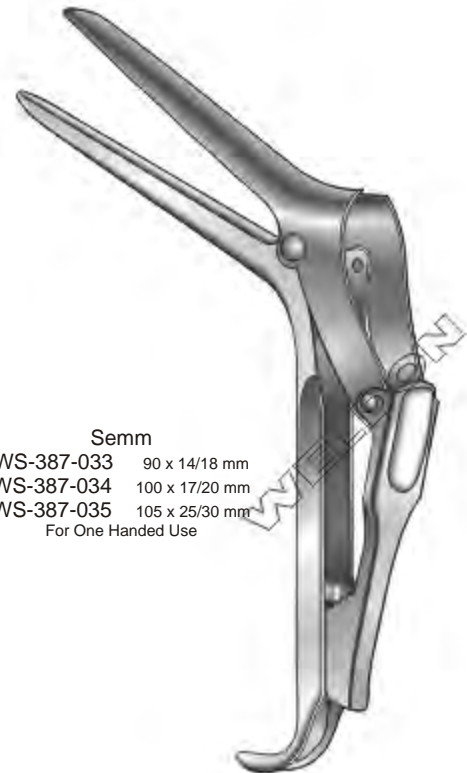

Semm
 WS-387-033 90 x 14/18 mm
 WS-387-034 100 x 17/20 mm
 WS-387-035 105 x 25/30 mm
 For One Handed Use

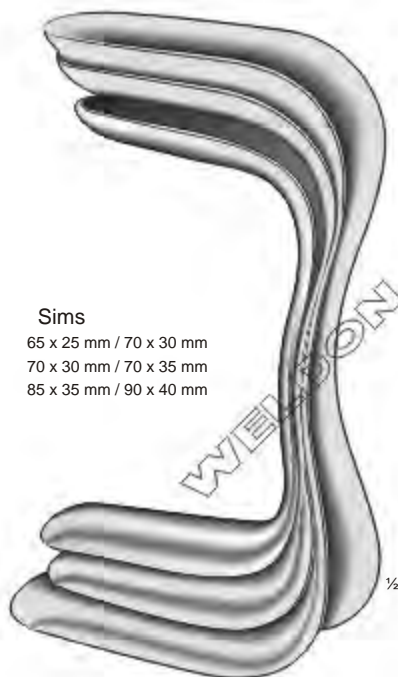

Sims
 WS-387-036 65 x 25 mm / 70 x 30 mm
 WS-387-037 70 x 30 mm / 70 x 35 mm
 WS-387-038 85 x 35 mm / 90 x 40 mm

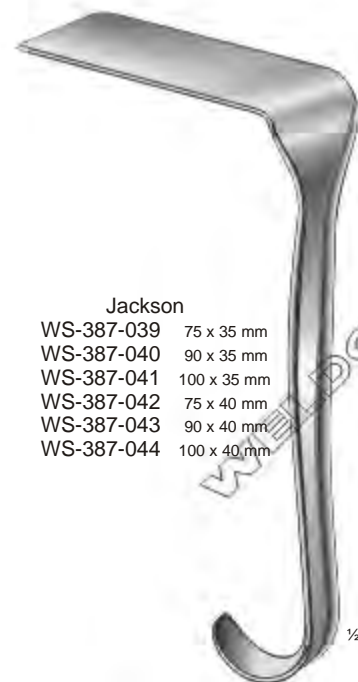

Jackson
 WS-387-039 75 x 35 mm
 WS-387-040 90 x 35 mm
 WS-387-041 100 x 35 mm
 WS-387-042 75 x 40 mm
 WS-387-043 90 x 40 mm
 WS-387-044 100 x 40 mm

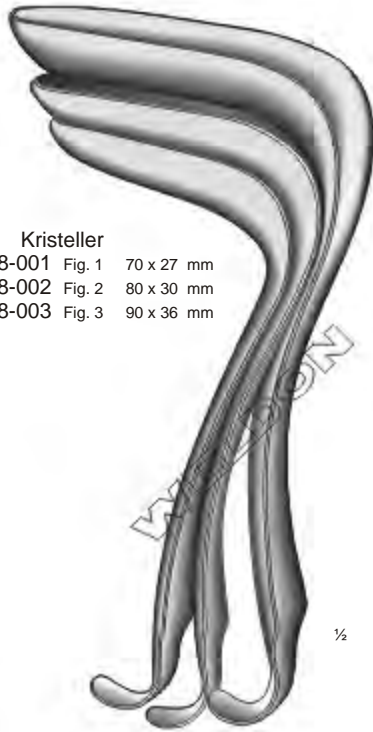
Vaginal Retractors | Valvas Vaginales | Scheidenhalter

Kristeller
 WS-388-001 Fig. 1 70 x 27 mm
 WS-388-002 Fig. 2 80 x 30 mm
 WS-388-003 Fig. 3 90 x 36 mm



Kristeller
 WS-388-004 Fig. 1 75 x 23 mm
 WS-388-005 Fig. 2 85 x 26 mm
 WS-388-006 Fig. 3 100 x 32 mm



Kristeller
 WS-388-007 Fig. 1
 WS-388-008 Fig. 2
 WS-388-009 Fig. 3
 Set of 1 Speculum And
 1 Retractor Each

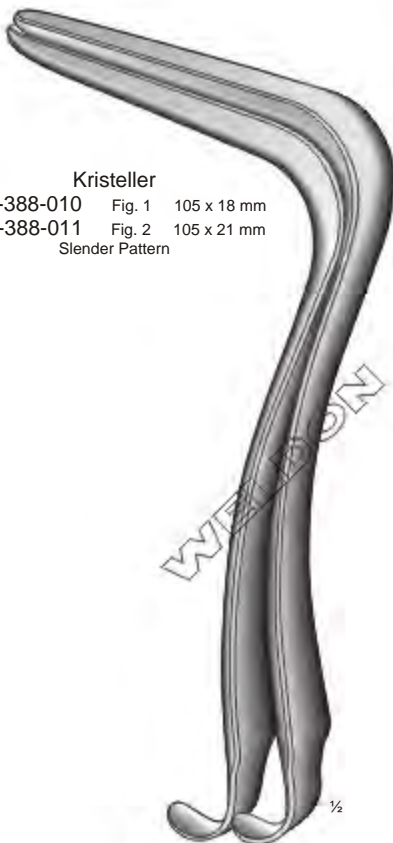

Kristeller
 WS-388-010 Fig. 1 105 x 18 mm
 WS-388-011 Fig. 2 105 x 21 mm
 Slender Pattern

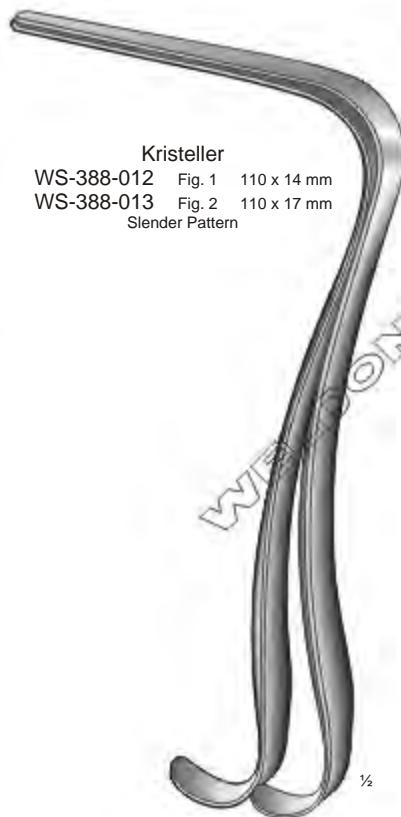

Kristeller
 WS-388-012 Fig. 1 110 x 14 mm
 WS-388-013 Fig. 2 110 x 17 mm
 Slender Pattern



Kristeller
 WS-388-014 Fig.1+1
 WS-388-015 Fig.2+2
 Set of 1 Speculum & 1 Retractor

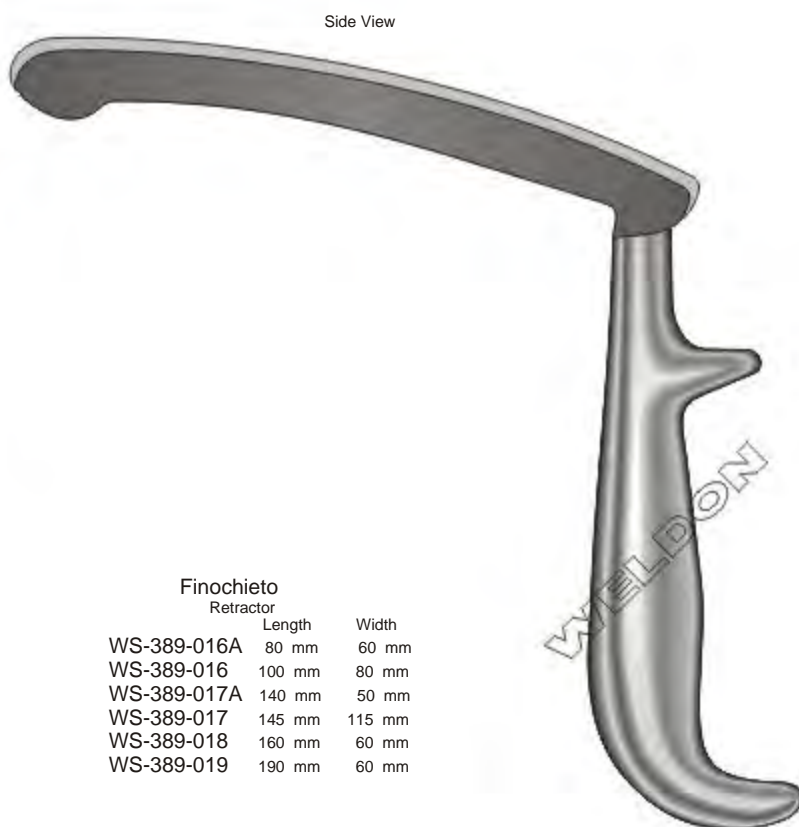

Finochieto
Retractor

	Length	Width
WS-389-016A	80 mm	60 mm
WS-389-016	100 mm	80 mm
WS-389-017A	140 mm	50 mm
WS-389-017	145 mm	115 mm
WS-389-018	160 mm	60 mm
WS-389-019	190 mm	60 mm

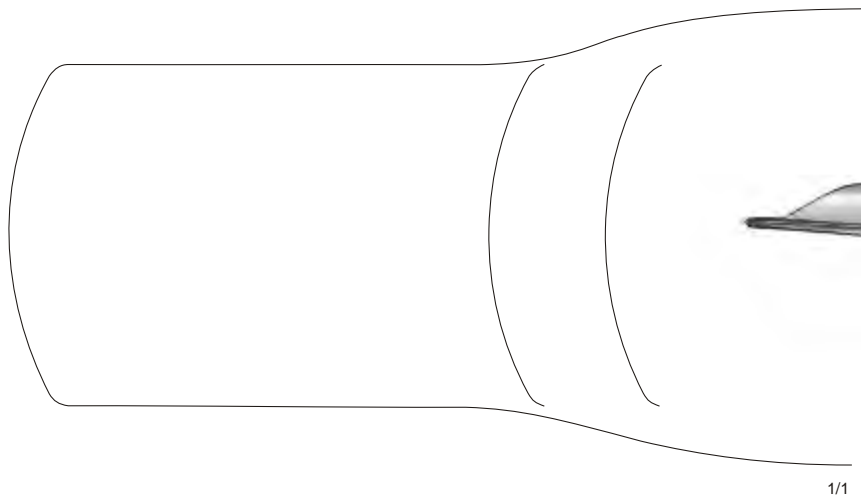

1/1

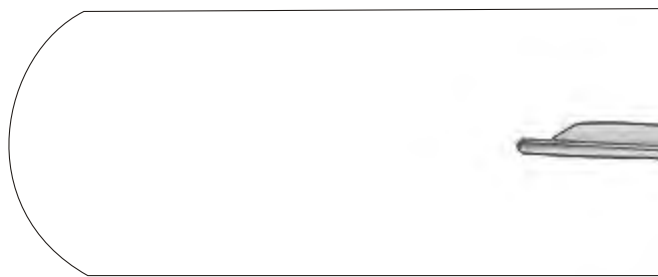

1/1

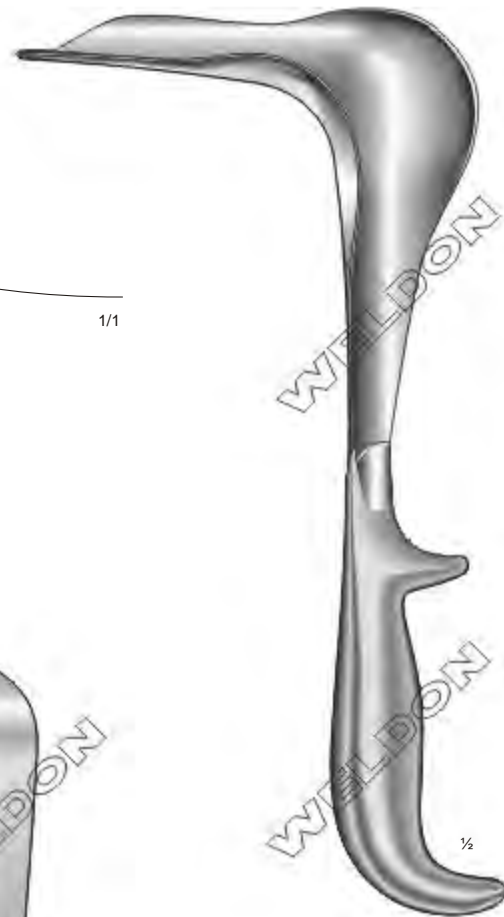

1/2

Doyen

	Fig	a mm	b mm
WS-390-031	1	75	45
WS-390-032	2	90	45
WS-390-033	3	110	45

WS-390-020 Fig. 1 55 x 35 mm
 WS-390-021 Fig. 2 85 x 35 mm
 WS-390-022 Fig. 3 115 x 35 mm

WS-390-023 Fig. 1 55 x 45 mm
 WS-390-024 Fig. 2 85 x 45 mm
 WS-390-025 Fig. 3 115 x 45 mm
 WS-390-026 Fig. 4 160 x 45 mm

WS-390-027 Fig. 1 55 x 60 mm
 WS-390-028 Fig. 2 85 x 60 mm
 WS-390-029 Fig. 3 115 x 60 mm
 WS-390-030 Fig. 4 160 x 60 mm
 Slightly Concave



1/2

Doyen



Kallmorgen Specula
 WS-391-034 70 x 40 mm, Fig. 1
 WS-391-035 90 x 40 mm, Fig. 2
 18.5 cm / 7¼"



Kallmorgen Retractor
 WS-391-036 70 x 33 mm, Fig. 1
 WS-391-037 90 x 33 mm, Fig. 2
 18.5 cm / 7¼"



Kallmorgen
 WS-391-038 Fig. 1+1
 WS-391-039 Fig. 2+2
 Set Of Two

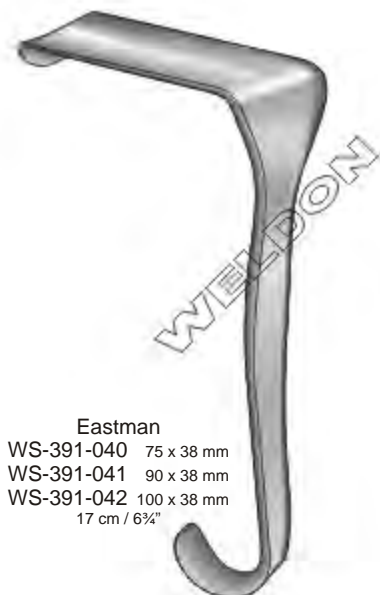

Eastman
 WS-391-040 75 x 38 mm
 WS-391-041 90 x 38 mm
 WS-391-042 100 x 38 mm
 17 cm / 6¾"

Vaginal Retractors | Valvas Vaginales | Scheidenhalter

Kristeller
 WS-392-043 Fig.0 - 110 x 20 mm
 WS-392-044 Fig.1 - 110 x 27 mm
 WS-392-045 Fig.2 - 110 x 30 mm
 WS-392-046 Fig.3 - 110 x 36 mm
 23 cm / 9"
 For Virgins, Vienna Pattern



Kristeller
 WS-392-047 Fig.0 - 115 x 17 mm
 WS-392-048 Fig.1 - 115 x 23 mm
 WS-392-049 Fig.2 - 115 x 26 mm
 WS-392-050 Fig.3 - 115 x 32 mm
 23 cm / 9"
 Vienna Pattern



Mathieu
 WS-392-051 Fig.1 - 100 x 13-23 mm
 WS-392-052 Fig.2 - 100 x 17-30 mm
 20 cm / 8"



Mathieu
 WS-392-053 Fig.1 - 100 x 11-21 mm
 WS-392-054 Fig.2 - 100 x 15-27 mm
 20 cm / 8"

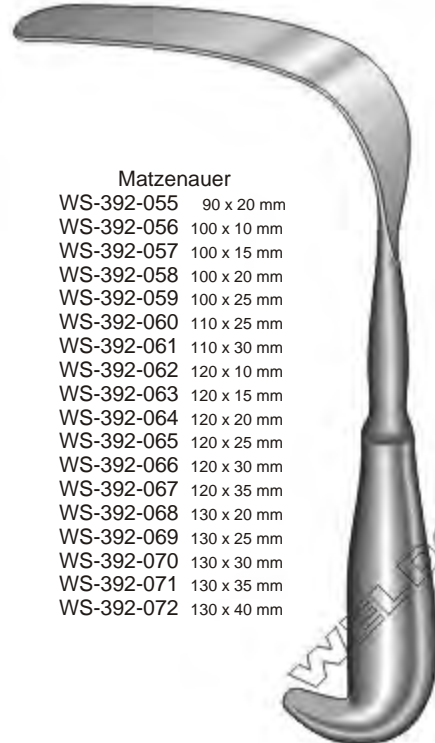

Matzenauer
 WS-392-055 90 x 20 mm
 WS-392-056 100 x 10 mm
 WS-392-057 100 x 15 mm
 WS-392-058 100 x 20 mm
 WS-392-059 100 x 25 mm
 WS-392-060 110 x 25 mm
 WS-392-061 110 x 30 mm
 WS-392-062 120 x 10 mm
 WS-392-063 120 x 15 mm
 WS-392-064 120 x 20 mm
 WS-392-065 120 x 25 mm
 WS-392-066 120 x 30 mm
 WS-392-067 120 x 35 mm
 WS-392-068 130 x 20 mm
 WS-392-069 130 x 25 mm
 WS-392-070 130 x 30 mm
 WS-392-071 130 x 35 mm
 WS-392-072 130 x 40 mm

22 cm / 8 3/4"



Landau
 WS-393-073 100 x 28 mm
 WS-393-074 110 x 38 mm
 29 cm / 11³/₈"



Breisky
 32 cm / 12¹/₂" - 42 cm / 16¹/₂"
 Vienna Pattern

- WS-393-075 130 x 20 mm
- WS-393-076 130 x 25 mm
- WS-393-077 130 x 30 mm
- WS-393-078 130 x 35 mm
- WS-393-079 130 x 40 mm
- WS-393-080 140 x 35 mm
- WS-393-081 140 x 40 mm
- WS-393-082 140 x 45 mm
- WS-393-083 150 x 25 mm
- WS-393-084 150 x 30 mm
- WS-393-085 150 x 35 mm
- WS-393-086 155 x 40 mm
- WS-393-087 160 x 30 mm
- WS-393-088 160 x 45 mm
- WS-393-089 170 x 30 mm
- WS-393-090 170 x 35 mm
- WS-393-091 180 x 40 mm
- WS-393-092 200 x 25 mm
- WS-393-093 220 x 25 mm
- WS-393-094 220 x 35 mm
- WS-393-095 220 x 40 mm
- WS-393-096 240 x 20 mm



Breisky
 28 cm / 11" - 31 cm / 12¹/₈"
 Vienna Pattern

- WS-393-097 80 x 25 mm
- WS-393-098 90 x 25 mm
- WS-393-099 100 x 10 mm
- WS-393-100 100 x 15 mm
- WS-393-101 100 x 20 mm
- WS-393-102 100 x 25 mm
- WS-393-103 100 x 30 mm
- WS-393-104 100 x 35 mm
- WS-393-105 100 x 40 mm
- WS-393-106 110 x 20 mm
- WS-393-107 110 x 25 mm
- WS-393-108 110 x 30 mm
- WS-393-109 120 x 10 mm
- WS-393-110 120 x 15 mm
- WS-393-111 120 x 20 mm
- WS-393-112 120 x 25 mm
- WS-393-113 120 x 30 mm
- WS-393-114 120 x 35 mm
- WS-393-115 120 x 40 mm

70 x 30 cm



Doyen
WS-394-116
24 cm / 9½"

75 x 38 cm



Auvard
WS-394-117
24 cm / 9½"

80 x 38 cm



Auvard
WS-394-118
24 cm / 9½"

Uterine Dilators | Dilatores Uterinos | Uterusdilatoren



Hegar
Single Ended
Pieces Per Set
WS-395-001 14 4 - 17 mm
WS-395-002 26 1 - 26 mm

	Ø mm		Ø mm
WS-395-003	1.0	WS-395-024	11.5
WS-395-004	1.5	WS-395-025	12.0
WS-395-005	2.0	WS-395-026	12.5
WS-395-006	2.5	WS-395-027	13.0
WS-395-007	3.0	WS-395-028	13.5
WS-395-008	3.5	WS-395-029	14.0
WS-395-009	4.0	WS-395-030	14.5
WS-395-010	4.5	WS-395-031	15.0
WS-395-011	5.0	WS-395-032	15.5
WS-395-012	5.5	WS-395-033	16.0
WS-395-013	6.0	WS-395-034	16.5
WS-395-014	6.5	WS-395-035	17.0
WS-395-015	7.0	WS-395-036	17.5
WS-395-016	7.5	WS-395-037	18.0
WS-395-017	8.0	WS-395-038	19.0
WS-395-018	8.5	WS-395-039	20.0
WS-395-019	9.0	WS-395-040	21.0
WS-395-020	9.5	WS-395-041	22.0
WS-395-021	10.0	WS-395-042	23.0
WS-395-022	10.5	WS-395-043	24.0
WS-395-023	11.0	WS-395-044	25.0
		WS-395-045	26.0

	Ø mm
WS-395-003A	1.0
WS-395-004A	1.5
WS-395-005A	2.0
WS-395-006A	2.5
WS-395-007A	3.0
WS-395-008A	3.5
WS-395-009A	4.0
WS-395-010A	4.5
WS-395-011A	5.0
WS-395-012A	5.5
WS-395-013A	6.0
WS-395-014A	6.5
WS-395-015A	7.0
WS-395-016A	7.5
WS-395-017A	8.0
WS-395-018A	8.5
WS-395-019A	9.0
WS-395-020A	9.5
WS-395-021A	10.0
WS-395-022A	10.5
WS-395-023A	11.0
WS-395-024A	11.5
WS-395-025A	12.0
WS-395-026A	12.5
WS-395-027A	13.0
WS-395-028A	13.5
WS-395-029A	14.0
WS-395-030A	14.5
WS-395-031A	15.0
WS-395-032A	15.5
WS-395-033A	16.0
WS-395-034A	16.5
WS-395-035A	17.0
WS-395-036A	17.5
WS-395-037A	18.0
WS-395-038A	18.5
WS-395-039A	19.0
WS-395-040A	19.5
WS-395-041A	20.0
WS-395-042A	20.5
WS-395-043A	21.0
WS-395-044A	21.5
WS-395-045A	22.0
WS-395-046A	22.5
WS-395-047A	23.0
WS-395-048A	23.5
WS-395-049A	24.0
WS-395-050A	24.5
WS-395-051A	25.0
WS-395-052A	25.5
WS-395-053A	26.0
WS-395-054A	26.5
WS-395-055A	27.0
WS-395-056A	27.5
WS-395-057A	28.0
WS-395-058A	28.5
WS-395-059A	29.0
WS-395-060A	29.5
WS-395-061A	30.0
WS-395-062A	30.5



Hegar
WS-395-046 Set of 8 Dilators
3 / 4 mm - 17 / 18 mm Ø
WS-395-047 Set of 13 Dilators
1 / 2 mm - 25 / 26 mm Ø
Double Ended

	Ø mm
WS-395-048	1.0 / 2.0
WS-395-049	3.0 / 4.0
WS-395-050	5.0 / 6.0
WS-395-051	7.0 / 8.0
WS-395-052	9.0 / 10.0
WS-395-053	11.0 / 12.0
WS-395-054	13.0 / 14.0
WS-395-055	15.0 / 16.0
WS-395-056	17.0 / 18.0
WS-395-057	19.0 / 20.0
WS-395-058	21.0 / 22.0
WS-395-059	23.0 / 24.0
WS-395-060	25.0 / 26.0



Hegar Uterine Dilators
With Ring Handle

Uterine Dilators | Dilataores Uterinos | Uterusdilatoren

Hegar
WS-396-061
 Set of 8 Pieces
 From 3 / 4 mm to 17 / 18 mm Ø
 In Boilable Canvas Roll



WS-396-078



Female Catheter
WS-396-076
 15 cm / 6"



WS-396-079



WS-396-080



WS-396-081



WS-396-082



WS-396-083B
 13 x 4 mm



WS-396-083C
 20 x 11 mm



WS-396-083D
 22 x 13 mm



Flebo Extractor
WS-396-083A
 50 cm / 19½"
 1.2 mm Diameter



Pratt
WS-396-062 Fig. 13/15 (4½ / 5 mm)
WS-396-063 Fig. 17/19 (5½ / 6½ mm)
WS-396-064 Fig. 21/23 (7 / 7½ mm)
WS-396-065 Fig. 25/27 (8½ / 9 mm)
WS-396-066 Fig. 29/31 (9½ / 10½ mm)
WS-396-067 Fig. 33/35 (11 / 11½ mm)
WS-396-068 Fig. 37/39 (12½ / 13 mm)
WS-396-069 Fig. 41/43 (13½ / 14½ mm)
 French Scale Sizes



Hank
WS-396-070 Fig. 9/10 (4½ / 5 mm)
WS-396-071 Fig. 11/12 (5½ / 6 mm)
WS-396-072 Fig. 13/14 (6½ / 7 mm)
WS-396-073 Fig. 15/16 (7½ / 8 mm)
WS-396-074 Fig. 17/18 (8½ / 9 mm)
WS-396-075 Fig. 19/20 (9½ / 10 mm)
 American Scale Sizes

Rubinstein Canula
WS-396-077
 28 cm / 11"

Risolia Canula
WS-396-083
 Handle Only
WS-396-084
 Complete With 4 Cones
 28 cm / 11"



Simpson
WS-397-001
27 cm / 10 3/4"
Malleable
Graduated in Inches

Simpson
WS-397-002
27 cm / 10 3/4"
Rigid
Graduated in Inches

Valleix
WS-397-003
28 cm / 11"
Rigid
Graduated in cm

Sims
WS-397-004 Malleable
WS-397-005 Rigid
32 cm / 12 1/2"
Graduated in cm

Sims
WS-397-006 Malleable
WS-397-007 Rigid
33 cm / 13"
With Probe
Graduated in cm

Collin
WS-397-007A
28 cm / 11"
Uterine Sound
Graduated in cm

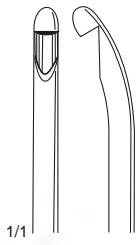
Suction Curettes, Uterine Biopsy Curettes | Curetas Aspiradoras, Curetas Para Biopsia
Saugkürretten, Biopsiekürretten

1/1

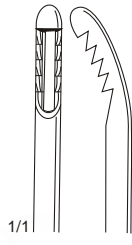

1/1

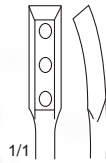

1/1



1/1

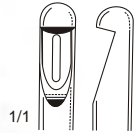

1/1

Randall
WS-398-008
 24 cm / 9½"
 4 mm Ø

 Endometrial Suction Biopsy Curettes
 With Luer-Lock Connection

Novak
WS-398-009
 23 cm / 9"
 4 mm Ø

With Luer-Lock Connection

Kevorkian
WS-398-010
 30 cm / 12"
 6 mm Ø

With Basket

Kevorkian
WS-398-011
 30 cm / 12"
 6 mm Ø

Without Basket

München
WS-398-012
 27 cm / 10½"
 4.8 mm Ø



Recamier-Sims-Bumm
31 cm / 12½"
Fig.00-Fig.16
Rigid, Sharp

Recamier-Sims-Bumm
31 cm / 12½"
Fig.00-Fig.16
Malleable, Sharp

Sharp Curettes
(Recamier Handle)

Blunt Curettes
(Sims Handle)

Recamier-Sims-Bumm
31 cm / 12½"
Fig.00-Fig.16
Rigid, Blunt

Recamier-Sims-Bumm
31 cm / 12½"
Fig.00-Fig.16
Malleable, Blunt

Uterine Curettes | Curetas Uterinas | Uterusküretten

Fig.	Width	Rigid, Sharp	Malleable, Sharp	Rigid, Blunt	Malleable, Blunt
00	5 mm	WS-400-013	WS-400-031	WS-400-049	WS-400-067
0	6 mm	WS-400-014	WS-400-032	WS-400-050	WS-400-068
1	7 mm	WS-400-015	WS-400-033	WS-400-051	WS-400-069
2	8 mm	WS-400-016	WS-400-034	WS-400-052	WS-400-070
3	9 mm	WS-400-017	WS-400-035	WS-400-053	WS-400-071
4	11 mm	WS-400-018	WS-400-036	WS-400-054	WS-400-072
5	12 mm	WS-400-019	WS-400-037	WS-400-055	WS-400-073
6	14 mm	WS-400-020	WS-400-038	WS-400-056	WS-400-074
7	15 mm	WS-400-021	WS-400-039	WS-400-057	WS-400-075
8	16 mm	WS-400-022	WS-400-040	WS-400-058	WS-400-076
9	19 mm	WS-400-023	WS-400-041	WS-400-059	WS-400-077
10	20 mm	WS-400-024	WS-400-042	WS-400-060	WS-400-078
11	21 mm	WS-400-025	WS-400-043	WS-400-061	WS-400-079
12	23 mm	WS-400-026	WS-400-044	WS-400-062	WS-400-080
13	25 mm	WS-400-027	WS-400-045	WS-400-063	WS-400-081
14	30 mm	WS-400-028	WS-400-046	WS-400-064	WS-400-082
15	35 mm	WS-400-029	WS-400-047	WS-400-065	WS-400-083
16	40 mm	WS-400-030	WS-400-048	WS-400-066	WS-400-084

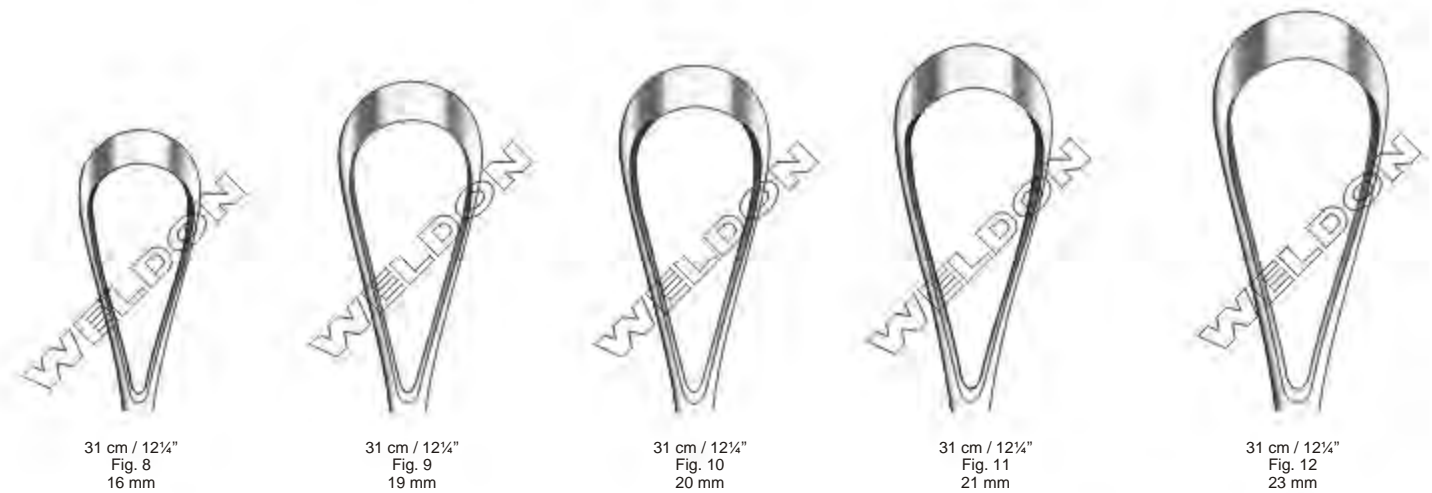
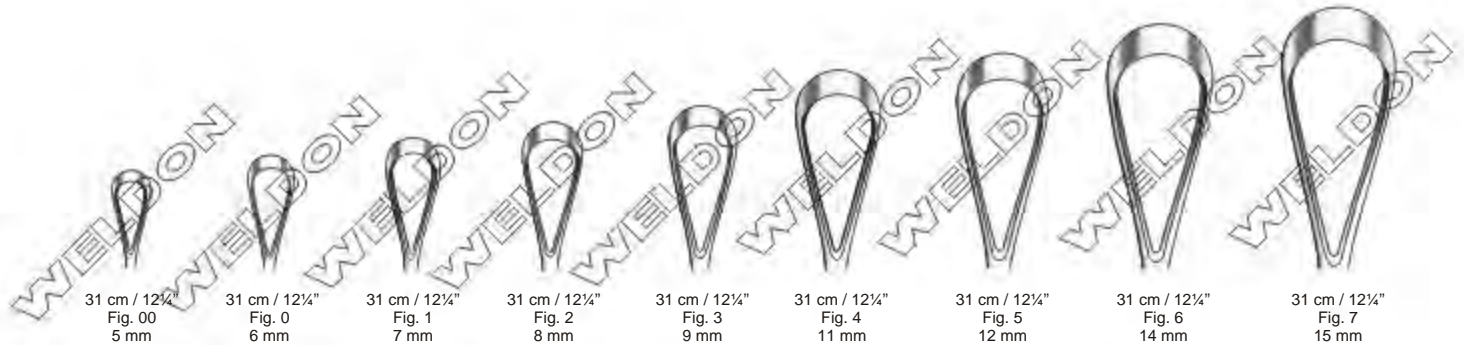

Recamier-Sims-Bumm

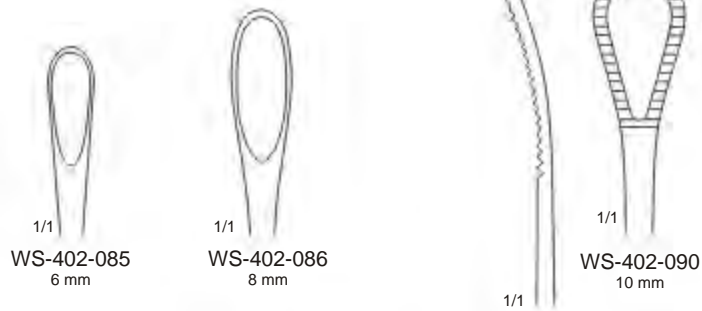
Uterine Scoops | Cucharillas Uterinas | Uteruslöffel

Gourdet
28 cm / 11"



Greene
28 cm / 11"
Malleable, Blunt



Sims (Herrera)
WS-402-093
25 cm / 10"



1/1

WS-403-094
9.8 x 6.8 mm



1/1

WS-403-095
11.6 x 8.3 mm



1/1

WS-403-096
13.2 x 10.0 mm



1/1

WS-403-097
16 x 11.6 mm



1/1

WS-403-098
18 x 12.6 mm



1/1

WS-403-099
20 x 13.8 mm



Simon
25 cm / 10"
Sharp, Rigid



1/1

WS-403-100
9.8 x 6.8 mm



1/1

WS-403-101
11.6 x 8.3 mm



1/1

WS-403-102
13.2 x 10.0 mm



1/1

WS-403-103
16 x 11.6 mm



1/1

WS-403-104
18 x 12.6 mm



1/1

WS-403-105
20 x 13.8 mm



Schroeder
31 cm / 12 1/4"
Sharp, Rigid

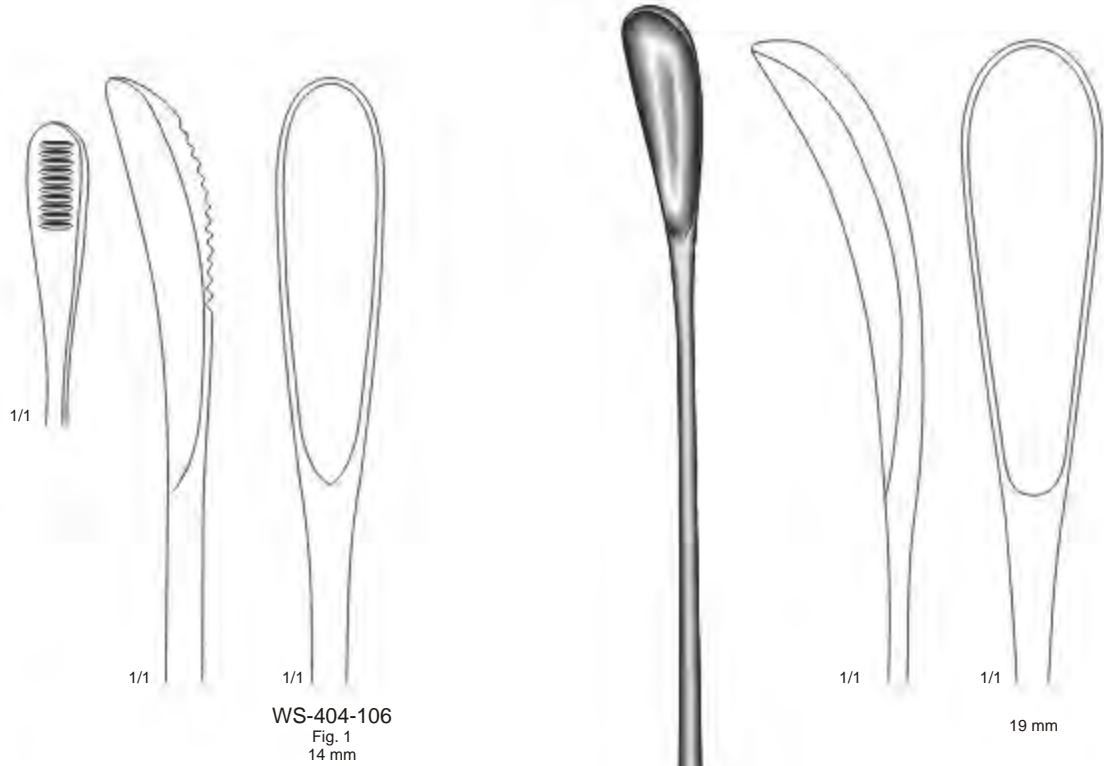

WS-404-106
Fig. 1
14 mm



Cuzzi
30 cm / 11 3/4"

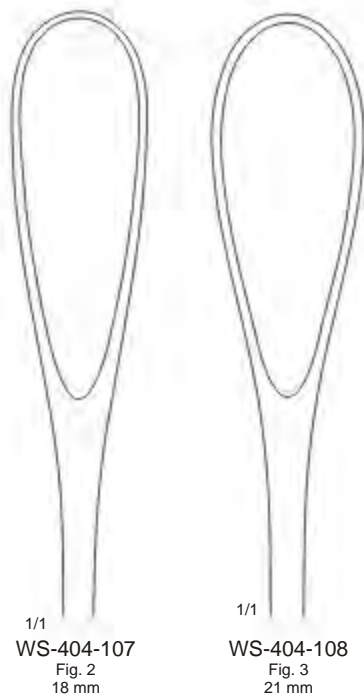

WS-404-107
Fig. 2
18 mm

WS-404-108
Fig. 3
21 mm



Wallich
WS-404-109
42 cm / 16 1/2"



Auxiliar Forceps
WS-405-001
36 cm / 14 1/4"



Sims
WS-405-002
26 cm / 10 1/2"
Vaginal Depressor



Braun
WS-405-003
31 cm / 12 1/8"



Smellie
WS-405-004
27 cm / 10 3/4"

Placenta and Ovum Forceps | Pinzas Para Aborto | Abortuszangen



Winter
28 cm / 11"



WS-406-005
Fig. 1



WS-406-006
Fig. 2



WS-406-007
Fig. 1



WS-406-008
Fig. 2



Ovum Forceps
WS-406-009
24 cm / 9½"
Straight



Placenta & Ovum Forceps
WS-406-010
32 cm / 12¼"
Curved

Uterine Tenaculum Forceps | Pinzas Para Cuello Uterino | Hakenzangen

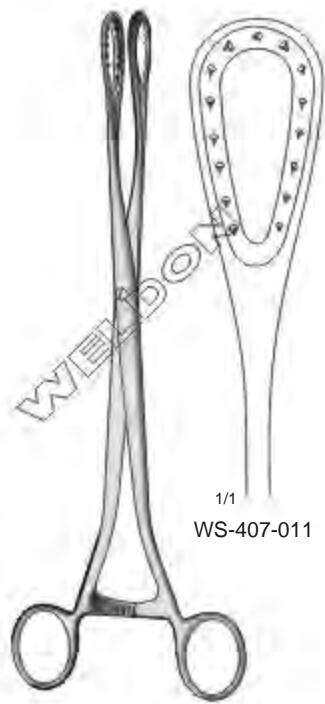

Saenger
27 cm / 10½"

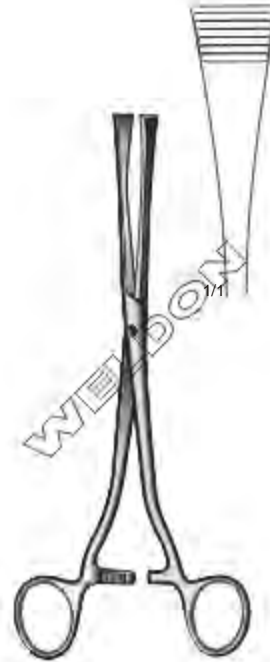
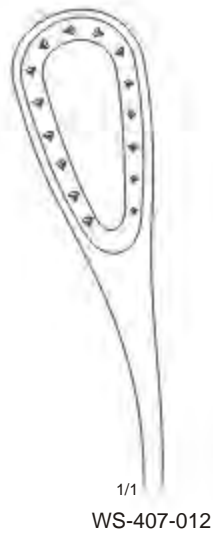

Green-Armytage
WS-407-013
21 cm / 8¼"
Uterine Clamps



Selheim
WS-407-014
32 cm / 12½"
Obstetrical Lever



Staude Moore
WS-407-015
17 cm / 6¾"
Strong Pattern



Barrett
WS-407-016
18 cm / 7"

Uterine Tenaculum Forceps | Pinzas Para Cuello Uterino | Hakenzangen



Pozzi
WS-408-017
25.5 cm / 10 $\frac{1}{4}$ "



Duplay
WS-408-018
25.5 cm / 10"

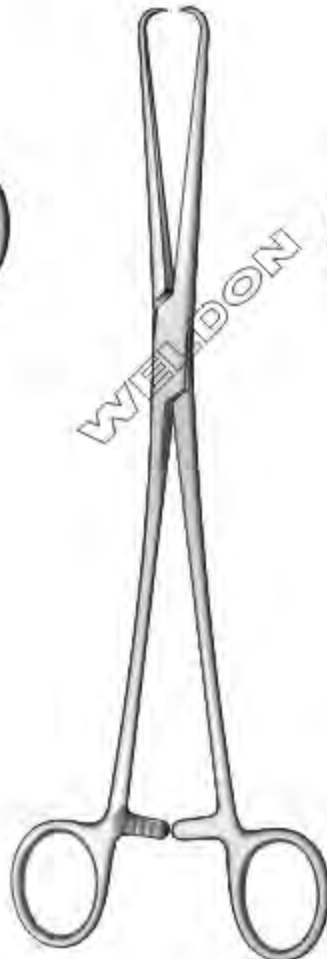

Schröder
WS-408-019
25 cm / 10"



Braun
WS-408-020
26 cm / 10 $\frac{1}{4}$ "

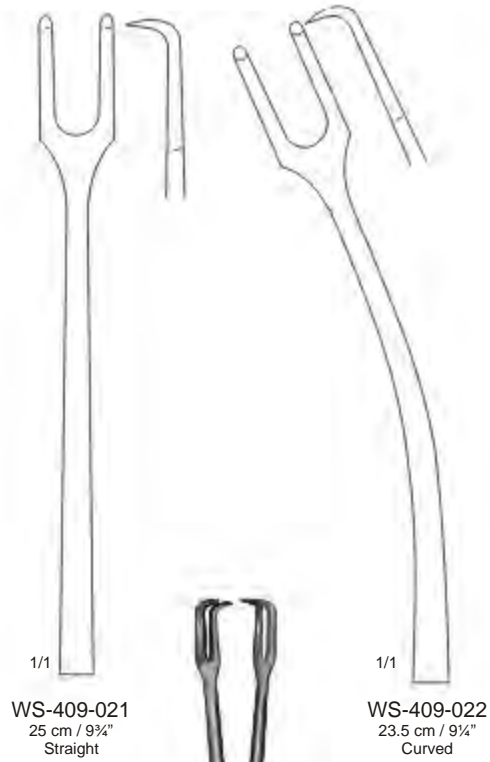

Schröder



Teale
WS-409-023
23 cm / 9"

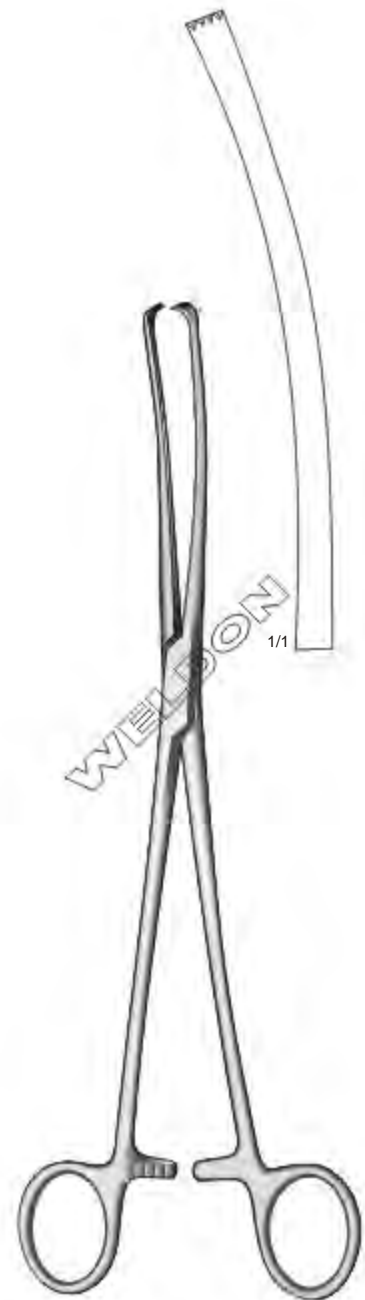

Lova
WS-409-024
26 cm / 10 1/4"

Uterine Tenaculum Forceps | Pinzas Para Cuello Uterino | Hakenzangen

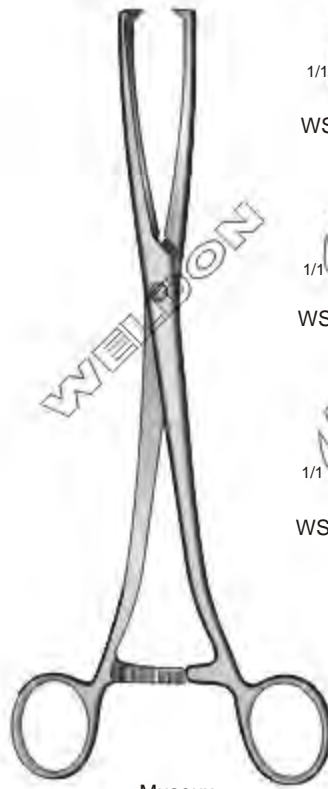

Maingot
WS-410-025
 20.5 cm / 8"
 Hysterectomy Forceps

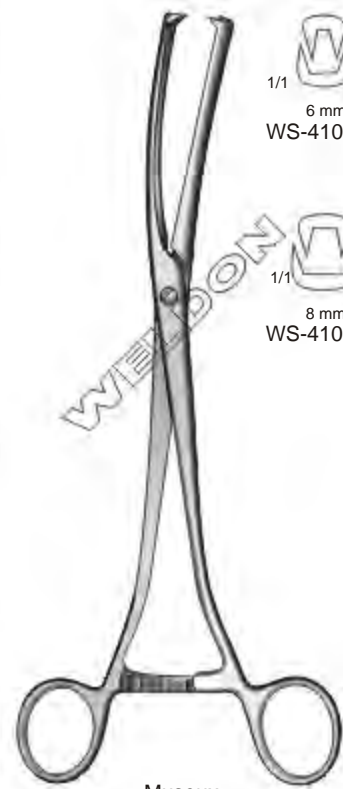

Museux
 24 cm / 9 1/2"

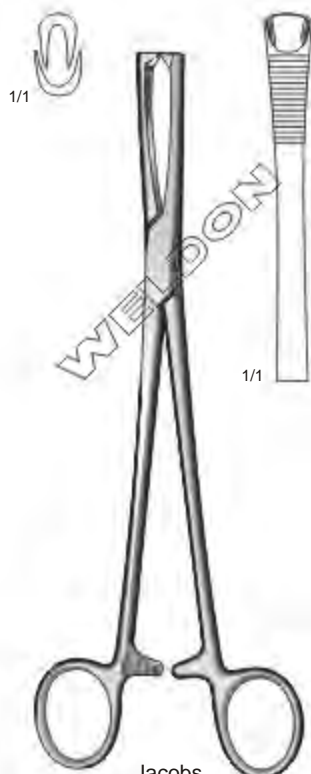

Museux
 24 cm / 9 1/2"
 Curved Sideways



Jacobs
WS-410-031
 21 cm / 8 1/4"



Henrotin
WS-410-032
 20.5 cm / 8"

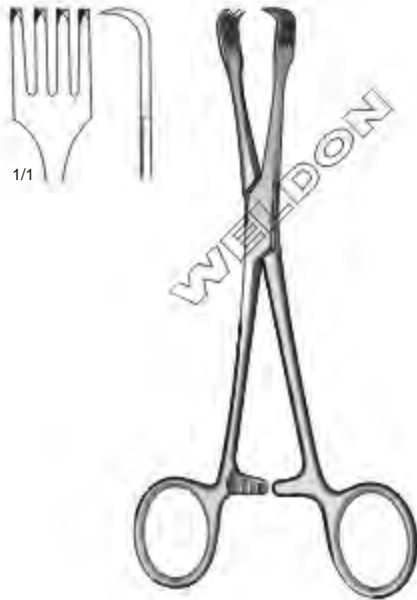

Braun
WS-411-033
16 cm / 6 1/4"

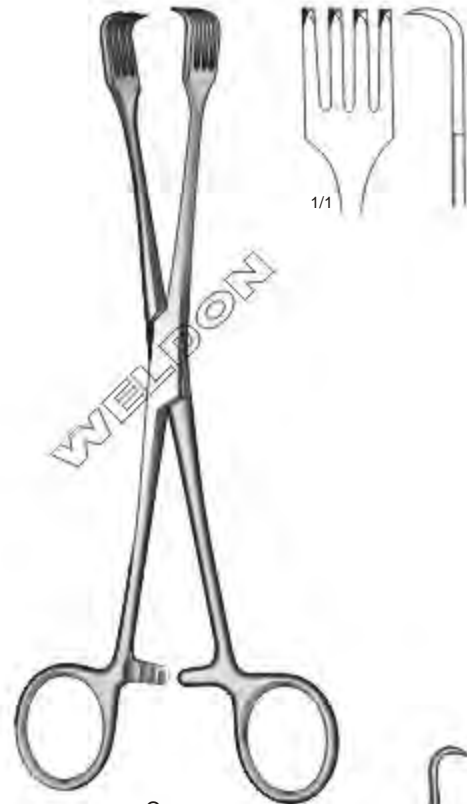

Czerny
WS-411-034
21 cm / 8 1/4"

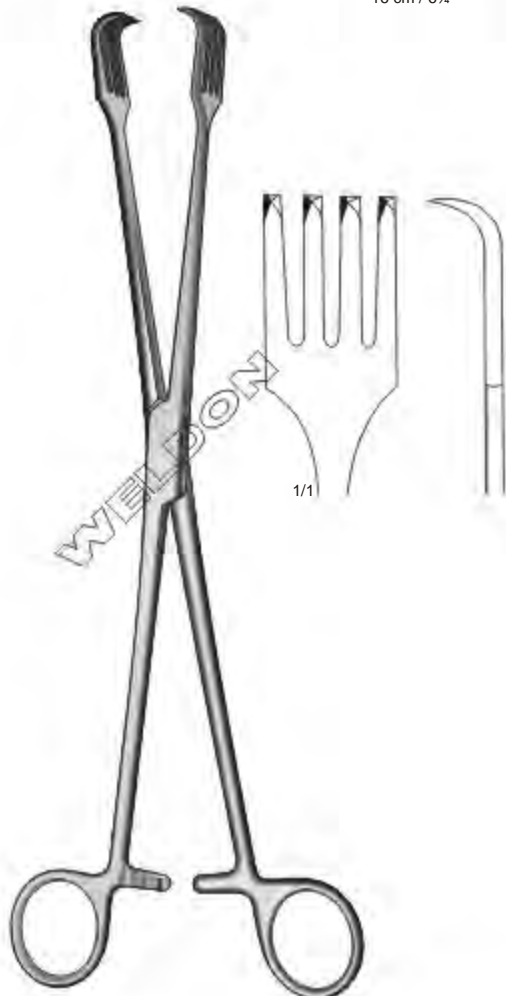

Tanaculum
WS-411-035
26 cm / 10 1/4"



Beacham
WS-411-036
26 cm / 10 1/4"
Amniotome



Skene
WS-411-037
24 cm / 9 1/2"

Uterine Polypus Forceps | Pinzas Para Pólipos Uterinos | Uterus-Polypenzangen

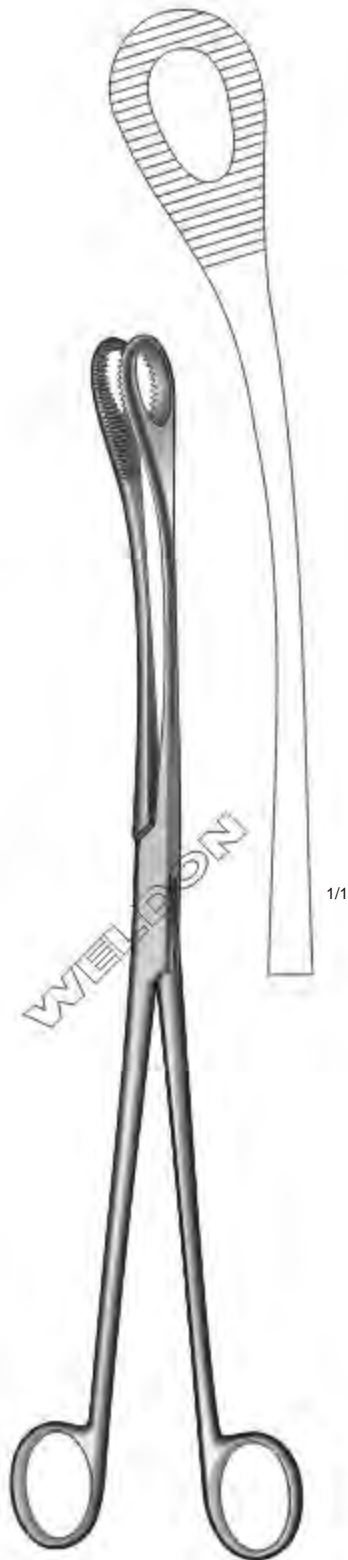

Kelly
WS-412-038
32 cm / 12½"



Noto
WS-412-039
27 cm / 10¾"



Doyen
WS-412-040
20 cm / 8"



Special Model
WS-413-041
34 cm / 13½"
cm & inch Scale



Collin
WS-413-042
35 cm / 13¼"
cm Scale



Breisky
WS-413-043
33 cm / 13"
cm & inch Scale



Doyen
WS-413-044
17 cm / 6¾"



Doyen
WS-413-045
14.5 cm / 5½"

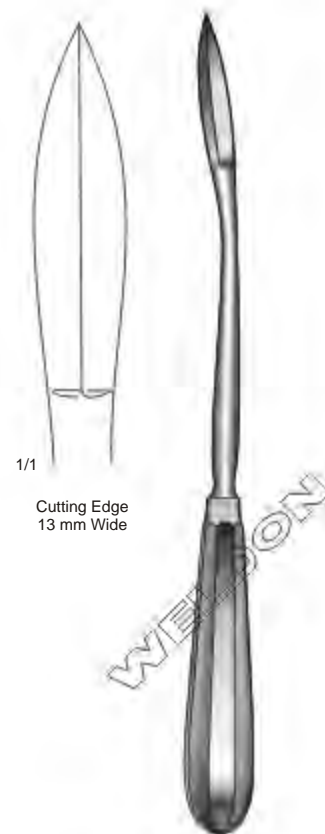

Segond
WS-413-046
28 cm / 11"

Uterine Seizing Forceps | Histerólabos | Uterusfasszange

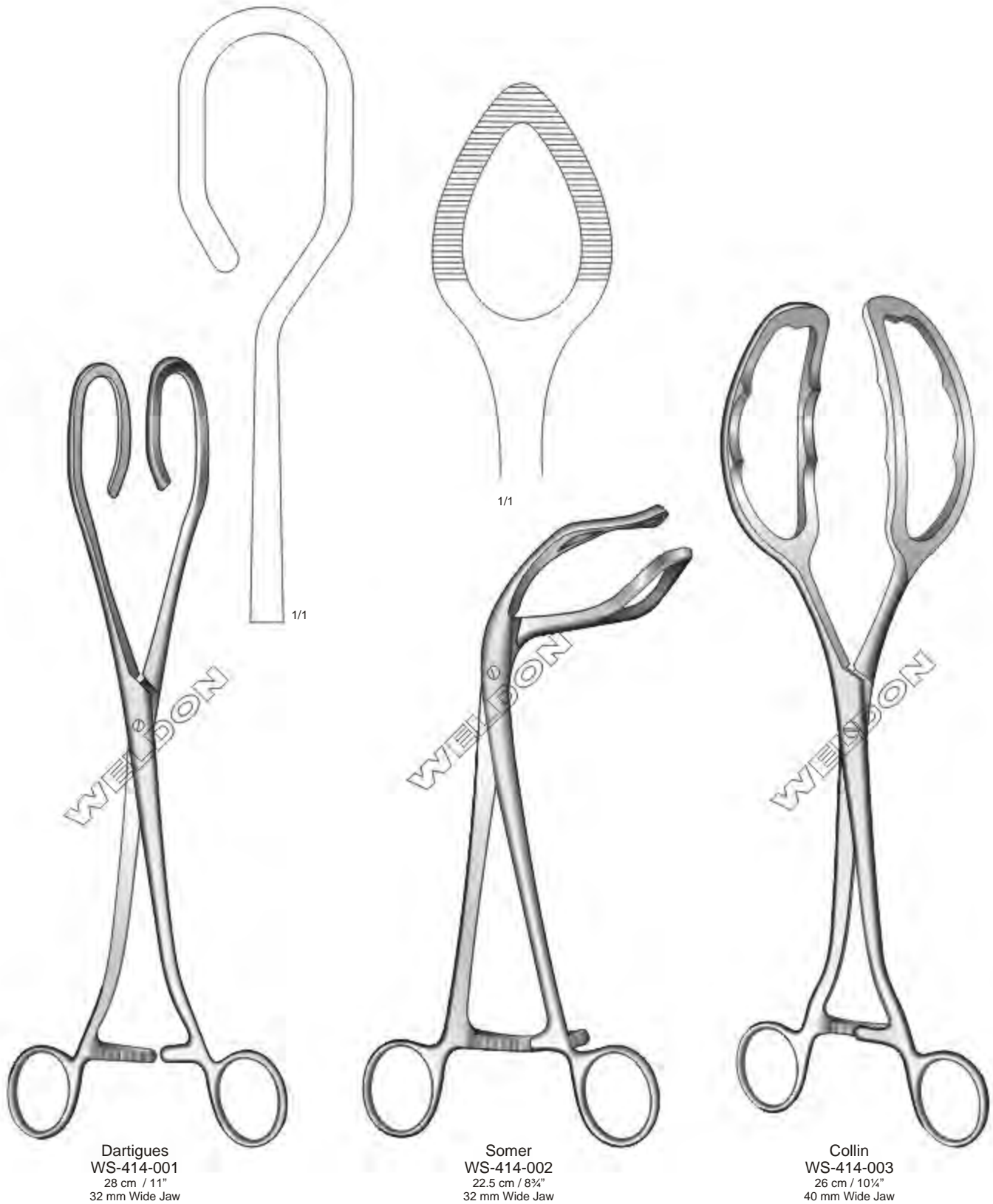



Friedman
WS-415-001
10 cm / 4"
Retractor, Self Retaining,
For Perineorrhaphy

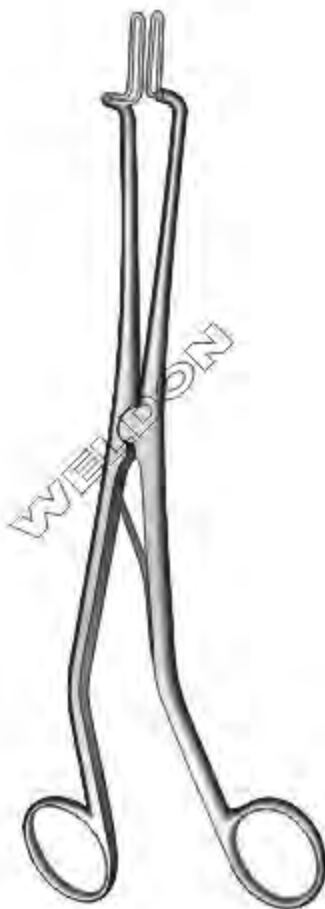

Kogan
WS-415-002
24.5 cm / 9¾"



Kogan
WS-415-003
24.5 cm / 9¾"
With Graduated Ratchet
And Fixing Screw

Uterine Biopsy Forceps | Pinzas Para Biopsia | Probeexzisionszangen

Gelhorn
 WS-416-001
 24 cm / 9½"
 8.6 mm Wide Jaw

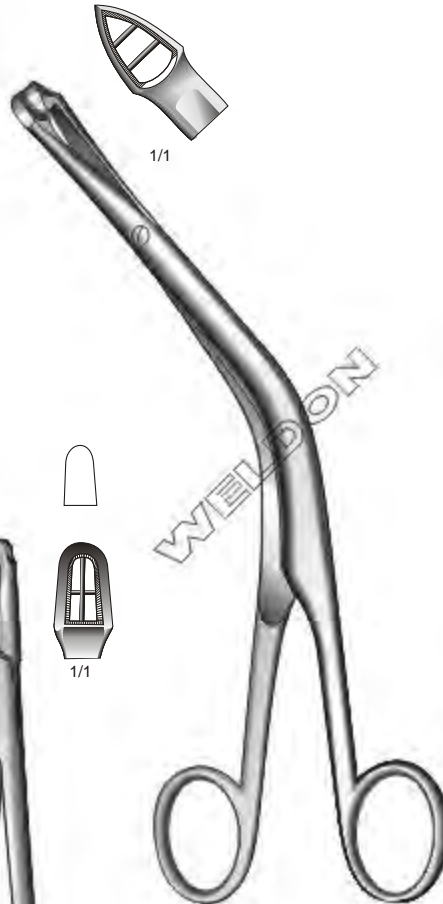

Faure
 WS-416-002
 21 cm / 8¼"
 8.4 mm WideJaw

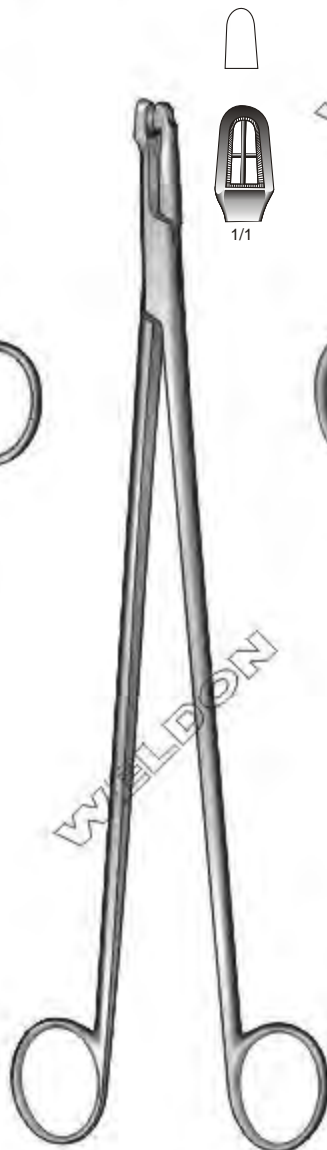

Schubert
 WS-416-003 21 cm / 8¼"
 WS-416-004 29 cm / 11½"
 4.8 mm Wide Jaw



Thoms-Gaylor
 WS-416-005 21 cm / 8¼"
 WS-416-006 24 cm / 9½"
 Jaw Ø 5.6 mm



Medina
 WS-416-002A
 23 cm / 9"
 Biopsy Forceps

Uterine Biopsy Forceps | Pinzas Para Biopsia | Probeexzisionszangen

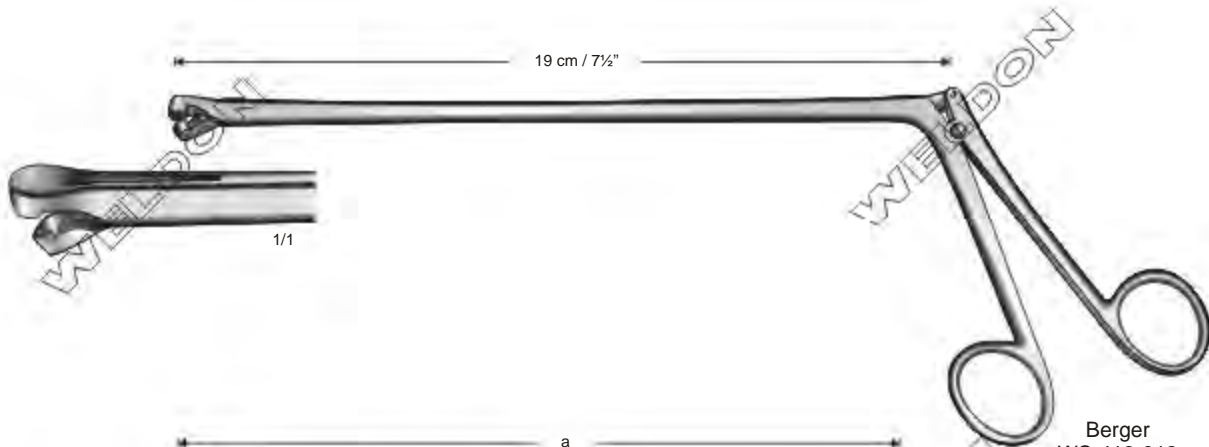

Berger
WS-418-012

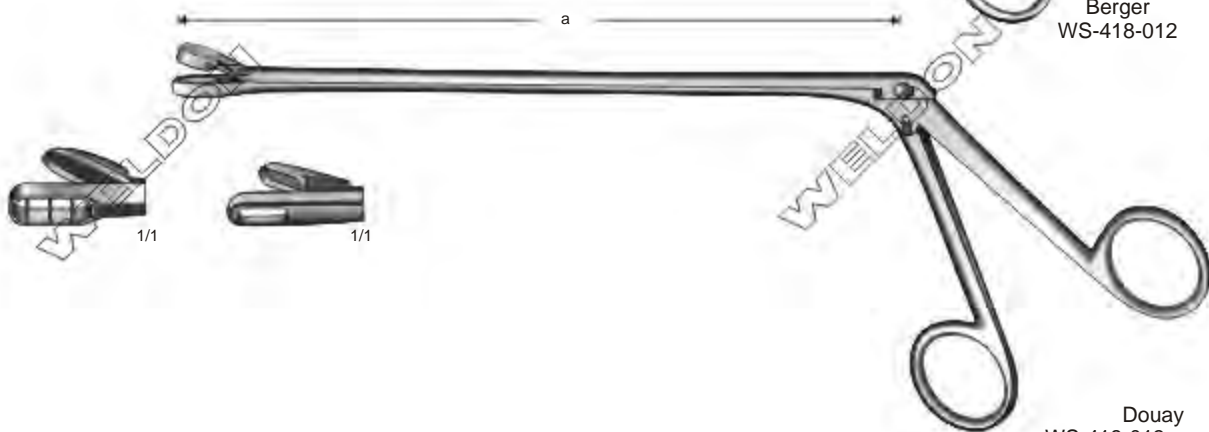

Douay
 WS-418-013 a = 20 cm / 8"
 WS-418-014 a = 25 cm / 10"
 WS-418-015 a = 30 cm / 11 1/4"
 WS-418-016 a = 35 cm / 13 3/4"
 WS-418-017 a = 40 cm / 15 1/4"

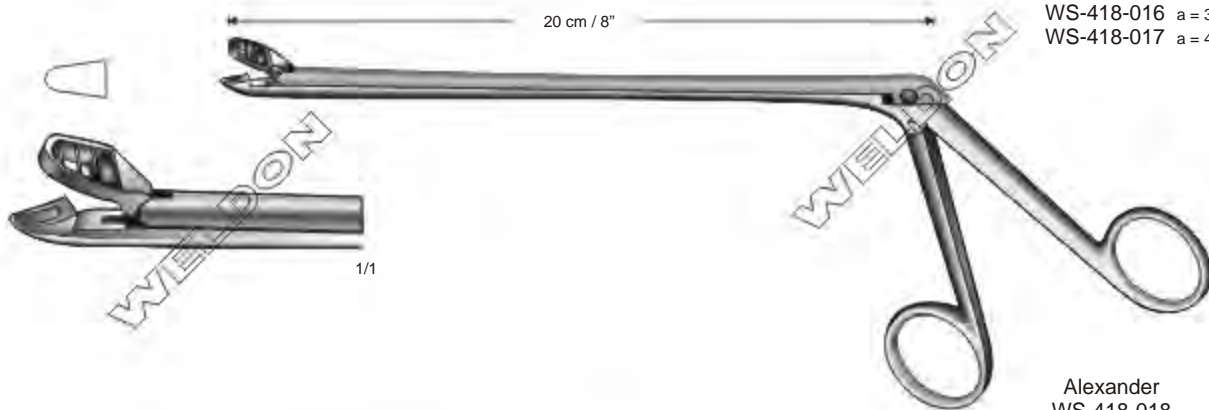

Alexander
WS-418-018

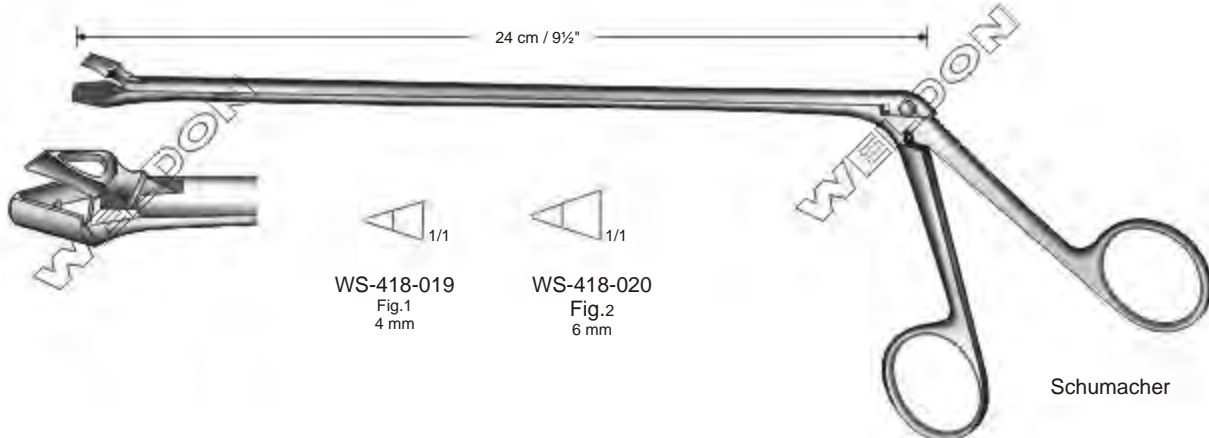

Schumacher

Uterine Biopsy Forceps | Pinzas Para Biopsia | Probeexzisionszangen

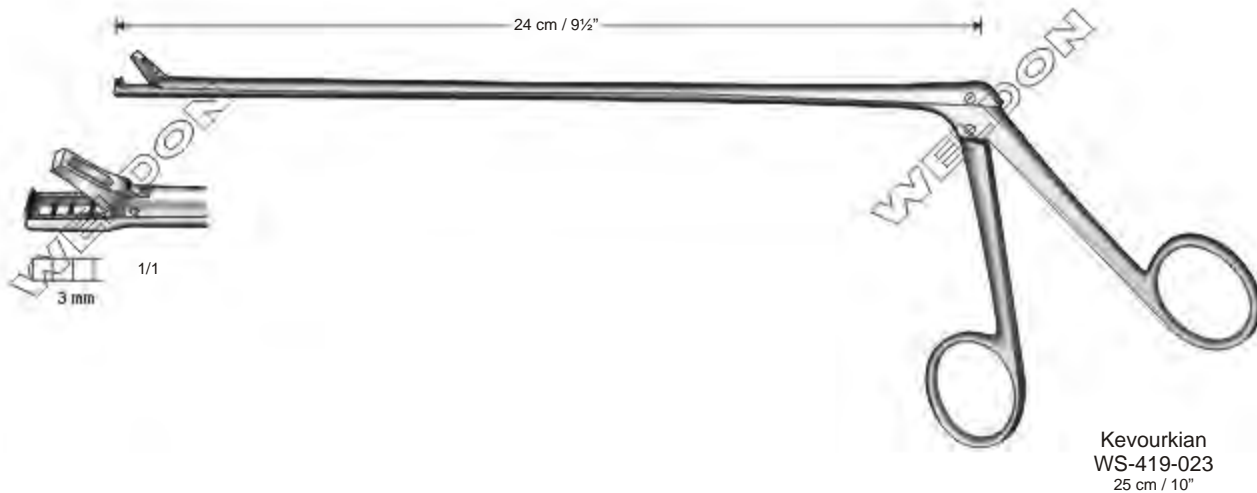

Tischler Biopsy Forceps | Tischler Pinzas Para Biopsia | Tischler Probeexzisionszangen

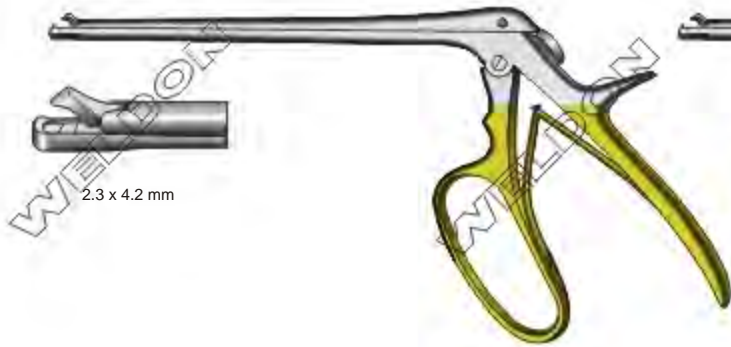

Baby Tischler Forceps
WS-420-024

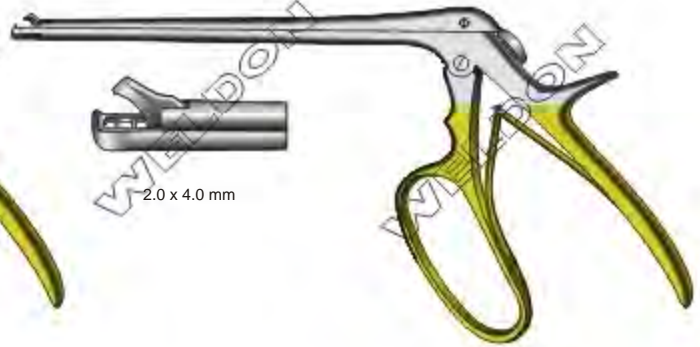

Mini Tischler Forceps
WS-420-025

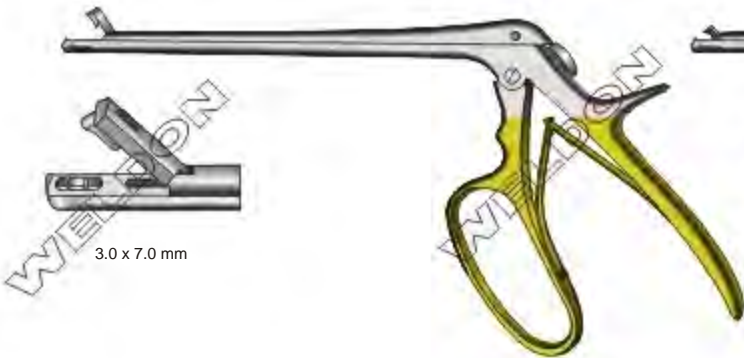

Morgan Tischler Forceps
WS-420-026

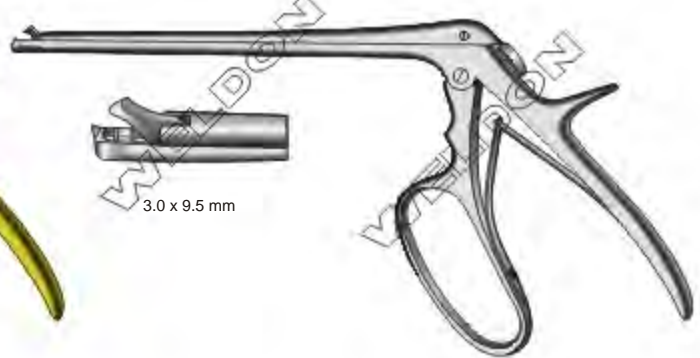

Kevorkian Tischler Forceps
WS-420-027



Burke Tischler Forceps
WS-420-028

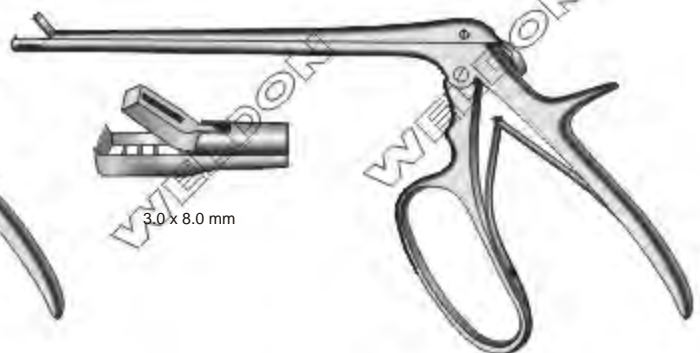

Kevorkian-Pacific Tischler Forceps
WS-420-029



Naegele
WS-421-003 36 cm / 14"
WS-421-004 40 cm / 16"



Simpson
WS-421-001
31 cm / 12¼"



Simpson-Luikart
WS-421-005
36 cm / 14"



Simpson-Braun
WS-421-002
36 cm / 14"



DeLee
WS-422-006
30 cm / 12"



Elliot
WS-422-007
32 cm / 12½"
WS-422-008
38 cm / 15"



DeLee
WS-422-009 36 cm / 14"
WS-422-010 39 cm / 15½"

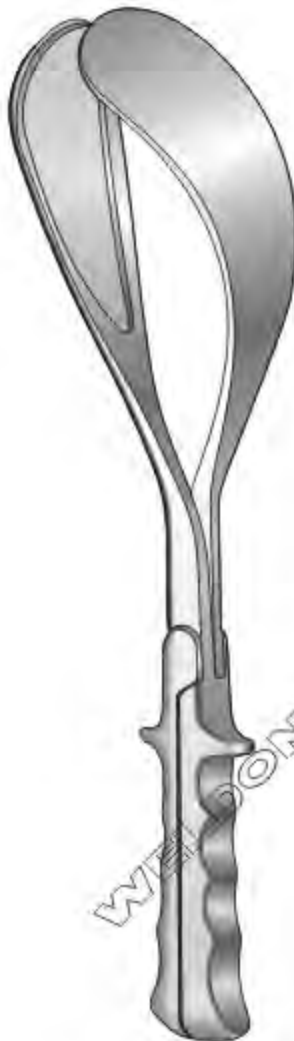

Mclean-Luikart
WS-422-011
38 cm / 15"

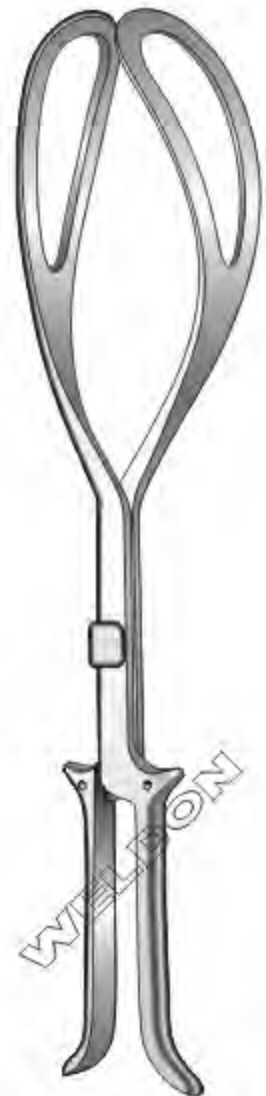

Kielland
WS-422-012
41 cm / 16"

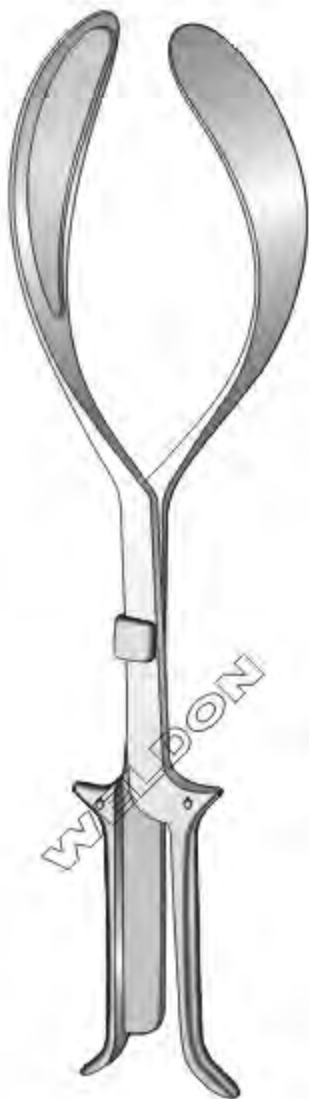

Kielland-Luikart
WS-423-013
40 cm / 15½"



Piper
WS-423-014
44 cm / 17¼"

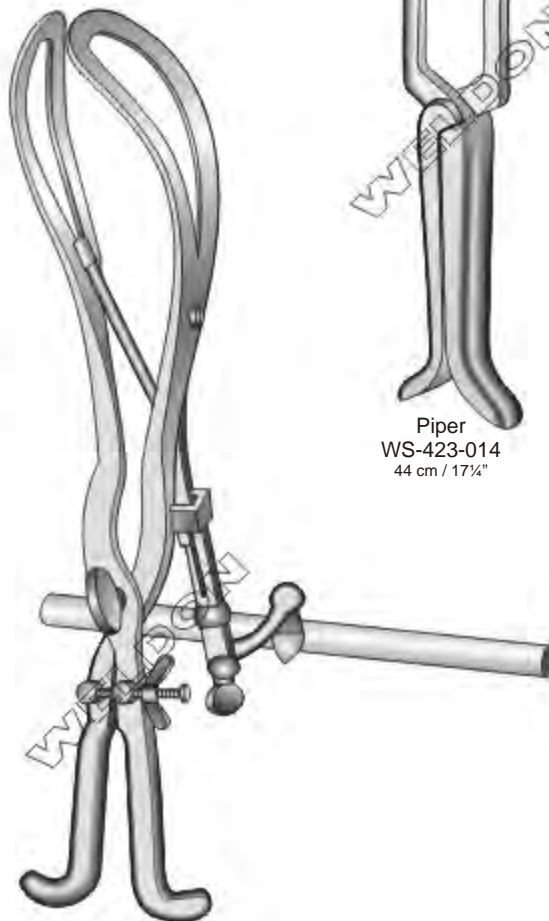

Tarnier
WS-423-015
40 cm / 15½"
With Traction Handle



Wrigley
WS-423-016
28 cm / 11"



**Episiotomy set
WS-424-017**

In Canvas Roll, Stored In Metal Case 200 x 100 x 30 mm
 Consisting of
 1 Dressing Forceps 14.5 cm
 1 Tissue Forceps 14.5 cm
 1 Mathieu Needle Holder 17 cm
 1 Braun-Stadler Episiotomy Scissors 15 cm
 1 Tissue Scissors 14.5 cm
 1 Kocher Hemostatic Forceps 14 cm



**Mod. Tübingen
WS-424-018**

Midwifery Set in Canvas Roll, Consisting of:
 1 Tissue Forceps 14.5 cm
 1 Dressing Forceps 14.5 cm
 1 Braun-Stadler Episiotomy Scissors 15 cm
 1 Nail File 10 cm
 1 Tissue Scissors, Curved 14.5 cm
 1 Nail Scissors 10.5 cm
 1 Busch Funicular Scissors 16 cm
 2 Rochester-Pean Hemostatic Forceps 16 cm
 1 Gross Sponge Forceps 20 cm
 1 Metal Catheter 12 French
 1 Funnel-Shaped Stethoscope
 1 Tape Measure, Linen, 1.5 m

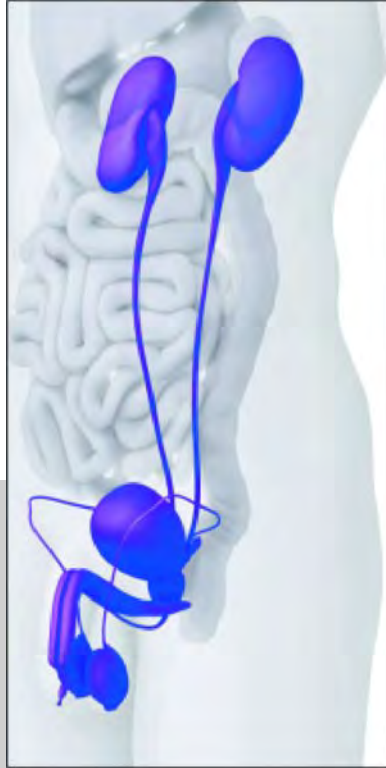

www.weldoninstruments.com

PROVEEDOR EXCLUSIVO:



Kidney Stone Forceps

Gall Stone Forceps & Scoops

Urethral Sounds

Circumcision Instruments

425 - 436

Urology

Urology
Urologia
Urologie

Kidney Stone Forceps | Pinzas Para Cálculos Renales | Nierensteinzangen

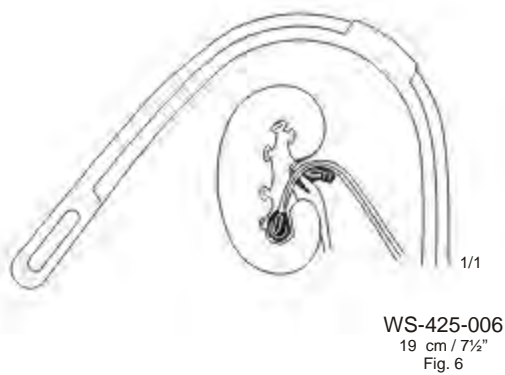
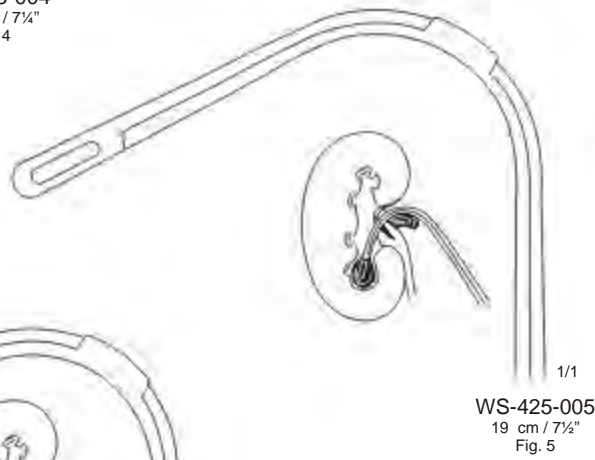
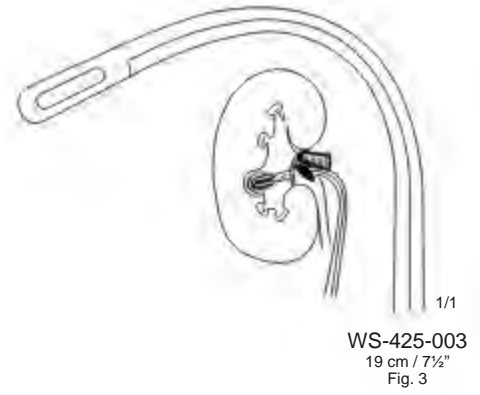
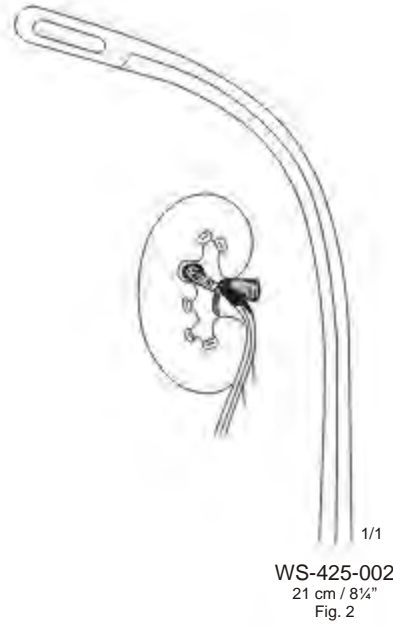

Gall Stone Forceps | Pinzas Para Cálculos Biliares | Gallensteinzangen



1/1

WS-426-008



1/1

WS-426-009

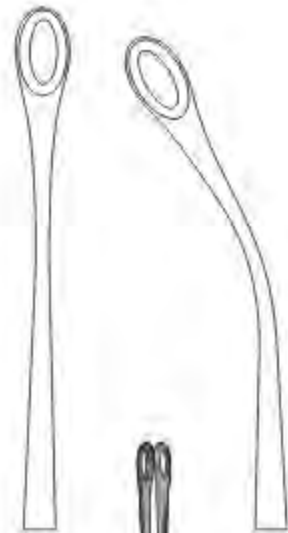

WS-426-010

WS-426-011



Mixer
WS-426-007
22 cm / 8 3/4"



Desjardins
23 cm / 9"



Blake
21 cm / 8 1/4"



Mayo-Blake
WS-427-012
21 cm / 8¼"
Straight



Mayo-Blake
WS-427-013
21 cm / 8¼"
Curved

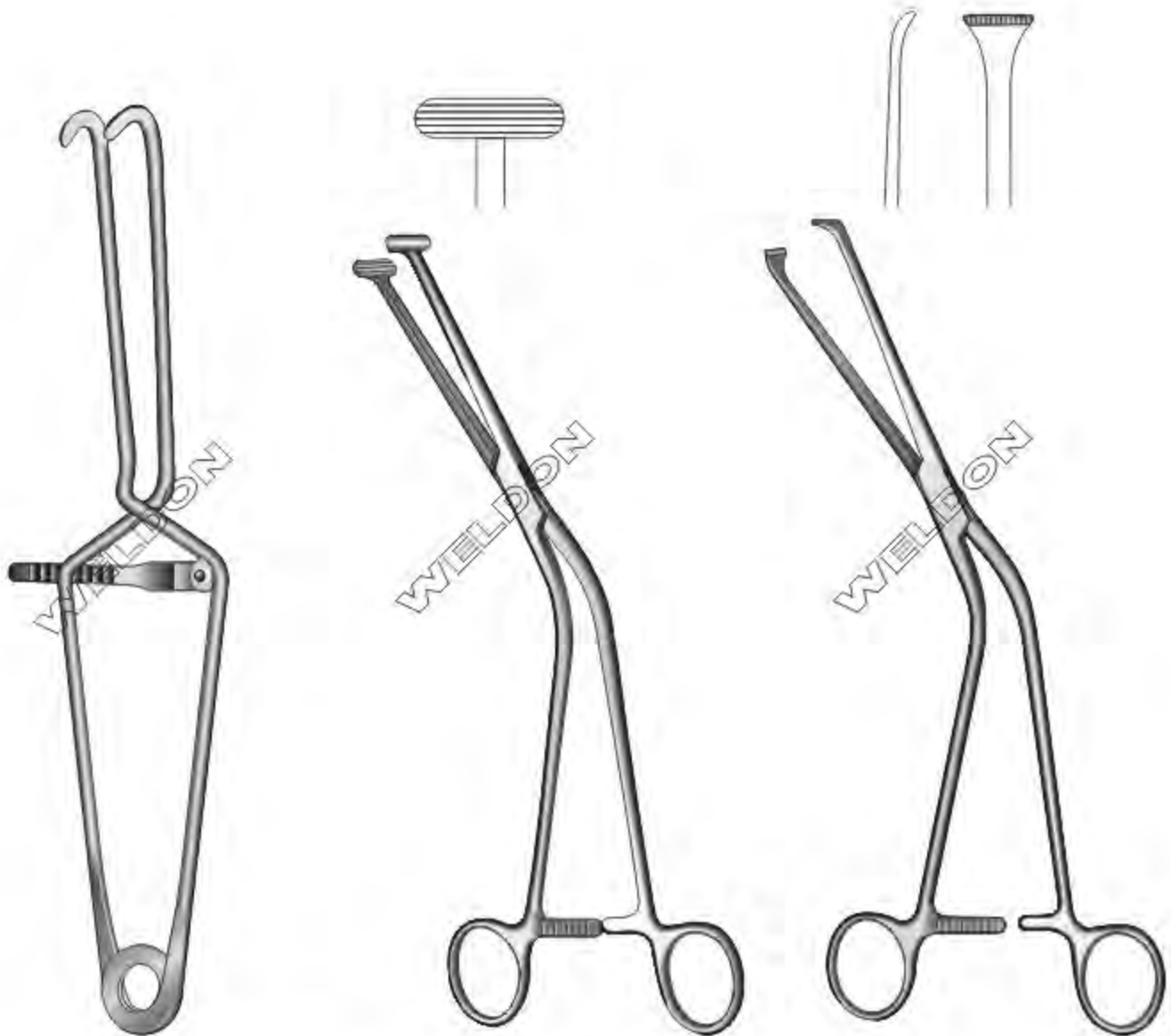

Millin
 WS-428-014
 Bladder Neck Spreader
 29 cm / 11½"

Millin
 WS-428-015
 24.5 cm / 9¾"

Millin
 WS-428-016
 23 cm / 9"

Gall Duct Dilators | Dilatores Para Conducto Biliar | Gallenkanaldilatatoren

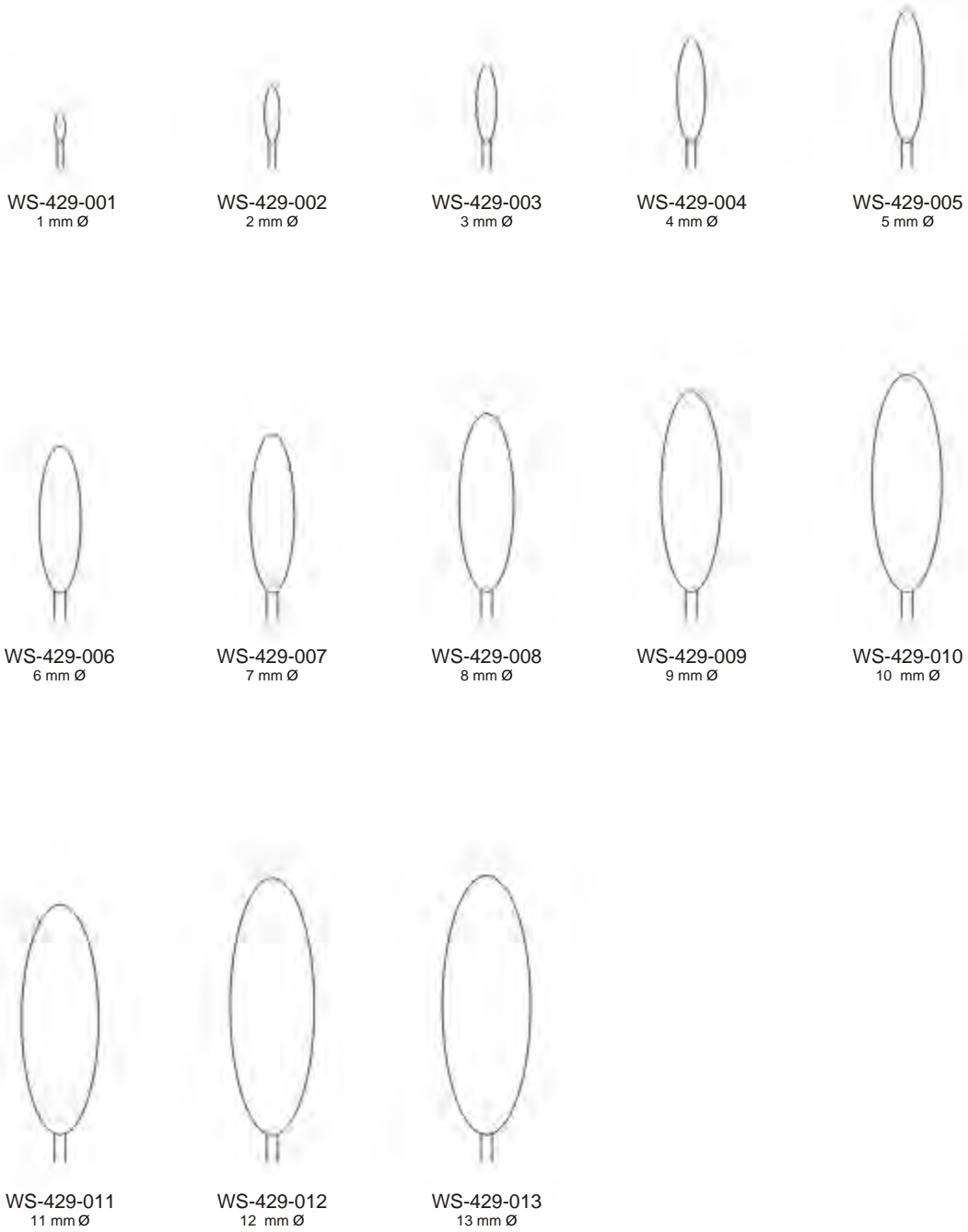

Bakes
Malleable Shaft
32 cm / 12½"

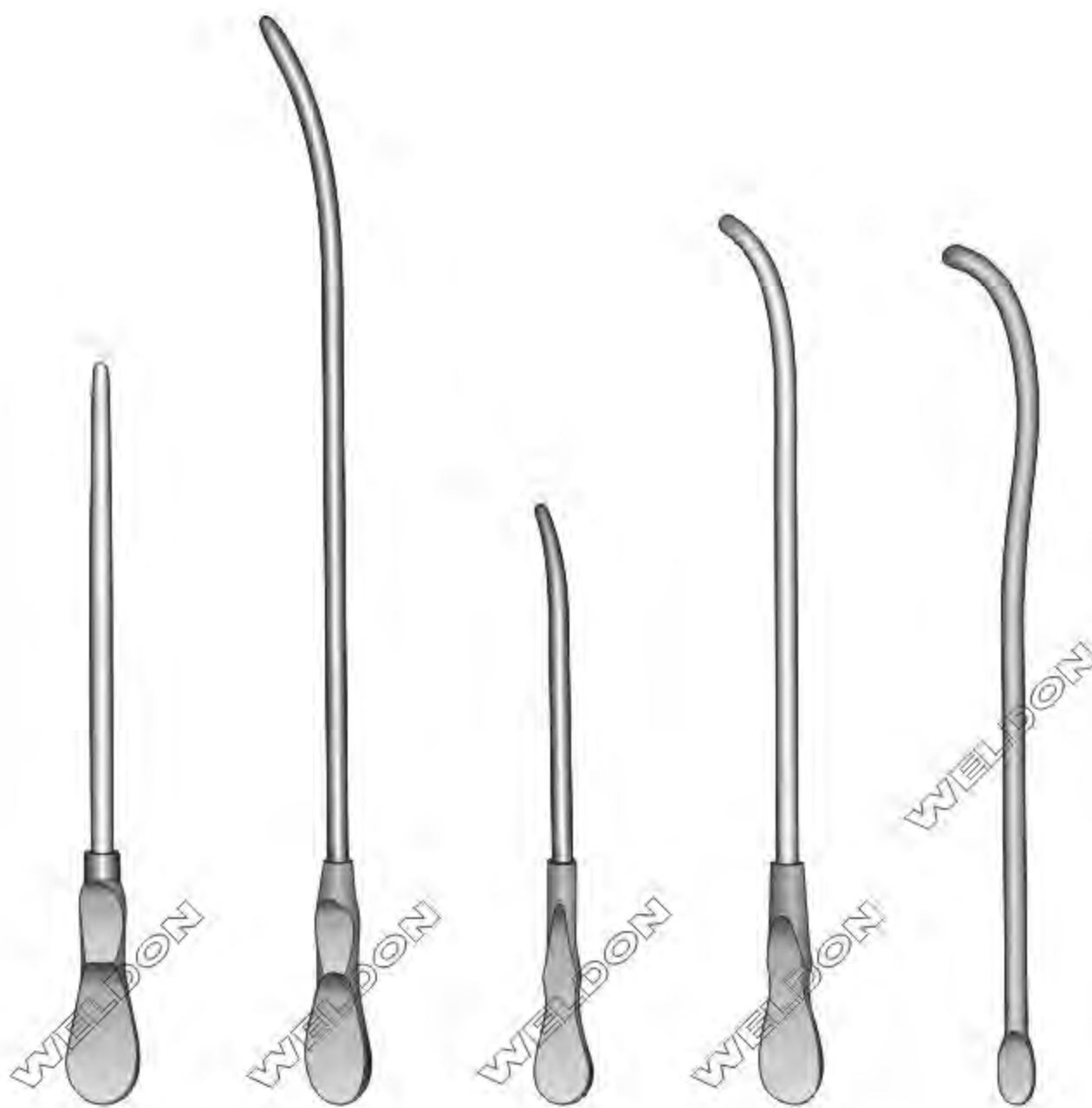

Dittel
22 cm / 8 $\frac{1}{2}$ "
Fig.1

Dittel
33.5 cm / 13 $\frac{1}{8}$ "
Fig.2

Dittel
18 cm / 7 $\frac{1}{8}$ "
Fig.3
For Children

Van Buren
27 cm / 10 $\frac{3}{4}$ "
Fig.4

Guyon
Fig.5 Without Thread
Fig.6 With Thread
26 cm / 10 $\frac{1}{4}$ "



mm Ø	Charr.	Dittel 22 cm / 8¾" Fig.1	Dittel 33.5 cm / 13½" Fig.2	Dittel 18 cm / 7⅞" Fig.3 For Children	Van Buren 27 cm / 10¼" Fig.4	Guyon 26 cm / 10¼" Fig.5 Without Thread	Guyon 26 cm / 10¼" Fig.6 With Thread
2	6	WS-431-014	WS-431-045	WS-431-060	WS-431-091	WS-431-106	WS-431-137
2½	7	WS-431-015	WS-431-046	WS-431-061	WS-431-092	WS-431-107	WS-431-138
2¾	8	WS-431-016	WS-431-047	WS-431-062	WS-431-093	WS-431-108	WS-431-139
3	9	WS-431-017	WS-431-048	WS-431-063	WS-431-094	WS-431-109	WS-431-140
3½	10	WS-431-018	WS-431-049	WS-431-064	WS-431-095	WS-431-110	WS-431-141
3¾	11	WS-431-019	WS-431-050	WS-431-065	WS-431-096	WS-431-111	WS-431-142
4	12	WS-431-020	WS-431-051	WS-431-066	WS-431-097	WS-431-112	WS-431-143
4½	13	WS-431-021	WS-431-052	WS-431-067	WS-431-098	WS-431-113	WS-431-144
4¾	14	WS-431-022	WS-431-053	WS-431-068	WS-431-099	WS-431-114	WS-431-145
5	15	WS-431-023	WS-431-054	WS-431-069	WS-431-100	WS-431-115	WS-431-146
5½	16	WS-431-024	WS-431-055	WS-431-070	WS-431-101	WS-431-116	WS-431-147
5¾	17	WS-431-025	WS-431-056	WS-431-071	WS-431-102	WS-431-117	WS-431-148
6	18	WS-431-026	WS-431-057	WS-431-072	WS-431-103	WS-431-118	WS-431-149
6½	19	WS-431-027	WS-431-058	WS-431-073	WS-431-104	WS-431-119	WS-431-150
6¾	20	WS-431-028	WS-431-059	WS-431-074	WS-431-105	WS-431-120	WS-431-151
7	21	WS-431-029		WS-431-075		WS-431-121	
7½	22	WS-431-030		WS-431-076		WS-431-122	
7¾	23	WS-431-031		WS-431-077		WS-431-123	
8½	24	WS-431-032		WS-431-078		WS-431-124	
8¾	25	WS-431-033		WS-431-079		WS-431-125	
8	26	WS-431-034		WS-431-080		WS-431-126	
9	27	WS-431-035		WS-431-081		WS-431-127	
9½	28	WS-431-036		WS-431-082		WS-431-128	
9¾	29	WS-431-037		WS-431-083		WS-431-129	
10	30	WS-431-038		WS-431-084		WS-431-130	
10 ⅛	31	WS-431-039		WS-431-085		WS-431-131	
10 ¼	32	WS-431-040		WS-431-086		WS-431-132	
11	33	WS-431-041		WS-431-087		WS-431-133	
11 ½	34	WS-431-042		WS-431-088		WS-431-134	
11 ¾	35	WS-431-043		WS-431-089		WS-431-135	
12	36	WS-431-044		WS-431-090		WS-431-136	

Gall Stone Scoops | Cucharas Para Cálculos Biliares | Gallensteinlöffel



WS-432-001
26.5 cm / 10½"
Malleable



Ochsner
WS-432-002
38 cm / 15"



Moynihan
WS-432-003
34 cm / 13½"
Malleable



1/1
WS-432-004



1/1
WS-432-005



1/1
WS-432-006



Desjardins
28 cm / 11"
Malleable

Gall Stone Scoops | Cucharas Para Cálculos Biliares | Gallensteinlöffel

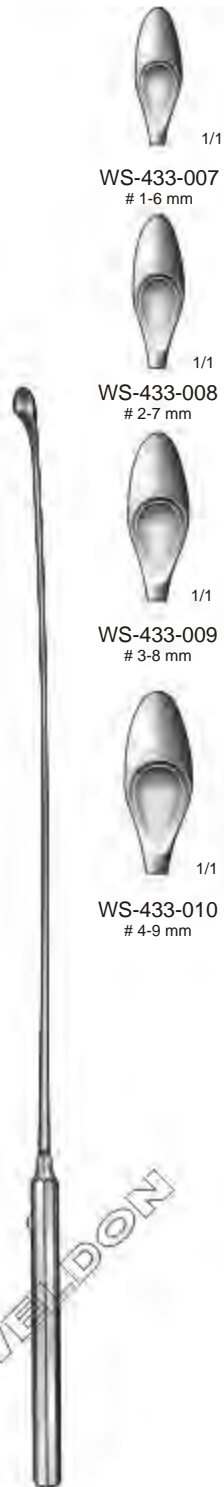

Desjardins
30 cm / 12"
Flexible



Luer-Korte
Malleable
32 cm / 12 3/4"

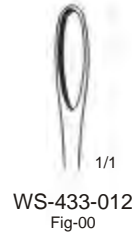

Mayo
26 cm / 10 1/4"
Malleable

Gall Stone Scoops | Cucharas Para Cálculos Biliares | Gallensteinlöffel



Mayo
WS-434-022
28 cm / 11"

WS-434-023
34 cm / 12 1/2"

Fergusson

WS-434-024
21.5 cm / 8 1/2"

WS-434-025
22 cm / 8 3/4"

WS-434-026
23.5 cm / 9 1/4"

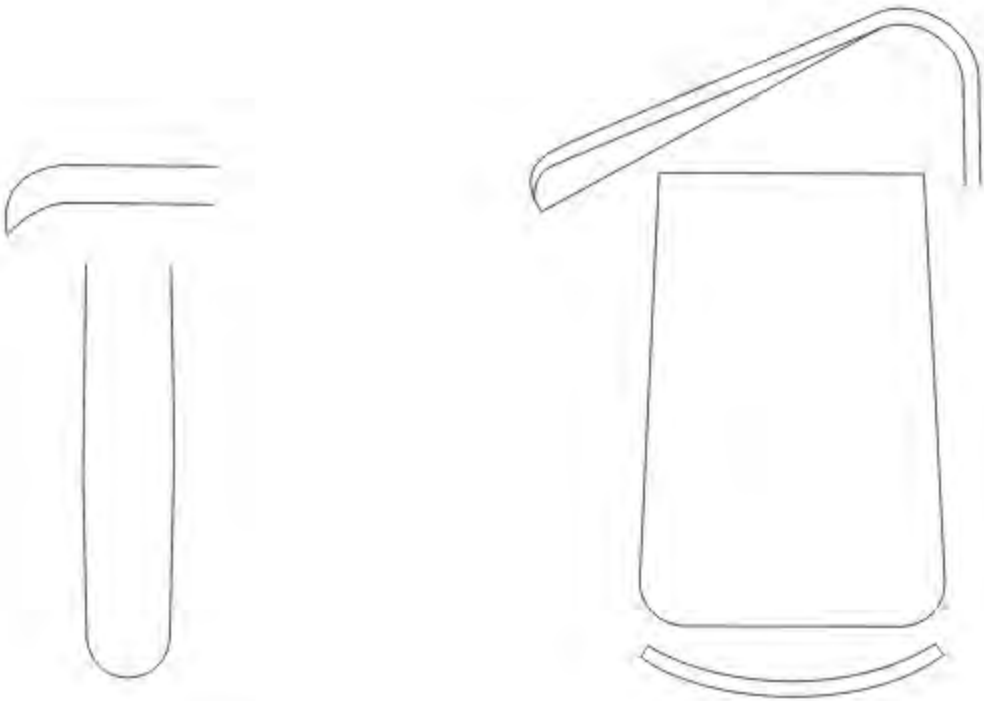

Young
WS-435-027
21.5 cm / 8½"



Young
WS-435-028
20.5 cm / 8"

Circumcision Clamp

- WS-436-001 8 mm Ø
- WS-436-002 11 mm Ø
- WS-436-003 13 mm Ø
- WS-436-004 16 mm Ø
- WS-436-005 21 mm Ø
- WS-436-006 26 mm Ø
- WS-436-007 32 mm Ø



Stockmann
 WS-436-008
 8 cm / 3¼"
 Penis Clamps



Strauss
 WS-436-009
 11 cm / 4¼"
 Penis Clamps



Guttman
 WS-436-010
 26½ cm / 10½"
 Secretion Scoop

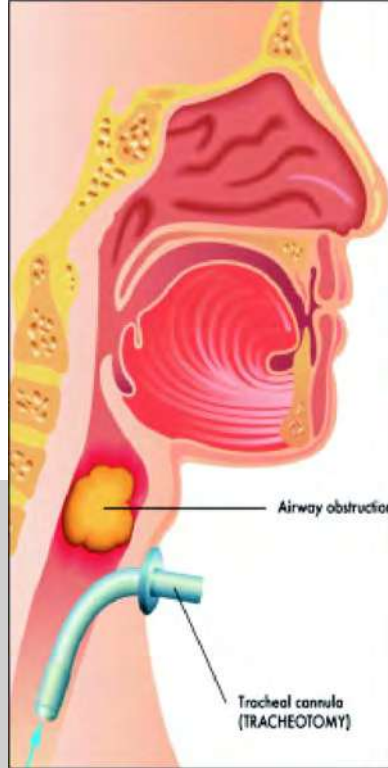

www.weldoninstruments.com

PROVEEDOR EXCLUSIVO:



Tracheotomy

Sinus & Hypophysectomy

Laryngo Bronchoscopy

Anaesthesia

437 - 460

Tracheotomy

Tracheotomy, Sinus & Hypophysectomy

Traqueotomia

Tracheotomie

Tracheal Dilators Forceps and Tubes | Dilatadores Traqueales, Pinzas y Tubos
Trachealdilatatoren, Kropffasszangen, Trachealkanülen

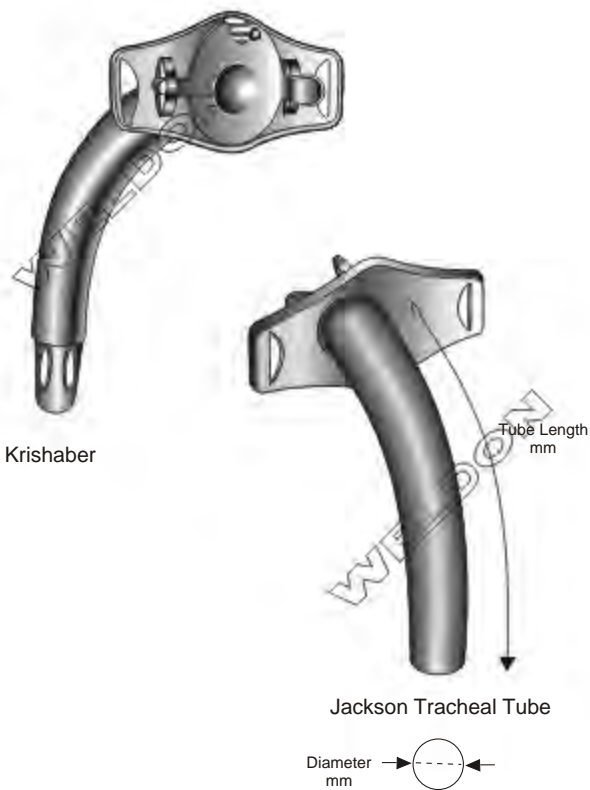
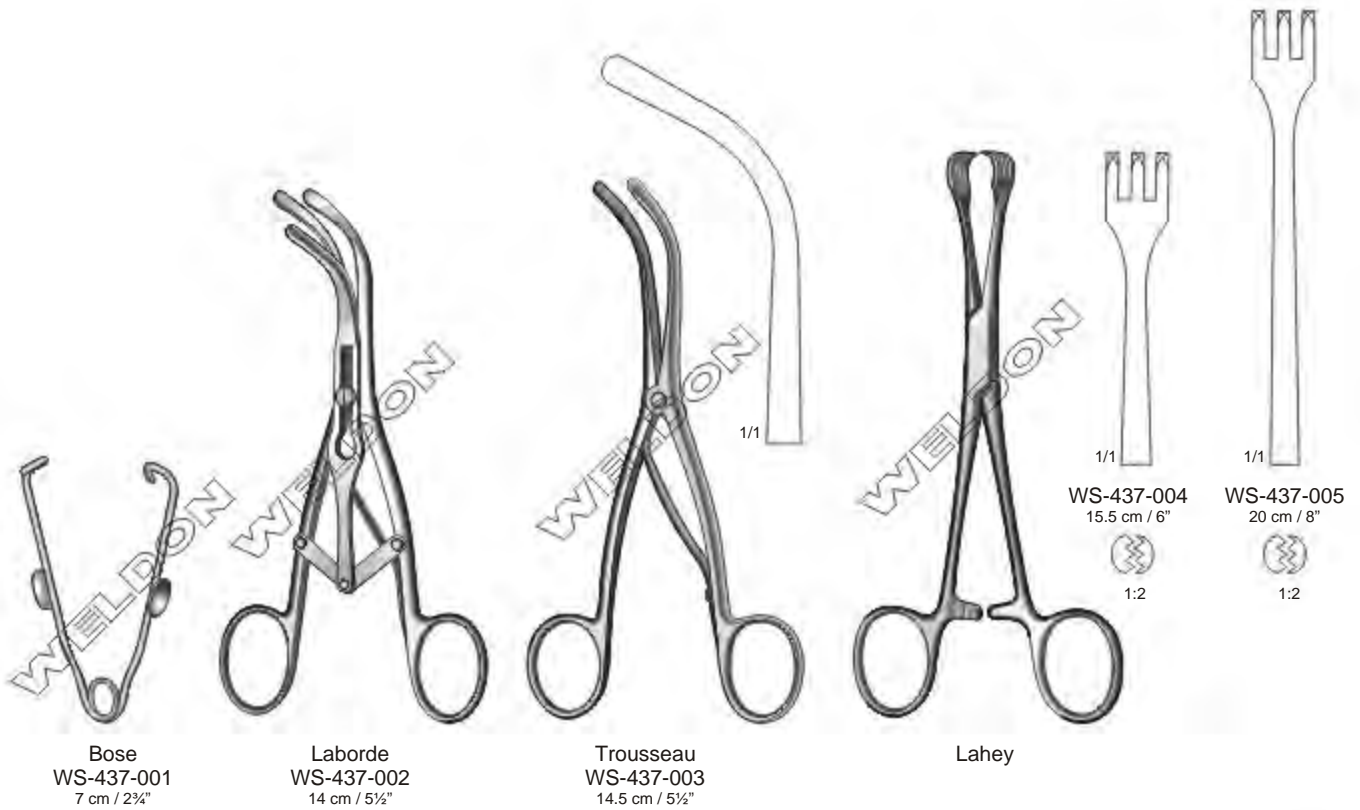

International Scale				
Tube Length mm	Diameter mm	Fig.	Krishaber	Jackson
45	4	0	WS-437-006	WS-437-016
50	5	1	WS-437-007	WS-437-017
55	6	2	WS-437-008	WS-437-018
60	7	3	WS-437-009	WS-437-019
65	8	4	WS-437-010	WS-437-020
70	9	5	WS-437-011	WS-437-021
75	10	6	WS-437-012	WS-437-022
80	11	7	WS-437-013	WS-437-023
85	12	8	WS-437-014	WS-437-024
90	13	9	WS-437-015	WS-437-025

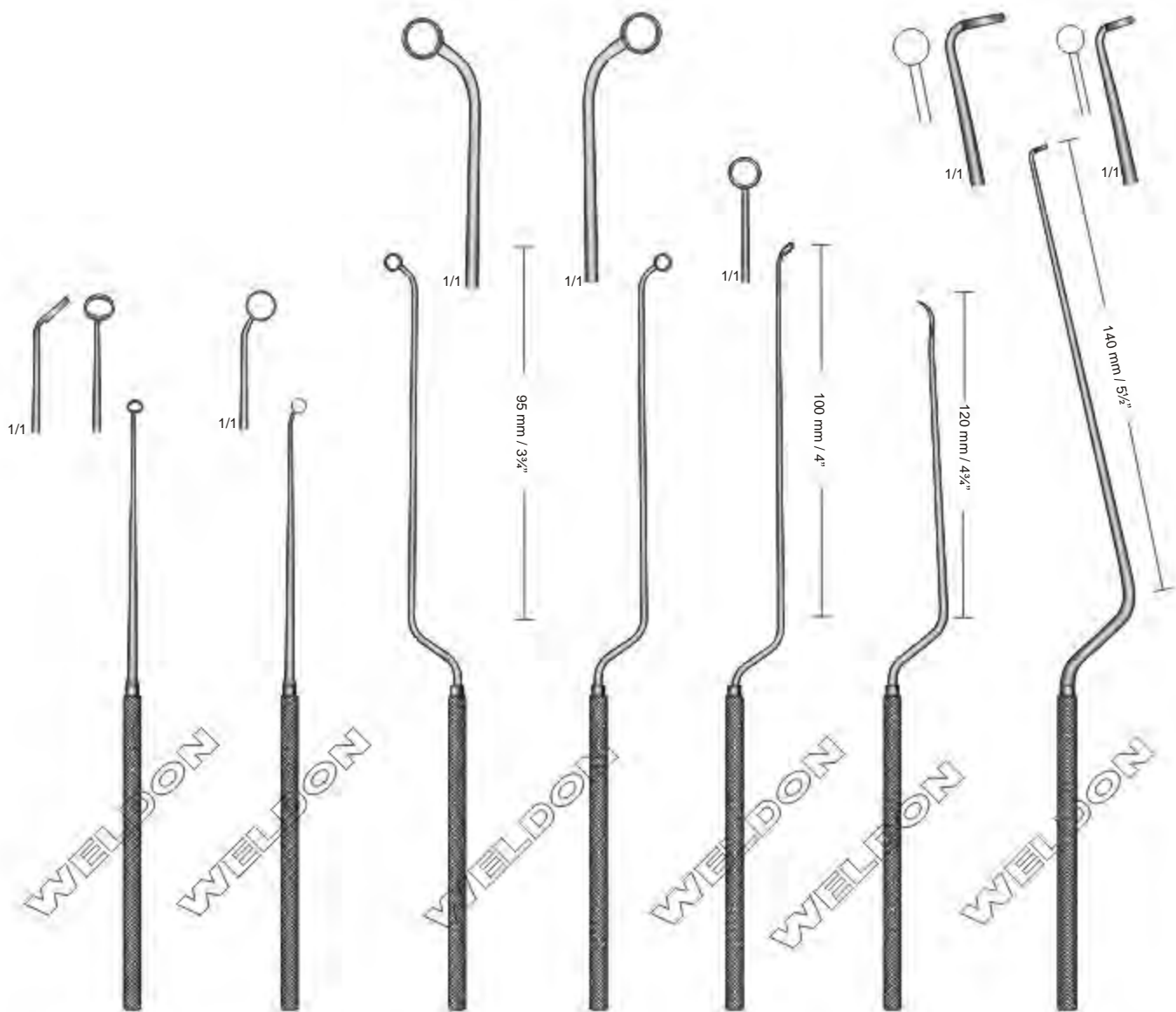

Ray
WS-438-001
 19 cm / 7 1/2"
 Ø 4 mm
 Curette, Horizontal 45°

Ray
WS-438-002
 19 cm / 7 1/2"
 Ø 4 mm
 Curette, Vertical 45°

Nicola
WS-438-003
 Ø 6.5 mm
 26 cm / 10 1/4"
 Malleable Curette
 Curved to Left

Nicola
WS-438-004
 Ø 6.5 mm
 26 cm / 10 1/4"
 Malleable Curette
 Curved to Right

Nicola
WS-438-005
 Ø 6.5 mm
 26 cm / 10 1/4"
 Malleable Curette

Nicola
WS-438-006
 21.5 cm / 8 1/2"
 Raspatory

Hardy
WS-438-007 Ø 4 mm
WS-438-008 Ø 6 mm
 26 cm / 10 1/4"
 Malleable Curette

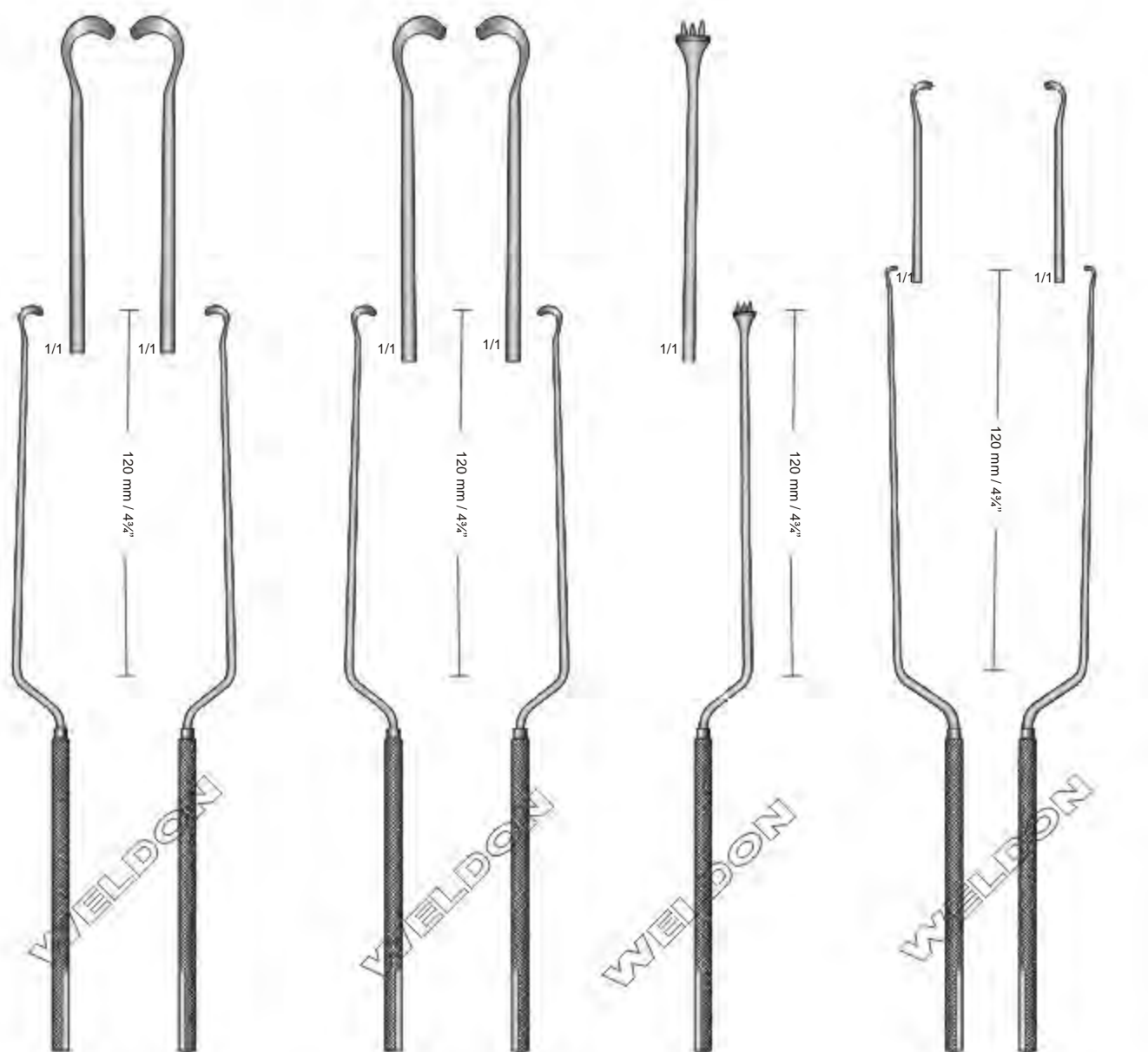

Hardy WS-439-009
21.5 cm / 8½"
Curved to Left
Pituitary Enculeators
Bayonet Shaped, Blunt

Hardy WS-439-010
21.5 cm / 8½"
Curved to Right

Hardy WS-439-011
21.5 cm / 8½"
Curved To Left
Dissector
Sharpened Inner Edge

Hardy WS-439-012
21.5 cm / 8½"
Curved To Right
Dissector

Hardy WS-439-013
21.5 cm / 8½"
Pituitary Implant Fork
Bayonet Shaped

Hardy-Fahlbusch WS-439-014
24.5 cm / 8½"
Curved to Left
Dissectors
Sharpened Inner Edge

Hardy-Fahlbusch WS-439-015
24.5 cm / 8½"
Curved to Right
Dissectors

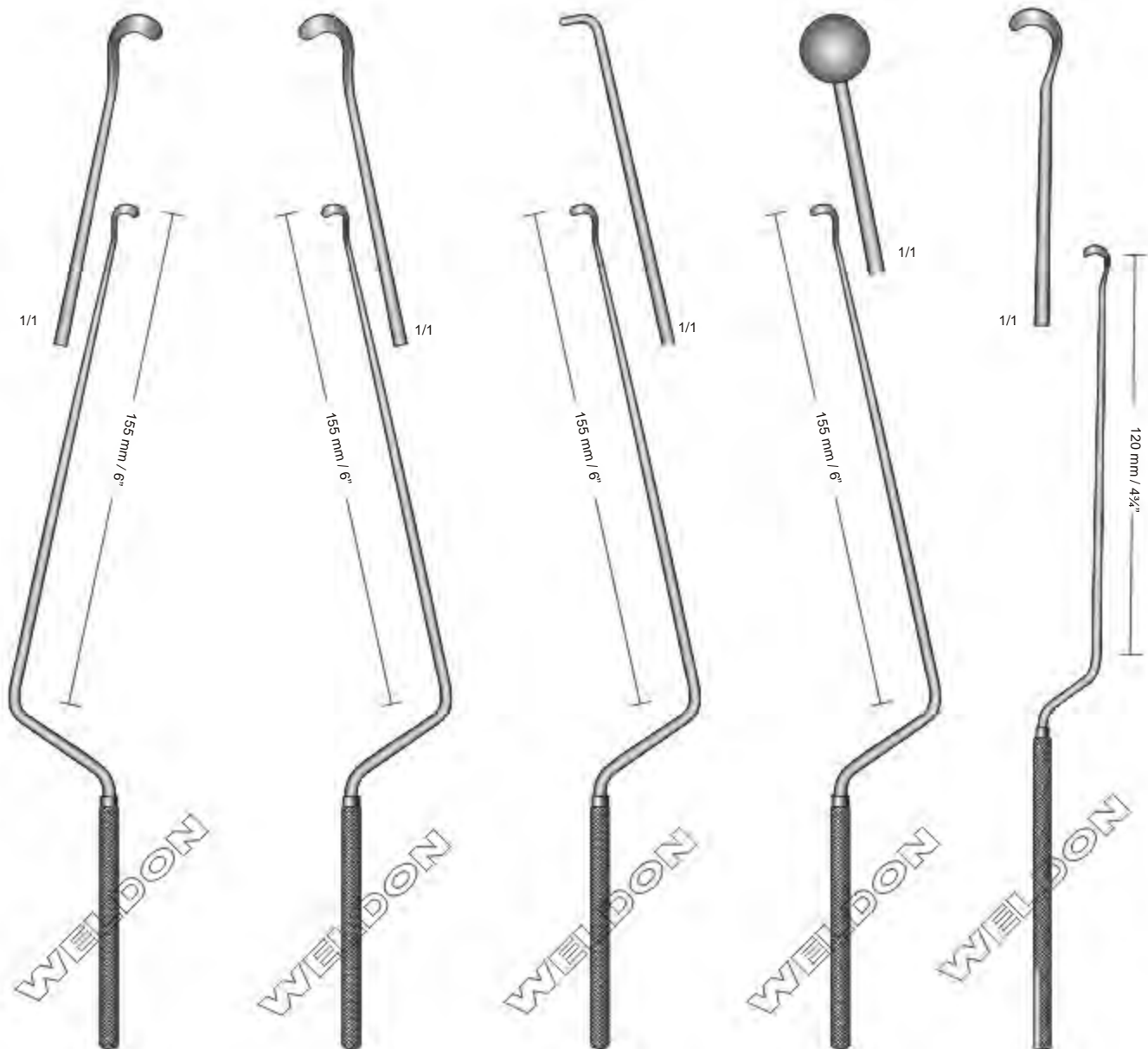

Landolt
WS-440-016
 26 cm / 10¼"
 Curved To Right
 Pituitary Enculeator
 Bayonet Shaped
 Blunt, Malleable

Landolt
WS-440-017
 26 cm / 10¼"
 Curved To Left
 Pituitary Enculeator
 Bayonet Shaped
 Blunt, Malleable

Landolt
WS-440-018
 26 cm / 10¼"
 Blunt Hook
 Bayonet Shaped
 Malleable

Landolt
WS-440-019
 26 cm / 10¼"
 Pituitary Curette
 Bayonet Shaped
 Malleable

Hardy
WS-440-020
 24.5 cm / 9½"
 Hypophysectomy
 Enculeator



Landolt-Reulen
WS-441-022
Ø 2.5 mm
26 cm / 10¼"
Curette, Rigid



Landolt-Reulen
WS-441-023
Ø 3.2 mm
26 cm / 10¼"
Raspatories, Rigid



Landolt-Reulen
WS-441-024
Ø 2.2 mm
26 cm / 10¼"
Raspatories, Rigid



Fahlbusch
WS-441-025
Ø 2.5 mm
26 cm / 10¼"
Curette, Malleable



Landolt-Reulen
WS-441-026
Ø 1.7 mm
26 cm / 10¼"
Blunt Hook, Rigid



Landolt-Reulen
WS-441-027
Ø 2 mm
26 cm / 10¼"
Dissector, Rigid

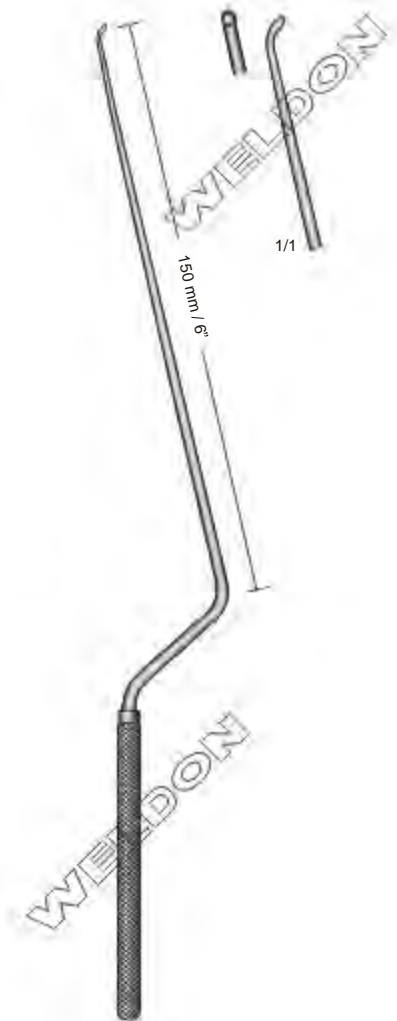

Fahlbusch
WS-441-021
26 cm / 10¼"
Scoop, Malleable

Micro Dissectors & Raspatories, Scalpel Handles | Micro Dissectores Y Legras, Mango Bisturies
 Mikro-Dissektor, Mikro Raspatorium, Skalpelli Griff

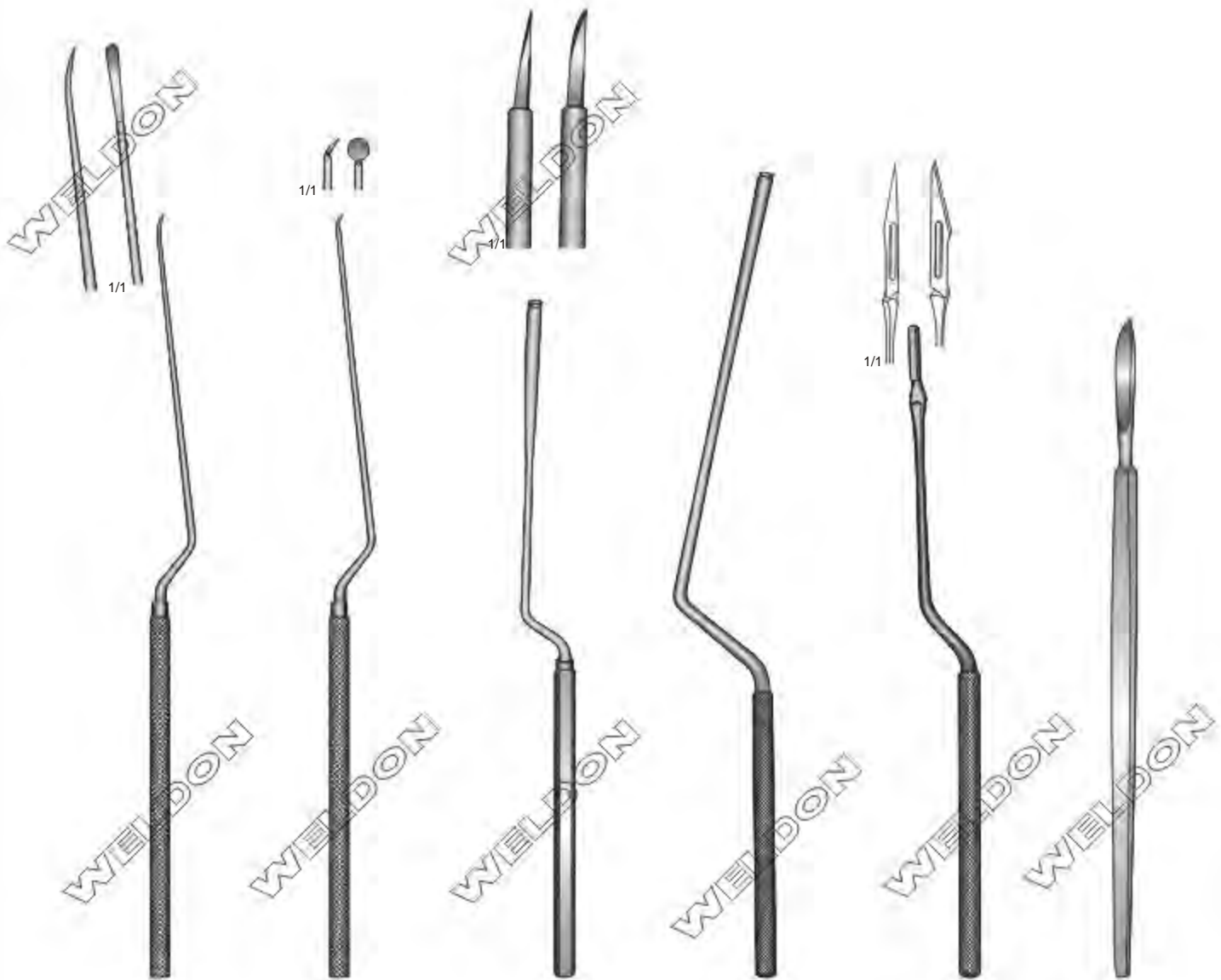

WS-442-028
 23 cm / 9"
 Micro Dissector
 Upwards Curved

WS-442-029
 23 cm / 9"
 Micro Raspatory
 Upwards Curved

Landolt
 WS-442-030
 21cm / 8 1/4"
 Scalpel Handle, Bayont-Shaped
 Square Shank

Landolt
 WS-442-031
 25 cm / 10"
 Scalpel Handle
 Bayont-Shaped Round

WS-442-032
 21 cm / 8 1/4"
 Scalpel Handle
 Blade Can Be Inserted
 From Both Sides
 Bayont-Shaped

Simon
 WS-442-033
 20 cm / 8"
 Scalpel, Straight



1/1

WS-443-034
4.2 x 6.2 mm
Fig. 00



1/1

WS-443-035
5.2 x 7.3 mm
Fig. 0



1/1

WS-443-036
6.8 x 9.6 mm
Fig. 1

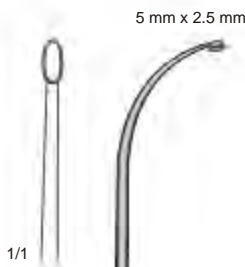

1/1



1/1



Halle
21.5 cm / 8½"
Artrum Curette
Malleable, Sharp



Mackay
WS-443-037
29 cm / 11½"
Artrum Curette
Curved Shaft
Straight End

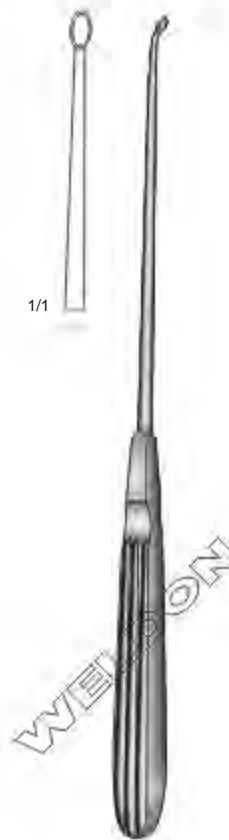

Mackay
WS-443-038
21 cm / 8½"
Artrum Curette
Straight Shaft
Curved End



Seiffert
WS-443-039
18 cm / 7"
Ø 1mm
Salival Probe
Silver



Fisher
WS-444-040
20.5 cm / 8"



Abraham
WS-444-041
21 cm / 8 1/4"



Bruenings
WS-444-042
20.5 cm / 8"



Mackay
WS-444-043
21 cm / 8 1/2"
Artrum Sickle Knife
Straight

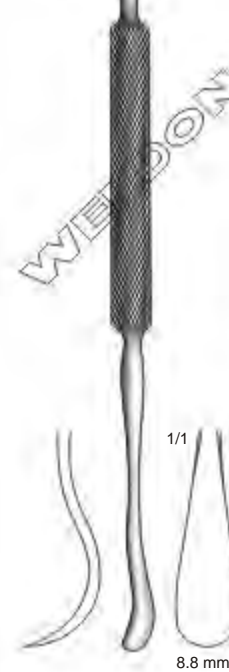
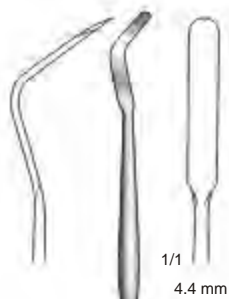

Carpenter
WS-445-044
 25 cm / 10"
 Tonsil Knife / Enucleator



Carpenter
WS-445-045
 24 cm / 9½"
 Tonsil Knife / Enucleator



Hajek
WS-445-046
 16.5 cm / 6½"
 3.5 mm
 Irrigation Canula
 Made of Silver



Ritter
WS-445-047 Ø 2.5 mm
WS-445-048 Ø 3 mm
WS-445-049 Ø 4 mm
WS-445-050 Ø 5 mm
 16 cm / 6¼"
 Frontal Sinus Bougies



10 mm

Hurd
WS-446-051
23 cm / 9"
Dissector And Pillar Retractor



12 mm

1/1



1/1

Henke
WS-446-052
23 cm / 9"
Dissector And Pillar Retractor



17 mm

1/1



1/1

Henke
WS-446-053
23 cm / 9"
Dissector And Pillar Retractor

Micro Scissors with Tubular Shafts, Forceps | Micro Tijeras Con Vástago Tubular, Pinzas
Mikro-Scheren mit Rohrschafe, Pinzetten

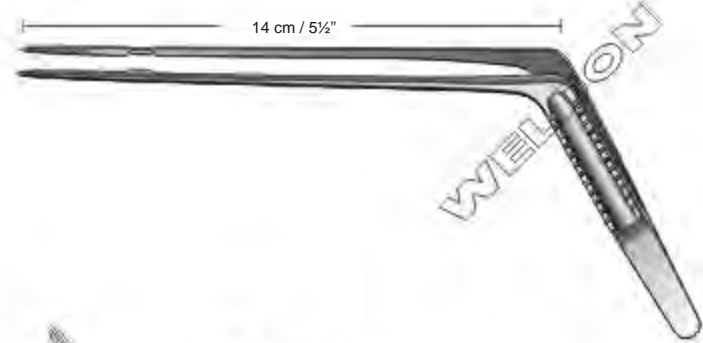
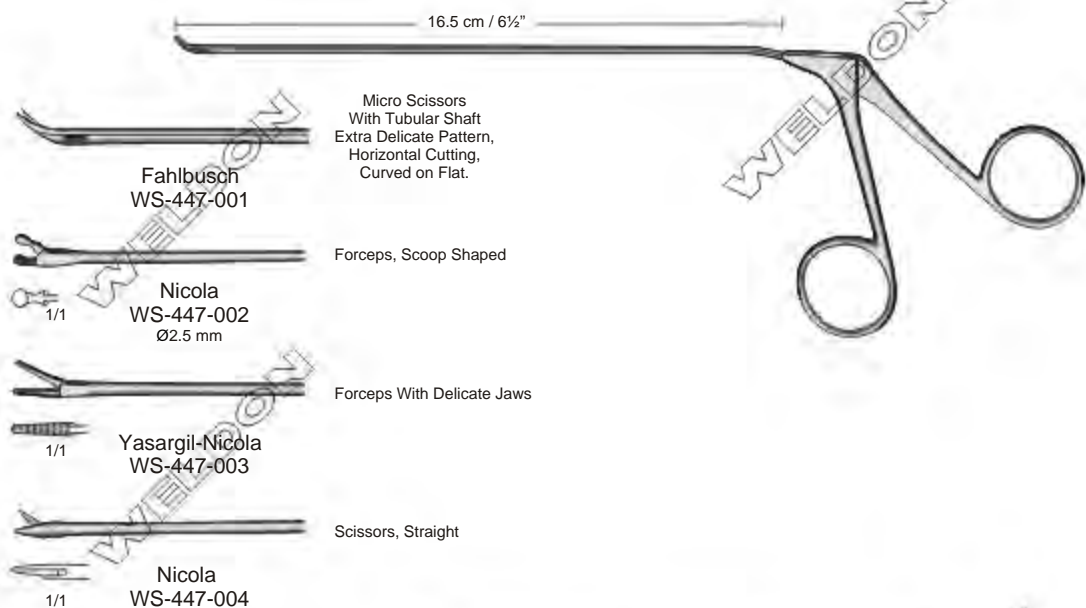

Landolt WS-447-005 Forceps, Angular



White
WS-447-006 18 cm / 7"
WS-447-007 23 cm / 9"

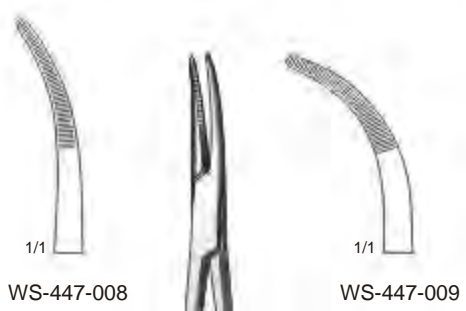

Schmitt
19 cm / 7½"

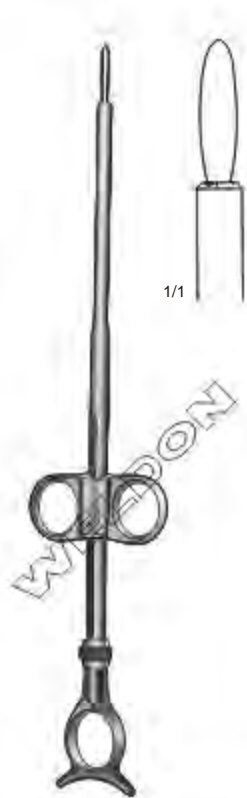
Tonsil Snares | Cierra-Nudos Para Amígdalas | Tonsillenschnürer

Eves
WS-448-001
 28 cm / 11"
 Shaft Ø 6 mm
 Without Ratchet

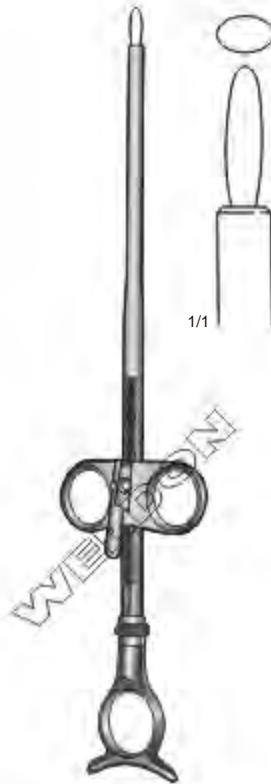

Eves
WS-448-002
 28 cm / 11"
 Shaft Ø 6 mm
 With Ratchet



Brünings
WS-448-003
 29 cm / 11½"
 Shaft End Ø 9.5 mm
 With Double Ratchet



WS-448-004 40 mm
WS-448-005 50 mm
 Wire Loop
 Package of 100 Pieces



WS-448-006
 0.3 mm Ø
 Snare Wire
 Package of 100 Piece

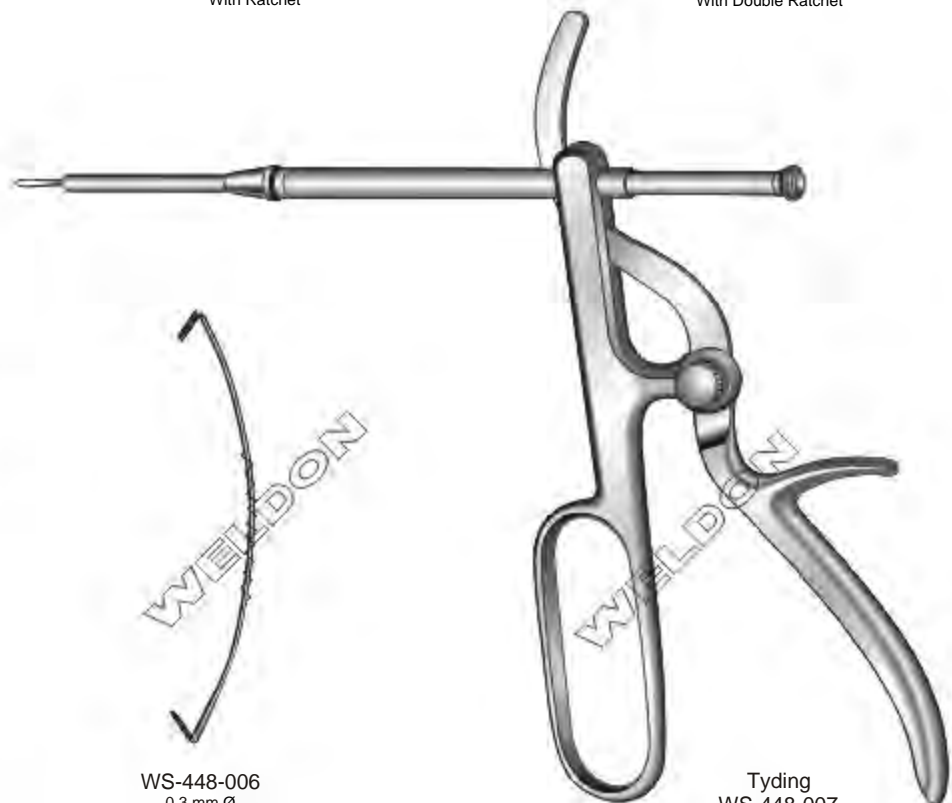

Tyding
WS-448-007
 With One Straight Tip

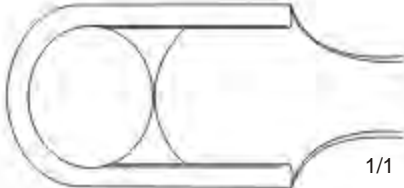

WS-449-008
18 cm / 7"
Fig. 1

1/1

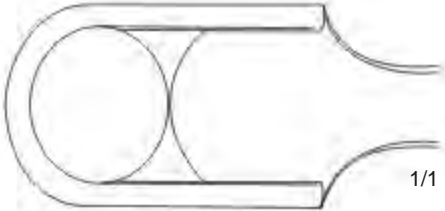

WS-449-009
22 cm / 8 3/4"
Fig. 2

1/1

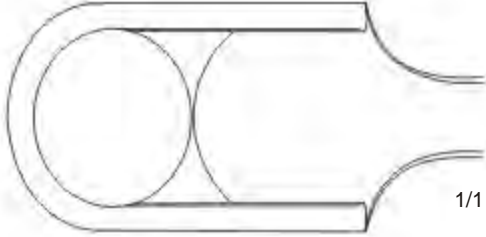

WS-449-010
26 cm / 10 1/4"
Fig. 3

1/1

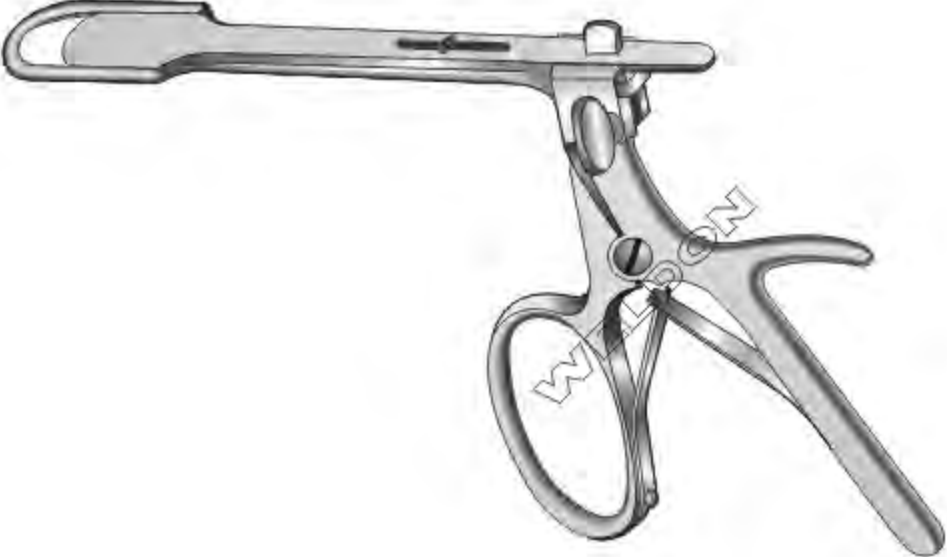

Deniel Telisectomy Forceps
Complete With 3 Tips

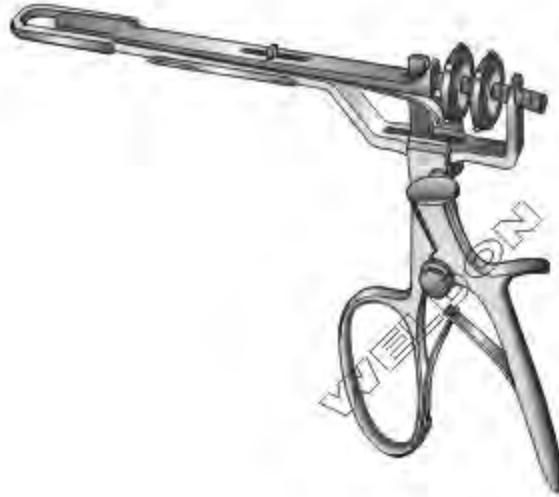
La Force

Hemostatic Tonsil Guillotine.

WS-450-011 Adult Size, Round End, 24 mm Opening.

WS-450-012 Child Size, Round End, 16 mm Opening.

WS-450-013 Adult Size, Square End, 24 mm Opening.

WS-450-014 Child Size, Square End, 16 mm Opening.

WS-450-015 Cutting Blade, Adult Size, Round.

WS-450-016 Cutting Blade, Child Size, Round.

WS-450-017 Cutting Blade, Adult Size, Square.

WS-450-018 Cutting Blade, Child Size, Square.

Saure

Tonsil Enucleation Guillotine, With Two Blades, One For Crushing & One For Cutting.

WS-450-019 Small

WS-450-020 Medium

WS-450-021 Large

WS-450-022 Cutting Blade Only - Small

WS-450-023 Cutting Blade Only - Medium

WS-450-024 Cutting Blade Only - Large

Sluder-Sauer

Tonsil Guillotine.

WS-450-025 Small

WS-450-026 Medium

WS-450-027 Large

WS-450-028 Blade Only - Small

WS-450-029 Blade Only - Medium

WS-450-030 Blade Only - Large

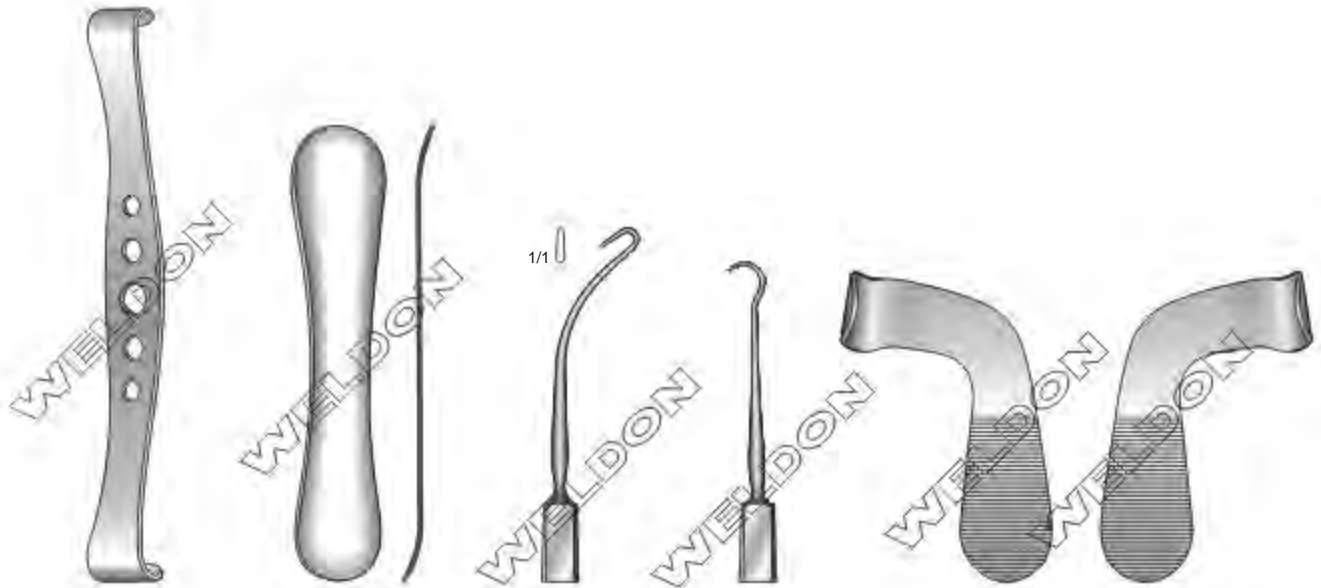

Berke
 WS-451-001
 9 x 13 mm & 10 x 15 mm Blades
 WS-451-002
 11 x 17 mm & 12 x 19 mm Blades
 Lid Everter

Jaeger
 WS-451-003
 Clear Plastic
 Lid Plate

Scobee
 WS-451-004
 Oblique Muscle Hook.
 Blunt Rounded Tip
 Side Curved Shank

Fink
 WS-451-005
 Oblique Muscle Hook
 Sharp

Walker
 WS-451-006 Right
 WS-451-007 Left
 Lid Everter



Mirror With Handle
 18.5 cm / 7 1/4"

Plane Laryngeal Mirrors

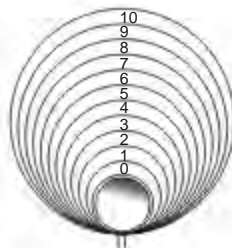

WS-451-008	Fig. 00	8 mm Ø	WS-451-020
WS-451-009	Fig. 0	10 mm Ø	WS-451-021
WS-451-010	Fig. 1	12 mm Ø	WS-451-022
WS-451-011	Fig. 2	14 mm Ø	WS-451-023
WS-451-012	Fig. 3	16 mm Ø	WS-451-024
WS-451-013	Fig. 4	18 mm Ø	WS-451-025
WS-451-014	Fig. 5	20 mm Ø	WS-451-026
WS-451-015	Fig. 6	22 mm Ø	WS-451-027
WS-451-016	Fig. 7	24 mm Ø	WS-451-028
WS-451-017	Fig. 8	26 mm Ø	WS-451-029
WS-451-018	Fig. 9	28 mm Ø	WS-451-030
WS-451-019	Fig. 10	30 mm Ø	WS-451-031
		With Handle	Without Handle



Mirror Only
 13.5 cm / 5 1/4"

Laryngeal Mirrors Handles | Espejos Laringeos y Mangos | Kehlkopfspiegel-Griffe

Shaft Length
12 cm / 4¾"
Without Handle



1/1
WS-452-032
Ø 6 mm
Fig. 000



1/1
WS-452-033
Ø 8 mm
Fig. 00



1/1
WS-452-034
Ø 10 mm
Fig. 0



1/1
WS-452-035
Ø 12 mm
Fig. 1

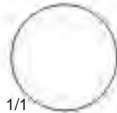

1/1
WS-452-036
Ø 14 mm
Fig. 2

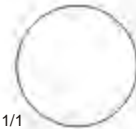

1/1
WS-452-037
Ø 16 mm
Fig. 3

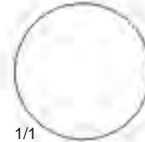

1/1
WS-452-038
Ø 18 mm
Fig. 4

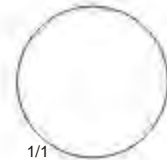

1/1
WS-452-039
Ø 20 mm
Fig. 5

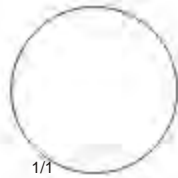

1/1
WS-452-040
Ø 22 mm
Fig. 6

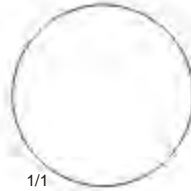

1/1
WS-452-041
Ø 24 mm
Fig. 7

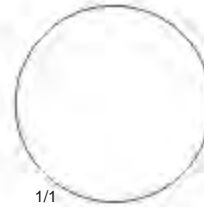

1/1
WS-452-042
Ø 26 mm
Fig. 8

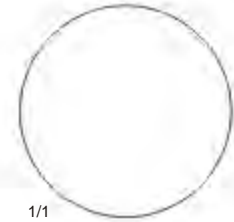

1/1
WS-452-043
Ø 28 mm
Fig. 9

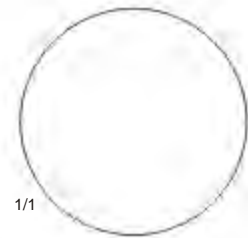

1/1
WS-452-044
Ø 30 mm
Fig. 10



WS-452-045
11 cm / 4⅝"
With Adjustable Screw



WS-452-046
11.5 cm / 4½"
With Chuck

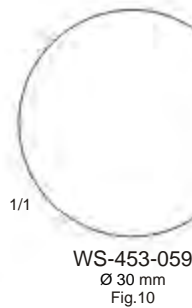
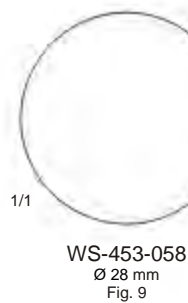
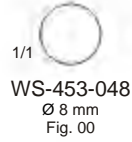

Plane
22 cm / 8³/₄"
Fixed Rhodium Handle

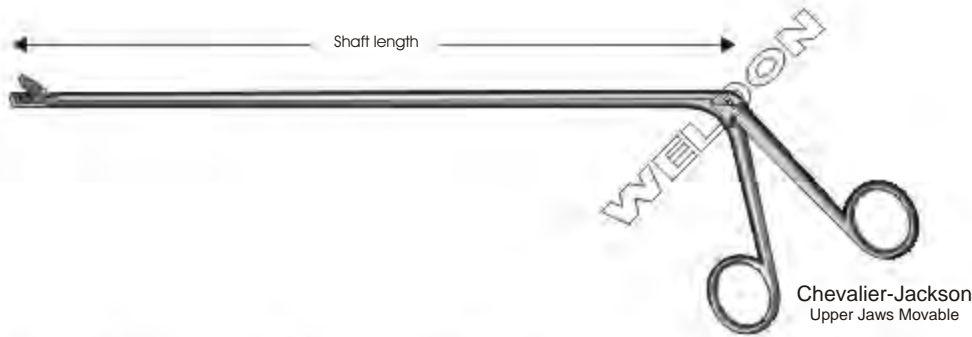

Michel
27 cm / 10³/₄"
Rhinoscopic Mirrors, Movable
Shaft Length
10 cm / 4"

**Broncho-Esophagoscopy Forceps | Pinzas Para Broncho-Esofagoscopia
Broncho-Oesophoskopiezangen**

Chevalier-Jackson
Upper Jaws Movable

Length 1/1
cm Inch

30	12	WS-454-001	WS-454-005	WS-454-009	WS-454-013	WS-454-017	WS-454-021	WS-454-025
40	16	WS-454-002	WS-454-006	WS-454-010	WS-454-014	WS-454-018	WS-454-022	WS-454-026
50	20	WS-454-003	WS-454-007	WS-454-011	WS-454-015	WS-454-019	WS-454-023	WS-454-027
60	24	WS-454-004	WS-454-008	WS-454-012	WS-454-016	WS-454-020	WS-454-024	WS-454-028



Huber
WS-454-029
Universal Handle
For Interchangeable Tubes & Tips

Bruenings
WS-454-030

WS-454-031 20 cm / 8"
WS-454-032 30 cm / 12"
WS-454-033 40 cm / 16"

Bruenings
WS-454-034
Laryngeal Tube, Curved
For Handles Above

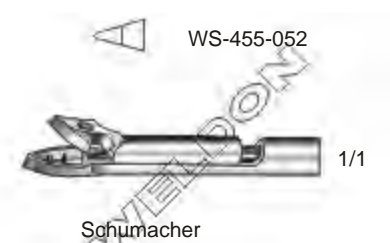
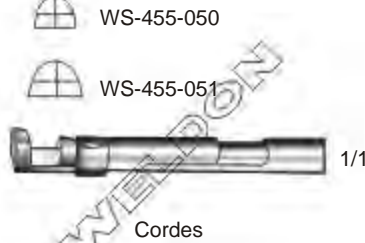
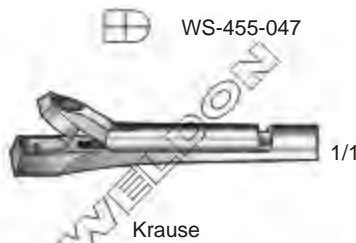
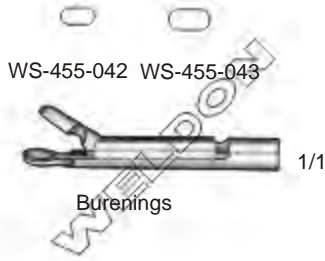
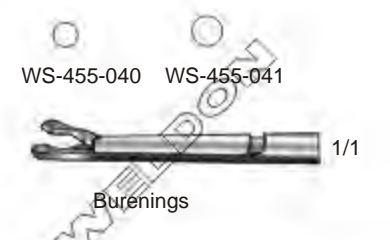
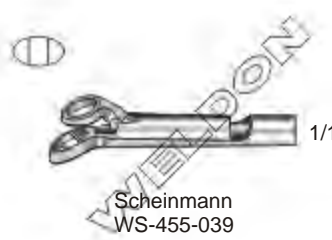
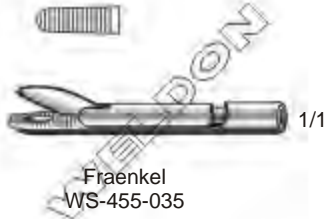
Exchangeable Tips | Pinzas Intercambiables | Auswechselbare Zangenaufsätze





WS-456-057
17 cm / 6¾"
WS-456-058
20 cm / 8"



WS-456-059
25 cm / 10"



Magill
Catheter Introducing Forceps



Miller
WS-457-001
Complete Set



Miller
Fiber Optic - (Cold Light Guide Fixed)

	Fig.	Working Length (mm)
BMFI-00-45	00	45
BMFI-0-55	0	55
BMFI-1-80	1	80
BMFI-2-130	2	130
BMFI-3-170	3	170
BMFI-4-180	4	180

Re-useable



Miller
Conventional

	Fig.	Working Length (mm)
BMCI-00-45	00	45
BMCI-0-55	0	55
BMCI-1-80	1	80
BMCI-2-130	2	130
BMCI-3-170	3	170
BMCI-4-180	4	180



Miller
Fiber Optic

	Fig.	Working Length (mm)
BMSI-00-45	00	45
BMSI-0-55	0	55
BMSI-1-80	1	80
BMSI-2-130	2	130
BMSI-3-170	3	170
BMSI-4-180	4	180

Single Use



McIntosh
WS-458-001
Complete Set

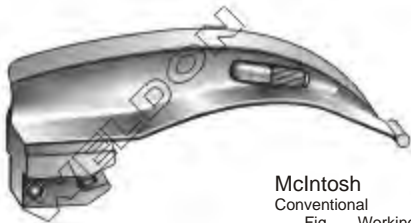

McIntosh
Conventional

	Fig.	Working Length (mm)
BMCC-0-55	0	55
BMCC-1-70	1	70
BMCC-2-78	2	78
BMCC-3-90	3	90
BMCC-4-103	4	103
BMCC-5-133	5	133
BMCC-6-150	6	150



McIntosh
Fiber Optic - (Cold Light Guide Fixed)

	Fig.	Working Length (mm)
BMFC-0-55	0	55
BMFC-1-70	1	70
BMFC-2-78	2	78
BMFC-3-90	3	90
BMFC-4-108	4	108
BMFC-5-133	5	133
BMFC-6-150	6	150

Re-Useable

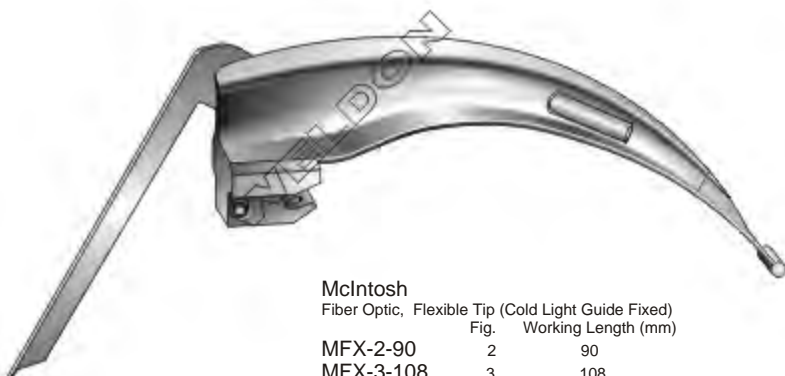

McIntosh
Fiber Optic, Flexible Tip (Cold Light Guide Fixed)

	Fig.	Working Length (mm)
MFX-2-90	2	90
MFX-3-108	3	108
MFX-4-130	4	130
MFX-5-150	5	150



McIntosh
WS-459-001
Complete Set



McIntosh
Mega Blade Fiber Optic

Fig.	Working Length (mm)
BMM-0-55	55
BMM-1-70	70
BMM-2-78	78
BMM-3-90	90
BMM-4-108	108
BMM-5-133	133
BMM-6-150	150



McIntosh
Fiber Optic

Fig.	Working Length (mm)
BMSC-0-55	55
BMSC-1-70	70
BMSC-2-78	78
BMSC-3-90	90
BMSC-4-108	108
BMSC-5-133	133
BMSC-6-150	150

Single Use



McIntosh

Fig.	Working Length (mm)
MFS-2-90	90
MFS-3-108	108
MFS-4-130	130
MFS-5-150	150

Single Use



PSW-100
Pediatric Handle
Fiber Optic



PSW-200
Standard Handle
Fiber Optic



PSW-300
Standard Handle
Fiber Optic
For Mega Blade



PSW-400
Standard Handle
Conventional



PSW-500
Pediatric Handle
Conventional



PSW-600
Stubby Handle



For Conventional
Laryngoscopes Blade
(2.5 Volts)

BW-10

BW-20

BW-30



For Fiber Optics
Laryngoscopes Blade
(2.5 Volts)

BW-40

BW-50



For Mini Oscope
Fiber Optics
(2.5 Volts)

BW-60

BW-70



For Mini Oscope
& Ophthalmoscopes
Halogen Fiber Optics
(2.5 Volts)

BW-80

BW-90



For Mini Oscope
Ophthalmoscopes Metal
Body Oscopes
(3 Volts)

BW-200

BW-300



For 4 Aperture
Ophthalmoscopes
(2.5 Volts)

BW-400



For Tongue Depressor
& Pen Light
(2.5 Volts)

BW-500



For Conventional
Mini Oscope
(2.5 Volts)

BW-100



www.weldoninstruments.com

PROVEEDOR EXCLUSIVO:



Nasal Specula

Nasal Cutting, Tampon & Polypus Forceps

Septum Forceps & Knives

Septum Elevators, Chisels & Gouges

461 - 508

Rhinology

Rhinology
Rinologia
Rhinologie



Voltolini
5 cm / 2"



1/1
WS-461-001



1/1
WS-461-002



1/1
WS-461-003



1/1
WS-461-004

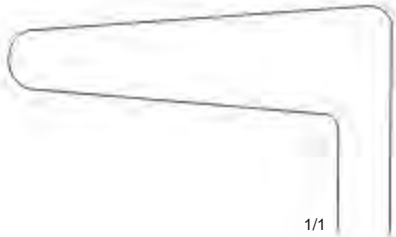

1/1
WS-461-005

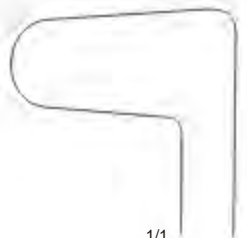

1/1
WS-461-006



Shah
7.5 cm / 3"
50 x 30 mm



Shah
7.5 cm / 3"
30 x 50 mm



1/1
WS-461-007

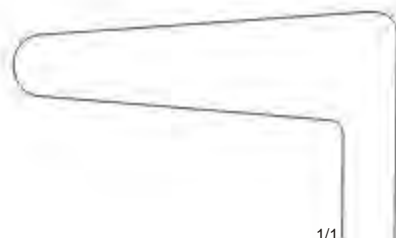

1/1
WS-461-008

Nasal Specula | Espéculos Nasaes | Nasenspekula

WS-462-009
8.5 x 6.0
70 mm



WS-462-010
9.0 x 7.0
71 mm



WS-462-011
12.5 x 8.0
72 mm



WS-462-012
15.0 x 8.5
73 mm



WS-462-013
16.5 x 9.0
74 mm

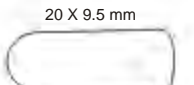

20 X 9.5 mm
WS-462-016
6.5 cm / 2½"
Fig. 1



WS-462-014
18.0 x 10.0
74 mm

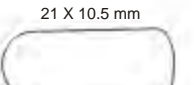

21 X 10.5 mm
WS-462-017
6.5 cm / 2½"
Fig. 2



WS-462-015
19.5 x 10.5
75 mm

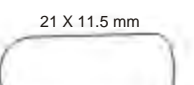

21 X 11.5 mm
WS-462-018
6.5 cm / 2½"
Fig. 3

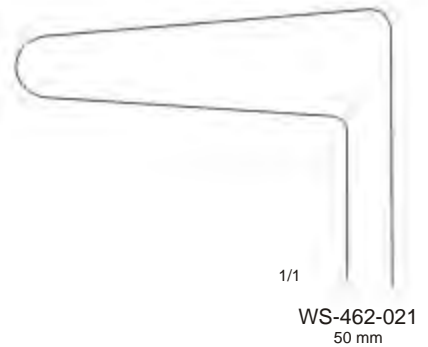
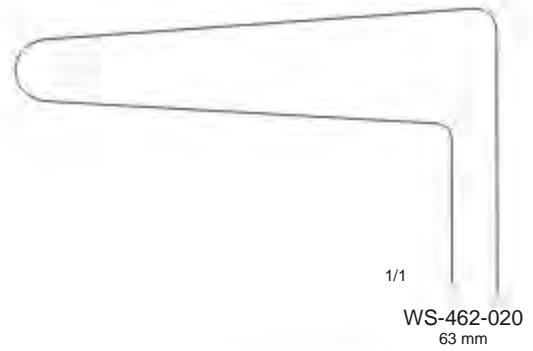
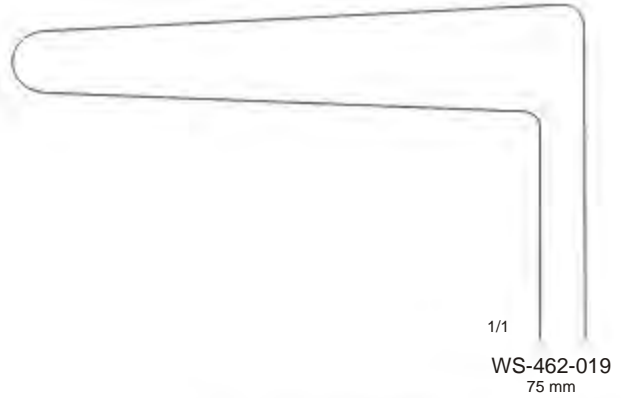
Thudichum

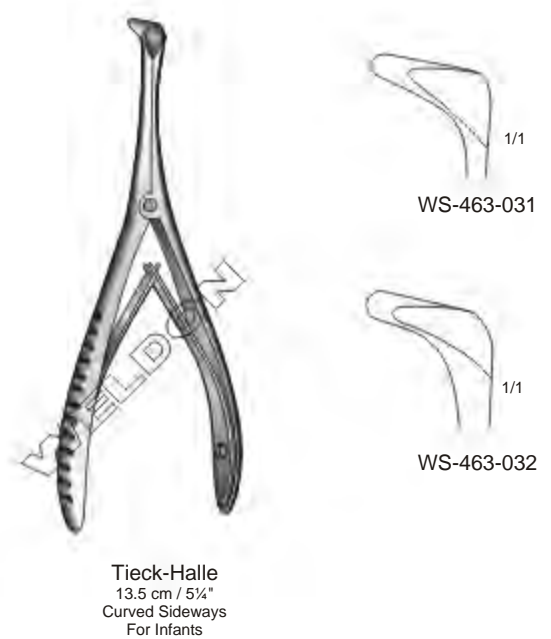
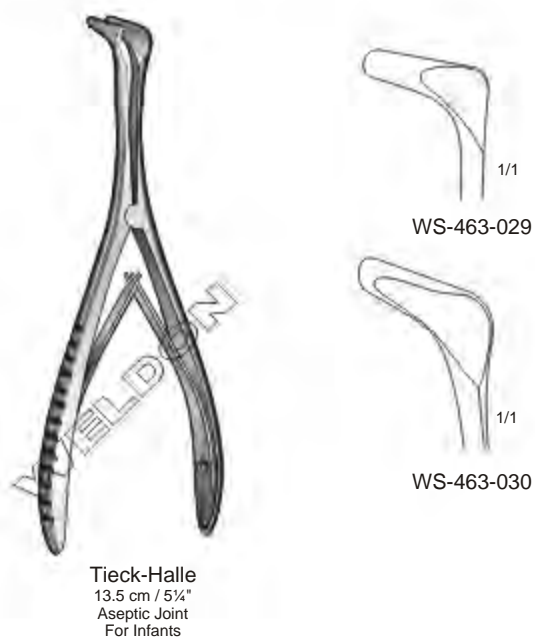
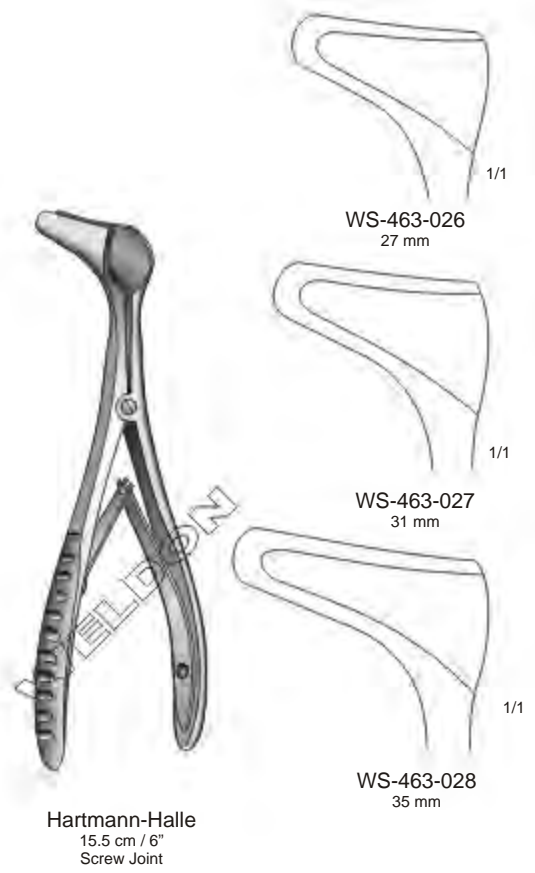
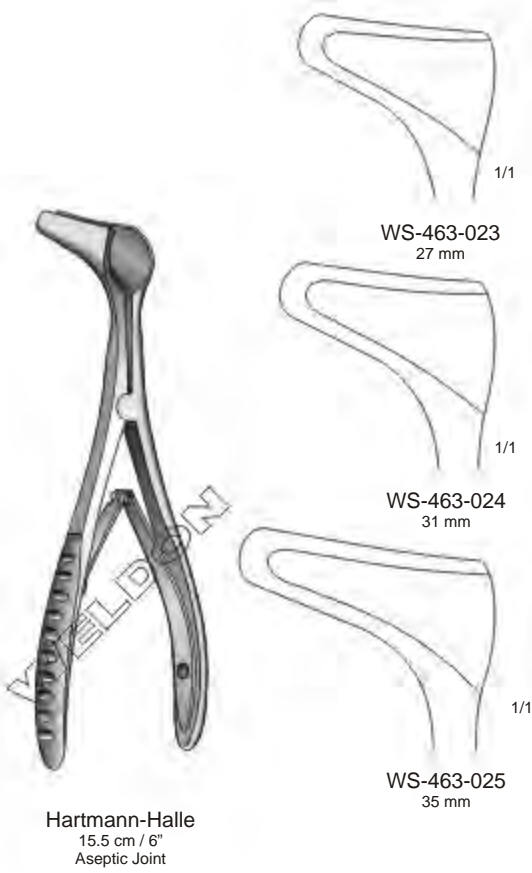
St Clair Thompson
7.3 cm / 2¾"



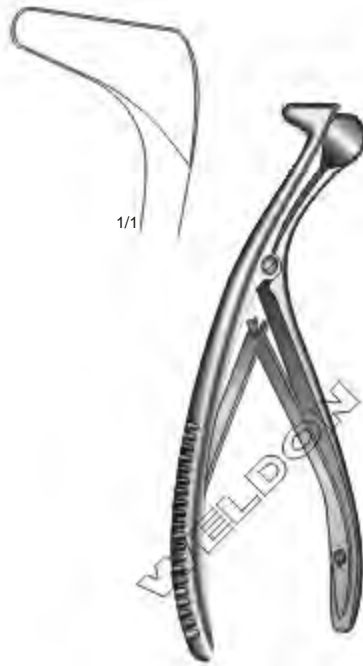

Beckmann
WS-464-033
14 cm / 5½"
Curved Sideways
For Infants



Beckmann
WS-464-034
15 cm / 6"
Curved Sideways

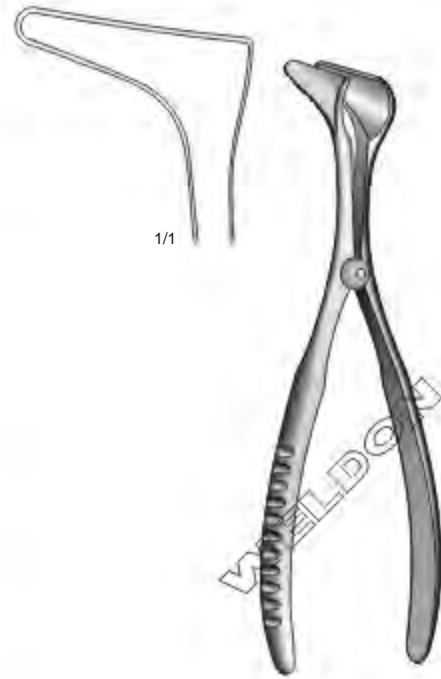

Hartmann
WS-464-035
14.5 cm / 5¾"
Light Pattern



Hartmann
16 cm / 6¼"

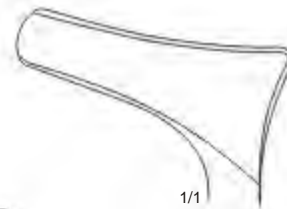

1/1
WS-464-036

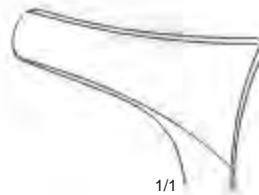

1/1
WS-464-037

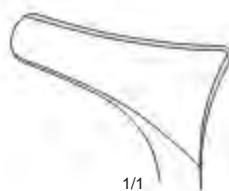

1/1
WS-464-038

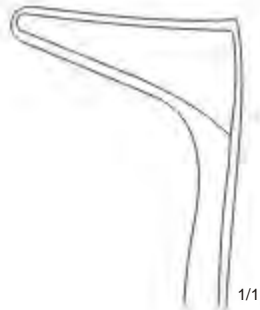

Wiener
WS-465-039
14 cm / 5½"
Small, Light Pattern



Wiener
WS-465-040
14 cm / 5½"
Medium

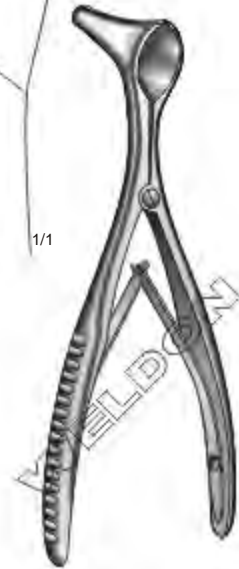
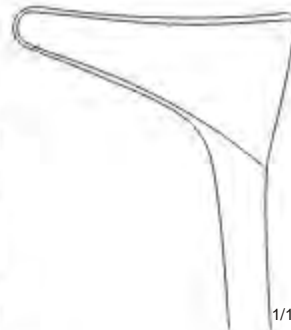

Wiener
WS-465-041
14 cm / 5½"
Large, Heavy Pattern

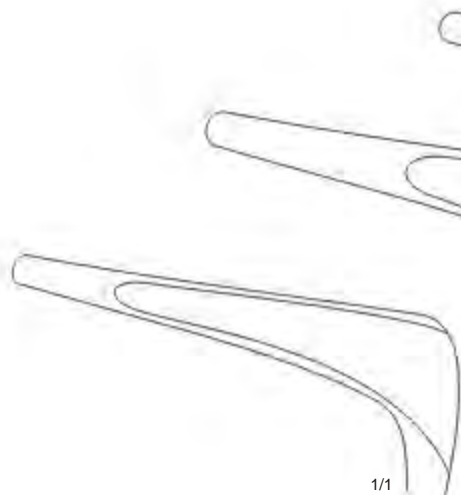

WS-465-044
41 mm
Fig. 3

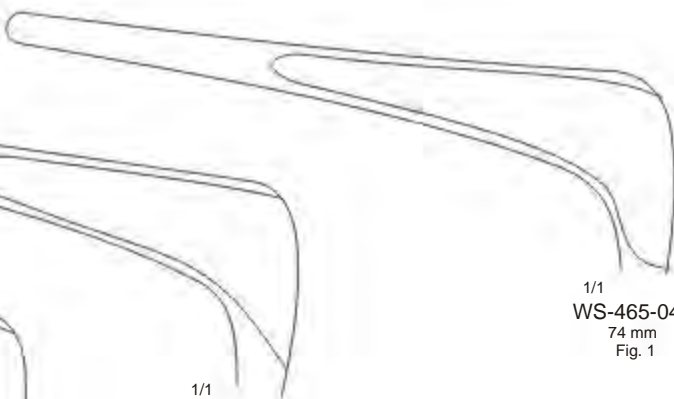

WS-465-045
60 mm
Fig. 2

1/1
WS-465-046
74 mm
Fig. 1

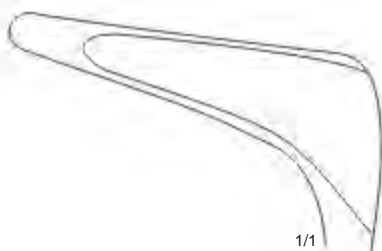

WS-465-043
38 mm
Fig. 4

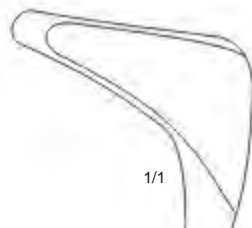

WS-465-042
20 mm
Fig. 5



Cottle
13.5 cm / 5¼"



1/1
WS-466-048
Fig.1
Infant

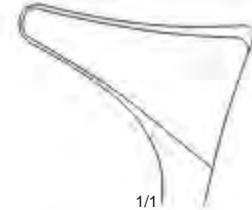

1/1
WS-466-051
Fig.1
Infant

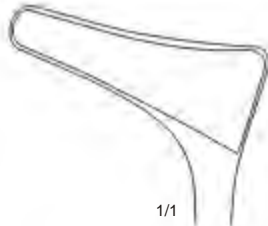

1/1
WS-466-049
Fig.2
Child

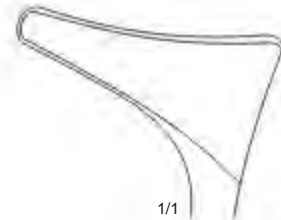

1/1
WS-466-052
Fig.2
Child

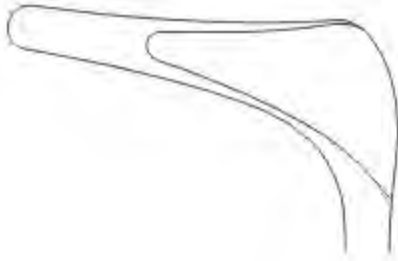

1/1
45 mm

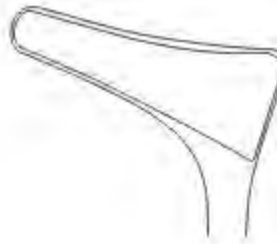

WS-466-050
Fig.3
Adult

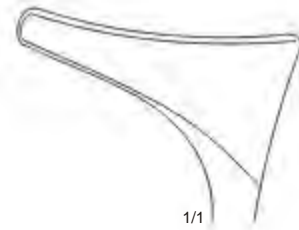

1/1
WS-466-053
Fig.3
Adult



Cottle
WS-466-047
13.5 cm / 5 1/4"
50 X 6 mm
Slightly Tapered Blades



Vienna Pattern
14.5 cm / 5 1/2"
US Style



Vienna Pattern
15 cm / 6"

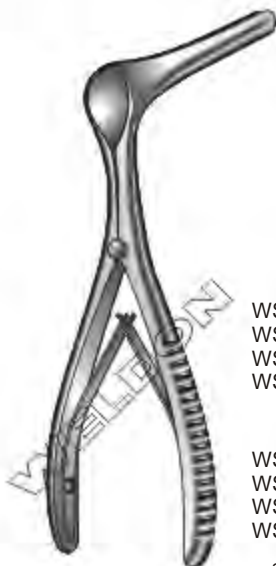
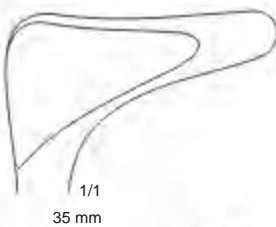
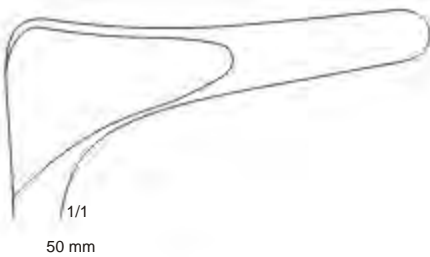
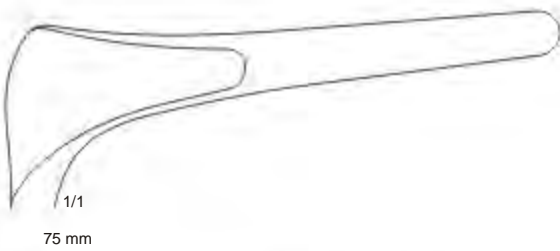
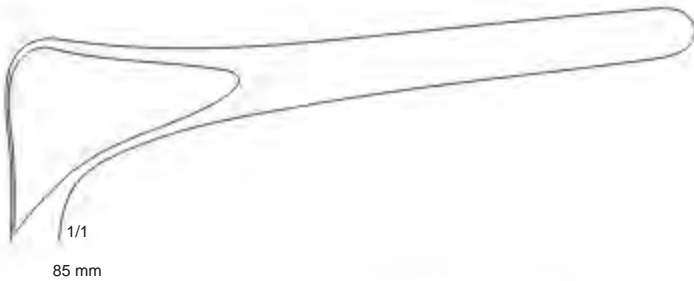

Killian
 WS-467-054 Fig. 1 36 x 7 mm
 WS-467-055 Fig. 2 56 x 7 mm
 WS-467-056 Fig. 3 75 x 7 mm
 WS-467-057 Fig. 4 90 x 7 mm
 14.5 cm / 5 7/8"
 Screw Joint

WS-467-058 Fig. 1 36 x 7 mm
 WS-467-059 Fig. 2 56 x 7 mm
 WS-467-060 Fig. 3 75 x 7 mm
 WS-467-061 Fig. 4 90 x 7 mm
 14 cm, 5 1/2"
 Septum Specula, Aseptic Joint



Yankauer
 WS-467-062
 19 cm / 7 1/2"



ST Clair Thompson
 24.5 cm / 9 3/4"
 Rhinoscopic Mirror, Bayonet

Nasal, Tampon and Polypus Forceps | Pinzas Para Taponamiento y Pólipos
 Nasentamponpinzetten, Nasenpolypenzangen



Troeltsch
 WS-468-001
 15 cm / 6"



Troeltsch
 WS-468-002
 18 cm / 7"



Gruenwald (Jansen)
 WS-468-003
 21.5 cm / 8½"



Lister
 WS-468-004
 15.5 cm / 6"



Westmacott
 WS-468-005
 20 cm / 8"



Lubet-Barbon
 WS-468-006
 18.5 cm / 7¼"
 Nasal Tampon Forceps

Nasal, Tampon and Polypus Forceps | Pinzas Para Taponamiento y Pólipos
Nasentamponpinzetten, Nasenpolypenzangen



Hartmann
WS-469-007
15 cm / 6"



Hartmann
WS-469-008
18.5 cm / 7 1/4"

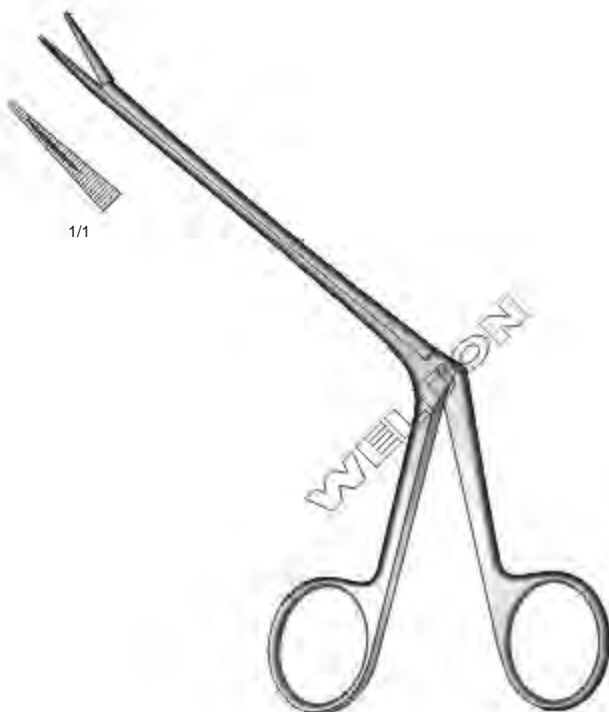

Hartmann
WS-469-009
19 cm / 7 1/2"



Tilley
WS-469-010
13.2 cm / 5 1/4"
2.20 mm

Nasal, Tampon and Polypus Forceps | Pinzas Para Taponamiento y Pólipos
Nasentamponpinzetten, Nasenpolypenzangen



Littauer
WS-470-011
18 cm / 7"



Killian
WS-470-012
17 cm / 6 3/4"

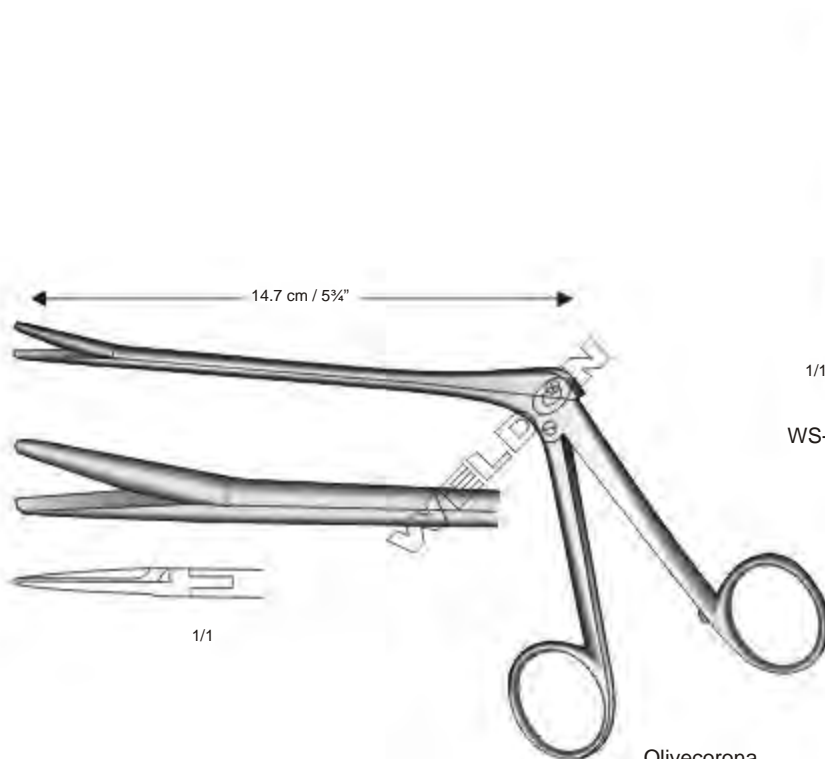

Heymann-Knight
WS-470-013
18 cm / 7"



Olivecorona
WS-470-014
22.5 cm / 9"

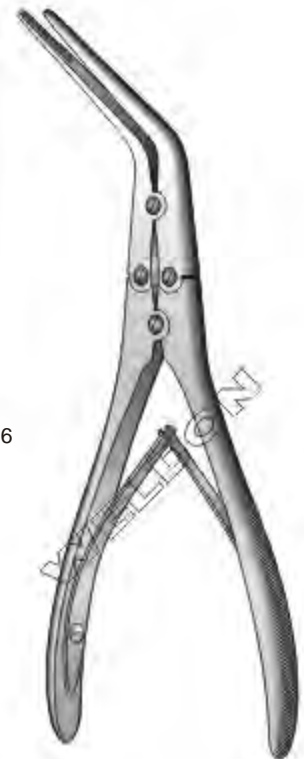
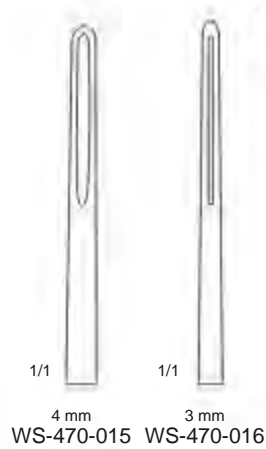

Kressner
22 cm / 8 3/4"



Quire
WS-471-017
12 cm / 4 3/4"

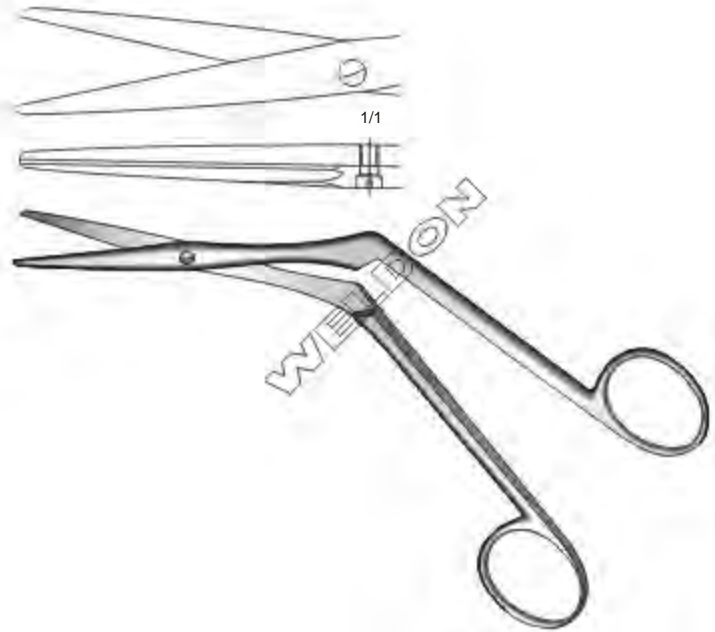

Heymann-Knight
WS-471-018
17.5 cm / 7"



Knight
WS-471-019
18 cm / 7"

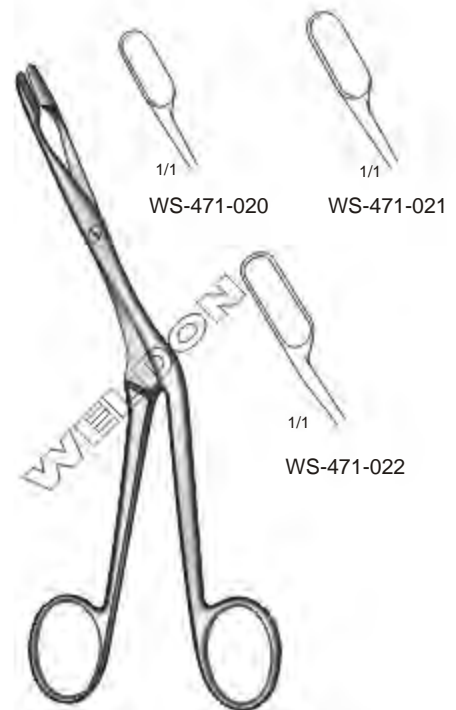

Heymann
18 cm / 7"

Nasal Septum and Cutting Forceps | Pinzas Para Tabique Y Cortantes Nasal
Septumzangen, Scharfe Nasenzangen



Graig
WS-472-023
16.5 cm / 6½"



Craig-Domnick
16.5 cm / 6½"

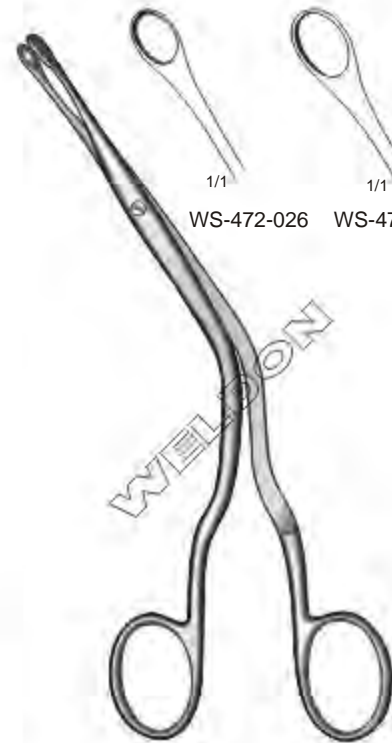

Luc
18.5 cm / 7¼"

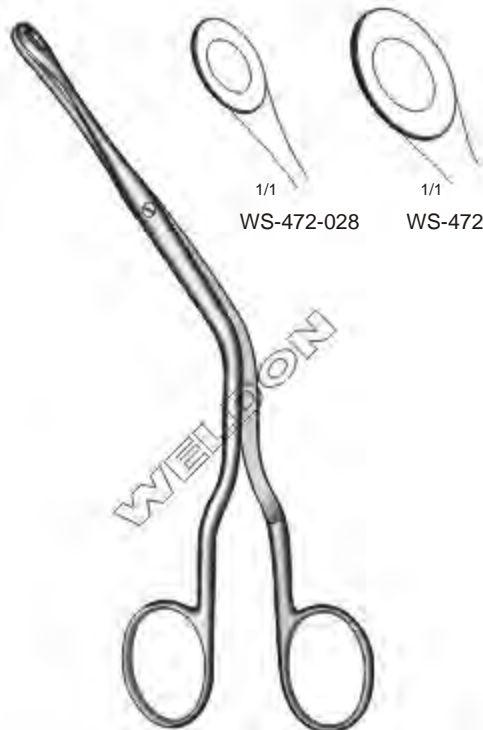

Luc
18.5 cm / 7¼"

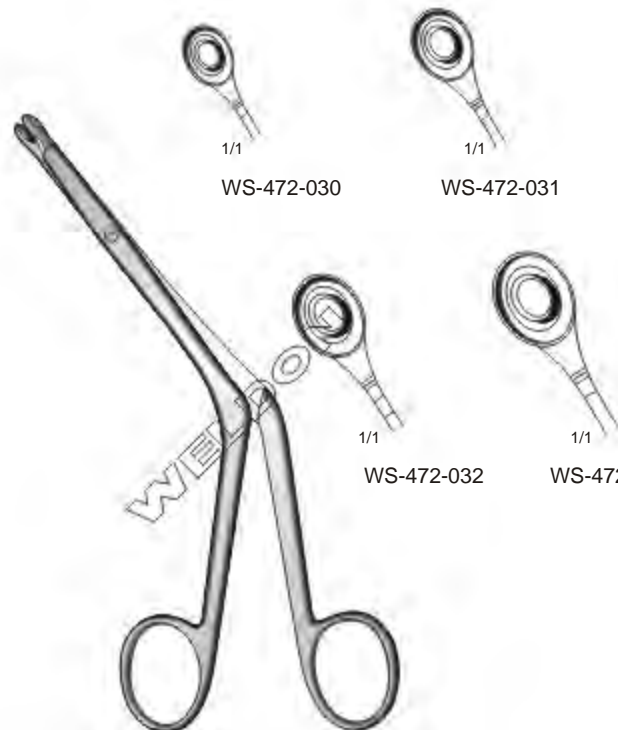

Brünings
16.5 cm / 6½"

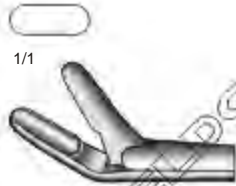

WS-473-036
Beak Upwards

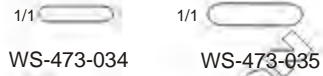

WS-473-034 WS-473-035



Gruewald-Henke
Through Cutting



WS-473-037
Straight

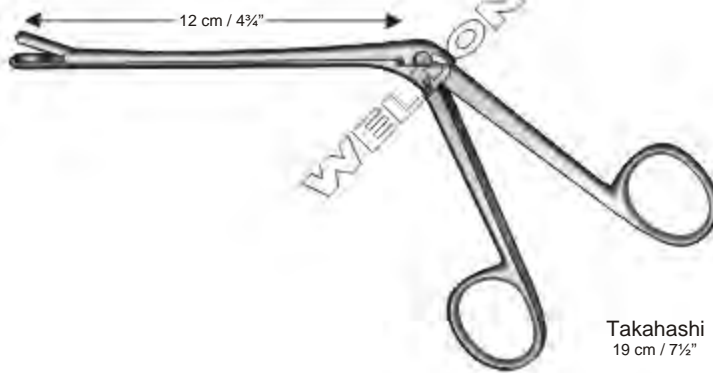

Takahashi
19 cm / 7 1/2"

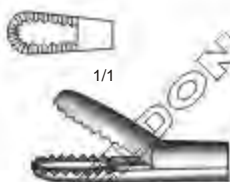

WS-473-038

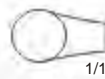

WS-473-039
Well With Neck



Watson-Williams
19 cm / 7 1/2"

Nasal Cutting Forceps | Pinzas Nasales Cortantes | Scharfe Nasenzangen



WS-474-040
5 mm



WS-474-041
7 mm



WS-474-042
9 mm



Watson-Williams
Ethmoidal Forceps

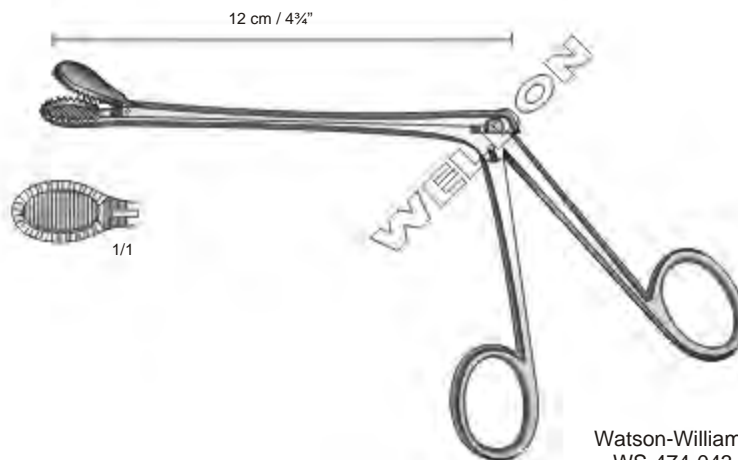

Watson-Williams
WS-474-043
Ethmoidal Forceps
Serrated Jaws

Nasal Cutting Forceps | Pinzas Nasaes Cortantes | Scharfe Nasenzangen



Straight

1/1
WS-475-044
3 mm

1/1
WS-475-045
3.5 mm

1/1
WS-475-046
4 mm

1/1
WS-475-047
4.5 mm

1/1
WS-475-048
5 mm



Angled At 45°

1/1
WS-475-049
3 mm

1/1
WS-475-050
3.5 mm

1/1
WS-475-051
4 mm

1/1
WS-475-052
4.5 mm

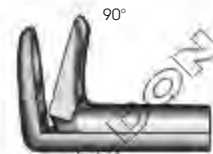

Angled At 90°

1/1
WS-475-053
3 mm
Fig. 1

1/1
WS-475-054
3.5 mm
Fig. 2

1/1
WS-475-055
4.5 mm
Fig. 3

1/1
WS-475-056
5 mm
Fig. 4

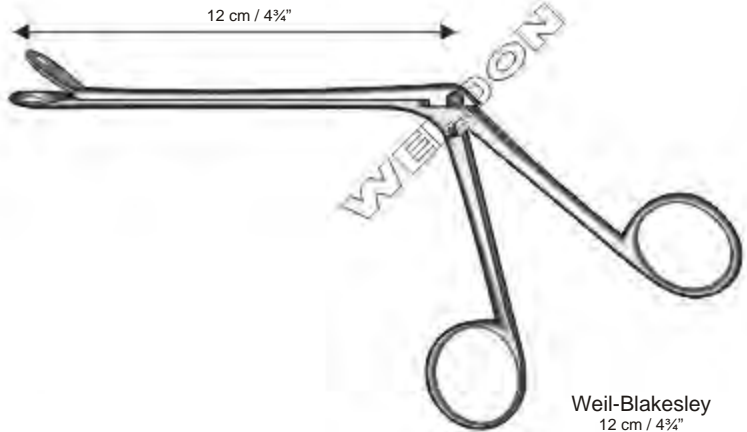

Weil-Blakesley
12 cm / 4 3/4"

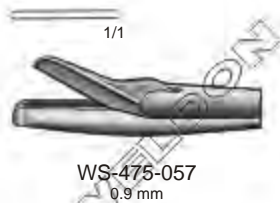

WS-475-057
0.9 mm

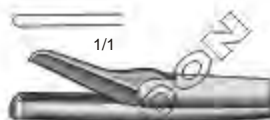

WS-475-058
1.2 mm

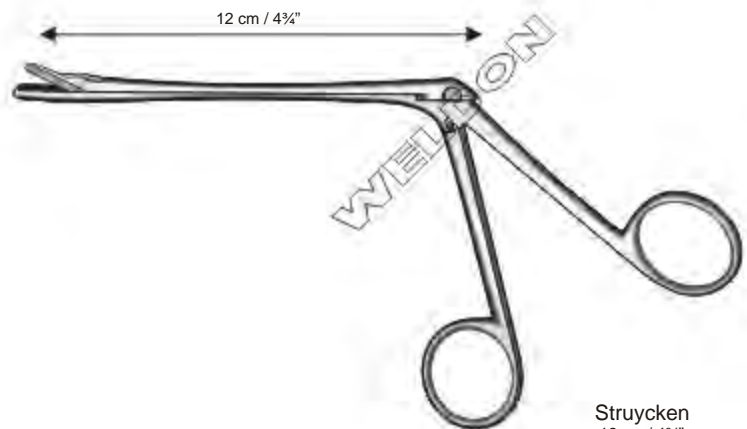

Struycken
12 cm / 4 3/4"

Nasal Cutting Forceps | Pinzas Nasales Cortantes | Scharfe Nasenzangen

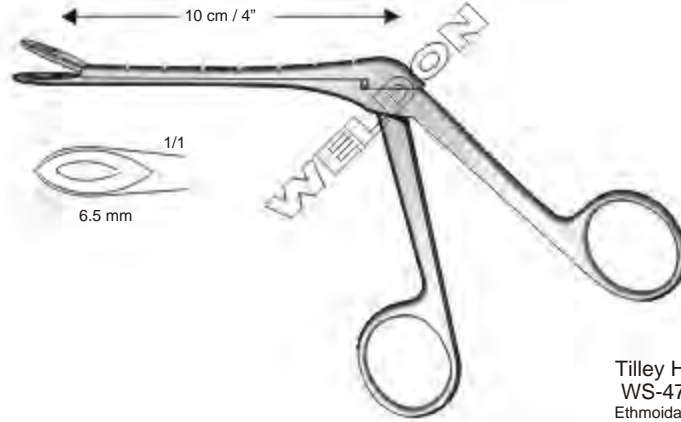

Tilley Henckel
WS-476-059
Ethmoidal Forceps
Graduated Shaft
Straight



WS-476-060
Ethmoidal Forceps
Straight

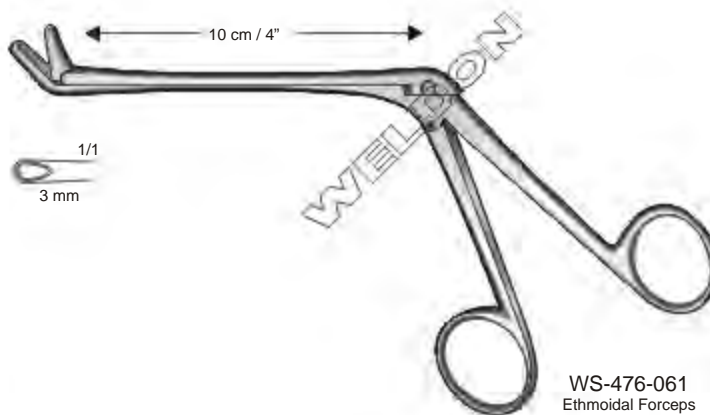

WS-476-061
Ethmoidal Forceps
Curved Upwards

Nasal Cutting Forceps | Pinzas Nasaes Cortantes | Scharfe Nasenzangen

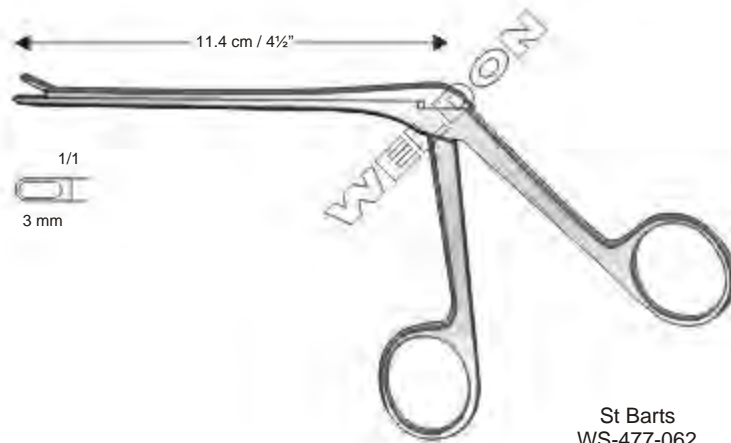

St Barts
WS-477-062
Rongeur, Straight

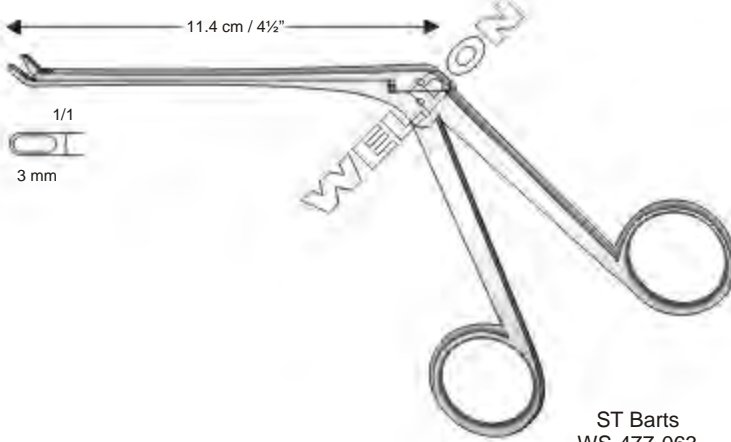

ST Barts
WS-477-063
Rongeur, Upward

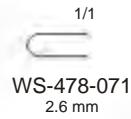
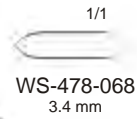
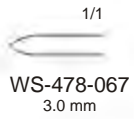
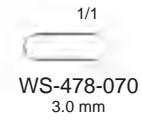
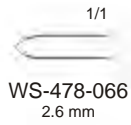
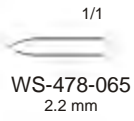

ST Barts
WS-477-064
Rongeur, Downward

Nasal Cutting Forceps | Pinzas Nasales Cortantes | Scharfe Nasenzangen

Myles
Shaft Length 12 cm / 4¾"



Myles
19 cm / 7½"
Shaft Length 12 cm / 4¾"



Hartmann
19 cm / 7½"
Shaft Length 12 cm / 4¾"



Hajek
WS-478-076
19 cm / 7½"
Shaft Length 12 cm / 4¾"



Schmeden
WS-478-077
19 cm / 7½"
Shaft Length 12 cm / 4¾"
Jaw Width 8 mm



Septum Straightening Forceps | Pinzas Para Enderezar el Tabique Nasal | Septumrichtzangen



Cottle-Walsham
23 cm / 9"



Kerssner
WS-479-081
21 cm / 8 1/4"



Asch
WS-479-082
22.5 cm / 8 3/4"

Septum Forceps | Pinzas Para Tabique Nasal | Septumzangen



WS-480-083
Protecting Cap

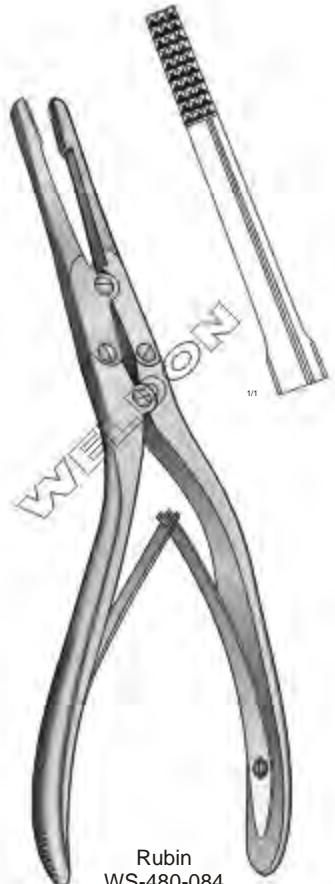

Rubin
WS-480-084
21 cm / 8 1/4"
Septum Motrselizer

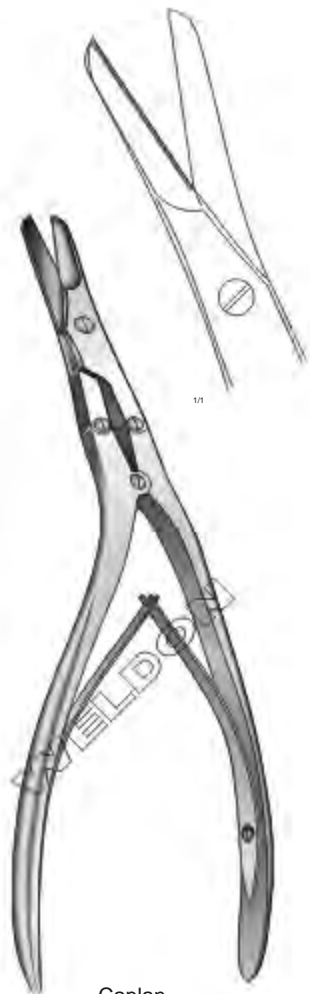

Caplan
WS-480-085
20 cm / 8"
Septum Scissors
Serrated

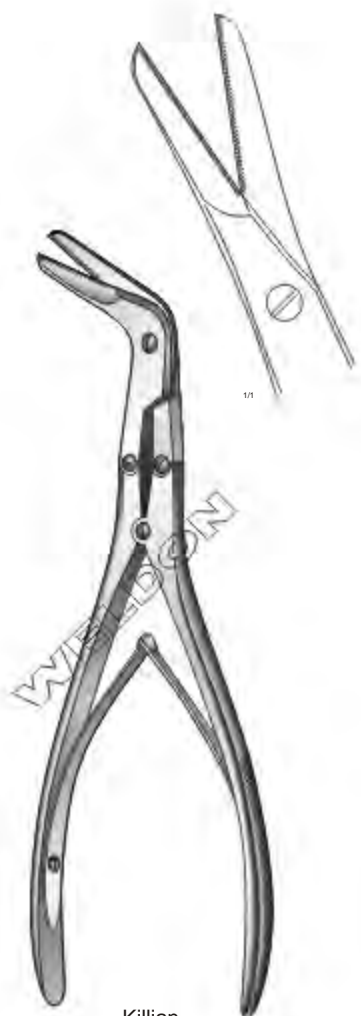

Killian
WS-480-086
21 cm / 8 1/2"
Septum Scissors
Serrated



Jansen-Struycken
WS-481-087
19 cm / 7½"



Middleton-Jansen
WS-481-088
19 cm / 7½"

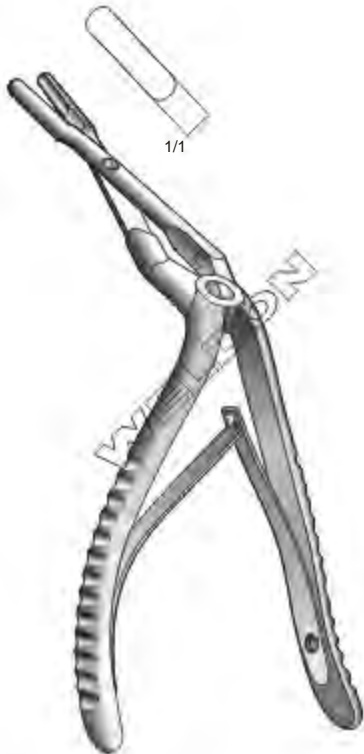

Middleton-Jansen
WS-481-089
19 cm / 7½"

Sphenoid Bone Punches | Pinzas Sacabocadas Para Esfenoides | Keilbeinstanzen

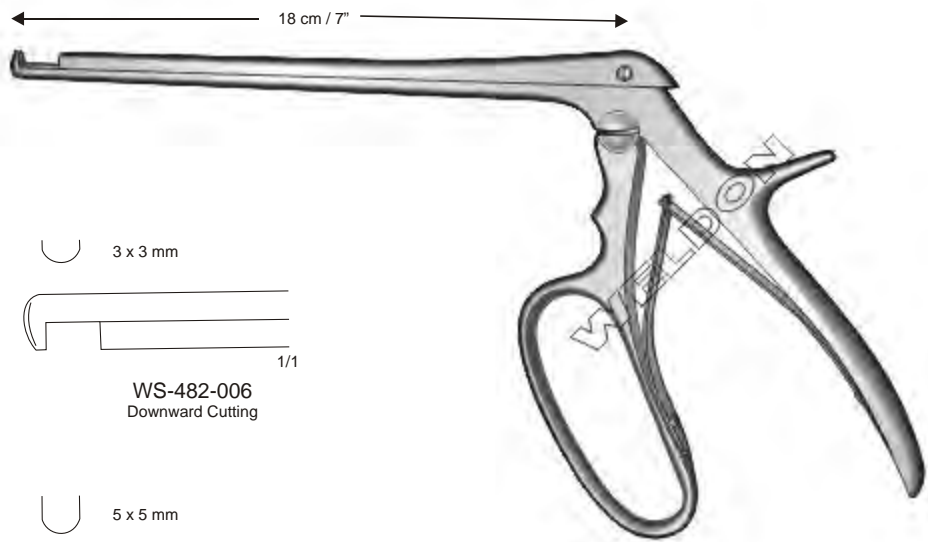
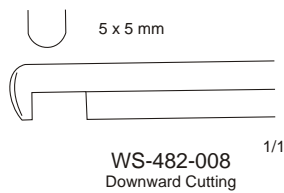
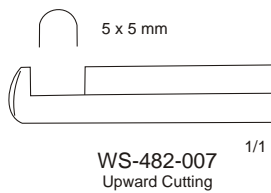
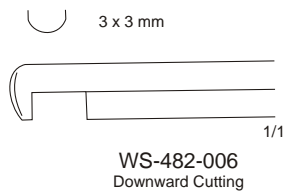
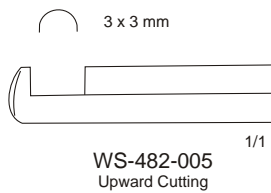
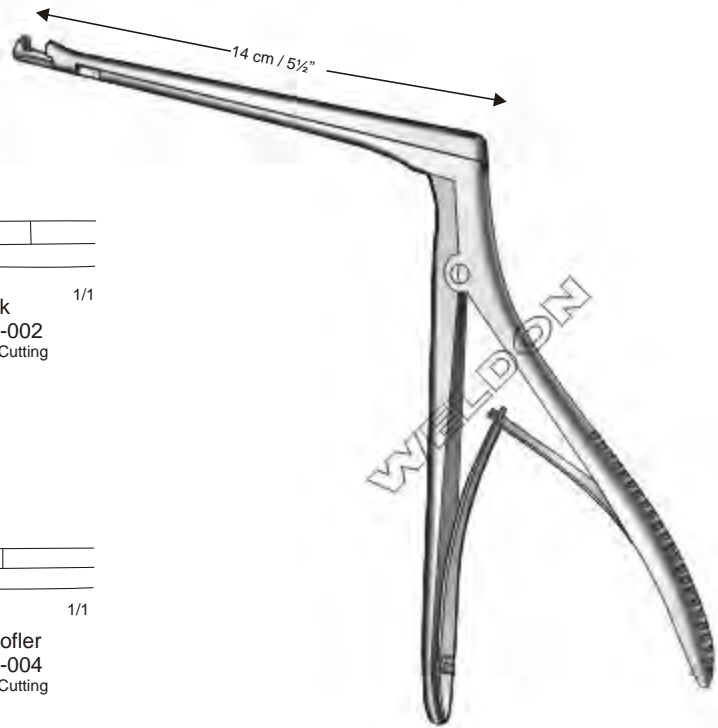
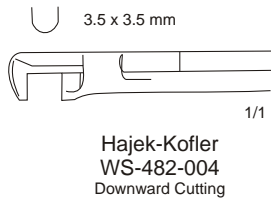
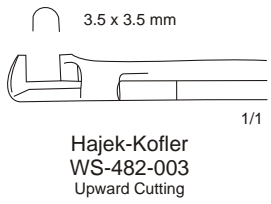
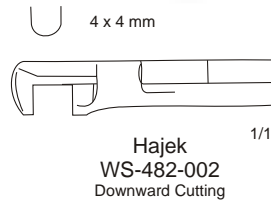
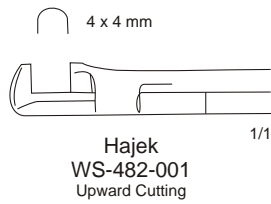

Ferris-Smith-Kerrison

Sphenoid Bone Punches | Pinzas Sacabocadas Para Esfenoides | Keilbeinstanzen

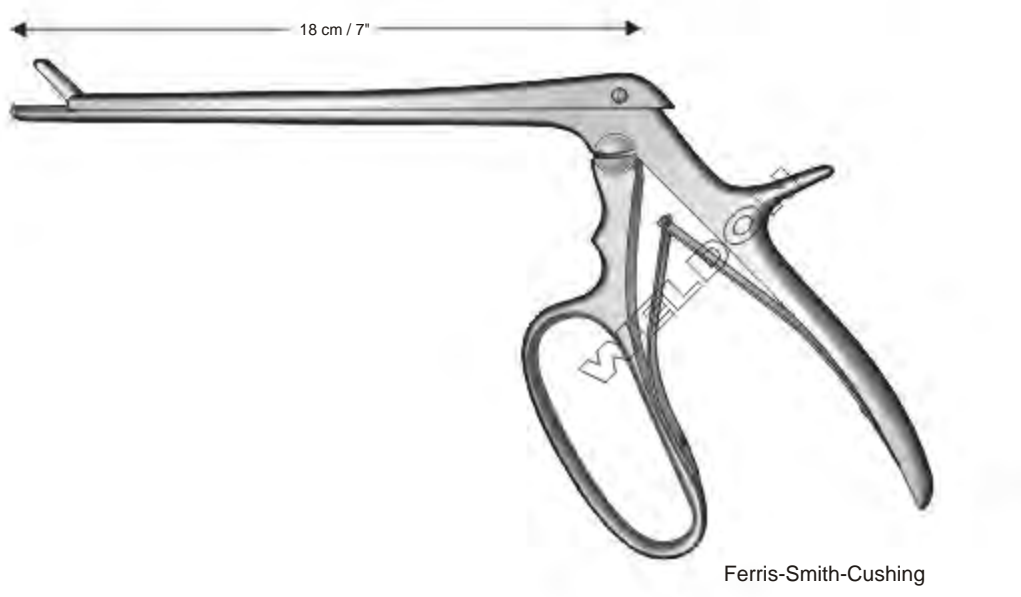
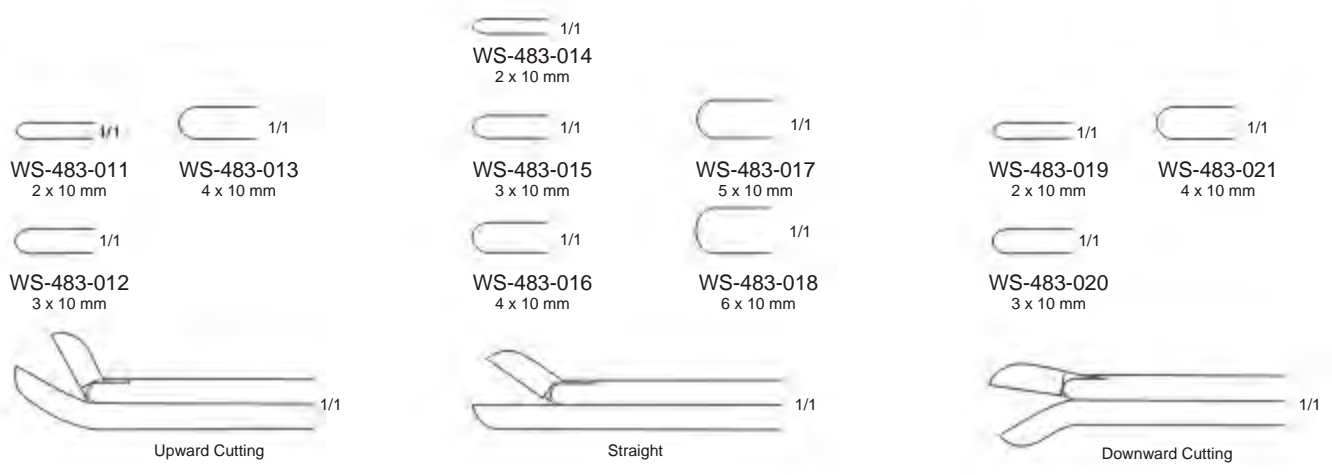
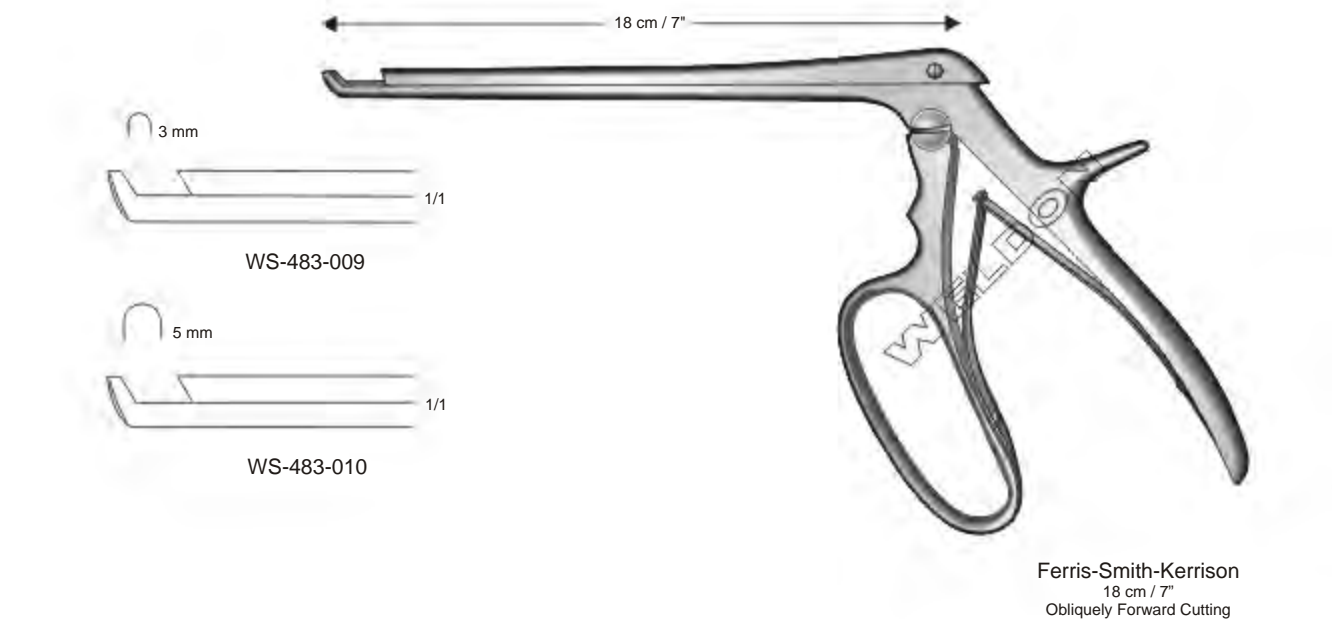

Sphenoid and Antrum Punch Forceps | Pinzas Sacabocadas Para Esfenoides y Seno Maxilar
Keilbeinstanzen, Antrumstanzen

3 x 3 mm
1/1
WS-484-023

4 x 4 mm
1/1
WS-484-024

5 x 5 mm
1/1
WS-484-025

6 x 6 mm
1/1
WS-484-026

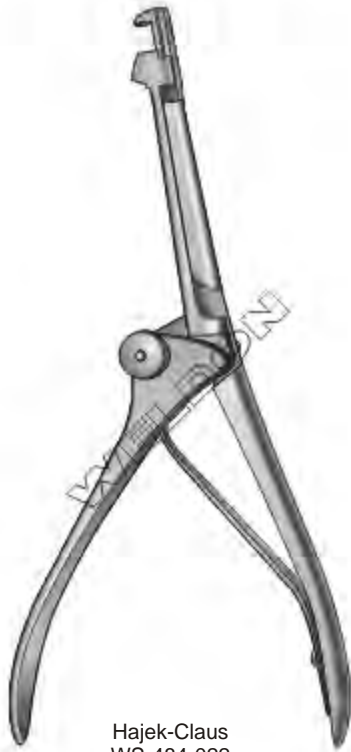

Hajek-Claus
WS-484-022
20 cm / 8"
5 mm Bite, Through Cutting



Kerrison
Upward Cutting

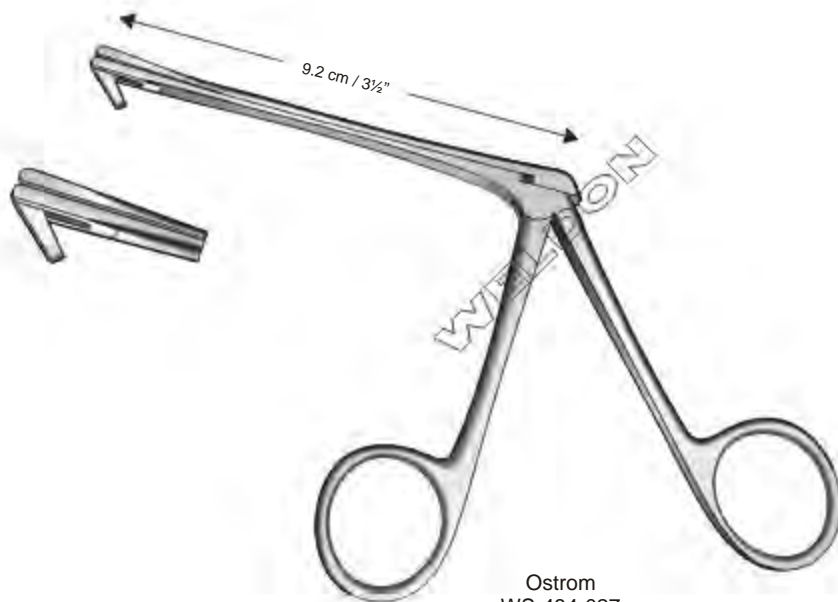

Ostrom
WS-484-027
Antrum Punch Reverse Action Jaw

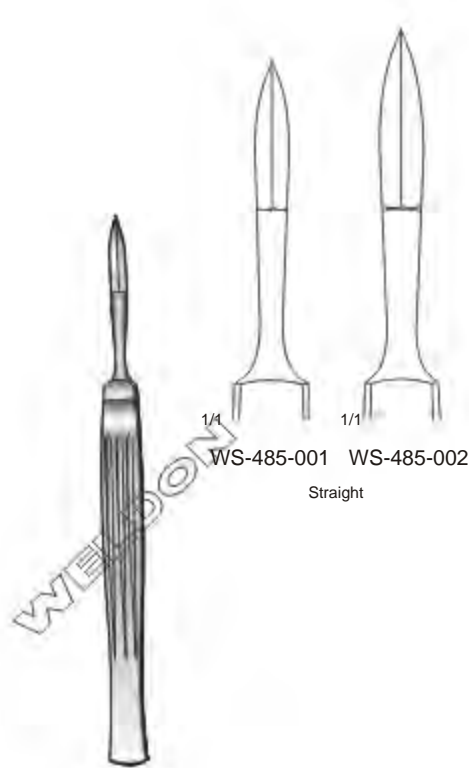

WS-485-001 WS-485-002
Straight

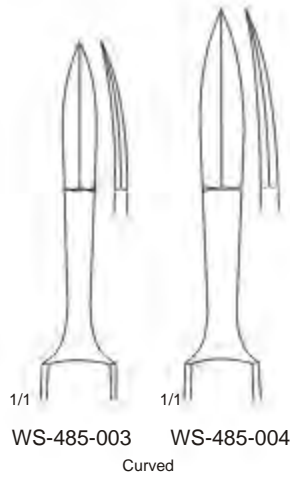

WS-485-003 WS-485-004
Curved

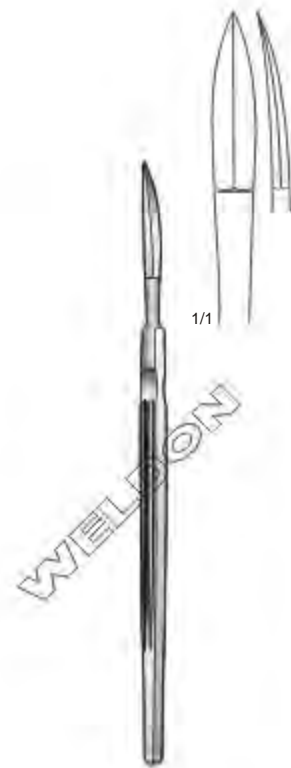

Fomon
WS-485-005
16 cm / 6¼"
Double-Edged



Joseph
WS-485-006
15 cm / 6"



Converse
WS-485-007
16 cm / 6¼"



Cottle
WS-485-008
14 cm / 5½"

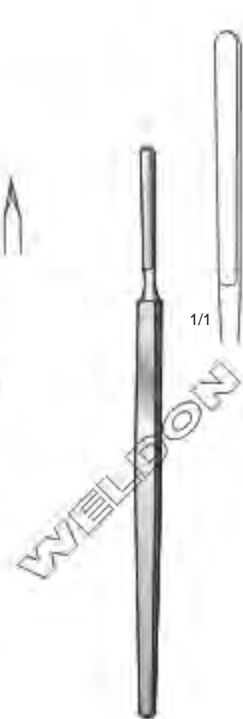

Cottle
WS-485-009
15 cm / 6"

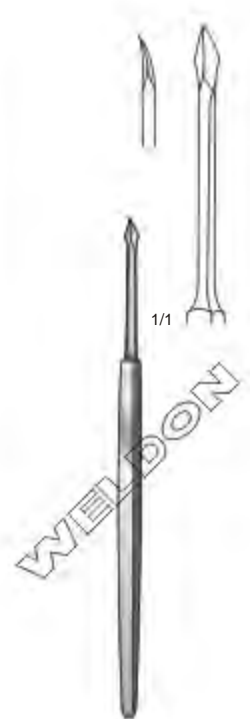

Masing
WS-485-010
13 cm / 5½"
Curved Blade, Pointed

Septum Knives, Swivel Kinves | Cuchillos Para Tabique Nasal | Septummesser, Schwingmesser



Freer
WS-486-011
15 cm / 6"



Freer
WS-486-012
19 cm / 7½"



Freer
WS-486-013
19 cm / 7½"



Freer
WS-486-014
19 cm / 7½"



Ballenger
21 cm / 8¼"



1/1

WS-486-015
3 mm



1/1

WS-486-016
4 mm



1/1

WS-486-017
5 mm



Ballenger
20 cm / 8"



1/1

WS-486-018
3 mm



1/1

WS-486-019
4 mm



1/1

WS-486-020
5 mm

Septum Elevators | Elevadores Para Tabique Nasal | Septumelevatorien



Mckenty
WS-487-021
20.5 cm / 8"



Mckenty
15.5 cm / 6"



Halle
WS-487-024
16 cm / 6 1/4"



Freer
WS-487-025
19 cm / 7 1/2"
Sharp



Freer
WS-487-026
19 cm / 7 1/2"
Blunt



Freer
WS-487-027
18.5 cm / 7 1/4"
Sharp / Blunt

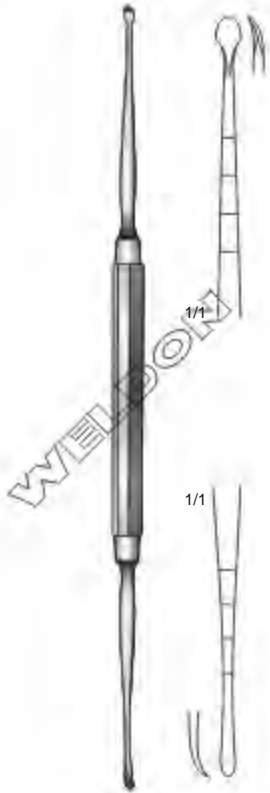

Freer
WS-487-028
20.5 cm / 8"
Sharp / Blunt

Septum Elevators | Elevadores Para Tabique Nasal | Septumelevatorien

Masing
WS-488-029
 21 cm / 8 1/4"
 3 / 2 mm



Cottle
WS-488-030
 21 cm / 8 1/4"



Killian
WS-488-031
 18 cm / 7"
 4 / 4 mm



Killian
WS-488-032
 23 cm / 9"
 4.5 / 4.5 mm



1/1



Pierce
WS-488-033
 21 cm / 8 1/4"



1/1



Pennington
WS-488-034
 21 cm / 8 1/4"
 4 / 4 mm



1/1



Roger
WS-488-035
 19.5 cm / 7 3/4"
 4 / 4 mm

Septum Elevators | Elevadores Para Tabique Nasal | Septumelevatorien



Hill
WS-489-036
 22 cm / 8 3/4"
 Semi-Sharp / Blunt
 Elevator

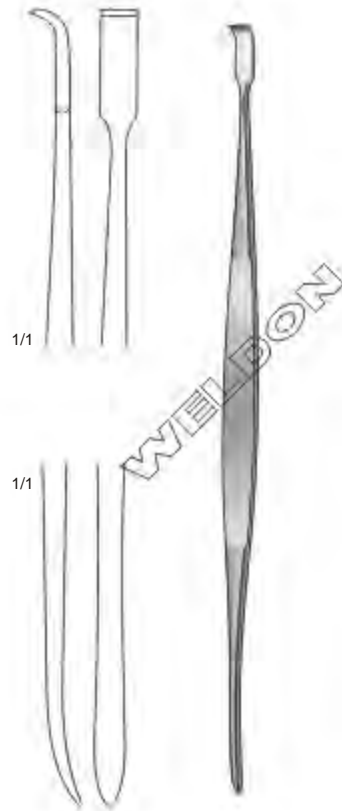

Howarth
WS-489-037
 21.5 cm / 8 1/4"
 Elevator



Watson-Cheyen
WS-489-038
 13 cm, 5 1/8"
 Raspatory



Watson-Cheyen
WS-489-039
 19 cm / 7 1/2"
 Raspatory

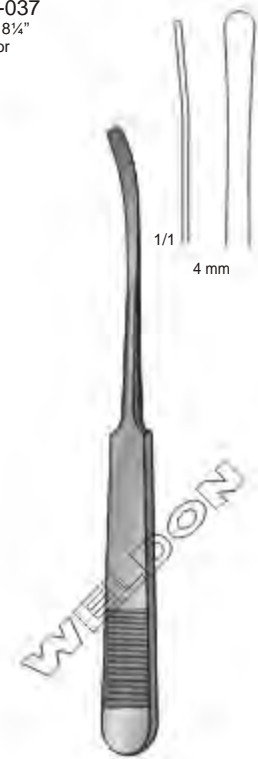

St Clair Thompson
WS-489-040 Sharp
WS-489-041 Blunt
 16 cm / 6 1/4"
 Raspatory, Periosteal Elevator

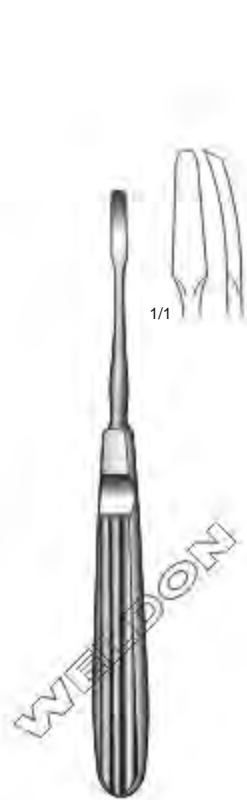
Septum Elevators | Elevadores Para Tabique Nasal | Septumelevatorien

Joseph
WS-490-042
 16 cm / 6¼"

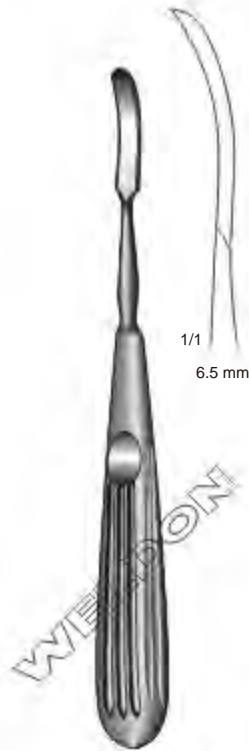

Joseph
WS-490-043
 18 cm / 7"



Joseph-Masing
WS-490-044
 22 cm / 8¾"

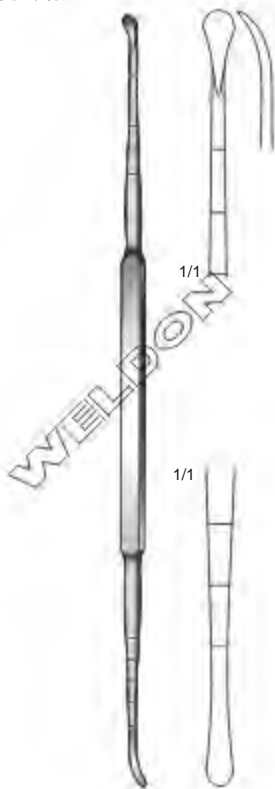

Cottle
WS-490-045
 21 cm / 8¼"
 4.5 / 4.5 mm



Cottle
WS-490-046
 20 cm / 8"

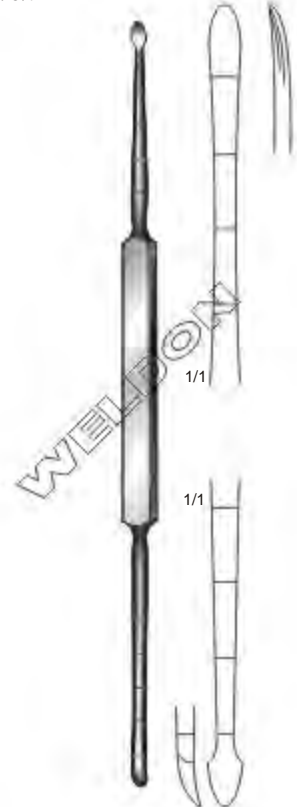

Cottle
WS-490-047
 21 cm / 8¼"
 3.3 / 3.7 mm

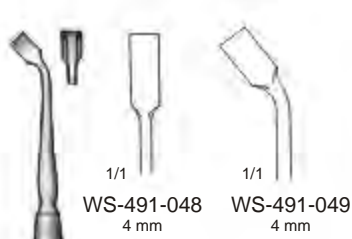

Freer
19 cm / 7½"



Freer
WS-491-050
16 cm / 6¼"
Curved



Freer
WS-491-051
16 cm / 6¼"
Straight



Freer
WS-491-052
15 cm / 6"
Septum Gouge



Ballenger
15.5 cm / 6"



Killian
WS-491-057
17 cm / 6¾"



Killian-Claus
WS-491-058
17 cm / 6¾"



Gorney
WS-491-056
18 cm
Suction Raspatory



Fomon
17 cm / 6¾"



WS-492-060
4 mm



WS-492-061
5 mm



WS-492-062
6 mm



WS-492-063
7 mm

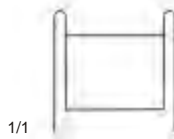

WS-492-064
16 mm

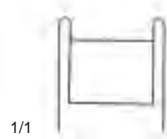

WS-492-065
14 mm

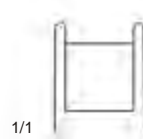

WS-492-066
12 mm

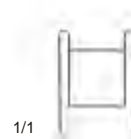

WS-492-067
10 mm



Cinelli
16 cm / 6¼"

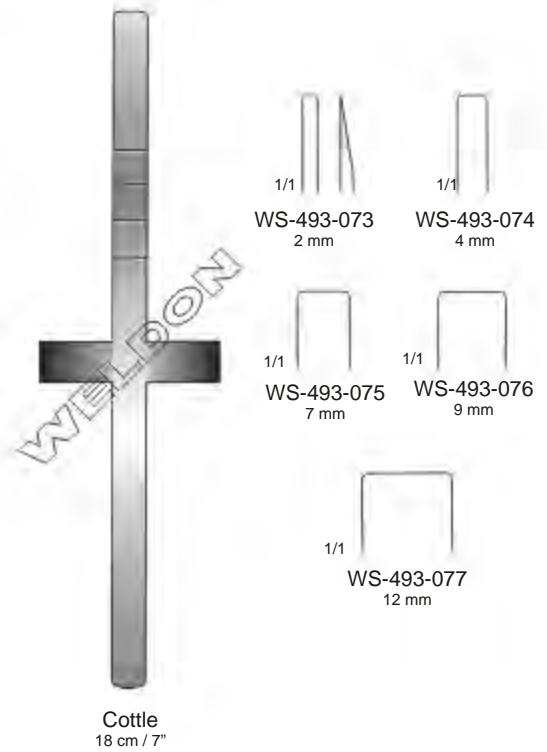
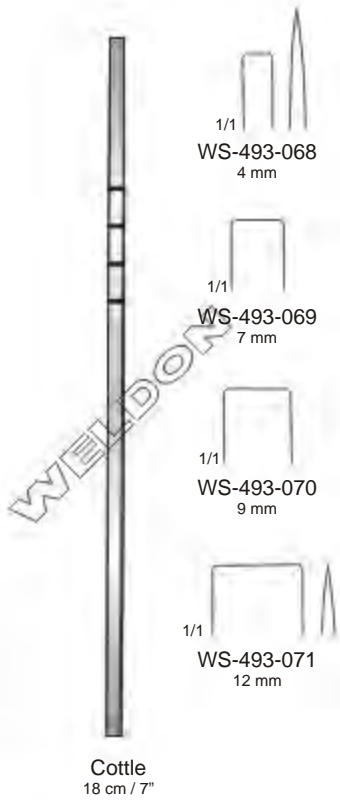

Osteotomes | Osteótomos | Osteotome

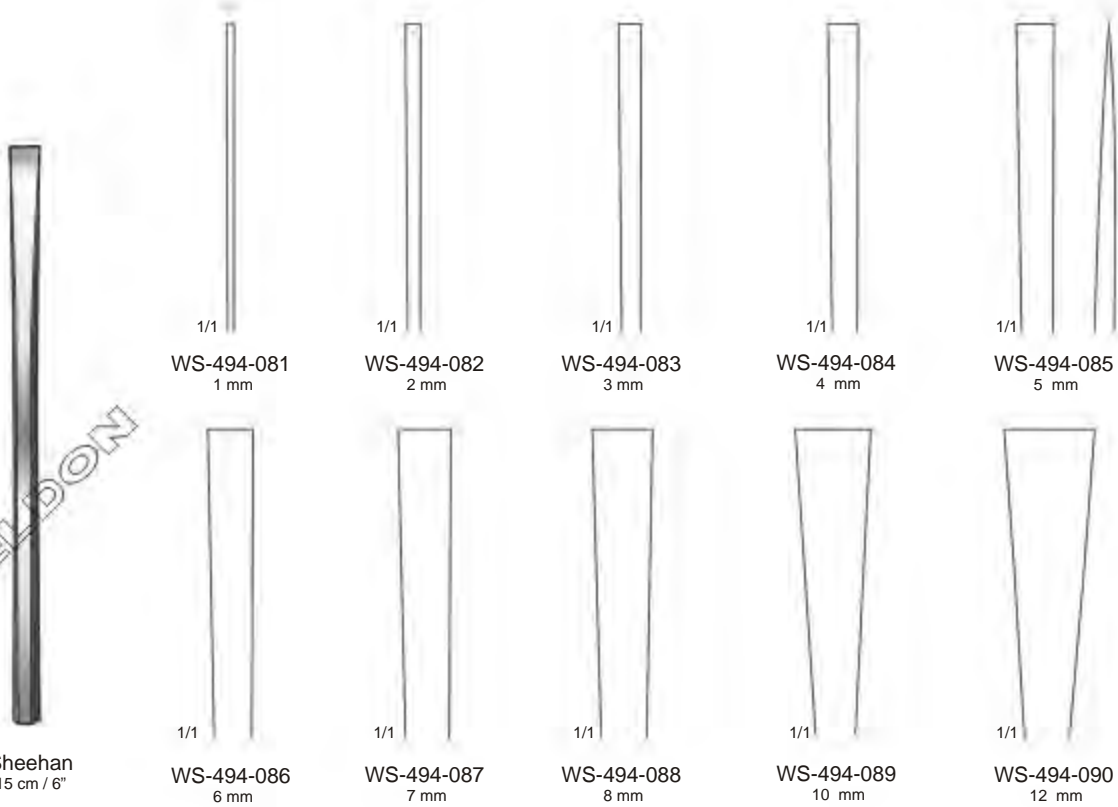

Sheehan
15 cm / 6"

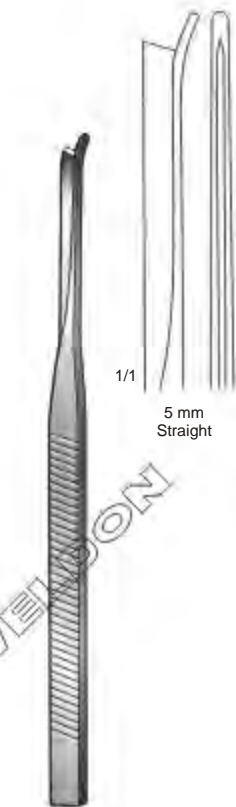

Silver
WS-494-091
18 cm / 7"

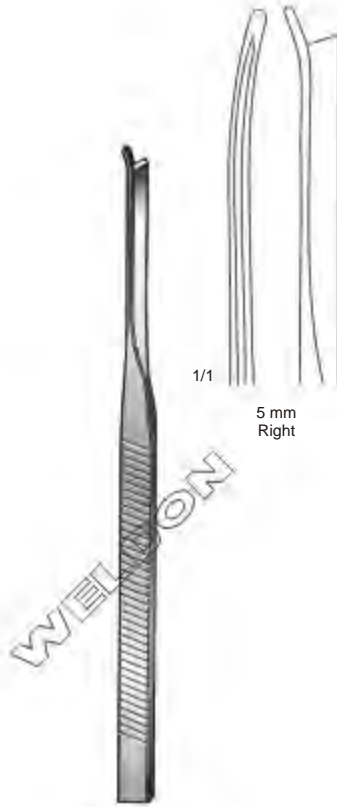

Silver
WS-494-092
18 cm / 7"



Silver
WS-494-093
18 cm / 7"



Joseph
WS-495-094
15 cm / 6"
Mucosa Hooklet
Sharp



Cottle
WS-495-095
17 cm / 6 3/4"
Sharp



Cottle
WS-495-096
15 cm / 6"
Sharp

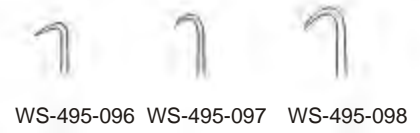

WS-495-096 WS-495-097 WS-495-098



Lange
WS-495-099
22 cm / 8 3/4"
Button End, Alar Hooklet



Fomon
WS-495-100
17 cm / 6 3/4"
Button End, Alar Hooklet



Killian
WS-495-101
16 cm / 6 1/4"
Probe, Angled



Killian
WS-495-102
16.5 cm / 6 1/2"
Probe, Curved

Nasal Hooks | Ganchitos Nasales | Nasenhäkchen



Freer
WS-496-103
15 cm / 6"
Sharp



Joseph
16 cm / 6 1/4"

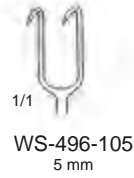

Fomon
WS-496-108
16 cm / 6 1/2"
Button Ended



Cottle-Neivert
WS-496-109
20 cm / 8"



Cottle
15 cm / 6"



Cottle
WS-496-113
14 cm / 5 1/2"



Cottle
WS-497-114
15 cm / 6"



Aufricht
WS-497-115
13.5 cm / 5 1/4"
Blunt



Kilner
WS-497-116
10 cm / 4"
Sharp

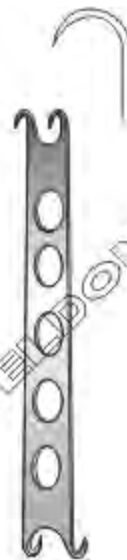

Converse
WS-497-117
12 cm / 4 3/4"
Alar Hooklet, Sharp



Aufricht
WS-497-118
19 cm / 7 1/2"



Yankauer
16 cm / 6 1/4"
Septum Suture Needles



WS-497-119



WS-497-120



WS-497-121



WS-497-122



WS-497-123



WS-497-124



WS-497-125



WS-497-126



WS-497-127



Neivert
WS-497-128
17 cm / 6 3/4"



Cottle
WS-497-129
14 cm / 5 1/2"
Saddle Hook

Sharp Currettes | Curetas Cortantes | Scharfe Küretten



Coakley
17 cm / 6¾"



WS-498-130



WS-498-131



WS-498-132



WS-498-133



WS-498-134



WS-498-135



Pratt
WS-498-136
21 cm / 8¼"



Faulkner
WS-498-137
21 cm / 8¼"



WS-498-138
20 cm / 8"

Antrum Curettes, Cheek Retractors | Curetas Para El Antro, Separadores Para Mejillas
Antrum Küretten, Wangenhalter



Sewall
WS-499-139
20 cm / 8"
Antrum Elevator



Mackie
WS-499-140
19.7 cm 7 3/4"
Antrum Curette

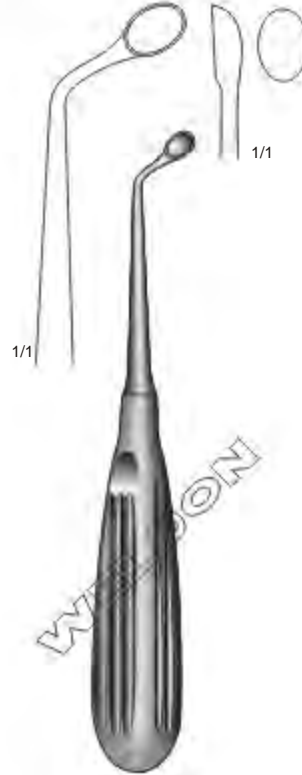

Uffenorde
WS-499-141
17 cm / 6 3/4"
Antrum Curette, Right

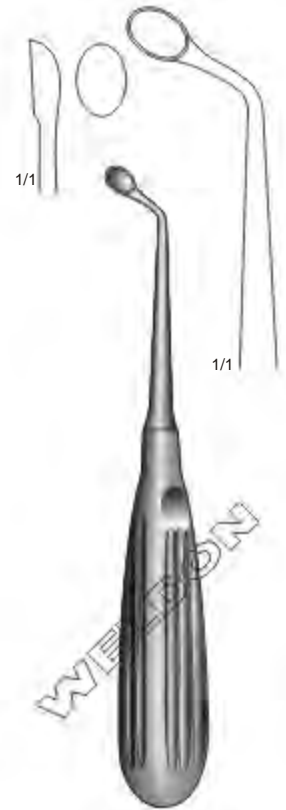

Uffenorde
WS-499-142
17 cm / 6 3/4"
Antrum Curette, Left



Passow
12 cm / 4 3/4"
Haemostatic Chisels



Sternberg
WS-499-145 12 cm / 4 3/4"
WS-499-146 13 cm / 5"
WS-499-147 13.5 cm / 5 1/2"
Cheek Retractor

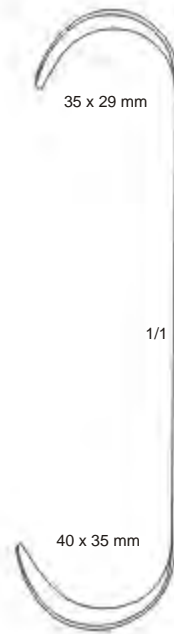

WS-499-148

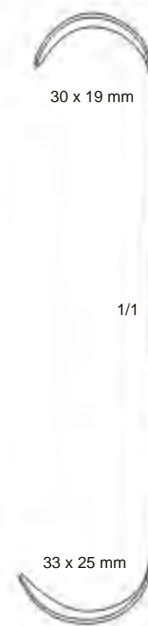

WS-499-149

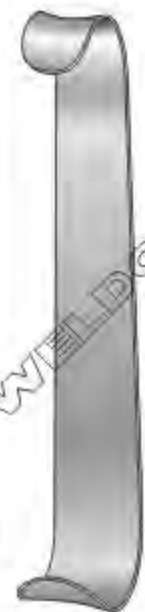

Kilner
15 cm / 6"
Cheek Retractor

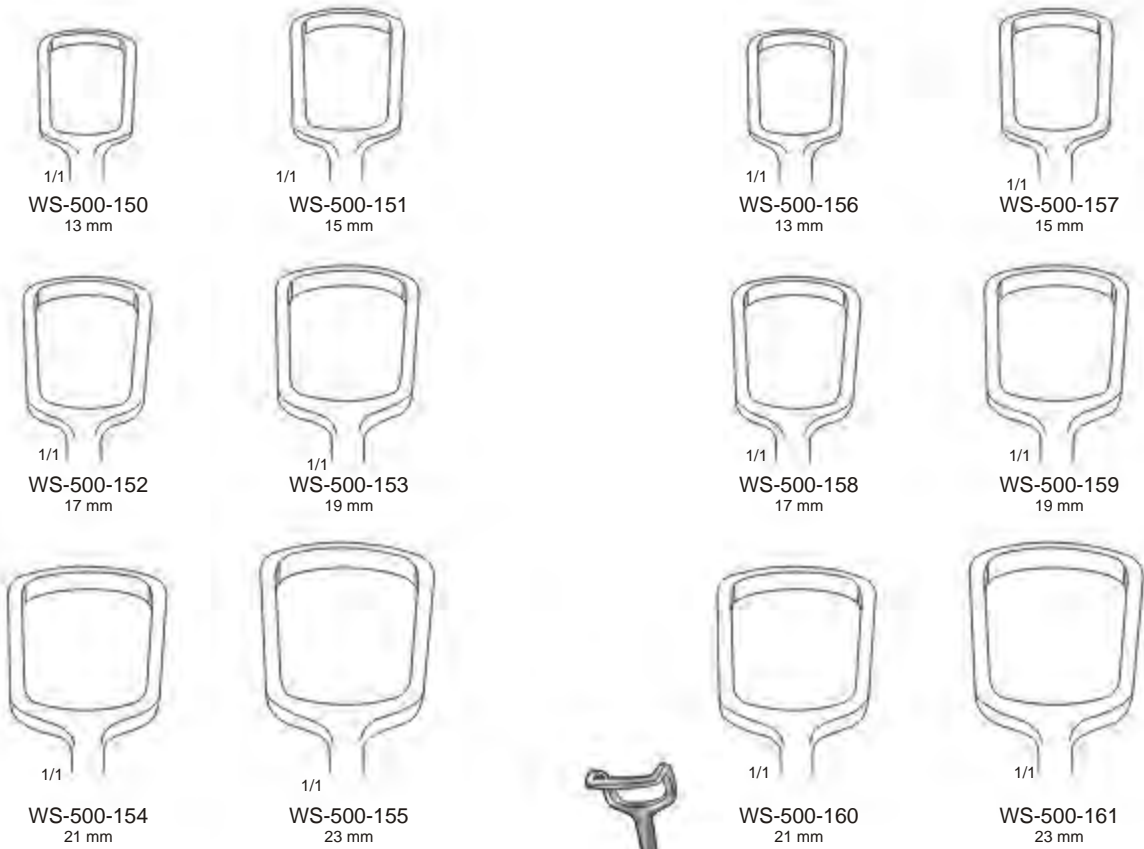
Adenoid Currettes | Cuchillos Para Adenoides | Ringmesser

Beckmann
 22 cm / 8¾"
 Straight Shaft

Beckmann
 22 cm / 8¾"
 Angled Shaft



1/1
WS-501-162



1/1
WS-501-167
8.5 mm



1/1
WS-501-163



1/1
WS-501-164



1/1
WS-501-168
10 mm



1/1
WS-501-169
13 mm



1/1
WS-501-165



1/1
WS-501-166



1/1
WS-501-170
16.5 mm



1/1
WS-501-171
18 mm



Beckmann
22.5 cm / 8¾"
Trapezoidal Fenestrated



St. Clair Thomson
21 cm / 8¼"
With Cage

Adenotomes, Antrum Retractor | Adenotomos, Separador De Antrum
Pharynx Tonsillotom, Retraktor Antrum



La Force
25 cm / 10"
Adenotomes
With One Spare Blade



WS-502-001



WS-502-002



WS-502-003

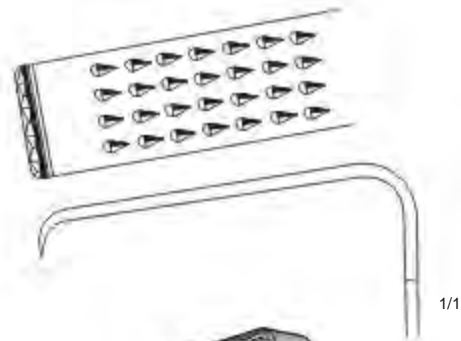

Bruenings Brunk
WS-502-004
21.5 cm / 8½"
Antrum Retractor



Joseph
WS-503-005
17 cm / 6¾"
Left



Joseph
WS-503-006
17 cm / 6¾"
Right



WS-503-007
Straight



WS-503-008
Left



WS-503-009
Right



Joseph
19 cm / 7½"
Working Length 40 mm

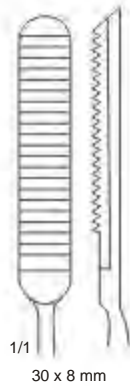

Cottle
WS-504-010
21 cm / 8 1/4"



Aufricht
21 cm / 8 1/4"

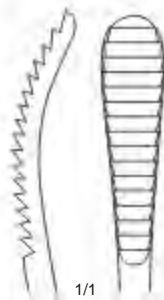

WS-504-011
Pushing Cut
32 x 9 mm

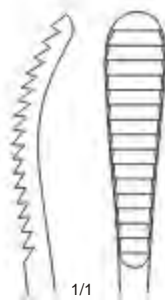

WS-504-012
Drawing Cut
32 x 9 mm



Lewis
19 cm / 7 1/2"
Drawing Cut 15 x 8 mm



WS-504-013
Fine

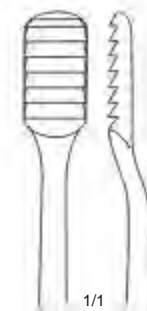

WS-504-014
Coarse



Maltz
19.5 cm / 7¾"
With Tungsten Carbide Insert



WS-505-015



WS-505-016

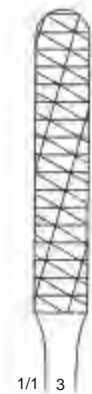

WS-505-017



WS-505-018



WS-505-019



WS-505-020



WS-505-021



WS-505-022



WS-505-023

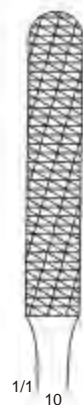

WS-505-024



Gallaher
WS-506-025
17 cm / 6 3/4"
45 x 6 mm



Gallaher
WS-506-026
17 cm / 6 3/4"
45 x 6 mm



Gallaher
WS-506-027
17 cm / 6 3/4"
45 x 6 mm



Maltz
WS-506-028
17 cm / 6 3/4"
34 x 7 mm



Josph
WS-506-029
16 cm / 6 1/4"
45 x 9 mm



Obwegeser
 WS-507-030 Fine
 WS-507-031 Medium Fine
 19 cm / 7½"
 Flat



Obwegeser
 WS-507-032 Fine
 WS-507-033 Medium Fine
 19 cm / 7½"
 Convex



Obwegeser
 WS-507-034 Fine
 WS-507-035 Medium Fine
 19 cm / 7½"
 Roof Shaped

Nasal Rasps | Escofinas Nasaes | Nasenraspeln



Fomon
20 cm / 8"
With Tungsten Carbide

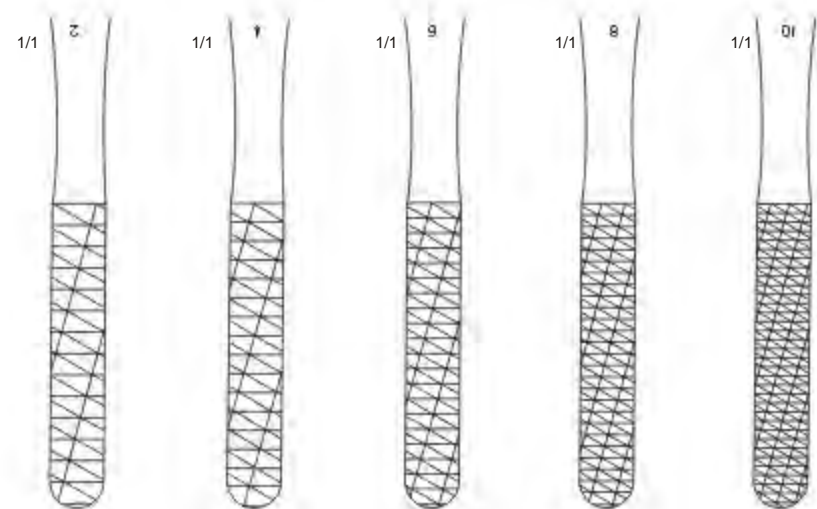
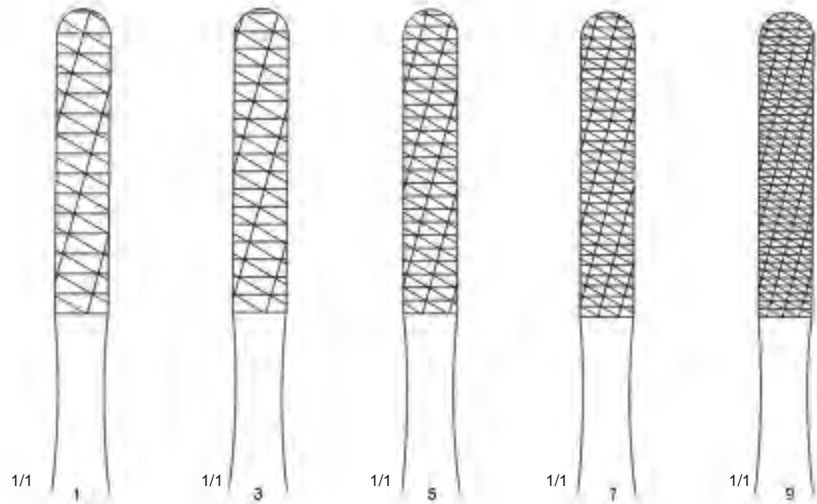

WS-508-036
30 x 8 mm

WS-508-037
40 x 7 mm

WS-508-038
40 x 7 mm

WS-508-039
40 x 7 mm

WS-508-040
40 x 7 mm

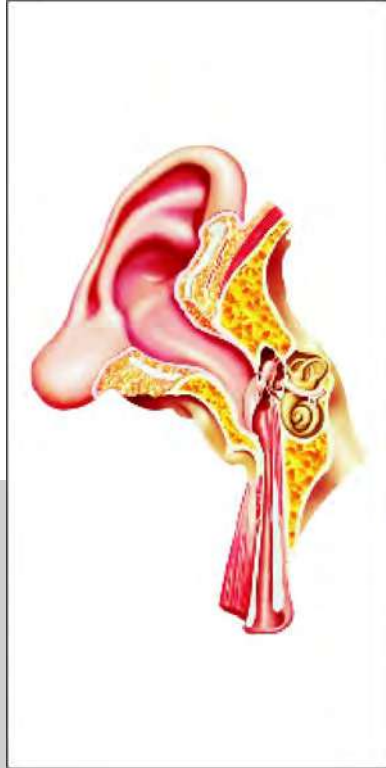

www.weldoninstruments.com

PROVEEDOR EXCLUSIVO:



Ear Specula & Tuning Forks

Micro Ear Forceps & Scissors

Ear Polypus Forceps









Ear Knives, Chisels, Gouges & Osteotomes

509 - 544

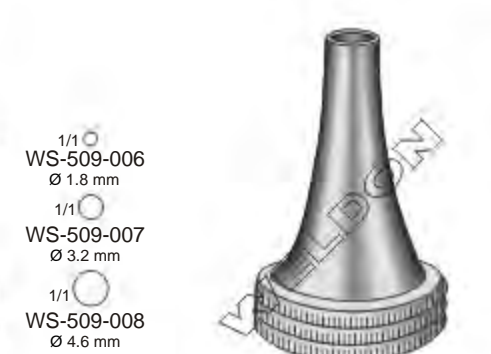
Otology

Otology
Otologia
Otolgie

All Measurements Refer To The Inner Diameter

 <p>1/1 WS-509-002 Ø 2 mm</p> <p>1/1 WS-509-003 Ø 3 mm</p> <p>1/1 WS-509-004 Ø 4 mm</p> <p>Politzer WS-509-001 Set Of 3 Sizes Aural Specula For Children</p>	 <p>1/1 WS-509-006 Ø 1.8 mm</p> <p>1/1 WS-509-007 Ø 3.2 mm</p> <p>1/1 WS-509-008 Ø 4.6 mm</p> <p>Hartmann WS-509-005 Ear Specula For Children Set Of 3 Sizes</p>	 <p>1/1 WS-509-010 Ø 3.5 mm</p> <p>1/1 WS-509-011 Ø 5 mm</p> <p>1/1 WS-509-012 Ø 6.5 mm</p> <p>1/1 WS-509-013 Ø 8.0 mm</p> <p>Hartmann WS-509-009 Set Of 4 Sizes Ear Specula For Adults</p>
 <p>1/1 WS-509-015 Ø 4.2 mm</p> <p>1/1 WS-509-016 Ø 5.2 mm</p> <p>1/1 WS-509-017 Ø 6.2 mm</p> <p>1/1 WS-509-018 Ø 7.2 mm</p> <p>Boucheron WS-509-014 Set Of 4 Sizes Ear Specula For Adults</p>	 <p>1/1 WS-509-020 2.8 x 3.5 mm</p> <p>1/1 WS-509-021 4 x 4.6 mm</p> <p>1/1 WS-509-022 5.2 x 6.2 mm</p> <p>1/1 WS-509-023 6.4 x 7.7 mm</p> <p>Gruber WS-509-019 Aural Specula , Oval Lumen Set Of 4 Sizes</p>	 <p>1/1 WS-509-025 4 x 2.7 mm</p> <p>1/1 WS-509-026 5 x 4.3 mm</p> <p>1/1 WS-509-027 7 x 5.4 mm</p> <p>1/1 WS-509-028 8 x 6.4 mm</p> <p>Heath WS-509-024 Set Of 4 Sizes Aural Specula , Oval Lumen</p>
 <p>1/1 WS-509-030 Ø 4 mm</p> <p>1/1 WS-509-031 Ø 5.5 mm</p> <p>1/1 WS-509-032 Ø 7 mm</p> <p>Toynbee WS-509-029 Set Of 3 Sizes Ear Specula For Adults</p>	 <p>1/1 WS-509-034 Ø 8 mm</p> <p>1/1 WS-509-035 Ø 9 mm</p> <p>Hartmann WS-509-033 Ø 8 mm Ear Specula For Adults For Post-Treatment, Aluminium,Black Anodized Set Of 2 Sizes</p>	

Ear Specula | Espéculos Auriculares | Ohrspekula

All Measurements Refer To The Inner Diameter

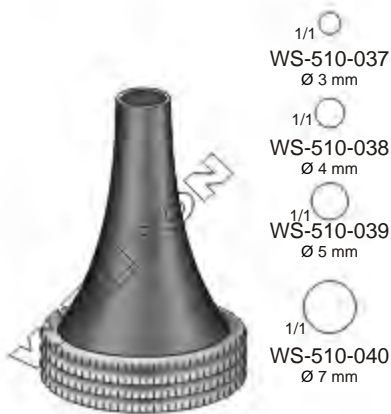

Hartmann
WS-510-036
 Ear Specula For Adults
 Aluminium, Black Anodized
 Set Of 4 Sizes

- 1/1
WS-510-037
Ø 3 mm
- 1/1
WS-510-038
Ø 4 mm
- 1/1
WS-510-039
Ø 5 mm
- 1/1
WS-510-040
Ø 7 mm



Tumarkin
WS-510-041
 Set Of 8 Sizes
 Ear Specula, Tapered Slot

- 1/1
WS-510-042
Ø 3.2 mm
- 1/1
WS-510-046
Ø 6.6 mm
- 1/1
WS-510-043
Ø 5 mm
- 1/1
WS-510-047
Ø 7 mm
- 1/1
WS-510-044
Ø 5.5 mm
- 1/1
WS-510-048
Ø 7.6 mm
- 1/1
WS-510-045
Ø 6.2 mm
- 1/1
WS-510-049
Ø 9.6 mm



Rosen
WS-510-050
 Aural Specula, Round Lumen
 Set Of 5 Sizes

- 1/1
WS-510-051
Ø 3 mm
- 1/1
WS-510-052
Ø 4 mm
- 1/1
WS-510-054
Ø 6 mm
- 1/1
WS-510-053
Ø 5 mm
- 1/1
WS-510-055
Ø 7 mm



Rosen
WS-510-056
 Aural Specula, Oval Lumen
 Set Of 5 Sizes

- 1/1
WS-510-057
3 x 4 mm
- 1/1
WS-510-058
4 x 5.5 mm
- 1/1
WS-510-059
5 x 7.5 mm
- 1/1
WS-510-060
6 x 8.5 mm
- 1/1
WS-510-061
7 x 9.5 mm



Shea
WS-510-062
 Set Of 5 Sizes
 Ear Specula, Oblique Ended

- 1/1
WS-510-063
3.3 x 4 mm
- 1/1
WS-510-064
3.9 x 5.5 mm
- 1/1
WS-510-065
5 x 7.4 mm
- 1/1
WS-510-066
5.8 x 8.3 mm
- 1/1
WS-510-067
7.3 x 9.7 mm



Zöllner
WS-510-068
 5.5 x 6.5 mm
 Ear Specula For Adults,
 Oval, Black Anodised
 Set Of 6 Sizes.

- 1/1
WS-510-069
5.5 x 6.5 mm
- 1/1
WS-510-072
8.5 x 9.5 mm
- 1/1
WS-510-070
6.5 x 7.5 mm
- 1/1
WS-510-073
9.5 x 10.5 mm
- 1/1
WS-510-071
7.5 x 8.5 mm
- 1/1
WS-510-074
10.5 x 11.5 mm

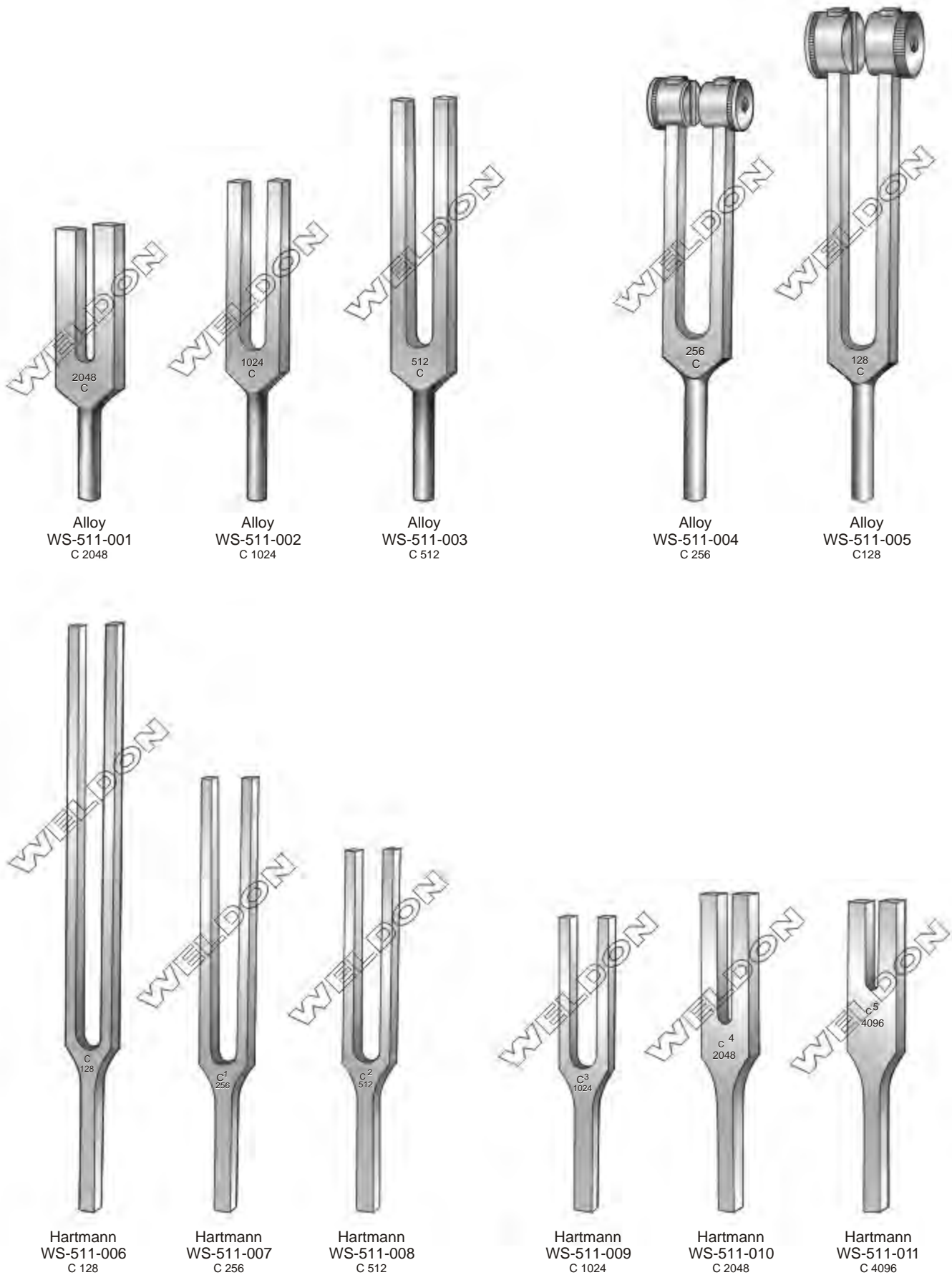

Hartmann
WS-512-012
 Tuning Fork Set Containing
 1 x c 128
 1 x c1 256
 1 x c2 512
 1 x c3 1024
 1 x c4 2048



WS-512-014
 100 ml
 Complete With Protection Disc & 2 Tips



WS-512-012A
 3 mm Ø

WS-512-012B
 3.5 mm Ø

WS-512-012C
 4 mm Ø

WS-512-012D
 4.5 mm Ø

WS-512-012E
 5 mm Ø

Itard
 Probe
 13 cm / 5"



Hartmann
WS-512-013
 Tuning Fork Set Containing
 1 x c 128
 1 x c1 256
 1 x c2 512
 1 x c3 1024
 1 x c4 2048
 1 x c5 4096



WS-512-015
 50 ml
 Ear Syringe
 Complete With Protection Disc & 2 Tips
WS-512-016
 100 ml

Micro Ear Forceps | Micro Pinzas Auriculares | Mikro-Ohrzangchen

Also Available in Black Finish

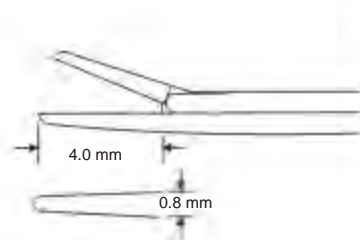

1/1	WS-513-001	8 cm / 3"	WS-513-003
1/1	WS-513-002	11 cm / 4 1/4"	WS-513-004
	Smooth		Serrated
		4.0 x 0.8 mm	



1/1	WS-513-005	8 cm / 3"	WS-513-007
1/1	WS-513-006	11 cm / 4 1/4"	WS-513-008
	Bent upward		Straight
		4.0 x 0.8 mm	

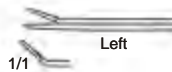
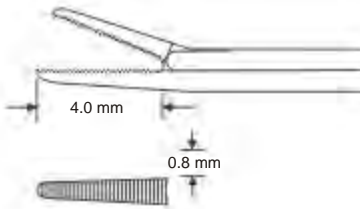

1/1	WS-513-009	8 cm / 3"	WS-513-011
1/1	WS-513-010	11 cm / 4 1/4"	WS-513-012
	Right		Straight
		4.0 x 0.8 mm	

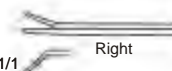

1/1	WS-513-013	8 cm / 3"	WS-513-015
1/1	WS-513-014	11 cm / 4 1/4"	WS-513-016
	Left		Straight
		4.0 x 0.8 mm	

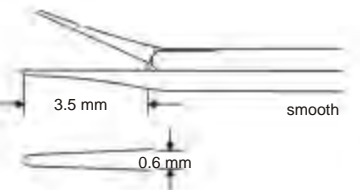

1/1	WS-513-017	8 cm / 3"	WS-513-019
1/1	WS-513-018	11 cm / 4 1/4"	WS-513-020
	Smooth		Serrated
		3.5 x 0.6 mm	

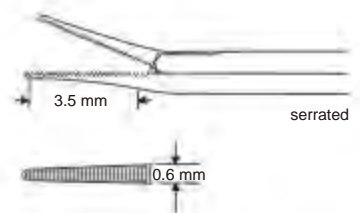

Black Finish

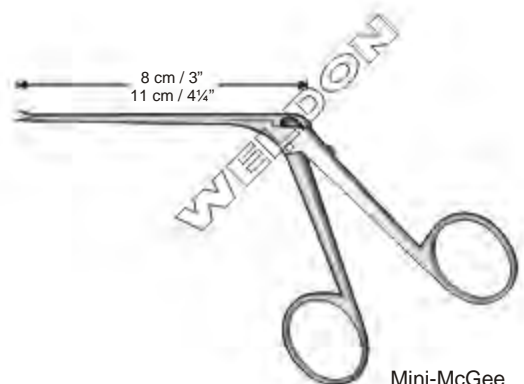

Mini-McGee

Micro Ear Forceps | Micro Pinzas Auriculares | Mikro-Ohrzängchen

Also Available in Black Finish

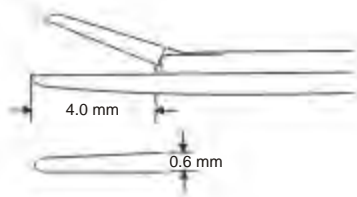

1/1
WS-514-021
Smooth, Straight

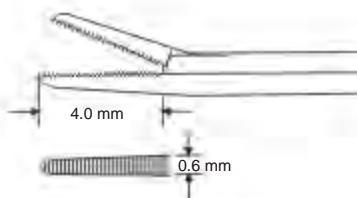
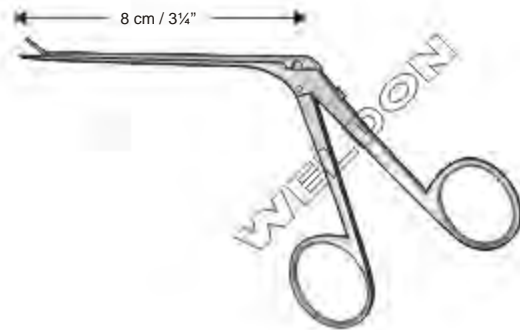

1/1
WS-514-022
4.0 x 0.6 mm
Straight, Serrated

1/1
WS-514-023
4.0 x 0.6 mm
Bent Upwards
Serrated

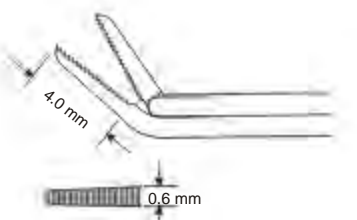
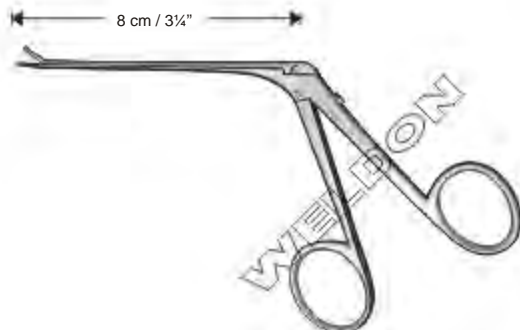

1/1
WS-514-024
4.0 x 0.6 mm
Right, Serrated

1/1
WS-514-025
4.0 x 0.6 mm
Left, Serrated

Micro Ear Forceps | Micro Pinzas Auriculares | Mikro-Ohrzangchen

Also Available in Black Finish

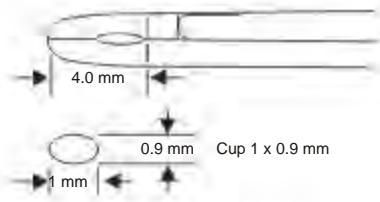

WS-515-026
4.0 mm
Straight



WS-515-027
4.0 mm
Bent Upward

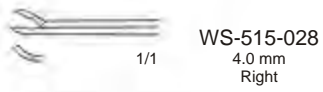

WS-515-028
4.0 mm
Right

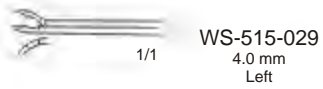

WS-515-029
4.0 mm
Left

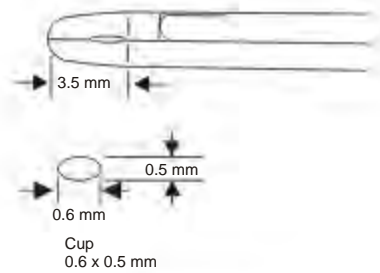

WS-515-030
3.5 mm
Straight

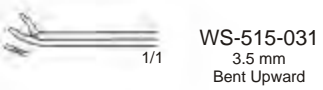

WS-515-031
3.5 mm
Bent Upward

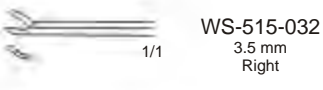

WS-515-032
3.5 mm
Right

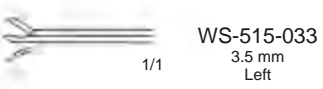

WS-515-033
3.5 mm
Left



Micro Ear Forceps | Micro Pinzas Auriculares | Mikro Ohrzangchen

WS-516-034
0.8 x 3.5 mm
Alligator Forceps
Straight



WS-516-035
1 x 5 mm
Alligator Forceps
Straight



WS-516-036
1.5 x 6 mm
Alligator Forceps
Straight



WS-516-037
0.8 x 3.5 mm
Alligator Forceps
Curved Up 65°



WS-516-038
0.8 x 3.5 mm
Alligator Forceps
Curved-Down 45°



WS-516-039
1 x 5 mm
Alligator Forceps
Curved To Left



WS-516-040
1 x 5 mm
Alligator Forceps
Curved To Right



Micro Ear Forceps
With
Tubular Shaft

Micro Cupped Forceps | Micro Pinzas Ahuecado | Mikro-Löffelzängchen

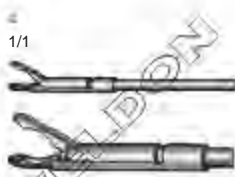

WS-517-041
0.9 x 1.0 mm
Straight, Oval Jaw

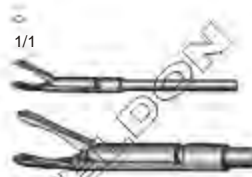

Wullstein
WS-517-042
0.8 x 1.3 mm
Straight, Oval Jaw

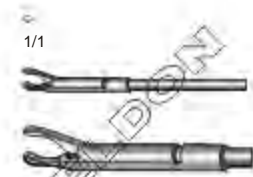

Wullstein
WS-517-043
Ø 1.0 mm
Straight, Round Jaw

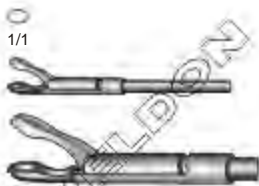

Wullstein
WS-517-044
1.7 x 2.5 mm
Straight, Oval Jaw



WS-517-045
0.9 x 1.0 mm
Curved Up, Oval Jaw



Wullstein
WS-517-046
0.8 x 1.3 mm
Left Curved, Oval Jaw

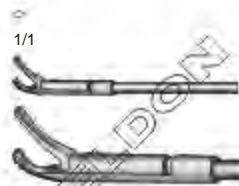

Wullstein
WS-517-047
0.8 x 1.3 mm
Right Curved, Oval Jaw

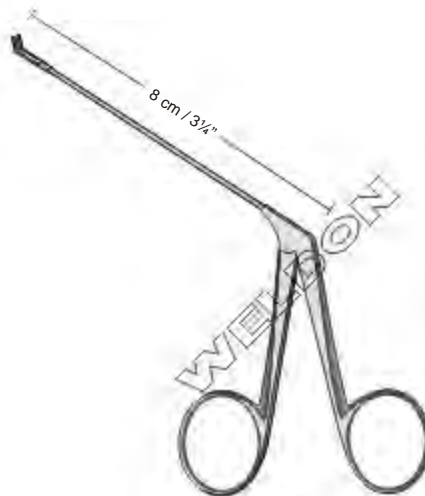

Micro Cupped Forceps
With Tubular Shaft

Micro Scissors and Forceps | Micro Tijeras y Pinzas | Mikro-Ohrscherchen, Löffelzängchen

**Cawthorne
Wullstein
WS-518-048**
4 mm x 1.5 mm
Micro Scissors, Straight
Sharp / Sharp



**Ormerod
WS-518-049**
4 mm x 1.7 mm
Aural Forceps, Round Cup, Straight

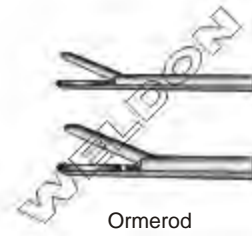

**Ormerod
WS-518-050**
5 mm x 1 mm
Aural Forceps, Oval Cup, Straight



**Shea
WS-518-051**
4 mm x 0.8 mm
Aural Forceps, Oval Cup, Straight



**Hough
WS-518-052**
1 mm x 5 mm
Aural Forceps, Serrated Jaws, Straight



**Cawthorne
WS-518-053**
1.25 mm x 7 mm
Aural Forceps, Smooth Jaws, Straight

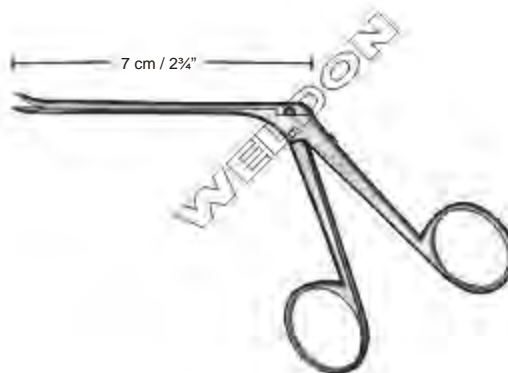

Micro Ear Scissors | Micro Tijeras Auriculares | Mikro-Ohrscherchen

Also Available in Black Finish



Bellucci
Very Fine

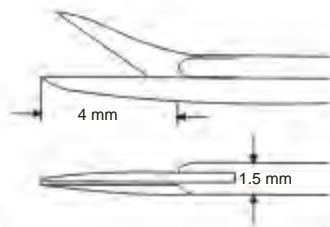

Black Finish



1/1

WS-519-054 8 cm / 3"

WS-519-055 11 cm / 4 1/4"
Straight



1/1

WS-519-056 8 cm / 3"

WS-519-057 11 cm / 4 1/4"
Bent Upward

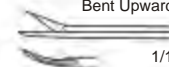

1/1

WS-519-058 8 cm / 3"

WS-519-059 11 cm / 4 1/4"
Right



1/1

WS-519-060 8 cm / 3"

WS-519-061 11 cm / 4 1/4"
Left

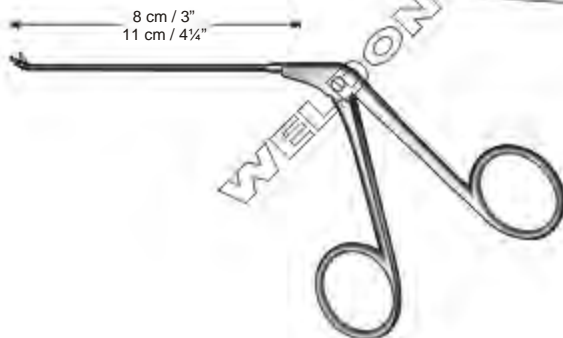

Wullstein
Shaft Ø 0.8 mm

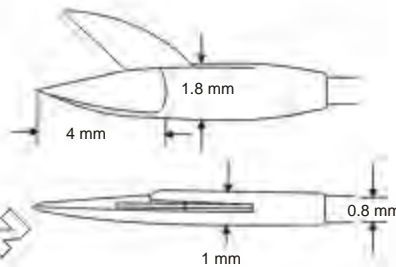

1/1

WS-519-062 8 cm / 3"

WS-519-063 11 cm / 4 1/4"
Straight



1/1

WS-519-064 8 cm / 3"

WS-519-065 11 cm / 4 1/4"
Bent Upward



1/1

WS-519-066 8 cm / 3"

WS-519-067 11 cm / 4 1/4"
Right



1/1

WS-519-068 8 cm / 3"

WS-519-069 11 cm / 4 1/4"
Left

Wire Bending Forceps | Pinzas Para Plegar Alambre | Drahtbiegezangchen



Greven
WS-520-070
8 cm / 3 1/4"
Wire Bending Forceps

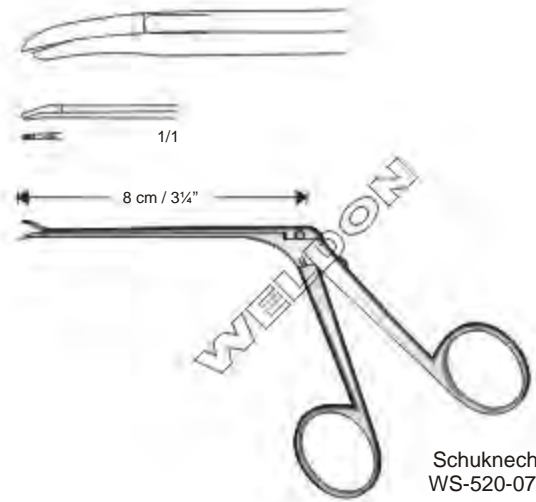

Schuknecht
WS-520-071

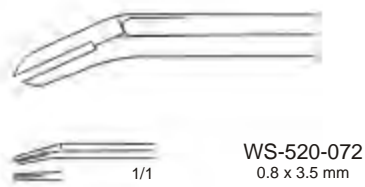

WS-520-072
0.8 x 3.5 mm

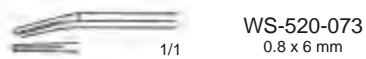

WS-520-073
0.8 x 6 mm

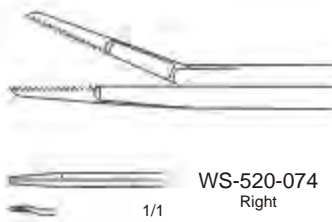

WS-520-074
Right

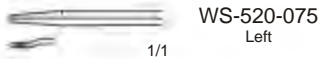

WS-520-075
Left

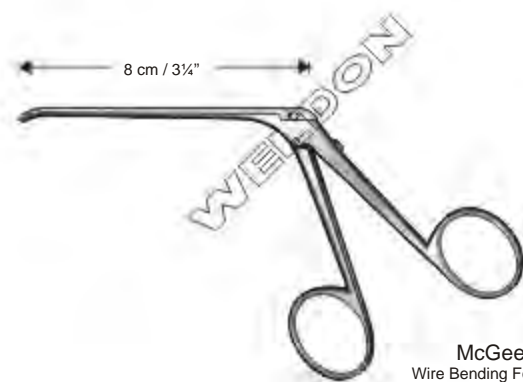

McGee
Wire Bending Forceps

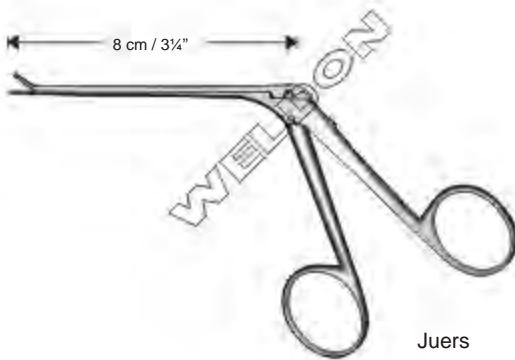

Juers

Malleus Nippers | Pinzas Para Cabezal Del Maléolo | Hammerkopfzängchen

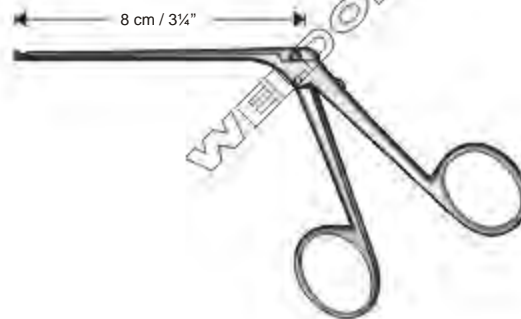
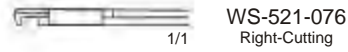
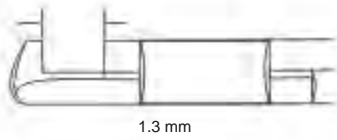

House-Dieter
Malleus Nipper
1.3 mm

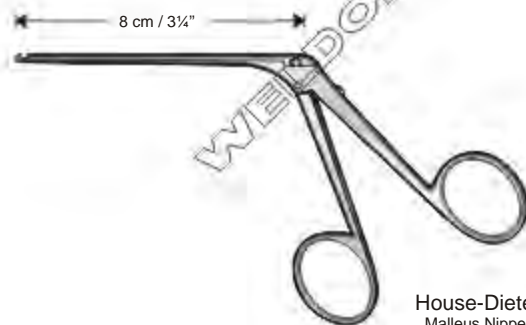
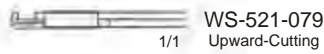
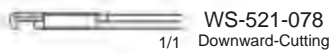

House-Dieter
Malleus Nipper
1.3 mm



Fuller
Teflon Piston Introducing Forceps
WS-521-080 8 cm / 3"
WS-521-081 11 cm / 4 1/4"
For Teflon Prothesis

Ear Polypus Forceps | Pinzas Para Pólipos Auriculares | Ohrpolypenzangen

Hartmann-Wullstein
WS-522-082
8.5 cm / 3½"
With Groove



Hartmann-Wullstein
WS-522-083
8.5 cm / 3½"



Hartmann
WS-522-084 8.5 cm / 3½"
WS-522-085 14 cm / 5½"
WS-522-086 16.5 cm / 6½"



Hartmann
WS-522-087 8.5 cm / 3½"
WS-522-088 14 cm / 5½"



Hartmann-Noyes
WS-522-089
9 cm / 3½"



Hartmann-Noyes
WS-522-090
9 cm / 3½"



Hartmann-Weingärtner
WS-522-091
8.5 cm / 3½"



Hartmann
WS-522-092
8.5 cm / 3½"



Hartmann
WS-522-093 2 mmØ
WS-522-094 2.5 mmØ
WS-522-095 3 mmØ
8.5 cm / 3½"

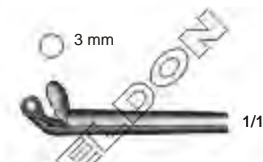

Hartmann
WS-522-096
8.5 cm / 3½"
3 mm



Struempel
WS-522-097
8.5 cm / 3½"



Hartmann
WS-522-098
8.5 cm / 3½"



Hartmann
WS-522-099
8.5 cm / 3½"

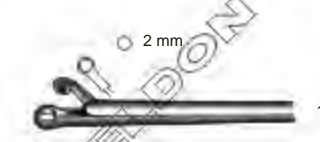

Hartmann-Hoffmann
WS-522-100
8.5 cm / 3½"
2 mm



Ear Polypus Forceps | Pinzas Para Pólipos Auriculares | Ohrpolypenzangen

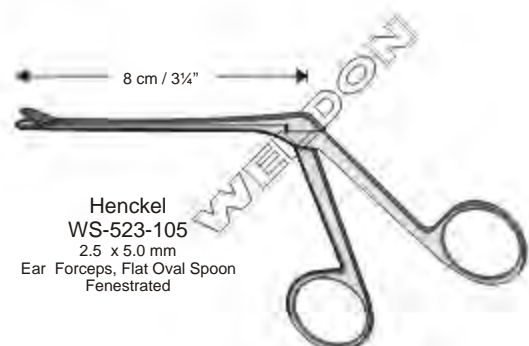
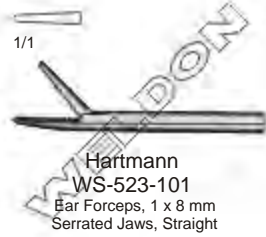



Ear Polypus Forceps | Pinzas Para Pólipos Auriculares | Ohrpolypenzangen

 1 mm
 2 mm
 1/1



Hartmann-Wullstein
 WS-524-106 1 mm
 WS-524-107 2 mm
 Ear Forceps, Cup-Shaped
 Staright

 0.8 x 6 mm
 1.8 x 8 mm
 1/1



Hartmann-Wullstein
 WS-524-108 0.8 x 6 mm
 WS-524-109 1.8 x 8 mm
 Ear Forceps, Serrated Jaws
 Staright



Hartmann-Wullstein
 Ear Forceps For Examination
 Extra Fine Pattern



Buck
 WS-524-110
 11.5 cm / 4 1/2"
 Foreign Body Forceps



Quire
 WS-524-111
 10.5 cm / 4"
 Foreign Body Lever

Ear Polypus Forceps | Pinzas Para Pólipos Aurilculares | Ohrpolypenzangen



Littauer
WS-525-001
12 cm / 4 3/4"



Hartmann
WS-525-002
12 cm / 4 3/4"
Fine Model



Hartmann
WS-525-003
14 cm / 5 1/2"
Regular Model



Hartmann
WS-525-004
13.5 cm / 5"
Ear Tampon Forceps
Delicate Pattern



Hartmann
WS-525-005
13.5 cm / 5"
Ear Tampon Forceps
Strong Pattern



Tilley
WS-525-006
14 cm / 5 1/2"
Ear Tampon Forceps
Extra Fine Pattern

Nasal Polypus Snares And Forceps | Polipómos y Pinzas | Nasenpolypenschnürer

Krause
WS-526-007
 25 cm / 10"
 Angled



Krause-Voss
WS-526-008
 25 cm / 10"
 Angled

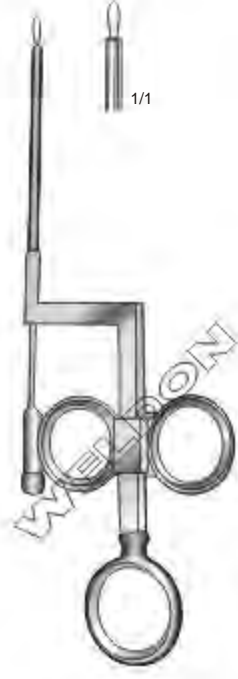

Wilde
WS-526-009
 25 cm / 10"
 Bayonet



Troeltsch (wilde)
WS-526-010
 11 cm / 4½"

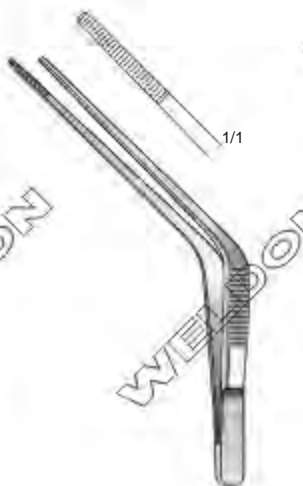

Troeltsch (wilde)
WS-526-011
 12 cm / 4¾"



Troeltsch (wilde)
WS-526-012
 13 cm / 5"

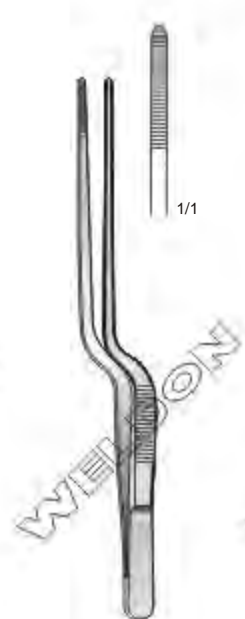

Lucae
WS-526-013 14 cm / 5½"
WS-526-014 16 cm / 6¼"

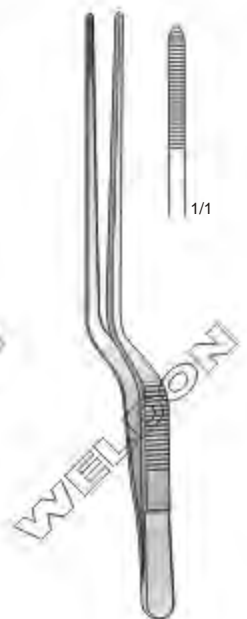

Jansen
WS-526-015 16 cm / 6¼"
WS-526-016 20 cm / 8"

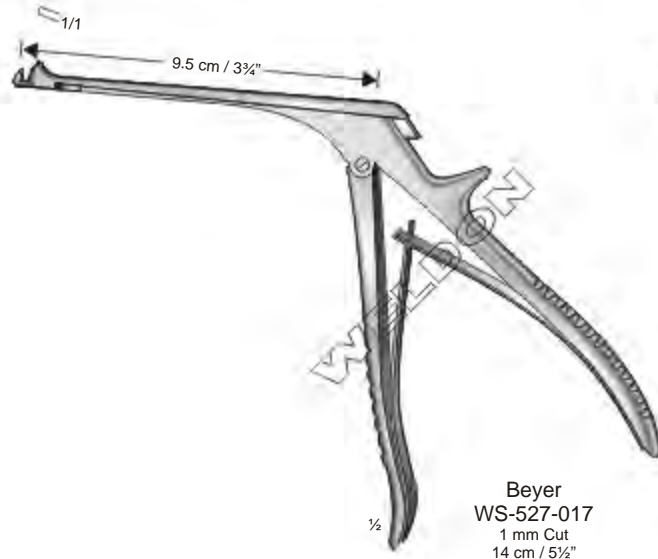

Beyer
WS-527-017
1 mm Cut
14 cm / 5 1/2"

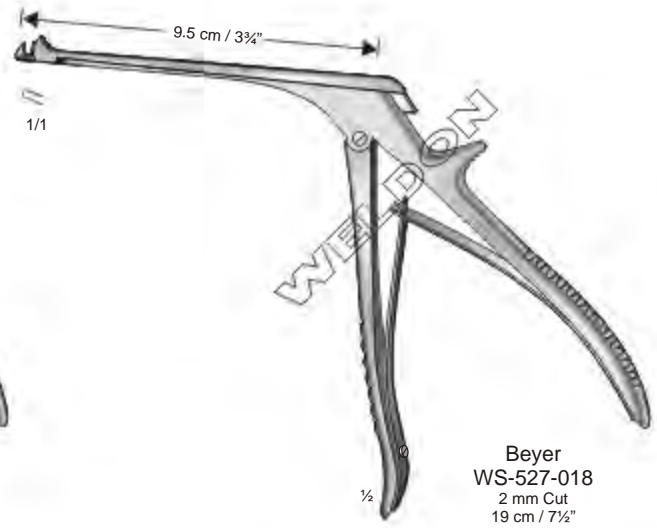

Beyer
WS-527-018
2 mm Cut
19 cm / 7 1/2"



Citelli
WS-527-019
3 mm Cut
17 cm / 6 3/4"

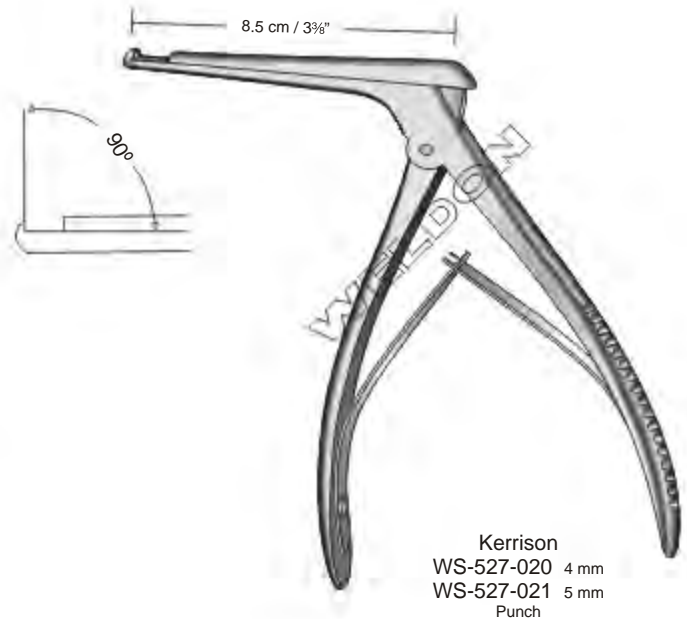

Kerrison
WS-527-020 4 mm
WS-527-021 5 mm
Punch

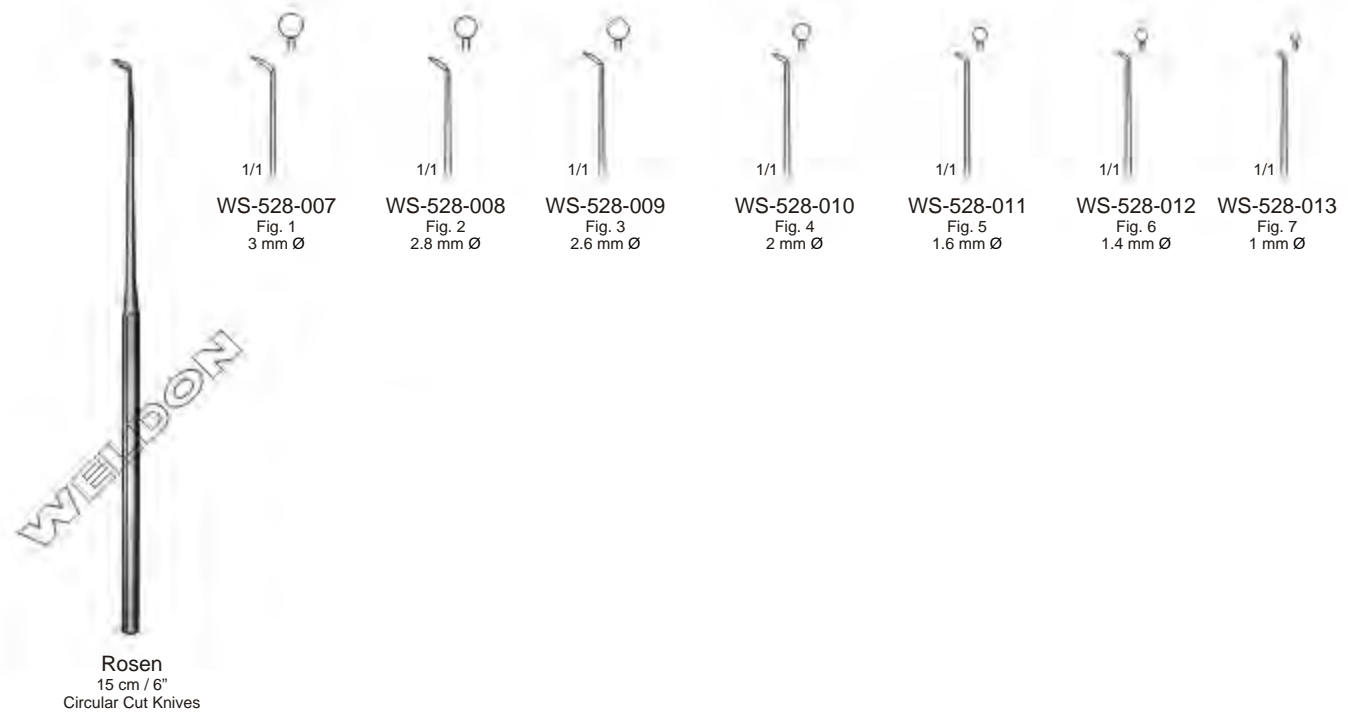
Knives | Cucharillas | Messer

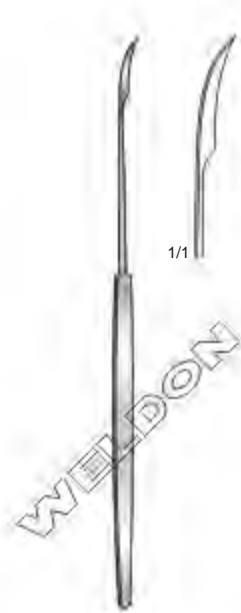

Politzer
WS-529-014
16 cm / 6¼"
Sickle Knife



Lucae
WS-529-015
16 cm / 6¼"
Tympanum Perforator
Bayonet-Shaped
For Children



Lucae
WS-529-016
19 cm / 7½"
For Adults



Lucae
WS-529-017
18 cm / 7"
Myringotome Bayonet Shaped
For Children



Politzer
WS-529-018
16 cm / 6¼"
Tympanum Perforator
Myringotome, Angled



Agnew (Politzer)
WS-529-019
17.5 cm / 7"
Myringotome, Angled



WS-529-020
17 cm / 6¾"
Universal-Myringotome
Adjustable Blade, Reversing
Into Handle



WS-530-021
16 cm / 6¼"
Foot Plate Knife
Straight



Plester
WS-530-022
16 cm / 6¼"
Sickle Knife
Slightly Curved



Thorburn
WS-530-023
16.5 cm / 6½"
Sickle Knife
Curved Tip



Beales
WS-530-024
17cm / 6¾"
Tendon Knife



WS-530-025
16 cm / 6¼"
Flap Knife, Round Cutting
2.4 x 3 mm



Plester
WS-530-026
16 cm / 6¼"
Flap Knife, Round Cutting
2.4 x 3.5 mm



Rosen
WS-530-027
16 cm / 6¼"
Knife And Elevator
Spear Pointed Blade



WS-530-028
16 cm / 6¼"
Round Cutting Knife
45° Angled, Slender

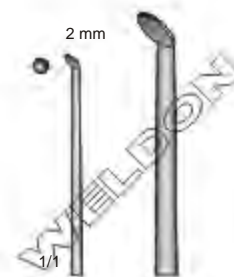

WS-530-029
16 cm / 6¼"
Round Cutting Knife
45° Angled



WS-531-030
Round Cutting Knife
45° Angled
Ø 2.6 mm



WS-531-031
Round Cutting Knife
90° Angled
Ø 3 mm



WS-531-032
Round Cutting Knife
90° Angled
Ø 1.5 mm



WS-531-033
Graft Holder and Elevator
2 mm Broad



WS-531-034
Elevator For Lifting Drum Forward
Slightly Angled
1 mm Broad



WS-531-035
Separator, Round Edge
Slightly Curved
1.8 mm Broad



Schuknecht
WS-531-036
Roller Knife For Incising Skin
90° Angled



Schuknecht
WS-531-037
Roller Knife
Blade, Inline With Shaft



WS-531-038
Excavator, Small
Double Curve Left



WS-531-039
Excavator, Small
Double Curve Right



16 cm / 6¼"



Barbara
16 cm / 6¼"

1/1

Barbara
WS-532-040

1/1

Barbara
WS-532-041

1/1

Barbara
WS-532-042

1/1

Rosen
WS-532-043

1/1

WS-532-044 0.3 mm
WS-532-045 0.6 mm
WS-532-046 1.0 mm
Angled at 25°

1/1

WS-532-047 0.3 mm
WS-532-048 0.6 mm
WS-532-049 1.0 mm
WS-532-050 1.2 mm
WS-532-051 1.5 mm
WS-532-052 2.0 mm
WS-532-053 2.5 mm
Angled at 45°

1/1

WS-532-054 0.3 mm
WS-532-055 0.6 mm
WS-532-056 1.0 mm
WS-532-057 1.2 mm
WS-532-058 1.5 mm
WS-532-059 2.0 mm
WS-532-060 2.5 mm
Angled at 90°

1/1

WS-532-061 0.5 mm
WS-532-062 1.0 mm

WELDON



WS-533-063
Needle Slightly Curved
Sharp Point



WS-533-064
Needle Strongly Curved
Sharp Point



Rosen
WS-533-065
Black Finish
Hook



WS-533-066
Straight, Sharp Point

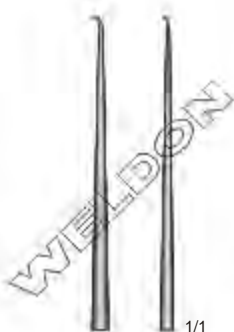

Shambaugh
WS-533-067 0.4 mm
WS-533-068 0.6 mm
WS-533-069 0.8 mm
WS-533-070 1.0 mm
Fenestra Hook
45° Angled



Shambaugh
WS-533-071 0.4 mm
WS-533-072 0.6 mm
WS-533-073 0.8 mm
WS-533-074 1.0 mm
Fenestra Hook
90° Angled



WS-533-075
Foot Plate Hook 1 mm
Retrograde Curved
For Adherences



Plester
WS-533-076
Scraper, 2 mm
60° Angled



Needle (Perforator)
Straight, Sharp Point
16 cm / 6 1/4"



Hook
16 cm / 6¼"



1/1

WS-534-077
Hook, Reverse Cutting
0.6 mm



1/1

Plester
WS-534-078
Footplate Hook,
90° Angled, Oval, Blunt
0.4 mm



1/1

WS-534-079
Hook, Straight Shaft
Slightly Angled At Tip



1/1

Hough
WS-534-080
Foot Plate Hook
90° Angled



1/1

Beale
WS-534-081
Straight Hook
Angled Upward



1/1

Plester
WS-534-082
Antrum Hook, Cylindric
90° Angled



1/1

Plester
WS-534-083
Antrum Hook, Cylindric
45° Angled



1/1

Plester
WS-534-084
Wire Guide And Applicator



1/1

Hughes
WS-534-085
Stapes Mobiliser
16.5 cm / 6½"

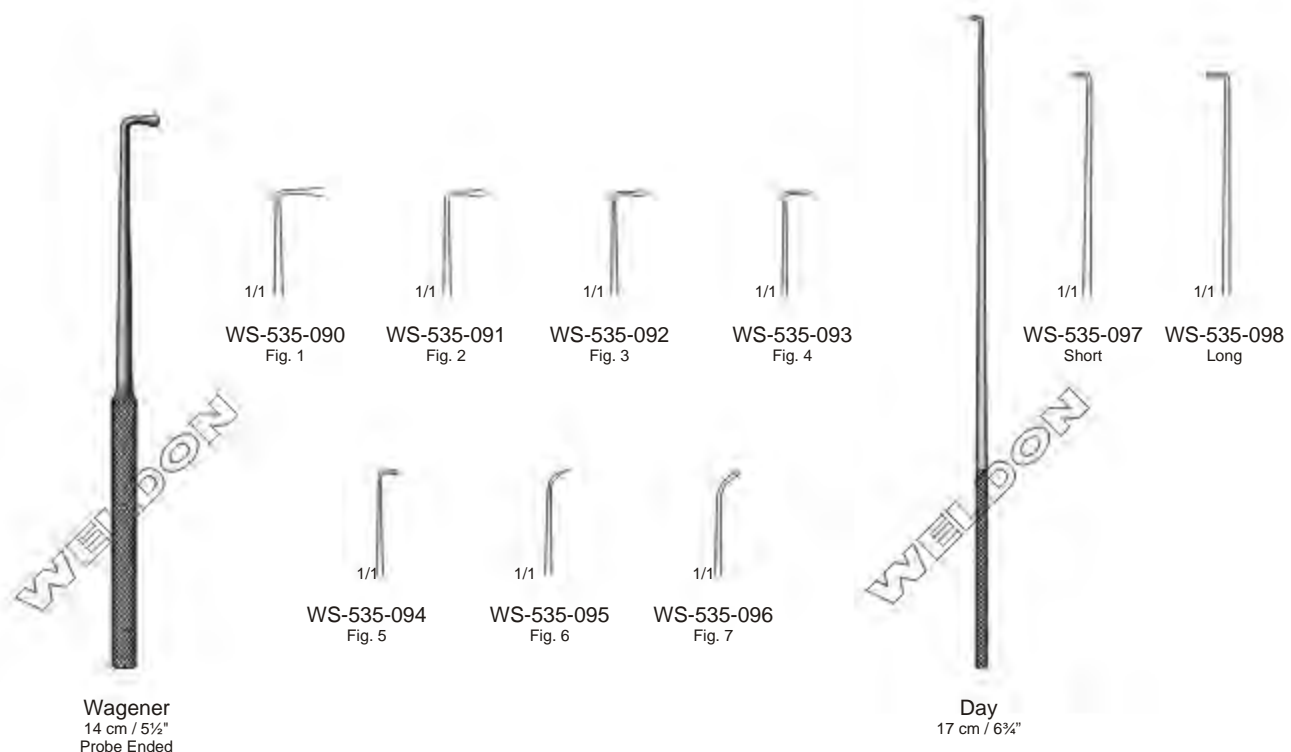
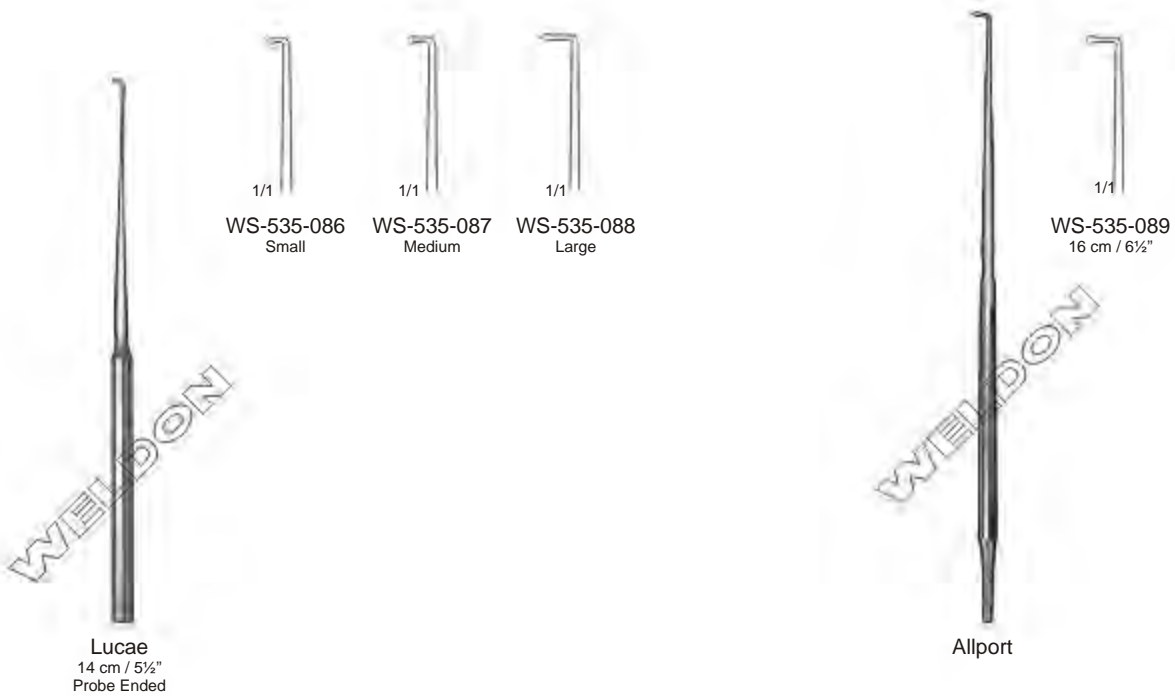

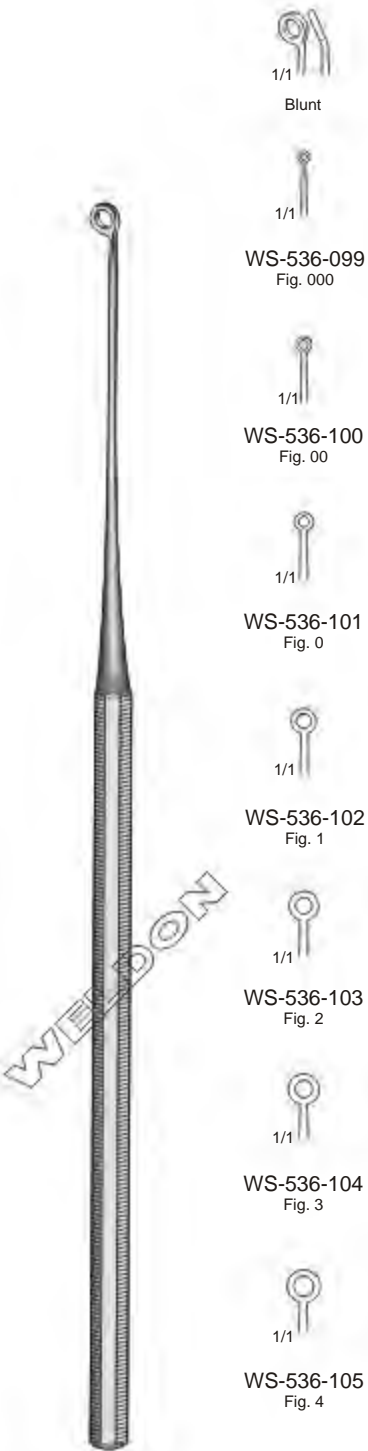
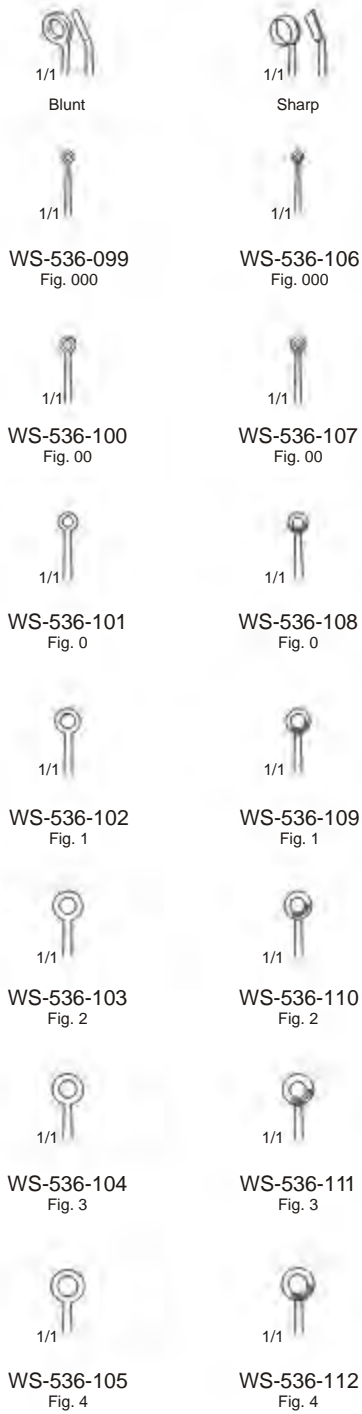
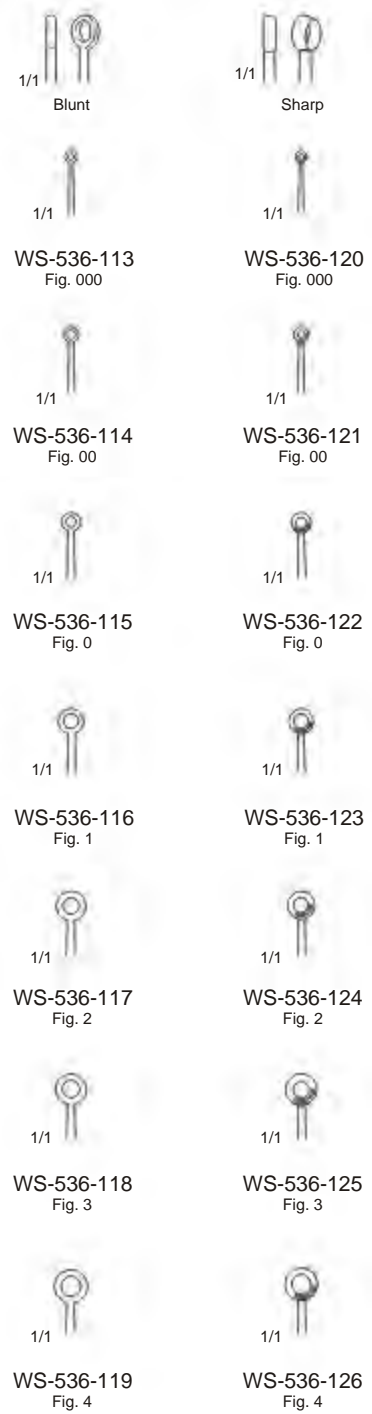
Ear Currettes | Curetas Auriculares | Ohrküretten

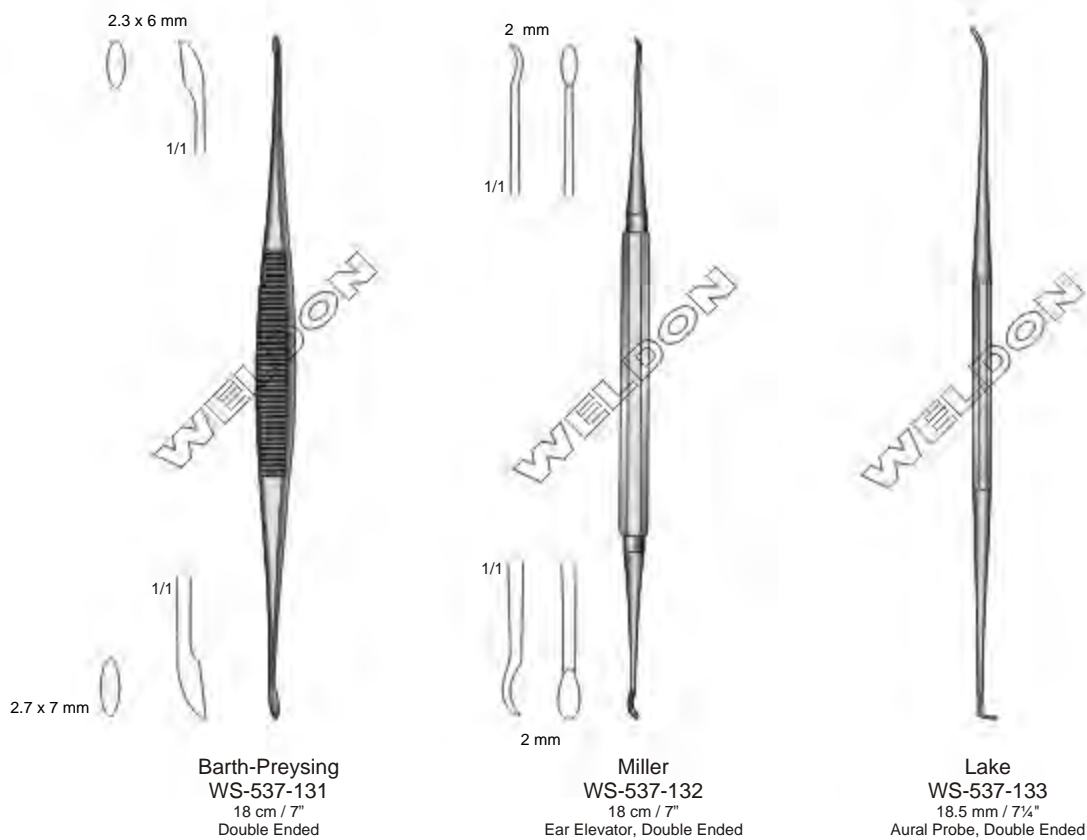
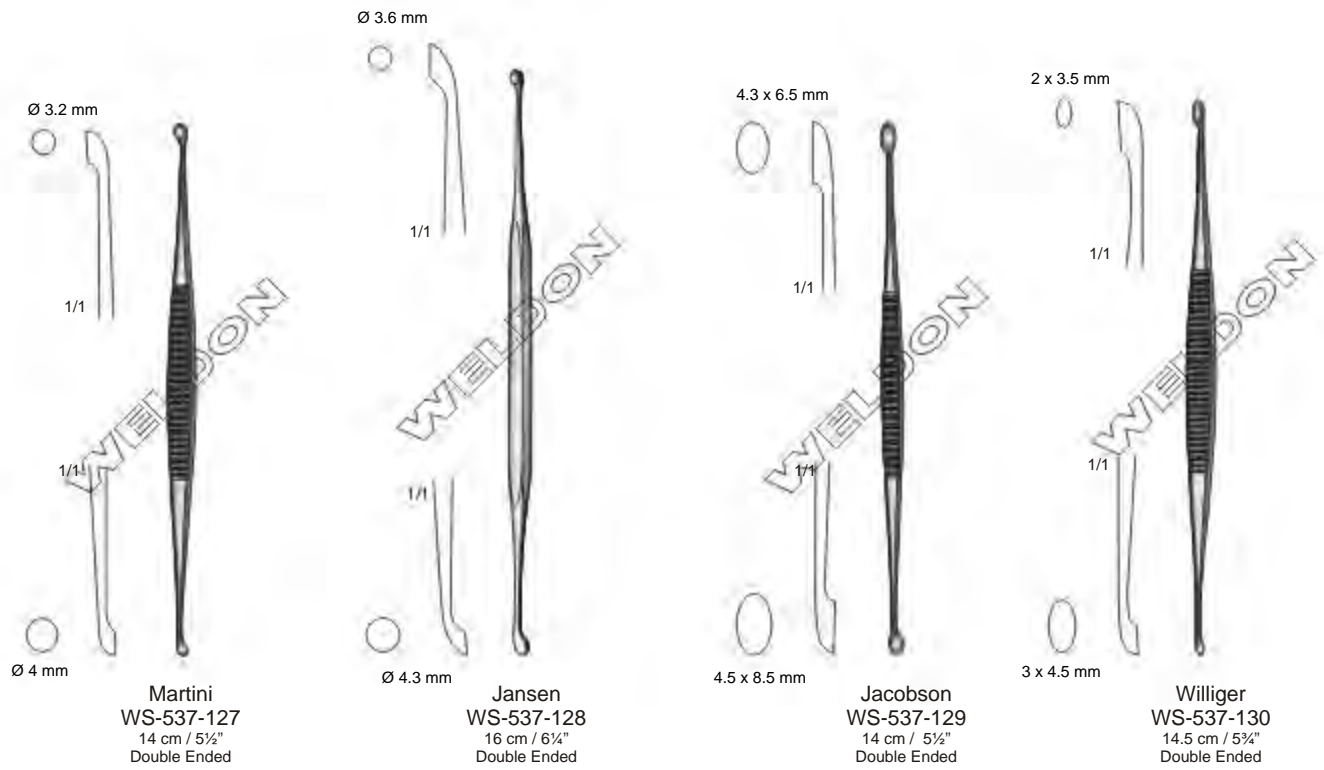
**Buck
Angled**
17 cm / 6¾"

**Buck
Straight**
17 cm / 6¾"





Mod. Weldon
 WS-538-134 Blunt
 WS-538-135 Sharp
 17 cm / 6¾"



Coxeter
 WS-538-136
 15 cm / 6"
 Blunt



Langenbeck
 WS-538-137
 13.3 cm / 5¼"
 Blunt

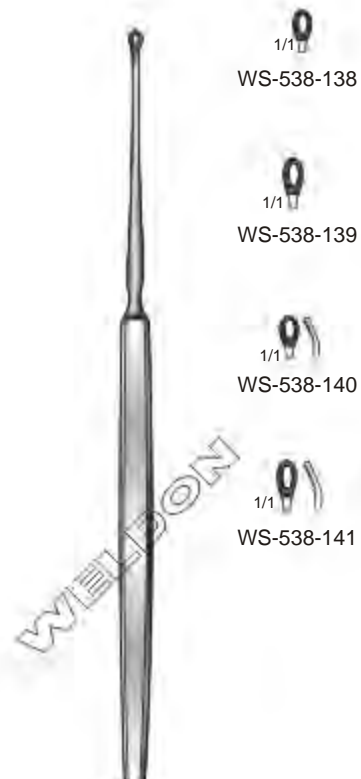

Shapleigh
 13.3 cm / 5¼"

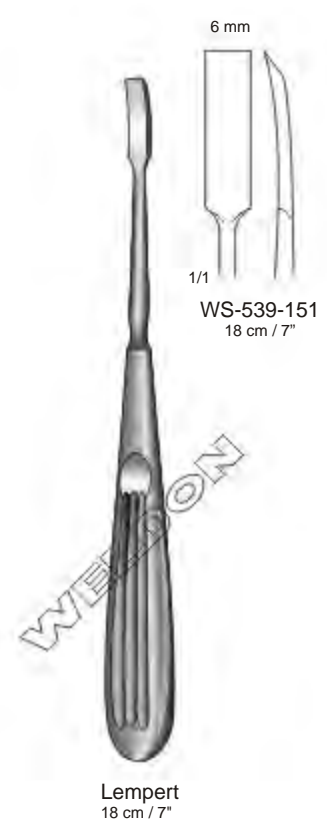
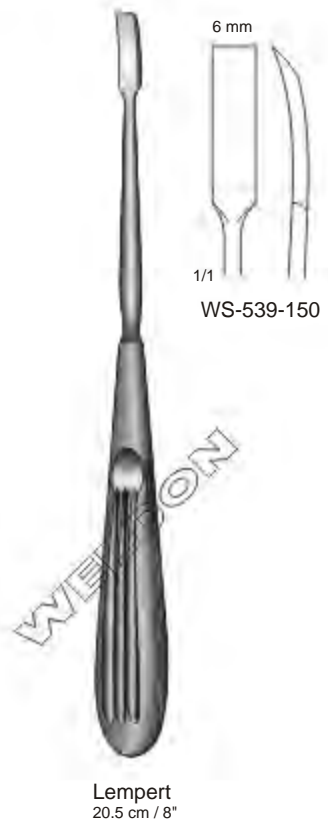
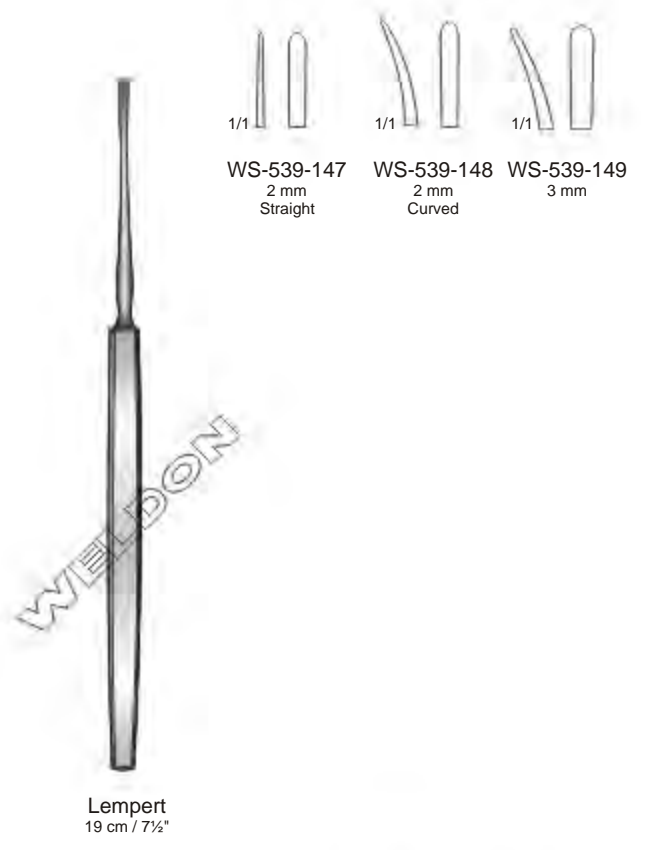
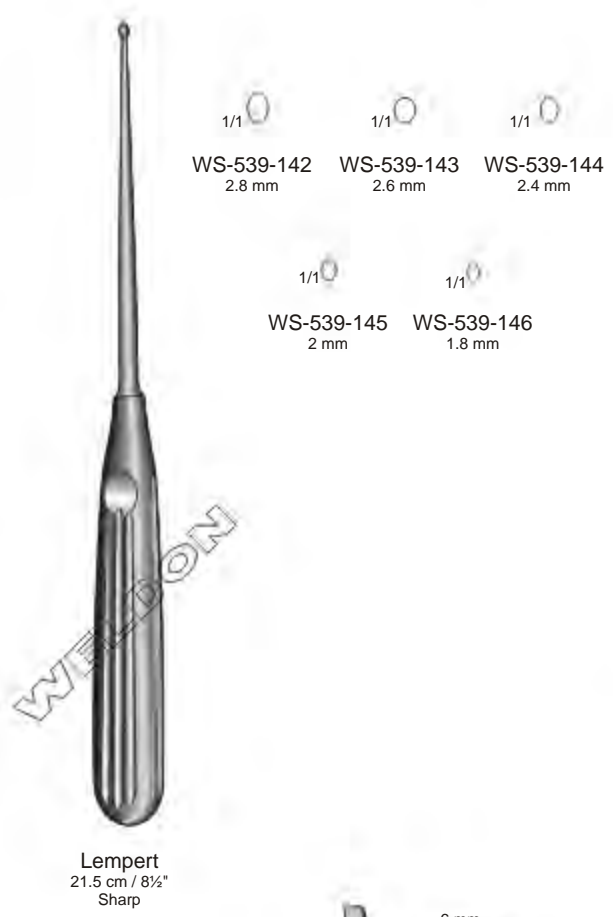

Chisels, Gouges, Micro Ear Curettes | Cinceles, Gubias, Micro Curetas Auriculares
Flachmeißel, Hohlmeißel, Mikro-Ohrküretten

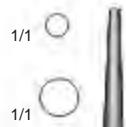
WS-541-164 \varnothing 3 mm
 WS-541-165 \varnothing 5 mm
 16 cm / 6 1/4"
 Haemostatic Tamper



Passow
 WS-541-166 2.5 mm
 WS-541-167 3.5 mm
 12 cm / 4 3/4"
 Haemostatic Chisel

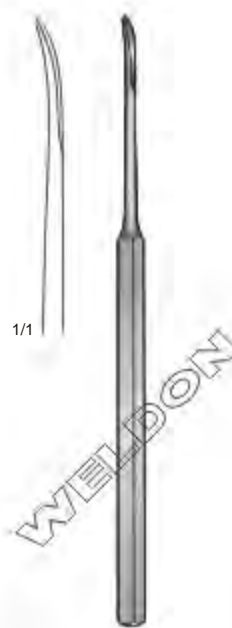

Thies
 WS-541-168 2 mm
 WS-541-169 3 mm
 WS-541-170 4 mm
 16 cm / 6 1/4"
 Gouges



Lucas
 WS-541-171 4 mm
 WS-541-172 6 mm
 16 cm / 6 1/4"
 Chisels



Lucas
 WS-541-173 3 mm
 WS-541-174 5 mm
 16 cm / 6 1/4"
 Gouges



WS-541-175 10 mm
 WS-541-176 15 mm
 WS-541-177 20 mm
 20 cm / 8"
 Osteotomes, Straight
 Handle Can be Sterilized In Steam
 143°C



WS-541-178 10 mm
 WS-541-179 15 mm
 WS-541-180 20 mm
 20 cm / 8"
 Osteotomes, Curved
 Handle Can be Sterilized In Steam
 143°C

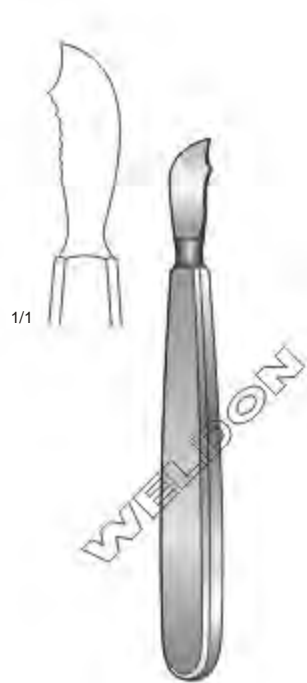

Muck
WS-542-181
 15 cm / 6"
 Periosteal Knife

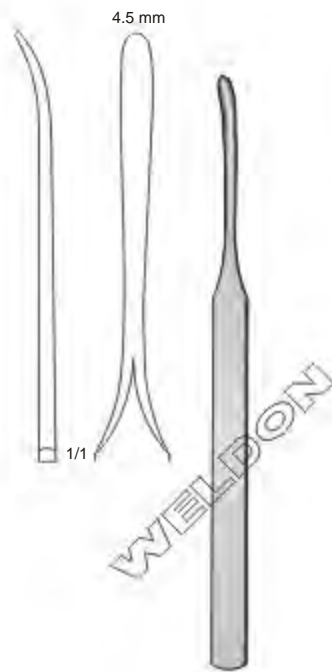

König
WS-542-182
 15 cm / 6"
 Elevator

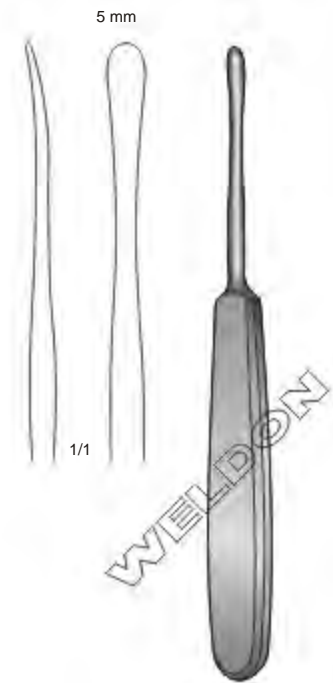

Sebileau
WS-542-183
 17.5 cm / 7"
 Elevator

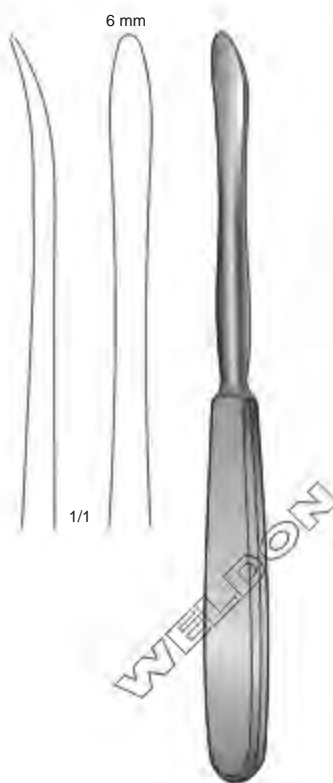

Langenbeck-Quervian
WS-542-184
 19.5 cm / 7 3/4"
 Elevator 6 mm

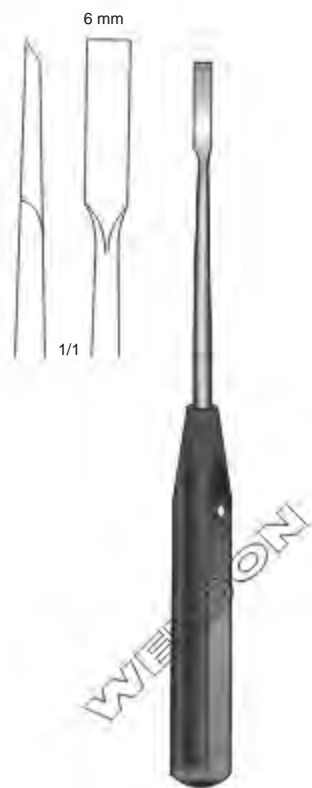

WS-542-185
 19 cm / 7 1/2"
 Raspatory 6 mm
 Straight, Tip Straight



WS-542-186
 19 cm / 7"
 Raspatory 6 mm
 Curved, Tip Straight

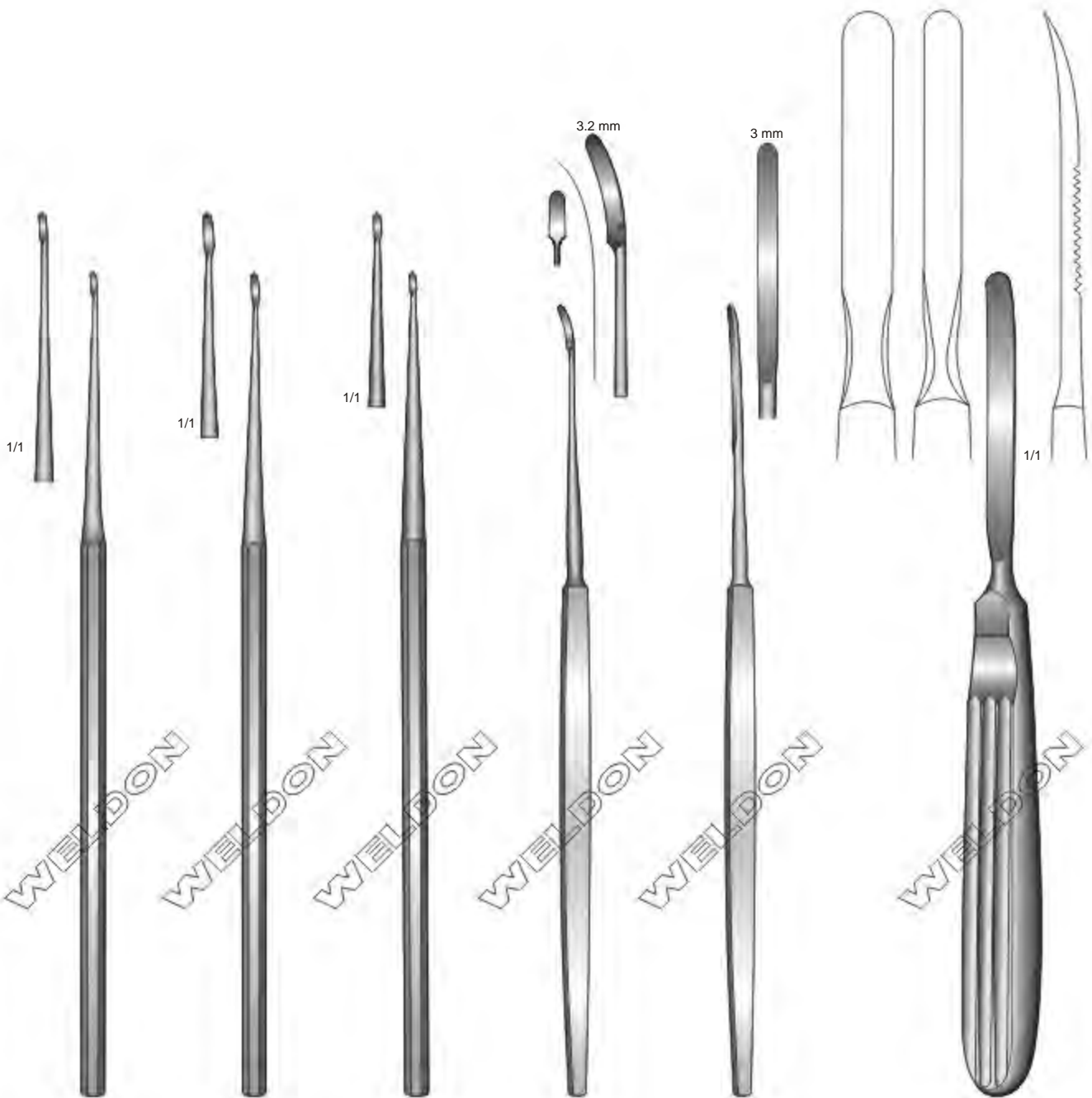

Beales
WS-543-187
16.5 cm / 6½"
Raspatory

Beales
WS-543-188
16.5 cm / 6½"
Raspatory,
Spatula End, Small

Beales
WS-543-189
16.5 cm / 6½"
Raspatory,
Spatula End, Small

Wullstein
WS-543-190
16 cm / 6¼"
Raspatory
Rounded Blade
Curved

Lempert
WS-543-191
16 cm / 6¼"
Raspatory, Narrow
Straight

WS-543-192 6 mm
WS-543-193 8 mm
16.5 cm / 6½"
Raspatory, Slightly Curved

Foreign Body Instruments | Instrumentos Para Cuerpos Extraños | Fremdkörperinstrumente

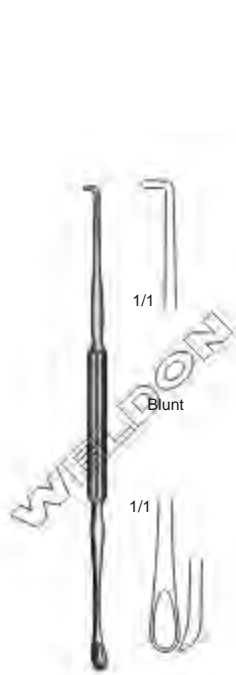

Gross
WS-544-194
12 cm / 4¾"
Ear Scoop / Hook



Weber-Loch
16 cm / 6¼"
Ear Loop



Billeau
16.5 cm / 6½"
Ear Loop



Moldenhauer
WS-544-200
15.5 cm / 6"
Foreign Body Lever



Zaufal
WS-544-201
15 cm / 6"
Foreign Body Lever



Hartmann
WS-544-202
16 cm / 6¼"
Ear Hooklet



www.weldoninstruments.com

PROVEEDOR EXCLUSIVO:



Tongue Spatulas & Depressors

Mouth Gags

Soft Tissue Retractors

Osteotomes & Elevators

545 - 560

Oral Maxillo Facial Surgery

Oral Maxillo-Facial Surgery
Cirugia Oral y maxilofacial
Mund Kiefer-Gesichtschirurgie



Spatula
WS-545-001
16 cm / 6¼"
Wooden
Package of 100 Pieces



Spatula
WS-545-002
15 cm / 6"
Plastic
Package of 100 Pieces



Haas
WS-545-003
16 cm / 6¼"
Acrylic Glass



Buchwald
WS-545-004
17 cm / 6¾"
Acrylic Glass



Spatula
WS-545-005
18.5 cm / 7¼"
Nylon



Spatel
WS-545-006
14.5 cm / 5¾"
Bending



Spatel
WS-545-007
14.5 cm / 5¾"

Tongue Depressors | Abajalenguas | Zungendrucker



Moritz Schmidt
WS-546-008
19 cm / 7½"



Hartmann
WS-546-009
15 cm / 6"
72 x 23 mm



Tobold
WS-546-010
15 cm / 6"
88 x 25 mm



Tobold
WS-546-011
14.5 cm / 5¾"
85 x 24 mm



WS-546-013
15 cm / 6"
43 mm



WS-546-012
14 cm / 5½"
36 mm

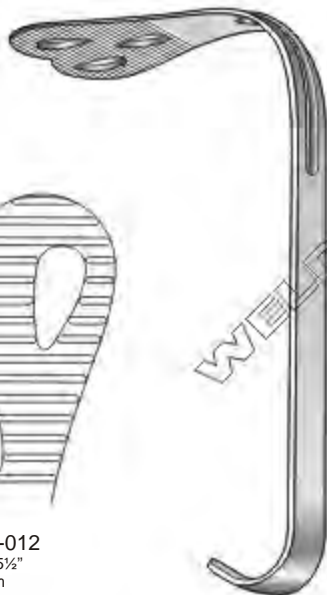

Wieder



Andrew
WS-546-014
11 cm / 4½"



Doyen
 WS-547-015 13 cm / 5", 24 / 30 mm
 WS-547-016 16 cm / 6¼", 30 / 34 mm



Kroenig
 WS-547-017
 15 cm / 6"



Mayo
 WS-547-018
 17 cm / 6¾"



Brünings
 WS-547-019
 19 cm / 7½"
 19 / 15 mm



Collin
 WS-547-020
 16.5 cm / 6½"

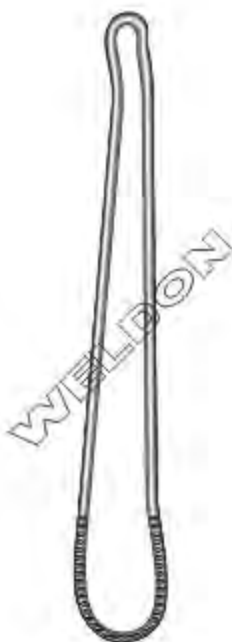

Mod. Martin
 WS-547-021
 16.5 cm / 6½"

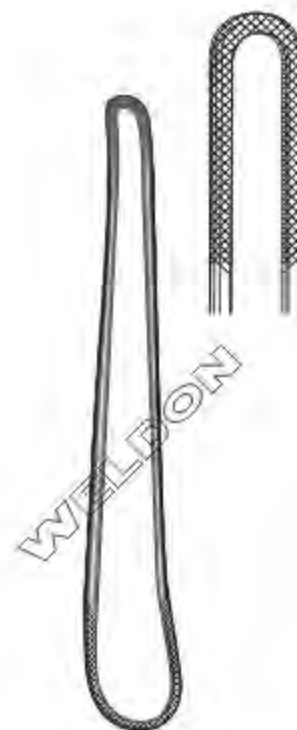

Frenzel
 WS-547-022
 16.5 cm / 6½"

Tongue Holding Forceps | Pinzas Tira-Lengua | Zungenzangen



Disimpaction Forceps | Pinzas Para Reposición | Repositionszangen

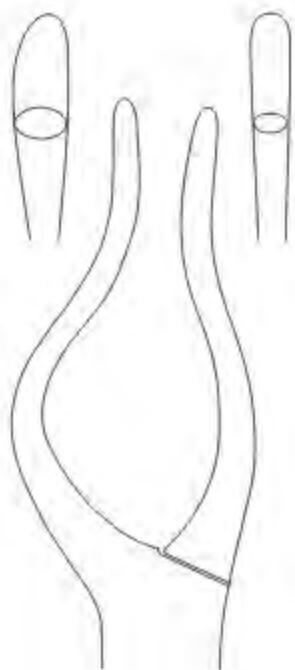

WS-549-007 Left
WS-549-008 Right

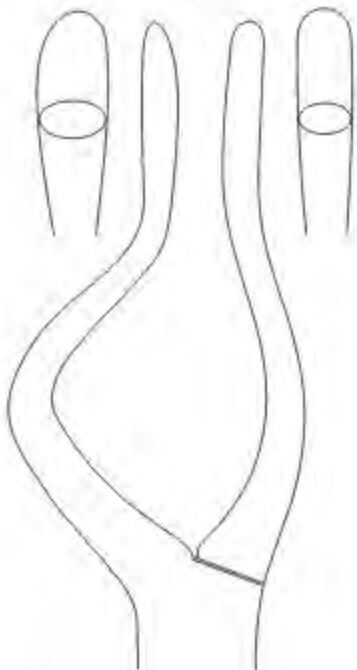

WS-549-009 Left
WS-549-010 Right

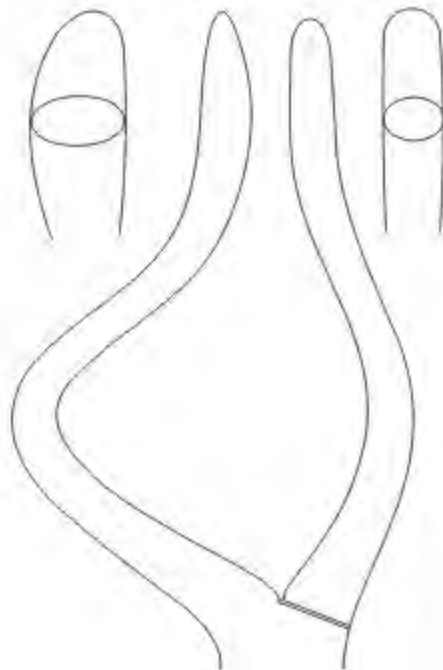

WS-549-011 Left
WS-549-012 Right



Rowe
22.5 cm / 9"
Left



Rowe
24 cm / 9 1/2"
Right



Heister
WS-550-001
13 cm / 5"



Molt
WS-550-002
11 cm / 4 1/4"



Molt
WS-550-003
13 cm / 5"

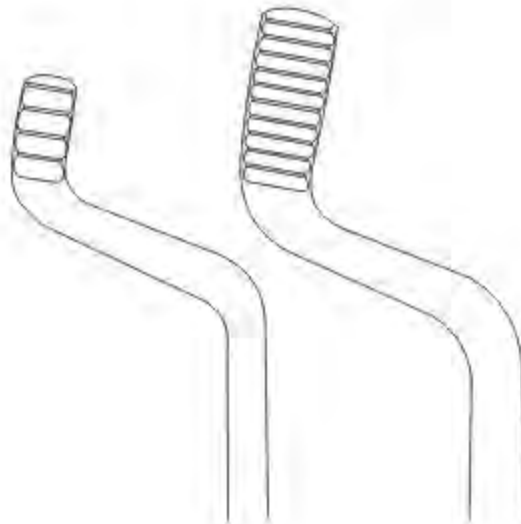

WS-550-005
16 cm / 6 1/4"

WS-550-006
20 cm / 8"



Denhart
WS-550-004
12 cm / 4 1/4"
Jaws 16 mm



Roser-König

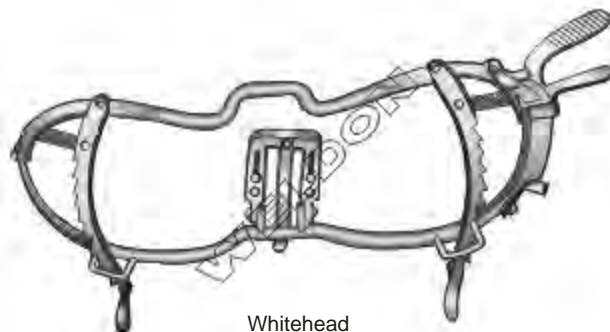

Whitehead
WS-551-007
13 cm / 5"



Whitehead
WS-551-008 11 cm / 4¼"
WS-551-009 13 cm / 5"
WS-551-010 15 cm / 6"



Seemann Seiffert
(Self Retaining)
WS-551-011 9 cm / 3½"
WS-551-012 11 cm / 4½"
WS-551-013 13 cm / 5"
WS-551-014 15 cm / 6"

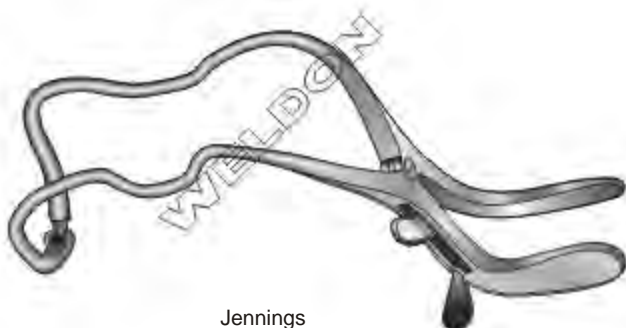

Jennings
WS-551-015 10.5 cm / 4"
WS-551-016 12.5 cm / 5"
WS-551-017 14.5 cm / 5¾"
WS-551-018 16.5 cm / 6½"



WS-552-019
70 x 29 mm

WS-552-020
80 x 34 mm

WS-552-021
85 x 38 mm

Tongue Depressor

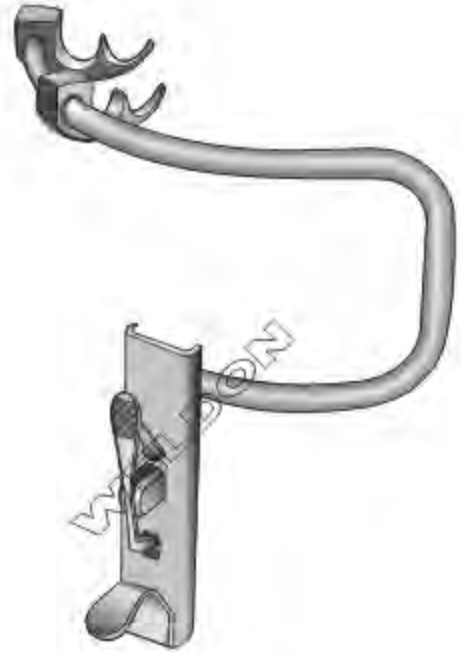

Kilner-Doughty
Complete With Frame
WS-552-022
Gag Only
WS-552-023
13.5 cm / 5¼"

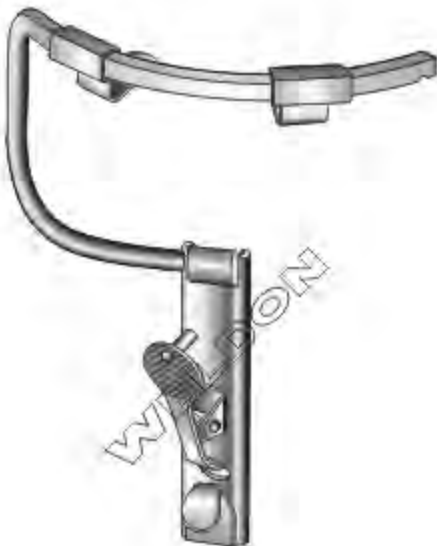

Davis-Meyer
WS-552-024
Frame Only
WS-552-025

Complete With Frame & 7 Tongue Depressors



WS-552-026 29 x 70 mm
WS-552-027 30.5 x 75 mm
WS-552-028 31.5 x 80 mm
WS-552-029 32.5 x 85 mm
WS-552-030 33.5 x 95 mm
WS-552-031 33.8 x 100 mm
WS-552-032 34 x 105 mm



Davis-Boyle
 WS-553-033
 Frame For Mouth Gag Only
 WS-553-034
 Complete With 5 Blades
 17 cm / 7"



Tongue Depressor
 WS-553-035 27 x 105 mm
 WS-553-036 25 x 90 mm
 WS-553-037 25 x 75 mm
 WS-553-038 22 x 60 mm
 WS-553-039 20 x 25 mm
 13.5 cm / 5 1/4"



Tongue Depressor
 WS-553-040 100 x 26 mm
 WS-553-041 85 x 25 mm
 WS-553-042 75 x 23 mm
 13.5 cm / 5 1/4"



WS-553-040A 100 x 26 mm
 WS-553-041A 85 x 25 mm
 WS-553-042A 75 x 23 mm
 With Suction Tube
 13.5 cm / 5 1/4"



McIvor
 WS-553-043
 Frame With Mouth Gag Only
 WS-553-043A
 Frame With Mouth Gag & Suction Tube
 WS-553-044
 Complete Set With 3 Blades
 WS-553-044A
 Complete Set With 3 Blades & Suction Tube
 15 cm / 6"

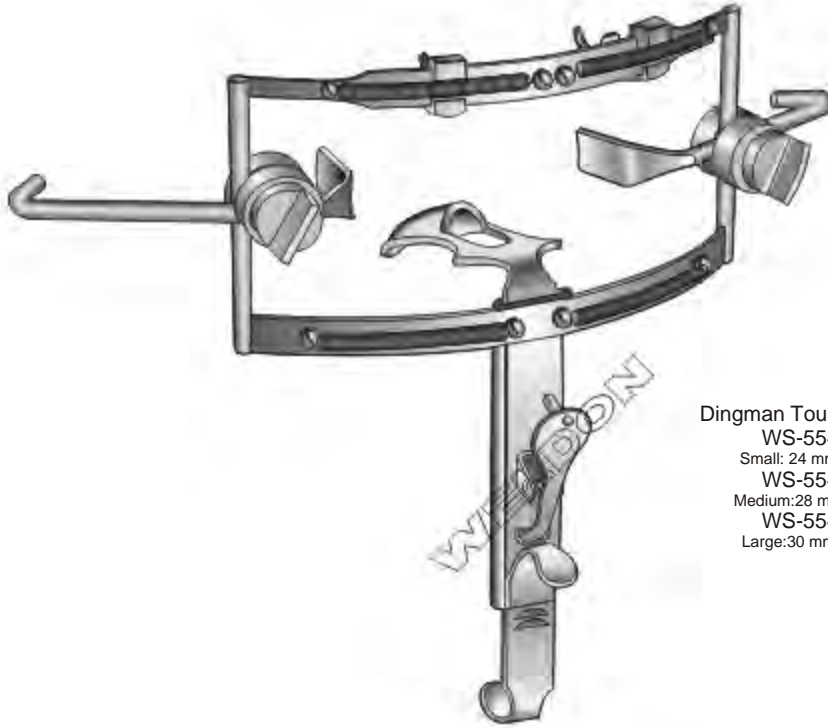

Dingman Tongue Blades
 WS-554-046
 Small: 24 mm x 52 mm
 WS-554-047
 Medium: 28 mm x 55 mm
 WS-554-048
 Large: 30 mm x 68 mm

Dingman Mouth Gag
 WS-554-045
 Complete With 3 Tongue Blades



Tongue Depressor
 WS-554-049 55 x 25 mm, Fig. 1
 WS-554-050 60 x 27 mm, Fig. 2
 WS-554-051 70 x 30 mm, Fig. 3

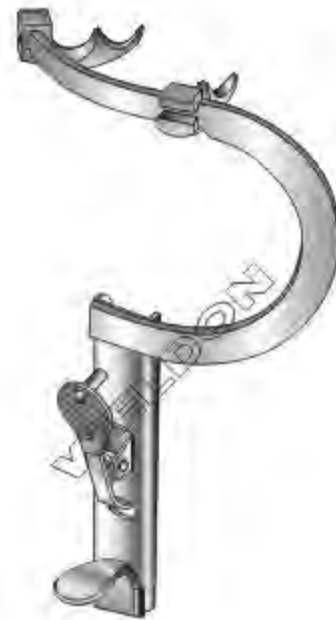

Köln
 WS-554-052
 Complete With Frame & 4 Tongue Depressors
 WS-554-053
 Frame Only

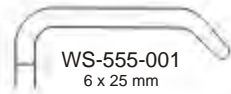

WS-555-001
6 x 25 mm

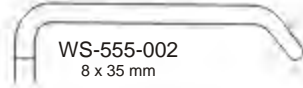

WS-555-002
8 x 35 mm

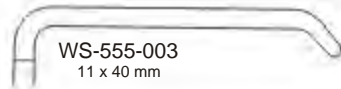

WS-555-003
11 x 40 mm



WS-555-004
11 x 55 mm



WS-555-005
14 x 70 mm

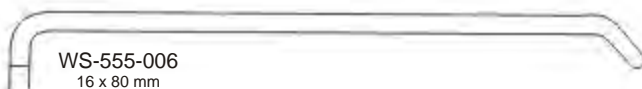

WS-555-006
16 x 80 mm



WS-555-007
43 x 11 mm



WS-555-008
57 x 11 mm

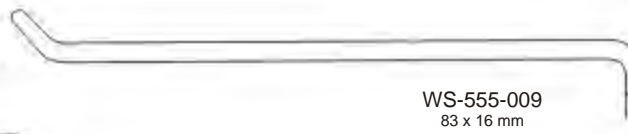

WS-555-009
83 x 16 mm



Obwegeser
21.5 cm / 8½"

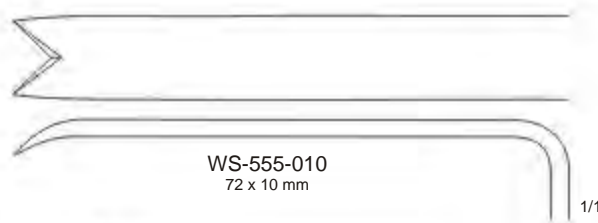

WS-555-010
72 x 10 mm

1/1

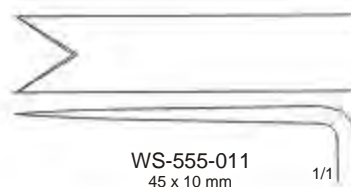

WS-555-011
45 x 10 mm

1/1



Obwegeser
Nasal Spine Retractor
22 cm / 8¾"

Obwegeser
21.5 cm / 8½"



Obwegeser
WS-556-012
16.5 cm / 6½"



Obwegeser
WS-556-013 8 mm
WS-556-014 10 mm
17 cm / 6¾"



Obwegeser
WS-556-015 18 cm / 7"
WS-556-016 28 cm / 11"



Obwegeser
WS-556-017
13 cm / 5"



Obwegeser
WS-556-018
23 cm / 9"



Obwegeser
WS-557-001
21.5 cm / 8½"
Splitting Osteotomes



Obwegeser
WS-557-002
21.5 cm / 8½"
Splitting Osteotomes



Obwegeser
21.5 cm / 8½"
Wedge Osteotomes



Obwegeser
21.5 cm / 8½"
Blade Osteotomes

Osteotomes | Osteótomos | Osteotome



WS-558-010
10 mm

WS-558-011
15 mm

Tessier
16 cm / 6¼"
Straight



WS-558-012
10 mm

WS-558-013
15 mm

Tessier
16 cm / 6¼"
Curved



WS-558-014
10 mm

WS-558-015
15 mm

WS-558-016
20 mm

WS-558-017
30 mm

Tessier
20.5 cm / 8"
Straight



WS-558-018
10 mm

WS-558-019
15 mm

Tessier
20.5 cm / 8"
Curved



WS-558-020

WS-558-021

Obwegesser
18.5 cm / 7¼"
Nasal Septum Osteotome

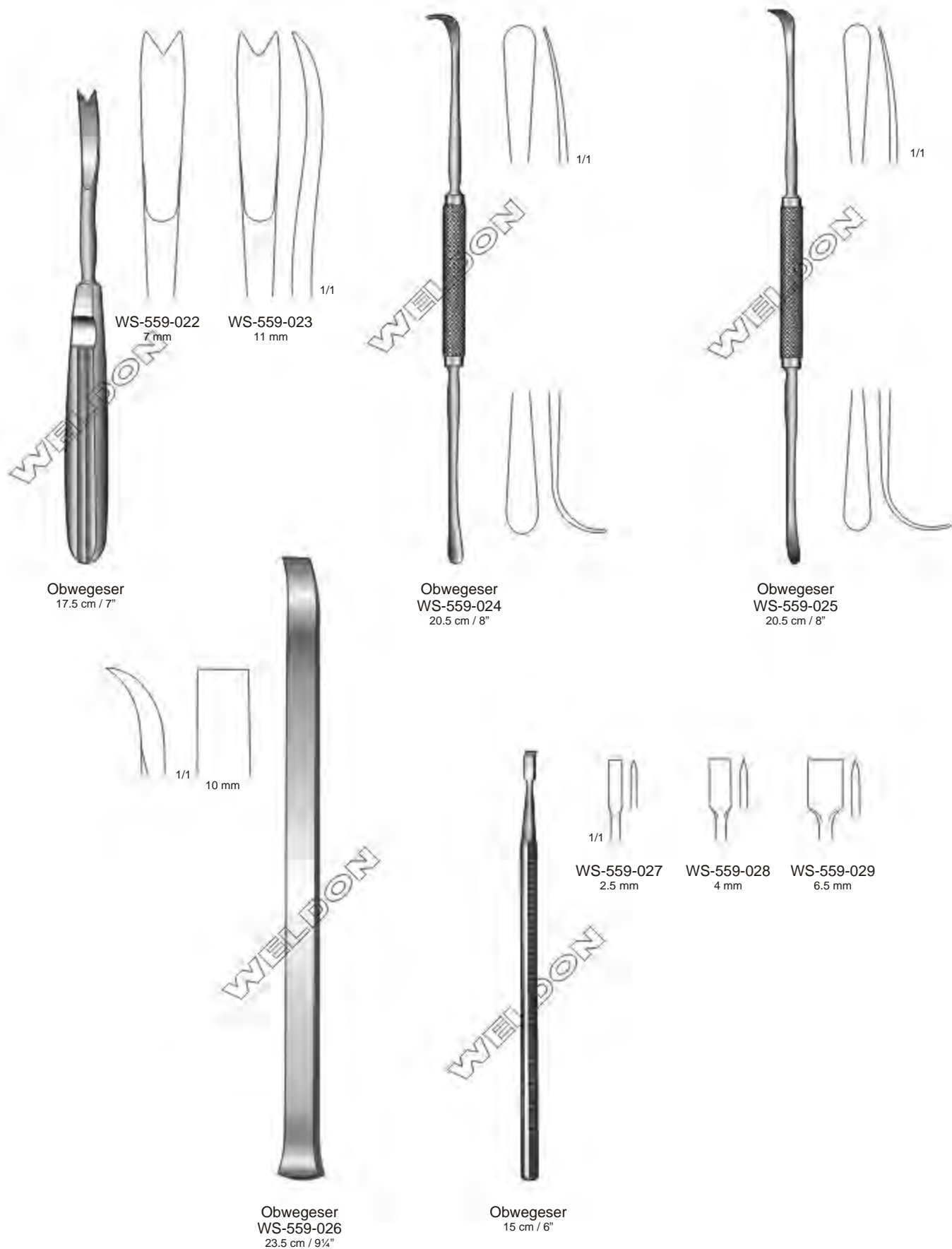

Periosteal Elevators | Legaras | Raspatorien



WS-560-030
6 mm



WS-560-031
7 mm



WS-560-032
9 mm



WS-560-033
11 mm



Obwegeser
17.5 cm / 7"



WS-560-034
5 mm



WS-560-035
7 mm



WS-560-036
9 mm



Obwegeser
20.5 cm / 8"



www.weldoninstruments.com

PROVEEDOR EXCLUSIVO:



Sterilizing Forceps, Drums & Trays

Needle Cases & Perforated Boxes

Nail Nippers

Cuticle Nippers & Scissors

561 - 568

Storage & Asepsis

Storage & Asepsis
Almacenaje y Aspesia
Aufbewahrung und Asepsis



Cheattle
WS-561-001
27 cm / 10½"



Cheattle
WS-561-002
27 cm / 10½"



Rogge
WS-561-003
23 cm / 9"



WS-561-004
30 cm / 11½"



Bunt (Mayo) Pin
WS-561-005
14 cm / 5½"
WS-561-005A
16 cm / 6¼"



Bunt (Mayo) Pin
WS-561-006 14 cm / 5½"
WS-561-006A 16 cm / 6¼"

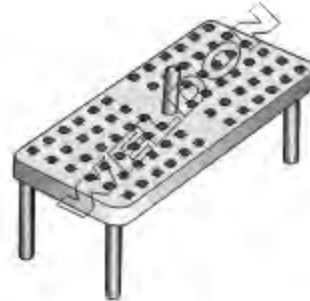

Endo Box
WS-562-007
100 X 40 X 50 mm



Sterilization Drums

	Ø x H
WS-562-008	80 x 80 mm
WS-562-009	105 x 120 mm
WS-562-010	140 x 140 mm
WS-562-011	160 x 120 mm
WS-562-012	160 x 150 mm
WS-562-013	190 x 150 mm
WS-562-014	190 x 190 mm
WS-562-015	240 x 160 mm
WS-562-016	240 x 240 mm
WS-562-017	290 x 160 mm
WS-562-018	290 x 240 mm
WS-562-019	340 x 160 mm
WS-562-020	340 x 340 mm
WS-562-021	390 x 190 mm
WS-562-022	380 x 290 mm



Needle Cases Rack
WS-563-023
For 22 Pieces
Scalar Rack

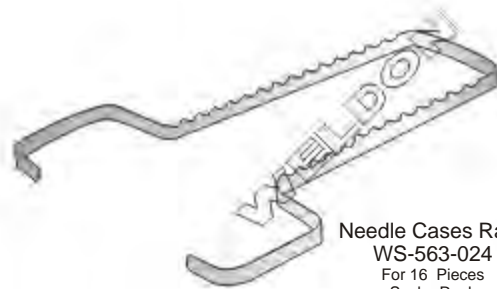

Needle Cases Rack
WS-563-024
For 16 Pieces
Scalar Rack



Needle Cases
WS-563-025
280 X 180 X 50 mm



Perforated Instrument Boxes

WS-563-026	170 X 70 x 35 mm
WS-563-027	180 X 80 x 40 mm
WS-563-028	200 x 100 x 40 mm
WS-563-029	200 x 100 x 50 mm
WS-563-030	200 x 100 x 60 mm
WS-563-031	220 x 120 x 60 mm
WS-563-032	250 x 120 x 60 mm
WS-563-033	300 x 150 x 60 mm
WS-563-034	300 x 200 x 80 mm
WS-563-035	400 x 160 x 80 mm
WS-563-036	400 x 200 x 100 mm
WS-563-037	500 x 200 x 120 mm



Needles Tray
WS-564-038
 200 X 100 X 25 mm



Instrument Tray

WS-564-039	150 x 100 x 50 mm
WS-564-040	200 x 100 x 50 mm
WS-564-041	220 x 120 x 50 mm
WS-564-042	240 x 140 x 50 mm
WS-564-043	200 x 150 x 50 mm
WS-564-044	250 x 200 x 50 mm
WS-564-045	300 x 250 x 50 mm
WS-564-046	300 x 200 x 50 mm
WS-564-047	350 x 250 x 50 mm
WS-564-048	400 x 300 x 50 mm
WS-564-049	450 x 300 x 50 mm
WS-564-050	450 x 350 x 50 mm



Mayo Tray
 Perforated

WS-564-051	150 x 100 x 25 mm
WS-564-052	200 x 100 x 25 mm
WS-564-053	220 x 120 x 25 mm
WS-564-054	240 x 140 x 25 mm
WS-564-055	200 x 150 x 25 mm
WS-564-056	250 x 200 x 25 mm
WS-564-057	300 x 250 x 25 mm
WS-564-058	300 x 200 x 25 mm
WS-564-059	350 x 250 x 25 mm
WS-564-060	400 x 300 x 25 mm
WS-564-061	450 x 300 x 25 mm
WS-564-062	450 x 350 x 25 mm



Instrument Trays
With Lid

WS-565-063	150 x 100 x 50 mm
WS-565-064	200 x 100 x 50 mm
WS-565-065	220 x 120 x 50 mm
WS-565-066	240 x 140 x 50 mm
WS-565-067	200 x 150 x 50 mm
WS-565-068	250 x 200 x 50 mm
WS-565-069	300 x 250 x 50 mm
WS-565-070	300 x 200 x 50 mm
WS-565-071	350 x 250 x 50 mm
WS-565-072	400 x 300 x 50 mm
WS-565-073	450 x 300 x 50 mm
WS-565-074	450 x 350 x 50 mm



Instrument Trays
Perforated

WS-565-075	240 x 240 x 50 mm
WS-565-076	260 x 170 x 47 mm
WS-565-077	260 x 170 x 28 mm
WS-565-078	280 x 240 x 60 mm
WS-565-079	520 x 240 x 75 mm
WS-565-080	520 x 240 x 100 mm



Instrument Trays
With Side Handle

WS-565-081	150 x 100 x 50 mm
WS-565-082	200 x 100 x 50 mm
WS-565-083	220 x 120 x 50 mm
WS-565-084	240 x 140 x 50 mm
WS-565-085	200 x 150 x 50 mm
WS-565-086	250 x 200 x 50 mm
WS-565-087	300 x 250 x 50 mm
WS-565-088	300 x 200 x 50 mm
WS-565-089	350 x 250 x 50 mm
WS-565-090	400 x 300 x 50 mm
WS-565-091	450 x 300 x 50 mm
WS-565-092	450 x 350 x 50 mm



Instrument Trays
With Lid

WS-565-093	170 x 70 x 35 mm
WS-565-094	180 x 080 x 40 mm
WS-565-095	200 x 100 x 40 mm
WS-565-096	200 x 100 x 50 mm
WS-565-097	200 x 100 x 60 mm
WS-565-098	220 x 120 x 60 mm
WS-565-099	250 x 120 x 60 mm
WS-565-100	300 x 150 x 60 mm
WS-565-101	300 x 200 x 80 mm
WS-565-102	400 x 160 x 80 mm
WS-565-103	400 x 200 x 100 mm
WS-565-104	500 x 200 x 120 mm

**Sterilizing Boxes
With Lock And Heater**

WS-566-105	170 x 070 x 35 mm
WS-566-106	180 x 080 x 40 mm
WS-566-107	200 x 100 x 40 mm
WS-566-108	200 x 100 x 50 mm
WS-566-109	200 x 100 x 60 mm
WS-566-110	220 x 120 x 60 mm
WS-566-111	250 x 120 x 60 mm
WS-566-112	300 x 150 x 60 mm
WS-566-113	300 x 200 x 80 mm
WS-566-114	400 x 160 x 80 mm
WS-566-115	400 x 200 x 100 mm
WS-566-116	500 x 200 x 120 mm

**Instrument Boxes
With Filters**

WS-566-117	170 x 070 x 35 mm
WS-566-118	180 x 080 x 40 mm
WS-566-119	200 x 100 x 40 mm
WS-566-120	200 x 100 x 50 mm
WS-566-121	200 x 100 x 60 mm
WS-566-122	220 x 120 x 60 mm
WS-566-123	250 x 120 x 60 mm
WS-566-124	300 x 150 x 60 mm
WS-566-125	300 x 200 x 80 mm
WS-566-126	400 x 160 x 80 mm
WS-566-127	400 x 200 x 100 mm
WS-566-128	500 x 200 x 120 mm

**Sterilizing Boxes
With Handles And Heater**

WS-566-129	170 x 070 x 35 mm
WS-566-130	180 x 080 x 40 mm
WS-566-131	200 x 100 x 40 mm
WS-566-132	200 x 100 x 50 mm
WS-566-133	200 x 100 x 60 mm
WS-566-134	220 x 120 x 60 mm
WS-566-135	250 x 120 x 60 mm
WS-566-136	300 x 150 x 60 mm
WS-566-137	300 x 200 x 80 mm
WS-566-138	400 x 160 x 80 mm
WS-566-139	400 x 200 x 100 mm
WS-566-140	500 x 200 x 120 mm



WS-567-001
14 cm / 5½"



WS-567-002 14 cm / 5½"
WS-567-003 16 cm / 6¼"



Turnbull
WS-567-004 11.5 cm / 4½"
WS-567-005 13 cm / 5"

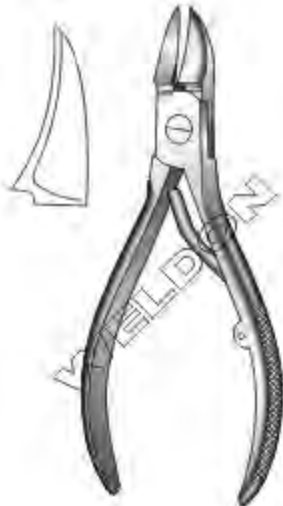

WS-567-006
13 cm / 5"



WS-568-007
12 cm / 4 1/2"



WS-568-008 11 cm / 4 1/2"
WS-568-009 13 cm / 5"
WS-568-010 15 cm / 6"



WS-568-011 11 cm / 4 1/2"
WS-568-012 13 cm / 5"



WS-568-013
10.5 cm / 4 1/4"



Cohen
WS-568-014
13 cm / 5"



Cohen
WS-568-015
13 cm / 5"



www.weldoninstruments.com

PROVEEDOR EXCLUSIVO:



Brain Retractors

Dura Dissectors, Hooks & Cannulas

Bone Punches & Leminectomy Rongeurs

Micro Scissors & Forceps

569 - 660

Neurosurgery Leminectomy

Neurosurgery, Leminectomy
Neurocirugia, Leminectomia
Neurochirurgie, Leminektomie

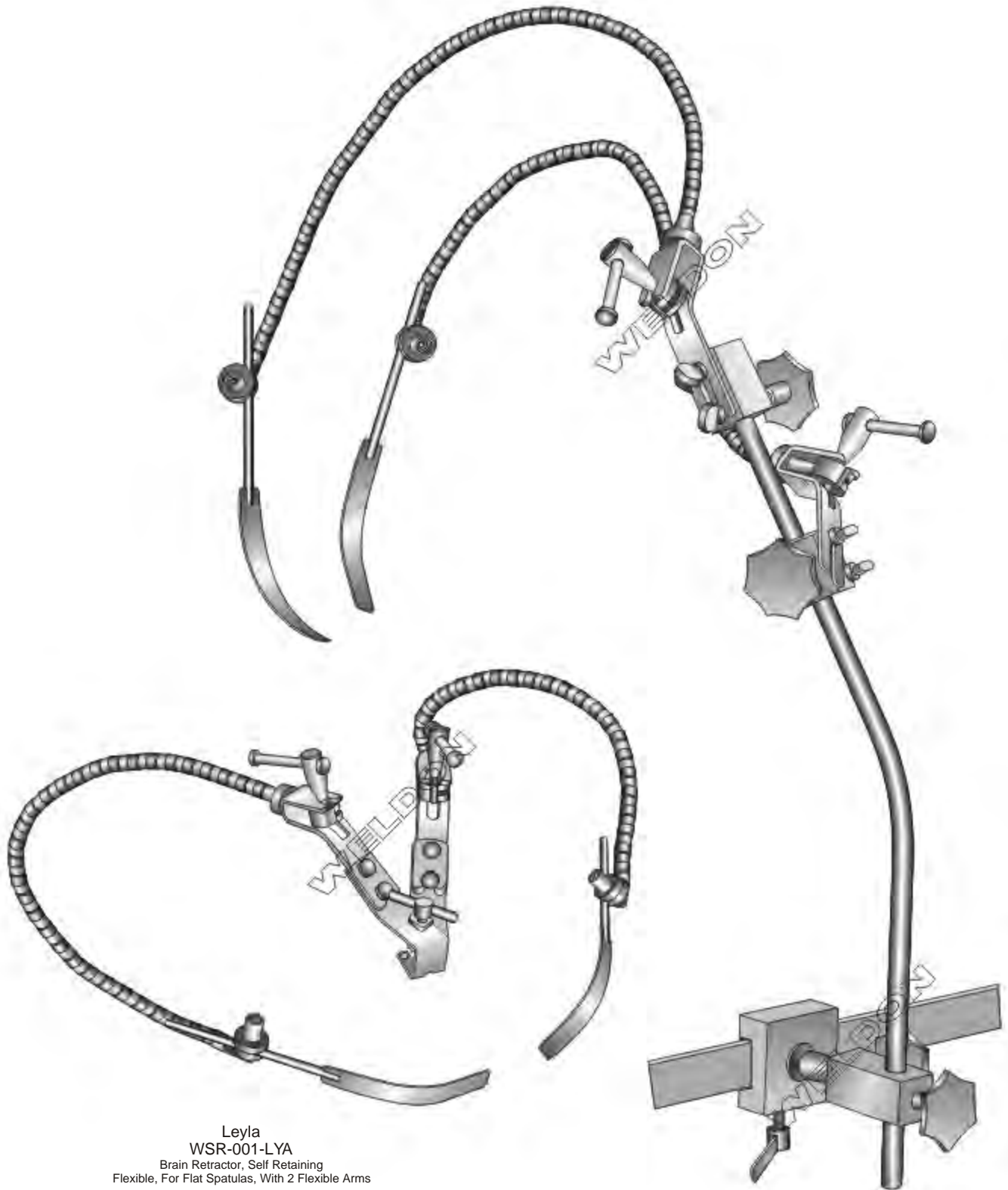

Leyla
WSR-001-LYA
Brain Retractor, Self Retaining
Flexible, For Flat Spatulas, With 2 Flexible Arms

Yasargil
WSR-002-YSR
Retractor For Fixation To Table Side Rails
With Two Arms And Spatulas

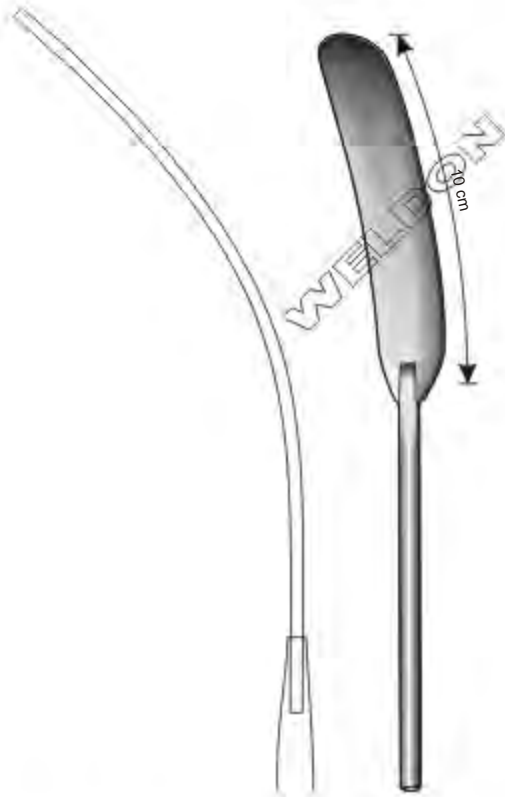
Heitz

- WS-570-001 8 mm
- WS-570-002 11 mm
- WS-570-003 14 mm
- WS-570-004 17 mm
- WS-570-005 20 mm
- 20 cm / 8"
- Malleable

Cushing

- WS-570-006 8 / 10 mm
- 17 cm / 6 3/4"
- WS-570-007 13 / 15 mm
- 20 cm / 8"
- WS-570-008 16 / 18 mm
- 28 cm / 11"

Olivecrona

- WS-570-009 7 / 9 mm
- WS-570-010 11 / 13 mm
- WS-570-011 15 / 18 mm
- WS-570-012 18 / 22 mm
- 18 cm / 7"
- Concave

Olivecrona

- WS-570-013 7 / 9 mm
- WS-570-014 11 / 13 mm
- WS-570-015 15 / 18 mm
- WS-570-016 18 / 22 mm
- 18 cm / 7"
- Convex

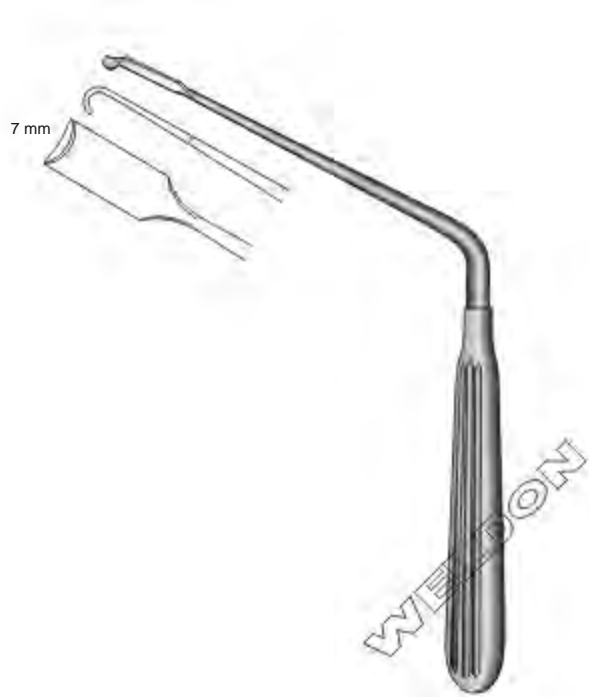

Scoville
WS-571-017
20 cm / 8"



Martin
WS-571-018
21 cm / 8½"



Scoville
WS-571-019
23.5 cm / 9"



Holsher
WS-571-020
24 cm / 9½"

Nerve Root Retractors, Dura Dissectors | Separadores Para la Raíz de Nervio, Disecadores Para Duramadre, Nervwurzelnaken, Duradisektoren



Horsley
WS-572-021
20 cm / 8"



Sachs
WS-572-022
21 cm / 8 1/4"



Love
WS-572-023
21.5 cm / 8 1/2"



Love
WS-572-024
18 cm / 7"

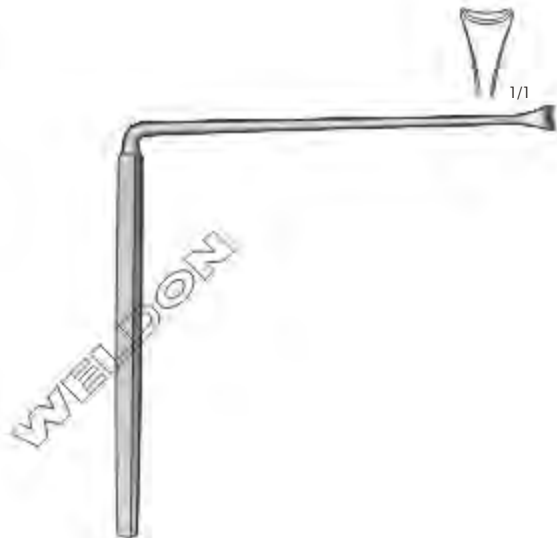

Love
WS-572-025
11 cm / 4 1/4"



Davis
WS-573-026
24.5 cm / 9 3/4"



Frazier
WS-573-027
15 cm / 6"



Hoen
WS-573-028
15 cm / 6"



Hoen
WS-573-029
15 cm / 6"

Dura Dissectors | Disecadores Para Duramadre | Duradissektoren



Penfield
WS-574-030
17.5 cm / 7"
Fig. 1



Penfield
WS-574-031
19.5 cm / 7 3/4"
Fig. 2



Penfield
WS-574-032
19.5 cm / 7 3/4"
Fig. 3



Penfield
WS-574-033
20 cm / 8"
Fig. 4



Penfield
WS-574-034
18.5 cm / 7 1/4"
Fig. 5



Graham
WS-575-035
16.5 cm / 6½"



Sachs
WS-575-036
18 cm / 7"



Tonnis
WS-575-037
14.5 cm / 5¾"



Adson
WS-575-038
20 cm / 8"



Lahey
WS-575-039
13 cm / 5"



Cushing
WS-575-040
14 cm / 5½"



Frazier
13 cm / 5"



WS-575-042
Blunt



Frazier
18 cm / 7"



WS-575-043
Sharp



WS-575-044
Blunt

Dura Knives, Dura Hooks | Cuchillos Para Duramadre, Ganchos Para Duramadre
Duramesser, Durahaken



Hoen
WS-576-045
22 cm / 8 3/4"



Dandy
WS-576-046
20 cm / 8"



Adson
WS-576-047
20 cm / 8"



Toennis

WS-576-048
13 cm / 5"

WS-576-049
19 cm / 7 1/2"

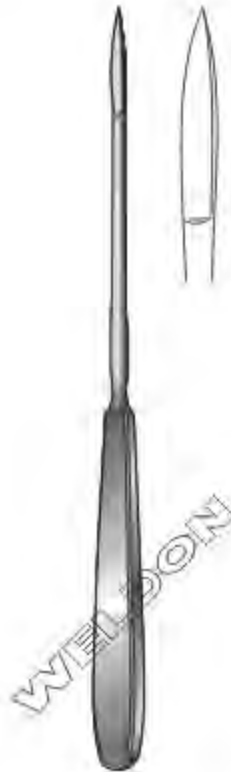

Halle
WS-576-050
20 cm / 8"

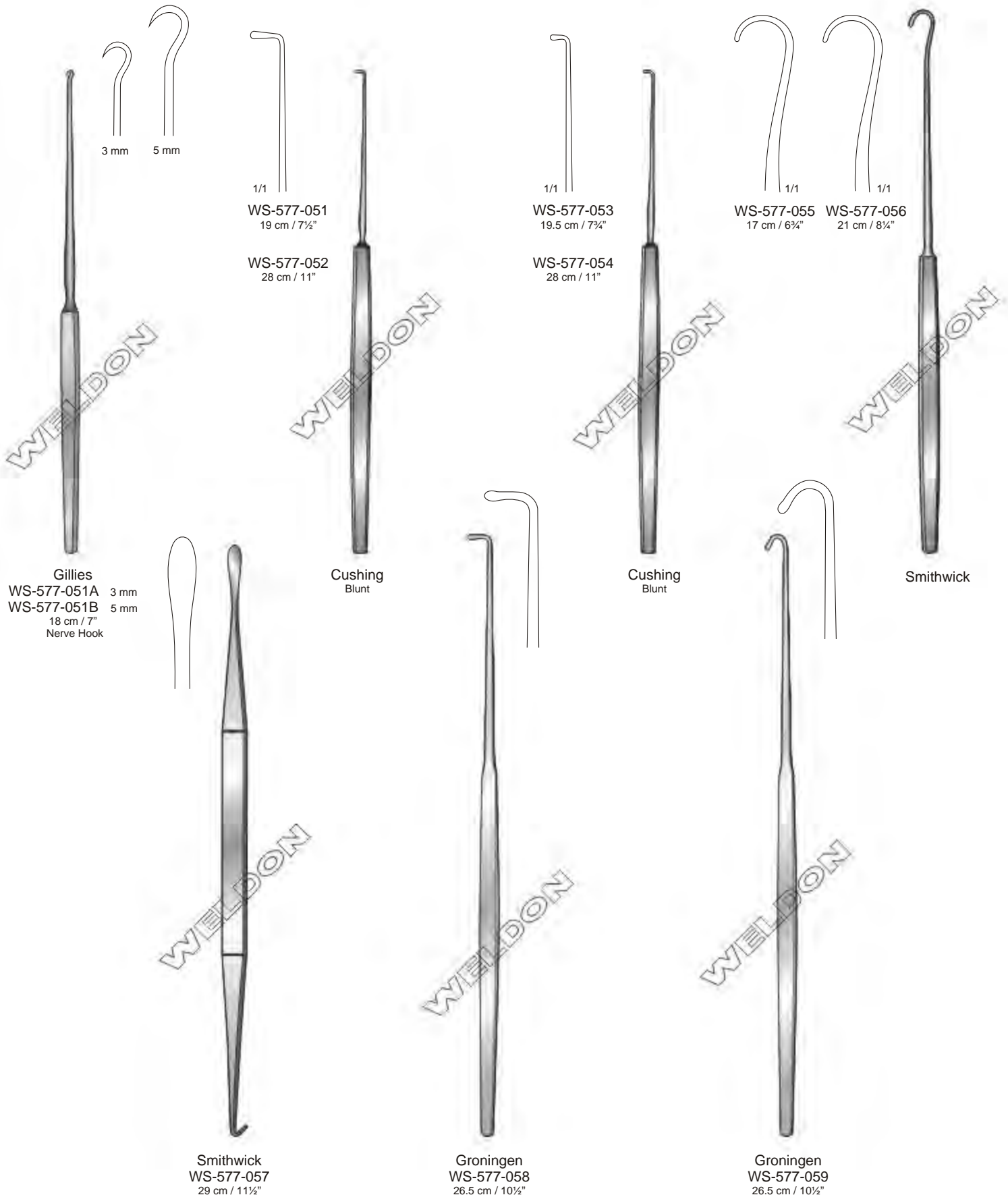



Gigli
WS-578-001
Wire Saw Handle



Gigli
WS-578-002 30 cm / 12"
WS-578-003 40 cm / 16"
WS-578-004 50 cm / 20"
WS-578-005 60 cm / 24"
WS-578-006 70 cm / 28"
Wire Saw



De Martel
WS-578-007
33 cm / 13"
Wire Saw Guide

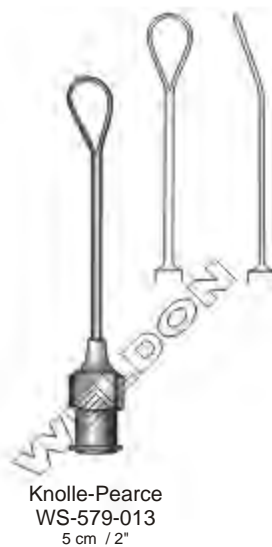
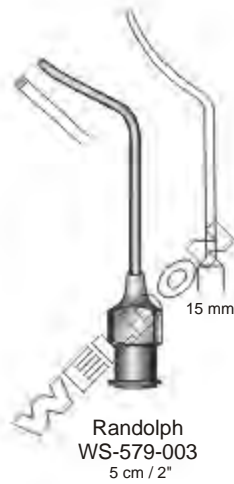

Clip Applying Forceps | Pinzas Clipadora | Klammerzange



McKenzie
 WS-580-001 15 cm / 6"
 WS-580-002 19 cm / 7½"
 Curved



McKenzie
 WS-580-003 15 cm / 6"
 WS-580-004 19 cm / 7½"
 Straight



Olivecrona-Toennis
 (Scoville)
 WS-580-005



Cloward
WS-581-006
16 cm / 6 1/4"

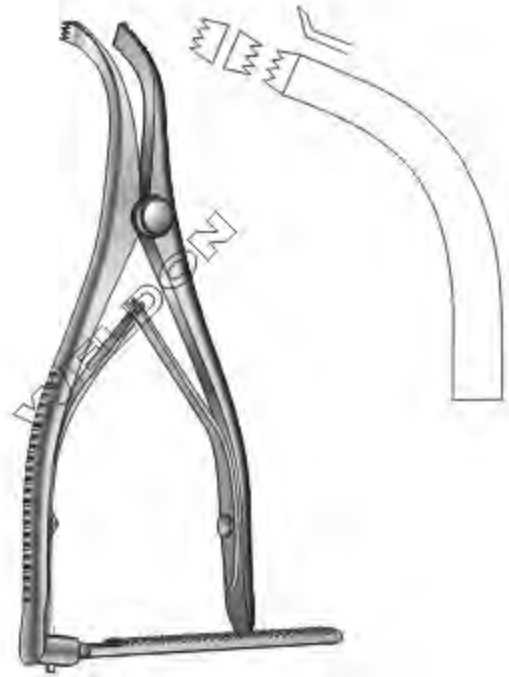

Inge
WS-581-007
16.5 cm / 6 1/2"

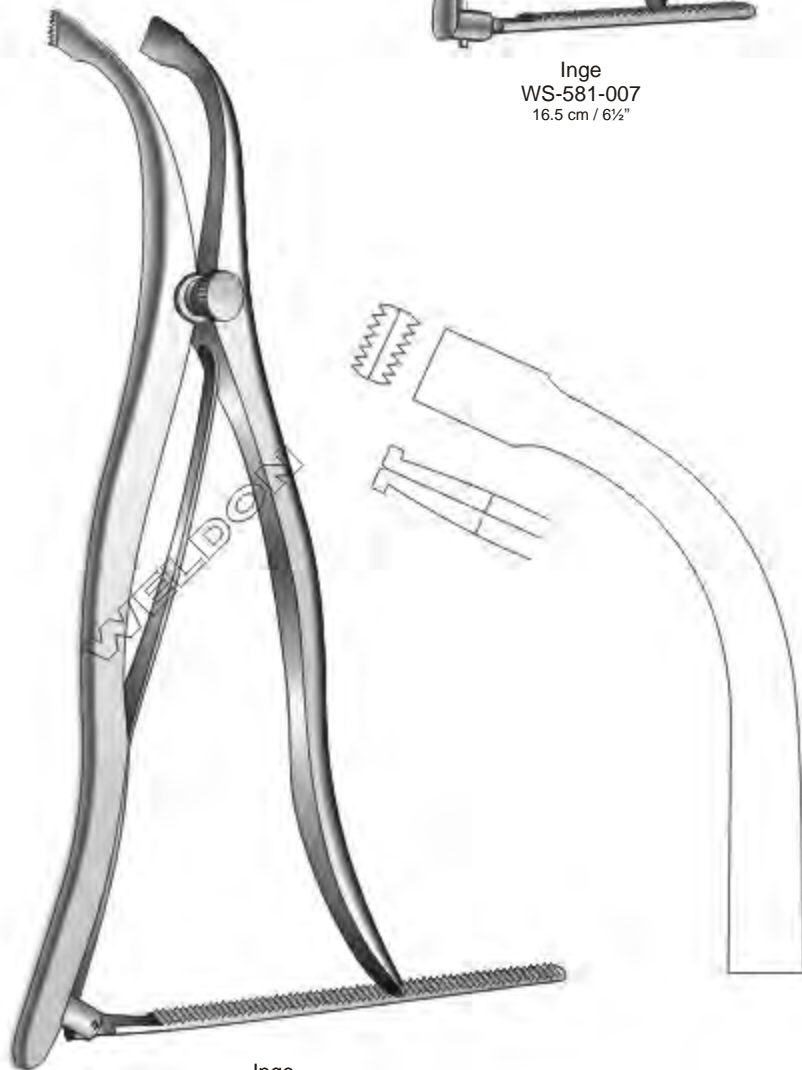

Inge
WS-581-008
25.5 cm / 10"

Bone Punches & Rongeurs | Pinzas Sabacobados | Keilbenstanzen

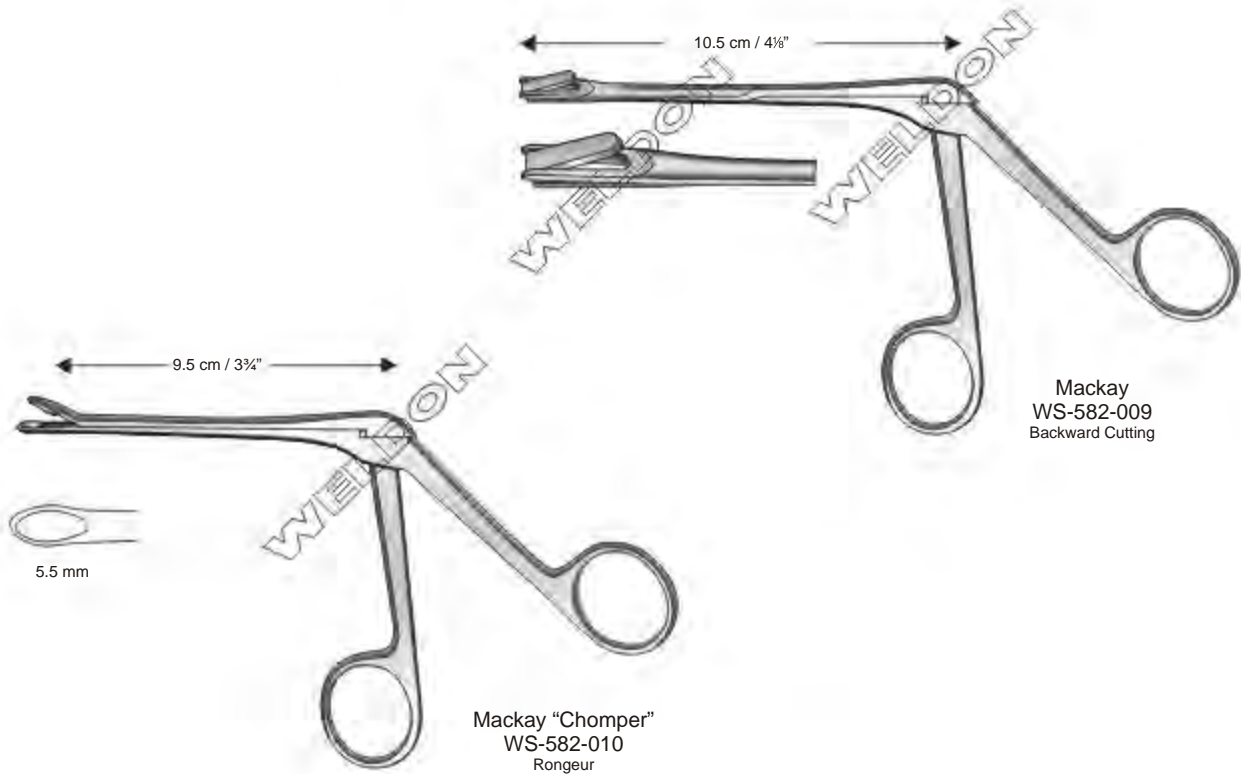

Mackay
WS-582-009
Backward Cutting

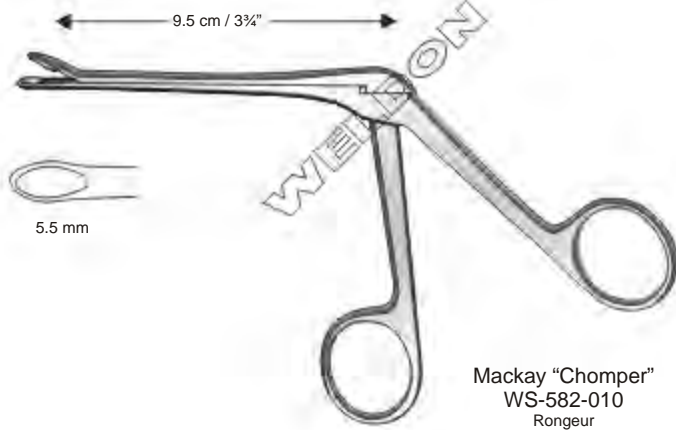

Mackay "Chomper"
WS-582-010
Rongeur

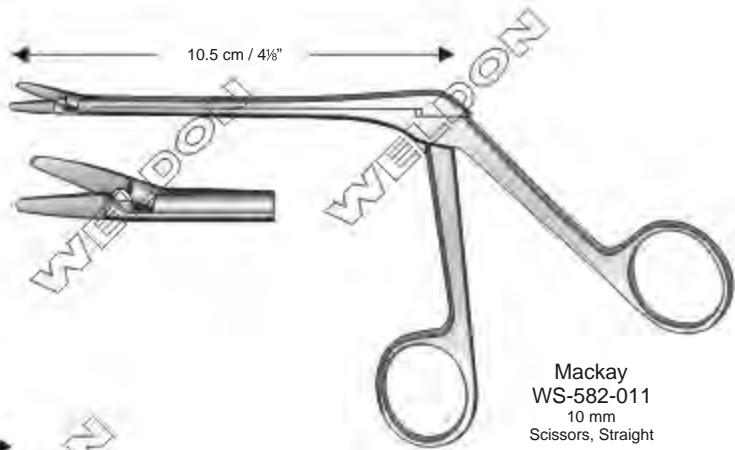

Mackay
WS-582-011
10 mm
Scissors, Straight

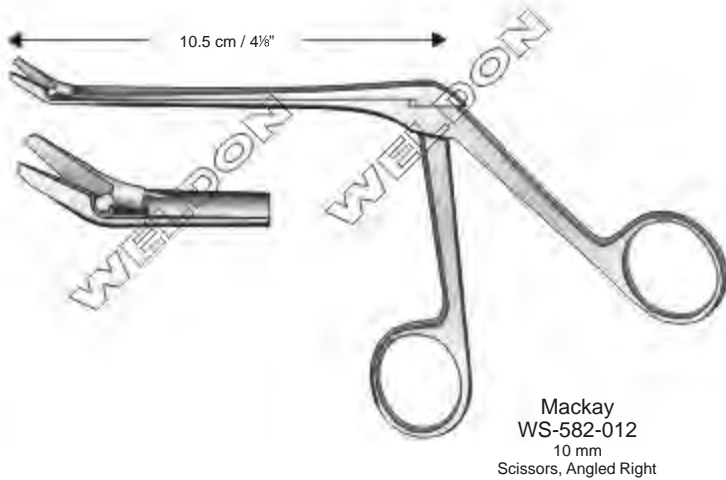

Mackay
WS-582-012
10 mm
Scissors, Angled Right

Bone Punches, Laminectomy Punches | Pinzas Sabacobados, Pinzas Para Laminectomia
Keilbenstanzen, Leminektomiezangen

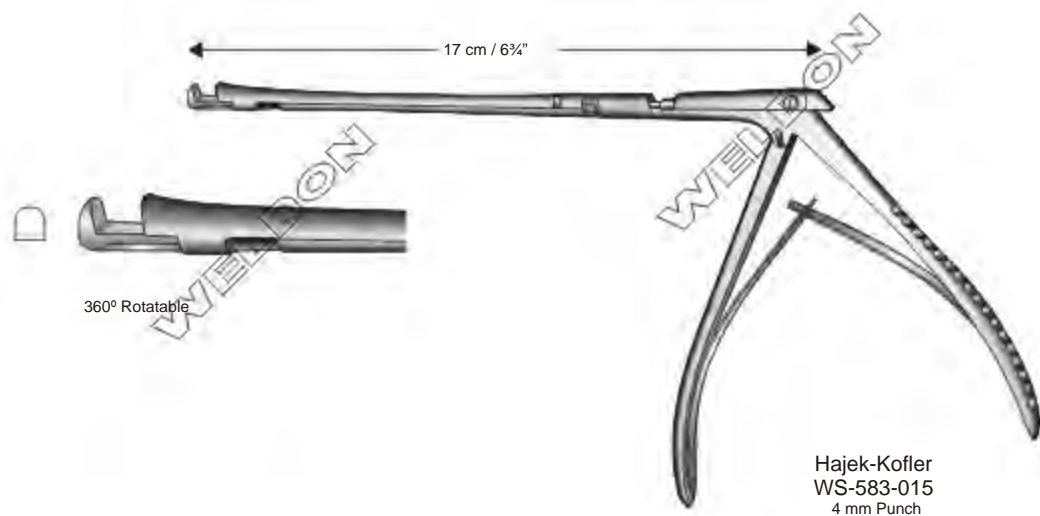
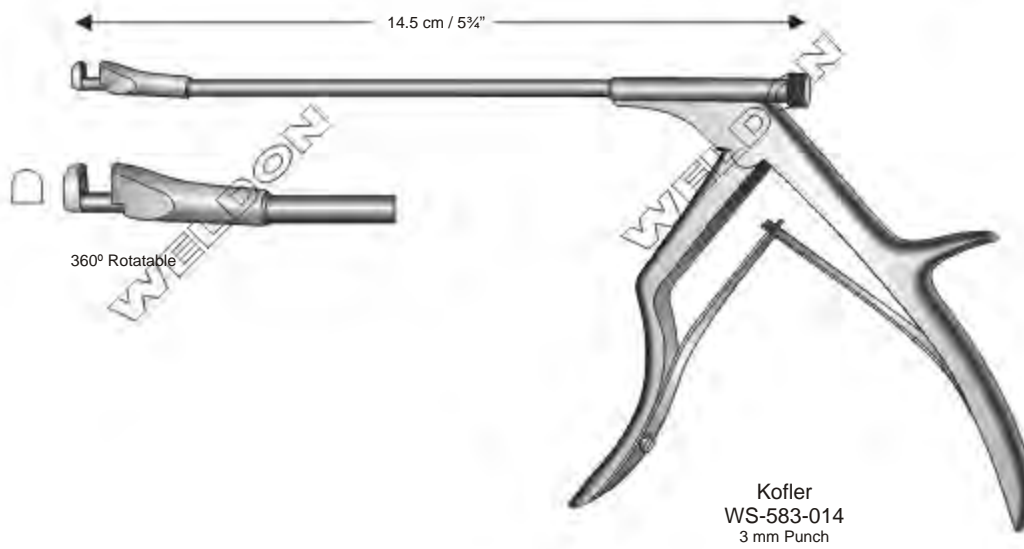
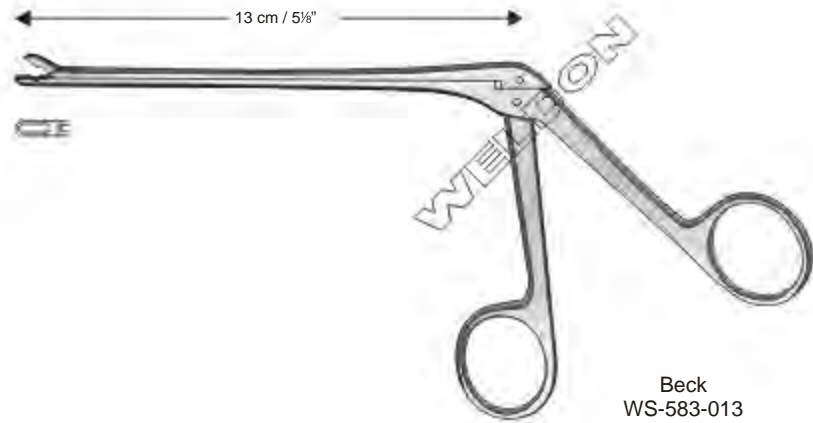

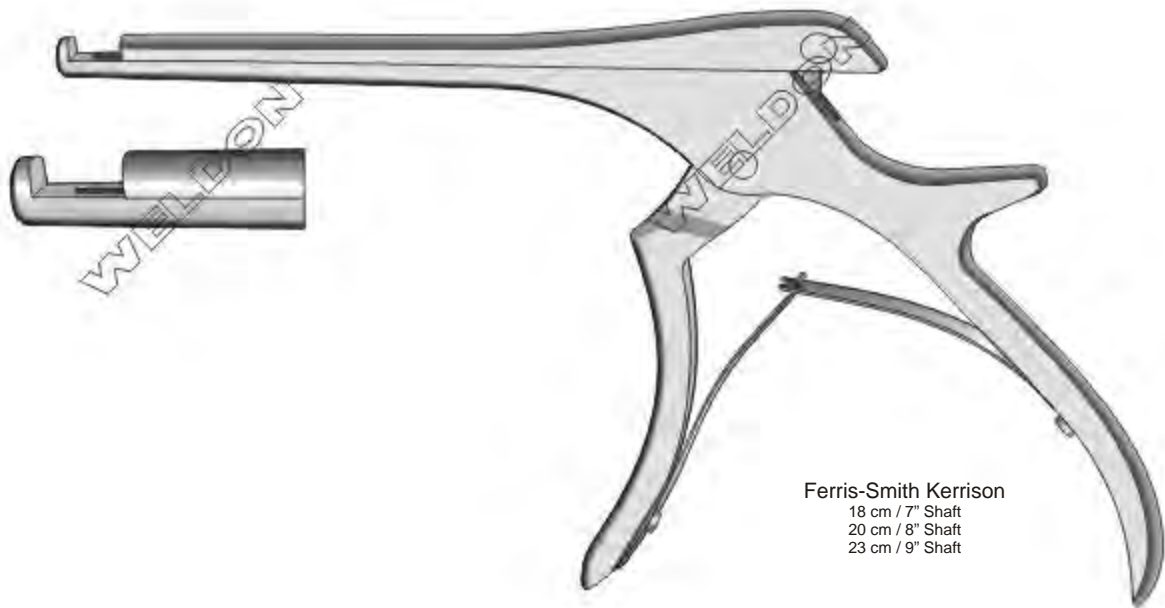

Ferris-Smith Kerrison
18 cm / 7" Shaft
20 cm / 8" Shaft
23 cm / 9" Shaft

Upward Cutting



WS-584-016 18 cm / 7"
WS-584-017 20 cm / 8"
WS-584-018 23 cm / 9"
1 mm

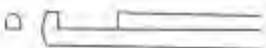

WS-584-019 18 cm / 7"
WS-584-020 20 cm / 8"
WS-584-021 23 cm / 9"
2 mm

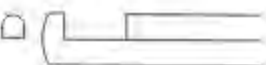

WS-584-022 18 cm / 7"
WS-584-023 20 cm / 8"
WS-584-024 23 cm / 9"
3 mm

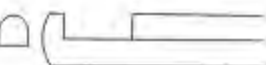

WS-584-025 18 cm / 7"
WS-584-026 20 cm / 8"
WS-584-027 23 cm / 9"
4 mm

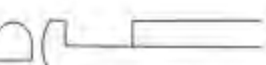

WS-584-028 18 cm / 7"
WS-584-029 20 cm / 8"
WS-584-030 23 cm / 9"
5 mm

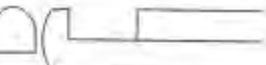

WS-584-031 18 cm / 7"
WS-584-032 20 cm / 8"
WS-584-033 23 cm / 9"
6 mm

Downward Cutting



WS-584-034 18 cm / 7"
WS-584-035 20 cm / 8"
WS-584-036 23 cm / 9"
1 mm

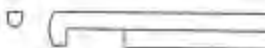

WS-584-037 18 cm / 7"
WS-584-038 20 cm / 8"
WS-584-039 23 cm / 9"
2 mm

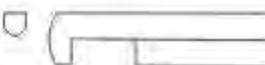

WS-584-040 18 cm / 7"
WS-584-041 20 cm / 8"
WS-584-042 23 cm / 9"
3 mm

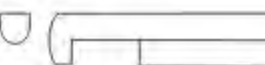

WS-584-043 18 cm / 7"
WS-584-044 20 cm / 8"
WS-584-045 23 cm / 9"
4 mm



WS-584-046 18 cm / 7"
WS-584-047 20 cm / 8"
WS-584-048 23 cm / 9"
5 mm

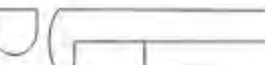

WS-584-049 18 cm / 7"
WS-584-050 20 cm / 8"
WS-584-051 23 cm / 9"
6 mm

Upward Cutting 40°



WS-584-052 18 cm / 7"
WS-584-053 20 cm / 8"
WS-584-054 23 cm / 9"
1 mm

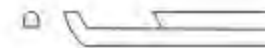

WS-584-055 18 cm / 7"
WS-584-056 20 cm / 8"
WS-584-057 23 cm / 9"
2 mm



WS-584-058 18 cm / 7"
WS-584-059 20 cm / 8"
WS-584-060 23 cm / 9"
3 mm

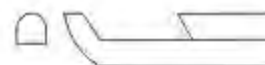

WS-584-061 18 cm / 7"
WS-584-062 20 cm / 8"
WS-584-063 23 cm / 9"
4 mm



WS-584-064 18 cm / 7"
WS-584-065 20 cm / 8"
WS-584-066 23 cm / 9"
5 mm



WS-584-067 18 cm / 7"
WS-584-068 20 cm / 8"
WS-584-069 23 cm / 9"
6 mm

Bone Punches, Laminectomy Punches | Pinzas Sabacobados, Pinzas Para Laminectomia
Keilbenstanzen, Laminektomiestanden

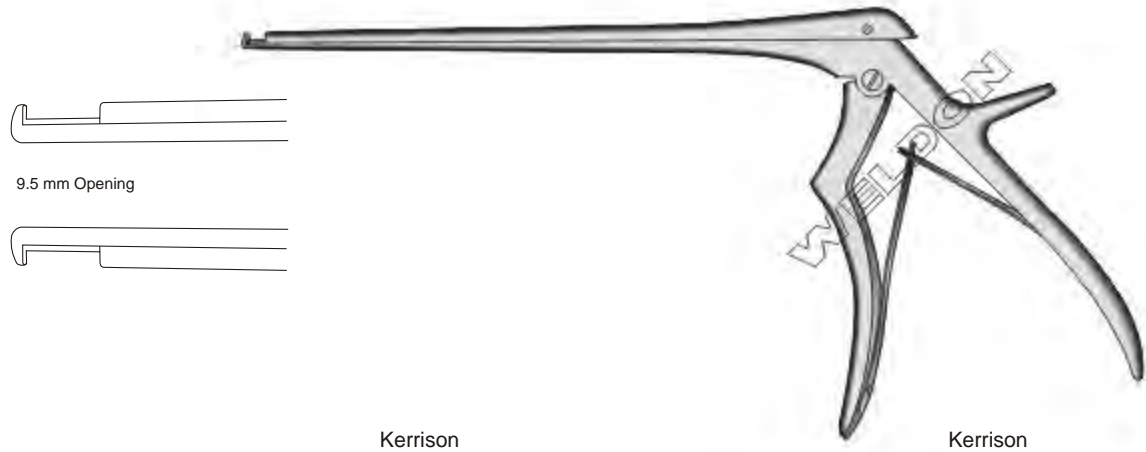

Kerrison

Kerrison

18 cm / 7" Shaft 90° Up-Bite	18 cm / 7" Shaft 90° Down-Bite	20 cm / 8" Shaft 90° Up-Bite	20 cm / 8" Shaft 90° Down-Bite	18 cm / 7" Shaft 40° Forward Angle	20 cm / 8" Shaft 40° Forward Angle	18 cm / 7" Shaft 40° Downward Angle	20 cm / 8" Shaft 40° Downward Angle	
WS-585-070A	WS-585-075A	WS-585-080A	WS-585-085A	WS-585-090A	WS-585-095A	WS-585-090AD	WS-585-095AD	1 mm Bite
WS-585-070	WS-585-075	WS-585-080	WS-585-085	WS-585-090	WS-585-095	WS-585-090B	WS-585-095B	2 mm Bite
WS-585-071	WS-585-076	WS-585-081	WS-585-086	WS-585-091	WS-585-096	WS-585-091B	WS-585-096B	3 mm Bite
WS-585-072	WS-585-077	WS-585-082	WS-585-087	WS-585-092	WS-585-097	WS-585-092B	WS-585-097B	4 mm Bite
WS-585-073	WS-585-078	WS-585-083	WS-585-088	WS-585-093	WS-585-098	WS-585-093B	WS-585-098B	5 mm Bite
WS-585-074	WS-585-079	WS-585-084	WS-585-089	WS-585-094	WS-585-099	WS-585-094B	WS-585-099B	6 mm Bite

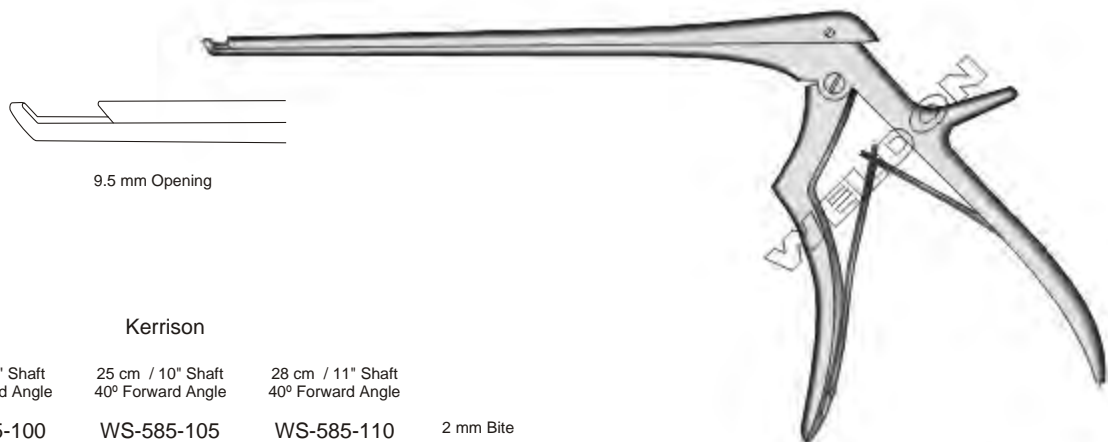

Kerrison

Kerrison

23 cm / 9" Shaft 40° Forward Angle	25 cm / 10" Shaft 40° Forward Angle	28 cm / 11" Shaft 40° Forward Angle	
WS-585-100	WS-585-105	WS-585-110	2 mm Bite
WS-585-101	WS-585-106	WS-585-111	3 mm Bite
WS-585-102	WS-585-107	WS-585-112	4 mm Bite
WS-585-103	WS-585-108	WS-585-113	5 mm Bite
WS-585-104	WS-585-109	WS-585-114	6 mm Bite

**Bone Punches, Laminectomy Punches | Pinzas Sabacobados, Pinzas Para Laminectomia
Keilbenstanzen, Leminektomiestanzen**
**Love-Kerrison
40° Forward Angle**

18 cm / 7" Shaft	20 cm / 8" Shaft	
WS-586-115	WS-586-120	2 mm Bite
WS-586-116	WS-586-121	3 mm Bite
WS-586-117	WS-586-122	4 mm Bite
WS-586-118	WS-586-123	5 mm Bite
WS-586-119	WS-586-124	6 mm Bite

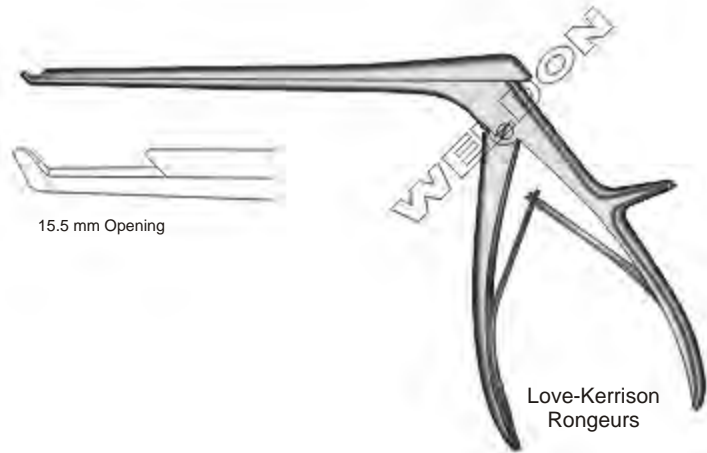
**Love-Kerrison
90° Upward**

18 cm / 7" Shaft	20 cm / 8" Shaft	
WS-586-125	WS-586-130	2 mm Bite
WS-586-126	WS-586-131	3 mm Bite
WS-586-127	WS-586-132	4 mm Bite
WS-586-128	WS-586-133	5 mm Bite
WS-586-129	WS-586-134	6 mm Bite

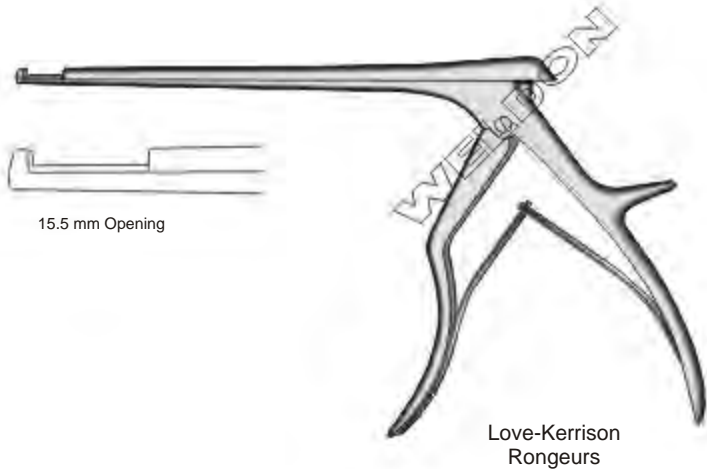

**Love-Kerrison
40° Forward Angle**

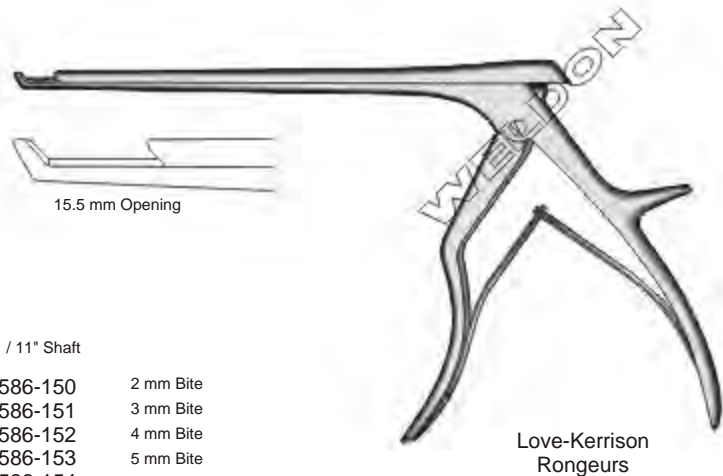
18 cm / 7" Shaft	20 cm / 8" Shaft	23 cm / 9" Shaft	28 cm / 11" Shaft	
WS-586-135	WS-586-140	WS-586-145	WS-586-150	2 mm Bite
WS-586-136	WS-586-141	WS-586-146	WS-586-151	3 mm Bite
WS-586-137	WS-586-142	WS-586-147	WS-586-152	4 mm Bite
WS-586-138	WS-586-143	WS-586-148	WS-586-153	5 mm Bite
WS-586-139	WS-586-144	WS-586-149	WS-586-154	6 mm Bite

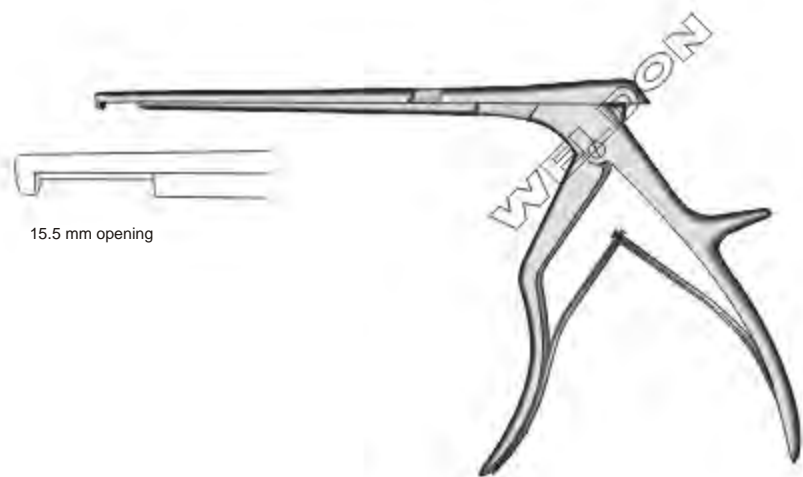

Love-Kerrison Rongeur
20 cm / 8" Shaft
90° Downward

- WS-587-155 2 mm Bite
- WS-587-156 3 mm Bite
- WS-587-157 4 mm Bite
- WS-587-158 5 mm Bite
- WS-587-159 6 mm Bite



15.5 mm opening

Laminectomy Rongeur

- 40° Forward - Angle
- | | |
|------------------------|------------------|
| 17.5 cm / 6 7/8" Shaft | 20 cm / 8" Shaft |
| WS-587-160 3 mm Bite | WS-587-161 |
| WS-587-162 5 mm Bite | WS-587-163 |

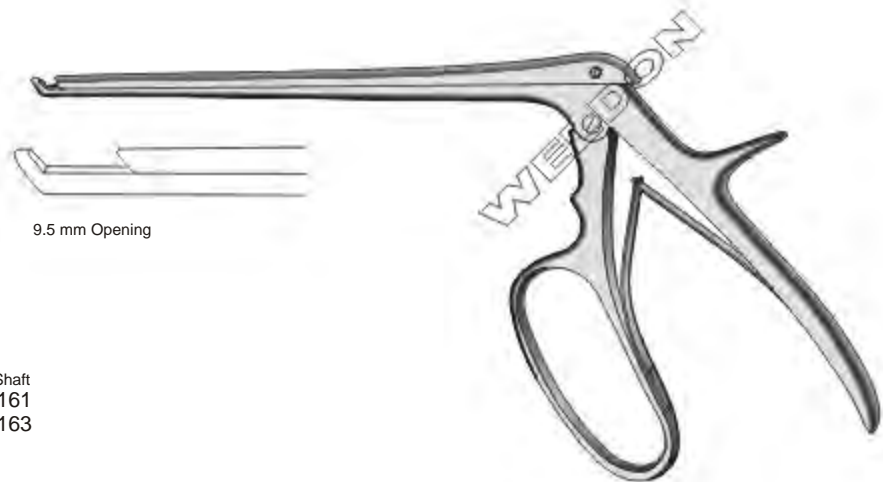

9.5 mm Opening

Sella Punches

- 18 cm / 7" Shaft
- WS-587-164 90° Upward Bite
 - WS-587-165 40° Upward Bite
 - WS-587-166 90° Downward Bite
 - WS-587-167 40° Downward Bite
- 2 mm Bite

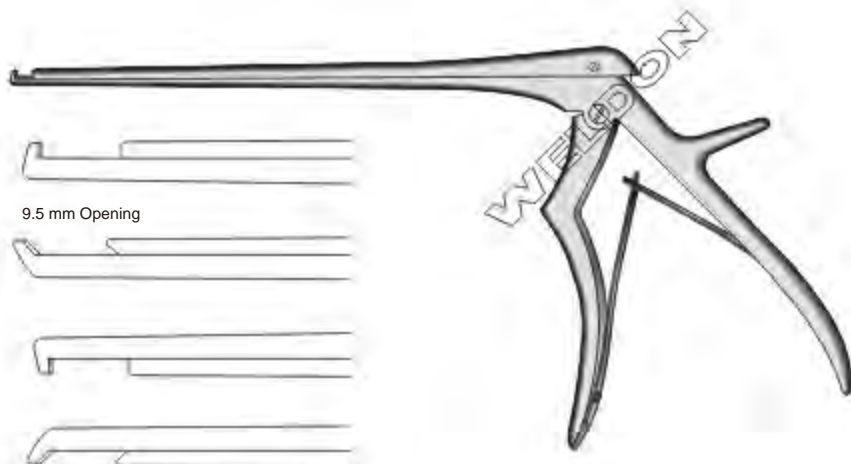

9.5 mm Opening

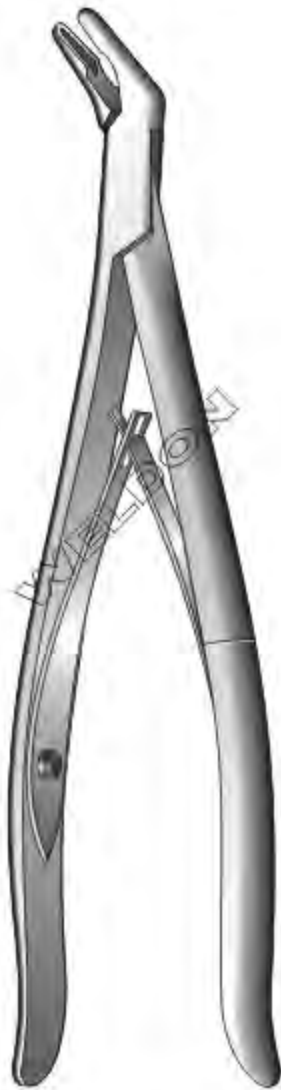

Stookey Cranial Rongeur
WS-588-168
19 cm / 7"
3 mm Bite



Straight	Downward Angle	Upward Angle	
WS-588-169	WS-588-175	WS-588-178	2 x 10 mm Bite
WS-588-170	WS-588-176	WS-588-179	3 x 10 mm Bite
WS-588-171	WS-588-177	WS-588-180	4 x 10 mm Bite
WS-588-172		WS-588-181	4 x 8 mm Bite
WS-588-173			6 x 10 mm Bite
WS-588-174			6 x 12 mm Bite



**Ferris-Smith
Cup Jaw Rongeurs**
18 cm / 7" Shaft
Straight

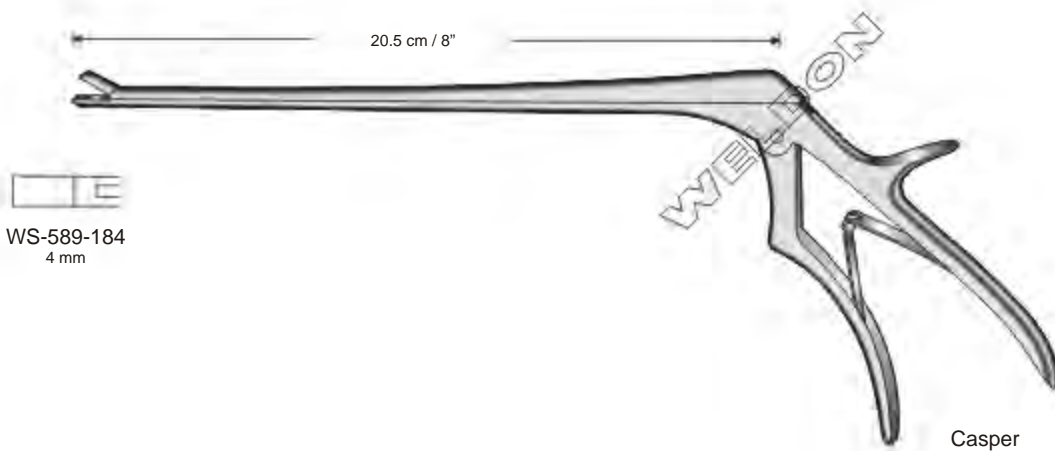
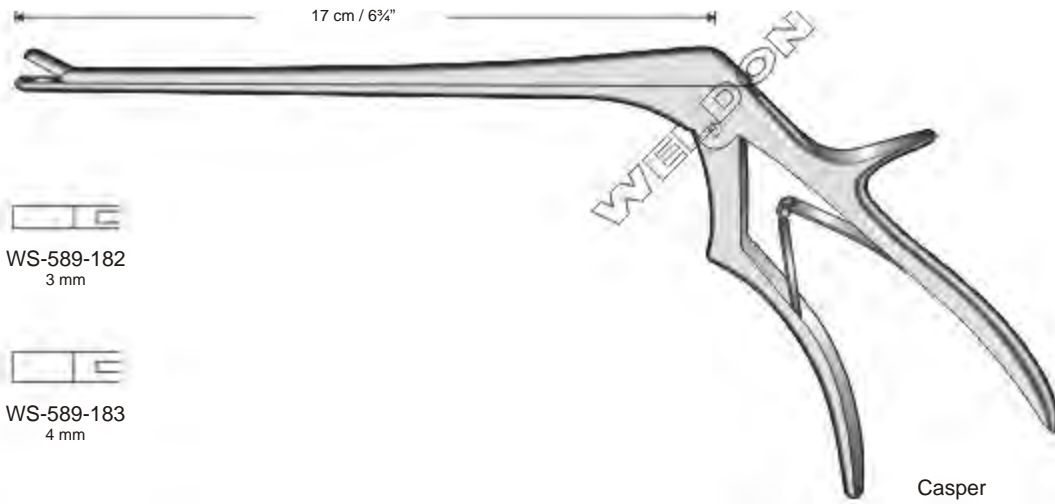

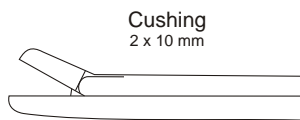
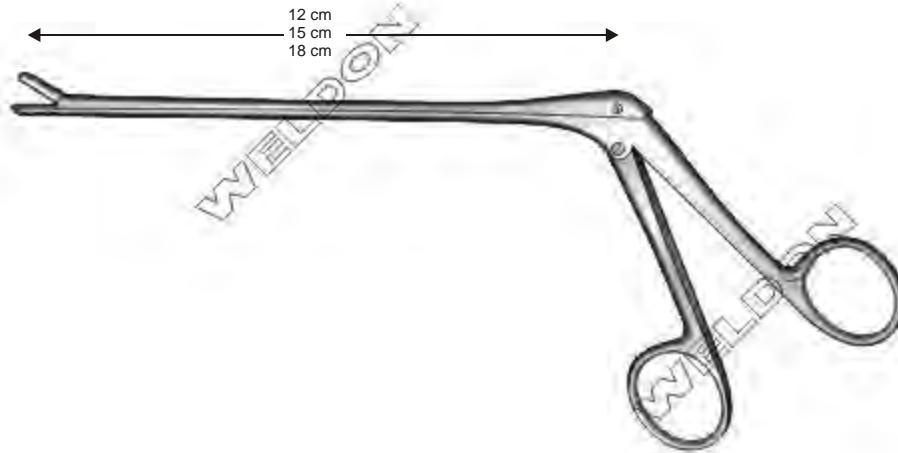
Bone Punches, Laminectomy Rongeurs | Pinzas Sabacobados, Pinzas Para Laminectomia
Keilbenstanzen, Laminektomiezangen

Cushing
 2 x 10 mm

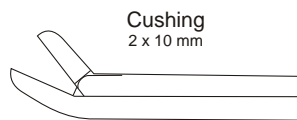
Straight
 WS-590-185 12 cm
 WS-590-186 15 cm
 WS-590-187 18 cm

Cushing
 2 x 10 mm

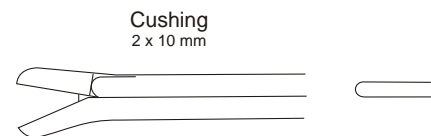
Upward, Angled at 45°
 WS-590-188 12 cm
 WS-590-189 15 cm
 WS-590-190 18 cm

Cushing
 2 x 10 mm

Downward, Angled at 45°
 WS-590-191 12 cm
 WS-590-192 15 cm
 WS-590-193 18 cm

Love-Gruenwald
 3 x 10 mm

Straight
 WS-590-194 12 cm
 WS-590-195 15 cm
 WS-590-196 18 cm

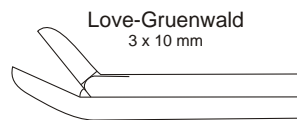
Love-Gruenwald
 3 x 10 mm

Upward, Angled at 45°
 WS-590-197 12 cm
 WS-590-198 15 cm
 WS-590-199 18 cm

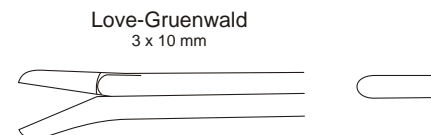
Love-Gruenwald
 3 x 10 mm

Downward, Angled at 45°
 WS-590-200 12 cm
 WS-590-201 15 cm
 WS-590-202 18 cm

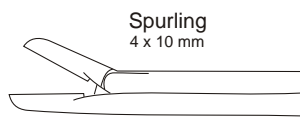
Spurling
 4 x 10 mm

Straight
 WS-590-203 12 cm
 WS-590-204 15 cm
 WS-590-205 18 cm

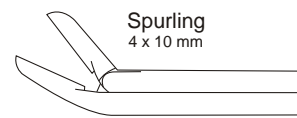

Spurling
 4 x 10 mm

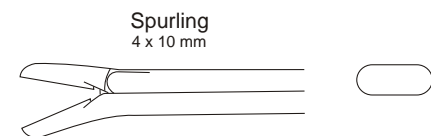
Upward, Angled at 45°
 WS-590-206 12 cm
 WS-590-207 15 cm
 WS-590-208 18 cm

Spurling
 4 x 10 mm

Downward, Angled at 45°
 WS-590-209 12 cm
 WS-590-210 15 cm
 WS-590-211 18 cm

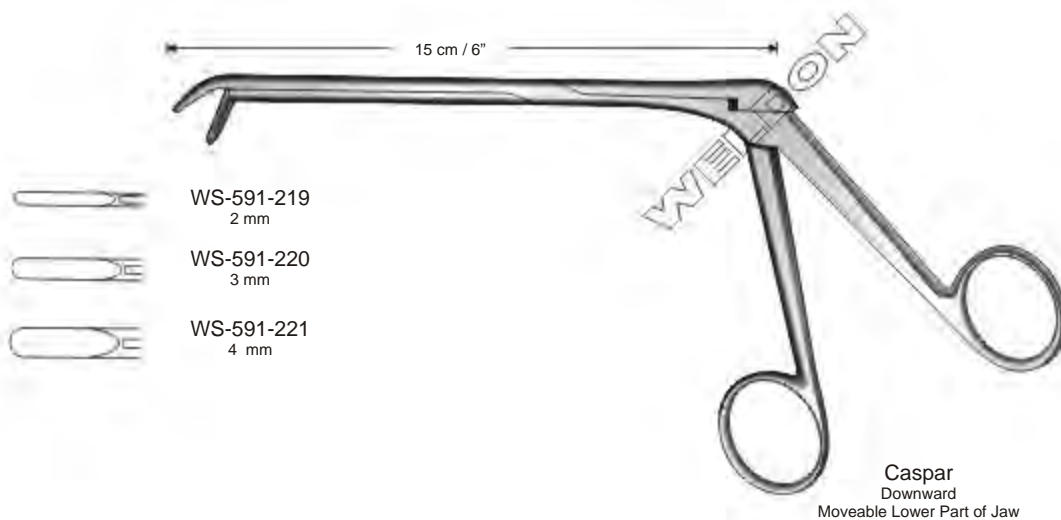
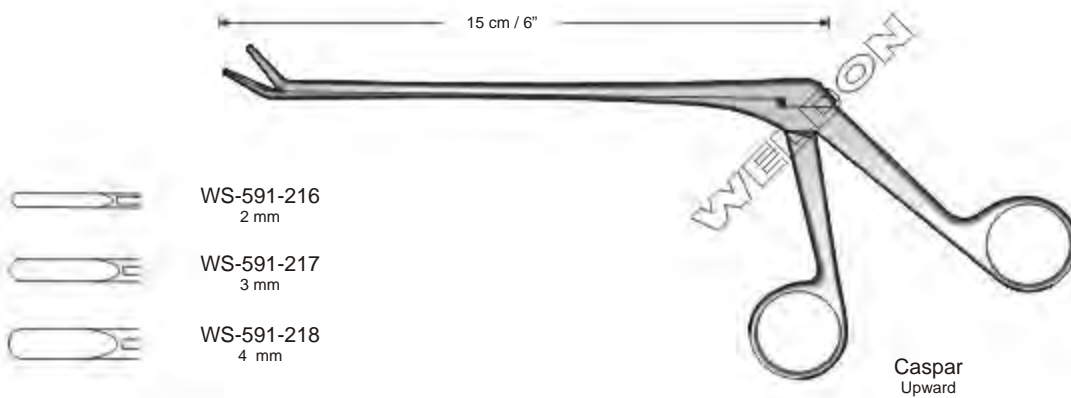
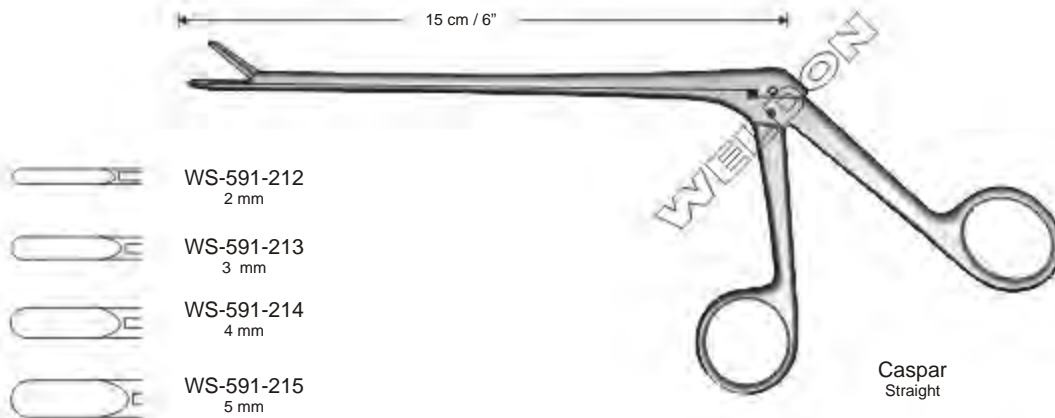
Bone Punches, Laminectomy Rongeurs | Pinzas Sabacobados, Pinzas Para Laminectomia
Keilbenstanzen, Leminektomiezangen

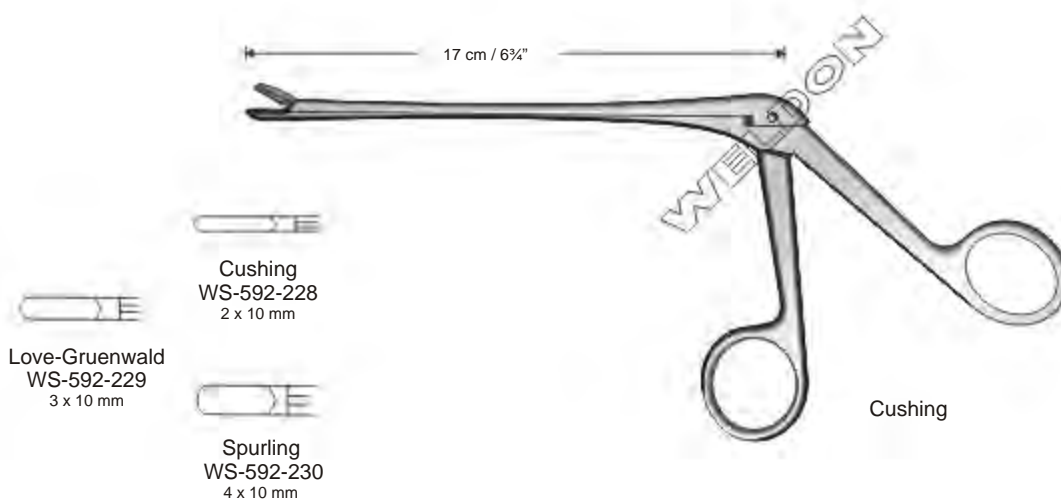

**Bone Punches, Laminectomy Rongeurs | Pinzas Sabacobados, Pinzas Para Laminectomia
Keilbenstanzen, Laminektomieezangen**



Schlesinger Rongeurs
 WS-593-231 2 x 10 mm Bite Straight
 WS-593-232 3 x 10 mm Bite Straight
 WS-593-233 4 x 10 mm Bite Straight
 WS-593-234 3 x 10 mm Bite Upward Angled
 13 cm / 5" Shaft
 With Groove Serrated Jaw



Schlesinger Rongeurs
 WS-593-235
 13 cm / 5" Shaft
 Serrated Jaws, Straight
 6 x 10 mm Bite
 Without Groove



WS-593-236
 Upward-Angle



WS-593-237
 Downward-Angle

Bone Punches, Laminectomy Rongeurs | Pinzas Sabacobados, Pinzas Para Laminectomia
 Keilbenstanzen, Laminektomieezangen

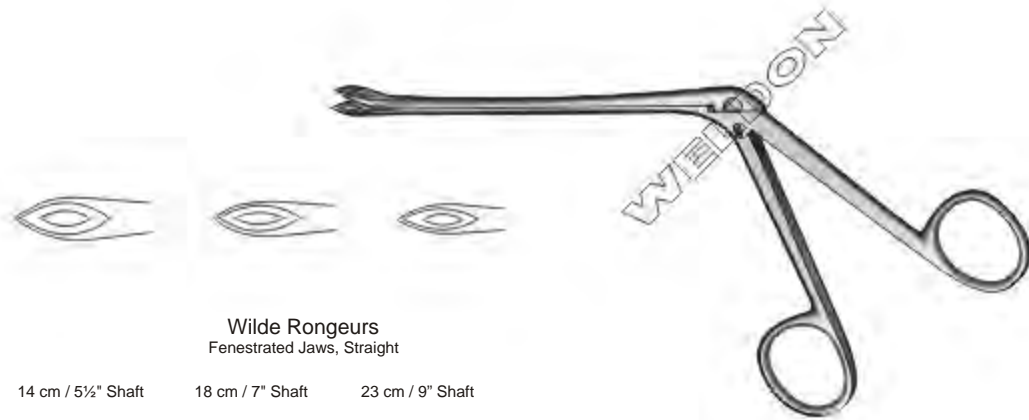

Wilde Rongeurs
 Fenestrated Jaws, Straight

14 cm / 5½" Shaft	18 cm / 7" Shaft	23 cm / 9" Shaft	
WS-594-238	WS-594-241	WS-594-244	4 mm Bite
WS-594-239	WS-594-242	WS-594-245	5 mm Bite
WS-594-240	WS-594-243	WS-594-246	6 mm Bite

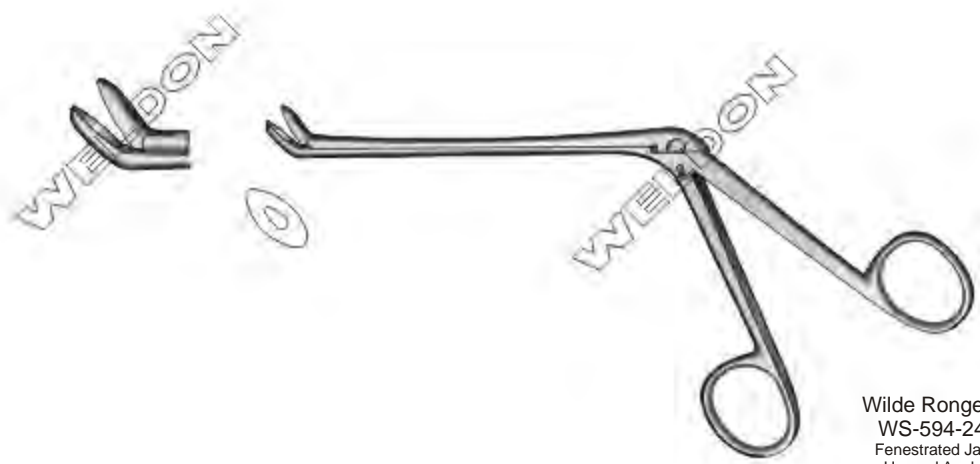

Wilde Rongeurs
 WS-594-247
 Fenestrated Jaws
 Upward Angled
 10.8 cm / 4¼" Shaft
 5 mm Bite



Jackson Rongeurs
 WS-594-248
 Fenestrated Jaws
 18 cm / 7" Shaft
 4 x 8 mm Bite
 Upward Angled at 70°

Bone Punches, Laminectomy Rongeurs | Pinzas Sabacobados, Pinzas Para Laminectomia
Keilbenstanzen, Leminektomiezzangen

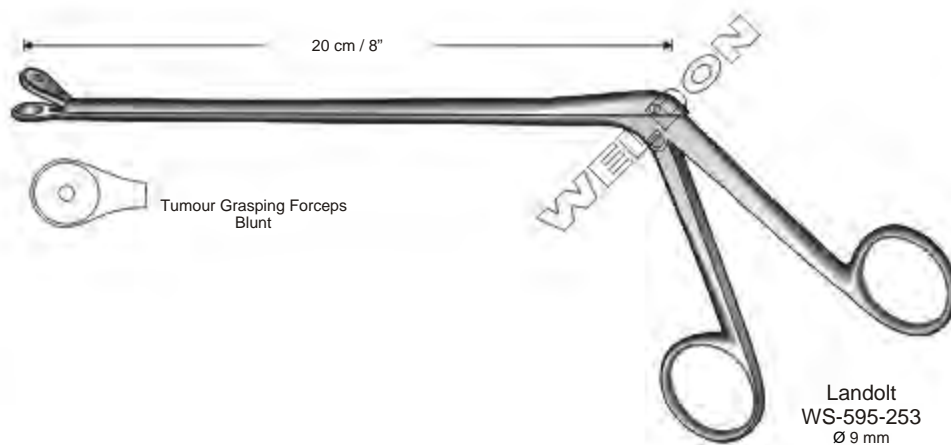
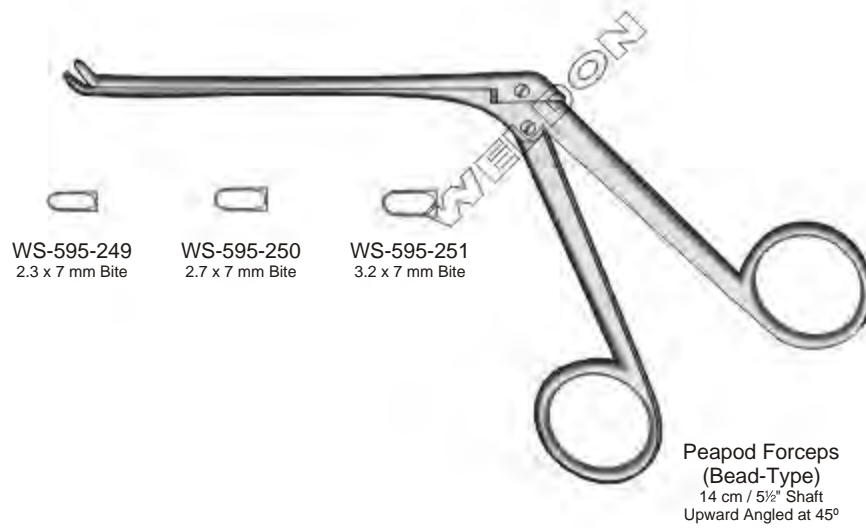

Bone Punches, Leminectomy Rongeurs | Pinzas Sabacobados, Pinzas Para Leminectomia
 Keilbenstanzen, Leminektomiezangen

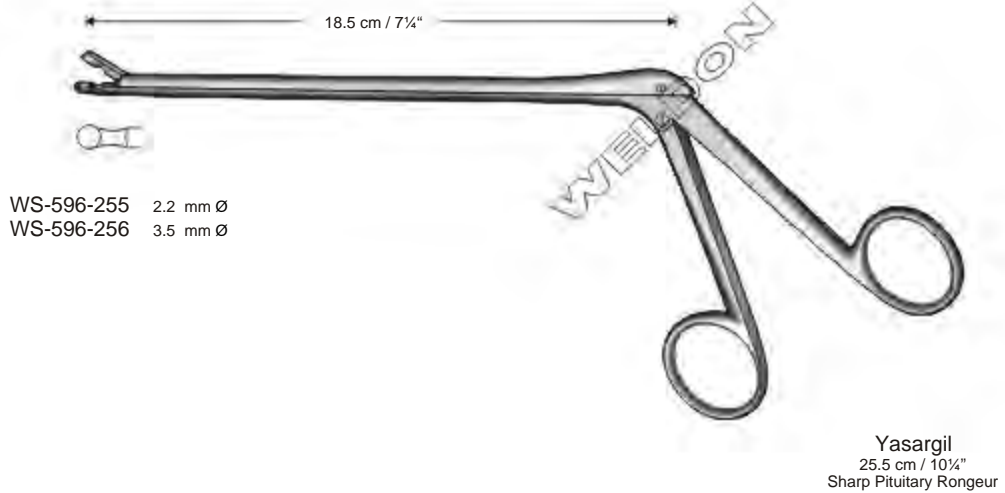
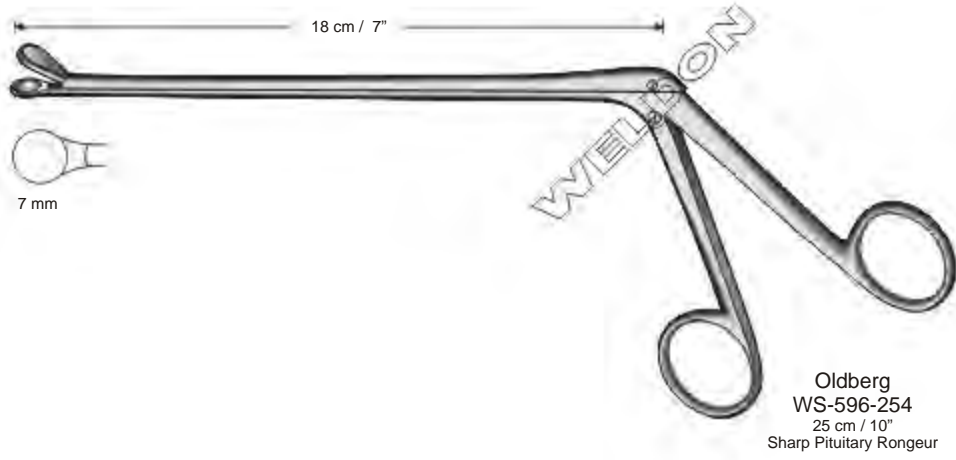

Bone Punches, Laminectomy Rongeurs | Pinzas Sabacobados, Pinzas Para Laminectomia
Keilbenstanzen, Leminektomiezangen

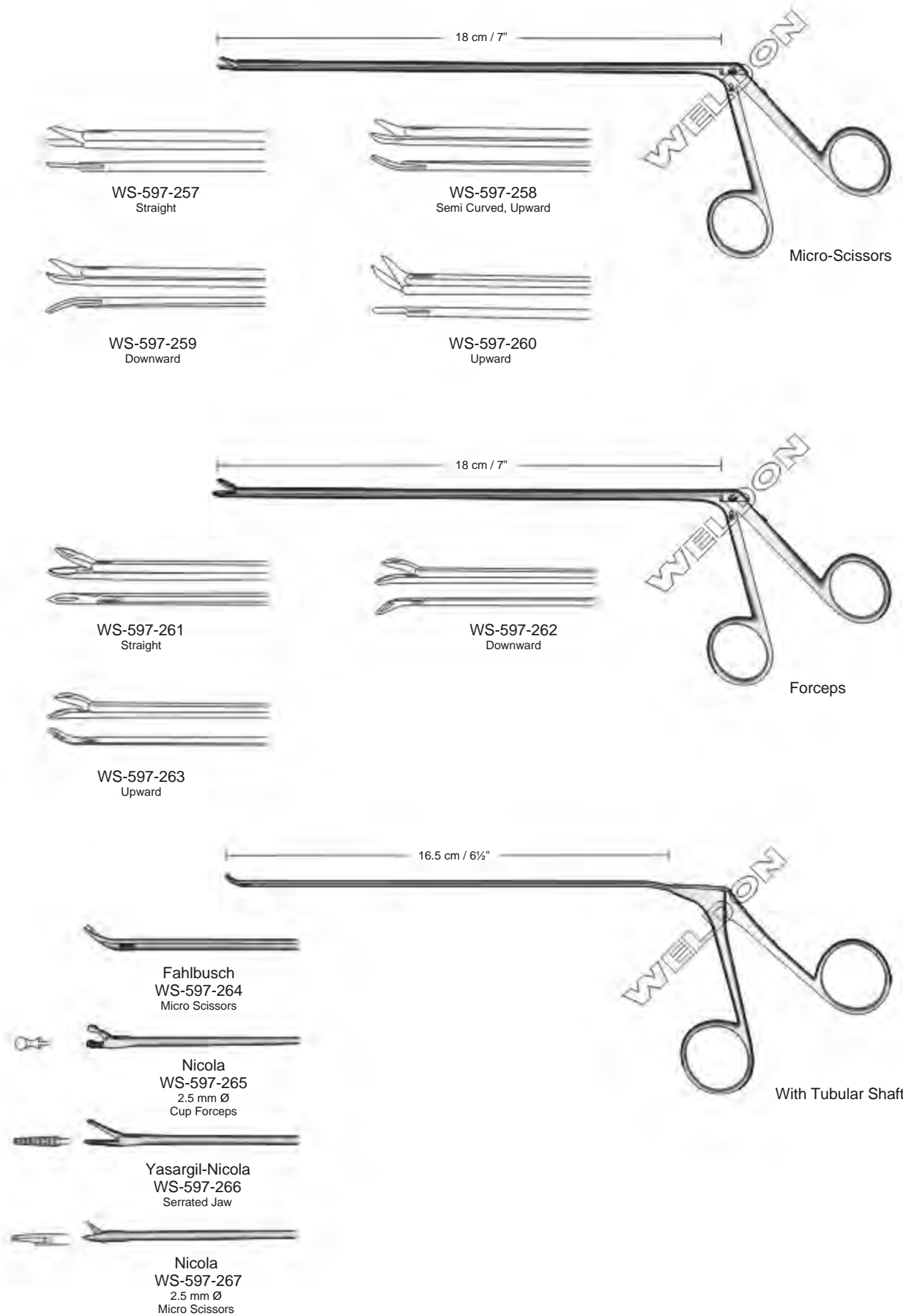

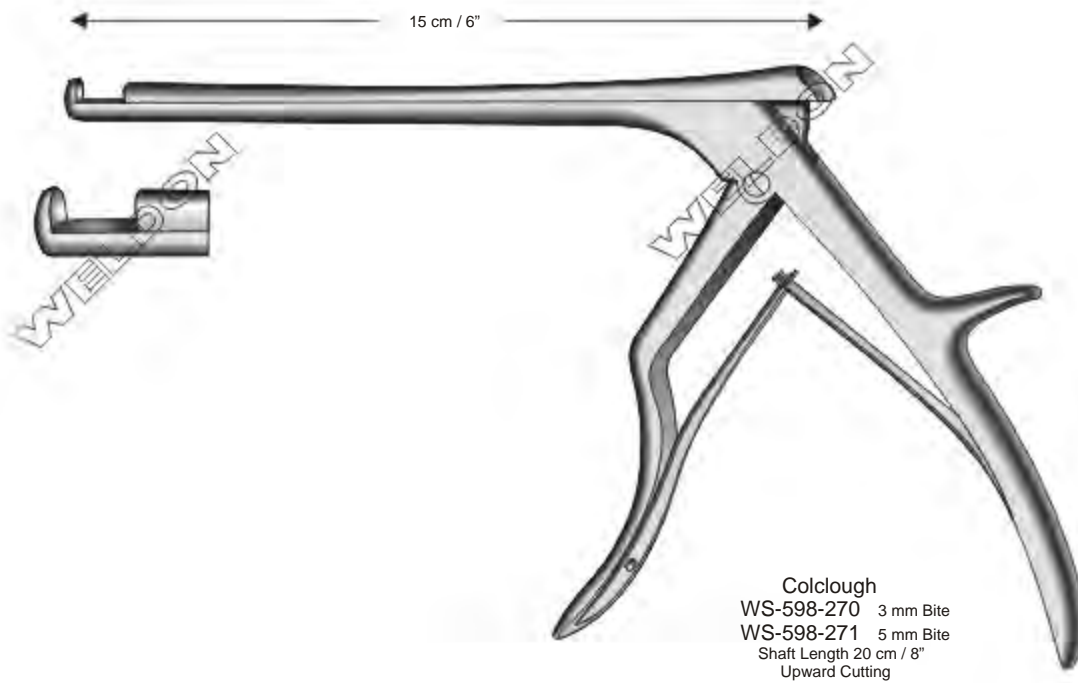
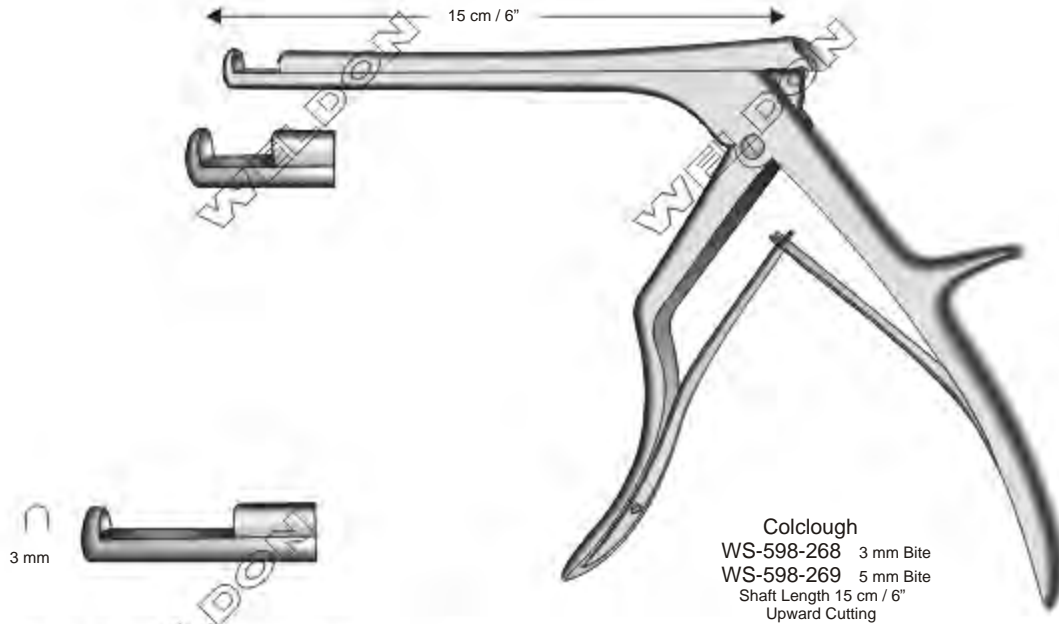

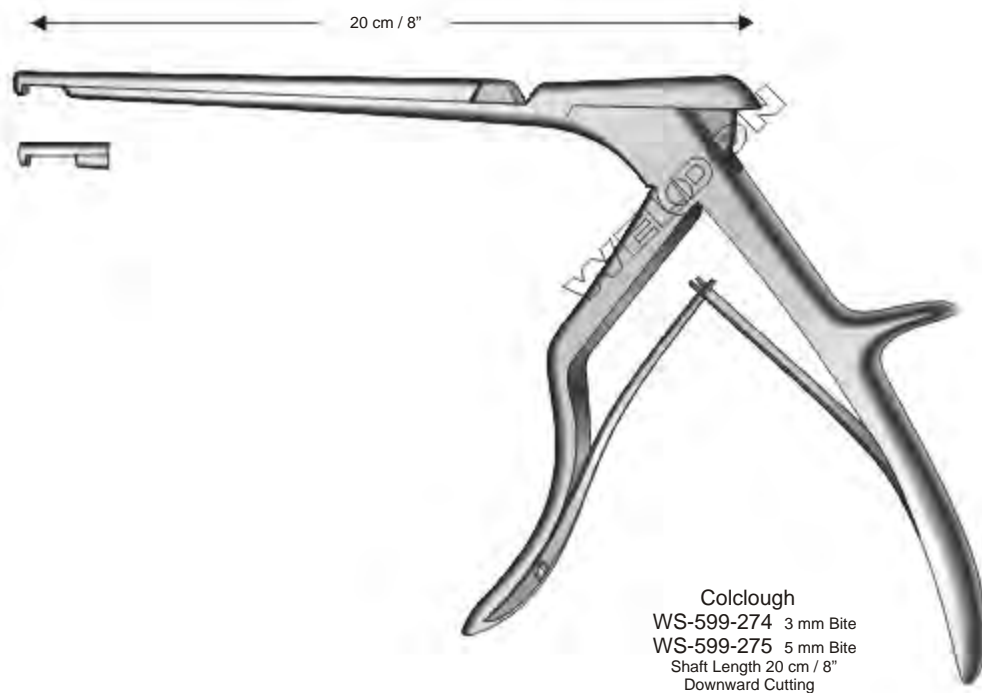
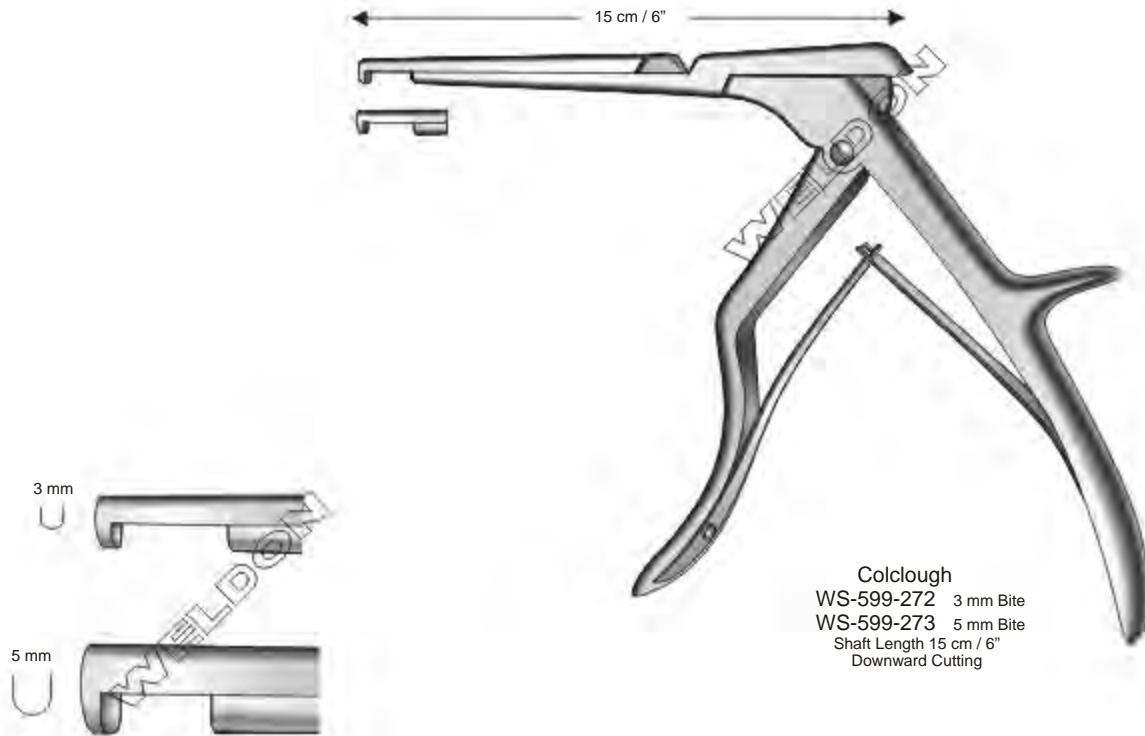

Bone Punches, Lemnectomy Rongeurs | Pinzas Sabacobados, Pinzas Para Leminectomia
Keilbenstanzen, Leminektomiezangen

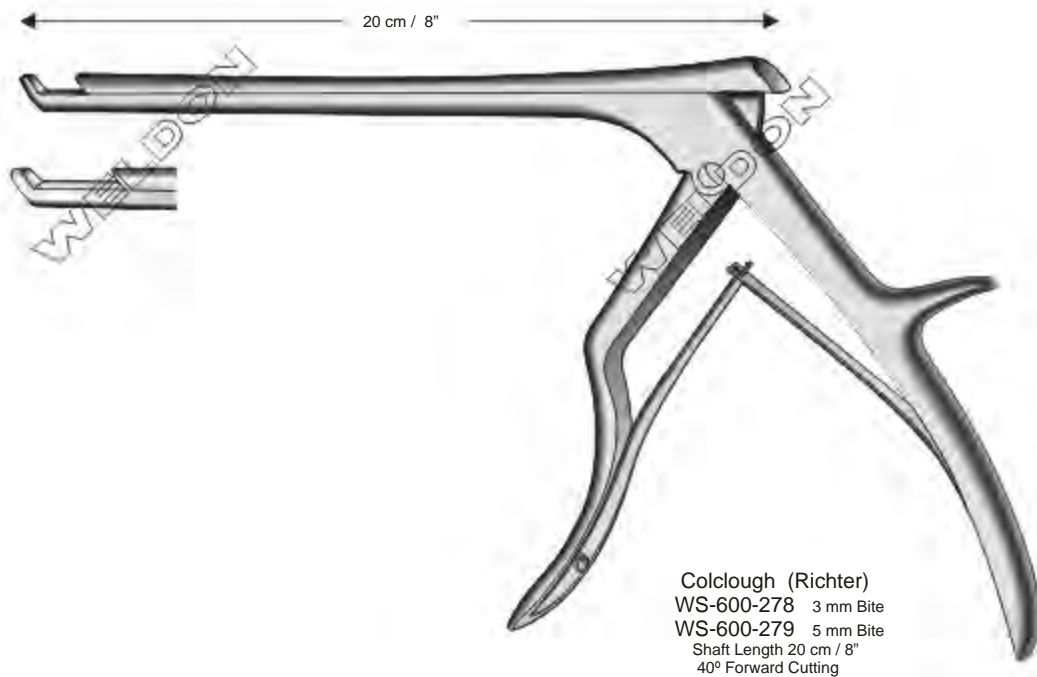
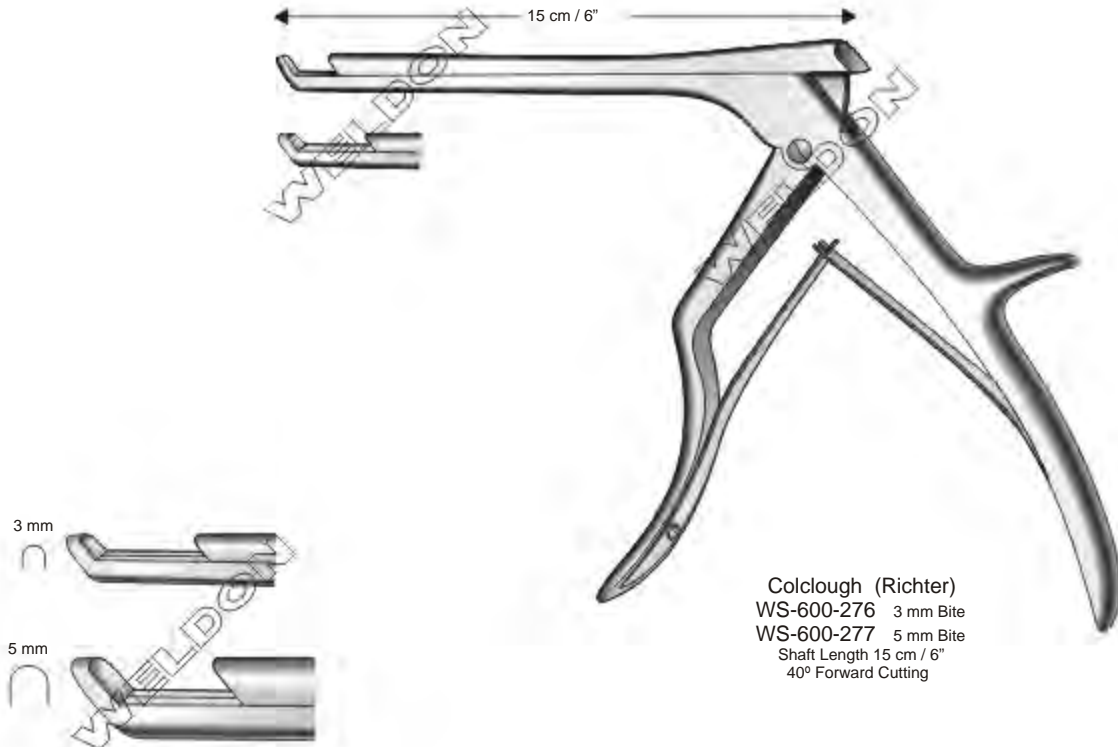

Intervertebral Disc Rongeur With Exchangeable Tips | Pinzas Sacabocada Para Discas Intervertebrales Con
Extremidades Cambrables | Bandscheibenstanzen Mit Austauschbaren Tipps

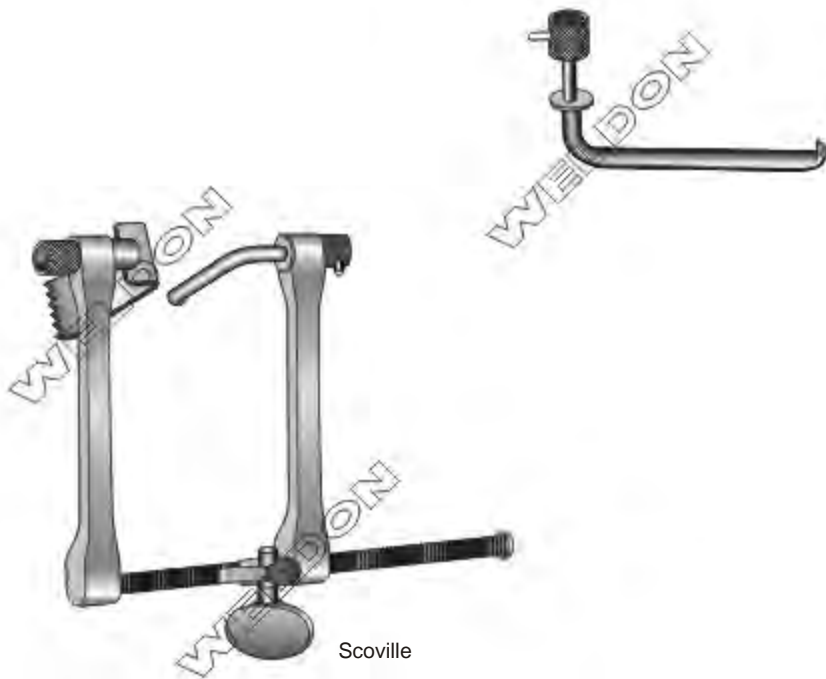

Colclough
WS-601-280
Consists of 3 Interchangeable & Rotatable Tips With Handle
WS-601-281
Handle Only

Self Retaining Retractors | Separadores Autoestáticos | Wundspreizer

WS-602-001
Hemilaminectomy Retractor
Self-Retaining Includes The Following:

WS-602-002
Hemilaminectomy Retractor Body
Arm Length 14.1 cm / 5^{5/8}"
Total Opening 12.7 cm / 5"

WS-602-003
Retractor Hook
Length 5.1 cm / 2"

WS-602-004
Retractor Blade - Optional
Blade Width x Depth 2.5 cm / 1" x 6.4 cm / 2^{1/2}"

WS-602-005
Retractor Blade - Optional
Blade Width x Depth 5.1 cm / 2" x 6.4 cm / 2^{1/2}"

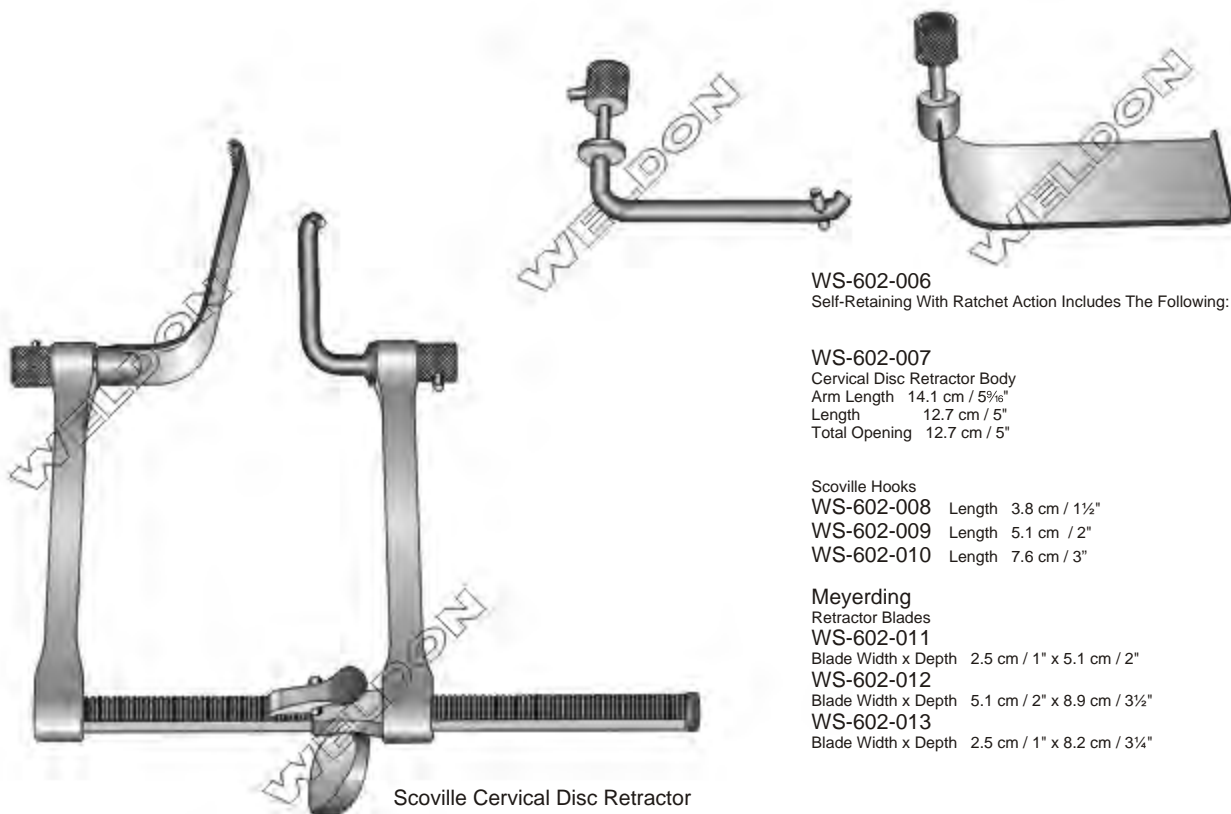

WS-602-006
Self-Retaining With Ratchet Action Includes The Following:

WS-602-007
Cervical Disc Retractor Body
Arm Length 14.1 cm / 5^{5/8}"
Length 12.7 cm / 5"
Total Opening 12.7 cm / 5"

Scoville Hooks
WS-602-008 Length 3.8 cm / 1^{1/2}"
WS-602-009 Length 5.1 cm / 2"
WS-602-010 Length 7.6 cm / 3"

Meyerding
Retractor Blades
WS-602-011
Blade Width x Depth 2.5 cm / 1" x 5.1 cm / 2"
WS-602-012
Blade Width x Depth 5.1 cm / 2" x 8.9 cm / 3^{1/2}"
WS-602-013
Blade Width x Depth 2.5 cm / 1" x 8.2 cm / 3^{1/4}"



Scoville

Hooks With Fixed Crossbar

WS-603-014 Crossbar Length 2.5 cm x 1", Length 3.8 cm x 1½"

WS-603-015 Crossbar Length 2.5 cm x 1", Length 5.6 cm / 2¼"

WS-603-016 Crossbar Length 2.5 cm x 1", Length 7.5 cm / 2¾"

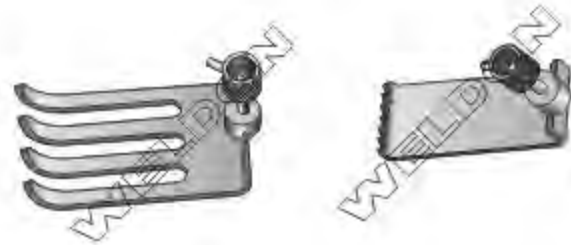

Taylor

Laminectomy Blades

WS-603-017 Blade Width x Depth 3.8 cm / 1½" x 4.5 cm / 1¾", Three Prongs

WS-603-018 Blade Width x Depth 5.1 cm / 2" x 4.8 cm / 1⅞", Four Prong

WS-603-019 Blade Width x Depth 5.7 cm / 2¼" x 6.4 cm / 2½", Four Prong

WS-603-020 Blade Width x Depth 5.7 cm / 2¼" x 7.9 cm / 3⅛", Four Prong

Scoville-Haverfield

WS-603-021

Hemilaminectomy Retractor

Self-Retaining With Ratchet Action And Hinged Arms Includes Following:

Scoville-Haverfield

WS-603-022

Hemilaminectomy Retractor Body

Arm Length 14.6 cm / 5¾"

Total Opening 17.8 cm / 7"

Scoville

Retractor Blades

WS-603-023 Blade Width x Depth 2.5 cm / 1" x 6.4 cm / 2½"

Scoville Hook

WS-603-024 Length 5.1 cm / 2"

Optional Blades

WS-603-025 Blade Width x Depth 2.9 cm / 1⅛" x 6.7 cm / 2⅝"

WS-603-026 Blade Width x Depth 2.5 cm / 1" x 8.9 cm / 3½"

Scoville

Retractor Blades, Four Prongs

WS-603-027 Blade Width x Depth 3.8 cm / 1½" x 4.1 cm / 1⅝"

WS-603-028 Blade Width x Depth 4.4 cm / 1¾" x 6.7 cm / 2⅝"

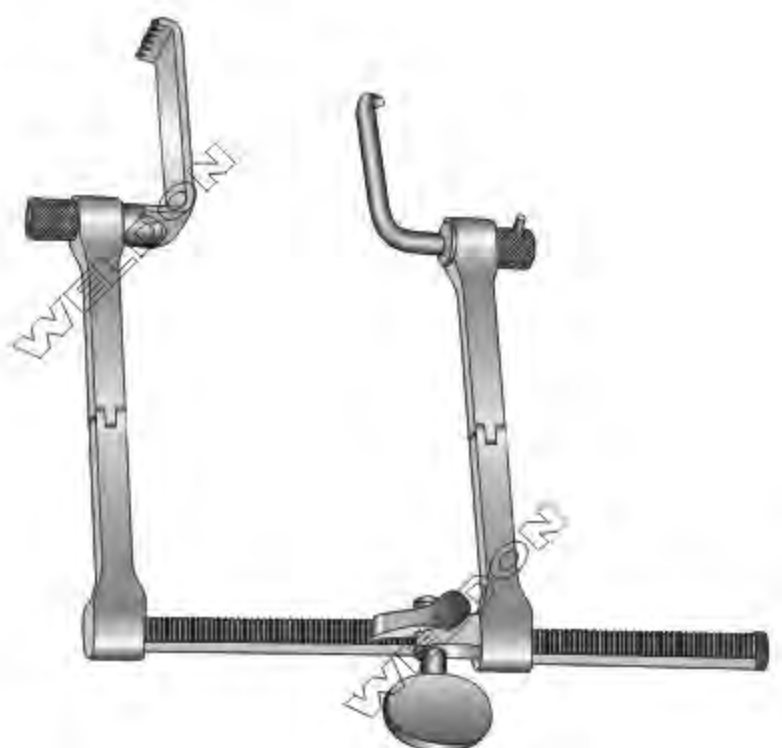

Scoville-Haverfield

Mirco Scissors, Bayonet | Micro Tijeras, Bayoneta | Mikro-Scheren, Bajonettförmig



WS-604-001 Straight
WS-604-002 Curved



Yasargil
22.5 cm / 9"



WS-604-003
Serrated
Straight



WS-604-004
Straight

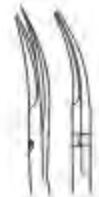

WS-604-005
Curved



Nagel
WS-604-006
20 cm / 8"



Nagel
WS-604-007
20 cm / 8"



DeBakey
WS-604-008
19 cm / 7 1/2"



Curved



WS-605-010
Straight

WS-605-011
Curved



Straight



WS-605-013
Straight



WS-605-014
Curved



Yasargil
WS-605-009
24.5 cm / 9 3/4"
Blunt



Yasargil
20 cm / 8"



Yasargil
WS-605-012
18.5 cm / 7 1/2"
Sharp



Yasargil
16.5 cm / 6 1/2"
Blunt

Mirco Scissors, Bayonet | Micro Tijeras, Bayoneta | Mikro-Scheren, Bajonettförmig

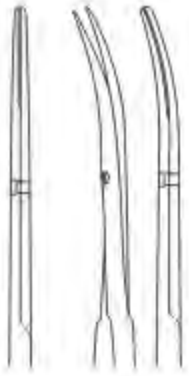

WS-606-015 Straight
WS-606-016 Curved



Curved

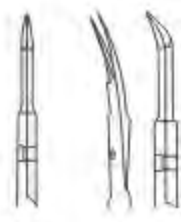

WS-606-018 Straight
WS-606-019 Curved

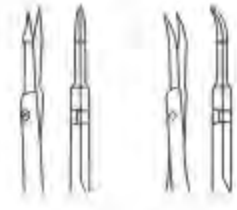

WS-606-020 Straight
WS-606-021 Curved



WS-606-022 Straight
WS-606-023 Curved



Yasargil
20 cm / 8"
Blunt



Yasargil
WS-606-017
20 cm / 8"
Sharp



Yasargil
22.5 cm / 9"



Yasargil
22.5 cm / 9"

Mirco Scissors, Bayonet | Micro Tijeras, Bayoneta | Mikro-Scheren, Bajonettförmig



WS-607-024
Sharp / Sharp



WS-607-027
Sharp / Sharp



WS-607-030
Sharp / Sharp



WS-607-025
Sharp / Blunt



WS-607-028
Sharp / Blunt



WS-607-031
Sharp / Blunt



WS-607-026
Blunt / Blunt



WS-607-029
Blunt / Blunt



WS-607-032
Blunt / Blunt



Shaft Length 7 cm / 2¾"
Complete Length 19.5 cm / 7¾"
Straight



Shaft Length 9 cm / 3½"
Complete Length 21.5 cm / 8½"
Straight



Shaft Length 12 cm / 4¾"
Complete Length 24.5 cm / 9¾"
Straight

Mirco Scissors, Bayonet | Micro Tijeras | Mikro-Scheren, Bajonettförmig



Shaft Length 7 cm / 2¾"
Complete Length 20 cm / 8"
Curved



Shaft Length 9 cm / 3½"
Complete Length 20 cm / 8"
Curved



Shaft Length 12 cm / 4¾"
Complete Length 24 cm / 9¾"
Curved

Mirco Scissors Straight | Micro Tijeras, Recta | Mikro-Scheren, Gerade



WS-609-042
Sharp / Blunt
Curved



WS-609-047
Sharp / Sharp
Straight



WS-609-043
Sharp / Sharp
Curved



Sharp / Blunt
Curved



Probe / Sharp
Curved



WS-609-048
Sharp / Sharp
Curved



WS-609-044
Sharp / Sharp
Straight



Müller
12 cm / 4¾"



Müller
WS-609-045
12 cm / 4¾"



Müller
WS-609-046
12 cm / 4¾"



Müller
17 cm / 6¾"

Mirco Scissors Straight | Micro Tijeras, Recta | Mikro-Scheren, Gerade



Vannas
8.5 cm / 3 3/8"

WS-610-049
Straight



WS-610-050
Sharp / Sharp
Curved



WS-610-051
Angled



Mc Clure
WS-610-052
9.5 cm / 3 3/4"

Straight



Vannas
12 cm / 4 3/4"

WS-610-053
Straight



WS-610-054
Curved



WS-610-055
Straight



10.5 cm / 4 1/8"

WS-610-056
Straight



WS-610-057
Curved



Noyes
WS-610-058
12.5 cm / 5"

Straight



Micro Scissors with Flat Grip, Straight | Micro Tijeras Con el Opretón Plano, Recta
Mikro-Federschere mit Flachgriffen und Karoprofil, Gerade

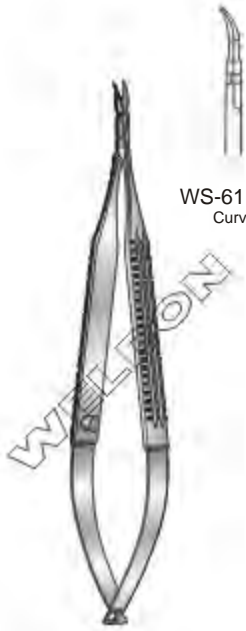

Vannas
12 cm / 4 1/4"



WS-611-059
Curved



WS-611-060
Angled



Biemer
WS-611-061
13 cm / 5 1/8"
Straight



WS-611-062
Straight



WS-611-063
Curved



16 cm / 6 1/4"



WS-611-064
Straight



WS-611-065
Curved



Vannas
16 cm / 6 1/4"



WS-611-066
Straight



WS-611-067
Curved



Millesi
16 cm / 6 1/4"

Micro Scissors with Flat / Round Grip, Straight | Micro Tijeras Con el Opretón Plano Y Redondas, Recta
 Mikro-Federscheren mit Flachgriffen und Rundgriffen Gerade



Micro-Scissors
 14.5 cm / 5 7/8"



Yasargil
 WS-612-071
 18.5 cm / 7 1/4"



Jacobson
 WS-612-072
 18.5 cm / 7 1/4"



Mirco Scissors with Flat Handles, Straight | Micro Tijeras Con Opretón Plano, Recta
Mikro-Federschere mit Flachgriffen, Gerade



WS-613-073
Straight



WS-613-074
Straight



WS-613-075
Curved



WS-613-076
Curved



WS-613-077



WS-613-078



WS-613-079



WS-613-080



WS-613-081

Fine Blades



WS-613-082



WS-613-083



WS-613-084



WS-613-085

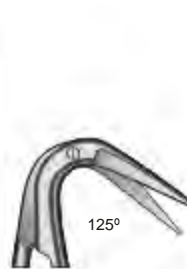

WS-613-086

Fine Blades
1 Blade With Probe



WS-613-087

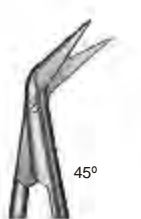

WS-613-088



WS-613-089



WS-613-090



WS-613-091

Very
Fine Blades



WS-613-092

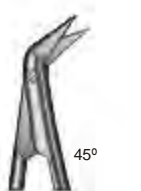

WS-613-093

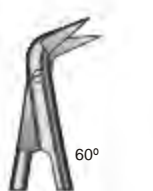

WS-613-094



WS-613-095



WS-613-096

Extremely
Fine Blades



16.5 cm / 6 1/2"

**Mirco Scissors with Flat Handles, Straight | Micro Tijeras Con Opretón Plano, Recta
Mikro-Federscheren mit Flachgriffen, Gerade**

WS-614-097
Straight

WS-614-098
Curved

WS-614-099
Curved

Fine Blades

WS-614-100

WS-614-101

WS-614-102

WS-614-103

WS-614-104

 Very
Fine Blades

WS-614-105

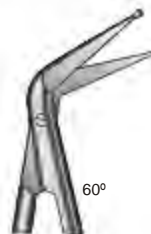
WS-614-106

WS-614-107

WS-614-108

WS-614-109

 Very
Fine Blades

WS-614-110

WS-614-111

WS-614-112

WS-614-113

WS-614-114

 Extremely
Fine Blades

WS-614-115

WS-614-116

WS-614-117

WS-614-118

WS-614-119

16.5 cm / 6½"

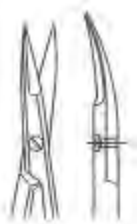

WS-615-120
Sharp / Sharp
Curved



WS-615-121
Sharp / Sharp
Straight



1 Blade With Probe



Sharp / Sharp
1 Blade Serrated
Straight



18 cm / 7"



Micro Scissors
WS-615-122
18 cm / 7"



Micro Thread Scissors
WS-615-123
For Material 8 / 0 & Smaller
18 cm / 7"

Micro Scissors | Micro Tijeras | Mikro-Scheren

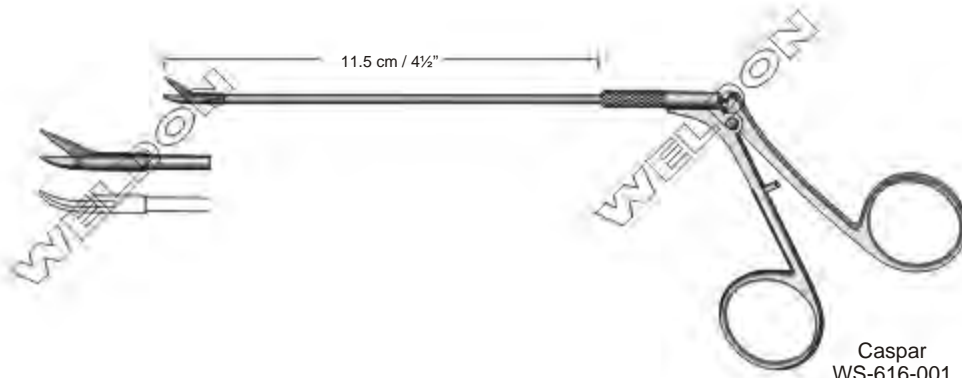

Caspar
WS-616-001
Straight
360° Rotatable

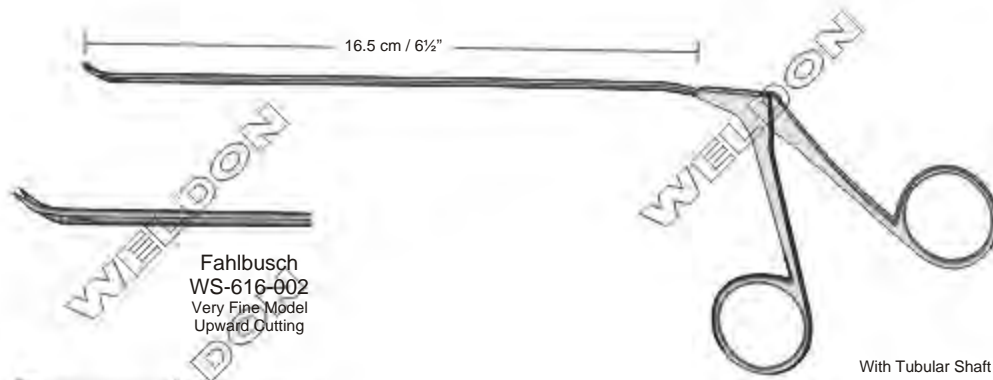

Fahlbusch
WS-616-002
Very Fine Model
Upward Cutting

Nicola
WS-616-003

With Tubular Shaft



WS-616-004
With Hand Grip
18 cm / 7"

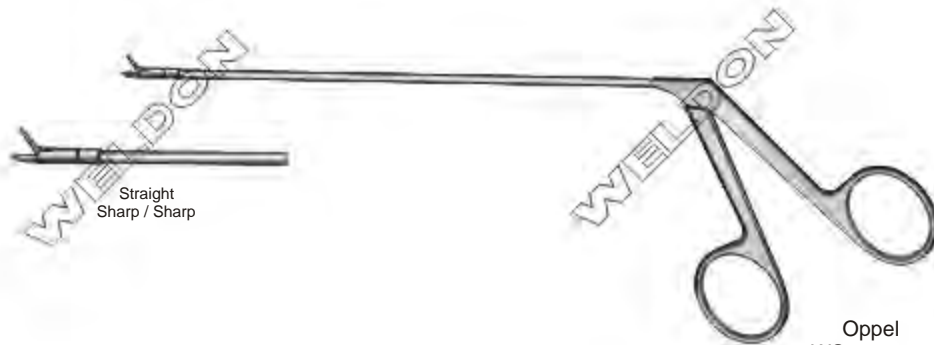

Straight
Sharp / Sharp

Oppel
WS-617-005
Micro Scissors
Flexible
Vertical Cutting

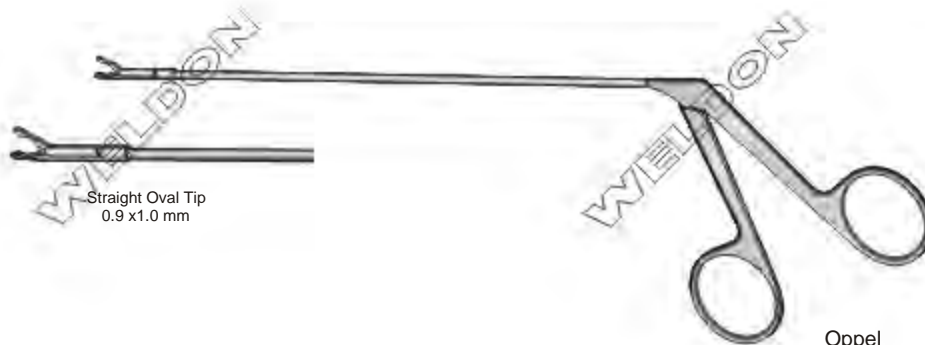

Straight Oval Tip
0.9 x 1.0 mm

Oppel
WS-617-006
Micro Forceps
Oval Cup
Flexible

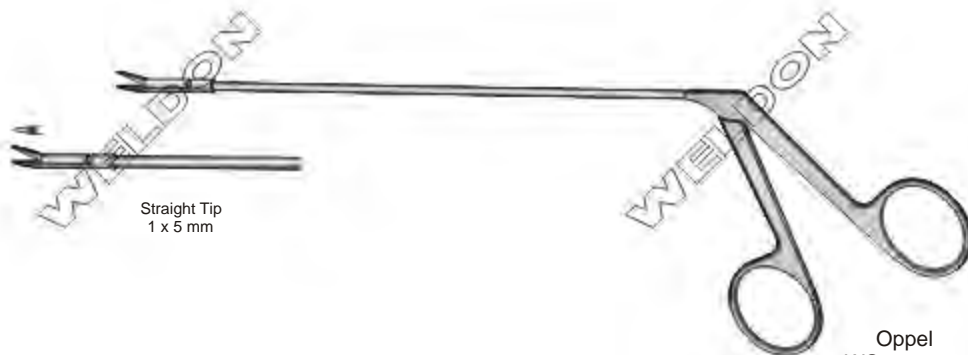

Straight Tip
1 x 5 mm

Oppel
WS-617-007
Micro Tubular Forceps
Flexible.



Yasargil
WS-618-001
22 cm / 8 3/4"



Yasargil
WS-618-002
22 cm / 8 3/4"



Hunt
WS-619-003
20 cm / 8"
Serrated



Hunt
WS-619-004
20 cm / 8"
Serrated



Hunt
WS-619-005
20 cm / 8"
Serrated

Tumor Siezing Forceps | Pizas Para Agarrar Tumors | Pinzetten Zum Fassen Von Gewebe

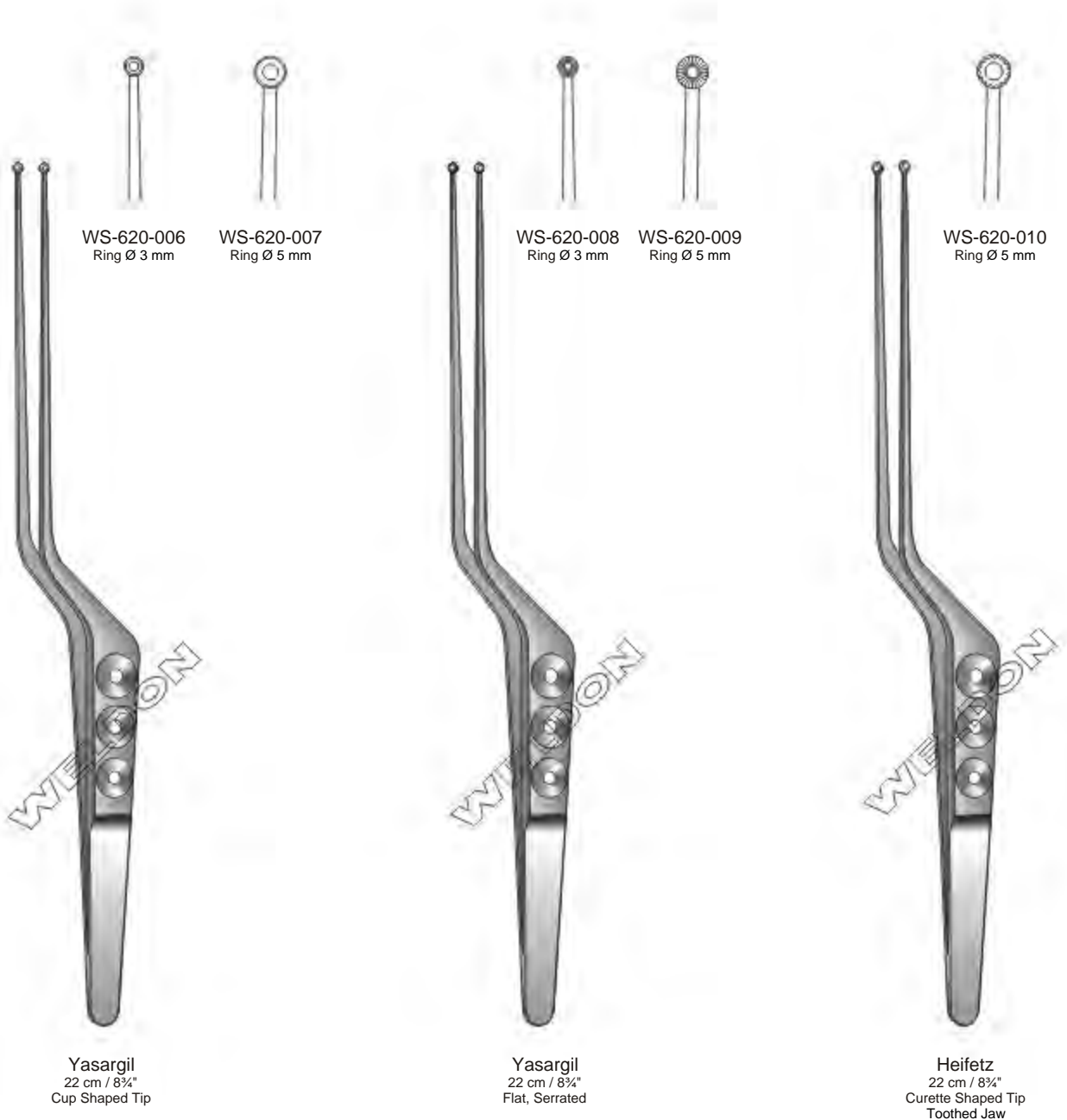

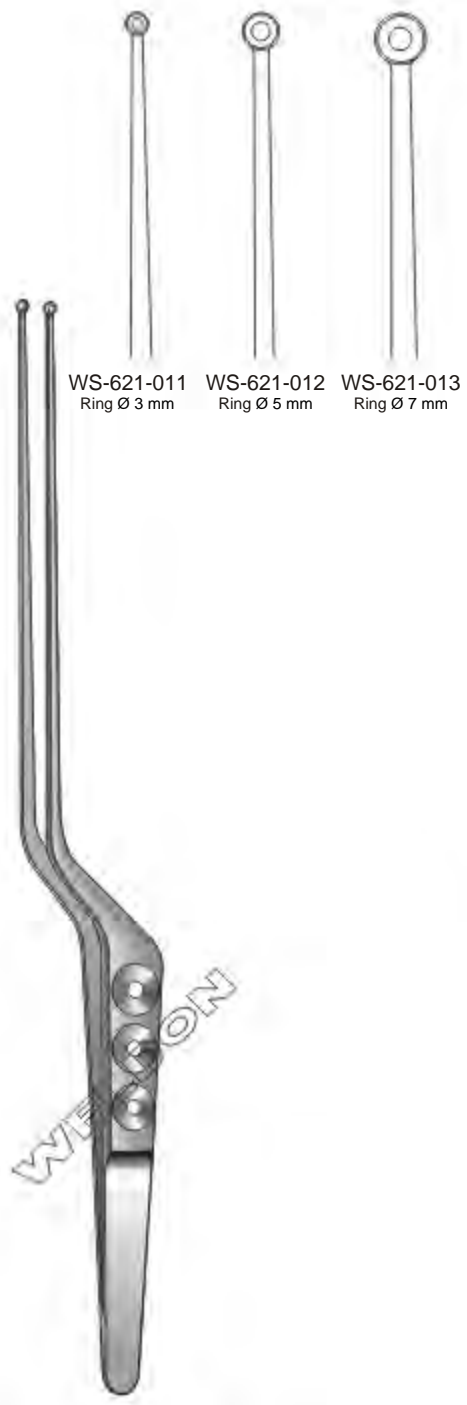

Yasargil-Sami
24 cm / 9½"
Cup Shaped Tip



Yasargil
20 cm / 8"
Serrated

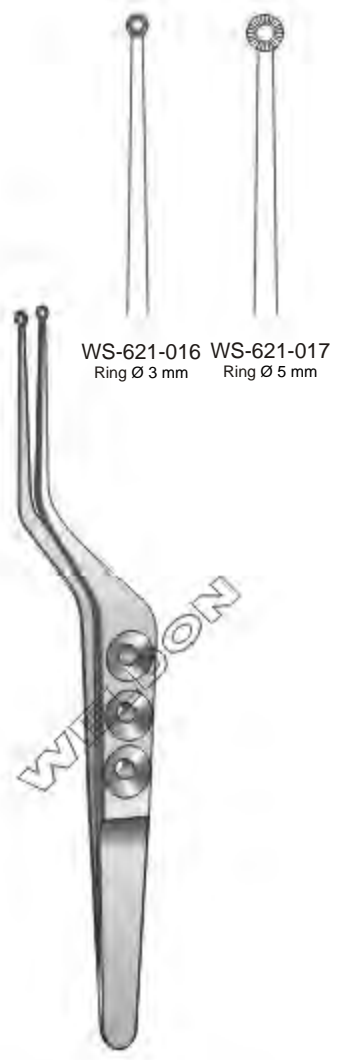

Yasargil
16.5 cm / 6½"
Serrated



Yasargil
WS-622-018
22 cm / 8¾"
Curette Shape, Serrated Tip



Yasargil
WS-622-019
22 cm / 8¾"
Curette Shape, Serrated Tip



WS-622-020
Ring Ø 3 mm
Curved to Left

WS-622-021
Ring Ø 3 mm
Curved to Right

Samii
22 cm / 8¾"
Curette Shape

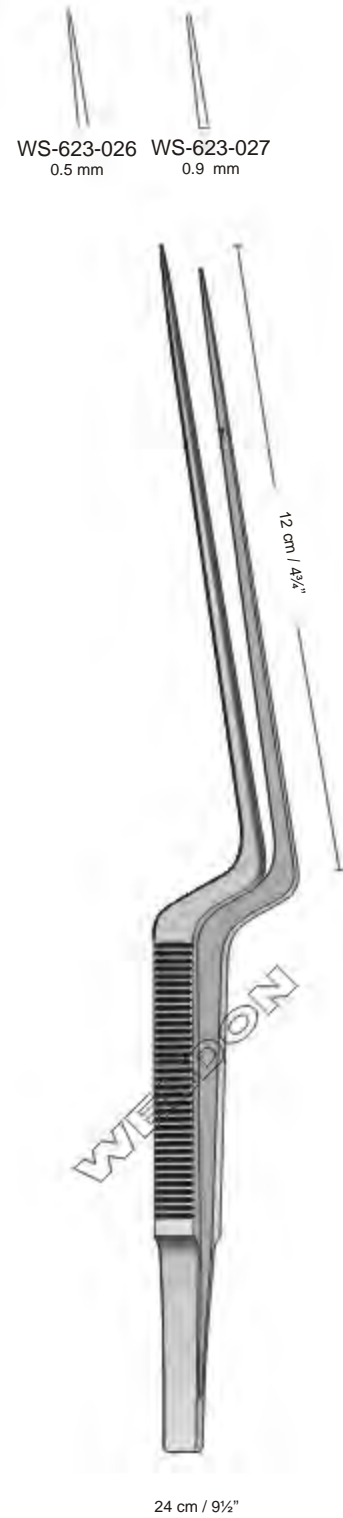
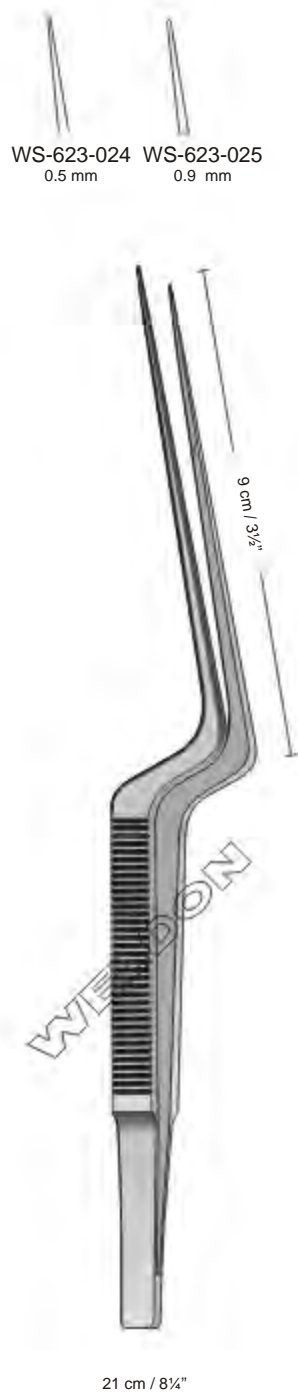

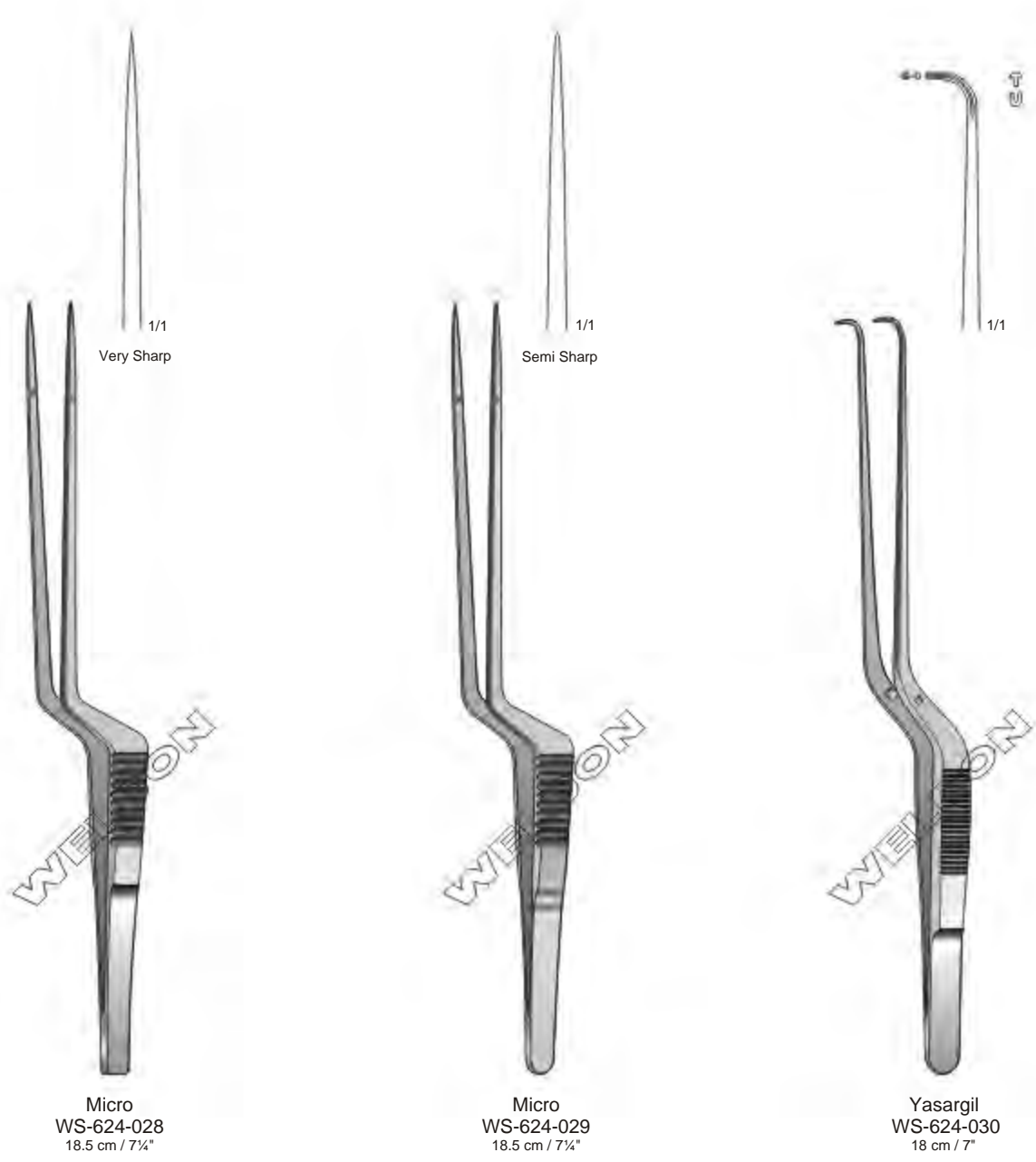

Micro
WS-624-028
18.5 cm / 7 1/4"

Micro
WS-624-029
18.5 cm / 7 1/4"

Yasargil
WS-624-030
18 cm / 7"

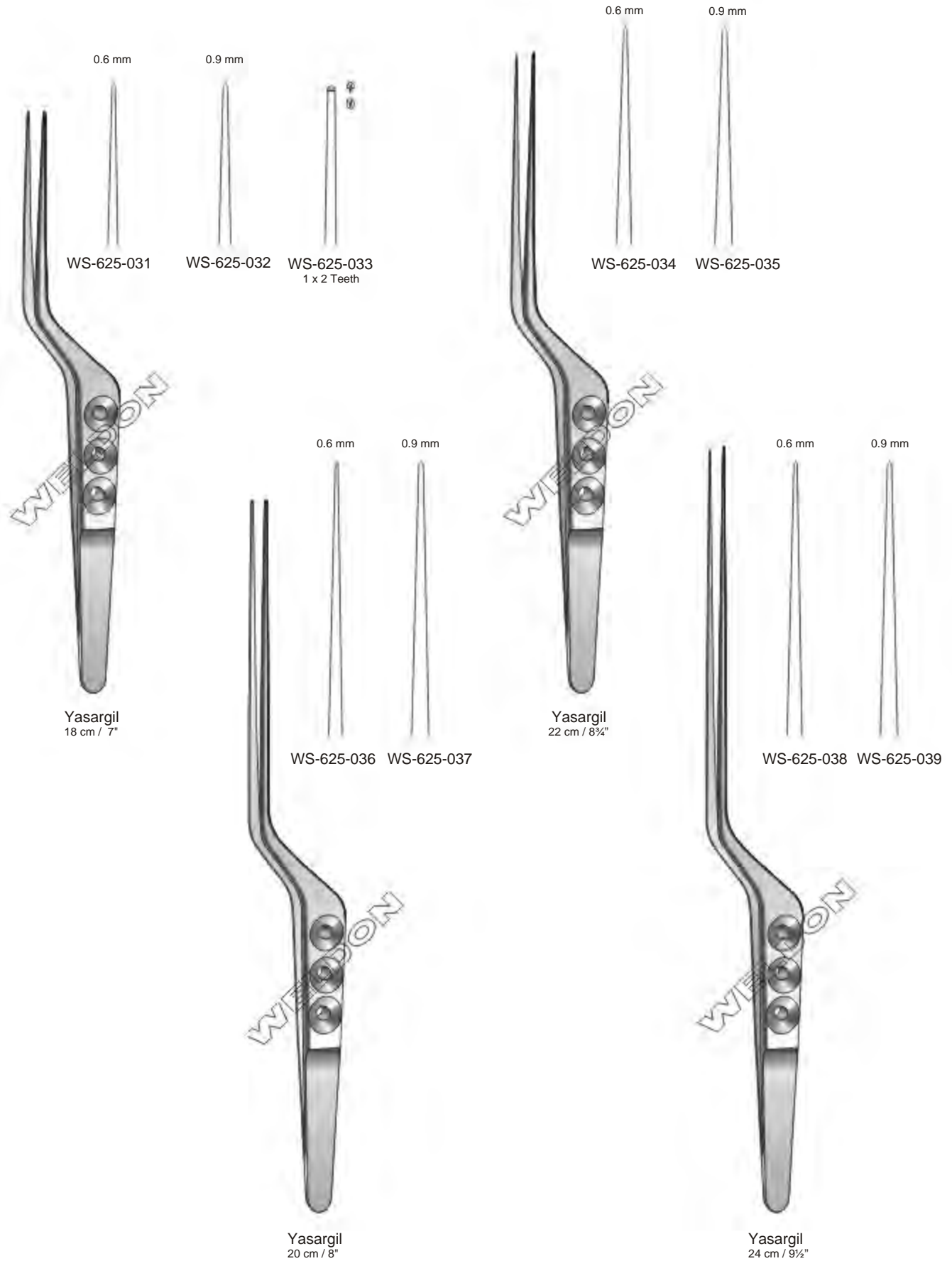

Micro Forceps with Round Grip and Stopper | Micro Pinzas Con Opretón Redonda y Tapón
Mikro-Pinzetten mit Rundgriff und Gewicht



WS-626-040
15 cm / 6"







WS-626-041
18.5 cm / 7¼"

WS-626-042
21 cm / 8¼"





WS-626-043
23 cm / 9"

WS-626-044
25 cm / 10"

Micro Forceps with Round Grip and Stopper | Micro Pinzas Con Opretón Redonda y Tapón
Mikro-Pinzetten mit Rundgriff und Gewicht

						
	Straight	Curved	Debaquey Teeth	Straight	Curved	Straight
15 cm / 6"	WS-627-045	WS-627-049		WS-627-055	WS-627-060	
18.5 cm / 7 1/4"	WS-627-046	WS-627-050	WS-627-053	WS-627-056	WS-627-061	WS-627-065
21 cm / 8 1/4"	WS-627-047	WS-627-051	WS-627-054	WS-627-057	WS-627-062	
23 cm / 9"				WS-627-058	WS-627-063	
25 cm / 10"	WS-627-048	WS-627-052		WS-627-059	WS-627-064	



					
	Straight With Diamond Dust	Debaquey Teeth	Straight	Curved	Straight With Diamond Dust

18.5 cm / 7 1/4"	WS-627-066	WS-627-068	WS-627-070	WS-627-072	WS-627-074
21 cm / 8 1/4"	WS-627-067	WS-627-069	WS-627-071	WS-627-073	WS-627-075



Micro Forceps with Flat Grip | Micro Pinzas Con Opretón Plano | Mikro-Pinzetten mit Flachgriff

1 mm



WS-628-076
 18 cm / 7"
WS-628-077
 25 cm / 10"

1 mm



WS-628-078
 18 cm / 7"
WS-628-079
 20 cm / 8"
 DeBakey Teeth

Ring Ø 1 mm



WS-628-080
 18 cm / 7"
 Straight

Ring Ø 1 mm



WS-628-081
 18 cm / 7"
 Curved

1 mm



WS-628-082
 18 cm / 7"
WS-628-083
 20 cm / 8"
 Straight



18 cm / 7"



20 cm / 8"



25 cm / 10"

Micro Tweezers with Flat Grip Diadust | Micro Pinzas Con Opretón Plano, Diadust
Mikro-Knüfpinzetten mit Flachgriff, Diadust



Round Grip
WS-629-084
20 cm / 8"



WS-629-085
Ring Ø 2.5 mm
18 cm / 7"

WS-629-086
Ring Ø 2.5 mm
20 cm / 8"

Round Grip



Kocher Micro Forceps
18 cm / 7"

WS-629-087
1 x 2 Teeth
Straight

WS-629-088
1 x 2 Teeth
Angled



Dressing Micro Forceps
WS-629-089
18 cm / 7"

With Plat Form

Micro Tweezers with Round Grip | Micro Pinzas Con Opretón Redondo
Mikro-Knüfpinzetten mit Rundgriffen

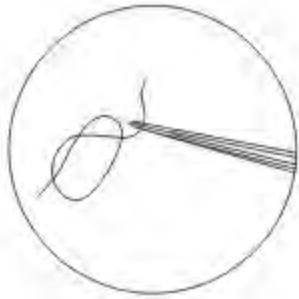

0.3 mm

0.5 mm



WS-630-090 Straight
WS-630-091 Curved

0.3 mm

0.3 mm



WS-630-092 Straight
WS-630-093 Curved

0.5 mm

0.5 mm



WS-630-094 Straight
WS-630-095 Curved



12 cm / 4 1/4"



15 cm / 6"



18 cm / 7"



Micro Tweezers | Micro Pinzas | Mikro-Knüfpinzetten



Lazar
WS-632-100
15.5 cm / 6"



Lazar
WS-632-101
15.5 cm / 6"



WS-632-102
18.5 cm / 7 1/4"

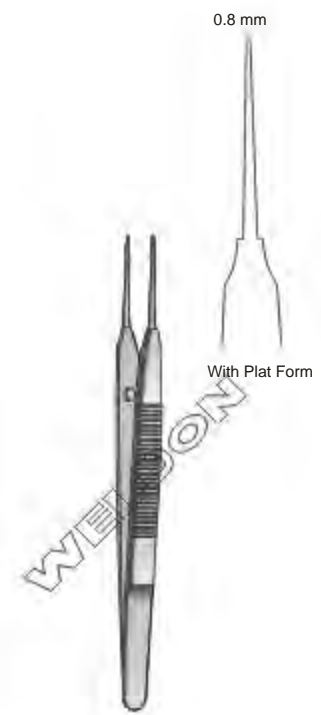

Austin
WS-632-103
14 cm / 5 1/2"



Bonner Model
WS-632-104
9.5 cm / 3 3/4"



WS-632-105
12 cm / 4 3/4"

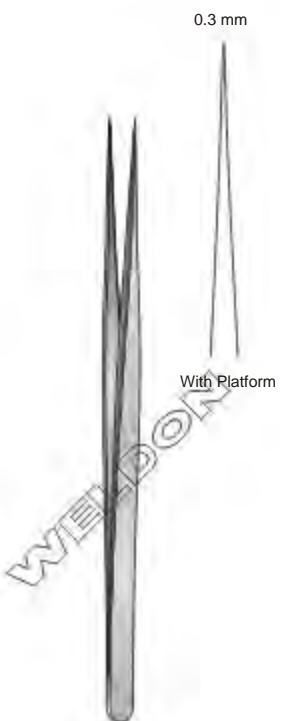

Vise
WS-632-106
13.5 cm / 5 1/4"

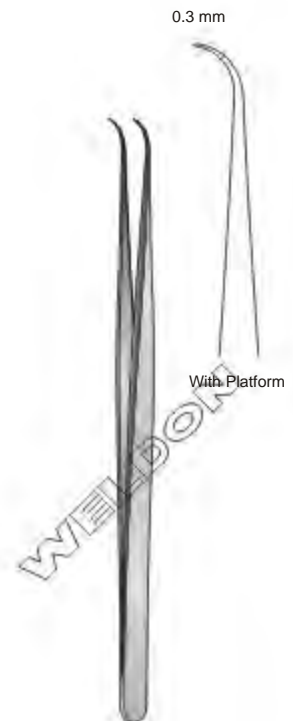

Vise
WS-632-107
13.5 cm / 5 1/4"

Micro Tweezers Jeweler Style | Micro Pinzas, Modelo Jewler | Mikro-Pinzetten, Uhrmacher Modelle

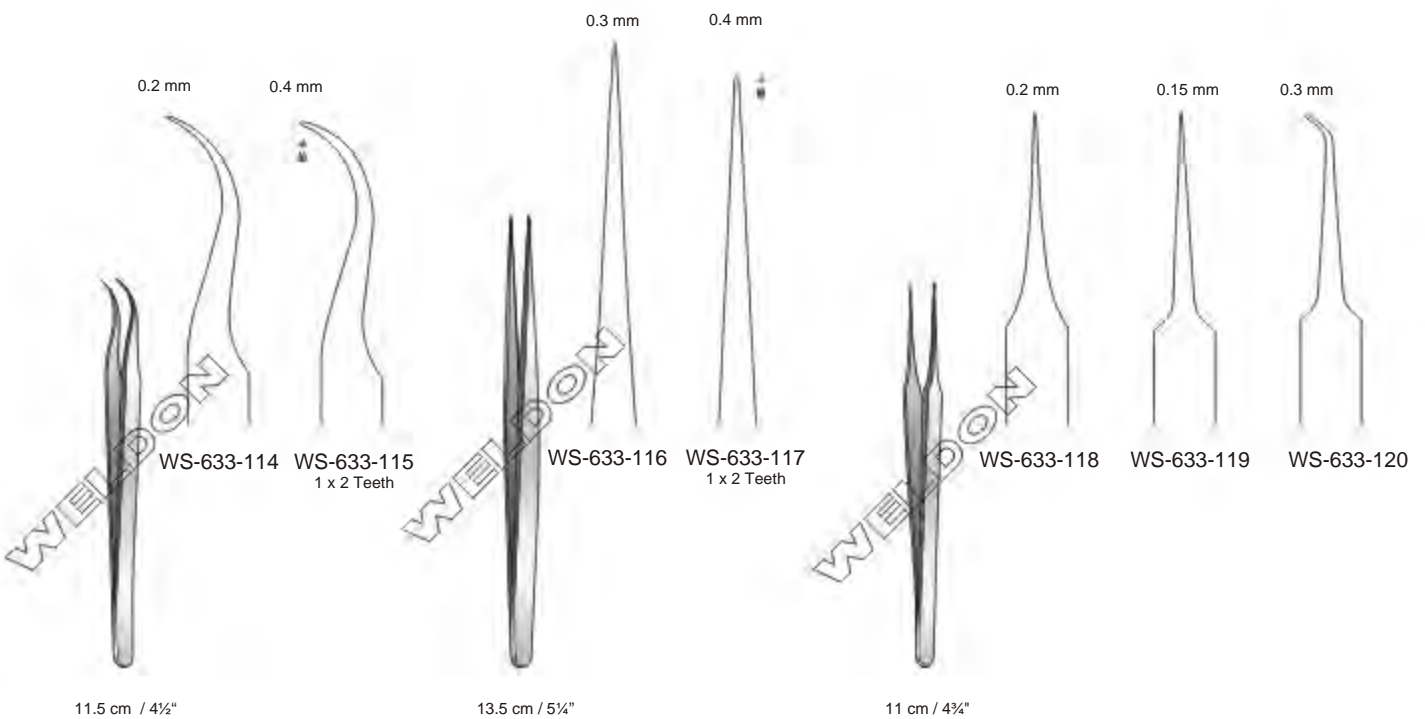
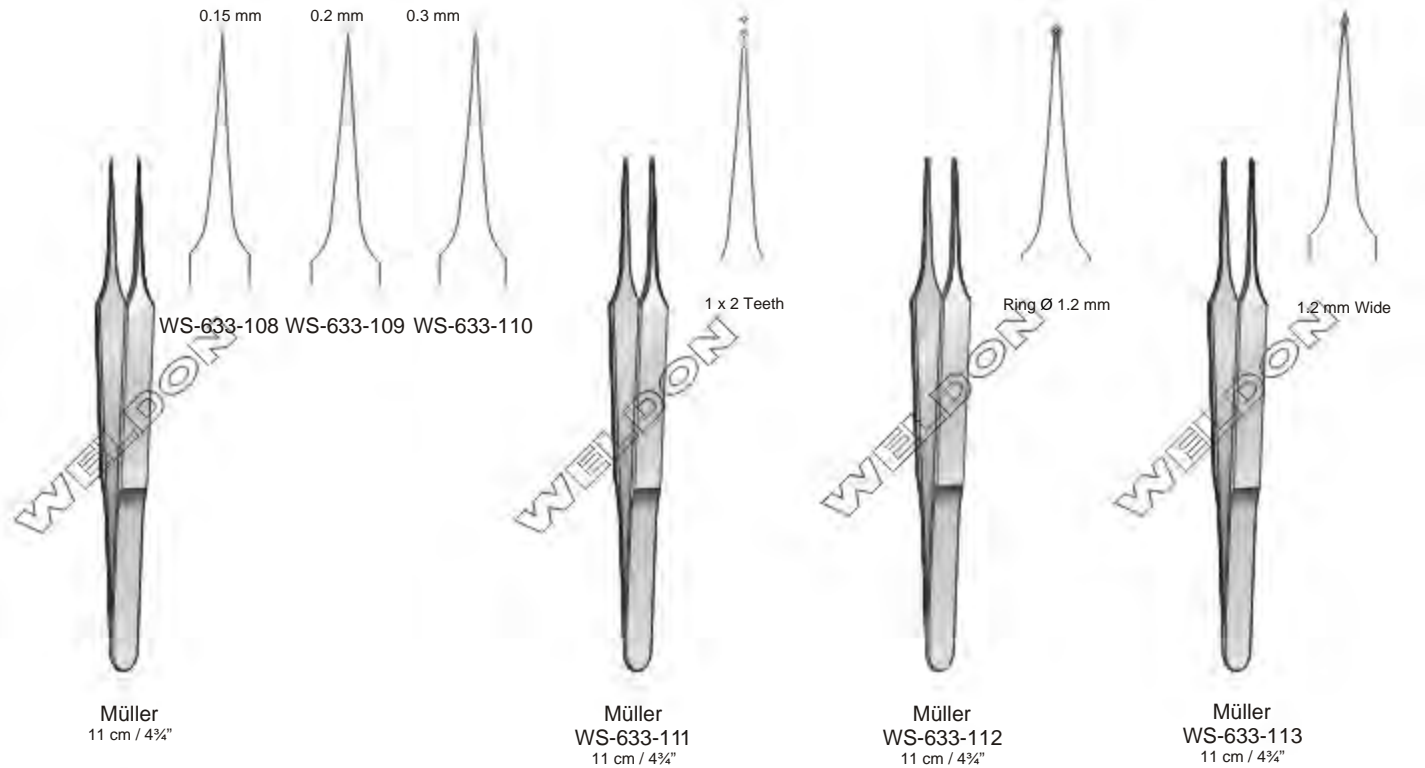

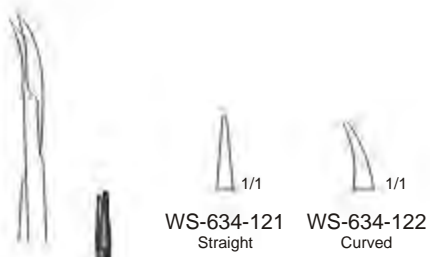

Yasargil
20 cm / 8"



Yasargil
22.5 cm / 9"

Micro Needle Holders, Round Grip | Micro Porta Agujas Con Apertón Redondo
Mikro-Nadelhalter mit Rundgriffen



1/1
WS-635-125
Straight



18.5 cm / 7¼"
Without Lock



1/1
WS-635-126
Curved



1/1
WS-635-127
Straight



18.5 cm / 7¼"
With Lock



1/1
WS-635-128
Curved



1/1
WS-635-129
20 cm / 8"
Without Lock



1/1
WS-635-130
23 cm / 9"
With Lock

Micro Needle Holders, Round Grip | Micro Porta Agujas Con Apertón Redondo
Mikro-Nadelhalter mit Rundriffen

WS-636-131
Straight

WS-636-132
Curved



Barraquer
12 cm / 4 3/4"
Without Lock

WS-636-133
Straight

WS-636-134
Curved



Barraquer
12 cm / 4 3/4"
With Lock

WS-636-135
11.5 cm / 4 1/2"
Straight

WS-636-136
12 cm / 4 3/4"
Curved



Barraquer
Without Lock

WS-636-137
Straight

WS-636-138
Curved



Reil
15 cm / 6"
Without Lock

WS-636-139
Straight

WS-636-140
Curved



15 cm / 6"
With Lock

Micro Needle Holders with T/C Inserts | Micro Porta Agujas Con T/C | T/C Mikro-Nadelhalter

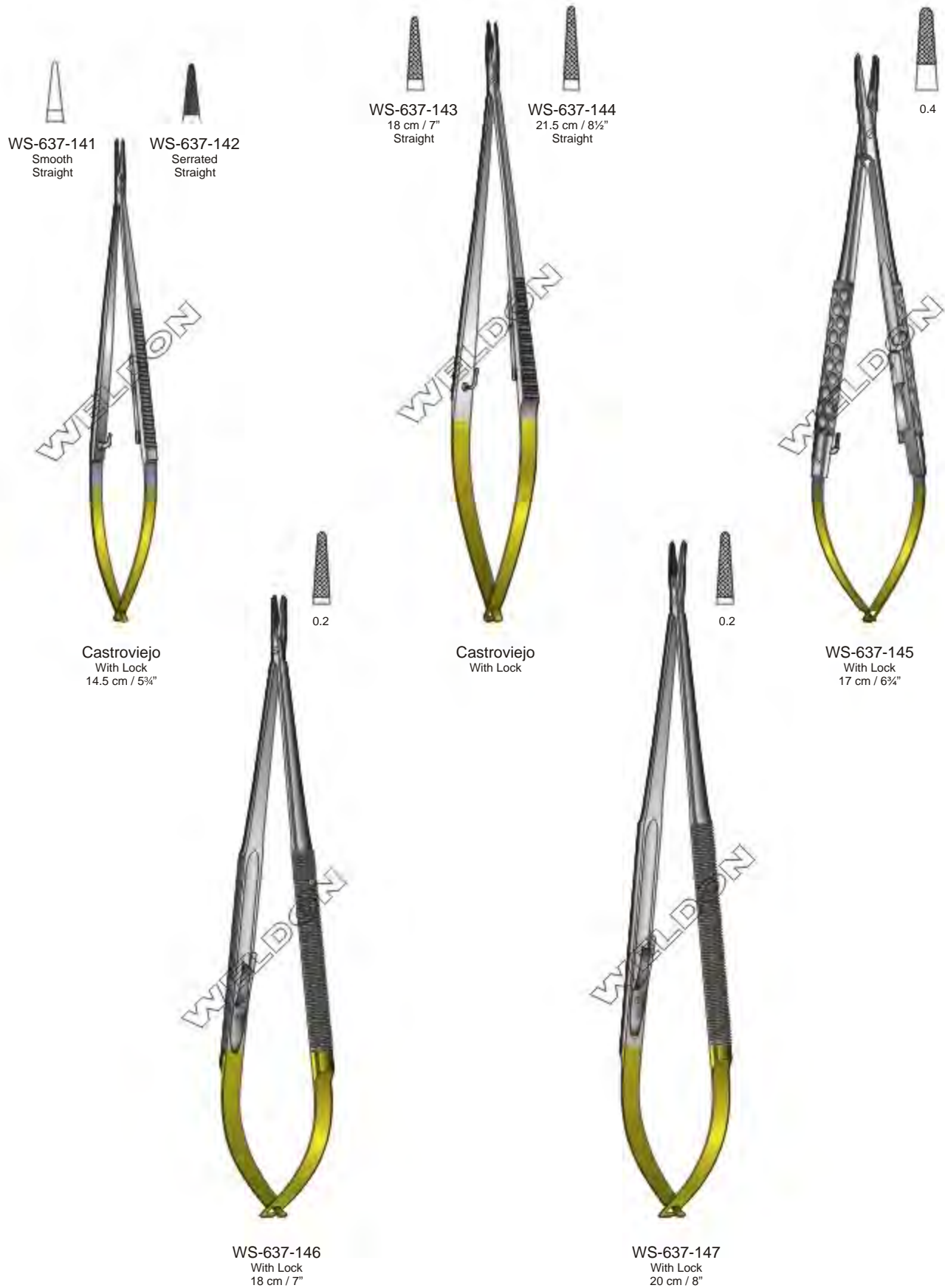

Micro Needle Holders, Flat Grip | Micro Porta Agujas Con Apertón Plano
Mikro-Nadelhater mit Flachgriffen

WS-638-148
Straight

WS-638-149
Curved



Castroviejo
With Lock
14.5 cm / 5 3/4"



WS-638-153
Straight

WS-638-154
Curved

Without Lock
16 cm / 6 1/4"

WS-638-150
Straight

WS-638-151
Straight



Jacobson
Without Lock
18.5 cm / 7 1/4"

WS-638-155
Straight

WS-638-156
Curved



Without Lock
18.5 cm / 7 1/4"



Straight

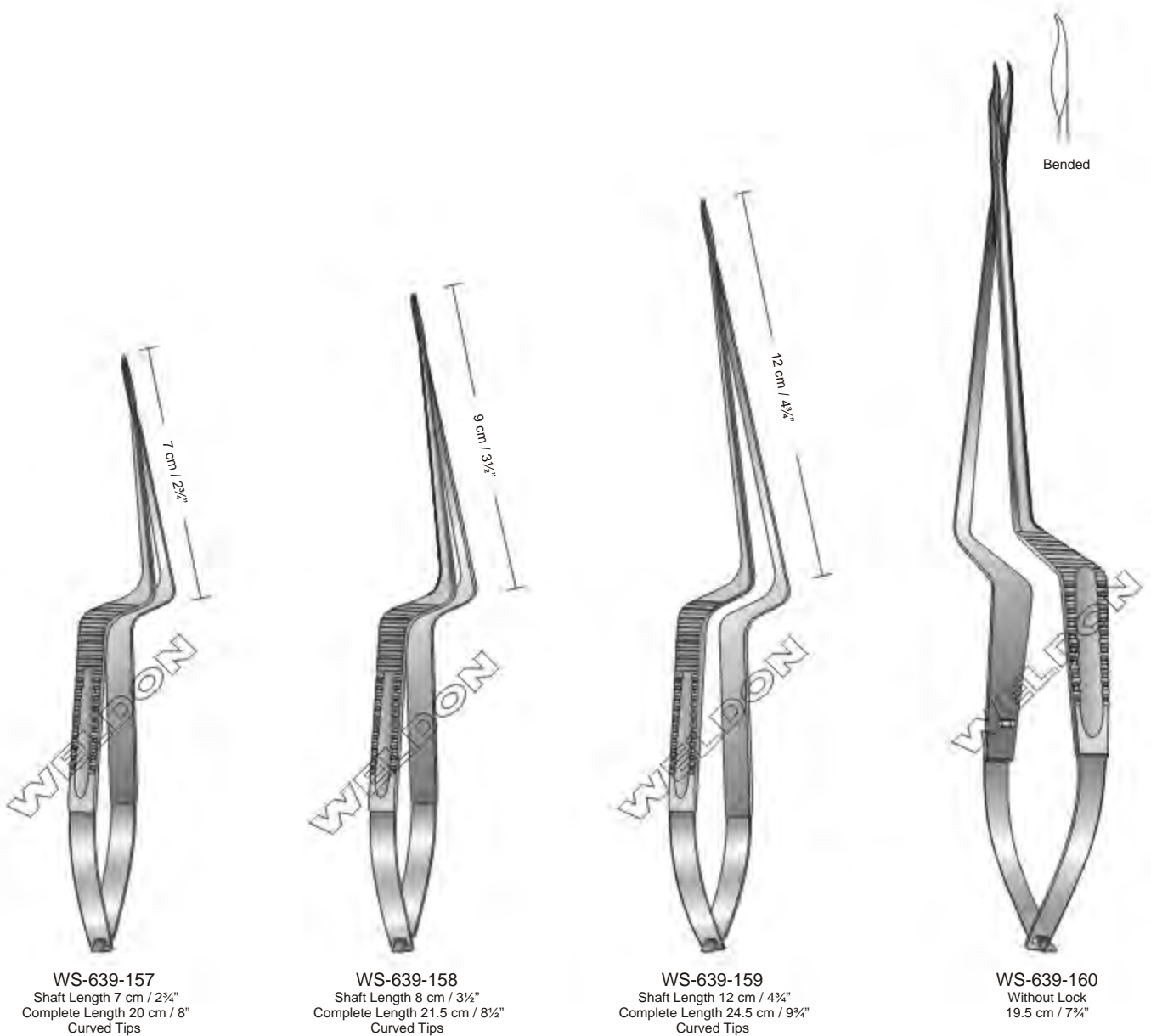

With Lock
WS-638-152
20 cm / 8"

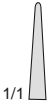
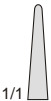

Micro Needle Holders, Diamond Dusted, Round Grip | Micro Porta Agujas, Diamond Dusted, Apertón Redondo
Diadust Mikro-Nadelhalter mit Rundgriffen

				
With Lock Hard Material	1/1	1/1	1/1	1/1
Length	7/0 & Smaller	5/0 & Smaller	4/0 & Smaller	4/0 & Smaller
12 cm / 4¾"	WS-640-161			
14.5 cm / 5¾"		WS-640-166		
16 cm / 6¼"	WS-640-162	WS-640-167		
18.5 cm / 7¼"	WS-640-163	WS-640-168	WS-640-171	
21 cm / 8¼"	WS-640-164	WS-640-169	WS-640-172	WS-640-174
23 cm / 9"	WS-640-165	WS-640-170	WS-640-173	WS-640-175
Without Lock Hard Material				
12 cm / 4¾"	WS-640-176			
14.5 cm / 5¾"		WS-640-181		
16 cm / 6¼"	WS-640-177	WS-640-182		
18 cm / 7¼"	WS-640-178	WS-640-183		
21 cm / 8¼"	WS-640-179	WS-640-184		
23 cm / 9"	WS-640-180	WS-640-185		

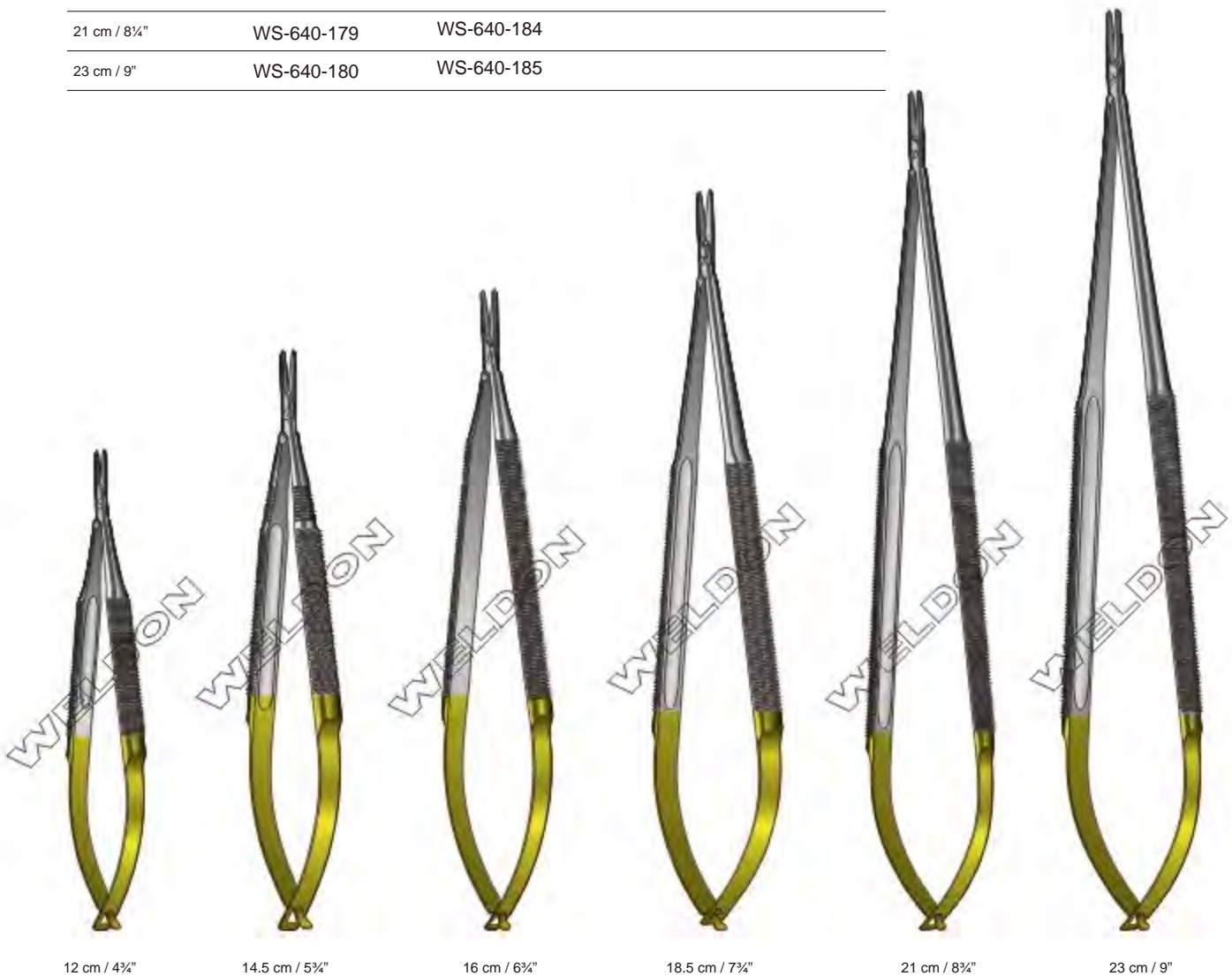

Micro Needle Holders, Diamond Dusted, Round Grip | Micro Porta Agujas, Diamond Dusted, Apertón Redondo
 Diadust Mikro-Nadelhalter mit Rundgriffen

With Lock Hard Material	
Length	2/0 & Smaller
19 cm / 7½"	WS-641-186
23 cm / 9"	WS-641-187
25 cm / 10"	WS-641-188
Without Lock Hard Material	
19 cm / 7½"	WS-641-189
23 cm / 9"	WS-641-190
25 cm / 10"	WS-641-191



19 cm / 7½"



23 cm / 9"



25 cm / 10"

Micro Needle Holders, Diamond Dusted, Flat Grip | Micro Porta Agujas, Diamond Dusted, Apertón Plano
Diadust Mikro-Nadelhalter mit Flachgriffen

 With Lock
 Hard Material

Length	7/0 & Smaller	5/0 & Smaller
14.5 cm / 5 3/4"	WS-642-192	WS-642-197
17 cm / 6 3/4"	WS-642-193	WS-642-198
18 cm / 7 1/4"	WS-642-194	WS-642-199
21 cm / 8 1/4"	WS-642-195	WS-642-200
23 cm / 9"	WS-642-196	WS-642-201

 Without Lock
 Hard Material

14.5 cm / 5 3/4"	WS-642-202	WS-642-207
17 cm / 6 3/4"	WS-642-203	WS-642-208
18 cm / 7 1/4"	WS-642-204	WS-642-209
21 cm / 8 1/4"	WS-642-205	WS-642-210
23 cm / 9"	WS-642-206	WS-642-211



14.5 cm / 5 3/4"



17 cm / 6 3/4"



18.5 cm / 7 1/4"



21 cm / 8 1/4"



23 cm / 9"

With lock
Hard Material



Length	5/0 & Smaller
18.5 cm / 7 1/4"	WS-643-212
21 cm / 8 1/4"	WS-643-213
23 cm / 9"	WS-643-214
Without lock Hard Material	
18.5 cm / 7 1/4"	WS-643-215
21 cm / 8 1/4"	WS-643-216
23 cm / 9"	WS-643-217



18.5 / 7 1/4"



21 cm / 8 1/4"



23 cm / 9"

Micro Needle Holders, Flat Grip | Micro Porta Agujas, Apertón Plano
Diadust Mikro-Nadelhalter mit Flachgriffen



Glasser
WS-644-218
Hard Materials
5/0 And Smaller
18 cm / 7"



Glasser
WS-644-219
Hard Materials
5/0 And Smaller
12.5 cm / 5"



WS-644-220

WS-644-221



18 cm / 7"
With Lock



WS-644-222
With Lock
Hard Materials
5/0 And Smaller
21 cm / 8 1/4"



WS-644-223
Without Lock
Hard Materials
5/0 And Smaller
21 cm / 8 1/4"

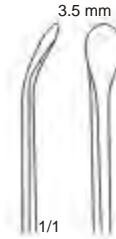

WS-645-003
Dissector
Semi Sharp
Curved

WS-645-004
Dissector
Semi Sharp
Curved

WS-645-005
Dissector
Semi Sharp
Curved



Yasargil
WS-645-001
20 cm / 8"



Yasargil
WS-645-002
22 cm / 8 3/4"



Al Mefty
20 cm / 8"



Al Mefty
WS-645-006
21.5 cm / 8 1/2"



1/1
WS-646-007

1/1
WS-646-008

1/1
WS-646-009

1/1
WS-646-010

Caspar
24.5 cm / 9¾"

Caspar
WS-646-011
21.5 cm / 8½"

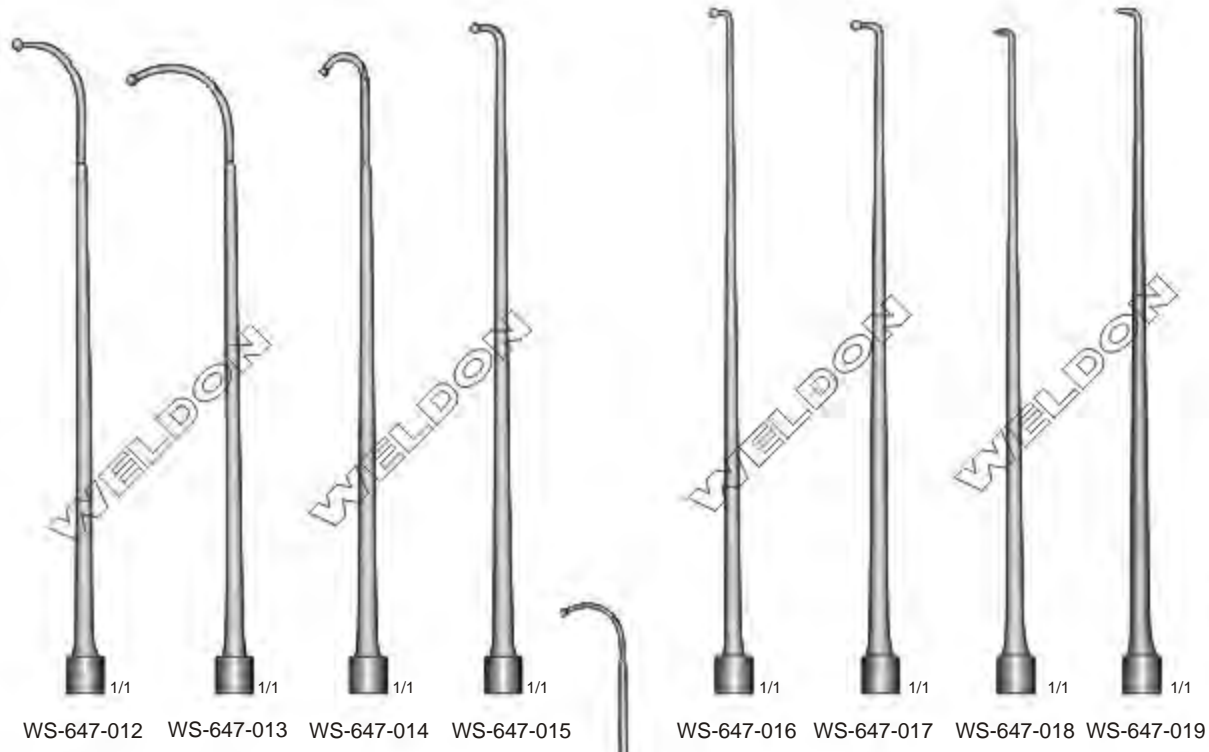

Yasargil
18.5 cm / 7¼"



Krayenbühl
18.5 cm / 7¼"



Vascular Dilator
12.5 cm / 5"

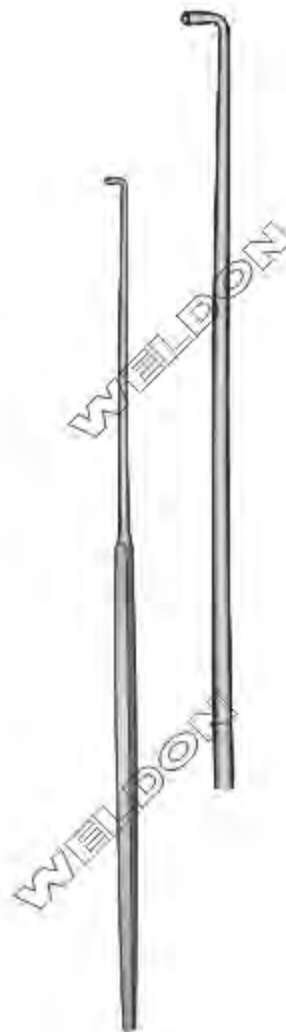

Cushing
WS-648-023
28 cm / 11"



Jacobson
WS-648-024
8.5 cm / 7 1/4"
Button Probe Ended
Angled

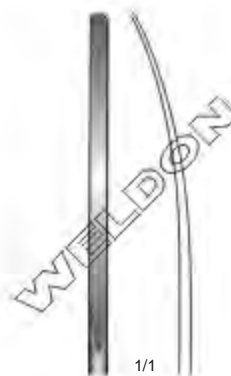

WS-649-025
18.5 / 7 1/4"



WS-649-026
21.5 cm / 8 1/2"



Caspar
WS-649-027
23 cm / 9"



Caspar
WS-649-028
23 cm / 9"



Caspar
WS-649-029
23 cm / 9"



Caspar
WS-650-030
Micro Dissector
20 cm / 8"



Caspar
WS-650-031
Micro Dissector
21 cm / 8 1/4"



Caspar
WS-650-032
Micro Dissector
21 cm / 8 1/4"



Caspar
WS-650-033
Ligature Adjuster
23 cm / 9"

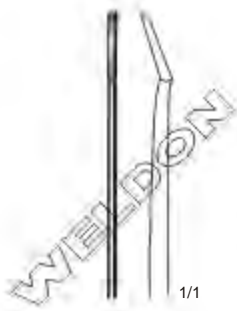

WS-651-034
Micro Raspatory
Angled



WS-651-035
Micro Dissector
Angled



WS-651-036
Micro Dissector
Angled



WS-651-037
Micro Raspatory
Semi Curved



WS-651-038
Micro Raspatory
Curved



Yasargil
18.5 cm / 7¼"



WS-652-039
Micro Raspatory
Semi Curved



WS-652-040
Micro Raspatory
Semi Curved

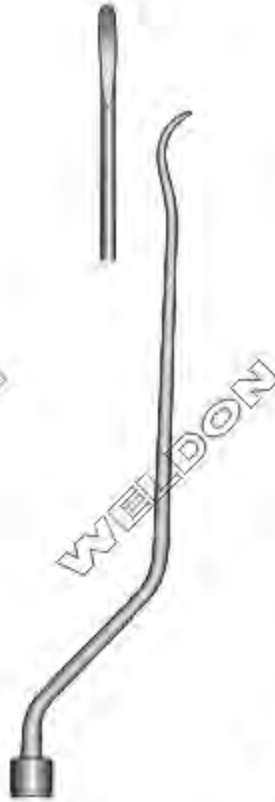

WS-652-041
Micro Raspatory
Upward



WS-652-042
Micro Curette
Sharp



Yasargil
18.5 cm / 7 1/4"

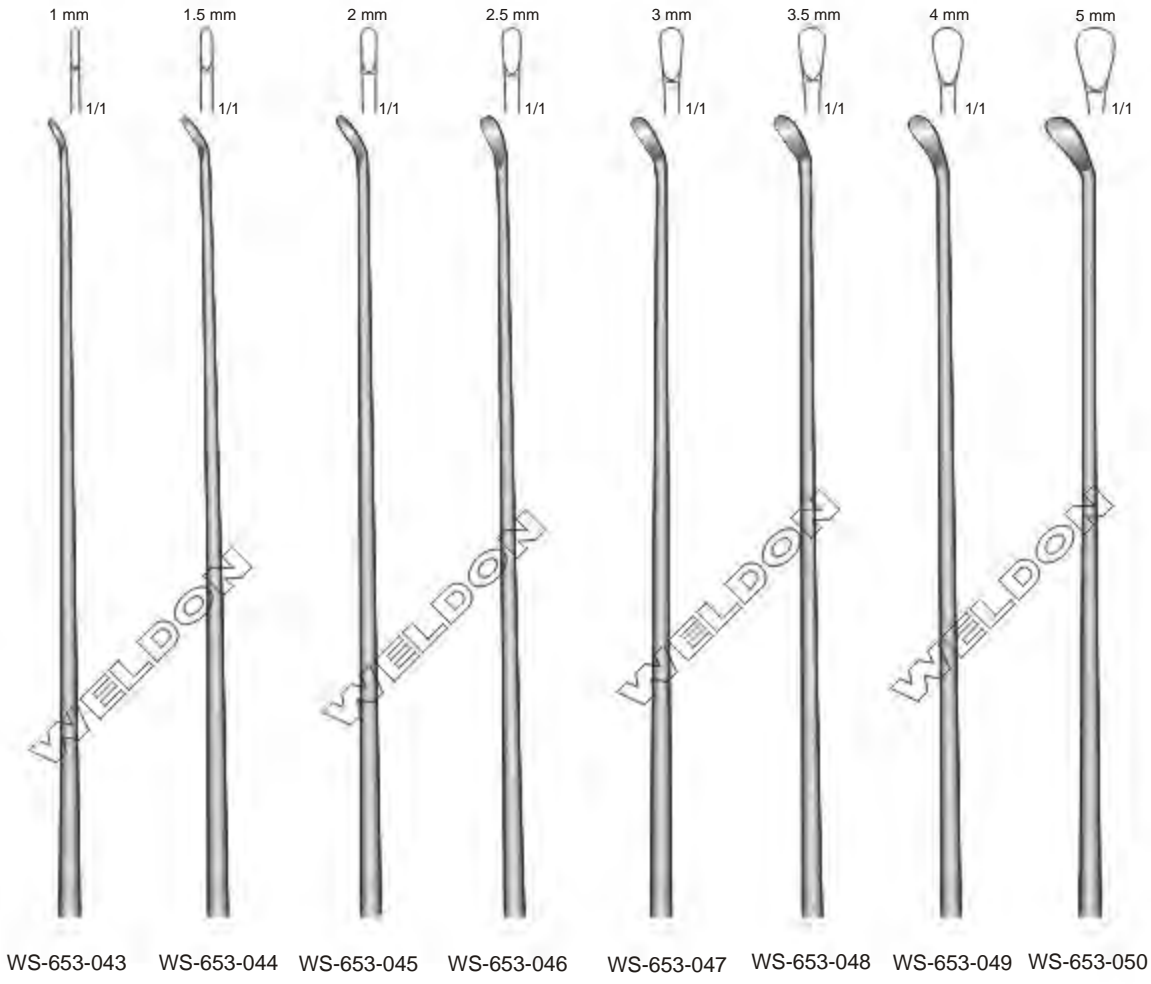

Samii
23 cm / 9"

Tumor Knives | Cuchillos Para Tumor | Tumormesser



WS-654-051

WS-654-052

WS-654-053

WS-654-054



Samii
23 cm / 9"

Samii
WS-654-055
Tumor Fabric Dispenser
23 cm / 9"

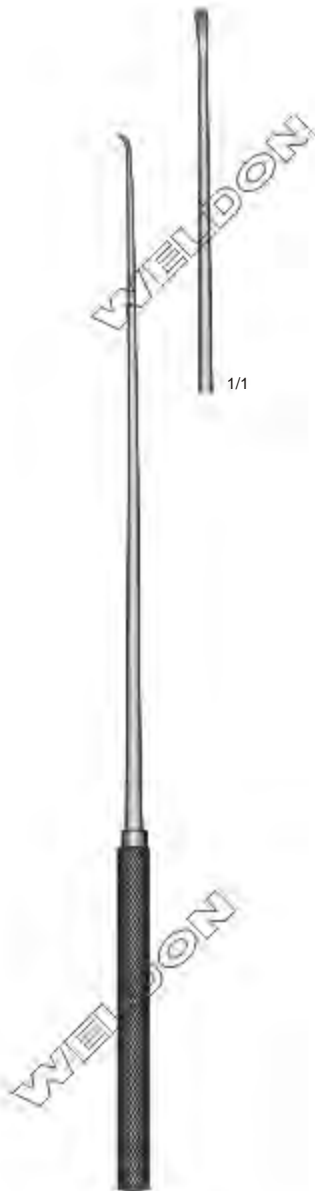

Oppel
WS-655-056
Micro Dissector
23 cm / 9"
Flexible, Sharp



Oppel
WS-655-057
Button Ended Probe
23 cm / 9"
Button Ø 2 mm, Angled 90°
Flexible, Blunt



Oppel
WS-655-058
Button Ended Probe
23 cm / 9"
Button Ø 2 mm, Angled 45°
Flexible, Blunt



WS-656-059
Micro Dissector
23 cm / 9"
Upward



WS-656-060
Micro Dissector
23 cm / 9"
Semi Curved, Blunt



WS-656-061
Micro Raspatory
23 cm / 9"
With Platform



WS-656-062
Micro Dissector
23 cm / 9"
Blunt



WS-656-063
Micro Raspatory
23 cm / 9"
With Platform



WS-657-064
Micro Hook
23 cm / 9"
Semi Sharp



WS-657-065
Micro Hook
23 cm / 9"
Blunt



WS-657-066
Micro Dissector
23 cm / 9"
Straight



WS-657-067
Micro Dissector
23 cm / 9"
Straight



WS-658-068
Micro Curette
Sharp
23 cm / 9"



WS-658-069
Micro Curette
Sharp, Angled
23 cm / 9"



WS-658-070
Micro Raspatory
With Platform
23 cm / 9"



Koos
WS-659-071
Upward

Koos
WS-659-072
Semi Curved

Koos
WS-659-073
Upward

Koos
WS-659-074
Semi Curved

Yasargil
WS-659-075
Semi Curved

Yasargil
WS-659-076
Upward



18.5 cm / 7 1/4"

Sharp Curettes, Micro Vascular Knives | Curetas Cortantes, Micro Cuchillos Vasculares
 Gewebekrallen, Scharfe Haken, Mikro-Gefäßmesser



WS-660-077
Holder
18.5 cm / 7 1/4"



Fisch
WS-660-078
Curette
Sharp, Angled 90°
18.5 cm / 7 1/4"



WS-660-079
Curette
Sharp, Angled 90°
18.5 cm / 7 1/4"



WS-660-080
Vascular Knife
Replaceable Grip For Splinter
10.5 cm / 4 1/8"



Jacobson
WS-660-081
12.5 cm / 5"



WS-660-082
Vascular Knife
18.5 cm / 7 1/4"

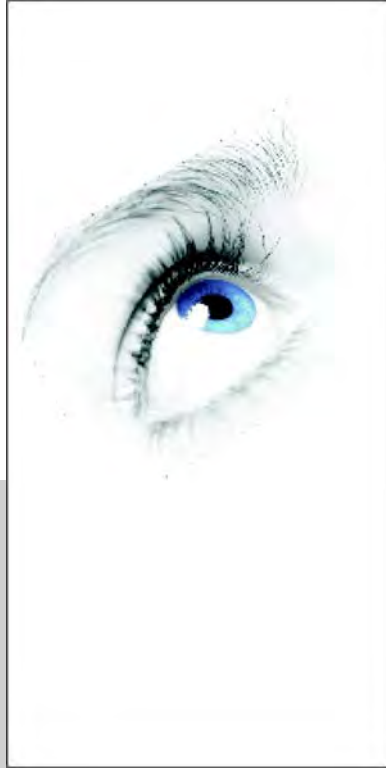

www.weldoninstruments.com

PROVEEDOR EXCLUSIVO:



Cannulas & I/A Instruments

Eye Speculas

Forceps & Scissors

Needle Holders & Retractors

661 - 752

Ophthalmology

Ophthalmology
Oftalmologia
Augenheilkunde



WS-661-001
Fixier Measuring Instrument
4.5 cm / 1 3/4"



Castroviejo
WS-661-002
Marking Caliper
15 mm



Castroviejo
WS-661-003
Marking Caliper
20 mm



Mendez
WS-661-004
11.5 cm / 4 1/2"
Measuring Ring



Maloney
WS-661-005
Keratometer



Modell Giessen
WS-661-006
Scale 1 - 30 mm



Scale
WS-661-007
1-20 cm

Cannulas | Cánulas | Kanülen

Kratz
WS-662-001
 Capsule Polishing Cannula

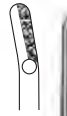

Kratz
WS-662-002
 Irrigating and Polishing Cannula
 20 Gauge / 0.90 x 34 mm



Teping
WS-662-003
 Aspirating Polishing Cannula
 23 Gauge / 0.64 mm



WS-662-004
 Capsule Polishing Cannula
 With Bulbous Tip
 18 Gauge / 1.20 mm



Kyu
WS-662-005
 Capsule Polishing Cannula
 22 Gauge / 0.70 mm



Kyu
WS-662-006
 Capsule Polishing Cannula
 23 Gauge / 0.64 mm



Greite
WS-662-007
 Capsule Polishing Cannula With Spoon
 22 Gauge / 0.70 mm



Brauweiler
WS-662-008
 Irrigating Cannula, Angled
 With Bulbous Tip, Rough
 21 Gauge / 0.80 mm



Busse
WS-662-009
 Cyclodialysis Spatula Cannula
 Length of Spatula 12 mm
 26 Gauge / 0.45 mm



WS-662-010
 Cyclodialysis Spatula Cannula
 Extremely Delicate
 Length of Spatula 10 mm
 26 Gauge / 0.45 mm

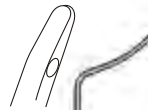

Mainz Model
WS-662-011
 Cyclodialysis Spatula Cannula
 Length of Spatula 12 mm
 2 Lateral Irrigating Openings
 20 Gauge / 0.90 mm



WS-662-012
 Irrigating Cystotome Cannula
 26 Gauge / 0.45 mm



Enzyme Cannula
WS-663-013
24 Gauge / 0.60 mm



Sautter
WS-663-014
Hydrodissection Cannula
27 Gauge / 0.40 mm



Sautter
WS-663-015
Hydrodissection Cannula
26 Gauge / 0.45 mm



Tuebingen Model
WS-663-016
Hydrodissection Cannula
30 Gauge / 0.30 mm



Frankfurt Model
WS-663-017
Hydrodissection Cannula
27 Gauge / 0.40 mm



Müller
WS-663-018
Irrigating Cannula
With Probe Tip
26 Gauge / 0.45 x 19 mm
Right



Müller
WS-663-019
Irrigating Cannula
With Prob Tip
26 Gauge / 0.45 x 19 mm
Left



Rentsch
WS-663-020
Irrigating Cannula
26 Gauge / 0.45 x 24 mm



Binkhorst
WS-663-021
Irrigating Cannula
22 Gauge / 0.70 x 36 mm
Right



Binkhorst
WS-663-022
Irrigating Cannula
22 Gauge / 0.7 x 36 mm
Left



Irrigating Cannula
WS-663-023
With Bulbous Tip
Extremely Delicate



Simcoe
WS-663-024
Irrigating/ Aspirating Cannula
Irrigating And Aspirating Tube
23 Gauge / 0.64 mm Each



Irrigating/ Aspirating Cannula
WS-663-025
Round Curve
Irrigating And Aspirating Tube
23 Gauge / 0.64 mm Each



Irrigating/ Aspirating Cannula
WS-663-026 22 Gauge / 0.70 mm Each
WS-663-027 26 Gauge / 0.45 mm Each
Irrigating And Aspirating Tube

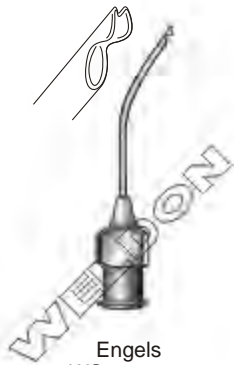

Engels
WS-664-028
 Iris Retractor
 Irrigating Cannula Tube
 21 Gauge / 0.8 mm

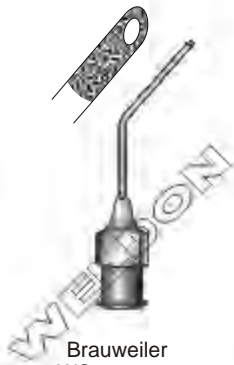

Brauweiler
WS-664-029
 Aspirating Cannula
 Angled, Bevelled, Rough
 21 Gauge / 0.80 mm

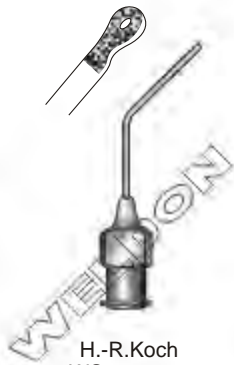

H.-R.Koch
WS-664-030
 Aspirating Cannula
 Angled, Rough
 21 Gauge / 0.80 mm

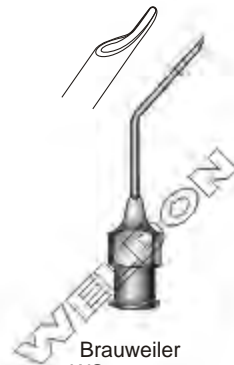

Brauweiler
WS-664-031
 Irrigating Cannula
 Angled
 21 Gauge / 0.80 mm

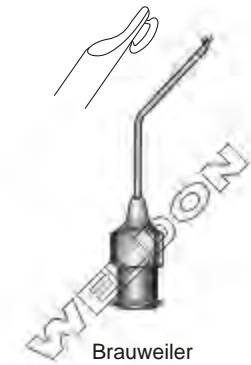

Brauweiler
WS-664-032
 Irrigating Cannula
 Angled
 With Bulbous Tip, Rough
 21 Gauge / 0.80 mm

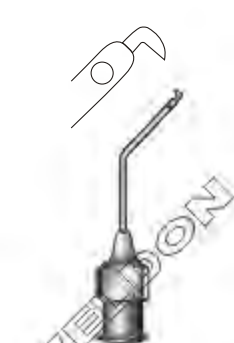

Agarwal
WS-664-033
 Irrigating Nucleus Chopper
 Tube 20 Gauge / 0.90 mm



Bonn Model
WS-664-034
 Lacrimal Cannula
 With Probe Tip



Bangerter
WS-664-035 21 Gauge / 0.80 x 60 mm
WS-664-036 23 Gauge / 0.64 x 60 mm
WS-664-037 21 Gauge / 0.80 x 40 mm
WS-664-038 23 Gauge / 0.64 x 40 mm
 Lacrimal Probe Cannula



Jünemann
 Lacrimal Probe Cannula
WS-664-039
 To Insert Suture Material
 21 Gauge / 0.80 x 35 mm



Jünemann
 Lacrimal Probe Cannula
WS-664-040
 To Insert Suture Material
 21 Gauge / 0.80 x 35 mm



Lacrimal Cannula
 WS-665-041 Silver
 WS-665-042 Stainless Steel
 Conical, Straight



Lacrimal Cannula
 WS-665-043 Silver
 WS-665-044 Stainless Steel
 Conical, Round Curve



Lacrimal Cannula
 WS-665-045 Silver
 WS-665-046 Stainless Steel
 Conical, Short Angle



Lacrimal Cannula
 WS-665-047 Silver
 WS-665-048 Stainless Steel
 Conical, Wide Angle



Lacrimal Cannula
 WS-665-049
 Cylindrical, Straight
 20 Gauge / 0.90 x 35 mm



Anel
 Lacrimal Cannula
 WS-665-050
 Straight
 23 Gauge / 0.64 mm



Anel
 Lacrimal Cannula
 WS-665-051
 Round Curve
 23 Gauge / 0.64 mm



Zirm
 WS-665-052
 Lasik Dissector Cannula
 25 Gauge / 0.5 mm



Zirm
 WS-665-053
 Lasik Irrigating Cannula
 20 Gauge / 0.9 mm



Nagata
 WS-665-054
 Sub-Tenon Injection Cannula
 24 Gauge / 0.60 mm



Dardenne
 WS-665-055
 Positioning Needle Cannula
 30 Gauge / 0.30 mm



Waldemar Bauer
 WS-665-056
 Lasik Cannula
 Double-Armed
 6 Irrigating Ports
 25 Gauge / 0.5 mm

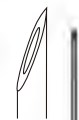

Retrobulbar
 WS-665-057 24 Gauge / 0.55 x 60 mm
 WS-665-058 25 Gauge / 0.50 x 35 mm
 WS-665-059 24 Gauge / 0.55 x 35 mm
 WS-665-060 25 Gauge / 0.50 x 50 mm
 WS-665-061 25 Gauge / 0.50 x 40 mm
 Injection Cannula



WS-666-062
Irrigating Vectis
Cannula



WS-666-063
Irrigating Vectis
Cannula
Small Model



Klöckner
WS-666-064
Expressor Cannula



PH.Jacobi
WS-666-065
Trabecular Aspirating Cannula



Burk
WS-666-066
Irrigating
Trabeculotomy Cannula
Right



Burk
WS-666-067
Irrigating
Trabeculotomy Cannula
Left



Irrigating Cannula
WS-666-068
For Visco Canalostomy
25 Gauge / 0.49 mm
7.0 mm Angled
Tapered Tube 5.0 mm Curved
0.19 mm



Aspirating Cannula
WS-666-069
Delicate
19 Gauge / 1.10 mm



Aspirating Cannula
WS-666-070
17 Gauge / 1.50 mm



Healon Cannula
WS-666-071
21 Gauge / 0.80 x 30 mm



Aspirating Cannula
WS-666-072
Inside: 24 Gauge / 0.55 mm
Outside: 20 Gauge / 0.9 mm



Aspirating Cannula
WS-666-073
Tapered Tube / 3.5 mm
25 Gauge / 0.5 mm



Aspirating Cannula
WS-666-074
Lateral Aspirating Port / 0.5 mm
20 Gauge / 0.9 mm



Laqua
WS-666-075
Aspirating Cannula
Inside: 21 Gauge / 0.8 mm
Outside: 19 Gauge / 1.1 mm



Kampik
WS-667-076
Aspirating Cannula
Inside: 22 Gauge / 0.7 mm
Outside: 20 Gauge / 0.9 mm



Aspirating Cannula
WS-667-077
With Silicone Brush
20 Gauge / 0.9 mm



Aspirating Cannula
WS-667-078
20 Gauge / 0.9 mm
Tapered Tube 7.0 mm
3.5 mm Angled
24 Gauge / 0.60 mm



Aspirating Tip
WS-667-079
20 Gauge / 0.9 mm



Aspirating Tip
WS-667-080
3.0 mm Angled
20 Gauge / 0.9 mm



Aspirating Tip
WS-667-081
With Silicone Tube at The Tip
20 Gauge / 0.9 mm



Aspirating Tip
WS-667-082
3.0 mm Angled
With Silicone Tube at The Tip
20 Gauge / 0.9 mm



Aspirating Tip
WS-667-083
Curved
Lateral Aspirating Port 0.3 mm
24 Gauge / 0.60 mm



Aspirating Tip
WS-667-084
Tapered Tube
5.0 mm Angled
30 Gauge / 0.3 mm
Aspirating Port Oval



Aspirating Tip
WS-667-085
20 Gauge / 0.9 mm
Tapered Tube 2.0 mm
24 Gauge / 0.6 mm



Weber
WS-667-086 5.0 mm
WS-667-087 10.0 mm
Aspirating Cannula
For Viscous Fluid
Inside: 22 Gauge / 0.7 mm
Outside: 20 Gauge / 0.9 mm



Roider
WS-667-088
Aspirating Cannula
For Viscous Fluid
Lateral Aspiration Port 0.7 mm
19 Gauge / 1.0 mm



Pfl-Cannula
WS-667-089
With Two Tubes
24 Gauge / 0.55 mm
Lateral Tube
25 Gauge / 0.5 mm



Bartz-Schmidt
WS-667-090
20 Gauge / 0.9 mm
2 Lateral Ports 0.5 mm
90° Transposed
Tapered Tube 19 mm
25 Gauge / 0.5 mm
With Probe Tip 0.9 mm
Aspirating Port 0.15 mm



Heidelberg Model
WS-667-091
Injection Cannula
For Viscous Fluid,
1.20 mm, 30°



WS-668-092
Irrigating Cannula Handpiece



Brauweiler WS-668-093
Irrigating Cannula Handpiece



Brauweiler WS-668-094
Aspirating Cannula Handpiece



D.D Koch-T. Kohnen WS-668-095
9 cm / 3 1/2"
Aspirating Handpiece
Aspirating Port 0.30 mm
Rough Tip
Tube 22 Gauge / 0.7 mm



D.D Koch-T. Kohnen WS-668-096
9 cm / 3 1/2"
Irrigating Handpiece
Tube 22 Gauge / 0.7 mm

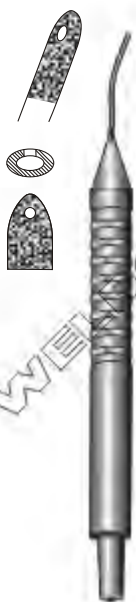

Aspirating Handpiece WS-668-097
9 cm / 3 1/2"
Aspirating Port 0.25 mm
Conical And Rough Tip
Oval Tube 0.95 x 0.55 mm



Irrigating Handpiece WS-668-098
9 cm / 3 1/2"
Irrigating Port 0.50 mm
Conical Tip
Oval Tube 0.95 x 0.55 mm



WS-668-099
9 cm / 3 1/2"
Aspirating Handpiece
Aspirating Port 0.30 mm
Tube 21 Gauge / 0.80 mm
Conical And Rough Tip



WS-668-100
9 cm / 3 1/2"
Irrigating Handpiece
Irrigating Ports 2 x 0.50 mm
Tube 21 Gauge / 0.80 mm
Conical And Rough Tip



Engels WS-668-101
9 cm / 3 1/2"
Iris Retractor-Irrigating Handpiece
Tube 21 Gauge / 0.8 mm



R. Koch
WS-669-102
 9 cm / 3½"
 Aspirating Port 0.3 mm
 Tube 19 Gauge / 1.1 mm
 Rough Tip



Brauweiler
WS-669-103
 9 cm / 3½"
 Angled
 Declined And Rough
 21 Gauge / 0.80 mm



H.-R. Koch
WS-669-104
 9 cm / 3½"
 Aspirating Handpiece
 Angled, Rough
 21 Gauge / 0.80 mm



Brauweiler
WS-669-105
 9 cm / 3½"
 Irrigating Handpiece
 Angled
 21 Gauge / 0.80 mm



Brauweiler
WS-669-106
 9 cm / 3½"
 Irrigating Handpiece, Angled
 With Bulbous Tip, Rough
 21 Gauge / 0.80 mm



R. Koch
WS-669-107
 9 cm / 3½"
 Irrigating Handpiece With Chopper
 Angled, Irrigating Ports 2 x 0.75 mm
 Tube 19 Gauge / 1.1 mm



Hoffmann
WS-669-108
 9 cm / 3½"
 Irrigating Handpiece With Chopper
 Angled, Irrigating Ports 2 x 0.5 mm
 Oval Tube 1.1 mm x 0.9 mm



Wilhelm
WS-669-109
 9 cm / 3½"
 Irrigating Handpiece With Chopper
 Angled, Irrigating Ports 2 x 0.75 mm
 Tube 19 Gauge / 1.1 mm



Neuhann/Sauder
WS-669-110
 9 cm / 3½"
 Irrigating Handpiece With Chopper
 Irrigating Ports 2 x 0.75 mm
 Tube 19 Gauge / 1.1 mm



HöH
WS-669-111
 9 cm / 3½"
 Chopper
 18 Gauge / 1.2 mm



Anis
WS-670-112
11.5 cm / 4½"
Ball Capsule Polisher



Rentsch
WS-670-113
11.5 cm / 4½"
Capsule Polishing Curette
Angled, 135°



Rentsch
WS-670-114
11.5 cm / 4½"
Capsule Polishing Curette
Angled, 135°



Meyhöfer
WS-671-001
11.5 cm / 4½"
Chalazion Curette
1 mm



Meyhöfer
WS-671-002
11.5 cm / 4½"
Chalazion Curette
2 mm



Meyhöfer
WS-671-003
11.5 cm / 4½"
Chalazion Curette
2.5 mm



Meyhöfer
WS-671-004
11.5 cm / 4½"
Chalazion Curette
3 mm



Meyhöfer
WS-671-005
11.5 cm / 4½"
Chalazion Curette
4 mm



Meyhöfer
WS-671-006
11.5 cm / 4½"
Chalazion Curette
4.5 mm

Curettes, Spoons | Curetas, Cucharas | Küretten, Löffel



Hebra
WS-672-007
Chalazion Curette
Small



Hebra
WS-672-008
Chalazion Curette
Medium



Hebra
WS-672-009
Chalazion Curette
Large



Axenfeld
WS-672-010
Chalazion Curette
Double Ended



Bunge
WS-672-011
Exenteration Curette
Medium



Bunge
WS-672-012
Exenteration Curette
Large



Rycroft A.C. Cannula
WS-673-013
 20 Gauge / 0.90 x 22 mm
WS-673-014
 25 Gauge / 0.50 x 25 mm
 5 Per Box, Sterile



Kratz Capsule Polisher
WS-673-015
 20 Gauge / 0.60 mm
WS-673-016
 21 Gauge / 0.80 mm
 5 Per Box, Sterile



Cystotome Cannula
WS-673-017
 Side Cutting
 25 Gauge / 0.50 mm
WS-673-018
 25 Gauge / 0.50 mm
 5 Per Box, Sterile



Sautter
WS-673-019
 Hydro Dissection Cannula
 27 Gauge / 0.40 x 22 mm
 5 Per Box, Sterile

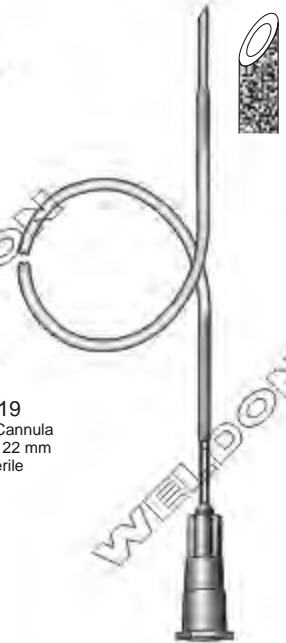

A.C. Maintainer
WS-673-020
 20 Gauge / 0.90 mm
 5 Per Box, Sterile



Hydro Dissection Cannula
WS-673-021
 With Flat Tip
 25 Gauge / 0.50 x 20 mm
 5 Per Box, Sterile



Lacrimal Cannula
WS-673-022
 Curved
 26 Gauge / 0.45 x 30 mm
 5 Per Box, Sterile



Irrigating vectis
Cannula
WS-673-023
 Double Hole
 25 Gauge / 0.50 Mm
 5 Per Box, Sterile



Irrigating / Aspirating Cannula
WS-673-024
 21 Gauge / 0.80 X 35 mm
 5 Per Box, Sterile

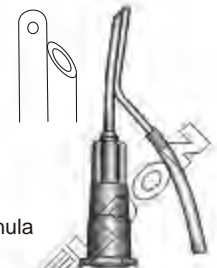

Simcoe
Irrigating / Aspirating
Cannula
WS-673-025
 Aspiration Port, 0.30 mm
 23/23 Gauge / 0.64 / 0.64 mm
 5 Per Box, Sterile



Retrolbulbar Cannula
WS-673-026
 25 Gauge / 0.50 x 40 mm
 5 Per Box, Sterile



Retrolbulbar cannula
WS-673-027
 Extra Long
 25 Gauge / 0.50 x 50 mm
 5 Per Box, Sterile



Atkinson
WS-673-028
 Retrolbulbar Cannula
 25 Gauge / 0.50 x 40 mm
 5 Per Box, Sterile



Atkinson
WS-673-029
 Retrolbulbar Cannula
 23 Gauge / 0.64 x 40 mm
 5 Per Box, Sterile



Atkinson
WS-673-030
 Peribulbar Cannula
 25 Gauge / 0.50 x 30 mm
 5 Per Box, Sterile

Eye Speculas | Especulos Oculares | Augenspekula



Barraquer
WS-674-001
Eye Speculum
Fenestrated



Barraquer
WS-674-002
Eye Speculum
Solid Blades



Barraquer
WS-674-003
Eye Speculum
Fenestrated
For Premature Infants



Barraquer
WS-674-004
Eye Speculum
Fenestrated, For Infants



Barraquer
WS-674-005
4 cm / 1 1/2"
Eye Speculum
Fenestrated, Round Blades



Barraquer
WS-674-006
Eye Speculum
Fenestrated, Round Blades



Barraquer
WS-674-007
Eye Speculum
Fenestrated, Round Blades
For Infants



Barraquer
WS-674-008
Eye Speculum
Fenestrated, Open Blades



Barraquer
WS-674-009
Frankfurt Model
Eye Speculum
Fenestrated, Large



Kratz-Barraquer
WS-675-010
Eye Speculum
Fenestrated, Round Blades



OHNO
WS-675-011 Right
WS-675-012 Left
Eye Speculum
Fenestrated



H.R.KOCH
WS-675-013
Eye Speculum
For Nasal Placement
Fenestrated
Open Blades



Eye Speculum
WS-675-014
For Nasal Placement
Fenestrated
Round Blades

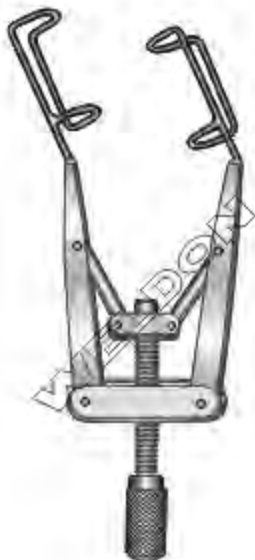

Kershner
WS-675-015
Eye Speculum
Open Blades
For Nasal And Temporal Placement

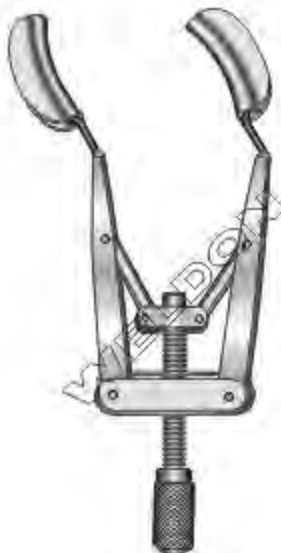

Kershner
WS-675-016
Eye Speculum
Solid Blades
For Nasal And Temporal Placement

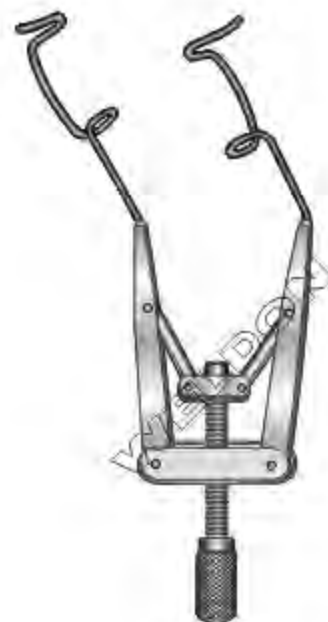

Liebermann-Tennant
WS-675-017
Eye Speculum
Fenestrated, Open Blades
For Temporal Placement

Eye Speculas, Adjustable | Especulos Oculares, Adjustable | Augenspekula, Justierbar

Barraquer-Oosterhuis
WS-676-018
 Eye Speculum
 Adjustable, Fenestrated



Barraquer-Oosterhuis
WS-676-019
 Eye Speculum
 Adjustable, Fenestrated
 For Infants



Barraquer-Oosterhuis
WS-676-020
 Eye Speculum
 Adjustable, Solid Blades



Barraquer-Oosterhuis
WS-676-021
 Eye Speculum
 Adjustable, Solid Blades
 For Infants



Barraquer-Oosterhuis
WS-676-022
 Eye Speculum
 Adjustable, Fenestrated
 Round Blades



Barraquer-Oosterhuis
WS-676-023
 Eye Speculum
 Adjustable, Fenestrated
 Round Blades, For Infants



Neuhann
WS-676-024 Solid Blades
WS-676-025 Fenestrated
 Eye Speculum
 Adjustable (Not Illustrated)



Barraquer-Oosterhuis-Kratz
WS-676-026
 Eye Speculum
 Adjustable, Fenestrated
 Open Blades



Kratz-Barraquer
WS-676-027
 Eye Speculum
 For Adults



Tazawa
WS-676-028 Right, Adjustable, Fenestrated
WS-676-029 Left, Adjustable, Fenestrated
 Eye Speculum
 Round Blades



Weiss
WS-677-030
Eye Speculum
Fenestrated



Weiss
WS-677-031
Eye Speculum
Fenestrated, Open Blades



Weiss
WS-677-032
Eye Speculum
Fenestrated, For Infants

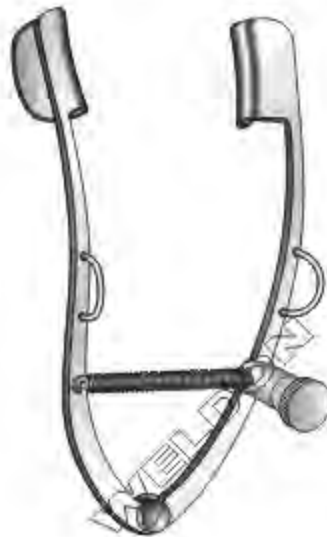

Weiss
WS-677-033
Eye Speculum
Solid Blades



Weiss
WS-677-034
Eye Speculum
Solid Blades, For Infants

Eye Speculas, Adjustable | Especulos Oculares, Adjustable | Augenspekula, Justierbar



Cook
WS-678-035
Eye Speculum
Large



Cook
WS-678-036
Eye Speculum
Medium



Cook
WS-678-037
Eye Speculum
Small



Murdock
WS-678-038
Eye Speculum
Right



Murdock
WS-678-039
Eye Speculum
Left



Murdock
WS-678-040
Eye Speculum
Small, Right



Murdock
WS-678-041
Eye Speculum
Small, Left



Cook
WS-679-042
Eye Speculum
For Infants



Bangerter
WS-679-043
Eye Speculum



Pretori
WS-679-044 Left
WS-679-045 Right
Eye Specula



Sauer
WS-679-046
Eye Speculum



Takeda
WS-679-047
Eye Speculum
Fenestrated, For Infants



Castroviejo
WS-679-048 Small (14 mm Blades)
WS-679-049 Medium (16 mm Blades)
WS-679-050 Large (18 mm Blades)
Lidsperre

Eye Speculas,Adjustable | Especulos Oculares,Adjustable | Augenspekula,Justierbar



Mellinger
WS-680-051
Eye Speculum

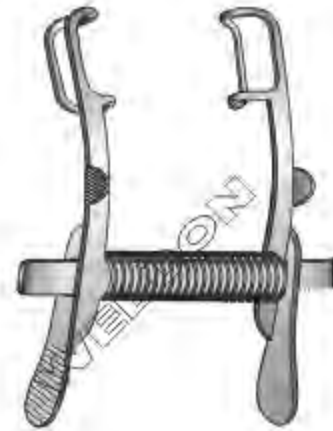

Mellinger
WS-680-052
Eye Speculum
For Infants



Mellinger-Beard
WS-680-053
Eye Speculum

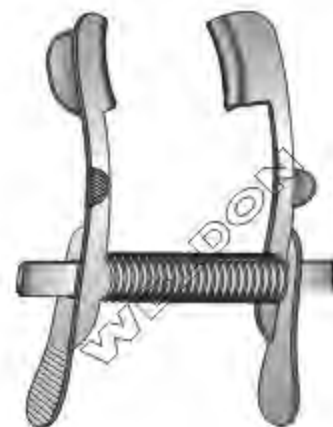

Mellinger-Beard
WS-680-054
Eye Speculum
For Infants

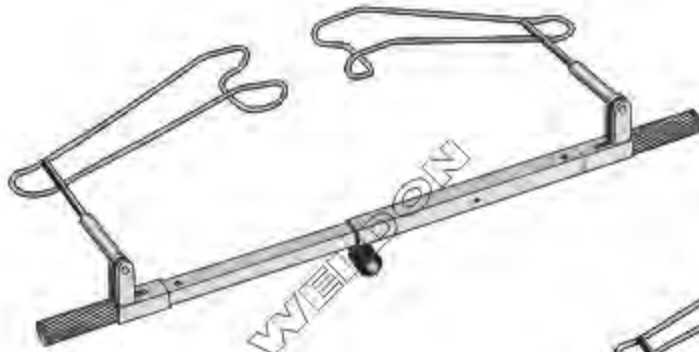

Schott
WS-681-055
Eye Speculum
Fenestrated
Weight 17gm

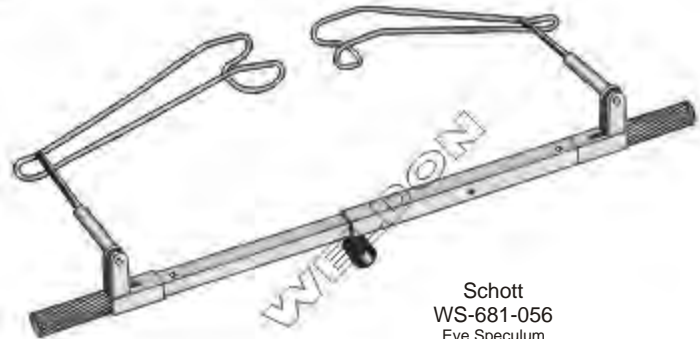

Schott
WS-681-056
Eye Speculum
Fenestrated, For Infants
Weight 17gm

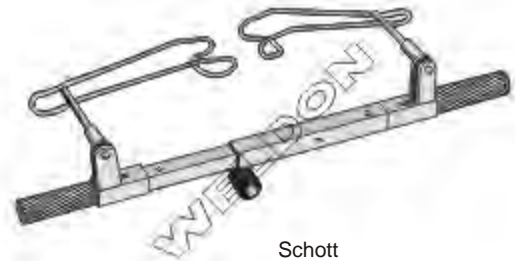

Schott
WS-681-057
Eye Speculum
Fenestrated, For Infants
Weight 13 gm



Schott
WS-681-058
Eye Specula
Solid Blades
Weight 17gm

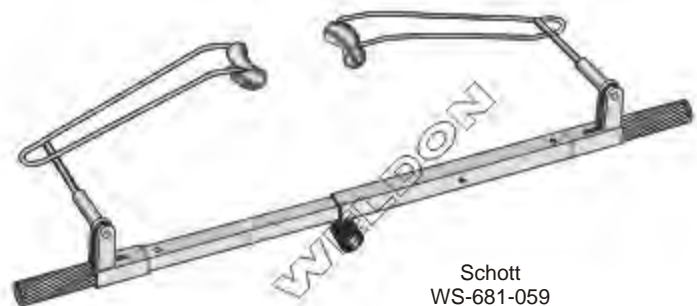

Schott
WS-681-059
Eye Speculum
Fenestrated With Aspiration
For Infants
Weight 17gm

Fixation Rings | Anillos de Fijación | Fixierungs-Ringe

Thornton
WS-682-001
10 cm / 4"
Fixation Ring
Inside Diameter 16 mm
12 Teeth



Thornton
WS-682-002
10 cm / 4"
Fixation Ring
Inside Diameter 16 mm
Swivelable 12 Teeth



Clear-Cornea-Incision
WS-682-003
10 cm / 4"
Fixation Ring
Inside Diameter 16 mm
Swivelable 12 Teeth



Clear-Cornea-Incision
WS-682-004
10 cm / 4"
Fixation Ring
Inside Diameter 16 mm
12 Teeth



Clear-Cornea-Incision
WS-682-005
10 cm / 4"
Fixation Ring
Inside Diameter 13 mm
9 Teeth



Fixation Ring
WS-682-006
10 cm / 4"
With Concentric Grooves
In The Interior Part Of The Ring
Inside Diameter 12 mm



Flieringa Fixation Ring
WS-682-007 15 mm
WS-682-008 16 mm
WS-682-009 17 mm
WS-682-010 18 mm
WS-682-011 19 mm
WS-682-012 20 mm
10 cm / 4"



Eye Dressing Forceps
WS-683-001AA
 Delicate, 0.7 mm Wide At Tip
WS-683-001A
 0.8 mm Wide At Tip
 10.0 cm / 4"
 Serrated, Straight

Eye Dressing Forceps
WS-683-001BB
 Delicate, 0.7 mm Wide At Tip
WS-683-001B
 0.8 mm Wide At Tip
 9.9 cm / 3³/₁₆"
 Serrated, Half Curved

Eye Dressing Forceps
WS-683-001CC
 Delicate, 0.7 mm Wide At Tip
WS-683-001C
 0.8 mm Wide At Tip
 9.7 cm / 3³/₁₆"
 Serrated, Full Curved

Iris Forceps
WS-683-001DD
 Delicate, 0.7 mm Wide At Tip
WS-683-001D
 0.8 mm Wide At Tip
 10 cm / 4"
 Straight, 1 x 2 Teeth

Iris Forceps
WS-683-001EE
 Delicate, 0.7 mm Wide At Tip
WS-683-001E
 0.8 mm Wide At Tip
 9.9 cm / 3³/₁₆"
 Half Curved, 1 x 2 Teeth

Iris Forceps
WS-683-001FF
 Delicate, 0.7 mm Wide At Tip
WS-683-001F
 0.8 mm Wide At Tip
 9.7 cm / 3³/₁₆"
 Full Curved, 1 x 2 Teeth

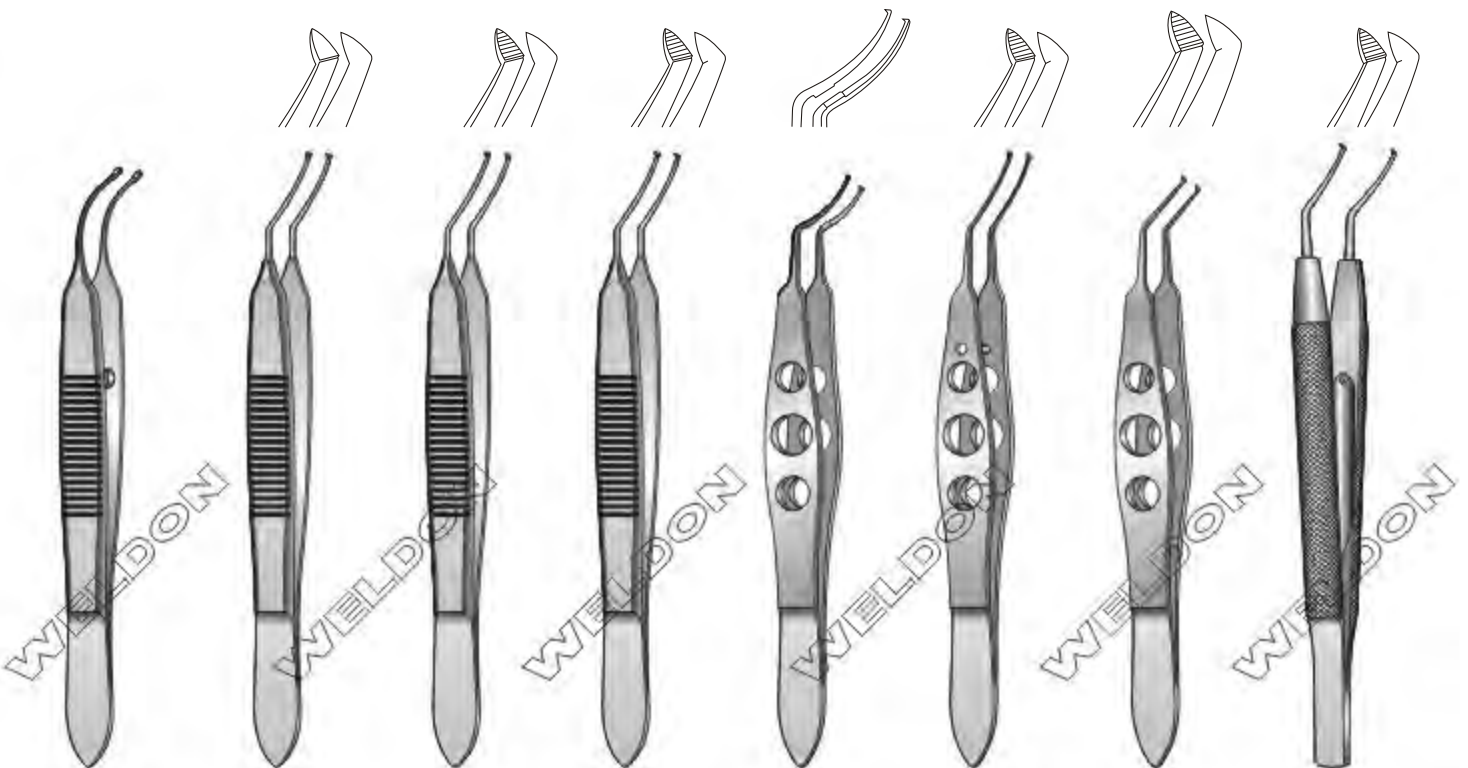

Arruga
WS-683-001
 10.5 cm / 4¹/₂"
 Capsule Forceps
 Calibrated Delicate

WS-683-002
 10.5 cm / 4¹/₂"
 Capsulorhexis Forceps
 Without Ridge
 Extremely Delicate

H.R.Koch
WS-683-003
 10.5 cm / 4¹/₂"
 Capsulorhexis Forceps
 With 2 - 13 mm Gauge

WS-683-004
 10.5 cm / 4¹/₂"
 Capsulorhexis Forceps
 Extremely Delicate

Masket
WS-683-005
 10.5 cm / 4¹/₂"
 Capsulorhexis Forceps

WS-683-006
 10.5 cm / 4¹/₂"
 Capsulorhexis Forceps
 Extremely Delicate

WS-683-007
 10.5 cm / 4¹/₂"
 Capsulorhexis Forceps
 Strong Model

WS-683-008
 10.5 cm / 4¹/₂"
 Capsulorhexis Forceps
 Extremely Delicate
 Round Handle

Forceps | Pinzas | Pinzetten

Lambert
WS-684-009
 10 cm / 4"
 Chalazion Forceps



Ayer
WS-684-010
 10 cm / 4"
 Chalazion Forceps



Desmarres
WS-684-011 20 mm
WS-684-012 25 mm
WS-684-013 31 mm
 9 cm / 3½"
 Chalazion Forceps



Cauer
WS-684-014
 Chalazion Forceps



Tobias Neuhann
WS-684-015
 12.5 cm / 5"
 Multifunction Micro Forceps
 23 Gauge / 0.65 mm

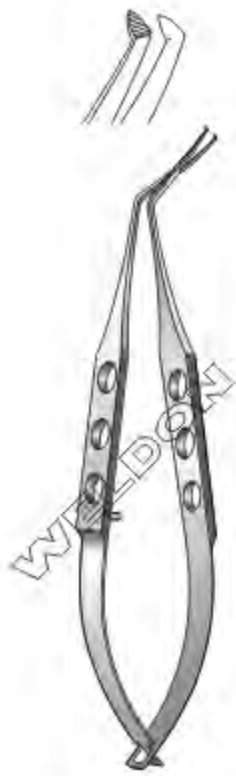

N. Inamura
WS-684-016
 11.5 cm / 4½"
 Capsulorhexis Forceps



Berke
WS-684-017
 9.5 cm / 3¾"
 Ptosis Forceps



Henry
WS-685-018
10 cm / 4"
Cilia Forceps



Gradle
WS-685-019
10 cm / 4"
Cilia Forceps



Barraquer
WS-685-020
10 cm / 4"
Cilia Forceps



Saupe
WS-685-021
10 cm / 4"
Cilia Forceps



Beer
WS-685-022
10 cm / 4"
Cilia Forceps



Bonaccolto
WS-685-023
11 cm / 4 1/8"



Barraquer
WS-685-024
10 cm / 4"
Cilia Forceps



Hamburg Model
WS-685-025
10 cm / 4"
Cilia And Foreign Body Forceps

Forceps | Pinzas | Pinzetten



Von Barsewisch
WS-686-026
8 cm / 3"
Anterior Chamber Forceps



Colibri Forceps
WS-686-027
8 cm / 3"
With Tying Platform

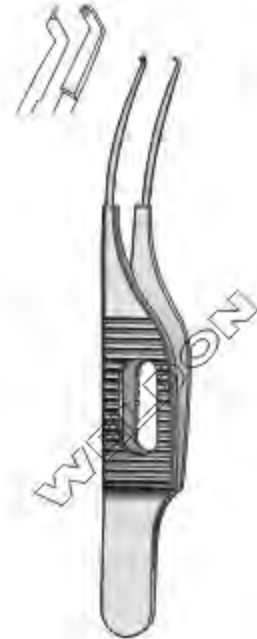

Micro Colibri Forceps
WS-686-028
8 cm / 3"
With Tying Platform



Micro Colibri Forceps
WS-686-029
8 cm / 3"
With Tying Platform-Extremely Delicate

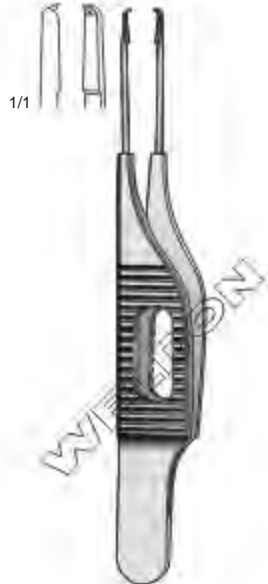

Zuerich Model
WS-686-030
8 cm / 3"
Suturing Forceps
Straight Delicate



Zuerich Model
WS-686-031
8 cm / 3"
Suturing Forceps
Angled Delicate



Von Graefe
WS-687-032A
11.4 cm / 4½",
Plain, 4.5 mm Jaws



Von Graefe
WS-687-032B
11.4 cm / 4½",
With Catch, 4.5 mm Jaws
Fixation Forceps



Von Graefe
WS-687-032CC Serrated
WS-687-032C 1 x 2 Teeth
7.2 cm / 2¾"
Curved, 0.7 mm Tip
Iris Forceps



Von Graefe
WS-687-032DD Serrated
WS-687-032D 1 x 2 Teeth
7.2 cm / 2¾"
Straight, 0.7 mm Tip
Iris Forceps



Von Graefe
WS-687-032EE Serrated
WS-687-032E 1 x 2 Teeth
7.2 cm / 2¾"
Curved, 0.7 mm Tip
Iris Forceps



Krefeld Model
WS-687-032
10 cm / 4"
Conjunctiva Forceps



Freiburg Model
WS-687-033
10 cm / 4"
Conjunctiva Forceps



Kaufmann
WS-687-034
9 cm / 3½"
Conjunctiva Forceps
With Tying Platform



Draeger
WS-687-035
10 cm / 4"
Conjunctiva Forceps
Non-Traumatic



Förster
WS-687-036
10 cm / 4"
Conjunctiva Forceps

Forceps | Pinzas | Pinzetten

Remy
WS-688-037
 8 cm / 3"
 Keratoplasty Forceps



Neuhann
WS-688-038
 8 cm / 3"
 Keratoplasty Forceps



Fixation Forceps
WS-688-039
 10 cm / 4"
 Straight, Width Of Prong 3 mm
 1 x 2 Teeth Each Side, 0.12 mm



Fixation Forceps
WS-688-040
 10 cm / 4"
 Curved, Width Of Prong 3 mm
 1 x 2 Teeth Each Side, 0.12 mm



Kremer
WS-688-041
 11.5 cm / 4½"
 Fixation Forceps
 Curved With Lock, Width of Prong 13 mm
 1 x 2 Teeth Each Side 0.12 mm



Kremer
WS-688-042
 11.5 cm / 4½"
 Fixation Forceps
 Straight With Lock, Width of Prong 13 mm
 1 x 2 Teeth Each Side 0.12 mm



Dressing Forceps-Ophthalmical

- WS-689-043 0.5 mm
- WS-689-044 0.7 mm
- WS-689-045 1 mm
- WS-689-046 1.2 mm
- WS-689-047 1.4 mm
- 10 cm / 4"
- Serrated



Dressing Forceps-Ophthalmical

- WS-689-048 0.5 mm
- WS-689-049 0.7 mm
- WS-689-050 1 mm
- WS-689-051 1.2 mm
- WS-689-052 1.4 mm
- 10 cm / 4"
- 1 x 2 Teeth



Graefe

- WS-689-053 Without Lock
- WS-689-054 With Lock
- 10 cm / 4"
- Fixation Forceps



Heidelberg Model

- WS-689-055
- 10 cm / 4"
- Fixation Forceps



Jess

- WS-689-056
- 10 cm / 4"
- Fixation Forceps



Barraquer

- WS-689-057
- 10 cm / 4"
- Fixation Forceps



Twist Fixation Hook

- WS-689-058 Right
- WS-689-059 Left

Forceps | Pinzas | Pinzetten



Iris Forceps
WS-690-060
9 cm / 3½"
Curved, Serrated



Iris Forceps
WS-690-061
9 cm / 3½"
Straight, Serrated



Bonn Model Iris Forceps
WS-690-062
9 cm / 3½"
Straight, Serrated



Bonn Model Iris Forceps
WS-690-063
9 cm / 3½"
Angled 6 mm, Serrated



Bonn Model Iris Forceps
WS-690-064
9 cm / 3½"
Angled 8 mm, Serrated



Bonn Model Iris Forceps
WS-690-065
9 cm / 3½"
Angled 6 mm, 1 x 2 Teeth



Bonn Model Iris Forceps
WS-690-066
9 cm / 3½"
Angled 8 mm, 1 x 2 Teeth



Bonn Model
WS-691-067
10 cm / 4"
Iris Forceps
Straight, 1 x 2 Teeth



Bonn Model
WS-691-068
10 cm / 4"
Iris Forceps
Long, Straight, 1 x 2 Teeth



Bonn Model
WS-691-069
10 cm / 4"
Iris Forceps
Long, Straight, 1 x 2 Teeth
With Tying Platform



Swiss Model
WS-691-070
10 cm / 4"
Iris Forceps
Curved, 1 x 2 Teeth



Heidelberg Model
WS-691-071
9 cm / 3 1/2"
Iris Forceps
Light Curve, 1 x 2 Teeth



Heidelberg Model
WS-691-072
9 cm / 3 1/2"
Iris Forceps
Strong Curve, 1 x 2 Teeth

Forceps | Pinzas | Pinzetten



Iris Forceps
WS-692-073
8 cm / 3"
Straight, 1 x 2 Teeth



Iris Forceps
WS-692-074
7.5 cm / 3"
Straight, 1 x 2 Teeth, Strong



Hamburg Model Iris Forceps
WS-692-075
9 cm / 3½"
Straight, 1 x 2 Teeth



Swiss Model Iris Forceps
WS-692-076
8 cm / 3"
Extremely Delicate, 1 x 2 Teeth



Elze
WS-692-077
7.5 cm / 3"
Iris Forceps

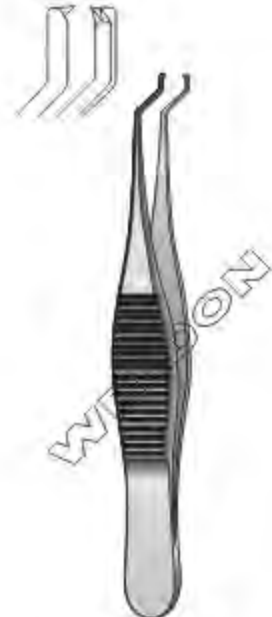

Hess-Engelking Iris Forceps
WS-692-078
1 x 2 Teeth



Neuhann
WS-693-079
8.5 cm / 3 1/4"
Implantation Forceps



Fechner
WS-693-080
8.5 cm / 3 1/4"
Implantation Forceps



Shepard
WS-693-081 Without Stop
WS-693-082 With Stop
10 cm / 4"
Implantation Forceps



Tenner
WS-693-083
10 cm / 4"
Implantation Forceps



Doden
WS-693-084
10 cm / 4"
Implantation Forceps

Forceps | Pinzas | Pinzetten



Elze
WS-694-085
10 cm / 4"
Implantation Forceps
For Retropupillary Lenses Without Holes



Holding Forceps
WS-694-086
10 cm / 4"
For Foldable IOLs



T.Kohnen
WS-694-087
10 cm / 4"
Implantation Forceps
Silicone Tube Coated

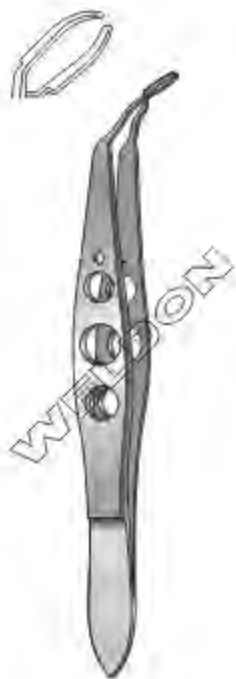

Folder
WS-694-088
10 cm / 4"
For Foldable IOLs



Spaleck
WS-694-089
10 cm / 4"
Folder For Silicone And
Acrylic IOLs Without Lock



Thomas Neuhann
WS-695-090
10 cm / 4"
Folder For Foldable IOLs



WS-695-091
10 cm / 4"
Folder
With Notches For Acrylic IOLs



Nucleus Splitter Forceps
WS-695-092
10 cm / 4"



H.-R.Koch
WS-695-093
10 cm / 4"
For Foldable 3-Piece IOLs



H.-R.Koch
WS-695-094
10 cm / 4"
Plate Haptic Iol Folder
Folding Technique For Plate Haptic



Akahoshi
WS-695-095
10 cm / 4"
Nucleus-Spreading Forceps
Pre-Chopper

Forceps | Pinzas | Pinzetten



Folder
WS-696-096
10 cm / 4"
With Lock
For Pharmacia CEEoN Edge



Explantation Forceps
WS-696-097
10 cm / 4"
For Soft IOLs



H.R.Koch
WS-696-098
12.5 cm / 5"
Universal Prefolder
For Foldable Silicone, Hydrogel Or Acrylic IOLs



H.R.Koch
WS-696-099
12.5 cm / 5"
Prefolder
For Pharmacia CEEoN Edge



Holding Forceps
WS-697-100
10 cm / 4"
For Foldable IOLs

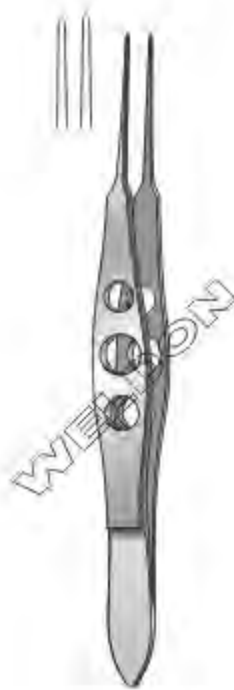

Strobel
WS-697-101
10 cm / 4"
Holding Forceps
For Pharmacia CEEon Edge



Lasik Corneal Flap
WS-697-102
10 cm / 4"
Forceps



Burrato
WS-697-103
10 cm / 4"
Lasik Corneal Flap
Forceps



Sattler
WS-697-104
10 cm / 4"
Muscle Forceps
Right



Sattler
WS-697-105
10 cm / 4"
Muscle Forceps
Left

Forceps | Pinzas | Pinzetten



Remky
WS-698-106
10 cm / 4"
Superior Rectus Forceps



Elschnig
WS-698-107
10 cm / 4"
Superior Rectus Forceps



Elschnig
WS-698-108
10 cm / 4"
Superior Rectus
Forceps, Delicate



Leyhecker
WS-698-109
10 cm / 4"
Superior Rectus Forceps



Castrovieio
WS-698-110
10 cm / 4"
Superior Rectus Forceps
With Tying Platform
Angled, 0.9 mm



Dardenne
WS-698-111
10 cm / 4"
Nucleus Forceps



Walser
 WS-699-112 0.5 mm
 WS-699-113 0.8 mm
 10 cm / 4"
 Suturing Forceps, Straight
 With Tying Platform



Castroviejo (New Model)
 WS-699-114 0.12 mm
 WS-699-115 0.3 mm
 WS-699-116 0.5 mm
 WS-699-117 0.9 mm
 WS-699-118 1.2 mm
 10 cm / 4"
 Suturing Forceps, Straight
 With Tying Platform



Munich Model
 WS-699-119
 10 cm / 4"
 Suturing Forceps, Straight, Conical
 With Tying Platform
 0.35 mm



Castroviejo
 WS-699-120 0.3 mm
 WS-699-121 0.6 mm
 WS-699-122 0.9 mm
 WS-699-123 1.2 mm
 10 cm / 4"
 Suturing Forceps, Straight
 With Tying Platform



Tuebingen Model
 WS-699-124
 10 cm / 4"
 Tying Forceps, Straight



Tuebingen Model
 WS-699-125
 10 cm / 4"
 Tying Forceps, Curved

Forceps | Pinzas | Pinzetten

Tuebingen Model
WS-700-126
 10 cm / 4"
 Tying Forceps
 Delicate



Bonn Model
WS-700-127
 10 cm / 4"
 Tying Forceps
 Extremely Delicate



Tying Forceps
WS-700-128
 10 cm / 4"
 Angled, 7.5 mm



Dardenne
WS-700-129
 10 cm / 4"
 Tying Forceps
 Angled, 6 mm



Kelman-Mcpherson
WS-700-130
 10 cm / 4"
 Fragment Forceps
 Angled, 7.5 mm



Gaskin
WS-700-131
 10 cm / 4"
 Fragment Forceps
 Angled, 9 mm



Bishop Harmon
 8.9 cm / 3 1/2"
WS-700-131A 0.6mm, 1 x 2 Teeth
WS-700-131B 0.4mm, 1 x 2 Teeth, Extra Delicate
WS-700-131C 0.3mm, 1 x 2 Teeth, Micro Surgery
WS-700-131D 0.6mm, Serrated
 Iris Forceps

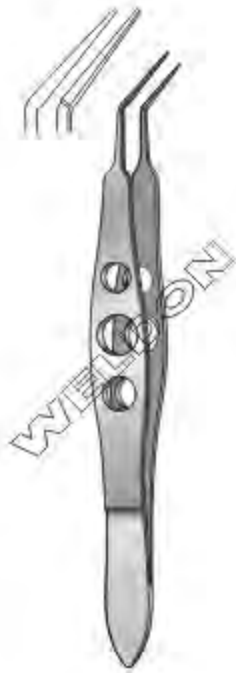

Gaskin
WS-701-132
 10 cm / 4"
 Fragment Forceps
 Angled, 11 mm

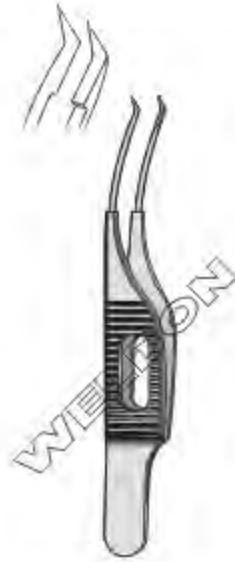

Barraquer
WS-701-133
 6 cm / 2½"
 Suture Removing Forceps



Paufigue
WS-701-134
 8 cm / 3"
 Tying Forceps



Paufigue
WS-701-135
 8 cm / 3"
 Tying Forceps
 Delicate



Bangarter
WS-701-136
 10 cm / 4"
 Tying Forceps



WS-701-137
 11.5 cm / 4½"
 Tying Forceps

Forceps Vitreoretinal | Pinzas Vitreoretinal | Pinzetten Vitreoretinal

Essen Model
WS-702-001
 10 cm / 4"
 Cerclage Forceps



Holz
WS-702-002
 Double Muscle Hook
 For Encircling Bands



Holz
WS-702-003
 Cerclage Forceps



Watzke
WS-702-004
 11.5 cm / 4½"
 Spreading Forceps

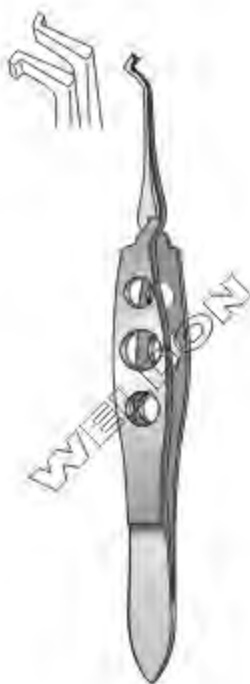

Hoerauf
WS-702-005
 9 cm / 3½"
 Spreading Forceps
 For Silicon Oil Removal



Pfennigwerth
WS-702-006
 10 cm / 4"
 Holding Forceps
 For Vitrectomy Lenses



Holding Forceps
WS-702-007
 For Sclera Pins



Insertion Forceps
WS-702-008
 9 cm / 3½"
 For Sclera Pins

Forceps Vitreoretinal | Pinzas Vitreoretinal | Pinzetten Vitreoretinal



WS-703-009
 Vitrectomy Forceps
 Straight, Serrated Tips
 20 Gauge / 0.9 mm
 WS-703-010
 Titanium
 12.5 cm / 5"



WS-703-011
 Vitrectomy Forceps
 Straight, Rough Tips
 20 Gauge / 0.9 mm
 WS-703-012
 Titanium
 12.5 cm / 5"



WS-703-013
 Vitrectomy Forceps
 Straight, Silicone Coated Tips
 20 Gauge / 0.9 mm
 WS-703-014
 Titanium
 12.5 cm / 5"



WS-703-015
 Vitrectomy Forceps
 Straight, Grip Tips
 20 Gauge / 0.9 mm
 WS-703-016
 Titanium
 12.5 cm / 5"



WS-703-017
 Vitrectomy Forceps
 45° Angled
 20 Gauge / 0.9 mm
 WS-703-018
 Titanium
 12.5 cm / 5"

Forceps Vitreoretinal | Pinzas Vitreoretinal | Pinzetten Vitreoretinal

WS-704-019
 Vitrectomy Membrane Peeler Forceps
 45° Angled
 20 Gauge / 0.9 mm
WS-704-020
 Titanium
 12.5 cm / 5"



WS-704-021
 Vitrectomy Forceps
 Horizontal, Subretinal
 45° Angled, 20 Gauge / 0.9 mm
WS-704-022
 Titanium
 12.5 cm / 5"



WS-704-023
 Vitrectomy Membrane Peeler Forceps
 90° Angled
 20 Gauge / 0.9 mm
WS-704-024
 Titanium
 12.5 cm / 5"



WS-704-025
 Vitrectomy Forceps
 Straight, Annular Tips
 20 Gauge / 0.9 mm
WS-704-026
 Titanium
 12.5 cm / 5"



WS-704-027
 Vitrectomy Forceps
 45° Angled, Vertical Tips, Subretinal
 20 Gauge / 0.9 mm
WS-704-028
 Titanium
 12.5 cm / 5"



WS-705-029
 Vitrectomy Forceps
 With Membrane Peeler Tips
 20 Gauge / 0.9 mm
WS-705-030
 Titanium
 12.5 cm / 5"



WS-705-031
 Vitrectomy Membrane Dissector
 Straight, Serrated Tips
 20 Gauge / 0.9 mm
WS-705-032
 Titanium
 12.5 cm / 5"



WS-705-033
 Vitrectomy Foreign Body Forceps
 20 Gauge / 0.9 mm
WS-705-034
 Titanium
 12.5 cm / 5"



WS-705-035
 Vitrectomy Membrane Dissector
 Curved
 20 Gauge / 0.9 mm
 12.5 cm / 5"



WS-705-036
 Vitrectomy Membrane Dissector
 45° Angled
 20 Gauge / 0.9 mm
WS-705-037
 Titanium
 12.5 cm / 5"

Forceps Vitreoretinal | Pinzas Vitreoretinal | Pinzetten Vitreoretinal

WS-706-038 0.2 mm x 0.05 mm
WS-706-039 0.3 mm x 0.05 mm
WS-706-040 0.2 mm x 0.1 mm
WS-706-041 0.3 mm x 0.1 mm
 Vitrectomy Forceps, Straight
 End Gripping, Extremely Delicate
 20 Gauge / 0.9 mm
 12.5 cm / 5"



WS-706-042
 Vitrectomy Forceps
 90° Angled, Pointed Tips
 20 Gauge / 0.9 mm
WS-706-043
 12.5 cm / 5"



WS-706-044
 12.5 cm / 5"
 Vitrectomy Forceps, Straight
 End Gripping, Extremely Delicate
 0.2 mm x 0.05 mm
 24 Gauge / 0.6 mm



WS-706-045
 12.5 cm / 5"
 Vitrectomy Forceps, Straight
 Grip Tips
 24 Gauge / 0.6 mm



Shaaf
WS-707-001
9 cm / 3½"
Cilia & Foreign Body Forceps



Hamburg Model
WS-707-002
9 cm / 3½"
Cilia & Foreign Body Forceps



WS-707-003
11.5 cm / 4½"
Foreign Body Needle
Straight



WS-707-004
11.5 cm / 4½"
Foreign Body Needle
Curved



Plange
WS-707-005
11.5 cm / 4½"
Foreign Body Spud



WS-707-006
11.5 cm / 4½"
Foreign Body Gouge



Hamburg Model
WS-708-001
 11.5 cm / 4½"
 Keratome
 Angled



Bonn Model
WS-708-002
 11.5 cm / 4½"
 Scleral Knife
 7 mm Blade



Bonn Model
WS-708-003
 11.5 cm / 4½"
 Scleral Knife
 4 mm Blade



Phaco Slit Knife
 Angled

WS-708-004	1.50 mm	WS-708-008	2.50 mm
WS-708-005	1.70 mm	WS-708-009	2.85 mm
WS-708-006	1.80 mm	WS-708-010	3 mm
WS-708-007	2 mm	WS-708-011	3.20 mm
		WS-708-012	3.50 mm

11.5 cm / 4½"



Neuhann
WS-708-013
 11.5 cm / 4½"
 lol- Knife
 Angled, 3.5 mm



Brauweiler

WS-708-014	5 mm, For 5 mm Lens Ø
WS-708-015	5.5 mm, For 6 mm Lens Ø
WS-708-016	6.0 mm, For 6.5 mm Lens Ø
WS-708-017	6.5 mm, For 7 mm Lens Ø

11.5 cm / 4½"
 lol- Knife, Angled



Chalazion Knife
WS-709-018
11.5 cm / 4½"
Delicate

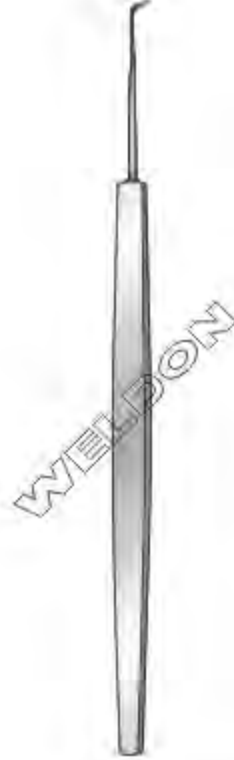

Sato Knife
WS-709-019
11.5 cm / 4½"
Long Blade



Sato Knife
WS-709-020
11.5 cm / 4½"



Dardenne
WS-709-021
10 cm / 4"
Sato Knife



Foerster
WS-709-022
10 cm / 4"
Sato Knife



Micro Round Knife
WS-709-023
10 cm / 4"
For Visco Canalostomy
1 mm

Stiletto

For Instruments With

WS-710-024	24 Gauge / 0.6 mm
WS-710-025	22 Gauge / 0.7 mm
WS-710-026	20 Gauge / 0.9 mm
WS-710-027	19 Gauge / 1.1 mm
WS-710-028	16 Gauge / 1.6 mm



Frankfurt Model
WS-710-029
11.5 cm / 4½"
Crescent Knife



Paufrage
WS-710-030
11.5 cm / 4½"
Keratoplasty Knife



Kuhnt
WS-710-031
11.5 cm / 4½"
Corneal Scarifier
Fig. 1



Kuhnt
WS-710-032
11.5 cm / 4½"
Corneal Scarifier
Fig. 2



Kuhnt
WS-710-033
11.5 cm / 4½"
Corneal Scarifier
Fig. 3



Lohmann
WS-711-001
11.5 cm / 4½"
Lasek- Epi- Peeler



Lasek-Trephine
WS-711-002 8 mm
WS-711-003 9 mm
11.5 cm / 4½"
With Crosshairs



Lasek-Funnel
WS-711-004 8.5 mm
WS-711-005 9.5 mm
11.5 cm / 4½"
With Crosshairs



Lohmann
WS-711-006
11.5 cm / 4½"
A-Lasek Trephine
8 x 10 mm
With Crosshairs



Lohmann
WS-711-007
11.5 cm / 4½"
A-Lasek Funnel
8.9 x 10.7 mm
With Crosshairs



Weber
WS-712-008
12.5 cm / 5"
Lens Loop
Small



Weber
WS-712-009
12.5 cm / 5"
Lens Loop
Large



Snellen
WS-712-010
12.5 cm / 5"
Lens Loop



Art
WS-712-011
12.5 cm / 5"
Lens Loop
Serrated



Lucky
WS-713-012
12.5 cm / 5"
Localizer



Laqua
WS-713-013
12.5 cm / 5"
Localizer



Laqua
WS-713-014
12.5 cm / 5"
Localizer
Double Ended



Meyer / Schwickerath
WS-713-015
12.5 cm / 5"
Localizer



Kreissig
WS-713-016
12.5 cm / 5"
Localizer
Double Ended



Sclera Depressor
WS-713-017
12.5 cm / 5"
Double Ended



Sclera Depressor
WS-713-018
12.5 cm / 5"
Double Ended
Roughened Ends



Foerster
WS-713-019
12.5 cm / 5"
Inside Diameter 6.5 mm
Fixation Ring With Localizer



Thomas Neuhann
 WS-714-001
 11.5 cm / 4½"
 Nucleus Dividing Hook



Zirm
 WS-714-002
 11.5 cm / 4½"
 Nucleus Dividing Hook



Tobias Neuhann
 WS-714-003
 11.5 cm / 4½"
 Chopper



Agarwal
 WS-714-004
 11.5 cm / 4½"
 Phaco-Karate-Chopper



Haefliger
 WS-714-005 For Right Hand
 WS-714-006 For Left Hand
 11.5 cm / 4½"
 Nucleus Dividing Hook



Nagahara
 WS-714-007
 11.5 cm / 4½"
 Nucleus Dividing Hook



Höh
WS-715-008
Chopper
With Irrigation
18 Gauge / 1.2 mm



Agarwal
WS-715-009
Irrigation Nucleus Chopper
20 Gauge / 0.9 mm



R.Koch
WS-715-010
10 cm / 4"
Irrigation Handpiece With Chopper
Angled
Irrigation Ports 2 x 0.75 mm
Tube 19 Gauge / 1.1 mm



Hoffmann
WS-715-011
10 cm / 4"
Irrigation Handpiece With Chopper
Angled
Irrigation Ports 2 x 0.5 mm
Oval Tube 1.1 x 0.9 mm



Thomas Neuhann/Sauder
WS-715-012
10 cm / 4"
Irrigation Handpiece With Chopper
Irrigation Ports 2 x 0.75 mm
Tube 19 Gauge / 1.1 mm



Tobias Neuhann
WS-716-013
11.5 cm / 4½"
Nucleus Rotator And Chopper



Thomas Neuhann / Nagahra
WS-716-014
11.5 cm / 4½"
Spatula and
Nucleus Dividing Hook

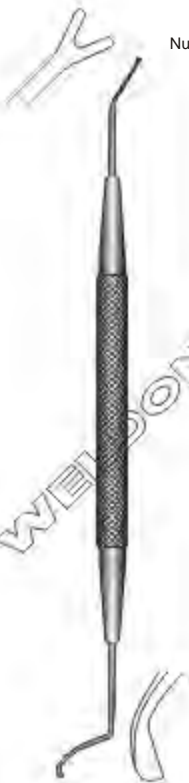

Thomas Neuhann
WS-716-015
11.5 cm / 4½"
Nucleus Rotator and
Nucleus Dividing Hook



Thomas Neuhann
WS-716-016
11.5 cm / 4½"
Iris Hook And
Nucleus Dividing Hook



Thomas Neuhann
WS-716-017
11.5 cm / 4½"
Spatula And
Nucleus Dividing Hook



Mainz Model
WS-717-018
11.5 cm / 4½"
Manipulator



Mainz Model
WS-717-019
11.5 cm / 4½"
Manipulator, New Model



Bremen Model
WS-717-020
11.5 cm / 4½"
Lens Loop Manipulator



Jacobi Manipulator
WS-717-021
WS-717-022
11.5 cm / 4½"
For 0.30 mm Lol Hole
For 0.20 mm Lol Hole



Sinsky
WS-717-023
11.5 cm / 4½"
Manipulator
For 0.20 mm Lol Hole



Lester
WS-717-024
11.5 cm / 4½"
Lens Loop Manipulator



Tandogan
WS-717-025
11.5 cm / 4½"
Explantation Hook For Lols



Frankfurt ,Model
WS-718-026
16.5 cm / 6½"
Iris Hook



Frankfurt Model
WS-718-027
16.5 cm / 6½"
Manipulator



Jacobi
WS-718-028
11.5 cm / 4½"
Iris Hook



Bonn Model
WS-718-029
11.5 cm / 4½"
Iris Hook
Extermly Delicate



Lund
WS-718-030
11.5 cm / 4½"
Iris Hook



Dardenne
WS-718-031
11.5 cm / 4½"
(Push-Pull)
Iris Hook



Neuhann
WS-719-032
10 cm / 4"
Nucleus Rotator



Agarwal
WS-719-033
10 cm / 4"
Globe Stabilizer And
Nucleus Manipulator



Liebermann
WS-719-034 Right Hand
WS-719-035 Left Hand
10 cm / 4"
Micro Finger
Nucleus Manipulator



Drysdale
WS-719-036
10 cm / 4"
Nucleus Manipulator
And Anterior Capsule Polisher



Henning-Friedrich
WS-719-037
10 cm / 4"
Lens Extraction Hook



Muenster Model
WS-719-038
15.5 cm / 6"
Suture Hook



Graefe
WS-720-039
12.5 cm / 5"
Strabismus Hook
Short

Hamburg Model
WS-720-043
12.5 cm / 5"
Strabismus Hook

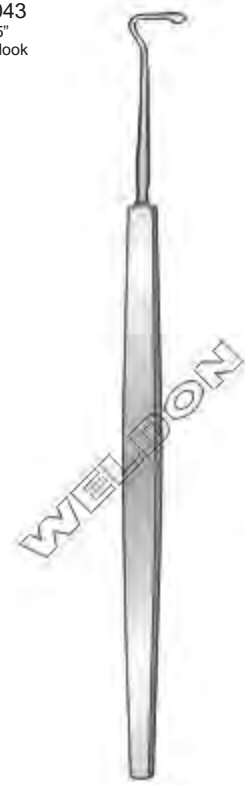

Malbran
WS-720-044
12.5 cm / 5"
Strabismus Hook

Bonn Model
WS-720-045
12.5 cm / 5"
Strabismus Hook

Jameson
WS-720-048
12.5 cm / 5"
Strabismus Hook



Wecker
WS-721-001
12.5 cm / 5"
Iris Spatula
Wide



Wecker
WS-721-002
12.5 cm / 5"
Iris Spatula
Slim



Wecker
WS-721-003
12.5 cm / 5"
Iris Spatula
Conical



Frankfurt Model
WS-721-004
12.5 cm / 5"
Iris Spatula



Frankfurt Model
WS-721-005
12.5 cm / 5"
Iris Spatula
Extremely Delicate



Iris Spatula
WS-721-006
12.5 cm / 5"
Angled, Conical
Extremely Delicate

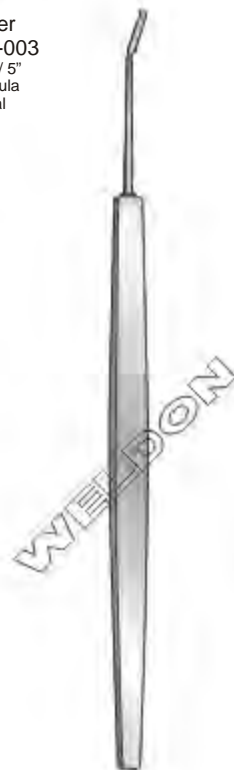

Bangerter
WS-721-007 1.00 x 0.25 mm
WS-721-008 1.50 x 0.25 mm
WS-721-009 2.00 x 0.25 mm
12.5 cm / 5"
Iris Spatula, Angled



Bangerter
WS-721-010 1.00 x 0.25 mm
WS-721-011 1.00 x 0.25 mm
WS-721-012 2.00 x 0.25 mm
12.5 cm / 5"
Iris Spatula, Round Handle, Angled



Elschnig
WS-722-013
 12.5 cm / 5"
 Spatula
 10 mm Long

Castroviejo
WS-722-014
 12.5 cm / 5"
 Spatula
 10 mm Long

Castroviejo
WS-722-015
 12.5 cm / 5"
 Spatula
 15 mm Long

Castroviejo
WS-722-016
 12.5 cm / 5"
 Spatula
 Double Ended
 10 / 15 mm Long

Bangerter
WS-722-017 6 mm
WS-722-018 10 mm
WS-722-019 12 mm
 12.5 cm / 5"
 Spatula



Castroviejo
WS-723-020
10 cm / 4"
Spatula
7 mm long



Spatula
WS-723-021
10 cm / 4"
Angled, 0.5 x 0.25 mm



Spatula
WS-723-022
10 cm / 4"
Angled, 1.0 x 0.25 mm



Hirschmann
WS-723-023
10 cm / 4"
Spatula



Steinmzt
WS-723-024
10 cm / 4"
Spatula
For Manual Lens Fragmentation
For Left-Handed Persons



Binkhorst
WS-723-025
12.5 cm / 5"
10 mm Long
Extremely Delicate



Rentsch
WS-723-026
12.5 cm / 5"
Spatula

Manipulators, Spatulas | Manipulantes, Espátulas | Manipulators, Spachtel



Essen Model
WS-724-027
11.5 cm / 4½"
Spatula



Wells
WS-724-028
11.5 cm / 4½"
Enucleation Spoon



Engels
WS-724-029
Phaco Spoon



D.D Koch
WS-724-030
9 cm / 3½"
Phaco Spatula



Amon
WS-724-031
9 cm / 3½"
Phaco Spatula



Zirm
WS-724-032
10 cm / 4"
Lasik Cornea Protector



Zirm
WS-724-033
10 cm / 4"
Lasik Cornea Surface
Cleaner



Foerster
WS-725-034
 12.5 cm / 5"
 Sato Knife
 Conical Shaft
 Front 30 Gauge / 0.3 mm
 Rear 20 Gauge / 0.9 mm



Membrane Spatula
WS-725-035
 12.5 cm / 5"
 1 mm Angled
 Long Rakes
 20 Gauge / 0.9 mm



Membrane Spatula
WS-725-036
 12.5 cm / 5"
 1 mm Angled
 Short Rakes
 20 Gauge / 0.9 mm



Membrane Spatula Knife
WS-725-037
 12.5 cm / 5"
 5 mm Angled
 All Edges Sharp
 20 Gauge / 0.9 mm



Membrane Spatula
WS-725-038
 12.5 cm / 5"
 0.5 mm Curved
 Short Rakes, Round Edge
 Rear 20 Gauge / 0.9 mm



Membrane Spatula
WS-725-039
 12.5 cm / 5"
 1.5 mm Angled
 20 Gauge / 0.9 mm



Membrane Spatula
WS-725-040
 12.5 cm / 5"
 2 and 4 mm Angled
 20 Gauge / 0.9 mm

Manipulators, Spatulas Vitreoretinal | Manipulantes, Espátulas Vitreoretinal
Manipulators, Spachtel Vitreoretinal

Membrane Spatula
WS-726-041
 12.5 cm / 5"
 With Pointed Tip
 5 mm Angled
 20 Gauge / 0.9 mm



Membrane Spatula
WS-726-042
 12.5 cm / 5"
 Subretinal Pic, Flat
 4 mm Angled
 0.3 x 0.2 mm
 20 Gauge / 0.9 mm



Membrane Spatula
WS-726-043
 12.5 cm / 5"
 Subretinal Pic, Flat
 4 mm Angled
 0.3 x 0.15 mm
 20 Gauge / 0.9 mm



Membrane Spatula
WS-726-044
 12.5 cm / 5"
 2 mm Angled
 20 Gauge / 0.9 mm



Lucke
WS-726-045
 12.5 cm / 5"
 Membrane Spatula
 Round Curved
 20 Gauge / 0.9 mm



Membrane Spatula
WS-726-046
 12.5 cm / 5"
 5 mm Angled
 20 Gauge / 0.9 mm



Membrane Spatula
WS-726-047
 12.5 cm / 5"
 2.5 mm Angled
 20 Gauge / 0.9 mm



Membrane Spatula
WS-727-048
12.5 cm / 5"
Rough, Angled
20 Gauge / 0.9 mm For MIS



Membrane Peeler
WS-727-049
12.5 cm / 5"
1 mm Angled
20 Gauge / 0.9 mm



Morris-Kroll
WS-727-050
12.5 cm / 5"
Membrane Peeler
1.5 mm Angled
20 Gauge / 0.9 mm



Membrane Peeler
WS-727-051
12.5 cm / 5"
Blunt
With Peeling Edges
20 Gauge / 0.9 mm



Membrane Peeler
WS-727-052
12.5 cm / 5"
Rough, Angled
20 Gauge / 0.9 mm For MIS



Membrane Peeler
WS-727-053
12.5 cm / 5"
1 mm Angled
24 Gauge / 0.6 mm



Neuhann
WS-728-001
 10 cm / 4"
 Suture Marker
 For Keratoplasty To Mark The Sutures,



Grene
WS-728-002
 10 cm / 4"
 Axis Marker
 Diameter 0.5 mm
 Concave Tip



Sinsky
WS-728-003
 10 cm / 4"
 Marking Hook
 Diameter 0.2 mm
 Round Tip



Hoffer
 Inside Diameter

WS-728-004	3 mm	WS-728-010	5 mm
WS-728-005	3.25 mm	WS-728-011	5.50 mm
WS-728-006	3.50 mm	WS-728-012	6 mm
WS-728-007	3.75 mm	WS-728-013	6.50 mm
WS-728-008	4 mm	WS-728-014	7 mm
WS-728-009	4.50 mm	WS-728-015	7.50 mm

10 cm / 4"
 Corneal Marker For Optic Zone



Thomas Neuhann
WS-728-016
 10 cm / 4"
 Corneal Marker
 4 Blades
 Inside Diameter 3 mm
 Outside Diameter 12 mm



Thomas Neuhann
WS-728-017
 10 cm / 4"
 Corneal Marker
 6 Blades
 Inside Diameter 3 mm
 Outside Diameter 12 mm



Thomas Neuhann
WS-728-018
 10 cm / 4"
 Corneal Marker
 8 Blades
 Inside Diameter 3 mm
 Outside Diameter 12 mm



Barraquer
WS-729-001
Needle Holder
Straight, Without Lock
Handle 6 mm
Total Length 10.5 cm



Barraquer
WS-729-002
Needle Holder
Straight, With Lock
Handle 6 mm
Total Length 10.5 cm



Barraquer
WS-729-003
Needle Holder
Curved, Without Lock
Handle 6 mm
Total Length 10.5 cm



Barraquer
WS-729-004
Needle Holder
Curved, With Lock
Handle 6 mm
Total Length 10.5 cm



Barraquer-Trounman
WS-729-005
Needle Holder
Straight, Without Lock
Handle 6 mm
Total Length 10 cm



Barraquer-Trounman
WS-729-006
Needle Holder
Straight, With Lock
Handle 6 mm
Total Length 10 cm

Needle Holders | Porta Agujas | Nadelhalter

Barraquer-Troutman
WS-730-007
 Needle Holder
 Curved, Without Lock
 Handle 6 mm
 Total Length 10 cm



Barraquer-Troutman
WS-730-008
 Needle Holder
 Curved, With Lock
 Handle 6 mm
 Total Length 10 cm



Castroviejo
WS-730-009
 Needle Holder
 Straight, Without Lock
 Total Length 9 cm



Castroviejo
WS-730-010
 Needle Holder
 Straight, With Lock
 Total Length 9 cm



Barraquer
WS-730-011
 Needle Holder
 Curved, Without Lock
 Jaw 0.55 mm
 Handle 8 mm
 Total Length 12 cm



Barraquer
WS-730-012
 Needle Holder
 Curved, With Lock
 Jaw 0.55 mm
 Handle 8 mm
 Total Length 12 cm



Barraquer
WS-731-013
 Needle Holder
 Curved, Without Lock
 Jaw 0.45 mm
 Handle 8 mm
 Total Length 12 cm



Barraquer
WS-731-014
 Needle Holder
 Curved, With Lock
 Jaw 0.45 mm
 Handle 8 mm
 Total Length 12 cm



Jacobi
WS-731-015
 Needle Holder
 Straight, Without Lock
 Handle 7 mm
 Total Length 11.5 cm



Jacobi
WS-731-016
 Needle Holder
 Straight, With Lock
 Handle 7 mm
 Total Length 11.5 cm



Jacobi
WS-731-017
 Needle Holder
 Curved, Without Lock
 Handle 7 mm
 Total Length 11.5 cm



Jacobi
WS-731-018
 Needle Holder
 Curved, With Lock
 Handle 7 mm
 Total Length 11.5 cm

Needle Holders | Porta Agujas | Nadelhalter

Barraquer
WS-732-019
 Needle Holder
 Curved, Without Lock
 Jaw 0.8 mm, Handle 8 mm
 Total Length 14 cm



Barraquer
WS-732-020
 Needle Holder
 Curved, With Lock
 Jaw 0.8 mm, Handle 8 mm
 Total Length 14 cm



Barraquer
WS-732-021
 Needle Holder
 Curved, Without Lock
 Jaw 0.55 mm, Handle 8 mm
 Total Length 14 cm



Barraquer
WS-732-022
 Needle Holder
 Curved, With Lock
 Jaw 0.55 mm, Handle 8 mm
 Total Length 14 cm



Barraquer
WS-732-023
 Needle Holder
 Curved, Without Lock
 Handle 10 mm
 Total Length 14 cm



Barraquer
WS-732-024
 Needle Holder
 Curved, With Lock
 Handle 10 mm
 Total Length 14 cm



Barraquer
WS-733-025
Needle Holder
Original Model
Curved, Without Lock
Handle 10 mm
Total Length 13 cm



Barraquer
WS-733-026
Needle Holder
With Strong Jaw
Curved, Without Lock
Handle 10 mm
Total Length 14 cm



Barraquer
WS-733-027
Needle Holder
With Strong Jaw
Curved, With Lock
Handle 10 mm
Total Length 14 cm



Castroviejo
WS-733-028
Needle Holder
Straight, Without Lock
Handle 10 mm
Total Length 13.5 mm



Castroviejo
WS-733-029
Needle Holder
Straight, With Lock
Handle 10 mm
Total Length 13.5 cm

Needle Holders | Porta Agujas | Nadelhalter

Castroviejo
WS-734-030
Needle Holder
Straight, Without Lock
Total Length 14 cm



Castroviejo
WS-734-031
Needle Holder
Straight, With Lock
Total Length 14 cm



Castroviejo
WS-734-032
Needle Holder
Curved, Without Lock
Total Length 14 cm



Castroviejo
WS-734-033
Needle Holder
Curved, With Lock
Total Length 14 cm



Castroviejo
WS-734-034
Needle Holder
Strong Curved, Without Lock
Total Length 14 cm



Castroviejo
WS-734-035
Needle Holder
Strong Curved, With Lock
Total Length 14 cm



Kalt
WS-735-036
13.5 cm / 5¼"
Needle Holder
Straight



Kalt
WS-735-037
13.5 cm / 5¼"
Needle Holder
Curved



Arruga
WS-735-038
13.5 cm / 5¼"
Needle Holder
Straight



Arruga
WS-735-039
13.5 cm / 5¼"
Needle Holder
Curved

Needle Holders | Porta Agujas | Nadelhalter

Boynton
WS-736-040
 Needle Holder



Combined Needle Holder / Scissors
WS-736-041 Without Lock
WS-736-042 With Lock
 12.5 cm / 5"



Axenfeld
WS-736-043
 Needle Holder



Rohrschneider
WS-736-044
 9 cm / 3½"
 Needle Holder
 Total Length 100 mm



Holding Forceps
WS-736-045
 10 cm / 4"
 For Sclera Pins



Kellnar
 WS-737-001 Right
 WS-737-002 Left
 Retrograde Probe



Hamburg Model
 WS-737-003 Right
 WS-737-004 Left
 Retrograde Probe

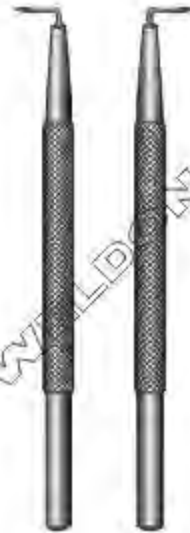

Mackensen Trabecular Probe
 WS-737-005 Right
 WS-737-006 Left
 Radius 7 mm

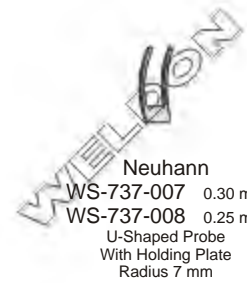

Neuhann
 WS-737-007 0.30 mm
 WS-737-008 0.25 mm
 U-Shaped Probe
 With Holding Plate
 Radius 7 mm



Harms Trabecular Probe
 WS-737-009 Right
 WS-737-010 Left
 Radius 7 mm



Jünemann Lacrimal Probe
 WS-737-011 0.60 mm, With Handle
 WS-737-012 0.80 mm, With Handle
 WS-737-013 1 mm, With Handle



Neuhann WS-737-014
 11.5 cm / 4½"
 Holder For U-Shaped Probe
 With Lock



Pigtail Probe
 WS-737-015 With Suture Holes
 WS-737-016 With Hook



Wilder
WS-738-017
10 cm / 4"
Lacrimal Probe
Delicate



Wilder
WS-738-018
10 cm / 4"
Lacrimal Probe
Medium



Wilder
WS-738-019
10 cm / 4"
Lacrimal Probe
Strong



Wilder
WS-738-020
10 cm / 4"
Lacrimal Probe
Slim, Delicate



Wilder
WS-738-021
10 cm / 4"
Lacrimal Probe
Slim, Medium



Wilder
WS-738-022
10 cm / 4"
Lacrimal Probe
Slim, Strong



Giessen Model
WS-738-023
8 cm / 3"
Lacrimal Probe



Bowman
 WS-739-024 Size 0000/000
 WS-739-025 Size 00/0
 WS-739-026 Size 1 / 2
 WS-739-027 Size 3 / 4
 WS-739-028 Size 5 / 6
 12.5 cm / 5"
 Lacrimal Probe
 Cylindrical, Silver



Bowman
 WS-739-029 Size 0000/000
 WS-739-030 Size 00/0
 WS-739-031 Size 1 / 2
 WS-739-032 Size 3 / 4
 WS-739-033 Size 5 / 6
 12.5 cm / 5"
 Lacrimal Probe
 Cylindrical, Stainless Steel



Bowman
 WS-739-034 Size 0000/000
 WS-739-035 Size 00/0
 WS-739-036 Size 1 / 2
 WS-739-037 Size 3 / 4
 WS-739-038 Size 5 / 6
 12.5 cm / 5"
 Lacrimal Probe
 Bulbous, Silver



Bowman
 WS-739-039 Size 0000/000
 WS-739-040 Size 00/0
 WS-739-041 Size 1 / 2
 WS-739-042 Size 3 / 4
 WS-739-043 Size 5 / 6
 12.5 cm / 5"
 Lacrimal Probe
 Bulbous, Stainless Steel



Mohr
WS-740-001
9 cm / 3½"
Glaucoma Punch



Jaeger
WS-740-002
10 cm / 4"
Lid Plate
Metal



Giessen Model
WS-740-003
12.5 cm / 5"
Lid Retractor



American Model
WS-740-004 Blunt
WS-740-005 Sharp
10 cm / 4"
Retractor, 4 x 4 Prongs



Müller
WS-740-006
7 cm / 2¼"
Retractor



Goldstein
WS-740-007
Retractor



Axenfeld Retractor
WS-741-008
12.5 cm / 5"
Four Pronged
Blunt



Axenfeld Retractor
WS-741-009 Blunt
WS-741-010 Sharp
12.5 cm / 5"
Three Pronged



Axenfeld Retractor
WS-741-011 Blunt
WS-741-012 Sharp
12.5 cm / 5"
Two Pronged



Rollet Retractor
WS-741-013
12.5 cm / 5"
Four Pronged
Sharp



Guthrie Retractor
WS-741-014
12.5 cm / 5"
Sharp, Large



Guthrie Retractor
WS-741-015
12.5 cm / 5"
Sharp, Small

Scissors | Tijeras | Scheren

Tuebingen Model
WS-742-001
 8 cm / 3¼"
 Capsulotomy Scissors
 Straight



Tuebingen Model
WS-742-002
 8 cm / 3¼"
 Capsulotomy Scissors
 Curved



Vannas
WS-742-003
 8 cm / 3¼"
 Capsulotomy Scissors
 Extremely Delicate
 Straight



Vannas
WS-742-004
 8 cm / 3¼"
 Capsulotomy Scissors
 Extremely Delicate
 Bent

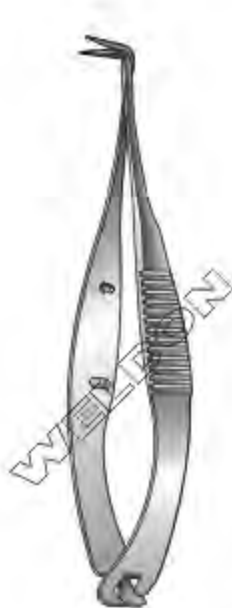

Vannas
WS-742-005
 8 cm / 3¼"
 Capsulotomy Scissors
 Extremely Delicate
 Angled on Flat



Vannas
WS-742-006
 8 cm / 3¼"
 Capsulotomy Scissors
 Extremely Delicate
 Angled to Left



Capsulotomy Scissors
 WS-743-007 9 mm Blade
 WS-743-008 11 mm Blade
 8 cm / 3 1/4"
 Angled on Flat



Capsulotomy Scissors
 WS-743-009
 8 cm / 3 1/4"
 13 mm Blade
 Tip Lightly Curved



Capsulotomy Scissors
 WS-743-010
 8 cm / 3 1/4"
 13 mm Blade
 Tip Strongly Curved



Capsulotomy Scissors
 WS-743-011
 8 cm / 3 1/4"
 10 mm Blade
 Tip Strongly Curved



Capsulotomy Scissors
 WS-743-012
 8 cm / 3 1/4"
 11 mm Blade
 Tip Lightly Curved



Capsulotomy Scissors
 WS-743-013
 8 cm / 3 1/4"
 7 mm Blade
 Tip Lightly Curved

Scissors | Tijeras | Scheren



Sutter
WS-744-014
10 cm / 4"
Corneal Scissors
Light Curved
Sharp / Sharp



Castroviejo
WS-744-015
10 cm / 4"
Corneal Scissors
Blunt / Blunt
Bent



Troutman-Castroviejo
WS-744-016 Right
WS-744-017 Left
10.5 cm / 4"
Corneal Scissors, With Stop



Troutman
WS-744-018 Right
WS-744-019 Left
10 cm / 4"
Corneal Scissors
Delicate



Castroviejo
WS-744-020 Right
WS-744-021 Left
10.5 cm / 4"
Corneal Scissors



Scissors
WS-745-022
10 cm / 4"
Strong Curve
Blunt / Blunt



Scissors
WS-745-023
10 cm / 4"
Light Curve
Blunt / Blunt



Scissors
WS-745-024
10 cm / 4"
Light Curve
Sharp / Sharp



Scissors
WS-745-025
10 cm / 4"
Straight
Sharp / Sharp



Scissors
WS-745-026
11 cm / 4¼"
Straight
Sharp / Sharp

Scissors | Tijeras | Scheren



Scissors
WS-746-027
10 cm / 4"
Bent
Blunt / Blunt



Scissors
WS-746-028
10 cm / 4"
Angled On Flat
Blunt / Blunt

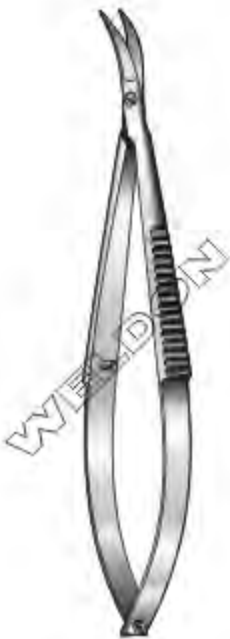

Castroviejo
WS-746-029
10 cm / 4"
Corneal Scissors
Strong Curve
Blunt / Blunt



Castroviejo
WS-746-030
10 cm / 4"
Corneal Scissors
With Stop, Strong Curved
Blunt / Blunt



Scissors
WS-746-031
10 cm / 4"
Strong Curve
Blunt / Blunt



Katzin
WS-747-032
10 cm / 4"
Keratoplasty Scissors
Curved Right



Katzin
WS-747-033
10 cm / 4"
Keratoplasty Scissors
Curved Left



Scissors
WS-747-034
11 cm / 4 1/4"
Straight
Sharp / Sharp



Castroviejo
WS-747-035
11.5 cm / 4 1/2"
Anterior Synechia Scissors



Castroviejo
WS-747-036
10.5 cm / 4"
Anterior Synechia Scissors
Delicate

Scissors | Tijeras | Scheren

Noyes
WS-748-037
 11 cm / 4¼"
 Iris Scissors, Straight
 Sharp / Sharp



Noyes
WS-748-038
 11 cm / 4¼"
 Iris Scissors, Straight
 Sharp / Blunt



Noyes
WS-748-039
 11 cm / 4¼"
 Iris Scissors, Straight
 Blunt / Blunt



Barraquer
WS-748-040
 6 cm / 2½"
 Iris Scissors
 7 mm Blade
 Blunt / Blunt



Wecker
WS-748-041 Sharp / Sharp
WS-748-042 Sharp / Blunt, Right
WS-748-043 Sharp / Blunt, Left
WS-748-044 Blunt / Blunt
 9 cm / 3½"
 Iris Scissors, 11 mm Blade

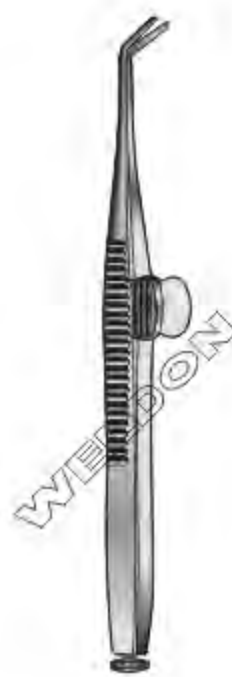

Wecker
WS-748-045 Sharp / Sharp
WS-748-046 Sharp / Blunt, Right
WS-748-047 Sharp / Blunt, Left
WS-748-048 Blunt / Blunt
 9 cm / 3½"
 Iris Scissors, 7 mm Blade



Trabeculum Scissors
WS-749-049
8 cm / 3"
Straight



Trabeculum Scissors
WS-749-050
8 cm / 3"
Curved



Combined
WS-749-051 Without Lock
WS-749-052 With Lock
12 cm / 4½"
Needle Holder / Scissors



Westcott Scissors
WS-749-053
Delicate
Blunt / Blunt
10 cm / 3¾"



Westcott
WS-749-054 Blunt / Blunt
WS-749-055 Sharp / Sharp
12 cm / 4½"
Scissors, Delicate

Scissors | Tijeras | Scheren



Bonn Model
WS-750-056
9 cm / 3½"
Tenotomy Scissors
Curved



Bonn Model
WS-750-057
9 cm / 3½"
Strabismus Scissors
Straight



Bonn Model
WS-750-058
9 cm / 3½"
Strabismus Scissors
Curved



Bonn Model
WS-750-059
9 cm / 3½"
Eye Scissors
Curved, Extremely Delicate



Bonn Model
WS-750-060
9 cm / 3½"
Eye Scissors
Straight, Extremely Delicate



Eye Scissors
WS-750-061
11.5 cm / 4½"
Bent
Sharp / Blunt



Eye Scissors
WS-750-062
11.5 cm / 4½"
Bent
Blunt / Blunt

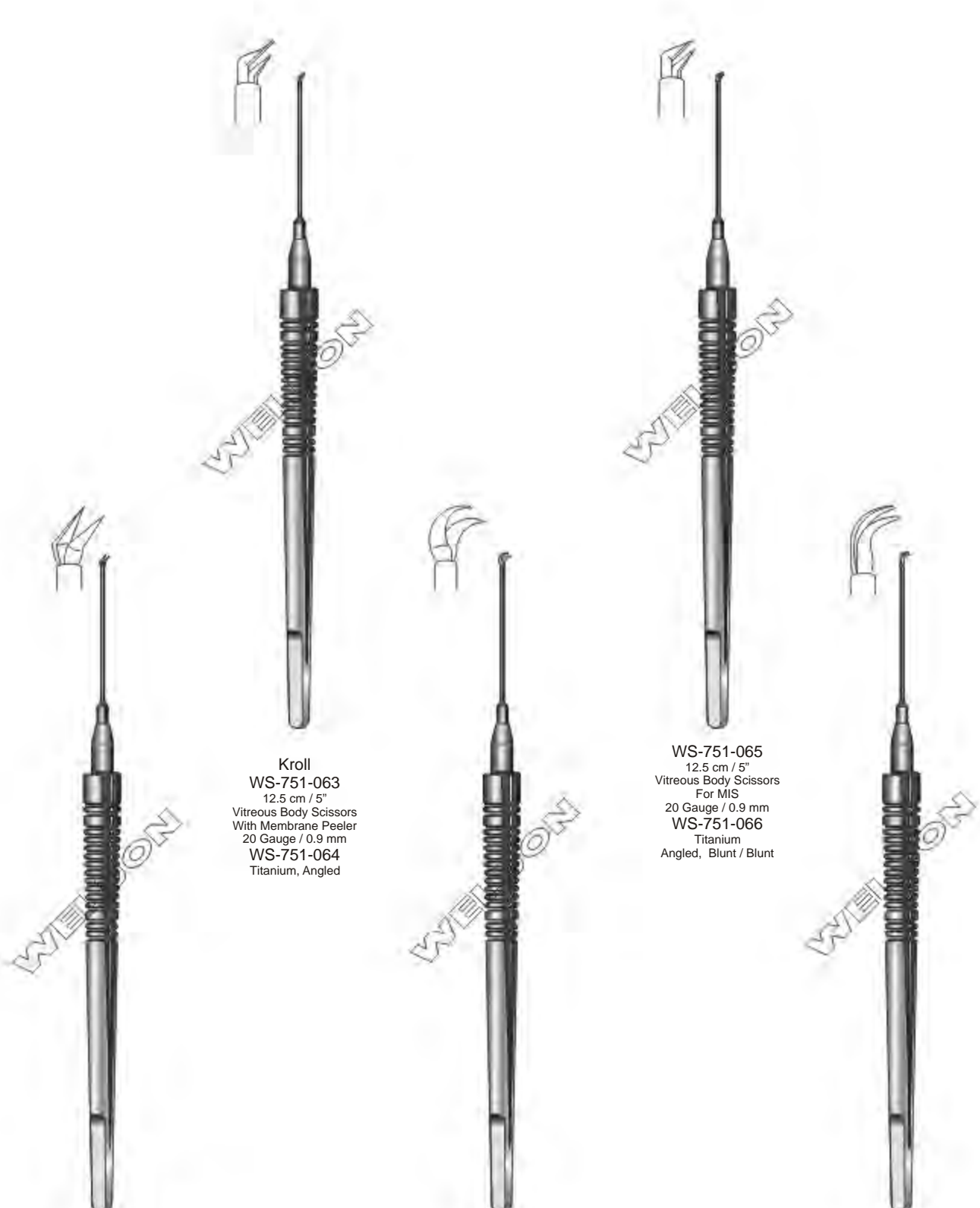

Kroll
 WS-751-063
 12.5 cm / 5"
 Vitreous Body Scissors
 With Membrane Peeler
 20 Gauge / 0.9 mm
 WS-751-064
 Titanium, Angled

WS-751-065
 12.5 cm / 5"
 Vitreous Body Scissors
 For MIS
 20 Gauge / 0.9 mm
 WS-751-066
 Titanium
 Angled, Blunt / Blunt

WS-751-067
 12.5 cm / 5"
 Vitreous Body Scissors
 20 Gauge / 0.9 mm
 WS-751-068
 Titanium
 45° Angled

WS-751-069
 12.5 cm / 5"
 Vitreous Body Scissors
 With Membrane Peeler
 20 Gauge / 0.9 mm
 WS-751-070
 Titanium
 Bent

WS-751-071
 12.5 cm / 5"
 Vitreous Body Scissors
 20 Gauge / 0.9 mm
 WS-751-072
 Titanium
 Round, Curve

Scissors | Tijeras | Scheren



Heimann
WS-752-076
12.5 cm / 5"
Vitreous Body Scissors
20 Gauge / 0.9 mm
WS-752-077
Titanium
Angled, Sharp / Sharp



Heimann
WS-752-073
12.5 cm / 5"
Vitreous Body Scissors
20 Gauge / 0.9 mm
WS-752-074
Titanium
Straight, Sharp / Sharp



Heimann
WS-752-078
12.5 cm / 5"
Vitreous Body Scissors
20 Gauge / 0.9 mm
WS-752-079
Titanium
Straight, Blunt / Blunt



Heimann
WS-752-075
12.5 cm / 5"
Vitreous Body Scissors
24 Gauge / 0.6 mm
Angled, Blunt / Blunt