

## Comparative Morphology of the Euglenid Pellicle. II. Diversity of Strip Substructure

BRIAN S. LEANDER and MARK A. FARMER

Center for Advanced Ultrastructural Research, 154 Barrow Hall, The University of Georgia, Athens, Georgia 30602, USA

**ABSTRACT.** The morphological diversity associated with the strip substructure of the euglenid pellicle was examined, and after identifying characters and states, we outlined hypotheses about their evolution. We have attempted to standardize terms necessary for analytical comparisons of strips by providing a glossary and comparing published synonyms. Most of the substructural diversity found in euglenids is demonstrated with 13 representative taxa. Strips are generally composed of two subcomponents: frames and projections. Frames support the basic shape of strips and many can be described as either S-shaped, plateau-shaped, M-shaped, or A-shaped. Projections branch laterally from the frames, are usually periodic, and can be described as thread-like structures, an indented plate, tooth-like structures, and plate-like structures. The ancestral state included strips that were few in number, flat, and fused. The strips became S-shaped and disjoined in the lineage leading to most euglenid taxa. These strips became secondarily flattened and fused in one lineage. In some lineages of phototrophs, the strips became increasingly robust. Two strips of different morphology formed the repeating pellicular unit or doublet in four taxa. These doublets evolved convergently at least three times and may provide insights into developmental patterns of the cytoskeleton.

**Key Words.** *Dinema*, *Euglena*, evolution, *Lepocinclis*, *Phacus*, *Ploetia*, *Rhabdomonas*, *Urceolus*.

THE general organization of the pellicle is common to all euglenids, and it embodies some of the most morphologically diverse structures in this taxon. The pellicle consists of four main components: the plasma membrane, repeating proteinaceous units called strips, subtending microtubules, and tubular cisternae of endoplasmic reticulum (Hofmann and Bouck 1976). The proteinaceous strips are composed primarily of articulins, are arranged in parallel, and articulate along their lateral borders (Bouck and Ngo 1996; Dubreuil and Bouck 1985; Dubreuil, Marrs, and Bouck 1992; Marrs and Bouck 1992). Below each strip is a set of parallel microtubules, where each microtubule in the set occupies a discrete position relative to the strip (Bricheux and Brugerolle 1986, 1987; Gallo and Shrével 1982; Hofmann and Bouck 1976; Mignot, Brugerolle, and Bricheux 1987). A cisterna of endoplasmic reticulum is also intimately associated with each strip and appears to function as a reservoir for calcium (Hofmann and Bouck 1976; Murray 1981).

The strips are the most obvious and distinctive components of the euglenid pellicle. Previous studies have shown that the morphology of the individual strips varies among taxa and is quite complex (Angeler, Müllner, and Schagerl 1999; Bourrelly, Couté, and Rino 1976; Bricheux and Brugerolle 1986, 1987; Dragos, Péterfi, and Craciun 1979; Dragos, Péterfi, and Popescu 1997; Dubreuil and Bouck 1985; Farmer and Triemer 1994; Gerola and Bassi 1981; Leedale 1964; Leedale and Hibberd 1974; Mignot 1965, 1966; Mikolajczyk 1975; Suzaki and Williamson 1986a, 1986b). Some authors have linked specific substructural features of strips to the degree of euglenoid movement (Dawson and Walne 1991; Dragos, Péterfi, and Popescu 1997; Dubreuil and Bouck 1985; Leedale and Hibberd 1974; Mikolajczyk 1975; Suzaki and Williamson 1985, 1986a, 1986b). It has also been demonstrated that the morphology of the strips remains almost invariable in both the relaxed and contracted stages of euglenoid movement (Suzaki and Williamson 1985, 1986a). These data suggest that the morphological diversity present at the level of strip substructure may provide a valuable source of phylogenetic information.

Papers that have focused on strip substructure often use different terms for homologous structures or the same terms for entirely different structures (e.g. Bricheux and Brugerolle 1986, 1987; Dawson and Walne 1991; Dragos, Péterfi, and Craciun 1979; Dragos, Péterfi, and Popescu 1997; Gerola and Bassi 1981; Hofmann and Bouck 1976; Leedale 1964; Mignot 1965;

Mignot, Brugerolle, and Bricheux 1987; Mikolajczyk 1975; Suzaki and Williamson 1985, 1986a, 1986b). This confusing terminology makes it difficult to compare the reconstructions of pellicle strips by different authors.

Accordingly, this paper attempts to accomplish four general objectives via classical comparative morphology: (1) provide an explicit set of preferred terms and many previously used synonyms relating to the characterization of strip morphology; (2) demonstrate the general diversity of strip substructure found in euglenids by presenting new data obtained from 13 disparate taxa; (3) identify characters and character states pertaining to the morphology of strips that provide information about phylogenetic relationships; (4) summarize knowledge about the diversity of strip substructure in a diagram delineating specific hypotheses about the character evolution of strips.

Along with our companion paper dealing with patterns of pellicular strips and pores (Leander and Farmer 2000), this work is intended to facilitate an accurate interpretation and classification of euglenid phylogeny. The strip substructural data are currently being expanded and combined with a maturing SSU rDNA database (e.g. Leander and Farmer 2001; Linton et al. 1999; Linton et al. 2000; Preisfeld et al. 2000). These efforts are providing robust apomorphy-based definitions for taxonomically important clades (Leander and Farmer 2001). The molecular phylogeny is also permitting us to test the hypotheses for the evolution of strip substructure proposed herein.

### METHODS AND MATERIALS

**Culture conditions.** Cultures of *Lepocinclis buetschlii* (UTEX LB 523), *Euglena cantabrica* (UTEX LB 1320), *Euglena myxocylindracea* (UTEX LB 1989), *Euglena terricola* (UTEX LB 1310), *Phacus brachykentron* (UTEX LB 1317), *Phacus pyrum* (UTEX 2354), and *Rhabdomonas costata* (UTEX LB 1278) were purchased from the Culture Collection of Algae at the University of Texas at Austin (UTEX). These cultures were maintained in an incubator at 20 °C on a 12-h light—12-h dark cycle. *Euglena myxocylindracea* was grown in *Euglena* Medium (EM-Greenblatt and Schiff 1959). *Lepocinclis buetschlii*, *E. cantabrica*, *E. terricola*, *P. brachykentron*, and *P. pyrum* were grown in soil/water medium with ammonium magnesium phosphate hexahydrate (0.1 g / 200 ml). *Rhabdomonas costata* was grown in soil/water medium with barley (1 grain/200 ml). *Entosiphon sulcatum* was isolated from the Delaware-Raritan canal in New Brunswick, NJ, and temporarily maintained in soil/water medium. *Dinema sulcatum*, *Ploetia costata*, and *Urceolus cyclostomus* were isolated from an intertidal marsh in Tuckerton, NJ. *Euglena helicoideus* (syn. *E. gi-*

Corresponding Author: B. Leander—Telephone number: 706-542-4080; FAX number: 706-542-4271; E-mail: farmer@cb.uga.edu

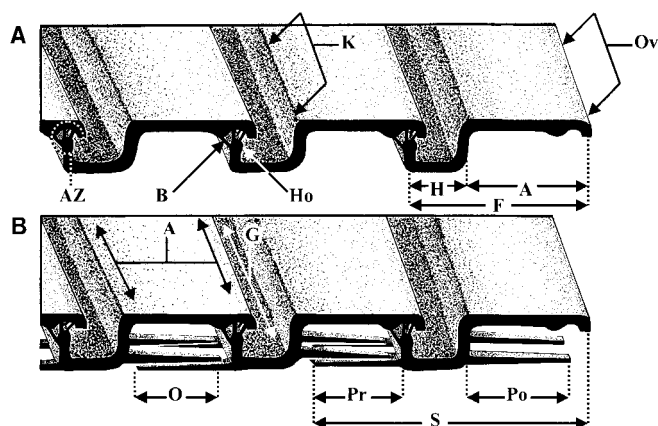

Fig. 1. Diagram illustrating the preferred terms used to describe the substructure of euglenid pellicle strips. Refer to Table 1 for definitions and Table 2 for synonyms. **A.** Pellicle strips without strip projections. In this context, the term "frame" (F) is synonymous with "strip" (S). **B.** Pellicle strips with strip projections. In this context, each strip (S) consists of a frame (F), prearticular projections (Pr), and postarticular projections (Po). A, arch; AZ, articulation zone; B, bridge; G, major groove; H, heel; Ho, hook; K, keel; O, zone of overlap; Ov, overhang.

gas-Gojdics 1953) was isolated from a freshwater pond in Athens, GA. An undescribed species conforming to the definition of *Euglena* (Goidjics 1953), designated as "*Euglena* sp.", was isolated from a bloom in marine sediments on Sapelo Island, GA.

**Electron microscopy and freeze fracture.** Cultured cells were concentrated by slow centrifugation into Eppendorf tubes. Cells of *D. sulcatum*, *E. helicoideus*, *P. costata*, and *U. cyclostomus* were isolated individually with a micropipette and flat-embedded. All living cells were chemically fixed and prepared for transmission and scanning electron microscopy (TEM and SEM, respectively) by the protocols described in Leander and Farmer (2000).

Cells of *E. myxocylindracea* were freeze fractured in the following manner. A tiny drop (~3  $\mu$ l) of concentrated cells was placed on a gold hat (diam. = 3 mm) and rapidly plunged into a bath of liquid propane. Frozen cells were transferred to a precooled specimen stage (-196  $^{\circ}$ C) of a Balzers BAF 301 freeze fracture device. Cells were slowly warmed to -100  $^{\circ}$ C, fractured with a precooled razor blade (-150  $^{\circ}$ C), and coated with platinum and carbon. The platinum/carbon replicas were cleaned with a 5.25% sodium hypochlorite solution for two hours, rinsed with distilled water, and placed on 300-mesh copper grids. The replicas were viewed under a JEOL 100 CXII Transmission Electron Microscope at 80 kV.

## RESULTS

**Descriptive terminology of strip substructure.** Previous terminology used to describe strip substructure varies greatly making comparative analyses difficult. Figure 1 illustrates the terms used in this paper to characterize strip substructure, and Table 1 explicitly defines each term.

We have introduced new terms for features of strips that have been neglected in the literature and were necessary for precise comparative analysis. For example, we have recognized the pellicle strip as consisting of both a fundamental unit called the "frame" (F) and "projections" that branch from the heel (H). These projections are either "prearticular" (Pr) or "postarticular" (Po) depending on their position relative to the "articulation zone" (Az) (Table 1, 2 and Fig. 1). Dragos, Péterfi, and

Table 1. Glossary for the preferred terms used to describe the substructure of euglenid pellicle strips. Refer to Fig. 1 and 26 for illustration of these features.

**Arch (A):** The fraction of the frame between the overhang (Ov) and the keel (K). When a discrete keel is absent, the arch is delimited by the transitional mid-point between the two opposite curves of the sigmoidal frame.

**Articulation Zone (AZ):** The space between the overhang (Ov) of one strip (S) and the hook (Ho) of an adjacent strip. Bridges (B) and microtubules are usually present within this zone.

**Bridges (B):** Connectives that physically link the overhang (Ov) of one strip (S) with the hook (Ho) of an adjacent strip within the articulation zone (AZ).

**Doublets:** A repeating unit of two strips that have different morphologies.

**Frame (F):** The fundamental component of strips (i.e., the strip excluding lateral projections). The properties of frames are best demonstrated in transverse section. Usually, the frame is sigmoidal and consists of at least an overhang (Ov), an arch (A), a heel (H), and a hook (Ho).

**Heel (H):** The fraction of the frame (F) between the hook (Ho) and the keel (K). When a discrete keel is absent, the heel is delimited by the transitional mid-point between the two opposite curves of the sigmoidal frame.

**Hook (Ho):** The margin of a heel (H) that resides below the overhang (Ov) of an adjacent strip (S).

**Keel (K):** Refers to a recognizable edge that defines the boundary between the arch (A) and the heel (H).

**Major Groove (G):** The extracellular space formed between any two articulating strips (S). The properties of the heel (H) of one strip and the overhang (Ov) of an adjacent strip determine the properties of the groove (e.g., depth, shape, and width).

**Median Depression:** Refers to the concave surface on the arches (A) of some taxa.

**Minor Groove (M):** A groove-like concavity in an arch (A) that runs along the longitudinal axis of the strip (Fig. 26). A modified median depression.

**Overhang (Ov):** The margin of an arch (A) that resides above the hook (H) of an adjacent strip (S).

**Pellicle:** The cytoskeletal complex of euglenids consisting of the plasma membrane, proteinaceous strips, microtubules, and tubular cisternae of endoplasmic reticulum.

**Postarticular Projection (Po):** Any proteinaceous extension branching from the heel (H) and positioned below the arch (A) of the same strip. These projections often reside above the prearticular projections (Pr) of an adjacent strip (S).

**Prearticular Projection (Pr):** Any proteinaceous extension branching from the heel (H) and positioned below the arch (A) of an adjacent strip (S). These projections often reside below the postarticular projections (Po) of an adjacent strip (S).

**Rib (R):** Any proteinaceous structure extending from the upper surface of prearticular projections (Pr). Usually, ribs are oriented perpendicular to the longitudinal axis of the strips (S) and perpendicular to the planar surfaces of plate-like projections (Fig. 26).

**Strip (S):** A repeating proteinaceous structure that lies directly below the plasma membrane and consists primarily of a frame (F) that is often sigmoidal in transverse section. The strip also includes any strip projections that branch from the heel (H) laterally. Strips are arranged in parallel along the longitudinal axis of the cell and may have either a longitudinal or helical orientation.

**Strip Projections:** Proteinaceous structures that are continuous with the frame and branch laterally from the heel. The projections may be either prearticular (Pr) or postarticular (Po) depending on their position relative to the articulation zone (AZ).

**Zone of Overlap (O):** The discrete region where the postarticular projections (Pr) of one strip (S) extend over the prearticular projections (Po) of an adjacent strip.

Table 2. Preferred terms used to describe strip substructure of euglenids and the synonymous terminology used in published literature. Refer to Fig. 1 and 26 for illustration of preferred terms.

Preferred terms	Synonymous terms	References
arch (A)	arch fold rib ridge  striation	Bricheux and Brugerolle 1986, 1987; Dragos, Péterfi, and Popescu 1997 Bricheux and Brugerolle 1986 Kirk and Juniper 1964 Dubreuil, Marrs, and Bouck 1992; Lefort-Trans et al. 1980; Mignot, Brugerolle, and Bricheux 1987; Mikolajczyk 1975; Sommer, 1965 Groupé 1947; Kirk and Juniper 1964; Leedale 1964; Mikolajczyk, 1975; Suzaki and Williamson 1986a
articulation zone (AZ) <sup>a</sup>	discontinuity groove joint zone notch	Leedale and Hibberd 1974 Buetow 1968; Leedale 1964 Bricheux and Brugerolle 1986, 1987 Hofmann and Bouck 1976; Mikolajczyk 1975; Sommer 1965
bridges (B)	bridges  fibrils interstrip linkers interconnecting fibers periodic projections	Bricheux and Brugerolle 1986, 1987; Dragos, Péterfi, and Popescu 1997; Dubreuil and Bouck 1985; Suzaki and Williamson 1986b Mikolajczyk 1975 Dawson and Walne 1991; Mignot, Brugerolle, and Bricheux 1987 Hofmann and Bouck 1976 Suzaki and Williamson 1986a
frame (F) <sup>a</sup>	dense fibrillar layer epiplasmic layer general aspect periplast protein layer submembrane layer	Lefort-Tran et al. 1980 Bricheux and Brugerolle 1987 Gerola and Bassi 1981 Mikolajczyk 1975 Angeler, Müllner, and Schagerl 1999 Hofmann and Bouck 1976
heel (H)	heel	Bricheux and Brugerolle 1986, 1987; Dawson and Walne 1991; Mignot, Brugerolle, and Bricheux 1987
hook (Ho)	hood  periodic projections ridge shaft knob-like protuberance	Bricheux and Brugerolle 1986, 1987; Dragos, Péterfi, and Popescu 1997; Mignot, Brugerolle, and Bricheux 1987 Suzaki and Williamson 1986a Buetow 1968; Leedale 1964 Mikolajczyk 1975 Gerola and Bassi 1981
keel (K) <sup>a</sup> major groove (G) <sup>a</sup>	groove	Bricheux and Brugerolle 1986, 1987; Dragos, Péterfi, and Popescu 1997; Dubreuil, Marrs, and Bouck 1992; Mignot, Brugerolle, and Bricheux, 1987; Mikolajczyk 1975; Lefort-Tran 1980; Suzaki and Williamson, 1986a
median depression <sup>a</sup> minor groove (M) <sup>a</sup>	depression deep longitudinal furrow depression	Mikolajczyk 1975 Bourrelly, Couté, and Rino 1976; Conforti and Tell 1989 Mikolajczyk 1975
overhang (Ov)	overhang knob	Sommer and Blum 1965 Gerola and Bassi 1981
pellicle	cuticle pellicle	Bourrelly, Couté, and Rino 1976; Mignot 1965, 1966 Angeler, Müllner, and Schagerl 1999; Bricheux and Brugerolle 1986, 1987; Dragos, Péterfi, and Popescu 1997; Hofmann and Bouck 1976; Kirk and Juniper 1964; Leedale 1967
prearticular projection (Pr) <sup>a</sup>	surface complex anterior plate-like projection big tooth flanges	Dubreuil, Marrs, and Bouck 1992 Dragos, Péterfi, and Popescu 1997 Mikolajczyk 1975 Buetow 1968; Leedale 1964
postarticular projection (Po) <sup>a</sup>	thick fibers indented plate little tooth posterior plate-like projection traversing fiber	Bricheux and Brugerolle 1986 Bricheux and Brugerolle 1986, 1987 Mikolajczyk 1975 Dragos, Péterfi, and Popescu 1997 Hofmann and Bouck 1976
ribs (R)	platelike projections ribs	Suzaki and Williamson 1986b Dragos, Péterfi, and Craciun 1979; Dragos, Péterfi, and Popescu 1997; Leedale 1964
strip (S)	band stria  strip	Mikolajczyk 1975 Angeler, Müllner, and Schagerl 1999; Conforti and Tell 1989; Dawson and Walne 1991 Dubreuil, Marrs, and Bouck 1992; Leedale 1964, 1967; Suzaki and Williamson 1986b
strip projections <sup>a</sup>	fibers fibrous layer flanges overlapping teeth plate-like projections traversing fibers traversing filaments	Kirk and Juniper 1964 Lefort-Tran et al. 1980 Buetow 1968; Gerola and Bassi 1981 Leedale 1964; Mignot 1965 Dragos, Péterfi, and Popescu 1997 Dubreuil and Bouck 1985 Suzaki and Williamson 1986a
zone of overlap (O)	overlap	Bricheux and Brugerolle 1986

<sup>a</sup> A new term proposed in this paper.

Popescu (1997) used the synonymous terms “anterior plate-like projection” and “posterior plate-like projection”, respectively. The qualifying terms “anterior” and “posterior” were abandoned because they have no descriptive value for taxa with strips arranged longitudinally. The “keel” (K) defines the boundary between the two major components of the frame, namely the heel (H) and the arch (A) (Table 1, 2 and Fig. 1). The “overhang” (Ov) of a strip refers to the margin of the arch that articulates via bridges (B) with the hook (Ho) of an adjacent strip (Table 1, 2 and Fig. 1).

A review of previously published synonyms is presented in Table 2. In some cases different terms have been applied to special states of a homologous structure. In these cases, we have provided a new single term for structures (i.e. characters) that have many states. For example, “strip projection” refers to the “traversing filaments” of Suzaki and Williamson (1986a); the “fibers” of Kirk and Juniper (1964); and the “teeth” of Leedale (1964), Mignot (1965), and Mikolajczyk (1975) (Table 2).

We also note that in some cases the same term refers to entirely different structures. For instance, Sommer (1965) referred to the arch (A) as the “ridge” whereas Leedale (1964) referred to the hook (Ho) as the “ridge” (Table 2). Along these lines, Dragos, Péterfi, and Popescu (1997) described ribs extending from posterior “plate-like projections” (syn. post-articular projections, Po) and, in an earlier paper, Suzaki and Williamson (1986b) used the term “plate-like projections” to label these ribs (Table 2). In these cases, we have abandoned the homonymous term (e.g. ridge and plate-like projection). The term “groove” suffers from this same problem, but we did not uncover any published synonyms and all previous authors have used the term consistently except Leedale (1964) and Buetow (1968). We have added the qualifying term “major” (G) to clarify our reference to the space between strips and to discriminate between the “minor groove” present along the arches (A) of some taxa (Table 1, 2).

Where synonyms exist for the same structure, we chose the term used most frequently and with the best descriptive value. As one example, we use “bridges” (B) after Dubreuil and Bouck (1985) to describe the connectives between the overhang (Ov) and the hook (Ho). Even though “interstrip linkers” (Dawson and Walne 1991; Mignot, Brugerolle, and Bricheux 1987) and “interconnecting fibers” (Hofmann and Bouck 1976) also have descriptive value, these terms appear to be applied less often in the literature (Table 2). Likewise, we chose the term “pellicle” over two other synonyms used to name the cytoskeleton of euglenids (Table 2).

**Diversity of strip substructure.** We examined the pellicles of 13 different taxa. These data demonstrate much of the morphological diversity known to occur at the level of strip substructure. The strips from each taxon are shown in transverse section with the overhangs oriented to the right.

*Dinema sulcatum* and *U. cyclostomus* are both phagotrophic euglenids with helical pellicles. The strips of *D. sulcatum* were extremely flat and thin (Fig. 2). Details of the articulation zones, hooks, and overhangs were obscured by electron-dense material; the presence or absence of projections was unclear. The strips of *U. cyclostomus* were also very thin. The frames were weakly sigmoidal, consisting of a shallow heel that was 4× the width of the arch (Fig. 3). No distinct keel was present between the heel and the arch. Prearticular projections and overhangs were present (Fig. 3).

*Euglena myxocylindracea*, *E. terricola*, *E. cantabrica*, and *Euglena* sp., are all phototrophic euglenids with helical pellicles. The strips of these taxa were significantly thicker than the strips of *D. sulcatum* and *U. cyclostomus*. The frames of *E.*

*myxocylindracea* were sharply sigmoidal, consisting of a rounded keel dividing a heel and an arch of equal width (Fig. 4). The arches terminated with pronounced overhangs. Many projections branched off of the heel in a periodic pattern (Fig. 4). The prearticular projections were thread-like in morphology and crisscrossed forming a mat of intertwined threads below the frames (Fig. 5). In tangential sections, the postarticular projections formed finer and straighter threads with greater periodicity when compared to the prearticular projections (data not shown).

The frames of *E. terricola* (Fig. 6) were similar to those in *E. myxocylindracea*, except that the arches were flatter and wider. The hooks, overhangs, prearticular projections and postarticular projections of *E. terricola* were almost identical to those in *E. myxocylindracea* (Fig. 6, 7).

The frames of *E. cantabrica* were sigmoidal, consisting of a sharp keel dividing a heel that was 1/3 the width of the arch (Fig. 8). The arches possessed shallow median depressions that accentuated the keel. The hooks and overhangs were similar to those in *E. myxocylindracea* and *E. terricola*. Also like the other phototrophic taxa, prearticular and postarticular projections were thread-like in appearance, where the postarticular projections were finer and more closely spaced (Fig. 9).

The frames of *Euglena* sp. were sigmoidal with a sharp keel (Fig. 10). The horizontal region of the heel was relatively robust and the vertical region leading to the keel was proportionately taller than the heels observed in *E. myxocylindracea*, *E. terricola*, and *E. cantabrica*. The plane of the arches was oriented roughly 75° to the horizontal region of the heel (Fig. 10). Despite their oblique orientation, the overhangs were similar to those observed in the other phototrophic taxa. However, the prearticular projections were more robust, linear, and evenly spaced (Fig. 11). We were not able to confidently identify postarticular projections.

*Lepocinclis buetschlii* and *P. brachycentron* are phototrophic euglenids with fairly rigid pellicles consisting of longitudinally arranged strips that become twisted at the posterior tip (Fig. 12, 16, respectively). In both taxa, the substructural morphology of the strips was similar. The strips of these taxa were significantly thicker than those of the taxa described previously.

The frames of *L. buetschlii* were sigmoidal, consisting of a sharp keel dividing a heel that was 1/5 the width of the arch (Fig. 13). The arches possessed a subtle median depression and a pronounced overhang. Prearticular and postarticular projections were evident when the strips were viewed in transverse section (Fig. 13). The postarticular projections were closely pressed to the cytoplasmic surface of the arches and were 2/3 the width of the arches. These projections appeared delicate and closely spaced when the strips were sectioned longitudinally (Fig. 13, 14). The prearticular projections consisted of two sub-components: a basal plate that was 1.5× the width of the heel and periodic structures arising from the upper surface of the plate (Fig. 13, 14, 15). The prearticular projections were robust and variable in width when viewed tangentially (Fig. 15).

Like *L. buetschlii*, the frames of *P. brachycentron* were sigmoidal and consisted of a sharp keel and a heel that was 1/5 the width of the arch (Fig. 17). Median depressions in the arches were less conspicuous; the overhangs were pronounced. Prearticular and postarticular projections were obvious when the strips were viewed transversely (Fig. 17). Unlike those of *L. buetschlii*, the postarticular projections in *P. brachycentron* appeared robust and less closely spaced; however like *L. buetschlii*, they were about 2/3 the width of the arches (Fig. 17, 18). The prearticular projections consisted of a basal plate that was 1/2 the width of the heel and robust periodic structures extending from the upper surface of the plate (Fig. 19, 20).

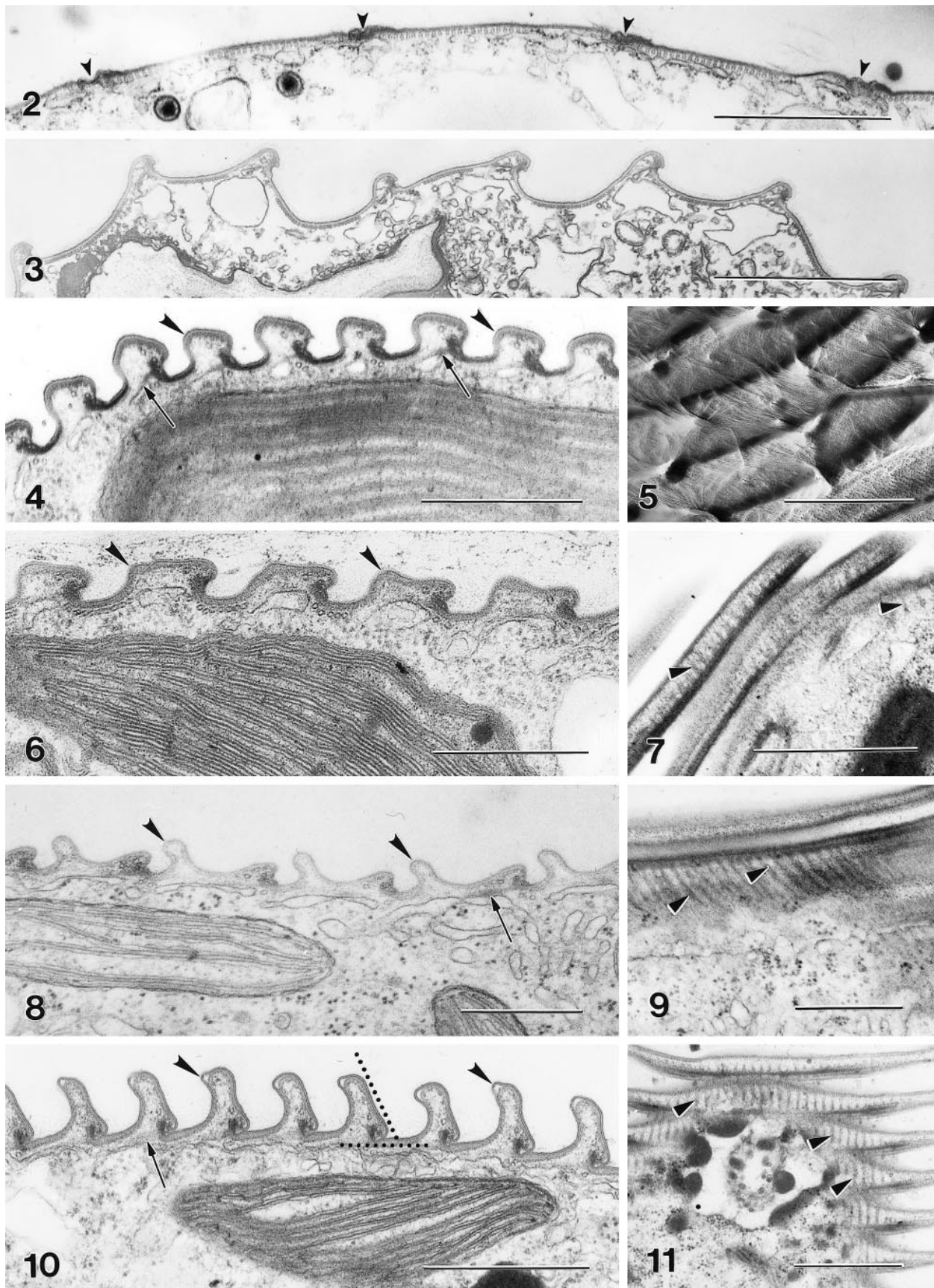

This plate was roughly 1/3 the width of the basal plate found in *L. buetschlii*.

*Euglena helicoideus*, a large phototrophic euglenid (~ 0.35 mm in length), has helically arranged pellicular strips and is capable of a modest degree of euglenoid movement. The strips were exceedingly thick. The frames were sigmoidal, consisting of a large, rounded keel and a heel that was 1/3 the width of the arch (Fig. 21). The strip projections were huge; the prearticular projections were 3× wider than the postarticular projections. Oblique and longitudinal sections through the strips demonstrated that the projections were continuous plates (Fig. 22, 23). Prearticular projections possessed ribs that extended off the projection's upper surface and articulated with the undersurface of the postarticular and prearticular projections of an adjacent strip (Fig. 22, 23, 26). Tangential views of the ribs demonstrated that they are oriented perpendicular to the longitudinal axis of the strips (Fig. 24, 26). The arch of *E. helicoideus* contained a deep median depression that took the form of a longitudinal groove and was called the "minor groove" (Fig. 21, 25, 26).

All of the taxa described above possessed repeating pellicular strips with identical morphology. We examined four taxa that possessed strips that did not conform to this general pattern. *Phacus pyrum*, *Ploetia costata*, *Entosiphon sulcatum*, and *Rhabdomonas costata* all possessed pellicles with repeating morphological units composed of two strips or "doublets" (Table 1).

*Phacus pyrum* is a phototrophic euglenid with pellicular strips arranged helically (Fig. 27). The organization of the strips resulted in an alternating pattern of depressed and raised articulation zones (Fig. 27, 28). The arches of each frame possessed a broad median depression. One frame in the doublet consisted of a raised keel, an arch that was 9× the width of the heel, and a depressed overhang (Fig. 28). The companion frame consisted of a depressed keel, an arch that was 15× the width of the heel, and a raised overhang (Fig. 28). Fairly robust prearticular projections were observed (Leander and Farmer 2001) and postarticular projections were not evident.

*Ploetia costata*, *E. sulcatum*, and *R. costata* are colorless euglenids with pellicular strips arranged longitudinally with no trace of a helical pitch (Fig. 29, 31, 33). Strip projections were not detected in any of these taxa, so the terms "strip" and "frame" are synonymous in this context. The strips of *P. costata* consisted of a sharp keel dividing the heel from the arch (Fig. 30). One strip in the doublet consisted of an arch that was 5× the width of the heel and formed a deep trough. The companion strip consisted of a broad, flat arch that was 13× the width of the heel (Fig. 30).

The strips of *E. sulcatum* were sigmoidal and lacked a discrete keel. The arches were slightly rounded, of the same width, and did not possess distinct overhangs (Fig. 31, 32). One strip in the doublet consisted of a heel that formed a deep (major)

groove and was 1/2 the width of the arch. The companion strip consisted of a heel that formed a shallower (major) groove and was 1/4 the width of the arch (Fig. 32).

The strips of *R. costata* were fused (Fig. 34). Delicate structures that extended from the frames and into the cytoplasm marked the locations of the articulation zones (Fig. 34). The strip doublets formed a sigmoidal structure, where one strip supported a shallow furrow and the companion strip formed a flat crest (Fig. 33, 34).

## DISCUSSION

Although all euglenids possess a pellicle with the same fundamental structure, a great deal of substructural diversity is present in the group. We have identified characters and states associated with the variability of strip frames and projections that can be used in phylogenetic analyses and taxonomy. In addition, there appears to be taxonomic value in the morphology of minor grooves, ribs, and strip doublets. We synthesize these data by presenting current knowledge about strip diversity in a series of hypotheses about their character evolution.

**Diversity of strip frames.** Very few authors have examined the utility of strip morphology for phylogenetic analysis. Gerola and Bassi (1981) concluded that transverse morphology of strips is inconsistent within major taxonomic groups (e.g. Radiatae and Serpentes) and can only be invoked to distinguish least inclusive taxa (species). However, recent molecular phylogenies of euglenids (Leander and Farmer 2001; Linton et al. 1999; Linton et al. 2000; Preisfeld et al. 2000) have shown that traditional taxonomic groups may not reflect genealogy.

We recognize four major character states for frames found in many different phototrophic taxa. It is likely that other states exist that have not yet been recognized and that intermediates between these states exist (Suzaki and Williamson 1986b). Each state may mark important cladogenetic events useful for the taxonomy and classification of euglenids. The four states can be labeled with symbols that approximate the shape of the frames: S, II, M, and A (Fig. 35). All four of these states contain a distinct keel that divides the heel from the arch. S-shaped frames possess a heel and a rounded arch of approximately equal or 2× the width. Examples of taxa with S-shaped frames are *Eutreptia pertyi* (data not shown), *Euglena mutabilis* (data not shown), *E. myxocylindracea* (Fig. 4, 35A), *E. splendens* (Hausmann and Mignot 1977), *Khawkinea pertyi* (Angeler 2000), and *Trachelomonas hyalina* (Mignot 1966). S-shaped frames are also present in colorless taxa with helical pellicles like *Distigma proteus* (Leander and Farmer 2000) and *Pernema trichophorum* (Mignot 1966).

Frames with flattened arches are called "plateau-shaped" (II) and are found in *E. gracilis* (Dubreuil and Bouck 1985; Lefort-Tran et al. 1980; Schwelitz et al. 1970), *E. stellata* (Dragos, Péterfi, and Craciun 1979; Mignot 1965), *E. terricola* (Fig.

←

Fig. 2–11. TEM micrographs of pellicular strips in different euglenid taxa. **2.** Transverse section of *Dinema sulcatum* showing strips that are thin and flat; details within the articulation zones (arrowheads) are obscure (Bar = 1 μm). **3.** Transverse section of *Urceolus cyclostomus*. The strips lack keels and possess broad heels and arches that are reduced to overhangs (Bar = 2 μm). **4.** Transverse section through *Euglena myxocylindracea* showing S-shaped frames, keels (arrowheads), and thread-like prearticular projections (arrows) (Bar = 0.5 μm). **5.** Replica of freeze-fractured strips in *E. myxocylindracea* as viewed from the cytoplasm showing the mat of intertwined thread-like projections that subtend the frames; the convex bodies are the cytoplasmic surfaces of heels (Bar = 0.5 μm). **6.** Transverse section of *E. terricola* showing keels (arrowheads) and plateau-shaped frames (Bar = 0.5 μm). **7.** Tangential section through *E. terricola* showing the periodicity of thread-like prearticular projections (arrowheads) (Bar = 1 μm). **8.** Transverse section of *E. cantabrica* showing pronounced keels (arrowheads), M-shaped frames, and a thread-like prearticular projection (arrow) (Bar = 0.5 μm). **9.** Tangential section through *E. cantabrica* showing the periodicity of thread-like prearticular projections (arrowheads). Finer postarticular projections are barely visible (arrows) (Bar = 0.5 μm). **10.** Transverse section through *Euglena* sp. showing keels (arrowheads), A-shaped frames, and prearticular projections (arrows). The planar surfaces of the arches are oriented roughly 75° to the horizontal regions of the heels (dotted lines) (Bar = 2 μm). **11.** Tangential section through *Euglena* sp. showing the periodicity of thread-like prearticular projections (arrowheads) that are more linearly arranged (Bar = 1 μm).

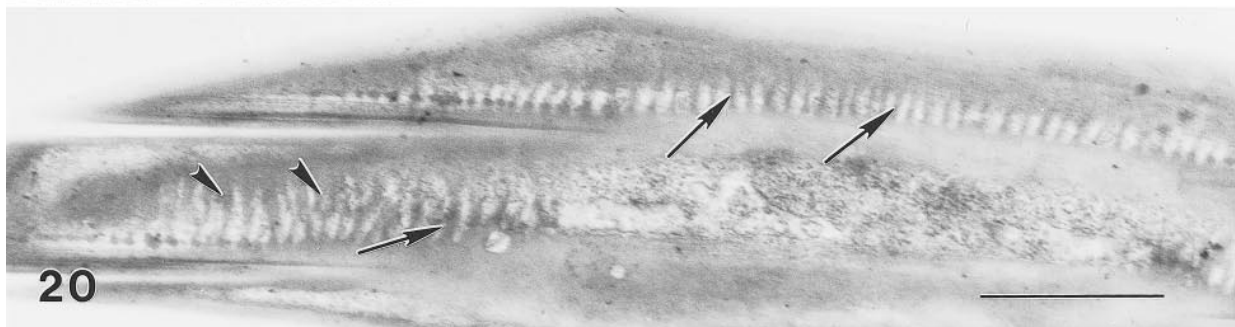
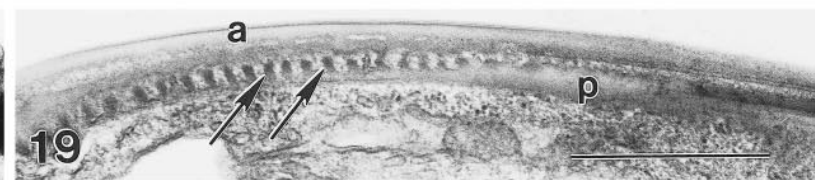
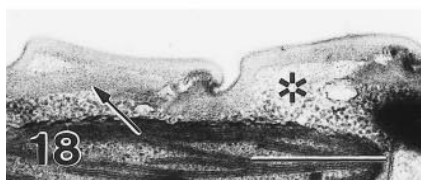
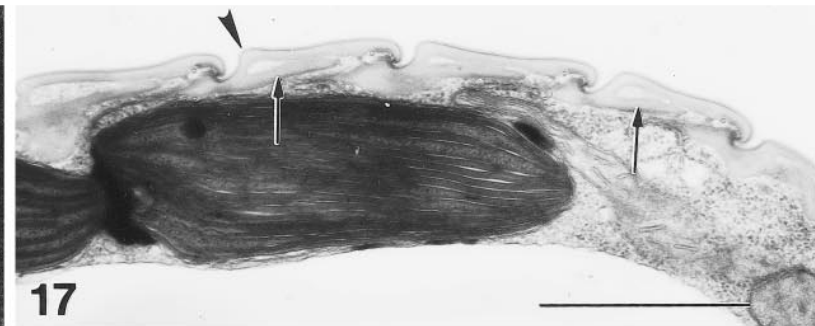
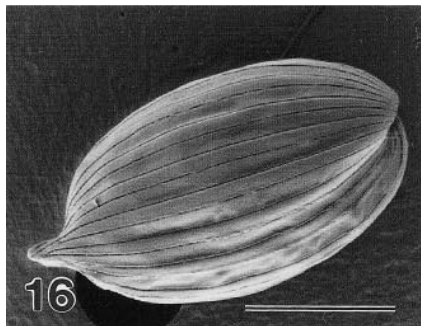
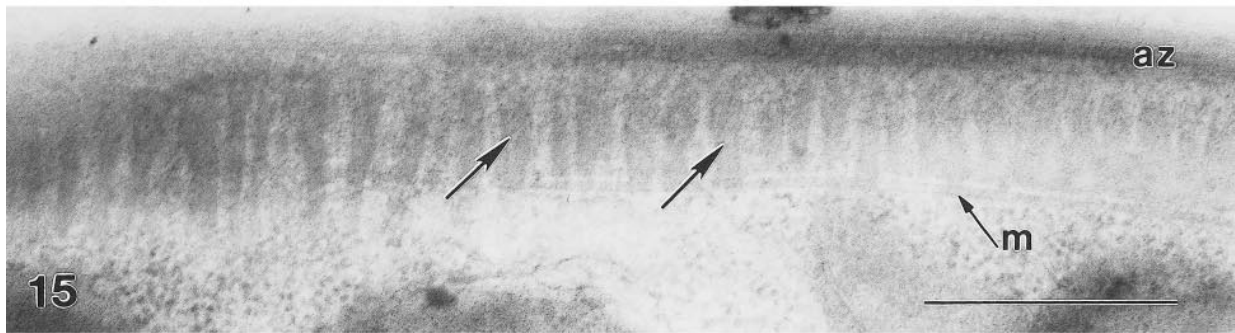
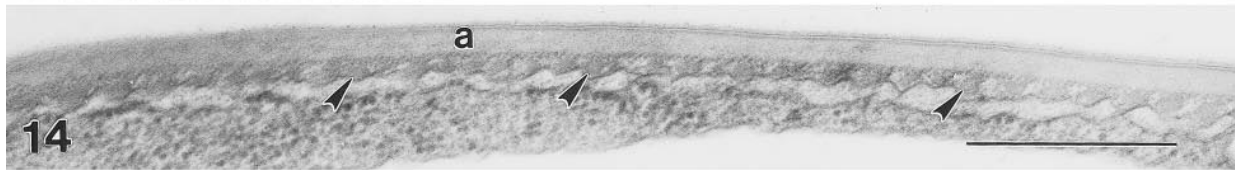
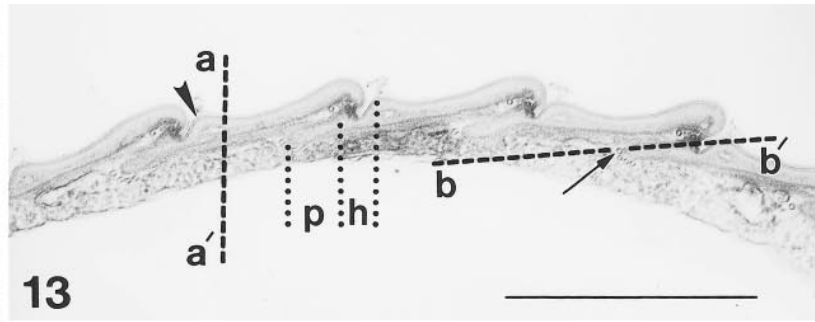
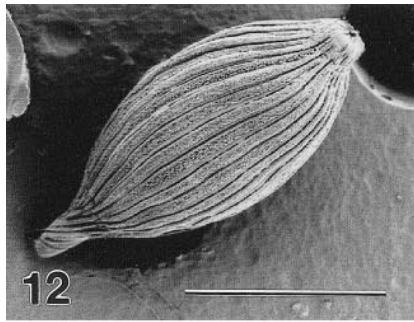

6, 35B), *E. tristella* (Péterfi, Dragos, and Craciun 1979), *E. viridis* (Dragos, Péterfi, and Craciun 1979; Foissner, 1977), and *Astasia longa* (Suzaki and Williamson 1986a). In some cases, the heel is about equal in width to the arch (*E. terricola*), but in most cases, the heel is narrower than the arch (*E. stellata* and *E. viridis*). *Cryptoglena pigra* (Owens, Farmer, and Triemer 1988; Rosowski and Lee 1978) appears to have plateau-shaped frames with arches that are about 19× the width of the heel. The frames of *L. buetschlii* (Fig. 13), *P. brachykentron* (Fig. 17), *E. acus* (Bricheux and Brugerolle 1986, 1987; Mignot 1965), and *P. curvicauda* (Bricheux and Brugerolle 1987) also appear plateau-shaped; however, their frames and projections are significantly more robust than the taxa previously mentioned. These robust frames may be monophyletically derived from the more delicate plateau-shaped frames, and this putative link is consistent with the morphological progression of strips outlined by Suzaki and Williamson (1986b) and the discussion that follows.

Frames that possess either a distinct median depression or a minor groove in the arch are recognized as “M-shaped”. *Euglena cantabrica* (Fig. 8, 35D) has relatively delicate M-shaped frames that resemble those of *E. caudata*, (Gerola and Bassi 1981), *E. granulata* (Arnott and Walne 1967), and *E. polymorpha* (Dragos, Péterfi, and Popescu 1997). More robust M-shaped frames have been observed in *E. spirogyra* (Leedale 1964), *E. fusca* (Suzaki and Williamson 1985), and *Cyclidiopsis acus* (Mignot, Brugerolle, and Bricheux 1987). By contrast, frames that possess an arch surface that is obliquely oriented to the horizontal region of the heel are designated as “A-shaped” (Fig. 35D). A-shaped frames were demonstrated with *Euglena* sp. (Fig. 10), an unlabeled taxon presented in Preisig et al. (1994), and perhaps *Tetreatreptia* (McLachlan, Sequel, and Fritz 1994).

**Diversity of strip projections.** Distinguishing features of strip projections may also provide evidence for phylogenetic relationships. Taxa such as *Distigma proteus* (Mignot 1965; Mikolajczyk 1975), *Peranema trichophorum* (Mignot 1966), and *Petalomonas cantuscigni* (Mignot 1966) have been shown to lack strip projections; thus, the mere presence of projections may help us to define an important clade of euglenids. The structure and organization of strip projections can range from being delicate and periodic to a robust plate. We recognize four primary character states relating to the morphology of strip projections: thread-like (Fig. 36A, 36B), indented plate (Fig. 36B, 36C), tooth-like (Fig. 36C, 36D), and plate-like (Fig. 36E).

Thread-like projections are relatively delicate and periodic. In some cases, the prearticular thread-like projections of one

strip crisscross with the projections of an adjacent strip forming a net-like mat beneath the frames (Dubreuil and Bouck 1985; Kirk and Juniper 1964; Lefort-Tran et al. 1980; Schwelitz et al. 1970; Suzaki and Williamson 1986a). Projections may also span across the widths of more than one neighboring strip (Kirk and Juniper 1964), a characteristic that has been observed in freeze-fracture replicas of *E. myxocylindracea* (Fig. 5) and *E. gracilis* (Dubreuil and Bouck 1985; Kirk and Juniper 1964; Lefort-Tran et al. 1980; Schwelitz et al. 1970) and in isolated pellicles of *Astasia longa* (Suzaki and Williamson 1986a). Projections that are delicate and relatively difficult to detect when the strips are viewed transversely, like those found in *E. myxocylindracea*, *E. terricola*, *E. cantabrica*, and *Euglena* sp., may be scored as thread-like (Fig. 6–11, 28, 36A, 36B). Other taxa described in the literature that possess thread-like projections include *E. polymorpha* (Dragos, Péterfi, and Popescu 1997), *E. stellata* (Dragos, Péterfi, and Craciun 1979; Mignot 1965), *E. viridis* (Dragos, Péterfi, and Craciun 1979), and *E. granulata* (Arnott and Walne 1967).

Some taxa possess very thick frames and strip projections that differ from threadlike projections not only by their degree of robustness but by being clearly visible when the strips are viewed in transverse section. This state for projections was demonstrated with *L. buetschlii* and *P. brachykentron* and may be scored as tooth-like (Fig. 12–20, 36C, 36D). These tooth-like prearticular projections consisted of flat periodic structures arising from the upper surface of a basal plate (Fig. 36C, 36D). This interpretation is consistent with Leedale’s (1964) 3-D reconstruction for the prearticular projections of *E. spirogyra*.

The postarticular projections in *L. buetschlii* and *P. brachykentron* were periodic and robust and did not stem from a basal plate (Fig. 13, 14, 18, 36C). Mignot (1965) described a similar state for the postarticular projections in *Euglena acus*. However, Bricheux and Brugerolle (1986) have revised this interpretation. They demonstrated that the postarticular projections (syn. indented plate) of *E. acus* are comprised of a plate that is “delicately indented” by fine, parallel notches oriented perpendicular to the longitudinal axis of the strip (Fig. 36B, 36C). Dragos, Péterfi, and Popescu (1997) also observed this “indented plate” morphology in the postarticular projections of *E. sanguinea*. This state is consistent with our observations of the postarticular projections present in *L. buetschlii*, *E. myxocylindracea*, *E. terricola*, and *E. cantabrica* (Fig. 36B, 36C). Even though the latter three taxa have thread-like prearticular projections, the general organization of their postarticular projections is similar to that found in *E. acus* and *E. sanguinea*. Perhaps a relatively inclusive clade may be defined apomorphically by the

←

Fig. 12–15. SEM and TEM micrographs of *Lepocinclis buetschlii*. **12.** SEM showing longitudinally arranged strips that become twisted at the posterior tip (Bar = 10  $\mu$ m). **13.** Transverse section showing keels (arrowhead), robust frames, and tooth-like prearticular projections. The heels (h) are much narrower than the arches. The postarticular projections are pressed closely to the inner surface of the arches (Bar = 1  $\mu$ m). Section a—a’ of Fig. 13 corresponds to Fig. 14 and cuts through the strip projections along the longitudinal axis of a strip. The prearticular projections consist of a basal plate (p) with tooth-like structures stemming from its upper surface. Section b—b’ of Fig. 13 corresponds to Fig. 15 and cuts tangentially through the articulation zone, the tooth-like prearticular projections, and a subtending microtubule (arrow). **14.** Longitudinal section showing the tooth-like prearticular projections in transverse section (arrowheads) and pressed closely to the fine postarticular projections of an adjacent strip; the postarticular projections form a delicate indented plate, which appears as a horizontal row of tiny dots that is positioned between the arch (a) of the same strip (above) and the prearticular projections (arrowheads) of an adjacent strip (below) (Bar = 0.5  $\mu$ m). **15.** Tangential section showing the periodicity and thickness of the tooth-like prearticular projections (arrows). The articulation zone (az) and a microtubule (m—arrow) provide reference points (Bar = 0.5  $\mu$ m). Fig. 16–20. SEM and TEM micrographs of *Phacus brachykentron*. **16.** SEM showing longitudinally arranged strips that become slightly twisted at the posterior tip (Bar = 10  $\mu$ m). **17.** Transverse section showing keels (arrowhead), robust frames, and robust tooth-like strip projections. The postarticular projections (arrows) are thicker than the prearticular projections (Bar = 1  $\mu$ m). **18.** Transverse section demonstrating that deep indentations (asterisk) reside between tooth-like postarticular projections (arrow) (Bar = 0.75  $\mu$ m). **19.** Oblique section showing the tooth-like structures (arrows) stemming from the narrow plate (p) of the prearticular projection. The keel of the strip articulating with the prearticular projection is to the left of its arch (a) (Bar = 0.75  $\mu$ m). **20.** Tangential section showing the periodicity and interconnectedness of the prearticular projections (arrows) and postarticular projections (arrowheads) (Bar = 1  $\mu$ m).



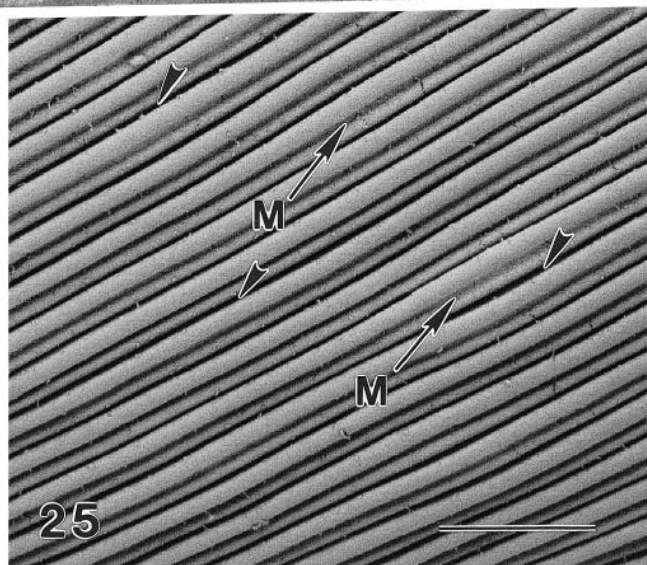
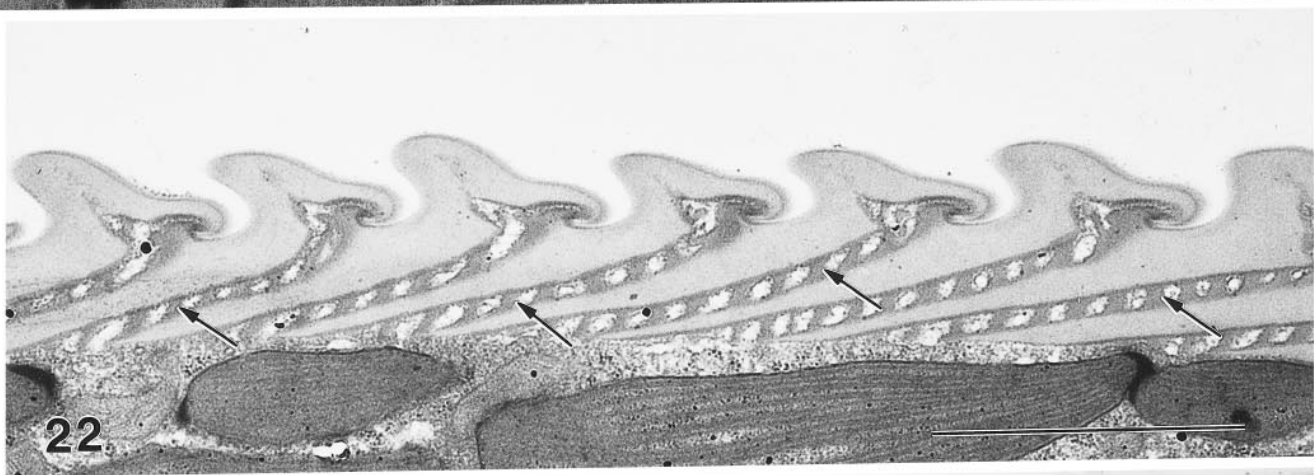
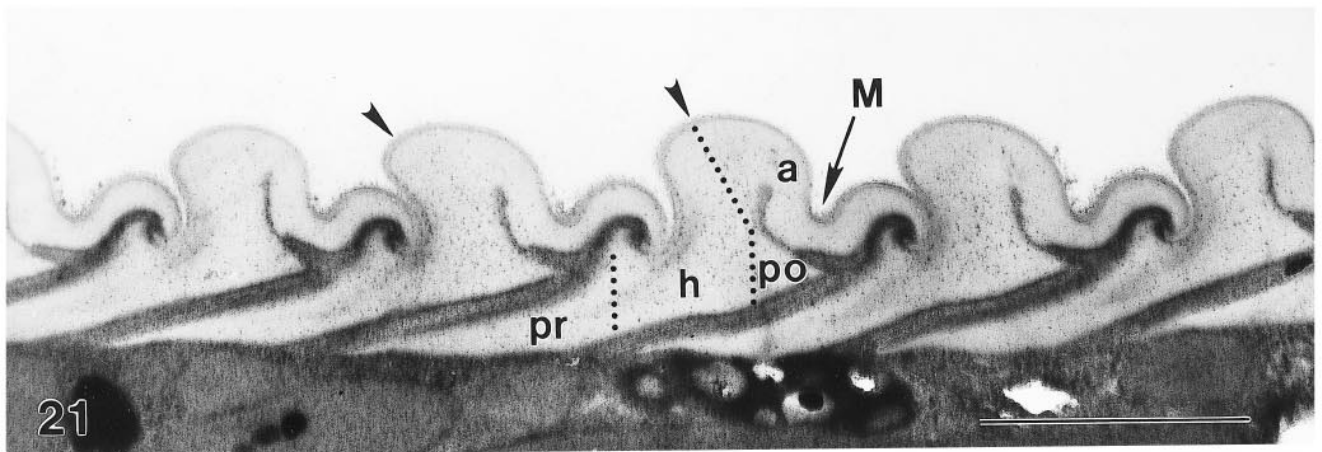

presence of postarticular projections that form “indented plates”.

The strip projections may also take the form of robust, continuous plates (Fig. 36E). An example of plate-like strip projections was described in *E. helicoideus* (Fig. 26). In this taxon, the prearticular projections were much wider than the postarticular projections. These states have also been described for *E. ehrenbergii* and *E. oxyuris* (Bricheux and Brugerolle 1987; Suzaki and Williamson 1986b).

It is unclear whether the morphology of strip projections is correlated with the degree of euglenoid movement. Some authors argue that there is a correlation (Dragos, Péterfi, and Popescu 1997) while others suggest, based on the diversity of strip thickness in taxa that undergo euglenoid movements, that there is not a correlation (Chu 1947; Suzaki and Williamson 1986b). In general, it does appear that taxa with thread-like projections tend to be capable of more euglenoid movement than taxa with tooth-like and plate-like projections.

**Minor grooves and ribs.** The frames of *E. helicoideus* are M-shaped in that the median depression on the arch has been modified into a deep longitudinal groove, the “minor groove” (Fig. 26). Minor grooves appear to be correlated with strip projections that form robust plates. In *E. helicoideus* the prearticular projections bear on the upper surface “ribs” oriented perpendicular to the longitudinal axis of the strips (Fig. 26).

Our 3-D reconstruction of *E. helicoideus* is consistent with the interpretations of Suzaki and Williamson (1986b) for the pellicles of *E. ehrenbergii* and *E. oxyuris*. In contrast, Mikolajczyk (1975) described the strips of *E. ehrenbergii* as possessing tooth-like prearticular projections. He also neglected to mention the presence of ribs and his interpretation may have relied too heavily on Mignot’s (1965) pellicular reconstruction of *E. acus*, which depicted tooth-like strip projections. Suzaki and Williamson (1986b) demonstrated that *E. ehrenbergii* possesses minor grooves, prearticular projections that form continuous plates, and perpendicularly oriented ribs on the prearticular projections. They briefly addressed the strip morphology of *E. oxyuris*, which also has minor grooves, plate-like strip projections, and ribs.

Despite these similarities, the strips of *E. helicoideus* do differ from those of *E. ehrenbergii* and *E. oxyuris*. In *E. ehrenbergii*, the keels are markedly sharper, the ribs are spaced further apart, the overhangs are more defined, and the hooks are more pronounced (bulbous in transverse section) (Fig. 26; Suzaki and Williamson 1986b). The strips of *E. helicoideus* are more similar to *E. oxyuris*. A primary difference, however, occurs in the morphology of the ribs. In *E. oxyuris*, the ribs do not appear continuous along their longitudinal axes (Suzaki and Williamson 1986b). Some of the ribs in *E. oxyuris* are also fused to both the upper surface of the prearticular projection of one strip and the lower surfaces of the postarticular projection, heel, and prearticular projection of an adjacent strip (Suzaki and Williamson 1986b). These features are not present in *E. helicoideus*. Godjics (1953) argued that differences in paramylon morphology suggest that *E. helicoideus* (syn. *E. gigas*) and *E.*

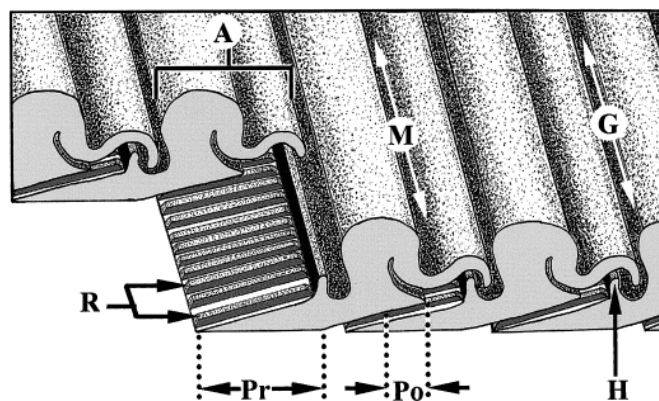

Fig. 26. Diagram illustrating the strips of *Euglena helicoideus*. Symbols defined in Fig. 1 except minor grooves (M) and ribs (R).

*oxyuris* are not synonyms. The differences in strip morphology described above may provide another criterion for discriminating between these two taxa.

We suggest that a well-defined clade of euglenids may be distinguished by the presence of minor grooves. This clade would at present include *Euglena helicoideus* (syn. *E. gigas*), *E. ehrenbergii*, *E. oxyuris*, *E. pseudospiroides*, and *Lepocinclis fusiformis*, where the two latter taxa were shown to possess minor grooves via SEM (Conforti and Tell 1989). The presence of ribs on the upper surface of the prearticular projections may also unite this clade. *Euglena spirogyra*, which was interpreted to possess ribs on the upper surface of tooth-like prearticular projections (Leedale 1964), would be excluded because our micrographs show that these “ribs” are actually postarticular projections forming an indented plate (data not shown).

**Strip doublets.** We have identified strip doublets in *P. pyrum*, *P. costata*, *E. sulcatum*, and *R. costata* (Fig. 27–34). In these taxa, two frames of different morphology constitute the repeating unit of the pellicle. Distinguishing features of strip doublets may provide useful morphological evidence for the recognition of phylogenetic relationships. Differences between the strips within the doublets may also provide morphological markers for following the maturation of strips from one generation to the next.

The morphology of the strip doublets differs significantly in *P. pyrum*, *P. costata*, and *E. sulcatum*. *Phacus pyrum* is a phototroph with helically arranged strips. Each arch in the doublet is M-shaped but one frame possesses a raised keel and a depressed overhang and the companion frame possesses the opposite configuration (Fig. 27, 28). In *P. costata*, the strips are arranged longitudinally, and each strip in the doublet possesses similar heels but different arches (Fig. 29, 30). The arch of one strip is flat and wide and the keel and the overhang oppose each other. The arch of the companion strip forms a deep “trough”, so the keel and the overhang point toward each other. By contrast, the longitudinal strips in the doublets of *E. sulcatum* pos-

←  
 Fig. 21–25. TEM and SEM micrographs of *Euglena helicoideus*. 21. Transverse section showing rounded keels (arrowheads), extremely robust M-shaped frames, and strip projections branching from the heel (h). The prearticular projections (pr) are wider than the postarticular projections (po). The arch contains a minor groove (m—arrow) (Bar = 1 μm). 22. Oblique section showing ribs (arrows) that protrude from the upper surface of the prearticular projections (Bar = 2 μm). 23. Longitudinal section demonstrating that the prearticular projections (pr) and the postarticular projections (po) form continuous plates. The keel of the strip articulating with the prearticular projection is to the left of its arch (a). Ribs (arrows) are shown in transverse section (Bar = 2 μm). 24. Tangential section demonstrating that the ribs (arrows) run perpendicular (dashed line) to the long axes of the strips (double-ended arrow) and are continuous along their own longitudinal axes (Bar = 2 μm). 25. SEM showing the periodicity and external morphology of the major grooves (arrowheads) and minor grooves (m—arrows) (Bar = 4 μm).

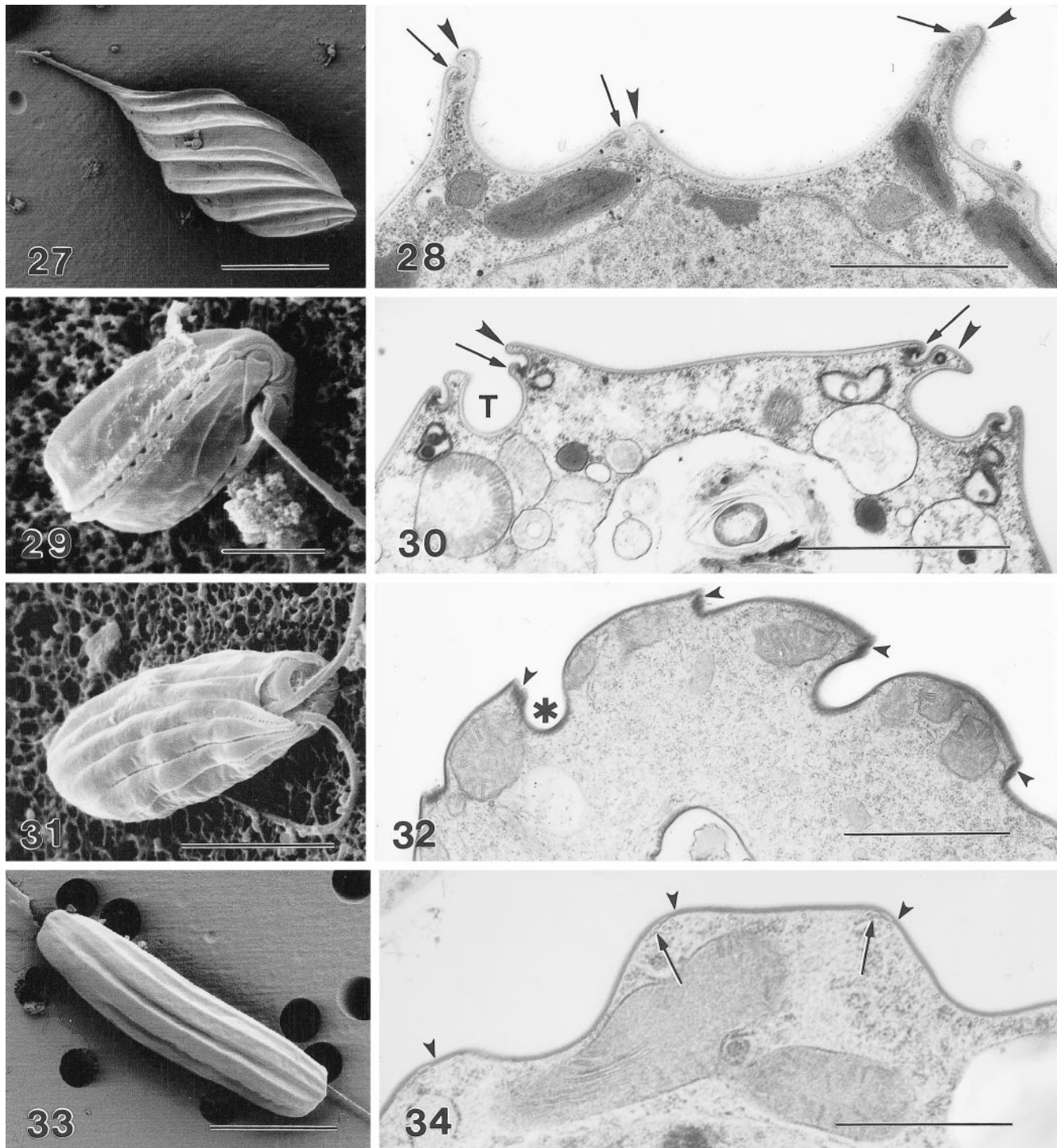

Fig. 27–34. SEM and TEM micrographs of four euglenid taxa that possess strip doublets. **27.** SEM of *Phacus pyrum* showing helically arranged strips and the alternating pattern of raised and depressed articulation zones (Bar = 10  $\mu\text{m}$ ). **28.** Transverse section through *P. pyrum* showing keels (arrowheads), overhangs (arrows), and M-shaped strips. One strip in the doublets possesses raised keels and depressed overhangs and the companion strip possesses the opposite configuration (Bar = 1  $\mu\text{m}$ ). **29.** SEM of *Ploetia costata* showing longitudinally arranged strips and overhangs (arrows), which indicate the margins of arches. The arch of one strip in the doublets forms a deep trough (T) and the arch of the companion strip is broad and flat (Bar = 2  $\mu\text{m}$ ). **30.** Transverse section through *P. costata* showing keels (arrowheads) and overhangs (arrows), which indicate the margins of arches. The arch of one strip in the doublets forms a deep trough (T) and the arch of the companion strip is broad and flat (Bar = 2  $\mu\text{m}$ ). **31.** SEM of *Entosiphon sulcatum* showing longitudinally arranged rounded strips (Bar = 5  $\mu\text{m}$ ). **32.** Semi-transverse section through *E. sulcatum* showing the articulation zones (arrowheads) and strips with similar rounded arches. The heel of one strip in the doublets forms a deep major groove (asterisk) and the heel of the companion strip forms a shallow major groove (Bar = 4  $\mu\text{m}$ ). **33.** SEM of *Rhabdomonas costata* showing longitudinally arranged strips (Bar = 8  $\mu\text{m}$ ). **34.** Transverse section through *R. costata*. The articulation zones (arrowheads) are marked by delicate structures (arrows) that branch from the strips into the cytoplasm. One strip in the doublets forms a furrow and the companion strip forms the top surface of a flat crest (Bar = 1  $\mu\text{m}$ ).

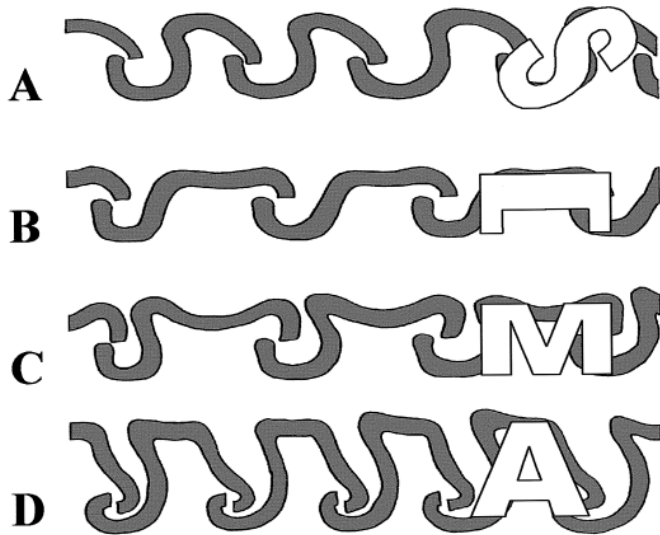

Fig. 35. Illustrations of the four main states associated with the frames of the euglenid pellicle. A) S-shaped frames. B) plateau-shaped (II) frames. C) M-shaped frames. D) A-shaped frames.

sess similar arches but different heels (Fig. 31, 32). The heel of one strip forms a deep groove and the heel of the companion strip forms a shallow groove.

These comparative data do not meet Remane's (1952) criteria for homology: (1) the shape of the frames differ in all three taxa; (2) differences between the strips within the doublets occur at different positions in all three taxa (the keel and the overhang in *P. pyrum*, the arch in *P. costata*, and the heel in *E. sulcatum*); and (3) there are no known intermediate states that bridge the doublets in these taxa. Therefore, we hypothesize that the manifestation of strips as distinct doublets in these taxa evolved convergently. In this context, we avoid the terms "median depression" and "minor groove" in reference to the trough-like arches in *P. costata* because we doubt that this arch morphology is homologous to the M-shaped frames of phototrophic taxa.

The doublets of *R. costata*, however, may be homologous to those of *E. sulcatum*. The strips of both taxa lack discrete keels. The doublets of *R. costata* consist of a trough composed of a single U-shaped strip and a crest formed of a single flat strip (Fig. 33, 34). We hypothesize that these strips, respectively, correspond to the deep-heeled strip and the shallow-heeled strip found in the doublets of *E. sulcatum* (Fig. 32, 34, 37C, 37D). If both the arch of the deep-heeled strip and the heel of the shallow-heeled strip of *E. sulcatum* regressed during their evolution, then doublets like those found in *R. costata* would emerge. If this occurred, we would predict that: (1) the flat strips supporting the crests of *R. costata* would be homologous to the arches of the shallow-heeled strips of *E. sulcatum*; (2) the U-shaped strips forming the troughs in *R. costata* would be homologous to the heels of the deep-heeled strips of *E. sulcatum*; and (3) the ordering of strips as doublets in these two taxa would be homologous. This would also explain why the individual strips of *R. costata* are not sigmoidal.

The presence of strip doublets supports the hypothesis that two adjacent strips comprise the functional unit of the pellicle. Patterns of pellicle pores have been shown to occur in rows separated by two, four, or eight strips; three states that differ by a power of two (Leander and Farmer 2000). This hypothesis is also supported by the semiconservative pattern of strip replication, where pairs of strips, one mature and one immature,

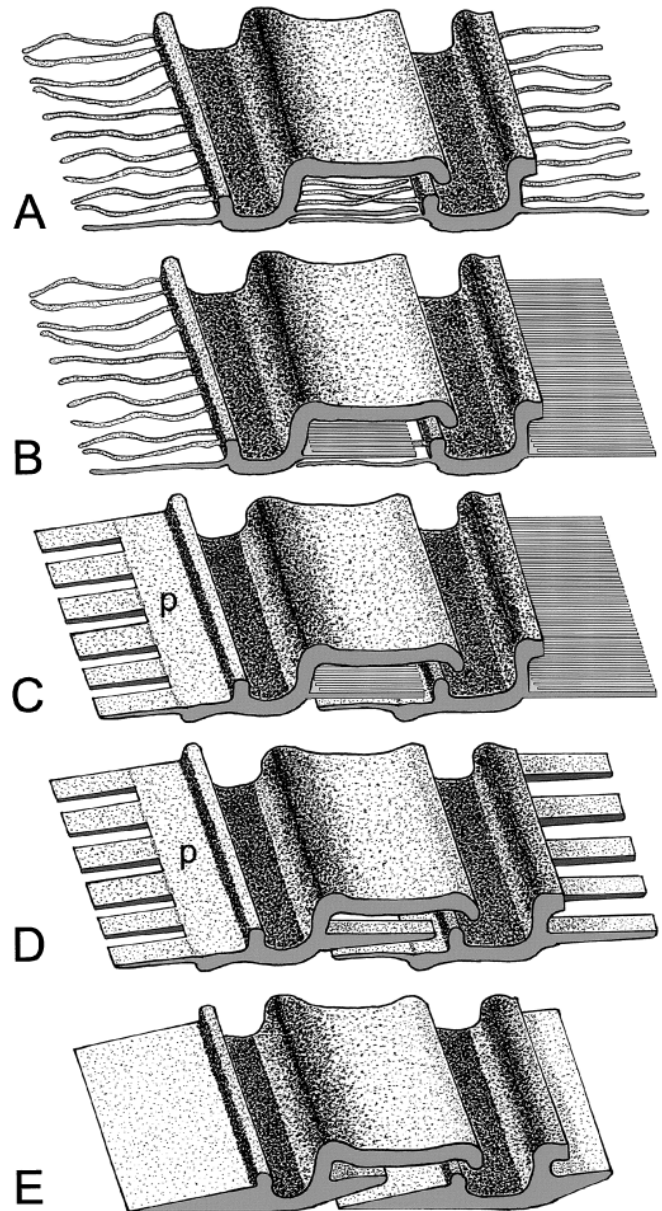

Fig. 36. Illustrations of the four main states associated with strip projections of the euglenid pellicle. In each illustration, the arch of the right-hand strip has been removed for clarity. A) Thread-like strip projections. B) Indented-plate morphology of postarticular projections. C) Tooth-like prearticular projections; p, basal plate. D) Tooth-like prearticular and postarticular projections; p, basal plate. E) Plate-like strip projections.

segregate together during cell division (Dawson and Walne 1991; Hofmann and Bouček 1976; Mignot, Brugerolle, and Bricheux 1987; Sommer and Blum 1965).

**Hypothetical trends in the evolution of strips.** Aside from a few specimens of uncertain affinity (Gray and Boucôt 1989; Loeblich, Jr. 1974), there is no fossil record available for euglenids. Therefore, studies of evolutionary trends within the group must rely on comparisons of character states found in extant taxa. We have integrated our own studies with a review of the literature in order to comprehensively outline what is currently known about the diversity of strips. When possible, these data are presented as linear progressions that simplify how

strip character states may have changed through evolutionary time (Fig. 37). Arrows between character states indicate hypothetical evolutionary polarities and apomorphic events (Fig. 37). Studies of macroevolutionary patterns demonstrate that the prevalence of cladogenesis largely overshadows the capacity to make inferences about anagenesis (McNamara 1990). Because we are dealing with character states that occur in extant taxa, the arrows in Fig. 37 also represent cladogenetic events.

Phylogenetic hypotheses based on morphological (Farmer, 1988; Leander and Farmer 2001; Montegut-Felkner and Triemer 1997; Triemer and Farmer 1991; Willey, Walne, and Kivic 1988) and molecular (Leander and Farmer 2001; Linton et al. 1999; Linton et al. 2000; Montegut-Felkner and Triemer 1997; Preisfeld et al. 2000) comparisons indicate that the ancestral euglenid was a phagotroph with few longitudinally arranged strips. We infer that the ancestral euglenid possessed strips similar to those found in *Scytomonas* (Mignot 1966): few in number (five), flat, broad, and fused (Fig. 37A). From this state, longitudinally arranged strips became U-shaped or slightly sigmoidal but still remained tightly joined at the articulation zones (Fig. 37B). Strips of this kind have been observed in *Petalomonas* and *Calycimonas* (Farmer 1988; Mignot 1966). From this state, the strips became obviously sigmoidal and could be anatomically separated into heels and arches. Strips like these diverged along separate evolutionary pathways (Fig. 37C, 37J).

In one pathway, the sigmoidal strips became ordered into doublets, where the strips within each doublet possessed heels that differed in morphology (Fig. 37C). Strips like these have been found in *Entosiphon* (Fig. 32). As discussed previously, both the arches of the deep-heeled strips and the heels of the shallow-heeled strips might have regressed leaving doublets comprised of a flat strip forming a crest and a U-shaped strip forming a trough (Fig. 37D). Even though these strips remained fused, delicate structures that extended into the cytoplasm marked the articulation zones. Strips of this kind have been observed in *Rhabdomonas* (Fig. 34). From this state, the strips became thicker and the U-shaped strips flattened out; however, delicate structures still marked the articulation zones (Fig. 37E). Strips like these have been described in *Menoidium* (Leedale and Hibberd 1974). The delicate structures marking the articulation zones eventually disappeared leaving an uninterrupted proteinaceous layer (Fig. 37F). This state has been observed in *Parmidium* and *Rhabdospira* (Cann 1986).

The strips of *P. costata*, *P. vitrea*, and *L. applanatum* are arranged longitudinally and are substructurally similar (Farmer and Triemer 1988, 1994). The strips of these taxa form a character state series of uncertain origin and polarity (Fig. 37G, 37H, 37I). The heels, keels, and overhangs are basically the same in each taxon; however, differences occur in the morphology of the arches. The strips of *P. costata* are ordered into doublets (Fig. 30, 37G), whereas the strips of *P. vitrea* and *L. applanatum* do not form obvious doublets. In *P. vitrea*, the arches are broad and flat (Fig. 37H), and in *L. applanatum*, the arches are trough-shaped (Fig. 37I). How these strips relate to other longitudinally arranged strips is currently unclear.

In a second pathway, sigmoidal strips became helically arranged and disjoined. Discrete overhangs and hooks developed between adjacent strips, which permitted the strips to slide and allow for euglenoid movements. These strips have been observed in *Anisonema* (Mignot 1966), where the strips lack a keel and possess narrow heels and wide, rounded arches (Fig. 37J). From this state, the heels widened with respect to the arches and euglenoid movements became profound (Fig. 37K). Strips like these have been observed in *Distigma proteus* (Angeller, Müllner, and Schagerl 1999; Gallo and Shrével 1982; Leander and Farmer 2000) and *Peranema trichophorum* (Mignot 1966). Thread-like prearticular projections, then, extended from the heels of these sigmoidal frames (Fig. 37L). This state has been observed in the colorless euglenid, *Khawkinia pertyi* (Angeler 2000). Strips like these gave rise to a second divergence.

Along one pathway, the heels continued to widen until the arches were no more than an overhang (Fig. 37M). This strip morphology has been found in *Urceolus cyclostomus* (Fig. 3). The arches eventually became indefinable leaving thin, flat strips and wrinkled areas of unknown organization marked the articulation zones (Fig. 37N). This state has been observed in *Dinema sulcatum* (Fig. 2). From here, the strips remained flat but began to thicken. The strips also became more segregated, leaving a gap between the strips that marked the articulation zones (Fig. 37O). Strips like these have been observed in *Distigma curvatum* (Angeller, Müllner, and Schagerl 1999). The strips then began to thicken unevenly so that the heel end of each strip was thicker than the arch end (Fig. 37P). Also, a thin hook-like region of the heel extended prearticularly beneath the overhang of an adjacent strip. Strips like these have been ob-

→

Fig. 37. Hypothetical scenario for the evolution of strips in the euglenid pellicle. Arrows represent polarities and cladogenetic events. Numbers designate the hierarchical positions of specific apomorphies using parsimony. Letters designate an example taxon that possesses the state marked; note that in most cases, a particular state may be found in many separate taxa, which are listed in the text. A) *Scytomonas pusilla* (Mignot 1966). B) *Petalomonas hovassei* (Mignot 1966). C) *Entosiphon sulcatum*. D) *Rhabdomonas costata*. E) *Menoidium bibacillatum* (Leedale and Hibberd 1974; Mignot 1965). F) *Parmidium scutulum* (Cann 1986). G) *Ploeotia costata*. H) *Ploeotia vitrea* (Farmer and Triemer 1988). I) *Lentomonas applanatum* (Farmer and Triemer 1994). J) *Anisonema costatum* (Mignot 1966). K) *Peranema trichophorum* (Mignot 1966). L) *Khawkinia pertyi* (Angeler 2000). M) *Urceolus cyclostomus*. N) *Dinema sulcatum*. O) *Distigma curvatum* (Angeler, Müllner, and Schagerl 1999). P) *Distigma elegans* (Angeler, Müllner, and Schagerl 1999). Q) *Euglena myxocylindracea*. R) *Euglena* sp. S) *Euglena terricola*. T) *Euglena cantabrica*. U) *Phacus pyrum*. V) *Lepocinclis buetschlii*. W) *Euglena helicoideus*. X) *Euglena texta* (Dragos, Péterfi, and Popescu 1997).

Ancestral state (A): Longitudinally arranged strips; strips few in number, e.g. five; broad, flat strips; fused at articulation zones; 1) Sigmoidal frames; raised articulation zones. 2) Strip doublets based on heels with different morphology. 3) Regression of the arches in the deep-heeled strips forming troughs; regression of the heels in the shallow-heeled strips forming flat crests; secondary strip fusion. 4) The trough-shaped strips flatten. 5) Complete fusion, no delicate structures marking the articulation zones. 6) Strip doublets based on arches with different morphology either develop or disappear. 7) The arches either become broader and flatter or narrower and troughlike. 8) Helically arranged strips; arches wider than heels and with overhangs; strip segregation at the articulation zones. 9) S-shaped frames; arches roughly equal in width; pronounced euglenoid movement. 10) Thread-like prearticular projections present. 11) Heels broaden; arches no more than an overhang. 12) Flat, thin strips; arches disappear. 13) Flat strips thicken. 14) Flat strips thicken unevenly. 15) Keels; S-shaped frames thicken; postarticular projections form an indented plate. 16) Plateau-shaped frames. 17) A-shaped frames; heels thicker than arches. 18) Median depressions, M-shaped frames. 19) Strip doublets based on an alternating pattern of raised and depressed articulation zones. 20) Strips more robust; tooth-like prearticular projections. 21) Plate-like strip projections; ribs on prearticular projections; minor grooves.

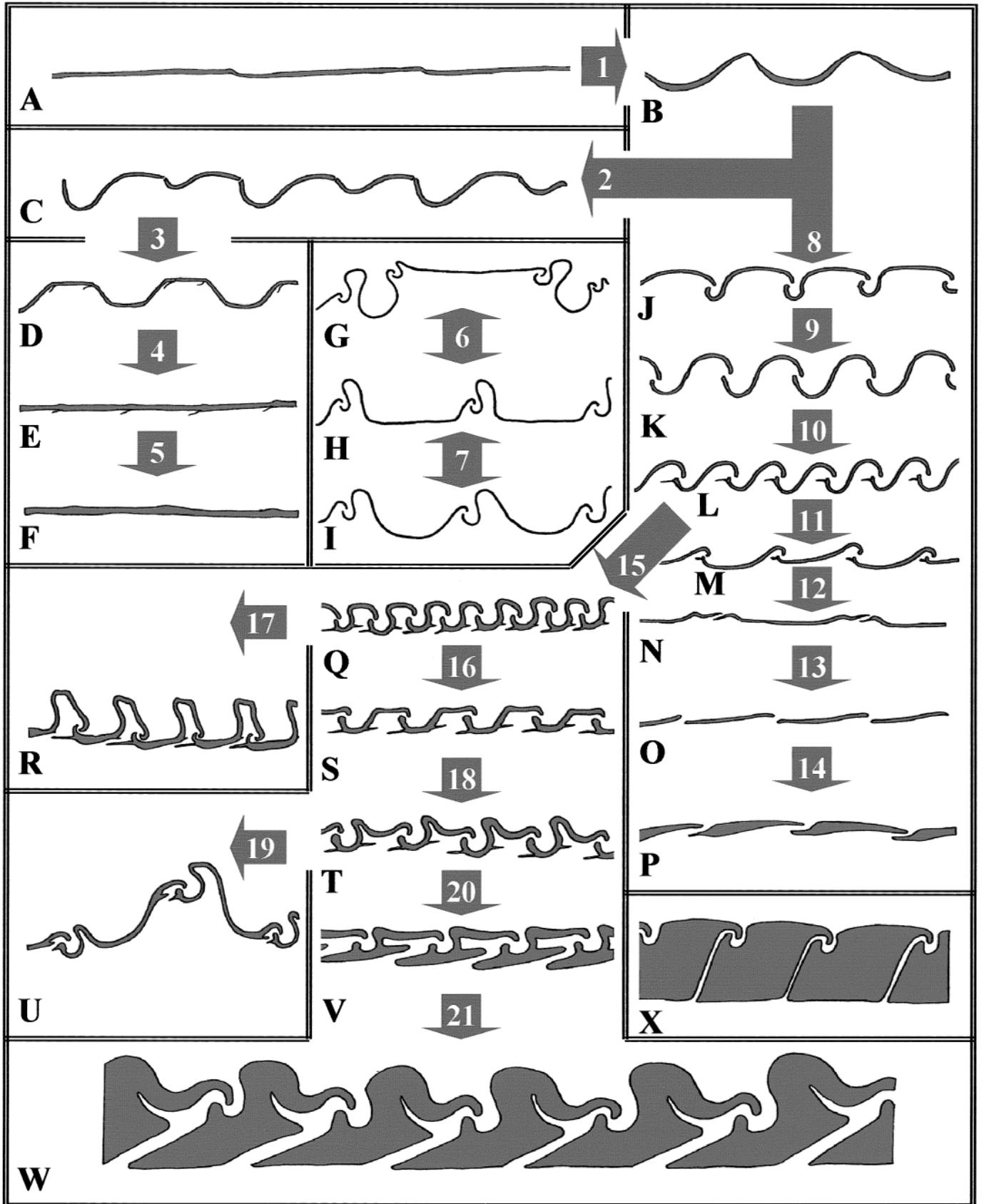

served in *Distigma elegans*, and *D. sennii* (Angeller, Müllner, and Schagerl 1999) The hook-like extensions of these strips may actually be homologous to the delicate structures marking the articulation zones of *Rhabdomonas* and *Menoidium*. If so, the hypothetical positions of strips D–F and N–O in Fig. 37 would need to be revised.

The second pathway from state L leads to the phototrophic euglenids, where the sigmoidal frames became thicker, developed a distinct keel, and further developed thread-like prearticular and postarticular projections (Fig. 35A, 36A, 37Q). Hypothetically, strips like these fit the ancestral state for all phototrophic euglenids and their colorless descendants (Fig. 37Q–X). Examples of this state have been observed in *E. mutabilis* (data not shown). From here, postarticular projections forming indented plates (Fig. 36B) emerged and both plateau-shaped (II) (Fig. 6, 7, 37S) and A-shaped (Fig. 10, 11, 37R) frames evolved (Fig. 35B, 35D). Median depression evolved within the arches of plateau-shaped (II) frames giving rise to delicate M-shaped frames (Fig. 35C, 37T). These frames also possessed thread-like prearticular projections, but the heels became narrower than the arches (e.g. *E. cantabrica*).

Some taxa with M-shaped frames evolved strip doublets like those found in *Phacus pyrum* (Fig. 27, 28, 37U) and *P. splendens* (Mignot 1965). Along a different pathway, the frames became more robust and the thread-like prearticular projections became tooth-like (Fig. 36C). Figure 37V illustrates a general state, so-called “robust frames”, that is common to many taxa; details of the strips in each taxon, however, often differ. Compare for example the strips of *E. fusca* (Suzaki and Williamson 1985, 1986b), *E. spirogyra* (Leedale 1964), *E. acus* (Bricheux and Brugerolle 1986, 1987; Mignot 1965), and *L. buetschlii* (Fig. 12–15). From this general state, the frames became huge, the strip projections became plate-like (Fig. 36D), and ribs evolved on the upper surfaces of the prearticular projections (Fig. 26). The ribs may be homologous to the periodic structures that stem from the basal plates of prearticular tooth-like projections (Fig. 36C). Also, the median depressions became modified into minor grooves (Fig. 37W). Strips like these have been found in *E. helicoideus* (Fig. 21–26, 37V), *E. ehrenbergii* (Suzaki and Williamson 1986b), and *E. oxyuris* (Suzaki and Williamson 1986b). The frames of *E. texta* (Dragos, Péterfi, and Popescu 1997) possess rounded arches, no strip projections, and the most extreme state for strip thickness (Fig. 37X). It remains unclear how these strips evolved.

#### ACKNOWLEDGMENTS

Financial support was provided by the National Science Foundation PEET (Partnerships for Enhancing Expertise in Taxonomy, grant no. DEB 4–21348). We also wish to thank E. W. Linton, A. Nudelman, V. Conforti, and R. E. Triemer for providing us with an unpublished manuscript on the molecular phylogeny of euglenids.

#### LITERATURE CITED

Angeler, D. G. 2000. A light microscopical and ultrastructural investigation and validation of *Khawkinea pertyi* comb. nova (Euglenophyta). *Algolog. Stud.*, **96**:89–103.

Angeler, D. G., Müllner, A. N. & Schagerl, M. 1999. Comparative ultrastructure of the cytoskeleton and nucleus of *Distigma* (Euglenozoa). *Europ. J. Protistol.*, **35**:309–318.

Arnott, H. J. & Walne, P. L. 1967. Observations on the fine structure of the pellicle pores of *Euglena granulata*. *Protoplasma*, **64**:330–344.

Bouck, G. B. & Ngo, H. 1996. Cortical structure and function in euglenoids with reference to trypanosomes, ciliates, and dinoflagellates. *Int. Rev. Cytol.*, **169**:267–318.

Bourrelly, P., Couté, A. & Rino, J. A. 1976. Ultrastructure de la cuticule de quelques eugléniens: I. *Euglena oxyuris* var. *Minor* defl. et *E-*

*glena spirogyra* var *Fusca* (Klebs) lemm. *Protistologica*, **12**:623–628.

Bricheux, G. & Brugerolle, G. 1986. The membrane cytoskeleton complex of euglenids. I. Biochemical and immunological characterization of epiplasmic proteins in *Euglena acus*. *Europ. J. Cell Biol.*, **40**:150–159.

Bricheux, G. & Brugerolle, G. 1987. The pellicular complex of euglenids. II. A biochemical and immunological comparative study of major epiplasmic proteins. *Protoplasma*, **140**:43–54.

Buetow, D. E. 1968. Morphology and ultrastructure of *Euglena*. In: Buetow, D. E. (ed.), *The Biology of Euglena*, Vol. I. Academic Press, NY. **4**:109–184.

Cann, J. P. 1986. Ultrastructural observations of taxonomic importance on the euglenoid genera *Gyropaigne* Skuga, *Parmidium* Christen, and *Rhabdospora* Pringsheim (Euglenida: Rhabdomonadina). *Arch. Protistenkd.*, **132**:395–401.

Chu, S. P. 1947. Contribution to our knowledge of the genus *Euglena*. *Sinensia*, **17**:75–136.

Conforti, V. & Tell, G. 1989. Ultrastructure of the pellicle and the envelope of some euglenoid flagellates from Argentina by means of S.E.M. *Nova Hedwigia*, **48**:187–206.

Dawson, N. S. & Walne, P. L. 1991. Structural characterization of *Eutreptia pertyi* (Euglenophyta). I. General description. *Phycologia*, **30**:287–302.

Dragos, N., Péterfi, L. S. & Craciun, C. 1979. Fine structure of *Euglena*. II. *Euglena stellata* Mainx and *Euglena viridis* Ehrenberg. *Nova Hedwigia*, **31**:223–246.

Dragos, N., Péterfi, L. S. & Popescu, C. 1997. Comparative fine structure of pellicular cytoskeleton in *Euglena* Ehrenberg. *Arch. Protistenkd.*, **148**:277–285.

Dubreuil, R. R. & Bouck, G. B. 1985. The membrane skeleton of a unicellular organism consists of bridged, articulating strips. *J. Cell Biol.*, **101**:1884–1896.

Dubreuil, R. R., Marrs, J. A. & Bouck, G. B. 1992. The cytoskeleton in euglenoids; cell form, surface motility, and cell replication are based on a membrane skeleton of repeating strips. In: Menzel, D., (ed.), *The cytoskeleton of the algae*. CRC Press, Inc., FL. **4**:59–78.

Farmer, M. A. 1988. A re-evaluation of the taxonomy of the Euglenophyceae based on ultrastructural characteristics. Dissertation. Rutgers The State University of New Jersey, New Brunswick, NJ. 295 p. Available on microfilm from University Microfilms International Order Number 8903434.

Farmer, M. A. & Triemer, R. E. 1988. A redescription of the genus *Ploetia* Duj. (Euglenophyceae). *Taxon*, **37**:319–325.

Farmer, M. A. & Triemer, R. E. 1994. An ultrastructural study of *Lentomonas applanatum* (Preisig) N. G. (Euglenida). *J. Eukaryot. Microbiol.*, **41**:112–119.

Foissner, W. 1977. Comparative light and electron microscopical studies on the argyrophilic structures of *Euglena viridis*. *Acta bio. Acad. Sci. hung.*, **28**:157–174.

Gallo, J. M. & Shrével, J. 1982. Euglenoid movement in *Distigma proteus*. I. Cortical rotational motion. *Biol. Cell*, **44**:139–148.

Gerola, F. M. & Bassi, M. 1981. Pellicle ultrastructure of some *Euglena* species. *Caryologia*, **34**:385–394.

Gojdics, M. 1953. *The Genus Euglena*. The University of Wisconsin Press, Madison.

Gray, J. & Boucot, A. J. 1989. Is *Moyeria* a euglenoid? *Lethaia*, **22**:447–456.

Greenblatt, C. L. & Schiff, J. A. 1959. A pheophytin-like pigment in dark-adapted *Euglena gracilis*. *J. Protozool.*, **6**:23–28.

Groupé, V. 1947. Surface striations of *Euglena gracilis* revealed by electron microscopy. *Proc. Soc. Exp. Biol. Med.*, **64**:401–403.

Hausmann, K. & Mignot, J. P. 1977. Untersuchungen an den mucocysten von *Euglena splendens* Dangeard 1901. *Protistologica*, **13**:213–217.

Hofmann, C. & Bouck, G. B. 1976. Immunological and structural evidence for patterned intussusceptive surface growth in a unicellular organism. *J. Cell Biol.*, **69**:693–715.

Kirk, J. T. O. & Juniper, B. E. 1964. The fine structure of the pellicle of *Euglena gracilis*. *J. Roy. Micro. Soc.*, **82**:205–210.

Leander, B. S. & Farmer, M. A. 2000. Comparative morphology of the euglenid pellicle. I. Patterns of strips and pores. *J. Eukaryot. Microbiol.*, **47**:469–479.

- Leander, B. S. & Farmer, M. A. 2001. The evolution of *Phacus* (Euglenozoa) as inferred from pellicle morphology and SSU rDNA. *J. Phycol.*, **37**:143–159.
- Leedale, G. F. 1964. Pellicle structure in *Euglena*. *Brit. Phycol. Bull.*, **2**:291–306.
- Leedale, G. F. 1967. *Euglenoid Flagellates*. Prentice Hall, Englewood Cliffs, NJ. p. 96–114.
- Leedale, G. F. & Hibberd, D. J. 1974. Observations on the cytology and fine structure of the euglenoid genera *Menoidium* Perty and *Rhabdomonas* Fresenius. *Arch. Protistenkd.*, **116**:319–345.
- Lefort-Tran, M., Bre, M. H., Ranck, J. L. & Poupoule, M. 1980. *Euglena* plasma membrane during normal and vitamin B<sub>12</sub> starvation growth. *J. Cell Sci.*, **41**:245–261.
- Linton, E. W., Hittner, D., Lewandowski, C., Auld, T. & Triemer, R. E. 1999. A molecular study of euglenoid phylogeny using small subunit rDNA. *J. Eukaryot. Microbiol.*, **46**:217–223.
- Linton, E. W., Nudelman, A., Conforti, V. & Triemer, R. E. 2000. A molecular analysis of the genus *Euglena* (Euglenophyta) using SSU rDNA. *J. Phycol.*, **36**:740–746.
- Loeblich, Jr., A. R. 1974. Protistan phylogeny as indicated by the fossil record. *Taxon*, **23**:277–290.
- Marrs, J. A. & Bouck, G. B. 1992. The two major membrane skeletal proteins articulins of *Euglena gracilis* define a novel class of cytoskeletal proteins. *J. Cell Biol.*, **118**:1465–1475.
- McLachlan, J. L., Sequel, M. R. & Fritz, L. 1994. *Tetretreptia pomquetensis* gen. et sp. nov. (Euglenophyceae): a quadriflagellate, phototrophic marine euglenoid. *J. Phycol.*, **30**:538–544.
- McNamara, K. J. 1990. *Evolutionary Trends*. The University of Arizona Press, Tucson, AZ. p. 1–368.
- Mignot, J. P. 1965. Ultrastructure des eugléniens. I. Étude de la cuticule chez différentes espèces. *Protistologica*, **1**:5–15.
- Mignot, J. P. 1966. Structure et ultrastructure de quelques euglénomonades. *Protistologica*, **2**:51–140.
- Mignot, J. P., Brugerolle, G. & Bricheux, G. 1987. Intercalary strip development and dividing cell morphogenesis in the euglenid *Cyclidiopsis acus*. *Protoplasma*, **139**:51–65.
- Mikolajczyk, E. 1975. The biology of *Euglena ehrenbergii* Klebs. I. Fine structure of pellicular complex and its relation to euglenoid movements. *Acta Protozool.*, **14**:233–240.
- Montegut-Felkner, A. E. & Triemer, R. E. 1997. Phylogenetic relationships of selected euglenoid genera based on morphological and molecular data. *J. Phycol.*, **33**:512–519.
- Murray, J. M. 1981. Control of cell shape by calcium in the Euglenophyceae. *J. Cell Sci.*, **49**:99–117.
- Owens, K. J., Farmer, M. A. & Triemer, R. E. 1988. The flagellar apparatus and reservoir/canal cytoskeleton of *Cryptoglena pigra* (Euglenophyceae). *J. Phycol.*, **24**:520–528.
- Péterfi, L. S., Dragos, N. & Craciun, C. 1979. Fine structure of *Euglena*. I. *Euglena tristella* Chu. *Nova Hedwigia*, **31**:197–221.
- Preisfeld, A., Berger, S., Busse, I., Liller, S. & Ruppel, H. G. 2000. Phylogenetic analysis of various euglenoid taxa (Euglenozoa) based on 18S rDNA sequence data. *J. Phycol.*, **36**:220–226.
- Preisig, H. R., Anderson, O. R., Corliss, J. O., Moestrup, Ø., Powell, M. J., Roberson, R. W. & Wetherbee, R. 1994. Terminology and nomenclature of protist cell surface structures. *Protoplasma*, **181**:1–28.
- Remane, A. 1952. Die Grundlagen des natürlichen Systems, der vergleichenden Anatomie und der Phylogenetik. Akad. Verlag, Leipzig.
- Rosowski, J. R. & Lee, K. W. 1978. *Cryptoglena pigra*: a euglenoid with one chloroplast. *J. Phycol.*, **14**:160–166.
- Schwellitz, F. D., Evans, W. R., Mollenhaur, H. H. & Dilley, R. A. 1970. The fine structure of the pellicle of *Euglena gracilis* as revealed by freeze-etching. *Protoplasma*, **69**:341–349.
- Sommer, J. R. 1965. The ultrastructure of the pellicle complex of *Euglena gracilis*. *J. Cell Biol.*, **24**:253–257.
- Sommer, J. R. & Blum, J. J. 1965. Cell division in *Astasia longa*. *Exp. Cell Res.*, **39**:504–527.
- Suzaki, T. & Williamson, R. E. 1985. Euglenoid movement in *Euglena fusca*: evidence for sliding between pellicular strips. *Protoplasma*, **124**:137–146.
- Suzaki, T. & Williamson, R. E. 1986a. Ultrastructure and sliding of pellicular structures during euglenoid movement in *Astasia longa* Pringsheim (Sarcocystidophora, Euglenida). *J. Protozool.*, **33**:179–184.
- Suzaki, T. & Williamson, R. E. 1986b. Pellicular ultrastructure and euglenoid movements in *Euglena ehrenbergii* Klebs and *Euglena oxyuris* Schmarda. *J. Protozool.*, **33**:165–171.
- Triemer, R. E. & Farmer, M. A. 1991. The ultrastructural organization of the heterotrophic euglenids and its evolutionary implications. In: Patterson, D. J. & Larsen, J. (ed.), *The Biology of Free-living Heterotrophic Flagellates*. Clarendon Press, Oxford. **13**:185–204.
- Willey, R. L., Walne, P. L. & Kivic, P. 1988. Phagotrophy and the origins of the euglenoid flagellates. *CRC Critical Reviews in Plant Science*, **7**:303–339.

Received: 06/28/00; 11/28/00; accepted 11/28/00