



Nouvelle Energie Hydroélectrique de l'Onive

Madagascar - Sahofika Hydropower Plant

**Environmental and Social Impact
Assessment - Version D**



Date: 07/14/2019

Version: D

TRACEABILITY

Version:	Date:	Commented on by	Status
A	04/21/2019		Internal Review
B	04/28/2019	SPV	First version shared with ONE and the donors
C	07/03/2019	All stakeholders	Version revised after public consultations, submitted to the ONE and shared with donors
D	07/14/2019	ONE	Chapters 9 and 10 restructured

ABBREVIATIONS

ADER	Rural Electrification Development Agency
AfDB	African Development Bank
BIF	Communal Land Office
BPR	Bypassed reach
LC	Land certificate
CLP	Local Park Committees
CNaPS	National Social Security Fund
DREEF	Regional Environment, Ecology and Forestry Directorate
ESIA	Environmental and Social Impact Assessment
MADHF	Medium-altitude dense humid rainforest
FTM	National Geographic and Hydrographic Institute
GCF	Contractualized Forest Management
GHG	Greenhouse gases
RAI	Relative Abundance Index
INSTAT	National Statistics Institute
MEEF	Ministry of Environment, Ecology and Forestry
MGA	Ariary (Madagascar currency - 1 Euro equals 4000 MGA)
IMT	Intermediate Means of Transport
MNP	Madagascar National Parks
STD	Sexually transmitted disease
NPA	New Protected Area
PS	(IFC) Performance Standards
DMP	Development and Management Plan
PAGOSE	Electricity Sector Governance and Operations Improvement Project
PDMC	Least Cost Power Development Plan
PNM	Marolambo National Park
IFC	International Finance Corporation
ESMS	Environmental and Social Management System
LF	Lichen forest
LT	Land title
UICN	International Union for Conservation of Nature
VOI	Vondrona Ifototra (local forest management body under a GCF)
IBA	Important bird area

LIST OF MALAGASY TERMS USED

<i>Fady</i>	Prohibited or taboo
<i>Fokontany</i>	Administrative division after the commune (equivalent to a neighborhood)
Koloala	Forest administration concept for sustainable forest management sites where logging permits are awarded through a competitive tendering process
Lavaka	Deep ovoid excavations with very steep walls, shaped in crystalline and metamorphic rock alterations as a result of runoff and sub-flows
Mangidy	Natural and traditional herbal tea medicine prepared from medicinal plants
Mofo Gasy	A rice flour cake made in Madagascar.
Savoka	Secondary forestry formation
Tanety	A Malagasy term used to designate hills with ferralitic soils
<i>Tavy</i>	Slash-and-burn farming
Toaka gasy	Local rum made from sugar cane
Varamba	A type of trolley consisting of a platform mounted on an ingenious hand-pushed wheel system that is used to carry items such as rice bags
Voly avotra	Back-up crop (off-season crops for scientists)
VOI (Vondron'Olona Ifotony)	Local grassroots community in one or more administrative districts (<i>Fokontany</i>)

CONTENTS

INTRODUCTION.....	15
1 PROJECT DESCRIPTION.....	16
1.1 PROJECT OBJECTIVE.....	16
1.2 PROJECT ORGANIZATION.....	16
1.2.1 THE CONCESSIONAIRE.....	16
1.2.2 DETAILED DESIGN AND CONSTRUCTION.....	17
1.2.3 TRANSMISSION AND DISTRIBUTION OF THE ELECTRICITY PRODUCED.....	17
1.2.4 EMPLOYMENT.....	17
1.3 LOCATION AND ACCESS.....	17
1.4 PROJECT COMPONENTS AND PHASING.....	18
1.4.1 PRELIMINARY ACTIVITIES.....	18
1.4.2 PERMANENT INFRASTRUCTURE.....	19
1.4.3 TEMPORARY INFRASTRUCTURE.....	31
1.4.4 CONSTRUCTION TECHNIQUES.....	35
1.4.5 IMPLEMENTATION SCHEDULE.....	36
1.5 IMPOUNDMENT AND COMMISSIONING.....	37
1.5.1 RESERVOIR FILLING.....	37
1.5.2 TESTING.....	37
1.6 OPERATION.....	38
1.6.1 HYDRAULIC OPERATION OF THE FACILITY.....	38
1.6.2 OPERATION OF THE RESERVOIR.....	39
1.6.3 SEDIMENT MANAGEMENT.....	40
1.7 PROJECT'S AREA OF INFLUENCE.....	40
2 ANALYSIS OF ALTERNATIVES.....	42
2.1 NATIONAL ENERGY CONTEXT.....	42
2.1.1 ACCESS TO ELECTRICITY.....	42
2.1.2 MADAGASCAR'S ENERGY POLICY.....	42
2.2 "NO-PROJECT" ALTERNATIVE.....	43
2.3 ALTERNATIVES TO THE SAHOFIKA HYDROPOWER PLANT.....	44
2.3.1 NATURE OF THE ALTERNATIVES CONSIDERED.....	44
2.3.2 RENEWABLE – SOLAR ENERGY.....	44
2.3.3 RENEWABLE - WIND ENERGY.....	46
2.3.4 RENEWABLE – HYDROELECTRIC ENERGY.....	47
2.3.5 OTHER RENEWABLE ENERGIES - BIOMASS, GEOTHERMAL ENERGY AND OCEANS.....	51
2.3.6 NON-RENEWABLE (THERMAL) ENERGY.....	51
2.4 COMPARISON OF ALTERNATIVES.....	52
2.5 FINDINGS OF THE ALTERNATIVES STUDY.....	54
2.6 OPTIMIZATION OF THE PLANT AND MINIMIZATION OF IMPACTS.....	54
2.6.1 DAM, WATERWAYS AND HYDROPOWER PLANT.....	54
2.6.2 IMPLEMENTATION OF PERMANENT LINEAR INFRASTRUCTURE.....	55
2.6.3 LOCATION OF TEMPORARY OR PERMANENT INFRASTRUCTURE NOT DEFINED.....	58
2.6.4 OPERATING MODE AND INSTREAM FLOW.....	59
2.6.5 MITIGATION MEASURES.....	59
3 REGULATORY AND LEGISLATIVE FRAMEWORK.....	61
3.1 NATIONAL FRAMEWORK.....	61
3.1.1 ENVIRONMENTAL LEGISLATION.....	61
3.1.2 LABOR LEGISLATION.....	62
3.1.3 INSTITUTIONAL ACTORS.....	65
3.1.4 PERMITS AND AUTHORIZATIONS.....	65
3.2 INTERNATIONAL FRAMEWORK.....	66
3.2.1 SOCIAL PROTECTION TREATIES AND CONVENTIONS.....	66

3.2.2	ENVIRONMENTAL PROTECTION TREATIES AND CONVENTIONS	67
3.3	INTERNATIONAL STANDARDS	67
3.3.1	IFC PERFORMANCE STANDARDS	67
3.3.2	AFDB INTEGRATED SAFEGUARD SYSTEM	68
4	CURRENT SITUATION.....	70
4.1	PHYSICAL ENVIRONMENT	70
4.1.1	RELIEF AND GEOGRAPHY	70
4.1.2	GEOLOGY AND SOILS	71
4.1.3	CLIMATE	74
4.1.4	RIVERS AND HYDROLOGY	77
4.1.5	WATER AND SEDIMENT QUALITY	78
4.1.6	SEDIMENT TRANSPORT	82
4.1.7	AIR QUALITY	84
4.1.8	NOISE	84
4.2	SOCIAL FRAMEWORK.....	87
4.2.1	STUDY AREA	87
4.2.2	GEOGRAPHICAL AND ADMINISTRATIVE LOCATION.....	91
4.2.3	THE “MERINA” AND “BETSIMISARAKA” ETHNIC GROUPS	94
4.2.4	POPULATION AND DEMOGRAPHIC DYNAMICS	95
4.2.5	HOUSEHOLDS AND FAMILIES.....	101
4.2.6	SOCIAL ORGANIZATION	103
4.2.7	THE LAND SYSTEM	106
4.2.8	LAND USE PLANNING	109
4.2.9	INFRASTRUCTURE AND PUBLIC SERVICES	112
4.2.10	AGRICULTURAL ACTIVITIES	119
4.2.11	OTHER ECONOMIC ACTIVITIES.....	129
4.2.12	EMPLOYMENT AND WORKING CONDITIONS.....	138
4.2.13	HOUSEHOLD INCOME AND EXPENDITURE.....	140
4.2.14	VULNERABILITIES	143
4.2.15	MAIN WATER-RELATED ACTIVITIES	144
4.2.16	SOCIAL CONTEXT OF THE DAM SITE.....	145
4.2.17	CULTURAL AND RELIGIOUS HERITAGE	147
4.2.18	ANALYSIS OF ROAD TRAFFIC IN THE STUDY AREA.....	155
4.2.19	SOCIAL CONTEXT - CORRIDOR OF THE TRANSMISSION LINE FROM THE DAM TO ANTANANARIVO ...	162
4.3	LEGALLY PROTECTED AND INTERNATIONALLY RECOGNIZED AREAS	170
4.3.1	MAROLAMBO NATIONAL PARK	170
4.3.2	MANAGEMENT TRANSFER SITES FOR THE MAROLAMBO NP PROTECTED AREA.....	173
4.3.3	A NEW PROTECTED AREA IN THE PROCESS OF BEING CREATED IN TSINJOARIVO AND AMBALAOMBY 175	
4.3.4	IBA OF THE ONIVE GAZETTED FOREST	178
4.3.5	NOSIVOLO RAMSAR SITE.....	180
4.4	BIODIVERSITY	181
4.4.1	METHODOLOGICAL APPROACH	181
4.4.1.1	TEAMS MOBILIZED	181
4.4.2	DEFINITION OF STUDY AREAS.....	184
4.4.3	DATA COLLECTION FOR THE TRANSMISSION LINE TO ANTANANARIVO	185
4.4.4	ESIA FIELD INVENTORIES	186
4.4.5	EXISTING PRESSURES ON ECOSYSTEMS AND SPECIES	199
4.4.5.1	DEFORESTATION.....	199
4.4.5.2	AGRICULTURAL ACTIVITIES.....	201
4.4.5.3	GOLD PANNING.....	201
4.4.5.4	POACHING.....	202
4.4.5.5	NATURAL BARRIERS TO ECOLOGICAL CONTINUITY.....	202
4.4.5.6	INTRODUCTION OF INVASIVE ALIEN SPECIES.....	203
4.4.6	HABITAT CHARACTERIZATION	204
4.4.6.1	BIOCLIMATIC CLASSIFICATION.....	204
4.4.6.2	TERRESTRIAL HABITATS: MEDIUM-ALTITUDE DENSE HUMID FOREST	205
4.4.6.3	TERRESTRIAL HABITATS: LICHEN WOODLAND	207
4.4.6.4	SECONDARY FORMATION (“SAVOKA”)	208

4.4.6.5	RIPARIAN HABITATS	211
4.4.6.6	NATURAL AND MODIFIED HABITATS.....	213
4.4.7	TERRESTRIAL FLORA	218
4.4.7.1	BIOGEOGRAPHICAL AFFINITIES OF SPECIES.....	219
4.4.7.2	CONSERVATION STATUS OF SPECIES.....	220
4.4.7.3	INVASIVE SPECIES	224
4.4.7.4	FLORA ASSOCIATED WITH HIGH CONSERVATION CONCERN SPECIES.....	225
4.4.7.5	BIOEVALUATION OF TERRESTRIAL FLORA	226
4.4.7.6	TERRESTRIAL FLORA: CASE OF THE TRANSMISSION LINE FROM BELANITRA TO ANTANANARIVO	229
4.4.8	TERRESTRIAL WILDLIFE.....	230
4.4.8.1	DATA FROM THE LITERATURE REVIEW - TERRESTRIAL VERTEBRATES.....	230
4.4.8.2	RESULTS OF SURVEY CAMPAIGN - TERRESTRIAL VERTEBRATES	232
4.4.8.3	CONSERVATION STATUS OF SPECIES - TERRESTRIAL VERTEBRATES	235
4.4.8.4	SPECIAL SPECIES OF TERRESTRIAL VERTEBRATES.....	242
4.4.8.5	QUANTITATIVE DATA ON TERRESTRIAL VERTEBRATES	243
4.4.8.6	BIOASSESSMENT OF TERRESTRIAL VERTEBRATES.....	250
4.4.8.7	TERRESTRIAL INVERTEBRATES	257
4.4.8.8	LAND FAUNA: CASE OF THE TRANSMISSION LINE FROM BELANITRA TO ANTANANARIVO.....	259
4.4.9	AQUATIC FLORA.....	260
4.4.9.1	CONSERVATION CONCERN SPECIES	260
4.4.9.2	INVASIVE SPECIES	260
4.4.10	AQUATIC FAUNA	260
4.4.10.1	AQUATIC FAUNA DATA FROM THE LITERATURE REVIEW	260
4.4.10.2	RESULTS OF THE SURVEY CAMPAIGN (FISH AND MACROCRUSTACEANS)	261
4.4.10.3	RESULTS OF BENTHIC MACROINVERTEBRATE SURVEY CAMPAIGN.....	265
4.4.10.4	BIOASSESSMENT OF AQUATIC FAUNA	268
4.4.11	DISCRETE MANAGEMENT UNITS FOR CRITICAL HABITATS	274
4.5	ECOSYSTEM SERVICES	278
4.5.1	TYPES OF ECOSYSTEM SERVICES.....	278
4.5.2	EVALUATION METHOD.....	278
4.5.3	MAIN USES OF NATURAL RESOURCES.....	278
4.5.3.1	USE OF FUELS FOR COOKING	279
4.5.3.2	USE OF PLANT RESOURCES IN THE UPSTREAM AREA.....	279
4.5.4	IDENTIFICATION OF PRIORITY ECOSYSTEM SERVICES	286
5	PHYSICAL IMPACT ANALYSIS	290
5.1	INFRASTRUCTURE FOOTPRINT	290
5.2	BACKFILL, EXCAVATED MATERIAL AND TEMPORARY SITES.....	291
5.2.1	RISKS RELATED TO THE EROSION OF LOOSE MATERIALS	291
5.2.2	ACID ROCK DRAINAGE	292
5.2.3	MITIGATION MEASURES.....	292
5.3	HYDROLOGICAL AND HYDRAULIC IMPACTS DOWNSTREAM.....	292
5.3.1	DAM CONSTRUCTION AND RIVER CLOSURE.....	292
5.3.2	FLOW IN THE BYPASSED REACH	293
5.3.3	HYDRAULIC IMPACT DOWNSTREAM FROM THE HYDROPOWER PLANT.....	296
5.3.4	INSTREAM FLOW	299
5.3.5	MITIGATION MEASURES.....	302
5.4	IMPACTS ON THE SEDIMENT REGIME.....	303
5.4.1	IMPACTS ON THE IMPOUNDMENT	303
5.4.2	DOWNSTREAM IMPACTS	303
5.4.3	MITIGATION MEASURES.....	304
5.5	POLLUTING EMISSIONS AND DISCHARGES	304
5.5.1	NOISE, DUST AND AIR EMISSIONS.....	304
5.5.2	LIQUID AND SOLID WASTE	306
5.5.3	ACCIDENTAL POLLUTION	308
5.6	CLIMATE CHANGE-RELATED IMPACTS.....	309
5.6.1	RISKS AND ANALYSIS METHOD	309
5.6.2	QUALITATIVE RISK ANALYSIS	309
5.6.3	RISK REGISTER AND ANALYSIS	315
5.6.4	RESILIENCE AND CLIMATE RISK MITIGATION MEASUREMENT.....	316

5.7	GREENHOUSE GAS EMISSIONS.....	317
5.7.1	CONSTRUCTION-RELATED EMISSIONS.....	317
5.7.2	RESERVOIR-RELATED EMISSIONS.....	317
5.7.2.1	CARBON CONTENT OF FLOODED AREAS.....	317
5.7.2.2	PROCESS FOR CONVERTING MOBILIZABLE CARBON INTO CO₂ AND CH₄.....	318
5.7.2.3	MODE OF AEROBIC OR ANAEROBIC DEGRADATION OF DROWNED BIOMASS.....	320
5.7.2.4	ASSUMPTIONS USED TO CALCULATE GROSS GHG EMISSIONS.....	322
5.7.2.5	GREENHOUSE GAS EMISSIONS FROM THE SAHOFIKA RESERVOIR.....	323
5.7.3	COMPARISON WITH OTHER ENERGY SOURCES.....	324
5.8	IMPACTS ON WATER QUALITY.....	325
5.8.1	RISK OF EUTROPHICATION OF THE RESERVOIR.....	325
5.8.2	RISK OF RESERVOIR POLLUTION.....	325
5.8.3	DOWNSTREAM WATER QUALITY.....	325
5.8.3.1	DOWNSTREAM FROM THE DAM.....	325
5.8.3.2	DOWNSTREAM FROM THE HYDROPOWER PLANT.....	326
5.8.4	MITIGATION MEASURES.....	326
5.9	DAM FAILURE.....	327
5.9.1	METHOD OF ANALYSIS.....	327
5.9.2	DESCRIPTION OF THE HYDRAULIC MODEL.....	327
5.9.3	RESULTS AND SENSITIVITY ANALYSIS.....	328
5.9.4	MITIGATION MEASURES.....	333
5.9.5	CONTENTS OF THE EMERGENCY RESPONSE PLAN.....	335
5.9.5.1	POSSIBLE CAUSES.....	335
5.9.5.2	STRUCTURE OF THE SAHOFIKA EMERGENCY RESPONSE PLAN.....	335
6	SOCIAL IMPACT ASSESSMENT AND MITIGATION.....	337
6.1	DETAILED SOCIAL INFLUENCE AREA.....	337
6.2	DESCRIPTION OF THE SOURCES OF IMPACTS ON THE HUMAN ENVIRONMENT.....	339
6.2.1	CONSTRUCTION/IMPROVEMENT OF ACCESS ROADS.....	339
6.2.2	SUPPLYING THE SITE.....	339
6.2.3	PRESENCE OF THE BASE CAMP AND SITE.....	339
6.2.4	CONSTRUCTION OF THE HYDROPOWER PLANT.....	339
6.2.5	IMPOUNDMENT OF THE RESERVOIR.....	339
6.2.6	OPERATION OF THE HYDROPOWER PLANT.....	339
6.3	SOCIAL ISSUES, OPPORTUNITIES AND RISKS.....	340
6.3.1	ROADS: OPENING UP AND COMMUNITY SAFETY.....	341
6.3.2	FOOD SELF SUFFICIENCY.....	341
6.3.3	PRESSURE ON PROTECTED AREAS.....	341
6.3.4	LAND MANAGEMENT.....	341
6.3.5	MARKET FOR LOCAL PRODUCTS.....	341
6.3.6	SOCIAL STABILITY.....	342
6.3.7	HEALTH.....	342
6.3.8	LOCAL PRACTICES.....	342
6.4	CONTEXTUAL ANALYSIS.....	342
6.5	IMPACTS AND MITIGATION MEASURES.....	344
6.5.1	IMPACT AND RESIDUAL IMPACT MITIGATION HIERARCHY.....	344
6.5.2	IMPACT SIGNIFICANCE.....	345
6.6	WORKING CONDITIONS.....	346
6.7	WORKER HEALTH AND SAFETY.....	348
6.7.1	CONSTRUCTION PHASE.....	348
6.7.2	OPERATION PHASE.....	349
6.8	COMMUNITY SAFETY AND SECURITY.....	352
6.8.1	CONSTRUCTION PHASE.....	352
6.8.2	OPERATION PHASE.....	353
6.9	COMMUNITY HEALTH.....	356
6.9.1	CONSTRUCTION PHASE.....	356
6.9.2	OPERATION PHASE.....	356
6.10	LOCAL EMPLOYMENT AND POPULATION INFLUX.....	358
6.10.1	DESCRIPTION OF THE PROBLEM IN THE CONTEXT OF THE PROJECT.....	358
6.10.2	IMPACTS OF THE PROJECT IN TERMS OF POPULATION INFLUXES.....	358

6.11	CULTURAL IMPACTS	366
6.12	COMMUNITY DEVELOPMENT PLAN	368
6.12.1	OBJECTIVE	368
6.12.2	OPPORTUNITY FOR INFRASTRUCTURE DEVELOPMENT	368
6.12.3	FOCUS POINTS	368
6.12.4	PROPOSED FRAMEWORK FOR COMMUNITY DEVELOPMENT ACTIONS	369
6.12.5	COMMUNITY DEVELOPMENT ACTION PLAN	371
6.13	IMPACTS AND MITIGATION MEASURES - TRANSMISSION LINE CORRIDOR.....	371
7	ENVIRONMENTAL IMPACT ASSESSMENT AND MITIGATION	373
7.1	IMPACTS AND MITIGATION MEASURES	373
7.1.1	IMPACT AND RESIDUAL IMPACT MITIGATION HIERARCHY	373
7.1.2	IMPACT SIGNIFICANCE	373
7.2	IMPACTS ON TERRESTRIAL HABITATS	373
7.2.1	NATURE OF IMPACTS.....	373
7.2.2	IMPACTS ON ENVIRONMENTAL RECEPTORS	375
7.2.3	RISK AVOIDANCE AND RISK REDUCTION MEASURES	376
7.2.4	COMPENSATORY AND ACCOMPANYING MEASURES FOR TERRESTRIAL ENVIRONMENTS	381
7.2.5	ECOLOGICAL MONITORING MEASURES.....	384
7.2.6	SUMMARY OF MITIGATION MEASURES - TERRESTRIAL ENVIRONMENTS.....	385
7.3	IMPACTS ON AQUATIC ENVIRONMENTS	390
7.3.1	NATURE OF IMPACTS.....	390
7.3.2	IMPACTS ON ENVIRONMENTAL RECEPTORS	390
7.3.3	RISK AVOIDANCE AND RISK REDUCTION MEASURES	392
7.3.4	COMPENSATORY/ACCOMPANYING MEASURES FOR AQUATIC AND RIPARIAN ENVIRONMENTS.....	393
7.3.5	SUMMARY OF MITIGATION MEASURES - AQUATIC ENVIRONMENTS.....	396
7.4	IMPACTS ON ECOSYSTEM SERVICES AND MITIGATION MEASURES.....	396
7.5	BIODIVERSITY ACTION PLAN	400
8	CUMULATIVE IMPACTS.....	401
8.1	DESCRIPTION OF OTHER POSSIBLE HYDROPOWER PLANTS.....	401
8.1.1	TSINJOARIVO HYDROELECTRIC POWER PLANT	401
8.1.2	ANDASIROTSAKA CONTROL DAM	402
8.1.3	THE LOHAVANANA HYDROPOWER PLANT	402
8.1.4	PROBABILITY AND SCHEDULE OF COMPLETION OF THE WORKS.....	403
8.2	CUMULATIVE IMPACT ANALYSIS	404
8.2.1	SPATIAL AND TEMPORAL BOUNDARIES	404
8.2.2	IDENTIFICATION OF ENVIRONMENTAL AND SOCIAL RECEPTORS	404
8.2.3	METHOD OF ASSESSING LIKELY CUMULATIVE IMPACTS	405
8.2.4	PRIMARY CUMULATIVE IMPACTS	405
8.2.5	SECONDARY CUMULATIVE IMPACTS ON SOCIAL RECEPTORS.....	406
8.2.6	SECONDARY CUMULATIVE IMPACTS ON ENVIRONMENTAL RECEPTORS.....	407
8.3	CUMULATIVE IMPACT MITIGATION MEASURES.....	407
9	ENVIRONMENTAL AND SOCIAL MANAGEMENT PLAN	410
9.1	NEHO AND EPC PLANS	410
9.2	E3S PATH TO THE CONSTRUCTION PHASE.....	410
9.3	ESMP-EPC	410
9.3.1	DOCUMENT LIFE	410
9.3.2	CONTENT OF THE ESMP-EPC	410
9.4	ESMP-NEHO	418
9.4.1	IMPLEMENTATION OF THE NEHO-ESMP	418
9.4.2	CONTENT OF THE NEHO-ESMP - CONSTRUCTION PHASE	419
9.4.3	CONTENT OF THE NEHO ESMP - OPERATIONS PHASE	423
10	MONITORING AND FOLLOW-UP PROGRAMS	428
10.1	ORGANIZATION.....	428

10.2	LEGAL AND REGULATORY REQUIREMENTS AND OBLIGATIONS	428
10.3	PERIODIC REPORTING MECHANISMS AND FREQUENCY	428
10.4	MONITORING PLAN	429
10.4.1	HYDROPOWER PLANT COMPONENT - CONSTRUCTION PHASE	430
10.4.2	HYDROPOWER PLANT COMPONENT - OPERATION PHASE	450
10.4.3	LINEAR INFRASTRUCTURE COMPONENT - CONSTRUCTION PHASE	458
10.4.4	LINEAR INFRASTRUCTURE COMPONENT - OPERATION PHASE	465
10.5	MONITORING PLAN.....	466
10.5.1	HYDROPOWER PLANT COMPONENT - CONSTRUCTION PHASE	467
10.5.2	HYDROPOWER PLANT COMPONENT - OPERATION PHASE.....	469
10.5.3	LINEAR INFRASTRUCTURE COMPONENT - CONSTRUCTION PHASE	470
10.5.4	LINEAR INFRASTRUCTURE COMPONENT - OPERATION PHASE.....	471
11	ADDENDUM: INTEGRATION OF THE RESULTS OF PUBLIC CONSULTATIONS.....	472

TABLES

TABLE 1 - MONTH-END RESERVOIR LEVEL- DRY, MEDIUM AND WET YEARS (M)	40
TABLE 2 - HYDROELECTRIC PROJECTS THAT COULD BE AN ALTERNATIVE TO THE PROJECT	48
TABLE 3 - COMBINATIONS OF HYDROELECTRIC PROJECTS THAT COULD BE AN ALTERNATIVE TO THE PROJECT..	48
TABLE 7 - APPLICABLE LEGAL INSTRUMENTS.....	61
TABLE 8 - ENTITIES INVOLVED IN THE ESIA APPROVAL PROCESS AND/OR IN THE PROJECT	65
TABLE 10 - INTERNATIONAL ENVIRONMENTAL PROTECTION CONVENTIONS	66
TABLE 11 - INTERNATIONAL ENVIRONMENTAL PROTECTION CONVENTIONS	67
TABLE 12 IFC PERFORMANCE STANDARDS (2012)	68
TABLE 13 - AfDB OPERATIONAL SAFEGUARDS AND CORRESPONDENCE WITH THE IFC'S PSS	68
TABLE 14 - RESERVOIR EVAPOTRANSPIRATION	77
TABLE 15 - RESULTS OF THE WATER BIOCHEMICAL ANALYSIS.....	79
TABLE 16 - RESULTS OF THE SEDIMENT BIOCHEMICAL ANALYSIS	79
TABLE 17 - IN SITU PHYSICO-CHEMICAL SURVEYS DURING THE WET SEASON.....	80
TABLE 18 - IN SITU PHYSICO-CHEMICAL SURVEYS DURING THE DRY SEASON	80
TABLE 19 - MEASURED SUSPENDED SOLIDS	83
TABLE 20 - SOUND INTENSITY MEASURED IN THE STUDY AREA	86
TABLE 21 - PROJECT-AFFECTED AREA.....	87
TABLE 22 - LOCALITIES VISITED AS PART OF SIA SURVEYS.....	88
TABLE 23 - PROJECT-AFFECTED ADMINISTRATIVE ENTITIES	91
TABLE 24 - TRENDS IN POPULATION NUMBERS AND DENSITY BY COMMUNE.....	98
TABLE 25 - TIME MEMBERS OF HOUSEHOLD SPENT IN THE COMMUNES.....	99
TABLE 26 - NUMBER OF HOUSEHOLDS SURVEYED IN THE PROJECT AREA (SAMPLING).....	101
TABLE 27 - GENDER DISTRIBUTION OF HEADS OF HOUSEHOLDS SURVEYED	102
TABLE 29 - AGE GROUP-BASED POPULATION DISTRIBUTION	103
TABLE 30 - BASIC DAY-TO-DAY ACTIVITIES.....	105
TABLE 31 - AVERAGE SIZE OF THE AGRICULTURAL PLOTS USED BY THE HOUSEHOLDS SURVEYED	107
TABLE 32 - LAND USE DISTRIBUTION IN THE PROJECT'S AREA OF INFLUENCE	107
TABLE 33 - PROPORTION OF HOUSEHOLDS BY RIGHTS VALIDATION METHOD.....	108
TABLE 34 - LAND TENURE STATUS (NUMBER OF PEOPLE SURVEYED).....	108
TABLE 35 - LAND USE STATISTICS IN THE PROJECT'S AREA OF INFLUENCE (AREAS IN KM ²)	109
TABLE 36 - RELATIVE LAND USE STATISTICS IN THE PROJECT'S AREA OF INFLUENCE	109
TABLE 37 - PER CAPITA LAND USE AREA (FORESTED AREA)	112
TABLE 38 - LAND USE AREA (FORESTED AREA) PER INHABITANT OUTSIDE THE PROTECTED AREAS	112
TABLE 39 - MEANS OF TRAVEL AND TRANSPORT USED IN THE PROJECT AREA	115
TABLE 40 - LEVEL OF EDUCATION OF THE HEADS OF HOUSEHOLD SURVEYED	116

TABLE 41 - FOOD AND CASH CROPS IN THE PROJECT'S AREA OF INFLUENCE	120
TABLE 42 - MAIN CROPS IN THE STUDY AREA	123
TABLE 43 - TYPE OF FOOD CROP CULTIVATION PER HOUSEHOLD AND PER COMMUNE (NUMBER OF HOUSEHOLDS SURVEYED).....	125
TABLE 44 - MAIN LIVESTOCK FARMING ACTIVITIES IN THE STUDY AREA.....	127
TABLE 45 - FISHING PRACTICES IN THE PROJECT'S AREA OF INFLUENCE	128
TABLE 46 - CRAFTSMEN IN THE PROJECT AREA.....	129
TABLE 47 - MAJOR MINING COMMODITIES IN THE STUDY AREA	133
TABLE 48 - MARKET DAYS IN THE STUDY AREA	137
TABLE 49 - MAIN SERVICES AVAILABLE IN THE PROJECT'S AREA OF INFLUENCE	137
TABLE 50 - SOCIO-PROFESSIONAL CATEGORIES OF THE HOUSEHOLDS SURVEYED.....	139
TABLE 51 - HOUSEHOLD MONETARY INCOME TABLE.....	140
TABLE 52 - GENDER-BASED DISTRIBUTION OF INCOME-GENERATING PEOPLE	140
TABLE 53 - INCOME GENERATED BY TYPE OF ECONOMIC ACTIVITY	142
TABLE 54 - CATEGORIZATION OF AVERAGE ANNUAL HOUSEHOLD EXPENDITURES.....	143
TABLE 55 - TYPE AND LEVEL OF USE OF THE ONIVE RIVER	144
TABLE 56 - FADY OR "PROHIBITIONS" IN THE PROJECT AREA	149
TABLE 57 - SURVEY OF TANGIBLE HERITAGE IN THE AREA OF INFLUENCE.....	150
TABLE 58 - COMMUNE CROSSED BY THE 2 KM CORRIDOR.....	162
TABLE 59 - SURVEY OF SENSITIVE SOCIO-ECONOMIC ASSETS IN THE 2 KM CORRIDOR.....	164
TABLE 60 - STATISTICS SHOWING CROP AREAS IN THE 2 KM CORRIDOR.....	165
TABLE 61 - STATISTICS OF INHABITED AREAS BY COMMUNE IN THE 2 KM CORRIDOR	166
TABLE 62 - CIVIL SOCIETY ORGANIZATIONS OPERATING IN THE 2 KM CORRIDOR.....	168
TABLE 63 - RELEVANT BODIES AND PROJECTS PRESENT IN THE REGION	169
TABLE 64 - LOCAL AUTHORITIES' EXPECTATIONS FROM AND PERCEPTIONS OF THE PROJECT	170
TABLE 65 - BIRD SPECIES THAT TRIGGERED THE CREATION OF THE ONIVE FOREST IBA	179
TABLE 66 - TERRESTRIAL BIOLOGICAL INVENTORY SITES.....	186
TABLE 67 - RAPID PLANT INVENTORY: DESCRIPTION OF THE PARAMETERS IDENTIFIED.....	188
TABLE 68 - DEFORESTATION IN THE HUMID ECOREGION OF MADAGASCAR (2005-2013).....	200
TABLE 69 - CLASSIFICATION AND SYNONYMY OF THE EASTERN MALAGASY FORMATION.....	204
TABLE 70 - STRUCTURAL CHARACTERISTICS OF THE EVERGREEN DENSE HUMID FOREST.....	206
TABLE 71 - STRUCTURAL DATA FOR LICHEN WOODLANDS	208
TABLE 73 - GEOGRAPHICAL AFFINITY OF PLANT SPECIES	219
TABLE 74 - LIST OF SPECIES CLASSIFIED BY THE IUCN	220
TABLE 75 - LIST OF CITES SPECIES	221
TABLE 76 - LIST OF INVASIVE SPECIES INVENTORIED	224
TABLE 77 - LIST OF SPECIES TARGETED FOR CONSERVATION	225
TABLE 78 - FLORA SPECIES REQUIRING CRITICAL HABITAT ANALYSIS	227
TABLE 79 - LIST OF SPECIES IDENTIFIED ALONG THE ANTANANARIVO-ANTANIFOTSY-BELANITRA SECTION.....	229
TABLE 80 - LIST OF DOCUMENTS CONSULTED PRIOR TO THE VARIOUS FIELD TRIPS.....	230
TABLE 81 - THREATENED TERRESTRIAL VERTEBRATES PRESENT IN THE PROJECT AREA ACCORDING TO THE IUCN	235
TABLE 82 - GEOGRAPHICAL DISTRIBUTION OF THREATENED TERRESTRIAL FAUNA SPECIES ACCORDING TO THE IUCN	236
TABLE 83 - LIST OF VERTEBRATE SPECIES INCLUDED IN THE CITES LIST.....	237
TABLE 84 - LIST OF VERTEBRATE SPECIES PROTECTED BY DECREE 2006-400	239
TABLE 85 - RELATIVE ABUNDANCE OF AMPHIBIAN AND REPTILE SPECIES IDENTIFIED	244
TABLE 86 - RELATIVE ABUNDANCE OF BIRD SPECIES IDENTIFIED IN FOUR STUDY SITES	246
TABLE 87 - RELATIVE ABUNDANCE OF SMALL MAMMAL SPECIES IN THE STUDY AREA	248
TABLE 88 - LENGTH OF TRANSECTS COVERED IN LEMUR STUDY SITES (KM).....	249
TABLE 89 - RELATIVE ABUNDANCE OF LEMUR SPECIES (IND/KM).....	250
TABLE 90 - TERRESTRIAL VERTEBRATE SPECIES REQUIRING CRITICAL HABITAT ANALYSIS	251
TABLE 91 - PRESENCE MATRIX OF RHOPALOCERA SPECIES IDENTIFIED	257
TABLE 92 - PRESENCE MATRIX OF TWO IDENTIFIED SPECIES OF HETEROCERA.....	258
TABLE 93 - ABUNDANCE OF FLYING INSECTS CAUGHT IN MALAISE TRAPS	258
TABLE 94 - ABUNDANCE OF SOIL AND LITTER INVERTEBRATES IN STUDY SITES	259
TABLE 95 - SUMMARY OF AQUATIC FAUNA INVENTORIES AND SURVEYS	262
TABLE 97 - LIST OF NATIVE AQUATIC SPECIES IDENTIFIED	269
TABLE 98 - LIST OF AQUATIC FAUNA SPECIES REQUIRING CRITICAL HABITAT ANALYSIS.....	273
TABLE 99 - THE MAIN PRODUCTS HARVESTED FROM THE FOREST	279

TABLE 100 - LIST OF PLANTS USED BY THE LOCAL POPULATIONS	282
TABLE 101 - EVALUATION OF ECOSYSTEM SERVICES	286
TABLE 102 - "EROSION CONTROL" MITIGATION MEASURES.....	292
TABLE 103 - ONIVE RIVER FLOW BETWEEN THE DAM AND THE PLANT, WITH AND WITHOUT THE PROJECT.....	294
TABLE 104 - "PHYSICAL IMPACT DOWNSIDE" MITIGATION MEASURES.....	302
TABLE 105 - QUALITATIVE DESCRIPTION OF SEDIMENT TRANSPORT OVER THE YEAR.....	303
TABLE 106 - "SEDIMENT REGIME" MITIGATION MEASURES	304
TABLE 107 - "NOISE, DUST AND AIR EMISSIONS" MITIGATION AND MONITORING MEASURES.....	305
TABLE 108 - "LIQUID AND SOLID WASTE" MITIGATION AND CONTROL MEASURES	307
TABLE 109 - "ACCIDENTAL POLLUTION" MITIGATION MEASURES.....	308
TABLE 110 - CLIMATE CHANGE MITIGATION MEASURES.....	316
TABLE 111 - CONSTRUCTION-RELATED GREENHOUSE GAS EMISSIONS	317
TABLE 112 - SIZE AND CARBON CONTENT OF FLOODED AREAS	318
TABLE 113 - RESERVOIR WATER RENEWAL RATE AND TIME (FULL RESERVOIR 140 HM ³).....	320
TABLE 114 - RESULTS OF MEASUREMENT OF GHG EMISSIONS FROM VARIOUS TROPICAL RESERVOIRS	322
TABLE 115 - ASSUMPTIONS FOR DROWNED BIOMASS DEGRADATION	323
TABLE 116 - GHG EMISSIONS COMPARED WITH OTHER ENERGY SOURCES.....	324
TABLE 117 - "WATER QUALITY" MITIGATION MEASURES	326
TABLE 118 - BASE FLOW - 100-YEAR FLOOD ACROSS THE UPSTREAM BASIN.....	327
TABLE 119 - EXPOSURE OF DOWNSTREAM VILLAGES TO A 100-YEAR FLOOD AND DAM FAILURE	330
TABLE 120 - SENSITIVITY ANALYSIS OF THE DAM FAILURE MODEL.....	333
TABLE 121 - "DAM FAILURE" MITIGATION MEASURES.....	334
TABLE 122 - CONTENTS OF THE EMERGENCY RESPONSE PLAN	335
TABLE 123 - PROJECT'S AREA OF INFLUENCE AND IDENTIFIED IMPACTS.....	337
TABLE 124 - SOURCES OF POTENTIAL IMPACTS ACCORDING TO THE VARIOUS PHASES OF THE PROJECT.....	340
TABLE 125 - "ENTRY INTO THE LAND" RISKS AND MITIGATION MEASURES.....	340
TABLE 126 - DEFINITION OF SOCIAL IMPACT SIGNIFICANCE	345
TABLE 127 - "WORKING CONDITIONS" RISKS AND MITIGATION MEASURES.....	347
TABLE 128 - "WORKER HEALTH AND SAFETY" RISKS AND MITIGATION MEASURES	351
TABLE 129 - "COMMUNITY SAFETY" RISKS AND MITIGATION MEASURES	354
TABLE 130 - "COMMUNITY HEALTH" RISKS AND MITIGATION MEASURES	357
TABLE 131 - "POPULATION INFLUX" RISKS AND MITIGATION MEASURES.....	364
TABLE 132 - "CULTURAL IMPACTS" RISKS AND MITIGATION MEASURES	367
TABLE 133 - COMMUNITY DEVELOPMENT ACTION PLAN.....	371
TABLE 134- RISKS AND MITIGATION MEASURES FOR "CONSTRUCTION AND OPERATION OF THE LINE"	372
TABLE 135 - DEFINITION OF THE SIGNIFICANCE OF ENVIRONMENTAL IMPACTS	373
TABLE 136 - TOTAL AREA OF HABITAT CURRENTLY IMPACTED BY THE PROJECT	374
TABLE 137 - "TERRESTRIAL BIODIVERSITY" MITIGATION MEASURES	385
TABLE 138 - IMPACT OF THE PROJECT ON AQUATIC ENVIRONMENTS IN THE OPERATION PHASE	390
TABLE 139 - "AQUATIC BIODIVERSITY" MITIGATION MEASURES	396
TABLE 140 - IMPACTS ON PRIORITY ECOSYSTEM SERVICES AND MITIGATION MEASURES.....	396
TABLE 141 - MITIGATION MEASURES FOR "ECOSYSTEM SERVICES".....	400
TABLE 142 - "BIODIVERSITY ACTION PLAN" MITIGATION MEASURES.....	400
TABLE 143 - PROBABILITY AND CONSTRUCTION SCHEDULE OF THE OTHER DAMS IN THE ONIVE.....	403
TABLE 144 - CUMULATIVE IMPACTS: ENVIRONMENTAL AND SOCIAL RECEPTORS.....	404
TABLE 146- SECONDARY CUMULATIVE IMPACTS ON SOCIAL RECEPTORS	406
TABLE 147 - SECONDARY CUMULATIVE IMPACTS ON ENVIRONMENTAL RECEPTORS	407
TABLE 148 - CUMULATIVE IMPACT MITIGATION MEASURES	407
TABLE 149 - "CUMULATIVE IMPACTS" MITIGATION MEASURES	408
TABLE 150 - STRUCTURE OF NEHO'S ESMS.....	419

FIGURES

FIGURE 1 - PROJECT LOCATION	18
FIGURE 2 - HYDROPOWER PLANT LAYOUT DIAGRAM.....	19
FIGURE 3 PLAN VIEW OF THE DAM.....	20
FIGURE 4 - UPSTREAM VIEW OF THE DAM	21

FIGURE 5 - TYPICAL SECTION OF THE DAM AT THE WEIR.....	22
FIGURE 6 - TYPICAL SECTIONS OF THE FEEDER TUNNEL FOR CERTAIN TYPES OF LAND	23
FIGURE 7 - LONGITUDINAL PROFILE OF THE WATERWAY	23
FIGURE 8 - PLAN VIEW OF THE WATERWAY (HEADRACE TUNNEL AND PENSTOCK).....	24
FIGURE 9 - LONGITUDINAL PROFILE SECTIONS OF THE PENSTOCKS.....	25
FIGURE 10 - ROUTE OF THE ENERGY EVACUATION LINE CORRIDOR	28
FIGURE 11 - EXAMPLES OF ACCESS ROAD OPTIONS WEST OF THE DAM	30
FIGURE 12 - ONIVE RIVER CROSSING BRIDGE DOWNSTREAM FROM THE DAM	30
FIGURE 13 - LOCATION OF THE VARIOUS AREAS OF THE OVERALL PROJECT.....	31
FIGURE 14 - LOCATION OF THE PROPOSED QUARRIES.....	34
FIGURE 15 - MONTH-END RESERVOIR LEVEL- DRY, MEDIUM AND WET YEARS (M)	39
FIGURE 16 - MADAGASCAR'S SOLAR ENERGY POTENTIAL (SOURCE: MINISTRY OF ENERGY AND MINES).....	45
FIGURE 17 - AVERAGE WIND POWER AVAILABLE AT 50 M	46
FIGURE 18 - HYDROPOWER FACILITIES CONSIDERED IN THE ALTERNATIVES ANALYSIS.....	49
FIGURE 19 - SCHEMATIC LAYOUT OF LINEAR INFRASTRUCTURE IMPLEMENTATION.....	56
FIGURE 20 - ROUTE OPTIONS CONSIDERED BETWEEN THE HYDROPOWER PLANT AND THE DAM	57
FIGURE 21 - SOIL MAP OF THE STUDY AREA	73
FIGURE 22 - SAHOFIKA AREA UMBROTHERMAL DIAGRAM.....	75
FIGURE 23 - ANTANIFOTSY OMBROTHERMAL DIAGRAM.....	75
FIGURE 24 - LONGITUDINAL PROFILE OF THE ONIVE FROM THE DAM SITE TO THE OCEAN.. ..	78
FIGURE 25 - COMMUNES DIRECTLY AFFECTED BY THE HYDROPOWER PLANT	88
FIGURE 26 - STUDY AREA MAP.....	90
FIGURE 27 - MAP OF ADMINISTRATIVE DIVISIONS IN THE PROJECT AREA	92
FIGURE 28 - DEMOGRAPHIC MAP OF THE PROJECT'S AREA OF INFLUENCE	96
FIGURE 29 - CHILD MORTALITY RATE IN MADAGASCAR FROM 1968 TO 2017	97
FIGURE 30 - CHILD MORTALITY RATE IN MADAGASCAR FROM 1960 TO 2016.....	98
FIGURE 31 - EVOLUTION OF THE BIRTH RATE PER 1000 INHABITANTS IN MADAGASCAR FROM 1960 TO 2016....	99
FIGURE 32 - AGE OF HOUSEHOLD MEMBERS SURVEYED.....	103
FIGURE 34 LAND USE MAP OF THE PROJECT'S AREA OF INFLUENCE	111
FIGURE 35 - MINING PERMIT LOCATION MAP.....	132
FIGURE 36 - CULTURAL/HERITAGE SITES LOCATION MAP	152
FIGURE 37 - TRAFFIC COUNTING SITES LOCATION MAP.....	157
FIGURE 38 - TRAFFIC IN ANTANIFOTSY, FROM ANTANIFOTSY TO BELANITRA.....	158
FIGURE 39 - TRAFFIC IN ANTANIFOTSY, FROM BELANITRA TO ANTANIFOTSY.....	159
FIGURE 40 - SUMMARY OF TRAFFIC AT THE BELANITRA BRIDGE FROM BELANITRA TO ANTANIFOTSY.....	161
FIGURE 41 - SUMMARY OF TRAFFIC AT THE BELANITRA BRIDGE, FROM BELANITRA TO ANTANIFOTSY	161
FIGURE 42 - MAP OF AREAS UNDER NATURAL RESOURCES CONSERVATION/MANAGEMENT STATUS.....	173
FIGURE 43 - LOCATION OF THE IBA OF THE ONIVE GAZETTED FOREST.....	179
FIGURE 44 - EXTENDED STUDY AREA OF THE HYDROPOWER PLANT SITE.....	184
FIGURE 45 - CLOSE STUDY AREA OF THE HYDROPOWER PLANT SITE.....	185
FIGURE 46 - MAP OF HABITATS IN THE CORRIDOR OF THE HIGH VOLTAGE (HV) LINE UP TO ANTANANARIVO ...	186
FIGURE 47 - MAP OF THE TERRESTRIAL BIODIVERSITY SITES SURVEYED.....	187
FIGURE 48 - DISTRIBUTION OF OBSERVATION TRANSECTS THROUGHOUT THE STUDY AREA	192
FIGURE 49 - LOCATION OF HYDROBIOLOGICAL SURVEY STATIONS	194
FIGURE 50 - LOCATION OF BENTHIC MACROINVERTEBRATE INVENTORY STATIONS.....	197
FIGURE 51 - DEFORESTATION IN THE PROJECT AREA BETWEEN 1989 AND 2018.....	201
FIGURE 52 - VEGETAL SUCCESSION OF POST-CROP FORMATIONS ON THE EAST SLOPE	210
FIGURE 53 - MAP OF NATURAL AND MODIFIED HABITATS IDENTIFIED FROM LANDSAT DATA	214
FIGURE 54 - DETAILED MAP OF NATURAL AND MODIFIED HABITATS.....	215
FIGURE 55 - DISTRIBUTION OF FLOW FACIES OBSERVED DURING THE WET SEASON	217
FIGURE 56 - DISTRIBUTION OF FLOW FACIES OBSERVED DURING THE DRY SEASON	217
FIGURE 57 - MAP OF OBSERVED OCCURRENCES OF THREATENED TAXA	224
FIGURE 58 - GRAPH OF SPECIFIC RICHNESS IN TERRESTRIAL VERTEBRATES ON THE SITES SURVEYED	232
FIGURE 59 - CUMULATIVE CURVES OF SPECIES IN EACH TAXONOMIC GROUP	234
FIGURE 60 - DISTRIBUTION THE 4 STATIONS BY MAJOR TAXONOMIC GROUP.....	266
FIGURE 61 - DISTRIBUTION OF BENTHIC MACROINVERTEBRATES - CURRENT AFFINITY	267
FIGURE 62 - DISTRIBUTION OF BENTHIC MACROINVERTEBRATES - POLLUTION RESISTANCE	267
FIGURE 63 - GEOGRAPHICAL DISTRIBUTION OF TAXA IN THE 4 SAMPLING STATIONS	268
FIGURE 64 - MAP OF THE DISCRETE MANAGEMENT UNIT FOR THE CONSERVATION OF RHEOCLES WRIGHTAE .	275
FIGURE 65 - MAROLAMBO NP FOREST UNIT	277

FIGURE 66 - FOREST UNIT OF THE NEW TSINJOARIVO - AMBALAOMBY PROTECTED AREA	277
FIGURE 67 - TRIBUTARY BASINS OF THE ONIVE BETWEEN THE DAM AND THE PLANT	294
FIGURE 68 - MEDIAN HYDROGRAPH OF THE ONIVE BETWEEN THE DAM AND THE PLANT, WITH AND WITHOUT THE PROJECT (M ³ /S)	295
FIGURE 69 - HYDROGRAPH OF THE ONIVE BETWEEN THE DAM AND THE PLANT, DRY AND WET DECENNIAL YEARS, WITH AND WITHOUT THE PROJECT (M ³ /S)	295
FIGURE 70 - HYDROGRAPHS OF THE ONIVE IMMEDIATELY DOWNSTREAM FROM THE PLANT, DECENNIAL DRY AND MEDIUM YEAR, WITH AND WITHOUT THE PROJECT (M ³ /S)	296
FIGURE 71 - FLOW VARIATIONS OVER 24 HOURS DOWNSTREAM FROM THE PLANT IN THE MOST IMPACTFUL CASE	298
FIGURE 72 - LEVEL VARIATIONS OVER 24 HOURS DOWNSTREAM FROM THE PLANT IN THE MOST IMPACTFUL CASE	299
FIGURE 73 – CALM DIVERSION BAYS INTERSPERSED WITH NATURAL SILLS DOWNSTREAM FROM THE PLANT ..	302
FIGURE 74 - AVERAGE AND CUMULATIVE VALUES OF PRECIPITATION IN NOVEMBER-APRIL AND MAY-OCTOBER 1948-2008 (MM).....	310
FIGURE 75 - CLIMATE CHANGE: EXPECTED MONTHLY TEMPERATURE CHANGE.....	310
FIGURE 76 - CLIMATE CHANGE: EXPECTED TRENDS IN MONTHLY PRECIPITATION	311
FIGURE 77 - CLIMATE CHANGE: EXPECTED MONTHLY PRECIPITATION TRENDS BY 2099 (RCP8.5)	312
FIGURE 78 - CLIMATE CHANGE: EXPECTED MONTHLY TEMPERATURE TRENDS.....	312
FIGURE 79 - CLIMATE CHANGE: EXPECTED TRENDS IN 25-YEAR DAILY PRECIPITATION EVENTS BY 2099 (RCP8.5)	313
FIGURE 80 – MAP OF NATURAL AND MODIFIED HABITATS IN THE FLOODED AREA	318
FIGURE 81 – AREAS HARDLY SUITABLE FOR RENEWAL AND CIRCULATION.....	321
FIGURE 82 – GHG EMISSIONS FROM BIOMASS DECOMPOSITION	324
FIGURE 83 - EXAMPLE OF A CROSS PROFILE AT A VILLAGE BORDERING THE MANGORO RIVER.....	328
FIGURE 84 – EXAMPLE OF A VILLAGE PROBABLY EXPOSED AS SOON AS THE 100-YEAR FLOOD OCCURS.....	329
FIGURE 85 – EXPOSURE OF DOWNSTREAM VILLAGES TO A 100-YEAR FLOOD AND DAM FAILURE	332
FIGURE 86 – MAP OF THE SOCIAL IMPACT ANALYSIS AREA	338
FIGURE 87 – EXAMPLE OF A THREE-DIMENSIONAL BIRD DIVERTER	381
FIGURE 88 - LOCATION OF PLANNED HYDROPOWER FACILITIES IN THE ONIVE AND MANGORO RIVER BASIN....	401
FIGURE 89 – THE SITE AND FALL OF TSINJOARIVO	402
FIGURE 90 – LOCATION OF THE LOHAVANANA PROJECT	403

PHOTOGRAPHS

PHOTO 1 - THE ONIVE RIVER AT THE DAM SITE (VIEW FROM THE LEFT BANK)	21
PHOTO 2 - VIEW OF THE ROCKY OUTCROP (RIGHT) FROM WHICH THE SURGE TANK WILL EMERGE	24
PHOTO 3 - VIEW OF THE GRASSY SLOPES WHERE THE PENSTOCK WILL BE BUILT.....	25
PHOTO 4 - HYDROPOWER PANT STUDY AREA DOWNSTREAM FROM THE ONIVE FALLS	26
PHOTO 5 - THE EXISTING ACCESS ROAD BETWEEN ANTANIFOTSY AND BELANITRA	29
PHOTO 7 - TYPICAL LANDSCAPE UPSTREAM FROM THE PROJECT WATERSHED	70
PHOTO 8 - THE ONIVE AND THE CHARACTERISTIC HILLY LANDSCAPE OF THE EAST, SEEN FROM THE ROCKY ESCARPMENT.....	71
PHOTO 9 - SAND BANK AND ROCKY OUTCROPS IN THE ONIVE RIVER BED AT THE DAM SITE.....	83
PHOTO 10 - PORTERS.....	100
PHOTO 11 - A MIGRANT FAMILY FROM AMBOHIMANDROSO BRINGING THEIR “MOFO GASY” SKILLS TO AMBOHITOMPOINA.....	101
PHOTO 12 - A WOMAN HEAD OF HOUSEHOLD WITH SOME CHILDREN FROM THE VILLAGE.....	102
PHOTO 14 - TRANSPORT ON A MAN’S BACK AND BY BICYCLE	114
PHOTO 15 - ANTENINA PRIMARY SCHOOL AND TSINJOARIVO SECONDARY SCHOOL.....	117
PHOTO 16 - A CLASSROOM IN A COMMUNITY SCHOOL WHERE ALL CLASSES ARE IN THE SAME ROOM.....	117
PHOTO 17 - THE PILOT HEALTH CARE CENTRE IN BEFOTAKA.....	118
PHOTO 18 - ANTANIFOTSY DISTRICT HOSPITAL CENTRE	118
PHOTO 19 - RICE CULTIVATION ON TAVY IN EAST BEFOTAKA (RICE STARTS TO GROW).....	121
PHOTO 20 - IRRIGATED RICE CULTIVATION.....	122
PHOTO 21 - AGRICULTURAL PRACTICES IN THE PROJECT AREA	124
PHOTO 22 - TARO GROWING COMBINED WITH BEANS IN BEFOTAKA	125
PHOTO 23 - HARNESSSED ZEBUS USED TO PULL CARTS FOR TRANSPORTATION AND TRAVEL PURPOSES	126
PHOTO 24 - FISHING TECHNIQUE USED IN THE ONIVE RIVER	129
PHOTO 25 - CRAFTSMEN IN THE STUDY AREA	130

PHOTO 26 - GOLD MINING.....	133
PHOTO 27 - TSINJOARIVO TOURIST SITE (THE ROVA AND THE WATERFALL)	135
PHOTO 28 - A FARMING HOUSEHOLD IN ANTAMBOHOMENA SELLING PASTRIES IN THE NEIGHBORHOOD	136
PHOTO 29 - AN INFORMAL SELLER OF “PARAKY GASY” (TOBACCO) ON THE BEFOTAKA MARKET DAY	136
PHOTO 30 – THE FARAVOHITRA-SAHOFIKA MARKET.....	137
PHOTO 31 - TRANSPORTING GOODS ON FOOT TO THE FARAVOHITRA-SAHOFIKA MARKET	138
PHOTO 32 - DAILY ACTIVITIES ON THE ONIVE RIVER	145
PHOTO 33 - A NATURAL WELL NEAR CROP FIELDS.....	145
PHOTO 34 – A TEMPORARY MARKET NEAR THE TEMPORARY CAMP.....	146
PHOTO 35 - JOB SEEKERS AT THE MARKET NEAR THE CAMP	146
PHOTO 36 - A GROUP OF WOMEN DOING THEIR LAUNDRY NEAR THE TEMPORARY CAMP	147
PHOTO 37 - A HOUSE IN THE VILLAGE OF FISORONANA	148
PHOTO 38 - SURVEY OF TANGIBLE HERITAGE IN THE AREA OF INFLUENCE.....	151
PHOTO 39 - “AVAN-DRAZANA”.....	153
PHOTO 40 - A FAMADIHANA (EXHUMATION) CEREMONY IN THE VAKINANKARATRA REGION	154
PHOTO 41 - A CHILD AT THE TIME OF CIRCUMCISION WEARING THE TRADITIONAL MALAGASY DRESS: THE MALABARY.....	154
PHOTO 42 - A TRADITIONAL WEDDING IN BELANITRA	155
PHOTO 43 - FOCUS GROUP DISCUSSIONS.....	164
PHOTO 44 - PARTICIPATORY MAPPING WITH THE VOIS.....	174
PHOTO 45 - VARIOUS TRIBUTARIES SURVEYED	194
PHOTO 46 - VARIOUS AQUATIC FAUNA INVENTORY METHODS USED	195
PHOTO 47 - VARIOUS AQUATIC FAUNA INVENTORY METHODS USED	196
PHOTO 48 - INVENTORY OF MACROINVERTEBRATES	197
PHOTO 49 - IDENTIFICATION OF MACROINVERTEBRATES.....	198
PHOTO 50 - VENTRAL SUCTION CUP OF SICYOPTERUS PUNCTISSIMUS.....	203
PHOTO 51 - EXOTIC FISH SPECIES	203
PHOTO 52 - MEGAPHILIA AND BUTTRESS OF VEGETAL SPECIES.....	205
PHOTO 53 - MODIFIED RIPARIAN HABITATS UPSTREAM FROM THE DAM SITE	212
PHOTO 54 - MODIFIED AND NATURAL SHORELINE HABITAT	212
PHOTO 55 - FARAVOHITRA AND SAHOFIKA MODIFIED RIVER HABITAT	213
PHOTO 56 - NATURAL RIPARIAN HABITAT DOWNSTREAM FROM THE DAM	213
PHOTO 57 - FROM LEFT TO RIGHT, THE ONIVE UPSTREAM FROM THE DAM, AT THE BPR AND DOWNSTREAM FROM THE PLANT	216
PHOTO 58 - NATURAL AND MODIFIED HABITATS OF ONIVE’S TRIBUTARIES.....	218
PHOTO 59 - VARIOUS MODIFIED AQUATIC HABITATS.....	218
PHOTO 60 - HYDROTHELPUSA AGILIS CAPTURED ON THE TRAIL DURING THE TRIP FROM THE PLANT TO THE DAM	261
PHOTO 61 - RHEOCLES CAUGHT BY MEANS OF A SEINE IN THE MAROTENINA RIVER.....	264
PHOTO 62 - ASTACOIDS MADAGASCARIENSIS AND AWAOUS AENEOFUSCUS	265
PHOTO 63 - GYRINIDAE BEETLE COLLECTED FROM STATIONS 1 AND 2 (LIMNOPHILE AND POLLUTION-RESISTANT TAXON)	266
PHOTO 64 - AQUATIC SPECIES AT RISK.....	270
PHOTO 65 - MOST DOWNSTREAM FALL FROM THE RAPIDS FORMING THE BYPASSED REACH OF THE ONIVE.....	270
PHOTO 66 - TWO OF THE FOUR MIGRATORY FISH SPECIES.....	271
PHOTO 67 - USE OF WOOD FOR CONSTRUCTION IN THE UPSTREAM AREA	280
PHOTO 68 - FIREWOOD AND UTILITY WOOD (MORTARS).....	281
PHOTO 69 - RAVENEA AND DYPISIS (RUM DISTILLATION STILL)	281
PHOTO 70 - DYPISIS AND RAVENEA (ARECACEAE) USED FOR A WATER SUPPLY PIPE TO GOLD PANNING SITES ..	282
PHOTO 71 - PANNING WITH BUTTRESS WOOD OR A LARGE TREE TRUNK	282
PHOTO 72 - USE OF WOOD FOR CONSTRUCTION IN THE UPSTREAM AREA.....	283
PHOTO 73 - FUNCTIONAL LEMUR TRAP IN AMBATOTSIPIHINA.....	284

Introduction

Madagascar is one of the world's countries with the least access to electricity. The majority of the population (87%) relies heavily on wood as their main energy source. The country's electricity production is largely dependent on thermal production based on imported fuels. This production has increased in recent years as a result of population growth, thereby directly contributing to global warming and to increasing financial deficits within the sector.

To address this situation, the Republic of Madagascar has embarked on a series of reforms and established a program called "Priority Hydroelectric Program" which focuses on several sites. These sites include Sahofika, which was subject to a restricted international call for tenders (No. 001/15/MEH).

On June 17, 2016, the Ministry of Water, Energy and Hydrocarbons declared the Eiffage, Eranove, Themis and HIER consortium the provisional contractor and signed, on December 2, 2016, a Project Agreement for the implementation of the Sahofika Hydropower Project ("the Project") This consortium will be responsible for designing, financing, building, operating and maintaining the Sahofika Hydropower Plant under a concession contract to be entered into with the Government of Madagascar, via a Malagasy company currently being established called Nouvelle Energie Hydroélectrique de l'Onive ("NEHO" or the "Concession Holder).

This document is the environmental and social impact assessment prepared by the Concession Holder to ensure the Project is in compliance with national legislation and the environmental and social policies of the International Finance Corporation and the African Development Bank.

1 Project Description

1.1 Project Objective

The Sahofika Hydropower Plant (the “Project”) is located on the Onive River. At the end of its construction, it will have an installed capacity of 192 MW, 130 MW of which will be 99% guaranteed. The objective of the Project is to supply basic low-cost renewable energy to the interconnected Antsirabé-Antananarivo grid. The average annual production will be 1570 GWh.

This large-scale facility will also contribute to the stability of the interconnected grid.

The site consists of a 60 m high main dam standing on the Onive River with a 140 hm³ reservoir that can be used as back-up during low-water periods, an underground tunnel followed by an overhead penstock all the way to the hydropower plant located 6.5 km further downstream (13 km along the Onive River bed).

The Project also includes outgoing power lines, and the entire set of infrastructures required for its construction or operation: access roads, service lines, temporary camps and permanent buildings, borrow and excavated materials areas, etc. All these are described in the following section of Chapter 1.

The Project also includes outgoing power lines, and all the infrastructure necessary for its construction or operation phase: access roads, service lines, temporary camps and permanent buildings, borrow pits and excavated areas, etc. All these assets are described in Chapter 1 below.

1.2 Project Organization

1.2.1 The Concessionaire

The Project developer is a four-company consortium including Eiffage, Eranove, Themis and HIER. Following a call for tenders by the Minister of Energy, the consortium was granted the Project as an independent producer, authorized via a concession in accordance with Article 23 of the Electricity Code.

Below is a brief description of the four companies:

- **Eiffage**: an international group headquartered in France and operating the world over in construction, infrastructure, energy and concessions;
- **Eranove**: a leading industrial group operating in the management of public services and the production of electricity and drinking water in Africa;
- **Neo Themis**: a developer of energy projects belonging to the Denham Capital group, and a leader in investments in developing countries, including Africa;
- **HIER** (Hydro Ingénierie Études et Réalisations): a Malagasy company specializing in hydropower plant projects.

This consortium has founded NEHO, a company incorporated under Malagasy law, which will be the Project Concessionaire as provided for by Article 23 of Act No. 2017-02 of April 10, 2018 on the Electricity Code (the “Electricity Code”) reforming the electricity sector in Madagascar.

NEHO shall be responsible for the Project's funding which will not come from a loan contracted by the Malagasy government

1.2.2 Detailed Design and Construction

For the detailed design and construction of the Project, NEHO will contract an engineering company supported by a design office under an EPC (Engineering + Procurement + Construction) type contract.

1.2.3 Transmission and Distribution of the Electricity Produced

The plant will be directly operated by NEHO. The electrical energy produced by the plant will be fed into the grid managed by JIRAMA, which will be responsible for its distribution.

1.2.4 Employment

During the construction phase, 1,200 people will be employed:

- Supervision (Company and Project management): about 200 people.
- Workers: about 1,000 people

During the operation phase, the entity responsible for the operation and maintenance of the dam will be staffed by 25 people organized around 5 main functions: management, personnel management, operation, maintenance, supply and stock management. An estimated equivalent number of permanent local jobs will be created for the services to be provided to the Operations and Maintenance team (security guards, maintenance staff, etc.)

1.3 Location and Access

The Hydropower Plant Project is located at latitude 19.5° South:

- On the Onive River;
- 100 km as the crow flies south-southeast of Antananarivo;
- 100 km as the crow flies from the Indian Ocean.

The power distribution line will connect the Project to Antananarivo, via Antanifotsy.

The Project area is accessible from the capital Antananarivo via paved road RN7 (Antananarivo-Antsirabe) to be used all the way down to Antanifotsy where a series of vehicle tracks followed by pedestrian tracks should be used over a distance of 60 km (as the crow flies) heading towards the east-southeast to reach the Project site. Along this entire route, the power distribution line will generally follow road access.

The Onive River at the dam site is crossed by dugout canoe, and a path cutting across the mountain leads to the hydropower plant site.

Figure 1 – Project Location

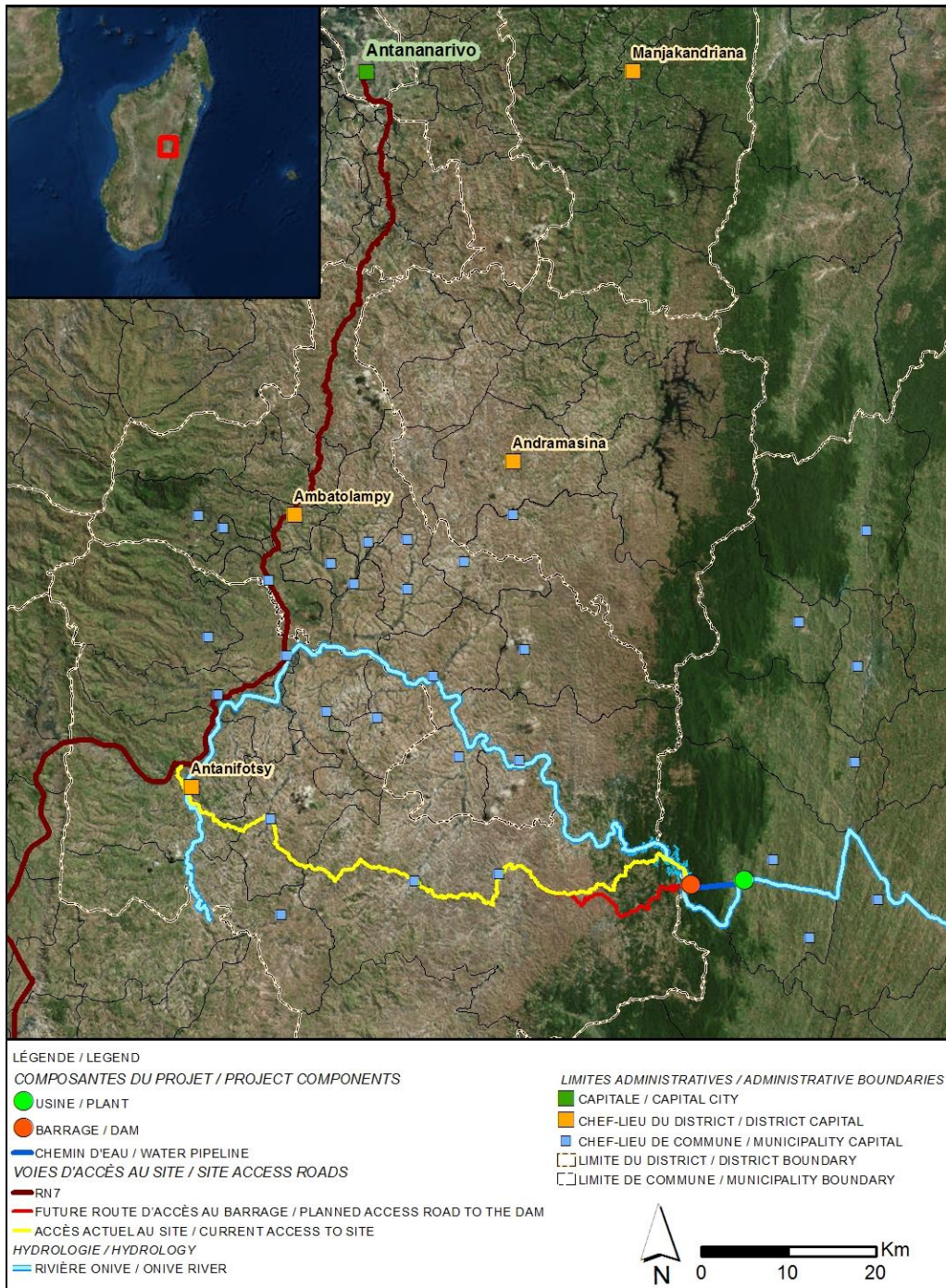

1.4 Project Components and Phasing

1.4.1 Preliminary Activities

The Project has been subject to a feasibility study. A significant amount of reconnaissance work has been carried out in the Project area as part of the studies conducted so far. The Project includes a lidar (laser topography from an aircraft) and a set of geological, hydrological and geotechnical studies.

The Project's detailed design is yet to be carried out and, therefore, the construction of the Project will be preceded by a set of additional preparatory activities, the aim of which will be to acquire fine-grained field data for this detailed design (topography, geology, geotechnics, hydrology, etc.).

Some of these activities, including geotechnical surveys for the water supply tunnel and hydrological monitoring of the Onive River, already took place in 2018.

Preliminary activities should be given due consideration since they will influence some of the Project's components such as the exact location of permanent (access roads or distribution line) or temporary infrastructure (quarries, disposal areas, construction site facilities, etc.).

1.4.2 Permanent Infrastructure

Figure 2 - Hydropower Plant Layout Diagram

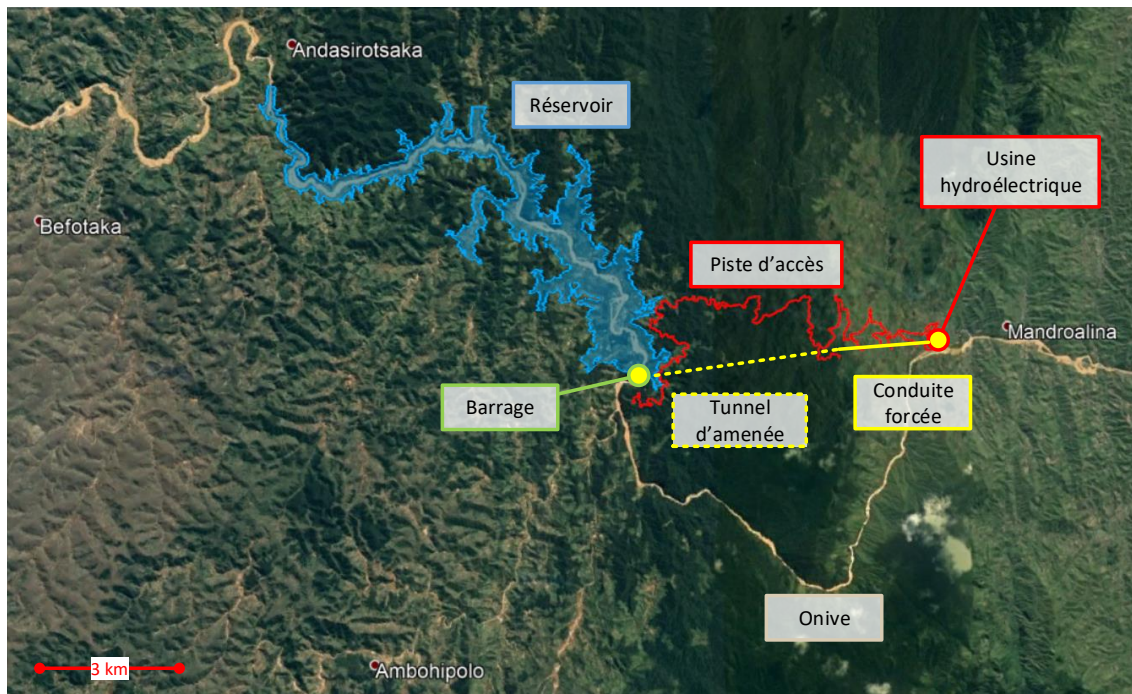

1.4.2.1.1. Dam and Reservoir

The design of a dam is based on the conditions of its foundation and the availability of materials, both of which were subject to geotechnical surveys in 2018. The selected design includes a main concrete dam that discharges most of the flood through an ungated weir, and includes a bottom gate (see Figure 4).

The dam is completed by a saddle dike, a type of auxiliary dam that raises the level of a saddle that is too low to allow the reservoir to be filled. This earth structure has a classic homogeneous dike profile with an upstream face sloped at 3.5H / 1V and a downstream face sloped at 2.5H / 1V.

The reservoir's footprint was slightly adjusted in August 2018 to take into account the boundaries of the LIDAR at the tailbay.

The main characteristics of the main dam are presented below.

- Dam type: RCC gravity dam with central evacuation on the downstream face

- Weir level: 1,328 m
- Peak level: 1,340 m
- Foundation level: 1,280 m
- Max. height on foundation: 60 m
- Length: 330 m
- Foundation: Gneiss - Migmatite
- Foundation treatment: Consolidation injections + waterproofing injection curtain + drainage

The following levels were considered for the design of the structures:

- Normal retention level (NRL): 1,328.00 m
- Highest Water Level (HWL) for the design flood: 1,337.20 m
- Maximum water level (MWL) in the impoundment for the safety flood: 1,338.95 m
- Maximum operating level (Q100): 1,335.30 m
- Minimum operating level (submergence criterion): 1,295.00 m
- For the normal retention level (1328):
 - Unusable storage volume: 11.5 hm³
 - Active reservoir storage volume: 128.5 hm³

Figure 3 Plan View of the Dam

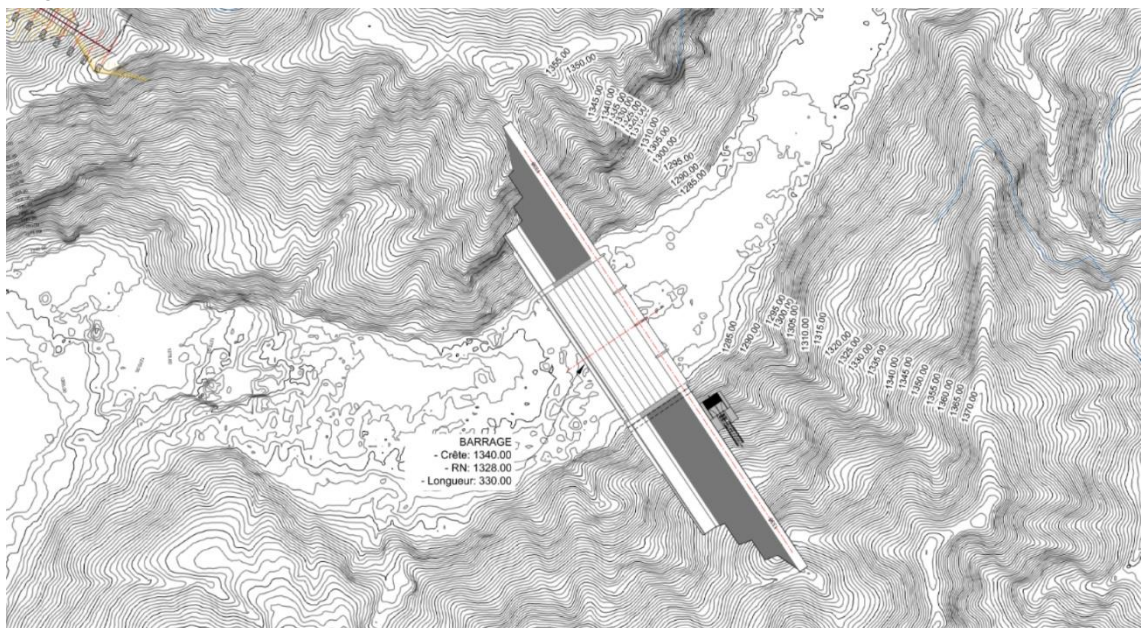

Figure 4 - Upstream View of the Dam

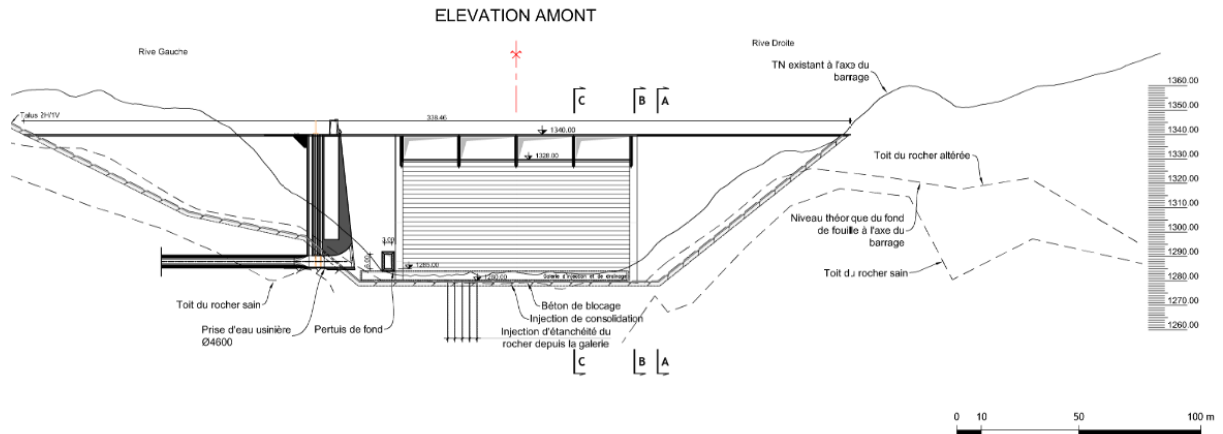
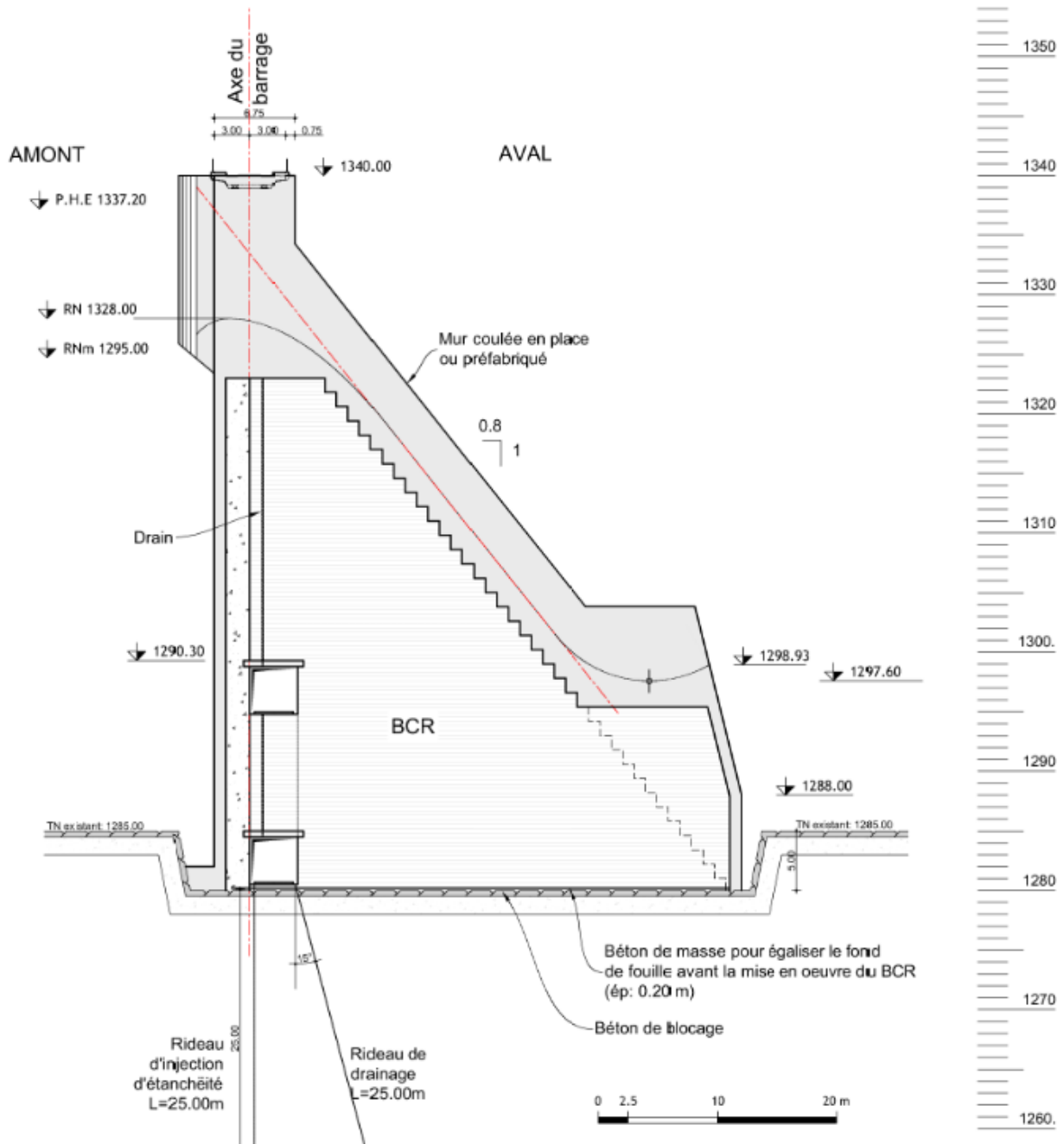

Photo 1 - The Onive River at the Dam Site (View from the left bank)



Figure 5 - Typical Section of the Dam at the Weir



1.4.2.2 Headrace Tunnel, Surge Tank and Penstocks

To channel the water from the upstream reservoir to the hydropower plant, various solutions were considered. The preliminary studies highlighted the significance of the geotechnical risk facing the Project, and the limited environmental and social issues along the grassy slopes (subject to regular burning) that dominate the hydropower plant site. The technical considerations were therefore directed towards a solution reducing the extent of this risk, which includes, from the water intake, a low-pressure gallery with a slight slope under the forest massif (up to 300m deep under it), a surge tank (shaft + emerging structure) and several penstocks.

The preliminary characteristics of the water intake, which is attached to the dam but in a separate structure to simplify the work interfaces, are as follows:

- Weir level: 1,288 m
- Dimensions of the hole: DN 4,60 m
- Grid area = 70 m² = 70 m².
- Water velocity at the RN grids: 0.75 m/s

The main characteristics of the headrace tunnel are as follows:

- Length: 4,240 m
- Upstream end altitude: 1288 m
- Downstream end altitude: 1165.50 m
- Longitudinal slope = 3%.
- Excavation method: explosive, excavator, rock breaker
- Coating: To be defined (no coating, concrete or shielding) according to the geotechnical risk and hydraulic pressures.
- Hydraulic diameter: 4.6 m (horseshoe section S≈17.3 m²)

Figure 6 - Typical sections of the feeder tunnel for certain types of land

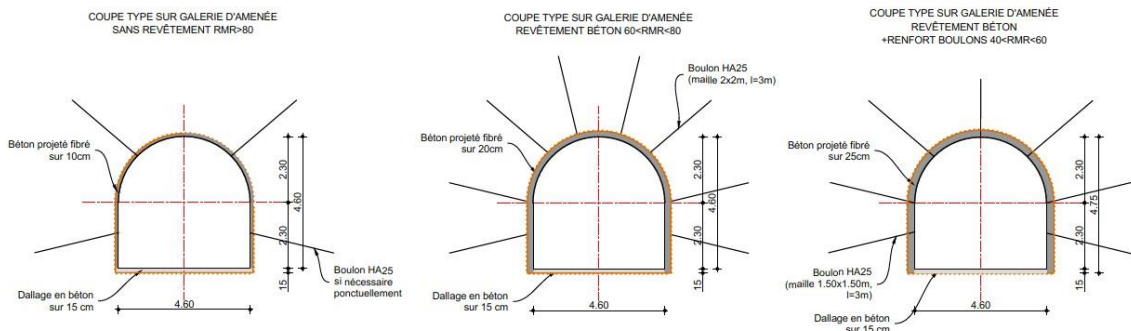

Figure 7 - Longitudinal profile of the waterway

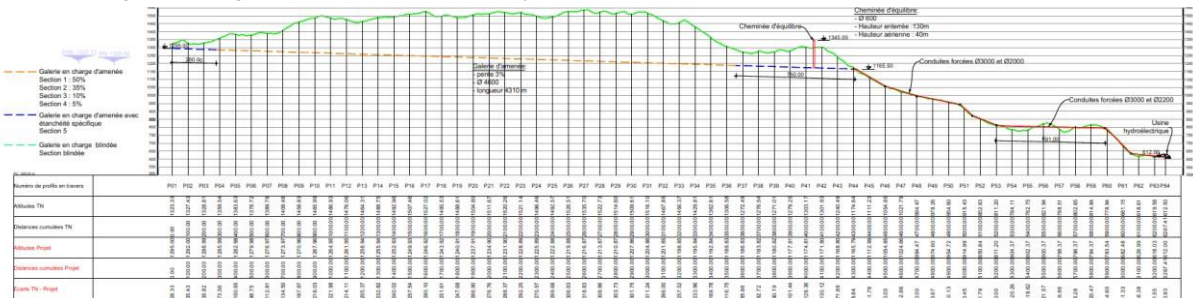
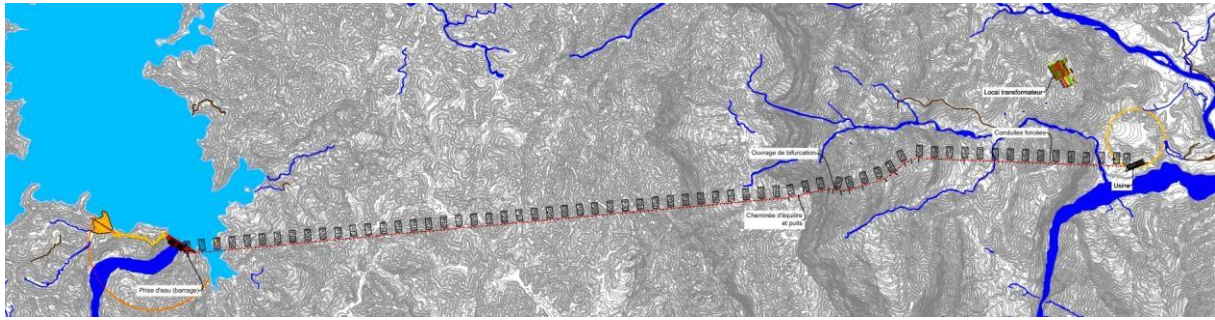

Figure 8 - Plan view of the waterway (headrace tunnel and penstock)



The surge tank is a 172 m deep vertical shaft with a 6 m hydraulic diameter and a 1 m diaphragm between the tunnel and the surge tank. It will emerge from the ground by about 45 m high, from a characteristic rocky outcrop.

Photo 2 - View of the rocky outcrop (right) from which the surge tank will emerge



The headrace tunnel will emerge with a transitional structure containing safety valves. From this point on, two penstocks (2,000 m in length and 3,000 mm in diameter) will be built. For logistical (transporting the pipes one inside the other) and construction purposes this diameter may vary along the pipes, the smallest diameter being located further downstream. This will be confirmed and validated in the detailed design.

Figure 9 - Longitudinal Profile Sections of the Penstocks

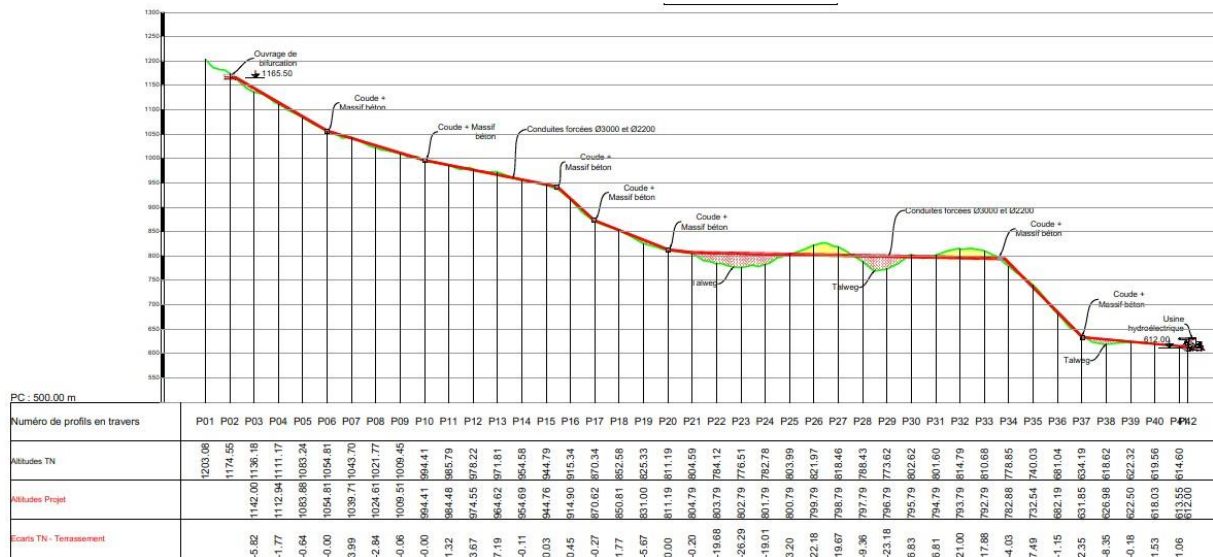

Photo 3 shows the grassy slopes on which the penstocks will be built. In the center right of this photo, one can see the radius of the preliminary topographical and geotechnical studies that follows the axis of the future penstock and, in the background, the Onive River and the village of Faravohitra, which is located near the hydropower plant.

Photo 3 - View of the grassy slopes where the penstock will be built



1.4.2.3 Hydropower Plant

The two penstocks will supply 4 and 3 groups, with two separate circuits. Some valves will be placed in front of each of the turbines.

The option of an underground installation of the plant, considered at the beginning, was quickly abandoned due to geotechnical risks. Therefore, the plant will be built on the surface, near the Onive River bed.

The plant was initially intended to stand at the bottom of the cliff located after the last fall of the Onive River, but was moved slightly downstream following studies created in 2017 studies.

Photo 4 - Hydropower Plant Study Area Downstream from the Onive Falls



The plant will be equipped with 7 turbines, but has been designed to accommodate up to 4 more (hence 11 in total) in the long term. This is a reserve that is not part of the concession but could be used in future to adapt the Project, for example to more favorable hydrological conditions than anticipated.

The operating requirements of the hydropower plant are as follows:

- 7 Pelton turbines with vertical axis
- Turbine power: $7 \times 28.5 \text{ MW} = 199.5 \text{ MW}$ at turbine output
- Nominal flow rate: $34.3 \text{ m}^3/\text{s}$
- Cos Phi: 0.85
- Upstream level: 1,295 to 1,335.30 m
- Downstream level: 612 m (operating)
- Gross load: 683 m to 725 m

The plant's sizes are as follows:

- Length: 97.50 m
- Width: 35 m
- Height: 25 m
- Altitude of the invert on the rock: 589.65 m

1.4.2.4 Switching Yard

The location of the 225 kV substation, on the surface and near the plant, is yet to be determined. Its design could include, in addition to the required energy evacuation

equipment, a section at a lower voltage level to supply the areas near the plant by connecting them to the interconnected grid.

1.4.2.5 **Distribution Line**

The outgoing power line will be a 225 kV double-circuit line on single poles.

It will follow the section of the access road to be created between the hydropower plant and the dam, with a common objective for both facilities to make the best use of existing deforested areas. As it crosses the forest corridor, the line will be buried over a distance of 1.6 km to minimize impacts on the ecological continuity of this corridor.

From the dam, the line will continue along the access road created for the Project until it reaches RN7 in Antanifotsy. Depending on the configuration of the interconnected network in Antanifotsy, the line passes through a substation or heads directly to Antananarivo which is close to RN7, still in a 225 kV double-circuit line on single poles, up to the Ambatolampy substation. From there it will continue as a 225 kV double-circuit line on single poles all the way to the station to be created in "Tana Sud 3". From the dam to Tana Sud 3, a 2 km wide corridor (2 x 1 km) where the line will be located was jointly defined by the technical, environmental and social teams, in order to minimize impacts. This corridor, within which the exact location of the line is still unknown, was used for this environmental and social impact study.

Furthermore, it is possible that the Project will only build the line from the hydropower plant to Antanifotsy, where it would be connected to a new Antananarivo-Antsirabé line financed and built as part of a separate project. In this study, we have analyzed impacts as if the Project would build the entire line to Tana Sud 3.

Figure 10 - Route of the Energy Evacuation Line Corridor

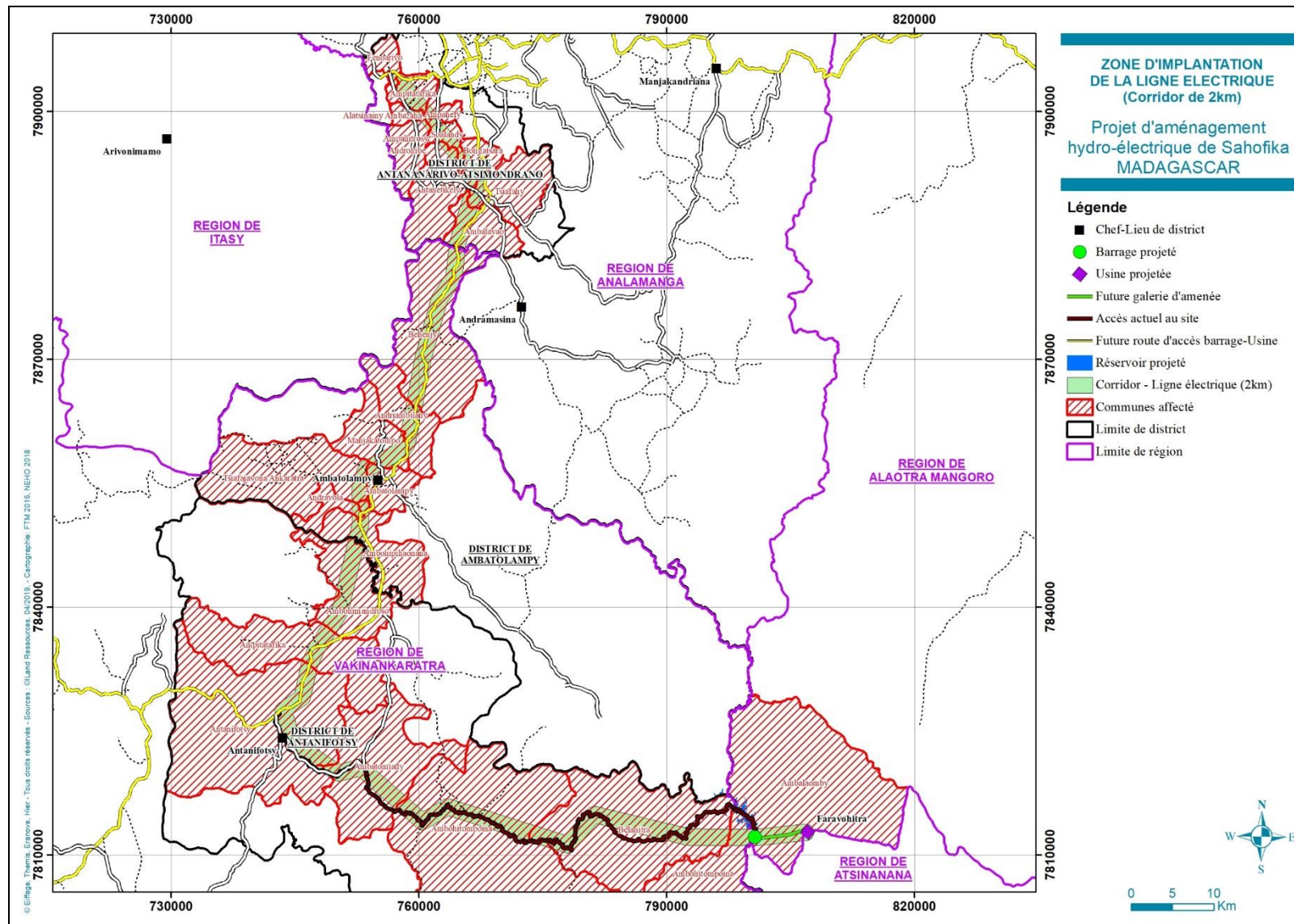

1.4.2.6 Access Routes

The site access strategy consists in connecting the site to RN7 from Antanifotsy, reinforcing and improving the existing track from Antanifotsy to Belanitra, and in opening a new access road to the right bank of the dam, located 20 km away from the road as the crow flies.

Photo 5 - The Existing Access Road between Antanifotsy and Belanitra



The technical, environmental and social teams considered various route options between Belanitra and the dam, again with a view to minimizing impacts (see analysis of the variants). The final route will be designed to minimize impacts by avoiding forested areas, especially those established for biodiversity conservation purposes. This objective is achievable because the landscape in this area is dominated by herbaceous plants caused by regular slash-and-burn practices.

Figure 11 - Examples of Access Road Options West of the Dam

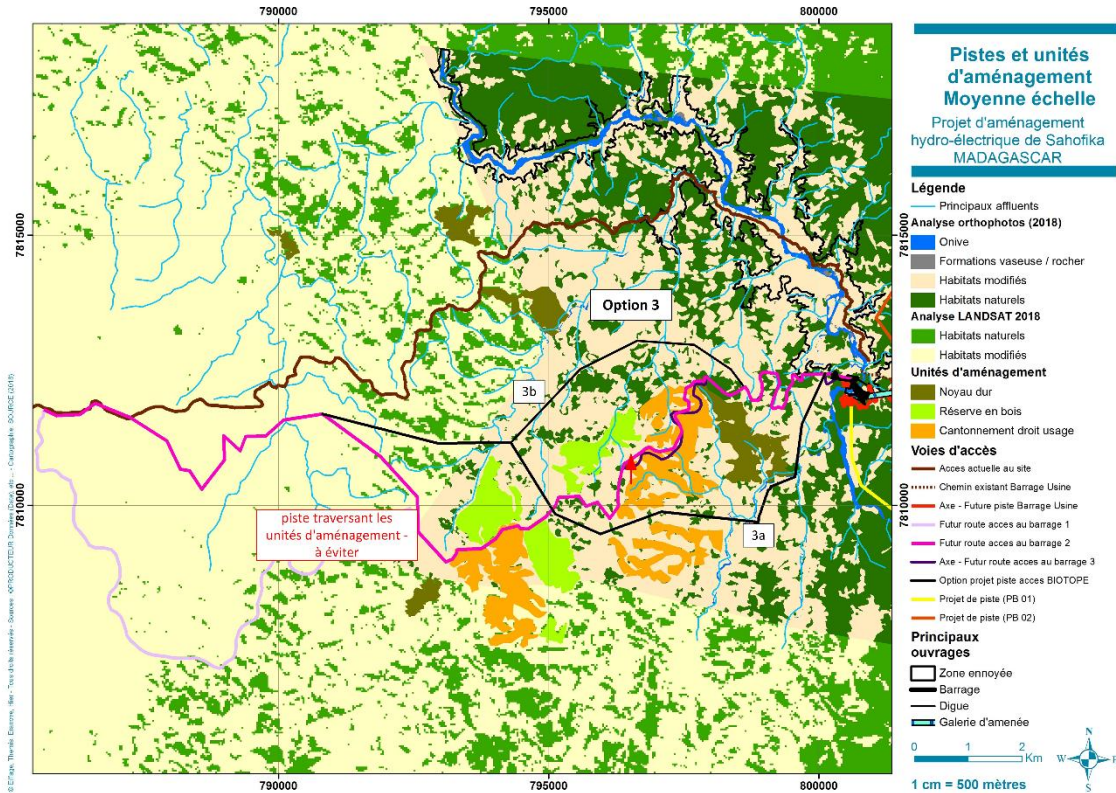

On the site of the main dam, the Onive River will be crossed by means of a permanent bridge (the dam crest, however, will not be open to traffic).

Figure 12 - Onive River Crossing Bridge Downstream from the Dam

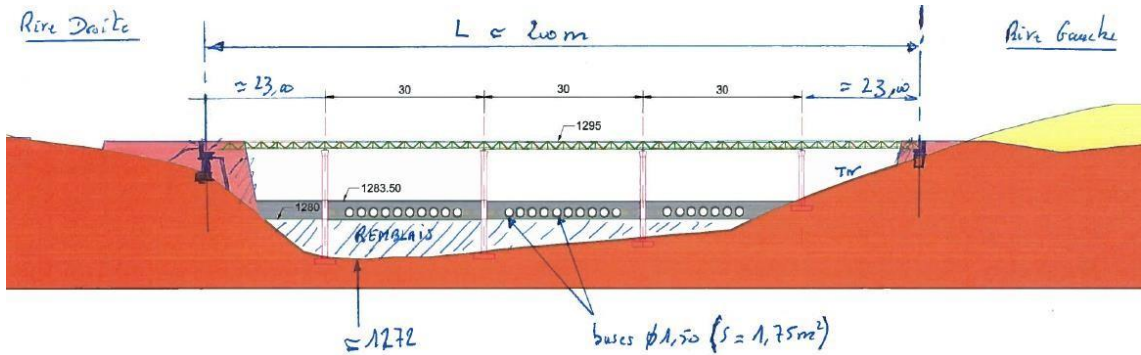

To connect the dam and the plant, it is necessary to cross the rocky escarpment as well as the forest corridor that is home to a rich biodiversity. Various solutions were considered and analyzed using a multi-criteria approach to avoid or minimize environmental and social impacts, while focusing on technically feasible solutions. The solution adopted consists in crossing the forest corridor using the areas already cleared by the locals as much as possible.

The options abandoned consisted in (i) taking the shortest route from the plant to the dam - this option would have affected too many natural habitats, or in (ii) following the Onive River bed - this option would have provided too much access to environments now protected by their isolation (for more details see the variants' analysis in Chapter 2).

These two paths will be open to the public, but under conditions yet to be defined. The roads to be built to connect Belanitra to the dam will be permanent and will be preserved after the hydropower project has been completed.

1.4.2.7 Other Infrastructure

Other permanent infrastructure includes:

- The Operating Staff Quarters (potentially used as a base camp during the construction phase). A suitable location with good exposure and offering a view on the dam has been identified on the right bank, downstream from the reservoir. This site presents the advantage of providing a road link in any situation (no crossing of the Onive River to join RN7).
- The dam service building.
- The hydropower service building.
- Service line and communication networks linking the dam and the plant: these linear facilities will be built in an opportunistic manner in the tunnel of the headrace tunnel.

1.4.3 Temporary Infrastructure

1.4.3.1 General Installation near the Hydropower plant

The main facilities are located near the village of Faravohitra, very close to the plant site overlooking the Onive River.

Figure 13 - Location of the Various Areas of the Overall Project

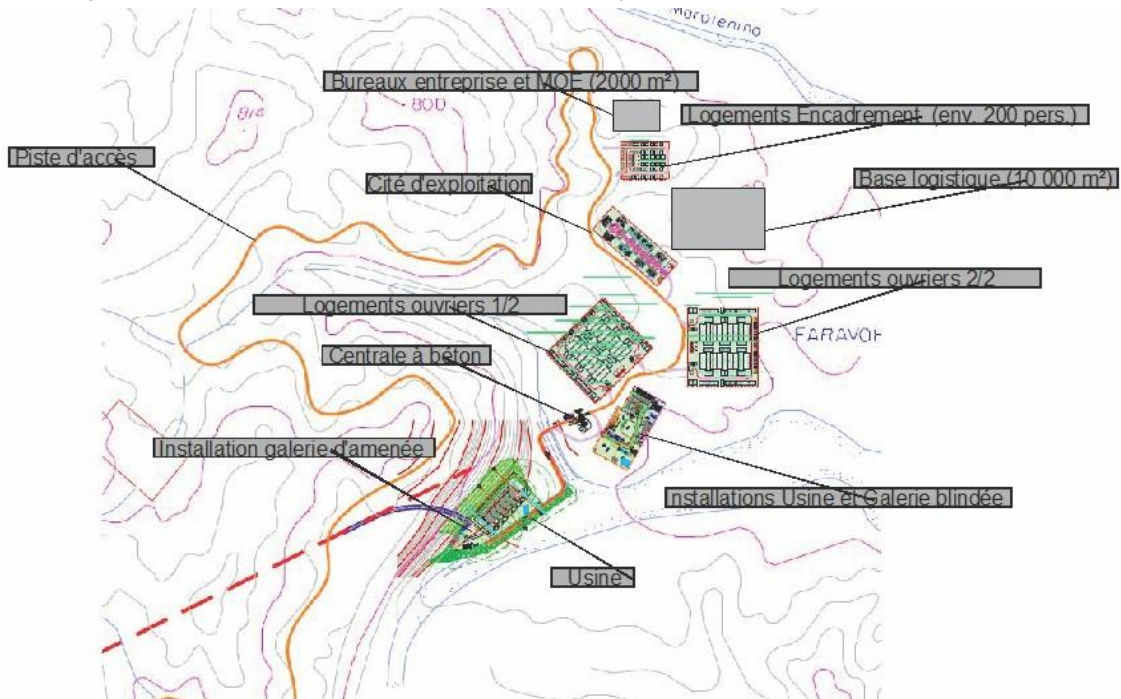

The installations will be designed to support the plant's construction activities and the pressure tunnels and timbered galleries as well as the pressure shafts and surge tanks. The main installations will be built in accordance with the following schedule:

- Clearing and stripping of the area
- Earthworks and backfilling of the facilities platform
- Installation of various pieces of equipment (workshops, stores, power plant, concrete plant, construction site, etc.).

The main facilities sites can be reached from the plant access road that will be built during the site preparation period.

1.4.3.2 **Offices and Base Camp**

The base and offices of the company and the Project management will be located in the general installation area near the plant. The base and offices will be connected to the access road and networks. In particular, they will be connected to the drinking water distribution network. A drinking water treatment plant will be installed for this purpose. All offices and the living area will be connected to the drainage and water treatment network installed in the general installation area.

The offices and the base camp will be connected to an electrical distribution network connected to a power generation plant installed near the camp area. The area will also be connected to a telecommunications relay (telephone and internet).

The bases will be composed of different types of prefabricated housing:

- Supervision (Company and project management): about 200 people.
- Workers: about 1,000 people

1.4.3.3 **Supply Platform**

The space available in the dam and waterway work areas, and the nature of the very uneven terrain, do not allow sufficient storage to be organized for the needs of the site.

A site of this nature relies on several different suppliers. It is not conceivable that each of the suppliers will deliver their supplies directly to the site due to access constraints.

The Concessionaire will set up a 10,000 m² logistics platform throughout the construction period. This platform will be located near the hydropower plant (see Figure 13).

This logistics platform will include:

- A secured storage area with a total surface area of 6,000 m².
- A 2000 m² covered storage warehouse.
- A 2,000 m² area dedicated to the shaping of reinforcements.
- Forklifts will be used to unload trucks, store materials and prepare packages. A fleet of trucks will be dedicated to supplying the various work areas of the site.

Operational Procedures

An on-site team will be in charge of order reception, classification and survey. All supplies will be delivered to the logistics base and refurbished on site.

The site will then be supplied daily from the logistics base in the form of kits for a day's production. Computerized inventory tracking at the logistics base will trigger orders of materials to avoid stockouts. The logistics base will be the suppliers' only address on the building site.

Advantages

Operating with a logistics platform provides several advantages:

- Limiting on-site storage to emergency stocks.
- Minimizing the size of construction site rights-of-way.
- Controlling the number of trucks on the site.
- Optimizing materials packaging.

1.4.3.4 Installation near the Dam

The dam site will accommodate a temporary platform that will be significantly smaller in size than the one near the plant. In particular, it will include:

- A manufacturing plant for the RCC gravity dam with a capacity of 200 m³/h installed near the dam construction site to ensure the on-site supply of this material using a conveyor.
- A dedicated concrete mixing plant with a capacity of 60 m³/h installed near the dam construction site to ensure the supply of BCV to the site. The latter will be transported by 8 m³ mixer trucks.

1.4.3.5 Other facilities

In addition to the main facilities and dam and plant facilities, temporary installation sites will also be built at the following locations:

- Saddle dike.
- Timbered gallery.
- Downstream window and surge tank.
- Upstream window and water intake.

1.4.3.6 Access to the Worksites

The Project's personnel will use the facilities made available to them near each construction site.

Shuttles will be provided to carry workers from the base camp to the site. The sites will be fenced and prohibited to the public. They will have a main gate for heavy and light vehicle access and a pedestrian entrance.

An access control system will be set up to keep track of the number of people present on underground sites, especially in galleries, at all times. This system will have the capacity to manage entries/exits through different accesses.

1.4.3.7 Borrow and Excavated Materials Areas

Considering the location of the dam, which is very far from the existing quarry sites, a survey campaign is being planned to establish and quantify materials available in the vicinity of the structures to be used for the following purposes:

- Riprap
- Road aggregates
- Subgrade layer

- Aggregate for structural concretes
- Aggregate for roller-compacted concrete (RCC)
- Sand

Two potential quarry sites have been identified so far: the first one is located in Ambatosira (19°44'43.2" / 47°32'57.5"), about 33km west of the planned dam site and the second one is located in Ambatoharanana (19°46'17.5" / 47°39'35.1") and is closer (20 Km).

Figure 14 - Location of the Proposed Quarries

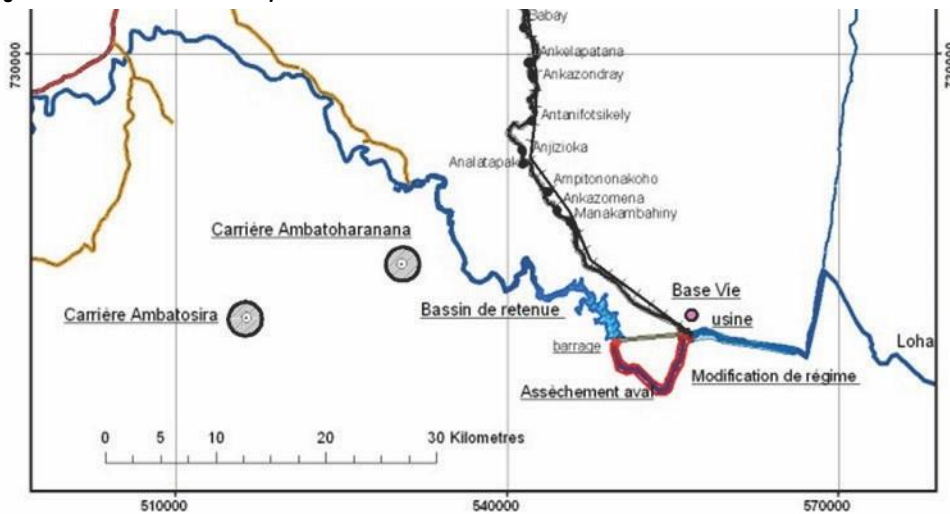

The quantities of processed materials required for the Project as a whole are as follows:

- Materials prepared for the subgrade layer of tracks 0/63: 248,400 T
- Roller-compacted concrete aggregates
 - 0/63: 260,000 T
 - Sand 0/5: 130,000 T
- Aggregates for roller-compacted concrete:
 - 0/63: 65,000 T
 - Sand: 32,500 T
- Conventional concrete aggregates:
 - 15/25: 89,420 T
 - /15: 78,900 T
 - Sand 0/5: 89,420 T
- Aggregates for shotcrete:
 - 15/20: 2,040 T
 - 10/15: 1,800 T
 - Sand 0/5: 2,040 T

This represents a total weight of 1,050,000 T of materials in place and, taking into account losses, a total weight of 1,100,000 T to be extracted, excluding rockfill.

Higher quality excavated materials will be used as filling materials for building platforms or tracks. Unsuitable materials will be disposed of at final disposal sites nearby (typically within a one-kilometer radius of the excavated materials production areas). The exact final excavated materials disposal sites are yet to be determined.

1.4.4 Construction Techniques

The Project consists mainly of earthworks followed by the installation of structures that are essentially made of concrete (dam, plant, headrace tunnel) or metal (penstock, line pylons). The main techniques to be used and of relevance for impact analysis, are described in this chapter.

1.4.4.1 Earthworks

Earthworks are carried out with respect to the following:

- Access tracks,
- Accesses and platforms of the distribution line pylons,
- Bedding and foundation of the dam in RCC,
- Water intake,
- Reinforcement of gallery heads and excavation work,
- Bedding and foundation of the saddle dike,
- The plant's platform.

The following three types of land are associated with separate earthmoving equipment:

- Soft ground: earthworks with a mechanical shovel,
- Mixed ground: excavation with a hydraulic rock breaker (HRB)
- Rocky ground: excavation by mining.

The first approximation of these types of land under the Project is as follows:

- Soft ground: 10%.
- Mixed ground: 25%.
- Rocky ground: 65%.

The materials from the higher quality excavated materials will be used as fill materials for the construction platforms. Unsuitable materials will be disposed of at appropriate sites and within a one-kilometer radius from the construction site.

1.4.4.4.2 Use of Explosives

The Project requires the use of explosives for excavation purposes in rocky environments.

Mining operations will be carried out by qualified personnel licensed to perform rock blasting operations. A blasting coordinator will be appointed. He/She will prepare a methodological note specifying:

- The phasing of the works.
- The location and alignment of the working faces.
- A technical note on the calculation of blasting pattern (drilling, type of explosives, priming...).
- The list of drilling, loading and explosives transport equipment.

- The drawing of the vibration measurement and monitoring system.

Test blasting will be performed. They will make it possible to develop blasting pattern that are suitable for the materials, the geometry of the excavated materials and the environmental constraints (vibrations, etc.).

1.4.4.2 **Diversification of the River**

To build the dam in a water-free and flood-free environment, it is necessary to locally divert the Onive River along its left bank (for the construction of the right half of the dam) and then along its right bank (for the construction of the left half of the dam). This will be achieved without a complete derivation of the riverbed. Thus, once the site installation and the main access roads have been completed, the construction of the upstream and downstream cofferdams will begin.

The diversion structure will be built in accordance with the following schedule:

- During the first work phase, a temporary wall will be built 2.50 m from the axis of the Projected structure (right bank side) to facilitate the diversion of water.
- Once this wall has been built, upstream and downstream cofferdam construction work can begin.
- Cofferdams will be installed in the form of dikes, upstream and downstream from the river (right bank side during the first phase of the work). These are embankment dikes covered with concrete embankments and sealed by a clay core.
- Once the first phase has been completed, the upstream and downstream cofferdams will be tilted to the left bank in order to allow the construction of the second phase of the dam.

The river will be diverted outside the rainy season.

1.4.4.3 **Concreting Works and Superstructures of the Dam**

The construction of the Sahofika dam will be completed in 4 phases: Phase 1 will start after the construction of the temporary diversion structure on the right bank, while Phase 2 will start after the latter has been tipped over to the left bank side. Phase 3 will then take place over the entire width of the structure. Once these concrete works have been completed, Phase 4 of the superstructure implementation will take place.

1.4.5 **Implementation Schedule**

The Project implementation schedule is based on the following assumptions:

- A 3-year development period, starting at the signing of the Project agreement and ending at the financial closure.
- A construction period spanning 5 years, starting at the financial closure and ending at the industrial commissioning of the facility.
- A 35-year operation period (concession period) starting from the industrial commissioning of the facility.

1.5 Impoundment and Commissioning

1.5.1 Reservoir Filling

The impoundment of the reservoir is a critical activity because it may expose design deficiencies. Therefore, it must be conducted in a precautionary manner, in accordance with a clear pre-established procedure, and subject to careful monitoring and observation. These precautions are intended to test the performance of the spillways, especially the crest threshold, and to identify:

- A structural dysfunction: appearance of cracks, movements.
- A lack of water tightness of the structures: leaks due to cracks, joints, equipment, bypasses.
- Abnormal behavior of the foundations: ground movement, appearance of unexpected stresses, water movements.
- Unexpected water flows: observation of piezometers, the surrounding area (detection of leaks in the reservoir, etc.), and measurement of the water rise speed.

In the rainy season, the reservoir could be fully filled within a few days. However, to keep any difficulties that may arise under control, the water will be raised in several successive phases of increasing impoundment level.

Once the level has been stabilized, they will be subject to the measurements and observations specified above. These phases will be interspersed with phases of lowered impoundment levels, to test the discharge capacity of the structure and assess its civil engineering behavior during the release of the water.

Underwater tests should preferably be conducted during periods that are suitable in terms of water availability, i.e. if possible outside low-water periods.

1.5.2 Testing

Before the hydropower plant is commissioned, testing will be carried out to determine whether it is operating properly, whether its performance meets the specifications outlined during the studies and whether it is sustained over time in a satisfactory manner.

The main performance criteria of the facility to be tested are as follows:

- Structural resistance and water tightness of the civil works (dam, reservoir, plant, gallery).
- Pressure losses in the waterway.
- Operation of the locking gates and valves: sealing, handling.
- Turbine operation: handling, efficiency, auxiliary systems.
- Alternator operation: efficiency, control, auxiliaries.
- Operation of transformers and the electrical system.
- Operation of command and control systems.
- Implementation of emergency procedures and back-up systems: generators, fire, pumping.
- Infrastructure and support systems: access roads, communications, operation city....

1.6 Operation

1.6.1 Hydraulic Operation of the Facility

The nominal flow rate of the hydroelectric power plant is 35 m³/s and the operating mode of the facility is intended to produce the maximum amount of energy (i.e. to turbine 35 m³/s as often as possible), using the reservoir's water reserve in the dry season when the natural flow of the Onive River is insufficient.

The plant will have seven identical turbines, and the turbine flow will therefore be reduced from 35 to 30 m³/s when one of the units (turbine and generator) is under maintenance.

Based on the hydrology analysis, the facility will operate below its capacity only:

- during the maintenance of one of the turbines.
- in exceptionally dry periods, in which case it is possible, if the reservoir has reached its minimum level during the dry season, that the turbine flow will only reach 35 m³/s for part of the day.

During the operation phase, the hydraulic regime of the Onive will therefore be modified as follows, depending on how the turbines and the reservoir are used:

- In the flood season, once the reservoir is full, the plant will operate at its nominal capacity, and therefore 35 m³/s will be permanently diverted from the reservoir to the plant:
 - Floods will be evacuated by means of a weir, so the level of the reservoir, which will be equal to or higher than the normal reservoir level (1,328m), while not exceeding the highest water level (1,337m), will vary according to the floods.
 - Between the dam and the plant: the river flow will be equal to the natural flow, reduced by 35 m³/s.
 - In the area downstream from the plant: the river flow will be equal to the natural flow.
- In the dry season:
 - The reservoir level, which is equal to the normal reservoir level (1,328m) at the beginning of the dry season, will gradually decrease but cannot be lower than the minimum operation level (1,295m).
 - Between the dam and the plant: the river flow will be equal to the natural flow reduced by 35 m³/s, but this value may not be less than the instream flow (5.7 m³/s).
 - In the area downstream from the plant: the river flow will be equal to the sum of the flow discharged from the dam (instream flow or more), the turbine flow and some natural lateral inflows between the dam and the plant. The turbine flow rate will be equal to 35 m³/s most of the time, except during very dry periods or during maintenance periods as mentioned above. It is only in very dry periods that intermittent operation will be possible.
- End of the dry season, resumption of floods (filling of the reservoir):
 - The reservoir level will gradually rise until it reaches the normal retention level (1,328 m). It is certain that the reservoir will be completely filled every year.
 - Between the dam and the plant: the river's flow rate will be equal to the instream flow (5.7 m³/s) until the reservoir is filled.
 - Downstream from the plant: the turbinated flow will be equal to 35 m³/s. The river's flow rate will be equal to the sum of the flow discharged by the dam, the

turbined flow and the few natural lateral inflows between the dam and the plant.

1.6.2 Operation of the Reservoir

The tidal range of the reservoir during the year will be determined by the occurrence of floods during the rainy season, and by the use of the reservoir's water to ensure guaranteed flow during the dry season.

The tidal range will vary from one year to the next.

In an average year, the reservoir level will drop a few meters without reaching the minimum operating level.

In a dry year, the minimum operating level may be achieved if the plant is operated to its full capacity. Thus, in a dry decennial year, the minimum operating level, which is 33 m below the normal operating level, could be reached during two consecutive months.

In a wet year, the reservoir will be less used and its level will therefore vary much less. Thus, in a wet decennial year, the hydroelectric facility will have the capacity to operate all year round at its nominal capacity and, therefore, the reservoir will not fall below its normal retention level. The velocity of the water in the reservoir may be significant (more than 1m/s locally) during extreme flood events (several thousand m³/s).

Figure 15 - Month-end Reservoir Level- Dry, Medium and Wet Years (m)

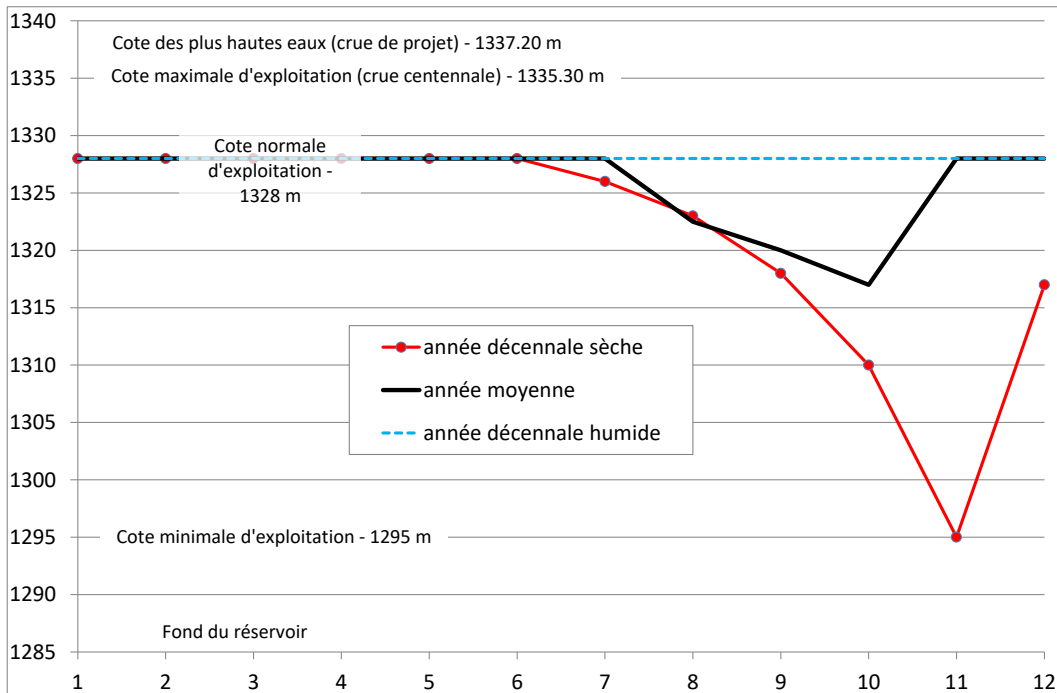

Table 1 - Month-end Reservoir Level- Dry, Medium and Wet Years (m)

	J	F	M	A	M	J	J	A	S	O	N	D
Dry decennial year	1,328 m or higher during flood events						1,323	1,318	1,310	1,295 minimum operating level		1,317
Average year	1328 m or more during flood events							1,322.5	1,320	1,317	1,328 m or higher	
Wet decennial year	1,328 m or higher during flood events											

1.6.3 Sediment Management

Sediments will be managed as follows:

- The coarser sediments will stop at the tailbay, but the reservoir’s tidal range over the years will allow some of them to migrate to the dam.
- Bottom gates are planned at the dam and near the water intakes in to flush away sediment deposits near the dam, so that they do not block the water intakes.
- Sediment removal will logically occur at the beginning of the rainy season, when (i) the reservoir level is low enough to generate high flushing speeds, and (ii) the inflow rate is sufficient to guarantee power generation while opening the bottom gates. This approach will replicate the natural processes of floods, during which solid transport is always at its highest during flood surges.

1.7 Project’s Area of Influence

Beyond the Project’s direct footprint described in the previous chapters, lies its area of influence. This term refers to areas that will be impacted by the Project because they are ecologically or socially connected to its infrastructure or activities.

The Project’s physical area of influence includes:

- The rights-of-way and the surroundings of the infrastructure to be built or rehabilitated.
- The area that will be flooded by the reservoir.
- The areas that will be affected by Project-induced nuisances (noise, dust, smoke):
 - Construction sites and their immediate surroundings.
 - Access roads to the dam from Antanifotsy, whether existing (and therefore subject to rehabilitation) or to be built.
 - Access roads required for the construction of the transmission line.
- The natural and social environments adjacent to the Project area that could be influenced by the Project.
- Special status areas (e.g. protected areas) that are close to the Project and whose management could be impacted by the Project.
- The area whose hydrological regime will be influenced by the operation of the plant, i.e. namely the reach from the dam to the confluence with the Mangoro River.
- The area to be affected in the event of a dam failure, i. e. the entire Onive area and then the Mangoro to the Indian Ocean.
- Resettlement sites for displaced persons.

The urban centers that will benefit from an improved electricity supply as a result of the Project are not considered to be part of the Project's area of influence, firstly because the impact on these populations will be essentially positive and, secondly, because the distribution of the additional electricity produced by the Project will be provided by a third party company, JIRAMA.

The social study areas are described in detail in Chapter 4.2.1. The biodiversity study areas are described in detail in Chapter 4.4.2.

2 Analysis of Alternatives

2.1 National Energy Context

2.1.1 Access to Electricity

In 2019 Madagascar is ranked by World Bank 185th country (out of 190) for access to electricity: only 15% of the population had access to electricity services in 2017 in this country and this rate was below 6% in rural areas.

The Malagasy electricity system includes 3 interconnected HV networks operated by JIRAMA:

- Antananarivo-Antsirabe: the largest network, located in the center of the country, will connect the Sahofika Hydropower Plant to this network.
- Toamasina, east of the country.
- Fianarantsoa, south of the country.

Firewood and charcoal have historically accounted for more than 90% of the energy consumed and the vast majority of the wood used comes from illegal and destructive logging of forest resources.

Dependence on petroleum products for electricity production has made the Malagasy electricity production system particularly vulnerable. Thus, JIRAMA's oil bill was nearly USD 150 million in 2014, which is equal to an increase of more than 100% compared to 2009. To mitigate the impacts of inconsistent oil price fluctuations on consumers, the government had to resort to subsidies that caused excessive pressure on public finances. Since the 1990s, the Government has liberalized the energy sector and encouraged private sector participation, using private power generation operators, and has delegated management responsibilities to local authorities where possible.

2.1.2 Madagascar's Energy Policy

2.1.2.1 Energy Strategy

In 2015, the Malagasy government adopted a New Energy Policy 2015-2030, as well as a National Development Plan 2015-2019. The objective is to achieve, by 2030, a 70% access rate to electricity or other modern lighting sources, and an 85% renewable electricity mix, 75% of which is based on hydropower.

The New Energy Policy's (NPE) implementation strategy sets objectives for the three sub-sectors of biomass (production and use), electricity and hydrocarbons, based on the following principles:

- Enhancing natural capital and preserving the environment;
- Access to sustainable energy for all;
- Assurance of the country's energy security and independence;
- Adaptation and reinforcement of the regulatory and institutional framework;
- Sustainable financing of energy needs.

2.1.2.2 Regulatory Framework Reform

A reform of the regulatory framework designed to implement the national energy policy is under way, and should, logically, be favorable to renewable energies. Self-production is already authorized in Madagascar. In this context, the electricity surplus can be sold provided that at least 70% of the electricity produced is consumed on site. The New Energy Policy also provides for a revision of the legislative framework for the electricity sector, which includes the introduction of specific legislation for renewable energies.

2.1.2.3 Donors' Strategies

Donors' strategies in the electricity sector in Madagascar are geared towards increasing installed capacity on and off the grid.

In 2016 the World Bank concluded an agreement with the government to improve electricity sector planning and financial sustainability and to strengthen JIRAMA's operational performance while increasing the reliability of electricity supply and limiting the degradation of existing infrastructure. The program, supported by a USD 65 million funding, is expected to be completed in 2020.

The EU and GIZ also support institutional capacity building in the Malagasy energy sector. In June 2017, KfW offered a EUR 14 million rural electrification grant to finance the construction of five hydropower plants with a total capacity of 13.3 MW in the Sava region.

2.2 "No-Project" Alternative

The Sahofika Hydropower Plant Project is justified firstly by a need to improve access to electricity in order to meet Madagascar's unmet demand for electricity and, secondly, by the national strategy to replace fossil fuel-based electricity production with renewable energy production.

Madagascar has two particularities that need to be taken into account when analyzing alternatives:

- The country is totally dependent on imports to meet its hydrocarbon demand, which has a significant impact on its trade balance and national budget.
- The country is not connected to any other country (due to its insularity) and, therefore, cannot import electricity produced by other countries.

In this context, if neither the Sahofika Hydropower Plant Project nor any of the alternatives were to be implemented, the current situation would be prolonged, with the following consequences:

- Negative impacts:
 - Access to electricity remains very low, affecting people's quality of life and economic development, with increased dependence on natural resources;
 - Continuation of greenhouse gas emissions up to 1,256,000 tons of CO₂eq per year (fuel oil/diesel plant emissions to provide the Project's 1,570 GWh per year, based on 800 gCO₂eq/kWh - see Chapter 5.7.3 for an estimate of GHG emissions avoided by the Project);
 - Increase in the country's external debt due to fuel purchases;
 - Failure to comply with the objectives of the national strategy for the energy sector and international commitments (Paris Agreement) made by Madagascar to reduce its greenhouse gas emissions.

- Positive impact:
 - Negative impacts of the Sahofika Project or its alternatives would be avoided.

The “no project” alternative would avoid the negative environmental or social impacts predicted and described in this study. However, this would also exclude the positive impacts expected nationwide that justify the Project. These include the country’s reduced dependence on fossil fuel imports needed to operate thermal power plants and its greenhouse gas emissions. They also include (i) contributing to the country’s attractiveness as a destination for foreign direct investment, and (ii) developing a strategic asset, providing cheap renewable energy.

For all the above reasons, the “no project” alternative is not considered an acceptable and sustainable option in the Malagasy context.

2.3 Alternatives to the Sahofika Hydropower Plant

2.3.1 Nature of the Alternatives Considered

The Sahofika Hydropower Plant is designed to produce up to 192 MW, 130 MW of which will be 99% guaranteed, and to produce 1570 GWh annually for the Antananarivo-Antsirabe interconnected grid. The construction time is about 4 years.

The purpose of the plant is to replace part of the current basic thermal production with renewable basic production, thereby reducing the country’s burden of importing fuel for thermal power plants.

The purpose of the analysis of technical alternatives is to compare the Sahofika project with other technical solutions playing the same role as that of the Project.

2.3.2 Renewable – Solar Energy

Madagascar has considerable solar energy potential, estimated at more than 2,800 hours of sunshine per year over almost the entire country. The solar energy potential is particularly important in the western and southern regions of the country.

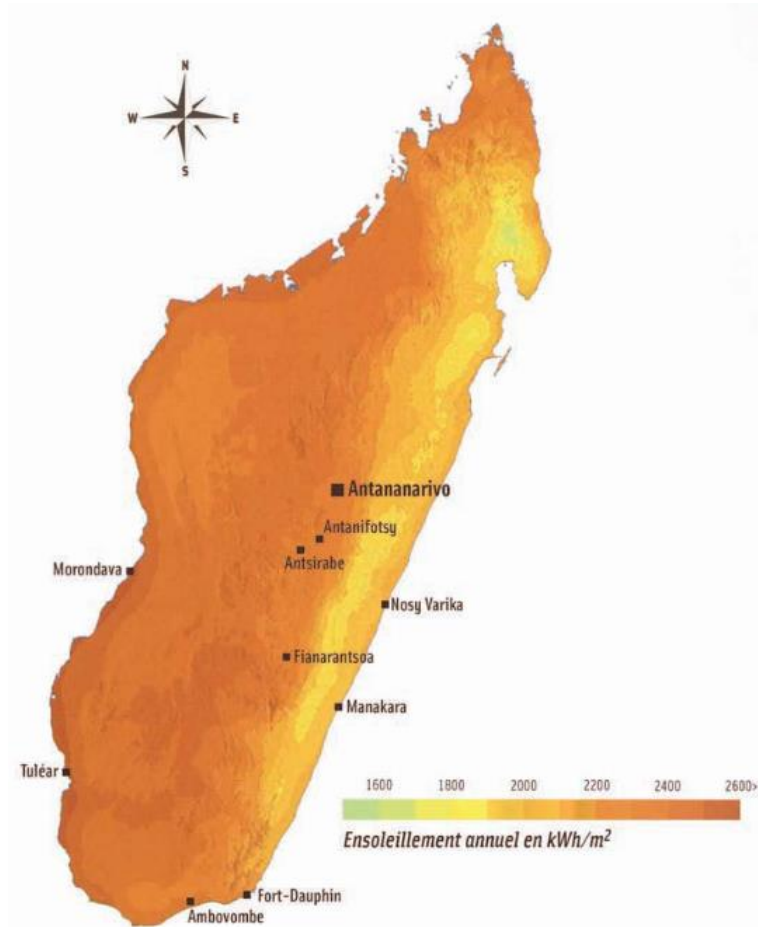
Figure 16 - Madagascar's Solar Energy Potential (Source: Ministry of Energy and Mines)

However, the development of solar energy is still in its infancy: Madagascar's first solar power plant was unveiled in September 2017 by GreenYellow. With a capacity of 0.13 MWp, this power plant would cover 40% of the needs of one of the island's main shopping centers. GreenYellow has developed a second 20 MWp solar power plant (expected average production: 32 GWh/year, equivalent to full power operation 18% of the time). In addition, the first prequalification request under the World Bank's "Scaling Solar" initiative was launched in October 2017 for a 25 MWp solar power plant.

If the development of solar energy appears to be an appropriate solution for certain isolated sites (rural electrification), the resistance and stability of interconnected networks should be given careful consideration when integrating solar capacities, due to their intermittency.

This intermittency is also the main reason why solar energy cannot represent an alternative to the Sahofika Project: The 2,800 hours of average annual sunshine account for production availability 30% of the time, well below the 99% guaranteed for the Project.

Under these conditions, achieving an annual production identical to that of the Sahofika Plant (1,570 GWh) with solar panels would require the installation of photovoltaic farms with a total capacity of 560 MW, corresponding to a footprint of around 10 km².

2.3.3 Renewable - Wind Energy

Madagascar has a considerable potential for wind energy production, which has not yet been subject to detailed studies. There are 3 types of winds in the country: coastal winds, local winds, and ocean winds including trade winds and cyclones.

Coastal and local winds can have present variations in daily intensity, and trade winds have seasonal variations, but they are the most reliable and constitute the main part of Madagascar's technical potential for the installation of wind power facilities. The northern, southern and eastern regions are the most favorable areas with wind speeds estimated at between 7.5 and 9 m/s in the north, compared to 6 to 9 m/s in the south. Considering the north-south areas along the east coast, with a wind speed of around 6.5 m/s, Madagascar has a potential of 2,000 MW of wind energy.

Figure 17 - Average Wind Power Available at 50 m

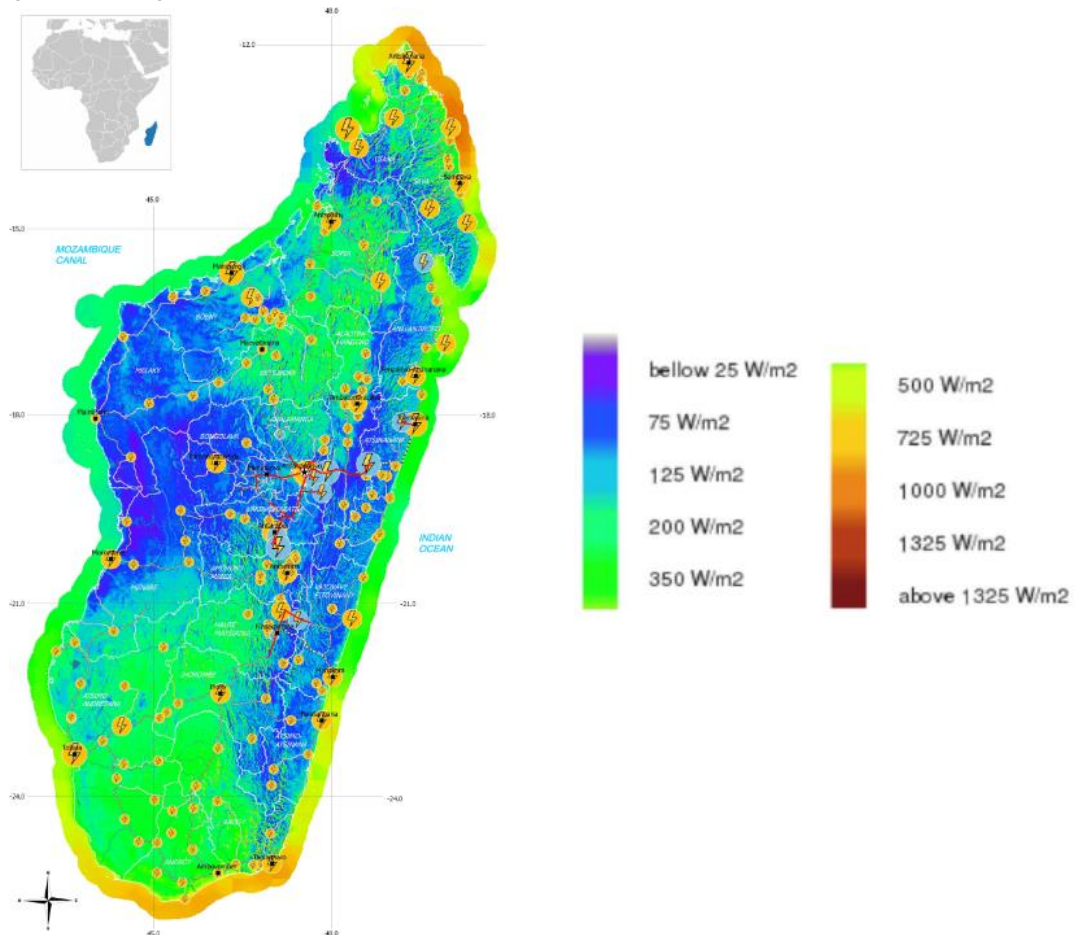

However, like solar energy, wind energy is not in itself an alternative to the Sahofika Project, due to its intermittency: assuming an optimistic load factor of around 50%, achieving an annual production identical to that of the Sahofika Hydropower Plant (1,570 GWh) with modern wind turbines (4 MW of installed capacity per wind turbine) would require the installation of around 90 wind turbines, with a total capacity of 360 MW, corresponding to a footprint of around several square kilometers.

The connection of wind turbines (possible on the coast) to the Antananarivo-Antsirabé interconnected grid would require a wind farm on the east coast, with a grid connection (i)

longer than that required for the Sahofika Plant, and (ii) across the forest corridor, as is the case for the Project.

2.3.4 Renewable – Hydroelectric Energy

Madagascar's hydraulic potential is one of the most considerable in Africa. 1,500 sites across the country have been identified and are at various stages of study for a total potential of nearly 8,000 MW of installed capacity. However, most of these facilities are small: there is a limited number of hydropower plants that can provide significant guaranteed generation.

2.3.4.1 “Small Hydropower Plants” Alternative

An alternative to the construction of a large plant such as the Sahofika Project could be to build multiple small hydroelectric power plants with a unit capacity of a few MW.

Unlike the Sahofika Project, these facilities would operate without a seasonal regulation reservoir (run-of-river hydroelectric power plants), because the construction of a dam to form a reservoir with seasonal regulation capacity requires a level of investment that is not compatible with the level of income generated by a small power plant. In the absence of regulation, small hydropower plants present a similar intermittent production problem to that found in the case of wind and solar power, but at a seasonal time step.

In the Malagasy context where (i) the rainy and dry seasons are very specific, and where (ii) the country is not interconnected and cannot export a production surplus, guaranteeing production of 130 MW 99% of the time with small hydroelectric facilities would require the construction of a significant number (several dozens, or even a hundred) of facilities designed for dry years' low flow periods, but with the capacity to resist flooding in the rainy season. Considering that on the Onive River, there is, for example, a ratio of 1 to 500 between the lowest and highest monthly flows, it is understood that a small power plant sized for a guaranteed flow of 0.5 m³/s should have a spillway sized for several hundred m³/s, which is not financially relevant.

Small hydropower plants also pose a strong environmental and social problem, linked to the following:

- The existence of multiple and dispersed sites has a strong cumulative impact on the natural and social environment (it is better to build a 192 MW site than 192 sites with a capacity of 1 MW) related to the cumulative lengths of tracks and power transmission lines.
- Small rivers, which are generally targeted for the construction of small hydroelectric facilities, are fragile environments that often play an essential role for the local biodiversity (reproduction of amphibians, invertebrate populations that are a source of food for fish in rivers further downstream) or for the populations (rice field irrigation).

Considering all the environmental and social risks associated with the construction of a multitude of small hydropower plants, as well as the societal cost that a hydroelectric strategy based on energy secured by small run-of-river plants would generate, through electricity pricing or subsidies, this alternative is not considered viable or acceptable.

2.3.4.2 “Large Hydropower Plants” Alternatives

Several studies have been conducted in recent years to assess the potential of Madagascar’s major hydropower plants and plan their development.

The most recent and relevant studies for the analysis of alternatives are as follows:

- The Least-Cost Electricity Access Development Project (PDMC), finalized in 2018 as part of the Electricity Sector Governance and Operations Improvement Project (PAGOSE)
- The “plant comparison” carried out in December 2009 included in the pre-feasibility study of a major hydropower plant for interconnected networks in Madagascar, conducted as part of the Energy and Electricity Sector Restructuring and Renovation Plan (P2RS2E)

The following table shows hydroelectric projects in the Antananarivo-Antsirabé interconnected network identified under the PDMC, which could constitute alternatives to the Sahofika Project:

Table 2 - Hydroelectric Projects that could be an Alternative to the Project

Project	Installed Capacity (MW)	Productible (GWh)	Firm Capacity (MW)
Mahavola	300	1,870	194
<i>Sahofika (as a reminder)</i>	<i>192</i>	<i>1,570</i>	<i>130</i>
Antafofo	160	1,220	94
Lohavanana	120	915	55.6
Antetezambato	142	908	57.5
Volobe	120	717	40.0
Ranomafana	93	393	15.6
Antetezambato extension	60	376	24.3
Talaviana	21	143	5.25
Andekaleka 4	34	139.9	0
Tsinjoarivo	21	115	3.5
Fanovana	9.2	62	3.8

This table calls for the following comments:

- Only one project (Mahavola) allows an annual production and firm capacity at least equal to that of the Sahofika Project and could therefore constitute an alternative to it.
- Any other alternative would require the combined construction of several facilities.

Several combinations are possible to achieve a producible and a firm capacity equivalent to that of the Sahofika Project. The alternatives for up to three facilities are described in Table 3.

It would certainly be possible to combine more than three facilities, but this raises a problem similar to that of small hydroelectric installations (see Chapter 2.3.4.1), namely multiple installations with a low regulatory capacity and therefore a low firm capacity.

Table 3 - Combinations of Hydroelectric Projects that could be an Alternative to the Project

Alternative	Project	Installed Capacity (MW)	Productible (GWh)	Firm capacity (MW)
<i>Basic solution</i>	<i>Sahofika (as a reminder)</i>	<i>192</i>	<i>1,570</i>	<i>130</i>

1	Mahavola	300	1,870	194
2	Antafofo + Volobe	280	1,937	134
3	Lohavanana + Antetезambato + Antetезambato extension	322	2,199	137.4

Figure 18 - Hydropower facilities considered in the alternatives analysis

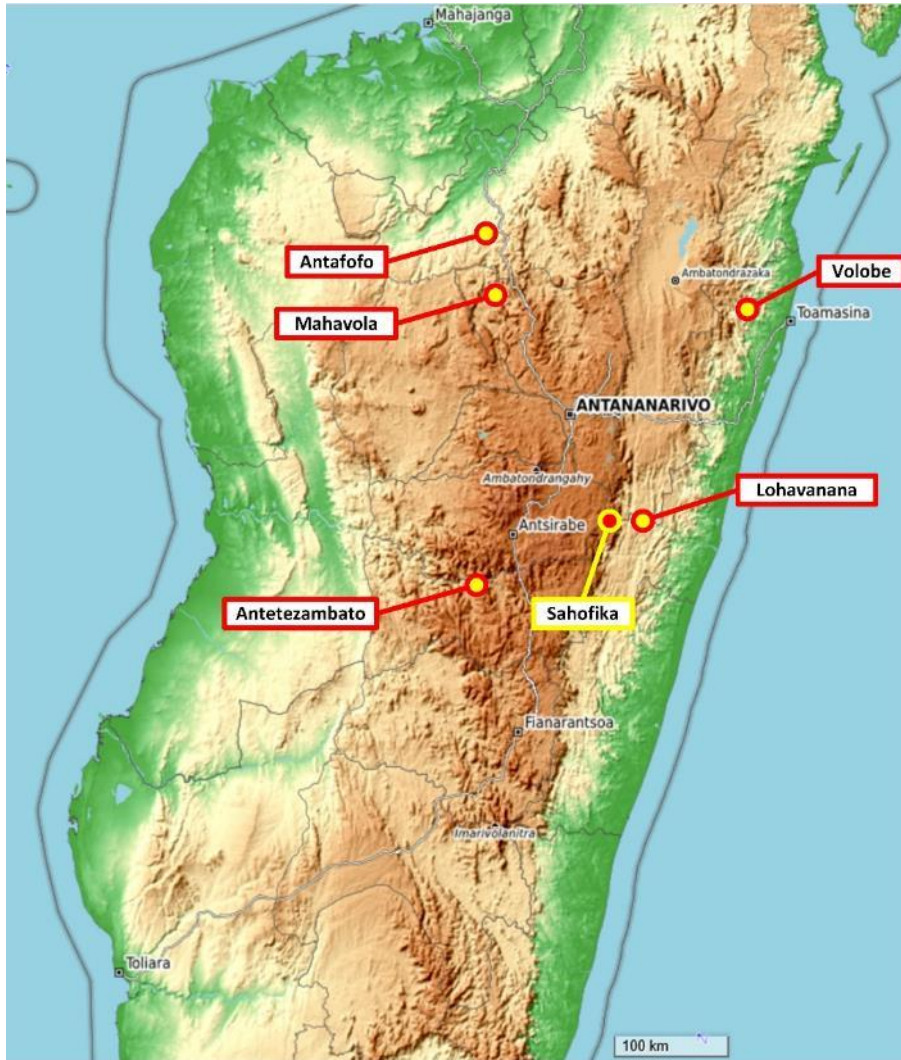

The environmental and social impacts of the various plants considered in Table 3 were assessed as part of P2RS2E. They are listed (with possible updates) in the following table. For each of the criteria used, the alternatives and the basic solution are classified from 1 (the least impacting) to 4 (the most impacting).

Table 4 - Comparison of the impacts of the hydroelectric alternatives considered

	Sahofika	Mahavola	Antafofo + Volobe	Lohavanana + Antetезambato + extension
Footprint (excluding linear infrastructure)	3	4	1	2
	Approx. 10 km ²	Approx. 60 km ²	Approx. 2 km ²	Approx. 5 km ²
Physical displacement	2	4	1	2
	Approx. 500	About 10 times	Some families	Equivalent to

	households	higher than Sahofika		Sahofika
Economic displacement	1	4	3	2
	Some households (line)	Numerous households (reservoir)	Several households (2 lines)	Slightly higher than Sahofika (2 lines)
Water use conflict and downstream impacts	1	3	4	2
	Low-water level support and limited use of the river	Village downstream	Villages impacted along and downstream from the diversion bays	limited use of the river
Area protected or internationally recognized as impacted	3	1	4	1
	New protected area (NPA) in the process of being created crossed by the line and road	None	Volobe: Existing NPA crossed by the line and road	None
Impacted terrestrial natural habitats	2	1	4	3
	5 km line	None	50 km line	10 to 20 km line
River stretch with a reduced flow rate	3	1	4	2
	12 km	6 km	14 km	11 km
Impacted aquatic natural habitats	1	2	4	3
	Modified habitat	Possibly modified habitat	Natural habitats stretching over 11 km	Probable natural habitats
Fragmentation of aquatic environments	1	2	3	3
	A naturally fragmented blocked river	A blocked river	Two blocked rivers	
Impact on critical habitats	2	1	4	2
	Yes (forest corridor)	Possible	Yes, higher than Sahofika (forest corridor)	Yes, like Sahofika (forest corridor)
Average ranking	1.90 (1 st)	2.30 (3 rd)	3.20 (4 th)	2.20 (2 nd)
Cost according to PDMC (c€/kWh)	4.4	5.6	4.2+7.3	6.3+4.7+3.6

The comparison of the environmental and social impacts of the various hydroelectric alternatives studied presented in Table 4 shows that:

- None of the alternatives considered outperforms the others on all social and environmental issues: each alternative has its weaknesses and strengths.
- The Sahofika plant appears to be a good alternative.

The investment costs per kWh indicated in the PDMC (see Table 5) also show that Sahofika has the capacity to provide low-cost electricity, which is important from the point of view of the Project's societal performance, as it is ultimately through the electricity tariff (paid by consumers) that the investment costs will have to be covered.

Table 5 – Construction Costs of the Hydroelectric Alternatives Considered

	Sahofika	Mahavola	Antafofo + Volobe	Lohavanana + Antetetzambato + extension
Cost according to the PDMC (c€/kWh)	4.4	5.6	4.2 + 7.3	6.3 + 4.7 + 3.6

(Source: PDMC 2018)

2.3.5 Other Renewable Energies - Biomass, Geothermal Energy and Oceans

Madagascar has potential ocean energy (currents and tidal power plants) and geothermal energy resources. The by-products of agricultural or forestry activities exploiting plant resources could also be used to supply biomass-based thermal power plants.

However, the exact extent of this potentials is yet to be identified at the national level through exploration programs and feasibility studies. There is currently far too little knowledge of these potential energy sources for them to be, even partially, a credible alternative to the Sahofika Project within a reasonable period of time. They are not discussed in any further detail in the following sections.

2.3.6 Non-Renewable (Thermal) Energy

To produce a quantity of energy equivalent to that of the Sahofika Project, thermal power plants could be considered.

From a purely technical point of view, thermal power plants, like the Sahofika Project, could produce basic energy without experiencing the intermittency issues associated with wind, solar and small hydroelectric power.

The construction of fuel- or diesel-based units would be a simple expansion (or extension) of the current situation. This alternative would have the following disadvantages:

- It would go against Madagascar's international commitments, and against the 2015 national energy policy to reduce greenhouse gas emissions.;
- It would contribute to increasing the country's dependence on imported fossil fuels.

The construction of gas-based units would pose the same problems, with the difference that greenhouse gas emissions could be lower than those generated by fuel oil or diesel-based alternatives (but still very much higher than those generated by renewable alternatives) if modern combined cycle technologies were chosen.

Finally, a nuclear-based thermal alternative would be technically possible, but it would go against the national renewable energy development policy, would require importing technologies and know-how and would be highly risky due to the country's lack of experience in this field.

2.4 Comparison of Alternatives

	Sahofika	Solar alone	Wind turbine alone	Thermal (gas, diesel, fuel oil)	Thermal (nuclear)	Small hydroelectricity	Large hydroelectricity (3 alternatives)
Capacity to provide 130MW guaranteed at 99%.	Yes	No	No	Yes	Yes	Yes, by multiplying facilities	Yes, by combining facilities
Compliance (national energy strategy)	Yes	Yes	Yes	No	No	Yes	Yes
Acceptability (Concessionaire's E&S policy)	Yes	Yes	Yes	Under certain conditions	No	No	Yes
Bankability (donor's E&S policy)	Yes	Yes	Yes	Under certain conditions	No	Uncertain	Yes
Proximity to the Antananarivo-Antsirabé network	Yes	Possible	No	Yes	Yes	Uncertain	Yes
Frequency regulation	Yes	No	No	Yes	Yes	No	Yes
Black-start capability	Yes	No	No	No	No	No	Yes
Physical footprint (excluding transport infrastructure)	10 km ²	10 km ²	A few km ²	< 1 km ²	< 1 km ²	A few km ²	From 2 to 60 km²
Greenhouse gas emissions	Low (reservoir and construction)	Low (construction)	Low (construction)	High	Low (construction)	Low (construction)	Low (reservoir and construction)
Avoidance of the forest corridor	No	Yes	No	Yes	Yes	Uncertain	Yes for 1 out of 3 alternatives
Impacts on critical habitats	Yes, especially the forest corridor	Avoidable					Probable to certain
Population displacement	Yes. About 500 physically displaced households	Probable economic displacement	Probable economic displacement				From a few households to several hundred
Societal cost	No - Low-cost energy	Yes (Overcapacity to be installed to produce 1,570 GWh)		Yes (imported hydrocarbons)	Yes (waste management)	Yes (high-cost energy)	No - Low-cost energy
Conclusion	Basic solution	Not acceptable - power not guaranteed		Not acceptable - against the national energy strategy		Unrealistic and expensive	Comparable to the Project and no less impacting

2.5 Findings of the Alternatives Study

The alternatives analysis considered all technically possible solutions to provide the same service as the Sahofika Project, namely 130 MW of guaranteed renewable energy supplying the interconnected Antananarivo-Antsirabe grid.

Thermal alternatives, which are incompatible with the national energy strategy, generate high levels of greenhouse gas emissions and force Madagascar to import expensive products, are not acceptable alternatives.

Non-hydro renewable alternatives (solar and wind) are disadvantaged by their intermittency and incapacity to provide guaranteed energy. They do not represent a possible alternative to the Sahofika Project.

Small hydroelectricity would require the construction of a multitude of facilities with an installed capacity far greater than that of the Project, to simply achieve the objectives of the Sahofika Project. This would be a particularly inefficient alternative from an economic point of view, and its feasibility (sufficient number of equippable sites) is not guaranteed.

Large hydroelectricity offers technically viable alternatives to the Sahofika Project that are consistent with the national energy strategy. These alternatives have been compared to the Project: none is without environmental or social impacts, and none appears to be significantly better than the others. The multi-criteria environmental and social analysis conducted showed that the Sahofika Project is one of the best alternatives and is therefore fully justified.

2.6 Optimization of the Plant and Minimization of Impacts

2.6.1 Dam, Waterways and Hydropower Plant

The implementation and technical solutions for the dam, waterways and hydropower plant have been subject to technical studies whose essential objective, as for any hydropower plant, has been to control the costs and risks of the Project. This approach has enabled the Sahofika Project to minimize environmental risks or impacts, making the best use of available space and resources. The main choices made are described below.

Dam Type

Due to the absence of a large source of building materials immediately available in the Project area, a gravity concrete dam (significantly less material intensive) was preferred over rockfill or earth dam solutions. This choice reduces the volumes of materials to be extracted for the construction site and is therefore environmentally beneficial.

Spillway Type

The spillway that has been selected is an ungated spillway. This type of spillway has the advantage of operating without human intervention: no valves need to be operated to drain the floods, which overflow in a controlled manner over the weir's crest. The ungated spillway also has the advantage of evacuating floating bodies such as tree trunks that are likely to be carried by water in the event of exceptional flooding accompanied by landslides or bank collapses upstream from the dam. This choice is therefore the most appropriate from the point of view of the safety of downstream populations and workers in the context of the Project where severe weather events (hurricanes) are possible

Waterway

The geotechnical studies informed the decision to choose a surface waterway with exposed penstocks. The main impacts associated with this option are social (the area where the penstocks will be installed is poor in biodiversity): these are visual impacts (the penstocks will be visible from a distance) and also the pathway constraints that will be imposed by the penstock (crossings must be provided for pedestrian traffic across the penstocks, which is easily manageable).

Plant Positioning

The positioning of the hydropower plant has been adjusted to optimize the use of the available head while taking into account topographical constraints. Since the various options considered do not present any significant difference in terms of social or environmental risks, the most technically efficient location was chosen.

Balance of Backfill and Excavated Materials

The possibility of reusing the volumes of excavated materials generated by the Project in areas where backfilling is required has been integrated into the technical studies to date and will also be taken into account in future detailed design studies. Balancing excavated and backfilled materials is important in order to minimize the number of borrow sites to be opened and the size of the final excavated material disposal sites: the technical and economic logic here is in line with the environmental logic, which requires minimizing the environmental footprint of the Project.

2.6.2 Implementation of Permanent Linear Infrastructure

The implementation of road and energy evacuation routes in the most sensitive areas has been subject to numerous exchanges between the technical, environmental and social teams, in order to minimize impacts on sensitive areas near the Project.

2.6.2.1 Between Antananarivo and Belanitra

This area does not cross any protected areas. However, it is more densely populated and, therefore, more used for socio-economic activities than the area near the Project.

For the power distribution line, a 2 km wide corridor within which the distribution line will be built has been defined. This corridor, which was initially planned along the existing RN7, has been moved to avoid the most populated areas, thus minimizing the risk of physical or economic displacement. The exact route of this line still needs to be defined and optimized from a technical and social point of view, in order to minimize its social and socio-economic impacts.

With respect to roads, the decision was made to use existing tracks and rehabilitate them on most of their route between Antanifotsy and Belanitra in order to avoid creating new ones in this area. Bridges will also be rehabilitated if necessary. Since these are public tracks, the Project will generate a positive social impact, while avoiding negative environmental impacts.

Figure 19 - Schematic Layout of Linear Infrastructure Implementation

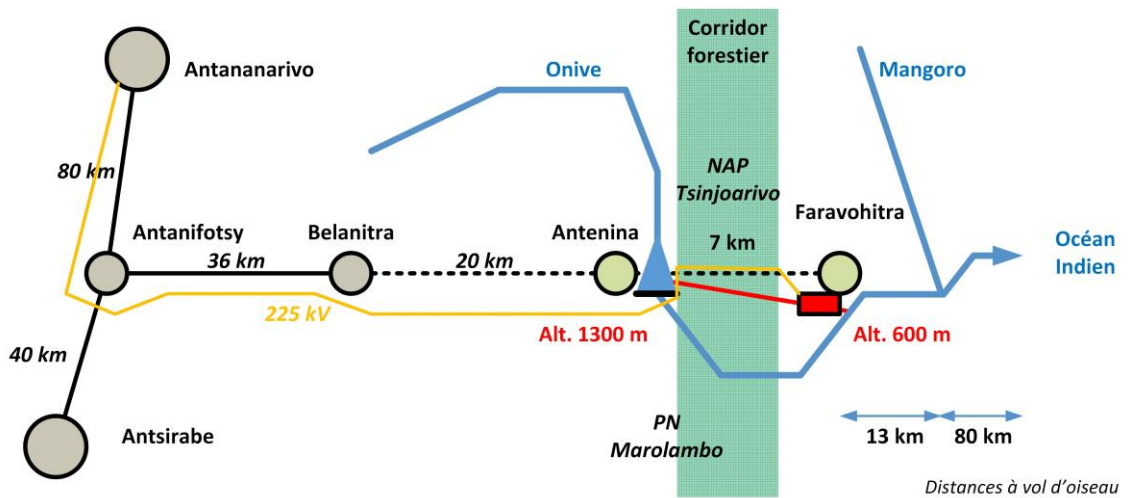

2.6.2.2 Between Belanitra and the Dam

This area crosses the protection zone (buffer zone) of the Marolambo Park. It is sparsely populated but harbors natural woodlands (increasing in number towards the east as one approaches the forest corridor) and woodlands managed by communities (see Chapter 4.3.2 for a detailed description). The Project will build the distribution line in this area, and also an access road to the dam, since there is no suitable road there.

The exact route of the line and access road still needs to be defined and optimized from a technical, environmental and social point of view, in order to minimize environmental and social impacts.

The principle agreed for this area is to adopt a layout and design of the line and road that avoids wooded areas as much as technically possible.

2.6.2.3 Between the Dam and the Hydropower Plant

This area crosses the forest corridor, which has a rich biodiversity. It is hardly populated and is mainly covered by forests that are home to valuable fauna and flora species. The Project will build the distribution line and an access road linking the hydropower plant to the dam in this area, since there are currently only pedestrian accesses.

Reflection on this area was based on the hierarchical principle of mitigation to avoid or minimize impacts on natural habitats before seeking to compensate them. The only option that would have avoided any impact on natural habitats is a tunnel passage of all infrastructures between the plant and the dam. This option has been discussed and not developed due to the prohibitive additional costs for the road and distribution line (around €100-200 million). On the other hand, the service line and the communication networks will be able to use the waterway gallery and it will therefore be possible to avoid the impacts of these two facilities.

Several options were then considered to minimize the impacts of the road and distribution line on natural environments (see Figure 20, which illustrates the text):

- Two track options from the plant to the surge tank, between points A and B. These two options correspond to the two technical possibilities of bypassing the cliff that separates the plant from the surge tank.

- Three track options to reach the dam, between Points C1, C2 and C3 on the one hand, and D on the other hand. These options are referred to as C1D green, C2D orange and C3D red hereinafter. These settings have been defined as follows:
 - The C3D red route seeks to bypass the forest massif and the rocky escarpment that supports it by following the course of the Onive as closely as possible. This is the route initially considered.
 - The C2D orange route aims to connect the surge tank to the dam by using the shortest distance possible (technical optimum).
 - The C1D green route aims to connect the surge tank to the dam by remaining close to the existing pedestrian path, and by using, as much as possible, the areas already cleared as a result of slash-and-burn activities by the local populations.

With these options, power lines are located as close as possible to the road's alignment to minimize access road rights-of-way and additional deforestation, with the possibility of having a short-distance buried section (the line being impossible to bury over the entire length of the route).

Figure 20 - Route Options Considered Between the Hydropower Plant and the Dam

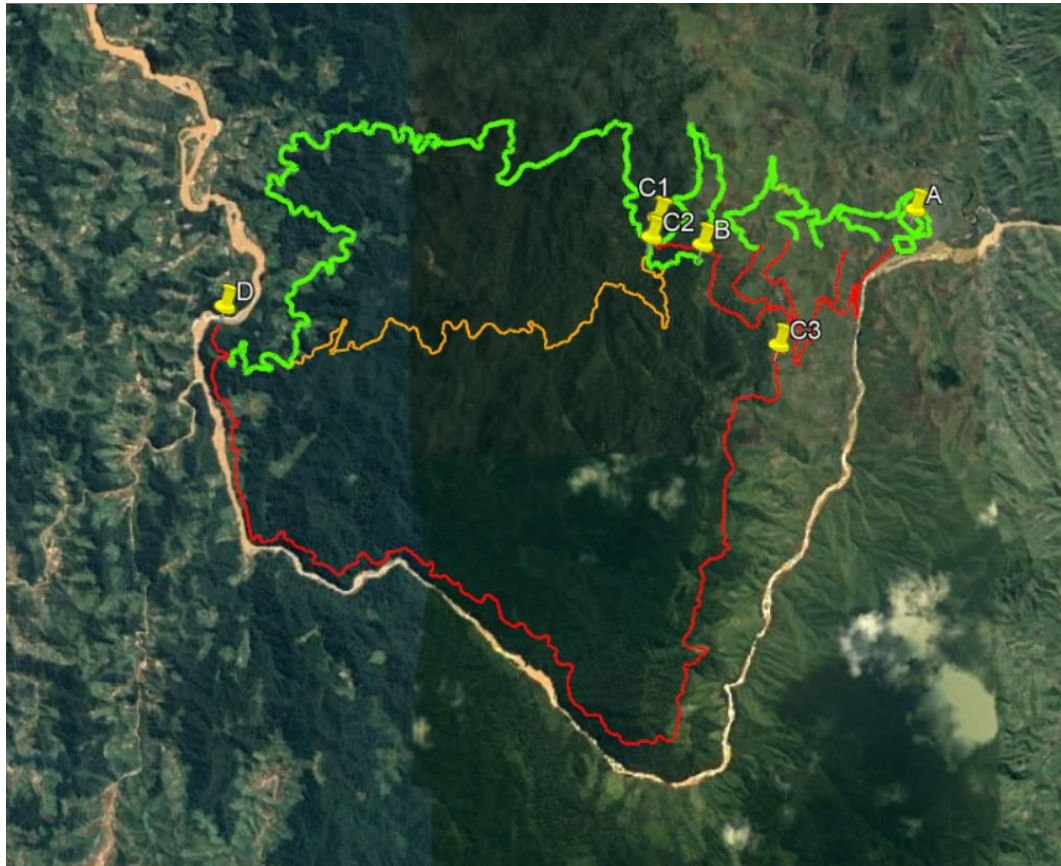

A multi-criteria analysis of these three options was conducted to select the one that would have the least impact from an environmental and social point of view. Sadabe, the NGO responsible for the protected area project in this part of the forest corridor, as well as the general and regional water and forest directorates, were consulted during the preparation of this analysis and on the selection of the preferred alternative. Details of this multi-criteria analysis are provided in the appendix.

The findings are as follows:

- Between the plant and the forest corridor (between points A and B):

- The two routes are comparable in terms of environmental and social impacts.
 - Environmental and social issues are easily managed in this area.
 - The green route is chosen, mainly because it has fewer topographical constraints (presence of cliffs along the red route) and therefore offers more flexibility and adaptability to avoid possible impacts during studies and works.
- Crossing the forest corridor
 - The red route along the Onive River, which had initially been considered, appeared to be the worst option, due to the length of the natural habitats crossed, and the fact that it opened up access to terrestrial and aquatic ecosystems that had been preserved hitherto by their inaccessibility.
 - The orange route, although technically preferred and better than the red route, does not meet the requirement to minimize environmental impacts and was abandoned.
 - The green route was chosen, essentially because it minimizes the environmental impacts that constitute the main risk faced in this area, by using the areas already impacted and thus avoiding creating a new corridor in addition to the existing pedestrian corridor. However, it is associated with a social issue relating to road safety (such as the orange line, due to the long descent from the top of the escarpment to the plant). With this option the distribution line will be buried over a distance of 1.6 km, where the selected route crosses the largest forest width.

The exact location of the facilities based on the routes selected is yet to be determined as part of the detailed studies, based on field surveys, which will need to involve technical and environmental teams to ensure that impacts are also minimized at this stage.

2.6.3 Location of Temporary or Permanent Infrastructure not Defined

This chapter concerns the temporary or permanent infrastructure that will be required in the dam area: quarries, excavated material areas, storage sites, camps and construction site areas, and the staff housing estate.

The exact location and footprint of these infrastructures is not known and the ESIA therefore prescribes the following approach to minimize impacts:

- Use the footprint of the future reservoir for temporary infrastructure and extraction sites as much as possible;
- At the dam, outside the reservoir area:
 - Implement temporary infrastructure on the right bank of the Onive River (west) rather than on the left bank to minimize risks to the new protected area;
 - Avoid natural habitats and agricultural areas to limit the volume of compensation or economic displacement.
- At the plant:
 - Avoid agricultural areas to limit the volume of compensation or economic displacement.

Photo 6 - Illustration of the route selection for the infrastructure between the dam and the plant

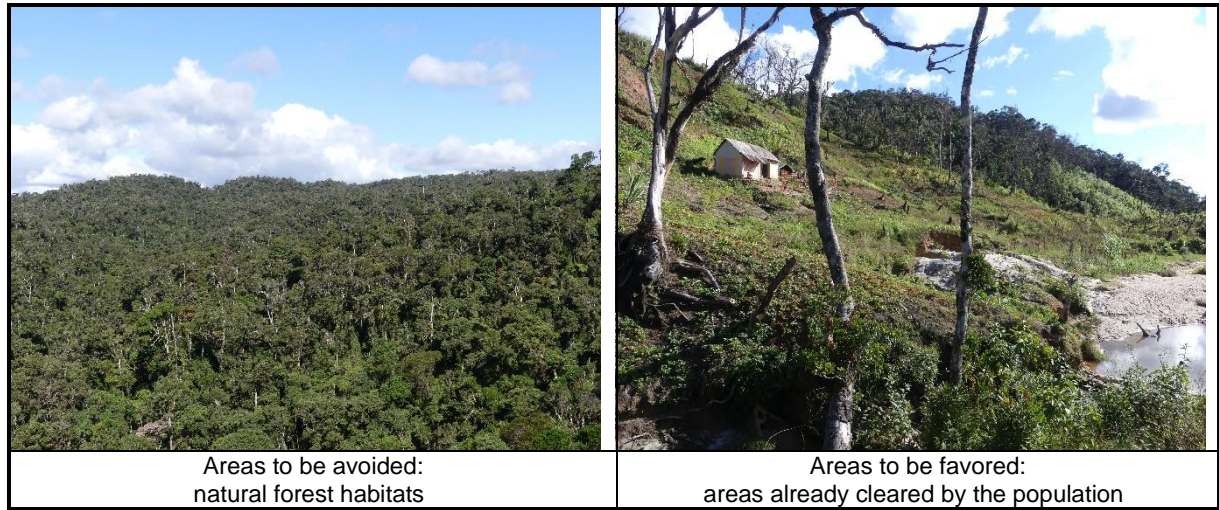

2.6.4 Operating Mode and Instream Flow

The operating mode of the Sahofika Hydropower Plant allows for low-water replenishment and, because of the objective of producing mainly basic energy, has little impact. Downstream risks were analyzed, and the search for an alternative operating mode did not appear necessary.

The instream flow initially selected for the Project during the feasibility studies is 5.7 m³/s, corresponding to 5% of the Onive module at the dam. The relevance of this value and the environmental and social consequences were studied and discussed during the preparation of the ESIA, and are presented in Chapter 5.3.4. In summary:

- Malagasy legislation does not impose a value or rule for instream flow.
- The current practice in Madagascar is to have an instream flow equal to zero or sometimes 2.5% of the module. Choosing a 5% environmental flow rate for the Project exceeds current practices in Madagascar and is therefore good practice..
- During the ESIA, there was no obvious reason for changing the option of an instream flow of 5.7 m³/s. However, it could be possible that the monitoring of the Project will lead to this option being changed over time: for this reason, the instream flow will be adjustable, for example from 4 to 8 m³/s.

2.6.5 Mitigation Measures

All mitigation measures related to the optimization of the plant are summarized in the following table:

Table 6 - Mitigation Measures for the “Optimization of the Plant”

#	Measure	Implementation	
		Period	By
Opti01	Optimized management of excavated and backfill materials to minimize the volumes extracted from borrow sites and the volumes placed in final storage.	Design and construction	EPC
Opti02	Definition and technical, environmental and social optimization of the exact route of the line and access road, by adopting a layout and design of the line and road that avoids forested areas as far as technically possible,	Design and construction	EPC

	based on the ESIA.		
Opti03	Installation of the track and distribution line between the dam and the plant according to the routes selected in the ESIA and using areas already cleared as much as possible. The exact location during detailed design must be based on field surveys that combine technical and environmental teams to ensure that environmental impacts are also minimized at this stage. The distribution line will be buried over a distance of 1.6 km, in accordance with ESIA recommendations.	Design and construction	EPC
Opti04	<p>For the installation of temporary or permanent infrastructures that are yet to be defined, select the sites by working with environmental and social experts.</p> <p>Use the footprint of the future reservoir for the installation of temporary infrastructure and extraction sites as much as possible.</p> <p>At the dam sites, outside the reservoir area:</p> <ul style="list-style-type: none"> ● Install temporary infrastructure on the right bank of the Onive River (west) rather than on the left bank to minimize risks to the new protected area; ● Avoid natural habitats and agricultural areas to limit the volume of compensation or economic displacement. <p>At the plant site: avoid agricultural areas to limit the volume of compensation or economic displacement.</p>	Design and construction	EPC
Opti05	Environmental and social supervision of the Project, to control the implementation of Opti01 to Opti04 actions and validate choices made.	Construction phase	NEHO
Opti06	Build crossings along the penstock for current users (pedestrians, domestic animals) in numbers and locations that are consistent with existing crossings.	Design and construction	EPC

3 Regulatory and Legislative Framework

All the instruments described in this chapter form the regulatory and legislative framework that the Sahofika Project must comply with.

3.1 National Framework

3.1.1 Environmental Legislation

The main legal instruments on which this study is based are listed in the table below.

Table 4 - Applicable Legal Instruments

Instrument - Effective Date and Amendments	Main Objectives / Content	Application being considered
Environmental Charter (Act 2015-003 laying down the fundamental rules and principles for environmental management)	Public or private investment projects, whether or not they are subject to authorization or approval by an administrative authority, or whether they are likely to harm the environment, must be subject to an impact study	Any natural or legal person has the right to participate in procedures prior to taking decisions likely to have adverse effects on the environment.
Ordinance No. 60-126 of October 3, 1960 establishing the hunting, fishing and wildlife protection regime	This instrument lays down the foundations of the law for the protection of wildlife species (birds and other wild animals, divided into three categories: protected species, game and harmful species)	One of the criteria for evaluating inventoried biological species.
Inter-ministerial Decree No. 4355-97 of May 13, 1997 on the definition and delineation of sensitive areas	Sensitive areas include coral reefs, mangroves, islets, tropical forests, erosion-prone areas, arid or semi-arid areas subject to desertification, wetlands, natural conservation areas, drinking, mineral or underground water protection areas, paleontological, archaeological and historical sites and their protection areas.	Several sensitive areas concerned in the study area (islets, tropical forests, erosion-prone areas, wetlands).
MECIE Decree (Ensuring investments are environmentally friendly) No.2004-167 of February 3, 2004	All investment projects must be subject to an impact study.	Impact assessments take the form of either an Environmental and Social Impact Assessment (ESIA) or an Environmental Commitment Program (ECP).
2015-005 of January 22, 2015 on the Redrafting of the Protected Areas Management Code	This law creates the Madagascar Protected Areas System, which is a structured and coherent system that includes all protected areas. It specifies certain provisions, including electricity production in protected areas in Madagascar.	Terms of co-location of the hydroelectric project with the NPA in the creation of Tsinjoarivo - Ambalaomby
Decree No.2017- 415 of May 30, 2017 establishing the terms and conditions for the application of Act No. 2015- 005 of February 26, 2015 redrafting the Protected Areas Management Code	This decree sets the terms and conditions for the application of Act No. 2015 - 005 of February 26, 2015 redrafting the Protected Areas Management Code	Requires the opinion of the Ministry of Protected Areas for the implementation of the Project. Restoration of damaged sites and compensation system

Instrument - Effective Date and Amendments	Main Objectives / Content	Application being considered
Decree No. 2001-122 establishing the conditions for the implementation of contractualized management of State forests	The purpose of the decree is to establish the conditions for the implementation of contractualized management of State forests with a view to delegating their management to grassroots communities formed by local residents. Contractualized Forest Management (GCF) is a way of transferring forest management to grassroots communities for the sustainable and secure local management of forest resources.	Procedures for the future management of the transfers of responsibility and public access to user rights areas
Decree No. 2005-849 of December 13, 2005 redrafting the general conditions for the application of Act No. 97-017 of August 8, 1997 revising the forestry legislation.	This decree describes, among other things, the forest regime, including logging operations, cutting permits and user fees, the regime of land clearing and wildfires, reforestation, the organization and missions of the public forest service, the relationship between the forest administration and decentralized territorial communities, and the national forest fund and rebates.	Cutting and clearing procedures for infrastructure development and compensation and mitigation measures (restoration and reforestation)
Decree No. 2006-400 on the classification of wildlife species.	This decree classifies wildlife species into three categories: protected (absolute protection or may result in the issuance of hunting or capture permits), harmful (authorized hunting, capture and consumption) and game (hunting and capture only authorized during the hunting season).	Some inventoried species are classified in categories I, II and III of this decree.

3.1.2 Labor Legislation

3.1.2.1 Labor Law and Worker Protection

Madagascar has legal instruments designed to regulate work and protect workers' health and safety. Institutions are being set up whose role is to protect or enforce protection measures provided for in these instruments.

The main legislative instruments in force are described below:

Workers' health and safety legislation:

Act No. 68-023 of December 17, 1968 establishes a pension scheme and creates the National Social Security Fund or CNaPS. This contributes to the protection of workers' health and safety since the CNaPS plays an important role in providing reparations for industrial accidents and occupational diseases.

Act No. 94-026 of November 17, 1994 on the Social Protection Code:

This code establishes a national social protection system which, according to Article 2, aims to "ensure a minimum level of social benefits related to human dignity for each citizen".

Act n°2003-044 of July 28, 2004 on the Labor Code:

Article IV of the Labor Code incorporates the health, safety and working environment provisions initially provided for by Act No. 94-027 of November 17, 1994, which it repealed. The Malagasy Labor Code includes the following principles which are also required by the IFC Performance Standards and the AfDB Integrated Safeguards System:

- The right of workers to join or form trade union organizations;
- Prohibition of harassment, including sexual harassment, and abuse of authority;
- Prohibition of discrimination based on trade union membership, disability, as well as “any form of discrimination based on age, sex, religion, origin or nationality”.
- “The legal working time of employees or workers of either sex, regardless of age, working on a time, task or piecework basis shall not exceed one hundred and seventy-three point thirty-three (173.33) hours per month.” (Equivalent to 40 hours per week).
- “Hours worked in excess of the legal working time shall be considered overtime and shall be subject to a premium.”

The following points differ from international standards:

- Child labor: “The minimum legal age for employment is fifteen (15) years throughout Madagascar.” However, “night work and overtime are prohibited for children up to the age of eighteen (18) years”.
- The following Article covers the electricity generation sector: “Women, regardless of age, may not be employed at night in any industrial establishment of any kind, public or private, secular or religious, or in any dependence on any of these establishments, even when these establishments are of a vocational or charitable nature, with the exception of establishments where only members of the same family are employed.”

Some Articles are relevant to the Sahofika Project, including:

- The work of foreigners is subject to prior authorization (work permit).
- “The establishment of a canteen for the benefit of workers shall be borne by the employer for establishments located more than five kilometers from the city center and not served by regular public transport or where the location of the establishment or the work organization does not allow workers to eat normally.”
- “The employer shall also keep a record for each special category of worker defined in this Code: day workers, probationary, apprenticeship, displaced, temporary, part-time and home workers, seasonal workers and workers under the age of eighteen (18).

3.1.2.2 Land Law

The main laws governing land in Madagascar are as follows:

- Act No. 2005-019 of October 17, 2005 establishing the principles governing the status of land, which, as its name indicates, establishes the general principles governing the various legal statuses of all land on national territory (whether public and private land owned by the State and decentralized authorities, or land owned by private persons).
- Act No. 2006-031 of November 24, 2006 establishing the legal regime for untitled private land ownership, the objective of which is to solve the problem of the existence of unregistered, unregistered but occupied land by granting occupants certificates of recognition of the right to untitled private property (or land certificates), which, while enforceable against third parties until proven otherwise, nevertheless has a lower legal value than a true land title.
- Act No. 2008-014 of July 23, 2008 on the private domain of the State, decentralized authorities and legal entities governed by public law, which more specifically defines the legal regime governing land in the private domain of legal entities governed by public law, as well as its implementing decree (Decree No. 2010-233 of April 20, 2010).

- Act No. 2008-013 of July 23, 2008 on the public domain, which more specifically defines the legal regime of the public domain of the State and decentralized authorities.
- Ordinance No. 60-146 of October 3, 1960 on the land registration system, which regulates land registration issues.

3.1.2.3 Gender Equality in Madagascar

The late 1980s marked the beginning of the integration of women's rights in Madagascar.

After the ratification of the Convention on the Elimination of All Forms of Discrimination against Women (CEDAW) in 1989, the country undertook the first amendments to its laws governing marriage in 1962 and 1967. Acts No. 90-013 and No. 90-014 established the right to choose the place of common residence by mutual agreement between the two spouses, since previously only the husband had this right. In addition, they introduced the ordinary matrimonial regime or "*zara mira*" instead of the "*kitay telo an-dalana*" which gave one third of the common property to the wife and the other two thirds to the husband as well as the possibility for both spouses to receive their share of the common property in the form of a sum of money..

Madagascar signed the SADC Protocol on Gender and Development (PSG) in 2008.

3.1.2.4 Access to Justice

Article 13, paragraph 5, of the 2010 Malagasy Constitution provides that "the law shall ensure that everyone has the right to justice, and insufficient resources shall not prevent this", or Article 1 of the Code of Civil Procedure (CPC), which recalls general provisions that "Any person may take legal action to obtain recognition or, if necessary, protection of their right". While there is no clear definition of access to the judge in the Malagasy legal system, it nevertheless appears from these texts that the concept of "access to the judge" is considered to be everyone's right.

3.1.2.5 Vulnerabilities

The concept of vulnerability is not defined in the Malagasy legal system, but the term is nevertheless used in various instruments and more specifically in the explanatory memorandum of two specific laws: Act No. 2008-030 of December 10, 2008 on the protection of the rights of older persons, which states that older persons "have become vulnerable because of their age", and Act No. 2014-040 of January 20, 2015 on trafficking in human beings, which states that: the term "taking advantage of a situation of vulnerability" is understood to mean taking advantage of any situation in which the person concerned considers that they have no real or acceptable alternative but to surrender.

While the concept of vulnerability is not expressly provided for in the instruments, the concept of "indigence" provided for in the decree implementing the decree regulating legal aid could be compared to the concept of "economic" vulnerability, although this term is not strictly used by the legislator. Under article 3 of the said decree, "To receive full assistance, the applicant for legal aid must justify that their monthly resources and those of their spouse or the total amount of the spouses' resources are lower than the Minimum Recruitment Salary" and article 4 of the same decree provides that "Legal aid may be granted automatically to workers who have been injured at work and are deprived of their faculties to resume their work; to one of the unemployed and destitute spouses, abandoned by the other, in the context of a request for a contribution to household

expenses or for maintenance for themselves and their children left behind without any means; to applicants for adoption by the Nation". Thus, article 1 of Decree No. 2009-970 regulating legal aid stipulates that: "In accordance with the provisions of Article 32 of the Code of Civil Procedure, legal aid may be granted in any event to: any person, any public or public utility institution, to private associations whose object is to provide assistance and which have legal personality, where, due to insufficient resources, such persons, institutions and associations are unable to exercise their rights in court, either as claimants or defendants (...)".

3.1.3 Institutional Actors

The main Malagasy authorities involved in the ESIA approval process are described in the table below, based on the MECIE decree.

Table 5 - Entities Involved in the ESIA Approval Process and/or in the Project

Name		Role
MEEF	Ministry of Environment, Ecology and Forests	Project owner or lead environmental authority, responsible for supervising the ONE and for ensuring the process for ensuring that investments are compatible with the environment (MECIE).
ONE	National Environmental Office	Operational body, delegated contracting authority (environmental authority) and one-stop shop for the implementation of the MECIE, placed under the supervision of the Ministry of the Environment. The ONE is thus called upon to coordinate Technical Evaluation Committees (TECs), direct the assessment of EIAs and issue environmental permits, coordinate the monitoring of the compliance of environmental management plans.
TEC	Ad hoc Technical Evaluation Committee	Interdepartmental committee that includes a representative of each department potentially involved in the Project. The TEC is responsible for evaluating the EIA documentation and issuing a technical opinion (positive or negative).
MEH	Ministry of Energy and Hydrocarbons	The MEH's environmental unit is responsible for ensuring that environmental and social concerns are taken into account in energy-related activities. In addition, the MEH is directly involved in the concession process in relation to the typology of the Project.

3.1.4 Permits and Authorizations

The following table presents the main types of permits and authorizations that will be required for the Project (subject to review by the Concessionaire's legal counsel), and the entity responsible for their acquisition:

Table 9 - Permits and authorizations

Description	To be obtained by
Building permits	NEHO
ESIA approval (including ESMP and RAP)	NEHO
Public Utility Declaration (DUP)	NEHO
Land access certificate	NEHO
Clearing authorizations	EPC or NEHO
Track opening authorizations	EPC or NEHO
Water collection permit for the production of drinking water	EPC
Permits for landfilling waste during the construction phase	EPC

Industrial authorizations for the construction phase (concrete mixing plant, crushing plant, inert material storage, etc.)	EPC
Permit to discharge treated wastewater into the environment	EPC
Permits for the storage, transportation and use of explosives	EPC
Quarry opening permits	EPC
Permits to extract rocks, sand, soil, and stones	EPC
Authorizations for the revegetation and reforestation of temporary sites	EPC
Authorization to export survey samples	EPC
Archaeological excavation permit	EPC or NEHO
Permits for landfilling waste during the operation phase	NEHO
Industrial authorizations for the operation phase (oil storage, etc.)	NEHO

3.2 International Framework

3.2.1 Social Protection Treaties and Conventions

The main international social conventions ratified or not by Madagascar and related to the Sahofika Project are presented in the table below:

Table 6 - International Environmental Protection Conventions

Instrument	Main Objectives	Status
<ul style="list-style-type: none"> ● International Convention on the Elimination of All Forms of Racial Discrimination ● International Covenant on Civil and Political Rights ● International Covenant on Economic, Social and Cultural Rights ● Convention on the Elimination of All Forms of Discrimination against Women ● Convention against Torture and Other Cruel, Inhuman or Degrading Treatment or Punishment ● Convention on the Rights of the Child 	Nine main international human rights instruments	Ratified
<ul style="list-style-type: none"> ● International Convention on the Protection of the Rights of All Migrant Workers and Members of Their Families ● International Convention for the Protection of All Persons from Enforced Disappearance ● Convention on the Rights of Persons with Disabilities 		Not ratified
UNESCO Convention concerning the Protection of the World Cultural and Natural Heritage, Paris, 1972	Ensure the most effective protection and conservation and the most active enhancement of cultural and natural heritage under conditions appropriate to each country	Ratified
African Charter on Human and Peoples' Rights (Organization of African Unity)	This charter is based on the Charter of the Organization of African Unity and the Charter of the United Nations as well as the Universal Declaration of Human Rights.	Ratified

Instrument	Main Objectives	Status
<ul style="list-style-type: none"> • Forced Labor Convention, 1930 (No. 29) • Freedom of Association and Protection of the Right to Organize Convention, 1948 (No. 87) • Right to Organize and Collective Bargaining Convention, 1949 (No. 98) • Equal Remuneration Convention, 1951 (No. 100) • Abolition of Forced Labor Convention, 1957 (No. 105) • Discrimination (Employment and Occupation) Convention, 1958 (No. 111) • Minimum Age Convention, 1973 (No. 138) • Worst Forms of Child Labor Convention, 1999 (No. 182) 	<p>Eight International Labor Organization (ILO) conventions protecting a fundamental freedom for the ILO</p>	<p>Ratified</p>

3.2.2 Environmental Protection Treaties and Conventions

The main international environmental protection conventions ratified by Madagascar and relevant to the Sahofika Project are presented in the table below:

Table 7 - International Environmental Protection Conventions

Instrument - Effective Date and Amendments	Main Objectives
Convention on Biological Diversity, Rio de Janeiro 1992	Biodiversity conservation; Sustainable use of its assets; Fair and equitable sharing of benefits arising from the utilization of genetic resources.
African Convention on the Conservation of Nature and Natural Resources, adopted in Algiers in 1968 and ratified in Madagascar in June 1970, new version in 2003	Improve environmental protection; Promote the conservation and sustainable use of natural resources; Harmonize and coordinate policies in these areas with a view to putting in place policies and programs that are environmentally sound, economically sound and socially acceptable.
Convention concerning the Protection of the World Cultural and Natural Heritage, Paris, 1972	Ensure the most effective protection and conservation and the most active enhancement of cultural and natural heritage under conditions appropriate to each country
United Nations Framework Convention on Climate Change, Kyoto 1992	Calls on countries to act according to their responsibilities and capacities to stabilize the concentration of greenhouse gases in the atmosphere
Convention on International Trade in Endangered Species of Wild Fauna and Flora, Washington 1973	International trade in the species listed in its appendices and in the parts and proceeds thereof that does not affect the conservation of biodiversity and is based on the sustainable use of wild species.
Ramsar Convention (Iran) in 1971	Ensure the conservation and wise use of wetlands of international significance.

3.3 International Standards

The Concessionaire requires that the Project comply not only with the requirements laid down by the national legislation, but also with the environmental and social policies of the International Finance Corporation (IFC) and the African Development Bank (AfDB).

3.3.1 IFC Performance Standards

The IFC is a subsidiary of the World Bank Group. Its purpose is to support private sector growth in developing countries. The IFC’s 2012 Environmental and Social Performance

Standards are the most commonly used international environmental and social standards. The IFC Performance Standards (PS) are described in Table 12.

Table 8 IFC Performance Standards (2012)

PS	Title	Scope
1	Assessment and management of environmental and social risks and impacts	Defines the provisions for ensuring proper management of E&S aspects, implementation of associated policies and responsibilities, including through an ESIA the requirements of which are defined by PS 1.
2	Workforce and working conditions	Defines the requirements for fair management of workforce and safe and healthy working conditions.
3	Rational use of resources and pollution prevention	Defines provisions for ensuring an adequate level of pollution prevention and control.
4	Community health, safety and security	Defines the provisions for ensuring that the negative impacts of a project on the host community are managed and controlled.
5	Land acquisition and involuntary resettlement	Defines provisions to minimize the negative social and economic impacts of any involuntary relocation, land acquisition, or restrictions on its use.
6	Biodiversity conservation and sustainable management of living natural resources	Defines the provisions for ensuring that the impacts of a project on nature, ecosystems, habitats and biodiversity are properly managed.
7	Indigenous peoples (not applicable to the Project)	Defines provisions for protecting indigenous peoples.
8	Cultural Heritage	Defines provisions for protecting cultural heritage from the negative impacts of the Project's activities, contributing to its preservation and promoting the equitable sharing of the proceeds from the use of cultural heritage.

The IFC Performance Standards are accompanied by a number of reference documents that will also be used in the Project:

- General EHS Guidelines (2007)
- IFC/EBRD Directive on Workers' Housing (2009)
- Guide to the implementation of PS 6 on Biodiversity (2012)
- World Bank OP 4.12, on Resettlement.

Good practice documents specific to the hydropower sector were also published in 2018 by the IFC:

- Good practices guide: EHS approaches for hydropower projects.
- Good practices guide: Environmental flow for hydroelectric projects.

3.3.2 AfDB Integrated Safeguard System

In 2013, the African Development Bank (AfDB) published an integrated safeguard system to promote inclusive and sustainable growth.

This integrated safeguard system includes the identification of five operational safeguards, which the Bank's clients are required to comply with when dealing with environmental and social impacts and risks. Operational safeguards have many similarities to the IFC's PSs, although they are organized differently. All AfDB operational safeguards are applicable to the Project.

Table 9 - AfDB Operational Safeguards and Correspondence with the IFC's PSs

#	Name of the Operational Safeguard	Corresponding IFC PS
OS 1	Environmental and social assessment	PS 1

OS 2	Involuntary resettlement: land acquisition, population displacement and compensation	PS 5
OS 3	Biodiversity, renewable resources and ecosystem services	PS 6
OS 4	Pollution prevention and control, hazardous materials and efficient use of resources	PS 3
OS 5	Working conditions, health and safety	PS 2

4 Current Situation

4.1 Physical Environment

4.1.1 Relief and Geography

The Onive basin, which covers a surface area of 4565 km² at the dam site, is located on the high plateaus of Madagascar, south of Tananarive. It is fairly compact in shape and has a rugged relief, especially in the western region, where altitudes reach 2,325 m and even 2,643 m in the Ankaratra massif. The central and southern parts of the basin have an average altitude of about 1,700 to 1,800 m. The proposed dam site is at an altitude of 1,300 m: this altitude is equivalent to that of the Capital to which the Project's transmission line will connect.

The floodplains have a low extension in the basin, which, combined with steep slopes and an interannual rainfall of around 1,400 mm, results in heavy flooding..

The basin is mainly covered by the Highlands prairie with local forest patches and primary forest patches on the eastern slope. Rice cultivation is developing in irrigated alluvial areas.

Photo 6 - Typical Landscape Upstream from the Project Watershed



In the eastern part of the dam site stands a chain of wooded mountains stretching from north to south, forming part of the Malagasy forest corridor. It's altitude in the Project area is in the order of 1,500 to 1,600 m. As it continues eastward, the relief drops sharply and loses nearly a thousand meters of altitude for about two kilometers: this is where the hydropower plant will be located, which will benefit from this natural waterfall. The altitude of the valley bottoms here is 600 m: it gradually decreases as one heads towards the

Ocean, located 95 km as the crow flies. In this area, the hilly landscape remains very rugged, but altitudes are still much lower than in the highlands.

Photo 7 - The Onive and the Characteristic Hilly Landscape of the East, Seen from the Rocky Escarpment



4.1.2 Geology and Soils

4.1.2.1 Geology

There are three main geological formations in the Onive basin:

- the crystalline bedrock,
- volcanic rocks,
- sedimentary soils.

The crystalline bedrock consists of Precambrian rocks (graphite system) which are mainly migmatites. There is also a set of gneiss and micaschists in the escarpment and forest corridor (Ambatolampy group). These rocks, which form just over a third of the basin, are impermeable, but their alteration layer has a significant retention capacity.

The western edge of the basin, which corresponds to the eastern slope of Ankaratra, is made up of basalt and labradorite, Pleistocene and Neogene volcanic rocks of Pleistocene age. Their decomposition gives red ferrallitic soils with low permeability, up to an altitude of about 1,800 m. Above 1,800 m, the soils are brown and much more permeable.

Sedimentary soils are mainly found in the valley bottoms of the Onive and its tributaries. They cover a fairly large part of the valley (rice field area).

4.1.2.2 Soils

Ferrallitic soils form the soil unit best represented in the basin, developing either on acidic rocks (migmatites) or on basic rocks (basalt).

- Ferrallitic soils predominate

- Black or andosolic humus ferralitic soils, typical of high altitude regions and characterized by the thickness of the upper horizon of black, silty, very porous, waterlogged humus. This type of soil cover a large part of this area. They are very diverse in their evolution and have the capacity to grow maize, cassava, and can be used to grow potatoes and for arboriculture purposes.
- Hydromorphic soils that consist of current and old marshes modified by drainage or alluvial soils from the exclusively basalt watershed. This type is the lowland where off-season crops and rice are grown.

In the communes of Antanifotsy and Tsinjoarivo, the majority of soils are predominantly red and yellow/red ferralitic soils and alluvial soils in the Onive Valley.

Soil observations and studies of the Alaotra catchment basins show that ferralitic soils, which characterized by a lateritic surface layer with thicknesses ranging from 10 to 50 cm, rest on a decomposing and non-cohesive bedrock. This type of soil is particularly prone to erosion and the formation of “lavakas”, which are deep ovoid excavations with very steep walls, shaped in crystalline and metamorphic rock alterations by runoff and underflows.

Hydromorphic soils occupy depressions. On the fluviolacustrine plains, there are two types of hydromorphic soils:

- Medium organic hydromorphic type: these are soils with a very fine clayey texture, suitable for rice cultivation;
- A peaty hydromorphic type with good to average suitability for flooded rice cultivation, and average for off-season agriculture without irrigation.

The following map shows soil conditions of the Project area.

Madagascar - Sahofika Hydropower Plant
 Environmental and Social Impact Assessment - Version D

Figure 21 - Soil Map of the Study Area

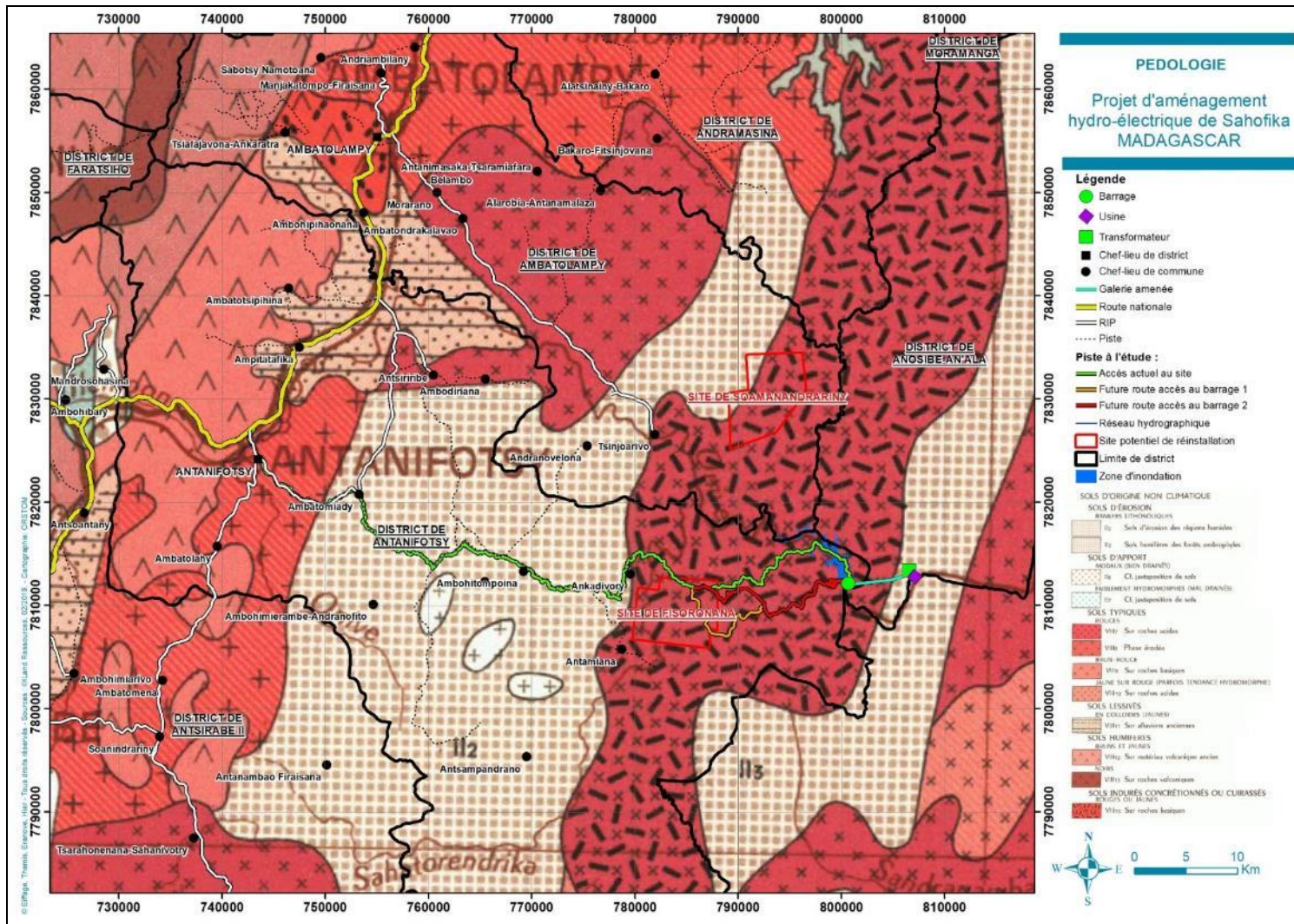

4.1.3 Climate

4.1.3.1 General Characteristics of the Climate

Due to its geographical position, Madagascar is subject to the influence of two major centers of meteorological influence that regulate the general atmospheric circulation conditions in the southwestern Indian Ocean: the low intertropical pressure zone in the north and the oceanic high pressure cell that is almost permanently centered in the southern Mascarene Islands.

Another important factor in Madagascar's climate is its orography. The relief consists of a continuous mountainous mass with peaks higher than 2,500 m and an average altitude of between 1,000 and 1,500 m. Like the rocky escarpment in the Project area, the eastern slopes are very steep and the coastal plains narrow. Trade winds have to cross or bypass this obstacle and this results in a general uplift of moist air. This results in the formation of trade wind orographic clouds and more or less abundant precipitation, depending on wind conditions and air humidity.

4.1.3.2 Seasonality

Madagascar has a rainy season running from November to March and a dry season stretching from April to October.

The cool period, from mid-May to September, coincides with the dry season: at this time, on the east coast, the southeast trade winds, which are fresh and dry everywhere except along the coast, where they release moisture accumulated over the ocean, are prevalent. As a result, on the east coast and on the eastern side of the mountains it can rain all year round, which fosters the development of tropical rainforest.

In inland areas the altitude makes the climate milder, at least at intermediate altitudes. Negative temperatures in cool periods typically occur above 2,000 meters and could therefore only be exceptional in the Project area, which peaks at 1,550 m.

4.1.3.3 Annual and Monthly Precipitation and Temperatures

There are two types of climate in the Project area, depending on altitude. There are no weather stations in the Project area. The nearest station that can provide recent data is Antsirabé, located 85 km west southwest of the Sahofika Project on the plateau. Therefore, aggregate meteorological data have been used to describe the typical characteristics of the local climate in this chapter.

Low altitude eastern part

The Climate in the lowest zone is characterized by:

- Warm perhumid bioclimate
- Average temperature: 23°C ;
- Minimum temperature: 20°C
- Annual rainfall > 2000 mm

Figure 22 - Sahofika Area Umbrothermal Diagram

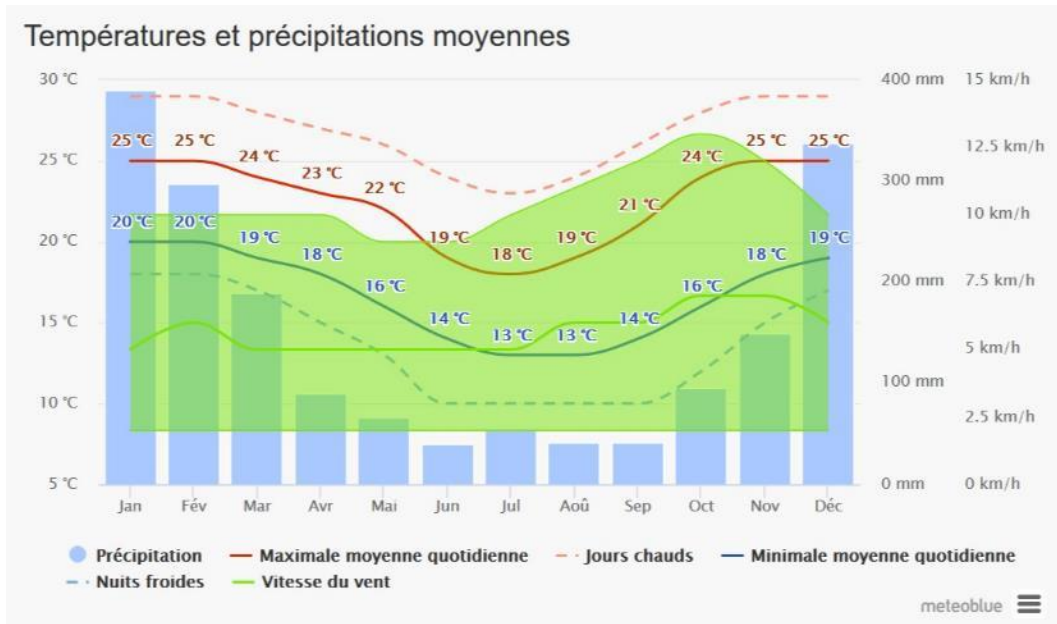

Moderate altitude part

In the highest zone, the climate is characterized by:

- Temperate wet-type bioclimate
- Average temperature: 10 to 15 °C
- 1,500 mm < Precipitation < 2000 mm
- The high plateau area is characterized by a humid climate in winter and a dry climate in summer with rainfall ranging from 900 to 1300 mm/year

Figure 23 - Antanifotsy Ombrothermal Diagram

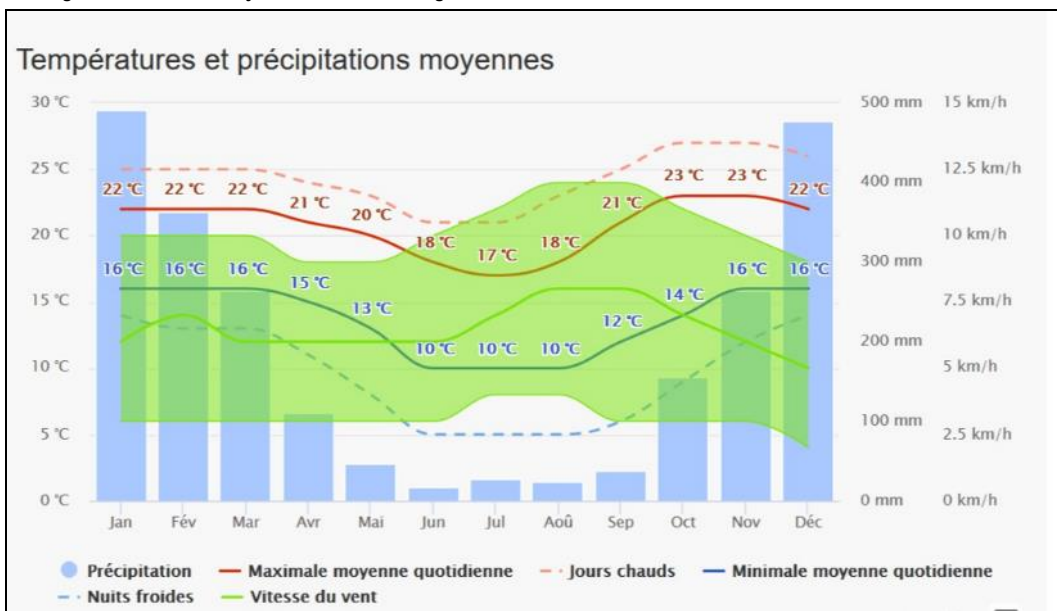

4.1.3.4 Winds

The wind regime is dominated by trade winds moving from east to west.

It is in the cool season that, as a result of the presence of the Indian Ocean high pressure cell, the general wind direction is best established. In the warm season, easterly winds are less regular and less active than in the cooler season.

Regardless of the region and season, wind speeds close to the ground are higher during the day than at night. This speed increases during the morning, reaches its maximum in the afternoon and then decreases at night.

Thunderstorms, which generally occur in the late afternoon, also contribute to increasing wind speed, which then blows in gusts that can be quite violent (speed above 50 km/h). Finally, it should be noted that the strongest winds are always observed during cyclones.

4.1.3.5 Tropical Cyclones

These are very severe and violent disturbances in the form of low pressure storms that affect a greater or lesser part of Madagascar during the warm season and create, for a period of variable duration (one week to fifteen days), a very specific type of weather generally characterized by abundant rainfall.

At its full development stage, a tropical cyclone can be seen on the sea-level pressure map as a deep depression with coarse circular and concentric isobars whose diameter can vary from a few dozen to a few hundred kilometers.

The passage of these meteors through a station results in a characteristic V-shaped barogram, the pressure in the center (eye of the cyclone) can be very low. On March 3, 1927, 940 mb were recorded at TOAMASINA (250 km northeast of the Project site).

Winds are strong and can exceed 250 km/h in gusts.

In Madagascar, rains can reach 500 to 600 mm in 24 hours during a cyclonic episode. In March 1959, rainfall collected on the east coast of Madagascar exceeded 1,000 mm over an a 500 km long and about 100 km wide area (maximum 1,983 mm). These persistent and torrential rains cause severe flooding and very serious damage.

Cyclones form on warm seas, at a distance from the Equator (5 to 7° latitude). Cyclones in the Indian Ocean move most frequently in a general East-West direction, with an average speed of about 20 km/h and occasional interruptions in movement that can last one or more days.

Wind strength decreases rapidly in a tropical cyclone arriving on land, but precipitation becomes very heavy.

According to a 1975 study of the six hundred and ninety-four cyclones recorded between 1849 and 1972 in the Indian Ocean, one hundred and fifty-five (22.3% of the total) affected the Malagasy coast. The distribution by coastal sector is as follows:

- 59 hurricanes hit between Antsiranana and Cape Masoala;
- 46 between Antongil Bay and Mahanoro;
- 49 between Mahanoro and Farafangana;
- 50 between Farafangana and Tolanaro.

It therefore seems that the entire eastern coast of Madagascar has, from north to south, a roughly equal probability of being hit by a cyclone from the Indian Ocean, even if the current climate change context is likely to change these values.

4.1.3.6 Evaporation

These two parameters are relatively unknown in Madagascar. Regarding evaporation, we have ORSTOM and INRA reservoir measurements at about ten stations.

Table 10 - Reservoir Evapotranspiration

	Daily averages of monthly interannual values (in mm/day)												Interannual average (mm)
	N	D	J	F	M	A	M	J	J	A	S	O	
Antananarivo (1960-1973)	4.79	4.06	4.38	4.08	3.83	3.73	3.04	2.46	2.53	3.01	4.20	4.89	1,368
Ambohidrano (1962-1971)	5.22	4.43	5.06	5.01	4.79	4.31	3.79	3.16	3.21	4.15	5.30	6.60	1,673

4.1.4 Rivers and Hydrology

4.1.4.1 The Onive

The Onive basin, upstream from its confluence with the Mangoro, covers 4,860 km².

The Onive River upstream from the Project site drains a vast basin (4,565 km²) where it collects many tributaries. The upper reaches of the Onive are generally calm, with the exception of areas of rapids and a few waterfalls, the most important of which are those of Tsinjoarivo (50 m high).

From the dam site (1,300 m above sea level), the Onive flows into a steep and narrow valley, interspersed with numerous waterfalls: the altitude of the bed drops from 1,300 to 600 m above sea level over a distance of 13 km, which creates the head used by the Project.

Between the hydropower plant and the confluence with the Mangoro River, the Onive River forms three distinct sections:

- For the first five kilometers downstream from the hydropower plant, the Onive forms a series of broad, calm reaches interspersed with natural sills and short areas of rapids. These diversion bays have some ability to absorb flow variations due to their low slope and wide width, but this ability is limited by their short length.
- The next four kilometers are steep: the bed is narrower.
- The last ten kilometers before the confluence with the Mangoro are very calm. The bed is about a hundred meters wide.

Figure 24 - Longitudinal Profile of the Onive from the Dam site to the Ocean..

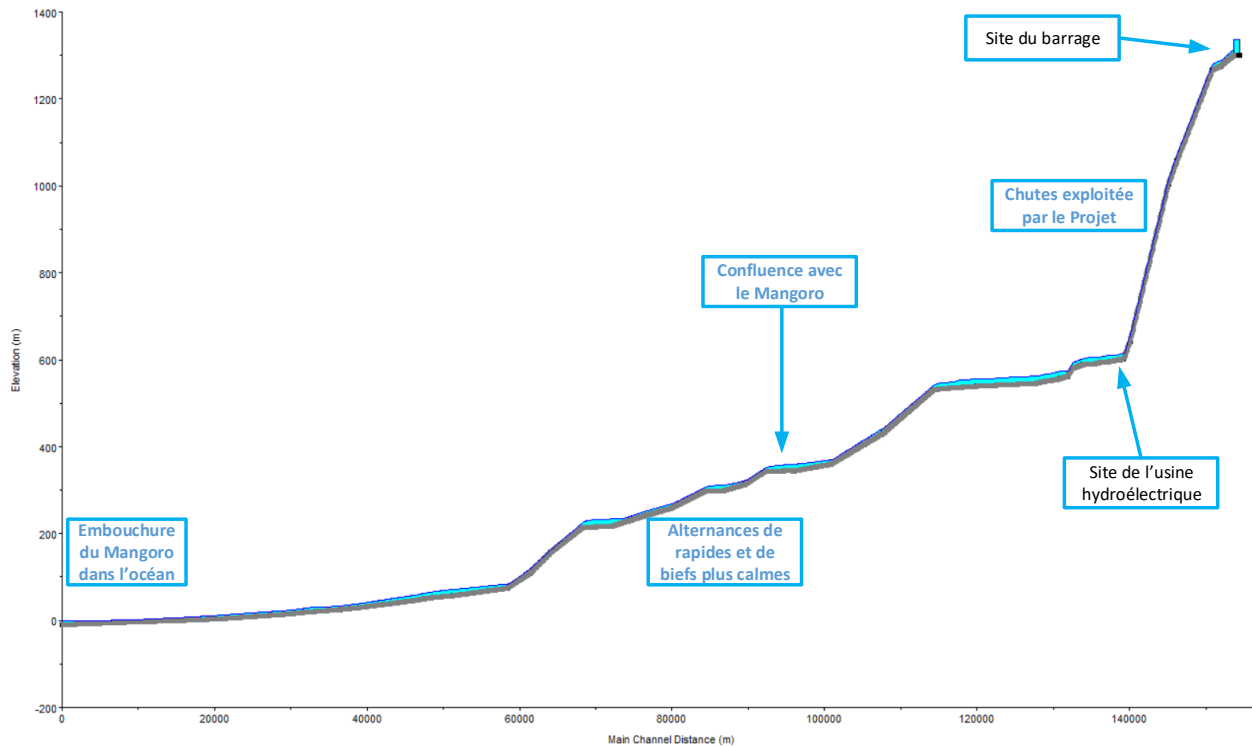

4.1.4.2 The Mangoro

The Mangoro River receives the waters of the Onive River 200 km away from its source. The total length of the Mangoro is 300 km. It drains a 17,175 km² watershed. The Mangoro, by virtue of the surface area of its basin and the volumes of water it flows, is the largest river on the eastern side.

The Mangoro-Onive confluence has a very peculiar shape: the two rivers flow in the same valley, exactly in the opposite direction, over a few dozen kilometers. After receiving water from the Onive, the Mangoro forks eastward through deep gorges with slopes greater than 10 cm/km. At 25 km from the mouth, the slope decreases slightly, as the bed widens but still remains cut off from the rapids. The Nosivolo River, which originates east of Fandriana, is the second major tributary of the right bank.

4.1.5 Water and Sediment Quality

4.1.5.1 Analyses Performed

Spot water and sediment quality analyses were conducted during the dry season as part of the ESIA. Water analyses targeted organic pollutants, pesticides and heavy metals. Sediment analyses targeted heavy metals and pesticides to identify pollutants that were not present in the water at the time of measurement, but were trapped in the sediment.

Water and sediment sampling was carried out on August 22, 2018 at two points in the Onive: at the dam site (water and sediment) and at the proposed plant site (water only). A cooler was used to carry the samples while a helicopter was used for travel, which reduced the time it took to transport the samples from the plant site to the laboratory to less than one hour and thus ensured that the process was of high quality.

The results of these analyses are presented in the following two tables.

Table 11 - Results of the Water Biochemical Analysis

Parameter	Methodology	Unit	Detection Threshold	Upstream: Dam	Downstream: Plant
Temperature	Electrochemical	°C		16.0	19.80
Total dry matter	Gravimetry	%		0.0010	0.0012
Dissolved oxygen saturation rate	Electrochemical (with probe)	%		60	65
Conductivity at 20°C	Electrochemical	µS/cm at 20°C	0 -3000 µS/cm	126.7	125.80
Ph	Electrometric		0 -14	7.6	7.60
BOD5	Dilutions	mg/l	0 mg/l	4.06	4.45
COD	Dichromate	mg/l	0 mg/l	12.53	13.12
Nitrate	Spectrophotometric	mgN03/l	0.1 mg/l	10.089	15.124
		mgN/l	0.023 mg/l	2.28	3.42
Phosphate	Spectrophotometric	mg P04/l	0.02 mg/l	0.28	0.29
		mg P/l	0.007 mg/l	0.090	0.094
Sulfate	Spectrophotometric	mgS04/l	0.1mg/l	88.42	90.55
Iron	Spectrophotometric	mg/l	0.1 mgFe/l	1.342	1.528
Arsenic	Spectrophotometric	µg/l	1µg/l	0.00	0.00
Cadmium	Spectrophotometric	µg/l	1µg/l	0.00	0.00
Chrome VI	Spectrophotometric	µg/l	10.0 µg/l	13.05	13.09
Lead	Spectrophotometric	µg/l	1µg/l	0.000	0.000
Mercury	Spectrophotometric	µg/l	1µg/l	0.00	0.00
Pesticides (spectrum)	Spectrophotometric	µg/l by pesticide	0.01 µg/l per pesticide	0.00	0.00
Total hydrocarbon	Chromatography	mg/l	0.1 mg/l	0.00	0.00
Fecal coliforms	Colony counts	colonies	nb in 100 ml	absent	absent
Salmonella	Colony counts	colonies	nb in 100 ml	absent	absent

Table 12 - Results of the Sediment Biochemical Analysis

Parameter	Method	Unit	Detection Threshold	Upstream: Dam	Downstream: Plant
Cadmium	Spectrophotometric	µg/kg	1µg/l	0.00	0.00
Chrome VI	Spectrophotometric	µg/kg	10.0 µg/l	25.98	26.06
Lead	Spectrophotometric	µg/kg	1µg/l	0.00	0.00
Mercury	Spectrophotometric	µg/kg	1µg/l	0.00	0.00
Pesticides (spectrum)	Spectrophotometric	µg/kg per pesticide	0.01 µg/l per pesticide	0.00	0.00

Some basic physico-chemical quality analyses were also carried out in the wet and dry seasons as part of the hydrobiological studies. The results of these analyses are presented in the following tables:

Table 13 - In situ Physico-Chemical Surveys during the Wet Season

Sections	Upstream from the Dam				Dam		
Upstream Station --> Downstream	Ivonta upstream from the falls	Ivonta downstream from the falls	LB tributary upstream from Anivorano	Median anivorano	Tributary farm, dam camp	Tributary downstream from LB camp	Tributary dam RB saddle dike
Date and time of measurement	04/18/2018 11:30	04/18/2018 10:20	04/11/2018 10:00	04/17/2018 11:00	04/11/2018 14:25	04/13/2018 08:00	04/13/2018 10:10
Conductivity (µS/cm)	13.6	15	12.4	Not recorded	17.1	17	21.5
pH	6.3	5.45	6.46	Not recorded	6.6	6.45	6.3
Dissolved O2 (mg/L)	8.35	7.88	9.1	Not recorded	8.6	8.2	7.8
% Dissolved O2	100.0%	96.2%	111.8%	Not recorded	109.5%	97.6%	88.4%
Temperature (°C)	17.7	18	18.4	Not recorded	19.8	17.3	18.5

Sections	Short-circuited section				Downstream from the Plant				
Upstream Station --> Downstream	T LB tributary in front of Befoza	LB tributary upstream fast	Sahava hotra downstream ford	Sahava hotra upstream from Onive confluence	Samolotona - forest	Upstream from Marotena	Ranomandry, Marotena Tributary	Marotena village	Tributary downstream from Sahofika
Date and time of measurement	04/12/2018 09:30	04/12/2018 12:04	04/15/2018 11:15	04/15/2018 09:50	04/14/2018 11:00	04/15/2018 12:15	04/15/2018 12:15	04/16/2018 11:15	04/16/2018 12:00
Conductivity (µS/cm)	10.7	18.9	14.8	14.5	9	10.5	23	12.5	25.5
pH	5.6	6.7	6.5	6.3	6	6.4	6.3	6.4	6.23
Dissolved O2 (mg/L)	8.42	7.92	8.5	8.75	9.4	8.66	8.59	8.66	6.9
% Dissolved O2	101.2%	99.0%	100.7%	102.5%	105.0%	100.5%	100.0%	100.5%	88.5%
Temperature (°C)	17.2	19.2	19.9	19.2	16.2	19.4	22.3	19.7	24.3

Table 14 - In situ Physico-Chemical Surveys during the Dry Season

Sections	Upstream from the Dam						Dam		
Upstream Station --> Downstream	Tributary LB upstream from Anivorano	Anivorano upstream from confluence	Anivorano upstream from fall	Tributary RB upstream from dam	Onive RB 1.5 km upstream from dam	Onive LB 1 km upstream from dam	Onive RB 1 km upstream from dam	Tributary Eiffage camp	Tributary camp Biotope
Date and time of measurement	10/17/2018 10:00	10/20/2018 09:00	10/20/2018 10:00	10/17/2018 16:00	10/28/2018 14:30	10/18/2018 09:00	10/18/2018 16:00	10/20/2018 12:00	10/20/2018 13:15
Conductivity	16	14.4	15.5	26.5	31.9	32	31.7	20	20.4

Conductivity (µS/cm)									
pH	6.25	6.4	5.6	5.52	5.9	7.05	6.4	5.81	6.1
Dissolved O ₂ (mg/L)	9	8.84	8.8	7.1	7.5	8.27	7.3	8.2	8.12
% Dissolved O ₂	109.4%	110.2%	115.4%	95.8	104.5%	85.7%	103.2%	106.3%	101.7 %
Temperature (°C)	17.2	18.8	20.6	23.7	24.2	22.2	24.3	21.1	19.2

Sections	Short-circuited section				Downstream from the Plant		
Upstream Station --> Downstream	BPR level rapids 500 m downstream from the dam	Onive BPR 2 km downstream from the dam	Tributary Sahavahotra Confluence Onive	Onive 500 m upstream from the plant	Marotenina Confluence Onive	2 km downstream from the plant	3 km downstream from the plant
Date and time of measurement	10/19/2018 14:00	10/19/2018 09:30	10/23/2018 08:30	10/23/2018 11:00	10/23/2018 14:20	10/24/2018 12:20	10/24/2018 08:30
Conductivity (µS/cm)	31	31	19.8	29.4	16.8	27.3	28.9
pH	6.9	6.89	5.91	6.8	5.3	6.33	6.58
Dissolved O ₂ (mg/L)	7.3	7.53	9.15	7.75	8.6	8.39	7.9
% Dissolved O ₂	98.7%	100.3%	104.2%	93.5%	100.0%	98.7%	93.5%
Temperature (°C)	22.9	22.2	18.7	21.9	22.9	20.7	20.7

4.1.5.1 **Results**

The biochemical quality of the waters in the upstream and downstream zones is comparable, with slightly colder water in the downstream area.

Nutrients

The nitrate measurements (2.28 and 3.42 mgNO₃-N/l) correspond to that of waters affected by human activities (typically 1 to 5 mgNO₃-N/l according to WHO) without any pollution. However, nitrate is present in sufficient quantities to contribute to the development of aquatic vegetation.

Phosphorus is usually rare in surface waters because it is quickly captured by aquatic flora. According to the WHO, overall background concentrations range from 0.005 to 0.020 mg/IPO₄-P. The values measured (0.09 mg/IPO₄-P) are above these thresholds, and close to the threshold value of 0.1 mg/IPO₄-P above which an aquatic environment is considered highly susceptible to eutrophication. It is likely that the concentrations measured are influenced by the practice of slash-and-burn, which releases large quantities of phosphorus mobilizable by rainwater into the ashes (phosphorus does not have a gas phase).

The marked BOD5 (greater than 4mgO/l) also indicates the measurable presence of organic matter that is likely to degrade rapidly and further increase the amount of nutrients available in the future reservoir.

In summary, the waters of the Onive contain enough nutrients to support eutrophication phenomena at least localized in stagnant areas. Such areas do not exist at this time, but could appear with the formation of the impoundment.

Microbiology

The salmonella and coliform measurements indicate that there is no pollution at the time of sampling. Measurements at another time of the year (e. g. at the beginning of the rainy season) are likely to give different results, but the Onive is in any case not a river with chronic fecal pollution.

Pollutants (Heavy Metals and Pesticides)

Chromium VI was the only heavy metal detected in the sediments and surface waters. Considering the context of the Project, it is clear that the chromium detected is of geological and non-industrial origin. However, it cannot be ruled out that gold panning activities may contribute to increasing the measurable presence of this heavy metal in aquatic environments. However, the concentrations measured are very low, and there is no pollution: the concentrations measured in water (13 µg/l) are for example 3.8 times lower than the maximum concentration level (50 µg/l) allowed for drinking water in the European Union.

The presence of pesticides has not been detected in water or sediment, which indicates that their use remains limited in the watershed and is not to date a source of chronic pollution of the Onive.

Physico-chemical Quality

Regarding the physico-chemical quality of the water, the first striking element is the relative homogeneity of the parameters recorded; the pH level ranges generally from 6 to 7 (acid to neutral water) except in certain tributaries, which is consistent with the majority of Malagasy rivers. Acid pH can be naturally occurring due to the presence of peaty wetlands. The waters are all properly oxygenated, except at the station furthest downstream sampled in the wet season, which had been found to have degraded habitats. This good oxygenation rate can be attributed to the high proportion of lotic facies

The second striking element is the low or very low conductivity of the water. Wet season values are slightly lower than those recorded during the dry season due to higher flows. Values below 20 µS/cm significantly reduce the efficiency of electric fishing. As a result, electric fishing was not carried out in the wet season at some stations.

4.1.6 Sediment Transport

The Onive has never been subject to regular sediment monitoring, and for this reason the Project has started to carry out sediment monitoring, the first results of which are shown here, accompanied by visual qualitative observations.

4.1.6.1 On-site Observations

The following observations were made on site:

- The waters of the Onive River contain high levels of suspended solids throughout the year.
- The bed of the Onive is mainly rocky, with many sandbanks on the banks and local gravel areas.

Photo 8 - Sand Bank and Rocky Outcrops in the Onive River Bed at the Dam Site



4.1.6.2 Transport Capacity

Sediment transport capacity varies with water velocity. However, the Project is clearly located in a landslide area: the steep reach that connects the dam to the plant with a sufficient slope to transport large blocks during the rainy season.

Sediment transport capacity varies with water velocity. However, the Project is clearly located in a fracture zone: the steep reach that connects the dam to the plant has a slope that is steep enough to transport large blocks during the rainy season.

4.1.6.3 Volumes

Suspended matter measurements to date indicate values in the order of 100 g/m³ during the rainy season. Historical measurements made by Orstom indicated values of about 50 g/m³ in the dry season and 500 g/m³ in the rainy season (expressed in order of magnitude).

Extrapolating these values to the six months of the dry season and six months of the rainy season, and assuming an additional 30% contribution corresponding to deep-seated solid transport, the annual supply to the dam site is estimated at between 1,500,000 and 2,000,000 tons per year (less than 1 million m³).

Table 15 - Measured Suspended Solids

Date:	TSS (mg/l)	Q (m ³ /s)	Date:	TSS (mg/l)	Q (m ³ /s)
12/06/2017	11		10/18/2018	32	15.0
02/19/2018	119	287.4	10/26/2018	40	14.1
03/07/2018	62	240.2	10/26/2018	37	14.1
08/05/2018	84	37.2	10/26/2018	33	14.1

08/05/2018	79	37.2	10/26/2018	45	14.1
08/05/2018	388	37.2	11/01/2018	30	12.4
08/05/2018	274	37.2	11/01/2018	39	12.4
08/27/2018	73	27.9	11/01/2018	34	12.4
08/27/2018	65	27.9	11/01/2018	41	12.4
08/27/2018	91	27.9	11/27/2018	214	48.6
09/15/2018	30	21.2	11/27/2018	257	48.6
09/15/2018	29	21.2	11/27/2018	156	48.6
09/15/2018	29	21.2	12/06/2018	87	51.9
09/15/2018	30	21.2	12/06/2018	437	51.9
10/18/2018	36	15.0	12/06/2018	552	51.9
10/18/2018	41	15.0	12/06/2018	165	51.9
10/18/2018	35	15.0			

4.1.7 Air Quality

The hydropower plant area is away from any industrial or traffic-related pollution.

Vegetation combustion is the main source of air quality degradation in the Project area:

- In buildings, when wood is used for heating or cooking. Not all places where wood is burned are necessarily equipped with a chimney to evacuate the smoke.
- In outdoor areas and seasonally at the end of the dry season, when slash-and-burn is practiced over large areas, generating large volumes of smoke.

Along the distribution line, as one approaches the busy roads and then Antananarivo, air quality gradually deteriorates: in addition to the seasonal impact of slash-and-burn fires, the daily impact of automobile traffic on the dust and combustion gas content of the air is also present.

The Project is unlikely to significantly or permanently affect air quality, and it was therefore not considered necessary to carry out an air quality measurement campaign. On the other hand, slash-and-burn practices remain an important factor to be taken into consideration, not so much for air quality reasons, but for personal safety reasons.

4.1.8 Noise

4.1.8.1 Measurement Campaign

A noise measurement campaign was conducted to establish a baseline noise level at various sites that will be subject to increased traffic and activities of all kinds during the construction and operation of the facility.

This is the case in particular (i) in villages and isolated houses from Antenina to Faravohitra that will be exposed to the nuisances caused by the construction works and (ii) in villages located along the construction site supply road, from Antanifotsy to Faravohitra.

Noise measurements were carried out at traffic counting sites in Antanifotsy, Belanitra, Faravohitra, and in the village of Ambatotsipihina (Antenina) at the dam site.

Noise measurements were carried out over a continuous 48-hour period at each site. The measurements were taken in October - November 2018, at the beginning of the rainy season with an integrator, recorder and precision frequency-weighted sound level meter (CESVA SC-20C model).

4.1.8.2 Result of the Measurements

The sound intensity observed is relatively low in Belanitra and Faravohitra. Measurements at the dam site were influenced by the presence of the temporary camp.

The noise level in the city of Antanifotsy is much higher, considering that it is a district capital where traffic is much higher than in rural areas.

Most of the main sources of noise are traffic-related: cars (4x4 vans and some trucks, bush taxis) and motorcycles passing between Antanifotsy and Belanitra. The area between Belanitra, Antenina and Faravohitra is relatively quiet. No particular noise was noticed at night; the entire area is quiet between 7.30 p.m. and 5 a.m., except at the dam site where the generator of the temporary camp was running until 9 p.m. in the evening.

In the rainy season, the average sound intensity can increase significantly due to rainfall, wind and thunder.

The table below shows the sound intensity measured at various sites, with average values taken in 48 hours continuously.

The definition of the various measurement parameters presented in the table is as follows:

- LCpk: Largest absolute value of the instantaneous sound pressure, C-weighted, since the beginning of the measurement, in decibels ;
- LE: Sound exposure level. It is the sound level that is kept constant for 1s at an energy equivalent constant to the energy accumulated during the entire measurement, in decibels;
- LeqT: Equivalent continuous level of sound pressure - Linear average of the instantaneous sound pressure over the entire period of time that the measurement lasts, in decibels; the duration of each measurement performed is 5 minutes.
- LeqT 1s: Equivalent continuous level of sound pressure for 1s, in decibels.

The most interesting data are the "LeqT" which is the average intensity measured over a 5-minute period.

Table 16 - Sound Intensity Measured in the Study Area

Site / Location	Date:	Duration	Start Time	Environment Type	Observation	Average value in 48 hours				Potential noise source
						LCpk	THE	LeqT	Leq1s	
Antanifotsy	10/15/2018 to 10/16/2018	48h	07h	Track edge	Traffic counting site at the exit of Antanifotsy towards Belanitra	112.9	148.9	Antanifotsy	10/15/2018 to 10/16/2018	48h
Belanitra	10/28/2018 to 10/29/2018	48h	08h30	On a Bridge	Counting site on the Onive bridge at the exit of Belanitra towards Antenina	80.5	62.2	Belanitra	10/28/2018 to 10/29/2018	48h
Antenina (At the dam)	11/05/2018 to 11/06/2019	48h	07h30	Temporary project camp	At the dam where the temporary project camp is located	80.3	95.4	Antenina (At the dam)	11/05/2018 to 11/06/2019	48h
Faravohitra	11/11/2018 to 11/12/2019	48h	08h	Village	Traffic counting site in Faravohitra	91.1	68.7	Faravohitra	11/11/2018 to 11/12/2019	48h

In Decibel (dB)	Level
< 50	Very low sound intensity area
50 to 70	Low sound intensity area
>70	Moderate to loud sound intensity area

Source: Socio-economic Survey, October 2018)

4.2 Social Framework

4.2.1 Study Area

4.2.1.1 Communes within the Study Area

The communes located in the Project's area of influence are presented in Table 21 and Figure 26 below. Figure 25 shows the 4 communes concerned by the hydropower plant alone.

Project Component	Commune	District	Region
Dam and its associated structures, impoundment area	Belanitra	Antanifotsy	Vakinankaratra
	Tsinjoarivo	Ambatolampy	
The Central Office	Ambalaomby	Anosibe An'Ala	Alaotra Mangoro
Access road	Antanifotsy	Antanifotsy	Vakinankaratra
	Ambatomiady		
	Ambohitompoina		
	Belanitra		
	Ambalaomby	Anosibe An'Ala	Alaotra Mangoro
Potential relocation site	Belanitra	Antanifotsy	Vakinankaratra
	Tsinjoarivo	Ambatolampy	

Figure 25 - Communes Directly Affected by the Hydropower Plant

Table 17 - Project-affected Area

Project Component	Commune	District	Region
Dam and its associated structures, impoundment area	Belanitra	Antanifotsy	Vakinankaratra
	Tsinjoarivo	Ambatolampy	
The Central Office	Ambalaomby	Anosibe An'Ala	Alaotra Mangoro
Access road	Antanifotsy	Antanifotsy	Vakinankaratra
	Ambatomiady		
	Ambohitompoina		
	Belanitra		
	Ambalaomby	Anosibe An'Ala	Alaotra Mangoro
Potential relocation site	Belanitra	Antanifotsy	Vakinankaratra
	Tsinjoarivo	Ambatolampy	

Figure 25 - Communes Directly Affected by the Hydropower Plant

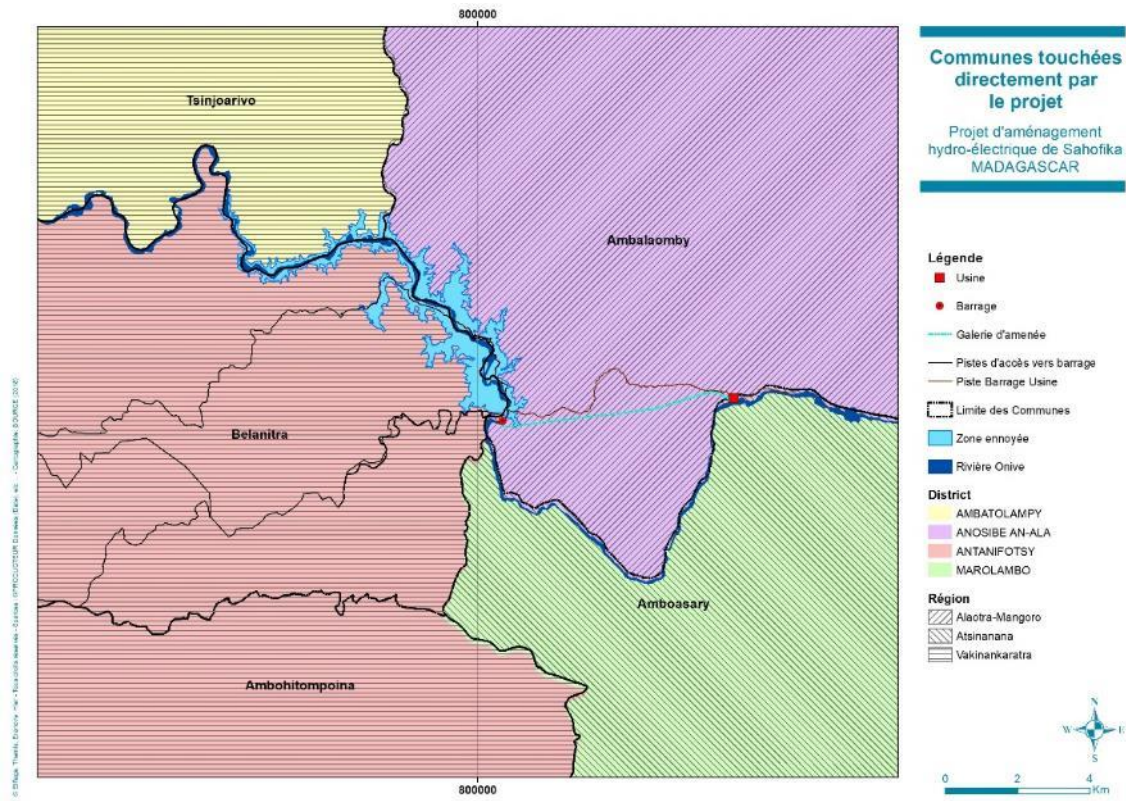

4.2.1.2 Local Areas Visited

The socio-economic surveys conducted in 2018 for the Sahofika Project at the household level took place in twenty (20) local areas throughout the study area. These surveys were conducted using a sampling method whose selection criteria are described in the table below.

Focus groups were held in nine (9) localities, including five (5) chief towns and four (4) fokontany. The authorities' surveys were conducted in Project-affected districts and communes and with traditional authorities, as well as in the Antenina and Faravohitra/Sahofika areas. The surveys carried out in these localities made it possible to collect socio-economic information, but also to assess the opinions and expectations of the population and the administration regarding the Sahofika Project.

The following table lists the localities visited as part of socio-economic surveys related to the Project:

Table 18 - Localities Visited as Part of SIA Surveys

Survey Type	District / Commune / Village Visited	Selection Criteria
Household survey (20 locations)	Fokontany and villages: Faravohitra, Sahofika Mandroalina, Fisoronana, Ankadivory, Ampangabe, Ambohimandroso Ilaka, Antsahondra, Ambatoharanana, Ampangabe, Antambohomena Antsahamaina, Sahavato Centre, Ankaditapaka, Ambatofotsy	<ul style="list-style-type: none"> Proximity or direct impact by Project components Socio-professional category Inclusivity of the various habitat types present in the selected fokontany

	Chief towns of the commune: Belanitra, Ambohitompoina, Ambatomiady, Tsinjoarivo, Antanifotsy	
Focus group (9 locations)	Fokontany: Faravohitra / Sahofika, Ankadivory, Antsahondra, Fisoronana Chief towns of the commune: Belanitra, Ambohitompoina, Ambatomiady, Tsinjoarivo, Antanifotsy	<ul style="list-style-type: none"> • Proximity or direct impact by Project components • High population concentration area • Isolated villages (very low population density) • Socio-professional category.
Survey with local and traditional authorities	Communes: Belanitra, Ambohitampoina, Ambatomiady, Antanifotsy, Tsinjoarivo. Ambalaomby District: Antanifotsy, Ambatolampy, Village: Antenina, Faravohitra / Sahofika	<ul style="list-style-type: none"> • Presence of decentralized territorial services and traditional chief. • Direct impact by Project components

Figure 26 - Study Area Map

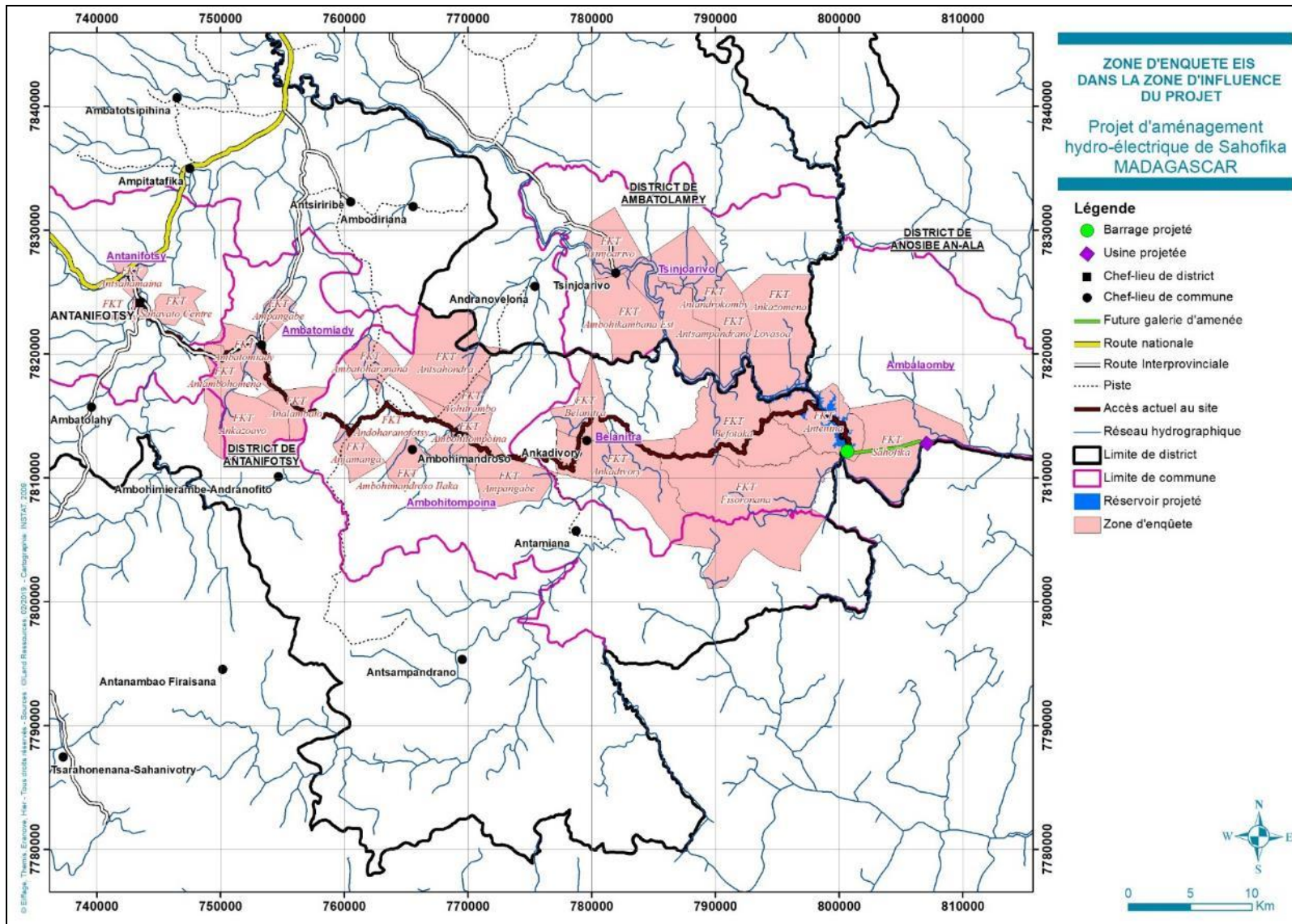

4.2.2 Geographical and Administrative Location

The Sahofika Project's area of influence affects the following administrative entities:

- Two (2) regions: Vakinankaratra and Alaotra Mangoro
- Three (3) districts: Antanifotsy, Ambatolampy and Anosibe An'Ala
- Six (6) communes: Belanitra, Tsinjoarivo, Ambalaomby, Ambatomiady, Ambohitompoina and Antanifotsy

This list does not include the installation of power lines

Table 19 - Project-affected Administrative Entities

Project Component	Commune	District	Region
Dam and its associated structures, Impoundment area	Belanitra	Antanifotsy	Vakinankaratra
	Tsinjoarivo	Ambatolampy	
The Central Office	Ambalaomby	Anosibe An'Ala	Alaotra Mangoro
Access road	Antanifotsy	Antanifotsy	Vakinankaratra
	Ambatomiady		
	Ambohitompoina		
	Belanitra		
	Ambalaomby	Anosibe An'Ala	Alaotra Mangoro
Potential resettlement sites	Belanitra	Antanifotsy	Vakinankaratra

Source: FTM 2015, Socio-economic survey, October 2018

Figure 27 - Map of Administrative Divisions in the Project Area

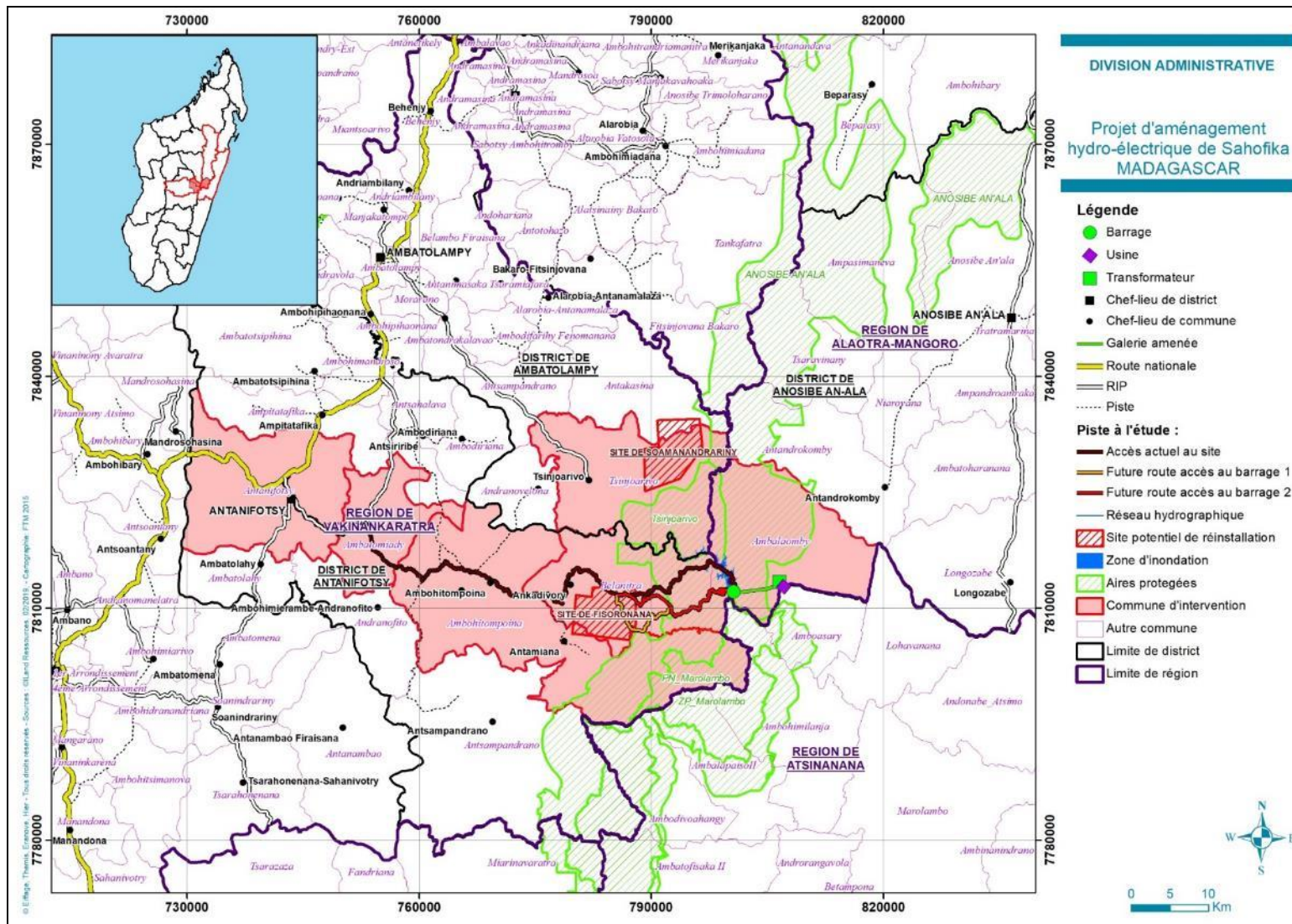

4.2.2.1 The Reservoir and Dam Area

The dam and reservoir area consists of four (4) *fokontany* including Antenina, Befotaka, Antandrokomby and Ankazomena, straddling the communes of Belanitra and Tsinjoarivo.

This is the area where the Project's footprint will be the largest. It currently houses about 5,760 people for all four *fokontany* (source: INSTAT 2009, updated by projection in 2019).

4.2.2.2 The Hydropower Plant Area

Two main villages are located in this area: Faravohitra and Sahofika. The village of Faravohitra, which is part of the commune of Ambalaomby, is located in the Sahofika *fokontany*, about 7 km east of the dam, and a few hundred meters from where the Sahofika Hydropower Plant and its ancillary infrastructure (roads serving the dam, substation and grid connection line) will be installed. The village of Sahofika (capital of *fokontany*) is connected to Faravohitra by a pedestrian path of approximately 2 km, or about 30 minutes' walk.

Faravohitra's name derives from the fact that it is the last mountain in the southwestern part of Anosibe An'Ala. The name "Faravohitra" means "the last mountain".

The Sahofika *fokontany* is subdivided into four (4) main villages including Faravohitra, Sahofika I and Sahofika II, South Sasa, and is home to approximately 550 people (source: INSTAT 2009, Projection in 2019).

4.2.2.3 Project Access Area

The Project area is accessible from the capital Antananarivo via paved road RN7 (Antananarivo-Antsirabe) to be used all the way down to Antanifotsy where a series of vehicle tracks followed by pedestrian tracks should be used over a distance of 60 km (as the crow flies) heading towards the east-southeast to reach the Project site.

The Project access road will cross the communes described below from Antanifotsy to the dam.

Antanifotsy

Antanifotsy is one of the seven (7) districts of the Vakinankaratra region; located along RN7, the capital of Antanifotsy is the nearest town to the dam area and is located 120 km from Antananarivo. The emblem of the Antanifotsy district is "Rano sy Vary" translated as "Water and Rice" which indicates a symbol of solidarity in the country.

The commune of Antanifotsy covers an area of 251 km²; it is the most populated, being the district capital and home to approximately 80,815 inhabitants (source: INSTAT 2009, Projection in 2019), composed of fifty-nine (59) *fokontany*.

Tsinjoarivo

The commune of Tsinjoarivo is the only one in the Ambatolampy district to be affected by the Project. The chief town of the commune is located 1h:30 from Ambatolampy, accessible by car via an existing track in average condition and about 1h from the commune of Belanitra (by motorcycle).

The commune is composed of fourteen (14) *fokontany* with a total area of 594 km² and a total population of approximately 28,108 (source: INSTAT 2009, Projection in 2019).

Ambatomiady

The commune of Ambatomiady is located between the communes of Ambohitompoina and Antanifotsy. With a surface area of 278 km², it currently has a total population of approximately 32,992 (source: INSTAT 2009, Projection in 2019) and eighteen (18) *fokontany*.

Ambohitompoina

The commune of Ambohitompoina is located before Belanitra from Antanifotsy. It has twenty-seven (27) *fokontany*. This commune is the best equipped in terms of community infrastructure. The chief town of the commune is more lively and equipped than that of Belanitra, some 1h:30 away by motorcycle from Belanitra and 4h to 5h away from the village of Antenina in the dry season.

With an area of 422 km², Ambohitompoina is the largest commune in the area. It has about 42,945 inhabitants (source: INSTAT 2009, Projection in 2019).

Belanitra

The commune of Belanitra is the last commune located in the east area of the Antanifotsy district. It has ten (10) *fokontany*. This commune is the most affected of all the communes in the area because it hosts most of the future flooded area.

With a total surface area of 343 km² and a total population of 14,191 (source: INSTAT 2009, Projection in 2019), the chief town of the commune is the last village accessible by car to reach the dam area.

4.2.3 The “Merina” and “Betsimisaraka” Ethnic Groups

The area is occupied mainly by two ethnic groups: the “Merina”, located mainly on the left bank of the Onive, on the side of the Vakinankaratra region; and the “Betsimisaraka”, located on the right bank of the Onive, on the side of the Alaotra Mangoro region (Nosibe An’Ala District).

4.2.3.1 The “Merina” Ethnic Group

The Merina ethnic group occupies the upper region of Madagascar, in the Analamanga, Vakinankaratra and Itasy regions.

The name of the kingdom Merina was created in Antananarivo by King Ralambo. The capital of Antananarivo was later named “IMerina Ambaniandro” or country raised under the sun before becoming “Antananarivo” or the city of the miles. Merina is considered a dominant ethnic group in number compared to all other ethnic groups living on the Great Island.

The Merina ethnic group practices ancestral worship and customs such as circumcisions, turning of the dead (Exhumation or Famadihana) or other important events such as the celebration of the Malagasy New Year or “Asaramanitra” which are a source of more or less popular celebration where “Hira gasy” (traditional music), “kabary” (speeches), “Dihy” (dancing) and “joro” (zebus sacrifice) are performed.

The language used is the official dialect that the whole country can use and understand. However, the Merina cannot always understand the dialects of other ethnic groups.

4.2.3.2 The “Betsimisaraka” Ethnic Group

The Betsimisaraka ethnic group mainly occupies the east coast of Madagascar, from Mananjary to Antalaha.

The Betsimisaraka are composed of the Antavaratra of the North, the Antatsimo of the South and the Varimo of the Center. These are communities with their own languages and cultures that make the wealth of the Betsimisaraka today.

The Betsimisaraka people are a sedentary people whose main activities revolve around fishing, agriculture and recently, crafts. Historically, the capital was East Fénive before becoming Tamatave for political and economic reasons due to the existence of its port.

Although some customs and habits differ among these heterogeneous people, common practices such as turning of the dead exist.

4.2.4 Population and Demographic Dynamics

4.2.4.1 Demographic Distribution in the Area of Influence

Figure 28 shows demographic distribution within the Project’s area of influence. The gradual decrease in population density from the West (Antanifotsy) to the East (site of the proposed dam and plant) is clearly visible.

Figure 28 - Demographic Map of the Project's Area of Influence

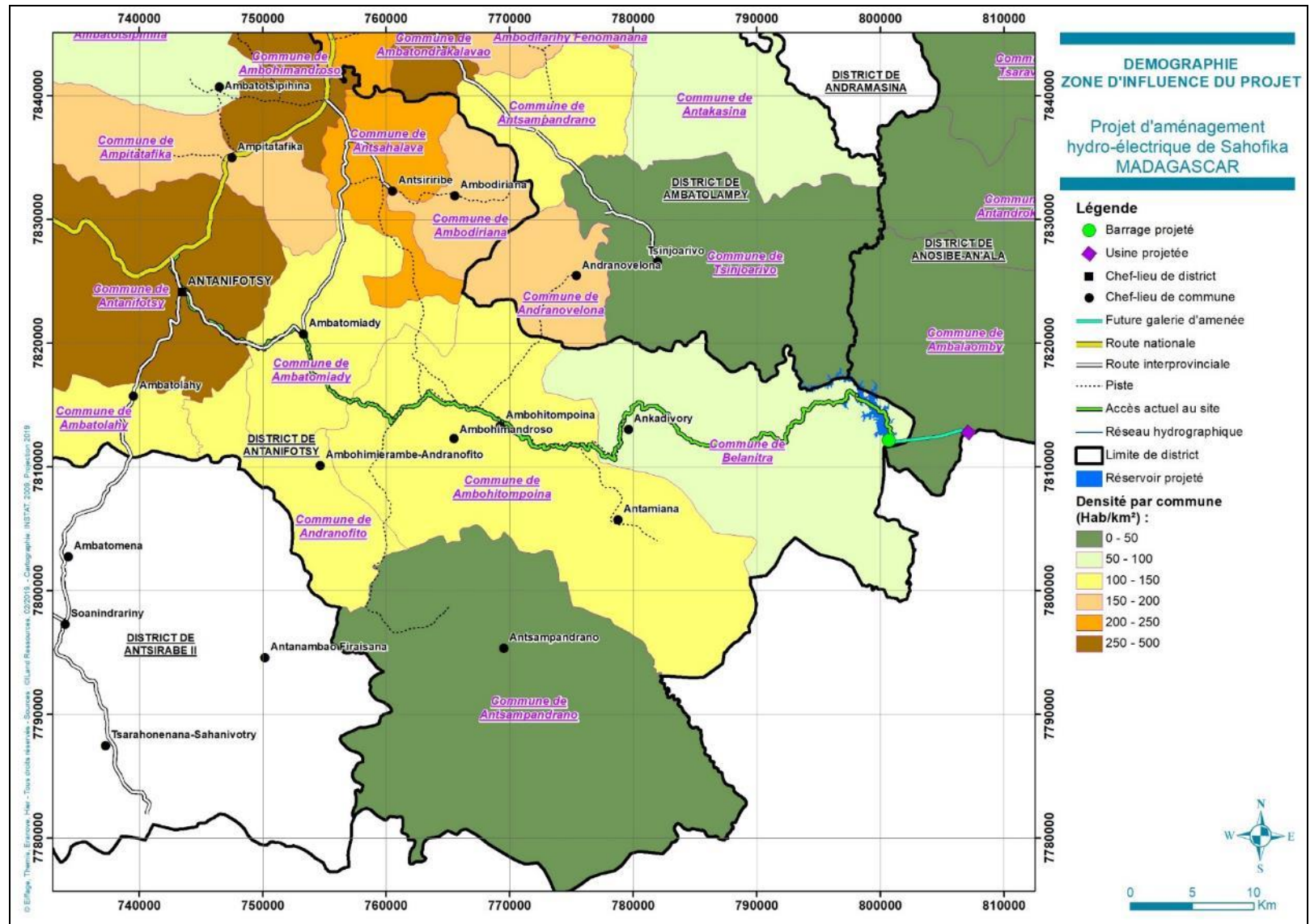

4.2.4.2 Demographic Situation

Based on the local authorities' population figures for the localities visited, the number of inhabitants is 207,500 (compared to 212,228 projected by INSTAT in 2019 based on 2009 data, with an average annual growth rate of 2.8%), 50.3% of whom are female and 49.7% male.

The population as a whole is relatively young with a large number of children and young people and a small proportion of elderly people: young people under 15 years of age make up 45% of the total population of which 15% are children under 5 years of age. The elderly (>65 years of age) represent only 3% according to the results of household sample surveys in the Project's area of influence.

The female population in the 15-45 age group represents 22% of the total population and 46% of the total female population.

Figure 29 - Child Mortality Rate in Madagascar from 1968 to 2017

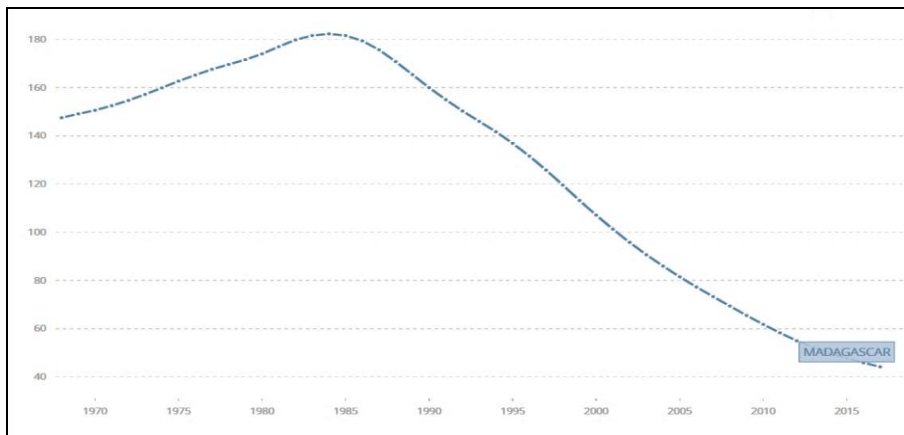

Source: <https://donnees.banquemondiale.org>

In Madagascar, fertility is constantly decreasing and birth mortality is decreasing nationwide, especially in rural areas. According to the Chief Medical Officer of Antanifotsy, this situation is due to the training and support of traditional birth attendants by community workers accredited by the Ministry of Public Health.

Figure 30 - Child Mortality Rate in Madagascar from 1960 to 2016

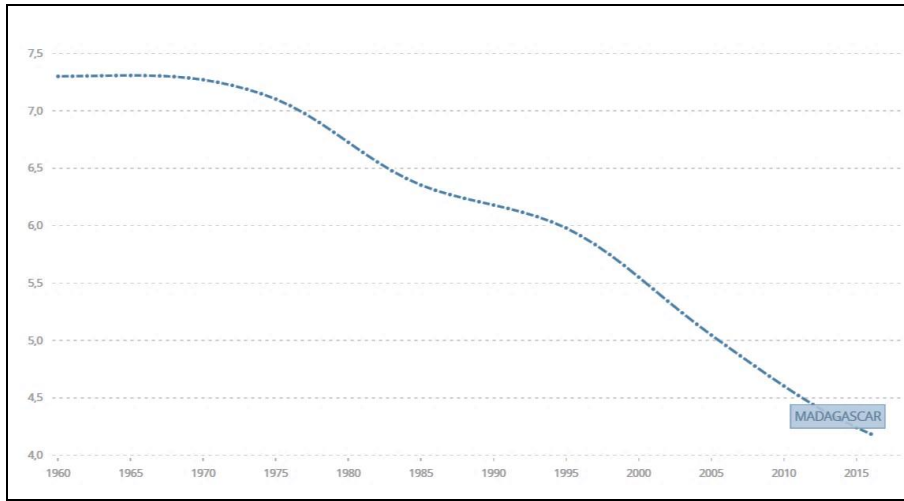

Source: <https://donnees.banquemondiale.org>

Based on Figures 4 and 5 above, the infant mortality rate in Madagascar has decreased from 7 to 4 in 57 years, representing an average decline of 9% in the mortality rate per decade.

Population trends (table below) were calculated using data provided by the commune authorities in the study area, and supplemented by data from INSTAT. These trends show a population growth rate of 23 to 64% in 10 years compared to an average of 31% in the Project’s area of influence as a whole.

Table 20 - Trends in Population Numbers and Density by Commune

Commune	Resident Population		Evolution in 10 years	Surface Area km ²	Projected Density 2019 Hab./km ²
	2009	2019 (projection)	2009-2019		
Tsinjoarivo	21,959	28,108	6,149	594	47
Antanifotsy	63,137	80,815	17,678	252	321
Ambatomiady	24,994	31,992	6,998	278	115
Ambohitompoina	33,551	42,945	9,394	422	102
Belanitra	14,191	23,585	9,394	343	69
Ambalaomby	3,737	4,783	1,046	290	16
Total	161,569	212,228	50,659	2,179	97

Source: INSTAT 2009 et Socio-economic Survey, October 2018

The population of Antanifotsy increases by nearly 2.8% per year, which is the highest population growth rate in the study area. This high growth rate is due to immigration and the high birth rate in the region.

With the exception of Antanifotsy, population density in the area is relatively low. Compared to urban areas such as the city of Antananarivo (WHO Report, January 2019) where population density can reach up to 25,287 inhabitants/km², rural areas tend to be sparsely populated in Madagascar. The national average density is 43.9 inhabitants/km²: the Project area, with an average density of 97 inhabitants/km², is therefore almost twice as densely populated as the rest of the country.

The commune of Ambalaomby, which covers the hydropower plant site and includes the villages of Faravohitra and Sahofika, has a very low population density, which is due in particular to a landlocked location and the prevalence of steeply-sloped areas.

According to the Chief Medical Officer in Antanifotsy, the birth rate in the Project area is about 40 births/1,000 inhabitants.

Figure 31 - Evolution of the Birth Rate per 1000 Inhabitants in Madagascar from 1960 to 2016

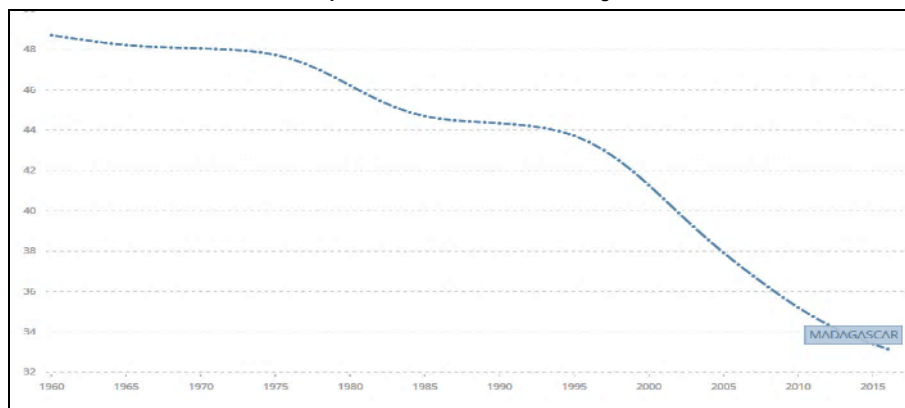

Source: <https://donnees.banquemondiale.org>

4.2.4.3 Migrations

Migration is not a new phenomenon in Madagascar. The peoples of the Highlands, i.e. the Merina and Betsileo, are among the most mobile ethnic groups in the country.

Over the past 30 years, farmers' increasing difficulty to survive on small farms has spurred them to seek off-farm income. Multi-activity (the combination of agricultural activity and non-agricultural employment) is becoming essential for the survival of families. The lack of employment opportunities in rural areas forces farmers to be more mobile. In the Project area, the city of Antsirabe became a center of attraction in the 1980s: the presence of industries (dairies, breweries, textile industries) attracted farmers who temporarily became workers. Although they work in factories, not all of them have given up their agricultural activities, as the income allows them to employ agricultural workers in their villages. Antananarivo and the chief towns are now also centers of attraction for migrants.

Male job-seekers are the main group involved in temporary migration from rural areas: few permanent migrations involve entire families.

Table 21 - Time Members of Household Spent in the Communes

Communes	< 1 year	1 to 5 year	5 to 10 year	10 to 15 year	<15 year
Ambatomiady	5	17	16	23	42
Ambohitompoina	6	11	12	21	38
Belanitra	3	15	11	28	34
Antanifotsy	7	11	18	18	48
Ambalaomby	1	2	9	11	24
Tsinjoarivo	2	4	11	12	21
Total	24	60	77	113	207
%	5%	12%	16%	24%	43%

Source: Socio-economic Survey, October 2018

More than 40% of the population surveyed in the study area has lived there for more than 15 years. These people are mostly natives of the region and consider their territory as the land of the ancestors. However, 17% of the resident population has lived in the region for less than 5 years. Most of these newcomers are immigrants (mainly young people between 20 and 40 years of age) or natives of the region from outside the region.

From the few temporary migrants we surveyed, it appears that three (3) types of relationships have played a role in people's decision to leave and seek work at their destination. These are (i) neighborhood and friendship links, (ii) employment links and (iii) family ties.

Out-migration from the Project's area of influence

The main motivation for individuals in the study area to leave their villages is the hope or possibility of higher incomes in productive lands or lands that are more attractive in terms of economic opportunities. The most concerned destination cities and villages (in order of importance) are as follows: Antananarivo, Ambositra, Maevatanana, Marolambo, Tsiroanomandidy, Anjozorobe, Ambatondrazaka and Antsirabe. Migrants are generally between 16 and 50 years old.

Workers from Antananifotsy or Belanitra who come to the capital Antananarivo or the city of Antsirabe are generally in the home-based work sector (domestic workers), street vending (natural remedies or mangidy, electronic equipment, etc.), portering (work as porter) or masonry in the construction industry.

In villages within Faravohitra, people are much more likely to look for work in Anosibe An'ala or Moramanga for reasons of ethnic proximity and accessibility, but the arrival of the Sahofika Hydropower Project could change this trend.

Photo 9 - Porters



Source: Socio-economic Survey, October 2018

Immigration in the area

As far as immigration is concerned, almost 95% of the immigrants in the area come from the highlands region (Antsirabe, Ambatolampy, Ambohimandroso and Antananarivo). The other immigrants are Betsimisaraka from Marolambo and Betsileos from Ambositra.

These people came in the area for trading purposes (spare parts, electronics, basic commodities, medicines) and then settled in agriculture and gold mining.

Photo 10 - A migrant family from Ambohimandroso bringing their "Mofa Gasy" skills to Ambohitompoina.



4.2.5 Households and Families

4.2.5.1 Households Surveyed

As part of the preparation of this ESIA, a sample of 150 households was surveyed. Their origin by *Fokontany* is detailed in the following table:

Table 22 - Number of Households Surveyed in the Project Area (Sampling)

<i>Fokontany</i>	Number of Households	<i>Fokontany</i>	Number of Households
Ambatofotsy	10	Antanifotsy	14
Ambatoharanana	3	Antsahamaina	8
Ambatoharanana East	4	Antsahondra	10
Ambatomiady	10	Befotaka	8
Ambohimandroso Ilaka	4	Fisoronana	8
Ambohitompoina	8	Mandroalina	4
Ampangabe	6	Sahavato center	10
Ankaditapaka	10	Sahofika	4
Ankadivory	8	Tsinjoarivo	2
Antambohomena	7	Vohitrambo	6
Antandrokomby	6		
Total			150

4.2.5.2 Head of Household

According to the household survey, the number of male heads of household is significantly higher than the number of female heads of household - 89.3% men and 10.7% women. These figures do not differ from the national trend, as observed across the country.

Women in the role of head of household are generally widows, divorced or single mothers and sometimes women whose spouses have left to work elsewhere (migration).

Table 23 - Gender Distribution of Heads of Households Surveyed

Gender	%
Male	85
Female	15
Total	100

Source: Socio-economic Survey, October 2018

This proportion of women heads of households in the Project area is lower than the national average, which is estimated at 22 % (MMR, 2014) and 28.5% in 2016 (<https://donnees.banquemondiale.org>). Regardless of gender, almost all heads of household are economically active.

The average age of male heads of household is lower than that of women: the difference is 4.5 years. This gap is related to the marital status of women (widowed, separated or divorced and in a common-law union). The number of separated or divorced women is similar to that of men in the same situation, indicating that single men have more mobility or opportunities outside the Project area.

Photo 11 - A woman head of household with some children from the village

4.2.5.3 Marriage

Being married does not prevent a woman from being the head of her household. However, the proportion is small (7.2%) and only concerns traditionally married or cohabiting women, whose spouses have migrated (usually to look for work).

The data collected show that 100% of the households surveyed are monogamous.

The proportion of unmarried heads of household is very low (0.2%). This situation shows that a person becomes the head of the household once he or she is married and has a household. In the study area, marriage is still at the heart of the family culture and model, which means that the concept of family is generally based on marriage.

Almost all (86%) heads of household surveyed are legally married, regardless of their age group.

Table 28 - Marital status of heads of households

Marital Status	%
Married	86

Divorced or single mother	2.7
Widowed	11.3
Total	100

Source: Socio-economic Survey, October 2018

People are gradually realizing the value of civil marriage as a means of securing individual rights and acquiring a family record booklet, given that children cannot go to school unless their birth has been declared and registered.

4.2.5.4 Household Structure

The most common type of household in the study area is mainly characterized by the dominance of a “Nuclear” type family (father, mother, and children). The average household size is 6 persons, with an average of 3 children per household. However, the commune of Ambalaomby has a few households with more than 10 individuals under the same roof.

Table 24 - Age Group-based Population Distribution

Age group of the household members surveyed	%
0 - 5 years	15.2
6 - 17 years	34.1
18 - 59 years	44.3
60 years and older	6.4
Total	100

Source: Socio-economic Survey, October 2018

Figure 32 - Age of household members surveyed

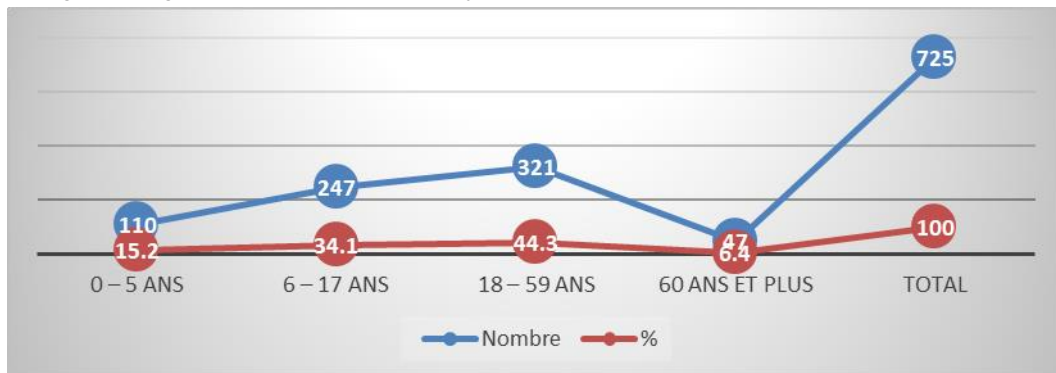

Source: Socio-economic Survey, October 2018

4.2.6 Social Organization

4.2.6.1 Role of the Elderly

Since local society in the study area is founded upon generational groups, the place of social elders is therefore defined by culture: this is the social prestige that the lower generations objectively ascribe to them within the village community. It is also important to note that the Betsimisaraka society is based on birthright.

While the status emphasizes the legal and social situation, the role emphasizes tasks to be performed and expected behaviors. Their role in traditional society is first and foremost linked to their status as “dignitaries”.

Elderly people in both the Vakinankaratra and Alaotra Mangoro regions are thus considered as experienced people, “who have lived, and have seen”.

Like in all the villages visited, the elderly in Faravohitra play several roles at different levels: at the socio-cultural level, for example, they play a crucial role in introducing young people to local practices (slaughtering a zebu, marriage proposals, speeches, rituals, etc.). This initiation is necessary for anyone who wants to be involved in decision-making processes within the village.

Photo 13 - The Tangalamena of Faravohitra-Sahofika



4.2.6.2 Social Conflict Mediators

There are 3 different levels of conflict resolution:

- If the conflict is about neighborhood or domestic issues, the conflicting parties involve traditional leaders (Ray Amand Reny or Olo be “Notable” in the Merina part, Tangalamena in Faravohitra). This practice is most common in the *fokontany*.
- If the conflict is not resolved through traditional leaders, it is resolved through the *fokontany* or a higher body, i.e. the mayor.
- If the conflict has not been resolved at these levels, the parties to the conflict may report the case to the competent authorities such as the gendarmerie or the court.

4.2.6.3 Spaces for Dialogue

There exists space for dialogue within the community. Meetings are not held periodically but rather on an ad hoc basis:

- Fokonolona (Village) meetings: these are meetings often led by the District Chief or Tangalamena to raise or resolve a social problem. It is mainly people from the grassroots community (hamlets or neighborhoods in a *fokontany*) who participate in this type of meeting.
- *Fokontany* (community) meetings: led by the head of the *fokontany*, with the participation of all local stakeholders, including the population, traditional authorities, members of the *fokontany* committee, members of village security...
- Communal Council: formal and decentralized body at the commune level, where discussions are held to resolve certain cases of conflict.

Conflict resolution mechanisms related to community safety include the following:

The “andrimasom-pokonolona” or “mobile neighborhood” (village security);

- The dina (a kind of social agreement);
- Law enforcement agencies including the mobile neighborhood and the gendarmerie.

The vast majority of the population say they use dialogue as a conflict resolution mechanism. Conflict resolution processes in the community are generally as follows:

Figure 33 - Steps in conflict resolution in relation to relevant actors

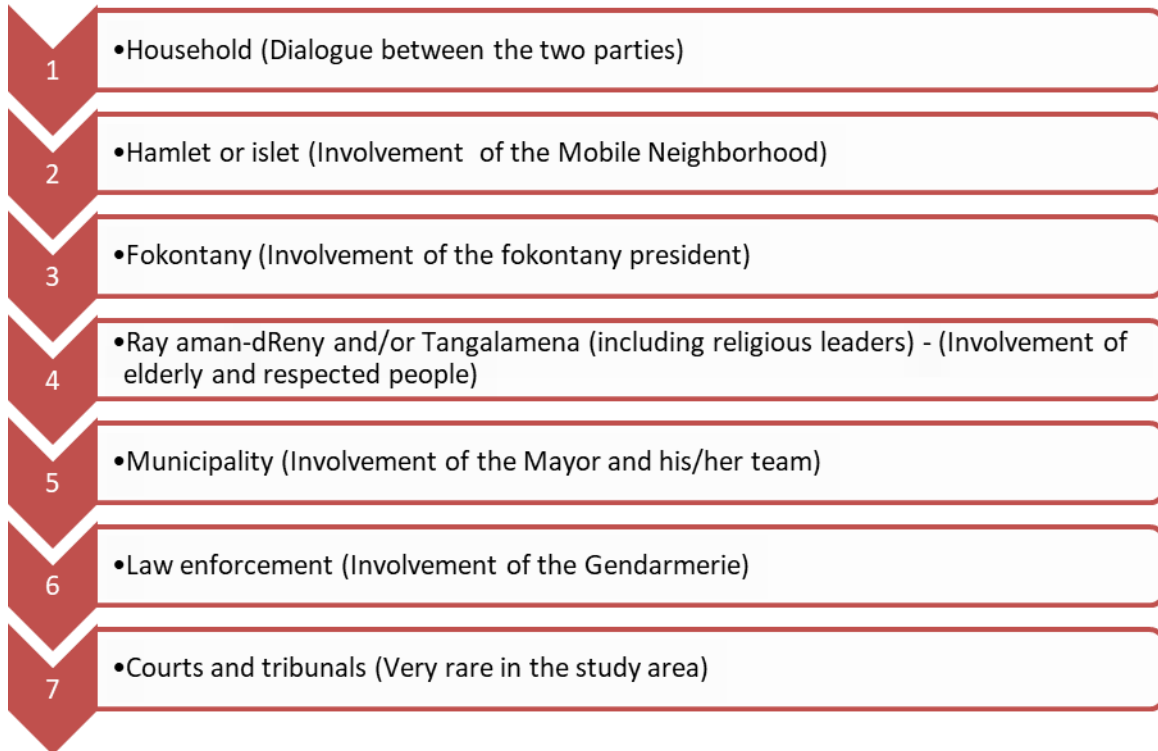

Source: Socio-economic Survey / Sahofika_October 2018

4.2.6.4 Gender-Based Approach

Daily life in the study area is organized around agriculture. The following tables present the basic day-to-day life activities of the local population, distinguishing between typical gender-specific activities.

Table 25 - Basic Day-to-day Activities

During the agricultural season	4h:00		8h:00	12h:00	14h:00	16h:00	17h:00	19h:00
	Morning		During the day		Afternoon		Evening	
Man	Wake up		Work in rice fields.	Lunch break	Work in rice fields		Lunch	Sleep
Woman	Wake up	Breakfast preparation	Work in rice fields. Lunch preparation	Lunch break	Household chores Work in rice fields.	Dinner preparation	Lunch	Sleep

Outside the agricultural	4h:00		8h:00	12h:00	14h:00	16h:00	17h:00	19h:00
	Morning		During the day		Afternoon		Evening	

season								
Man	Wake up		Gold panning	Lunch break	Work in upland fields / Gold panning		Lunch	Sleep
Woman	Wake up	Breakfast preparation	Gold panning	Lunch break	Household chores Gold panning	Dinner preparation	Lunch	Sleep

Source: Socio-economic survey, October 2018

Overall, men and women take part in activities generating income for the household; it is the proportion that makes the difference, since women traditionally are responsible for household chores or for looking after children.

In hilly and mountainous areas, upland crops are also grown on slopes from January to April. With respect to rice farming, men are responsible for heavy physical work such as plowing, and women take care of less demanding physical tasks such as pricking out. In addition, women are involved in the cultivation of upland crops such as beans, maize and vegetables. With regard to meal preparation, women are responsible for cooking, as well as for looking after children and/or collecting firewood and water for the kitchen.

Crafts products made of reeds and swamp grasses, such as carpets or tsihy, baskets, hats, etc., are the preserve of women.

Women manage the family budget: the husband gives all his income to the wife.

Decisions on how to spend money generated by the income obtained are made through discussions between spouses, and revenues are spent by mutual agreement.

Women in the role of head of household are generally widows, divorced women or single mothers and sometimes women whose spouses are working at other locations (migration).

Nevertheless, 53% of the people generating income among the households surveyed are women. Women are more active in terms of financial contributions in households. This might be due to the large number of single women (heads of household) adding to married women who also participate in generating income for the household.

4.2.7 The Land System

4.2.7.1 Existing Land System

The presence of communal land offices in the communes of Antanifotsy, Ambohitompoina, Ambatomiady, Tsinjoarivo, Belanitra, all of which are functional except the Belanitra land office, has been noted. These land offices conduct a legal procedure that recognizes traditional land rights as a legal right, which does not have the same value as holding a land title but is sufficient for land security. Land offices are public entities that manage untitled, but occupied private properties. Land management decentralization consists in the creation of a new authority vested in communes and mayors, through the creation of communal land offices. Land offices are required to formalize occupancy and tenure rights in areas that are not yet titled or registered, by issuing land certificates. The land office provides land certificates that facilitate the application for a property title or land registration. Obtaining a land owner's certificate is enough to secure a piece land even if such certificate cannot have the same value as a land title. Land offices are under the authority of the land service center. The Project area's land service center is centralized in Ambatolampy.

Most of the area is registered in the state domain, which means that the majority of people do not have land titles. Nevertheless, there are titled lands or lands with a land certificate, especially in areas close to the main towns. The reservoir, dam and power plant area is a state-owned land, occupied formally or informally by the population, and usually notified between villagers or in the *fokontany*.

Based on the surveys conducted, each household owns at least one plot of land, a house or an agricultural plot. Land acquisition or land use rights are mainly through:

- Inheritance in the majority of cases;
- Purchasing: generally observed in areas of economic interest (rare in the case of isolated villages);
- Rental ;

Free occupation: this consists in occupying, free of charge, a piece of land that is free or belongs to a neighbor.

Table 26 - Average Size of the Agricultural Plots Used by the Households Surveyed

Commune	Average size of the agricultural plots (m ²)
Ambatomiady	15.767
Ambohitompoina	4.427
Belanitra	3.701
Antanifotsy	6.789
Ambalaomby	1.964
Tsinjoarivo	1.731
Average	5.730

Source: Socio-economic Survey, October 2018

It should be noted that there are no specific land rules applicable in the peripheral area (known as the “protection” zone) of Marolambo Park beyond the community-led natural resource management through the VOIs. The population accesses the protection zone in a way to allow the VOIs to control how the area is used. This practice is not fully effective in protected areas within the study area, which generally increases the rate of deforestation in the area.

4.2.7.2 Land Use

The following table presents the characteristics of the environment and land use distribution for the entire area of influence.

Table 27 - Land Use Distribution in the Project's Area of Influence

Characteristic of The Environment	Land Use
Agricultural land	Recent crops and fallows Plantations
Savannah area	Pasture and fallow area
Forest area	Area generally occupied by natural forests (protected or unprotected) and plantations, used for daily or commercial use of wood
River plain and lowland	Rice fields and farming area
Populated areas	Construction of housing or other infrastructure
Stripped areas	Logging and slash-and-burn farming (on mountain ranges and open forests), gold mining quarry

Water bodies	Rivers and tributaries (daily or commercial use, for agriculture, livestock, gold mining, fishing)
--------------	--

Source: Socio-economic Survey, October 2018

4.2.7.3 Status and Land Tenure Security

Two thirds of the populations surveyed are aware of the existence of land offices (70%) but only 30% have already visited them. These figures seem limited but they reflect an improvement in the accessibility of land services: while only 17% declare that they have already visited a government land administration office, the proportion of those who have visited a communal land office (called "BIF", short for the Malagasy term *Birao Ifoton'ny Fananan-tany*) is 30% for the same people surveyed. People go to the land office mainly to obtain information and, to a lesser extent, to apply for a certificate.

In general, and with wide variations from one locality to another, households rely on various methods of validation to prove their rights: undocumented social recognition, land certificates (CF), land titles (TF) or papers issued at the *fokontany* level or between villagers. These are official documents (deed of sale, deed of donation, tax receipt, etc.).

On average, 75% of households across the study area use mainly small pieces of paper written amongst themselves or at the *fokontany* level to prove rights to their plots, 20% of households use the land certificate as their main way of securing their land while 1% use the land title and 4% of households have no specific documentation to prove their rights.

In Antanifotsy, all titled lands are in the name of a single person (named Ramanantsoa) since the post-colonization period and no fragmentation has been carried out to date, based on information that his descendants are dispersed in Madagascar making it impossible to share the property.

Table 28 - Proportion of Households by Rights Validation Method

No documents available	Small pieces of paper mainly	Mainly a land certificate	Mainly a land title deed	Total
4%	75%	20%	1%	100%

Source: Socio-economic Survey, October 2018

Access to land is becoming increasingly difficult for the population. This situation is exacerbated by population growth, combined with regional migration flows. Faced with this constraint, rural households adopt several strategies to improve their income:

- Indirect tenure¹ (IVF): overall, 32% of households access land through this method. The vast majority of IVF practitioners already own at least one plot. On average, the surface area covered by IVF plots represents 48% of the total cultivated surface area. 63% of households taking land under IVF are engaged in rental or sharecropping contracts, 45% benefit from loans or delegation of rights. Solidarity schemes within the family or neighborhood play a limited but important role for households receiving loans.
- Free occupation and sharecropping are the most common forms of land use in the study area. Only 3% of respondents stated that they own their land. More than 2/3 of the population uses or occupies lands free of charge, i.e. without compensation.

Table 29 - Land Tenure Status (number of people surveyed)

Commune	Property Owner	Tenant	Mixing	Free Occupancy
---------	----------------	--------	--------	----------------

¹ The indirect tenure method consists, for the owner, in entrusting his/her farm to a third party in return for an in-kind sharing of the products of the harvest - sharecropping -, or for a monetary lease - land leasing.

Ambatomiady	-	3	6	24
Ambohitompoina	2	1	5	20
Belanitra	-	1	5	24
Antanifotsy	2	3	6	21
Ambalaomby		2	1	3
Tsinjoarivo	1	1	5	27
Total (%)	3%	7%	17%	73%

Source: Socio-economic survey/Sahofika October 2018. It should be noted that a household can meet several criteria

4.2.8 Land Use Planning

4.2.8.1 Land Use Mapping

An assessment of the initial state of land use is important since the local population is primarily dependent on natural resources for their livelihood. This also makes it possible to understand and analyze the potential loss of resources available to the population, analyze the migration-related impact in relation to the existing system and pressure on the existing resource. The analysis was carried out using 2015 and 2018 Landsat images.

About 30% of the area of influence is composed of diversified forest cover (Natural forest and plantation). The non-forest zone is composed of about 38% savannah, 30% agricultural land and bare soil. The rest is made up of other classes such as water bodies. Land use is influenced by the presence of the Marolambo National Park and the management transfer areas located in its peripheral "protection" zone (see Chapter 4.3.2 for more details). The following tables provide surface statistics by land use type.

Table 30 - Land Use Statistics in the Project's Area of Influence (areas in km²)

Commune	Dense forest	Degraded forest	Wooded savannah	Crop / bare soil / Savannah mosaic	Cultivated area / rice field	Grassy savannah	Water body	Not classified	Total
Ambalaomby	123.2	23.7	127.7	4.3	1.0	5.7	0.6	-	286.2
Tsinjoarivo	32.1	67.4	25.5	67.4	30.1	93.1	3.6	3.5	322.7
Ambatomiady	-	9.4	21.2	49.8	68.4	4.2	0.0	-	153.1
Ambohitompoina	46.9	163.2	125.9	9.6	94.9	125.2	0.3	1.1	567.2
Antanifotsy	-	20.5	49.5	84.5	153.6	18.8	0.4	-	327.2
Belanitra	0.1	106.6	80.3	-	15.8	67.2	1.2	0.5	272.4
Total	202.3	390.9	430.2	215.7	363.8	314.2	6.8	5.0	1928.8

Table 31 - Relative Land Use Statistics in the Project's Area of Influence

Commune	Dense forest	Degraded forest	Wooded savannah	Crop / bare soil / Savannah mosaic	Cultivated area / rice field	Grassy savannah	Water body	Not classified	Total
Ambalaomby	43.0%	8.3%	44.6%	1.5%	0.3%	2.0%	0.2%	0.0%	100%
Tsinjoarivo	9.9%	20.9%	7.9%	20.9%	9.3%	28.8%	1.1%	1.1%	100%
Ambatomiady	0.0%	6.2%	13.9%	32.5%	44.7%	2.7%	0.0%	0.0%	100%
Ambohitompoina	8.3%	28.8%	22.2%	1.7%	16.7%	22.1%	0.1%	0.2%	100%

Madagascar - Sahofika Hydropower Plant
 Environmental and Social Impact Assessment - Version D

Antanifotsy	0.0%	6.3%	15.1%	25.8%	46.9%	5.8%	0.1%	0.0%	100%
Belanitra	0.0%	39.1%	29.5%	0.0%	5.8%	24.7%	0.7%	0.2%	100%
Total	10.5%	20.3%	22.3%	11.2%	18.9%	16.3%	0.4%	0.3%	100%

Figure 33 Land Use Map of the Project's Area of Influence

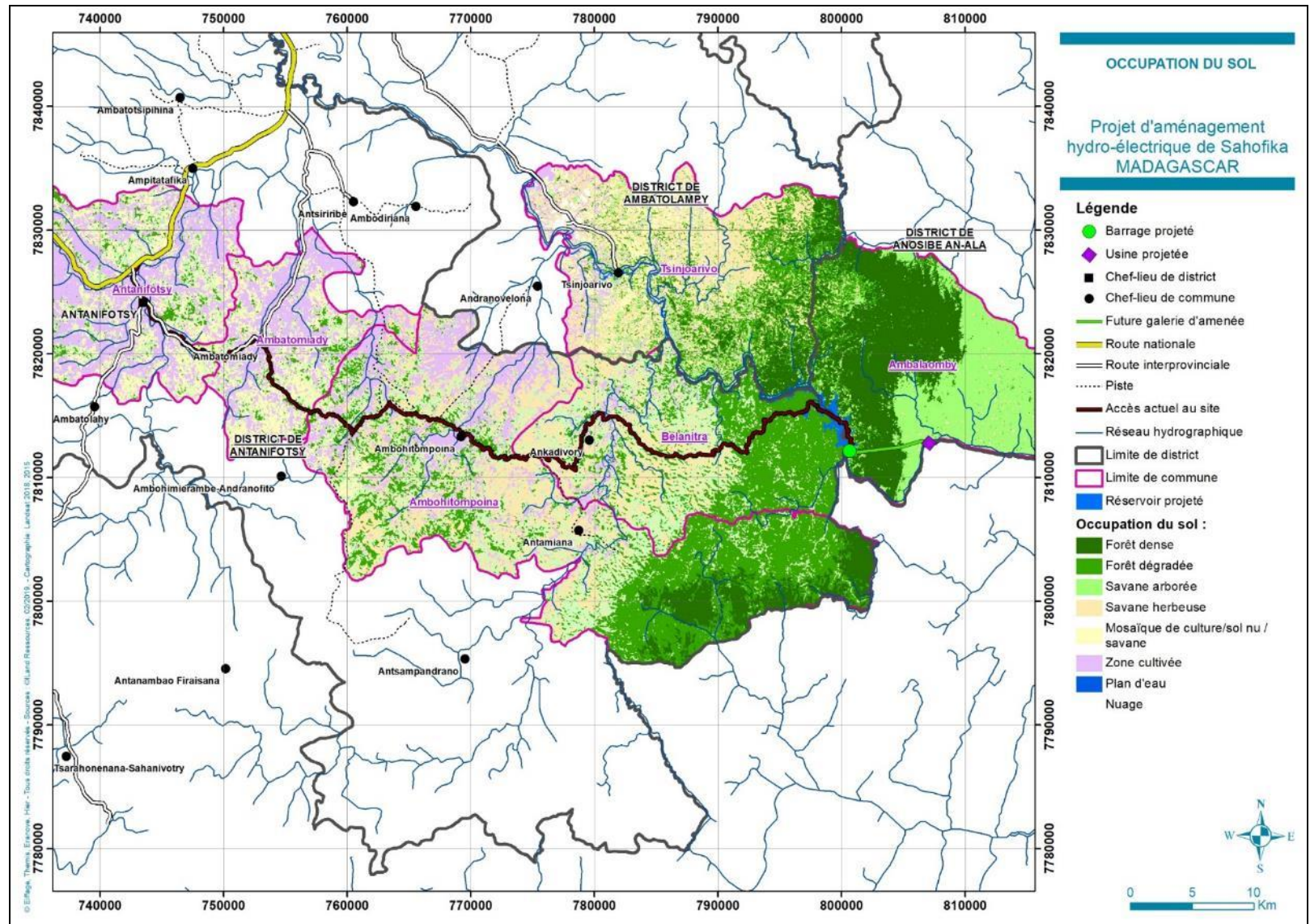

4.2.8.2 Availability of Forest Resources

Based on the assessment of the population currently in the area, the available areas of forest resources and/or wooded area per inhabitant are presented in the following table:

Table 32 - Per Capita Land Use Area (forested area)

Commune	Estimated population in 2019	Area by vegetation type in 2018 (km ²)			Hectare per capita in 2019		
		Dense forest	Degraded forest	Wooded savanna	Dense forest	Degraded forest	Wooded savanna
Ambalaomby	4,783	123.18	23.70	127.73	2.58	0.50	2.67
Tsinjoarivo	28,108	32.10	67.44	25.50	0.11	0.24	0.09
Ambatomiady	31,992	-	9.44	21.25	-	0.03	0.07
Ambohitompoina	42,945	46.92	163.24	125.88	0.11	0.38	0.29
Belanitra	23,585	0.09	106.57	80.30	0.00	0.45	0.34
Antanifotsy	80,815	-	20.46	49.51	-	0.03	0.06

The following table shows the same area (in ha) per inhabitant of forested areas, but excluding those located at protected sites in each commune where access is controlled. The large gaps show that the majority of forest resources that people may want to exploit are in fact located in protected areas.

Table 33 - Land use area (forested area) per inhabitant Outside the Protected Areas

Commune	Estimated population in 2019	Area by vegetation type in 2018 (km ²)			Hectares per inhabitant in 2019		
		Dense forest	Degraded forest			Dense forest	Degraded forest
Ambalaomby	4,783	1.20	0.23	92.24	0.03	0.00	1.93
Tsinjoarivo	28,108	3.37	31.47	14.07	0.01	0.11	0.05
Ambatomiady	31,992		9.44	21.25	-	0.03	0.07
Ambohitompoina	42,945	0.04	55.94	111.47	0.00	0.13	0.26
Belanitra	23,585	0.03	30.37	65.72	0.00	0.13	0.28
Antanifotsy	80,815		20.46	49.51	-	0.03	0.06

4.2.9 Infrastructure and Public Services

4.2.9.1 Transport Infrastructure and Modes

Road Transport Infrastructure

The Project area is accessible via RN7 (asphalt road) all the way to Antanifotsy, which is a track in poor condition accessible by 4x4 vehicles. A truck connects the town of Antanifotsy to the town of Belanitra. From Belanitra, a track accessible by motorcycle reaches the dam area and an existing footpath connects the dam to the Faravohitra Power Plant. The entire route is difficult to access during the rainy season.

There is also a track linking the city of Ambatolampy and the commune of Tsinjoarivo in about 1h:30 minute's drive. From Tsinjoarivo, a track accessible by motorcycle provides

access to the dam area. This route is shorter and more or less acceptable (5 hours of track) compared to a 7-hour access track via Antanifotsy (7 hours of track)

The dam and plant area is generally characterized by the poor state or even non-existence of passable tracks linking villages to the main town. For the Faravohitra, Antenina, Befotaka and surrounding areas, a long walk to places from which a motorcycle taxi journey is possible is the most effective way of getting around. In this context, transport refers mainly to the act of transporting agricultural products or foodstuffs necessary to meet domestic needs (water, firewood, food, etc.).

Rail transport

The railway line connecting Antananarivo and Antsirabe crosses Antanifotsy, hence the name Antanifotsy station. The Micheline "Viko" line provides tourist trips and passenger transport on the Tananarive-Antsirabe line upon request. This line is not currently operational because it is undergoing rehabilitation.

Travel and Transportation Typology

The means of transport used in the Project area include walking while carrying weight on the head or back, intermediate means of transport (MIT; these are means of transport other than cars and bare-back porters), used in the Sahofika Project: bicycles, motorcycles, trolleys, carts.

These transport activities are divided into three (3) main categories:

- Travel for domestic purposes: Travel to collect water and firewood, as well as basic necessities.
- Commercial transport and agricultural activities: Travel to the fields, transportation of commercial products, evacuation and marketing.
- Access to services and travel for social reasons: The reasons for these trips are varied: going to the health center or hospital, to markets, family visits, fulfilling social obligations, accompanying children to school, etc.

The modes of travel and transport are characterized by the following:

- Frequent trips (several times a day) on a regular basis, to the village or to specific places outside the village, related to domestic activities (water and firewood supply, village grocery), but also short leisure trips or taking the children to school.
- Travel related to agricultural production and marketing. Depending on the season, this may involve going to the fields to plow or harvest crops, purchasing agricultural inputs or marketing excess production. The latter two activities depend on the agricultural characteristics of the locality. However, agricultural products are generally marketed locally.
- Periodic trips to markets or, for some, to their work place. These trips are more frequent.
- Irregular travel: usually for health reasons, family visit.
- Long trips to major cities (Antananarivo, Antsirabe...), generally reserved for those who can afford them.

Photo 12 - Transport on a Man's Back and by Bicycle

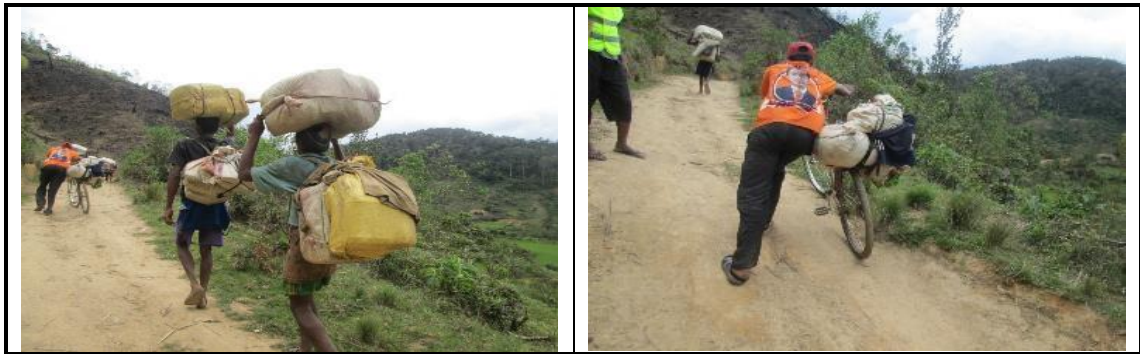

Table 34 - Means of Travel and Transport Used in the Project area

Journey	Means used	Access type	State	Cost	Traveler	Constraints / Problems encountered
Faravohitra in Antenina	Feet	Path	Bad	-	Rum carrier Other travelers: Trader, Project intervener, local population	High slope, Forest area No village or rest area (grocery store, small market, etc.)
Antenina in Belanitra	Feet, Motorcycle	Track	Bad	MGA 30,000 per motorcycle	Rum carrier traveling on foot Other travelers: Trader, Project worker, local population	Cost of travel by motorcycle too expensive for the majority of the population. Bad condition of motorcycles, fuel prices (black market). Poor track condition
Belanitra in Antanifotsy	Feet, Motorcycle Cart Bicycle	Track	Bad	MGA 50,000 per motorcycle (90 000Ar from Antenina to Antanifotsy) MGA 30,000 per 50 Kg of goods for carts MGA 20,000 / goods for bicycles	Rum carrier traveling on foot Trader (direct seller), Local population, Project worker	Cost of motorcycle travel too expensive for the majority of the population. Bad condition of motorcycles, fuel prices (black market). Rain, rhythm of the traction animals (zebu fatigue), Station (parking) of the carts and rest area of the zebu in urban areas (Antanifotsy, Ambohitompoina, Ambatomiady). Poor track condition
Tsinjoarivo in Antenina	Feet, Motorcycle	Track	Bad (but shorter compared to the Antanifotsy route)	MGA 90,000 per motorcycle	Trader (direct seller), Local population, Project worker	Cost of motorcycle travel too expensive for the majority of the population. Bad condition of motorcycles, fuel prices (black market). Poor track condition
Antanifotsy-Belanitra	Car (truck and 4x4)	Track	Bad	MGA 1,000 per Kg of goods	Traders (wood collector,...) and Project worker	Rarity of cars operating in the area, very high costs for citizens.

Source: Socio-economic Survey, October 2018

4.2.9.2 Public Networks: Water, Electricity, Telephone

In the Project area, more than nine (9) out of ten (10) households do not have access to the main public services (water, telephone, electricity). Only Antanifotsy is connected to the national electricity grid, a water network and has access to the mobile telephone network.

Drinking Water

Only Antanifotsy has a connection to the national electricity grid and a water network.

Mobile Telephony

The mobile telephone network is more and more difficult to pick up as you move away from Antanifotsy. Thus, from Antenina, it takes an hour's walk to reach a point where SMS can be received/sent, and where calls are sometimes possible.

Electricity

Only the city of Antanifotsy is connected to the electricity grid of JIRAMA, Madagascar's public electricity and water supply company.

According to the results of the surveys of selected households, 39% of the populations not connected to the electricity grid access electricity via a solar panel. The energy consumed varies according to the capacity of the solar panel, which in turn depends on the price of the panel. These figures include the use of a small limited solar panel to charge devices such as telephones. Access to electricity depends on the economic capacity of each household.

Sanitation and Waste

In terms of sanitation and waste management, only the communes of Antanifotsy and Ambohitompoina have a waste collection service.

4.2.9.3 Education

The educational level of the populations is relatively low overall: 9% of the active populations have never been to school, 51% have reached primary level, 35% have reached secondary level and only 5% (on the Antanifotsy, Ambohitompoina, Ambatomiady and Tsinjoarivo side) have studied at university.

Table 35 - Level of Education of the Heads of Household Surveyed

Level of study	%
Not in school	9.4
Primary school	50.7
Secondary level 1 (college type)	21.3
Secondary level 2 (high school type)	14
Higher (University or Higher School)	4.6
Total	100

Source: Socio-economic Survey, October 2018

In the study area, the distance between the village and the primary school is generally less than 2 km. All the *fokontany* have a primary school, a public or private school (mostly Catholic) or a community school. Secondary schools are located in the main towns of the commune for general secondary schools, and high schools are located in Tsinjoarivo, Antanifotsy and Ambohitompoina.

Photo 13 - Antenina Primary School and Tsinjoarivo Secondary School



A large majority of children attend primary school. The primary school enrolment rate is quite high in the area, reaching 86%. However, there is also a high drop-out rate, especially among girls (parental assistance for childcare and premature work) during primary school. Thus, only 67% of enrolled children complete primary school in the study area.

Parents are motivated to send their children to school, but are generally hindered by a lack of resources.

Infrastructure is generally in poor condition and insufficient. For example, several classes are grouped in a single room for most primary schools due to a lack of infrastructure.

Photo 16 -

Photo 14 - A classroom in a community school where all classes are in the same room



4.2.9.4 Health

The public health service in the Project area includes one (1) District Hospital Centre in Antanifotsy, one (1) Basic Health Centre (BHC) in each commune and two (2) pilot health centers (run by volunteers) in Befotaka and Antsahondra respectively. These infrastructures are currently in poor condition and clearly insufficient for the entire area.

Remote villages such as Faravohitra and Antenina suffer from this deficit combined with the lack of quick access to these health centers. A long walk from half a day to a day is to be planned in case of illness to reach the nearest Center (Befotaka with a minimum of equipment), which excludes access to care in case of emergency. In addition, there is a lack of doctors or health professionals. Populations tend to use traditional medicine to address the lack of access to care.

Photo 15 - The Pilot Health Care Centre in Befotaka



Only Antanifotsy has a pharmacy, the other centers are satisfied with a drug depot with the strict minimum for care. Some shops sell medicines, without any control or advice. The nearest specialized services (medical imaging, analysis, etc.) are in Antsirabe.

Photo 16 - Antanifotsy District Hospital Centre



The common diseases observed in the area and cited by the populations are as follows:

- Fever and malaria
- Coughing
- Back pain or sciatica
- Belly aches and pains

- The flu
- Sexually transmitted diseases: no concrete figures are available at the study area level.

With regard to STDs, despite a low prevalence rate of HIV infection in Madagascar among the adult population aged 15 to 49 years, estimated at 0.2% in 2016 (CNLS, UNAIDS), the risk of explosion remains considerable due to the high prevalence of traditional STDs (prevalence of 12% of syphilis among pregnant women according to the same study) and the high risk sexual behaviors of the general population. According to updated data, it is estimated that 31,000 people were living with HIV in 2016 throughout Madagascar (CNLS, 2018).

4.2.9.5 **Socio-cultural Infrastructures**

Socio-cultural infrastructure is concentrated in the district chief towns. Antanifotsy has a Youth Animation and Promotion Centre (CAPJ). The “Tranompokonolona”, a public hall intended for community meetings or community festivals, exists in some communes (Ambohitompoina, Ambatomiady and Tsinjoarivo) and is used for a few rare artistic events (song galas, shows, martial arts...). There are sometimes ²parish halls and libraries (Information Centers, Alliance Française...). Sports fields, especially football fields, are common up to the level of Communes and *fokontany*. As a result, there are also many sports associations.

4.2.10 **Agricultural Activities**

4.2.10.1 **Sources of Livelihood and Income**

Agriculture and livestock are by far the main activities (and therefore the sources of income and livelihood) of the populations in the Project area, followed by gold panning, mainly 4 to 6 months a year on the Antenina side, Faravohitra to Ambohitompoina.

Gold panning is mainly practiced in the dry season. Nevertheless, some farmers carry out the activity all year round even in the rainy season: these cases are in the minority and depend in particular on the area, the water level and the needs of the farmers.

4.2.10.2 **Cropping Systems**

Crops grown in the Study Area are divided into two (2) types: subsistence or food crops (mainly self-consumed crops: their actual gross margin is less than 50% of their calculated gross margin) and cash crops (their actual gross margin is more than 20% of their calculated gross margin) where a significant portion of production is destined for sale. As a reminder:

- The gross margin calculated corresponds to “gross income” less “intermediate consumption” or operating expenses, which disappear in the production act.
- The actual gross margin refers to the actual profit received by the farmer following the placing on the market of his agricultural production.

² A building used by a parish, usually of a Catholic faith, to accommodate training, skills development activities or cultural and religious events. Its rooms are accessible to all upon agreement and payment of fees to the manager.

The majority of the farmers we met produce food crops for their own their food supply. Agricultural holdings generally have multiple productions and can be described as diversified agricultural holdings.

Food crops include rice, maize, potatoes, sweet potatoes, manioc, taro, etc. But these food crops can become cash crops if their production (from a commercial point of view) becomes important.

Table 36 - Food and Cash Crops in the Project's Area of Influence

	Food Crop Cultivation	Cash Crop Cultivation
Irrigated rice	X	X
Upland rice	X	X
Corn	X	X
Sweet potato	X	
Cassava	X	
Taro	X	
Beans	X	
Sugar cane		X
Coffee		X
Bredes	X	X
Potato	X	X
Tomato		X

Source: Socio-economic Survey, October 2018

4.2.10.3 Cropping Methods

Two (2) cultivation methods are observed in the area: *Tavy cultivation* (slash-and-burn, slope or tanety cultivation) and irrigated or *Horaka* cultivation.

Slash-and-burn

Slash-and-burn agriculture is practiced in humid tropical areas and in forest regions with accentuated relief, especially in the Alaotra Mangoro region, with the aim of self-sufficiency. In the Faravohitra area and in the Befotaka *fokontany*, old or recent work has thus been carried out on the *Tavy*, a term that refers to this cultivation system characteristic of the forest areas of eastern Madagascar, in which upland rice plays a predominant role.

The *Tavy*, which can be found everywhere in the *fokontany* from Befotaka to Faravohitra, is an operation that consists in clearing and burning an area of natural vegetation to cultivate it. The principle of the functioning of the *Tavy* cropping system is as follows:

- Primary forest logging: with the presence of protected areas, this type of forest still exists in the area, but, due to the presence of a local monitoring system (e. g. via VOIs), people tend to exploit the forest but in a less systematic way.
- The exploitation of the secondary forest or *savoka* (secondary forest stand that gradually replaces the primary forest under the action of external agents). This type of forest is the most exposed to the practice of *Tavy*.
- Tilling: is the operation that consists in clearing, cutting, or cutting down vegetation before slash-and-burn.

- Tamaratsany: refers to both the plot that received a *Tavy* the previous year and the type of vegetation it supports, which consists of a grassy mat;
- Tramatrema: is the next stage (2 and 3 years after the *Tavy*). The vegetation is already much denser, with savannah formation and regrowth of trees and shrubs.

At the plot scale, the practice of *Tavy* results in the following chronological sequence:

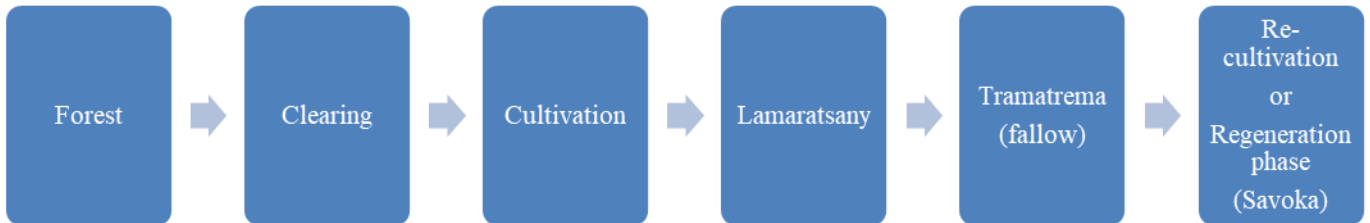

Photo 17 - Rice Cultivation on Tavy in East Befotaka (rice starts to grow)



Irrigated Farming

Irrigation is commonly reserved for rice cultivation. Irrigated rice cultivation involves numerous operations. The soil is prepared in several stages: first plowing, irrigation of the plot, then passage of a zebu-drawn harrow to prepare pricking out operations. Rice is first sown in a nursery and transplanted about one (1) month after sowing. Weeding is carried out around December, often with one (1) or two (2) weeding rounds followed by manual weeding. The harvest takes place between March and April. The straws are harvested and then threshed to obtain paddy rice.

In the area of influence, the vast majority of the valleys, especially along the Onive, are irrigated.

Photo 18 - Irrigated Rice Cultivation



Local rice field irrigation system



A rice field in Fisoronana

Table 37 - Main Crops in the Study Area

Yield and Production	Timeline	Growing method (tools used)	Product destination	Cost of production	Selling price on the market	Processing mode	Cultivation area	Constraints
tons/ha	September-October (pricking out) March (harvest) Sown in April and harvested in August	Slash-and-burn cultivation (<i>Tavy</i>) or irrigated cultivation, Human labor, Traditional spade, Zebu, Weeder, Plow, Harrow.	Self-consumption for the majority (100% of production for 85% of the population); sale only when money is needed. For Fisoronana, Tsinjoarivo, Antsahondra and Ankadivory (80% of the production consumed and 20% placed on the market in the surroundings).	MGA 200,000 for 10 ares	MGA 1800 to 2700 per Kilo of white rice	Paddy peeled by human workers (78%). Husking machine in Antanifotsy, Ambohitompoina, Ambatomiady, Tsinjoarivo and Belanitra.	Each village has its own cultivation area, whether on the slopes or on rice fields developed and irrigated close to or several kilometers away from the houses	Traditional technique Low yield, Access to seeds, fertilizers and insecticide (too expensive), Climate disasters (climate change), Insect pests (legionnaires, rice lice, etc.).
tons/ha	Sown in March and harvested in July (5 months) Or Sown in October and harvested in February.	Slash-and-burn cultivation or on Tanety in the Merina part, Human labor, Traditional spade.	Own consumption in the majority of families	MGA 50,000 for 10 ares	MGA 500 per Kilo	Consumed fresh and sun-dried for preservation (70% of family production)	Slope on the hills, herbaceous areas around the village	Development of the cultivation area, Pest insects, Vol.
kg/100 m ²	Sown in October and harvested in February	Rainfed cropping	Autoconsumed and sale of overproduction	MGA 100,000 for 10 ares	MGA 2,500 per Kilo	Consumed fresh and sun-dried for preservation (85% of family production)	Rice field and irrigated area	Destructive insects and seeds.
tons/ha	Planting usually in October but possible every month of the year. Harvested after 10 to 12 months of planting.	Cultivation on Baiboho (on the bottom of the slope) Crushed and mixed in a hole Traditional metal barrel (for fermentation).	Local and regional market (production of toaka gasy or artisanal rum) Toaka gasy sold up to Faratsiho and Ambatolampy by collectors, brokers and dealers.	MGA 800 /liter	MGA 2,000 per liter	Mouth sticks (Consumed after harvests: -1%). Distillery (Sugar canes transformed into toaka gasy and intended for sale).	Bottom of the slope from Befotaka to Faravohitra.	Archaic cultivation technique (low yield), Transport for the evacuation of the products (long walk, weight of the product).

Source: Socio-economic survey, October 2018

The division of labor between men and women is described as follows:

- For men: soil preparation work (plowing, building dikes and small irrigation canals, leveling)
- For women: installation and maintenance work (sowing, nurseries, pricking out, weeding/weeding).

Traditional Rice Farming Method

Farmers in the Project area have a strong rice farming tradition. The micro-parcel, delimited by bunds and generally smaller than 40 ares, is fixed by socio-cultural and community traditions: cultural practices remain traditional but are well adapted to the type of environment:

- Plowing with a spade or plow followed by a harrowing;
- Manual pricking out in crowds or in line but at densities adjusted according to the farmer's appreciation (age of seedlings, variety, rain delay...);
- Small hydro-agricultural facilities (earth water supply channels, reservoirs, impoundment dikes, etc.);
- Soil management by adding organic manure (park manure, compost...) and ferralitic clay taken from the lower slopes, on peat soils.

Photo 19 - Agricultural Practices in the Project Area

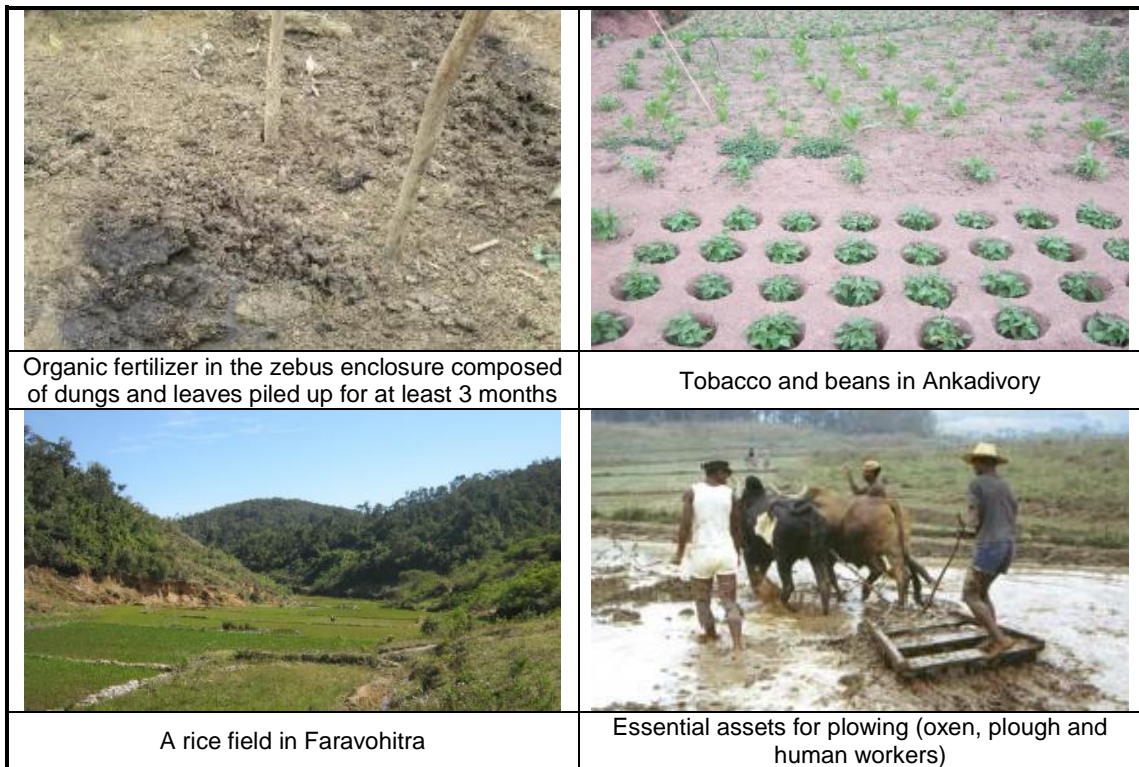

The “Voly avotra” or Off-season Farming

Voly avotra, which is defined as a fallback crop (off-season crops for scientists), consists in cultivating an off-season rice field. It consists in continuously working the land to have a plot of land that is productive on an almost permanent basis. This system allows farmers to secure their daily food during the lean season when food is scarce and prices are high (December-January).

Voly avotra is therefore a substitute to rice and allows the land to restore its fertility for the next rice season depending on the farmers. Generally, farmers grow legumes or grasses.

Photo 20 - Taro Growing Combined with Beans in Befotaka

The following table shows the distribution of food crop types by household surveyed in the Project area.

Table 38 - Type of Food Crop Cultivation per Household and per Commune (number of households surveyed)

Commune	Coffee	Sugar cane	Beans	Corn	Cassava	Sweet potato	Potato	Rice	Taro
Ambatomiady	-	-	14	22	18	-	22	23	
Ambalaomby	1	1	1	2	3			4	-
Ambohitompoina	-	-	24	27	29	-	31	31	7
Antanifotsy	-	-	16	25	14	-	15	23	-
Belanitra	-	-	15	19	13	1	22	23	-
Tsinjoarivo	-	-	9	13	15	-	16	16	2
Total (%)	0.2%	0.2%	15%	21%	18%	0.2%	21%	23%	1.6%

Source: Socio-economic survey, October 2018

Along with maize, rice and potatoes are the main food crops grown by the households surveyed in the Project area and in the Vakinankaratra region more specifically. The commune of Ambalaomby is known for its coffee production and for the cultivation of sugar cane that can be found in the village of Faravohitra-Sahofika.

4.2.10.4 Livestock and Fish Farming

Livestock Farming

Livestock farming is common, but generally on a very small scale.

The problems generally facing livestock farming in the study area are as follows: insufficient veterinary supervision, extension, genetic improvement, animal health assistance and the establishment of production infrastructure and insecurity issues (livestock theft).

Photo 21 - Harnessed Zebus Used to Pull Carts for Transportation and Travel Purposes



Fish Farming

Fish farming is a breeding activity that is beginning to spread in the area. There are some farmers from Antanifotsy in Befotaka who create basins on their rice fields for fish farming involving mostly tilapias and carps.

In the study area, people sell their fish when they need money. However, they also sell their fish for safety reasons: after the rice harvests, theft becomes easy because the fish are more exposed.

Surveys show that off-season crops, although less profitable, are preferred to fish farming because they are not exposed to theft. Some fish farmers sell their products during the dry period (April and June) because the price is attractive, with fresh fish being scarce during this period.

Table 39 - Main Livestock Farming Activities in the Study Area

Table 44 - Type of speculation	Breeding method	Product destination	Unit production (MGA)	Unit selling price (MGA)	Cattle drive trails area	Constraints
Gasy chicken and poultry	Free and/or fenced (Antanifotsy, Ambohitompoina, Tsinjoarivo and Ambatomiady)	Autoconsumption, Local market, Antananarivo, Antsirabe (chicken from Antanifotsy and Tsinjoarivo)	4,000	15,000 to 20,000	In the village, Chicken Gasy from Antananifotsy sent to Antananarivo with 200 heads per week	Disease (Barika), Vol.
Pork	Free (Faravohitra), Semi-intensive (use of feed and natural grazing) for the Befotaka area, Intensive (for Ambohitompoina-Tsinjoarivo area).	Local market and Antanifotsy Market for sending productions to Antananarivo	5,000/Kg	9,000/Kg	Partitioned in the owner's yard, In the village and wooded area.	Diseases (African swine fever and Ramoletaka), Feed costs.
Cattle	Backyard free-range breeding associated with agriculture, Cattle breeding for work (draught zebu), meat and milk, A newborn zebu can be used after 7 years.	Mainly the local market Raised for land works (rice cultivation) or to pull carts	4,000/Kg	10,000/Kg,(Meat) 2,000/L,(Milk)	Natural grazing area for 98% of herders, wooded area, herbaceous area and in the zebu enclosure (for those who cultivate fodder, -2% of herders).	Diseases: distomatosis and symptomatic anthrax, Insufficient feed intake for cows.
Fish farming	Fish farming in the rice fields takes place during and after the rice cycle "vary vakiambiaty". The start of livestock farming depends on the rice cultivation calendar and the availability of fry. The rice field is stocked from the 8 th day after pricking out when the seedlings are well rooted and the water has become less muddy.	Self-consumed, Sold on the local market or transferred to small storage ponds for off-season fish farming.	2,000/Fry	10,000/Kg	Basin on the rice fields and basin developed on the field.	No understanding of breeding techniques, Use of phytosanitary products in the rice field, Accessibility: delivery and transportation of fry and production, Attack by predators (bird, frog, large aquatic insect, tadpole), Vol.

Source: Socio-economic survey, October 2018

4.2.10.5 Fishing

Table 40 - Fishing Practices in the Project's Area of Influence

Type of speculation	Fishing method	Fishing area and season	Yield by type of speculation	Processing and product destination	Cost to the producer	Cost to the market
Tilapia	Fishing with various nets, longline, traps, netting, bare hands, and harpooning without snorkelling.	Onive River and tributaries. September and October.	3 to 5 tilapias per day	Family consumption or local sale of fresh produce	½ work day equivalent to MGA 2,500	MGA 11,000 per Kilo 3 tilapias sold at MGA 7,000
Carp	Fishing with various nets, longline, traps, netting, bare hands and harpooning without snorkelling.	Onive River and tributaries September to December	5 carps per day	Family consumption or local sale of fresh produce	½ work day equivalent to MGA 2,500	MGA 10,000 per Kilo 5 carps sold at MGA 12,500
Eel	Artisanal fishing	Onive River and tributaries. August to December.	1 to 3 eels per day	Family consumption or local sale of fresh produce	½ work day equivalent to MGA 2,500	1 large eel sold at MGA 12,000
Crustaceans (camaron, crab)	Artisanal fishing	Onive River and tributaries. September to December	1,5 Kg per day of fishing	No processing techniques because all the production is marketed fresh.	One working day is equivalent to MGA 5,000	MGA 14,000 per Kilo

Source: Socio-economic survey, October 2018

Concerning the distribution of tasks for the practice of fishing, men are traditionally involved in creating fishing equipment and generally they are the ones who carry out the activity itself. Women only intervene after fishing (preparation, cooking, sometimes selling fish locally).

According to an FAO study, Madagascar's freshwater is poor and no indigenous species are qualified to be used as farmed or intensively exploited fish. To remedy this situation, several species have been introduced into continental water bodies, including the currently dominant carp and tilapia.

In the study area, the Onive River is the most important fishing site since it is the largest watercourse in the area. But according to scientists and local people, this river has a high level of turbidity, which hinders fishing and prevents farmers from carrying out this activity in a suitable way. This situation has been observed in the field by the way the locals consider this activity, which is generally practiced as a leisure activity and sometimes as an occasional activity. Fishing is therefore a source of occasional food and a kind of recreational activity for those who fish, representing about 10% of the resident population in the study area.

In addition, we learned that rivers such as Onive are not potential fishing areas because of their high turbidity level.

Secondary watercourses are present across each fokontan. Part of the population in Faravohitra for example goes fishing in the Marotenina watercourse. People generally fish tilapia, carp, crustaceans and eels in these rivers. Interwinded roots often shelters crabs or crayfish.

Photo 22 - Fishing technique Used in the Onive River



Apart from tilapia, carp, eels and crustaceans, the population also fishes for “vily” or “patsa” (freshwater shrimp species), only for self-consumption.

4.2.10.6 Hunting

During focus groups, the locals did not discuss hunting practices in the Sahofika Project area. However, biodiversity surveys conducted in the field for ESIA have shown the presence of traps in forests. It is obvious that the local population avoids talking about this subject, probably because they aware that this activity is prohibited.

4.2.11 Other Economic Activities

4.2.11.1 Craftsmanship

The various artisanal activities listed in the Project area are described in the following table.

Table 41 - Craftsmen in the Project Area

Types of craftsmanship	Raw material	Sampling area	Quantity of product /year	Cost / product	Unit/product price	Product destination
Blacksmith	Iron	Collected from landfills, bought from private individuals	4 tons (in the study area)	MGA 400	MGA 1,000	Local market
Carpenter, carpenter	Wood	Dense forests (from Befotaka to Faravohitra) and reforestation area (from Antanifotsy to Ankadivory)	800 tons (for a little over 40 carpenters in the area)	MGA 40,000 (per log)	MGA 98,000 (per product from a log)	Local market and Antananarivo
Weaving,	Dombeya	Dense	200 Carts for	MGA 22,000	MGA 40,000	Local market

braiding	(Hafotra), Other thread plants, Dyeing.	forests	just over 700 professional weavers)	/Cart	(per cart product)	
Brick molding	Earth	In the vicinity of the rice fields	75,000 bricks	MGA 20	MGA 60	Local market

Source: Socio-economic survey, October 2018

Photo 23 - Craftsmen in the Study Area

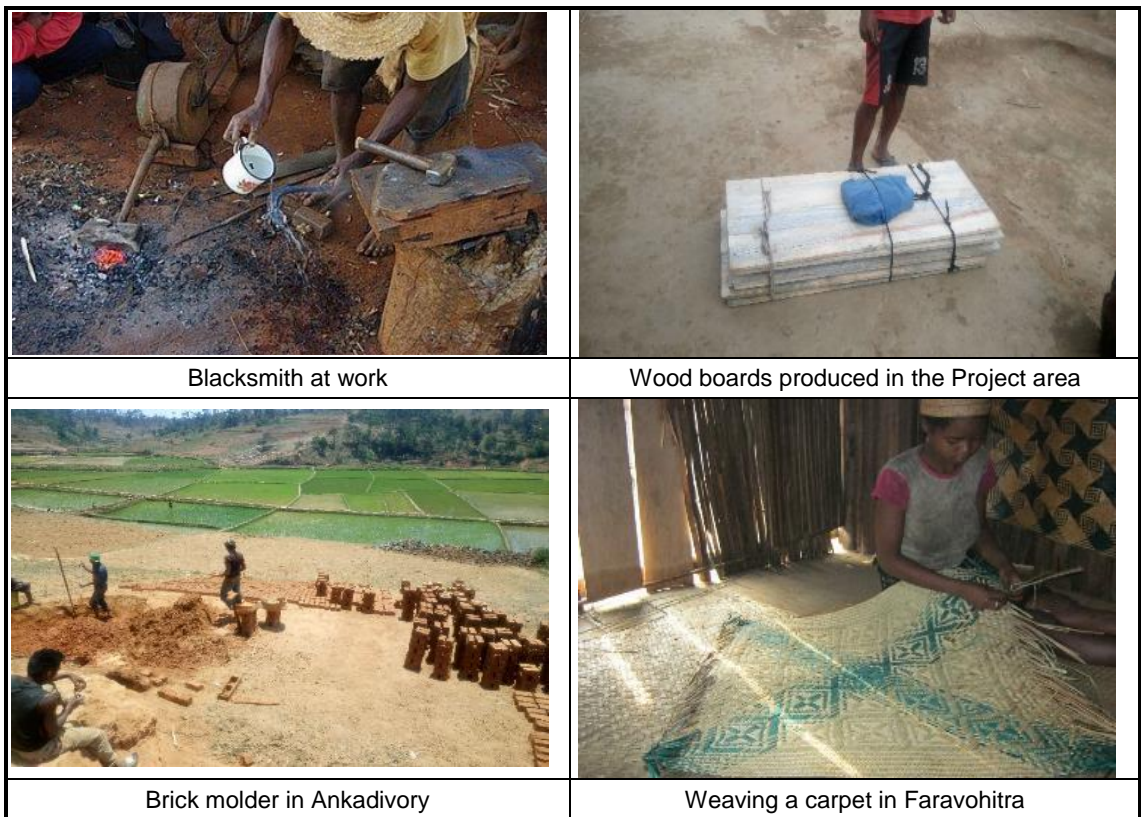

4.2.11.2 Mining Activities

In the Project area, several mine pitheads of various statuses were found:

Two operating permits, one for small operators and research permits are located along the access road and on the resettlement site areas (Sources: BCMM 01/2019).

These mine tiles are presented in the map below.

Figure 34 - Mining Permit Location Map

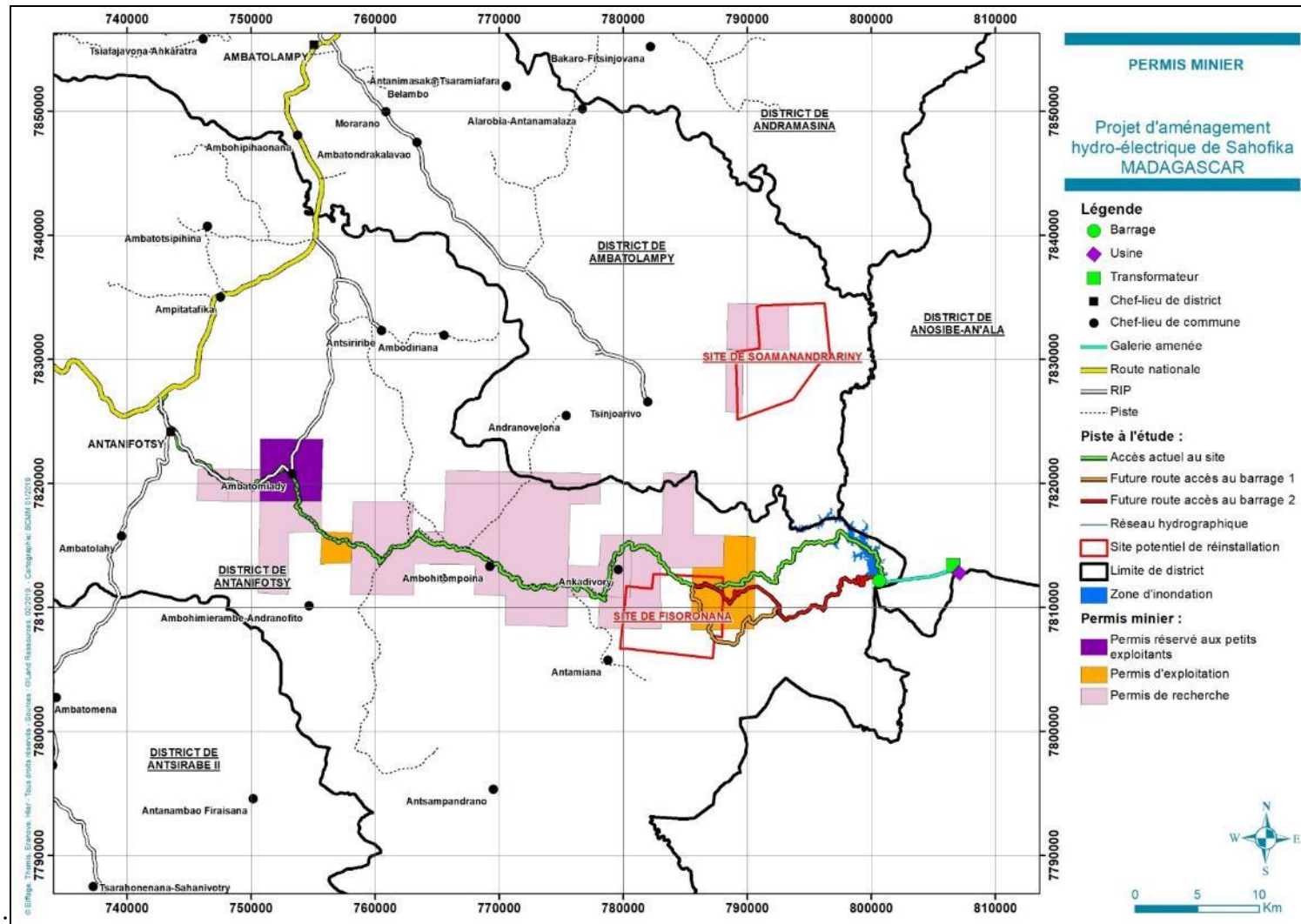

The main mining products exploited in the area are presented in Table 47.

Table 42 - Major Mining Commodities in the Study Area

Types of products	Extraction Area	Quantity of Products/Year	Destination of the Product
Gold	Along the Onive River On the tanety (hill, vast herbaceous area...) Belanitra, Ankadivory, Fisoronana, Ambohitompoina, Tsinjoarivo, Befotaka, Faravohitra (Mandroalina),	48 kg*	Local market (Befotaka, Ambohitompoina) and foreign market in Antananarivo
Sapphire	In the area from Faravohitra to Marolambo	Not defined	Sri Lankan collector in Ambohitompoina

(*) Source: Local gold market in Ambohitompoina (every Friday)

With respect to artisanal gold mining, operators were classified in accordance with the density of their production unit and the nature of the function performed on the site. Thus, “large operators”, “small operators” and “workers” were identified.

Large Gold Panners

This term does not refer to mass or industrial mining. It refers to artisanal mining, but with a higher production.

These are gold panners who have the production tools and a fairly high working capital. This capital allows them to hire workers in their production unit. On average, ten (10) to twelve (12) workers are required to work for this type of operator. They are paid daily at the end of their shift. Operators often have their children on school vacation or unemployed to help them in their work. According to them, using their own children to work on the sites is more beneficial because, under these conditions, the money stays in the family. We have identified approximately fifteen (15) large regular operators in the Project’s area of influence. Only one (1) in Ankadivory has a motor pump that supplies them with gold washing water. To search for gold, these gold panners generally use the panning method, and no chemicals (such as mercury).

Photo 24 - Gold Mining



Facility of a large abandoned gold mine in Ankadivory

Children from Mandroalina searching for gold on the Onive River in Faravohitra

Source: Socio-economic Survey, October 2018

Small Gold Panners

The small gold panners form the largest group in number terms. They can be estimated at more than 10,000 people over the entire study area. However, it is difficult to provide an accurate estimate of their number. They are in greater numbers in the areas between Ambohitompoina and Befotaka.

Women are predominant in numbers in this category of gold panners, with housewives, widows, young girls, and food sellers involved in this activity. However, it is not uncommon to also see unemployed children, young people and men in this category of gold panners, sometimes entire families. Virtually none of these gold panners has a license.

Since they are unable to acquire the resources required for large-scale gold production, they are content to dig up the ground to search for stones or pick up those rejected by large gold panners.

Another method consists in basic washing of the stones by means of a calabash in the small dams that they build. Productions are small. Their daily profit is about 2 dg/day on average.

Daily Workers

These people work for the "large gold panners" and are usually paid MGA 4,000/day. Their working day starts at 7:00 am and ends at 5:00 pm. This activity generally involves young people, heads of household or sometimes entire families.

Workers' tasks are often gender specific. Men are assigned to tasks that require a great deal of physical strength. Thus, they are responsible for digging up and washing the soil. Women are in charge of transporting the excavated soil and also for providing washing water. However, these positions are not fixed. Sometimes women wash up the soil or men take the soil to the washing point.

Daily employment as workers in artisanal production units is highly valued by the population. 15% of the gold panner population at various sites are involved in this type of work which gives them more confidence financially, since they are remunerated on a daily basis with or without production, unlike gold panners whose earnings depend on their daily production.

4.2.11.3 Tourism**Tourism Infrastructure**

The main factor in the development of the tourism sector is the availability of reception facilities. With respect to reception facilities, there is only one 30-room hotel in Antanifotsy, 2 cottages that can accommodate about 40 people in Tsinjoarivo and one 20-room hotel in Ambohitompoina. Therefore, the study area has a total of 50 hotel rooms and 2 cottages.

Catering is also rather underdeveloped, since there is no restaurant in the area that meets the required standards. In Tsinjoarivo, there are two (2) caterers with the capacity to cater for around 100 people. In Antanifotsy, there are three (3) professional caterers who can handle Malagasy or Western meal orders.

Tourist Sites in the Project Area

The Project's area of influence is rich in potential tourist sites, most of which are still untapped or are difficult to exploit because they are difficult to access.

Marolambo Park is currently managed by MNP, and the Tsinjoarivo NPA is being developed by the Sadabe NGO. However, these protected areas, as they currently stand, do not attract a large number of tourists for the reason mentioned above. The area will have considerable potential once tracks are rehabilitated for the purpose of the Project, due to their proximity to the capital Antananarivo.

In the Faravohitra area, there are waterfalls and a cave along the Onive. These are untapped potential tourist sites.

Tsinjoarivo Site

This destination, which is on UNESCO's Tentative World Heritage List, consists of waterfalls, cascades, a royal house or Rova and hiking trails (<http://www.macp.gov.mg/blog/patrimoine-tsinjoarivo/>).

However, tourist activity remains limited because only a few foreign tourists come to visit the site each year, along with Malagasy historians and students occasionally on a research visit.

Photo 25 - Tsinjoarivo Tourist Site (The Rova and the waterfall)

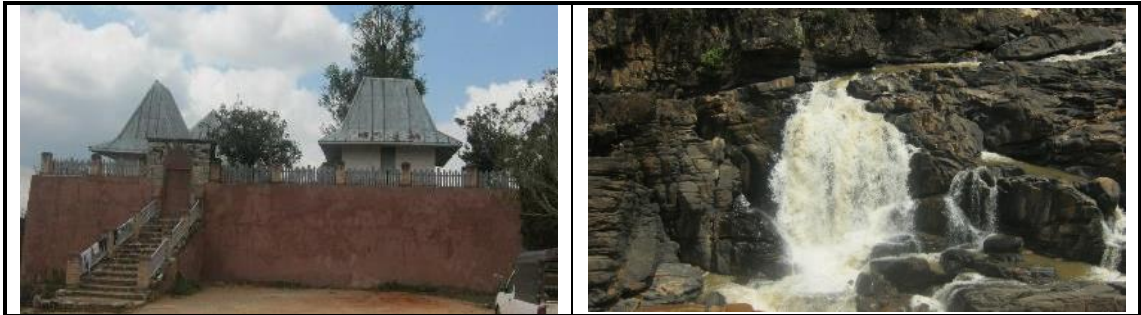

Source: Socio-economic Survey, October 2018

Ambohitompoina

"Ambohitompoina" means the "Rituals Mountain". This site has a place of ritual (on the way out of the village in the direction of Belanitra) where worshippers, including descendants of the royal family, organize, every year, a worship event during which a zebu is sacrificed. There is also a place in Ambohitompoina (an hour's walk away) called Ambohijatovo: this is a sacred hill where everyone can make a sacrifice in order to fulfill a wish. It is also an excursion destination for locals (Easter Monday picnic, etc.) thanks to its green landscape and natural waterfall.

These forms of traditional cultures can attract tourists, but some of the cults are isolated and prohibited to people from the outside.

4.2.11.4 Trade and Services

Main Commercial Activities

The residential economy (mainly personal services, retail trade, agricultural mutual aid activities, as well as administered services, mainly education, health and social work) is largely predominant in the study area. The education-health-social welfare sector offers by far the most numerous services jobs (6% of jobs, mainly in the “intermediate professions” and “employees” categories). Agriculture (74% of jobs, mainly farmers), micro-retailers, administrative and building services are the primary sectors of industry in the study area.

Photo 26 - A farming household in Antambohomena selling pastries in the neighborhood



With the exception of a few gold facilities in Ankadivory (not operational since 2013), Tsinoarivo (still operational), wood processing units (in Ambohitompoina and Antanifotsy) and a dairy plant in Antanifotsy, agriculture and the tertiary sector are more prominent, in the study area, than the almost non-existent secondary industrial sector.

Photo 27 - An Informal Seller of “Paraky Gasy” (tobacco) on the Befotaka Market Day



Market Days

The market day is the only day when all merchants gather at the same place to sell staple products that are essential for the local population. These are foodstuffs (rice, beans, manioc, dried fish), electronic tools (radio, telephone, USB key for music), clothes, etc.

The market day is also a time to meet people and a place to exchange ideas.

Faravohitra-Sahofika's market day is Wednesday. All the merchants in the area (from Befotaka or Marolambo and even from very remote places such as Ambatolampy and Faratsiho) gather there for business. Most of the goods consist of Toaka gasy (local rum), rice, zebu meat, PPNs and small electronic devices.

Photo 28 – The Faravohitra-Sahofika Market



Table 43 - Market Days in the Study Area

Village	Day
Sahofika / Faravohitra	Wednesday
Befotaka	Thursday
Belanitra	Monday
Ambohitompoina	Friday
Antanifotsy	Monday
Tsinjoarivo	Thursday

Source: Socio-economic Survey, October 2018

Shops and Services Available

The services currently available in the area are presented in the table below. Modern services such as Internet or document printing are non-existent in the Project area. Multimedia services such as satellite television are widespread throughout the area, even in Antenina.

Table 44 - Main services Available in the Project's Area of Influence

Location	Main Shops and Services Available
Antanifotsy	Photocopying, small restaurant and grocery, catering (Malagasy and European cuisine), health center (hospital), veterinary, education (primary, secondary), vocational training, public administration at municipal and district levels, microfinance (otiv and cecam), hairdressing, post office, motorcycle taxi, truck freight transport, passenger transport (bush taxi), carpentry, hotel, electricity, Public Security (Police), Social Action (Vahatra, NGO), market.
Ambohitompoina	Small restaurant and grocery store, health center (CSB), veterinary, education (primary, secondary), land office, microfinance (Cecam), hairdressing, post office, motorcycle taxi, carpentry, decorator, hotel, market, public administration at municipal level
Ambatomiady	Small restaurant and grocery store, health center (CSB), Veterinary, Education (Primary, Secondary), land office, microfinance (Cecam), hairdressing, post office, motorcycle taxi, public administration at the municipal level, market
Tsinjoarivo	small restaurant and grocery, caterer (various cuisines), health centre (CSB), Veterinary, Education (primary, secondary), Land office, Microfinance (Cecam),

	hairdressing, post office, motorcycle taxi, decorator, hotel, public administration at commune level, market
Belanitra	Small restaurant and grocery store, caterer (various kitchens), health center (CSB), Education (Primary, Secondary), Land Office, Public Administration At The Communal Level, Market
Befotaka	Community health center, education (primary), walking freight transport.
Faravohitra	Education (primary), freight transport on foot.

Source: Socio-economic Survey, October 2018

4.2.12 Employment and Working Conditions

There is a very high degree of heterogeneity in employment and working conditions in the Study Area. Almost all income-generating activities carried out by households fall within the scope of the informal sector. Some households (from rentier families or with a monopoly) can generate good incomes, but the majority of the working population has limited incomes and livelihoods from the exploitation of natural resources.

Local employment is characterized by very precarious working conditions.

Employment in the area consists of micro-units, with an average size of 1.4 jobs per unit. Self-employment is the most common form of employment, which reflects the fragmentation of household activities: seven (7) out of ten (10) households have a single employee who is the head of the household himself supported by his wife and children.

Photo 29 - Transporting Goods on Foot to the Faravohitra-Sahofika Market



Employment in the area is characterized by a virtually non-existent social protection system, except for civil servants and those in formal employment with external organizations operating in the area.

People work an average of 36 hours per week and the standard daily salary/income in the area is between MGA 4,000 and 5,000 per day. This is the norm in rural areas. The 36 hours per week are calculated on the basis of a daily work week of 6 to 7 hours from Monday to Saturday morning. Workers typically wake up at 5 or 6 a.m. to start work at around 7 or 8 a.m. and return home at 4 p.m. with a lunch break of about 1 hour. However, this function may change with the seasons (in the rainy season, workers leave earlier in order to avoid afternoon rains and, in the dry season, the lunch break is longer because of the heat).

Road conditions are clearly a stumbling block for transport activities and therefore for the economy as a whole. The area's landlocked nature impedes the labor market and the

long walks for pedestrian carriers reflect the difficult, poorly paid work that people engage in.

4.2.12.1 The Labor Market

The labor market in the Study Area does not have a unified structure but is segmented into four (4) markets:

- Traditional rural employment (agriculture and livestock)
- Informal employment
- Formal employment (private and public)
- Temporary employment

Despite the occupation rate of the working population, job quality remains a major issue: 92% of total jobs are vulnerable jobs, i.e. jobs that do not include any minimum social security or worker health care measures.

Pedestrian goods carriers are by far the most exposed to the risks of injury and diseases such as dry cough, general fatigue, sciatica, etc. The mortality rate due to occupational accidents is high and is exacerbated by the fact that the distance to reach a basic health center only increases risks.

Table 45 - Socio-Professional Categories of the Households Surveyed

Main Activity	Number of People
Farmer	74%
Teacher	9%
Trader	7%
Doctor, Pastor / Priest / Catechist, Craftsman, Constable / Police / Military, Office employee	4%
Carpenter	3%
No activity	2%
Retired (e)	1%
Total	100%

Source: Socio-economic Survey, October 2018

The virtual non-existence of industrial installations and service companies in the area means that the skills required to perform demanding professional work are hardly available on the local market.

In areas such as agriculture where local people are competent, the productivity rate remains low compared to the national average. This is due to a lack of education and, more specifically, to poor access to innovations by practitioners.

Regarding new emerging activities, it is worth noting that the numerous social and infrastructure projects in the region provide an opportunity for young local motorcyclists who are experiencing a significant new source of income by carrying passengers on tracks that are often impassable for other vehicles.

Overall, the unstable nature of work in rural areas seems to cause workers to engage in other activities in parallel with their agricultural work. Indeed, almost 99% of the households surveyed say they are engaged in other activities (excluding agriculture).

4.2.13 Household Income and Expenditure

4.2.13.1 Households Living below the Poverty Line

The vast majority of households live below the poverty line.

The average income was estimated from the monetary income of each household surveyed. The households classified as “poor” are those whose annual monetary income does not meet the threshold of 2 PPP dollars per day (about MGA 7,000/d or MGA 2,520,000 /year). It should be noted that in rural areas such as the Project’s area of influence, most households earn less than MGA 10,000 per day.

Out of the total number of households approached in the area of influence, 84% have monetary incomes of MGA 7,000 / day (2 PPP³ dollars) or less, and can therefore be classified as “poor”.

Table 46 - Household Monetary Income Table

Annual Household Income	%
Less than MGA 500,000	17.3
[MGA 500,000 – MGA 1,000,000]	38.1
[MGA 1,000,000 – MGA 4,000,000]	31.2
[MGA 4,000,000 – MGA 8,000,000]	10.7
[MGA 8,000,000 – MGA 12,000,000]	2.7
+ more than MGA 12,000,000	1.3
Annual Household Income	%

Source: Socio-economic Survey, October 2018

The above table shows that more than 1/3 of the total number of people selected have annual incomes ranging from MGA 500,000 to MGA 1,000,000. These people are classified as households living in poverty because the normal poverty threshold is under MGA 2,520,000 per year.

Nevertheless, it was noted that there are few people who can earn more than MGA 12,000,000 per year, which is more than 12 times the income of the majority.

Households with an income of less than MGA 500,000/year (17% of the population surveyed) live in extreme poverty, their activities allowing them only to survive with the strict minimum.

4.2.13.2 Households' Income

Women account for 53% of the income-generating people in the households surveyed. Therefore, they are more active in terms of financial contributions to households. This can be attributed to the large number of single women (heads of household) combined with married women who also contribute to household incomes.

Table 47 - Gender-based Distribution of Income-generating People

Commune	Men	Women	Total
Ambatomiady	50%	50%	100%

³ PPP Dollar = Purchasing Power Parity dollar, World Bank 2015

Ambohitompoina	44%	56%	100%
Belanitra	49%	51%	100%
Antanifotsy	45%	55%	100%
Ambalaomby	60%	40%	100%
Tsinjoarivo	44%	56%	100%
Entire area	47%	53%	100%

Source: Socio-economic Survey, October 2018

Table 53 summarizes economic activities and income generated based on workload.

Table 48 - Income Generated by Type of Economic Activity

Type of work	Effort	Gross Income Generated	Related Expenditure	Remarks
Tanety farming	60 to 70 working days per year	MGA 1,700,000 to 2,800,000/ha	MGA 600,000/ha	Work on <i>Tavy</i> with laborers
Irrigated agriculture	40 to 50 working days per year	MGA 2,800,000 to 3,700,000/ha	MGA 1,300,000 MGA/ha	Traditional method
Cattle breeding	30 working days/year	MGA 900,000/zebu	MGA 100,000/zébu	Working day calculated on the basis of zebu occupancy, i.e. 2H/D. Income equivalent to the selling price of an adult zebu.
Pig farming	45 working days/year	MGA 630,000/pig	MGA 240,000/pig	Occupancy of a pig equivalent to 3H/D. Purchase of feed for a pig equivalent to MGA 1000/D.
Fish farming	26 working days/year	MGA 2,000,000 to 3,200,000/basin	MGA 600,000/basin	This expenditure only concerns the purchase of fry and pond development. The food consists of worms produced by natural fermentation.
Carrier	260 days/year	MGA 2,560,000/year	MGA 800,000/year	Income equivalent to MGA 50,000 per week. Food-related expenditure is MGA 25,000/week
Motorcycle taxi	60 days/year	MGA 5,400,000/year	MGA 2,200,000/year	Fuel expenses and maintenance. Income calculated on the basis of MGA 90,000/day.
Teacher	250 days/year	MGA 3,600,000/year	MGA 180,000/year	Expense related to the purchase of supplies and teaching materials (5% of income)
Physician	270 days/year	MGA 7,200,000/year	MGA 2,160,000/year	A doctor earns about MGA 20,000/day.
Gold panner	120 working days/year	MGA 2,400,000/year	MGA 300,000/year	Based on 1.5 g of gold found per week. (smallholders' income)

Source: Socio-economic Survey, October 2018 - 1 EUR = 4000 MGA

4.2.13.3 Household Expenditure Management

Households can purchase essential products for their daily needs (soap, oil, salt, sugar, coffee, etc.) by selling surplus food produce. However, families are often forced to sell their stocks even if they are insufficient for a whole year. The proceeds from these sales are used either to pay for daily essentials or to pay for school fees, medicines, etc., and to buy the food they need during the lean season (November to January), when rice prices are at their highest.

It is generally from August that the difficult period begins, i.e. households have exhausted their agricultural production stock, and are developing strategies for economic “survival”. Large-scale rice cultivation activities also begin during this period (plowing, breaking up the soil, pricking out). This is a very difficult time for most of the population in Madagascar. Larger farmers with large stocks in excess of their own consumption can afford to sell their production during this period for a very advantageous price. Food is the largest item of household expenditure in the study area.

Table 49 - Categorization of Average Annual Household Expenditures

Expenditure Item	Amount (MGA)	%
Power supply	1,042,722	38
Transportation	244,705	10
Housing	242,118	9
Agricultural inputs (seed, fertilizer and pesticide)	340,000	12
Health	134,816	5
Social duties	106,198	4
Drinking water supply	92,975	3
Education	276,883	10
Clothing	87,609	3
Others	160,000	6
Total	2,728,026	100

Source: Socio-economic Survey, October 2018

Food and agricultural inputs are the largest expenditure items for the households surveyed in the Project’s area of influence. Throughout the year, 12% of a household’s expenses are spent on agricultural inputs such as chemical fertilizers or herbicides.

Politrine, which is distributed by Solevo Madagascar and AGRIVET following a standard distribution chain (importer, wholesaler, retailer and sales kiosk and local point of sale), accounts for 99% of the pesticides used. They are mainly used in rice farming and market gardening. There is no support or information on the risks associated with their use.

4.2.14 Vulnerabilities

Considering the environment of poverty and isolation that characterizes the Project area, vulnerable individuals and groups need to be given careful attention to avoid being more severely impacted and to ensure that they have access to the special benefits or attention that their condition requires.

The IFC and AfDB define vulnerability as follows: a person or group may be disadvantaged or vulnerable on grounds such as race, color, sex, language, religion, political or other opinion, national or social origin, property, birth or other status. Consideration should also be given to factors such as gender, age, ethnicity, culture, literacy, health status, physical or mental disability, poverty or economic disadvantage, as well as exclusive dependence on natural resources

Based on this definition, which is broad in scope in relation to the Project area, the following people should be classified as vulnerable:

- People with chronic and mental illness and people with disabilities, estimated at less than 5% in the study area.
- The elderly (>65 years of age) representing only 3% of the population according to the results of household sample surveys in the Project's area of influence.
- Women heads of household, widows, divorced women whose vulnerability is linked to the absence or weakness of the support they receive; they are estimated at 11% of the population.
- Families (households) whose head is destitute or almost destitute and therefore live in extreme poverty. 38% reported an annual income of less than MGA 1,000,000
- Literacy: 9% of the working population is out of school

4.2.15 Main Water-related Activities

4.2.15.1 Surface Water Use

Surface water uses are similar upstream and downstream from the area where the dam will be built. The following table provides information on the frequency of use of the Onive River.

Table 50 - Type and Level of Use of the Onive River

Utilization	Upstream Area	Downstream Area
Domestic use (washing, showering, etc.)	++	++++
Consumption	-	-
Fishing	+	++
Aquaculture	-	+
Channel irrigation	-	+++
Watering of agricultural production	++	++
Gold mining	++	+++
Livestock watering	-	+

Source: Socio-economic Survey, October 2018

The river is an important social and recreational place. It is a swimming place for some. For women, it is a place where they perform their everyday chores (washing up or laundry) and a workplace for gold miners or fishermen.

Midday is the time with the highest number of people using the water points; children rush in as soon as they leave school; farmers take a break because it is too hot to work in the fields. Women go there to fetch water for cooking.

The main economic activities directly linked to the Onive River are gold panning, which is the most widespread, and fishing. Agriculture, and irrigated agriculture in particular, depend on the river's tributaries. As far as non-irrigated agriculture is concerned, market gardening requires regular watering outside the rainy season.

As far as pastoral activities are concerned, herdsman shepherd their zebus or herds to the river to water them.

Photo 30 - Daily Activities on the Onive River



Source: Socio-economic Survey, October 2018

4.2.15.2 Groundwater Use

Groundwater is used through wells and mountain water sources. Village wells are used for drinking water and for other daily purposes. A well usually belongs to one household but is used by several families.

There are two types of well: (i) A natural well, located in the valleys, which people use to fetch water for drinking and for other daily purposes, and also to water crop fields, or (ii) a dug well, generally located inside the village, built by villagers seeking groundwater through manual drilling.

Photo 31 - A natural well near crop fields



4.2.16 Social Context of the Dam Site

The proposed dam site is uninhabited, but there are a few houses on the left bank overlooking the dam and the area upstream from its axis. During the Project preparation period, a temporary camp was installed near the proposed dam axis to allow experts hired by the Project to conduct preliminary studies (geology, hydrology, environment, social, etc...).

The establishment of the temporary camp (whose presence was limited to the 2018 dry season) attracted a section of the local population looking for potential employment at the Project site or to set up a business nearby, and a new temporary social structure quickly

emerged. It is described here because it illustrates, on a small scale, the social phenomena that will occur around the Sahofika Project site during the construction phase.

4.2.16.1 Creation of a Market near the Camp

A temporary market quickly appeared in the vicinity of the Project’s temporary camp. About twenty grocery stands and small restaurants were created within one (1) month. These places were generally run by women from nearby hamlets (Antenina and Faravohitra).

Photo 32 – A Temporary market near the temporary camp



4.2.16.2 Concentration of Job Seekers at the Dam Site

People looking for jobs related to opportunities generated by the construction works were observed at the market near the temporary camp. They were generally men from nearby villages (Faravohitra, Sahofika, Antenina, Ankazomena, etc.) or sometimes from remote areas (Ambalaomby, Belanitra, Ambohitompoina, etc.). They were waiting for opportunities while working in the market.

Photo 33 - Job seekers at the Market near the Camp



4.2.16.3 Temporary Job Creation

The presence of the temporary camp has generated a limited number (due to its small size) of direct and indirect jobs such as:

- Services for project staff and workers installed in or passing through the temporary camp: cooking, cleaning, laundry, etc. This activity was mainly carried out by women from neighboring hamlets (Antenina and Faravohitra)
- Trade: The establishment of the market can have negative impacts (risks related to alcohol, violence, and prostitution) but it generates employment and at least a temporary source of income.
- Temporary work in the camp: this is generally about the transportation (carrying) of objects/materials, requested by the Project workers and staff.

Photo 34 - A group of women doing their laundry near the temporary camp



4.2.17 Cultural and Religious Heritage

4.2.17.1 Local Practices

Generally, families in the study area are nuclear-type families with a father, a wife and their children. This is a traditional society, where almost 90% of the population follows and practices local customs and habits specific to each region. The Project's area of influence is a rural area, with populations predominantly of the "Merina" and "Betsimisaraka" ethnic groups who practice the activities and practices encountered in the rural areas of the Highlands and the Betsimisaraka.

Community or village meetings are common in each *fokontany* and are called "Fivoriam-pokolona" or "Fivoriam-pokontany". All men and women over 18 years of age must attend these meetings during which decisions are taken by a majority of votes cast by a show of hands.

Several forms of social practices were noted in the Project's area of influence, including the following:

- The Dina consists in enforcing a rule in a village. Anyone who breaches this rule must pay a predefined amount of money depending on the offence. Nevertheless, this form of customary law is currently beginning to disappear in the area due to interference with legal rights and local collective consensuses;
- Circumcision;
- Traditional weddings;
- Village festivals;
- The second funeral, “Manala-Voady” (offering a meal in charity when a previously announced promise is kept);
- *Fady*” or taboos are common customary practices observed in the regions of Vainankaratra and Alaotra Mangoro;
- The turning of the dead or “Famadiana” (Exhumation);
- Various traditional beliefs and practices such as “Vatolahy”: The Vatolahy is a stele to which people are attached by faith. This practice is observed in particular in the Alaotra Mangoro region. Depending on the location, shape and inclination, these erected stones convey messages or take on certain meanings;
- The blue color: a particular attachment to this color has been observed in the area. A large majority of the residential houses in the Fisoronana to Ambatomiady have something in blue.

Photo 35 - A house in the village of Fisoronana



4.2.17.2 The *Fady* or Taboo

In the Betsimisaraka area, the most notorious aspect concerns the “*Fady* days” and other taboos that can impede development actions. For example, working the land is prohibited on three (3) days of the week, Tuesday, Thursday and Sunday.

On the Merina side, in Antsahondra, it is forbidden to wash one’s head with irrigation water in rice fields. This is a special practice, but is respected by the locals.

In Belanitra, it was noted that it is forbidden to collect or work on stones during the rice grain hatching period or “Tera-bary”. It is also prohibited to practice “Famamo” or go fishing by sending toxic products or using nets or “harato”. It is also forbidden to light the river on the Belanitra Bridge.

All sacred places have their “*Fady*” respected by the local population (practicing or not).

Table 56 presents the *Fady* that are relevant to the Project and should be respected by all.

Table 51 - *Fady* or “Prohibitions” in the Project Area

Section	Fady (or “Prohibition”)	Note
Antanifotsy - Antananarivo	Pigs are prohibited in all sacred sites	Important to be abided by
	It is forbidden to bring garlic and chives into the granite quarries of Ambohimasimbola (CR Soalandy).	Important to be abided by
	It is forbidden to bring garlic and goats into the <i>fokontany</i> of Antalaho (Androhibe).	Important to be abided by
	Profaning sacred places (<i>Doany</i> , vatolampy, sacred tree)	Important to be abided by
	Stone cutting in the rainy season	
Faravohitra - Antanifotsy	Wearing the red color on the Onive River	
	Profaning sacred places (<i>Doany</i> , vatolampy, sacred tree), valid for Merina and Betsimisaraka (for example, do not urinate in the surroundings)	Important to be abided by
	Insulting sacred places, ancestors and “Mpita-hazomanga” (<i>Raiamandreny</i> and <i>Tangalamena</i>)	Important to be abided by
	Provision of white onions and pork meat next to the sacred sites of Betsimisaraka (<i>Doany</i> , Tsangambato, Tomb)	Important to be abided by
	Working the land on Tuesday in the Betsimisaraka (Sahofika) part	This normally applies to agricultural work but a discussion with the “ <i>notables</i> ” [dignitaries] of the village is recommended before the works start
	Extraction, collection and processing of stones during the hatching period of rice grains or “Tera-bary” (Merina part)	
	Going out and walking around the village after 7 pm (Befotaka to Sahofika)	Important to be abided by
	Lighting the rivers on the Belanitra bridge	Important to be abided by
	Washing your head with irrigation water in the rice field (Ambohitompoina, Antsahondra)	
	Using nets and toxic products to capture fish (Merina and Betsimisaraka)	
	Pointing your finger at something (mountain, tomb) or someone, you have to bend it before pointing it.	
	Placing an uncircumcised child (boy) on your shoulders.	
	Trampling on the “ <i>fandambanana</i> ” or “artisanal mat” reserved for plates during meals (one must be careful about his, especially in the Betsimisaraka part)	Important to be abided by if you are invited to a home
	Refusing to accept invitations to meals when requested by a home	This is a symbol of courtesy and should be respected as much as possible to maintain good relations with the local population
	<ul style="list-style-type: none"> ● Insults in public ● Flirting with married women ● “Games” involving money 	This is a request made by the population of the dam and reservoir area

4.2.17.3 Tangible Heritage

At the end of the heritage survey in the Project’s area of influence, more than twenty cultural sites of varying importance were observed in various areas. The various sites inventoried include “*Doany*” (traditional places of worship), tombs, places of remembrance, archaeological sites, natural heritage (protected areas).

The table below summarizes the heritage and cultural value of each site.

Table 52 - Survey of Tangible Heritage in the Area of Influence

	Name	Location	Value according to locals	Classification
1	Ambodifanto	Antenina	Important	<i>Doany</i>
2	Ankorohoro	Antenina	Important	<i>Doany</i>
3	Vatomasina 01	Antenina Ambony	Moderate	<i>Doany</i>
4	Vatomasina 02	Antenina Ambony	Moderate	<i>Doany</i>
5	Vatomasina 03	Antenina Ambony	Moderate	<i>Doany</i>
6	Ambatofolaka	Faravohitra	Moderate	<i>Doany</i>
7	Faditra / Jiro	Faravohitra	Moderate	<i>Doany</i>
8	Tsangambato	Faravohitra	Important	Remembrance place
9	Tsangambato	Faravohitra	Important	Remembrance place
10	Shrine (on the side of a mountain)	Faravohitra	Important	Shrine
11	Shrine (Valley)	Faravohitra	Important	Shrine
12	Tsangambato 01	Faravohitra	Important	Remembrance place
13	Tsangambato 02	Sahofika	Important	Remembrance place
14	Shrine	Sahofika Tsena	Important	Shrine
15	Ambatotsipihina	Ambatotsipihina	Low	<i>Doany</i>
16	Ambatotsipihina (Fasana)	Ambatotsipihina	Important	Shrine
17	Andohasaha	Ambohitompoina	Moderate	<i>Doany</i>
18	Trano Tany / Hazo Mandeharà	Ambohitompoina	Important	<i>Doany</i>
19	Amboidahy	Befotaka	Low	<i>Doany</i>
20	Ankoromaka	Befotaka	Low	<i>Doany</i>
21	Tampon'i Fisoronana	Fisoronana	Important	<i>Doany</i>
22	Vohitrarivo	Vohitrarivo	Important	Archaeological site
23	Anosimasina	Tsinjoarivo	Important	Archaeological site
24	Mahalavaolona	Tsinjoarivo	Important	<i>Doany</i>
25	Ampasambazimba	Ankazoambo	Moderate	<i>Doany</i>
26	Vato masina	Analavory	Moderate	<i>Doany</i>
27	Ambatomitsangana	Ambatomitsangana	Important	<i>Doany</i>
28	Marolambo protected area	Belanitra and Ambohitompoina	Medium	Natural heritage

Source: Socio-economic Survey, October 2018

Doany represent the majority of the sites located and inventoried during the survey. *Doany* are the sanctuaries of traditional cults in Madagascar. These places are very present in rural areas, as is the case in the Project area. It is important to note that the *Doany* here are in their simplest form: a stone, a tree stump or a mound.

The "Fisokina", which are poles or posts with zebu skulls at the top, are monuments honoring ancestors. Betsimisaraka communities have numerous sacred places where ancestors are honored.

Photo 36 - Survey of Tangible Heritage in the Area of Influence



According to the surveys, sixteen (16) out of the twenty-seven (27) sites listed or 60% are important to the respondents. In terms of geographical distribution, seven (7) “important” sites are located between Faravohitra and Sahofika and three (3) are located in the vicinity of Antenina.

This table also shows that the *Doany* located in the vicinity of Antenina Ambony are all classified as of “average” value, because they are revered by only a small community. They are likely to be submerged by the waters.

In the context of the Project, the *Doany* of the Befotaka *fokontany*, are classified as of “low” value because they are far from the area to be directly impacted and because they have lost almost all interest in the eyes of the local population.

Figure 35 - Cultural/Heritage Sites Location Map

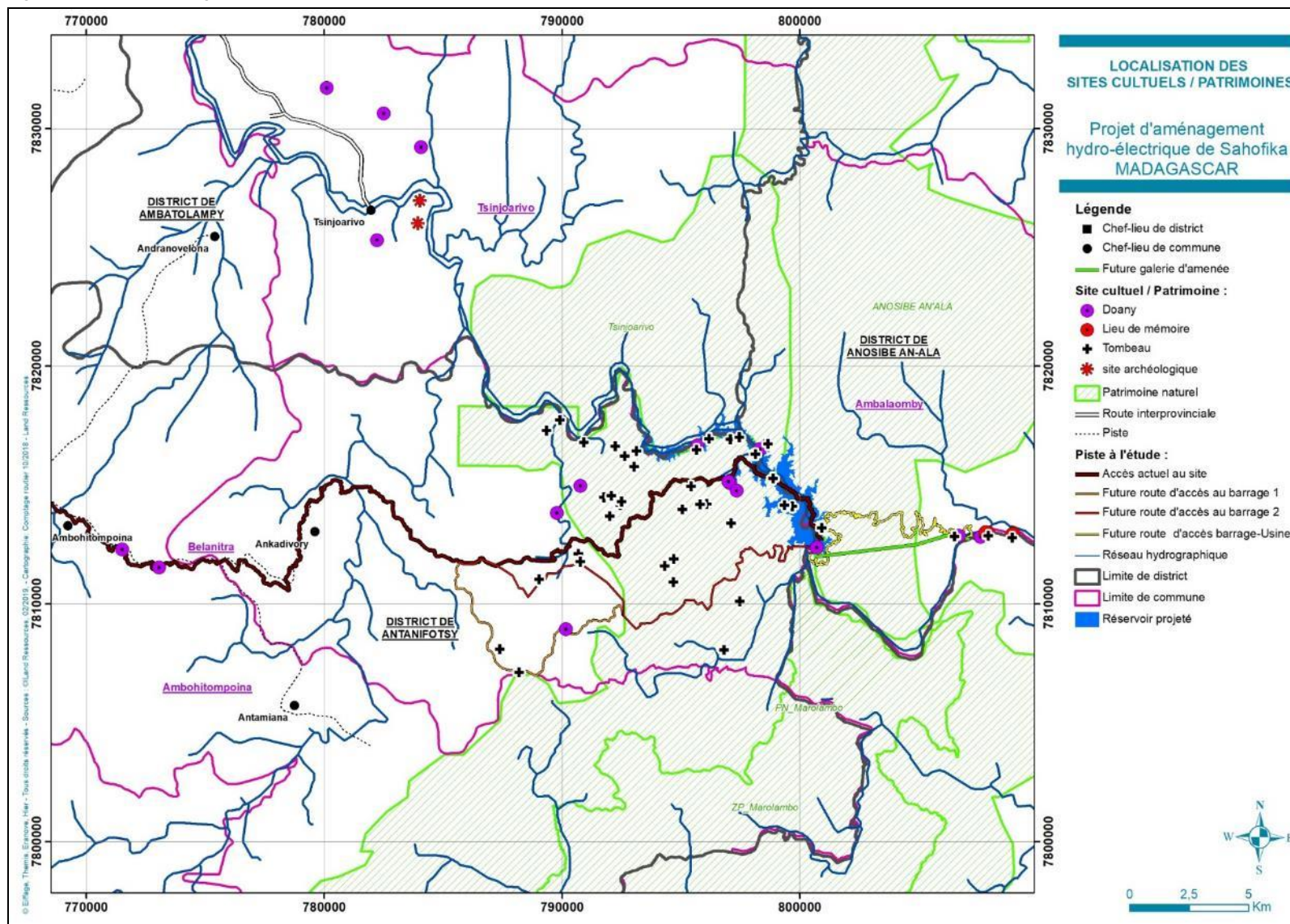

4.2.17.4 The “Avan-Drazana” in the Betsimisaraka Communities

The “Avan-Drazana” is a gathering moment in which families from remote areas are invited to clean and rehabilitate family shrines. The event usually takes place once a year from November 1 and lasts for a week, but is not mandatory as the family can organize it on any date of their choice.

The celebration takes place in the village and involves everyone, but those who go and clean the tombs are also entitled to a jerrycan of alcohol (20 to 50 liters for a dozen men). It should be noted that only men can go to the shrines to clean them up. Women wait in the village where the festival takes place.

Photo 37 - “Avan-drazana”



At the shrine, before starting the cleaning work, the traditional chief or Tangalamena speaks and asks the ancestors for permission to perform the cleaning. It is only after he has performed a ritual process that the cleaning can begin.

4.2.17.5 The “Famadihana” (exhumation)

This practice is widespread across the study area, especially in the Vakinankaratra region. It consists in returning the dead and replacing the fabrics wrapping up their bodies. This a special vision of the dead. According to local dignitaries, “Famadihana” means that when a person dies, they are called a deceased person. Then a time comes when the whole family decides to take the body back and elevate it to the rank of *Razana* or ancestor; this is what is called “Famadihana” or the turning of the dead, i.e. turn the person’s body over so that they become a *Razana* or ancestor.

This is an event where people celebrate and rejoice and is seen as a reunion with the lost ones. Before a person’s remains are placed back in the shrine and a speech is given in their memory, they will be walked around it seven times.

This ritual requires a great deal of preparation and, above all, a large amount of money because the principle is to invite the whole population of the village in addition to the extended family. The expenses are covered by the family of the dead.

Photo 38 - A Famadihana (exhumation) ceremony in the Vakinankaratra region



4.2.17.6 Circumcision

For residents in the study area, an uncircumcised adult is not considered a real man. The purpose of circumcision is therefore to turn boys into men, and to clean impurity supposedly acquired from birth. This practice also echoes that of certain religions such as Christianity whose adepts are numerous in the study area. It takes place mainly during the southern winter (from May to July).

Photo 39 - A child at the time of circumcision wearing the traditional Malagasy dress: the Malabary



Source: Vozama, 2018

4.2.17.7 Marriage

Traditional Malagasy marriage is highly codified and the couple must respect each step for the union to be declared legitimate by the community. In the study area, this traditional form is still maintained by some families, especially families on the “Merina” side who have the means to maintain it (middle class and rich).

People in economic difficulty abandon this form of marriage and chose a simpler way to get married in order to reduce expenses, but usually always in an official way (legal marriage).

First step: the “Fiantranoana”

This phase of the Malagasy marriage is hardly practiced these days, especially in urban areas. During the “fiantranoana”, the suitor’s family goes to the bride’s home to ask the bride’s family for permission to come and propose to her on a different day. In the city, it is replaced by the arrival of the groom at the girl’s home to inform the parents that he and his family will come “to introduce themselves”.

Second step: the “Fisehoana” (presentations)

The suitor and his family come to introduce themselves to the bride’s family. The suitor expresses his love for the young girl and his intention to take her as his wife. For Malagasy people, it is very important to obtain the blessing of parents before a marriage is celebrated to avoid it being annulled.

Third step: the “vodiondry”

This is the most important step in traditional marriage. This is a phase of “negotiation” (often symbolic) between the families of the married couple.

Literally, the word vodiondry means “sheep’s rump”. This is the most tender and appreciated part of the sheep, and is reserved for elders during official ceremonies. This step is equivalent to “Engagement”.

Photo 40 - A traditional wedding in Belanitra

***Last steps: civil and religious marriage***

These are the last stages of the Malagasy marriage. In the past, these two steps did not exist. It was Western colonization that brought these practices into the country’s culture. However, these last two stages are becoming increasingly important for the younger generations.

4.2.18 **Analysis of Road Traffic in the Study Area**

Four (4) traffic metering sites have been installed on the access road between Antanifotsy and Faravohitra:

- Site 1: at the exit of Antanifotsy (Belanitra side) – Metering over a week 24/7
- Site 2: at the entrance of Belanitra - Metering over a week 24/7
- Site 3: at the exit of Belanitra, on the Onive bridge - Metering over a week 24/7
- Site 4: At the entrance of the village of Faravohitra - Metering over a week from 6 am to 7 pm

These sites are identified in Figure 37. Counting was carried out over a week, day and night, on an hourly basis and included pedestrian, cart, bicycle, motorcycle, car and passenger transport.

4.2.18.1 **Traffic counting at the exit of Antanifotsy (Site 1)**

Traffic from Antanifotsy to Belanitra (site 1)

Intermediate means of transport account for most of the traffic counted. In total, there are 5,535 of them, or 64.2% of the traffic. In this category, bicycles and rickshaws account for 3,889 or 45.1% of the total; motorcycles account for 1,316 or 15.3% of the total, and carts and *varamba* 330 or 3.8% of the total counted in this direction.

There are 2,952 pedestrians, representing 34.2% of the traffic.

Freight transport cars account for 88 or 1.02% of the traffic. In this category, trucks account for 84 or 0.97%, and other cars (pickup trucks, 4x4s, and vans) account for 4 or only 0.04% of the traffic in this direction.

Personnel transportation cars (light cars, vans and 4x4, minibuses, coaches and trucks) account for 34 or 0.39% of counted traffic only. No tractors and machinery were counted during the 7 days.

See Figure 38.

Figure 36 - Traffic Counting Sites Location Map

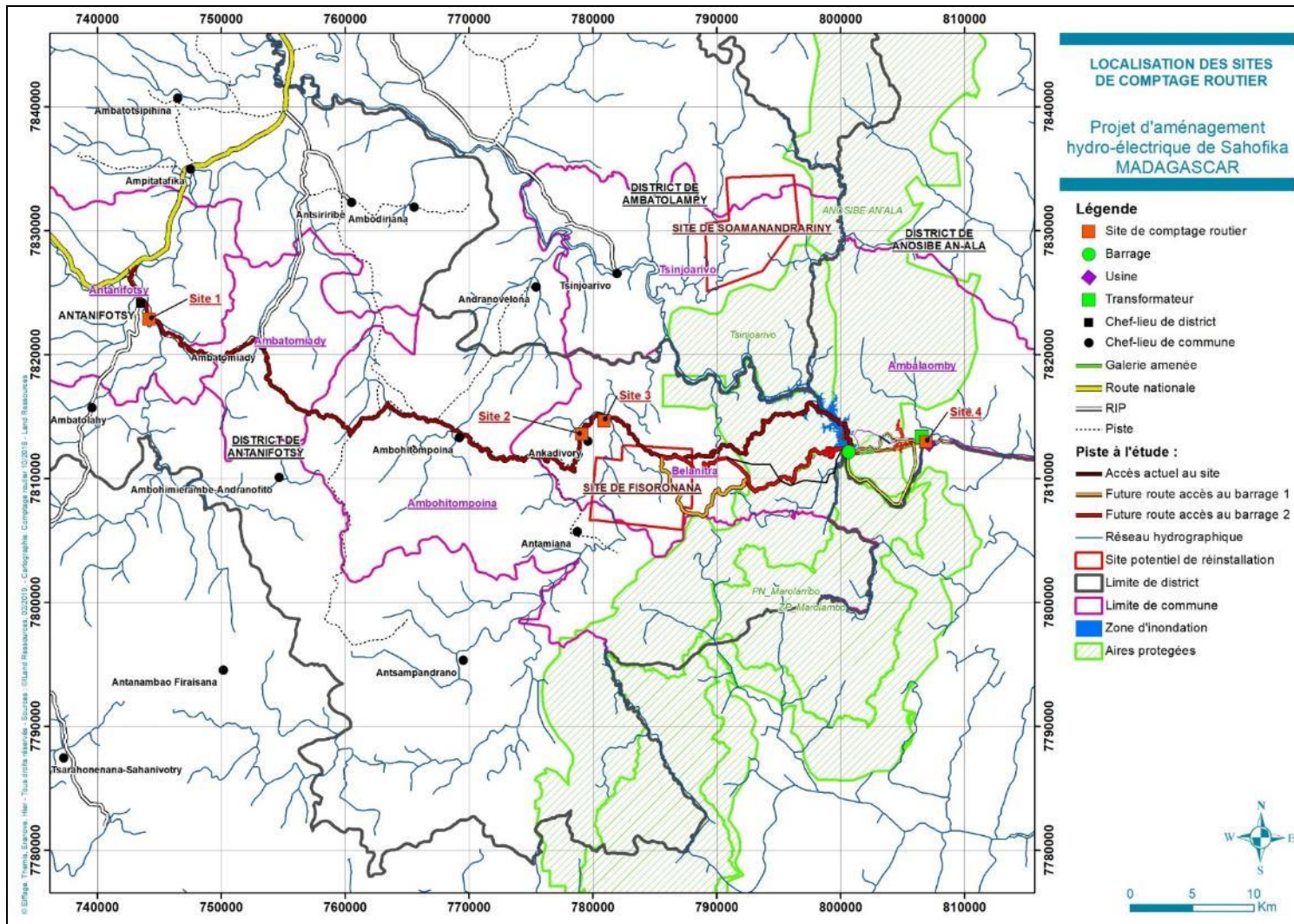

Figure 37 - Traffic in Antanifotsy, from Antanifotsy to Belanitra

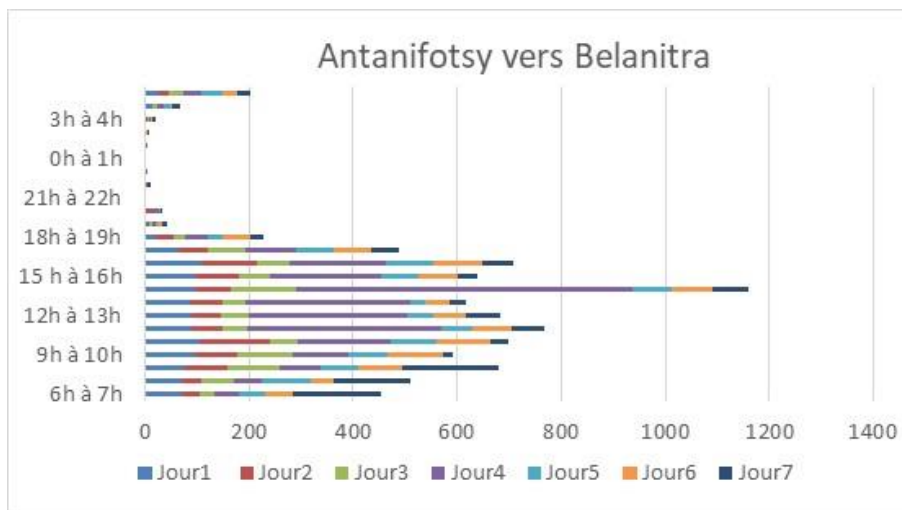
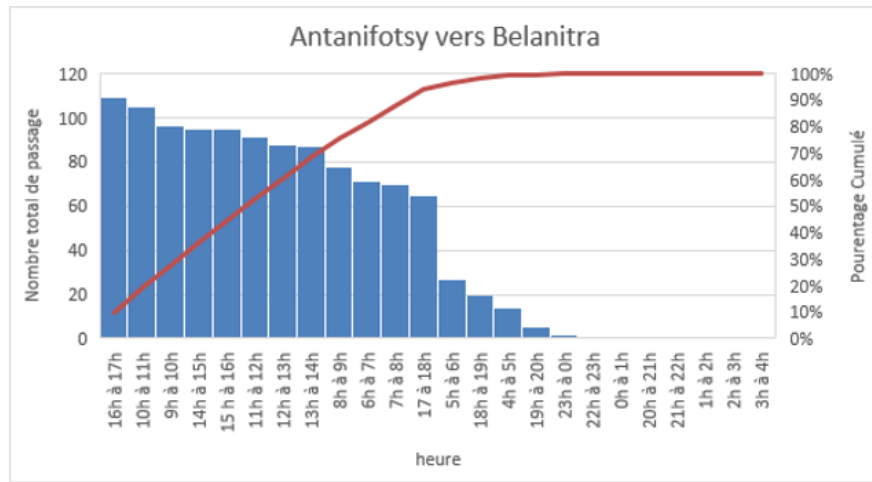
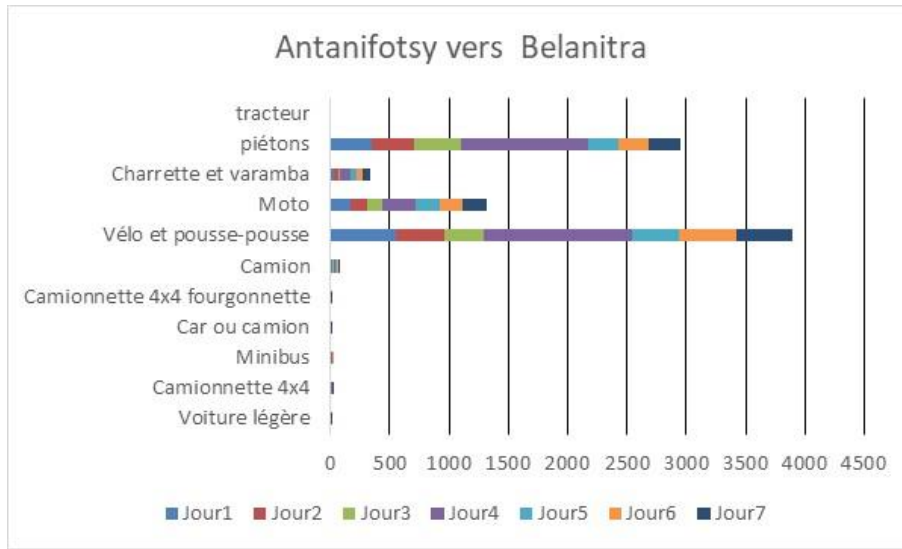
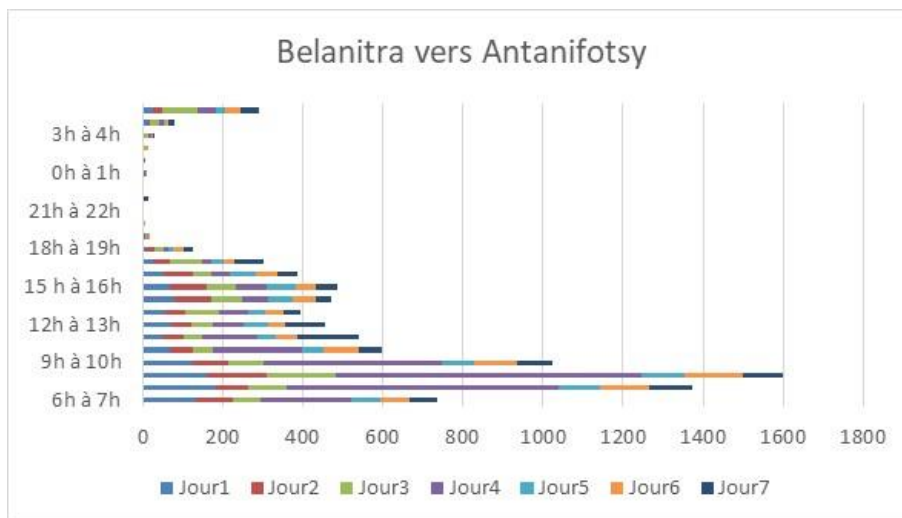
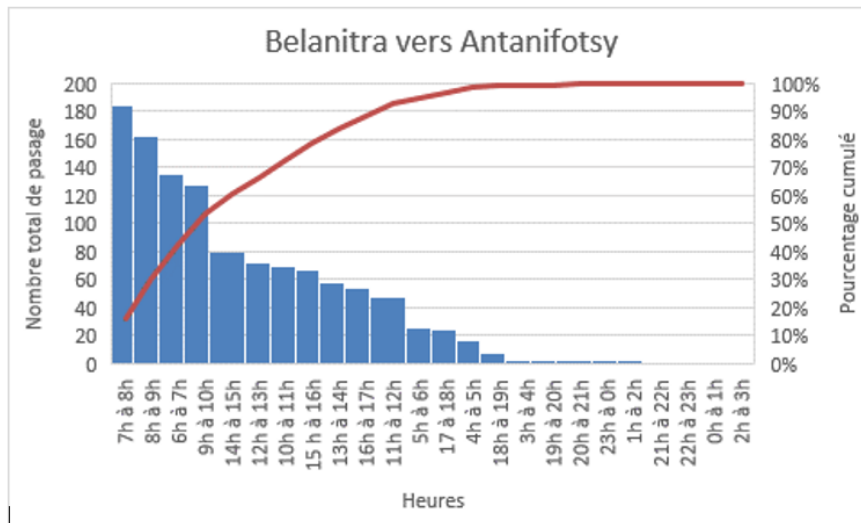
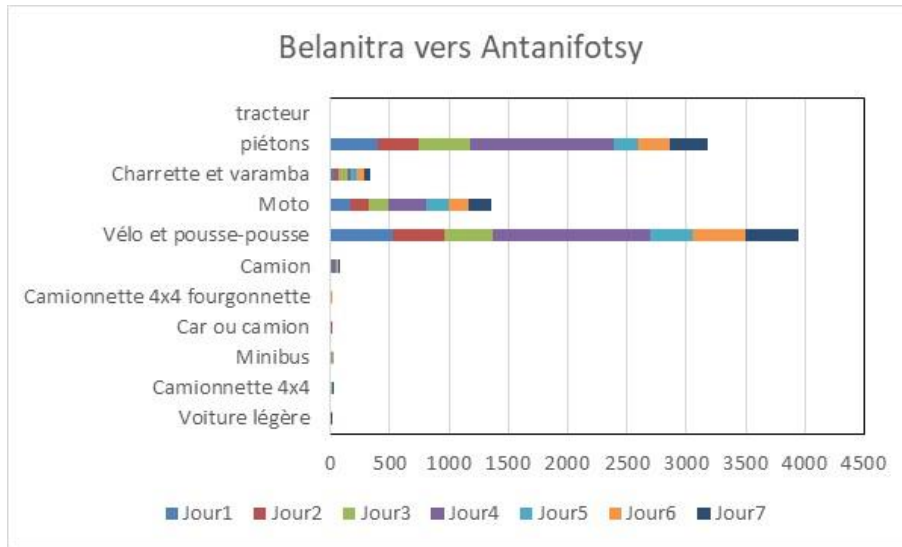

Figure 38 - Traffic in Antanifotsy, from Belanitra to Antanifotsy



Traffic from Belanitra to Antanifotsy (Site 1)

In this direction, there are 5,639 intermediate means of transport, representing 63.0% of the total traffic counted. Bicycles and rickshaws account for 3,944 or 44.0% of the total number counted in this direction, motorcycles account for 1,356 or 15.2% of the total, and carts and varamba account for 339 or 3.8% of the total.

There are 3,181 pedestrians, representing 35.5% of the total traffic in this direction;

There are 88 freight cars, representing 0.98% of the traffic in this direction. In this category, there are 83 trucks, or 0.92% of the traffic, and 3 other cars (pickup truck, 4x4, and van), representing 0.05% of the total.

Personal transport cars (light cars, vans and 4x4s, minibuses, coaches and trucks) account for 45 or 0.50% of traffic in this direction.

4.2.18.2 **Traffic Counting at the Entrance of Belanitra (site 2)**

Traffic from Antanifotsy to Belanitra (Site 2)

Observation at this counting station indicates that pedestrians represent the largest part of the traffic. There are 1,092 of them in the Antanifotsy to Belanitra direction, or 65.0% of the total traffic in this direction.

Intermediate means of transport account for 583, or 34.7% of the total traffic; bicycles and rickshaws total 326, or 19.4% of the traffic; motorcycles account for 147, or 8.7% of the traffic, and carts total 110, or 6.5% of the traffic.

The number of freight transport cars counted is 5 or 0.3% of the traffic. There are 2 "trucks", or 0.1% of the traffic, and 3 vans, 4x4s and vans, or 0.2% of the traffic.

During the 7 days of counting, only one (1) personal transport car was observed. No light cars, minibuses, buses, trucks, or machines were observed.

Traffic from Belanitra to Antanifotsy (Site 2)

The total number of traffic vehicles observed in this direction during the 7 days of counting is 1,467. Pedestrians account for the bulk of this traffic (962 or 65.6% of the total).

There are 500 intermediate means of transport (34.0% of the total); in this category there were 291 bicycles and rickshaws (19.8% of the traffic), 123 motorcycles (8.4% of the traffic), and 86 carts and varamba (5.8% of the traffic).

There are 4 freight transport cars, or 0.3% of the traffic. In this category there were 2 trucks (0.1% of the traffic); there were also 2 passages of the van, 4x4, and minivan category.

Traffic Counting at the Belanitra Bridge over the Onive River (site 3)

Traffic from Antenina to Belanitra

There were 3,221 crossings in the Antenina to Belanitra direction during the 7 days of counting. Pedestrians account for the largest share of this traffic, with 2,707 pedestrians, or 84.0% of all traffic in this direction. There are 513 intermediate means of transport, or 15.9% of the total. In this category, bicycles and rickshaws are in the majority (355 or 11.0% of total traffic); there were 86 motorcycles (2.7% of the traffic), and carts and varamba accounted for 72 (2.2% of the traffic).

In the other categories, only one freight car in the “pickup, 4x4, and van” category during the 7 days took the risk of crossing the bridge.

Traffic from Belanitra to Antenina:

In this direction, only pedestrians and intermediate means of transport were observed for a total of 3,401 crossings. Pedestrians, numbering 2,794, accounted for 82.1% of traffic in this direction. Bicycles and rickshaws accounted for 440, or 12.9% of the total in this direction, motorcycles 96, or 2.8% of total traffic in this direction, and carts and *varamba* 71, or 2.1% of traffic in this direction.

Figure 39 - Summary of traffic at the Belanitra Bridge from Belanitra to Antanifotsy

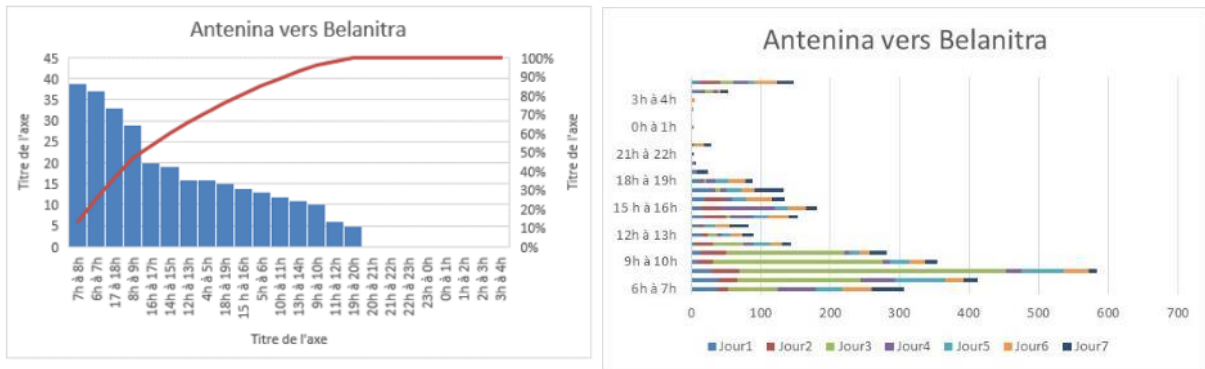
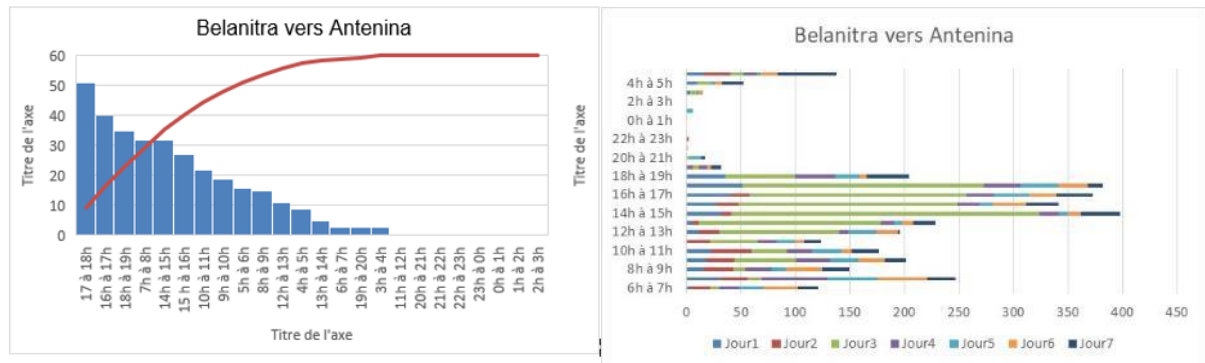

Figure 40 - Summary of Traffic at the Belanitra Bridge, from Belanitra to Antanifotsy



4.2.18.3 Periods of Increased Traffic on Sites 1, 2 and 3

Monday, which is Belanitra’s Market Day, is when traffic is highest. There were 2,610 passengers in both directions combined out of the 6,622 passengers counted during the 7 days of counting, or 39.41% of the total.

For the “Antenina to Belanitra” direction, there is increased traffic between 7 and 9 am, the total number of passengers during this time equaling 996 out of the 3,221 passengers counted in this direction, for one week, or 30.92% of this total.

For the “from Belanitra to Antenina” direction, however, traffic is much higher between 2 and 6 pm. There are 1,494 passengers during this time compared to a total number of 3,401 passengers counted in this direction during one week (or 43.92% of this total).

4.2.18.4 Counting between Antenina and Faravohitra (Site 4)

This counting was carried out over a week from 6 am to 7 pm.

Traffic from Faravohitra to Antenina

The total traffic observed in this direction is 1,341. Rum carriers account for 167, or 12.4% of the total; other carriers account for 58, or 4.3% of the total, and other travelers 1116, or 83.2% of the total. No carts, bicycles or motorcycles can cross the path from Faravohitra to Antenina and were therefore not observed during the 7 days of counting.

Traffic from Antenina to Faravohitra

The total traffic observed in this direction is 1,620. Rum carriers account 24, or 1.5% of the total; other carriers account for 267, or 16.5% of the total, and “other travelers” 1,329, or 82.0% of the total.

4.2.18.5 Increased Traffic Period (day and time) on the Faravohitra Site

Villages in the surroundings of Faravohitra have 3 (three) market days: Tuesday and Wednesday are the Sahofika market days; Friday is the Faravohitra market day. It can be seen that traffic increases during these days. Thus, on Tuesday, there are 254 crossings in the Faravohitra to Antenina direction, and 458 passages in the Antenina to Faravohitra direction. On Wednesday (second Market Day in Sahofika), there are 312 crossings from Faravohitra to Antenina, and 284 crossings from Antenina to Faravohitra.

On Friday, which is the Faravohitra Market Day, there are 323 crossings from Faravohitra to Antenina, and 358 passengers from Antenina to Faravohitra.

In addition, there is an increase in traffic between 8 and 11 am from Antenina to Faravohitra and from 2 to 5 pm from Faravohitra to Antenina, indicating that more than three hundred people walk from the reservoir dam area to the plant site every Friday to profit from the Faravohitra market.

4.2.19 Social Context - Corridor of the Transmission Line from the Dam to Antananarivo

4.2.19.1 Study Area

The corridor crosses three (3) regions, four (4) districts, twenty-six (26) communes and is divided into 2 main axes (Figure 10 shows a map of the corridor).

Table 53 - Commune Crossed by the 2 km Corridor

N°	Region	District	Commune	Sections
1	Alaotra Mangoro	Anosibe An’ala	Ambalaomby	Section 2: Power Plant - Dam - Antanifotsy
2	Vakinankaratra	Antanifotsy	Belanitra	
3			Ambohitompoina	
4			Ambatomiady	
5			Anjahamanga	
6			Antanifotsy	
7			Ambatolampy	Antanifotsy - Tàna Sud
8		Ambohimandroso		
9		Ambohipihaonana		
10		Behenjy		
11		Andriambilany		
12	Manjakatempo			

N°	Region	District	Commune	Sections
13			Andravola	
14			Ambatolampy	
15			Tsiafajavona Ankaratra	
16			Ampitatafika	
17			Alatsinainy Ambazaha	
18			Bongatsara	
19			Ampanefy	
20			Fenoarivo	
21	Analamanga	Antananarivo - Atsimondrano	Soalandy	
22			Tsiafahy	
23			Ambalavao	
24			Ampahitrosy	
25			Antanetikely	
26			Androhibe	

4.2.19.2 Stakeholder Engagement

Stakeholder consultation was carried out at two levels:

- Discussions with the local authorities of the administrative entities concerned by the corridor.
- Meeting with the organizations concerned.

With respect to surveys of local and traditional authorities, discussions focused on the following points:

- Recalling the context of the Project;
- Noting the major constraints / problems encountered in the region for which they are responsible;
- Noting the main assets of the region and the obstacles/factors limiting the development of these assets;
- Noting the development projects planned in the communes (industrial, tourist, agricultural or agro-forestry projects);
- Noting appreciations/opinions on the Project: People's level of knowledge and understanding of the Project and the activities that will be carried out, the expected positive and negative impacts they perceive, their concerns with regard to this investment in the region and their perception of their relationship with the Project;
- Collecting documents and socio-economic data (demographic data, economic activity data, habits and customs, etc.) from decentralized authorities and public service offices.
- Identifying the sensitive socio-economic assets affected by the corridor.

At this stage, the District Chiefs, Mayors and *Fokontany* Chiefs potentially affected by the corridor were consulted. Their collaboration has been very helpful. The majority requested that the communication of the Project be fluid and that work schedules be shared so that they can prepare and make the necessary arrangements.

The following organizations were also consulted:

- JIRAMA: Some information on the route of the existing transmission line along RN7 was exchanged.

- Real estate services: Consultation with real estate services was aimed at understanding the existing land system in the constituency.
- Telma: a line buried underground along RN7 must be noted.
- Madarail, which is in charge of the railway network from Antananarivo to Antsirabe.

4.2.19.3 Sensitive Socio-economic Assets Identified

Sensitive socio-economic assets were identified at two levels:

- On a large-scale map, in A0 format during focus groups gathering the *Fokontany* Chiefs concerned by the corridor.
- By land use analysis; based on an interpretation (vectorization) of the Google Earth image to remove cultivated and residential areas.

Photo 41 - Focus Group Discussions



Survey of Sensitive Assets

The identification of sensitive assets with local authorities made it possible to survey the following assets along the corridor from Faravohitra to Antananarivo (Commune of Fenoarivo/Ampitatafika).

Considering the very large size of the corridor, no inspection of the identified assets was conducted, and an onsite counter-inspection will be necessary during studies to determine the exact location of the line.

Table 54 - Survey of Sensitive Socio-economic Assets in the 2 km Corridor

Asset	Number of people
Tomb	431
Church	127
School (public and private, primary to high school) or training center	126
Water tower + spring	21
Administrative Office	27
Football field	20
Hospital and Basic Health Centre (BHC)	14
Marketplace	9
Station	2
Slaughterhouse	1
Hydroelectric dam	1

Pylon (Airtel)	2
Palace	1
Sacred site	13
Famoloana (community place to work with the harvested rice)	2
Quarry (gold, granite and precious stones)	10
Tourist site and excursion site	3
Subdivision	1
Fountain terminals	33
Well	9

Land Use Analysis

The sizes of agricultural lands affected by the corridor are presented in the table below. In total, 37% of the corridor area is cultivated. The communes of Androhibe, Ampanefy, Fenoarivo, and Alatsinainy Ambazaha have the largest sizes of cultivated lands, with more than 80% of the cultivated corridor.

Table 55 - Statistics Showing Crop Areas in the 2 km Corridor

District	Commune	Size of Cultivated Areas in the Corridor (ha)	Total Corridor Area (ha)	% of Cultivation Area per Commune Affected by the Corridor
Antananarivo – atsimondrano	Androhibe	105.9	109.7	96.6%
Antananarivo – atsimondrano	Ampanefy	133.5	155.9	85.7%
Antananarivo – atsimondrano	Fenoarivo	102.6	122.2	84.0%
Antananarivo – atsimondrano	Alatsinainy Ambazaha	77.1	96.1	80.3%
Ambatolampy	Ambohipihaonana	543.1	794.8	68.3%
Antananarivo – atsimondrano	Soalandy	616.3	985.0	62.6%
Ambatolampy	Ambatolampy	164.7	278.9	59.0%
Antanifotsy	Ampitatafika	587.6	1,012.5	58.0%
Antananarivo – atsimondrano	Ampitatafika	529.5	1012.5	52.3%
Antanifotsy	Ambohimandroso	1,268.0	2,236.1	56.7%
Antanifotsy	Antanifotsy	1,682.0	3,169.5	53.1%
Ambatolampy	Tsiafajavona Ankaratra	373.3	765.3	48.8%
Antanifotsy	Ambatomiady	984.0	2,164.8	45.5%
Antanifotsy	Ambohitompoina	1,389.5	4,190.0	33.2%
Ambatolampy	Manjakatombo	302.6	933.3	32.4%
Ambatolampy	Andriambilany	297.4	956.3	31.1%
Antananarivo – atsimondrano	Bongatsara	204.2	657.3	31.1%
Ambatolampy	Andravola	57.3	184.9	31.0%
Antananarivo – atsimondrano	Tsiafahy	134.8	445.6	30.3%
Antananarivo – atsimondrano	Antanetikely	6.2	22.3	27.7%
Antananarivo – atsimondrano	Ambalavao	298.0	1,197.5	24.9%
Ambatolampy	Behenjy	910.2	3,955.1	23.0%
Antananarivo – atsimondrano	Ampahitrosy	58.5	299.1	19.6%
Antanifotsy	Belanitra	962.3	5,112.1	18.8%

District	Commune	Size of Cultivated Areas in the Corridor (ha)	Total Corridor Area (ha)	% of Cultivation Area per Commune Affected by the Corridor
Anosibe an'ala	Ambalaomby	89.3	1,450.8	6.2%
	TOTAL	11,877.7	32,307.3	36.8%

The residential areas affected by the corridor are presented in the table below. Approximately 3.5% of the corridor area is a residential area:

Table 56 - Statistics of Inhabited Areas by Commune in the 2 km Corridor

District	Commune	Size of Inhabited Area in the corridor (ha)	Total Corridor Area (ha)	Inhabited Area per Commune Affected by the Corridor
Antananarivo - atsimondrano	Ampitatafika	242.0	921.8	26.3%
Antananarivo - atsimondrano	Alatsinainy Ambazaha	14.9	96.1	15.6%
Antananarivo - atsimondrano	Bongatsara	95.1	657.3	14.5%
Antananarivo - atsimondrano	Ampanefy	18.1	155.9	11.6%
Antananarivo - atsimondrano	Fenoarivo	13.0	122.2	10.6%
Antananarivo - atsimondrano	Soalandy	101.4	985.0	10.3%
Ambatolampy	Ambohipihaonana	62.3	794.8	7.8%
Antananarivo - atsimondrano	Tsiafahy	30.4	445.6	6.8%
Antanifotsy	Antanifotsy	135.4	3,169.5	4.3%
Ambatolampy	Behenjy	149.8	3,955.1	3.8%
Antanifotsy	Ampitatafika	31.2	1,012.5	3.1%
Antananarivo - atsimondrano	Ambalavao	35.0	1,197.5	2.9%
Antanifotsy	Ambatomiady	62.3	2,164.8	2.9%
Ambatolampy	Andriambilany	21.2	956.3	2.2%
Antanifotsy	Ambohitompoina	81.2	4,190.0	1.9%
Ambatolampy	Manjakatempo	12.4	933.3	1.3%
Antananarivo - atsimondrano	Ampahitrosy	2.6	299.1	0.9%
Antananarivo - atsimondrano	Antanetikely	0.1	22.3	0.4%
Antanifotsy	Belanitra	22.5	5112.1	0.4%
Ambatolampy	Andravola	0.7	184.9	0.4%
Antananarivo - atsimondrano	Androhibe	0.1	109.7	0.1%
Anosibe an'ala	Ambalaomby	1.2	1,450.8	0.1%
Ambatolampy	Ambatolampy	0.2	278.9	0.1%
Antanifotsy	Ambohimandroso	0.6	2,236.1	0.0%
Ambatolampy	Tsiafajavona Ankaratra	0.2	765.3	0.0%
	TOTAL	1,133.8	3,2216.6	3.5%

4.2.19.4 Social Groups and Traditional Authorities

Section 1: Antanifotsy to Antananarivo (Fenoarivo-Ampitatafika)

In the Vakinankaratra region, like in the entire Malagasy territory, there are two types of parallel powers: State power and the traditional power of *Andriana*, *Olobe*, *Mpitakazomanga* and *Tangalamena*. In the corridor area, people call elders “Raiamandreny” whose functions and responsibilities are limited to advice, mediation and conflict management at the local level.

This type of traditional power is important for the future implementation of the Resettlement Action Plan, especially with respect to the Complaint/Dispute Management Mechanism.

Conflict resolution mechanisms are adopted by grassroots communities to preserve peace, social cohesion and community safety. In general, to resolve conflicts considered of lesser importance, communities value dialogue as a resolution mechanism. The *Raimandreny* (elders) and the *fokontany* chief play a significant role in their outcome. In the absence of a consensus between belligerents, cases are referred to the Town Hall.

Section 2: Faravohitra Power Plant in Antanifotsy

A small difference with Section 2 lies in the influence of the proximity of the eastern woodland, the isolation of villages and therefore the special relationship with natural resources.

Regarding the role and status of people in a society, two social groups can be defined in the Ambatomiady study area in Befotaka. The existing social groups are the political and economic elites and the peasants. While the former are in a minority and influence political and economic policies in the area, the latter are reservoirs of low-cost labor and constitute the main local food producers. In most cases, it is the Merina and some Betsileo migrants who have in their midst the elites holding decision-making powers. The general population is composed of Merina traders and peasants living with migrants in search of social identity.

The only traditional authorities in the area are the Elders or *Raiamandreny* in the Merina area (elderly and experienced people) and the *Tangalamena* or Holders of the Powerful Wand in the Betsimisaraka area of Sahofika-Faravohitra.

Civil Society Organizations

The civil society organizations present throughout the area are listed below. They contribute to economic and social development thanks to their roles in education, awareness raising, project financing, training and capacity building. OPCIs facilitate collaboration between neighboring communes.

Intercommunal Public Cooperation Bodies - OPCI

Several OPCIs were observed in the area:

- OPCI Miray: Ambohimandroso, Ampitatafika, Ambatotsipihina, Antsahalava, Ambodiriana
- OPCI Est: Ambohitompoina, Antsampandrano, Anjamanga, Belanitra
- OPCI Centre: Antanifotsy, Ambatolahy, Soamanandrany, Ambatomiady, Andranofito

- OPCI Fiombonantsoa: Ambohiborona, Andranomiady, Antsampanimahazo, Faratsiho, Faravohitra, Miandravivo, Ramainandro, Valabetokana, Vinaninony Sud
- OPCI FAV: Andriambilany, Behenjy, Tsiafajavona, Manjakatempo, SabotsyNamatoana, BelamboFiraisana
- OPCI in the process of being established: Ambatolampy (geographically with OPCI FAV), Andravola, Ambohimpahaonana, Andriantsivalana (geographically with OPCI Mazava Atsinanana)

Civil Society Organization Operating in the Area

Several stakeholders from CSOs (Civil Society Organizations) were interviewed during this study. These organizations support STDs (Decentralized Technical Services) and CTDs (Decentralized Territorial Communities), and local communities in particular, in various activities summarized in the table below:

Table 57 - Civil Society Organizations Operating in the 2 km Corridor

Name	Focus Area
RFD ; ONG Miarintsoa ; PGDI	Health and education; sanitation; good governance
ONG MIARINTSOA ; Seecaline; Association Vonona; ONG Sadabe; Association Lovasoa	Sanitation; mothers and children; protected areas; canal
PSDR	Dam
ONG Lalana ; ONG Miarintsoa ; Nouvelle Planète ; Groupe MIZARA ; Terre Sainte	Environment; sanitation; social, economic, drinking water supply, women and youth training; nurses' salaries
ONG Ciret	Drinking water supply
SEECALINE	Mothers and children
ANAE; FID ; Poulet gasy	Dam; rural development
ONG MIARINTSOA	Sanitation and hygiene
ONG GRET, AGEAA and PASSOBA	Drinking water supply and health
Tanamasoandro, ZINA, AINGA and Tsaramasoandro	Associations for agricultural production in Ambohitompoina

4.2.19.5 Habits and Customs

Ethnic Groups Present

The population is mainly made up of the Merina ethnic group and migrants such as the Betsileo, Sihanaka and Antandroy. In this group, habits and customs are homogeneous along the High Voltage Line: Christian faith with strong syncretism with traditional pagan practices, mainly the cult of ancestors through the practices of *Famadihana* (exhumation). Taboos (*fady*) and other prohibitions are almost unanimously respected within families and lineages, and even outside, by those who live in the same land without necessarily being practitioners.

The Fady

The *Fady* is generally linked to the traditional Malagasy religion. Respecting the *Fady* can be considered a service in exchange for the blessings of the ancestors. The list of *Fady* to be respected in the Project area is presented in Table 56.

4.2.19.6 **Existing Infrastructure**

The Road and Rail Network

Along the Antanifotsy - Faravohitra section, the line will follow the Project’s main access road. From Antanifotsy, the line will be built along RN7 (without being too close, in order to minimize social impacts) to the commune of Tsiafahy, then along RN 1 all the way to the Tana Sud substation.

A rail network follows RN7 through the corridor to Antanifotsy. This network is managed by Madarail, linking Antananarivo-Antsirabe, currently under rehabilitation, based on information collected at Madarail.

Agricultural Infrastructure

Agricultural dams and water reservoirs are present in several communes and their maintenance is the responsibility of users organized in various user associations.

Other Infrastructure

The following infrastructure was also noted along or near the corridor:

- An existing JIRAMA HV line
- The Telma Backbone (underground fiber)
- A small hydroelectric dam is located in Behenjy, along RN7

4.2.19.7 **Existing Development Projects**

The following projects are present in the corridor area:

Table 58 - Relevant Bodies and Projects Present in the Region

Speaker	Possible Field Of Activity and/or Interaction
JIRAMA	Electricity and water supplier
TELMA	Telecommunications operator (telephone, internet, mobile banking) The Telma backbone (underground fiber) passes through Antanifotsy to Antananarivo
CSA	Development value chains and support for producer farmers
CASEF Vakinankaratra	Structuring value chains and improving land security
MNP	Management of protected areas in Madagascar (Marolambo)
WWF	Wildlife protection
SADABE	Protection of wild fauna (including the Sadabe lemur species)
YOU	Local and community forest management in protected areas
FORMAPROD	Technical training for out-of-school youth
PROTANA	Support to the Timber/Energy sector in Itasy and the Analamanga region, for technical support for market gardening and fruit products, local poultry breeding
ProDecID	Inclusive communal development and decentralization project
GRET	Improvement of potable water supply in the Bongatsara commune

4.2.19.8 **Local Authorities’ Expectation and Perception**

The expectations and perceptions of local authorities are presented in the table below:

Table 59 - Local Authorities' Expectations from and Perceptions of the Project

Expectations	Perceptions
Road rehabilitation and construction	This project will bring unprecedented socio-economic development to the region
Employment for the local population	
Electrification of villages	This project is good for the region, which has never seen the arrival of such infrastructure since Madagascar's independence.
Improvement of living conditions	
Increased incomes for households within the region	
Increased tax revenue.	
Regular communication on the progress of the Project	

4.3 Legally Protected and Internationally Recognized Areas

The protected or internationally recognized areas (current and future) close to the Project area or over which Project infrastructure (dam, access roads, water pipe, reservoir, lines...) encroaches consist of the following:

- The Marolambo National Park and the three areas under management transfer (VOI) in the Commune of Belanitra (Antenina, Fisoronana and Befotaka) located in its protection zone (buffer zone surrounding the central core);
- The NPA being created in Tsinjoarivo - Ambalaomby, currently under Koloala status (concept of the Forest Administration for sustainable forest management sites for which logging permits are allocated by auction) and therefore exposed to forest logging.
- Important Bird and Biodiversity Areas (IBA)
- "Classified Forest of the Onive"

4.3.1 Marolambo National Park

4.3.1.1 Description of the PNM

The Marolambo National Park (PNM) is located in the southern part of the Project area and covers the natural forest area of Fandriana - Marolambo, which is included in the forest corridor crossing Madagascar from the northeast to the southeast. It is linked to the Ranomafana National Park ("Atsinanana Rainforests" World Heritage Site) in the south and Andasibe-Mantadia National Park in the north by a series of forest fragments with no protection status.

The PNM classification process started before 2010 (under temporary protection, with a surface area of 189,247 ha) and was finalized in 2015, with a Decree adopted by the Government Council after Madagascar National Parks (MNP) prepared a 5-year Development and Management Plan (PAG) in 2013. The Park's PAG is being updated by MNP.

Classified in IUCN category II, the Park covers 95,063 ha, and is surrounded by a "protection zone" formed by the old temporary boundary. As defined by the Protected Areas Code, the protection zone is "the area adjacent to the Protected Area in which agricultural, pastoral and fishing production activities or other types of activities are carried out in a way to avoid causing irreparable damage to the Protected Area".

The park, which is part of PAs managed by Madagascar National Parks (MNP), is representative of the medium-altitude dense humid rainforest used for the conservation of natural habitats, their biodiversity and associated ecosystem services.

According to the Protected Areas Network Management Plan (GRAP Plan) developed by the MNP in 2001 and updated in 2014, the PNM is classified in Strategy B: High Biodiversity- Higher level of threat.

Indeed, the PNM has a very high level of biodiversity and endemism: 324 plant species with 89.9% endemism, at least two palm tree species of the Aceraceae family on the IUCN red list, 10 lemur species, 70 bird species, 23 reptile species, 41 amphibian species, etc.

Gold panning, human occupation, clearing for fertile land acquisition and lemur trapping are the main threats to the Park.

In its overall strategy to involve local communities located on the periphery of national parks in its conservation efforts, the MNP is implementing a green belt initiative that consists in transferring to communities the responsibility for managing the remaining forests around national parks, so that they can meet their daily wood needs while being responsible for the parks' conservation. The communities manage these areas through associations called VOI.

In the case of the PNM, the protection zone consists of several sites under a management transfer regime (29 in total) that form the green belt. The VOIs managing these transferred areas are bound by contracts signed with the forestry administration, and are supported by the MNP.

Local Park Committees (CLPs) also carry out co-surveillance missions with Park officers. CLPs, which have about ten members, are based in the direct peripheral *fokontany* of the Park. The *fokontany* where MNP co-management structures are present are those of Fisoronana, Antenina, Befotaka and Manaripatsa in the commune of Belanitra and Salehy, Ambohitsara, Taolandravina, Andranambomaro and Mandroalina in the commune

4.3.1.2 Governance of the PNM

Governance Level	Entity	Roles and Responsibilities
Decision-making body	Ministry of Environment, Ecology and Forestry	<ul style="list-style-type: none"> • Oversight of Pas and final decision on all management issues; • Implementation of the State's policy on the regulation, promotion, creation, management and control of protected areas in Madagascar's Protected Areas System; • Coordination of the contribution of other ministerial departments and the participation of decentralized services and local authorities at all stages of the process of creating, changing boundaries or status of a Protected Area; • Issuance of an opinion in accordance with the legislation in force for any construction, commercial agreements and those relating to tourist activities, any extractive activity, any electricity production activity, any extraction of non-timber forest products, any fishing or hunting activity, any underwater hunting, any water catchment, any grazing and other agricultural or similar activities within the PAs; • Granting of scientific research authorizations through a RFP after a positive opinion from the site's operational manager; • For the satisfaction of the vital needs of the local populations, in the event of an emergency, a natural disaster or for the respect of their tradition; the proposal submitted to the Council of Government to authorize certain prohibited forest activities or

		<ul style="list-style-type: none"> harvesting in the PA concerned, regardless of their status; Legal proceedings against infringements, offences and crimes committed within the PA as well as those committed in the protected and/or peripheral area; Notification and transmission of technical, legal and geographical information and data to the relevant ministerial departments for each PA that has acquired temporary or permanent protection status in their respective categories, in accordance with the provisions of the Protected Areas Code; Land tenure security for any PA other than the private PA, with the support of the operational manager of each site;
Management body	Madagascar National Parks	<ul style="list-style-type: none"> Operational Manager of the Marolambo NP; Sustainable conservation and administration of biological diversity and natural and cultural heritage; Implementation of the Park's development and management plan and preparation of its revision; Development of the park in accordance with the requirements of the plan and establishment of adequate infrastructure as well as the implementation and monitoring of management programs; Planning, coordination and evaluation of conservation and development operations in the park and its surrounding area; Signing of community management agreements; Signing of various agreements for the implementation and monitoring of management programs; Exercise of surveillance and control of the Park aimed at educating, preventing and sanctioning certain activities that do not comply with the objectives of the Protected Area; Use of research and ecological monitoring to strengthen park management; Management of the funds entrusted to it and intended for the Park and income generated by the activities; Financial sustainability of the management of the Protected Area in collaboration with the Ministry in charge of Protected Areas;
Co-management body	Local Park Committee (LPC)	<ul style="list-style-type: none"> Park monitoring and control; Follow-up of the work carried out by MNP; Environmental education and awareness; Participatory ecological monitoring;
	Fire Committee	<ul style="list-style-type: none"> Preventive & active firefighting;
	Tangalamena and elders	<ul style="list-style-type: none"> Awareness raising, application of Dina, resolution of social problems with local communities;
	COSAP	<ul style="list-style-type: none"> Awareness raising, lobbying; Decision on support for the development of local residents; Resolution of disputes between the MNP and local residents;
Supporting Body	Any partner likely to support the management of the Park	<ul style="list-style-type: none"> Technical and financial support in the implementation of activities according to their respective sectors of intervention and capacity building of the various local management/co-management bodies.

Figure 41 - Map of areas under natural resources conservation/management status

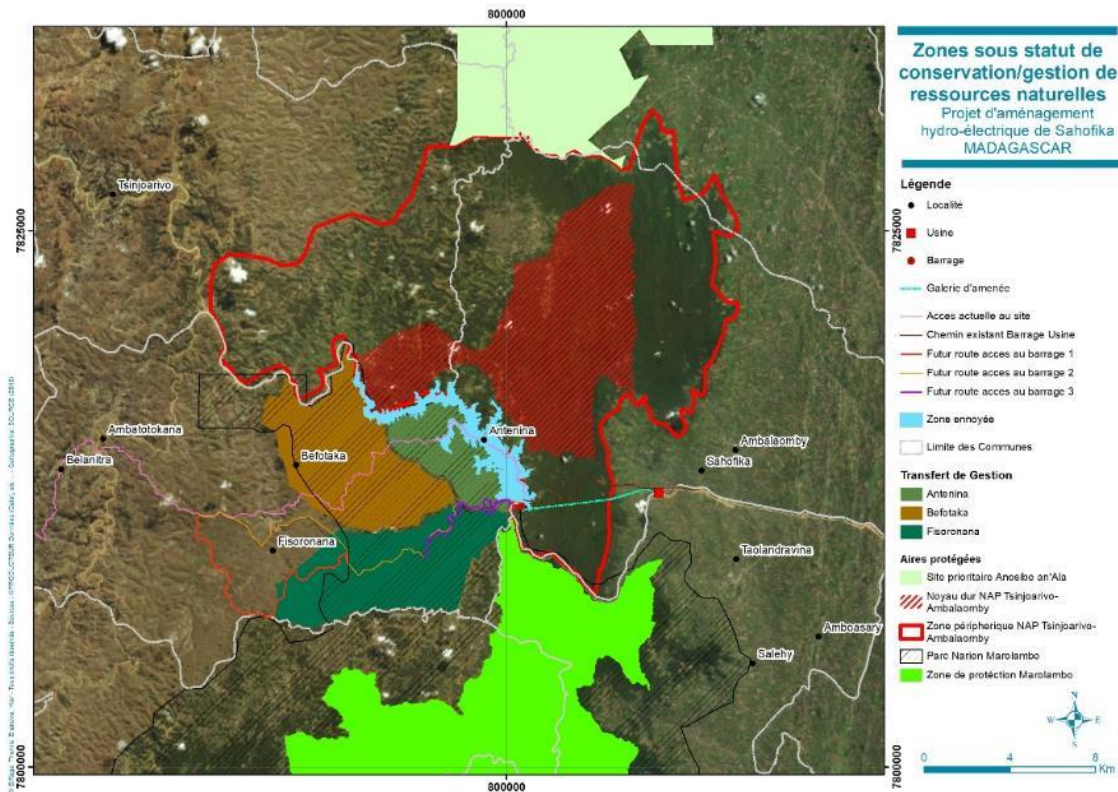

4.3.2 Management Transfer Sites for the Marolambo NP Protected Area

Under the Malagasy forestry legislation it is possible to transfer to grassroots communities the responsibility for managing part of the forests under the authority of the MEEF. This management transfer system is being used in Madagascar to help people to adopt a sustainable management approach to forest resources. In particular, it provides a framework for the use of forest resources in peripheral areas (“protection zones”) of protected areas, as is the case with the Marolambo National Park.

The management of areas and natural resources outside the GCFs is the responsibility of the MEEF.

4.3.2.1 Management Transfer Sites Concerned by the Project

Management transfers in the peripheral area of the PNM concerned by the Sahofika Project take the form of Contractualized Forest Management (GCF) transfers. GCF is a way of transferring forest management to grassroots communities for a sustainable and secure local management of forest resources.

Zoning, included in the simplified GCF management plans, recommends various management units:

- Plots of forest under strict conservation measures;
- Parcels where the populations concerned can exercise their users’ right (in particular in terms of cutting wood for domestic use);
- Forest restoration areas;
- Crop areas.

Grassroots communities contract with the DREEF of their administrative district for the sustainable management of a management transfer area, with the approval of the commune concerned. The contracts are valid for a three-year period and are renewed subject to a positive evaluation by the DREEF.

Three GCFs are operational in the commune of Belanitra, in the PNM protection area, between Antanifotsy and the proposed dam site:

- Befotaka;
- Fisoronana;
- Antenina.

4.3.2.2 Participatory Mapping and Site Evaluation under the GCF Scheme

In the absence of official mapping, participatory mapping was organized to identify and locate the management units of the areas transferred to the VOI, specify the boundaries of the *fokontany* and the potential areas for forest restoration and reforestation, determine the number of households composing each village/hamlet of the *fokontany* and the location of crop areas and tombs.

Photo 42 - Participatory mapping with the VOIs



Meetings with representatives of the villages forming each *fokontany* were also organized to analyze how the degree of effectiveness of current area management by the VOIs, and to carry out an analysis of the need for wood (species, size) for hut construction purposes or as firewood.

4.3.2.3 Governance of Sites under Management Transfer

Governance level	Entity	Roles and Responsibilities
Decision-making body	Ministry of the Environment, Ecology and Forestry and its decentralized services	<ul style="list-style-type: none"> ● Responsible for local and regional participatory forest planning; ● Awareness raising on the possibility of carrying out management transfers according to the state of the resources concerned, the competence of the VOIs, the existence of surrounding pressures; ● Technical advice: information on the legislation in force, procedure to be followed, supervision on technical tasks; ● Supervision of community resource management, ensuring the application of forest law in terms of compliance with specifications and resource control; ● Technical supervision of the Association in the execution of the contract; ● Monitoring, control and evaluation of the performance of the management transfer contract;
Management body	Fanantenana VOI (Antenina), Tsaratantana	<ul style="list-style-type: none"> ● Voluntary and legal socio-organizational structure of the VOI; ● Participation in the delimitation of the forest, based on traditional rights (limits defined by consensus and recognized by the parties involved in the transfer as well as members of neighboring

	VOI (Fisoronana), Taratry ny Ala VOI (Befotaka)	villages; <ul style="list-style-type: none"> Control of access to the forest; Application of the Dina; Reporting to the Head of the Forest Administration every six months for the implementation of the activities provided for in the Action Plan, the specifications and the Dina; Maintaining a record book of the use of the forest resources under its management;
Monitoring and support body	Commune	<ul style="list-style-type: none"> First link in the chain of decisions on the admissibility of VOI applications; Launching the investigation process as soon as the request for management transfer is submitted through the investigation commission appointed by the municipal council; Arbitration of pre-contractual disputes and dispute management; Support in the structuring of the VOI; Circulation of information (rights and obligations) to the various stakeholders; Contribution to dynamizing the population within the framework of the elaboration of a communal strategy; Support for the formalization and ritualization of the management transfer process.
Supporting body	Any partner likely to support the management of the transferred sites	<ul style="list-style-type: none"> Technical and financial support in the implementation of activities according to their respective sectors of intervention and capacity building of the various local management/co-management structures

4.3.2.4 Organizational Evaluation of the VOIs

The organizational assessment of the VOIs has revealed some weaknesses. While the three VOIs generally have regulatory management instruments (Articles of Association, Rules of Procedure, Dina), an internal organization, a strategic decision-making process, a well-defined vision and mission, there are still gaps in terms of project designing, development, formal and informal collaboration, advocacy techniques and leadership.

In addition to the official structures (forestry service, MNP and the rural commune of Belanitra), only NGO "Fondation Avenir Madagascar" is supporting these VOIs, mainly in the area of reforestation. Geographical isolation largely prevents these VOIs from opening up to other partnership opportunities. Nevertheless, all VOIs want to continue to manage forests placed under their responsibility and hope to renew their contracts.

An evaluation of the effectiveness of VOI management in Befotaka and Antenina is planned by the Vakinankaratra DREEF in 2019, with a view to renewing contracts. This process is funded by the MNP, in its capacity as manager of the Marolambo National Park.

4.3.3 A New Protected Area in the Process of being created in Tsinjoarivo and Ambalaomby

4.3.3.1 Description

A project to create a New Protected Area (NPA) in the Tsinjoarivo and Ambalaomby forests is currently being led by the Sadabe NGO based in Tsinjoarivo, Ambatolampy District. Sadabe has been conducting research and support activities for local development in the Commune of Tsinjoarivo for about ten years.

The Project to create the NPA initially focused on the Tsinjoarivo forest. At the end of 2016, the entire process of creating the NPA was completed: presentation of the site and survey, report on the site's biodiversity richness, public consultation, environmental and social impact study, etc.

In 2017, the NPA Proponent (NGO Sadabe) submitted to the General Forestry Directorate a proposal to extend the boundaries of the NPA project to the Commune of Ambalaomby and received approval in principle, subject to compliance with the process for creating a protected area in accordance with the Protected Areas Code.

The Tsinjoarivo - Ambalaomby site is located in the centre and eastern slopes of Madagascar, in the Vakinankaratra and Alaotra-Mangoro regions, about 100 km southeast of Antananarivo.

With a total area of 26,471 ha, including a central core measuring 11,342 ha and a 15,129 ha buffer zone, the site is divided into two eco-regions: the Tsinjoarivo forest, which is an upland natural forest ecosystem, and the Ambalaomby forest, which is an eastern mid-altitude natural forest ecosystem.

The Tsinjoarivo-Ambalaomby forest massif is a forest corridor that connects the Marolambo National Park in the south, separated by the Onive River, and the Antandrokomby Rural Commune forest in the north.

Logging for marketing, harvesting forest products for the livelihood of the local population, forest and vegetation fires and clearing for new croplands are the main threats to the forest. Poaching mainly affects large lemurs (*Eulemur rubriventer*, *Propithecus diadema*).

The main management objectives pursued at the "Tsinjoarivo Ambalaomby" site include ensuring long-term conservation of biodiversity integrity, sustainable ecological functions and the maintenance of ecosystem productivity necessary for the well-being of riparian communities, as well as the sustainable use of natural resources.

Specific management objectives include:

- Maintaining the site's various ecosystems and connectivity between wetland fragments;
- Protecting the viable populations of endemic and threatened fauna and flora species;
- Developing ecotourism and the sustainable use of natural resources to contribute to poverty reduction.
- Maintaining livelihood sources and improving the living conditions of communities

In 2019, the proponent of the Tsinjoarivo NPA, Sadabe, received support from an international NGO, Rainforest Trust, to finance the creation of the NPA. The NGO's website indicates that it has raised more than \$1 million.

4.3.3.2 Status of the NPA Ranking

The protection of the NPA starts with temporary protection, followed by permanent protection. The temporary protection of a site aims to provide extensive publicity on the initiative of creating a Protected Area, to confirm the existence of a significant biological diversity, to maintain the relevance of the criteria of endemism and representativity of the site and to limit the risk of increasing anthropogenic pressure and natural degradation until the publication of the decree establishing classification as a Protected Area.

Pursuant to current regulations, the Proponent submitted, to the SAPM Commission, on January 11, 2019, the overall development plan and the draft decree for the temporary

protection of the site. The draft decree, as amended following comments and remarks by stakeholders, is currently being reviewed by a legal expert before being submitted to the Ministries concerned with a view to obtaining the interministerial decree for the temporary protection of the site during the first half of 2019.

The temporary protection of the Tsinjoarivo Ambalaomby NAP has been granted for a period of two (02) years, renewable once. The decree establishing the Protected Area concerned must be issued before the end of this period.

The Regional Directorates in charge of Protected Areas in the Vakinankaratra and Alaotra-Mangoro regions are designated as site managers. However, the temporary management of the Protected Area may be delegated to a public or private person by decree. This decree shall determine the terms of the delegation of authority, and the rights and obligations of the parties.

The essential mission of the proponent of a site under temporary protection status is focused on the definitive creation of the Protected Area and consists in:

- Maintaining the integrity of the site;
- Establishing the Protected Area Development and Management Plan to be approved by the Ministry in charge of Protected Areas;
- Establishing the Environmental Management and Social Protection Plan and securing the environmental permit;
- Establishing and operationalizing the Steering and Evaluation Committee, a regional or inter-regional body in charge of general orientation with a view to obtaining the final status of the Protected Area being created;
- Conducting the final delimitation of the Protected Area;
- Defining the type of governance and future management structure;
- Preparing a draft decree for the final creation of the Protected Area;
- Publicizing and disseminating the final decree establishing the NPA;
- Resolving conflicts with other sectors with the support of the Ministry in charge of Protected Areas.

4.3.3.3 Regulations and Boundaries of the Zoning of the NPA Being Created

A Protected Area consists of a central core and a buffer zone. The central core is a sanctuary area of biological, cultural or religious, historical, aesthetic, morphological and archaeological interest, constituted as a perimeter of integral preservation. The buffer zone is space in which activities are regulated to ensure better protection of the main part of the Protected Area and to guarantee the vocation of each component.

According to article 76, paragraph 4 of Decree No. 2017-415 of May 30, 2017 establishing the terms and conditions for the application of the Madagascar Protected Areas Code, “no extractive and electricity production can be undertaken in a central core”.

Part of the Project’s footprint area is included within the provisional boundaries of the NPA being created: dam, water pipe, track linking the dam and the plant and floodplain: a consultation process between the Consortium, the NPA proponent and the forest administration has been conducted since November 2017 with a view to ensuring mutually beneficial coexistence between the Sahofika Project and the NPA. The central core’s boundary was thus discussed and approved between the Consortium and Sadabe, in order to avoid or minimize the negative impacts of the Sahofika Project on the

conservation objectives of the NPA being created and to identify opportunities for positive interactions.

The NPA's overall development plan and the draft by-law amended on January 28, 2019 consider the hydroelectric project's footprint areas in its zoning and regulations (authorized activities). Prepared in accordance with the Protected Areas Code, this comprehensive development plan is a document that gives a first outline of the boundaries of the site and its potential surface area, a list of the stakeholders concerned and the potential management method for the Protected Area. This plan is a basic draft of the development and management plan to be established during the final phase of the creation of the Protected Area. It will be updated when the NPA has been finally ranked.

4.3.3.4 Categorization of the NPA in the Process of Being Created

According to the provisions of Article 40 of the Protected Areas Code, extractive activities (upstream oil extraction or mining) as well as electricity production activities within the Protected Area are only permitted in protected areas of the "Protected Harmonious Landscape" type (equivalent to the IUCN category V).

The Tsinjoarivo-Ambalaomby NPA Global Development Plan proposes IUCN Category VI, referred to in the Protected Areas Code as "Natural Resources Reserve", as an appropriate category for the NPA, taking into account development and management objectives: protecting species and biodiversity, maintaining ecological functions and connectivity and protecting the well-being of the population.

The Protected Areas Code stipulates that the management category, which depends only on the main management objectives of the site, contributes to the determination of the governance mode for the Protected Area. The selection of the governance mode must be initiated in a participatory manner and under the supervision of the proponent or manager of the Protected Area.

In the context of temporary protection, the overall development plan is a basic draft of the development and management plan to be drawn up during the final phase of the Protected Area's creation. The management and development plan, management tool and basic draft for the final creation of the protected area, will specify, among other things, the management objectives, boundaries, zoning, regulations for each zone, and determine the governance mode of the NPA (resulting from the categorization and management objectives).

4.3.4 IBA of the Onive Gazetted Forest

The Important Bird and Biodiversity Areas (IBA) of the Onive gazetted forest covers the Tsinjoarivo NPA and extends from north to south over a distance of more than 75 km. It is bordered by the Onive River in the southern part of the site. It was established in 2001, on the basis of data collected in 1998, and is supported by NGO Asity Madagascar, an affiliate of Birdlife International.

The Onive gazetted forest is one of the key areas for biodiversity in Madagascar. Covering 76,972 ha, it is home to bird species characteristic of medium-altitude dense humid rainforests, many of which are endemic to Madagascar. In addition to threatened mammal species (*Eulemur rubriventer*, *Varecia variegata variegata variegata*, *Propithecus diadema*, *Fossa fossana*, *Cryptoprocta ferox*), this area is home to 5 threatened bird species, including 1 vulnerable species (*Brachypteracias leptosomus*) and

4 near-threatened species (*Accipiter henstii*, *Atelornis crossleyi*, *Crossleyia xanthophrys*, and *Xanthomixis cinereiceps*).

Figure 42 - Location of the IBA of the Onive Gazetted Forest

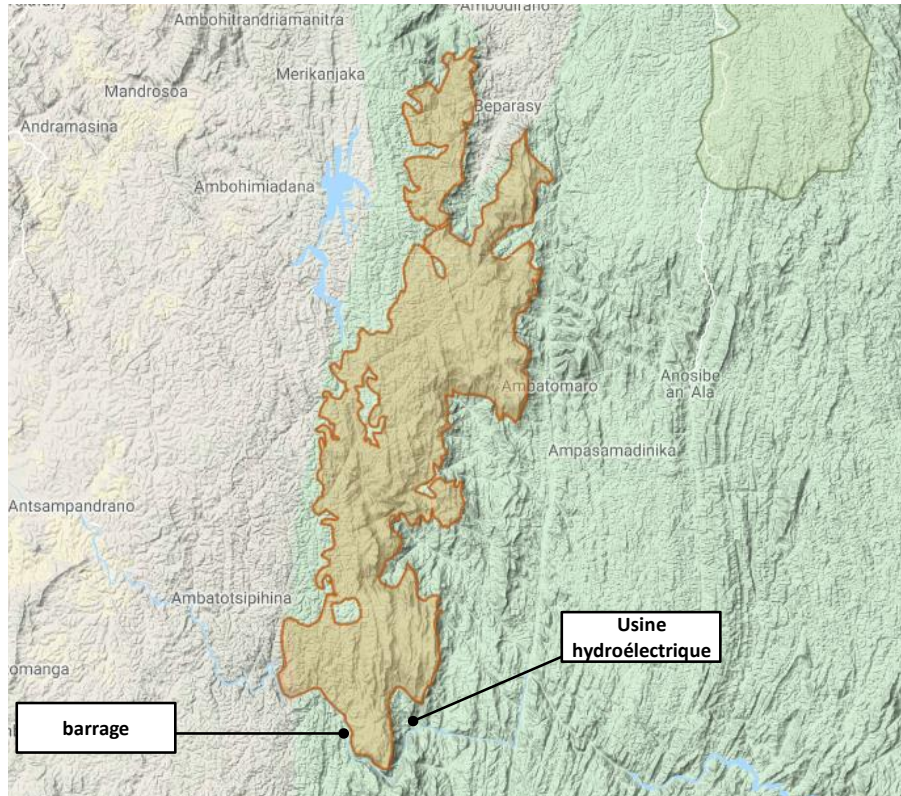

The full list of species that triggered the creation of this IBA is presented in Table 65:

Table 60 - Bird Species that Triggered the Creation of the Onive Forest IBA

Species	IUCN Status	Seasons	Estimated Population	IBA Criterion
<i>Alectroenas madagascariensis</i>	LC	Resident	Present	A3
<i>Coua reynaudii</i>	LC	Resident	Present	A3
<i>Coua caerulea</i>	LC	Resident	Present	A3
<i>Sarothrura insularis</i>	LC	Resident	Present	A3
<i>Mentocrex kioloides</i>	LC	Resident	Present	A3
<i>Accipate henstii</i>	NT	Resident	Present	A1
<i>Brachypteracias leptosomus</i>	VU	Resident	Present	A1, A2, A3
<i>Atelornis pittoides</i>	LC	Resident	Present	A1, A3
<i>Atelornis crossleyi</i>	NT	Resident	Present	A1, A2, A3
<i>Philepitta castanea</i>	LC	Resident	Present	A3
<i>Neodrepanis coruscans</i>	LC	Resident	Present	A3

<i>Newtonia amphichroa</i>	LC	Resident	Present	A3
<i>Hypositta corallirostris</i>	LC	Resident	Present	A2, A3
<i>Pseudobias wardi</i>	LC	Resident	Present	A1, A3
<i>Neomixis viridis</i>	LC	Resident	Present	A3
<i>Bradypterus brunneus</i>	LC	Resident	Present	A1, A2, A3
<i>Oxylabes madagascariensis</i>	LC	Resident	Present	A3
<i>Xanthomixis zosterops</i>	LC	Resident	Present	A3
<i>Xanthomixis cinereiceps</i>	NT	Resident	Present	A1, A2, A3
<i>Crossleyia xanthophrys</i>	NT	Resident	Present	A1, A2, A3
<i>Cryptosylvicola randrianasoloi</i>	LC	Resident	Present	A2, A3
<i>Randia pseudozosterops</i>	LC	Resident	Present	A1, A3
<i>Monticola sharpei</i>	LC	Resident	Present	A1, A2, A3
<i>Foudia omissa</i>	LC	Resident	Present	A3
<i>Ploceus nelicourvi</i>	LC	Resident	Present	A3

The criteria used by Birdlife are as follows:

- A1: Globally threatened species (VU, EN or CR)
- A2. Restricted-range species (global range of less than 50,000 km²)
- A3. Species related to specific biomes

Since its inception, the IBA has not been subject to any survey updates (more than 20 years ago) or research, protection or conservation work. The NGO Asity Madagascar, which is the IBA's reference entity, considers that an update of the IBA fact sheet (list of bird species, conservation issues) is currently required, and is a prerequisite for any reflection on possible conservation actions to be carried out in the IBA.

4.3.5 Nosivolo Ramsar Site

The Nosivolo River has been declared a Ramsar site since September 17, 2010.

The Nosivolo River and its watershed are bordered by four districts of the four neighboring regions:

- The District of Fandriana - Amoron'i Mania Region in the Southwest;
- Antanifotsy District - Vakinankaratra Region in the North-West;
- Nosivarika District - Vatovavy Fitovinany Region in the Southeast;
- Mahanoro District - Atsinanana Region in the North-East.

The wetlands of Nosivolo include permanent and temporary watercourses, their sources, marshes and lowland rice fields, catchment areas composed of hills with steep slopes crossed by gullies, with remnants of dense humid forests, highly fragmented gallery forests that are grassy or covered with secondary vegetation (savoka). Forests are often interspersed with food crops or rain-fed rice fields. Reforested (by families or

communities) eucalyptus trees are found near villages generally bordering watercourses. Most of the banks of these watercourses are occupied by cocoa, banana and sugar cane fields.

The presence of four species of fish: *Bedotia sp. Nosivolo* (VU), *Katria Katria* (EN), *Rheocles sikorae* (DD), *Rheocles wrightae* (EN), and *Oxylapia polli* (EN) which are endemic only to the Nosivolo area, constitutes the special biological interest of the Ramsar Nosivolo site. The specificity of their habitats and the respective distribution of these species, along altitudinal boundaries, reinforce the ecological significance of this wetland (Raminosoa et al, 2003).

Other endemic species threatened with extinction and belonging to various taxa also inhabit the other ecosystems of the catchment area. These include reptiles, primates, and arthropods. The steep slope of the river (>25% on average) and the presence of several natural forest remains in the basin play a very important role in regulating summer rainfall flooding in the Marolambo and Mahanoro districts.

4.4 Biodiversity

4.4.1 Methodological Approach

4.4.1.1 Teams Mobilized

Three teams were mobilized to prepare the biodiversity component of the ESIA:

- A team for the study of terrestrial fauna and flora composed of:
 - An ecologist, land wildlife expert and member of the IUCN-Primate Specialist Group;
 - A flora and vegetation expert;
 - A flora and vegetation researcher;
 - Four assistants from the University of Antananarivo: a botanist, a herpetologist, a mammalogist and an entomologist.
 - A wildlife and aquatic habitats research team:
 - A hydrobiologist team leader;
 - A doctor in hydrobiology (handling of the electric fishing equipment, identification, biometrics, habitat surveys);
 - Two assistant hydrobiologists;
- A team dealing with institutional and governance issues:
 - An expert in natural resources governance and institutional relationships;
 - A socio-environmentalist;
 - A forestry expert.

4.4.1.2 Scoping Field Visits

An environmental and social framework scoping field visit of the Sahofika project was carried out in October 2017. This made it possible to prepare implementation of the ESIA and learn about biodiversity issues facing the Project area. In particular, it made it possible to highlight the following main characteristics of the study area:

- A very heterogeneous landscape, composed of primary forests of the medium-altitude dense humid evergreen type, degraded forests, post-cultivation formations, cleared plots, grasslands and croplands;

- A rich flora, dominated by the Euphorbiaceae, Rubiaceae, Clusiaceae, Myrtaceae, Melastomataceae, Sapindaceae and Orchidaceae families;
- The presence of threatened species of the “precious woods” category according to the CITES and IUCN lists;
- Plant formations rich in orchids (Aerangis, Angraecum, Aeranthes, Jumellea, Benthamia, Bulbophyllum, Cynorkis and Nervilia);
- Several dozen vertebrate species, including many species endemic to Madagascar, and threatened species listed by CITES and the IUCN;
- Nine fish species (including one native and one endemic) and two crustacean species (endemic) over the entire study area;
- Natural habitats under extreme pressure, especially due to deforestation and ecosystem degradation;
- A project to create a New Protected Area (NPA) in part of the Project’s footprint;
- Presence of the Marolambo National Park in the Project’s area of influence;
- Three natural resource management transfer areas within the Project’s footprint area, in connection with the Marolambo National Park,

4.4.1.3 Literature Review

Wildlife and Terrestrial Flora

Thanks to literature review it was possible to:

- Determine the study areas required for the EIS;
- Determine the various plant formations present as well as the characteristic species of the region likely to be present on site;
- Understand issues related to the requirements of national legislation and international standards;
- Acquire good knowledge of the state of biodiversity (identification of survey sites and list of target species, especially those likely to trigger critical habitat) as well as access and safety conditions in the extended study area to facilitate field visits.

All pre-existing or published sources of information (theses, dissertations, scientific articles, activity reports and databases) available to date on the sector and surrounding areas have been reviewed with the following objectives in mind:

- Determine the plant formations and characteristic species of the region present or likely to be present based on published or pre-existing data;
- Gain a good understanding of the biodiversity of the study area to identify species likely to generate issues within the Project area;
- Harmonize the Project with:
 - The process of creating the Tsinjoarivo Ambalaomby NPA;
 - The Marolambo National Park Development and Management Plan,
 - Areas under management transfer contract: evaluation of the effectiveness of management by VOIs and possible renewal of contracts by the forest administration and its partners.

Aquatic Fauna and Flora

Bibliographical research was carried out in order to:

- Acquire good knowledge of the study area's biodiversity and physical characteristics to facilitate field surveys (identification of study sites and list of target species likely to trigger critical habitat);
- Understand the issues related to the requirements of national legislation and international standards;

As is the case with other flower and fauna communities, the study area is characterized by highly incomplete hydrobiological literature. There is virtually no study of its aquatic flora.

Nevertheless, more extensive data (National, Eastern Madagascar) were recovered:

- Specialized books, often old (pre-1970);
- More contemporary scientific articles (post 1990) on very targeted topics in general on species description or classification revision;
- Digital databases such as the "Faunafri" online database, the IUCN Global Red List, the CITES List, national red lists

In addition, exchanges with national and international specialists on the taxonomic groups concerned were also carried out in order to establish the exhaustiveness of the data sources.

In a nutshell, the ichthyofauna of Madagascar's inland waters has the following two main characteristics:

- A small number of species considering the size and diversity of the territory;
- A high rate of endemism.

Following this bibliographical review, a list of threatened and/or endemic species likely to be present on the site was drawn up. This list was compared with the list of species inventoried on site in order to draw conclusions about their presence/absence.

As with the terrestrial flora and fauna component, the bibliographic and survey data from the scoping mission served as a database for the protocols used to conduct the EIA Inventories.

4.4.1.4 Cartographic Analyses

Mapping Analyses were carried out in order to:

- Spatialize the various information collected (biological, administrative and governance) to properly analyze the Project's impacts on the biological environment;
- Display and describe the various study areas in relation to the location of the proposed Project infrastructure;
- Identify and define the Project's various issues with respect to local community resource use data and habitat distribution (terrestrial and aquatic, natural and modified habitat) within the Project's footprint ;
- Identify and propose the various measures or alternatives that could lead to a net gain in biodiversity in terms of the foreseeable and unpredictable impacts induced by the establishment and implementation of the Project;
- Conduct participatory mapping with local stakeholders to identify recent administrative boundaries and better understand the extent to which the various planning units in the designated areas are anchored to the Project's area of influence.

4.4.2 Definition of Study Areas

The hydropower plant study area was defined as follows:

- An **extended study area** (Figure 43) that includes the Onive watershed and most of its tributaries upstream and downstream from the Project site, and includes the close study area, the southern part of the Mangoro watershed, priority conservation areas and protected areas such as Marolambo National Park and RAMSAR Nosivolo site.
- A **close study area** (Figure 44) defined by the flooded part of the Onive upstream from the dam, the environments affected by the infrastructure installation works (dam, penstock, surge tank, plant, etc.), the environments crossed by the access roads (RN7 - Dam and Dam - Plant), the areas of direct influence anticipated according to the main characteristics mentioned above (in particular the consideration of the watersheds of the tributaries directly concerned in the Project's area of influence)

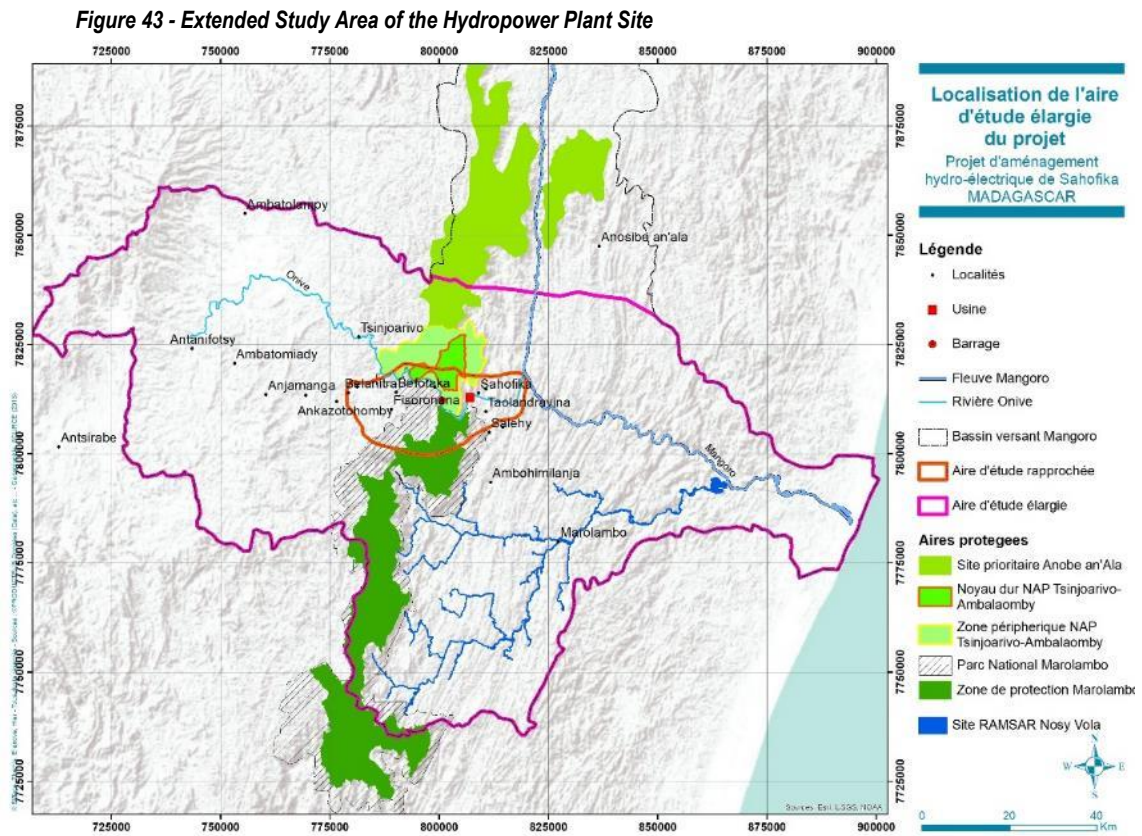
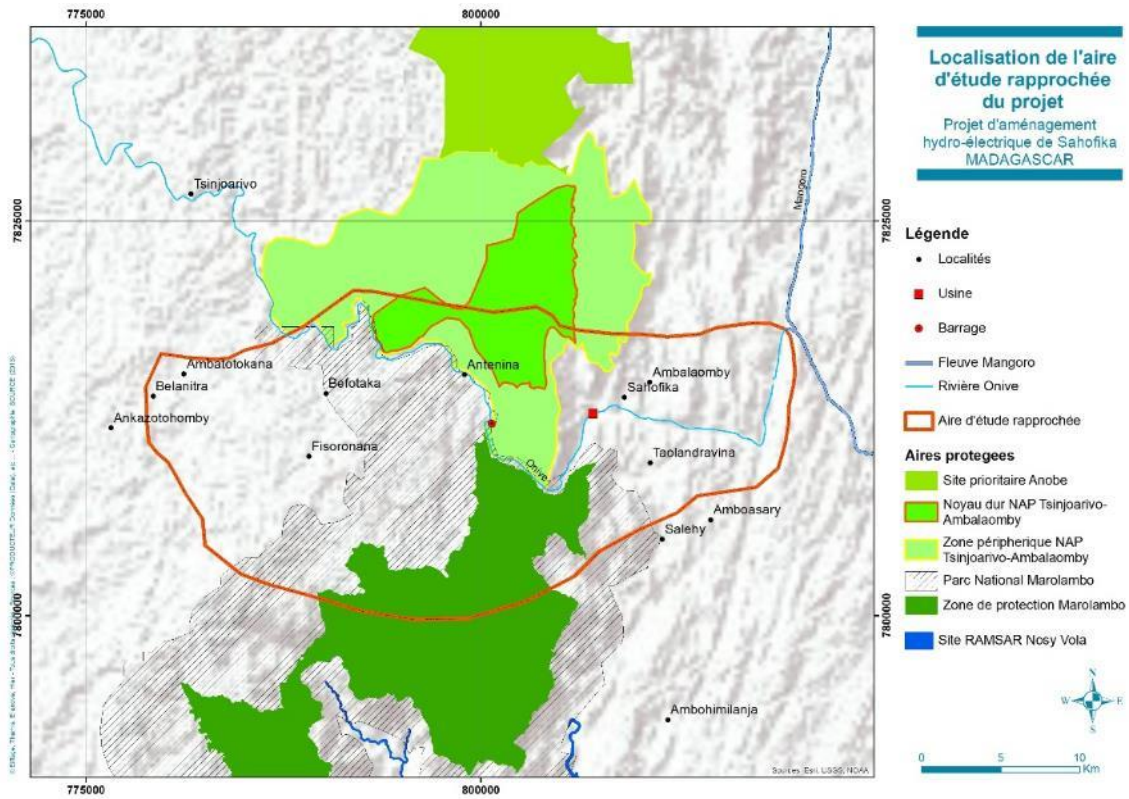

Figure 44 - Close Study Area of the Hydropower Plant Site



Note regarding Figure 45: Tsinjoarivo's NPA contours are not yet official and are therefore indicative.

4.4.3 Data Collection for the Transmission Line to Antananarivo

With respect to impacts associated with the line in the modified habitats between the Project (Plant and Dam) and Belanitra, the first data were collected during the 2018 survey phases.

Additional data relating to the proposed corridor between Befotaka and Antananarivo as shown in Figure 45 were collected in March 2019, and analyzed in the validated section (Befotaka-Antananarivo) for the alignment of the High Voltage line (located therefore to the West of Befotaka).

It should be noted that the survey protocols were adapted to suit the requirements of the task: since the vegetation consists of a mosaic of herbaceous plants of Eucalyptus and/or Pine plantations, a systematic survey method was used. This method consists in delineating a 30 m x 30 m area in the Pine and Eucalyptus plantations and in surveying all the species present in the survey area. The name, maximum height and diameter of each individual identified, were recorded. With respect to herbaceous vegetation, direct observation was carried out. The name of each individual observed was recorded. The height and recovery rate of the plant formation was estimated on site.

Figure 45 - Map of Habitats in the Corridor of the High Voltage (HV) Line up to Antananarivo

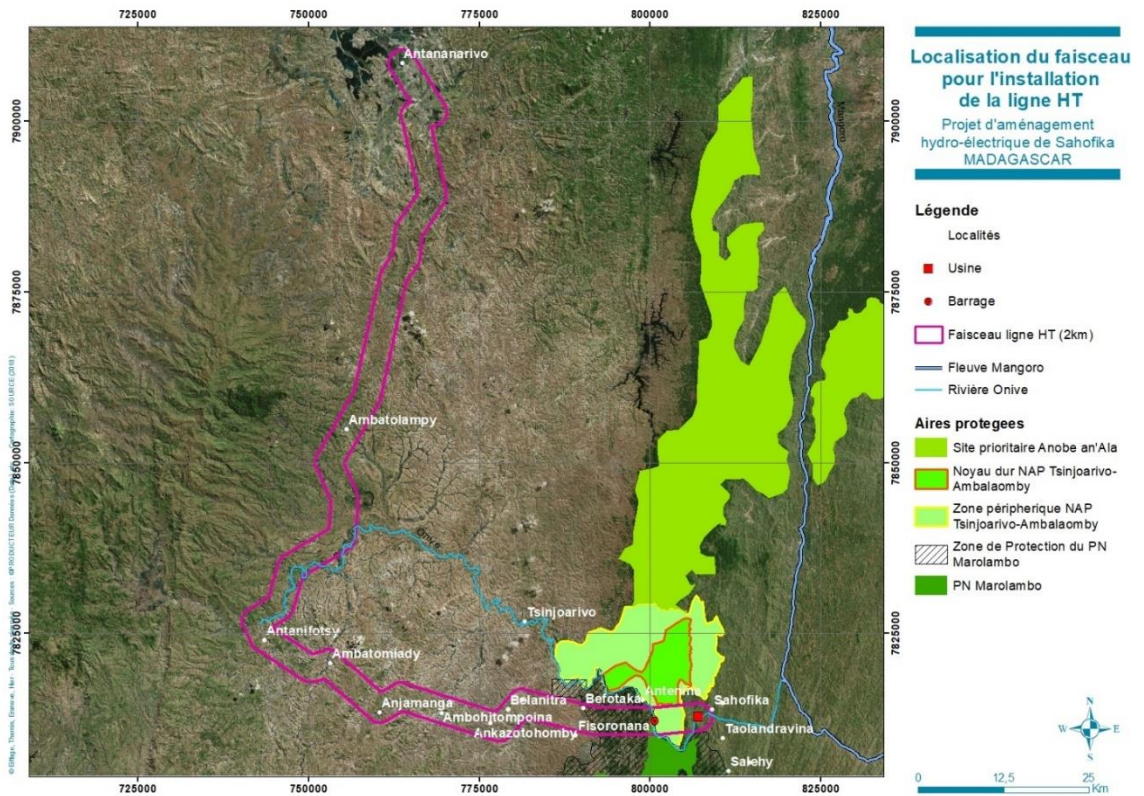

4.4.4 ESIA Field Inventories

The literature and survey data from the scoping visits served as a database for the protocols used to conduct the ESIA inventories.

4.4.4.1 Survey Schedule

The field inventories carried out for the land component took place in March-April 2018 for the wet season and in September 2018 for the dry season. For the aquatic component, wet season data were collected in April 2018 and dry season data derive from inventories conducted in October 2018.

The detailed schedule of these inventories is provided in the Annexes.

4.4.4.2 Survey Sites for the Terrestrial Biological Environment

The main habitats and the various areas concerned or affected by the Project were analyzed. The details and plan of the inventoried sites are provided in Table 66 and Figure 47.

Table 61 - Terrestrial Biological Inventory Sites

	Camp	Area covered during the survey period
2018 wet season	Camp 1: Dam site (2018 wet season)	Habitats in the flooded area on the left and right banks of the Onive River Part of the areas crossed by the access road to the dam
	Camp 2: Area downstream from the dam (2018 wet season)	Corridor in the downstream area of the dam and on the north shore
	Camp 3: Antaniketza	Fragments of forests southwest of Antenina, concerned by

	(2018 wet season)	the establishment of access roads
	Camp 4: Sahofika (2018 wet season)	Part of Faravohitra, Mandroalina and Sahofika affected by the installation of the plant and other related infrastructure
2018 dry season	Camp 5: Flooded area between Antenina and Ankorohoro	Natural and modified habitats in the flooded area including VOI, NPA Tsinjoarivo forest fragments and forest fragments with no protection status
	Camp 6: South side of the groundwater gallery	Forest corridor between the headrace tunnel and the Onive River, a forest area that is not included in the new protected area project

Figure 46 - Map of the Terrestrial Biodiversity Sites Surveyed

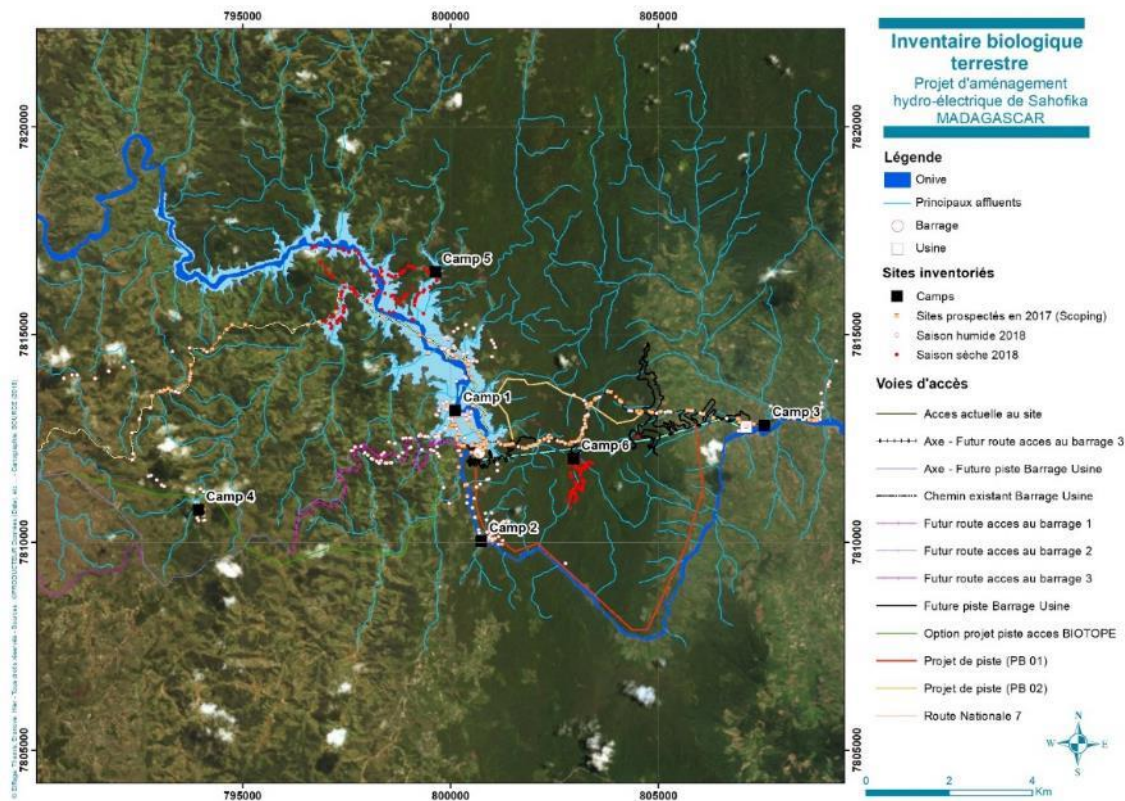

4.4.4.3 Terrestrial Environment - Flora and Vegetation Data Collection

Various standardized protocols have been implemented to collect plant data on the identified sites:

- Itinerant collection method;
- Vegetation survey method using the Gautier linear survey (1994) and Braun Blanquet surface survey (1965) methods;
- Ethnobotanical survey;
- Analysis of floristic and structural data.

Habitats were characterized using the mixed line-to-surface survey method (Gautier, 1994) to collect data on their physiognomy and floristic composition.

Itinerant Collection

The method consists in collecting, identifying and making herbaria botanical specimens of fertile plants (in flower or fruit), especially those of groups likely to be associated with ecological issues. For each specimen collected, the parameters identified are as follows:

- Name of the plant;
- Geographic coordinates;
- Habitat type (Natural or modified habitat);
- Plant phenology (in flower, fruit or vegetative state);
- Habitat characteristics (relief, topography, substrate).

Linear survey (Gautier et al., 1994)

The linear survey method combines the advantages of the line transect method used by Buell & Cantlon (1950), Bauer (1943) and Devineau (1980, 1984) and the quadrat point method used for phytosociological analysis of grasslands by Long & al. (1958), and by Daget & Poissonet (1971), to which it is most similar. The linear survey method consists in surveying the portion of vegetation that is above an imaginary straight line 100 m long on the ground, placed in a vegetation surface considered homogeneous (Gautier et al., 1994). The measurements consist in surveying all plant masses that come into contact with a vertical line (materialized with a pole). For each contact, the species concerned and the contact heights are recorded.

Surface Survey

This method complements the previous one by providing a series of structural parameters often used in forestry: the distribution of seed individuals (diameter at chest height >10 cm) by diameter class, stand density, basal area and biovolume. A plot of 0.1 ha, centered on the centre line of each linear survey, is delineated. It is materialized by stakes planted at the corners of juxtaposed squares measuring 5 m on each side, placed on either side of the survey line.

Rapid Survey

The rapid survey method was used to complete the descriptive or physiognomic data of habitats. This method makes it possible to optimize the number of field days and to obtain a large amount of information on flora and vegetation. Work to be carried out in a prospected formation unit in describing the physiognomy of the formation and in identifying characteristic species. The parameters identified are described in the table below.

Table 62 - Rapid Plant Inventory: Description of the Parameters Identified

Environmental Parameters	Structural Parameters	Floral Parameters
<ul style="list-style-type: none"> ● Geographical coordinates ● Substrate type ● Topographic level ● Slope ● Exposure ● Orientation 	<ul style="list-style-type: none"> ● Type of formation (primary/secondary forest, other) ● Height of the formation ● Number and height of each stratum ● Stratum recovery rate ● Measurement of the largest diameter ● Height of the trunk 	<ul style="list-style-type: none"> ● List of the most frequent and abundant species ● Characteristic species for each stratum ● List of species ● List of threatened species found in the area

The results obtained using this method have also made it possible to complete the mapping of the vegetation.

Study of Associated Flora

A phytosociological study was conducted for each target species identified as likely to trigger critical habitat. The method used made it possible to identify the associated flora (i.e. all species living in the same environment as the target species) and therefore give a good ecological indication of the target species' habitat. The point-centered quarter method or QCP method (Daget & Poisonnet, 1971) was used to identify the associated flora. With this method, the adult individual of the selected species is taken as the center of the quadrats. In total, 3 to 5 mature individuals of each selected species were studied.

4.4.4.4 Terrestrial Environment - Analysis and Processing of Flora and Vegetation Data

Specimen Identification and Ecological Status Assessment

In addition to work conducted to identify herbarium specimens, scientific documents, books and articles were consulted. The Tropicos database and the Catalogue of Madagascar's Vascular Plants were used to confirm the identified names, updated taxonomy and occurrence data for each species. For each identified species, a check was carried out to use the updated name while avoiding synonymy problems.

Biogeographical Analysis

Data on the biogeographical distribution of each species were obtained from information displayed in the Tropicos database. Knowledge of the range of each species is indeed essential for impact analysis purposes, especially in cases where it is necessary to ensure a net gain in biodiversity.

Structural and Dendrometric Data Analysis

Linear survey data were analyzed and processed to describe the vertical structure, horizontal structure and volume of wood provided by the vegetation, per unit area.

4.4.4.5 Terrestrial Environment - Wildlife Data Collection and Analysis

To collect as much information as possible on the wildlife species present in the various survey areas, inventories based on direct observation, trapping and survey protocols were conducted for each zoological group. The purpose of the terrestrial wildlife inventory was to develop the initial terrestrial wildlife database (baseline) in order to:

- Determine the fauna richness and diversity of each site studied;
- Describe the spatial range of species within the study area;
- Identify the forms of threats to species and their habitats.

Amphibians and Reptiles

To identify the specific diversity of herpetofauna in the study areas, the following three standard and complementary techniques were adopted:

- Direct observation along sample routes (transect)
- Systematic search of refuges and biotopes
- Trapping holes with plastic barriers

From a taxonomic point of view, the name used in the Glaw & Vences (2007) reptile and amphibian guide book, supported by the IUCN data, has been used in this study.

The analysis of amphibian and reptile data focused on the population status of the species identified. To this end, an estimate of the relative abundance of each of them has been made. The frequency of observation of species was assessed on the basis of efforts made, and the number of individuals found during a defined survey period (8 hours per day for 5, or 40 hours). The following distinct abundance categories have therefore been established:

- Low abundance species: Frequency of observation is less than 5.
- Fairly abundant species: Frequency of observation is between 5 and 10.
- Abundant species: Frequency of observation is between 10 and 20.
- Very abundant species: Frequency of observation is greater than 20.

Birds

To identify as many bird species as possible, three complementary methods were used for each site.

- Specific observations: This method consists in recording birds seen or heard along sample routes. Since most birds are present early in the morning, the research was conducted between 5:00 am and 10:00 am. Species identification was carried out by visual observation using a pair of binoculars. The average travel speed was about 1.5 km per hour.
- General observations: observations at any time of the day were also made in order to establish the presence (qualitative data) of species not found during specific observations.
- Presence index: the inventory of avian species has been supplemented by evidence of presence (feathers, active nests, regurgitation balls, etc.).

The taxonomy and scientific names used are consistent with those used by Morris & Hawkins (1998) except for:

- For the *Phyllastrephus* genus, the Cibois (2001) classification was adopted;
- For *Pseudocossyphus*, the synonym *Monticola* was used.

With respect to data analysis, the MacKinnon list method determined the Relative Abundance Index (RAI) of the various species at each site. The index ranges from 0 (least abundant species) to 1 (most abundant species). Each species is ranked according to the value of its RAI:

- Occasional species: RAI smaller than 0.20 (less than 5 times observed);
- Low abundance species: RAI between 0.20 and 0.40 (5 to 10 observations);
- Fairly abundant species: RAI between 0.40 and 0.60 (10 to 15 observations) ;
- Abundant species: RAI between 0.60 and 0.80 (15 to 20 observations) ;
- Very abundant species (Ta): RAI greater than 0.80 (greater than 20 observations).

Mammals

- Three trapping techniques were used for the inventory of small mammals: trap holes and Sherman (rodents, insectivores) and Japanese net (bats). Trapping activities were supplemented by surveys.
- Trap holes: The same amphibian and reptile trap holes were used to capture small mammals. A bucket in place for 24 hours is considered a hole trap-night.
- Standard traps: They are composed of 40 Sherman traps with a size of 22.5 cm x 8.6 cm x 7.4 cm to capture animals alive. Trap lines cover various micro-habitats in order to increase the probability of catching species, especially those with specific ecological niche requirements. The traps are baited with peanut butter and the traps are checked twice a day: at dawn and at the end of the afternoon. A trap-night is defined by a trap that is open for 24 hours (from dawn to the next dawn). The relative abundance (in %) of each species caught is the ratio between the number of individuals of a species and the total number of individuals caught in the site. No lethal traps were used during the trapping sessions.
- Japanese net: Two 12 m long, 2.50 m wide and 0.025 m wide Japanese nets were used to catch bats (flying mammals). The traps were set up in an open space not far from the creek beds between 6:00 pm and 10:00 p m.
- Surveys: Knowledge of the carnivorous and bat species present in the area was supplemented by surveys of guide books or local people, using the corresponding guide books.

The taxonomy of small mammals considered in this study is consistent with the Soarimalala & Goodman review (2011) and information from the IUCN website. For carnivores and bats, the taxonomy in the Vahatra Association's guide books on these two zoological groups was chosen.

Lemurs

Four methods (transects, active research, surveys, photo traps) have been adopted to identify the lemur community in the study areas:

- Transects: The direct observation method along the transect was used to detect species by direct observation or listening. The length of each transect is set at 1 km. Two transects were installed in Ankidy, Anivorano, Berena and corridor while one transect was installed in the Antaniketsa site (Figure 48). Daytime observations were made between 06:00 and 10:00 and in the afternoon between 3:00 and 6:00 while nighttime observations took place between 7:00 and 10:00. The recorded details are time of contact, species, number of animals, height of the animal from the ground, activity deployed, distance of the animal from the track, group composition and coordinates (GPS) for each group of day lemurs. In terms of relative abundance, the individuals found of a species were counted in order to highlight the number of individuals per kilometer of travel.
- Active research: Traces of feeding of lemur species such as *Daubentonia madagascariensis* and *Hapalemur sp* were identified.
- Surveys: A series of questions were asked to local assistants to obtain information about lemurs in the study areas. The guide book by Mittermeier et al (2010) was shown to the respondents as a reference.
- Photo trap: This technique allows makes it possible to take pictures of an animal moving in front of the installed photo trap.

The taxonomy mentioned in the guide book "Lémuriens de Madagascar" [Lemurs of Madagascar] (Mittermeier et al., 2014) was considered for this study.

Figure 47 - Distribution of Observation Transects Throughout the Study Area

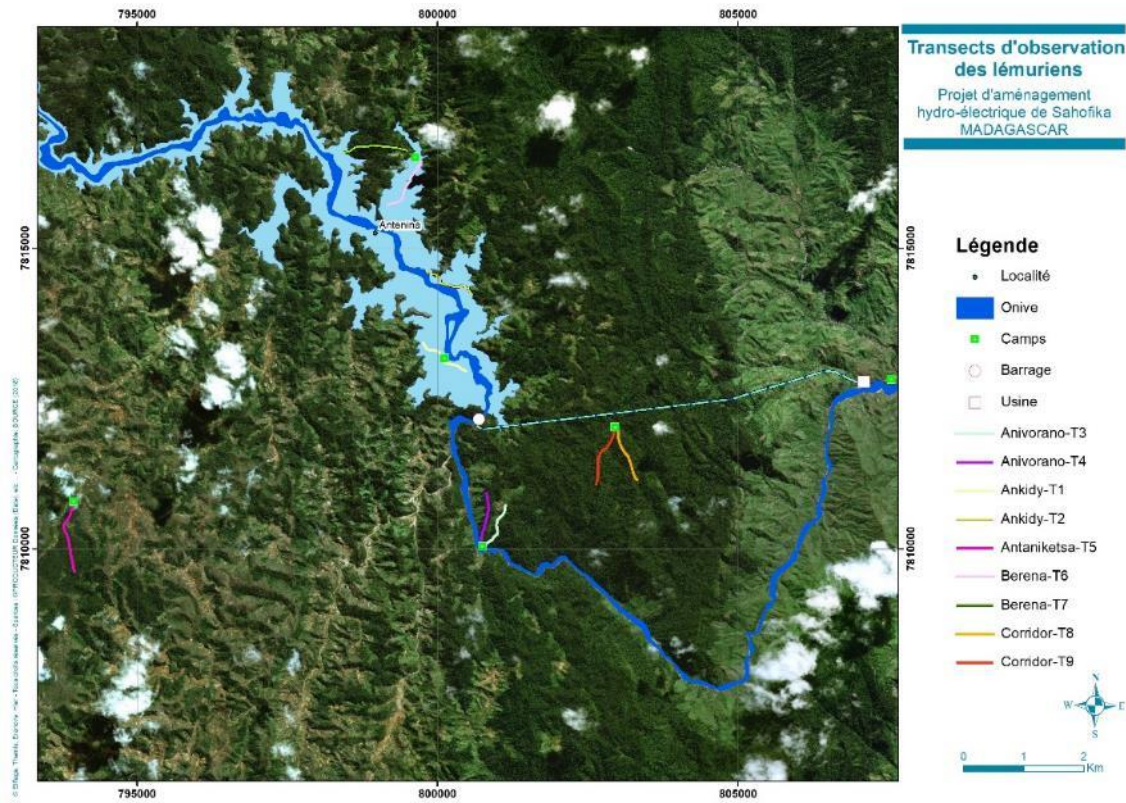

Insects

Entomofauna inventories were carried out only in the wet season, i.e. in March-April. Five complementary methods have been adopted to determine the diversity and sensitivity of the terrestrial insect community (butterflies, ants, etc.) in the survey areas.

- General collection: General collection consists in prospecting the habitats of species and manually collecting individuals (using a pair of pliers). Smaller species such as ants are harvested using a vacuum cleaner. The specimens are kept in alcohol at 70%.
- Butterfly net: The butterfly net is used to hunt the most active species of Rhopaloceran-Lepidoptera. Throughout a track, butterflies in flight or at rest are captured by a half-rotation net shot. Captured individuals are pinched at the chest between the thumb and forefinger and placed in papillotes.
- Manual collection: Manual collection consists in observing and harvesting the young stages (caterpillars or cocoons) of Lepidoptera on their host plant. For some species such as *Argema mittrei* and *Antherina suraka*, the presence of faeces may indicate the existence of their population in the site. Individuals are stored in vials filled with 70% concentrated alcohol.
- Malaise trap: This type of trap is particularly used to capture flying insects. The principle is based on intercepting insects while they are flying. The trap designed with 1mm² mesh screens is installed perpendicular to the wind direction. At the lateral top of the sails there is a hole-opening communicating with a bottle containing a soapy solution with a few drops of formaldehyde added. This bottle is used to recover specimens. On the site, a Malaise trap is installed in a semi-open and representative place where the floristic composition is sufficiently diversified. The trapping time is set at 72 hours.

- Tray traps: This type of trap is designed to capture insects from the soil and litter. The principle consists in intercepting animals crawling on the ground. In practice, a plastic box corresponding to a trap is buried so that its edge is flush with the ground level. Then, a 70% alcohol solution is poured up to a third of the can. This preservation solution is used to kill captured individuals and prevent one from being eaten by the other. In each study site, 30 trap traps are installed. The distance between the two successive boxes is fixed at 10 m and the trapping time is 72 hours.

Part of the species determination was conducted in the field using a hand magnifying glass and consulting the specialized literature for each group of Arthropods. It should be noted that the identification of Arthropod species, a very diversified group, was mainly conducted at the Laboratory of Zoology and Animal Biodiversity of the University of Antananarivo.

For data analysis purposes, and to be able to compare insect diversity in the study sites, the following measuring orders are used:

- The taxonomic wealth which is the number of families present in the taxonomic orders or suborders.
- Absolute abundance is the number of individuals sampled per taxon.

Shannon's diversity index (H'): This is a measurement of the composition, number and relative abundance of taxa in an ecosystem

4.4.4.6 Aquatic Environment - Ichthyologic Fauna

A census of ichthyologic fauna was carried out. The following methods were used:

- Fish inventory by electric fishing;
- Fish inventory using various instruments (traps, casting net and seine);
- Inventory of benthic macroinvertebrates (0.5 mm Surber mesh net);
- Surveys of local populations.

Surveyed Sites

The sampling sites were selected to provide a representative image of the various habitats found in the study area. Tributaries located upstream from the dam and concerned by the rise in water level (due to the construction of the dam) have been retained, but also tributaries located at the By-passed Reach (BPR), more specifically concerned by the construction of related structures (penstock, tracks...). Tributaries located at and downstream from the future plant were also inventoried. The various sites sampled in the wet and dry seasons are distributed as follows (see also Figure 49):

- Upstream from the dam: 10 sites spread over the Onive (3 stations) and 4 tributaries (7 stations);
- Dam: 3 sites on 3 tributaries;
- By-passed reach (between the dam and the proposed plant): 7 sites spread over the Onive (2 sites upstream from the rapids area and one site downstream from the rapids area) and 3 tributaries (2 sites on 2 tributaries upstream from the rapids area and 2 sites on a tributary downstream from the rapids area);
- Downstream plant: 6 sampling sites on 4 tributaries (including 5 located on the same sub-watershed: Marotenina) and 2 sites on the Onive;

Figure 48 - Location of Hydrobiological Survey Stations

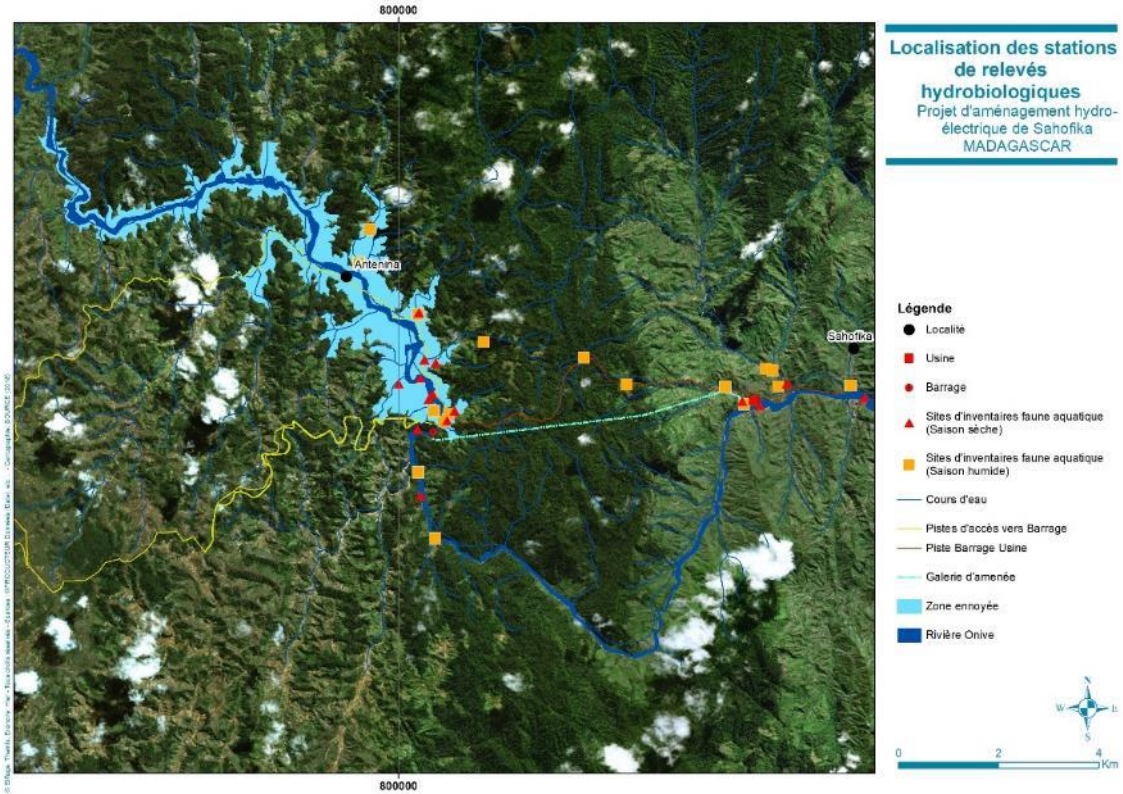

The Onive was only inventoried during the second dry season: for safety and fishing efficiency reasons, a low water level was preferable.

Photo 43 - Various Tributaries Surveyed

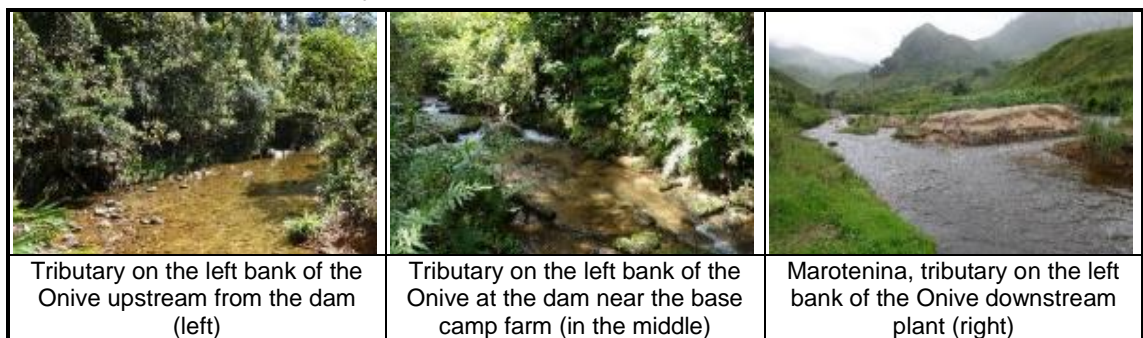

Collection Methods

During the scoping phase (October 2017), various collection methods were tested according to various habitat types and available fishing gear. The methods tested were as follows:

- Angling: this method targets pelagic and benthic daytime species;
- Fish trap: Baited nets (cassava or sweet potato) were placed during the day and night. This method targets day and night, pelagic and benthic species;

- “Spider” type flat gillnets: This fishing gear has been used on deep-water stations. The nets were set up day and night to maximize capture. This method mainly aims to target nocturnal species, mainly pelagic, which are restricted to calm areas.

Photo 44 - Various Aquatic Fauna Inventory Methods Used



Due to taboo (“fady”) reasons in the upstream area of the dam, the use casting nets, which is often an effective fishing gear for the inventory of ichthyofauna, was not used. However, the complementarity of the various prospecting techniques made it possible to obtain a relatively complete picture of the entire study area.

Based on water conductivity measurements taken during the scoping phase, the electric fishing technique was deployed during the wet and dry season inventories, in order to complete the first data collected. This technique was coupled with the casting net (in areas where the gear is not taboo) and seine over the entire surveyed area.

Surveys

In order to complete and cross-check the inventory data, surveys on the potential presence of certain aquatic species were conducted among the local population. In addition, local fishermen in action, regardless of their fishing techniques (net, hand, angling, traps, etc.), were consulted in order to observe the species they were able to collect in the study site. A total of 26 people were surveyed throughout the three inventory sessions.

The questions asked were about:

- The species present in the Onive or tributaries, specifying the diversion bays;
- The spatial and temporal variability of the distribution of these species
- The evolutionary trend in population dynamics (appearance, increase, depletion, extinction of species);

- Fishing techniques used

In addition, photos of most of the species likely to be found in the study area were presented on a tablet to the respondents in order to validate the determination of the species cited.

Biometrics, post-collection handling

All fish specimens collected were counted, measured and identified. Photos were taken for each species. When in doubt about the exact determination of taxa, one or more specimens were preserved in alcohol and identified in the laboratory of the Department of Animal Biology of the University of Antananarivo.

Photo 45 - Various Aquatic Fauna Inventory Methods Used

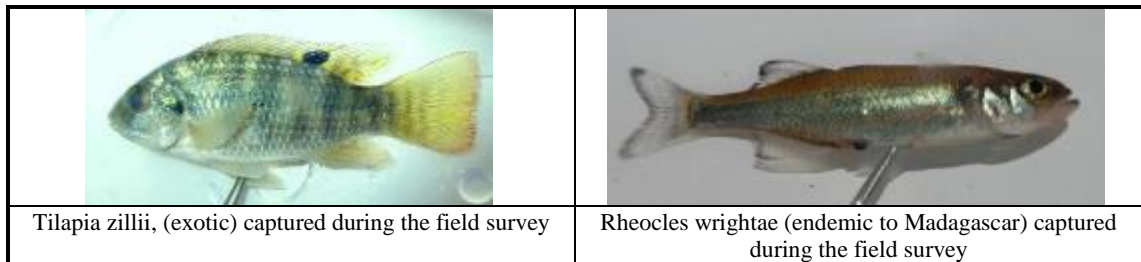

4.4.4.7 Aquatic Environment - Macroinvertebrates

Benthic macroinvertebrates are known to provide a reliable picture of the overall quality of an aquatic environment through their ability to integrate the various disturbances that can affect a freshwater ecosystem.

No aquatic macroinvertebrate species enjoys protection status in Madagascar due to limited data on these groups. However, it is known that there is a very high rate of endemism in benthic macroinvertebrates, sometimes approaching 100% for some taxa (e. g. mayflies).

Location of Stations

Four macroinvertebrate observation stations were sampled to define baseline state before the construction of the plant. They are distributed as follows (see also Figure 50):

- 2 stations on the Onive: upstream from the dam and at the bypassed reach (BPR). The station upstream from the dam is located about 1 kilometer away from the dam site, on the left bank of the Onive. The BPR station is located about 2 km downstream from the dam site on the right bank of the Onive.
- 2 stations on the tributaries of the Onive River upstream from the dam site. The first tributary is located on the left bank of the Onive about 3 km upstream from the dam site and is characterized by a diversified and relatively preserved habitat. The second tributary is located on the right bank of the Onive River about 2 km upstream from the dam site. It is characterized by a higher level of degradation related to valley development for rice cultivation and more widespread human disturbances at the basin level (deforestation for cultivation).

Figure 49 - Location of Benthic Macroinvertebrate Inventory Stations

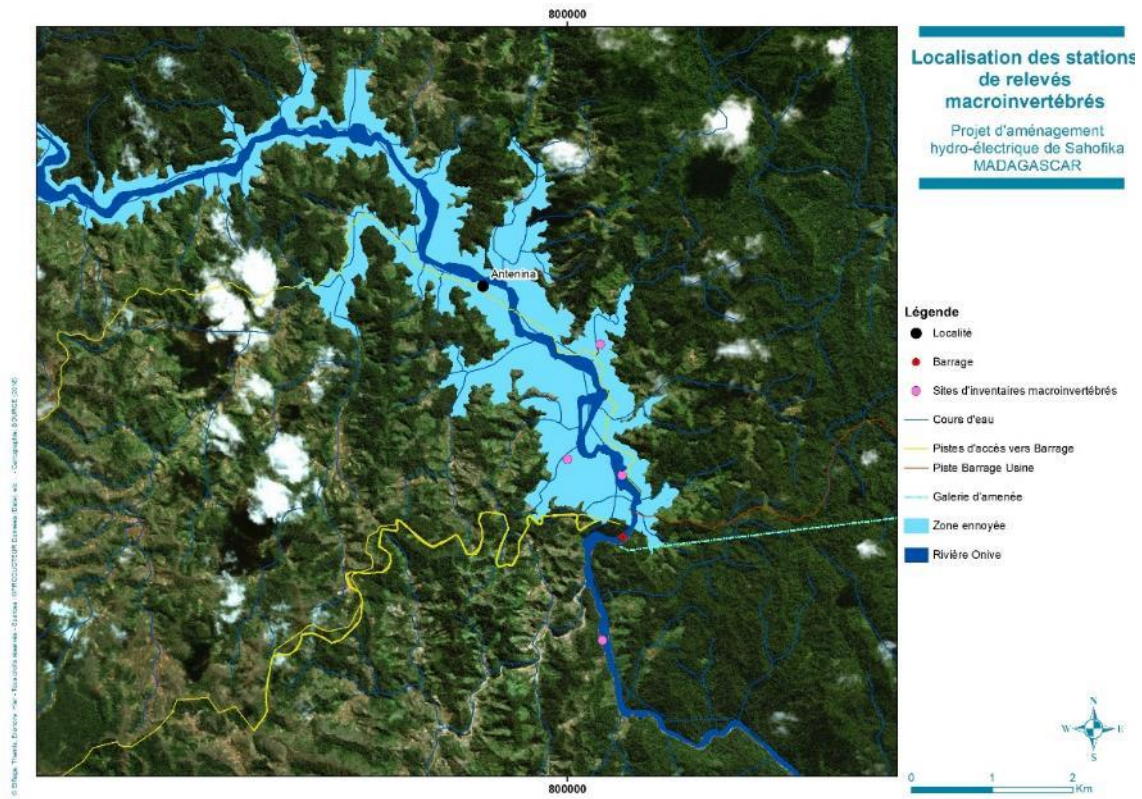

Sampling Protocol

Sampling was conducted in accordance with Standardized Global Biological Index (IBGN) methodology and the associated NF T 90-350 standard, taking into account habitat diversity and representativeness (substrate/speed pair) on the one hand and the qualities of houses on the other hand. The inventories were carried out at low water levels in the dry season with hydrological conditions stabilized for several days.

Photo 46 - Inventory of Macroinvertebrates



The stations were chosen for their representativeness of the stream segment and the heterogeneity of flow facies. They were subject to a habitat description on a dedicated sheet and a diagram distributing the substrate/speed pairs.

Sampling was carried out from downstream to upstream. The 8 samples were collected in 2 or 3 different vials and fixed for storage in 90° alcohol for laboratory determination. Double labelling was carried out to ensure traceability of the samples.

Sorting protocol and determination

The samples were sorted in situ using brushes and fine tongs and by resuspension by shaking the less dense elements. The sorting, determination and counting of individuals was carried out by the DBA laboratory of the University of Antananarivo under binocular examination using determination keys and literature on the subject:

- Tachet et al., 1996. Introduction à l'étude des macroinvertébrés des eaux douces ;
- Tachet et al., 2006. Invertébrés d'eau douce. Systématique, biologie, écologie ;
- Gerber & Gabriel, 2002. Aquatic invertebrates of south african rivers;
- Elouard & Gibon, 2001. Biodiversité et biotypologie des eaux continentales de Madagascar.
- Suhling & Martens, 2007. Dragonflies and damselflies of Namibia.

Photo 47 - Identification of Macroinvertebrates



4.4.4.8 Assessment of Conservation Issues

For flora

The resulting list of species was compared with updated data on threatened species (CITES, IUCN and GSPM) to identify species with conservation concerns in the study area.

For IUCN status, data are taken from the IUCN database.

However, for CITES status, Appendices I, II and III published on October 4, 2017 were used to identify threatened species. At the national level, the Madagascar Plant Specialists Group or GSPM has published a catalogue on Madagascar's threatened plants with three conservation statuses; Critically Endangered, Endangered and Vulnerable. The data published in this catalogue have been taken into account for the bio assessment of the species identified in this study.

For fauna

The assessment is carried out for each of the threatened species based on the scientific and technical references available in Madagascar (recent publications, available conservation status, including IUCN and field observations and experiences).

In addition, reference frameworks that could provide information on species protection, such as the CITES Convention and the 2006-400 Decree on the National Protection of Wildlife Species, were also considered.

4.4.4.9 Expert Opinion on the Data Collected

Madagascar's biodiversity is extremely rich, but basic data (bibliographic and preliminary inventories) may be very limited depending on the taxa. To this end, the Sahofika project consulted scientific stakeholders (NGOs, research laboratories, etc.) in Madagascar and abroad (hydrobiology) in order to provide external advice from experts not directly involved in the work carried out to verify the scientific rigor of the results obtained. All the opinions and recommendations formulated have been taken into account in the drafting of this report.

Flora

For flora, the Madagascar Plant Specialists Group (GSPM) was asked to give its opinion on the various methodological approaches adopted, as well as on the descriptions of the results obtained.

Terrestrial Wildlife

With regard to terrestrial fauna, the Vahatra Association, working in the area of scientific capacity building and development (biology, ecology and conservation biology) and enjoying a national and international reputation in the field of biodiversity assessment in Madagascar, was approached. Vahatra provided an opinion on the methodological approach, relevance and completeness of the literature review as well as on the completeness and quality of the data collected and associated analyses in the field.

4.4.5 Existing Pressures on Ecosystems and Species

4.4.5.1 Deforestation

Deforestation at the Ecoregion Level

Deforestation is a major problem for Madagascar, with serious consequences for biodiversity conservation and ecosystem protection. The causes are multiple and of anthropogenic origin:

- The practice of “*Tavy*”, which is a farming method for rice production on the slopes and contributes to a subsistence economy. This practice is frequent especially for farmers in the eastern forest;
- In rural and landlocked areas, deforestation is a system that farmers use to acquire land. This practice is closely linked to the land context and customary law;

Several initiatives have been taken to try to stop deforestation over the past decades. The most important of these initiatives is the creation of new protected areas and the expansion of existing protected areas, which are considered a priority to achieve the objective of the Durban vision⁴.

⁴ In 2003, in Durban, South Africa, the Government of Madagascar announced a vision for the country by tripling the size of protected areas from 1.7 million hectares to 6 million hectares.

In Madagascar, the ecosystem most affected by deforestation is the dense humid forest of the East (low and medium altitude). A recent study was conducted on the wet ecoregion of Madagascar and showed an increase in the rate of deforestation from 2005 to 2013, from 0.5% per year between 2005 and 2010 to 0.94% per year between 2010 and 2013. Detailed data on the deforestation rate for this ecoregion are presented in Table 68 below.

The study areas (extended and close) are part of this ecoregion and are not immune to Tavy problems.

Table 63 - Deforestation in the Humid Ecoregion of Madagascar (2005-2013)

	Forest Cover Area (thousands of hectares)			Deforestation Rate (% per year)	
	2005	2010	2013	2005 - 2010	2010 - 2013
Whole ecoregion	4556	4457	4345	0.5	0.94
800 m below sea level	1712	1666	1616	0.6	1.15
800 m above sea level	2844	2790	2729	0.44	0.82

Deforestation at the Local Level

As part of the ESIA, a deforestation analysis between 1989 and 2018 was conducted for the study area. The results of these analyses show the following points:

- A major loss of forest cover in the Project area;
- The change in forest cover starts from a specific point, which may be a residential area, valleys or banks;
- The areas most affected by deforestation over the past 30 years are the western parts of the corridor (Andasirotsaka, Befotaka, Antenina) and the western and southwestern part of Manaripatsa;
- Deforestation in the eastern part has reached the foot of the eastern cliff or Angavo.

Figure 50 - Deforestation in the Project Area between 1989 and 2018

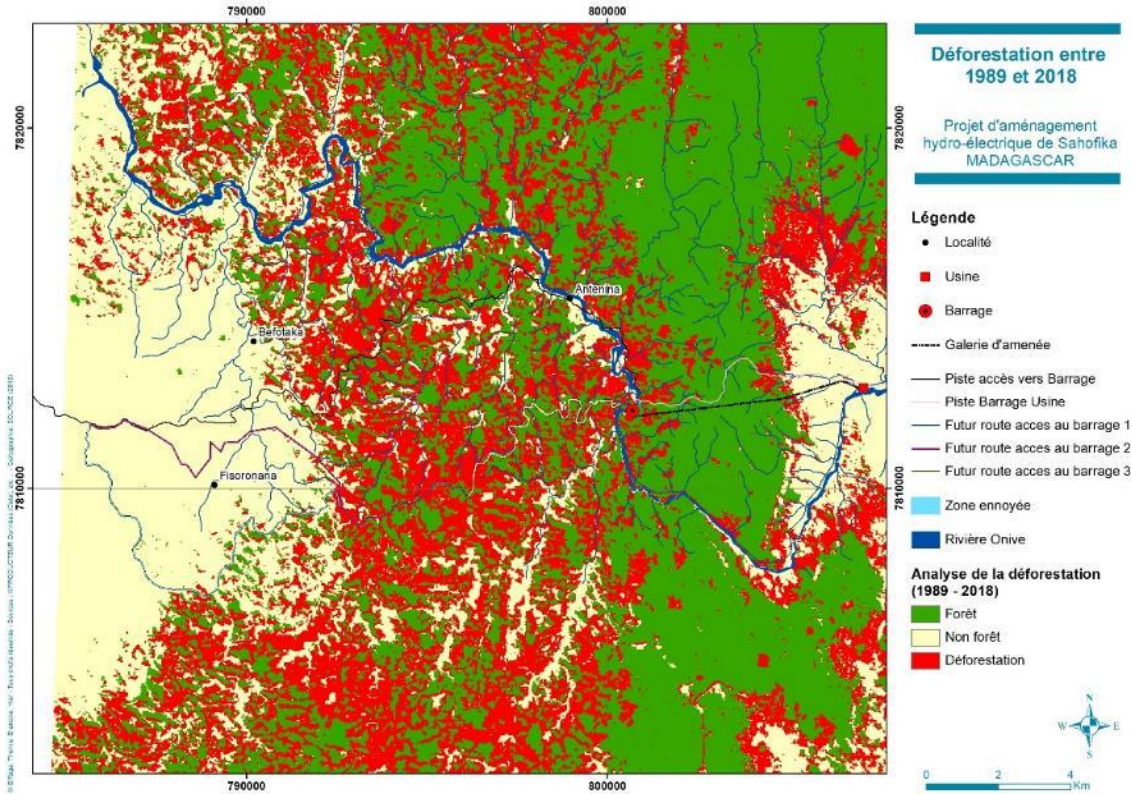

4.4.5.2 Agricultural Activities

Agricultural activities are a widespread source of degradation of terrestrial ecosystems and, incidentally, aquatic ecosystems.

Agricultural practice based on slash-and-burn farming leads to massive deforestation and rapid degradation of natural habitats. The clearing of natural habitats is carried out with a view to extending the cultivation plots and building new houses. The extension of inhabited areas continues to the detriment of forest areas and we are witnessing a transformation of the natural landscape and a fragmentation of the continuity of this forest corridor. Biodiversity in the terrestrial and aquatic region is threatened by these pressures.

The fallow system, which is shortened due to various factors (such as the land problem, the considerable increase in the number of farmers) is accelerating the fragmentation and degradation of forests in the area.

The production of local rum is a threat to certain plant species used as ferments. Seed individuals of these species are overexploited in the area and have become increasingly threatened.

4.4.5.3 Gold Panning

Artisanal gold mining contributes to the degradation of riparian habitats and dense rainforests. It also disrupts the life of aquatic fauna and flora due to the high turbidity generated in the Onive.

Siltation of valleys and river plains is common in the upstream part of the dam. This is due to erosion and gold panning in the upstream parts. This is a major problem for irrigated farming, which encourages farmers to clear forest plots for slash-and-burn.

It should be added that during the ESIA field trips, an increase in gold panning upstream from the dam was observed and reported during discussions with the villagers. This phenomenon is an indirect impact of the Sahofika Project as the gold panners intensify their activities in anticipation of the flooding of the area, which will then be made inaccessible.

4.4.5.4 Poaching

The lemur species in the area are subject to hunting, as evidenced by the presence of traditional traps. Diurnal species such as *Eulemur fulvus*, *E. rubriventer* are mainly targeted by these traps. The animals caught are locally consumed for their meat. The population also hunts game such as *Tenrec ecaudatus* and certain bird species as a source of protein during the so-called lean season (end of the dry season).

4.4.5.5 Natural Barriers to Ecological Continuity

The natural barrier to ecological continuity in the rapids area between the dam and the hydropower plant is a limiting factor for some fish and macrocrustacean species, especially amphihaline migratory species. These species need to switch alternately from a freshwater phase to a saltwater phase in order to complete their life cycle. This is true for eels (*Anguilla mossambica* and *Anguilla marmorata*) in particular as well as some Gobiidae such as *Awaous aenofuscus* and *Sicyopterus franouxi*. This rapids area is made up of very large waterfalls (see Photo 65). These falls constitute a natural barrier for several species, including the Rheocles absent upstream from this rapids area.

Gobiidae have efficient crossing capacity as they use their suction cup to cling to rock walls. However, the latter seem to be absent upstream from this rapids area, mainly because of the distance from the sea (limited range for these species). Indeed, *Sicyopterus punctissimus* and *Awaous aeneofuscus* have a ventral suction cup resulting from the transformation of their pelvic fin. Studies conducted in Reunion Island on the very close species *Sicyopterus lagocephalus* show that it allows them to cross obstacles of up to 90° (Voegtli et al., 2002). This morphological transformation occurred over time, in an evolutionary way, to allow them to cross very difficult natural obstacles such as waterfalls measuring several meters in height.

Photo 48 - Ventral Suction Cup of *Sicyopterus Punctissimus*



Eels have a different method of crossing, by creeping: they are able to move by creeping on wet surfaces with a slight to moderate slope. The more abundant literature on the European eel species of metropolitan France, and morphologically very close, shows that only the smallest individuals are able to cross vertical walls without needing support. They seem to use the surface tension force created when their bodies come into contact with the wet wall to maintain themselves on these vertical walls. But as they grow, the weight/surface tension ratio, which is proportional to their length, increases, which explains why only the smallest individuals (less than about a dozen cm in height) can use this progression mode (Legault, 1986 and 1987 in Baudoin et al. 2014).

4.4.5.6 Introduction of Invasive Alien Species

The introduction of invasive alien species is a major factor in the decline of native species (Benstead et al., 2003; De Rham, 1996). This is particularly the case for native species such as *Rheocles wrightae* and *Ratsirakia sp.* inventoried during the field surveys and largely subject to predation by carnivorous and exotic species, especially by *Channa maculata* present in the study area (Máiz-Tomé et al., 2018). This voracious predator introduced into Madagascar in the 1970s has since colonized the country very quickly thanks to its high tolerance for low-oxygenated and low-quality waters, its high fertility and the protection of juveniles by adults. In addition, the introduction of the guppy *Gambusia holbrooki* is also an additional threat. Indeed, this mosquito larvae predator, which is very widespread in Madagascar, has spread as a result of the conversion of valleys into rice fields. It also feeds on fry of native species, leading to the decline of numerous taxa (Benstead et al., 2003).

Photo 49 - Exotic Fish Species

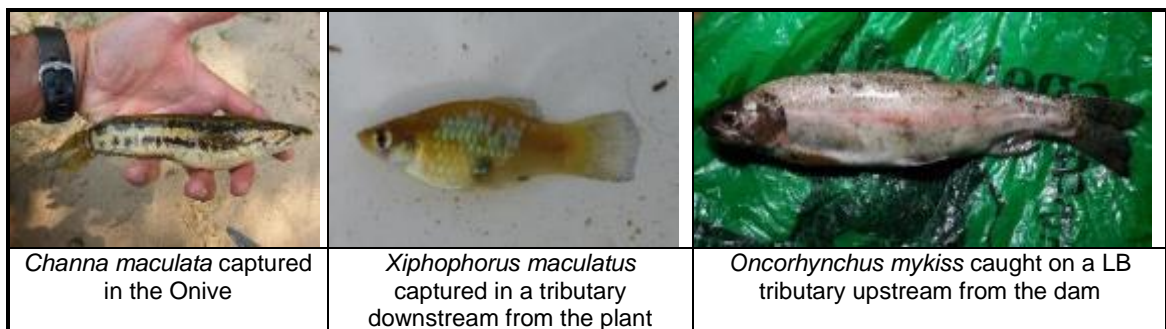

4.4.6 Habitat Characterization

4.4.6.1 Bioclimatic Classification

Bioclimatic Data

The classification of Madagascar's bioclimates developed by Cornet in 1974 is adopted to describe the bioclimatic characteristics of the study area. It is based on the type of formation found in an environment and cumulative water deficit data over the dry season, knowing that a season is defined as the sequence of consecutive periods with a climatic water deficit.

The study area is part of the Subhumid Floor, comprising part of the Central Plateaus and the depression of the Mangoro watershed. It is in the dry season undergrowth, attenuated by fog and has a rainfall exceeding 1,200 mm per year and considerable fog-like atmospheric humidity in the dry season. The average annual temperature is 18°C and the maximum is 25°C. The daily thermal amplitude is significant at higher altitudes.

Description of the Ecofloristic Zone

The study area is part of the **Eastern Domain** (Humbert, 1965). In this region, altitude plays a major role and has considerable influence on the types of formation. The table below summarizes the various classifications and associated synonyms to define the forest of the *Domaine de l'Est de Madagascar*.

Table 64 - Classification and Synonymy of the Eastern Malagasy Formation.

Perrier de la Bathie (1921)		Humbert (1955, 1965)		Koechlin et al (1974)	
Altitude (m)	Nomenclature	Altitude (m)	Nomenclature	Altitude (m)	Nomenclature
0-800	Eastern Forest	50-800	Eastern Umbrophilic dense forest	0-800	Low-level evergreen dense humid forest
800-2000	Moss and herbaceous undergrowth forest and lichen forest	800-1450	Dense umbrophilous medium altitude forest	800-1800	Dense mountain rainforest
		1450-1800	Dense mountain umbrophilous forest and lichen woodland	1800-2000	Dense mountain sclerophyll forest

According to these data, the study area is defined by the presence of:

- A dense forest with herbaceous undergrowth and lichen forest, according to Perrier de la Bathie (1921);
- A dense rainforest of the *Tambourissa* and *Weinmannia* series; lichen forest according to Humbert (1965).
- The typical characteristics of the formation are as follows: dense, multistrata, with a closed upper stratum, located between 15 and 25 m, composed of large trees and evergreen species, rich in epiphytes, mosses well present on tree trunks, a high taxa richness characteristic of humid forests, and a flora dominated by endemic species of Madagascar.

The primary formation is a dense umbrophilic mid-altitude lichen forest type, found in environments that have not yet been transformed or exploited by farmers.

4.4.6.2 Terrestrial Habitats: Medium-altitude Dense Humid Forest

The distribution of evergreen dense rainforest in the study area is determined and conditioned by environmental factors, the history of colonization of the area by local populations and the presence and influences of projects/organizations involved in the management and protection of natural resources.

On the eastern slope, the forest is found from 1020 to 1080 m above sea level. However, part of the escarpment (eastern cliff) is exposed due to uncontrolled fires and slash-and-burn (*Tavy*). On the western part, the compact forest block constituting the corridor is found from an altitude of 1360 m.

On the western slope, the first wooded areas found from the high plateau are located in the valleys from 1550 m above sea level in the forest islands of Befotaka and Antenina.

Due to human activities, different variants of secondary or post-cultural formations are visible throughout the Project area.

Biological Forms and Characteristic Adaptations

The region is subject to the influences of altitude and subhumid tropical weather conditions. Topographical conditions, rainfall distribution and daily temperature differences determine the distribution of plant species:

- **The buttress** is developed in large trees *Canarium* spp. (Burseraceae), *Sloanea* spp. (Elaeocarpaceae), *Cryptocaria* spp. (Lauraceae) and *Faucherea* (Sapotaceae). This allows tall trees to settle well on the ground and resist wind gusts, especially in rough terrain. The presence of these tall buttressed trees at a given site is an indicator of the health of the formation;
- Abundant humidity and cool climate facilitate the establishment, development and **abundance of mosses and lichens** on tree trunks and soil. They are well marked in formations from 1200 m above sea level;
- **Megaphilia** or the presence of large leaves is characteristic of wetland flora. It is due to high humidity and the intensity of solar radiation. This characteristic is observed in some species such as *Anthocleista* spp. (Gentianaceae), *Cryptocaria* spp. (Lauraceae), *Memecylon* spp. (Melastomataceae), *Apodocephala* spp. (Asteraceae) and *Ficus* spp. (Moraceae);
- **Epiphytism** or epiphytic richness is characteristic of humid medium- and high-altitude forests. Indeed, the study area is very rich in ferns and epiphytic orchids.

Photo 50 - Megaphilia and Buttress of Vegetal Species



The megaphilia of certain species and the abundance of mosses and lichens even on the branches over 20 m above the ground	The buttress of large trees allowing them to stick well to the ground and be protected against strong winds
---	---

Horizontal Structure

The medium-altitude dense humid rainforest is dense and rich in species. It is characterized by a linear density of 108 to 294 individuals per 100 m of survey line. These individuals represent an average of 75 to 80 species, dominated by dicotyledons of the Mesophanerophyte group and Megaphanerophytes.

The densest and richest formations in terms of species varieties are mid-point and ridge formations, while the poorest are those on the tops of mountain ranges and shallow soil environments.

Vertical Structure

In general, the forest is dense, high and composed of different strata. The canopy is well closed, is between 15 to 25 m above ground and emerging formations can reach heights of up to 30 m. Emerging species in the formation are as follows: *Canarium* spp. (Burseraceae), *Sloanea* spp. (Elaeocarpaceae), *Dalbergia* spp. (Fabaceae), *Podocarpus* spp. (Podocarpaceae) and *Chrysophyllum boivinianum* (Sapotaceae).

- The top layer is closed to tightly closed, with a recovery rate of 80 to 95%. It is dense and composed of tall straight-trunked and slightly branched tress, with a large diameter of 50 to 80 cm, such as *Cryptocaria* spp. (Lauraceae), *Symphonia* spp. (Clusiaceae), *Podocarpus madagascariensis* (Podocarpaceae), *Syzygium* spp. (Myrtaceae) and *Weinmannia* spp. (Cunoniaceae). Depending on the environment, large trees with a diameter at chest height of more than 120 cm can be found. In the upper stratum, there is a great diversity of epiphytic orchids, the most represented genera being *Angraecum*, *Bulbophyllum*, *Aeranthes* and *Jumellea*.
- The average strata are found between 8 to 15 m high. They are open to slightly closed, characterized by a recovery rate of 60 to 80%, composed of shrubs and trees of the future. The most frequent taxa are *Myrsine* spp. (Primulaceae), *Syzygium* spp. (Myrtaceae), *Polyscias* spp. (Araliaceae), *Diospyros* spp. (Ebenaceae), *Psychotria* spp., *Gaertnera* spp., *Canthium* spp., *Coffea* spp., *Rhotmania* spp. (Rubiaceae), *Grewia* spp., *Dombeya* spp., (Malvaceae), *Croton* spp., (Euphorbiaceae), *Ravenea* spp. and *Dyopsis* spp. (Arecaceae).
- The lower stratum is characterized by a grassy mat, young plants and shrubs. It is clear and shelters characteristic species such as *Impatiens* spp. (Balsaminaceae), *Commelina* spp. (Commelinaceae), *Dyopsis* spp. (Arecaceae), *Myrsine* spp. (Primulaceae), *Cyathea* spp. (Cyatheaceae) and terrestrial Orchids.

Depending on the nature of the soil or topography, different variants of the medium-level evergreen dense rainforest can be found in the study area. In general, the highest and densest forests are found in deep soil, lowland or mid-soil environments. At the top of the massifs, the height of the formation does not exceed 15 m and the canopy is open to slightly closed, with a recovery rate of 50 to 60%. The table below summarizes the structural characteristics of the medium-altitude dense humid rainforest found in the study area.

Table 65 - Structural Characteristics of the Evergreen Dense Humid Forest

Parameters	Maximum	Average
------------	---------	---------

Canopy height (m)	28	21.51 (± 9.3)
Recovery rate of the upper stratum (%)	100	95 (± 3.25)
Seed diameter (m)	135	30 (± 1.93)
Basal area m²	28	25.18 (± 1.93)
Biovolume (m³/ha)	315	250 (± 65.15)

4.4.6.3 Terrestrial Habitats: Lichen Woodland

The lichen forest formation is an altitudinal and climatic variant of the dense, evergreen, medium-altitude humid forest. In the Project's area of influence, the formation occurs more than 1450 m above sea level. With relief not exceeding 1600 m in altitude in the Project's area of influence, the fate of the lichen forest in this area is uncertain, regardless of the implementation of the Project. This uncertainty is due to the gradual rise of the species characteristic of the lower level in a context of climate change: a difference of 1°C in temperature represents a difference of about 200m in altitude, and it is likely that with the increase in average temperatures, species from the dense medium altitude humid forest will gradually reach the lichen forest.

Horizontal Structure

Lichen woodlands are predominant in areas higher than 1450 m above sea level, as found in the corridor between the dam and the plant. The data collected show that the formation is characterized by:

- A linear density of 122 to 305 individuals per 100 m of survey;
- A dense to very dense undergrowth, dominated by herbaceous plants;
- An open/slightly closed canopy, with a recovery rate of less than 80%;
- An abundance of epiphytes composed of pteridophytes and orchids;
- These individuals are represented by 66 to 90 species of which the most represented families are as follows: Rubiaceae, Euphorbiaceae, Orchidaceae, Salicaceae, Asteraceae and Myrtaceae ;
- The large trees characteristic of the formation are *Symphonia spp* (Clusiaceae), *Eugenia spp* (Myrtaceae), *Sloanea rhodantha* (Elaeocarpaceae), and *Weinmannia spp* (Cunoniaceae).

Vertical Structure

Due to climatic conditions (low temperature, high precipitation) and exposure of habitats to the wind, lichen woodlands were characterized by:

- An average height of 8 to 12 m with lower formations that can be found in thin soil or shallow bedrock environments;
- The presence of three to four strata with dense to very dense undergrowth and a slightly closed upper stratum. The average stratum is dense and composed of shrubs of young trees;
- Tree trunks and branches are covered with mosses and lichens;
- On average, the largest diameter does not exceed 60 m, as measured in *Podocarpus madagascariensis* (Podocarpaceae).

Table 66 - Structural Data for Lichen Woodlands

Parameters	Maximum	Average
Canopy height (m)	13	10 (± 3.72)
Recovery rate of the upper stratum (%)	85	65 (± 22.5)
Seed diameter (m)	62	16 (± 10.31)
Basal area m^2	18	13.12 (± 4.91)
Biovolume (m ³ /ha)	210	180 (± 32.19)

4.4.6.4 Secondary Formation (“Savoka”)

Slash-and-burn practices (“Tavy”) and bush fires are the causes of forest degradation in favor of secondary formations. The environment’s colonization process and the type of plant succession are not similar on both sides, especially in the eastern part (Sahofika) and the western part (Antenina and Dam).

Plant Succession on the Eastern Slope of the Forest Corridor

For the eastern part, the data are synthesized by the Razanadravao (1997) scheme presented in Figure 52, and based on models and analyses provided by various studies. The various phases are as follows:

- Clearing of primary forests:
 - Farmers choose the plots to be cleared according to several criteria including the presence of soil fertility indicator species, distance from the village, distance from a water point and slope;
 - Forest clearing is carried out from May to the end of June;
 - The cut down plant masses are left on site for drying;
 - The slash-and-burn of the crop plot is carried out at the end of the dry season or before the first rainfall;
 - Sowing is done at the beginning of the rainy season (October-November).
- First growing season (Year 1):
 - The plot is used only for rice cultivation;
 - Weeding activities are carried out between January and March depending on the abundance of weeds in the crop plots;
 - The harvest is carried out from May to the end of June;
 - After the harvest season, the plot is left to rest.
- Second year of cultivation (Year 2):
 - The second year of farming begins with the clearing of the plots with shovels and cutters. Biomasses are collected in the center of the plot and incinerated;
 - Then sowing is performed at the beginning of the rainy season. The same cycle of activities as the first year follows..;
 - Production is lower in the second year compared to the first year due to considerable degradation of soil fertility.
- Allowing the plots to rest:
 - After the second year of cultivation, farmers abandon their plot of land and look for another one (natural forest or old secondary formation). The abandoned plot is successively colonized by different types of formations, characterized by their floristic compositions and physiognomy. These different stages of evolution are as follows:

- 0 to 1 years after the abandonment of the cultivation plots, the environment is covered by low, discontinuous vegetation, dominated by pioneer, ruderal and invasive species. The most frequent and abundant include: *Solanum* spp. (Solanaceae), *Ageratum conizoides*, *Bidens pilosa* (Asteraceae), *Lantana camara* (Lamiaceae), and grasses.
 - 1 to 3 years later, the vegetation evolves and becomes denser, reaching 2 m in height and is dominated by shrubs such as *Harungana madagascariensis* (Hypericaceae), *Trema orientalis* (Cannabaceae), *Afromomum angustifolium* (Zingiberaceae), *Psiadia altissima* (Asteraceae);
 - 3 to 4 years A shrub formation of 6 to 8 m occupies the area. The physiognomic and floristic characteristics of the formation vary according to environmental conditions and soil quality, including fertility. The formation is dense and closed with a beginning of stratification.
 - 6 to 7 years later and without the slightest disturbances such as clearing or fire, the so-called Savoka formation (Malagasy term for secondary formations) can reach 10 m in height. It is rich in woody vegetation, especially for formations with rich soil, and whose organic matter is not eroded by runoff. Formations on degraded soils have a slower evolution and do not allow the presence and abundance of woody plants: they evolve in Savoka in *Ravenala madagascariensis* (Strelitziaceae) and *Sticherus flagellaris* (Gleicheniaceae) after 10 or 15 years.
 - After 25 years of evolution, Savoka in *Harungana madagascariensis* (Hypericaceae) can become a 12 to 14 m high tree formation, classified as Savoka aged by Razanadravao (1997) or as fallow aged forest by Rasoanaivo *et al.* (2015). The formation has a well-defined physiognomic structure, composed of three strata (herbaceous, shrubby and woody), dominated by native and indigenous forest woody species, a large part of which is endemic to Madagascar.
- *Tavy recovery*: Several contexts and parameters come into play in the plant succession cycle. Several contexts and parameters come into play in the plant succession cycle. In areas where population growth is less important and where land and land availability do not pose major problems for local residents, post-crop formations can or may evolve to regain their original characteristics. In other cases, (high increase in the number of farmers and a considerable reduction in the size of areas suitable for the practice of *Tavy*), the cycle of gradual vegetation evolution is interrupted by land clearing and diversified farming practices. This interruption of the fallow period leads to the gradual degradation of the vegetation cover until the grasslands are established. This is the case, for example, around the village of Sahofika, with the forest boundary considerably receding and the dominance of grassy formations.

Figure 51 - Vegetal Succession of Post-Crop Formations on the East Slope

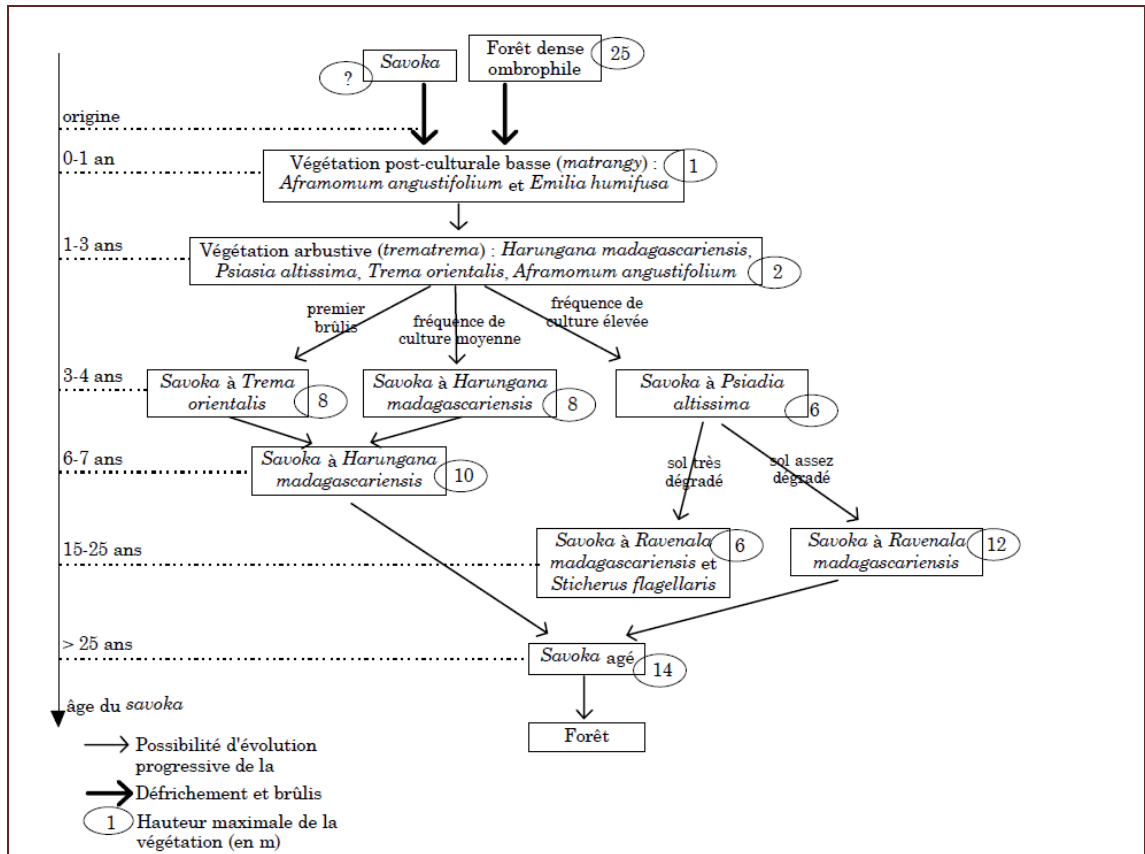

Vegetal Succession on the West Slope of the Forest Corridor

To the west of the forest corridor (Antenina, Befotaka and Manaripatsa areas), a significant fragmentation and degradation of the natural forest is observed. The process of colonization of the environment and plant succession are described by Livarilala (2003).

Farmers clear forests for rice production. The crop plots are abandoned after two successive seasons and left fallow for an undefined period or are used for other crops such as market gardening, sugar cane planting or others:

- During the first year after abandoning the crops, the plots are dominated by ruderal, pioneer or invasive herbaceous species. The characteristic species include: *Clidemia hirta* (Melastomataceae), *Ageratum conizoides*, *Bidens pilosa* (Asteraceae) and *Urena lobata* (Malvaceae). Adding to these species are shrubs: *Lantana camara* and *Clerodendrum* spp. (Lamiaceae). The formation is low, does not exceed 1.5 m, is discontinuous and dense in the wet season. This stage is classified as “herbaceous fallow”;
- After 2 or 3 years of rest, the formation can reach the stage of “dense shrub fallow”, measuring to 2 to 5 m in height, characterized by the abundance of *Solanum auriculatum* (Solanaceae), *Lantana camara* (Lamiaceae), *Harungana madagascariensis* (Hypericaceae). Herbaceous species include *Ageratum conizoides* (Asteraceae), *Clidemia hirta* (Melastomataceae) and grasses.

- o Without anthropogenic action or the fire, the formation reaches a stage known as “tree fallow” from its seventh year. It is dense, measures 5 to 8 m in height, and is composed of *Aphloia theiformis* (Aphloiaceae), *Harungana madagascariensis* (Hypericaceae), *Maesa lanceolata* (Maesaceae), *Clerodendrum* spp., *Lantana camara* (Lamiaceae) and some forest species such as *Cryptocaria* spp. (Lauraceae), *Apodocephala* spp. (Asteraceae), *Canarium* spp. (Burseraceae) and *Chrysophyllum* spp. (Sapotaceae).

At this stage, the formation can be cleared again by farmers for a new rice crop, because they believe that the soil has regained its fertility.

Tree-filled fallows are able to recover the original characteristics of dense, moist, medium-altitude forests if they are protected from fire and clearing. The most important factors that ensure forest recovery are the quantity of seeds stored in the soil, the presence and abundance of discharges, and their continuity or proximity to protected forest blocks.

Very short or interrupted fallows, overexploitation of the environment due to traditional farming practices and the periodic bush fires or uncontrolled fires contribute to forest degradation, and the disappearance of secondary shrubby formations in favor of grassy or meadow formations, dominated by Grasses and Cyperaceae.

Table 72 - Characteristics of the Various Stages of Post-crop Formations

Classes (Randriamalala & al. 2006)	Structural and Floristic Data Collected		
	Height (m)	Taxa characteristics	Reference Site
Meadow	≤ 1	Poaceae, Cyperaceae,	Poor soil environments (part of the Belanitra Barrage access road) Faravohitra, Sahofika, Befotaka
Herbaceous fallow land	≤ 1,5 m	Ageratum, Clidemia, Tristema, Solanum, Olyra, Lantana camara, Psidium	River banks, Onive bank
Shrub fallow	2 to 5 m	Lantana camara, Psiadia, Harungana madagascariensis, Maesa lanceolata, Clerodendron, Psidium	Abundant in the upstream part of the dam (former camp site 1, in the vicinity of the dam)
Fallow land with trees	5 to 8 m	Harungana madagascariensis, Cryptocaria, Eugenia, Maesa lanceolata, Aphloia,	In the vicinity of the dam, Site 4, access roads to the dam (before descent to Antenina),

4.4.6.5 Riparian Habitats

The riverside landscape of the Onive is quite heterogeneous due to human activities in the area, including agriculture and gold panning. The areas described in this paragraph are the banks of the floodplain up to proposed hydropower plant site.

Dam Site and Upstream Area

The modified habitats occupy a large part of the river environment of the upstream part of the dam (from Andasirotsaka to Ambatotsipihina). They are represented by cropping plots (Tavy plots, sugar cane plots, sweet potato plots, cassava plots or other plots) or fallow land. These environments have experienced activities to exploit and transform their original vegetation cover and are occupied by exotic, cultivated or invasive species. In

Antenina, the narrow plain banks, rich in alluvial deposits, are used by farmers for irrigated rice cultivation purposes. In the dry season, these environments are left to rest (fallow) and are colonized by herbaceous plants such as *Cyperus madagascariensis*, *Eleocharis dulcis*, *Lepironia articulata* (Cyperaceae), *Ageratum conizoides* (Asteraceae) and *Portulaca* sp. (Portulacaceae).

Photo 51 - Modified Riparian Habitats Upstream from the Dam Site



The natural habitats upstream from the dam are generally of the medium altitude dense humid forest type. They can be characterized by the presence of small beaches and dunes on the banks or by rock formations in the foreground (major bed of the Onive), followed by natural forest on the slopes. These natural riparian habitats do not have any species specific to them.

Photo 52 - Modified and Natural Shoreline Habitat



Downstream from the Dam Site

The modified habitats characterize much of the downstream portion of the dam from the forest exit to the proposed plant site. Modified habitats are also found on the banks of the Onive River in the forest corridor, due to the presence of *Tavy* and gold panning activities in the area. The modified habitat, in the vicinity of the plant site, is a meadow, dominated by herbaceous plants including Poaceae and Cyperaceae. In addition, some species such as *Raffia ruffa* (Arecaceae) and *Voaccanga thouarsii* (Apocynaceae), which are characteristic of river banks, are found there.

Photo 53 - Faravohitra and Sahofika Modified River Habitat

Natural riparian habitats are essentially rocky, due to topography, physical characteristics of the environment and current velocity. The medium-altitude dense humid rainforest occupies the upper banks and can be flooded by river water during the rainy season. Shoreline habitats do not have particular characteristics or plant species specific to them, apart from herbaceous plants and small ferns.

Photo 54 - Natural Riparian Habitat Downstream from the Dam

4.4.6.6 Natural and Modified Habitats

Terrestrial habitats

The natural terrestrial habitat found in the Project's footprint corresponds to the class of dense moist forests and high-altitude lichen forests. Natural habitats form a generally coherent system in the forest corridor, but are very fragmented in the western and eastern edges of the corridor.

These fragments are characterized by:

- The presence of plant species characteristic of the medium-altitude dense humid rainforest;
- Their importance in terms of genetic resources;
- Their use as a source of plant and building materials by riverside communities (ecosystem services);
- A challenge for the preservation of rivers and their watersheds as a whole;
- Shelters for some wildlife species that are isolated due to forest fragmentation and degradation.

The natural terrestrial habitats identified in the Sahofika Project area are vulnerable and highly threatened by existing anthropogenic pressures.

Modified habitats predominate in the Project's footprint area outside the forest corridor. These modified habitats are formed by grasslands, post-crop formations, cropland and bare soil. They are expanding due to population growth and slash-and-burn practices.

Figure 52 - Map of Natural and Modified Habitats Identified from Landsat Data

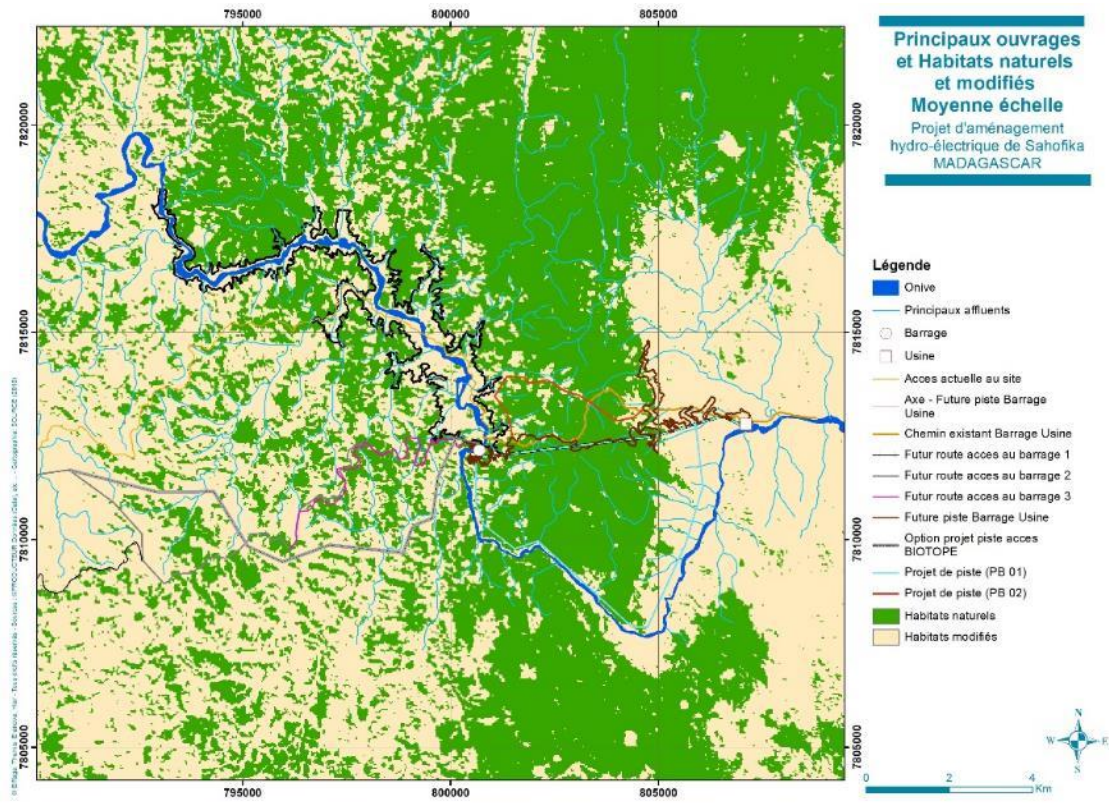
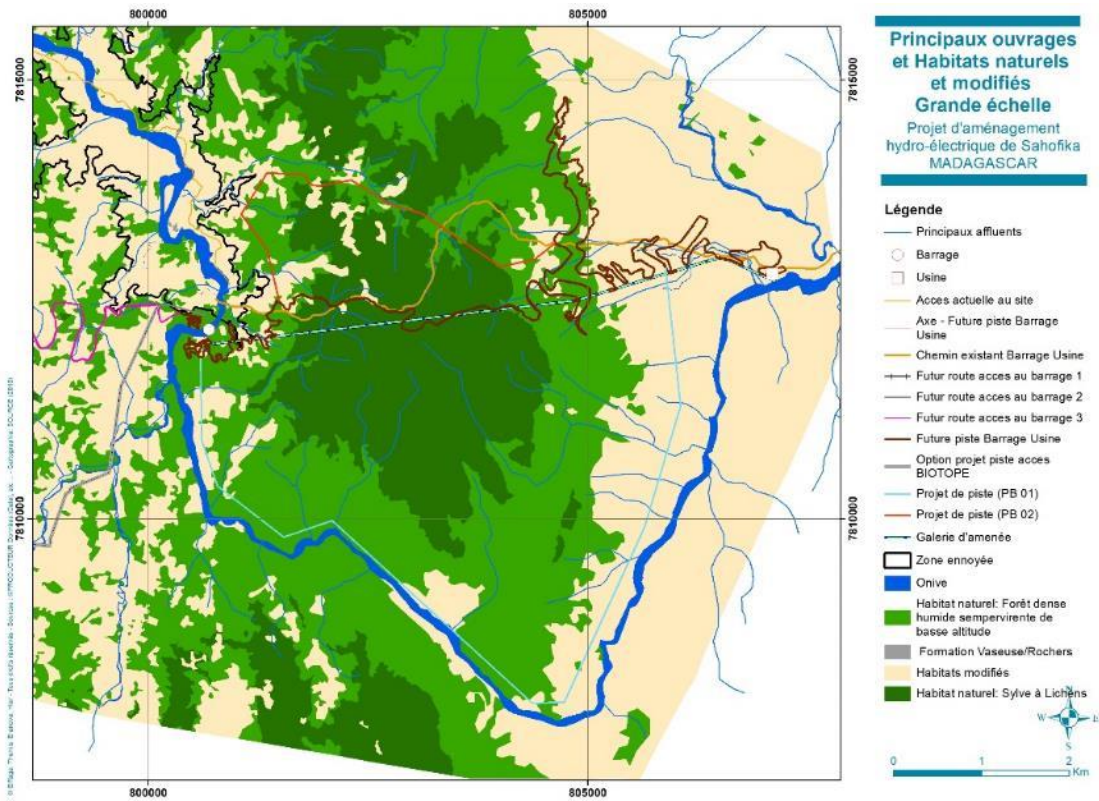

Figure 53 - Detailed Map of Natural and Modified Habitats



Aquatic habitats: the Onive

Hydromorphological surveys of aquatic habitat were conducted as part of the ESIA’s wet and dry season campaigns. Thirty-two (32) stations were analyzed (16 in the wet season and 16 in the dry season).

The areas surveyed during the ESIA’s wet and dry season inventory campaign highlighted the predominance of sand and silt in the minor bed of most tributaries (except for the most torrential areas). These are generally not very biogenic substrates for the development of aquatic fauna. Coarse mineral substrates (stones, pebbles and gravel) are also quite well represented at most of the stations; they are of crucial importance because they allow habitat diversification. In addition, they represent a more biogenic habitat compared to the dominant substrates inventoried (better reception capacity of the environment and egg-laying support for aquatic fauna).

On the Onive, habitat surveys revealed a very high level of fine material clogging and turbidity, leading to homogenization and a significant deterioration in the quality of aquatic habitat throughout the study area, from the upstream part of the dam to the downstream part of the plant.

Turbidity and clogging are often an important river degradation parameter in Madagascar. They are linked to significant fine suspended transport. These 2 characteristics are the result of intense erosion in the watersheds caused by deforestation, slash-and-burn cultivation and gold panning. Finally, with regard to fauna assessed on the basis of the various elements recorded, the general quality of aquatic habitat is homogeneous on the Onive, whether upstream from the dam, at the dam, at the BPR or downstream from the plant.

Photo 55 - From left to right, the Onive upstream from the dam, at the BPR and downstream from the plant



In conclusion, and considering the significant number of exotic fish and shellfish species introduced into the Onive River, it is considered to be an entirely **modified habitat** by international standards, due to the high level of anthropisation associated with human activities in the catchment area.

Aquatic habitats: the tributaries of the Onive

Turbidity and clogging are generally less significant in tributaries whose overall tributary quality varies greatly from one station to another and from one tributary to another.

The tributaries of the Onive River have certain diversity in terms of flow facies at the various stations analyzed and inventoried, as shown in Figure 55 and Figure 56.

Figure 54 - Distribution of Flow Facies Observed during the Wet Season

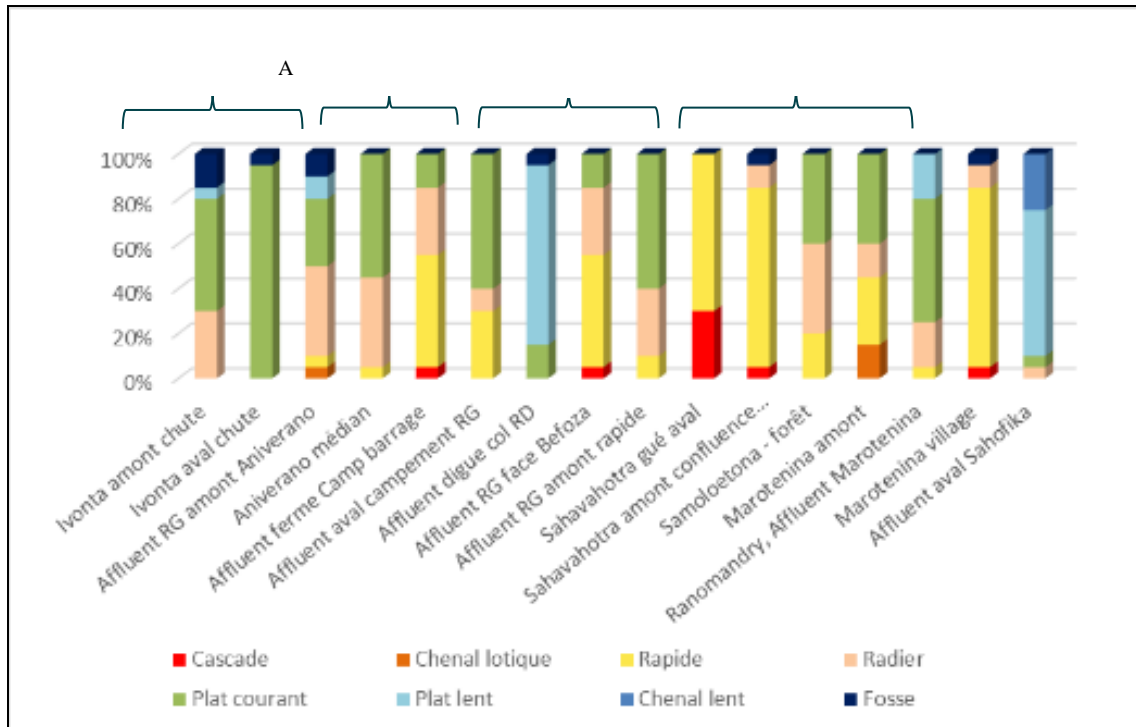
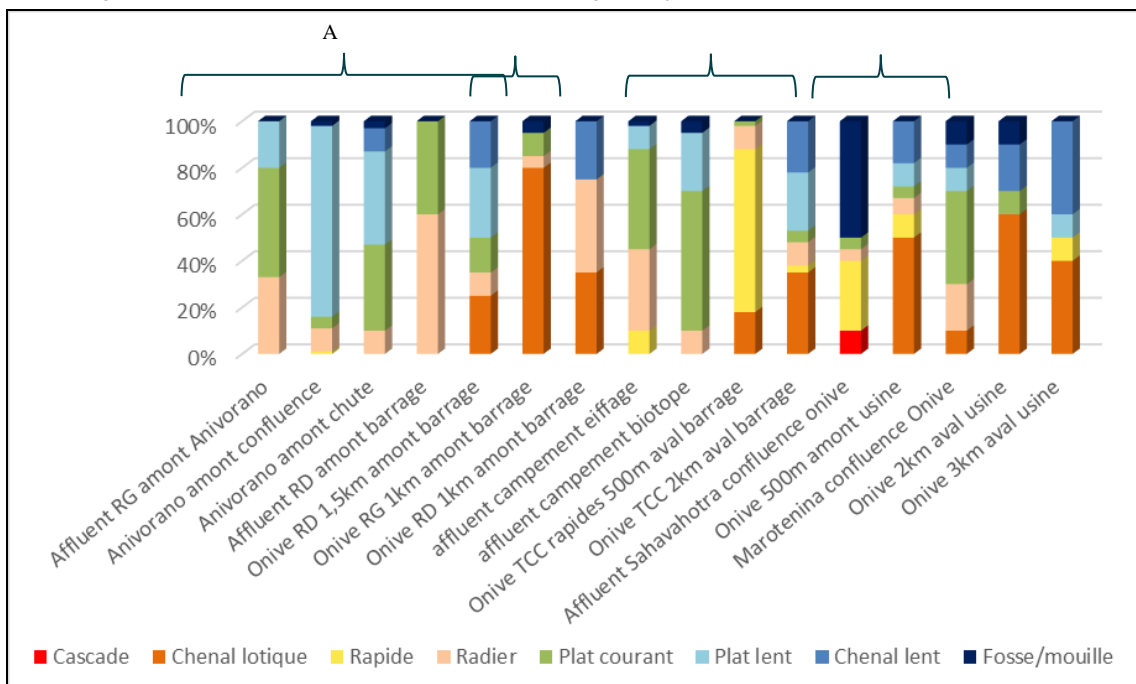

Figure 55 - Distribution of Flow Facies Observed during the Dry Season



These diagrams confirm certain elements of aquatic habitat qualification. Rivers such as the LB upstream tributary Anivorano (upstream dam) or Ranomandry (downstream plant) have a very good general quality and are also characterized by a good diversity of flow facies and an alternation between slow and fast zones. This alternation and diversity are crucial for the development of a diversified fauna and the completion of their entire life cycle.

Of the various watercourses found in the study area, only the Samoloetona, a tributary of the Marotenina River, which is itself a tributary of the Onive River downstream from the

plant, has preserved habitat that has had very little impact from human presence. This river flows through a wooded watershed, which has so far been unlikely to be deforested.

Photo 56 - Natural and Modified Habitats of Onive's Tributaries

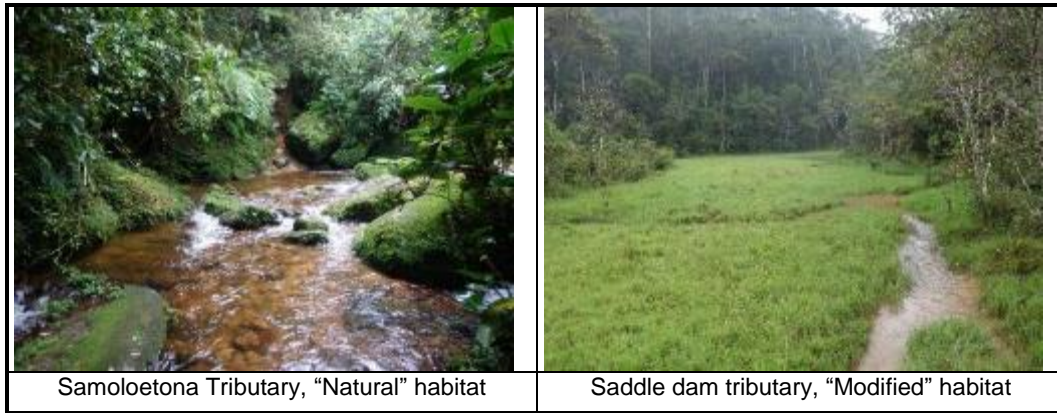

Overall:

- The most forested areas have better habitat quality and are less affected by clogging and fine suspended matter transport problems.
- The areas on the right bank of the Onive appear to be more degraded than those on the left bank. However, deforestation is progressing rapidly in the increasingly fragmented forest areas on the left bank.
- The overall quality of the tributaries of the Onive River is highly variable.

In conclusion, aquatic habitat is considered as "modified" habitat throughout the Project area, except in the heart of the forest, especially in the Samoloetona tributary, which can be considered as "natural" habitat.

Photo 57 - Various Modified Aquatic Habitats



4.4.7 Terrestrial Flora

The flora of the study area is composed of at least 611 species in 340 genera and 93 families. The complete list of species is provided in the ESIA appendices.

The most represented families are as follows:

- Orchidaceae (80 species) ;

- Rubiaceae (52 species) ;
- Poaceae (35 species) ;
- Fabaceae (26 species).

The most diversified genera are as follows:

- *Bulbophyllum* (19 species) ;
- *Cyathea* (10 species) ;
- *Aerangis* (9 species) ;
- *Cynorkis* (9 species).

Four of the five strictly Malagasy families are inventoried in the area:

- Asteropeiaceae (*Asteropeia rhopaloides*) ;
- Physenaceae (*Physena madagascariensis*) ;
- Sphaerosepalaceae (*Rhopalocarpus louvelii*, *R. macrorhamnifolius*, *R. similis*) ;
- Sarcolaenaceae (*Leptolaena gautieri*, *L. multiflora*, *Sarcolaena multiflora*, *Schizolaena exinvolucrata*).

4.4.7.1 Biogeographical Affinities of Species

Analysis of biogeographic affinity shows that the flora is dominated by endemic species of Madagascar (75.49%). The table below describes the geographical affinity of the plant species:

Table 67 - Geographical Affinity of Plant Species

Biogeographic Affinity	Rate (%)
Endemic to Madagascar	75.49
Madagascar, Africa	0.18
Madagascar, Comoros	1.59
Madagascar, Comoros, Africa	1.59
Madagascar, Comoros, Asia	0.18
Madagascar, Comoros, Mascarenes	1.76
Madagascar, Comoros, Mascarenes, Africa	3.35
Madagascar, Comoros, Mascarenes, Africa, Asia	0.35
Madagascar, Comoros, Mascarenes, Africa, Australia	0.18
Madagascar, Comoros, Mascarenes Seychelles, Africa, Asia	0.18
Madagascar, Comoros, Mascarenes, Australasia/Pacific, Seychelles, Madagascar, Africa, Asia, New World	2.12
Madagascar, Mascarenes	3.17
Madagascar, Mascarenes, Africa	3.53
Madagascar, Mascarenes, Africa, Asia	1.06
Madagascar, Mascarenes, Africa, Asia, Australia	0.18
Madagascar, Mascarenes, Africa, Asia, New World	3.00
Madagascar, Mascarenes, Africa, New World	0.35

4.4.7.2 Conservation Status of Species

Species on the IUCN Red List

Twenty-nine (29) flora species are included in the IUCN Red List. *Ravenea lakatra* (Arecaceae) is a palm variety classified as Critically Endangered (CR) and five other species are classified as Endangered (En):

- *Dypsis lutea* is a palm tree species
- *Khaya madagascariensis* is a tree species that belongs to the “African mahogany” (to be distinguished from the real mahogany).
- *Podocarpus rostratus* is a conifer endemic to Madagascar.
- *Malagasia alticola* is a tree species, unique representative of the genus *Malagasia*.
- *Leptolaena multiflora* is a small tree with endemic flowers from Madagascar.

Table 74 presents the full list of species classified by the IUCN.

Table 68 - List of Species Classified by the IUCN

N°	FAMILY	TAXA	IUCN
1	Arecaceae	<i>Ravenea lakatra</i> (Jum.) Beentje	CR
2	Arecaceae	<i>Dypsis lutea</i> (Jum.) Beentje & J. Dransf.	EN
3	Meliaceae	<i>Khaya madagascariensis</i> Jum. & H. Perrier Search in The Plant List	EN
4	Podocarpaceae	<i>Podocarpus rostratus</i> Mr. Laurent	EN
5	Proteaceae	<i>Malagasia aff. Alticola</i> (Capuron) L.A.S. Johnson & B.G. Briggs	EN
6	Sarcolaenaceae	<i>Leptolaena multiflora</i> Thouars	EN
7	Piperaceae	<i>Peperomia hildebrandtii</i> Vatke ex C. DC.	EN
8	Arecaceae	<i>Dypsis decipiens</i> (Becc.) Beentje & J. Dransf.	VU
9	Arecaceae	<i>Dypsis louvelii</i> Jum. & H. Perrier	VU
10	Fabaceae	<i>Dalbergia monticola</i> Bosser & R. Rabev.	VU
11	Fabaceae	<i>Dalbergia orientalis</i> Bosser & R. Rabev.	VU
12	Arecaceae	<i>Dypsis procumbens</i> (Jum. & H. Perrier) J. Dransf., Beentje & Govaerts	NT
13	Fabaceae	<i>Dalbergia chapelieri</i> Baill.	NT
14	Podocarpaceae	<i>Podocarpus madagascariensis</i> Baker	NT
15	Arecaceae	<i>Dypsis baronii</i> (Becc.) Beentje & J. Dransf.	LC
16	Arecaceae	<i>Dypsis fibrosa</i> (C.H. Wright) Beentje & J. Dransf.	LC
17	Arecaceae	<i>Dypsis pinnatifrons</i> Mart.	LC
18	Arecaceae	<i>Ravenea madagascariensis</i> Becc.	LC
19	Arecaceae	<i>Ravenea sambiranensis</i> Jum. & H. Perrier	LC
20	Asteropeiaceae	<i>Asteropeia rhopaloides</i> (Baker) Baill.	LC
21	Clusiaceae	<i>Garcinia mangorensis</i> (R. Vig. & Humbert) P. Sweeney & Z.S. Rogers	LC
22	Clusiaceae	<i>Garcinia pauciflora</i> Baker	LC
23	Clusiaceae	<i>Garcinia verrucosa</i> Jum. & H. Perrier	LC
24	Cyperaceae	<i>Pycnus flavescens</i> (L.) P. Beauv. ex Rchb.	LC
25	Cyperaceae	<i>Pycnus macrostachyos</i> (Lam.) J. Raynal	LC
26	Elaeocarpaceae	<i>Sloanea rhodantha</i> (Baker) Capuron	LC
27	Fabaceae	<i>Viguieranthus pervillei</i> (Drake) Villiers	LC
28	Proteaceae	<i>Faurea forficuliflora</i> Baker	LC
29	Sarcolaenaceae	<i>Leptolaena gautieri</i> G.E. Schatz & Lowry	LC
30	Sphaerosepalaceae	<i>Rhopalocarpus louvelii</i> (Danguy) Capuron	LC

Species on the CITES List

A total of 103 species belong to CITES Appendix II, which includes species whose status is not of direct concern, but which could be threatened if trade in their specimens is not controlled. They are divided into five families: Cyatheaceae, Ebenaceae, Euphorbiaceae, Fabaceae and Orchidaceae.

Table 69 - List of CITES Species

N°	FAMILY	TAXA	CITES
1	Cyatheaceae	<i>Cyathea acutula</i> (R.M. Tryon) Janssen & Rakotondr.	Annex II
2	Cyatheaceae	<i>Cyathea appendiculata</i> Baker	Annex II
3	Cyatheaceae	<i>Cyathea approximata</i> Bonap.	Annex II
4	Cyatheaceae	<i>Cyathea boivinii</i> Mett. ex Kuhn var. <i>boivinii</i>	Annex II
5	Cyatheaceae	<i>Cyathea boivinii</i> var. <i>hildebrandtii</i> (Kuhn) Janssen & Rakotondr.	Annex II
6	Cyatheaceae	<i>Cyathea decrescens</i> Mett. var. <i>decrescens</i>	Annex II
7	Cyatheaceae	<i>Cyathea dregei</i> Kunze	Annex II
8	Cyatheaceae	<i>Cyathea remotifolia</i> Bonap.	Annex II
9	Cyatheaceae	<i>Cyathea similis</i> C. Chr. var. <i>similis</i>	Annex II
10	Cyatheaceae	<i>Cyathea viguieri</i> Tardieu	Annex II
11	Ebenaceae	<i>Diospyros gracilipes</i> Hiern	Annex II
12	Ebenaceae	<i>Diospyros haplostylis</i> Boivin ex Hiern	Annex II
13	Ebenaceae	<i>Diospyros myriophylla</i> (H. Perrier) G.E. Schatz & Lowry	Annex II
14	Ebenaceae	<i>Diospyros parvifolia</i> Hiern	Annex II
15	Ebenaceae	<i>Diospyros</i> sp 1	Annex II
16	Ebenaceae	<i>Diospyros</i> sp 2	Annex II
17	Ebenaceae	<i>Diospyros sphaerosepala</i> Baker	Annex II
18	Euphorbiaceae	<i>Euphorbia</i> sp1	Annex II
19	Euphorbiaceae	<i>Euphorbia</i> sp2	Annex II
20	Euphorbiaceae	<i>Euphorbia</i> sp3	Annex II
21	Fabaceae	<i>Dalbergiachapelieri</i> Baill.	Annex II
22	Fabaceae	<i>Dalbergiamonticola</i> Bosser & R. Rabev.	Annex II
23	Fabaceae	<i>Dalbergiaorientalis</i> Bosser & R. Rabev.	Annex II
24	Orchidaceae	<i>Aerangis articulata</i> (Rchb. f.) Schltr.	Annex II
25	Orchidaceae	<i>Aerangis ellisii</i> (B.S. Williams) Schltr.	Annex II
26	Orchidaceae	<i>Aerangis fastuosa</i> (Rchb. f.) Schltr.	Annex II
27	Orchidaceae	<i>Aerangis hyaloides</i> (Rchb. f.) Schltr.	Annex II
28	Orchidaceae	<i>Aerangis hyaloides</i> (Rchb. f.) Schltr.	Annex II
29	Orchidaceae	<i>Aerangis macrocentra</i> (Schltr.) Schltr.	Annex II
30	Orchidaceae	<i>Aerangis modesta</i> (Hook. f.) Schltr.	Annex II
31	Orchidaceae	<i>Aerangis monantha</i> Schltr.	Annex II
32	Orchidaceae	<i>Aerangis stylosa</i> (Rolfe) Schltr. Search in The Plant List	Annex II
33	Orchidaceae	<i>Aeranthes antennophora</i> H. Perrier	Annex II
34	Orchidaceae	<i>Aeranthes ecalcarata</i> H. Perrier	Annex II
35	Orchidaceae	<i>Aeranthes multinodis</i> Bosser	Annex II
36	Orchidaceae	<i>Aeranthes nidus</i> Schltr.	Annex II
37	Orchidaceae	<i>Aeranthes ramosa</i> Rolfe	Annex II
38	Orchidaceae	<i>Angraecum danguyanum</i> H. Perrier	Annex II
39	Orchidaceae	<i>Angraecum imerinense</i> Schltr.	Annex II
40	Orchidaceae	<i>Angraecum linearifolium</i> Garay	Annex II
41	Orchidaceae	<i>Angraecum mauritanum</i> (Pear.) Strike.	Annex II
42	Orchidaceae	<i>Angraecum onivense</i> H. Perrier	Annex II
43	Orchidaceae	<i>Angraecum pauciramsum</i> Schltr.	Annex II
44	Orchidaceae	<i>Angraecum viguieri</i> Schltr.	Annex II
45	Orchidaceae	<i>Benthamia flavida</i> Schltr.	Annex II
46	Orchidaceae	<i>Benthamia glaberrima</i> (Ridl.) H. Perrier	Annex II
47	Orchidaceae	<i>Brownleea parviflora</i> Harv. ex Lindl.	Annex II
48	Orchidaceae	<i>Bulbophyllum afzelii</i> Schltr.	Annex II
49	Orchidaceae	<i>Bulbophyllum ankaizinense</i> (Jum. & H. Perrier) Schltr.	Annex II

50	Orchidaceae	<i>Bulbophyllum aubrevillei</i> Bosser	Annex II
51	Orchidaceae	<i>Bulbophyllum auriflorum</i> H. Perrier	Annex II
52	Orchidaceae	<i>Bulbophyllum baronii</i> Ridl.	Annex II
53	Orchidaceae	<i>Bulbophyllum bryophilum</i> Hermans	Annex II
54	Orchidaceae	<i>Bulbophyllum coriophorum</i> Ridl.	Annex II
55	Orchidaceae	<i>Bulbophyllum kainochiloides</i> H. Perrier	Annex II
56	Orchidaceae	<i>Bulbophyllum leandrianum</i> H. Perrier	Annex II
57	Orchidaceae	<i>Bulbophyllum lemuraeoides</i> H. Perrier	Annex II
58	Orchidaceae	<i>Bulbophyllum leptostachyum</i> Schltr.	Annex II
59	Orchidaceae	<i>Bulbophyllum manganotii</i> Bosser	Annex II
60	Orchidaceae	<i>Bulbophyllum molossus</i> Rchb. f.	Annex II
61	Orchidaceae	<i>Bulbophyllum multiflorum</i> Ridl.	Annex II
62	Orchidaceae	<i>Bulbophyllum oclusum</i> Ridl.	Annex II
63	Orchidaceae	<i>Bulbophyllum onivense</i> H. Perrier	Annex II
64	Orchidaceae	<i>Bulbophyllum pervillei</i> Rolfe	Annex II
65	Orchidaceae	<i>Bulbophyllum rubiginosum</i> Schltr.	Annex II
66	Orchidaceae	<i>Bulbophyllum rutenbergianum</i> Schltr.	Annex II
67	Orchidaceae	<i>Calanthe madagascariensis</i> Rolfe ex Hook. f.	Annex II
68	Orchidaceae	<i>Cymbidiella flabellata</i> (Thouars) Rolfe	Annex II
69	Orchidaceae	<i>Cymbidiella pardalina</i> (Rchb. f.) Garay	Annex II
70	Orchidaceae	<i>Cynorkis ampullacea</i> H. Perrier ex Hermans	Annex II
71	Orchidaceae	<i>Cynorkis angustipetala</i> Ridl.	Annex II
72	Orchidaceae	<i>Cynorkis flexuosa</i> Lindl.	Annex II
73	Orchidaceae	<i>Cynorkis graminea</i> (Thouars) Schltr.	Annex II
74	Orchidaceae	<i>Cynorkis lilacina</i> Ridl.	Annex II
75	Orchidaceae	<i>Cynorkis lindleyana</i> Hermans	Annex II
76	Orchidaceae	<i>Cynorkis lowiana</i> Rchb.	Annex II
77	Orchidaceae	<i>Cynorkis papillosa</i> (Ridl.) Summerh.	Annex II
78	Orchidaceae	<i>Cynorkis speciosa</i> Ridl.	Annex II
79	Orchidaceae	<i>Disa buchenaviana</i> Kraenzl.	Annex II
80	Orchidaceae	<i>Disa embodied</i> Lindl.	Annex II
81	Orchidaceae	<i>Disperis discifera</i> H. Perrier	Annex II
82	Orchidaceae	<i>Eulophiella roempleriana</i> Schltr.	Annex II
83	Orchidaceae	<i>Gastrorchis francoisii</i> Schltr.	Annex II
84	Orchidaceae	<i>Gastrorchis humblotii</i> (Rchb. f.) Schltr.	Annex II
85	Orchidaceae	<i>Gastrorchis humblotii</i> var. <i>schlecteri</i> (H. Perrier) Senghas ex Bosser & P.J. Cribb	Annex II
86	Orchidaceae	<i>Gastrorchis lutea</i> (Bosser) Senghas	Annex II
87	Orchidaceae	<i>Gastrorchis pulchra</i> Humbert & H. Perrier	Annex II
88	Orchidaceae	<i>Jumellea arborescens</i> H. Perrier	Annex II
89	Orchidaceae	<i>Jumellea francoisii</i> Schltr.	Annex II
90	Orchidaceae	<i>Jumellea punctata</i> H. Perrier	Annex II
91	Orchidaceae	<i>Jumellea stenophylla</i> (Frapp. ex Cordem.) Schltr.	Annex II
92	Orchidaceae	<i>Liparis henrici</i> Schltr.	Annex II
93	Orchidaceae	<i>Liparis ochracea</i> Ridl.	Annex II
94	Orchidaceae	<i>Liparis puncticulata</i> Ridl.	Annex II
95	Orchidaceae	<i>Microcoelia gilpinae</i> (Rchb. f. & S. Moore) Summerh.	Annex II
96	Orchidaceae	<i>Nervilia simplex</i> (Thouars) Schltr.	Annex II
97	Orchidaceae	<i>Oeonia rosea</i> Ridl.	Annex II
98	Orchidaceae	<i>Oeonia volucris</i> (Thouars) Spreng.	Annex II
99	Orchidaceae	<i>Polystachya anceps</i> Ridl.	Annex II
100	Orchidaceae	<i>Polystachya rosea</i> Ridl.	Annex II
101	Orchidaceae	<i>Polystachya tsinjoarivensis</i> H. Perrier	Annex II
102	Orchidaceae	<i>Satyrium amoenum</i> (Thouars) A. Rich.	Annex II
103	Orchidaceae	<i>Satyrium trinerve</i> Lindl.	Annex II

Species on the GSPM Red List

The Madagascar Plant Specialists Group (GSPM) is a group of specialists that works closely with IUCN to analyze and identify the country's threatened endemic species. The GSPM has developed a red list of Madagascar's vascular plants and a catalogue of threatened plants. The species on this list are still awaiting publication in the IUCN list. The GSPM criteria are scientifically recognized and scientifically sound.

Of the 251 threatened species published in its catalogue, three are present in the study area, among others:

- *Aeranthus nidus* (Orchidaceae), assessed as endangered (EN);
- *Angraecum viguieri* Schltr. (Orchidaceae), assessed as endangered (EN) ;
- *Peperomia hildebrandtii* Vatke ex C. DC (Piperaceae), with a vulnerable status (VU) which is currently in EN status on the IUCN list.

The two EN GSPM species concerned (*Aeranthus nidus* / *Angraecum viguieri* Schltr) are currently being evaluated by the IUCN, but due to the relevance of the GSPM list, they have nevertheless been taken into account in the list of species requiring critical habitat analysis.

Spatial Range of Threatened Species

Threatened species in the study area are found mainly in undisturbed forests (natural habitats). They are distributed in various topographical areas such as valleys, lowlands, midlands, ridges and highlands.

These threatened species include groups that are characteristic of specific environments such as:

- *Dalbergia* spp. (Fabaceae), found mainly in deep soil low and mid-slopes;
- *Euphorbia* spp. (Euphorbiaceae) in more or less open environments, on thin ground or on rocks;
- *Cyathea* spp. (Cyatheaceae), present in valleys and lowlands;
- *Palms* (*Ravenea* and *Dypsis* - Arecaceae) have a fairly wide distribution in the dense rainforest but do not tolerate the rocky substrates of the Onive River's banks;
- Orchids and some species of large trees such as *Podocarpus madagascariensis* (*Podocarpaceae*) have a wide distribution in the dense forest and can be observed in different habitat types.

Figure 56 - Map of Observed Occurrences of Threatened Taxa

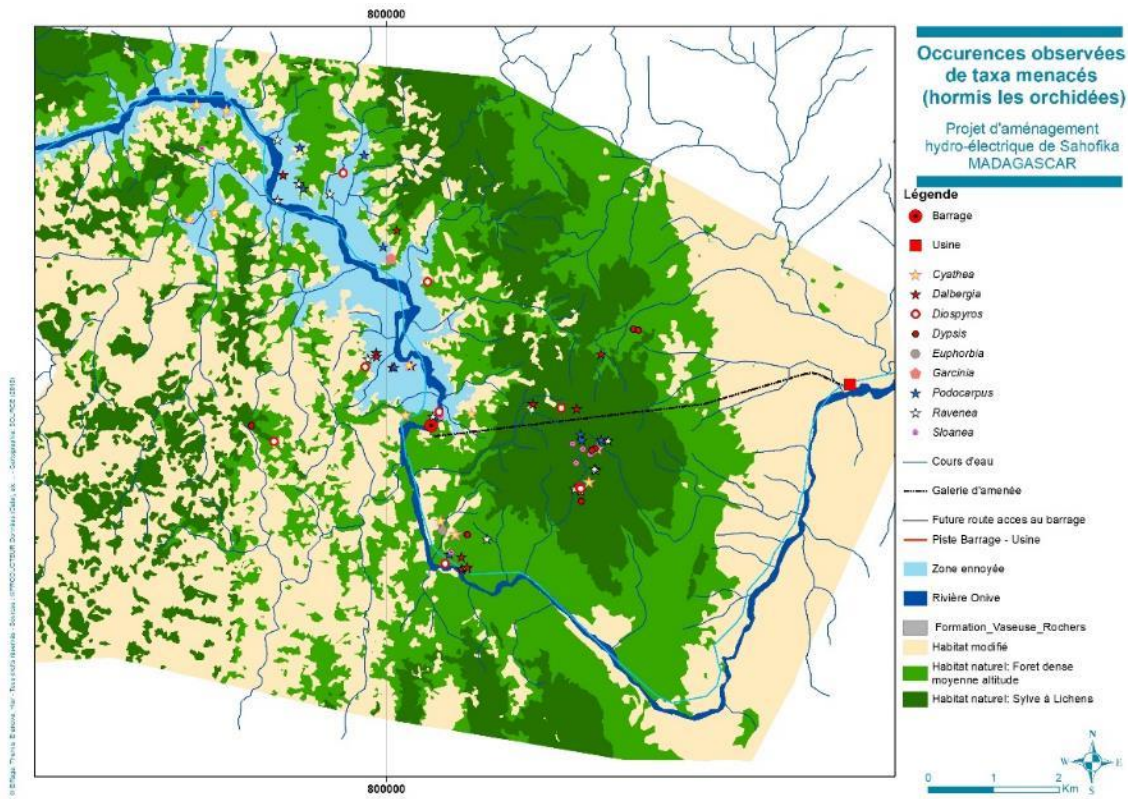

4.4.7.3 Invasive Species

Habitat anthropization facilitates the establishment, development and spread of invasive species in the natural environment, especially in modified non-forestry habitats such as young post-crop formations. A total of 20 species are inventoried in the area, four of them being classified as harmful by the IUCN (*Lantana camara*, *Clidemia hirta*, *Psidium guajava* and *P. cattleianum*).

Table 70 - List of Invasive Species Inventoried

N°	FAMILY	TAXA
1	Acanthaceae	<i>Stachytarpheta jamaicensis</i> (L.) Vahl
2	Asteraceae	<i>Ageratum conyzoides</i> L.
3	Asteraceae	<i>Bidens pilosa</i> L.
4	Asteraceae	<i>Solanum mauritianum</i> Scop.
5	Euphorbiaceae	<i>Ricinus communis</i> L.
6	Fabaceae	<i>Albizia lebbbeck</i> (L.) Benth.
7	Fabaceae	<i>Desmodium incanum</i> (Sw.) DC.
8	Fabaceae	<i>Mimosa pudica</i> L.
9	Gleicheniaceae	<i>Dicranopteris linearis</i> (Burm. f.) Underw.
10	Lamiaceae	<i>Lantana camara</i> L.
11	Melastomataceae	<i>Clidemia hirta</i> (L.) D. Don
12	Myrtaceae	<i>Eucalyptus robusta</i> Sm
13	Myrtaceae	<i>Psidium cattleianum</i> Sabine
14	Myrtaceae	<i>Psidium guajava</i> L.
15	Poaceae	<i>Imperata cylindrica</i> (L.) Raeusch.
16	Proteaceae	<i>Grevillea banksii</i> R. Br.

17	Pteridaceae	<i>Dicranopteris linearis</i> (Burm. f.) Underw.
18	Zingiberaceae	<i>Aframomum angustifolium</i> (Sonn.) K. Schum.
19	Zingiberaceae	<i>Hedychium coronarium</i> J. Koenig
20	Myrtaceae	<i>Melaleuca quinquenervia</i> (Cav.) S.T. Blake

4.4.7.4 Flora Associated with High Conservation Concern Species

Target Species

Endemic, woody species, characteristic of high conservation concern, medium-altitude dense humid rainforests are chosen as target species for the study of associated flora. In total, there are 10 of them and they are found in large forest blocks. Associated species live with the target species and have about the same ecophysiological requirements or living conditions.

The results of the analysis of the target species and associated species make it possible to consider possible management activities for high conservation concern species in order to mitigate the possible negative impacts of the Project.

Table 71 - List of Species Targeted for Conservation

N	FAMILY	TAXA	Biogeographic Affinity	IUC N	CITE S
1	Arecaceae	<i>Ravenea lakatra</i> (Jum.) Beentje	Endemic	CR	-
2	Arecaceae	<i>Dyopsis lutea</i> (Jum.) Beentje & J. Dransf.	Endemic	EN	-
3	Meliaceae	<i>Khaya madagascariensis</i> Jum. & H. Perrier	Endemic	EN	-
4	Podocarpaceae	<i>Podocarpus rostratus</i> Mr. Laurent	Endemic	EN	-
6	Arecaceae	<i>Dyopsis decipiens</i> (Becc.) Beentje & J. Dransf.	Endemic	VU	-
7	Arecaceae	<i>Dyopsis louvelii</i> Jum. & H. Perrier	Endemic	VU	-
8	Fabaceae	<i>Dalbergia monticola</i> Bosser & R. Rabev.	Endemic	VU	-
9	Fabaceae	<i>Dalbergia orientalis</i> Bosser & R. Rabev.	Endemic	VU	-
10	Ebenaceae	<i>Diospyros gracilipes</i> Hiern	Endemic	-	Annex II

Families and Species Associated with Target Species

In the study area, *Dalbergia* spp. (Ebenaceae) and *Podocarpus madagascariensis* have common characteristics in terms of plant association:

- The families most associated with these species are as follows: Sapotaceae, Lauraceae, and Elaeocarpaceae ;
- The species associated with these target species are *Chrysophyllum boivinianum*, *Symphonia macrocarpa*, *Sloanea rhodantha*, *Cryptocaria* spp. and *Apodocephala angustifolia*.

Ravenea lakatra is a less frequent species in the area and is found in deep soil environments, with a slope between 20 to 30% at mid- and high-water levels. Its characteristic associations are as follows:

- Associated families: Rubiaceae, Myrtaceae and Clusiaceae ;
- Associated species are *Syzygium emirnense*, *Gaertnera macrostipulata*, *Chrysophyllum boivinianum*, *Weinmannia commersonii* and *Garcinia pauciflora*.

Khaya madagascariensis is found only once in the area. Analysis of the associated flora for the species shows that:

- Its associated families are Lauraceae, Euphorbiaceae, Sapotaceae and Cunoniaceae;
- Its associated species are *Podocarpus madagascariensis*, *Phyllarthron articulatum*, *Syzygium emirnense* and *Sloanea rhodantha*.

Dypsis lutea, *D. louvelii* and *D. decipiens* have the same associated families, which are Araliaceae, Asteraceae and Myrtaceae. At the species level, *D. lutea* is associated with *Tambourissa purpurea*, *Syzygium emirnense*, *Chrysophyllum boivinianum* and *Drypetes madagascariensis*. The species *D. louvelii* is associated with *Polyscias madagascariensis*, *Syzygium emirnense* and *Tambourissa parvifolia*. In contrast, *D. decipiens* is associated with *Diospyros gracilipes*, *Sloanea rhodantha*, *Dilobeia thouarsii* and *Cryptocaria pervillei*.

4.4.7.5 Bioevaluation of Terrestrial Flora

Table 78 presents species that meet at least one of the following critical habitat criteria:

- Species listed EN or CR by the IUCN or GSPM,
- Restrict-range species (<50,000 km²)
- Endemic species listed NT or VU by the IUCN.

Since 75% of species in Madagascar are endemic, the endemism criterion alone was not chosen as a critical habitat criterion for the species listed by the IUCN as LC and whose range is not restricted, since they are widely distributed throughout the Malagasy territory.

A total of 14 flora species require critical habitat analysis.

Table 72 - Flora Species Requiring Critical Habitat Analysis

Species	IUCN Status	GSPM status	Affinities	Area of occurrence	Ecological importance	Use by the local population	THREATS	Possibility of triggering critical habitat	Observed	Probability of occurrence in the study area
<i>Dyopsis decipiens</i> (Becc.) Beentje & J. Dransf.	VU	-	Endemic to Madagascar	42,846 km ²	Characteristic of dense medium-level moist forests (FDHMA) and lichen forests (SL).	Construction of hunting tools and equipment	Deforestation,	YES	Yes (Between 1000 to 1550 m in altitude)	Proven
<i>Dyopsis louvelii</i> Jum. & H. Perrier	VU	-	Endemic to Madagascar	8,884km ²		Construction of hunting tools and equipment	Deforestation	YES	Yes (Between 1000 to 1500 m in altitude)	Proven
<i>Dyopsis procumbens</i> (Jum. & H. Perrier) J. Dransf., Beentje & Govaerts	NT	-	Endemic to Madagascar	50,000km ² >50,000km ²		Construction of hunting tools and equipment	Deforestation	YES	Yes (up to 1200 m in altitude)	Proven
<i>Dyopsis lutea</i> (Jum.) Beentje & J. Dransf.	EN	-	Endemic to Madagascar	1,435 km ²		Construction of hunting tools and equipment	Deforestation	YES	Yes (Between 1100 to 1400 m in altitude)	Proven
<i>Ravenea lakatra</i> (Jum.) Beentje	CR	-	Endemic to Madagascar	50,000km ² >50,000km ²		Construction timber, consumption	Deforestation, Selective logging	YES	Yes (Up to 1200 m in altitude)	Proven
<i>Dalbergia orientalis</i> Bosser & R. Rabev.	VU	-	Endemic to Madagascar	Unknown		Characteristic of humid forests, Precious woods of Madagascar (FDHMA, SL)	Softwood lumber	Deforestation, Selective logging	YES	Yes (Between 1000 to 1400 m in altitude)
<i>Dalbergia chapelieri</i> Baill.	NT	-	Endemic to Madagascar	Unknown	Characteristic of humid forests, Precious woods of Madagascar	Softwood lumber	Deforestation, Selective logging	YES	Yes (up to 1500 m in altitude)	Proven
<i>Khaya madagascariensis</i> Jum. & H. Perrier	EN	-	Endemic to Madagascar	Unknown	Characteristics of humid forests (FDHMA, SL)	Construction timber	Deforestation, Selective logging	YES	Yes (Up to 1500 m in altitude)	Proven
<i>Podocarpus</i>	NT	-	Endemic to	50,000km ²		Construction and	Deforestation,	YES	Yes (up to	Proven

Madagascar - Sahofika Hydropower Plant
 Environmental and Social Impact Assessment - Version D

<i>madagascariensis</i> Baker			Madagascar	>50,000km ²		timber products	Selective logging		1550 m in altitude)	
<i>Podocarpus rostratus</i> Mr. Laurent	EN	-	Endemic to Madagascar	21229 km ²		Construction and timber products	Deforestation, Selective logging	YES	Yes (Between 1500 to 1550 m in altitude)	Proven
<i>Malagasia</i> aff. <i>alticola</i> (Capuron) L.A.S. Johnson & B.G. Briggs	EN	-	Endemic to Madagascar	Unknown	Characteristic of lichen woodlands (one foot inventoried)	None	Deforestation	YES	Yes (Between 1000 to 1550 m in altitude)	Proven
<i>Peperomia hildebrandtii</i> Vatke ex C. DC	EN	VU	Endemic to Madagascar	1633km ²	Characteristics of humid forests (FDHMA, SL)	None	Deforestation	YES	Yes (Between 1000 to 1400 m in altitude)	Proven
<i>Aeranthus nidus</i>	-	EN	Endemic to Madagascar	-		None	Deforestation	YES	Yes	Proven
<i>Angraecum viguieri</i>	-	EN	Endemic to Madagascar	-		None	Deforestation	YES	Yes	Proven

4.4.7.6 Terrestrial Flora: Case of the Transmission Line from Belanitra to Antananarivo

The preliminary mapping analysis of natural and modified habitats carried out on the corridor shows that after the Marolambo National Park protection zone, the corridor does not cross any natural habitat sector. Outside the forest corridor going west, the landscape is mainly composed of man-made vegetation, namely *Eucalyptus* and *Pinus* plantations, and pseudo-steppe vegetation.

These formations are poor in species and are qualified as Modified Habitat under international standards (IFC PS6 and AfDB OS3)..

Most of the species inventoried are invasive species, see Table 73.

Table 73 - List of Species Identified Along The Antananarivo-Antanifotsy-Belanitra Section

Family	Species	Invasive Species
Aphloiaceae	<i>Aphloia theiformis</i>	
Asteraceae	<i>Ageratum conyzoides</i>	Yes
Asteraceae	<i>Bidens pilosa</i>	Yes
Asteraceae	<i>Psiadia altissima</i>	Yes
Asteraceae	<i>Elephantopus scaber</i>	Yes
Asteraceae	<i>Helichrysum faradifani</i>	Yes
Asteraceae	<i>Helichrysum madagascariense</i>	Yes
Asteraceae	<i>Helichrysum phyllicaeifolium</i>	Yes
Clusiaceae	<i>Psorospermum fanerana</i>	
Cyperaceae	<i>Cyperus latifolius</i>	Yes
Dennstaedtiaceae	<i>Pteridium aquilinum</i>	Yes
Ericaceae	<i>Erica conyzoides</i>	Yes
Ericaceae	<i>Vaccinium secundiflorum</i>	
Fabaceae	<i>Desmodium incanum</i>	Yes
Fabaceae	<i>Crotalaria sp.</i>	
Fabaceae	<i>Acacia dealbata</i>	
Gleicheniaceae	<i>Dicranopteris linearis</i>	Yes
Lamiaceae	<i>Lantana camara</i>	Yes
Malvaceae	AIDS rhombifolia	Yes

Myrtaceae	<i>Eucalyptus robusta</i>	
Myrtaceae	<i>Psidium cattleyanum</i>	Yes
Myrtaceae	<i>Psidium guajava</i>	Yes
Pinaceae	<i>Pinus patula</i>	
Poaceae	<i>Imperata cylindrica</i>	
Poaceae	<i>Aristida similis</i>	
Poaceae	<i>Paspalum commersonii</i>	
Poaceae	<i>Rhynchelytrum rethinks</i>	
Proteaceae	<i>Grevillea banksii</i>	Yes
Rosaceae	<i>Rubus rosaeifolius</i>	Yes
Rubiaceae	<i>Gaertnera sp.</i>	
Solanaceae	<i>Solanummauritianum</i>	Yes

4.4.8 Terrestrial Wildlife

4.4.8.1 Data from the Literature Review - Terrestrial Vertebrates

The study area's dense rainforest is one of Madagascar's richest regions in terms of vertebrate species. The main documents used to list the species known or potentially present in the study area are described in the table below.

Table 74 - List of Documents Consulted prior to the Various Field Trips

Authors	Title	Year	Type
Goodman S.M. & Schütz H.	Observations of lemurs in the forest east of Tsinjoarivo, Ambatolampy. Lemur News 4: 14	1999	Publication
Goodman S.M., Rakotondravony D., Raherilalao M.J., Rakotomalala D., Raselimanana A.P., Soarimalala V., Duplantier J.M., Duchemin J.B., Rafanomezantsoa	Inventaire biologique de la forêt de Tsinjoarivo, Ambatolampy. Akon'ny Ala 27	2000	Publication
Land Resources	Appui a la mise en place des sites Koloala production dans la CIREEF de Moramanga	2000	Document

Rakotondravony H.	Inventaire biologique des reptiles et amphibiens dans le corridor Fandriana - Marolambo	2000	Report
Lehman S.H., Ratsimbazafy J.	Inventaire biologique des lémurien dans le corridor Fandriana - Marolambo	2000	Report
Livarilala H.M.	Utilisation de l'espace forestier dans le <i>fokontany</i> d'Antenina	2003	Memoir Memoir
Department of Animal Biology	Inventaire biologique de la faune de la forêt d'Antenina, Commune de Belanitra, Région du Vakinankaratra	2011	Report
Raherilalao M.J. & Goodman S.M.	Histoire naturelle des familles et sous-familles endémiques d'oiseaux de Madagascar	2011	Guide Book
Voahangy S. & Goodman S.M.	Les petits mammifères de Madagascar	2011	Guide Book
Goodman S.M.	Les chauves-souris de Madagascar	2011	Guide Book
Andrianirina N.	Détection de changement de la couverture forestière du site Antenina Vakinankaratra à l'aide de la télédétection	2012	Memoir Memoir
Goodman S.M.	Les Carnivores de Madagascar	2012	Guide Book
Goodman S.M. & Raherilalao M.J.	Atlas d'une sélection de vertébrés terrestres de Madagascar	2013	Guide book
Mittermeier, R.A., Louis, E.E. Jr., Langrand, O., Schwitzer, C., Rylands, A.B., Rajaobelina, S., Ratsimbazafy, J., Rasoloarison, R., Hawkins, F., Roos, C., Richardson, M., Kappeler, P.M.	Lémuriens de Madagascar	2014	Guide book
Mahalinirina O.Y.	Évaluation de la mise en œuvre du plan d'aménagement et de gestion simplifiée de la forêt d'Antenina	2016	Memoir Memoir
NGO SADABE	Création de la NAP Tsinjoarivo-Ambalaomby District d'Ambatolampy et d'Anosibe An'ala dossier de mise en protection temporaire	2018	Document
Goodman S.M., Raherilalao M.J., Sébastien W.	Les aires protégées terrestres de Madagascar: leur histoire, description et biote.	2018	Book
IUCN	http://www.iucnredlist.org/	2018	Internet

4.4.8.2 Results of Survey Campaign - Terrestrial Vertebrates

Overall Richness

A total of 180 species of terrestrial vertebrates, including 37 species of amphibians, 27 species of reptiles, 85 bird taxa and 31 species of mammals, were inventoried in all study areas during the survey campaigns (wet and dry seasons). The specific richness at each site is represented by the graph below (the location of the inventory sites is described in Chapter **Erreur ! Source du renvoi introuvable.**). The Ankidy site (Camp 1) is relatively rich in terrestrial vertebrates, followed by Anivorano (Camp 2) and Berena (Camp 5). Few species were recorded in Faravohitra (Camp 3) and at the Corridor site (Camp 6).

Figure 57 - Graph of Specific Richness in Terrestrial Vertebrates on the Sites Surveyed

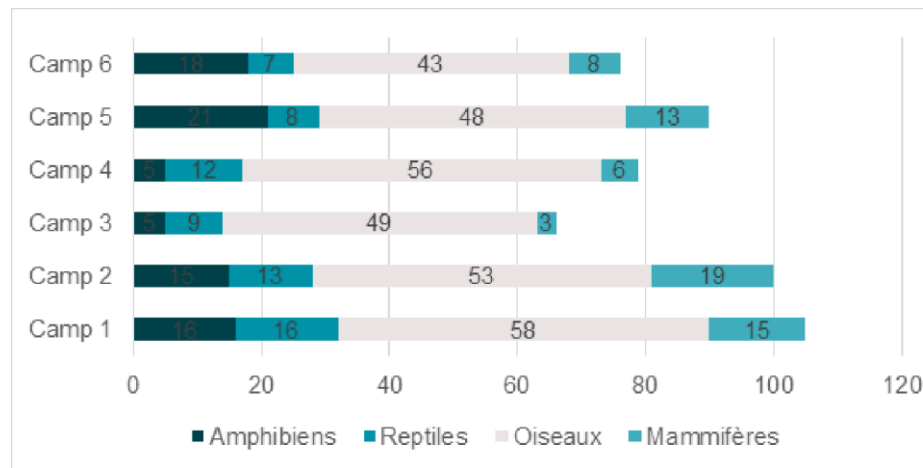

Cumulative Species Curves

The cumulative species curves provide a graphical representation of changes in the cumulative number of species depending on the number of sampling days. The curve flattens (saturation plateau) when the majority of species at an inventoried site have been recorded.

For amphibians, the species saturation plateau was reached at all sites except Berena (Camp 5), indicating that other species may be present.

For reptiles, no new species were observed from the fifth day of sampling for Ankidy, Anivorano and Berena, from the fourth day for Antaniketsa and the Corridor, and from the third day for Faravohitra. This suggests that the majority of reptile species in these sites are probably listed.

For avian fauna, no species were newly observed on the last day of the inventory for each site, which may mean that all bird species present have been recorded.

For mammals, the appearance of the cumulative curves of the species in Faravohitra and Antaniketsa shows that a true plateau is reached, indicating that the majority of the species present in these sites have been recorded. For Ankidy and Berena, other mammalian species could also be present.

Figure 58 - Cumulative Curves of Species in each Taxonomic Group

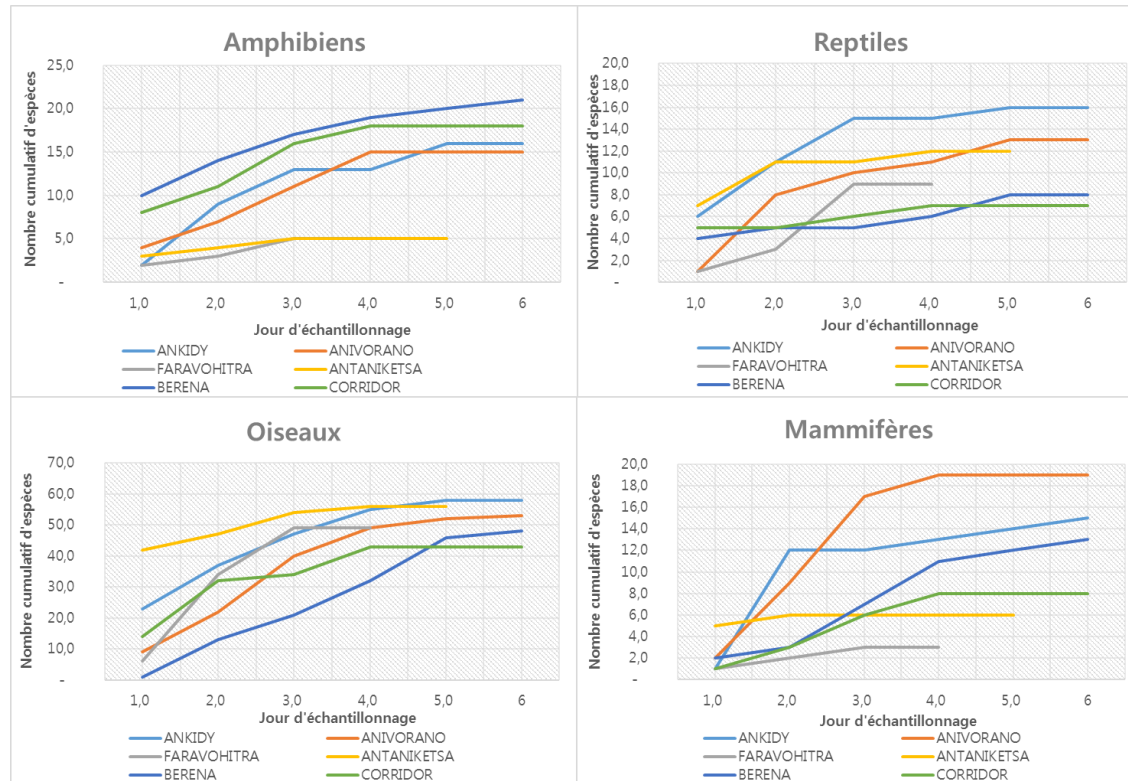

Endemicity

Of the 181 faunal species found or known in the six observation sites:

- 142 species are endemic to Madagascar;
- 11 species are endemic to the region (Madagascar and its neighboring islands);
- 07 species are found in the neighboring islands;
- 07 species are observed in several African countries;
- 14 species species have a wide range, reaching as far as Europe..

4.4.8.3 Conservation Status of Species - Terrestrial Vertebrates

Endemic and Limited Distribution Species

By international biodiversity standards, 137 species are endemic to Madagascar, with 36 amphibian species, 26 reptile species, 48 bird species whose breeding area is strictly restricted to Madagascar and 27 mammal species. The complete list of these species is provided in the Annex.

Species with a geographical range less than the 50,000 km² geographical indicator defined by the IFC and known in the study area are as follows: *Boophis rufiocularis*, *Calumma oshaughnessyi*, *Cheirogaleus sibreei*, *Gephyromantis blanci*, *G. spiniferus*, *G. thelenae*, *Lepilemur mustelinus*, *Lygodactylus bivittis*, *Microcebus lehilahytsara*, *Plethodontohyla brevipes*, *Propithecus diadema*, *Trachylepis boettgeri*.

Except for *Trachylepis boettgeri* which has “minor concern” status, these threatened species (CR-EN-VU-NT) are endemic to central and eastern Madagascar and their conservation should be prioritized because of their vulnerability to the destruction of their natural habitat.

As for flora, since the majority of fauna species in Madagascar are endemic, the endemism criterion alone was not chosen as a critical habitat criterion for the species listed by the IUCN as LC and whose range is not restricted, since they are widely distributed throughout the Malagasy territory

IUCN Status

Based on the IUCN status of these terrestrial vertebrate species, 24 species are threatened with extinction, including 02 critical endangered species (CR), 03 endangered species (EN), 10 vulnerable species (VU) and 8 near-threatened species (NT). We note the presence of a species with insufficient data: *Cheirogaleus major*. The other 155 species have a “Minor Concern” (LC) status. A known threatened small mammal species (*Voalavo antsahabensis*, EN) known in the central highlands was not caught during trapping sessions.

The following table presents all terrestrial vertebrate species at risk according to the IUCN:

Table 75 - Threatened Terrestrial Vertebrates Present in the Project Area According to the IUCN

Class	Order	Family	Species	IUCN
Amphibians	Anura	Mantellidae	<i>Gephyromantis thelenae</i>	EN
	Anura	Mantellidae	<i>Boophis rufiocularis</i>	NT
	Anura	Mantellidae	<i>Bleached gephyromantis</i>	NT
	Anura	Mantellidae	<i>Gephyromantis spiniferus</i>	VU
	Anura	Microhylidae	<i>Plethodontohyla brevipes</i>	VU
Birds	Podicipediforms	Podicipedidae	<i>Tachybaptus pelzelinii</i>	EN
	Passeriformes	Bernieridae	<i>Hartertula flavoviridis</i>	NT

	Plecaniforms	Threskiornithidae	<i>Lophotibis cristata</i>	NT
	Coraciiformes	Brachypteraciidae	<i>Atelornis crossleyi</i>	NT
	Accipitriforms	Accipitridae	<i>Accipate henstii</i>	NT
	Passeriformes	Vangidae	<i>Xenopirostris polleni</i>	NT
	Passeriformes	Philepittidae	<i>Neodrepanis hypoxantha</i>	VU
Mammals	Primates	Cheirogaleidae	<i>Cheirogaleus sibreei</i>	CR
	Primates	Indriidae	<i>Propithecus diadema</i>	CR
	Primates	Daubentoniidae	<i>Daubentonia madagascariensis</i>	EN
	Rodentia	Nesomyidae	<i>Voalavo antsahabensis</i>	EN
	Primates	Lepilemuridae	<i>Lepilemur mustelinus</i>	NT
	Primates	Lemuridae	<i>Eulemur fulvus</i>	NT
	Primates	Cheirogaleidae	<i>Microcebus lehilahytsara</i>	VU
	Primates	Lemuridae	<i>Eulemur rubriventer</i>	VU
	Primates	Indriidae	<i>Avahi laniger</i>	VU
	Primates	Lemuridae	<i>Grey Hapalemur</i>	VU
Reptiles	Afrosoricida	Tenrecidae	<i>Microgale monticola</i>	VU
	Squamata	Gekkonidae	<i>Lygodactylus bivittis</i>	VU
	Squamata	Chamaeleonidae	<i>Calumma oshaughnessyi</i>	VU

The following table shows the distribution of high conservation concern species according to the various geographical sectors of the Project (the location of the sites mentioned is described in Chapter 4.4.4.2):

Table 76 - Geographical Distribution of Threatened Terrestrial Fauna Species According to the IUCN

Area	Conservation concern species According to the IUCN
Access to the dam, fragments of forest located between Befotaka and the dam (Antaniketsa site),	<ul style="list-style-type: none"> • Lemurs (<i>Hapalemur griseus</i>) • Birds (<i>Accipiter henstii</i>, <i>Atelornis crossleyi</i>, <i>Xenopirostris polleni</i>)
At the dam, Ankidy site	<ul style="list-style-type: none"> • Lemurs (<i>Avahi laniger</i>, <i>Daubentonia madagascariensis</i>, <i>Eulemur fulvus</i>, <i>Hapalemur griseus</i>) • Birds (<i>Xenopirostris polleni</i>) • Reptiles (<i>Calumma oshaughnessyi</i>, <i>Lygodactylus bivittis</i>) • Amphibians (<i>Gephyromantis thelenae</i>, <i>Plethodontohyla brevipes</i>)
Upstream from the dam, Berena site	<ul style="list-style-type: none"> • Lemurs (<i>Avahi laniger</i>, <i>Cheirogaleus sibreei</i>, <i>Daubentonia madagascariensis</i>, <i>Eulemur fulvus</i>, <i>E. rubriventer</i>, <i>Hapalemur griseus</i>, <i>Lepilemur mustelinus</i>, <i>Microcebus lehilahytsara</i>) • Birds (<i>Atelornis crossleyi</i>) • Reptiles (<i>Calumma oshaughnessyi</i>, <i>Lygodactylus bivittis</i>)

In the forest corridor, Anivorano and Corridor sites	<ul style="list-style-type: none"> • Day and night lemurs (<i>Cheirogaleus sibreei</i>, <i>Daubentonia madagascariensis</i>, <i>Eulemur fulvus</i>, <i>E. rubriventer</i>, <i>Hapalemur griseus</i>, <i>Lepilemur mustelinus</i>, <i>Microcebus lehilahytsara</i>, <i>Propithecus diadema</i>) • Micromammals (<i>Microgale monticola</i>) • Birds (<i>Accipiter henstii</i>, <i>A. madagascariensis</i>, <i>Atelornis crossleyi</i>, <i>Hartertula flavoviridis</i>, <i>Lophotibis cristata</i>, <i>Neodrepanis hypoxantha</i>, <i>Xenopirostris pollenii</i>) • Reptiles (<i>Calumma oshaughnessyi</i>) • Amphibians (<i>Boophis rufiocularis</i>, <i>Gephyromantis blanci</i>, <i>G. spiniferus</i>, <i>G. thelenae</i>, <i>Plethodontohyla brevipes</i>)
Plant area (Faravohitra site) and around the beginning of the power line	<ul style="list-style-type: none"> • Birds (<i>Accipiter madagascariensis</i>, <i>A. henstii</i>, <i>Tachybaptus pelzelinii</i>, <i>Xenopirostris pollenii</i>)

CITES Species

Among the 181 species listed, 33 are listed in CITES, including 12 species in Appendix I, 20 species in Appendix II and one (01) species in Appendix III. The other species are not listed in the CITES Appendices. As a reminder:

- Appendix I shall include all species threatened with extinction which are or may be affected by trade
- Appendix II shall include: (i) all species which; although not necessarily now threatened with extinction, may become so unless trade in specimens of such species is subject to strict regulation in order to avoid utilization incompatible with their survival; and (b) other species which must be subject to regulation in order that trade in specimens of certain species may be brought under effective control
- Appendix III shall include all species which any Party identifies as being subject to regulation within its jurisdiction for the purpose of preventing or restricting exploitation, and as needing the co-operation of other Parties in the control of trade.

The following Table shows the vertebrate species from the CITES list identified in the Project area.

Table 77 - List of Vertebrate Species Included in the CITES List

Class	Order	Family	Species	CITES Status
Birds	Accipitriforms	Accipitridae	<i>Accipitate madagascariensis</i>	Appendix II
	Psittaciformes	Psittacidae	<i>Agapornis canus</i>	Appendix II
	Accipitriforms	Accipitridae	<i>Buteo brachypterus</i>	Appendix II
	Strigiforms	Strigidae	<i>Asio madagascariensis</i>	Appendix II
	Psittaciformes	Psittacidae	<i>Coracopsis nigra</i>	Appendix II
	Strigiforms	Strigidae	<i>Otus rutilus</i>	Appendix II
	Psittaciformes	Psittacidae	<i>Coracopsis vasa</i>	Appendix II
	Falconiformes	Falconidae	<i>Falco newtoni</i>	Appendix II
	Strigiforms	Tytonidae	<i>Tyto alba</i>	Appendix II

	Accipitriforms	Accipitridae	<i>Accipate francesiae</i>	Appendix II
Mammals	Primates	Cheirogaleidae	<i>Cheirogaleus sibreei</i>	Appendix I
	Primates	Indriidae	<i>Propithecus diadema</i>	Appendix I
	Primates	Cheirogaleidae	<i>Cheirogaleus major</i>	Appendix I
	Primates	Daubentoniidae	<i>Daubentonia madagascariensis</i>	Appendix I
	Primates	Lepilemuridae	<i>Lepilemur mustelinus</i>	Appendix I
	Primates	Lemuridae	<i>Eulemur fulvus</i>	Appendix I
	Primates	Cheirogaleidae	<i>Microcebus lehilahytsara</i>	Appendix I
	Primates	Lemuridae	<i>Eulemur rubriventer</i>	Appendix I
	Primates	Indriidae	<i>Avahi laniger</i>	Appendix I
	Primates	Lemuridae	<i>Grey Hapalemur</i>	Appendix I
	Carnivora	Eupleridae	<i>Galidia elegans</i>	Appendix II
	Carnivora	Vivveridae	<i>Viverricula indica</i>	Appendix III
Reptiles	Squamata	Boidae	<i>Acrantophis madagascariensis</i>	Appendix I
	Squamata	Boidae	<i>Sanzinia madagascariensis</i>	Appendix I
	Squamata	Gekkonidae	<i>Uroplatus fimbriatus</i>	Appendix II
	Squamata	Chamaeleonidae	<i>Calumma nasutum</i>	Appendix II
	Squamata	Gekkonidae	<i>Phelsuma quadriocellata</i>	Appendix II
	Squamata	Chamaeleonidae	<i>Calumma brevicorne</i>	Appendix II
	Squamata	Chamaeleonidae	<i>Calumma gastrotaenia</i>	Appendix II
	Squamata	Chamaeleonidae	<i>Calumma malthe</i>	Appendix II
	Squamata	Chamaeleonidae	<i>Furcifer willsii</i>	Appendix II
	Squamata	Gekkonidae	<i>Uroplatus phantasticus</i>	Appendix II
Squamata	Chamaeleonidae	<i>Calumma oshaughnessyi</i>	Appendix II	

Species protected by the National Decree 2006-400

According to the National Wildlife Protection Decree (2006-400), 78 of the 180 species listed are classified as protected animals (Category I, Class I-II), 05 species are harmful (Category II), 67 are game species (Category III) and 30 species are not mentioned in the decree.

Regarding the protected species in Protected Class I, the hunting, capture, possession, consumption and marketing of these fauna species are strictly prohibited, except for capture and export for the purposes of scientific studies and exchanges, captive breeding or exhibition in accordance with the provisions applicable to species in Annexes I and II of the CITES list.

“Protected II” species may be subject to hunting or capture permits, but the collection quota is set by the CITES management authority on the proposal of the scientific authority.

The fact that a species is listed by National Decree 2006-400 does not systematically translate into a need for critical habitat analysis within the meaning of IFC and AfDB policies.

Table 78 - List of Vertebrate Species Protected by Decree 2006-400

Class	Order	Family	Species	Decree 2006-400
Amphibians	Anura	Mantellidae	<i>Boophis rufioculis</i>	Cat. I, Class. I
	Anura	Microhylidae	<i>Plethodontohyla brevipes</i>	Cat. I, Class. I
	Anura	Mantellidae	<i>Mantidactylus melanopleura</i>	Cat. I, Class. I
	Anura	Mantellidae	<i>Boophis picturatus</i>	Cat. I, Class. I
	Anura	Mantellidae	<i>Bleached gephyromantis</i>	Cat. I, Class. II
	Anura	Mantellidae	<i>Boophis albipunctatus</i>	Cat. I, Class. II
	Anura	Mantellidae	<i>Gephyromantis sculpturatus</i>	Cat. I, Class. II
	Anura	Mantellidae	<i>Boophis marojezensis</i>	Cat. I, Class. II
	Anura	Mantellidae	<i>Gephyromantis plicifer</i>	Cat. I, Class. II
Birds	Accipitriforms	Accipitridae	<i>Accipitate madagascariensis</i>	Cat. I, Class. I
	Podicipediforms	Podicipedidae	<i>Tachybaptus pelzelni</i>	Cat. I, Class. I
	Columbiformes	Columbidae	<i>Alectroenas madagascariensis</i>	Cat. I, Class. I
	Passeriformes	Locustellidae	<i>Amphilais seebohmi</i>	Cat. I, Class. I
	Accipitriforms	Accipitridae	<i>Aviceda madagascariensis</i>	Cat. I, Class. I
	Cuculiformes	Cuculidae	<i>Coua reynaudii</i>	Cat. I, Class. I
	Caprimulgiformes	Caprimulgidae	<i>Caprimulgus enarratus</i>	Cat. I, Class. I
	Accipitriforms	Accipitridae	<i>Polyboroides radiatus</i>	Cat. I, Class. I
	Passeriformes	Vangidae	<i>Pseudobias wardi</i>	Cat. I, Class. I

Passeriformes	Bernieridae	<i>Randia pseudozosterops</i>	Cat. I, Class. I
Pelecaniformes	Threskiornithidae	<i>Lophotibis cristata</i>	Cat. I, Class. I
Coraciiformes	Brachypteraciidae	<i>Atelornis crossleyi</i>	Cat. I, Class. I
Accipitriformes	Accipitridae	<i>Accipate henstii</i>	Cat. I, Class. I
Passeriformes	Vangidae	<i>Xenopirostris polleni</i>	Cat. I, Class. I
Passeriformes	Philepittidae	<i>Neodrepanis hypoxantha</i>	Cat. I, Class. I
Psittaciformes	Psittacidae	<i>Agapornis canus</i>	Cat. I, Class. II
Accipitriformes	Accipitridae	<i>Buteo brachypterus</i>	Cat. I, Class. II
Strigiformes	Strigidae	<i>Asio madagascariensis</i>	Cat. I, Class. II
Psittaciformes	Psittacidae	<i>Coracopsis nigra</i>	Cat. I, Class. II
Strigiformes	Strigidae	<i>Otus rutilus</i>	Cat. I, Class. II
Psittaciformes	Psittacidae	<i>Coracopsis vasa</i>	Cat. I, Class. II
Columbiformes	Columbidae	<i>Treron australis</i>	Cat. I, Class. II
Pelecaniformes	Scopidae	<i>Scopus umbretta</i>	Cat. I, Class. II
Pelecaniformes	Ardeidae	<i>Striata Bittern</i>	Cat. I, Class. II
Pelecaniformes	Ardeidae	<i>Ardea purpurea</i>	Cat. I, Class. II
Gruiformes	Rallidae	<i>Dryolimnas cuvieri</i>	Cat. I, Class. II
Passeriformes	Bernieridae	<i>Bernieria madagascariensis</i>	Cat. I, Class. II
Coraciiformes	Brachypteraciidae	<i>Atelornis pittoides</i>	Cat. I, Class. II
Cuculiformes	Cuculidae	<i>Coua caerulea</i>	Cat. I, Class. II
Passeriformes	Vangidae	<i>Cyanolanius madagascarinus</i>	Cat. I, Class. II
Passeriformes	Ploceidae	<i>Foudia omissa</i>	Cat. I, Class. II

				II
	Passeriformes	Philepittidae	<i>Neodrepanis coruscans</i>	Cat. I, Class. II
	Passeriformes	Vangidae	<i>Newtonia amphichroa</i>	Cat. I, Class. II
	Passeriformes	Bernieridae	<i>Oxylabes madagascariensis</i>	Cat. I, Class. II
	Passeriformes	Philepittidae	<i>Philepitta castanea</i>	Cat. I, Class. II
	Passeriformes	Muscicapidae	<i>Monticola sharpei</i>	Cat. I, Class. II
	Passeriformes	Vangidae	<i>Hypositta corallirostris</i>	Cat. I, Class. II
	Passeriformes	Vangidae	<i>Leptopterus chabert</i>	Cat. I, Class. II
	Gruiformes	Rallidae	<i>Sarothrura insularis</i>	Cat. I, Class. II
	Leptosomiforms	Leptosomidae	<i>Leptosomus discolor</i>	Cat. I, Class. II
	Passeriformes	Vangidae	<i>Tylas eduardi</i>	Cat. I, Class. II
	Passeriformes	Ploceidae	<i>Ploceus nelicourvi</i>	Cat. I, Class. II
	Passeriformes	Vangidae	<i>Vanga curvirostris</i>	Cat. I, Class. II
	Passeriformes	Bernieridae	<i>Xanthomixis zosterops</i>	Cat. I, Class. II
Mammals	Primates	Cheirogaleidae	<i>Cheirogaleus sibreei</i>	Cat. I, Class. I
	Primates	Indriidae	<i>Propithecus diadema</i>	Cat. I, Class. I
	Primates	Cheirogaleidae	<i>Cheirogaleus major</i>	Cat. I, Class. I
	Primates	Daubentoniidae	<i>Daubentonia madagascariensis</i>	Cat. I, Class. I
	Primates	Lepilemuridae	<i>Lepilemur mustelinus</i>	Cat. I, Class. I
	Primates	Lemuridae	<i>Eulemur fulvus</i>	Cat. I, Class. I
	Primates	Cheirogaleidae	<i>Microcebus lehilahytsara</i>	Cat. I, Class. I
	Primates	Lemuridae	<i>Eulemur rubriventer</i>	Cat. I, Class. I

	Primates	Indriidae	<i>Avahi laniger</i>	Cat. I, Class. I
	Primates	Lemuridae	<i>Grey Hapalemur</i>	Cat. I, Class. I
	Carnivora	Eupleridae	<i>Galidia elegans</i>	Cat. I, Class. I
	Afrosoricida	Tenrecidae	<i>Hemicentetes semispinosus</i>	Cat. I, Class. II
	Afrosoricida	Tenrecidae	<i>Setifer setosus</i>	Cat. I, Class. II
Reptiles	Squamata	Boidae	<i>Sanzinia madagascariensis</i>	Cat. I, Class. I
	Squamata	Gekkonidae	<i>Lygodactylus bivittis</i>	Cat. I, Class. I
	Squamata	Gekkonidae	<i>Uroplatus fimbriatus</i>	Cat. I, Class. II
	Squamata	Chamaeleonidae	<i>Calumma nasutum</i>	Cat. I, Class. II
	Squamata	Gekkonidae	<i>Phelsuma quadriocellata</i>	Cat. I, Class. II
	Squamata	Chamaeleonidae	<i>Calumma brevicorne</i>	Cat. I, Class. II
	Squamata	Chamaeleonidae	<i>Calumma gastrotaenia</i>	Cat. I, Class. II
	Squamata	Chamaeleonidae	<i>Calumma malthe</i>	Cat. I, Class. II
	Squamata	Chamaeleonidae	<i>Furcifer willsii</i>	Cat. I, Class. II
	Squamata	Gekkonidae	<i>Uroplatus phantasticus</i>	Cat. I, Class. II
	Squamata	Chamaeleonidae	<i>Calumma oshaughnessyi</i>	Cat. I, Class. II
	Squamata	Gekkonidae	<i>Phelsuma lineata</i>	Cat. I, Class. II

4.4.8.4 Special Species of Terrestrial Vertebrates

Invasive Species - Terrestrial Vertebrates

Six invasive species are present in the Project area:

- five non-native species
 - Birds: *Acridotheres tristis*, *Bubulcus ibis*
 - Amphibians: *Ptychadena mascareniensis*
 - Rodents: *Rattus rattus*, *Suncus murinus*
- a native species: *Tenrec ecaudatus* (insectivorous mammal)

The natural vegetation in areas modified by human activities, including clearing and slash-and-burn, is invaded by exotic rodents. In Ankidy, for example, 88 individuals of *Rattus rattus* were captured during the trapping session. This is related to human activities and the presence of various plots of maize and rice around the forest fragments. The absence of native species (*genus Eliurus*) in Ankidy seems to be due to the dominance of the black rat, which alters the faunal composition by eliminating native species. In Anivorano and in the heart of the corridor itself, few black rat individuals were identified.

Migratory Species - Terrestrial Vertebrates

Migratory species in the study area and its surroundings are seasonally present and consist of eleven bird species, including one locally migratory species (*Alectroenas madagascariensis*), five regionally and in Africa (*Cuculus rochii*, *Eurystomus glaucurus*, *Merops superciliosus*, *Phedina borbonica*) and five long-range migratory species (*Ardea alba*, *A. purpurea*, *Bubulcus ibis*, *Bitterns striata*, *Milvus migrans*, *Saxicola torquatus*). *Eurystomus glaucurus*, observed during the scoping field trip, was not reviewed during the ESIA field trips. This African migratory species breeds in Madagascar at the end of the dry season (September-November).

Vertebrates dependent on wetlands

Among the vertebrates in the Sahofika Project area, only 11 species of birds are dependent on wetlands such as marshes, small streams or rice fields: *Amphilais seebohmi*, *Ardea alba*, *A. purpurea*, *Bubulcus ibis*, *Butorides striata*, *Dryolimnas cuvieri*, *Egretta alba*, *Egretta ardesiaca*, *Lophotibis cristata*, *Scopus umbretta* and *Tachybaptus pelzelinii*.

4.4.8.5 Quantitative Data on Terrestrial Vertebrates

Amphibians and Reptiles

All 66 species of amphibians and reptiles known in the study area were listed following direct observations. No other information on herpetofauna species was obtained through surveys. Some species are dominant while others are rare. Thirty-three species live in primary forests and 13 species are found in mixed forest environments (primary and secondary). Only one species is found in Africa and therefore has a wide geographical distribution: the invasive frog *Ptychadena mascareniensis*. The following tables show the relative abundance of each herpetofauna species in Ankidy, Anivorano, Berena and Corridor.

Table 79 - Relative Abundance of Amphibian and Reptile Species Identified

Class	Order	Family	Species	Anki dy	Anivora no	Bere na	Corridor
				Not very abundant, Aa Quite abundant, Abundant, Abundant , Ta Very abundant			
Amphibians	Anura	Hyperoliidae	<i>Heterixalus madagascariensis</i>	Aaa	Aaa	-	-
	Anura	Hyperoliidae	<i>Heterixalus punctatus</i>	-	Pa	-	-
	Anura	Hyperoliidae	<i>Heterixalus betsileo</i>	Ab	Ab	Ta	-
	Anura	Mantellidae	<i>Boophis albipunctatus</i>	Aaa	Aaa	Aaa	-
	Anura	Mantellidae	<i>Blommersia blommersae</i>	-	-	Aaa	Aaa
	Anura	Mantellidae	<i>Boophis goudotii</i>	-	-	Aaa	-
	Anura	Mantellidae	<i>Boophis luteus</i>	-	-	Aaa	-
	Anura	Mantellidae	<i>Boophis marojezensis</i>	-	-	Aaa	-
	Anura	Mantellidae	<i>Mantidactylus biporus</i>	-	-	Aaa	-
	Anura	Mantellidae	<i>Mantidactylus opiparis</i>	-	-	Aaa	-
	Anura	Mantellidae	<i>Spinomantis aglavei</i>	-	Aaa	Aaa	Aaa
	Anura	Mantellidae	<i>Gephyromantis spiniferus</i>	-	-	-	Aaa
	Anura	Mantellidae	<i>Gephyromantis sculpturatus</i>	Aaa	-	-	-
	Anura	Mantellidae	<i>Mantidactylus grandidieri</i>	-	-	-	Aaa
	Anura	Mantellidae	<i>Guibemantis pulcher</i>	-	-	-	Ab
	Anura	Mantellidae	<i>Boophis madagascariensis</i>	Ab	Ab	Ab	Ab
	Anura	Mantellidae	<i>Gephyromantis asper</i>	Ab	Ab	Ab	Ab
	Anura	Mantellidae	<i>Guibemantis liber</i>	Ab	Ab	Ab	Ab
	Anura	Mantellidae	<i>Mantidactylus femoralis</i>	Ab	Ab	Ab	Ab
	Anura	Mantellidae	<i>Mantidactylus melanopleura</i>	Ab	Aaa	-	-
	Anura	Mantellidae	<i>Aglyptodactylus madagascariensis</i>	Ta	Ab	Ab	Ab
	Anura	Mantellidae	<i>Mantidactylus betsileanus</i>	Pa	-	Ab	Ab
	Anura	Mantellidae	<i>Gephyromantis thelenae</i>	Pa	Aaa	-	-
	Anura	Mantellidae	<i>Boophis rufiocularis</i>	-	-	-	Pa
	Anura	Mantellidae	<i>Bleached gephyromantis</i>	-	-	-	Pa
	Anura	Mantellidae	<i>Gephyromantis plicifer</i>	-	-	-	Pa
	Anura	Mantellidae	<i>Boophis erythrodactylus</i>	-	-	Pa	-
	Anura	Mantellidae	<i>Boophis picturatus</i>	-	-	Pa	-
	Anura	Mantellidae	<i>Boophis sibilans</i>	-	-	Pa	-
	Anura	Mantellidae	<i>Spinomantis peraccae</i>	-	-	-	Pa
Anura	Mantellidae	<i>Guibemantis timidus</i>	Pa	-	-	-	

	Anura	Microhylidae	<i>Plethodontohyla notosticta</i>	-	-	-	Aaa
	Anura	Microhylidae	<i>Platypelis grandis</i>	-	-	-	Ab
	Anura	Microhylidae	<i>Plethodontohyla brevipes</i>	Aaa	Aaa	-	-
	Anura	Microhylidae	<i>Platypelis pollicaris</i>	-	Aaa	Ab	-
	Anura	Microhylidae	<i>Platypelis tuberifera</i>	-	-	Ab	Ab
	Anura	Microhylidae	<i>Plethodontohyla bipunctata</i>	Aaa	Ab	-	-
	Anura	Ptychadenidae	<i>Ptychadena mascareniensis</i>	Ta	-	Ta	-
Reptiles	Squamata	Boidae	<i>Acrantophis madagascariensis</i>	-	Pa	-	-
	Squamata	Boidae	<i>Sanzinia madagascariensis</i>	-	Pa	-	-
	Squamata	Chamaeleonidae	<i>Calumma oshaughnessyi</i>	Ab	Aaa	Aaa	Ab
	Squamata	Chamaeleonidae	<i>Furcifer willsii</i>	-	-	Aaa	-
	Squamata	Chamaeleonidae	<i>Calumma brevicorne</i>	Ab	Aaa	Ab	Ab
	Squamata	Chamaeleonidae	<i>Calumma malthe</i>	Aaa	Aaa	Pa	Ab
	Squamata	Chamaeleonidae	<i>Calumma gastrotaenia</i>	Ab	Ab	Ta	Ta
	Squamata	Chamaeleonidae	<i>Calumma nasutum</i>	Ab	Ab	Ta	Ta
	Squamata	Colubridae	<i>Liophidium torquatum</i>	Pa	-	-	-
	Squamata	Gekkonidae	<i>Phelsuma lineata</i>	-	-	Ab	Ab
	Squamata	Gekkonidae	<i>Phelsuma quadriocellata</i>	Ab	Ab	-	-
	Squamata	Gekkonidae	<i>Lygodactylus bivittis</i>	Pa	-	Pa	-
	Squamata	Gekkonidae	<i>Uroplatus phantasticus</i>	-	-	-	Pa
	Squamata	Gekkonidae	<i>Uroplatus fimbriatus</i>	-	Pa	-	-
	Squamata	Gerrhosauridae	<i>Zonosaurus aeneus</i>	Aaa	-	-	-
	Squamata	Gerrhosauridae	<i>Zonosaurus madagascariensis</i>	Ab	Ab	-	-
	Squamata	Lamprophiidae	<i>Compsophis boulengeri</i>	Aaa	Aaa	-	-
	Squamata	Lamprophiidae	<i>Liopholidophis doliocercus</i>	Aaa	-	-	-
	Squamata	Lamprophiidae	<i>Liopholidophis sexlineatus</i>	Aaa	-	-	-
	Squamata	Lamprophiidae	<i>Dromicodryas bernieri</i>	-	Aaa	-	-
Squamata	Scincidae	<i>Amphiglossus astrolabi</i>	Aaa	Aaa	-	-	
Squamata	Scincidae	<i>Amphiglossus punctatus</i>	Pa	-	-	-	
Squamata	Scincidae	<i>Trachylepis boettgeri</i>	Pa	-	-	-	

Birds

Of the 85 species known at the current stage of avian fauna in the study area, 83 species are observed directly in their habitat while two other species are known following discussions with the locals. Traces of the Northern Ruffed Ibis (*Lophotibis cristata*) were observed in the corridor during biological surveys in September 2018. The species is endemic and is classified as almost threatened (NT) by the IUCN. Its population is threatened by hunting and the destruction of its habitats (small rivers within degraded primary forests).

The abundance indices are presented in the following Table.

Three forest species (*Brachypteracias leptosomus*, *Cryptosylvicola randrianasoloi* and *Neomixis striatigula*) were not observed in the study sites despite the habitat typology and their known distribution.

Table 80 - Relative Abundance of Bird Species Identified in Four Study Sites

Order	Family	Species	Ankidy	Anivorano	Berena	Corridor
			Occasional Oc, Not very abundant, Aa Fairly abundant, Abundant			
Accipitriformes	Accipitridae	<i>Accipate francesiae</i>	-	Pa	Oc	Pa
Accipitriformes	Accipitridae	<i>Accipate henstii</i>	-	Oc	-	-
Accipitriformes	Accipitridae	<i>Accipitate madagascariensis</i>	-	-	-	Oc
Accipitriformes	Accipitridae	<i>Aviceda madagascariensis</i>	Oc	-	-	-
Accipitriformes	Accipitridae	<i>Buteo brachypterus</i>	Pa	Pa	-	Aaa
Accipitriformes	Accipitridae	<i>Milvus migrans</i>	Pa	Oc	Oc	-
Accipitriformes	Accipitridae	<i>Polyboroids radiatus</i>	Pa	Oc	Aaa	Oc
Caprimulgiformes	Apodidae	<i>Zoonavena grandidieri</i>	-	-	Ab	-
Charadriiformes	Charadriidae	<i>Charadrius leschenaultii</i>	Oc	-	Oc	-
Charadriiformes	Turnicidae	<i>Turnix nigricollis</i>	-	-	-	-
Columbiformes	Columbidae	<i>Alectroenas madagascariensis</i>	-	Aaa	-	Aaa
Columbiformes	Columbidae	<i>Streptopelia picturatus</i>	Pa	Aaa	Pa	-
Columbiformes	Columbidae	<i>Treron australis</i>	-	Pa	Oc	Pa
Coraciiformes	Brachypteraciidae	<i>Atelornis crossleyi</i>	-	Pa	Pa	Pa
Coraciiformes	Brachypteraciidae	<i>Atelornis pittoides</i>	Oc	-	-	-
Coraciiformes	Alcedinidae	<i>Corythornis madagascariensis</i>	Pa	Pa	-	-
Coraciiformes	Alcedinidae	<i>Corythornis vintsioides</i>	Pa	Pa	Pa	-
Coraciiformes	Meropidae	<i>Merops superciliosus</i>	Ab	-	-	-
Cuculiformes	Cuculidae	<i>Centropus toulou</i>	Ab	Aaa	Ab	-
Cuculiformes	Cuculidae	<i>Coua caerulea</i>	Aaa	Ab	Aaa	Ab
Cuculiformes	Cuculidae	<i>Coua reynaudii</i>	Pa	Pa	Pa	Pa
Cuculiformes	Cuculidae	<i>Cuculus rochii</i>	-	-	Ab	Ab
Falconiformes	Falconidae	<i>Falco newtoni</i>	Aaa	-	Pa	Aaa
Gruiformes	Rallidae	<i>Dryolimnas cuvieri</i>	-	-	Pa	-
Gruiformes	Rallidae	<i>Sarothrura insularis</i>	Aaa	Pa	Pa	-
Leptosomiformes	Leptosomidae	<i>Leptosomus discolor</i>	Ab	Ta	Ab	Ta
Passeriformes	Sturnidae	<i>Acridotheres tristis</i>	Ta	-	Ab	-
Passeriformes	Locustellidae	<i>Amphilaus seebohmi</i>	Oc	-	Oc	-
Passeriformes	Bernieridae	<i>Bernieria madagascariensis</i>	Ab	Ab	Ab	Ab
Passeriformes	Vangidae	<i>Calicalicus madagascariensis</i>	Ab	Ab	Ab	Ab

Passeriformes	Nectariniidae	<i>Cinnyris notatus notatus</i>	Ab	Ta	-	-
Passeriformes	Nectariniidae	<i>Cinnyris souimanga</i>	Ab	Ta	Ab	Ta
Passeriformes	Cisticolidae	<i>Cisticola cherina</i>	Ab	Oc	-	-
Passeriformes	Muscicapidae	<i>Copsychus albospecularis</i>	Ab	Aaa	Ab	Aaa
Passeriformes	Campephagidae	<i>Coracina cinerea</i>	Ab	-	-	Aaa
Passeriformes	Vangidae	<i>Cyanolanius madagascarinus</i>	Ab	Ab	-	Aaa
Passeriformes	Dicruridae	<i>Dicrurus forficatus</i>	Ab	Aaa	Ab	Aaa
Passeriformes	Ploceidae	<i>Foudia madagascariensis</i>	Ab	Aaa	Ab	-
Passeriformes	Ploceidae	<i>Foudia omissa</i>	Pa	Pa	-	-
Passeriformes	Bernieridae	<i>Hartertula flavoviridis</i>	-	-	-	Pa
Passeriformes	Vangidae	<i>Hypositta corallirostris</i>	-	-	-	Pa
Passeriformes	Pycnonotidae	<i>Hypsipetes madagascariensis</i>	Ta	Ta	Ta	Ta
Passeriformes	Vangidae	<i>Leptopterus chabert</i>	-	-	Aaa	-
Passeriformes	Estrildidae	<i>Lonchura chick</i>	Ab	Oc	Aaa	-
Passeriformes	Alaudidae	<i>Mirafrwa hova</i>	Aaa	Oc	Aaa	-
Passeriformes	Muscicapidae	<i>Monticola sharpei</i>	-	Oc	Oc	-
Passeriformes	Motacillidae	<i>Motacilla flaviventris</i>	Aaa	Pa	Aaa	Pa
Passeriformes	Philepittidae	<i>Neodrepanis coruscans</i>	Aaa	Aaa	Aaa	Aaa
Passeriformes	Philepittidae	<i>Neodrepanis hypoxantha</i>	-	-	-	Pa
Passeriformes	Cisticolidae	<i>Neomixis tenella</i>	Aaa	-	-	-
Passeriformes	Cisticolidae	<i>Neomixis viridis</i>	Ab	Ab	-	-
Passeriformes	Acrocephalidae	<i>Nesillas typica</i>	Ab	Ab	Ab	Ab
Passeriformes	Vangidae	<i>Newtonia amphichroa</i>	Oc	Pa	-	Aaa
Passeriformes	Vangidae	<i>Newtonia brunneicauda</i>	Ab	Ab	Ab	Ab
Passeriformes	Bernieridae	<i>Oxylabes madagascariensis</i>	Pa	Aaa	-	Ab
Passeriformes	Hirundinidae	<i>Phedina borbonica</i>	Ab	-	-	-
Passeriformes	Philepittidae	<i>Philepitta castanea</i>	Ab	Ab	Ab	Ab
Passeriformes	Ploceidae	<i>Ploceus nelicourvi</i>	-	Aaa	Pa	Aaa
Passeriformes	Vangidae	<i>Pseudobias wardi</i>	Pa	Aaa	Pa	Ab
Passeriformes	Bernieridae	<i>Randia pseudozosterops</i>	Pa	Aaa	-	Aaa
Passeriformes	Muscicapidae	<i>Saxicola torquatus</i>	Aaa	-	Aaa	-
Passeriformes	Monarchidae	<i>Terpsiphone mutata</i>	Ab	Ab	Ab	Ab
Passeriformes	Vangidae	<i>Tylas eduardi</i>	Pa	Aaa	-	Aaa
Passeriformes	Bernieridae	<i>Xanthomixis zosterops</i>	-	-	Aaa	Aaa
Passeriformes	Vangidae	<i>Xenopirostris polleni</i>	Pa	Pa	-	Pa
Passeriformes	Zosteropidae	<i>Zosterops maderaspatanus</i>	Ta	Ta	Ta	Ta
Pelecaniforms	Ardeidae	<i>Ardea purpurea</i>	-	-	Oc	-
Pelecaniforms	Ardeidae	<i>Bubulcus ibis</i>	Pa	Oc	Oc	-

Pelecaniforms	Ardeidae	<i>Striata Bittern</i>	Pa	-	Oc	-
Pelecaniforms	Ardeidae	<i>Egretta dimorpha</i>	-	-	Oc	-
Pelecaniforms	Threskiornithidae	<i>Lophotibis cristata</i>	-	-	-	Oc
Pelecaniforms	Scopidae	<i>Scopus umbretta</i>	Aaa	Pa	-	-
Psittaciformes	Psittacidae	<i>Agapornis canus</i>	Oc	Pa	-	-
Psittaciformes	Psittacidae	<i>Coracopsis nigra</i>	Pa	Aaa	Pa	Aaa
Psittaciformes	Psittacidae	<i>Coracopsis vasa</i>	Ab	Ab	-	Ab

Small Mammals

A total of 99 individuals of small mammals were captured using the hole-trapping technique with nine native species (*Gymnuromys roberti*, *Hemicentetes semispinosus*, *Microgale cf. cowani*, *Microgale dobsoni*, *Microgale cf. gracilis*, *Microgale cf. longicaudata*, *Microgale cf. taiva*, *Microgale cf. parvula*, *Microgale cf. principula*) and one alien species (black rat-*Rattus rattus*). For the latter, two young individuals were captured in trap holes, one in Ankidy and another one in Anivorano.

The number of small mammals caught with a Sherman trap is 115 individuals, including 103 rodents and 12 Afrosoricids. These species are composed of *Rattus rattus* (102 individuals), *Eliurus grandidieri* (1 individual) and *Microgale dobsoni* (12 individuals).

In terms of relative abundance (see table below), the Ankidy site is dominated by exotic rodents (*Rattus rattus*), with a relatively high abundance (as a percentage of catches) of 85.6%.

Table 81 - Relative Abundance of Small Mammal Species in the Study Area

Family	Species	Ankidy	Anivorano	Antaniketsa	Berena	Corridor
Tenrecidae	<i>Hemicentetes semispinosus</i>	6.7%				
Tenrecidae	<i>Microgale cf. cowani</i>	2.9%	2.70%			
Tenrecidae	<i>Microgale cf. gracilis</i>		5.40%			
Tenrecidae	<i>Microgale cf. longicaudata</i>	1.9%	8.10%	12.5%		4.8%
Tenrecidae	<i>Microgale cf. parvula</i>	1.9%				2.4%
Tenrecidae	<i>Microgale cf. taiva</i>		8.10%		35.7%	64.3%
Tenrecidae	<i>Microgale dobsoni</i>		64.90%	12.5%	57.1%	28.6%
Tenrecidae	<i>Microgale principula</i>				7.1%	
Nesomyidae	<i>Eliurus cf. grandidieri</i>		2.70%			
Nesomyidae	<i>Gymnuromys roberti</i>	1.0%				
Muridae	<i>Rattus rattus</i>	85.6%	8.10%	75.0%		

Bats

With regard to catching bats by means of Japanese nets, no individuals were caught. It should be noted that no trapping by this device has been carried out in the Faravohitra and Antaniketsa sites.

However, various publications summarized in Goodman & Ramasindrazana (2013) have mentioned the presence of bat species with wide geographical range in the study area. These species include *Rousettus madagascariensis*, *Paremballonura atrata*, *Myzopoda aurita*, *Mormopterus jugularis*, *Scotophilus robustus*, and *Miniopterus majori*.

However, various publications summarized in the book by Goodman & Ramasindrazana (2013), Goodman et al. (2018) and the IUCN site (2018) mentioned the presence of bats species with wide geographical range in the study area, including *Chaerephon atsinanana*, *Eidolon dupreanum*, *Hipposideros commersoni* and others, *Miniopterus egeri*, *Miniopterus majori*, *Miniopterus manavi*, *Miniopterus sororculus*, *Mormopterus jugularis*, *Myzopoda aurita*, *Neoromicia matroka*, *Paremballonura atrata*, *Pipistrellus raceyi*, *Rousettus madagascariensis*, and *Scotophilus robustus*.

All these species, which are potentially present in the study area, are endemic to Madagascar. Only *Eidolon dupreanum* (VU) and *Hipposideros commersoni* (NT) are included in the IUCN Red List of Threatened and Near Threatened Species.

In addition, all the above-mentioned species have a wide range and are known in several areas of the rainforests of Madagascar's central and central-eastern plateau.

Lemurs

The table below summarizes the distance covered for day and night observations made for lemurs during observation sessions in the five study sites (Ankidy, Anivorano, Antaniketsa, Berena and Corridor). No lemur transects were installed in Faravohitra whose habitats (grassy savannah) are not suitable for these species.

Table 82 - Length of Transects Covered in Lemur Study Sites (km)

	Ankidy	Anivorano	Faravohitra	Antaniketsa	Berena	Corridor
Day transects (km)	12	12	-	5	12	12
Night transects (km)	5	5	-	2	5	5

The results of the relative abundance (indiv./km) of each lemur species in the five sites are presented in the following table. The abundance of lemurs in the study area varies from 0.2 individuals/km to 2 individuals/km. Comparing the lemur population in the study area with other dense rainforests of the same altitudinal level, lemurs in the inventory sites are not very abundant. This low abundance may be due to the decrease in activity of these animals due to weather conditions during surveys. As for nocturnal species, *Cheirogaleus sibreei* was observed only once in Anivorano where sampling nights at this site were heavily rainy. Two *Microcebus* individuals were identified in the sites

inventoried in the dry season (Berena and Corridor). No individuals were found during surveys in the wet season, i.e. in the other four sites. It should be noted that the presence of the species in the upstream part of the dam has been proven by the capture of a few individuals in Antenina during biological inventories for the establishment of an ecotourism site in Antenina (Ralison & Rasarimanana in 2011). Regarding *Lepilemur mustelinus*, individuals were observed in Anivorano and feeding traces were observed in Ankidy. Its presence in the Antenina forest (right bank) is mentioned by Ralison & Rasarimanana (2011). The presence of *Daubentonia madagascariensis* was only detected through feeding traces.

As far as diurnal species are concerned, *Propithecus diadema*, only recorded in Anivorano, is one of the lemur species that are abundant in this site. Apart from observed individuals, traces of grey *Hapalemur* feeding were observed in Ankidy, Anivorano and Antaniketsa.

Table 83 - Relative Abundance of Lemur Species (ind/km)

Family	Species	Ankidy	Anivorano	Antaniketsa	Berena	Corridor
Cheirogaleidae	<i>Microcebus lehilahytsara</i>				0.2	0.4
Cheirogaleidae	<i>Cheirogaleus sibreei</i>		0.20			
Indriidae	<i>Propithecus diadema</i>		0.83			
Cheirogaleidae	<i>Cheirogaleus major</i>	0.40	-	0.50		
Daubentoniidae	<i>Daubentonia madagascariensis</i>					
Lepilemuridae	<i>Lepilemur mustelinus</i>		0.80		0.2	0.80
Lemuridae	<i>Eulemur fulvus</i>		0.58		0.25	
Indriidae	<i>Avahi laniger</i>	1.20			2.00	
Lemuridae	<i>Eulemur rubriventer</i>		0.42		0.08	0.08
Lemuridae	<i>Grey Hapalemur</i>	1.50	1.33	0.80	0.33	

4.4.8.6 Bioassessment of Terrestrial Vertebrates

The bioassessment (regulatory status, conservation status, distribution and occurrence, potential and proven criticality of habitat, etc.) of the 308 terrestrial vertebrate species distributed in the eastern and central highlands has resulted in a list of known conservation species, including 63 species requiring critical habitat analysis.

The main threat to these species lies in the degradation of their natural habitat due to anthropogenic pressures (illegal hunting, land clearing, deforestation, selective logging, erosion, etc.) or natural disasters (cyclones, floods).

Table 84 - Terrestrial Vertebrate Species Requiring Critical Habitat Analysis

Class	Family	Species	IUCN Status	Endemicity	Limited distribution	Criticality level of the habitat	Site known for the distribution of the species	Observed	Probability of occurrence in the study area
Amphibians	Mantellidae	Gephyromantis eiselti	EN	Madagascar	Yes (795 km ²)	1	Andasibe	No	Probable
	Mantellidae	Gephyromantis thelenae	EN	Madagascar	Yes (795 km ²)	1	Andasibe, Mantadia	Yes	Proven
	Mantellidae	Mantidactylus madecassus	EN	Madagascar	Yes (1290 km ²)	1	Andringitra massive	No	Unlikely
	Mantellidae	Boophis rhodoscelis	EN	Madagascar	Yes (1637 km ²)	1	Ranomafana, Antoetra	No	Probable
	Mantellidae	Mantidactylus albofrenatus	EN	Madagascar	Yes (1851 km ²)	1	Andasibe, Anosibe An'ala	No	Probable
	Mantellidae	Boophis boehmei	EN	Madagascar	Yes (2490 km ²)	1	East	No	Probable
	Mantellidae	Mantella cowanii	EN	Madagascar	Unknown	1	High plateau and central-east	No	Probable
	Mantellidae	Gephyromantis leucocephalus	NT	Madagascar	Yes (13771 km ²)	2	Midongy from the south to Taolagnaro	No	Unlikely
	Mantellidae	Boophis rufioculis	NT	Madagascar	Yes (22,394 km ²)	2	Central part of the eastern rainforest	Yes	Proven
	Microhylidae	Plethodontohyla tuberata	NT	Madagascar	Yes (22539 km ²)	2	Centre (Antoetra, Ankaratra, Angavokely)	No	Probable
	Mantellidae	Bleached gephyromantis	NT	Madagascar	Yes (24088 km ²)	2	Ranomafana, Andringitra mountains to the Anosyrian mountains	Yes	Proven
	Microhylidae	Anodonthyla boulengerii	NT	Madagascar	Yes (24370 km ²)	2	East	No	Probable
	Mantellidae	Mantidactylus cowanii	NT	Madagascar	Yes (31715 km ²)	2	Many localities in the central-east (Andasibe, Antoetra, Ambohitantely)	No	Probable

	Mantellidae	Boophis majori	VU	Madagascar	Yes (6475 km ²)	2	East (south of Andringitra)	No	Probable
	Microhylidae	Plethodontohyla brevipes	VU	Madagascar	Yes (6509 km ²)	1	Ranomafana NP	Yes	Proven
	Mantellidae	Gephyromantis cornutus	VU	Madagascar	Yes (6857 km ²)	2	Central-East (Andasibe, Vohimana, Vohidrazana, Mandraka, Anjozorobe)	No	Probable
	Mantellidae	Boophis brachykir	VU	Madagascar	Yes (8513 km ²)	2	Nosy be, Manongarivo, Amber Mountain	No	Unlikely
	Mantellidae	Mantella madagascariensis	VU	Madagascar	Yes (9434 km ²)	2	Central East (Niagarakely south of Ranomafana)	No	Probable
	Mantellidae	Gephyromantis spiniferus	VU	Madagascar	Yes (16404 km ²)	2	Southeast (Andringitra to Andohahela)	Yes	Proven
Mammals	Cheirogaleidae	Cheirogaleus sibreei	CR	Madagascar	Yes (100 km ²)	1	Tsinjoarivo	Yes	Proven
	Indriidae	Propithecus diadema	CR	Madagascar	Yes (44292 km ²)	2	Mananara-Nord, Mantadia, Zahamena, Betampona, Ambatovaky, Mangerivola, Marotandrano, Andriantantely, Tsinjoarivo, Marokitay, Anosibe an'ala, Anjozorobe, Didy, Iofa, Maromizaha, Sandranantitra	Yes	Proven
	Daubentoniidae	Daubentonia madagascariensis	EN	Madagascar	No	2	Widespread	Yes	Proven
	Lepilemuridae	Lepilemur betsileo	EN	Madagascar	Yes (3000 km ²)	1	Fandriana	No	Unlikely
	Indriidae	Propithecus edwardsi	EN	Madagascar	Yes (5170 km ²)	1	Ranomafana	No	Unlikely
	Tenrecidae	Voalavo antsahabensis	EN	Madagascar	Yes (605 km ²)		Anjozorobe	No	Unlikely

	Lepilemuridae	Lepilemur mustelinus	NT	Madagascar	Yes (37559 km ²)	2	Eastern forest (between the Onive and Mangoro rivers (south) to the Maningory River (north)	Yes	Proven
	Lemuridae	Eulemur fulvus	NT	Madagascar	No	2	Mantadia, Andringitra, Zahamena, Tsaratanana, Ambatovaky, Ambohitantely, Analamazaotra, Bora, Mangerivola, Manongarivo, Tampoketsa- Analamaitso, Ankarafantsika,	Yes	Proven
	Hipposideridae	Hipposideros commersoni	NT	Madagascar	No	2	All over Madagascar	No	Highly likely
	Pteropodidae	Rousettus madagascariensis	NT	Madagascar	No	2	Widely distributed but rare or absent in the highlands and arid southwestern part of the country	No	Highly likely
	Indriidae	Avahi laniger	VU	Madagascar	No	2	Between the Bemarivo (north) and Nosivolo / Mangoro (south) rivers	Yes	Proven
	Lemuridae	Eulemur rubriventer	VU	Madagascar	No	2	Tsaratanana Massif to Ivohibe Peak and Manampatrana River	Yes	Proven
	Lemuridae	Grey Hapalemur	VU	Madagascar	No	2	Wide distribution in the eastern part	Yes	Proven
	Tenrecidae	Limnogale mergulus	VU	Madagascar	Yes (2000 km ²)	2	Antsampandrano Forest Station, Ankaratra Massif, Antanifotsy Village (Andringitra), Andekaleka, Ranomafana,	No	Probable

							Antsirabe		
	Cheirogaleidae	Microcebus rufus	VU	Madagascar	Yes (5200 km ²)	2	Ranomafana NP to Andringitra NP	No	Unlikely
	Cheirogaleidae	Microcebus lehilahytsara	VU	Madagascar	Yes (8350 km ²)	2	Andasibe, Maromizaha, R.S. Analamazaotra, PN Mantadia, Tsinjoarivo	Yes	Proven
	Eupleridae	Cryptoprocta ferox	VU	Madagascar	No	2	Widely distributed (from east to west) but rare in the central highlands and spiny forests of the south	No	Probable
	Pteropodidae	Eidolon dupreanum	VU	Madagascar	No	2	Widely distributed (ribs and central plateau)	No	Probable
	Eupleridae	Eupleres goudotii	VU	Madagascar	No	2	Eastern Rainforest, from Amber Mountain (north) to Mandrare River (south)	No	Probable
	Eupleridae	Fossa fossana	VU	Madagascar	No	2	Rain forest (Sambirano region in the northwest, from Amber Mountain NP to Andohahela NP in the east part	No	Probable
	Eupleridae	Galidictis fasciata	VU	Madagascar	No	2	Eastern Rainforest (from Marojejy NP to Andohahela)	No	Probable
Birds	Rallidae	Sarothrura watersi	EN	Madagascar	No	1	Eastern Forest (Analamazaotra, Andapa, Torotorofotsy, Anjozorobe, Ranomafana / Vohiparara, PN Andringitra	No	Probable
	Podicipedidae	Tachybaptus pelzelinii	EN	Madagascar	No	2	West and Central Madagascar	Yes	Proven
	Accipitridae	Accipate henstii	NT	Madagascar	No	2	Everywhere in	Yes	Proven

							Madagascar except the southwest		
	Accipitridae	Accipitate madagascariensis	NT	Madagascar	No	2	Everywhere in the primary forests	Yes	Proven
	Brachypteraciidae	Atelornis crossleyi	NT	Madagascar	No	2	Rain forest (Tsaratanana south to Andohahela)	Yes	Proven
	Threskiornithidae	Lophotibis cristata	NT	Madagascar	No	2	All over Madagascar	No	Highly likely
	Vangidae	Xenopirostris polleni	NT	Madagascar	No	2	Eastern Rainforest	Yes	Proven
	Bernieridae	Crossleyia xanthophrys	NT	Madagascar	No	2	Eastern Rainforest (from Tsaratanana in the north to Andohahela in the south)	No	Probable
	Bernieridae	Hartertula flavoviridis	NT	Madagascar	No	2	Rain forest (Manongarivo in the northwest to Andohahela in the south)	Yes	Proven
	Bernieridae	Xanthomixis cinereiceps	NT	Madagascar	No	2	Eastern Middle Altitude Rainforest	No	Highly likely
	Mesitornithidae	Mesitornis unicolor	VU	Madagascar	No	2	All over Madagascar	Yes	Proven
	Philepittidae	Neodrepanis hypoxantha	VU	Madagascar	No	2	Marojejy and Anjanaharibe-Sud Mountains in the north to the Andohahela Mountains in the south	Yes	Proven
	Brachypteraciidae	Brachypteracias leptosomus	VU	Madagascar	No	2	Eastern Low and Medium Altitude Rainforest (Daraina to Andohahela)	No	Highly likely
	Glareolidae	Glareola ocularis	VU	Madagascar	No	2	All over Madagascar	Yes	Proven
Reptiles	Chamaeleonidae	Calumma hilleni	EN	Madagascar	Yes (820 km ²)	1	Ankaratra, Andringitra, Ivohibe, Ambohijanahary, Ibity, Itremo,	No	Probable
	Chamaeleonidae	Brookesia dentata	EN	Madagascar	Yes (1300 km ²)	1	Northwest (Ankarafantsika)	No	Unlikely

	Chamaeleonidae	Calumma parsonii	NT	Madagascar	Yes (39800 km ²)	2	Eastern Rainforest (Southern Anjanaharibe to Ranomafana), Masoala Peninsula and Manongarivo in the northwestern part	No	Highly likely
	Lamprophiidae	Pseudoxyrhopus imerinae	NT	Madagascar	Yes (40000 km ²)	2	Central and southeastern highlands: Ananokely, Andohahela, Andrangoloaka, Ibity, Vohisokina	No	Unlikely
	Chamaeleonidae	Calumma oshaughnessyi	VU	Madagascar	Yes (18000 km ²)	2	Highlands, southeast between Tsinjoarivo - Antoetra (north) and Andohahela (south)	Yes	Proven
	Gekkonidae	Lygodactylus bivittis	VU	Madagascar	Yes (17767 km ²)	2	Marojejy (north) and Andasibe - Ambatovy (east), Makira (northeast)	Yes	Proven
	Lamprophiidae	Pseudoxyrhopus oblectator	VU	Madagascar	Yes (17434 km ²)	2	Ranomafana, Anjozorobe, Ambatovy and other sites in the escarpment of the central part	No	Highly likely
	Gekkonidae	Uroplatus ebenau	VU	Madagascar	Yes (7632 km ²)	2	Northern low altitude area, including Nosy Be	No	Unlikely
	Scincidae	Trachylepis boettgeri	LC	Madagascar	Yes (42891 km ²)	2	Central highlands (Betafo, Antananarivo, Ankaratra, Andringitra, Anjozorobe- Angavo, Kalambatritra)	No	Probable

4.4.8.7 Terrestrial Invertebrates

Butterflies and Caterpillars

Twenty-six (26) species of Rhopalocera (butterflies) were inventoried during the field trip. 11 of these are forest species and 19 are endemic to Madagascar. No species are listed by the IUCN. The specific composition of the Rhopalocera fauna is more or less similar between study sites.

For Heterocera, which are generally nocturnal, two diurnal species were recorded: *Chrysidia madagascariensis* (Uranidae) and *Thyrosticta* sp. (Arctiidae).

Although no species has IUCN status, *Chrysidia madagascariensis* and *Charaxes antamboulou* are highly sought after for insect trade purposes. The first species is very abundant in the Sahofika area.

Regarding caterpillars, it is mainly the species of Sphingidae, Saturniidae (*Antherina suraka*) and Lasiocampidae (*Borocera marginepuctata* and *Borocera cajani*) that were recorded.

These three species, which are endemic to Madagascar, are potentially usable for silk production. The abundance of Sphingidae species in the study area shows that this forest is already more or less degraded.

It is likely that rare, endemic and threatened species of Rhopalocera butterflies such as *Hovala* sp. and *Perrotia* sp. can be found in the Sahofika area, although they have not been observed there. It should be noted that these species were recorded in the Antenina site (Rasamy et al., 2011).

Table 85 - Presence Matrix of Rhopalocera Species Identified

Families	Species	Habitat	Distribution	Total project footprint	Sites			
					S 1	S 2	S 3	S 4
Hesperiidae	Borbo ratek	F	Md	1	1	0	0	0
Hesperiidae	Coeliadis ramanatek	FXA	Md	1	0	1	1	1
Hesperiidae	Coeliadis rama	FXA	Md	1	0	0	1	1
Papilionidae	Papilio delalandei	F	Md	1	1	1	0	0
Papilionidae	Graphium endochus	F	Md	1	1	0	0	0
Pieridae	Eurema hapale	AT	MG _u	1	1	0	1	1
Pieridae	Eurema floricola	F	AT	1	0	1	1	1
Pieridae	Mylothris phileris	F	Md	1	1	1	1	0
Nymphalidae	Heteropsis angulifascia	F	Md	1	1	0	0	0
Nymphalidae	Poultry Heteropsis	F	Md	1	0	1	1	1
Nymphalidae	Heteropsis iboina	FX	Md	1	0	1	1	1
Nymphalidae	Strabena rakoto	G _u XA	Md	1	1	0	0	0
Nymphalidae	Strabena smithii	FX	Md	1	0	1	1	1
Nymphalidae	Melanitis leda helena	G _u XC	AT	1	1	1	1	1
Nymphalidae	Hypolimnae bolina jacintha	XA	AT	1	1	1	1	0
Nymphalidae	Phalanta phalantha aethiopica	G _u AX	AT	1	0	0	1	0
Nymphalidae	Junonia eurodace	F	Md	1	1	0	0	0
Nymphalidae	Junonia andremihaja	AX	Md	1	0	1	0	0
Nymphalidae	Neptis kikiideli	F	Md	1	1	0	0	0
Nymphalidae	Precis oenone epiclelia	XA	MR	1	0	0	1	1
Nymphalidae	Salamis anacardii duprei	FX	Md	1	1	0	0	0
Nymphalidae	Antamboulou Charaxes	F	Md	1	1	0	0	0
Acraeidae	Actinote encedon	AX	AT	1	0	0	1	1

Acraeidae	Actinote zitza	G _n XAC	Md	1	1	0	0	0
Lycaenidae	Saribia tepahi	F	Md	1	1	0	0	0
Lycaenidae	Leptotes patching up	FX	Md	1	0	1	1	1
Total number of species				26	1	1	1	1
1: Present; 0: Absent; Md : endemic to Madagascar; MR : Malagasy region (Indian Ocean islands); AT : Afrotropical (Sub-Saharan Africa to Madagascar; OW : Old world; A : human environment, C : cosmopolitan, F : forest species, FS : both forest and savannah species, FX : forest or secondary formation, FXA : forest or secondary formation or anthropogenic environment, Gu : pasture or natural meadow or not, GuXA : natural meadow or secondary formation or anthropogenic environment, X : secondary formation or forest edge, XA : secondary formation or anthropogenic environment. (Source concerning habitat, taxa distribution and conservation status: Lees et al. 2003)								
S1: Ankidy ; S2: Anivorano ; S3: Sahofika ; S4: Antaniketsa								

As for Heterocera, a group generally nocturnal, 2 species initially nocturnal but now diurnal were recorded: *Chrysiridia madagascariensis* (Uranidae) and *Thyrosticta* sp. (Arctiidae).

Table 86 - Presence Matrix of two identified species of Heterocera

Families	Species	Habitat	Distributi on	IU CN	Nb	Sites			
						S1	S2	S3	S4
Uranidae	<i>Chrysiridia madagascariensis</i>	FXA	Md	-	1	1	1	0	1
Arctiidae	<i>Thyrosticta</i> sp.	FXA	Md	-	1	1	0	0	1
Total number of employees					2	2	1	0	2
Legend: 1: Present; 0: Absent; Md: Endemic to Madagascar, FXA: Forest or secondary formation or human environment, -: No IUCN status									
S1: Ankidy ; S2: Anivorano ; S3: Sahofika ; S4: Antaniketsa									

Chrysiridia madagascariensis and *Thyrosticta* sp. are not strictly forest species, but they are endemic to Madagascar.

Flying Insects

The flying insects in the area are Orthoptera, Diptera, Coleoptera, Dictyoptera, Hymenoptera, Homoptera and Trichoptera. None have IUCN conservation status. The population of flying insects is relatively similar between sites.

Table 87 - Abundance of flying insects caught in Malaise traps

Taxa	Site 1: Ankidy		Site 2: Anivorano	
	Taxa Richness	Absolute abundance	Taxa Richness	Absolute abundance
Orthopterans	2	2	2	2
Diptera	3	10	6	8
Beetles	5	8	4	6
Dictyoptera	1	2	1	3
Hymenoptera	4	8	3	3
Homopterans	0	0	2	2
Trichoptera	1	5	1	7
TOTALS	16	35	19	31

Arthropods in the soil and bedding

These are the groups collected from the traps. The samples are dominated by Hymenoptera, Diptera and Beetle. None of the species listed is listed by the IUCN.

Table 88 - Abundance of soil and litter invertebrates in study sites

Taxa	Site 1: Ankidy		Site 2: Anivorano	
	Taxa Richness	Absolute abundance	Taxa Richness	Absolute abundance
ARACHNIDES				
Aranae	2	44	2	10
Dust mites	1	16	1	0
INSECTS				
Diptera	9	25	6	76
Beetles	9	131	4	80
Phasmopters	0	0	0	1
Hymenoptera	6	107	3	18
Orthopterans	3	20	3	26
Heteropterous	3	6	0	0
Homopterans	1	1	1	1
Thysanurae	1	1	1	2
Collembola	0	0	1	3
Lepidoptera	0	0	1	1
CRUSTACEES				
Amphipods	1	1	1	1
Isopods	1	9	0	0
MYRIAPODES	0	0	1	3
TOTALS	37	361	25	222

Bioassessment of Terrestrial Invertebrates

None of the terrestrial invertebrate species in the study area meets the criteria for triggering a critical habitat analysis.

4.4.8.8 Land fauna: Case of the Transmission Line from Belanitra to Antananarivo

Due to the highly modified nature of habitats between Belanitra and Antananarivo, the biodiversity inventory along the transmission line between Belanitra and Antananarivo focused on birds, which are the main species exposed in the event of installation.

Due to the absence of highly migratory birds in Madagascar and taking into account the results of avian fauna inventories and literature review, the bird species likely to be impacted by electrocution and collisions are birds of prey such as *Falco newtoni*, *F. eleonora*, *Milvus aegyptius*. These species are adapted to open environments (savannahs, pseudo steppe, plantations, etc.)

These species do not have a particular conservation status and do not trigger the critical habitat criteria.

4.4.9 Aquatic Flora

4.4.9.1 Conservation concern species

The aquatic flora is very poorly described in Madagascar and no species is classified as Endangered or Vulnerable according to the IUCN. During low-water field studies, very few specimens were observed. Due to the lack of data on this taxon, it was not considered appropriate to undertake a field inventory.

4.4.9.2 Invasive Species

The Water hyacinth (*Eichhornia crassipes*), an invasive aquatic plant native to South America, is present in Madagascar. It was not observed in the Project area during field studies, either along the Onive River or in small tributaries, although the species can occupy various water bodies such as rivers, irrigation channels, rice fields and fishing grounds.

It therefore does not represent a threat at the moment but could appear in the future in the area.

4.4.10 Aquatic Fauna

4.4.10.1 Aquatic Fauna Data from the Literature Review

The study area straddles the eastern and central highlands.

The eastern region of Madagascar and, by extension the eastern slope, which are exposed to the SE trade winds and characterized by a hot and humid climate, were until recently largely covered with rainforest. As a result, according to current data, this region is the richest in native fish species: 61% of endemic species are restricted exclusively to the eastern forest region, including most species of the endemic Bedotiidae family (Stiassny, 1994, in De Rham, 1996). However, the eastern region is ecologically very heterogeneous and includes very different natural environments. While inland rivers are faster due to the nature of the terrain and generally have clearer waters, some rivers, especially the larger ones such as the Mangoro, have turbid waters due to erosion caused by human activities in their watersheds.

In the central region of the central highlands of Madagascar whose altitude exceeds 600 m, the indigenous ichthyofauna is very poor and probably limited to 5 species, of which only 2 or 3 are endemic to this region (De Rham, 1996). Today most aquatic habitats in the highlands contain only introduced species, while the native cichlid *Paratilapia polleni*, once widespread throughout the island (Kiener, 1963), has almost completely disappeared from the upper parts of its original range.

More specifically, in the study area, Stiassny et al (1992) and Ralambomanana (2013) note the presence of Bedotiidae of the Rheocles genus (gathering at least 7 species all threatened in Danger or Critical Threat of extinction according to the IUCN) and Eleotridae of the genus *Ratsirakia* (insufficient data for IUCN listing but endemic to Madagascar) on the tributaries of the Mangoro. The study reveals the negative impacts of excessive deforestation, and silting of river beds on these species.

Finally, a study carried out on part of the study area in the upstream zone revealed the presence of numerous species of macroinvertebrates, exotic fish species and two

endemic macrocrustacean species in Madagascar on the right bank of the Onive Antena: *Astacoids caldwelli* (IUCN Vulnerable) and *Hydrothelphusa agilis* (Oliarinony & Rambelason, 2011).

During the ESIA surveys, the bibliographic data as well as the inventory data from the scoping field visit served as a database for the inventories and specified the protocols (type and sampling effort, selection of areas and stations to be inventoried). During the field trip, special attention was paid to threatened and migratory species requiring critical habitat analysis.

Photo 58 - *Hydrothelphusa agilis* captured on the trail during the trip from the plant to the Dam



4.4.10.2 Results of the Survey Campaign (Fish and Macrocrustaceans)

Summary Results of Inventory and Survey Data

In total, during the three field trips, there are 20 fish species (including survey data), including 4 endemic to Madagascar and 3 native to Madagascar, and 3 crustacean species endemic to the entire study area.

Considering the low efficiencies of electric fishing due to low conductivity and the size of the study area, the analysis of the results a qualitative (specific) and non-quantitative (species abundances and densities) are proposed. However, this provides a sufficiently accurate picture of the composition of the aquatic stand.

During the field trips, it emerged that the fish procession is relatively different between the upstream and downstream from the rapids area located on the downstream portion of the bypassed reach (BPR). Therefore, it seemed appropriate to present the data according to this distinction. The downstream limit of the rapids area is located approximately 600 m upstream from the plant site.

Table 95 summarizes observations of species during the various field trips. These data make it possible to draw conclusions on the presence of species upstream and downstream from the rapids area (Firm/very probable/unlikely/unlikely to be confirmed). Some cells are merged at the survey level because the Malagasy vocabulary does not always make it possible to distinguish morphologically related species.

Table 89 - Summary of Aquatic Fauna Inventories and Surveys

Group	Family	Name TAXON	Endemicity, range and distribution	October 2017		April 2018		October 2018		Surveys		Upstream presence	Downstream presence
				Upstream	Downstream	Upstream	Downstream	Upstream	Downstream	Upstream	Downstream		
Fish	Anabantidae	<i>Microctenopoma ansorgii</i>	Exotic			X						Verified	Very likely
	Anguillidae	<i>Anguilla mossambica</i>	IP	X				X		X	X	Verified	Very likely
		<i>Anguilla marmorata</i>	Africa, OOI							X	X	To be confirmed	Very likely
	Bedotiidae	<i>Rheocles wrightae</i>	East Mada.				X		X		X	Absent	Proven
		<i>Rheocles sp. Ambatovy</i>	East Mada.				X		X		X	Absent	Proven
	Centrarchidae	<i>Micropterus salmoides</i>	Exotic							X	X	Very likely	To be confirmed
	Channidae	<i>Channa maculata</i>	Exotic	X		X		X		X	X	Proven	To be confirmed
	Cichlidae	<i>Oreochromis sp.</i>	Exotic	X			X	X	X	X	X	Proven	Proven
		<i>Oreochromis niloticus</i>	Exotic						X			Very P.	Proven
		<i>Tilapia zillii</i>	Exotic	X		X		X	X			Proven	Proven
		<i>Tilapia sparmani</i>	Exotic						X			Very likely	Proven
		<i>Tilapia rendalli</i>	Exotic	X								Proven	Very likely
	Clupeidae	<i>Sauvagella madagascariensis</i> (3)	East Madagascar								X	Absent	Unlikely
	Cyprinidae	<i>Carassius auratus</i>	Exotic	X		X		X		X	X	Proven	Proven
		<i>Cyprinus carpio</i>	Exotic	X		X				X	X	Proven	Proven
	Eleotridae	<i>Ratsirakia sp.</i>	Madagascar		X		X		X		X	Unlikely	Proven
Gobiidae	<i>Awaous aeneofuscus</i>	Africa							X		X	Unlikely	Proven
	<i>Sicyopterus franouxi</i>	Madagascar							X		X	Unlikely	Proven
Poeciliidae	<i>Gambusia holbrooki</i>	Exotic	X	X	X	X	X	X	X	X	Proven	Proven	
	<i>Xiphophorus hellerii</i>	Exotic						X	X	X	Very likely	Proven	
	<i>Xiphophorus maculatus</i>	Exotic				X		X			Very likely	Proven	
Salmonidae	<i>Oncorhynchus mykiss</i>	Exotic			X				X	X	Proven	Very likely	
Cr	Parastacidae	<i>Astacoides caldwelli</i>	Madagascar		X	X		X		X	X	Proven	Proven

Madagascar - Sahofika Hydropower Plant
 Environmental and Social Impact Assessment - Version D

u s t a c e a n s		<i>Astacoides madagascariensis</i>	Madagascar					X				Proven	Very likely
	Potamonautidae	<i>Hydrothelphusa agilis</i>	Madagascar		X	X	X	X	X	X	X	Proven	Proven
Under Total Species (3)				8	4	9	7	9	12	12	17	17	21
Total Species (3)				11		14		17		16		23	

Legend: OO: West Indian Ocean / IP: Indo Pacific

The surveys carried out made it possible to cross-reference and verify most of the data. Thus, among the 5 additional species sampled during the second field trip 3 had already been reported by the surveys during the scoping. This shows, on the one hand, that the data collected in the surveys are reliable and, on the other hand, that the inventories have been relatively effective. Indeed, among all the 20 fish species present or to be confirmed, only 2 species were never observed during the 3 surveys. These are *Anguilla marmorata* and *Micropterus salmoides*. However, according to the literature (species present in the study area but infrequent) and the low probabilities of determination error by the respondents, the presence of these species was considered very likely. In addition, *Micropterus salmoides* was probably not caught due to the fishing methods used. Indeed, it prefers large environments and slower areas that are more difficult to prospect. Concerning *Anguilla marmorata*, the literature shows that it is less present in Madagascar at altitude, where the *Anguilla mossambica* species is by far the dominant eel species (Kiener, 1963).

A third species, *Sauvagella madagascariensis*, reported by several people in the surveys on the downstream plant area could not be observed. This euryhaline species (possible seasonal presence) is found in the study area at the upstream edge of its range; its presence is considered uncertain and therefore unlikely. Moreover, there is a high risk of confusion with other pelagic species such as *Rheocles*. It has therefore not been included among the 20 fish species recorded.

Photo 59 - *Rheocles* caught by means of a seine in the Marotenina River



Finally, there is a very good concordance between the sampling results and the survey data, which also converge towards a high scarcity of fish stocks in relation to gold panning activities, deforestation and increased turbidity and associated clogging.

There is also good complementarity between the 3 campaigns: among the 18 fish species observed, only 6 were observed during the 3 field trips; the inventories of the second campaign allowed the identification of 5 additional species compared to the scoping field trip. The new species observed during the third season were already suspected in the study area. Indeed, their presence had been reported by the surveys. Concerning macrocrustaceans, 2 species out of 3 were recorded during the 3 field trips.

This information confirms the interest of carrying out several fish survey campaigns using electric fishing techniques but also fishing gear such as seines, which have been complementary to electric fishing.

Photo 60 - *Astacoids madagascariensis* and *Awaous aeneofuscus*

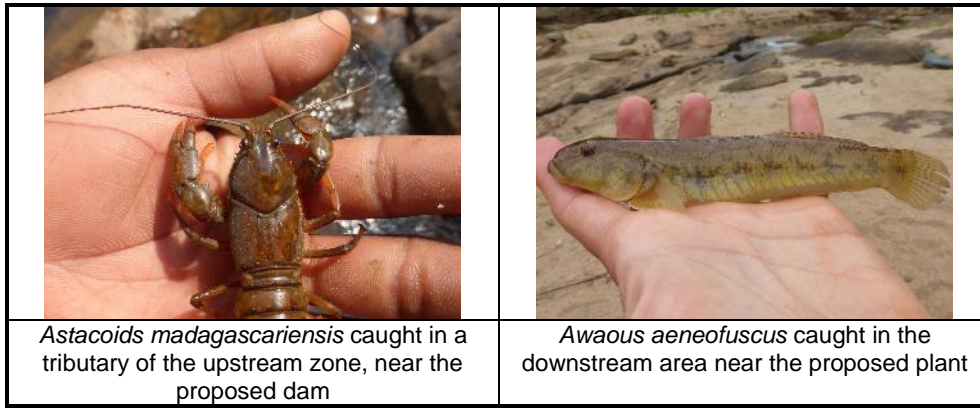

Astacoids madagascariensis caught in a tributary of the upstream zone, near the proposed dam

Awaous aeneofuscus caught in the downstream area near the proposed plant

4.4.10.3 Results of Benthic Macroinvertebrate Survey Campaign

Determinations could generally only be made at the family level (which remains the taxonomic level generally recommended by the IBGN standard NF T90 350 that we followed). Nevertheless, it is often interesting, when it is possible to make determinations that extend to the genus in order to enhance existing ecological information, which is imprecise at the family level. However, considering the very low level of knowledge on Madagascar's macroinvertebrates, it was not possible to push the determination any further.

The complete faunal lists for the 4 stations are presented in the Appendix. A summary table of total abundances and taxon richness by station is presented below (see Figure 49 for the location of hydrobiological survey stations).

Table 96 - Summary of Abundance and Taxon Richness by Sampled Station

Date:	Tributaries		Onive	
	10/17/2018	10/17/2018	10/18/2018	10/19/2018
Station	Station 1: Tributary LB upstream Anivorano	Station 2: Tributary RB upstream dam	Station 3: Upstream dam level	Station 4: BPR level
Total Abundance (number of individuals)	419	106	63	51
Total Taxonomic Wealth (number of taxa)	20	12	15	7

The results show that macroinvertebrate abundances are higher at the 2 stations located on the tributaries, and are more preserved (up to 419 individuals). Station 1 has the highest taxonomic richness (20 taxa, compared to 7 to 15 on the other stations). These characteristics correspond to a relatively diverse habitat but to the likely limiting trophic resource. The habitat analysis confirms this hypothesis: indeed, the clogging and turbidity observed are low compared to station 2 (tributary located on the right bank of the Onive), but also in comparison with the 2 stations located on the Onive.

Habitat surveys on the Onive have highlighted a very high level of clogging in fine materials with a grain size of less than 0.5 mm (mesh size), as well as very high turbidity, leading to homogenization and deterioration of the quality of aquatic habitat. This seems to be confirmed by a very low abundance in Onive samples: 50 to 65 individuals, which is particularly low. Taxa are also poorly diversified.

At the RB upstream dam tributary station, habitat surveys highlighted a degradation of the environment caused by human activities (recalibration and development of the valley for rice cultivation, deforestation on the scale of the catchment area), leading to clogging by fine materials and homogeneity of aquatic habitats.

An in-depth analysis of existing ecological data and the distribution of inventoried taxa is proposed below in the form of distribution diagrams of the individuals sampled.

Figure 59 - Distribution the 4 stations by major taxonomic group

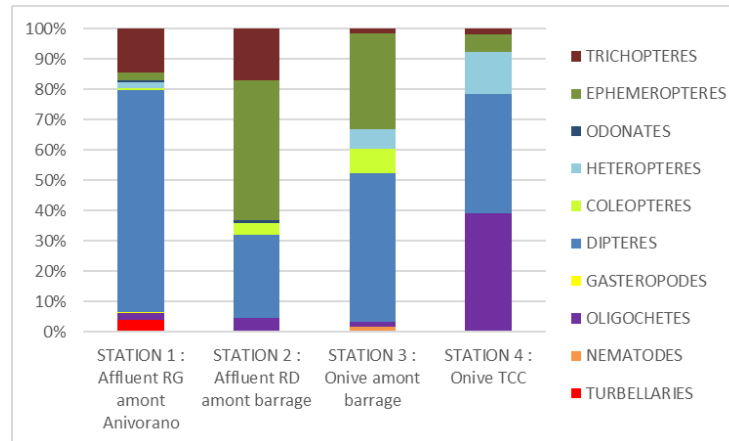

This first analysis highlights the proportion of Trichoptera and Ephemeroptera in relation to other taxa. These are the groups that bring together the most sensitive and demanding species among the inventoried groups. It can be seen that station 2, despite a disturbed habitat, is the one with the highest proportion of Trichoptera and Ephemeroptera (more than 60%); station 1, characterized by preserved habitat and maximum diversity and abundance, has only a small proportion for these taxa (less than 20%). On the Onive, it should be noted that Station 4 has only a very small proportion of Trichoptera and Ephemeroptera (less than 10%), which represents very small numbers, the total abundance on this station being very limited (51 individuals).

Photo 61 - Gyrinidae beetle collected from stations 1 and 2 (limnophile and pollution-resistant taxon)



Two analyses of the taxa ecology were carried out (affinity to current and taxa resistance to pollution), despite a determination generally limited to the family. Affinity to the current is of particular interest to analyze because, in addition to characterizing the station,

rheophilic species are often more demanding species, while limnophiles are often more tolerant with respect to habitat and water quality.

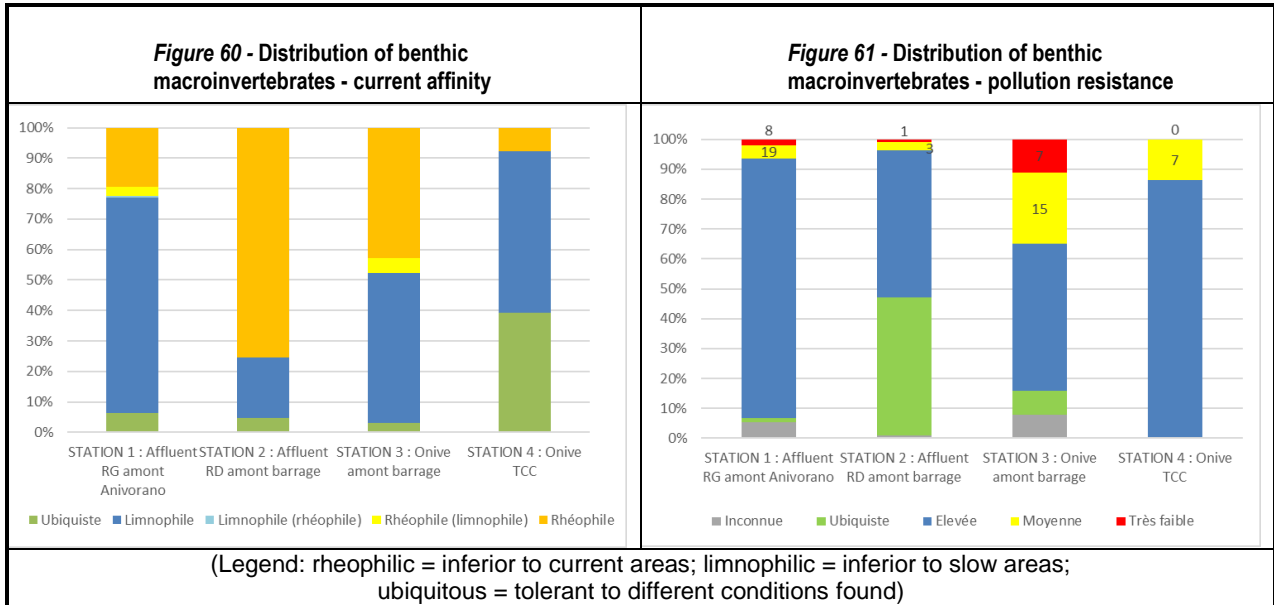

Station 2 is the one with the most rheophilic individuals while station 4 on the Onive has the least affinity for current. In terms of pollution resistance, the trends are relatively different. While the proportions of individuals sensitive to pollution are very low for all species combined, Stations 1 and 3 seem to stand out with a higher overall quality level. Although Station 4 contains more than 10% of moderately sensitive individuals, this must be put into perspective because of the very low total abundance. In the end, this only corresponds to a total of 7 individuals sampled.

Endemicity and in a broader sense the known range of the species that constitute the taxa determined is also an interesting descriptive element. However, the level of determination to the family and the lack of knowledge of Malagasy macroinvertebrate species is a limiting factor in this analysis. Indeed, in the best case (station 2) about 40% of the individuals sampled belong to taxa whose distribution is unknown. It should always be noted on this Station 2 that nearly half of the population is made up of taxa endemic to Madagascar, or even probably to eastern Madagascar. The fauna list indicates that the 49 individuals corresponding to this procession belong to a single taxon: the Ephemeroptera, family Baetidae (*Afroptilum* genus)..

Figure 62 - Geographical Distribution of Taxa in The 4 Sampling Stations

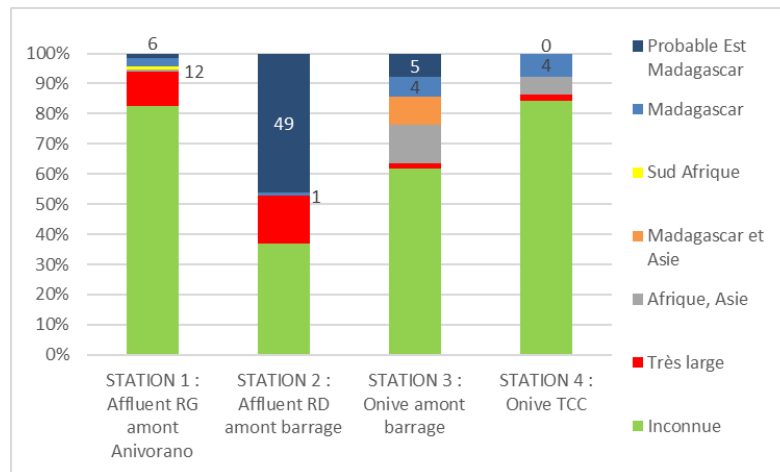

In conclusion, the macroinvertebrate populations are poor in terms of both abundance and diversity at the 4 stations sampled. The environment appears relatively undiversified and trophic resources are probably limited (particularly on Stations 2, 3 and 4). The analyses proposed, despite a majority determination to the family, are highly contrasted but seem to argue for a slightly higher quality of Stations 1 to 3 (upstream tributaries dam and Onive upstream dam), while all indicators converge towards a poor quality at Station 4 (Onive at the BPR).

4.4.10.4 Bioassessment of Aquatic Fauna

The 23 species of fish and shellfish identified include:

- 7 endemic species of Madagascar including 2 more precisely from the east of the country (*Rheocles wrightae* and *Rheocles sp. Ambatovy*),
- 3 species native but not endemic to Madagascar, including eels (*A. marmorata* and *A. mossambica*), with a wide distribution (Western Indian Ocean or Indo-Pacific),
- 13 exotic species.

It should be noted that the entire family of Bedotiidae, including the rainbow fishes of Madagascar *Rheocles wrightae* and *Rheocles sp. Ambatovy*, are endemic to eastern Madagascar. In addition, all the 16 Bedotiidae species described and listed by the IUCN are threatened with the exception of 1 near-threatened species and 2 for which there is insufficient data.

The issues of species conservation have been addressed in the table. This analysis was made in light of the various data collected for these species, as well as inventory data. Only the 10 native and endemic species are represented. There are no migratory species triggering critical habitat.

Table 90 - List of Native Aquatic Species Identified

Group	Family	Taxon	Malagasy name	Amphihaline migrator (1)	IUCN Status (1)	Endemicity, range (1)	Main pressures	Need for a critical habitat assessment
Fishes	Anguillidae	<i>Anguilla marmorata</i>	Amalombandana	Yes	LC	IP	Ecological continuity, Fishing	No
		<i>Anguilla mossambica</i>	Amalomaitso	Yes	LC	Africa, OOI	Ecological continuity, Fishing	No
	Bedotiidae	<i>Rheocles wrightae</i>	Zono mavovatana	No	EN	East Madagascar	Deforestation, Clogging of fine sediments Exotic species	Yes
	Bedotiidae	<i>Rheocles sp. Ambatovy</i>	Zono fotsikely	No	Not evaluated	East Madagascar	Deforestation, Clogging of fine sediments Exotic species	Yes
	Eleotridae	<i>Ratsirakia sp.</i>	Soliboka	No	DD	Madagascar	Deforestation, Clogging of fine sediments Exotic species	No
	Gobiidae	<i>Awaous aeneofuscus</i>	Toho banana	Yes	LC	Africa	Ecological continuity, Deforestation, Clogging of fine sediments	No
		<i>Sicyopterus franouxi</i>	Andrisatry	Yes	LC	Madagascar	Ecological continuity, Deforestation, Clogging of fine sediments	No
	Macro-Crustaceous	Parastacidae	<i>Caldwelli astacoids</i>	Orana	No	VU	Madagascar	Deforestation, Clogging of fine sediments, fishing
<i>Astacoids madagascariensis</i>			Orana	No	LC	Madagascar	Deforestation, Clogging of fine sediments, fishing	No
Potamonautidae		<i>Hydrothelphusa agilis</i>	Foza	No	LC	Madagascar	Deforestation, Clogging of fine sediments	No

Legend: OOI: West Indian Ocean / IP: Indo Pacific

Endangered Species

Out of the 23 species of fish and crustaceans listed, 1 species of fish is threatened according to the IUCN with a status of “EN: Endangered” (*Rheocles wrightae*), 1 species of crustacean is threatened with a status of “VU: Vulnerable” (*Astacoid caldwelli*) and 1 species of fish recently discovered is currently being described (*Rheocles sp. Ambatovy*). Also a Bedotiidae (endemic to eastern Madagascar) whose range seems limited like most rainbow fish species, is also very likely to be threatened. This third species was recently discovered during studies carried out in the Ambatovy quarry area near Moramanga, about 100 km northeast of the study area, in the same Mangoro catchment area.

Photo 62 - Aquatic Species at Risk

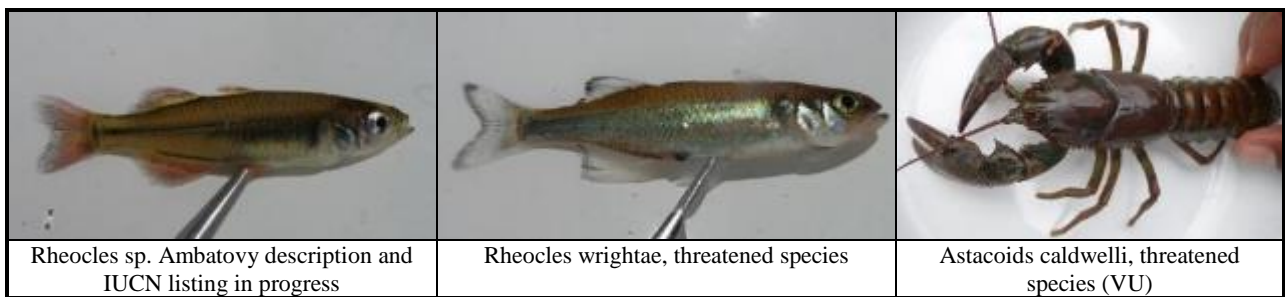

Species *Rheocles wrightae* (threatened EN)

Inventory and survey data converge towards the presence of this species and the second species of the same genus being described in the downstream area of the study area, more precisely downstream from the rapids area, both on the main river Onive and on the tributaries. More precisely, it is present both in the extreme downstream area from the BPR (downstream from the falls) and the downstream section of the plant. The rapids zone located at the bypassed reach constitutes an impassable natural obstacle for these species, which are therefore absent upstream from there.

Photo 63 - Most downstream fall from the rapids forming the bypassed reach of the Onive



Surveys could not provide reliable information on a possible evolutionary trend in the species’ abundance.

The population of rainbow fish species endemic to eastern Madagascar *Rheocles wrightae* seems important on the Onive at the site of the future plant, and more especially in tributaries in the lower part of the catchment area, including the Marotenina River.

It is a non-migratory species with a known restricted range of less than 5,000 km² in the eastern sector of Madagascar, in the Mangoro catchment area (Máiz-Tomé et al., 2018).

Stiassny & Reinthal (1992) and Stiassny & Rodriguez (2001) specify that the majority of species in the Rheocles genus are found in the eastern central part of Madagascar. More precisely, several species of the Rheocles genus are recorded in the Mangoro catchment area, including *R. wrightae*. This species was therefore observed in its known range.

This species is sensitive to deforestation and the associated consequences of habitat and water quality degradation (increased turbidity, water temperature and riverbed plugging). This species can also suffer indirect impacts (predation by exotic species *O. mykiss* and especially *Channa maculata*).

Finally, ecosystem services related to this species have been identified; the species is subject to a fishing practice identified during surveys with the inhabitants of villages located around the future plant, even if fishing for this species is carried out in an opportunistic manner.

Astacoid Caldwelli (threatened VU)

Bibliographic data show that the presence of this crayfish species was known in the study area, as was the *Hydrotelphusa agilis* crab (Oliarinony & Rambeloson, 2011). Inventory and survey data show that this species is present in the tributaries of the Onive River but not in the main river. Although it seems to be more prevalent in the most forested tributaries of the study area and the least impacted by the conversion of valleys to rice cultivation areas, it is not possible to accurately map the distribution of the species over the study area.

The literature confirms this hypothesis of distribution in preserved tributaries and shows that this crayfish species is known to be the rarest in Madagascar. Its range is located in the high plateaus where it is restricted to rivers characterized by a wooded catchment area. The requirements and dynamics of this species are poorly understood, especially the links between the decline of the species and deforestation of valleys converted into rice fields (Jones, 2010).

Migratory Species

Of the 20 fish species recorded, 4 are migratory species. None of these species are threatened according to the IUCN.

Photo 64 - Two of the four migratory fish species

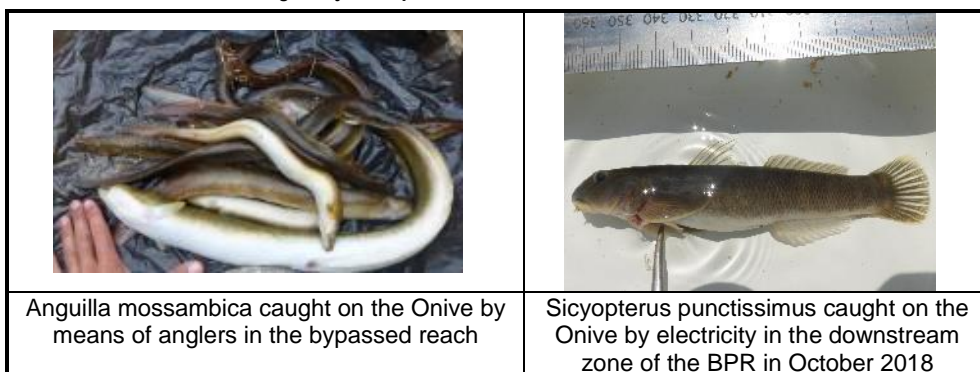

The 4 migratory species correspond to 2 species of Anguillidae (*Anguilla marmorata*, *Anguilla mossambica*) and 2 species of Gobiidae (*Awaous aeneofuscus*, *Sicyopterus franouxii*). To complete their life cycle, they need to switch from fresh water to salt water

(growth/reproduction). The presence of the 2 species of Gobiidae upstream from the rapids area is unlikely, due to the distribution ranges of these species. The impact of the Project will therefore be less significant for the latter two species. However, the presence of eels upstream from the bypassed reach has been proven, demonstrating the ability of this species to cross the falls.

Exotic Species

All the crustaceans recorded are endemic to Madagascar. On the other hand, most of the fish species caught in the study area are exotic: 13 out of a total of 20 species recorded during the 3 field trips (including surveys).

Among the 13 exotic species, only the Black bass *Micropterus salmoides* has not been observed. It should be noted that the common carp *Cyprinus carpio* is assessed as vulnerable VU. However, since this classification is linked to the high risk of genetic pollution in its original range in Central Europe, this data was not taken into consideration while determining the conservation concern status. Indeed, the species is exotic to Madagascar and does not present any ecological conservation challenge. This exotic species has been present in Madagascar since 1914 (introduction for economic and food purposes). In some very lentic biotopes (lakes), it can develop more strongly due to its affinity with lentic areas.

Finally, the plant's impact is not considered significant (or even positive) for exotic species.

Table 91 - List of Aquatic Fauna Species Requiring Critical Habitat Analysis

Class	Family	Species	IUCN Status	Endemicty	Limited distribution	Criticality level of the habitat	Site known for the distribution of the species	Observed	Probability of occurrence in the study area
Actinopterygii	Bedotiidae	Rheocles wrightae	EN	Madagascar	Yes (7,335 km ²)	1	Mangoro basin downstream Plant	Yes	Proven
	Bedotiidae	Rheocles sp. ambatovy	Not evaluated	Madagascar	Unknown	1	Ambatovy - Mangoro Basin downstream Plant	Yes	Proven
Malacostraca	Parastacidae	Astacoides caldwelli	VU	Madagascar	Yes (11 930km ²)	2	East Centre Madagascar	Yes	Proven

4.4.11 Discrete Management Units for Critical Habitats

The identification of critical/essential habitats for species is based on discrete management units (DUMs) relevant to the viability of these species. The DMU is defined as an area with a definable boundary within which biological communities have common points and constitute a coherent and connected habitat for a population of the species concerned.

4.4.11.1 *DMU for Rheocles wrightae and R. sp. Ambatovy*

Rheocles genus *species* are the only identified fish species that can trigger critical habitat. The associated DMU corresponds to:

- The Onive and its tributaries downstream from the rapids area to the confluence with the Mangoro River (about 19 km on the Onive River);
- The Mangoro and its tributaries upstream from the confluence with the Onive River. In the absence of more precise information, the entire catchment area will be included, considering that the species was found in the Moramanga district (at an altitude of 900-1000 m), as part of the inventories carried out for the Ambatovy mining project;
- The Mangoro and its tributaries downstream from the confluence with the Onive to the confluence with the Nosivolo right bank tributary (including about 70 km for the Mangoro only), because the species is unknown in the lower part of the river, downstream from the confluence with the Nosivolo, but is known in the upstream parts of the Nosivolo catchment area.

Figure 63 - Map of the Discrete Management Unit for the Conservation of *Rheocles Wrightae*

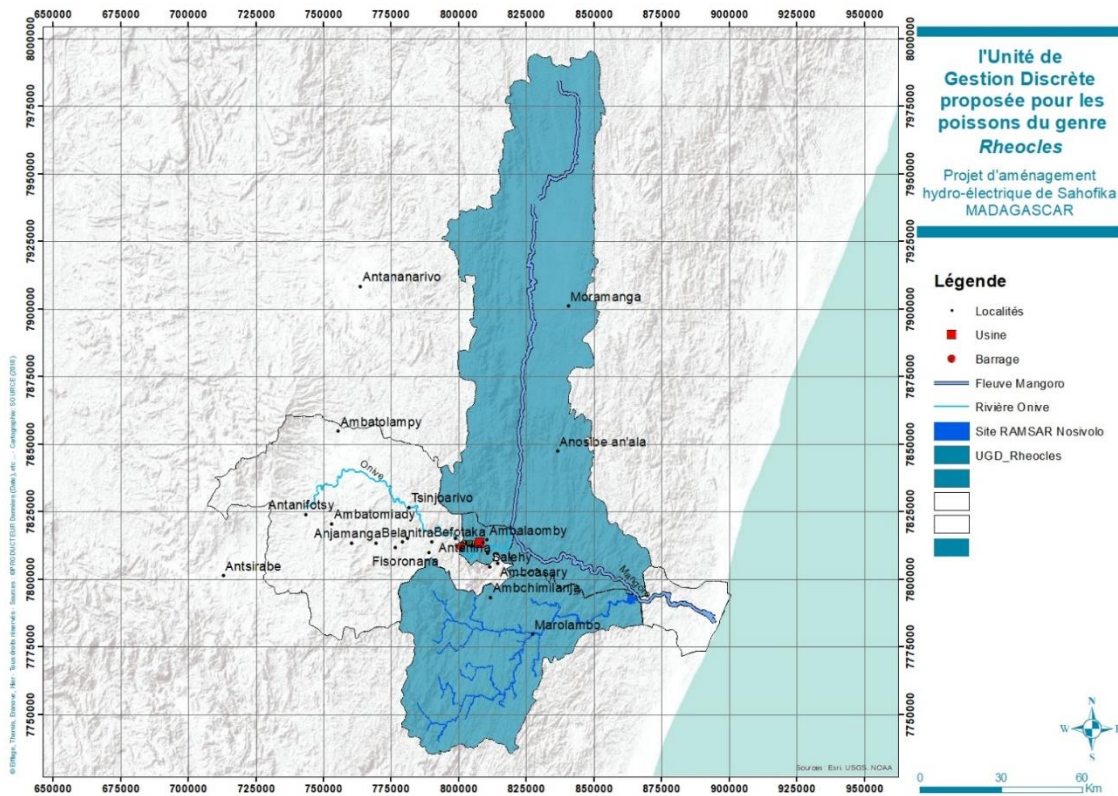

This DMU totals about 900,000 ha, an area of the same order of magnitude as the known range of the species (733,500 ha according to the IUCN). However, it should be noted that this distribution is poorly known and unreliable.

The Project is located on the edge of this DMU. Even if the area has only been inventoried over a distance of about 6 km on the Onive (upstream from the DMU) and 8.5 km on its tributaries, the habitat can be considered homogeneous on the Onive between the plant and the confluence with the Mangoro River (no major tributaries, homogeneous land use, etc.). In addition, according to the information provided (hydraulic modelling carried out to date at the Feasibility Study stage), a potential impact of flow and water level variations exists between the plant and the confluence with the Mangoro River. This impact varies according to the mode of operation of the installation and appears significant in the event of a complete shutdown and then resumption of turbinning. It should be noted that this hypothesis is described in hydraulic modelling as a rare scenario, which can only be considered in the driest years (about one year out of seven).

The species *Rheocles sp. Ambatovy* listed with level 1 habitat criticality is not subject to a specific DMU due to knowledge gaps for this species being described. It should be noted, however, that the range of *Rheocles wrightae* appears to be fairly close to that of *Rheocles sp. Ambatovy*. Besides, it seems that the ecology of these species shows similarities (observation of the 2 species during inventories on the same stations). Therefore, the proposed bioassessment and criticality analysis elements for *Rheocles wrightae* will also apply to *Rheocles sp. Ambatovy*, as will the avoidance, reduction and compensation measures. Therefore, the *Rheocles wrightae* DMU can be considered as providing coverage to *Rheocles sp. Ambatovy*.

The *Rheocles* genus species' DMU therefore includes most of the Mangoro catchment area, upstream from its confluence with Nosivolo, without integrating the Onive course

upstream from the Sahofika Falls. The approximate surface area of this DMU is 900,000 ha, 190 ha of which are located on the Onive.

4.4.11.2 DMU for *Astacoides caldwelli*

The third aquatic species likely to trigger critical habitat is *Astacoides caldwelli*. The baseline survey made it possible to specify that it is present on the close study area only on wooded tributaries and that it is absent from the Onive. Additional information provided by the bibliography and transcribed by the IUCN suggests that the species is also present further south in the Nosivolo River basin and in an area extending northward to Antananarivo and Moramanga. However, it is not possible to specify the species' range, which would affect small, slightly turbid rivers but is absent from the main hydrographic axes.

The relevant DMU selected for *Astacoides caldwelli* corresponds to the natural habitats of the mid-altitude evergreen dense rainforest and the lichen forest.

1.1.1.1 DMU Natural Forests

Forest habitats in the Project area are formed by the forest corridor linking Marolambo NP with the new Ambalaomby protected area and the remnants of natural forests located in the Mangoro catchment area. These forest habitats are located at the eastern limit of the central region, and belong to the Domaine du Centre (Humbert, 1955), whose vegetation is characterized by a medium-altitude dense humid rainforest (800-1200 m) of the series in Tambourissa and Weinmannia with herbaceous undergrowth. These natural forest habitats are identified as critical habitats for certain threatened fauna and flora species.

A comprehensive DMU for threatened forest habitat and these threatened fauna and flora species corresponds to the natural forests of the central middle altitude domain and lichen forests within the Mangoro "B" basin as proposed by Wilmé et al (2006). Although such a DMU is relevant in the evolutionary sense, it would nevertheless be a very extensive DMU, which would need to be refined in particular for species that cannot cross the Onive, or for species limited to lichen woodlands such as "*Malagasia aff. alticola*".

We therefore propose the protected areas of the forest corridor, to the north and south of the Project to be used as a DMU:

- Marolambo National Park (95,063 ha);
- New Tsinjoarivo Ambalaomby Protected Area (26,471 ha).

These two DMUs total 121,534 ha.

Figure 64 - Marolambo NP Forest Unit

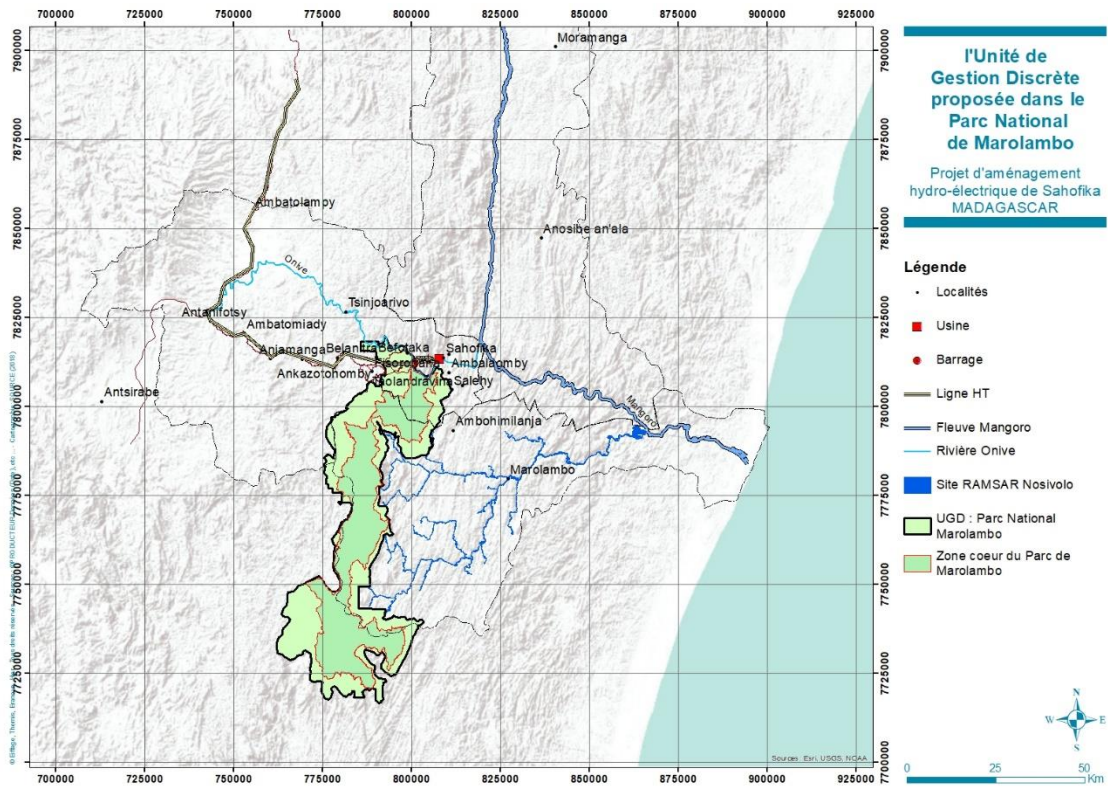
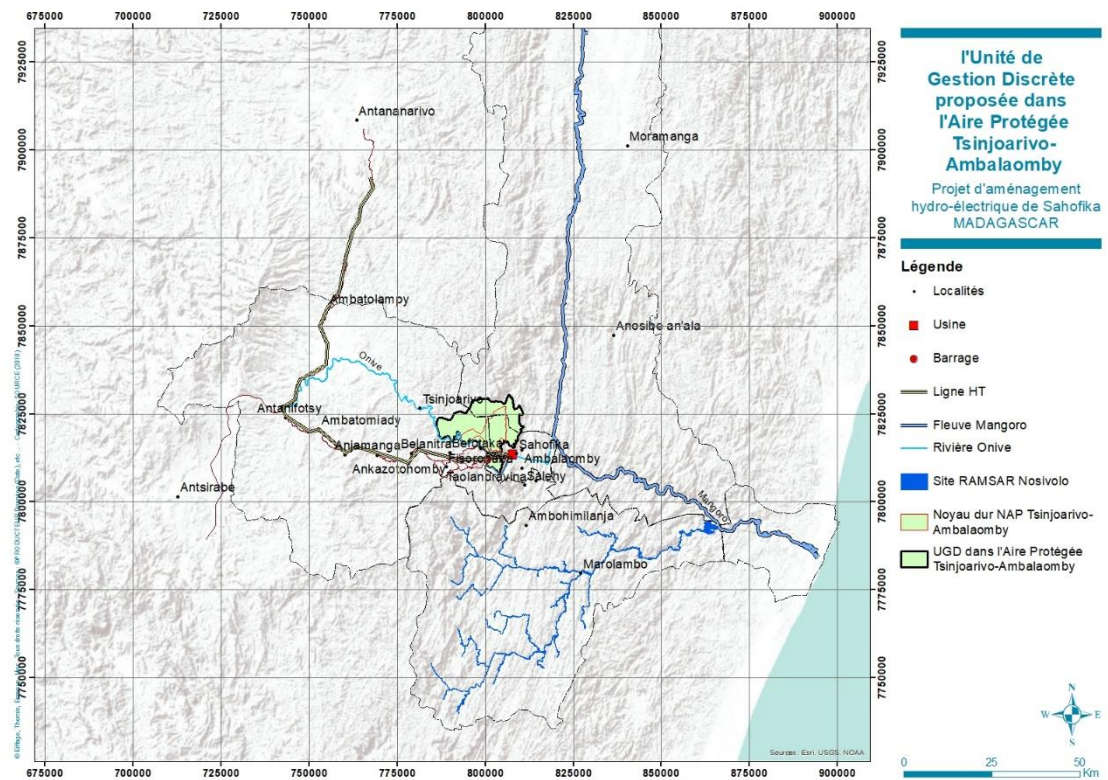

Figure 65 - Forest unit of the New Tsinjoarivo - Ambalaomby Protected Area



4.5 Ecosystem Services

4.5.1 Types of Ecosystem Services

There are four categories of ecosystem services identified in the IFC and AfDB policies:

- Provisioning services, which are services are the products obtained from ecosystems such as food, fresh water, wood, fiber, and fuels.
- Regulating services, which are defined as the benefits obtained from the regulation of ecosystem processes such as climate regulation, disease regulation, and water purification;
- Cultural services, which include non-material benefits that people obtain from ecosystems (e.g. aesthetic, spiritual, educational, recreational);
- Supporting services, which are natural processes that maintain other services (e.g. nutrient cycling, soil formation, primary production).

In addition, for these 4 categories, there are 2 types of ecosystem services:

- Type I: Ecosystem-based supply, regulatory, cultural and support services, over which the client has direct management control or significant influence and where impacts on these services may negatively affect communities. They will be considered a priority in the following circumstances:
 - Project operations are likely to have a significant impact on the ecosystem service;
 - The impact will result in a direct negative impact on the livelihoods, health, safety, security and/or cultural heritage of the affected communities;
 - The Project has direct management control or significant influence in the service.
- Type II: Ecosystem-based supply, regulatory, cultural and support services over which the client has direct management control or significant influence and on which the Project is directly dependent for its activities. They will be considered as priorities in the following circumstances:
 - The Project is directly dependent on the service for its primary operations;
 - The Project has direct management control over or significant influence on the service.

4.5.2 Evaluation Method

Surveys were conducted in villages directly and indirectly affected by the Project to collect data on ecosystem services, including:

- Identifying the natural resources (plants, animals, water, etc.) most used by local populations;
- Identifying and locating sites for the extraction of natural resources by local populations, making it possible to assess the Project's impacts on the socio-economic component and ecosystem service;
- Evaluating the available stock for each resource type in their natural habitat.

4.5.3 Main Uses of Natural Resources

The following table summarizes the main products harvested from the forest. These uses are detailed in the following paragraphs.

Table 92 - The Main Products Harvested from the Forest

Products harvested	Use	Quantity collected/ye ar	Period	Sampling mode and area	Destination of the product
Wood (natural forest, pine, eucalyptus)	Fuel (local), Construction (local and outdoor), Furniture (local and outdoor)	864 Trucks or 22,464 Tons for all 20 localities visited (based on 18 trucks/week)	All year round	Traditional tools (saw and axe), All wooded areas (forest, plantations, wooded savannah)	Local use (68%) and the rest is sold on the foreign market to Antananarivo (from Ambohitompoina and Belanitra).
Honey	Power supply	1,300 liters	November and June	By hand and with straw smoke In the Befotaka forests and the forest areas from Antenina to Faravohitra	Family consumption and local market.
Medicinal plant, Plant for use as a raw material for weaving	Healing Weaving of carpets, baskets and hats	624 tons for all 20 localities visited.	All year round for medicinal plants and November for weaving plants	Manual picking in forests	Local market in the area and Antananarivo.

Source: Socio-economic survey, October 2018

4.5.3.1 Use of fuels for Cooking

Wood is the main fuel used for cooking food. Local people collect dry wood from the forest throughout the Project area, including debris from trees torn off by cyclones, namely *Nuxia capitata* (Valanirana), *Dalbergia sp.* (Voamboana), *Weinnmania sp.* (Lalona), etc.

On average, each household consumes about 30 to 40 kg of firewood per day to prepare household and animal food. Food products such as beans and tubers (cassava, etc.) require a large amount of energy for cooking. The environmental impact of this use of wood is currently negligible because farmers only recover dead or dry wood. However, population growth could change this situation.

4.5.3.2 Use of Plant Resources in the Upstream Area

Due to the large difference between ecosystems in the upstream (dam, reservoir...) and downstream (hydropower plant) areas of the Project, we describe the use of resources in these two areas separately in this chapter and the next.

The populations located in the upstream area (around the dam and reservoir, escarpment forest between the dam and the plant) are mainly farmers who practice agriculture during the rainy season and gold panning, especially in the dry season. Their way of life is dependent on the exploitation of natural resources. The species most used by these populations are presented in Table 100.

Construction Uses

Building huts and canoes or manufacturing tools requires the use of certain resources, several of which are collected in forests. To build huts, people use a large quantity of timber on beams, frames and doors and windows. On average, the size of a cell is 6 m x





4 m. The wood requirements for the construction are about 3 m3. The main elements of a wooden hut are renewed approximately every 20 years. Some brick huts are also visible in the area, but the materials come from outside the area.

The most commonly used woods include:

- Floors: *Cryptocaria spp* (Lauraceae), *Faucherea spp* (Sapotaceae) and *Podocarpus madagascariensis* (Podocarpaceae) ;
- Beams: *Garcinia sp.* (Clusiaceae) and *Dilobeya sp* (Proteaceae);
- Torchis: tree ferns *Cyathea spp* (Threatened according to CITES).

The latter species is also used to enhance construction, if other resources are unavailable in the nearest forests.

Photo 65 - Use of wood for construction in the upstream area

	
<p><i>Cryptocaria spp.</i> and <i>Faucherea spp.</i> for the construction of the Antenina bridge</p>	<p><i>Cyathea spp.</i> (Beam) <i>Chrysophyllum</i> and <i>Podocarpus</i> (Window), (<i>Sapotaceae</i>), <i>Eugenia</i> (reinforcement)</p>
	
<p>Bamboo for roofs, <i>Faucherea</i> for doors</p>	<p><i>Harungana madagascariensis</i> exploited for various uses</p>



Other Uses of Wood

A significant reduction in the amount of resources available in the region’s forest patches is observed by local populations. A large part of the resources used, for example for the fabrication of canoes, is only present in the forest area of the corridor where the NPA project is located.

The logging of large trees for hive production is also observed in the upstream part of the dam.

Rum distillation, a well-developed activity in the area, also requires the use of a large quantity of firewood for stills. It also requires the bark of certain plant species being removed for fermentation: *Eugenia spp.*, *Syzygium spp.* (*Myrtaceae*), *Vepris spp.* and *Citrus spp.* (*Rutaceae*) are among the most sought-after species.



Gold panning also requires the use of wood for various reasons:

- Fabrication of screening equipment, made with the buttresses of *Canarium spp.* (*Burseraceae*), *Sloanea spp.* (*Elaeocarpaceae*) or other;
- Depending on the area of operation, also called “Quarry” by local populations, gold panning may require the use of a water supply pipe to facilitate mining operations. These pipes are made with palm stipes and tree trunks. The length of the pipe can vary from 100 to 300m, depending on environmental conditions.



Some species have cultural and religious values for local communities:

- *Podocarpus* spp. (*Podocarpaceae*) is used for the manufacture of coffins. It is a forest species whose large trees of exploitable size are only found in the corridor;
- *Raffia ruffa* (*Arecaceae*) and *Chrysophyllum* spp. (*Sapotaceae*) are of cultural and ritual value to local communities.

Table 93 - List of Plants Used by the Local Populations

Family	Taxon	Vernacular Name	Use	Collection Area
Apocynaceae	<i>Petchia</i> sp	Hazondrano	Construction	Forest fragments closest to villages
Fabaceae	<i>Albizia</i> spp.	Sambalahy	Construction	
Lauraceae	<i>Cryptocaria</i> spp.	Sary	Construction	
Meliaceae	<i>Astrotrichilia</i> sp	Tsiramiramy	Construction	
Connaraceae	<i>Agelaea pentagyna</i>	Vahimainty	Rope and other uses of vegetable fibers	
Malvaceae	<i>Grewia</i> spp.	Hafotra	Rope and other uses of vegetable fibres	
Malvaceae	<i>Dombeya</i> spp.	Hafotra	Rope and other uses of vegetable fibres	
Myrtaceae	<i>Eugenia</i> spp.	Rotra	Ferment (rum)	
Myrtaceae	<i>Syzygium</i> spp.	Zamborizano	Ferment (rum)	
Rutaceae	<i>Melicope</i> spp.	Fatraina	Ferment (rum)	
Rutaceae	<i>Vepris</i> spp.	Fatraina	Ferment (rum)	
Araliaceae	<i>Schefflera</i> spp.	Voantsilana	Medicinal	
Lamiaceae	<i>Clerodendrum</i> spp.	Befaroratra	Medicinal	
Pandanaceae	<i>Pandanus</i> spp.	Vakoana	Basket-weaving	Protected area or large forest blocks
Podocarpaceae	<i>Podocarpus madagascariensis</i>	Hetatra	Construction, Cultural	
Elaeocarpaceae	<i>Sloanea</i> spp.	Vanaka	Construction, Crafts, Rite/cultural	
Fabaceae	<i>Dalbergia</i> spp.	Voamboana	Construction, Lumber	

Bignoniaceae	Phyllarthron spp.	Zahana	Construction, timber, medicinal products	
Cannellaceae	Cinamosma fragrans	Mandravasaroetra	Construction, Medical	
Arecaceae	Ravenea spp.	Anivona	Construction, Local consumption	
Bignoniaceae	Chrysophyllum boivinianum	Famelona	Rite	
Poaceae	Arundinaria spp.	Volotsangana	Fish trap	Marshes and wetlands
Cyperaceae	Cyperus spp.	Herana	Basket-weaving	
Arecaceae	Raphia ruffa	Rofia, Baobao	Basket-weaving, Construction, Culture	Cultivation plots
Lamiaceae	Lantana camara	Radrika	Firewood, Medical	Savoka
Cannabaceae	Trema orientalis	Andrarezina	Construction, Fuelwood, Construction	
Pteridaeeae	Adiantum spp.	Viliantsahona	Medicinal	
Maesaceae	Maesa lanceolata	Teza	Construction, Medical	
Melastomataceae	Clidemia hirta	Mazambody	Ferment (rum)	

4.5.3.3 Use of Plant Resources in the Downstream Area

For the populations of Faravohitra and Sahofika, located about 5 km from the natural forest, in a landscape dominated by grasslands, logging is less significant. Indeed, they have adapted with the resources available in their environment: traditional huts and houses are built with a greater use of clay and straw. For some constructions, walls are built with stems of *Raffia ruffa* (Arecaceae). Sheet metal roofs are also present, but their use is limited due to prohibitive costs.

Basket-weaving is more developed in the downstream area, due to the availability of the necessary plant materials.

Photo 70 - Use of wood for construction in the upstream area

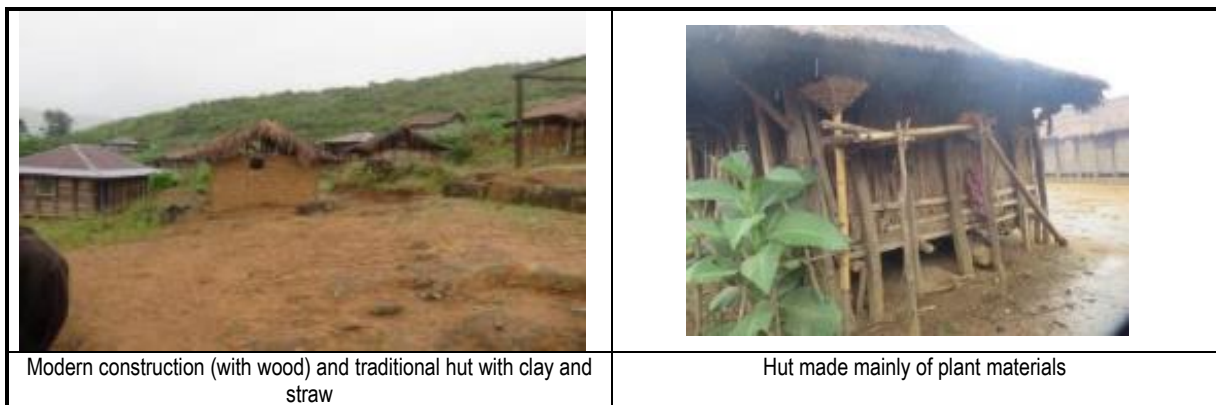



4.5.3.4 Use of Wildlife

Although no signs of collection were observed during the field trip, the presence of reptile species (*Calumma*, *Furcifer*, *Phelsuma*) known on international markets and collection authorized by CITES for commercial purposes could arouse the interest of operators. In addition, guides reported the hunting of large *Sanzinia* snakes for consumption.

For small mammals, tenrecinae species (small insectivorous mammals, similar to hedgehogs: *Hemicentetes semispinosus*, *Setifer setosus*, *Tenrec ecaudatus*) are the main species concerned by hunting and poaching according to local guides. These species are valued by the local populations for their meat, and are highly prized especially towards the end of the wet season when the animal is the fattest.

The lemur species in the area, mainly in the corridor, are subject to hunting. Traditional traps were identified during observations in Anivorano and Ambatotsipihina.

Photo 71 - Functional lemur trap in Ambatotsipihina



Like many localities in Madagascar, freshwater fish species (lakes, rivers, ponds, etc.) are also consumed by local populations. These species provide a dietary supply of protein and sometimes fat (eels).

4.5.3.5 Access to Drinking Water

The forest acts as a real purification plant, facilitating water infiltration and retaining or filtering organic pollutants through root systems before recharging groundwater. Three

quarters of the accessible fresh water comes from forest watersheds where sources are still numerous in areas where the forest has been preserved.

4.5.4 Identification of Priority Ecosystem Services

Table 94 - Evaluation of Ecosystem Services

	Impact level (Type I)	Relevance to affected communities (Type I)	Dependency level (Type II)	Management control level (Type I and II)	Priority?
	Is the Project likely to have a significant impact on the ecosystem service?	Will the impact result in a direct negative impact on the livelihood, health, safety and/or cultural heritage of the affected communities?	Does the Project depend directly on the service for its primary operations?	Does the Project have direct control over management or a significant influence on the service?	If yes to all the above questions concerning Type I or Type II
SUPPLIES					
Harvesting	Yes	Yes	Yes	Yes	Yes
Livestock	Yes	Yes	No	Partial	Yes
Fishing	Yes For example, eels migratory species will be impacted	Yes (fishing activity practiced locally in the Onive and its tributaries but the activity is less and less practiced because of the scarcity of the resource)	No	Yes	Yes (Priority Type I)
Wild foods: gathering and hunting	Partial	Yes	No	No	Probable
Biochemicals, natural medicines and pharmaceuticals	Partial	Partial	No	No	Probable
Wood and other wood fibers	Partial	Partial	No	No	Probable
Other fibers	No	Partial	No	No	No
Biofuels	Partial	No	No	No	No
Fresh water	Yes Modification of aquatic habitat and water physico-chemistry in the reservoir and on the short-circuited section (CPT) and modification of flows in the CPT and downstream from the plant	Yes: Households use Onive water for agricultural uses and tributary water (upstream dam) for domestic and agricultural uses	No	Yes	Yes (Priority Type I)
Irrigation of rice fields	Partial	Yes: The water from tributaries, especially upstream from the dam, is	No	Yes	Yes

		diverted to feed the rice fields			
Gold panning	Yes: Increased gold panning activities upstream from the dam with a view to flooding the area, which will then be made inaccessible. Then, as soon as the dam is impounded, this activity is eliminated at the reservoir level	Yes: Gold panning leads to the clearing of alluvial areas, soil erosion	No	Yes	Yes
Genetic resources	Partial: the Onive ensures the connectivity of aquatic fauna populations by promoting exchanges between upstream and downstream populations and freshwater to saltwater (4 species of migratory fish) The facility will be an additional element of fragmentation of their biotope	Yes	No	No	Probable (type 1)
REGULATION					
Air quality regulation	No	No	No	No	No
Global climate regulation	Yes. Replacement of fossil fuel-based thermal energy sources.	No	No	Partial	No
Local / Regional climate regulation	Partial	Yes	Yes	Partial	Yes
Water regulation	Yes: Upstream dam: Replacement of a river regime by a lake regime over a linear stretch of about fifteen kilometers upstream from the dam (creation of a water reservoir) Modification of the hydrology of the river in the	Yes	Yes	Yes	Yes (Priority Type I)

	<p>bypassed reach (about 17 km)</p> <p>Changes in hydrological conditions in the BPR and downstream from the plant</p> <p>Positive impact on low water level support and flood control downstream from the dam</p>				
Erosion control	<p>Yes: Large areas will be cleared during the construction work, which increases the risk of erosion on land already highly sensitive to erosion.</p>	<p>Yes: Erosion impacts agriculture, which is the main activity and source of income of the populations affected by the Project</p>	Yes	Yes	Yes
Water purification and waste treatment	<p>Yes The risks of soil degradation and pollution, due to construction works and increased risks of soil erosion, are likely to impact the ability of ecosystems and soils to filter water and remove organic pollutants.</p>	Yes	Partial	Yes	Yes
Disease regulation	<p>Partial: The modification of aquatic habitats (disappearance of fast facies upstream from the dam in favor of slow and deep lake areas will favor vectors of diseases already present, however, such as <i>Schistosoma</i>, vector of bilharzia.</p>	Yes	Yes	Partial	Probable
Pest control	No	Yes	No	Partial	No
Pollination	No	Yes	No	No	No
Regulation of natural disasters	<p>Partial Small flood reduction but probably low impact on the highest floods</p>	Partial	No	No	Probable

Madagascar - Sahofika Hydropower Plant
 Environmental and Social Impact Assessment - Version D

CULTURAL					
Sacred or spiritual sites	Partial	Partial	No	Partial	Probable
Areas used for religious purposes	No	No	No	No	No
SUPPORT					
Nutrient capture and recycling	Partial: Nitrogen and nitrates captured in the reservoir of water stored mainly in the sediment and occasionally released into the water of the Onive but not recovered	Yes: possible water pollution by nitrogen and nitrates in the water of the Onive (accumulation/release phenomena)	No	Partial	Yes
Primary production	Partial	Yes	No	Partial	Yes

5 Physical Impact Analysis

5.1 Infrastructure Footprint

The estimated footprint of the Project's infrastructure is described in the following table. The total area covered by permanent infrastructure is approximately 1,061 ha, 84% of which corresponds to the reservoir. Roads and linear infrastructure represent the second largest footprint (15% of the total).

Permanent Infrastructure	Ground Area (ha)
Access road to the dam from Antanifotsy	
Rehabilitation of Antanifotsy in Belanitra - 58 km	0
Creation of Belanitra at the dam site - 38 km	38
Reservoir	
(Minimum operating level: 1295.00 m)	(140)
(Normal impoundment level: 1328.00 m)	(700)
Highest Water Mark: 1337.20 m	890
Dam, spillway and shoreline excavation	5
Collar dam	2
Operator's city and dam buildings/technical spaces	2
Road and line from the dam to the hydropower plant - 30km	120
Penstock pipe	2
Hydropower plant	0.7
City of operation	1.5
Position	2
Temporary infrastructure	Ground area (ha)
Construction site installations dam, saddle dam and headrace tunnel	2
Surge tank installations, substation and plant	4.5
Areas for the final disposal of surplus excavated material	A few hectares

Since not all detailed design activities have been completed, most of the values given in the table are indicative and have been determined based on the preliminary studies. These values will be confirmed in the detailed design. The following assumptions have been used to estimate the quantities not yet known:

- Average width of the access road to the dam: 10 m
- Average width of the track corridor + line between the dam and the plant: 40 m

5.2 Backfill, Excavated Material and Temporary Sites

5.2.1 Risks Related to the Erosion of Loose Materials

5.2.1.1 Nature of the Risks

Earthworks, installation and work sites, material extraction and disposal areas, embankments and excavated material are all areas that present a risk of erosion and gullyng in the event of rainfall due to changes in slopes, natural drainage conditions and clearing.

The impact of erosion is:

- In the short term, an increase in sediment inputs and turbidity in rivers due to the entrainment of materials, which is harmful to aquatic environments and water uses in general;
- In the medium and long term, an increase in erosion-prone areas due to gullyng, and the creation of unstable areas that can lead to landslides or uncontrollable regressive erosion of mountain slopes.

The impact will be of moderate importance, with moderate intensity, local reach and temporary duration.

5.2.1.2 Control of Erosion and Sedimentation Risks

The control of erosion risks requires rigorous management of the areas concerned, from initial clearing to revegetation or final stabilization of the sites concerned:

- Crushing and storage of deforestation / clearing products for reuse when replanting soils,
- Recovery and storage of topsoil, in piles less than 2 m high, protected from rain and runoff, for reuse when revegetating the soil,
- Temporary storage of excavated material in dedicated areas in layers not exceeding 4 m in height and separated by terraces allowing the circulation of machinery,
- Shaping of the work areas and facilities with counter-slopes allowing a controlled flow of surface water to a basin for collecting and settling runoff water from drained water, allowing it to be clarified before being discharged into an existing watercourse.
- Drainage of installations, track edges and work areas towards settling basins: no undecanted water discharge into the natural environment.
- Establishment of temporary or permanent watercourse crossings for construction vehicles (regardless of its size, any watercourse crossed by vehicles for construction purposes must be protected from crossing by rolling directly into the bed),
- Establishment of final disposal areas for surplus excavated material on modified habitats only (no deforestation) and away from natural flow paths (temporary or permanent) of surface water.
- Shaping of disposal areas and excavations at the end of the construction site to ensure their stability, public safety and controlled surface water circulation.
- Installation of topsoil and mulch, and revegetation using local species or non-invasive species authorized and approved by an experienced botanist.

Considering Madagascar's specific climate, which is characterized by a very marked rainy season, a project such as Sahofika's requires a plan to manage the volumes of topsoil and shredded soil, and deposit and continuous monitoring of the site in order to implement these methods.

5.2.2 Acid Rock Drainage

Acid rock drainage is a process whereby an acidic mineral solution is produced and flows regularly following sulphuric acid production induced when certain minerals (metallic sulphides) come into contact with the air during large excavations.

The problem of acid rock drainage is quite common in the mining sector and specific tests are carried out to assess the risk of acidification of the water draining the waste rock deposited following the dissolution of the sulphides.

In dam projects it is rarer (due to the lower volumes of excavated material generated compared to the mining industry), and depends mainly on the geological context. Due to the lithological context of Sahofika (gneiss and migmatites and potentially dolerites) there is no risk. In addition, the volumes involved remain limited (4 km x 4.5m diam. or about 50,000 m³ for the headrace), unlike mining projects where the volumes are huge over the operation period.

This issue is not expected to cause any impact.

5.2.3 Mitigation Measures

All mitigation measures related to erosion control are summarized in the following table:

Table 95 - "Erosion Control" Mitigation Measures

#	Measure	Implementation	
		Period	By
Ero01	Preparation of a plan for earthworks / excavated material / backfill management and erosion prevention submitted to NEHO for approval and incorporating the principles of Chapter 5.2.1.2 of the ESIA.	Pre-construction	EPC
Ero02	Engagement in the EPC team of an "Erosion Control Manager" in charge of implementing the plan prepared as part of the Ero01 action.	Construction	EPC
Ero03	Installation of crossing structures on all watercourses to be crossed by vehicles or construction machinery.	Construction	EPC
Ero04	Shaping of final disposal areas for surplus materials to facilitate their integration into the landscape.	Design and construction	EPC

5.3 Hydrological and Hydraulic Impacts Downstream

5.3.1 Dam Construction and River Closure

5.3.1.1 Construction Phase

During the construction of the Sahofika Hydropower Plant, the only activity likely to temporarily modify the flow of the Onive River is the transition from the first to the second diversion phase. This risk must be anticipated and integrated into detailed design and

work planning in order to ensure continuity of downstream flow, and in all cases a flow downstream from the plant that is always equal to or greater than the instream flow (5.7 m³/s).

5.3.1.2 First Filling

The volume of the reservoir formed by the dam at normal operating level is 140.5hm³ (dead volume of 11.5hm³ + useful volume of 128.5 hm³), i.e. 4% of the average annual water supply of the Onive to the dam site. The filling of the reservoir will therefore be possible over a single season. The actual duration of the filling will depend on the natural flow of the Onive at the time the filling starts, and on the technical constraints applicable to the first filling (verification of the stability of the structure and the impoundment): considering the natural flows of the Onive, this filling will last between one week (assumption of rapid filling in the flood season) and two months (slow filling in the dry season). During this period, a flow downstream from the plant must always be equal to or greater than the instream flow (5.7 m³/s).

5.3.2 Flow in the Bypassed Reach

5.3.2.1 Flow Reduction Factors

Diverting part of the Onive's flow for hydroelectric production will reduce flow in the bypassed reach from the dam to the hydropower plant. The modification of the hydrological regime of this reach will be determined by the following two parameters:

- Instream flow: a minimum flow of 5.7 m³/s will be permanently discharged from the dam into the bypassed reach, regardless of hydrological conditions or the operating condition of the hydroelectric facility.
- Design flow: the maximum flow that can be used by the hydroelectric facility is 35 m³/s.

When the natural flow of the Onive upstream from the hydropower plant exceeds 40.7m³/s (design flow + instream flow), the excess flows will therefore be discharged downstream, in addition to the instream flow.

5.3.2.2 Lateral Inflows

Between the dam and the plant, the Onive receives tributaries whose flows will be added to those discharged by the dam. However, these tributaries have small watersheds. The largest of these tributaries (basin 9 in Figure 67) has an area of 68 km² (1.5% of the Onive basin at the dam) and flows into the Onive immediately downstream from the dam site. In total, the tributary basins between the dam and the plant cover an area of 97 km² (2.2% of the Onive basin at the dam), two thirds of which correspond to basin 9.

Figure 66 - Tributary Basins of the Onive between the Dam and the Plant

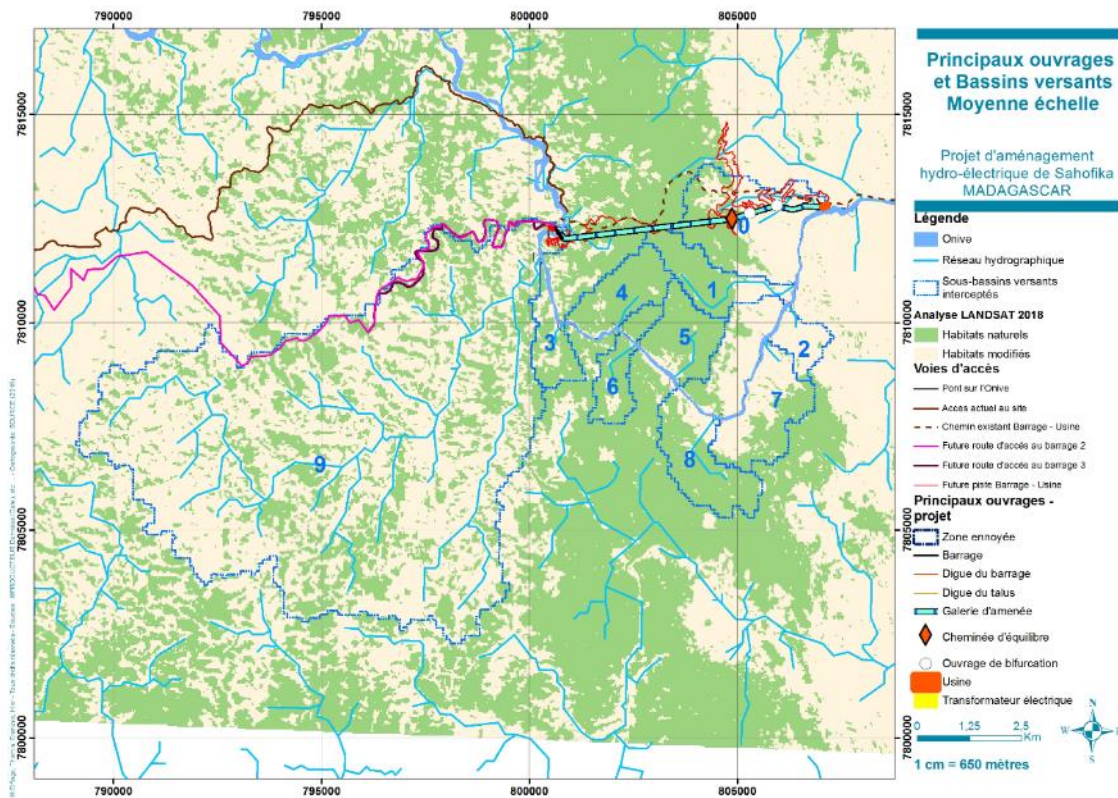

5.3.2.3 Modified Hydrological Regime

The modified hydrological regime in the bypassed reach described in the following table and figure for a median year. Only the lateral inflows from basin 9 were considered to represent the average conditions in the bypassed reach, both because it is by far the most important basin (other inflows are marginal) and because this basin flows into the bypassed reach immediately downstream from the dam.

The inflows from basin 9 were estimated in proportion to the inflows from the Onive, based on the ratios of the surface areas of the catchment areas. Their contribution to the flow of the bypassed reach is small compared to the flow discharged by the dam.

Table 96 - Onive River Flow between the Dam and the Plant, with and without the Project

Median year m ³ /s	N	D	J	F	M	A	M	J	J	A	S	O
Median annual flow without the Project	60.9	122.8	175.6	259.8	216.2	138.0	81.2	59.9	47.7	39.6	32.5	31.5
Median annual flow with project	7.9	69.8	122.6	206.8	163.2	85.0	28.2	6.9	6.4	6.3	6.2	6.2
Of which:												
Lateral inflow (basin 9)	0.9	1.8	2.6	3.8	3.2	2.0	1.2	0.9	0.7	0.6	0.5	0.5
Flow rate discharged by the dam	7.0	68.0	120.0	203.0	160.0	83.0	27.0	6.0	5.7	5.7	5.7	5.7

Figure 67 - Median Hydrograph of the Onive between the Dam and the Plant, with and without the Project (m³/s)

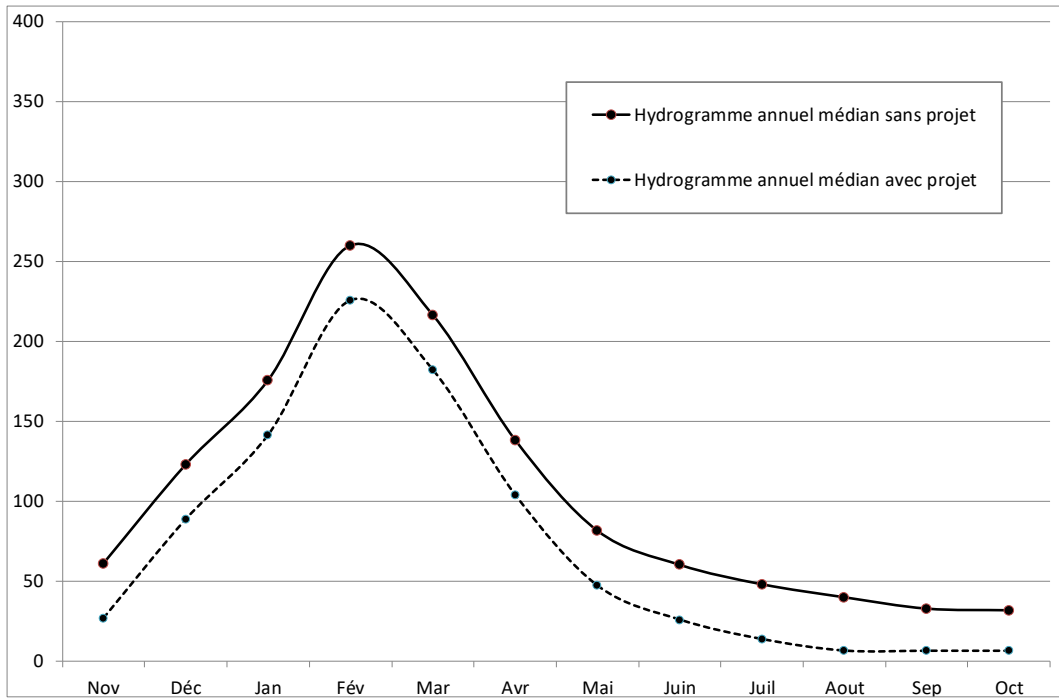
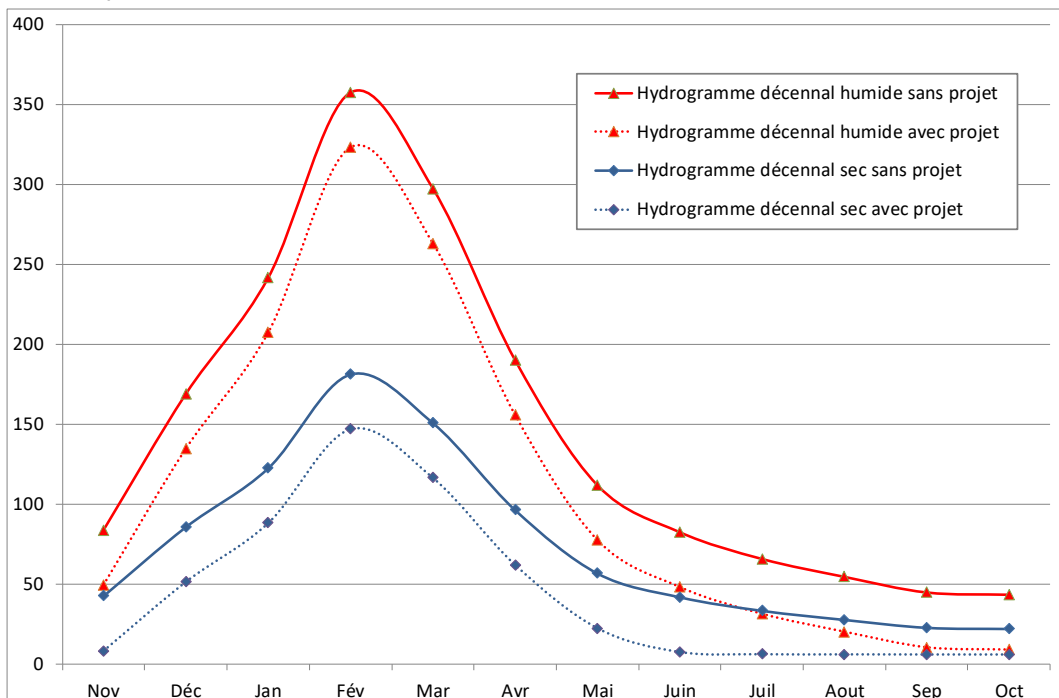

Figure 68 - Hydrograph of the Onive between the Dam and the Plant, Dry and Wet Decennial Years, with and without the Project (m³/s)



5.3.3 Hydraulic Impact Downstream from the Hydropower Plant

5.3.3.1 Annual Hydrograph

Using the reservoir to increase available low water flows will result in a change in the annual downstream flow rate (see Figure 70):

- Low water levels will on average be less marked, the flow immediately downstream from the plant being generally close to 40.7m³/s (turbined flow + instream flow, without taking into account marginal lateral inputs).
- Flood rises will be later, due to the filling of the reservoir at the end of the dry season. This phenomenon will only be marked in dry years.
- In the rainy season, once the reservoir is full, the downstream hydraulic regime will remain unchanged: it will be determined as it is today by the natural flood regime.

From a hydraulic point of view, these changes will result in higher water levels in the dry season (low water level support) and lower water levels at the beginning of the rainy season, when the reservoir is filled. However, water levels and monthly average flows will remain in the range of seasonal variations in a natural regime.

Figure 69 - Hydrographs of the Onive immediately downstream from the plant, decennial dry and medium year, with and without the Project (m³/s)

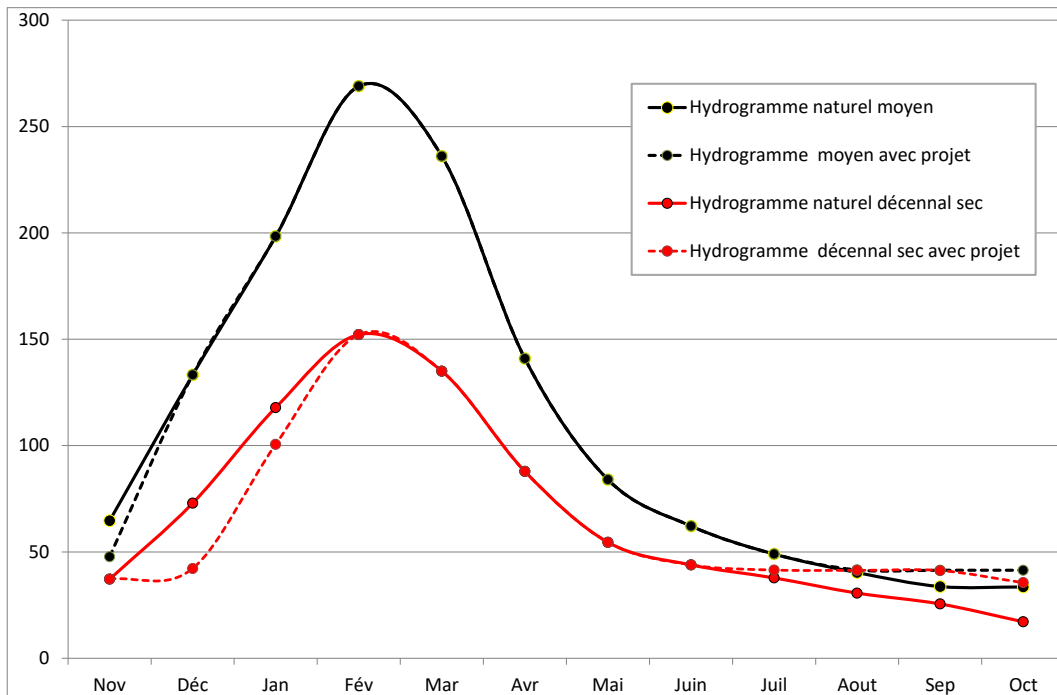

5.3.3.2 24-hour Hydrograph - Flood Season

During the flood season and outside maintenance periods, the turbinated flow will be constant and equal to 35 m³/s. The variations in hydraulic regime downstream from the hydropower plant will be as before the completion of the Project, entirely determined by variations in the natural flow of the Onive River.

5.3.3.3 24-hour Hydrograph - Dry Season, General Case

About 6 years out of 7, the volume of the reservoir will be sufficient to ensure a constant turbinated flow equal to 35 m³/s throughout the dry season downstream from the plant.

On the other hand, 1 year out of 7, the volume of the reservoir will be insufficient to guarantee a constant turbinated flow equal to 35 m³/s throughout the dry season downstream from the plant: the deficit will materialize at the end of the dry season, before the rains resume.

5.3.3.4 24-hour Hydrograph - Dry Season, in a Very Dry Year***Frequency of Occurrence***

In dry years (about one year out of seven), if the reservoir reaches its minimum operating level and the natural flow of the Onive is less than 40.7 m³/s (design flow 35m³/s + instream flow 5.7 m³/s), it will be possible that the turbinated flow will no longer be constant, but will vary during the day.

Possible operating mode in a very dry year

The technically possible method of operation that would have the greatest impact would be to turbine 0m³/s for part of the day, then 35m³/s for the rest of the day (assuming that all turbines are available).

A numerical model of the downstream hydraulic impact was carried out to represent this phenomenon. The modelled scenario corresponds to the following assumptions:

- Dry decennial year;
- Reservoir at minimum operating level (no low water support possible);
- Typical day of the driest month (October): the natural flow of the Onive entering the reservoir is then 16.8 m³/s;
- Turbination of the entire incoming flow over 24 hours over the shortest possible period of time (most impactful scenario):

(unit: m ³ /s)	Instream flow	Turbinated flow rate	Natural inflow
For 16 hours	5.7	0	16.8
For 7 hours	5.7	35	16.8
During 1 hour	5.7	21.3	16.8
24-hour average	16.8		16.8

- Lateral inflows corresponding to a dry ten-year period. Tributary flows were estimated on the basis of Onive flows, pro rata to the catchment areas:
 - Tributaries of the Onive between the dam and the plant: 0.36 m³/s
 - Main tributary on the left bank between the plant and the confluence of the Mangoro river: 0.29 m³/s
 - Main tributary on the right bank between the plant and the confluence of the Mangoro river: 0.28 m³/s
 - Mangoro: 21.35 m³/s

The modelled downstream boundary is the outlet of the characteristic 7.7 km long flat reach that connects the Onive to the Mangoro River: this boundary is located 19 km downstream from the hydropower plant. This limit was chosen by considering (i) the progressive damping of flow variations as one moves further away from the plant,

especially along the last slightly sloping reach, (ii) the elimination of relative flow variations in the Onive by the contribution of the Mangoro, which increases the river flow by 130%. The relevance of the selection this limit is confirmed by the results presented below.

Impact on Flows

Hydraulic modelling shows that the flow variations induced by turbine stops and restarts propagate along the bed of the Onive River with little overall damping, up to the confluence with the Mangoro River. From this confluence, flow variations are smoothed out and become much less significant.

Figure 70 - Flow variations over 24 hours downstream from the plant in the most impactful case

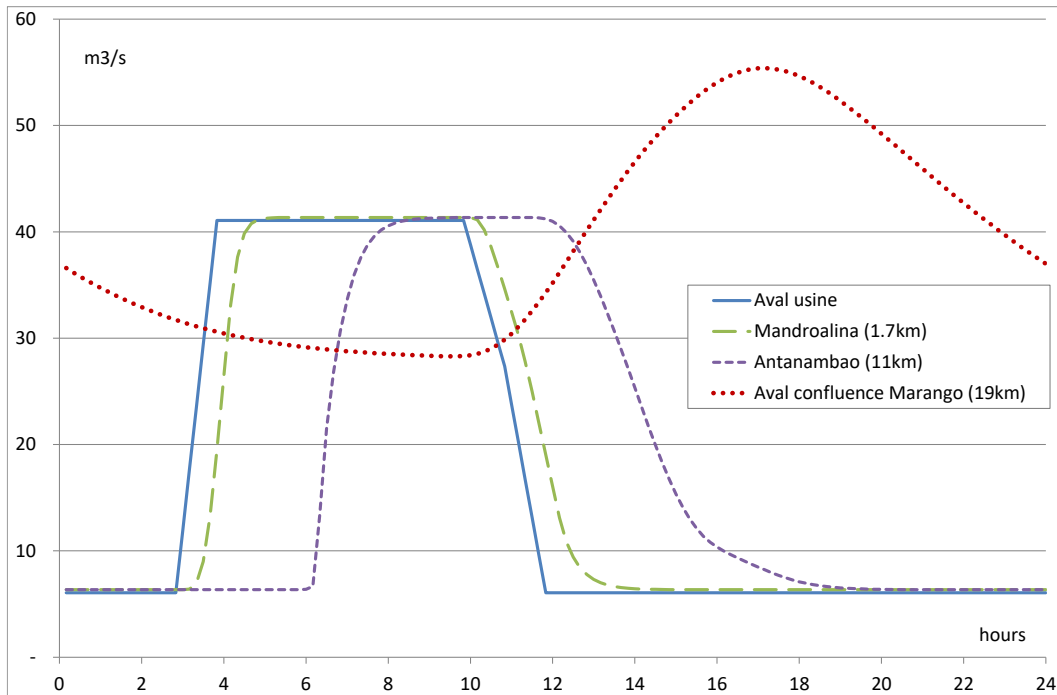

Impact on Water Levels

Flow variations will result in level variations that have been estimated using the hydraulic model. Due to the morphology of the bed, which consists of a series of natural thresholds that control the water level (see Figure 73), the level variations described below should be considered as orders of magnitude. The actual level variations will depend on the shape of each natural threshold: this shape is not currently known.

The daily amplitudes expected in the worst case (as a reminder, in the dry season, only about one year out of seven) are in the order of 50 cm.

These variations will be anticipated (the operator will know that the minimum operating level of the dam will be reached) and the populations will therefore be informed.

Figure 71 - Level variations over 24 hours downstream from the plant in the most impactful case

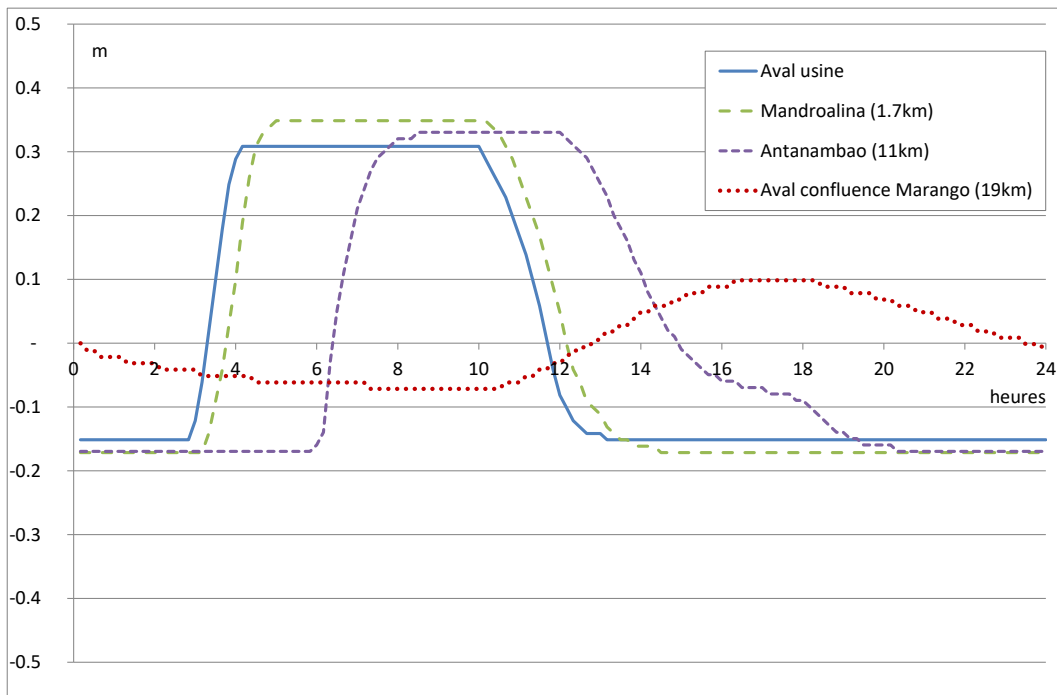

By simulating a violent start of the 7 turbines within 5 minutes, the estimated downstream water rise times based on the hydraulic model are between 20 and 40 minutes over the first kilometer. The maximum water rise rates are between 3 and 6 cm/minute. These rates are manageable in terms of public safety, but require specific prevention mechanisms to avoid accidents, mainly for people who have ventured into the riverbed for a static activity (fisherman, children playing on an island...). It should be remembered that these mechanisms will only be necessary on average during the dry season and one year out of seven, when the turbines start up only.

5.3.4 Instream Flow

5.3.4.1 Relevance of Instream Flow

In the absence of legislation requiring a calculation method or a minimum value for instream flow, the definition of instream flow is the result of a fair balance between

- an objective of efficient use of water resources, and
- an objective of minimizing environmental and social impacts, while preserving current uses.

The Onive bed has a typical V-shaped appearance in the reach between the reservoir and the plant, with a major sandy-rochemical bed and a minor bed that is essentially rocky. The central part of the bed is deeper, eroded by solid transport during flood periods. The lateral slopes of the bed are marked, without being very steep: they are in the range of 1:10 to 1:5 (1 to 2 meters deep at 10 m from the edge).

The average flow velocity is as in any mountain area of the order of one meter per second:

- Slower velocities by order of magnitude (about 0.1 m/s) are only observed in water holes, where the depth and width of the bed are very high due to the morphological singularity of the bed.
- Faster velocities by order of magnitude (about 10 m/s) are only observed in near-vertical falls, which are numerous between the dam and the plant.

The flow profile of the Onive in typical sections for flows of 2, 4, 5.7 and 8 m³/s, for water velocities between 0.5 and 2 m/s is described in the table and figure below:

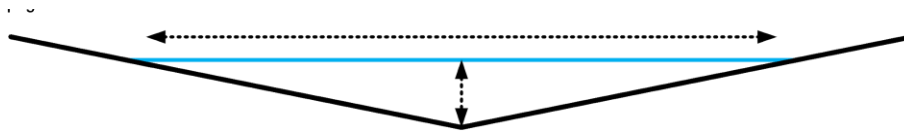

Water velocity (m/s)	Flow rate (m ³ /s)	Side slope of 1:5		Side slope of 1:10	
		Depth	Width	Depth	Width
0.5	2	0.9	8.9	0.6	12.6
	4	1.3	12.6	0.9	17.9
	5.7	1.5	15.1	1.1	21.4
	8	1.8	17.9	1.3	25.3
1.0	2	0.6	6.3	.4	8.9
	4	0.9	8.9	0.6	12.6
	5.7	1.1	10.7	0.8	15.1
	8	1.3	12.6	0.9	17.9
2.0	2	0.4	4.5	0.3	6.3
	4	0.6	6.3	0.4	8.9
	5.7	0.8	7.5	0.5	10.7
	8	0.9	8.9	0.6	12.6

The functions of the Onive River that must be preserved through the instream flow are described in the following table:

Physical functions	Throughput requirement to preserve the function
Water transport	Function preserved regardless of the instream flow value.
Transport of sediments from the Onive	Function preserved during flood periods regardless of the value of the instream flow in the dry season.
Social functions	Water requirement
Physical boundary: the flow prevents the river bed from being easily crossed on foot and becoming a crossing point between the left and right banks of the Onive.	Function preserved until the bed is walkable (speed greater than 0.5 m/s and depth greater than 0.5 m): the above table shows that an instream flow of about 2 m ³ /s may not be sufficient, but that a flow of 4 m ³ /s would probably be appropriate
Rare recreational or household activities (swimming, laundry...)	A few dozens to a few hundred liters per second.
No water collection for agricultural or industrial water-consuming activities.	No need for instream flow.
Environmental functions	Water requirement
Maintain a continuous aquatic environment.	The rock-made bed is not very permeable, and only an instream flow well below 1 m ³ /s would likely disappear locally between the rocks and

	could generate discontinuities.
Maintain a common aquatic environment to avoid the formation of stagnant water areas that would pose a health and environmental problem.	The largest quiet area, just downstream from the dam, is 450m x 55m. Assuming a depth of 5m, an instream flow of 1.4 m ³ /s would be required to ensure its complete daily renewal and thus prevent the qualification of standing water.
Access to drinking water for wildlife	A few liters per day
Preservation of the riparian forest	Due to strong natural fluctuations, the riparian forest is already composed of species that are used to being out of water for half the year.
Habitat for aquatic conservation concern species	Only one species that triggers critical habitat frequents the bypassed reach: <i>Rheocles wrightae</i> (Chapter 4.4.10), which can only frequent the downstream end of the reach, however, because it cannot pass the falls. The impact of the Project on this species will be specifically monitored, including instream flow monitoring.

In conclusion:

- The proposed instream flow of 5.7 m³/s probably makes it possible to maintain the essential functions of the Onive River in the bypassed reach: the Project’s monitoring will have to confirm this, especially with regard to *Rheocles wrightae* and also to verify that the bed is nowhere easily accessible by foot.
- A slightly lower instream flow (up to 4 m³/s) could possibly fulfill the same functions, and could be considered in the future, but not before the follow-up at 5.7 m³/s is completed.
- A much lower instream flow (2 m³/s or less) would certainly not fulfill the functions, and should therefore be avoided.
- A higher instream flow is not justified at present, but may be necessary in the long term if facilities such as climate change make it necessary.

5.3.4.2 Adaptability of the Instream Flow

Taking into account the conclusions of the previous chapter, and taking into account the possibility that (i) a 4 m³/s flow rate may eventually prove sufficient to maintain the physical, social and environmental functions of the Onive in the bypassed reach, or (ii) a different instream flow regime may prove necessary in the future, it is expected that the intake of the instream flow will have a variable capacity of 4 to 8 m³/s, i.e. a possible fluctuation of -30 to +40%.

5.3.4.3 Instream Flow Turbine

The 5.7 m³/s instream flow is expected to be turbinated (a turbine having a wide operating range with stable efficiency) in particular to allow rural electrification in the vicinity of the Project - this is a solution that has yet to be confirmed based on detailed design.

If this solution is chosen, the supply line of the micro-power plant must be equipped with a by-pass to allow the un-turbinated flow to pass through and ensure that the instream flow is discharged at all times.

Figure 72 – Calm Diversion Bays Interspersed with Natural Sills Downstream from the Plant



5.3.5 Mitigation Measures

The impacts of the modified regime on environmental and social receptors are described in Chapters 6 and 7.

All mitigation measures related to downstream physical impacts are summarized in the following table:

Table 97 – “Physical Impact Downstream” Mitigation Measures

#	Measure	Implementation	
		Period	By
Aval01	Maintain a permanent instream flow of 5.7m ³ /s downstream from the dam at all stages of construction and testing.	Construction and water supply	EPC
Aval02	Water intake supplying the instream flow designed in a way to allow the flow to be adjusted, and with the possibility of supplying a micro-power plant.	Design and construction	EPC
Aval03	When the reservoir is first filled, schedule a test of at least 16 hours with only the applied instream flow. Visual observations on the bypassed reach and downstream from the plant (before and at the end of the 16 hours) to verify continuity of the flow and identify any singularities that may appear.	Tests, at the time of impoundment	NEHO, in coordination with the EPC
Aval04	Permanent maintenance of an instream flow downstream from the dam.	Operation	NEHO

5.4 Impacts on the Sediment Regime

5.4.1 Impacts on the Impoundment

Impacts on the sediment regime are impacts that, in the case of large reservoirs, are spread over time and are progressive.

Due to the operating mode of the reservoir and the sizing of the hydropower plant, the following sediment dynamics are expected in the reservoir:

- The finest sediments will remain in suspension and will be carried to the waterway or to the water intakes or spillway without stopping in the impoundment.
- The coarser sediments will stop at the tailbay while the intermediate sediments will land at the bottom of the reservoir at a greater or lesser distance from the dam depending on their weight and the hydrodynamics of the reservoir. The tidal flow of the reservoir over the years will allow some of this sediment to migrate to the dam, while others will remain permanently trapped in the reservoir.

The dynamics of the sediment landed at the bottom of the reservoir will be largely determined by the dynamics of the reservoir and by the hydrology of the Onive:

- Transport will be at the highest when the reservoir level is very low at the end of the dry season, and the rise in flooding is high and rapid, thus allowing a significant volume of sediment to be remobilized.
- Transport will be lowest when, at the end of the dry season, the reservoir level is high (typically at normal operating level), and the flood rise is slow, resulting in slow velocities in the reservoir and a low capacity to remobilize the landed sediments.

The bottom gates provided at the dam level and near the water intakes will make it possible to evacuate the sediments that will settle near the dam, so that they do not block the water intakes.

5.4.2 Downstream Impacts

Sediment discharge through the bottom gates will logically occur at the beginning of the rainy season, when (i) the reservoir level is low enough to generate high driving speeds, and (ii) the inflow rate is sufficient to guarantee power generation while opening the bottom gates.

This approach will replicate the natural functioning of floods where solid transport is always most important during the flood display described in the following table:

Table 98 - Qualitative Description of Sediment Transport over The Year

	N	D	J	F	M	A	M	J	J	A	S	O
Reservoir level average year (m)	1,328 m or more									1,322.5	1320	1317
Median inflow from the Onive (m ³ /s)	60.9	122.8	175.6	259.8	216.2	138.0	81.2	59.9	47.7	39.6	32.5	31.5
Sediment supply in the reservoir	Considerable and growing inflows					Decreasing inflows			Low inflows			
Sediment dynamics in the reservoir	Displacement caused by rising floods		Landing in the full impoundment						Displacement due to lowering of the reservoir level			

The dead volume of the reservoir is 6 hm³. If it is confirmed that the average inflows are in the order of 2 hm³ of sediment per year, then the cumulative deficit in sediment downstream could represent three years of inflows from the Onive upstream from the Project site. The deficit will be significant, especially in the early years while the less fine

sediments pass through to the bottom gates. However, it is important to note that the bed of the Onive is essentially rocky until its confluence with the Mangoro. As a result, it is not expected that the bed will sink as it could have been if the sediments were the main material of the downstream bed. However, it is possible that the morphology of some of the sandbanks downstream from the Sahofika Plant may change over time.

The impact of the Project on the sediment regime is not associated with a significant or immediate risk: it does not require mitigation measures per se, but it will be necessary to monitor its evolution to ensure its availability along a sufficient database to monitor the evolution of sediment dynamics.

5.4.3 Mitigation Measures

The only mitigation measure related to impacts on the sediment regime is summarized in the following table:

Table 99 – “Sediment Regime” Mitigation Measures

#	Measure	Implementation	
		Period	By
Sédi01	In addition to the monthly monitoring of suspended solids (see action Qeau03), annual monitoring during the first three years and then at regular intervals (to be determined on the basis of the first three years) from: <ul style="list-style-type: none"> • Sedimentation of the reservoir (bathymetry or lidar) The evolution of the sand banks over the 3 km downstream from the hydropower plant (visual monitoring in the dry season)	Exploitation	NEHO

5.5 Polluting Emissions and Discharges

5.5.1 Noise, Dust and Air Emissions

5.5.1.1 Nature of Impacts

The construction activities planned for 54 months involve a combination of air emissions in the form of noise, dust and emissions of gases such as exhaust gases. These risks mainly concern the construction period: once the operation phase has begun, the noise, dust and atmospheric emissions of the Project will be negligible.

The main sources of releases and atmospheric emissions during construction will be:

- The movement of vehicles and construction machinery,
- Earthworks,
- Explosive fire,
- Exhaust gases from internal combustion engines (generators, vehicles, etc.) containing fine particles and gases (Nox, SO₂, CO),
- Material production sites (concrete mixing plant, crusher, and quarry).

These discharges and atmospheric emissions will be present at all construction sites, but in different proportions depending on the activities carried out. They also concern the site’s supply routes.

Noise, dust and atmospheric emissions can have a negative impact on site personnel and local populations if they are not controlled. For site personnel as well as for local populations, the risks concern people’s health (hearing system disorders, respiratory disorders - pharyngitis, bronchitis, rhinitis, etc.), well-being (quality of sleep, cleanliness of the personal environment or work environment) and safety (asphyxia, inaudible alarms, poor visibility on the slopes).

The factors that aggravate these risks are well known:

- Maintenance and control of internal combustion engines (exhaust gases from vehicles and construction machinery),
- Drought conditions of roads and uncoated traffic surfaces and vehicle speeds (dust),
- Work in a confined environment (evacuation of exhaust gases and gases emitted during blasting, dust),
- Activity times (higher tolerance for daytime noise),
- Weather conditions (no wind...)

With the exception of the latter, all these aggravating factors can be mitigated by implementing appropriate measures.

The most sensitive receptors are also known:

- On construction sites, workers are exposed to these nuisances in a diffuse but continuous way,
- In confined areas (waterway gallery), workers may be exposed to high concentrations of dust or gases,
- Houses and public places close to the site’s activity areas, in particular:
 - Houses along supply routes and along the transmission line,
 - The school and further back the village of Faravohitra which are located near the construction site of the plant and main facilities. The school is located 350 m away from the proposed location of the hydropower plant and construction site facilities.

5.5.1.2 Mitigation Measures

The mitigation of risks related to noise, dust and air emissions consists in:

- Implementing measures to reduce emissions,
- Monitoring noise levels, air quality and emissions on the basis of pre-established threshold values.

The following table lists the mitigation and control measures to be implemented:

Table 100 – “Noise, Dust and Air Emissions” Mitigation and Monitoring Measures

#	Measure	Object	Completion Criteria	Implementation
Atmo01	Regular watering in the dry season. Establish a follow-up of complaints related to dust and take measures to limit their impact	Dust emitted by vehicle traffic on uncoated surfaces used by the Project	Good visibility for drivers following another vehicle. Complaints handled	EPC, construction phase

Atmo02	Limitation of the speed of construction vehicles to 40 km/h on the tracks and 15 km/h on working platforms or in installations	Dust and noise	Recording (GPS or tachometer) and speed check.	EPC, construction phase
Atmo03	Installation of speed bumps in populated areas (in agreement with the authorities responsible for public roads)		Effective slowing of vehicles	EPC, construction phase
Atmo04	Prohibition of the use of explosives from 21h to 7h for surface work (authorized underground)	Noise	Schedules respected	EPC, construction phase
Atmo05	Continuous noise measurement at the Faravohitra school, one month before the start of the work and during the work. Organization of the site in such a way that the ambient noise level does not increase by more than 3dB (IFC guidelines)	Noise	Noise level maintained below the ambient noise level before work plus 3dB	EPC, construction phase
Atmo06	Minimization of emissions: <ul style="list-style-type: none"> • Measurement before the first entry and then monthly of the exhaust gases from thermal equipment used in tunnels. • Prohibition of access to the tunnel for the most emitting equipment if the thresholds are exceeded. 	Dust and gas in tunnels	Air quality in the tunnel during working hours in accordance with the following average thresholds (IFC guidelines): CO: 55 mg/m ³ NO ₂ : 40 mg/m ³ SO ₂ : 20 mg/m ³ PM _{2.5} : 25 mg/m ³ PM ₁₀ : 50 mg/m ³	EPC, construction phase
Atmo07	Installation of ventilation in tunnels to ensure air quality in accordance with SFI standards.			EPC, construction phase
Atmo08	Continuous measurement of air quality in the tunnel: CO, NO ₂ , SO ₂ , PM _{2.5} and PM ₁₀ .			EPC, construction phase
Atmo09	Measurement before the first use and then semi-annual of the exhaust gases from the thermal equipment used on site.	Emissions from internal combustion engines	Emissions meeting Euro 3 standard	EPC, construction phase
Atmo10	Stopping and prohibiting on site vehicles emitting a cloud of smoke affecting the visibility or breathability of the air		Exceptionally polluting vehicles stopped immediately and prohibited.	EPC, construction phase
Atmo11	Favor the use of electric ATVs for the travel of the Project E&S team		Electric mountain bikes made available, used and maintained.	NEHO

5.5.2 Liquid and Solid Waste

5.5.2.1 Nature of Impacts

With more than a thousand workers at its peak period, the site will generate several tons of waste and several dozens of m³ of wastewater every day.

All this solid and liquid waste must be recovered, sorted and treated before being released into the environment (treated wastewater, runoff or mine water collected and settled, machinery cleaning water and concrete mixers collected, settled and treated) or placed in final disposal (solid waste).

Since there is no official sewerage network or landfill in the Project area, the Project will have to create its own facilities and organize its own waste collection and treatment line, starting with the installation of receptacles (bins, toilets...) in all work areas.

5.5.2.2 Waste Collection, Treatment and Management

For solid waste, a sorting system will have to be put in place. The nature of this sorting will depend on the existing recycling structures in Madagascar: at a minimum, organic waste and metal waste will be sorted, the former for composting and the latter for recycling.

Liquid and solid waste treatment facilities will comply with:

- A general principle to avoid the uncontrolled release of pollutants into the environment from wastewater release or waste storage/dumping sites;
- Malagasy standards for the collection, treatment and management of solid and liquid waste
- The 2007 IFC General Environmental, Health and Safety Guidelines for implementation principles, and for liquid discharge limit values.
- The same approach will apply to the operating period, during which the quantity of waste generated will be significantly smaller.

5.5.2.3 Impact Mitigation Measures

The following table lists the mitigation and control measures to be implemented:

Table 101 - "Liquid and Solid Waste" Mitigation and Control Measures

#	Measure	Implementation	
		Period	By
Dech01	Preparation and implementation of a plan for the collection, treatment and management of liquid and solid waste for the construction phase, taking into account the three principles set out in the ESIA (avoid the uncontrolled spread of pollutants, compliance with Malagasy standards, compliance with IFC recommendations)	Construction	EPC
Dech02	As part of initial and subsequent formation, raise workers' awareness of solid and liquid waste management.	Construction	EPC
Dech03	Internal control of waste collection (keeping a register) and effluent quality.	Construction	EPC
Dech04	Preparation of a waste management plan for the operation phase, taking into account the waste management hierarchy (reduce, recycle, compost, landfill), and distinguishing between them: <ul style="list-style-type: none"> ● Domestic waste from the city of operation and staff. ● Organic waste (floating wood, water hyacinths). ● Industrial waste resulting from operations and maintenance activities. 	Exploitation	NEHO

5.5.3 Accidental Pollution

5.5.3.1 Nature of the Risks: Construction Phase

The construction site of the dam and associated infrastructure is likely to generate accidental pollution, following, for example, accidental oil spills (oil spills, improper filling of reservoirs, etc.) or toxic products (solvents, paints, varnishes), contaminated cleaning water, etc.

The main risk of such accidental pollution is pollution of the soil or aquatic environments.

The management of this risk requires the implementation of preventive and corrective measures in the event of an incident:

- Preventive measures:
 - Systematic installation of impoundment basins or collection receptacles in the event of leakage of polluting products at their storage or use site, in order to avoid uncontrolled release into the environment,
 - Creation of dedicated concrete areas to fill up vehicles/machinery or maintain them, with collection of runoff products.
 - Provision of accidental spill management kits in construction equipment and on construction sites.
- Accidental spill management measures:
 - Containment of the leak,
 - Collection of polluted soil and treatment as industrial waste.
- Training and awareness-raising of workers on all measures, in particular machine operators.

5.5.3.2 Nature and Management of Risks: Operation Phase

During the operation phase, the main risks of accidental spills into the environment will be related to (i) the maintenance and fuel supply facilities for the Project's vehicles, and (ii) hydromechanical and electromechanical equipment.

In order to prevent these risks, the operator must have a site dedicated to the maintenance and fuel supply of its vehicles.

Facilities supporting hydromechanical and electromechanical equipment, and storage sites for oils and other petrochemical or chemical products, should be designed and sized in such a way that direct leakage into the environment without impoundment is impossible. If this is not possible for some parts in direct contact with water, then these parts will only use biodegradable oils.

5.5.3.3 Mitigation Measures

All mitigation measures related to accidental pollution are summarized in the following table:

Table 102 – "Accidental Pollution" Mitigation Measures

#	Measure	Implementation	
		Period	By
Poll01	Preparation and implementation of a pollution and spill management plan for the construction phase, taking into account the principles set out in the ESIA.	Construction	EPC
Poll02	As part of initial and subsequent training, training of workers in the prevention and management of	Construction	EPC

	spills of polluting products.		
Poll03	Sizing (i) the operator’s facilities supporting hydromechanical and electromechanical equipment, and (ii) storage sites for oils and other petrochemical or chemical products, so that direct leakage into the environment without retention is impossible. Where this is not possible, use biodegradable oil.	Design and construction	EPC
Poll04	Construction for the operator of maintenance and fuel supply facilities for the Project’s vehicles to contain accidental leaks and maintenance products.	Design and construction	EPC
Poll05	Use of biodegradable oil for hydromechanical and electromechanical equipment presenting a risk of uncontrolled leakage into the environment, in particular for all parts in direct contact with water.	Exploitation	NEHO

5.6 Climate Change-related Impacts

5.6.1 Risks and Analysis Method

The Project is located in a climatic zone characterized by marked dry and wet seasons, with regular cyclonic episodes: the hot and rainy season extends from November to April and the dry season from May to October, with less rainfall between September and October. Temperatures and precipitation are unevenly distributed in the Project area, and are influenced by altitude.

In a context of global warming, one of the first expected consequences of the increase in energy available in the atmosphere is an increase in climate variability.

The analysis of risks specific to the context of the Sahofika Project was conducted on the basis of available local and global data, following the methodology of the Guide for Resilience to Climate Change prepared by the International Hydropower Association (IHA) for hydropower facilities.

5.6.2 Qualitative Risk Analysis

The scoping stage is used to assess the nature of the climate changes expected in the Sahofika Project area. Local historical data are used to identify past changes, while global climate models are used to assess the most likely future changes.

5.6.2.1 Past: Local Climate Data

There is no meteorological station in the Sahofika Project area that can provide long climate series. There are also few meteorological stations with complete data series covering several decades in Madagascar, and in particular there are none in the Project area. The data used by the Project to describe the meteorological situation are therefore data from neighboring stations or long series reconstructed using global models.

Precipitation

As part of the Sahofika Project feasibility studies, rainfall data for the Project’s watershed were reconstructed for the period 1948-2008 using a reanalysis model, i.e. a global model that best provides an objective estimate of past weather conditions.

The calculated precipitation totals for the wet (November-April) and dry (May-October) seasons are presented in Figure 74.

These rainfall data indicate over the sixty years covered:

- Higher wet-season precipitation in the most recent decades, including more pronounced wet years: the three most humid years are associated with recent decades, while the two least humid years are associated with the oldest years.
- Relatively stable dry-season precipitation on average, but with possibly increasing variability: the driest and wettest years are associated with the most recent years.

Figure 73 - Average and Cumulative Values of Precipitation in November-April and May-October 1948-2008 (mm)

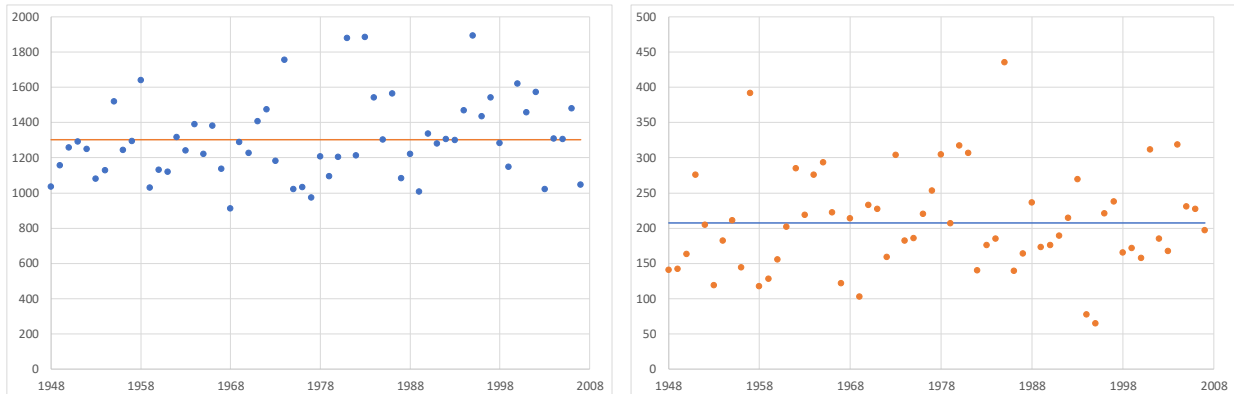

5.6.2.2 Future: Global Climate Models

The Climate Change Knowledge Portal developed by the World Bank provides a visualization of climate change in different regions of the world, based on the 35 main models used by the IPCC. It was used to obtain a vision of the expected medium and long term changes in the Sahofika Project region.

The reference scenarios considered are RCP4.5 and RCP8.5 which, without going into too much detail, correspond to the medium and extreme (highest warming) scenarios currently under consideration.

The reference period considered is 2020-2099, which gives a vision of the expected changes in the long term, compared to the reference period 1986-2005. The results indicated in this chapter are the Malagasy average (medians and extreme values according to climate models), and the results specific to the pithead (1° x 1°) covering the Project area (“BPR csm1 1” model).

The results of these scenarios are presented below.

Temperature: Monthly Averages

The expected temperature increase in the Project area compared to the reference period is +0.7 to 1.5°C.

Figure 74 - Climate Change: Expected Monthly Temperature Change

	Project Area – 2020-2099	Madagascar – 2020-2099
--	--------------------------	------------------------

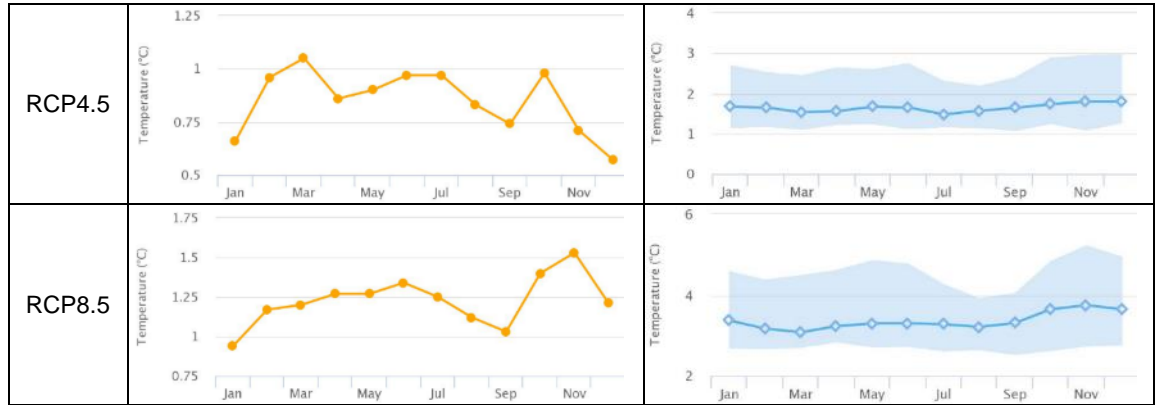

This warming is less severe than the Malagasy average (+1.5 to 4°C), which is due to the fact that climate models predict a more marked increase in temperatures in the western part of Madagascar than in the eastern part. However, this is a significant warming in a mountain environment, where 0.5°C corresponds to the average difference between two areas with an altitude difference of 100m. A warming of 1.5°C could therefore lead to the replacement at the escarpment crest of part of the lichen forests in the Project area (highest forests) by dense moist forest currently found at lower elevations.

Precipitation: Monthly Averages

The variations in average monthly and annual precipitation expected according to the median models and scenarios are small: less than 3% on an annual scale in the long term.

Figure 75 - Climate Change: Expected Trends in Monthly Precipitation

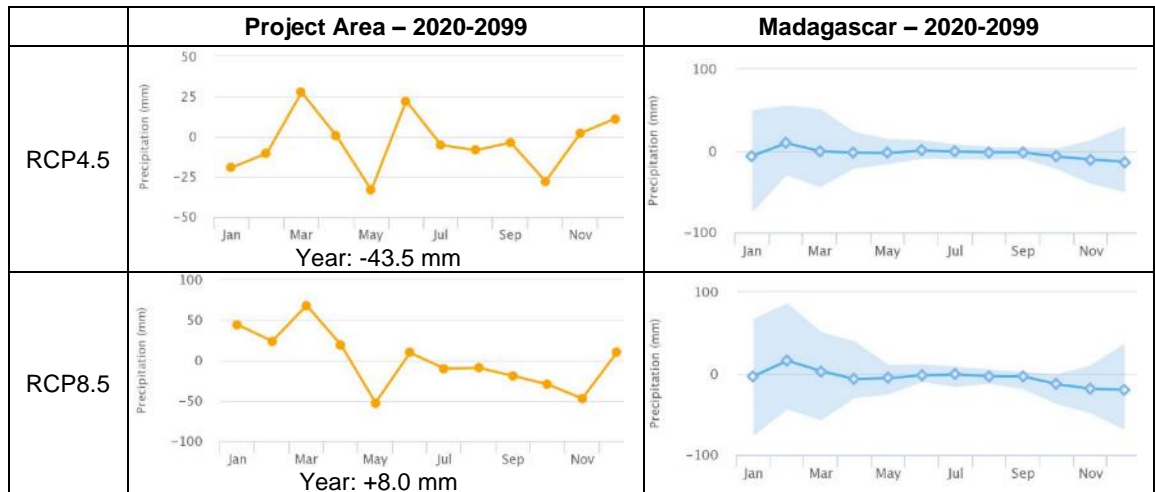

These small variations are not specific to the Project area, but on the contrary are found at the scale of Madagascar, but with a strong regional variability: As a result of climate change, it is expected that northern Madagascar will receive a little more rainfall, while the south would receive slightly less. For the Project area, southeast of Antananarivo, the average monthly precipitation regime is not expected to change (although this does not exclude greater variability).

Figure 76 - Climate Change: Expected Monthly Precipitation Trends by 2099 (RCP8.5)

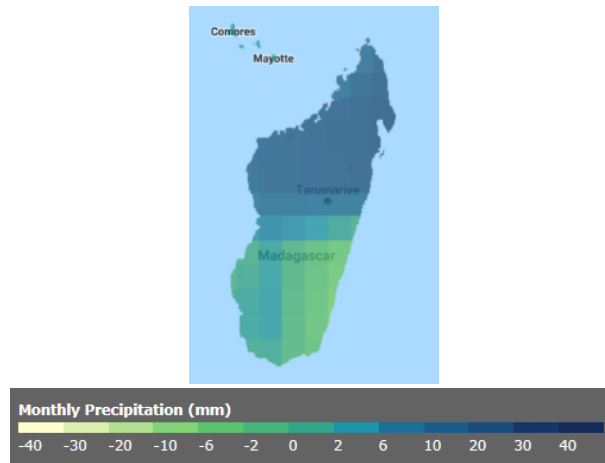

Maximum precipitation over 24 hours - 25-year precipitation event

The variations in maximum 24-hour precipitation (typically during a cyclonic event) expected according to the median models and scenarios are also low, with values in the Sahofika Project area of around 30mm of additional 24-hour precipitation for a 25-year precipitation event, representing about 10% of the average monthly rainfall volume in the rainy season.

Figure 77 - Climate change: expected monthly temperature trends

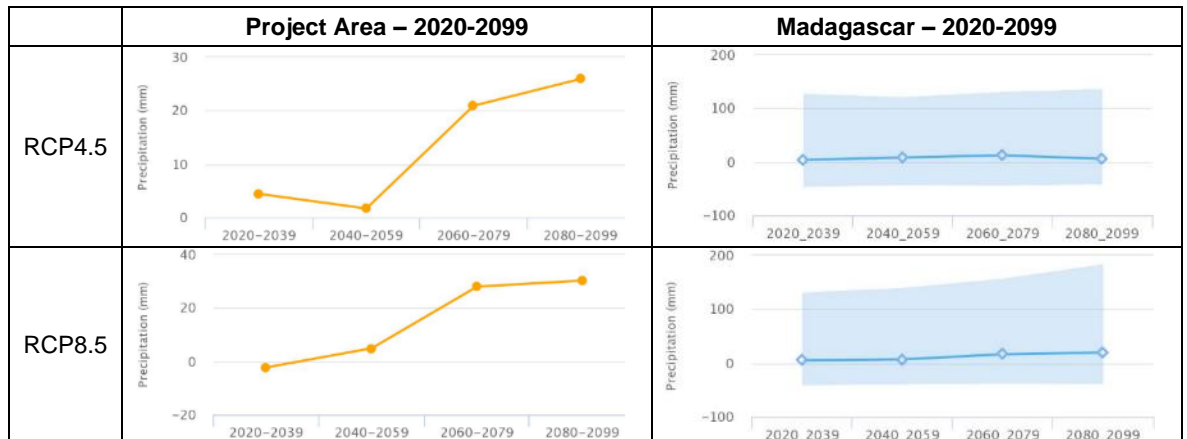

This result is consistent with the median of the Projections for Madagascar, but it is important to highlight the high variability of the results of the various models at the Madagascar scale, as shown in the following figure, and therefore the uncertainty regarding the expected evolution of extreme rainfall.

Figure 78 - Climate change: expected trends in 25-year daily precipitation events by 2099 (RCP8.5)

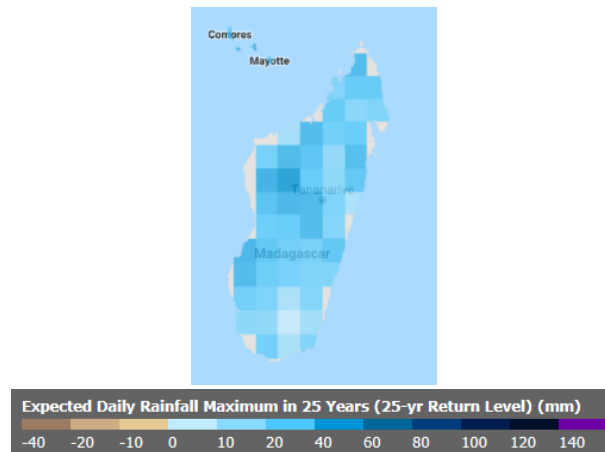

5.6.2.3 Non-climatic Change Factors

Deforestation and the change in land use and occupation, with a conversion of forest areas into cropping areas and the excavation of lowlands for rice cultivation, are very important factors in modifying surface flows and therefore the flood regime in the Project area.

The areas that have been cleared in recent years in the Project watershed are very large and it can be assumed that the modification of runoff mechanisms has significantly impacted the hydrological and sedimentary dynamics of the Project area.

Deforestation and land conversion is an important factor to consider in assessing changes that may affect the Sahofika Project in the long term, not to mention that these changes could be reversible through reforestation initiatives.

5.6.2.4 Summary of Expected Changes in the Project Area

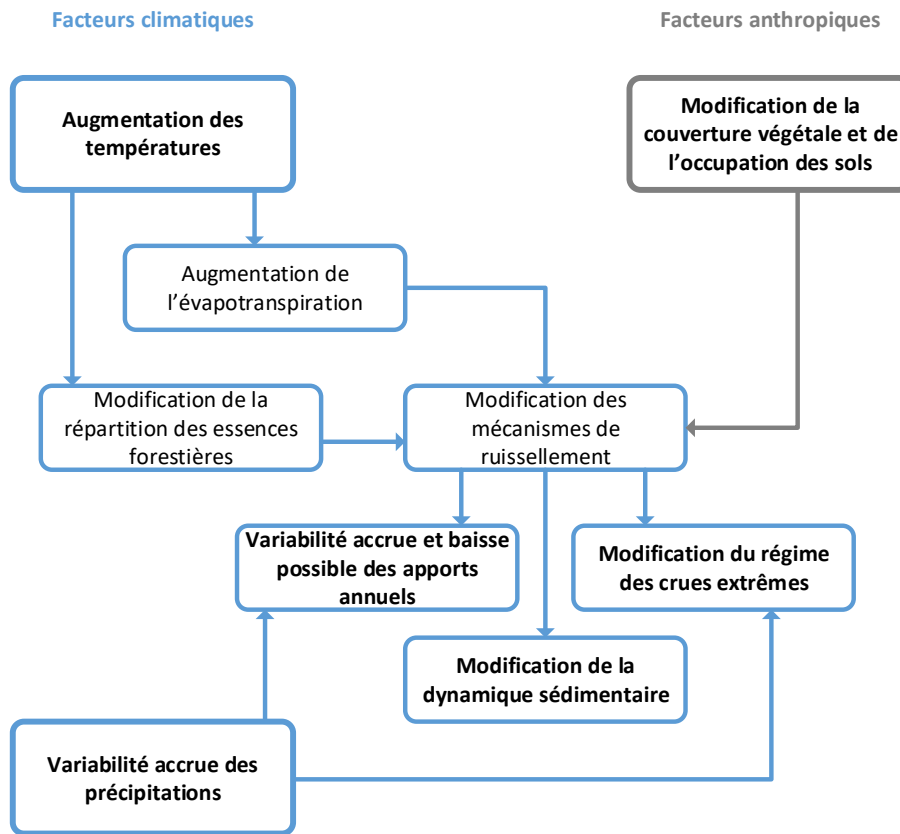

5.6.3 Risk Register and Analysis

The following register lists the climate change factors that may generate risks in the Sahofika project.

Risk factor induced by climate change	Time scale	Possible consequence	Magnitude of the impact (low, significant, important)	Probability (possible, probable, certain)	Risk (low, significant, important)
Decrease in the average natural inflows from the reservoir (increased evapotranspiration)	Progressive, medium to long term	Energy production: few consequences on energy production in an average year because the reservoir fills up every year	Low	Certain	Low
Decrease in average natural inputs from tributaries downstream from the dam, impacting ecosystems.	Progressive, medium to long term	The instream flow is very much higher than the flow of the tributaries and the Onive would therefore not be affected by a decrease in the water conditions of these tributaries.	Low	Possible	Low
Increased variability of annual inputs: increase in the frequency or intensity of dry years	Progressive, medium to long term	Energy production: consequences on the producible and on the continuity of service	Low	Certain	Low
Intensification of extreme phenomena that may affect dam safety (floods)	Sporadic event	Dam safety: Flood exceeding the anticipated project flood	Important	Possible	Important
Intensification of extreme phenomena that may affect the power transmission line (wind)	Sporadic event	Energy transmission: Wind exceeding the line design criteria and loss of the energy evacuation line	Significant	Possible	Significant
Increased sediment supply and reduced reservoir capacity.	Progressive, medium to long term	Energy production: little risk of significant reduction in reservoir capacity, from which sediments must be removed regularly anyway.	Low	Probable	Low
Evolution of the distribution of forest ecosystem species caused by temperature increase	Progressive, medium to long term	Potential impact on reforestation programs, mitigation measures of the Project, or on ecosystems in the watershed.	Significant	Certain	Significant
Increase in the precariousness of the populations living near the Project due to climate change	Progressive, short to long term	Tensions and social difficulties around the Project.	Significant	Probable	Significant

5.6.4 Resilience and Climate Risk Mitigation Measurement

Resilience and climate risk mitigation measures are proposed for each of the identified risks. When defining these measures, account was taken of the evolving nature of climate risk: on the one hand, knowledge of the Sahofika Project area, and in particular its hydrometeorological context, will improve considerably with the implementation of the Project. On the other hand, knowledge of the consequences of climate change will also improve over time.

The risk factors listed in the risk register (previous chapter) that are associated with a low risk are related to the hydrological and sedimentary regime of the Onive: due to their low conservation concern status, these risk factors do not require mitigation measures at this time, but they must be monitored and reassessed regularly.

For risk factors that are associated with a significant risk, specific mitigation measures are defined:

- Weather monitoring for the transmission line
- Monitoring of forest ecosystems in the watershed
- Raising the awareness of the populations of the Project area to climate risk and integration of a climate resilience objective into the social support measures of the Sahofika Project (Community Development Plan).

For the risk factor associated with a significant risk, namely the risk of flooding exceeding the forecasts made for the sizing of the Project, it is recommended that a finer climate risk modelling (downscaling) be carried out during the detailed design and that the facility be designed in such a way as to be able to integrate a possible future increase in its flood discharge capacity.

All these measures are summarized in the following table:

Table 103 – Climate Change Mitigation Measures

#	Measure	Implementation	
		Period	By
Clim01	Climate risk modelling (downscaling): calculation of the sensitivity of the Project's floods to expected climate changes, and design of the hydropower plant in such a way as to be able to integrate a possible future increase in its flood evacuation capacity.	Detailed design	EPC
Clim02	Daily hydrological monitoring of Onive inflows	Exploitation	NEHO
Clim03	Weekly sedimentary monitoring of Onive inflows (suspended matter)	Exploitation	NEHO
Clim04	Annual sediment monitoring of the reservoir	Exploitation	NEHO
Clim05	Meteorological monitoring at the dam site	Exploitation	NEHO
Clim06	Meteorological monitoring - transmission line: <ul style="list-style-type: none"> ● Definition of two monitoring points and installation of stations ● Operation and maintenance of stations 	Construction	EPC
		Exploitation	NEHO
Clim07	Sensitization of the populations of the Project area to climate risk and integration of a climate	Construction and operation	NEHO

	resilience objective into the social support measures of the Sahofika Project (Community Development Plan).		
Clim08	Verification of project floods every ten years, based on acquired hydrological data. Monitoring of forest ecosystems in the catchment area: on the basis of satellite images, mapping every 10 years of forest areas and types of forests. Verification of the resilience of the facility in accordance with the HIA Climate Resilience Guide.	Exploitation	NEHO

5.7 Greenhouse Gas Emissions

5.7.1 Construction-related Emissions

Construction emissions have been estimated on the basis of the volumes and quantities required to carry out the Project. The methodology used is that of the Inter-American Development Bank (IDB, 2012). It is the most recent and complete methodology available. It provides emission factors that, when applied to the Project quantities and volumes (provided by EPC), allow the footprint of construction activities, expressed in tons of CO₂eq, to be deducted. The emission factors of the latest version of the ADEME carbon database were also used (ADEME, 2014).

Table 104 – Construction-related Greenhouse Gas Emissions

Materials	Quantity		CO ₂ eq footprint		CO ₂ eq balance (tons)
Deforestation of dense tropical forest	35	ha	310,200	kgCO ₂ eq/ha	10,857
Concrete dosed at 350kg	235,000	m ³	1905	kgCO ₂ eq/m ³	447,675
Concrete dosed at 150 kg	245,000	m ³	816	kgCO ₂ eq/m ³	200,025
Furniture excavators	3,800,000	m ³	36.7	kgCO ₂ eq/m ³	139,460
Furniture backfill	2,710,000	m ³	36.7	kgCO ₂ eq/m ³	99,457
Steel (reinforcement, penstock)	31,200,000	kg	1.1	kgCO ₂ eq/kg	34,320
Fuel	13,600,000	liter	2.7	kgCO ₂ eq/l	36,720
Post and line / aluminum (cables)	1,500,000	kg	9	kgCO ₂ eq/kg	13,500
Total					982,014

Greenhouse gas emissions from construction represent an estimated carbon footprint of 982,014 tons CO₂eq, or an order of magnitude of 1 million tons CO₂eq.

5.7.2 Reservoir-related Emissions

5.7.2.1 Carbon Content of Flooded Areas

The areas which, as a result of the creation of the reservoir, will be converted to aquatic habitat have been calculated on the basis of the Project's imagery and lidar topography. Their carbon content has been established on the basis of IPCC average data (IPCC, 2003).

Table 105 - Size and Carbon Content of Flooded Areas

Land use planning	Area (ha)			Carbon content	
	Before impoundment	After impoundment	Variation	tC/ha	tC
Crops and fallows	616		-616	10	6,160
Drill bit	145		-145	130	18,850
Water	129	890	761	0	0
Total	890	890	0		25,010

Figure 79 – Map of natural and modified habitats in the flooded area

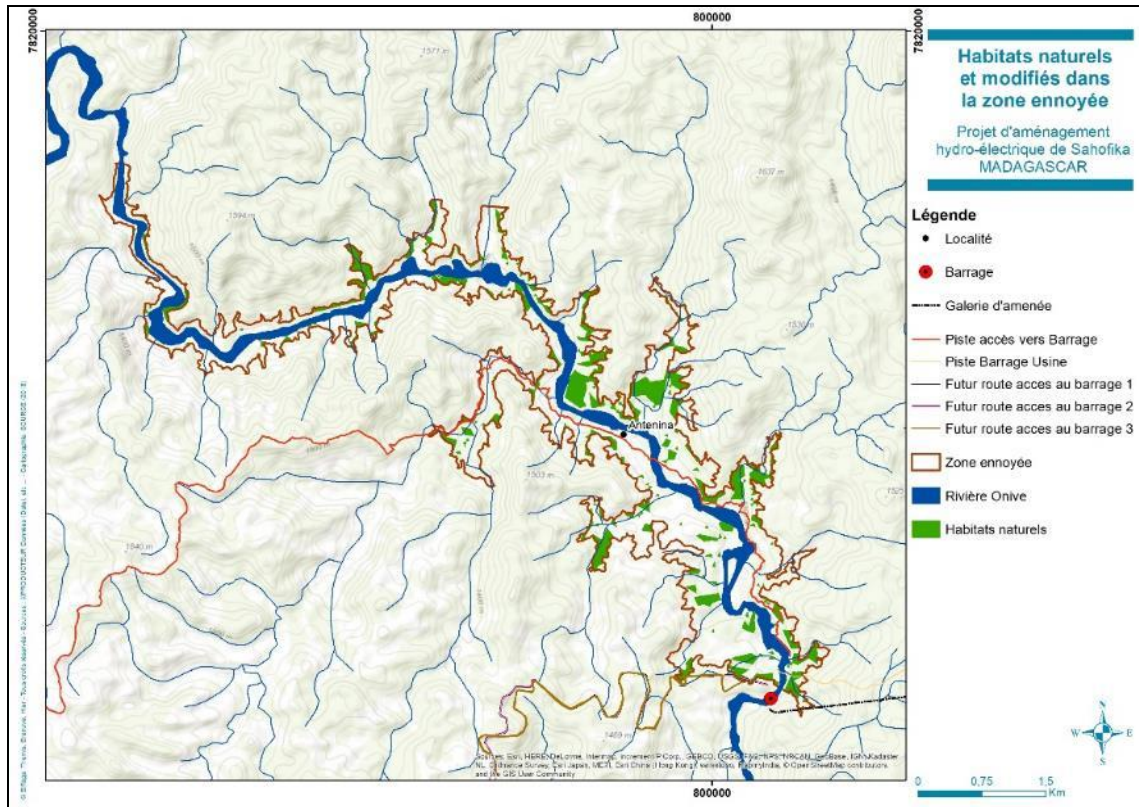

5.7.2.2 Process for Converting Mobilizable Carbon into CO₂ and CH₄

Fate of permanently drowned mobilizable carbon

The carbon dioxide CO₂ and methane CH₄ emissions generated by the creation of a hydropower plant such as Sahofika depend on a set of complex and interdependent processes, described in a simplified way in the following diagram:



Determining Factors

The determining factors for future GHG emissions in the case of Sahofika are as follows:

The **vegetation cover and soil type** of the floodplain area before the reservoir is created is the determining parameter for the carbon inputs of the reservoir in the short term (during the first years after filling). In the longer term, the quality of water from upstream will be the determining factor.

The hydrodynamics of the reservoir will determine the vertical exchanges between the deep layers (most likely to be anoxic) and the surface layers (most likely to be oxygenated) of the reservoir, and thus the diffusion of gases (CO₂, CH₄ and O₂) at the water-air interface. The hydrodynamics of the reservoir is not yet precisely known, although the three phenomena that will determine it are identified:

- Variation in the quality (physical and biochemical) and flow rate of the water entering the reservoir: the mixing induced upstream by inflows from the Onive will probably have an effect over a few kilometers but not on the entire reservoir (13 km long). The dam has no other significant contribution capable of generating mixing across the dam.
- Local climate: wind-induced shear and wave action can facilitate the mixing of the water in the reservoir. However, the Project area is generally windless: the strong wind phenomena it experiences are episodic and generally in the form of gusts as rainstorms approach or during cyclonic events. In addition, the relatively high average depth of the reservoir (about 20 m), as well as the dendritic contour of the reservoir, will not be favorable to a generalized mixing at depth of the water in the reservoir due solely to surface phenomena.
- The operation of the dam will affect the quality of water discharged downstream (which may vary according to the season, depending on whether the dam overflows or not) and on the tidal range.

Carbon sequestration by sediments and in the subsoil of the reservoir will be due to a complex set of phenomena that can be summarized in two causes:

- The mineralization of available organic carbon due to biological or chemical processes;
- The sequestration of organic or inorganic carbon in or under the sediments, due to the absence of a migration route to the waters of the reservoir: this phenomenon will be more intense in areas where fine sediments will accumulate to form a low-permeability layer, capable of retaining insoluble carbon elements, or of preventing the migration of decomposition products from the buried biomass.

5.7.2.3 Mode of Aerobic or Anaerobic Degradation of Drowned Biomass

In the case of the Sahofika reservoir, the rate of water renewal will be highly variable during the year, with the certainty of complete water renewal several times a year.

Table 106 – Reservoir Water Renewal Rate and Time (Full Reservoir 140 hm³)

Months	Inlet flow rate	Renewal rate	Theoretical complete renewal time (days)
January	194.2	372%	8.3
February	263.4	504%	6.2
March	231.1	442%	7.0
April	138.0	264%	11.7
May	82.3	157%	19.7
June	60.9	116%	26.6
July	48.0	92%	33.8
August	39.5	76%	41.1
September	33.0	63%	49.1
October	32.8	63%	49.4
November	63.3	121%	25.6
December	130.5	250%	12.4

Considering (i) the relatively good oxygenation of the waters entering the reservoir but also the marked biological and chemical oxygen demand (see Table 15), (ii) the absence under current conditions of anoxic zones and (iii) the variable water renewal time during

the year, the development of anoxic zones in the future reservoir is possible but should remain located in areas where water circulation will be limited by the reservoir configuration. This will result locally in anaerobic decomposition of the drowned biomass and thus in the transformation of the decomposed carbon into CO₂ and CH₄.

Figure 80 – Areas Hardly Suitable for Renewal and Circulation

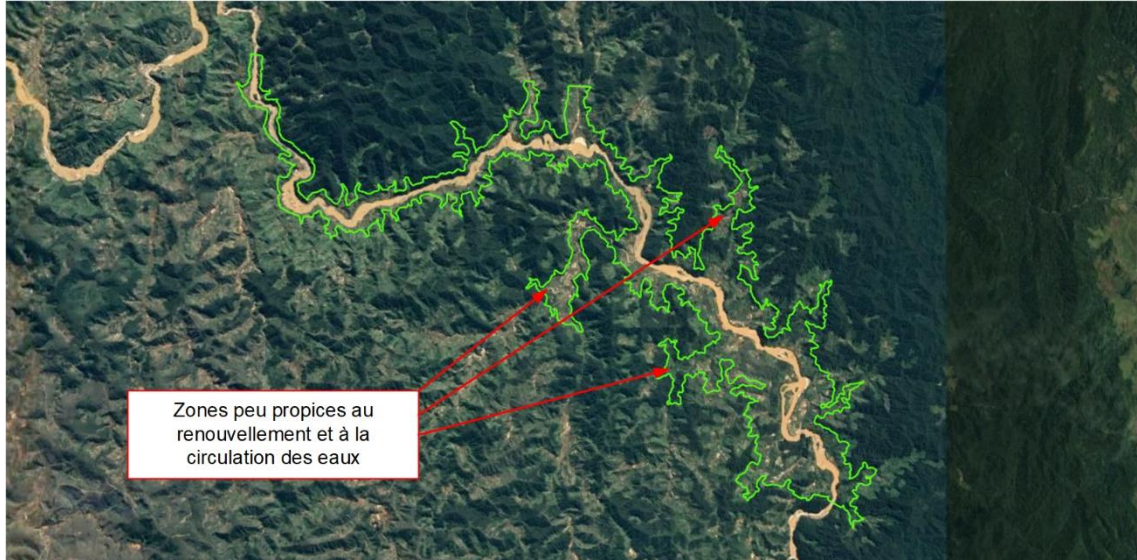

The table below presents the main quantified lessons from the review of 29 scientific Articles or publications. These case studies are described here for comparison purposes, and because they have been very well documented. Of course, the Sahofika Project differs from these projects (for example, its flooded wooded area is much smaller than that of Petit Saut, which was entirely wooded), but the description of the greenhouse gas generation phenomena that occurred there is very interesting because it provides an indication of what can be expected in the context of the Project.

It is important to note that GHG emissions from hydroelectric reservoirs have been calculated for some studies on the surface of reservoirs alone, without taking downstream emissions into account. In the case of Petit Saut, all downstream discharges (degassing and estuary) were taken into account.

Table 107 - Results of measurement of GHG emissions from various tropical reservoirs

Case study	Features and Characteristics	Emissions
Petit Saut	flooded area: 300 / 360 km ² (average/max) reservoir volume: 2.5/3.5 km ³ (min/max) average depth: 11.3 m average stay time: 5.2 months drowned biomass: estimated at 9.85 MtC in 1997 oxycline depth: 5 to 7 m	cumulative first 3 years (1994-1996): ▶ C: 1.1 Mt (82% CO ₂ , 18% CH ₄) ▶ CO ₂ eq: 9.1 Mt (37% CO ₂ , 63% CH ₄) cumulative over 10 years (1993-2003): ▶ C: 2.2 Mt (86% CO ₂ , 14% CH ₄) ▶ CO ₂ eq: 16.4 Mt (43% CO ₂ , 57% CH ₄) cumulative 3 years (2001-2003): ▶ C: 0.35 Mt (89% CO ₂ , 11% CH ₄) ▶ CO ₂ eq: 2.3 Mt (51% CO ₂ , 49% CH ₄)
Rosa et Al (2006)	Emission of greenhouse gases by 9 hydroelectric reservoirs in Brazil, between 3 and 25 degrees South latitude.	Emissions of CO ₂ eq from reservoirs: ▶ as CO ₂ : 1,558 t/km ² /year (min: 62, max 3100) ▶ as CH ₄ : 716 t/km ² /year (min:80, max: 1800) Excluding the two extreme cases, 73% of CO ₂ equivalents are emitted as CO ₂ and 27% as CH ₄ (96% of the carbon released as CO ₂ and 4% as CH ₄)
Barros et Al (2011)	Study of CO ₂ and CH ₄ emissions based on data from 85 hydroelectric reservoirs located between 68°N and 25°S. 141 CO ₂ emission estimates and 89 CH ₄ emission estimates were used.	CO ₂ emissions in mg C per m ² per day (R ² =0.40): C-CO ₂ =exp(3.06-0.16 log(age) -0.01 latitude + 0.41 log(DOC)) - 400 Emissions of CH ₄ in mg C per m ² per day (R ² =0.53): C-CH ₄ =exp(1.33-0.36 log(age)-0.32 log(depth)+0.39 log(DOC)-0.01 latitude) age: in years latitude: in degrees DOC: dissolved organic carbon entering in mgC/m ² /day average depth of the impoundment in m

It is also useful to recall here the experiments on aerobic decomposition of organic matter carried out on the Nam Leuk dam (Laos):

Type of organic matter	Time required to reach 50% decomposition (days)
Roots (< 20 mm diameter)	302
Foliage	340
Low vegetation	380
Litter	463
Dead wood	1,733
Roots (> 20 mm diameter)	> 1,733
Trunks	6,932

5.7.2.4 Assumptions used to Calculate Gross GHG Emissions

The assumptions presented in the table below apply to the estimation of GHG emissions caused by biomass degradation in the flooded area at the normal retention level. Emissions include gases from (i) the surface of the reservoir (mainly by diffusion) and (ii)

the downstream side of the reservoir (degassing and diffusion). The degradation of underground biomass (trunks and roots) and soil carbon have not been taken into account because they are not decisive in either the short or long term.

Table 108 - Assumptions for Drowned Biomass Degradation

Type of carbon that can be mobilized	Assumption made	Basis for assumptions
Soft biomass (leaves, crops, savannah, grasses)	Percentage likely to decompose in gaseous form: 100%.	This part of the biomass corresponds to the fraction with the fastest decomposition rate. It is therefore the least likely to be stored in the sediment; we consider that it will degrade completely
	Half decomposition time: 1.5 years	The decomposition time is based on the results of Nam Leuk (see table above) and Petit Saut (half decomposition time = 2.5 years)
	Carbon is emitted as CO ₂ at an average rate of 80%.	The proportion of carbon emitted as CO ₂ is estimated as follows: the minimum (75%) corresponds to a balance (50/50) between aerobic and anaerobic processes. The values are consistent with the results observed at Petit Saut (82%).
Hard biomass (trunks and branches, visible woody part)	Percentage likely to decompose in gaseous form: 50%.	Petit Saut: 42% of the total biomass (drowned and overhead). All the authors agree that a significant part of the trunk biomass probably never decomposes into gaseous form.
	Half decomposition time: 20 years	Nam Leuk: 19.2 years Petit Saut: 23 years
	The proportion of carbon released as CH ₄ is estimated at 7.5%.	Concerning the proportion of carbon that will decompose into CH ₄ , the literature shows rates of 4% to 11%.

5.7.2.5 Greenhouse Gas emissions from the Sahofika Reservoir

Greenhouse gas emissions from the Sahofika reservoir have been estimated for a period of 100 years. As a first approximation, net emissions were assumed to be equal to gross emissions. Foliage was considered to represent 0.2% of tree biomass.

Finally, GHG emissions are estimated in CO₂eq: it has been considered that the warming power of CH₄ over a 100-year life cycle is 25 times higher than that of CO₂.

As the following graph shows, emissions are concentrated in the early years. Year zero is the partial deforestation of the impoundment. **Cumulative greenhouse gas emissions over 100 years total 225,356 tCO₂eq**, mainly concentrated in the early years.

Figure 81 – GHG Emissions From Biomass Decomposition

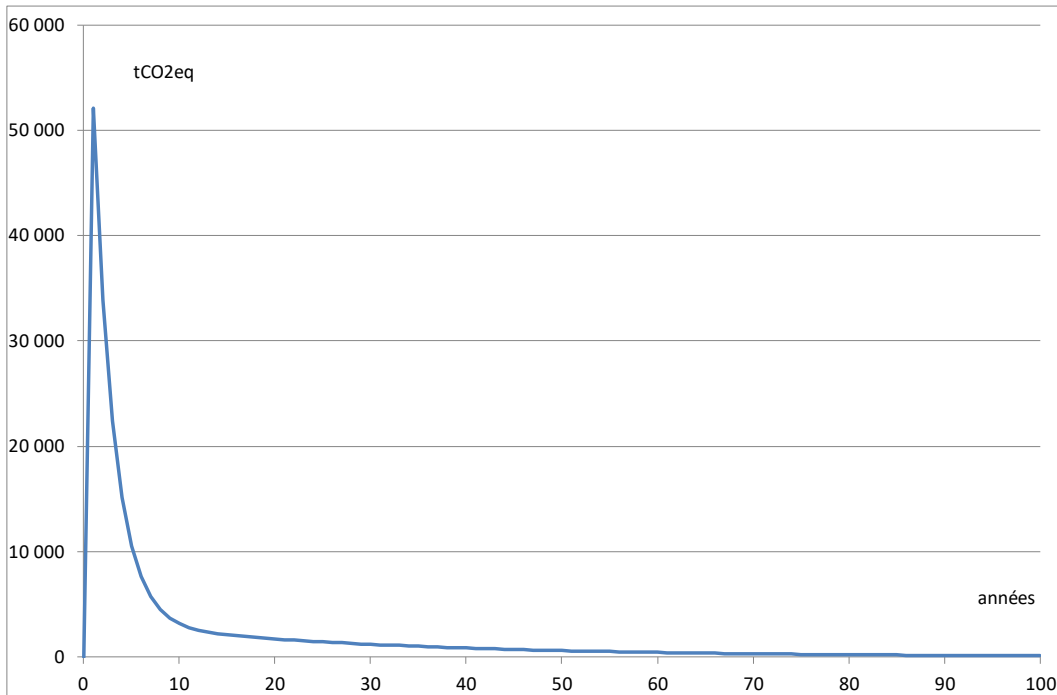

5.7.3 Comparison with Other Energy Sources

The table below compares the net emissions specific to the Sahofika Plant compared to other energy sources:

Table 109 - GHG Emissions Compared with Other Energy Sources

Energy Source	Average Emissions gCO2/kWh		
	First three years	First 10 years	100 years
Coal	929		
Fuel oil	760		
Natural Gas (TAG)	551		
Madagascar’s energy mix ⁵	464.8		
Sahofika	23.0	10.1	1.4

The table shows that the Sahofika Plant will, from the very first years, be significantly less emitting than a thermal equivalent (source for coal, fuel oil and natural gas: IPCC).

Based on an average annual production of 1,570 GWh and in comparison with Madagascar’s current average energy mix, the **Sahofika Hydropower Plant will avoid 7.14 million tons of CO₂eq over the first ten years.**

⁵ Jean-Philippe Praene, Vanessa Rakotoson. Environmental sustainability of electricity generation under insular context : An LCA-based scenario for Madagascar and Reunion island by 2050. International Journal of Engineering Researches and Management Studies, IJERMS, 2017, 2 (4), pp.24-42

5.8 Impacts on Water Quality

5.8.1 Risk of Eutrophication of the Reservoir

The quality analyses performed as part of the ESIA (see Chapter 4.1.5) revealed a high biological and chemical oxygen demand, as well as sufficient nutrient levels (nitrates and phosphates) to contribute to possible eutrophication phenomena.

Adding to these nutrients will be added those generated by the decomposition of the biomass drowned in the reservoir (see the description of the biomass decomposition process in Chapter 5.7.2.3). The complete renewal of the water in the reservoir several times a year (on average 25 times a year) will prevent widespread and lasting eutrophication of the water in the reservoir. However, the reservoir contains areas that, because of their configuration, will be unsuitable for water renewal and circulation and will therefore be more likely to become eutrophic. These areas are now identifiable (see Figure 81) and can therefore be monitored over the life of the plant. In order to minimize the risk of eutrophication, two actions can be implemented:

- Vegetation removal in the most vegetated areas (forests) before impoundment: the forest areas in the reservoir footprint cover about 145 ha, which represents an area that can be completely cleared during the construction years.
- Monitoring of reservoir areas that are not conducive to water renewal and circulation, paying particular attention to the development of aquatic invasive species such as the water hyacinth, present in Madagascar but currently absent from the Project area. This monitoring will consist in visual observations carried out on a quarterly basis in the areas concerned.

5.8.2 Risk of Reservoir Pollution

The quality analyses performed as part of the ESIA (see Chapter 4.1.5) showed the absence or very low presence of non-organic pollutants (pesticides, heavy metals) in the waters of the Onive River. On the other hand, it is likely that the presence or installation of residential areas near the reservoir will generate a risk of surface water pollution. To prevent this risk, a limit of 100m above the highest water level of the reservoir has been included in the relocation action plan, in order to avoid excessive proximity of the houses to the reservoir. This 100m limit will also play a safety role, to prevent homes with potentially very young children from being too close to the water.

The Project will have to follow the fact that no one will settle in this 100m zone in the future.

5.8.3 Downstream Water Quality

5.8.3.1 Downstream from the Dam

The quality of the water discharged from the dam will vary, depending on whether it is discharged by the spillway (oxygenated surface water) or discharged by deeper intakes (possibly less oxygenated or non-oxygenated water). However, the presence of multiple major natural sills and rapids downstream from the dam in the Onive riverbed will allow the spilled water to be quickly reoxygenated and degassed, thus rebalancing its dissolved gas content.

It is anticipated that the biochemical quality of the water downstream from the dam will not be significantly affected by the operation of the Sahofika Plant, but this should be verified through water quality monitoring, with oxygen content being the most important parameter.

5.8.3.2 Downstream from the Hydropower Plant

The water that will be turbined by the hydropower plant and discharged into the Onive will have a biochemical quality close to that of the water in the reservoir at the water intake, with a possible variation in the dissolved gas content as it passes through the Pelton turbines: degassing will be possible in particular in the event that an oxycline is formed in the reservoir at a higher level than the water intake. This degassing would make it possible to rebalance the dissolved gas content of the discharged water, by removing excess gases and reoxygenating the turbined water, which would be important for aquatic ecosystems (if necessary due to the formation of a high oxycline).

Like with the downstream area from the dam, it is anticipated that the biochemical quality of the water downstream from the hydropower plant will not be significantly affected by the operation of the Sahofika Plant, but this point will have to be verified through water quality monitoring, with oxygen content as the most important element here too.

5.8.4 Mitigation Measures

All mitigation measures related to water quality are summarized in the following table:

Table 110 – “Water Quality” Mitigation Measures

#	Measure	Implementation	
		Period	By
Qeau01	Vegetation removal in the most vegetated areas (forests) before impoundment (approx. 145 ha). The possibility for the populations to recover the wood in the flooded area will be studied with the DGEF.	Construction, before impoundment	EPC or NEHO
Qeau02	Quarterly visual and olfactory monitoring of reservoir areas not conducive to water renewal and circulation, with particular attention to the development of aquatic invasive species such as the water hyacinth.	Exploitation	NEHO
Qeau03	Weekly monitoring of the oxygen content of the water downstream from the hydropower plant (100m downstream) and the dam (500m downstream). Monthly monitoring: NO ₃ , PO ₄ , BOD ₅ and suspended solids. Annual monitoring (October): heavy metals and pesticides water and sediment	Construction: last year before operation Operation, 1 st and 2 nd years	NEHO
Qeau04	Preparation and implementation of an annual water quality monitoring program, based on the results of the first two years (Qeau03)	Operation, 3 rd year and beyond	NEHO

5.9 Dam Failure

5.9.1 Method of Analysis

The consequences of a dam failure were assessed for the ESIA using the following tools:

The publicly available topographic data and satellite images (Google Earth and Opentopomap) were used to determine the morphology of the valley and to locate villages likely to be affected. The satellite images available are of very good quality and make it possible to locate villages or even isolated houses as far as the mouth of the Mangoro River at the ocean. However, topographic data are of variable quality, especially in areas where the Onive and Mangoro rivers are the most steep-sided. Topography is where the analysis shows its limits.

- A numerical model of the consecutive flows of a dam failure was performed using a one-dimensional transient (HEC-RAS model).

The failure was modelled for the following conditions:

- Full reservoir at 1,335 m (200 hm³) - 100-year flood conditions;
- The Mangoro basin in 100-year flood upstream from the Onive-Mangoro confluence. The natural inflows used for modelling were distributed pro rata to the areas of the sub-basins. They are presented in the Table.118
- Dam failure with the formation a breach from top to bottom within 6 hours, over the entire height of the dam and over a width of 40m at the bottom.

Table 111 – Base Flow - 100-year Flood across the Upstream Basin

River	Mangoro at the confluence with the Onive	Level at the dam site	Lateral inflows between the dam and the plant	Main tributary on the left bank of the Onive before confluence with the Mangoro	Main tributary on the right bank of the Onive before confluence with the Mangoro
Watershed (km ²)	5800	4565	97	80	75
Flow rate (m ³ /s)	2962	2331	49	41	38

5.9.2 Description of the Hydraulic Model

The model extends from the reservoir-dam to the ocean.

Cross profiles have been positioned wherever villages, hamlets or isolated houses near water have been identified, as shown in the following figure.

Figure 82 - Example of a cross profile at a village bordering the Mangoro River

The topography of these profiles was evaluated based on Google Earth's digital terrain model, with the following corrections:

- The bed width was adjusted to coincide with the exact width measurable in the satellite images, in order to obtain a sufficiently fine representation of the volume of water required for the lateral spreading of the flood wave;
- Some profiles were adjusted at altitude by interpolation, especially in narrow sections between wider areas, where the kriging used by the terrain model tended to move up and down the river.

A standardized bathymetry was used for each cross profile: 1 meter deep at 10m from the edge and 3m deep in the centre of the river.

The following upstream and downstream hydraulic conditions were used:

- Height-volume law of the Sahofika Project for the upstream reservoir
- Water level equal to zero on arrival in the ocean.

Linear pressure drops were calculated for a Manning coefficient everywhere equal to 0.05, and a stationary flow calculation with the mean flow of the Onive and Mangoro was used to verify that this coefficient did not give absurd results (water levels too low or too high compared to the bed limits).

The default contraction and expansion coefficients were maintained (0.1 and 0.3), and the accuracy of the calculations was increased to 1 mm for water lines and 0.001 m³/s for flows.

5.9.3 Results and Sensitivity Analysis

Numerical modelling produced the following results:

- Due to the steep slope, gravity phenomena play an important role (the Froude number is often greater than 1): as a result, the dam empties quickly and the flood wave moves quickly with a small amount of time along the route. The flood wave is felt at sea level (140 km from the dam) 9 hours and 15 minutes after the start of the failure, and reaches its peak 2.5 hours later, 11 hours and 45 minutes after the failure. This represents an average speed of 15.1 km/h (4.2 m/s).
- With a 100-year flood as the initial condition, the modelling revealed that several inhabited areas were potentially exposed to flooding, even before the dam failure wave passed. The results presented below take this into account.
- The passage of a dam failure wave is fast (a few hours) and because of the mild climate in Madagascar, the urgency to avoid victims would essentially consist in taking people to safety in the event of a failure.
- The only strategic infrastructure likely to be impacted is the Project's bridge and hydropower plant.

Table 119 and Figure 85 present the 47 inhabited sites identified between the dam and the ocean, and their level of exposure to a 100-year flood or dam failure (an inhabited place was considered exposed to a flood event if it was less than 5 m above the water line). It should be noted that these are preliminary results produced for the ESIA and will need to be confirmed by more accurate modelling during the Sahofika Project.

Figure 84 shows an example of a village, Ambinanisahasaty (profile 90741), located on both sides of the Mangoro River, which is probably exposed during the 100-year flood. This example illustrates the fact that, in most cases, villages are on hillsides and not all houses are equally exposed or protected.

Figure 83 – Example of a village probably exposed as soon as the 100-year flood occurs



Table 112 – Exposure of Downstream Villages to a 100-year Flood and Dam Failure

Profile (km)	Left Bank		Right bank		Water level (m)			Houses possibly exposed in the event of:
	Name	Altitude (m)	Name	Altitude (m)	Normal conditions	Centennial flood	Maximum in the event of dam failure	
143580	Dam							
141853	Detached house	1291			1278	1282	1288	Dam failure
140696			Detached house	1300	1268	1270	1276	
136083			Detached house	1088	1060	1064	1069	
134974			Detached house	1015	1006	1009	1013	Dam failure
129077	Faravohitra	612			603	607	614	Dam failure
127090	Hamlet 32	602	Hamlet 33	602	598	603	610	100-year flood or dam failure
121811	Hamlet 30	572	Hamlet 31	573	562	566	575	Dam failure
120373			Hamlet 29	588	557	563	571	
118903	Atanambao	559	Atanambao		550	559	567	100-year flood or dam failure
117612			Hamlet 28	560	548	554	562	Dam failure
113429	Hamlet 27	559			545	551	558	
107563	Hamlet 26	561				547	552	
105280			Hamlet 25	554	535	542	546	
104298			Lohavanana	541	533	537	541	100-year flood or dam failure
97702			Hamlet 24	440	433	439	442	
90741	Ambinanisahasaty	369	Ambinanisahasaty	373	361	365	369	
85919	Hamlet 23	352			348	355	359	
85483			Hamlet 22	362	347	354	359	Dam failure
82119	Hamlet 21	351			344	347	350	100-year flood or dam failure
79537	Hamlet 20	329			315	318	322	
76427			Hamlet 19 (promontory)	317	300	307	312	Dam failure
74237			Hamlet 18	316	299	302	305	
69856	Hamlet 16	280	Hamlet 17	278	260	265	268	
65067	Hamlet 15	251			236	239	243	
62242			Hamlet 14	231	220	228	234	100-year flood or dam failure
58259			Hamlet 13	230	216	221	225	Dam failure

Madagascar - Sahofika Hydropower Plant
 Environmental and Social Impact Assessment - Version D

54081	Hamlet 12	176			158	161	162	
51308	Hamlet 11	127			110	115	118	
48341	Hamlet 10	88			76	80	84	Dam failure
41242			Hamlet 9	68	59	67	71	100-year flood or dam failure
37763	Hamlet 8	84			53	59	63	
36250			Hamlet 7	63	48	54	58	Dam failure
34474			Hamlet 6	50	44	50	54	100-year flood or dam failure
29050	Hamlet 5	43			32	36	39	Dam failure
26361			Hamlet 4	33	27	30	33	100-year flood or dam failure
23464	Andovolalina	31			23	28	31	
22469			Hamlet 3	33	22	26	30	Dam failure
19149	Hamlet 1	23	Hamlet 2	24	16	20	23	100-year flood or dam failure
10855	crossing	12	crossing	12	6	10	12	
4371	Betsizaraina	15			1	4	6	
0	Salehy	6	Ambodiharina	6	0	1	2	Dam failure
	Ocean							

Figure 84 – Exposure of Downstream Villages to a 100-year Flood and Dam Failure

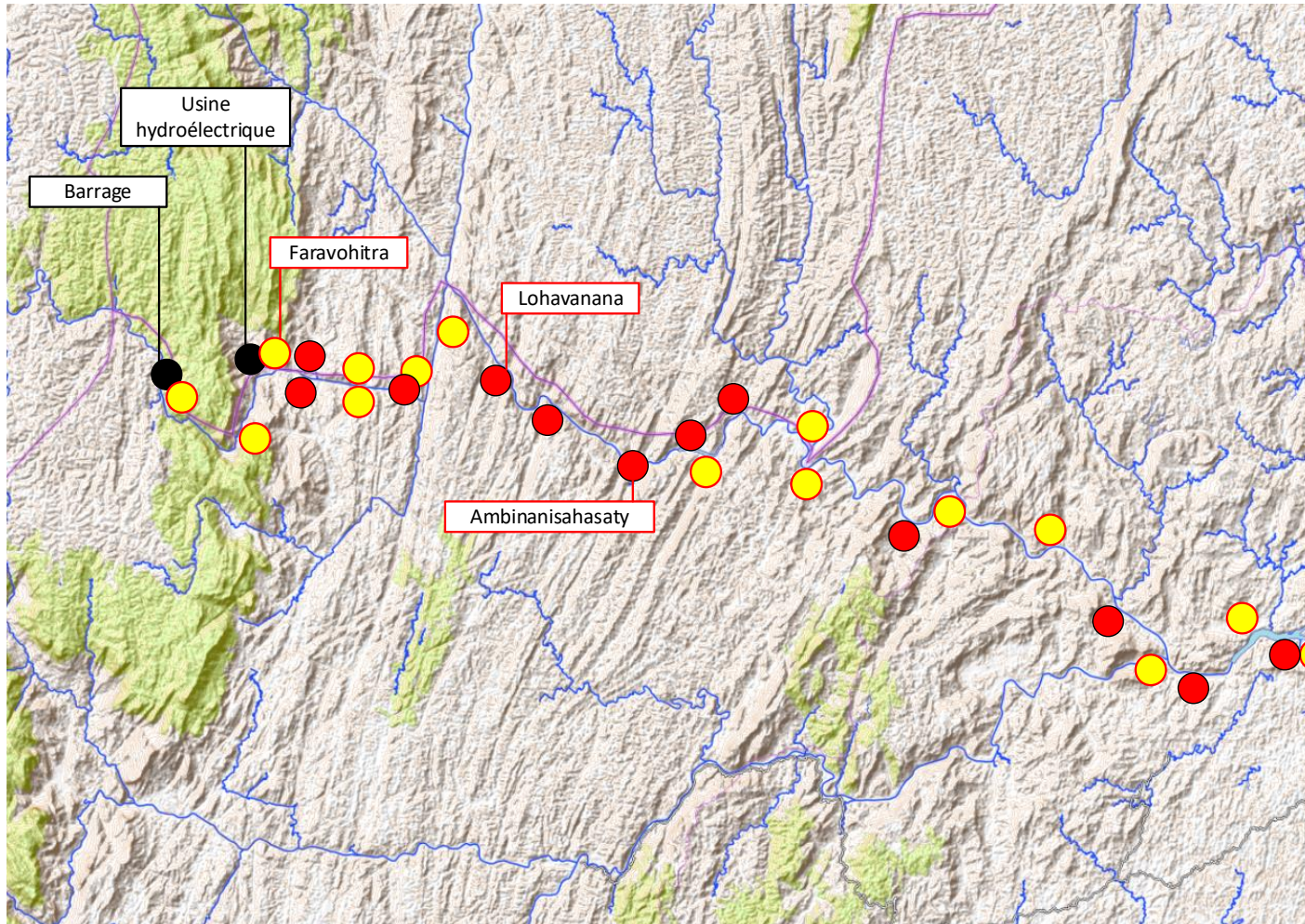

Village exposé à la crue centennale et à l'onde de rupture du barrage



Village exposé à l'onde de rupture du barrage

Note: In Figure 85, villages mentioned in Table 119 but not exposed to the dam failure wave are not shown for readability reasons.

A sensitivity analysis of the hydraulic model results was conducted, modifying (i) the Manning roughness coefficient, and (ii) simulating failures twice as slow or twice as fast. The results of this sensitivity study are presented in Table 120:

Table 113 – Sensitivity Analysis of the Dam Failure Model

	Model used (Manning = 0.05 and failure in 6 hours)	Model with Manning = 0.04	Model with failure in 12 hours	Model with failure in 3 hours
Beginning of the arrival of the wave in Faravohitra	1h 00'	1h 00'	1h 40'	0h 45'
Arrival of the wave peak in Faravohitra	4h 30'	4h 25'	8h 40'	2h 25'
End of the wave in Faravohitra	16h 40'	16h 40'	20h 30'	14h 50'
Maximum water level in Faravohitra	614.12 m	612.93 m	612.72 m	614.95 m
Peak flow in Faravohitra	+ 8,503 m ³ /s	+ 8,546 m ³ /s	5,995 m ³ /s + 5,995 m ³ /s	10,263 m ³ /s + 10,263 m ³ /s
Beginning of the arrival of the wave at the ocean	9h 15'	8h 50'	11h 15'	7h 55'
Arrival of the wave peak at the ocean	11h 45'	10h 50'	15h 30'	9h 55'
End of the wave at the ocean	22h 20'	23h 40'	30h	20h 30'
Peak flow at the ocean	6 232 m ³ /s + 6 232 m ³ /s	6,477 m ³ /s + 6,477 m ³ /s	+ 4,972 m ³ /s	+ 6,806 m ³ /s

Note: The dam failure begins at 00:00'. The peak flow indicated is that which comes in addition to the 100-year base flood flow.

The sensitivity analysis of the hydraulic dam failure model shows:

- A marked influence of the dam's failure rate on the speed and peak of the flood wave downstream. However, the dam failure rate remains a parameter that cannot be precisely assessed, as it depends on triggers that are not anticipated by nature (geological weakness, human error, etc.).
- A limited influence of the various scenarios on level variations.

The greatest perceived uncertainty in the preparation and use of the hydraulic model is that related to topography, including the exact elevation of the most exposed houses relative to the riverbed. It is essentially this point that will need to be verified in the field when preparing the emergency plan for the dam.

5.9.4 Mitigation Measures

The dam failure analysis showed the presence of 46 inhabited areas downstream from the dam, between the dam and the ocean. Of these 46 sites, 13 would probably not be exposed to a dam failure, 16 would be exposed to a dam failure, but not a 100-year flood, and finally, 17 would probably be exposed to a dam failure, and a 100-year flood: these

figures are indicated using the conditional, as a refined dam failure model will have to be performed (with site visits) to confirm the actual exposure of villages.

In the absence of a civil security structure in the country, the Project will set up an alert system to enable the populations concerned to take shelter in the event of an exceptional flood, whether natural or caused by a malfunction or failure of the dam. The additional risk caused by a potential failure of the dam will thus be compensated by a reduction in the populations' exposure to natural floods. This alert system will require a means of communication: the Project will opt for a VHF (or equivalent) solution, that makes it possible to combine an alert system and provide improved access to the populations thanks to the possibility of vocal exchanges.

All these measures are summarized in the following table:

Table 114 – “Dam Failure” Mitigation Measures

#	Measure	Implementation	
		Period	By
Rupt01	Visit all the inhabited places exposed downstream, taking into account the possible water upwelling in the Mangoro River upstream from the confluence with the Onive. Verification of local topography, historical flood levels, house elevations relative to the riverbed and the presence of refuge sites within walking distance.	Construction, before impoundment	EPC
Rupt02	Hydraulic model of the ten-year, centennial flood and dam failure, based on the detailed project and field visit. Identification of exposed villages and possible refuge sites.	Construction, before impoundment	EPC
Rupt03	Preparation of an emergency response plan based on the model defined in the ESIA.	Construction, before impoundment	EPC
Rupt04	Implementation of the operational elements of the emergency response plan, including information and training of villagers, means of communication and alerting the villages concerned (VHF or telephone antennas), and marking of refuge areas in the villages concerned.	Construction, before impoundment	EPC
Rupt05	Operation and maintenance of the communication system described in the Rupt04 action.	Operation	NEHO
Rupt06	Every ten years: verification and update of the emergency response plan.	Operation	NEHO

5.9.5 Contents of the Emergency Response Plan

5.9.5.1 Possible Causes

The Emergency Response Plan (ERP) to be prepared prior to filling the reservoir will define the measures to be implemented by NEHO in the event of an emergency situation likely to impact downstream populations, and therefore requiring information or response from civil protection services.

The relevant emergency situations in the context of the Project are as follows:

- Spill by the Sahofika Plant of a flow equal to or greater than the ten-year flood without risk of dam failure, for one of the following reasons:
 - Natural raw water
 - Lowering of the reservoir for technical emergency reasons
- Spill (or risk of spillage) by the Sahofika Plant that exceeds the capacity of the spillway, with the risk of dam failure, for one of the following reasons:
 - Loss of integrity of the dam or its components
 - Inflow rate higher than the discharge capacity of the Sahofika dam

Each of these emergency situations will be modelled in order to assess the downstream consequences of such an event.

5.9.5.2 Structure of the Sahofika Emergency Response Plan

The ERP will be prepared in accordance with the recommendations of IGBC (ICOLD, 2017).

The ERP will consist of three documents:

Table 115 - Contents of the Emergency Response Plan

	Minimum content	Document life
Risk Analysis	<ul style="list-style-type: none"> ● Typical scenarios that could generate an emergency situation (breach, exceptional spill...) ● Downstream wave modelling for each scenario as well as for decadal or centennial natural floods ● Mapping for each scenario of the progression and magnitude of the flood wave and the inhabited areas impacted 	Internal document for the preparation of internal and external ERPs. Reviewed every ten years.
Internal ERP	<ol style="list-style-type: none"> a. Name or position of NEHO persons authorized to initiate emergency procedures and of the person responsible for mitigation measures at the dam site and their coordination; b. Name, position and contact of NEHO persons authorized to contact villages downstream to order them to reach refuge sites; c. Name or position of the person responsible for liaison with the Malagasy authorities; d. Names and contacts of representatives of the Malagasy authorities to be contacted in the event of an emergency; e. For each scenario (see risk analysis), a description of the measures to be taken internally to control this situation or event and to limit its consequences, this description must include the safety equipment and resources available; f. Measures to limit the risks to persons at the 	Internal document Reviewed annually Reviewed every ten years

	<p>hydropower plant site, including warning system and action to be taken when the warning is triggered;</p> <p>g. Measures taken to ensure that, in the event of an incident, the Malagasy authorities are informed promptly, the type of information to be provided immediately and measures concerning the communication of more detailed information as it becomes available;</p> <p>h. If necessary, arrangements shall be made to train staff in the tasks they are expected to perform and, where appropriate, to coordinate this action with external emergency services;</p> <p>i. Emergency measures to support people who have lost their homes.</p>	
<p>External ERP</p>	<p>a. Name, position and contact details of NEHO persons authorized to contact the Malagasy authorities to initiate emergency procedures;</p> <p>b. Plan and technical description of the Sahofika Plant;</p> <p>c. Description of emergency scenarios and mapping for each scenario of the progression and magnitude of the flood wave (see risk analysis);</p> <p>d. Provisions to support mitigation measures taken at the site.</p>	<p>Document for the Malagasy authorities</p> <p>Reviewed every ten years or at the request of the Malagasy authorities</p>

6 Social Impact Assessment and Mitigation

6.1 Detailed Social Influence Area

The Project's detailed social influence area is described in the following table.

Table 116 – Project's Area of Influence and Identified Impacts

Type of Impact	Area of Influence
Traffic: impacts related to vehicle and passenger traffic	Main access track between Antanifotsy and Antenina via Belanitra Pedestrian routes between Antenina and Faravohitra
Nuisances: impacts related to noise and dust caused by the Project	Villages and isolated houses from Antenina to Faravohitra Villages located along the main track from Antanifotsy to Antenina
Inflow of people/local employment: impacts and risks related to the influx of people and local employment	Inflows: Villages and land near construction sites (Antenina and Faravohitra). Employment: population of affected villages and job seekers from outside the impacted area.
Health and safety: risks to the health and safety of populations and workers	All communes impacted by the Project in the three (3) districts: Antanifotsy, Ambatolampy, Anosibe An'ala
Heritage: impacts on tangible and intangible cultural heritage	The area around the dam and reservoir, the Powerhouse and related infrastructure Along the track between Antanifotsy and Antenina
Use of natural resources: impacts on access to natural resources (water, river, NTFPs, timber, wildlife, ecosystem services)	Natural resources related to the Onive River and its banks (from the upstream part of the reservoir to the downstream part of the plant), and to the environments crossed by the Project between Antenina and Faravohitra. The forest
Risks specific to vulnerable individuals ;	All communes impacted by the Project in the three (3) districts: Antanifotsy, Ambatolampy, Anosibe An'ala
Risks specific to women (gender approach)	All communes impacted by the Project in the three (3) districts: Antanifotsy, Ambatolampy, Anosibe An'ala

The area of influence of the sites where the Sahofika Hydropower Plant Project was located was on the following administrative entities:

- Six (6) communes: Belanitra, Tsinjoarivo, Ambalaomby, Ambatomiady, Ambohitompoina and Antanifotsy
- Three (3) districts: Antanifotsy, Ambatolampy and Anosibe An'Ala
- Two (2) regions: Vakinankaratra and Alaotra Mangoro

The following map shows the extent of the social impact analysis area

Figure 85 – Map of the Social Impact Analysis Area

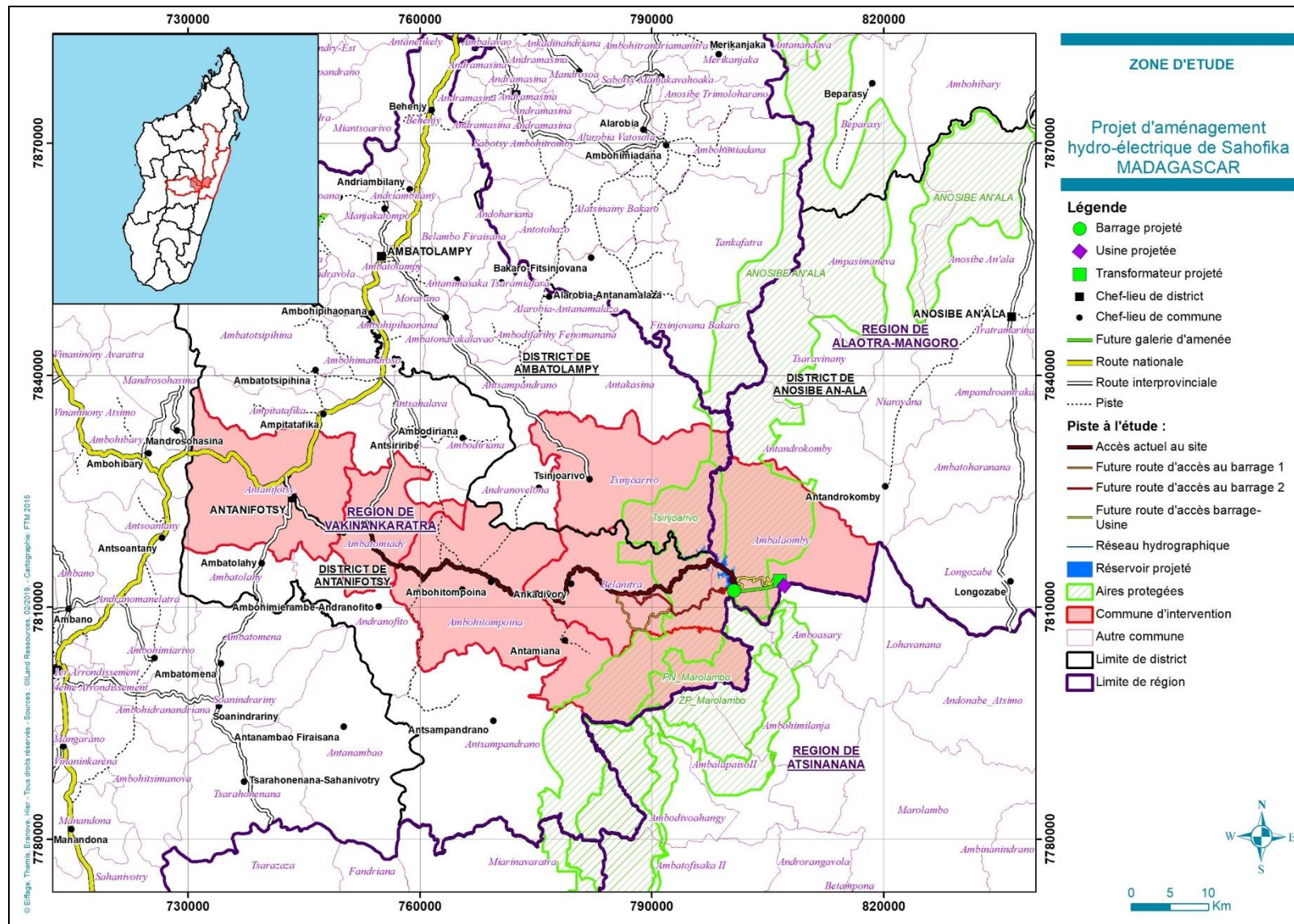

6.2 Description of the Sources of Impacts on the Human Environment

The physical impacts described in Chapter 5 are the initial sources of the social impacts described below.

6.2.1 Construction/Improvement of Access Roads

The construction and improvement of roads involves a number of social risks during the construction phase (risks of accidents, nuisances, or inconveniences) which are essentially linked to the activities of the construction machinery that will be found on the built roads.

The transport of excavation and backfill materials, material spreading and compaction work require machinery that is rarely found on the region's roads.

6.2.2 Supplying the Site

The transportation of equipment and materials on rehabilitated or created roads will expose road users to risks. Traffic will increase significantly on some sections compared to the current situation. In addition, several exceptional loads will have to be transported to the dam.

6.2.3 Presence of the Base Camp and Site

A minimum of two life base camps will be built: one in the dam area and one in the plant area. The presence of the base camps and the construction site will attract people looking for work or with services or products to sell.

The presence of non-native workers from different cultures will generate risks, for example social unrest and the transmission of various diseases.

6.2.4 Construction of the Hydropower Plant

The construction of the hydropower facility will result in heavy traffic around the construction sites, and many nuisances (noise, dust...) during the 54-month construction phase.

6.2.5 Impoundment of the Reservoir

The creation of the reservoir will lead to the flooding of inhabited and cultivated areas: This is the main negative socio-economic impact of the Project. These aspects are addressed in the Resettlement Action Plan (RAP) that complements this ESIA. For the purposes of this report, only social impacts other than those related to the loss of land, livelihoods or places of residence are addressed.

6.2.6 Operation of the Hydropower Plant

Impacts during the operation phase will be mainly related to public safety issues: traffic on the created trails, hydraulic impacts downstream, access to the reservoir.

The sources of impacts can be listed as follows for information purposes according to the various phases of the Project:

Table 117 - Sources of Potential Impacts According to the Various Phases of the Project

PROJECT PHASE	SOURCE OF IMPACT
PREPARATION STAGE	The preparation phase is already well advanced and the first sources of impact have already been identified: Presence of workers Demand for goods and services Surveys and investigations Information and consultation process: individual and group meetings
BUILDING PHASE	Civil engineering works Brushing, stripping and earth moving dredging and backfilling Development and creation of access roads Construction of migrant workers' base camps and their use Population influx and access to local employment Transport of equipment and heavy material Crane, dump truck and compactor Materials and equipment for penstock and surge tank Transport of building materials Cement for the construction of the dam Construction materials for buildings Construction materials for roads Staff travel Water filling (filling the reservoir)
OPERATION PHASE	Creation of the reservoir Reservoir edge installations Changes in water regime and quality Tidal flow of the reservoir Protection and security of installations Transport of material and circulation of personnel

All procedures related to the acquisition of land and compensation for loss of livelihood are described in the Resettlement Action Plan (RAP) that complements this ESIA.

To avoid incidents related to the conduct of work in areas that have not been acquired or compensated for by the Project, it will be important for the EPC to put in place a procedure for entering the land, including validation and marking of the areas released and accessible to the Project, and training of personnel likely to enter such land.

Table 118 - "Entry into the Land" Risks and Mitigation Measures

Nature of the risk	Risk	#	Mitigation Measure	Implementation	
				Period	By
Carrying out work or activities on land that has not been acquired or released	Low	Entr01	Implementation of a procedure for entering the land, including validation and marking of the areas released and accessible to the Project, and training of personnel likely to enter such land	Before and during construction	EPC

6.3 Social Issues, Opportunities and Risks

The main issues and risks related to the implementation of the Project are defined below:

6.3.1 Roads: Opening up and Community Safety

During the construction phase, the access roads leading to the Project area, between Antanifotsy and the dam / power plant, will be used by heavy vehicles, which is not currently the case. The continued presence of these vehicles on the road will create accident risks.

Apart from Project vehicles, the rehabilitated road will encourage other vehicles to use this track and therefore increase traffic density. Since the local population is not used to this type of traffic, the risk of accidents can become higher.

The road access that will be created from Belanitra to Faravohitra will play a very important role in opening up the area, especially for people in the vicinity of the hydropower plant. However, during both the construction and operation phases, public traffic on this track will have to be regulated, for reasons relating to (i) road safety, (ii) the crossing of two protected areas (Marolambo NP and NPA of Tsinjoarivo), and (iii) the general responsibility of the Concessionaire as owner of the track.

6.3.2 Food Self Sufficiency

About 890 hectares of land will be drowned by the formation of the reservoir, including about 30% of agricultural land used by people affected by the reservoir. The lowlands in the reservoir area are used for the cultivation of rice and other staples. The disappearance of this area will result in a loss of livelihood that is being addressed under the RAP.

6.3.3 Pressure on Protected Areas

The loss of agricultural land may lead to additional pressures on protected areas, especially because:

- People who are not displaced under the RAP could look for agricultural production sites that match their production habits. These production sites are often forests.
- The newly created reservoir will provide access to areas protected by canoes and boats, which may lead to increased pressure on the latter
- The construction/rehabilitation of tracks will lead to an influx of migrants, with an increased risk for protected areas, as unemployed newcomers may tend to move closer to the forest to have easier access to resources.

6.3.4 Land Management

The vast majority of people work the land without any land rights. The Project will secure the land on which its infrastructure will be built.

To protect displaced populations, the Project will also ensure land tenure security of resettlement sites for displaced people so that they can have full enjoyment of the land. These activities present a risk of weakening the situation of undisplaced people who will be without land titles.

6.3.5 Market for Local Products

Due to the loss of production sites, the disruption of transport on the roads leading to the various production sites, higher demand due to the presence of workers, the monetization

of the local economy due to job creation, but also the presence of migrants who will come to the area to look for work, a significant increase in local product prices is expected.

6.3.6 Social Stability

Several local production systems will be temporarily or permanently destabilized. Conflicts could arise between people who will be displaced and those who will not, but also between indigenous and non-indigenous populations and newcomers (job seekers, traders of all kinds, services, etc.).

The use of the reservoir could also become a source of conflict: it is quite possible that populations accustomed to fishing on water bodies will migrate to the reservoir to develop their activities.

Local traditional authorities could also be affected by the fact that the Project under construction may be piloted at the regional / national level.

The presence of foreign workers and in particular the risks of spontaneous migration of people seeking employment (which has already started with the current study and planning period) could also have a negative impact on social stability.

6.3.7 Health

The main public health risk for a large-scale project such as the Sahofika Project is the risk of the proliferation of sexually transmitted diseases (STDs) in the area. The following elements are likely to increase the risk of the spread of communicable diseases in the area:

- The arrival of workers for construction activities;
- The creation of potential meeting points such as temporary markets, usually spontaneously created according to the needs of those working in the Project;
- Job creation / search: external people will be attracted by the Project and will come to the area in order to find a job.

These cases have already been observed during the preparation phase of the Project:

- Migration flow: in addition to temporary migrants, other people can come to the area to settle permanently when they see the potential, especially after the rehabilitation of the track. This point is all the more essential as the area is marked by potential gold mining areas.
- Tourism: the creation / rehabilitation of the trail service can develop tourism in the area in relation to the presence of protected areas. Unfortunately, tourist flows can also contribute to the increased risk of STD proliferation.

6.3.8 Local Practices

The arrival of foreigners/non-natives can have negative impacts in the local community if they do not respect local practices. Sacred sites, rituals, different local practices are generally a sensitive subject in the eyes of the local population.

6.4 Contextual Analysis

Considerations guiding the implementation of the Project's mitigation measures are as follows:

- A young population: 50% of the population is under 18 years of age.
- Low level of schooling: 50% of the population only reaches primary school level or less.
- Nearly 75% of the population lives mainly from agriculture and uses production methods adapted to the situations and means of the population, but very inefficient and dependent on meteorology and forest resources in part.
- Breeding is carried out in the traditional way, without veterinary controls and without breed improvement and mainly in extensive mode.
- Fishing and aquaculture are very secondary practices, but nevertheless exist in the area.
- The energy consumed is mainly wood-related.
- In the area, the rate of deforestation ranges from 1 to 2% per year depending on the level of isolation. By extracting the protected areas created, there is virtually no more forest and woody material for households to use.
- The territory is landlocked and there is no direct access to the sea. The poor quality of existing transport links in the region hinders trade, but has also kept pressure on protected areas and forests at a relatively low level compared to other parts of the country, which motivates the creation of new protected areas there.
- Land is managed in a traditional way and remains extremely problematic.
- About 50% of households have a monetary income of less than 8 million MGA per year (2200 USD/year) or for an average household of 7 people, 0.86 USD/day per person. 50% of the affected population lives with the equivalent of less than 2 USD per person-day.
- Traffic on the roads is mainly by order of importance by bicycle or rickshaw, on foot, by motorcycle and by cart. Trucks and other motor vehicles represent less than 1%, due to the poor quality of the road, which explains the low level of trade.

The Project could generate the following changes:

- Improved access roads will lead to an opening up of the area and the end of certain commercial monopolies: production will have the capacity to leave the area more easily and the selling prices of production will be balanced with those of the market at regional / national level.
- The land registration process for Project lands as well as those related to resettlement will establish a land rights registration procedure that could be replicated and used in the area.
- The Project will generate an upgrade of existing GSM cellular networks to cover the region, both for the construction and operating period, thereby opening up the region to external communication opportunities.
- An improvement in access to electricity at the national level but also at the local level with the initiatives that will be carried out by the Concessionaire to develop rural electrification in the vicinity of the Project area.
- Development of the local economy (supply of goods and services) due to the benefits induced by the presence of a large industrial operator.

This large-scale project will bring about a profound socio-economic change in the region as a result of:

- Improved existing traffic lanes.
- New roads being created.

- Hundreds of direct and indirect jobs being created in the short and medium terms and will also skills development opportunities for the local population.
- Easier trading activities.
- A much greater monetarization of services and various exchanges.
- Significantly improved tourist potential in the area.
- An additional local market for agricultural and livestock production.
- Higher prices of some commodities, and greater accessibility of others.
- Increased ethnic mix due to the presence of workers and migrants.
- Displacement of several hundred households.
- Creation of new villages.
- Inflation being a major risk: the area that is currently developing almost in autarky due to supply and marketing difficulties will quickly be opened up and open to trade and demand from the Project's employees..

The main social impacts will start with the improvement of existing roads and the creation of new ones, and will then be more concentrated around places of employment, life bases and construction sites and on the roads through which equipment and construction materials will arrive.

The positive and negative socio-economic impacts will be at their peak during the construction period of the hydropower plant. This situation will last about 4 years and will decrease rapidly after the reservoir is filled, the plan is commissioned and operations begin.

The sources of impact are similar in nature for the various components of the hydropower plant. However, there will be an amplification phenomenon as the various construction sites start up:

- Increased number of workers
- Increases input consumption
- Increasing frequency of road use
- Increased trade exchanges
- Increased consumption of water and local food resources
- Increased excavated material

The construction of the power transmission line will not experience this amplification phenomenon: its impacts will be localized, diffuse and temporary, with several mobile worksites.

6.5 Impacts and Mitigation Measures

6.5.1 Impact and Residual Impact Mitigation Hierarchy

The approach used to define impacts follows the requirements of Malagasy legislation and IFC and AfDB policies, which require that impacts be mitigated as follows (using the terms of Malagasy legislation):

- As a priority, seek to "Remove" the impact in order to avoid it,
- Second, if it is impossible to remove the impact, try to "Reduce" it as much as possible.

- If the measures to reduce an impact do not make it insignificant, the impact remaining after reduction is called residual impact and additional mitigation measures are implemented to “compensate” it.

6.5.2 Impact Significance

In order to facilitate the reading of the ESIA and the identification of the most significant impacts, the significance of each of the impacts was noted as follows:

Table 119 – Definition of Social Impact Significance

Probability of occurrence	Consequences		
	Impact limited in time or space, with no impact on life or livelihoods	Widespread or lasting impact with no consequences on life or livelihoods	Impact on life or livelihoods
Very likely	Moderate	Important	Important
Possible	Low	Moderate	Important
Unlikely	Low	Low	Moderate

6.6 Working Conditions

The main risks related to employment conditions during the construction phase but also during the operation phase are related to forms of illegal employment or discrimination that could develop along the subcontracting chain. Compliance with Malagasy legislation and the principles of the IFC and the AfDB must be ensured and monitored for all service providers involved in the Project. It should be noted that under the Project, the minimum age of workers will be raised to 18 years (legislation authorizes work from 15 years of age).

All risks and associated mitigation measures are summarized in the following table; all of them are used to eliminate or minimize the risks described:

Table 120 - "Working Conditions" Risks and Mitigation Measures

Nature of the risk	Risk	#	Mitigation Measure	Implementation	
				Period	By
In particular, forms of unlawful employment or engagement: <ul style="list-style-type: none"> • Work by minors (under 18 years of age), • Engagement of personnel without formal commitment declared to the State services, • Hiring staff without a written contract, • Unpaid overtime, • Any form of discrimination or harassment. 	Moderate	Trav01	<ul style="list-style-type: none"> • Prepare a human resources (HR) policy incorporating the key principles of Malagasy legislation and IFC and AfDB standards, including the obligation for all companies involved in the Project to comply with this policy, and information on the content of this policy when hiring workers. • Disclose this policy on bulletin boards in the Project's social areas (offices, cities, etc.). • Include this policy in all subcontracted contracts by requiring (i) compliance with this policy by these companies and (ii) the obligation to require compliance by any company contracted by this subcontractor. 	Design, construction and operation	EPC before operation, NEHO after
		Trav02	<ul style="list-style-type: none"> • Regular monitoring (at start-up and once a month) of compliance with HR policy by companies working for the Project, based on audits of workers. • Exclusion after first warning of companies and service providers found in default. 		
		Trav03	Provision of a recourse mechanism to workers as part of the HR policy, in accordance with IFC and AfDB standards		
Unequal opportunities for women to access employment.	Moderate	Trav04	Ensure a gender-friendly work environment (including no unisex toilets or changing rooms) during the construction and operation phases.	Design, construction and operation	EPC before operation, NEHO after
		Trav05	Explicitly indicate in the offers that the positions are open to both men and women.		
		Trav06	For qualified or responsible positions, ensure a gender balance of pre-selected candidates invited for an interview		

6.7 Worker Health and Safety

6.7.1 Construction Phase

The construction phase requires the implementation of a set of activities, all of which are, to varying degrees, associated with accident risks. Some of the activities to be carried out on the site are particularly at risk because they leave little or no room for error or can have severe consequences, for example: work at heights, work in excavations or confined spaces, work on electrical systems, work on pressure systems, work on, above or in water, use of explosives, movements of heavy construction machinery.

Road accidents will also be a significant risk for the Project during both the construction and operation phases, due to the distances to be covered, the stiffness of some access roads (descent from the rocky escarpment to the plant), the frequent poor condition of public roads and the vehicles using them, and finally the difficult weather conditions that can occur.

For the construction phase, the EPC will be responsible for the organization and management of health and safety risks within the perimeter of the facilities and work sites: all persons entering these sites (workers, suppliers, visitors, NEHO employees, etc.) must comply with the EPC rules, which in return must be clearly informed of these rules. The EPC's ability to prepare and implement a worker health and safety management plan that meets the most stringent requirements, and the fact that the EPC has modern health and safety management tools and methods proven on other sites of similar size were key factors in the choice of the EPC company.

The EPC will prepare a "Worker Health and Safety Plan" with the objective of eliminating or minimizing the risk of accidents. It will be complemented by an "Emergency Prevention and Management Plan" to define the means and methods used to manage any emergency situation that may occur. The specifications for these two plans are specified below.

The EPC will also prepare a Management Plan for the Base Camp and Workers' City, the aim of which will be to provide workers with a healthy living environment.

6.7.1.1 Specifications for the EPC Workers' Health and Safety Plan

This plan will be prepared with reference to the following elements:

- Worker Health and Safety Chapter of the ESIA
- IFC EHS Guidelines:
 - Chapter 2 "Occupational Health and Safety"
 - Chapter 4.2 "Occupational Health and Safety"

In particular, this plan will describe the following elements:

- Health and safety rules and organization.
- Staff training
- Collective protective equipment.
- Personal protective equipment.
- Medical resources (staff, equipment, insurance), medical follow-up of workers and management of first aid.

- Activities subject to specific training, permit or prior authorization.
- Procedures for prior risk analysis and approval of working conditions for new tasks or activities at risk, including: excavation work, work at height, lifting, storage and use of explosives, work on or under water, live systems, pressure systems.
- Traffic management plan within the site area, including risk reduction measures for workers.
- Minimization of workers' exposure to noise, dust and air emissions (see actions Atmo01 to Atmo10 of the ESIA)
- HSE monitoring and recording of incidents and accidents (for transmission to NEHO): near misses, incidents/accidents without lost time, accidents with lost time, fatalities.
- Regulation of access to site related facilities:
 - Safekeeping.
 - Separation of the site and public areas.
 - Intrusion prevention.
- Standardized contractual obligations for the respect and implementation of the EPC Workers' Health and Safety Plan by the entire chain of EPC subcontractors working on facilities and work areas under the control of the EPC.

6.7.1.2 Specifications for the EPC Emergency Prevention and Management Plan

This plan will be prepared with reference to the following elements:

- Worker Health and Safety Chapter of the ESIA
- Chapter 3.7 "Emergency Preparedness and Response" of the IFC General EHS Guidelines

This plan will include catastrophic risks of natural origin (cyclone) or not, such as a cofferdam failure or a partial collapse of the tunnel.

This plan will take into account the absence in the area of the Project of a rescue or care structure likely to be mobilized quickly in the area (hospital, fire brigade, SAMU...).

The EPC Emergency Prevention and Management Plan covers all persons working in facilities and work areas under the control of the EPC or exposed to activities under the control of the EPC, whether these persons are EPC workers, subcontractors' workers or members of the public.

6.7.1.3 Management Plan for the Base Camp and Workers' City

This plan will be prepared with reference to the following elements:

- Worker Health and Safety Chapter of the ESIA
- SFI Guide for Workers' Housing ([here](#))

The plan will include the establishment of a workers' canteen (in accordance with Malagasy legislation) to provide healthy food for workers.

6.7.2 Operation Phase

For the operation phase, the risks of certain activities purely related to construction will be eliminated, but some risks will remain, for example those related to vehicle traffic. For this

phase, NEHO will develop this phase a health and safety management system for its workers, based on risk analysis and ISO45001 standards.

All risks and associated mitigation measures are summarized in the following table; all these mitigation measures are intended to eliminate or minimize the risks described.

Table 121 - “Worker Health and Safety” Risks and Mitigation Measures

Nature of the Risk	Risk	#	Mitigation Measure	Implementation	
				Period	By
Any type of accident or incident during construction activities	Important	Sstr01	Preparation and implementation of a Worker Health and Safety Plan for the construction phase, approved by NEHO, and in accordance with ESIA specifications.	Before and during construction	EPC
Emergency situation of natural or technological origin	Important	Sstr02	Preparation and implementation of an Emergency Prevention and Management Plan for the construction phase, approved by NEHO, and in accordance with ESIA specifications.	Before and during construction	EPC
Health and safety responsibility not clearly defined	Important	Sstr03	Appointment within the EPC of a Health and Safety Manager in charge of the preparation, updating and implementation of the Workers’ Health and Safety Plan and the Emergency Prevention and Management Plan. The Health and Safety Manager reports directly to the site manager, and defines the resources he needs to ensure and control the implementation of the two plans mentioned above.	Before and during construction	EPC
Effective compliance with health and safety rules by the chain of subcontractors	Important	Sstr04	Include standard contractual obligations for the respect and implementation of the EPC Workers’ Health and Safety Plan in all contracts of companies in the subcontracting chain.	When subcontracting subcontractors	EPC
	Important	Sstr05	Continuous monitoring of compliance with the Workers’ Health and Safety Plan by the companies working for the Project, organized by the Health and Safety Manager. Exclusion after first warning of companies and service providers found in default.	During construction	EPC
Conduct of security personnel	Moderate	Sstr06	If security personnel (private or public seconded) are contracted for the Project, train them in the United Nations Voluntary Principles for Security and Human Rights.	Design, construction and operation	EPC before operation, NEHO after
Healthy environment during non-working hours	Important	Sstr07	Preparation and implementation of a Base Camp and Workers’ City Management Plan for the construction phase, approved by NEHO, and in accordance with ESIA specifications.	During construction	EPC
Risk related to AIDS and other STDs	Important	Sstr08	Implement a systematic program to raise awareness among workers (induction) and regular awareness among populations (specialized NGOs) to ensure that the population, workers and at-risk groups are aware of the modes of contamination and have the means to protect them.	Before and during construction	EPC (workers) and NEHO (populations)
Health risk related to food and water	Moderate	Sstr09	Provide drinking water at all installations and worksites. Train workers (induction) in the risks of food poisoning or drinking water.	During construction	EPC

6.8 Community Safety and Security

6.8.1 Construction Phase

Construction site installations and work sites will be prohibited to the public. The main risks to public safety in the construction phase are therefore related to public/Project interactions in the context of the Project's use of the public domain: the use of public roads by Project vehicles, and the nuisances generated or the risks of accidents with third parties are the main risks in this respect.

This risk is worsened by the lack of alternatives to road transport, and the absence of major suppliers in the Project area.

The nuisances generated by traffic are noise, dust and atmospheric emissions: these impacts and the associated mitigation measures have been described in Chapter 5.5.1.

The mitigation of accident risks requires, on the one hand, the implementation during the construction phase of a specific management plan and, on the other hand, measures to minimize interactions with third parties on the tracks that will be under the Project's control.

6.8.1.1 Specifications for the EPC Road Traffic and Access Management Plan

This plan will be prepared with reference to the following elements:

- ESIA Chapters on "Noise, Dust and Air Emissions" and "Community Health and Safety"
- IFC EHS Guidelines:
 - Chapter 3.4 "Traffic safety"
 - Chapter 3.5 "Transport of dangerous goods"

This plan will include, among other things:

- Speed limits specific to the Project vehicles, with the installation of GPS or tachometers for monitoring and control.
- A driver training program, covering the basic rules (compliance with speed limits, wearing a seat belt, vehicle condition).
- Restrictions on traffic at night or during heavy rainfall.

6.8.1.2 Mitigation of Interaction Risks on the Site's Tracks

From Belanitra to Faravohitra, the Project will build its own tracks and therefore and which will, therefore, have private status - taking into account, however, that these tracks will be located in the buffer zones of two protected areas, Marolambo National Park and Tsingoarivo NPA.

The presence of these tracks will generate an expectation from the population or other potential users (state services, etc.) that it does not seem realistic to want to contain during the five years of construction through a strict ban on use. However, it is essential that the use of this track by the public during the construction period be regulated to avoid any accidents. It is therefore proposed that the following mechanism be implemented:

- The Project is setting up a shuttle bus to and from Belanitra-Faravohitra once in the morning and once in the evening, during the day:

- This shuttle is managed by NEHO's social team, which keeps statistics on the use of the shuttle (number of passengers and baggage weight) for the operation phase.
 - Passengers are welcomed on pre-registration, subject to availability.
 - The trip is subject to a charge, at a price corresponding to the practice for public transport in Madagascar over this distance. The sums collected are donated for the actions of the Project's Community Development Plan.
 - The shuttle operates only on days when weather conditions permit it and the EPC does not prohibit it.
- Representatives of State services or protected areas who wish to use the trail to access areas served by these trails should contact the NEHO social team. In all cases, these people leave their own vehicles in Belanitra except for emergency vehicles or vehicles of protected area managers for control missions.
 - For pedestrians, bicycles, motorcycles and carts from Belanitra to the dam site:
 - in order to avoid the risk of accidents, construction of a pedestrian - bicycle - motorcycle cart track along the proposed road, in order to separate traffic.
 - awareness-raising activities in villages on the use of this trail by pedestrians, bicycles, motorcycles and carts.
 - From the dam site to Faravohitra (pedestrians only):
 - Installation of a pedestrian crossing on the bridge.
 - Securing the pedestrian path from the dam to Faravohitra against the risk of interaction with Project traffic by developing crossings between the vehicular and pedestrian paths or by building local bypasses.

6.8.2 Operation Phase

The risks to public safety during the operation phase are related to:

- Vehicle traffic and accident risks: this risk is of the same nature as during the construction phase, but of a smaller magnitude due to lower traffic levels. The experience of the construction phase will make it possible to set up a regulated use of the Belanitra-Faravohitra track, with the aim of safely opening up the villages located near the hydropower plant. It should be borne in mind that the track that will descend from the escarpment will be long and steep (about 10 km to 10% of average slope) and that it would be inconsistent to allow any vehicle to travel freely on it.
- The operating conditions of the hydroelectric facility, including any rapid variations in flow that may occur downstream from the dam or hydropower plant as a result of the operation of the Project.
- Sailing on the reservoir: the populations are already accustomed not to sail during major floods, and not to approach the dam site by pirogue because it is followed by dangerous rapids. It will be necessary to sensitize the populations so that they keep this habit: with the dam as now, a person dragged downstream during flood periods would be lost. A ban on navigation for 1 km upstream from the dam will be put in place (this ban may be lifted for special cases such as the search for a body).
- Dangerousness of the reservoir for children: the calm waters of the reservoir could give a false impression of safety to children who cannot swim, and for this reason, among others, it will be necessary to prevent families from settling near the reservoir.

All risks and associated mitigation measures are summarized in the following table; all the measures are designed to eliminate or minimize the risks described.

Table 122 - "Community Safety" Risks and Mitigation Measures

Nature of the risk	Risk	#	Mitigation Measure	Implementation	
				Period	By
Accidents related to the traffic of construction site vehicles involving third parties	Important	Séco01	Preparation and implementation of a Road Traffic and Access Management Plan for the construction phase, approved by NEHO, and in accordance with ESIA specifications. This plan will include a ban on supply traffic to the site via Belanitra on Monday, Belanitra's market day. This plan will also include monitoring of human and vehicle traffic to adapt the Project's vehicle traffic rules if necessary.	Before and during construction	EPC
	Important	Séco02	Preparation and implementation of a Road Traffic and Access Management Plan for the operation phase, approved by NEHO, and in accordance with ESIA specifications.	Exploitation	NEHO
Acceptance of the Project if the Belanitra-Faravohitra track created for the Project is totally prohibited to populations and third parties. Risk of accident if the road created is used in an uncontrolled manner.	Low	Séco03	Installation of a shuttle bus making the round trip Belanitra-Faravohitra once in the morning and once in the evening, during the day: <ul style="list-style-type: none"> • This shuttle is managed by NEHO's social team, which keeps statistics on the use of the shuttle (number of passengers and baggage weight) for the operation phase. • Passengers are welcomed on pre-registration, subject to availability. • The trip is subject to a charge, at a price corresponding to the practice for public transport in Madagascar over this distance. The sums collected are donated for the actions of the Project's Community Development Plan. • The shuttle operates only on days when weather conditions permit and the EPC does not prohibit it. Representatives of state services or protected areas who wish to use the trail to access areas served by these trails should contact the NEHO social team. In all cases, these people leave their own vehicles in Belanitra except for emergency vehicles or vehicles of protected area managers for control missions.	During construction	NEHO Social Team
Interactions with pedestrians and bicycles	Important	Séco04	For pedestrians, bicycles, motorcycles and carts from Belanitra to the dam site: <ul style="list-style-type: none"> • in order to avoid the risk of accidents, construction of a pedestrian-bike path along the proposed road, with the aim of separating vehicle and pedestrian or bicycle traffic. The use by motorcycles of this track is prohibited. • Awareness-raising activities in villages on the use of this trail by pedestrians and bicycles. 	Before and during construction	EPC

			<p>From the dam site to Faravohitra (pedestrians only):</p> <ul style="list-style-type: none"> • Installation of a public pedestrian crossing on the bridge. • Securing the pedestrian path from the dam to Faravohitra against the risk of interaction with Project traffic by developing crossings between the vehicular and pedestrian paths or by building local bypasses. 		
<p>Acceptance of the Project if the Belanitra-Faravohitra track created for the Project is totally prohibited to populations and third parties.</p> <p>Risk of accident if the road created is used in an uncontrolled manner.</p>	Important	Séco05	<p>Organization of a consultative seminar with representatives of the population, state representatives and protected area managers to set up a circulation mechanism to open up the hydropower plant area, while minimizing the risk of accidents or use of the track for activities affecting protected areas.</p>	Before the operation phase	NEHO
	Important	Séco06	<p>Based on the conclusions of the seminar, implementation of a regulated traffic system, managed by NEHO in coordination with protected area managers.</p>	Exploitation	NEHO
<p>Risks related to rapid flow variations induced by dam gate operations</p>	Important	Séco07	<p>Installation of signs prohibiting access to the river to all roads for 500 m downstream</p>	During construction	EPC
	Important	Séco08	<p>Raising awareness of the risks of rapid flow variations among the most exposed people, especially downstream residents and children living in the vicinity (less than 5 km from the dam), as soon as the gates are filled and tested.</p>	Exploitation	NEHO
	Important	Séco09	<p>Programming and/or forecasting of flow variations that can be anticipated (spillage due to flood rise, sediment emptying), visual inspection of the downstream part of the dam before opening the gates and prior information to the downstream populations, using if necessary the communication system described in the Rupt04 action.</p>	Exploitation	NEHO
<p>Safety of persons navigating on the reservoir</p>	Moderate	Séco10	<p>Installation of an overhead cable prohibiting navigation on the reservoir within 1 km of the dam.</p>	Before impoundment	EPC
	Moderate	Séco11	<p>Information and awareness raising for canoeists.</p>	Before impoundment	NEHO
<p>Protection of populations against natural flooding (positive impact)</p>	Positive impact	Séco12	<p>On the basis of actions Rupt02 to Rupt04, set up a warning mechanism for downstream populations in the event of exceptional natural flooding likely to impact them.</p>	Before operation	EPC
<p>Risks related to rapid flow variations induced by turbine shutdowns and resumptions at the hydropower plant</p>	Moderate	Séco13	<p>Set up an audible alarm downstream from the plant, from the river opposite Faravohitra and in the exposed sites identified during the Downstream03 action tests.</p>	During commissioning	EPC
<p>Raising awareness among the youngest</p>	Moderate	Séco14	<p>Organize an annual visit to the dam and the plant for a specific age group (generally 10 years) to raise awareness and sensitize them to the risks associated with the operation.</p>	Exploitation	NEHO
<p>Safety of families around the reservoir</p>	Moderate	Séco15	<p>Expropriation and delimitation (boundary or equivalent) of a 100 m strip around the reservoir with prohibition to settle there. Annual verification that no one has relocated to this area.</p>	RAP Implementation and Operation	NEHO

6.9 Community Health

6.9.1 Construction Phase

During the construction phase, the main risks to the health of the communities will be related to:

- Increased incidence of AIDS and other sexually transmitted diseases;
- Health risks in the event of the development of slums or unhealthy establishments (gastrointestinal diseases, diarrhea, and cholera) linked to the uncontrolled installation of opportunists.
- Exposure to nuisances from site activities (noise, dust and atmospheric emissions), especially along traffic routes, which may affect sleep or aggravate respiratory symptoms.

6.9.2 Operation Phase

During the operation phase, the main health risk is the possible development of waterborne diseases. However, it is noted that, due to the significantly lower air temperature, the reservoir area is not as conducive to mosquito development as the plant area, and an impact is not currently certain: this point will therefore need to be monitored.

The risk STDs spreading will continue in the operation area if the Project area is opened to tourism.

All risks and associated mitigation measures are summarized in the following table; all the measures are designed to eliminate or minimize the risks described.

Table 123 - "Community Health" Risks and Mitigation Measures

Nature of the risk	Risk	#	Mitigation Measure	Implementation	
				Period	By
Increased incidence of HIV and other sexually transmitted diseases associated with construction or tourism development.	Important	Saco01	Implement a systematic and regular population awareness program (specialized NGO) to ensure that the population and at-risk groups are aware of the modes of contamination and have the means to protect them. (see also action Sstr08)	Before, during construction and during operation	NEHO
Increased incidence of gastrointestinal infections associated with the presence of informal human settlements created by workers/migrants	Moderate	Saco02	Implement an awareness and information program for people in the areas concerned, which will help to identify risks and disseminate basic hygiene measures.	Before and during construction	NEHO
Possible development of waterborne diseases	Moderate	Saco03	Capacity building and monitoring of statistics on waterborne diseases treated by health centers in the area of influence	Exploitation	NEHO
	Moderate	Saco04	Delimitation (demarcation or equivalent marking lasting over time) of a 100 m strip around the reservoir.	Construction	EPC
	Moderate	Saco05	Expropriation of the delimited area around the reservoir with prohibition to settle there (see measure Séco15). Annual verification that no one has relocated to this area.	Implementation of the RAP	NEHO
Health risks due to the exposure of populations to noise, dust and atmospheric emissions from construction activities	Moderate	Saco06	Minimization of exposure of populations to noise, dust and air emissions (see actions Atmo01 to Atmo10 of the ESIA)	Design, construction and operation	EPC before operation, NEHO after

6.10 Local Employment and Population Influx

6.10.1 Description of the Problem in the Context of the Project

The construction of the Sahofika Plant and the formation of the reservoir will lead to the arrival of people who will have been hired in connection with the Project, or of voluntary migrants in search of new economic opportunities. The majority of these migrants will be people who abandon living conditions considered unfavorable or less attractive, and who will settle in the Project area because they have been hired, or simply because of a perceived opportunity related to the Project without specific employment guarantee.

The term “migrants” therefore covers a wide spectrum of individual or family choices and social micro-dynamics that will vary over the life of the Project. However, due to Madagascar’s island situation, most of these migrants will come from Madagascar. The “migrants” may be:

- People who come from the area but have left it, for example for the Antananarivo metropolis, and who will come back to live with relatives or at home to benefit from the Project in order to improve their living or employment conditions.
- Persons employed by the Project (by NEHO, the EPC or EPC subcontractors) who will sometimes be accompanied by their families.
- Contractors and suppliers of goods or services (and their potential employees) who will establish themselves in the area, either as direct suppliers to the Project or to take advantage of the local increase in economic exchanges.
- People attracted by the exploitation of the resources made accessible by the Project.
- People looking for a job, qualified or not.

6.10.2 Impacts of the Project in Terms of Population Influxes

The direct labor requirement of the Project, estimated at a peak of several hundred unskilled local jobs, is a significant opportunity for the populations of the villages affected by the Project and the surrounding villages, both in terms of direct earnings (income) but also in terms of the experience that people employed by working on a large organized site will acquire.

To these direct jobs one must add the new opportunities that will be created by the jobs created. The need for food products and services will be multiplied, offering new markets to be conquered by the populations.

During the operation phase, the installation of the staff housing estate near the dam should also be accompanied by the development of commercial opportunities for the sale of goods and services.

Finally, the development of economic exchanges and the opening up of the Project area will be important sources of long-term income and will increase the opportunities for people from or outside the Project area to find employment there.

Beyond these positive impacts, the arrival of the population in the area is also associated with a number of negative impacts, which are described below.

6.10.2.1 Insecurity, Prostitution and Violence against Women and Girls

The massive influx of people, regardless of the reason, context and location, can be accompanied by increased insecurity.

The arrival of workers living far from their families and with higher incomes than those of the local populations, as well as the arrival of young men seeking employment, can encourage aggressive or inappropriate behavior related to alcohol consumption, the development of prostitution and violence against women and girls. The increased numbers of gambling and drinking establishments are additional factors that contribute to the emergence of such violence.

An associated consequence is generally an increase in the prevalence of sexually transmitted diseases, including AIDS. The prevalence of sexually transmitted diseases in the area could increase significantly.

These risks are mainly related to:

- Belanitra, an important village, where the new private road leading to the dam site will begin, is the point through which all people from Antsirabé or Antananarivo will pass. However, it should be the village where these risks will be greatest due to several unfavorable factors. Belanitra has a certain reception capacity, and is already a place of economic exchanges.
- Antenina and the vicinity of the dam: this area has a low capacity and a population with limited income. The houses located in the footprint of the dam and reservoir will also be physically relocated
- Faravohitra will be the main place of arrival and settlement for migrants seeking employment from the lower part of the Onive basin, due to its proximity to the hydropower plant construction site. This village also has a low capacity and a population with limited income.

6.10.2.2 Social Conflicts

Social and cultural conflicts can also arise during a large influx of people from diverse backgrounds and cultures. They can arise from a lack of knowledge or mutual understanding of each other's culture, which can be interpreted as a lack of respect or provocation. Non-compliance with Fady by uninformed people (migrants or workers) can, for example, be a trigger factor.

These conflicts may arise in relation to non-Malagasy people working on the Project, or between Malagasy populations, especially between newcomers and people who have been settled for a long time in villages affected by the Project.

6.10.2.3 Conflicts Related to Access to Employment

The issue of local preference for access to employment can be a source of significant conflict and must therefore be discussed and clarified with all stakeholders.

There are high employment expectations from the Project. The principle established by NEHO is to give priority to people from villages affected by the Project's right of way when it comes to the hiring of unskilled workers. This calls for a number of comments:

- The Project may not have the opportunity to hire all the people looking for work. Employment will be provided in compliance with the legal requirements (for example, a person who knows how to drive a truck will not be hired as a driver if he or she does not have a license).

- People's employment by the Project will increase pressure on the local labor market, and in particular on the availability of labor, for example for agricultural activities
- Some of the people to be hired locally may not adapt to the requirements of the site (health and safety rules, follow-up of instructions, punctuality) and may therefore have to be terminated. There is a risk that these individuals, along with those who have not been hired at all, will form groups that will oppose the Project in various ways.
- It will be important that the local recruitment mechanism put in place be transparent and equitable when it comes to identifying residents of affected villages.

6.10.2.4 Land Disputes

The Project area is historically not very prone to land conflicts, and no land-related violent incidents have been reported in recent years. This does not mean that no incidents have ever occurred, but if they have, they certainly have not attracted the attention of the media or academics. This suggests that the incidents, if any, were rather limited in scale and were resolved by local authorities without the involvement of central government, police or the army.

Tensions over land issues are likely to increase gradually with the arrival of additional people, without necessarily becoming violent. The most obvious probable causes of the expected increase in these tensions are as follows:

- Increasing pressures on land associated with population growth, resulting in local people having difficulty finding land for planting and agriculture, accusing "migrants" who have obtained land they did not "deserve" for this situation, and turning their anger against them;
- Allegations of non-compliance with local customs by migrants;
- Political interference, when politicians fuel resentment to strengthen their electoral base;
- Misunderstandings about informal and imprecise land agreements, with customary landowners thinking they were simply renting land on a temporary basis, and migrants thinking they understood that they had a permanent user right, the right to plant trees or build, the right to sell or transfer, etc.

6.10.2.5 Increased Pressure on Natural Resources

Population growth combined with land losses, the distribution of monetary compensation and the possible abandonment of agricultural activities in favor of jobs on the Project site may result in increased pressure on agricultural and natural food resources (timber, NTFPs, fishing, poaching). However, improving the area's roads and thus commercial chains could limit the villages' food supply difficulties. On the other hand, collusion between wholesalers to organize shortages and artificially increase prices is also possible.

Marolambo National Park and Tsinjoarivo NPA could be subject to strong pressures (collection of non-timber forest products, poaching, etc.). The risks of repercussions on the natural environment are real.

6.10.2.6 Risks of Relocation on Project lands

The release of the Project's rights-of-way, and in particular the reservoir and its 100m safety strip, will not be done simultaneously with their use by the Project: there is a risk that people will settle on land released by the Project.

This risk will not be specific to the construction period, but will also concern the operating period, during which it will be necessary to ensure that no one comes to settle within the limit of the highest waters, increased by a 100m protection band.

6.10.2.7 Increased Pressure on Basic Services to the Population

The infrastructure in the affected villages cannot cope with a large influx of people. Access to water, already difficult and problematic for the populations in all 5 affected villages, will be a major challenge from the construction phase.

The infrastructure present in the villages in the Project area does not currently have the capacity to meet the needs caused by a large influx of people. Some infrastructures, such as education and health services, are already very undersized and do not meet the needs of the population.

6.10.2.8 Lifestyle Changes

The construction of the dam and the formation of the reservoir will lead to significant changes in the area. Some individuals and even families will be forced to change activities or will have to show resilience to adapt their activities to new constraints and rapid changes in the socio-economic context.

The inhabited areas near the dam and the hydropower plant will accommodate the offices and the city of operation as well as associated services (school, gendarmerie, pharmacies, etc.) and gradually transform into small towns. This phenomenon will be accentuated by the fact that these places will find themselves on new access roads and traffic routes for goods and people. All these factors can have a more or less significant impact on the lifestyle of the villages concerned.

The transformation of these rural areas, the arrival of new authorities and the decrease in available land could lead to a decrease or change in traditional authority. The proactivity of traditional authorities, their ability to take advantage of new opportunities and their ability to respond to the needs of their populations in the new context that is emerging will be crucial in maintaining or not maintaining traditional authority.

6.10.2.9 Mitigation and Management Measures***Monitoring of Demographic Trends in the Area***

A quarterly demographic monitoring in the Project area will be implemented. This monitoring will cover the Antenina, Belanitra and Faravohitra sectors and will allow NEHO to monitor dynamics and identify areas where the influx is concentrated.

Raising Public Awareness of Health Issues and Violence Against Women

Actions to raise awareness of STDs and the risks of violence against women are planned as part of the ESIA's program of action against public health risks. These actions will start before construction begins.

Establishment of a Clear, Transparent and Equitable Recruitment Mechanism

Recruitment for the site will mainly be carried out by the EPC and its subcontractors: the EPC will therefore have to set up, within the framework of its PGESC, a labor recruitment system consistent with NEHO's objectives and making it possible to mitigate the population influx:

- Unskilled labor: priority (without guarantee of employment) to local workers from families displaced by the Project - The names of these people and their possible skills will be provided by NEHO.
- Recruitment with equal opportunities for men and women.
- Prohibition of on-site hiring of construction workers.
- Establishment of decentralized recruitment offices to avoid an accumulation of job seekers on construction sites:
 - Antananarivo: qualified personnel (two or more years of higher education)
 - Antanifotsy: qualified personnel (bac +2 or more) and low-skilled personnel (bac level or less).
 - Belanitra: low-skilled (baccalaureate level or less) or unskilled personnel.
 - Sahofika: low-skilled (baccalaureate level or less) or unskilled personnel.
- Transparency of the recruitment process.

The EPC Contractor shall prepare a detailed recruitment procedure, also applicable to its subcontractors, that takes these principles into account.

The recruitment that will be carried out directly by NEHO will follow the same rules.

Support Public Infrastructure Reinforcement

NEHO will carry out a program during the construction phase to improve the community infrastructure of the villages. This program will be renewed at NEHO's discretion during the operation phase. The procedures for the implementation of this program will be defined in the community development mechanism (see the chapter "Community Development Plan") which will be established before the start of construction. In principle, this mechanism will work as follows:

- The available amounts will be defined by NEHO.
- Rural electrification will be a priority.
- NEHO will organize meetings with representatives of the population and the administration to identify the actions to be carried out with these amounts.
- NEHO will have the possibility to refuse certain requests, in particular those relating to unsustainable infrastructure in the long term, or only serving particular interests.

Awareness of the Cultural Practices in the Area

The induction that workers hired by the EPC and its subcontractors or NEHO will receive will include an awareness of the cultural habits and practices of the Project area, including the fady and prohibited ones described in Chapter 4.2.17.2. This awareness will be aimed at mitigating the risk of conflict related to culture gaps. In particular, a code of conduct for employees will be prepared by the EPC.

NEHO will also contribute to the knowledge

Enhanced Conservation of Protected Areas

A series of actions are planned to mitigate the negative impacts that the population influx could have on biodiversity in protected areas (Marolambo Park and Tsinjoarivo NPA). This includes:

- Material assistance for better protection.
- The prohibition of consuming or introducing wild meat into the site and living areas.
- Raising workers' awareness of conservation issues in the Project area.
- Control with protected area managers of vehicle traffic passing through protected areas.

All risks and associated mitigation measures are summarized in the following table; all the measures are designed to eliminate or minimize the risks described.

Table 124 - "Population Influx" Risks and Mitigation Measures

Nature of the risk	Risk	#	Mitigation Measure	Implementation	
				Period	By
Lack of knowledge of population growth in the area	Important	Affl01	Quarterly demographic monitoring in the Project area. This monitoring will cover the Antenina, Belanitra and Faravohitra sectors and will allow NEHO to monitor dynamics and identify areas where the influx is concentrated.	Before, during construction and during operation	NEHO
Health problems and violence against women	Important	Affl02	Actions to raise awareness of STDs and the risks of violence against women are planned as part of the ESIA's program of measures against public health risks. These actions will start before construction begins.	Before and during construction	NEHO
Need for a clear, transparent and egalitarian recruitment mechanism	Moderate	Affl03	the EPC will have to set up, as part of its CFSP, a system for recruiting the workforce	Before and during construction	EPC
Access to employment for resettled persons	Moderate	Affl04	Priority access to employment (without guarantee of employment) for local workers from families displaced by the Project - The names of these people and their possible skills will be provided by NEHO	Before and during construction	EPC and NEHO
Absence or saturation of public infrastructure	Moderate	Affl05	Preparation and implementation of a program to improve community infrastructure in villages and a Community Development Plan, including a rural electrification component. Budget for the construction phase: €2.5 million	Design, construction and operation	NEHO
	Moderate	Affl06	Secondment in coordination with the administration of law enforcement officials to Faravohitra and in the vicinity of the dam site, trained in the United Nations Voluntary Principles for Security and Human Rights.	Design, construction and operation	NEHO
Non-respect by the Project or the newcomers of the cultural practices of the area	Moderate	Affl07	The induction that workers hired by NEHO, the EPC and its subcontractors will receive will include an awareness of the cultural habits and practices of the Project area, including the Fady. This awareness will be aimed at mitigating the risk of conflict related to culture gaps.	Throughout the duration of the Project	EPC and NEHO
	Moderate	Affl08	A code of conduct for employees will be prepared by the EPC.	During construction	EPC
Increased impact on protected areas	Important	Affl09	A series of actions are planned to mitigate the negative impacts that the population influx could have on biodiversity in protected areas (Marolambo Park and Tsinjoarivo NPA). This includes: <ul style="list-style-type: none"> • Material assistance for better protection. • The prohibition of consuming or introducing wild meat into the site and living areas. • Raising workers' awareness of conservation issues in the Project area. • Control with protected area managers of vehicle traffic passing through protected areas 	Throughout the duration of the Project	NEHO

Poor information of the population, rumors, difficult access to information	Moderate	Aff110	Prepare and implement a stakeholder engagement plan before work begins, including a recourse and conflict management mechanism.	Throughout the duration of the Project	NEHO
Proliferation of informal economic activity (alcohol, prostitution, poaching, fencing)	Moderate	Aff111	Provide maximum service within the bases. Establish management rules for the functions of the bases with schedules established for employees. Entry control on the database. Do not allow spontaneous camping within a radius of protection of the Remote Sites. Radius to be defined with local authorities.	Before and during construction	EPC
Increase in the price of certain commodities/products. Risk of collusion between wholesalers or resellers to create artificial shortages in order to raise prices.	Moderate	Aff112	Weekly monitoring of local market prices for basic food products. Intervene in the event of an abnormal change in these prices compared to the history. If necessary, make agreements with resellers to pre-finance purchase/transport to support price maintenance.	Before and during construction	NEHO Social Team
Non-respect of fady and prohibited by the populations	Moderate	Aff113	Sensitization of EPC staff and its chain of subcontractors to the applicable fady in the Project area	Before and during construction	EPC
	Moderate	Aff114	Discussion with the village "elders" in the Betsimisaraka part (Sahofika,) before starting the work, to explain that the site will do earthworks but not agricultural work. Make sure with the notables that this is compatible with the fady banning tillage on Tuesdays.	Before construction	NEHO
	Moderate	Aff115	Sensitization of NEHO staff and its chain of subcontractors to the applicable fady in the Project area	Throughout the duration of the Project	NEHO
Respect for the information of local authorities and administrations	Moderate	Aff116	Implementation of a procedure for the systematic declaration of the interventions of the Project teams (NEHO, EPC and any other party involved in the Project)	Throughout the duration of the Project	NEHO

6.11 Cultural Impacts

The risks of cultural and cultural impacts are mainly related to possible archaeological finds, as well as to the proper management of the site's interactions with places of worship or tombs that are present in the region.

On the latter point, it is the linear infrastructure (roads and lines) that pose the main risks. The RAP describes the risks and accompanying measures for the reservoir and dam area.

All risks and associated mitigation measures are summarized in the following table; all the measures are designed to eliminate or minimize the risks described.

Table 125 - "Cultural Impacts" Risks and Mitigation Measures

Nature of the risk	Risk	#	Mitigation Measure	Implementation	
				Period	By
Risk related to losses of previously unidentified buried cultural property	Low	Cult01	Preparation and implementation of a chance discovery procedure for any contractor who will perform excavations or cuttings. Training of personnel in charge of excavations (or their follow-up) on the nature of possible finds and the measures to be applied in the event of a find.	Before and during construction	EPC
Risks related to existing places of worship	Moderate	Cult02	Detailed mapping of cultural sites and tombs during field studies for the implementation of linear infrastructure (roads and tracks), and engagement with stakeholders to agree on avoidance measures.	Design and construction	EPC

6.12 Community Development Plan

6.12.1 Objective

For the successful integration of the Project into its social environment, NEHO plans to implement a series of community support measures. In a different context, these actions would have been directed towards vulnerable populations, but since 84% of the people affected by the Project live below the poverty line, the Community Development Plan will be aimed at this population as a whole.

NEHO will carry out a program during the construction phase to improve the community infrastructure of the villages. In principle, this mechanism will work as follows:

- The available amounts will be defined by NEHO.
- Rural electrification will be a priority.
- NEHO will organize meetings with representatives of the population and the administration to identify the actions to be carried out with these amounts.
- NEHO will have the possibility to refuse certain requests, in particular those relating to unsustainable infrastructure in the long term, or only serving particular interests.

6.12.2 Opportunity for Infrastructure Development

Public infrastructures are very rare in the Project area and the populations lack basic infrastructures and services: roads, electricity, drinking water, sanitation, telephone, health center... There are schools but they have very few resources.

NEHO has chosen, on a voluntary basis, to contribute to improving this situation, but will not be able to meet all the needs. This possibility was raised as soon as the Concessionaire's offer was submitted, with an indicative proposal for rural electrification formulated as follows:

"The installation of a turbine on the instream flow release structure guarantees a power level that is commensurate with the consumption of the facility itself (including the operating city) and these communities. There are indeed several villages within a 10 km radius of the dam, which could consume 250 to 500 kVA.

This rural electrification project would require: (i) 20 kV line(s) (AAAC 37 mm² 3 phases), (ii) low-voltage lines, (iii) 20kV/B2 transformers, and (iv) wooden poles."

The expectations of the populations formulated during the various meetings and discussions during the preparation of the ESIA were mainly related to access roads and electrification.

The completion of the Project will de facto lead to the completion of some of the infrastructure required for the Project, the most obvious being the communication route linking the plant to the national road network.

6.12.3 Focus Points

The construction of infrastructure in some villages will change their attractiveness and consequently their economic and demographic development. To the extent that the Project is located between a National Park and a New Protected Area, the infrastructure choices that will be made will have to be compatible with the management plans of these

areas, and integrate the need not to contribute to increasing anthropogenic pressures on the areas planned for biodiversity conservation.

The Project is not intended to replace the State services, or to play the role of operator of the public infrastructure that it would have contributed to achieve. It will therefore be necessary to integrate institutional aspects into the definition of the infrastructures to be proposed, with a clear vision of responsibilities for each sub-project:

- who will own the infrastructure?
- who will exploit it?
- who will pay for operation and maintenance (and possibly collect payments)?

At the request of the communes, the Project will apply a principle of accountability of the communes by involving them in the Project management of the infrastructures covered by the Community Development Plan.

The selection of beneficiary villages and hamlets should include the following aspects:

- Ongoing or planned initiatives and programs, whether led by state, international or non-governmental actors;
- Protected area management plans;
- The obligation in principle to include resettlement areas and villages close to the Project among the beneficiaries, while seeking to avoid increasing population concentrations near biodiversity conservation areas;
- The availability of national or private operators to operate in the area;
- The ability of households to pay for services that will be charged for;
- The costs of building the infrastructure.
- Current distribution of populations

The populations likely to be assisted by the Project are unevenly distributed.

To the west, from Antanifotsy to Antenina (dam/reservoir area): we are gradually moving from an asphalted/electrified environment easily accessible from the capital to an area of tracks that cannot be driven on and are not served by the electricity grid. The main access to the Project will be through this area, which will benefit from an improved track.

Between the dam site and the plant, there is no village.

To the east of the hydropower plant, there are a few villages near the plant site (including Faravohitra and Sahofika) that are connected to each other by pedestrian or canoe paths. These villages are not connected to an important urban area in the East: When they want to go to Antananarivo, the inhabitants of these villages cross the escarpment on foot and reach the dam/reservoir area, then Antanifotsy where they get public transport. Seen from Antanifotsy, one can practically look at this eastern zone as a dead end (even if it is connected by the river or by roads to even more isolated areas by going even further east).

6.12.4 Proposed Framework for Community Development Actions

6.12.4.1 Principles

The actions financed by the Project will be implemented in the following area:

- Between Antanifotsy and Antenina;

- In the villages near the plant (including Faravohitra and Sahofika)
- In resettlement areas
- The actions financed by the Project will be defined:
 - In consultation with the populations concerned, their representatives and the decentralized services of the State;
 - In coordination with actors (institutional, international, private or civil society) carrying out conservation or development programs in the area;
 - In accordance with Malagasy laws and protected area management plans.
- The actions financed by the Project must:
 - Include a formalized institutional and financial structure that guarantees their sustainability;
 - promote the economic development of villages, tourism development and the long-term reduction of dependence on natural resources
 - Combine in a balanced way facilities with immediate effect (access to electricity, mobile phone network, etc.) and long-term measures (support for education, training);
 - Benefit the community or groups representative of the community (e.g. schoolchildren, women, fishermen, farmers, etc.).

6.12.4.2 Identification of Actions to Be Carried Out

A consultant or civil society organization will be recruited to identify a program of action, based on the principles set out above.

The consultant will take into account the fact that the following elements are necessary for the Project and will be built anyway. They can therefore be shared with the populations of the Project area:

- The rehabilitated track from Antanifotsy to the dam, the status (private or public) of this track to be confirmed;
- The communication route through the dam crest to the plant and Faravohitra. It is recommended that the status of this track remain private, so that the SPV can regulate its use (vehicle condition, rain barriers, speed...);
- A mobile phone network around the dam and the plant.

6.12.4.3 Approach to Rural Electrification

A preliminary demand and supply analysis was conducted by the Rural Electrification Project. A detailed study remains to be carried out, but the following principles have been adopted:

- The solution initially envisaged is coherent, with some adjustments that need to be studied, such as the possibility or not of connecting the villages near the plant from the plant (so as not to have an overhead distribution line from the dam to the plant). The use of stand-alone solutions (e.g. photovoltaic with batteries) can also be considered, as they are very common in Madagascar.
- Detailed technical studies are still required to define the “rural electrification” component of the Project.
- Rapid temporary measures could be put in place to provide electricity to the population from the construction phase, for example by means of solar terminals.

In all cases, the procedures for implementing rural electrification will be defined in coordination and under the control of the Rural Electrification Development Agency (ADER), which is the competent authority in this field.

6.12.4.4 Budget

The anticipated “community development” budget for the construction phase is €2.5 million, or 0.5% of the investment amount.

6.12.5 Community Development Action Plan

Table 126 - Community Development Action Plan

#	Measure	Implementation	
		Period	By
Devt01	If the micro central solution is chosen, installed on the water intake for the instream flow of a by-pass, allowing the connection of a micro-power station, and automated to return to the river the water not used by the micro-power station in order to satisfy the instream flow obligation.	Design and construction	EPC
Devt02	Implementation of a technical solution to supply a local distribution network from the plant	Design and construction	EPC
Devt03	Detailed technical studies and legal and institutional arrangements for the implementation of the rural electrification component of the Project, including rapid temporary measures could be put in place to provide electricity to the population from the construction phase, for example through solar terminals.	Starting the Project	NEHO
Devt04	Preparation of a detailed Community Development Plan based on the principles identified in the ESIA.	After the definition of the rural electrification component	NEHO

6.13 Impacts and Mitigation Measures - Transmission Line Corridor

To guide the socio-economic impact analysis in relation to the descriptions in the original framework of the study area, the following points were noted as the main sources of socio-economic impact:

- Land acquisition and use (these issues are addressed separately in the Land Acquisition and Transmission Line Compensation Framework):
 - Land acquisitions (location of pylons)
 - Site preparation and site installation (for substation construction, pylon installation) and storage of equipment and materials
 - Quarrying and borrowing (for gravel and sand)
- Opportunities and nuisances during construction:
 - Traffic of vehicles and trucks for the supply of materials and equipment and machinery for the works (installation of pylons)
 - Recruitment of the workforce and its presence on the construction sites
 - Clean-up and restoration of disturbed sites after construction
- Maintenance work (infrastructure and rights-of-way).

All risks and associated mitigation measures are summarized in the following table; all are designed to eliminate or minimize the risks described.

Table 127- Risks and Mitigation Measures for "Construction and Operation of the Line"

Nature of the risk	Risk	#	Mitigation Measure	Implementation	
				Period	By
Impacts on sensitive social receptors in the construction phase	Low	Lign01	Define and optimize from a technical and social point of view the exact route of the transmission line, in order to minimize the social and socio-economic impacts, between Belanitra and Antananarivo, taking into account the sensitivities listed in the ESIA.	Before and during construction	EPC
Impacts on sensitive social receptors in the operation phase	Low	Lign02	Inform people along the line of their rights and duties with regard to the line. Plan maintenance operations to minimize impacts on crops and agricultural production.	Exploitation	NEHO

7 Environmental Impact Assessment And Mitigation

7.1 Impacts and Mitigation Measures

7.1.1 Impact and Residual Impact Mitigation Hierarchy

The approach used to define impacts follows the requirements of Malagasy legislation and IFC and AfDB policies, which require that impacts be mitigated as follows (using the terms of Malagasy legislation):

- As a priority, seek to “Remove” the impact in order to avoid it,
- Second, if it is impossible to remove the impact, try to “Reduce” it as much as possible.
- If the measures to reduce an impact do not make it insignificant, the impact remaining after reduction is called residual impact and additional mitigation measures are implemented to “compensate” it.

7.1.2 Impact Significance

In order to facilitate the reading of the ESIA and the identification of the most important impacts, the significance of each of the impacts was noted as follows, with reference to threatened species within the meaning of Malagasy legislation or according to donor criteria for “critical habitats”:

Table 128 - Definition of the Significance of Environmental Impacts

Probability of occurrence	Consequences		
	Impact limited in time or space on fauna or flora, without consequence on threatened species or natural habitats	Widespread or sustainable impact on fauna or flora, with no consequences for threatened species or natural habitats	Impact on threatened species or natural habitats
Very likely	Moderate	Important	Important
Possible	Low	Moderate	Important
Unlikely	Low	Low	Moderate

7.2 Impacts on Terrestrial Habitats

7.2.1 Nature of Impacts

The physical impacts of the Sahofika Project have been described in Chapter 5 and will in turn result in impacts on the components of habitats and biodiversity that will be negatively affected by these physical impacts, known as environmental receptors.

7.2.1.1 Habitat Loss/Degradation/Disruption

This type of impact concerns all habitats that will receive or be close to the Project’s infrastructure.

Between the hydropower plant and the dam

The access road and transmission line between the dam and the plant, including access to the surge tank, have a hold on forest blocks considered critical habitats because (i) they contain high conservation concern species, and (ii) they are already threatened due to deforestation and overexploitation of natural resources. The work will result in an additional loss of this habitat.

Around the plant and dam, the most important footprint is that of the reservoir and infrastructure that will be built temporarily or permanently for the Project.

Between the dam and the exit of Marolambo Park

The access roads and the transmission line between the dam and the exit of Marolambo Park cross different plant formations within the protection zone (= buffer zone) of Marolambo Park. The initially planned route, 10.1 km long, crossed the site under the management transfer of Fisoronana.

From the exit of Marolambo Park to Antananarivo

The transmission line only crosses modified habitats in this area, including eucalyptus or pine plantations used by the population as sources of wood.

Surface balance:

As a precautionary principle with regard to the Project elements still to be detailed, a 20% increase coefficient was arbitrarily applied to terrestrial habitats.

Table 129 - Total Area of Habitat Currently Impacted by the Project

TOTAL		Increased footprint (ha) for terrestrial habitats	
			%
Natural habitats (critical)	Medium-altitude dense humid forest	213	16%
	Lichen forest	3	0%
Modified Habitats	Culture	174	13%
	Secondary forest	752	56%
	Degraded formation	57	4%
Water (modified habitat)		144	11%
TOTAL		1 341	100%

7.2.1.2 Modification of Habitat Types

Rising water levels, project emissions (noise, dust), construction and then operation activities will lead to a change in the functional structure of some habitats, and consequently to a change in their attractiveness for the fauna and flora species that currently use them.

7.2.1.3 Diversification and Intensification of Threats to Fauna And Flora

The opening of access roads (to dams and between dams and factories), population growth through the arrival of project staff and migrants will represent sources of threats to fauna and flora. There is a real risk of increased demand for natural resources by populations and a lack of respect for the ecological integrity of the ecosystem and biodiversity by those who will use the access roads opened by the Project.

7.2.1.4 Fire Risks

There are many possible causes of fires, but the main source is related to the storage and use of hydrocarbon products required for the operation of vehicles, machinery and portable construction equipment. The various habitat types existing in the area are likely to burn, especially in the dry season.

7.2.1.5 Erosion Risks

The risks of erosion have been described in Chapter 5.2.1 concerning physical impacts. Erosion can lead to loss of fauna and flora habitats, habitat disturbance or degradation due to siltation and pollution of the aquatic environment

7.2.1.6 Light Nuisances

Continuous night lighting during the construction and operation phase is a potential source of nuisance for certain species of fauna both during the day and at night (insects, reptiles, bats, etc.). Light sources and continuous lighting can disrupt the way these species live, or kill them.

7.2.2 Impacts on Environmental Receptors

7.2.2.1 Destruction of individuals of fauna and flora

During construction works (construction, development, track rehabilitation, clearing), vehicles will be used to transport materials; machinery will be mobilized for earthworks and other construction activities. As a result, the destruction of plant and wildlife individuals during this work is certain.

7.2.2.2 Wildlife Escape

Disruptions caused by the Project (physical impacts) in the natural environment will affect some wildlife species and therefore encourage emigration. The most sensitive species will be forced to leave their usual place because of the nuisances generated by the Project. In addition, project activities can disrupt the reproductive cycle and behavior of certain groups of animals due to changes in the home range or even in the diet.

7.2.2.3 Introduction and Spread of Invasive Alien Species

All activities contributing to the change or transformation of land use by the Project are likely to promote the introduction and development of invasive alien species in the area. The transport activities of construction materials and vehicle movements are among the causes of their introduction into the area. As invasive species are already present in the area, their spread can be facilitated by infrastructure development work if appropriate control measures are not taken into account by the Project. These species are harmful to biodiversity and the ecosystem and difficult to control, especially in an ecoregion such as the Project's footprint.

7.2.2.4 Risk of Collision of Avian Species along the High Voltage Line

The risk of electrocution or collision with power lines is a major cause of bird mortality. In the case of a 220kV line, the length of the insulators (typically 2.50m or more) and more generally the distances between metal parts subjected to different voltage levels are such that the risk of electrocution is zero. On the other hand, there is a real risk of collision, especially for birds in low visibility (night, fog) or at high speeds. The ground wire,

because of its small diameter which makes it less visible and because of its position above the other cables, is the one that generates the greatest risk.

In the absence of highly migratory birds in Madagascar and taking into account the results of avian fauna inventories in the Project area, the bird species likely to be affected by electrocution and collisions are as follows:

- Between the start of the power line in Sahofika and Belanitra, forest habitat raptor species, including *Accipiter francesiae*, *A. henstii*, *A. madagascariensis*, *Buteo brachypterus*, *Aviceda madagascariensis*, and *Polyboroides radiatus*;
- Between Belanitra and Antananarivo, species of birds of prey adapted to open environments (savannahs, pseudo-steppe, plantations, etc.) including *Falco newtoni*, *F. eleonora*, *Milvus aegyptius*.

Except around Henst (*Accipiter henstii*), which has a quasi-threatened-NT status, these species have no special conservation status and none trigger the “critical habitat” criteria.

7.2.3 Risk avoidance and risk reduction measures

7.2.3.1 Public and employee information and awareness program

Before the start of the Project and during the works, the Project will implement a program to inform and raise awareness among the population and workers about the risks to fauna and flora in the Project area, the benefits of a protected natural environment and rich biodiversity, and the measures implemented by the Project in this regard.

This program will be prepared with managers or proponents of biodiversity conservation areas and will include

- Raising awareness and informing the population concerned about the Project and biodiversity protection measures;
- Sharing information, training and capacity building of project employees on the environmental measures taken by the Project;
- Prohibition of access by persons other than personnel to construction sites and prohibition of movement of project employees in unauthorized areas, including habitats with ecological implications;
- Ongoing evaluation of the effectiveness of the measures taken in order to correct or adjust them if necessary.

7.2.3.2 Maximum avoidance of natural and critical habitats during final establishment

The principles for locating road alignments and energy evacuation lines in the most sensitive areas were subject to numerous exchanges between the technical, environmental and social teams during the preparation of the ESIA, in order to minimize the impacts on the sensitive areas near the Project: this work was described in Chapter 2.6.2.

It remains to be defined and optimized from a technical and social point of view the exact location of the Project’s infrastructures (during the detailed design), in order to minimize the impacts on biodiversity and social receptors.

Between Antananarivo and Belanitra

This area does not cross any protected areas and natural habitats, but it does cross plantations of eucalyptus and pine trees used by the populations, which should be avoided as much as possible.

Concerning roads (main roads or access to pylon construction points), in order to avoid the creation of new tracks in this area, it was decided to use existing tracks to the maximum, rehabilitating them where necessary.

Between Belanitra and the dam

This area crosses the protection zone (buffer zone) of the Marolambo Park. It is sparsely populated, but there are natural woodlands (their number increases to the east as the forest corridor approaches) and woodlands managed by the population. The Project will build the transmission line in this area, but also an access road to the dam, as there is no suitable road here.

The principle adopted for this area is to adopt a layout and design of the line and road that avoid wooded areas as much as technically possible, with the involvement of VOI.

Between the dam and the hydropower plant

This area crosses the forest corridor, which is very rich in terms of biodiversity. It is almost unpopulated and is mainly covered with forests that are home to fauna and flora species of great interest. The Project will build the transmission line and an access road linking the hydropower plant to the dam in this area, as there are only pedestrian accesses at the moment.

The principles that have been adopted for this area are as follows:

- the service line and communication networks will have the capacity to use the waterway gallery and therefore impacts can be avoided for both infrastructures.
- The route chosen (see Chapter 2.6.2) is the one that makes it possible to reduce environmental impacts as much as possible, by using the areas already impacted and thus avoiding creating a new corridor in addition to the existing pedestrian corridor. In this option the transmission line will be buried over a distance of 1.6 km, where the selected route crosses the largest forest width (exact positioning to be confirmed in the detailed design phase).

Optimization of the implementation of temporary or permanent infrastructures

This measure concerns the temporary or permanent infrastructure that will be required in the dam area: quarries, excavation areas, storage sites, camps and construction site areas, and the city of operation.

The exact position and footprint of these infrastructures is not defined and the ESIA therefore prescribes the following approach to minimize impacts:

- Use as much as possible the footprint of the future reservoir for temporary infrastructure and extraction sites (without exposing the sites to flooding from the Onive);
- At the dam, outside the reservoir area:
 - Implement temporary infrastructure on the right bank of the Onive (to the west) rather than on the left bank to minimize risks to the new protected area;
 - Avoid natural habitats and agricultural areas to limit the volume of compensation or economic displacement.
- At the plant level:
 - Avoid agricultural areas to limit the volume of compensation or economic displacement.

7.2.3.3 Measures to Preserve The Ecological Continuum For Wildlife

Linear infrastructure (line and access track) between the dam and the plant may alter genetic connectivity for fauna and flora. This risk varies greatly depending on the species and their ecology and depends on several factors such as the physical interruption of the forest continuum caused by deforestation, changes in land use, or vehicle noise.

This risk has already been reduced by the choice of the location of linear infrastructure in the most impacted, deforested and frequented part of the forest corridor. Additional measures are adopted to best combat the fragmentation of the forest corridor within the framework of the Project:

- The transmission line will be buried over a distance of 1.6 km, where the selected route crosses the largest forest width (exact positioning to be confirmed in the detailed design phase).
- The width of the tracks (treadmill) will be limited to 5 m in wooded areas, to preserve as much as possible the continuity of the canopy.
- Night traffic (between 8pm and 6am) between the dam and the plant will be prohibited for scheduled or regular activities of the site or operation, and will be reserved for emergencies and exceptional circumstances.

7.2.3.4 Avoidance or reduction of impacts on individuals (flora and fauna) with a high conservation stake

Flora

Several threatened plant species found in the extended study area may be found on sites where infrastructure and associated activities are accessed and/or located. Clearing can lead to the disappearance of individuals or a population of these threatened species. The following measures should be adopted in the event of the presence of these species:

- The precise identification, marking and location of flora species that have triggered critical habitat (see 4.4) in order to avoid them when infrastructure is precisely located in forest areas;
- Adapting rights-of-way and activities with potential impacts as much as possible to avoid affecting them.

Wildlife: Clearing vegetation and then moving along the trails could kill animals with limited mobility (small mammals, chameleons, lizards, amphibians), juveniles (chicks) or animals with restricted home ranges (crayfish).

In order to reduce the negative impacts due to construction and then exploitation activities on all these forest animal species and especially high conservation concern species, the following measures are recommended and must be taken into account:

- Seasonality of cutting work on large trees likely to carry bird nests: In order to minimize impacts on birds nesting in forest areas (between the dam and the plant), cutting of large trees to free rights-of-way will take place outside the birds' preferred nesting period, which corresponds to the months of August to December.
- Sequenced clearing and deforestation after the final establishment of infrastructure crossing forest areas, in order to drive wildlife away:
 - Tree felling
 - Leave 24 hours for the residual fauna to escape (especially reptiles, chameleons, entomofauna),

- Finalization of the clearing and cleaning of the area with storage of the vegetation collected on the edges of the rights-of-way for grinding or composting (no slash-and-burn).
- Large trees identified as feeding grounds (fruit-eating species) and dormitories for lemurs should be avoided. These trees will be easily recognizable by the abundance of young plants and the presence of excrement;
- Minimization of the risk of wildlife crushing:
 - Traffic control between the dam and the plant (the road is not open to all vehicles)
 - Raising driver awareness and training in the removal of wildlife species from traffic lanes,
 - Restrictions on night traffic,
 - Speed limited to 40 km/h between the dam and the plant,
 - Monitoring and geo-referencing of crushing points.

7.2.3.5 Combating the introduction and spread of invasive alien species

The introduction of other invasive species, in addition to the invasive alien species identified during the inventories, is possible, in particular through the transport movements of construction materials by project vehicles and the movement of workers. The control of the introduction and spread of these species in the Project area e must be ensured by the Project.

During the work and during the recovery period of native vegetation in areas subject to revegetation, monitoring and management of IAS is important because the development of these species can limit the development of native species. Particular attention should be paid to all imported and stored materials. The Project will have to adopt measures to be applied when carrying out the activities of cleaning the plots, stripping and earthworks for:

- Identify the invasive species present on the site and its surroundings before the work is carried out;
- Manually or mechanically remove shrub or tree EEEs, ensuring that the root system is removed;
- Eradicate these species through appropriate measures (on-site disposal and incineration of plant debris);
- Carry out a preliminary study of the material supply sites (quarries, others).

7.2.3.6 Avoid the use of local natural resources

The construction and installation of infrastructure requires the use of local materials such as wood, water, gravel and other materials. Excessive, irrational demand by the Project would lead to overexploitation of these resources and become a threat to the ecosystem and biodiversity. For these reasons, the Project must organize its supply chain in such a way as to avoid impacts on existing forested areas in the vicinity of the Project. The wood used in construction must come from entities with a cutting and/or sales authorization from the competent services, in the case where the supply is made in Madagascar.

7.2.3.7 Fire prohibition and minimization of fire risk

Open fires will be prohibited throughout the construction and operation period.

The risk of fire will be minimized by:

- Equipping worksites where flammable products are used with fire extinguishers,
- Training staff in the use of fire extinguishers, and,
- Recalling the basic rules concerning the use of flammable products.

7.2.3.8 Support and accompaniment of managers of areas under status for the protection of biodiversity

The construction and operation phase of the infrastructure will last several years and will lead to movements of people in the area. The capacities of managers of status areas must be strengthened so that they can best ensure compliance with the regulations governing the areas and can contribute to the protection of biodiversity.

This measure will be detailed in consultation with the entities concerned, the DGEF and the competent DREFs. It concerns:

- MNP, as manager of Marolambo Park,
- Sadabe, as promoter of the Tsinjoarivo NPA
- The potential future manager (possibly Sadabe)
- The VOIs

7.2.3.9 Minimization of light pollution

Construction and operating sites will be designed and managed to minimize the impact of light pollution with the following actions:

- Avoid continuous lighting, and opt for activation by presence detectors for outdoor comfort lighting,
- Use low-light bulbs or use floor-oriented lighting for outdoor lighting.

7.2.3.10 Protection of CITES species and fight against poaching

The species listed in the Project area are essentially listed in Appendix II, namely "(i) all species which, although not necessarily currently threatened with extinction, could become so if trade in specimens of these species were not strictly regulated, and (ii) certain species which require regulation to be effective in controlling their trade".

The Project will, through the creation of roads, possibly facilitate access to these species and their illegal exploitation, or to other forms of illegal activities such as poaching.

A program and specific measures to protect these species and to combat illegal trade and poaching will be defined with protected area managers and promoters as part of the actions already planned to regulate traffic and strengthen the control and protection of biodiversity.

7.2.3.11 Reduced risk of collision with the power line

The risk of collision mainly concerns raptors and the guard cable, during the phases of diving towards identified prey on the ground, i.e. during a high speed flight from top to bottom.

In the forest corridor where the greatest number of potentially affected species are present, three-dimensional bird diverters (not two-dimensional bird diverters hanging under the cable) will be installed on the guard cables.

Figure 86 – Example of a three-dimensional bird diverter

7.2.4 Compensatory and accompanying measures for terrestrial environments

The IFC and AfDB performance standards require that the Project does not cause a net loss of biodiversity (natural habitats) and generates a net gain for species and habitats considered “critical”. As a result of these requirements, and considering the residual impacts of the Project after the risk avoidance and risk reduction measures described in Chapter 7.2.3, compensatory measures for terrestrial biodiversity are required.

The compensation aims to offset with positive actions the residual negative effects not avoided by the design of a project or insufficiently mitigated by the implementation of reduction measures. It is a question of implementing compensatory measures near the impacted environments in order to guarantee their functionality, in a sustainable way. In other words, the compensation must make it possible to conserve overall and, in the case of the Sahofika project, to improve the environmental quality of the environments because of the critical nature of the habitats affected.

Given current assumptions about infrastructure capacity, the Project will destroy about 216 ha of natural forest, considered a critical natural habitat, including 213 ha of dense medium-altitude forest and 3 ha of lichen woodland.

7.2.4.1 Restoration of degraded areas in forests adjacent to the forest corridor

Active restoration (planting and reforestation of native species with effective defenses against logging, grazing and fire) of degraded areas in forests adjacent to the main forest corridor is intended to compensate for the loss of critical forest habitats for many heritage species (birds, reptiles, amphibians, mammals). The ultimate goal will be to return to the structure, diversity and dynamics of the original ecosystem, restoring its essential functions (primary production, resilience, protection), and enabling local populations to benefit from some of its multiple ecosystem services.

Based on the calculation of the areas impacted by each project element (dam, flooded area, tracks, life base, surge tank, etc.) to be specified during the detailed design, the critical habitat loss of medium-altitude dense humid rainforest and woodland and lichen forest was estimated at 216 Ha. The planned reforestation effort will eventually cover an area equal to twice the area actually impacted (for example, 432 ha, if the 216 ha area is confirmed).

It will take several decades for the restored land to begin to regain functionalities similar to those of a native forest. It should be noted, however, that restoration is being implemented here in addition to contributing to the conservation of most of the impacted forest massif, and that proximity to this largely intact massif should ensure greater effectiveness in restoration efforts.

It is recommended that this forest restoration program be carried out with the following goals:

- Achieve a sustainable reforestation area equal to twice the area lost.
- Ensure or restore connectivity between remaining forest scraps.
- Identify sites to be restored in cooperation with MNP and the Tsinjoarivo - Ambalaomby NPA, targeting sites within the areas managed and preferably protected by these entities or in management transfer areas.
- In the areas formerly cleared upstream from the dam, in order to optimize the protection of the dam against silting and the protection of the tributaries supplying the Onive, coming from the NPA in creation of Tsinjoarivo - Ambalaomby.

The restoration recommended within the framework of this project must involve:

- A detailed ecological analysis of the state of forest degradation: A brief observation during fieldwork revealed that the quality of the forest ecosystem in the area is very heterogeneous, with significant fragmentation, and generally presenting only small trees;
- A commitment of a set of actors and objectives in the medium and long term: the presence of VOIs and protected area managers, who manage these forest resources, is an asset for the implementation of forest restoration;
- A call to various forestry techniques: the protection or production of indigenous plants in nurseries.

Reforestation plants will be provided by the Project (which could have its own nursery). The restored land will have to be subject to an effective and sustainable protection status, within the framework of the governance of natural resources to be put in place within the Project area and around existing protected areas.

7.2.4.2 Support for the Conservation Of The Natural Forests Of Tsinjoarivo NPA And Marolambo National Park

The Project will contribute to the establishment of the Tsinjoarivo NPA and the protection of Marolambo National Park. The precise procedures of this support have yet to be defined, in partnership with the entities managing these protected areas and their various stakeholders (including the relevant public authorities).

It is already suggested to contribute to significantly reducing the rate of deforestation affecting these protected areas by strengthening capacities to monitor and control illegal land clearing, poaching, etc. Despite the uncertainties surrounding their estimation, the areas thus “saved” can therefore be counted among the biodiversity “gains” generated by the Project.

In this context, it would be useful, as suggested by the DREDD of Vakinankaratra, to set up a yardmaster to ensure the verbalization of offences, with a specific status allowing him to work in the two districts of Vakinankaratra and Alaotra-Mangoro.

7.2.4.3 Support in Updating IBA Data

In order to avoid increasing disparities between the ornithological data of the Project and the data of the IBA of the ONVIE Classified Forest, the Project will contribute to the updating of the IBA data through the IBA's referent NGO, Asity Madagascar. The precise procedures of this support have yet to be defined, and may be extended to other more specific bird conservation activities within the framework of the Biodiversity Action Plan.

7.2.4.4 Reforestation Program In Management Transfer Areas

It is specified that the management of the existing VOI in Antenina will be determined in coordination with the MNP and DREDD, the competent authorities.

Concerning the resettlement area, with improved access to the site and infrastructure operation, new arrivals will be expected in the area, in addition to the people who will be relocated. These arrivals will certainly increase the need for wood, especially for timber and service.

In order to avoid pressure on natural forests in status areas, and on land targeted for forest restoration, it is recommended to develop a reforestation program with fast-growing species from the construction phase onwards.

This reforestation should be carried out in grassland areas outside natural forest areas, in order to make service wood readily available. Reforestation will not be carried out in agricultural areas unless there is an explicit amicable agreement with the persons concerned. The VOI development plan will determine the various areas to be planted and the implementation procedures.

Reforestation plants will be provided by the Project (which could have its own nursery).

There is reforestation experience in the area.

A production hypothesis is put forward below:

- Eucalyptus plantation, a fast-growing species that can produce quality barrels that can be used as lumber and service;
- The plantation is carried out on acidic soil (old *Tavy* or former forest soils) but benefiting from a minimum of maintenance, silvicultural care and a minimum of protection (in particular against fire)
- Silvicultural care to be applied:
 - Thinning (from 1000 individuals at planting to 500 individuals per hectare from the 5th year onwards. Thinning is an operation consisting in removing a certain number of trees from a plot in favor of those left in place;
 - Pruning at the end of year 2 and at the end of year 4: Pruning is a technique consisting in regularly raising the crown of trees intended for the production of timber, in order to limit the development of knots, by regularly cutting the branches;
 - Fire protection: firewalls, security guards.

It should be noted that for a first production cycle of 5 years, the average diameter obtained is 35 cm. For every hectare of reforestation over 5 years, we will have 500 individuals representing 187 m³.

7.2.5 Ecological Monitoring Measures

7.2.5.1 Ecological Monitoring Of Habitats

The construction and installation phase of the infrastructure will last several years and will lead to the destruction and/or degradation of certain habitats. For these reasons, ecological monitoring should be carried out to study the evolution of habitats and remarkable fauna and flora. This monitoring will cover all forest areas and fauna and flora high conservation concern species. An initial condition will be carried out beforehand and periodic follow-ups will be recommended during and at the end of the installation phase. The process consists in:

- Establish permanent monitoring plots before, during and after the work to assess the conservation status of habitats and associated remarkable species;
- Carry out regular population monitoring of species with conservation challenges;
- Analyze the information observed on the changes generated by the Project;
- Identify and implement adjustment measures if necessary.

7.2.5.2 Ecological Monitoring Of Target Species And Adaptation

A monitoring program for a number of target species, fauna and flora that have triggered critical habitat analyses will be undertaken with protected area managers and promoters in order to:

- Check in the long term that there is no net loss of biodiversity,
- Identify possible adaptive measures to be implemented,
- Improve knowledge of these species and thus contribute to their protection.

7.2.6 Summary of Mitigation Measures - Terrestrial Environments

All mitigation measures related to terrestrial biodiversity are summarized in the following table:

Table 130 - "Terrestrial Biodiversity" Mitigation Measures

Nature of the risk	Risk	#	Measure	Implementation	
				Period	By
Lack of awareness by the public or NEHO employees of the biodiversity protection measures implemented by the Project	Low	BioT01	<ul style="list-style-type: none"> Raising awareness and informing the population concerned about the Project and biodiversity protection measures. Information sharing, training and capacity building for NEHO employees on the environmental measures taken by the Project. 	Before starting work, during construction and operation	NEHO
Lack of awareness by EPC employees of the biodiversity protection measures implemented by the Project	Low	BioT02	Information sharing, training and capacity building for EPC employees and the subcontracting chain on the environmental measures taken by the Project.	Before and during construction	EPC
Risk of project encroachment greater than that estimated in the event of uncontrolled access by people to the most sensitive habitats as part of the Project	Moderate	BioT03	Prohibition of access by persons other than personnel to construction sites and prohibition of movement of project employees in unauthorized areas, including habitats with ecological implications.	During construction	EPC
Impacts related to the construction of linear infrastructure on the environment and in particular wooded areas.	Low	BioT04	Establishment of linear infrastructures between Antananarivo and Belanitra: <ul style="list-style-type: none"> Avoid forested areas as much as possible to minimize deforestation (use recent aerial/satellite images and field visits to identify forested/deforested areas). Make maximum use of existing tracks, rehabilitating them where necessary rather than creating new ones.	Design and construction	EPC
Impacts related to the construction of linear infrastructure on the environment and in particular management transfer areas.	Moderate	BioT05	Between Belanitra and the dam: Adopt a layout and design of the line and road that avoid wooded areas as far as technically possible; consult VOI and NEHO for approval of the affected wooded areas	Design and construction	EPC
Disproportionate impacts on sensitive species and habitats in the event of inappropriate infrastructure location, and risk of non-compliance with the principle of mitigation hierarchy.	Important	BioT06	Between the dam and the hydropower plant: Pass the service line and communication networks through the waterway gallery. For road and line layout: <ul style="list-style-type: none"> Recognize and make maximum use of areas already impacted as described in the ESIA. Bury the buried transmission line over a distance of 1.6 km, where the selected route crosses the largest forest width. Limit the width of the tracks (treadmill) to 5 m in wooded areas. 	Design and construction	EPC

			<ul style="list-style-type: none"> Have the implementations validated by NEHO. 		
Disproportionate impacts on sensitive species and habitats in the event of inappropriate infrastructure location, and risk of non-compliance with the principle of mitigation hierarchy.	Important	BioT07	<p>Optimization of the implementation of temporary or permanent infrastructures:</p> <ul style="list-style-type: none"> Use as much as possible the footprint of the future reservoir for temporary infrastructure and extraction sites (without exposing the sites to flooding from the Onive); At the dam, outside the reservoir area: (i) Locate temporary infrastructure on the right bank of the Onive (to the west) rather than on the left bank to minimize risks to the new protected area and (ii) Avoid natural habitats and agricultural areas to limit the volume of compensation or economic displacement. At the plant level: Avoid agricultural areas to limit the volume of compensation or economic displacement. 	Design and construction	EPC
Impacts related to the construction of linear infrastructure on VOI management transfer areas.	Moderate	BioT08	Consult VOIs and protected area managers/developers for the validation of the routes or locations proposed by the EPC for infrastructure between Belanitra and the plant.	Design and construction	NEHO
Fragmentation of the corridor caused by vehicle traffic during construction.	Important	BioT09	Night traffic (between 8pm and 6am) between the dam and the plant will be prohibited for scheduled or regular site activities, and will be reserved for emergencies and exceptional circumstances approved by NEHO. Installation of barriers and guard posts at the ends of the forest.	Construction	EPC
Fragmentation of the corridor caused by vehicle traffic during operation.	Important	BioT10	Night traffic (between 7pm and 7am) between the dam and the plant will be prohibited for programmable or regular operational activities, and will be reserved for emergencies and exceptional circumstances. Installation of barriers and guard posts at the ends of the forest (coordinated management with the proponent / NPA manager)	Exploitation	NEHO
Impacts on flora species with a conservation stake between the dam and the plant	Important	BioT11	<p>Protection of endangered flora (between the dam and the plant):</p> <ul style="list-style-type: none"> The precise identification, marking and localization of the flora species that triggered the critical habitat listed in the ESIA in order to avoid them when the infrastructure is located in forest areas; The maximum adaptation of the rights-of-way and impact activities or the relocation of the specimens concerned to avoid damaging them. 	Design and construction	EPC
Insufficient implementation of flora protection measures (follow-up action)	Moderate	BioT12	Monitoring of actions to protect flora threatened by the EPC.	Design and construction	NEHO
Impacts on wildlife species with a conservation issue between the dam and the plant	Important	BioT13	<p>Protection of endangered wildlife (between the dam and the plant):</p> <ul style="list-style-type: none"> Sequenced clearing and deforestation after the final establishment of the infrastructure crossing forest areas, in order to drive wildlife away: (i) Felling of trees, then (ii) Leaving 24 hours for residual fauna to escape (in particular reptiles, chameleons, entomofauna), 	Construction	EPC

			<p>then (iii) Finalization of the clearing and cleaning of the area with storage of vegetation collected on the edges of the rights-of-way for grinding or composting (no slash-and-burn).</p> <ul style="list-style-type: none"> • In order to minimize impacts on birds nesting in forest areas (between the dam and the plant), large tree cutting for footprint release will be done outside the birds' preferred nesting period, which corresponds to the months of August to December. • Large trees identified as feeding grounds (fruit-eating species) and dormitories for lemurs should be avoided. These trees will be easily recognizable by the abundance of young plants and the presence of excrement; • Minimization of wildlife crushing risk: (i) Driver awareness and training in removing wildlife species from traffic lanes, and (ii) Speed limited to 40 km/h between the dam and the plant. 		
Insufficient implementation of wildlife protection measures (follow-up action)	Moderate	BioT14	Monitoring of actions to protect wildlife threatened by the EPC.	Design and construction	NEHO
Impacts on wildlife species with a conservation issue between the dam and the plant	Important	BioT15	<p>Minimization of the risk of wildlife crushing:</p> <ul style="list-style-type: none"> • Traffic regulation between the dam and the plant in coordination with the promoter/manager of the NPA and with consultation of the populations (the road is not open to all vehicles) • Raising driver awareness and training in the removal of wildlife species from traffic lanes, • Restrictions on night traffic, • Speed limited to 40 km/h between the dam and the plant, • Monitoring and geo-referencing of points where wildlife specimens have been crushed. 	Exploitation	NEHO
Introduction and spread of invasive alien species	Moderate	BioT16	<p>Combating the introduction and spread of invasive alien species:</p> <ul style="list-style-type: none"> • Identify the invasive species present on the site and its surroundings before the work is carried out; • Manually or mechanically remove shrub or tree EEEs, ensuring that the root system is removed; • Eradicate these species through appropriate measures (on-site disposal and incineration of plant debris); • Carry out a preliminary study of the material supply sites (quarries, others). 	Design and construction	EPC
Increased fire risk due to the presence of the Project.	Moderate	BioT17	<p>Fire prevention:</p> <ul style="list-style-type: none"> • Open fires are prohibited throughout the construction period. • Equip worksites where flammable products are used with fire extinguishers, • Train staff in the use of fire extinguishers, and in, • Remind the basic rules regarding the use of flammable products. 	Construction	EPC

Insufficient capacity of protected area managers/proponents and VOIs to strengthen the protection, conservation and monitoring of status areas.	Important	BioT18	Support and accompaniment of managers of areas under status for the protection of biodiversity.	Construction and operation	NEHO
Luminous impact of lighting on nocturnal species.	Low	BioT19	Minimization of light pollution <ul style="list-style-type: none"> • Avoid continuous lighting, and opt for activation by presence detectors for outdoor comfort lighting, • Use low-light bulbs or use floor-oriented lighting for outdoor lighting. 	Construction	EPC
Luminous impact of lighting on nocturnal species.	Moderate	BioT20	Minimization of light pollution <ul style="list-style-type: none"> • Avoid continuous lighting, and opt for activation by presence detectors for outdoor comfort lighting, • Use low-light bulbs or use floor-oriented lighting for outdoor lighting. 	Exploitation	NEHO
Risk of increased illegal trade in CITES species due to improved access to the Project area.	Important	BioT21	Preparation and implementation of a program for the protection of CITES species and the fight against illegal trade and poaching defined with protected area managers and promoters as part of the actions already planned to regulate traffic and strengthen control and protection of biodiversity.	Exploitation	NEHO
Destruction of natural forests in the infrastructure footprint between the dam and the plant.	Important	BioT22	Preparation and implementation of a program to restore degraded areas in forests adjacent to the forest corridor (final area equal to twice the amount of woodland lost).	Construction and operation	NEHO
Increased pressure on protected or threatened species in protected areas.	Important	BioT23	Support for the conservation of the natural forests of Tsinjoarivo NPA and Marolambo National Park.	Construction and operation	NEHO
Increased pressure on areas under management transfer, increased wood requirements	Moderate	BioT24	VOI support program: reforestation in management transfer areas and preservation of ecosystem services.	Construction and operation	NEHO
Insufficient mitigation measures and habitat degradation between the dam and the plant (follow-up action).	Low	BioT25	Preparation and implementation of an ecological habitat monitoring program between the dam and the plant, integrating the influence of climate change on the lichen forest.	Construction and operation	NEHO
Insufficient mitigation measures for the most sensitive fauna and flora species between the dam and the plant (follow-up action).	Low	BioT26	Preparation and implementation of a monitoring program for a number of target species, fauna and flora that have triggered critical habitat analyses will be undertaken with protected area managers and promoters (to be combined with the previous measure).	Construction and operation	NEHO
Risk of collision of birds of prey with the guard cables of the transmission line.	Moderate	BioT27	Between the plant and the dam, three-dimensional bird diverters are installed on the guard cables.	Construction	EPC

Madagascar - Sahofika Hydropower Plant
 Environmental and Social Impact Assessment - Version D

Disparities between the ornithological data of the Project and the data of the IBA	Low	BioT28	Support for updating the data of the IBA of the Onive Classified Forest, in collaboration with the referring NGO.	Construction	NEHO
--	-----	--------	---	--------------	------

7.3 Impacts on aquatic environments

7.3.1 Nature of impacts

The physical impact of the Project on the aquatic environment is summarized in the table below.

Table 131 - Impact of the Project on aquatic environments in the operation phase

Hydrographic sector	Impact of the Project on aquatic environments	
	Km of watercourse	Surface area (ha)
ONIVE + tributaries impacted upstream from the dam (flooded area)	32.0	144
ONIVE, short section circulated	14.0	84
ONIVE downstream plant, until the confluence with the Mangoro river	19.0	190

7.3.2 Impacts on environmental receptors

7.3.2.1 Aquatic Habitat Modification

Upstream from the dam (reservoir)

In terms of the reservoir upstream from the future dam, the Project will modify the hydromorphology of the river and consequently the habitat for aquatic fauna and flora. The various stream flow facies will be replaced by a body of water. This morphological modification will be accompanied by physico-chemical modifications as described in Chapter 5.8.

These physico-chemical alterations will be combined with those already existing in the Onive due to deforestation and gold panning.

The associated rise in water will lead to the flooding of an area of about 144 ha of watercourses (Onive and tributaries).

Downstream from the reservoir

The physico-chemical alterations will have repercussions downstream from the reservoir, with also a different sediment regime, caused by a different hydraulic regime.

7.3.2.2 Obstacle to Ecological Continuity

The presence of the dam will be an impassable obstacle to ecological continuity. Migratory species in particular will no longer be able to access the areas upstream from the dam. Four (4) species are concerned according to inventories and surveys across the study area, including 3 probably upstream from the dam; these are the 2 species of Anguillidae (*Anguilla marmorata*, *Anguilla mossambica*) and two species of Gobiidae (*Sicyopterus franouxi* and *Awaous aeneofuscus*). The conservation concern status for these species is moderate. Although no species are threatened according to the IUCN, their conservation is essentially an issue for the people who fish them (see Chapter 4.2.10.5 on fishing). At the population level, the construction of the dam is not able to endanger these species, but it will constitute a potential additional element of habitat fragmentation and population decline.

Non-migratory species and in particular threatened species of high concern such as *Rheocles wrightae* and *Astacoides caldwelli* are not concerned by this problem. Indeed, they are not migratory and will have the capacity to complete their entire life cycle downstream from the dam for *Rheocles wrightae* and on the tributaries for *Astacoides caldwelli*.

7.3.2.3 Obstacle to Sediment Continuity

The dam will constitute an obstacle to sediment continuity in the long term and will generate an accumulation of sediments upstream from the reservoir, including fine sediments and a deficit downstream. However, this phenomenon is not permanent because the sediments will have the capacity to pass through at the discretion of the floods and as soon as the minimum exploitation coast is approached or even reached.

7.3.2.4 Reduced Flow and Habitat in the Bypassed Reach

A significant portion of the flow will be captured at the dam and will feed the turbines placed in the plant. The bypassed reach (BPR) created between these two points has a stream length of about 14 km and an estimated area of about 80 ha.

The reduction in flow will be significant in the dry season, when only the instream flow (5.7 m³/s) will be discharged into the bypassed reach. The decrease in flow will result in a reduction in aquatic habitat on the section concerned. However, high-conservation concern status threatened species only frequent the extreme downstream part of the diversion bay concerned (1.5 km long, upstream from the hydropower plant), because they cannot cross the falls.

7.3.2.5 Modification of the Hydrological Regime Downstream from the Dam

Between the dam and the plant

The flow transiting from the BPR will have a value in the dry season greater than or equal to the instream flow, set at this stage at 5.7 m³/s, and supplemented by some insignificant lateral inflows from the tributaries (a few tenths of m³/s). During high water periods, the filling of the upstream reservoir will cause a delay in flooding at the end of the dry season. This delay and therefore potential impact will depend on the minimum level reached by the reservoir and on the filling time of the reservoir according to the rainfall in the upstream catchment area.

Downstream from the plant

The flow downstream from the plant will be at a low water level most often close to 40.7 m³/s (instream flow increased by the turbinated flow of 35 m³/s), without taking into account marginal lateral inputs between the dam and the plant. Low water flows will therefore be increased ("low water support"), while floods will be delayed in the high water season since the flood wave can only propagate from the actual filling of the reservoir.

In addition, the facility will only produce below its capacity:

- During maintenance of one of the turbines (stable turbinated flow reduced to 30m³/s);
- In very dry periods (on average 1 year out of 7 according to the models carried out); in which case it is possible, if the reservoir reaches its minimum level during the dry season, for the turbinated flow to reach 35 m³/s only part of the day (production at peak hours).

This operation in a very dry year (1 year out of 7) will result in rapid and frequent (daily) variations in the flow and therefore in the water level downstream from the plant. Hydraulic studies conducted show that these variations in flow rate and water level will impact the Onive up to the confluence with the Mangoro River (over a distance of approximately 19 km downstream from the plant).

This operation can lead to:

- During the water rise phase, an increase in hydraulic constraints penalizing in particular for pelagic species such as *Rheocles*, threatened and inhabiting slow or uncommon environments, which will therefore be likely to be sensitive to these flow variations.
- During the descent phase, trapping of aquatic fauna in water pockets.

7.3.2.6 Proliferation of Aquatic Alien Invasive Species

The transition from a relatively diverse mosaic of aquatic habitats in terms of flow facies to a uniform lentic zone will favor the least demanding species with rapid development capacities, especially invasive alien species; *Cyprinus carpio* or *Channa maculata carp*, predator of *Rheocles wrightae* in particular. These species have already been present in the Onive and its tributaries for many years. However, it was noted that these species are more abundant in the upstream areas than in the downstream areas, the latter being those that support threatened rainbow fish.

In addition, native crayfish populations are declining nationally, due to habitat degradation on the one hand, but also to the introduction of invasive alien species and their fishing for consumption and sale. The latter two limiting factors may be favored by population movements during the construction and operation of the hydropower plant. It should also be recalled that in the Mangoro basin near Moramanga, the invasive alien species *Procambarus virginalis* has been present for several years.

7.3.2.7 Mortality and Injuries of Aquatic Fauna in Structures

The water intake at the dam is likely to carry fish to the penstock and then to the turbines, with guaranteed fatality due to the head and the type of turbine used, regardless of the size or stage of development of the fish.

Turbining the instream flow at the dam level for local electrification is also likely to cause fish to flow to the turbine, resulting in variable mortality and injury.

However, this impact must be qualified and put into perspective with the fact that these 2 water intakes are planned at 33 m below the normal level of the reservoir (at the Feasibility Study stage). As a result, fish will only evolve nearby and could only be dragged into the turbine water path in very dry years.

There are also no species with a conservation stake in the Onive upstream from the dam.

7.3.3 Risk avoidance and risk reduction measures

7.3.3.1 Environmental commissioning

The operation phase of the facility will be preceded by a test phase and a progressive filling.

When the reservoir is first filled, it is planned (Action Downstream 03) to schedule a test of at least 16 hours with only the applied instream flow. During this test, visual observations

on the bypassed reach and downstream from the plant (before and at the end of the 16 hours) will be made to verify the continuity of the flow and identify any singularities that may appear.

Ichthyologists will be associated with this test, in order to accurately assess the possible impact of different environmental variations and conditions on the habitat of aquatic species in the Onive or even on the species themselves. The parameters recorded may be variations in flow velocity, wet surface and risk areas (insufficient depth, excessive velocity for example for aquatic species and in particular for *Rheocles wrightae*).

7.3.3.2 Maintenance and Relevance of Instream Flow

Maintaining the instream flow at all times is essential to preserving aquatic life in the shorted section. The value that has been chosen at this stage (5.7 m³/s) will ensure a continuous flow forming a river strictly speaking, but of reduced size compared to the Onive in a natural regime.

It will be essential that this instream flow be maintained at all times, including during river closure operations for the construction of the dam.

In addition, since Critical Habitat has been identified in the aquatic environments of the nearby study area (*Rheocles wrightae* threatened EN according to the IUCN) and more particularly in the downstream sector of the BPR (downstream rapid), it will be necessary to assess the relevance of the instream flow regime adopted, on the downstream end of the bypassed reach. In the current state of knowledge on the ecology of *Rheocles Wrightae*, it is not possible to conclude on a significant impact of the implementation of this instream flow on the populations of this species.

7.3.4 Compensatory/accompanying measures for aquatic and riparian environments

The IFC and AfDB performance standards require that the Project does not cause a net loss of biodiversity (natural habitats) and generates a net gain for species and habitats considered "critical". As a result of these requirements, and considering the residual impacts of the Project after the risk avoidance and risk reduction measures described in Chapter 7, compensatory measures for terrestrial biodiversity are required.

The compensation aims to offset with positive actions the residual negative effects not avoided by the design of a project or insufficiently mitigated by the implementation of reduction measures. It is a question of implementing compensatory measures near the impacted environments in order to guarantee their functionality, in a sustainable way. In other words, the compensation must make it possible to conserve overall and, in the case of the Sahofika project, to improve the environmental quality of the environments because of the critical nature of the habitats affected.

Given current assumptions on infrastructure footprint, the Project could potentially affect 27.5 km of critical habitat for *Rheocles-type* fish, including 19 km between the plant and the confluence with the Mangoro River, positive impacts would also be possible but are not certain.

7.3.4.1 Further Knowledge of *Rheocles wrightae* and *Rheocles sp. Ambatovy*

This measure is a prerequisite for any restoration project in favor of the species. Indeed, the literature review highlighted the lack of knowledge about these species.

The two components of this measure will focus on (i) genetic sequencing of the species with a view to deploying techniques for research of the species by environmental DNA

(eDNA), (ii) finer description of the habitat and ecology of the species via an initial coupled eDNA survey effort to target areas where the species is present (hydrographic section), then by traditional fish inventory in a second step (electric fishing, fishing gear) on the sections that have revealed the presence of the species, in order to describe the species' habitat more precisely (temperature and physico-chemistry in situ, flow rates, depths, flow facies, substrate, sealing,...). The study area for this measure would be the Mangoro basin, with a focus on the Project area.

Considering the high rate of endemism in the *Rheocles* genus, this measure will also make it possible to verify if there is not a subspecies specific to the study area.

This measure will be carried out in coordination with IUCN (so that the knowledge acquired is available to all) in order to contribute to improving the knowledge of this species and thus contribute to its better protection and conservation.

7.3.4.2 Targeted and Adapted Control of Invasive Alien Species

The transition from a mosaic of relatively diverse aquatic habitats in terms of flow facies upstream from the reservoir to a uniform lentic zone will favor the least demanding species with rapid development capacities, such as invasive alien species such as *Cyprinus carpio* or *Channa maculata*, a predator of the *Rheocles*. However, these species are already present in the Onive and some of its tributaries throughout the close study area for many years and rainbow fishes are nevertheless able to maintain themselves.

In addition to this risk, there is also the risk of the introduction of the invasive alien crayfish species *Procambarus virginalis*. Already present in the Mangoro basin near Moramanga for several years, it has been a major threat to endemic crayfish species due to its reproductive capacity by parthenogenesis (Jones *et al.*, 2008).

This fight will necessarily be coupled with the following measure, which allows the local population to be involved in the problem of aquatic IAS.

Beforehand, a bibliographic search of the various existing and internationally implemented management measures on the targeted species will be carried out. It will make it possible to pre-select certain actions whose feasibility will be analyzed. The most realistic intervention methods considering the context of the study area and the means that can be mobilized will be selected and an action plan will be developed.

Monitoring through fish inventories and surveys of fishermen and local populations will make it possible to assess the effectiveness of the action and, if necessary, to correct it.

7.3.4.3 Raising awareness among local populations to target the capture of Invasive Alien Species (IAS) rather than native threatened species (*R. wrightae*) and crayfish

The literature shows that many species, including threatened endemic fish species such as *Rheocles*, are regularly consumed by local populations. This fishing pressure is in addition to the various limiting factors affecting the species.

Surveys carried out have confirmed that some rare or threatened species are under fishing pressure. This is particularly the case for *Rheocles* ("zono" in Malagasy) but also for crayfish ("orana" in Malagasy). However, the surveys also revealed that due to the depletion of fish stocks (linked to the consequences of gold panning and deforestation), fishing pressure has been decreasing for several years.

The use of certain traditional fishing techniques (angling or fishing with gillnets or non-gillnets with large mesh) makes it possible to target less demanding and less heritage

species. These species are often IAS such as: carp, mainly exotic tilapia and *Channa maculata*. These species are already fished and appreciated for consumption.

Consequently, raising awareness of ecological issues among the local population can, through on-site meetings such as *Fokontany* meetings, help to preserve rare and threatened species, including native *Rheocles* and crayfish.

This type of measure can also involve local populations and make them actors in the management of their natural heritage.

7.3.5 Summary of Mitigation Measures - Aquatic Environments

All mitigation measures related to aquatic biodiversity are summarized in the following table:

Table 132 - "Aquatic biodiversity" Mitigation Measures

Nature of the risk	Risk	#	Measure	Implementation	
				Period	By
Impact of the modified hydrological regime on habitats downstream from the dam and plant	Important	BioA01	During the implementation of the Aval03 action: ichthyologists will be involved in this test, in order to accurately assess the possible impact of different environmental variations and conditions on the habitat of aquatic species in the Onive or even on the species themselves.	During the first filling of the impoundment	NEHO in coordination with EPC
Total drying of the bed downstream from the dam.	Low	BioA02	Maintaining the instream flow at all times in the bypassed reach (5.7 m3/s)	Construction and commissioning	EPC
Total drying of the bed downstream from the dam.	Moderate	BioA03	Maintaining the instream flow at all times in the bypassed reach (5.7 m3/s)	Exploitation	NEHO
Inadequate protection measures implemented due to poor knowledge of the ecology of the species.	Important	BioA04	Further knowledge of Rheocles wrightae and Rheocles sp. Ambatovy, in coordination with IUCN, and improvement of knowledge of this species to contribute to its better protection and conservation.	Construction and operation	NEHO
Possible risks for Rheocles wrightae due to the Project.	Important	BioA05	Conservation measures for the species Rheocles wrightae and Rheocles sp. Ambatovy (if impacts confirmed by monitoring).		NEHO
Development of invasive species (aquatic fauna or flora) in the reservoir.	Moderate	BioA06	Targeted and adapted control of aquatic invasive alien species.	Exploitation	NEHO
Development of invasive species (aquatic fauna or flora) in the reservoir.	Moderate	BioA07	Raising awareness among local populations to target the capture of Invasive Alien Species (IAS) rather than native threatened species (R. wrightae) and crayfish.	Exploitation	NEHO

7.4 Impacts on Ecosystem Services and Mitigation Measures

Table 133 - Impacts On Priority Ecosystem Services And Mitigation Measures

	Impact level (Type I)	Relevance to affected communities (Type I)	Dependency level (Type II)	Management Control Level (Type I and II)	Mitigation Measures
	Is the Project likely to have a significant impact on the ecosystem service?	Will the impact result in a direct negative impact on the livelihood, health, safety and/or cultural heritage of the affected communities?	Does the Project depend directly on the service for its primary operations?	Does the Project have direct control over management or a significant influence on the service?	
SUPPLIES					

Harvesting	Yes	Yes	Yes	Yes	See RAP
Livestock	Yes	Yes	No	Partial	See RAP
Fishing	Yes For example, eels migratory species will be impacted	Yes (fishing activity practiced locally in the Onive and its tributaries but the activity is less and less practiced because of the scarcity of the resource)	No	Yes	Assistance in the conversion to fishing of species that will develop in the reservoir, replacing eel fishing
Wild foods: gathering and hunting	Partial	Yes	No	No	Support for VOIs (see Action BioT24)
Biochemicals, natural medicines and pharmaceuticals	Partial	Partial	No	No	Support for VOIs (see Action BioT24)
Wood and other wood fibers	Partial	Partial	No	No	Support for VOIs (see Action BioT24)
Fresh water	Yes Modification of aquatic habitat and water physico-chemistry in the reservoir and on the short-circuited section (CPT) and modification of flows in the CPT and downstream from the plant	Yes: Households use Onive water for agricultural uses and tributary water (upstream dam) for domestic and agricultural uses	No	Yes	See RAP
Irrigation of rice fields	Partial	Yes: The water from tributaries, especially upstream from the dam, is diverted to feed the rice fields	No	Yes	See RAP
Gold panning	Yes: Increased gold panning activities upstream from the dam with a view to flooding the area, which will then be made inaccessible. Then, as soon as the dam is impounded, this activity is eliminated at the reservoir level	Yes: Gold panning leads to the clearing of alluvial areas, soil erosion	No	Yes	See RAP
Genetic resources	Partial: the Onive ensures the connectivity of aquatic and ornithological fauna populations by promoting	Yes	No	No	The upstream part of the dam will probably no longer be accessible to migratory species.

	exchanges between upstream and downstream populations and from freshwater to saltwater (4 migratory fish species). The facility will be an additional element of fragmentation of their biotope				The migratory species in the area are not associated with conservation issues. No mitigation measures.
REGULATION					
Local / Regional climate regulation	Partial	Yes	Yes	Partial	Contribution to the reduction of greenhouse gas emissions. No mitigation measures.
Water regulation	<p>Yes: Upstream dam: Replacement of a river regime by a lake regime over a linear stretch of about fifteen kilometers upstream from the dam (creation of a water reservoir)</p> <p>Modification of the hydrology of the river in the bypassed reach (about 17 km)</p> <p>Changes in hydrological conditions in the BPR and downstream from the plant</p> <p>Positive impact on low water level support and flood control downstream from the dam</p>	Yes	Yes	Yes	See downstream impact measures (Downstream01 to Downstream04).
Erosion control	<p>Yes: Large areas will be cleared during the construction work, which increases the risk of erosion on land already highly sensitive to erosion.</p>	Yes: Erosion impacts agriculture, which is the main activity and source of income of the populations affected by the Project	Yes	Yes	See erosion control measures (Ero01 to Ero04).

Water purification and waste treatment	Yes The risks of soil degradation and pollution, due to construction works and increased risks of soil erosion, are likely to impact the ability of ecosystems and soils to filter water and remove organic pollutants.	Yes	Partial	Yes	See waste management measures (Dech01 to Dech04).
Disease regulation	Partial: The modification of aquatic habitats (disappearance of fast facies upstream from the dam in favor of slow and deep lake areas will favor vectors of diseases already present, however, such as <i>Schistozoma</i> , vector of bilharzia.	Yes	Yes	Partial	See measures relating to the prevention of waterborne diseases (Saco03 and Saco04).
Regulation of natural disasters	Partial Small flood reduction but probably low impact on the highest floods	Partial	No	No	Reduction of downstream risk for populations. See measurement Séco12.
SUPPORT					
Nutrient capture and recycling	Partial: Nitrogen and nitrates captured in the reservoir of water stored mainly in the sediment and occasionally released into the water of the Onive but not recovered	Yes: possible water pollution by nitrogen and nitrates in the water of the Onive (accumulation/release phenomena)	No	Partial	See measures Qeau01 to Qeau04 relating to the preservation of water quality
Primary production	Partial	Yes	No	Partial	See measures Qeau01 to Qeau04 relating to the preservation of water quality

Table 134 - Mitigation Measures for “Ecosystem Services”

#	Measure	Implementation	
		Period	By
Ecos01	Assistance in the conversion to fishing of the species that will develop in the reservoir, replacing the eel fishery.	First year of filling the reservoir	NEHO

7.5 Biodiversity Action Plan

In addition to the mitigation measures described in Chapter 7, a Biodiversity Action Plan (BAP) will be prepared by the Project to ensure and verify a lack of net loss (and net gain where possible) of biodiversity for species requiring critical habitat analysis identified in the ESIA.

The BAP will cover the construction period and the operating period. It will be prepared as a continuation of the ESIA and will include:

- A timetable and details of all actions related to biodiversity protection.
- A timetable and support measures for the effective establishment of the Tsinjoarivo NPA.
- A refined definition of the discrete management units introduced in the ESIA.
- An assessment of critical habitat losses and risks of net loss of biodiversity despite the mitigation measures described in the ESIA, by species or taxon if relevant.
- A program of additional mitigation and monitoring measures to verify the absence of net losses, defined in consultation with the managers/proponents of protected areas close to the Project, and with civil society organizations involved in species conservation in Madagascar and more specifically in the vicinity of the Project area.
- Justification of the additionality of the measures with current or future public policies and programs in Madagascar, paying particular attention to which measures do not replace or duplicate existing or planned funding.
- The definition of qualitative or quantitative thresholds and time objectives to confirm the success of the actions implemented, or on the contrary to indicate the failure of a mitigation measure and the need to implement corrective measures.

Table 135 - “Biodiversity Action Plan” Mitigation Measures

#	Measure	Implementation	
		Period	By
Pab01	Preparation, implementation and monitoring of a Biodiversity Action Plan	Preparation before construction and then implementation.	NEHO

8 Cumulative Impacts

This chapter looks into the risks of cumulative impacts with other hydroelectric projects. The analysis is limited to the hydroelectricity sector (including the line), as there are no other large-scale infrastructure projects or programs in the area that could generate cumulative impacts with the Project.

8.1 Description of Other Possible Hydropower Plants

The possibility of building hydroelectric dams on the Onive and Mangoro rivers has been considered since the 1960s.

Three facilities (in addition to Sahofika) have been identified and studied:

- The Tsinjoarivo site
- The Andasirotsaka site
- The Lohavanana site

These three sites are located on the map below and described later in the chapter.

Figure 87 - Location of Planned Hydropower Facilities in the Onive and Mangoro River Basin

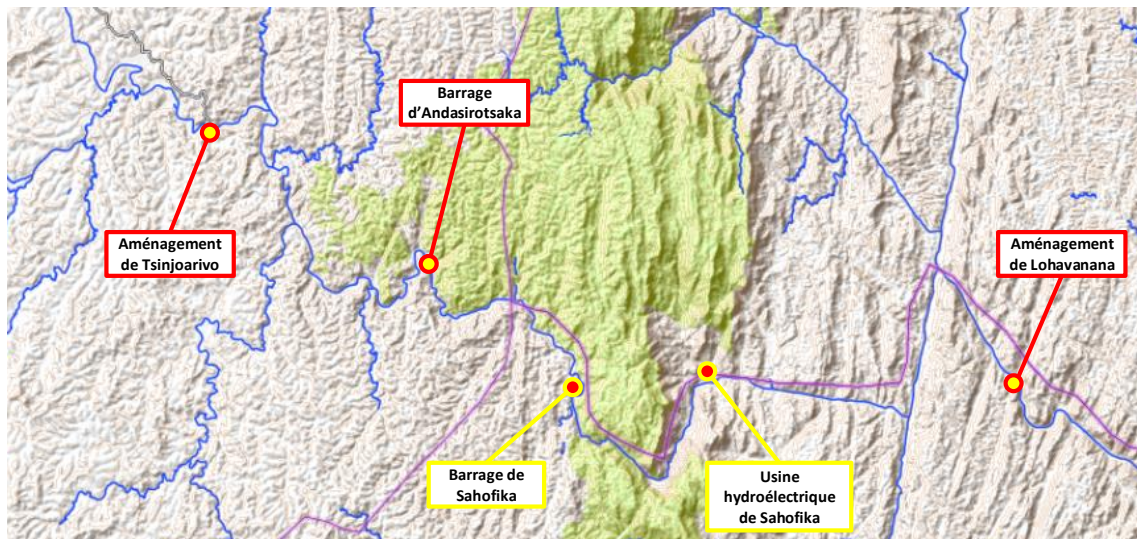

8.1.1 Tsinjoarivo Hydroelectric Power Plant

The Tsinjoarivo site is located on the Onive River, upstream from Sahofika. It was studied by SEM - EDF in 1964. It is included in the call for expressions of interest launched by the MEEH in 2017.

This is a medium-power run-of-river facility (15 to 45 MW) that uses an existing 50m head with hydrological characteristics similar to those of Sahofika. The site is restricted by existing rice fields (it would drown a vast agricultural plain) and by its proximity to the historic site of Tsinjoarivo (see Chapter 4.2.11.3)..

Figure 88 – The site and fall of Tsinjoarivo

The Tsinjoarivo natural waterfall would be located about 39 km upstream from the Sahofika dam (or 26 km upstream from the high water reservoir), following the Onive and Mangoro rivers.

The 1964 study proposed 21 MW equipment with a turbinated flow rate of 50 m³/s and a production rate of 115 GWh/year. Since local demand is out of proportion with production and since the facility has a low guaranteed production, it is intended to supply the interconnected Antananarivo-Antsirabé network. It would be possible for the facility to be connected to the Project's 225kV line, or to be connected to a lower voltage substation.

8.1.2 Andasirotsaka Control Dam

The Andasirotsaka site is a site that has been considered on the Onive for the implementation of complementary regulation (not for hydroelectric production). It is located 1.5 km from the end of the Sahofika reservoir at 1325 m, and its foot would be drowned during major flood events. It could be considered in the future, if the downstream facilities of Sahofika and Lohavanana are built.

This project has not been subject to recent studies.

8.1.3 The Lohavanana Hydropower Plant

The information on this facility comes from the “comparative of power plants” carried out in December 2009 and included in the pre-feasibility study of a major hydropower plant for interconnected networks in Madagascar, carried out as part of the Restructuring and Renovation Plan for the Energy and Electricity Sector (P2RS2E).

The Lohavanana site is located on the Mangoro River, downstream from the Onive-Mangoro confluence. It enjoys a very large catchment area (11,500 km²). The proposed facility cuts through a loop of the Mangoro by a 2000 m gallery, and thus exploits a 110 m waterfall. The water intake of the Lohavanana hydropower plant would be located approximately 27 km downstream from the Sahofika Hydropower Plant, following the Onive and Mangoro rivers.

Figure 89 – Location of the Lohavanana Project

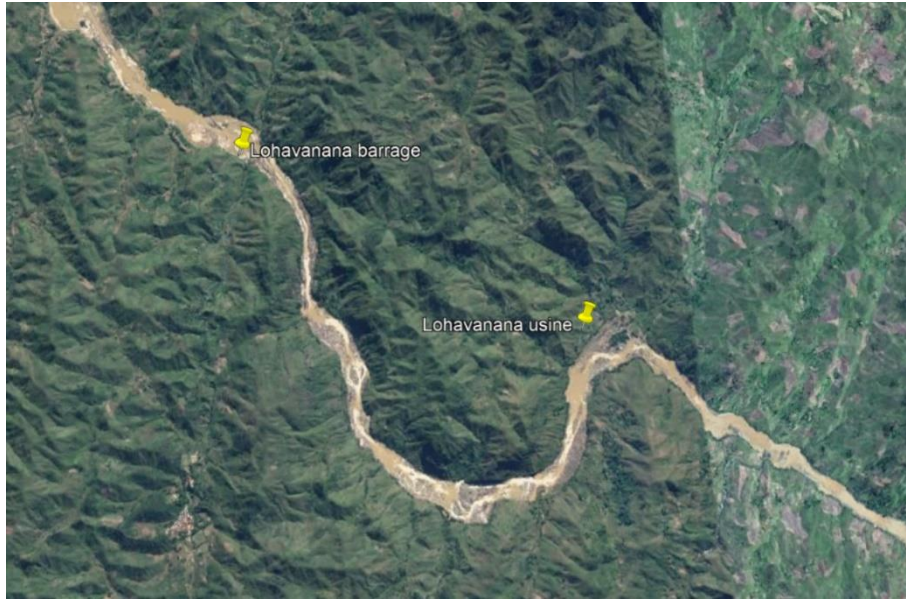

This is a run-of-river facility that was studied in 2001 with the following characteristics:

- Small daily regulatory capacity (peak production), but not seasonal.
- Average annual flow rate: 314 m³/s
- Design flow rate 150 m³/s
- Gross fall 109 m
- Installed capacity 4x30 MW for a production capacity of 915 GWH/year.

The Sahofika plant would lead to a regulation of downstream flows, and would therefore benefit the Lohavanana project. The increase in flow would reach 20 m³/s in a dry year, which would represent a very significant part of the low water flow in Lohavanana and would allow it to be equipped more economically.

The main impacts of the Lohavanana project relate to the flooding of inhabited and cultivated areas upstream, and the impact on ecological continuity in the bypassed reach.

The Lohavanana hydropower plant is also intended to supply the interconnected Antananarivo-Antsirabé grid, probably via a 225 kV line given its installed capacity. This line should, like that of the Project, cross the forest corridor.

8.1.4 Probability and schedule of completion of the works

In terms of agenda, we will base the analysis of cumulative impacts on the following assumptions:

Table 136 - Probability and construction schedule of the other dams in the Onive

Plant	Probability of occurrence	Probable Construction Dates
Sahofika Hydroelectric Power Plant	Under preparation, commissioned around 2024	2020-2024
Tsinjoarivo Hydroelectric Power Plant	Probable, call for tenders made	in the short to medium term
Lohavanana Hydropower Plant	Possible, no current call for tenders	in the medium to long term

Andasirotsaka Control Dam	Unlikely, no current call for tenders	in the medium to long term, and not before Sahofika and/or Lohavanana are in service
----------------------------------	---------------------------------------	--

8.2 Cumulative Impact Analysis

The analysis presented below follows the approach recommended in the IFC's Good Practice Manual for Cumulative Impact Assessment.

8.2.1 Spatial and Temporal Boundaries

The spatial framework for the analysis of cumulative impacts associated with downstream hydroelectric projects corresponds to the Mangoro basin (including the Onive basin), the rights-of-way of any reservoirs that may be formed, and the environments (social or natural) near these rights-of-way that may therefore be within their area of influence.

The analysis has no time limit as it covers the construction period and then the operating period of the facilities in question.

8.2.2 Identification of Environmental and Social Receptors

Environmental and social receptors are all areas, habitats, species, persons and socio-economic actors likely to be impacted if the planned facilities are carried out within the spatial limits defined for the assessment of cumulative impacts. The following table provides a description of these receptors:

Table 137 - Cumulative Impacts: Environmental and Social Receptors

Receiver	Sahofika	Tsinjoarivo	Andasirotsaka	Lohavanana
Physical movement	Approx. 500 households	Probably several hundred homes	Probably several dozens or hundreds of households	Probably several dozen households
Socio-economic activities impacted	family farming	family farming, large areas concerned	family farming, large areas concerned	family farming, small areas concerned
Impact on public infrastructure	Rehabilitation and creation of a road access from Antanifotsy to Sahofika.	Rehabilitation of road access from Antanifotsy to Tsinjoarivo.	Creation of road access, probably from Sahofika	Creation of road access, probably from Sahofika
Impacted aquatic environments	Modified aquatic habitat of the Onive. A species of EN fish downstream from the falls.	Modified aquatic habitat of the Onive.	Modified aquatic habitat of the Onive.	Natural aquatic habitat of Mangoro de l'Onive. At least one species of fish (EN).
Crossing the forest corridor	Yes, for the road and the line, for about 3.5 km as the crow flies	no	no	Like Sahofika
Protected or internationally recognized areas with an impact	Project located in the protection zone of Marolambo Park. Line and track crossing the Tsinjoarivo NPA	World Cultural Heritage Site nearby.	Project located in the Marolambo Park Protection Zone	Line and track crossing the Tsinjoarivo NPA

8.2.3 Method of Assessing Likely Cumulative Impacts

Since the additional analysis of cumulative impacts focuses on hydropower plants, the proposed analysis uses a traditional primary / secondary impact approach for facilities of this nature:

8.2.4 Primary Cumulative Impacts

As shown in Table 145, there are four types of negative primary cumulative impacts that can be generated by the construction of hydroelectric facilities upstream or downstream from the Sahofika Project: impacts related to sediment transport, water retention formation, fragmentation of aquatic environments, and impacts related to water quality changes and greenhouse gas emissions.

Table 145 - Primary Cumulative Impacts

	Cumulative impacts of Sahofika and...		
	...Tsinjoarivo	...Andasirotsaka	...Lohavanana
Changes in the downstream seasonal hydrological regime	Run-of-river construction, no change in the seasonal hydrological regime. ▶ No cumulative impact	Book intended for the modification of the seasonal hydrological regime. ▶ Positive cumulative impact on low water level support	Run-of-river construction, no change in the seasonal hydrological regime. ▶ No cumulative impact
Modification of the downstream daily hydrological regime	In case of daily peak operation of Tsinjoarivo, flow variations will be absorbed by the Sahofika reservoir.	Any variations in flow will be absorbed by the Sahofika reservoir. ▶ No cumulative impact	Lohavanana has the ability to operate at a daily peak independently of Sahofika.
Modification of the sedimentary regime	Run-of-river facility with low sediment retention capacity. ▶ No cumulative impact	Reservoir with annual tidal range, capable of retaining some of the sediments such as Sahofika. ▶ Cumulative primary impact on sediment transport	Run-of-river facility with low sediment retention capacity. ▶ No cumulative impact
Creating a impoundment	Each of the proposed structures involves the formation of a reservoir and the corresponding impacts, including the loss of agricultural land, will necessarily accumulate. ▶ Cumulative primary impact: formation of reservoirs		
Fragmentation of the aquatic environment	Both structures use existing waterfalls, and the upper reaches of the Onive is a modified aquatic habitat with no conservation implications. Once Sahofika is built, there will be no further fragmentation issues upstream ▶ No cumulative impact		Facility impacting on ecological continuity that will be added to that of Sahofika. ▶ Cumulative primary impact on fragmentation of the aquatic environment
Changes in water quality Greenhouse gases	Water quality problems will mainly result from the release of nutrients from drowned biomass and the flooding of potentially cultivated land. The volumes of nutrients or pesticides mobilized will increase with the number of reservoirs, and these chemical or organic pollutants will accumulate downstream from one dam to another. Since water quality will be mainly affected in the first few years (typically 2 to 4 years) after dam impoundment, the more concomitantly dam construction would be, the more negative impacts on water quality and greenhouse gas emissions would accumulate. The risk mainly concerns Tsinjoarivo, as the other facilities have a low probability of being commissioned at the same time as Sahofika.		
	▶ Cumulative primary impact: change in water quality and greenhouse gases	▶ No cumulative impact	

The consequences of these primary impacts on the previously identified environmental and social receptors are described in the following chapters.

8.2.5 Secondary Cumulative Impacts on Social Receptors

Table 138- Secondary Cumulative Impacts On Social Receptors

	Cumulative impacts of Sahofika and...		
	...Tsinjoarivo	...Andasirotsaka	...Lohavanana
Resettlement of populations	<p>All the facilities considered require the relocation of homes. Cumulative impacts could occur if affected households relocated to areas that would in turn be expropriated for one of the other facilities.</p> <p>► Possible cumulative secondary social secondary impact: re-expropriation by subsequent projects of physically displaced persons by the Project</p>		
Land losses	<p>The problem is similar to the previous case. Cumulative impacts could occur if affected landowners acquired land in areas with compensation that would in turn be expropriated for another facility.</p> <p>► Possible secondary social cumulative secondary impact: re-expropriation by subsequent projects of land acquired as compensation for land lost as a result of the Project</p>		
Loss of livelihood: access to agricultural land	<p>This risk concerns people who use land (which they do not necessarily own) for agricultural or agro-forestry production. As in the two cases above, cumulative impacts could occur if people affected by the Project leased land in areas that would in turn be expropriated for another facility to compensate for their loss of income.</p> <p>► Possible secondary social cumulative impact: re-expropriation by subsequent projects of land used to compensate for income lost as a result of the Project</p>		
Loss of livelihood: fishing	<p>This risk concerns people fishing in the Eel Project area (the only migratory species fished). Cumulative impacts could occur if people affected by the Project redirected their income strategy towards eel fishing activity downstream from the Project (not upstream, where eels will no longer have access), in the diversion bays that would in turn likely be neglected by eels in the event of the construction of Lohavanana.</p>		
	<p>► No risk of cumulative secondary social impact</p>	<p>► Possible secondary social cumulative impact: further loss of livelihood for those who have shifted their income strategy to eel fishing downstream from the Project</p>	
Losses of public property or public infrastructure	<p>In the absence of public or collective infrastructure losses caused by the Project, cumulative impacts are not possible.</p> <p>► No cumulative impact</p>		
Nuisances during construction	<p>The nuisances associated with the construction of hydroelectric facilities are local and the spatial and temporal distance of the construction activities of the three projects excludes the risk of cumulative impacts.</p> <p>► No cumulative impact</p>		
Population influx and employment	<p>The spatial and temporal distance of the construction activities of the three projects excludes the risk of negative cumulative impacts. On the other hand, a timely sequence of construction of downstream facilities would allow people who have acquired experience on a project to value this experience on subsequent projects.</p> <p>► No negative cumulative impact</p>		
Public Health	<p>The spatial and temporal distance of the construction activities of the three projects excludes the risk of negative cumulative impacts during the construction phase. On the other hand, the risks associated with waterborne diseases specific to water retention in the region could increase with the increase in drowned areas. However, this remains to be confirmed in the context of an analysis of the development of such diseases within the framework of the Project.</p> <p>► Possible cumulative secondary social impact: increased risk of waterborne diseases after reservoir filling</p>		

8.2.6 Secondary Cumulative Impacts On Environmental Receptors

Table 139 - Secondary Cumulative Impacts On Environmental Receptors

	Cumulative impacts of Sahofika and...		
	...Tsinjoarivo	...Andasirotsaka	...Lohavanana
Emissions and discharges (solid / liquid) related to construction	The risks of air, liquid or solid pollution associated with the construction of hydroelectric facilities are local and the spatial and temporal distance of the construction activities of the three projects excludes the risks of cumulative impacts. ► No cumulative impact		
Modification and fragmentation of aquatic habitats	This risk only concerns the downstream part of the Sahofika Project, as the high Onive River is a modified habitat dominated by introduced species. If the Lohavanana Project is built, the aquatic environments downstream from the Sahofika Plant would be fragmented if no instream flow and fish passage measures are taken in Lohavanana.		
	► No cumulative impact		► Secondary cumulative environmental impact: loss and fragmentation of aquatic habitats for anadromous or conservation-important species downstream from Sahofika
Flooding of terrestrial habitats	The area of natural terrestrial habitat lost will increase with the number of projects and the extent of their reservoirs. However, considering the small size of the reservoirs, the small amount of natural habitat they contain, and their remoteness from the Sahofika Project, the risk of significant cumulative impacts on the loss of natural terrestrial habitat is not considered plausible, unless reforestation was carried out in the footprint of future compensation reservoirs. ► Possible secondary cumulative environmental impact: flooding by subsequent projects of reforested land to compensate for natural habitats lost as a result of the Project		
Impacts on recognized or protected areas	► No cumulative impact	Pressure on protected areas will increase with the number of facilities (Andasirotsaka reservoir on the MNP, Lohavanana power line in the NPA), as they will serve as a refuge for species (terrestrial, chiropterans and birds) that have also lost habitats. ► Cumulative secondary environmental secondary impact: increased pressure on protected areas	

8.3 Cumulative Impact Mitigation Measures

The proposed measures to mitigate the risks associated with cumulative impacts are described below. They take into account the fact that the short-term construction of the Tsinjoarivo facility is considered more likely than that of the other facilities.

Table 140 - Cumulative Impact Mitigation Measures

Cumulative impact identified	Proposed Mitigation Measure	Residual risk
Re-expropriation by subsequent projects of: <ul style="list-style-type: none"> • people physically displaced by the Project • land acquired as compensation for land lost as a result of the Project • land used to compensate 	Action: Do not plan a relocation site for the Sahofika Project within the footprint of the other projects. Inform the populations affected by the Project of the risk of construction of other hydropower plants. Assist people who want more specific information to access it, based on publicly available	Low (the residual risk will materialize if a person affected by the Project knowingly chooses to direct his or her life strategy towards one of the areas likely to be flooded by subsequent facilities, and that subsequently

for land lost as a result of the Project	information. Implementation: NEHO, social team.	this facility is actually built.)
Further loss of livelihood for those who have shifted their income strategy to fishing downstream from the Project	Timetable: during the preparation of the RAP and public consultations with the people affected by the Project.	
Increased risk of waterborne diseases after filling reservoirs	Action: Disclosure of the action program implemented under the Project to mitigate risks related to waterborne diseases under the Project, and the results of the follow-up with the other projects. Implementation: NEHO, social team. Disclosure of information on NEHO's website. Timeframe: as actions are implemented and monitoring results are available.	None to low on the Project's area of influence (the waterborne diseases likely to develop in the various reservoirs are a priori the same, and therefore the solutions adopted for Sahofika will cover any additional risks generated by the downstream reservoirs)
Loss and fragmentation of aquatic habitats for anadromous or conservation-important species downstream from Sahofika	Action: Do not adopt biodiversity risk mitigation measures for Sahofika that depend on habitats that would in turn be impacted if subsequent facilities were developed. Share Sahofika biodiversity monitoring results (on the Project website) to enable other projects to benefit from Sahofika's experience. Implementation: NEHO, environmental team. Timeframe: During the preparation and implementation of the ESIA.	None
Subsequent projects deplete reforested land to compensate for natural habitats lost as a result of the Project		
Increased pressure on protected or recognized areas	Action: Disclose information on actions taken to support the Tsinjoarivo NPA and the MNP. Capacity building of the Tsinjoarivo NPA and the MNP in the assessment and management of negative impacts. Implementation: NEHO, environmental team. Timeframe: Disclosure of information as it becomes available. Capacity building during the first year of construction of the Project.	Low if subsequent developers align themselves with the good practices introduced by the Project and comply with national legislation.

All mitigation measures related to cumulative impacts are summarized in the following table:

Table 141 - "Cumulative impacts" Mitigation Measures

#	Measure	Implementation	
		Period	By
Cumu01	Do not plan a relocation site for the Sahofika Project within the footprint of the other projects. Inform the populations affected by the Project of the risk of construction of other hydropower plants. Assist people who want more specific information to access it, based on publicly available information.	During the preparation of the RAP and public consultations with the people affected by the Project	NEHO, social team.
Cumu02	Disclosure of the action program implemented under the Project to mitigate risks related to waterborne diseases under the Project, and the results of the follow-up with the other projects. Disclosure of information on NEHO's website.	As actions are implemented and the results of the monitoring carried out become available	NEHO, social team.
Cumu03	Do not adopt biodiversity risk mitigation measures	In the	NEHO,

	for Sahofika that depend on habitats that would in turn be impacted if subsequent facilities were developed. Share Sahofika biodiversity monitoring results (on the Project website) to enable other projects to benefit from Sahofika's experience.	preparation and implementation of the ESIA	environmental team.
Cumu04	Disclose information on actions taken to support the Tsinjoarivo NPA and the MNP. Capacity building of the Tsinjoarivo NPA and the MNP in the assessment and management of negative impacts.	From the first year of construction of the Project.	NEHO, environmental team.

9 Environmental and Social Management Plan

9.1 NEHO and EPC Plans

The achievement of E&S objectives requires the implementation of the actions defined in this ESIA. NEHO is responsible for the proper implementation of these actions vis-à-vis the competent Malagasy authorities, its shareholders and the donors who finance the Project.

Taking into account that (i) the Project will be executed until it is commissioned by a private company through an EPC contract, and (ii) a significant proportion of the E&S actions of the Project will be under construction implemented by that company, it has been decided to separate the E&S Management Plan into two parts:

- The PGES-EPC will be prepared and implemented by the EPC company (see Chapter 9.39.3).
- the NEHO ESMP will be implemented by NEHO (see Chapter 9.4).

9.2 E3S Path To The Construction Phase

9.3 ESMP-EPC

9.3.1 Document Life

The operational version of the EPC ESMP will be prepared and finalized in this way:

- Based on the actions identified in the ESIA as being part of the EPC, the EPC company prepares a draft of the ESMP-EPC.
- The draft of the ESMP-EPC is reviewed by NEHO, then finalized by the EPC company until approved by NEHO to form the initial version of the ESMP-EPC.
- The ESMP-EPC is then the reference document for the daily monitoring of the E&S performance of the EPC’s activities, without however taking precedence over the contractual or legally enforceable documents of the Project.

The ESMP-EPC is then treated as a living document that is updated during the construction phase if it is necessary, for example:

- if the EPC or NEHO identify necessary improvements to the ESMP-EPC to correct elements that require it;
- if any of the competent authorities of the state or any of the Project’s funders require an amendment to correct a non-compliance.

9.3.2 Content of the ESMP-EPC

The following table presents a summary of the actions to be implemented by the works company.

#	Measure	Implementation	
		Period	By

Opti01	Optimization of the management of excavated soil and backfill to minimize the volumes extracted from borrow sites and the volumes placed in final storage.	Design and construction	EPC
Opti02	Definition and technical, environmental and social optimization of the exact route of the line and access road, by adopting a layout and design of the line and road that avoids forested areas as far as technically possible, based on the ESIA.	Design and construction	EPC
Opti03	Layout of the track and transmission line between the dam and the plant according to the routes selected in the ESIA and using as much as possible the areas already cleared. The exact location during detailed design must be based on field surveys that combine technical and environmental teams to ensure that environmental impacts are also minimized at this stage. The transmission line will be buried over a distance of 1.6 km, in accordance with ESIA recommendations.	Design and construction	EPC
Opti04	<p>For the establishment of temporary or permanent infrastructures not yet defined, select the sites by associating environmental and social experts.</p> <p>Use the footprint of the future reservoir for temporary infrastructure and extraction sites as much as possible.</p> <p>At the dam, outside the reservoir area:</p> <ul style="list-style-type: none"> • Implement temporary infrastructure on the right bank of the Onive (to the west) rather than on the left bank to minimize risks to the new protected area; • avoid natural habitats and agricultural areas to limit the volume of compensation or economic displacement. <p>At the plant level: avoid agricultural areas to limit the volume of compensation or economic displacement.</p>	Design and construction	EPC
Opti06	Arrange crossings along the penstock for current users (pedestrians, pets) in numbers and locations that are consistent with existing crossings.	Design and construction	EPC
Ero01	Preparation of a plan for earthworks/excavated t/fill materials management and erosion prevention submitted to NEHO for approval and incorporating the principles of Chapter 5.2.1.2 of the ESIA.	Pre-construction	EPC
Ero02	Engagement in the EPC team of an "Erosion control manager" in charge of implementing the plan prepared as part of the Ero01 action.	Construction	EPC
Ero03	Installation of crossing structures on all watercourses to be crossed by vehicles or construction machinery.	Construction	EPC
Ero04	Shaping of final disposal areas for surplus materials to facilitate their integration into the landscape.	Design and construction	EPC
Downstream01	Maintain a permanent instream flow of 5.7m ³ /s or more downstream from the dam at all stages of construction and testing.	Construction and water supply	EPC
Downstream02	Water intake supplying the instream flow sized in such a way as to allow the flow to be adjusted, and with the possibility of supplying a micro-	Design and construction	EPC

	power plant.		
Atmo01	Regular watering in the dry season. Establish a follow-up of complaints related to dust and take measures to limit their impact	Construction phase	EPC
Atmo02	Limitation of the speed of construction vehicles to 40 km/h on the tracks and 15 km/h on working platforms or in installations	Construction phase	EPC
Atmo03	Installation of speed bumps in populated areas (in agreement with the authorities responsible for public roads)	Construction phase	EPC
Atmo04	Prohibition of the use of explosives from 21h to 7h for surface work (authorized underground)	Construction phase	EPC
Atmo05	Continuous noise measurement at the Faravohitra school, one month before the start of the work and during the work. Organization of the site in such a way that the ambient noise level does not increase by more than 3dB (IFC guidelines)	Construction phase	EPC
Atmo06	Minimization of emissions: <ul style="list-style-type: none"> Measurement before the first entry and then monthly of the exhaust gases from thermal equipment used in tunnels. Prohibition of access to the tunnel for the most emitting equipment if the thresholds are exceeded.	Construction phase	EPC
Atmo07	Installation of ventilation in tunnels	Construction phase	EPC
Atmo08	Continuous measurement of air quality in the tunnel: CO, NO ₂ , SO ₂ , PM _{2.5} and PM ₁₀ .	Construction phase	EPC
Atmo09	Measurement before the first use and then semi-annual of the exhaust gases from the thermal equipment used on site.	Construction phase	EPC
Atmo10	Stopping and prohibiting on site vehicles emitting a cloud of smoke affecting the visibility or breathability of the air	Construction phase	EPC
Dech01	Preparation and implementation of a plan for the collection, treatment and management of liquid and solid waste for the construction phase, taking into account the three principles set out in the ESIA (avoid the uncontrolled spread of pollutants, compliance with Malagasy standards, compliance with IFC recommendations)	Construction	EPC
Dech02	As part of initial and subsequent training, raise workers' awareness of solid and liquid waste management.	Construction	EPC
Dech03	Internal control of waste collection (keeping a register) and effluent quality.	Construction	EPC
Poll01	Preparation and implementation of a pollution and spill management plan for the construction phase, taking into account the principles set out in the ESIA.	Construction	EPC
Poll02	As part of initial and subsequent training, training of workers in the prevention and management of spills of polluting products.	Construction	EPC
Poll03	Sizing (i) the operator's facilities supporting hydromechanical and electromechanical equipment, and (ii) storage sites for oils and other petrochemical or chemical products, so that direct leakage into the environment without retention is impossible. Where this is not possible, use biodegradable oil.	Design and construction	EPC
Poll04	Construction for the operator of maintenance and fuel supply facilities for the Project's vehicles to contain accidental leaks and maintenance products.	Design and construction	EPC

Clim01	Climate risk modelling (downscaling): calculation of the sensitivity of the Project's floods to expected climate changes, and design of the hydropower plant in such a way as to be able to integrate a possible future increase in its flood evacuation capacity.	Detailed design	EPC
Clim06	Meteorological monitoring - transmission line: <ul style="list-style-type: none"> Definition of two monitoring points and installation of stations Operation and maintenance of stations	Construction	EPC
Qeau01	Vegetation removal in the most vegetated areas (forests) before impoundment (approx. 145 ha). The possibility for the populations to recover the wood in the flooded area will be studied with the DGEF.	Construction, before impoundment	EPC or NEHO
Rupt01	Visit of all the inhabited places exposed downstream, taking into account the possible upwelling of water in the Mangoro River upstream from the confluence with the Onive. Verification of local topography, historical flood levels, house elevations relative to the riverbed and the presence of refuge sites within walking distance.	Construction, before impoundment	EPC
Rupt02	Hydraulic model of the ten-year, centennial flood and dam failure, based on the detailed project and field visit. Identification of exposed villages and possible refuge sites.	Construction, before impoundment	EPC
Rupt03	Preparation of an emergency response plan based on the model defined in the ESIA.	Construction, before impoundment	EPC
Rupt04	Implementation of the operational elements of the emergency response plan, including information and training of villagers, means of communication and alerting the villages concerned (VHF or telephone antennas), and marking of refuge areas in the villages concerned.	Construction, before impoundment	EPC
Entr01	Implementation of a procedure for entering the land, including validation and marking of the areas released and accessible to the Project, and training of personnel likely to enter such land	Before and during construction	EPC
Trav01	<ul style="list-style-type: none"> Prepare a human resources (HR) policy incorporating the key principles of Malagasy legislation and IFC and AfDB standards, including the obligation for all companies involved in the Project to comply with this policy, and information on the content of this policy when hiring workers. Disclose this policy on bulletin boards in the Project's social areas (offices, cities, etc.). Include this policy in all subcontracted contracts by requiring (i) compliance with this policy by these companies and (ii) the obligation to require compliance by any company contracted by this subcontractor.	Design and construction	EPC
Trav02	<ul style="list-style-type: none"> Regular monitoring (at start-up and once a month) of compliance with HR policy by companies working for the Project, based on audits of workers. Exclusion after first warning of companies and service providers found in default.	Design and construction	EPC
Trav03	Provision of a recourse mechanism to workers as part of the HR policy, in accordance with IFC and AfDB standards	Design and construction	EPC

Trav04	Ensure a gender-friendly work environment (including no unisex toilets or changing rooms) during the construction and operation phases.	Design and construction	EPC
Trav05	Explicitly indicate in the offers that the positions are open to both men and women.	Design and construction	EPC
Trav06	For qualified or responsible positions, ensure a gender balance of pre-selected candidates invited for an interview	Design and construction	EPC
Sstr01	Preparation and implementation of a Worker Health and Safety Plan for the construction phase, approved by NEHO, and in accordance with ESIA specifications.	Before and during construction	EPC
Sstr02	Preparation and implementation of an Emergency Prevention and Management Plan for the construction phase, approved by NEHO, and in accordance with ESIA specifications.	Before and during construction	EPC
Sstr03	Appointment within the EPC of a Health and Safety Manager in charge of the preparation, updating and implementation of the Workers' Health and Safety Plan and the Emergency Prevention and Management Plan. The Health and Safety Manager reports directly to the site manager, and defines the resources he needs to ensure and control the implementation of the two plans mentioned above.	Before and during construction	EPC
Sstr04	Include standard contractual obligations for the respect and implementation of the EPC Workers' Health and Safety Plan in all contracts of companies in the subcontracting chain.	When subcontracting subcontractors	EPC
Sstr05	Continuous monitoring of compliance with the Workers' Health and Safety Plan by the companies working for the Project, organized by the Health and Safety Manager. Exclusion after first warning of companies and service providers found in default.	During construction	EPC
Sstr06	If security personnel (private or public seconded) are contracted for the Project, train them in the United Nations Voluntary Principles for Security and Human Rights.	Design, construction and operation	EPC before operation, NEHO after
Sstr07	Preparation and implementation of a Base Camp and Workers' City Management Plan for the construction phase, approved by NEHO, and in accordance with ESIA specifications.	During construction	EPC
Sstr08	Implement a systematic program to raise awareness among workers (induction) and regular awareness among populations (specialized NGOs) to ensure that the population, workers and at-risk groups are aware of the modes of contamination and have the means to protect them.	Before and during construction	EPC (workers) and NEHO (populations)
Sstr09	Provide drinking water at all installations and worksites. Train workers (induction) in the risks of food poisoning or drinking water.	During construction	EPC
Séco01	Preparation and implementation of a Road Traffic and Access Management Plan for the construction phase, approved by NEHO, and in accordance with ESIA specifications. This plan will include a ban on supply traffic to the site via Belanitra on Monday, Belanitra's market day. This plan will also include monitoring of human and vehicle traffic to adapt the Project's vehicle traffic rules if necessary.	Before and during construction	EPC
Séco04	For pedestrians, bicycles, motorcycles and carts from Belanitra to the dam site: <ul style="list-style-type: none"> ● in order to avoid the risk of accidents, 	Before and during construction	EPC

	<p>construction of a pedestrian-bike path along the proposed road, with the aim of separating vehicle and pedestrian or bicycle traffic. The use by motorcycles of this track is prohibited.</p> <ul style="list-style-type: none"> Awareness-raising activities in villages on the use of this trail by pedestrians and bicycles. <p>From the dam site to Faravohitra (pedestrians only):</p> <ul style="list-style-type: none"> Installation of a public pedestrian crossing on the bridge. <p>Securing the pedestrian path from the dam to Faravohitra against the risk of interaction with Project traffic by developing crossings between the vehicular and pedestrian paths or by building local bypasses.</p>		
Séco07	Installation of signs prohibiting access to the river to all roads for 500 m downstream	During construction	EPC
Séco10	Installation of an overhead cable prohibiting navigation on the reservoir within 1 km of the dam.	Before impoundment	EPC
Séco12	On the basis of actions Rupt02 to Rupt04, set up a warning mechanism for downstream populations in the event of exceptional natural flooding likely to impact them.	Before operation	EPC
Séco13	Set up an audible alarm downstream from the plant, from the river opposite Faravohitra and in the exposed sites identified during the Downstream03 action tests.	During commissioning	EPC
Saco04	Delimitation (demarcation or equivalent marking lasting over time) of a 100 m strip around the reservoir.	Construction	EPC
Saco06	Minimization of exposure of populations to noise, dust and air emissions (see actions Atmo01 to Atmo10 of the ESIA)	Studies, construction	EPC
Affl03	the EPC shall set up, as part of its HECSMP, a system for recruiting the workforce	Before and during construction	EPC
Affl04	Priority access to employment (without guarantee of employment) for local workers from families displaced by the Project - The names of these people and their possible skills will be provided by NEHO	Before and during construction	EPC and NEHO
Affl07	The induction that workers hired by NEHO, the EPC and its subcontractors will receive will include an awareness of the cultural habits and practices of the Project area, including the Fady. This awareness will be aimed at mitigating the risk of conflict related to culture gaps.	Throughout the duration of the Project	EPC and NEHO
Affl08	A code of conduct for employees will be prepared by the EPC.	During construction	EPC
Affl11	Provide maximum service within the bases. Establish management rules for the functions of the bases with schedules established for employees. Entry control on the database. Do not allow spontaneous camping within a radius of protection of the Remote Sites. Radius to be defined with local authorities.	Before and during construction	EPC
Affl13	Sensitization of EPC staff and its chain of subcontractors to the applicable fady in the Project area	Before and during construction	EPC
Cult01	Preparation and implementation of a chance discovery procedure for any contractor who will perform excavations or cuttings. Training of personnel in charge of excavations (or their	Before and during construction	EPC

	follow-up) on the nature of possible finds and the measures to be applied in the event of a find.		
Cult02	Detailed mapping of cultural sites and tombs during field studies for the implementation of linear infrastructure (roads and tracks), and engagement with stakeholders to agree on avoidance measures.	Design and construction	EPC
Lign01	Define and optimize from a technical and social point of view the exact route of the transmission line, in order to minimize the social and socio-economic impacts, between Belanitra and Antananarivo, taking into account the sensitivities listed in the ESIA.	Before and during construction	EPC
BioT02	Information sharing, training and capacity building for EPC employees and the subcontracting chain on the environmental measures taken by the Project.	Before and during construction	EPC
BioT03	Prohibition of access by persons other than personnel to construction sites and prohibition of movement of project employees in unauthorized areas, including habitats with ecological implications.	During construction	EPC
BioT04	Establishment of linear infrastructures between Antananarivo and Belanitra: <ul style="list-style-type: none"> • Avoid forested areas as much as possible to minimize deforestation (use recent aerial/satellite images and field visits to identify forested/deforested areas). • Make maximum use of existing tracks, rehabilitating them where necessary rather than creating new ones. 	Design and construction	EPC
BioT05	Between Belanitra and the dam: <ul style="list-style-type: none"> • Adopt a layout and design of the line and road that avoid wooded areas as far as technically possible; consult VOI and NEHO for approval of the affected wooded areas 	Design and construction	EPC
BioT06	Between the dam and the hydropower plant: Pass the service line and communication networks through the waterway gallery. For road and line layout: <ul style="list-style-type: none"> • Recognize and make maximum use of areas already impacted as described in the ESIA. • Bury the buried transmission line over a distance of 1.6 km, where the selected route crosses the largest forest width. • Limit the width of the tracks (treadmill) to 5 m in wooded areas. • Have the implementations validated by NEHO. 	Design and construction	EPC
BioT07	Optimization of the implementation of temporary or permanent infrastructures: <ul style="list-style-type: none"> • Use as much as possible the footprint of the future reservoir for temporary infrastructure and extraction sites (without exposing the sites to flooding from the Onive); • At the dam, outside the reservoir area: <ol style="list-style-type: none"> (i) Locate temporary infrastructure on 	Design and construction	EPC

	<p>the right bank of the Onive (to the west) rather than on the left bank to minimize risks to the new protected area and (ii) Avoid natural habitats and agricultural areas to limit the volume of compensation or economic displacement.</p> <ul style="list-style-type: none"> At the plant level: Avoid agricultural areas to limit the volume of compensation or economic displacement. 		
BioT09	<p>Night traffic (between 8pm and 6am) between the dam and the plant will be prohibited for scheduled or regular site activities, and will be reserved for emergencies and exceptional circumstances approved by NEHO. Installation of barriers and guard posts at the ends of the forest.</p>	Construction	EPC
BioT11	<p>Protection of endangered flora (between the dam and the plant):</p> <ul style="list-style-type: none"> The precise identification, marking and localization of the flora species that triggered the critical habitat listed in the ESIA in order to avoid them when the infrastructure is located in forest areas; The maximum adaptation of the rights-of-way and impact activities or the relocation of the specimens concerned to avoid damaging them. 	Design and construction	EPC
BioT13	<p>Protection of endangered wildlife (between the dam and the plant):</p> <ul style="list-style-type: none"> Sequenced clearing and deforestation after the final establishment of the infrastructure crossing forest areas, in order to drive wildlife away: (i) Felling of trees, then (ii) Leaving 24 hours for residual fauna to escape (in particular reptiles, chameleons, entomofauna), then (iii) Finalization of the clearing and cleaning of the area with storage of vegetation collected on the edges of the rights-of-way for grinding or composting (no slash-and-burn). In order to minimize impacts on birds nesting in forest areas (between the dam and the plant), large tree cutting for footprint release will be done outside the birds' preferred nesting period, which corresponds to the months of August to December. Large trees identified as feeding grounds (fruit-eating species) and dormitories for lemurs should be avoided. These trees will be easily recognizable by the abundance of young plants and the presence of excrement; Minimization of wildlife crushing risk: (i) Driver awareness and training in removing wildlife species from traffic lanes, and (ii) Speed limited to 40 km/h between the dam and the plant. 	Construction	EPC
BioT16	<p>Combating the introduction and spread of invasive alien species:</p>	Design and construction	EPC

	<ul style="list-style-type: none"> Identify the invasive species present on the site and its surroundings before the work is carried out; Manually or mechanically remove shrub or tree EEEs, ensuring that the root system is removed; Eradicate these species through appropriate measures (on-site disposal and incineration of plant debris); Carry out a preliminary study of the material supply sites (quarries, others). 		
BioT17	<p>Fire prevention:</p> <ul style="list-style-type: none"> Open fires are prohibited throughout the construction period. Equip worksites where flammable products are used with fire extinguishers, Train staff in the use of fire extinguishers, and in, Remind the basic rules regarding the use of flammable products. 	Construction	EPC
BioT19	<p>Minimization of light pollution</p> <ul style="list-style-type: none"> Avoid continuous lighting, and opt for activation by presence detectors for outdoor comfort lighting, Use low-light bulbs or use floor-oriented lighting for outdoor lighting. 	Construction	EPC
BioT27	Between the plant and the dam, three-dimensional bird diverters are installed on the guard cables.	Construction	EPC
BioA01	During the implementation of the Aval03 action: ichthyologists will be involved in this test, in order to accurately assess the possible impact of different environmental variations and conditions on the habitat of aquatic species in the Onive or even on the species themselves.	During the first filling of the impoundment	NEHO in coordination with EPC
BioA02	Maintaining the instream flow at all times in the bypassed reach (5.7 m3/s)	Construction and commissioning	EPC
Devt01	If the microcentral solution is chosen, installed on the water intake for the instream flow of a bypass, allowing the connection of a micro-power station, and automated to return to the river the water not used by the micro-power station in order to satisfy the instream flow obligation.	Design and construction	EPC
Devt02	Implementation of a technical solution to supply a local distribution network from the plant	Design and construction	EPC

9.4 ESMP-NEHO

9.4.1 Implementation of the NEHO-ESMP

The ESMP-NEHO for the construction phase is described in Chapter 9.4.2. In the form of a summary of all the actions identified in the ESIA as being the responsibility of NEHO. The ESMP-NEHO is not subject to change, except by mutual agreement with donors or competent authorities, if a change appears necessary to ensure the legality or compliance of the Project.

To organize and monitor the implementation of the ESMP-NEHO, NEHO will develop for the construction phase an Environmental and Social Management System (ESMS) structured according to ISO9001/14001 standards, with the following content:

Table 142 - Structure of NEHO's ESMS

Chapter	Title
1	NEHO's environmental and social policy
2	Environmental and social aspects
3	Regulatory framework
4	Objectives of the Project
5	Environmental and social management plans
6	Organization and responsibilities
7	Training, awareness and capacity building
8	Communication
8.1	Regular internal meetings and reports
8.2	Regular external meetings and reports
8.3	Exceptional meetings and reports
9	Documentation of the SGES
10	Operational control
11	Prevention and response to emergencies
12	Monitoring and monitoring indicators
13	Non-compliance management, corrective and preventive actions
14	Quarterly management review

9.4.2 Content of the NEHO-ESMP - Construction Phase

#	Measure	Implementation	
		Period	By
Opti05	Environmental and social supervision of the Project, to control the implementation of Opti01 to Opti04 actions and validate the choices made.	Construction phase	NEHO
Atmo11	Favor the use of electric ATVs for the travel of the Project E&S team	Construction and operation	NEHO
Clim07	Sensitization of the populations of the Project area to climate risk and integration of a climate resilience objective into the social support measures of the Sahofika Project (Community Development Plan).	Construction and operation	NEHO
Qeau01	Vegetation removal in the most vegetated areas (forests) before impoundment (approx. 145 ha). The possibility for the populations to recover the wood in the flooded area will be studied with the DGEF.	Construction, before impoundment	EPC or NEHO
Qeau03	Weekly monitoring of the oxygen content of the water downstream from the hydropower plant (100m downstream) and the dam (500m downstream). Monthly monitoring: NO ₃ , PO ₄ , BOD ₅ and suspended matter. Annual monitoring (October): heavy metals and pesticides water and sediment	Construction: last year before operation Operation, 1st and 2nd years	NEHO
Sstr08	Implement a systematic program to raise awareness among workers (induction) and regular awareness among populations (specialized NGOs) to ensure that the population, workers and at-risk groups are	Before and during construction	EPC (workers) and NEHO (populations)

	aware of the modes of contamination and have the means to protect them.		
Séco03	<p>Installation of a shuttle bus making the round trip Belanitra-Faravohitra once in the morning and once in the evening, during the day:</p> <ul style="list-style-type: none"> • This shuttle is managed by NEHO's social team, which keeps statistics on the use of the shuttle (number of passengers and baggage weight) for the operation phase. • Passengers are welcomed on pre-registration, subject to availability. • The trip is subject to a charge, at a price corresponding to the practice for public transport in Madagascar over this distance. The sums collected are donated for the actions of the Project's Community Development Plan. • The shuttle operates only on days when weather conditions permit and the EPC does not prohibit it. <p>Representatives of state services or protected areas who wish to use the trail to access areas served by these trails should contact the NEHO social team. In all cases, these people leave their own vehicles in Belanitra except for emergency vehicles or vehicles of protected area managers.</p>	During construction	NEHO Social Team
Séco05	Organization of a consultative seminar with representatives of the population, state representatives and protected area managers to set up a circulation mechanism to open up the hydropower plant area, while minimizing the risk of accidents or use of the track for activities affecting protected areas.	Before the operation phase	NEHO
Séco11	Information and awareness raising for canoeists.	Before impoundment	NEHO
Séco15	Expropriation and delimitation (boundary or equivalent) of a 100 m strip around the reservoir with prohibition to settle there. Annual verification that no one has relocated to this area.	RAP Implementation and Operation	NEHO
Saco01	Implement a systematic and regular population awareness program (specialized NGO) to ensure that the population and at-risk groups are aware of the modes of contamination and have the means to protect them. (see also action Sstr08)	Before, during construction and during operation	NEHO
Saco02	Implement an awareness and information program for people in the areas concerned, which will help to identify risks and disseminate basic hygiene measures.	Before and during construction	NEHO
Saco05	Expropriation of the delimited area around the reservoir with prohibition to settle there (see measure Séco15). Annual verification that no one has relocated to this area.	Implementation of the RAP	NEHO
Affl01	Quarterly demographic monitoring in the Project area. This monitoring will cover the Antenina, Belanitra and Faravohitra sectors and will allow NEHO to monitor dynamics and identify areas where the influx is concentrated.	Before, during construction and during operation	NEHO
Affl02	Actions to raise awareness of STDs and the risks of violence against women are planned as part of the ESIA's program of measures against public health risks. These actions will start before construction begins.	Before and during construction	NEHO
Affl04	Priority access to employment (without guarantee of employment) for local workers from families	Before and during	EPC and NEHO

	displaced by the Project - The names of these people and their possible skills will be provided by NEHO	construction	
Affl05	Preparation and implementation of a program to improve community infrastructure in villages and a Community Development Plan, including a rural electrification component. Budget for the construction phase: €2.5 million	Design, construction and operation	NEHO
Affl06	Secondment in coordination with the administration of law enforcement officials to Faravohitra and in the vicinity of the dam site, trained in the United Nations Voluntary Principles for Security and Human Rights.	Design, construction and operation	NEHO
Affl07	The induction that workers hired by NEHO, the EPC and its subcontractors will receive will include an awareness of the cultural habits and practices of the Project area, including the Fady. This awareness will be aimed at mitigating the risk of conflict related to culture gaps.	Throughout the duration of the Project	EPC and NEHO
Affl09	A series of actions are planned to mitigate the negative impacts that the population influx could have on biodiversity in protected areas (Marolambo Park and Tsinjoarivo NPA). This includes: <ul style="list-style-type: none"> • Material assistance for better protection. • The prohibition of consuming or introducing wild meat into the site and living areas. • Raising workers' awareness of conservation issues in the Project area. Control with protected area managers of vehicle traffic passing through protected areas	Throughout the duration of the Project	NEHO
Affl10	Prepare and implement a stakeholder engagement plan before work begins, including a recourse and conflict management mechanism.	Throughout the duration of the Project	NEHO
Affl12	Weekly monitoring of local market prices for basic food products. Intervene in the event of an abnormal change in these prices compared to the history. If necessary, make agreements with resellers to pre-finance purchase/transport to support price maintenance.	Before and during construction	NEHO Social Team
Affl14	Discussion with the village "elders" in the Betsimisaraka part (Sahofika,) before starting the work, to explain that the site will do earthworks but not agricultural work. Make sure with the notables that this is compatible with the fady banning tillage on Tuesdays.	Before construction	NEHO
Affl15	Sensitization of NEHO staff and its chain of subcontractors to the applicable fady in the Project area	Throughout the duration of the Project	NEHO
BioT01	<ul style="list-style-type: none"> • Raising awareness and informing the population concerned about the Project and biodiversity protection measures. • Information sharing, training and capacity building for NEHO employees on the environmental measures taken by the Project. 	Before starting work, during construction and operation	NEHO
BioT08	Consult VOIs and protected area managers/developers for the validation of the routes or locations proposed by the EPC for infrastructure between Belanitra and the plant.	Design and construction	NEHO
BioT12	Monitoring of actions to protect flora threatened by the EPC.	Design and construction	NEHO
BioT14	Monitoring of actions to protect wildlife threatened by the EPC.	Design and construction	NEHO
BioT18	Support and accompaniment of managers of areas under status for the protection of biodiversity.	Construction and operation	NEHO
BioT22	Preparation and implementation of a program to restore degraded areas in forests adjacent to the forest corridor (final area equal to twice the amount	Construction and operation	NEHO

	of woodland lost)		
BioT23	Support for the conservation of the natural forests of Tsinjoarivo NPA and Marolambo National Park	Construction and operation	NEHO
BioT24	VOI support program: reforestation in management transfer areas and preservation of ecosystem services	Construction and operation	NEHO
BioT25	Preparation and implementation of an ecological habitat monitoring program between the dam and the plant, integrating the influence of climate change on the lichen forest.	Construction and operation	NEHO
BioT26	Preparation and implementation of a monitoring program for a number of target species, fauna and flora that have triggered critical habitat analyses will be undertaken with protected area managers and promoters (to be combined with the previous measure).	Construction and operation	NEHO
BioT28	Support for updating the data of the IBA of the Onive Classified Forest, in collaboration with the referring NGO.	Construction	NEHO
BioA01	During the implementation of the Aval03 action: ichthyologists will be involved in this test, in order to accurately assess the possible impact of different environmental variations and conditions on the habitat of aquatic species in the Onive or even on the species themselves.	During the first filling of the impoundment	NEHO in coordination with EPC
BioA04	Further knowledge of <i>Rheocles wrightae</i> and <i>Rheocles sp. Ambatovy</i> .	Construction and operation	NEHO
Ecos01	Assistance in the conversion to fishing of the species that will develop in the reservoir, replacing the eel fishery.	First year of filling the reservoir	NEHO
Pab01	Preparation, implementation and monitoring of a Biodiversity Action Plan	Preparation before construction and implementation	NEHO
Cumu01	Do not plan a relocation site for the Sahofika Project within the footprint of the other projects. Inform the populations affected by the Project of the risk of construction of other hydropower plants. Assist people who want more specific information to access it, based on publicly available information.	During the preparation of the RAP and public consultations with the people affected by the Project	NEHO, social team.
Cumu02	Disclosure of the action program implemented under the Project to mitigate risks related to waterborne diseases under the Project, and the results of the follow-up with the other projects. Disclosure of information on NEHO's website.	As actions are implemented and the results of the monitoring carried out become available	NEHO, social team.
Cumu03	Do not adopt biodiversity risk mitigation measures for Sahofika that depend on habitats that would in turn be impacted if subsequent facilities were developed. Share Sahofika biodiversity monitoring results (on the Project website) to enable other projects to benefit from Sahofika's experience.	In the preparation and implementation of the ESIA	NEHO, environmental team.
Cumu04	Disclose information on actions taken to support the Tsinjoarivo NPA and the MNP. Capacity building of the Tsinjoarivo NPA and the MNP in the assessment and management of negative impacts.	From the first year of construction of the Project.	NEHO, environmental team.
Devt03	Detailed technical studies and legal and institutional arrangements for the implementation of the rural electrification component of the Project, including rapid temporary measures could be put in place to provide electricity to the population from the	Starting the Project	NEHO

	construction phase, for example through solar terminals.		
Devt04	Preparation of a detailed Community Development Plan based on the principles identified in the ESIA.	After the definition of the rural electrification component	NEHO

9.4.3 Content of the NEHO ESMP - Operations Phase

#	Measure	Implementation	
		Period	By
Downstream03	When the reservoir is first filled, schedule a test of at least 16 hours with only the applied instream flow. Visual observations on the bypassed reach and downstream from the plant (before and at the end of the 16 hours) to verify the continuity of the flow and identify any singularities that may appear.	Tests, at the time of impoundment	NEHO, in coordination with the EPC
Downstream04	Maintain a permanent instream flow of 5.7m ³ /s or more downstream from the dam.	Exploitation	NEHO
Sédi01	In addition to the monthly monitoring of suspended solids (see action Qeau03), annual monitoring during the first three years and then at regular intervals (to be determined on the basis of the first three years) from: <ul style="list-style-type: none"> • Sedimentation of the reservoir (bathymetry or lidar) • The evolution of the sand banks over the 3 km downstream from the hydropower plant (visual monitoring in the dry season) 	Exploitation	NEHO
Atmo11	Favor the use of electric ATVs for the travel of the Project E&S team	Construction and operation	NEHO
Dech04	Preparation of a waste management plan for the operation phase, taking into account the waste management hierarchy (reduce, recycle, compost, landfill), and distinguishing between them: <ul style="list-style-type: none"> • Domestic waste from the city of operation and staff. • Organic waste (floating wood, water hyacinths). Industrial waste resulting from operations and maintenance activities.	Exploitation	NEHO
Poll05	Use of biodegradable oil for hydromechanical and electromechanical equipment presenting a risk of uncontrolled leakage into the environment, in particular for all parts in direct contact with water.	Exploitation	NEHO
Clim02	Daily hydrological monitoring of Onive inflows	Exploitation	NEHO
Clim03	Weekly sedimentary monitoring of Onive inflows (suspended matter)	Exploitation	NEHO
Clim04	Annual sediment monitoring of the reservoir	Exploitation	NEHO
Clim05	Meteorological monitoring at the dam site	Exploitation	NEHO
Clim06	Meteorological monitoring - transmission line: <ul style="list-style-type: none"> • Definition of two monitoring points and installation of stations Operation and maintenance of stations	Exploitation	NEHO
Clim07	Sensitization of the populations of the Project area to climate risk and integration of a climate resilience objective into the social support	Construction and operation	NEHO

	measures of the Sahofika Project (Community Development Plan).		
Clim08	Verification of project floods every ten years, based on acquired hydrological data. Monitoring of forest ecosystems in the catchment area: on the basis of satellite images, mapping every 10 years of forest areas and types of forests. Verification of the resilience of the facility in accordance with the HIA Climate Resilience Guide.	Exploitation	NEHO
Qeau02	Quarterly visual monitoring of areas of the reservoir that are not conducive to water renewal and circulation, with particular attention to the development of aquatic invasive species such as water hyacinth.	Exploitation	NEHO
Qeau03	Weekly monitoring of the oxygen content of the water downstream from the hydropower plant (100m downstream) and the dam (500m downstream). Monthly monitoring: NO3, PO4, BOD5 and suspended matter. Annual monitoring (October): heavy metals and pesticides water and sediment	Construction: last year before operation Operation, 1st and 2 nd years	NEHO
Qeau04	Preparation and implementation of an annual water quality monitoring program, based on the results of the first two years (Qeau03)	Operation, 3 rd year and beyond	NEHO
Rupt05	Operation and maintenance of the communication system described in the Rupt04 action.	Exploitation	NEHO
Rupt06	Every ten years: verification and update of the emergency response plan.	Exploitation	NEHO
Trav01	<ul style="list-style-type: none"> Prepare a human resources (HR) policy incorporating the key principles of Malagasy legislation and IFC and AfDB standards, including the obligation for all companies involved in the Project to comply with this policy, and information on the content of this policy when hiring workers. Disclose this policy on bulletin boards in the Project's social areas (offices, cities, etc.). <p>Include this policy in all subcontracted contracts by requiring (i) compliance with this policy by these companies and (ii) the obligation to require compliance by any company contracted by this subcontractor.</p>	Exploitation	NEHO
Trav02	<ul style="list-style-type: none"> Regular monitoring (at start-up and once a month) of compliance with HR policy by companies working for the Project, based on audits of workers. <p>Exclusion after first warning of companies and service providers found in default.</p>	Exploitation	NEHO
Trav03	Provision of a recourse mechanism to workers as part of the HR policy, in accordance with IFC and AfDB standards	Exploitation	NEHO
Trav04	Ensure a gender-friendly work environment (including no unisex toilets or changing rooms) during the construction and operation phases.	Exploitation	NEHO
Trav05	Explicitly indicate in the offers that the positions are open to both men and women.	Exploitation	NEHO
Trav01	<ul style="list-style-type: none"> Prepare a human resources (HR) policy incorporating the key principles of Malagasy legislation and IFC and AfDB standards, including the obligation for all companies involved in the Project to comply with this policy, and information 	Exploitation	NEHO

	<p>on the content of this policy when hiring workers.</p> <ul style="list-style-type: none"> Disclose this policy on bulletin boards in the Project's social areas (offices, cities, etc.). <p>Include this policy in all subcontracted contracts by requiring (i) compliance with this policy by these companies and (ii) the obligation to require compliance by any company contracted by this subcontractor.</p>		
Sstr06	If security personnel (private or public seconded) are contracted for the Project, train them in the United Nations Voluntary Principles for Security and Human Rights.	Exploitation	NEHO
Seco02	Preparation and implementation of a Road Traffic and Access Management Plan for the operation phase, approved by NEHO, and in accordance with ESIA specifications.	Exploitation	NEHO
Seco06	Based on the conclusions of the seminar, implementation of a regulated traffic system, managed by NEHO in coordination with protected area managers.	Exploitation	NEHO
Seco08	Raising awareness of the risks of rapid flow variations among the most exposed people, especially downstream residents and children living in the vicinity (less than 5 km from the dam), as soon as the gates are filled and tested.	Exploitation	NEHO
Seco09	Programming and/or forecasting of flow variations that can be anticipated (spillage due to flood rise, sediment emptying), visual inspection of the downstream part of the dam before opening the gates and prior information to the downstream populations, using if necessary the communication system described in the Rupt04 action.	Exploitation	NEHO
Seco14	Organize an annual visit to the dam and the plant for a specific age group (generally 10 years) to raise awareness and sensitize them to the risks associated with the operation.	Exploitation	NEHO
Seco15	Expropriation and delimitation (boundary or equivalent) of a 100 m strip around the reservoir with prohibition to settle there. Annual verification that no one has relocated to this area.	RAP Implementation and Operation	NEHO
Saco01	Implement a systematic and regular population awareness program (specialized NGO) to ensure that the population and at-risk groups are aware of the modes of contamination and have the means to protect them. (see also action Sstr08)	Before, during construction and during operation	NEHO
Saco03	Capacity building and monitoring of statistics on waterborne diseases treated by health centers in the area of influence	Exploitation	NEHO
Saco06	Minimization of exposure of populations to noise, dust and air emissions (see actions Atmo01 to Atmo10 of the ESIA)	Exploitation	NEHO
Affl05	Preparation and implementation of a program to improve community infrastructure in villages and a Community Development Plan, including a rural electrification component.	Design, construction and operation	NEHO
Affl06	Secondment in coordination with the administration of law enforcement officials to Faravohitra and in the vicinity of the dam site, trained in the United Nations Voluntary Principles for Security and Human Rights.	Design, construction and operation	NEHO
Affl07	The induction that workers hired by NEHO and its subcontractors will receive will include an awareness of the cultural habits and practices of	Throughout the duration of the Project	NEHO

	the Project area, especially the Fady. This awareness will be aimed at mitigating the risk of conflict related to culture gaps.		
Affl09	A series of actions are planned to mitigate the negative impacts that the population influx could have on biodiversity in protected areas (Marolambo Park and Tsinjoarivo NPA). This includes: <ul style="list-style-type: none"> • Material assistance for better protection. • The prohibition of consuming or introducing wild meat into the site and living areas. • Raising workers' awareness of conservation issues in the Project area. Control with protected area managers of vehicle traffic passing through protected areas	Throughout the duration of the Project	NEHO
Affl10	Prepare and implement a stakeholder engagement plan before work begins, including a recourse and conflict management mechanism.	Throughout the duration of the Project	NEHO
Affl15	Sensitization of NEHO staff and its chain of subcontractors to the applicable fady in the Project area	Throughout the duration of the Project	NEHO
Lign02	Inform people along the line of their rights and duties with regard to the line. Plan maintenance operations to minimize impacts on crops and agricultural production.	Exploitation	NEHO
BioT01	<ul style="list-style-type: none"> • Raising awareness and informing the population concerned about the Project and biodiversity protection measures. • Information sharing, training and capacity building for NEHO employees on the environmental measures taken by the Project. 	Before starting work, during construction and operation	NEHO
BioT10	Night traffic (between 7pm and 7am) between the dam and the plant will be prohibited for programmable or regular operational activities, and will be reserved for emergencies and exceptional circumstances. Installation of barriers and guard posts at the ends of the forest (coordinated management with the proponent / NPA manager)	Exploitation	NEHO
BioT15	Minimization of the risk of wildlife crushing: <ul style="list-style-type: none"> • Traffic regulation between the dam and the plant in coordination with the promoter/manager of the NPA and with consultation of the populations (the road is not open to all vehicles) • Raising driver awareness and training in the removal of wildlife species from traffic lanes, • Restrictions on night traffic, • Speed limited to 40 km/h between the dam and the plant, • Monitoring and geo-referencing of points where wildlife specimens have been crushed. 	Exploitation	NEHO
BioT18	Support and accompaniment of managers of areas under status for the protection of biodiversity.	Construction and operation	NEHO
BioT20	Minimization of light pollution <ul style="list-style-type: none"> • Avoid continuous lighting, and opt for activation by presence detectors for outdoor comfort lighting, • Use low-light bulbs or use floor-oriented lighting for outdoor lighting. 	Exploitation	NEHO

BioT21	Preparation and implementation of a program for the protection of CITES species and the fight against illegal trade and poaching defined with protected area managers and promoters as part of the actions already planned to regulate traffic and strengthen control and protection of biodiversity.	Exploitation	NEHO
BioT22	Preparation and implementation of a program to restore degraded areas in forests adjacent to the forest corridor (final area equal to twice the amount of woodland lost)	Construction and operation	NEHO
BioT23	Support for the conservation of the natural forests of Tsinjoarivo NPA and Marolambo National Park	Construction and operation	NEHO
BioT24	VOI support program: reforestation in management transfer areas and preservation of ecosystem services	Construction and operation	NEHO
BioT25	Preparation and implementation of an ecological habitat monitoring program between the dam and the plant, integrating the influence of climate change on the lichen forest.	Construction and operation	NEHO
BioT26	Preparation and implementation of a monitoring program for a number of target species, fauna and flora that have triggered critical habitat analyses will be undertaken with protected area managers and promoters (to be combined with the previous measure).	Construction and operation	NEHO
BioA03	Maintaining the instream flow at all times in the bypassed reach (5.7 m ³ /s)	Exploitation	NEHO
BioA04	Further knowledge of <i>Rheocles wrightae</i> and <i>Rheocles sp. Ambatovy</i> .	Construction and operation	NEHO
BioA05	Conservation measures for the species <i>Rheocles wrightae</i> and <i>Rheocles sp. Ambatovy</i> (if impacts confirmed by monitoring).		NEHO
BioA06	Targeted and adapted control of aquatic invasive alien species.	Exploitation	NEHO
BioA07	Raising awareness among local populations to target the capture of Invasive Alien Species (IAS) rather than native threatened species (<i>R. wrightae</i>) and crayfish	Exploitation	NEHO
Pab01	Implementation and monitoring of the Biodiversity Action Plan	Exploitation	NEHO

10 Monitoring and Follow-Up Programs

10.1 Organization

The Project's environmental and social monitoring and follow-up will be organized and managed by NEHO's E&S team.

The environmental and social management system that will be prepared for the Project will describe how this monitoring will be carried out. However, the following principles have been agreed:

- A Project Monitoring Committee involving (i) protected area managers and promoters and VOIs on the one hand and (ii) independent and recognized experts on the other hand will be set up. He will have access to monitoring documents and will play an advisory role to advise NEHO's E&S team in charge of monitoring.
- The follow-up will focus on:
 - Monitoring the effective implementation of ESMP and ESIA measures.
 - The identification and definition of adaptive measures that may be required if certain objectives of the ESMP are not met.
 - Monitoring the legal or regulatory changes in the environmental and social aspects applicable to the Project, with a view to their proper implementation.

The monitoring and follow-up program will be reviewed and adapted as necessary for the operation phase.

As far as possible, all monitoring and follow-up actions that allow it will be carried out by directly involving the populations (participatory monitoring).

10.2 Legal and Regulatory Requirements and Obligations

The monitoring and follow-up programs of the Project will be conducted with the essential objective of meeting the requirements of:

- Malagasy legislation;
- International treaties and conventions ratified by the Republic of Madagascar;
- The environmental and social requirements of the donors involved in the Project.

10.3 Periodic Reporting Mechanisms and Frequency

Reports presenting the results of environmental and social monitoring and follow-up, including all the measures described in the following two chapters, will be sent to the ONE and donors:

- Every six months during the construction phase;

- Every year during the operation phase.

10.4 Monitoring Plan

Monitoring measures are described (by phase and component) in the following tables. This monitoring plan will be reviewed at the start of the works and regularly thereafter to ensure it is relevant. Any substantial changes will be discussed in advance with the ONE and donors.

The monitoring plan is organized into two components and two phases.

The two components are as follows:

- Hydropower plant component: this component includes all the infrastructure that will be built between the reservoir dam area (included) and the hydropower plant area (included), including the access road from the dam to the plant and the energy evacuation line from the plant to the dam.
- Linear infrastructure component: this component includes the energy evacuation line from the dam to its connection point at Antananarivo, and the access roads that will be built or rehabilitated for the Project in this same area, whether they are access roads to the hydropower plant, or access roads to construction sites (quarries, pylon sites, etc.).

The two phases are as follows:

- Construction: all activities necessary for the commissioning of the Project, including finishing or restoration work resulting from the construction phase and which could extend beyond the commissioning date.
- Operation: all operation and maintenance activities necessary for the production of electricity by the “hydropower plant” component and its discharge into the national grid by the “linear infrastructure” component.

10.4.1 Hydropower Plant Component - Construction Phase

Issue/Impact	Mitigation Measures	Indicators	Monitoring method	Frequency	By	Schedule of events
Optimization of the hydropower plant	Opti01: Optimization of the management of excavations and embankments to minimize the volumes extracted from borrow sites and the volumes placed in final storage.	Volumes, characteristics and locations of extraction or disposal of materials.	Supporting note to be produced and approved before the opening of new extraction or disposal sites	Before any new extraction or disposal sites are opened	Preparation of the note: EPC Approval: NEHO	During the entire construction phase
Optimization of the hydropower plant	Opti02: Definition and technical, environmental and social optimization of the exact route of the line and access road, adopting a layout and design of the line and road that avoids forested areas as far as technically possible, based on the ESIA.	Area of impacted (deforested) forested areas Physical movement avoided as much as possible for lines and access.	Supporting note to be produced and approved at the end of the design studies, and before the start of the work concerned	At the end of the design studies, and before the start of the works concerned	Preparation of the note: EPC Approval: NEHO	During the entire detailed design and construction phase
Optimization of the hydropower plant	Opti03: Layout of the track and transmission line between the dam and the plant according to the selected route and using as much as possible the areas already cleared. Exact implementation during detailed design must be carried out on the basis of field surveys that combine technical and environmental teams to effectively ensure that environmental impacts are minimized. The transmission line will be buried over a distance of 1.6 km.	Area of impacted (deforested) forested areas	Supporting note to be produced and approved at the end of the design studies, and before the start of the work concerned	At the end of the siting studies, and before the start of the works concerned	Preparation of the note: EPC Approval: NEHO	Throughout the entire detailed study phase.
Optimization of the hydropower plant	Opti04: For the establishment of temporary or permanent infrastructures not yet defined, select the sites by associating environmental and social experts. Use the footprint of the future reservoir for temporary infrastructure and extraction sites as much as possible.	No destruction of natural habitat and no unintentional loss of agricultural land due to the establishment of temporary infrastructure.	Supporting notes to be produced and approved during the design studies, and before the start of the work concerned	During the design studies, and before the start of the works concerned	Preparation of the note: EPC Approval: NEHO	During the entire detailed design and construction phase

	<p>At the dam, outside the reservoir area:</p> <ul style="list-style-type: none"> • Implement temporary infrastructure on the right bank of the Onive (to the west) rather than on the left bank to minimize risks to the new protected area; • avoid natural habitats and agricultural areas to limit the volume of compensation or economic displacement. <p>At the plant level: avoid agricultural areas to limit the volume of compensation or economic displacement.</p>					
Optimization of the hydropower plant	Opti06: Arrange crossings along the penstock for current users (pedestrians, pets) in numbers and locations that are consistent with existing crossings.	Passages created, in number and location consistent with existing passages	Supporting notes to be produced and approved during design studies. Verification of the actual realization on site	During design studies. After completion of the work concerned	Preparation of the note: EPC Verification: NEHO	During the detailed design and construction phase
Backfill, excavated material and temporary sites	Ero01: Preparation of a plan for the management of earthworks / excavation / backfill and erosion prevention submitted to NEHO for approval and incorporating the principles of chapter 5.2.1.2 of the ESIA.	Plan prepared before work begins	Plan prepared and approved before work begins	Before carrying out the work concerned	Preparation of the plan: EPC Verification: NEHO	Preparation before the construction phase Implementation during the construction phase
Backfill, excavated material and temporary sites	Ero02: Engagement in the EPC team of an "Erosion control manager" in charge of the implementation of the plan prepared as part of the Ero01 action.	Erosion control manager recruited and maintained during the duration of erosion risk control work	Name and CV of the erosion control manager communicated	Before carrying out the work concerned	Commitment: EPC CV approval: NEHO	From the beginning to the end of construction activities involving erosion control.
Backfill, excavated	Ero03: Installation of crossing structures on all watercourses to be crossed by vehicles or	No watercourses crossed by vehicles or	Visual inspections of construction sites	During the entire construction	Installation of crossing	From the beginning to

material and temporary sites	construction machinery.	construction machinery without a crossing structure		phase	structures: EPC Visual inspection: NEHO	the end of construction activities.
Backfill, excavated material and temporary sites	Ero04: Shaping of the final disposal areas for surplus materials in order to facilitate their integration into the landscape.	Final disposal areas shaped to fit into the landscape	Visual inspections of construction sites	During the entire construction phase	Shaping of disposal areas: EPC Visual inspection: NEHO	From the beginning to the end of construction activities.
Hydraulic impact downstream	Downstream01: Maintaining a permanent instream flow of 5.7m3/s downstream from the dam.	Downstream flow never less than 5.7 m3/s	Flow measurement during episodes where the natural flow is reduced	At all stages of construction and testing	Implementation: EPC Control: NEHO	From the beginning to the end of construction and commissioning activities
Hydraulic impact downstream	Downstream02: Water intake supplying the instream flow sized to allow the flow rate to be adjusted, and with the possibility of supplying a micro-power plant.	Water intake supplying the instream flow dimensioned to allow the flow rate to be adjusted from 4 to 8 m3/s	Supporting note to be produced and approved during design studies.	During the design studies and execution of the works concerned	Preparation of the note: EPC Verification: NEHO	During the detailed design and construction phase
Hydraulic impact downstream	Downstream03: When the reservoir is first filled, schedule a test of at least 16 hours with only the applied instream flow. Visual observations on the bypassed reach and downstream from the plant (before and at the end of the 16 hours) to verify the continuity of the flow and identify any singularities that may appear.	Test performed	Visual observations on the bypassed reach and downstream from the plant	During the test phase	NEHO	During the test phase
Limitation of noise, gas and dust emissions	SFX01: Regular watering in the dry season due to dust emitted by vehicle traffic on the uncoated surfaces used by the Project. Establish a follow-up of complaints related to dust and take measures to limit their impacts.	Good visibility for drivers following another vehicle. Complaints handled	Visual inspections and complaint analysis	Continuous	EPC	During the construction phase
Limitation of noise, gas and dust emissions	SFX02: Limitation of the speed of construction vehicles to 40 km/h on the tracks and 15 km/h on working platforms or in installations	Recorded vehicle speed	Recording (GPS or tachometer) and speed check.	Continuous	EPC	During the construction phase
Limitation of noise, gas and dust emissions	SFX03: Installation of speed bumps in populated areas (in agreement with the authorities responsible for public roads)	Donkey backs built in authorized locations	Visual inspection: Effective slowing of vehicles	During construction / rehabilitation of	EPC	During the construction phase

				the tracks		
Limitation of noise, gas and dust emissions	SFX04: Ban on the use of explosives from 9pm to 7am for surface work (allowed underground)	Schedules respected	Hearing inspection	Continuous	EPC	During the construction phase
Limitation of noise, gas and dust emissions	SFX05: Continuous noise measurement at Faravohitra school, one month before starting work and during construction. Organization of the site in such a way that the ambient noise level does not increase by more than 3dB (IFC guidelines)	Noise level maintained below the ambient noise level before work plus 3dB	Sound level meter	Continuous	EPC	During the construction phase
Limitation of noise, gas and dust emissions	SFX06: Prohibition of access to the tunnel for the most emitting machines if the thresholds are exceeded.	Air quality in the tunnel during working hours in accordance with the following average thresholds (IFC guidelines): CO: 55 mg/m3 NO2: 40 mg/m3 SO2: 20 mg/m3 PM2.5: 25 mg/m3 PM10: 50 mg/m3	Continuous sensor	Continuous	EPC	During the construction phase
Limitation of noise, gas and dust emissions	SFX07: Installation of ventilation in tunnels to ensure air quality in accordance with SFI standards.		Visual inspection: Functional ventilation	Continuous	Implementation: EPC Verification: NEHO	During the construction phase
Limitation of noise, gas and dust emissions	SFX10: Stopping and banning vehicles emitting a cloud of smoke that affects the visibility or breathability of the air	Exceptionally polluting vehicles stopped immediately and prohibited.	Visual inspection	Continuous	EPC	During the construction phase
Limitation of noise, gas and dust emissions	SFX11: Where possible, favor the use of electric ATVs for the travel of the Project E&S team	Electric mountain bikes made available, used and maintained.	Visual inspection	Continuous	NEHO	During the construction phase
Solid and liquid waste	Dech01: Preparation and implementation of a plan for the collection, treatment and management of liquid and solid waste, taking into account the three principles set out in the ESIA	Avoid the uncontrolled spread of pollutants, compliance with Malagasy standards, compliance with IFC recommendations	Plan prepared and implemented	Continuous	Preparation and implementation of the plan: EPC Verification: NEHO	Preparation before the construction phase Implementation during the construction phase
Solid and liquid waste	Dech02: As part of initial and subsequent training, raising workers' awareness of solid and liquid waste management.	Training provided	Register of training provided	Continuous	EPC	During the construction phase
Risk of accidental pollution	Poll01: Preparation and implementation of a pollution and spill management plan for the construction phase, taking into account the	Plan prepared before work begins	Plan prepared and approved before work begins	Before carrying out the work concerned	Preparation of the plan: EPC	Preparation before the construction

	principles set out in the ESIA.				Verification: NEHO	phase Implementatio n during the construction phase
Risk of accidental pollution	Poll02: As part of initial and subsequent training, training of workers in the prevention and management of spills of polluting products.	Training provided	Register of training provided	Continuous	EPC	During the construction phase
Risk of accidental pollution	Poll03: Sizing (i) the operator's facilities supporting hydromechanical and electromechanical equipment, and (ii) storage sites for oils and other petrochemical or chemical products, so that direct leakage into the environment without retention is impossible. Where this is not possible, use biodegradable oil.	Sizing to prevent non-biodegradable oil leaks into the environment	Supporting note to be produced and approved during design studies.	During the design studies and execution of the works concerned	Preparation of the note: EPC Verification: NEHO	During the detailed design and construction phase
Risk of accidental pollution	Poll04: Construction for the operator of maintenance and fuel supply facilities for the Project's vehicles to contain accidental leaks and maintenance products.	Conforming installations built.	Supporting note to be produced and approved during design studies.	During the design studies and execution of the works concerned	Preparation of the note: EPC Verification: NEHO	During the detailed design and construction phase
Climate Change	Clim01: Climate risk modelling (downscaling): calculation of the sensitivity of Project floods to expected climate changes, and design of the hydropower plant so as to be able to integrate a possible future increase in its flood evacuation capacity.	Climate risk studied according to IHA recommendations	Climate resilience study to be produced and approved during design studies.	During the design studies and execution of the works concerned	Preparation of the note: EPC Verification: NEHO	During the detailed design and construction phase
Surface water quality	Qeau01: Vegetation removal in the most vegetated areas (forests) before impoundment (approx. 145 ha).	Vegetation removed before impoundment	Visual inspection	Once, before impoundment	Implementatio n: EPC or NEHO Verification: NEHO	Before impoundment
Risk of dam failure	Rupt01: Visit of all inhabited places exposed downstream, taking into account the possible rise of water in the Mangoro River upstream from the confluence with the Onive. Verification of local topography, historical flood levels, house elevations relative to the riverbed and the presence of refuge sites within walking distance.	Visits and surveys carried out.	Supporting note to be produced and approved during detailed design.	During the design studies and execution of the works concerned	Preparation of the note: EPC Verification: NEHO	During the detailed study phase.
Risk of dam	Rupt02: Hydraulic model of the ten-year,	Hydraulic model	Supporting note to be	During the design	Preparation of	During the

failure	centennial flood and dam failure, based on the detailed project and field visit. Identification of exposed villages and possible refuge sites.	performed	produced and approved during design studies.	studies and execution of the works concerned	the note: EPC Verification: NEHO	detailed study phase, before impoundment
Risk of dam failure	Rupt03: Preparation of an emergency response plan according to the model defined in the ESIA.	Plan prepared and approved	Approval of the Plan by NEHO	Once in a while	Preparation of the plan: EPC Verification: NEHO	Before filling the reservoir
Risk of dam failure	Rupt04: Implementation of the operational elements of the emergency response plan, including information and training of villagers, means of communication and alerting the villages concerned (VHF or telephone antennas), and marking of refuge areas in the villages concerned.	Operational elements of the emergency response plan put in place	Approval by NEHO	Once in a while	Implementation: EPC Verification: NEHO	Before filling the reservoir
Carrying out work or activities on land that has not been acquired or released	Entr01: Implementation of a procedure for entering the land, including validation and marking of the areas released and accessible to the Project, and training of personnel likely to enter such land.	Land entry procedure prepared and implemented	Procedure to be produced and approved.	Before the start of field work	Preparation and implementation: EPC Verification: NEHO	Before and during construction
Use in accordance with the law and good practices	Trav01 <ul style="list-style-type: none"> Prepare a human resources (HR) policy incorporating the key principles of Malagasy legislation and IFC and AfDB standards, including the obligation for all companies involved in the Project to comply with this policy, and information on the content of this policy when hiring workers. Disclose this policy on bulletin boards in the Project's social areas (offices, cities, etc.). Include this policy in all subcontracted contracts by requiring (i) compliance 	HR policy prepared and implemented	Policy to be produced and approved.	Before the start of the work	Preparation and implementation: EPC Verification: NEHO	Before and during construction

	with this policy by these companies and (ii) the obligation to require compliance by any company contracted by this subcontractor.					
Use in accordance with the law and good practices	Trav02: Exclusion after first warning of companies and service providers found lacking illegal employment.	Breach of contract by companies engaged in illegal employment	Audits	Continuous	EPC	During the construction phase
Use in accordance with the law and good practices	Trav03: Provision of a recourse mechanism to workers under the HR policy, in accordance with IFC and AfDB standards	Recourse mechanism prepared and implemented	Recourse mechanism to be produced and approved.	Before the start of the work	Preparation and implementation: EPC Verification: NEHO	Before and during construction
Equal opportunities for women to access employment.	Work04: Ensure a gender-friendly work environment (including no unisex toilets or changing rooms) during the construction and operation phases.	Non-discriminatory working environment.	Internal control NEHO	Continuous	EPC	During the construction phase
Equal opportunities for women to access employment.	Work05: Indicate explicitly in the offers that the positions are open to both men and women.	Indication included in job offers.	Internal control NEHO	During recruitment	EPC	During the construction phase
Equal opportunities for women to access employment.	Work06: For qualified or responsible positions, ensure a gender balance of pre-selected candidates invited for an interview	Significant representation of women in qualified or responsible positions.	Internal control NEHO	Continuous	EPC	During the construction phase
Worker health and safety - Any type of accident or incident during construction activities	Sstr01: Preparation and implementation of a Worker Health and Safety Plan for the construction phase, approved by NEHO, and in accordance with ESIA specifications.	Plan prepared and approved	Approval of the Plan by NEHO	Once in a while	Preparation of the plan: EPC Verification: NEHO	Before the construction phase
Worker health and safety - Natural or technological emergency	Sstr02: Preparation and implementation of an Emergency Prevention and Management Plan for the construction phase, approved by NEHO, and in accordance with ESIA specifications.	Plan prepared and approved	Approval of the Plan by NEHO	Once in a while	Preparation of the plan: EPC Verification: NEHO	Before the construction phase
Worker health and safety - Health and safety responsibility not clearly defined	Sstr03: Appointment within the EPC of a Health and Safety Manager in charge of the preparation, updating and implementation of the Workers' Health and Safety Plan and the Emergency Prevention and Management Plan.	Health and Safety Manager recruited and maintained during the construction work	Name and CV of the Health and Safety Manager communicated	Before starting construction work	Commitment: EPC CV approval: NEHO	From the beginning to the end of construction activities

	The Health and Safety Manager reports directly to the site manager, and defines the resources he needs to ensure and control the implementation of the two plans mentioned above.					
Worker health and safety - Effective compliance with health and safety rules by the subcontractors' chain	Sstr04: Include standardized contractual obligations for the respect and implementation of the EPC Workers' Health and Safety Plan in all contracts of companies in the subcontracting chain.	Obligations under subcontractor contracts	Internal control EPC	When preparing contracts	EPC	When subcontracting subcontractors
	Sstr05: Continuous monitoring of compliance with the Workers' Health and Safety Plan by the companies working for the Project, organized by the Health and Safety Manager. Exclusion after first warning of companies and service providers found in default.	Compliance with the Workers' Health and Safety Plan	Supervision organized by the Health and Safety Manager	Continuous	EPC	During construction
Worker health and safety - Behavior of security personnel	Sstr06: If security personnel (private or public seconded) are contracted for the Project, train them in the United Nations Voluntary Principles for Security and Human Rights.	Training provided	Register of training provided	To the commitment of the persons concerned	EPC	During construction
Worker health and safety - Healthy environment during non-working hours	Sstr07: Preparation and implementation of a Base Camp and Workers' City Management Plan for the construction phase, approved by NEHO, and in accordance with ESIA specifications.	Plan prepared and approved	Approval of the Plan by NEHO	Once in a while	Preparation of the plan: EPC Verification: NEHO	Preparation before the construction phase Implementation during the construction phase
Worker health and safety - Risk related to AIDS and other STDs	Sstr08: Implement a systematic program to raise awareness among workers (induction) and among populations (specialized NGOs) to ensure that the population, workers and at-risk groups are aware of the modes of contamination and have the means to protect them.	Awareness provided	Register of sensitizations provided	Annual	EPC (workers) and NEHO (populations)	Before and during construction
Worker health and safety - Food and water health risk	Sstr09: Provide drinking water at all installations and work sites. Train workers (induction) in the risks of food poisoning or drinking water.	Water made available Training provided	Supervision organized by the Health and Safety Manager Register of training provided	Continuous At the time of hiring and annually	EPC	During construction
Community safety and security	Seco01: Preparation and implementation of a Road Traffic and Access Management Plan for	Plan prepared and approved	Approval of the Plan by NEHO	Once in a while	Preparation of the plan: EPC	Preparation before the

	the construction phase, approved by NEHO, and in accordance with ESIA specifications. This plan will include a ban on supply traffic to the site via Belanitra on Monday, Belanitra's market day. This plan will also include monitoring of human and vehicle traffic to adapt the Project's vehicle traffic rules if necessary.				Verification: NEHO	construction phase Implementation during the construction phase
Community safety and security	Seco03: Installation of a shuttle bus making the round trip Belanitra-Faravohitra once in the morning and once in the evening, according to the conditions defined in the ESIA.	Shuttle set up	Passenger and baggage / cargo transport register	Continuous	NEHO	During construction
Community safety and security	Seco04: For pedestrians, bicycles, motorcycles and carts from Belanitra to the dam site: <ul style="list-style-type: none"> in order to avoid the risk of accidents, construction of a pedestrian-bike path along the proposed road, in order to separate vehicle traffic and pedestrians or bicycles. The use by motorcycles of this track is prohibited. Awareness-raising activities in villages on the use of this trail by pedestrians and bicycles. 	Built track Awareness raising carried out	Supervision by the EPC Health and Safety Manager + approval by NEHO Register of sensitizations provided	During the construction of the accesses At the beginning then annually	EPC	During the construction of Belanitra's access to the dam.
Community safety and security	Seco04: From the dam site to Faravohitra (pedestrians only): <ul style="list-style-type: none"> Installation of a public pedestrian crossing on the bridge. Securing the pedestrian path from the dam to Faravohitra against the risk of interaction with Project traffic by developing crossings between the vehicular and pedestrian paths or by building local bypasses. 	Secure pedestrian access, not exposed to construction site traffic	Supervision by the EPC Health and Safety Manager + approval by NEHO	Weekly inspections	EPC	During construction

Community safety and security	Seco07: Installation of signs prohibiting access to the river to all roads for 500 m downstream	Signage put in place	Supervision by the EPC Health and Safety Manager + approval by NEHO	Inspection after installation	EPC	During construction, before the first filling
Community safety and security	Seco10: Installation of an overhead cable prohibiting navigation on the reservoir within 1 km of the dam.	Cable installed	Supervision by the EPC Health and Safety Manager + approval by NEHO	Inspection after installation	EPC	During construction, before the first filling
Community safety and security	Seco12: On the basis of actions Rupt02 to Rupt04, set up a warning mechanism for downstream populations in the event of exceptional natural flooding likely to impact them.	Alert mechanism set up	Supervision by the EPC Health and Safety Manager + approval by NEHO	Inspection after installation	EPC	During construction, before the first filling
Community safety and security	Seco13: Set up an audible alarm downstream from the plant, from the river opposite Faravohitra and in the exposed sites identified during the Downstream action03 tests.	Audible alarm set up	Supervision by the EPC Health and Safety Manager + approval by NEHO	Inspection after installation	EPC	During construction, before the first filling
Health and safety of families around the reservoir	Seco15: Expropriation and delimitation (boundary or equivalent) of a 100 m strip around the reservoir with prohibition to settle there. Annual verification that no one has relocated to this area.	Expropriation and delimitation carried out.	Internal control	Inspection after installation and annual inspection	EPC and NEHO	Implementation of the RAP
Health and safety of families around the reservoir	Saco04: Delimitation (boundary marking or equivalent marking lasting over time) of a 100 m strip around the reservoir.	Delimitation set up	Supervision by the EPC Health and Safety Manager + approval by NEHO	Inspection after installation	EPC	During construction, before the first filling
Incidence of HIV and other sexually transmitted diseases associated with tourism construction or development.	Saco01: Implement a systematic and regular population awareness program (specialized NGO) to ensure that the population and at-risk groups are aware of the modes of contamination and have the means to protect them.	Awareness provided	Register of sensitizations provided	Annual	NEHO	Before and during construction
Incidence of gastrointestinal infections associated with the presence of informal human settlements	Saco02: Implement an awareness and information program for people in the areas concerned, which will help to identify risks and disseminate basic hygiene measures.	Awareness provided	Register of sensitizations provided	Annual	NEHO	Before and during construction
Health problems and violence against women	Affl02: Actions to raise awareness of STDs and the risks of violence against women are planned as part of the ESIA's program of	Awareness provided	Register of sensitizations provided	Annual	NEHO	Before and during construction

	measures against public health risks. These actions will start before construction begins.					
Need for a clear, transparent and egalitarian recruitment mechanism	Infl03: the EPC will have to set up a manpower recruitment system as part of its ESMPC	Recruitment system prepared and approved	Approval by NEHO	Continuous	EPC	Before and during construction
Access to employment for resettled persons	Affl04: Priority access to employment (without guarantee of employment) for local workers from families displaced by the Project - The names of these people and their possible skills will be provided by NEHO	Lists and contacts of local workers prepared by NEHO Percentage of local workers hired by the EPC or its subcontractors	Internal control NEHO Workers' register	Continuous	NEHO EPC	Before and during construction
Absence or saturation of public infrastructure	Affl05: Preparation and implementation of a program to improve the collective infrastructure of villages and a Community Development Plan, including a rural electrification component.	Plan prepared and implemented	Internal control + dissemination on the NEHO website	Continuous	NEHO	During construction
Absence or saturation of public infrastructure	Affl06: Detachment in coordination with the administration of law enforcement officials in Faravohitra and in the vicinity of the dam site, trained in the United Nations Voluntary Principles for Security and Human Rights.	Mobilized and trained law enforcement representatives.	Internal control	Continuous	NEHO	During construction
Respect by the Project or the newcomers for the cultural practices of the area	Affl07: The induction that will be received by workers hired by NEHO, the EPC and its subcontractors will include an awareness of the cultural habits and practices of the Project area, including the Fady. This awareness will be aimed at mitigating the risk of conflict related to culture gaps.	Induction provided	Register of inductions provided	For any newcomer related to the Project	EPC and NEHO	Before and during construction
Increased impact on protected areas	Inflow09: A series of actions are planned to mitigate the negative impacts that the population inflow could have on biodiversity in protected areas (Marolambo Park and Tsinjoarivo NPA). This includes: <ul style="list-style-type: none"> • Material assistance for better protection. • The prohibition of consuming or introducing wild meat into the site and 	Raising awareness among workers Memoranda of Understanding with entities in charge of protected areas	Awareness register Internal control NEHO	At the beginning of the work and annually thereafter	NEHO	During the construction phase

	<p>living areas.</p> <ul style="list-style-type: none"> • Raising workers' awareness of conservation issues in the Project area. • Control with protected area managers of vehicle traffic passing through protected areas 					
Poor information of the population, rumors, difficult access to information	Aff10: Prepare and implement a stakeholder engagement plan before work begins, including a recourse and conflict management mechanism.	Plan prepared and implemented	Internal control + dissemination on the NEHO website	Continuous	NEHO	Throughout the duration of the Project
Proliferation of informal economic activity (alcohol, prostitution, poaching, fencing)	Aff11: Provide maximum service within the bases. Establish management rules for the functions of the bases with schedules established for employees. Entry control on the database. Do not allow spontaneous camping within a radius of protection of the Remote Sites. Radius to be defined with local authorities.	Basic life management plan prepared and implemented	Approval of the Plan by NEHO	Once in a while	Preparation of the plan: EPC Verification: NEHO	Preparation before the construction phase Implementation during the construction phase
Induced or organized increase in the prices of certain commodities/products.	Aff12: Monitoring of local market prices for basic food products. Intervene in the event of an abnormal change in these prices compared to the history. If necessary, make agreements with resellers to pre-finance purchase/transport to support price maintenance.	Commodity prices	Follow-up on local market prices	weekly	NEHO Social Team	Before and during construction
Non-respect of fady and prohibited by the populations	Inf13: Awareness of the EPC staff and its chain of subcontractors about the fady applicable in the Project area	Induction provided	Register of inductions provided	For any newcomer related to the Project	EPC	Before and during construction
Non-respect of fady and prohibited by the populations	Aff14: Discussion with the "notables" of the village in the Betsimisaraka part (Sahofika,) before starting the work, to explain that the site will do earthworks but not agricultural work. Make sure with the notables that this is compatible with the fady banning tillage on Tuesdays.	Discussion held and agreement reached	Minutes of the meeting	Once before construction	NEHO	Before construction
Non-respect of fady and	Aff15: Awareness of NEHO staff and its chain of subcontractors about fady applicable in the	Induction provided	Register of inductions provided	For any newcomer related	NEHO	Before and during

prohibited by the populations	Project area			to the Project		construction
Respect for the information of local authorities and administrations	Affl16: Implementation of a procedure for the systematic declaration of the interventions of the Project teams (NEHO, EPC and any other party involved in the Project)	Procedure set up and executed	Register of notifications	Each time a new team is mobilized in the field	NEHO	Before and during construction
Risk related to losses of previously unidentified buried cultural property	Cult01: Preparation and implementation of a chance discovery procedure for any contractor who will perform excavations or cuttings. Training of personnel in charge of excavations (or their follow-up) on the nature of possible finds and the measures to be applied in the event of a find.	Procedure set up and executed	Approval of the procedure by NEHO	Once in a while	Preparation and implementation: EPC Verification: NEHO	Preparation before the construction phase Implementation during the construction phase
Risks related to existing places of worship	Cult02: Detailed mapping of cultural sites and tombs during field studies for the implementation of linear infrastructure (roads and tracks), and engagement with stakeholders to agree on avoidance measures.	Mapping of cultural sites Reporting of decided avoidance measures produced before construction	Control by NEHO's social team before construction	Continuous	EPC Verification: NEHO	Design and construction
Lack of awareness by the public or NEHO employees of the biodiversity protection measures implemented by the Project	BioT01: <ul style="list-style-type: none">Raising awareness and informing the population concerned about the Project and biodiversity protection measures.Information sharing, training and capacity building for NEHO employees on the environmental measures taken by the Project.	Awareness and information provided	Register of awareness / information provided	Annual for all, and for any newcomer related to the Project	NEHO	Before and during construction
Lack of awareness by EPC employees of the biodiversity protection measures implemented by the Project	BioT02: Information sharing, training and capacity building for EPC and subcontractor chain employees on the environmental measures taken by the Project.	Awareness and information provided	Register of awareness / information provided	Annual for all, and for any newcomer related to the Project	EPC	Before and during construction

<p>Risk of project encroachment greater than that estimated in the event of uncontrolled access by people to the most sensitive habitats as part of the Project</p>	<p>BioT03: Prohibition of access of persons other than personnel to construction sites and prohibition of movement of project employees in unauthorized areas, including habitats with ecological implications.</p>	<p>Effective prohibition of access.</p>	<p>Internal control and security EPC</p>	<p>Continuous</p>	<p>EPC</p>	<p>During the entire construction phase</p>
<p>Disproportionate impacts on sensitive species and habitats in the event of inappropriate infrastructure location, and risk of non-compliance with the principle of mitigation hierarchy.</p>	<p>BioT06: Between the dam and the hydropower plant: Pass the service line and communication networks through the waterway gallery. For road and line layout:</p> <ul style="list-style-type: none"> ● Recognize and make maximum use of areas already impacted as described in the ESIA. ● Bury the buried transmission line over a distance of 1.6 km, where the selected route crosses the largest forest width. ● Limit the width of the tracks (treadmill) to 5 m in wooded areas. ● Have the implementations validated by NEHO. 	<p>Implantations in accordance with ESIA requirements</p>	<p>Supporting note to be produced and approved before work</p>	<p>Before work</p>	<p>Preparation of the note: EPC Approval: NEHO</p>	<p>Design and construction</p>
<p>Disproportionate impacts on sensitive species and habitats in the event of inappropriate infrastructure location, and risk of non-compliance with the principle</p>	<p>BioT07: Optimization of the implementation of temporary or permanent infrastructures:</p> <ul style="list-style-type: none"> ● Use as much as possible the footprint of the future reservoir for temporary infrastructure and extraction sites (without exposing the sites to flooding from the Onive); 	<p>Implantations in accordance with ESIA requirements</p>	<p>Supporting note to be produced and approved before work</p>	<p>Before work</p>	<p>Preparation of the note: EPC Approval: NEHO</p>	<p>Design and construction</p>

<p>of mitigation hierarchy.</p>	<ul style="list-style-type: none"> At the dam, outside the reservoir area: (i) Locate temporary infrastructure on the right bank of the Onive (to the west) rather than on the left bank to minimize risks to the new protected area and (ii) Avoid natural habitats and agricultural areas to limit the volume of compensation or economic displacement. At the plant level: Avoid agricultural areas to limit the volume of compensation or economic displacement. 					
<p>Impacts related to the construction of linear infrastructure on VOI management transfer areas.</p>	<p>BioT08: Consult VOIs and protected area managers/developers for the validation of the routes or locations proposed by the EPC for infrastructure between Belanitra and the plant.</p>	<p>VOI and protected area managers/proponents consulted on the basis of EPC supporting notes</p>	<p>Minutes of the meeting</p>	<p>Once before the construction of the objects in question</p>	<p>NEHO</p>	<p>Design and construction</p>
<p>Fragmentation of the corridor caused by vehicle traffic during construction.</p>	<p>BioT09: Night traffic (between 8pm and 6am) between the dam and the plant will be prohibited for scheduled or regular site activities, and will be reserved for emergencies and exceptional circumstances approved by NEHO. Installation of barriers and guard posts at the ends of the forest.</p>	<p>No night traffic</p>	<p>Guarding and barriers</p>	<p>Continuous</p>	<p>EPC</p>	<p>During the entire construction phase</p>
<p>Impacts on flora species with a conservation stake between the dam and the plant</p>	<p>BioT11: Protection of endangered flora (between the dam and the plant):</p> <ul style="list-style-type: none"> The precise identification, marking and localization of the flora species that triggered the critical habitat listed in the ESIA in order to avoid them when the infrastructure is located in forest areas; 	<p>Implantations in accordance with ESIA requirements</p>	<p>Supporting note to be produced and approved before work</p> <p>Monitoring by NEHO's ecologist (Biot12 action)</p>	<p>Before work</p>	<p>Preparation of the note: EPC</p> <p>Approval: NEHO</p>	<p>Design and construction</p>

	<ul style="list-style-type: none"> The maximum adaptation of the rights-of-way and impact activities or the relocation of the specimens concerned to avoid damaging them. 					
Impacts on wildlife species with a conservation issue between the dam and the plant	<p>BioT13: Protection of endangered wildlife (between the dam and the plant):</p> <ul style="list-style-type: none"> Sequenced clearing and deforestation after the final establishment of the infrastructure crossing forest areas, in order to drive wildlife away: (i) Felling of trees, then (ii) Leaving 24 hours for residual fauna to escape (especially reptiles, entomofauna), then (iii) Finalization of the clearing and cleaning of the area with storage of vegetation collected on the edges of the rights-of-way for crushing or composting (no slash-and-burn). In order to minimize impacts on birds breeding in forest areas, cutting of large trees for release of rights-of-way will be done outside the birds' preferred nesting period, which corresponds to the months of August to December. Large trees identified as feeding grounds (fruit-eating species) and dormitories for lemurs should be avoided. These trees will be easily recognizable by the abundance of young plants and the presence of excrement; 	Timetable and working methods in accordance with ESIA requirements	<p>Internal control and supporting notes by the EPC</p> <p>Monitoring by NEHO's ecologist (Biot14 action)</p>	Continuous	<p>Preparation of the note: EPC</p> <p>Approval: NEHO</p>	During the entire construction phase

	<ul style="list-style-type: none"> Minimization of wildlife crushing risk: (i) Driver awareness and training in removing wildlife species from traffic lanes, and (ii) Speed limited to 40 km/h between the dam and the plant. 					
Introduction and spread of invasive alien species	<p>BioT16: Controlling the introduction and spread of invasive alien species:</p> <ul style="list-style-type: none"> Identify the invasive species present on the site and its surroundings before the work is carried out; Manually or mechanically remove shrub or tree EEEs, ensuring that the root system is removed; Eradicate these species through appropriate measures (on-site disposal and incineration of plant debris); Carry out a preliminary study of the material supply sites (quarries, others). 	Spread of invasive alien species avoided	<p>Internal control and supporting notes by the EPC</p> <p>Monitoring by NEHO's ecologist (Biot14 action)</p>	Continuous	<p>Preparation of the note: EPC</p> <p>Approval: NEHO</p>	During the detailed design phase and the entire construction phase
Increased fire risk due to the presence of the Project.	<p>BioT17: Fire Prevention:</p> <ul style="list-style-type: none"> Open fires are prohibited throughout the construction period. Equip worksites where flammable products are used with fire extinguishers, Train staff in the use of fire extinguishers, and in, 	Imposed rules and training provided	Supporting note to be produced and approved before work + training register	Before work	<p>Preparation of the note: EPC</p> <p>Approval: NEHO</p>	Before and during the construction phase

	<ul style="list-style-type: none"> Remind the basic rules regarding the use of flammable products. 					
Means available to protected area managers/proponents and VOIs to strengthen the protection, conservation and monitoring of protected areas.	BioT18: Support and accompaniment of managers of areas under status for the protection of biodiversity.	Implementation of actions decided with protected area managers	Control with the monitoring committee Disclosure on NEHO's website of planned and completed actions	Continuous	NEHO	During the construction phase
Luminous impact of lighting on nocturnal species.	BioT19: Minimization of light pollution <ul style="list-style-type: none"> Avoid continuous lighting, and opt for activation by presence detectors for outdoor comfort lighting, Use low-light bulbs or use floor-oriented lighting for outdoor lighting. 	Lighting in accordance with ESIA requirements	Supporting note to be produced and approved before work	Before work	Preparation of the note: EPC Approval: NEHO	During the construction phase
Destruction of natural forests in the infrastructure footprint between the dam and the plant.	BioT22: Preparation and implementation of a program to restore degraded areas in forests adjacent to the forest corridor (final area equal to twice the amount of woodland lost).	Program prepared and implemented	Control with the monitoring committee Disclosure on NEHO's website of planned and completed actions	Continuous	NEHO	During the construction phase
Increased pressure on protected or threatened species in protected areas.	BioT23: Support for the conservation of the natural forests of Tsinjoarivo NPA and Marolambo National Park.	Program prepared and implemented with managers	Control with the monitoring committee Disclosure on NEHO's website of planned and completed actions	Continuous	NEHO	During the construction phase
Increased pressure on areas under management transfer, increased wood requirements	BioT24: VOI support program: reforestation in management transfer areas and preservation of ecosystem services.	Program prepared and implemented	Control with the monitoring committee Disclosure on NEHO's website of planned and completed actions	Continuous	NEHO	During the construction phase
Insufficient mitigation measures for the	BioT26: Preparation and implementation of a monitoring program for a number of target species, fauna and flora that have triggered	Program prepared and implemented	Control with the monitoring committee	Continuous	NEHO	During the construction phase

most sensitive fauna and flora species between the dam and the plant (follow-up action).	critical habitat analyses will be undertaken with protected area managers and proponents (to be combined with the BioT25 measure).		Disclosure on NEHO's website of planned and completed actions			
Disparities between the ornithological data of the Project and the data of the IBA	BioT28: Support for updating the data of the IBA of the Onive Classified Forest, in collaboration with the referring NGO.	Updated IBA data for the O-level Classified Forest	Control with the monitoring committee Disclosure on NEHO's website of planned and completed actions	Once in a while	NEHO	During the construction phase
Impact of the modified hydrological regime on habitats downstream from the dam and plant	BioA01: During the implementation of the Aval03 action: ichthyologists will be involved in this test, in order to accurately assess the possible impact of different environmental variations and conditions on the habitat of aquatic species in the Onive or even on the species themselves.	Precise assessment of the impact of different environmental variations and conditions on the habitat of aquatic species in the Onive	Visual observation	During the tests	NEHO in coordination with EPC	During the first filling of the impoundment
Total drying of the bed downstream from the dam.	BioA02: Maintenance of the instream flow in the bypassed reach at all times (5.7 m3/s)	Spill flow never lower than instream flow	Measuring the spilled flow rate	continues from the closure of the river	EPC	Construction and commissioning
Inadequate protection measures implemented due to poor knowledge of the ecology of the species.	BioA04: Further knowledge of Rheocles wrightae and Rheocles sp. Ambatovy, in coordination with IUCN and improvement of knowledge of this species to contribute to its better protection and conservation.	Enrichment of the ecological knowledge of Rheocles sp. in coordination with IUCN	Disclosure on NEHO's website of planned and completed actions	Three-year program	NEHO	During the construction phase
Possible risks for Rheocles wrightae due to the Project.	BioA05: Conservation measures for the species Rheocles wrightae and Rheocles sp. Ambatovy (if impacts confirmed by monitoring).	Corrective measures if necessary	Disclosure on NEHO's website of planned and completed actions	To be defined	NEHO	During the construction phase
Compliance of biodiversity actions with donor requirements	PAB01: Preparation, implementation and monitoring of a Biodiversity Action Plan	Preparation and implementation of a Biodiversity Action Plan	According to the program	According to the program	NEHO	During the construction phase
Cumulative Impacts	Cumu01: Do not plan a relocation site for the Sahofika Project within the footprint of the other projects. Inform the populations affected by the Project of the risk of construction of other hydropower plants. Assist people who want more specific information to access it, based on publicly available information.	Resettlement sites not exposed to future hydropower plants.	Selection of relocation sites	Continuous	NEHO, social team.	During the preparation of the RAP and public consultations with the people affected by the

						Project
Cumulative Impacts	Cumu03: Do not adopt biodiversity risk mitigation measures for Sahofika that depend on habitats that would in turn be impacted if subsequent facilities were developed. Share Sahofika biodiversity monitoring results (on the Project website) to enable other projects to benefit from Sahofika's experience.	Sites for implementing compensatory measures that are not exposed to future hydropower plants.	Choice of sites for the implementation of compensatory measures	Continuous	NEHO.	During the construction phase
Cumulative Impacts	Cumu04: Disclose information on actions taken to support the Tsinjoarivo NPA and the MNP. Capacity building of the Tsinjoarivo NPA and the MNP in the assessment and management of negative impacts.	Information disclosed	Disclosure on the Project website	Continuous	NEHO, environmental team.	From the first year of construction of the Project.
Community Development	Devt01: If the microchannel solution is chosen, installed on the water intake for the instream flow of a by-pass, allowing the connection of a micro-station, and automated to return to the river the water not used by the micro-station in order to satisfy the instream flow obligation.	Instream flow obligation met	Flow measurement	Continuous	EPC	Design and construction
Community Development	Devt02: Implementation of a technical solution to supply a local distribution network from the plant	Supply a local electrical distribution network from the plant	Available connection	Before the end of the work	EPC	Design and construction
Community Development	Devt03: Detailed technical studies and legal and institutional arrangements for the implementation of the rural electrification component of the Project, including rapid temporary measures could be put in place to provide electricity to the population from the construction phase, for example through solar terminals.	Study carried out and approved	Study results published on the Project website and communicated with local populations and authorities	At the beginning of construction	NEHO	Starting the Project
Community Development	Devt04: Preparation of a detailed Community Development Plan based on the principles set out in the ESIA.	Plan prepared	Plan disclosed on the Project website and communicated with local populations and authorities	At the beginning of the Project, then reviewed annually.	NEHO	During construction

10.4.2 Hydropower Plant Component - Operation Phase

Issue/Impact	Mitigation Measures	Indicators	Monitoring method	Frequency	By	Schedule
Hydraulic impact downstream	Downstream04: Permanent maintenance of a instream flow downstream from the dam.	Instream flow maintained	Measurement of the flow discharged from the dam downstream	Continuously	NEHO	During the entire operation phase
Limitation of noise, gas and dust emissions	SFX10: Stopping and banning vehicles emitting a cloud of smoke that affects the visibility or breathability of the air	Exceptionally polluting vehicles stopped immediately and prohibited.	Visual inspection	Continuous	NEHO	During the operation phase
Limitation of noise, gas and dust emissions	SFX11: Favor the use of electric ATVs for the Project E&S team's travel	Electric mountain bikes made available, used and maintained.	Visual inspection	Continuous	NEHO	During the operation phase
Solid and liquid waste	Dech04: Preparation of a waste management plan for the operation phase, taking into account the waste management hierarchy, and distinguishing (i) domestic waste from the operation city and staff, (ii) organic waste (floating wood, water hyacinths) and (iii) industrial waste from operation and maintenance activities.	Plan prepared and implemented	Internal implementation control	Continuous	NEHO	During the operation phase
Risk of accidental pollution	Poll05: Use of biodegradable oil for hydromechanical and electromechanical equipment with a risk of uncontrolled leakage into the environment, in particular for all parts in direct contact with water.	Use of biodegradable oil for hydromechanical and electromechanical equipment with a risk of uncontrolled leakage into the environment	Checking the type of oil used	Monthly internal inspections	NEHO	During the operation phase
Climate Change	Clim08: Verification every ten years of project floods, based on acquired hydrological data. Verification of the resilience of the facility in accordance with the HIA Climate Resilience Guide.	Verification of the climatic resilience of the hydropower plant.	According to IHA guide. Climate resilience of hydropower plants	Every ten years	NEHO	During the operation phase

Climate Change	Climate07: Sensitization of the populations of the Project area to climate risk.	Sensitization carried out.	Register of awareness measures.	Annually	NEHO	During the operation phase
Climate Change	Clim07: Integration of a climate resilience objective into the social support measures of the Sahofika Project (Community Development Plan).	Climate resilience integrated into the DCP.	Internal control NEHO	When preparing the DCP	NEHO	During the operation phase
Risk of dam failure	Rupt06: Verification and update of the emergency response plan.	Emergency response plan reviewed and updated as necessary	Internal control NEHO	Every ten years	NEHO	During the operation phase
Equal opportunities for women to access employment.	Work04: Ensure a gender-friendly work environment (including no unisex toilets or changing rooms) during the construction and operation phases.	Non-discriminatory working environment.	Internal control NEHO	Continuous	NEHO	During the operation phase
Equal opportunities for women to access employment.	Work05: Indicate explicitly in the offers that the positions are open to both men and women.	Indication included in job offers.	Internal control NEHO	During recruitment	NEHO	During the operation phase
Equal opportunities for women to access employment.	Work06: For qualified or responsible positions, ensure a gender balance of pre-selected candidates invited to an interview	Significant representation of women in qualified or responsible positions.	Internal control NEHO	Continuous	NEHO	During the operation phase
Worker health and safety - Behavior of security personnel	Sstr06: If security personnel (private or public seconded) are contracted for the Project, train them in the United Nations Voluntary Principles for Security and Human Rights.	Training provided	Register of training provided	To the commitment of the persons concerned	NEHO	During the operation phase
Community safety and security	Seco02: Preparation and implementation of a Road Traffic and Access Management Plan for the operation phase, approved by NEHO, and in accordance with ESIA specifications.	Plan prepared and implemented	Internal implementation control	continuous	NEHO	During the operation phase
Community safety and security	Seco05: Organization of a consultative seminar with representatives of the population, state representatives and protected area managers to set up a circulation mechanism to open up the hydropower plant area, while minimizing the risk of accidents or use of the track for activities impacting protected areas.	Seminar organized and concluded	Internal implementation control	Once in a while	NEHO	Before the operation phase
Community safety and security	Seco06: Implementation of a regulated traffic system based on the conclusions of the seminar, managed by NEHO in coordination with protected area managers.	Regulated circulation set up	Internal implementation monitoring with protected area managers	continuous	NEHO	Before and during the operation phase
Community safety and security	Seco08: Awareness of the risks of rapid flow variations for the most exposed people, especially people living downstream and	Awareness raising carried out	Register of sensitizations carried out	Before modification of the hydrological	NEHO	Before and during the operation

	children living in the vicinity (less than 5km from the dam), from the time of filling and testing the gates.			regime, then annually		phase
Community safety and security	Seco09: Programming and/or forecasting of flow variations that can be anticipated (spillage due to flood rise, sediment emptying), visual inspection of the downstream side of the dam before opening the gates and prior information of the downstream populations, using if necessary the communication system described in the Rupt04 action.	Visual inspection and information of populations before significant predictable or scheduled flow variations	Register of inspections and population information	Before artificial changes in the hydrological regime that are predictable or programmable	NEHO	During the operation phase
Community safety and security	Seco11: Information and awareness raising for pirogues navigating on the reservoir.	Awareness raising carried out	Register of sensitizations carried out	Before filling the reservoir, then annually	NEHO	Before and during the operation phase
Community safety and security	Seco14: Organize an annual visit to the dam and the plant for a specific age group (generally 10 years), in order to awaken them and raise their awareness of the risks associated with the operation.	Visits and awareness raising carried out	Register of sensitizations carried out	Before filling the reservoir, then annually	NEHO	Before and during the operation phase
Community safety and security	Saco05: Expropriation of the delimited area around the reservoir with prohibition to settle there (see measure Seco15). Annual verification that no one has relocated to this area.	Expropriation and verification carried out.	Internal control	Inspection after installation and annual inspection	NEHO	RAP Implementation and Operation
Incidence of HIV and other sexually transmitted diseases associated with tourism construction or development.	Saco01: Implement a systematic and regular population awareness program (specialized NGO) to ensure that the population and at-risk groups are aware of the modes of contamination and have the means to protect them.	Awareness provided	Register of sensitizations provided	Annual	NEHO	During the operation phase
Absence or saturation of public infrastructure	Affl05: Preparation and implementation of a program to improve the collective infrastructure of villages and a Community Development Plan, including a rural electrification component.	Plan prepared and implemented	Internal control + dissemination on the NEHO website	Continuous	NEHO	During the operation phase
Absence or saturation of public infrastructure	Affl06: Detachment in coordination with the administration of law enforcement officials in Faravohitra and in the vicinity of the dam site, trained in the United Nations Voluntary Principles for Security and Human Rights.	Mobilized and trained law enforcement representatives.	Internal control	Continuous	NEHO	During the operation phase

Respect by the Project or the newcomers for the cultural practices of the area	Affl07: The induction that will be received by workers hired by NEHO, the EPC and its subcontractors will include an awareness of the cultural habits and practices of the Project area, including the Fady. This awareness will be aimed at mitigating the risk of conflict related to culture gaps.	Induction provided	Register of inductions provided	For any newcomer related to the Project	EPC and NEHO	During the operation phase
Increased impact on protected areas	Inflow09: A series of actions are planned to mitigate the negative impacts that the population inflow could have on biodiversity in protected areas (Marolambo Park and Tsinjoarivo NPA). This includes: <ul style="list-style-type: none"> • Material assistance for better protection. • The prohibition of consuming or introducing wild meat into the site and living areas. • Raising workers' awareness of conservation issues in the Project area. • Control with protected area managers of vehicle traffic passing through protected areas 	Raising awareness among workers Memoranda of Understanding with entities in charge of protected areas	Awareness register Internal control NEHO	At the beginning of the work and annually thereafter	NEHO	During the operation phase
Poor information of the population, rumors, difficult access to information	Affl10: Prepare and implement a stakeholder engagement plan before work begins, including a recourse and conflict management mechanism.	Plan prepared and implemented	Internal control + dissemination on the NEHO website	Continuous	NEHO	During the operation phase
Non-respect of fady and prohibited by the populations	Affl15: Awareness of NEHO staff and its chain of subcontractors about fady applicable in the Project area	Induction provided	Register of inductions provided	For any newcomer related to the Project	NEHO	During the operation phase
Respect for the information of local authorities and administrations	Affl16: Implementation of a procedure for the systematic declaration of the interventions of the Project teams (NEHO, EPC and any other party involved in the Project)	Procedure set up and executed	Register of notifications	Each time a new team is mobilized in the field	NEHO	During the operation phase

Lack of awareness by the public or NEHO employees of the biodiversity protection measures implemented by the Project	<p>BioT01:</p> <ul style="list-style-type: none"> Raising awareness and informing the population concerned about the Project and biodiversity protection measures. Information sharing, training and capacity building for NEHO employees on the environmental measures taken by the Project. 	Awareness and information provided	Register of awareness / information provided	Annual for all, and for any newcomer related to the Project	NEHO	During the operation phase
Fragmentation of the corridor caused by vehicle traffic during operation.	<p>BioT10: Night traffic (between 7pm and 7am) between the dam and the plant will be prohibited for programmable or regular operational activities, and will be reserved for emergencies and exceptional circumstances. Installation of barriers and guard posts at the ends of the forest</p>	<p>No night traffic</p> <p>Coordinated management with the proponent / NPA manager</p>	Guarding and barriers	Continuous	NEHO	During the operation phase
Impacts on wildlife species with a conservation issue between the dam and the plant	<p>BioT15: Minimization of the risk of wildlife crushing:</p> <ul style="list-style-type: none"> Traffic regulation between the dam and the plant in coordination with the promoter/manager of the NPA and with consultation of the populations (the road is not open to all vehicles) Raising driver awareness and training in the removal of wildlife species from traffic lanes, Restrictions on night traffic, Speed limited to 40 km/h between the dam and the plant, 	<p>Regulated daytime traffic</p> <p>Coordinated management with the proponent / NPA manager</p>	<p>Guarding and barriers</p> <p>Register of actions to minimize the risk of crushing</p>	Continuous	NEHO	During the operation phase
Means available to protected area managers/propon	<p>BioT18: Support and accompaniment of managers of areas under status for the protection of biodiversity.</p>	Implementation of actions decided with protected area managers	Control with the monitoring committee	Continuous	NEHO	During the operation phase

ents and VOIs to strengthen the protection, conservation and monitoring of protected areas.			Disclosure on NEHO's website of planned and completed actions			
Luminous impact of lighting on nocturnal species.	<p>BioT20: Minimization of light pollution</p> <ul style="list-style-type: none"> • Avoid continuous lighting, and opt for activation by presence detectors for outdoor comfort lighting, • Use low-light bulbs or use floor-oriented lighting for outdoor lighting. 	Lighting in accordance with ESIA requirements	Internal control	Continuous	NEHO	During the operation phase
Risk of increased illegal trade in CITES species due to improved access to the Project area.	BioT21: Preparation and implementation of a program for the protection of CITES species and the fight against illegal trade and poaching defined with protected area managers and promoters as part of the actions already planned to regulate traffic and strengthen biodiversity control and protection.	Program prepared and implemented	Control with the monitoring committee	Continuous	NEHO	During the operation phase
Destruction of natural forests in the infrastructure footprint between the dam and the plant.	BioT22: Preparation and implementation of a program to restore degraded areas in forests adjacent to the forest corridor (final area equal to twice the amount of woodland lost).	Program prepared and implemented	Control with the monitoring committee Disclosure on NEHO's website of planned and completed actions	Continuous	NEHO	During the operation phase
Increased pressure on protected or threatened species in protected areas.	BioT23: Support for the conservation of the natural forests of Tsinjoarivo NPA and Marolambo National Park.	Program prepared and implemented with managers	Control with the monitoring committee Disclosure on NEHO's website of planned and completed actions	Continuous	NEHO	During the operation phase
Increased pressure on areas under management transfer, increased wood requirements	BioT24: VOI support program: reforestation in management transfer areas and preservation of ecosystem services.	Program prepared and implemented	Control with the monitoring committee Disclosure on NEHO's website of planned and completed actions	Continuous	NEHO	During the operation phase
Insufficient mitigation	BioT26: Preparation and implementation of a monitoring program for a number of target	Program prepared and implemented	Control with the monitoring committee	Continuous	NEHO	During the operation

measures for the most sensitive fauna and flora species between the dam and the plant (follow-up action).	species, fauna and flora that have triggered critical habitat analyses will be undertaken with protected area managers and promoters (to be combined with the previous measure).		Disclosure on NEHO's website of planned and completed actions			phase
Total drying of the bed downstream from the dam.	BioA03: Maintenance of the instream flow in the bypassed reach at all times (5.7 m3/s)	Spill flow never lower than instream flow	Measuring the spilled flow rate	Continuous	NEHO	During the operation phase
Development of invasive species (aquatic fauna or flora) in the reservoir.	BioA06: Targeted and adapted control of aquatic invasive alien species.	Program prepared and implemented	Control with the monitoring committee Disclosure on NEHO's website of planned and completed actions	Continuous	NEHO	During the operation phase
Development of invasive species (fauna or flora) in the reservoir.	BioA07: Raising awareness among local populations to target the capture of Invasive Alien Species (IAS) rather than native threatened species (R. wrightae) and crayfish.	Awareness raising carried out	Sensitization register	Annual	NEHO	During the operation phase
Ecosystem services	Ecos01: Assistance for the conversion to fishing of species that will develop in the reservoir, replacing eel fishing.	Assistance provided	Training register	One-year one-time program	NEHO	First year of filling the reservoir
Compliance of biodiversity actions with donor requirements	PAB01: Implementation and monitoring of a Biodiversity Action Plan	Implementation of a Biodiversity Action Plan	According to the program	According to the program	NEHO	During the operation phase
Cumulative Impacts	Cumu02: Disclosure of the action program implemented under the Project to mitigate risks related to waterborne diseases under the Project, and the results of the follow-up with the other projects.	Information disclosed	Information disclosed on the Project website.	As actions are implemented	NEHO	During the operation phase
Cumulative Impacts	Cumu03: Do not adopt biodiversity risk mitigation measures for Sahofika that depend on habitats that would in turn be impacted if subsequent facilities were developed. Share Sahofika biodiversity monitoring results (on the Project website) to enable other projects to benefit from Sahofika's experience.	Sites for implementing compensatory measures that are not exposed to future hydropower plants.	Choice of sites for the implementation of compensatory measures	Continuous	NEHO.	During the operation phase
Cumulative Impacts	Cumu04: Disclose information on actions taken to support the Tsinjoarivo NPA and the MNP. Capacity building of the Tsinjoarivo NPA and the MNP in the assessment and management of negative impacts.	Information disclosed	Disclosure on the Project website	Continuous	NEHO, environmental team.	During the operation phase

Madagascar - Sahofika Hydropower Plant
 Environmental and Social Impact Assessment - Version D

Community Development	Dev04: Preparation of a detailed Community Development Plan based on the principles set out in the ESIA.	Plan prepared	Plan disclosed on the Project website and communicated with the populations and authorities	Plan reviewed annually.	NEHO	During the operation phase
-----------------------	--	---------------	---	-------------------------	------	----------------------------

10.4.3 Linear Infrastructure Component - Construction Phase

Issue/Impact	Mitigation Measures	Indicators	Monitoring method	Frequency	By	Schedule
Optimization of linear infrastructures	Opti01: Optimization of the management of excavations and embankments to minimize the volumes extracted from borrow sites and the volumes placed in final storage.	Volumes, characteristics and locations of extraction or disposal of materials.	Supporting note to be produced before the opening of new extraction or disposal sites	Before any new extraction or disposal sites are opened	Preparation of the note: EPC Approval: NEHO	During the entire construction phase
Optimization of linear infrastructures	Opti02: Definition and technical, environmental and social optimization of the exact route of the line and access road, adopting a layout and design of the line and road that avoids forested areas as far as technically possible, based on the ESIA.	Area of impacted (deforested) forested areas Physical movement avoided as much as possible for lines and access.	Supporting note to be produced and approved at the end of the design studies, and before the start of the work concerned	at the end of the design studies, and before the start of the work concerned	Preparation of the note: EPC Approval: NEHO	During the entire detailed design and construction phase
Backfill, excavated material and temporary sites	Ero01: Preparation of a plan for the management of earthworks / excavation / backfill and erosion prevention submitted to NEHO for approval and incorporating the principles of chapter 5.2.1.2 of the ESIA.	Plan prepared before work begins	Plan prepared and approved before work begins	Before carrying out the work concerned	Preparation of the plan: EPC Verification: NEHO	During the detailed design and construction phase
Backfill, excavated material and temporary sites	Ero02: Engagement in the EPC team of an "Erosion control manager" in charge of the implementation of the plan prepared as part of the Ero01 action.	Erosion control manager recruited and maintained during the duration of erosion risk control work	Name and CV of the erosion control manager communicated	Before carrying out the work concerned	Commitment: EPC CV approval: NEHO	From the beginning to the end of construction activities involving erosion control.
Backfill, excavated material and temporary sites	Ero03: Installation of crossing structures on all watercourses to be crossed by vehicles or construction machinery.	No watercourses crossed by vehicles or construction machinery without a crossing structure	Visual inspections of construction sites	During the entire construction phase	Installation of crossing structures: EPC Visual inspection: NEHO	From the beginning to the end of construction activities.

Backfill, excavated material and temporary sites	Ero04: Shaping of the final disposal areas for surplus materials in order to facilitate their integration into the landscape.	Final disposal areas shaped to fit into the landscape	Visual inspections of construction sites	During the entire construction phase	Shaping of disposal areas: EPC Visual inspection: NEHO	From the beginning to the end of construction activities.
Limitation of noise, gas and dust emissions	SFX01: Dust emitted by vehicle traffic on uncoated surfaces used by the Project. Regular watering in the dry season. Establish a follow-up of complaints related to dust and take measures to limit their impacts.	Good visibility for drivers following another vehicle. Complaints handled	Visual inspections and complaint analysis	Continuous	EPC	During the construction phase
Limitation of noise, gas and dust emissions	SFX02: Limitation of the speed of construction vehicles to 40 km/h on the tracks and 15 km/h on working platforms or in installations	Recorded vehicle speed	Recording (GPS or tachometer) and speed check.	Continuous	EPC	During the construction phase
Limitation of noise, gas and dust emissions	SFX03: Installation of speed bumps in populated areas (in agreement with the authorities responsible for public roads)	Donkey backs built in authorized locations	Visual inspection	During construction / rehabilitation of the tracks	EPC	During the construction phase
Limitation of noise, gas and dust emissions	SFX04: Ban on the use of explosives from 9pm to 7am for surface work (allowed underground)	Schedules respected	Hearing inspection	Continuous	EPC	During the construction phase
Limitation of noise, gas and dust emissions	SFX10: Stopping and banning vehicles emitting a cloud of smoke that affects the visibility or breathability of the air	Exceptionally polluting vehicles stopped immediately and prohibited.	Visual inspection	Continuous	EPC	During the construction phase
Solid and liquid waste	Dech01: Preparation and implementation of a plan for the collection, treatment and management of liquid and solid waste, taking into account the three principles set out in the ESIA	Avoid the uncontrolled spread of pollutants, compliance with Malagasy standards, compliance with IFC recommendations	Plan prepared and implemented	Continuous	Preparation and implementation of the plan: EPC Verification: NEHO	During the construction phase
Solid and liquid waste	Dech02: As part of initial and subsequent training, raising workers' awareness of solid and liquid waste management.	Training provided	Register of training provided	Continuous	EPC	During the construction phase
Risk of accidental pollution	Poll01: Preparation and implementation of a pollution and spill management plan for the construction phase, taking into account the principles set out in the ESIA.	Plan prepared before work begins	Plan prepared and approved before work begins	Before carrying out the work concerned	Preparation of the plan: EPC Verification: NEHO	During the detailed design and construction phase
Risk of accidental pollution	Poll02: As part of initial and subsequent training, training of workers in the prevention	Training provided	Register of training provided	Continuous	EPC	During the construction

	and management of spills of polluting products.					phase
Carrying out work or activities on land that has not been acquired or released	Entr01: Implementation of a procedure for entering the land, including validation and marking of the areas released and accessible to the Project, and training of personnel likely to enter such land	Land entry procedure prepared and implemented	Procedure to be produced and approved.	Before the start of field work	Preparation and implementation: EPC Verification: NEHO	Before and during construction
Use in accordance with the law and good practices	Trav01 <ul style="list-style-type: none"> • Prepare a human resources (HR) policy incorporating the key principles of Malagasy legislation and IFC and AfDB standards, including the obligation for all companies involved in the Project to comply with this policy, and information on the content of this policy when hiring workers. • Disclose this policy on bulletin boards in the Project's social areas (offices, cities, etc.). • Include this policy in all subcontracted contracts by requiring (i) compliance with this policy by these companies and (ii) the obligation to require compliance by any company contracted by this subcontractor. 	HR policy prepared and implemented	Policy to be produced and approved.	Before the start of the work	Preparation and implementation: EPC Verification: NEHO	Before and during construction
Use in accordance with the law and good practices	Trav02: Exclusion after first warning of companies and service providers found lacking illegal employment.	Breach of contract by companies engaged in illegal employment	Audits	Continuous	EPC	During the construction phase
Use in accordance with the law and good practices	Trav03: Provision of a recourse mechanism to workers under the HR policy, in accordance with IFC and AfDB standards	Recourse mechanism prepared and implemented	Recourse mechanism to be produced and approved.	Before the start of the work	Preparation and implementation: EPC	Before and during construction

					Verification: NEHO	
Equal opportunities for women to access employment.	Work04: Ensure a gender-friendly work environment (including no unisex toilets or changing rooms) during the construction and operation phases.	Non-discriminatory working environment.	Internal control NEHO	Continuous	EPC	During the construction phase
Equal opportunities for women to access employment.	Work05: Indicate explicitly in the offers that the positions are open to both men and women.	Indication included in job offers.	Internal control NEHO	During recruitment	EPC	During the construction phase
Equal opportunities for women to access employment.	Work06: For qualified or responsible positions, ensure a gender balance of pre-selected candidates invited to an interview	Significant representation of women in qualified or responsible positions.	Internal control NEHO	Continuous	EPC	During the construction phase
Worker health and safety - Any type of accident or incident during construction activities	Sstr01: Preparation and implementation of a Worker Health and Safety Plan for the construction phase, approved by NEHO, and in accordance with ESIA specifications.	Plan prepared and approved	Approval of the Plan by NEHO	Once in a while	Preparation of the plan: EPC Verification: NEHO	Before the construction phase
Worker health and safety - Natural or technological emergency	Sstr02: Preparation and implementation of an Emergency Prevention and Management Plan for the construction phase, approved by NEHO, and in accordance with ESIA specifications.	Plan prepared and approved	Approval of the Plan by NEHO	Once in a while	Preparation of the plan: EPC Verification: NEHO	Before the construction phase
Worker health and safety - Health and safety responsibility not clearly defined	Sstr03: Appointment within the EPC of a Health and Safety Manager in charge of the preparation, updating and implementation of the Workers' Health and Safety Plan and the Emergency Prevention and Management Plan. The Health and Safety Manager reports directly to the site manager, and defines the resources he needs to ensure and control the implementation of the two plans mentioned above.	Health and Safety Manager recruited and maintained during the construction work	Name and CV of the Health and Safety Manager communicated	Before starting construction work	Commitment: EPC CV approval: NEHO	From the beginning to the end of construction activities
Worker health and safety - Effective compliance with health and safety rules by the subcontractors' chain	Sstr04: Include standardized contractual obligations for the respect and implementation of the EPC Workers' Health and Safety Plan in all contracts of companies in the subcontracting chain.	Obligations under subcontractor contracts	Internal control EPC	When preparing contracts	EPC	When subcontracting subcontractors
	Sstr05: Continuous monitoring of compliance with the Workers' Health and Safety Plan by	Compliance with the Workers' Health and	Supervision organized by the Health and Safety	Continuous	EPC	During construction

	the companies working for the Project, organized by the Health and Safety Manager. Exclusion after first warning of companies and service providers found in default.	Safety Plan	Manager			
Worker health and safety - Behavior of security personnel	Sstr06: If security personnel (private or public seconded) are contracted for the Project, train them in the United Nations Voluntary Principles for Security and Human Rights.	Training provided	Register of training provided	To the commitment of the persons concerned	EPC	During construction
Worker health and safety - Healthy environment during non-working hours	Sstr07: Preparation and implementation of a Base Camp and Workers' City Management Plan for the construction phase, approved by NEHO, and in accordance with ESIA specifications.	Plan prepared and approved	Approval of the Plan by NEHO	Once in a while	Preparation of the plan: EPC Verification: NEHO	Before the construction phase
Worker health and safety - Risk related to AIDS and other STDs	Sstr08: Implement a systematic program to raise awareness among workers (induction) and among populations (specialized NGOs) to ensure that the population, workers and at-risk groups are aware of the modes of contamination and have the means to protect them.	Awareness provided	Register of sensitizations provided	Annual	EPC (workers) and NEHO (populations)	Before and during construction
Worker health and safety - Food and water health risk	Sstr09: Provide drinking water at all installations and work sites. Train workers (induction) in the risks of food poisoning or drinking water.	Water made available Training provided	Supervision organized by the Health and Safety Manager Register of training provided	Continuous At the time of hiring and annually	EPC	During construction
Community safety and security	Seco01: Preparation and implementation of a Road Traffic and Access Management Plan for the construction phase, approved by NEHO, and in accordance with ESIA specifications.	Plan prepared and approved	Approval of the Plan by NEHO	Once in a while	Preparation of the plan: EPC Verification: NEHO	Preparation before construction Implementation during the construction phase
Respect by the Project or the newcomers for the cultural practices of the area	Affl07: The induction that will be received by workers hired by NEHO, the EPC and its subcontractors will include an awareness of the cultural habits and practices of the Project area, including the Fady. This awareness will be aimed at mitigating the risk of conflict related to culture gaps.	Induction provided	Register of inductions provided	For any newcomer related to the Project	EPC and NEHO	Before and during construction
Proliferation of informal economic activity (alcohol,	Affl11: Provide maximum service within the bases. Establish management rules for the functions of the bases with schedules	Basic life management plan prepared and implemented	Approval of the Plan by NEHO	Once in a while	Preparation of the plan: EPC	Preparation before the construction

prostitution, poaching, fencing)	established for employees. Entry control on the database. Do not allow spontaneous camping within a radius of protection of the Remote Sites. Radius to be defined with local authorities.				Verification: NEHO	phase Implementati n during the construction phase
Non-respect of fady and prohibited by the populations	Infl13: Awareness of the EPC staff and its chain of subcontractors about the fady applicable in the Project area	Induction provided	Register of inductions provided	For any newcomer related to the Project	EPC and NEHO	Before and during construction
Respect for the information of local authorities and administrations	Affl16: Implementation of a procedure for the systematic declaration of the interventions of the Project teams (NEHO, EPC and any other party involved in the Project)	Procedure set up and executed	Register of notifications	Each time a new team is mobilized in the field	NEHO	Before and during construction
Risk related to losses of previously unidentified buried cultural property	Cult01: Preparation and implementation of a chance discovery procedure for any contractor who will perform excavations or cuttings. Training of personnel in charge of excavations (or their follow-up) on the nature of possible finds and the measures to be applied in the event of a find.	Procedure set up and executed	Approval of the procedure by NEHO	Once in a while	Preparation and implementation: EPC Verification: NEHO	Preparation before the construction phase Implementati n during the construction phase
Risks related to existing places of worship	Cult02: Detailed mapping of cultural sites and tombs during field studies for the implementation of linear infrastructure (roads and tracks), and engagement with stakeholders to agree on avoidance measures.	Mapping of cultural sites Reporting of decided avoidance measures produced before construction	Control by NEHO's social team before construction	Continuous	EPC Verification: NEHO	Design and construction
Impacts on sensitive social receptors in the construction phase	Lign01: Define and optimize from a technical and social point of view the exact route of the transmission line, in order to minimize the social and socio-economic impacts, between Belanitra and Antananarivo, taking into account the sensitivities listed in the ESIA.	Optimized line layout, minimized social impacts	Supporting note submitted by the EPC, subject to NEHO's approval	Ongoing during detailed design	EPC	Before and during construction
Lack of awareness by EPC employees of the biodiversity protection measures implemented by the Project	BioT02: Information sharing, training and capacity building for EPC and subcontractor chain employees on the environmental measures taken by the Project.	Awareness and information provided	Register of awareness / information provided	Annual for all, and for any newcomer related to the Project	EPC	Before and during construction

Risk of project encroachment greater than that estimated in the event of uncontrolled access by people to the most sensitive habitats as part of the Project	BioT03: Prohibition of access of persons other than personnel to construction sites and prohibition of movement of project employees in unauthorized areas, including habitats with ecological implications.	Effective prohibition of access.	Internal control and security EPC	Continuous	EPC	During the entire construction phase
Impacts related to the construction of linear infrastructure on the environment and in particular wooded areas.	BioT04: Establishment of linear infrastructure between Antananarivo and Belanitra: <ul style="list-style-type: none"> Avoid forested areas as much as possible to minimize deforestation (use recent aerial/satellite images and field visits to identify forested/deforested areas). Make maximum use of existing tracks, rehabilitating them where necessary rather than creating new ones. 	Implementation avoiding wooded areas as much as possible and using existing trails	Supporting note to be produced and approved before work	Before work	Preparation of the note: EPC Approval: NEHO	Design and construction
Impacts related to the construction of linear infrastructure on the environment and in particular management transfer areas.	BioT05: Between Belanitra and the dam: Adopt a layout and design of the line and road that avoid wooded areas as much as technically possible; consult VOI and NEHO for approval of the affected wooded areas	Implementation avoiding wooded areas as much as possible and using existing trails	Supporting note to be produced and approved before work	Before work	Preparation of the note: EPC Approval: NEHO	Design and construction
Impacts related to the construction of linear infrastructure on VOI management transfer areas.	BioT08: Consult VOIs and protected area managers/developers for the validation of the routes or locations proposed by the EPC for infrastructure between Belanitra and the plant.	VOI and protected area managers/proponents consulted on the basis of EPC supporting notes	Minutes of the meeting	Once before the construction of the objects in question	NEHO	Before construction
Means available to protected area managers/propon	BioT18: Support and accompaniment of managers of areas under status for the protection of biodiversity.	Implementation of actions decided with protected area managers	Control with the monitoring committee	Continuous	NEHO	During the construction phase

ents and VOIs to strengthen the protection, conservation and monitoring of protected areas.			Disclosure on NEHO's website of planned and completed actions			
Compliance of biodiversity actions with donor requirements	PAB01: Preparation, implementation and monitoring of a Biodiversity Action Plan	Preparation and implementation of a Biodiversity Action Plan	According to the program	According to the program	NEHO	During the construction phase

10.4.4 Linear Infrastructure Component - Operation Phase

Monitoring measures for the linear infrastructure component in the operation phase are very limited (only monitoring of exposure to climate change), as these infrastructures will be returned to the state and will therefore no longer be under NEHO's control.

ISSUE/IMPACT	mitigation measures	indicators	Monitoring method	frequency	responsible person	timetable
Impacts on sensitive social receptors in the operation phase	Lign02: Inform people along the line of their rights and duties with regard to the line. Plan maintenance operations to minimize impacts on crops and agricultural production.	Informing the population Maintenance plan for the operation phase minimizing the impacts given to the operator (Jirama)	Record of information sessions Internal control NEHO	Once, before the operation phase	NEHO	Before the operation phase
Risk of collision of birds of prey with the guard cables of the transmission line.	BioT27: Between the plant and the dam, three-dimensional bird diverters are installed on the guard cables.	Three-dimensional "Bird diverters" installed on the ground cables	Visual inspection	Once in a while	EPC	When installing the ground cables

10.5 Monitoring plan

Follow-up actions are described (by phase and component) in the following tables. This monitoring plan will be reviewed at the start of the work and regularly thereafter to ensure its relevance. Any substantial changes will be discussed in advance with the ONE and donors.

The monitoring plan is organized according to the same components and phases as the monitoring plan.

- The two components are as follows:
- Hydropower plant component: this component includes all the infrastructure that will be built between the reservoir dam area (included) and the hydropower plant area (included), including the access road from the dam to the plant and the energy evacuation line from the plant to the dam.
- Linear infrastructure” component: this component includes the energy evacuation line from the dam to its connection point at Antananarivo, and the access roads that will be built or rehabilitated for the Project in this same area, whether they are access roads to the hydropower plant, or access roads to construction sites (quarries, pylon installation site, etc...).

The two phases are as follows:

- Construction: all activities necessary for the commissioning of the Project, including finishing or restoration work resulting from the construction phase and which could extend beyond the commissioning date.
- Operation: all operation and maintenance activities necessary for the production of electricity by the “hydropower plant” component and its discharge into the national grid by the “linear infrastructure” component.

10.5.1 Hydropower Plant Component - Construction Phase

Theme	Monitoring indicator	Means and methods of measurement	Frequency	By	Schedule
Noise, gas and dust emissions	SFX08: Continuous measurement of air quality in the tunnel: CO, NO2, SO2, PM2.5 and PM10.	Air quality measurement. Air quality in the tunnel during working hours in accordance with the following average thresholds (IFC guidelines): CO: 55 mg/m3 NO2: 40 mg/m3 SO2: 20 mg/m3 PM2.5: 25 mg/m3 PM10: 50 mg/m3	Continue	EPC	During the construction of the tunnel
Noise, gas and dust emissions	Good visibility for drivers following another vehicle.	Visual inspections and complaint analysis	During weekly site visits	NEHO	During the construction phase
Noise, gas and dust emissions	SFX05: Noise measurement at Faravohitra school	Sound level meter.	During weekly site visits	NEHO	During the construction phase
Noise, gas and dust emissions	SFX06: Measurement of exhaust gases from thermal equipment used in tunnels.	Portable tester.	Before the first entry and then monthly	EPC	During the construction phase
Noise, gas and dust emissions	Atmo09: Measurement before the first use and then semi-annual of the exhaust gases from the thermal equipment used on the site. Emissions meeting Euro 3 standard	Portable tester.	Before the first entry and then semi-annual	EPC	During the construction phase
Solid and liquid waste	Dech03: Internal control of waste collection.	Register of solid waste collected	Continue	EPC	During the construction phase
Solid and liquid waste	Dech03: Internal control of effluent quality.	Monthly measurement of wastewater quality	Monthly	EPC	During the construction phase
Solid and liquid waste	Verification of the register of training provided - training of workers on the issue of solid and liquid waste.	Verification of the EPC register	During weekly site visits	NEHO	During the construction phase
Risk of accidental pollution	Verification of the register of training provided - training of workers on the management of spills of polluting products.	Verification of the EPC register	During weekly site visits	NEHO	During the construction phase
Surface waters	Surface water quality	Surface water sampling and analysis (pH, TSS, COD, COD, BOD5, Oils and fats) Comparison with the initial state and upstream values (reference state see Table 1)	Weekly	EPC	During the preparation and construction phase

Use in accordance with the law and good practices	Trav02: Regular monitoring of HR policy compliance by companies working for the Project	Audit of workers	once a month	EPC	During the preparation and construction phase
Lack of knowledge of population growth in the area	Affl01: Demographic monitoring in the Project area. This monitoring will cover the Antenina, Belanitra and Faravohitra sectors and will allow NEHO to monitor dynamics and identify areas where the influx is concentrated.	Demographic monitoring	quarterly	NEHO	During the construction phase
Implementation of flora protection measures	BioT12: Monitoring of actions to protect flora threatened by the EPC.	Support for the implementation of the EPC by a NEHO ecologist	During the implementation work	NEHO	Design and construction
Implementation of wildlife protection measures	BioT14: Monitoring of actions to protect wildlife threatened by the EPC.	Continuous monitoring of the EPC's work by a NEHO ecologist	During the implementation work	NEHO	Design and construction
Risk of habitat degradation between the dam and the plant (follow-up action).	BioT25: Ecological monitoring of habitats between the dam and the plant, integrating the influence of climate change on the lichen forest.	Preparation and implementation of an ecological monitoring program for habitats	According to the program	NEHO	During the construction phase
Stakeholder engagement, grievances	Stakeholder engagement and complaint management activities	Register of stakeholder engagement and complaint management activities	Monthly statistics	NEHO	During the construction phase
Accidents involving members of the public	Number of accidents and severity	Accident register	Monthly statistics	NEHO	During the construction phase
Accidents involving workers	Number of accidents and severity	Accident register	Monthly statistics	EPC	During the construction phase

10.5.2 Hydropower Plant Component - Operation Phase

Theme	Monitoring Indicators	Means And Methods Of Measurement	Frequency	By	Schedule
Hydraulic impact downstream	Measurement of the flow discharged from the dam downstream	Measurement of the flow discharged from the dam downstream	Continuously	NEHO	During the entire operation phase
Sediment monitoring	Sédi01: Followed by: <ul style="list-style-type: none"> Sedimentation of the reservoir The evolution of the sand banks over the 3 km downstream from the hydropower plant 	Sedimentation of the reservoir: bathymetry or lidar Evolution of sand banks: visual monitoring in the dry season	Annual monitoring during the first three years and then at regular intervals (to be determined on the basis of the first three years)	NEHO	During the entire operation phase
Solid and liquid waste	Effective implementation of the waste management plan for the operation phase	Internal implementation control	Monthly inspections	NEHO	During the entire operation phase
Risk of accidental pollution	Poll05: Use of biodegradable oil for hydromechanical and electromechanical equipment with a risk of uncontrolled leakage into the environment.	Internal implementation control	Monthly inspections	NEHO	During the entire operation phase
Climate Change	Clim08: Monitoring of forest ecosystems in the catchment area (woodlands and forest types)	Mapping based on satellite images.	Every ten years	NEHO	During the entire operation phase
Climate Change	Clim02: Hydrological monitoring of Onive inflows	Calculation based on measured flows and levels.	daily	NEHO	During the entire operation phase
Climate Change	Clim03: Sedimentary monitoring of Onive inflows	Suspended matter measurements	weekly	NEHO	During the entire operation phase
Climate Change	Clim05: Meteorological monitoring at the dam site	Weather station.	continuous	NEHO	During the entire operation phase
Surface water quality	Qeau02: Monitoring of areas of the reservoir that are not conducive to water renewal and circulation, paying particular attention to the development of aquatic invasive species such as water hyacinth.	Visual and olfactory monitoring	quarterly	NEHO	During the entire operation phase
Surface water quality	Qeau03: Water quality monitoring.	Oxygen content of the water downstream from the hydropower plant (100m downstream) and the dam (500m downstream). Action: NO3, PO4, BOD5	Weekly Monthly	NEHO	During the first two years of the operation phase

		and suspended matter. Heavy metals and pesticides water and sediment	Annual (October):		
Surface water quality	Qeau04: Preparation and implementation of an annual water quality monitoring program, based on the results of the first two years (Qeau03)	To be defined after the first two years of monitoring	To be defined after the first two years of monitoring	NEHO	Operation, 3 rd year and beyond
Community Health	Saco03: Capacity building and monitoring of statistics on waterborne diseases treated by health centers in the area of influence	Monitoring of waterborne diseases carried out	Annual	NEHO	During the entire operation phase
Lack of knowledge of population growth in the area	Affl01: Demographic monitoring in the Project area. This monitoring will cover the Antenina, Belanitra and Faravohitra sectors and will allow NEHO to monitor dynamics and identify areas where the influx is concentrated.	Demographic monitoring	yearly	NEHO	During the entire operation phase
Impacts on wildlife species with a conservation issue between the dam and the plant	BioT15: Minimizing the risk of wildlife crushing: Monitoring and geo-referencing of points where wildlife specimens have been crushed.	Record of animal species crushing	Continuous	NEHO	During the entire operation phase
Risk of habitat degradation between the dam and the plant (follow-up action).	BioT25: Ecological monitoring of habitats between the dam and the plant, integrating the influence of climate change on the lichen forest.	Preparation and implementation of an ecological monitoring program for habitats	According to the program	NEHO	During the entire operation phase
Stakeholder engagement, grievances	Stakeholder engagement and complaint management activities	Register of stakeholder engagement and complaint management activities	Quarterly statistics	NEHO	During the entire operation phase
Accidents involving members of the public	Number of accidents and severity	Accident register	Monthly statistics	NEHO	During the entire operation phase
Accidents involving workers	Number of accidents and severity	Accident register	Monthly statistics	NEHO	During the entire operation phase

10.5.3 Linear Infrastructure Component - Construction Phase

Theme	Monitoring indicators	Means and methods of measurement	Frequency	By	Schedule
Noise, gas and dust	Atmo09: Measurement before the first use and then semi-	Portable tester.	Before the first entry	EPC	During the

emissions	annual of the exhaust gases from the thermal equipment used on the site. Emissions meeting Euro 3 standard		and then semi-annual		construction phase
Solid and liquid waste	Dech03: Internal control of waste collection.	Register of solid waste collected	Continue	EPC	During the construction phase
Solid and liquid waste	Verification of the register of training provided - training of workers on the issue of solid and liquid waste.	Verification of the EPC register	During weekly site visits	NEHO	During the construction phase
Risk of accidental pollution	Verification of the register of training provided - training of workers on the management of spills of polluting products.	Verification of the EPC register	During weekly site visits	NEHO	During the construction phase
Stakeholder engagement, grievances	Stakeholder engagement and complaint management activities	Register of stakeholder engagement and complaint management activities	Monthly statistics	NEHO	During the construction phase
Accidents involving members of the public	Number of accidents and severity	Accident register	Monthly statistics	NEHO	During the construction phase
Accidents involving workers	Number of accidents and severity	Accident register	Monthly statistics	EPC	During the construction phase

10.5.4 Linear Infrastructure Component - Operation Phase

Monitoring measures for the linear infrastructure component in the operation phase are very limited (only monitoring of exposure to climate change), as these infrastructures will be returned to the state and will therefore no longer be under NEHO's control.

Theme	Monitoring indicators	Means and methods of measurement	Frequency	By	Schedule
Climate Change	Clim06: Weather monitoring - transmission line: <ul style="list-style-type: none"> • Definition of two monitoring points and installation of stations • Operation and maintenance of stations 	Weather station.	continuous	Site definition: EPC Action: NEHO	Before the operation phase During the entire operation phase

11 Addendum: Integration of the Results of Public Consultations

The program and detailed report of the public consultations that were conducted for the ESIA and RAP are provided in the appendices. Some of the comments received led to changes or clarifications in the text of the ESIA. The nature of these modifications and clarifications is described in the following table, with a reference to the chapters where they were made.

#	Modification or clarification	Chapter
1	Modification and clarification of the color codes of the alternative routes between the dam and the plant.	2.6.2.3
2	Clarification on the seasonality of the work of cutting down large trees likely to carry bird nests.	7.2.3.4
	Insertion of precision on the seasonality of cutting operations in the BioT13 action	7.2.6 9.3.2
3	Replacement of the term "bush meat" by the term "wild meat".	Four occurrences in the document
4	Update of information on the IBA of the Onive Classified Forest.	4.3.4
5	Introduction of an additional measure to support the updating of IBA data, called BioT28.	7.2.4.3 7.2.6 9.4.2
6	Indication that the road will be permanent.	1.4.2.6
7	Indication that reforestation will not be done on cultivation areas.	7.2.4.4
8	Note: the reforestation plants will be provided by the Project (which could have its own nursery).	7.2.4.2 7.2.4.4
9	Addition of a field entry procedure, including validation and marking of the areas released and accessible to the Project, and training of personnel likely to enter such areas.	6.2.6 9.3.2
10	Clarification that the possibility of recovering wood from the flooded area will be studied with the DGEF in order to find a mechanism that complies with the law and, if possible, is suitable for local populations.	5.8.4
11	Clarification that the promoter of the Tsinjoarivo NPA, Sadabe, will receive support from an international NGO, Rainforest Trust, a priori for the financing of the creation of the NPA.	4.3.3.1
12	Clarification in the Seco01 action that the traffic management plan will also include monitoring of passenger and vehicle traffic to adapt, if necessary, the traffic rules for the Project's vehicles.	6.8.2 9.3.2
13	Clarification that the prohibition to access the reservoir within 1 km of the dam may be lifted for special cases such as searching for a body.	6.8.2
14	Indication that the track provided for pedestrians and bicycles will also be authorized for motorcycles and carts.	6.8.1.2
15	Introduction of a new measure for the implementation of a systematic reporting procedure for the interventions of the Project teams (NEHO, EPC and any other party involved in the Project).	6.10.2.9
16	Introduction of the principle of empowering communes by involving them in the Project management of the infrastructures covered by the Community Development Plan.	6.12.3
17	Clarification that the financing of the Project will not come from a loan from the Malagasy government.	1.2.1
18	Clarification that the bridges will also be rehabilitated (if necessary) between Antanifotsy and Belanitra.	2.6.2.1

19	It is specified that the management of the existing VOI in Antenina will be determined in coordination with the MNP and DREDD, the competent authorities.	7.2.4.4
20	It is specified that the procedures for the implementation of rural electrification will be defined in coordination and under the control of the Rural Electrification Development Agency (ADER), which is the competent authority in this field.	6.12.5.3
21	It is specified that it would be useful, as suggested by the DREDD of Vakinankaratra, to set up a yardmaster to ensure the verbalization of offences, with a specific status allowing him to work in the two districts of Vakinankaratra and Alaotra-Mangoro.	7.2.4.2
22	It is specified that the vehicles of protected area managers may use the Project's tracks for control missions.	6.8.1.2 6.8.2 9.4.2
23	Clarification of the phrase "the road is not free access for all", replaced by "the road is not free access for all vehicles"	7.2.3.4 7.2.6 9.4.1
24	Added the principle of participatory monitoring for all monitoring actions that allow it.	10.1