



grass valley

A **BELDEN** BRAND

# **XVP-3901**

**3G/HD/SD Up, Down & Cross Converter  
with Audio Processor**

**Guide to Installation and Operation**

M886-9900-332

2015-08-05

[www.grassvalley.com](http://www.grassvalley.com)

## Electromagnetic Compatibility



This equipment has been tested for verification of compliance with FCC Part 15, Subpart B requirements for Class A digital devices.

---

**NOTE:** This equipment has been tested and found to comply with the limits for a Class A digital device, pursuant to part 15 of the FCC Rules. These limits are designed to provide reasonable protection against harmful interference when the equipment is operated in a commercial environment. This equipment generates, uses, and can radiate radio frequency energy and, if not installed and used in accordance with the instruction manual, may cause harmful interference to radio communications. Operation of this equipment in a residential area is likely to cause harmful interference in which case the user will be required to correct the interference at his own expense.

---



This equipment has been tested and found to comply with the requirements of the EMC directive 2004/108/CE:

- EN 55022 Class A radiated and conducted emissions
- EN 55024 Immunity of Information Technology Equipment
- EN 61000-3-2 Harmonic current injection
- EN 61000-3-3 Limitation of voltage changes, voltage fluctuations and flicker
- EN 61000-4-2 Electrostatic discharge immunity
- EN 61000-4-3 Radiated electromagnetic field immunity – radio frequencies
- EN 61000-4-4 Electrical fast transient immunity
- EN 61000-4-5 Surge immunity
- EN 61000-4-11 Voltage dips, short interruptions and voltage variations immunity

---

Manufactured under license from Dolby Laboratories. Dolby and the Double-D symbol are trademarks of Dolby Laboratories.

---

## Table of Contents

<b>1</b>	<b>XVP-3901 3G/HD/SD Up, Down &amp; Cross Converter with Audio Processor .....</b>	<b>1</b>
1.1	Introduction .....	1
1.2	Features .....	1
1.3	XVP-3901 Models .....	2
1.3.1	XVP-3901 (full model).....	3
1.3.2	XVP-3901-FS.....	4
1.3.3	XVP-3901-DC .....	5
1.3.4	XVP-3901-UC .....	6
1.3.5	XVP-3901-XC.....	7
1.4	Front Card-edge Interface.....	8
<b>2</b>	<b>Installation.....</b>	<b>9</b>
2.1	Installation of Rear Connector Panels .....	9
2.2	Card Installation .....	10
2.3	Installation of the Optical Interface (option) .....	10
2.4	Installation of the Audio Modules (option).....	10
2.5	ABUS Connection to Companion Audio Cards.....	10
2.6	Rear Panels and Connectors.....	11
2.6.1	Images of rear connector panels .....	11
2.6.2	Summary of rear panel connections .....	12
2.6.3	Details of rear panel connections .....	13
<b>3</b>	<b>User Interface.....</b>	<b>16</b>
3.1	Control options.....	16
3.2	Card-Edge Status LED .....	16
<b>4</b>	<b>Local control using the Densité frame control panel .....</b>	<b>18</b>
4.1	Overview .....	18
4.2	Menu for local control.....	18
<b>5</b>	<b>Remote control using iControl.....</b>	<b>19</b>
5.1	The iControl graphic interface window.....	19
5.2	Video Input/Output panel .....	22
5.2.1	Input/Output Config Tab.....	23
5.2.2	Input 2 tab .....	23
5.2.3	Deglitcher tab.....	24
5.2.4	Freeze tab .....	26
5.2.5	SFP Info tab .....	27
5.3	Video Processing panel .....	28
5.3.1	Basic tab .....	28
5.3.2	Advanced tab .....	29
5.4	Video Outputs panel – 3G/HD Output tab .....	29
5.4.1	3G/HD Output – ARC tab.....	31
5.4.2	3G/HD Output – Timing tab .....	34
5.4.3	3G/HD Output – Advanced tab .....	34
5.4.4	3G/HD Output – Meta tab .....	35

5.4.5	3G/HD Output – AFD tab.....	40
5.4.6	3G/HD Output – De-interlacer tab .....	41
5.5	Video Outputs panel – SD Output tab .....	41
5.5.1	SD Output – ARC tab .....	43
5.5.2	SD Output – Timing tab .....	48
5.5.3	SD Output – Advanced tab.....	49
5.5.4	SD Output – Meta tab.....	50
5.5.5	SD Output – AFD tab.....	56
5.5.6	SD Output – De-interlacer tab .....	58
5.6	Audio Processing panel.....	58
5.6.1	Audio Processing Tab .....	59
5.6.2	Downmix tab.....	60
5.6.3	AES Inputs tab.....	62
5.6.4	Status tab .....	63
5.7	Dynamic Proc. panel .....	63
5.8	Audio Outputs panel .....	66
5.8.1	CH 1-2, CH 3-4, ... CH 15-16 tabs, and AES1, ... AES4 tabs.....	67
5.8.2	Config tab .....	68
5.9	Audio Modules panel.....	69
5.10	Dolby Metadata panel.....	70
5.10.1	Path 1 & Path 2 tabs.....	70
5.10.2	Input/Output tab.....	78
5.11	ALC panel.....	79
5.11.1	Config tab .....	80
5.11.2	PGM1-8 tabs .....	80
5.12	Loudness Panel.....	83
5.12.1	Loudness   Config panel.....	83
5.12.2	Loudness   PGM panel.....	84
5.12.3	Loudness   Logging Panel.....	86
5.13	Fingerprint panel.....	87
5.14	Reference panel .....	88
5.15	A-BUS panel.....	89
5.16	Monitoring panel .....	89
5.16.1	Thumbnails tab .....	89
5.16.2	RALM tab.....	90
5.17	Test panel.....	91
5.18	Factory/Presets panel.....	92
5.18.1	Factory/Presets tab .....	92
5.18.2	Edit Presets Label.....	93
5.18.3	Profiles.....	93
5.18.4	GPI tab .....	95
5.18.5	Automatic Preset Recall tab .....	97
5.19	Options panel .....	101
5.19.1	Audio option.....	101
5.19.2	Key/Fill option: .....	102
5.19.3	Dynamic Processing option: .....	102
5.19.4	Loudness Measurement option: .....	103
5.19.5	ALC option.....	103



5.19.6	XVP Full Upgrade option (XVP-3901-UG-xx2XVP):.....	104
5.20	Alarm Config panel .....	104
5.21	Info panel .....	107
<b>6</b>	<b>Audio Modules .....</b>	<b>109</b>
6.1	Dolby E and Dolby Digital decoder .....	110
6.1.1	Control tab.....	110
6.1.2	Dolby E tab.....	111
6.1.3	Dolby Digital tab .....	112
6.1.4	PCM tab .....	112
6.2	Dolby Digital and Dolby Digital Plus encoder .....	113
6.2.1	Shuffler Inputs Section.....	113
6.2.2	Configuration Section.....	113
6.2.3	Status: .....	114
6.3	Dolby E encoder.....	115
6.3.1	Input and Output channel selection .....	115
6.3.2	Configuration.....	115
6.3.3	Status: .....	116
6.4	Upmixing using Linear Acoustic Technology upMAX™ .....	116
6.5	N-channel ALC and upmix licensed by Linear Acoustic .....	118
6.5.1	Config tab.....	119
6.5.2	Basic tab .....	120
6.5.3	Advanced Configuration – ALC PGM 1 & 2.....	121
6.5.4	Upmix using Linear Acoustic UpMAX™ .....	126
6.6	N-channel ALC licensed by Jünger Audio & upmix by Linear Acoustic.....	127
6.6.1	ALC Models.....	127
6.6.2	Program Configurations.....	127
6.6.3	Loudness Monitoring.....	132
6.6.4	ALC PGMx Configuration.....	133
6.6.5	Notes.....	136
<b>7</b>	<b>Automation Using RS-422 .....</b>	<b>137</b>
7.1	Load Image R0 Command.....	137
<b>8</b>	<b>Specifications.....</b>	<b>139</b>
<b>9</b>	<b>Contact Us.....</b>	<b>142</b>
	Grass Valley Technical Support.....	142
	Corporate Head Office .....	142
<b>ANNEX 1</b>	<b>– XVP-3901 Local User Interface .....</b>	<b>143</b>
<b>ANNEX 2</b>	<b>– AFD FUNCTIONS .....</b>	<b>148</b>
<b>ANNEX 3</b>	<b>– Installing the Optical Interface.....</b>	<b>152</b>
<b>ANNEX 4</b>	<b>– Installing the Audio Modules .....</b>	<b>154</b>
<b>ANNEX 5</b>	<b>– Dolby Digital Main Channel Output Functions .....</b>	<b>157</b>
<b>ANNEX 6</b>	<b>– Loudness Logging and the Audio Loudness Analyzer.....</b>	<b>158</b>



# 1 XVP-3901 3G/HD/SD Up, Down & Cross Converter with Audio Processor

## 1.1 Introduction

The XVP-3901 is a highly integrated module designed to synchronize, convert and process 3Gbps, HD and SD signals into 3G/HD/SD hybrid plants. The card offers a dual multi-rate 3G/HD/SD input and provides simultaneous 3G/HD and SD outputs. Each output path provides independent format, color space and aspect ratio conversion necessary to maintain a constant signal format at each of the two outputs. With its new higher video quality using advanced motion adaptive pixel based de-interlacing, the XVP-3901 provides outstanding results regardless of the formats and conversions made.

A fiber input/output cartridge is offered as an option. This integrates and makes fiber connectivity easier to install and configure. Once the cartridge is installed, the inputs or outputs are selectable through the control interface. The input of the card allows you to select between fiber and copper inputs. The outputs offer 3G/HD path on copper and the SD path on copper, but the fiber module allows you to select between the SD or 3G/HD outputs to be sent to each fiber connector.

To further improve on-air presentation, the XVP-3901 offers a background keying capability which allows side panels or letterbox black bars, introduced by aspect ratio conversion, to be filled with video or graphics from the second input. The ARC function offers fixed presets as well as variable user configurable aspect ratios. The support of AFD (Active Format description) SMPTE-2016, VLI (Video Line Index) RP-186 and WSS (Wide Screen Signaling) allows the card to adjust its ARC automatically without any external intervention. It will also re-insert the proper AFD, VLI or WSS on the output along with other HANC and VANC information. With the integration of the frame sync, incoming feed signals can be synched to house and have the proper ARC when entering the facility. The XVP-3901 also offers a video proc-amp with full YUV/RGB level controls and RGB gamut correction.

The XVP-3901 audio capabilities are equally advanced, with processing of up to 32 channels of audio, with automatic delay to keep lip-sync. It provides shuffling and down-mixing, and options include dynamic processing (limiter, compressor, and expander), and four AES inputs/outputs for additional flexibility. The new loudness measurement option allows the measurement and logging of up to 4 audio programs with iControl Loudness Monitoring software to analyze and report compliance with respect to various loudness legislations around the world (See iControl Loudness Monitoring).

The XVP-3901 has 2 on-board sockets for optional modules, including Dolby E and Dolby Digital decoding, upmixing using Linear Acoustic upMAX™ technology, Dolby E encoding, Dolby Digital and Dolby Digital Plus encoding. In addition to Grass Valley's own automatic loudness control (ALC) solution for up to eight programs, the XVP-3901 offers ALC using the AEROMAX™ technology by Linear Acoustic, or Level Magic™ by Jünger Audio, implemented using optional modules.

One RS-422 port is provided for automation control of ARC/User presets and a second port for Dolby Metadata input and output. 6 GPIs for user presets recall and input selection and 6 GPIs for their corresponding tally outputs.

The XVP-3901 generates audio/video fingerprints for both outputs (via an iControl option) to detect and measure lip-sync errors in a broadcast facility.

## 1.2 Features

- Up/Down/Cross/ARC converter with frame sync
- Offers a multi-rate 3G/HD/SD input and simultaneous 3G/HD and SD outputs
- Supported formats include: 1080p59.94, 1080p50, 1080i59.94, 1080i50, 720p59.94, 720p50, 1080p23, 1080p23sF, 1080p25, 1080p29, 480i59.94, 576i50
- Support for both Level A and Level B 3G formats
- Flexible HD/SD/URS reference input
- Advanced Video de-interlacing for higher image quality
- User-programmable additional fixed video delay up to 15 frames

- MPEG pre-processor mode
- Automatic ARC using AFD (SMPTE-2016) , Video index (RP-186) and WSS
- Custom and fixed ARC presets
- Keyer option for filling black pillars and letter box
- Built-in proc-amp with YUV/RGB color correction and legalizer
- Processes and converts Ancillary data such as closed-captions (CEA-608-B/CEA-708B), teletext (ETSI EN 300 706/OP-47), time code and Dolby Metadata
- Optional optical fiber module
- Serial and GPIO ports for automation or audio metadata
- 16 channels embedded audio processing (32 channels internal)
- Offers 4 AES inputs and outputs
- Audio Downmix: 5.1 to Lt/Rt or Lo/Ro
- Audio dynamic processor (compressor/limiter/expander)
- Basic Automation capabilities based on audio signal type detection
- Optional on-board Automatic Loudness Control with Grass Valley Wideband process up to 8 programs
- Optional loudness measurement of up to 4 audio programs and logging with iControl.
- Loudness compliant to EBU R128, ATSC A/85 and ARIB TR-B32 and (up to ITU-R BS.1770-3).
- Dolby E compatible
- Audio metadata insertion, extraction and processing
- Perfect audio/video synchronization plus additional audio fixed delay of up to 2 seconds
- Compatible with Grass Valley audio processing cards like UAP and DAP
- Optional Dolby E and Dolby Digital decoder module
- Optional Dolby E encoder module
- Optional Dolby Digital and Dolby Digital Plus encoder module
- Optional Linear Acoustic upMAX™ module
- Optional Linear Acoustic ALC module
- Optional Junger ALC module
- A/V fingerprint generation (an iControl option) for lip-sync measurement

### 1.3 XVP-3901 Models

The XVP-3901 is available in models with reduced functionality for applications where the full capabilities of the XVP-3901 are not required. The various models that are available are described below.

- *Note that each of these models can be upgraded to a fully-functional XVP-3901 with the purchase of an upgrade key. See Section 5.19 for details.*
- *The Audio, Key/Fill and Dynamic Processing options described in Section 5.19 are available on all models.*

This chart summarizes the functionality of the various models

Feature	Models				
	XVP-3901	XVP-3901-FS	XVP-3901-DC	XVP-3901-UC	XVP-3901-XC
SD-to-SD with ARC	•	•	•		
HD-to-HD, 3G-to-3G (same format)	•	•		•	•
3G/HD-to-3G/HD	•				•
SD-to-3G/HD (720p/1080i/1080p)	•			•	
3G/HD (720p/1080i/1080p)-to-SD	•		•		
SD/HD to HD/SD	•				
Simultaneous 3G/HD and SD outputs	•				

### 1.3.1 XVP-3901 (full model)

This block diagram shows the functionality of the XVP-3901 full model.

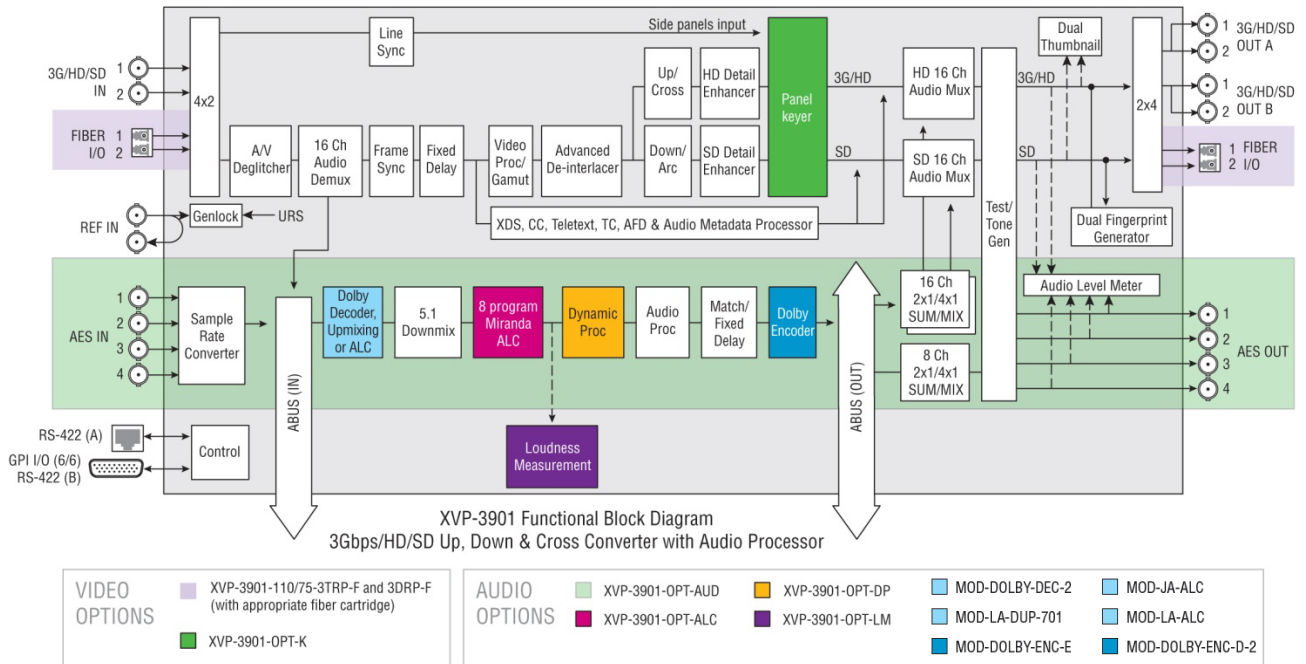

Figure 1.1 Functional block diagram XVP-3901

This chart shows the video formats supported by the XVP-3901 at its inputs and outputs

XVP-3901									
Input \ Output		SD		HD			3G		
		525	625	720p50	720p59.94	1080i50	1080i59.94	1080p50	1080p59.94
SD	525	X			X		X		X
	625		X	X		X		X	
HD	720p50		X	X		X		X	
	720p59.94	X			X		X		X
	1080i50		X	X		X		X	
	1080i59.94	X			X		X		X
	1080p23.98	X			X		X		X
	1080pSF23.98	X			X		X		X
	1080p25		X	X		X		X	
1080p29.97	X			X		X		X	
3G	1080p50		X	X		X		X	
	1080p59.94	X			X		X		X

### 1.3.2 XVP-3901-FS

The XVP-3901-FS is a highly integrated 3G/HD/SD frame synchronizer, aspect ratio converter and video/audio signal processor. It is similar to the full XVP-3901 except that it does not have up/down/cross conversion capabilities. It is available in a variant (XVP-3901-FS-R) that supports rear panels incorporating a bypass relay.

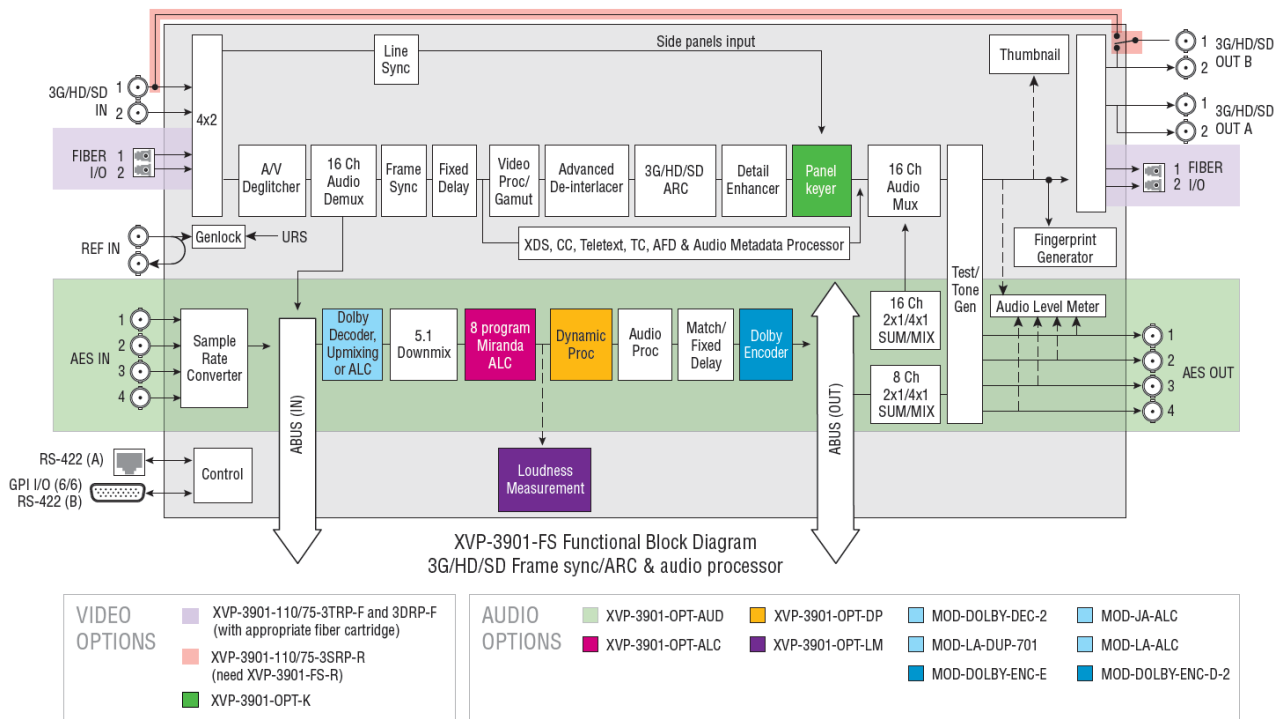

Figure 1.2 Functional block diagram XVP-3901-FS

This chart shows the video formats supported by the XVP-3901-FS at its inputs and outputs

Input \ Output		SD		HD				3G	
		525	625	720p50	720p59.94	1080i50	1080i59.94	1080p50	1080p59.94
SD	525	X							
	625		X						
HD	720p50			X					
	720p59.94				X				
	1080i50					X			
	1080i59.94						X		
	1080p23.98						X		
	1080pSF23.98						X		
	1080p25						X		
3G	1080p29.97						X		
	1080p50							X	
	1080p59.94								X

### 1.3.3 XVP-3901-DC

The XVP-3901-DC is a highly integrated 3G/HD/SD downconverter and video/audio signal processor. It is similar to the full XVP-3901 except that it does not have up and cross conversion capabilities.

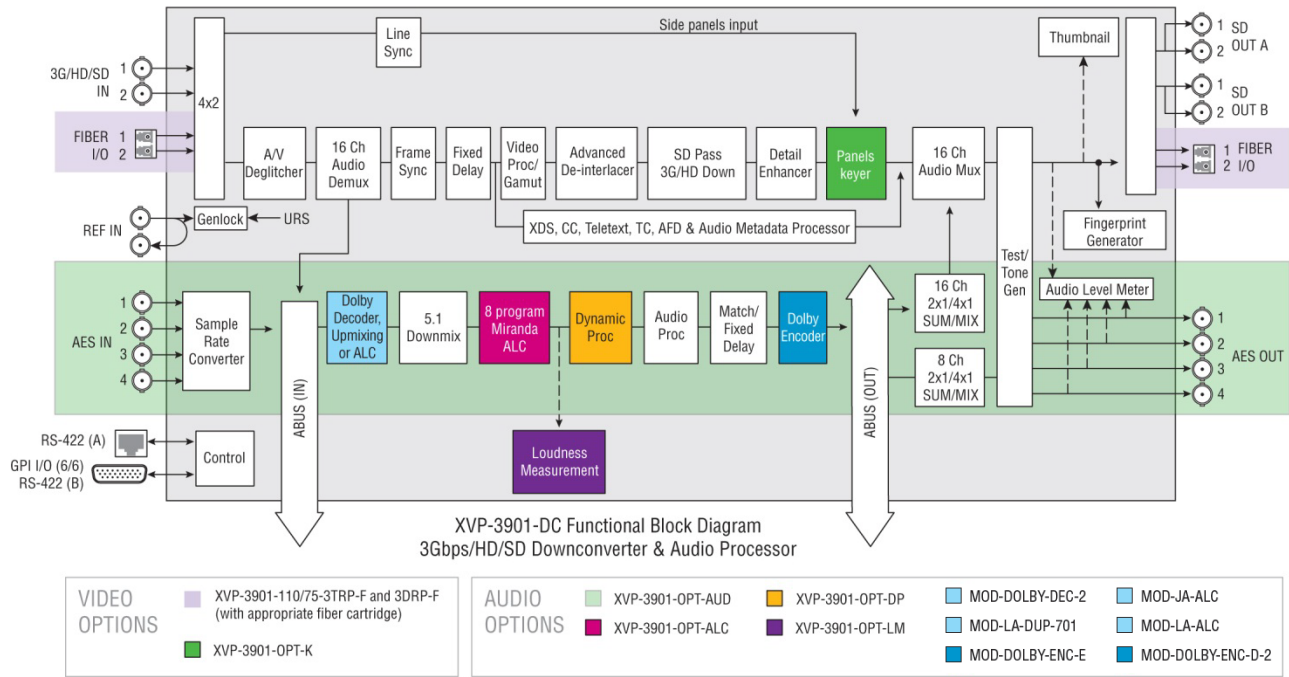

Figure 1.3 Functional block diagram XVP-3901-DC

This chart shows the video formats supported by the XVP-3901-DC at its inputs and outputs

XVP-3901-DC			
		Output	
		SD	
Input		525	625
SD	525	X	
	625		X
HD	720p50		X
	720p59.94	X	
	1080i50		X
	1080i59.94	X	
	1080p23.98	X	
	1080pSF23.98	X	
	1080p25		X
	1080p29.97	X	
3G	1080p50		X
	1080p59.94	X	

1.3.4 XVP-3901-UC

The XVP-3901-UC is a highly integrated 3G/HD/SD upconverter and video/audio signal processor. It is similar to the full XVP-3901 except that it does not have cross and down conversion capabilities.

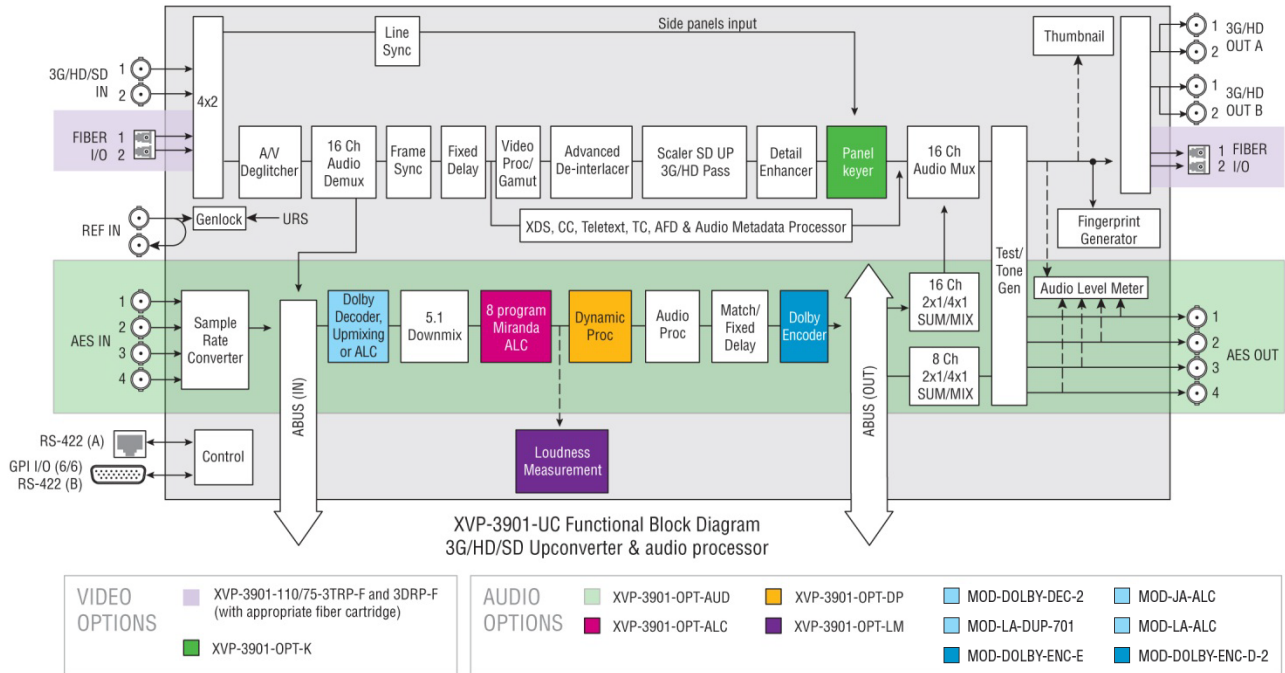

Figure 1.4 Functional block diagram XVP-3901-UC

This chart shows the video formats supported by the XVP-3901-UC at its inputs and outputs

XVP-3901-UC							
Input \ Output		HD				3G	
		720p50	720p59.94	1080i50	1080i59.94	1080p50	1080p59.94
SD	525		X		X		X
	625	X		X		X	
HD	720p50	X					
	720p59.94		X				
	1080i50			X			
	1080i59.94				X		
	1080p23.98				X		
	1080pSF23.98				X		
	1080p25			X			
3G	1080p29.97				X		
	1080p50					X	
	1080p59.94						X



### 1.3.5 XVP-3901-XC

The XVP-3901-XC is a highly integrated 3G/HD cross converter and video/audio signal processor. It is similar to the full XVP-3901 except that it does not have up and down conversion capabilities.

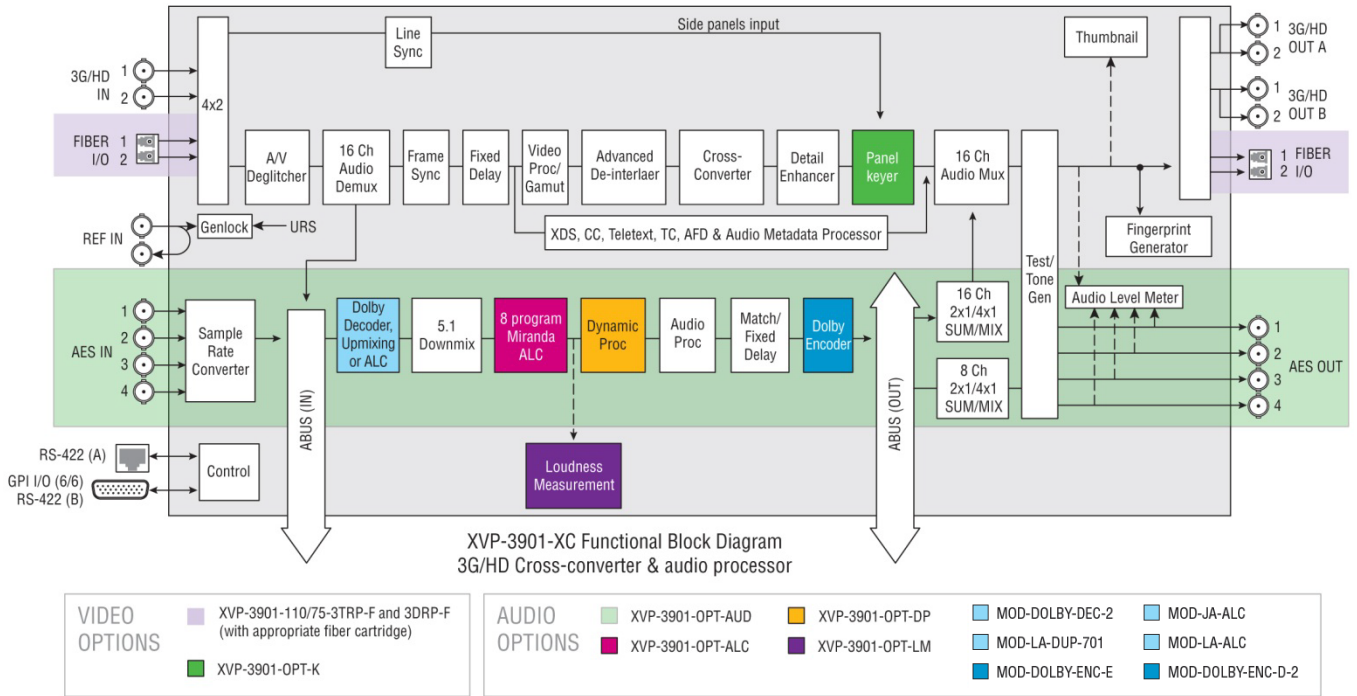

**Figure 1.5** Functional block diagram XVP-3901-XC

This chart shows the video formats supported by the XVP-3901-XC at its inputs and outputs

<b>XVP-3901-XC</b>							
Input \ Output		HD				3G	
		720p50	720p59.94	1080i50	1080i59.94	1080p50	1080p59.94
<b>HD</b>	720p50	X		X		X	
	720p59.94		X		X		X
	1080i50	X		X		X	
	1080i59.94		X		X		X
	1080p23.98		X		X		X
	1080pSF23.98		X		X		X
	1080p25	X		X		X	
<b>3G</b>	1080p29.97		X		X		X
	1080p50	X		X		X	
	1080p59.94		X		X		X

## 1.4 Front Card-edge Interface

The front card-edge of the XVP-3901 incorporates three elements:

- Status LED (see section 3.2)
- Select Button (see section 4)
- ABUS connector (see section 2.5)

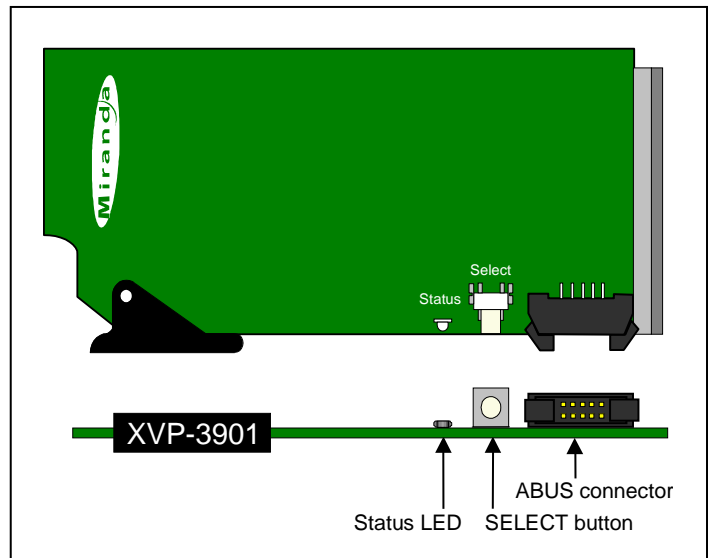

**Figure 1.6** Front card-edge layout

## 2 Installation

### 2.1 Installation of Rear Connector Panels

Grass Valley Densité-series cards are each associated with a rear connector panel, which must be installed in the Densité frame before the card can be inserted.

The XVP-3901 card is designed to fit into Grass Valley's Densité-3 frame. Eight different rear connector panels are available:

- XVP-3901-75-3DRP-F Double-slot-width panel with 75Ω audio and fiber I/O
- XVP-3901-110-3DRP-F Double-slot-width panel with 110Ω audio and fiber I/O
- XVP-3901-75-3DRP-R Double-slot-width panel with 75Ω audio and bypass relay
- XVP-3901-110-3DRP-R-F Double-slot-width panel with 110Ω audio, bypass relay and fiber I/O
- XVP-3901-75-3TRP Triple-slot-width panel with 75Ω audio
- XVP-3901-75-3TRP-F Triple-slot-width panel with 75Ω audio and fiber I/O
- XVP-3901-110-3TRP Triple-slot-width panel with 110Ω audio
- XVP-3901-110-3TRP-F Triple-slot-width panel with 110Ω audio and fiber I/O

See section 2.6 for details of the signal connections available on each of these panel types.

All cards and rear panels can be installed with the frame power on. The card has connectors which plug into a mid-frame mother board for distribution of power and for connection to the controller card, and a second connector which plugs directly into the rear connector panel for input and output.

***The rear connector panel must be installed with the card out of the frame.***

- To remove an existing card from the slot, tilt up the swivel handle on the front of the card to lever the connectors apart, then use the handle to pull the card straight out of the slot.

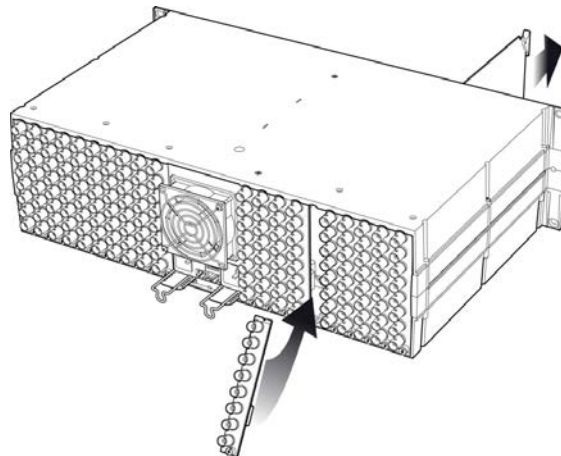

**Figure 2.1** Densité-3 frame – rear panel installation

**To install the connector panel:**

1. If a card is installed in the slot whose rear panel is being changed, remove it as described above.

2. Remove the existing panel (either blank or belonging to an existing card that is being changed) by releasing the captive screw(s) at the bottom.
3. Position the new panel and secure it in place with the captive screw(s) at the bottom.

## 2.2 Card Installation

Once a matching rear connector panel has been installed, install the XVP-3901 card as follows:

1. Open the front panel of the frame.
2. Slide the XVP-3901 card into the slot and push gently on the handle to seat the connectors.

The card should be inserted into the right-most slot associated with the double-slot or triple-slot rear panel. Inserting the card into the wrong slot will not damage the card, and will be flagged by the on-card status LED flashing red to indicate that there is no connection to the rear panel.

3. Close the front panel of the frame.

## 2.3 Installation of the Optical Interface (option)

Refer to Annex 3 on page 152.

## 2.4 Installation of the Audio Modules (option)

Refer to Annex 4 on page 154.

## 2.5 ABUS Connection to Companion Audio Cards

When the XVP-3901 is used in conjunction with one or two companion audio cards (Grass Valley's AAP, DAP or UAP series), the ABUS flat cable must be installed between the ABUS connector of the XVP-3901 and the connectors on the audio cards. The ABUS flat cable is supplied with the audio card.

Note that audio cards from the Densité 2RU series will require 3RU extenders for both the card and the associated rear panel in order to fit into the Densité 3RU frame with the XVP-3901.

**Note:** If only one audio card is used, you must use the two end connectors on the ABUS cable, and leave the center connector unplugged

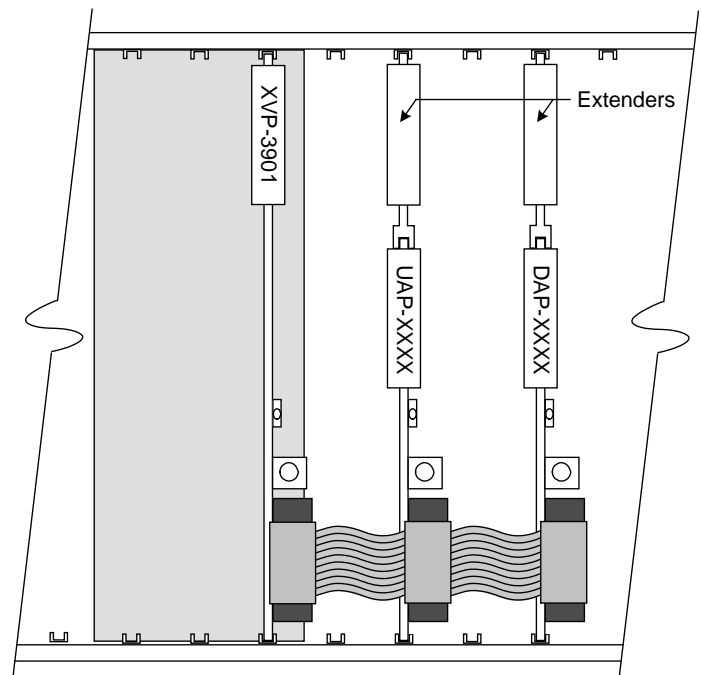

**Figure 2.2** ABUS flat cable installation

## 2.6 Rear Panels and Connectors

### 2.6.1 Images of rear connector panels

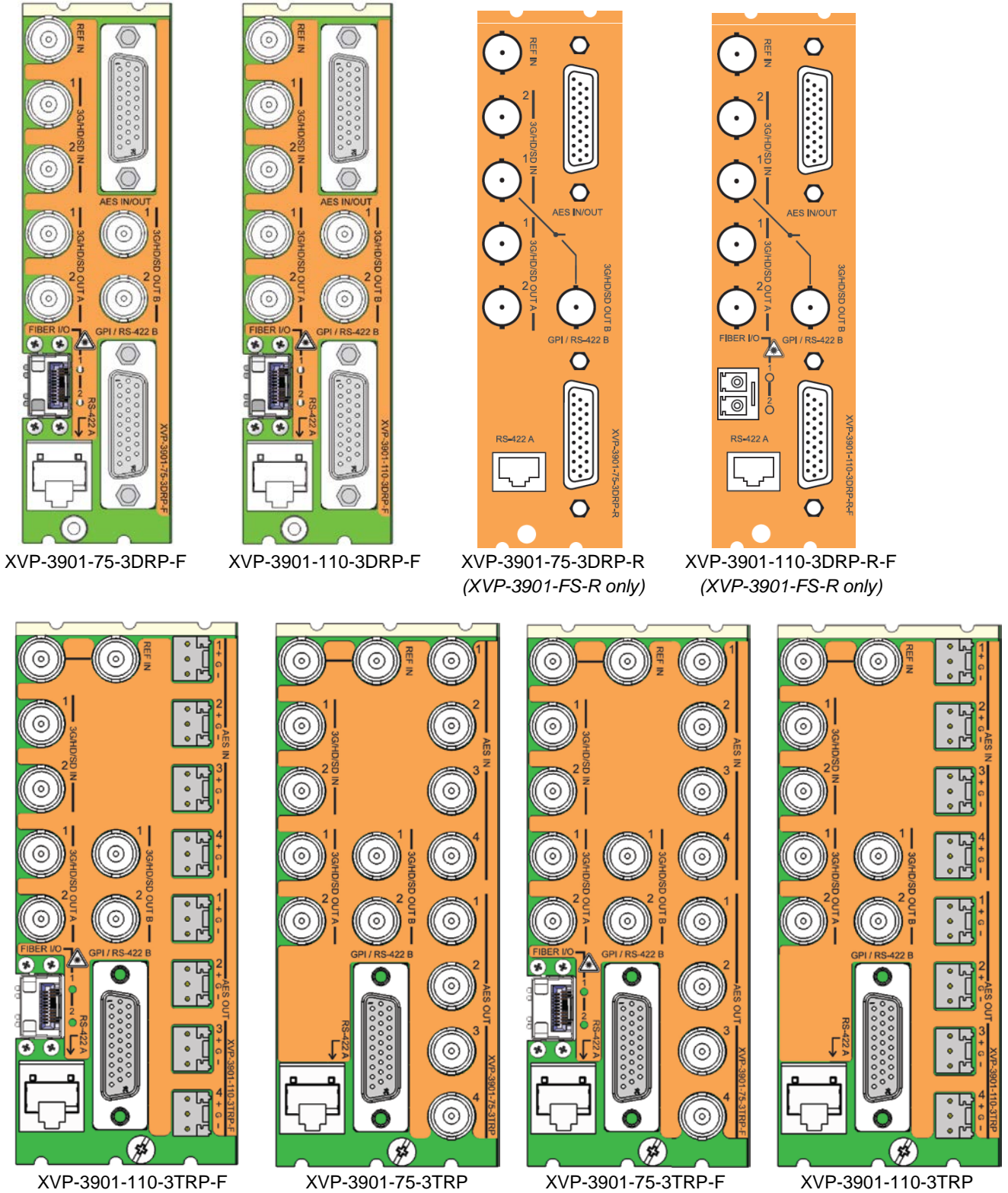

Figure 2.3 XVP-3901 Rear Panels

## 2.6.2 Summary of rear panel connections

The chart summarizes the connectors featured on each of the available XVP-3901 rear connector panels.

<b>XVP-3901-75-3DRP-R</b>								
<b>XVP-3901-110-3DRP-R-F</b>								
<b>XVP-3901-75-3DRP-F</b>								
<b>XVP-3901-110-3DRP-F</b>								
<b>XVP-3901-75-3TRP</b>								
<b>XVP-3901-75-3TRP-F</b>								
<b>XVP-3901-110-3TRP</b>								
<b>XVP-3901-110-3TRP-F</b>								
Double-slot-width panel					◆	◆	◆	◆
Triple-slot-width panel	◆	◆	◆	◆				
<b>CONNECTORS</b>								
Ref IN	◆	◆	◆	◆	◆	◆	◆	◆
Ref IN loop out	◆	◆	◆	◆				
3G/HD/SD IN	2	2	2	2	2	2	2	2
3G/HD/SD OUT A	2	2	2	2	2	2	2	2
3G/HD/SD OUT B	2	2	2	2	2	2	1	1
AES IN (110Ω) on WECO	4	4						
AES IN (75Ω) on BNC			4	4				
AES OUT (110Ω) on WECO	4	4						
AES OUT (75Ω) on BNC			4	4				
AES I/O (110Ω) on D-SUB					4 / 4		4 / 4	
AES I/O (75Ω) on D-SUB						4 / 4		4/4
GPI (6 in/6 out) & RS-422 B on D-SUB	◆	◆	◆	◆	◆	◆	◆	◆
RS-422 A on RJ45	◆	◆	◆	◆	◆	◆	◆	◆
Fiber I/O module	◆		◆		◆	◆	◆	
Bypass Relay							◆	◆

### 2.6.3 Details of rear panel connections

#### REF IN – Studio reference input

For external synchronization, connect a black studio reference signal to the BNC labeled **REF IN**.

- The loop (where available) must be terminated if not used.

The reference input must conform to SMPTE 170M/SMPTE 318M/ITU 624-4/BUT 470-6 for standard definition signals and SMPTE 274M / SMPTE 296M for high definition signals and is used to phase the HD/SD SDI outputs to the studio. A reference mismatch may occur if there is a difference between the input video format's frame rate and the reference format's frame rate. When a mismatch occurs, the output will freeze to the reference frame rate and produce an input error and the card-edge Status LED will turn red to indicate the mismatch.

Note that in the case of HD signals of the same frame rate, any reference signal may be used to genlock any output signal, regardless of scan type (progressive or interlaced). When a 720p/tri-level sync reference signal is used with an interlaced output, the output is synchronized but there may be a delay of one field depending on when the synchronization started.

#### 3G/HD/SD SDI IN – Serial digital HD/SD input

Connect up to two serial digital video signals, conforming to the SMPTE 424M standard for 3G input signals, SMPTE 292M standard for HD input signals or SMPTE 259M standard for SD input signals, to the BNC labeled **HD/SD SDI IN**. The XVP-3901 will automatically switch to the detected line/frame rate format.

#### 3G/HD/SD SDI OUT – Serial digital video outputs

The XVP-3901 provides two pairs of 3G/HD/SD SDI video outputs on BNC connectors, labeled **3G/HD/SD SDI OUT A1 & A2**, and **3G/HD/SD SDI OUT B1 & B2**. The SDI video signal conforms to the SMPTE 424M, SMPTE 292M or SMPTE 259M-C standard.

#### AES IN / OUT – Discrete AES3 digital audio inputs and outputs (8)

The AES inputs and outputs can be configured for 110 ohm impedance using WECO connectors, or 75 ohm impedance using BNC connectors. The choice is made through the use of an appropriate rear connector panel.

Rear Panel Type	Connector / Impedance
XVP-3901-110-3TRP-F	WECO 110Ω
XVP-3901-110-3TRP	WECO 110Ω
XVP-3901-75-3TRP-F	BNC 75 Ω
XVP-3901-75-3TRP	BNC 75 Ω

To allow for a double-width rear panel, two versions (75 Ω and 110 Ω) of a panel with the AES IN and OUT presented on a 26-pin D-SUB connector are available:

Rear Panel Type	Connector / Impedance
XVP-3901-110-3DRP-F	D-SUB 26 110Ω
XVP-3901-75-3DRP-F	D-SUB 26 75 Ω

The pinout of the D-SUB connector for both 110Ω and 75Ω rear panels is shown in this chart.

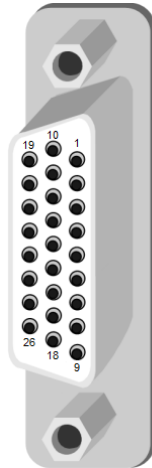

XVP-3901-110-3DRP-F 110 Ohm rear	Pin #	XVP-3901-75-3DRP-F 75 Ohm rear
AES IN 1 (Hi)	1	AES IN 1
AES IN 1 (Lo)	10	GND
AES IN 2 (Hi)	2	AES IN 2
AES IN 2 (Lo)	11	GND
AES IN 3 (Hi)	3	AES IN 3
AES IN 3 (Lo)	12	GND
AES IN 4 (Hi)	4	AES IN 4
AES IN 4 (Lo)	13	GND
AES OUT 1 (Hi)	5	AES OUT 1
AES OUT 1 (Lo)	14	GND
AES OUT 2 (Hi)	6	AES OUT 2
AES OUT 2 (Lo)	15	GND
AES OUT 3 (Hi)	7	AES OUT 3
AES OUT 3 (Lo)	16	GND
AES OUT 4 (Hi)	8	AES OUT 4
AES OUT 4 (Lo)	17	GND
GND	19, 20, 21, 22, 23, 24, 25, 26	GND
N/C	9, 18	N/C

### Fiber I/O – Fiber-optic inputs and outputs

Rear panels whose part number ends in –F incorporate a fiber optic interface. The interface consists of two parts:

- A socket on the rear panel into which an SFP interface module is plugged
- An SFP (Small Form-factor Pluggable) module into which the optical fibers are plugged, and which incorporates the optical/electrical interface

The optical fibers must be terminated in an LC connector.

See **Annex 3** for instructions on installing and removing the SFP interface module, and for plugging and unplugging the LC-terminated fibers.

The current SFP modules supported are:

SFP Modules	Description
SFP-RR-LC	Dual Rx module with LC connector
SFP-TT-S13S13-LC	Dual Tx module at 1310 nm with LC connector
SFP-RT-S13-LC	Single Rx and Tx transceiver module at 1310 nm with LC connector
SFP-R-LC	Single Rx module with LC connector
SFP-T-S13-LC	Single Tx module at 1310 nm with LC connector



**GPI / RS-422 B – GPI I/O and Metadata I/O**

The rear panel connector on a 26-pin D-SUB provides:

- 6 GPI: 4 to recall user-configurable presets and 2 for input selection. Note that GPI 6 can be reconfigured to trigger a Loudness reset.
- 6 GPO: output tallies for the selected user preset and the input selection.
- RS-422 Tx/Rx differential pair: serial port for audio metadata

GPI and GPO are both contact closure to ground, except GPI 1 and GPI 5 which can also trigger events on contact release.

**Note – On the XVP-3901-FS-R model, GPI-5 and GPI-6 are not functional.**

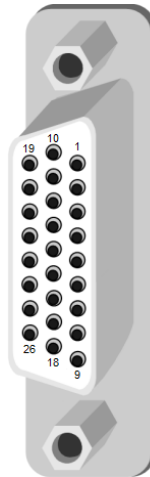

Function	I/O	Pin #
GPI 1 (USER1)	In	14
GPI 2 (USER2)	In	5
GPI 3 (USER3)	In	15
GPI 4 (USER4)	In	6
GPI 5 (INPUT 1)	In	7
GPI 6 (INPUT 2) or (Reset Loudness)	In	17
GPO 1 (USER1)	Out	22
GPO 2 (USER2)	Out	23
GPO 3 (USER3)	Out	24
GPO 4 (USER4)	Out	25
GPO 5 (IN1 SEL.)	Out	26
GPO 6 (IN2 SEL.)	Out	18
RS422-TX1 (+)	Out	19
RS422-TX0 (-)	Out	11
RS422-RX1 (+)	In	12
RS422-RX0 (-)	In	21
GND	-	1, 2, 3, 4, 8, 9, 10, 13, 16, 20

**RS-422 A – Machine Control Interface (RJ45 socket):**

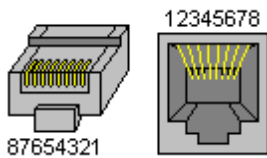

RS-422 Label	Pin #
RS422-TX+	1
RS422-TX-	2
RS422-RX+	3
RS422-RX-	6
N/C	4,5,7,8

### 3 User Interface

#### 3.1 Control options

The XVP-3901 can be controlled in three different ways:

- The local control panel and its push-buttons can be used to move through a menu of parameters and to adjust parameter values (see section 4).
- Grass Valley’s iControl system can be used to access the card’s operating parameters from a remote computer, using a convenient graphical user interface (GUI) (see section 5).
- Grass Valley’s RCP-200 panel.

#### 3.2 Card-Edge Status LED

The status monitor LED is located on the front card-edge of the XVP-3901, and is visible through the front access door of the DENSITÉ frame. This multi-color LED indicates the status of the XVP-3901 by color, and by flashing/steady illumination.

The chart shows how the various error conditions that can be flagged on the XVP-3901 affect the LED status.

- If a cell is gray, the error condition cannot cause the LED to assume that status
- If more than one LED status is possible for a particular error condition, the status is configurable. See Section 5.20 for details.
- The factory default status is shown by a ⚙

The LED will always show the most severe detected error status that it is configured to display, and in the chart error severity increases from left to right, with green representing no error/disabled, and flashing red the most severe error.

Error Condition	LED Status			
	Green	Yellow	Red	Flashing Red
Cooling Fan 1 error				⚙
Cooling Fan 2 error				⚙
Health Error				⚙
No Rear				⚙
Input 1 video error			⚙	
Input 2 video error			⚙	
Input 2 format mismatch			⚙	
Input 2 failover	⚙			
Fiber selection error			⚙	
Carrier 1 detect error			⚙	
Carrier 2 detect error (keyer mode)	⚙			
Carrier 2 detect error (switcher mode)			⚙	
Carrier 2 detect error (failover mode)			⚙	
Reference missing			⚙	

(continued)

Error Condition	LED Status			
	Green	Yellow	Red	Flashing Red
Reference mismatch			✳	
Card System error			✳	
Manual Freeze		✳		
Test Mode		✳		
AES 1 presence error	✳			
AES 2 presence error	✳			
AES 3 presence error	✳			
AES 4 presence error	✳			
Silence detected Channel 1	✳			
Silence detected Channel 2	✳			
Silence detected Channel 3	✳			
Silence detected Channel 4	✳			
Silence detected Channel 5	✳			
Silence detected Channel 6	✳			
Silence detected Channel 7	✳			
Silence detected Channel 8	✳			
Silence detected Channel 9	✳			
Silence detected Channel 10	✳			
Silence detected Channel 11	✳			
Silence detected Channel 12	✳			
Silence detected Channel 13	✳			
Silence detected Channel 14	✳			
Silence detected Channel 15	✳			
Silence detected Channel 16	✳			

✳ : Factory default.

If the LED is Flashing Yellow, it means that the card is selected for local control using the Densité frame's control panel. See Section 4 for details.

## 4 Local control using the Densité frame control panel

### 4.1 Overview

Push the SELECT button on the XVP-3901 card edge (see Section 1.4) to assign the local control panel to operate the XVP-3901. Use the control panel buttons to navigate through the menu, as described below.

All of the cards installed in a Densité frame are connected to the frame's controller card, which handles all interaction between the cards and the outside world. There are no operating controls located on the cards themselves. The controller supports remote operation via its Ethernet ports, and local operation using its integrated control panel.

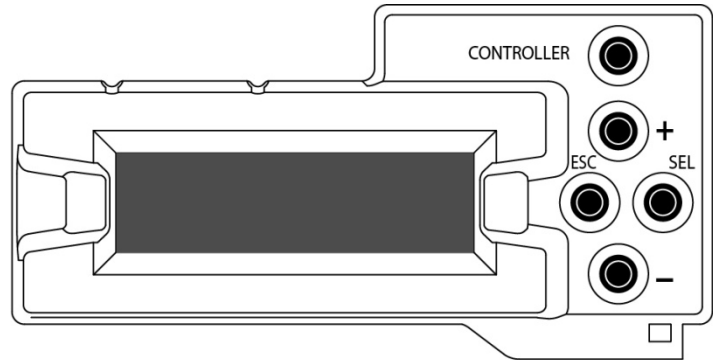

**Figure 4.1** Densité Frame local control panel

The local control panel is fastened to the front of the CPU-ETH2 controller card, and when installed is located in the front center of the frame, positioned in front of the power supplies. The panel consists of a display unit capable of displaying two lines of text, each 16 characters in length, and five pushbuttons.

The panel is assigned to operate any card in the frame by pushing the SELECT button on the front edge of that card.

- Pushing the CONTROLLER button on the control panel selects the Controller card itself.
- The STATUS LED on the selected card flashes yellow.

The local control panel displays a menu that can be navigated using the four pushbuttons located beside the display. The functionality of the pushbuttons is as follows:

[+] [-] Used for menu navigation and value modification

[SELECT] Gives access to the next menu level. When a parameter value is shown, pushing this button once enables modification of the value using the [+] and [-] buttons; a second push confirms the new value

[ESC] Cancels the effect of parameter value changes that have not been confirmed; pushing [ESC] causes the parameter to revert to its former value.

Pushing [ESC] moves the user back up to the previous menu level. At the main menu, [ESC] does *not* exit the menu system. To exit, re-push the [SELECT] button for the card being controlled.

If no controls are operated for 30 seconds, the controller reverts to its normal standby status, and the selected card's STATUS LED reverts to its normal operating mode.

### 4.2 Menu for local control

The XVP-3901 has operating parameters which may be adjusted locally at the controller card interface.

- Press the SELECT button on the XVP-3901 front card edge to assign the Densité frame's local control panel to the XVP-3901
- Use the keys on the local control panel to step through the displayed menu to configure and adjust the XVP-3901.

The complete menu structure is shown in Annex 1 to this document, beginning on page 141.

## 5 Remote control using iControl

The operation of the XVP-3901 may be controlled using Grass Valley's iControl system.

- This manual describes the control panels associated with the XVP-3901 and their use.
- Please consult the iControl User's Guide for information about setting up and operating iControl.

In iControl Navigator or iControl Websites, double-click on the XVP-3901 icon to open the control panel.

### 5.1 The iControl graphic interface window

The basic window structure for the XVP-3901 is shown in figure 5.1. The window identification line gives the card type (XVP-3901) and the slot number where the card is installed in its Densité frame.

There are four main sections in the window itself, identified in figure 5.1:



Figure 5.1 XVP-3901 iControl graphic interface window

**Section 1.** The top section displays seven icons on the left. These icons report different statuses such as card communication status, input signal and reference signal format and statuses. In some instances, they relate to conditions defined through parameters settings.



Icon # 1 2 3 4 5 6 7







Move the mouse over an icon and a status message appears below the icon providing additional information. If there is an error, the error status message appears in the message area without mouse-over.











- If there are multiple errors, the error messages cycle so all can be seen
- The icon whose status or error message is shown is highlighted with a mauve background



The table below describes the various status icons that can appear, and how they are to be interpreted.

- In cases where there is more than one possible interpretation, read the error message in the iControl window to see which applies.

**Table –iControl Status Icon interpretation**

<b>Icon #1 – Manual Card Configuration</b>	
	Remote card control activated. The iControl interface can be used to operate the card
	Local card control active, The card is being controlled using the Densité frame control panel, as described in section 4. Any changes made using the iControl interface will have no effect on the card.
<b>Icon #2 – Input 1 status</b>	
 (green)	Signal detected and valid. <ul style="list-style-type: none"> <li>• Beneath the icon, the format will be indicated as 3G, HD or 525 or 625, and the specific format details will be listed if the cursor is moved over the icon.</li> </ul>
 (red)	Signal absent No rear Reference mismatch Video/TRS error
<b>Icon #3 – Input 2 status</b>	
 (green)	Signal detected and valid
 (red)	Signal absent No rear Reference mismatch Format mismatch with output format (Key/Fill mode) Video/TRS error

<b>Icon #4 – Audio Status</b>	
 (green)	Audio OK
 (yellow)	Yellow alarm condition detected on 1 or more channels
 (red)	Red alarm condition detected on 1 or more channels
 (gray)	All audio disabled
 (red)	Card System Mismatch – the audio cards detected on the ABUS do not match the configuration selected in the ABUS panel
<b>Icon #5 – Reference</b>	
 (green)	Reference OK. Mouse over to see the source of the reference, and its format, e.g. External, NTSC
 (red)	Reference missing
 (gray)	Reference absent
<b>Icon #6 – Operation Mode</b>	
 (green)	Operation mode: process – normal processing of the input signal
 (yellow)	Operation mode: TEST – color bar and audio test tones enabled (see Sect. 5.17)
 (yellow)	Operation mode: Manual Freeze ON (see Sect. 5.2 – Freeze tab)

Icon #7 – Health Monitoring	
 (green)	Hardware OK
 (red)	Hardware Health Monitoring (Fan1, Fan2, Hardware fault detected) If this icon appears red, return the card to Grass Valley and specify the error code.

**Section 2.** The left portion of the window contains access buttons for all the parameter groups, which become highlighted when they are selected; the main panel (4) then displays the group’s set of parameters. Each of the groups is described in detail below.

**Section 3.** The lower left corner of the window identifies the Preset currently in use or “Custom” if none is applicable.

**Section 4.** The main panel contains all the parameters specific to the group selected. It may contain several tabs to help manage the different parameters.

Each of the panels associated with the groups accessed from the buttons in Section 2, and shown in Section 4, is described individually in the following sections.

## 5.2 Video Input/Output panel

This panel allows input selection, second input operation mode selection, and control of the deglitcher and freeze functions.

*Input Select:* choose one of the two inputs connected to the rear panel.

- Input 1&2 assignments are done in the Input/Output Config Tab below.
- Note that the XVP will switch the inputs on the switch line only when using this control and not while using the Input Config controls.
- The video input status in the top section (icon #2 and #3) refers only to the inputs selected here.



**Figure 5.2** Video Input/Output panel



### 5.2.1 Input/Output Config Tab

*Input Config:* use the pulldowns to select the rear panel input that will be used when the inputs are selected:

- BNC IN – use one of the electrical inputs
- Fiber IN – use one of the fiber optic inputs (1, 2 or both will be listed)
- The pulldowns are greyed and non-functional if the installed rear panel does not incorporate a fiber SFP socket
- If the Fiber Input name is red in the pulldown, it indicates that an appropriate fiber module has not been detected in the SFP socket

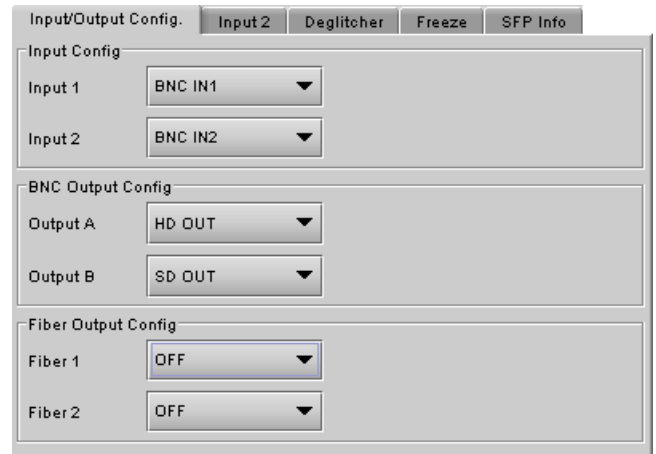

**Figure 5.3** Video Input/Output – I/O Config tab

*BNC Output Config:* Use the pulldowns to select whether the named output will be HD or SD.

*Fiber Output Config:* Use the pulldowns to turn the fiber transmitters for each output ON (either HD OUT or SD OUT) or OFF

- This section of the panel only appears when a rear module with a fiber SFP socket is installed
- If the selection is invalid (e.g. no appropriate transmitter installed in the SFP socket) then the selection will be red in the pulldown and a warning message will appear if it is selected
- Information about the installed SFP module can be found in the SFP Info tab, which only appears when a rear module with a fiber SFP socket is installed

### 5.2.2 Input 2 tab

*Input 2 Mode:* Specify the operation mode for the second input using the pulldown. Available choices are:

- **2x1 Switch:** when this mode is selected, the card can be manually switched between the 2 inputs, using the radio buttons in the *Input Select* area. Keep in mind that all current settings (ARC, audio, etc.) will remain and be applied to input 2.
- **Fail Over:** when this mode is selected, the card will automatically switch from input 1 to input 2 when input 1 is lost for a delay longer than the *Auto Switch Delay* set below.
  - All current settings (ARC, audio, etc.) will remain and be applied to input 2.
  - The card will remain on input 2, even if input 1 returns to normal, until it is manually reset to input 1

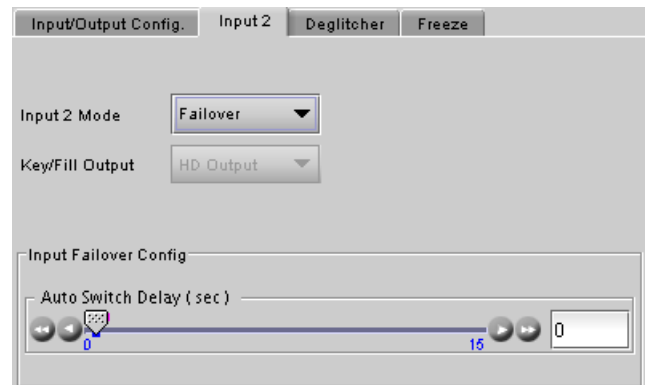

**Figure 5.4** Video Input/Output – Input 2 tab

*Auto Switch Delay (sec):* using the slider, set the *Auto Switch Delay*, from 0 to 15 seconds in steps of 1 second.

Some points to note for the Failover mode:

- The Failover mode only switches from input 1 to input 2, not from 2 to 1.

- If input 2 and Failover mode are both selected, an error is reported by iControl and the card edge LED turns red. The second input is always required in this mode.
  - Both input signals must be present – the system cannot switch to input 2 if there is no signal there – and the absence of either of the signals will be flagged as an error (icon #2 and card-edge LED red)
  - If there is no input 2, the iControl carrier detect icon for input 2 will be red, but no input error will be flagged.
- **Key / Fill:** when this mode is selected, the card uses input 1 as the main video input, and the second input is used as background graphics to the output side panels or letterbox. For this mode to function properly:
- The second input must be the same format as the output.
  - In order for the two signals to be properly phased at the keyer, it is necessary for the second input to be timed between 414 pixels and 1 line+413 pixels ahead of the output timing.
  - If the second input is lost, the specified background color is used until the input comes back.
  - Input 2 selection in the Input Select area is disabled in the Key/Fill mode.

The format and status for the second input is displayed in an icon at the top of the interface.

*Key/Fill Output:* Use the pulldown to select whether the Key/Fill output will be SD or HD.

### 5.2.3 Deglitcher tab

When the Deglitcher is active, the card supports a hot-switch between two signals (either on the same input, or between the card's two inputs) without producing a freeze on the frame sync, and without producing artifacts on the output.

**The deglitcher must be disabled when the input is asynchronous to the reference. Otherwise, it will create audio and video glitches at the output.**

*Mode:* select OFF or ON from the pulldown.

- Note that the Deglitcher cannot be enabled for 1080p23, 1080p23sF, 1080p25 and 1080p29 sources

For this mode to function correctly, the following requirements must be met:

- The two inputs must be synchronized to the reference
- They must be phased within one line of each other
- They must be phased to within +/- ½ line of the HREF of the reference signal

The offset from the VREF can be variable, but a distance of greater than 10 lines could create an artifact in the active video. If the two signals are more than 1 line apart, we will see a vertical jump at the moment of switching that is proportional to the number of vertical lines of offset between the two signals. This will last for only one frame. There may also be problems in the transition when in the AFD automatic or forced mode.

When a reference is present and the deglitcher is active, the card reports the difference in timing between the input and the reference when the transition occurs.

- If the reference is missing when the deglitcher is activated, the Input timing to reference box will indicate “Missing reference” in red, and the reference status icon at the top of the iControl window will turn red and show the message “Reference missing”.
- If the deglitcher is OFF, the reference status icon will be grey, and its message will read “Reference absent”

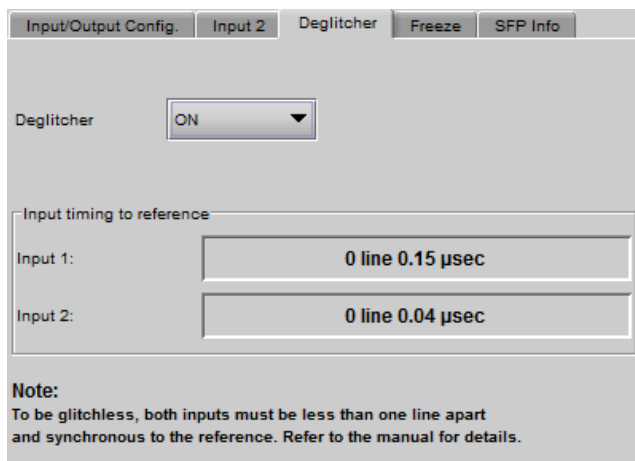

**Figure 5.5** Video Input/Output – Deglitcher tab

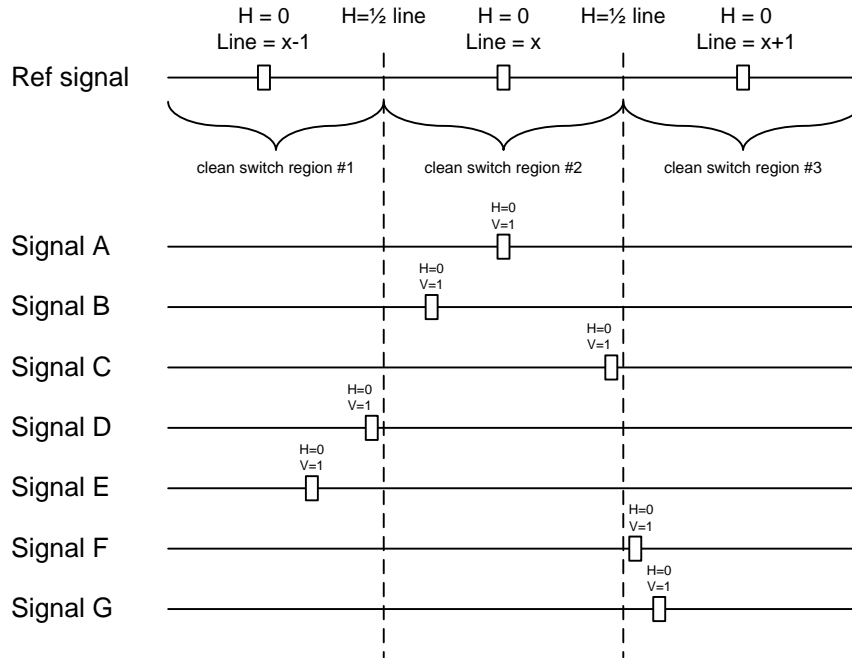

To perform a glitch-free switch between two sources, they must be in the same clean switch region. A clean switch region is contained within  $\pm \frac{1}{2}$  line about an H=0 point in the reference signal, as shown by the dotted lines in the figure. There is a clean switch region centered on every H interval. As you can see, vertical alignment with the reference is not important for the deglitcher to operate properly.

You may switch between signals A, B or C, without any glitch, and also between signals D ↔ E and signals F ↔ G. Any other transition, like A ↔ D, will cause a vertical image shift for one frame.

To determine whether a clean hot switch is possible, you need to determine whether the two input signals lie in the same clean switch region. There are two ways to measure the position of the signals with respect to the reference:

- Use the deglitcher tab in iControl (Input → Deglitcher)
- Use the controller menu in Appendix 2 (video → timing → in timing to ref).

When the deglitcher mode is on, each of these sources will display the alignment offset between the reference signal and the input signal. Knowing the offset for both input signals, you can determine if they are in the same clean switch region. If so, any hot-switch between those two signals will be glitch less.

To determine the limits of a clean switch region, you must know the input's line length in  $\mu\text{s}$ . The first region is delimited by  $+\frac{1}{2}$  line and  $-\frac{1}{2}$  line of the reference. For example, with an SD (525) signal the line length is  $63.5 \mu\text{s}$  and so the first region lies between  $-31.76 \mu\text{s}$  and  $31.76 \mu\text{s}$ . Other regions can be found by adding or removing a multiple of line length to the two boundaries.

Example: for an SD (525) input signal, we have these clean switch regions:

- 1 line and  $-31.76 \mu\text{s}$  to 0 line and  $-31.76 \mu\text{s}$
- 0 line and  $-31.76 \mu\text{s}$  to 0 line and  $31.76 \mu\text{s}$
- 0 line and  $31.76 \mu\text{s}$  to 1 line and  $31.76 \mu\text{s}$
- etc.

**Practical examples:**

*Example 1:* we have two SD (525) sources, one that indicates an offset of  $-25\ \mu\text{s}$  with respect to the reference (A) and the other an offset of  $-35\ \mu\text{s}$  (B). We know that a clean switch region limit is present at  $-\frac{1}{2}$  line, which corresponds to  $-31.76\ \mu\text{s}$ . We can now determine that this switch will not be clean, because the two sources are on opposite sides of the limit, and are therefore not in the same clean switch region.

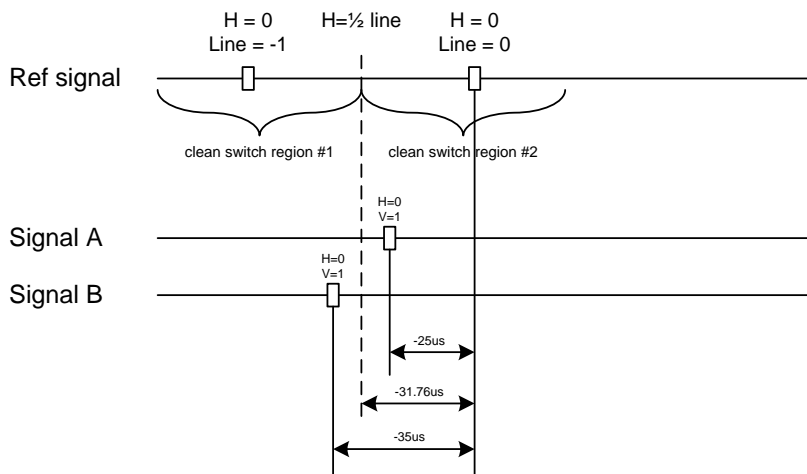

*Example 2:* We have two SD (525) sources, one that indicates an offset of  $50\ \mu\text{s}$  with respect to the reference (A) and the other an offset of  $40\ \mu\text{s}$  (B). We know that a clean switch region limit is present at  $+\frac{1}{2}$  line and another one at  $\frac{1}{2}$  line plus one line. These correspond to  $31.76\ \mu\text{s}$  and  $95.28\ \mu\text{s}$ . We can now determine that this switch will be clean, because the two sources are inside the same clean switch region.

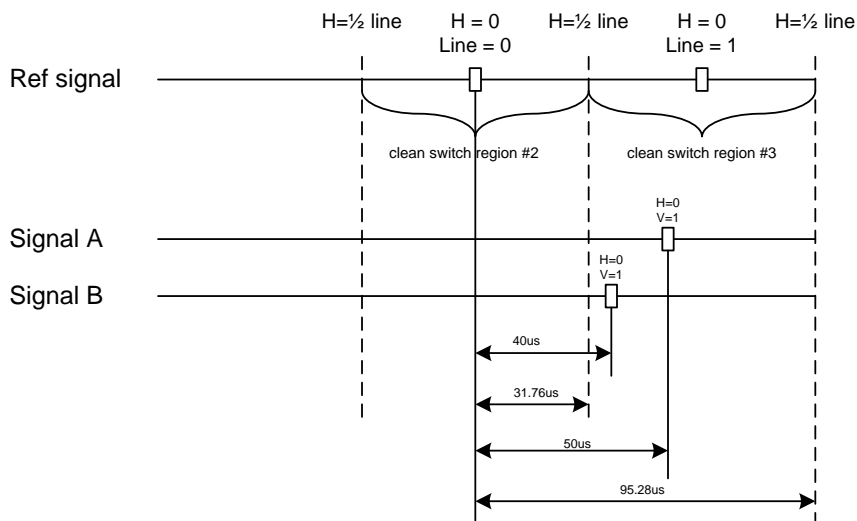

**5.2.4 Freeze tab**

*Freeze type:* This is a pull-down menu with four options – FIELD 1, FIELD 2, FRAME and BLACK. It determines the manner in which the XVP-3901 responds to a manual freeze, a video input switch (“hotswitch” as defined by SMPTE recommended practice RP-168, revised January 2002), a loss of input signal or other input errors. The four possible options yield the following results:

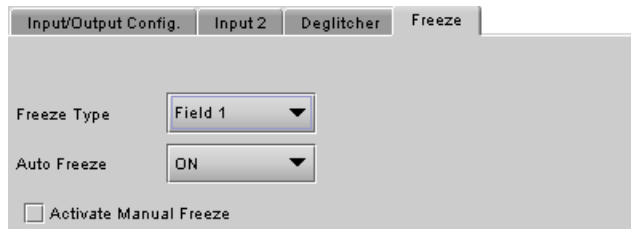

**Figure 5.6** Video Input/Output – Freeze tab

Freeze Option	Auto Freeze Mode	Manual Mode
• Field 1	Freeze to last valid FIELD	Freeze to last valid FIELD 1
• Field 2		Freeze to last valid FIELD 2
• Frame		Freeze to last valid FRAME
• Black	Freeze to BLACK	

*Auto Freeze:* This pulldown (ON/OFF) enables or disables the auto freeze function. In Auto Freeze mode, a reference must be present to ensure a glitchless output when a freeze is activated. There are only two freeze possibilities in Auto mode: freeze to last valid Field or freeze to black. When Auto Freeze mode is disabled, the content of the active picture will reflect whatever garbage is present at the input but, if a reference is present, the output synchronization will be maintained to avoid unlocking downstream equipment.

*Manual:* Select this checkbox to immediately freeze the output according to the mode selected in the Freeze Type pull-down.

**Note:** The manual freeze setting is saved in the non-volatile memory of the card. If the manual freeze is activated and the power is cycled, the card will start in freeze mode at the next power-up and the output will be invalid. Just turn off the manual freeze to restore the output.

In all cases, audio will be muted when there is an input error. See the audio section for more information.

### 5.2.5 SFP Info tab

This tab only appears when a rear panel with a fiber SFP socket is installed. These panels are identified by the suffix -F in the panel name.

The data boxes in this tab identify the vendor name and part number, and the optical power – incoming for a receiver (RX) or outgoing for a transmitter (TX).

*NOTE: The current version of the XVP-3901 supports CWDM SFP modules, but the Part Number data window in this panel displays an incorrect part number for these modules. This discrepancy will be resolved in a subsequent release.*

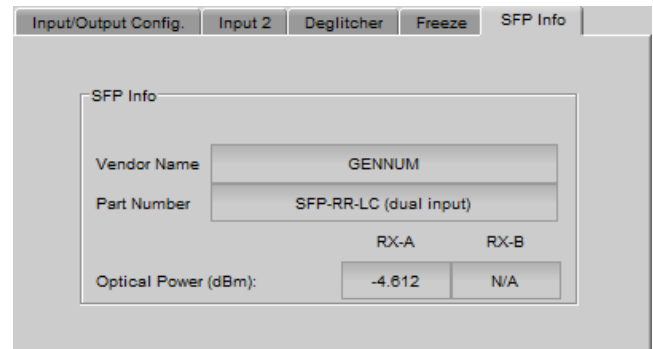

**Figure 5.7** Video Input/Output – SFP Info tab

### 5.3 Video Processing panel

This panel contains color-correction parameters that apply to the input signal. You can configure the video processor differently for an SD input than for a 3G/HD input. The card will remember the different parameters and will load them automatically without user intervention based on whether the video input is SD or 3G/HD. Ensure the card has a video signal of the desired format before changing the configuration.

**Proc Mode:** Select whether the processing controls will be presented in YCbCr or RGB format.

- It is important to understand that gain/offset values from the current Proc Mode will be applied to the newly selected mode. This may cause adverse effect. To avoid it, return the gain/offset values to their default values (zero).

**RGB Gamut:** When ON, all illegal YCbCr colors in the RGB space will be clipped to a legal value.

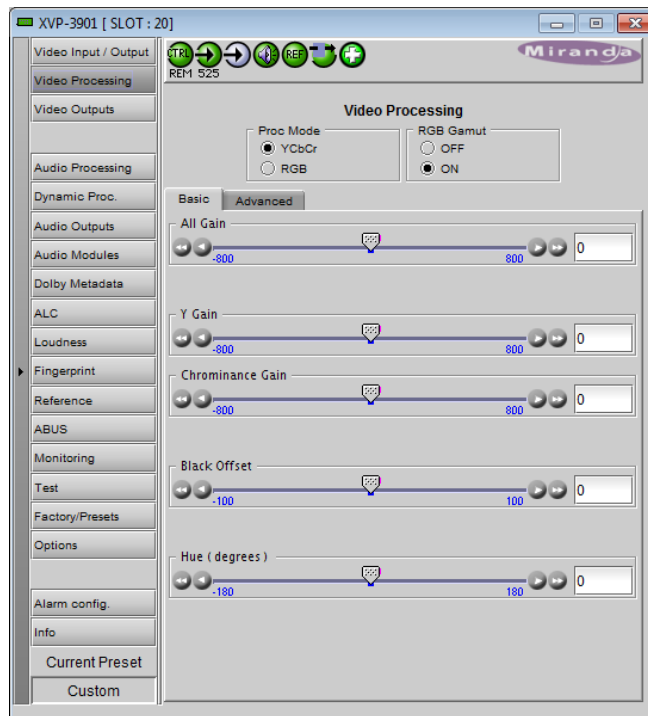

Figure 5.8 Video Processing panel – Basic tab

#### 5.3.1 Basic tab

**All Gain:** Sets Luma and Chroma gains, or G, B and R gains to a specific value. When other gains are individually set, ALL GAIN reflects the average value of the combined gains.

The choice of processing mode made at the top of the panel determines what other controls are provided. The table below lists the sliders and the available control ranges.

- For gain control, a nominal value of 0 represents 100% gain, while -800 represents 0% gain, and +800 represents 200% gain.

Y Cb Cr mode	
Slider name	Range
All gain	-800 to +800
Y Gain	-800 to +800
Chrominance Gain	-800 to +800
Black Offset	-100 to +100
Hue (degrees)	-180 to +180

RGB mode	
Slider name	Range
All Gain	-800 to +800
G Gain	-800 to +800
B Gain	-800 to +800
R gain	-800 to +800

### 5.3.2 Advanced tab

This tab provides individual controls for each of these parameters.

Y Cb Cr mode		RGB mode	
Slider name	Range	Slider name	Range
Y Gain	-800 to +800	G Gain	-800 to +800
Cb Gain	-800 to +800	B Gain	-800 to +800
Cr Gain	-800 to +800	R Gain	-800 to +800
Y Offset	-100 to +100	G offset	-100 to +100
Cb Offset	-100 to +100	B Offset	-100 to +100
Cr Offset	-100 to +100	R Offset	-100 to +100

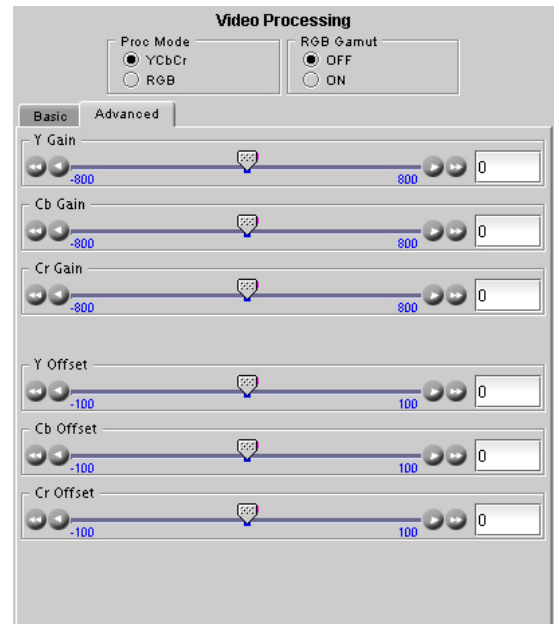

Figure 5.9 Video Processing – Advanced tab

### 5.4 Video Outputs panel – 3G/HD Output tab

This panel allows control over several aspects of the video output:

- aspect ratio conversion
- timing control
- image quality processing
- metadata insertion.

The upper portion of the panel is occupied by two video screen images, labelled *Input* and *Output*. These screens do not show the actual video being processed by the XVP-3901, but rather show graphic images that represent the geometric aspects of the input signal and the output that results after it is exposed to the current ARC processing functions. The image is a green circle on a white background; the circle is used because it is easy to see if it is asymmetrical. Lines on the images indicate protected areas for the AFD implementation.

Aspect Ratio Conversion (ARC) modifies the video active picture shape as the signal is converted between SD at 4:3 aspect ratio and HD/SD at 16:9 aspect ratio. If the input is simply stretched or squeezed to fit the output, the image will be asymmetrically distorted; this is called *anamorphic* distortion. If the image is expanded or contracted symmetrically, it must be cropped, and/or have new blank background segments added to it, in order to fill the output picture. The ARC processing in the XVP-3901 allows a wide range of symmetrical and asymmetrical picture size modification, coupled with cropping and background addition, to be applied to an input signal.



Figure 5.10 Video Outputs – 3G/HD Output

When the Input AFD Mode is set to *Auto*, all the ARC settings are set automatically according to the AFD flag (see the table in Annex 2 beginning on page 148) and cannot be changed by the user.

- There are some exceptions – with certain input AFD codes the masks can be customized. Each mask can be customized for each different AFD code allowing different mask settings according to each specific code. For certain AFD codes that are less used, the masks cannot be configured and will be de-activated.

### The Input Screen

The *Input* preview screen shows the portion of the input image which will be presented at the XVP-3901 output. It has a pull-down *AFD Mode* menu at the top right corner through which the user specifies how AFD (Active Format Descriptor) information will be handled. Available choices are: [4:3, 16:9, Auto, Forced] for SD inputs and [16:9, Auto, Forced] for HD inputs.

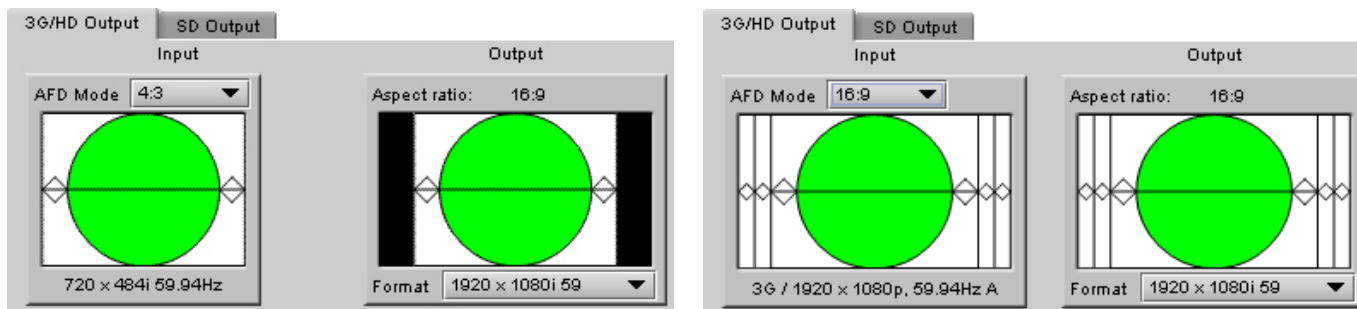

Figure 5.11 Screens for 3G/HD output

You can configure the AFD mode differently for an SD input than for a 3G/HD input. The card will remember the different parameters and will load them automatically without user intervention based whether the video input is SD or 3G/HD. Ensure the card has a video signal of the desired format before changing the AFD mode configuration.

**Note 1 – Auto mode:** When *Auto* is selected, all the ARC values are automatically set based on the AFD flag detected at the input, and the ARC controls and presets described below are **disabled**. Annex 2 shows the AFD functions implemented. If no AFD flag is detected at the input, the card uses the Default AFD flag specified in the AFD tab

**Note 2 – Forced mode:** Forced mode is useful when the input AFD flag is unreliable, missing or if the user wants a simple way to force the aspect ratio conversion. The function is the same as the Auto mode, except that the incoming AFD flag is ignored, and a user-specified forced flag is used instead. As in the Auto mode, the ARC controls and presets described below are **disabled**.

**Note 3 – 4:3 or 16:9:** ARC settings can be manually set using the ARC tab controls.

The input screen shows how much of the input signal will appear at the output after the ARC processing in the XVP-3901. It does so by showing any cropped portions of the image in blue.

### The Output Screen

The output screen shows the final result of the ARC processing.

- The side panels and letterbox regions are shown in the selected background color
- The masks are shown in Gray

3G/HD output – A pull-down menu at the bottom of the screen allows the user to select the output format:

- 1920x1080p – Level A (mapping 1), 1920x1080p – Level B, 1920x1080i or 1280x720p, with the frame rate matching the input.



### 5.4.1 3G/HD Output – ARC tab

Under the ARC (Aspect Ratio Conversion) tab, several sub-sections are found allowing extended control over how the output will be displayed. For convenience, ARC presets are available for frequently-encountered aspect ratio conversions.

- These controls are disabled when the ARC Mode pulldown on the Input Screen is set to *Auto* or *Forced*

You can configure the ARC parameters differently for an SD input than for a 3G/HD input. The card will remember the different parameters and will load them automatically without user intervention based on whether the video input is SD or 3G/HD. Ensure the card has a video signal of the desired format before changing the configuration.

When using manual aspect ratio mode (AFD mode is 4:3 or 16:9), the card will remember automatically all the parameters for the different combinations of input/output aspect ratio conversions (see the combinations below). This means you can configure the card once for each type of conversion and then the card will restore the configuration automatically when the proper input format and input/output aspect ratio is encountered.

- SD 4:3 to 3G/HD 16:9
- SD 16:9 to 3G/HD 16:9
- 3G/HD 16:9 to 3G/HD 16:9

#### 5.4.1.1 Input sub-section

*Input: Crop – Horizontal and Vertical*

The crop controls allow selection of a portion of the original image – the amount of horizontal and vertical cropping is expressed as a percentage of the size of the original image.

The user can manually adjust the level of horizontal and vertical cropping. Horizontal cropping is done on an 8-pixel basis. Vertical cropping is done on 4-line basis. To achieve non-symmetrical vertical or horizontal cropping, uncheck the *Center* box underneath and position the image using the *Tilt* function described below.

Input cropping changes the scaling factor between the input and the output. If we crop the input (H&V) by 10%, the output image is resized and scaled by +10%. By providing different H and V cropping, the user can produce an anamorphic image.

The padlock icon appearing next to the data window allows the data to be “locked”. See the paragraph *Locking controls* under *Output sub-section* below for a discussion of this option.

*Input: Tilt*

Once a smaller window has been established by cropping the input signal, it can be moved vertically (*Tilt*, expressed in lines) within the original image to place the desired portion of the image in view. By default, a *Center* check box beneath the Tilt scroll box forces the cropping window to be centered on the input window. When it is checked, the necessary Tilt value will be calculated and displayed in the Tilt data window. You cannot tilt if the cropping value is zero.

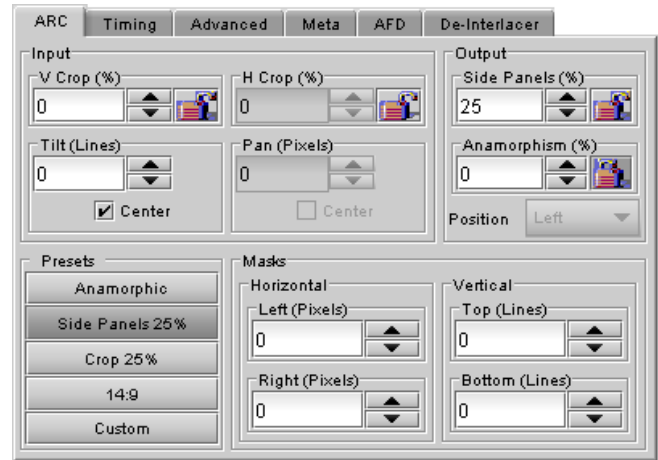

**Figure 5.12** Video Output 3G/HD - ARC tab

*Input: Pan*

Once this smaller window is established, it can be moved horizontally (*Pan*, expressed in pixels) within the original image to place the desired portion of the image in view. A *Center* check box beneath the *Pan* scroll box forces the cropping window to be centered on the input window. When checked, the necessary *Pan* value will be calculated and displayed in the data window. You cannot *Pan* if the cropping value is zero.

### 5.4.1.2 Output sub-section

*Output: Side Panels*

This scrollable data entry box is used to shrink the width of the image so that the output image has blanked areas on each side of the displayed picture, which occupy the indicated percentage of the screen width. These areas are symmetric about the center, so a setting of 25% side panels would show a bar 12.5% of the screen width on each side of the image. 25% is the maximum value; entering a smaller value reduces the width of the side panels, but crops the image top and bottom. This control is disabled when the input is 16:9.

*Output: Anamorphism*

This control box allows the output image to be resized asymmetrically. Anamorphism is expressed in percent, where positive values indicate an increase in width with respect to height, and negative values a decrease in width with respect to height.

*Output: Position*

This pull-down allows the positioning of the output picture when side panels are in use. The picture can be moved totally to the left, centered or totally to the right. This control is not available in Auto AFD mode or Forced AFD mode. The picture will be centered by default when an ARC Preset is selected.

*Locking controls*

Represented by padlock icons, these buttons allow the *V Crop*, *H Crop*, *Side Panels* and *Anamorphism* controls to be "locked". When a control is locked, user access to that control is disabled. Changes to unlocked controls will not affect the data values of locked controls. There is some interactivity within the locking function, as follows:

- If either *V Crop* or *H Crop* is locked, *Anamorphism* is unlocked.
- If either *Side Panels* or *Anamorphism* is locked, the other is unlocked, along with *V Crop* and *H Crop*.

### 5.4.1.3 Presets sub-section

For convenience in manual operation, several of the most common conversion situations are pre-programmed into the XVP-3901, and can be quickly accessed. The available Presets change according to the AFD mode and Output Format selections made using the pull-downs on the input and output screens.

The chart in Figure 5.13 illustrates graphically the effect of each preset on the input image.

- Only those presets for which an output is shown will appear on the Video Output panel.
- For example, when the input and output formats are the same, only the *Bypass* button will appear
- In all cases, a button labeled *Custom* will appear, and will be selected whenever the parameter settings do not correspond exactly to one of the available presets

The advantage of using Presets is to provide a unique conversion without having to specify the H&V scaling factor or the percentage of cropping/side panels and anamorphism. When an ARC Preset is selected, it re-centers the output picture in case of side panels or letterbox, but it does not affect the output masks.

Output Format 16:9		
Input Format (selected by AFD Mode pulldown)	4:3	16:9
Presets	Output after ARC processing	
Anamorphic		
Side Panels 25%		
Crop 25%		
14:9		
Bypass		

**Figure 5.13** Available Presets for various AFD Mode selections (16:9 output)

#### 5.4.1.4 Masks sub-section

##### *Mask: Horizontal and Vertical*

Sometimes with aspect ratio conversion, some of the edges of the original image are exposed in the output signal. Often, there will be artifacts in the source along these edges, extending for several lines vertically or several pixels horizontally after conversions. Masks are adjustable “curtains” which can be used to frame the output image, covering up the edge artifacts and leaving a clean transition from image to mask.

Four scroll boxes with data windows for reporting and direct data entry are used to set the mask position on the four sides of the output image. Top and bottom position are set in lines, while left and right position are set in pixels.

Masks should be adjusted by viewing the output on a video monitor and positioning the masks to cover edge effects with a minimum loss of clean picture content. Usually masks are the final adjustment to be made. The masking is shown on the top right Output screen by graying out the masked portion. Note that mask – or Background - color may be changed in the *Advanced* tab. The maximum amount of masking that can be introduced depends on the image

format, and is measured starting from the edges of the displayed image, as shown in the following table. Masks can cover a maximum of 25% of the active area.

**Note:** all masks are adjusted in steps of 2 pixels or 2 lines. *Available Presets for various AFD Mode selections (16:9 output)*

### 5.4.2 3G/HD Output – Timing tab

The Timing tab provides access to timing adjustments which affect the signal outputs. There are two slider controls, each with a data reporting box which shows the current value, and into which values can be typed directly. The total delay is reported at the top of the window.

**Vertical HD (lines):** With this adjustment, a value ranging from -16 to +15 lines compared to the reference or the processing delay, may be set. This adjustment can be used in conjunction with the horizontal timing adjustment.

**Horizontal HD (µs):** With this adjustment, a value ranging from zero to the equivalent of 1 horizontal line in the current output format compared to the reference or the frame boundary may be set.

**Additional Frame Delay:** This parameter affects the overall processing delay of the card. It adds supplemental frame delay to the current processing delay. This parameter will add a delay ranging from 0 to 15 interlaced frames (steps of 33 ms in 59.94 Hz and 40 ms in 50 Hz) to the current processing delay. Without a reference, the normal processing delay is 1 frame. You can extend this delay up to 16 frames if the additional delay is 15. With a reference, up to 15 frames can be added to the frame sync delay which depends on the timings between the input and the reference.

Note that, in order to compensate for the processing delay of a Dolby E/ and Dolby Digital decoder or a Dolby E encoder installed on the XVP-3901 or on the companion audio card, the additional frame delay must be set to at least one (1) frame. On the other hand, if a Dolby Digital and Dolby Digital Plus encoder is installed, the additional frame delay must be set to at least six (6) frames for 59.94 Hz formats and at least five (5) frames for 50 Hz formats.

### 5.4.3 3G/HD Output – Advanced tab

The *Advanced* tab provides controls over the type and level of detail enhancement that will be performed, and the color of the mask. The panel differs between 3G/HD output and SD output

#### 5.4.3.1 Image Processing section

**MPEG Preprocessor Mode:** This control changes the functionality of the detail enhancer.

- When MPEG preprocessor is activated ('ON'), the adaptive detail enhancer will use a psycho-visual model to increase the level of details and the sharpness of edges without adding high frequency content that may be difficult to encode at a lower bit rate on a downstream MPEG encoder.

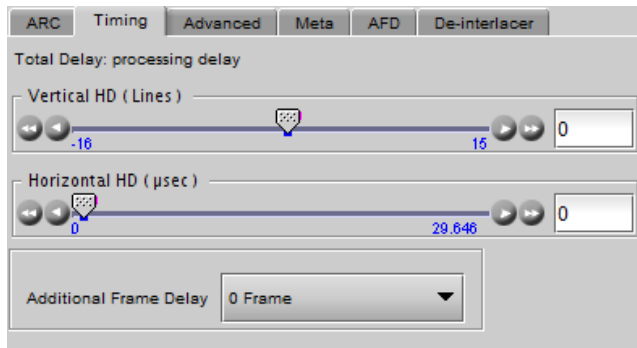

Figure 5.14 Video Output 3G/HD - Timing

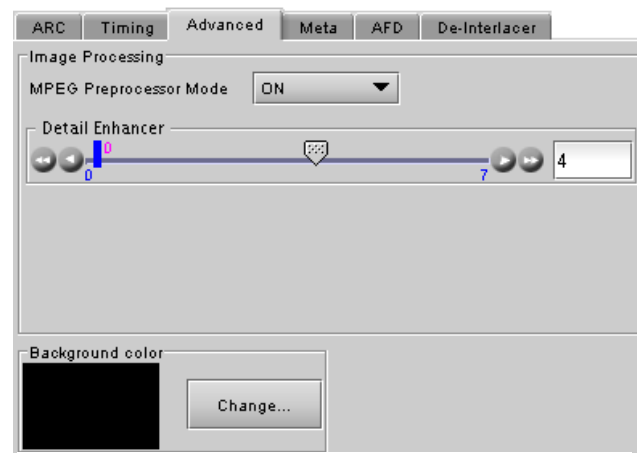

Figure 5.15 Video Output 3G/HD – Advanced tab

- When the MPEG preprocessor is deactivated (*OFF*), the adaptive detail enhancer will increase the details and the sharpness of edges without causing ringing on the HD output. In this mode (*OFF*), high frequency content is added to the HD video output to improve graphic contents and characters. This setting is very useful for upconverted material in character generation (CG) applications.

**Detail Enhancer:** Enhances the perceived sharpness of fine detail and edges. A single control adjusts both Horizontal and Vertical detail enhancement: a slider and a data reporting/entry box allow the user to select a value ranging from 0 (no enhancement) to 7 (maximum enhancement). The default value varies according to the processing mode: 4 for SD to HD mode and 0 for HD to HD mode.

### 5.4.3.2 Background Color section

The color patch (black by default) indicates the color that will be used for the masks, and will therefore surround the output image when it does not occupy the full output screen. Click on the *Change...* button to open the Background Colors window. This window includes YCbCr sliders with data entry boxes, and a color preview patch. The color is represented by an 8-bit value for each component.

- If you have selected an illegal RGB color, it will be flagged as “Invalid RGB” beneath the color patch, and also within the color patch shown in the Advanced tab if you apply it. This invalid RGB color will not be clipped by the Gamut correction. Make sure you select a valid RGB color if you care about Gamut errors.
- Colors for HD and SD masks are specified independently when the corresponding output format is selected. The same color is used in 720p and 1080i.

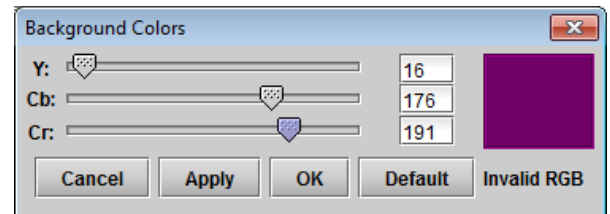

Figure 5.16 Background color

### 5.4.4 3G/HD Output – Meta tab

The Meta tab provides resources to deal with Metadata incorporated into the incoming signal.

#### 5.4.4.1 Meta / Meta sub-tab

##### Closed Caption section

**Presence:** this icon turns green in the presence of valid incoming EIA-708-B or EIA-608-B closed captioning data as per SMPTE-334M when an HD source is installed or when line 21 closed captions are detected when an SD source is installed.

**Insertion:** The pull-down is used to select between *Auto* or *OFF*. Availability of these controls is affected by whether or not Line 21 of the input SD or output SD signal has been configured as blanking; see *SD Input/Output Config* subsection below for details.

When *Auto* is selected, closed captioning information is processed as follows:

- SD to 3G/HD Upconversion:**  
The closed-captioning information from line 21 field 1 and the V-chip information from line 21 field 2 of the incoming 525-line signal may be inserted as ancillary packets required for FCC compliance. NTSC and DTV closed captions will be embedded, in the 3G/HD

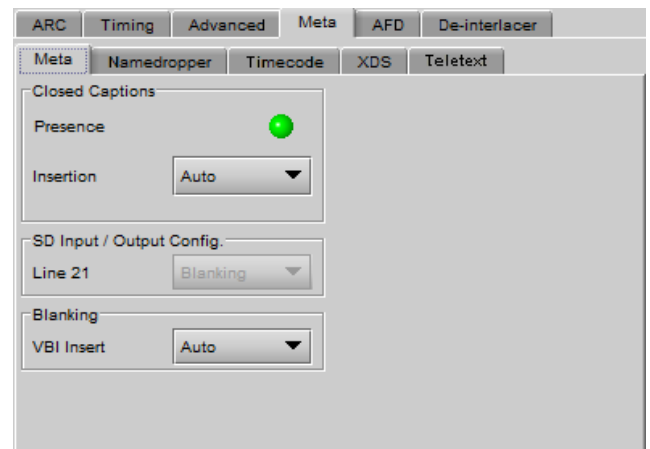

Figure 5.17 Video Outputs 3G/HD - Meta/Meta

outputs, within EIA-708-B packets as per SMPTE 334M. CC1 from NTSC field 1 is up-converted to DTV service 1, and CC3 from field 2 is up-converted to DTV service 2.

- **3G/HD to 3G/HD Cross-conversion:**  
EIA-708-B closed captions are detected at the input and re-inserted into the output 3G/HD signal conforming to the selected output 3H/HD format. EIA-608-B closed captions as per SMPTE 334M are not converted. Closed captions insertion is disabled for 50Hz and 1080p23/1080p23sF/1080p25/1080p29 sources.

**SD Input/Output Config section**

*Line 21:* Specifies if line 21 (or line 23 in PAL) shall be considered as blanking or active video; this selection affects *Close Caption* availability, controlled in the *Close Caption* sub-section of this tab (see above). Depending on the settings and input/output selected, it also affects the output video, as shown in this table:

For 3G/HD Output:

Input Format	Line 21 Status	CC Insertion	Effect on HD Output
3G/HD 60 Hz	N/A	Off	No DTV closed captions.
	N/A	Auto	DTV closed captions enabled
SD 60 Hz	Blanking	Off	Input line 21 ignored for scaling, image slightly upscaled. No DTV closed captions.
		Auto	Input line 21 ignored for scaling, image slightly upscaled. DTV closed captions enabled.
	Active	N/A	Input line 21 has video. No DTV closed captions.
3G/HD 50 Hz	N/A	N/A	No effect
SD 50 Hz	Blanking (line 23)	N/A	Input line 23 ignored for scaling, image slightly upscaled. No DTV closed captions.
	Active	N/A	Input line 23 has video. No DTV closed captions.

The *Line 21* pulldowns in the SD Output Meta/Meta subtab and the 3G/HD Output Meta/Meta subtab follow each other – change one and the other is also changed.

**Blanking section**

Insertion of the Vertical Blanking Interval content may be set to *OFF* or *Auto*, using the pull-down box. Insertion is disabled if no VBI data is present.

- For HD outputs, VBI insertion may only be enabled when the detected input is HD.
- Audio, closed-captioning, time-code, and AFD data is not handled by this parameter. The only exception is time code during HD-to-HD operation, in which case the user must enable this parameter along with the time code insertion pulldown menu, in order to properly process time code insertion.
- HD to HD (same format): All incoming HANC packets within H blanking and VANC packets within VBI may be bypassed to the output.
- HD to HD (different format) cross-conversions also supported.
- HD to HD blanking conversions are applied on luminance channel only. Packets in chrominance channel not supported.
- VBI insertion is disabled for 1080p23/1080p23sF/1080p25/1080p29 input HD formats
- 3G to 3G conversions: same as for HD to HD conversions

**5.4.4.2 Meta / Namedropper sub-tab**

Namedropper is a method of inserting control information for down-stream graphics inserters. It is a waveform-shape located on line 18 in SD, but a VANC packet on line 11 in HD.

The XVP-3901 detects the presence of Namedropper data in the program arriving at its input, and flags it using the status icon in this panel, which turns green when Namedropper data is detected.



Figure 5.18 Video Output 3G/HD - Meta/Namedropper

### 5.4.4.3 Meta / Timecode sub-tab

**SD inputs:** In the case of an SD input, the DVITC in the VBI interval is transcoded into ATC time code packets for the 3G/HD output.

Two types of ATC packets may be produced in 3G/HD:

- VITC
- LTC.

VITC type time code is handled by Timecode 1 parameters whereas Timecode 2 parameters handle LTC type time code insertion in 3G/HD. It is not possible to automatically detect 2 different lines of timecode. In order to have the possibility to enable and produce LTC type time code make sure to set the SD Detection Line in Timecode 1 to a specific line number. Doing so will unlock the Timecode 2 parameters.

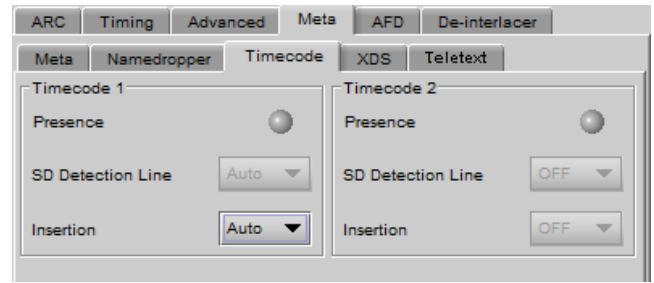

Figure 5.19 Video Output 3G/HD - Meta/Timecode

**HD inputs:** all incoming ATC packets (including type LTC) are bypassed to the HD output. **Make sure to enable both timecode and VBI (in Meta tab) parameters.**

The XVP-3901 does not pass LTC type timecode detected within input HD formats 1080p23 / 1080p23sF / 1080p25 / 1080p29. It is not necessary to enable VBI to pass incoming VITC type time code for the aforementioned formats.

Timecode binary group data is guaranteed to be transparent from input to output, except for 1080p23/1080p23sF/1080p25/1080p29 input formats.

**Presence:** A presence icon is available for each type of incoming ATC packet. The Timecode 1 Presence icon turns green when VITC type timecode is detected and the Timecode 2 Presence icon turns green when LTC type timecode is detected. If the input is SD, then the presence of each icon depends on the selection of the SD Detection Line parameter.

**SD Detection Line:** Select *AUTO* mode to automatically detect the line that contains the timecode. If time code appears on multiple lines, the first is selected. Select a specific line if desired; this allows a choice to be made when multiple time code lines are present. There is no AUTO selection available for Timecode 2.

**Insertion:** Insertion options are available through a pull-down menu, offering these choices:

- AUTO: Time code is inserted if present; insertion is disabled if no time code is present.
- OFF: Time code insertion at the output is disabled.

### 5.4.4.4 Meta / XDS sub-tab

This tab displays controls and settings for V-Chip and Copy Generation Management System (CGMS) control. The settings in this tab affect both HD and SD outputs simultaneously.

#### V-Chip Program Rating

The Presence icon is green when V-Chip information is detected within incoming SD line 21 (CEA-608) or HD (CEA-708 NTSC bytes) closed-captions, and gray otherwise. This presence icon is held green for 10 seconds after V-Chip information has stopped being detected.

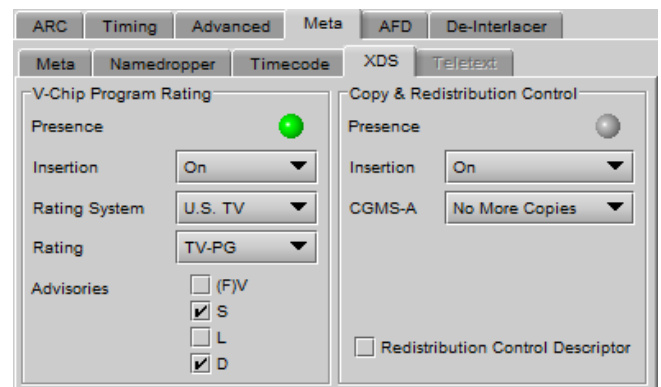

Figure 5.20 Video Outputs SD - Meta/XDS tab



**Note:** In order for V-Chip information to appear at the outputs, you must enable Closed Captions insertion for the intended output. The control is found on the Video Outputs/Meta/Meta subtab; see section 5.4.4.1 on page 35.

*Insertion:* Use the pulldown to turn insertion ON or OFF.

- When ON, information is inserted according to the Rating System, Rating and Advisories selected here. Any incoming V-Chip information is overwritten

If no closed-captions are detected at the input, this feature will effectively become a V-Chip generator.

- When OFF, any incoming V-Chip rating information is passed through untouched.

If no closed-captions are detected at the input, none will be available at the outputs

*Rating system and associated ratings:*

MPA	U.S. TV	CDN E	CDN F
N/A	None	E	E
G	TV-Y	C	G
PG	TV-Y7	C8+	8 ans +
PG-13	TV-G	G	13 ans +
R	TV-PG	PG	16 ans +
NC-17	TV-14	14+	18 ans +
X	TV-MA	18+	
Not Rated			

*Advisories:*

These apply only to the U.S. TV rating system; disabled when any other system is selected.

- (F)V Violence (FV = fantasy violence for children’s programming)
- S Sexual situations
- L Coarse or crude language
- D Suggestive dialog

**Copy and Redistribution Control (CGMS)**

The Presence icon is green when CGMS information is detected within incoming SD line 21 (CEA-608) or HD (CEA-708 NTSC bytes) closed-captions, and gray otherwise. This presence icon is held green for 10 seconds after CGMS information has stopped being detected.

**Note:** In order for CGMS information to appear at the outputs, you must enable Closed Captions insertion for the intended output. The control is found on the Video Outputs/Meta/Meta subtab; see section 5.5.4.2 on page 51.

*Insertion:* Use the pulldown to turn insertion ON or OFF.

- When ON, information is inserted according to the selection made in the CGMS-A pulldown and the Redistribution Control Descriptor (RCD) checkbox. Any incoming information is overwritten.

If no closed-captions are detected at the input, this feature will effectively become a CGMS generator.



- When OFF, any incoming CGMS information is passed through untouched.

Insertion: Use the pulldown to turn insertion ON or OFF.

- When ON, information is inserted according to the selection made in the CGMS-A pulldown. Any incoming information is overwritten.
- When OFF, any incoming copy/distribution information is passed through untouched.

CGMS-A options:

- Copying permitted
- No more copies
- One copy permitted
- No copy permitted

Redistribution Control Descriptor: select this checkbox to force the RCD bit found within the CGMS XDS packet to 1.

For a full description of CGMS control and its purpose, refer to the CEA-608 standard.

#### 5.4.4.5 Meta / Teletext sub-tab

In **50 Hz operation only**, incoming teletext on SD signals can be converted to OP-47 and inserted in the HD output. This panel configures this functionality.

**SD inputs** – incoming SD Teletext waveforms conforming to the ETSI EN 300 706 standard are converted to OP-47 packets and inserted in the outgoing HD signal.

- The *Incoming Teletext Presence* indicators 7 to 22 indicate the SD lines where teletext data, conforming to ETSI EN 300 706, has been detected.
- Use the checkboxes in the *Teletext to OP-47 Selection* area to choose the lines whose teletext information will be converted to OP-47 and inserted in the HD output.

The insertion mode pulldown offers two modes of operation:

- OFF – no teletext packets will be inserted as OP-47 at the output
- AUTO – the incoming teletext from the lines selected in the *Teletext to OP-47 Selection* checkboxes above the pulldown will be converted to OP-47 packets, and inserted in the outgoing HD signal, in the line selected in the *Insertion Line* pulldown.

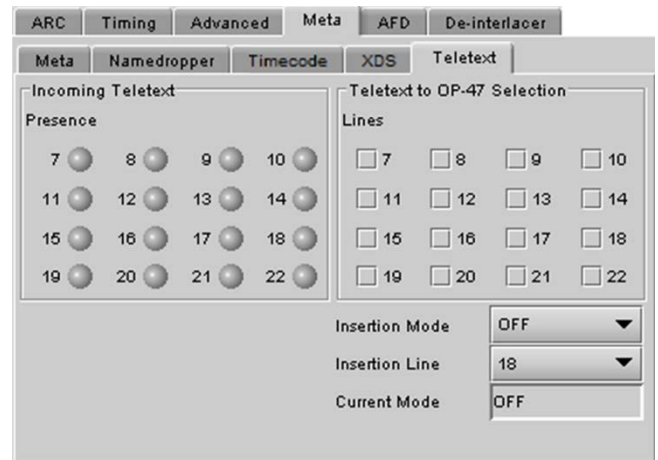

Figure 5.21 Video Output 3G/HD - Meta/Teletext tab

**HD Inputs** – incoming teletext (OP-47) is passed through to the output as received (PASS mode).

- The presence indicators 7 to 22 represent SD line number data detected in any incoming OP-47 packet. For example, if presence indicators 8 and 10 are turned on, this indicates detected OP-47 data is carrying teletext data derived from (or targeted for) SD lines 8 and 10.
- The *Teletext to OP-47 Selection* checkboxes are active, and can be configured so as to be ready when the input is switched to an SD source. They have no effect on an HD source.

**Current Mode** – this databox displays the current operating mode – AUTO, OFF or PASS

### 5.4.5 3G/HD Output – AFD tab

The Active Format Descriptor (AFD) flag is used to identify the aspect ratio and protected areas of a video signal. The XVP-3901 uses this flag in some cases to adjust the output aspect ratio and image cropping to obtain the best possible presentation of the image. The AFD flag is implemented differently in SD and HD:

- In HD, the AFD flag (SMPTE 2016) is sent in an ancillary packet, normally found on line 11 in the vertical ancillary space.
- In SD, the AFD flag may be sent as a VLI signal (RP 186), as a WSS signal (ITU-R BT.1119-2) for PAL only, and as an AFD packet (SMPTE 2016).

When an AFD flag is present at the input, the card can perform an automatic adjustment of the aspect ratio. See the appendix for more details.

#### 5.4.5.1 Default settings section

*Default/Forced:* this text box is labeled according to the mode selected in the Input Screen pulldown in the Video Output Group – see page 30

- In AUTO mode, labeled DEFAULT and shows the current default AFD code to be used if no valid AFD code is detected at the input.
- In FORCED mode, labeled FORCED, and shows the code that is forced into the system input regardless of the actual input code.
- In 4:3 (SD input) or 16:9 mode, the data box is empty and the controls are grey. In this mode, ARC settings can be manually set using the ARC tab controls.

*Change:* Click the Change button to open the *Select AFD* panel showing the available AFD codes that could be used as the default. Click on one to select it, then click *Apply* or *OK* at the bottom of the panel.

*Keep Last:* click in this checkbox to use the last detected AFD code at the input as the default code to be used in the *Auto* mode when no AFD flag is detected. This box is disabled in the *Forced* mode.

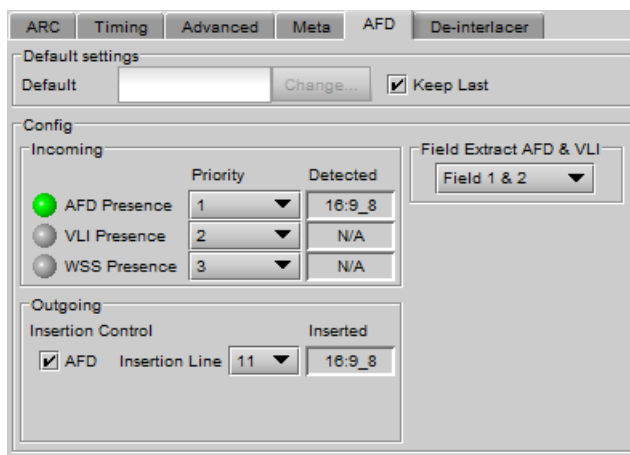

Figure 5.22 Video Output 3G/HD – AFD tab

#### 5.4.5.2 Config section

**Incoming** – the three types of AFD are shown, with a presence icon for each, and a pulldown to establish the priority of each type. The priorities are reset with each new selection; e.g. if AFD is 1 and VLI is 2, and you use the pulldown to choose VLI priority as 1, then AFD will be bumped down to 2.

- Ignore a specific flag completely by selecting “Don’t use” as its priority level.

The available types depend on the input format – AFD only for HD inputs; AFD and VLI for SD-59.94 Hz inputs, and all three types for SD-50 Hz inputs.

The set priority is used only during AUTO mode. The XVP-3901 will examine the incoming data in the selected order of priority in order to extract the AFD data. If, in AUTO mode, an AFD flag is set to priority 1 and is missing at the input, the XVP-3901 will use the incoming AFD flag set to the next priority level.

The *Detected* box shows the AFD code detected.

**Outgoing** – on the HD output, the AFD code shown in the *Inserted* box will be inserted in the line selected in the *Insertion Line* pulldown, as an Ancillary Aspect Ratio packet (SMPTE 2016). Deselect the AFD checkbox to inhibit insertion. Note that VLI and WSS flags cannot be inserted on HD-SDI signals.

**Field Extract AFD & VLI** – Select the field from which AFD and VLI will be extracted:

- Field 1
- Field 2
- Field 1 & 2

Note that this selection applies to both HD and SD outputs, and can also be set from the equivalent panel in the SD Output section (see page 57).

### 5.4.6 3G/HD Output – De-interlacer tab

Some interlaced video sources are film-based originating from 24p film images. For optimum scaling performance, it would be best to de-interlace this type of source by simply merging the source’s fields to recreate the original 24p image, thereby introducing no de-interlacing artifacts prior to scaling and format conversion.

*Film mode:* When The Film Mode selection is set to ON, the XVP-3901 monitors the input for film-based sequences and applies the proper algorithm.

Film detection is provided for 3:2, 2:2 (59Hz and 50 Hz sources) and 5:5 sequences.

*Video Over Film:* When the film mode is enabled, turn ON the Video-Over-Film (VOF) function to detect and bypass field-merging on certain video regions such as scrolling video characters over an entire film frame, thereby preventing any unwanted combing effects.

There is only one de-interlacer on the card. Any changes made within this tab will be copied over to the De-interlacer tab in the Video Output (SD) panel.

### 5.5 Video Outputs panel – SD Output tab

This panel allows control over several aspects of the standard definition video output:

- aspect ratio conversion
- timing control
- image quality processing
- metadata insertion.

The upper portion of the panel is occupied by two video screen images, labelled *Input* and *Output*. These screens do not show the actual video being processed by the XVP-3901, but rather show graphic images that represent the geometric aspects of the input signal and the output that results after it is exposed to the current ARC processing functions. The image is a green circle on a white background; the circle is



Figure 5.23 Video Output 3G/HD - De-Interlacer tab



Figure 5.24 Video Outputs – SD Output

used because it is easy to see if it is asymmetrical. Lines on the images indicate protected areas for the AFD implementation.

Aspect Ratio Conversion (ARC) modifies the video active picture shape as the signal is converted between SD at 4:3 aspect ratio and HD/SD at 16:9 aspect ratio. If the input is simply stretched or squeezed to fit the output, the image will be asymmetrically distorted; this is called *anamorphic* distortion. If the image is expanded or contracted symmetrically, it must be cropped, and/or have new blank background segments added to it, in order to fill the output picture. The ARC processing in the XVP-3901 allows a wide range of symmetrical and asymmetrical picture size modification, coupled with cropping and background addition, to be applied to an input signal.

When the Input AFD Mode is set to *Auto*, all the ARC settings are set automatically according to the AFD flag (see the table in Annex 2 beginning on page 148) and cannot be changed by the user.

- There are some exceptions – with certain input AFD codes the masks can be customized. Each mask can be customized for each different AFD code allowing different mask settings according to each specific code. For certain AFD codes that are less used, the masks cannot be configured and will be de-activated.

### The Input Screen

The *Input* preview screen shows the portion of the input image which will be presented at the XVP-3901 output. It has a pull-down *AFD Mode* menu at the top left corner through which the user selects the aspect ratio of the input signal. Available choices are: [4:3, 16:9, Auto, Forced] for SD inputs and [16:9, Auto, Forced] for HD inputs.

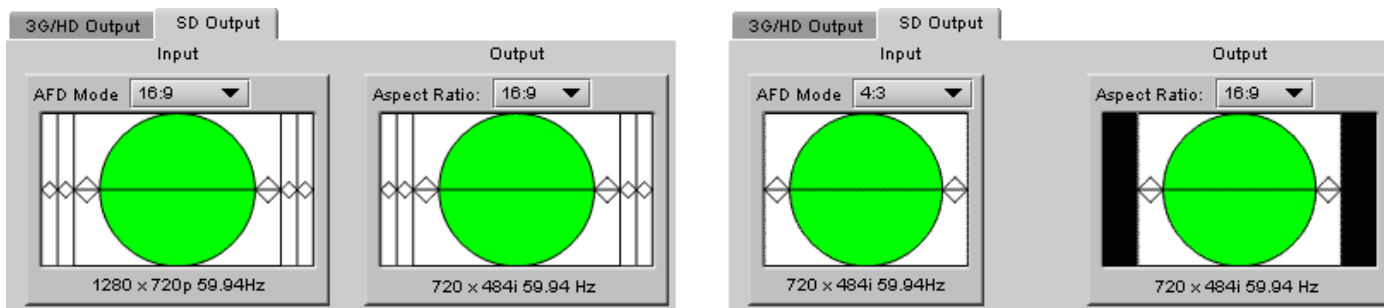

Figure 5.25 Screens for SD output

You can configure the AFD mode differently for an SD input than for a 3G/HD input. The card will remember the different parameters and will load them automatically without user intervention based on whether the video input is SD or 3G/HD. Ensure the card has a video signal of the desired format before changing the AFD mode configuration.

**Note 1 – Auto mode:** When *Auto* is selected, all the ARC values are automatically set based on the AFD flag detected at the input, and the ARC controls and presets described below are **disabled**. Annex 2 shows the AFD functions implemented. If no AFD flag is detected at the input, the card uses the Default AFD flag specified in the AFD tab

**Note 2 – Forced mode:** Forced mode is useful when the input AFD flag is unreliable, missing or if the user wants a simple way to force the aspect ratio conversion. The function is the same as the *Auto* mode, except that the incoming AFD flag is ignored, and a user-specified forced flag is used instead. As in the *Auto* mode, the ARC controls and presets described below are **disabled**.

**Note 3 – 4:3 or 16:9:** ARC settings can be manually set using the ARC tab controls.

The input screen shows how much of the input signal will appear at the output after the ARC processing in the XVP-3901. It does so by showing any cropped portions of the image in blue.

### The Output Screen

The output screen shows the final result of the ARC processing.

- The letterbox and side panel regions are shown in the selected background color

- The masks are shown in Gray

A pull-down menu at the top of the screen allows the user to select the output aspect ratio:

- Either 4:3, 16:9, or AUTO.
- AUTO output setting allows the XVP-3901 to automatically select between a 4:3 or 16:9 output aspect ratio. This decision is based on factors including the input AFD flag during input AUTO or FORCED modes, and the ARC settings during manual modes. The aim of this output AUTO mode is to reduce the amount of side panel or letterbox regions. Refer to the AFD table at the end of this document in order to understand visually this mode of operation

Incoming AFD	SD Output AFD code insertion			Incoming AFD	SD Output AFD code insertion		
	4:3	16:9	Auto		4:3	16:9	Auto
4:3_2	4:3_2	16:9_8	16:9_8	16:9_2	4:3_8 or 4:3_10	16:9_2	16:9_2
4:3_3	4:3_3	16:9_11	4:3_3	16:9_3	4:3_11	16:9_3	16:9_3
4:3_4	4:3_4	16:9_4	16:9_4	16:9_4	4:3_4	16:9_4	16:9_4
4:3_8	4:3_8	16:9_9	4:3_8	16:9_8	4:3_8 or 4:3_10	16:9_8	16:9_8
4:3_9	4:3_9	16:9_9	4:3_9	16:9_9	4:3_8	16:9_9	4:3_8
4:3_10	4:3_10	16:9_8	16:9_8	16:9_10	4:3_10	16:9_10	16:9_10
4:3_11	4:3_11	16:9_11	4:3_11	16:9_11	4:3_11	16:9_11	16:9_11
4:3_13	4:3_13	16:9_11	4:3_13	16:9_13	4:3_13	16:9_11	4:3_13
4:3_14	4:3_14	16:9_14	16:9_14	16:9_14	4:3_11	16:9_14	16:9_14
4:3_15	4:3_15	16:9_15	16:9_15	16:9_15	4:3_8	16:9_15	16:9_15

Table 1 ARC decisions based on incoming AFD and 4:3/16:9/Auto mode selection

Note: when a choice of AFD flags is offered, preferred behavior can be set using the *Alternate ARC* control found under the AFD tab.

- The output format is shown at the bottom of the window: 720x484i 59; 704x484i 59; 720x576i 50; 704x576i 50.
  - Note – when an HD input is down-converted to SD, the output Horizontal resolution can be selected as either 720 pixels (default) or 704 pixels. The choice is made in the *Video Output – Advanced* panel (see page 50) and is displayed beneath the output screen. In all other cases the SD Horizontal resolution is 720 pixels.

### 5.5.1 SD Output – ARC tab

Under the ARC tab, several sub-sections are found allowing extended control over how the output will be displayed. For convenience, ARC presets are available for frequently-encountered aspect ratio conversions.

- These controls are disabled when the ARC Mode pulldown on the Input Screen is set to *Auto* or *Forced*

You can configure the ARC parameters differently for an SD input than for a 3G/HD input. The card will remember the different parameters and will load them automatically without user intervention depending if the video input is SD or 3G/HD. Ensure the card has a video signal of the desired format before changing the configuration.

When using manual aspect ratio mode (AFD mode is 4:3 or 16:9), the card will remember automatically all the parameters for the different combinations of input/output aspect ratio conversions (see the combinations below). This means you can configure the card once for each type of conversion and then the card will restore the configuration automatically when the proper input format and input/output aspect ratio is encountered.

- SD 4:3 to SD 4:3
- SD 4:3 to SD 16:9
- SD 16:9 to SD 4:3
- SD 16:9 to SD 16:9
- 3G/HD 16:9 to SD 4:3
- 3G/HD 16:9 to SD 16:9

### 5.5.1.1 Input section

*Input: Crop – Horizontal and Vertical*

The crop controls allow selection of a portion of the original image – the amount of horizontal and vertical cropping is expressed as a percentage of the size of the original image.

The user can manually adjust the level of horizontal and vertical cropping. Horizontal cropping is done on an 8-pixel basis. Vertical cropping is done on 4-line basis. To achieve non-symmetrical vertical or horizontal cropping, uncheck the *Center* box underneath and position the image using the *Tilt* function described below.

Input cropping changes the scaling factor between the input and the output. If we crop the input (H&V) by 10%, the output image is resized and scaled by +10%. By providing different H and V cropping, the user can produce an anamorphic image.

The padlock icon appearing next to the data window allows the data to be “locked”. See the paragraph *Locking controls* under *Output sub-section* below for a discussion of this option.

*Input: Tilt*

Once a smaller window has been established by cropping the input signal, it can be moved vertically (*Tilt*, expressed in lines) within the original image to place the desired portion of the image in view. By default, a *Center* check box beneath the Tilt scroll box forces the cropping window to be centered on the input window. When it is checked, the necessary Tilt value will be calculated and displayed in the Tilt data window. You cannot tilt when cropping value is zero.

*Input: Pan*

Once this smaller window is established, it can be moved horizontally (*Pan*, expressed in pixels) within the original image to place the desired portion of the image in view. A *Center* check box beneath the Pan scroll box forces the cropping window to be centered on the input window. When checked, the necessary Pan value will be calculated and displayed in the data window. You cannot Pan if the cropping value is zero.

### 5.5.1.2 Output section

*Output: Side Panels / Letterbox*

This scrollable data entry box is used to shrink the width of the image so that the output image has blanked areas on each side of the displayed picture, which occupy the indicated percentage of the screen width. These areas are

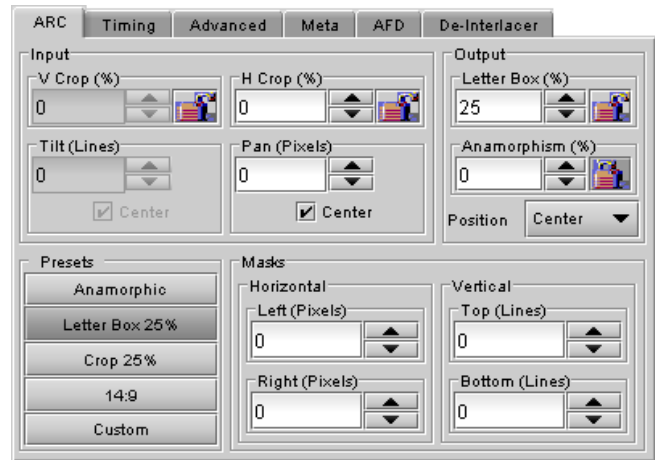

Figure 5.26 Video Outputs SD – ARC tab

symmetric about the center, so a setting of 25% side panels would show a bar 12.5% of the screen width on each side of the image. 25% is the maximum value; entering a smaller value reduces the width of the side panels, but crops the image top and bottom. This control is disabled when the input is 16:9.

Treatment of Letterbox is similar, except that blanked areas are above and below the image.

*Output: Position*

This control allows the positioning of the output picture when side panels or letterbox are present. For side panels, the picture can be moved totally to the left, centered or totally to the right. When letterbox is present, the picture can be moved to the top, to the center or to the bottom of the frame. This control is not available in Auto AFD mode or Forced AFD mode. The picture will be centered by default when an ARC Preset is selected.

*Output: Anamorphism*

This control box allows the output image to be resized asymmetrically. Anamorphism is expressed in percent, where positive values indicate an increase in width with respect to height, and negative values a decrease in width with respect to height.

*Locking controls*

Represented by padlock icons, these buttons allow the *V Crop*, *H Crop*, *Anamorphism* and *Side Panels* controls to be "locked". When a control is locked, user access to that control is disabled. Changes to unlocked controls will not affect the data values of locked controls. There is some interactivity within the locking function, as follows:

- If either *V Crop* or *H Crop* is locked, *Anamorphism* is unlocked.
- If either *Side Panels* or *Anamorphism* is locked, the other is unlocked, along with *V Crop* and *H Crop*.

### 5.5.1.3 Presets section

For convenience in manual operation, several of the most common conversion situations are pre-programmed into the XVP-3901, and can be quickly accessed. The available Presets change according to the AFD mode and Output Format selections made using the pulldowns on the input and output screens.

The charts in figures 5.26a and 5.26b illustrate graphically the effect of each preset on the input image.

- Only those presets for which an output is shown will appear on the Video Output panel.
- For example, when the input and output formats are the same, only the *Bypass* button will appear
- In all cases, a button labeled *Custom* will appear, and will be selected whenever the parameter settings do not correspond exactly to one of the available presets

The advantage of using Presets is to provide a unique conversion without having to specify the H&V scaling factor or the percentage of cropping/side panels and anamorphism. When an ARC Preset is selected, it re-centers the output picture in case of side panels or letterbox, but it does not affect the output masks.



Output Format 4:3 (when selected on the SD Video Output panel)		
Input Format (selected by AFD Mode pulldown)	4:3	16:9
Presets	Output after ARC processing	
Anamorphic		
Letter Box 25%		
Crop 25%		
14:9		
Bypass		

**Figure 5.27a** Available Presets for AFD Mode selections (4:3 output)



Output Format 16:9 (when selected on the SD Video Output panel)		
Input Format (selected by AFD Mode pulldown)	4:3	16:9
Presets	Output after ARC processing	
Anamorphic		
Side Panels 25%		
Crop 25%		
14:9		
Bypass		

**Figure 5.27b** Available Presets for various AFD Mode selections (16:9 output)

### 5.5.1.4 Masks section

#### Mask: Horizontal and Vertical

Sometimes with aspect ratio conversion, some of the edges of the original image are exposed in the output signal. Often, there will be artifacts in the source along these edges, extending for several lines vertically or several pixels horizontally after conversions. Masks are adjustable “curtains” which can be used to frame the output image, covering up the edge artifacts and leaving a clean transition from image to mask.

Four Scroll boxes with data windows for reporting and direct data entry are used to set mask position on the four sides of the output image. Top and bottom position are set in lines, while left and right position are set in pixels. Masks should be adjusted by viewing the output on a video monitor and positioning the masks to cover edge effects with a minimum loss of clean picture content. Usually masks are the final adjustment to be made. The masking is shown on the top right Output screen by graying out the masked portion. Note that mask – or Background - color may be changed in the *Advanced* tab. The maximum amount of masking that can be introduced depends on the image

format, and is measured starting from the edges of the displayed image, as shown in the following table. Masks can cover a maximum of 25% of the active area.

Image format	Pixels	Lines
525	106	76
625	106	88

**Note:** all masks are adjusted in steps of 2 pixels or 2 lines.

### 5.5.2 SD Output – Timing tab

The Timing tab provides access to timing adjustments which affect the signal outputs. There are two slider controls, each with a data reporting box which shows the current value, and into which values can be typed directly. The total delay is reported at the top of the window.

*Vertical SD (lines):* With this adjustment, a value ranging from  $-8$  to  $+7$  lines, compared to the reference or the processing delay, may be set. This adjustment can be used in conjunction with the horizontal timing adjustment.

*Horizontal SD ( $\mu$ sec):* With this adjustment, a value ranging from zero to the equivalent of 1 horizontal line in the current operating format (e.g. ranging from  $0$  to  $63.46 \mu$ s for 525-line operation and  $0$  to  $64.00 \mu$ s for 625-line operation) compared to the reference or the frame boundary, may be set.

*Additional Frame Delay:* This parameter affects the overall processing delay of the card. It affects both the HD and SD output by adding supplemental frame delay to the current processing delay. This parameter will add a delay ranging from  $0$  to  $15$  interlaced frames (i.e. steps of  $33$  ms in  $59.94$  Hz and  $40$  ms in  $50$  Hz) to the current processing delay. Without a reference, the normal processing delay is 1 frame. You can extend this delay up to  $16$  frames if the additional delay is  $15$ . With a reference, up to  $15$  frames can be added to the frame sync delay which depends on the timings between the input and the reference.

Note that, in order to compensate for the processing delay of a Dolby E and Dolby Digital decoder or a Dolby E encoder installed on the XVP-3901 or on the companion audio card, the additional frame delay must be set to at least one (1) frame. On the other hand, if a Dolby Digital and Dolby Digital Plus encoder is installed, the additional frame delay must be set to at least six (6) frames for  $59.94$  Hz formats and at least five (5) frames for  $50$  Hz formats.

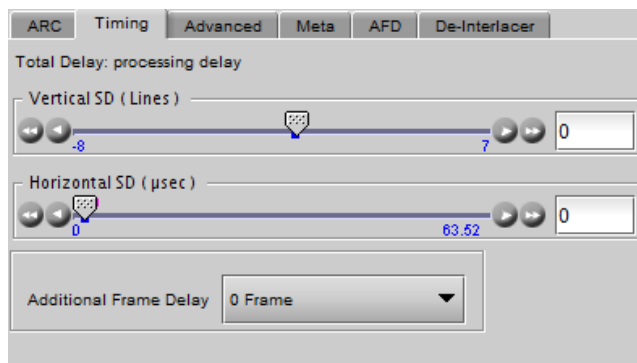

**Figure 5.28** Video Outputs SD - Timing tab

### 5.5.3 SD Output – Advanced tab

The *Advanced* tab provides controls over the type and level of detail enhancement that will be performed, and the color of the mask.

#### 5.5.3.1 Image Processing section

Separate controls are provided for Horizontal and Vertical detail enhancement:

*Horz. Detail Enhancer Mode:* this pull-down box controls the type of horizontal detail enhancement, which may improve sharpness of textures and contours.

- *High Freq* boosts high frequencies of the input signal
- *Medium Freq* boosts medium frequencies of the input signal

*Horz. Detail Enhancer:* a slider and a data reporting/entry box allow the user to select a value in the range 0 (no enhancement) to 7 (maximum enhancement). The default value is 1 for HD to SD mode, and 0 for SD to SD mode

*Vert Detail Enhancer Mode:* this pull-down box controls the type of vertical detail enhancement, which may improve sharpness of textures and contours.

- *High Freq* boosts high frequencies of the input signal
- *Medium Freq* boosts medium frequencies of the input signal

*Vert. Detail Enhancer:* a slider and a data reporting/entry box allow the user to select a value in the range -8 (some softening) to +7 (maximum enhancement). Set the value to 0 for no enhancement. The default value is 1 for HD to SD mode, and 0 for SD to SD mode

#### 5.5.3.2 Background color section

This color patch (black by default) indicates the color that will be used for the masks, and will therefore surround the output image when it does not occupy the full output screen. Click on the *Change...* button to open the Background Colors window. This window includes YCbCr sliders with data entry boxes, and a color preview patch. The color is represented by an 8-bit value for each component.

- If you have selected an illegal RGB color, it will be flagged as “Invalid RGB” beneath the color patch, and also within the color patch shown in the Advanced tab if you apply it. This invalid RGB color will not be clipped by the Gamut correction. Make sure you select a valid RGB color if you care about Gamut errors.
- Colors for HD and SD masks are specified independently when the corresponding output format is selected.

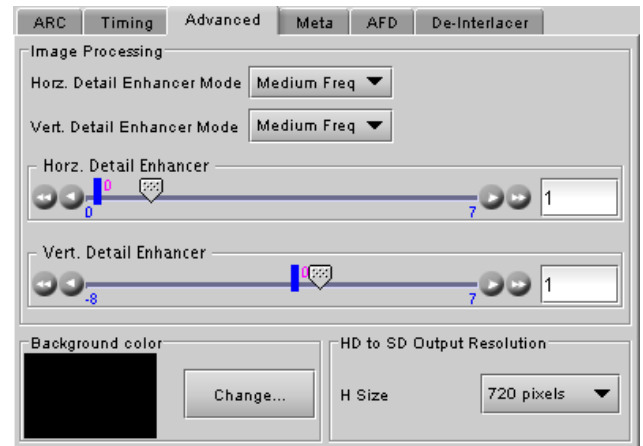

Figure 5.29 Video Outputs SD - Advanced tab



Figure 5.30 Background colors

### 5.5.3.3 HD to SD Output Resolution

Select the output image width (in pixels) when the SD output is down-converted from HD. Choices are: 720 pixels (default) and 704 pixels.

- Normal SD image width is 720 pixels. In ATSC applications MPEG encoders will crop to 704 pixels for encoding and the set-top box will stretch back to 720 pixels creating 2% anamorphism. To compensate for this problem, the user may select 704 pixels using the *H Size* pull-down. This will compress the down-converted image to 704 pixels instead of 720 pixels. When stretched back to 720 pixels by the set-top box, the anamorphism will be eliminated. This functionality is only available for HD-to-SD conversions. The factory default for this parameter is 720 pixels. The value selected here appears in the pull-down beneath the Output Screen at the top of the panel when an HD-to-SD down-conversion is selected.

### 5.5.4 SD Output – Meta tab

The Meta tab provides resources to deal with Metadata incorporated into the incoming signal. It has three associated sub-tabs, described below.

#### 5.5.4.1 Warning messages

Warning messages may appear at the bottom of the Meta and AFD panels when conflicts arise because of the settings. See Figure 5.28 for an example. The possible messages and their meanings are as follows:

- **AFD/ Timecode line insertion conflict. Refer to manual.** [message in red letters]  
*Conditions:* HD to SD, same line set for AFD and Timecode 1 (or Timecode 2) insertion (duplicate time code included)  
*Consequences:* Since DVITC timecode and SMPTE-2016 AFD cannot reside on the same line, timecode data will not appear on the insertion line but AFD data will be inserted.
- **AFD/ VLI line insertion conflict. Refer to manual.** [message in red letters]  
*Conditions:* Both AFD and VLI flags are inserted and AFD is set to line 14 during 59 Hz or line 11 during 50 Hz operation.  
*Consequences:* Since the SMPTE-2016 AFD cannot reside on the same line as VLI, the VLI flag will not appear on the insertion.
- **Dolby Metadata/Timecode line insertion conflict. Refer to manual.** [message in red letters]  
*Conditions:* HD to SD, same line set for Dolby Metadata VANC Stream1 (or Stream 2) and Timecode 1 (or Timecode 2) insertion (duplicate time code included)  
*Consequences:* Since DVITC timecode and Dolby metadata cannot reside on the same line, timecode data will not appear on the insertion line but Dolby metadata data will be inserted.
- **Dolby Metadata/VLI line insertion conflict. Refer to manual.** [message in red letters]  
*Conditions:* HD/SD to SD, line 14 (59 Hz) or line 11 (50 Hz) set for Dolby Metadata VANC Stream1 (or Stream 2) and VLI insertion enabled  
*Consequences:* Since VLI data is transmitted on line 14 for 525 output signals and line 11 for 625 output signals, VLI data will not appear on line 14 (or line 11 for 625) but Dolby metadata data will be inserted.
- **Dolby Metadata/Teletext line insertion conflict. Refer to manual.** [message in red letters]  
*Conditions:* HD/SD to SD (625 only), same line set for Dolby Metadata VANC Stream1 (or Stream 2) and teletext insertion  
*Consequences:* Since teletext and Dolby metadata cannot reside on the same line, teletext data will not appear on the insertion line but Dolby metadata data will be inserted.
- **Teletext/VLI line insertion conflict. Refer to manual.** [message in red letters]  
*Conditions:* HD/SD to SD (625 only), line 11 enabled for teletext and VLI insertion enabled

*Consequences:* Since VLI data is transmitted on line 11 for 625 output signals, it shall be replaced by any down-converted teletext data to be inserted on line 11.

- **Teletext/Timecode line insertion conflict. Refer to manual.** [message in red letters]  
*Conditions:* HD/SD to SD (625 only), same line enabled for teletext and Timecode 1 or Timecode 2 (duplicate time code included) insertion  
*Consequences:* Since DVITC timecode and teletext cannot reside on the same line, timecode data shall be replaced by any down-converted teletext data.
- **Timecode 2 will overwrite Timecode 1 insertion. Refer to manual.** [message in red letters]  
*Conditions:* HD to SD, same line set for Timecode 1 and Timecode 2 insertion (duplicate timecode included)  
*Consequences:* Any LTC type incoming timecode will be inserted over any VITC type incoming timecode specified by the Timecode 2 *SD Insertion Line* parameter.
- **AFD insertion will overwrite incoming TC/Teletext on insertion line. Refer to manual.** [in blue letters]  
*Conditions:* SD to SD, both AFD and VBI insertion enabled  
*Consequences:* Since timecode and SMPTE-2016 AFD cannot reside on the same line, any incoming timecode is blanked and the AFD data is inserted. This occurs on the selected AFD insertion line.
- **Dolby Metadata insertion will overwrite incoming TC/Teletext on insertion line. Refer to manual.** [in blue letters]  
*Conditions:* SD to SD, both Dolby Metadata and VBI insertion enabled  
*Consequences:* Since Dolby metadata and ancillary data like timecode cannot reside on the same line, any incoming timecode is blanked and Dolby metadata is inserted. This occurs on the selected Dolby metadata insertion line.
- **Dolby Metadata/AFD insertion will overwrite incoming TC/Teletext on insertion line. Refer to manual.** [in blue letters]  
*Conditions:* SD to SD, both Dolby Metadata and AFD including VBI insertion enabled  
*Consequences:* Since Dolby metadata, AFD, and ancillary data like timecode cannot reside on the same line, any incoming timecode is blanked and Dolby metadata or AFD is inserted. This, of course, shall occur on the selected Dolby metadata or AFD insertion line.

#### 5.5.4.2 Meta / Meta sub-tab

##### **Closed Caption section**

*Presence:* this icon turns green in the presence of incoming EIA-708-B or EIA-608-B closed captioning data when an 3G/HD source is installed or when line 21 closed captions are detected when an SD source is installed.

*Insertion:* The pull-down is used to select between *Auto* or *OFF*. Availability of these controls is affected by whether or not Line 21 of the input SD or output SD signal has been configured as blanking; see *SD Input/Output Config* subsection below for details.

When *Auto* is selected, closed captioning information is processed as follows:

##### *3G/HD to SD Downconversion:*

As described in EIA-708-B, closed captioning within a 3G/HD signal is embedded in the form of ANC packets. The XVP-3901 extracts all NTSC legacy (compliance) closed captions from within incoming EIA-708-B DTV closed captions, buffers, and re-inserts the data within line 21 of the output SD signals as per EIA-608-B standard. Processing is restricted to NTSC CC information (Service 0) only.

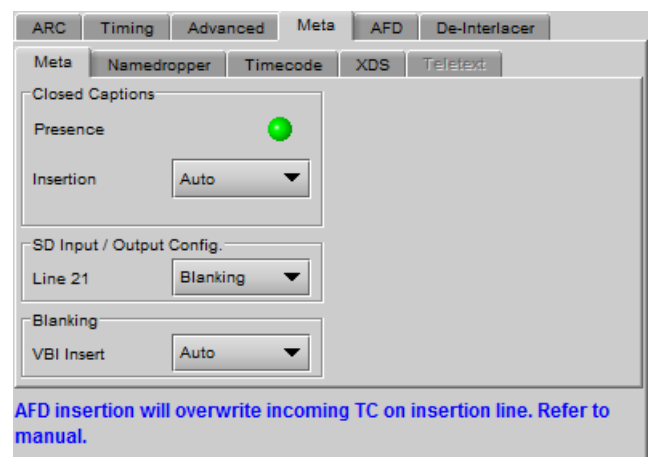

**Figure 5.31** Video Outputs SD - Meta/Meta tab

The XVP-3901 also supports incoming EIA-608-B CC packets conforming to SMPTE 334M. However, EIA-708-B packets have priority. If both are embedded in the source, the EIA-708-B packets are decoded, as explained above, and the EIA-608-B packets are discarded. If no EIA-708-B packets are detected, EIA-608-B packets are automatically extracted if detected.

Closed captions insertion is disabled for 50Hz and 1080p23/1080p23/1080p25/1080p29 sources.

*SD to SD operation:*

In order to allow the XVP-3901 to properly handle incoming closed captions on line 21, make sure to set *SD Input/Output Config* to *Blanking* and make sure to set *Insertion* to *Auto*.

**SD Input/Output Config section**

*Line 21:* Specifies if line 21 (or line 23 in PAL) shall be considered as blanking or active video; this selection affects *Close Caption* availability, controlled in the *Close Caption* sub-section of this tab (see above). Depending on the settings and input/output selected, it also affects the output video, as shown in this table:

*For SD Output:*

Input Format		Line 21 Status		CC Insertion	Effect on SD Output
3G/HD 60 Hz	Blanking	Off			Line 21 blanked, first active line is 22, image slightly downscaled
		Auto			CC run-in on line 21, first active line is 22, image slightly downscaled.
SD 60 Hz	Blanking	N/A			Line 21 has active video and may be resized.
		Active	Off		Line 21 blanked.
SD 60 Hz	Active	Auto			Input line 21 copied to output.
		N/A			Line 21 has active video and may be resized.
3G/HD 50 Hz	Blanking	N/A			Line 23 blanked, first active line is 24.
		Active	N/A		Line 23 has video and may be resized.
SD 50 Hz	Blanking	N/A			Line 23 blanked, first active line is 24.
		Active	N/A		Line 23 has active video and may be resized.

The *Line 21* pulldown also appears in the HD Video Output Panel, and the two follow each other; change the selection in one and the other is also changed.

**Blanking section**

Insertion of the Vertical Blanking Interval may be set to *OFF* or *AUTO*, using the pull-down box. Insertion is disabled if no VBI data is present.

- For SD outputs, VBI insertion may only be enabled when the detected input is SD.
- Audio, closed-captioning, time-code, and AFD data is not handled by this parameter. The only exception is time code during SD to SD operation, in which case the user must use this parameter to enable/disable time code insertion.
- SD to SD: All incoming HANC packets within H blanking, VANC packets within VBI, and VBI lines may be bypassed to the output.

**5.5.4.3 Meta / Namedropper sub-tab**

Namedropper is a method of inserting control information for down-stream graphics inserters. It is a waveform-shape located on line 18 in SD, but a VANC packet on line 11 in HD.

The XVP-3901 detects the presence of Namedropper data in the program arriving at its input, and flags it using the status icon in this panel, which turns green when Namedropper data is detected.



**Figure 5.32** Video Outputs SD - Meta/Namedropper



#### 5.5.4.4 Meta / Timecode sub-tab

If the input is 3G or HD SDI, the ATC packet will be transcoded to SD only when ATC timecode is present on the HD input video. When enabled, timecode insertion is automatic when there is embedded timecode in the source.

- The XVP-3901 supports two types of incoming 3G/HD ATC timecode conversion - VITC timecode and LTC type timecode.
- Timecode 1 parameters handle VITC type timecode whereas LTC type timecode is handled by Timecode 2 parameters.
- The XVP-3901 does not pass LTC type timecode within input HD formats  
1080p23/1080p23sF/1080p25/1080p29.
- Timecode binary group data is not guaranteed for  
1080p23/1080p23sF/1080p25/1080p29 input HD formats, but it will be transparent for all other input formats.

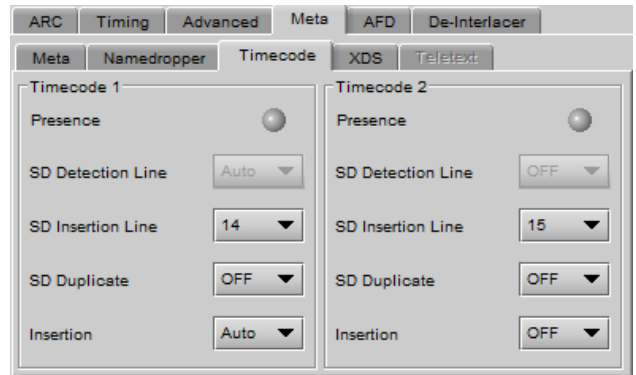

**Figure 5.33** Video Outputs SD - Meta/Timecode tab

**Presence:** A presence icon is available for each type of incoming ATC packet. The Timecode 1 Presence icon turns green when VITC timecode is detected and the Timecode 2 Presence icon turns green when LTC timecode is detected. If the input is SD, then the presence of each icon depends on the selection of the SD Detection Line parameter.

**SD Detection Line:** This parameter is only available when the input signal is SD SDI, and is used only for timecode presence. Select *AUTO* mode to automatically detect the line that contains the timecode. If time code appears on multiple lines, the first is selected. Select a specific line if desired; this allows a choice to be made when multiple time code lines are present.

**SD Insertion Line:** the line on which timecode is to be inserted is selectable through a pull-down menu, between lines 10 and 20 for 525-line output, and between lines 7 and 22 for 625-line output.

- This control is disabled when the input is SD

**Duplicate:** forces a second copy of the time code to be inserted on the 2<sup>nd</sup> line following the selected line. For example, selecting line 14 for time code insertion, and turning timecode duplication *ON*, will result in time code being inserted into both lines 14 and 16. Note that time code cannot be inserted on lines outside the allowable range, so for example, if line 19 is selected for time code insertion in a 525 line output, and timecode duplication is turned *ON*, the duplicate time code which would have appeared on line 21 will not be inserted because the upper bound for time code is line 20. Thus, the timecode duplication function has no effect when the selected line for time code is 19 or above for 525-line outputs, or 21 or above for 625-line outputs.

- This control is disabled when the input is SD

**Insertion:** Insertion options are available through a pull-down menu, offering these choices:

**AUTO:** Time code is inserted if present; insertion is disabled if no time code is present.

**OFF:** Time code insertion at the output is disabled.

- This control is disabled when the input and output are both SD. In this case, VBI Blanking may be used to enable/disable time code insertion – see *Blanking* sub-section above

### 5.5.4.5 Meta / XDS sub-tab

This tab displays controls and settings for V-Chip and Copy Generation Management System (CGMS) control. The settings in this tab affect both HD and SD outputs simultaneously.

#### V-Chip Program Rating

The Presence icon is green when V-Chip information is detected within incoming SD line 21 (CEA-608) or HD (CEA-708 NTSC bytes) closed-captions, and gray otherwise. This presence icon is held green for 10 seconds after V-Chip information has stopped being detected.

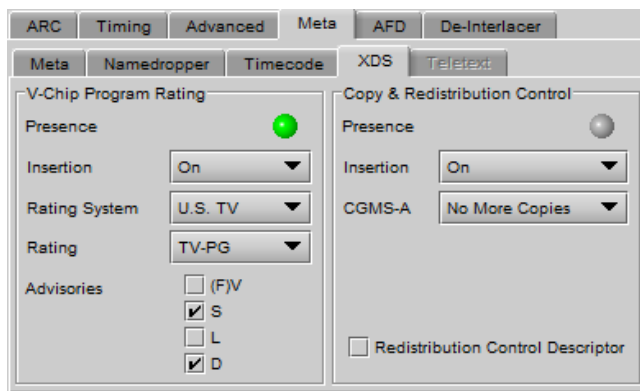

Figure 5.34 Video Outputs SD - Meta/XDS tab

**Note:** In order for V-Chip information to appear at the outputs, you must enable Closed Captions insertion for the intended output. The control is found on the Video Outputs/Meta/Meta subtab; see section 5.5.4.2 on page 51.

*Insertion:* Use the pulldown to turn insertion ON or OFF.

- When ON, information is inserted according to the Rating System, Rating and Advisories selected here. Any incoming V-Chip information is overwritten  
If no closed-captions are detected at the input, this feature will effectively become a V-Chip generator.
- When OFF, any incoming V-Chip rating information is passed through untouched.  
If no closed-captions are detected at the input, none will be available at the outputs

*Rating system and associated ratings:*

MPA	U.S. TV	CDN E	CDN F
N/A	None	E	E
G	TV-Y	C	G
PG	TV-Y7	C8+	8 ans +
PG-13	TV-G	G	13 ans +
R	TV-PG	PG	16 ans +
NC-17	TV-14	14+	18 ans +
X	TV-MA	18+	
Not Rated			

*Advisories:*

These apply only to the U.S. TV rating system; disabled when any other system is selected.

- (F)V Violence (FV = fantasy violence for children’s programming)
- S Sexual situations
- L Coarse or crude language
- D Suggestive dialog



### Copy and Redistribution Control (CGMS)

The Presence icon is green when CGMS information is detected within incoming SD line 21 (CEA-608) or HD (CEA-708 NTSC bytes) closed-captions, and gray otherwise. This presence icon is held green for 10 seconds after CGMS information has stopped being detected.

**Note:** In order for CGMS information to appear at the outputs, you must enable Closed Captions insertion for the intended output. The control is found on the Video Outputs/Meta/Meta subtab; see section 5.5.4.2 on page 51.

*Insertion:* Use the pulldown to turn insertion ON or OFF.

- When ON, information is inserted according to the selection made in the CGMS-A pulldown and the Redistribution Control Descriptor (RCD) checkbox. Any incoming information is overwritten.

If no closed-captions are detected at the input, this feature will effectively become a CGMS generator.

- When OFF, any incoming CGMS information is passed through untouched.

*Insertion:* Use the pulldown to turn insertion ON or OFF.

- When ON, information is inserted according to the selection made in the CGMS-A pulldown. Any incoming information is overwritten.
- When OFF, any incoming copy/distribution information is passed through untouched.

CGMS-A options:

- Copying permitted
- No more copies
- One copy permitted
- No copy permitted

Redistribution Control Descriptor: select this checkbox to force the RCD bit found within the CGMS XDS packet to 1.

For a full description of CGMS control and its purpose, refer to the CEA-608 standard.

#### 5.5.4.6 Meta / Teletext sub-tab

In **50 Hz operation only**, incoming OP-47 packets in HD signals can be converted to Teletext and inserted in the SD output. This panel configures this functionality.

**HD Inputs** – incoming OP-47 packets in the HD signal are converted to Teletext and inserted in the outgoing SD signal.

- The *Incoming Teletext Presence* indicators 7 to 22 represent SD line number data detected in any incoming OP-47 packet. For example, if presence indicators 8 and 10 are turned on, this indicates detected OP-47 data is carrying teletext data derived from (or targeted for) SD lines 8 and 10.
- The *SD Output Teletext Insertion Lines* checkboxes are used to select the SD output lines that can receive

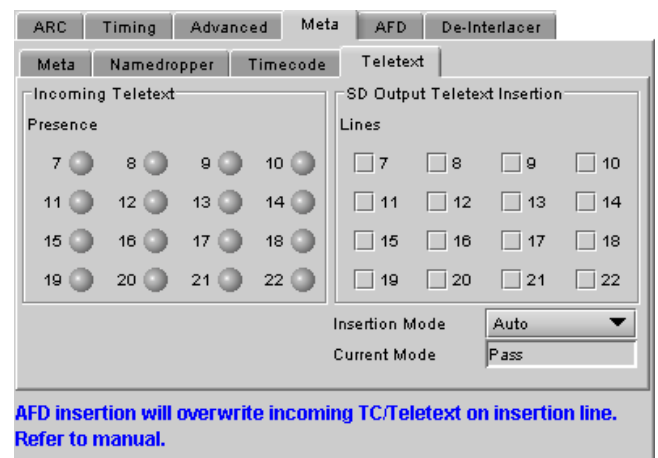

**Figure 5.35** Video Outputs SD - Meta/Teletext tab

teletext data from the incoming OP-467 packets. The actual assignment of data to these lines is determined by the mode selected in the *Insertion Mode* pulldown.

The *Insertion Mode* pulldown offers two modes of operation:

- Auto – Teletext data will be inserted on the enabled lines, represented by the *SD Output Teletext Insertion Lines* checkboxes, only if incoming OP-47 packets carry teletext data targeted for these lines
- Bulk – the teletext will be inserted in the lines selected in the checkboxes above the pulldown, in the order of arrival (first line detected in incoming OP-47 packets is inserted in the first line checked, etc). If there are more incoming lines than lines selected, the extra lines will be lost. If there are fewer incoming lines than lines selected, the extra selected lines will not carry any teletext. For example, if Lines 9, 11, and 14 are selected and presence indicators 15, 16, 19, and 20 are turned on, then detected OP-47 packets with embedded data from lines 15, 16, and 19 will be inserted on SD output lines 9, 11, and 14 respectively. The data from line 20 will be lost.

**SD inputs** – incoming teletext is passed through to the output as received; the lines cannot be changed (Pass mode).

- The *Incoming Teletext Presence* indicators 7 to 22 indicate the SD lines where teletext data, conforming to ETSI EN 300 706, has been detected.
- The *SD Output Teletext Insertion Lines* checkboxes are active, and can be configured so as to be ready when the input is switched to an HD source. They have no effect on an SD source..

**Current Mode** – this databox displays the current operating mode – AUTO, BULK or PASS

### 5.5.5 SD Output – AFD tab

The Active Format Descriptor (AFD) flag is used to identify the aspect ratio and protected areas of a video signal. The XVP-3901 uses this flag in some cases to adjust the output aspect ratio and image cropping to obtain the best possible presentation of the image. The AFD flag is implemented differently in SD and HD:

- In HD, the AFD flag (SMPTE 2016) is sent in an ancillary packet, normally found on line 11 in the vertical ancillary space.
- In SD, the AFD flag may be sent as a VLI signal (RP 186), as a WSS signal (ITU-R BT.1119-2) for PAL only, and as an AFD packet (SMPTE 2016).

When an AFD flag is present at the input, the card can perform an automatic adjustment of the aspect ratio. See the appendix for more details.

#### 5.5.5.1 Default settings section

*Default/Forced:* this text box is labeled according to the mode selected in the Input Screen pulldown in the Video Output Group – see page 42.

- In AUTO mode, labeled DEFAULT and shows the current default AFD code to be used if no valid AFD code is detected at the input.
- In FORCED mode, labeled FORCED, and shows the code that is forced into the system input regardless of the actual input code.
- In 4:3 (SD input) or 16:9 modes, the data box is empty and the controls are grey. In these modes, ARC settings can be manually set using the ARC tab controls.

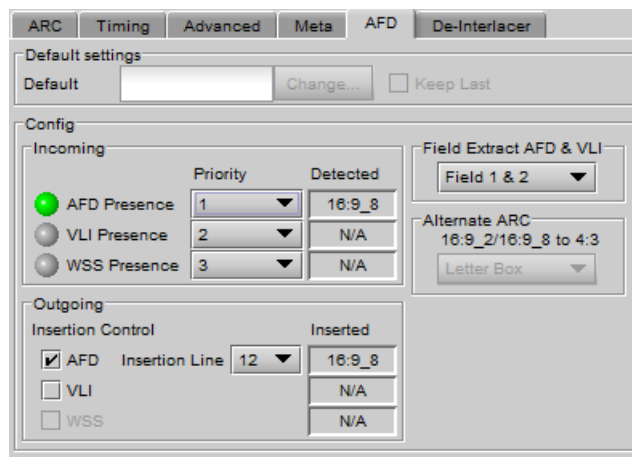
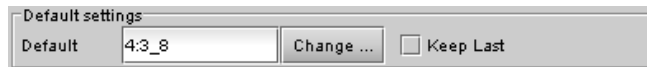

Figure 5.36 Video Outputs SD - AFD tab



**Change:** Click the Change button to open the *Select AFD* panel showing the available AFD codes that could be used as the default. Click on one to select it, then click *Apply* or *OK* at the bottom of the panel.

**Keep Last:** click in this checkbox to use the last detected AFD code at the input as the default code to be used in the *Auto* mode when no AFD flag is detected. This box is disabled in the *Forced* mode.

### 5.5.5.2 Config section

**Incoming** – the three types of AFD are shown, with a presence icon for each, and a pulldown to establish the priority of each type. The priorities are reset with each new selection; e.g. if AFD is 1 and VLI is 2, and you use the pulldown to choose VLI priority as 1, then AFD will be bumped down to 2.

- Ignore a specific flag completely by selecting “Don’t use” as its priority level.

The available types depend on the input format – AFD only for HD inputs; AFD and VLI for SD-59.94 Hz inputs, and all three types for SD-50 Hz inputs.

The set priority is used only during input AFD AUTO mode. The XVP-3901 will examine the incoming data in the selected order of priority in order to extract the AFD data. If, in AUTO mode, an AFD flag is set to priority 1 and is missing at the input, the XVP-3901 will use the incoming AFD flag set to the next priority level.

The *Detected* box shows the AFD code detected.

**Outgoing** – on the SD output, the AFD code shown in the *Inserted* box will be inserted in up to three different formats simultaneously. Supported formats are shown; select their respective checkboxes to enable insertion. AFD will be inserted in the line selected in the *Insertion Line* pulldown. Note that VLI is normally inserted on line 14, so if AFD is placed on line 14 using the pulldown, VLI will not be inserted.

**Field Extract AFD & VLI** – Select the field from which AFD and VLI will be extracted:

- Field 1
- Field 2
- Field 1 & 2

Note that this selection applies to both SD and HD outputs, and can also be set from the equivalent panel in the HD Output section (see page 40).

### Alternate ARC section

When the output is 4:3 SD, if the input AFD setting is set to Auto or Forced mode and the input AFD is a full screen 16:9 (AFD code 16:9\_2 or 16:9\_8), the output image may be scaled in one of 2 ways. Use the pulldown to select which will be used:

- **Letterbox:** Uses the traditional 16:9 letter box within a 4:3 frame where there is no loss of image.
- **Center Cut:** The XVP-3901 provides a second alternative – the input is horizontally cropped about the center to create a full screen 4:3 image. Choosing this alternative essentially removes 25% of the original image.

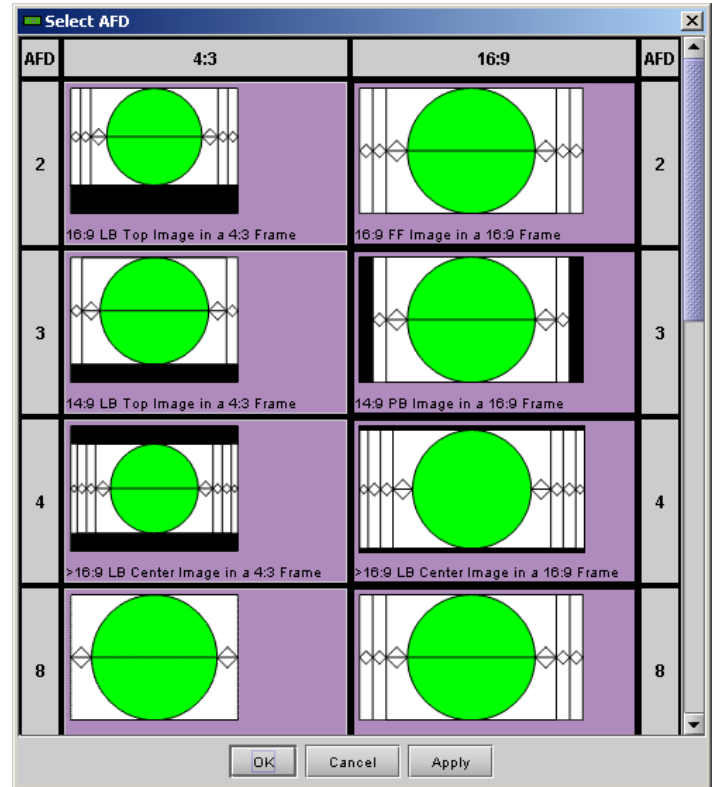

**Figure 5.37** Select AFD panel

### 5.5.6 SD Output – De-interlacer tab

Some interlaced video sources are film-based originating from 24p film images. For optimum scaling performance, it would be best to de-interlace this type of source by simply merging the source’s fields to recreate the original 24p image, thereby introducing no de-interlacer artifacts prior to scaling and format conversion.

*Film mode:* When The Film Mode selection is set to ON, the XVP-3901 monitors the input for film-based sequences and applies the proper algorithm.

Film detection is provided for 3:2, 2:2 (59Hz and 50 Hz sources) and 5:5 sequences.

*Video Over Film:* When the film mode is enabled, turn ON the Video-Over-Film (VOF) function to detect and bypass field-merging on certain video regions such as scrolling video characters over an entire film frame, thereby preventing any unwanted combing effects.



Figure 5.38 Video Outputs SD - De-interlacer tab

There is only one de-interlacer on the card. Any changes made within this tab will be copied over to the De-interlacer tab in the Video Output – 3G/HD panel.

## 5.6 Audio Processing panel

The Audio Processing panel provides full audio processing and delay parameters for up to 32 channels. The first 16 channels come from the embedded input channels and/or the discrete AES inputs. The second set of 16 channels comes from the output channels of the following modules:

- Dolby E and Dolby Digital decoder module(s)
- Linear Acoustic’s upMAX™ module(s)
- Downmix

The 32 processed audio channels can be assigned later to the Dolby E encoder module, the Dolby Digital and Dolby Digital Plus encoder modules, the 3G/HD output embedder, the SD output embedder, the discrete AES outputs, or sent to one or two DAP or UAP companion cards using the A-BUS. To enable the “Audio Processing” functionality, you must either have enabled the audio option or you must have an external audio card connected through the ABUS.

You can configure the audio processor differently for an SD input than for a 3G/HD input. The card will remember the different parameters and will load them automatically without user intervention based on whether the video input is SD or 3G/HD. Ensure the card has a video signal of the desired format before changing the configuration.

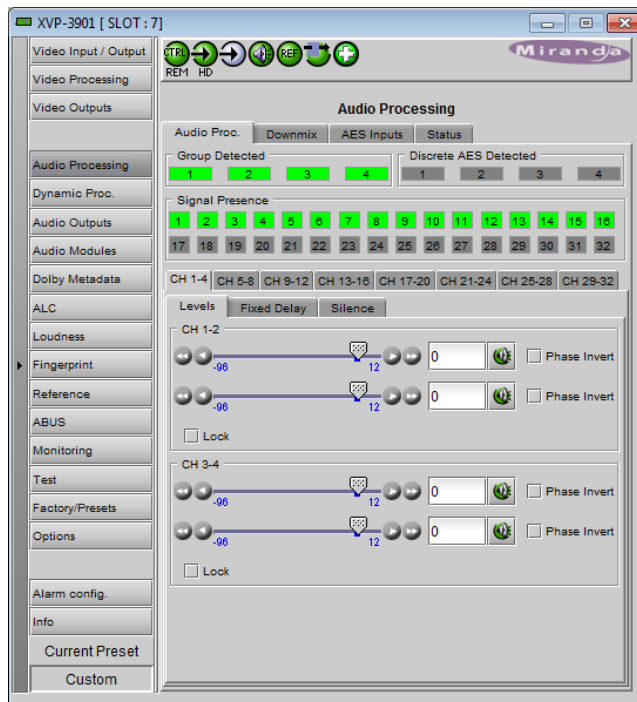

Figure 5.39 Audio Processing - Audio Proc tab

#### Group Detected section

Status indicators turn green when audio groups 1, 2, 3 or 4 are detected in the incoming signal. The Group Detected warning color can be configured by the user in the Alarm Config panel (Sect. 5.20)

*Discrete AES Detected* section

Signal presence indicators monitor the presence of AES inputs. The indicators turn green when AES input signals are detected. The Discrete AES Detected warning color can be configured by the user in the Alarm Config panel (Sect. 5.20)

*Signal Presence* section

Signal presence indicators monitor the audio channel presence and are related to the Silence parameters defined in the Ch XX/Silence tab (see details below): the indicator is green when an active signal is present and configurable when a silence is detected according to the “no signal” threshold and the channel detection warning. The Signal Presence warning color can be configured by the user in the Alarm Config panel (Sect. 5.20)

**5.6.1 Audio Processing Tab**

**CH 1-4, .... CH 29-32 Tabs**

Each of these tabs controls *Levels*, *Fixed Delays* and *Silence* detection for four audio channels; each channel is provided with a set of controls.

*Levels sub-tab*: grouped by pair of channels, each channel has the following controls:

*Level* (slider and input box): Sets the audio gain from -96 to 12 dB in 0.5 dB steps. For non-PCM audio, the level value is overridden to 0 dB.

*Mute* (speaker button): Mutes the selected audio channel

*Phase Invert*: When checked, inverts the selected audio channel phase.

*Lock*: “Locks” both channel sliders together for levels and delay (coarse only), so that moving one slider moves the other one as well.

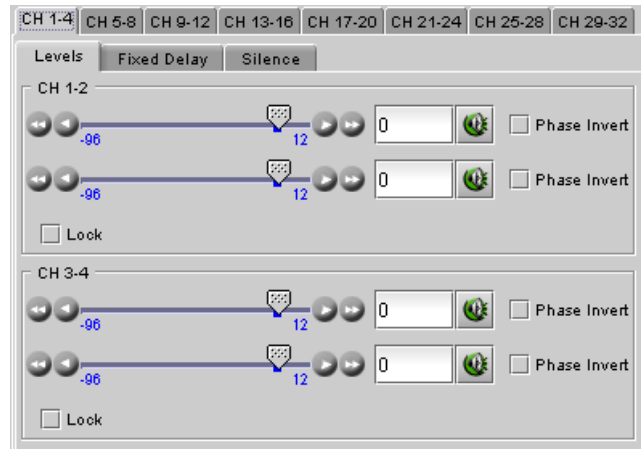

**Figure 5.40** Audio Processing - Levels sub-tab

*Fixed Delay sub-tab*: although the XVP-3901 automatically matches audio and video throughput timing, provision is made for the user to insert an audio delay offset from the nominal value, in order to deal with problems such as lip-sync errors and audio phase alignment in the incoming feed. For each channel, two sliders allow the delay to be adjusted.

- *Coarse* – adjusts the delay in milliseconds, over a range of values that depends on the Additional Frame Delay set on the timing tab in the Video Output group (see page 34), as follows:

<u>Additional Frame Delay</u>	<u>Adjustment Range (59.94 Hz)</u>	<u>Adjustment Range (50 Hz)</u>
0	0 to 2000 ms	0 to 2000 ms
1	-33 to 2000 ms	-40 to 2000 ms
2	-66 to 2000 ms	-80 to 2000 ms
3	-99 to 2000 ms	-120 to 2000 ms
...	...	...
15	-500 to 2000 ms	-600 to 2000 ms

- *Fine* – adjusts the delay in audio sample increments, from -100 to +100 samples.



**Figure 5.41** Audio Processing - Fixed Delay sub-tab

Silence sub-tab

This tab sets the card's behavior in the event of a loss or absence of audio signal. The Signal Presence indicators are then triggered according to these settings:

**Silence Detect:** select which audio channels to monitor for audio silences by checking their boxes. This enables the signal presence indicators to change color when there is no signal present which activates the audio silence alarm. Otherwise, when checkboxes are not checked, the signal presence indicator turns grey and the audio silence alarm is not activated

**Threshold:** Signal absence is declared when the signal level is lower than the signal threshold for a duration longer than the No Signal Delay. The threshold can be set to -72, -66, -60, -54, -48 dBFS. The default value is -60 dBFS.

**No Signal Delay:** The period for which signal must be continuously absent before an alarm can be triggered can be adjusted from 3 to 255 seconds in preset steps: 3, 5, 7, 10, 15, 20, 30, 40, 50, 60, 90, 120, 180, 210, 240, 255 sec. The default value is set to 15 seconds.

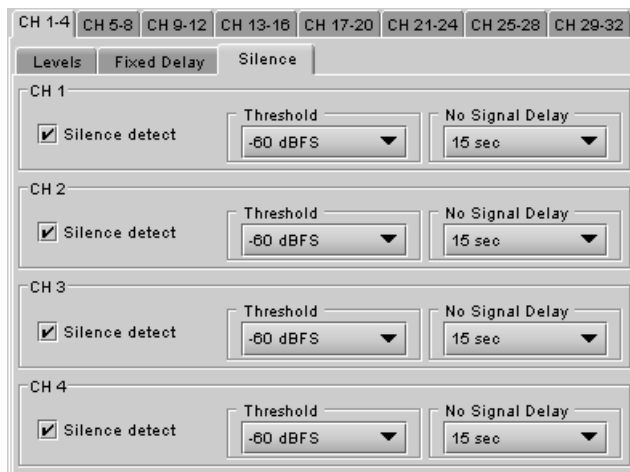

Figure 5.42 Audio Processing - Silence sub-tab

5.6.2 Downmix tab

This tab provides resources to control the downmix of a “5.1 channel” surround-sound audio signal into an LtRt or LoRo stereo pair. The 5.1 terminology refers to six discrete audio channels, with the low frequency effect (LFE) channel of limited bandwidth designated as the “.1” channel. The downmix can be done using any of the 32 audio channels processed by the audio processor using the Input Channels controls in the interface.

**Input Channels:** Use the 6 pulldowns to select the source channels for the downmix process.

Downmix:

Operating Mode: Use the pulldown to select the downmix operating mode:

- OFF: Downmix is disabled. Output channels pass through unchanged.
- Manual: Downmix follows the downmix parameters manually configured by the user.
- Follow Metadata Path 1: Downmix follows the downmix parameters of Metadata Path 1.
- Follow Metadata Path 2: Downmix follows the downmix parameters of Metadata Path 2.

Level Normalization: use the pulldown to select the type of normalization to be applied on the downmix output level.

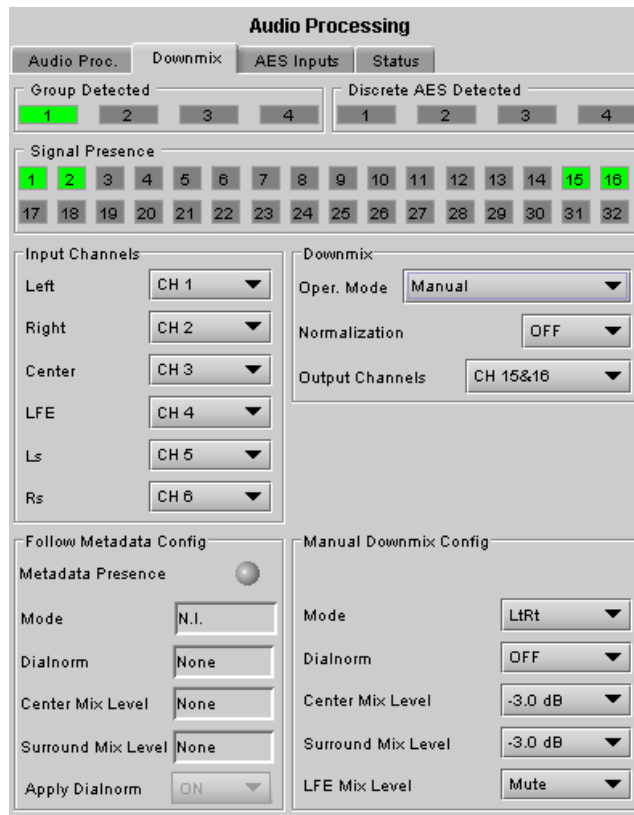

Figure 5.43 Audio Processing - Downmix tab



- OFF: Downmix output level is not normalized. Clipping may occur depending on the input channel levels and the selected mix levels.
- Level A: Downmix output level is normalized based on the applied mix levels to provide a uniform output over the range of mix levels available. Clipping will never occur, even with full scale input channels and mix levels.
- Level B: Downmix output level is normalized based on the channel configuration to provide a uniform output loudness between 3/2 and 2/0 programs. Downmixing a 3/2 program produces a loudness attenuation compared to the same program in 2/0 at the same input loudness. To provide a uniform output loudness, a loudness attenuation is applied only on 2/0 programs. If the operating mode is *Follow Metadata*, the channel configuration is given by the Dolby Digital coding mode parameter in the metadata. If the operating mode is *Manual*, the channel configuration is given by the selected mix levels: a 2/0 channel configuration is achieved by setting Center, Surround, and LFE Mix Levels to *Mute*. Any other combination of mix levels is assumed to be a 3/2 channel configuration. Level-B normalization also includes Level-A normalization, based on the applied mix levels. Clipping will never occur, even with full scale input channels and mix levels.
- This selection is not available when *Oper. Mode* is OFF.

Output Channels: Select the audio channels whose content will be replaced by the output of the downmix processor

- 7&8
- 15&16
- 23&24
- 31&32
- This selection is not available when the *Operating Mode* is OFF (downmix disabled).

### **Manual Downmix Config / Default Metadata Config**

The heading of this area of the panel changes depending on the selection in the *Operating Mode* pulldown above, but the available controls are the same in both cases.

- Operating Mode = Manual – the controls are used to set up the Manual Downmix parameters.
- Operating Mode = Follow Metadata Path 1 or 2 – the controls are used to set up the default downmix parameters for situations where the selected metadata path contains no data.

*Mode*: this pulldown menu selects the downmix mode:

- LtRt: Enables the downmix of 5.1 channels into an LtRt (Left total Right total) matrix surround encoded stereo pair. The input signals on the channel pair selected as the Output Channels are discarded.
- LoRo: Enables the downmix of 5.1 channels into an LoRo (Left only Right only) stereo pair, which is a conventional stereo signal. The input signals on the channel pair selected as the Output Channels are discarded.

*Dialnorm*: this pulldown selects the dialog normalization level. Select OFF to prevent the downmix from applying the dialnorm.

[OFF, -1 dBFS, -2 dBFS, -3 dBFS, ....., -31 dBFS]

*Center Mix Level* – sets the center channel downmix level to the selected value

[+3 dB, +1.5dB, 0 dB, -1.5 dB, -3 dB, -4.5 dB, -6 dB, Mute]

*Surround Mix Level* – sets the surround channels (Ls & Rs) downmix level to the selected value

[+3 dB, +1.5dB, 0 dB, -1.5 dB, -3 dB, -4.5 dB, -6 dB, Mute]

*LFE Mix Level* – sets the LFE channels downmix level to the selected value.

[+10 dB, +9 dB, +7.5, +6 dB, +4.5 dB, +3 dB, +1.5dB, 0 dB, -1.5 dB, -3 dB, -4.5 dB, -6 dB, Mute]

- Note: The *LFE Mix Level* pulldown sets the LFE downmix level for both *Manual* and *Follow Metadata Path 1 or 2* operation modes, whether or not the metadata is present in the selected path.

The block diagrams below show the configuration of the LtRt surround sound downmixer and the LoRo stereo downmixer.

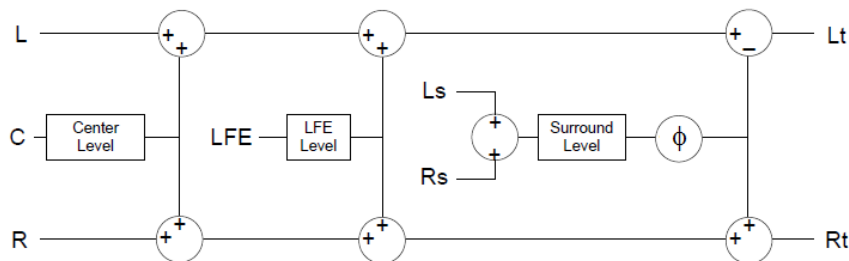

Figure 5.44 LtRt Surround Sound downmixer

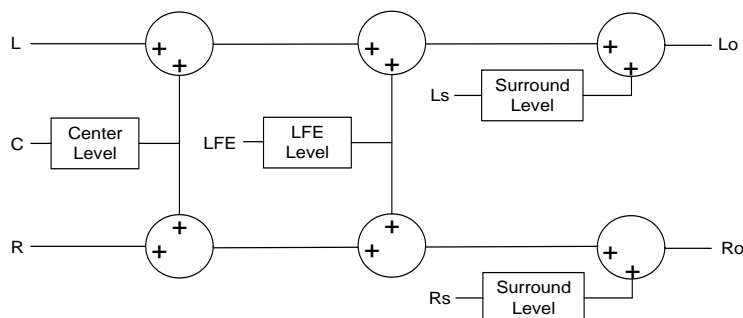

Figure 5.45 LoRo Stereo downmixer

**Follow Metadata Config:**

This section reports on Metadata presence in the selected path if the Follow Metadata Path 1 or 2 Operating Mode is selected. The four data boxes below the Metadata status icon indicate the current mode, plus the values in use for Dialnorm, Center Mix Level and Surround Mix Level.

**5.6.3 AES Inputs tab**

The status icons at the top of the tab indicate which Groups and discrete AES are detected, and which of the 32 channels have signal present.

**Audio Proc Input Selection**

This section provides a selection between the embedded audio and the discrete AES inputs. Channels 1 to 8 will always be the first 8 embedded channels. However, channels 9 to 16 can be either embedded channels 9 to 16 or the 8 discrete channels from the 4 AES inputs, selected using the pull-down.

**Sample Rate Converter**

Use the pull-downs to select between OFF and Auto for each of the four AES.

- OFF: Sample rate conversion is disabled. Use only if the AES input is always 48 kHz synchronous to the video input OR if the AES input carries non-PCM audio (Dolby or other) with its channel status indicating "Linear PCM".



Figure 5.46 Audio Processing - AES Inputs tab



- AUTO: Sample rate conversion is automatic, based on the input audio type. Sample rate conversion is enabled for PCM audio, and bypassed for non-PCM audio.

### 5.6.4 Status tab

The Status tab reports the type of audio present at the input and the Dolby E alignment.

Audio Type Status:

- PCM – the audio channel carries PCM audio (orange)
- Dolby E – the audio channel carries Dolby E encoded audio (blue)
- AC3 – the audio channel carries Dolby Digital encoded audio (violet)
- NPCM – the audio channel carries Dolby Digital Plus or non-PCM other than Dolby E or Dolby Digital (yellow).

Dolby E Alignment:

- When Dolby E audio is present, this panel will display the offset/delay between the Dolby E and the video output timing of the card. You may click the Auto Align button to automatically adjust the audio timing delay to ensure a perfect alignment with the video. This is equivalent to changing manually the audio delay in the audio processor. If you change the output timing of the card or the video output format, you may have to re-align the Dolby E.
- The offset is not available for any type of audio other than Dolby E.



Figure 5.47 Audio Processing - Status tab

The measured Dolby E offset can be a positive OR a negative value. A negative value indicates the Dolby E is in advance compared to the video and additional delay should be added to the audio channel pair.

A positive value indicates the Dolby E is late compared to the video and the audio delay must be reduced for this channel pair. Sometimes, the audio delay cannot be compensated because it would mean to have an audio delay lower than the processing delay of the card. In this case, you have to add an extra frame delay to the video to provide more range to the audio delay.

## 5.7 Dynamic Proc. panel

This panel provides controls for dynamic processing of the audio passing through the XVP-3901. The audio processing (XVP-3901-OPT-AUD) and the dynamics processing (XVP-3901-OPT-DP) options must be activated to access this functionality. Individual and independent controls are provided for each of the 32 channels.

These parameters affect the output audio channels (HD/SD embedded and AES), the audio channels assigned to the Dolby E encoder and the Dolby Digital and Dolby Digital Plus encoder modules, as well as the audio channels sent to the DAP or UAP companion cards.

Note that unlike the audio processing configuration, only one (1) dynamic processing configuration is saved by the card, regardless of the input format (3G/HD or SD).

- Access the individual channel controls through 4 master tabs and sub-tabs

The functionality of these controls is identical for each channel, and is explained here.

The upper right-hand corner of each tab contains a graphic depicting the transfer characteristic of the channel as configured by the current dynamic processing settings. Images will be shown below to illustrate the effect of the various controls

**Mode**

Use the pulldown to select the operating mode for this channel, from among these options:

- Mono: applies the dynamics processing settings only to the selected channel
- Stereo: applies the dynamics processing settings to the channel pair (e.g. 1 & 2, 7 & 8, etc.)
- Group 1: applies the dynamics processing settings only to the channel assigned to Group 1
- Group 2: applies the dynamics processing settings only to the channel assigned to Group 2

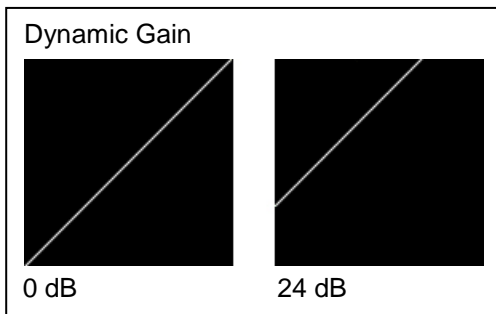

Figure 5.48 Dynamic Processing panel

Click the *Bypass Settings* checkbox to bypass all the dynamics processing settings set up in this panel for this channel.

**Dynamic Gain**

Sets the audio dynamic gain from 0 to 24 dB (in 1 dB steps) applied to the selected channel. The dynamic gain is applied at the end of the dynamics processing chain.



**Limiter Threshold**

A *limiter* is a type of compressor designed for a specific purpose, to limit the level of a signal to a certain threshold. Whereas a compressor will begin smoothly reducing the gain above the threshold, a limiter will almost completely prevent any additional gain above the threshold. A limiter is like a compressor set to a very high compression ratio (typically  $1/\infty$ ).

For example, if the limiter threshold is set to -20 dBFS and the input signal level is -10 dBFS (10 dB above the threshold), the signal level at the output of the limiter will be -20 dBFS.

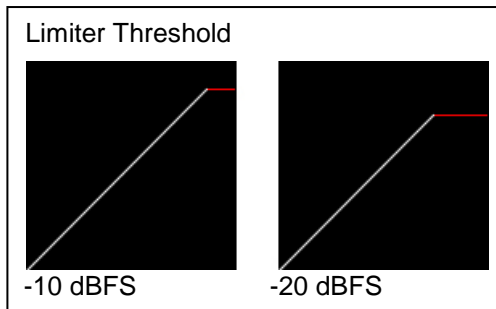

- Use the *Limiters Threshold* slider to set the threshold from -20 dBFS to 0 dBFS (1 dB steps).

### Compressor

*Audio compression* is a method of reducing the dynamic range of a signal. All signal levels above the specified threshold are reduced by the specified ratio. When the signal level exceeds the threshold, the compressor will begin smoothly to reduce the gain, following the attack time, until the output level reflects the specified compression ratio. When the signal level is below the threshold, the compressor will begin smoothly to increase the gain, following the release time, until the output level matches the input level.

For example, if the compressor threshold is set to -20 dBFS and a ratio of 1/2, and the input signal level is -10 dBFS (10 dB above the threshold), the signal level at the output of the compressor will be smoothly reduced to -15 dBFS (following the attack time). Then, if the input signal level suddenly drops to -30 dBFS (10 dB below the threshold), the signal level at the output of the compressor will smoothly go back to -30 dBFS (following the release time).

Use the *Attack Time* pulldown to set the attack time. The attack time specifies how fast the compressor will reduce the gain:

- Possible values: 1 ms, 5 ms, 10 ms, 20 ms, 40 ms, 80 ms, 160 ms.

Use the *Release Time* pulldown to set the release time. The release time specifies how fast the compressor will increase the gain:

- Possible values: 48 dB/s, 36 dB/s, 24 dB/s, 18 dB/s, 12 dB/s, 9 dB/s, 6 dB/s

Use the *Ratio* pulldown to set the compression ratio (i.e. slope of the transfer curve). The compression ratio specifies how much the output level changes with respect to the input level:

- Possible values: 1/1 (OFF), 1/1.25, 1/1.5, 1/1.75, 1/2, 1/3, 1/4, 1/8, 1/16

Use the *Threshold* slider to set the compression threshold (i.e. break point in the transfer curve). The compression threshold specifies the level above which the compressor will process the signal.

- Range -60 dB to 0 dB

### Expander

*Audio expansion* means to expand the dynamic range of a signal. It is basically the opposite of audio compression. Like compressors and limiters, an audio expander has an adjustable threshold and ratio. Whereas compression and limiting take effect whenever the signal goes *above* the threshold, expansion effects signal levels *below* the threshold. Any signal below the threshold is expanded downwards by the specified ratio.

For example, if the expander threshold is set to -40 dBFS and a ratio of 2/1, and the input signal level is -60 dBFS (20 dB below the threshold), the signal level at the output of the expander will be reduced to -80 dBFS. Then, if the input signal level suddenly increases to -30 dBFS (10 dB above the threshold), the signal level at the output of the expander will go back to -30 dBFS.

Use the *Ratio* pulldown to set the expansion ratio (i.e. slope of the transfer curve). The expansion ratio specifies how much the output level changes with respect to the input level :

- Options available: 1/1 (OFF), 1.125/1, 1.25/1, 1.375/1, 1.5/1, 1.625/1, 1.75/1, 1.875/1, 2/1

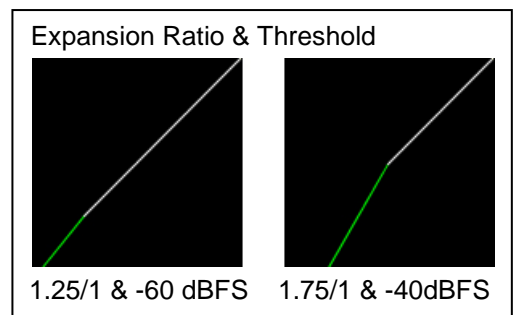
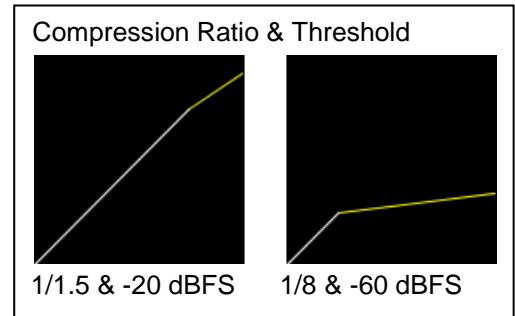

Use the *Threshold* slider to set the expansion threshold (i.e. break point in the transfer curve). The expansion threshold specifies the level below which the expander will process the signal.

- Range -80 dB to -40 dB

**Dynamics for 1 minute.**

Click the *Dynamics for 1 minute* button to display the dynamics processing in the meters at the bottom of the panel for a period of one minute. Dynamics metering is enabled by groups of 16 channels: Channels 1-16 or Channels 17-32, selected depending on the *Channels* tab selected at the top of the panel



**Figure 5.49** Dynamics for 1 minute display

- The right-hand portion of this section shows the output channels of the dynamics processor on level meters, as found in the RALM panel.
- The left-hand side shows approximately how much dynamic processing is being applied to the signal (by amplitude) on a channel basis.
- The example shown above is the result of substantial compression being applied to Channel 1

**5.8 Audio Outputs panel**

This panel provides additional audio processing for the 16 audio channels embedded in the 3G/HD and SD output, and for the four AES outputs:

- audio channel shuffling
- level adjustment
- mixing
- audio embedding mode.

The XVP-3901 may be paired with up to two DAP or UAP cards for additional audio channel inputs to the mixers and for discrete AES/analog outputs.

You can configure the audio output shufflers/mixers (3G/HD, SD and AES) differently for an SD input than for a 3G/HD input. The card will remember the different parameters and will load them automatically without user intervention based on whether the video input is SD or 3G/HD. Ensure the card has a video signal of the desired format before changing the configuration.



**Figure 5.50** Audio Outputs panel

The panel has a set of tabs at the top to allow the appropriate audio channels to be accessed (figure 5.49). The available controls are virtually identical in all cases, so they will be described only once.

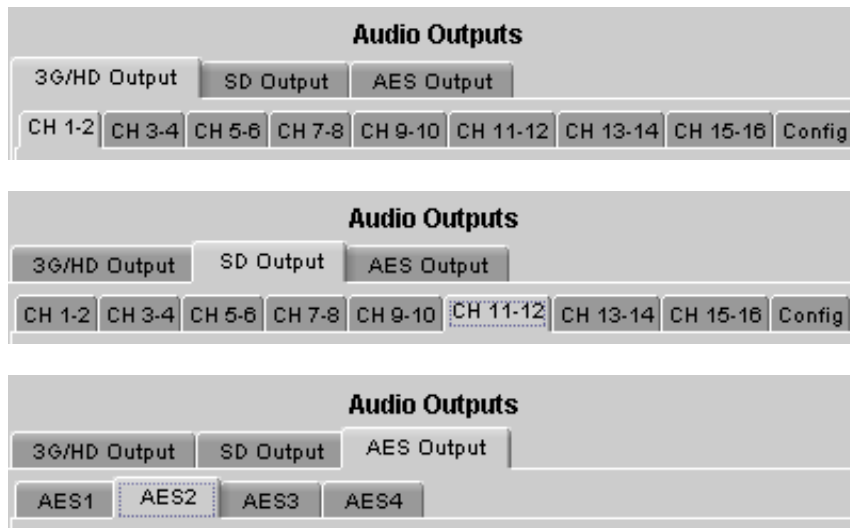

Figure 5.51 Audio outputs tab structure

### 5.8.1 CH 1-2, CH 3-4, ... CH 15-16 tabs, and AES1, ... AES4 tabs

Each of these tabs provides all necessary controls for the output mixers. The example shown is for 3G/HD Output, CH 1-2, but all panels have the same controls.

**Operation Mode (Off, A, SUM(A+B), Mix):** This menu allows the source(s) of each output channel to be selected – a single channel, the sum of two channels or a mix of two channels.

**Off:** The output channel is muted.

**A:** The output channel is the channel source (*ABUS Select* and *Channel*) selected in sub-menu SOURCE A.

**SUM (A+B):** The output channel is the sum of the two channels sources (*ABUS Select* and *Channel*) selected in sub-menus SOURCE A and SOURCE B.

- If you select this option, the SUM (A+B) Level pull-down is activated, allowing you to reduce the level of the summed output (0dB, -3dB or -6dB).

**Mix:** The output channel is a mono mix of the (*ABUS Select* and *Channel*) selected in sub-menus SOURCE A and SOURCE B.

**Mix 4Ch:** This mode allows a 3-input or 4-input mix on the chosen even output. A standard 2-input mix is available on the odd output. On the same tab, the two

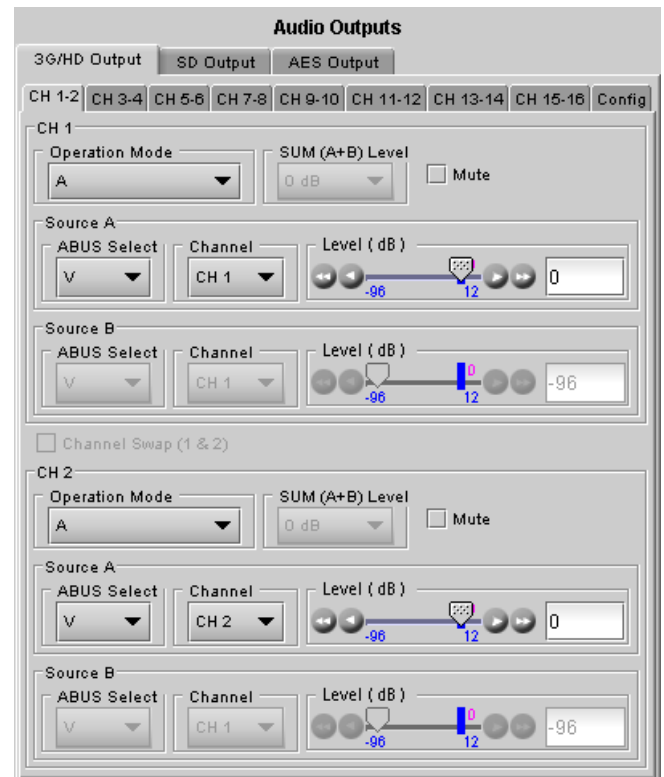

Figure 5.52 Audio Outputs operating controls

selected sources of the even channel are mixed with the one or two selected sources of the odd channel. The four sources are mixed, with the level of each source adjusted using its slider or data entry box. You can swap the odd and even output by putting a check mark in the Channel Swap (1&2) checkbox. Note that in the Mix 4Ch mode, if the Mute box is checked, only the even channel sources will be muted, the odd channel sources will still pass to the output.

**Note:** in the case of SUM and MIX, if either of the two input channels is non-PCM, the output will always be SOURCE A

**Mute:** Mute the audio channel by checking this box. In the MIX4Ch mode, checking this box will mute only the sources of the selected output channel.

**Source A & Source B:** These sub-sections allow the source channels (A and B) to be selected for each output channel.

**ABUS Select:** V, A1, A2: selects the embedded input audio (V), one of two audio companion cards (A1 or A2 channels 1-8) or one of two Dolby E and Dolby Digital decoder modules installed on companion cards (A1 or A2 channels 9-16) to be used as the source for this channel. Note: The ABUS card system is configured in the ABUS panel.

**Channel:** Channel 1, ..., Channel 16: selects the channel to be used from the selected audio source.

**Level (dB):** Sets the audio gain of the channel source from -96 to +12 dB in 0.5 dB steps. For non-PCM audio, the level value is overridden to 0 dB.

### 5.8.2 Config tab

A Config tab is available in the 3G/HD tab and the SD tab, but not in the AES tab,

In each case, the tab contains only an Output – Audio Insert pull-down.

Use the pull-down in this tab to enable (AUTO) or disable (OFF) audio embedding in the output.

- When OFF is selected, no audio is embedded in the HD output.
- When AUTO is selected, only those audio groups containing at least one audio channel will be embedded at the output.

For SD outputs, the number of bits to be embedded must also be selected, and so the options in the pull-down are:

- OFF
- Auto 20 bits
- Auto 24 bits

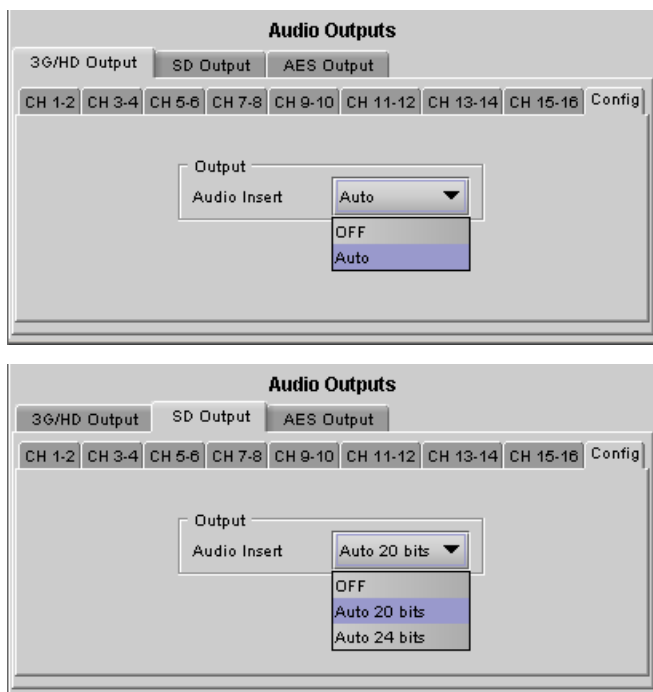

Figure 5.53 Audio Outputs - Config tabs



### 5.9 Audio Modules panel

The XVP-3901 has two on-board sockets for optional audio modules. The supported modules are:

- MOD-DOLBY-DEC-2   Dolby E and Dolby Digital decoder
- MOD-LA-DUP-701    Linear Acoustic upMAX™
- MOD-DOLBY-ENC-D-2   Dolby Digital and Dolby Digital Plus encoder
- MOD-DOLBY-ENC-E    Dolby E encoder
- MOD-LA-ALC-X-YYY   Automatic Loudness Control using the AeroMAX™ licensed technology by Linear Acoustic
- MOD-JA-ALC-X-YYY   Automatic Loudness Control using the Level Magic™ licensed technology by Jünger Audio

Any of these modules can be inserted in either socket 1 or 2. When a module is installed in one of these sockets, its controls will appear in the appropriate tab in this panel.

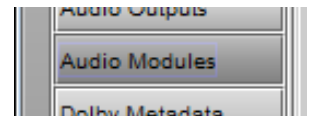

See Section 0 beginning on page 109 for detailed descriptions of all of the available modules and their associated control panels.

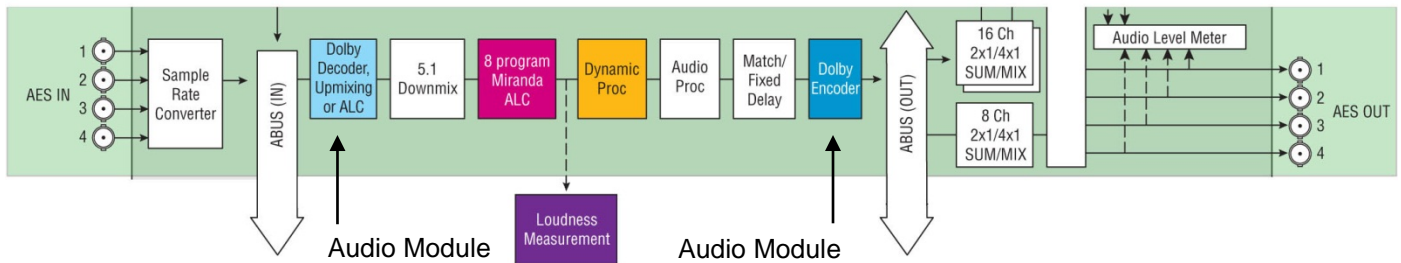

The Dolby E and Dolby Digital decoder, Linear Acoustic upMAX™ (upmix), Linear Acoustic AeroMAX™ (ALC) or Jünger Audio Level Magic™ (ALC) modules are located at the input of the audio processing path, as shown in this block diagram of the XVP-3901 audio processing section. If both modules are installed, the Dolby E and Dolby Digital decoder module is located before the upmix or ALC modules in the audio processing path, to allow the decoded channels to be upmixed. The Dolby E encoder and the Dolby Digital and Dolby Digital Plus encoder modules are located at the end of the audio processing path.

The output channels of the above modules are always fixed and depend only on the module socket number in which it is inserted. The outputs for module 1 will always be in the range 17 to 24. The output for module 2 will always be in the range 25 to 32. Refer to the table below for a quick overview of the output channels versus the installed modules and their module position:

Installed Module	Output channels when in Module #1	Output channels when in Module #2
MOD-DOLBY-DEC-2	17-24	25-32
MOD-LA-DUP-701	17-22	25-30
MOD-DOLBY-ENC-D-2	17-18	25-26
MOD-DOLBY-ENC-E	17-18	25-26
MOD-LA-ALC-X-YYY	17-24 (depending on number of channels)	25-32 (depending on number of channels)
MOD-JA-ALC-X-YYY	17-24 (depending on number of channels)	25-32 (depending on number of channels)

It must be noted that the MOD-LA-DUP-701 has only 6 outputs and the MOD-DOLBY-ENC-D-2/E has only 2 outputs. In these cases, only the first 6 or 2 channels are used. The MOD-LA-ALC-X-YYY and MOD-JA-ALC-X-YYY modules may have from 2 to 8 outputs depending on the model used.

The processing delay for all MOD-LA-ALC-X-YYY and MOD-JA-ALC-X-YYY modules is ¼ of a video frame. To compensate for this processing delay, the user must increase the processing delay of the card by +1 frame. This additional processing delay must be added manually in the Video Output panel under the Timing tab.

### 5.10 Dolby Metadata panel

This panel provides resources for managing the flow of Dolby metadata through the XVP-3901. The Dolby metadata panel is part of the audio processing option (XVP-3901-OPT-AUD).

- Note that unlike the audio processing configuration, only one (1) Dolby metadata configuration is saved by the card, regardless of the input format (3G/HD or SD).

Multiple layers of tabs allow the user to drill down to the various available controls. For notational purposes, the path to a particular control panel will be described here as:

[layer 1 tab] → [layer 2 tab] → [layer 3 tab]

For example, the panel shown in the figure on the right would be described as:

[Path #1] → [Probe 1] → [Dynamic Range]



Figure 5.54 Dolby Metadata panel

#### 5.10.1 Path 1 & Path 2 tabs

These two tabs are identical in layout, and will be described together.

- Note that the Generator and Probe are path-specific; i.e. Path #1 has Generator 1 and Probe 1, while Path #2 has Generator 2 and Probe 2.

**Input Presence:** Status icons are provided to indicate sources where Dolby Metadata is present and valid. The following are shown:

- VANC Stream 1
- VANC Stream 2
- RS-422B
- Decoder 1 (grey if not installed)
- Decoder 2 (grey if not installed)

**Source:** This area allows source selection for Path #1.

- The currently-active pathway is shown in green.

**Primary:** Use this pulldown to select the primary metadata source for this path.

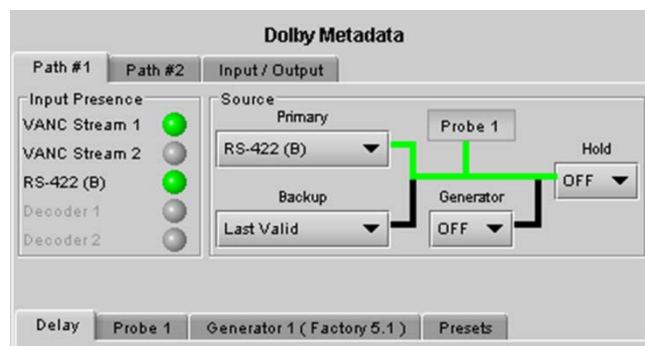

Figure 5.55 Dolby Metadata - Path 1 tab



The pulldown shows the same sources as appear in the Input Presence section. The Decoder 1 & 2 sources will appear in red if the modules are not installed.

Note: When decoding PCM audio, the Dolby E and Dolby Digital decoder does not generate any metadata. If a decoder is selected as a source for a specified metadata path, the generator on the same path will be automatically turned ON when the decoder is decoding PCM audio. The content of the generator must have been previously configured. Refer to “Generator automated mode” below for details.

**Backup:** use this pulldown to select the source that will be used if the primary source becomes unavailable or invalid. In addition to the available primary sources, the list includes:

- Last valid – return to the last valid source used
- Blank – no metadata output
- Generator – use the internal generator

**Generator:** Use this pulldown to turn the internal generator ON or OFF. Turning it ON selects it as the source. The generator creates a complete, specific set of metadata, which is configured in the Generator tab.

**Generator automated mode:**

The generator is turned on or off automatically in specific conditions to avoid loss of metadata at the output stream. There are two specific conditions which will trigger the automation behaviors:

1. When a Dolby E and Dolby Digital decoder module is installed and selected as the metadata source of a path, the audio metadata from a Dolby E input stream will be decoded and passed. When the decoder is fed with PCM audio, the Dolby E and Dolby Digital decoder will not provide metadata. Instead, the generator of the selected path will be automatically turned on. It is the responsibility of the user to configure the generator with the proper PCM metadata parameters.
2. When an upMAX<sup>tm</sup> module is installed and configured to operate in *Follow Metadata* mode, the resulting upMAX<sup>tm</sup> mode is dictated by the *coding mode* parameter of the probed metadata stream. When the metadata stream coding mode is 2/0, the upMAX<sup>tm</sup> mode is set to *Upmix* and the generator will be turned on to generate 5.1 metadata for the upmixed audio content. It is the responsibility of the user to configure the generator with the proper 5.1 metadata parameters. If the metadata stream coding mode is 3/2, the upMAX<sup>tm</sup> mode is set to *Pass* and the generator will be turned off to let the input metadata stream go through. If the coding mode detected is other than 2/0 or 3/2 or there is no metadata, the reversion mode is used. In that case, the generator will be turned on for the *Upmix* and *AutoMAX* reversion modes, and off for *Pass* reversion mode. The generator affected is tied to the module's socket (i.e. generator on path 1 for upMAX<sup>tm</sup> in socket 1; generator on path 2 for upMAX<sup>tm</sup> in socket 2).

Notes:

- If the two conditions are true, the upMAX<sup>tm</sup> automation has precedence over the decoder because the upMAX<sup>tm</sup> is located after the decoder in the audio processing path.
- No automation is provided for the generator content. The generator content is always under user control and must have been previously configured if used in these conditions.

**Hold:** Use the pulldown to select Hold ON or OFF.

- ON – freezes the Metadata values used in the output bitstream
- OFF - allows the current metadata to pass to the output

**Probe 1:** this box shows where the audio metadata probing occurs in the path.

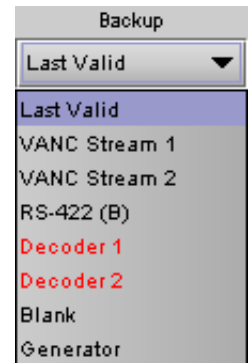

### 5.10.1.1 [Path #1] → [Delay]

Through **Coarse** and **Fine** adjustments, a fixed delay can be applied to the Metadata bitstream. It is useful when processing, like watermarking, is applied to the audio signal outside the XVP-3901. The delayed Metadata bitstream will stay properly timed with its associated audio signal.

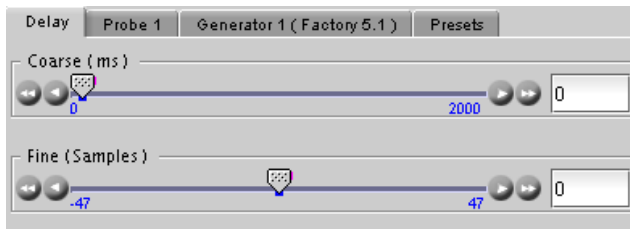

Figure 5.56 Dolby Metadata - [Path #1] → [Delay]

### 5.10.1.2 [Path #1] → [Probe 1]

The Probe function allows the user to view information about the Metadata in the program stream. There are no controls in this panel or its subpanels, except for the program select buttons.

The *Probe 1* section at the left of the panel shows information about the data stream in the metadata path.

- The two parameters at the top indicate the **Program Configuration** and the **Video Frame Rate** of the Metadata bitstream.
- Depending on the Program configuration, one to eight programs are included in a Metadata bitstream. The **Program Select** zone allows the selection of one Metadata program.

The text boxes below the program select buttons report on the data rate, coding mode and dialnorm value of the selected program.

### [Path #1] → [Probe 1] → [Audio Processing]

This panel reports the status of the audio processing:

- DC Highpass Filter
- Bandwidth Lowpass Filter
- LFE Lowpass Filter
- Surround 90° Phase Shift
- Surround Channel Attenuator

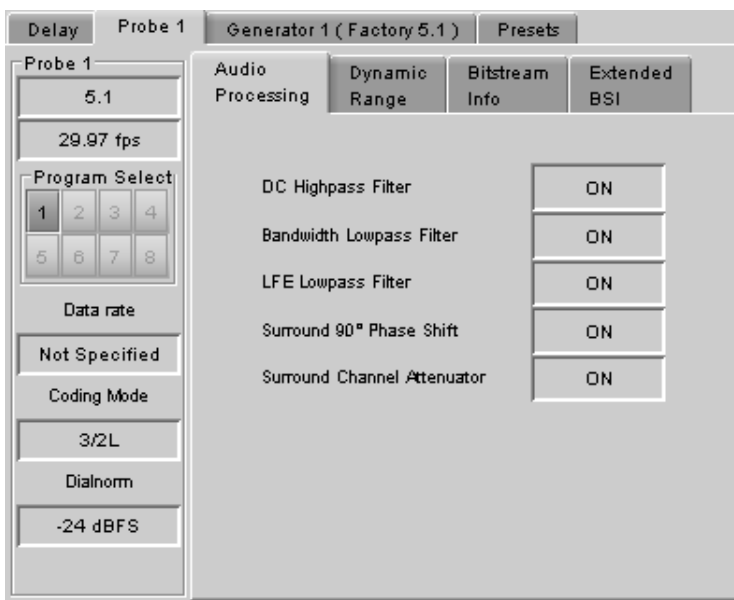
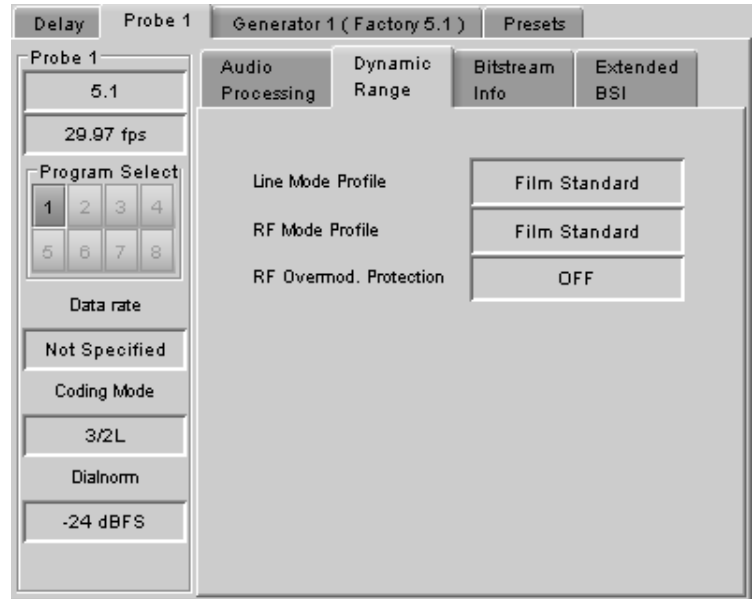

Figure 5.57 [Path #1] → [Probe 1] → [Audio Processing]

**[Path #1] → [Probe 1] → [Dynamic Range]**

This panel reports the status of Dynamic Range processing:

- Line Mode Profile
- RF Mode Profile
- RF Overmod. Protection



**Figure 5.58** [Path #1] → [Probe 1] → [Dynamic Range]

**[Path #1] → [Probe 1] → [Bitstream Info]**

This panel reports the status of the metadata bitstream:

- Bitstream Mode
- Center Downmix Level
- Surr. Downmix Level
- Dolby Surr. Mode
- Copyright Bit
- Original Bitstream
- Audio Production Info
- Mix Level
- Room Type

Additional bitstream information is found in the Extended BSI tab

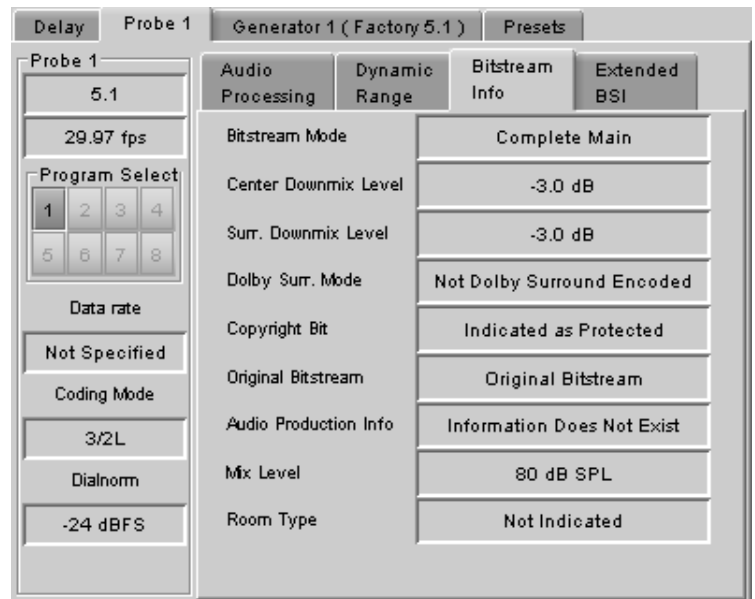

**Figure 5.59** [Path #1] → [Probe 1] → [Bitstream Info]

[Path #1] → [Probe 1] → [Extended BSI]

- Preferred Stereo Downmix
- Lt/Rt Center Mix Level
- Lt/Rt Surround Mix Level
- LoRo Center Mix Level
- LoRo Surround Mix Level
- Surround EX mode
- Converter Type

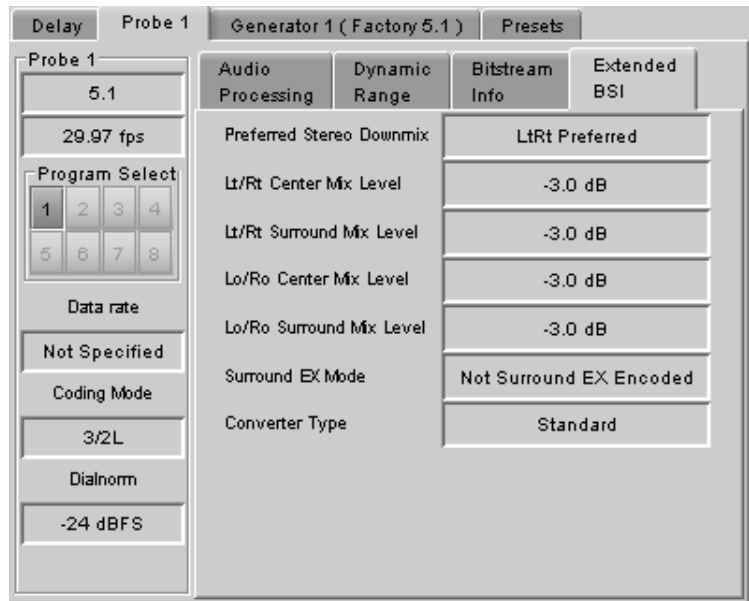

Figure 5.60 [Path #1] → [Probe 1] → [Extended BSI]

5.10.1.3 [Path #1] → [Generator 1]

The tab name includes a bracketed item (Factory 5.1 in the figure) indicating which of the metadata presets is currently loaded in the generator.

The upper left Pulldown sets the **Program Configuration**. The text box below it shows the **Video Frame Rate**, which is set automatically by the card.

Use the Program Select buttons to select the program to configure.

Use the Coding Mode and Dialnorm pulldowns to set these parameters in the generator output.

[Path #1] → [Generator 1] → [Audio Processing]

This panel allows configuration of the audio processing parameters:

- Extended Bitstream info 1
- Extended Bitstream info 2
- DC Highpass Filter
- Bandwidth Lowpass Filter
- LFE Lowpass Filter
- Surround 90° Phase Shift
- Surround Channel Attenuator

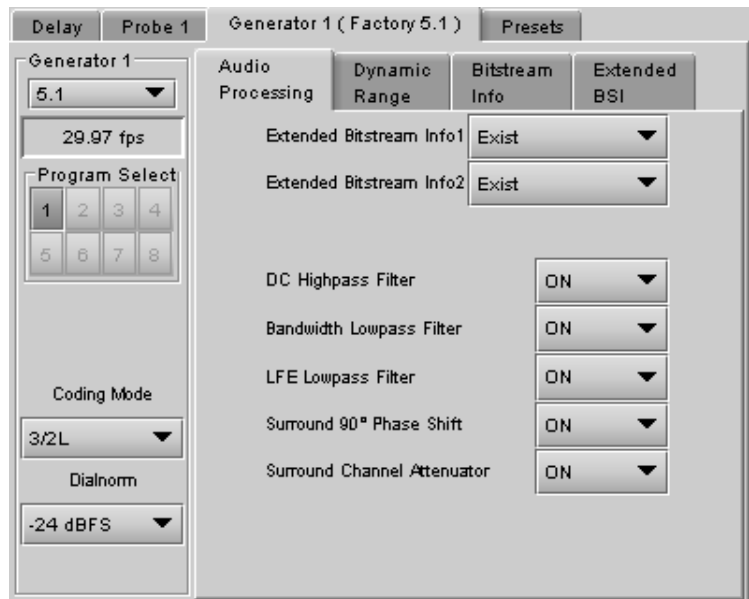
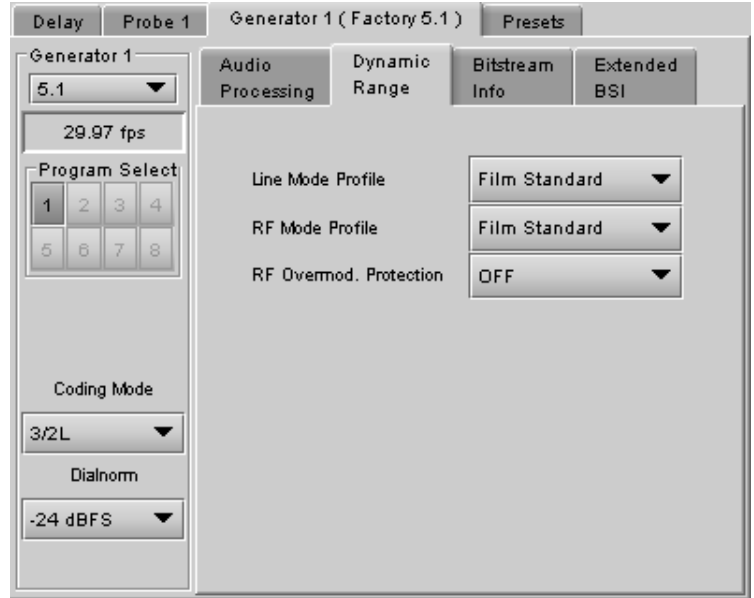

Figure 5.61 [Path #1] → [Generator 1]

**[Path #1] → [Generator 1] → [Dynamic Range]**

This panel allow configuration of the Dynamic Range processing parameters:

- Line Mode Profile  
[None, Film Standard, Film light, Music standard, Music light, Speech]
- RF Mode Profile  
[None, Film Standard, Film light, Music standard, Music light, Speech]
- RF Overmod. Protection



**Figure 5.62** [Path #1] → [Generator 1] → [Dynamic Range]

**[Path #1] → [Generator 1] → [Bitstream Info]**

This panel allows configuration of the metadata bitstream info parameters. Use the pull downs to select the appropriate values:

- Bitstream Mode
- Center Downmix Level
- Surr. Downmix Level
- Dolby Surr. Mode
- Copyright Bit
- Original Bitstream
- Audio Production Info
- Mix Level
- Room Type



**Figure 5.63** [Path #1] → [Generator 1] → [Bitstream Info]

[Path #1] → [Generator 1] → [Extended BSI]

- Preferred Stereo Downmix
- Lt/Rt Center Mix Level
- Lt/Rt Surround Mix Level
- LoRo Center Mix Level
- LoRo surround Mix Level
- Surround EX mode
- Converter Type

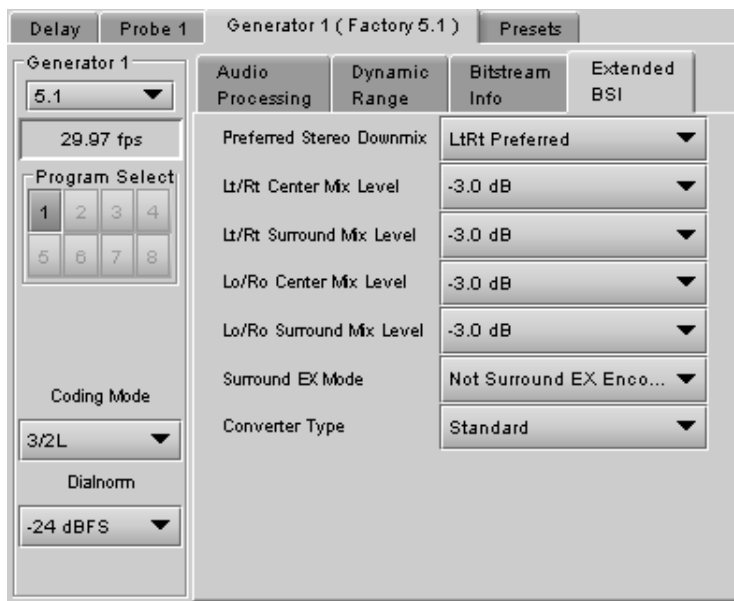

Figure 5.64 [Path #1] → [Generator 1] → [Extended BSI]

5.10.1.4 [Path #1] → [Presets]

Because there are many parameters to set for the generator, it is convenient to be able to save a configuration for easy recall. The Presets tab offers several convenient functions for this purpose.

The XVP-3901 allows the user to save 10 configurations. These are labeled METADATA 1 to METADATA 10 by default, but the user can edit the names via the **Edit Presets Labels...** button at the bottom of the tab.

In addition, the XVP-3901 is preloaded with two fixed data sets named Factory 2.0 and Factory 5.1.

The Current Generator Preset databox at the top of the tab reports the current preset in use. If all parameter values do not match the preset values, the box will show “Custom”.

The **Generator Presets** pulldown gives access to all 12 available presets. The two buttons to the right then allow two options:

- Load – load the generator with the values stored in the preset, overwriting the current settings
- Save – overwrite the values stored in the preset with the values currently set on the card (only for the ten user-settable presets – the Factory presets cannot be changed).

The **Save Probe To** pulldown gives access to the 10 user-settable presets. Once one is selected, clicking on the Save button saves the values detected by the probe into the user presets, in effect setting the preset to match the current program stream.

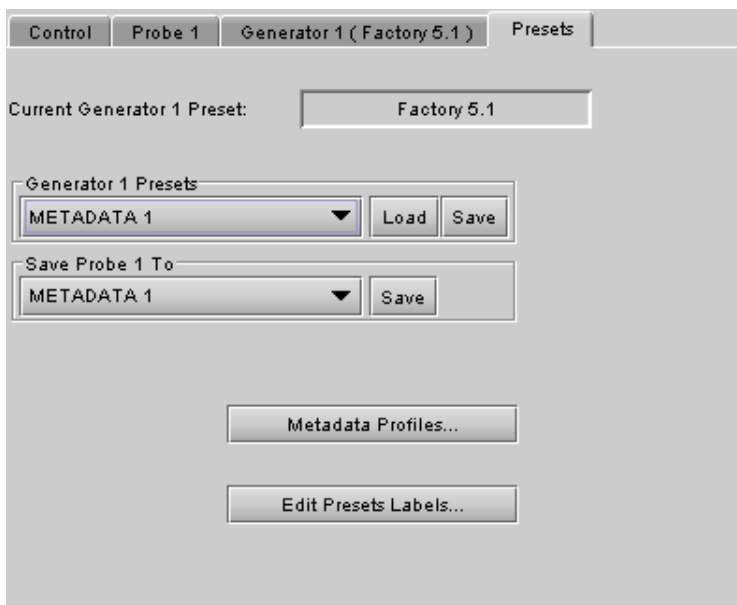
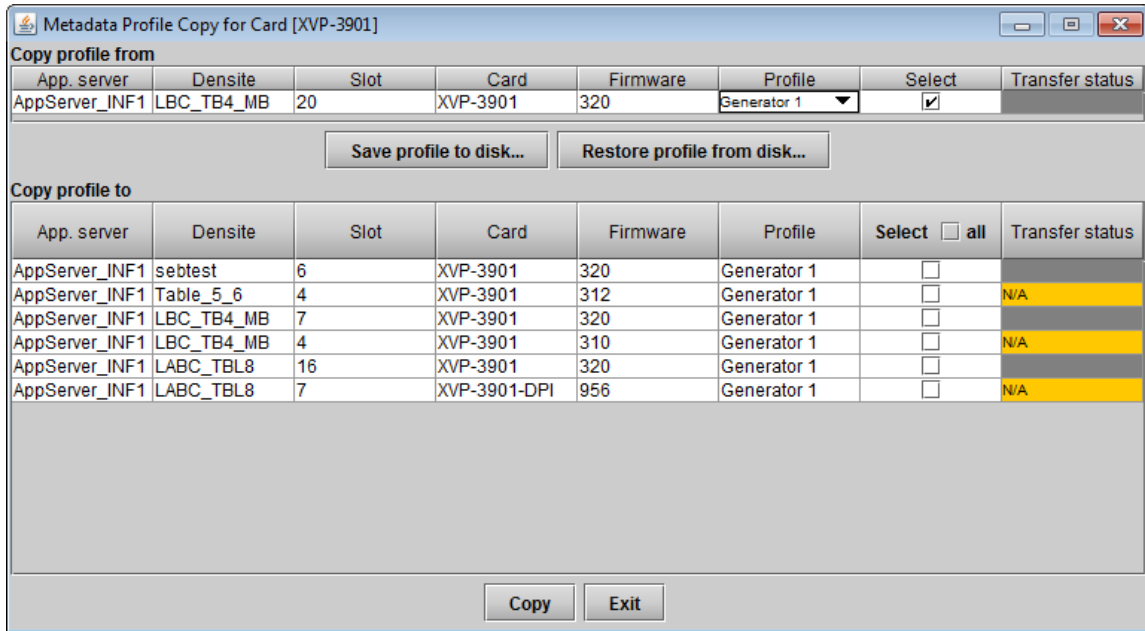

Figure 5.65 [Path #1] → [Presets]

**Note** – If you attempt to save the card configuration to a User Preset when the Metadata generator settings do not correspond to a Metadata Preset value (i.e. if the Current Generator Preset data box shows “Custom”), you will trigger a warning because of the way the Metadata Generator settings are saved. See page 92 for a complete explanation. You may need to return to this panel and save the “custom” settings into a Metadata preset before you can save the card configuration to a User Preset.

- Avoid this by getting in the habit of saving the Generator Metadata settings each time you change them.

The **Metadata Profiles...** button gives access to a panel that allows the user to copy the card settings from this XVP-3901 to other XVP-3901 cards accessible via iControl. These profiles are also compatible with the DAP-1781 metadata profiles.



**Figure 5.66** Metadata Profile Copy window

The **Copy profile from** line shows the current XVP-3901 card.

- The Profiles column contains a pulldown that lists the profiles that are available to copy.
- The list includes the two generators, plus the 10 metadata presets

You can save the selected profile to disk for future recall:

- Click the **Save profile to disk...** button and select a disk location and file name to save the file.

You can recall a previously-saved profile from disk and load it into the card:

- Click the **Restore profile from disk...** button and find the appropriate file
- Click **Open** to load the contents of the file into the current XVP-3901

The **Copy profile to** area shows all other XVP-3901 cards that have been detected on the iControl network.

- The Profile column will show the same profile that was selected for the current XVP-3901 in the Profile pulldown.

- Click the Select checkbox for any cards to which you wish to copy the profile, or select all of them using the Select All checkbox in the column header.
- Click **Copy** to transfer the selected profile to the selected recipient cards.

### 5.10.2 Input/Output tab

This tab provides resources to configure the input and output selections and processing of metadata for the XVP-3901 card.

#### VANC Metadata Extractor

The card can extract 2 Dolby metadata streams from the VANC interval according to the specified SDID (range = 01 to 09). The presence of each stream is reported in the interface.

#### VANC Metadata Inserter

The card can insert 2 metadata streams in the VANC interval for each output (3G/HD and SD outputs). Use the four sets of pulldowns to configure metadata insertion in VANC Stream 1 and VANC Stream 2 for your outputs.

Insertion: Select the source of metadata to insert

- Off: No metadata is inserted.
- Path 1: Metadata from Path 1 is inserted
- Path 2: Metadata from Path 2 is inserted
- ABUS A1: Metadata from the ABUS A1 card is inserted
- ABUS A2: Metadata from the ABUS A2 card is inserted

Insertion Line: Select the VANC line in which the metadata will be inserted. The range depends on the output format:

- 3G/HD: lines 9 to 20
- SD (525) lines 12 to 19
- SD (625) lines 8 to 22

SDID: Select the VANC metadata packet SDID to be inserted. The SDID is used to specify the relationship between the VANC metadata stream and the first channel of its associated audio program.

Note: If the card is configured to insert a special SDID at the output, any Dolby Metadata packets at the input with the same SDID will be deleted. Any other SDID packets not inserted by the card will be passed through untouched.

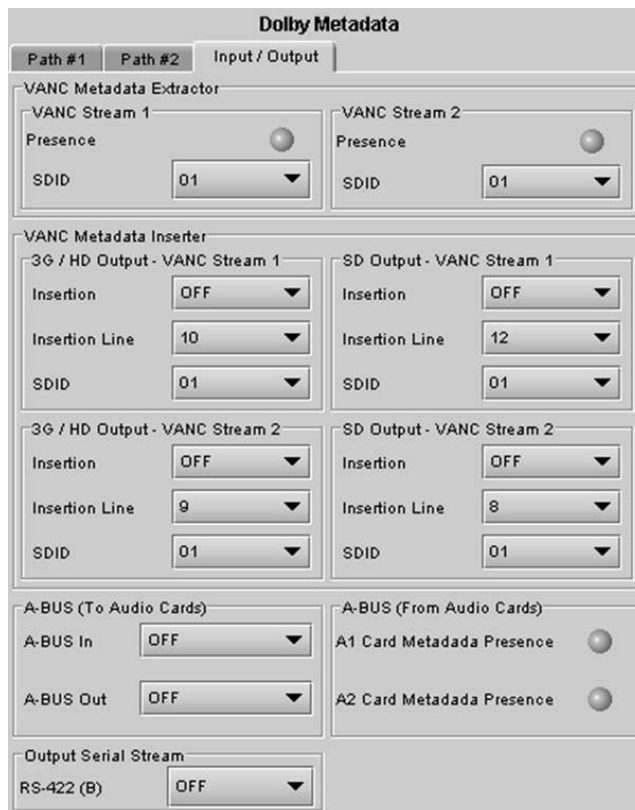

Figure 5.67 Dolby Metadata – Input/Output tab

SDID	Associated channel pair
01	No association, or only one audio program
02	Channel pair 1&2
03	Channel pair 3&4
04	Channel pair 5&6
05	Channel pair 7&8
06	Channel pair 9&10
07	Channel pair 11&12
08	Channel pair 13&14
09	Channel pair 15&16



**A-BUS (To Audio Cards)**

A-BUS In: Use this pulldown to select the source of metadata that will be sent to the external audio cards (if present) on the input A-BUS.

- OFF: No metadata is sent on the input A-BUS
- VANC Stream 1: Extracted VANC Stream 1 is sent on the input A-BUS
- VANC Stream 2: Extracted VANC Stream 2 metadata is sent on the input A-BUS
- RS-422 (B): Input RS-422(B) metadata is sent on the input A-BUS

A-BUS Out: Use this pulldown to select the source of metadata that will be sent to the external audio cards (if present) via the output A-BUS.

- OFF: No metadata is sent on the output A-BUS
- Path 1: Metadata from Path 1 is sent on the output A-BUS
- Path 2: Metadata from Path 2 is sent on the output A-BUS

**A-BUS (From Audio Cards)**

Use this pulldown to select the metadata stream to be sent on the RS-422(B) output.

- OFF: No metadata is sent on the RS-422(B) output
- Path 1: Metadata from Path 1 is sent on the RS-422(B) output
- Path 2: Metadata from Path 2 is sent on the RS-422(B) output
- ABUS A1: Metadata from the ABUS A1 card is sent on the RS-422(B) output
- ABUS A2: Metadata from the ABUS A2 card is sent on the RS-422(B) output

**5.11 ALC panel**

Minimizing loudness differences between segments in a playout channel is an important issue in a world where multiple programs originating in different formats from different sources must be integrated seamlessly. The Automatic Loudness Control (ALC) option is the solution to this need. It uses Grass Valley’s proprietary *wideband* ALC algorithm.

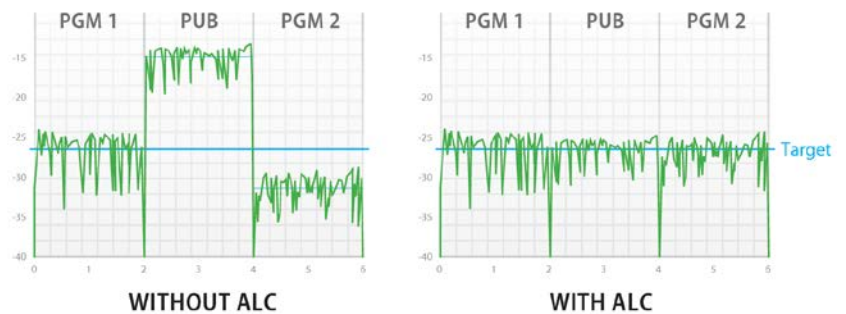

- Identified as XVP-3901-OPT-ALC-X, where X can be 2, 4, 6, 8 or 16 input channels. The table shows the ALC models available, and the number and type of programs supported to occupy the available channels:

Model	Description	Program types supported
<b>XVP-3901-OPT-ALC-2</b>	2-Channel ALC, up to 2 independent programs	Mono, 2.0
<b>XVP-3901-OPT-ALC-6</b>	6-Channel ALC, up to 6 independent programs	Mono, 2.0, 3.0, 4.0, 5.1
<b>XVP-3901-OPT-ALC-8</b>	8-Channel ALC, up to 8 independent programs	Mono, 2.0, 3.0, 4.0, 5.1, 7.1
<b>XVP-3901-OPT-ALC-16</b>	16-Channel ALC, up to 8 independent programs	Mono, 2.0, 3.0, 4.0, 5.1, 7.1

Note: The ALC works with PCM audio. If non-PCM audio like Dolby E or Dolby Digital is fed to the module, it will be ignored and all the program channels will be bypassed to prevent interference with the other PCM audio channels.

### 5.11.1 Config tab

#### Channels per program

Pull-downs are available to select the number of channels per program. Depending on the ALC model, you may have different possible selections, from 1 to 8 channels per program.

#### Input channels selection

An input shuffler allows any combination of the available channels to be used as inputs to each ALC program.

Note: An input channel cannot be assigned to more than one program, and can only be used once within a program.

#### Global Config

The Mode pull-down selects preset values for target, sliding window and loudness units that apply to loudness monitoring for all programs on this XVP-3901:

Mode	Target	Short-Term Time Window	Loudness Unit
EBU R128	-23	3 sec	LUFS
A85 ITU BS.1770	-24	10 sec	LKFS
ARIB TR-B32	-24	3 sec	LKFS

**Enable Loudness Monitoring** turns ON the ALC input and output loudness monitoring for all programs.

### 5.11.2 PGM1-8 tabs

#### Loudness monitoring

When turned ON, the loudness meters display the program input loudness (before ALC processing), the dynamic correction applied by the ALC, the ALC limiter correction, and the program output loudness (after ALC processing).

The input and output loudnesses are given in **LUFS** or **LKFS**, depending on the Mode selected in the Config tab. Loudness meters are integrated over a “sliding window” period which is also mode dependent.

Dynamic and limiter corrections are always given in dB. Each correction meter is integrated over a period of 250 milliseconds.

#### ALC Presets

Three factory presets for the ALC are available to cover most broadcast applications.



Figure 5.68 ALC panel – Config tab

- **Factory Light** – The ALC applies low dynamic range compression on the audio program content. The overall response time is relatively slow, which reduces the ALC ability to tightly follow the target output loudness. Using this preset, the program content will sound a little more dense, while keeping most of the original program dynamic range.
- **Factory Standard** – The ALC applies moderate dynamic range compression on the audio program content. The overall response time is also moderate, which allows the ALC to follow the target output loudness quite well. This preset is well-suited for most types of audio content. It is the factory preset loaded when loading the card default parameters.
- **Factory Heavy** – The ALC applies high dynamic range compression on the audio program content. The overall response time is relatively fast, which improves the ALC ability to tightly follow the target output loudness. Using this preset, the program output content will sound much more dense, less dynamic.

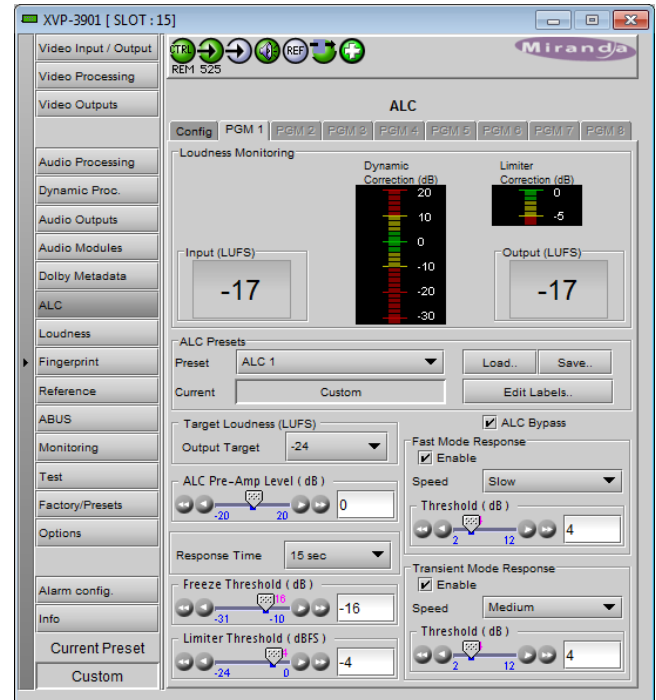

**Figure 5.69** ALC panel – PGM 1, 2, 3, .... or 8 tab

5 user presets are also available to save and load custom configurations of the ALC. These presets are labeled ALC 1 to 5 but the user can edit the preset names via the “Edit Labels” button.

We **STRONGLY** recommend starting with the ALC factory preset (Light, Standard, Heavy) that is closest to the desired objective, then fine tuning it to reach the desired goal. This will minimize the troubles that will likely be encountered as many adjustments interact.

### **ALC Bypass**

Checking this box bypasses the ALC program processing, and the input channels pass-through the output unaltered.

### **Target Loudness**

The *Output Target* pulldown sets the target output loudness. This value sets the *average* output loudness. Due to the program dynamics, the actual output loudness will move around the selected target. The units of measurement and the nominal value, as well as the window size for the measurements (not shown on this panel) are set by the [Mode](#) pulldown in the Config tab.

Although the nominal Target Loudness is reset according to the table above when the *Mode* is changed, the user may change the value at any time using the pulldown, where the available range is -10 to -31 for all modes.

Here’s the time-domain response of the ALC:

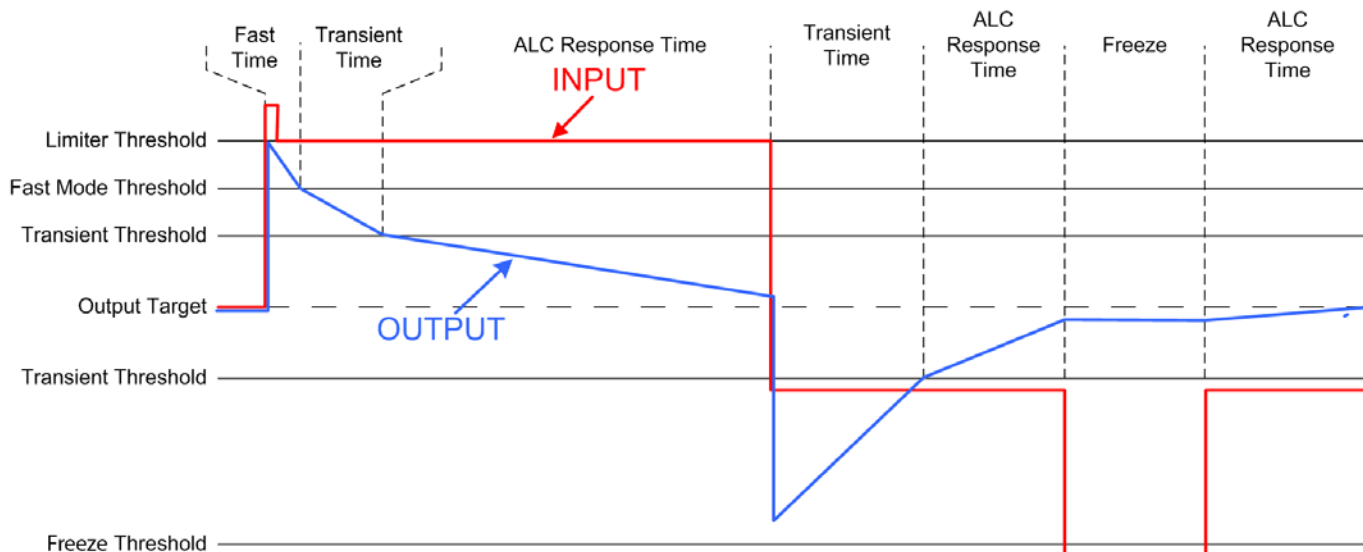

### ALC Pre-Amp Level

A pre-amp stage is available in front of the ALC to compensate for programs having an input loudness out of the ALC tracking range (very low or very high input loudness). The pre-amp level ranges from -20 dB to +20 dB, in steps of 1 dB.

### Fast Mode Response

The *Fast Mode Response* is optional and is enabled by checking the **Enable** box.

The ALC *Fast Mode Response* kicks in whenever the input loudness goes over the **Fast Mode Threshold** and loudness is reduced at the rate set in the *Speed* pull-down (slow = 100 ms; fast = 25 ms). The **Fast Mode Threshold** is given in dB with respect to the target loudness and ranges from 2 to 12 dB, in dB steps.

### Transient Mode Response

The *Transient Mode Response* is optional and is enabled by checking the **Enable** box.

The ALC *Transient Mode Response* kicks in whenever the input loudness goes over or under the **Transient Mode Threshold**. The **Transient Mode Threshold** is symmetric with respect to the target loudness and ranges from 2 to 12 dB, in dB steps. When the input loudness is over the **Transient Mode Threshold**, loudness is reduced following the rate set by the *Speed* pull-down. When the input loudness is under the **Transient Mode Threshold**, loudness is increased, again following the *Speed* pull-down, which ranges from Slow (up to 15 seconds) to Fast (up to 4 seconds).

### Response Time

Outside of the *Fast* and *Transient* modes ranges, the ALC performs loudness correction slowly, following the **Response Time**. Response time values are : 5 sec, 10 sec, 15 sec, 20 sec, 30 sec, 45 sec, 1 min, 5 min, 10 min, 15 min, 20 min.

### Freeze Threshold

The **Freeze Threshold** sets the threshold below which the ALC will not increase loudness. This prevents quiet portions of programs (and noise) from being unintentionally boosted. If the input program loudness is under the **Freeze Threshold** for more than 30 seconds, the ALC will smoothly return to 0 dB of loudness correction.

**Limiter Threshold**

The **Limiter Threshold** will limit the output loudness under the selected threshold. This prevents loud portions of programs from being unintentionally clipped. If the input program loudness is over the **Limiter Threshold**, the ALC will reduce the loudness very quickly, in 1 millisecond.

**5.12 Loudness Panel**

**Note:** In order to use the loudness measurement capabilities of the XVP-3901, the Loudness Option must be installed. See Loudness Measurement option: on page 103 for details.

The XVP-3901 allows the user to measure the loudness of audio streams passing through it. The measurement process is flexible:

- All major loudness standards are supported.
- The measurement standards can be customized if desired.
- Up to four programs can be measured at once.
- Each program can be selected from an internal XVP-3901 metadata path, or defined manually.
- Segment markers can be inserted from a variety of triggers.
- Log files of the measurements can be stored externally, for analysis using Grass Valley’s Audio Loudness Analyzer.

**5.12.1 Loudness | Config panel**

**Global Config**

All loudness measurements performed by this XVP-3901 conform to the same standard, which is selected here using the Meter Mode pulldown.

Six options are available:

Standard	Target	Short-Term Time Window	Relative Gating	Loudness Unit
EBU R128-2010	-23	3 sec	-8 dB	LUFS
EBU R128-2011	-23	3 sec	-10 dB	LUFS
A85 ITU BS.1770.1	-24	10 sec	N/A	LKFS
A85 ITU BS.1770.2	-24	10 sec	-10 dB	LKFS
ARIB TR-B32	-24	3 sec	-10 dB	LKFS
Custom	-31 to -1	1 to 15 sec	-8, -10, N/A	LKFS

For the 5 defined standards, the other three pulldowns are inactive, but display their preset values in gray.

If Custom is selected, the other three pulldowns are active, and values can be chosen according to the user’s needs. The range of available values is shown in the chart.

**Global Control**



**Figure 5.70** Loudness panel – Config tab

The XVP-3901 can monitor loudness on up to four programs specified by the user.

- In this panel, select which programs will be active using the PGM 1 to PGM 4 checkboxes.
- The tabs for the selected programs will become active, allowing each program to be defined.

*Enable Loudness Monitoring* turns all loudness monitoring functions ON or OFF

*RESET* resets the measurements, and places a segment marker in the log file (but only if *User Event* is selected in the Segment Marker area).

*RUNNING / PAUSE* shows the current status of the loudness monitoring.

- Click the button to change the status.
- PAUSE stops the measurement until the button is clicked again, but keeps the last value for logging and measurement.

### Segment Marker

Select the checkboxes corresponding to the events for which you want a segment marker inserted in the loudness log file:

- User Event – a manually-triggered RESET (but not a PAUSE).
- GPI – a trigger received externally via GPI input. GPI6 can be configured to trigger a Loudness reset; the control is located on the **Factory/Presets | GPI** tab (see section 5.18.4 on page 95)
- Dialnorm change – a change in Dialnorm value in the incoming metadata stream.
- Coding Mode Change – a change in the coding mode, either through the manual settings or detected in the incoming metadata stream.

Note that segment marker triggers in one PGM will generate segment markers in the logs for all PGMs.

### 5.12.2 Loudness | PGM panel

Four PGM panels – PGM 1, PGM 2, PGM 3 and PGM 4 – are available, each activated by selecting the appropriate checkbox in the LOUDNESS-CONFIG panel.

Use these panels to define the programs whose loudness will be monitored by this XVP-3901.

#### Program Settings

Operation Mode: Use the pulldown to select to source of the program definition:

- Manual: Use the Manual Coding controls to define the program channel
- Path 1: Use Path 1 as defined in the Dolby Metadata panel (see section 5.10.1 on page 70)
- Path 2: Use Path 2 as defined in the Dolby Metadata panel (see section 5.10.1 on page 70)



Figure 5.71 Loudness panel – PGM 1 tab

**Manual program definition:**

Select Manual in the Operation Mode pulldown.

Select the coding mode (e.g. 2/0, 3/2L, etc.) from the Manual Coding Mode pulldown

Assign inputs to the program channels using the Input Channels pulldowns

- For each program channel, input CH 1 to CH 32 can be selected
- Each input can only be selected once in a program.
- Only the program channels corresponding to the selected coding mode will be enabled

The chart shows the coding modes that are available, and the program channels that are enabled for each.

Coding Mode	Program Channels					
	Left	Right	Center	LFE	Ls	Rs
1/0			X			
2/0	X	X				
3/0	X	X	X			
3/0L	X	X	X	X		
2/1	X	X			X	
2/1L	X	X		X	X	
3/1	X	X	X		X	
3/1L	X	X	X	X	X	
2/2	X	X			X	X
2/2L	X	X		X	X	X
3/2	X	X	X		X	X
3/2L	X	X	X	X	X	X

**Metadata (Path 1 and Path 2) program definition**

If Metadata from Path 1 or Path 2 is selected as the source, the Manual Coding Mode pulldown is disabled.

The Program Select switcher allows the user to select from among up to eight available programs (program 1 is the default selection).

Once a program is selected, its Dialnorm and Coding Mode are extracted and displayed in the data boxes below the switcher.

Note that:

- If the user selects a Metadata source (Path 1 or Path 2), but no metadata is present, the selection defaults to Manual mode.
- In Manual mode, there is no dialnorm to extract.



### Measurements

The Measurements area displays results from the loudness measurements performed on the selected program according to the settings made in the Config tab. The three data boxes show these values:

- Short term (S) Loudness averaged over the short-term time window set in the Config tab.
- True peak MAX Maximum true peak level found in all selected input channels
- Momentary MAX Loudness averaged over a 400 ms sliding rectangular time window

The chart shows a running plot of the last 15 seconds of the value of the Short Term (yellow trace) and Momentary (green trace) loudness values. The bar graph at the right indicates the current Momentary value.

A reset, initiated by a user via the Reset button on the Config tab, or via a GPI event (configured on the Factory/Presets | GPI tab; see section 5.18.4 on page 95 for more information), will reset all of these measurements.

### 5.12.3 Loudness | Logging Panel

This panel monitors logging activity for all loggers connected to the application server associated with this XVP-3901 and its associated Densité frame.

- The Logging Activity icon will be GREEN when logging activity is detected.
- The number of loggers connected to the appserver is shown in the data box.

#### About Log Files

Loudness logs contain data for a period of up to 24 hours. New log files are started:

- when the logging function is enabled
- every 24 hours after logging was enabled, until logging is disabled
- when the reference changes
- when the global config is changed,



Figure 5.72 Loudness panel – Logging tab

See **ANNEX 6 – Loudness Logging and the Audio Loudness Analyzer** beginning on page 158 for detailed instructions on activating logging and analyzing the logged data files.



## 5.13 Fingerprint panel

Fingerprinting technology on this card functions in conjunction with iControl.

- ***iControl 4.0 and higher is required.***

XVP-3901 streaming is ON by default, but the management of the stream is handled in iControl, and there is no local control of the process at this card control panel, except to select the window, and to turn streaming OFF if there are problems with the stream or the network.

- Use the pulldown at the top of the panel to turn Fingerprint Streaming ON or OFF

See the iControl Version 4.00 User's Guide (Grass Valley document 226-99M00-271) for a description of Fingerprint management in iControl.

The relevant text can be found in the section called 'Lip-Sync Detection and Monitoring' which is in the chapter titled 'Working with iControl as an Operator'

Individual, independently-adjustable fingerprints are generated for the 3G/HD output and for the SD output. Use the tabs in the panel to select one of these.

### Zone

Select the area of the image within which fingerprint data will be calculated and streamed.

- The selected area is shown as a blue outline on the control panel window, superimposed over a thumbnail of the video.
- The thumbnail is only available when the Input Control box is selected in the Thumbnail panel.

**Default Window** – a factory default is specified which is applied consistently to all Grass Valley fingerprinting devices. It places the window in the central "action area" of the image, generally avoiding letterboxes and static graphics that are usually found in the periphery of the image.

**Full Screen** – opens the window to include the complete video image.

**Start/Stop Line & Pixel** – allows the user to create a custom window in response to particular or unusual image content.

- The custom window can be placed anywhere within the picture.
- Type the value into the data box and Enter, or use the scroll arrows to change the value

**Use a mouse to resize** – you may also use your mouse to move and resize the window. Click within the blue frame and it will turn yellow and display control handles. Mouse over a handle until the cursor switches to an arrow icon, and then drag the handle to resize the window. When you are not over a handle, the 4-arrow cursor allows you to drag the window to a new location



**Figure 3.73** 3G/HD output or SD output

- While you are resizing with the mouse, the start and stop line and pixel are shown in the top left of the frame area, in this format:  
[start line, start pixel][stop line, stop pixel]
- The original position of the frame remains visible while the size or position is being changed, so the amount of change can easily be seen

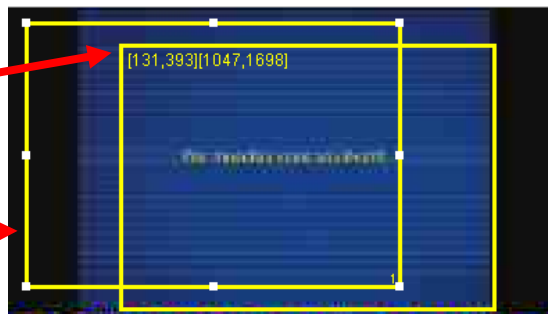

Figure 3.74 Fingerprint panel – window resizing

### 5.14 Reference panel

This group of parameters allows the selection of the reference to be used by the XVP-3901.

Use the radio buttons in the Reference Source area to select from the following options:

- Auto – this mode selects the first source detected in this order of priority:
  - External Reference input
  - URS
  - Selected Input signal
- External – selects the signal connected to the rear-panel REF IN connector
- URS (Universal Reference Signal) – selects the internal reference from the backplane
- Input – uses the currently-selected input signal.

URS Format – use the radio buttons in the URS Format area to select whether the URS is OFF, 29.97 Hz or 25 Hz.

- When URS is OFF, the URS reference format source cannot be selected, and will also be ignored by the automatic detection mode.



Figure 5.75 Reference panel

## 5.15 A-BUS panel

When companion audio cards such as the DAP and UAP are used to provide additional audio channels, the A-BUS audio bus links the installed audio cards and the XVP-3901. This panel is used to instruct the XVP-3901 about the presence of installed audio cards and the system configuration.

### Multiple Card Config sub-section

**A1/A2 Presence:** Monitors the presence of companion audio cards installed in the chassis (see section 2.1 XVP-3901 Installation).

**Card System Config:** To enable the audio bus, use the pull-down box and select your system's configuration. Selecting Video restricts available audio signals to audio signals on the video card; Video / A1 or Video / A1 / A2 adds the audio channels incoming from the installed audio cards that have been detected.

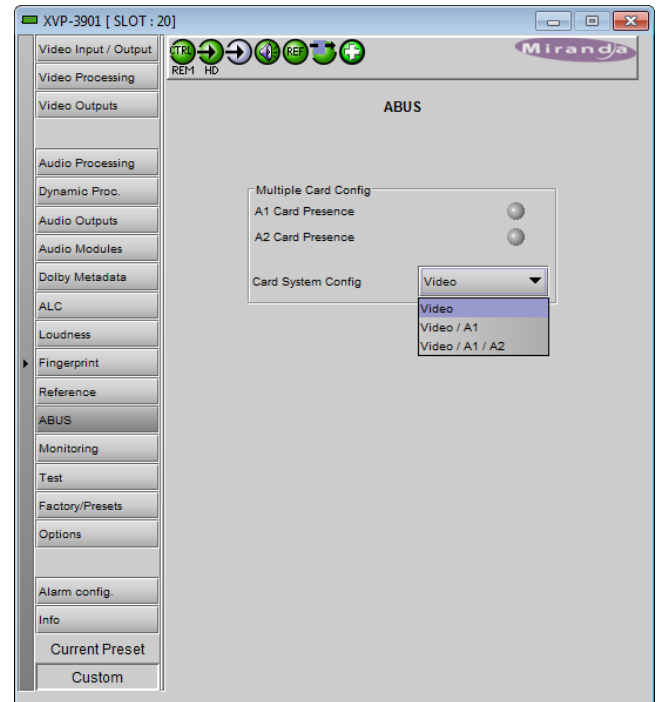

Figure 5.76 A-BUS panel

## 5.16 Monitoring panel

### 5.16.1 Thumbnails tab

The thumbnail area displays thumbnail images for the inputs and outputs selected in the Player area.

**Player** – Click the checkbox to display the thumbnail

**Control** – Click the checkboxes to apply the Mode, Format, Quality and Refresh Rate settings to these thumbnails.

**Mode** – select between Video mode and Test mode. Use Video mode for normal operation.

**Format** – choose the thumbnail size: small, medium, large

**Quality** – choose the quality of the displayed image by selecting Poor, Normal or HiQ (High Quality) from the pulldown list

**Refresh Rate** – select the desired refresh rate from the pull-down box. The choices are:

[Fast, 1 sec, 2 sec, ..., 9 sec, 10 sec.]



Figure 5.77 Monitoring - Thumbnails

### 5.16.2 RALM tab

The Remote Audio Level Meter (RALM) panel displays audio output level meters for up to 8 channels. Channels are displayed in pairs, so up to four meters will be present in the meter display window. The source for each meter is selected using the pull-downs in the RALM Remote Control area at the bottom of the control panel.

- OFF
- HD Out CH 1&2 up to CH 15&16
- SD Out CH 1&2 up to CH 15&16
- AES Out 1 to AES Out 4

The meter is divided into three zones, and the dividing points and color of each zone are individually configurable under the *Meter Ballistics Config* tab.

*Speed* – select the meter response from the pull-down list, options are [ fast, medium, slow ]



Figure 5.78 Monitoring - RALM tab

#### 5.16.2.1 RALM Connections tab

Use the radio buttons to turn the meter display ON (RALM) or OFF for the indicated channels. The meter appears directly above the controls.

*Reset Counter:* click this button to reset the overload counter on the ALM display to zero. See the next section for instructions on setting up the overload counter.

#### 5.16.2.2 Meter Ballistics Config tab

*Type* – select a type of meter from the pull-down list

*Upper Zone Limits* – select the crossover level between the upper and middle zones of the meter (the range of values shown in the pull-down list depends on the type of meter selected)

*Lower Zone Limits* – select the crossover level between the middle and lower zones of the meter (the range of values shown in the pull-down list depends on the type of meter selected)

*Color samples* – the three samples show the current selected color for the upper, middle and lower zones of the meter.

- Click on the color sample of a zone to open a color selection panel to choose a different color for that zone

*Overload Cursor* – The overload cursor appears on the meter as an arrowhead in the meter scale. The two pull-down boxes set the position of the overload cursor on the left and right meters. If the audio level on that channel goes above the cursor, the Overload Counter at the top of the meter is incremented.

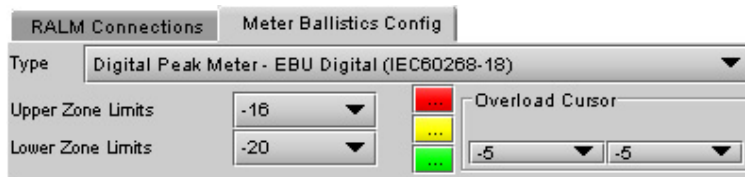

Figure 5.79 RALM - Meter Ballistics Config

The *Overload Counter* shows a running count of the number of overloads detected. The Overload level is shown by a marker beside the meter, and its position can be set under the *Meter Ballistics Config* tab

The *Phasemeter* (located at the bottom of the RALM meter display) is a small meter that represents the phase correlation factor between the two channels of a pair.

Note – The level and phase meters are disabled for channels carrying non-PCM audio (Dolby E, Dolby Digital, Dolby Digital Plus or other non-PCM types).

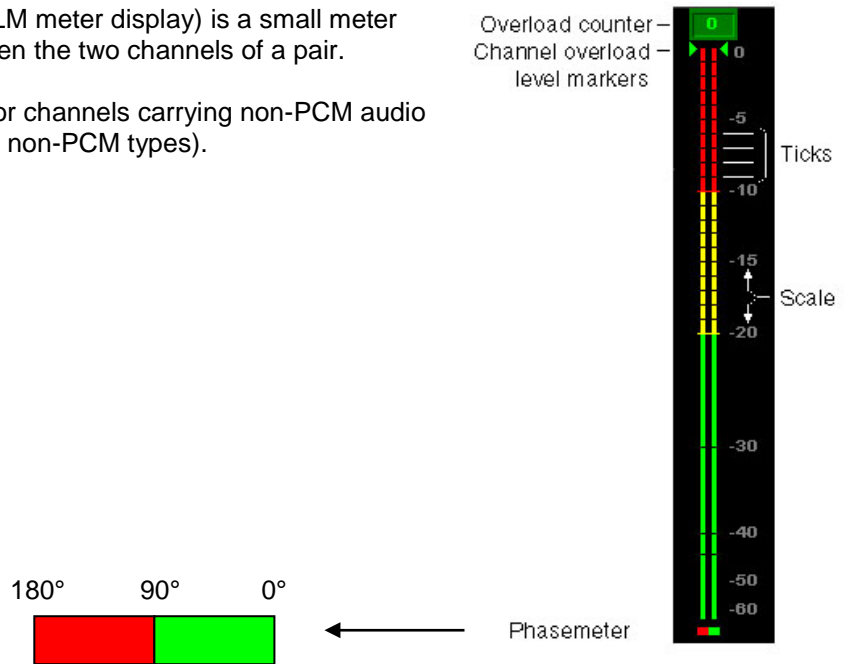

Figure 5.80 RALM meter display

### 5.17 Test panel

This panel contains a single checkbox that sends a 75% color bar test pattern (100% white), along with audio test tones (a continuous tone on right channel with pulsed tone on left channel in every pair) to the XVP-3901 output.

Note – the card must have a valid reference in order to generate a test pattern.



Figure 5.81 Test panel

## 5.18 Factory/Presets panel

### 5.18.1 Factory/Presets tab

#### Factory section

**Load Factory:** Clicking this button will restore the card to a factory default state. Two checkboxes enable the user to choose whether to include Parameters and/or Alarms in the restoration process

- Note that User Presets are not changed

#### User Presets section

The XVP-3901 has memory registers which can hold up to 5 user-defined parameter settings.

The *Current Preset* box (at the bottom left corner of the panel) displays the last loaded preset. Any change to the card configuration after a preset is loaded will change the display to "Custom" instead of the preset number.

**Select** any one of the five presets using the pull-down list. The name of the currently-selected User Preset is shown on the pulldown box.

Click **Load** to load the contents of the selected User Preset into the XVP-3901. All parameter settings and values will be replaced by the contents of the selected User Preset.

- The first 4 user presets can be recalled by GPI User Preset 1 to 4, as configured in the GPI tab.

Click **Save** to store the current parameter settings and values from the XVP-3901 into the selected User Preset. The existing contents of the preset will be overwritten.

**Note:** if you see a pop-up warning box like this when you click *Save*, you will need to decide how to deal with the Metadata Generator presets. Click on the Metadata FAQ button to learn more about this issue.



Figure 5.82 Factory/Presets panel and tab

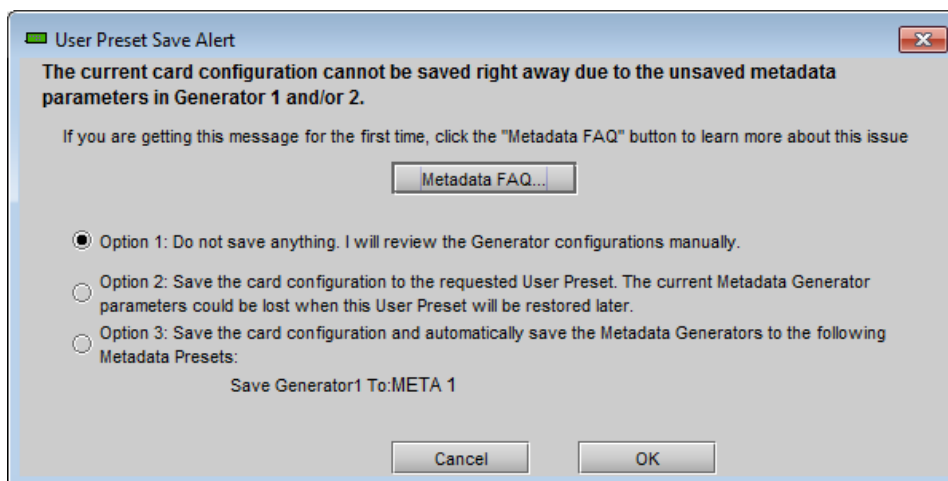
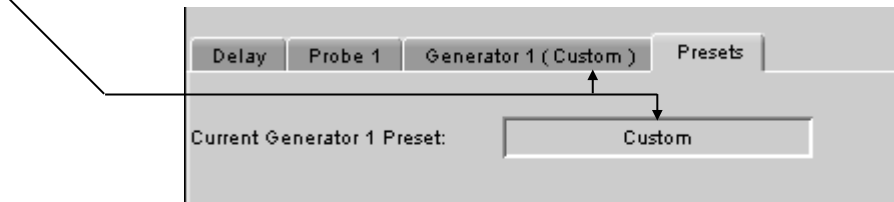

Figure 5.83 User Preset Save Alert warning panel

Briefly explained, a User Preset stores all the parameter values on the XVP-3901 card **except** the parameter values for the Metadata generators. These values are stored in a separate set of registers, and the User Preset saves the contents of these registers plus a pointer to the register that was most recently used. If you change any of the Metadata values but do not update the Metadata register by saving it, the values referenced by the pointer are not the current values. If you save to a user preset under this circumstance, the User Preset will not contain the changed values, and they cannot be recovered if you later load the card from the preset.

The **User Preset Save Alert** panel will be triggered any time you attempt to save when the Generator Metadata values have been changed but not saved. You can tell when this is the case, as both the User Preset box on the main panel, and the Current Generator Preset box in the Presets tab, as well as the Generator tab label, will all read *Custom*



**Figure 5.84** How to tell when the metadata generator settings have not been saved

The warning box gives you three options for dealing with the situation:

- Option 1 – abort the save process, so that you can go back and manually save the metadata parameters (see instructions on page 76)
- Option 2 – go ahead and save anyway, but be aware that if you recall this User Preset you will probably not restore the current metadata generator settings
- Option 3 – Save the Metadata presets first, in the Metadata register whose name is displayed (it will be last register that was used, and if it is one of the factory registers a Save will not be allowed, so you might want to consider option 1), and then save the User Preset.

Use the radio buttons to select one of these options (option 1 is the default), and click OK to proceed.

### **Lock Input Selection section**

When User Presets are saved, the input selection is saved as well. This means that changing User Preset may change input selection, depending on which one is associated with the User Preset. This is the normal behavior when "Update Input Select with User Preset" is chosen.

Selecting "Do Not Change Input Select with User Preset" forces the input selection to remain unchanged, while applying all other settings associated with the selected preset.

### **5.18.2 Edit Presets Label...**

Click this button to open a window where you can define the name assigned to each user preset. This is the name that will appear on the pull-down in the User Presets section. The labels will also be copied from card to card when a copy profile is performed.

### **5.18.3 Profiles...**

Use *Profiles* to save or recover the entire card configuration (including user presets if desired) on an external disk, or to copy it to another XVP-3901 card.



Click on *Profiles* to open the Profile Copy window.

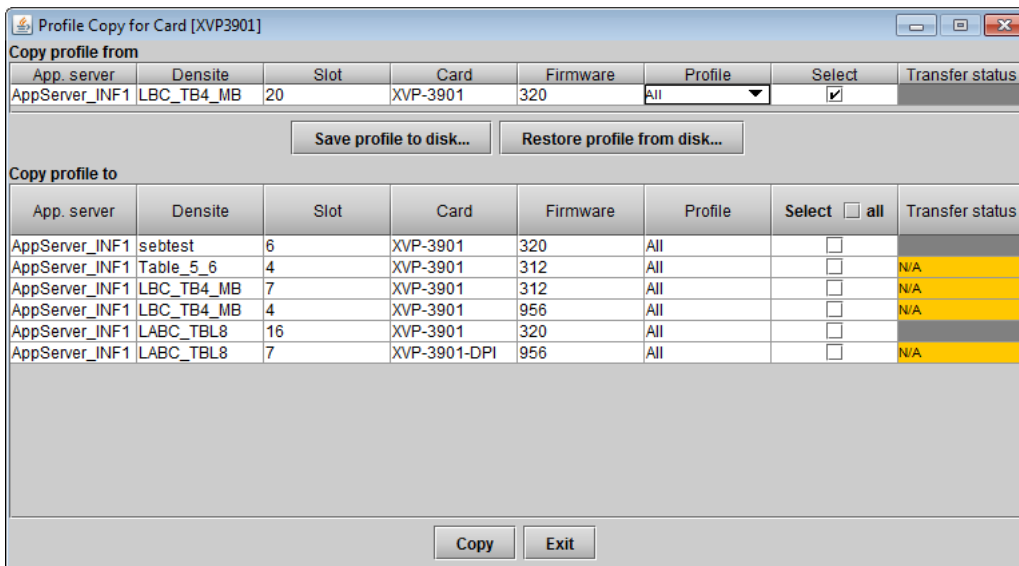

Figure 5.85 Profile copy for card window

### 5.18.3.1 Copy profile from

This line shows this XVP-3901 card, and identifies it by App server, Densité frame and slot number, card type and firmware version.

The *Profile* column has a pulldown that allows you to select which profiles you will work with, and gives these choices:

- Current, User1, User2, User3, User4, User5, All

The *Select* column includes a checkbox (preselected checked) to confirm that you want to work with the current card.

### 5.18.3.2 Save Profile to Disk...

Click this button to open a Save dialog allowing you to specify a file name and location to which the selected profiles for this card will be saved.

*Hint - It is a good idea to create a folder for these files, because they are not explicitly identified as XVP-3901 profiles, and will be difficult to find and identify if not clearly named and conveniently located.*

- Click the save button once the name and location have been identified in the Save box
- If the file is saved correctly, the Transfer Status box on the right of the *Copy profile from* line will indicate *Succeeded* against a green background
- If the file was not saved for some reason, the Transfer Status box to the right of the *Copy profile from* line will indicate *Failed* against a red background

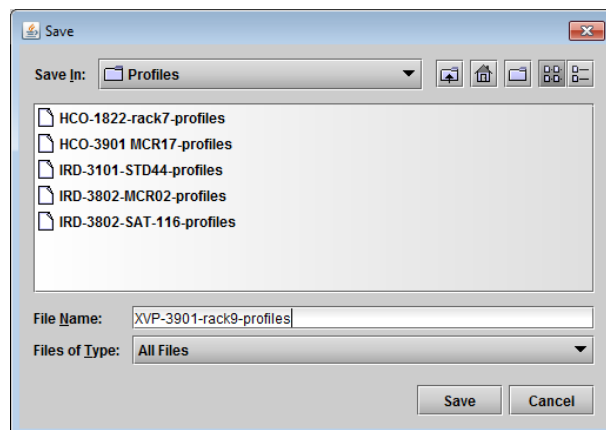
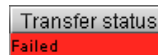
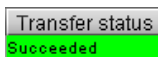

Figure 5.86 Save Profile to Disk dialog



### 5.18.3.3 Restore profiles from disk...

Click this button to open an *Open* dialog box within which you can locate and select a valid XVP-3901 profile file.

- Click Open to read the contents of the file and to reconfigure this XVP-3901's profiles according to its contents
- While the reconfiguration is in progress, the Transfer Status box on the right of the *Copy profile from* line will indicate *Working* against a yellow background
- When the reconfiguration is complete, the Transfer Status box on the right of the *Copy profile from* line will indicate *Succeeded* against a green background

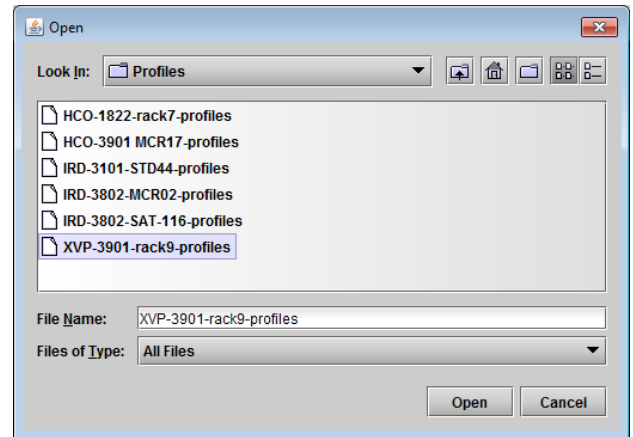

**Figure 5.87** Restore profiles from disk dialog

### 5.18.3.4 Copy profile to section

This line shows other XVP-3901 cards that are available on the iControl network, each identified by App server, Densité frame and slot number, card type and firmware version.

The *Profile* column shows the same information as is shown for the current card in the *Copy profile from* line, i.e. one of the following:

- Current, User1, User2, User3, User4, User5, All

The *Select* column includes a checkbox to identify which XVP-3901 cards you wish to copy profiles into from the current card.

- For convenience, a *Select all* checkbox is provided in the column header

Click *Copy* to copy the selected profiles from this card into the selected other XVP-3901 cards

- While the profile copy operation is in progress, the Transfer Status box on the right of the *Copy profile to* line will indicate *Working* against a yellow background
- When the profile copy operation is complete, the Transfer Status box on the right of the *Copy profile to* line will indicate *Succeeded* against a green background

### 5.18.4 GPI tab

The six GPI inputs are used to trigger some selected functions, as follows:

- GPI 1 – Restore User Preset 1 configuration
- GPI 2 – Restore User Preset 2 configuration
- GPI 3 – Restore User Preset 3 configuration
- GPI 4 – Restore User Preset 4 configuration
- GPI 5 – Select card input 1
- GPI 6 – Select card input 2 OR Reset Loudness

The GPIs are all contact closures to ground (GND). To select a User Preset (GPI 1 to 4) or an Input Select (GPI 5 & 6), simply short the corresponding GPI input pin to any GND pin. GPI 1 & 5 can also be used to trigger a different function when the GPI contact closure is released (low to high transition).

Note that GPI 6 has two possible functions, selected by the pull-down:

- Select Input 2, as described above
- Reset Loudness – see page 84 for details

GPI loading is a “single load” process triggered by a transition to ground: it needs to be activated only for a short period (around 10 milliseconds) to be detected by the card. Since it is not activated by a level, it is not necessary to maintain the level at ground after the activation.

Enable the indicated function for each GPI by clicking the checkbox beside it; disable it by clicking the box again to remove the checkmark. The GPI events are sent to the audio card through the ABUS regardless of the state of the checkbox.



Figure 5.88 Factory/Presets – GPI tab

The current state of each GPI is reported by the “State” icon.

- When a contact closure to ground is present on the GPI input, the state icon will be green.
- Otherwise, the state icon will be gray.

GPOs are also contact closure to ground. A low level indicates the GPO is currently active. When a user preset is activated by GPI, iControl or by the card menu, the corresponding User Preset GPO is also activated. If the card configuration is modified, the GPO will be cleared at the same time.

Action on Release, Load...

You can select actions to occur when GPI 1 and GPI 5 are released, allowing a “switch & return” type of operation.

- GPI 1 triggers USER 1 when activated; it can trigger USER 5 when released.
- GPI 5 selects Input 1 when activated; it can trigger Input 2 when released

Use the checkboxes to activate these release functions.

Note that you may activate either *User Presets Recall* in the GPI tab as described here, or *Automatic Preset Recall* in the Automatic Preset Recall tab, but only one of these may be active at a time. If Automatic Preset Recall is active when you select an action in this tab, a warning box will appear to remind you that enabling this function here will disable the Automatic Preset Recall, and giving you the choice to proceed, or to cancel the selection.

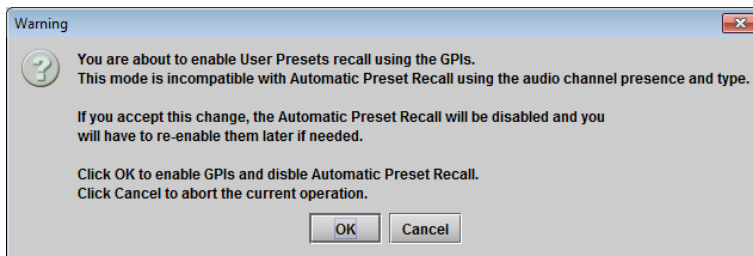

Figure 5.89 Presets selection warning

### 5.18.5 Automatic Preset Recall tab

XVP-3901 offers the user the possibility to select a user preset based on the status of the incoming audio.

Access to the User1 and User2 presets can be triggered automatically when specific combinations of input audio signals are detected at the XVP-3901 input.

Switching card parameters in mid-program is more complex than switching them manually in an off-line situation because of the need to minimize or eliminate any transition effects, and is generally quite specific to the card configuration and the audio modules that are installed. Because of this, a fully automatic configuration of the feature is not possible, and user involvement is required. Set-up instructions are given below.

The Automatic Preset Recall (APR) feature uses the status of audio appearing at the 16 input audio channels to determine whether activation of a preset is required.

- The user specifies the combination of audios that must appear on all 16 channels using a concise Presence/Type string notation in a data box, one for each of the two user presets.
- For reference, the current input Presence/Type string is shown in a data box.
- The current input status for each channel is also displayed in a color and text graphic.

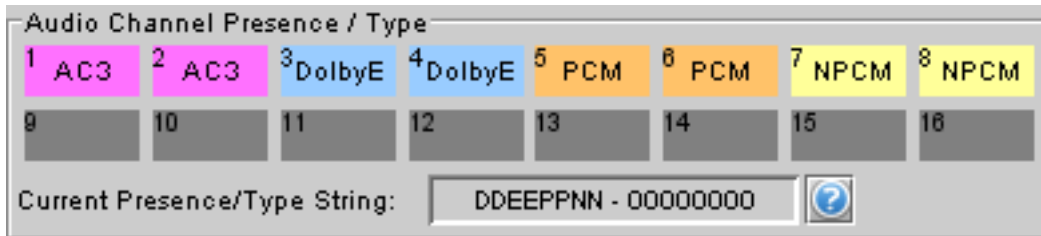

The display and string notation used in the iControl panel is as follows:

Audio Type	Audio Channel Presence/Type Graphic		Presence/Type string character
	Label	Color Code	
Audio Not Present	(blank)	Dark Gray	0
PCM	PCM	Orange	P
Non-PCM	NPCM	Yellow	N
Dolby E	DolbyE	Blue	E
Dolby Digital	AC3	Fuchsia	D
Dolby Digital Plus	NPCM	Yellow	N
Don't Care	(only in string)	(only in string)	X

Auto Preset Recall is only available under the following conditions:

- Audio option is enabled;
- Audio option is disabled, but an audio card like the DAP-1781 is connected to the XVP-3901 using the ABUS AND the Card System parameter is set to "A1" or "A1A2".

Otherwise, the tab will be grayed and inaccessible.

**Audio Presence Detector section**

Implementing this feature requires the use of an audio presence detector, since *Audio Not Present* is one of the parameters used in the detection process. This is not the same as an audio silence detector, which finds quiet portions in a present audio signal (the XVP-3901’s silence detectors are set up in the Audio Processing panel).

Use the *Threshold* pulldown to set the level (in dBFS) below which the XVP-3901 will consider the audio to be absent.

Range: -72 (default), -66, -60, -54, -48

Use the *No Signal Duration* pulldown to set the time interval for which the audio must be continuously detected as absent before the Signal Absent status will be confirmed and active.

Range: 33 msec (default), to 100 msec in steps of 10 msec.



Figure 5.90 Automatic Preset Recall tab

**Automatic Preset Recall section**

To activate this feature, click Enable Preset Recall

- Always configure the User Presets 1 & 2 before activating this feature, as the card will try to reload the previously saved presets every time you try to change the card’s configuration. First, uncheck Enable Preset Recall, configure the card according to the first preset, save it and then proceed the same way for the second preset. Finally, enable the Automatic Preset Recall by checking the Enable Preset Recall.
- Note that you may activate either *Automatic Preset Recall* as described here, or *User Presets Recall* in the GPI tab, but only one of these may be active at a time. If User Presets Recall is active when you click Enable Preset Recall in this tab, a warning box will appear to remind you that enabling this function here will disable the User Presets Recall, and giving you the choice to proceed, or to cancel the selection.

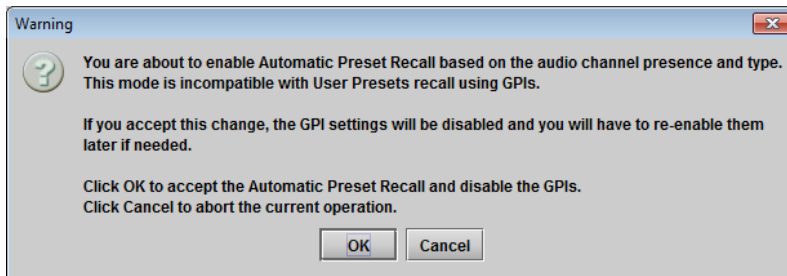

Figure 5.91 Presets selection warning

*Audio Conditions* – type a Presence/Type string into the data box for each of the presets that you wish to recall automatically. Priority will be given to the first condition (USER 1). For example, if you want to do something when 5.1 audio is detected and something else when it is not detected, define the audio condition for 5.1 as the first condition.

The string represents the input configuration that will trigger the preset.

- A useful way to determine the appropriate entry is to set up the inputs to the configuration of interest, and then copy the string that appears in the Current Presence/Type String data box into the User Preset data box. Note that unused channels should be set to 'X' (don't care) rather than 0 (absent).

While you are typing, note that:

- Only the characters that are significant can be typed; other keystrokes have no effect
- Characters are not case sensitive, although they appear as capitals in the databox.
- Click and drag to select one or more characters to type
- If you stop typing before filling all the selected character spaces, all remaining spaces will be filled with X (i.e. don't care) once you move the focus away from the box.
- The XVP-3901 will automatically detect conflicts, i.e. audio conditions that could call both presets simultaneously. This could arise because of Don't Care situations, or because the same string was accidentally entered in both preset boxes. The most recently entered string will appear in red and will not be active. In case of conflicts, the User Preset 1 condition will have priority.

Delay – set the delay between the detection of the condition that triggers the loading of a preset, and the actual execution of the preset.

- The range in the scroll box is from 0 msec up to 500 msec, continuously variable.
- For XVP-3901, the default value is 30 msec, but the optimum value really depends on the application.

The Delay parameter is used to delay the loading of a User Preset into the card's hardware. The delay range will be from the fastest audio condition detection time to the longest processing delay of the card.

To begin, note that the Audio Type detector and the Audio Presence detector are both located at the input to the card:

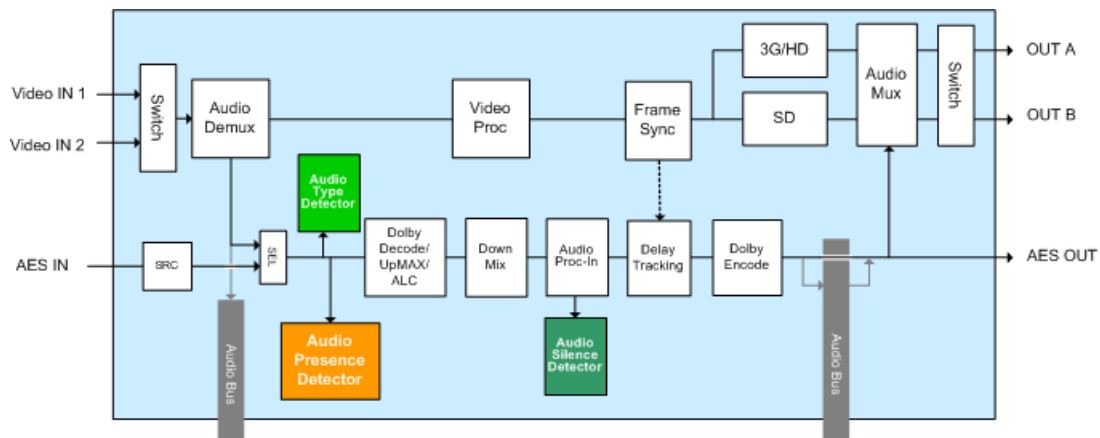

**Figure 5.92** Relative position of audio presence and type detectors

The idea is to calculate the time delay as the audio passes through the XVP-3901 between the time at which the audio condition is detected, and the time when the audio arrives at the location where the changes in processing need to be applied. The new preset should only be applied then, so that the processing change is applied only to the new audio type.

Each card preset may contain hundreds of parameters: some are used to configure input parameters and others output parameters. Unfortunately, all changes are applied more or less at one time, so some compromise is often required when processing delays through the card are relatively long, such as in Dolby Digital and Dolby Digital Plus

encoding applications. Understanding what processing changes are required, and where those changes are applied in the signal path through the XVP-3901, will help in making the most effective choice of delay time.

Most of the time, the different presets are nearly identical and only a few parameters will change from one preset to another. Obviously, if the preset needs to control input and output parameters at the same time, it will be impossible to select a perfect Delay.

Application for the Automatic Preset Recall:

Figure 5.90 shows the application. When DV is present on embedded input channels 7-8, it is passed at the output. When not present, a downmix version of the main 5.1 will be used. It has been determined by the customer that the audio level on the DV channels is always above -72 dBFS because of the noise floor. If it goes below that threshold, we can assume there is no audio present.

User Preset 1 will be recalled when DV is present on the embedded audio input channels 7-8. The embedded audio output shuffler for channels 7-8 will be programmed to pass the input channels 7-8.

User Preset 2 will be recalled when DV is silent on the embedded audio input channels 7-8. The embedded audio output shuffler for channels 7-8 will be programmed to pass the output downmix channels 15-16 made from channels 1-6.

The No Signal Duration will be set to 30 msec and the Threshold to -72 dBFS. Assuming the total processing delay of the XVP is set to 66 msec to give enough reaction time between the detection of the silence and the application of the preset, the Automatic Preset Recall should be configured as shown in the picture below:

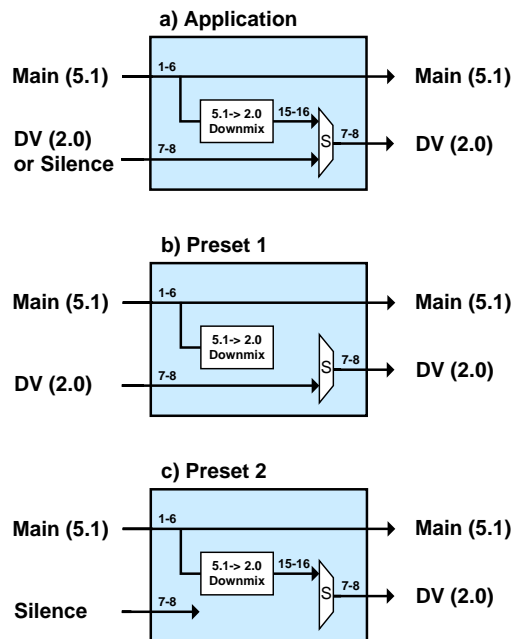

Figure 5.93 Application for automatic preset recall

Audio Presence Detector		
Threshold	-72 dBFS	No Signal Duration
	▼	30 msec ▼
Automatic Preset Recall		
<input checked="" type="checkbox"/> Enable Preset Recall	Audio Conditions	Delay
	Presence/Type (P,E,D,N,0,X)	in msec
	1 8 9 16	
1- USER1 (Late Night Show)	XXXXXXXXPP - XXXXXXXX	8
2- USER2 (Network 2.0)	XXXXXXXX00 - XXXXXXXX	10

The delay to apply the preset has been optimized to take into account the No signal Duration, the total processing delay of the card and the internal reaction times of the card. Determining the accurate preset Delay to apply is rather complicated. Please contact our Technical Support department if you experience any difficulties.

## 5.19 Options panel

Six options are available for the XVP-3901:

- Discrete AES and 32 Channel Internal Audio Processing Option (XVP-3901-OPT-AUD)
- Key/fill option (XVP-3901-OPT-K)
- Dynamic Processing Option (XVP-3901-OPT-DP)
- Loudness Measurement option (XVP-3901-LM)
- ALC option (XVP-3901-OPT-ALC-X)
- XVP-3901 Full Upgrade option (XVP-3901-OPT-UG-xx2XVP)

To activate each of these options, you must

- Obtain a license key from Grass Valley, A Belden Brand..
- Type the license key in the box
- Click on ENABLE OPTION to enable the option's features.

### 5.19.1 Audio option

Enables the discrete AES I/Os, the 32-channel internal audio processing and the Dolby metadata processing.

*Note: When the Audio option is not enabled, all discrete AES I/Os and audio processing features are disabled. If there is embedded audio and Dolby metadata in the input signal, they pass through to the output signal.*

*However, when the Audio option is not enabled (using a software key) BUT there are companion audio cards installed and connected to the XVP-3901 with the ABUS cable, the Audio Processing, Audio Output and Dolby metadata controls will be available and functional.*

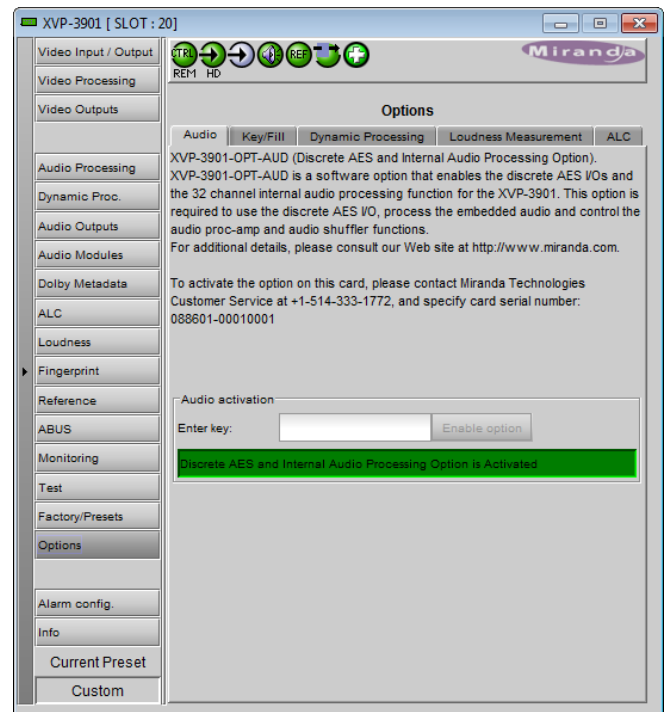

**Figure 5.94** Audio option



### 5.19.2 Key/Fill option:

This option is used to enable the background key/fill functionality for the side panels and letterbox.



Figure 5.95 Key/Fill option

### 5.19.3 Dynamic Processing option:

This option enables the audio dynamics processing functionality of the XVP-3901.

- *Note: The Audio option must be enabled before enabling the Dynamic Processing option*



Figure 5.96 Dynamic Processing option



### 5.19.4 Loudness Measurement option:

This option enables the loudness measurement and logging functionality of the XVP-3901.

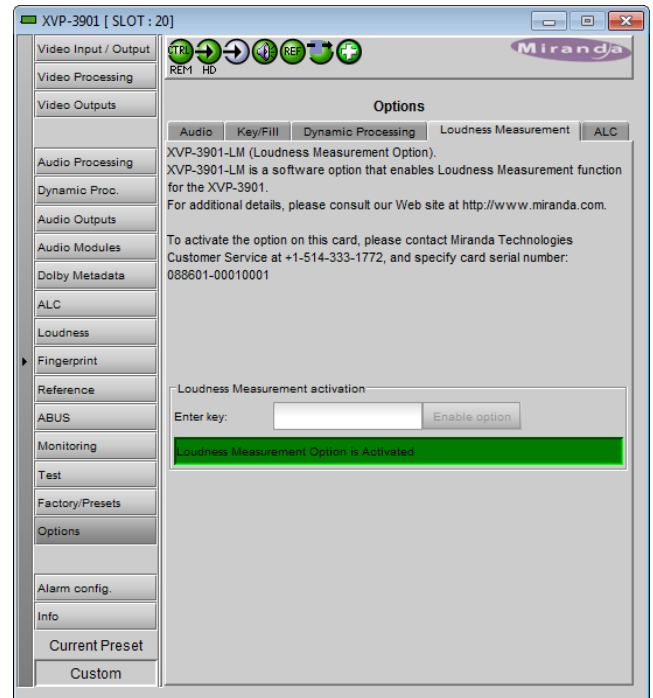

Figure 5.97 Loudness Measurement option

### 5.19.5 ALC option

This option enables the Automatic Loudness Control feature of the XVP-3901.

Note that this option is available for 2, 6, 8 or 16 channels. A separate license key is required for each of these, and the data window below the *Enter key* data box will indicate which is currently enabled, e.g.:

**ALC XVP-3901-OPT-ALC-16** for the 16 channel option

If the currently-enabled option is 2, 6, or 8 channels, the *Enter key* data box will be available to upgrade to a greater number of channels.



Figure 5.98 ALC option

### 5.19.6 XVP Full Upgrade option (XVP-3901-UG-xx2XVP):

This option can be used to upgrade an XVP-3901-UC, -FS, -DC, or -XC model to a full XVP-3901.

- The option name varies depending on which model you have – **xx** in the upgrade option name is the current model designation. For example, the option to upgrade an XVP-3901-XC to a full XVP-3901 will appear as XVP-3901-UG-XC2XVP
- The tab for this option does not appear in this panel if the card is a full XVP-3901 (as shown in the figures above).

## 5.20 Alarm Config panel

This panel allows the alarm reporting of the XVP-3901 to be configured. The panel opens in a new window when the button is clicked, and can be resized if needed.

The panel is organized in columns.

### Status/Name

This contains an expandable tree listing all the alarms reported by this XVP-3901 card.

- Each alarm name includes an icon that shows its current status:  
 Green – no alarm flagged  
 Red – alarm is flagged  
 Gray – error not applicable in this case  
 Black – Disabled
- Some alarms may be text-only and the alarm status is shown in the name and not by a status icon, e.g.:

 Hardware Failure Description (Hardware OK)

The **Card LED**, **Overall alarm** and **GSM contribution** columns contain pulldown lists that allow the level of contribution of each individual alarm to the alarm named in the column heading to be set.

- Click on the alarm icon to see the available levels; then click on one to select it

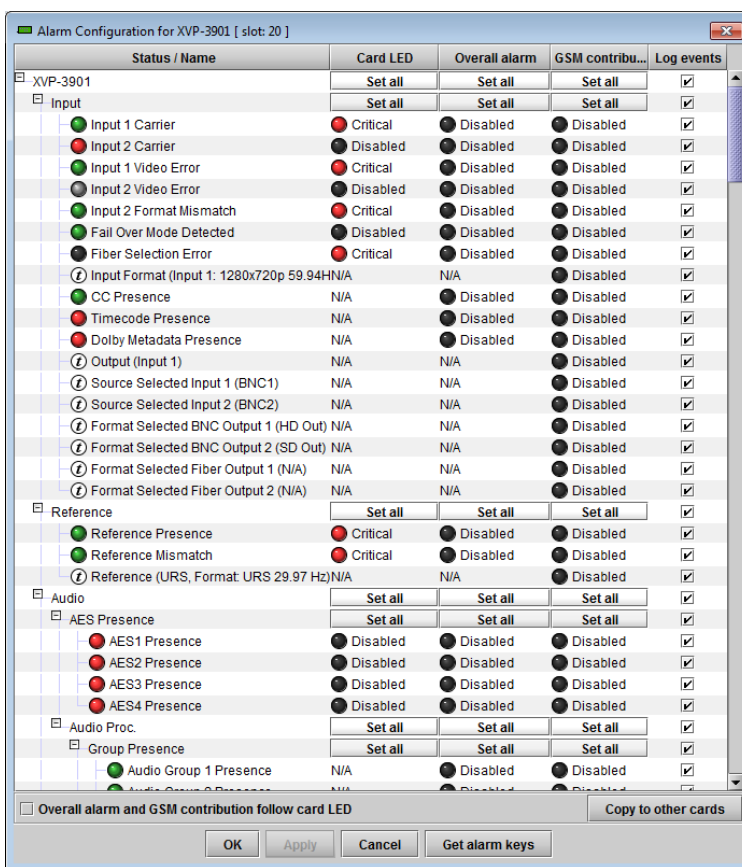

Figure 5.99 Alarm Configuration panel

### Card LED

This column allows configuration of the contribution of selected individual alarms to the status LED located on the front card edge. The Card LED status is shown at the bottom of the alarm tree in the Status/Name column.

**Overall Alarm**

This column allows configuration of the contribution of each individual alarm to the Overall Alarm associated with this card. The Overall Alarm is shown in the upper left corner of the iControl panel, and also appears at the bottom of the Status/Name column.





**GSM Contribution**

This column allows configuration of the contribution of each individual alarm to the GSM Alarm Status associated with this card. GSM is a dynamic register of all iControl system alarms, and is also an alarm provider for external applications. The possible values for this contribution are related to the Overall alarm contribution:

- If the Overall alarm contribution is selected as Disabled, the GSM alarm contribution can be set to any available value
- If the Overall alarm contribution is selected as any level other than disabled, the GSM contribution is forced to follow the Overall Alarm.

**Levels associated with these alarms:**

The pulldown lists may contain some or all of the following options:

- |   |   |
|---|---|
|  Disabled    | The alarm makes no contribution (black icon)                            |
|  Minor       | The alarm is of minor importance (yellow icon)                          |
|  Major       | The alarm is of major importance (orange icon)                          |
|  Critical    | The alarm is of critical importance (red icon)                          |
|  Passthrough | The alarm exists but has no effect (used for text and composite alarms) |

**Shortcut:** if you click in one of the Set All boxes beside a section heading, you will open a pulldown that lets you assign a level to all alarms in that section of the column simultaneously.

Once the alarms are configured, you may accept the changes or discard them:

**Log Events**

iControl maintains a log of alarm events associated with the card. The log is useful for troubleshooting and identifying event sequences. Click in the checkbox to enable logging of alarm events for each individual alarm.

At the bottom of the window are several other controls

**Overall alarm and GSM contribution follow card LED**

Click in the checkbox to force the Overall alarm and GSM contribution to be identical to the Card LED status

- All Overall alarms and GSM contributions for which there is a Card LED alarm will be forced to match the Card LED alarm
- All Overall Alarms and GSM contributions for which there is no Card LED alarm will be forced to Disabled

A warning box will open allowing you to confirm the action, since it will result in changes to the configuration and there is no *undo* function.

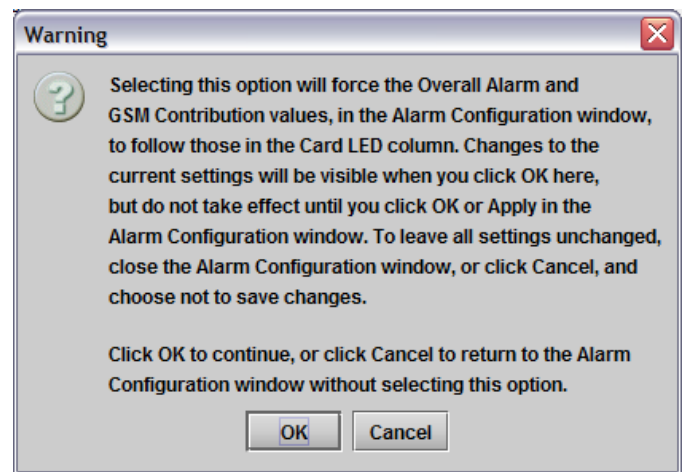

Figure 5.100 Warning for Follow LED change

**Copy to other cards**

Click this button to open a panel that allows the alarm configuration set for this card to be copied into another XVP-3901 card.

- Select one or more destination cards from the list in the window by clicking in the checkboxes, or all of them by clicking in the *All* checkbox
- Note that when you do a Copy Profile for this card (see Sect.5.18), the alarm configuration is copied along with all the other settings.

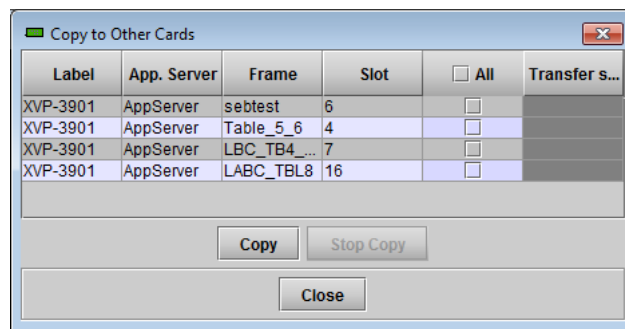

Figure 5.101 Copy to other cards window

**Get alarm keys**

Click this button to open a save dialog where you can save a file containing a list of all alarms on this card and their current values, along with an Alarm Key for each. The alarm keys are useful for system integration and troubleshooting.

- The file is saved in Excel.csv format

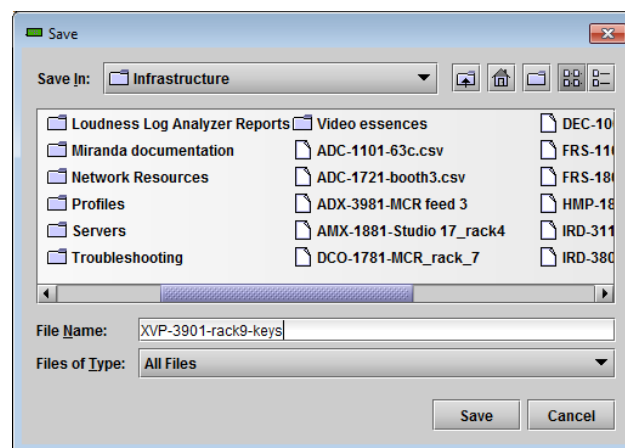

Figure 5.102 Get alarm keys dialog

**OK, Apply, Cancel**

- **OK** accepts the settings and closes the window once the card confirms that there are no errors.
- **Apply** accepts the settings, but leaves the window open
- **Cancel** closes the window without applying any changes, and leaves the previous settings intact.

## 5.21 Info panel

The top two lines in this panel identify the model of this XVP-3901, and the rear panel that is currently installed.

When the XVP-3901 is included in an iControl environment, certain information about the card should be available to the iControl system. The user can enter labels and comments that will make this card easy to identify in a complex setup. This information is entered into data boxes in the Info control panel.

**Card Model:** identifies the card model (FULL, XC, UC, DC or FS)

**Rear Type:** identifies the rear module currently installed.

**Optic Fiber:** identifies the optic fiber module currently inserted in the fiber module socket, and the module vendor.

*NOTE: The current version of the XVP-3901 supports CWDM SFP modules, but the Optical Fiber Module data window in this panel displays an incorrect identification for these modules. This discrepancy will be resolved in a subsequent release.*

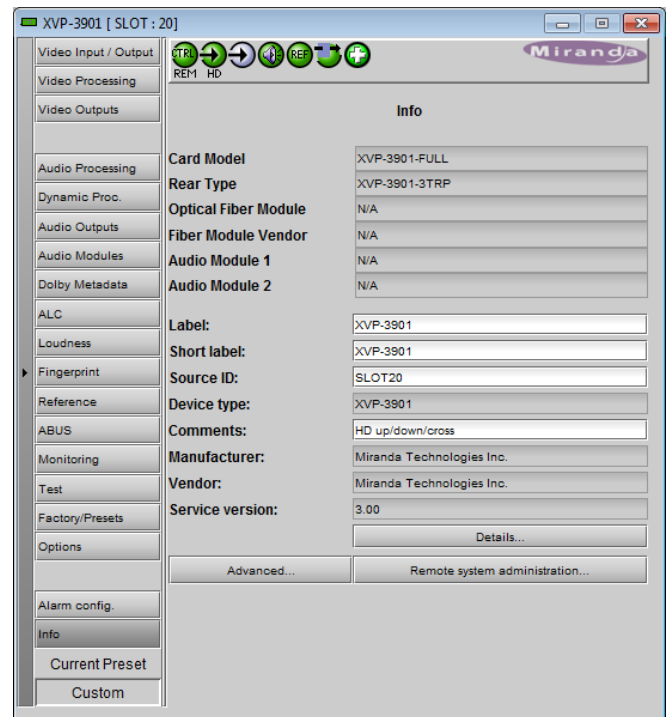

**Figure 5.103** Info panel

**Audio Modules:** identifies any audio modules installed in slots 1 and 2

**Label:** type the label that is shown for this XVP-3901 when it appears in iControl applications

**Short Label** type the short-form label that iControl uses in some cases (8 characters)

**Source ID** type a descriptive name for this XVP-3901

**Comments:** type any desired text

The remaining data boxes show manufacturing information about this card.

Three buttons in the panel give access to other information.

- **Details...:** Reports the Firmware version, service version, and panel version for this card

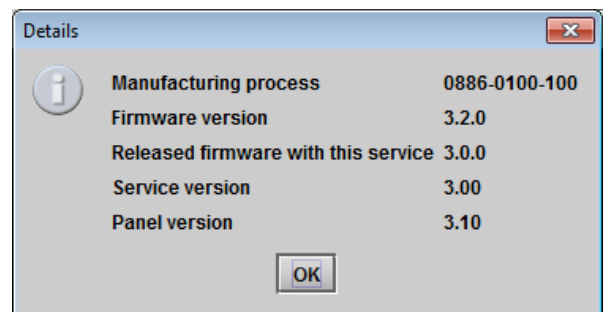

**Figure 5.104** Details window

- **Advanced...**: Shows the LongID for this card. The LongID is the address of this XVP-3901 in the iControl network.

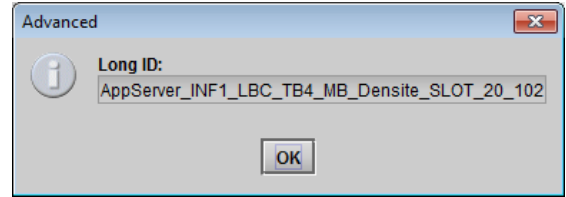

Figure 5.105 Advanced window

- **Remote System Administration** – opens the Joining Locators window, which lists remote lookup services to which this XVP-3901 is registered.

**Add:** Force the iControl service for this XVP-3901 to register itself on a user-specified Jini lookup service, using the following syntax in the data box:

jini://<ip\_address>

where <ip\_address> is the ip address of the server running the lookup service, e.g.:

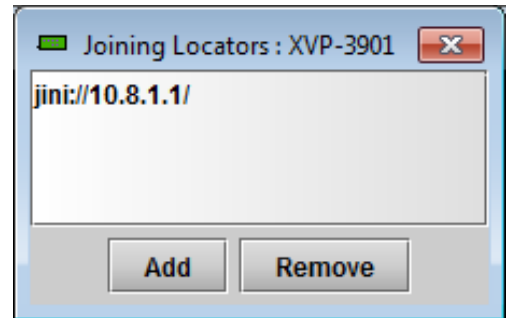
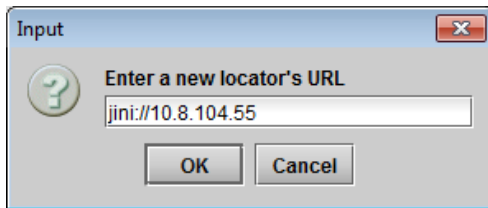
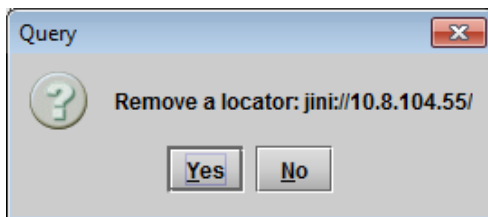

Figure 5.106 Joining Locators window



**Remove:** select one of the services listed in the window by clicking on it, and click *Remove* to open a query box allowing you to delete it from the window.



## 6 Audio Modules

The XVP-3901 supports the use of up to two optional audio processing modules, user-installed into sockets on the main circuit board.

- See Annex 3 beginning on page 154 for a description of the module installation and removal procedure

A number of different modules are available, allowing the functionality of the XVP-3901 to be customized. This section of the manual describes each of the available modules in detail.

Module	Description	See section
MOD-DOLBY-DEC-2	Dolby E and Dolby Digital decoder	6.1 on page 110
MOD-DOLBY-ENC-D-2	Dolby Digital and Dolby Digital Plus encoder	6.2 on page 113
MOD-DOLBY-ENC-E	Dolby E encoder	6.3 on page 115
MOD-LA-DUP-701	Upmixing using Linear Acoustic Technology upMAX™	6.4 on page 116
MOD-LA-ALC-N*	N-channel ALC licensed by Linear Acoustic	6.5 on page 118
MOD-LA-ALC-N*-DUP	N-channel ALC and upmix licensed by Linear Acoustic	
MOD-JA-ALC-N*	N-channel ALC licensed by Jünger Audio	6.6 on page 127
MOD-JA-ALC-N*-DUP	N-channel ALC licensed by Jünger Audio & upmix by Linear Acoustic	

\* N = 2, 6 or 8, referring to the number of channels processed.

The Dolby decoder, Linear Acoustic upMAX™ (upmix), Linear Acoustic AeroMAX™ (ALC) or Jünger Audio Level Magi™ (ALC) modules are located at the input of the audio processing path, as shown in this block diagram of the XVP-3901 audio processing section. If both modules are installed, the Dolby E and Dolby Digital decoder module is located before the upmix or ALC modules in the audio processing path, to allow the decoded channels to be upmixed. The Dolby E encoder and the Dolby Digital and Digital Plus encoder modules are located at the end of the audio processing path:

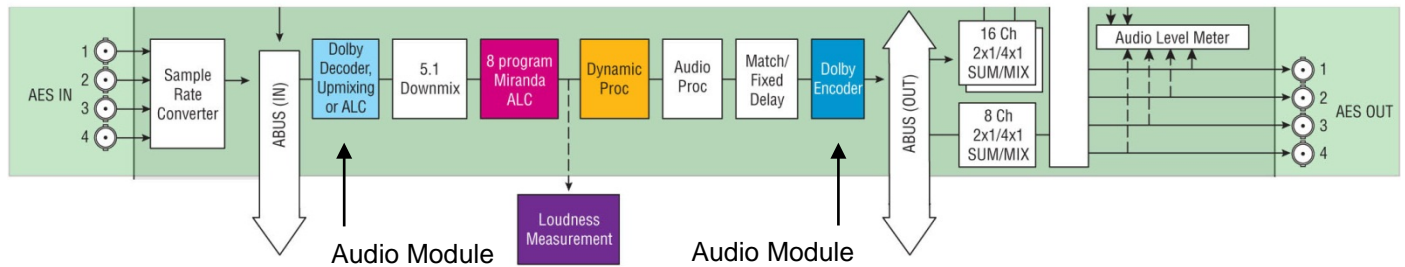

The output channels of the above modules are always fixed and depend only on the module socket number in which it is inserted. The outputs for module 1 will always be in the range 17 to 24. The output for module 2 will always be in the range 25 to 32. Refer to the table below for a quick overview of the output channels versus the installed modules and their module position:

Installed Module	Output channels when in Module #1	Output channels when in Module #2
MOD-DOLBY-DEC-2	17-24	25-32
MOD-LA-DUP-701	17-22	25-30
MOD-DOLBY-ENC-D-2	17-18	25-26
MOD-DOLBY-ENC-E	17-18	25-26
MOD-LA-ALC-X-YYY	17-24 (depending on number of channels)	25-32 (depending on number of channels)
MOD-JA-ALC-X-YYY	17-24 (depending on number of channels)	25-32 (depending on number of channels)



It must be noted that the MOD-LA-DUP-701 has only 6 outputs and the MOD-DOLBY-ENC-D-2/E has only 2 outputs. In these cases, only the first 6 or 2 channels are used. The MOD-LA-ALC-X-YYY and MOD-JA-ALC-X-YYY modules may have from 2 to 8 outputs depending on the model used.



The processing delay for all MOD-LA-ALC-X-YYY and MOD-JA-ALC-X-YYY modules is ¼ of a video frame. To compensate for this processing delay, the user must increase the processing delay of the card by +1 frame. This additional processing delay must be added manually in the Video Output page under the Timing tab.

## 6.1 Dolby E and Dolby Digital decoder

- Identified as MOD-DOLBY-DEC-2 on the module tab.

The decoder supports Dolby E, Dolby Digital or PCM signals. Any other non-PCM signal will be lost through the decoder module; its outputs will be muted.

For a Dolby E input signal, the decoder outputs a metadata bitstream which may be used by the audio processing and the audio modules, embedded in the SD outputs, or sent to the RS-422 output. See the Dolby Metadata tab.

A selector is provided at the Decoder input, but the output channels of the Decoder are mapped to channels 17 to 24 when module is in slot#1 or channels 25-32 when module is in slot#2.

### 6.1.1 Control tab

The **Bitstream Detection Mode** dictates the action taken by the decoder for each type of input bitstream.

In **Auto** mode, the decoder automatically recognizes and decodes PCM, Dolby Digital or Dolby E input bitstreams. If **Dolby E only** is selected, the decoder recognizes and decodes only Dolby E bitstreams; otherwise the decoder outputs are muted. The same behavior applies for the **Dolby Digital only** selection. If **Mute (OFF)** is selected, all outputs are muted for any type of input bitstreams; the Mute mode disables the Dolby E and Dolby Digital decoder.

The **Input Selection** determines the Dolby E and Dolby Digital decoder input channel pair. See **Audio Processing/AES Inputs** for the input selection from the audio card.

The **Decoder Status** section indicates the bitstream format detected at the decoder input. The possible values are: Dolby E (16, 20 or 24 bits), Dolby Digital (16 or 32 bits, Channel 1, 2 or both), PCM. The detected Dolby format will give access to the corresponding tab in the row beside the Control tab.

The **Dolby Digital** section at the bottom of the tab is available only if the input bitstream is Dolby Digital, and the Detection Mode is Dolby Digital or Auto.

- Refer to ANNEX 5 at the end of this document: *Dolby Digital Main Channel Output Functions*.

The **Stream Select** parameter selects the stream number to be decoded when multiple Dolby Digital bitstreams are embedded within a single channel pair.



Figure 6.1 Audio Modules - Dolby E and Dolby Digital Decoder - Control



The **AES Channel Select** parameter selects which AES3 channel is the source of the Dolby E and Dolby Digital decoder if the Dolby Digital data is configured in Professional 16-bit format. If the selected channel does not contain a valid Dolby Digital bitstream, the channel data will be passed to the decoder output as a PCM signal.

The **Listening Mode** parameter selects the main channel output listening mode. It is active only for a Dolby Digital input signal.

- **Full** is the standard mode.
- Monitoring in **3 Stereo** mode reproduces only the left, right and center channels, the surround channels are muted.
- In **Phantom** mode, the center channel output is muted.
- The **Stereo** mode will output only on the left and right channels, and the **Mono** mode only on center channel.
- Refer to ANNEX 5 at the end of this document: Dolby Digital Main Channel Output Functions.

### 6.1.2 Dolby E tab

The **Dolby E** tab indicates status information for the selected Dolby E bitstream.

The **Dolby E Common Status** section shows two values that are common to all programs contained in the Dolby E bitstream: **Program Configuration** and **Frame Rate**.

The **Decoder to Proc Channel Assignment** section gives the decoder output mapping to the internal channels of the XVP-3901.

- The **Main Output** sub-section shows channel assignments related to the Program Configuration.

The **Prg 1 to Prg 8** sub-tabs indicate Metadata information associated with each Dolby E program: **Coding Mode**, **Bitstream Mode**, **Dialnorm** (dialog normalization) value, **Line Mode Profile**, **RF Mode Profile**, **Dolby Surround Mode**, **Surround EX Mode** and **Preferred Stereo Downmix**. The number of programs depends on the Program Configuration.

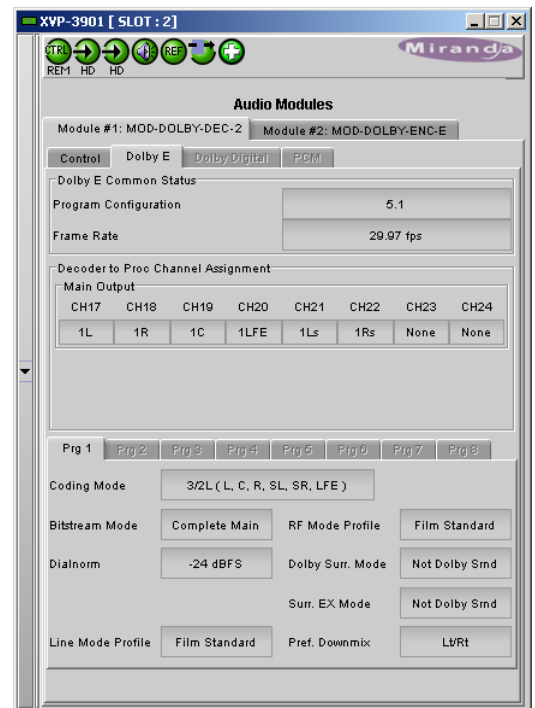

**Figure 6.2** Dolby E and Dolby Digital decoder - Dolby E tab

### 6.1.3 Dolby Digital tab

The **Decoder to Proc Channel Assignment** section indicates the output channel assignment. The Main Output sub-section shows channels assignment related to the Program Configuration.

The **Dolby Digital Status** section indicates status information for the Dolby Digital bitstream selected at the bottom of the **Control** tab:

- Coding Mode
- Data Rate
- Bitstream Mode
- Dialnorm value
- Dolby Surround Mode
- Surround EX Mode
- Preferred Stereo Downmix Mode

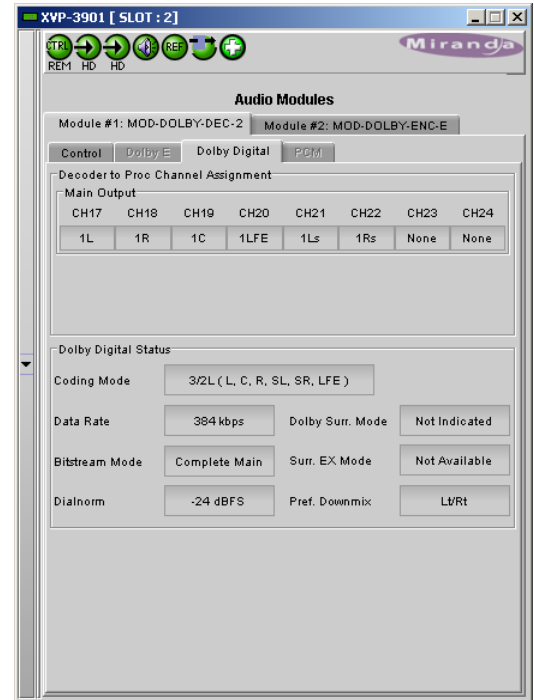

Figure 6.3 Dolby E and Dolby Digital decoder - Dolby Digital tab

### 6.1.4 PCM tab

The **PCM** tab section indicates the output audio assignment of the Dolby E and Dolby Digital decoder module when its input is a PCM signal.

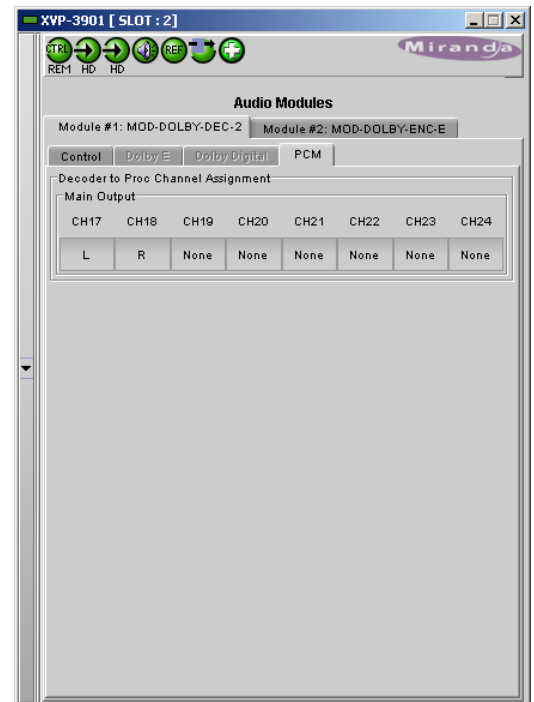

Figure 6.4 Dolby E and Dolby Digital decoder - PCM tab

## 6.2 Dolby Digital and Dolby Digital Plus encoder

- Identified as MOD-DOLBY-ENC-D-2 on the module tab. The Dolby Digital Plus functionality is available in module version 5.1.0.0 and higher (version number shown in the upper right corner of the tab).

### 6.2.1 Shuffler Inputs Section

An input shuffler allows any combination of the input channels (default are CH1 to CH6). The input labeling will follow the Metadata (Coding Mode parameter for the selected Program).

- Pulldowns: Available input channels 1 to 32

This encoder places the output on channels 17 and 18 when the module is installed in socket #1 and channels 25 and 26 when installed in socket #2.

#### Dolby Digital Plus

Select the checkbox to activate Dolby Digital Plus encoding instead of Dolby Digital. Available in module version 5.1.0.0 and higher.

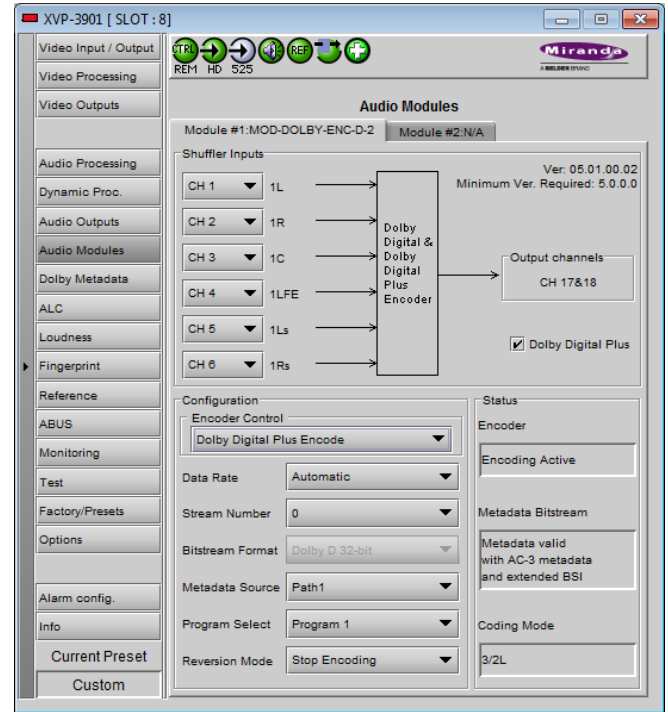

Figure 6.5 Audio Module - Dolby Digital and Dolby Digital Plus Encoder

### 6.2.2 Configuration Section

#### Encoder Control

Use the pulldown to select the operational mode: **Dolby Digital Encode** or **Dolby Digital Plus Encode** (as selected using the *Dolby Digital Plus* checkbox) or **Pass-through**.

Test signals at -18, -20 dBFS and silence are available for each mode.

- Encode** test modes will generate a test bit-stream containing a 1 kHz sine wave for full bandwidth channels and 100 Hz for the LFE channel of a 5.1 program.
- In **Pass-through** test modes, it will generate a 1 kHz PCM sine wave at its outputs.

When the encoding mode changes, the output mutes and resumes in the selected mode within one second.

#### Data Rate

The card can encode at all Dolby Digital data rates between 56 kbps and 640 kbps and all Dolby Digital Plus data rates between 32 kbps and 1024 kbps, although there are constraints in regards to data rate versus channel configuration (audio coding mode) – see Table 1.

It supports automatic switching of the data rate based on the *Coding Mode*.

#### Stream Number

Sets the output stream number from 0 to 6.

Table 1: Auto Data Rate Assignment

Coding Mode	Dolby Digital Automatic 384	Dolby Digital Automatic 448	Dolby Digital Plus Automatic
1/0	96 kbps	96 kbps	64 kbps
2/0	192 kbps	256 kbps	128 kbps
2/1, 3/0	256 kbps	256 kbps	160 kbps
2/2, 3/1	320 kbps	320 kbps	192 kbps
3/2	384 kbps	448 kbps	192 kbps

**Bitstream Format**

The output mode of the Dolby Digital bit-stream can be set to 32-bit, 16-bit Channel 1 or 16-bit channel 2. The default setting is 32-bit. The output mode of Dolby Digital Plus is always 32-bit.

**Metadata Source**

Selects the Metadata Path (Path 1 or 2) used for encoding. Refer to **Dolby Metadata tab** to access settings.  
[Path 1, Path 2]

**Program Select**

Selects the Metadata Program used for encoding. Refer to **Dolby Metadata tab** to access settings.  
[Program 1, Program 2, Program 3, Program 4, Program 5, Program 6, Program 7, Program 8]

**Reversion Mode**

This parameter specifies the module's behavior when its selected **Metadata Source** is lost or corrupted.  
[Use last valid Metadata, Stop Encoding]

**Encoding Latency**

The Dolby Digital and Dolby Digital Plus encoding latency is 187 msec. The encoding latency is automatically compensated (to avoid lip-sync issues) when the video additional frame delay (**Timing** tab) is set to at least six (6) frames for 59.94 Hz formats and at least five (5) frames for 50 Hz formats.

**6.2.3 Status:**

Text boxes report current status for Encoder, Metadata bitstream and Coding Mode

**Encoder**

This box indicates the operational status of the encoder.

**Metadata Bitstream**

This box indicates the status of the selected Metadata bitstream. The Metadata will be reported as invalid if it contains missing and/or invalid parameters or erroneous segment checksums.

**Coding Mode**

This box indicates the Coding Mode parameter in the selected Metadata bitstream.

## 6.3 Dolby E encoder

- Identified as MOD-DOLBY-ENC-E on the Module tab

### 6.3.1 Input and Output channel selection

#### Shuffler Inputs

An input shuffler allows any combination of the available channels to be used as inputs. Default is CH1 to CH8.

- Pulldowns: Available input channels 1 to 32

#### Output Channels

This encoder places the output on channels 25 and 26

### 6.3.2 Configuration

#### Encoding Mode

The operational mode can be **Dolby E Encode** or **Pass-through**.

Test signals at -18, -20 dBFS and silence are available for each mode.

- Encode** test modes will generate a test bit-stream containing a 1 kHz sine wave for full bandwidth channels and 100 Hz for the LFE channel of a 5.1 program.
- In **Pass-through** test modes, it will generate a 1 kHz PCM sine wave at its outputs.



Figure 6.6 Audio Modules - Dolby E encoder

When the encoding mode changes, the output mutes and resumes in the selected mode within one second. In both encoding and pass-through mode, the delay through the encoder is always one video frame.

#### Bit Depth

This parameter specifies the number of bits per word used in the Dolby E bitstream. When using an output data width of 16 bits, the available program configuration will be limited to those which require a maximum total of 6 channels.

#### 48 kHz Pull-down

When Pull-down mode is enabled the encoder will output the Dolby E bitstream at a sample rate of  $(1000/1001) * 48$  kHz.

#### Metadata Source

*Metadata* is the only option. Refer to the **Dolby Metadata** panel (section 5.10) for information and configuration.

#### Reversion Mode

This parameter specifies the module's behavior when its selected **Metadata Source** is lost or corrupted.  
[Use last valid Metadata, Stop Encoding]

**Note:** With version 1.1.2.0 of the Dolby E encoder, the **Reversion Mode** is forced to *Use last valid Metadata* due to a limitation in the module itself. The *Stop Encoding* mode will be available in future versions of the encoder.

#### Encoding Latency

The Dolby E encoding latency is one (1) video frame (33 msec for 59.94 Hz formats and 40 msec for 50 Hz formats). The encoding latency is automatically compensated (to avoid lip-sync issues) when the video additional frame delay (**Timing** tab) is set to at least one (1) frame.

### 6.3.3 Status:

Text boxes report current status for Encoder, Video Frame Sync, Reference Frame Rate and Metadata bitstream.

#### Encoder

This parameter indicates the operational status of the encoder.

#### Video Frame Sync

This parameter indicates the status of the video reference signal provided to the encoder.

#### Reference Frame Rate

This parameter indicates the frame rate of the video reference signal provided to the encoder. It will be set to **Not Indicated** if the frame rate is not recognized.

#### Metadata Bitstream

This box indicates the status of the selected Metadata bitstream. The Metadata will be reported as invalid if it contains missing and/or invalid parameters or erroneous segment checksums

## 6.4 Upmixing using Linear Acoustic Technology upMAX™

- Identified as MOD-LA-DUP-701 on the module tab.

This optional module integrates the upMAX™ upmixer function licensed by Linear Acoustic. This processing creates a 5.1 channel surround field (Left, Right, Center, LFE, Left-Surround, Right-Surround) from a 2.0 channel stereo input (Left, Right)

The **Config - Mode** pull-down box offers four different processing solutions:

#### Pass Mode

Select the input channels to the L, R, C, LFE, Ls and Rs inputs with the pull-down menus. These channels are passed through unaltered and are assigned to the output channels selected using the Output Channels pulldown

#### Upmix Mode

Select the input channel pair to the L/R inputs with the pull-down menu. The resulting 5.1 channels are assigned to the output channels selected using the Output Channels pulldown.

#### AutoMAX-II™ Mode

Select the input channel pair to the L/R inputs with the pull-down menu. The resulting 5.1 channels are assigned to the output channels selected using the Output Channels pulldown. Additionally the channels selected at the C, LFE, Ls and Rs inputs are summed with the outputs of the upmixing process.

This mode also allows a 5.1 audio present at the input to pass through. It will auto switch between a stereo and a 5.1 audio source to provide a 5.1 audio output at all times.

- Set up the transition between the two modes to be unobtrusive by selecting transition speeds for each case – upmix-to-pass and pass-to-upmix – using the two AutoMAX-II Transition Speed pulldowns
- Use the 5.1/2.0 Detection Threshold slider to set the level at which some 5.1 channels are considered to be silent, identifying the input as 2.0

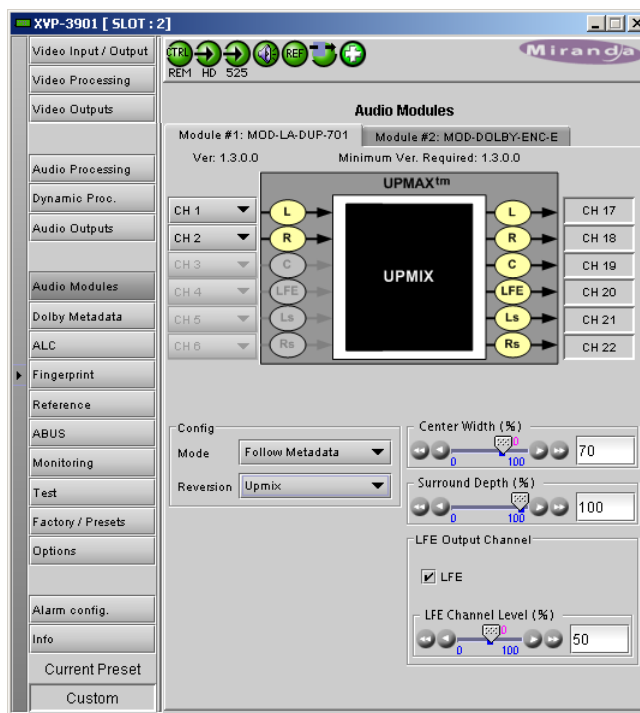

Figure 6.7 Audio Modules - Linear Acoustic UpMAX

**Note:** The AutoMAX-II™ algorithm is supported by firmware version 1.3.1.0 and later. Firmware version 1.3.0.0 supports only the AutoMAX-I™ algorithm. The AutoMAX-I™ algorithm does not support the upmix-to-pass and pass-to-upmix transition speeds.

### **Follow Metadata mode**

This mode may be useful for sources that switch between stereo and 5.1. The *Coding Mode* parameter in the first program of the Dolby metadata will set the Operating Mode between Pass and Upmix modes.

**Note:** In *Follow Metadata* mode, the metadata generator will be automatically turned ON when the upMAX™ module is upmixing to provide a valid metadata stream for the upmixed audio content. The generator content must have been previously configured with valid 5.1 metadata parameters. When the upMAX™ module is set to *Pass* mode by the incoming metadata stream, the generator will be automatically turned OFF to let the incoming metadata stream pass through. Refer to **Generator automated mode** in the Dolby metadata panel section for further details (page 71).

If the *Coding Mode* parameter (in the Dolby Metadata panel) is other than 3/2 (i.e. 5.1 channels) or 2/0 (i.e. stereo channels) or if the selected metadata path does not carry metadata, the Operating mode will follow the Reversion Mode pull-down.

<b>Coding Mode (Metadata):</b>	<b>Operating Mode:</b>
3/2	PASS
2/0	UPMIX
1+1, 1/0, 3/0, 2/1, 3/1, 2/2, or metadata is not present	Reversion Mode

The **Reversion Mode** pull-down sets the default Operating Mode to: Pass, Upmix, Last Valid (Last valid *Coding Mode*), AutoMAX.

### **Adjustments**

The “surround field” can be adjusted with the Center channel Width control and the Surround channel Depth control. The bass enhancement signal for the LFE channel is derived from the Left, Center and Right channels. The LFE checkbox and LFE Channel Level (%) slider control the LFE output.

### **Latency**

The upMAX™ processing latency is automatically compensated by the card.

**Note:** when in UPMIX and AUTOMAX modes, the last channel pair of the output channels selection (channels 7-8, 15-16, 23-24 or 31-32) are reserved for future use and muted.

**Note:** The upMAX™ works with PCM audio. If non-PCM audio like Dolby E or Dolby Digital is fed to the module, it will be ignored and silenced to prevent interference with the other PCM audio channels.



### 6.5 N-channel ALC and upmix licensed by Linear Acoustic

Minimizing loudness differences between segments in a playout channel is an important issue in a world where multiple programs originating in different formats from different sources must be integrated seamlessly. The MOD-LA-ALC Automatic Loudness Control (ALC) module is the Grass Valley/Linear Acoustic solution to this need. It uses Linear Acoustic's AeroMAX™ *multiband* loudness control algorithm.

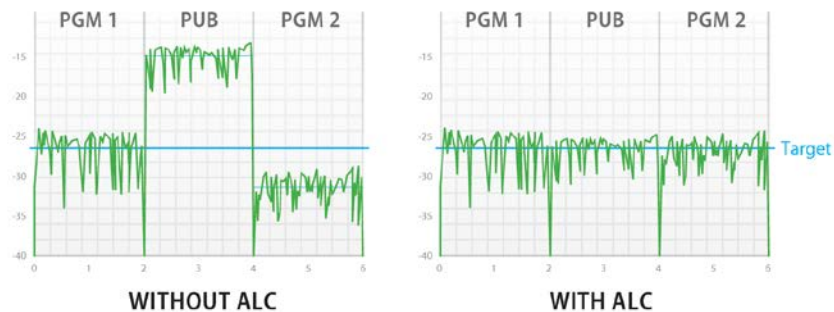

- Identified as MOD-LA-ALC-X-YYY on the module tab where X can be 2, 6 or 8 input channels and -YYY is the optional -DUP UpMAX™ module. The table shows the available MOD-LA-ALC models.

Model	Description	Output Channel Config.	
		PGM 1	PGM2
<b>MOD-LA-ALC-2</b>	2-Channel ALC licensed by Linear Acoustic	Up to 2.0	N/A
<b>MOD-LA-ALC-2-DUP</b>	2-Channel ALC and upmix licensed by Linear Acoustic	Up to 5.1	N/A
<b>MOD-LA-ALC-6</b>	6-Channel ALC licensed by Linear Acoustic	Up to 5.1	N/A
<b>MOD-LA-ALC-6-DUP</b>	6-Channel ALC and upmix licensed by Linear Acoustic	Up to 5.1	N/A
<b>MOD-LA-ALC-8</b>	8-Channel ALC licensed by Linear Acoustic	Up to 5.1	Up to 2.0
<b>MOD-LA-ALC-8-DUP</b>	8-Channel ALC and upmix licensed by Linear Acoustic	Up to 5.1	Up to 2.0

Depending on the model, different channel configurations are possible as listed in the table above.

The 6-channel ALC supports only a single program (either 5.1 or 2.0, but 4, 3 and 1 can be used), but the 8-channel ALC supports 2 independent programs.

- The first program (PGM 1) can only be configured as a single program 5.1 ALC or a 2.0 ALC. It is not possible to configure it as a 3x2, a 6x1 or any other channel combination with more than one program. If you are using only 3 channels (left, right and center), you can use the 5.1 configuration and leave the other 3 channels assigned to silence channels. You can even use the 5.1 ALC for a single mono channel as long as the other channels are assigned to silence channels.
- The second program (PGM 2) can only be configured as a 2.0 stereo program, but you can use it as a single mono program.

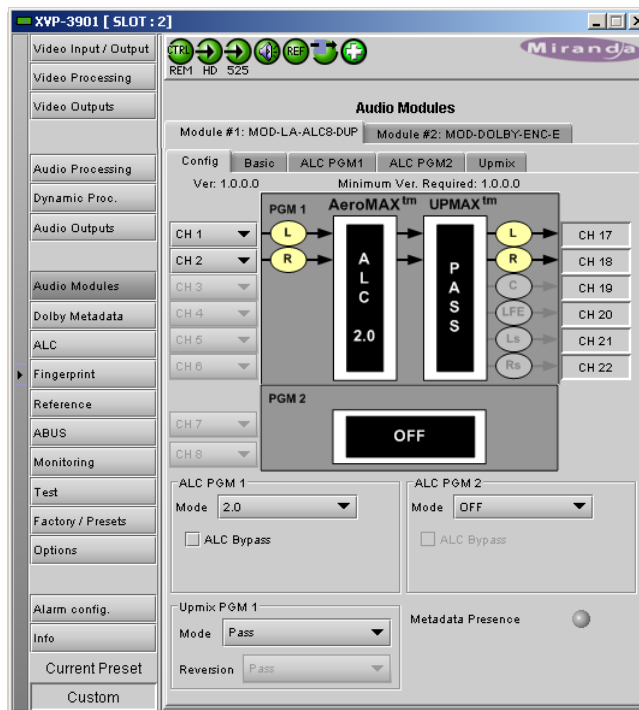
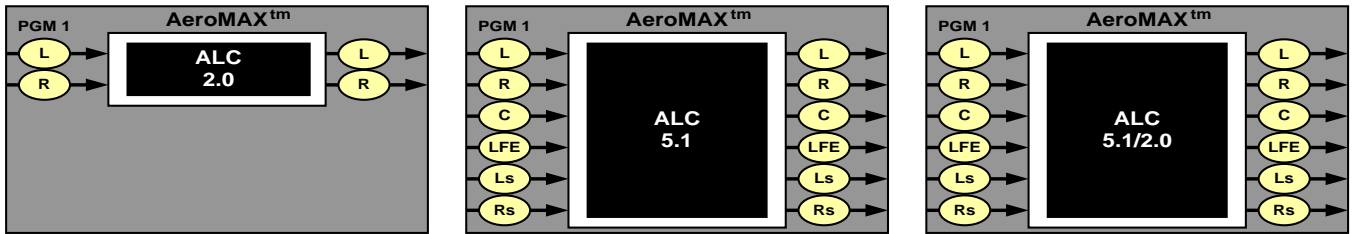

Figure 6.8 Audio Modules - LA-ALC-DUP



The figure below shows some of the most popular operating modes for the 5.1 ALC.



Modules with a –DUP feature the optional upMAX™ upmixer function licensed by Linear Acoustic. This processing creates a 5.1 channel surround field (Left, Right, Center, LFE, Left-Surround, Right-Surround) from a 2.0 channel stereo input (Left, Right). It is the same technology used on the MOD-LA-DUP-701 module. The figure below shows some typical configurations of the ALC equipped with the upmixer. The two pictures on the right show the upMAX™ in AutoMAX-II™ mode, where the configuration switches automatically between 2.0 and 5.1.

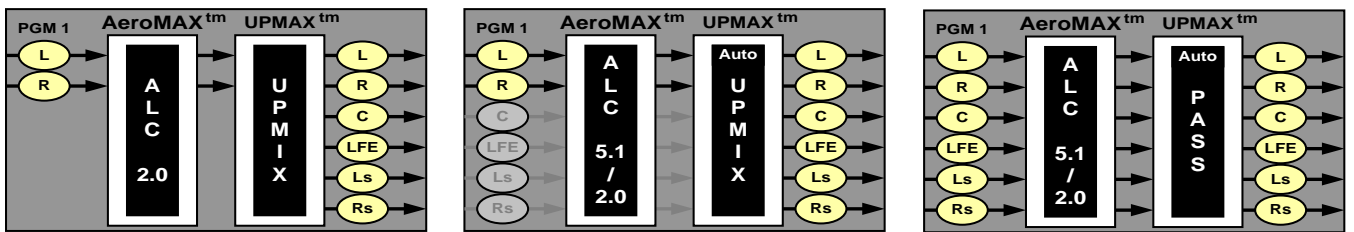

Note: The MOD-LA-ALC-X-YYY works with PCM audio. If non-PCM audio like Dolby E or Dolby Digital is fed to the module, it will be ignored and silenced to prevent interference with the other PCM audio channels.

**Latency**

The MOD-LA-ALC module processing latency is automatically compensated (to avoid lip-sync issues) when the additional video frame delay (**Timing** tab) is set to at least one (1) frame.

**6.5.1 Config tab**

The **ALC PGM x Mode** pull-downs specify the channel configuration for Program 1 & 2 (PGM 1 & 2). Depending on the ALC model, you may have different possible selections like 5.1, 2.0 or 5.1/2.0. This will indicate in which configuration you want to operate the module. If you want to do ALC on a stereo channel, select 2.0. For 5.1 input, select 5.1. The 5.1/2.0 configuration should be used when you have both 5.1 and 2.0 inputs, but you want to do an upmix on the 2.0 input, hence producing a constant 5.1 output. To upmix a mono channel, use the 2.0 configuration and assign both inputs to the desired mono channel.

If you have an ALC module with the –DUP upmix functionality, you can also configure the **Upmix PGM 1 Mode**.

If you set the ALC to work in 2.0 or 5.1/2.0 mode, the pull-down box offers four different processing solutions:

**Pass Mode**

Input channels are passed from the input to the output untouched.

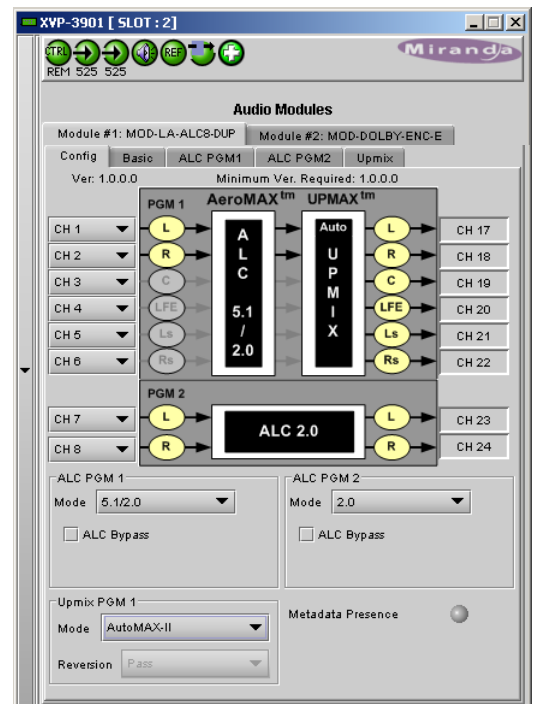

Figure 6.9 LA-ALC-DUP - Config tab

**Upmix Mode**

The first 2 channels (L & R) are upmixed. The other input channels in PGM 1 are ignored.

**AutoMAX-II™ Mode**

In this mode, the module will automatically detect the presence of 5.1 or 2.0 channels at the input. When 2.0 is detected, the incoming stereo will be upmixed. When 5.1 is detected, the incoming 5.1 channels will automatically be passed through untouched.

**Follow Metadata mode**

This mode is another way to switch between 2.0 stereo and 5.1 and produce a constant 5.1 output. The *Coding Mode* parameter in the first program of the Dolby metadata will set the Operating Mode between Pass and Upmix modes.

**Note:** In *Follow Metadata* mode, the metadata generator will be automatically turned ON when the upMAX™ module is upmixing to provide a valid metadata stream for the upmixed audio content. The generator content must have been previously configured with valid 5.1 metadata parameters. When the upMAX™ module is set to *Pass* mode by the incoming metadata stream, the generator will be automatically turned OFF to let the incoming metadata stream pass through. Refer to *Generator Automated* mode in the Dolby metadata panel section for further details.

If the *Coding Mode* parameter is other than 3/2 (i.e. 5.1 channels) or 2/0 (i.e. stereo channels) or if the selected metadata path does not carry metadata, the Operating mode will follow the Reversion Mode pull-down.

The **Reversion Mode** pull-down sets the default Operating Mode to: Pass, Upmix, Last Valid (Last valid *Coding Mode*), AutoMAX.

**6.5.2 Basic tab**

The “Basic” tab is the easiest way to configure the ALC module. You can use it to load an ALC Preset and specify the output level for each program.

Of course, all processing controls are accessible and users can custom design the presets that might be even more appropriate for a given situation. We strongly recommend starting with the ALC preset that is closest to the desired objective, then fine tuning it to reach the desired goal. This will minimize the troubles that will likely be encountered as many adjustments interact.

**ALC Presets**

- **TV 5B GEN - TeleVision 5-Band GENERAL.** This is the most commonly used preset. It provides a moderate degree of dynamic range processing, and is appropriate for all types of content. It is the factory default for all core preset choices.
- **TV 5B LIGHT - TeleVision 5-Band LIGHT.** This is very similar to TV 5B GEN, however the ratio of the multiband compression has been reduced closer to 2:1 for a more gentle action. Please be aware that lessening the processing lessens the ability of the unit to control loudness tightly to a given target.
- **TV 5B HVY - TeleVision 5-Band HEAVY.** Similar to TV 5B GEN, however the ratio of the multiband compression has been increased for a more dense and less dynamic sound.

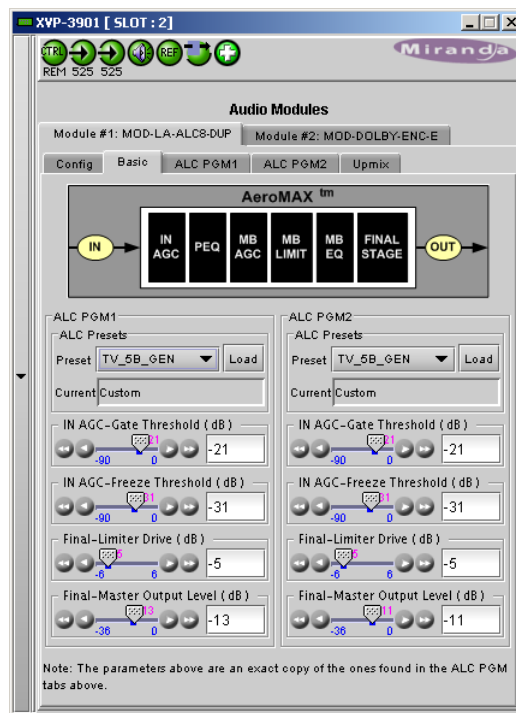

Figure 6.10 LA-ALC-DUP - Basic tab

- **TV 5B LOUD - TeleVision 5-Band LOUD.** Similar to TV 5B HVY, but louder and more punchy.
- **ITU LOUDness LMT** - Utilizes a specially tuned Input AGC plus Multiband Limiters and the Final Limiter to slowly adjust the average program loudness to a given value and the multiband and final limiters will act until the AGC catches up. This preset is appropriate for ingest or live applications but because the Multiband AGC is bypassed it has less ability to manage spectral balance which is important for transmission.
- **PROTECTION LIMIT** - Bypasses all processing except for the final output limiter which is set only to prevent overload.

NOTE: All presets (except **PROTECTION LIMIT**) were tuned to produce audio that will have an average dialog loudness of **-24 dB/LKFS** as measured by a Dolby LM100.

For the other parameters in the Basic tab, refer to the Advanced Configuration section below.

### 6.5.3 Advanced Configuration – ALC PGM 1 & 2

We **STRONGLY** recommend starting with an ALC preset and modifying from there. Preset creation starting from scratch is an incredibly time consuming process requiring large amounts of time and huge amounts of content spanning all genres including music of every type, films of every type, television dramas and sitcoms of every type, and talking-head programs of every type. Linear Acoustic has already done much of the heavy lifting, and provides presets based on their own listening and feedback from customers over the past few years. Certain parameters such as crossover frequencies and channel coupling are not adjustable and are hard-coded to the most appropriate values. That being said, access to all adjustable parameters is provided. There are no factory adjustments hidden from users. Be careful with this power as most all settings interact with each other, sometimes in ways that might not be immediately audible.

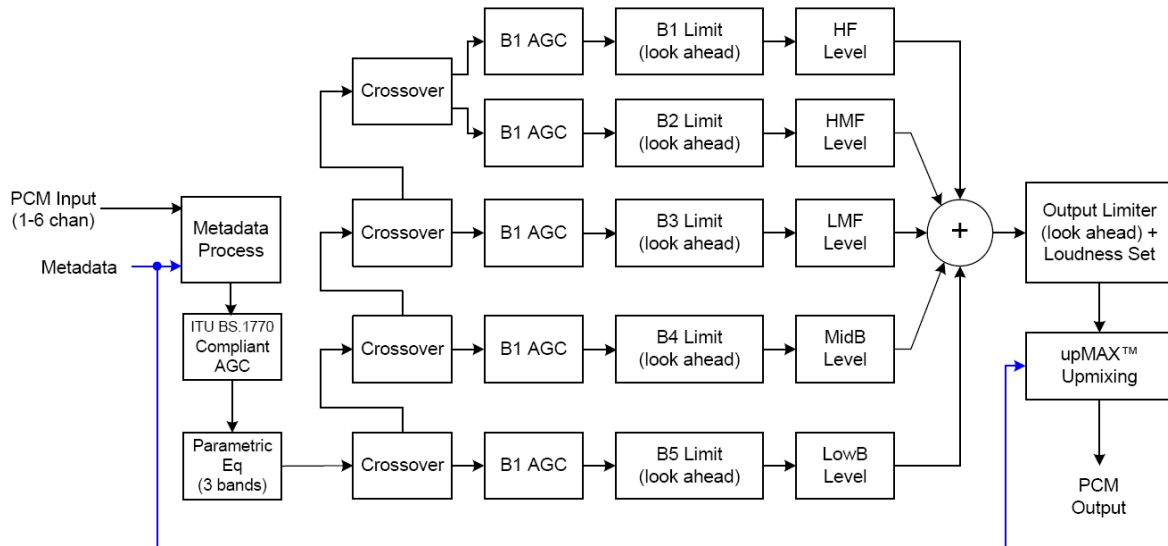

**Figure 6.11** General signal flow of the AeroMAX™ processing core

The drawing above shows the general signal flow of the processing core to indicate what part of the chain is being adjusted by each parameter. Note that this signal flow is also captured in the “Adjust Processing” menu, with the top of the list being the input, and the bottom of the list being the output.

### A word on the crossovers

The multiband crossovers in the AeroMAX™ consist of second order LinkwitzRiley style filters that are hard coded to specific frequencies. As the processing required for television applications is not as aggressive as other mediums, little advantage can be gained from changing these values, and the remainder of the processing relies on these characteristics remaining constant.

For reference, the crossover frequencies are:

- Band 1 (Low Bass): 20 Hz - 60 Hz
- Band 2 (Mid Bass): 30 Hz - 200 Hz
- Band 3 (Low Mid): 170 Hz - 1.15 kHz
- Band 4 (High Mid): 950 Hz - 6.1 kHz
- Band 5 (Brilliance): 5.2 kHz - 24 kHz

### Input AGC

The input AGC is a very slow acting front-end gain control with a 36dB gain range whose only purpose is to make sure that the following processing stages are fed with the correct average audio levels. It is basically the automatic equivalent of an operator slowly riding a gain control on a console to keep the audio close to reference level. Wideband in nature, the AGC is not meant to perform rapid gain reduction or expansion as its actions will be more audible, as with all wideband gain processors. As a slow gain rider, its actions are nearly inaudible thanks to the multiband processing that follows it. The AGC has two stages of gating where the gain expansion is slowed or stopped to prevent background noise increasing.

Adjustable parameters are:

- Gate Threshold: 0dBFS to -90dBFS (default: -30dBFS). Gating sets the point at which the AGC release is made extremely slow to prevent increasing background noise and allow the AGC to return to unity gain.
- Freeze Threshold: 0dBFS to -90dBFS (default: -42dBFS). Freeze stops all gain change (i.e. when the audio drops to silence), and remains frozen at its current gain value until the threshold is exceeded.

**NOTE:** Adjust Gate and Freeze to match plant practices. Very quiet audio (such as a golf match) benefits from having processing frozen when input audio drops below a given level to prevent “boosting the cricket” sounds.

- Ratio: 1:1 to Inf:1 (default: 12.0:1)
- Range: 0dB - 36 dB (default: 24dB). Range sets how much gain expansion above unity is performed, and this amount is subtracted from the total AGC gain range of 36dB, so the default value allows for 24dB of expansion and 12dB of compression. This adjustment is reflected in real time by changing the AGC meter scale.
- Threshold: -18dBFS - 0dBFS (default: -16dBFS)
- Attack: 0 - 150, slowest - fastest (default: 21)
- Release: 0 - 150, slowest - fastest (default: 47)
- Progressive Release: 0 - 100, slowest - fastest (default: 50). Sets the speed at which the release time is increased faster at very low gain values. This feature approximates a logarithmic release to help recovery from dramatic gain reduction more quickly.

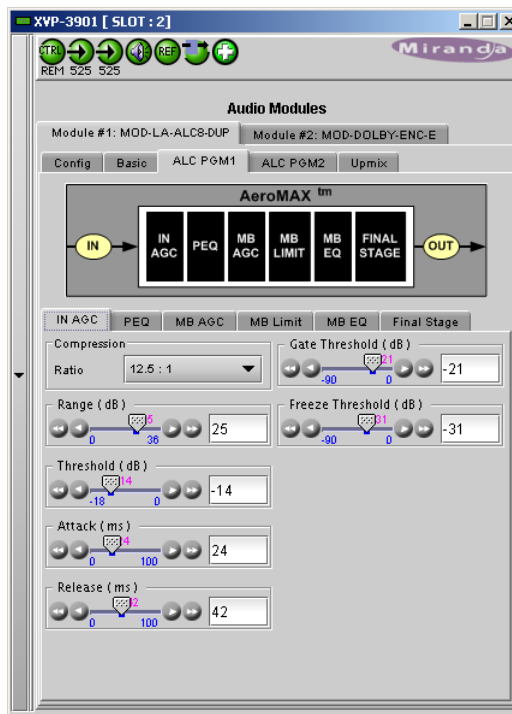

Figure 6.12 ALC - Input AGC

## Parametric Equalization (PEQ)

Three bands of parametric equalization are provided for fine tuning if necessary. None of the factory-supplied presets use the parametric equalizers, but they are provided to create notch filters or other effects if necessary. Each filter has a gain control with a +/-12dB range, a center frequency control that varies from 20 Hz to 22.050 kHz, and a bandwidth or “Q” control that varies between 0 and 10. Normal default settings for all bands are Gain = 0dB, in other words bypassed.

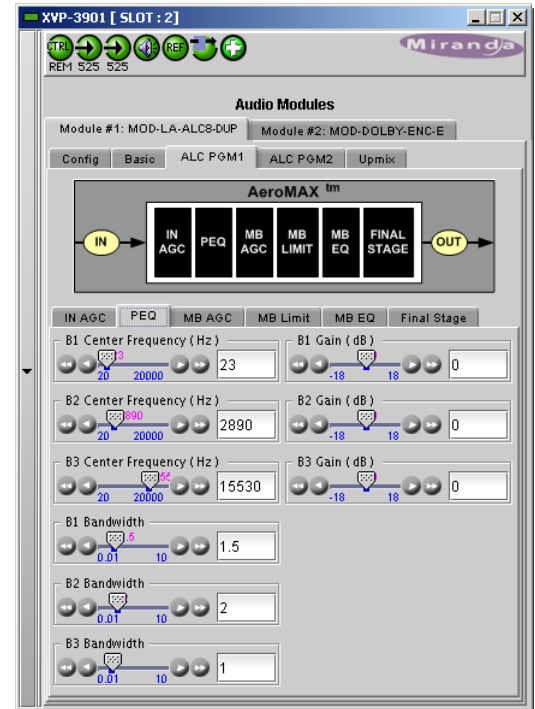

Figure 6.13 ALC - PEQ Parameters

## Multiband AGC

This section is the heart of the dynamics processing engine. A multiband AGC (i.e. compressor) that allows for medium ratio (3:1 is default) adjustment of audio band. Adjustable parameters are divided amongst three tabs:

### Main

- Compression Ratio: 1.0:1 - Inf:1 (default: 3.0:1)
- Range: 0dB - 36dB (default: 24dB). Range sets how much gain expansion above unity is able to be performed. This adjustment is reflected in real time by changing the AGC meter scale.
- Progressive Release: 0 - 100, slowest - fastest (default: 50). Sets the speed at which the release time is increased faster at very low gain values. This feature approximates a logarithmic release to help recovery from dramatic gain reduction more quickly.

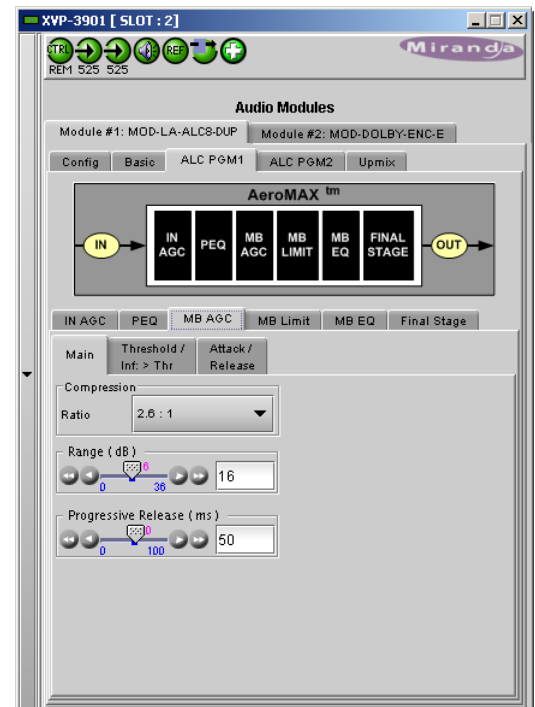
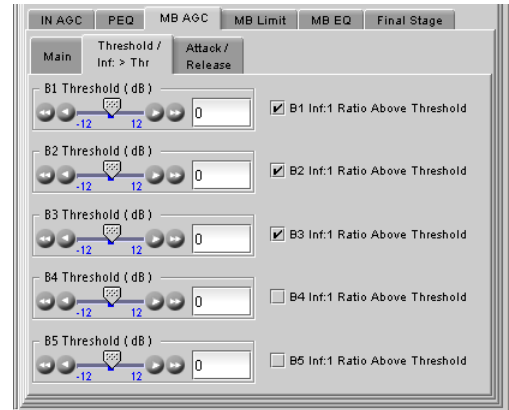

Figure 6.14 ALC - MB AGC - Main

**Threshold /Inf > Thr**

- B1 - B5 AGC Thresh(old): -12.00dB - +12.00dB (default: 0.00dB all). The reference point for the attack and release parameters to act on the audio signal present in that band.
- B1-B5 Inf:1 Above Thresh: Enabled / Disabled (default: B1: Enabled, B2: Enabled, B3: Disabled, B4: Disabled, B5: Disabled). AGC automatically increases the ratio to *Infinity:1* once a signal exceeds the threshold (set below), allowing for expansion below the threshold and limiting above the threshold. Useful for bass frequency control.



**Figure 6.15** ALC - MB AGC - Threshold

**Attack / Release**

- B1 - B5 AGC Attack: 0 - 150, slowest - fastest (defaults: B1:46, B2:88, B3:88, B4:88, B5:92). How fast an input signal is acted upon once it crosses the set threshold
- B1 - B5 AGC Release: 0 - 150, slowest - fastest (defaults: B1:50, B2:60, B3:86, B4:88, B5:92). How fast an input signal recovers from a gain change once that signal falls below the set threshold.

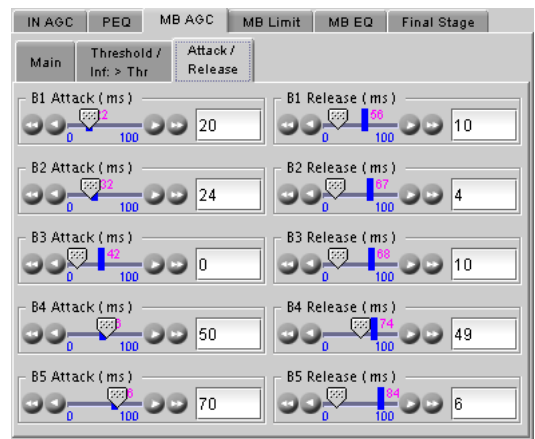

**Figure 6.16** ALC - MB-AGC - Attack/Release

## Multiband Limiters

Performs multiband limiting of the signals coming from the multiband compressor.

- B1 - B5 Lim(it) Thresh(old): +12.00dB - 0.00dB (default: B1:+4.25dB, B2:+4.25dB, B3:+6.50dB, B4:+9.00dB, B5:+9.00dB). The point above which limiting action takes place at an Infinity:1 ratio.
- B1 Soft Clip Thresh(old): +12.00dB - 0.00dB (default: +3.00dB)
- B2 Soft Clip Thresh(old): +12.00dB - 0.00dB (default: +6.00dB). The point above which band one (low bass) is very quickly limited, acting more like a clipper without the artifacts. This helps maintain a “tight” bass sound.

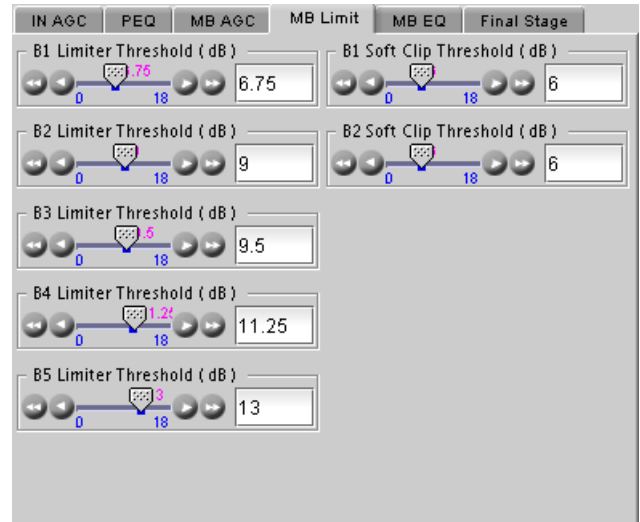

Figure 6.17 ALC module - MB Limiter

## Multiband EQ

This is the section where each of the processing bands is summed and where overall frequency response can be tailored.

- B1 - B5 Out(put) Mix: -12dB - + 12dB (defaults: 0dB, all bands). Sets the mix level for each band summing all bands back together. These controls are prior to the final look-ahead limiter and increasing gain may cause more final limiting (possibly more than desired).

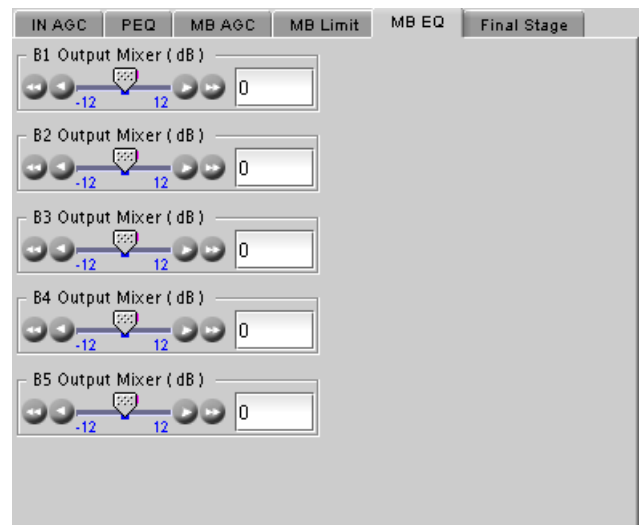

Figure 6.18 ALC module - MB Equalizer



## Final Stage

This final section of the processor is where the final look-ahead peak limiter and bass soft clipper are adjusted. The look-ahead limiters are wideband, limited to 6dB of gain reduction, are extremely fast, and due to their look-ahead nature are virtually transparent even at full gain reduction. Their purpose is to control peaks that make it through the multiband section. Adjustable parameters are:

- Final Limiter Drive: -6dB - +6dB (default: -5dB). Sets the level at which the wideband sum of all bands is fed to the final limiter.
- Output Level: -36dB - 0dB (default: -13dB for PGM1, -11 dB for PGM2). Sets the output level for the current preset. Can be used to match the measured loudness of one preset to another. This is useful as more aggressive presets will measure differently from less aggressive versions.

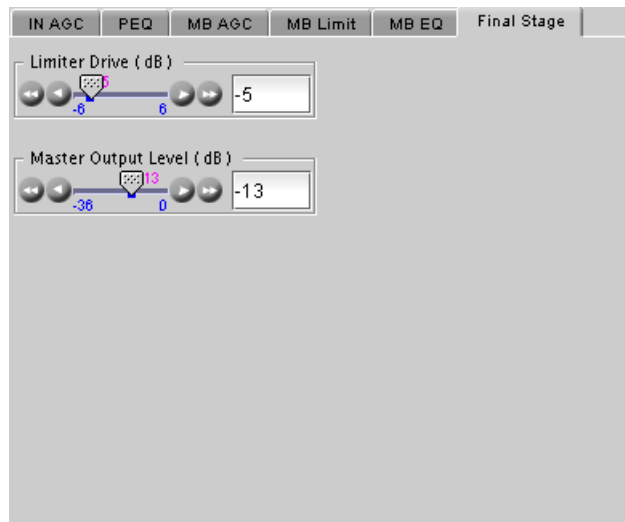

Figure 6.19 ALC Module - Final Stage

## 6.5.4 Upmix using Linear Acoustic UpMAX™

### Surround Field Adjustments

The “surround field” can be adjusted with the Center channel Width control and the Surround channel Depth control.

### AutoMAX-II Transition Speed

When the upmix operates in AutoMAX-II™ mode, the speed of the transitions from 2.0 to 5.1, and 5.1 to 2.0, can be configured to provide smooth and unobtrusive changeovers.

- Set the “Upmix-to-Pass” and “Pass-to-Upmix” transition speeds independently, over the range *Instant* to *Very Slow*

### 5.1/2.0 Detection Threshold

This parameter is used when the upmix operates in AutoMAX-II™ mode to detect silence on some of the 5.1 channels to determine if 5.1 or 2.0 is detected.

### LFE Output Channel

The bass enhancement signal for the LFE channel is derived from the Left, Center and Right channels. The LFE checkbox and LFE Channel Level slider control the LFE output

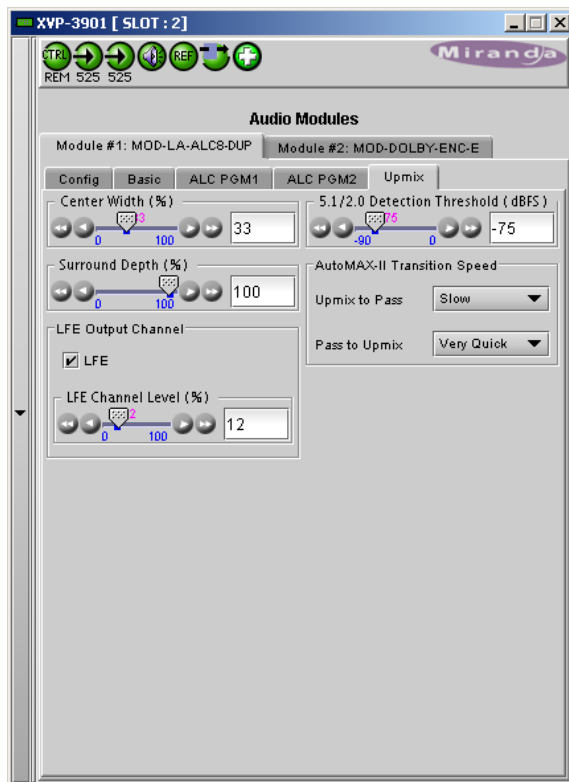
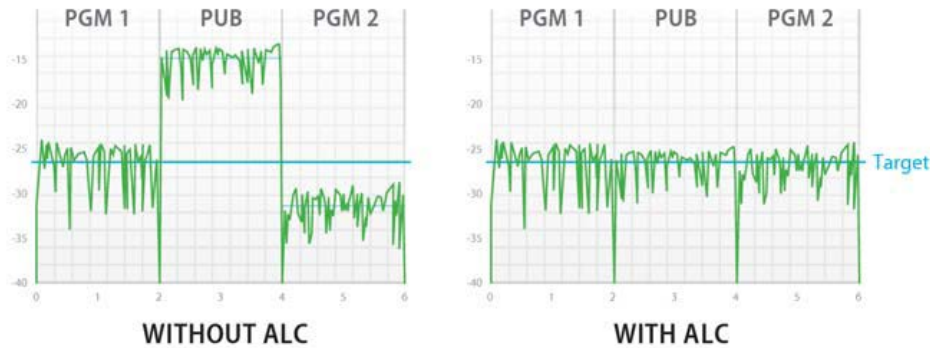

Figure 6.20 ALC module - Upmix using UpMAX



## 6.6 N-channel ALC licensed by Jünger Audio & upmix by Linear Acoustic

Minimizing loudness differences between segments in a playout channel is an important issue in a world where multiple programs originating in different formats from different sources must be integrated seamlessly. The MOD-JA-ALC Automatic Loudness Control (ALC) module is the Jünger Audio solution to this need.



### 6.6.1 ALC Models

Identified as MOD-JA-ALC-N-YYY on the module tab where N can be 2, 6 or 8 input channels and -YYY is the optional -DUP UpMAX™ function by Linear Acoustic. The table shows the available MOD-JA-ALC models.

Model	Description
MOD-JA-ALC-2	2-Channel ALC licensed by Jünger Audio
MOD-JA-ALC-2-DUP	2-Channel ALC licensed by Jünger Audio and upmix by Linear Acoustic
MOD-JA-ALC-6	6-Channel ALC licensed by Jünger Audio
MOD-JA-ALC-6-DUP	6-Channel ALC licensed by Jünger Audio and upmix by Linear Acoustic
MOD-JA-ALC-8	8-Channel ALC licensed by Jünger Audio
MOD-JA-ALC-8-DUP	8-Channel ALC licensed by Jünger Audio and upmix by Linear Acoustic

### 6.6.2 Program Configurations

This section explains the different program configurations for the ALC and the upmix (when available) depending on the installed ALC module. The figures below show the graphic interface for some of these configurations.

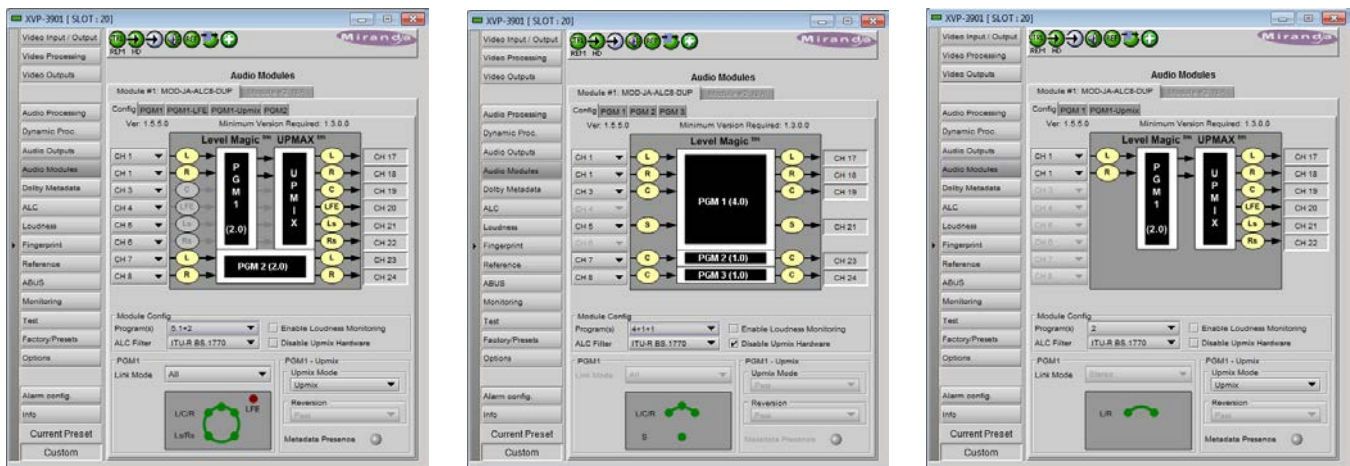

Select the **Config** tab to set up the program configuration and input/output channels.

**Input & Output Channel Selection**

- Use the pull-downs on the left side of the graphic to connect EAP-3101 input channels to the inputs of the JA-ALC module.
- The JA-ALC module outputs will appear on the EAP-3101 channels shown to the right of the graphic.

**Module Configuration**

Use the *Program(s)* pull-down to select the configuration of the inputs to the JA-ALC module.

- The presence or absence of upmix changes the ALC channel configuration. For this reason, it is possible for the user to disable the upmix functionality. This functionality will not be present if the current module model does not have a –DUP. When upmix is disabled, the upmix parameters are not configurable.
- Select the Disable Upmix Hardware checkbox to disable the upmix functionality

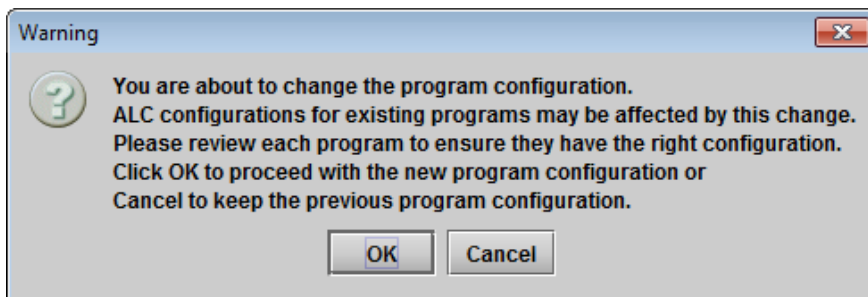

**Figure 6.21** JA-ALC module - Configuration

The list displayed in the pull-down changes depending on whether upmix is available.

- If upmix is not available (either the –DUP option is not enabled, or else the *Disable Upmix Hardware* checkbox beside the pull-down is selected), a very extensive list of program configurations appears, ranging from a single mono input up to a 5.1 input plus two mono inputs, and everything in between (depending, of course, on the number of channels available in the module – 2, 6 or 8). See the chart below for a complete listing.
- If upmix is available (-DUP option is enabled, and the *Disable Upmix Hardware* checkbox is not selected), then a much more limited selection is available, as shown in the chart below. Of course, upmix works on 2-channel inputs only, but in some modes the JA-ALC module will switch between passing the input through if it is 5.1, and upmixing it if it is 2-channel, so 5.1 inputs appear in the pull-down list.

Changing the Program Configuration may affect the selected preset for the other programs. This is especially true if the number of programs increases or decreases. The following pop-up may appear:



Note that it may take up to 10 seconds for the new configuration to be established and for the panel to update.

**Channel Configuration tables**

The table below shows the possible configurations for 2, 6 and 8-channel ALC modules. The first column for each version indicates the configurations without upmix (or when upmix is disabled). The other 2 columns indicate the possible configurations when the upmix is enabled and in the specified mode.

JA-ALC-8 (no upmix)	Upmix: >Pass >Auto >Follow	Forced Upmix	JA-ALC-6 (no upmix)	Upmix: >Pass >Auto >Follow	Forced Upmix	JA-ALC-2 (no upmix)	Upmix: >Pass >Auto >Follow	Forced Upmix
5.1	5.1		5.1	5.1				
5.1+2	5.1+2							
5.1+1	5.1+1							
5.1+1+1	5.1+1+1							
4			4					
4+2								
4+1								
4+1+1								
3			3					
3+2								
3+1								
3+1+1								
2	2	2	2	2	2	2		2
2+2	2+2	2+2	2+2					
2+1	2+1	2+1	2+1					
2+1+1	2+1+1	2+1+1	2+1+1					
2+2+2			2+2+2					
2+2+1			2+2+1					
2+2+1+1			2+2+1+1					
2+1+1+1			2+1+1+1					
2+1+1+1+1			2+1+1+1+1					
2+2+2+2								
2+2+2+1								
2+2+2+1+1								
2+2+1+1+1								
2+2+1+1+1+1								
2+1+1+1+1+1								
2+1+1+1+1+1+1								
1			1			1		
1+1			1+1			1+1		
1+1+1			1+1+1					
1+1+1+1			1+1+1+1					
1+1+1+1+1			1+1+1+1+1					
1+1+1+1+1+1			1+1+1+1+1+1					
1+1+1+1+1+1+1								

It can be seen that the upmix is only available in one upmix configuration for the 2-channel ALC. It is not possible to use the upmix in PASS, AutoMAX-II or Follow Metadata Path configuration.

**ALC Filter**

The **ALC filter** parameter sets the type of filtering applied to the audio content by the ALC to measure the audio loudness

- The **ITU-R BS.1770** mode (factory) is the most common way to measure loudness, given in LKFS units.
- The **Jünger Level mode** is a Jünger proprietary peak operating level control, given in dBFS units.

When changing the ALC filter to **ITU-R BS.1770**, the link mode may be affected. If the value is going to change, a pop-up informing the user that the link mode will be affected will appear. Click OK to continue and modify the Link mode or Cancel to abort the ALC filter change.

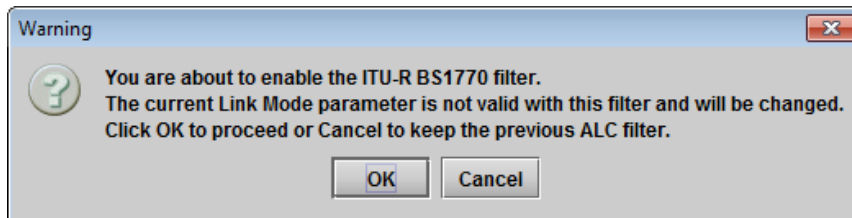

### PGM 1 Link Mode

The **Link Mode** parameter defines how the audio channels of PGM1 are linked together.

The link modes available depend on the ALC Filter parameter.

- In ITU-R BS1770, only 4 link modes are available.
- In Jünger Level mode, 10 modes are available.

Refer to the table below for the complete list. The graphic below the *Link Mode* pulldown illustrates the current selection.

Link Mode	Jünger Level Mode Linking	ITU-R BS.1770 Mode Linking
Mono	1.0 (1 mono channel)	1.0 (1 mono channel)
Stereo	2.0 (1 stereo channel pair)	1x2.0 (1 stereo channel pair)
All	5.1 (6 surround channels) L/R/C/Ls/Rs are linked, LFE is processed separately	1x5.1 (6 surround channels) L/R/C/Ls/Rs are linked, LFE is processed separately
Live	L/R/C are linked, Ls and Rs are linked separately, LFE is processed separately	Not supported
Movie	L and R are linked, Ls and Rs are linked separately, C and LFE are processed separately	Not supported
Quad	L/R/Ls/Rs are linked, C and LFE are processed separately	Not supported
All (LFE Linked)	5.1 (6 surround channels + LFE link) L/R/C/Ls/Rs and LFE are linked	1x5.1 (6 surround channels + LFE link) L/R/C/Ls/Rs and LFE are linked
Live (LFE Linked)	L/R/C are linked, Ls and Rs are linked separately, LFE is linked with L/R/C	Not supported
Movie (LFE Linked)	L and R are linked, Ls and Rs are linked separately, C is processed separately, LFE is linked with L/R and C	Not supported
Quad (LFE Linked)	L/R/Ls/Rs are linked, C is processed separately, LFE is linked with L/R/Ls/Rs and C	Not supported

The factory default is ALL for a 6-channel program, STEREO for a 2-channel program and MONO for a 1-channel program.

The link mode parameter is only enabled for a 5.1 program. For all other programs, it cannot be modified by the user, but its value may change depending on the conditions listed above.

When changing the **ALC filter** mode, the link mode may be affected. For a selected link mode, the program channels can be linked using multiple groups, with independent controls for each of these groups. A separate tab will appear in the interface for each group. Each tab will have its own loudness monitoring, its presets and its ALC parameters to configure.

## PGM 1 – Upmix

Use the *Upmix Mode* pulldown to select the Program 1 upmix mode (upmix only functions on program 1):

### **Pass**

Input channels are passed from the input to the output untouched.

### **Upmix**

The first 2 input channels (L & R) are upmixed to generate a 5.1 output regardless of whether the input is 2.0 or 5.1. All other input channels are ignored.

### **AutoMAX-II**

In this mode, the upMAX™ will automatically detect the presence of 5.1 or 2.0 channels at the input. When 2.0 is detected, the incoming stereo will be upmixed. When 5.1 is detected, the incoming 5.1 channels will automatically be passed through untouched.

### **Follow METADATA**

This mode is another way to switch between 2.0 stereo and 5.1 and produce a constant 5.1 output. The *Coding Mode* parameter in the first program of the Dolby metadata will set the Operating Mode between Pass and Upmix modes.

**Note:** In *Follow Metadata* mode, the metadata generator will be automatically turned ON when the upMAX™ module is upmixing to provide a valid metadata stream for the upmixed audio content. The generator content must have been previously configured with valid 5.1 metadata parameters. When the upMAX™ module is set to *Pass* mode by the incoming metadata stream, the generator will be automatically turned OFF to let the incoming metadata stream pass through. Refer to *Generator Automated* mode in the Dolby metadata panel section for further details (page **Error! Bookmark not defined.**).

If the *Coding Mode* parameter is other than 3/2 (i.e. 5.1 channels) or 2/0 (i.e. stereo channels) or if the selected metadata path does not carry metadata, the Operating mode will follow the *Reversion Mode* pull-down.

## Reversion Mode

The reversion mode is only active when the Upmix Mode is set to *Follow Metadata*. It has no effect in other modes. When the input metadata disappears, the upMAX™ is forced into the operating mode selected using the *Reversion* pulldown:

- Pass
- Upmix
- Last Valid
- AutoMAX

Hint - if the module is in the *Follow Metadata* mode, and the Metadata presence icon is grey, the reversion mode is active.

## Upmix Configuration

To set up the parameters of the upmix, go to the PGM1-Upmix tab in the Audio Modules .

When Upmix is available (-DUP option active, and *Disable Upmix Hardware* not selected), the tab is present, and the following adjustments are available.

### Surround Field Adjustments

The “surround field” can be adjusted with the Center channel Width control and the Surround channel Depth control.

### AutoMAX-II Transition Speed

When the upmix operates in AutoMAX-II™ mode, the speed of the transitions from 2.0 to 5.1, and 5.1 to 2.0, can be configured to provide smooth and unobtrusive changeovers.

- Set the “Upmix-to-Pass” and “Pass-to-Upmix” transition speeds independently, over the range *Instant* to *Very Slow*

### 5.1/2.0 Detection Threshold

This parameter is used when the upmix operates in AutoMAX-II™ mode to detect silence on some of the 5.1 channels to determine if 5.1 or 2.0 is detected.

### LFE Output Channel

The bass enhancement signal for the LFE channel is derived from the Left, Center and Right channels. The LFE checkbox and LFE Channel Level slider control the LFE output

## 6.6.3 Loudness Monitoring

Loudness monitoring and ALC are accessed through the various PGMX tabs that appear in the Audio Modules panel.

- The tabs that appear are determined by the configuration selected in the Config tab
- Each program has a tab of its own, e.g. PGM1, PGM2, PGM3, etc.
- If PGM1 is 5.1, and its LFE is not linked, the LFE will have its own tab, PGM1-LFE

Automatic Level Control using the Jünger Audio Level Magic™ system can be enabled or disabled for each program.

- Select the Bypass checkbox beneath the graphic to disable the ALC

When enabled, the loudness meters display the input loudness (before ALC processing), the dynamic correction applied by the ALC, the limiter correction applied by the ALC, and the program output loudness (after ALC processing). The input and output loudnesses are given in **LKFS**, based on ITU-R BS.1770.

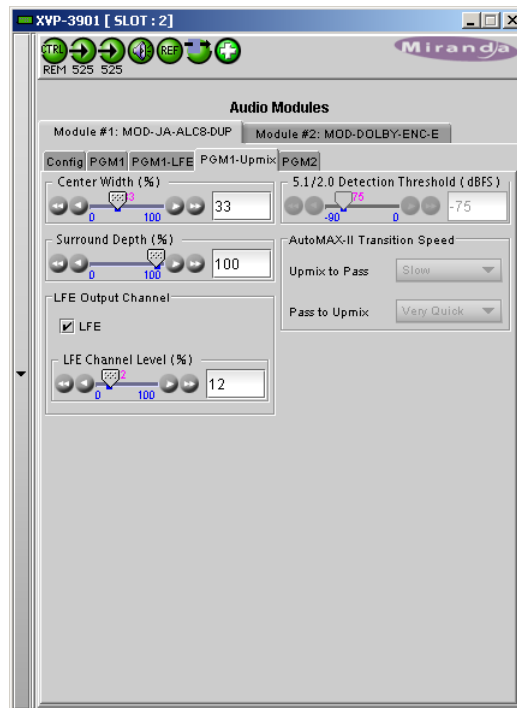

Figure 6.22 JA-ALC module - Upmix

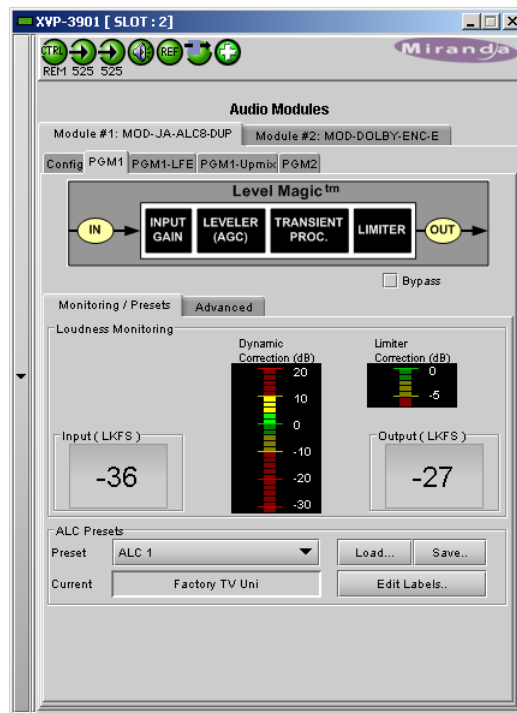

Figure 6.23 JA-ALC module - Loudness

**Presets**

The *Preset* pulldown allows the JA-ALC module to be configured for this program according to a set of stored values. There are:

- Five user-accessible registers that can be saved and recalled
- Four factory supplied read-only registers

The user can edit the label text for the five user-accessible registers

The presets hold values for the parameters that are set in the Advanced tab for each program.

- The available controls are described in the next section
- The contents of the read-only "Factory" presets are listed there (page 135)

**6.6.4 ALC PGMx Configuration**

For each program, the ALC parameters can be adjusted to obtain the desired behavior. This block diagram shows the processing stages in the signal path:

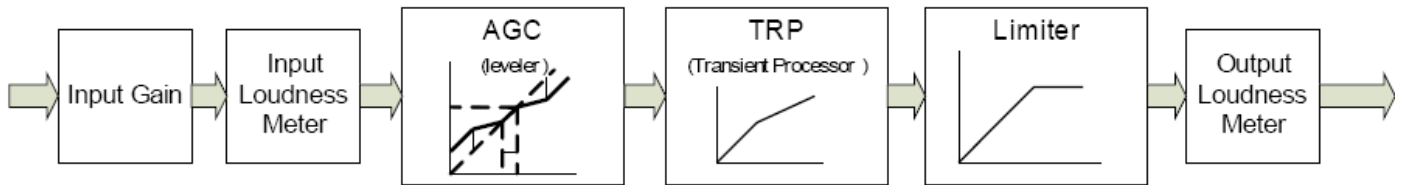

View the **Audio Modules / PGMx / Advanced** tab to access the available controls.

**6.6.4.1 Input Gain**

An input gain stage is available in front of the ALC to compensate for programs having an input loudness out of the ALC tracking range (very low or very high input loudness). The input gain ranges from -20 dB to +20 dB, in steps of 1 dB.

**6.6.4.2 Leveler**

The figure on the next page illustrates the transfer function and the parameters that can be adjusted.

**Target loudness - Operating Level**

- **Target loudness** sets the desired output loudness in **LKFS** according to ITU-R BS.1770. Level Magic continuously fits, as closely as possible, the average loudness to the target loudness.
- **Operating Level** sets the desired output level in **dBFS**. Level Magic continuously fits as close as possible the average level to the operating level. However, the high-dynamic audio material can cause small deviations from the operating level.

Note: High-dynamic range audio material can cause small deviations from the target loudness or operating level.

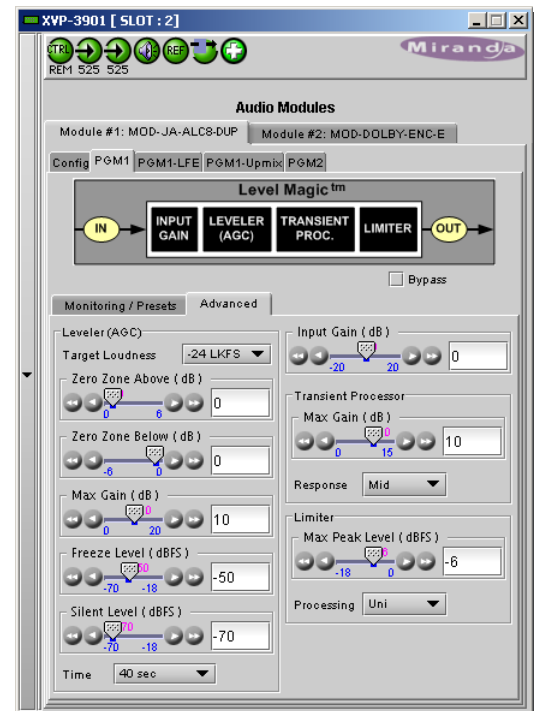

**Figure 6.24** JA-ALC - ALC configuration



**Zero Zone Above**

The *Zero Zone Above* parameter makes it possible to keep some long-term dynamics above the target, normally reduced or eliminated by the leveler, in the processed signals. With the *Zero Zone Above*, all input signals with a loudness above the target but less than (*Target Loudness + Zero Zone Above*) will be left untouched by the leveler. Only signals with a loudness above the *Zero Zone Above* will be attenuated.

**Zero Zone Below**

The *Zero Zone Below* parameter makes it possible to keep some long-term dynamics below the target, normally reduced or eliminated by the leveler, in the processed signals. With the *Zero Zone Below*, all input signals with a loudness below the target but greater than (*Target Loudness + Zero Zone Below*) will be left untouched by the leveler. Only signals with a loudness below the *Zero Zone Below* will be amplified.

**Max gain**

To avoid unwanted signal amplification, the AGC amplification is limited to the adjustable *Max Gain* (dB-value).

**Freeze Level**

*Freeze Level* makes it possible to avoid undesired leveling during signal breaks and overshoots following signal attacks. If the input signal level goes down and reaches the *Freeze Level*, all the states of the AGC (leveler) and transient processor will be frozen and kept unchanged until the input signal level rises again.

**Silent Level**

For signal levels below the *Silent Level*, the gain of the transient processor goes to 0 dB to prevent an amplification of the noise floor. It is similar to the “Noise Gate” threshold used in state-of-the-art dynamic range processors.

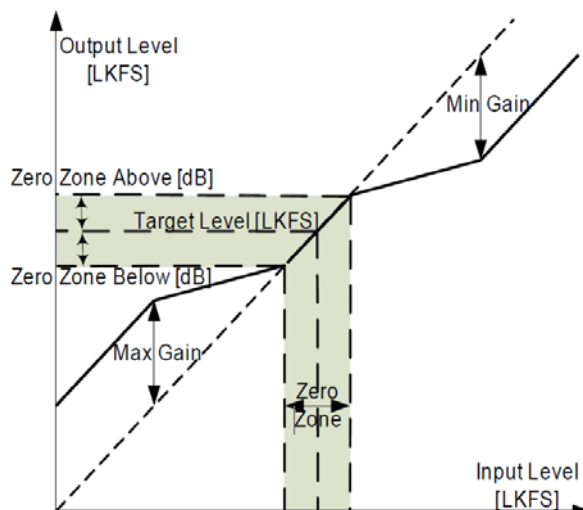

**6.6.4.3 Transient Processor**

The transient processor should prevent “transients” in audio signals, like the attack phase of musical sound or spoken word. The transient processor is mainly full automatically controlled by internal Level Magic logic. However, the user can adjust some parameters that affect the behavior of Transient processor.

**Max Gain**

To avoid unwanted signal amplification the transient processor amplification is limited to the adjustable *Max Gain*. It ranges from 0 to 20 dB, in dB steps.

**Response**

Sets the response (grip) of the transient processor to: Soft, Mid, Hard.

**6.6.4.4 Limiter**

**Max Peak Level**

The *Max Peak Level* defines the absolute maximum range to which the audio is limited to. It ranges from the target loudness to 0 dBFS.

**Processing**

Sets the program type for the limiter processing:

- Live, Speech, Pop, Uni, Classic

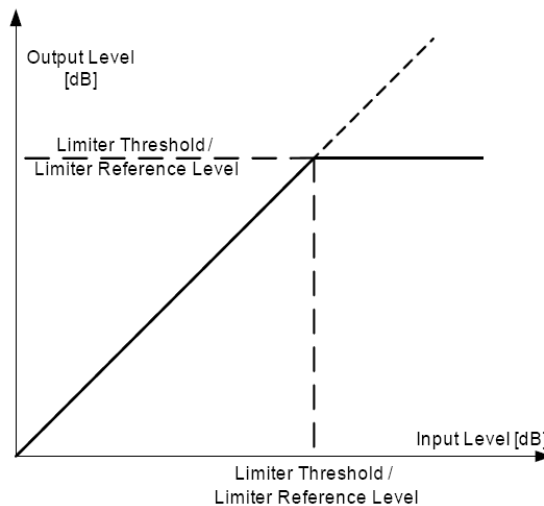



### 6.6.4.5 Presets

The four available “Factory” presets are configured as follows:

	Preset name	Units	Factory TV uni	Factory Sport	Factory Show	Factory Movie
<b>Leveler</b>	Input Gain	dB	0	0	0	0
	Operating Level	dBFS	-24	-24	-24	-24
	Loudness Target	LKFS				
	Zero Zone Above	dB	0	0	0	0
	Zero Zone Below	dB	0	0	0	0
	Max Gain	dB	10	10	12	8
	Freeze level	dBFS	-50	-42	-44	-57
	Silent level	dBFS	-70	-70	-70	-70
	Time	sec/min	40 sec	20 sec	40 sec	2 min
<b>Transient Processor</b>	Response	-	Mid	Hard	Mid	Soft
	Max. gain	dB	10	10	10	6
<b>Limiter</b>	Max Peak Level	dBFS	-6	-6	-6	-6
	Processing	-	Uni	Live	Speech	Uni

The upmix operating modes will differ depending on the ALC model and the program configuration. See the table below for the list of upmix operating modes versus the ALC PGM1 program config.

PGM 1 Config.	Upmix Operating Mode
2	Pass, Upmix (refer to the figures below).
6	Pass, Upmix, AutoMAX-II, Follow Metadata

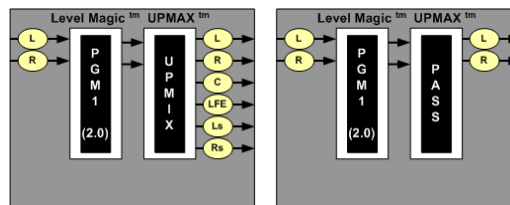

### 6.6.4.6 Upmix mode feedback

iControl indicates the current upmix mode (Upmix or Pass) when operating in AutoMAX-II or Follow Metadata mode. See the examples in the figures below. Note the grey channels, the “Auto/Meta” indicators and the Upmix/Pass labels.

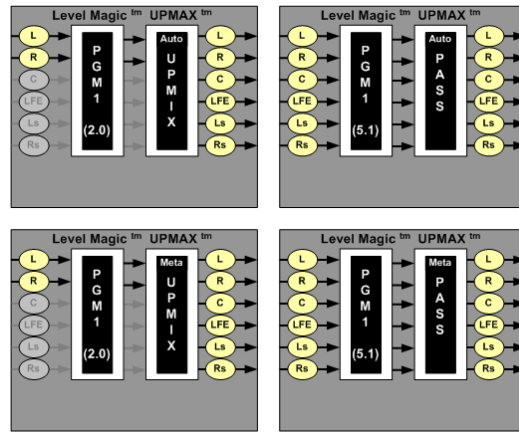

### 6.6.5 Notes

- The MOD-JA-ALC-N-YYY works with PCM audio. If non-PCM audio such as Dolby E or Dolby Digital is fed to the module, it will be ignored and silenced to prevent interference with the other PCM audio channels.
- The processing delay for all MOD-JA-ALC-N-YYY modules is  $\frac{1}{4}$  of a video frame. To compensate for this processing delay, the user must increase the processing delay of the card by +1 frame. This additional processing delay must be added manually in the Video Output page under the Timing tab.

## 7 Automation Using RS-422

Some card behaviors can be controlled using the RS-422 port. This is especially useful for automation systems. For detailed information about the protocol including the handshaking, please refer to the Oxtel Series Automation Protocol manual. The "Transport Layer" chapter gives more details about the encapsulation of the command strings described below.

In the current version, we use the "Load image R0" command from the protocol to load User Presets, Factory Defaults or ARC Presets.

### 7.1 Load Image R0 Command

In the original protocol, the R0 command has 2 parameters which have been renamed "Layer" and "Oper\_String" for this application. The supported values for each of these parameters are defined in the table below.

- Layer 0 is used to load User Presets or the factory defaults.
- Layer 1 is used to load ARC Presets on the HD output
- Layer 2 is used to load ARC Presets on the SD output.

Command	Layer	Oper_String	Description
R0	0	USER_1	Load user preset 1
R0	0	USER_2	Load user preset 2
R0	0	USER_3	Load user preset 3
R0	0	USER_4	Load user preset 4
R0	0	USER_5	Load user preset 5
R0	0	FACTORY	Load factory default
R0	1	0-1-SIDE25	IN 4:3, OUT 16:9 with 25% side panels
R0	1	0-1-CROP25	IN 4:3, OUT 16:9 with 25% input center V crop
R0	1	0-1-ANAM	IN 4:3, OUT 16:9, anamorphic stretched
R0	1	0-1-14/9	IN 4:3, OUT 16:9, 14:9 output aspect ratio
R0	1	1-1-BYPASS	IN 16:9, OUT 16:9, bypass
R0	2	0-0-BYPASS	IN 4:3, OUT 4:3, bypass (no ARC)
R0	2	0-1-SIDE25	IN 4:3, OUT 16:9 with 25% side panels
R0	2	0-1-CROP25	IN 4:3, OUT 16:9 with 25% input center V crop
R0	2	0-1-ANAM	IN 4:3, OUT 16:9, anamorphic stretched
R0	2	0-1-14/9	IN 4:3, OUT 16:9, 14:9 output aspect ratio
R0	2	1-1-BYPASS	IN 16:9, OUT 16:9, bypass
R0	2	1-0-LBOX25	IN 16:9, OUT 4:3 with 25% letterbox
R0	2	1-0-CROP25	IN 16:9, OUT 4:3 with 25% input center H crop
R0	2	1-0-ANAM	IN 16:9, OUT 4:3, anamorphic compressed
R0	2	1-0-14/9	IN 16:9, OUT 4:3, 14:9 output aspect ratio

**Example:**

To convert a 4:3 input to 16:9 with 25% side panels at the output, the " R010-1-SIDE25" command string should be encapsulated and sent by the automation to the card. In this case, the final string would be:

<STX0>R010-1-SIDE25:<CRC low><CRC high>

Where <STX0>, <CRC low> and <CRC high> are described in the Oxtel Series Automation Protocol manual.

It is the responsibility of the automation to send valid commands for each input/output aspect ratio combination. For example, an Oper\_String of "0-1-SIDE25" will have an unpredictable behavior when the input is HD and the output is HD because the input/output aspect ratios are 16:9.

## 8 Specifications

### VIDEO INPUT

SIGNAL	SMPTE 259M-C (270Mbps) and SMPTE 292M (1.485, 1.485/1.001 Gbps) SMPTE 424M (2.970, 2.970/1.001 Gbps)
SUPPORTED FORMATS	SD: 480i59.94, 576i50 HD: SMPTE 274M: 1080i59.94, 1080i50, 1080p23, 1080p23sF, 1080p25, 1080p29 HD: SMPTE 296M: 720p59.94, 720p50 HD: SMPTE 425 Level A (mapping 1), Level B: 1080p59.94, 1080p50
EMBEDDED AUDIO	SMPTE 299M (HD), SMPTE 272 (SD)
CABLE LENGTH	325 m Belden 1694A at 270 Mbps 180 m Belden 1694A at 1.485 Gbps 90 m Belden 1694A at 2.970 Gbps
RETURN LOSS	>15 dB up to 3 GHz

### OPTICAL INPUTS (2)

SIGNAL	SMPTE 297M-2006 compliant HD/SD-SDI SMPTE 424M, 292M, and 259M-C compliant Supports data rates of 270, 1483.5, 1485, 2967, 2970Mb/s
CABLE LENGTH	>10km of SMF fiber (9/125) at wavelengths between 1260nm and 1600nm

### VIDEO OUTPUT

SIGNAL (2)	SMPTE 259M-C (270Mbps) and SMPTE 292M (1.485, 1.485/1.001 Gbps) SMPTE 424M (2.970, 2.970/1.001 Gbps)
SUPPORTED FORMATS	SD: 480i59.94, 576i50 HD: SMPTE 274M: 1080i59.94, 1080i50 HD: SMPTE 296M: 720p59.94, 720p50 HD: SMPTE 425 Level A (mapping 1), Level B: 1080p59.94, 1080p50
RETURN LOSS	>15 dB from up to 3 GHz
JITTER	SD/HD: < 0.2 UI (alignment jitter) 3G: < 0.4 UI (alignment jitter)

### OPTICAL OUTPUTS (2)

SIGNAL	HD/SD-SDI SMPTE 424M, 292M, and 259M-C compliant Supports data rates of 270, 1483.5, 1485, 2967, 2970Mb/s
WAVELENGTH	1310 nm
OPTICAL OUT POWER	-6 dBm typical

**VIDEO PROCESSING PERFORMANCE**

SIGNAL PATH 10 bits minimum  
PROCESSING DELAY 1 frame in all processing mode. Up to 15 additional frames of delay can be added.

**REFERENCE INPUT**

SIGNAL (1) SMPTE 170M/SMPTE 318M/ITU 624-4 black burst  
SMPTE 274M / SMPTE 296M Tri-Level Sync  
RETURN LOSS >35 dB up to 5.75 MHz

**AUDIO**

**DIGITAL INPUTS (4)**

- SAMPLING FREQUENCY 32 to 96 KHz
- QUANTIZATION Up to 24 bits

**DIGITAL OUTPUTS (4)**

- SAMPLING FREQUENCY 48 KHz
- QUANTIZATION 24 bits

**INPUTS - AES3**

LEVEL 0.2 to 7 Vp-p  
INPUT IMPEDANCE 110 ohms balanced

**INPUTS – AES-3ID**

LEVEL 0.2 to 2 Vp-p  
INPUT IMPEDANCE 75 ohms  
RETURN LOSS 15 dB @ 6 MHz

**OUTPUTS – AES3**

LEVEL 2.7 Vp-p  
OUTPUT IMPEDANCE 110 ohms balanced

**OUTPUTS – AES-3ID**

LEVEL 1.0 Vp-p  
INPUT IMPEDANCE 75 ohms  
RETURN LOSS 15 dB @ 6 MHz

**A-BUS CONNECTOR**

As per A-BUS Standard, Grass Valley, A Belden Brand.

**AUDIO PROCESSING PERFORMANCE**

QUANTIZATION	24 bits
SAMPLING	48 KHz, synchronous
NUMBER OF CHANNELS	32 channels, 4 embedded groups, 4 AES inputs/outputs
FREQUENCY RESPONSE	$\pm 0.02$ dB (20 Hz to 20 KHz)
SNR	123 dB (A weighted)
THD + N	-138 dB (20 Hz to 20 KHz)

**GPI INPUTS (6)**

SIGNAL	Contact closure to ground (opto-isolated), common ground
VOLTAGE	0V to 7V max.

**GPI OUTPUTS (4)**

SIGNAL	Opto-isolated, common ground
VOLTAGE	-5V to 24V max.
CURRENT	60mA max.

**TEST PATTERN GENERATOR**

VIDEO	Color bars:	100% white bar with 75% color
AUDIO	Left channel:	pulsed 1 KHz tone
	Right channel:	steady 1 KHz tone

**MISCELLANEOUS**

POWER	25 W
PHYSICAL FORMAT	Densité 3RU size



## 9 Contact Us

### Grass Valley Technical Support

For technical assistance, contact our international support center, at 1-800-547-8949 (US and Canada) or +1 530 478 4148.

To obtain a local phone number for the support center nearest you, please consult the *Contact Us* section of Grass Valley's website ([www.grassvalley.com](http://www.grassvalley.com)).

An online form for e-mail contact is also available from the website.

### Corporate Head Office

Grass Valley  
3499 Douglas-B.-Floreani  
St-Laurent, Quebec H4S 2C6  
Canada

Telephone: +1 514 333 1772

Fax: +1 514 333 9828

[www.grassvalley.com](http://www.grassvalley.com)

# ANNEX 1 – XVP-3901 Local User Interface

Menu level	LEV1	LEV2	LEV3	LEV4	VALUES	Conditions
Card Status	STATUS	GENERAL STATUS			CARD MODEL/REAR TYPE / OPTIC TYPE / AUDIO MODULE / FAN ERROR 1 or 2/ CRITICAL HEALTH (XXXX XXXX) IN NO CARRIER / IN FORMAT / IN TRS ERROR / IN2 OUT MISMATCH/ FIBER NO SIGNAL/REF FORMAT/ REF MISMATCH ABUS: NONE, A1, A2/ GROUP PRESENCE 1 to 4/ AES PRESENCE CC PRESENCE/ TC 1 PRESENCE/ TC 2 PRESENCE / AFD PRESENCE/ NAME DROPPER PRESENCE	
Configuration load Configuration save GPI Enable	CONFIG	LOAD SAVE GPI	GPI 1 ACTIVATION GPI 1 RELEASE GPI 2 ACTIVATION GPI 3 ACTIVATION GPI 4 ACTIVATION GPI 5 ACTIVATION GPI 5 RELEASE GPI 6 ACTIVATION		[USER1, USER2, USER3, USER4, USER5] [USER1, USER2, USER3, USER4, USER5] [LOAD, USER1, DISABLE] [LOAD, USER2, DISABLE] [LOAD, USER3, DISABLE] [LOAD, USER4, DISABLE] [USELECT, INPUT, 1, DISABLE] [USELECT, INPUT, 2, DISABLE] [USELECT, INPUT, 2, DISABLE]	Audio option only
Input Selection Input Configuration	INPUT	INPUT SELECT INPUT CONFIG *	INPUT 1 INPUT 2		[INPUT, 1, INPUT 2] [BNC IN1, FIBER IN1] [BNC IN2, FIBER IN1, FIBER IN2] [2x1 SWITCH, FALLOVER, KEY/FILL] [HD OUT, SD OUT] [0, ..., 3, ..., 15] seconds [NO, YES]	Requires –F rear module Requires –F rear module Key/fill mode only Failover mode only
Failover Emergency Delay Lock Input Selection		INPUT 2 MODE KEY/FILL OUTPUT FAIL DELAY LOCK INPUT				
Output Configuration	OUTPUT	OUTPUT CONFIG	BNC OUT-A 1&2 BNC OUT-B 1&2 FIBER OUT 1 * FIBER OUT 2 *		[HD OUT, SD OUT] [HD OUT, SD OUT] [OFF, HD OUT, SD OUT] [OFF, HD OUT, SD OUT]	Requires –F rear module Requires –F rear module
Reference Source URS rate	REFERENCE	SOURCE URS			[AUTO, REF, URS, IN] [OFF, URS-29.97, URS-25]	
Input Aspect Ratio mode	ASPECT	AFD MODE			[4.3, 16:9, AUTO, FORCED] [16:9, AUTO, FORCED] [4.3, 0, 4:3, 1, ..., 16:9, 15, KEEP LAST] [4.3, 0, 4:3, 1, ..., 16:9, 15] [IGNORE, 1, 2, 3] [IGNORE, 1, 2, 3] [IGNORE, 1, 2, 3] [LETTERBOX, CENTER CUT] [OFF, ON]	SD input HD input auto AFD mode forced AFD mode SD in 625 SD in Auto/Forced mode only
Default AFD flag Forced AFD flag		DEFAULT FORCED AFD PRIORITY VLI PRIORITY WSS PRIORITY ALTERNATE ARC				
Deglitcher mode	DEGLITCHER					
Procamp Mode Overall gain	PROCAMP	MODE ALL GAIN Y/G GAIN C/B GAIN C/R GAIN SATURATION BLACK/G OFFSET C/B OFFSET C/R OFFSET HUE RGB GAMUT			[YCbCr, RGB] [800, ..., 0, 1, ..., 800] no unit [800, ..., 0, 1, ..., 800] no unit [800, ..., 0, 1, ..., 800] no unit [800, ..., 0, 1, ..., 800] no unit [800, ..., 0, 1, ..., 800] no unit [100, ..., 0, 1, ..., 100] no unit [100, ..., 0, 1, ..., 100] no unit [180, ..., 0, 1, ..., 180] unit = DEG [OFF, ON]	
Chroma gain						
RGB gamut legalization						
HD ARC presets	HD VIDEO OUT	PRESET			[CUSTOM, BYPASS] [CUSTOM, SIDE, CROP, ANAMORPHIC, 14:9] [1080i, 720p, 1080p LEVEL A, 1080p LEVEL B]	SD input 16:9 -> 16:9 4:3 -> 16:9
Output format	FORMAT	FORMAT				
Input vert crop Input horiz crop Input vert position Input horiz position Output horiz size	ARC	ARC	V CROP (IN) H CROP (IN) TILT (IN) PAN (IN) SIDE PANELS (OUT) DVE PAN (OUT)		[0, ..., 25] step=4 lines unit=% [0, ..., 25] step=8 pixels unit=% [0, ..., 25] step=2 unit=lines [0, ..., 25] step=4 unit=lines [0, ..., 25] step=8 pixels unit=% [CENTER, LEFT, RIGHT]	16:9 -> 16:9 16:9 -> 16:9 4:3 -> 16:9 4:3 -> 16:9

# GUIDE TO INSTALLATION AND OPERATION

Output Mask	MASK	TOP BOTTOM LEFT RIGHT	unit =LINE unit =LINE unit =PIXL unit = PIXL	Format dependant min range > 25%
MPEG mode HD Detail enhancer level Background color (8-bit)	ADVANCED	MPEG DETAIL BKGND COLOR	[0, 2, ..., xx] [0, 2, ..., xx] [0, 2, ..., xx] [0, 2, ..., xx] [OFF, ON] [OFF 1, ..., 7] [1, ..., 16, ..., 254] [1, ..., 128, ..., 254] [1, ..., 128, ..., 254] [1, ..., 128, ..., 254]	
HD Audio embedding	METADATA	AUDIO	[OFF, AUTO]	
Timecode Insertion SD Timecode line detection		TIMECODE 1 INSERTION SD LINE DETECT	[OFF, AUTO] [AUTO, 10, ..., 14, ..., 20] [AUTO, 7, ..., 14, ..., 22]	525 SD in 625 SD in
Timecode Insertion SD Timecode line detection		TIMECODE 2 INSERTION SD LINE DETECT	[OFF, AUTO] [AUTO, 10, ..., 14, ..., 20] [AUTO, 7, ..., 14, ..., 22]	525 SD in 625 SD in
Closed Captioning Insertion Line 21 mode Line 23 mode VBI passthrough AFD Insertion AFD Line Insert		CLOSED CAPTION LINE 21 VBI AFD INSERTION LINE INSERT	[OFF, AUTO] [ACTIVE, BLANKING] [ACTIVE, BLANKING] [OFF, ON] [OFF, AFD] [9, 10, 11, ..., 19]	SD in 525 SD in 625 HD->HD
Additional Frame Delay Timing in line steps Timing in pixel steps Input Timing to REF Input Timing to REF	TIMING	FRAME VERT HOR IN 1 TIME TO REF IN 2 TIME TO REF	[0, 1, ..., 15] [1-16, -15, ..., 0, ..., 15] [0, ..., 29.65] step=13.5ns [display timing] [display timing]	unit=LINE unit=µs
SD/HD De-Interlacer	DE-INTERLACER	FILM MODE VIDEO OVER FILM	[OFF, ON] [OFF, ON]	Film mode must be ON
SD ARC presets	PRESET		[CUSTOM, BYPASS] [CUSTOM, LETTER BOX, CROP, ANAMAMORPHIC, 14:9] [CUSTOM, SIDE, CROP, ANAMAMORPHIC, 14:9]	4:3 -> 4:3, 16:9 -> 16:9 16:9 -> 4:3 4:3 -> 16:9
Output aspect ratio	ASPECT		[4:3, 16:9]	
Input vert crop Input horiz crop Input vert position Input horiz position Output vert size Output horiz size	ARC	V CROP (IN) H CROP (IN) TILT (IN) PAN (IN) LETTERBOX (OUT) SIDE PANELS (OUT) DVE PAN (OUT) DVE TILT (OUT)	[0, ..., 25] [0, ..., 25] [0, ..., 25] [0, ..., 25] [0, ..., 25] [0, ..., 25] [CENTER, LEFT, RIGHT] [CENTER, TOP, BOTTOM]	step=4 lines unit=% step=8 pixels unit=% step=2 unit=lines step=4 unit=lines step=4 lines unit=% step=8 pixels unit=%
Output Mask	MASK	TOP BOTTOM LEFT RIGHT	[0, 2, ..., xx] [0, 2, ..., xx] [0, 2, ..., xx] [0, 2, ..., xx]	unit =LINE unit =LINE unit =PIXL unit = PIXL
Hor. detail enhancer mode Vert. detail enhancer mode SD Horizontal detail enhancer level SD Vertical detail enhancer level Background color (8-bit)	ADVANCED	H DETAIL MODE V DETAIL MODE H DETAIL V DETAIL BKGND COLOR	[MED, HIGH] [MED, HIGH] [OFF, ..., 7] [1, ..., 16, ..., 254] [1, ..., 128, ..., 254] [1, ..., 128, ..., 254]	Format dependant min range > 25%
SD Audio embedding	METADATA	AUDIO	[OFF, AUTO, 20 BITS, AUTO 24 BITS]	
Timecode Insertion SD Timecode line detection		TIMECODE 1 INSERTION LINE DETECT	[OFF, AUTO] [AUTO, 10, ..., 14, ..., 20] [AUTO, 7, ..., 14, ..., 22]	525 SD in 625 SD in
SD timecode line insertion		LINE INSERT	[10, 11, ..., 14, ..., 20]	525 SD out 625 SD out
SD Timecode Duplicate		DUPLICATE	[7, ..., 14, ..., 22]	SD out
Timecode Insertion SD Timecode line detection		TIMECODE 2 INSERTION LINE DETECT	[OFF, AUTO] [AUTO, 10, ..., 14, ..., 20]	HD in 525 SD in

SD timecode line insertion			[AUTO, 7, ..., 14, ..., 22] [10, 11, ..., 14, ..., 20] [7, ..., 14, ..., 22] [OFF, ON]	LINE INSERT DUPLICATE	625 SD in HD in 525 SD out HD in 625 SD out HD in	
SD Timecode Duplicate			[OFF, AUTO] [ACTIVE, BLANKING] [ACTIVE, BLANKING] [OFF, ON] [OFF, ON] [2, ..., 19] [9, 10, 11, ..., 19] [OFF, ON] [OFF, ON]	CLOSED CAPTION LINE 23 VBI AFD VLI WSS	525 SD in SD in and/or out 525 SD in and/or out 625 SD->SD 525 SD out 625 SD out 625 SD out	
Closed Captioning Insertion			[0, 1, ..., 15] [-16, -15, ..., 0, ..., 15] [0, ..., 64] step=37ms [display timing] [display timing]	FRAME VERT HOR IN 1 TIME TO REF IN 2 TIME TO REF	unit=LINE unit=µs	
Line 21 mode			[OFF, ON] [OFF, ON]	FILM MODE VIDEO OVER FILM	Film mode must be ON	
VBI passthrough			[EMBED, CH 9-16, AES IN 1-4] [OFF, CH01, ..., CH32] step = .5dB	CHANNEL 09 - 16 PROC	All the audio parameters are available only if the audio option is activated and if an audio card is present.	
AFD Insertion			[1-96, ..., 0, ..., 12] [OFF, ON] [OFF, ON] [0, 2000]	CHANNEL 1		
AFD Line Insert			[MONO, STEREO, GROUP 1, GROUP 2] [0 dBFS, ..., -20 dBFS] [1 ms, 10 ms, 40 ms, 160 ms] [48 dB/s, 24 dB/s, 12 dB/s, 6 dB/s] [0 dBFS, -1 dBFS, ..., -60 dBNFS] [1/1, 1/1.25, 1/1.5, 1/1.75, 1/2, 1/3, 1/4, 1/8, 1/16] [-40 dBFS, -41 dBFS, ..., -80 dBFS] [1/1, 1.125/1, 1.25/1, 1.375/1, 1.5/1, 1.625/1, 1.875/1, 2/1]	DE-INTERLACER CHANNEL 09 - 16 PROC	LOCK LEVEL PHASE INVERT MUTE DELAY MSEC DELAY SAMPLES DYN GROUP MODE LIMITER COMPRESSOR	unit=ms unit=sample
VLI Insertion			[1-100, 0, 100] THRESHOLD [0 dBFS, ..., -20 dBFS] ATTACK TIME [1 ms, 10 ms, 40 ms, 160 ms] RELEASE TIME [48 dB/s, 24 dB/s, 12 dB/s, 6 dB/s] THRESHOLD [0 dBFS, -1 dBFS, ..., -60 dBNFS] RATIO [1/1, 1/1.25, 1/1.5, 1/1.75, 1/2, 1/3, 1/4, 1/8, 1/16] THRESHOLD [-40 dBFS, -41 dBFS, ..., -80 dBFS] RATIO [1/1, 1.125/1, 1.25/1, 1.375/1, 1.5/1, 1.625/1, 1.875/1, 2/1]	AUDIO	EXPANDER DYNAMIC GAIN --- --- CHANNEL 32	
WSS Insertion			[OFF, ON] [OFF, ON]	CHANNEL 1		
Additional Frame Delay			[EMBED, CH 9-16, AES IN 1-4] [OFF, CH01, ..., CH32] step = .5dB	CHANNEL 1		
Timing in line steps			[1-96, ..., 0, ..., 12] [OFF, ON] [OFF, ON] [0, 2000]	CHANNEL 1		
Timing in pixel steps			[MONO, STEREO, GROUP 1, GROUP 2] [0 dBFS, ..., -20 dBFS] [1 ms, 10 ms, 40 ms, 160 ms] [48 dB/s, 24 dB/s, 12 dB/s, 6 dB/s] [0 dBFS, -1 dBFS, ..., -60 dBNFS] [1/1, 1/1.25, 1/1.5, 1/1.75, 1/2, 1/3, 1/4, 1/8, 1/16] [-40 dBFS, -41 dBFS, ..., -80 dBFS] [1/1, 1.125/1, 1.25/1, 1.375/1, 1.5/1, 1.625/1, 1.875/1, 2/1]	CHANNEL 1		
Input Timing to REF			[1-100, 0, 100] THRESHOLD [0 dBFS, ..., -20 dBFS] ATTACK TIME [1 ms, 10 ms, 40 ms, 160 ms] RELEASE TIME [48 dB/s, 24 dB/s, 12 dB/s, 6 dB/s] THRESHOLD [0 dBFS, -1 dBFS, ..., -60 dBNFS] RATIO [1/1, 1/1.25, 1/1.5, 1/1.75, 1/2, 1/3, 1/4, 1/8, 1/16] THRESHOLD [-40 dBFS, -41 dBFS, ..., -80 dBFS] RATIO [1/1, 1.125/1, 1.25/1, 1.375/1, 1.5/1, 1.625/1, 1.875/1, 2/1]	CHANNEL 1		
Input Timing to REF			[1-100, 0, 100] THRESHOLD [0 dBFS, ..., -20 dBFS] ATTACK TIME [1 ms, 10 ms, 40 ms, 160 ms] RELEASE TIME [48 dB/s, 24 dB/s, 12 dB/s, 6 dB/s] THRESHOLD [0 dBFS, -1 dBFS, ..., -60 dBNFS] RATIO [1/1, 1/1.25, 1/1.5, 1/1.75, 1/2, 1/3, 1/4, 1/8, 1/16] THRESHOLD [-40 dBFS, -41 dBFS, ..., -80 dBFS] RATIO [1/1, 1.125/1, 1.25/1, 1.375/1, 1.5/1, 1.625/1, 1.875/1, 2/1]	CHANNEL 1		
SD/HD De-Interlacer			[1-100, 0, 100] THRESHOLD [0 dBFS, ..., -20 dBFS] ATTACK TIME [1 ms, 10 ms, 40 ms, 160 ms] RELEASE TIME [48 dB/s, 24 dB/s, 12 dB/s, 6 dB/s] THRESHOLD [0 dBFS, -1 dBFS, ..., -60 dBNFS] RATIO [1/1, 1/1.25, 1/1.5, 1/1.75, 1/2, 1/3, 1/4, 1/8, 1/16] THRESHOLD [-40 dBFS, -41 dBFS, ..., -80 dBFS] RATIO [1/1, 1.125/1, 1.25/1, 1.375/1, 1.5/1, 1.625/1, 1.875/1, 2/1]	CHANNEL 1		
Audio Embed/Discrete Level and Delay lock			[1-100, 0, 100] THRESHOLD [0 dBFS, ..., -20 dBFS] ATTACK TIME [1 ms, 10 ms, 40 ms, 160 ms] RELEASE TIME [48 dB/s, 24 dB/s, 12 dB/s, 6 dB/s] THRESHOLD [0 dBFS, -1 dBFS, ..., -60 dBNFS] RATIO [1/1, 1/1.25, 1/1.5, 1/1.75, 1/2, 1/3, 1/4, 1/8, 1/16] THRESHOLD [-40 dBFS, -41 dBFS, ..., -80 dBFS] RATIO [1/1, 1.125/1, 1.25/1, 1.375/1, 1.5/1, 1.625/1, 1.875/1, 2/1]	CHANNEL 1		
Channel Phase Inversion			[1-100, 0, 100] THRESHOLD [0 dBFS, ..., -20 dBFS] ATTACK TIME [1 ms, 10 ms, 40 ms, 160 ms] RELEASE TIME [48 dB/s, 24 dB/s, 12 dB/s, 6 dB/s] THRESHOLD [0 dBFS, -1 dBFS, ..., -60 dBNFS] RATIO [1/1, 1/1.25, 1/1.5, 1/1.75, 1/2, 1/3, 1/4, 1/8, 1/16] THRESHOLD [-40 dBFS, -41 dBFS, ..., -80 dBFS] RATIO [1/1, 1.125/1, 1.25/1, 1.375/1, 1.5/1, 1.625/1, 1.875/1, 2/1]	CHANNEL 1		
Channel Mute			[1-100, 0, 100] THRESHOLD [0 dBFS, ..., -20 dBFS] ATTACK TIME [1 ms, 10 ms, 40 ms, 160 ms] RELEASE TIME [48 dB/s, 24 dB/s, 12 dB/s, 6 dB/s] THRESHOLD [0 dBFS, -1 dBFS, ..., -60 dBNFS] RATIO [1/1, 1/1.25, 1/1.5, 1/1.75, 1/2, 1/3, 1/4, 1/8, 1/16] THRESHOLD [-40 dBFS, -41 dBFS, ..., -80 dBFS] RATIO [1/1, 1.125/1, 1.25/1, 1.375/1, 1.5/1, 1.625/1, 1.875/1, 2/1]	CHANNEL 1		
Lip-Sync Correction			[1-100, 0, 100] THRESHOLD [0 dBFS, ..., -20 dBFS] ATTACK TIME [1 ms, 10 ms, 40 ms, 160 ms] RELEASE TIME [48 dB/s, 24 dB/s, 12 dB/s, 6 dB/s] THRESHOLD [0 dBFS, -1 dBFS, ..., -60 dBNFS] RATIO [1/1, 1/1.25, 1/1.5, 1/1.75, 1/2, 1/3, 1/4, 1/8, 1/16] THRESHOLD [-40 dBFS, -41 dBFS, ..., -80 dBFS] RATIO [1/1, 1.125/1, 1.25/1, 1.375/1, 1.5/1, 1.625/1, 1.875/1, 2/1]	CHANNEL 1		
Fine Audio Alignment			[1-100, 0, 100] THRESHOLD [0 dBFS, ..., -20 dBFS] ATTACK TIME [1 ms, 10 ms, 40 ms, 160 ms] RELEASE TIME [48 dB/s, 24 dB/s, 12 dB/s, 6 dB/s] THRESHOLD [0 dBFS, -1 dBFS, ..., -60 dBNFS] RATIO [1/1, 1/1.25, 1/1.5, 1/1.75, 1/2, 1/3, 1/4, 1/8, 1/16] THRESHOLD [-40 dBFS, -41 dBFS, ..., -80 dBFS] RATIO [1/1, 1.125/1, 1.25/1, 1.375/1, 1.5/1, 1.625/1, 1.875/1, 2/1]	CHANNEL 1		
Dynamic Audio Proc			[1-100, 0, 100] THRESHOLD [0 dBFS, ..., -20 dBFS] ATTACK TIME [1 ms, 10 ms, 40 ms, 160 ms] RELEASE TIME [48 dB/s, 24 dB/s, 12 dB/s, 6 dB/s] THRESHOLD [0 dBFS, -1 dBFS, ..., -60 dBNFS] RATIO [1/1, 1/1.25, 1/1.5, 1/1.75, 1/2, 1/3, 1/4, 1/8, 1/16] THRESHOLD [-40 dBFS, -41 dBFS, ..., -80 dBFS] RATIO [1/1, 1.125/1, 1.25/1, 1.375/1, 1.5/1, 1.625/1, 1.875/1, 2/1]	CHANNEL 1		
Audio Silence Enable			[1-100, 0, 100] THRESHOLD [0 dBFS, ..., -20 dBFS] ATTACK TIME [1 ms, 10 ms, 40 ms, 160 ms] RELEASE TIME [48 dB/s, 24 dB/s, 12 dB/s, 6 dB/s] THRESHOLD [0 dBFS, -1 dBFS, ..., -60 dBNFS] RATIO [1/1, 1/1.25, 1/1.5, 1/1.75, 1/2, 1/3, 1/4, 1/8, 1/16] THRESHOLD [-40 dBFS, -41 dBFS, ..., -80 dBFS] RATIO [1/1, 1.125/1, 1.25/1, 1.375/1, 1.5/1, 1.625/1, 1.875/1, 2/1]	CHANNEL 1		
Audio Silence Threshold			[1-100, 0, 100] THRESHOLD [0 dBFS, ..., -20 dBFS] ATTACK TIME [1 ms, 10 ms, 40 ms, 160 ms] RELEASE TIME [48 dB/s, 24 dB/s, 12 dB/s, 6 dB/s] THRESHOLD [0 dBFS, -1 dBFS, ..., -60 dBNFS] RATIO [1/1, 1/1.25, 1/1.5, 1/1.75, 1/2, 1/3, 1/4, 1/8, 1/16] THRESHOLD [-40 dBFS, -41 dBFS, ..., -80 dBFS] RATIO [1/1, 1.125/1, 1.25/1, 1.375/1, 1.5/1, 1.625/1, 1.875/1, 2/1]	CHANNEL 1		
Audio Silence Delay			[1-100, 0, 100] THRESHOLD [0 dBFS, ..., -20 dBFS] ATTACK TIME [1 ms, 10 ms, 40 ms, 160 ms] RELEASE TIME [48 dB/s, 24 dB/s, 12 dB/s, 6 dB/s] THRESHOLD [0 dBFS, -1 dBFS, ..., -60 dBNFS] RATIO [1/1, 1/1.25, 1/1.5, 1/1.75, 1/2, 1/3, 1/4, 1/8, 1/16] THRESHOLD [-40 dBFS, -41 dBFS, ..., -80 dBFS] RATIO [1/1, 1.125/1, 1.25/1, 1.375/1, 1.5/1, 1.625/1, 1.875/1, 2/1]	CHANNEL 1		
Downmix Mode			[1-100, 0, 100] THRESHOLD [0 dBFS, ..., -20 dBFS] ATTACK TIME [1 ms, 10 ms, 40 ms, 160 ms] RELEASE TIME [48 dB/s, 24 dB/s, 12 dB/s, 6 dB/s] THRESHOLD [0 dBFS, -1 dBFS, ..., -60 dBNFS] RATIO [1/1, 1/1.25, 1/1.5, 1/1.75, 1/2, 1/3, 1/4, 1/8, 1/16] THRESHOLD [-40 dBFS, -41 dBFS, ..., -80 dBFS] RATIO [1/1, 1.125/1, 1.25/1, 1.375/1, 1.5/1, 1.625/1, 1.875/1, 2/1]	CHANNEL 1		
Downmix Level Normalization			[1-100, 0, 100] THRESHOLD [0 dBFS, ..., -20 dBFS] ATTACK TIME [1 ms, 10 ms, 40 ms, 160 ms] RELEASE TIME [48 dB/s, 24 dB/s, 12 dB/s, 6 dB/s] THRESHOLD [0 dBFS, -1 dBFS, ..., -60 dBNFS] RATIO [1/1, 1/1.25, 1/1.5, 1/1.75, 1/2, 1/3, 1/4, 1/8, 1/16] THRESHOLD [-40 dBFS, -41 dBFS, ..., -80 dBFS] RATIO [1/1, 1.125/1, 1.25/1, 1.375/1, 1.5/1, 1.625/1, 1.875/1, 2/1]	CHANNEL 1		
Input Channels Selection			[1-100, 0, 100] THRESHOLD [0 dBFS, ..., -20 dBFS] ATTACK TIME [1 ms, 10 ms, 40 ms, 160 ms] RELEASE TIME [48 dB/s, 24 dB/s, 12 dB/s, 6 dB/s] THRESHOLD [0 dBFS, -1 dBFS, ..., -60 dBNFS] RATIO [1/1, 1/1.25, 1/1.5, 1/1.75, 1/2, 1/3, 1/4, 1/8, 1/16] THRESHOLD [-40 dBFS, -41 dBFS, ..., -80 dBFS] RATIO [1/1, 1.125/1, 1.25/1, 1.375/1, 1.5/1, 1.625/1, 1.875/1, 2/1]	CHANNEL 1		
Output Channels Selection			[1-100, 0, 100] THRESHOLD [0 dBFS, ..., -20 dBFS] ATTACK TIME [1 ms, 10 ms, 40 ms, 160 ms] RELEASE TIME [48 dB/s, 24 dB/s, 12 dB/s, 6 dB/s] THRESHOLD [0 dBFS, -1 dBFS, ..., -60 dBNFS] RATIO [1/1, 1/1.25, 1/1.5, 1/1.75, 1/2, 1/3, 1/4, 1/8, 1/16] THRESHOLD [-40 dBFS, -41 dBFS, ..., -80 dBFS] RATIO [1/1, 1.125/1, 1.25/1, 1.375/1, 1.5/1, 1.625/1, 1.875/1, 2/1]	CHANNEL 1		
Downmix Levels Source			[1-100, 0, 100] THRESHOLD [0 dBFS, ..., -20 dBFS] ATTACK TIME [1 ms, 10 ms, 40 ms, 160 ms] RELEASE TIME [48 dB/s, 24 dB/s, 12 dB/s, 6 dB/s] THRESHOLD [0 dBFS, -1 dBFS, ..., -60 dBNFS] RATIO [1/1, 1/1.25, 1/1.5, 1/1.75, 1/2, 1/3, 1/4, 1/8, 1/16] THRESHOLD [-40 dBFS, -41 dBFS, ..., -80 dBFS] RATIO [1/1, 1.125/1, 1.25/1, 1.375/1, 1.5/1, 1.625/1, 1.875/1, 2/1]	CHANNEL 1		
Manual/Default Center Level			[1-100, 0, 100] THRESHOLD [0 dBFS, ..., -20 dBFS] ATTACK TIME [1 ms, 10 ms, 40 ms, 160 ms] RELEASE TIME [48 dB/s, 24 dB/s, 12 dB/s, 6 dB/s] THRESHOLD [0 dBFS, -1 dBFS, ..., -60 dBNFS] RATIO [1/1, 1/1.25, 1/1.5, 1/1.75, 1/2, 1/3, 1/4, 1/8, 1/16] THRESHOLD [-40 dBFS, -41 dBFS, ..., -80 dBFS] RATIO [1/1, 1.125/1, 1.25/1, 1.375/1, 1.5/1, 1.625/1, 1.875/1, 2/1]	CHANNEL 1		
Manual/Default Surround Level			[1-100, 0, 100] THRESHOLD [0 dBFS, ..., -20 dBFS] ATTACK TIME [1 ms, 10 ms, 40 ms, 160 ms] RELEASE TIME [48 dB/s, 24 dB/s, 12 dB/s, 6 dB/s] THRESHOLD [0 dBFS, -1 dBFS, ..., -60 dBNFS] RATIO [1/1, 1/1.25, 1/1.5, 1/1.75, 1/2, 1/3, 1/4, 1/8, 1/16] THRESHOLD [-40 dBFS, -41 dBFS, ..., -80 dBFS] RATIO [1/1, 1.125/1, 1.25/1, 1.375/1, 1.5/1, 1.625/1, 1.875/1, 2/1]	CHANNEL 1		
Metadata source Path Selection			[1-100, 0, 100] THRESHOLD [0 dBFS, ..., -20 dBFS] ATTACK TIME [1 ms, 10 ms, 40 ms, 160 ms] RELEASE TIME [48 dB/s, 24 dB/s, 12 dB/s, 6 dB/s] THRESHOLD [0 dBFS, -1 dBFS, ..., -60 dBNFS] RATIO [1/1, 1/1.25, 1/1.5, 1/1.75, 1/2, 1/3, 1/4, 1/8, 1/16] THRESHOLD [-40 dBFS, -41 dBFS, ..., -80 dBFS] RATIO [1/1, 1.125/1, 1.25/1, 1.375/1, 1.5/1, 1.625/1, 1.875/1, 2/1]	CHANNEL 1		
Audio Sample Rate Converter			[1-100, 0, 100] THRESHOLD [0 dBFS, ..., -20 dBFS] ATTACK TIME [1 ms, 10 ms, 40 ms, 160 ms] RELEASE TIME [48 dB/s, 24 dB/s, 12 dB/s, 6 dB/s] THRESHOLD [0 dBFS, -1 dBFS, ..., -60 dBNFS] RATIO [1/1, 1/1.25, 1/1.5, 1/1.75, 1/2, 1/3, 1/4, 1/8, 1/16] THRESHOLD [-40 dBFS, -41 dBFS, ..., -80 dBFS] RATIO [1/1, 1.125/1, 1.25/1, 1.375/1, 1.5/1, 1.625/1, 1.875/1, 2/1]	CHANNEL 1		
HD Embed. Output Shuffler/Mixer			[1-100, 0, 100] THRESHOLD [0 dBFS, ..., -20 dBFS] ATTACK TIME [1 ms, 10 ms, 40 ms, 160 ms] RELEASE TIME [48 dB/s, 24 dB/s, 12 dB/s, 6 dB/s] THRESHOLD [0 dBFS, -1 dBFS, ..., -60 dBNFS] RATIO [1/1, 1/1.25, 1/1.5, 1/1.75, 1/2, 1/3, 1/4, 1/8, 1/16] THRESHOLD [-40 dBFS, -41 dBFS, ..., -80 dBFS] RATIO [1/1, 1.125/1, 1.25/1, 1.375/1, 1.5/1, 1.625/1, 1.875/1, 2/1]	CHANNEL 1		



Key:XX.XX.XX.XX  
Key:XX.XX.XX.XX  
Key:XX.XX.XX.XX  
[NO, YES]  
[NO, YES]

DYN PROC ON/OFF  
LOUDNESS ON/OFF  
UPG2FULL ON/OFF  
CARD PARAMETERS  
CARD LED ALARMS

Dynamic Proc Option  
Full Model Card Option  
Factory Card Parameters  
Factory Led Alarms

FACTORY RESET

Note: Some menu items may not be present depending on card model, input format, or card configuration.

## ANNEX 2 – AFD FUNCTIONS

The charts below show the conversions that will be performed by the XVP-3901 when the Active Format Descriptor (AFD) processing is activated by selecting AUTO in the *AFD Mode* pulldown on the input screen of the HD Video Output or SD Video Output panels.

In the images shown in the chart:

BLACK  Indicates that this portion of the transmitted image will be black



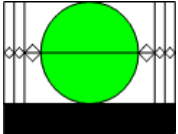
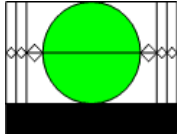
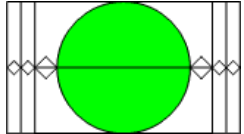
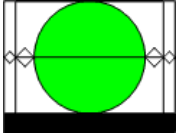
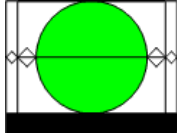
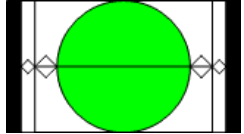
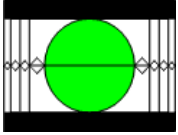
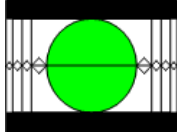
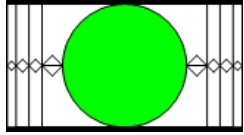

GREY  indicates Protected Area, consisting of picture content which may be cropped for optimum display on screens with a different aspect ratio.

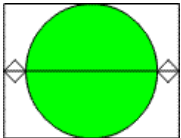
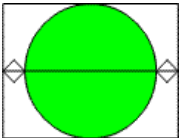
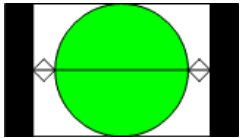
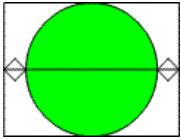
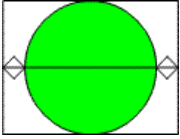
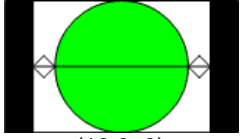
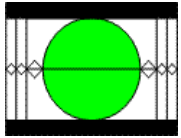
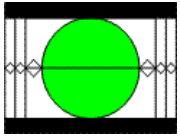
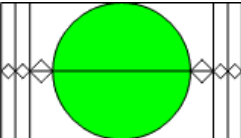
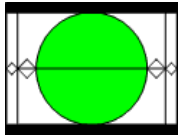
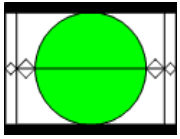
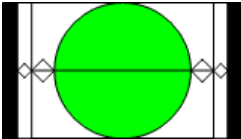
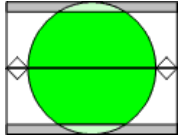
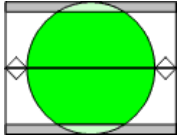
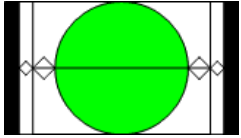
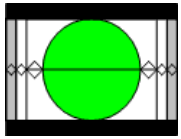
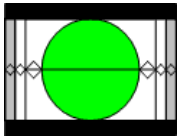
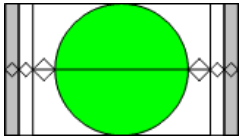
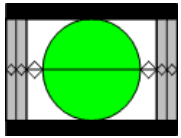
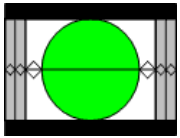
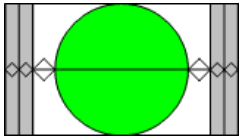
(\*) Asterisk indicates the output selection when the SD Output Aspect Ratio is set to AUTO.

Input signal	4:3	Output signal	16:9
16:9 Letterbox (top) image in a 4:3 frame  (4:3_2)	16:9 Letterbox (top) image in a 4:3 frame  (4:3_2)	16:9 Full frame image in a 16:9 frame  (16:9_8)*	
14:9 Letterbox (top) image in a 4:3 frame  (4:3_3)	14:9 Letterbox (top) image in a 4:3 frame  (4:3_3)*	14:9 Pillar-box image in a 16:9 frame  (16:9_11)	
> 16:9 Letterbox (center) image in a 4:3 frame  (4:3_4)	> 16:9 Letterbox (center) image in a 4:3 frame  (4:3_4)	> 16:9 Letterbox (center) image in a 16:9 frame  (16:9_4)*	

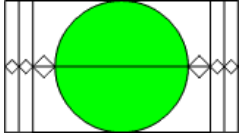
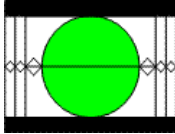
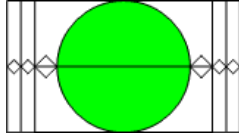
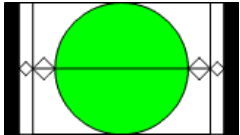
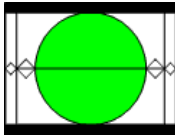
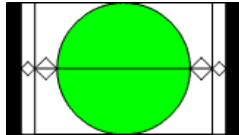
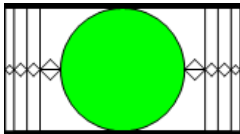
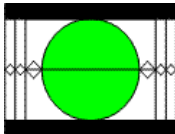
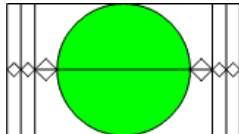
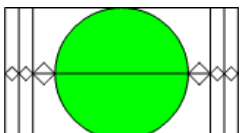
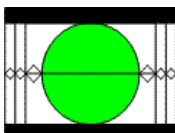
Input signal	4:3	Output signal	16:9
4:3 Full frame image in a 4:3 frame  (4:3_8)	4:3 Full frame image in a 4:3 frame  (4:3_8)*	4:3 Pillar-box image in 16:9 frame  (16:9_9)	
4:3 Full frame image in a 4:3 frame (use preferred 4:3_8 code instead)  (4:3_9)	4:3 Full frame image in a 4:3 frame  (4:3_9)*	4:3 Pillar-box image in 16:9 frame  (16:9_9)	
16:9 Letterbox image in 4:3 frame  (4:3_10)	16:9 Letterbox image in 4:3 frame  (4:3_10)	16:9 Full frame image in a 16:9 frame  (16:9_8)*	
14:9 Letterbox image in a 4:3 frame  (4:3_11)	14:9 Letterbox image in a 4:3 frame  (4:3_11)*	14:9 Pillar-box image in a 16:9 frame  (16:9_11)	
4:3 Image shoot and protect 14:9 in a 4:3 frame  (4:3_13)	4:3 Image shoot and protect 14:9 in a 4:3 frame  (4:3_13)*	14:9 Pillar-box image in a 16:9 frame  (16:9_11)	
16:9 Letterbox image shoot and protect 14:9 in a 4:3 frame  (4:3_14)	16:9 Letterbox image shoot and protect 14:9 in a 4:3 frame  (4:3_14)	16:9 Image shoot and protect 14:9 in a 16:9 frame  (16:9_14)*	
16:9 Letterbox image shoot and protect 16:9 in a 4:3 frame  (4:3_15)	16:9 Letterbox image shoot and protect 16:9 in a 4:3 frame  (4:3_15)	16:9 Image shoot and protect 14:9 in a 16:9 frame  (16:9_15)*	

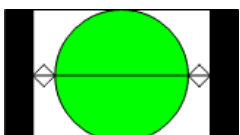
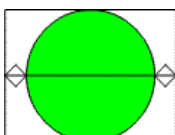
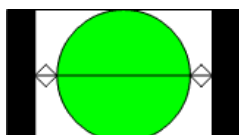
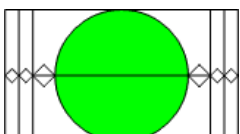
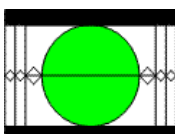

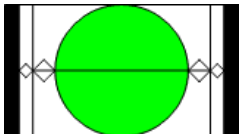
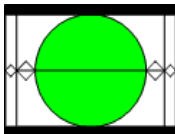
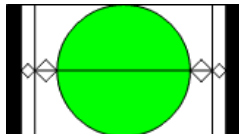
Input signal	4:3	Output signal	16:9
16:9 Full frame image in a 16:9 frame (use preferred 16:9_8 flag instead)  <p>(16:9_2)</p>	16:9 Letterbox image in 4:3 frame  <p>(4:3_10) as shown here or (4:3_8) as in box below</p>	16:9 Full frame image in a 16:9 frame  <p>(16:9_2)*</p>	
14:9 Pillar-box image in a 16:9 frame (use preferred 16:9_11 flag instead)  <p>(16:9_3)</p>	14:9 Letterbox image in a 4:3 frame  <p>(4:3_11)</p>	14:9 Pillar-box image in a 16:9 frame  <p>(16:9_3)*</p>	
> 16:9 Letterbox (center) image in a 16:9 frame  <p>(16:9_4)</p>	16:9 Letterbox image in 4:3 frame  <p>(4:3_4)</p>	16:9 Protected Full frame image in a 16:9 frame  <p>(16:9_4)*</p>	
16:9 Full frame image in a 16:9 frame  <p>(16:9_8)</p>	16:9 Letterbox image in 4:3 frame  <p>(4:3_10) as shown here, or (4:3_8) as in box below</p>	16:9 Full frame image in a 16:9 frame  <p>(16:9_8)*</p>	
4:3 Pillar-box image in 16:9 frame  <p>(16:9_9)</p>	4:3 Full frame image in a 4:3 frame  <p>(4:3_8)*</p>	4:3 Pillar-box image in 16:9 frame  <p>(16:9_9)</p>	
16:9 Protected Full frame image in a 16:9 frame  <p>(16:9_10)</p>	16:9 Letterbox image in 4:3 frame  <p>(4:3_10)</p>	16:9 Protected Full frame image in a 16:9 frame  <p>(16:9_10)*</p>	
14:9 Pillar-box image in a 16:9 frame  <p>(16:9_11)</p>	14:9 Letterbox image in a 4:3 frame  <p>(4:3_11)</p>	14:9 Pillar-box image in a 16:9 frame  <p>(16:9_11)*</p>	

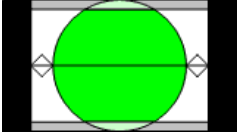
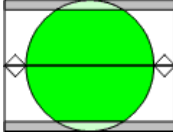
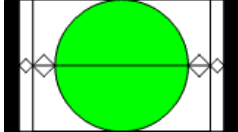
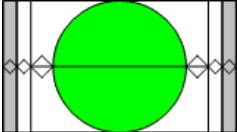
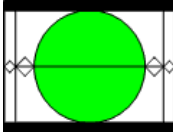
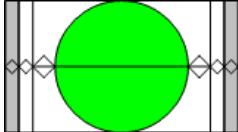
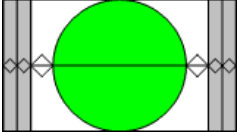
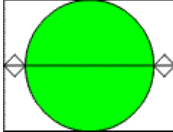
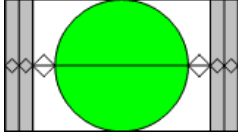
Input signal	4:3	Output signal 16:9
<p>4:3 Pillar-box image Shoot and protect 14:9 in a 16:9 frame</p>  <p>(16:9_13)</p>	<p>4:3 Image shoot and protect 14:9 in a 4:3 frame</p>  <p>(4:3_13)*</p>	<p>14:9 Pillar-box image in a 16:9 frame</p>  <p>(16:9_11)</p>
<p>16:9 Image shoot and protect 14:9 in a 16:9 frame</p>  <p>(16:9_14)</p>	<p>14:9 Letterbox image in a 4:3 frame</p>  <p>(4:3_11)</p>	<p>16:9 Image shoot and protect 14:9 in a 16:9 frame</p>  <p>(16:9_14)*</p>
<p>16:9 Image shoot and protect 4:3 in a 16:9 frame</p>  <p>(16:9_15)</p>	<p>4:3 Full frame image in a 4:3 frame</p>  <p>(4:3_8)</p>	<p>16:9 Image shoot and protect 4:3 in a 16:9 frame</p>  <p>(16:9_15)*</p>

## ANNEX 3 – Installing the Optical Interface

*Installing and removing the Fiber I/O interface cartridge requires special care. This annex describes the process.*

Some rear panels used with the XVP-3901 incorporate a fiber optic interface. The interface consists of two parts:

- A socket on the rear panel into which an SFP interface module is plugged
- An SFP (Small Form-factor Pluggable) module into which the optical fibers are plugged, and which incorporates the optical/electrical interface

### Cautions and Warnings



SFP Transmitter modules contain a class 1 laser, which emits invisible radiation whenever the module is powered up. Because the SFP is hot-swappable, the module may be powered up as soon as it is installed.

**DO NOT LOOK INTO AN OPERATING SFP MODULE'S CONNECTORS, AS EYE DAMAGE MAY RESULT.**



The SFP module is sensitive to electrostatic discharge (ESD). It is recommended that you use an ESD-preventive wrist strap grounded to the Densité chassis while handling the SFP module.



SFP modules are subject to wear, and their useful lifetime is reduced each time they are inserted or removed. Do not remove them more often than is absolutely necessary.



Never remove or install an SFP module with the fiber optic cables connected. Damage to the cables could result.



The presence of dust and debris can seriously degrade the performance of an optical interface. It is recommended that you insert a dust plug into the SFP module whenever a fiber optic cable is not connected.

### Installing an SFP module

1. Make sure that the bale clasp lever is in the closed position

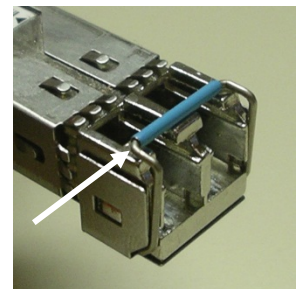

2. Position the SFP module so that the recessed slot is lined up with the tab side of the socket.

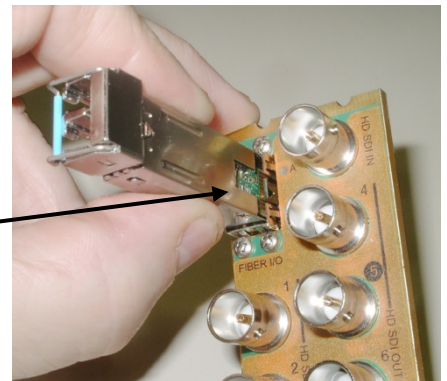
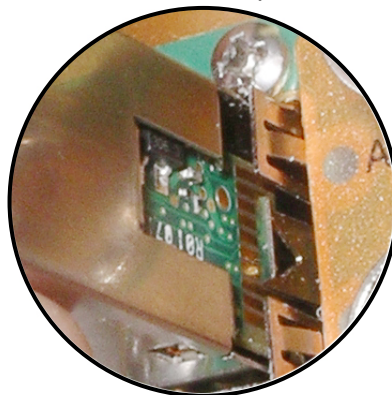

- Slide the module straight into the socket, and push gently until it clicks into position.

### Connecting the fiber optic cables

- Remove the dust plug from the SFP module if present
- Verify that the exposed end of the optical fiber in the LC connector is clean
  - Carefully remove any debris if necessary.
- Plug the LC-terminated fiber optic cable into the SFP module

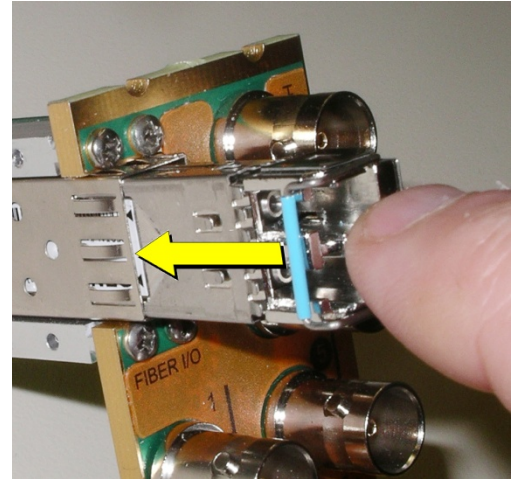

### Removing the fiber optic cables

- Grasp the LC fiber optic connector that is plugged into the SFP module, and pull it straight out to disengage the optical fiber from the SFP.
  - Never pull the fiber optic cable itself, as catastrophic damage may occur.
- Insert a dust plug into the SFP module.

### Removing the SFP module

- Move the bale clasp lever to the open position.

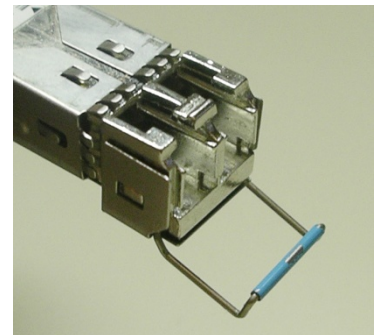

- Grasp the SFP module between your thumb and forefinger, and pull it straight out of the slot.
  - Do NOT pull on the bale clasp lever to remove the module, as it is easily damaged
  - You may find that you need to wiggle the module, or perhaps push it into the slot a bit, before it will release and slide out.

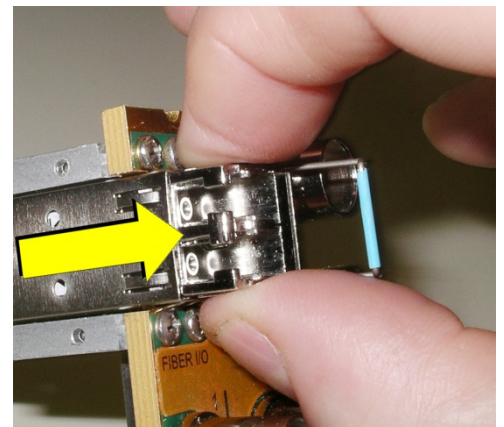

- Insert a dust plug into the SFP module.



## ANNEX 4 – Installing the Audio Modules

### To install an audio module:

1. Remove the card from the frame
2. The two available sockets are located near the top and bottom of the card, and are labeled MODULE #1 and MODULE #2

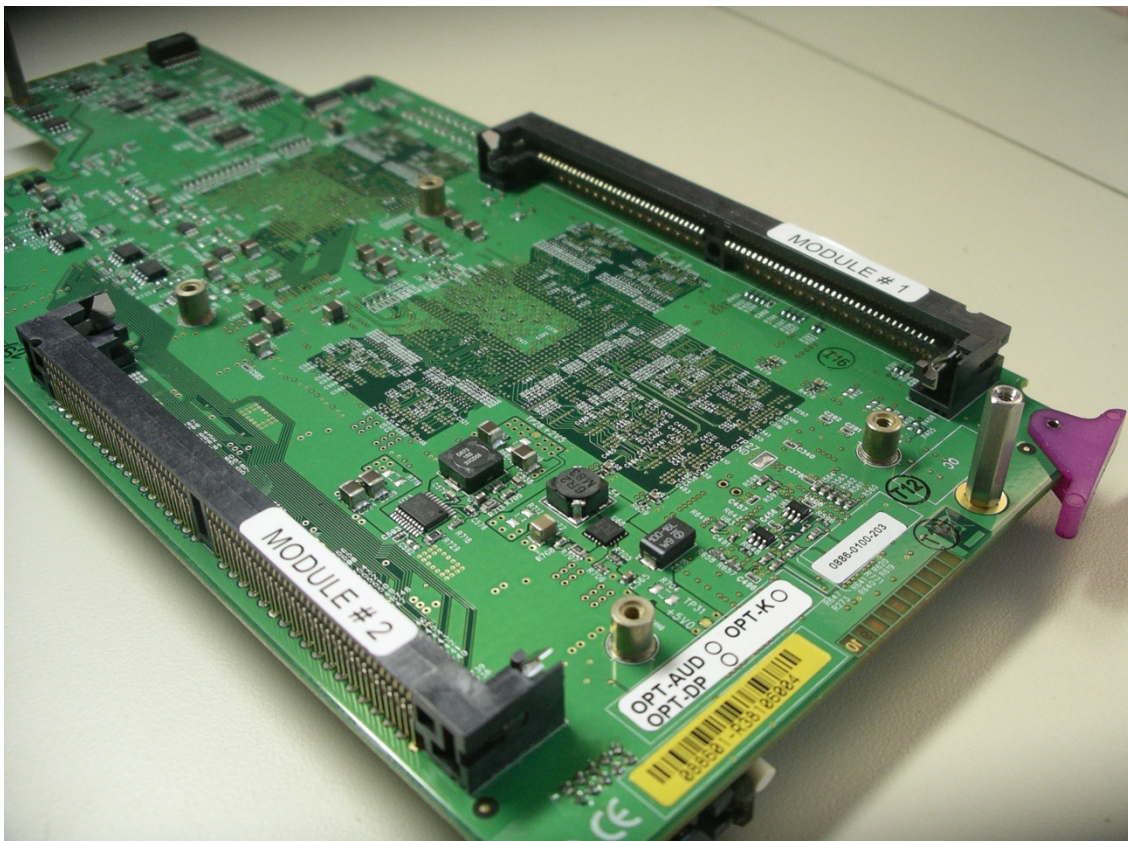

3. Remove the audio module from its packaging.

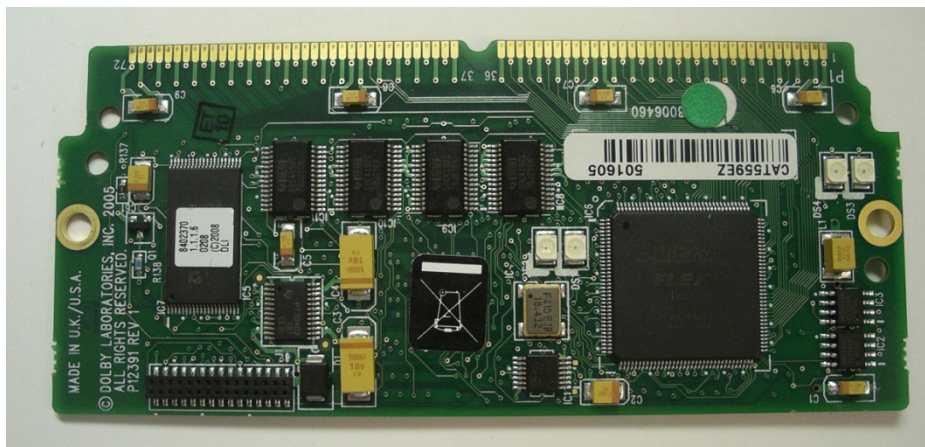



4. Hold the audio module tilted at about a 30 degree angle and insert its connector into one of the available sockets, as shown in the photo below.

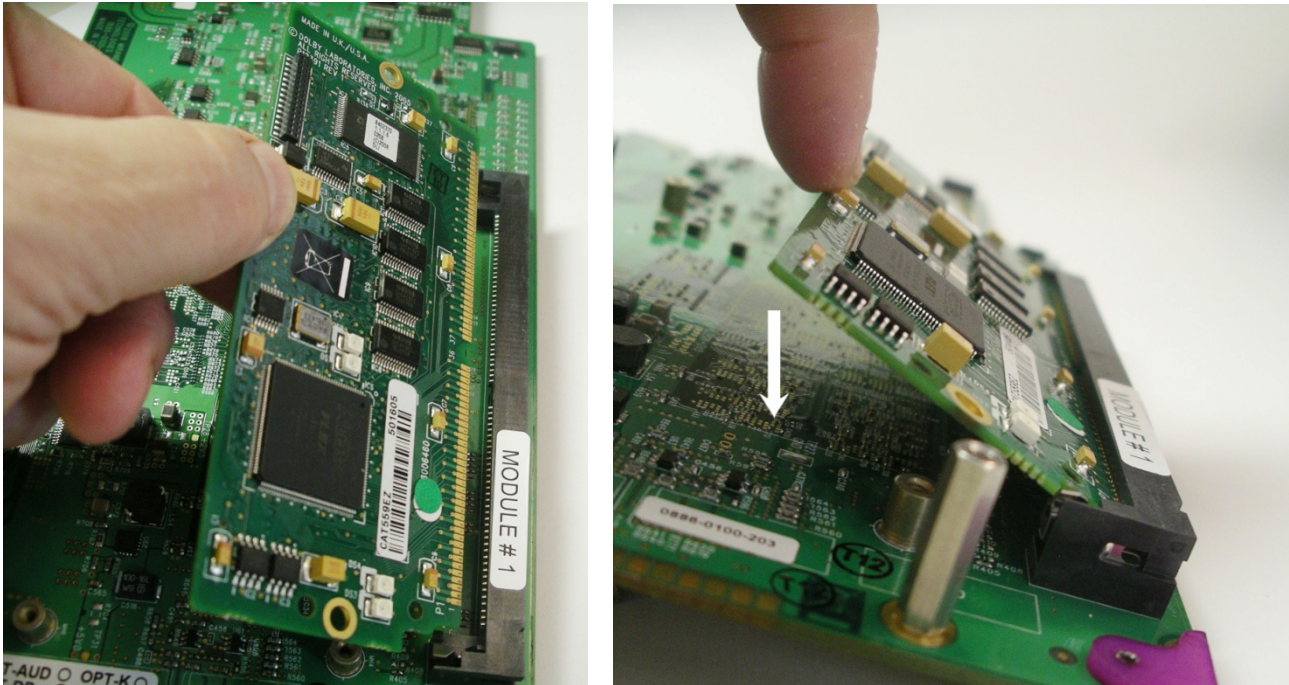

5. Push down on the module until it is parallel to the surface of the card. It will click into place
6. Installed the 2 provided screws in the holes on each side of the module, securing the module to the posts on the card.

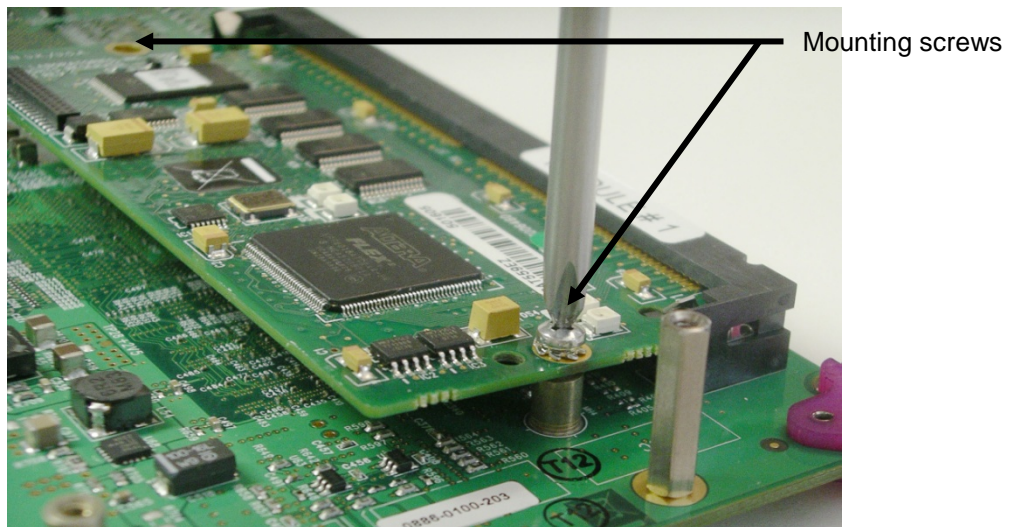

7. Insert the card in the frame.
8. Make sure that the module is correctly detected in the detected "Audio modules" tab of the card's panel or in the "General Status" menu of the local user interface (card edge menu). Controls and parameters for the module installed are available only in the "Audio modules" tab of the card's panel.



**To remove an audio module:**

1. Remove the card from the frame
2. Remove the two screws that secure the module to the card



3. Push outward on the two metal clips that hold the module in the horizontal position, one located at each corner of the socket. The module will release and tilt upward

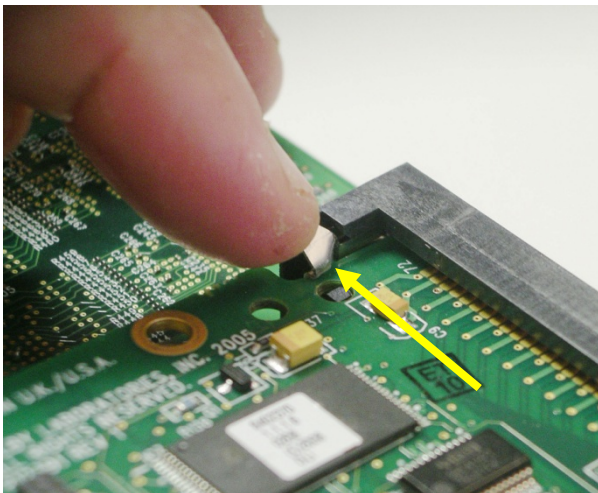

4. Pull the module out of the socket

## ANNEX 5 – Dolby Digital Main Channel Output Functions

Coding Mode	Listening Mode	Main Channel Output Function
3/2	Full	All 3/2 channels
	3 Stereo	3 Stereo downmix of 3/2 channels
	Phantom	Phantom downmix of 3/2 channels
	Stereo	Lo/Ro downmix
	Mono	Lo+Ro
2/2	Full	All 2/2 channels
	3 Stereo	Default to Stereo mode
	Phantom	Default to Full mode
	Stereo	Lo/Ro downmix
	Mono	Lo+Ro
3/1	Full	All 3/1 channels
	3 Stereo	S mixed into L and R with smix coefficient
	Phantom	C mixed into L and R with cmix coefficient
	Stereo	Lo/Ro downmix
	Mono	Lo+Ro
2/1	Full	All 2/1 channels
	3 Stereo	S mixed into L and R with smix coefficient
	Phantom	Default to Full mode
	Stereo	Lo/Ro downmix
	Mono	Lo+Ro
3/0	Full	Default to 3 Stereo mode
	3 Stereo	All 3/0 channels
	Phantom	C mixed into L and R with cmix coefficient
	Stereo	Lo/Ro downmix
	Mono	Lo+Ro
2/0	Full	Default to Stereo mode
	3 Stereo	Default to Stereo mode
	Phantom	Default to Stereo mode
	Stereo	2/0 channels
	Mono	L+R
1/0	Full	Default to Mono mode
	3 Stereo	Default to Mono mode
	Phantom	Default to Mono mode
	Stereo	Default to Mono mode
	Mono	Mono center channel output
1+1	Full	Default to Stereo mode
	3 Stereo	Default to Stereo mode
	Phantom	Default to Stereo mode
	Stereo	L and R output
	Mono	L+R



## ANNEX 6 – Loudness Logging and the Audio Loudness Analyzer

### Activating and Managing Loudness Logging

Use iControl or iControl Solo to activate the loudness logging feature of the XVP-3901, and specify the location where the log files will be saved for future analysis.

1. In the Logical View of your iControl Application (iControl Solo or iControl Navigator) open the Managers folder, and double-click on Loudness Logger

- Note that in Navigator, there may be more than one logger available; be sure to select the one associated with the appserver whose DensitéManager was used to install the XVP-3901.

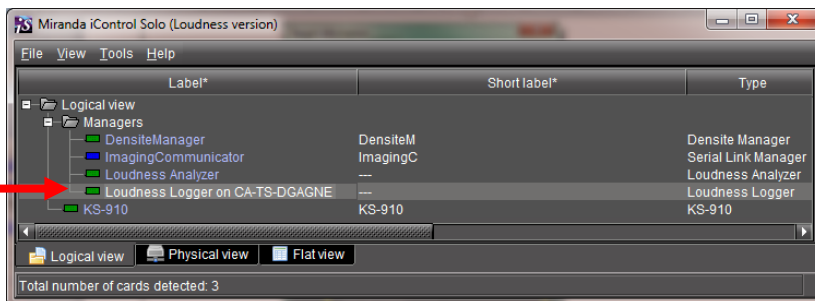

2. A list of loudness monitoring resources will appear, including your XVP-3901.

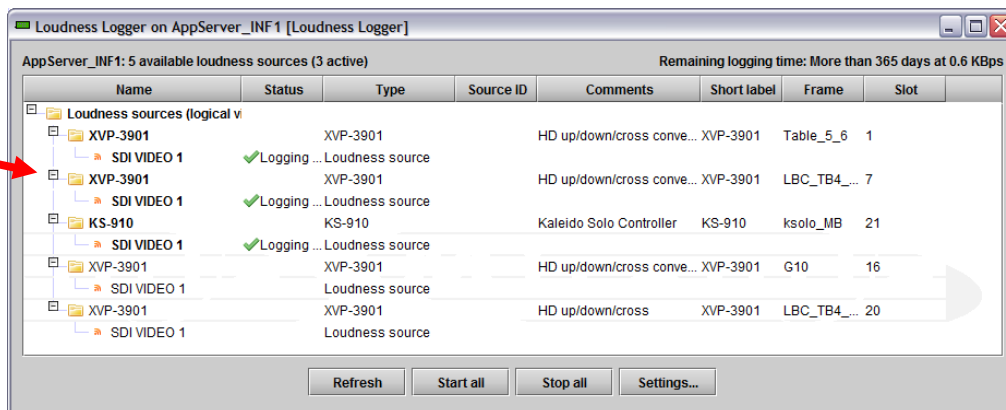

3. Click “Settings” to specify the path to the location where loudness data files will be saved.
4. Browse to the desired location and click the “Apply” button.  
*Note that the Settings apply to all loudness sources reported in the window, so be careful not to change them if other sources are active.*
5. To start logging on an individual XVP-3901, right-click on its icon and select “Start”
6. To start logging on all the loudness sources in the display, click the “Start all” button.
7. Look under “Status” and verify that logging is in progress, as indicated by the green check mark.
8. To stop logging, right-click on the individual XVP-3901 and select “Stop”, or click “Stop all” to stop logging on all devices in the list.

## Starting the Audio Loudness Analyzer from iControl

The Audio Loudness Analyzer processes the log files saved from the XVP-3901, as described above.

1. From your iControl Application (iControl Solo or iControl Navigator), double-click *Loudness Analyzer*.

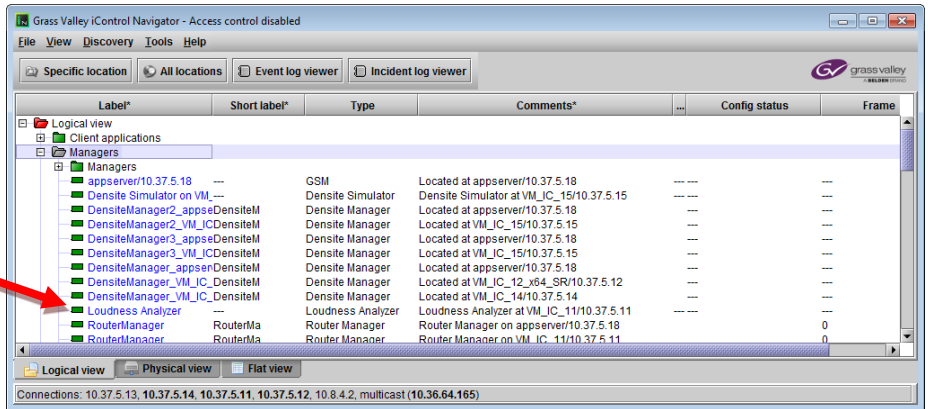

The complete user manual for the Audio Loudness Analyzer is available from the Help menu in the Loudness Analyzer window.

2. Pull down Help and select Open Help to see the manual
3. Consult the manual as necessary to perform the loudness analysis.

