



HEWLETT
PACKARD

MEASUREMENT • COMPUTATION • SYSTEMS
For Science • Engineering • Business • Industry • Education • Medicine

1986





HEWLETT PACKARD

Computers, Peripherals & Calculators

| | | | |
|--------------------------------|------------|-------------------------------|-----|
| Business Computers..... | 61 | Datacom Network Testing | 126 |
| Calculators..... | 52 | Digitizer | 107 |
| Computers..... | 38, 61, 65 | Disc Drives..... | 89 |
| CRT & Data Entry Systems..... | 84 | Engineering Workstations..... | 65 |
| Data Acquisition Systems | 286 | Graphics Tablet..... | 107 |

General Purpose Electronic Instruments & Systems

| | | | | | |
|--------------------------|-----|------------------------------------|---------------|--------------------------|-----|
| Amplifiers | 490 | Data Analyzers/ Generators..... | 466 | Displays..... | 108 |
| Analog VMs..... | 203 | Digital Circuit Testers..... | 372 | DMMs, DVMs | 203 |
| Board Test Systems | 382 | Digital IC Test Systems | 366, 369, 468 | Electronic Counters..... | 224 |
| Component Testers..... | 325 | | | Fiber Optics | 570 |
| | | | | F & T Standards | 252 |

RF & Microwave Measurement

| | | | |
|-----------------------------|-----|--------------------------------|-----|
| Amplifiers | 490 | Microwave Counters..... | 224 |
| Coaxial Test Equipment..... | 552 | Microwave Link Analyzers | 162 |
| Electronic Counters | 224 | Microwave Semiconductors | 739 |
| Frequency Synthesizers..... | 447 | Microwave Test Equipment | 552 |

Logic & Processor-Based Circuit Analysis

| | | | |
|--------------------------------|---------------|-------------------------------------|-----|
| Board Test Systems | 382 | IC Troubleshooters | 372 |
| Data Generators/Analyzers..... | 466 | Logic Analyzers..... | 410 |
| Digital Circuit Testers..... | 372 | Logic Troubleshooting Systems | 372 |
| Digital IC Test Systems | 366, 369, 468 | Memory Test System | 366 |

CAE/CAD

| | | | |
|--|-----|-------------------------------|-----|
| Computer-Aided Work Software (CAW)..... | 174 | Finite Element Analysis | 177 |
| Digital Oscilloscopes..... | 420 | Fourier Analyzers..... | 701 |
| Digital Vibration Control..... | 709 | Graphics Systems | 181 |
| | | Logic Analyzers..... | 410 |

Data Acquisition, Control & Test

| | | | |
|--|------------|------------------------------------|-----|
| Board Test Systems | 382 | Digitizer | 107 |
| Computers..... | 38, 61, 65 | Electronic Counters | 224 |
| Data Acquisition, Test & Control Systems..... | 286 | Graphics Tablet | 107 |
| | | Hewlett-Packard Interface Bus..... | 112 |

Telecommunications & Datacommunications

| | | | |
|-----------------------------------|-----|--|----------|
| Amplifiers | 490 | Digital Communications Measurements..... | 143 |
| Data Generators | 466 | Fiber Optics | 570 |
| Data & Voice Testing | 133 | Frequency Synthesizers..... | 447 |
| Datacommunications Software | 132 | Microwave Counters..... | 224 |
| Datacommunications Testers | 126 | Microwave Radio Testing | 155, 161 |

Hewlett-Packard Interface Bus (HP-IB) System Products

| | | | |
|--------------------------------|-----|---------------------------------------|---------------|
| Analysts | 639 | Data Acquisition, Test & Control..... | 286 |
| Board Test Systems | 382 | Digital IC Test System..... | 366, 369, 468 |
| Component Testers..... | 325 | Electronic Counters | 224 |
| Computers & Peripherals..... | 117 | Extenders | 124 |
| Data Analyzers/Generators..... | 466 | Fiber Optics | 570 |

Other Products

| | | | |
|--|-----|----------------------------------|-----|
| Adapters..... | 742 | Cables | 742 |
| Analytical Instruments for Chemistry..... | 736 | CRT Displays | 108 |
| Cabinet Accessories..... | 744 | Digital Education Products | 381 |
| | | Dimensional Measurement..... | 732 |

HP Computer Museum
www.hpmuseum.net

For research and education purposes only.



B. CLARK

| | | | | | |
|--------------------------------------|-----|-------------------------------------|-------------|-----------------------------|----------|
| Handheld Computers | 52 | Multiprogrammers | 313 | Supplies & Accessories..... | 109, 772 |
| Hewlett-Packard Interface Bus..... | 112 | Peripherals | 84 | Support | 759 |
| Hewlett-Packard Interface Loop | 58 | Personal Computers..... | 38 | Tape Drives..... | 90-93 |
| HP-IB Extenders | 124 | Portable Computers..... | 44, 78 | Technical Computers..... | 65 |
| Modems | 88 | Recorders, Printers, Plotters | 94, 98, 391 | Terminals | 84 |

| | | | | | | | |
|------------------------------|-----|--------------------------|-----|-----------------------------|---------|-----------------------------|-----|
| Frequency Synthesizers | 447 | LCR Meters..... | 336 | Plotters..... | 98, 391 | Signal Analyzers..... | 639 |
| Function Generators..... | 447 | Memory Test System | 366 | Power Supplies..... | 260 | Signal Generators | 522 |
| HP-IB | 112 | Oscillators | 447 | Pulse Generators..... | 476 | Sweep Oscillators | 493 |
| HP-IL..... | 58 | Oscilloscopes | 420 | Recorders, Printers | 94, 391 | Waveform Analyzers..... | 420 |
| Impedance Analyzers | 328 | PC Instruments..... | 193 | Semiconductor Testers | 349 | Waveform Synthesizers | 447 |

| | | | | | |
|---------------------------------|---------|-----------------------------|-----|----------------------------------|-----|
| Millimeter-Wave Equipment | 550 | Power Meters..... | 576 | Sweep Oscillators..... | 493 |
| Network Analyzers..... | 588 | RF Impedance Analyzer | 332 | Transceiver Test Equipment | 728 |
| Noise Figure Meter | 584 | RF Voltmeter..... | 223 | Waveguide Test Equipment | 552 |
| Oscilloscopes | 420 | Signal Analyzers..... | 639 | Video Test Equipment..... | 168 |
| Plotters | 98, 391 | Signal Generators | 522 | | |

| | |
|--|---------|
| Microprocessor Development System..... | 183 |
| Plotters..... | 98, 391 |
| Signature Analyzers | 372 |

| | | | | | |
|---|-----|--------------------------|---------|----------------------------|---------|
| 2D ME Modeling | 177 | Overview | 170 | Support | 176 |
| ME/CAD System | 177 | Plotters | 98, 391 | Third-Party Software | 175 |
| Mechanical Engr/Test | 179 | Spectrum Analyzers | 640 | Workstations..... | 65, 172 |
| Microprocessor Development Systems..... | 183 | | | | |

| | | | | | |
|--------------------------------------|-----|--------------------------------------|-------------|-------------------------------|-----|
| Hewlett-Packard Interface Loop | 58 | PC Instruments..... | 193 | Voltmeters, Multimeters | 203 |
| Memory Test System | 366 | Recorders, Plotters & Printers | 94, 98, 391 | Waveform Analyzers..... | 420 |
| Multiprogrammers | 313 | | | | |

| | | | | | |
|--------------------------------|---------|----------------------------------|-----|----------------------------------|-----|
| Microwave Test Equipment | 552 | Private VF Circuit Testing..... | 166 | Sweep Oscillators..... | 493 |
| Network Analyzers..... | 588 | Pulse Code Modulation | 143 | Telecommunications Test..... | 143 |
| Noise Figure Meter | 584 | Pulse Generators..... | 476 | Transceiver Test Equipment | 728 |
| Plotters | 98, 391 | Radio & FDM Carrier Testing..... | 151 | Video Test Equipment..... | 168 |
| Power Meters..... | 576 | Signal Generators | 522 | | |

| | | | | | |
|---------------------------------------|-----|-------------------------|---------|-------------------------------|-------------------------|
| Graphics Tablet | 107 | Plotters | 98, 391 | Sources..... | 447, 466, 476, 493, 522 |
| Measurement & Control Processor | 308 | Power Meter | 576 | Telecommunications Test | 143 |
| Multiprogrammers | 313 | Power Supplies..... | 260 | Voltmeters, Multimeters | 203 |
| Noise Figure Meter | 584 | Pulse Generators..... | 476 | Waveform Analyzers..... | 420 |
| Oscilloscopes | 420 | Signal Generators | 522 | | |

| | | | | | |
|---------------------------------|-----|--------------------------------|-----|------------------------------|-----|
| Frequency & Time Standards..... | 252 | Microwave Semiconductors | 739 | Pressure & Temperature | 734 |
| Laser Interferometers..... | 732 | Operating Cases..... | 754 | Transit Cases | 750 |
| Medical Instrumentation..... | 740 | Optoelectronic Devices | 738 | X-Ray Systems | 756 |

CONTENTS

| | |
|---------------------------------|-----------------|
| ALPHABETICAL INDEX | 15 |
| MODEL NUMBER INDEX | 26 |
| New Product Highlights..... | 1 |
| About Hewlett-Packard | 11 |
| Free Publications | 757 |
| Ordering Information..... | 758 |
| Customer Support | 759 |
| Sales & Support Offices | 774 |
| Information Request Cards..... | Back of catalog |
| Price Reference | 785 |

PRODUCT SECTIONS

| | | | |
|--|-----|---|-----|
| Amplifiers | 490 | Millimetre Wave Testing | 550 |
| Analytical Instruments for Chemistry | 736 | Multimeters | 203 |
| Business Computer Systems..... | 61 | Network Analyzers..... | 588 |
| Cabinet Accessories..... | 744 | Noise Figure Meter | 584 |
| Cables & Adapters..... | 742 | Operating Cases..... | 754 |
| Circuit Test Systems | 382 | Oscilloscopes & Waveform Analyzers..... | 420 |
| Component & Semiconductor Measurement | 325 | PC Instruments..... | 193 |
| Computer Aided Engineering | 170 | Personal Computers & Calculators | 38 |
| Computer Peripherals..... | 84 | Plotters & Recorders..... | 391 |
| Data Acquisition, Control & Test..... | 286 | Power Meters..... | 576 |
| Data Generators & Data Analyzers | 466 | Power Supplies..... | 260 |
| Datacommunications Test Equipment..... | 126 | Pressure & Temperature..... | 734 |
| Digital Circuit Testers..... | 372 | Pulse Generators..... | 476 |
| Dimensional Measurements | 732 | Signal Analyzers..... | 639 |
| Electronic Counters..... | 224 | Signal Generators | 522 |
| Fiber Optic Test Equipment | 570 | Solid State Devices | 738 |
| Frequency & Time Standards..... | 252 | Sweep Oscillators..... | 493 |
| Frequency, Function & Waveform Synthesizers..... | 447 | Technical Computer Systems..... | 65 |
| Hewlett-Packard Interface Bus..... | 112 | Telecommunications Test Equipment..... | 143 |
| Logic Analyzers..... | 410 | Transceiver Test Equipment | 728 |
| Logic Development Systems | 183 | Transit Cases | 750 |
| Medical Instrumentation..... | 740 | Video Test Equipment..... | 168 |
| Microwave Test Equipment | 552 | X-Ray Equipment | 756 |



Identifies products having the Hewlett-Packard Interface Bus (HP-IB) capability. HP-IB is our implementation of ANSI/IEEE Standard 488, "Digital interface for programmable instrumentation." For the complete story, see pages 112-125.



Identifies products having Hewlett-Packard Interface Loop (HP-IL) capability. HP-IL provides serial loop interfacing for portable, battery-powered systems on the bench or in the field. See page 58.



Identifies newly introduced products or capabilities. New products are also indicated by **boldface** listings in the Model Number Index.

Specifications describe the product's performance.

Parameters that are described as **typical**, **nominal**, or **approximately** (\approx) are supplemental characteristics intended to provide information useful to applying the product.



HP 9000 Series 300 Modular Computers

The Series 300 is a family of high-performance technical workstations designed for instrument control and computer-aided design applications. Its modular design provides a high level of adaptability with choice of performance levels and displays, and compatibility across hardware and software boundaries alike. With the Series 300 you can build a system from scratch. Choose computational power, color, screen resolution, peripherals and accessories. And it's integrated, so all the components will work together, no matter what the configuration. As your computing needs change, your choices can change as easily as they were made in the first place, with the highly flexible Series 300 Modular Computers. See page 70.

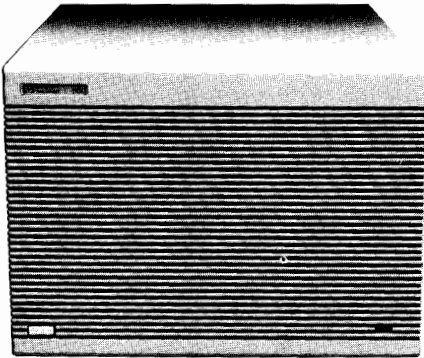

HP 9000 Series 500 Model 550 Computer

The Model 550 is the cornerstone of a multi-user graphics system with the power to respond like a single-user workstation. The system provides mainframe performance, floating point computation, and support of multiple high-performance graphics workstations, all in a networked environment. And in a very small package. When combined with other components, the Model 550 can add exceptional dimensions to a design team's performance. Consider first-time draws of 60,000 vectors per second, redraws just as fast, user access to 4,000 lines of transform engine microcode, 2 Mbyte per second computer-to-display-station interface, and more. It all adds up to more graphics performance per dollar, plus the predictable response you demand. See page 74.



Vectra Personal Computer

The Vectra Personal Computer accommodates ever-changing business needs with its flexible modular design and powerful MS-DOS 3.1 operating system. Select the exact system components for your needs, choosing from a vast range of IBM PC/AT compatible hardware and software by Hewlett-Packard, IBM®, and other manufacturers.

The seven IBM PC/AT™-compatible I/O accessory slots and the Hewlett-Packard Human Interface Loop (HP-HIL) provide unlimited capabilities for your expanding and changing needs. And Vectra software has been developed and adapted to implement such versatile, easy-to-use features as HP Touch, the HP Mouse, Graphics Tablet, and the Personal Applications Manager operating system shell by HP. See page 42.

IBM PC/AT™ is a U.S. trademark of International Business Machines Corporation.
IBM® is a registered U.S. trademark of International Business Machines Corporation.

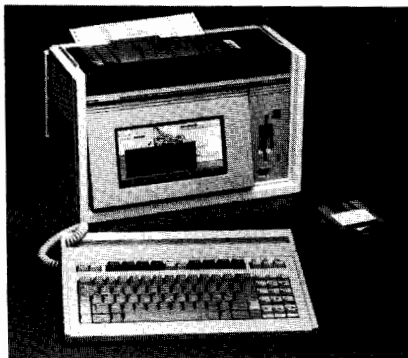

The HP Integral Personal Computer

The Integral PC is the first personal computer to deliver the performance of the UNIX operating system in a fully integrated, affordable, easy-to-use package. Everything you need for full computing power—a printer, keyboard, monitor, mass storage, and an optional HP Mouse—is provided in the transportable Integral PC.

The standard 512K bytes of memory is expandable to 2.5M bytes; with Bus Expanders, the RAM can be boosted up to 7M bytes. And, there are 256K bytes of ROM, with the built-in HP-UX, HP's customized version of the UNIX operating system. Also included in ROM is the Personal Applications Manager (PAM), a friendly user interface, and the HP Windows multi-window manager. See page 78.



The HP Portable PLUS Personal Computer

More than just a portable computer, the Portable PLUS is a powerful, durable traveling companion that shares information and peripherals with desktops or acts as a terminal to mainframes. In one small package, you can carry all the tools you need to be productive in the field or while traveling.

The Portable PLUS is easily tailored to handle varying duties with the programs and data that you use most often installed directly in the computer as plug-in ROMs. You also have the option of loading disc-based software into the Electronic Disc of the Portable PLUS. In either case, there is no need to carry discs or disc drives—just the lap-sized PLUS. See page 44.



OfficeShare LAN

OfficeShare, Hewlett-Packard's personal computer local area network (PC LAN), is based on the industry-standard IEEE 802.3 PC LAN and the MS9™-DOS 3.1 operating system. It connects HP and IBM® personal computers for low-cost file and peripheral sharing, and provides a link to HP's Personal Productivity Center through the HP AdvanceNet networking strategy. This link accesses powerful integrated office solutions, as well as sharing the benefits of Microsoft Network (MS™-Net) software compatibility.

Up to 30 personal computers may be connected to each 185-metre network segment, using any HP Touchscreen II or Vectra Personal Computer with a hard disc as a network server. The typical system supports up to eight nodes per network server.

Remote file access permits transparent file storage and transfer on shared discs, which enables the personal computers to share printers and eliminates the need to learn separate file access methods on the LAN. See page 51.

MS™-DOS and MS™-Net are U.S. trademarks of Microsoft, Inc.
IBM® is a registered U.S. trademark of International Business Machines Corporation.

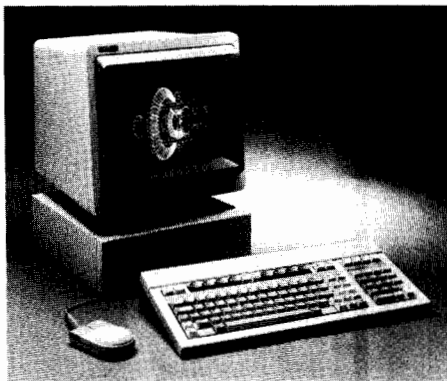

HP 2393A Graphics Terminal

Designed for both business and technical applications, the HP 2393A Graphics Terminal provides full graphics and alphanumeric and supports a wide variety of input and output options. It is a high quality yet affordable solution for the graphics terminal needs of HP 3000, HP 1000 and HP 9000 Computer users. Besides its extensive graphics features, the HP 2393A provides full alphanumeric capabilities, including math, italic, bold and line-drawing characters, up to twelve pages of memory, and enhanced vertical scrolling to support 160-column text. See page 84.



HP 2394A Data Entry Terminal

The HP 2394A Data Entry Terminal offers an innovative approach to remote data entry applications. The HP 2394A has local forms cache, so users can store forms they need in terminal memory for recall to the display immediately when required. Extensive local edit checks, modified data tag, and menu-driven forms design improve data entry throughput. The HP 2394A also has ergonomic features such as integral tilt and swivel plus smooth horizontal scrolling. See page 85.



HP 7907A Fixed/Removable Disc Drive

The HP 7907A offers 20.5 megabytes of fixed storage and 20.5 megabytes of removable storage on a handy 8-inch cartridge. On-line data access rate is 22.6 transactions per second. The HP 7907A conforms to the HP-IB/CS-80 standards, and its intelligent controller supports an off-line back-up that copies data between the fixed and removable discs in less than two minutes. See page 92.

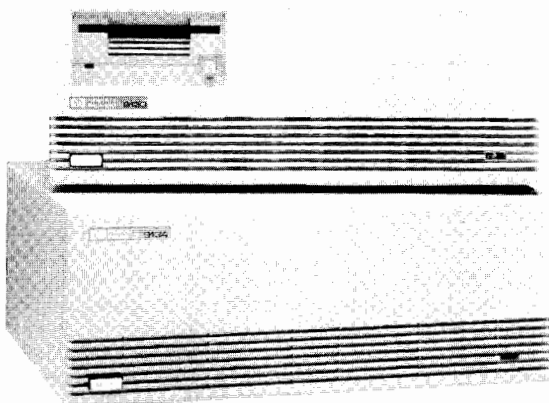

HP 9133,34H/9153,54A Winchester Hard Discs

The HP 9153H (10-Mbyte) and 9133H (20-Mbyte) combine the storage of HP's hard discs with the backup and interchange capabilities of 3 1/2 inch microflops in compact packages. In addition, the microflops are compatible with HP 9122D/S and 9114A data storage units. For floppy-based computer systems, the HP 9154A (10 Mbyte) and 9134H (20-Mbyte) hard-disc-only models add Winchester performance and convenience. All four of these units are supported on the HP Touchscreen, HP 9000 Series 80, and HP Series 200 computers. See page 89.

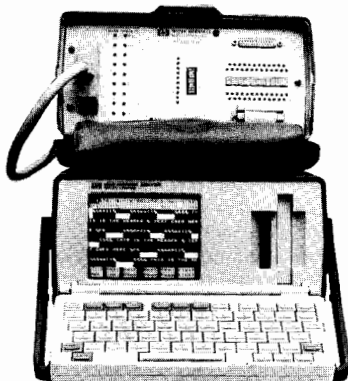

HP 4951B Protocol Analyzer

The new HP 4951B Protocol Analyzer includes all of the features of the HP 4951A (monitors and decodes data transmission, simulates datacomm network components, performs bit error rate tests, and remotely transfers data and programs) as well as several new software features. A new video output port enables users to hook up the analyzer to a video monitor and view what appears on the screen of the protocol analyzer on the larger video monitor at the same time. A separate RS-232C/V.24 printer or remote port enhances the remote testing capability of the analyzer while allowing users to transfer data, programs, and applications to any member of the HP protocol analyzer family.

The HP 4951B has available an SNA analysis package, an asynchronous terminal emulator program, an X.25 package, an X.21 interface kit, and a DDCMP decode and simulation package. The additional versatility that these software packages afford, along with the standard analysis of SDLC, HDLC, BSC, and most other character-synchronous or asynchronous protocols, means that users of all major data communications protocols can do their jobs faster, more easily, and more thoroughly than before. See page 129.

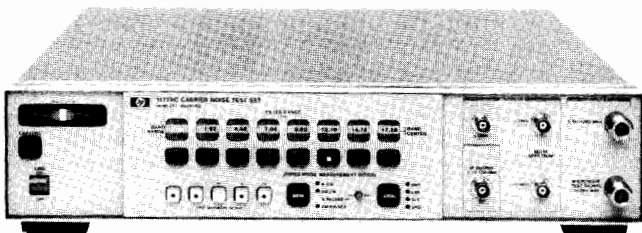

HP 11729C Carrier Noise Test Set

The HP 11729C Carrier Noise Test set measures single-sideband phase noise from 5 MHz to 18 GHz and features three new capabilities in addition to those of its predecessor, the HP 11729B. A 640-MHz SAW filter improves broadband noise floor of the external reference signal to typically -145 dBm/Hz at 10-MHz offset from 10 GHz. The SAW device can be configured into a 640-MHz self-oscillator to replace the external low-noise reference signal in the frequency-discriminator method. This technique is useful for testing free-running devices such as tunable GasFET, Gunn-diode, or YIG-tuned sources. Additional circuitry permits AM and phase noise measurements on many pulsed carriers. See page 712.

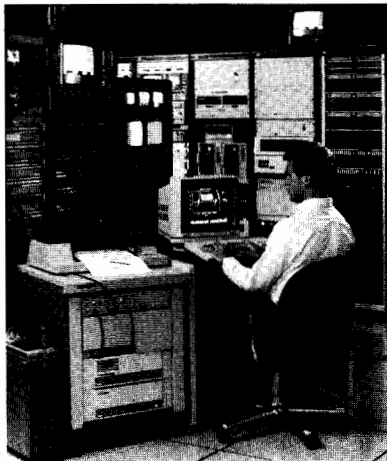

HP 51810S Video Measurement System

Hewlett-Packard's expertise in automatic test equipment now includes video product evaluation. The HP 51810S combines new and existing hardware with advanced software to provide a high-throughput manufacturing system that measures over 60 parameters on NTSC baseband video signals.

At the heart of the computer-based system is the HP 5180A Waveform Recorder, which digitizes the video signal from the device under test. The system extracts gain, phase, timing, noise and distortion parameters from the signal, compares them to preset limits, and stores them for later analysis in a database.

Key features include task separation, which allows less-skilled operators to run predefined tests easily while providing full flexibility to quality-assurance and test managers. Offering a database for storing test results, the system simplifies quality monitoring and parameter trending. Hard copies are obtained using any of several optional HP-GL plotters and printers.

Although intended primarily for production testing of video products, the system will also find applications in research and development, quality assurance, and broadcasting due to the wide variety of measurements it can make. See page 168.

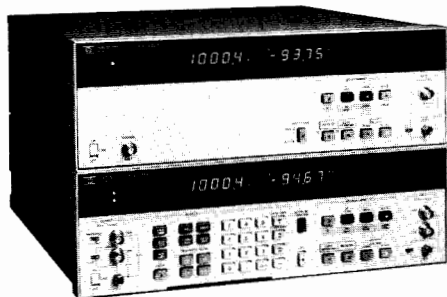

HP 8903B Audio Analyzer, HP 8903E Distortion Analyzer

The HP 8903B Audio Analyzer and HP 8903E Distortion Analyzer provide unparalleled versatility and performance for audio measurements from 20 Hz to 100 kHz. The HP 8903B and HP 8903E combine the functionality of an audio frequency counter, sensitive ac voltmeter, dc voltmeter, high-performance distortion analyzer and SINAD meter into a compact, versatile package. In addition, the HP 8903B includes a programmable, low-distortion oscillator (20 Hz to 100 kHz). With its internal oscillator, the HP 8903B performs automatic signal-to-noise ratio measurements as well as swept distortion and frequency response measurements. Both instruments employ fully automatic input range selection and notch filter tuning to ensure accurate, repeatable results. Other analyzer features include fully balanced input, true rms and average detection and two slots for any of six optional audio filters. With typical residual distortion below 0.003% (20 Hz to 20 kHz), the HP 8903B and HP 8903E can characterize most audio electronic equipment. Receiver SINAD testing is easy with the dedicated SINAD measurement of these analyzers. For system applications, simple yet complete HP-IB programming makes the HP 8903B and HP 8903E ideal solutions for any audio measurement needs. See page 722.

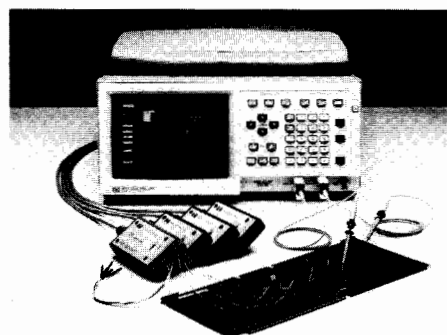

HP 1631A/D Logic Analyzers

The HP 1631A and 1631D are dedicated benchtop logic analyzers that provide state analysis, timing analysis, and digitizing oscilloscope functions all in one instrument. As general-purpose system-integration tools for the digital hardware designer, the HP 1631A/D window in on specific analog events to provide information for troubleshooting and characterizing systems. These new models provide the full capabilities of the HP 1630A/D, including state and timing channels, inverse assembly, and preprocessor support. Two analog channels are available with 200 megasample/second digitizing rate, allowing simultaneous, single-shot capture and storage of waveforms up to 50-MHz bandwidth. See page 410.



HP 9430 Memory Test System

Excellent timing accuracy and long-term stability, coupled with new standards in software productivity, are offered by the HP 9430 Memory Test System. This system represents a versatile and economical solution to the testing of the most common semiconductor memories in end-user and manufacturing environments.

With its flexible architecture, the system is designed to provide an upgrade path for your next-generation memories. High mean time between failures (MTBF) and a one-year calibration period contribute to maximum availability of the system to perform your testing tasks throughout the year. The application-oriented, modular software structure can be readily learned and substantially reduces programming costs.

The HP 9430 is compact. All tester hardware, including controller and mass storage device, is contained in one cabinet (plus testhead). The result is an intelligent, stand-alone system that requires no external host computer for either testing or program development. See page 366.

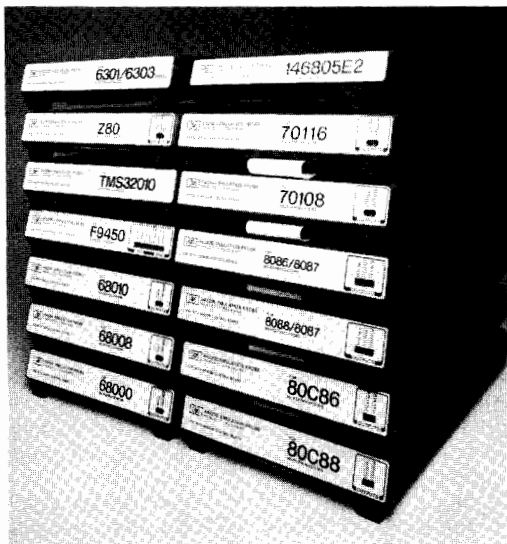

HP 64000 Emulation and Microprogram Subsystems

Fourteen new emulation subsystems and a microprogram development subsystem significantly expand processor support capabilities of the HP 64000 Logic Development System. These subsystems provide an important link between the software-development environment and the target system to enhance designer and programmer productivity, which reduces the time for new-product development. In addition to standard emulation features, many of these new emulators address functions that are integrated directly on the processors themselves.

The microprogram development subsystem supports all phases of microprogram-based (bit slice) product design, development, and maintenance. Additionally, the HP 64000 system allows simultaneous analysis of multiple processors, an increasingly important capability because many digital systems incorporate 8- or 16-bit processors with microprogrammable (bit slice) processors. See pages 188 and 191.



HP 3065 Digital/Analog In-Circuit Board Test Family

Four new in-circuit board test products greatly expand the HP 3065 family of board testers. They consist of two new controllers and two new test stations that can be combined in any way to meet your testing applications. Controller and test-station combinations, ranging from the entry-level HP 3065CL/HL to the top-of-the-line HP 3065CX/HX, all offer 5-MHz digital in-circuit testing with HP's exclusive Safeguard In-circuit Analysis to help prevent digital IC damage. The excellent reliability of all these systems allows HP to offer a 99% Guaranteed Uptime Service for the entire HP 3065 family. See page 387.

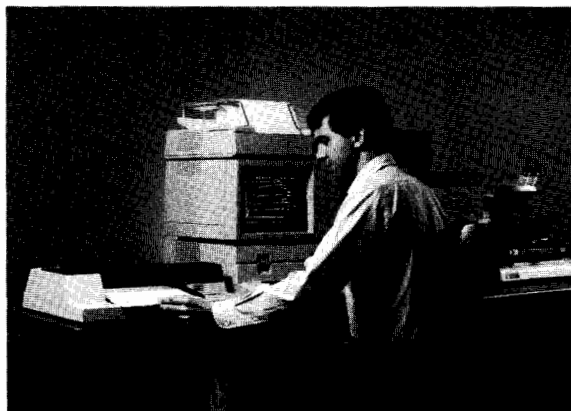

HP 94445A Parameter Extraction Software

You need accurate transistor model parameters to generate precise circuit simulations for IC design. TECAP (Transistor Electrical Characterization and Analysis Program) gives you these model parameters quickly and easily. TECAP shortens your IC design cycle and saves valuable engineering and production resources.

TECAP system hardware performs I-V and C-V measurements on your developmental wafers or discrete transistors. TECAP software transforms the measured data into transistor model parameters that precisely match your particular fab circuit simulation and yield better IC designs.

Because you begin wafer fabrication with a superior design, only minimal adjustments may be necessary at this stage. You save valuable engineering and production resources by eliminating wasteful fab runs.

The TECAP software uses the computing power of the HP 9000 Series 200 PASCAL workstations. The software, written in PASCAL 3.0, is menu-driven and requires no programming expertise. The program is simple to learn and commands don't have to be memorized. TECAP offers an "integrated" solution, where measurement, parameter extraction, device simulation, and plotting routines are included in one unified program.

TECAP precisely extracts model and parameters from measured data by evaluating a non-linear, least-squares-fit algorithm. After computing the model parameters, you can use the device simulator to verify accuracy. The simulator takes into account the external resistances of the transistors, and solves an admittance matrix to give you meaningful, practical simulations. See page 364.

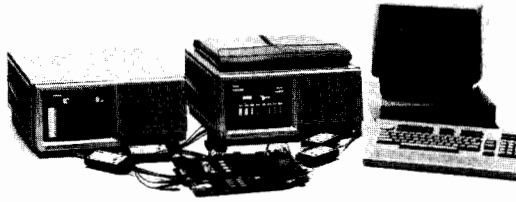

HP 8175A Digital Signal Generator

Combining high data rates with programmable pattern durations, intelligent cycling and interaction with devices under test, the new HP 8175A provides for simulation of a wide range of digital signals in IC, board and module design and test.

The HP 8175A enhances your engineering and test process by offering the versatility and performance you need in digital design and test. Early simulation of not-available elements speeds your design cycle through reduced integration time. Automated, at-speed testing improves your production quality.

When configured with logic analyzers from the HP 1630/31 families, the HP 8175A forms part of a complete test system. The Digital Signal Generator provides stimulus to the device under test, and the Logic Analyzer measures the response in terms of logic states and timing characteristics.

The photo shows an HP 8175A (left) and an HP 1630G (right) in a stimulus-response measurement set-up. The automated measurement is controlled from an HP series 200 controller.

For more information on the HP 8175A, see page 470. For information on the HP 1630/31 Logic Analyzers, see pages 411 and 414.

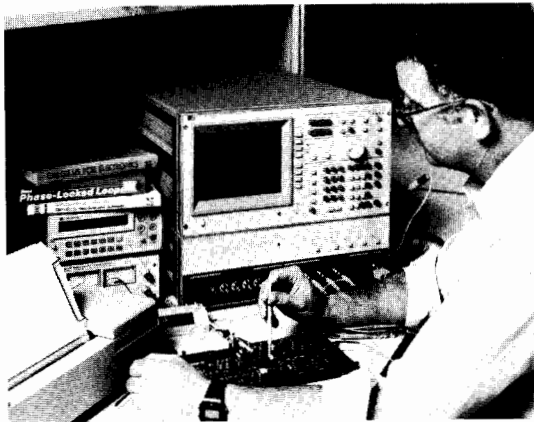

HP 4194A Impedance/Gain-Phase Analyzer

The HP 4194A Impedance/Gain-Phase Analyzer performs impedance and transmission measurements, graphic analysis, and computation quickly and efficiently. Additionally, the HP 4194A can copy its graphics display to a printer or plotter, without the aid of an external controller. The HP 4194A features wide-range impedance measurement from 100 Hz to 40 MHz with high accuracy of 0.17% and gain-phase measurement from 10 Hz to 100 MHz with high accuracy of 0.1dB.

Measurement data can be displayed on a color CRT, and graphics analysis functions such as markers and line cursors can be used to obtain impedance and transmission parameters from the measurement data.

Built-in equivalent circuit analysis/frequency characteristics simulation enables you to characterize components, and the data manipulation function enables you to easily extract secondary parameters.

With the built-in Auto Sequence Program (ASP) function, all measurement and analysis can be automated, expanded, and customized without the aid of an external controller.

The HP 4194A enables you to perform quick evaluation of materials, components, and circuits, thereby increasing engineering productivity. See page 328.

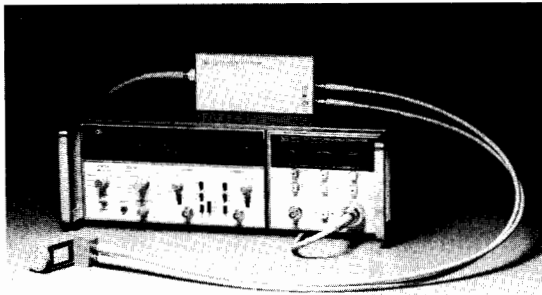

HP 5356D Harmonic Mixer Driver

Monitor or measure pulsed and CW frequencies from 36 Hz to 110 GHz with the HP 5356D and an HP 11970Q,U,V or W mixer. The HP 5356D harmonic mixer driver, along with the HP 11970 mixers, down-converts the frequency for measurement with the HP 5345A/5355A microwave frequency counter. Frequencies within pulses as small as 75 nanoseconds can be measured, and a profile of characteristics can be determined. This makes it ideal for radar applications and VCO post-tuning drift or FSK modulation measurements. Additional frequency-converter heads are available, which allow measurements from dc to 40 GHz, making this a most versatile combination of products for frequency and time interval measurements. See page 232.



HP 5350A, 5351A, 5352A CW Microwave Frequency Counters

Choose 20, 26.5 or 40 GHz and get all the basic performance of the higher priced products for less cost. These new counters are designed with GaAs (Gallium Arsenide) integrated circuitry, which simplifies and reduces parts for high reliability and low cost of ownership. With a sensitivity of -30 dBm at 26.5 GHz and -20 dBm at 40 GHz, a frequency range of 500 MHz to 40 GHz can be measured on a single input connector. A second input measures 10 Hz to 525 MHz and offers resolution to a millihertz. HP-IB data rates of greater than 80 readings-per-second make these counters ideal for systems. Standard features include keyboard and display lockout, math functions and HP-IB. A temperature-compensated crystal oscillator (TCXO) is standard; an optional oven time base and an optional high-stability oven time base are available for all three products. Rear input connectors and input protection are also available for both the HP 5350A and HP 5351A counters. See page 226.

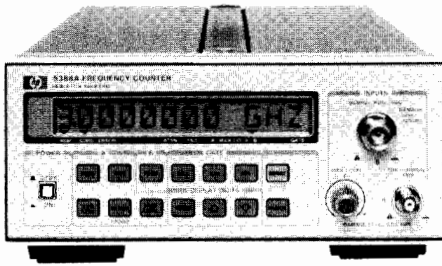

HP 5386A Frequency Counter

For portable, low-cost frequency measurements to 3 GHz, consider the new HP 5386A. This counter features -27 dBm sensitivity, 9 digits of resolution per second, a 12-character liquid-crystal display, and HP-IB standard. Both frequency and period measurements can be made with the low-frequency port. A half-rack-width package enhances the counter's utility for calibration and maintenance applications, and conserves rack space for systems applications. The alphanumeric LCD can be used as a remote display for operator prompts or for displaying scaled measurements with appropriate units. An optional oven timebase lengthens the calibration period for kilohertz accuracy (at 3 GHz) from six months to a full year. See page 234.

HP 3852S Data Acquisition and Control System

With the HP 3852S Data Acquisition and Control System you get capable hardware plus system software to create a powerful data acquisition system that you can easily configure to your needs. A full keyboard with two displays means easy checkout of system wiring. Plug-in voltmeters and input/output accessories with removable terminal modules for field wiring speed up system configuration. You'll have powerful system software for fast and easy start-up using a tool set of capabilities needed in data acquisition, capabilities such as data analysis, presentation, distribution and archiving.

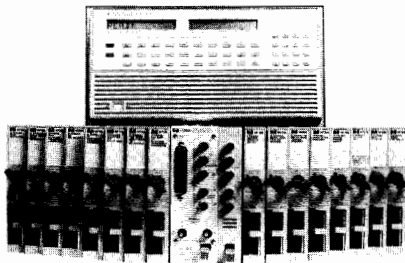

The HP 3852S Data Acquisition and Control System consists of an HP 3852A mainframe; optional HP 3853A extenders; a selection of plug-in voltmeters, multiplexers, and input/output accessories; an HP Series 200 computer; and system software. You can choose any combination of these capabilities. The HP 3852A Data Acquisition and Control Unit has eight slots for plug-in accessories. If more slots are needed, add up to seven extenders with 10 slots per extender.

You can use the HP 3852S to perform accurate, low-level and noise-rejecting measurements as well as high-speed measurements. You can resolve one-microvolt signals with the integrating DVM and make scanned readings at up to 100,000 per second with the high-speed DVM. The HP 3852S is a single card-cage product that lets you make a wide range of measurements as well as control and sequence your test. See page 300.

HP 5180T/U and 5183T/U Digitizing Oscilloscopes

The HP 5180, shown here, and the HP 5183 are two-channel digitizing oscilloscopes that combine precision digitizers and waveform analyzers. The HP 5180T offers 20 Msamples/s, 10-bit resolution, 60-dB dynamic range, and 16K memory. In comparison, the HP 5183T offers 4 Msamples/s, 12-bit resolution, 72-dB dynamic range, and 512K memory. The HP 5180U and 5183U are four-channel versions of the HP 5180T and 5183T.

All four oscilloscopes feature powerful trigger enhancements, with the HP 5180 offering selectable sensitivity and bitrigger and the HP 5183 offering dropout, sequential, bitrigger, composite, and high-frequency triggering. In addition, time-base features such as main-only, mixed, and toggle in the HP 5180 and main-only, mixed, burst, and adaptive sample rate in the HP 5183T give more measurement control and conserve memory.

Once a signal has been digitized and recorded, the HP 5180T/U and HP 5183T/U are ready for complete signal analysis (e.g., FFT, pulse, integrate, differentiate, waveform math, rms, peak-to-peak). Touchscreen displays guide users through menus for analysis, cursor control, display, plot or disc operations. Waveform and measurement setups can be stored on optional internal discs or on external discs.

The HP 5180's applications include video test plus floppy media and drive test, whereas the HP 5183 is aimed at sonar, modem, communications, and disc testing. See page 422.

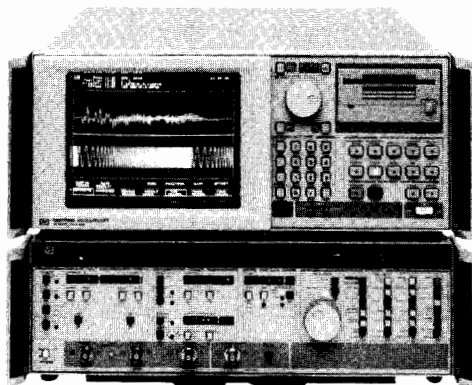

HP 54110D and 54200A/D Digitizing Oscilloscopes

The HP 54110D, shown here, is a full-color, 1-GHz digitizing oscilloscope featuring automatic parameter measurements, digital storage, infinite persistence, pretrigger viewing, and setup aids that simplify time-domain measurements for digital design.

Ideal for capturing high-speed, single-shot events, the HP 54200A and 54200D are fully-programmable, 200-Msample/s, 50-MHz digitizing oscilloscopes that offer a variety of automatic measurements. The HP 54200D also includes triggering modes similar to logic analyzers. See pages 430 (HP 54110D) and 434 (HP 54200A/D).

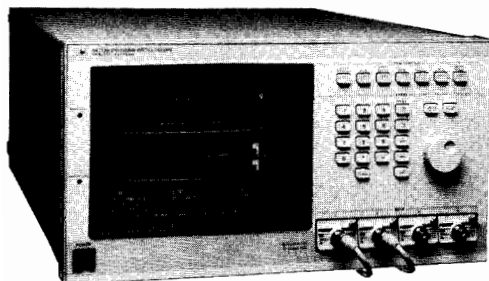

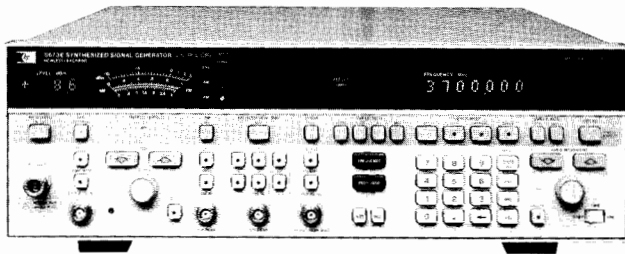

HP 8673E Synthesized Signal Generator

Full microwave test signal simulation is now available from 2 to 18.0 GHz with the HP 8673E Synthesized Signal Generator. Using the digital keyboard-entry style of the earlier HP 8673B, the new generator features AM, FM and pulse modulation for matching the simulation requirements of modern system and component test. Output amplitude ranges from +10 to -120 dBm, with AM rates to 100 kHz and FM rates to 10 MHz, depending on modulation index. Pulse modulation features >80-dB on/off ratio, <35-ns rise/fall times and <100-ns pulse widths. Simultaneous modulations are possible. See page 546.

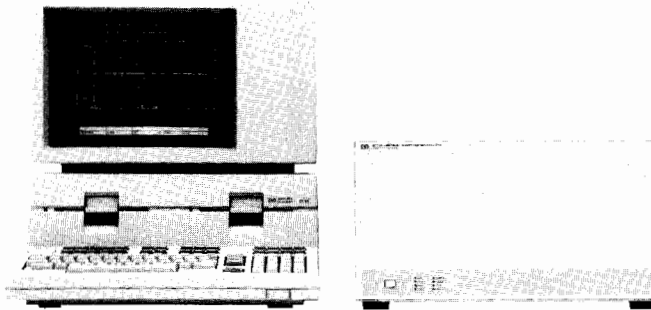

HP 8770A Arbitrary Waveform Synthesizer

New technology in the form of an ultrafast D-to-A converter enables the HP 8770A to generate 125 million waveform samples per second, equivalent to a dc to 50 MHz frequency coverage, with an amplitude resolution of 12 bits (1 : 4096). This remarkable capability challenges old test concepts for simulating test waveforms for computer hard-disk head testing, electromagnetic pulse simulations, and RF receiver tests. In addition, it provides a highly-versatile test source for many ATE systems. Complimenting this hardware, HP 11775A Waveform Generation Software operates on HP 200-Series desktop computers and gives the operator powerful waveform construction routines that can add controlled amounts of noise or distortion as required by the particular test simulation. See page 450.

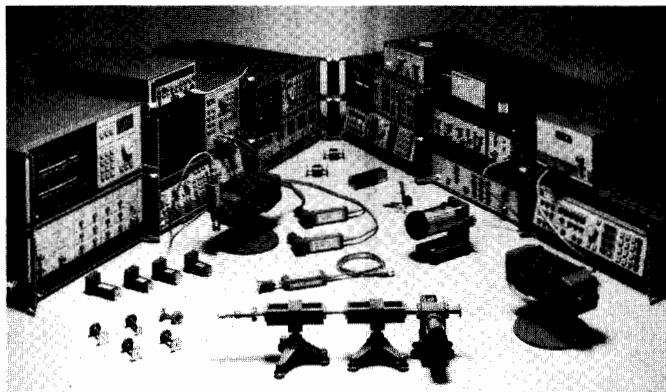

HP Millimeter-Wave Product Line

Hewlett-Packard introduces a new line of millimeter-wave test equipment that includes signal analyzers and frequency counters to 110 GHz, sweepers and synthesizers to 60 GHz, scalar and vector network analyzers to 60 GHz, waveguide accessories to 60 GHz, and power meters to 50 GHz. For a complete description of the new millimeter-wave product line, see page 550.

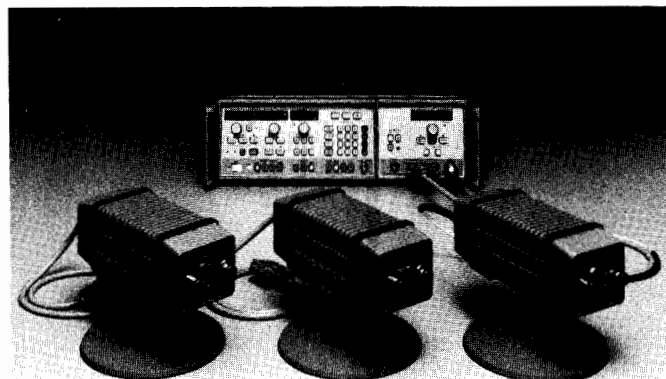

HP Millimeter-Wave Source Modules

Hewlett-Packard is addressing the growing millimeter-wave market with the new HP 83550-series millimeter-wave source modules. These high efficiency frequency multipliers can be used to extend the features and performance of existing 11 to 20 GHz microwave sources to the 26.5 to 40 GHz (HP 83554A), 33 to 50 GHz (HP 83556A), and 40 to 60 GHz (HP 83556A) millimeter-wave frequency ranges.

These source modules are the center of Hewlett-Packard's new millimeter-wave measurement solutions. They are easily configured with existing sweep oscillators and network analyzer configurations to extend component test to millimeter-wave frequencies. The source modules can also be driven by Hewlett-Packard's high performance synthesizers to answer the growing demand for solutions to complex millimeter-wave signal simulation applications. Finally, the source modules are remoteable, making them easy to use in the research and design lab, on the production floor, or in field test. See page 512.

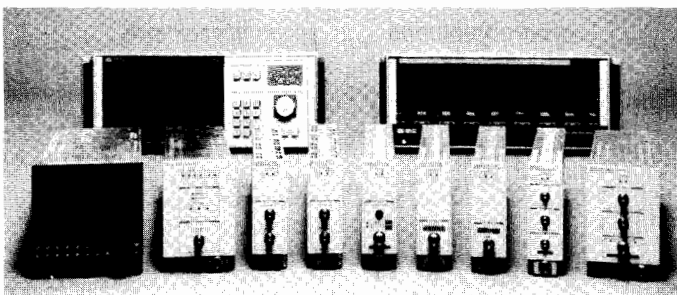

HP 71000 Modular Spectrum Analyzers

Put together the spectrum analyzer that best meets your needs with the new HP 71000 Modular Spectrum Analyzer family. The HP 71000 family includes a rugged, reliable mainframe, two high-performance display units, and a selection of modules that perform various spectrum analyzer and tracking generator functions.

Three standard, factory configured HP 71000 systems covering RF, microwave, and millimeter frequency ranges are available. Options include the large, stand-alone display, the HP 70903A wide-bandwidth IF section, and extended warranty coverage. The system components can be combined in different ways for a variety of instrument applications, and as your measurement requirements change, new modules can be added. The modules, displays, and mainframes can also be ordered individually or as custom systems. See page 647.

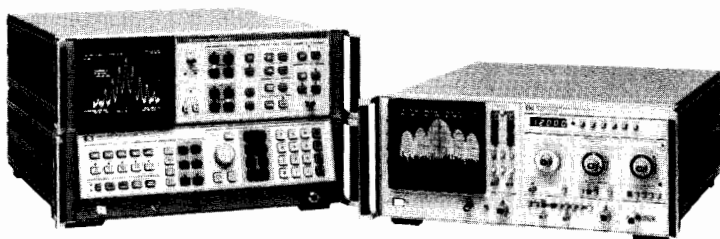

HP 8567A, 8570A RF and Microwave Spectrum Analyzers

The HP 8567A RF Spectrum Analyzer (10 kHz - 1500 MHz) is fully automatic, with built-in firmware to reduce your test time and lessen the data processing load on your computer. Is EMI testing cutting into your budget? The HP 8567A has the accuracy necessary for EMI testing and is compatible with Hewlett-Packard measurement software and accessories to help you complete your EMI testing at minimal cost. Measurement routines can be stored in the HP 8567A and executed by pressing a softkey. This allows repetitive operations and customized tests to be performed by an operator who has little or no expertise in signal analysis. See page 668.

The HP 8570A Microwave Spectrum Analyzer features internal preselection over a wide 1.7 to 22 GHz frequency range to provide the dynamic range and overload protection necessary for most signal analysis applications. Precise measurements are made quickly and easily with features such as three-knob operation and digital display. Documented results are obtained conveniently with the direct-to-plotter HP-IB output. Ease-of-use and accuracy make the HP 8570A an ideal choice for lab and production uses. See page 676.

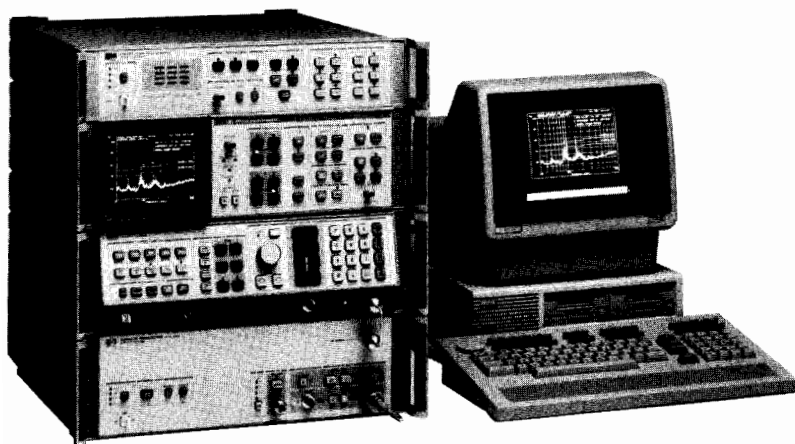

HP 8574A CISPR Spectrum Analyzer/EMI Receiver

A total solution for EMI measurements, from product design through compliance testing, is now available from Hewlett-Packard. The new HP 8574A CISPR Spectrum Analyzer/EMI Receiver combines the high-performance of the HP 8568B Spectrum Analyzer with the improved sensitivity and overload protection of the new HP 85685A RF Preselector. The HP 85650A Quasi-Peak Adapter completes a system designed to CISPR (Comite International Special des Perturbations Radioelectrique) Publication 16 recommendations and meets the measurement requirements for military and commercial standards, including FCC and VDE. System features include peak, quasi-peak, and average detection. The receiver gives you the accuracy needed to perform indoor or open-site EMI tests with confidence. In addition, the spectrum analyzer, an indispensable diagnostic aid throughout EMI design and evaluation, is a powerful tool for general-purpose signal analysis. See page 671.

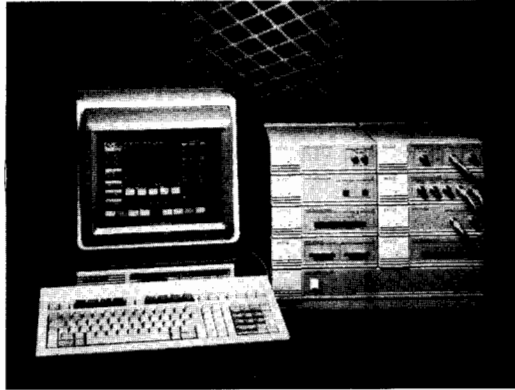

HP PC Instruments

HP PC Instruments offer a cost-effective and easy-to-use personal-computer-based solution to the automated test and measurement needs of a wide range of technical professionals. Working in concert with the HP Vectra PC, HP Touchscreen PC, the IBM PC, PC/XT, and PC/AT, PC Instruments operate in both manual and programmatic modes. Their soft front panels simulate instrument control panels on your PC, allowing you to simply touch the HP 150 screen or use a mouse with the IBM PC to set functions, ranges and values, and take measurements. You can also use the soft front panel to enter many of the instrument parameters that have been traditionally typed into the system. PC Instruments also help you to develop programs faster. A few easy-to-remember commands, such as OUTPUT and MEASURE, control your PC Instruments from Microsoft® BASIC. An optional data acquisition software package provides simple menu-driven programs for voltage scanning, temperature measurement, and graphics. An add-on HP-IB Command Library can also turn your PC into a versatile HP-IB instrument controller that controls both PC Instruments and HP-IB instruments from the same BASIC program. The HP PC Instrument System includes these modules: Digital Multimeter, Digitizing Oscilloscope, Function Generator, Universal Counter, Relay Multiplexer, Dual Voltage Digital-to-Analog Converter, Digital Input/Output, and Relay Actuator. See page 193.

Microsoft® and Microsoft BASIC® are US registered trademarks of Microsoft Corporation.

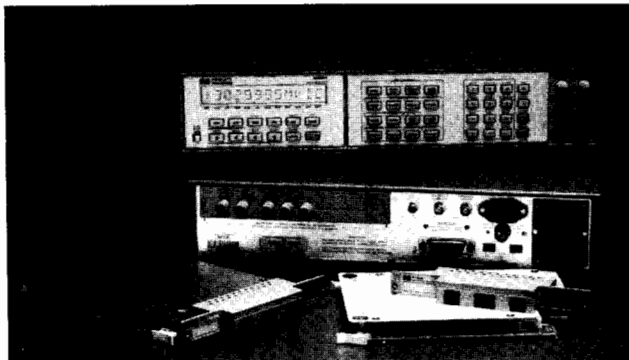

HP 3457A Multimeter

The new HP 3457A Multimeter gives you seven measurement functions with $3\frac{1}{2}$ to $6\frac{1}{2}$ digits of resolution. Select the reading rate you need for your measurement task from less than 1 per second in $6\frac{1}{2}$ digits to greater than 1350 per second at $3\frac{1}{2}$ digits. Basic dc volts accuracy is 5 ppm for 24 hours.

You can combine measurement functions of dcV, acV, dcI, acI, ohms, frequency, and period with the optional scanning plug-ins to create a small test system with or without a computer. For larger applications, the HP 3457A gives you a task-oriented command set to make your programming self-documenting and easy to understand. The memory features of program memory, reading memory, and state memory can free your computer for other tasks while the HP 3457A is performing your measurements. In all, the HP 3457A adds up to great performance at modest cost. See page 205.

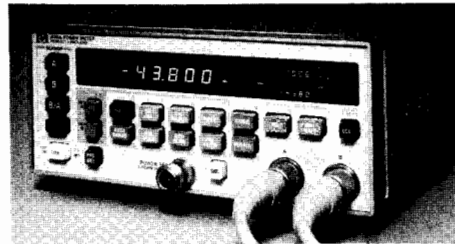

HP 438A Dual-Sensor Power Meter (Option 700, CIIL Programming)

For automatic testing systems built to the US Air Force MATE (Modular Automatic Test Equipment) standard, system instruments are controlled by a test language called CIIL (Control Interface Intermediate Language). The HP 438A Option 700 responds to CIIL commands and provides all the measuring power of the dual-sensor meter, which can not only sense power at two points but also compute ratios of and differences between the two readings. HP 438A has become the power meter of choice for automatic systems because it packs two channels into a half-rack width only 88.1mm (3.5-inch) high, and because of its 25,000 hours MTBF reliability, proven with actual warranty data. See page 577.

HP 6621A-6624A System DC Power Supplies

These HP-IB multiple-output, series-regulated system power supplies feature a combination of intelligence, performance and low price that makes them the preferred choice for controlled power systems applications.

Four models, each offering a total of 160 watts output power, offer a variety of output combinations of 40 and 80 watts with voltages up to 50 volts and currents to 10 amperes. Each output can produce power in two ranges. For example, model 6622A has two 80-watt outputs. Each of these can produce 80 watts at either 20 volts or 50 volts. When operating below 20 volts, each output can source or sink up to 4 amperes. When operating between 20 volts and 50 volts, each output can source or sink up to 1.6 amperes. Output combinations include:

- 6621A - 2 outputs at 80 watts, both 0-7 or 0-20 volts
- 6622A - 2 outputs at 80 watts, both 0-20 or 0-50 volts
- 6623A - 1 output at 80 watts, 0-7 or 0-20 volts; 1 at 40 watts, 0-20 or 0-50 volts; 1 at 40 watts, 0-7 or 0-20 volts
- 6624A - 4 outputs at 40 watts: two at 0-7 or 0-20 volts and two at 0-20 or 0-50 volts.

The built-in interface is tailored to the power supply, resulting in simpler programming. Self-contained measurement and readback capabilities eliminate the need for scanning the output or using a separate DVM to monitor the supplies. See page 276.

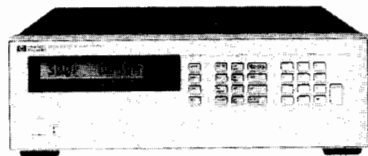



Hewlett-Packard Company is in the business of developing, manufacturing and marketing measurement and computation products and systems used by people in science, engineering, business, industry, education and medicine. These products are known for their high quality, reliability and advanced technology and include calculators, computers and peripherals, electronic instruments, instruments for chemical analysis, medical instrumentation, and electronic components.

Headquartered in Palo Alto, California, Hewlett-Packard employs approximately 85,000 people worldwide, of whom some 57,000 work in the U.S.A. Product research and manufacturing activity is highly decentralized, with facilities in the U.S., the UK, Europe, Japan, Southeast Asia, Latin America and Canada. The worldwide sales organization includes more than 100 sales and support offices in the U.S., and some 240 sales and support offices and distributorships in 75 other countries.

With 1984 sales in excess of 6.04 billion dollars, HP is ranked in the top 60 U.S. industrial corporations. About 40 percent of these sales were generated outside the United States.

HP Instruments

Hewlett-Packard's first product, developed in 1939, was an audio oscillator based on a new and innovative design. In the company's first 20 years, this oscillator was the foundation for an ever-broadening line of test and measurement instruments used primarily by engineers and scientists. The first HP catalog, published in 1943, used 24 pages to describe a total product offering of 12 instruments. This 1986 edition has 784 pages on which are detailed some 1,700 instruments, computers and accessories out of the company's total offering of more than 7,000 products. Customers use HP instruments to evaluate the performance of their own electrical equipment, in developing products,

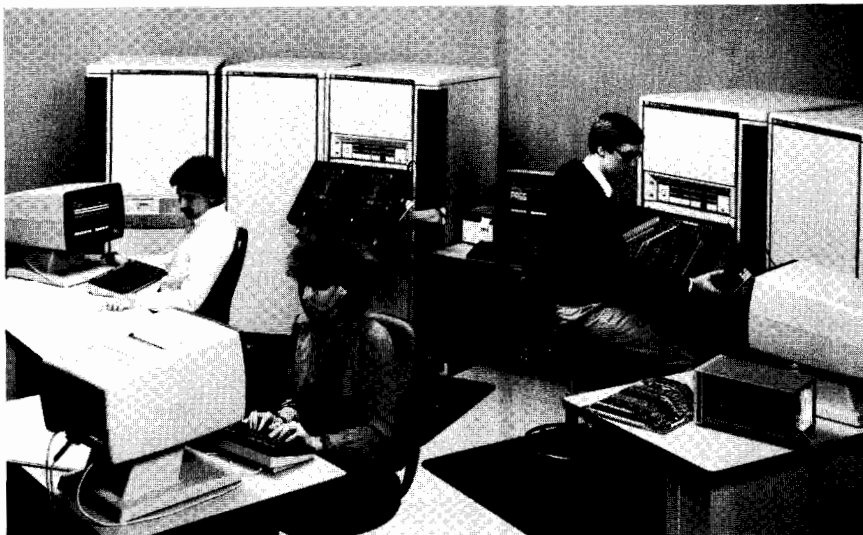

An illustration of HP's ongoing commitment to upgrading customer productivity is the HP 3065 family of digital/analog, in-circuit board testers. HP has continually enhanced the HP 3065 since its introduction, expanding the number of tests available, raising test rates, supporting multiple testheads and terminals, adding a hybrid card, and enabling the HP 3065 to communicate with other HP board-test systems. A new addition, HP Q-STAR network (Quality Systems for Test, Analysis and Control), provides hardware links and software to automatically acquire data from most CAD systems, support paperless repair, and provide Statistical Quality Control. These systems stand behind HP's guarantee of 99 percent up-time service.

in controlling quality and manufacturing processes, and in field service applications.

In addition to the electronics industry, major markets for HP instruments include telecommunications, aerospace, aviation, and scientific research. In fact, HP instruments are used in almost every industry where precise testing, measurement and control are required.

HP Computers

HP's first computer was introduced in 1966. Its purpose was to gather and analyze the data produced by HP electronic instruments. Today, HP computers and their peripheral devices (terminals, mass storage devices, printers and plotters) are themselves a major product line and account for a substantial portion of the company's sales. The broad range of HP computation products and systems offers solutions for businesses, manufacturers and individuals as well as engineers and scientists.

HP leadership in key technical computer markets has been the outgrowth of the company's strong famil-

arity with engineering, scientific and manufacturing applications. By linking networks of personal computers and terminals, powerful HP minicomputers provide mainframe capabilities for thousands of businesses and industries. Other computers are optimized for control of instrument systems, making it easier for customers to design and assemble electronic test systems.

HP's advanced data communications technology is the key to the enhanced productivity of such computerized systems. With the ability to combine words, data, and graphics, HP computer networks automate the many tasks involved. Specific application solutions along these lines are offered not only to engineers and scientists but also to manufacturers, distributors, retailers, financial institutions, hospitals, government agencies and schools.

HP Measurement Systems

Under the impact of a growing scarcity and rising cost of technical manpower, the need is accelerating for

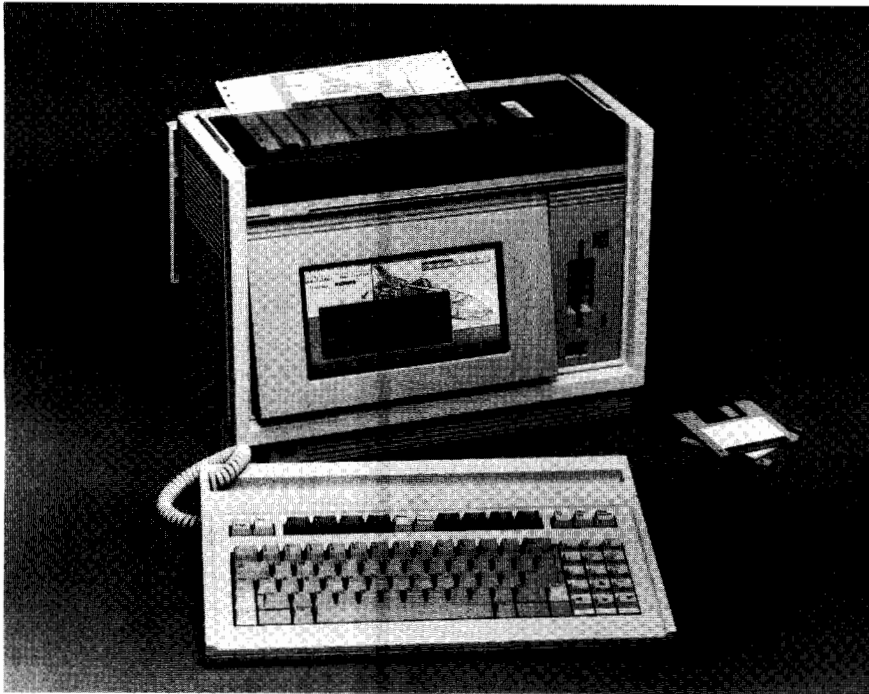

The world's first portable engineering workstation, the Integral Personal Computer, was built to meet the needs of the technical professional. Constructed around the MC 68000 microprocessor, with a UNIX-based multitasking operating system, this recent addition to the HP9000 family can be used for multiple applications. For example, when used as an instrument controller, the Integral can initiate measurements, apply its processing power to evaluating results, and help document the measurements.

measurement systems, with their higher speed, accuracy, repeatability and productivity. HP instruments and computers are designed with systems in mind.

In 1965 HP set about creating its own internal standard for the interfacing of all future HP instruments and HP computers. That standard became a worldwide standard, IEEE-488, and it is used by more than 250 manufacturers in more than 14 countries. We call this standard HP-IB, the Hewlett-Packard Interface Bus. In this catalog system-ready products are marked with the symbol



In all cases the goal of HP systems is to provide essential information in useful form and in the most efficient and timely manner. The end result is

improved productivity of our customers' processes and organizations—the unifying purpose of HP's business.

Other HP Products

In addition to electronic measurement and computation products, HP manufactures a number of other product lines, all of them related by basic electronics technology. Among these are electronic components such as microwave semiconductor and optoelectronic devices. Other important fields of interest include medicine and analytical chemistry. Today, hospitals and clinics use HP equipment for patient monitoring, diagnosis and therapy, as well as data management. Analytical instruments are widely used in the chemical, energy, pharmaceutical and food industries, as well as in medical and chemical research programs for government and industry.

HP Innovation

The continuing growth of Hewlett-Packard is based to a significant degree on a strong commitment to research and development. Between 8 and 10 percent of sales revenue is invested in R&D. In 1984 this amounted to 592 million dollars. This increasing investment has enabled HP to stay at the forefront of technology and to maintain a steady flow of new and useful products. More than half of the company's 1984 orders were for products introduced during the previous three years, a clear indication of the importance of HP's product-development efforts.

Each of HP's 54 product divisions has the primary responsibility for developing its own products. Together, the divisions account for close to 85 percent of the company's annual R&D budget. The remaining 15 percent is invested in more basic, higher risk, longer term research under-

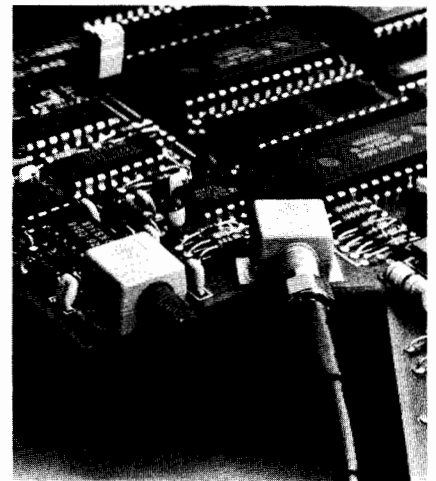

Hewlett-Packard's research and development span a wide range of technologies. Experts in materials and optics, as well as manufacturing and circuit design, collaborated on the HFBR-0400 line of fiber optic components. HFBR-0400 is the first auto-insertable, wave-solderable fiber optic link. It has a 25-MHz bandwidth, can support data rates up to 40 Mbd over distances up to 2.5 km, and is specified for the five major fiber diameters. Constructed from a flame-retardant plastic, it meets new standards for mechanical strength, dimensional stability and solvent and chemical resistance.

taken by HP Laboratories, the central source of technical support for the divisions. Through endeavors in areas of science and technology, the corporate laboratories also help the company develop new areas of business. Customers benefit through access to computers and instruments that are at the forefront of technology.

HP Support

The same high level of engineering excellence that HP commits to the development of advanced products also goes into creating high quality support services. Hewlett-Packard's support organization consists of a worldwide sales and service network staffed by highly trained engineers and technicians. Our support starts before you purchase an HP product and continues long after the product has been delivered.

Before you purchase a product or system, HP sales representatives are available to help you assess your needs and choose the product or system that meets your immediate and longer term requirements.

If your needs are best filled by an instrument system, we offer applications and training support to help you obtain full use of your system, hardware support to help maximize system up time, and software support to keep your system software current and productive.

To help you plan your system and its use, we offer the consulting and training expertise of experienced systems engineers. For the installation and maintenance of your system and its components, we offer the services of customer engineers. And for the long-term support of your system, HP offers an extensive menu of services. The menu includes contract or as-needed calibration and repair with on-site and at-HP options, as appropriate. Update services are available for both software and hardware, as is training for your own service personnel.

HP's worldwide support network ensures prompt availability of

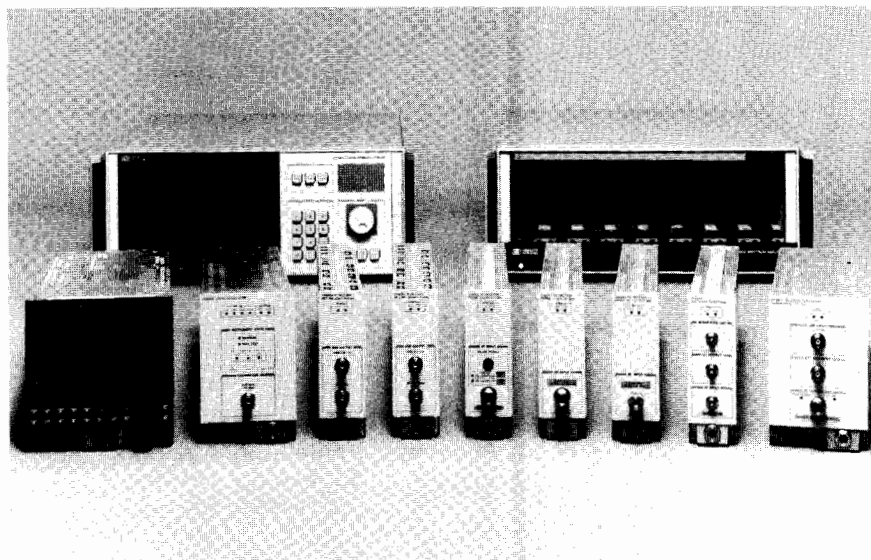

Instrument development philosophy at Hewlett-Packard has followed a policy of system integration and modularization. Nearly all instruments introduced in the last several years can operate on the Hewlett-Packard Interface Bus, HP's enhancement of the IEEE-488 standard. Most recently, HP has been pursuing modularization options in its product design. A good example is the HP 70000 Measurement System, which can be configured as an RF, microwave or millimeter-wave spectrum analyzer, depending upon which modules are used.

replacement parts throughout the production life of products and beyond. Replacement parts services also include parts stocking recommendations based on extensive component reliability histories and the numbers and mix of HP products to be supported.

For products requiring consumable supplies, such as recording paper, ribbons and magnetic media, we offer fast, convenient service from well-stocked supply centers that can also provide personal computers and software, peripherals and terminals, cables and connectors, workstation furniture, books and learning aids.

HP's comprehensive support also includes extensive information services. In addition to supplying excellent hardware and software manuals, HP makes available a wide variety of no-charge publications to help you choose the HP products that best fill your needs, to help you benefit from applications knowledge acquired by users inside and outside of HP, and to help you maintain your HP products. These publications range from new-

product announcements, catalogs, product family brochures and single-product data sheets, through application notes and programming aids, to service notes and maintenance periodicals.

The support services outlined above are described in more detail in the back sections of this catalog. Your nearest HP office can either supply the support services you need or help you obtain them. The locations of HP offices are listed on the back pages of this catalog.

The HP Catalog

This catalog is divided into sections that are based on product families: circuit test systems, oscilloscopes, signal analyzers, telecommunications test equipment and so on. Many of these sections are prefaced by descriptions of basic kinds of measurements and the techniques of measurement that are associated with the featured products.

The catalog offers two different indexes. One is alphabetical by instrument type or name; the other is numerical by HP model number.

The product descriptions presented

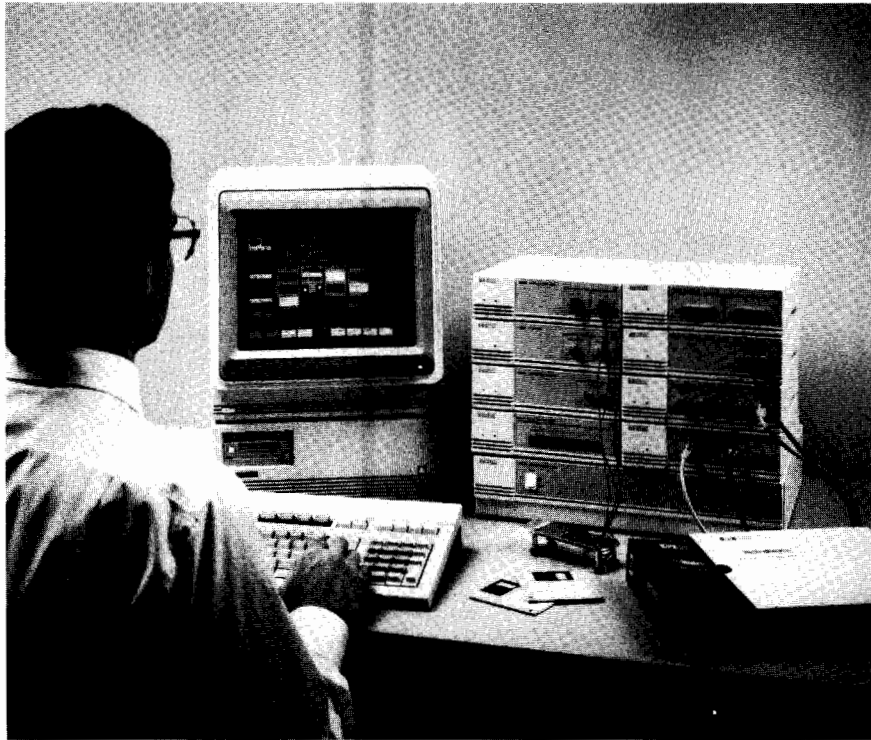

With PC Instruments, HP has taken one more step toward its goal of driving automated solutions down the price/performance curve. This personal-computer-based system is designed around software and measurement modules that allow the HP Touchscreen Personal Computer and IBM PC, PC/XT and PC/AT to function as instrument controllers, thus adding engineering capabilities to computers that had previously been used primarily for graphics, calculations and report generation. In addition to the modules, PC Instruments have I/O libraries that permit the computers to control up to 14 HP-IB instruments at a time.

in the catalog are as complete as reasonably possible in a publication such as this. In some cases it will be necessary to refer to a data sheet for a full set of specifications. Data sheets are available on request at local HP sales offices.

The locations of HP sales and service offices are listed on the back pages of this catalog. The listing also indicates the types of products normally available through each office (not all offices handle the full line of HP products).

Contacting HP

Your calls to your local HP office will be routed to the person best qualified to give you assistance if you tell the operator your specific product interest: instruments, computers, medical, analytical, or components.

Our sales force is made up of specialists in each of these five major

product areas. Staff engineers are always available during business hours to respond to your needs or to obtain answers from appropriate sources. Our HP sales representatives are supported by the HP systems engineering organization, which has specialists in measurement and computation systems.

Information on product availability, prices and order status is immediately available through our worldwide order processing network.

Suggestions Welcomed

The purpose of this catalog is to give you the most information possible about Hewlett-Packard products, along with some company background that may be useful in reaching decisions as to product and system needs. The major emphasis in this catalog is instrument products

and systems, with some representation by HP's other product categories. Literature describing these other product categories in detail is available through your local sales office.

If you have any comments and suggestions about how we can make this catalog more useful to you, please let us know by writing to:

Hewlett-Packard Co.
Steve Duer
Catalog Manager
3200 Hillview Avenue
Palo Alto, CA 94304



A

AC

| | |
|--|----------------------------|
| Digital Voltmeters | 203-217 |
| Probes | 208 |
| True RMS Voltmeters | 210, 211, 214, 220 |
| Access and Test System | 166 |
| Accessories | |
| Cabinets | 744 |
| Cables/Connectors | 121, 218, 629, 635, 742 |
| Camera | 444 |
| Camera, Solid State | 682, 684 |
| Computer | 772 |
| Connectors, Adapters | 743 |
| Data Generator/Analyzer | 468 |
| EMI Measurement | 672, 673 |
| HP Touch | 40, 42 |
| IC Test | 469 |
| Logic Analyzer | 416 |
| Network Analyzer | 599-602, 616, 622, 628-638 |
| Operating Cases | 754 |
| Optical | 575 |
| Oscilloscope | 444 |
| PC Instruments | 198 |
| PCM/TDM | 150 |
| Personal Computer Networking | 50 |
| Pulse Generator | 488 |
| Signal Generator | 539 |
| SLMS | 152, 153 |
| Spectrum Analyzer | 672, 673, 697, 698 |
| Transit Cases | 750 |
| Voltmeter | 218 |
| Waveguide | 553-555, 560, 563, 565-568 |
| Active Probes | 377 |
| Adapters | |
| 50-75Ω | 539, 601, 623, 698, 743 |
| Cables/Connectors | 742 |
| Quasi-Peak | 673 |
| Waveguide | 554, 555 |
| AdvanceLink | 50 |
| AdvanceNet | 50 |
| Air Line Extensions | 553 |
| Alphanumeric LED Displays | 738 |
| AM/FM Signal Generators | 524-548 |
| AM/FM/φM Modulation Analyzer | 719 |
| AM/FM/φM Signal Generators | 526-534 |
| AM/FM Test Source | 721 |
| Amplifiers | |
| Broadband Power | 490-492 |
| Broadband Preamp | 491 |
| Distribution | 258 |
| Plug-Ins for Oscillographic Recorder | 403-405 |
| Power Supply | 283 |
| Microwave | 490, 491 |
| RF | 492 |
| Analog Circuit Test System | 386-390 |
| Analog-to-Digital Converters . 68, 72, 123, 289, 299, 318, 321 | |
| Analog Input/Output Cards, | |
| HP-1000 A-Series | 310 |
| Analog Voltmeters | 219-223 |
| Analizers | |
| Audio | 722 |
| Audio Spectrum | 688 |
| Automatic Network | 624, 637 |
| Automatic Scalar Network | 594 |

| | |
|--|----------------------------|
| Automatic Spectrum | 647-654, 660-669, 701, 710 |
| Customer Support | 761, 768 |
| Data | 466 |
| Data Line | 141 |
| Digital Transmission | 148 |
| Distortion | 142, 722-727 |
| Fourier (FFT) | 701 |
| Frequency Stability | 710 |
| Gain-Phase | 605, 612 |
| Impedance/Gain-Phase | 328 |
| LF Impedance | 330 |
| Logic | 183, 410-419 |
| Microwave Link | 162 |
| Modulation | 719 |
| Network | 588-638 |
| Phase Noise | 710-714 |
| Phase Noise, Side Band | 710, 714 |
| Primary Multiplex | 145 |
| Protocol | 129-131 |
| RF Impedance | 332 |
| RF Signal Modulation | 719 |
| Selective Level | 142, 156 |
| Semiconductor Parameter | 358 |
| Spectrum | 647-710 |
| Signature | 372-376 |
| Software Performance Analyzer | 188-190 |
| Telephone Line | 141 |
| Training | 760 |
| Vibration | 709 |
| Video | 168 |
| Wave | 142, 156, 639, 657, 727 |
| Waveform | 420 |
| Applications Support | 762 |
| APC-3.5 series Adapters | 743 |
| APC-7® series Adapters | 743 |
| Assemblers, Logic Development System | 186 |
| Arbitrary Waveform Synthesizer | 450 |
| Atomic Clock/Frequency Standard | 253 |
| Attenuators | |
| 75-Ohm General Purpose | 163 |
| Coaxial, Fixed | 556 |
| Coaxial, Microwave, OEM | 556 |
| Waveguide | 554, 560 |
| Automatic | |
| Audio Distortion Analyzer | 722 |
| Calibration DMMs | 208-210, 215 |
| Computer Aided Test Systems | 324 |
| Data Acquisition Systems | 286-307, 314, 319 |
| Data Loggers | 289-294 |
| Impedance Analyzers | 328-333 |
| Impedance/Gain-Phase Analyzer | 328 |
| LCR Meters | 334-345 |
| Measurement & Analysis Systems | 314, 319 |
| Network Analyzers | 624, 626-637 |
| Power Meters | 577, 578 |
| Scalar Network Analyzers | 594, 603 |
| Selective Level Meter | 152 |
| Synthesizers | 452-457, 524-534, 544-546 |
| Spectrum Analyzers | 647-653, 659-670, 701, 710 |
| Test Systems | 324, 647, 667, 714 |
| Transceiver Test System | 728 |
| Video Measurement System | 168 |



**B**

| | |
|--|---------------|
| Balanced 2/4 Wire Audio Channel Selector | 145 |
| Bar Code Readers | 54, 739 |
| Bar Code Wand, Digital | 54, 739 |
| Bar Graph Array, LED | 738 |
| Baseband Video Measurement System | 168 |
| Battery Operated | |
| Calculators/Computers | 52-60 |
| Counters | 235, 248-251 |
| Disc Drive | 89 |
| DMMs | 214-217 |
| Microwave Power Meter | 579 |
| Beam Lead Diode | 739 |
| Bias Networks | 630 |
| Bias Supply, Transistor | 630 |
| Bit Error Rate Test Sets | 136, 146, 147 |
| Bipolar Transistors | 739 |
| BNC Series Adapters | 742 |
| Board Test Fixtures | 390 |
| Board Tester, Analog | 386-389 |
| Board Tester, Digital | 386-389 |
| Board Tester, Training | 761 |
| Breadboard Cards, Multiprogrammer | 318, 321 |
| Bridges, Directional | 597, 598 |
| Broadband Amplifiers | 490-492 |
| Broadband Phase Comparator | 253 |
| Broadband Sampling Voltmeter | 223 |
| Business Computers | 61 |

C

| | |
|---|-----------------------|
| Cabinet Accessories | 744 |
| Cabinet Identification | 744, 748 |
| Cable Assemblies | 742 |
| Cable Kit, Scalar Analyzer | 600 |
| Cables/Connectors | 742 |
| Cables, HP-IB | 121 |
| Cables, HP-MSIB | 651 |
| Cables, Optical | 575 |
| CAD Software | 177 |
| Calculators, Handheld Computers & Peripherals | |
| Bar Code Reader Module | 54 |
| Bar Code Wand, Digital | 54 |
| Card Reader | 54 |
| Cassette Drive | 54 |
| Catalog | 772 |
| Expansion Pod | 54 |
| Financial Programmable | 52 |
| I/O ROM | 54 |
| Memory Modules | 53, 55 |
| Optical Wand | 54 |
| Printer/Plotter | 55 |
| Scientific Programmables | 52 |
| Calibration Data, Attenuators | 556 |
| Calibration Kits (Network Analyzer) | 625, 629, 631, 637 |
| Calibration Service Agreements | 765 |
| Calibrators | |
| AM/FM (HP 8901A) | 721 |
| Power Meter, for HP 432 Series | 582 |
| Range, for HP 435B Power Meter | 579 |
| Time Interval | 238-240 |
| Cardiography/Cardiovascular Instrumentation | 740 |
| Carrier Preamp | 404 |
| Carrier Testing | 151 |

| | |
|--|-------------------------------------|
| Carts, Instrumentation | 444 |
| Cases, Combining | 748 |
| Catalog, Computer Users Supplies and Accessories | 772 |
| Cavity Frequency Meters | 565 |
| Cellular Radio Test System | 731 |
| Cesium Beam Frequency Standard | 253 |
| Chromatographs, Gas | 736 |
| Chromatographs, Liquid | 737 |
| Circuit Test Systems | 386-390 |
| Circuit Testers, Digital | 377-380, 386-389 |
| Clip, Logic | 379 |
| Clock, Atomic | 253 |
| Clock, Digital | 123 |
| C Meter/C-V Plotter | 362 |
| Coaxial | |
| Accessories | 552-569, 743 |
| Adapters | 743 |
| Air Lines | 553 |
| Attenuators | 556-560 |
| Crystal Detectors | 564 |
| Directional Couplers | 562 |
| Directional Detectors | 563 |
| Dual Directional Coupler | 562 |
| Fixed Attenuators | 556 |
| Filters | 240, 568 |
| Frequency Meters | 565 |
| Harmonic Mixer | 568 |
| Low-Pass Filters | 240, 568 |
| Noise Sources | 586 |
| Pad Attenuators | 556 |
| Power Sensors | 580, 583 |
| Shorts | 567 |
| Sliding Loads | 567 |
| Slotted Line Carriage | 566 |
| Slotted Line | 566 |
| Slotted Section | 566 |
| Step Attenuators | 558 |
| Switches | 569 |
| Terminations | 567 |
| Thermistor Mounts | 583 |
| Thermocouple Mounts | 580 |
| Waveguide Adapters | 553 |
| Comb Generator | 698 |
| Combining Cases | 748 |
| Communications, Data | 50 |
| Communications Test Equipment | 141, 142, 143-167, 452, 456, 457 |
| Communications Test Set | 137 |
| Comparator, Logic | 379 |
| Comparator, Phase | 253 |
| Compilers, Logic Development Systems | 186 |
| Component & Semiconductor Measurement | |
| Digital IC Test System | 358, 369 |
| Digital IC Tester | 369, 468 |
| Impedance, LCR Meters | 328-348 |
| Memory | 366 |
| Semiconductor Parametric Test | 349-362 |
| Components, Solid State | 738, 739 |
| Computer-Aided Design | 170-182 |
| Computer-Aided Work Software | 174-177 |
| Computers & Peripherals | |
| A, E & F-Series Computers | 82 |
| A-Series Measurement & Control Cards | 310 |
| Automatic Test Systems | 314, 319, 324 |



- Business Computer Systems 61-64
 Computer Users Catalog 772
 Disc Drives 89-92
 Disc/Tape Drives 90-93
 Display Boards 70
 Display Terminals, CRT 84-87
 Engineering Workstations 65-74
 Flexible Disc Drives 89
 Graphics Tablets 107
 Handheld Computers 52, 53
 HP-IL Peripherals 54
 Interactive Terminals 84-87
 Interfacing Summary 83, 110
 Laser Printers 94-96
 LaserJet Printer 94
 Line Printers 94
 Modems 55, 88
 Modular Computers 42, 66, 70, 77
 Monitors 70
 Networking and Data Communications 50
 Personal Computers 52-60
 Plotters 98-104
 Portable Computers 44
 Printers 94-96
 RAM Cards 72
 Supplies and Accessories 772
 Support 759
 Tape Drives 93
 Technical Computers 65-78
 Winchester Hard Disc Drives 89
- Connector Adapters 743
 Connectors, Microwave Precision 743
 Connectors, Optical 575
- Converters
 A-to-D 68, 72, 123, 289, 299, 318, 321
 D-to-A 122, 195, 281, 292, 293, 299, 309, 318, 321, 428
 Serial-to-Parallel 122
- Counters, Electronic
 Counter/Synchronizer 230
 Counter/Timer 237-239, 241-251
 Counter/Tracking Generator 690
 Digital Multimeter/Counter 290, 296, 373
 DVM/DMM 242-247
 HP-IB /HP-IL 235
 Low Cost 234-236, 251
 Microwave 226-233
 Microwave Source, Synchronizer 230
 Oscilloscope Expansion Module 438
 PC Instruments Universal Counter 196, 197
 Plug-In Adapter 241
 Portable, Battery Operated 235, 248-251
 Pulsed RF 232
 Reciprocal 226-230, 232-235, 237, 241-246, 248-250, 290, 296
 Time Interval 237, 241-251
 Time Interval Probes 240
 Universal 237-251
- Counter/Totalizer Card 296-299, 308, 309, 318, 321
- Coupler, Acoustic 55
 Couplers, Directional (Coax and Waveguide) 554, 562
 CRT Displays 84, 108
 Crystal Detectors 564, 565
 Crystal Oscillators 257
- Current Tracer, Digital 378
 Customer Support 759
- D**
 D/A Converters 122, 195, 281, 292, 293, 299, 309, 318, 321, 428
 D/A Converter Cards, Multiprogrammer 318, 321
- Data
 Acquisition Systems 65-75, 286-307, 314, 319
 Acquisition System Training 760
 Analyzer 466
 Communications 38, 40, 42, 44, 46, 50, 61, 78, 126-142
 Error Analyzer 136
 Generators 148, 466
 Interchange 89
 Line Analyzer 141
 Logger 289, 294
 Transmission Test Set 136
- Data Acquisition
 PC Instruments Data Logging Package 201, 202
 PC Instruments Data Acquisition Software 198, 199
 Systems 193-200, 286-309, 314
 System Training 760
 Voltmeters/Counters 195, 196, 205-213, 241-248, 290, 296
- Datcommunications Test Equipment
 Bit Error Rate Test Sets 134, 136
 General Information 126, 133
 Network Circuit Access Test Set 140
 Protocol Analyzer 129
 Selective Voltmeter 142
 Telephone & Data Line Analyzers 141
 Transmission Impairment Test Sets 134, 138, 140
- DC**
 Milliammeters 208-223
 Source/Monitor 357
 Voltmeters 195, 212-219, 222, 296
- DC Power Supplies**
 Amplifier/Power Supply 283
 Autoranging 270, 278, 280
 Condensed Listing 261
 Constant-Current Sources 285
 Digitally Controlled 282
 Dual Tracking 265-269
 General Information 260
 General Purpose: 10-30 W Output 265
 General Purpose: 25-200 W Output 268
 General Purpose: 100-2000 W Output 270, 272
 General Purpose: 300-11,000 W Output 274
 HP-IB Programmable 276, 278-281
 Precision Voltage Sources 284
 Programmable 278-281
 Source/Monitor 357
 Specifications, Definitions 264
 Transistor Bias 630
- Decade Capacitor 348
 Defibrillator 741
 Degaussers 253, 409
 Delay Generators 468, 473, 478-489



- Detectors**
 Adapter 599
 Coaxial, Microwave, OEM 564
 Crystal, Coaxial and Waveguide 554, 564, 565
 Error 147, 148
 Slotted Line 566
Development Station 186
Development Systems, Logic 183
Differential Gain/Phase, Video System 168
Digital
 AC Voltmeters 203-217
 Analyzer, Logic 414
 Analyzer, Signature 372-376
 Bar Code Reader Module 54
 Bar Code Wand 54, 739
 Board Tester 386-389
 Cassette Drive 54
 Circuit Test 372-380, 386-389
 Current Tracer 378
 DC Voltmeters 195, 203-218, 296
 DC Voltmeter/Counter 242-247
 Education Course 381
 IC Memory Test System 366
 IC Testers 358, 369, 386-389, 468
 IC Test System 369
 Impedance Analyzers 328-333
 In-Circuit Board Test Systems 382-390
 Input/Analog Comparator Card 318, 321
 Input/Output Card HP-1000 Series 310
 Input/Output Module 296-299
 Input Card, Multiprogrammer 318, 321
 I/O for PC Instruments 195
 LCR Meters 336-345
 Microprocessor Troubleshooting 372-376
 Multimeters 195, 196, 203-212, 214-217
 Multimeter, Signature 372-374
 Noise Figure Meter 586
 Output Card, Multiprogrammer 318, 321
 PC Board Test System 386-389
 Power Meter 577, 578, 582
 Pressure Gauge 734
 Programmable Power Supplies 260-263, 276-281
 Signal Analyzers 372-376
 Signal Generators 466-475
 Signature Analyzers 372-376
 Spectrum Analyzers 647-654, 657, 659-698, 699, 701
 Stimuli 466-475
 Thermocouple Card, Multiprogrammer 321
 Thermometers 290, 296, 308, 735
 D/A Current Converter Card 296-299, 308, 309, 318, 321
 D/A Voltage Converter Card 296-299, 308, 309, 318, 321
 Transmission Analyzer 148
 Troubleshooting 372-380
 Voltmeters 203-217
Digital-to-Analog Converters 122, 195, 281, 292, 293, 299, 318, 321, 428
Digitizing Oscilloscopes 420-442
Dimensional Measurements 732
Diodes 739
Diode Array Spectrophotometers 737
Directional Bridges 597, 598
Disc Drives 89-92
Disc/Tape Drives 90-93
Displays
 Instrumentation 84, 108
 LED 738
Distortion Analyzers 719, 722-727
Distribution Amplifier 258
DLTS Analysis System 354
Double Balanced Mixer 568
Doublers, Frequency 539, 542
Down Converters 164, 697
Drafting Plotters 103
Dual Tracking Power Supplies 265-269
Dual VHF Switch Module 122
Dual Voltage DAC for PC Instruments 195
Dynamic Signal Analyzer 701, 703, 706
E
Eight-Pen Plotters 101-104
Emitters/Detectors 738
 Optical Reflective Sensor 738
Electronic Counters 224-251
EMI Measurement Software and Accessories 672, 673
EMI Measurement Systems 671, 682
Emulators, Microprocessor 188
Engineering Documentation Software 182
Engineering Graphics Systems Software (EGS) 181
EPROM Development Kit 68, 72
Error Rate Measurements 146-148
Extenders, HP-IB 124, 125
F
FDM/Carrier Systems Testing 151, 159
FDM Network Surveillance Software 154, 159
Fiber Optics
 Cable 575, 738
 Connectors 575, 738
 Multiplexer 738
 Test Equipment 570-575
 Transmitters/Receivers 738
Filters
 Coaxial and Waveguide 568
 High Pass 600, 568
 Low Pass 240, 568, 600, 684
Film Recorder 105
Finite Element Analysis System 177
Fourier Analyzer 701, 703, 706
FM Modulation Analyzer 719
FM Signal Generators 524-548
Frequency
 Counters 205-207, 224-251
 Counter/Tracking Generator 690
 Doublers 539, 542
 Meters, Coaxial and Waveguide 554, 565
 Reference Card, Multiprogrammer 318, 321
 Stability Analyzer 710
 Synthesizers 543-548
Frequency Standards 252-259
 Cesium 253



- Distribution Amplifier 258
- Frequency and Time Standards
- General Information 252
- Quartz 257
- Rubidium 254
- Standby Power Supplies 259
- Frequency Selective Meter and
- Tracking Oscillator 156, 456
- Function Generators 447-453, 458-465
- Function Generator for PC Instruments 196
- Furniture, Workstation 772
- G**
- Gas Chromatographs 736
- GC/Mass Spectrometer Systems 736
- Generators
- Arbitrary Waveform (DC-50MHz) 428, 450
- Data 148, 466
- Delay 468, 473, 478-489
- Function 447-453, 458-465
- Jitter 149
- Noise 586
- Pattern 146-148, 475
- PRBS 470, 475
- Pulse 476-489
- Pulse/Function 459-461
- Signal 522-549
- Square Wave 450-453, 458-464
- Sweep 452-457, 463, 493-521
- Timing 489
- Tracking 156, 456, 651, 678, 682, 688, 690, 692, 695
- Vector 466
- Word 466
- Graphics
- Displays 108
- Film Recorder 105
- Generator (HP-IB Interface for displays) 97
- Plotters 98-104
- Printers 95, 96
- Software 49, 61, 68, 69, 73, 75, 78, 104, 181, 397
- Supplies 772
- Tablet 107
- Terminals 66, 70, 84-87
- H**
- Handheld Calculators & Computers 53, 772
- Hardware Support 765
- Harmonic Mixers (Coaxial and Waveguide) 568, 697
- Headspace Sampler 736
- Hewlett-Packard Interface Bus (HP-IB) 112-125
- Hewlett-Packard Interface Loop (HP-IL) 58
- High Power Attenuators 556
- High Power Sensors 580
- High Resistance Meter 347
- High Speed ADC Card, Multiprogrammer 321
- HP-FE Software 177
- HP-IB
- Analog-to-Digital Converter 123
- ASCII-to-Parallel Converter 122
- Attenuator/Switch Driver 558
- Cables 121
- Channel Selector 145
- Command Library for HP Touchscreen 200
- Command Library & Interface for IBM PC, PC/XT, PC/AT 200
- Digital Clock 123
- Digital-to-Analog Converter 122, 281
- Extenders 124, 125
- Frequency Counters 224-235, 237, 241-250
- General Information 112-115
- Graphics Tablet 107
- Relay Actuator 122, 558
- Spectrum Analyzers 647-677, 680-685, 701-708
- Switch 122
- Switch Controller 153
- Switch/Control Unit 311
- Switch Driver 558
- Time Synthesizer 489
- Training 115
- VHF Switch 122
- HP-IL 58
- HP-HIL 40, 70, 71
- HP TechWriter Software 182
- HP Touch 40, 42
- HP Windows 78
- I**
- IC Testers, Digital 358, 369, 386-389, 468
- IC Test System, Digital 369
- IC Test System, Memory 366
- IGES Translator Software 182
- Impedance Analyzers 328-333
- Impedance/Gain-Phase Analyzer 328
- Impedance Meter 334
- Impedance Transformers (50-75 Ω) 698
- In-circuit Functional Tester 386
- Indicators, LED 738
- Industrial Data Acquisition/Control System 308
- InkJet Printer 95, 96
- Integral, The 78
- Integrators 737
- Interface Bus (HP-IB) 112
- Interface Cards for Computers 68, 72, 75, 83
- Interface Cards & Software for PC Instruments 198
- Interface Loop (HP-IL) 58
- Interface Kits
- HP-IL 55
- IBM Disc/Tape 89
- Multiprogrammer 315, 316, 318
- Interfacing Summary for Computers 83, 110
- Interference & Noise Test Set 155
- Interference & Noise Measurement System 155
- Interrupt Card, Multiprogrammer 318, 321
- Interferometers, Laser 732, 733
- I-Q Tutor Training Kit 151
- Isolators, Optical 738
- Isolators, Waveguide 555
- J**
- Jitter Generator & Receiver 149
- K**
- Kits, Rack Mounting 744, 745, 748
- Kits, Fiber Optic Link 738
- L**
- Laboratory Automation Systems 737
- Laser Interferometers 732, 733
- Laser Printers 94-96



- LaserJet Printers 94, 95, 96
 Laser Transducer System 733
 LCR Meters 336–345
 LCZ Meters 340
 LED Displays 738
 LED Indicators 738
 LF Impedance Analyzer 330
 Light Bar Modules, LED 738
 Light Emitting Diodes 738
 Limiters 698
 Liquid Chromatographs 737
 Log Level Preamp 405
 Logic
 Analyzer, Development Systems 188
 Analyzer Training Courses 760
 Analyzers 410–419
 Clip 379
 Current Tracer 378
 Comparator 379
 Development System 183
 Pattern Generator 474
 Probes 377
 Pulser 378
 Signal Sources 466, 476
 Troubleshooting Systems 372, 380
 Low Distortion Generators 156, 457
 Low Distortion Measurement 159
 Low Frequency Spectrum Analyzer 688
 Low Level ADC Card, Multiprogrammer 318, 321
 Low Resistance Meters 210, 347
- M**
 Magnetic Bubble Memory Card 68, 72
 Magnetic Tape Recorders, Analog 407
 Mass Selective Detectors 736
 Mass Spectrometers 736
 Matrix Switch (HP-IB) 311, 359, 569
 Measurement and Control Cards,
 HP-1000 A-Series 310
 Measurement and Analysis System 424–427, 429
 Measurement Graphics Software 48, 61, 396
 Measurement Plotting System 396
 Measuring Receiver 715
 Mechanical Design & Drafting System 178
 Mechanical Engineering/Test 179
 Medical Instrumentation 740
 Memory Card, Multiprogrammer 318
 Memory Modules, HP-41, HP-71 and HP-75 52, 53
 Memory Test System 366
 Meters
 AC 203–222
 Capacitance 336–345, 362
 Carrier Noise 712
 Digital Multimeter 195, 196, 203–212, 214–217
 Distortion 719, 722–727
 Frequency 205–207, 224–251, 564, 565
 High Resistance 347
 Impedance 328–333
 LCR 336–345
 LCZ 340
 Low Resistance 210, 347
 Modulation 719
 Multifunction 195, 196, 203–212, 214–217, 222
 Noise Figure 586
 Ohmmeter 195, 196, 203–212, 214–217, 347
 PC Instruments Digital Multimeter 195, 196
 Peak Power 583
 Picoampere 360
 Power (RF/Microwave) 576–583
 Q 346
 Signature 373–375
 Standing-Wave-Ratio (SWR) 566
 Susceptance 328, 330, 332, 336, 337
 True RMS 208, 210, 212, 214, 215, 220
 Vector Impedance 334
 Microprocessor Training 381
 Microprocessor Troubleshooting 183, 372–376
 Microwave
 Amplifiers 490, 491
 Counters 226–233
 Diodes 739
 Down-Converter 712
 Link Analyzers 162
 Measurement System 717
 Network Analyzers 588, 626–637
 Noise Figure Meter 586
 Power Measuring Equipment 576–583
 Radio Testing 151
 Semiconductors 739
 Signal Generators 540–548
 Source Synchronizer 230
 Spectrum Analyzers 647, 660–667, 674, 676,
 678, 684, 694
 Sweep Oscillators 493–521
 Synthesizers 543–548
 Test Equipment 552–569
 Transistors 739
 Millimeter Wave Instrumentation
 Adapters 555
 Attenuators 554, 555
 Bends 555
 Counters 226
 Detectors 554
 Directional Couplers 555
 Frequency Meters 554
 General Information 552
 Harmonic Mixers 697
 Network Analyzer 626
 Power Sensors 580, 581
 Shorts 555
 Spectrum Analyzers 647, 659, 660, 664, 674
 Straight Sections 555
 Sweep Oscillator 512
 Terminations 555
 Twists 555
 Milliohmmeter 203–222, 347
 Miniature Fiber Optic Link 738
 Mixers, Double-Balanced 568
 Mixers, Coaxial and Waveguide 568, 697
 Modal Analysis 709
 Modems 55, 88, 161
 Modular Computers 42, 70–73, 77
 Modulation Analyzer 719
 Modulator/Demodulator 55, 88, 161
 Modulators, Absorptive 542, 549, 601
 Modulators, PIN 542
 Modulation Test Source 721
 Modules (HP-41, HP-71, HP-75) 52–54, 56



- Monitors 70
- Multimeters 203-222
- Multimeter, Signature 373
- Multiplex (Primary) Analyzer 145
- Multiplexers 205-207, 290, 296-305, 311, 312
- Multiprogrammers 313-323
- N**
- NC Drill Software 182
- Network Analysis, General Information 588-593
- Network Analyzers 588-638
- Automatic 624, 637
- Automatic Scalar 594
- Millimeter-Wave 631
- Scalar 596, 603
- Training Courses 631
- Vector 614-638
- Networking for Business Computers 61
- Networking for HP 9000 Computers 65-76
- Networking for Personal Computers 50
- Noise
- Figure Meter 586
- Generator 587
- Measurements 155, 584, 710, 712
- Noise and Interference Test Set 155
- Noise and Interference Measurement System 155
- Non-Impact Printers 94-96
- O**
- Obstetrical and Neonatal Instrumentation 740
- OEM**
- Computers 65-82
- Displays, CRT 108
- Graphics Plotters 98-104
- HP-IL Interface Kit 55
- Measurement Plotting System 396
- Microwave Attenuators 560
- Microwave Components 560
- Microwave Crystal Detectors 564
- Microwave Switches 569
- Optoelectronic Components 738
- Power Supplies 260
- OfficeShare 51
- Ohmmeters 203-218, 222
- Operating Cases 754
- Optical Accessories 575, 738
- Optical Pulse Power Meter 574
- Optical Receiver 575
- Optical Signal Source 572
- Optocouplers 738
- Optoelectronics 738
- OR Monitors 741
- Oscillators**
- Audio 449
- Function 447-453, 458-465
- General Information 447-449
- Low Frequency 156, 450-464
- Sinewave 447-464
- Squarewave 450-453, 458-464
- Sweep 452-457, 463, 493-521
- Synthesized Sweep 452-457, 496-499
- Oscillographic Recorders 403
- Oscilloscopes 420
- Camera 444
- Digital Waveform Storage 422-429, 438
- Digitizing 197, 198, 420-442
- Measurement System 438
- PC Instruments Digitizing Oscilloscope 197, 198
- Software, Oscilloscope Measurement System 438
- Software, Waveform Measurement Library 427, 429, 438
- Spectrum Analyzer Plug-In 647, 651, 680, 682, 684
- Testmobiles 444
- Variable Persistence Storage 430, 433, 446
- P**
- pA Meter/DC Voltage Source 360
- Pad, Coaxial Attenuator 556
- Page Printer 94
- Parameter Extraction Software 364
- Patient Monitors 741
- Pattern Generator, Digital 466
- Pattern Generator/Error Detector 146, 147
- PC Board Testers 386-389
- PC Instruments 193-202
- PCM Test Equipment 143-150
- Peak Power Meters 583
- Performance Board 469
- Perinatal Instrumentation 740
- Personal Applications Manager (PAM) 40, 42, 44, 71, 78
- Personal Calculators & Handheld Computers 52-60
- Personal Computers 38-60
- Personal Computer (PC) Instruments 193-202
- Phase Comparator 253
- Phase Meters 612, 617
- Phase Modulation Analyzer 710-714, 719
- Phase Noise Measurement 710-714
- Phase Sensitive Demodulator 405
- Photoplotter/NC Drill Software 182
- PIN Diodes 739
- PIN Modulators, Microwave 542
- PIN Photodiodes 739
- Plotter Accessories and Supplies 109, 772
- Plotters, Drafting 103
- Plotters, Graphics 99-104
- Portable
- Counters 234-236, 248-251
- Computers 44, 78
- Data Logger/Data Acquisition System 290
- Power Meter 579
- Spectrum Analyzers 680-685, 699, 727
- Voltmeters 211-222
- Portable PLUS, The 44
- Power Amplifiers 490-492
- Power Dividers 561, 601
- Power Meter Calibrators 582
- Power Meter/Measuring Receiver 715
- Power Meter, Optical 574
- Power Meters, RF & Microwave 576-583
- Power Sensors, RF & Microwave 580-583
- Power Splitters 561, 601
- Power Supplies
- Amplifier/Power Supplies 283
- Atomic Clock 259
- Condensed Listing 261-263
- Constant Current Sources 285
- Digitally Controlled 278-282
- Dual Tracking 265-269
- Frequency Standards 259
- HP-IB Programmable 278-281
- Laboratory 265-267



- Multiprogrammer Control 260, 313
 Precision Current, Voltage Sources 284, 285
 Programmable 260-263, 278-282
 Specifications, Definitions 264
 Standby 259
 Power Supply/Amplifier 283
 PRBS Generators 470, 475
 Preamplifiers 240, 404, 405, 491, 492
 Precision Coaxial Connectors 742
 Precision Frequency Reference 651
 Precision Frequency Sources 252-259
 Precision Oscillator 257
 Preprocessor, Logic State Development System 190
 Preselectors 672, 694
 Pressure Probes, Quartz 734
 Primary Multiplex Analyzer 145
Printers
 Graphics 94-96
 Laser 94-96
 Line 94-96
 Supplies 772
 Thermal 95, 96
Probes
 Accessories 218, 377
 Active 698
 Digital Multimeter 218
 High Frequency 218
 Logic 377
 Pressure 734
 Slotted Line 566
 Temperature 218, 735
 Time Interval 240
 Voltage Divider 218
 Programming Development Aids, HP Series 80 48
 Programming Development Aids, The Integral 78
 Protocol Analyzers 126-131
 Protocol Analyzer Software Solutions 132
 Pulse Adder, Splitter, Inverter 488
 Pulse Generators 476-489
 Configurable 488
 High Power 483
 Programmable 479-482
 Pulse/Function Generators 476, 479-482, 459-465
Pulsers, Logic 378
Q
 Q Meter 346
 Quartz Frequency Standard 257
 Quasi-Peak Adapter 673
 Quartz Pressure Probe 734
 Quartz Pressure Set 734
 Quartz Thermometer 735
R
 Rack Mount Kits 744, 745, 748
 Rack Shelf for PC Instruments 198
 Rack Slides 745, 746, 749
 Range Calibrator (for HP 435B Power Meter) 579
 Readers, Card (HP-41 CV/CX) 54
 Receiver, Measuring 715
 Receiver, Optical 575
Recorders
 Oscillographic 403
 Instrumentation Tape 407
 Measurement Plotting System 396
 Waveform 422-429
 X-Y 396-401
 Reflection/Transmission Test Sets 628, 635, 637
 Relay Actuator (HP-IB) 122, 558
 Relay Actuator for PC Instruments 198
 Relay Output Card, Multiprogrammer 318, 321
 Remote Access and Test System 166
 Resistance Meter 203-218, 222
 Resuscitation Instrumentation 741
 RF Amplifiers 492
 RF Impedance Analyzer 332
 RF Preselector 672
 RF Spectrum Analyzers 647, 654, 657, 660, 662, 668, 680, 682, 690, 692
 RF Test System 728
 RMS Voltmeters 208, 210, 212, 214, 215, 220
 ROMs, The Portable PLUS 44
 Rotary Air Line, Coaxial 553
 Rotary Joint, Coaxial 553
 Rotary Vane Attenuators, Waveguide 560
 Rubidium Frequency Standard 254
S
 Samplers, Automatic 736
 S-Parameter Test Sets 628, 634, 636
 Scalar Network Analyzers 594-604
 Scanner 205-207, 290, 296, 308, 359
 Scanner Cards, Multiprogrammer 318, 321
 Schottky Diodes 739
 Selective Level Measuring Set 152
 Selective Level Voltmeters 142, 152, 156
 Semiconductor/Component Test Systems 356, 366, 369
 Semiconductor Parameter Analysis System 352
 Semiconductor Parameter Analyzer 358
 Semiconductor Parameter Extraction Software 364
 Semiconductor Parametric Test System 349
 Sensor Modules 580, 716
 Sensors, Microwave Power 580, 583
 Series 10 Professional Calculators 52
 Series 10-500 Supplies and Accessories 772
 Series 80 Interfaces 46
 Series 80 Personal Computers 46
 Series 80 Programming Development Aids 48
 Service 768
 Series 80 ROMs 46
 Series 80 Software 48
 Shorts, Coaxial 567, 637
 Shorts, Waveguide 554, 567
Signal Analyzers
 Audio 722
 Automatic Spectrum 647-653, 659-669, 701, 710
 Digital 709
 Distortion 142, 722-727
 General Information 639-646
 Modulation 719
 Phase Noise 710-714
 Spectrum 647-710
 Video 168
 Signal Conditioners 403-406
Signal Generators
 Accessories 539, 542, 549
 Avionics 538
 General Information 522



| | | | |
|--|---------------------------------------|---|---------------------------|
| HF, VHF, UHF, SHF | 524-548 | Scalar Network Analyzer | 600, 604 |
| Microwave | 540-548 | Signal Generator Test | 718 |
| Programmable | 524-534, 543-548 | Transceiver Test | 728 |
| Pulse Modulator | 549 | Video Test | 168 |
| Sweep | 529 | Software Support | 764 |
| Synthesized | 524-534, 543-548 | Solid State | |
| Signal Monitoring Software | 670 | Displays, Lamps, Optocouplers, Fiber Optics | 738 |
| Signal Sources | 452, 454-461, 524-548 | Diodes, Transistors, Integrated Products | 739 |
| Signal Sources, Optical | 572 | Source, AM/FM Test | 721 |
| Signal Sources, Programmable | 450-460, 463, 524-534, 543-548 | Source, Optical | 572 |
| Signature Analysis, Troubleshooting System | 372 | Source, Signal | 452, 454-461, 524-548 |
| Signature Analysis | 372-376 | Spectrophotometer, Diode Array | 737 |
| Signature Analyzer, Digital | 376 | Spectrophotometric Detector, Hi Speed | 737 |
| Signature Multimeter, Digital | 373 | Spectrum Analyzers, General Information | 639-646 |
| Single Sideband Phase Noise Test Set | 712 | Spectrum Analyzers | 647-710 |
| Slides for Rack Mounting | 745, 746, 749 | Spectrum Analyzer Preselector | 672, 694 |
| Sliding Load (Coaxial and Waveguide) | 567 | Spectrum Monitoring | 670 |
| SLMS System Software | 154 | Stability Analyzer, Frequency | 710 |
| Slotted Lines (Coaxial and Waveguide) | 566 | Standard Capacitor Sets | 348 |
| SMA, SMB, SMC Series Adapters | 742 | Standards, Frequency and Time | 252-259 |
| Software | | Standby Power Supply | 259 |
| Applications Solutions | 48, 57, 68, 69, 73, 75 | Standing Wave Ratio (SWR) Meter | 566 |
| Business | 61-64, 68, 69, 73 | Step Attenuators, Coaxial | 558-560 |
| CAD | 177 | Stepping Motor Control | 318, 321 |
| Computer-Aided Work Software | 174 | Stimuli, Digital | 466-475 |
| Datacom Software Solutions | 48, 68, 69, 73, 75, 132 | Storage-Normalizer | 638 |
| Engineering Documentation | 182 | Strip Chart Recorders | 403 |
| Engineering Graphics Systems (EGS) | 181 | Supplies, Plotter & Printer | 772 |
| Finite Element Analysis | 178 | Support, Customer | 759 |
| Graphics | 49, 61, 68, 69, 73, 75, 104, 181, 396 | Sweep Oscillators, General Information | 493-495 |
| HP FE | 177 | Sweep Oscillators | 452-457, 463, 493-521 |
| HP-IB Command Library | 200 | Sweep Signal Generator | 529 |
| HP-41 | 57 | Sweeper Synthesizers | 452, 456, 457, 496-499 |
| HP-71 | 57 | Switch Controller, HP-IB | 153, 311, 558 |
| HP-75 | 57 | Switches | |
| IGES Translator | 182 | AC Power Controller | 323 |
| Logic State Analyzer | 188 | Access, Distribution and Bidirectional | 153 |
| Logic State High Level Analysis | 190 | Actuators | 122, 205, 558 |
| Logic State Performance Analysis | 188 | HP-IB Driver | 558 |
| Mechanical Design & Drafting | 178 | Coaxial, Microwave OEM | 569 |
| NC Drill | 182 | Matrix Microwave | 569 |
| Oscilloscope Measurement System | 438 | Matrix (HP-IB) | 311, 359 |
| Parameter Extraction (TECAP) | 364 | 5-Port Coaxial | 569 |
| PC Instruments Data Acquisition | 198, 199 | Relay Multiplexer for PC Instruments | 195 |
| Photoplotter/NC Drill | 182 | SPDT | 569 |
| Series 10 | 57 | VHF Switch, HP-IB | 122, 311 |
| Series 80 | 48 | Swivel Adapter | 553 |
| Signal Monitoring | 670 | Synchronizer/Counter | 230 |
| Spectrum Analyzer System | 667, 670, 673, 710 | Synchronizer, Microwave Source | 230 |
| Technical Documentation | 182 | Synthesized Function Generator | 450 |
| Technical Software Solutions | 175 | Synthesized Signal Generators | 524-534, 543-548 |
| The Integral | 78 | Synthesized Signal Sources | 452-457, 524-534 |
| The Portable PLUS | 44 | Synthesized Sweep Oscillators | 452-457, 496 |
| Touchscreen II Personal Computers | 41 | Synthesizer, Arbitrary Waveform | 450 |
| Translator (IGES) | 182 | Synthesizer, Time | 489 |
| Vectra | 43 | Synthesizers, Automatic | 452-457, 524-534, 544-546 |
| Vector Network Analyzer | 624 | Synthesizers, Frequency | 452-457, 524-534, 543-548 |
| Waveform Measurement | 427 | Systems | |
| Waveform Generator | 429 | Automatic Test | 314, 319, 324 |
| Word Processing | 69, 73 | CAD | 177 |
| Software Pacs | | Digital Diagnostic | 372 |
| Active Device Measurement | 630 | Digital IC Test | 369 |
| Basic Network Measurement | 630 | DLTS Analysis | 354 |
| Cellular Radio Test | 731 | Laser Measurement | 732 |
| | | Logic Development | 183 |



- Memory Test 366
 Noise & Interference Measurement 155
 Real-Time Computer 80
 Semiconductor Test 349-356
 Video Measurement 168
 Waveform Generation 450
 Waveform Measurement 424, 427, 429
 System I, System II Cabinets 744, 748
- T**
- Tablet, Graphics 107
 Tape Degausser 409
 Tape Drives 90, 93
 Tape Recorders, Analog Magnetic 407
 TECAP Parameter Extraction Software 364
 Technical Computers and Peripherals 65-83
 Asynchronous Serial Interface 68, 72, 75
 BCD Input Interface 68, 72
 Breadboard Card 68, 72
 Bus Expander 68, 72
 Color Video Interface 68, 72, 75
 Eight-Channel Multiplex Card 75
 EPROM Card Datacom Interface 68, 72, 75
 Flexible Disc Drives 89
 General Interfaces 68, 72, 75
 GPIO Interface 55, 68, 72, 75
 Graphics Tablet 107
 HP-IB Interface 68, 72, 75
 HP-IL/HP Series 80 Interface 55
 Integral, The 78
 I/O Expander 313
 Interfacing Summary 83
 Local Area Network Interface 72, 75
 Magnetic Bubble Memory Card 68, 72
 Micro Winchester Disc Drives 89
 Multiprogrammer: I/O Expander & Converter 313
 Plotters, Graphics 99-104
 Programmable Datacomm Interface 68, 72
 RGB Color Video Interface 68, 72, 75
 RJE Interface 68, 72, 75
 Serial Interface 68, 72
 Shared Resource Management Interface 72, 75
 Two Channel DMA Controller Interface 68, 72
 Winchester Hard Disc Drives 89-92
 Technical Documentation Software 182
 Technical Software Solutions 175
 Telecommunications Test Equipment 142, 143-167
 Access Switch 153
 Amplifier, Error Detector Input 150
 Attenuator—75 Ω General Purpose 162
 Audio Channel Selector: HP-IB Controlled 145
 Balanced 2/4-wire Audio Channel Selector 145
 Bidirectional Switch 153
 Carrier Testing 142, 151, 156, 159
 Cellular Radio Test Equipment 731
 Controller, Switch 153
 Converter, 75 Ω Unbal/110 Ω Bal 150
 Data Generator 148
 Data Line Analyzers 141
 Detector, Error 147, 148
 Digital Transmission Analyzer 148
 Down Converter 164
 Error Rate Measurements 146-148
 FDM Measurements 142, 151-154, 156-160
 FDM Surveillance Software 142, 154, 159
 HP-IB Controlled Channel Selector 145
 Isolator, PCM Test Equipment 150
 Jitter Generator & Receiver 149
 Microwave Counters 226-234
 Microwave Link Analyzers 162
 Microwave Network Analyzers 626-637
 Microwave Radio Testing 151
 Modulation Analyzer 715, 719
 Modulator/Demodulator 161
 Noise and Interference Test Set 155
 Noise and Interference Measurement System 155
 Pattern Generator/Error Detector 146
 PCM Terminal Test Set 144
 PCM Testing 143
 Power Meters 577-583
 Primary Multiplex Analyzer 145
 Remote Access and Test System 166
 Remote Automatic Surveillance Systems 154
 Selective Level Measuring Sets 152, 156, 159
 Selective Level Meters 152, 156, 159
 SLMS Accessories 153
 Switch, Access 153
 Switch Controller 153, 558
 Telephone Line Analyzer 141
 Transmission Impairment Measuring Sets 134-140
 Voice & Data Testing 133
 Temperature Measurement 735
 Termination Panel, Multiprogrammer 323
 Terminations, Coaxial and Waveguide 554, 567
 Terminals, Display 84-87
 Test Head 469
 Testmobiles 444
 Test Set, Digital Logic 380
 Test Set, Signal Generator 718
 Test System, Digital IC 369
 Test System, Memory 366
 Thermistor Sensors, Coaxial and Waveguide 583
 Thermocouple Power Meters 578, 579
 Thermocouple Power Sensors 580
 Thermocouple Scanning Cards 297, 308, 321
 Thermometer, Quartz 735
 ThinkJet Printer 95, 96
 Time Base (HP 7035B) 399
 Time Domain Network Measurement 626
 Time Interval Counters 237, 241-251
 Time Module, HP-41 54
 Time Standards 252
 Time Synthesizer 489
 Timer/Pacer Cards, Multiprogrammer 318, 321
 Timing Analyzer, High-Speed Development System 190
 Timing Generator, HP-IB 489
 TNC Adapters 742
 Touch-Hold Probe 218
 Touch, HP 40
 Touchscreen HP-IB Controller 201
 Touchscreen PCIB Controller 201
 Touchscreen II Personal Computers 40
 Tracer, Current 378
 Tracking Generators 156, 456, 651, 678, 682, 688, 690, 692, 695
 Tracking Generator Module (HP 70310A) 651
 Training, Logic 381
 Training, Microprocessor 381



| | | | |
|---|-----------------------|---|-------------------------------------|
| Training Support | 760 | Voice/Data Testing | 133 |
| Transceiver Modulation Analyzer | 719 | Voltmeters | 203-223 |
| Transceiver Test System | 728 | Analog | 219-222 |
| Transfer Function Analyzer | 701 | Digital | 203-218 |
| Transient Digitizers | 420-429 | RF | 223 |
| Transient Generators | 428 | W | |
| Transient Recorders | 420-429 | Waveform Analyzers | 168, 420-429, 701, 703, 706, 709 |
| Transmission Impairment Measuring Sets | 134-142 | Waveform, Arbitrary Synthesizer | 450 |
| Transmission Line Test Software | 604 | Waveform Digitizers | 420-429 |
| Transmission Test Sets | 137 | Waveform Recorders | 396-402, 420-429 |
| Transistor Bias Supply | 630 | Waveguide | |
| Transistor Test Fixtures | 630, 634, 636 | Attenuators | 554, 560 |
| Transistors, Bipolar | 739 | Calibration Kits | 631 |
| Transit Cases | 750 | Coaxial Adapters | 553 |
| Translator Software (IGES) | 182 | Detectors | 554, 565 |
| Troubleshooting, Digital | 380 | Directional Couplers | 563 |
| True RMS Voltmeters | 208-212, 214-216, 220 | Frequency Meters | 554, 565 |
| Tuners, Microwave | 568 | Harmonic Mixers | 568, 697 |
| Two-Channel Real Time Spectrum Analyzer | 706, 709 | Holders | 553 |
| Type N Series Adapters | 743 | Low-Pass Filters | 568 |
| Type N Short | 567, 637 | Movable Shorts | 567 |
| U | | Shorting Switch | 567 |
| UHF Signal Generators | 526, 529, 532, 542 | Slide Screw Tuners | 568 |
| Ultrasound Imaging | 740 | Sliding Loads | 567 |
| Upconverter Simulator for Microwave | | Sliding Shorts | 567 |
| Link Analyzer | 165 | Slotted Sections | 566 |
| V | | Stand | 553 |
| Vector Film Recorder | 105 | Terminations | 567 |
| Vector Generator | 466 | Thermistor Mounts | 583 |
| Vector Impedance Meter | 334 | Variable Attenuators | 560 |
| Vector Network Analyzers | 588, 605-616, 618-638 | Waveguide-Waveguide Adapters | 554 |
| Vector Voltmeter | 617 | Wideband Amplifiers | 490, 492 |
| Verification Kits (Network Analyzer) | 600 | Word Generator | 466 |
| Vectra Personal Computer | 42 | Word Processing Printer and Accessories | 94-96 |
| VHF Signal Generator | 535, 538 | Workstation Printers | 94-96 |
| VHF Switch Module | 122, 311 | X | |
| Vibration Analyzer | 703, 706, 709 | X-Ray Systems, Scientific & Industrial | 756 |
| Video Interface | 68, 72, 75 | X-Y Recorders | 396-401 |
| Video Measurement System | 168 | | |

MODEL NUMBER INDEX

New product listings are printed in bold face type

HP-11C Advanced Scientific Programmable 52
 HP-12C Advanced Financial Programmable 52
 HP-15C Advanced Scientific Programmable with Matrices 52
 HP-16C Advanced Programmable for Digital Electronics
 and Computer Science 52
 HP-41CV/CX Advanced Calculators 52
 HP-41 CV/CX Opt. 001 Custom Calculator 56
 HP-71B Handheld Computer 53
 HP-75D Handheld Computer 53
 HP-85B Personal Computer 46
 HP-86B Personal Computer 46

100

105B Quartz Oscillator 257
HP 110 - The Portable PLUS 44
 141T System Spectrum Analyzers 686
 141T Spectrum Analyzer Mainframe 687
 HP 150 Touchscreen II Personal Computers 40
 182T Large Screen Display Mainframe 680, 682, 684
 197B Oscilloscope Camera 444

200

214B Pulse Generator 483
HP 260 Business Computers 61
 281 Series Coaxial-Waveguide Adapters 553
 292 Series Waveguide-Waveguide Adapters 553, 554

300

334A Distortion Analyzer 726
 339A Distortion Measuring Set 725
 346A/B/C Noise Source 587
 355 Series Coaxial Step Attenuators 558
 360 Series Coaxial Low-pass Filters 568
 362A Series Waveguide Low-pass Filters 568
365 Series mm-Wave Waveguide Isolators 554
370 Series mm-Wave Fixed Attenuators 554
 375 Series Waveguide Variable Attenuators 560
 382 Series Waveguide Precision Variable Attenuators 554, 560

400

400E & EL AC Voltmeters 221
 400F & FL AC Voltmeters 221
 400 GL AC Voltmeter 221
 410C Voltmeter 222
 415E SWR Meter 566
 420C Coaxial Crystal Detector 564
 422A Series Waveguide Crystal Detectors 554, 565
 423A/B Coaxial Crystal Detectors 564
 424A Series Waveguide Crystal Detectors 565
 427A Voltmeter 222
 428B Clip-on DC Milliammeter 223
 432 Series Power Meters 582
 435B Power Meter 579
 436A Power Meter 578
 436A-E40 Power Sensor Calibration System 576
 438A Dual Power Meter 577
438A Option 700 MATE - Programmed Power Meter 577
 442B Slotted Line RF Probe 566
 444A Slotted Line Untuned Probe 566
 447B Slotted Line Detector Probe 566
 478A Coaxial Thermistor Mount 583
 486A Series Waveguide Thermistor Mounts 583

500

532 Series Waveguide Frequency Meters 554, 565
 536A Coaxial Frequency Meter 565
 537A Coaxial Frequency Meter 565
 545A Logic Probe 377

546A Logic Pulsar 378
 547A Current Tracer 378
 548A Logic Clip 379

700

752 Series Waveguide Directional Couplers 555, 563
 774D Coaxial Dual Directional Coupler 562
 775D Coaxial Dual Directional Coupler 562
 776D Coaxial Dual Directional Coupler 562
 777D Coaxial Dual Directional Coupler 562
 778D Coaxial Dual Directional Coupler 562
 779D Coaxial Directional Coupler 562
 786D Coaxial Directional Detector 563
 787D Coaxial Directional Detector 563
 788C Coaxial Directional Detector 563
 789C Coaxial Directional Detector 563
 796D Coaxial Directional Coupler 562
 797D Coaxial Directional Coupler 562
 798C Coaxial Directional Coupler 562

800

809C Slotted Line Carriage 566
 810B Series Waveguide Slotted Sections 566
 816A Coaxial Slotted Section 566
 853A Spectrum Analyzer Display 680, 682, 684
 870A Series Waveguide Slide Screw Tuners 568
897 Series E-, H-Plane Waveguide Bends 554
898 Series Waveguide Twists 554
899 Series Waveguide Straight Sections 554

900

905A Coaxial Sliding Load 567
 908A Coaxial 50-Ohm Termination 567
 909A/C/D/E Coaxial 50-Ohm Termination 567
 910 Series Waveguide Terminations 555, 567
 911A/C Coaxial Sliding Loads 567
 914 Series Waveguide Sliding Loads 567
 920 Series Waveguide Moving Shorts 555, 567
 923A Waveguide Sliding Short 567
 930A Waveguide Shorting Switch 567
 932A Waveguide Harmonic Mixer 568
 938A Frequency Doubler Set 542
 940A Frequency Doubler Set 542

1000

HP 1000 Computers and Systems 80
 1000/26 Computer System 80
 1000/27 Computer System 80
 1000/29 Computer System 80
 1000/60 Computer System 80
 1000/65 Computer System 80
 1006A Testmobile 444
 1007A Testmobile 444
 1008A Testmobile 444
 1040A Spectrophotometric Detector 737
 1051A & 1052A Combining Cases 748
 1090 Liquid Chromatograph Systems 737
 1117B Testmobile, Oscilloscope 445
 1340A Display Module 108
 1345A Digital Display 108
 1630A/D/G Logic Analyzers 414
 1630 A/D + 24D Logic Analysis Measurement Techniques 760
 1631A/D Logic Analyzers 411
 1645A Date Error Analyzer 136
 1741A 100 MHz Oscilloscope, Analog Variable Persistence
 Storage 446
 1950A Two Channel Expansion Module 438
 1965A Gated Universal Counter Module 438



| | |
|---|-----|
| 1980 Oscilloscope Measurement System..... | 438 |
| 1980B + 24A Waveform Measurement System Training..... | 760 |

2000

| | |
|---|-------------------|
| 2106BK Board Computer..... | 82 |
| 2113E Computer..... | 82 |
| 2117F Computer..... | 82 |
| 2137A Computer..... | 82 |
| 2139A Computer..... | 82 |
| 2156B Computer..... | 82 |
| 2178C Model 60 Computer Systems..... | 81 |
| 2179C Model 65 Computer Systems..... | 81 |
| 2196C/D Model 26 Computer Systems..... | 81 |
| 2197C/D Model 27 Computer Systems..... | 81 |
| 2199C/D Model 29 Computer Systems..... | 81 |
| 2225A ThinkJet Personal Printer..... | 95, 96 |
| 2250 Measurement & Control Processor..... | 308 |
| 2285A Local Area Network..... | 75 |
| 2392A Display Terminal..... | 85 |
| 2393A Graphics Terminal..... | 84 |
| 2394A Data Entry Terminal..... | 85 |
| 2486A Micro 26 Computer System..... | 81 |
| 2487A Micro 27 Computer System..... | 81 |
| 2489A Micro 29 Computer System..... | 81 |
| 2563A Line Printer..... | 94 |
| 2565A Line Printer..... | 94 |
| 2566A Line Printer..... | 94 |
| 2625A Dual System Display Terminal..... | 86 |
| 2626A Display Station..... | 86 |
| 2627A Color Graphics Terminal..... | 84 |
| 2628A Word Processing Terminal..... | 87 |
| 2680 Laser Printing System..... | 94 |
| 2685B Laser Print Station..... | 94 |
| 2686A LaserJet PLUS Printer..... | 94, 95, 96 |
| 2688A Page Printer..... | 94 |
| 2689A Laser Printing System..... | 94 |
| 2804A Quartz Thermometer..... | 735 |
| 2813C Quartz Pressure Probe..... | 734 |
| 2813D Quartz Pressure Set..... | 734 |
| 2816A Pressure Signal Processor..... | 734 |
| 2932A General Purpose Printer..... | 95, 96 |
| 2934A Business Printer..... | 95, 96 |

3000

| | |
|---|------------|
| HP 3000 Series 37, 37XE, 42, 48, 58, & 68/Business Computer Systems..... | 64 |
| 3046A/B Selective Level Measuring System..... | 159 |
| 3047A Phase Noise Measurement System..... | 710 |
| 3054A Automatic Data Acquisition/Control System..... | 292 |
| 3054C Automatic Data Acquisition/Control System..... | 295 |
| 3054DL Data Logger..... | 294 |
| 3055S PC Based Data Acquisition Unit..... | 306 |
| 3056DL Data Logger..... | 289 |
| 3060A/3061A/3062A User's Course..... | 761 |
| 3061A/3062A In-circuit Functional Test System (HP-IB)..... | 386 |
| 3065 Board Test Family (HP-IB)..... | 387 |
| 3065C + 24D Board Test System User Training..... | 761 |
| 3312A Function Generator..... | 462 |
| 3314A Function Generator..... | 463 |
| 3325A Function Generator/Frequency Synthesizer/Sweeper..... | 452 |
| 3326A Two-Channel Synthesizer (HP-IB)..... | 454 |
| 3335A Frequency Synthesizer..... | 456 |
| 3336A/B/C Synthesizer/Level Generator..... | 156, 457 |
| 3350 Series Laboratory Automation Systems..... | 737 |
| 3390A Series Integrators..... | 737 |
| 3400A RMS Voltmeter..... | 220 |
| 3406A Broadband Sampling Voltmeter..... | 223 |

| | |
|---|------------|
| 3421A Data Acquisition/Control Unit..... | 290 |
| 3435A Digital Voltmeter..... | 217 |
| 3437A High Speed Digital Voltmeter..... | 213 |
| 3455A 6½ Digit DMM..... | 212 |
| 3456A Systems DVM..... | 210 |
| 3457A Multimeter..... | 205 |
| 3466A 4½ Digit Autoranging DMM..... | 214 |
| 3468A/B 5½ Digit Multimeter (HP-IL)..... | 215 |
| 3478A 5½ Digit Multimeter (HP-IB)..... | 208 |
| 3488A Switch Control Unit (HP-IB)..... | 311 |
| 3497A Data Acquisition/Control Unit..... | 296 |
| 3498A Extender..... | 299 |
| 3529A Magnetometer Probe..... | 223 |
| 3551A Transmission Test Set..... | 137 |
| 3552A Transmission Test Set..... | 137 |
| 3561A Dynamic Signal Analyzer (HP-IB)..... | 703 |
| 3562A Dynamic Signal Analyzer (HP-IB)..... | 706 |
| 3575A Gain/Phase Meter..... | 612 |
| 3577A Network Analyzer (HP-IB)..... | 605 |
| 3577S Network Analyzer System..... | 610 |
| 3580A Spectrum Analyzer..... | 699 |
| 3581A Wave Analyzer..... | 727 |
| 3581C Selective Voltmeter..... | 142 |
| 3582A Spectrum Analyzer..... | 701 |
| 3585A Spectrum Analyzer..... | 654 |
| 3586A/B Selective Level Meter..... | 156 |
| 3586C Wave Analyzer..... | 657 |
| 3708A Noise and Interference Test Set..... | 155 |
| 3708S Noise and Interference Measurement System..... | 155 |
| 3711A IF/BB Transmitter (70/140 MHz IF)..... | 162 |
| 3712A IF/BB Receiver (70/140 MHz IF)..... | 162 |
| 3717A 70 MHz Modulator/Demodulator..... | 161 |
| 3730B Down Converter: RF to IF..... | 164 |
| 3736B RF Module (1.7 to 4.2 GHz)..... | 164 |
| 3737B RF Module (3.7 to 8.5 GHz)..... | 164 |
| 3738B RF Module (5.9 to 11.7 GHz)..... | 164 |
| 3739B RF Module (10.7 to 14.5 GHz)..... | 164 |
| 3746A Selective Level Measuring Set (32 MHz)..... | 152 |
| 3750A Attenuator, 75 Ω..... | 163 |
| 3754A Access Switch..... | 153 |
| 3755A Switch Controller..... | 153 |
| 3756A 90 MHz Bi-directional Switch..... | 153 |
| 3757A 8.5 MHz Access Switch..... | 153 |
| 3762A Data Generator..... | 148 |
| 3763A Error Detector..... | 148 |
| 3764A Digital Transmission Analyzer..... | 148 |
| 3770B Telephone Line Analyzer..... | 141 |
| 3776A PCM Terminal Test Set..... | 141, 144 |
| 3776B PCM Terminal Test Set..... | 141, 144 |
| 3777A HP-IB-Controlled Channel Selector..... | 145 |
| 3779C Primary Multiplex Analyzer (CEPT)..... | 145 |
| 3779D Primary Multiplex Analyzer (Bell)..... | 145 |
| 3780A Pattern Generator/Error Detector..... | 146 |
| 3781A Pattern Generator (CEPT and CCITT Compatible)..... | 147 |
| 3781B Pattern Generator (BELL Compatible)..... | 147 |
| 3782A Error Detector (CEPT and CCITT Compatible)..... | 147 |
| 3782B Error Detector (BELL Compatible)..... | 147 |
| 3785A Jitter Generator & Receiver (CEPT)..... | 149 |
| 3785B Jitter Generator & Receiver (Bell)..... | 149 |
| 3852A Data Acquisition/Control Unit..... | 301 |
| 3852S Data Acquisition/Control System..... | 300 |
| 3964A Instrumentation Tape Recorder..... | 408 |
| 3968A Instrumentation Tape Recorder..... | 408 |

4000

| | |
|--|-----|
| 4061A Semiconductor/Component Test System..... | 356 |
| 4062B Semiconductor/Parametric Test System..... | 349 |
| 4063A Semiconductor Parameter Analysis System..... | 352 |
| 4064A DLTS Analysis System..... | 354 |

MODEL NUMBER INDEX

New product listings are printed in bold face type

| | |
|--|----------------|
| 4085M Switching Matrix..... | 359 |
| 4140B pA Meter/DC Voltage Source..... | 360 |
| 4141B DC Source/Monitor..... | 357 |
| 4145A Semiconductor Parameter Analyzer..... | 358 |
| 4191A RF Impedance Analyzer..... | 332 |
| 4192A LF Impedance Analyzer..... | 330 |
| 4193A Vector Impedance Meter..... | 334 |
| 4194A Impedance/Gain - Phase Analyzer..... | 328 |
| 4261A Digital LCR Meter..... | 344 |
| 4262A Digital LCR Meter..... | 344 |
| 4274A Multifrequency LCR Meter..... | 336 |
| 4275A Multifrequency LCR Meter..... | 336 |
| 4276A LCZ Meter..... | 340 |
| 4277A LCZ Meter..... | 340 |
| 4280A 1 MHz C Meter/C-V Plotter..... | 362 |
| 4328A Milliohmmeter..... | 347 |
| 4329A High Resistance Meter..... | 347 |
| 4342A Q Meter..... | 346 |
| 4440B Decade Capacitor..... | 348 |
| 4760AI Cardiography Instrumentation..... | 740 |
| 4925B Bit Error Rate Test Set..... | 136 |
| 4935A Transmission Impairment Measuring Set..... | 134 |
| 4936A Transmission Impairment Measuring Set..... | 134 |
| 4937A Transmission Impairment Measuring Set..... | 140 |
| 4938A Network Circuit Access Test Set..... | 140 |
| 4945A Transmission Impairment Measuring Set..... | 138 |
| 4951B Protocol Analyzer..... | 129 |
| 4953A Protocol Analyzer..... | 130 |
| 4955A Protocol Analyzer..... | 131 |
| 4955A + 24A Protocol Analyzer User's Training..... | 761 |
| | |
| 5000 | |
| 5005A Signature Multimeter..... | 373 |
| 5005B Signature Multimeter..... | 373 |
| 5006A Signature Analyzer..... | 376 |
| 5011T Logic Troubleshooting Kit..... | 380 |
| 5021A Logic Troubleshooting Kit..... | 380 |
| 5022A Logic Troubleshooting Kit..... | 380 |
| 5023A Logic Troubleshooting Kit..... | 380 |
| 5024A Logic Troubleshooting Kit..... | 380 |
| 5035T Logic Lab..... | 381 |
| 5036A Microprocessor Lab..... | 381 |
| 5061A Cesium Beam Frequency Standard..... | 253 |
| 5061A with Option 004 Tube..... | 253 |
| E21-5061A Flying Clock (Cesium)..... | 253 |
| 5065A Rubidium Frequency Standard..... | 254 |
| E21-5065A Portable Rubidium Time Standard..... | 254 |
| 5087A Distribution Amplifier..... | 258 |
| 5089A Standby Power Supply..... | 259 |
| 5180A Waveform Recorder..... | 426 |
| 5180S Waveform Measurement System..... | 427 |
| 5180T,U Precision Digitizing Oscilloscopes..... | 422-424 |
| 5182A Waveform Recorder/Generator..... | 428 |
| 5183T,U Precision Digitizing Oscilloscopes..... | 422 |
| 5182S Waveform Generation System..... | 429 |
| 5314A Universal Counter..... | 251 |
| 5315A & 5315B Universal Counters..... | 248 |
| 5316A Universal Counter..... | 248 |
| 5328B Universal Counter..... | 247 |
| 5334A Universal Counter..... | 242 |
| 5335A Universal Counter..... | 244 |
| 5340A Microwave Frequency Counter..... | 231 |
| 5342A Microwave Frequency Counter..... | 228 |
| 5343A Microwave Frequency Counter..... | 228 |
| 5344S Microwave Source Synchronizer..... | 230 |
| 5345A Electronic Counter..... | 232, 241 |
| 5350A Microwave Frequency Counter..... | 226 |
| 5351A Microwave Frequency Counter..... | 226 |
| 5352A Microwave Frequency Counter..... | 226 |
| 5355A Automatic Frequency Converter..... | 232 |

| | |
|---|------------|
| 5356A, B, C, D Frequency Converter Heads..... | 232 |
| 5359A Time Synthesizer..... | 489 |
| 5363B Time Interval Probes..... | 240 |
| 5370B Universal Time Interval Counter..... | 237 |
| 5382A Frequency Counter..... | 236 |
| 5383A Frequency Counter..... | 236 |
| 5384A Frequency Counter..... | 235 |
| 5385A Frequency Counter..... | 235 |
| 5386A Frequency Counter..... | 234 |
| 5427A Digital Vibration Control System..... | 709 |
| 5501A Laser Transducer System..... | 733 |
| 5528A Laser Measurement System..... | 732 |
| 5880A Gas Chromatograph..... | 736 |
| 5890A Gas Chromatograph..... | 736 |
| 5970B Mass Selective Detector..... | 736 |
| 5988A GC/Mass Spectrometer..... | 736 |
| 5995C GC/Mass Spectrometer..... | 736 |

6000

| | |
|---|------------|
| 6002A Autoranging DC Power Supply..... | 280 |
| 6010A 1000 Watt Autoranging Power Supply..... | 270 |
| 6011A 1000 Watt Autoranging Power Supply..... | 270 |
| 6012B/200 Watt Autoranging Power Supply..... | 270 |
| 6023A 200 Watt Autoranging Power Supply..... | 270 |
| 6024A 200 Watt Autoranging DC Power Supply..... | 270 |
| 6030A 1000 Watt Autoranging System Power Supply..... | 280 |
| 6031A 1000 Watt Autoranging System Power Supply..... | 280 |
| 6032A 1000 Watt Autoranging System Power Supply..... | 280 |
| 6033A 200 Watt Autoranging System Power Supply..... | 280 |
| 6038A 200 Watt Autoranging System Power Supply..... | 280 |
| 6114A & 6115A Precision DC Power Supplies..... | 284 |
| 6129C-6131C Digitally Controlled Voltage Sources..... | 282 |
| 6140A Digital Current Source..... | 282 |
| 6177C Precision DC Current Source..... | 285 |
| 6181C Precision DC Current Source..... | 285 |
| 6186C Precision DC Current Source..... | 285 |
| 6200B-6209B DC Power Supplies..... | 265-267 |
| 6212B-6218B DC Power Supplies..... | 265-267 |
| 6227B Dual Tracking DC Power Supply..... | 268 |
| 6228B Dual Tracking DC Power Supply..... | 268 |
| 6234A Dual Output Power Supply..... | 265-267 |
| 6235A Triple Output Power Supply..... | 266 |
| 6236B Triple Output DC Power Supply..... | 266 |
| 6237B Triple Output DC Power Supply..... | 266 |
| 6253A Dual Output DC Power Supply..... | 268 |
| 6255A Dual Output DC Power Supply..... | 268 |
| 6259B DC Power Supply..... | 272 |
| 6260B DC Power Supply..... | 272 |
| 6261B DC Power Supply..... | 272 |
| 6263B DC Power Supply..... | 272 |
| 6264B DC Power Supply..... | 272 |
| 6266B DC Power Supply..... | 272 |
| 6267B DC Power Supply..... | 272 |
| 6268B DC Power Supply..... | 272 |
| 6269B DC Power Supply..... | 272 |
| 6274B DC Power Supply..... | 272 |
| 6281A DC Power Supply..... | 268 |
| 6282A DC Power Supply..... | 268 |
| 6284A DC Power Supply..... | 268 |
| 6286A DC Power Supply..... | 268 |
| 6289A DC Power Supply..... | 268 |
| 6291A DC Power Supply..... | 268 |
| 6294A DC Power Supply..... | 268 |
| 6296A DC Power Supply..... | 268 |
| 6299A DC Power Supply..... | 268 |
| 6434B DC Power Supply..... | 274 |
| 6443B DC Power Supply..... | 274 |
| 6448B DC Power Supply..... | 274 |
| 6453A DC Power Supply..... | 274 |
| 6456B DC Power Supply..... | 274 |



| | | | |
|--|----------------|--|--------------------|
| 6459A DC Power Supply | 274 | 8081A Repetition Rate Generator, 300 MHz | 488 |
| 6464C DC Power Supply | 274 | 8082A Pulse Generator | 487 |
| 6466C DC Power Supply | 274 | 8083A Output Amplifier, 300 MHz | 488 |
| 6469C DC Power Supply | 274 | 8084A Word Generator, 300 MHz | 488 |
| 6472C DC Power Supply | 274 | 8091A Repetition Rate Generator, 1 GHz | 488 |
| 6475C DC Power Supply | 274 | 8092A Delay Generator/Frequency Divider | 488 |
| 6477C DC Power Supply | 274 | 8093A Output Amplifier, 1 GHz | 488 |
| 6479C DC Power Supply | 274 | 8111A 1 Hz-20 MHz Pulse/Function Generator | 461 |
| 6483C DC Power Supply | 274 | 8112A Programmable Pulse Generator | 478 |
| 6621A System Power Supply | 276 | 8116A Pulse/Function Generator | 459 |
| 6622A System Power Supply | 276 | 8150A Optical Signal Source | 572 |
| 6623A System Power Supply | 276 | 8151A Optical Pulse Power Meter | 574 |
| 6624A System Power Supply | 276 | 8160A Programmable Pulse Generator | 480 |
| 6824A DC Power Supply/Amplifier | 283 | 8161A Programmable Pulse Generator | 480 |
| 6825A DC Power Supply/Amplifier | 283 | 8165A Programmable Signal Source | 458 |
| 6826A DC Power Supply/Amplifier | 283 | 8170A Logic Pattern Generator | 474 |
| 6827A DC Power Supply/Amplifier | 283 | 8175A Digital Signal Generator | 470 |
| 6901S Measurement & Analysis System | 314 | 8180A Data Generator | 369, 468 |
| 6940B Multiprogrammer | 320 | 8180/8182A + 24A Operating Techniques Course | 761 |
| 6941B Multiprogrammer Extender | 320 | 8180/8182A + 24H Programming Techniques Course | 761 |
| 6942A Multiprogrammer | 316 | 8181A Data Generator Extender | 371, 468 |
| 6942A + 24D Multiprogrammer User's Training | 760 | 8182A Data Analyzer | 369, 468 |
| 6942S Computer Aided Test System | 319 | 8340A Synthesized Sweeper | 496, 543 |
| 6943A Multiprogrammer Extender | 316 | 8341A Synthesized Sweeper | 496, 543 |
| 6944A Series 200 Multiprogrammer | 315 | 8349B Microwave Amplifier | 491 |
| 6944A + 24D Multiprogrammer's User Course | 760 | 8350B Sweep Oscillator Mainframe | 500 |
| 6944S Series 200 Multiprogrammer System | 319 | 8403A Modulator | 549 |
| | | 8405A Vector Voltmeter | 617 |
| | | 8406A Comb Generator | 698 |
| | | 8408B Network Analyzer Subsystem | 637 |
| | | 8408S Automatic Network Analyzer System | 637 |
| | | 8410C Network Analyzer Mainframe | 633 |
| | | 8410S series Network Analyzers | 632 |
| | | 8411A Harmonic Frequency Converter | 633 |
| | | 8412B Phase-Magnitude Display | 633 |
| | | 8414B Polar Display | 633 |
| | | 8418B Auxiliary Power Supply | 633 |
| | | 8443A Tracking Generator-Counter | 690 |
| | | 8444A Tracking Generator | 692 |
| | | 8444A Option 059 Tracking Generator | 674, 678, 682, 694 |
| | | 8445B Automatic Preselector | 695 |
| | | 8447 series Amplifiers | 492 |
| | | 8450A Diode Array Spectrophotometer | 737 |
| | | 8451A Diode Array Spectrophotometer | 737 |
| | | 8470A/B Coaxial Crystal Detectors | 564 |
| | | 8471A Coaxial Crystal Detector | 564 |
| | | 8472A Coaxial Crystal Detector | 564 |
| | | 8473B/C Coaxial Crystal Detectors | 564 |
| | | 8477A Power Meter Calibrator | 582 |
| | | 8478B Coaxial Thermistor Mount | 583 |
| | | 8481A/B/H Power Sensors | 580 |
| | | 8482A/B/H Power Sensors | 580 |
| | | 8483A Power Sensor | 580 |
| | | 8484A Power Sensor | 580 |
| | | 8485A Power Sensor | 580 |
| | | 8486A mm-Wave Power Sensor | 580 |
| | | 8491A/B Coaxial Fixed Attenuators | 556 |
| | | 8492A Coaxial Fixed Attenuator | 556 |
| | | 8493A/B/C Coaxial Fixed Attenuators | 556 |
| | | 8494A/B/G/H Coaxial Step Attenuators | 558 |
| | | 8495A/B/D/G/H/K Coaxial Step Attenuators | 558 |
| | | 8496A/B/G/H Coaxial Step Attenuators | 558 |
| | | 8497K Coaxial Step Attenuator | 558 |
| | | 8498A Coaxial Fixed Attenuator | 556 |
| | | 8501A Storage-Normalizer | 621 |
| | | 8502A/B Reflection Transmission Bridges | 561, 616 |
| | | 8503A/B S-Parameter Test Sets | 622 |
| | | 8505A Network Analyzer | 618 |
| | | 8507D Network Analyzer Subsystem | 624 |
| | | 8507S Automatic Network Analyzer System | 624 |
| 7000 | | | |
| 7015B X-Y Recorder | 399 | | |
| 7035B X-Y Recorder | 399 | | |
| 7045B X-Y Recorder | 401 | | |
| 7046B X-Y Recorder | 401 | | |
| 7090A Measurement Plotting System | 396 | | |
| 7414A 4-Channel Oscillographic Recorder | 403 | | |
| 7418A 6 to 8 Channel Oscillographic Recorder | 403 | | |
| 7470A 2-Pen Graphics Plotter | 83, 99 | | |
| 7475A 6-Pen Graphics Plotter | 83, 99 | | |
| 7510A Vector Film Recorder | 83, 105 | | |
| 7550A 8-Pen Graphics Plotter | 101 | | |
| 7580B 8-Pen Drafting Plotter | 103 | | |
| 7585B 8-Pen Drafting Plotter | 103 | | |
| 7586B 8-Pen Drafting Plotter | 103 | | |
| 7673A Automatic Sampler | 736 | | |
| 7907A Disc/Tape Drive | 92 | | |
| 7911P/R Disc/Tape Drives | 91 | | |
| 7912P/R Disc/Tape Drives | 91 | | |
| 7914P/R Disc/Tape Drives | 91 | | |
| 7914CT Disc/Tape Drive | 91 | | |
| 7914ST Disc/Tape Drive | 91 | | |
| 7933H/G Disc Drives | 92 | | |
| 7935H/G Disc Drives | 92 | | |
| 7941A Disc Drive | 90 | | |
| 7942A Disc/Tape Drive | 90 | | |
| 7945A Disc Drive | 90 | | |
| 7946A Disc/Tape Drive | 90 | | |
| 7970E 1/2" Magnetic Tape Subsystem | 93 | | |
| 7974A 1/2" Magnetic Tape Subsystem | 93 | | |
| 7974A with NRZI Option | 93 | | |
| 7978A 1/2" Magnetic Tape Subsystem | 93 | | |
| 8000 | | | |
| 8005B Pulse Generator | 484 | | |
| 8011A Pulse Generator | 484 | | |
| 8012B Pulse Generator | 485 | | |
| 8013B Pulse Generator | 485 | | |
| 8015A Pulse Generator | 486 | | |
| 8016A Word Generator | 473 | | |
| 8018A Serial Data Generator | 475 | | |
| 8080A Mainframe | 488 | | |

New product listings are printed in bold face type



| | |
|---|-----------------|
| 8510A Network Analyzer | 626 |
| 8510A + 24D Network Analyzer User's Course | 631 |
| 8510S Network Analyzers | 626 |
| 8510T Network Analyzer System..... | 627 |
| 8511A Frequency Converter | 628 |
| 8512A Reflection/Transmission Test Set (500 MHz-18 GHz).... | 628 |
| 8513A Reflection/Transmission Test Set (45 MHz-26.5 GHz) | 628 |
| 8514A S-Parameter Test Set (500 MHz-18 GHz) | 628 |
| 8515A S-Parameter Test Set (45 MHz-26.5 GHz) | 628 |
| 8552A Spectrum Analyzer—IF Section | 686 |
| 8552B Spectrum Analyzer—IF Section | 686 |
| 8553B Spectrum Analyzer, Tuning Section | 690 |
| 8554B Spectrum Analyzer, Tuning Section | 692 |
| 8555A Spectrum Analyzer, Tuning Section | 694 |
| 8556A Spectrum Analyzer, Tuning Section | 688 |
| 8557A Spectrum Analyzer | 680 |
| 8558B Spectrum Analyzer | 682 |
| 8559A Spectrum Analyzer | 684 |
| 8565A Spectrum Analyzer | 678 |
| 8566B Spectrum Analyzer | 659, 660, 664 |
| 8566A + 24D Spectrum Analyzer Programming | 761 |
| 8566S Automatic Spectrum Analyzer | 667 |
| 8567A Spectrum Analyzer | 659, 668 |
| 8568B Spectrum Analyzer | 659, 660, 662 |
| 8568A + 24D Spectrum Analyzer Programming | 761 |
| 8568S Automatic Spectrum Analyzer | 667 |
| 8569B Spectrum Analyzer | 674 |
| 8570A Spectrum Analyzer | 676 |
| 8574A CISPR EMI Spectrum Analyzer/Receiver | 671 |
| 8614A Signal Generator | 542 |
| 8616A Signal Generator | 542 |
| 8620C Sweep Oscillator | 165, 515 |
| 8640B AM/FM Signal Generator | 535 |
| 8640B Option 004, Avionics Signal Generator | 538 |
| 8642A/B Synthesized Signal Generators | 526 |
| 8656B Synthesized Signal Generator | 524 |
| 8660A Synthesized Signal Generator | 532 |
| 8660C Synthesized Signal Generator | 532 |
| 8662A Synthesized Signal Generator | 529 |
| 8663A Synthesized Signal Generator | 529 |
| 8671A Microwave Frequency Synthesizer | 548 |
| 8672A Synthesized Signal Generator | 544 |
| 8672S MW Synthesized Generator (0.1 to 18 GHz) | 548 |
| 8673B Synthesized Generator (2 to 26.5 GHz) | 544 |
| 8673C/D Synthesized Signal Generators (0.1 to 18/26 GHz) | 547 |
| 8673E Synthesized Signal Generator (2 to 18 GHz) | 546 |
| 8683A/B/D Signal Generators | 540 |
| 8684A/B/D Signal Generators | 540 |
| 8709A Phase-lock Synchronizer | 632 |
| 8717B Transistor Bias Supply | 630 |
| 8721A Coaxial Directional Bridge | 561 |
| 8731-8735 series PIN Modulators | 549 |
| 8743B Reflection/Transmission Test Unit | 635 |
| 8745A S-Parameter Test Set | 634 |
| 8746B S-Parameter Test Set | 636 |
| 8748A S-Parameter Test Set | 616 |
| 8750A Storage-Normalizer | 638 |
| 8754A Network Analyzer | 614 |
| 8756A Scalar Network Analyzer | 603 |
| 8757A Scalar Network Analyzer | 596 |
| 8757S Automatic Scalar Network Analyzer System | 594 |
| 8761A & B Coaxial Switches | 569 |
| 8770A Arbitrary Waveform Synthesizer | 450 |
| 8770S Waveform Synthesizer System | 450 |
| 8801A Low Gain Preamplifier | 404 |
| 8802A Medium Gain Preamplifier | 404 |
| 8803A High Gain Preamplifier | 404 |
| 8805B Carrier Preamplifier | 404 |
| 8806B Phase Sensitive Demodulator | 405 |
| 8808A Logarithmic Preamplifier | 405 |
| 8809A Signal Coupler | 405 |
| 8815A General Purpose Integrator | 405 |
| 8821A Medium Gain Amplifier | 406 |
| 8900C/D Peak Power Meter | 583 |
| 8901A Modulation Analyzer | 719 |
| 8901B Modulation Analyzer | 719 |
| 8902A Measuring Receiver | 715 |
| 8902S Microwave Measurement System | 717 |
| 8903B Audio Analyzer | 722 |
| 8903E Distortion Analyzer | 722 |
| 8952A Signal Generator Test Set | 718 |
| 8953A Transceiver Test Set | 729 |
| 8954A Transceiver Interface | 729, 730 |
| 8955A RF Test System | 728 |
| 8956A System Interface | 728, 730 |
| 8957S Cellular Radio Test System | 731 |
| 8958A Cellular Radio Interface | 731 |
| 8970A Noise Figure Meter | 586 |
| 9000 | |
| HP 9000 Engineering Workstation | 65 |
| 9020A/B/C/AS/AT HP 9000 Model 520 Computer | 74 |
| 9050A/AM/AT Model 550 Computer | 74 |
| 9111A Graphics Tablet | 107 |
| 9114A Double-Sided 3½" Disc Drive | 89 |
| 9122D/S 3½" Microfloppy Disc Drive | 89 |
| 9123D Dual 3½" Drive (for HP Touchscreen II) | 40 |
| 9125S Single-Sided 5¼" Flexible Disc Drive | 89 |
| 9133H 20 Mbyte Winchester/3½" Microfloppy | 89 |
| 9134H 20 Mbyte Winchester Hard Disc | 89 |
| 9142A ¼" Tape Subsystem | 89 |
| 9144A ¼" High Performance Tape Subsystem | 93 |
| 9153A 10 Mbyte Winchester/3½" Microfloppy | 89 |
| 9154A 10 Mbyte Winchester Hard Disc | 89 |
| 9411B Switch Controller | 324 |
| 9412A Modular Switch | 324 |
| 9413A VHF Switch | 324 |
| 9414A Matrix Switch | 324 |
| 9430 Memory Test System | 366 |
| 9807A The Integral Personal Computer | 78 |
| 9816A/S Personal Technical Computer | 66, 67 |
| 9817A/H/L Personal Modular Computer | 66, 67 |
| 9826A/S Technical Computer | 66, 67 |
| 9836A/C/U/CU/CS/S/T/CT Technical Computer | 66, 67 |
| 9837H Technical Computer | 66, 67 |
| 9876A Thermal Line Printer | 95, 96 |
| 9888A Bus Expander | 68, 72 |
| 9915B Modular Run-Only Computer | 77 |
| 9920A/U/S/T Modular Computer | 66, 67 |
| 10000 | |
| 10021A PC Instruments Oscilloscope Probe | 198 |
| 10040A PC Instruments Oscilloscope Probe | 198 |
| 10062A Protective Cover | 471 |
| 10110B BNC Male to Dual Banana Plug | 743 |
| 10111A Shielded Banana Plug to BNC Female | 743 |
| 10113A Triple Banana Plug to Dual BNC Female | 743 |
| 10233A Printer Interconnect Cable for HP 1645A | 136 |
| 10269B 9-Probe Interface | 416 |
| 10275A PDP-11 UNIBUS Interface | 416 |
| 10276A LSI-11 Interface | 416 |
| 10342B Bus Preprocessor | 416 |
| 10387A Interface, Type 303 Modems (HP 1645A) | 136 |
| 10388A Interface, CCITT V.35 (HP 1645A) | 136 |
| 10389A Interface, Breakout Box (RS-232C/V.24) (HP 1645A) | 136 |
| 10501A Cable Assembly | 742 |
| 10502A Cable Assembly | 742 |



| | |
|---|---------------|
| 10503A Cable Assembly | 742 |
| 10514A Double-Balanced Mixer | 568 |
| 10525E Logic Probe | 377 |
| 10529A Logic Comparator | 379 |
| 10534A Double-Balanced Mixer | 568 |
| 10541A Reference Boards | 379 |
| 10541B Preprogrammed Reference Boards | 379 |
| 10590A Plug-in Adapter (HP 5345A) | 241 |
| 10595A Board Extender Kit (HP 5345A) | 241 |
| 10638A Degausser | 253 |
| 10656A HP 5035T Texts & Lab Workbooks | 381 |
| 10657A HP 5035T Component & Wire Kit | 381 |
| 10821A Probe Accessory Kit (HP 5363B) | 240 |
| 10833A/B/C/D HP-IB Cables | 121 |
| 10834A HP-IB Cable Adapter | 121 |
| 10842A Extender Board Kit (HP 5342/5343/5344S) | 229 |
| 10855A Broadband Preampifier | 240 |
| 10856A Low Pass Filter Kit | 240 |
| 10870A Service Kit (HP 5370B) | 237 |
| 10871A Service Kit (HP 5180A) | 426 |
| 10872A Parallel Interface | 426 |
| 10873A Rack Mount Kit | 426 |
| 10874A Slide Mount Kit | 426 |
| 10875A/B DMA Cables | 426 |
| | |
| 11000 | |
| 11000A Cable Assembly | 742 |
| 11001A Cable Assembly | 742 |
| 11002A Test Leads | 742 |
| 11003A Test Leads | 742 |
| 11035A Cable Assembly | 742 |
| 11036A AC Probe for HP 410C | 222 |
| 11075A & 11076A Instrument Cases | 749 |
| 11096B High Frequency Probe | 218 |
| 11340A/B/C HP-IL Cable Assemblies | 291 |
| 11500A/B Cable Assemblies | 742 |
| 11501A Cable Assembly | 742 |
| 11509A Fuseholder | 539 |
| 11511A Coaxial Short | 567 |
| 11512A Coaxial Short | 567, 617 |
| 11515A Waveguide Adapter | 553 |
| 11516A Waveguide Adapter | 553 |
| 11517A Mixer | 697 |
| 11518A-11520A Waveguide Taper Sections | 697 |
| 11524A APC-7 to N (female) Adapter | 742 |
| 11525A APC-7 to N (male) Adapter | 742 |
| 11533A APC-7 to SMA (male) Adapter | 742 |
| 11534A APC-7 to SMA (female) Adapter | 742 |
| 11536A Probe Tee for HP 8405A | 617 |
| 11540A Waveguide Stand | 553 |
| 11545A-11548A Waveguide Holders | 553 |
| 11549A Power Splitter for HP 8405A | 617 |
| 11565A Coaxial Short | 567 |
| 11566A Air Line Extension | 553 |
| 11567A Air Line Extension | 553 |
| 11570A Accessory Kit for HP 8405A | 617 |
| 11581A Attenuator Set | 556 |
| 11582A Attenuator Set | 556 |
| 11583A/C Attenuator Sets | 556 |
| 11588A Swivel Adapter | 553 |
| 11590B Bias Network | 630 |
| 11600B Transistor Fixture | 634 |
| 11602B Transistor Fixture | 634 |
| 11604A Universal Extension for HP 8745A | 634 |
| 11605A Flexible Arm for HP 8743A | 635 |
| 11606A Rotary Air Line | 553 |
| 11608A Transistor Fixture | 636 |
| 11609A Cable Kit for HP 8410S | 633 |
| 11610B Test Port Extension Cable | 635 |
| 11612A Bias Network | 630 |
| | |
| 11635A Bias Decoupling Network | 630 |
| 11636A/B Power Dividers | 561, 601 |
| 11643A Series Millimeter-Wave Test Set Kits | 631 |
| 11644A Series Millimeter-Wave Calibration Kits | 631 |
| 11650A Accessory Kit for HP 8410S | 633 |
| 11664A/D/E Detector for HP 8755, 8756 and 8757 | 599 |
| 11664C Detector Adapter for HP 8755, 8756 and 8757 | 599 |
| 11665B Modulator for HP 8755, 8756 and 8757 | 601 |
| 11667A/B Power Splitters | 561, 601 |
| 11668A 50 MHz High Pass Filter for HP 8755, 8756 and 8757 | 600 |
| 11672A Service Accessory Kit for HP 8660A/C | 534 |
| 11675B Leveling Cable Assembly for HP 784C | 165 |
| 11678A Low Pass Filter Kit | 600 |
| 11679A/B Extension Cables for HP 8755, 8756 and 8757 | 600 |
| 11683A Range Calibrator | 579 |
| 11684/5/6/8/9A Low Pass Filters | 600 |
| 11687A Adapter, 50 to 75Ω | 539 |
| 11690A Frequency Doubler | 539 |
| 11691D Coaxial Directional Coupler | 562 |
| 11692D Coaxial Dual Directional Coupler | 562 |
| 11693A Limiter | 698 |
| 11694A Matching Transformer, 50-75 Ω | 698 |
| 11708A Attenuator (for Calibrating HP 8484A) | 580 |
| 11710B Down Converter | 539 |
| 11712A Service Support Kit (for HP 8671A, 8672A/S) | 545, 548 |
| 11713A Attenuator/Switch Driver | 558 |
| 11714A Service Support Kit (for HP 8662A, 8663A) | 531 |
| 11715A AM/FM Test Source | 721 |
| 11716A/B Interconnection Kits | 558 |
| 11717A Attenuator/Switch Rack Mount Kit | 558 |
| 11720A Pulse Modulator | 542 |
| 11721A Frequency Doubler | 539 |
| 11722A Sensor Module | 716 |
| 11723B Software Application Pac for HP 8953A & 85B | 729 |
| 11726A Support Kit for HP 8673B/C/D | 545 |
| 11729C Carrier Noise Test Set | 712 |
| 11731A Frequency Extension Retrofit Kit | 548 |
| 11732A Frequency Extension Retrofit Kit | 548 |
| 11736A I-Q Tutor Training Kit | 151 |
| 11740S Phase Noise Measurement System | 714 |
| 11775A Waveform Generation Software | 451 |
| 11790A/B Software Application Pac for HP 8953A & 9816S, 9826S, 9836S | 729 |
| 11791A Software for HP 8955A, 9816S & 9836S | 728 |
| 11792A Sensor Module | 717 |
| 11793A Microwave Converter | 717 |
| 11794A Software Pac | 717 |
| 11795A Software Pac | 718 |
| 11797A Cellular Radio Test Software | 731 |
| 11801A/B/C On-Site Service Kits for HP 8642A/B | 528 |
| 11805A Software Application Pac for HP 8953A | 729 |
| 11850A/B Power Splitters | 561, 616, 622 |
| 11851A RF Cable Kit for HP 8505A | 616, 623 |
| 11852A 50-75 Ω Minimum Loss Pad | 601, 623 |
| 11853A 50 Ω Type N Accessory Kit | 623 |
| 11854A 50 Ω BNC Accessory Kit | 623 |
| 11855A 75 Ω Type N Accessory Kit | 623 |
| 11856A 75 Ω BNC Accessory Kit | 623 |
| 11857A/B Test Port Extension Cables for HP 8503A & B | 616, 634 |
| 11858A Transistor Fixture Adapter | 623 |
| 11866A APC-7 Calibration Kit | 637 |
| 11867A RF Limiter | 698 |
| 11869A Adapter for HP 86200 Series Sweeper Plug-ins | 503, 520 |
| 11870A Low Pass Filter | 684 |
| 11873A Accuracy Enhancement Program (for HP 8408B) | 637 |
| 11970 Series Harmonic Mixers | 697 |

MODEL NUMBER INDEX

New product listings are printed in bold face type

| | |
|---|-----------------|
| 11971 Series Harmonic Mixers | 697 |
| 11975A Microwave Power Amplifier..... | 490 |
| 12000 | |
| 12060B 8-Channel Analog Input Card..... | 310 |
| 12061A 32-Channel Analog Input Expansion Card..... | 310 |
| 12062A 4-Channel Analog Output Card..... | 310 |
| 12063A 32-Channel Digital Multifunction Card..... | 310 |
| 12153A A700 Writable Control Store Card..... | 82 |
| 12156A A700 Floating Point Processor..... | 82 |
| 12157A A-Series Battery Backup System..... | 82 |
| 13000 | |
| 13064A Tape Degausser..... | 408 |
| 13395A Headspace Sampler..... | 736 |
| 14000 | |
| 14513A Rack Kit (for one unit, 3½ in. H)..... | 267, 269 |
| 14515A Rack Kit (for one unit, 5¼ in. H)..... | 269 |
| 14521B Rack Kit (for Bench Series)..... | 267 |
| 14523A Rack Kit (for two units, 3½ in. H)..... | 267, 269 |
| 14525A Rack Kit (for two units, 5¼ in. H)..... | 269 |
| 14533B Pocket Programmer..... | 282 |
| 14534A Pocket Programmer Cable..... | 282 |
| 14535A Interface Kit, DCPS-to-HP 1000 Computers..... | 282 |
| 14536A DCPS Chaining Cable..... | 282 |
| 14540A 1000 Cable Assembly, Multiprogrammer-to-HP 1000 Computers..... | 320 |
| 14541A Chaining Cable, HP 6940B or 6941B to HP 6941B..... | 320 |
| 14550B Interface Kit, Multiprogrammer-to-HP 1000 Computers..... | 320 |
| 14551A Multiprogrammer Service Kit..... | 320 |
| 14558A Termination Panel..... | 320 |
| 14570A AC Power Controller..... | 323 |
| 14711A Field Service Kit..... | 323 |
| 14711D Field Service Kit..... | 323 |
| 14750A Computer Aided Test Programming Package..... | 319 |
| 14750R Right to Reproduce CAT Program Pkg..... | 319 |
| 14751A Computer Aided Test Programming Package..... | 319 |
| 14801A PC Instruments Rack Shelf | 198 |
| 14802A PC Instruments Terminal Block | 198 |
| 14855AA PC Instruments Data Acquisition System | 198, 199 |
| 14856AA PC Instruments Data Acquisition System | 198, 199 |
| 14857AA HP-IB Command Library for MS-DOS | 200 |
| 14858A ASYST Scientific Software..... | 199 |
| 15000 | |
| 15104A Pulse Adder/Splitter..... | 488 |
| 15115A Pulse Splitter/Inverter..... | 488 |
| 15116A Pulse Inverter..... | 488 |
| 15179A Rack Adapter Frame..... | 485 |
| 15406A-15423A HP 8180A/82A Accessories..... | 469 |
| 15408A-15411A HP 8175A Accessories..... | 471 |
| 15413A Tristate Pod for HP 8180A/81A..... | 469 |
| 15414A Tristate Unit for HP 8180A/81A..... | 469 |
| 15415A Plug-on Miniprobe..... | 471 |
| 15424A Performance Board..... | 369, 469 |
| 15425A Test Head..... | 369, 469 |
| 15426A Receptacles..... | 469 |
| 15427A DUT Board..... | 469 |
| 15428A Relays..... | 469 |
| 15429A Solder-in Receptacles..... | 471 |
| 15430A Cable for Master-Slave Operation..... | 471 |
| 15453A-15458A HP 8170A Accessories..... | 474 |
| 15461A ECL Pod..... | 471 |
| 15462A TTL/CMOS Pod..... | 471 |
| 15463A Trigger Pod..... | 471 |
| 15475A Optical Cleaning Kit..... | 575 |

| | |
|--|-----|
| 15507A Isolator..... | 150 |
| 15508B Converter (75 Ω Unbal. - 110 Ω Bal.)..... | 150 |
| 15508C Converter (75 Ω Unbal. - 120 Ω Bal.)..... | 150 |
| 15509A/B Amplifiers..... | 150 |
| 15510A 75 Ω Cable Accessory..... | 150 |
| 15511A 120 Ω Cable Accessory..... | 150 |
| 15512A Cable..... | 150 |
| 15513A Cable..... | 150 |
| 15514A Transit Case..... | 150 |
| 15515B Loop Holding Unit..... | 150 |
| 15518A/B/C Loop Holding Accessories..... | 150 |
| 15580A 20 MHz High-Impedance Active Probe..... | 153 |
| 15581B 25 MHz High-Impedance Passive Probe..... | 153 |
| 15582A Return Loss Kit..... | 153 |
| 15589A Instrument Cart..... | 153 |
| 15600A Isolator (3.7 to 4.2 GHz)..... | 164 |
| 15601A Isolator (5.9 to 6.5 GHz)..... | 164 |
| 15602A Isolator (7.1 to 8.1 GHz)..... | 164 |
| 15603A Isolator (10.7 to 11.7 GHz)..... | 164 |
| 15609A Remote Extender Cable..... | 164 |

16000

| | |
|---|-----|
| 16005A Probe..... | 347 |
| 16006A Probe..... | 347 |
| 16007A/B Test Leads..... | 347 |
| 16008A Resistivity Cell..... | 347 |
| 16014A Series Loss Test Adapter..... | 346 |
| 16023B DC Bias Controller..... | 339 |
| 16034B Test Fixture for Chip Components..... | 339 |
| 16047A Direct Coupled Test Fixture..... | 329 |
| 16047B Test Fixture with Safety Cover..... | 339 |
| 16047C Test Fixture for High Frequencies..... | 329 |
| 16047D Direct Coupled Test Fixture..... | 329 |
| 16048A Test Leads, BNC..... | 329 |
| 16048B Test Leads, RF Miniature..... | 329 |
| 16048C Test Leads, Alligator Clips..... | 329 |
| 16048D Test Leads, BNC (2m)..... | 343 |
| 16053A Test Leads..... | 361 |
| 16054A Connection Selector..... | 361 |
| 16055A Test Fixture..... | 361 |
| 16056A Current Divider..... | 361 |
| 16058A Test Fixture..... | 359 |
| 16061A Test Fixture..... | 345 |
| 16062A Test Leads..... | 345 |
| 16063A Test Leads..... | 345 |
| 16064A Retrofit Kit for Comparator..... | 343 |
| 16065A External DC Bias Test Fixture..... | 343 |
| 16066A Test Fixture Adapter..... | 351 |
| 16067A 24-pin DIP Low Leakage Fixture..... | 351 |
| 16068A 48-pin DIP Low Leakage Fixture..... | 351 |
| 16069A Universal Low Leakage Fixture..... | 351 |
| 16070A General Purpose DIP Fixture..... | 351 |
| 16071A Universal Fixture..... | 351 |
| 16072A Personality Broad..... | 351 |
| 16073A Personality Board..... | 353 |
| 16075A Relay Test Adapter..... | 351 |
| 16076A System Test Module..... | 351 |
| 16077A Extension Cable Fixture..... | 351 |
| 16079A System Test Module..... | 353 |
| 16080A Direct Coupled Test Fixture..... | 363 |
| 16081A Test Leads..... | 363 |
| 16082A Test Leads..... | 363 |
| 16083A Pulse Bias Noise Clipper..... | 363 |
| 16083B External Bias Adapter..... | 355 |
| 16085A Terminal Adapter..... | 329 |
| 16086A Accessory Kit..... | 329 |
| 16091A Coaxial Fixture Set..... | 333 |
| 16092A Spring Clip Fixture..... | 333 |
| 16093A/B Binding Post Fixture..... | 333 |
| 16094A Probe Fixture..... | 333 |



| | |
|---|-----|
| 16095A Probe Fixture..... | 331 |
| 16096A 2-Port Component Test Fixture..... | 331 |
| 16097A Accessory Kit..... | 331 |
| 16099A Test Fixture Adapter..... | 335 |
| 16117A Low Noise Test Leads..... | 347 |
| 16143A Probe Cable..... | 347 |
| 16145A Interconnection Cable Set..... | 353 |
| 16146A Measurement Cable..... | 353 |
| 16147A Text Fixture..... | 353 |
| 16148A Test Leads..... | 353 |
| 16262B Software Disc Set..... | 351 |
| 16262C Application Software..... | 351 |
| 16263A Application Software..... | 353 |
| 16264A Control Software..... | 353 |
| 16380A/C Standard Capacitor Sets..... | 348 |
| 16451A Dielectric Test Adapter..... | 346 |
| 16462A Auxiliary Capacitor..... | 346 |
| 16470A/B/C Reference Inductors..... | 346 |

17000

| | |
|---|-----|
| 17090B Measurement Graphics Software..... | 396 |
| 17108A Time Base..... | 399 |
| 17580B HP-ISPP Software..... | 104 |

18000

| | |
|---|-----|
| 18107A External Oscillator (HP 2804A)..... | 735 |
| 18110A Laboratory Probe and Cal Module, 26 mm (1 in.) (HP 2804A)..... | 735 |
| 18111A Laboratory Probe and Cal Module, 232 mm (9.1 in.) (HP 2804A)..... | 735 |
| 18138A X.25 Interface Kit..... | 132 |
| 18144A Protocol Decode Pack..... | 132 |
| 18145A Remote Pack..... | 132 |
| 18146A CCITT #7 Decode..... | 132 |
| 18151JA X.25 Certification & Analysis System..... | 132 |
| 18153A SNA Analysis..... | 132 |
| 18154A X.21 Interface Kit..... | 132 |
| 18155A BSC-X.25 Decode..... | 132 |
| 18178A X.21 Interface Kit..... | 132 |
| 18186A SNA Analysis..... | 132 |
| 18187A DDCMP Decode/Simulate..... | 132 |
| 18193A X.25 Package..... | 132 |
| 18197A Combination X.21 & RS-232C/V.24 Interface Pod..... | 132 |
| 18199A CCITT #7 CCS7 Analysis..... | 132 |
| 18201A Async Terminal Emulator..... | 132 |

19000

| | |
|--|-----|
| 19395A Headspace Sampler..... | 736 |
| 19800A/B Waveform Measurement Library..... | 438 |
| 19801A/B/C Waveform Measurement Library..... | 438 |
| 19807A Service Extender for HP 1980 Expansion Modules..... | 442 |
| 19811A Plot/Sequence ROM..... | 439 |
| 19860A Digital Waveform Storage..... | 438 |

20000

| | |
|---|-----|
| 25501D 16 Channel High Speed Analog Input Card..... | 309 |
| 25502B 32 Channel High Level Multiplexer Card..... | 309 |
| 25503D 32 Channel Low Level Multiplexer Card..... | 309 |
| 25503E 32 Channel Low Level Multiplexer with Thermocouple Reference Connector..... | 309 |
| 25504D 16 Channel Relay Multiplexer Card..... | 309 |
| 25504E 16 Channel Relay Multiplexer with Thermocouple Reference Connector..... | 309 |
| 25510D 8 Channel Isolated Voltage/Current Analog Output Card..... | 309 |
| 25511B 32 Channel Digital Input Card..... | 309 |
| 25512B 4 Channel Counter Input Card..... | 309 |
| 25513B 32 Channel Digital Output Card..... | 309 |
| 25514B 16 Channel Digital Relay Output Card..... | 309 |

| | |
|--|-----|
| 25515B 4 Channel Pulse Output Card..... | 309 |
| 25516B 16 Channel In/16 Channel Out Digital Multifunction Card..... | 309 |
| 27110A HP-IB Interface..... | 75 |
| 27112A General-Purpose Interface..... | 75 |
| 27116A HP-CIO Extender Card..... | 75 |
| 27122A RJE Interface..... | 75 |
| 27123A SRM Interface..... | 75 |
| 27125A LAN Interface..... | 75 |
| 27128A Asynchronous Serial Interface..... | 75 |
| 27130A Eight-Channel Multiplex Card..... | 75 |
| 27505A HP Word/150..... | 49 |

30000

| | |
|---|--------|
| 33300 Series Coaxial Step Attenuators..... | 560 |
| 33311B/C Coaxial Switches..... | 569 |
| 33312B Coaxial Switch..... | 569 |
| 33313B Coaxial Switch..... | 569 |
| 33320 Series Coaxial Step Attenuators..... | 560 |
| 33330B/C Coaxial Crystal Detectors..... | 564 |
| 33340A/B/C Coaxial Attenuator..... | 556 |
| 34110A Carrying Case..... | 218 |
| 34111A High Voltage Probe..... | 218 |
| 34112A Touch-Hold Probe..... | 218 |
| 34118A Test Lead Kit..... | 218 |
| 35151D The Calendar..... | 49 |
| 35152D The List Manager..... | 49 |
| 35153D The Writer..... | 49 |
| 35154D The Speller..... | 49 |
| 35155D The Planner..... | 49 |
| 35156D The Personal Correspondence Pack..... | 49 |
| 35157D The Personal Organizer Pack..... | 49 |
| 35177M JetStart (for HP ThinkJet)..... | 48 |
| 35178M LaserStart (for HP LaserJet)..... | 48 |
| 35723A HP Touch Accessory..... | 70, 87 |
| 35731A/B Monochrome Monitor..... | 70, 87 |
| 35741A/B Color Monitor..... | 70 |
| 36569A HPMessage..... | 49 |
| 37014B FDM Measurement Software..... | 154 |
| 37016A FDM Network Surveillance Software..... | 154 |
| 37050S FDM Network Monitoring System..... | 154 |
| 37051S FDM Measurement System..... | 154 |
| 37100S Remote Access and Test System..... | 166 |
| 37201A HP-IB Extender..... | 125 |
| 37203A HP-IB Extender..... | 124 |
| 37203L HP-IB Extender (Plug-In Card)..... | 124 |
| 37212A Stand Alone Modem..... | 88 |
| 37213A Modem Card..... | 88 |
| 37214A Modem Interface Card Cage..... | 88 |
| 37215A Modem Interface Card..... | 88 |
| 37216A Terminal Interface Card..... | 88 |
| 37461A Display..... | 152 |

40000

| | |
|--|-----|
| 43100A Defibrillator..... | 741 |
| 43700 Flash X-Ray Systems..... | 756 |
| 43855A Cabinet X-Ray Systems..... | 756 |
| 44462A 10 Channel Multiplexer Assembly..... | 291 |
| 44463A Extra Connector Block..... | 291 |
| 44464A Breadboard Assembly..... | 291 |
| 44465A 8-Bit In, 8-Bit Out Digital I/O Assembly..... | 291 |
| 44466A Extra Connector Block for HP 44465A..... | 291 |
| 44469A Seven 10:1 Dividers..... | 291 |
| 44538A Standard Test Fixture Kit..... | 390 |
| 44539A Large Test Fixture Kit..... | 390 |
| 44540A Dual Test Fixture Kit..... | 390 |
| 45310A BASIC Programmer's Library..... | 48 |
| 45311A ICON Design System..... | 48 |
| 45400D WordStar®..... | 49 |
| 45405A Deluxe VisiCalc..... | 49 |

MODEL NUMBER INDEX

New product listings are printed in bold face type



| | |
|--|------------|
| 45406E TextCharts/IBM | 49 |
| 45408C DataFax™ by Link System..... | 48 |
| 45411A Drawing Gallery | 49 |
| 45412A VT100 Terminal Emulator | 48 |
| 45413G/H Calculator/HP-UX | 68 |
| 45414A Transend COMplete™..... | 48 |
| 45416A Condor™ ₃ | 48 |
| 45418A Executive MemoMaker | 49 |
| 45419C Programmer's Tools..... | 48 |
| 45420E MemoMaker for the IBM PC..... | 49 |
| 45420G/H MemoMaker..... | 68 |
| 45421A Executive Card Manager | 48 |
| 45422A Personal Card File..... | 48 |
| 45422E Personal Card File for IBM PC..... | 48 |
| 45423A Financial Calculator..... | 49 |
| 45424A MultiMate | 49 |
| 45427D WordStar Professional®..... | 49 |
| 45429A WordStar Professional Options..... | 49 |
| 45431A AdvanceLink/150..... | 48 |
| 45431E AdvanceLink/IBM for the IBM PC..... | 48 |
| 45433A Gallery Picture Library Vol. II..... | 49 |
| 45435A Touchscreen Programmer's Tools..... | 48 |
| 45437A The Gallery Collection | 49 |
| 45438G/H Management Solution HP-UX | 68 |
| 45439A Monitor/IBM PC..... | 48 |
| 45442A ExecuDesk System | 49 |
| 45443A Forms Master | 48 |
| 45444A ExecuDesk | 49 |
| 45445D BASIC by Microsoft®..... | 48 |
| 45446D Compiled BASIC by Microsoft | 48 |
| 45447D Pascal by Microsoft..... | 48 |
| 45448A COBOL by Microsoft..... | 48 |
| 45449D FORTRAN by Microsoft..... | 48 |
| 45450D GW™ BASIC by Microsoft..... | 48 |
| 45452D Lattice® C Compiler..... | 48 |
| 45455A BPI General Accounting™..... | 49 |
| 45456A BPI Accounts Receivable™..... | 49 |
| 45457A BPI Accounts Payable™..... | 49 |
| 45458A BPI Payroll™..... | 49 |
| 45460A BPI Inventory Control™..... | 49 |
| 45461A BPI Job Cost™..... | 49 |
| 45462A/B Picture Perfect™..... | 49, 68, 73 |
| 45463A/B Diagraph™..... | 49, 68, 73 |
| 45465A MicroPlan™..... | 49 |
| 45466A MicroPlan™ Consolidation Module..... | 49 |
| 45467A GraphPlan™..... | 49 |
| 45468C dBASE II..... | 48 |
| 45468D dBASE II™..... | 48 |
| 45472B User-Definable Softkeys..... | 68 |
| 45473D MicroSoft MultiPlan™..... | 49 |
| 45474D MicroSoft Word..... | 49 |
| 45475B Games/200 | 68 |
| 45480B Data Grapher/200..... | 68, 73 |
| 45481B Context MBA™..... | 73 |
| 45482A 1-2-3™ from Lotus™..... | 49 |
| 45482K 1-2-3 from Lotus..... | 49 |
| 45484A Graphwriter®..... | 49 |
| 45488A PFS®: File and PFS®: Report..... | 49 |
| 45489A PFS: Write®..... | 49 |
| 45490A PFS: Graph®..... | 49 |
| 45498A Symphony™ by Lotus..... | 48 |
| 45502A MicroPlan (CP/M) (for Series 80)..... | 49 |
| 45503A MicroPlan Cons. Option (for Series 80)..... | 49 |
| 45504K MemoMaker/Time Management, Opt. 400..... | 48 |
| 45511D Dow Jones Spreadsheet Link™..... | 48 |
| 45513A Charting Gallery..... | 49 |
| 45515G/H TKISolver®/HP-UX..... | 68 |
| 45516/17/18/19G TKISolverPack®/HP-UX Software..... | 68 |
| 45520C Rags to Riches Ledger™..... | 49 |
| 45521C Rags to Riches Sales™..... | 49 |
| 45522C Rags to Riches Receivables™..... | 49 |
| 45523C Rags to Riches Payables™..... | 49 |
| 45524G/H MicroTrak™/HP-UX..... | 69 |
| 45537B Graphics Editor/200..... | 69, 73 |
| 45538B Text Editor/200..... | 69, 73 |
| 45540A Painter..... | 49 |
| 45545A R:BASE™ 4000/150..... | 49 |
| 45549K Microsoft™ Word..... | 49 |
| 45554K MultiMate™..... | 49 |
| 45555K Executive Card Manager..... | 49 |
| 45580A Milestone® (for Series 80)..... | 48 |
| 45581A Datebook™ II (for Series 80)..... | 48 |
| 45582A Personal Datebook™..... | 48 |
| 45583A dBASE II (for Series 80)..... | 48 |
| 45584A WordStar/80 (CP/M) (for Series 80)..... | 49 |
| 45587A MailMerge®/80 (CP/M) (for Series 80)..... | 49 |
| 45588A SpellStar®/80 (CP/M) (for Series 80)..... | 49 |
| 45639A EtherMail/150 User Software..... | 48 |
| 45640A Touchscreen Internal Modem..... | 48 |
| 45641B Touchscreen 3278 Emulation Accessory with File Transfer | 48 |
| 45643A Extended I/O Accessory..... | 55 |
| 45644A EtherLink™/150..... | 48 |
| 45645A EtherShare™/150..... | 48 |
| 45646A EtherPrint™/150..... | 48 |
| 45647A EtherMail™/150 Server Software..... | 48 |
| 45649A EtherStart™/150..... | 48 |
| 45680A Type-a-Line..... | 49 |
| 45861A Touchscreen HP-IB Controller..... | 201 |
| 45862A Touchscreen PCIB Controller..... | 201 |
| 46020A HP-HIL Keyboard..... | 70 |
| 46060A HP-HIL Mouse..... | 70 |
| 46082A 15/30 Meter Remote Extension..... | 70 |
| 46083-89A HP-HIL Input Devices..... | 70, 71 |
| 47956A AutoCAD 8/150..... | 48 |
| 50000 | |
| 50011B HP-IB Instrument Control Using Series 200 BASIC..... | 760 |
| 50004A HP 6942A Multiprogrammer User's Course..... | 323 |
| 50015A Data Acquisition and Control Fundamentals..... | 761 |
| 50016E HP-IB Instrument Programming with HP 1000E/F Series Computers..... | 760 |
| 50600B Instrument Application Services..... | 762 |
| 50902A OfficeShare Network Server Software..... | 48 |
| 50903A OfficeShare Network User Software..... | 48 |
| 50961A SRM Coax Interface..... | 68, 72, 75 |
| 51800A Waveform Measurement System..... | 427 |
| 51810A, R Video-Measurement Set..... | 168 |
| 51810S Video-Measurement System..... | 168 |
| 51820A Waveform Generation Software..... | 429 |
| 52126A Intel Multibus Interface..... | 416 |
| 54001A 1-GHz Active Probe Pod..... | 433 |
| 54002A 50Ω BNC Input Pod..... | 433 |
| 54003A 1-MΩ Probe Pod..... | 433 |
| 54100A 1-GHz Digitizing Oscilloscope..... | 430 |
| 54100D 1-GHz Digitizing Oscilloscope with Logic Triggering..... | 430 |
| 54110D 1-GHz Color Digitizing Oscilloscope..... | 430 |
| 54200A 200-Msample/s Digitizing Oscilloscope..... | 434 |
| 54200D 200-Msample/s Digitizing Oscilloscope With Logic Triggering..... | 434 |
| 54300A Probe Multiplexer..... | 443 |
| 55005S Logic Troubleshooting System..... | 372 |
| 59301A ASCII-Parallel Converter..... | 122 |
| 59303A Digital-to-Analog Converter..... | 122 |
| 59306A HP-IB Relay Actuator..... | 122 |
| 59307A HP-IB VHF Switch..... | 122 |
| 59309A HP-IB Digital Clock..... | 123 |
| 59313A HP-IB Analog-to-Digital Converter..... | 123 |

59401A Bus System Analyzer.....121
 59500A Multiprogrammer HP-IB Interface.....320
 59501B HP-IB Power Supply Programmer.....123, 281
 K34-59991A Broadband Linear Phase Comparator.....253
 K70-59992A Rack Mount Adapter Kit (HP 5342A, 5343A).....229

60000

61001A PC Instruments System Power Unit.....198
 61010AA PC Instruments Digital I/O.....195
 61011AA PC Instruments Relay Multiplexer.....195
 61012AA PC Instruments Dual Voltage DAC.....195
 61013AA PC Instruments Digital Multimeter.....195, 196
 61014AA PC Instruments Function Generator.....196
 61015AA PC Instruments Universal Counter.....196, 197
 61016AA PC Instruments Digitizing Oscilloscope.....197, 198
 61017AA PC Instruments Relay Actuator.....198
 61060AA PC Instruments Interface for HP Touchscreen.....198
 61061AA PC Instruments Interface for IBM PC.....198
 61062AA HP-IB Command Library for MOS-DOS
 (HP Vectra PC & IBM PC Version).....200
 61086AA PC Instruments Data Logging Package
 for HP Touchscreen.....201, 202
 61087AA PC Instruments Data Logging Package
 for IBM PC.....202
 61088AA PC Instruments Electronic Bench Package
 for HP Touchscreen.....202
 61089AA PC Instruments Electronic Bench Package
 for IBM PC.....202
 64000 Logic Development System.....183
 64000 Logic Development Concepts and Measurements.....760
 64000 System Pascal Programming Course.....760
 64100A Development Station.....186
 64110A Development Station.....186
 64200S Series Emulators.....188
 64276A Run Control.....191
 64302A Emulation Bus Analyzer.....188
 64310A Software Performance Analyzer.....188
 64310A + 24A Software Performance Analyzer
 Training.....760
 64320S 25MHz Logic State Software Analyzer.....191
 64330 High-Level Software Analyzer.....188
 64340 Real-Time, High-Level Software Analyzer.....188
 64500S PROM Programmer.....192
 64600 Series Preprocessors.....190
 64610S High Speed Hardware/Timing Analyzer.....190
 64600S + 24F Hardware/Timing Analyzer Training.....760
 64620S Software/State Analyzer.....190
 64800 Series Cross Assemblers/Compilers.....192
 69280A Breadboard Card.....321
 69321B D/A Voltage Converter.....321
 69322A Quad D/A Voltage Converter Card.....321
 69331B Digital Output Card.....321
 69332A Open Collector Output Card.....321
 69335A Stepping Motor Control Card.....321
 69336B High Speed Scanner Card.....321
 69351C Voltage Regulator Card.....321
 69370A D/A Current Converter Card.....321
 69380A Breadboard Output Card.....321
 69422A High Speed A/D Converter Card.....321
 69423A Low Level A/D Converter Card.....321
 69430A Isolated Digital Input Card.....321
 69431A Digital Input Card.....321
 69433A Relay Output With Readback Card.....321
 69434A Event Sense Card.....321
 69435A Pulse Counter Card.....321
 69436A Process Interrupt Card.....321
 69480A Breadboard Input Card.....321
 69500A Unloaded Resistance Output Card.....321
 69501A-69513A Power Supply Control Cards.....321
 69520A Power Supply Programming Card.....321

69602B Timer/Pacer Card.....321
 69700A-69706A Resistance Output Cards.....318
 69709A Power Supply Control Card.....318
 69720A Digital-to-Analog Voltage
 Converter Card.....318
 69721A Digital-to-Analog Current
 Converter Card.....318
 69730A Relay Output Card.....318
 69731B Digital Output Card.....318
 69735A Pulse Train Output/Stepping Motor
 Control Card.....318
 69736A Timer/Pacer Card.....318
 69750A Scan Control/Pacer Card.....318
 69751A Analog-to-Digital Converter Card.....318
 69752A 64 Channel FET Scanner Card.....318
 69754A 32 Channel Relay Scanner Card.....318
 69755A 16 Channel FET Scanner Card.....318
 69759A 500 kHz A/D Converter Card.....318
 69770A Isolated Digital Input Card.....318
 69771A Digital Input/Analog Comparator Card.....318
 69775A Counter/Totalizer Card.....318
 69776A Interrupt Card.....318
 69790B Memory Card.....318
 69791A/69792A 1 Megaword Memory System.....318
 69793A Breadboard Card.....318

70000

70001A Modular Measurement System Mainframe.....651
 70205A Graphics Display Module.....651
 70206A System Graphics Display.....651
 70300A Tracking Generator Module.....651
 70310A Precision Frequency Reference Module.....651
 70800A/B/C/D/E HP-MSIB Cables.....651
 70900A Local Oscillator Module.....651
 70902A IF Section Module (Res BW 10 Hz - 300 kHz).....651
 70903A IF Section Module (Res BW 100 kHz - 3 MHz).....651
 70904A RF Section Module (100 Hz - 2.9 GHz).....651
 70905A RF Section Module (50 kHz - 22 GHz).....651
 70906A RF Section Module (50 kHz - 26.5 GHz).....651
 70907A External Mixer Interface Module.....651
 71000S Spectrum Analyzer System Reference.....647
 71100A RF Spectrum Analyzer (100 Hz - 2.9 GHz).....647, 650
 71200A Microwave Spectrum Analyzer
 (50 kHz - 22/26.5 GHz).....647, 650
 71300A Millimeter Spectrum Analyzer.....647, 650

80000

81511A Optical Head, 550 to 950 nm.....574
 81512A Optical Head, 900 to 1750 nm.....574
 81519A Optical Receiver.....575
 81800S Digital Circuit Test System.....369
 81800A Software Pac.....369, 469
 82104A Card Reader (HP-41CV/CX).....54
 82143A Printer/Plotter (HP-41CV/CX).....54
 82153A Optical Wand (HP-41CV/CX).....54
 82160A HP-IL Module (HP-41CV/CX).....54
 82161A Digital Cassette Drive.....54
 82162A Printer/Plotter.....55
 82164A HP-IL/RS-232C Interface.....55
 82166C HP-IL Interface Kit.....55
 82168A Acoustic Coupler.....55
 82169A HP-IL/HP-IB Interface.....55
 82180A Extended Functions/Memory Module (HP-41CV).....55
 82181A Extended Memory Module.....55
 82182A Time Module (HP-41CV).....54
 82183A Extended I/O Module.....54
 82184A Plotter Module.....54
 82400A Card Reader (HP-71B).....54
 82401A HP-IL Interface (HP-71B).....54
 82402A HP-IL Extender.....54



MODEL NUMBER INDEX

New product listings are printed in bold face type

| | | | |
|--|--------------------------|---|----------------------|
| 82420A 4K Memory Module (HP-71B)..... | 55 | 83572A/B 26.5-40 GHz RF Plug-in for HP 8350B..... | 510 |
| 82440A Software Development Utility (HP-71B)..... | 56 | 83590A 2-20 GHz RF Plug-in for HP 8350B..... | 504 |
| 82441A FORTH/Assembler (HP-71B)..... | 56 | 83592A/B/C 0.01-20 GHz RF Plug-in for HP 8350B..... | 504 |
| 82479A Data Acquisition Pac (HP-71/HP 3421A)..... | 57 | 83594A 2-26.5 GHz RF Plug-in for HP 8350B..... | 504 |
| 82487A Custom Keyboard Overlays (HP-71B)..... | 56 | 83595A 0.01-26.5 GHz RF Plug-in for HP 8350B..... | 504 |
| 82491-82494A/B Custom Modules (HP-71B)..... | 56 | 84811A Peak Power Sensor..... | 583 |
| 82501A Custom Keyboard Overlays (HP-41)..... | 56 | 85011A System Software for HP 8507D..... | 625 |
| 82502A Custom Magnetic Cards (HP-41)..... | 56 | 85013A Basic Measurements Application Pac (HP 8510A)..... | 630 |
| 82504A Custom Keyboard Touchpads..... | 56 | 85014A Active Device Measurements Application Pac (HP 8510A)..... | 630 |
| 82508A/B Custom Modules (HP-41)..... | 56 | 85015B System Software for HP 8756S and 8757S..... | 600, 604 |
| 82509A/B Custom Modules (HP-41)..... | 56 | 85016B Transmission Line Test Software for HP 8756S and 8757S..... | 600, 604 |
| 82700A 8K-Byte Memory Module (HP-75)..... | 55 | 85020A/B RF Directional Bridge for HP 8755, 8756, 8757..... | 597 |
| 82713A Plug-in Module Simulator (HP-75)..... | 56 | 85022A System Cable Kit for HP 8756S and 8757S..... | 600 |
| 82718A Expansion Pod (HP-75)..... | 54 | 85023A/B/C/D System Verification Kit for HP 8756S and 8757S..... | 600 |
| 82721A Custom Keyboard Overlays (HP-75)..... | 56 | 85025A/B AC/DC Detector for HP 8757A..... | 598, 599 |
| 82722A Custom Magnetic Cards (HP-71B, HP-75)..... | 56 | 85025C Detector Adapter for HP 8757A..... | 550, 599 |
| 82725A Bar Code Reader Module (HP-75)..... | 54 | 85026A Waveguide Detector for HP 8757A..... | 550, 551, 599 |
| 82726-82729A/B Custom Modules (HP-75)..... | 56 | 85027A/B/C Microwave Directional Bridge for HP 8755, 8756, 8757..... | 597 |
| 82800A VisiCalc Plus®..... | 49 | 85031A APC-7 Calibration and Verification Kit for HP 8507D..... | 625 |
| 82801A Graphics Presentation Pack..... | 49 | 85032A 50 Ω Type-N Calibration Kit..... | 625 |
| 82802A BASIC Training..... | 48 | 85033A SMA Calibration Kit..... | 625 |
| 82804A General Statistics..... | 48 | 85040B Reflection/Transmission Test Set..... | 637 |
| 82805A Basic Stat. and Data Manipulation..... | 48 | 85041A Transistor Text Fixture Kit..... | 630 |
| 82806A Regression Analysis..... | 48 | 85043A System Rack Kit..... | 627 |
| 82807A Statistical Analysis Multi-Pac..... | 48 | 85050A 7mm Calibration Kit..... | 629 |
| 82808A Linear Programming..... | 48 | 85051A 7mm Verification Kit..... | 629 |
| 82809A Waveform Analysis..... | 48 | 85052A 3.5mm Calibration Kit..... | 629 |
| 82810A AC Circuit Analysis..... | 48 | 85053A 3.5mm Verification Kit..... | 629 |
| 82811A Math..... | 48 | 85054A Type N Calibration Kit..... | 629 |
| 82812A Electronics Engineering MultiPac..... | 48 | 85129A Millimeter-Wave Measurement Software for HP 8510A..... | 631 |
| 82813A Surveying..... | 48 | 85130A Special 3.5mm to 7mm Adapter Kit..... | 629 |
| 82816A Text Editing Pack..... | 49 | 85131A 3.5mm Test Port Return Cable..... | 629 |
| 82817A IMPAC (Information Mgmt. Pack)..... | 49 | 85131B 3.5mm Test Port Return Cable Set..... | 629 |
| 82823A WORD/80..... | 49 | 85132A 7mm Test Port Return Cable..... | 629 |
| 82824A FILE/80..... | 49 | 85132B 7mm Test Port Return Cable Set..... | 629 |
| 82830A VisiCalc Plus..... | 49 | 85650A Quasi-Peak Adapter..... | 673 |
| 82831A Graphics Presentation Pack..... | 49 | 85685A RF Preselector..... | 672 |
| 82832A BASIC Training..... | 48 | 85863A BASIC Software Library for HP 8566A/B or 8568A/B..... | 667 |
| 82834A General Statistics..... | 48 | 85864B EMI Measurement Software for HP 8566A/B or 8568A/B..... | 673 |
| 82835A Basic Stat. and Data Manipulation..... | 48 | 85865A Signal Monitoring Software for HP 8566A/B or 8568A/B..... | 670 |
| 82836A Regression Analysis..... | 48 | 86200 series RF Plug-ins for HP 8620C and 8350B..... | 520 |
| 82837A Statistical Analysis Multi-Pac..... | 48 | 86222A/B RF Plug-ins for HP 8620C and 8350B..... | 518 |
| 82838A Linear Programming..... | 48 | 86240A/B/C RF Plug-ins for HP 8620C and 8350B..... | 519 |
| 82839A Waveform Analysis..... | 48 | 86251A 7.5-18.6 GHz RF Plug-in for HP 8620C and 8350B..... | 519 |
| 82840A AC Circuit Analysis..... | 48 | 86290B/C RF Plug-ins for HP 8620C and 8350B..... | 517 |
| 82841A Math..... | 48 | 86720A Frequency Extension Unit..... | 548 |
| 82842A Electronics Engineering MultiPac..... | 48 | 88104A File Manager..... | 49 |
| 82843A Surveying..... | 48 | 88140LC 67.0 Mbyte Tape..... | 93 |
| 82846A Personal Productivity Pack..... | 48 | 88140SC 16.0 Mbyte Tape..... | 93 |
| 82847A Business Productivity Pack..... | 49 | 88500A IBM Disc/Tape Interface..... | 89 |
| 82855A MicroSoft MultiPlan (CP/M)..... | 49 | | |
| 82861K PC 2622 (ROM-based)..... | 48 | | |
| 82862K Opt. 400 BASIC by Microsoft..... | 48 | | |
| 82906A Graphics Printer..... | 95, 96 | | |
| 82912A 9-Inch Monitor (HP-85B HP-86B)..... | 47 | | |
| 82913A 12-Inch Monitor (HP-85B HP-86B)..... | 47 | | |
| 82938A HP-IL/Series 80 Interface..... | 55 | | |
| 82973A HP-IL Interface Card..... | 55 | | |
| 83522A 0.01-2.4 GHz RF Plug-in for HP 8350B..... | 506 | | |
| 83525A/B 0.01-8.4 GHz RF Plug-in for HP 8350B..... | 506 | | |
| 83540A/B 2-8.4 GHz RF Plug-in for HP 8350B..... | 508 | | |
| 83545A 5.9-12.4 GHz RF Plug-in for HP 8350B..... | 508 | | |
| 83550A 8-20 GHz RF Plug-in for HP 8350B..... | 508 | | |
| 83554A 26.5-40 GHz Millimeter-Wave Source Module..... | 512-514, 550, 551 | | |
| 83555A 33-50 GHz Millimeter-Wave Source Module..... | 512-514, 550, 551 | | |
| 83556A 40-60 GHz Millimeter-Wave Source Module..... | 512-514, 550, 551 | | |
| 83570A 18-26.5 GHz RF Plug-in for HP 8350B..... | 510 | | |
| | | 90000 | |
| | | 91290A 5¼" HP Qualified Media..... | 89 |
| | | 92150D 600 ft. ½" Reel-to-Reel..... | 93 |
| | | 92150E 1200 ft. ½" Reel-to-Reel..... | 93 |
| | | 92150F 2400 ft. ½" Reel-to-Reel..... | 93 |
| | | 92192A 3½" Doublesided Microfloppy..... | 89 |
| | | 92242L 60.0 Mbyte Tape..... | 89 |
| | | 92242S 15.0 Mbyte Tape..... | 89 |



| | |
|--|--------------------|
| 92248BA Cross Reference Utility | 48 |
| 92267A/B Digital Bar Code Wands..... | 54 |
| 94445A TECAP-Parameter Extraction Software | 364 |
| 97033A HP-UX 5.0 Operating System | 71 |
| 97038JA Context MBA™ | 69 |
| 97050A BASIC for HP Model 520 Computer..... | 74 |
| 97052A BASIC 3-D Graphics | 75 |
| 97053A IMAGE/QUERY 9000 DBMS | 75 |
| 97056A BASIC Asynch Terminal Emulator | 75 |
| 97058A SRM for BASIC Systems..... | 75 |
| 97060A Graphics Processor | 75 |
| 97062A RGB Interface | 75 |
| 97070/80 HP-UX for HP Model 520 Computer..... | 74 |
| 97071/81 Fortran 77 Compilers for HP-UX | 74 |
| 97072/82 Pascal Compilers for HP-UX..... | 74 |
| 97074/84A Graphics 9000/DGL | 75 |
| 97075/85A Graphics 9000/AGP | 75 |
| 97076A Asynch Datacomm for HP-UX | 75 |
| 97077/87A HP-UX RJE Emulator for HP Series 500 | 75 |
| 97079/89 HP-UX for HP Models 530, 540, 550 | 74 |
| 97086 HP 1000 to HP 9000 Applications Migration..... | 74 |
| 98242A I/O Card Cage Upgrade Kit | 70 |
| 98243A HP Series 300 Processor Upgrade Kit | 70 |
| 98253A EPROM Programmer Interface | 72 |
| 98255A EPROM Card..... | 72 |
| 98256A 256-Kbyte RAM..... | 72 |
| 98257A 1-Mbyte RAM Card..... | 72 |
| 98259A Magnetic Bubble Memory Card | 72 |
| 98287A Series 300/98700H Interface | 72 |
| 98305A HP EGS Software | 69, 73, 182 |
| 98310A HP EGS Photoplotter and | |
| NC Drill Option Software | 182 |
| 98311A HP EGS IGES Pre-and | |
| Post-Processor Software | 182 |
| 98360 HP-DRAFT..... | 69 |
| 98515A HP-UX 5.1 Application Execution Environment..... | 71 |
| 98517A HP-UX 5.1 Programming Environment | 71 |
| 98518A HP-UX FORTRAN 77 Compiler | 71 |
| 98519A HP-UX Pascal Compiler..... | 71 |
| 98520A HP-UX DGL/AGP Graphics Library | 71 |
| 98542/43A Med. Res. Bit-Mapped Display Boards..... | 70 |
| 98544/45A High Res. Bit-Mapped Display Boards | 70 |
| 98546A Low Res. Alpha/Graphics Video Board..... | 70 |
| 98353A HP-FE Software..... | 177 |
| 98365A/66A Mechanical Design & Drafting Software..... | 178 |
| 98597A HP-UX 5.1 Programming Environment | 71 |
| 98598A HP-UX FORTRAN 77 Compiler | 71 |
| 98599A HP-UX Pascal Compiler..... | 71 |
| 98561A/B Series 300 CPU Box with Processor Board..... | 70 |
| 98568 Eight-Slot I/O Expander | 70, 71 |
| 98580A/81A/82A/83A Factory-Bundled Series 300 Systems..... | 71 |
| 98600A HP-UX DGL/AGP Graphics Library | 71 |
| 98601/02/03/04A ROM-Based BASIC Language Systems...67, 68 | |
| 98613A/B RAM-Based BASIC Language Systems | 67, 71 |
| 98614A RAM-Based HPL 2.0 Language System | 67 |
| 98615B/C RAM-Based Pascal Language Systems | 67, 71 |
| 98619A SRM Operating System | 73 |
| 98620B Two Channel DMA Controller/Interface..... | 68, 72 |
| 98622A GPIO Interface..... | 68, 72 |
| 98623A BCD Interface | 68, 72 |
| 98624A HP-IB Interface..... | 68, 72 |
| 98625A/B High-Speed HP-IB Disc Interface | 68, 72 |
| 98626A RS-232C Serial Interface..... | 72 |
| 98627A RGB Color Video Interface | 68, 72 |
| 98628A Datacomm Interface..... | 68, 72 |
| 98629A SRM Interface..... | 72, 73 |
| 98630A Breadboard Interface | 68 |
| 98633A HP 6944A Multiprogrammer Interface | 72 |
| 98635A Floating Point Math Board | 72 |
| 98640A Analog Input Interface..... | 68, 72 |
| 98641A RJE Interface | 68, 72 |
| 98642A 4-port RS-232C MUX Interface | 72 |
| 98643A LAN/300 ThinMAU Interface | 72 |
| 98644A RS-232 Serial Interface | 68, 72 |
| 98670/80A HP-UX Operating Systems..... | 67 |
| 98690A PDI Development Package for HP 98691A | 72 |
| 98691A Programmable Datacomm Interface | 68, 72 |
| 98693A SRM Access for HP-UX..... | 69, 71, 72 |
| 98694A SRM Access for HP-UX systems | 75 |
| 98695A IBM 3270 Coax Interface..... | 72 |
| 98710A Graphics Accelerator..... | 70, 75 |
| 98781A 17" High Res. Monochrome Monitor | 70 |
| 98782A 19" High Res. Color Monitor..... | 70 |
| 98791B HP 2392A/VT100 Terminal Emulator | 69, 73 |
| 98792A TEK 4010/HP 2622A Terminal Emulator | 69, 73 |
| 98795A IBM 3278 Emulator Software | 69 |
| 98797/98A RJE Software for HP-UX..... | 69, 71 |
| 98815A HP Graphics Presentation/200..... | 69, 73 |
| 98817A HP Project Management/200..... | 69, 73 |
| 98819A HP TechWriter Software | 69, 73, 182 |
| 98820A/B/C HP Statistics Library..... | 69, 73 |
| 98821A HP Numerical Analysis Library 200..... | 69, 73 |
| 9888A Bus Expander..... | 68, 72 |
| 98627A Color Video Interface..... | 68, 72 |
| 00041-15042 Automatic Start and Cassette | |
| Duplication Module (HP-41CV/CX) | 54 |
| 00041-15043 HP-IL Development Module (HP-41CV/CX)..... | 54 |
| 00071-90068 Vol. I: Detailed Design Description..... | 56 |
| 00071-90069 Vol. II: Entry Point and Poll Interfaces | 56 |
| 00071-90070 Vol. III: Operating System Source Listings..... | 56 |
| 00075-15001 I/O ROM (HP-75)..... | 54 |
| 0960-0054 SMA-Female Short (50 Ohm) | 567 |
| 0960-0055 SMA-Male Short (50 Ohm)..... | 567 |
| 1250-XXXX Series Adapters and Connectors | 742 |
| 1251-2277 Dual Banana Plug to BNC Female..... | 742 |
| 1251-2816 Dual Banana Plug (for Cable)..... | 742 |
| 1460-XXXX Series Cabinet Parts..... | 747 |
| 1490-XXXX Series Slide Kits, Casters | 749 |
| 1494-XXXX Series Slide Kits | 746 |
| 5040-XXXX Series Rack Frames..... | 748 |
| 5060-XXXX Control Panel Covers | 748 |
| 5060-XXXX Filler Panels..... | 748 |
| 5060-XXXX Rack Adapter Frames..... | 748 |
| 5060-XXXX Rack Mounting Kits..... | 748 |
| 5060-XXXX Series Racking Accessories, Covers | 748, 749 |
| 5061-XXXX Series System II Cabinet Parts..... | 744 |
| 8120-18XX Cables and Adapters | 742 |
| 9211-XXXX Series Operating Cases | 755 |
| 9211-XXXX Series Transit Cases | 750 |
| 82401-90023 HP-IL | 56 |

PERSONAL COMPUTERS & CALCULATORS

Overview

Advanced Personal Computers

Hewlett-Packard computers were first developed to meet a growing need for complex automatic test systems in industry. In the 20 years since the first HP computer was introduced, we've expanded our product line to include innovative personal computers for professional, business, office and computation systems.

Sophisticated test and measurement, instruments, such as those used today in research and manufacturing, require equally sophisticated controllers. Linking Hewlett-Packard's advanced personal computers to instrumentation creates a practical, cost-effective way to program and perform test procedures, analyze and compare data, and record and plot results. Coupled with powerful software tailored to your specific application, HP computers and instruments provide an integrated, single-vendor approach to a wide variety of measurement and computation environments.

Factory automation managers, data processing experts, and professionals in office management, engineering, and scientific environments can find an HP personal computer to fit their needs — as well as one that supports the level of assistance required for successful automation of an instrument system. With many built-in applications and programming aids, plus an unequalled variety of peripherals and accessories, HP computers provide a range of computing power for both novices and experienced users.

Touchscreen II and Touchscreen MAX II — Personal computers that offer an easy introduction to office automation and computer-controlled instruments. The HP Touch accessory lets you control your system by simply touching the screen.

Touchscreen HP-IB Controller and Touchscreen PCIB Controller — Integrating the Touchscreen II and the test and measurement instruments you use every day. We provide the hardware and software to control instrumentation on the IEEE-488 bus and HP PC Instruments Bus, using the Touchscreen II. See the Hewlett-Packard Interface Bus section for more information.

Vectra — Personal computers that have your future in mind, with a modular design that lets you configure a system to your requirements, while retaining add-on capabilities that don't penalize your system operation or budget. Software and hardware compatibility with the IBM® PC/AT™ includes a TopView-compatible environment manager; HP enhancements include greater versatility in input device management and mass storage support.

Portable PLUS — Personal computers that carry full-size computing features in a portable package, giving you a battery-powered, mobile companion that communicates with desktops and mainframes.

Series 80: HP-85B and HP-86B — Personal computers that are fully integrated instrument controllers, with powerful CPUs, multiple operating systems, a built-in printer on the HP-85B, and extensive communications interfacing to match your system needs.

HP-71 and HP-75 — Handheld computers that communicate with desktops and mainframes and that have full-size computing features in a small portable package, which you can take to the field for data collection or to the manufacturing floor for low-cost control.

PC Instruments — Personal-computer instrumentation products that form a unique hardware and software system, linking test and measurement instruments with personal computers. You can simultaneously monitor and control as many as eight different instruments per interface card from the screen of your HP Touchscreen II, Touchscreen MAX II, IBM PC, PC/XT™, and PC/AT personal computer. See the PC Instruments section for complete information on these products.

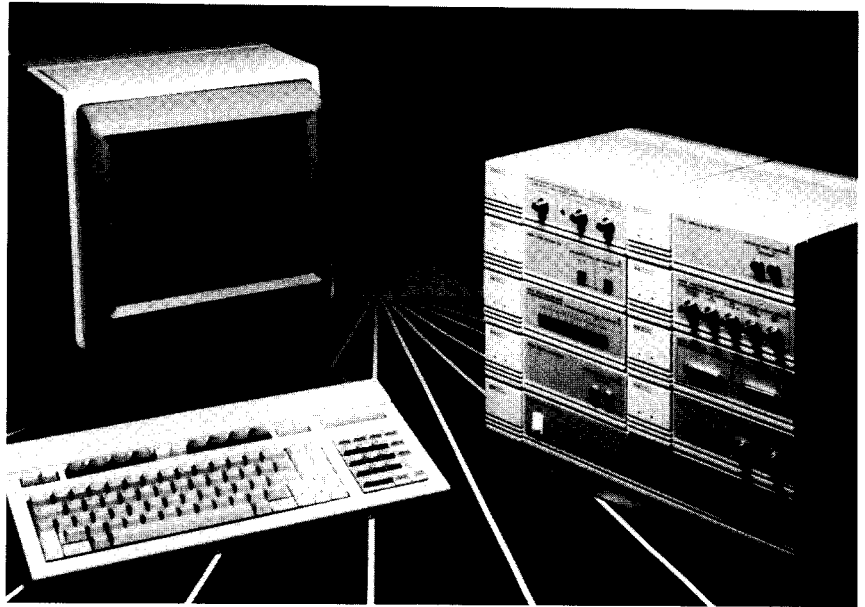

Using the PCIB and HP's PC Instruments, you can easily create your own automated test and measurement systems.

Advanced HP personal computers are also at the heart of IEEE-based measurement systems and computer-aided engineering systems, providing quick solutions to design, simulation, modeling, and test problems. In addition, such products as the Semiconductor Productivity Network, Manufacturing Resource Planning, and the HP Materials, Production, and Management programs combine the efficiency of HP personal computers with the strength of HP mainframes. For complete information on these applications, refer to the Technical and Business computers section.

Computational Tools for Data Acquisition and Instrument Control

HP's series of advanced calculators and handheld computers offers portability with the power of a computer. They are designed for use in science, engineering, and mathematics and can stand alone or be used as part of a system. Handheld computers are ideal in remote data collection with or without bar code, or as system controllers in field or manufacturing environments.

Advanced calculators and handheld computers may be enhanced to increase calculating options, ranging from classwork to complex engineering calculations. And they can become the intelligent center of a system by adding the Hewlett-Packard Interface Loop (HP-IL). This bit-serial interface for battery-operable systems provides the link to your instruments, peripherals, desktop computers, modems, and terminals. With HP-IL and add-ons, your handheld computer can transfer information collected from remote sites, or monitor and control production operations, processes, and experiments.

Handheld computers serve with HP-IL in applications that:

- Connect HP-IL systems to RS-232C devices.
- Link low-cost HP-IL systems with high-performance HP-IB computers and lab equipment.
- Control equipment operating with parallel bus structures.
- Display data on a standard video monitor.

Peripherals used with these applications via HP-IL interface and/or interface converter include digital cassette drives, portable disc drives, thermal printers and plotters, the battery-powered HP ThinkJet printer, two-pen graphics plotters, and an acoustic coupler/modem.

Sharing Information and Resources

Networking capabilities provide the links between individual personal computers, mainframes, minicomputers, and associated peripherals. Successful networking, however, is more than just sharing information and peripherals. It is the efficient integration of data management functions: transparent access to information; management of data and resources; and compatible, reliable storage.

As a leader in developing industry-wide networking and communications standards, HP offers a full range of personal computers, workstations, and host computers that you can configure into fully integrated systems that are exactly suited to your application. The links in such systems are made through the HP AdvanceNet architecture, which encompasses our overall range of networking products.

The products used to implement HP AdvanceNet deliver efficient, industry-standard data communications, along with data and resource management, personal computer networking, and system-to-system networking. For true multi-vendor solutions, HP AdvanceNet products support both interactive and batch capabilities between HP systems and IBM mainframes, and link HP computers to the IBM PC, IBM PC/AT, and IBM PC/XT computers.

The broad range of networking alternatives supported by HP AdvanceNet offers the greatest latitude for network design, implementation, and growth paths. These products are based on industry or *de facto* standards for maximum compatibility, today and tomorrow.

IBM® is a registered U.S. trademark of International Business Machines Corporation.
IBM PC/AT™, IBM PC/XT™, and PC-DOS™ are U.S. trademarks of International Business Machines Corporation.
MS™-DOS is a U.S. trademark of Microsoft Corp.

PERSONAL COMPUTERS & CALCULATORS

Personal Computer Matrix

Touchscreen IIs, Vectra, Portable PLUS, Series 80

39



HP Personal Computers

This chart briefly summarizes HP's wide range of personal computer products. Refer to the "Peripherals" section, page 110, for peripheral and accessory product descriptions. For more information on each personal computer, see the page referenced in the last column. Software information is provided in the "Software Choices" section.

If you have more questions about a computer or its usefulness for your application, please call the local Hewlett-Packard Sales and Service Office listed in the telephone directory white pages, or see page 774. Ask for the computer department. For your nearest HP dealer in the U.S., call toll-free 800-FOR-HPPC.



The HP Touchscreen II lets you control your system by touching the screen and also supports a range of peripherals for data entry, communication, and display.

| Computer | Touchscreen II, Touchscreen MAX II | Vectra | Portable PLUS | Series 80 | HP-75 | HP-71 |
|--|---|--|---|--|---|--|
| Microprocessor/CPU | Intel 8088 | Intel 80286 | Intel 80C86 | HP | HP | HP |
| Operating System | MS™-DOS 2.11 PAM | MS-DOS 3.1 | MS-DOS 2.11 PAM | HP-BASIC | HP BASIC (48K ROM-based) | HP BASIC (64K ROM-based) |
| Languages | BASIC, COBOL, FORTRAN, GW BASIC, C Compiler, Pascal | BASIC, MS-DOS Macro Assembler | See Software choices, page 48 | BASIC, Assembler | BASIC | BASIC, Forth, Assembler |
| Memory | 160K ROM, 256K RAM Expands to 640K | 256K RAM Expands to 3.6M | 128K-byte RAM Expands to 896K | 85B - 32K bytes 86B - 128K bytes Expands to 640K | 16K RAM Expands to 24K | 17.5K RAM Expands to 33.5K (129K w/module) |
| Mass Storage | Multiple configurations | Multiple configurations | Multiple configurations | Multiple configurations | Multiple configurations | Multiple configurations |
| Networking Data Comm. I/O | Built-in: 1 HP-IB port, 1 RS-232C/RS-422 port, 1 RS-232C port, add'l. HP-HIL port | HP-IB, HP-IL, HP-HIL, RS-232C, RS-422, internal modem, Centronics, OfficeShare | HP-IL, RS-232C, Portable/Desktop Link, internal modem | HP-IB, HP-IL, GPIO, internal modem | HP-IL, HP-IB, RS-232C, GPIO, internal modem | HP-IL, HP-IB, RS-232C, GPIO |
| I/O Slots | 4 | 7 | 2 | 4 | 3 | 4 |
| Display | HP Touch, 12 inch 27-line x 80-col. | HP Touch, 12 inch 24-line x 80-col. monochrome/color | Flat panel LCD 25-line x 80-col. | 85B - 5 inch 16 line x 32 col. 86B - 9 or 12 inch 24 line x 80 col. | 32-character LCD scroll to 96 char. 25 line x 80 col. | 22-character LCD scroll to 96 char. 25 line by 80 col. |
| Keyboard | HP-HIL device port Function keys: 8 screen labeled, 12 programmable | HP-HIL device port | Full size 8 function keys Shifted numeric pad | Standard typewriter 85B-8 function keys 86B-14 function keys | Touch-type QWERTY | Block QWERTY Numeric keypad |
| Refer to Page | 40 | 42 | 44 | 46 | 54 | 54 |



PERSONAL COMPUTERS & CALCULATORS

Touchscreen II & Touchscreen MAX II



The HP Touchscreen MAX II, with a Winchester disc drive, is ideal for use with test and measurement instruments.

The Touchscreen II and Touchscreen MAX II Personal Computers

The Touchscreen II family products are a natural for business and industrial systems. They deliver the processing power and memory space necessary to execute lengthy, complex applications. And with more than 600 software packages, you can design office automation or instrument controller systems using the Touchscreen II family and discover solutions you never thought possible with a personal computer.

The Touchscreen II Family Features

- 8 MHz Intel 8088 microprocessor
- 8 MHz Intel 8087 co-processor (optional)
- HP Touch Accessory
- MS™-DOS 2.11
- Personal Applications Manager (PAM) and disc utilities
- Support in the U.S. for more than 600 software packages
- High-resolution graphics display
- Hewlett-Packard Human Interface Link (HP-HIL)
- Low profile keyboard
- Flexible data communications features
- Choice of dual microfloppy or Winchester hard disc storage
- Productivity in IBM environments
- 256K-byte RAM, expandable to 640K bytes
- 160K-byte ROM
- 12-inch screen with built-in display tilt
- Four accessory slots
- Built-in HP 2623 terminal features

PAM

The Personal Applications Manager (PAM) is the primary interface between the user and the MS-DOS 2.11 operating system. PAM is an operating system "shell" that provides an attractive alternative to confusing MS-DOS commands, and has been designed to work harmoniously with HP Touch to facilitate ease of use. To work directly with the MS-DOS command structure, PAM can easily be bypassed.

HP Touch Accessory

Hewlett-Packard's Touchscreen II personal computers encourage "hands-on" interaction. HP Touch is provided as a user-installable accessory. Unlike any other touch-sensitive display available today, HP Touch is totally integrated into the system. Other touch screens use overlays that distort the display; HP Touch does not interfere, either physically or visually, with the display. A matrix of light beams is created using a series of light-emitting diodes (LEDs) embedded along the vertical and horizontal sides of the display.

HP-HIL Device Port

The Hewlett-Packard Human Interface Link (HP-HIL) port on the keyboard adds new dimensions for input via the HP Mouse for Graphics Gallery applications or the Graphics Tablet with Drawing Gallery applications. You can plug in and use HP-HIL devices without reconfiguring the system.

These devices can be used separately or together, and since each device connects to the last one, new devices don't need extra ports on the computer. In addition, the easily transportable input devices can be shared on several different systems: simply unplug a device from one system and plug it into another.

Graphics Display

The Touchscreen's display monitor, a full-size 12-inch screen, provides high-quality resolution for sharp, clear text and graphics. The 27-line by 80-column screen is ergonomically designed for user comfort, and includes built-in display tilt for maximum convenience. Lines 25 and 26 are designated for labeling function keys, and line 27 is reserved for system status and error messages.

Keyboard

The low-profile keyboard has 107 sculptured keys with dished home keys, and includes full local editing keys (cursor control, display scroll, next- and previous-page jump, and insert/delete keys for both single characters and lines). An 18-key numeric pad may be used as a graphics keypad for terminal applications. The keyboard includes eight screen-labeled and 12 programmable function keys, and is connected to the terminal by an 8-foot coiled cable.

System Expansion

The Touchscreen IIs come with four accessory slots that provide a number of solutions for expanding your system. Add storage space: large-capacity Winchester options of 10M bytes, 20M bytes, and 40M bytes, plus back-up tape storage devices. Tailor the Touchscreen IIs: a full spectrum of Hewlett-Packard printers, plotters, modems, accessories, and software to match your current and future requirements. An Intel 8087 co-processor accessory is available for speedy, real-number computation using FORTRAN, Pascal, and C programming languages and the MS-DOS macroassembler.

Ergonomic Design

The Touchscreen II is ergonomically designed for user comfort and convenience. With its small footprint and cable cover system, you can set the Touchscreen II flush against a wall and set a disc drive or printer on top, leaving more space on your desk. The power switch, brightness control, and keyboard connector are located on the front and side panels for easy access.

Data Communications

The HP Touchscreen II family comes standard with one RS-232C port, one RS-232C or RS-422 port, one HP-HIL port on the keyboard, and one HP-IB port. The Touchscreen IIs, with their built-in terminal capability, can take advantage of HP's powerful networking options to share information with other computer systems ranging from the Portable PLUS to HP, IBM®, and DEC® mainframes.

Other capabilities include IBM 3278 terminal emulation with file transfer, VT100 terminal emulation, Monitor/IBM PC, and AdvanceLink, which allows ASCII and binary file transfer between the Touchscreens and other HP computer systems (e.g., the HP 3000), plus the IBM PC. Additional data communications capabilities include the EtherSeries™/150 local area network from 3Com™, which links up to 100 Touchscreens or IBM PCs, and OfficeShare, the HP AdvanceNet-compatible PC LAN. See the Networking section for data communications product descriptions.

8087 Co-Processor Accessory

Increased speed and precision in arithmetic, logarithmic, and trigonometric functions are provided by the addition of an Intel 8087 processor as a companion to the Touchscreen II's 8088. The 8087 can multiply 32- and 64-bit floating-point numbers up to 100 times faster than the 8088, depending upon application. It is supported by the Pascal, Lattice® C, and FORTRAN compilers and MS-DOS macroassembler offered on the Touchscreen II. The 8087 co-processor plugs into the Touchscreen II processor board and does not occupy an accessory slot. It must be installed by an HP customer engineer or authorized HP personal computer dealer.



Software Solutions

The Touchscreen II and Touchscreen MAX II are designed to meet the needs of industrial, engineering, and manufacturing professionals by managing work through the use of sophisticated, industry-standard and -specific programs. Most of the best-selling software packages now run on the HP Touchscreen II family, and have been enhanced to take advantage of such easy-to-use Touchscreen II features as HP Touch, softkeys, and PAM.

In addition to the applications software, there is a wide selection of programming languages and programmer's tools available for the Touchscreens. Such software tools as BASIC, Compiled BASIC, GW™-BASIC, Pascal, COBOL, and Lattice C Compiler, as well as assemblers, utilities, and various graphics tools, help you develop custom programs.

Hewlett-Packard is committed to a comprehensive third-party software development program. This new software is directly aimed at giving you more productivity tools for engineering, scientific, and analytical applications. The Hewlett-Packard Software Catalog lists these packages in detail. Also refer to *Your Source for Software Solutions* catalog for up-to-date program listings.

Specifications

Microprocessor/CPU: Intel 8088, 8 MHz

Operating System: MS-DOS 2.11

Memory: 256K-byte RAM, expandable to 640K bytes; 160K-byte ROM

Screen Space: 27-line by 80-column, 12-inch diagonal

Display Enhancements: Inverse video, underline, blinking, half-bright, or any combination

Alphanumeric: 640 x 378 pixels

Graphics: 512 x 390 pixels

Alternate graphics: 640 x 400 pixels (not supported by firmware/terminal mode)

Optional HP Touch Accessory: User-installable

Character Set: Roman8, line-drawing, Math Standard, bold and italics, depending on applications

Total of 896 characters; local language characters

6 x 9 enhanced dot matrix in 8 x 14 dot-character cell

Keyboard:

Detachable, typewriter-style with 8-ft. (2.43 m) coiled cable

One HP-HIL device port

Full ASCII code

Eight screen-labeled function keys;

12 programmable function keys

Auto repeat, N-key rollover, cursor controls

18-key numeric/graphics pad

Weight:

CPU: 27 pounds (12.27 kilograms) (without keyboard)

Keyboard: 4.7 pounds (2.14 kilograms)

Dimensions:

CPU/display: 12.8 x 14.6 x 13.4 inches (325 x 370 x 342 mm)

Keyboard, flat: 18 x 8.9 x 1.2 inches (456 x 225 x 30 mm)*

Keyboard, standing: 18 x 8.9 x 2.3 inches (456 x 225 x 58 mm)

*Home-row height per ZH1/618 (German Ergonomic Standard)

Peripherals and Accessories for the Touchscreens

See the Peripherals section, page 110, for product descriptions of peripherals and accessories.

™ MS™-DOS and GW™-BASIC are U.S. trademarks of Microsoft Corp.

EtherSeries™/150 and 3Com™ are U.S. trademarks of 3Com Corporation.

• IBM® is a registered U.S. trademark of International Business Machines Corporation.

DEC® is a registered U.S. trademark of Digital Equipment Corporation.

Microsoft® is a registered U.S. trademark of Microsoft Corp.

Lattice® is a registered U.S. trademark of Lattice, Inc.

How to Order Your Touchscreen II and Touchscreen MAX II

For more information on the Touchscreen II family, contact your HP sales representative or your local HP personal computer dealer.

For the nearest dealer in the U.S., call toll-free: 800-FOR-HPPC

Ordering Information

| | | Price |
|---|---|--------|
| Touchscreen II Personal Computer | | |
| HP 45851A | Touchscreen II CPU with PC Kit* | \$2830 |
| HP 35723A | HP Touch Accessory (user-installable option) | \$300 |
| HP 9123D | Dual 3½ inch Microfloppy Disc Drive (710K bytes each drive) | \$715 |
| HP 45885A | 8087 Co-Processor Accessory (optional) | \$595 |

*The Touchscreen II basic system comes with the CPU/terminal (HP 2623 features — block mode with graphics), 256K bytes of memory, one RS-232C port, one RS-232C or RS-422 port, one HP-IB port, a system port for the HP Touch accessory, an internal expansion slot for the 8087 co-processor accessory or other custom boards, four accessory slots, and a 12-inch display. The PC kit includes the HP extended keyboard with HP-HIL port and keyboard cable, power cord, and disc drive cable, plus the Operating System Master Disc and Work Master Disc (containing MS-DOS 2.11, PAM, and disc utilities), and full documentation.

Touchscreen MAX II Personal Computer System

| | | |
|-----------|--|--------|
| HP 45851A | Touchscreen II CPU with PC Kit | \$2830 |
| HP 35723A | HP Touch Accessory (user-installable option) | \$300 |
| HP 9153A | 10M-Byte Winchester/Microfloppy, or | \$1040 |
| HP 9133H | 20M-Byte Winchester/Microfloppy, or | \$1240 |
| HP 9133L | 40M-Byte Winchester/Microfloppy | \$4240 |
| HP 45885A | 8087 Co-Processor Accessory (optional) | \$595 |

The Touchscreen MAX II Personal Computer comes with the same features as the Touchscreen II PC and HP Touch accessory, plus your choice of storage: 10M-, 20M-, or 40M-byte Winchester, each with dual 3½ inch, double-sided microfloppy with 710K bytes per disc.

Touchscreen II Terminal

| | | |
|-----------|--|--------|
| HP 45850A | HP Touchscreen II CPU with Terminal Kit | \$3730 |
| HP 35723A | HP Touch Accessory (user-installable option) | \$300 |

HP 45885A 8087 Co-Processor Accessory (optional) \$595

The Touchscreen II Terminal has the Touchscreen II CPU and HP Touch features. The Terminal Kit includes the HP extended keyboard with HP-HIL port and keyboard cable, power cord, and complete documentation for using the Touchscreen II as a terminal.

Touchscreen Instrument Controllers

| | | |
|---|--|--------|
| HP 45861A | Touchscreen HP-IB Controller | \$3330 |
| The Touchscreen HP-IB Controller includes the Touchscreen II CPU with PC Kit and the HP-IB Command Library. | | |
| HP 45862A | Touchscreen PCIB Controller | \$4935 |
| The Touchscreen PCIB Controller includes the Touchscreen II CPU with PC Kit, 384K RAM Memory Board, PC Instruments Interface, and GW BASIC. | | |
| HP 35723A | HP Touch Accessory (user-installable option) | \$300 |

Reference Documentation

| | | |
|-----------|--|-------|
| HP 45624A | Touchscreen MS-DOS User's Guide | \$50 |
| HP 45625A | Touchscreen Technical Reference Manual | \$100 |
| HP 45435A | Touchscreen Programmer's Tools | \$295 |



PERSONAL COMPUTERS & CALCULATORS

The Vectra Personal Computer

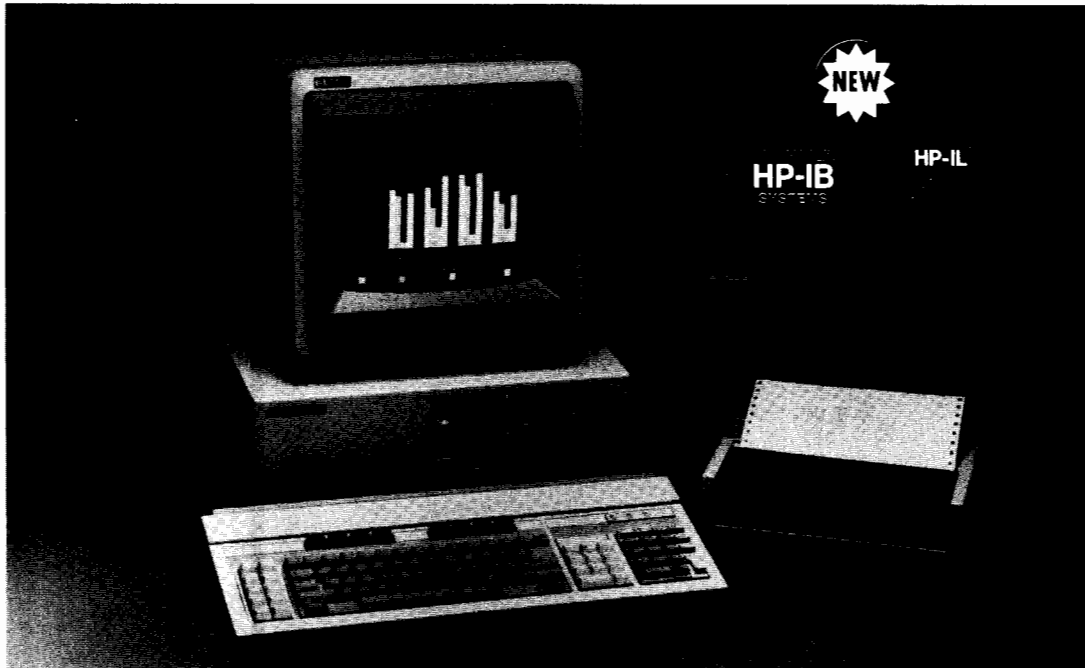

The new Vectra Personal Computer, powerful and IBM PC/AT™ compatible

Versatile and Flexible

Hewlett-Packard's Vectra Personal Computer has been designed to simplify your computing needs. You can select the exact combination of hardware and software that is best for your business today, without restricting your options for the future. The heart of the system is the Vectra PC's 8 MHz Intel 80286 microprocessor. You can start with either a 256K-byte or 640K-byte memory, which can be expanded to more than 3M-bytes. Add to your system any time, from an almost unlimited range of compatible hardware and software by HP, IBM, and numerous other manufacturers.

Vectra's features offer the greatest flexibility of any desk-top personal computer. It is compatible with the IBM PC/AT, yet is smaller, more powerful, and easier to use. Vectra's MS-DOS 3.1 operating system lets you run virtually all IBM PC/AT-compatible software, so you can choose from among the most popular programs for word processing, business graphics, spreadsheet analysis, data base management, and communications.

Vectra Features

- 8 MHz Intel 80286 16-bit microprocessor
- Optional 5.33 MHz Intel 80287 numeric co-processor
- Vectra Disc Operating System (optional):
 - MS-DOS 3.1
 - Personal Applications Manager (PAM)
- Optional BASIC Interpreter and MS-DOS Macro Assembler
- Hewlett-Packard Human Interface Loop (HP-HIL) accessory port
- HP Touch Accessory, HP Mouse, graphics tablets, bar code wand (optional)
- Flexible data communications options
- Supports flexible and hard disc storage
- Hardware and software compatible with IBM PC/AT
- 64K-byte ROM
- Sockets for two additional ROM chips
- 256K-byte and 640K-byte RAM; expandable up to 3.64M bytes
- Three half-height data storage cartridge shelves:
 - Two shelves with front access for flexible disc drives
 - One hard-disc shelf
- Seven PC/AT-compatible I/O accessory slots

- Detachable, keyboard with HP-HIL port (compatible with the IBM PC/AT, with HP enhancements)
- Choice of 12-inch 640 x 400 monochrome or color monitors (optional)
- 3278 terminal emulator
- 20M-byte half-height and 40M-byte full height internal hard discs (optional)

PAM

HP's Personal Applications Manager (PAM) is an operating system shell that serves as the primary interface between the user and the MS-DOS 3.1 operating system. You don't have to type complex commands to start a program running; the screen identifies a single function key you press to start any given application. In addition, PAM has been designed to work with HP Touch, HP Mouse, or keyboard to facilitate ease of use. For experienced users who want to work directly with the MS-DOS command structure, PAM can easily be bypassed.

HP-HIL Device Port

The Hewlett-Packard Human Interface Loop (HP-HIL) port on the Vectra PC lets you connect up to seven input devices without using an expansion slot. For example, the Vectra keyboard, HP Mouse, and HP Touch accessory are all attached with the HP-HIL. You can pick the input devices that work best with the software you use.

HP Touch Accessory

HP Touch, an optional user-installable accessory, offers ease and convenience for the user.

Graphics Display

Choose a monochrome or color screen for your Vectra display monitor. The full-size 12-inch screens provide high-quality resolution for sharp, clear text and graphics. The 25-line by 80-column screens are ergonomically designed for user comfort, and include built-in display tilt and swivel for maximum convenience.

Keyboard

The adjustable-tilt Vectra keyboard has 103 step-sculptured keys with tactile feedback and color-coded legends. The keyboard includes eighteen function keys, a numeric keypad with cursor control, a separate cursor control pad, and an HP-HIL port, and is connected to the terminal by an 8-foot coiled cable.



System Expansion

The Vectra PC comes with seven IBM PC/AT™-compatible accessory slots that provide a number of options for such system expansions as memory cards, data communications interfaces, and graphics boards.

Add data storage capacity: up to three internal data storage devices plus external disc and tape drives. You can start with a 360K-byte or 1.2M-byte 5¼ inch flexible disc and add more later. There are 20M-byte and 40M-byte internal hard discs for large-capacity storage situations.

Tailor the Vectra PC: a full spectrum of Hewlett-Packard printers, plotters, modems, accessories, external storage devices, and software are available to match your current and future requirements. And the 80287 co-processor accessory is available for fast, real-number computation.

Data Communications

HP's Vectra PC has many available communications options: RS232/Centronics ports, RS232/422 ports, 1200 baud and 2400 baud modems, HP-IL port, HP-IB communications port, IBM 3278, 2392, DEC VT100 terminal emulators — more than enough for all your data communications needs. Vectra's sophisticated communications capabilities let you take advantage of HP's powerful networking options to share information with a range of computer systems, from the HP Portable PLUS and Touchscreen II personal computers, IBM personal computers, as well as HP, IBM, and other host computers.

OfficeShare, the HP AdvanceNet-compatible local area network (LAN), will link as many as 30 Vectra personal computers (or Vectra PCs and IBM PCs) for sharing data, data storage, printers, plotters, electronic mail, etc. To extend your options, the Vectra PC is also compatible with 3Com and other industry-standard LANs. See the "Networking and Data Communications" section of this catalog for complete product descriptions.

Software Solutions

The Vectra personal computer offers a full range of choices in software, from off-the-shelf IBM PC/AT applications to popular business programs.

The Vectra PC runs such business applications as WordStar, VisiCalc, RBase 5000, 1-2-3 from Lotus, and will let you access most information retrieval services. HP's AdvanceWrite word processing software lets you choose a working level that meets your specific needs and abilities. HP TextCharts lets you quickly create professional-looking overhead presentations. Executive Card Manager is an easy-to-use file manager with a built-in report writer, autodial feature, and more; Executive Card Manager: Templates gives you 21 modifiable formats for various business applications.

Refer to *Your Source for Software Solutions* catalog for up-to-date program listings for the Vectra PC.

Description

Executive Card Manager
 Executive Card Manager Templates
 Executive Spreadsheet
 Executive MemoMaker
 HP Message (current IBM version)
 AdvanceLink 2392
 AdvanceWriter I,II,III
 Lotus 1-2-3
 Lotus Symphony
 Multimate
 Multimate Advantage
 WordStar®/2000/Plus
 WordStar®/2000
 WordStar®

WordStar® (Professional Pac)
 RBase™ 5000
 RBase™ Program Interface
 HP Access
 Print Central

Futures:

Charting Gallery
 Drawing Gallery
 Picture Library

Ask your HP rep or dealer about the latest software offerings.

Specifications

System Processing Unit: Intel 80286, 8 MHz

Optional Numeric Co-Processor: 5.33 MHz Intel 80287

Operating System: MS-DOS 3.1

Memory: 256K-byte or 640K-byte RAM in 128K-byte increments; expandable to 3.64M bytes

Keyboard:

Detachable, with 8-ft. coiled cable
 Adjustable tilt feature
 One HP-HIL port
 Eighteen function keys

Weight:

SPU with one flexible disc drive: 26 pounds (11.8 kilograms)
 Keyboard: 4.2 pounds (1.9 kilograms)

Dimensions:

SPU: 16.7 x 15.4 x 6.3 inches (42.5 x 39.0 x 16.0 cm)
 Keyboard, flat: 20.6 x 8.8 x 1.3 inches (52.5 x 22.0 x 3.5 cm)

Peripherals and Accessories for the Vectra PC

See the "Peripherals" section, page 110, for product descriptions of peripherals and accessories.

How to Order Your Vectra Personal Computer

For more information on the Vectra, contact your HP sales representative or your local HP personal computer dealer.

For the nearest dealer in the U.S., call toll-free: 800-FOR-HPPC

Ordering Information

| | | Price |
|------------------|---|--------|
| HP 72425A | Vectra Model 25 PC The Vectra personal computer Model 25 includes an SPU with 256K bytes of memory and one 360K-byte internal 5¼ inch flexible disc drive, keyboard and documentation. | \$3199 |
| HP 72435A | Vectra Model 35 PC The Vectra personal computer Model 35 includes an SPU with 256K bytes of memory and one 1.2M-byte internal 5¼ inch flexible disc drive, keyboard and documentation. | \$3399 |
| HP 72445A | Vectra Model 45 PC The Vectra personal computer Model 45 includes an SPU with 640K bytes of memory and one 1.2M-byte internal 5¼ inch flexible disc drive, keyboard and documentation. | \$3599 |

MS-DOS® is a U.S. trademark of Microsoft Corp.
 IBM PC/AT® is a U.S. trademark of International Business Machines Corporation.
 3Com® is a U.S. trademark of 3Com Corporation.
 dBASE® is a U.S. trademark of Ashton-Tate.
 1-2-3® and Lotus® are U.S. trademarks of Lotus Development Corp.

IBM® is a registered U.S. trademark of International Business Machines Corporation.
 Microsoft® is a registered U.S. trademark of Microsoft Corp.
 VisiCalc® is a registered U.S. trademark of VisiCorp.
 WordStar® is a registered U.S. trademark of MicroPro International Corp.



The Most Durable Lap-Portable Computer

More than just a portable computer, the Portable PLUS is a powerful, durable traveling companion that shares information and peripherals with desktops or acts as a terminal to mainframes. In one small package, you can carry all the tools you need to be productive in the field or while traveling.

The Portable PLUS is easily tailored to handle varying duties, with the programs and data that you use most often installed directly on the computer as plug-in ROMs. You also have the option of loading disc-based software into the Electronic Disc of the Portable PLUS. In either case, there is no need to carry discs or disc drives — just the lap-sized PLUS.

Portable Power and Convenience

- Full 16-bit CMOS 8086 microprocessor
- Continuous Memory expands from 128K to 896K bytes
- Plug-in ROM software
- Built-in electronic disc drive
- Personal Applications Manager (PAM)
- MS™-DOS 2.11
- Built-in HP-IL, RS-232C, and optional modem interface ports
- HP Link and Portable-Desktop Link for data and peripheral sharing
- Built-in terminal emulation
- Compatible with HP Touchscreens
- Productive in IBM environments
- Full keyboard and numeric keypad
- Full-size 25-line by 80-column LCD screen
- Integrated 20-hour power supply
- Two accessory slots

Convenient and Durable Design

At under ten pounds, and no larger than a three-ring binder, the Portable PLUS is the most durable lap-sized computer for professionals on the go. It offers a full-size display and keyboard with numeric keypad for fast field calculations, plus the built-in HP-IL and RS-232C interfaces for fast data transfer to peripherals, desktop computers, or mainframes. And it runs on rechargeable batteries for up to 20 hours.

The Portable PLUS's autostart capability lets you skip over the PAM menu and begin computing sessions in a custom program. And, the integrated power supply and Continuous Memory let you return instantly to interrupted work, making it the most convenient portable to use whenever and wherever your work takes you.

Personal Applications Manager (PAM)

Serving as the main menu on the Portable PLUS, the PAM acts as a shield between the user and the operating system. This eliminates the complexity of MS-DOS command structures and provides an easy front-end menu and keystroke format.

Plug-in ROM Software

The Portable PLUS runs full-feature software in a plug-in ROM, containing everything necessary to complete your work. This ROM-based software offers the reliability and speed of a Winchester disc. Frequently accessed programs can be user-installed into the Portable PLUS, eliminating the need for a separate disc drive. And loading programs is fast (as much as five times faster than floppy discs). You can choose to install your own custom-designed ROM- or EPROM-based applications.

Built-in Electronic Disc Drive

The HP Electronic Disc (E-Disc) is a convenient method of temporarily storing data and programs while the Portable PLUS is being used away from an HP 9114A Portable Disc Drive, Touchscreen or Vectra PC, or IBM® PC. With the Portable PLUS's expandable RAM, there is plenty of room for disc-based programs and large data files, and it's fast: E-Disc loads and accepts programs and data up to 10 times faster than a traditional floppy disc drive. The E-disc is much more durable than a built-in floppy disc, and it extends battery life by requiring much less power.

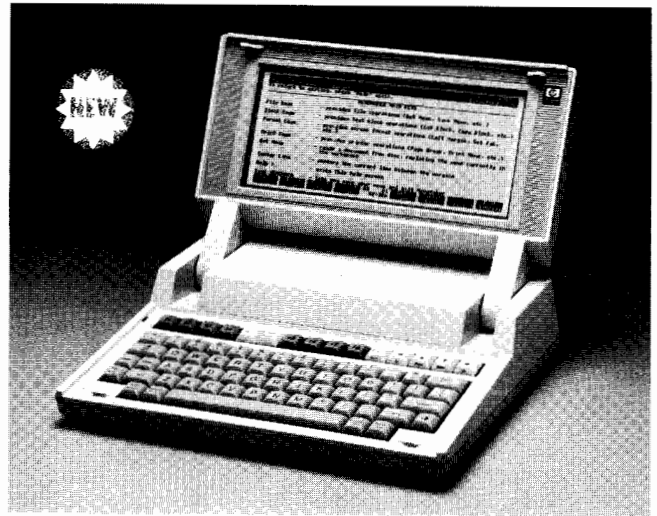

The Portable PLUS is a durable, reliable, lap-portable computer designed for mobile computing conditions.

Sharing with Desktops

The HP Portable-Desktop Link connects the Portable PLUS with the HP Touchscreen II family, HP Vectra, or the IBM PC family. By installing an HP Interface Loop (HP-IL) and software on your desktop computer, you can quickly transfer data or applications software between the Portable PLUS and the desktop model. In addition, printers connected to the desktop computer can be used as output devices for the Portable PLUS.

Data Communications and Terminal Emulation

The Portable PLUS built-in Terminal Emulator supports an optional 300/1200 bps modem and a serial interface connection to allow transfer of files with host computers as well as information networks. With the addition of communications accessories, the Portable PLUS supports full block mode terminal communications, emulates the HP 2622 and DEC® VT102 terminals, runs HP DESK and IBM PROFS applications, and supports automated and unattended file transfer.

Optional Modem — This Hayes-compatible internal modem enables communications over normal dial-up telephone lines at speeds up to 1200 bps, cutting the cost of long-distance data communication. The auto-answer and auto-dial features, using either Touch-Tone™ or pulse dialing, make the Portable PLUS a perfect companion for remote location data communications.

IBM Terminal Emulation — The Portable PLUS running PC 2622 emulation software can be used in conjunction with an HP 3000 minicomputer to access IBM hosts. Also, the Portable PLUS with PC 2622 can emulate a full-screen IBM 3278 display station by using IBM or third-party protocol converters. This terminal emulation capability is the path to accessing most mainframe applications that typically function on IBM 3270-type terminals.

PPC Access — The full block mode capability of the Portable PLUS with PC 2622 allows access to HP's Personal Productivity Center. This permits such operations as full-screen editing within the functions of the HP DeskManager.

LCD Display

The Portable PLUS uses advanced LCD technology and a non-glare surface to improve the readability of its 25-line by 80-column display. The flat panel, variable contrast, and tilt features contribute to user comfort. With an optional video interface, a CRT monitor can be connected to duplicate the Portable PLUS's display.

Keyboard

The full-size keyboard on the Portable PLUS offers the features of a desktop computer: 75 sculptured keys, eight screen-labeled function keys, shifted 10-key numeric keypad, and flexible key mapping. The numeric keypad speeds the work of entering figures into such programs as spreadsheets, test and measurement calculations, and data analysis.



Memory and Expansion Ports

The Portable PLUS has two expansion ports that may be used for additional memory, plug-in ROM software, or other special-function cards. The Software Drawer holds up to 12 user-installed ROMs of 32K- or 128K-byte capacity. The Memory Drawer includes 128K bytes of Continuous Memory RAM; two additional 128K memory cards may be added to the drawer.

Random access memory space is allocated by the user to system memory or E-Disc. System memory is used for program execution and data file operations; the E-Disc is used for program and data storage.

Battery Power

The Portable PLUS's 20-hour battery life is twice as long as most other portables, providing two weeks of average computing time between recharges. And the Portable PLUS can be used during battery recharging. A sophisticated memory protection scheme ensures that your data will be preserved in the Portable PLUS for approximately one month, and the PAM screen provides a continuous display of power reserves. When power reserve reaches 5%, the computer automatically turns off until the recharger is connected to it, protecting your data until you get to a power source.

Software Solutions

The Portable PLUS combines its powerful ROM-based software and E-Disc capability with the fast MS-DOS 2.11 operating system and large-capacity user memory to deliver the computing performance of traditional desktop models. Whenever your workload takes you into the field, flies you around the country, or follows you home, your Portable PLUS is packed with software solutions to all your computation problems. See the "Software Choices" section, page 48, for a listing of Portable PLUS applications packages.

ROM-Based Applications — A wide range of high-productivity software is available for the Portable PLUS; choose from such popular core applications as 1-2-3™ from Lotus™, Microsoft® Word, MemoMaker/Time Management, and the PC 2622 and VT102 terminal emulator.

Custom ROM Applications — Hewlett-Packard's custom ROM program enables you to design software for specific applications. Either programs or data can be installed on industry-standard 32K-byte or 128K-byte custom ROMs, or 32K-byte EPROMs. A maximum capacity of 24 128K-byte ROMs can be achieved using both Software Drawers. The flexible configuration of the ROM disc permits program execution from RAM or ROM.

Disc-Based Software — In addition to the plug-in ROM software, there is a wide selection of disc-based software available through HP and third-party vendors. Such tools as GW™-BASIC, and Pascal programming languages, and the Lattice C Compiler will enhance custom program development. Application software that can be loaded from floppy discs into the E-Disc includes data base managers, such as dBASE II™, data communications and networking programs, accounting systems, and a variety of personal solution packages, such as The List Manager and The Speller.

Refer to *Your Source for Software Solutions* for up-to-date software information.

Specifications

Microprocessor: 16-bit Intel 80C86, 5.33 MHz

Operating System: MS-DOS 2.11

Memory: 128K-byte continuous user RAM, expandable to 896K bytes; 192K-byte expandable ROM

Expansion Capability: Two plug-in ports for 128K RAM Memory Drawer and 12-socket ROM Software Drawer. (Memory Drawer may be expanded to a maximum of 384K bytes by use of additional memory cards.)

Built-In Mass Storage: Electronic Disc

Bundled Software:

PAM — Personal Applications Manager
 HPLINK — For the Portable-Desktop Link
 TERM — Terminal link for HP 2622 emulation
 SECURE — Password protection utility
 EDLIN — Low-level MS-DOS text editor
 Self-diagnostics utility

Display: Flat panel, liquid-crystal, anti-glare screen with variable tilt and contrast

Alphanumeric: 25-line by 80-column

Graphics: 200 x 480 pixel

Character Attributes: Inverse video, underline, blinking, half-bright, and all combinations

Character Set: Roman8, extended character set, multiple character fonts

Keyboard: Full size, 75 sculptured keys, eight screen-labeled function keys, shifted numeric keypad, flexible key mapping

Data Communications: Built-in HP-IL and 9-pin RS-232C

Modem: Optional 300/1200 bps, direct-connect, pulse and tone dial, Hayes command compatible

Power Supply: Three permanently installed lead acid gel D cell batteries; battery recharger

Battery: Continuous use — 20 hours on full charge

Two-week typical run-time

Shelf life — 6 months on full charge

Service life — 5 years

Low battery life — 1 week from 5% level, typical

Weight: Basic unit — under 9 pounds (4 kilograms)

Maximum configuration — under 10 pounds (4.5 kilograms)

Dimensions: 13 x 10 x 3 inches (330 x 254 x 76 mm)

How to Order Your Portable PLUS

For more information on the Portable PLUS, contact your HP sales representative or your local HP personal computer dealer.

For the nearest dealer in the U.S., call toll-free: 800-FOR-HPPC

Ordering Information

HP 45711B

The HP Portable PLUS Personal Computer
 The HP Portable PLUS basic system comes with 128K bytes of RAM, 192K bytes of ROM, two plug-in ports for RAM and ROM expansion, built-in E-Disc mass storage, MS-DOS 2.11 and PAM with bundled utilities, flat-panel LCD display with 25-line by 80-column screen, full-size keyboard, built-in HP-IL, modem, and RS-232C communications ports, integrated power supply and battery recharger, soft carrying case with shoulder strap, and complete documentation.

Price

\$295

Peripherals and Accessories for the Portable PLUS

See the Peripherals section, page 110, for product descriptions of peripherals and accessories.

™ MS™-DOS, Microsoft™ Word, and GW™-BASIC are U.S. trademarks of Microsoft Corp. 1-2-3™ and Lotus™ are U.S. trademarks of Lotus Development Corp. dBASE II™ is a U.S. trademark of Ashton-Tate.

Touch-Tone™ is a U.S. trademark of AT&T.

* IBM® is a registered U.S. trademark of International Business Machines Corporation.

DEC® is a registered U.S. trademark of Digital Equipment Corporation.

Microsoft® is a registered U.S. trademark of Microsoft Corp.

Lattice® is a registered U.S. trademark of Lattice, Inc.



PERSONAL COMPUTERS & CALCULATORS

Series 80

HP-85B and HP-86B

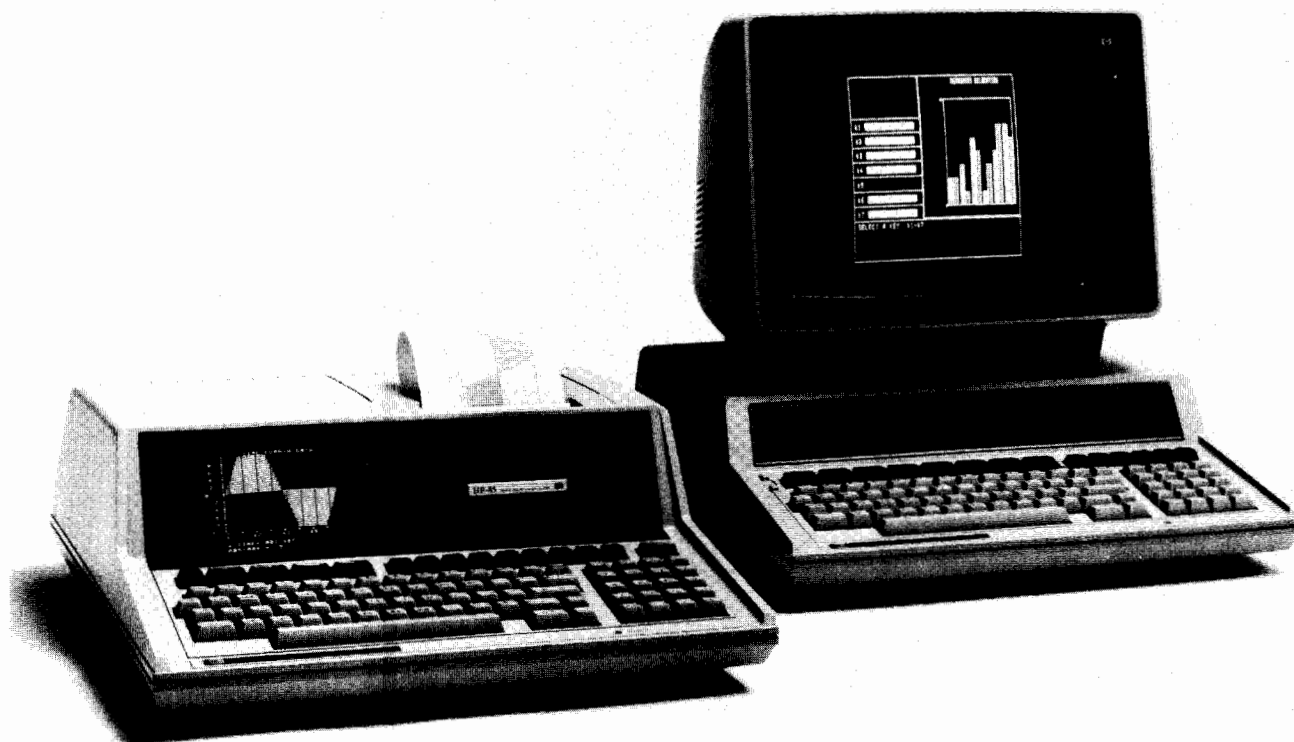

The HP Series 80 products are particularly well-suited to technical analysis and dedicated controller applications.

The Series 80 Personal Computers

The HP-85B and HP-86B Series 80 products are highly refined personal computers that serve as programmable tools for technical analysis and as dedicated controllers for data collection systems, machine tools, and medical instrumentation. The Series 80 product offerings include an exceptionally broad choice of options, with everything from language enhancement ROMs to interfaces, and from voice output to terminal emulation. With over 600 software packages available, you can choose a comprehensive, reliable solution for instrumentation control problems.

The HP-85B personal computer supports low cost data acquisition and dedicated applications requiring ease of programming, strong I/O capability, and a compact integrated system. The built-in CRT, printer, and mass storage give it a unique physical package, and the easily expanded backplane offers exceptional versatility.

The HP-86B is configured as a modular system with separate monitor and disc drive. It offers greater power than the HP-85B, while retaining the strong computational and interfacing capabilities. The BASIC language on the HP-86B is a superset of the HP-85B language, and the HP-86B memory is expandable up to 640K bytes. The optional CP/M® operating system increases the HP-86B access to personal productivity software.

The Series 80 personal computers offer a multitude of upgrade paths, including memory expansion, data communications, speech synthesis, flexible I/O, multiple operating systems and languages, BASIC language extensions, and EPROM capabilities. Through various enhancements and software packages, the HP-85B and HP-86B communicate with HP 1000 and HP 3000 minicomputers.

Series 80 Personal Computers — Interfacing for Instrument Control

| | HP-85B | HP-86B |
|---------------------------|---------------------------------|--------------------------------------|
| CPU | HP Custom | HP Custom |
| Display (lines x columns) | 16 x 32 | 24 x 80 |
| Choice of display | No | Yes (9" or 12") |
| Special function keys | 8 | 14 |
| Portability | Yes | No |
| Graphics terminal | 256 x 196 pixels | 544 x 240 pixels |
| Integrated printer | Yes | No |
| Integrated mass storage | Tape cartridge | No |
| Standard memory | 32K bytes | 128K bytes |
| Maximum RAM | 32K bytes | 640K bytes |
| Memory | | |
| Electronic Disc memory | 32K + modules | 32K-byte increments of avail. memory |
| EPROM capability | Yes (optional) | Yes (optional) |
| Dedicated I/O | Opt. plug-in | HP-IB (IEEE 488) |
| Open I/O slots | 4 | 4 |
| CP/M | No | Yes (optional) |
| HP 2622 emulation | No | Yes (optional) |
| Modem | Yes (optional) | Yes (optional) |
| Data communications | Yes (optional) | Yes (optional) |
| Speech synthesis | Yes (optional) | Yes (optional) |
| Languages | HP Enhanced BASIC, Assembler | HP Enhanced BASIC, Assembler |

The Best BASIC in the Industry

The Series 80 BASIC language differs from that on most microcomputers by providing more power, as well as the tools, that simplify your programming and interfacing processes. The Series 80 set of 177 commands and functions is expandable, through optional ROMs or binary programs, to 335 or greater (as compared to the typical 149 commands/functions of other microcomputers).



Low-cost data acquisition and dedicated applications are the specialty of the HP-85B.

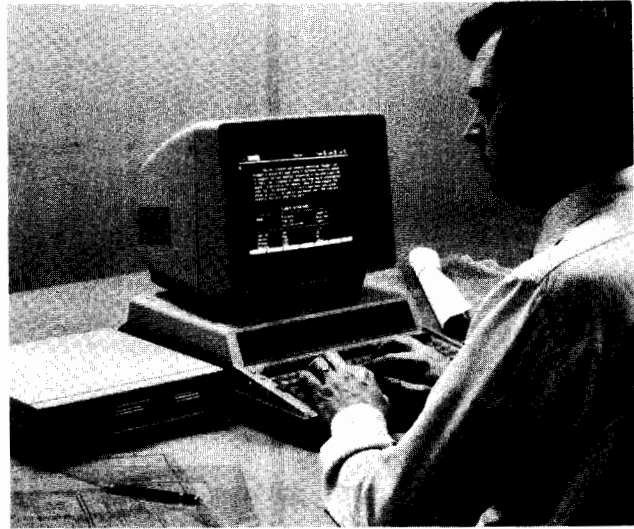

Separate monitor and disc drive typify the HP-86B modular architecture.

Graphics

The abundant graphics capabilities of Series 80 BASIC allows you to draw any desired figure on the display. A single command can draw a set of X-Y axes, complete with tic marks and numerical labels.

Electronic Disc

HP's Electronic Disc simulates a mechanical disc drive, but with extremely high speed. Programs written for mechanical memory can be modified to run at high-speed electronic memory, and any portion of program memory on the HP-86B can be reconfigured to use as electronic disc.

An Exceptional Input/Output Device

The ability of the Series 80 to interface to and communicate with a variety of devices, such as instruments, machinery, and custom products, requires a combination of hardware features and software capabilities. One example is the ease of programming using the I/O ROM: dozens of unique commands facilitate communication with external devices. Buffered transfers let you talk to a slow instrument while continuing with other activities, and interrupt branching lets you service an interrupting instrument while maintaining control of all communications activity.

Programming a variety of I/O interfaces is simplified by the use of common protocol. Typically, the same commands are used to communicate over RS-232C, HP-IB, GPIO, BCD, and other interfaces. In addition, interfaces are easily installed, without tools or disassembly, in a slot on the back of the computer. And virtually any digital device can be interfaced and connected to a Series 80 personal computer.

Software Solutions

An outstanding selection of technical, as well as general-purpose software supports the diversity of Series 80 applications. The "Software Choices" section of this catalog lists many of the packages for the Series 80. In addition, the *Series 80 Personal Computer Software Catalog* offers a complete listing of software solutions in such areas as productivity, engineering, physical sciences, CAD/CAE, and software tools.

How to Order Your Series 80

For more information on the HP-85B and HP-86B, contact your HP sales representative or your local HP personal computer dealer.

For the nearest dealer in the U.S., call toll-free: 800-FOR-HPPC

Ordering Information

| | | Price |
|------------------|---|--------------|
| HP 85B | The HP-85B Personal Computer The HP-85B Personal Computer comes with HP-BASIC language, 32K-byte Electronic Disc memory, 32K-byte user memory, 64K-byte ROM, tape cartridge, four expansion ports, built-in printer, 5-inch diagonal CRT display, typewriter-style keyboard with eight user-definable soft keys, and complete owner's manual and programming guides. | \$3495 |
| HP 86B | The HP-86B Personal Computer The HP-86B Personal Computer comes with HP-BASIC language, 96K-byte Electronic Disc memory (expandable to 608K bytes), 128K-byte user memory (expandable to 640K bytes), 64K-byte ROM, four expansion ports, built-in HP-IB port, HP-IB cable, typewriter-style keyboard with 14 user-definable soft keys and keyboard overlay, and complete owner's manual and programming guides. | \$1695 |
| HP 82912A | 9-Inch Monitor | \$295 |
| HP 82913A | 12-Inch Monitor | \$325 |

Peripherals and Accessories for the Series 80

See the Peripherals section, page 110, for product descriptions of peripherals and accessories.



Touchscreen IIs, Vectra, Portable PLUS, Series 80

Hewlett-Packard Your Source for Software Solutions

The programs listed in this section are for use on the Touchscreen II, Touchscreen MAX II, Vectra, Portable PLUS, HP-85B, and HP-86B personal computers. Refer to *Your Source for Software Solutions* for up-to-date software information.

The Hewlett-Packard *Software Selection Guide* features listings of HP software products that can be used to automate test and measurement applications. Associated computer-aided engineering software packages are also included.

Software Package Order Number Designations

The last letter in each software package order number indicates the personal computer(s) that support the package.

| Order No. | Personal Computer |
|-----------|---|
| A | Touchscreen II and Touchscreen MAX II (HP-85B and HP-86B, as noted) |
| C | Portable PLUS |
| — | Vectra software is described on page 42. |
| D | Touchscreen IIs and Portable PLUS |
| E | IBM® PC, IBM PC/XT™, IBM PC/AT™ |
| K | Portable PLUS Plug-In ROM |
| M | Peripherals |

| Order No. | Description | Price |
|--|--|----------------|
| HP 45445D | BASIC by Microsoft® | \$140 |
| HP 82802A | BASIC Training | \$115 (HP-85B) |
| HP 82832A | BASIC Training | \$115 (HP-86B) |
| HP 82862K | Opt. 400 BASIC by Microsoft | \$360 |
| HP 45446D | Compiled BASIC by Microsoft | \$295 |
| HP 45450D | GW™-BASIC by Microsoft | \$395 |
| HP 45448A | COBOL by Microsoft | \$750 |
| HP 92248BA | Cross Reference Utility | \$59 |
| HP 45449D | FORTRAN by Microsoft | \$395 |
| HP 45447D | Pascal by Microsoft | \$350 |
| HP 45435A | Touchscreen Programmer's Tools | \$295 |
| HP 45310A | BASIC Programmer's Library | \$115 |
| HP 45419C | Programmer's Tools | \$395 |
| HP 45452D | Lattice® C Compiler | \$495 |
| HP 45311A | ICON Design System | \$199 |
| HP 45443A | Forms Master | \$295 |
| Engineering and Graphics | | |
| HP 82804A | General Statistics | \$95 (HP-85B) |
| HP 82834A | General Statistics | \$95 (HP-86B) |
| HP 82805A | Basic Stat. and Data Manipulation | \$95 (HP-85B) |
| HP 82835A | Basic Stat. and Data Manipulation | \$95 (HP-86B) |
| HP 82806A | Regression Analysis | \$95 (HP-85B) |
| HP 82836A | Regression Analysis | \$95 (HP-86B) |
| HP 82807A | Statistical Analysis Multi-Pac (G.S./BSDM/Regression Analysis) | \$215 (HP-85B) |
| HP 82837A | Statistical Analysis Multi-Pac (G.S./BSDM/Regression Analysis) | \$215 (HP-86B) |
| HP 82808A | Linear Programming | \$95 (HP-85B) |
| HP 82838A | Linear Programming | \$95 (HP-86B) |
| HP 82809A | Waveform Analysis | \$95 (HP-85B) |
| HP 82839A | Waveform Analysis | \$95 (HP-86B) |
| HP 82810A | AC Circuit Analysis | \$95 (HP-85B) |
| HP 82840A | AC Circuit Analysis | \$95 (HP-86B) |
| HP 82811A | Math | \$95 (HP-85B) |
| HP 82841A | Math | \$95 (HP-86B) |
| HP 82812A | Electronics Engineering Multi-Pac (AC Circuit Analysis/Math/Waveform Analysis) | \$215 (HP-85B) |
| HP 82842A | Electronics Engineering Multi-Pac (AC Circuit Analysis/Math/Waveform Analysis) | \$215 (HP-86B) |
| HP 82813A | Surveying | \$95 (HP-85B) |
| HP 82843A | Surveying | \$95 (HP-86B) |
| HP 47956A | AutoCAD™/150 | \$2000 |
| Data Base Management and Networking | | |
| HP 45431A | AdvanceLink/150 | \$215 |
| HP 45431E | AdvanceLink/IBM (IBM PC) | \$295 |
| HP 45439A | Monitor/IBM PC | \$95 |



The Touchscreen II not only supports a variety of peripherals, but can run over 600 software products.

| Order No. | Description | Price |
|-------------------|---|-------|
| HP 45641B | Touchscreen 3278 Emulation Accessory with File Transfer PC 2622 (ROM-based) | \$199 |
| HP 82861K | Touchscreen Internal Modem | \$199 |
| HP 45640A | Dow Jones Spreadsheet Link™ | \$199 |
| HP 45511D* | Transend COMPLETE™ | \$199 |
| HP 45414A | VT100 Terminal Emulator | \$199 |
| HP 45412A | OfficeShare Network Server Software | \$199 |
| HP 50902A | OfficeShare Network User Software | \$199 |
| HP 35177M | JetStart (for use with ThinkJet) | \$99 |
| HP 35178M | LaserStart (for use with LaserJet) | \$99 |

*Touchscreen II only.

EtherSeries™ Local Area Networking products from 3Com™

provide a cost-effective way to share information and peripherals, such as large-capacity discs and printers, using a Touchscreen MAX II as the LAN hub. Link to other Touchscreens and IBM PCs.

| | | |
|------------------|--------------------------------|-------|
| HP 45644A | EtherLink™/150 | \$199 |
| HP 45645A | EtherShare™/150 | \$199 |
| HP 45646A | EtherPrint™/150 | \$199 |
| HP 45647A | EtherMail™/150 Server Software | \$239 |
| HP 45639A | EtherMail™/150 User Software | \$199 |
| HP 45649A | EtherStart™/150 | \$199 |

Data Base Management

| | | |
|------------------|-------------------------------------|----------------|
| HP 45504K | MemoMaker/Time Management, Opt. 400 | \$199 |
| HP 82846A | Personal Productivity Pack | \$199 (HP-86B) |
| HP 45416A | Condor™ 3 | \$199 |
| HP 45468D | dBASE II™ | \$199 |
| HP 45468C | dBASE II | \$199 |
| HP 45583A | dBASE II (for Series 80 with CP/M) | \$199 |
| HP 45498A | Symphony™ by Lotus | \$199 (HP-86B) |
| HP 45580A | Milestone® (for Series 80) | \$199 |
| HP 45581A | Datebook™ II (for Series 80) | \$199 |
| HP 45582A | Personal Datebook™ | \$199 |
| HP 45408C | DataFax™ by Link System | \$199 |
| HP 45422A | Personal Card File | \$199 |
| HP 45422E | Personal Card File for the IBM PC | \$199 |
| HP 45421A | Executive Card Manager | \$199 (HP-86B) |

| Order No. | Description | Price |
|-----------|---|----------------|
| HP 45555K | Executive Card Manager | \$245 |
| HP 45488A | PFS®:File and PFS®:Report | \$265 |
| HP 82817A | IMPAC (Information Mgmt. Pack) | \$115 (HP-85B) |
| HP 45545A | R:BASE™ 4000/150 | \$495 |
| HP 45442A | ExecuDesk System ExecuDesk, Executive MemoMaker, Deluxe VisiCalc®, Personal Card File, Charting Gallery, Financial Calculator | \$895 |
| HP 45444A | ExecuDesk | \$95 |

Electronic Spreadsheets

| | | |
|-----------|--|----------------|
| HP 45482A | 1-2-3™ from Lotus™ | \$495 |
| HP 45482K | 1-2-3 from Lotus | \$495 |
| HP 45467A | GraphPlan™ | \$300 |
| HP 45465A | MicroPlan™ | \$400 |
| HP 45502A | MicroPlan (CP/M) (for Series 80) | \$500 |
| HP 45466A | MicroPlan™ Consolidation Module | \$200 |
| HP 45503A | MicroPlan Cons. Option (for Series 80) | \$300 |
| HP 45473D | Microsoft Multiplan™ | \$195 |
| HP 82855A | Microsoft Multiplan (CP/M) | \$295 (HP-86B) |
| HP 45405A | Deluxe VisiCalc | \$250 |
| HP 82800A | VisiCalc Plus® | \$240 (HP-85B) |
| HP 82830A | VisiCalc Plus | \$275 (HP-86B) |
| HP 45423A | Financial Calculator | \$39.95 |
| HP 82847A | Business Productivity Pack | \$615 (HP-86B) |

Accounting Systems

| | | |
|-----------|-----------------------------|-------|
| HP 45457A | BPI Accounts Payable™ | \$475 |
| HP 45456A | BPI Accounts Receivable™ | \$475 |
| HP 45455A | BPI General Accounting™ | \$475 |
| HP 45460A | BPI Inventory Control™ | \$475 |
| HP 45461A | BPI Job Cost™ | \$475 |
| HP 45458A | BPI Payroll™ | \$475 |
| HP 45520C | Rags to Riches Ledger™ | \$99 |
| HP 45521C | Rags to Riches Sales™ | \$99 |
| HP 45522C | Rags to Riches Receivables™ | \$99 |
| HP 45523C | Rags to Riches Payables™ | \$99 |

Personal Solutions

| | | |
|-----------|----------------------------------|---------|
| HP 35151D | The Calendar | \$49.95 |
| HP 35155D | The Planner | \$49.95 |
| HP 35152D | The List Manager | \$49.95 |
| HP 35156D | The Personal Correspondence Pack | \$125 |
| HP 35157D | The Personal Organizer Pack | \$125 |
| HP 35154D | The Speller | \$49.95 |
| HP 35153D | The Writer | \$49.95 |

Word Processing and Graphics

| | | |
|-----------|------------------------------------|----------------|
| HP 36569A | HPMessage | \$300 |
| HP 45400D | WordStar® | \$350 |
| HP 45584A | WordStar/80 (CP/M) (for Series 80) | \$350 |
| HP 82823A | WORD/80 | \$275 (HP-86B) |
| HP 45418A | Executive MemoMaker | \$245 |
| HP 45420E | MemoMaker for the IBM PC | \$180 |

| Order No. | Description | Price |
|-----------|---|-----------------------|
| HP 27505A | HPWord/150 | \$340 |
| HP 82816A | Text Editing Pack | \$115 (HP-85B) |
| HP 45489A | PFS:Write® | \$140 |
| HP 45588A | SpellStar®/80 (CP/M) (for Series 80) | \$125 |
| HP 45587A | MailMerge®/80 (CP/M) (for Series 80) | \$125 |
| HP 82824A | FILE/80 | \$270 (HP-86B) |
| HP 88104A | File Manager | \$200 (HP-86B) |
| HP 45427D | WordStar Professional® | \$550 |
| HP 45429A | WordStar Professional Options | \$250 |
| HP 45549K | Microsoft™ Word | \$395 |
| HP 45474D | Microsoft Word | \$375 |
| HP 45680A | Type-a-Line | \$69 |
| HP 45554K | MultiMate™ | \$495 |
| HP 45424A | MultiMate | \$495 |
| HP 82801A | Graphics Presentation Pack | \$240 (HP-85B) |
| HP 82831A | Graphics Presentation Pack | \$275 (HP-86B) |
| HP 45513A | Charting Gallery | \$265 |
| HP 45463A | Diagraph™ | \$430 |
| HP 45411A | Drawing Gallery | \$340 |
| HP 45437A | The Gallery Collection (Charting Gallery, Drawing Gallery, Gallery Picture Library Vol. II) | \$585 |
| HP 45433A | Gallery Picture Library Vol. II | \$95 |
| HP 45490A | PFS:Graph® | \$140 |
| HP 45462A | Picture Perfect™ | \$325 |
| HP 45406E | TextCharts/IBM | \$200 |
| HP 45540A | Painter | \$195 (IBM announced) |
| HP 45484A | Graphwriter® | \$395 |

™ IBM PC/XT™ and IBM PC/AT™ are U.S. trademarks of International Business Machines Corporation.

GW™-BASIC, Microsoft™ Word, MS™-DOS, and Multiplan™ are U.S. trademarks of Microsoft Corp.

Dow Jones Spreadsheet Link™ is a U.S. trademark of Dow Jones & Company, Inc.

EtherSeries™, 3Com™, EtherLink™, EtherShare™, EtherPrint™, EtherMail™, and EtherStart™ are U.S. trademarks of 3Com Corporation.

Condor™ is a U.S. trademark of Condor Computer Corp.

dBASE II™ is a U.S. trademark of Ashton-Tate.

Symphony™, Lotus™, and 1-2-3™ are U.S. trademarks of Lotus Development Corp.

Datebook™ II and Personal Datebook™ are U.S. trademarks of Organic Software, Inc.

DataFax™ is a U.S. trademark of Link Systems, Inc.

Transend COMplete™ is a U.S. trademark of Transend Corporation.

GraphPlan™, MicroPlan™, MicroPlan™ Consolidation Module, Rags to Riches Ledger™, Rags to Riches Sales™, Rags to Riches Receivables™, and Rags to Riches Payables™ are U.S. trademarks of Chang Laboratories, Inc.

BPI Accounts Payable™, BPI Accounts Receivable™, BPI General Accounting™, BPI Inventory Control™, BPI Job Cost™, and BPI Payroll™ are U.S. trademarks of BPI Systems, Inc.

MultiMate™ is a U.S. trademark of Multimate International Corporation.

Diagraph™ and Picture Perfect™ are U.S. trademarks of Computer Support Corporation.

R:BASE™ 4000/150 is a U.S. trademark of Microrim, Inc.

AutoCAD™/150 is a U.S. trademark of Autodesk, Inc.

* IBM® is a registered U.S. trademark of International Business Machines Corporation.

Microsoft® is a registered U.S. trademark of Microsoft Corp.

Lattice® is a registered U.S. trademark of Lattice, Inc.

DEC® is a registered U.S. trademark of Digital Equipment Corporation.

Milestone® is a registered U.S. trademark of Organic Software, Inc.

PFS®: File & PFS®: Report, PFS®: Graph, and PFS®: Write are registered U.S. trademarks of Software Publishing Corporation.

VisiCalc®, VisiCalc Plus® and Deluxe VisiCalc® are registered U.S. trademarks of VisiCorp.

Graphwriter® is a registered U.S. trademark of Graphics Communications, Inc.

WordStar®, WordStar Professional®, SpellStar®, and MailMerge® are registered U.S. trademarks of MicroPro International Corp.



PERSONAL COMPUTERS & CALCULATORS

Networking/Data Communications

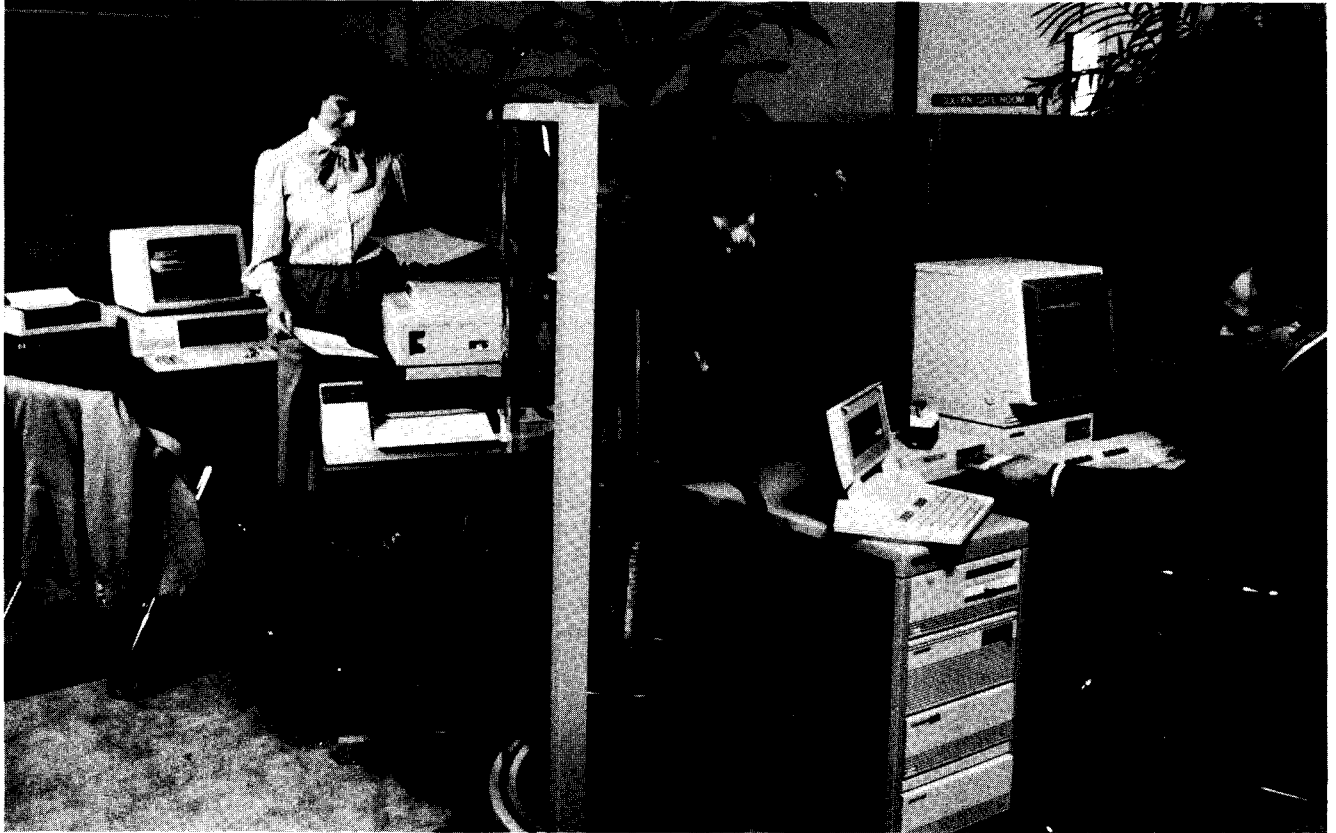

The HP Touchscreen II personal computer helps automate offices by providing access to HP 3000 and DEC minicomputers and IBM mainframes. The Touchscreen II also can exchange information with IBM PCs and with the Portable PLUS personal computer from Hewlett-Packard.

Personal Computers and Networking

Local area networks (LANs) are the links that connect individual (and sometimes incompatible) personal computers, mainframes, minicomputers, and related peripherals. The network is a data- and resource-sharing system; each individual network node can easily and reliably communicate and exchange information with other nodes.

Compatibility

HP has been among the leaders in the development of industry-wide standards for networking and communications. Our personal computers, workstations, and host computers communicate via a network based on ISO, IEEE, and *de facto* industry standards.

Industry Standards — HP uses the International Standard Organization (ISO) seven-layer Open Systems Interconnect (OSI) Reference Model as the basis for its HP AdvanceNet architecture. The X.25 standard for public or private data networks and the IEEE 802.3 standard for local area networks represent standards within the OSI Reference Model.

De Facto Standards — Both batch and interactive communications in System Network Architecture (SNA®) and bisync environments are supported by HP AdvanceNet, and new product developments will enhance compatibility with SNA and such other *de facto* standards as DCA/DIA.

HP AdvanceNet

Hewlett-Packard's AdvanceNet is a communications strategy and network architecture designed to provide a broad range of networking alternatives. HP AdvanceNet delivers workable solutions to a multitude of data communication problems, along with data and resource management, personal computer networking and system-to-system (multi-vendor) networking. These capabilities provide you with fast and effective communications that improve the productivity of users and programmers alike.

In developing the strategy for HP AdvanceNet, HP combined unique products and solutions that focus on cost-efficient yet expandable networking. HP AdvanceNet offers price and performance alternatives for existing and new systems, as well as the flexibility to enlarge and enhance the system as your needs evolve. And your long-term investment in networking is protected by the many alternatives for system upgrades and connections that are supported by HP AdvanceNet.

Hewlett-Packard's network management products enable you to easily design, configure, monitor, and control your network.

Architecture Interfacing

HP AdvanceNet unites two data processing methods: HP's local interactive access to processing and IBM's centralized batch processing. The SNA approach used by IBM performs the same functions, with different implementations, as the OSI reference

model. The HP AdvanceNet strategy interfaces HP equipment with IBM and IBM plug-compatible products for both SNA and bisync environments.

Comprehensive networking architecture integrates the elements of various vendors' hardware and software products to achieve a network that is transparent to the user. This transparency permits interaction within multi-vendor systems, and allows a remote system to operate with the same capabilities as a local system. HP AdvanceNet, which follows the OSI reference model and standard protocols, is just such a comprehensive architecture.

The components most suitable for your application can be selected from different vendors without compromising the unique needs of your data communications environment. The chosen components must communicate with the HP products in your network. The compatibility of future hardware and software additions to your HP AdvanceNet system is ensured by HP's commitment to industry-standard modeling.

AdvanceLink

The extensive data communications capabilities of AdvanceLink connect your Touchscreen II or Touchscreen MAX II to IBM PCs, to other Touchscreen IIs, to the Vectra personal computer, and to modems. With AdvanceLink, the Touchscreen II can transfer files between most mainframes, public data bases, and personal computers.



The powerful command language of AdvanceLink lets you automate such repetitive tasks as modem dialing and logging onto remote computers or public information systems. In addition, the AdvanceLink functions are easily controlled from the Personal Applications Manager (PAM) menu.

The built-in Monitor program helps you exchange information with other Touchscreen IIs, the Vectra, or the HP 3000 mainframe. And when you add the Monitor/IBM PC accessory product to AdvanceLink, you can transfer files between Touchscreen IIs, Vectras, and IBM PCs. Both ASCII and binary files can be transferred using full-duplex modems and phone lines or by a direct cable connection between the Touchscreen IIs and the IBM PC.

Touchscreen 3278 Emulation

You can gain access to software and data bases on an IBM host computer when the Touchscreen 3278 Emulation Accessory with File Transfer is installed on your Touchscreen II or Touchscreen MAX II. The terminal emulation function offers the advantages of an IBM 3278 terminal plus the convenience of local computing. And the File Transfer feature lets you upload and download files, and use the host computer to transfer data between the Touchscreens and IBM PCs.

Acculink™

The DEC® VT100 and older VT52 terminals can be imitated using Acculink on the Touchscreen II, Touchscreen MAX II, or Vectra. You can run DEC minicomputer-based application software and exchange ASCII and binary files. Acculink supports easy terminal emulation, including error checking and macro file construction.

Touchscreen Internal Modem

Exchanging information over phone lines between Touchscreen IIs and Vectras, or between these and other personal computers, is as easy as plugging in a phone jack. The Internal Modem installed on your Touchscreen II, Touchscreen MAX II, or Vectra offers the capability of tapping into data bases and using subscription services. Its 1200-baud operation means fast communications and lower phone bills, while older systems remain compatible with its 300-baud rate. With AdvanceLink and the Internal Modem on your HP personal computer, you can exchange files with a remote HP 3000 computer.

Portable-Desktop Link

More than a cable and interface card, the Portable-Desktop Link (PDL) connects the HP Portable PLUS personal computer and the Touchscreen II, Touchscreen MAX II, Vectra, or the IBM PC, creating an efficient data exchange network. The Portable PLUS is linked to the Touchscreens and Vectras with the HP Extended I/O Accessory and to the IBM PC with the HP-IL Interface Card. The Portable PLUS can take advantage of these links to use printers or disc drives connected to the desktop personal computer.

OfficeShare Network

OfficeShare is HP's personal computer local area network (PC LAN), connecting personal computers for file and peripheral sharing. OfficeShare software also provides a LAN connection to the HP 3000 business computer for terminal communication and file transfer.

- Industry-standard IEEE 802.3 PC LAN
- Uses MS™-DOS 3.1
- Up to 30 personal computers per 185-meter segment
- Links personal computers (HP to HP, HP to IBM, and HP to others)
- Compatible with HP AdvanceNet for HP 3000 access
- MS™-Net-based software provides simple network access and compatibility with other personal computer networks using Microsoft networks (e.g., IBM).
- Transparent file, remote file access (RFA), and peripheral sharing

Up to 30 personal computers may be connected to each 185-meter network segment of the OfficeShare LAN, using any HP Touchscreen or Vectra with a hard disc as a network server. The network server can support up to eight nodes in a typical system.

An HP 3000 computer can be accessed through OfficeShare's PC LAN capability for terminal communication with file transfer; with an HP 3000-based PC LAN, the PC network server is optional.

The RFA feature allows network users to store and access files on shared discs connected to the server. This access is transparent to the personal computer user, eliminating the need to learn another file access method. In addition, transparent printer access enables the personal computers to share printers.

The OfficeShare Network, linked to the HP 3000 computer, offers users increased capabilities. The personal computers access the HP 3000 as a terminal, with the ability to develop HP 3000 application software. This HP AdvanceNet connection also provides access to HPDesk, remote data bases, larger printers, and file transfer using AdvanceLink.

EtherSeries™/150 LAN

The 3Com™ Corporation's EtherSeries/150 is a popular, stand-alone, EtherNet™ - compatible personal computer local area network.

- EtherNet-compatible, *de facto* standard PC LAN
- Supports MS-DOS commands
- Links personal computers (HP to HP and HP to IBM)
- Up to 100 nodes per 300-meter cable segment
- Four to eight active users per server

Five EtherSeries hardware and software products link HP Touchscreen II and Vectra personal computers, as well as IBM PC and PC-compatible computers. Connected together with an HP Touchscreen MAX II as a network server, they form a sophisticated data communications web. EtherSeries products utilize HP Touch to select messages and operations, and support MS-DOS commands, application programs, and data files. **EtherLink™/150** — This connects the personal computers to the LAN, enabling them to share programs, information, printers, and fixed-disc storage with the network server.

EtherShare™/150 — Used with EtherLink, this software component of the LAN allows communications among the personal computers.

EtherPrint™/150 — Printers attached to the HP Touchscreen MAX II network server can be accessed by the linked personal computers using EtherPrint.

EtherMail™/150 — This server software functions as a network post office, providing fast, efficient electronic mail delivery.

EtherStart™/150 — This plug-in module lets a Touchscreen II operate in the LAN without a floppy disc drive, automatically loading the operating system software from the network server when the Touchscreen II is turned on.

™ Ethernet™ is a U.S. trademark of Xerox Corp.
 UNIX™ is a U.S. trademark of Bell Laboratories.
 Acculink™ is a U.S. trademark of IE Systems, Inc.
 MS™-DOS and MS™-Net are U.S. trademarks of Microsoft, Inc.

EtherSeries™, 3Com™, EtherLink™, EtherShare™, EtherPrint™, EtherMail™, and EtherStart™ are U.S. trademarks of 3Com Corporation.

* DEC® is a registered U.S. trademark of Digital Equipment Corporation.
 SNA® and IBM® are registered U.S. trademarks of International Business Machines Corporation.

PERSONAL COMPUTERS & CALCULATORS

Personal Computation

Models HP-12C, HP-11C, HP-15C, HP-16C, HP-41CV, HP-41CX

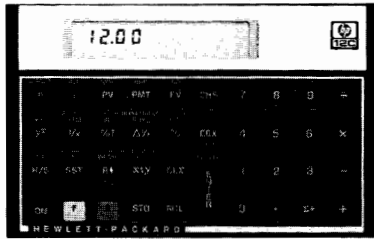

HP 12C

What's Right for You?

Whether it's a professional calculator, an advanced calculator, or a handheld computer, Hewlett-Packard products can give you the sense of pride that comes from knowing you own a computational tool that has been designed—in every detail—to be the finest of its kind.

HP Series 10 Professional Calculators meet the needs of professionals in business, engineering, and computer science. Solve problems specific to your field and save time by eliminating unnecessary calculations. Each calculator is programmable and has special functions, Continuous Memory, and a liquid crystal display.

The flexible and powerful HP-41CV and HP-41CX Advanced Calculators perform tasks from arithmetic calculations to data analysis. Both models offer a wide variety of software.

The HP-71 Handheld Computer is a powerful computational tool for engineers and scientists. It is also well suited to manufacturing applications like quality control, portable data acquisition, and test instrument control. Create hardware, software, firmware, and interfaces using complete documentation including HP-71 internal specifications.

The HP-75D Handheld Computer is ideal as a remote data collection and information processing tool, whether operated from the keyboard or used with a bar code wand. Use it in field service and sales reporting, inventory control, tracking work in process, and more.

The HP-41, HP-71, and HP-75 are expandable, portable, and highly customizable. The Custom Products Program provides personalized solutions for your applications. To assemble completely portable systems, as well as to communicate with instruments and computers, use the versatile HP-IL Interface. It connects calculators and handheld computers with controllers, instruments, and peripherals.

Series 10 Professional Calculators

All Series 10 calculators come with long-life disposable batteries, a soft carrying case, and an Owner's Handbook. The HP-12C and HP-11C also come with a Problem-Solving Guide.

Size: All Series 10 calculators measure 12.7 x 8.0 x 1.5 cm (5 x 3 1/8 x 5/8 in.).

HP-12C Advanced Financial Programmable

The HP-12C is a powerful financial calculator that is a favorite of business professionals in banking, real estate, and investment. It features basic time and money functions, Net Present Value, Internal Rate of Return, plus a bond function that calculates yield-to-maturity and price. Write your own programs or use HP's prewritten software solutions for specific applications.

HP-11C Advanced Programmable Scientific

Scientists, engineers, and mathematicians find the HP-11C easy to learn and easy to use. Built-in functions include: statistics, a random number generator, trigonometrics, hyperbolics and inverses as well as permutations and combinations. The HP-11C has subroutine and indirect addressing capability plus conditional tests and flags. Insert new instructions, access any part of a program, and easily delete program lines. At the touch of a single key, branch to any one of five independent programs.

HP-15C Advanced Programmable with Matrix Functions

The HP-15C has special functions that help scientists, engineers and mathematicians solve problems involving matrices and complex arithmetic. Use built-in matrix functions to operate on up to five matrices (a maximum of 64 elements). Perform transpositions, determine norms, and find determinants. The HP-15C has two parallel stacks—one for the real, and another for the imaginary, part of a complex number. It also has Solve and Integrate functions. Features include 448 program lines, label addressing, insert/delete editing, 7 subroutine levels, program review, 10 flags, and conditional tests.

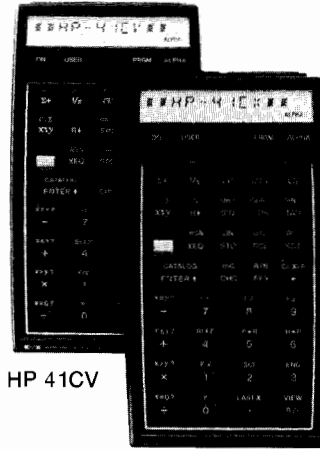

HP 41CV

HP 41CX



HP-16C Programmable for Computer Science

The HP-16C is specifically designed for computer science and digital electronic applications. Number base modes make it easy to convert between binary, octal, decimal, and hexadecimal bases. In addition to calling and editing programs, the HP-16C has extensive bit manipulation capability: shift, rotate, set, test, summation, and mask. Select word size, 1's and 2's complements, and unsigned mode. Emulate instructions of most available processors. The calculator has four Boolean logic operators: AND, OR, XOR, and NOT.

HP-41 Advanced Calculators

The HP-41CV and HP-41CX provide the heart of expandable computational systems. They combine the speed, power, and accuracy of computers with the portability, touch-key simplicity, and low cost of handheld calculators. RPN (Reverse Polish Notation) provides a consistent and efficient logic system.

In addition to all the built-in functions of the HP-41CV, the HP-41CX features built-in Time and Extended Functions/Memory modules, a text-file editing function, and 19 other functions not available in the HP-41CV.

Alpha capability lets you label programs with easy-to-remember names. Each program is autonomous and each can have up to 100 different local labels for branching within the program. The HP-41 also features up to six levels of subroutines, 10 conditional tests, 56 internal flags, powerful loop control, indirect addressing, and both local and global branching. Functions and programs can be assigned to almost any key.

A complete system of status annunciators indicates mode conditions. Error messages pinpoint calculation errors and ten different tones provide audible feedback. Continuous Memory saves programs and data even when the calculator is turned off.

Dedicated plug-in peripherals are available and, through HP-IL, the HP-41 can transmit and receive data, perform a wide variety of control functions, and communicate with larger computers, peripherals, modems, terminals, and instruments.

Choose from a broad range of HP-written Application Pacs and Solutions Books as well as from Users' Library programs. Hewlett-Packard offers a Custom Products Program for those who require customized software solutions in large quantities. (See page 56 for more information on Custom Products.)

HP-41 Specifications

User memory (bytes): 2,233 (319 registers) built into HP-41CV/CX; 6,433 (919 registers) maximum.

Extended memory (bytes): 868 (124 registers) built into HP-41CX; HP 82180A Extended Functions/Memory Module, 868 (124 registers) optional for HP-41CV.

Extended memory modules (bytes): HP 82181A Extended Memory Module, 1,666 (238 registers) optional for HP-41CX/CV.

Built-in functions: Over 200 in HP-41CX; over 128 in HP-41CV.

Keyboard: Redefinable, alphanumeric (HP-41CX/CV).

Display: LCD, 10 digits; 12 alpha characters (scroll to 24) (HP-41CX/CV).

Power requirements: Four 1.5V, size N batteries (HP-41CX/CV).

Size: 3.3 x 7.9 x 14.2 cm (1.3 x 3.1 x 5.7 in) (HP-41CX/CV).

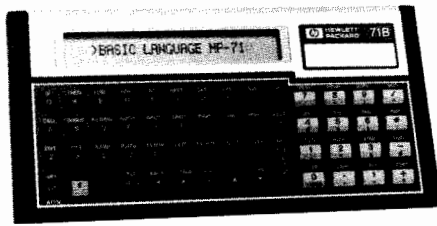

HP-71B



HP-75D



HP-71 Handheld Computer

The HP-71 Handheld Computer bridges the gap between advanced programmable calculators and portable computers. It is a powerful computational tool for individuals and is also well suited to manufacturing applications like quality control, portable data acquisition, and test instrument control. Its full CMOS CPU has a 4-bit intelligent external bus and 64-bit internal registers.

The HP-71 uses a powerful BASIC language that runs nearly as fast as compiled BASIC and allows structured programming techniques. It supports a sophisticated file management system and an advanced calculator mode (CALC). The operating system can be further enhanced by using FORTH or assembler languages.

Powerful CALC mode, combined with a 10-digit key pad, allows quick solutions and fast, easy input of numeric data. A variable assigned a value in BASIC retains that value in CALC mode, and vice versa. Any numeric expression that can be keyed in and evaluated in BASIC can also be evaluated in CALC mode. Perform computations on up to 15 independent variables using built-in statistics functions. And use a complete set of trig functions to evaluate complex equations.

Over 240 instructions complement the HP-71 BASIC language. Parameters can be passed from main programs to subprograms. Built-in typing aids reduce program and data entry time. And each key on the keyboard (except the blue and gold shift keys) is redefinable.

Use the built-in quartz-crystal clock to create clock/calendar dependent programs that must begin and run when no one will be there to control the process.

Optional HP-IL interfacing provides access to a broad array of accessories, peripherals, instruments and other computers. Four ports accept any combination of memory modules or application software. And applications can be customized through the Custom Products program.

Documented internal specifications allow development of hardware, software, interfaces and firmware. (See the Custom Products and Programming Development Aids on page 56 for publication names and numbers.)

HP-71 Specifications

User memory (bytes): 17.5K built in, 33.5K (129K using 3rd party modules) maximum.

Read only memory (bytes): 64K built in, 320K maximum.

Memory modules (bytes): HP 82420A, 4K (user memory—add a maximum of four); 16K, 32K, 48K, or 64K (read only memory—add a maximum of four).

Transfer rate (bytes/sec): 8K (copying to a loop, no devices on loop); 6.4K (copying in a file); 4.5K (OUTPUT statement, no formatting (USING)); 4K (ENTER statement, no formatting (USING) and version 1B of the HP-IL module).

Programming languages: HP BASIC (built in); FORTH and assembler (optional).

Keyboard: Block QWERTY, redefinable, alphanumeric with separate keypad.

Display: LCD, 22 characters (scroll to 96).

Power requirements: Four 1.5V, size AAA alkaline batteries.

Size: 19 x 9.7 x 2.5 cm (7.5 x 3.8 x 1.0 in).

HP-75D Handheld Computer

The HP-75D is ideal as a remote data collection and information processing tool whether operated from the keyboard or used with a bar code wand. It has an 8-bit CMOS Series 80 personal computer CPU with built-in HP-IL and Digital Bar Code Wand interfaces. It is a fully-integrated, battery-powered computer.

Data collected with the HP-75D can be processed at remote sites or transferred to another computer using the portable HP 82168A Acoustic Coupler or the HP 82718A Expansion Pod. With HP-IL, up to 30 devices can be connected for mass storage on cassettes or disc drives, printing, plotting, measurement and access to larger systems. HP-IL interface converters also make it possible to connect the HP-75 to HP-IB, RS-232C, and GPIO devices, and to other HP computers.

The built-in 48K-byte ROM BASIC operating system has 167 system commands, including 41 numeric functions. Multiple file structure allows any number of files (up to available memory space) to be in memory at the same time. The built-in text file allows storage of text and basic files. A 256 character set includes both upper- and lower-case ASCII characters with true descenders, as well as several special characters.

Continuous Memory assures that data and programs will be saved even when the computer is turned off. A typewriter-like keyboard allows fast data entry, and more than 190 key combinations can be redefined. Simple keystrokes call up a "hidden" numeric keypad for quick input of numeric data.

The HP-75D becomes a single integrated data communications package when used with the HP 82718A Expansion Pod (which has built-in 3 of 9 Code and Code 11 software, 300-baud modem, electronic disc, and 32K or 64K bytes of RAM). For five more bar code decoders, use the HP 82725A Bar Code Reader Module. (The HP 92267A/B Digital Bar Code Wand is required to read bar code.)

A built-in appointment function provides audio alarm and message options. TIME mode calls up the system clock and allows the execution of time- and date-dependent programs. A built-in card reader allows the use of small, inexpensive magnetic cards for storage of programs, text files, data files, and keyboard redefinitions.

Comes with Owner's Manual, Reference Manual, Owner's Pac, Keyboard Overlay Kit, field case, rechargeable battery pack, recharger/AC adapter, HP-IL cables, and card holder.

HP-75 Specifications

User memory (bytes): 16K built in, 24K maximum (plus 32K or 64K with Expansion Pod).

Read only memory (bytes): 48K built in, 144 maximum.

Memory modules: HP 82700A, 8K (user memory—add a maximum of one); 32K (read only memory—add a maximum of three).

Programming language: HP BASIC

Keyboard: Touch-type QWERTY, redefinable, alphanumeric.

Display: LCD, 32 characters (scroll to 96).

Power requirements: Three rechargeable nickel-cadmium batteries (2 to 3 weeks of normal use between charges, or 20 to 30 hours of continuous use).

Size: 12.7 x 25.4 x 3.2 cm (5 x 10 x 1.25 in)

Ordering Information

| | Price |
|---------|----------|
| HP-12C | \$129.00 |
| HP-11C | 79.00 |
| HP-15C | 120.00 |
| HP-16C | 120.00 |
| HP-41CV | 125.00 |
| HP-41CX | 125.00 |
| HP-71B | 129.00 |
| HP-75D | 147.00 |



PERSONAL COMPUTERS & CALCULATORS

Personal Computation

Enhancements & HP-IL Peripherals

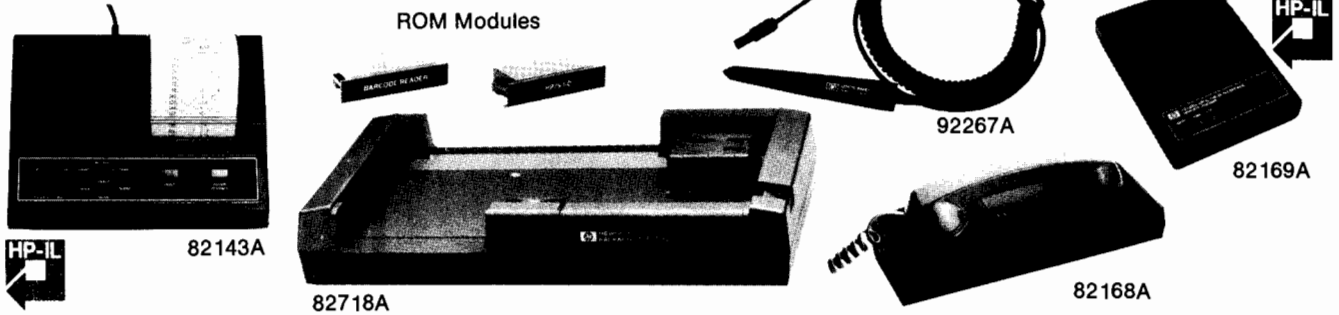

Enhancements and HP-IL Peripherals

HP-41:

HP 82182A Time Module

With this module (built into the HP-41CX), the HP-41CV can become a time-scheduled system controller, an alarm clock, an appointment reminder, a calendar, a timer, even an advanced stopwatch.

HP 82160A HP-IL Interface Module

Plugs into any one of the four ports in the HP-41, connecting it with HP-IL peripherals and instruments. Gives the HP-41 control of up to 30 devices on the loop. Three function sets are supplied: printer, mass storage, and general input/output (I/O).

Size: 2.8 x 1.2 x 0.4 cm (1.1 x 0.5 x 0.2 in)

Cable length: (two attached cables) 80 cm (31 in) each

Data Transfer Rate: 150 bytes/second (typical HP-41 transfer rates)

HP 82183A Extended I/O Module

Provides 59 I/O functions beyond those provided by the HP 82160A HP-IL Module. These functions enhance mass storage, character manipulation, HP-IL control and advanced control of the HP-41 and devices on the HP-IL loop.

HP 82184A Plotter Module

Provides plotting capability for the HP-41 using the HP 82162A Printer/Plotter. Plotting programs are included in the module for quick and easy generation of high-quality graphics. Develop graphics programs as well as plot and print HP bar code.

HP 82104A Card Reader

Allows programs and data to be saved on magnetic cards which contain 32 registers, 16 per side. Adds over 30 control functions to the HP-41; keeps track of cards as they are read, and prompts for the next card; permits a program to be run, but not reviewed or altered through normal operations; reads HP-67/97 program cards, making all necessary translations into HP-41 code.

HP 82143A Thermal Printer/Plotter

Quietly provides numeric, upper- and lower-case alpha, doublewide characters, high-resolution plotting capabilities, and intensity control. Allows user-defined special characters.

HP 82153A Optical Wand

Easily inputs data or programs into the HP-41 when passed across a printed page of HP bar code. Most HP-41 software is available in HP bar code, including Users' Library programs and Solutions Books.

00041-15042 Automatic Start and Cassette Duplication Module

Lets you write programs that automatically set status, configure memory, access peripherals, or provide prompts. The mass copy feature provides a means of duplicating programs and data from cassette to cassette, cassette to 3 1/2" HP-IL disc, and from disc to disc.

00041-15043 HP-IL Development Module

Allows you to change the contents of any control register and poll certain status bits. Characters can be inserted at, or removed from, any position in the Alpha register. Makes it possible to add a second HP-41 to the HP-IL loop to display the mnemonics of HP-IL messages as they travel around the loop.

HP-71:

HP 82401A HP-IL Interface

Allows direct connection to any HP-IL product, and to HP-IB, RS-232C, and GPIO devices using interface converters. Facilitates simultaneous control of up to 30 devices on the loop and, through secondary addressing, up to 930 devices. Allows printer, display, mass storage, and general input/output operations.

HP 82402A Dual HP-IL Adaptor

Allows the HP-71 to have two independent, isolated HP-IL loops simultaneously, using only one port and two HP-IL modules. Control local instruments with one loop while the other is networked to a supervisory computer. Or use one loop for data logging and the other for battery conservation by using peripherals only as needed.

HP 82400A Card Reader

Offers an inexpensive means of storage for programs and data. Cards can be encoded as a private file so they may be copied and executed, but not viewed or edited, to ensure protection from being overwritten. Automatic verification assures accuracy.

HP-75:

HP 82718A Expansion Pod

A 300-baud, direct-connect modem with 32K (Opt. 64 has 64K) bytes of non-volatile electronic disc. Modem and electronic disc commands are built into the pod's 16K-byte ROM software. The direct-connect, serial, asynchronous, full-duplex modem is compatible with Bell 103/113 modems.

Electronic disc uses RAM to emulate a flexible disc as a high-speed disc drive, for fast data transfer and data file access. Create, access and modify files; establish a hierarchical directory structure; and copy files into and out of the electronic disc.

Two bar code decoders are built in—3 of 9 Code and Code 11.

HP 82718A Expansion Pod Opt. E64

Includes 64K bytes of electronic disc memory; the direct-connect modem and all related modem functions are excluded.

HP 82725A Bar Code Reader Module

This 8K-byte ROM module can decode 3-of-9, Interleaved 2-of-5, Industrial 2-of-5, 2-of-7 (Codabar), Code 11, Universal Product (UPC A or E), or European Article Number (EAN 8 or 13) Codes. (Not required to read 3-of-9 Code or Code 11, if you use the HP 82718A Expansion Pod.) Use the module with the HP 92267A or HP 92267B Bar Code Reader wand.

HP 92267A/B Digital Bar Code Wands

Use these wands with the HP-75D and HP 82725A Bar Code Reader Module. The HP 92267A is a high resolution (0.13 mm, or 0.005 in) wand recommended for reading high-density labels that are generally produced on specialized printers. The medium resolution (0.19 cm, or 0.0075 in) HP 92267B is recommended for reading bar code labels produced on good-quality dot matrix printers.

00075-15001 I/O ROM

Enhances the BASIC language capability of the HP-75D with HP-IL controller and advanced programming commands. It can be used with any HP-IL talker or listener device. The major I/O statements provided by the ROM are OUTPUT, ENTER, SENDIO, ENTIO\$, and SEND.

HP-41, HP-71, and HP-75:

HP 82161A Digital Cassette Drive

Uses a digital-quality mini-cassette to store up to 128K bytes of information. Rewind time is under 30 seconds and it can access over 250 bytes of information per second. STANDBY mode enables an HP-IL controller to turn the drive on or off remotely.

Size: 17.8 x 13.2 x 6.1 cm (7 x 5.2 x 2.4 in)

Data Format

Number of tracks: 2

Density: 335 bits/cm (850 bits/inch)

Format: 256 bytes/record (8 bits/byte)

Formatted capacity: 512 records (131,072 bytes)



HP 82162A Thermal Printer/Plotter

Provides numeric upper- and lower-case alpha, doublewide characters, and intensity control.

Two chief features distinguish the HP 82162A from the HP 82143A dedicated Printer/Plotter. It can be used by the HP-71 and HP-75 as well as the HP-41, and it has a 101-character buffer for enhanced graphics capabilities and a FORMAT function which automatically centers or justifies copy to the left and right margins.

STANDBY mode enables any HP-IL controller on the loop to manage its power consumption.

Size: 17.8 x 13.2 x 6.1 cm (7 x 5.2 x 2.4 in)

Cable length: 86 cm (34 in)

Character sets: 96 standard ASCII, 127 modified-expanded ASCII

HP 2225B ThinkJet Personal Printer

Prints bidirectionally at 150 characters/second to produce 80-column pages of graphics or text in the office or field. With sound pressure under 50 decibels, printer noise is minimal.

An inexpensive, disposable cartridge holds the print head and ink reservoir and can print about 500 pages before replacement. It features an 11 x 12 dot-matrix format text mode with a logic-seeking feature, bold mode, and 216 printable characters to meet multilingual printing needs. Uses single sheets or fanfold paper.

Size: 8.9 x 29.2 x 20.6 cm (3.5 x 11.5 x 8.1 in)

HP 9114A Disc Drive

For a detailed description refer to Disc Drives, beginning on page 89.

HP 82168A Acoustic Coupler (modem)

Provides remote communications capabilities over telephone lines through HP-IL. Access "dial-up" computer systems through telephone lines. Data transmission rate is 300 baud. Use anywhere a conventional (G-type) receiver is available.

With the HP-41, use with the Extended I/O Module. The I/O ROM or Utilities Card (available in the HP-75 Solutions Book) is required for HP-75 operation. The Terminal Emulator program, available in the Acoustic Coupler Owner's Manual, is a convenient addition.

Size: 25.7 x 9.7 x 5.7 cm (10.1 x 3.8 x 2.2 in)

Ordering Information

| | Price |
|---|----------|
| HP-41: | |
| HP 82180A Extended Functions/Memory Module | \$75.00 |
| HP 82181A Extended Memory Module | 75.00 |
| HP 82182A Time Module | 75.00 |
| HP 82160A HP-IL Interface Module | 125.00 |
| HP 82183A Extended I/O Module | 75.00 |
| HP 82184A Plotter Module | 75.00 |
| HP 82104A Card Reader | 195.00 |
| HP 82143A Thermal Printer/Plotter | 385.00 |
| HP 82153A Optical Wand | 125.00 |
| 00041-15042 Automatic Start and Cassette Duplication Module | 35.00 |
| 00041-15043 HP-IL Development Module | 75.00 |
| HP-71: | |
| HP 82420A 4K Byte Memory Module | 75.00 |
| HP 82401A HP-IL Interface | 125.00 |
| HP 82402A Dual HP-IL Adapter | TBA |
| HP 82400A Card Reader | 165.00 |
| HP-75: | |
| HP 82700A 8K Byte Memory Module | 195.00 |
| HP 82718A Expansion Pod (32K, modem) | 875.00 |
| HP 82718A Opt. 64 (64K, modem) | 1,175.00 |
| HP 82718A Opt. E64 (64K, no modem) | 1,150.00 |
| HP 82725A Bar Code Reader Module | 75.00 |
| HP 92267A Digital Bar Code Wand | 160.00 |
| HP 92267B Digital Bar Code Wand | 150.00 |
| 00075-15001 I/O ROM | 95.00 |
| HP-41, HP-71, and HP-75: | |
| HP 82161A Digital Cassette Drive | 550.00 |
| HP 82162A Thermal Printer/Plotter | 450.00 |
| HP 2225B ThinkJet Personal Printer | 495.00 |
| HP 82168A Acoustic Coupler | 495.00 |
| HP 9114A Disc Drive | 795.00 |

HP-IL Instruments and Interfaces

HP-41, HP-71, and HP-75:

Instrument Options

For a detailed description of instruments you can use with the HP-41, HP-71, and HP-75, see numerical index for page numbers. HP 3468A Digital Multimeter; HP 3421A Data Acquisition/Control Unit; HP 5384A/HP 5385A Opt. 003 Frequency Counters; HP 1630A/D/G Logic Analyzers; HP 4945A Transmission Impairment Measuring Set.

HP 82164A HP-IL/RS-232C Interface

Translates HP-IL signals into RS-232C signals, and vice versa, for connection of HP-IL systems with RS-232C devices. Provides bit-serial asynchronous data communication. Information can be sent and received (in true half- and full-duplex mode) in EIA RS-232C compatible voltage levels. When a controller is used, it must be an HP-IL device. Comes with one HP-IL cable and AC adapter.

HP 82169A HP-IL/HP-IB Interface

Permits linkage of HP-IL systems with HP-IB (IEEE 488, 1978) computers and lab equipment. Its key feature is its friendly, flexible two-mode (Translator and Mailbox) operation. Responds to most HP-IL and HP-IB commands. When a controller is used, it can be either an HP-IL or HP-IB device. AC adapter included.

HP 82165A HP-IL/GPIO Interface

Allows HP-IL to control equipment operating with parallel bus structures. Contains I/O buffering and a built-in power supply that operates from an HP standard AC adapter that is included.

HP 92198A Mountain Computer HP-IL 80-Column Video Interface (U.S.)

Display data and listings on a standard video monitor. Add an RF modulator and use it with a conventional TV set. View in 24-row-by-80-column or 20-row-by-40-column format. Characters also can be displayed in inverse video.

HP-IL Interfaces for Other Computers

HP 82938A HP-IL/Series 80 Interface

Provides a communication link between portable battery-operable products and larger computers. Gather data in the field, and then access an HP Series 80 personal computer to do more complex analyses. Allows use of the built-in graphics capabilities of Series 80 Personal Computers.

HP 45643A Extended I/O Accessory

Provides a communication link between The PORTABLE and the Touchscreen or Touchscreen MAX computers via the HP-IL interface. Transfer up to two pages of text per second, with 500 words per page. Comes with instructions, plus software on a 3/2" disc.

HP 82973A HP-IL Interface Card

Provides a communication link between The PORTABLE and IBM PC/XT computers via HP-IL interfacing. Transfer up to two pages, with 500 words each, of text per second. Comes with instructions, plus software on a 5/4" disc.

HP 82166C HP-IL Interface Kit

A design kit that provides the necessary special components needed to incorporate HP-IL into other devices. After designing HP-IL in, components can be purchased separately from HP. Included in the kit are complete component-level documentation, four complete sets of parts for prototype evaluation, and HP-IL development software.

Ordering Information

| | Price |
|--|--------|
| HP-41, HP-71, and HP-75: | |
| HP 82164A HP-IL/RS-232C Interface | 295.00 |
| HP 82169A HP-IL/HP-IB Interface | 395.00 |
| HP 82165A HP-IL/GPIO Interface | 295.00 |
| HP 92198A Mountain Computer HP-IL 80-Column Video Interface (U.S.) | 325.00 |
| HP 82938A HP-IL/Series 80 Interface | 295.00 |
| HP 45643A Extended I/O Accessory | 175.00 |
| HP 82973A HP-IL Interface Card | 150.00 |
| HP 82166C HP-IL Interface Kit | 395.00 |

PERSONAL COMPUTERS & CALCULATORS

Personal Computation Accessories, Custom Products

Accessories

Series 80, HP-41, HP-71, and HP-75:

Accessories such as owner's manuals, programming pads, magnetic cards, thermal paper, battery packs, rechargers, and software manuals are readily available for all types of HP calculators.

Custom Products and Programming Development Aids

Through customization, the powerful HP-41, HP-71, and HP-75 can be tailored with your own software to perform the functions that will increase performance productivity.

Using customer- or third-party written programs, the HP-41, HP-71, or HP-75 can be customized using Custom ROMs, EPROMs, Magnetic Cards, and Keyboard Overlays. The HP-41 can also be customized with Custom Keyboard Touchpads and Bar Code.

The services of Independent Custom Consultants (ICCs) make the customization process easy. (A list of ICCs is available from your HP Sales Representative.) ICCs are application-oriented software houses with in-depth training on HP products and system integration. They convert software to finished Custom Products and can write and field test software, package the system, write user's manuals, and more. Choose and contact an ICC to help you decide if customized HP products can be used to help meet your needs.

HP-41:

HP-41CV or HP-41CX Opt. 001 Custom Calculator

The trigonometric function labels are removed from the keys, eliminating unnecessary and possibly distracting nomenclature. Label the keys to precisely fit your application to minimize potential error. Custom Keyboard Overlays and Keyboard Touchpads label keys to improve ease of use.

HP 82504A Custom Keyboard Touchpads

Relabel the HP-41 keyboard with special functions assigned to each key. Available in a variety of background and printing colors.

HP Bar Code

Provides cost-efficient storage on paper that's easy to use, duplicate and distribute. It can represent any operation performed from the keyboard and preserves special key assignments, programs, and data. Reproduce it using the HP 82184A Plotter Module.

HP-71:

HP 82440A Software Development Utility

Allows development of HP-71 BASIC, FORTH, or assembler language source files using a personal computer. Listings of typical programs for Series 80 and IBM PC computers, as well as instructions for setting up other PCs are included. An HP-IL/HP-IB or HP-IL/RS-232C Interface is required. Software comes on mini cassette.

HP 82441A FORTH/Assembler

Provides an extended software development environment for your HP-71. The FORTH operating system is a very effective language for instrument control applications. It allows routines to be called from BASIC and vice versa.

Create FORTH primitives, HP-71 binary files, or language extension (LEX) files to extend the BASIC language. Create and edit text files for use as source files for BASIC, FORTH, or assembler language programs, as well as non-programming related purposes. Use any terminal device connected to your HP-71 through an interface as an external keyboard and display for the HP-71.

Plug-In Module Simulation Procedure (PMSP)

Simulate any Custom ROM Module developed for the HP-71 through one of its memory ports. Insert the FORTH/Assembler ROM to use the larger keyboard and display of the HP 150, Series 80, or other personal computers in software program development. This sheet explains the procedure (available through an HP Sales Representative or Independent Custom Consultant).

HP-71 Internal Design Specifications (IDS) Documents

00071-90068 Volume I: Detailed Design Description

Provides details on the internal operation of the HP-71.

00071-90069 Volume II: Entry Point and Poll Interfaces

Provides details on over 700 operating system entry points.

00071-90070 Volume III: Operating System Source Listings

Provides details on source code listings.

82401-90023 HP-IL

Provides details on the HP-IL interface, including entry points and source code listing.

00071-90071 Hardware Design Specification

Provides details on hardware bus specifications.

HP-75:

HP 82713A Plug-In Module Simulator (PMS)

Provides ROM simulation capability for the HP-75. Store programs or files on the simulator or use it for software evaluations when developing a Custom ROM Module. Three simulators may be used.

HP-41, HP-71, and HP-75 Custom ROM Modules

HP-41: HP 82508A/B, HP 82509A/B

Provide 4K or 8K bytes of memory with each module, or nearly 21,000 program lines with up to four 8K byte modules.

HP-71: HP 82491A/B, HP 82492A/B, HP 82493A/B, HP 82494A/B

Provide 16K, 32K, 48K, or 64K bytes of program storage in a plug-in module. May be used in quantities of one to four for a maximum capacity of 256K ROM. (Minimum order: 100 modules.)

HP-75: HP 82726A/B, HP 82727A/B, HP 82728A/B, HP 82729A/B

Provide 8K, 16K, 24K, or 32K bytes of program storage in a plug-in module. May be used in quantities of one to three for a maximum capacity of 96K ROM. (Minimum order: 100 modules.)

HP-41, HP-71, and HP-75 Custom Magnetic Cards

HP-41: HP 82502A

Cards used with the HP-41 and HP-67/97 can be customized to load up to 225 bytes each.

HP-71 and HP-75: HP 82722A

Cards used with the HP-71 or HP-75 can be customized to load up to 1.3K bytes each.

HP-41, HP-71, and HP-75 Custom Keyboard Overlays

HP-41: HP 82501A

HP-71: HP 82487A

HP-75: HP 82721A

Relabel the keyboard with special user-defined functions assigned to each key. Available in a variety of colors.

Ordering Information

| | Price |
|--|----------|
| HP-41: | |
| HP-41CV Opt. 001 Custom Calculator | \$225.00 |
| HP-41CX Opt. 001 Custom Calculator | 325.00 |
| HP-71: | |
| HP 82440A Software Development Utility | 35.00 |
| HP 82441A FORTH/Assembler ROM | 150.00 |
| 00071-90068 Volume I: Detailed Design Description | 50.00 |
| 00071-90069 Volume II: Entry Point and Poll Interfaces | 50.00 |
| 00071-90070 Volume III: Operating System Source Listings | 200.00 |
| 82401-90023 HP-IL | 50.00 |
| 00071-90071 Hardware Design Specification | 200.00 |
| HP-75: | |
| HP 82713A Plug-In Module Simulator | 495.00 |
| NOTE: Please contact an ICC for Custom Products prices. | |

HP Users' Library

The Users' Library is a source of programs written and submitted by users of HP-41, HP-71, and HP-75 calculators and handheld computers. Programs cover a wide variety of applications. Documentation includes instructions and program listings. Software is also available prerecorded on magnetic cards, mini-cassettes, or HP-IL 3 1/2" discs. A custom cassette/disc duplication service is available. Subscribers receive a complete list of programs, plus notification of special discounts, contests, and special promotions. For more information, contact the Users' Library, Dept. 39UL, 1000 N.E. Circle Blvd., Corvallis, OR 97330.

PERSONAL COMPUTERS & CALCULATORS

Personal Computation

Software

57



Software

Hewlett-Packard offers a wide range of software packages as application pacs and solutions books. Each application pac comes with a comprehensive manual, a plug-in application module, and when applicable, prerecorded magnetic cards, a keyboard overlay, and quick reference card. Solutions books come with complete documentation. Magnetic cards, mini data cassettes, or HP-IL 3 1/2" discs are also available. Both application pacs and solutions books are available from dealers and HP Representatives.

Series 10:

| | Price |
|--|---------|
| 00011-90009 HP-11C Solutions Handbook | \$15.00 |
| 00012-90021 HP-12C Leasing Applications Handbook | 15.00 |
| 00012-90015 HP-12C Real Estate Applications Handbook | 15.00 |
| 00012-90009 HP-12C Solutions Handbook | 15.00 |
| 00012-90022 HP-12C Training Guide | 15.00 |
| 00015-90011 HP-15C Advanced Functions Handbook | 15.00 |

HP-41:

Application Pacs

| | |
|--|---------|
| 00041-15055 HP-41 Advantage | \$49.00 |
| 00041-15018 Aviation (for pre-flight use) | 35.00 |
| 00041-15024 Clinical Lab & Nuclear Medicine | 35.00 |
| 00041-15006 Circuit Analysis | 35.00 |
| 00041-15004 Financial Decisions | 35.00 |
| 00041-15049 Math/Statistics | 45.00 |
| 00041-15022 Games | 35.00 |
| 00041-15023 Home Management | 35.00 |
| 00041-15016 Real Estate | 45.00 |
| 00041-15019 Thermal & Transport Science | 35.00 |
| 00041-15039 Petroleum Fluids | 75.00 |
| 00041-15026 Securities | 35.00 |
| 00041-15001 Standard Applications | 35.00 |
| 00041-15002 Statistics | 35.00 |
| 00041-15027 Stress Analysis-Mechanical Engineering | 35.00 |
| 00041-15021 Structural Analysis-Civil Engineering | 45.00 |
| 00041-15005 Surveying | 35.00 |
| 00041-15020 Machine Design | 35.00 |
| 00041-15017 Navigation | 45.00 |
| 00041-15042 Auto/Start Duplication ROM | 35.00 |
| 00041-15043 HP-41 HP-IL Development Module | 75.00 |

Solutions Books

Business:

| | |
|---|-------|
| 00041-90094 Business Statistics/Marketing/Sales | 15.00 |
| 00041-90096 Home Construction Estimating | 15.00 |
| 00041-90086 Lending, Savings, & Leasing | 15.00 |
| 00041-90136 Real Estate | 15.00 |
| 00041-90137 Small Business | 15.00 |

Engineering:

| | |
|---|-------|
| 00041-90093 Antennas | 15.00 |
| 00041-90100 Chemical Engineering | 15.00 |
| 00041-90089 Civil Engineering | 15.00 |
| 00041-90092 Control Systems | 15.00 |
| 00041-90088 Electrical Engineering | 15.00 |
| 00041-90139 Fluid Dynamics & Hydraulics | 15.00 |
| 00041-90140 Heating, Ventilating & Air | 15.00 |

AMPI (TM) Statistics is a trademark of American Micro Products, Inc.

Conditioning

| | |
|--|-------|
| 00041-90090 Mechanical Engineering | 15.00 |
| 00041-90138 Solar Engineering | 15.00 |
| 00041-90441 Structural Design (cassette based) | 15.00 |

Computation:

| | |
|-----------------------------|-------|
| 00041-90084 Geometry | 15.00 |
| 00041-90083 High-Level Math | 15.00 |
| 00041-90082 Test Statistics | 15.00 |

Other:

| | |
|---|-------|
| 00041-90145 Calendars | 15.00 |
| 00041-90102 Chemistry | 15.00 |
| 00041-90099 Games I | 15.00 |
| 00041-90443 Games II | 15.00 |
| 00041-90143 Optometry I (General) | 15.00 |
| 00041-90144 Optometry II (Contact Lenses) | 15.00 |
| 00041-90142 Physics | 15.00 |
| 00041-90141 Surveying | 15.00 |
| 00041-90543 1984 Taxes | 15.00 |
| 00041-90395 Time Module Solutions I | 15.00 |

HP-71:

Application Pacs

| | |
|---|-----------------|
| HP 82481A AC Steady State Circuit Analysis | 15.00 |
| HP 82484A Curve Fitting | 15.00 |
| HP 82479A Data Acquisition | to be announced |
| HP 82488A Data Communications | 15.00 |
| HP 82482A Finance | 15.00 |
| HP 82441A FORTH/Assembler | 15.00 |
| HP 82480A Math | 15.00 |
| HP 82440A Software Development Utility (with mini-cassette) | 35.00 |
| HP 82489A AMPI (TM) Statistics | 125.00 |
| HP 82483A Surveying | 150.00 |
| HP 82485A Text Editor | 15.00 |
| HP 82490A HP-41 Translator | 125.00 |

Solutions Books

| | |
|-------------------------------|-------|
| 00071-90065 Games | 15.00 |
| 00071-90066 General Utilities | 15.00 |
| 00071-90064 Math | 15.00 |

HP-75:

Application Pacs

| | |
|---------------------------------|--------|
| 00075-15035 Data Communications | 125.00 |
| 00075-15001 I/O ROM | 15.00 |
| 00075-15015 Math | 145.00 |
| 00075-15012 Surveying | 195.00 |
| 00075-15019 Text Formatter | 15.00 |
| 00075-15014 VisiCalc (R) | 15.00 |

Solutions Books

| | |
|--|-------|
| 00075-13008 Electronics | 45.00 |
| 00075-13009 Finance | 45.00 |
| 00075-13006 Games I | 45.00 |
| 00075-13007 Games II | 45.00 |
| 00075-13016 Graphics | 45.00 |
| 00075-13013 I/O Utilities | 45.00 |
| 00075-13015 Mass Media Duplication/Privacy | 45.00 |
| 00075-13003 Math I | 45.00 |
| 00075-13004 Math II | 45.00 |
| 00075-13005 Math III | 45.00 |
| 00075-13010 Real Estate | 45.00 |
| 00075-13011 Statistics | 45.00 |
| 00075-13012 Test Statistics | 45.00 |

For additional information or a demonstration of Hewlett-Packard professional calculators and handheld computers, visit your nearest HP sales representative or HP dealer. For the location and number of the one nearest you, call toll-free 1-800-FOR-HPPC (1-800-367-4772).

PERSONAL COMPUTERS & CALCULATORS

Hewlett-Packard Interface Loop Low Cost Interface for Battery-Operable Systems

Hewlett-Packard Interface Loop (HP-IL)

The Hewlett-Packard Interface Loop, HP-IL, is a bit-serial interface designed for low cost battery-operable systems. HP-IL allows HP-41 calculators and HP-71, HP-75, The PORTABLE, HP 150 and other computers to be used as system controllers, capable of transmitting and receiving data, and performing a wide variety of information management functions. In addition, HP-IL allows the HP-41, HP-71, and HP-75 to be used for instrument control.

In HP-IL systems, devices are connected by two-wire cables leading from the output port of one device to the input port of the next, until all devices form a closed loop. This loop structure provides a unique capability through: auto address assignment, device capability identification, power ON/OFF control, and error checking.

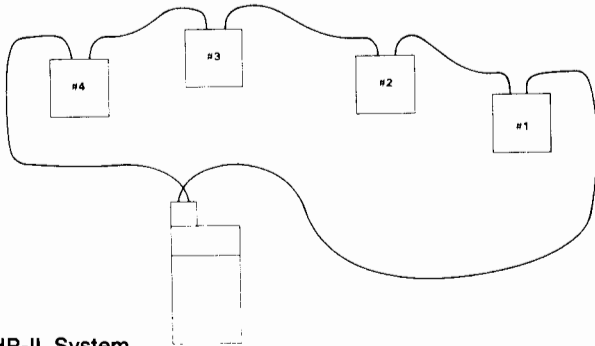

HP-IL System

Auto Address Assignment

In order to distinguish between devices on the loop, each device must have an address, a number from 1 to 30. An HP-41, HP-71, HP-75, or other mainframe, as the controller, uses the address to specify and control the devices on the loop. HP-IL enables the controller to assign addresses automatically, starting with the address 1 for the device next to the controller in the direction of the information transfer.

Device Capability Identification

Most HP-IL devices contain an accessory identification number that tells the system controller its device type, such as "printer" or "mass storage device". Upon execution of a PRINT command, the controller polls each device on the loop until it finds the device that responds with the appropriate accessory ID number for printers. Device identification frees the user from having to know the address of each device on the loop. This feature also allows software to be run and written without regard to system orientation, address switches or preassigned addresses, making HP-IL a truly user-friendly interface.

Power ON/OFF Control

Several HP-IL peripherals support STANDBY mode. Peripherals can be powered on or off, under program control, to conserve battery life. The ON/OFF feature allows an HP-IL system to be used for remote applications.

Automatic Error Checking

HP-IL allows for automatic error checking of any data being transmitted on the loop. Because each character must return to the device that originally sent it, the device compares the returning character with a copy of the one that was sent. If the two do not match, an error message is generated.

Hold-Until-Ready Protocol

HP-IL provides a simple means of coordinating the transfer of data. Some devices send and receive data at high rates while other devices work at a slower pace. In the HP-IL system, devices hold each piece of information until they are ready to receive another. When ready, they pass the information to the next device. By the time a piece of information makes a complete loop, all devices are ready to accept new information. This "hold-until-ready protocol" assures that fast and slow devices can operate in the same HP-IL system.

The Versatility of HP-IL

HP-IL is an ideal, low cost interface option for those applications requiring low power and maximum portability. HP-IL also provides a link between battery-powered devices and more powerful computational products. Through HP-IL interface converters, an HP-41 calculator, HP-71, HP-75, or other computer can pass information to desktop computers, modems, terminals, instruments and peripherals. With the HP-IL Interface Kit, an HP-IL interface can be built into microprocessor-based products, making them into HP-IL devices.

HP-IB and HP-IL

HP-IL is not intended as a replacement for HP-IB, but rather as a low-cost, low-power alternative below HP-IB in price and performance.

Although HP-IB and HP-IL serve the same basic function—interfacing controllers, instruments and peripherals—they differ in many respects.

1. Because of HP-IL's lower power consumption, it is usable with portable, battery-powered systems. Generally, HP-IB is not.
2. HP-IL system components will generally be low cost and have moderate performance; HP-IB system components are medium- to high-performance and generally cost more.
3. HP-IL systems work at relatively low data rates compared to HP-IB, and relatively high data rates compared to RS-232C. For example, the HP-71 and The PORTABLE can transmit at speeds of 5K to 6K bytes per second (50,000 to 60,000 baud on RS-232C). HP-IL maximum data rate at a 100 metre distance is 20K bytes per second; this rate is not dependent on HP-IL cable length.
4. HP-IL allows device separations of up to 100 metres with shielded, twisted pairs (10 metres with zip cord). HP-IB requires extender hardware for long distance connections.

The HP-IL Logo

Just as the HP-IB interface is designated by the HP-IB symbol, Hewlett-Packard identifies the HP-IL interface with its own symbol. Wherever this logo appears, it indicates that that mainframe, peripheral, instrument, etc., is HP-IL compatible.





HP-IL Products and Applications Summary

| Model | Application | See Page |
|---|---|----------|
| HP-41 Advanced Calculator (with HP 82160A HP-IL Interface Module) | Control: HP-IL bench/field controller Computation: Field data collection | 52 |
| HP-71 Handheld Computer (with HP 82401A HP-IL Interface) | Control: HP-IL bench/field controller Computation: Data acquisition, field analysis | 53 |
| HP-75 Handheld Computer (with HP-IL built-in) | Control: HP-IL bench/field controller Computation: Data collection, field analysis Remote transaction processing | 53 |
| Series 80 Personal Computers (with HP 82938A Interface) | HP-IL bench controller; field data analysis control | 46 |
| The PORTABLE (with HP-IL built in) | Computation and field analysis Remote transaction processing Battery or AC operation | 44 |
| The PORTABLE PLUS (with HP-IL built in) | Computation and field analysis Remote transaction processing Battery or AC operation | 44 |
| The Integral PC (with HP 82924A HP-IL Interface) | HP-IL bench controller; field data analysis control | 78 |
| HP 82402A Dual HP-IL Adapter | Allows two HP 82401A HP-IL modules to be plugged into the HP-71 simultaneously. | 54 |
| HP 82169A HP-IB Interface | Bench conversion from HP-IL to IEEE-488 computers, peripherals and instruments | 55 |
| HP 82164A RS-232C Interface | Bench conversion between HP-IL and RS-232C signals for terminals, modems, computers and peripherals | 55 |
| HP 82165A GPIO Interface | Bench conversion between HP-IL and parallel devices Digital data acquisition interface from HP-IL to most computers | 55 |
| HP 82938A Series 80 Interface | Bench conversion from HP-IL to Series 80 Personal Computers | 55 |
| HP 82166C HP-IL Interface Kit | Components that can be built into a device, providing HP-IL capability | 55 |
| HP 45643A Extended I/O Accessory | Driving HP-IL peripherals, including ThinkJet, plus parallel printers Allows communication between The PORTABLE and Touchscreen, and Touchscreen MAX | 55 |
| HP 82973A HP-IL Interface Card | Allows communication, using HP-IL, between The PORTABLE and the IBM PC/XT. Driving HP-IL peripherals | 55 |
| HP 82161A Digital Cassette Drive | Bench/field program storage Bench/field data storage Bench/field data logging Field data collection | 54 |
| HP 82162A Thermal Printer/Plotter | Bench/field hard copy Data logging Simple plotting Computational hard copy | 55 |
| ThinkJet Printer (HP-IL option) | Bench/field full-page, hard-copy output Low noise environments High-resolution graphics and text Battery operation | 273 |

| Model | Application | See Page |
|---|---|----------|
| HP 9114A 3 1/2" Flexible Disc Drive (with HP-IL built in) | Bench/field program storage Bench/field data storage Bench/field data logging Bench/field data collection Bench/field data exchange with Series 80 and Series 200 personal computers Battery or AC operation | 89 |
| HP 82168A Acoustic Coupler (Modem) | Remote communications capability Telephone data access | 55 |
| HP 1630A/D/G Logic Analyzer | Bench logic design, development, and testing Digital diagnosis and debugging Timing analysis, state analysis, performance analysis, and interactive state/timing analysis | 414 |
| HP 3421A Data Acquisition/Control Unit | Bench/field automated measurement, channel selections and control Lab bench experimentation and control Portable experimentation and data collection | 290 |
| HP 3468A Digital Multimeter | Bench/field automated measurement Scientific experimentation Lab bench experimentation & trouble shooting Bench/field automated service & diagnostic tool | 208 |
| HP 4945A Transmission Impairment Measuring Set (TIMS) | Bench testing of voice grade data channels, program channels, and high speed digital channels Master/slave capability for end-to-end testing Automatic gain slope measurement Programmable sweep | 139 |
| HP 5384A/HP 5385A Opt. 003 Frequency Counters | Bench, systems, field-automated measurement | 235 |



PERSONAL COMPUTERS & CALCULATORS

Personal Computer

Comparison Chart

| | Calculators | | | | | Handheld Computer |
|--|-------------|------------|------------------|----------|------------|-------------------|
| | Financial | Scientific | Computer Science | Advanced | HP-41CV/CX | |
| | HP-12C | HP-11C | HP-15C | HP-16C | HP-41CV/CX | HP-71B |
| Operating Features | | | | | | |
| Continuous Memory | ● | ● | ● | ● | ● | ● |
| RPN logic system | | | | | | S |
| Algebraic system | | | | | | ● |
| BASIC language | | | | | | ● |
| FORTH/Assembler languages | | | | | | S |
| Error recovery (last x) | ● | ● | ● | ● | ● | ● |
| Maximum number of storage registers | 20 | 21 | 67 | 101R | 319* | • |
| Maximum number of digits displayed | 10 | 10 | 10 | 10F | 10 | 12 |
| Number of digits used in computation | 10 | 10 | 10 | 10D | 10 | 12 |
| Rechargeable batteries/AC recharger | | | | | ● | |
| Long-life disposable batteries | ● | ● | ● | ● | ● | ● |
| AC Adapter | | | | | | ● |
| Software Support | | | | | | |
| Application Pacs (with modules) | | | | | ● | ● |
| Solution Books/Handbooks | ● | ● | ● | | ● | ● |
| Users' Library programs | | | | | ● | ● |
| Accessory Support | | | | | ●+ | ● |
| Memory Modules | | | | | ● | |
| Extended Memory Modules | | | | | ● | ● |
| Enhancement Modules | | | | | ● | ● |
| Multipurpose rechargeable battery pack | | | | | ● | ● |
| AC Adapter | | | | | ● | ● |
| General Features | | | | | | |
| One-year limited warranty | ● | ● | ● | ● | ● | ● |
| Display separates thousands (in BASIC on HP-71B, by program control) | ● | ● | ● | ●F | ● | ● |
| Diagnostic self-check | ● | ● | ● | ● | ● | ● |
| Error codes/messages | ● | ● | ● | ● | ● | ● |
| Redefinable keys | | ● | ● | ● | ● | ● |
| Alpha mode/display/keyboard | | ● | ● | ● | ● | ● |
| Status annunciators | ● | ● | ● | ● | ● | ● |
| Automatic power off | ● | ● | ● | ● | ● | ● |
| Audible tones | | | | | ● | ● |
| Programming Features | | | | | | |
| Maximum number of program lines | 99 | 203 | 448 | 203 | 6,433* | • |
| Shared program/storage memory | ● | ● | ● | ● | ● | ● |
| Alpha program labels | | | | | ● | ● |
| Single-character program labels | | | | | ● | ● |
| Numeric program labels | | 5 | 5 | 6 | 56 | ‡ |
| Program review (single- and backstep) | ● | 10 | 20 | 10 | 100 | ‡ |
| Insert/delete editing | ● | ● | ● | ● | ● | ● |
| GO TO | ● | ● | ● | ● | ● | ● |
| Levels of subroutines | | 4 | 7 | 4 | 6 | 6* |
| Conditional tests | 2 | 8 | 12 | 8 | 10 | Unlimited |
| Flags | ● | 2 | 10 | 6 | 56 | 128 |
| Pause | | ● | ● | ● | ● | ● |
| Indexed looping (DSE, ISG) | | ● | ● | ● | ● | ●B |
| Indirect control of: Data storage/recall | | ● | ● | ● | ● | ●B |
| Storage register arithmetic | | ● | ● | ● | ● | ●B |
| Branching | | ● | ● | ● | ● | ●B |
| Looping | | ● | ● | ● | ● | ●B |
| Display format | | ● | ● | ● | ● | ●B |
| Flags | | ● | ● | ● | ● | ●B |
| Integer/fraction truncation | ● | ● | ● | ●F | ● | ●B |
| Alpha string manipulation | | | | | ● | ●B |
| Dedicated Input/Output Devices | | | | | | |
| Card Reader | | | | | P | P |
| Printer/Plotter | | | | | P | P |
| Optical wand | | | | | P | P |
| HP-IL Interface | | | | | | |
| HP-IL Peripherals | | | | | | |
| Digital Cassette Drive | | | | | P | P |
| Thermal Printer/Plotter | | | | | P | P |
| ThinkJet Printer | | | | | P | P |
| Disc Drive | | | | | P | P |

Symbols
 ● Built-in feature or function.
 + To be used with the HP-41C only.
 * The HP-41CV has 319 registers or 2,233 bytes built in, (expandable to 919 registers or 6,454 bytes).
 The HP-41CX has 443 registers or 3,105 bytes of main and extended memory built in (expandable to 919 registers or 6,454 bytes).
 The HP-71 is limited only by available memory (expandable to 33.5K; 129K using 3rd party modules).

| | Calculators | | | | | Handheld Computer |
|--|-------------|------------|------------------|----------|------------|-------------------|
| | Financial | Scientific | Computer Science | Advanced | HP-41CV/CX | |
| | HP-12C | HP-11C | HP-15C | HP-16C | HP-41CV/CX | HP-71B |
| HP-IL Interfaces: | | | | | | |
| HP-IB | | | | | | P |
| RS-232C | | | | | | P |
| GPIO | | | | | | P |
| Series 80 | | | | | | P |
| General Arithmetic Features | | | | | | |
| + , - , X , / , √x , 1/x , CHS | ● | ● | ● | ● | ● | ● |
| Ln x , e ^x | ● | ● | ● | ● | ● | ● |
| y ^x , Log x , 10 ^x , x ² , π | | | | | | ● |
| Absolute value | | | | | | ● |
| Storage register arithmetic | ● | ● | ● | | ● | ● |
| Business Features | | | | | | |
| Maximum number of dedicated financial registers | 5 | | | | | |
| Solves for: | | | | | | |
| Number of periods (n), compound interest (i), present value (PV), payment (PMT), future value (FV) | ● | S | S | | S | S |
| Simple interest | ● | S | | | S | S |
| Amortization (accumulated interest/remaining balance) | ● | S | | | S | S |
| Net present value (NPV) and internal rate of return (IRR) | ● | | S | | S | S |
| Beginning/end of period selection | ● | S | S | | S | S |
| Calendar functions | ● | | | | S | ● |
| Clock | | | | | | |
| Bond: | | | | | | |
| Yield-to-maturity | ● | | | | S | |
| Price | ● | | | | S | |
| Depreciation (SL, DB, SOYD) | ● | S | | | S | |
| Scientific Features | | | | | | |
| Solve (root finder) | | S | ● | | S | S |
| Integrate (numerical integration) | | S | ● | | S | S |
| Math Exceptions | | | ● | | S | ● |
| Matrix operations | | | ● | | S | S |
| Complex functions | | S | ● | | S | S |
| Bit manipulation | | | | | S | S |
| Boolean operators (NOT, OR, AND, XOR) | | | | | ● | S |
| Complement modes (1's, 2's, unsigned) | | | | | ● | S |
| Number base arithmetic (binary, octal decimal, hexadecimal) | | | | | ● | S |
| Metric conversions | | | | | ● | S |
| Trigonometric functions: Modes (degrees, radians) (grads) | | ● | ● | | ● | ● |
| Sin, Sin ⁻¹ , Cos, Cos ⁻¹ | | ● | ● | | ● | ● |
| Tan, Tan ⁻¹ | | ● | ● | | ● | ● |
| Hyperbolics and inverses | | ● | ● | | S | S |
| Rectangular ↔ polar coordinates | | ● | ● | | ● | S |
| Decimal angle ↔ angle in degrees (hrs)/min/sec. | | ● | ● | | ● | S |
| Degrees ↔ radians | | ● | ● | | ● | ● |
| Fixed and scientific notation | ● | ● | ● | ●F | ● | ● |
| Engineering notation | | ● | ● | | ● | ● |
| Automatic under/over flow into scientific | ● | ● | ● | ●F | ● | ● |
| Statistical Functions | | | | | | |
| Percent | ● | ● | ● | | ● | ● |
| Percent change | ● | ● | ● | | ● | ● |
| Percent total | ● | ● | ● | | ● | ● |
| Mean/standard deviation (1- or 2-variable; up to 15 variables on HP-71) | ● | ● | ● | | ● | ● |
| n, Σx, Σx ² , Σy, Σy ² , Σxy | ● | ● | ● | | ● | ● |
| Weighted mean | ● | ● | ● | | S | ● |
| Linear regression or estimate | ● | ● | ● | | S | ● |
| Correlation coefficient | ● | ● | ● | | S | ● |
| Normal distribution | S | S | S | | S | ● |
| Factorial function | ● | ● | ● | | ● | ● |
| Gamma function | ● | ● | ● | | S | ● |
| Random number generator | S | ● | ● | | S | ● |
| IEEE Floating-Point math standard | | | | | | ● |

‡ With the HP-71, any BASIC program can be labeled with up to eight alpha characters.
 B BASIC.
 D Ten digits are used in computation when in Floating-Point Decimal Mode. Word size is user-specifiable in other modes, up to 64 bits.
 F Using Floating-Point Decimal Mode.
 P Peripheral available.
 R 16-bit registers.
 S Available in software form. (Programs written for HP-11C can also be used on the HP-15C.)



The user-friendly, reliable **HP 260** is designed for small businesses requiring a powerful computing system.

Integrated Information Solutions

Hewlett-Packard pioneered distributed data processing for keeping track of inventories and payables, generating invoices, organizing payrolls, and producing timely reports. Collection, access, and dissemination of data are made easy for any organization, from large corporate headquarters to branch offices and departments. HP also developed business automation systems that meet all the transaction processing demands of today's offices. This includes functions that are also required in the data processing side of your company, such as word processing, electronic mail, and report writing.

HP's solutions to increasing the productivity of everyone in your office include: the HP 260 Business Computer and the HP 3000 family of integrated information systems. The strength of HP communications products united with the flexibility of these systems lets you place cost-efficient, task-oriented computers where you need them.

Priced from \$10,800 to \$240,000

HP 260 Small Business Computer

The affordable HP 260 system is designed for small businesses requiring a powerful yet easy-to-use computer system. Its uncomplicated operation is facilitated by softkey-driven processing and full-screen display forms that are tailored to resemble standard business forms. The user-friendly, reliable HP 260 is fully compatible with its predecessor, the HP 250.

The HP 260 offers three models, each of which can be installed by the customer. The models are differentiated by the amount of disc storage initially purchased with the system processor unit (SPU). The same SPU is provided with each of the models; each model can be housed in an optional mini-rack cabinet.

- Exceptionally easy to install and use
- Data file communication with HP 3000 systems
- 16-bit processor
- 192K bytes of system memory
- 320K bytes of user memory (five 64K-byte partitions)

- Four HP-HIL ports for HP 45262D workstations (or five ports for RS-232C, RS-422, or current loop asynchronous serial interfaces)
- HP-IB peripheral interface channel for parallel disc drives and printers
- HP 260 system software

HP 260 Software Solutions

System software for the HP 260 is designed to help improve office productivity, analyze key business statistics, and communicate with management and customers.

IMAGE/260 — This data base management system simplifies the storing and management of your business information.

QUERY/260 — Provides a simple method of instantly accessing information in the IMAGE/260 data base.

REPORT WRITER/260 — Aids in efficient writing programs to produce reports.

GPL/260 — A Graphics Plotting Library that allows you to generate graphs, charts, and overhead slides on a variety of HP graphics plotters.

The HP 260 also has a broad range of application software available for meeting the particular needs of many business types. The HP 260 can communicate with HP 3000 systems, with HP 250 systems, or with other HP 260 systems, and can also emulate an IBM® 2780/3780 batch terminal. A wide variety of application software designed by independent third-party suppliers is also available for the HP 260.

HP 3000 Business Computers

The HP 3000 family ranges from the entry-level Series 37 office computer to the high-performance, interactive Series 68 mainframe. The members of this family share the Multiprogramming Executive (MPE) operating system, featuring cache memory, high-level languages, a variety of peripherals, remote console capability, the ability to interchange software without modification, and power failure recovery for system memory. General-purpose capabilities include simultaneous transaction processing, data communications, on-line program development, and batch operations in COBOL II, RPG, BASIC, FORTRAN 77, Pascal, and SPL/3000.

The HP 3000 systems offer a complete data base management and inquiry facility that provides the basis for developing custom-tailored information management systems. The TurboIMAGE data base management system offers the capability to describe data structures, define data relationships, and provide a high-level language interface for accessing and maintaining the information within the data base. Query/3000, a data base support tool included with TurboIMAGE, is designed for use by application programmers and data base administrators. Through the use of Query/3000, it is possible to locate, update, and report on data within TurboIMAGE data bases.



Programs created for our largest system can run on our smallest. And vice versa. This compatibility is one of the **HP 3000** family's important strengths.

HP 3000 computers may be interconnected via a network, which can also integrate them with HP 1000 systems and computers, such as HP personal computers as the Touchscreen families, Vectra, and Portable PLUS, HP 9000 engineering workstations, and IBM mainframes.

Application Development and Software Solutions

A comprehensive set of application development tools are available on the HP 3000. Together, these tools provide valuable services to data base designers, data base administrators, application programmers, and end users. Software packages running on the HP 3000 family of computers make HP the perfect choice for automating your office. See the "Personal Productivity Center" section for descriptions of office software packages.

Hewlett-Packard also offers industrial and manufacturing applications software products for the HP 3000.

Networking and Data Communications

HP 3000 users can increase productivity through high-speed local area networks (LANs). Hewlett-Packard's LAN/3000 Link and NS/3000 (Network Services) software make a powerful local network easy to install, use, maintain, and expand. And you can expand your network to include multi-vendor communications. The LAN/3000 Link includes everything you need to connect your HP 3000 to an industry-standard LAN. And the NS/3000 software provides sophisticated networking capabilities.

HP Semiconductor Productivity Network provides computer-integrated manufacturing solutions for the semiconductor industry, through effective WIP tracking, engineering analysis, process control, planning, facilities monitoring, and cost accounting.

HP Materials Management/3000 helps you manage the materials planning and control functions of a manufacturing operation.



BUSINESS COMPUTER SYSTEMS

Personal Productivity Center

HP Production Management/3000 is an interactive application system for managing manufacturing production planning and control.

HP Maintenance Management provides the tools to better manage your maintenance tasks, including work order control, preventive maintenance scheduling, and spare parts inventory.

HP Pay automates your company's payroll functions.

SFD/3000 integrates inventory distribution control, order processing, and other distributor-oriented functions.

Innovative Productivity Solutions

Hewlett-Packard's Personal Productivity Center is a powerful office system solution that integrates personal computing, office automation, distributed data processing, and telecommunications. Based on the HP 3000 family of business computers, the Personal Productivity Center enables both office and data processing staff to share information and resources.

You can choose from a variety of workstations that complement the versatility and power of the HP 3000. Our friendly Touchscreen II Personal Computer, Vectra Personal Computer, the mobile Portable PLUS, and even the IBM® PC can serve as a workstation in the Personal Productivity Center.

With HPDeskManager, the core of the Personal Productivity Center, members of your workgroup can send and receive text, charts, graphs, and spreadsheets, which will integrate the typically isolated work of individuals into a coordinated team effort. HPDeskManager features a simple screen menu that moves you freely from one task to another in consistent, conversational commands.

Hardware and software bundles are priced from \$49,885 to \$70,230

HP OFFICE-ASSIST

HP OFFICE-ASSIST services are designed to aid you in implementing your HP computer system. They provide you with the tools, on-site assistance, and product training you need for successful implementation.

HP OFFICE-ASSIST consists of Customer Application Analysis (CAA) and Project Implementation Assistance (PIA). CAA provides an assessment of your current business environment to determine how office systems applications can best be implemented. PIA services address the needs of the office system and HPDeskManager or HPWord.

To ensure that every office receives a total productivity solution, the PIA services are included with each Personal Productivity Center. PIA consists of the HP OFFICE-ASSIST Implementation Handbook and Supplements, as well as HPDeskManager and/or HPWord Administration and Training courses. HP support representatives visit your site to introduce your project team to the Personal Productivity Center and maintain the support you need for your office system.



The Personal Productivity Center helps you increase office productivity by sharing information and resources within your workgroup and throughout your company.

The Professional System

This entry-level office solution is based on the HP 3000 Series 37 computer. The Professional System includes a processor with 1M bytes of memory, a 55M-byte disc drive and cartridge tape backup, system console, and four HP Touchscreen II personal computers.

Software designed for an integrated office solution is standard with the Professional System. Easy-to-use HPDeskManager allows system users to send and receive messages, documents, graphics, and spreadsheets.

The Professional System also offers personal computing products. HPMessage is the gateway into the HPDeskManager electronic mail network, allowing passage of messages and personal computer files to other users in the network, whether those users have personal computers, terminals, or even IBM PCs. AdvanceLink software allows you easy access to HP 3000 applications and public information facilities. Executive MemoMaker word processing software can help business professionals and managers create polished letters, memos, and reports.

- **Series 37 System Processor**
 - 1M-byte main memory
 - HP 2392A console
 - 55M-byte mass storage
 - 67M-byte cartridge tape backup
 - One modem and six direct connect ports
- **Four HP Touchscreen II Personal Computers**
 - 256K-byte standard memory; expandable to 640K byte
 - 710K-byte dual 3½ inch microfloppy disc drive
 - MS™-DOS operating system
 - HP Personal Applications Manager (PAM)
 - HP Touch
 - 12-inch green phosphor high-resolution display
 - Block-mode graphics display capability with HP 3000 software

- **HPDesk Manager**
- **HPMessage**
- **AdvanceLink**
- **Executive MemoMaker**
- **HP OFFICE-ASSIST Project Implementation Assistance**

The Workgroup System

The Personal Productivity Center concept of workgroup computing reflects the way an organization works. The HP 3000 departmental computer and the HP Touchscreen II personal computer work together to share information and peripherals. This eliminates many time-consuming tasks and reduces work duplication for professionals and secretaries in the office environment.

The Workgroup System includes the HP 3000 Series 37 computer with 1M bytes of memory, two 55M-byte disc drives, cartridge tape backup, system console, and four HP Touchscreen II personal computers. HPDeskManager serves as the office time management, word processing, electronic mail, and filing system.

The Workgroup System provides professionals with personal support tools, combining the benefits of the friendly HP Touchscreen personal computers and the power of the HP 3000 departmental computer. But HP also recognizes the crucial role of administrative personnel in improving office productivity. So, the Workgroup System also includes secretarial word processing, spelling correction, and list management capabilities.

Overall HP 3000 compatibility ensures your system's growth path to larger solutions. Software is upwardly compatible to preserve your investment in it, and system upgrades can be done quickly and easily.

- **Series 37 System Processor**
 - 1M-byte main memory
 - HP 2392A console
 - 110M-byte mass storage
 - 67M-byte cartridge tape backup
 - One modem and six direct connect ports

• **Four HP Touchscreen II Personal Computers**

- 512K-byte memory
- 10M-byte disc drive
- MS-DOS operating system
- HP Personal Applications Manager (PAM)
- HP Touch
- 12-inch green phosphor high-resolution display
- Block-mode graphics display capability with HP 3000 software

• **HPDeskManager**

- HPWord
- HPSpell
- HPListKeeper
- HPMessage
- AdvanceLink
- ExecuDesk
- Executive MemoMaker
- Charting Gallery
- Personal Card File
- Deluxe VisiCalc®
- HP OFFICE-ASSIST Project Implementation Assistance

Personal Productivity Center Tools

The Personal Productivity Center offers unique tools for your information management needs. These tools improve individual productivity, as well as the effectiveness of the entire team, through faster communications, resource sharing, easy information access, integrated applications, and document management tools.

Advanced Office Pack — This HP 3000 productivity pack delivers all the software and implementation assistance necessary to support a mixed workgroup of managers, professionals, and secretaries.

- HPDeskManager
- HPWord
- HPSpell
- HPListKeeper
- HPEasyChart
- HPDraw
- Deluxe VisiCalc/3000
- HP OFFICE-ASSIST Project Implementation Assistance

Secretarial Word Processing Pack —

This is a comprehensive solution to document preparation and production needs. HPWord provides secretarial word processing as well as integrated spelling verification through HPSpell, while HPListKeeper is available for personal data management.

- HPDeskManager
- HPWord
- HPSpell
- HPListKeeper
- HP OFFICE-ASSIST Project Implementation Assistance

Base Pack — Boosting productivity at every level of the workgroup, from managers and professionals to secretaries, requires integration of all aspects of personal, business, and office computing. HPDeskManager combines all the necessary elements required to deliver that increased efficiency.

- HPDeskManager
- HP OFFICE-ASSIST Project Implementation Assistance



HP's Personal Productivity Center offers a variety of powerful business systems to meet your office and data processing needs.

Professional Pack/Touchscreen — The Professional Pack/Touchscreen fills the needs of both managers and professionals for comprehensive word processing, spreadsheets, graphics, personal data base management, and communications, as well as fast and easy context switching and data transfer from one application to another. It also enables the personal computer user to connect into the Personal Productivity Center.

- ExecuDesk
- Executive MemoMaker
- Personal Card File
- Charting Gallery
- Deluxe VisiCalc
- AdvanceLink
- HPMessage

Professional Pack/IBM PC — The Professional Pack/IBM PC enables those managers and professionals with IBM personal computers to become members of the Personal Productivity Center network. The pack includes word processing and the same personal data base software that's provided for managers and professionals using HP Touchscreen II Personal Computers, as well as software that allows IBM PC and HP Touchscreen users to communicate and share information.

- MemoMaker/IBM PC
- Personal Card File/IBM PC
- AdvanceLink/IBM PC
- HPMessage/IBM PC

Services Pack/Touchscreen and

Services Pack/IBM PC — The Services Pack for the HP Touchscreen II Personal Computer or the IBM PC consists of those products necessary to connect the HP Touchscreen II or IBM PC into the Personal Productivity Center network. This connectivity means that you can quickly and easily communicate with members of your workgroup,

as well as with others in your worldwide network. Yet you can still choose the personal computer applications software that best suits your needs.

- AdvanceLink
- HPMessage

Office System Tools

HPDeskManager is the communications backbone of the Personal Productivity Center. It offers a set of tightly integrated fundamental office facilities: multi-system electronic mail, basic word processing, personal electronic filing, and time management. Any HP 3000-compatible terminal or personal computer, even the Portable PLUS or Vectra, connected to an HP 3000 computer system can access HPDeskManager.

HPWord/3000 is a sophisticated and extremely easy-to-use secretarial word processor that runs on the HP 3000 family of business computers.

HPWord/150 offers the same user interface and keystrokes as HPWord/3000, and the two software products are file compatible; HPWord/150 runs stand-alone on the HP Touchscreen II Personal Computer.

HPSpell is a software subsystem that verifies the spelling of either individual words or ASCII documents.

HPListKeeper is a tool that allows users to create, edit, find, sort, and print exactly the information needed in a natural, understandable form: simple lists.

TDP/3000 is a powerful command-driven document production system.

HPAccess is an HP Touchscreen application that provides personal computer users access to information stored in popular personal computer data bases. HPAccess also works with **HPAccess Central**, running on a host HP 3000, to access IMAGE/3000 data.

BUSINESS COMPUTER SYSTEMS

Business Computer Matrix

Print Central/3000 and Print Central/Touchscreen or Print Central/IBM PC work together to provide HP Touchscreen (or IBM PC and PC/XT™) personal computer users with the ability to print personal computer applications to shared office and system printers.

HPMenu unifies office software with other applications through easy-to-use menus.

HPEasyChart is a software subsystem of the HP 3000 that produces pie, bar, and line charts, as well as scattergrams.

HPDraw is a graphics software for presentation text and figure design on the HP 3000.

DSG/3000 is a sophisticated interactive system for creating charts, graphs, production plans, and other graphic outputs.

HPTelex II enables HP 3000 users to prepare and send telex messages from HPTelex II, from HPDeskManager, or from user-written application programs.

HPConvert/WPS allows batch document conversion, in both directions, between HPWord and Wang OIS systems.

ExecuDesk integrates many HP personal computer software products, allowing you to transfer information between applications as well as switch from one application to another without losing your place.

Executive MemoMaker lets you use your HP Touchscreen II Personal Computer to create and revise documents, check spelling, merge text and Charting or Drawing Gallery graphics, and combine several documents.

MemoMaker/IBM PC lets you use your IBM PC to create and revise documents

without complicated word processing commands.

Personal Card File or Personal Card File/IBM PC combines the ease-of-use of a traditional desktop cardfile with the convenience of an automatic telephone dialing device and the power of a computerized information management system.

Charting Gallery allows you to transfer confusing columns of numbers from existing spreadsheets or manually enter data to create professional-looking charts and graphs.

Drawing Gallery enables you to create such graphics as text charts, organization charts, and process flow diagrams, and also includes a wide range of ready-made pictures to enhance visual presentations.

Deluxe VisiCalc with Consolidation is the tool for preparing budgets, forecasting sales and expenses, or performing other financial projections.

AdvanceLink or AdvanceLink/IBM PC—HP's AdvanceLinks are communications software packages that allow your HP Touchscreen II Personal Computer, IBM PC, IBM PC/AT™, or IBM PC/XT to communicate with almost any computer, anywhere. An easy-to-use, menu-driven package, AdvanceLink has file transfer capabilities and command file builders for customizing and automating your data communications. Popular public data bases and information facilities are also accessible at the touch of a finger.

Portable-Desktop Link — The Portable-Desktop Link is a powerful, yet easy-to-use

tool that enables you to form a link between the IBM PC or PC-XT and the Portable PLUS computer. The HP-IL interface consists of hardware and software that enables you to transfer information between an IBM PC and the Portable PLUS.

HPMessage/for the Touchscreen II Personal Computer or HPMessage/for the IBM PC brings the HP Touchscreen II, IBM PC, or PC/XT user into the HPDeskManager electronic mail network.

TextCharts/IBM PC is appropriate for IBM PC users who desire presentation-quality text on paper or overhead transparencies.

™IBM PC/XT™ and PC/AT™ are U.S. trademarks of International Business Machines Corporation.

MS™ DOS is a U.S. trademark of MicroSoft Corp.

*IBM® is a registered U.S. trademark of International Business Machines Corporation.

Deluxe VisiCalc® is a registered U.S. trademark of VisiCorp.

Business Computer Matrix

This chart briefly summarizes HP's business computer products. Refer to the "Personal Computers and Calculators" section of this catalog for complete descriptions of the Touchscreen IIs, Vectra, and Portable PLUS. Peripheral and accessory product descriptions are in the "Peripherals" section of this catalog.

If you have more questions about a computer or its usefulness for your application, please call the local Hewlett-Packard Sales and Service Office listed in the telephone directory white pages, or see page 774. Ask for the computer department.

| HP 3000 Business Computers | Series 31 | Series 37XE | Series 42 | Series 48 | Series 56 | Series 69 |
|----------------------------|--|--|--|--|--|--|
| Operating System | MPE | MPE | MPE | MPE | MPE | MPE |
| Languages | BASIC, COBOL II, FORTRAN 77, Pascal, RPG, SPL/3000 | BASIC, COBOL II, FORTRAN 77, Pascal, RPG, SPL/3000 | BASIC, COBOL II, FORTRAN 77, Pascal, RPG, SPL/3000 | BASIC, COBOL II, FORTRAN 77, Pascal, RPG, SPL/3000 | BASIC, COBOL II, FORTRAN 77, Pascal, RPG, SPL/3000 | BASIC, COBOL II, FORTRAN 77, Pascal, RPG, SPL/3000 |
| Memory | 512K bytes, expands to 2M bytes | 1M bytes, expands to 2M bytes | 1M bytes, expands to 3M bytes | 2M to 4M bytes | 4M to 8M bytes | 4M to 8M bytes |
| Mass Storage | 55M-byte disc, plus combinations to 2.1G byte | 55M-byte disc, plus combinations to 2.1G byte | Combinations of discs up to 3.2G bytes | Disc drive to 4.2G bytes | Disc drive to 4.2G bytes | Disc drive to 9.7G bytes |
| Terminal Connections | 7 point-to-point, expands to 14 | 7 point-to-point, expands to 28 | 60 point-to-point, expands to 92 | 120 point-to-point, expands to 152 | 120 point-to-point, expands to 152 | 336 point-to-point, expands to 400 |
| Data Comm. Links | 1 | 3 | 3 | 7 | 7 | 24 |



The HP 9000s are HP's family of 16- and 32-bit technical computers. Designed primarily for scientific and engineering tasks, they cover a wide spectrum of applications ranging from simple instrument control to complete computer-aided design (CAD) and manufacturing (CAM). The HP 9000s are divided into three series—Series 200 and 300 (16/32-bit) and Series 500 (32-bit).

The HP 9000 is a true "family", with many things in common—common technology, operating systems, languages, peripherals and networking. There are also common applications: while each model is optimal for a specific task, it can also take on the functions of the others, so there is an economy of "overlap" without going to an entirely new computer.

HP 9000 Technology

Technology for the HP 9000 computer family was developed both within and without HP. The Motorola MC 68000 microprocessor, a 16-bit computer chip with a 32-bit internal data path, has been an industry standard for 16-bit computers for a number of years and is regarded as both inexpensive and reliable. It is available in 8 and 12.5 MHz versions, both of which have been implemented on the HP 9000 Series 200 computers. On the new Series 300 computers, two different Motorola CPUs are available: the 10 MHz MC68010, for use in an entry-level to mid-range configuration, and the 16.6 MHz MC68020, which is an especially effective high speed processor. One megabyte of RAM is standard with both, expandable up to 7.5 megabytes.

The 32-bit chip was developed by HP as a means of increasing speed and accuracy and decreasing size. It delivers over 450,000 transistors placed in an area about a quarter-of-an-inch square, with an execution speed of 1 million IPS. The 32-bit CPU and its sister RAM chips became the basis for the HP 9000 Series 500 computers.

Series 200

The Series 200 computers are ideal for scientific and engineering applications requiring both high speed and data-handling capabilities, while remaining relatively low cost. They can serve in stand-alone computer applications, as instrument controllers, or as computer-aided design/manufacturing (CAD/CAM) systems when the computing capability of a mainframe or superminicomputer is not required.

The Series 200 machines can also be interfaced to a Series 500 machine as a 'front-end' workstation to feed design data to the 32-bit machine for computation and then receive it back for graphic evaluation or additional rework.

Series 200 computers are available in a small "personal" model, a low-cost modular workstation, a modular rack-mount controller, a desktop workstation and a high-performance workstation.

Series 300

The newest entry to HP's line of modular, high-performance workstations is the Series 300. This highly compatible system is designed to give more performance at lower prices, with maximum flexibility in the forefront of design.

The Series 300 offers several advantages over its predecessors: Lower entry price makes it suitable for dedicated instrument control applications. Better performance at the high end means more control with complex engineering design and scientific computational problems. A variety of display systems lets the Series 300 adapt precisely to the customer's needs. And most importantly, a growth path is achieved from low end to high end in computational performance, I/O capability and displays, with compatibility across hardware boundaries for operating systems and application software alike.

At introduction Series 300 supports the full range of memory and access cards of the Series 200, as well as most of its software. It supports BASIC and Pascal, and HP-UX, a System V UNIX* which in turn supports new networking products and offers libraries of Starbase Graphics, HP Windows 9000 and DIO libraries for instrument control.

Series 300 computers are available in two levels of product structure: Mix-and-Match systems, which provide the flexibility of choosing from an array of components, and Bundled Systems, providing prepackaged choices for specific applications.

Series 500

Series 500 computers are among the most powerful for their size ever built, having the full 32-bit data-addressing capability of larger mainframes and minicomputers. As powerful as they are, Series 500 computers can be made even more powerful by the simple addition of plug-in CPU cards, which can increase the power and speed of a Series 500 up to 2.8 times.

Any computation-intensive application is the logical proving ground for a Series 500 machine—three-dimensional modeling, finite element analysis, complex mathematical matrices, noise and stress analysis, and computer-aided design. As the "high end" in a Series 200-500 coupling, they can form the computational basis for the most complex and demanding tasks, while leaving the Series 200 machines to do the other relatively simpler tasks in the project.

Series 500 machines are available as an integrated desktop workstation, a modular/rack computer, or a stand-alone console for multi-user environments.

Languages and Operating Systems

HP 9000 computers have a full complement of programming languages to enhance their computational abilities.

HP BASIC is a highly enhanced version of standard BASIC that is simply and logically structured yet immensely powerful. It has clear, high-level graphics commands, responsive instrument control, and easy, interactive

program editing and debugging. And HP BASIC includes its own operating system, needing no other to run. It operates on all models of Series 200 and 300, and the Model 520.

HP Pascal is a highly sophisticated tool for the advanced programmer. A compiled language, it offers high speed and the ability to "fine tune" the machine to a specific application. It has powerful and versatile programming structures and extensive debugging capabilities. Like HP BASIC, HP Pascal has its own operating system, and operates on all models of Series 200 and 300.

Besides BASIC and Pascal, HP provides the HP-UX operating system, HP's implementation of System V UNIX* developed by AT&T. HP-UX is fully compatible with standard UNIX systems, providing access to a wide expanse of software. HP-UX features a choice of languages — Pascal, FORTRAN 77 or C. In addition, HP-UX contains extensions such as virtual memory, multiple CPU support+, multi-tasking and single- or multi-user capabilities, and a rich assortment of engineering tools. For complex problems involving several software programs, HP-UX also offers the ability to connect several programs together via a simple set of commands. It operates on Models 220 and 236, and all Series 300 and 500 models.

Application Software

A rich assortment of application software is available for HP 9000 computers, both from HP and third parties via the HP PLUS program. Included are packs for office and project management, packs aimed at the scientist or engineer for analysis and design, and highly specialized packs for software and data base development. Both HP and HP PLUS offer the user more than 300 software packs, with the list growing constantly.

Interfaces and Peripherals

Available with the Series 200, 300 & 500 hardware are interfaces and peripherals that embrace a wide variety of computer applications. The most comprehensive is HP-IB (HP's implementation of IEEE Standard 408-1978) which ensures compatibility between HP computers and peripherals. In addition, there is the Human Interface Link (HP-HIL) for daisy-chaining input devices, RS-232, GPIO, BCD, Asynchronous 8-channel Multiplexer, Data Communications, Color Video and others.

Peripherals for HP 9000 computers comprise one of the largest selections in the industry—mass storage devices, printers, plotters, graphics tablets, digitizers, a mouse, and modems. In addition, the HP 9000 family is compatible with many of HP's instruments.

+Series 500 machines only
*UNIX is a trademark of AT&T



Series 200 Family

HP 9000 Series 200

The Series 200 is HP's line of technical workstations, based on the Motorola MC68000 family of micro-processors, with 16/32-bit internal architecture. For engineering or scientific calculations which require high speed and data-handling capabilities, Series 200 computers can provide cost-effective, reliable performance.

Series 200 Technical Computers include Models 216, 217, 220, 226, 236, and 237 (ordered as Models 9816, 9817, 9920, 9826, 9836, and 9837).

Series 200 Base Systems

Model 217

The Model 217 is a capable, attractively priced modular workstation with an MC68010 processor. The Model 217A box computer has built-in HP-IB and RS-232 interfaces, internal memory capacity up to 6.14 Mbytes and six backplane slots. It also offers the HP Human Interface Link (HP-HIL) for daisy-chaining input devices such as the optional keyboard and mouse. The Model 217 is compatible with BASIC 3.0 and Pascal 3.0.

Model 220

The Model 220 Modular Computer is rack-mountable with separately available keyboards, monitors, and disc drives. It can serve in complex design and engineering problems and is compatible with HP instruments for all types of measurement, test, and control applications.

The Model 220A has 128 Kbyte RAM, built-in HP-IB interface, and a 15 slot backplane, and is compatible with BASIC 3.0, Pascal 3.0 and SRM. The Model 220U has the 12.5 MHz processor and will support 3.07 Mbyte internal RAM. It includes the HP-IB interface and eight backplane slots. It is compatible with BASIC 3.0, Pascal 3.0, SRM, and single- or multi-user HP-UX.

Model 226

The Model 226 Technical Computer is equally at home in instrument/test control applications or computational assignments, and is ideal for CAT applications.

The Model 226A features a 178mm (7-inch) monochrome CRT with 400x300 graphics, 128 Kbyte internal RAM, integrated 5/4 inch flexible disc drive, integrated keyboard, and HP-IB interface. It has an eight-slot backplane, can support up to 2.05 Mbytes internal RAM, and is compatible with BASIC, HPL, Pascal, and SRM.

Model 236

The Model 236s are the most integrated of the Series 200s and have applications from electronic design to mechanical drafting to computerized graphics. The Models 236A/C (base systems) and Models 236S/CS (bundled systems) feature the 8 MHz processor board, while the Models 236U/CU (base systems) and Models 236T/CT (bundled systems) have the 12.5 MHz processor.

The Model 236A Technical Computer features a 310mm (12-inch) monochrome CRT with 512x390 graphics, 128 Kbyte internal RAM, two integrated 5/4 inch flexible disc drives, integrated keyboard, and HP-IB interface. It has an eight-slot backplane, supports up to 2.05 Mbyte RAM, and is compatible with BASIC 3.0 and Pascal 3.0. The Model 236C includes the integrated keyboard, interface, disc drives, eight backplane slots and RAM capacity of the Model 236A, but substitutes a 12" color CRT with 512x390x4 programmable map graphics and 4,096 color shades. It is compatible with BASIC 3.0 and Pascal 3.0.

The Model 236U has the 12.5 MHz processor, and the same CRT, keyboard, disc drives, backplane slots and interface as the Model 236A. It is compatible with BASIC, HPL, Pascal, and single- or multi-user HP-UX. It will support up to 1.54 Mbyte internal RAM. The Model 236CU also has the 12.5 MHz processor, and features the same keyboard, color CRT, interface, backplane slots and disc drives as the Model 236C. In addition to BASIC and Pascal, it is also compatible with single- or multi-user HP-UX. It will also support 1.54 Mbyte internal RAM.

Series 200 Bundled Systems

Model 216

The Model 216S has a 229mm (9-inch) monochrome CRT with 400x300 graphics, detached keyboard, 384 Kbyte internal RAM, plus an additional 128 Kbyte RAM (512 Kbyte total), and two backplane slots. It is compatible with BASIC, HPL and Pascal. HP-IB and RS-232C interfaces are built in. An option (opt. 256) is provided to delete BASIC and 256K RAM if desired.

Model 217

The Model 217H includes the Model 217A base system, plus 512 Kbyte RAM, the HP-HIL keyboard, and a 322mm (14-inch) monochrome monitor with alpha/graphics composite video interface cards. It is compatible with BASIC 3.0 and Pascal 3.0. Model 217L includes these features in addition to a base system with 1 Mbyte RAM and single-user HP-UX.

Model 220

The Model 220S includes the Model 220A base system plus 2M HP-IB cable, rack mount kit, HP 98203A keyboard and 3M extension cord, HP 98204A Composite Video Card set, and an additional 512 Kbyte RAM (640Kb total). It includes BASIC 3.0 and Pascal 3.0.

The Model 220T is based on the Model 220U base system, includes 1.02 Mbyte RAM, and single- or multi-user HP-UX. It also includes the HP 98204A keyboard, HP-IB interface, and Composite Video Card set. It has an 11-slot backplane and is compatible with BASIC, Pascal and SRM.

Model 226

The Model 226S Computer includes the Model 226A base system, an additional 512 Kbyte RAM (640Kb RAM total), BASIC 3.0, Pascal 3.0 and SRM.



Model 216



Model 217

Model 236

The Model 236CS includes the Model 236C base color system, with an additional 512Kb RAM (640Kb total), BASIC 3.0 and Pascal 3.0. It has six backplane slots.

The Model 236S is based on the Model 236A, includes 512 Kbyte additional RAM (640Kb RAM total), BASIC 3.0 and Pascal 3.0. Six backplane slots are standard.

The Model 236T is based on the Model 236U, includes four backplane slots, 1.02 Mbyte RAM, and single- or multi-user HP-UX with C, FORTRAN 77, and HP Pascal Compilers, MC68000 Assembler, and Graphics/9000 DGL.

The Model 236CT is based on the Model 236CU base color system, and includes 1.02 Mbyte RAM, single- or multi-user HP-UX with C, FORTRAN 77, HP Pascal Compilers, MC68000 Assembler, and Graphics/9000 DGL.

Model 237

The Model 237 is a high-performance graphics workstation featuring high-resolution display and a 12.5 MHz processor. It provides the power and speed required by engineers and scientists involved in laboratory analysis, printed and integrated circuit board design, mathematical modeling, statistics, and 2-D mechanical drafting.

The Model 237H features the 12.5 MHz processor with memory management hardware and cache memory, a 431mm (17-inch) monochrome display with 1024x768 resolution and bit-mapping capabilities, built-in HP-IB floating-point math hardware, the HP-HIL keyboard, mouse, and 512 Kbyte RAM.

HP 9000 Series 200

| | Price |
|---|---------|
| 9816S Model 216S Computer w/BASIC | \$5,150 |
| 9817A Model 217A Computer | 3,495 |
| 9817H Model 217H Computer w/512Kb RAM, keyboard and terminal | 6,510 |
| 9817L Model 217L Computer w/1 Mb RAM, keyboard, terminal & single-user HP-UX. | 9,495 |
| 9920A Model 220A Modular Computer | 4,500 |
| 9920U Model 220U Modular Computer w/12.5 MHz Processor | 5,700 |
| 9920S Model 220S Modular Computer w/keyboard, BASIC, Pascal, 640 Kb RAM | 8,000 |
| 9920T Model 220T Modular Computer w/12.5 MHz Processor, single-user HP-UX, keyboard | 11,000 |
| Multi-user HP-UX | 12,500 |
| 9826A Model 226A Computer | 9,535 |
| 9826S Model 226S Computer w/640 Kb RAM, BASIC, Pascal, SRM | 11,555 |
| 9836A Model 236A Computer | 12,470 |

| | |
|--|--------|
| 9836C Model 236C Color Computer | 15,590 |
| 9836U Model 236U Computer w/12.5 MHz Processor | 13,595 |
| 9836CU Model 236CU Color Computer w/12.5 MHz Processor | 16,685 |
| 9836CS Model 236CS Color Computer w/640 Kb RAM, BASIC, Pascal | 17,510 |
| 9836S Model 236S Computer w/640 Kb RAM, BASIC, Pascal | 14,420 |
| 9836T Model 236T Computer w/12.5 MHz Processor, 1.02 Mb RAM, single-user HP-UX | 18,500 |
| Multi-user HP-UX | 20,000 |
| 9836CT Model 236CT Color Computer w/12.5 MHz Processor, 1.02 Mb RAM, single-user HP-UX | 21,500 |
| Multi-user HP-UX | 23,000 |
| 9837H Model 237H Computer w/12.5 MHz Processor, monitor, keyboard, 512Kb RAM, mouse | 14,500 |

Languages and Operating Systems

HP 98601A ROM-based BASIC 2.0 Language System. Includes one system ROM board, BASIC 2.0 Language Manual Kit, and BASIC 2.0 Utilities Pack.

HP 98602A ROM-based BASIC 2.0 plus extensions 2.1. Includes one ROM board, BASIC 2.0 with Extensions Manual Kit and BASIC 2.0 Utilities Pack.

HP 98603A ROM-based BASIC 4.0 Language System. Includes 1 ROM-based system board, HPL 4.0 Language Manual Kit and BASIC 4.0 Utilities Pack.

HP 98604A ROM-based HPL 2.0 Language System. Includes one system ROM board, HPL 2.0 Language Manual Kit, and HPL 2.0 Utilities. (Not available for Models 220 or 236C).

HP 98613A RAM-based BASIC 3.0 Language System. Includes system flexible disc and Language Extensions disc, BASIC 3.0 Language Manual Kit, and BASIC 2.0 Utilities Pack.

HP 98613B RAM-based BASIC 4.0 Language System. Includes system flexible disc and Language Extensions Disc, BASIC 4.0 Language Manual Kit and BASIC 4.0 Utilities Pack.

HP 98614A RAM-based HPL 2.0 Language System. Includes System Flexible disc, HPL 2.0 Language Manual Kit, and HPL 2.0 Utilities Pack. (Not available for Models 220 or 236C).

HP 98615B RAM-based Pascal 3.0 Language System. Includes System Flexible disc set and Pascal 3.0 Language Manual Kit.

HP 98615C RAM-based Pascal 3.1 Language System. Includes system flexible disc set and Pascal 3.1 Language Manual Kit.

HP 98670A Single-user HP-UX Operating System.

HP 98680A Multi-user HP-UX Operating System.

TECHNICAL COMPUTER SYSTEMS

Technical Computers

HP 9000 Series 200 (cont.)

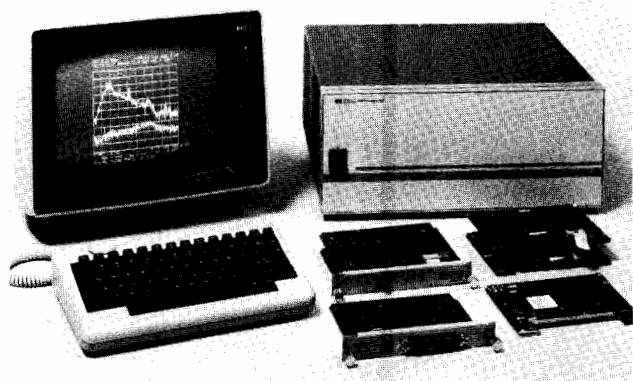

Model 220

| Languages and Operating Systems | Price |
|--|---------|
| HP 98601A ROM-based BASIC 2.0 | \$1,415 |
| HP 98602A ROM-based BASIC 2.0 w/extensions 2.1 | 3,000 |
| HP 98603A ROM-based BASIC 4.0 Language System | 2,500 |
| HP 98604A ROM-based HPL 2.0 | 1,415 |
| HP 98613A RAM-based BASIC 3.0 | 860 |
| HP 98613B RAM-based BASIC 4.0 Language System | 860 |
| HP 98614A RAM-based HPL 2.0 | 355 |
| HP 98615B Pascal 3.0 | 995 |
| HP 98615C RAM-based BASIC 4.0 Language System | 995 |
| HP 98670A Single-user HP-UX | 2,500 |
| HP 98680A Multi-user HP-UX | 4,000 |

Series 200 Interfaces

Interfaces for Series 200 computers include:

HP 50961A #200 Coax Adapter and Interface. Allows connection to Shared Resource Management (SRM) system.

HP 98255A EPROM Card. Contains 16 sockets for EPROMS to allow up to 256Kb of storage using INTEL 27128A EPROMS or equivalent.

HP 98620B DMA Controller Card. Server has DMA built in.

HP 98622A GPIO Interface. Provides 16 bits of latched input and output data for bidirectional information transfer, and permits interfacing to GPIO-compatible equipment.

HP 98623A BCD Interface. Connects the Series 200 computer with bit-parallel, digit-parallel, binary-coded decimal devices for data input.

HP 98624A HP-IB Interface. Allows communication with as many as 14 HP-IB compatible instruments.

HP 98625A/B High-speed Disc Interface for connection of disc drives and other devices to Series 200/300 computers.

HP 98627A RGB Color Interface. Includes four BNC cables.

HP 98628A Data Communications Interface. Provides both protocol management and electrical levels for asynchronous serial communications.

HP 98630A Breadboard Card. Allows the user to customize his own interface cards. Provides the basic circuitry needed to interface to the Series 200 backplane.

HP 98640A Analog-to-digital converter. Provides seven channels of 55,000-reading-per-second data acquisition.

HP 98641A RJE Interface. Includes DTE (male cable).

HP 98644A Serial Interface. Provides bit-serial communication between the Series 200 computers and asynchronous EIA RS-232C devices.

HP 98691A Programmable Datacomm Interface. Provides broad capabilities that can be tailored to meet special datacomm and/or serial interfacing needs.

HP 9888A Bus Expander. Provides a total of 16 additional card slots for all Series 200 computers, with eight slots for either memory or I/O and eight slots for memory only.

Series 200 Interfaces

| | Price |
|---|-------|
| HP 50961A (opt. 200) SRM Coax Adapter and Interface | \$945 |
| HP 98255A EPROM Card | 300 |
| HP 98259A Magnetic Bubble Memory | 1,900 |
| HP 98620B DMA Controller Card | 500 |
| HP 98622A GPIO Interface | 355 |
| HP 98623A BCD Interface | 385 |
| HP 98624A HP-IB Interface | 330 |
| HP 98625A/B High-speed HP-IB Interface | 605 |
| HP 98627A RGB Color Interface | 1,010 |
| HP 98628A Data Communications Interface | 485 |
| HP 98630A Breadboard Card | 320 |
| HP 98640A Analog-to-Digital Computer | 990 |
| HP 98641A RJE Interface | 1,250 |
| HP 98644A Serial Interface | 190 |
| HP 98691A Programmable Datacomm Interface | 650 |
| HP 9888A Bus Expander | 3,530 |

System Software

Numerous software packages are available for the Series 200 computers, including programs for computer-aided design, mechanical engineering, mathematics and statistics, and project and office management.

HP 45413G/H Single-/Multi-user Calculator/HP-UX. Provides the functionality of an HP Series 10 calculator with HP's popular calculator functions—math, statistics, trigonometry and financial.

HP 45420G/H Single-/Multi-user MemoMaker HP-UX. Word processor for memos, business letters or reports.

HP 45438G/H Single-/Multi-user Management Solution/HP-UX. Bundled Software package, includes MemoMaker, Multiplan and MicroTrak at a 15% savings over the combined list price of the three individual packs.

HP 45462B Picture Perfect™. Interactive graphics software that transforms your data into pie, vertical bar, horizontal bar, line and combined bar/line charts.

HP 45463B Diagraph™. Clip art software, allows you to create a variety of professional-looking presentation aids, organizational charts, flow charts, diagrams, forms, signs and word charts.

HP 45472B User-Definable Softkeys. Provides user-definable softkeys, enhanced editing features and a caps lock indicator.

HP 45473G/H Single-/Multi-user Multiplan®/HP-UX. Electronic worksheet designed for financial modeling, planning, forecasting and other analytical tasks.

HP 45475B Games/200. Challenge your computer with Robot Tank and Cribbage.

HP 45480B Data Grapher/200. A data analysis and display tool that turns numbers into graphs and charts. Files can be merged with HP TechWriter.

HP 45515G/H Single-/Multi-user TK!Solver®/HP-UX. Equation-solving software package that allows you to solve complex mathematical models that cannot be easily done with programming languages, calculators or spreadsheets.

HP 45516G TK!SolverPack®/HP-UX Financial Management. Designed to work with TK!Solver. Models include compound interest, net present value, debt service, cost of equity capital, financial statement analysis, stock option pricing, bond swaps, convertible debt and bond refunding decision.

HP 45517G TK!SolverPack®/HP-UX Mechanical Engineering. Designed to work with TK!Solver. Includes elastic beam bending, springs, area moment of inertia, Mohr's circle, rotational systems, heat transfer, fluid flow and hydraulics.

HP 45518G TK!SolverPack®/HP-UX Building Design and Construction. Designed to work with TK!Solver. Models include beam and column design, mortgages, payment on energy saving investments, heating costs and solar heat gain, construction cost estimation and calculations for rafters and stairs.

HP 45519G TK!SolverPack®/HP-UX Introductory Science. Designed to work with TK!Solver. Models include Chemistry, Biology, Physics, Thermodynamics and population studies.



Model 226



Model 236

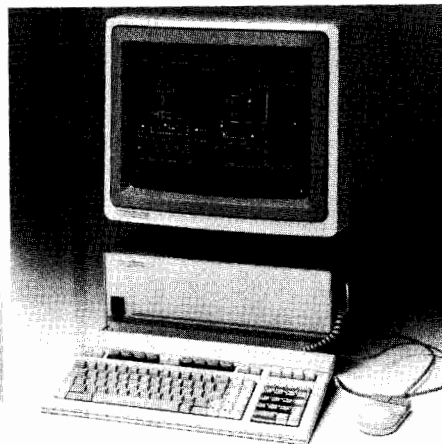

Model 237

HP 45524G/H Single-/Multi-user MicroTrak™/HP-UX. Project Management package, used to plan projects, coordinate resources, track accompanying costs, evaluate 'what-if' scenarios, quickly generate reports and easily print time-scaled schedules.

HP 45537B Graphics Editor/200. General purpose drawing tool for creating charts and diagrams such as flowcharts, organizational charts, process flow diagrams and text slides. Files can be merged with HP TechWriter.

HP 45538B Text Editor/200. An easy-to-use text processor for creating reports, memos and high-quality letters.

HP 97038JA Context MBA™ - Performs electronic spreadsheet, word processing, business graphics, telecommunications, and data management.

HP 98305 Engineering Graphics System/200 (HP EGS/200) - A computer-aided design and drafting system that allows you to create schematics of electronic designs, printed circuit board artwork, 2D mechanical drawings, and other engineering drawings.

HP 98360 HP-DRAFT. A very fast, flexible, general-purpose drafting package with options for mechanical engineering drawings.

HP 98693A SRM Access Utilities for HP-UX. Allows Series 200 HP-UX systems to transfer files to/from the SRM system and to chase SRM peripherals.

HP 98791B DEC™ VT100/HP2622 Emulator Software - Provides emulation of Digital Equipment Corporation's VT100, and HP 2392A terminals.

HP 98792 TEK™ 4010/HP 2622 Emulator Software - Provides emulation of Tektronix 4010 graphics terminal and HP 2622 terminal.

HP 98795A IBM 3278 Emulator Software - Provides IBM™ 3278 Model 2 terminal emulation when used with the 98695A interface.

HP 98797 RJE Emulator for single-user HP-UX.

HP 98798 RJE Emulator for multi-user HP-UX.

HP 98815 Graphics Presentation - Produces bar, line, and pie charts, and features four character fonts and seven color choices for paper or overhead slides.

HP 98817 Project Management - Analyzes project networks using CPM, PERT, and MPM techniques, with output in GANTT chart form.

HP 98819 HP TechWriter. A Document Editor that allows you to merge words and graphics in one document.

HP 98820A/B/C Statistics Library - Contains Part I and Part II, including basic, general, and regression statistics, and an advanced library of general statistics.

HP 98821 Numerical Analysis Library/200 - Has seven main sections; root finders, numerical integration, ode solvers, eigen and fourier analysis and interpolation.

| | |
|--|--------|
| HP 45420H MemoMaker®/HP-UX | \$395 |
| HP 45438G The Management Solution/HP-UX | 1,118 |
| HP 45438H the Management Solution/HP-UX | 2,159 |
| HP 45462B Picture Perfect™ | *595 |
| HP 45463B Diagraph™ | *695 |
| HP 45472B User-definable Softkeys | 79 |
| HP 45473G Multiplan®/HP-UX | 345 |
| HP 45473H Multiplan®/HP-UX | 595 |
| HP 45475B Games/200 | 49 |
| HP 45480B Data Grapher/200 | *295 |
| HP 45481B Context MBA™ | 795 |
| HP 45515G TK!Solver®/HP-UX | 499 |
| HP 45515H TK!Solver®/HP-UX | 999 |
| HP 45516G TK!SolverPack®/HP-UX | |
| Financial Management | 125 |
| HP 45517G TK!SolverPack®/HP-UX | |
| Mechanical Engineering | 125 |
| HP 45518G TK!SolverPack®/HP-UX | |
| Building Design and Construction | 125 |
| HP 45519G TK!SolverPack®/HP-UX | |
| Introductory Science | 125 |
| HP 45524G MicroTrak™/HP-UX | 775 |
| HP 45524H MicroTrak™/HP-UX | 1,550 |
| HP 45537B Graphics Editor/200 | *445 |
| HP 45538B Text Editor/200 | *275 |
| HP 98305 HP EGS/200 | 10,000 |
| HP 98360 HP-DRAFT | 12,000 |
| HP 98693A SRM Access for HP-UX Systems | 500 |
| HP 98791B DEC™ VT100/HP2622 Emulator Software | 500 |
| HP 98792A TEK™ 4010/HP 2622A Terminal Emulator | 350 |
| HP 98795A 3270 Display Station Emulator | 300 |
| HP 98797A RJE Emulator for single-user HP-UX | 1,010 |
| HP 98798A RJE Emulator for multi-user HP-UX | 2,525 |
| HP 98815 Graphics Presentation | 750 |
| HP 98817 Project Management | 500 |
| HP 98819 HP TechWriter | 795 |
| HP 98820A Statistics Library | 1,500 |
| HP 98820B Statistics Library Part I | 925 |
| HP 98820C Statistics Library Part II | 750 |
| HP 98821 Numerical Analysis Library/200 | 500 |

*Runs on Series 300 with compatibility hardware. See the following section for more Series 300 software and hardware.

Context MBA™ is a trademark of Context Management Systems.

DEC™ is a trademark of Digital Equipment Corporation.

TEK™ is a trademark of Tektronix Corporation.

IBM™ is a trademark of International Business Machines.

Picture Perfect™ is a trademark of Computer Support Corp.

Diagraph™ is a trademark licensed to Computer Support Corp.

TK!Solver & TK!SolverPack are registered trademarks of Software Arts, Inc.

Multiplan is a registered trademark of MicroSoft Corp.

MicroTrak is a trademark of SofTrak Systems

Series 200 System Software

| | Price |
|----------------------------|-------|
| HP 45413G Calculator/HP-UX | \$75 |
| HP 45413H Calculator/HP-UX | 150 |
| HP 45420G MemoMaker®/HP-UX | 195 |

TECHNICAL COMPUTER SYSTEMS

Technical Computers

HP 9000 Series 300

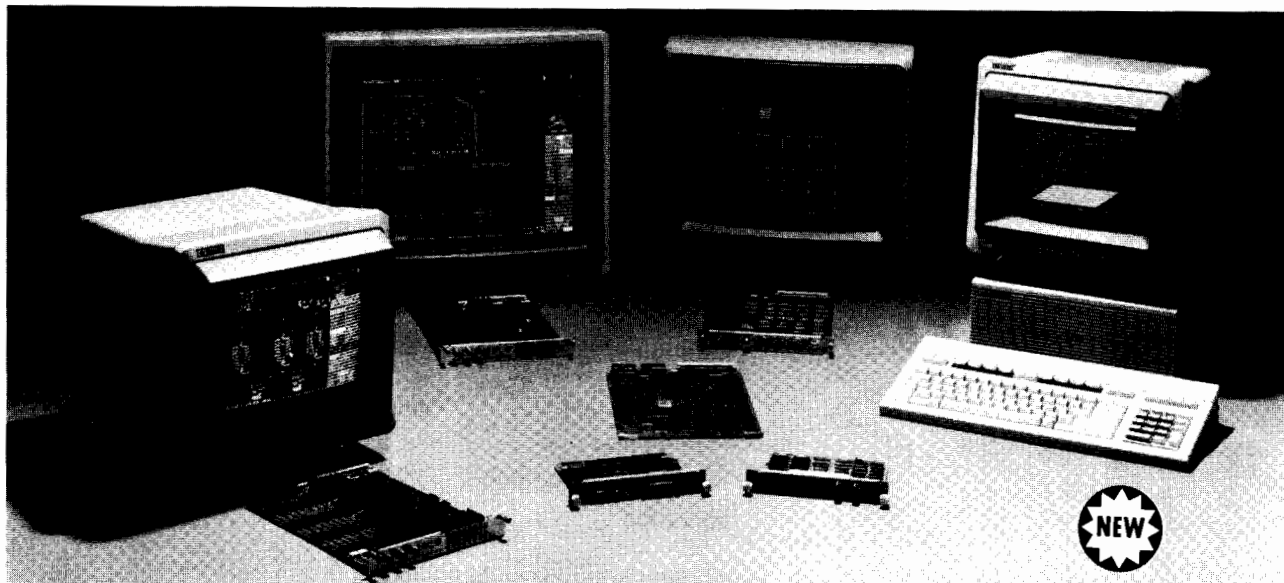

Series 300 with Board Options

HP 9000 Series 300

The new Series 300 is a modular family of high performance technical workstations designed for instrument control and computer aided design applications. Series 300 was developed with maximum flexibility in mind, allowing users to build a system directly in relationship to their needs. Two levels of product structure are available: a full range of Mix-and-Match component products, making it feasible to custom-tailor a product, and Bundled systems for choosing an appropriate system with minimal time invested.

The two CPU's offered are based on the Motorola MC68010 (Model 310) and MC68020 (Model 320) with a 32-bit internal architecture. Users may choose from five bit-mapped display offerings with low or high resolution monochrome and color.

Series 300 can boast high speed and excellent performance from low end to high end.

Individual Modular Components

The following components are designed for use in Mix-and-Match configurations. For peripheral compatibility information see the Interfacing Summary, page 83.

SPUs

Model 310

HP 98561A Model 310 SPU with 10 MHz 68010 processor. Includes 1 Mbyte built-in RAM, HP-IB, RS-232, audio, HP-HIL and 512x400 B/W bit-mapped display interfaces. A battery-backed real-time clock is standard. Box includes slot for CPU board and slot for display board, plus 4 I/O slots for additional memory or I/O cards. Keyboard and monitor are not included.

Model 320

HP 98561B Model 320 32-bit SPU with 16.6 MHz 68020 processor board which includes a 16 Kbyte cache and MC68881 floating point coprocessor. The SPU box also contains the HP-IB/HP-HIL/RS-232 battery-backed real-time clock interface card and 1 Mbyte RAM card. Two DIO slots are available for adding additional memory or I/O. Keyboard, video board and monitor must be ordered separately.

Bit-Mapped Displays

HP 98542A Medium Resolution monochrome bit-mapped video board. 512x400 pixels displayed.

HP 98543A Medium Resolution color bit-mapped video board. 512x400 pixels, 16 colors.

HP 98544A High Resolution monochrome bit-mapped video board. 1024x768 pixels displayed.

HP 98545A High Resolution color bit-mapped video board. 1024x768 pixels, 16 colors.

HP 98546A Medium Resolution B/W alpha/graphics video board set for Series 200 display compatibility. 512x390 graphics pixels.

Monitors

HP 35731A/B 12" Monochrome Monitor, 60 Hz, 115 VAC, for use with 98542A video board or 98561A video output.

HP 35741A/B 12" Color Monitor, 60 Hz, 115 VAC, for use with 98543A video board.

HP 98781A 17" High Resolution Monochrome Monitor, 60 Hz, 115 VAC, for use with 98544A video board.

HP 98782A 19" High Resolution Color Monitor, 60 Hz, 115 VAC, for use with 98545A video board and 98700H Graphics Display System.

HP-HIL Input Devices

HP 35723A HP-HIL Touchscreen bezel. For 12" monitors 35731A and 35741A.

HP 46020A HP-HIL Keyboard. U.S. ASCII version.

HP 46060A HP-HIL Mouse.

HP 46081A HP-HIL ID Module.

HP 46082A/B 15/30 Meter Remote Extension.

HP 46083A HP-HIL Knob.

HP 46084A HP-HIL Security ID Module.

HP 46085A HP-HIL Control Dial Box.

HP 46086A HP-HIL 32-Button Box.

HP 46087A HP-HIL Digitizer, ANSI A/ISO A4-size. Opt. 001 adds the 46089A 4-button cursor w/crosshair.

HP 46088A HP-HIL Digitizer, ANSI B/ISO A3-size. Opt. 001 adds the 46089A 4-button cursor w/crosshair.

HP 46089A 4-button cursor for 46087/88.

Upgrades

HP 98242A I/O Card Cage Upgrade Kit. Four slot I/O card cage for 98561A having no built-in I/O (opt. 004).

HP 98243A Series 300 Processor Upgrade Kit. Includes HP-IB/HP-HIL/RS-232/battery-backed real-time clock interface card.

HP 98568A Direct connect passive I/O expander for Series 300 SPUs. Attaches directly to 98561A/B adding 8 I/O slots for additional memory, I/O or accessory cards.

HP 98701A Additional four planes of graphics memory for the 98700H.

HP 98710A Graphics Accelerator for the 98700H.

Series 300 Modular Components

| Series 300 Modular Components | Price |
|--|---------------|
| HP 35723A HP-HIL Touchscreen Bezel | \$300 |
| HP 35731A/B 12" Monochrome Monitor | \$325 |
| HP 35741A/B 12" Color Monitor | \$995 |
| HP 46020A HP-HIL Keyboard | \$225 |
| HP 46060A HP-HIL Mouse | \$148 |
| HP 46081A HP-HIL ID Module | \$205 |
| HP 46082A/B 15/30 Meter Remote Extension | \$720/\$1,010 |
| HP 46083A HP-HIL Knob | \$170 |
| HP 46084A HP-HIL Security ID Module | \$150 |

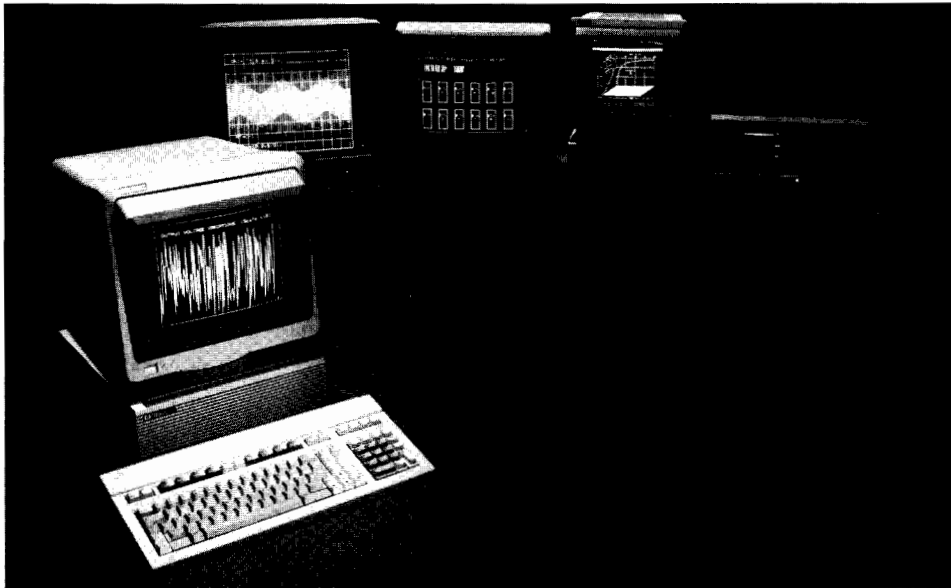

Series 300 and Display Options

| | |
|---|----------|
| HP 46085A HP-HIL Control Dial Module | \$1,200 |
| HP 46086A HP-HIL 32-Button Box | \$795 |
| HP 46087A HP-HIL, Digitizer, Ansi A/ISO A4 | \$735 |
| HP 46088A HP-HIL Digitizer, ANSI B/ISO A3-size | \$1,160 |
| HP 46089A 4-button Cursor w/crosshair | \$235 |
| HP 98242A I/O Card Cage Upgrade Kit | \$450 |
| HP 98243A Series 300 Processor Upgrade Kit | \$9,600 |
| HP 98256A 256 Kbyte RAM Card | \$600 |
| HP 98257A 1 Mbyte RAM Card with Parity Check | \$2,000 |
| HP 98542A Medium-resolution Monochrome Video Board | \$800 |
| HP 98543A Medium-resolution Color Video Board | \$2,400 |
| HP 98544A High-resolution Monochrome Video Board | \$1,400 |
| HP 98545A High-resolution Color Video Board | \$4,500 |
| HP 98546A Display Compatibility Interface | \$850 |
| HP 98561A SPU w/10 MHz MC68010 Processor, Opt. 001/002/003 | \$4,750 |
| HP 98561B 32-bit SPU w/16 MHz MC68020 Processor Board | \$11,800 |
| HP 98568A Direct Connect Passive I/O Expander | \$1,900 |
| HP 98701A Additional Graphics Memory | \$2,740 |
| HP 98781A 17" High-resolution Monochrome Monitor | \$1,500 |
| HP 98782A 19" High-resolution Color Monitor | \$3,050 |

Series 300 Bundled Systems

HP 98580A - Measurement Automation System
Based on Model 310, offers 1 Mbyte RAM standard, 35731A 12" monochrome monitor, 46020A Keyboard, BASIC 4.0. Includes a 10 MHz MC68010 Processor, HP-IB, RS-232, HP-HIL and medium resolution monochromatic video interfaces, battery-backed real-time clock, four slot card cage for additional memory, I/O and access cards.

HP 98581A - Entry Design Automation System
Based on Model 310, consisting of 98561A SPU opt. 003, 98543A medium resolution color Video Board, 35741A 12" Color Monitor, 46020A Keyboard. Includes a 10 MHz MC 68010 processor with a built-in 1 Mbyte RAM, HP-IB, RS-232, HP-HIL Interfaces, battery-backed real-time clock, a four-slot card cage for additional memory, I/O and accessory cards.

HP 98582A - High Performance Computer Aided Engineering System
Based on Model 320, high resolution monochrome system consisting of 98561B SPU, 98257A RAM Card, 98544A high resolution monochrome Video Board, 98781A 17-inch monochrome monitor, 46020A Keyboard. Included 2 Mbytes RAM, HP-IB, RS-232, HP-HIL interfaces, battery-backed real-time clock, one I/O card slot is available for adding a memory, I/O or accessory card.

HP 98583A - High Performance Design Automation System
Based on Model 320, high-resolution Color system consisting of 98561B SPU, 98545A high resolution color video board, 98782A 19" color monitor, 98568A 8-slot expander, 98620B DMA controller, 98625A high-speed disc interface, 46020A HP-HIL keyboard, 46081A 2.4 meter HP-HIL extension. Includes 16.6 MHz MC68020 processor with 2 Mbytes RAM, HP-IB, RS-232, HP-HIL interfaces, battery-backed real-time clock, seven available I/O card slots for additional memory, I/O and accessory cards.

| Series 300 Bundled Systems | Price |
|---|----------|
| HP 98580A Measurement Automation System | \$7,750 |
| HP 98581A Entry Design Automation System | \$7,850 |
| HP 98582A High-performance Software Engineering System | \$11,225 |
| HP 98583A High-performance Design Automation System | \$17,225 |

Languages and Operating Systems
BASIC, Pascal, and HP-UX run on all Series 300 and 200 systems.

HP-UX:
HP 97033A Multi-user HP-UX 5.0 Operating System. Includes HP Windows/9000, Personal Applications Manager (PAM), C Compiler, FORTRAN 77 Compiler, Pascal Compiler, MC680X0 Assembler, Symbolic Debugger, RS-232 Data Communications, Device I/O Library, Starbase Graphics Library and DGL/AGP Graphics Library.

HP 98515A Single-user HP-UX 5.1 Application Execution Environment. Includes HP-UX kernel, installation software, HP Windows/9000 and Personal Applications Manager (PAM).

HP 98517A/97A HP-UX 5.1 Programming Environment. Includes commands, C Compiler, MC680X0 Assembler, Symbolic Debugger, RS-232 Data Communications, Device I/O Library and Starbase Graphics Library. Requires 98515A for single-user only.

HP 98518A/98A HP-UX FORTRAN 77 Compiler. Requires 98517A/97A.

HP 98519A/99A HP-UX Pascal Compiler. Requires 98517A/97A.

HP 98520A/600A HP-UX DGL/AGP Graphics Library. Requires 98517A/97A.

HP 98693A SRM Access Utilities for HP-UX
HP 98797A/98A RJE Software for HP-UX

BASIC 4.0 Language System:
HP 98603A ROM-based BASIC 4.0 Language System. Includes one ROM board, BASIC 4.0 Manual Kit, and BASIC 4.0 Utilities Pack.

HP 98613B RAM-based BASIC 4.0 Language System. Includes one system disc set, BASIC 4.0 Utilities Pack and manuals.

Pascal 3.1 Language System:
HP 98615C RAM-based Pascal 3.1 Language System. Includes system disc set and Pascal 3.1 Manual Set.

TECHNICAL COMPUTER SYSTEMS

Technical Computers

HP 9000 Series 300 (cont.)

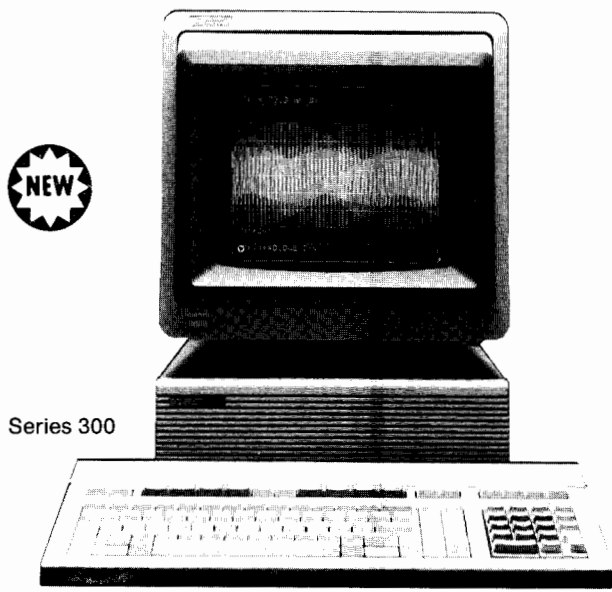

Series 300

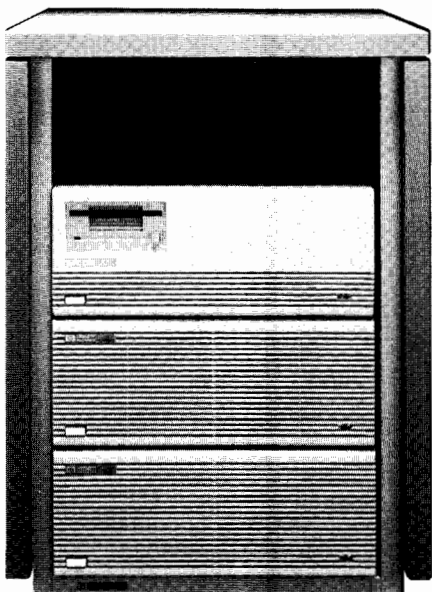

Series 300 with Expander and HP 9133

Languages and Operating Systems

| | Price | |
|---|--------|----------|
| | Single | Multi |
| HP 97033A HP-UX 5.0 Operating System | \$ | \$ 4,000 |
| HP 98515A HP-UX 5.1 Application Execution Environment | 350 | |
| HP 98517A/97A HP-UX 5.1 Programming Environment | 900 | 1,440 |
| HP 98518A/98A HP-UX 5.1 FORTRAN 77 Compiler | 500 | 800 |
| HP 98519A/99A HP-UX 5.1 Pascal Compiler | 500 | 800 |
| HP 98520A/600A HP-UX 5.1 DGL/AGP Graphics Library | 1,000 | 1,600 |
| HP 98603A ROM-based BASIC 4.0 Language System | 1,860 | |
| HP 98613B RAM-based BASIC 4.0 Language System | 860 | |
| HP 98615C RAM-based Pascal 3.1 Language System | 995 | |
| HP 98693A SRM access Utilities for HP-UX | 500 | 500 |
| HP 98797A/98A RJE Software for HP-UX | 1,010 | 2,525 |

Series 300 Interfaces

Interfaces for the Series 300 include:

HP 50961A #200 SRM Coax Interface. Allows connection to Shared Resource Management (SRM) system.

HP 98253A EPROM Programmer Interface. Includes EPROM Programmer Card for installation in any HP-DIO backplane slot.

HP 98255A EPROM Card. Contains 16 sockets for EPROMs to allow up to 256 Kb of storage using INTEL 27128A EPROMs or equivalent.

HP 98256A 256 Kbyte RAM Memory Card. No cabling requirements.

HP 98257A 1 Mbyte RAM Card. No cabling requirements

HP 98259A 128K Bubble Memory Interface. Non-volatile memory. Appears to be a flexible disc to the operating systems supporting it.

HP 98287A Interface to connect the Series 300 with the 98700H.

HP 98568A Series 300 Bus Expander

HP 98620B 2-channel DMA controller

HP 98622A GPIO Interface. Provides 16 bits of latched input and output data for bidirectional information transfer, and permits interfacing to GPIO-compatible equipment.

HP 98623A BCD Interface. Connects the Series 300 computers with bit-parallel, digit-parallel, binary-coded decimal services for data input.

HP 98624A HP-IB Interface. Allows communication with as many as 14 HP-IB compatible instruments.

HP 98625A/B High Speed Disc Interface for connection of disc drives and other HP-IB devices to Series 200/300.

HP 98626A/44A RS-232C Serial Interface. Used for simple asynchronous I/O applications.

HP 98627A RGB Color Video Output Interface

HP 98628A Data Communications Interface. Provides both protocol management and electrical levels for asynchronous serial communications.

HP 98629A SRM Interface

HP 98630A Breadboard Interface. Provides backplane buffering circuits and dual-inline holes for user-mounted circuit components.

HP 98633A 6944A Multiprogrammer Interface.

HP 98635A Floating Point Math Board.

HP 98640A Analog-to-Digital Card (ADC). Provides seven channels of 55,000-reading-per-second data acquisition.

HP 98641A RJE 2780/3780 Interface. Can emulate IBM 2780/3780 when used with the 98797/98A/R/M software in an HP-UX system and a synchronous modem.

HP 98642A 4-port RS-232C MUX Interface. Includes 3 direct connect and 1 modem port for use with Series 200/300 HP-UX operating systems.

HP 98643A LAN/300 link with ThinMAU (requires 50951A/52A). Connects Series 300 to IEEE 802.3 10 Mb/second ThinLAN.

(Opt. 241) Delete ThinMAU and Tee Connector.

HP 98644A RS-232C Serial Interface. Provides bit-serial communication between the Series 200/300 computers and asynchronous EIA RS-232C devices.

HP 98690A PDI Development Package for 98691A.

HP 98691A Programmable Datacomm Interface. Provides broad capabilities that can be tailored to meet special datacomm and/or serial interfacing needs.

HP 98695A IBM 3270 Coax Interface. Allows Models 216/220/236 to connect to an IBM-compatible 3270 controller.

HP 9888A HP-DIO Bus Extender. Provides total of 16 additional card slots for Series 200/300 with eight slots for either memory or I/O and eight slots for memory only.

Series 300 Interfaces

| | Price |
|--|-------|
| HP 50961A (opt. 200) - Resource Management Coax Adapter & Interface for Series 200 Systems | \$945 |
| HP 98253A EPROM Programmer Interface | 1,500 |
| HP 98255A EPROM Card | 300 |
| HP 98256A 256 Kbyte RAM Card | 600 |
| HP 98257A 1 Mbyte RAM Card | 2,000 |
| HP 98259A 128 Kbyte Magnetic Bubble Memory Card | 1,900 |
| HP 98287A 98700H Interface | 655 |
| HP 98568A Series 300 Bus Expander | 1,900 |
| HP 98620B 2-channel DMA Controller Card | 500 |
| HP 98622A 16-bit GPIO Interface Card | 355 |
| HP 98623A 43-line BCD Interface Card | 385 |
| HP 98624A HP-IB Interface | 330 |
| HP 98625A High Speed HP-IB Disc Interface | 605 |
| HP 98626A RS-232 Serial Interface | 380 |
| HP 98627A RGB Color Video Output Interface | 1,010 |
| HP 98628A Datacomm Interface | 485 |



Expanded Series 300 with Optional Peripherals

| | |
|--|-------|
| HP 98629A SRM Interface | 655 |
| HP 98630A Breadboard Interface | 320 |
| HP 98633A 6944A Multiprogrammer Interface | 350 |
| HP 98635A Floating Point Math Card | 975 |
| HP 98640A 7-channel ADC Interface | 990 |
| HP 98641A IBM™ RJE 2780/3780 Interface | 1,250 |
| HP 98642A 4-port RS-232C MUX Interface | 600 |
| HP 98643A LAN/300 Link | 1,300 |
| HP 98644A RS-232C Serial Interface | 190 |
| HP 98690A PDI Development Package for 98691A | 405 |
| HP 98691A Programmable Datacomm Interface | 650 |

Series 300 Networking

LAN:

HP 50951A/52A NS/9000 Series 300 Networking Software for HP-UX. Requires 98643A LAN/300 interface.

SRM Servers:

HP 50960S SRM Server System. Includes 50960A server, 82913A monitor, 98619A SRM operating system, and 46020A keyboard (U.S. ASCII version only).

HP 50960A SRM Server. Includes 98619A operating system, 50961A Opt. 200 coax adapter and interface, interfaces for video monitor and keyboard, CPU, 1/2 Mbyte RAM memory, DMA, HP-IB in 325mm-wide case.

HP 98619A SRM Operating System. Includes software and manual. Requires 50960A/S or 9920A Opt. 500 configurations. Must order opt. 022, software on 1/4" cartridge tape, or opt. 001, upgrade from previous SRM operating system.

HP 9920A SRM Server System. Opt. 500 Includes: Model 220 computer, 98256A 256 Kb RAM boards, 98620B DMA Controller board, 98625A high-speed HP-IB interface, 98203A keyboard, 98204A composite video interface, 98028A SRM multiplexer, 98629A SRM interface, & 98619A SRM operating system. Also requires 82912A/13A monitor.

SRM Workstation Hardware:

HP 50961A SRM Coax Adapter and Interface. Includes Series 300 SRM interface card, coax adapter and BNC T-connector. Requires coax adapter on server and RG58C/U coax cables w/BNC connectors.

HP 98629A SRM Interface. Requires 98028A Multiplexer for every four workstations and 97061 cables for each workstation.

SRM Workstation Software:

HP 98693A SRM Access Utilities for HP-UX. Opt. 022 on 1/4" tape cartridge, opt. 045 on 3 1/2" flexible disc.

Series 300 Networking

| | |
|--|---------|
| HP 50960A SRM Server | \$6,445 |
| HP 50960S SRM Server System | 6,995 |
| HP 50961A SRM Coax Adapter and Interface | 945 |

| | |
|--|-------|
| HP 98619A SRM Operating System | 2,000 |
| HP 98629A SRM Interface | 945 |
| HP 98693A SRM Access Utilities for HP-UX | 500 |
| HP 9920A SRM Server System | 4,500 |
| Option 500 | 5,500 |

Series 300 System Software

Most of HP's popular software packages run on the Series 300 using the Display Compatibility Interface. In addition, some of the packages have been ported to run on the Series 300 without the compatibility interface. In these ported programs, the code has been translated for HP's BASIC 4.0 and Pascal 3.1.

HP 45462B Picture Perfect™. Interactive graphics software that transforms your data into pie, vertical bar, horizontal bar, line and combined bar/line charts.

HP 45463B Diagraph™. Clip art software that allows you to create a variety of professional-looking presentation aids, organizational charts, flow charts, diagrams, forms, signs and word charts.

HP 45480B Data Grapher/200. A data analysis and display tool that turns numbers into graphs and charts. Files can be merged with HP TechWriter.

HP 45481B Context MBA™. Performs financial analysis, word processing, business graphics, telecommunications and data management.

HP 45537B Graphics Editor/200. A general purpose drawing tool for creating charts and diagrams such as flowcharts, organization charts, process flow diagrams and text slides. Files can be merged with HP TechWriter.

HP 45538B Text Editor/200. An easy-to-use text processor for creating reports, memos and high-quality letters.

HP 98791B HP 2392A & VT100 Terminal Emulator*. Allows HP Series 200/300 WS to I/F to DEC Host. Includes most features of full screen editor. Runs on Pascal 2.0.

HP 98792A TEK 4010/HP 2622A Terminal Emulator**. Enables Series 200 listed to emulate whether a Tektronix 4010 terminal or an HP 2622A terminal is used.

HP 98305A HP EGS/200*. Allows user to create schematics of electronic designs, printed circuit board artwork, 2D technical drawings and other engineering drawings.

HP 98815A HP Graphics Presentation/200. Produces bar, line and pie charts. Features four character fonts and can produce 1-7 color output on paper for overheads.

HP 98817A HP Project Management/200. Performs PERT, CPM, and MPM network analysis. Produces GANTT chart output.

HP 98819A HP TechWriter*. A low-cost document editor that eliminates the need for technical professionals to manually "cut and paste" pictures into memos and documents.

HP 98820A HP Statistics Library/200. Broad statistics program including basic statistics and data manipulation, regression, general statistics and analysis of variance.

HP 98821A HP Numerical Analysis Library 200. Has seven main sections - root finders, numerical integration, ode solvers, eigen and fourier analysis and interpolation.

Series 300 System Software

| | Price |
|---|---------|
| HP 45462B Picture Perfect™ | \$595 |
| HP 45463B Diagraph™ | 695 |
| HP 45480B Data Grapher/200 | 295 |
| HP 45481B Context MBA™ | 795 |
| HP 45537B Graphics Editor/200 | 445 |
| HP 45538B Text Editor/200 | 275 |
| HP 98791B HP 2392A/VT100 Terminal Emulator* | 250-300 |
| HP 98792A TEK 4010/HP 2622A Terminal Emulator** | 350 |
| HP 98305A HP EGS/200* | 10,000 |
| HP 98815A HP Graphics Presentation/200 | 750 |
| HP 98817A HP Project Management/200 | 500 |
| HP 98819A HP TechWriter* | 795 |
| HP 98820A HP Statistics Library/200 | 1,500 |
| HP 98821A HP Numerical Analysis Library/200 | 500 |

*Package requires the use of the Series 200 ID PROM.

**Requires the use of a non-HP-HIL keyboard.

Picture Perfect is a trademark of Computer Support Corp.

Context MBA is a trademark of Context Management Systems

Diagraph is a trademark licensed to Computer Support Corp.



Model 520

HP 9000 Series 500

The HP 9000 Series 500 is HP's 32-bit computer line and is one of the most powerful computers for its size. For applications which require 32-bit 'number-crunching' and speed, the Series 500 offers the alternative to a super mini-computer or mainframe. Three-dimensional modeling, finite element analysis, complex mathematical matrices, integrated/printed circuit design and analysis, mechanical drafting and design, noise and stress analysis, and software engineering are a few of the applications for which the Series 500 can be used.

The Series 500 computers are available as either an integrated workstation featuring graphics display on your choice of terminals, a keyboard and mass storage (Model 520), or a component configuration (Model 550) that permits selecting the peripherals you need.

The Series 500 computers include Models 520 and 550 (ordered as 9020 and 9050).

Series 500 Base Systems

Model 520

Model 520 is a compact workstation, suitable for desk or table top. With integrated mass storage and choice of CRT, the Model 520 is a "mainframe on a desk" that can solve the entire range of engineering and scientific problems. All of the Model 520s feature an integrated keyboard, 12 slot memory/processor module, 2 Mbyte RAM, a 4-slot backplane and an integrated 5-1/4 inch flexible disc drive. The Model 520s are compatible with BASIC or HP-UX.

Model 520A features a 310mm (12-inch) standard color CRT with 512x390 graphics and 4,096 color shades. Model 520B has a high performance 310mm (12-inch) monochrome CRT with 560x455 graphics. Model 520C features a high performance 330mm (13 inch) color CRT with 560x455 graphics and 8 true colors with 4,913 dithered colors. Built-in options for Models 520A/B/C include additional CPUs, additional RAM, additional IOPs (for I/O expanders), 10 Mbyte Winchester disc, 400 lpm thermal printer, and light pen.

Model 550

The new Model 550 is a high performance, full 32-bit computer with the power to handle complex design problems in a locally managed environment. It provides the freedom of high performance and real-time accuracy, right on your desktop. Teamed with key application software and networking, the powerful new Model 550 can help a design team shorten the design cycle, thereby maintaining a competitive edge through timely introduction.

Built-in options for the Model 550 include additional CPUs, RAM and IOPs for almost unlimited capacity, providing the latitude to change or modify as need dictates.

In addition, Model 550 is the cornerstone for a system which can include one or more ultra high-performance multi-user HP 98700H Graphics Display Stations. Such a system combines mainframe performance, floating point computation and support of multiple high-performance graphics stations, all in a controlled, networked environment that responds as well as a single-user system.

Series 500 Bundled Systems

Model 520

Models 520AS and 520AT are based on the Model 520A, include the standard color CRT, and are compatible with BASIC or HP-UX. Model 520AS includes 2 Mbytes of RAM, the 97093A Winchester

10 Mbyte fixed disc, integrated 97090A thermal printer, BASIC 3D Graphics, and BASIC language system. It is compatible with single-user HP-UX.

The Model 520AT has 2 Mbytes of RAM, integrated thermal printer, the 27100A HP-IB interface, single-user HP-UX, FORTRAN 77, C, Pascal Compilers and Graphics/9000 DGL/AGP. It is compatible with the BASIC operating system.

Model 550

The Model 550AM is based on the Model 550A and includes 2 Mbytes of RAM (up to 10 Mbytes total in 2 Mbyte increments, or up to 5 Mbytes of high-speed RAM in 512 Kbyte increments), built-in HP-IB Interface (standard), the 27130A 8-channel multiplexer, Multi-user HP-UX, Fortran 77, C, Pascal Compilers and Graphics/9000 DGL/AGP.

The Model 550AT is based on the Model 550A system and includes 2 Mbytes of RAM (up to 10 Mbytes of standard RAM total in 2 Mbyte increments, or up to 5 Mbytes of high speed RAM in 512 Kbyte increments), built-in HP-IB Interface (standard), the 27130A 8-channel multiplexer, Single-user HP-UX, Fortran 77, C, and Pascal Compilers and Graphics/9000 DGL/AGP.

A complete line of peripherals is available for interfacing to Series 500 computers. For a list of supported peripherals, refer to the peripheral interfacing table on page 83.

HP 9000 Series 500

| | Price |
|--|----------|
| 9020A Model 520A Computer w/standard color CRT | \$30,900 |
| 9020B Model 520B Computer w/monochrome CRT | 35,000 |
| 9020C Model 520C Computer w/high performance color CRT | 50,000 |
| 9020AS Model 520AS Computer w/standard color CRT, BASIC | 35,830 |
| 9020AT Model 520AT Computer w/standard color CRT, single-user HP-UX | 39,300 |
| 9050A Model 550A | 19,425 |
| 9050AM Model 550AM | 20,180 |
| 9050AT Model 550AT | 25,560 |

Languages and Operating Systems

HP 97050 - Single-user Basic for the Model 520. Multi-tasking using internal 10 Mbyte disc as system disc.

HP 97070/80 - Single-/Multi-user FORTRAN 77 Compiler. For HP-UX systems only, offering full implementation of the latest ANSI standard plus MIL-STD 1753 and other extensions.

HP 97072/82 - Single-/Multi-user RJE software. Allows for batch data transmission to another computer using IBM 2780/3780 binary synchronous protocol

HP 97079/89 - Single-/Multi-user, multi-tasking HP-UX operating system for Models 530, 540 and 550.

HP 97086 - HP 1000 to 9000 Applications Migration. Used to transport programs from an HP 1000 RTE-6/VM system to an HP 9000 HP-UX system.

Languages and Operating Systems

| | Price |
|--|---------|
| HP 97050A Single-user BASIC for Model 520 (must specify medium) | \$2,500 |
| HP 97070 Single-user HP-UX for Model 520 | 2,020 |
| HP 97071 Single-user Fortran 77 Compiler for HP-UX systems | 2,020 |
| HP 97072 Single-user Pascal Compiler for HP-UX systems | 2,020 |
| HP 97079 Single-user HP-UX for Models 530/540/550 | 2,020 |
| HP 97080 Multi-user HP-UX for Model 520 | 5,000 |
| HP 97081 Multi-user Fortran 77 Compiler for HP-UX systems | 4,500 |
| HP 97082 Multi-user HP Pascal Compiler for HP-UX systems | 4,500 |
| HP 97086 HP 1000 to 9000 Applications Migration | 1,010 |
| HP 97089 Multi-user HP-UX for Models 530/540/550 | 5,000 |

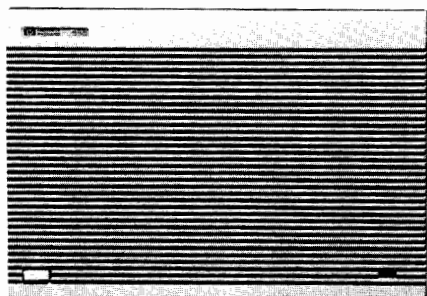

Model 550

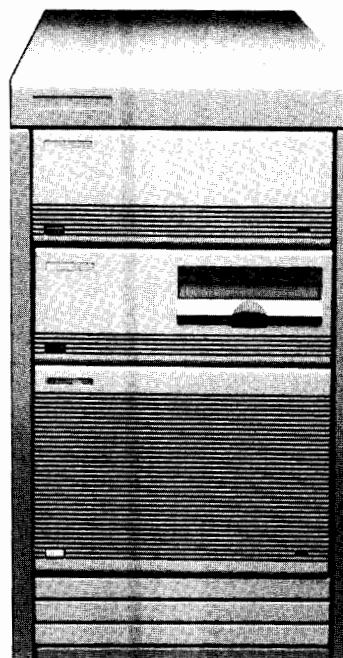

Rack-mounted Model 550 with Peripherals

Series 500 Interfaces

The following interfaces and memory enhancements are available for the Series 500 computers:

HP 2285A - Local Area Network (LAN) - Consists of a self-contained Ethernet interfacing box, transceiver, HP-IB interface and software to provide an Ethernet switching interface between Series 500 computers.

HP 27110A - HP-IB Interface. Allows communication with as many as 31 HP-IB-compatible device addresses and 15 standard device loads.

HP 27112A - GPIO Interface. Provides 16 bits of latched input and output data for bidirectional information transfer, and permits interfacing to GPIO-compatible equipment.

HP 27116A - HP-CIO Service Extender. Extender card for out-of-card-cage access to an operating HP-CIO Interface card.

HP 27122A - RJE Interface. Used by HP-UX 97077/87 software for batch data transmission to another computer using IBM 2780/378/binary synchronous protocol.

HP 27125A - LAN Interface. Provides connection to IEEE 802.3 or Ethernet LAN. Requires HP 30241A Medium Access Unit and HP 92254 Attachment Cable.

HP 27128A - ASI Interface. Single channel asynchronous interface for linking to an RS-232C-compatible device.

HP 27130A - Eight-channel Multiplexer Interface. Supports up to eight RS-232C-compatible devices.

HP 50961A (opt. 500) - SRM Interface. Used by BASIC and HP-UX software for access to shared discs, printers, and plotters on Shared Resource Management (SRM) system.

HP 97060 - Graphics Processor. An intelligent external graphics processor offering full access to a 1,024x768x8 graphics display system.

HP 97062A - RGB Interface. Color video interface used by BASIC 97052, HP-UX 97074/84, and Graphics software 97075/85 to display color graphics in an external CRT monitor.

HP 98700H (opt. 050) - Interface to connect 98700H to Model 550.

HP 98710A - Graphics Accelerator.

Series 500 Interfaces

| Series 500 Interfaces | Price |
|---|---------|
| HP 27110A HP-IB Interface | \$1,010 |
| HP 27112A GPIO Interface | 700 |
| HP 27116A HP-CIO Service Extender | 400 |
| HP 27122A RJE Interface | 2,115 |
| HP 27125A LAN Interface | 2,200 |
| HP 27128A ASI Interface | 910 |
| HP 27130A 8-Channel Multiplexer Interface | 2,100 |
| HP 50961A (opt. 500) - SRM Coax Adapter and Interface | 2,395 |
| HP 97062A RGB Interface | 2,520 |
| HP 98700H (opt. 050) - Model 550 Interface | 15,000 |
| HP 98710A Graphics Accelerator | 7,310 |

System Software

All Series 500 computers can be configured to run BASIC and HP-UX, allowing access to the following applications software:

BASIC:

HP 97052 - BASIC 2D/3D Graphics. This package provides high performance graphics for the engineer or scientist and includes a comprehensive set of viewing and clipping functions.

HP 97053 - IMAGE/9000 DBMS. This package features two levels of data objects and data retrieval, and puts a user-friendly, interactive interface between the user and the data base.

HP 97056 - BASIC Asynchronous Terminal Emulator - The emulator package offers a simple, convenient method to link Series 500 machines to a host computer.

HP 97058 - Shared Resource Management software. SRM software allows Series 500 BASIC computers and peripherals to be linked together in a local area network.

HP-UX:

HP 50953 - N/S 9000 Software for single-user HP-UX Series 500 systems. Provides access to IEEE 802.3 LAN and HP AdvanceNet communication service.

HP 50954 - N/S 9000 Software for multi-user HP-UX systems, see HP 50953.

HP 79300S/M - MUSE™ Word Processor - A technical word processor providing office-grade word processing for the scientist and engineer.

HP 97074/84 - Graphics 9000/DGL - Fundamental device-independent graphics system.

HP 97075/85 - Graphics 9000/AGP - Advanced interactive graphics systems consisting of a set of procedures called from an application program.

HP 97076 - HP-UX Async Communications Software - Provides a convenient method of linking Series 500 computers to other HP-UX systems, System III Unix Systems, and remote host computers.

HP 97077/87 - Series 500 HP-UX RJE Emulator. Single/Multi-user software enables the Series 500 to communicate with remote computers and peripherals that support IBM 2780/3780 RJE data transmission protocols.

HP 98694A - SRM Access Utilities for HP-UX. Allows Series 500 HP-UX systems to transfer files to/from the SRM system and to share SRM peripherals.

Additional software packages are available through Hewlett-Packard's arrangement with third-party software suppliers.

UNIX is a registered trademark of AT&T Bell Labs.

SOFTOOL®, FPE™, CCC™, and CC™ are trademarks of Softool Corporation.

MUSE™ is a trademark of MARC Analysis Research Corporation.

VAX™ is a trademark of Digital Equipment Corporation.

Series 500 System Software

| Series 500 System Software | Price |
|---|----------------|
| HP 79300MA Muse Word Processor | \$2,725-10,090 |
| HP 97052A BASIC 3-D Graphics | 1,200 |
| HP 97053A IMAGE/QUERY 9000 DBMS | 1,200 |
| HP 97056A BASIC Asynch Terminal Emulator | 505 |
| HP 97058A SRM for BASIC systems | 200 |
| HP 97074A/84A Graphics 9000/DGL | 800/2,000 |
| HP 97075A/85A Graphics 9000/AGP | 1,600/4,000 |
| HP 97076A Asynch Datacomm for HP-UX systems | 505 |
| HP 97077/87A Series 500 HP-UX RJE Emulator | 2,020/5,045 |
| HP 98694A SRM Access for HP-UX systems | 500 |

TECHNICAL COMPUTER SYSTEMS

Technical Computers

Networking - An Overview

HP Networking

HP networking is an effective means of harnessing and controlling the vast amounts of data created in companies using different vendors with different equipment. Our strategy allows these companies to access and manipulate data throughout their entire computing network. By addressing key issues, HP has developed a long-term networking strategy that satisfies all your communication needs.

- **Transparency:** We strive to create networks so completely transparent that the user will have the same capabilities on a remote system that are available on a local system.
- **Flexibility:** A broad range of data communication alternatives for both local and remote communication, combined with a variety of upgrades, provide the flexibility to enlarge or modify as need dictates. This provides true, long-term investment protection.
- **Industry Standard Design:** The end goal of industry standard is also the main objective of networking: achieving interconnectivity between different equipment from different vendors. Any effective networking solution is built and designed with a firm commitment to industry standard.
- **Reliability:** A networking solution is only as good as the company that develops, sells and services it.

By addressing these key issues, Hewlett Packard provides a well-balanced, workable networking solution that lets you move and manage information from workstation to workstation, from department to department or throughout an entire company. It addresses the networking needs of today and tomorrow, providing a total solution that grows with your company.

HP AdvanceNet

HP's strategy for networking, called HP AdvanceNet, will eventually link all major HP computer systems with each other, with HP personal computers, and with computers made by other manufacturers. It is being implemented under the industry standard Local Area Network (LAN) specified by IEEE 802.3. This is already available on the HP 9000 Series 500 and HP 3000s.

HP AdvanceNet offers price/performance alternatives for creating cost-effective networks now, with upgradeability and connection alternatives inherent in its architecture for investment protection in the future.

NS/9000 Local Area Networking (LAN)

Network Services/9000 provides transparent Remote File Access (RFA) between HP-UX systems. It also provides file transfer (NFT) between HP systems which support HP AdvanceNet protocol, such as the HP 3000.

Link-level access capability is provided for customers who have the expertise to write inter-vendor software.

NS/9000 and the 98643A LAN/300 Link combine to provide high-speed local area network communication supporting either IEEE 802.3 or Ethernet LAN standards.

HP 9000 Networking

| Feature | Local Area Network (LAN) | uucp, uux, cu | 2392A/VT100 Emulator | Shared Resource Management (SRM) |
|---------------------------|--------------------------|-----------------------------|-------------------------------|-------------------------------------|
| Operating system required | HP-UX | HP-UX | Stand-alone or Pascal | BASIC, HP-UX or Pascal |
| Network services provided | RFA, NFT, LLA | NFT, RCX, VT | VT, NFT | NFT (HP-UX), RFA (BASIC and Pascal) |
| Systems on network | HP 9000, HP 3000 | Any HP-UX, most async hosts | Any HP, DEC, most async hosts | HP 9000, HP 9835/45 |
| Bit rate | 10 Mbps | 9.6 Kbps | 9.6 Kbps | 750 Kbps |
| Maximum distance | 1500m | Unlimited | Unlimited | 1000m |
| Maximum nodes | 1024 | Unlimited | Unlimited | 63 |
| Connect method | Coax | RS-232C, X.25 | RS-232C | Coax |

Key: NFT - Net File Transfer RFA - Remote File and Directory Access VT - Terminal Access RCX - Remote Command Execution LLA - Line Level Access

HP-UX Asynchronous Data Communications

HP-UX, most UNIX* operating systems and UNIX-like systems can communicate using Unix to Unix Copy (uucp) protocol over hardwired, leased, dial-up and X.25 lines. File transfer, remote command execution (uux) and virtual terminal (cu) capabilities are provided. HP-UX electronic mail uses the uucp facility.

Uucp connections (except hardwire) are generally not dedicated. Systems communicate on demand. Your system can simultaneously communicate with as many systems as you have available ports (subject to single- and multi-user license limits). There is no limit to the number of systems with which you can potentially communicate in turn.

Any RS-232C interface is sufficient for hardwired operation, although the direct-connect ports of the 98642A Mux are not recommended. All other connections require a modem-compatible interface and cable. An X.25 connection requires a modem port of an HP 2334A Option 123 Multi-MUX X.25 cluster controller.

The virtual terminal capability of cu makes your virtual terminal (through your system) appear to be a terminal connected to a remote system. Cu can communicate with most systems that are compatible with 7- or 8-bit asynchronous ASCII terminals. In general, cu works with any system with which HP terminals work, except for block-mode applications.

*UNIX is a trademark of AT&T.

HP 2392A and VT100 Terminal Emulator

The HP 2392A and VT100 Terminal Emulator package can benefit you in three ways. First, you can use your Series 200/300 computer as a terminal to a host computer so that you can develop and run programs, access host peripherals, maintain files, and sign on to timeshare systems. Second, you can transfer files between the host computer and disc drives connected to your Series 200/300. Third, you can run application packages such as HPDESKMANAGER for the HP 3000 or the EDT editor for the DEC VAX/VMS* system. These applications support HP block mode or VT100 terminals.

*DEC, VT100, VAX/VMS are registered trademarks of Digital Equipment Corporation.

Shared Resource Management

An SRM network consists of one or more SRM servers and up to 63 workstations. The server provides a shared hierarchical file system and spooled printer and plotter support. Workstations communicate only with servers, and vice-versa. Workstation-to-workstation and server-to-server communication is not supported.

BASIC and Pascal workstations can be discless using the server's file system as their sole file system (including system boot). HP-UX workstations may be included in the SRM network. HP-UX workstations transfer files to and from the SRM Server and submit data for spooling to a printer and plotter by merely writing to a file in one of the server's spool directories.

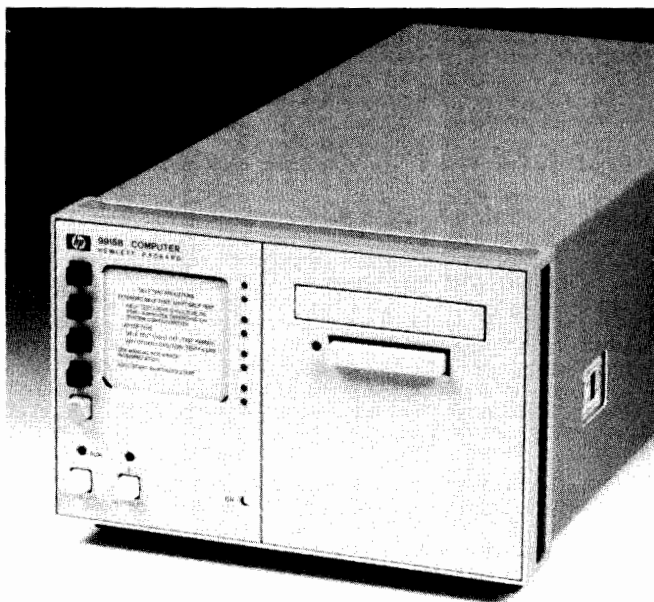

HP 9915B



The HP 9915B is a modular computer that derived from the HP-85B desktop system but excludes keyboard, crt, tape drive and printer. This makes it ideal for integration into an automated system, omitting features not needed in a pre-programmed controller. Its optimal applications are in automated testing, measurement and control applications where durability is essential, eg. instrument control applications using a rack-mountable controller; machine control for presses, cutting, or sawing machines and transfer lines; test-bench control for chemical processes; nitrogen and exhaust analyses; product component control like quality control-goods, inward control and manufacturing supervision; data collection and control in labs and in environmental protection. In these applications, the HP 9915B can be used as a front end controller or host-controlled by an HP-1000 or other computers.

The HP 9915B is a viable alternative to custom-made microcomputer systems and board computers, which are expensive but difficult to engineer, program and develop.

The HP 9915B is an extended version of the earlier HP 9915A model. Software compatibility with the HP 9915A allows customers to switch over to the HP 9915B very easily.

Efficient Program Development

Programs for the HP 9915B can be developed and debugged on the HP-85B and transferred to the HP 9915B via either EPROM, tape cartridge, or other Mass Storage devices. Applications can be running in about half the time it would take for a microcomputer or boardcomputer.

By using a Program Development Kit and other accessories the HP 9915B can also be used as its own development station.

For non-volatile storage and fast loading in industrial environments, the HP 9915B accepts 32K bytes of EPROM storage for application programs. Program development software is available that allows the designer to program EPROMS with commercially available PROM programmers.

- Run-Only Computer for test, measurement and computational applications in harsh environments.
- Intensive self-test function after power on.
- Rack-mountable for easy integration into a system.
- Custom operator interface - remote buttons and LEDs, keyboard and CRT control for operator convenience.
- Built-in EPROM board (max. 32K bytes), I/O ROM, Program Development ROM, and a Mass Storage/E-Disc ROM set
- Powerful BASIC language operating system. HP-85B compatible.
- Graphics capabilities.

32K Byte of user read/write memory and 32K byte of built-in Electronic Disc (E-Disc) read/write memory are available in the HP 9915B. The E-Disc memory can be expanded to up to 416K bytes by inserting memory modules into the I/O ports. The E-Disc is electronically accessed by a built-in Mass Storage/E-Disc ROM set and makes data transfer about 150 times faster than data transfer using tape.

Flexible Design for Operator Interface

Offering a variety of operator interfaces, the HP 9915B can be tuned to the application as required. The program start button and eight (four shiftable) software-definable function keys will suffice for applications requiring minimal attention. For extensive operator interactions, the pushbuttons and LEDs can be remotely controlled and CRT displays, standard or custom keyboards can be added.

Since all of the HP-85's graphics capabilities are built into the HP 9915B, charts, histograms, block diagrams and other graphics may be easily displayed via an external CRT. CRT and keyboard are available as optional products.

I/O Capabilities

The HP 9915B BASIC language includes a powerful set of statements to simplify I/O, providing the user with interrupt, bit manipulation, high speed transfer, software control of interface and easy data formatting. I/O drivers are built in and the following plug-in interfaces can be used: HP-IB (IEEE 488-1978); RS-232-C (serial); GPIO (8-bit/16-bit parallel); BCD (binary coded decimal); HP-IL (Interface Loop) and FDL (Factory Data Link).

Additional Features

A complete line of peripherals is available for the HP 9915B including printers, plotters, and flexible- and winchester disc drives. HP multiprogrammers are available for analog input and output, digital input and output, stepper motor control, timing and counting.

Ordering Information

| | |
|--|--------|
| HP 9915B Modular Computer with 32K RAM memory, 32K E-Disc memory, I/O ROM, Program Development ROM and Mass Storage/E-Disc ROM set. | \$2040 |
| Opt.001 Built-in Tape Drive | \$ 450 |
| Opt.002 Operator Interface Capability (for commercial video monitors, keyboards and remote front panel control) | \$ 370 |
| HP 82908A 64K E-Disc Memory Module | \$ 390 |
| HP 82909A 128K E-Disc Memory Module | \$ 590 |
| HP 98150B HP 9915B Opt.002 Program Development Kit Includes System Development Manuals, Accessory Keyboard, Tape Duplication and EPROM Programming Software Pack. | \$ 610 |
| HP 98155A Keyboard | \$ 420 |
| HP 82912A Monitor 9" | \$ 295 |
| HP 82913A Monitor 12" | \$ 325 |



TECHNICAL COMPUTER SYSTEMS

The Integral PC



The Integral Personal Computer from HP is the first low-priced, UNIX-based transportable personal computer to provide the power and performance of a UNIX desktop computer. The mouse is optional.

The HP Integral Personal Computer

The Integral PC is the first personal computer to deliver the performance of the UNIX™ operating system in a fully integrated, affordable, easy-to-use package. Everything you need for full computing power — a printer, keyboard, monitor, mass storage, and an optional HP Mouse — is provided in the transportable Integral PC.

The standard 512K bytes of memory is expandable to 2.5M bytes; with Bus Expanders, the RAM can be boosted up to 7M bytes. And, there's 256K bytes of ROM, with the built-in HP-UX, Hewlett-Packard's customized version of the UNIX operating system. HP-UX incorporates a superset of industry-standard capabilities, such as powerful real-time control and shared memory enhancements. Also included in ROM is the Personal Applications Manager (PAM), a friendly user interface, and the HP Windows multi-window manager.

PAM simplifies the user approach to the powerful operating system, and has been customized for the Integral PC's multi-tasking environment. For high-end users, the Integral PC also offers traditional UNIX operating system shells.

The Integral PC Features

- Motorola 68000, 16/32-bit microprocessor, 8 MHz
- 16-bit graphics processor
- 256K byte ROM contains:
 - HP-UX kernel
 - HP Windows
 - Personal Applications Manager (PAM)
- Standard 512K byte RAM expands to:
 - 2.5M bytes in main system
 - 7M bytes with Bus Expanders
- Microfloppy 3½ inch disc drive, 710K byte
- Amber/black electroluminescent 9-inch display
- Two Hewlett-Packard Human Interface Loop (HP-HIL) connectors
- Built-in HP ThinkJet Printer
- Fully functional, typewriter-style keyboard
- HP-IB interface
- Two expansion ports; extendable to ten with bus expander option
- Compatible with HP 9000 family of HP-UX computers
- Compatible with HP Series 80 Personal Computers

HP-UX and the Integral PC

The UNIX operating system, written in the high-level C language, is uniquely capable of operating on a wide range of hardware — from micros to mainframes. HP-UX 2.1 is a genuine UNIX operating system product, which lets the Integral PC transcend the architectural barriers of such systems as MS™-DOS and PC-DOS™ for powerful software development programs.

The HP-UX kernel is stored in ROM, providing the Integral PC with on-board power. You can run UNIX-operating-system-based software programs and applications installed on 3½ inch floppy discs, eliminating the necessity of a Winchester hard disc.

UNIX Operating System Software Library

A substantial amount of UNIX-based software is available, especially for software development, text processing, and communications. The library includes Pascal, FORTRAN, and "C" compilers, designed primarily for programming experts. Additionally, a Device Independent Library (DIL) provides high-level language control of instruments through compiled languages. This saves time when programming high-performance computer-aided test solutions.

Real-time extensions are available through HP-UX to provide reliable interrupt handling and priority setting in a multi-tasking instrument control environment.

Personal Applications Manager

Hewlett-Packard's Personal Applications Manager (PAM) is a software shell that insulates the user from the complexity of the UNIX operating system. The PAM menu visually translates the UNIX system commands into simple directions. PAM can be bypassed to work directly with the HP-UX command structure, if desired.

HP Windows

HP Windows gives your Integral PC the ability to work as you do: set a project aside, and return to it later — right where you left off. No disc swapping or applications reloading. The windows can be modified while applications are running, and multiple windows can reside simultaneously on the screen. No program modification is required to take advantage of the HP Windows feature.

Multi-Tasking

The Integral PC's multi-tasking feature puts at your disposal the simultaneous capabilities of several terminals. You can write a report while a spreadsheet is recalculating, or take readings from an instrument while printing a file.

Internal Disc Drive

One-half of the Integral PC RAM may be allocated as RAM disc, an internal disc drive that lets applications execute at higher speeds than a standard microfloppy disc drive. Applications requiring two disc drives can use the RAM disc as the second drive.

Graphics Display

The Integral PC features a 9-inch, 24-line x 80-column, amber and black electroluminescent (EL) display. The flat panel display is tilt-adjustable, compact, and very readable. The Integral PC's bit-mapped display uses square pixels, which produce excellent, high-quality graphics. It has 256 pixels vertically and 512 pixels horizontally. The 16-bit graphics processor supports high-speed line drawing and can change windows rapidly.

Keyboard

The Integral PC offers a fully spaced, 90-key, typewriter-style keyboard. The detachable, low-profile keyboard includes a numeric keypad, eight function keys, flexible key mapping, and an 8-foot coiled cable.

HP-HIL Device Connectors

A second HP-HIL port on the Integral PC lets you use creative input devices, such as the optional HP Mouse, in addition to the keyboard.

Internal Printer

The built-in HP ThinkJet Personal Printer delivers permanent, high-quality printouts at a quiet 150 characters per second. It offers an 11 x 12 dot character matrix text print resolution, in an ink-jet dot-matrix printing method. Full graphics printing is standard, too.

Interfaces and Data Communications

Two expansion ports, two HP-HIL ports, and an HP-IB interface provide I/O capabilities for the Integral PC. HP-IB is a very flexible and powerful interface; up to 14 peripherals and instruments can be controlled simultaneously from the Integral PC. In addition, the Bus Expander option expands a single port to five ports; two Bus Expanders would provide up to ten ports. A wide variety of U.S. and international modems are supported by the RS-232C card.

Software Solutions

Enhancements to the UNIX operating system, such as HP Windows, PAM, and graphics, create a unique environment for software on the Integral PC. Packaged with the Integral PC are the software solutions you need to operate in this environment.

The Tutor Disc for quick, easy lessons on operating the Integral PC.

The Utilities Disc for such common operations as copying and formatting discs.

HP-UX Commands Disc containing the most popular HP-UX commands, and capable of creating custom commands and functions when used with the Applications Disc. This disc includes C-Shell, a command processor with C-like syntax.

Standard Applications Disc provides such program functions as word processing, simple drawings, simple math calculations, and a pure-fun game. Included on this disc are several different character fonts, as well as a font editor for creating custom fonts.

System Disc contains utilities such as HP Graphics Language (HPGL) Window Driver, HP-IB printer and plotter device drivers, RS-232C printer serial drivers, and the local language versions of PAM.

Diagnostics Disc quickly runs a diagnostic test of the system.

Specifications

Microprocessor/CPU: Motorola 68000, 16/32-bit processor running at 8 MHz

Graphics Processor: 16-bit, with 32K bytes of dedicated RAM

Operating System: HP-UX

Memory: 256K bytes ROM

512K bytes RAM, expandable to 2.5M bytes in main system and to 7M bytes with I/O expanders

Mass Storage: Single 710K byte double-sided, double-density 3 1/2 inch microfloppy

Display: 9-inch electroluminescent (EL), 24-line x 80-column screen with adjustable tilt; 256 x 512 pixels

Keyboard: Fully spaced, 90-key, full-travel typewriter-style HP-HIL compatible

Eight function keys

Numeric pad

Flexible key mapping

Internal Printer: Built-in ThinkJet

150 cps

1K byte buffer

11 x 12 dot character matrix text print resolution

96 x 96 or 192 x 96 dots per inch graphics resolution

Bold and underline print modes

Less than 50 dB sound pressure printing noise

Input/Output: HP-IB, two HP-HIL, and two expansion ports (can be extended to ten ports using two Bus Extenders)

Weight: 25 pounds (11.4 kilograms)

Dimensions: 7 x 13 x 16 inches (178 x 330 x 406 mm)



Collect your data, analyze it, and print your report all at the same time on the same computer. The HP Integral PC provides instrument control, software development, and office support — from a single, integrated package.

Ordering Information

HP 9807A The Integral Personal Computer
The Integral PC comes complete with the HP-UX 2.1 operating system, 16/32-bit microprocessor and graphics processor, 256K-byte ROM, 512K-byte RAM, 710K-byte 3 1/2 inch microfloppy disc drive, 9-inch EL display, built-in ThinkJet Printer that includes 50 sheets of paper and a printhead, low-profile 90-key keyboard with numeric keypad, internal clock and speaker, power cable, six applications and utilities discs, and comprehensive documentation.

Price

\$4995

Software for the Integral Personal Computer

The following applications software for the Integral PC is available from Hewlett-Packard; additional third-party software is available directly from the vendors.

Ordering Information

| | | Price |
|------------------|--|--------------|
| HP 82857J | HP-UX "C" | \$295 |
| HP 82860J | HP-UX Technical BASIC | \$295 |
| HP 82856J | HP-UX Development System | \$495 |
| HP 82815J | Datacomm | \$195 |
| HP 45524G | MicroTrak™/HP-UX | \$775 |
| HP 45473G | Microsoft® Multiplan™/HP-UX | \$345 |
| HP 45420G | MemoMaker/HP-UX | \$195 |
| HP 45413G | Calculator/HP-UX | \$75 |
| HP 45438G | The Management Solution/HP-UX (Includes MemoMaker, MicroTrak, Multiplan) | \$1118 |
| HP 45515G | TK!Solver®/HP-UX | \$499 |
| HP 45516G | TK!SolverPack®/HP-UX Financial Management | \$125 |
| HP 45517G | TK!SolverPack®/HP-UX Mechanical Engineering | \$125 |
| HP 45518G | TK!SolverPack®/HP-UX Bldg. Design & Const. | \$125 |
| HP 45519G | TK!SolverPack®/HP-UX Introductory Science | \$125 |

Peripherals and Accessories for the Integral PC

See the Peripherals section, page 110, for product descriptions of peripherals and accessories.

TM UNIX™ is a U.S. trademark of AT&T Bell Laboratories.

MS™-DOS and Multiplan™ are U.S. trademarks of Microsoft Corporation.

PC™-DOS is a U.S. trademark of International Business Machines Corporation.

MicroTrak™ and SofTrak™ are U.S. trademarks of SofTrak Systems.

Microsoft® is a registered U.S. trademark of Microsoft Corp.

TK!Solver® and TK!SolverPacks® are registered U.S. trademarks of Software Arts, Inc.

How to Order Your Integral Personal Computer

For more information on the Integral PC, contact your HP sales representative or your local HP personal computer dealer.

For the nearest dealer in the U.S., call toll-free: 800-FOR-HPCC



TECHNICAL COMPUTER SYSTEMS

Dedicated Multi-User Real-Time Computer Systems

HP1000 Systems

- Computer-aided manufacturing
- Computer-aided design
- Computer-aided test

HP 1000 Systems — Real-Time Solutions for Manufacturing and Engineering

HP 1000 is a complete, compatible family of multi-user systems, interfaces, peripherals, and software uniquely qualified to satisfy your manufacturing productivity needs at every level. HP 1000 systems provide you with the power and versatility needed for real-time number crunching applications — from process monitoring and control to supervising a network of computers.

A Choice of Processing Power Levels

HP 1000 systems offer a choice of three general levels of processing power, as summarized below.

| Performance Level | HP 1000 Processor | Instructions per Second (fastest instructions) | Floating Point Operations per Second |
|-------------------|-------------------|--|--------------------------------------|
| 1 | A600+ E-Series | 1,000,000 1,000,000 | 64,000 39,000 |
| 2 | A700 F-Series | 1,000,000 1,000,000 | 204,000* 183,000 |
| 3 | A900 | 3,000,000 | 500,000 |

*With hardware floating point processor, which is optional in Micro 27 system, standard in Model 27 system.

Flexible Versatile Micro/1000 or Rack-Mount Packaging

HP 1000 Computer Systems based on A600+, A700, and A900 processors are available in an economical Micro/1000 package that can be placed on a table or bench, installed in a space-saving vertical floor-mount that features roll-about convenience and portability, or rack mounted in a larger cabinet. In addition to its compactness and convenience, the Micro/1000 package can also incorporate integrated mass storage (a 20 megabyte mini Winchester disc and a 710 kilobyte microfloppy disc). For applications that need more card cage slots than the Micro/1000 package provides, A600+, A700, and A900 processors and E-Series and F-Series based systems are available in larger rack mounted configurations.

Real Time Executive (RTE) Operating System-Based Compatibility

Compatibility of design throughout the HP 1000 family enables you to harness the precise level of power you need for a specific application and also gives you a clear growth path. Even after you've matched the proper combination of HP 1000 products to your initial needs, you remain free to choose an impressive number of options to keep pace with your growth. Or, if your needs change, you can smoothly reconfigure your HP 1000 to handle new applications. This compatibility extends through:

- **HP 1000 Computers.** The A600+, A700, A900, E-Series, and F-Series computers use the same basic instruction set, so you can change processors to fit your needs with little effect on software, peripherals, or operator training. Within the A-Series (A600+, A700, and A900), software will run on all three processors without change. You can use the full "supermini" capability of the A900 for developing programs to run on the highly cost-effective A600+ computer or the mid-range A700 computer.
- **HP 1000 Systems Expansion.** You can move up from the smallest memory-based system to the largest disc-based system at any time — all at once or in increments.

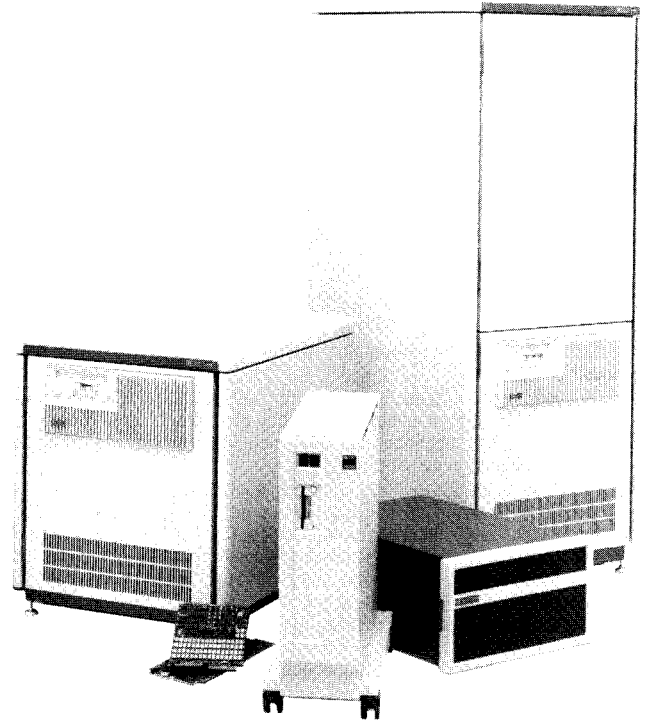

- **RTE Operating System.** HP's Real-Time Executive (RTE) operating system provides a solid, secure foundation of system services that are common across all of the supported HP 1000 computers. You can choose the RTE system and configuration that best suits your application and be confident that high-level language programs written and executed on one RTE system will execute on others as well with minimal modification (no change at all between A-Series computers).
- **HP 1000 Software.** HP 1000 software products for program development, data base management, graphics, and distributed systems networking are supported across the entire HP 1000 product line. In addition, software for process control, quality decision management, and programmable controller communications are supported in all A-Series computers. This universality of HP 1000 software helps you to tailor comprehensive, coherent solutions to your specific application needs. Further help is available from a growing array of HP 1000 software offered by third party suppliers under the HP PLUS software program.

Eight HP 1000 System Models to Choose From

The HP 1000 family includes three A-Series systems with Micro/1000 packaging, three A-Series systems in rack cabinet, and E-Series and F-Series systems in rack cabinet. Each is based on a system processor unit that includes the computer, system console and disc interfaces, the system cabinet, and the RTE operating system. With a hard disc and optional software, each model can be used to develop programs in BASIC, FORTRAN 77, Pascal, and Macro/1000 Assembly language. All systems also support data base management, graphics, and distributed systems networking.

HP 1000 systems support sharable memory-resident data arrays up to 1.998 megabytes and virtual data arrays up to 128 megabytes in main memory and on disc. An enhancement package to RTE-A, called VC+, provides virtual code support for the development and execution of large programs — up to 7.75 megabytes — with automatic and transparent segmentation.

A wide choice of peripherals, I/O cards (including measurement and control cards, and an integral modem card), and software can be added to work together on your applications to maximize the value of your system investment. HP 1000 computers are well-suited to many application areas, but especially those listed on the following page.



Plant Automation

HP's wide range of hardware and software supports automation of instruments and machines as well as monitoring and control of real-time processes. The HP 1000 can help improve productivity and reduce costs. For low point-count data acquisition, test and control applications, A-Series Measurement and Control Cards provide many analog interfacing functions without the need for an add-on peripheral device. For details, see page 310.

Computer Networking

HP's networking software makes it easy to connect HP 1000 systems and other systems across a city or a continent, sharing vital information throughout the network.

Data Base Management

Informed management decisions flow easily and confidently from the timely, accurate information maintained in an Image/1000 data base.

Interactive Graphics

Hewlett-Packard offers a complete line of graphics hardware and software — products for simplifying presentation of complex data or developing product designs. In addition to supporting the traditional graphic displays such as bar charts, pie charts, and histograms, Graphics/1000 software gives you the interactive, two and three dimensional capability needed for computer-aided drafting, mapping and design.

Automated Test Systems

An HP Automated Test System can be configured from the HP 1000 A, E and F-Series computers and a wide range of electronic instruments to perform virtually any electronic test application. Whether you're testing microcircuits or aircraft engines, an ATS/1000 system can include all the hardware and software needed for fast, accurate, and thorough testing.

Ordering Information

| | Price |
|--|--------------|
| HP 1000 Micro 26 Sys Proc Unit* w/512kB memory | \$10,000 |
| HP 1000 Micro 27 Sys Proc Unit* w/512kB memory | \$13,160 |
| HP 1000 Micro 29 Sys Proc Unit* w/768kB memory | \$24,600 |
| HP 1000 Model 26 Sys Proc Unit* w/512kB memory | \$15,560 |
| HP 1000 Model 27 Sys Proc Unit* w/512kB memory | \$23,250 |
| HP 1000 Model 29 Sys Proc Unit* w/768kB memory | \$33,400 |
| HP 1000 Model 60 Sys Proc Unit* w/256kB memory | \$23,750 |
| HP 1000 Model 65 Sys Proc Unit* w/256kB memory | \$34,050 |

*Requires system console and system disc for operation.

HP 1000 System Summary

| | Micro 26 | Micro 27 | Micro 29 | Model 26 | Model 27 | Model 29 | Model 60 | Model 65 |
|---|--|--------------------------|----------|--|--------------------------|---|----------------------|----------------------|
| Base system computer type | HP 2486A | HP 2487A | HP 2489A | HP 2196C/D | HP 2197C/D | HP 2199C/D | HP 2178C | HP 2179C |
| Memory cycle time | 454 ns | 500 ns | 181 ns* | 454 ns | 500 ns | 181 ns* | 665 ns | 420 ns |
| Operating system | RTE-A | RTE-A | RTE-A | RTE-A | RTE-A | RTE-A | RTE-6/VM | RTE-6/VM |
| Virtual Code+ available? | Yes | Yes | Yes | Yes | Yes | Yes | No | No |
| Recommended system console terminal | HP 2392A | HP 2392A | HP 2392A | HP 2392A | HP 2392A | HP 2392A | HP 2392A | HP 2392A |
| I/O Channels Available | 10-45 | 8-42 | 7-41 | 16-48 | 13-48 | 13-48 | 11-27 | 11-27 |
| Maximum memory | 4MB Parity or 8MB ECC | 4MB Parity or 8MB ECC | 6MB ECC | 4MB Parity or 8MB ECC | 4MB Parity or 8MB ECC | 24MB ECC | 2MB Parity or ECC | 2MB Parity or ECC |
| Recommended system discs | Optional built-in, 20MB fixed & 710kB microfloppy discs | | | HP 7911R (28.1MB) | HP 7911R (28.1MB) | HP 7914R (132.1MB) | HP 7911R (28.1MB) | HP 7911R (28.1MB) |
| Alternative disc choices | HP 7907A/7911/7912/7914/CT/P/R/7933H/ 7935H/7941A/7942A/7945A/7946A | | | HP 7907A/7911R/7912R/7914R/7933H/7935H/ 7941A/7942A/7945A/7946A | | HP 7906M/MR/7911R/7912R/ 7914R/7920M/7925M/7933H/ 7935H | | |
| | 23-404MB | | | 23-404MB | | 19-404MB | | |
| Flexible disc available? | Yes | Yes | Yes | Yes | Yes | Yes | Yes | Yes |
| H/W floating point? | No | Optional | Yes | No | Yes | Yes | No | Yes |
| Graphics/1000-II available? | Yes | Yes | Yes | Yes | Yes | Yes | Yes | Yes |
| PMC/1000 available? | Yes | Yes | Yes | Yes | Yes | Yes | No | No |
| QDM/1000 available? | No | No | No | Yes | Yes | Yes | No | No |
| Programmable controller interface available? | Yes | Yes | Yes | Yes | Yes | Yes | No | No |
| HP 2250 Meas & Cntrl Proc available | Yes | Yes | Yes | Yes | Yes | Yes | Yes | Yes |
| Meas & Cntrl I/F available? | Yes | Yes | Yes | Yes | Yes | Yes | No | No |
| Image/1000-II available? | Yes | Yes | Yes | Yes | Yes | Yes | Yes | Yes |
| DS/1000-IV communication w/HP 1000 & 3000 available? | Yes | Yes | Yes | Yes | Yes | Yes | Yes | Yes |
| Communication with IBM systems available? | Yes | Yes | Yes | Yes | Yes | Yes | Yes | Yes |
| Data Link support? | Yes | Yes | Yes | Yes | Yes | Yes | Yes | Yes |
| ATS/1000 Integration Services available? | No | No | No | No | No | Yes | Yes | Yes |

* Average effective access time, assuming 88% cache hit rate.

TECHNICAL COMPUTER SYSTEMS

HP1000 A-Series, E-Series, and F-Series Computers

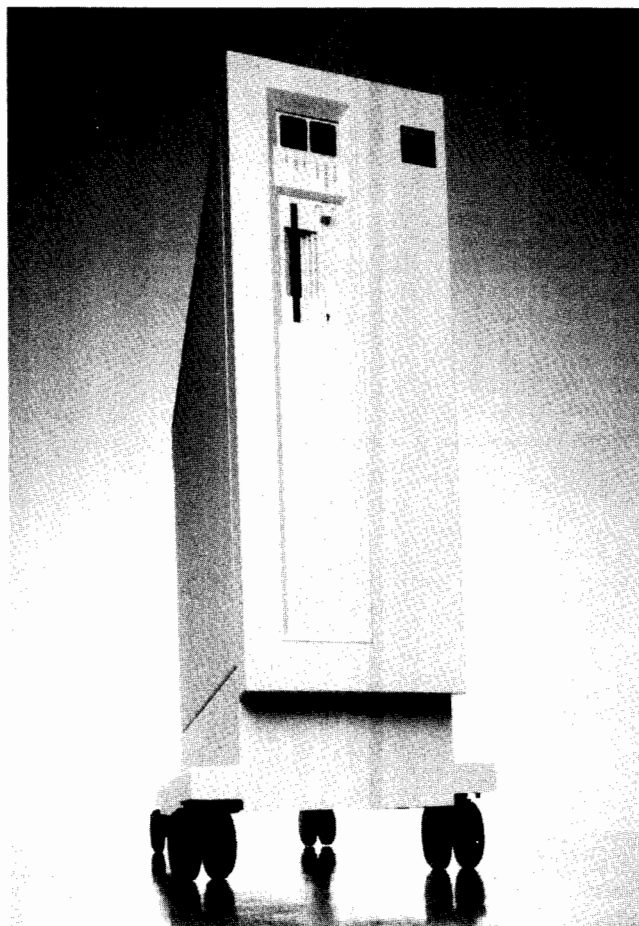

HP 1000 A-Series

A-Series computers implement a distributed intelligence I/O design in which each I/O card has its own processor. This processor controls direct access transfers to/from memory with extra intelligence that supports chained multiblock transfers without interrupting the CPU. This leaves the CPU free to concentrate on arithmetic tasks with few interruptions and great efficiency.

The A600+ microcomputer offers 1,000,000 instructions per second execution speed (fastest instructions) and double precision floating point firmware for real-time operation. The A600+, price/performance leader of low-cost microcomputers, supports VC+ enhancements and is available as a two-board computer, box computer, system, or Micro/1000 system (shown above).

The A700 computer adds optional floating point hardware with scientific and vector instruction sets to the basic capability of the A600+ microcomputer for superior support of computer simulation, graphics, and other computation-intensive uses. The A700 is also microprogrammable, so it can be optimized for higher performance or user-customized applications. It is available as a system, Micro/1000 system (shown above), or box computer.

The A900 computer incorporates a pipeline implementation and a cache memory scheme, providing three times the performance of an

A700 computer. The A900's hardware floating point processor and scientific vector instruction sets are built-in, and 768k bytes of ECC memory is standard, assuring system integrity. The A900 is the ultimate computation machine designed to meet the most demanding needs of OEMs, system designers, software suppliers and end users. It is available as a system, Micro/1000 system (shown at left), or box computer.

HP 1000 E-Series

The E-Series computer provides variable microcycle timing, microprogrammable block I/O, a microprocessor port, asynchronous memory, and large control store address space. E-Series computers are available in two models, HP 2109E and 2113E, with up to 2 Mbytes of mainframe memory and 9 or 14 I/O channels, expandable to 46 channels. (Also available as HP 2109EK board computer.)

HP 1000 F-Series

For users who need faster than E-Series processing speed, HP offers the HP 2117F computer which features a hardware floating point processor that speeds calculations (2.2 to 6 times faster than E-Series) and a scientific instruction set for fast execution of trigonometric and logarithmic functions (compute sine in less than 48 microseconds). A fast FORTRAN processor, also standard in the HP 2117F, provides firmware microcode for over a dozen instructions—e.g., array address calculations, parameter passing, and other routines—that run 2 to 20 times faster than conventional software execution speed. An optional vector instruction set can be provided for fast matrix calculations. The HP 2117F computer features high performance 420 ns memory and is fully user-microprogrammable.

Alternate Memory Systems

HP continues its lead in memory technology by being the first to offer 256k RAM memory: a 2 megabyte error correcting code (ECC) board for the A600+ and A700, and a 3 megabyte ECC memory board for the A900.

Parity checking memory is standard in HP 1000 memory systems for the A600+, A700, and E and F-Series. And, for very large systems in critical applications, Error Correcting Code (ECC), standard in the A900 and optional in the A600+, A700, and E and F-Series, detects and corrects all single-bit errors and detects all double-bit errors.

Ordering Information

| | Price |
|--|----------|
| HP 2106BK A600+ Board Computer w/128 kB memory | \$3,410 |
| HP 2156B A600+ Computer w/128 kB memory | \$7,590 |
| HP 2137A A700 Computer w/128 kB memory | \$9,820 |
| HP 2139A A900 Computer w/768 kB memory | \$23,900 |
| HP 2109E E-Series Computer w/64 kB memory | \$10,575 |
| HP 2113E E-Series Computer w/128 kB memory | \$13,175 |
| HP 2117F F-Series Computer w/128 kB high perf memory | \$20,875 |
| HP 12153A A700 Writable Control Store Card | \$2,010 |
| HP 12156A A700 Floating Point Processor | \$4,310 |
| HP 12157A A-Series Battery Backup System | \$555 |

Quantity discounts are available.

A complete list of HP 1000 computer accessories is available from your HP Sales Office.

TECHNICAL COMPUTER SYSTEMS

Peripheral Interfacing Summary

This table shows peripherals that can be connected to many Hewlett-Packard technical computers. Information about EMI compliance and support of a specific system is available from a Hewlett-Packard sales office in your area.

HP Technical Computer Interfacing Summary

| Peripherals | Page | Technical Computers | | | | | | | | | | | | |
|---------------------------------------|------|--|---------|---|------------------------------|----------------|---|---|---|---------------|---|-----------------------------|---|---|
| | | HP9915 85B & 85B I/O 86B 87A 87XM | HP9020* | | HP9030* 9040 9050 U | HP Series 200* | | | | HP1000 Series | | HP Series 300*, 310, 320 | | |
| | | | B | U | | B | H | P | U | E,F | A | B | U | P |
| 2225A ThinkJet Printer | 95 | • | • | • | • | • | • | • | • | | | • | • | • |
| 2392A Terminal | 85 | | | • | • | | | | | | | | • | |
| 2393A Graphics Terminal | 84 | | | • | | | | | | | | | • | |
| 2563A/65A/66A Line Printer | 94 | | • | • | • | • | | • | • | • | • | • | • | • |
| 2625A Dual System Terminal | 86 | | • | • | • | | | | | • | • | | • | |
| 2626A Display Terminal | 86 | | | • | • | | | | | • | • | | | |
| 2627A Color Graphics Terminal | 84 | | | • | • | | | | | • | • | | • | |
| 2628A Word Processing Terminal | 87 | | • | • | • | | | | | • | • | | • | |
| 2686A Laser Jet Printer | 95 | | • | • | • | • | | • | • | • | • | • | • | • |
| 2688A Laser Printer | 94 | | | • | • | | | | | • | | | | |
| 2932A General Purpose Printer | 95 | • | • | • | • | • | • | • | • | • | • | • | • | • |
| 2934A Office Printer | 95 | • | • | • | • | • | • | • | • | • | • | • | • | • |
| 37201A HP-IB Extender | 125 | • | • | • | • | • | • | • | • | | • | • | • | • |
| 37203A HP-IB Extender | 124 | • | • | • | • | • | • | • | • | • | • | • | • | • |
| 37203L HP-IB Extender | 124 | | | | | | | | | | • | | | |
| 37212A Modem | 88 | • | | • | • | | | | • | • | | | • | • |
| 37213A/4A/5A/6A System Modem | 88 | | | | | | | | | • | • | | | |
| 7470A 2-pen Plotter | 99 | • | • | • | • | • | • | • | • | • | • | • | • | • |
| 7475A 6-Pen Plotter | 100 | • | • | • | • | • | • | • | • | • | • | • | • | • |
| 7510 Vector Film Recorder | 106 | | | | | | | | | | | | | |
| 7550A Graphics Plotter | 101 | • | • | • | • | • | | • | • | • | • | • | • | • |
| 7580B/85B/86B 8-Pen Drafting Plotters | 103 | • | • | • | • | • | • | • | • | • | • | • | • | • |
| 7907A General Purpose Cartridge Disc | 92 | | † | • | • | • | | • | • | | • | • | • | • |
| 7914CT/P/R 132Mb CS/80 Disc/Tape | 91 | | • | • | • | • | | • | • | | | • | • | • |
| 7914ST Tape/Disc | 91 | | | | | | | | | | • | | • | |
| 7914TD Tape/Disc | 91 | | • | • | • | | | | | • | • | | • | |
| 7941A/45A Disc Drive | 90 | | • | • | • | • | | • | • | | • | • | • | • |
| 7933H 404Mb CS80 Fixed Disc | 92 | | • | • | • | • | | • | • | • | • | • | • | • |
| 7935H 404Mb CS80 Removable Disc | 92 | | • | • | • | • | | • | • | • | • | • | • | • |
| 7942A/46A Disc/Tape | 90 | | • | • | • | • | | • | • | | • | • | • | • |
| 7970E 1/2" Tape Drive | 93 | | | | | | | | | • | • | | | |
| 7974A 1/2" Tape Drive | 93 | | • | • | • | | | | | | • | | • | |
| 7978A 1/2" Tape Drive | 93 | | • | • | • | | | | | | • | | • | |
| 82906A Impact Printer | 95 | • | | | | • | • | • | • | | • | • | • | • |
| 9111A Graphics Tablet | 107 | • | • | • | • | • | | • | • | • | • | • | • | • |
| 9122D/S 3-1/2" Drive | 89 | | • | • | • | • | | • | • | • | • | • | • | • |
| 9133H 20.0Mb Winchester/Microfloppy | 89 | | • | • | • | • | | • | • | | • | • | • | • |
| 9134H 20.0Mb Stand Alone Winchester | 89 | | • | • | • | • | | • | • | | • | • | • | • |
| 9144A 1/4" Cartridge | 93 | | • | • | • | • | | • | • | • | • | • | • | • |
| 9153A 10.0Mb Winchester/Microfloppy | 89 | | • | • | • | • | | • | • | | • | • | • | • |
| 9154A 10.0Mb Stand Alone Winchester | 89 | | • | • | • | • | | • | • | | • | • | • | • |

* H=HPL, B=BASIC, P=Pascal, U=HP-UX

† Special requirements or device limitations involved in this configuration.
Consult your HP Sales representative or authorized dealer for details.



COMPUTER PERIPHERALS

Interactive Terminals

Models 2393A, 2627A

- Supports HP Touch, graphics tablet, mouse, and bar code reader
- High quality graphics (two resolution modes: 512x390 and 640x400)
- Complete independent alphanumeric
- Up to 12 pages of memory

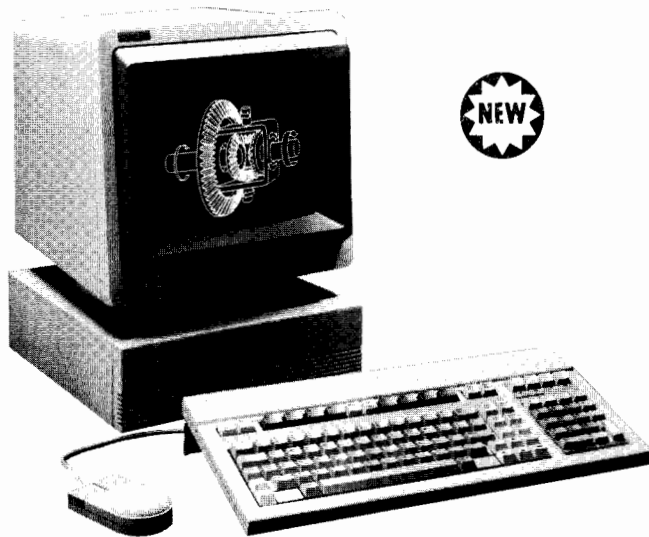

HP 2393A

HP 2393A Graphics Terminal

The HP 2393A combines bit-mapped vector graphics on a monochrome raster display with comprehensive alphanumeric capabilities. You'll find it a versatile terminal in many applications.

The 2393A's unique HP-HIL (Human Interface Link) interface lets you connect multiple input devices—like HP-Touch, Mouse, Graphics Tablet and Bar Code Reader.

The 2393A also offers a range of output options, so you can connect it to printers, plotters, film recorders and large screen projectors.

Software support for the 2393A includes popular HP packages like DSG/3000, HP DRAW, HP EASYCHART, HP MAP, Graphics 1000/II and Graphics 9000. In addition, you can use the 2393A with many third-party software packages, including Precision Visuals™ DI-3000™ and GRAFMAKER™, ISSCO®'s DISSPLA® and TELL-A-GRAF®, and SAS Institute's SAS/GRAPH™. The 2393A has ANSI X3.64 and TEKTRONIX® 4010/4014 compatibility too, so you can use it on a variety of computer systems.

The HP 2393A is one of the most flexible graphics terminals in its class, providing quality and reliability at a surprisingly affordable price.

HP 2393A Graphics Terminal

\$2095

Precision Visuals, DI-3000 and GRAFMAKER are trademarks of Precision Visuals, Inc.

ISSCO, DISSPLA and TELL-A-GRAF are registered trademarks of Integrated Software Systems Corporation.

SAS/GRAPH is a trademark of SAS Institute, Inc.

- High Quality Color Display
- Graphics software support
- Hardcopy and video interface
- HP 17623A graphics tablet support



HP 2627A

HP 2627A Color Graphics Terminal

The HP 2627A offers a high quality color raster display with fast vector graphics. It is ideally suited for business and technical applications where color aids the comprehension of relationships and trends.

Eight basic colors are provided, with hundreds of additional user-defined colors available, including those that match HP plotter pens.

With vector graphics and local polygonal area fill, you can create shapes, symbols and tpestyles quickly and easily.

The 2627A also provides color alphanumeric. Up to eight color pairs (foreground / background) can be used on a per character basis to differentiate lines and identify critical fields.

A variety of output devices are available for the 2627A, including graphics and alphanumeric printers and video output for large-screen monitors, cameras, etc. You can also use an HP graphics tablet as an input device on the 2627A.

Like the HP 2393A Graphics Terminal, the 2627A is compatible with many graphics software packages.

The 2627A offers an ANSI compatibility option, so you can use it on "ANSI-speaking systems. And the TEKTRONIX® compatibility mode allows the 2627A to operate with PLOT 10® software.

HP 2627A Color Graphics Terminal

\$5975

PLOT 10 and TEKTRONIX are registered trademarks of Tektronix Inc.

DEC is a registered trademark of Digital Equipment Corporation.

COMPUTER PERIPHERALS

Interactive Terminals

Models 2392A, 2394A

85



- Compact size
- Block/forms mode
- Up to 4 pages of memory (additional 4 pages optional)
- Integral tilt and swivel
- Optional printer port

- High resolution display
- Local forms cache
- Advanced edit checks
- Up to 8 pages of memory



HP 2392A

HP 2392A Display Terminal

The HP 2392A is a compact, low cost, block mode terminal designed for a wide range of applications — from data entry to program development. Features like integral tilt and swivel, 12-inch diagonal anti-glare screen, and a low-profile, adjustable keyboard help make your work more pleasant. With smooth scrolling, you can easily view up to 4 pages of text or data (up to 8 pages optional). Data entry applications are made easier using forms mode and the standard line drawing set to emulate existing paper forms. High speed datacomm (up to 19,200 bits per second) shortens response time.

It is also easy for you to generate hardcopy, since the 2392A has an optional user-installable printer port. Choose between an RS232C serial or a Centronics®-type parallel interface module.

Besides being compatible with HP computers and software, the 2392A has a no-cost ANSI (American National Standards Institute) option so it can communicate with ANSI "speaking" computer systems too — like DEC® computers.

HP 2392A Display Terminal

\$1375



HP 2394A

HP 2394A Data Entry Terminal

Traditional data entry applications involve repeated downloading of forms from the computer for data input. The HP 2394A Data Entry Terminal, however, offers a more innovative approach.

The 2394A stores forms locally in the terminal's memory to be displayed quickly — without system downloading. Local edit checks on the 2394A let you know immediately when an error is made, so you don't send mistakes to the system. And the 2394A's modified data tag feature reduces data communication traffic, transmitting to the system only those fields that have been modified. This lets you use your system resources, data communications equipment, and networking facilities more efficiently. The advanced capabilities of the 2394A make it an ideal workstation in HP 3000/VPLUS or HP/IBM Interactive Mainframe Facility applications.

The data entry operator's work is further enhanced by the 2394A's ergonomic design — providing all the popular features and capabilities of the HP 2392A Display Terminal.

HP 2394A Data Entry Terminal

\$1795



COMPUTER PERIPHERALS

Interactive Terminals

Models 2625A, 2626A

- IBM 3276 Compatibility
- Simultaneously-active dual system ports for HP and IBM
- Optional Graphics
- Optional word processing function
- Multiple Workspaces
- Multiple Windows
- Dual Data Communications Ports
- Multipoint Data Communications
- Interactive Forms Design



HP 2625A

HP 2625A Dual System Display Terminal

The HP 2625A brings HP and IBM compatibility together in a single terminal. With the data entry features of the HP 2622A Block Mode Terminal on port 1, and IBM 3276 Display Station features on port 2, the HP 2625A offers convenience and cost savings to multiple system users.

Both ports remain active at all times, allowing tasks to run concurrently on both hosts. The HP 2625A also connects to non-HP systems supporting ASCII asynchronous point-to-point data communications in character mode.

Option 523 adds HP 2623A graphics features enhanced to provide polygonal area fill, rubberband line, and Tektronix 4014 compatibility. The graphics option allows the HP 2625A to run HP and other major industry software packages (see the HP 2623A product summary).

All the text editing features of the HP 2628A Word Processing Terminals can be added to the HP 2625A. Option 528 allows the HP 2625A to operate with HPWORD software on an HP 3000 system.

The HP 2625A also offers 19.2 kbps high-performance datacomm, smooth vertical scrolling, forms/format mode, and 11 national character sets. Configuration flexibility allows you to daisy-chain up to 32 terminals for both local and remote operations.

With IBM 3276 emulation, HP 2622A data entry, HP 2623A and Tektronix 4014 graphics, and HP 2628A word processing, the HP 2625A is actually five terminals in one.

HP 2625A Dual System Display Terminal

\$3495



HP 2626A

HP 2626A Multi-Window Terminal

The HP 2626A is a high performance terminal which provides unique display capabilities and data communications flexibility. The HP 2626A display memory can be divided into four independent workspaces, and the display screen into four separate windows to examine and manipulate the contents of the workspaces. This capability amounts to four virtual terminals which may be changed from application to application or system to system.

Dual data communication ports can be linked to workspaces to display data from two different computers, or one port may be linked to a computer and the other used as an external RS232 serial printer port. Data may be communicated to the computer using block, line, line modify, or character modes in a point-to-point or multipoint environment.

The HP 2626A is ideally suited for program development or data entry particularly when taking advantage of the easy to use function key approach to forms design. The line length may be set from 80 to 160 characters so that 132 column reports as well as double width pages may be handled, with viewing via horizontal scrolling.

HP 2626A Display Station

\$4900

COMPUTER PERIPHERALS

Interactive Terminals

Models 2628A, 35731, 35723A

87



- Complete word processing
- Optional graphics
- High speed data entry

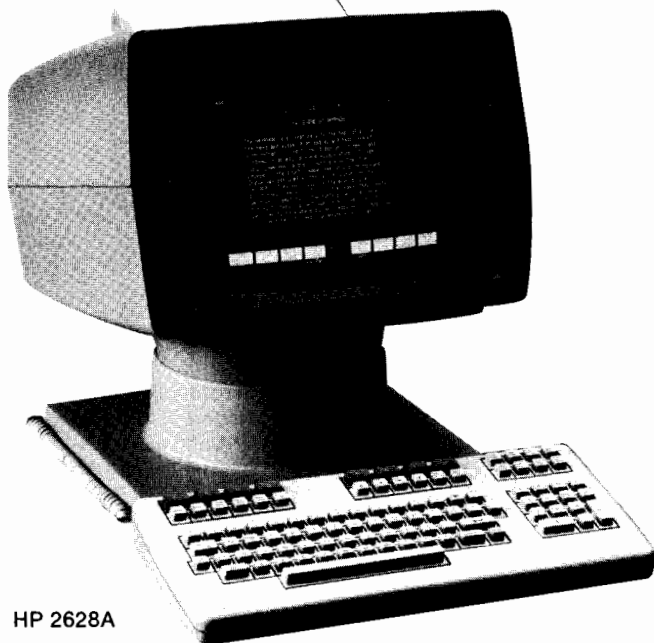

HP 2628A

HP 2628A Word Processing Terminal

The HP 2628A combines HPWORD word processing, graphics, and data entry capability in one terminal.

For HP 300 system users with both word processing and data processing requirements, the HP 2628A is ideal. As a word processing terminal designed for use with HPWORD (Hewlett-Packard's word processing software for HP 3000 computer systems), the HP 2628A allows you to create, edit, and store documents. Keyboard overlays provide a full graphics and word processing keyboard, including syntactic keys (character, word, line, sentence, phrase and paragraph) for cursor positioning and editing functions such as delete, move and copy. Letter quality copies of the documents can be printed by an optional HP daisywheel printer attached to the terminal, or a selection of system printers.

Option 523 provides all the graphics capabilities of the popular HP 2623A Graphics Terminal, with enhanced features that include polygonal area fill, rubberband line, and Tektronix 4014 mode. Like the HP 2623A, the HP 2628A is compatible with HP and other major industry software packages (listed in this guide under the HP 2623A product summary). Tektronix 4014 compatibility allows the terminal to use PLOT 10 software as well.

When the HP 2628A is not being used a word processing terminal on an HP 3000, it can perform all the data entry functions of the HP 2622A Block Mode Terminal. The HP 2628A's six pages of alphanumeric memory make it an ideal terminal for programmers, and VPLUS/3000 support allows HP block mode screen-oriented applications to be run.

In addition, the HP 2628A offers high-performance 19.2 kbps datacomm, smooth vertical scrolling, forms/format mode, optional integral thermal printer, plus 11 national character sets.

HP 2628A Word Processing Terminal

\$3195

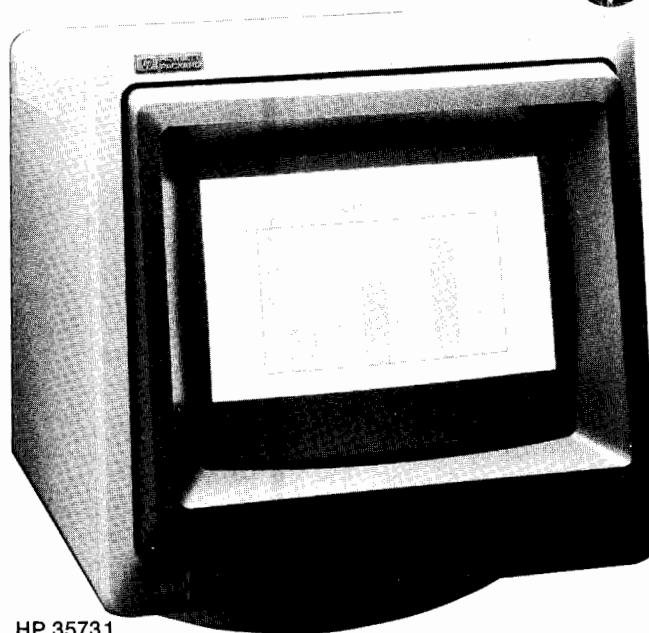

HP 35731

35731 HP Monochrome Monitor

The 35731 HP Monochrome Monitor is a 12-inch, high resolution monochrome video display unit used as an integral component of HP terminals, PCs and workstations.

The monitor features an easy-to-read green phosphor display, as well as compatibility with HP systems that use 512x390 or 640x400 resolutions. It supports the HP Touch Accessory via the HP-HIL interface.

Ergonomic features on the monitor include an anti-glare screen and built-in tilt and swivel for adjusting the screen viewing angle. The monitor also has front panel brightness and contrast controls to make display adjustments more convenient for you.

Ordering Information

35731A HP Monochrome Monitor

35731B HP Monochrome (International)

Price

\$325

\$340

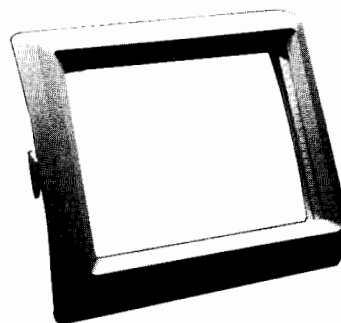

HP 35723A

35723A HP Touch Accessory

The 35723A HP Touch Accessory is a 12-inch, user-installable touchscreen bezel. When you add HP touch to your HP computer or terminal that supports the HP-HIL (Human Interface Loop), you transform your ordinary screen into an interactive touchscreen. HP Touch gives you an easy and natural way of communicating with your computer.

HP Touch has a maximum resolution of 43 vertical by 57 horizontal, giving you 2451 touch points. You can define touch areas of varying shapes and sizes, giving you programming flexibility for a wide range of applications.

35723A HP Touch Accessory

\$300

COMPUTER PERIPHERALS

Dial-Up Modems

Models 37212A, 37213A/4A/5A/6A

- Auto-dial and auto-answer
- Automatic data-rate recognition and configuration
- Full duplex 1200 bps and 300 bps on dial-up lines

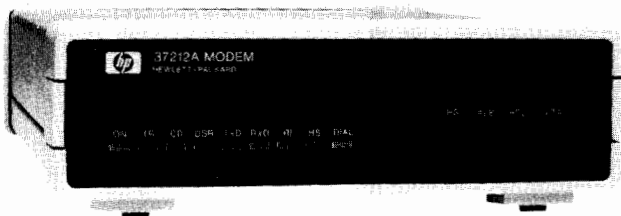

HP 37212A

Dial-Up Modem Family

The need for computers to communicate over long distances has increased rapidly over the last few years. The increased reliance on data communications has made it essential for modems to be able to operate completely unattended.

To facilitate this requirement, HP now provides a family of dial-up modems all of which are designed for full duplex operation over the Public Switched Telephone Network. The modems all conform to Bell-212A and CCITT V.22 standards for communication at 1200 bps or 300 bps.

Automated Features

In order to benefit from completely unattended operation, all HP modems have auto-dial, auto-answer, and automatic data-rate recognition and configuration.

Which Modem Should You Use

The HP 37212A is a stand-alone modem with integral power supply. Modem control lines are not required, hence this modem is ideal as a universal modem for use with any computer, terminal, or any other device which uses an RS-232C/V.24 interface.

The HP 37213A/4A/5A/6A Systems Modem is designed specifically for use with HP 1000 A/L-Series and M/E/F-Series computers. The Systems Modem is based on a rack which will hold up to seven modem or other interface cards and is ideal for larger systems and for systems where the number of I/O slots in the computer is limited.

HP 37212A Stand Alone Modem

The HP 37212A is an "intelligent" stand alone modem incorporating a microprocessor to provide modem control and auto-dial facilities for HP interactive display terminals, calculators and computers which do not support switched line modems via RS232C/V.24. Either synchronous or asynchronous communication can be conducted. Commands are passed from a terminal or computer through the RS232C/V.24 interface (using secondary TxD as an asynchronous command channel in the case of synchronous operation). The HP 37212A can also operate on leased lines.

In addition to the commands available through the interface, the HP 37212A can also be operated in 'Dumb' mode, from the front panel. Non-volatile storage is provided for modem configuration and for 23 74-character strings which can be used for telephone numbers and log-on sequences. The strings can be linked together to provide completely automatic connection and log-on. A telephone is not required, but a second telephone connector is provided on the rear panel to allow one to be connected in parallel with the modem. The modem contains an integral power supply for ac operation, and also can operate from a dc supply where ac power is unavailable, e.g., telecoms and medical applications.

- Compatible with Bell 212A and CCITT V.22
- Central site and stand-alone versions
- Local analog and remote digital loopback

HP 37213A/4A/5A/6A Systems Modem

The Systems Modem is designed for use with all HP 1000 Computers and communicates with the computer through an 8-channel multiplexer (HP 12040B in A/L-Series or HP 12792B in M/E/F-Series) and a single multiway cable.

HP 37214A Modem Interface Card Cage

The Systems Modem is based on the HP 37214A Card Cage. This has space for up to seven modem or other interface cards in any combination. The eighth slot of the Card Cage is reserved for use by the integral controller and dialer which communicates with the user program by simulating an interactive display terminal. The controller and dialer provide the control signals, the pulse and DTMF dialing control, and loopback control for up to seven modem cards. Local analog loopback or remote digital loopback may be selected under program control to allow a user program to pass data and to check the integrity of the looped modem link. Also a local diagnostic terminal port enables monitoring of all the modem interface lines for diagnostic purposes.

HP 37213A Modem Card

The HP 37213A is a single card modem. As with the HP 37215A/6A, it plugs into the HP 37214A Card Cage. It communicates with Bell 212A compatible modems at 1200 or 300 bps and with any CCITT V.22 (Alternatives A and B) compatible modem at 1200 bps. Asynchronous or synchronous communication is supported. The HP 37213A is also compatible with the Vadic 3450 Series Triple Modem. The Modem can perform both pulse and DTMF (tone) dialing under user program control. Two interfaces are provided, one for the 8-channel Multiplexer and one for an RS232C port for applications that either do not use a Multiplexer or require synchronous communication. Local analog or remote digital loopback may be performed under user program control.

HP 37215A Modem Interface Card

For applications where a PTT supplied modem must be used or where a modem is already available, an HP 37215A Modem Interface Card may be used in place of an HP 37213A Modem Card. The HP 37215A provides buffered RS232C and V.24/V.28 compatible lines for controlling all common switched line, full-duplex modems. Loopback of most external modems may be performed under user program control. The Modem Interface Card also provides auto-configuration of port speed with auto-answer modems. Auto-dialing is not possible when using external modems.

HP 37216A Terminal Interface Card

The HP 37216A allows direct connection of local interactive display terminals to unused Multiplexer ports. With the Terminal Interface Card, one local terminal can be connected to one port of the 8-channel Multiplexer via a standard 25-pin D-type connector.

Ordering Information

| Ordering Information | Price |
|-------------------------------------|--------|
| HP 37212A Stand Alone Modem | \$1046 |
| HP 37213A Modem Card | \$1125 |
| HP 37214A Modem Interface Card Cage | \$1715 |
| HP 37215A Modem Interface Card | \$190 |
| HP 37216A Terminal Interface Card | \$170 |

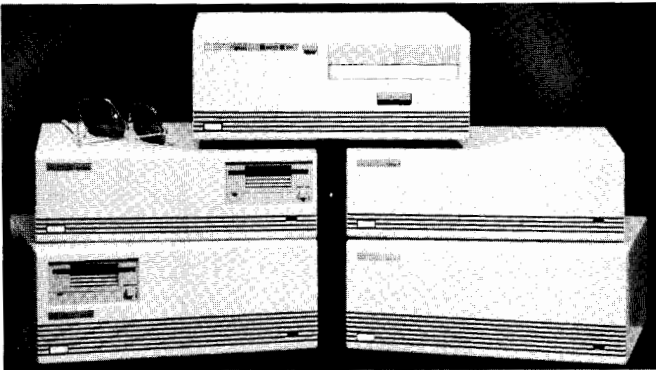

Hewlett-Packard offers you a full line of data storage solutions to fit your personal or technical computer requirements. HP's wide range of disc drives cover a variety of prices, capacities and performance.

3 1/2" Microfloppy Personal Data Storage Solutions

HP 9122D Dual 3 1/2" Drive—HP 9122S Single 3 1/2" Drive

The HP 9122D is a highly reliable, double-sided 3 1/2" microfloppy designed for use with HP's desktop and personal computers. Available in both dual and single configurations, the HP 9122D and HP 9122S provide up to 1420 and 710 Kbytes of formatted capacity, respectively. This disc drive is supported on the Touchscreen Series 80 and Touchscreen II and HP 9000-Series 200, 300, and 500.

HP 9114A Portable 3 1/2" Disc Drive

Designed for HP's Portable computer family as well as, Series 40 and Series 70, the HP 9114A provides up to 710 Kbytes of formatted capacity in a lightweight, battery-operated package. The 3 1/2" disc drive reads, writes, and initializes double-sided media in both single-sided and double-sided formats. This feature allows data exchange with single-sided drives currently in use.

HP 9123D Dual 3 1/2" Drive (for HP Touchscreen II) See pg. 41

Hard Disc Personal Data Storage Solutions

HP 9153A/9154A 10 Megabyte Winchester Hard Disc

The HP 9153A combines the storage and performance capabilities of HP's 10 Mbyte hard disc with the backup and interchange capabilities of the 3 1/2" microfloppy in one compact package. The removable media is fully compatible with the HP 9122D/S, HP 9123D and HP 9114A data storage units. The 9154A, hard disc only model, adds Winchester performance and convenience to floppy-based computer systems. These models are supported on the Touchscreen II, HP 9000-Series 200, 300 and 500 and Series 80 computers.

HP 9133H/9134H 20 Megabyte Winchester Hard Disc

The storage capabilities of HP's 20 Mbyte hard disc with the backup and interface capabilities of the 3 1/2" microfloppy are combined in the HP 9133H. The removable media is fully compatible with the HP 9122D/S, the HP 9123D, and HP 9114A data storage units. The HP 9133H and 9134H are well suited for business and technical large memory applications—general accounting, data base management, and integrated applications. They are supported on the Touchscreen II, Series 80, and HP 9000-Series 200, 300, and Series 500 computers.

1/4" Tape Backup Solution

HP 9142A 1/4" Tape Subsystem

The HP 9142A is a low cost 1/4" streaming tape backup solution designed for personal computers. This drive stores approximately 13 to 52 Mbytes of information on the HP Touchscreen and Touchscreen II PCs and up to 60 Mbytes on the IBM PC/XT/AT and COMPAQ Portable. This subsystem allows both file and image backup and restore operations. The format, utilizing 50% data redundancy, offers error correction for increased data reliability. The HP 9142A transfers data at a rate of 2 Mbytes/minute and 1 Mbyte/minute with verification.

Interface Solutions

HP 88500A IBM Disc/Tape Interface

Hewlett-Packard provides you with an interface solution to connect your HP tape or disc to your IBM PC/XT/AT and COMPAQ Portable. This easy-to-install system includes the powerful Data Manager and Tape Backup software. One short slot interface card allows you to connect up to 7 discs and 1 tape. The HP 88500A supports the 9154A and 9134H discs as well as the 9142A tape.

Data Interchange

HP 9125S—IBM PC 5 1/4" Data Interchange

The HP 9125S is a single 5 1/4" disc drive that gives the HP Touchscreen and Touchscreen II data compatibility with the IBM-PC via 5 1/4" discs. Connected by HP-IB to the Touchscreen computers, the drive can read, write, and initialize discs in IBM-PC format as well as HP format. The discs can be moved between IBM and HP computer systems for easy data exchange.

Ordering Information

| | Price |
|---|--------|
| HP 9114A Double-sided 3 1/2" Disc Drive | \$ 795 |
| HP 9122D Double-sided 3 1/2" Dual Disc Drive | \$1390 |
| HP 9122S Double-sided 3 1/2" Single Disc Drive | \$1090 |
| HP 9123D Double-sided 3 1/2" Dual Drive | \$ 715 |
| HP 9125S Single-sided 5 1/4" Flexible Disc Drive | \$1200 |
| HP 9133H 20 Mbyte Hard Disc plus 3 1/2" Microfloppy | \$2740 |
| HP 9134H 20 Mbyte Hard Disc (Winchester only) | \$2390 |
| HP 9142A 1/4" Tape Backup Subsystem | \$1690 |
| HP 9153A 10 Mbyte Hard Disc plus 3 1/2" Microfloppy | \$1940 |
| HP 9154A 10 Mbyte Hard Disc (Winchester only) | \$1690 |
| HP 88500A IBM Disc/Tape Interface | \$ 199 |
| HP 91290A 5 1/4" HP Qualified Media (Box of 10) | \$ 58 |
| HP 92192A 3 1/2" Double-sided Microfloppy (Box of 10) | \$ 69 |
| HP 92242S 15 Mbyte Tape (9142 only-Box of 5 tapes) | \$ 129 |
| HP 92242L 60 Mbyte Tape (9142 only-Box of 5 tapes) | \$ 180 |

See the Technical Data Sheet #5953-6857, "Data Storage for Personal and Portable Computers" for detailed support information.



COMPUTER PERIPHERALS

CS/80 Desktop Disc Drive Family

Models 7941A, 7945A, 7942A, 7946A

- Customer installable
- Convenient desktop package
- Quieter operation

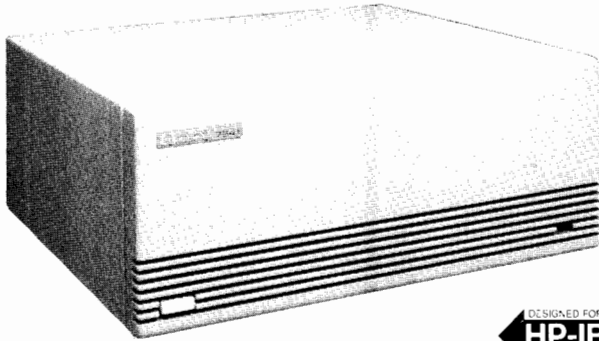

HP 7941A

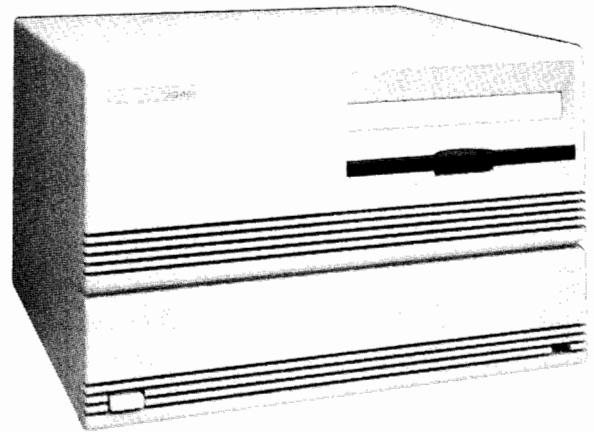

HP 7946A



HP 7941A/45A and HP 7942A/46A

The HP 7941A and HP 7945A are 24- and 55-Mbyte disc drives, respectively. The HP 7942A and HP 7946A products feature the same 24 and 55 megabyte capacities but include a 1/4-inch cartridge tape drive integrated into a single unit. These products are designed and priced for use on entry-level multi-user systems and high performance work stations.

Both the disc products and the disc/tape products employ the same efficient command structure (CS/80) and HP-IB interface as the HP 7911, 7912, 7914, 7933, and 7935 mass storage products. This commonality in command structure allows you to mix and match a wide range of compatible mass storage solutions.

The disc and the disc/tape products are customer installable and contain extensive self-test capabilities resident in the controller. Both package designs provide quick access to all replaceable assemblies.

The disc and disc/tape products are quiet enough to operate unnoticed in an office environment and are small enough to place on top of a desk. Both feature adapter kits to fit in 19-inch EIA rack enclosures or in HP's mobile mini-rack.

With a 30ms average disc seek time and a typical data transfer rate of one megabyte per minute for the tape drive, these disc and disc/tape products provide the performance needed for the entry-level multi-user system high performance work stations.

Features

HP 7941A and HP 7945A Disc Drive

- Small stand-alone desktop cabinet (HxWxD = 130mm x 325mm x 285mm)
- Quiet operation with sound power <50 dBa.
- Customer installable
- Average seek time of 30ms
- Fits in 19-inch EIA rack enclosure with an HP 19500B adapter kit

Features

HP 7942A and HP 7946A Disc/Tape Drive

- Customer installable
- The disc drives have an average seek time of 30ms. The tape drive can typically transfer data at one megabyte per minute.
- The tape drive has read-after-write capabilities and automatic error detection and correction for enhanced data reliability
- Small stand-alone desktop cabinet (HxWxD = (208mm x 325mm x 285mm))
- Quiet operation with sound power <50 dBa.
- Fits in 19-inch EIA rack enclosure with an HP 19501A adapter kit

Description

HP 7941A/7945A Disc Drives

The HP 7941A and HP 7945A are 24- and 55-Mbyte disc drives. Each of these products includes a fixed Winchester disc drive, intelligent HP-IB Command Set 80 controller and power supply — all in a compact desktop package.

Description

HP 7942A/7946 Disc/Tape Drives

The HP 7942A and HP 7946A are mass storage systems combining either a 24-Mbyte or a 55-Mbyte fixed disc drive with a built-in 1/4-inch cartridge tape drive, intelligent HP-IB Command Set 80 Controller and power supply — all in a compact desktop package. A single controller integrates and controls the tape and disc drives.

Operating Characteristics

Electromagnetic Emissions

Radiated and conducted interference:

- HP 7941A, 7942A, 7945A, 7946A - For U.S.A., designed to meet FCC Docket 20780 for Class B computing peripheral devices.
- HP 7941A, 7942A, 7945A, 7946A - For Europe, designed to meet VDE 0871 for Level B computing devices. FTZ licensed on some HP systems. Refer to your local sales representative for more information.

Safety

The HP 7941A, 7942A, 7945A, 7946A meet all applicable safety standards of the following:

- IEC 380 and 435
- UL 114 and 478
- CSA 22.2 no. 154

Ordering Information

| | Price |
|--|-----------|
| HP 7941A (24Mbyte) disc | \$ 5,500 |
| HP 7945A (55Mbyte) disc | \$ 7,500 |
| HP 7942A (24Mbyte disc/tape cartridge) | \$ 8,500 |
| HP 7946A (55Mbyte disc/tape cartridge) | \$10,500 |
| Opt 015 Voltage selector set for 230V (For non-U.S. shipments) | N/C |
| Opt 550 Deletes one-metre HP-IB cable | Less \$85 |
| HP 19500B Rack kit for mounting HP 7941A and HP 7945A in 19-inch EIA rack enclosures | \$85 |
| HP 19501A Rack kit for mounting HP 7942A and HP 7946A in 19-inch EIA rack enclosures | \$165 |

COMPUTER PERIPHERALS

CS/80 Disc Drive Family

Models 7911, 7912, 7914, 7914CT, 7914ST

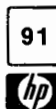

- Performance
- Reliability
- Serviceability

- Integral self test and diagnostics
- Internal microprocessor controller

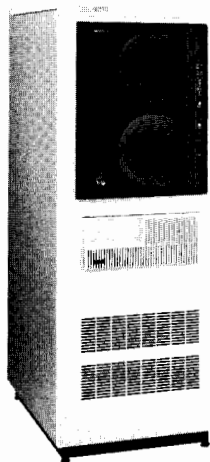

HP 7914ST

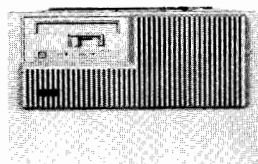

HP 7911R, 7912R, 7914R

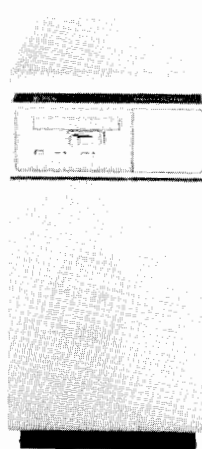

HP 7911P,
7912P,
7914P

7914CT

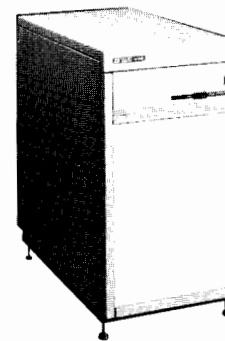

Hewlett-Packard offers the HP 7911, 7912, and 7914 family of disc products. To ensure flexibility in configuring mass storage needs, each disc product employs the same efficient command structure (CS/80) and the same interface standard (HP-IB), allowing you to mix and match a wide range of compatible storage solutions with little or no need for additional control hardware or software modification.

All of the CS/80 family disc products contain a sophisticated, internal controller which performs advanced, self-diagnostic routines to facilitate maintenance and servicing. These self-diagnostic capabilities, coupled with careful design and engineering, promote a highly reliable and serviceable disc drive which will provide greater system uptime and productivity.

HP 7911, 7912, 7914 Disc/Tape Drives

These Disc/Tape Drives are a family of products designed to satisfy all peripheral storage requirements in a single compact package. Each product utilizes a unique integrated storage concept, featuring a reliable Winchester disc mechanism for mass storage, and a ¼-inch cartridge tape drive for backup and user I/O.

The product line provides mass storage capacities from 28.1 to 132.1 Mbytes; they include the 7911 (28.1 Mbytes), 7912 (65.6 Mbytes), and 7914 (132.1 Mbytes).

HP 7914ST Mass Storage Subsystem

The HP 7914ST is a complete mass storage subsystem offering 132 megabytes of Winchester disc storage and an HP 7974A half-inch tape drive in a 1600mm high system cabinet. An option for a second 132-Mbyte disc drive in the same cabinet is also available.

HP 7914 CT Disc/Tape Drive

The 7914 CT disc/tape package combines the 7914 disc drive with the 9144A ¼ inch cartridge tape drive in a mobile mini-rack (Rosebud family cabinet). The new cartridge tape drive has read after write capabilities which helps to reduce image backup time.

Operating Characteristics

Electromagnetic Emissions

The 7911, 7912, and 7914 are designed to meet FCC Docket 20780 for Class A computing devices. For Europe, they are designed to meet VDE 0871 for Level A computing devices and are FTZ licensed on some HP systems.

Safety

The HP 7911, 7912, and 7914 meet all applicable safety standards of the following: CSA 22.2 No. 154, IEC 380 and 435, UL 114 and UL 478.

Ordering Information

| Ordering Information | Price |
|---|---------------|
| HP 7911P/R (28.1 Mbytes) | \$13,350 |
| HP 7912P/R (65.6 Mbytes) | \$14,800 |
| HP 7914P/R (132.1 Mbytes) | \$17,350 |
| Opt 001: Dedicated tape controller (HP 7911, 7912, and 7914) | add \$ 1,840 |
| Opt 015: 220-volt operation | N/C |
| Opt 140: Delete cartridge tape drive | less \$ 3,570 |
| HP 7914ST (132.1 Mbytes) | \$27,500 |
| Opt 002: Adds cartridge tape drive and second controller (for HP 3000 only) | add \$ 5,410 |
| Opt 015: 220-volt operation | N/C |
| Opt 114: Adds second HP 7914R (less cartridge tape drive) | add \$13,830 |
| Opt 240: Adds cartridge tape drive to first HP 7914R | add \$ 3,570 |
| HP 7914CT (132.1Mb) | \$17,350 |
| Opt 015 220-volt operation | N/C |
| Opt 140 Delete cartridge tape drive | less 3,500 |

COMPUTER PERIPHERALS

CS/80 Disc Drive Family Continued

Models 7907, 7933, 7935

- Performance
- Reliability
- Serviceability

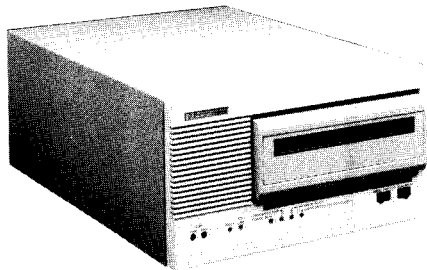

HP 7907



The HP 7907A is a complete peripheral storage product providing user I/O, mass storage, and backup capabilities. The 7907A combines a state-of-the-art fixed/removable disc mechanism with an intelligent controller using the CS/80/HP-IB protocol. The result is a high performance, environmentally rugged disc sub-system providing a cost effective backup and software distribution capability as well as an easy path to data interchange between systems.

Features

Disc Drive

- 41 Mbytes of formatted disc storage
- 20.5 Mbytes of fixed storage/20.5 Mbytes of removable storage in an easy to use front-loading 8" cartridge
- HP standard CS/80/HP-IB protocol
- Average seek time 30 ms
- Ramp-loaded heads for added reliability
- Front panel or system activated image backup/restore in less than 3 minutes
- Environmentally rugged design
- Available in either an HP92211A cabinet or standard 19" EIA rackmount
- Customer installable

Description

The HP 7907A is a complete mass storage subsystem featuring 20.5 Mbytes of formatted removable storage in an easy-to-use front loading configuration. Add to this an additional 20.5 Mbytes of formatted fixed storage, a fast 45 ms Total Device Average Transaction Time, a small light-weight package, 19" EIA rackmount capability and an offline backup capability and you have an ideal mass storage system for applications such as Automatic Test, On-Site Data Logging, and Computer Aided Engineering.

Electromagnetic Emissions

Radiated and conducted interference:

- HP 7907A-For U.S.A. designed to meet FCC Docket 20780 for Class B computing devices.
- HP 7907A-For Europe, designed to meet applicable VDE 0871 requirements for computing devices.

Safety

The HP7907A meets all applicable safety standards of the following:

- IEC 380 and 435
- UL 114 and 478
- CSA C22.2 No. 154

- Integral Self Test and Diagnostics
- Internal Microprocessor Controller

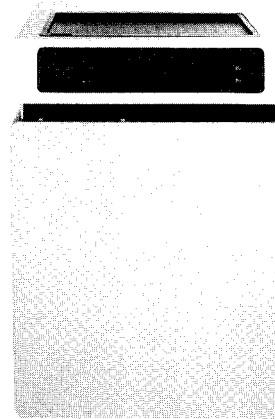

HP 7933H,
7935H



HP 7933H Disc Drive

The HP 7933H Disc Drive is a 404-MB fixed media device that provides high levels of performance, reliability, and serviceability. The performance of the HP 7933H promotes overall greater system efficiency. The advanced reliability and serviceability features are reflected by the exceptionally low maintenance costs of this product. A bundled package of three HP 7933H's is available as the HP 7933G at a reduced price.

HP 7935H Disc Drive

The HP 7935H Disc Drive is a removable media device that provides 404 Mbytes of removable media for increased system flexibility and greater system uptime for private data volume configurations and disc-to-disc backup/restore operations. This product is available in an HP 7935G package of three drives at a reduced price.

Electromagnetic Emissions

The HP 7933 and HP 7935 are designed to meet FCC Docket 20780 for Class A computing devices. For Europe, they are designed to meet VDE 0871 for Level A computing devices and are FTZ licensed on some HP systems.

Safety

The HP 7933 and HP 7935 meet all applicable safety standards of the following:

- CSA 22.2 No. 154
- IEC 380 and 435
- UL 114 and UL 478

Ordering Information

| | |
|---|----------|
| HP 7907A (41 Mbytes) | \$12,500 |
| 015-240V/50Hz | N/C |
| 550-Delete HP-IB Cable | Less 85 |
| HP 7933H (404 Mbytes) | \$25,700 |
| HP 7933G (1.212 Gbytes) | \$63,700 |
| HP 7935H (404 Mbytes) | \$28,300 |
| HP 7935G (1.2 Gbytes) | \$74,400 |
| Standard Input Power: 208 volts | N/C |
| Opt 120: For 120-volt operation in U.S.A., Canada | N/C |
| Opt 220: For 220-volt operation in Canada | N/C |
| Opt 221: For 220-volt operation in continental Europe | N/C |
| Opt 222: For 220-volt operation in Switzerland | N/C |
| Opt 223: For 220-volt operation in Denmark | N/C |
| Opt 241: For 240-volt operation in United Kingdom | N/C |
| Opt 242: For 240-volt operation in Australia, New Zealand | N/C |

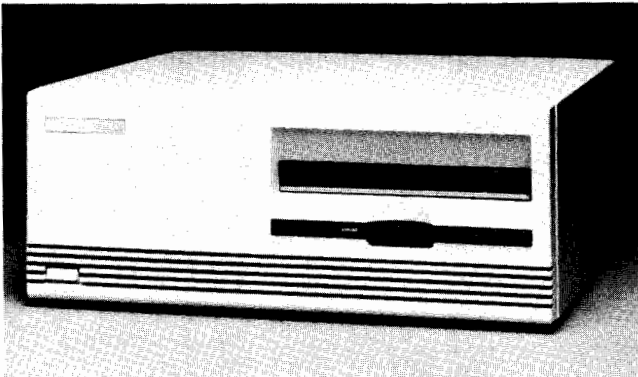

HP 9144A 1/4" Tape Subsystem

The Hewlett-Packard Family of Magnetic Tape Subsystems provides a range of solutions to meet your format, capacity, and performance needs. The four major applications of our tape subsystems are:

- * Backup protection against equipment failure and operator error
- * Archival storage for economical, long term data preservation
- * Data exchange with other computers and system software updates
- * Online mass storage for data logging and tape processing

1/4" Tape Backup Solution

HP 9144A 1/4" Tape Subsystem

The HP 9144A is a fast, reliable 1/4" Tape backup solution for 15 to 200 Mbytes of disc storage. It is a convenient backup alternative to multiple floppy discs at approximately one-third the cost of the faster half-inch tape drives. Using both 16 and 67 Mbyte cartridges, it provides performance up to 2 Mbytes per minute. The drive offers a read-while-write feature, Media Monitor, and extensive error detection and correction capabilities. Format compatibility with the 7908/11/12/14/42/46 integrated cartridge subsystems is an additional feature.

The HP 9144A allows for software distribution and data interchange between many HP systems. The HP's technical systems: HP 1000, HP 9000-Series 200, 300, 500 can use the 9144A to facilitate data exchange via the 1/4" tape cartridge. (True data exchange is dependent on the software, operating system and host system's level of compatibility).

Support for the 9144A is provided by the following HP systems: Touchscreen PC, Touchscreen II, HP 1000 Series A, HP 9000 Series 200, 300, and 500. (Cartridges formatted on the 9144A are not compatible with those formatted on the 9142A.)

1/2" Tape Backup Solutions

HP 7978B 1/2" Magnetic Tape Subsystems

HP 7978B 1/2" Magnetic Tape Subsystem is designed for fast, reliable backup of large systems typically with greater than 400 Mbytes of storage. This tape subsystem offers both 6250 cpi (GCR) and 1600 cpi (PE) densities. The GCR formatted capacity of approximately 140 Mbytes per 2400 foot reel reduces data storage costs. This streaming drive features 75 ips read-write speed (250 ips rewind speed) and provides up to three times the transfer rate of the HP 7974A using Immediate Response and Read-Ahead buffering. Increased reliability, extensive front panel diagnostics and ease of repair are additional benefits of the HP 7978B. The drive is mounted in an upright cabinet and includes an HP-IB interface. The HP 7978B is supported on the HP 1000-A Series as well as the HP 3000-Series 37, 39, 40/42, 44/48, 58 and 64/68.

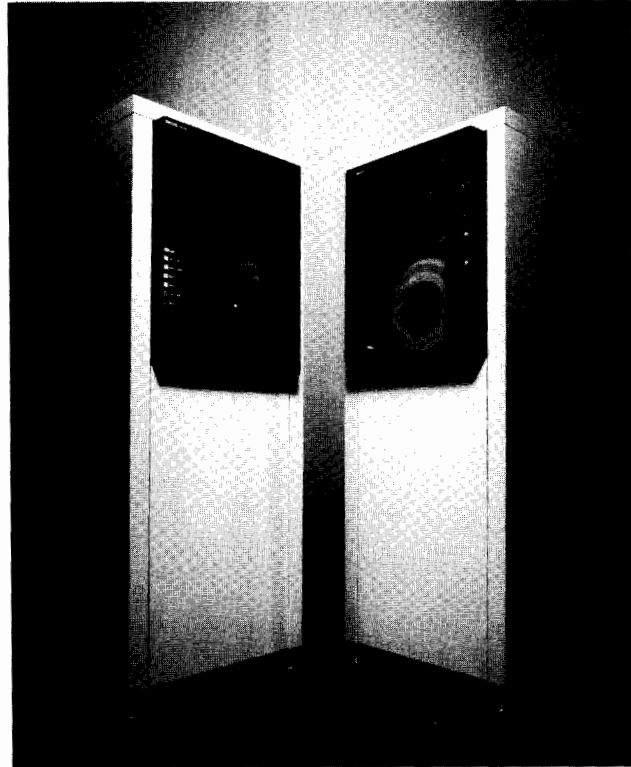

HP 7878A and HP 7874A 1/2" Magnetic Tape Subsystems

HP 7974A 1/2" Magnetic Tape Subsystem

The HP 7974A is the low cost subsystem designed for backup of approximately 130 to 400 Mbytes of disc storage with its 1600 cpi (PE) density. The 800 cpi (NRZI) capability can be added if dual density is required for data exchange. In the streaming mode, the drive operates at 100 ips (200 ips rewind speed). This feature results in transfer rates twice that of the HP 7970E. The HP 7974A is also a start/stop drive operating at a tape speed of 50 ips with tension arm buffering. Support is provided by the following systems: HP 1000-A Series, the HP 3000-Series 37, 39, 40/42, 44/48, 64/68, and the HP 9000-Series 300 and 500 HP-UX.

HP 7970E 1/2" Magnetic Tape Subsystem

The HP 7970E tape drive offers support for additional HP computer systems. Providing 1600 cpi (PE) density, the drive is available with a choice of parallel differential or HP-IB interfaces and is supported on most HP computer systems. Using tension arm buffering, it operates in start-stop mode at 45 ips (160 ips rewind) and provides system transfer rates up to 3.5 Mbytes/minute. This drive offers a 1/2" reel-to-reel solution for HP 1000-Series E/F, HP 3000-Series III and OEM customers. The HP 7970E is available in either a lo-boy cabinet or prepared for rack mounting.

Ordering Information

| | Price |
|--|-------------------|
| HP 7970E 1/2" Magnetic Tape Subsystems | \$10,160-\$17,176 |
| HP 7974A 1/2" Magnetic Tape Subsystems (1600 cpi) | \$13,335 |
| HP 7974A with NRZI option (1600/800 cpi) | \$15,835 |
| HP 7978A 1/2" Magnetic Tape Subsystems (6250/1600 cpi) | \$22,700 |
| HP 9144A 1/4" Tape Backup Subsystem | \$ 3,500 |
| HP 88140LC 67.0 Mbyte Tape (9144 only-Box of 5 tapes) | \$ 200 |
| HP 88140SC 16.0 Mbyte Tape (9144 only-Box of 5 tapes) | \$ 150 |
| HP 92150D 600 Ft. 1/2" Reel-to-Reel (Box of 10 tapes) | \$ 135 |
| HP 92150E 1200 Ft. 1/2" Reel-to-Reel (Box of 10 tapes) | \$ 175 |
| HP 92150F 2400 Ft. 1/2" Reel-to-Reel (Box of 10 tapes) | \$ 240 |

See the Technical Data Sheet #5953-6831, "The HP Family of Magnetic Tape Subsystems" for detailed support information.

COMPUTER PERIPHERALS

Line Printers, Laser Printers

Models 2563A, 2565A, 2566A, 2680A, 2685B, 2686A, 2688A, 2689A

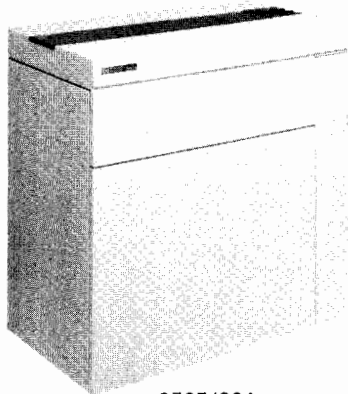

2565/66A

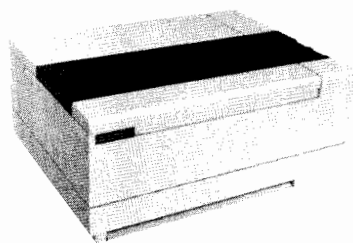

2563A

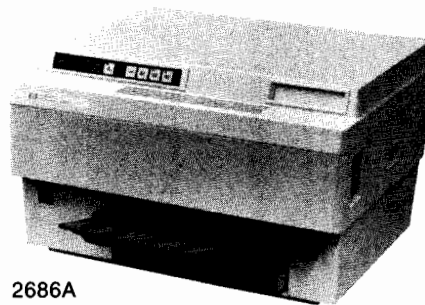

2686A
LaserJet Printer Family

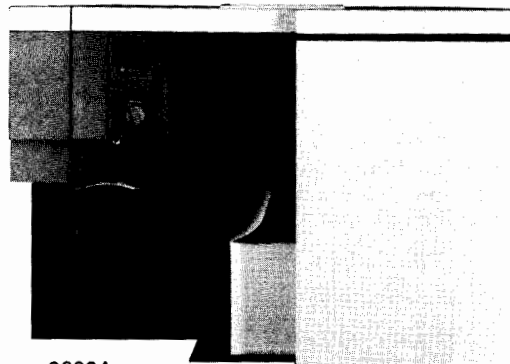

2680A

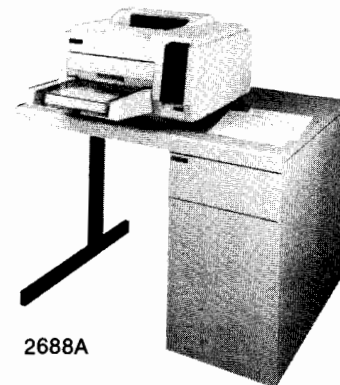

2688A



2689A

Line Printers

HP 2563A, 2565A and 2566A

The HP 2563A, 2565A and 2566A are fully supported line-matrix printers, printing at 300, 600 and 900 lpm, respectively, in standard mode. The HP 2563A, 2565A and 2566A offer many special user features such as graphics, bar code printing, multiple character fonts, 16-channel vertical format control, high density printing and compressed print. The HP 2563A, 2565 and 2566A utilize the Hewlett-Packard Printer Command Language which enables upward and downward compatibility with other Hewlett-Packard printers.

Laser Printers

HP LaserJet/LaserJet PLUS Printers

The HP LaserJet/LaserJet PLUS printers are low-cost, professional PC laser printers that provide letter-quality text and graphics for workstation-based applications. The LaserJet/LaserJet PLUS printers print at 8 pages-per-minute and are compatible with IBM and IBM compatibles, DEC, Wang, Apple, HP 150, and others. In addition to the LaserJet printer's features, the LaserJet PLUS printer provides 1/2 meg of memory for higher density graphics, forms design capability, downloadable fonts, and an optional Centronics interface. The LaserJet PLUS printer is expanded into applications such as document workstation printing, enhanced merged text and graphics, and the electronic publications marketplace.

Ideal for Word Processing Use

The HP LaserJet/LaserJet PLUS printers feature quiet operation (< 55 dBA), multiple character fonts per page, multiple paper sizes (up to legal size), single sheet paper or envelopes, workstation on-demand printing, and compact, desktop size.

Maintenance

The HP LaserJet/LaserJet PLUS printers are easy to maintain and operate. The disposable cartridges containing the main electrophotographic components make the printers easy to service and very reliable. The LaserJet/LaserJet PLUS printers require no scheduled preventive maintenance.

Character Font Flexibility

The standard character font for the LaserJet/LaserJet PLUS printers is Courier 10 (Portrait and Landscape). There are additional optional fonts for both printers in plug-in cartridges, including both fixed pitch and proportionally spaced fonts. Software selectable, this allows printing of multiple fonts on the same page. In addition, downloadable font families are available for the LaserJet PLUS printer.

HP 2688A

The HP 2688A page printer is a medium speed, low to medium print volume laser electrophotographic printer. This printer is ideally suited for applications requiring high print quality such as letters, reports and documents. The maximum print speed of 12 ppm and the quiet operation (55 dBA) make it an excellent office printer for merged text and graphics printing.

HP 2680A/85B

The HP 2680A Laser Printing System (LPS) operates at 45 ppm on plain 8.5-inch by 11-inch fanfold paper. It features continuous paper feed for paper handling reliability, non-contact fusing, and a data control system that is capable of handling variable size characters, electronic forms and multiple pages of print on one sheet of paper. If remote printing is required, the HP 2685B is designed for remote location printing. The 2685B configuration includes the HP 2680 laser printer, controller, terminal, disc drive and magnetic tape.

HP 2689A

The HP 2689A Laser Printing System provides IBM mainframe (and compatible) computer users a cost-effective way to enjoy the benefits of laser printing. The HP 2689A communicates to the IBM mainframe through the HP 26029A interface unit and the HP 2680A laser printer. This IBM mainframe plug-compatible laser printer operates at 45 ppm on plain 8.5-inch by 11-inch fanfold paper. The HP 2689A laser printer is known for its high reliability, affordability, and easy implementation.

Output Design Service

HP also offers an Output Design Service. This service is a personalized form design, logo and signature scanning service.

Ordering Information

| | Price |
|--------------------------------|-----------|
| HP 2565A Line Printer | \$18,766 |
| HP 2566A Line Printer | \$21,766 |
| HP 2563A Line Printer | \$5,780 |
| LaserJet Printer | \$2,995 |
| LaserJet PLUS Printer | <\$3,995 |
| HP 2688A Page Printer | \$29,950 |
| HP 2680A Laser Printing System | \$76,780 |
| HP 2685B Laser Printing System | \$119,740 |
| HP 2689A Laser Printing System | \$99,950 |

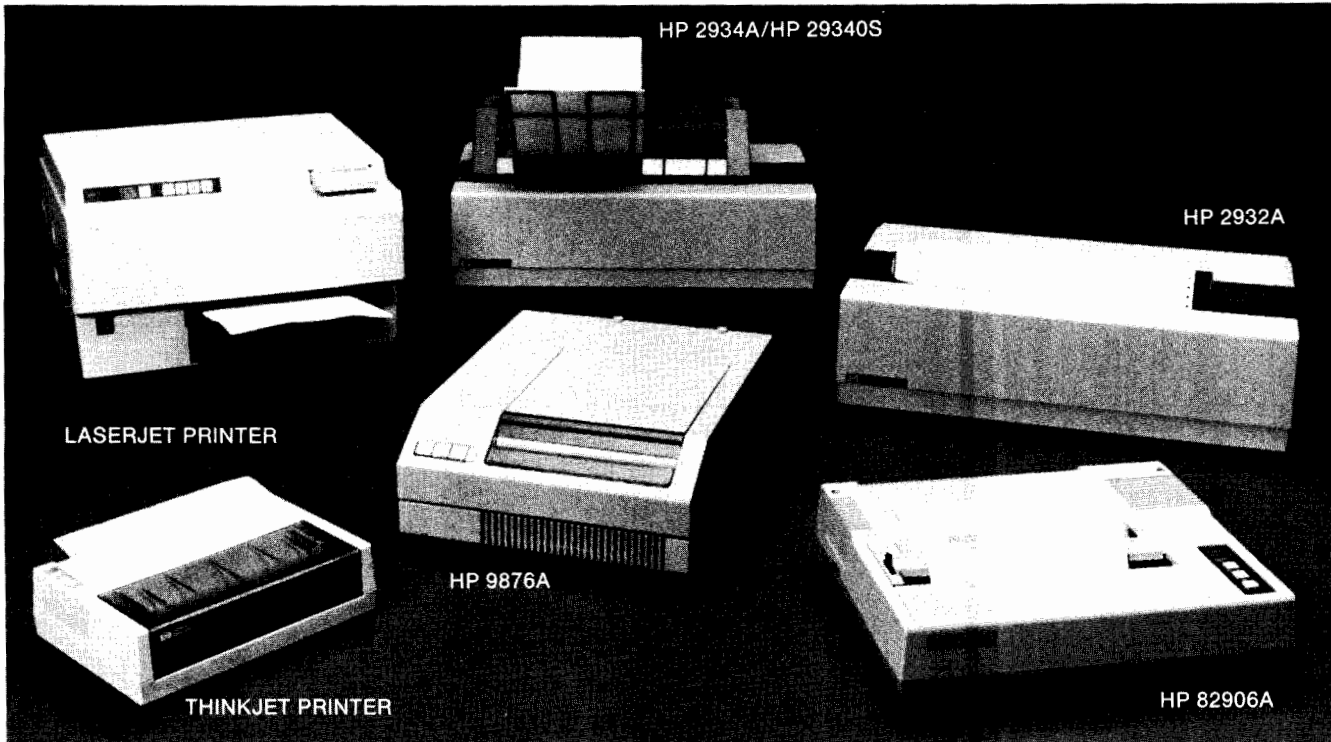

Personal Printers

Hewlett-Packard's personal printers offer compact convenience and economy without sacrificing performance.

The ThinkJet Personal Printer

- 150-cps Printing
- Quiet Operation
- High-quality Text and Graphics
- Four Interface Versions

The low-cost ThinkJet family of personal printers offers fast, quiet, portable printing. The ThinkJet printers feature a disposable print head cartridge, high-quality printing, and both friction and pin-feed capability. Four different print pitches provide the flexibility you need for a variety of applications ranging from reports to spreadsheets.

The HP 82906A Personal Printer

- 160-cps Printing
- Impact Printing for Forms Flexibility
- Graphics
- Last-form Tearoff

The HP 82906A is an economical 80-column, dot matrix impact printer that produces fast text and graphics on single sheets or fanfold paper. A variety of print pitches and character styles are available, plus last-form tear-off, user-defined character set and HP raster graphics.

General Purpose Printers

HP's general purpose printers include a range of non-impact and impact printers. The non-impact thermal printers offer quick, quiet printing. The impact printers offer both permanent copy and multipart forms capability.

The HP 2932A General Purpose Printer

- 200-cps Draft Quality Printing
- Paper-handling Flexibility
- Front Forms Loading and Straight Paper Path
- Last-form Tearoff

The HP 2932A General Purpose Printer offers 200-cps printing and a variety of paper-handling features for printing applications requiring versatility and high reliability. Typical applications include financial reports, customer invoices, and factory floor lists. The HP 2932A is frequently shared among several users.

The HP 9876A Thermal Line Printer

- 480 Lines-Per-Minute Printing
- Three Interface Options

The 9876A offers fast, quiet line printing at 480 lines per minute. It is ideal for producing high-speed listings, working reports or quick plots and graphics. Featuring HP-IB, 8-bit parallel, and RS-232C interface options, the 9876A is compatible with a wide variety of computers and terminals.

Word Processing Printers and Accessories

HP offers a range of word processing printers and accessories to meet a variety of application needs. You can choose from full-font daisywheel printers, a personal laser printer, and a dual-mode impact printer. All offer professional-looking copies of text with a minimum of operator interaction.

The HP 2934A Business Printer

- 200-cps Draft and 67-cps Letter-quality Printing
- Word Processing Print Features
- Plug-in Font Cartridges
- 90-dpi Graphics* and Automatic Bar Code Generation
- Last-form Tearoff

The HP 2934A Dual-mode Printer offers selectable print modes, 136-column printing, graphics capability, and a comprehensive selection of printing and paper handling features. When matched with the HP 29340S Single-bin Sheet Feeder, it provides an excellent single-printer solution for those who need letter-quality printing as well as data processing speed and multipart forms capability.

*Graphics support on the HP 3000 via screen dump.

The LaserJet Personal Printer

- 8-Page-per-minute Printing
- Letter-quality Text
- Graphics
- Character-font Flexibility

The LaserJet Personal Printer provides letter-quality text and graphics. Its fast printing and quiet operation make it an ideal workstation printer for a variety of applications. It utilizes a disposable cartridge that contains the main printing components. (See page 94 for additional information on LaserJet Printers)

COMPUTER PERIPHERALS

Workstation Printers (cont.)

Models ThinkJet, 82906A, 2932A, 9876A, 2934A, LaserJet

| PRINTER \ FEATURE | SPEED | PRINT QUALITY | GRAPHICS | MULTIPART FORMS | SHEET FEEDER | NOISE | STANDARD INTERFACE |
|----------------------------------|---------------------------|---|----------|-----------------|---|--------|---|
| ThinkJet Printer | 150 cps | <ul style="list-style-type: none"> • Draft Quality • 11x12 Dot Matrix | Yes | No | No | <50dBA | 4 versions, each with own interface 2225A (HP-IB) 2225B (HP-IL) 2225C (Centronics) 2225D (RS-232C) |
| HP 82906A Impact Printer | 160 cps | <ul style="list-style-type: none"> • Draft Quality • 9x9 Dot Matrix | Yes | Yes | No | 62dBA | HP-IB |
| HP 2932A General Purpose Printer | 200 cps | <ul style="list-style-type: none"> • Draft Quality • 9x12 Dot Matrix | Yes | Yes | No | <55dBA | RS-232C Standard Options: #035 RS-422 #042 Centronics-type Parallel #046 HP-IB |
| HP 2934A Business Printer | Dual Mode 200 & 67 cps | 67 cps <ul style="list-style-type: none"> • Letter Quality • 36x24 Dot Matrix 200 cps <ul style="list-style-type: none"> • Draft Quality • 9x12 Dot Matrix | Yes | Yes | Accessory: HP 29340S Single Bin Sheet Feeder | <55dBA | RS 232 Options: #034 Multipoint Synchronous (Nth terminal) #035 RS-422 #039 SNS/Data Link Cable included #042 Centronics-type Parallel #046 HP-IB |
| LaserJet Printer | 8 ppm | <ul style="list-style-type: none"> • Letter Quality | Yes | No | Yes (Built-in) | <55dBA | |
| HP 9876A Thermal Line Printer | 480 lpm | <ul style="list-style-type: none"> • Draft Quality • 5x7 Dot Matrix | Yes | No | No | <57dBA | HP-IB Standard Options: #001 8 bit parallel for use with 2640 series terminal #002 RS-232C |

Ordering information

ThinkJet Printer (all versions)

| | |
|-------------------------------------|--------|
| 2225A ThinkJet Printer (HP-IB) | \$ 495 |
| 2225B ThinkJet Printer (HP-IL) | \$ 495 |
| 2225C ThinkJet Printer (Centronics) | \$ 495 |
| 2225D ThinkJet Printer (RS-232C) | \$ 495 |
| HP 2686A LaserJet Printer | 3495 |
| HP 2932A Impact Printer | 2595 |
| HP 2934A Dual-mode Business Printer | 2995 |
| HP 29340S Single-bin Sheet Feeder | 650 |
| HP 82906A Impact Printer | 795 |
| HP 9876A Thermal Printer | 6080 |

Price



In fields as diverse as engineering, chemistry, medicine, finance, and marketing, the need for hardcopy graphics is growing. The reason is simple: graphics provide a comprehensive, easy-to-understand overview of numerical data.

Producing hardcopy graphics does not have to be difficult or expensive. Basically, there are three types of devices used to produce graphics—printers, plotters and film recorders. Each has its own applications. Printers are raster devices which use closely spaced dots to create working-quality drawings generally in black and white. Plotters, on the other hand, are vector devices which produce colorful, visually perfect graphics with sharp lines and smooth curves. And the new HP 7510 vector film recorder produces colorful 35-mm slides for formal presentations.

With Hewlett-Packard graphics peripherals, you can quickly generate professional, hardcopy graphs and charts from design, measurement, and computational data.

Data Display Graphics

Data analysis usually requires extrapolating trends over time, studying relationships between variables, making comparisons between entities, and looking for exceptions and variances. All these lend themselves to graphic portrayal.

By using graphics, you eliminate printouts with pertinent data buried in long listings of hundreds or even thousands of variables. Effective graphics can help you spot key ideas, trends, and relationships that might otherwise go unnoticed. In addition, graphics can improve communications at meetings, and make you appear more professional and better prepared. Reports can be shorter, and easier to understand.

Design Graphics

Hardcopy graphics are a vital part of the computer-aided design and computer-assisted drafting fields. Tedious and time-consuming plans and schematics can be produced quickly and accurately using a plotter. HP drafting plotters create visually perfect drawings for applications in mechanical, electrical, and civil engineering, architecture, and drafting.

Interfaces

There are two interfaces for connecting HP plotters and the HP 7510 color film recorder with HP and non-HP computer systems: the HP-IB (IEEE-488-1978) and the RS-232-C/CCITT V.24. These options make it easy to integrate an HP plotter into almost any computer system.

HP-GL

Hewlett-Packard plotters understand HP-GL (Hewlett-Packard Graphics Language), a set of easy-to-understand mnemonic commands for controlling machine functions such as character generation and axis production. These internal commands simplify programming; for example, it often takes just one or two instructions to draw arcs or circles or define and fill a polygon.

Plotting Media and Pen Choices

Each HP plotter uses chart paper and at least one additional medium: plots can be drawn on transparency film for overhead projection, on high-gloss presentation paper for reports or graphic hand-outs, or on vellum, double-matte polyester film, and tracing bond for engineering and drafting drawings.

HP makes three types of pens—fiber-tip, roller-ball, and liquid-ink drafting pens. The fiber-tip pens for both paper and transparency film come in two widths, a fine tip for grids, tick marks, and labels, and a wide tip for bold titles, heavy lines, and filled-in areas. For engineering and drafting media, refillable drafting pens come in six standard widths, and disposable drafting pens come in two widths and four colors. Roller-ball pens in one width and four colors.

Intelligent Pen Control

All HP plotters change pens automatically under program control so no operator intervention is necessary. To produce graphics of consistently high quality, HP plotters precisely control pen movements through the use of sophisticated electronic circuitry. As pens descend, their motion is automatically damped to preserve pen tips. When pens are returned to their stalls after use, they are automatically capped so they stay fresh and last longer.

Graphics Software

HP plotters are supported on most Hewlett-Packard computer systems, desktop computers, and intelligent terminals. In addition, many popular graphics application and integrated software packages support these plotters on HP and non-HP computer systems and personal computers.

Film Recorder Output

With the standard 35-mm camera back, the HP 7510 color film recorder can accommodate 35-mm slide and print film, and Polaroid instant slide film. With an optional camera back, the recorder can also use instant print film. Another option is a Kodak instant slide module which produces fully developed instant slides one at a time.

Reliability

HP plotters, and the HP 7510 color film recorder, are built for professionals by professionals. HP has been manufacturing graphics plotters for over 15 years. An HP's commitment to product integrity means quality is built-in to every plotter and film recorder we make.

COMPUTER PERIPHERALS

Introduction to Hardcopy Graphics (cont.)

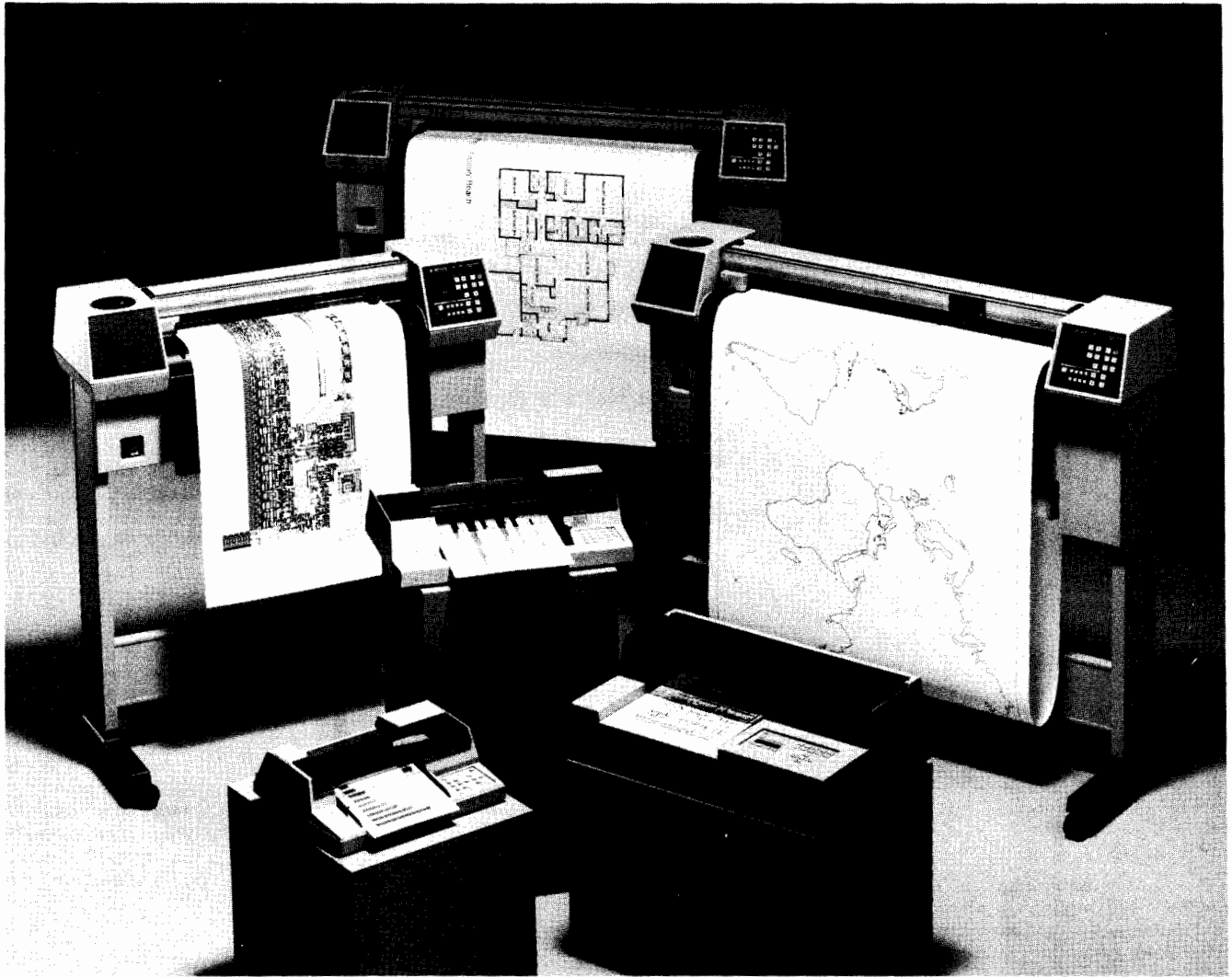

| | HP 7470A | HP 7475A | HP 7550A | HP 7580B HP 7585B | HP 7586B |
|---------------------------|--|--|---|--|---|
| Number of pens | 2 in individual pen stalls | 6 in carousel | 8 in carousel | 8 in carousel | 8 in carousel |
| Pen types | Paper, transparency | Paper, transparency, | Paper, transparency, liquid-ink roller-ball | Paper, liquid-ink roller-ball, | Paper, liquid-ink roller-ball |
| Media sizes | A4/A | A4/A, A3/B | A4/A, A3/B | A4/A, A3/B, A2/C, A1/D, (A0/E HP 7585B only) | A4/A, A3/B, A2/C, A1/D, A0/E |
| Media types | Paper, transparency film | Paper, transparency film, | Paper, transparency film, vellum, polyester film | Paper, vellum, tracing bond, polyester film | Paper, vellum, tracing bond, polyester film |
| Media load methods | Manual sheet loading for above media types | Manual sheet loading for above media types | Automatic sheet feed for paper, transparency film Manual sheet loading for above media types | Manual sheet loading for above media types | Automatic roll feed for above media types except tracing bond Manual sheet loading for above media types |
| Interfaces | RS-232-C/CCITT V.24 or (HP-IB) IEEE-488 or HP-IL | RS-232-C/CCITT V.24 or (HP-IB) IEEE-488 | RS-232-C/CCITT V.24 and (HP-IB) IEEE-488 | RS-232-C/CCITT V.24 and (HP-IB) IEEE-488 | RS-232-C/CCITT V.24 and (HP-IB) IEEE-488 |
| Page | 99 | 99 | 101 | 103 | 103 |



- Low cost, high performance
- Choice of six- or two-pen models

- Plot on paper
- Plot on HP overhead transparency film

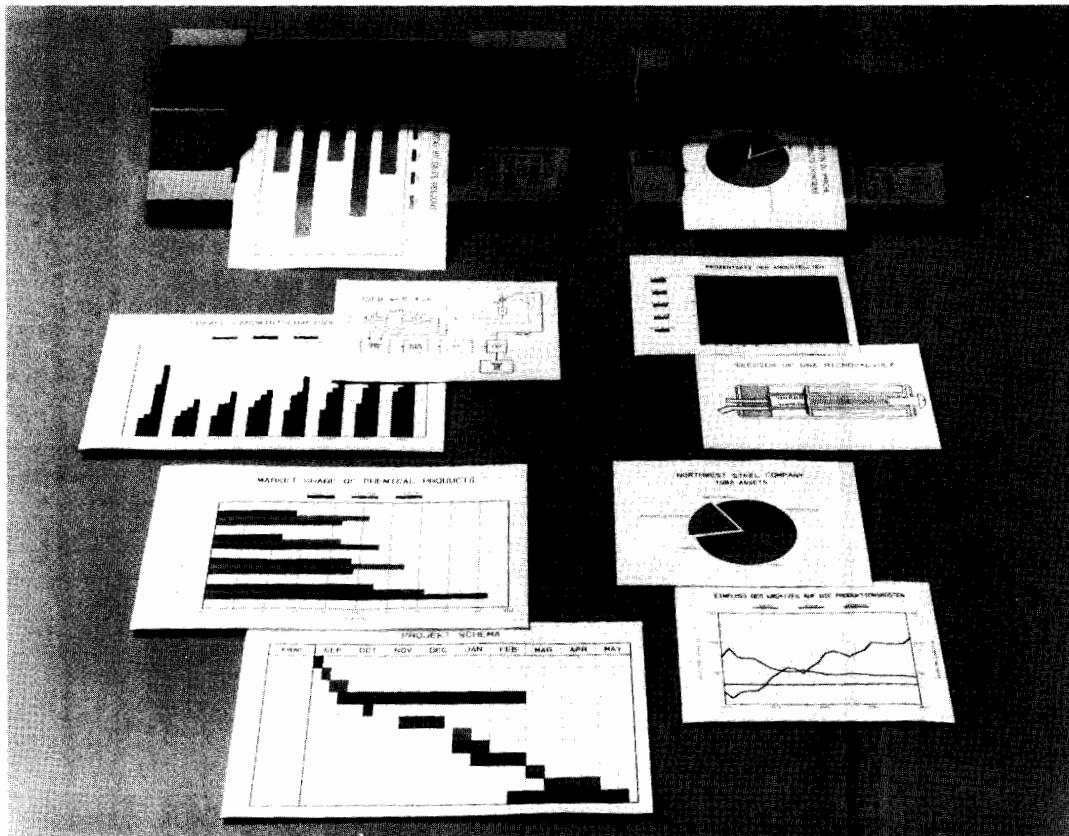

Hewlett-Packard's HP 7470A and 7475A graphics plotters provide the kind of graphics excellence you would expect to find only in much more expensive plotters. They feature the same high-quality components and innovative paper-moving technology which were introduced in HP's drafting plotters and which make it possible to offer high performance plotters at affordable prices. Refer to the table below for a quick comparison of the main features available in each plotter.

Measurement Applications

The HP 7470A and 7475A add hardcopy graphics capability to intelligent instruments and instrument systems with HP-IB (IEEE 488-1978). For most applications that use a display screen and an oscilloscope camera, these plotters can produce high-quality hardcopy of the screen for a cost that is substantially lower than camera film. Because they plot directly from measured data, they eliminate problems created by distortion from the screen. And plotter output provides better visual resolution than photographs. Many systems without screen displays can also have the benefits of HP 7470A or 7475A hardcopy graphics at very little additional cost.

Easy to Use

When the HP 7475A or 7470A plotters are turned on, default conditions are automatically established for most plotting parameters. In many cases, it is only necessary to load the pens and plotting medium in order to start plotting.

Media and pen loading are also easy. A guide control lever makes media alignment perfect every time. The front panel can be used to select pens, to halt the program for exchanging pen colors, or to move the plot forward to "view" what you have plotted.

The front panel also allows easy access to the plotter's digitizing capability and scaling points. And, on the HP 7475A, push buttons can rotate plots 90 degrees or run a demonstration plot directly from the plotter.

Intelligence Features

Intelligence features are built directly into these plotters to save you time by eliminating the need for software-generated characters and functions. Many HP-GL instructions (more than 50 in the HP 7475A; more than 40 in the HP 7470A) govern such tasks as labeling, pen movement, drawing arcs and circles, and selecting from a large variety of character sets. The HP 7475A has 19 character sets in-

| Features | HP 7475A | HP 7470A |
|----------------------------|--|--|
| Media sizes | Two ANSI sizes: A (8.5 x 11 in.) and B (11 x 17 in.) Two ISO sizes: A4 (210 x 297 mm) and A3 (297 x 420 mm) | One ISO size: A4 (210 x 297 mm) |
| Pens | Six fiber-tip; programmable pen selection; automatic capping | Two fiber-tip; programmable pen selection; automatic capping |
| HP-GL instructions | More than 50 instructions | More than 40 instructions |
| Character sets | 19 sets, including ISO European standards and Katakana | Five sets |
| Standard interfaces | HP-IB (IEEE 488-1978) or RS-232-C (CCITT V.24) | HP-IB (IEEE 488-1978) or RS-232-C (CCITT V.24) or HP-IL |
| | Each plotter incorporates one permanent interface option. | |
| Technology | Both plotters use the same micro-grip drive for paper movement and have the same high resolution, repeatability, and velocity. | |

Computer Applications

The HP 7470A and 7475A provide hardcopy computer graphics for technical, scientific, and business applications. Colorful A4/A-size charts and graphs are ideal for reports and overhead transparencies. Use them for summarizing data, identifying trends, comparing results, and focusing on exceptions. The larger A3/B-size plots that can be drawn on the HP 7475A are particularly useful for time lines, PERT charts, schematics, engineering drawings, and other applications where you need to show visual detail.



COMPUTER PERIPHERALS

Graphics Plotters

Model 7470A and 7475A (cont'd)

cluding ISO European sets, Katakana, ASCII, and Roman 8 extensions; the HP 7470A has five internal character sets.

The HP 7475A's extra HP-GL instructions, which are used for filling rectangles and wedges for pie and bar charts, provide an enhancement especially designed for professional graphics.

Writing Systems

The HP 7470A has two built-in pen stalls which make two-color plotting easy. For plots with more than two colors, the program can be halted through program or front panel control; new pens can then be installed and plotting resumed. The HP 7475A's six-pen carousel allows you to store up to six different pen colors or a variety of colors and widths.

Several automatic features are included to protect the tip of the pen and increase pen life. When housed in the stall or carousel, the pen is capped to prevent premature drying. When a pendown command is given, the pen force is damped and the pen is gently lowered to the plotting surface.

High-Quality Output

The HP 7470A and 7475A have an addressable step size of 0.025

mm (0.001 in.). With this resolution, they can plot up to 1000 points in a 1-inch line. When commanded to return to the same point with no pen change, they achieve this repeatability within 0.1 mm (0.004 in.) Because of this outstanding resolution and repeatability, both plotters produce straight lines and smooth circles that have an artist-drawn appearance.

Interface Options

The HP 7475A and 7470A are easy to interface with most HP and non-HP computers. Both plotters offer the RS-232-C/CCITT V.24 or HP-IB (IEEE 488-1978) interface. With the RS-232-C option, a dual input/output cable is available for connecting the plotters with a terminal and computer. In addition, the HP 7470A offers a third interface option, HP-IL. This interface is used to connect the plotter with low-cost, portable HP systems.

Graphics Software

HP offers a full line of graphics software packages for use on most HP computer products. And software is also available for many non-HP computers. These packages make it easy for non-programmers to use the HP 7470A and 7475A plotters. Details are available from any HP sales and support office.

Specifications

| | HP 7475A | HP 7470A |
|---------------------------------|--|--|
| Resolution | Smallest addressable step size: 0.025 mm (0.001 in.) | |
| Repeatability | With a given pen: 0.1 mm (0.004 in.) From pen to pen: 0.2 mm (0.008 in.) | |
| Pen velocity (each axis) | Pen up, 50.8 cm/s (20 in./s); pen down, maximum — 38.1 cm/s (15 in./s), programmable — 1 to 38 cm/s in 1 cm/s increments | |
| Acceleration | Approximately 2 g's | |
| Environmental range | Operating, 0°C to 55°C Non-operating, -40°C to 75°C | |
| Plotting area | | |
| X-axis | 258 mm (10.2 in.), A/B 275 mm (10.8 in.), A4/A3 | 191 mm (7.5 in.) A 191 mm (7.5 in.), A4 |
| Y-axis | 198 mm (7.80 in.), A 192 mm (7.56 in.), A4 414 mm (16.3 in.), B 402 mm (15.8 in.), A3 | 257 mm (10.2 in.), A 272 mm (10.7 in.), A4 |
| Interfaces | HP-IB (IEEE 488-1978), implements the following HP-IB functions as defined in IEEE 488-1978: SH1, AH1, T2, TE0, LE0, SR1, RL0, DC1, DT0, L2, PP0. (listen only or address less than 7, otherwise PP2) | |
| | RS-232-C/CCITT, asynchronous serial ASCII with switch selectable baud rates of 75, 110, 150, 200, 300, 600, 1200, 2400, 4800, 9600. External clock input capabilities with intermediate baud rates of up to 9600 baud. 1024 byte buffer. | Same as HP 7475A except 255 byte buffer. |
| | | HP-IL, Hewlett-Packard Interface Loop for use with portable systems. |
| Power Requirements | Source: 100, 120, 200, 240 V~ -10%, +5% Frequency: 48-66 Hz | |
| | Consumption: 35 W maximum | Consumption: 25 W maximum |
| Size: | | |
| Height | 127 mm (5 in.) | 127 mm (5 in.) |
| Width | 568 mm (22.4 in.) | 432 mm (17 in.) |
| Depth | 367 mm (14.5 in.) | 343 mm (13.5 in.) |
| Weight: | | |
| Net | 7 kg (16.0 lb) | 6 kg (13.5 lb) |
| Shipping | Approx. 11 kg (25.0 lb) | Approx. 10 kg (22.0 lb) |
| FCC | FCC certified to conform to limits set for radio frequency interference when used with a Class B computing device. | |

Accessories Supplied

HP 7475A

- HP 07475-90001 Interfacing and Programming Manual
- HP 07475-90002 Operation and Interconnection Manual
- HP 07475-90004 Reference Card

HP 7470A

- HP 07470-90001 Interfacing and Programming Manual
- HP 07470-90002 Operator's Manual
- HP 07470-90003 Interconnection Guide
- HP 07470-90004 Reference Card

Power cords and an assortment of pens and drawing media are also supplied with the plotters. The media size and the appropriate power cord are determined by plotter destination. The HP-IL cable (½-metre) is supplied with Option 003 only.

Note: Interface cables are not supplied with Option 001 and Option 002 plotters.

Ordering Information

Options

- 001 RS-232-C/CCITT V.24 (cable not included) N/C
- 002 HP-IB (IEEE 488-1978) (cable not included) N/C
- 003 HP-IL for 7470A only (cable included) N/C

Note: Option 001, 002, or 003 must be specified when ordering HP 7470A; Option 001 or 002 must be specified with HP 7475A.

Interface Cables

- HP 13242G Male-male, special RS-232-C cable for use with Option 001, HP 150 Personal Computer \$69
- HP 17255D Male-female, special RS-232-C cable for use with Option 001, IBM Personal Computers \$50
- HP 17355F Male-male standard cable for use with Option 001 \$52.50
- HP 17455A Eavesdrop cable for use with Option 001 \$75
- HP 10833A or HP 45529A or HP 31389A HP-IB 1-metre cable for use with Option 002 \$81
- HP 82167A HP-IL ½-metre cable (included with Option 003) \$6

Plotters

- HP 7470A Two-pen Graphics Plotter \$1095
- HP 7475A Six-pen Graphics Plotter \$1895

COMPUTER PERIPHERALS

8-pen Automatic Sheet Feed Plotter

Model 7550A

101



- Ideal for high-volume, shared environments
- Requires minimum operator supervision
- Uses drafting media, pens

- High throughput
- 6 g acceleration, 80 cm/s (31.5 in./s)
- Accepts A3/B- and A4/A-size media



HP 7550A

Hewlett-Packard's new sheet feed 7550A plotter is an innovative graphics tool for business and technical users alike. Automatic cut sheet feed capability for paper and transparencies makes the HP 7550A ideal for unattended plotting or multiple color copies. With an unmatched 6 g of acceleration, the HP 7550A can produce quick graphs for problem-solving or decision making, or working drawings for drafting or design systems. And the HP 7550A meets Hewlett-Packard's high performance standards, so it creates professional-looking graphs for reports and presentations.

Fast Throughput

The HP 7550A's fast acceleration and pen speed mean shorter plotting time. The HP 7550A draws in any direction at 80 cm/s (31.5 in./s) and letters at approximately 7-9 characters per second. It uses the powerful MC68000 16-bit microprocessor. The HP 7550A is also equipped with a replot capability so if an entire plot will fit in the replot buffer (\approx 12K bytes), the HP 7550A can produce up to 99 original color copies without rerunning the program, freeing your computer to go on with other tasks.

Minimum Operator Supervision

The HP 7550A eliminates manual paper handling of A3/B- and A4/A- size sheets of paper, and transparency film. The carousel allows eight pens to be loaded at once, and the plotter caps the pens when not in use to keep ink fresh. The HP 7550A automatically senses the type of carousel loaded, then sets the optimal pen speed and force. It also senses what paper size is being used.

High Quality Output

With an addressable resolution of 0.025 mm (0.001 in.) and mechanical resolution of 0.006 mm (0.00025 in.), the HP 7550A makes smooth arcs and draws lines that meet precisely. It also has a curved line generator which can be invoked when exceptionally smooth curves are required.

With 20 character sets, the HP 7550A is ideal for international business. Choices include Katakana and ISO European languages for Denmark, France, Germany, Italy, Norway, Portugal, Spain, Sweden, and the United Kingdom. The HP 7550A letters in two fonts: arc font with proportional spacing for maximum readability and stick font with fixed character spacing for speed.

Features

The front-panel display and function keys guide users through each plotter setup, report plotter status, and give program messages. The HP 7550A rotates graphs 90 degrees for a choice of either horizontal or vertical formats, and aligns graphs to pre-printed forms and grids, all from the front panel.

The HP 7550A accepts standard A4/A- and A3/B-size paper, double-matte polyester film, vellum, and A4/A-size transparency film. Pen choices include liquid-ink, roller-ball, paper, and transparency pens. Because of its complete device control command set and dual interface - HP-IB (IEEE-488) and RS-232-C/CCITT V.24, the HP 7550A is adaptable to most system environments.

COMPUTER PERIPHERALS

8-pen Automatic Sheet Feed Plotter

Model 7550A (cont'd)

Technical Applications

The drawing quality, media flexibility, automatic sheet feed and fast plotting time of the HP 7550A make it ideal for quick working drawings or small format final drawings in computer-aided design, or for technical graphics in manufacturing, testing, or research and development. The HP 7550A is supported by many technical graphics software packages; the HP 7550A can draw A3/B-size check plots and working drawings to help relieve overburdened drafting plotters, produce quick, problem-solving graphs or engineering analyses, and plot charts and graphs on transparency film for technical presentations. And the HP 7550A does it all quickly and easily.

Business Applications

The HP 7550A is suited to business graphics users who appreciate the value of color hardcopy graphics, need quality graphics in quantity, and want a plotter that requires a minimum of operator supervision. Financial graphs, project schedules, forecasts and text charts are typical uses for a HP 7550A in a business environment. And both HP and non-HP graphics software packages make it easy for anyone to use the HP 7550A.

Software

Software support is available for the HP 7550A on many HP and non-HP computer systems, as well as HP and non-HP personal computers. In addition to HP's Industry Standard Plotting Package (see page 104, a variety of graphics packages for nonprogrammers is available. These software packages cover both business and technical applications. Complete information is available from any HP Sales and Support office.

Specifications

Media sizes: accommodates ISO A4 (210 x 297 mm), ANSI A (8.5 x 11 in.), ISO A3 (297 x 420 mm), and ANSI B (11 x 17 in.)

Maximum plotting area: pen axis, 254 mm (9.97 in.) for A/B, 272 mm (10.65 in.) for A4/A3; paper axis, 411 mm (16.12 in.) for B, 399 mm (15.65 in.) for A3, 196 mm (7.68 in.) for A, 190 mm (7.45 in.) for A4.

Resolution: smallest addressable step size is 0.025 mm (0.001 in.); mechanical resolution is 0.006 mm (0.00025 in.)

Repeatability: with a given pen, 0.1 mm (0.004 in.)

Pen Velocity: pen down, maximum, 80 cm/s (31.5 in./s) in increments of 1 cm/s, from the front panel 10 to 80 cm/s (4 to 31.5 in./s) in increments of 5 cm/s; pen up 80 cm/s (31.5 in./s)

Acceleration: maximum approximately 6 g's; programmable from 1 to 6 g's in increments of 1 g.

Pen force: 15 to 66 grams

Power requirements: source, 100, 120, 220, 240 V, -10%, +5%; frequency, 48 - 66 Hz; consumption, 100 W maximum

Interfaces: HP-IB implements the following HP-IB functions as defined in IEEE 488-1978: SH1, AH1, T6, L3, SR1, RL0, DC1, DT0, C0, PP0, for listen only, PP1 for address greater than 7, and PP2 for address of 7 or less, device address front panel selectable, default value - 5; RS-232-C/CCITT V.24, asynchronous serial ASCII with front panel selectable baud rates of 75, 110, 150, 200, 300, 600, 1200, 2400, and 9600, default value - 2400

Buffer size: default, 1024 bytes; from the program expandable to 12K bytes

Character sets: 20 sets, each in two character fonts, including, the following ISO registered sets: International Reference Version (002); United Kingdom (004), U.S. ASCII (006), Swedish (010), Swedish for Names (011), Katakana (013), JIS ASCII (014), Italian (015),

Portuguese (016), Spanish (017), German (021), French (025), Norwegian (060), Norwegian II (061), plus HP 9825 character set, French/German, Scandinavian, Spanish/Latin America, Special Symbols, and Roman 8 Extensions

Environmental range: operating, 0°C to 55°C; nonoperating, -40°C to 75°C; automatic sheet feeder, operating with paper, 10 - 40°C and 0 - 80% RH, with transparency film, 15 - 35°C and 25 - 75% RH

Size: height, 215 mm (8.5 in.); width, 670 mm (26.4 in.); depth with A4/A loading tray/no catcher, 432 mm (17.0 in.), A4/A loading tray with catcher, 682 mm (26.8 in.), A3/B loading tray/no catcher, 635 mm (25.0 in.), A3/B loading tray with catcher, 896 mm (35.3 in.)

Weight: net approximately 17.3 kg (38.0 lb), shipping approximately 25.0 kg (55.0 lb)

Pens: 8 per carousel: fiber-tip, roller-ball, and liquid-ink

Media: manual feed, chart paper, high-gloss paper, transparency film, vellum, double-matte polyester mylar film; automatic sheet-feed, chart paper and transparency film.

Accessories Supplied

| | HP Part Number |
|--|----------------|
| Interfacing and Programming Manual | 07550-90001 |
| Operation and Interconnection Guide | 07550-90002 |
| Pocket Guide | 07550-90003 |
| A4/A Media Loading Tray | 07550-60152 |
| A4/A Paper Catcher | 07550-40167 |
| Pen carousel for fiber-tip transparency pens | 07550-60050 |
| Pen carousel for fiber-tip paper pens | 07550-60051 |

A power cord and an assortment of fiber-tip pens, paper and transparency media are also supplied with the plotter. The media size and appropriate power cord are determined by destination. Drafting pens and drafting media are available; please refer to the Computer Users Catalog for a complete listing.

Ordering Information

| Interface cables | Price |
|---|-------|
| HP 17355D Male-female RS-232-C/CCITT V.24 cable for use in remote modem environments; pins 1-25 wired end-to-end | \$115 |
| HP 17255F Female-female RS-232-C/CCITT V.24 cable, adapted for use with IBM personal computer interface | \$50 |
| HP 17255D Male-female RS-232-C/CCITT V.24 cable, adapted for use with HP 150 personal computer interface | \$50 |
| HP 17855A RS-422-A adapter cable | \$200 |
| HP 10833A or 45529A HP-IB 1-metre cable; RFI shielded | \$81 |
| HP 10833A or 45529B HP-IB 2-metre cable; RFI shielded | \$91 |

Accessories Available

| | |
|---|-------|
| HP 17526A A3-size Media Handling Kit, including media loading tray, media catcher, 50 sheets A3-size plotter paper | \$160 |
| HP 17525A B-size Media Handling Kit, including media loading tray, media catcher, 50 sheets B-size plotter paper | \$160 |

HP 7550A Graphics Plotter

\$3900

COMPUTER PERIPHERALS

Eight-pen Drafting Plotters

Models 7580B, 7585B, 7586B

103



- HP 7580B accepts sheets up to ISO A1 (ANSI D)
- HP 7585B, 7586B accept sheets up to ISO AO (ANSI E)
- HP 7586B accepts rolls up to 919 mm (36.2 in.)
- New low prices
- Frame-to-frame long-axis plotting on HP 7586B
- HP-IB and RS-232-C/CCITT V.24 (switch selectable)

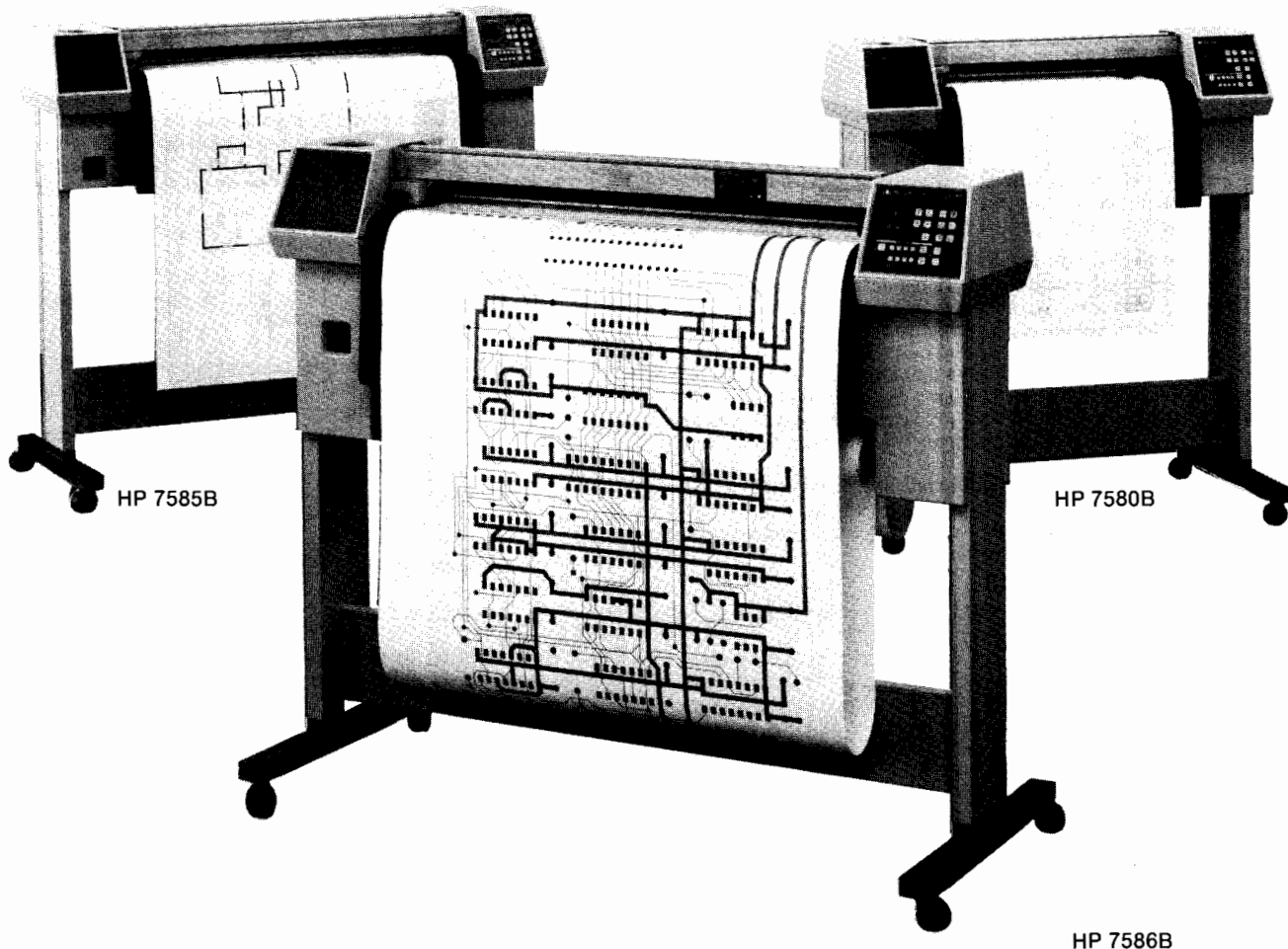

HP drafting plotters are built for the design professional. HP drafting plotters are reliable because designers depend on their plotters—and when the drafting plotter goes down, so does productivity. And HP drafting plotters are fast—because designers don't have time to sit around and wait for plots to finish. And they produce high quality drawings—because the quality of the plotter output reflects the quality of a designer's work.

HP offers an entire family of full-size, high-performance drafting plotters—the HP 7580, 7585, and 7586. The only difference between these plotters is media size. The HP 7580B accepts sheets ranging from ISO A4 through A1 (ANSI A through D). The HP 7585B accepts sheets ranging from ISO A4 through A0 (ANSI A through E). The HP 7586B is a combined single-sheet and roll-feed plotter. It accepts sheets ranging from ISO A4 through A0 (ANSI A through E), plus it plots on rolls in standard widths up to 919 mm (36.2 in.) and lengths up to 46 m (150 ft).

All three drafting plotters draw on individual sheets of paper, vellum, double-matte polyester film, and tracing bond. The HP 7586B also draws on rolls of paper, vellum and polyester film. Users have a choice of roller-ball, fiber-tip, and liquid-ink drafting pens in various colors and line widths. When not in use, pens rest in an eight-pen carousel and are capped automatically. Common uses in industry include computer-aided drafting; computer-aided design of printed circuit boards, integrated circuits, and mechanical parts; architectural or civil engineering design; and mapping applications.

Roll Feed Available on HP 7586B

The HP 7586B roll-feed plotter is designed for high volume, continuous feed, and long-axis plotting. With the HP 7586B, you can run large numbers of plots, then store them neatly on a roll or remove each plot as it is finished. The HP 7586B's frame-to-frame long-axis technique allows you to draw plots up to 46 m (150 ft). Long-axis plots are divided into sections and drawn one frame at a time. And the plotter automatically aligns each section to ensure the plot continues exactly where it left off.

Advanced Pen Control and Writing Systems

When a sheet is loaded, the HP drafting plotters automatically sense the sheet size and set the limits of pen motion. These plotters also sense which type of pen carousel has been loaded, and automatically choose the proper velocity, acceleration and pen force settings for the various ink and media combinations.

In addition, these plotters have an intelligent pen control system. On descent, pen motion is damped as the pen approaches the surface of the medium so that delicate pen tips are not damaged and pen bounce is minimized. Pens last longer and plotted lines are uniform from start to finish.

COMPUTER PERIPHERALS

Eight-pen Drafting Plotters (cont'd)

Models 7580B, 7585B, 7586B

High Quality Output

While the addressable resolution of the HP drafting plotters is excellent at 0.025 mm (0.001 in.), the pen and the drawing medium actually move on an even finer grid to create high quality lines. These movements are servo controlled with a mechanical resolution of 0.003 mm (0.00012 in.).

A microprocessor keeps pen velocity and acceleration constant regardless of direction so diagonal lines are the same quality as lines drawn parallel to the axes.

High Throughput

At 60 cm/s maximum velocity and 4 g's of acceleration, HP drafting plotters are fast. When a slower speed is required to accommodate a drawing medium, throughput remains high because pen-up movements are always executed at maximum speed, and pen lift delays are kept to a minimum because the pen is lifted slightly on small moves (as when labeling) and to maximum height only on long moves.

Simple, Powerful Command Set

Programming is easy using the Hewlett-Packard Graphics Language (HP-GL). The commands implemented on the plotters allow the user to draw lines, circles, arcs, to position labels, change character size, slant and direction, digitize, and more. They can rescale the plotting area in convenient user-defined units, rotate the plot 90 degrees, or "window" and plot only a portion of the original plot. Included in these commands are several area-fill instructions which make it easy to use patterns or solid coloring in wedges, rectangles, and polygons.

In addition, these plotters offer quality labeling. Each has 21 character sets in three fonts to provide the programmer with a large range of annotation capabilities including mapping symbols, special centered symbols, and foreign language characters.

Software Support

HP drafting plotters are supported on a number of application software packages for HP and non-HP computers.

For users of Industry Standard FORTRAN subroutines, a software package, HP-ISPP (Hewlett-Packard Industry Standard Plotting Package), is available. HP ISPP contains 15 graphics subroutines and can be easily installed on most ASCII-based systems that offer the equivalent of 32,000 16-bit words for user application program space.

Contact your HP sales representative for current software information.

Specifications

Media sizes

HP 7580B (sheets): minimum, 203 x 267 mm (8 x 10.5 in.); maximum, 622 x 1231.9 mm (24.5 in. x 48.5 in.); includes standard sizes A4/A, A3/B, A2/C, A1/D

HP 7585B and 7586B (sheets): minimum, 203 x 267 mm (8 x 10.5 in.); maximum 927 x 1231.9 mm (36.5 x 48.5 in.); includes standard sizes A4/A, A3/B, A2/C, A1/D, A0/E, excludes some nonstandard sizes between A3/B and A2/C

HP 7586B (rolls): width, 267 mm (10.5 in.) to 298 mm (11.75 in.) and 546 mm (21.5 in.) to 919 mm (36.2), length 46 meters (150 ft), roll core, inner diameter, 51 mm ± 1.6 mm (2.0 in.)

Maximum Plotting Area: Single sheets, drawing sheet less margins; roll media, roll width times frame length less margins; long-axis plotting, roll width less 30 mm (1.2 in.) margin times roll length.

Frame Lengths for Roll Media: Roll widths less than 298.5 mm (11.75 in.), 431.8 mm (17 in.); roll widths greater than 721.4 mm (28.4 in.), 1219.2 mm (48 in.); roll widths between 298.5 and 721.4 mm, 914.4 mm (36 in.)

Margins: Sheets, normal mode, three margins approx. 15 mm (.59 in.) each, fourth margin approx. 39 mm (1.5 in.); expand mode, three margins approx. 5 mm (.2 in.) each, fourth margin approx. 29 mm (1.1 in.)

Rolls, normal mode, 15 mm (.59) each side, expand mode, not recommended

Resolution: smallest addressable move, 0.025 mm (0.001 in.); mechanical resolution, 0.003 mm (0.00012 in.)

Repeatability (for a given pen): on paper, vellum, or 0.075 mm (0.003 in.) double-matte polyester film at 10-30 C: 0.10 mm (0.004 in.)

Endpoint Accuracy: on double-matte polyester film (3 mil) at 18-30°C, level floor: 0.1% of the move or 0.25 mm (0.0098 in.), whichever is greater.

Pen velocity: pen down, maximum: 60 cm/s (24 in./s) independent of vector direction; programmable: 1 to 60 cm/s in 1-cm increments (0.4 to 24 in./s); front panel selectable: 10 to 60 cm/s in 10-cm increments (4 to 24 in./s); front panel selectable: 10 to 60 cm/s in 10-cm increments (4 to 24 in./s). Pen up, 60 cm/s (24 in./s) independent of vector direction.

Acceleration: maximum, 4 g (39 m/s², 129 ft/s²); programmable, 1 to 4 g in 1-g increments (9.7 to 39 m/s², 32 to 128 ft/s²).

Pen force: programmable and front panel selectable: 10 to 66 grams in 8-gram increments.

Power requirements: source, 100, 120, 220, 240 V ~ -10%, +5%; frequency, 48-66 Hz single phase; consumption, 182 W max.

Interfaces (selectable from a rear-panel switch): HP-IB (IEEE 488-1978), implements the following HP-IB functions as defined in IEEE 488-1978: SH1, AH1, T6, L3, SR1, RL0, DC1, DT0, C0, PP0 for listen-only, PP1 for address greater than 7, and PP2 for address of 7 or less. For more on these codes, refer to the HP-IB section of this catalog.

RS-232-C/CCITT V.24, asynchronous serial ASCII with switch selectable baud rates of 50, 75, 110, 134.5, 150, 200, 300, 600, 1200, 1800, 2400, 3600, 4800, 7200 and 9600.

Buffer Size: 18,432 bytes

Environmental Range: operating: temperature, 0°C to 55°C, relative humidity, sheets, 5% to 95% (0°C to 40°C), rolls, 30% to 70% (10°C to 30°C); nonoperating: temperature, -40°C to 75°C

Size: HP 7580B, height, 1188 mm (46.8 in.), width, 1087 mm (42.8 in.), depth, 557 mm (21.9 in.)

HP 7585B and 7586B, height, 1188 mm (46.8 in.), width, 1392 mm (54.8 in.), depth, 557 mm (21.9 in.)

Weight: HP 7580B, net weight, 59.1 kg (130 lb), shipping weight, approx. 114 kg (250 lb)

HP 7585B, net weight, 70.4 kg (155 lb), shipping weight, approx. 131 kg (290 lb)

HP 7586B, net weight, 86.4 kg (190 lb), shipping weight, approx. 147.8 kg (325 lb)

Pens: 8 per carousel: fiber-tip, drafting, roller-ball.

Media: most standard paper, vellum, and double-matte polyester film, 3 or 4 mil thick.

Accessories Supplied

| | |
|---|-------------------------|
| Interfacing and Programming Manual | HP Part No. 07580-90034 |
| Operator's Manual | 07580-90033 |
| Programmer's Reference Card | 07580-90035 |
| 3 Pen Carousels | |
| Drafting pen carousel | 07580-60081 |
| Roller ball carousel | 07580-60082 |
| Fiber tip carousel | 07580-60035 |
| Male-to-male RS-232-C/CCITT V.24 cable | 17355M |
| An assortment of pens and various drawing media and cleaning supplies are also provided with the plotter. Drafting media and other plotter supplies are available from Hewlett-Packard. | |
| HP Drafting Supplies Catalog | 5957-4118 |

Ordering Information

| | |
|----------------------------------|-----------------------|
| HP 7580B Drafting Plotter | Price \$ 9,900 |
| HP 7585B Drafting Plotter | \$12,900 |
| HP 7586B Drafting Plotter | \$16,900 |

Options

| | |
|--|-------|
| 051 for use with HP 9000, Series 200 computers | N/C |
| 052 for use with HP Series 100 personal computers | N/C |
| 053 for use with HP 3000 computers | N/C |
| 058 for use with HP Series 80 personal computers | N/C |
| 059 for use with HP 9000, Series 500 computers | N/C |
| 060 for use with HP 1000 computers | N/C |
| 065 for use with non-HP computers | N/C |
| HP 17580BHP-ISPP Software (specify media option from Table 1) | \$300 |

Table 1

| No. | Media Options for HP-ISPP | Price |
|-----|--|-------|
| 001 | 800 BPI magnetic tape, 9-track, unlabeled, unblocked, 72 byte fixed-length records, ASCII character code | N/C |
| 002 | 1600 BPI magnetic tape, 9-track, unlabeled, unblocked, 72 byte fixed-length records, ASCII character code | N/C |
| 003 | Flexible diskette, single-sided, single-density, compatible with Digital Equipment Corporation RX01 dual drive used under RT-11 operating system | N/C |

COMPUTER PERIPHERALS

Color Film Recorder

Model 7510

105



- High-quality 35-mm slides
- Vector technology
- High-resolution output

- Multi-user capability
- Easy-to-use
- Dual interface, RS-232-C and HP-IB

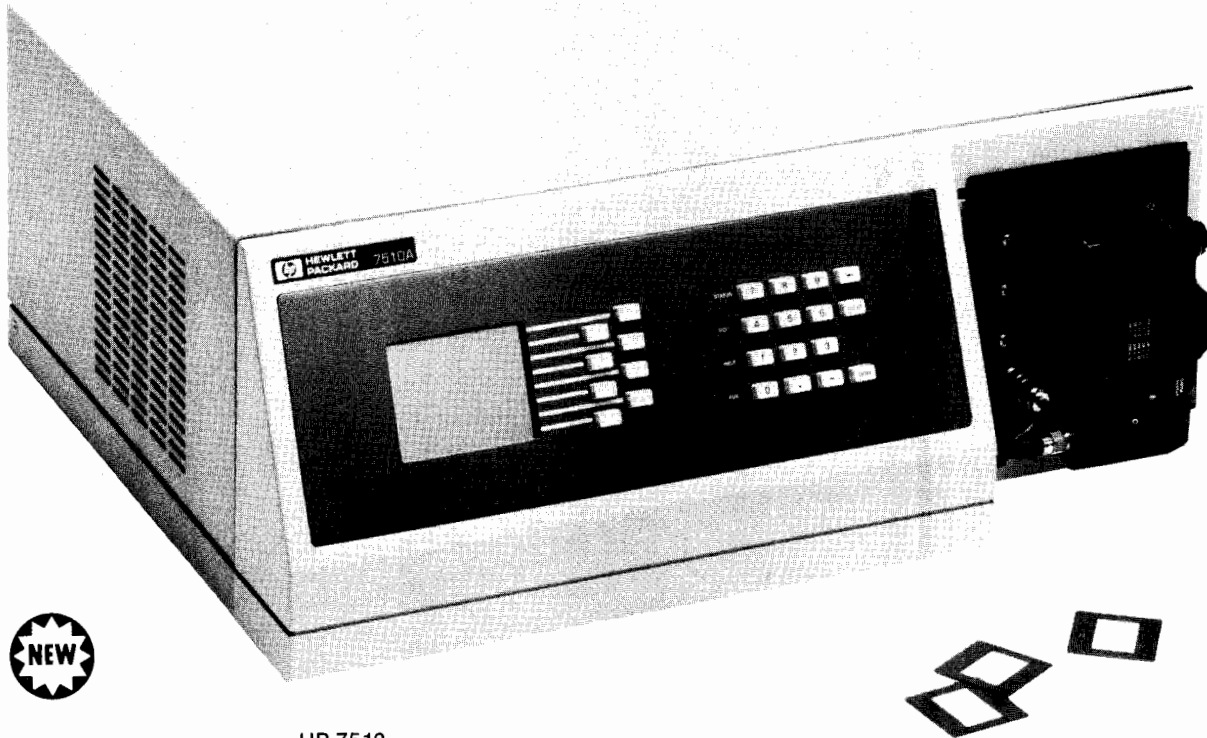

HP 7510

The HP 7510 color film recorder produces high-quality 35-mm slides for business and technical presentations. Bright, colorful slides help maximize audience impact and speaker credibility, and add polish to your presentation. And even with advanced capabilities, the HP 7510 is simple to use, and requires no technical or artistic expertise.

Highest Quality Slides

Nothing attracts and holds audience attention like high-resolution 35-mm slides. While most slide-making systems use raster technology or rely on screen resolution, the HP 7510 uses vector technology with a 16,322 line addressable resolution. That's so you get smooth curves and diagonal lines without "jaggies."

Camera Modules and Output Options

The HP 7510 comes with a 35-mm camera back that accommodates 35-mm slide and print film, and Polaroid instant slide film. Prints can be used to preview or proofread slides, as hardcopies to include in reports, or as visuals for your script or storyboard.

Two optional camera backs are available. One is a Polaroid camera back which accommodates instant print film. The other is a Kodak instant slide module which produces fully developed instant slides one at a time.

Variety of Color Choices

The HP 7510 uses a system of internal color filters that allow you to create charts and graphs using 16 million different colors. An easy-to-use, large liquid crystal display gives you access to color-coordinated palettes.

Ease Of Use

Using the HP 7510 requires no special expertise. Just turn the HP 7510 on, create your chart using graphics software, and load the film in the recorder. Everything else is automatic. All that is left for you to do is remove the results.

Convenience

An HP 7510 film recorder can take the panic out of last-minute presentations, fine-tuning, or periodic updates. With the HP 7510, you get same-day or even immediate results. Most slides can be recorded on film in a matter of minutes; after that, your 35-mm film can be sent to an overnight or one-hour developer. For rush jobs, you can use Polaroid instant slide film, or the optional Kodak instant slide camera module.

By using an HP 7510 instead of a slide-making service, you can keep confidential data confidential. If you have sales figures, or details about a new product, your information never has to leave your office.



COMPUTER PERIPHERALS

Color Film Recorder

Model 7510



Multi-user Capability

The HP 7510 color film recorder is designed to be a shared peripheral. A centrally located HP 7510 can receive input from many users so several departments can benefit from the use of slides. Because everything is automatic, there's no need for constant operator supervision.

Two Built-in Interfaces

To make interfacing easy, the HP 7510 comes with two built-in interfaces, RS-232-C/CCITT V.24 and HP-IB (IEEE-488-1978). It's compatible with most personal, mini, and mainframe computer systems. And the HP 7510 has two RS-232-C connectors, so it can be connected in series with a computer and terminal.

Sophisticated Features

If you plan to do your own programming, you'll appreciate the HP 7510's internal intelligence. The HP 7510 contains HP-GL (Hewlett-Packard Graphics Language) instructions that let you perform complex drawing tasks with minimal effort. Firmware features include film compensation curves, polygon fill, automatic film advance, exposure counter, and camera module sensing. To speed system communications, the HP 7510 features the powerful MC 68000 microprocessor.

Graphics Software

Because the HP 7510 uses vector technology, it accepts the vector output produced by most graphics software directly — eliminating the need for expensive vector-to-raster conversion cards.

The HP 7510 is supported by many of the same software packages that support HP's line of plotters. Contact the nearest HP sales and support office for specific information, or contact the vendor of your current graphics software for details about their support plans.

Specifications

Resolution: addressable points per frame, 16,344 x 10,896

Film supported: using supplied 35-mm camera module, 35-mm slide film — Kodachrome 25 and 64, Ektachrome 100 and 200, Polarachrome 40, Fujichrome 100 and 200, Agfachrome 100 and 200; 35-mm print films — Kodacolor 100, Fujicolor 100, Agfacolor 100; using optional Polaroid instant print camera module, Polaroid 331 and 339.



Environmental range: operating, 0°C to 55°C; non-operating, -40°C to 75°C

Interfaces: HP-IB (IEEE 488-1978) implements the following functions as defined in IEEE 488 — SH1, AH1, T6, L3, SR1, RL0, DC1, DT0, C0, PP2 for address 7 or less, PP1 for address greater than 7, and PP0; RS-232-C/CCITT V.24 asynchronous serial ASCII with switch selectable baud rates of 75, 110, 150, 200, 300, 600, 1200, 2400, 4800, 9600; 1024-byte buffer

Power requirements: source, 100, 120, 200, 240 V~ -10%, +5%; frequency, 48-66 Hz; 150 W maximum

Size: height, 215 mm (8.5 in.); width, 609 mm (24 in.); depth, 457 mm (18 in.)

Weight: net, 20.8 kg (46 lbs.); shipping, approx. 25 kg (55 lbs.)

FCC: FCC certified to limits sets for radio frequency interface when used with a class B computing device

Accessories Supplied

35-mm Camera Module
 HP 7510 Operating Manual
 Appropriate power cord, determined by destination
 Note: interface cables are not supplied with the film recorder. They must be ordered separately.

Part Number

HP 17510A
 07510-90902

Ordering Information

HP 7510 Color Film Recorder

Price

\$13,995

Options

| | |
|--|---------|
| HP 17510A 35-mm Camera Module (in addition to supplied module) | \$2,500 |
| HP 17515A Polaroid Instant Print Camera Module | \$1,600 |



- Sixteen user-definable softkeys
- Durable ceramic surface

- Direct tablet to display interaction
- Electrostatic platen technology

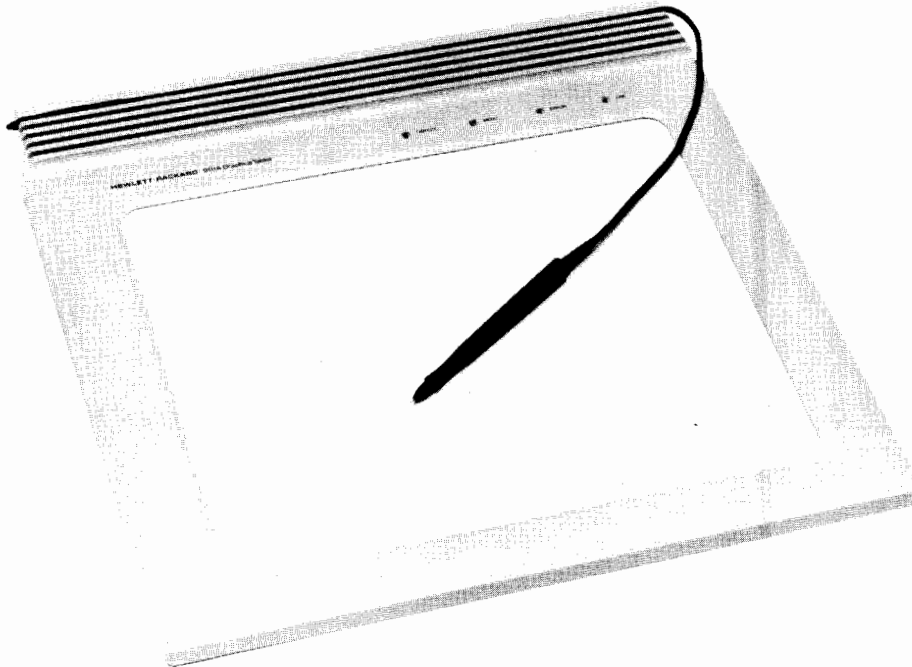

Hewlett-Packard's 9111A graphics tablet adds a new dimension to interactive graphics systems equipped with the HP-IB (IEEE-488) interface. With the tablet's cursor moving capability, the user can use single-point or continuous digitizing modes to create designs, to enter graphic data from source documents, or select information from a customized menu.

Programmable Capability

Twenty-seven HP-GL commands provide the user with precise control of all tablet functions. Two features of the 9111A which affect the rate of data transfer are programmable. The tablet update rate can range from a minimum of 1 to a maximum of 60 points per second. The maximum rate matches the refresh rate of most display screens, permitting smooth cursor movement. When the tablet is programmed by eliminating the overhead of ASCII conversion in the mainframe.

Sixteen softkeys can be programmed by the user. In addition, any portion of the active digitizing area can be defined as soft keys for increased menu selection capability.

Additional Features

The tablet is made of high quality durable materials which make it another superior Hewlett-Packard product. The platen's hard ceramic surface resists scratches and pits: the stylus is slim and lightweight with good tactile feedback on the switch position. Interchangeable inked and non-inked refills are available for the stylus. For audio feedback, the 9111A has a four-octave beeper which is programmable in tone, volume, and duration.

Software Tools

Graphics tablet system tools are available for use with the HP-85 computers. Basic language extensions and manual supplements are available as options for users of HP 9000 series 200 computers.

Specifications

Resolution: 0.100 mm (0.00394 in.)

Accuracy: ± 0.600 mm (0.0236 in.) at 20°C for each measured point, change of 0.004 mm for each °C deviation from 20°C

Repeatability: \pm resolution unit

Data rate: programmable from 1 to 60 coordinate pairs per second, actual rate ± 2 Hz from programmed rate

Active digitizing area: 218.5 x 300.8 mm (8.6" x 11.8"); can be extended to include the area occupied by the 16 softkeys

Document material: single sheet, electrically nonconductive, homogenous, less than 0.5 mm thick

Interface: HP-IB (IEEE 488-1978). Implements the following HP-IB functions as defined in IEEE 488-1978: SH1, AH1, T5, TE0, L4, LE0, SR1, RL0, PP2, DC1, DT0, C0

Power requirements: source: 100V, 120V, 220V, 240V, $\pm 10\%$ frequency: 48 to 66 Hz; consumption: 100 V/200 mA max, 120 V/165 mA max, 220 V/90 mA max, 240 V/80 mA max, 25 W max

Environmental range: 0° to 55°C, 5% to 90% RH (40°C)

Dimensions: 440 L x 440 W x 85 mm H (17.3" x 17.3" x 3.4")

Weight: net 5.8 kg (12.8 lb.). Shipping 10.8 kg (23.8 lb)

Ordering Information

| Option | HP Computer | Description | Price |
|--------|------------------------------|--|-------|
| 026 | HP 9000 Series 200 Model 226 | Supplements to BASIC Language Reference and BASIC Programming Techniques manuals; BASIC extensions | N/C |
| 036 | HP 9000 Series 200 Model 236 | Same as above | N/C |
| 045 | HP 9845B | System tutorial | N/C |
| 059 | HP 9000 Series 500 | For purposes of documentation | N/C |
| 085 | HP-85 | System tutorial and tools software | N/C |
| 086 | HP-86/87 | 9111A Graphics Tablet Programming Guide | N/C |
| 100 | HP 1000 | For purposes of documentation | N/C |
| 145 | HP 9845C | Sample program | N/C |

HP 9111A Graphics Tablet

\$2275



COMPUTER PERIPHERALS

Graphic Displays

Models 1345A, 1340A

- Digital (16-bit TTL) interface (HP 1345A)
- Random vector plotting (HP 1345A)
- Programmable intensity, speed, and line type (HP 1345A)

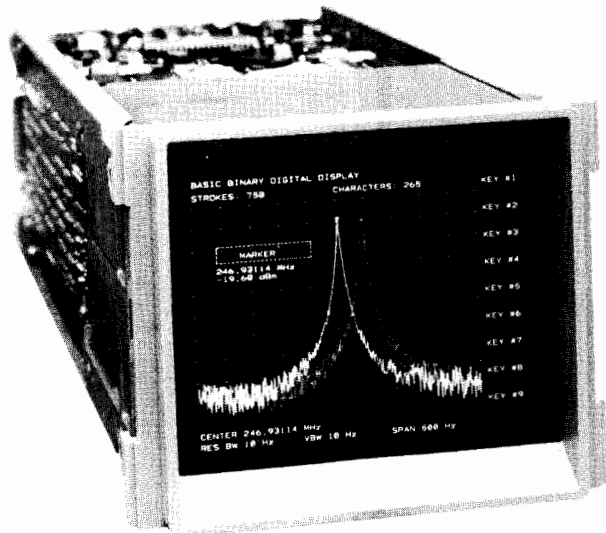

HP 1345A - high-speed, high-resolution graphics in a digital display.

High-speed, High-resolution CRT For OEM And End-user Applications

With the trend toward computer-controlled architecture and CRT graphics, HP's 1345A provides a 16-bit TTL interface, allowing it to be easily integrated into any instrument or system. Its electrostatic CRT supplies fast writing rates with high resolution and low power consumption.

With a 2048 x 2048 addressable resolution, the HP 1345A provides high-resolution graphics and a crisp, well-focused electron beam.

Digital Interface

The HP 1345A is a high-performance, digital-display module that generates and displays information derived from digital information received through its 16-bit TTL I/O port.

The 16-bit I/O allows you to digitally interface the HP 1345A to a microprocessor-based system. With the many peripheral interfacing adapters (PIAs) that are available, interfacing a digital system to an HP 1345A can be accomplished in a fraction of the time required for interfacing displays with analog inputs. The 16-bit I/O also operates with both 8-bit and 16-bit microprocessors, which assures compatibility with present and future instrument systems.

A Display for Measuring Instruments

In a spectrum analyzer, for example, the HP 1345A's high data acceptance and vector drawing rates allow complex traces to be generated as rapidly as new data is acquired.

Multiple programmable intensity levels can be used to differentiate between complex overlapping traces.

A Display For Medical Instruments

When used in medical instrumentation, the HP 1345A's high resolution ensures that it faithfully preserves input signals for accurate diagnosis when monitoring physiological parameters. The speed of the HP 1345A allows it to update an entire picture, even one with several waveforms displayed, in real-time as new data is acquired.

A Display for Mobile, Portable Equipment

The HP 1345A's light weight, low power requirement, and rugged construction make it ideal for mobile or portable equipment. The HP 1345A is a unitized structure, which is independently rugged without a cabinet.

OEM Cabinets

The HP 1345A can be easily integrated into almost any instrument or system console design. To simplify cabinet design, HP offers several OEM cabinets for the HP 1345A—these are attractively styled and accommodate circuitry for many applications.

- Designed for production test as well as monitoring and diagnostic systems (HP 1340A)
- Easy system integration

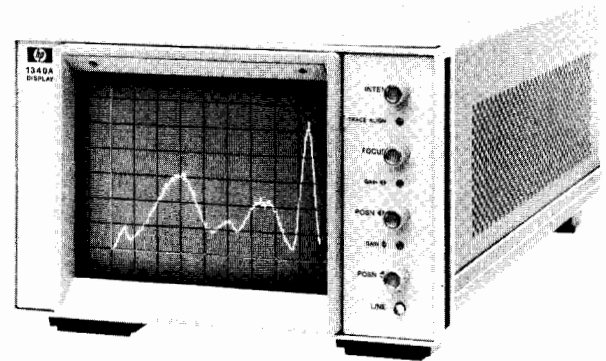

HP 1340A, option 315 - rugged analog display module in HP system II half-rack cabinet.

HP 1345A Features

| Interface | 16-bit TTL |
|--|------------------------------------|
| Viewing area | 12.5 x 9.6 cm (31.75 x 24.4 in) |
| Addressable resolution | 0-20247X 0-2047Y |
| OEM module without power supply | Yes |
| Fully self-contained peripheral | No |
| Random vector plotting | Yes |
| Programmable intensity, speed, and line type | Yes |

High-performance Plus Easy System Integration

The HP 1340A is an analog display module (15.3 cm/6 in) designed for production test and measurement systems as well as for analytical instrumentation.

Design Flexibility

The HP 1340A is a rugged display module that is easy to integrate into an instrument or system console. HP offers a variety of cabinet configurations for the HP 1340A, simplifying system design.

Its integrated circuits contain most of the X, Y, and Z amplifier components, ensuring high reliability. The X and Y attenuators, input impedance, polarity, and bandwidth limiting are internally switch-selectable.

Separate Control Panel

The HP 1340A has a separate control panel that can be located to suit the design. For simplicity in integrating the HP 1340A, its control functions are all dc inputs (0 to 5 V) to the IC amplifiers. The controls can be operated remotely from the HP 1340A, or you can order the HP 1340A without a control panel if you want to use your own controls.

Applications

The small space requirements of the HP 1340A and the light weight of dc-power option 002 make it ideal for airborne or system applications requiring minimum size and weight.

The HP 1340A's resolution, viewing area (114 cm²/17.7 in²), and brightness make it suitable for spectrum, network, and logic analyzers as well as for non-destructive test systems or instruments. It is also useful as a display for communication system analyzers, chemical and scientific analysis systems, and some medical diagnostic systems.

Ordering Information

HP 1345A digital display
HP 1340A analog display

Price

\$3600.
\$1800.



- New disposable drafting pens



Hewlett-Packard offers a complete line of pens, drawing media, and accessories, including pen holders, digitizing sites, drafting pen tips, and cleaning aids. And all these supplies are manufactured in the HP tradition of quality — quality that you'll see reflected in your work.

Disposable Drafting Pens

These pens are designed especially for preliminary drawings on paper or final drawings on vellum. Disposable drafting pens come in two widths and four colors. They have stainless steel tips, are easy to use, and require no cleaning or refilling.

Thirty-pen Organizers

This 6-inch modular organizer stores up to 30 short-body or long-body pens. They're stackable, so you can mix and match according to your needs. The pens are held securely in place by a high-density foam. The organizer is made of sturdy, smoked acrylic. In addition, HP offers a 33-pen "personal" organizer for fiber-tip, roller-ball, and short-body drafting pens — so HP has a pen organizer for every need.

Pens and Media

HP offers four different types of pens and six different types of media so you can select the pen/media combination that's right for your application. Fiber-tip pens are available for both paper and transparency film. Roller-ball pens come in four colors. And in addition to disposable drafting pens, HP offers long-body and short-body drafting pens in six standard tip widths.

Sheets of plotter paper, both regular and glossy, tracing bond, vellum, polyester film, and overhead transparency film are available in a range of standard sizes, both English and metric. Polyester film, vellum, and regular paper come in 914.4 mm (36 in.) and 609.6 mm (24 in.) rolls for use with the HP 7586B roll-feed drafting plotter.

- New pen organizers



For small ISO A4- and ANSI A-size graphics needs, supplies may be ordered in convenient kits. Overhead transparency kits and a paper and pen kit are available.

Ordering Information

Plotter supplies may be ordered from any HP sales and support office, from your local retail dealer, or through HP's direct telephone ordering service. The HP Computer User's Catalog (P/N 5953-2450) describes the complete range of plotter supplies and accessories.

For Best Results

| | Paper | Glossy Paper Transparency Film | Tracing Bond | Vellum | Polyester Film |
|----------------------------------|--|-----------------------------------|--|--|--|
| Fiber-tip pens (paper) | HP 7470 HP 7475 HP 7550 HP 7580 HP 7585 HP 7586 | | | | |
| Fiber-tip pens (transparency) | | HP 7470 HP 7475 HP 7550 | | | |
| Roller-ball pens | | | HP 7550 HP 7580 HP 7585 HP 7586 | | |
| Disposable drafting Pens | HP 7550 HP 7580 HP 7585 HP 7586 | | | HP 7550 HP 7580 HP 7585 HP 7586 | |
| Refillable drafting pens | | | | HP 7550 HP 7580 HP 7585 HP 7586 | HP 7550 HP 7580 HP 7585 HP 7586 |



COMPUTER PERIPHERALS

Commercial Computer Peripherals

Interfacing Summary

HP Commercial Computer Interfacing Summary¹

This table shows peripherals that can be connected to many Hewlett-Packard commercial computers. Information about EMI compliance

and support of a specific system is available from a Hewlett-Packard sales office in your area.

Peripherals

Commercial Computers

| | See Page | HP 250/260 | | HP 3000s | | | | | | | | | |
|------------------------------|----------|------------|--------|----------|------|------|----|------|----|----|----|----|----|
| | | HP 250 | HP 260 | Series | 30R/ | 37/ | | 40/ | | | | | |
| | | | | IIIR | 33R | 37XE | 39 | 40SX | 42 | 44 | 48 | 64 | 68 |
| Personal Mass Storage | | | | | | | | | | | | | |
| HP 9144A | 89 | | | | | • | • | • | • | • | • | • | • |
| System Storage | | | | | | | | | | | | | |
| HP 7941A | 90 | • | • | | | | | | | | | | |
| HP 7945A | 90 | • | • | | | •* | •* | •* | •* | •* | •* | •* | •* |
| HP 7933/35H | 92 | | | • | • | • | • | • | • | • | • | • | • |
| HP 7942A | 90 | • | • | | | | | | | | | | |
| HP 7946A | 90 | • | • | | | | | | | | | | |
| HP 7911/12 | 91 | • | • | | • | | • | • | • | • | • | • | • |
| HP 7914 | 91 | | | | | • | • | • | • | • | • | • | • |
| HP 7914TD | 91 | | | | | | • | • | • | • | • | • | • |
| HP 7914ST | 91 | | | | | • | • | • | • | • | • | • | • |
| HP 7914CT | 91 | | | | | • | • | | • | | • | | • |
| Tape Drives | | | | | | | | | | | | | |
| HP 7974A | 93 | | | | | • | • | • | • | • | • | • | • |
| HP 7978B | 93 | | | | | • | • | • | • | • | • | • | • |
| HP 7970E | 93 | | | • | • | • | • | • | • | • | • | • | • |
| Workstation Printers | | | | | | | | | | | | | |
| HP 2225A/B/C/D ThinkJet | 95 | • | • | | | | | | | | | | |
| HP 2932/34A | 95 | • | • | | • | • | • | • | • | • | • | • | • |
| HP 2601A | 95 | • | • | • | • | • | • | • | • | • | • | • | • |
| HP 2686 LaserJet | 94 | • | • | | | • | • | • | • | • | • | • | • |
| System Printers | | | | | | | | | | | | | |
| HP 2563A | 94 | • | • | • | • | • | • | • | • | • | • | • | • |
| HP 2565/66A | 94 | | | • | | • | • | • | • | • | • | • | • |
| HP 2688A | 94 | | | | | • | • | • | • | • | • | • | • |
| HP 2680A | 94 | | | | • | • | • | • | • | • | • | • | • |
| HP 2685B | 94 | | | | | • | • | • | • | • | • | • | • |
| Plotters | | | | | | | | | | | | | |
| HP 7470A | 99 | • | • | • | • | • | • | • | • | • | • | • | • |
| HP 7475A | 100 | • | • | • | • | • | • | • | • | • | • | • | • |
| HP 7550A | 101 | • | • | • | • | • | • | • | • | • | • | • | • |
| HP 7580B | 103 | | | • | • | • | • | • | • | • | • | • | • |
| HP 7585B | 103 | | | • | • | • | • | • | • | • | • | • | • |
| HP 7586B | 103 | | | • | • | • | • | • | • | • | • | • | • |
| Tablets | | | | | | | | | | | | | |
| HP 9111A | 107 | | | •* | •* | •* | •* | •* | •* | •* | •* | •* | •* |
| HP 17623A | 107 | | | •* | •* | •* | •* | •* | •* | •* | •* | •* | •* |

¹This abbreviated interfacing summary is designed as a quick reference guide for peripherals supported on HP's commercial systems. Since configuring peripherals on systems can involve specific cabling, I/O board and operating system requirements as well as software support issues, consult your HP sales representative or authorized dealer before making a final selection. Use this interfacing summary as a guideline ONLY. Data is subject to change without notice.

*Special requirements or device limitations are involved in this configuration. Consult your HP sales representative or authorized dealer for details.

COMPUTER PERIPHERALS

Personal & Portable Computer Peripherals

Interfacing Summary

111



HP Personal & Portable Computer Interfacing Summary¹

This table shows peripherals that can be connected to many Hewlett-Packard personal & portable computers. Information about EMI

compliance and support of a specific system is available from a Hewlett-Packard sales office in your area.

Peripherals Personal & Portable Computers

| | See Page | Series 80 | | | The Portable | The Integral | Series 100 | | |
|------------------------------|----------|-----------|----|----|--------------|--------------|-------------|----------------|--------------------|
| | | 85 | 86 | 87 | | | Touchscreen | Touchscreen II | Touchscreen MAX II |
| Personal Mass Storage | | | | | | | | | |
| HP 9122D/S | 89 | •* | •* | •* | • | • | • | • | • |
| HP 9114A | 89 | | | | • | | | | |
| HP 9125S | 89 | | | | • | | • | | • |
| HP 9154A | 89 | •* | •* | •* | • | • | | • | • |
| HP 9134H | 89 | •* | •* | •* | • | • | | • | • |
| HP 9153A | 89 | •* | •* | •* | • | • | | • | • |
| HP 9133H | 89 | •* | •* | •* | • | • | | • | • |
| HP 9144A | 93 | | | | | | • | • | • |
| HP 9142A | 89 | | | | | | • | • | • |
| Workstation Printers | | | | | | | | | |
| HP 2225A/B/C/D ThinkJet | 95 | • | • | • | • | • | • | • | • |
| HP 82906A | 95 | • | • | • | • | • | • | • | • |
| HP 2671G/73A | 95 | • | • | • | • | • | | | • |
| HP 2932/34A | 95 | • | • | • | • | • | | | • |
| HP 2601A | 95 | • | • | • | • | • | | | • |
| HP 2686 LaserJet | 94 | | | | • | • | • | • | • |
| Plotters | | | | | | | | | |
| HP 7470A | 99 | • | • | • | • | • | • | • | • |
| HP 7475A | 100 | | • | • | • | • | • | • | • |
| HP 7550A | 101 | | • | • | • | • | • | • | • |
| HP 7580B | 103 | | • | • | • | • | • | • | • |
| HP 7585B | 103 | | • | • | • | • | • | • | • |
| Tablets | | | | | | | | | |
| HP 9111A | 107 | • | | • | | | | | |

••• supported

| | See Page | IBM | | | | Apple | | | | DEC | | | AT&T | TI | Wang | |
|------------------------------|----------|-----|----|----|------|-------|-----|-----|------------|-----|---------|----------|---------|----|------|---------|
| | | PC | XT | AT | PCjr | Ile | Ilc | III | Mac-Intosh | 100 | 350 PRO | Rain-bow | PC 6300 | | | Com-paq |
| Personal Mass Storage | | | | | | | | | | | | | | | | |
| HP 9114A | 89 | • | • | | | | | | | | | | | | | |
| HP 9154A | 89 | •* | •* | •* | | | | | | | | | | •* | | |
| HP 9134H | 89 | •* | •* | •* | | | | | | | | | | •* | | |
| HP 9142A | 89 | •* | •* | •* | | | | | | | | | | •* | | |
| Workstation Printers | | | | | | | | | | | | | | | | |
| HP 2225A/B/C/D ThinkJet | 95 | • | • | • | • | • | • | • | • | | | | • | • | • | |
| HP 2686 LaserJet | 94 | • | • | • | • | • | • | • | •* | | | • | • | • | | |
| Plotters | | | | | | | | | | | | | | | | |
| HP 7470A | 99 | • | • | • | • | • | • | • | • | • | • | • | • | • | • | • |
| HP 7475A | 100 | • | • | • | • | • | • | • | • | • | • | • | • | • | • | • |
| HP 7550A | 101 | • | • | • | • | • | • | • | • | • | • | • | • | • | • | • |
| HP 7580B | 103 | • | • | • | • | • | • | • | • | • | • | • | • | • | • | • |
| HP 7585B | 103 | • | • | • | • | • | • | • | • | • | • | • | • | • | • | • |
| HP 7586B | 103 | • | • | • | • | • | • | • | • | • | • | • | • | • | • | • |

¹This abbreviated interfacing summary is designed as a quick reference guide for peripherals supported on HP's commercial systems. Since configuring peripherals on systems can involve specific cabling, I/O board and operating system requirements as well as software support issues, consult your HP sales representative or authorized dealer before making a final selection. Use this interfacing summary as a guideline ONLY. Data is subject to change without notice.

*Special requirements or device limitations are involved in this configuration. Consult your HP sales representative or authorized dealer for details.



HEWLETT-PACKARD INTERFACE BUS

Versatile Interconnect System for Instruments and Controllers

General Information

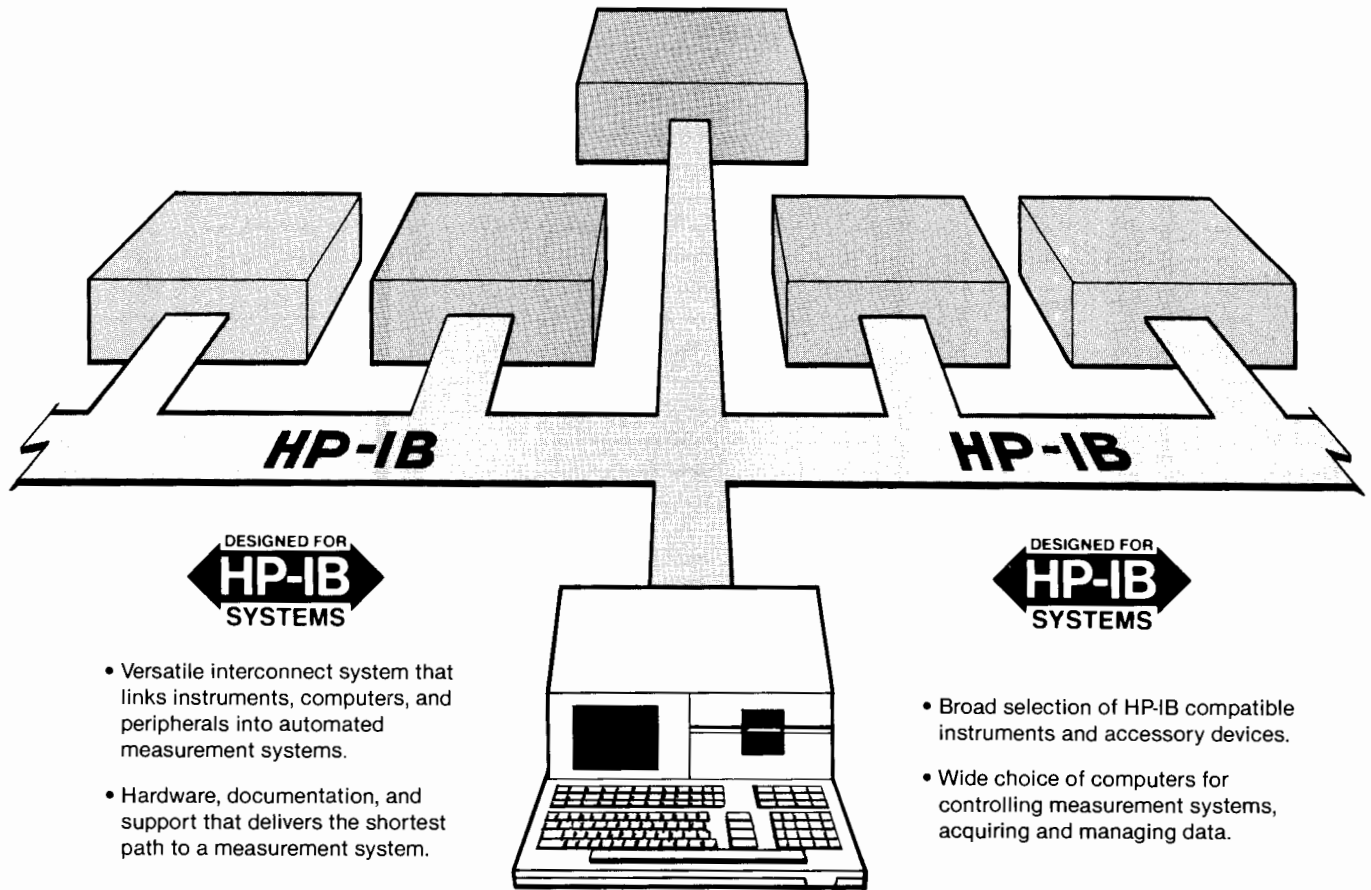

Advantages of HP-IB Systems

There are many applications where the measurement power of interactive instruments can be further enhanced by coupling them to desktop or minicomputers. Operating in a remote mode can provide more exact, error-corrected results as compared with conventional manual operation techniques.

Presently, three major parameters combine to reduce significantly the engineering development costs of configuring measurement systems:

1. The Hewlett-Packard Interface Bus, also known as "HP-IB";
2. Distributed computing through the growing number of "smart" instruments with internal microprocessors;
3. The broad choice of computers ranging from "friendly", easy-to-program desktop computers to more sophisticated computer systems capable of managing multi-station instrument clusters and complex data bases.

Relationship Between HP-IB and Other Interface Standards

Hewlett-Packard is committed to the overall advancement of measurement technology and has for some time been working on the problems of simplifying and standardizing means of instrumentation interfacing. An example of such an effort is the intimate involvement with the HP-IB from its conception at HP to its present status as a world instrumentation interface standard (IEEE 488-1978 and IEC 625-1).

In mid-1972, Hewlett-Packard began to participate in various international standardization bodies. The U.S. Advisory Committee, composed of diverse interests represented by both users and manufacturers, first established initial goals, then adopted the interface concept utilized by the HP Interface Bus as an appropriate starting point. A draft document was subsequently written and evaluated by members of the Committee, then submitted as the U.S. Proposal to the IEC (International Electrotechnical

Commission) Working Group in the autumn of 1972. Since then, the interface definition has undergone a number of minor changes to accommodate various needs at the international level.

In September 1974, the parent technical committee, IEC TC66, approved the main interface draft document for a formal ballot among the member nations of the IEC. Balloting took place in 1976, and IEC recommendation 625-1 was adopted. The IEC recommendation, using a different connector, is totally compatible with the present definition of the HP-IB.

Meanwhile, the IEEE Standards Board approved IEEE Standard 488-1975 "Digital Interface for Programmable Instrumentation", first published in 1975 and again published in 1978 with minor editorial changes as IEEE Standard 488-1978. The IEEE standard is also fully compatible with the HP-IB. In January 1976, the American National Standards Institute adopted the

IEEE Standard and published it initially as ANSI Standard MC 1.1.

The standardized interface concept is now widely accepted. Hundreds of manufacturers in more than fourteen countries offer thousands of products that use the HP-IB concepts articulated in IEEE-488. As more instrumentation interface standards evolve from the HP-IB, we will clearly indicate the relationship of the Hewlett-Packard Interface Bus to those standards, just as we have done with ANSI/IEEE Standard 488 and IEC Publication 625-1.

Why the HP Interface Bus Name?

As the list of HP products available with the "new digital interface" grew, our customers sought a convenient way to identify those products having the interface capability. In response, in 1974 we adopted the name "Hewlett-Packard Interface Bus" or simply "HP-IB". We will continue to use the identifying name and this symbol:



Both are used with appropriate HP products so that their interface capabilities may be readily identified.

The Hewlett-Packard Interface Bus fully complies with IEEE Standard 488. As such, it incorporates the mechanical, electrical and functional specifications of the Standard. A fourth and vital element of any interface system is the operational aspect of a product at both the human-machine interface and machine-machine interface at the HP-IB port. HP-IB capability provides additional user

benefits that are beyond the scope of IEEE Standard 488. Typical user conveniences include high-level language implementation of interface functions, underscored program codes on the front panel of the instruments for easy programming, convenient data output formats, and designed-in "Learn Mode" capabilities. In addition, we provide complete support documentation in the form of programming and interfacing guides, application notes and operation manuals that illustrate the added benefits for users of products with HP-IB capability.

Single-Source Systems Approach

The decision to use a "system" instead of conventional manual methods must be based on an engineering evaluation of benefits versus costs. The many benefits associated with a systems approach include:

- More consistent results in repeated measurements—a system is not subject to operator fatigue.
- Greater throughput because systems are generally faster.
- More thorough testing because system speed allows more parameters to be measured in a shorter time.
- Results expressed in engineering or scientific units, because many systems controllers are capable of on-line data manipulation.
- Greater accuracy because system errors can be measured automatically, stored and accounted for in the results.
- "Adaptive" data acquisition wherein a system can be programmed to branch to other measurements to help pinpoint when it senses an abnormal condition.
- Measurement results can be stored in computer memory or on hard copy.



This HP 8957S Cellular Radio Test Set shows how a specific need can be met by combining specialized and multipurpose instruments, interconnecting them via HP-IB, and controlling them with a desktop computer.

It is our objective to make the integration of instrumentation systems easier by providing instruments and computers designed for systems applications. Computers are designed with HP-IB options that allow easy hook-up to the bus and incorporate easy-to-use bus commands in their software. HP's policy when designing HP-IB compatible instruments is to eliminate interfacing ambiguities associated with controllers and instruments operating per the ANSI/IEEE and IEC standards by adopting guidelines consistent interface design.

Proper training on system components is very important for efficient use of any interface system. Therefore, we offer training at sales and service offices worldwide on HP desktop computers, computer systems and instruments as they relate to the HP-IB. In the area of HP-IB support documentation, we offer general interface technical descriptions, Operating and Service Manuals with programming information, Instrument/Controller Introductory Operating Guides, Quick Reference Guides and Application Notes.

Technical assistance during system development is available at most local HP sales and service offices from resident systems engineers who specialize in desktop computers, computer systems and instruments.

How the HP Interface Bus Operates

All active interface circuitry is contained within the various HP-IB devices, and the interconnecting cable (containing 16 signal lines) is entirely passive. The cable's role is

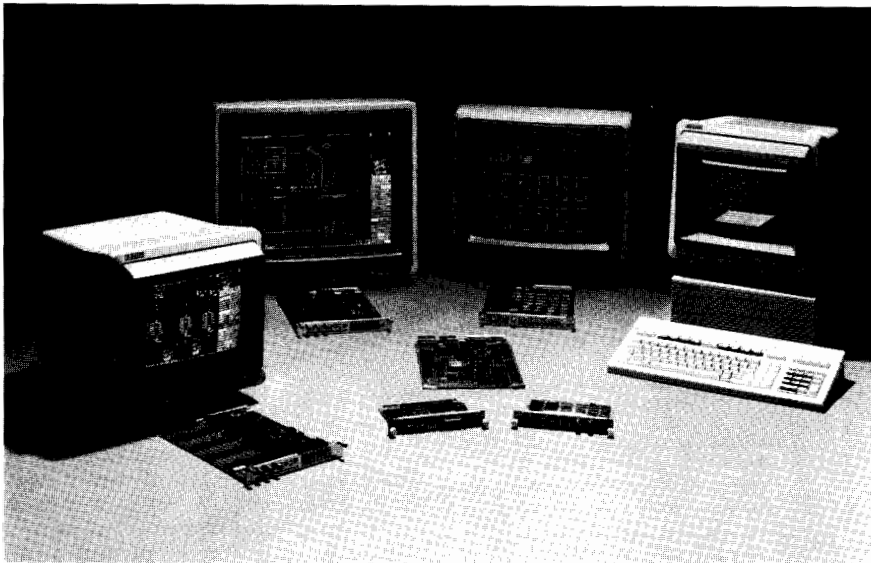

The HP 9000 family of technical workstations offers an extensive line of HP-IB system controllers in its Series 200 and Series 500 computers. The newest member of the family, the Series 300 shown here, broadens this line with new flexibility and upgradability. Series 300 offers two system processing units, four monitor options, and two other display options. All Series 300 components are compatible, so there is no need to modify software when changing monitors or SPUs.



HEWLETT-PACKARD INTERFACE BUS

Versatile Interconnect System for Instruments and Controllers



General Information

limited to that of interconnecting all devices in parallel so that any one device may transfer data to one or more other participating devices.

Every participating device (instrument, controller, accessory module) must be able to perform at least one of the roles of TALKER, LISTENER or CONTROLLER. A TALKER can transmit data to other devices via the bus, and a LISTENER can receive data from other devices via the bus. Some devices can perform both roles (e.g., a programmable instrument can LISTEN to receive its control instructions and TALK to send its measurement results).

A minimum HP-IB system consists of one TALKER and one LISTENER, without a CONTROLLER. In this configuration, data transfer is limited to direct transfer between one device manually set to "talk only" and one or more devices manually set to "listen only" (e.g., a measuring instrument talking to a printer for semi-automatic data logging).

A CONTROLLER manages the operation of the bus system primarily by designating which devices are to send and receive data, and it may also command specific actions within other devices.

The full flexibility and power of the HP-IB become more apparent, however, when one device that can serve as CONTROLLER/TALKER/LISTENER (e.g., calculator or computer) is interconnected with other devices that may be either TALKERS or LISTENERS, or both (e.g., frequency synthesizers, counters, power meters, relay actuators, displays, printers, etc.), depending on the application. An HP-IB controller participates in the measurement by being programmed to schedule measurement tasks, set up individual devices so that they can perform these tasks, monitor the progress of the measurement as it proceeds, and interpret the results of the measurement. HP offers controllers that can be programmed in high-level languages such as BASIC, FORTRAN, HPL, and Pascal.

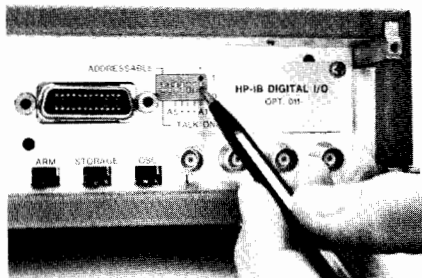

Rear panel switches are set so instrument will either be addressable by controller in a multi-device system, or will simply "talk only" to another device such as a printer.

HP-IB Connections and Structure

The HP-IB has a party-line structure where all devices on the bus are connected in parallel. The 16 signal lines within the passive interconnecting HP-IB cable are grouped into three clusters according to their functions:

1. Data Bus (8 signal lines)
2. Data Byte Transfer Control Bus (3 signal lines)
3. General Interface Management Bus (5 signal lines).

The DATA BUS consists of eight signal lines that carry data in bit-parallel, byte-serial format across the interface. These signal lines carry addresses, program data, measurement data, universal commands and status bytes to and from devices interconnected in a system. Identification of the type of data present on the DIO signal lines is indicated by the ATN (attention) signal. When the ATN signal is true (asserted), either addresses or universal commands are present on the data bus and all connected devices are required to monitor the DIO lines. When the ATN message is false, device-dependent data (e.g., programming data) is carried between devices previously addressed to talk and listen.

Transfer of each byte on the Data Bus is accomplished via a set of three signal lines: DAV (data valid), NRFD (not ready for da-

ta), and NDAC (not data accepted). These signals operate in an interlocked handshake mode. Two signal lines, NRFD and NDAC, are each connected in a logical AND (wired OR) to all devices connected to the interface. The DAV signal is sent by the talker and received by potential listeners whereas the NRFD and NDAC signals are sent by potential listeners and received by the talker.

The General Interface Management Lines manage the bus to effect an orderly flow of messages. The IFC (interface clear) message places the interface system in a known quiescent state. SRQ (service request) is used by a device to indicate the need for attention or service and to request an interruption of the current sequence of events. REN (remote enable) is used to select between two alternate sources of device program data. EOI (end or identify) is used to indicate the end of a multiple byte transfer sequence or, in conjunction with ATN, to execute a polling sequence.

It is not possible in this limited space to go into detail on each signal line's role. But you should note that every HP-IB device need not be able to respond to all the lines. As a practical and cost-effective matter, each HP-IB device usually responds only to those lines that are pertinent to its typical function on the bus. (Details are covered in each device's operating manual.)

HP-IB Training and Support

To assist you in configuring HP-IB measurement systems, Hewlett-Packard has field sales people trained in electronic instruments, desktop computers and computer systems. Also available for technical consultation are computing controller systems engineers and HP-IB instrumentation specialists.

HP-IB training courses on HP-IB controllers and instruments are listed below. Courses are conducted at a convenient HP location. Some courses can be taught at your site with special arrangements.

- HP-IB Instrument System Training With HP Model 26 Controllers 4 days
- HP-IB Instrument Programming With HP 1000E/F Series Controllers 4 days
- Instrument Interface with HP-IB 4 days

Service and Warranty Considerations

Hewlett-Packard has dedicated measurement system service people who perform on-site maintenance of HP instrumentation on customer-configured systems as well as HP-configured systems. Service contract coverage is available to meet your specific measurement system service needs and can be tailored to include extended warranty, calibration and extended hours of coverage. Contact your local sales and service office for further information on HP-IB service contract information.

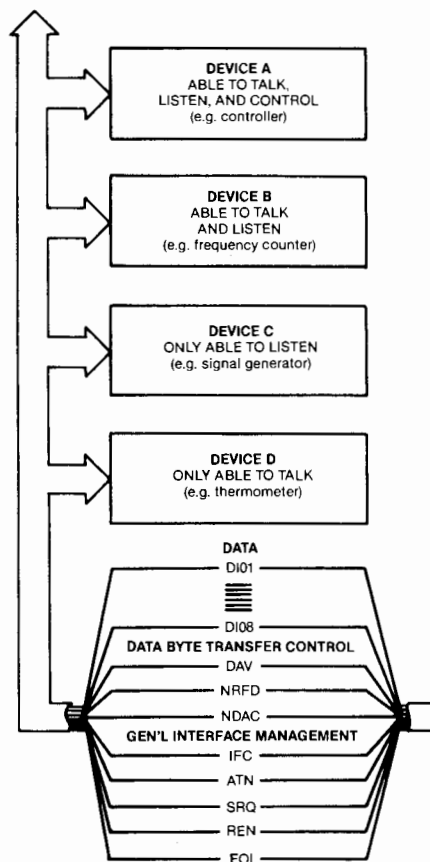

Interface connections and bus structure.

Every HP-IB device and HP-configured system carries a standard Hewlett-Packard warranty appropriate to that product. The warranty period for each product will be provided on request at the time of sale and is specified in documentation supplied with the product. HP takes responsibility for standard HP-IB systems performing as specified. However, software or interfacing that has not been provided by Hewlett-Packard as part of a standard system delivered by HP is not covered by this warranty.

In all cases, overall operational responsibility for those HP-IB systems assembled by a customer from individual HP-IB devices rests with the customer.

HP-IB Specifications Summary

Interconnect Devices

Up to 15 maximum on one contiguous bus.

Interconnection Path

Star or linear bus network; total transmission path length 2 metres times number of devices or 20 metres, whichever is less. Operating distances can be extended; see pages 124 and 125.

Message Transfer Scheme

Byte-serial, bit-parallel asynchronous data transfer using locked 3-wire handshake technique.

Data Rate

One megabyte per second maximum over limited distance; 250-500 Kbytes per second typical over full transmission path (actual data rate depends on individual device characteristics).

Address Capability

Primary addresses, 31 TALK and 31 LISTEN; secondary (2-byte) addresses, 961 TALK and 961 LISTEN. Maximum of 1 TALKER and up to 14 LISTENERS at a time.

Control Shift

In systems with more than one controller, only one can be active at a time. A currently active controller can pass control to another, but only designated system controller can assume control over others.

Interface Circuits

Driver and receiver circuits are TTL-compatible.

HP-IB Interface Functions

HP-IB functions are the predefined capabilities that can be designed into an HP-IB device. These capabilities and their alphanumeric codes are summarized in the table. Because the codes completely describe interface capability and are therefore particularly useful to system designers and specifiers, they are more and more frequently appearing in technical data and on system components. On HP system-ready products they are listed near the HP-IB connector, and they are included in the specifications for most of the HP-IB products in this catalog.

Connector Lock Screw Compatibility

HP-IB products delivered now and in recent years are equipped with connectors having ISO *metric-threaded* lock screws and stud mounts. Very early HP-IB products have non-metric parts, but are readily distinguished from the metric by color: metric-threaded parts are black, whereas non-metric parts have a shiny nickel finish. HP-IB Metric Conversion Kit (HP P/N 5060-0138) is available to convert these early instruments.

Reference Publications

- *Tutorial Description of the Hewlett-Packard Interface Bus*. This 94-page reference chronicles the development of byte-serial, bit-parallel interface system stan-

dards, describes their relationship to HP-IB, presents a working overview of HP-IB, and includes useful information such as suggestions for improving software performance and verification programs. Free copies are available from your nearest HP office. Ask for publication number 5952-0156.

- *ANSI/IEEE-488-1978, Digital Interface for Programmable Instrumentation*, published by the Institute of Electrical and Electronics Engineers, 345 East 47th Street, New York, NY 10017.
- *IEC 625-1, An Interface System for Programmable Measuring Apparatus (Byte Serial Bit Parallel)*, published by the International Electrotechnical Commission, 1 rue de Varembe, 1211 Geneva 20, Switzerland.

Interface Capability Codes for HP Products

| Interface Function | Basic Code | Capability Code |
|------------------------------|------------|--|
| Source Handshake | SH | SH0 No capability |
| | | SH1 Full capability |
| Acceptor Handshake | AH | AH0 No capability |
| | | AH1 Full capability |
| Talker (Extended Talker) | T(TE) | T(TE)0 No capability |
| | | T(TE)1 Basic talker, serial poll, talk only |
| | | T(TE)2 Basic talker, serial poll |
| | | T(TE)3 Basic talker, talk only |
| | | T(TE)4 Basic talker |
| | | T(TE)5 Basic talker, serial poll, talk only, unaddresses if MLA ¹ |
| | | T(TE)6 Basic talker, serial poll, unaddresses if MLA ¹ |
| | | T(TE)7 Basic talker, talk only, unaddresses if MLA ¹ |
| Listener (Extended Listener) | L(LE) | L(LE)0 No capability |
| | | L(LE)1 Basic listener, listen only |
| | | L(LE)2 Basic listener |
| | | L(LE)3 Basic listener, listen only, unaddresses if MTA ² |
| | | L(LE)4 Basic listener, unaddresses if MTA ² |
| Service Request | SR | SR0 No capability |
| | | SR1 Full capability |
| Remote Local | RL | RL0 No capability |
| | | RL1 Full capability |
| | | RL2 No local lockout |
| Parallel Poll | PP | PP0 No capability |
| | | PP1 Remote configuration |
| | | PP2 Local configuration |
| Device Clear | DC | DC0 No capability |
| | | DC1 Full capability |
| | | DC2 Omit selective device clear |
| Device Trigger | DT | DT0 No capability |
| | | DT1 Full capability |
| Driver Electronics | E | E1 Open collector (250kb/s max) |
| | | E2 Tri state (1Mb/s max) |
| Controller ³ | C | C0 No capability |
| | | C1 System controller |
| | | C2 Send IFC and take charge |
| | | C3 Send REN |
| | | C4 Respond to SRQ |
| | | C5 Send interface messages, receive control, pass control to self, parallel poll, take control synchronously |

¹MLA: My Listen Address

²MTA: My Talk Address

³There are 29 controller levels. These are the more significant levels.



HEWLETT-PACKARD INTERFACE BUS

Versatile Interconnect System for Instruments and Controllers



HP-IB Product Summaries

Standard HP-IB Systems

Many application requirements can be satisfied with a standard HP-IB measurement system — a system assembled, tested, and

documented by Hewlett-Packard. Pre-configured systems save you design and setup time, and HP guarantees overall specified

system performance. Installation and service contracts are available from your local HP Sales and Service Office.

Standard HP-IB Measurement Systems

| Application | HP Model | HP Controller | System Name/Characteristics | Page |
|---|-------------|--------------------------------------|---|------|
| Data Logging, Acquisition, and Control | 2250 | 1000 | Industrial Data Acquisition & Control. | 308 |
| | 3054A/S | 85, Series 200 | Fast, flexible, and precise data acquisition system with a wide choice of controllers. | 292 |
| | 3054C | 1000 | Computer based automatic data acquisition/control system. | 295 |
| | 3054DL | 85 | Complete data logger. | 294 |
| | 3056DL | 85 | Complete data logger (HP-IB & HP-IL). | 289 |
| | 3852S | Series 200 | Data Acquisition/Control System | 300 |
| | 6901S | Series 200 | Measurement and Analysis System: includes CAT software. | 314 |
| 6944S | Series 200 | HP Series 200 Multiprogrammer System | 319 | |
| Network Analysis | 3577S | Series 200 | Network Analyzer System: 100 kHz to 200 MHz; full 12-term error correction; S to H, Y or Z parameters; disc storage/recall of device, setup and calibration data. | 610 |
| | 8408B | 85 | Automatic Microwave Network Analyzer: 500 MHz to 18 GHz. | 637 |
| | 8507D | Series 200 | Automatic RF Network Analyzer: measures complex impedance, transfer functions, group delay; 500 kHz to 1.3 GHz. | 624 |
| | 8510A | Series 200 | Microwave Network Analyzer: measures transmission and reflection parameters, 45 MHz to 26.5 GHz. | 626 |
| | 8756S/8757S | Series 200 | Automatic Scalar Network Analyzers: measure insertion loss, gain, return loss, SWR, reflection coefficient & power. | 594 |
| Spectrum Analysis | 8566S | Series 200 | Automatic Spectrum Analyzer: covers 100 Hz to 22 GHz; exceptional frequency tuning accuracy and resolution. | 667 |
| | 8567S | Series 200 | Automatic Spectrum Analyzer: 10 kHz to 1.5 GHz | 667 |
| | 8568S | Series 200 | Automatic Spectrum Analyzer: covers 100 Hz to 1.5 GHz; exceptional frequency tuning accuracy and resolution. | 667 |
| | 8574A | Series 200 | CISPR EMI Spectrum Analyzer/Receiver for FCC and VDE EMI measurements. | 671 |
| | 71000S | Series 200 | Modular Automatic Spectrum Analyzer Systems. | 647 |
| Frequency Stability Analysis | 3047A | Model 236 | Phase Noise Measurement System: high resolution and phase noise measurements. | 710 |
| | 11740S | Model 236 | Microwave Phase Noise Measurement System: automatic phase noise measurements on carriers from 5 MHz to 18 GHz. | 714 |
| Microwave Signal Analysis | 8902S | Series 200 | Microwave Measurement System for accurate modulation, frequency, and low-level power measurements to 26.5 GHz. | 717 |
| Waveform Analysis/Generation | 5180S | Series 200 | Waveform Measurement System: automatic time-domain measurements of captured waveforms. | 427 |
| | 5180T | Series 200 | Digitizing Oscilloscope | 423 |
| | 5182S | Series 200 | Waveform Generation System: draw, trace, edit, and create arbitrary waveforms; modify captured waveforms for playback. | 429 |
| | 5183T | Series 200 | Digitizing Oscilloscope | 422 |
| Signal Generator Calibration | 8952A | Series 200 | RF Signal Generator Test Set: performance verification for HP 8640B, 8642A/B, 8656A/B, 8662A Signal Generators. | 718 |
| Transceiver Testing | 8953A | 85/Series 200 | Transceiver Test Set for AM and FM transceivers, 150 kHz to 990 MHz. | 729 |
| | 8955A | Series 200 | RF Test System for AM and FM transceivers to 1000 MHz, transmitters to 120 W. | 728 |
| | 8957S | Series 200 | Cellular Radio Test System: compatible with AMPS (U.S. system) and TACS (UK system) protocols; complete RF testing to 1000 MHz. | 731 |
| Circuit Testing | 3061A/3062A | Series 200 | In-circuit functional test system. | 386 |
| | 3065C | Series 200 | Analog Board Test System: fast, accurate fault location on loaded printed circuit boards. Opt. 100 tests microprocessors. | 387 |
| | 55005S | 85 | Semiautomatic, at-speed functional testing of digital products. | 372 |
| Frequency Division Multiplex (FDM) Network Surveillance | 3046A/B | 85 | Frequency Division Multiplex (FDM) network surveillance system: automates HP 3586A/B Selective Level Meters. | 159 |
| | 37050S | 1000 | FDM Network Monitoring System: simultaneous control of multiple selective level measuring sets. | 154 |
| | 37051S | Model 216 | FDM Measurement System: sequential control of multiple selective level measuring sets. | 154 |
| Microwave Radio Performance Testing | 3708S | Model 216 | Noise and Interference Measurement System: automatic measurements of microwave radios under flat-fade conditions. | 155 |
| Semiconductor/Component Testing | 4061A | Series 200 | Semiconductor/Component Test System: I-V, multifrequency C-V, quasi-static C-V. | 356 |
| | 4062B | Model 236 | Semiconductor Parametric Test System: I-V, 1-MHz C-V through the 48-pin switching matrix. | 349 |
| | 4063A | Model 236 | Semiconductor Parameter Analysis System: precise I-V, 1-MHz C-V, temperature measurements through the 6/12-channel switching matrix. | 352 |
| | 4064A | Model 236 | DLTS Analysis System: ready-to-use system for 1-MHz C-V, C-t, DLTS analysis. | 354 |
| Power Sensor Calibration | 436A-E40 | 85 | Calibrates RF & MW power sensors; good for metrology labs. | 576 |

Individual Hewlett-Packard Products Available with HP-IB Capability

| Products Related to | HP Model | Product Name/Characteristics | Page |
|--------------------------------|---|--|----------|
| Control and Computation | 85B | Personal Computer (uses HP 82937A Interface) | 46 |
| | 86B | Personal Computer (HP 82937A interface built-in) | 46 |
| | HP 150 | Touchscreen Personal Computer | 40 |
| | HP 150 MAX | Touchscreen MAX Personal Computer | 40 |
| | HP 1000 A600+ | Computer (HP 2156B; uses HP 12009A Interface) | 80 |
| | HP 1000 A700 | High Performance Computer (HP 2137A; uses HP 12009A Interface) | 80 |
| | HP 1000 A900 | High Performance Computer (HP 2139A; uses HP 12009A interface) | 80 |
| | HP 1000 E-series | Computers (HP 2109E & 2113E use HP 59310B Interface) | 80 |
| | HP 1000 F-series | High-performance computers (HP 2117F uses HP 59310B Interface) | 80 |
| | 9020A/B/C/AS/AT | Computer | 74 |
| | 9050A/AM/AT | Technical Computer | 74 |
| | 9915B | Modular Run-Only Computer | 77 |
| | 9816A/S | Personal Technical Computer | 66 |
| | 9817A/H/L | Technical Computer | 66 |
| | 9826A/S | Technical Computer | 66 |
| | 9836U/CU/T/CT | Technical Computer | 66 |
| | 9837H | Technical Computer | 66 |
| | 98580A | Modular Computer | 71 |
| | 98581A | Modular Computer | 71 |
| | 98582A | Modular Computer | 71 |
| 98583A | Modular Computer | 71 | |
| 9920A/S | Modular Computer | 66 | |
| Stimulus | 3314A | Function Generator: 0.001 Hz to 19.99 MHz | 463 |
| | 3325A | Synthesizer/Function Generator/Sweeper: 1 μ Hz to 21 MHz | 452 |
| | 3326A | Two-Channel Synthesizer: dc to 13 MHz | 454 |
| | 3335A | Synthesizer/Level Generator: 200 Hz to 81 MHz | 456 |
| | 3336A/B/C | Synthesizer/Level Generator: 10 Hz to 21 MHz | 457 |
| | 4140B | PA Meter/DC Voltage Source | 360 |
| | 4141B | DC Source/Monitor | 357 |
| | 4145A | Semiconductor Parameter Analyzer | 358 |
| | 5182A | Waveform Recorder/Generator: 20 MHz, 10 bits, 16K word memory | 428 |
| | 5359A | Time Synthesizer: 1 ns accuracy: 50 ps increments, 100 ps jitter | 489 |
| | 6002A Option 001 | DC Power Supply: 200 W autoranging. Listen only | 280 |
| | 6030A | System Power Supply: 1000W, 200 Vdc, 17A, autoranging with status readback | 278 |
| | 6031A | System Power Supply: 1000W, 20 Vdc, 120A, autoranging with status readback | 278 |
| | 6032A | System Power Supply: 1000W, 60 Vdc, 50A, autoranging with status readback | 278 |
| | 6033A | System Power Supply: 200W, 20 Vdc, 30A, autoranging with status readback | 278 |
| | 6038A | System Power Supply: 200W, 60 Vdc, 10A, autoranging with status readback | 278 |
| | 6129C Opt. P05 or J99 | Precision Voltage Source: \pm 50 Vdc at 5 A (requires HP 59301A) | 282 |
| | 6130C Opt. P05 or J99 | Precision Voltage Source: \pm 50 Vdc at 1A (requires HP 59301A) | 282 |
| | 6131C Opt. P05 or J99 | Precision Voltage Source: \pm 100 Vdc at 0.5 A (requires HP 59301A) | 282 |
| | 6140A Opt. P05 or J99 | Precision Current Source: \pm 100 mA at 100 Vdc (requires HP 59301A) | 282 |
| | 6621A | System Power Supply: dual output, dual range, 20V/4A or 7V/10A per output | 276 |
| | 6622A | System Power Supply: dual output, dual range, 10V/1.6A or 20 V/4A per output | 276 |
| | 6623A | System Power Supply: triple output | 276 |
| | 6624A | System Power Supply: quad output | 276 |
| | 6940B | Multiprogrammer (requires HP 59500A) | 320 |
| | 6942A | Multiprogrammer: automatic test, data acquisition and control | 316 |
| | 8016A Option 001 | Word Generator: 9 x 32 bit. Listen only | 473 |
| | 8018A Option 001 | Serial Data Generator: 50 MHz, 2048-bit memory. Listen only | 475 |
| | 8112A | Programmable Low Cost Pulse Generator: 20 ns to 950 ms period | 478 |
| | 8116A | Programmable Pulse/Function Generator: 1 mHz to 50 MHz | 459 |
| | 8150A | Optical Signal Source: 850 nm, 250 MHz | 572 |
| | 8160A | Programmable Pulse Generator: 20 ns to 999 ms period | 480 |
| | 8161A | Programmable Pulse Generator: 10 ns to 980 ms period | 480 |
| | 8165A | Programmable Signal Source: 0.001 Hz to 50 MHz | 458 |
| | 8170A | Logic Pattern Generator: 8 x 4096/12 x 2048 bit; 2 MHz | 474 |
| | 8175A | Digital Signal Generator: 24 x 1024/2 x 8192 bit; 50/100 MHz | 470 |
| | 8180A | Data Generator: 50 MHz, 1024 bit/channel | 468 |
| | 8181A | Data Generator Extender | 468 |
| | 8340A | Synthesized Sweeper: 10 MHz to 26.5 GHz | 496, 543 |
| | 8341A | Synthesized Sweeper: 10 MHz to 20 GHz | 496, 543 |
| | 8350B | Sweep Oscillator: 10 MHz to 40 GHz | 500 |
| | 8620C Option 011 | Sweep Oscillator: 10 MHz to 22 GHz | 515 |
| | 8642A/B | Synthesized Signal Generator: 100 kHz to 2.115 GHz | 526 |
| | 8656B | Signal Generator: 0.1 to 990 MHz | 524 |
| | 8660A, C Option 005 | Synthesized Signal Generators: 10 kHz to 2.6 GHz. Listen only | 532 |
| | 8662A | Synthesized Signal Generator: 10 kHz to 1280 MHz. | 529 |
| | 8663A | Synthesized Signal Generator: 100 kHz to 2560 MHz. | 529 |
| | 8671A | Microwave Frequency Synthesizer: 2 to 6.2 GHz | 548 |
| | 8672A | Synthesized Signal Generator: 2 to 18 GHz | 545 |
| | 8672S | Synthesized Signal Generator: 100 MHz to 18 GHz | 548 |
| 8673B/E | Synthesized Signal Generator: 2 to 26.5 GHz/2 to 18 GHz | 544, 546 | |
| 8673C/D | Synthesized Signal Generator: 50 MHz to 18, 26.5 GHz | 547 | |

HEWLETT-PACKARD INTERFACE BUS

Versatile Interconnect System for Instruments and Controllers

Individual HP-IB Product Summary



Individual Hewlett-Packard Products Available with HP-IB Capability (cont.)

| Products Related to | HP Model | Product Name/Characteristics | Page |
|----------------------|---|---|----------|
| Stimulus (cont.) | 8770A | Arbitrary Waveform Synthesizer: dc to 50 MHz | 450 |
| | 59501B | Power Supply Programmer: Isolated D-to-A Converter ± 10 Vdc at 10 mA | 281 |
| Measurement | 436A Option 022 | Power Meter: -70 dBm to +44 dBm, to 50 GHz | 578 |
| | 438A | Dual-channel Digital Power Meter: -70 dBm to +44 dBm, to 50 GHz | 577 |
| | 853A | Spectrum Analyzer Display | 680-685 |
| | 1630A/D/G | Logic Analyzer | 414 |
| | 1631A/D | Logic Analyzers with built-in scopes | 411 |
| | 1950A | Two Channel Expansion Module for HP 1980 System | 438 |
| | 1965A | Gated Universal Counter for HP 1980 System | 438 |
| | 1980A/B | Oscilloscope Measurement System: fully programmable | 438 |
| | 19860A | Digital Waveform Storage for HP 1980 System | 438 |
| | 2250 | Measurement & Control System | 308 |
| | 2804A Option 010 | Quartz Thermometer: 0.05°C accuracy | 735 |
| | 3421A | Data Acquisition/Control Unit | 290 |
| | 3437A | System Digital Voltmeter: high speed, 3½ digits | 213 |
| | 3455A | Digital Voltmeter: 5½ or 6½ digits, auto calibration | 212 |
| | 3456A | Digital Voltmeter: 3½ to 6½ digit voltmeter, 1 nV sensitivity | 210 |
| | 3457A | Multimeter: 3½ to 6½ digits; measures voltage, current, resistance, frequency | 205 |
| | 3478A | Digital Multimeter: 3½ to 5½ digits; 5 functions | 208 |
| | 3497A | Data Acquisition Control Unit | 296 |
| | 3561A | Dynamic Signal Analyzer: 125 μ Hz to 100 kHz | 703 |
| | 3562A | Dynamic Signal Analyzer: dual channel, 64 μ Hz to 100 kHz | 706 |
| | 3577A | Network Analyzer: 5 Hz to 200 MHz | 605 |
| | 3582A | 2-channel Real Time (FFT) Spectrum Analyzer | 701 |
| | 3585A | Swept Spectrum Analyzer: 20 Hz to 40 MHz | 654 |
| | 3586A/B/C | Selective Level Meter: 50 Hz to 32.5 MHz | 657 |
| | 3708A | Noise and Interference Test Set | 155 |
| | 3717A | Wideband 70 MHz modem | 161 |
| | 3746A | 32.5 MHz Selective Level Measuring Set: CCITT and Bell FDM Systems | 152 |
| | 3764A | Digital Transmission Analyzer | 148 |
| | 3776A | PCM Terminal Test Set: CEPT/CCITT networks | 141, 144 |
| | 3776B | PCM Terminal Test Set: Bell/Japanese/CCITT networks | 141, 144 |
| | 3779C | Primary Multiplex Analyzer: CEPT 2 Mb/s PCM systems | 145 |
| | 3779D | Primary Multiplex Analyzer: Bell 1.5 Mb/s PCM systems | 145 |
| | 3781A/3782A | Pattern Generator/Error Detector: CEPT and CCITT PCM/TDM systems | 147 |
| | 3781B/3782B | Pattern Generator/Error Detector: Bell PCM/TDM systems | 147 |
| | 3785A | Jitter Generator and Receiver: CEPT PCM/TDM systems | 149 |
| | 3785B | Jitter Generator and Receiver: Bell PCM/TDM systems | 149 |
| | 3852S | Data Acquisition/Control System | 300 |
| | 4140B | μ A Meter/DC Voltage Source | 360 |
| | 4141B | DC Source/Monitor | 357 |
| | 4145A | Semiconductor Parameter Analyzer | 358 |
| | 4191A | RF Impedance Analyzer: 1 to 1000 MHz | 332 |
| | 4192A | LF Impedance Analyzer: 5 Hz to 13 MHz | 330 |
| | 4193A | Vector Impedance Meter: 400 kHz to 110 MHz | 334 |
| | 4194A | Impedance/Gain-Phase Analyzer | 328 |
| | 4262A Option 101 | Digital LCR Meter | 344 |
| | 4274A | Multifrequency LCR Meter: 11 spots, 100 Hz to 100 kHz | 336 |
| | 4275A | Multifrequency LCR Meter: 10 spots, 10 kHz to 10 MHz | 336 |
| | 4276A | LCZ Meter: 801 spots, 100 Hz to 20 kHz | 340 |
| | 4277A | LCZ Meter: 701 spots, 10 kHz to 1 MHz | 341 |
| | 4280A | 1-MHz C Meter/C-V Plotter | 362 |
| | 4945A Option 101 | Transmission Impairment Measurement System (TIMS) | 139 |
| | 4955A | Protocol Analyzer | 131 |
| | 5005B | System Signature Multimeter | 373 |
| 5006A | Signature Analyzer | 376 | |
| 5180A | Waveform Recorder | 426 | |
| 5316A | Universal Counter: 100 MHz/1.3 GHz, 100 ns TI | 248 | |
| 5328B | Universal Counter: to 512 MHz, 10 ns TI | 247 | |
| 5334A | Automatic Universal Counter: 100 MHz/1.3 GHz, 2 ns TI | 242 | |
| 5335A | Automatic Universal Counter: 200 MHz/1.3 GHz, 2ns TI | 244 | |
| 5340A Option 011 | Automatic Microwave Counter: 10 Hz to 18 GHz | 231 | |
| 5342A Option 011 | Automatic Microwave Counter: 10 Hz to 18 GHz | 228 | |
| 5343A Option 011 | Microwave Frequency Counter: 10 Hz to 26.5 GHz | 228 | |
| 5344S | Microwave Source Synchronizer: 0.5 GHz to 18 GHz | 230 | |
| 5345A Option 011,012 | General Purpose Plug-In Counter | 232 | |
| 5350A | Microwave Frequency Counter: 10 Hz to 20 GHz | 226 | |
| 5351A | Microwave Frequency Counter: 10 Hz to 26.5 GHz | 226 | |
| 5352A | Microwave Frequency Counter: 10 Hz to 40 GHz | 226 | |

Individual Hewlett-Packard Products Available with HP-IB Capability (cont.)

| Products Related to | HP Model | Product Name/Characteristics | Page |
|-----------------------|--|--|----------|
| Measurement (cont.) | 5355A | Pulse, CW Counter: 400 Hz to 110 GHz | 232 |
| | 5363B | Time Interval Probes | 240 |
| | 5370B | Precision Time Interval Counter: ± 20 ps single-shot resolution | 237 |
| | 5384A | 225 MHz Frequency Counter | 235 |
| | 5385A | 1 GHz Frequency Counter | 235 |
| | 5386A | Frequency Counter: 3 GHz | 234 |
| | 5501A | Laser Transducer | 733 |
| | 5528A | Laser Measurement System | 732 |
| | 6030A | System Power Supply: 1000 W, 200 Vdc, 17A, autoranging with status readback | 278 |
| | 6031A | System Power Supply: 1000 W, 20 Vdc, 120 A, autoranging with status readback | 278 |
| | 6032A | System Power Supply: 1000 W, 60 Vdc, 30 A, autoranging with status readback | 278 |
| | 6033A | System Power Supply: 200 W, 20 Vdc, 30 A, autoranging with status readback | 278 |
| | 6038A | System Power Supply: 200 W, 60 Vdc, 10 A, autoranging with status readback | 278 |
| | 6621A | System Power Supply: dual output, dual range, 20V/4A or 7V/10A per output | 276 |
| | 6622A | System Power Supply: dual output, dual range, 50V/1.6A or 20V/4A per output | 276 |
| | 6623A | System Power Supply: triple output | 276 |
| | 6624A | System Power Supply: quad output | 276 |
| | 6940B | Multiprogrammer (requires HP 59500A interface) | 320 |
| | 6942A | Multiprogrammer: automatic test, data acquisition and control | 316 |
| | 7090A | Measurement Plotting System: 3-channel A-D converter to 3 kHz | 396 |
| | 8151A | Optical Pulse Power Meter: 250 MHz | 574 |
| | 8182A | Data Analyzer: 50 MHz real-time capability; 1024 bit/channel | 468 |
| | 8501A | Storage Normalizer for HP 8505A RF network analyzer | 621 |
| | 8503A & 8503B | S-Parameter Test Set: 50 or 75 ohm, for HP 8505A | 622 |
| | 8505A | RF Network Analyzer: 500 kHz to 1.3 GHz | 618 |
| | 8507D | Network Analyzer Subsystem: 500 kHz to 1.3 GHz | 624 |
| | 8510A | Network Analyzer | 626 |
| | 8558B Option E98 | EMI Measurement System | 682 |
| | 8566B | Spectrum Analyzer: 100 Hz to 324 GHz | 660, 664 |
| | 8567A | Spectrum Analyzer: 10 kHz to 1.5 GHz | 668 |
| | 8568B | Spectrum Analyzer: 100 Hz to 1.5 GHz | 660, 662 |
| | 8569B | Spectrum Analyzer: 10 MHz to 115 GHz | 674 |
| | 8756A/8757A | Scalar Network Analyzer: 10 MHz to 60 GHz | 596, 603 |
| | 8901A | Modulation Analyzer: 150 kHz to 1.3 GHz | 719 |
| | 8901B | Modulation Analyzer: 150 kHz to 1.3 GHz | 719 |
| | 8902A | Measuring Receiver: 150 kHz to 1.3 GHz | 715 |
| | 8903A | Distortion Analyzer: 20 Hz to 100 kHz | 722 |
| | 8903E | Audio Analyzer: 20 Hz to 100 kHz | 722 |
| | 8954A | Transceiver Interface | 730 |
| | 8956A | System Interface | 730 |
| | 8958A | Cellular Radio Interface | 731 |
| | 8970A | Noise Figure Meter: 10 to 1500 MHz | 586 |
| | 11729C | Carrier Noise Test Set: 5 MHz to 18 GHz | 712 |
| 54100A/D | Digitizing Oscilloscopes: 1 GHz | 430 | |
| 54110D | Color 1-GHz Digitizing Oscilloscope | 430 | |
| 54200A/D | Digitizing Oscilloscopes: 200 M samples/s | 433 | |
| 54300A | Probe Multiplexer | 430 | |
| 70300A | Tracking Generator Module: 20 Hz to 2.9 GHz | 651 | |
| 70310A | Precision Frequency Reference Module | 651 | |
| 71100A | RF Spectrum Analyzer: 100 Hz to 2.9 GHz | 647 | |
| 71200A | Microwave Spectrum Analyzer: 50 kHz to 22/26.5 GHz | 647 | |
| 71300A | Millimeter Wave Spectrum Analyzer | 647 | |
| 85650A | Quasi-Peak Adapter | 673 | |
| 85685A | RF Preselector: 20 Hz to 2 GHz | 672 | |
| Switching Scanning | 2250 | Measurement and Control Subsystem | 308 |
| | 3421A | Scanner: to 30 channels; A/D converter | 290 |
| | 3488A | Versatile switching for automated testing (VHF, matrix, general purpose) | 311 |
| | 3497A | Data Acquisition/Control Unit | 296 |
| | 3852A | Data Acquisition/Control Unit | 301 |
| | 4085M | Switching Matrix | 359 |
| Translation or Timing | 3326A | Two-Channel Synthesizer/Sweeper: dc to 13 MHz | 454 |
| | 3497A | Data Acquisition Control Unit | 296 |
| | 3754A | 25 MHz Access Switch (requires HP 3755A switch controller) | 153 |
| | 3756A | 90 MHz Switch (requires HP 3755A) | 153 |
| | 3757A | 8.5 MHz Access Switch (requires HP 3755A) | 153 |
| | 3777A | Telecommunications Channel Selector: up to 30 channels; dc to 110 kHz | 145 |
| | 6940B | Multiprogrammer (requires HP 59500A interface) | 320 |
| | 6942A | Multiprogrammer (no interface required) | 316 |



HEWLETT-PACKARD INTERFACE BUS

Versatile Interconnect System for Instruments and Controllers

Individual HP-IB Product Summary



Individual Hewlett-Packard Products Available with HP-IB Capability (cont.)

| Products Related to | HP Model | Product Name/Characteristics | Page | |
|-------------------------------|--|--|---|-----|
| Translation or Timing (cont.) | 9411B | Switch Controller | 324 | |
| | 9412A | Modular Switch (requires HP 9411B switch controller) | 324 | |
| | 9413A | VHF Switch (requires HP 9411B) | 324 | |
| | 9414A | Matrix Switch (requires HP 9411B) | 324 | |
| | 11713A | Attenuator/Switch Driver (controls coax switches, step attenuators and microwave matrix switches) | 558 | |
| | 37201A | HP-IB Extender: twisted-pair or modems | 125 | |
| | 37203A/L | HP-IB Extender: coax and fiber optics | 124 | |
| | 59301A | ASCII-to-Parallel Converter: string to 16 characters | 122 | |
| | 59303A | Digital-to-Analog Converter | 122 | |
| | 59306A | Relay Actuator: for programmable switches, attenuators | 122 | |
| | 59307A | VHF Switch: two 50-ohm, bidirectional, dc to 500 MHz | 122 | |
| | 59309A | Digital Clock: month, day, hour, minute, second | 123 | |
| | 59313A | Analog-to-Digital Converter | 123 | |
| | 59501B | Power Supply Programmer: isolated D-to-A converter ± 10 Vdc at 10 mA | 123, 281 | |
| | Storage | 3964A Option 007 | Instrumentation Tape Recorder: 4 channel, Listen only | 408 |
| | | 3968A Option 007 | Instrumentation Tape Recorder: 8 channel, Listen only | 408 |
| 5180A | | Waveform Recorder (digital oscilloscope): 20 MHz, 10 bits, 16K-word capacity | 426 | |
| 7907A | | Disc/Tape Drives: 20.5 Mb fixed disc drive, 20.5 Mb 1/4" tape drive | 92 | |
| 7911P/R | | Disc/Tape Drives: 28.1 Mb fixed disc drive, 67 Mb 1/4" tape cartridge drive | 91 | |
| 7912P/R | | Disc/Tape Drives: 65.6 Mb fixed disc drive, 67 Mb 1/4" tape cartridge drive | 91 | |
| 7914P/R | | Disc/Tape Drives: 132.1 Mb fixed disc drive, 67 Mb 1/4" tape cartridge drive | 91 | |
| 7914ST | | Disc/Tape Drives: 132.1 Mb fixed disc drive, 1/2" reel-to-reel tape drive | 91 | |
| 7933 | | Disc Drive: 404 Mb fixed | 92 | |
| 7935 | | Disc Drive: 404 Mb removable | 92 | |
| 7941A | | Disc Drive: 24 Mb fixed disc drive | 90 | |
| 7942A | | Disc/Tape Drive: 24 Mb fixed disc drive, 67 Mb 1/4" tape cartridge drive | 90 | |
| 7945A | | Disc Drive: 55 Mb fixed disc drive | 90 | |
| 7946A | | Disc/Tape Drive: 55 Mb fixed disc drive, 67 Mb 1/4" tape cartridge drive | 90 | |
| 7970E | | 1/2" Magnetic Tape Subsystem: 40 Mb formatted capacity | 93 | |
| 7974A | | 1/2" Magnetic Tape Subsystem: 40 Mb formatted capacity | 93 | |
| 7978A | | 1/2" Magnetic Tape Subsystem: 140 Mb formatted capacity | 93 | |
| 9114A | | Portable 3 1/2" Disc Drive: 710 Kb formatted capacity | 89 | |
| 9122D/S | | Double-sided 3 1/2" Disc Drive: 1420 Kb dual (HP 9122D), 710 Kb single-sided (HP 9122S), random access storage | 89 | |
| 9123D | | Dual 3 1/2" Drive for HP Touchscreen II | 89 | |
| 9125S | | Single 5 1/4" Flexible Disc Drive: up to 360 Kb formatted, IBM/HP format compatible | 89 | |
| 9133H | | 20 Megabyte Winchester Hard Disc plus 3 1/2" microfloppy | 89 | |
| 9134H | | 20 Megabyte Winchester Hard Disc: stand-alone model | 89 | |
| 9142A | | 1/4" Tape Backup Subsystem: up to 60 Mb formatted capacity | 89 | |
| 9144A | | 1/4" Tape Backup Subsystem: 16 and 67 Mb formatted capacity | 93 | |
| 9153A | | 10 Megabyte Winchester Hard Disc plus 3 1/2" microfloppy | 89 | |
| 9154A | 10 Megabyte Winchester Hard Disc: stand-alone model | 89 | | |
| 88500A | IBM Disc/Tape Interface: single 5 1/4" disc drive providing data compatibility with IBM-PC from the HP Touchscreen | 89 | | |
| Data Entry, Displays | 2225A | ThinkJet Ink-jet Printer | 95 | |
| | 2563A | Line Printer: 300 lines/minute dot matrix | 94 | |
| | 2565A/66A | Line Printers: 600/900 lines per minute | 94 | |
| | 2680A, 2688A | Laser Page Printers | 94 | |
| | 2932A | Impact Printer | 95 | |
| | 2934A | Dual Mode Impact Printer | 95 | |
| | 7090A | Measurement Plotting System: 6-pen | 396 | |
| | 7470A | Graphics Plotter: 2-pen | 99 | |
| | 7475A | Graphics Plotter: 6-pen | 99 | |
| | 7510A | Color Film Recorder: 35mm slides | 105 | |
| | 7550A | Automatic Sheet-Feed 8-Pen Plotter | 101 | |
| | 7580B, 7585B, 7586B | Large Format Drafting Plotters | 103 | |
| | 9111A | Graphics Tablet: graphics input | 107 | |
| | 9876A | Thermal Line Printer: 480 lines/minute | 95 | |
| | 37461A | Display | 152 | |
| | 82906A | Impact Printer | 95 | |
| Interface Cabling | 10833A-10833D | HP-IB Interconnection Cables | 121 | |
| | 10834A | HP-IB Interconnection Cable Adapter: 2.3 cm (0.91 in.) | 121 | |
| HP-IB Extension | 37201A | HP-IB Extender: twisted pair or modems | 125 | |
| | 37203A/L | HP-IB Extender: coaxial or fiber optic cable | 124 | |
| Design/Serviceing | 59401A | Bus System Analyzer | 121 | |



HEWLETT-PACKARD INTERFACE BUS

Versatile Interconnect System for Instruments and Controllers

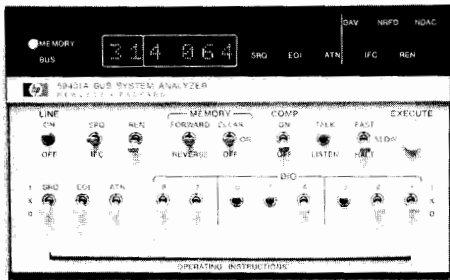

HP 59401A

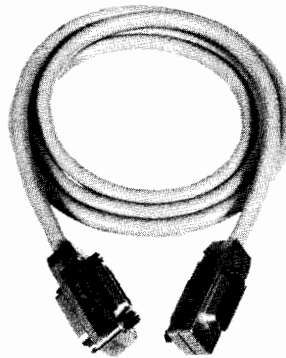

HP 10833A/B/C/D



HP 10834A

HP 59401A Bus System Analyzer

The HP-IB (IEEE 488) concept has greatly simplified many of those things which have in the past made instrument interfacing a burdensome task. Even so, software errors can occur if the system designer does not completely understand the bus system or the capabilities of the instruments and other devices being interfaced. Hardware problems can occur if the instruments/devices are not functioning properly, or if they are not completely compatible with the bus standard.

The HP 59401A Bus System Analyzer is especially useful in design and service work. It simplifies and speeds up the diagnosis of software and hardware problems by allowing the user to see the status of all bus lines, including the actual characters on the bus data lines. Because the HP 59401A can also drive all bus lines, it can completely exercise another Talker, Listener or Controller—which is especially useful in verifying compatibility of new or user-designed products with the HP-IB.

There are several choices of analyzer operating speed. It may be operated at one character at a time (useful for software debugging), at 2 characters per second, or at regular bus speed. It may also be operated at a variable rate as determined by the external clock input.

The analyzer's 32 character memory can be used to store bus characters in the Listen mode, or to output characters to the bus in the Talk mode. When the analyzer is in the Compare mode, a stream of bus traffic may be stopped on a pre-selected character—and at that time a trigger pulse is available, which is very useful when analyzing transient or timing problems related to the bus.

HP 59401A Specifications

Display: monitors all bus lines. Represents data lines, any memory location, or DIO front panel switch settings; in octal code and ASCII character.

Listen mode: stores up to 32 characters of bus traffic in memory for real time and repetitive testing. In Compare mode, halts bus traffic when a selected character is present, and user can display any one of the previous 31 characters stored in memory.

Timing: accept <750 ns; ready <750 ns.

Talk mode: bus lines can be driven directly from front panel switches; memory can be loaded from front panel switches for driving bus with a 32 character sequence.

Timing: (1) data changed >500 ns before DAV pulled low; (2) ATN driven low >1 μs before DAV pulled low; (3) DAV driven high <700 ns after NDAC is false; (4) DAV driven low <700 ns after NRFD is false, if conditions 1 and 2 are met.

Operating speeds: one character at a time, 2 characters per second, regular bus speed, or variable rate determined by external clock input; in either Listen or Talk mode.

External clock input: 1 standard power TTL gate input; ≤10 MHz repetition rate.

Compare output: provides 1 standard power TTL gate output (LOW TRUE) sync pulse when bus character is same as front panel switches.

HP-IB load: 1 bus load (capable of driving 14 other bus devices).

General

Temperature ranges: operating, 0 to 50°C; storage, -40 to +75°C.

Humidity: 95% relative, 0 to 40°C.

Power requirements: 100, 120, 220, or 240 V +5%, -10%; 48 to 66 Hz; ≤42 VA.

Size: 145.5 H, 205.1 W, 495.3 mm D (5.730" x 8.075" x 19.500").

Weight: net, 5.64 kg (12.44 lb).

Accessories

HP 5061-0089 front handle kit

HP 10833B 2 m (6.6 ft) bus cable, furnished

HP 59401A Bus System Analyzer

Price

\$3900

HP-IB Interconnection Cables

Cables for interconnecting HP-IB devices are available in four different lengths. The connector block at both ends of each HP-IB cable (photo above) has a plug on one side and a matching receptacle on the other, so that several cables may be conveniently connected in parallel, thus simplifying system interconnection. Lock screws provide for secure mounting of each connector block to an HP-IB instrument, or to another cable connector block.

SPECIAL NOTE: HP-IB cables are not always included with individual HP-IB devices, particularly those that normally connect directly to an HP computing controller. (The HP-IB interface for HP computing controllers contains the necessary cable and connector). Product listings in this catalog should be checked to see if HP-IB cables are furnished.

The HP 10833 series of cables feature an improved shielding design to help improve RFI levels in systems. This series of cables, with the RFI shielding, exhibits significantly lower radiated emissions than previous HP-IB cables.

The HP 10834A adapter is a shielded HP-IB to HP-IB adapter. It provides additional clearance between the HP-IB cable and the rear panel of the instrument. This allows easier access to switches, cables, and other connectors that may be in close proximity to the HP-IB connector.

Ordering Information

HP 10833A HP-IB Cable, 1m (3.3 ft)

HP 10833B HP-IB Cable, 2m (6.6 ft)

HP 10833C HP-IB Cable, 4m (13.2 ft)

HP 10833D HP-IB Cable, 0.5m (1.6 ft)

HP 10834A Adapter

Price

\$80

\$90

\$100

\$80

\$30



HEWLETT-PACKARD INTERFACE BUS

Versatile Interconnect System for Instruments and Controllers

Models 59301A, 59303A, 59306A, 59307A

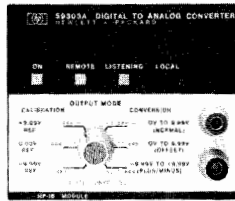

HP 59303A

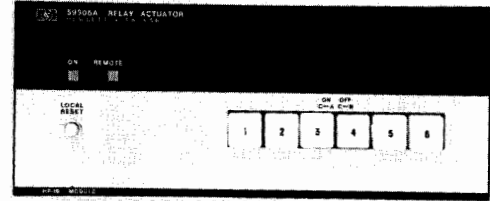

HP 59306A

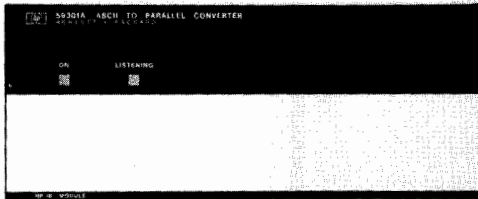

HP 59301A

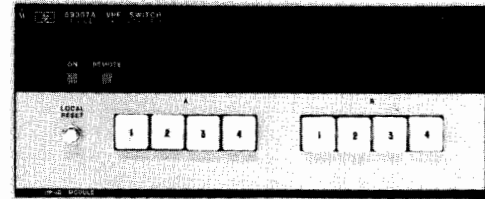

HP 59307A

HP-IB Accessory Modules

Modules in the HP 59300, 59400 and 59500-series are ideal building blocks for use with instruments to extend measurement capabilities. Modules listed here can be interconnected via the HP-IB to HP measuring instruments, signal sources and recording devices capable of operating directly on the HP-IB. In addition, these modules frequently serve as useful ways to interconnect with devices which are not themselves capable of direct HP-IB operation.

Instrument requirements differ. Some only output or accept data on the HP-IB. Others can be remotely programmed by ASCII characters sent along the HP-IB. These modules can work with instruments on any of these levels with or without a controller. Each module having controls can be operated stand-alone from its front panel, or it can be placed in automatic operation under program control.

Module provision for stand-alone, local operation also has important system benefits. The operator can set up and check out the system under manual control, avoiding otherwise complex and time consuming error tracing. Each module has status indicator lights that make it easy to monitor operation.

HP 59301A ASCII-to-Parallel Converter

Accepts byte-serial ASCII characters from the HP-IB and converts them to parallel output. In operation, ASCII characters transmitted serially along the bus are converted into 4-bit characters with the first ASCII character received being interpreted as the most significant digit. A string of up to 16 characters terminated by linefeed is converted and placed upon the output lines. The linefeed character causes the HP 59301A to output a print command (strobe).

With the HP 59301A, instruments controlled via BCD or binary can be operated using HP-IB. For example, the HP 59301A can be used with HP 6129C through 6131C and 6140A (Option J99 or P05) digitally-controlled power supplies for HP-IB programmable voltage and current. The HP 59301A can additionally be used to control other functions using its hexadecimal format.

General

Size: 101.6 mm H¹ x 212.9 mm W x 294.6 mm D (4" x 8.38" x 11.6").
Weight: net 1.70 kg (3.78 lb). Shipping 2.33 kg (5.16 lb).

HP 59301A ASCII-to-Parallel Converter \$800

HP 59303A Digital-to-Analog Converter

Accepts a string of serial ASCII characters and converts any three consecutive input digits to an analog output voltage, accurate to 0.1% in 30 μ s. Fully programmable via the HP-IB or manually operated from the front panel. A concentric control on the front panel makes it easy to select the digit group for conversion and the output mode. The

¹Height includes feet. With feet removed height is 88.1 mm (3.45").

conversion switch is used to select the three digits of the character string that the DAC will change into analog voltage. The three output modes (NORMAL, OFFSET, and PLUS/MINUS) make the converter convenient for use directly with a variety of data logging devices, avoiding the need for auxiliary equipment to shift zero level or change polarity.

A primary application for the HP 59303A is to present on a logging device the data points being taken with a measuring instrument (like a frequency counter). A controller is not required for operation. Compatible logging devices include strip chart recorders, X-Y plotters, and displays.

General

Size: 101.6 mm H¹ x 105.9 mm W x 294.6 mm D (4" x 4.17" x 11.6").
Weight: net 2.61 kg (5.80 lb). Shipping 3.17 kg (7.04 lb).

HP 59303A Digital-to-Analog Converter \$2000

HP 59306A Relay Actuator

Has six Form-C relays that provide for control of external devices either manually from front panel pushbuttons or remotely from the HP-IB. Relay contacts are specified to switch 24 V dc or 115 V ac at 0.5 A. Each relay can be programmed independently or multiple relays can be switched together. Front panel pushbuttons light to indicate the state of each relay.

The HP 59306A is ideal for providing control of microwave coaxial switches (HP 8761 A/B) as well as control of microwave programmable step attenuators (HP 8494 through 8496 G/H) using external dc power supplies.

General

Size: 101.6 mm H¹ x 212.9 mm W x 294.6 mm D (4" x 8.38" x 11.6").
Weight: net 2.64 kg (5.87 lb). Shipping 3.23 kg (7.18 lb).

HP 59306A Relay Actuator \$1100

HP 59307A Dual VHF Switch

This module provides two single pole 4-throw switches controlled from front panel pushbuttons or remotely from the HP-IB. The HP 59307A is a dc to 500 MHz 50 Ω switch designed to maintain fast pulse transition times. The switches are independent and bidirectional for optimum use in multiplexing 50 Ω signal lines into measuring instruments. The HP 59307A is ideal to switch a standard delay, frequency, or voltage into a measurement loop for purposes of system calibration.

General

Size: 101.6 mm H¹ x 212.9 mm W x 294.6 mm D (4" x 8.38" x 11.6").
Weight: net 2.64 kg (5.87 lb). Shipping 3.23 kg (7.18 lb).

HP 59307A VHF Switch \$950



HEWLETT-PACKARD INTERFACE BUS

Versatile Interconnect System for Instruments & Controllers

Models 59308A, 59309A, 59313A, 59501B



HP 59309A

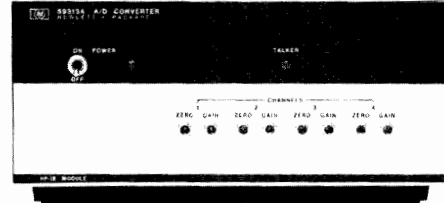

HP 59313A

HP 59309A HP-IB Digital Clock

Displays month, day, hour, minute, and second, and upon command will output time via the interface bus. Time can be set into the clock by local control, or by remote commands received from the HP-IB. The clock accepts a small internal battery which can provide more than a day's standby in case of short power interruptions. Additionally, an auxiliary power supply such as the K10-59992 can sustain the clock for up to one year.

General

Size: 101.6 mm H¹ x 105.9 mm W x 294.6 mm D (4" x 4.17" x 11.6").

Weight: net 1.70 kg (3.78 lb). Shipping 2.84 kg (6.31 lb).

HP 59309A HP-IB Digital Clock

\$1500

¹Height includes feet. With feet removed height is 88.1 mm (3.45").

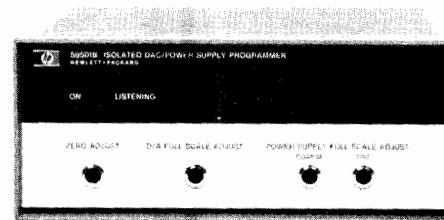

HP 59501B

HP 59313A Analog-to-Digital Converter

Four channel converter allows analog data with a full scale range of up to ± 10 V dc to be digitized and transmitted via HP-IB to a computing controller.

On command from the controller, the instrument can be programmed to perform a single conversion or a series of internally-paced conversions in six selectable rates of up to 200 per second on one channel, or up to 50 per second on each of four channels. Sampling can also be initiated externally by a TTL transition or contact closure to ground. Included is a program-controlled reverse channel capable of driving small lamps, relays or TTL devices.

General

Size: 101.6 mm H¹ x 212.9 mm W x 345.4 mm D (4" x 8.38" x 13.6").

Weight: net 5.45 kg (12.0 lb). Shipping 6.36 kg (14.0 lb).

HP 59313A Analog-to-Digital Converter

\$2300

HP 59501B Power Supply Programmer (isolated DAC)

This single-channel digital-to-analog converter can control a wide range of power supplies (output voltage, or current), as well as other analog programmable devices. It may also be used as a low level signal source, depending on the speed of the controller. It has two output ranges (0-1 and 0-10 V dc in unipolar mode; -1 to +1 and -10 to +10 V dc in bipolar mode), as well as photo-isolators which electrically separate HP-IB control and data lines from power supply circuitry by up to 600 V dc. (For additional details see page 281)

General

Size: 101.6 mm H¹ x 212.9 mm W x 194.6 mm D (4" x 8.38" x 11.6").

Weight: net 2.61 kg (5.80 lb). Shipping 3.17 kg (7.04 lb).

HP 59501B Power Supply Programmer

\$760

| HP Model | Description | Dimensions—max. height x width x depth mm (inches) | Net Weight kg (lb) | Shipping Weight kg (lb) | Price |
|----------|-----------------------------|---|-----------------------|----------------------------|--------|
| 59301A | ASCII-to-Parallel Converter | 101.6 x 212.9 x 294.6 (4 x 8.38 x 11.6) | 1.70 (3.78) | 2.32 (5.16) | \$ 800 |
| 59303A | Digital-to-Analog Converter | 101.6 x 105.9 x 294.6 (4 x 4.17 x 11.6) | 2.61 (5.80) | 3.17 (7.04) | \$2000 |
| 59306A | Relay Actuator | 101.6 x 212.9 x 294.6 (4 x 8.38 x 11.6) | 2.64 (5.87) | 3.23 (7.18) | \$1100 |
| 59307A | VHF Switch | 101.6 x 212.9 x 294.6 (4 x 8.38 x 11.6) | 2.64 (5.87) | 3.23 (7.18) | \$ 950 |
| 59309A | HP-IB Digital Clock | 101.6 x 105.9 x 294.6 (4 x 4.17 x 11.6) | 1.70 (3.78) | 2.84 (6.31) | \$1500 |
| 59313A | Analog-to-Digital Converter | 101.6 x 212.9 x 345.4 (4 x 8.38 x 13.6) | 5.45 (12.0) | 6.36 (14.0) | \$2300 |
| 59401A | Bus System Analyzer | 145.5 x 205.1 x 495.3 (5.73 x 8.08 x 19.5) | 5.64 (12.44) | 9.1 (20) | \$3900 |
| 59501B | Power Supply Programmer | 101.6 x 212.9 x 294.6 (4 x 8.38 x 11.6) | 2.61 (5.80) | 3.17 (7.04) | \$ 760 |



HEWLETT-PACKARD INTERFACE BUS

Versatile Interconnect System for Instruments and Controllers

Models 37203A, 37203L

- Transparent HP-IB extension up to 1000 metres
- HP-IB transfer rate up to 50 k bytes/s
- Supports all HP-IB functions including pass control and parallel poll

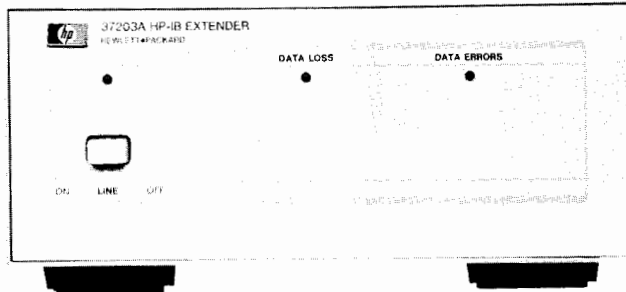

HP 37203A

- Electrical isolation plus error detection and correction protect HP-IB from transmission errors
- Transmission over single low-cost coaxial cable or, with option 001, dual optical fiber

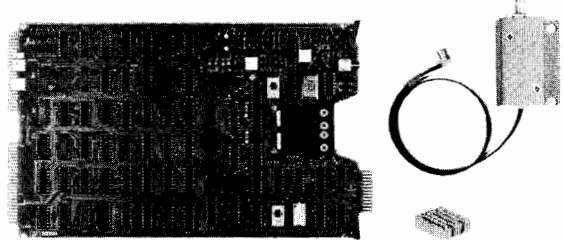

HP 37203L



HP 37203A HP-IB Extender

The HP 37203A HP-IB Extender overcomes the range limitations imposed by the cabling rules of the Interface Bus and provides high-speed, low-cost extension up to 1000 metres.

HP 37203A's are used in pairs: each Extender serialises the normally parallel HP-IB information and transmits it to the other Extender where it is reconverted back to its original format. The transmission medium can be a single low-cost coaxial cable for both directions of transmission or, when Option 001 is fitted, dual optical fiber.

The HP 37203A is in general compliance with each of the following standards and supports their major capabilities

- IEEE Standard 488-1978
- ANSI Standard MC1.1
- IEC Standard 625-1

HP 37203L HP-IB Extender

The HP 37203L is a repackaged version of the HP 37203A on an L-series computer card specifically designed for installation in the HP 2250A Measurement and Control Processor and HP 1000 A-series Computer. It operates in conjunction with a HP 37203A or another HP 37203L at the other end of the link. The transmission media and distances are the same as for the HP 37203A. The HP 37203L is supplied as a single circuit card together with two cable assemblies. Power is supplied from the HP 2250A or Computer mainframe. Operating characteristics are identical to those of the HP 37203A.

Operating Characteristics (HP 37203A/L) Speed/Range

The table below shows the trade-off between maximum byte transfer rate and distance for coaxial cable and optical fiber.

Table 1. Nominal HP-IB Transfer Rates and Response Times

| | Max HP-IB byte transfer rate (kbytes/sec) | Max SRQ propagation delay (μ s) | Max Parallel Poll response time (μ s) |
|----------------------------------|---|--|--|
| Coaxial Cable | | | |
| Short* (at normal speed) | 50 | 14 | 20 |
| 250m (max range at normal speed) | 40 | 18 | 25 |
| 500m (max range at 1/4 speed) | 14.2 | 55 | 75 |
| 1000m (max range at 1/16 speed) | 2.75 | 200 | 270 |
| Fiber Optics (opt 001) | | | |
| Short* | 50 | 14 | 20 |
| 250m | 39 | 20 | 25 |
| 1000m | 25 | 30 | 40 |

*For distances <250m, interpolate between Short and 250m.

Parallel Poll Operation

The HP 37203A supports the Parallel Poll function but because of the absolute transmission delay, a guaranteed response cannot be delivered within 200 ns, as required by IEEE 488. Instead, the response from distant devices is returned as rapidly as possible to the polling controller.

Error Detection and Correction

Data is transmitted across the link in frames. Each frame includes a cyclic redundancy check code which is rechecked when the frame is received. Any transmission errors which are detected cause the frame to be rejected. Data integrity is maintained by automatic retransmission of the rejected data frame. The presence of errors in the received data causes the DATA ERRORS indicator on the HP 37203A front panel to be illuminated. A break in the link, or loss of power at the remote Extender will cease all activity on the Bus until the link is re-established.

Transmission Over Coaxial Cable

The standard serial link between Extenders is a single coaxial cable which is used for transmission in both directions. Coaxial cable was chosen for this link because it is relatively inexpensive, easy to handle, and easy to obtain. The use of Belden type 9248B cable (or equivalent) is recommended.

Transmission Over Optical Fiber

Option 001 of the HP 37203A/L provides the capability of operation over duplex optical fiber as a user-selectable alternative to coaxial cable. The use of optical fiber removes the metallic path between the Extenders and, therefore, eliminates all risk of electromagnetic pick-up on the link. Option 001 is recommended for use in severe electrical environments or where the use of electrical signaling is not acceptable. A further advantage of optical fiber is that it enables a higher byte transfer rate to be attained for transmission distances greater than 250m than is possible with coaxial cable (see Table 1).

The HP 37203A is also available from Instruments DIRECT 800-523-2121 (US only).

Accessories

| | Price |
|------------------------------------|----------|
| HP 39200B Duplex fiber optic cable | \$3.20 |
| HP 92179G Coaxial Cable | \$0.77/m |
| HP 92226A BNC Connector, male | \$4.00 |

Options (HP 37203A/L)

| | |
|--|--------|
| 001: Fiber Optic Interface | +\$460 |
| 010: Power Fail Option for use with HP 3000 Computer | +\$55 |
| 301: Rack Mount Adaptor (HP 37203A only) | +\$30 |
| 302: Dual Rack Mount Adaptor (HP 37203 only) | +\$50 |

Ordering Information

| | |
|--------------------------|--------|
| HP 37203A HP-IB Extender | \$1285 |
| HP 37203L HP-IB Extender | \$1020 |

- Transparent extension of HP-IB systems
- Operation over twin-pair cable or modems
- Automatic error detection and correction

- High immunity to electrical interference
- Multi-point (multi-drop) capability
- Auto-dialler interface

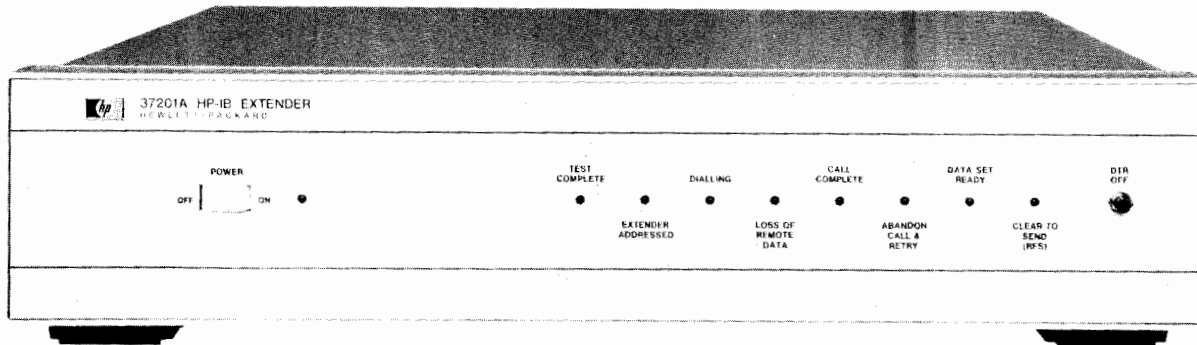

The 37201A HP-IB Extender overcomes the limited range available with direct HP-IB cable interconnections. Each 37201A converts parallel data from the interface bus into a serial bit stream, suitable for transmission to a remote site, and reconverts incoming serial data to bit-parallel HP-IB format. An HP-IB system can therefore be split into two or more discrete parts separated by HP-IB Extenders and a serial data link. A range of 1000 metres is obtainable if twin-pair cable is used for the transmission path, and virtually unlimited range is available if a modem link is used. Communication between Extenders is full duplex, allowing information to flow in both directions simultaneously.

Integrity of HP-IB data and control signals is assured by an automatic error-checking protocol, which retransmits any data corrupted in transmission. The 37201A is in general compliance with each of the following standards and supports their major capabilities:

- IEEE Standard 488-1978
- ANSI Standard MC1.1
- IEC Standard 625-1

Twin-Pair Cable Operation

Twin twisted-pair cable provides a simple inexpensive transmission medium for distances up to 1000 metres. The serial data rate is nominally 20 kbit/s. Suitable cable is available as an accessory (HP Part Number 8120-1187). Transformer coupling within the 37201A gives a high degree of immunity from the effects of common mode signals. This, combined with the automatic error correction capability, makes the 37201A suitable for use in an electrically hostile environment.

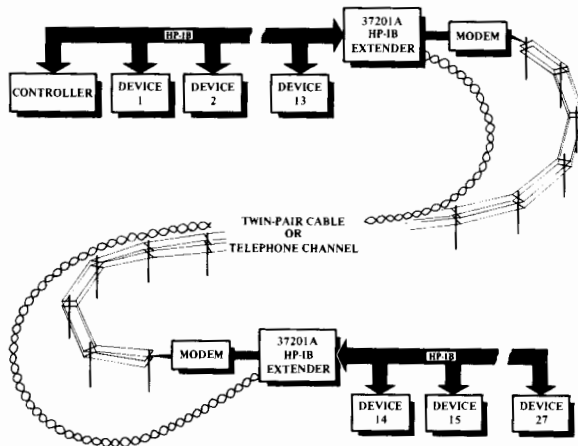

Point-to-point connection using twin twisted pair cable or full duplex modem link.

A pair of HP-IB Extenders provides a transparent interface between local and remote HP-IB devices. Program control of the 37201A is seldom necessary. Consequently, HP-IB Extenders can be added to an HP-IB system usually without any modification of software and without writing special routines to control the Extenders.

The 37201A supports the full range of HP-IB functions with the exception of Parallel Poll and Pass Control.

Modem Link Operation

The 37201A is designed to operate with a wide range of synchronous and asynchronous modems over private lines, leased lines, or the public switched (dial-up) telephone network. The data interface is compatible with EIA RS-232C and CCITT V.24 and V.28 standards. Asynchronous data rates provided are: 150, 300, 600, and 1200 bit/s. For synchronous modems, operation at any bit rate up to 19.2 kbit/s is possible. Besides operating in point-to-point mode, the 37201A can be used with modems in a multi-point (multi-drop) leased line configuration involving up to 31 remote sites. When operating over the public switched telephone network, connections may be dialed manually. Alternatively, an external auto-dialler may be used to make connections under program control. The 37201A has an RS-366/V.25 interface to permit operation with an auto-dialler.

The error checking/correcting communications protocol used in the 37201A protects against errors introduced by poor quality data circuits. It even provides immunity to major interruptions in the data link, such as dropouts, line breaks and modem sync loss, and recovers automatically without loss of data.



DATA COMMUNICATIONS TEST EQUIPMENT

General Information: Protocol Analysis

The growth of demands on datacomm systems is matched only by the burden of developing and maintaining them. Factors impeding datacomm support include:

- Increasingly multi-vendor systems
- AT&T divestiture
- Shortage of skilled service personnel
- Exploding system complexity
- Less tolerance for system malfunction
- Proliferation of incompatible systems, standards, and equipment
- User demands for increased speed, reliability, and services

Maximizing system availability and utility requires increasingly sophisticated testing. As just one example, consider the wasted time and expense of calling in the wrong vendor for service when testing can assure you of calling the right one. Clearly, your network's performance can only be as good as your ability to measure and test. Hewlett-Packard has a proud history of contributions to the datacomm test industry. Table 1 lists some of our retiring instruments with suggested replacements. As your testing needs grow, we stand ready to help with equipment, systems, training, and support to develop and maintain your system, at any level, in any environment.

Any datacomm network can be divided into protocol (user level) links between computers, terminals, or other Data Terminal Equipment (DTE). Two DTEs communicate across a digital link such as RS-232/V.24, RS-449, or V.35. If the digital link is long, it may contain an analog path such as a telephone line. Guaranteeing transparency of the DTE-to-DTE link is the function of protocol.

| Domain | New Product | Old Product |
|------------------|--|---|
| PROTOCOL TESTING | 4951B Protocol Analyzer 4953A Protocol Analyzer 4955A Protocol Analyzer | 1640B Serial Data Analyzer |
| DIGITAL TESTING | 1645A Data Error Analyzer 4925B Bit Error Rate Tester | 4925A Bit Error Rate Test Set |
| ANALOG TESTING | 4945A TIMS 4935A TIMS 4935S TIMS 4936A TIMS 4937A TIMS 4937S TIMS 4938A TIMS | 4940A TIMS 4943A TIMS 4944A TIMS 3551A TIMS (BELL) 3550B TIMS 3552A TIMS (CCITT) |



Because user interaction is with system protocol, the first section deals with protocol testing. Digital and analog testing are discussed in following sections. Test points in a typical system for the three domains of datacomm testing are shown in Figure 1.

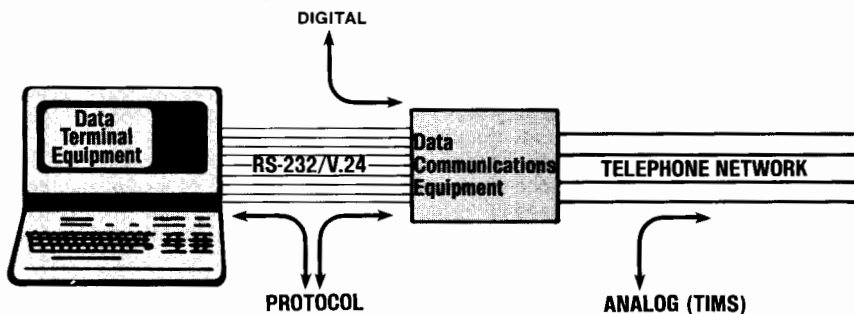

Protocol Analysis

In datacommunications, protocol can be defined as "rules governing the exchange of information between two pieces of data processing equipment". Protocol may take the form of characters or bit fields separate from or added at the beginning or end or in the midst of user data, plus control lead changes. It is needed for message:

- Framing and Synchronization
- Error Detection and Recovery
- Sequence Control
- Acknowledgement
- Link Initialization and Disconnection
- Addressing and Routing

With low speed, simple datacomm networks an observer can watch data flow on a simple data monitor, visually searching for anomalies. This observer needs intimate knowledge of his network's protocol, as well as the capacity for inexhaustible attention to detail. Modern high-speed, complex, multilevel protocols, and very complex networks, make real-time manual analysis (monitor mode) virtually impossible. A protocol analyzer can make complex automated testing easy, and provide many other more sophisticated capabilities.

Besides the monitor mode discussed above, a protocol analyzer offers two other fundamental modes of operation. These are data analysis mode and simulate mode. In data analysis mode, as in monitor mode, the analyzer is nonintrusively connected at the digital interface, and the system functions as though no analyzer were present. In analysis it can:

- store selected data for future use
- display only selected data
- trigger on selected events
- interpret advanced protocols
- count or time events
- verify protocol function
- evaluate system performance
- detect protocol incompatibilities

Simulation opens a whole new dimension of datacomm support. Besides the analysis tools mentioned above, the analyzer can now replace elements of the network under test. It can imitate the network to a DTE and exercise segments of the network without loading down the system or risking system failure because of malfunction in the tested segment. The analyzer can simulate a DTE into the network for system troubleshooting or certification.

Protocol analyzers can be used for:

- Troubleshooting
- System integration
- System installation
- Fault isolation
- Software and hardware development
- Network performance optimization

Different test applications and environments require different protocol analyzers. For field service, portability, ease of use, and remote capability would be key features. Speed, power, and large capture memory characterize needs of an EDP center. R&D and manufacturing require automation and programmability. In the fast changing world of protocol, versatility and power to add new capabilities are needed for any application.

The Hewlett-Packard Protocol Analyzer Family

HP offers a family of three protocol analyzers to meet different application requirements. While maintaining family compatibility each analyzer is tailored for a different environment, with different features and characteristics. The HP 4951B, 4953A, and 4955A have common operating, setup, mass storage, remote transfer, and display characteristics. An overview of differences and similarities can be seen in the family chart at right. Family features are discussed on these two pages, with individual highlights on the following three pages.

Ease of Use

Hewlett-Packard protocol analyzers use a softkey-driven menu human interface to provide sophisticated testing capability without cryptic programming or long development times. With dynamic relabeling of the softkeys only choices appropriate to the setup and menu level are presented to the operator. No special programming skills or obscure code words need be learned. Complex tests can be written and run using only the softkeys. For example, to measure the time between Request To Send and Clear To Send leads going high, the softkey sequence would be WHEN, LEAD, RTS, ON GOTO BLOCK, 2, START, TIMER, 1, WHEN, LEAD, CTS, ON, GOTO BLOCK, 3, STOP, TIMER, 1. With each press of a softkey a new set of softkey labels appears. The HP 4953A and 4955A even provide softkey mnemonics for level 2 and 3 protocol triggers and send strings without reference to binary tables. Complete setups and monitor and simulate menus can be stored to tape for reuse or distribution.

All three analyzers have typewriter quality, full ASCII keyboards for easy entry of triggers or send strings. All keyboards fold against the fronts of the instruments to protect CRT, tape drives, and keyboard. There are no exposed cables to be damaged. HP 4953A and 4955A keyboards lock at any angle for operator convenience.

HP analyzers use high resolution CRTs, allowing sophisticated display of complex protocols to make even real-time analysis easy. Special displays are provided to make visual analysis of high level protocols or complex control lead handshaking quick, sure, and easy, on real-time, buffered, or taped data.

Power

Besides the character traffic on a channel, HP protocol analyzers capture all lead activity and mark each event with a unique time stamp. This time stamp remains with the data in buffer or on tape. It is used for event-to-event timing measurements and to create timing diagram displays. The time and lead information also allows complete analysis of traffic at a later time, in another analyzer, or at a remote location. Relative time relationships are maintained without filling the buffer or tapes with idle line time.



Sophisticated triggering allows the operator to program the analyzer to take a variety of actions in response to different system events. Character strings, lead transitions, errors, complicated protocol activity, or any event at the interface can trigger the analyzer to send a string, increment a counter, start a timer, start or stop tape or display, highlight, or take other actions. Triggering effectively automates protocol analysis.

Most common protocols are built into the HP family with specialized displays, instrument setup, and triggering mnemonics available as needed. User-defined character asynchronous/synchronous allows operation in most nonstandard protocols. Many protocols not inherent in the analyzers are available as application programs.

Besides powerful analysis abilities in nonintrusive monitor mode, all family members offer powerful simulate capability. Softkey/menu programming allows easy stimulus/response testing of network components without tying up other network resources. All the triggering and analysis capabilities are available while actively simulating networks or components. Simulation can be especially useful in isolating intermittent or infrequent troubles, or for testing a new application or device before system connection. The simulate menu specifies the analyzer as a DTE or DCE (see preceding page), transmitting in full or half duplex with user-defined or automatic control of control leads. Send strings may be entered from the keyboard or copied from buffer data.



DATA COMMUNICATIONS TEST EQUIPMENT

General Information: Protocol Analysis

Protocol Analyzer Family Summary

| | 4951B | 4953A | 4955A |
|--|---|--|---|
| Protocols | Async, Sync, Bisync, SDLC, HDLC, SNA, DDCMP, X.25, X.21 | Async, Sync, Bisync, SDLC, HDLC, SNA, DDCMP, X.25, X.21, X.75, BSC-framed X.25, CCITT#7/CCS7 | Async, Sync, Bisync, SDLC, HDLC, SNA, DDCMP, X.25, X.21, BSC-X.25, CCITT#7 |
| Physical Interfaces | RS-232C/V.24, RS-449/422A/423A, MIL-188C, X.20/X.21 | RS-232C/V.24, RS-449/422A/423A V.35, MIL-188C, X.20/X.21 | RS-232C/V.24, RS-449/422A/423A V.35, MIL-188C, X.20/X.21 |
| Data Rates | 50 bps - 19.2 kbps | 50 bps to 72 kbps | 50 bps to 72 kbps |
| Data Codes | ASCII, EBCDIC, HEX, EBCD, Transcode, Baudot, IPARS | ASCII, EBCDIC, HEX, EBCD, Transcode, Baudot, User Defined | ASCII, EBCDIC, HEX, EBCD, Transcode, Baudot, User Defined |
| Error Checking | CRC-CCITT, CRC-16, CRC-12, CRC-6, LRC | CRC-CCITT, CRC-16, CRC-12, CRC-6, LRC | CRC-CCITT, CRC-16, CRC-12, CRC-6, LRC |
| Remote Operation | Transfer data, menus, SW applications via RS-232C/V.24 | Transfer data, menus, SW applications via RS-232C/V.24 Total control via RS-232C/V.24 | Transfer data, menus, SW applications via RS-232C/V.24 Total control via HP-IB |
| Printer Output | Any ASCII RS-232C/V.24 | Any ASCII RS-232C/V.24 Graphics on HP 2932A, HP 2934A and HP29716, HP2673A | HP-IB Graphics on HP 2932A, HP 2934A and HP 26716, HP 2673A |
| Control Monitor | 5 Leads | 15 Leads | 15 Leads |
| Lead Display | LCD/LED on Pod | LEDs on CRT | SoftLEDs on CRT |
| Data Capture Buffer | 32 Kbyte RAM Continuous | 64 Kbyte 256 Kbyte (Optional) | 256 Kbyte RAM |
| Programming | Softkey Monitor and Simulate Menus | Softkey Monitor and Simulate Menus | Softkey Monitor and Simulate Menus BASIC |
| Triggering | 63 Simultaneous Triggers | 63 Simultaneous Triggers | 63 Simultaneous Triggers |
| Timers/Counters | 5 each | 5 each | 5 each |
| Send String | 1750 characters total | 1750 characters total | 1750 characters total |
| X.25 Certification | No | No | Yes |
| Video Output | Yes | No | No |
| BERT | Yes | No | No |
| Autoconfigure | Yes | No | No |
| Auto Increment N(r), N(s), P(r), P(s) | No | Yes | Yes |
| Other | Battery Backup of Menus/Data | Cursor Timing Autostart Tapefile | HP-IB Real-time clock External Trigger |
| Tape Drive | 1 Optional | 1 Standard | 2 Standard |
| Weight | 6.4 kg (14 lb) | 15.5 kg (34 lb) | 22 kg (49 lb) |
| Size (HWD-cm) (HWD-inches) | 11.2 x 25.9 x 28.6 cm (4.4 x 10.2 x 11.3 in) | 19.6 x 42.5 x 41.2 cm (7.8 x 16.8 x 16.3 in) | 19.6 x 42.5 x 65.4 cm (7.8 x 16.8 x 25.7 in) |
| Keyboard | Full ASCII 6 softkeys | Full ASCII, 8 softkey Locks in any position | Full ASCII, 8 softkey Locks in any position |
| Display | 5-inch diagonal 16 lines, 32 characters/line | 9-inch diagonal 25 lines, 80 characters/line | 9-inch diagonal 25 lines, 80 characters/line |



HP 4951A



HP 4953A

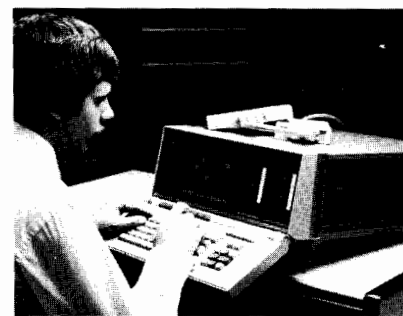

HP 4955A

Software Accessories

Software accessories are HP-supplied programs on tape which extend the usefulness and life of your protocol analyzer by providing additional capabilities. These software accessories guarantee that your protocol analyzer will not be obsolete by changing technology or standards. As evidence of HP's commitment to protect your protocol analyzer investment, please refer to the table on page 132 detailing the software accessories.

Remote

All HP protocol analyzers support the remote exchange of data, menus and applications programs. The HP 4953A provides a

separate RS-232C/V.24 connector for total unattended remote control of up to 16 instruments. The HP 4955A uses the interface pod and requires limited operator interaction. The HP 4951B also provides a separate RS-232C/V.24 connector. For the HP 4951B, remote control is supported for both the separate RS-232C/V.24 connector and the interface pod. For additional technical details, please contact your Sales Representative.

Applications

Major applications involving protocol analyzers include field service, Electronic Data Processing (EDP) support; network component research, development, manufacture

and service; and general network troubleshooting. With the new HP 4951B joining the HP 4953A and the HP 4955A, Hewlett-Packard is your source for total network development, test and support. Besides test equipment, Hewlett-Packard provides the utmost in training and field support for datacomm users. Your local sales representative will be happy to provide information about the Datacomm Seminar, Protocol Seminar, or Customer Engineering services available in your area, as well as more detailed information or a demonstration of the Hewlett-Packard protocol family members meeting your needs.

DATA COMMUNICATIONS TEST EQUIPMENT

Protocol Analyzer

Model 4951B

129

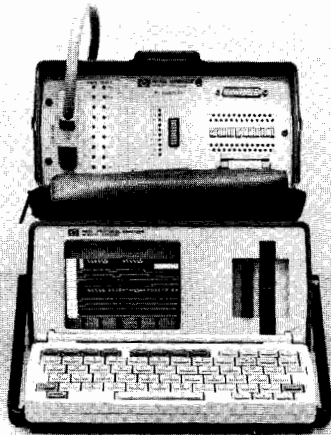

HP 4951B

HP 4951B Protocol Analyzer

The HP 4951B is a portable data communications protocol analyzer used for the installation and maintenance of data terminal and data communication equipment. With it you can monitor and decode data transmissions, simulate network components, perform bit error tests and remotely transfer data and programs through a separate RS-232C/V.24 port. External viewing is supported via a standard RS-170 video port. Its small size, weight, and price combined with its ease of use, power, and versatility, make it ideal for field service testing needs. Integral mass storage allows you to capture large amounts of data for future analysis. With the push of a key, Auto Configure automatically determines line parameters and begins monitoring data. For testing at remote installations, the HP 4951B is compatible with the HP 4953A and the HP 4955A. Additional capabilities are provided through software accessories. Please refer to page 132 for details.

General Operating Characteristics

Protocols: X.25, SNA, X.21, DDCMP, HDLC, SDLC (NRZI), BSC, IPARS, and character asynchronous or synchronous protocols.
Data Transfer Rates (bps): 50, 75, 110, 134.5, 150, 200, 300, 600, 1200, 1800, 2000, 2400, 3200, 3600, 4800, 7200, 9600, 12000, 14400, 16000, 19200, teletext 1200/75, and EXTERNAL up to 19200 full duplex for all monitoring, simulation, triggering, and BERT tests. Exceptions: asynchronous at 12000 bps; synchronous NRZI at 12000, 14400, and 16000 bps. BERT at Teletext 1200/75, 16000, 14400, and 150 bps.

The HP 4951B can capture a complete buffer full of data at line speeds up to 64 kbps (bit-oriented protocols only, no triggering).

Data Codes: ASCII, EBCDIC, Baudot, Six Bit Transcode, IPARS, and EBCD.

Capture Memory: 32 Kbytes of RAM stores data characters, timing, and lead status information.

Optional Tape Drive: 512 Kbytes. Store data, timing information, and menu configurations.

Lead Status: The status of five control leads are stored for each interface. They are RTS, CTS, DTR, DSR, and CD for RS-232C/V.24 and CS, RS, RR, TR, and DM for the RS-449 interface.

Character Framing: 5,6,7, or 8 information bits, plus parity. For asynchronous systems, select 1, 1.5, or 2 stop bits per character.

Error Checking: CRC-CCITT, CRC-16, CRC-12, CRC-6, LRC and parity.

Triggers: 63. Consisting of characters, errors, interface lead transitions or timer values. May be simultaneously active up to 19200 bits per second.

Timers: Five. Each timer has a maximum count of 65565 ms. Resolution 1 ms.

Counters: Five. Each counter may be incremented up to 9999.

Keyboard: Full ASCII keyboard with six softkeys and cursor control.

Display: 12.7 cm (5 in.) diagonal with 16 lines and 32 characters per line.

Display Formats: DTE data over DCE data, Data and Lead State, DTE data only, DCE data only, and Frame and Packet decode.

Send Strings: 255 characters per string maximum; 1750 characters total.

Remote Capability: Separate rear panel RS-232 C/V.24 port or use the interface pod.

Bit Error Rate Testing: Simultaneously measure bit errors, block errors, errored seconds, and percent error free seconds.

Block size: 63, 511, 1000, or 2047 bits.

Patterns: 63, 511, or 2047 bit pseudo random sequence.

Character framing: Select 5, 6, 7 or 8 bits per character and parity.

Inject error function: Inject single errors or bursts of errors.

Additional Characteristics: Auto configuration of all setup parameters. Battery backed-up RAM for all setups, data, and menus. Select bit order as LSB or MSB first and select the bit sense as inverted or normal. Video output is RS-170.

Interface Accessories

HP 18173A, HP 18174A, HP 18179A and HP 18180A.

Each interface is supplied with the appropriate 1.5-meter cable.

HP 18173A

RS-232C/V.24 Interface: Ten switches for line isolation. Twenty-five test points for monitoring, forcing, or cross-patching. One non-dedicated MARK/SPACE tri-state monitor for user patching to any line. Nine hard-wired activity indicators: TD, RD, TC, RC, DTR, DSR, RTS, CTS, and CD.

HP 18174A

RS-449 Interface: Nine dedicated activity indicators: SD, RD, ST, RT, RS, CS, TR, DM, and RR. Balanced RS-422A drivers.

18179A

RS-232C/V.24 Interface: with a complete breakout box and tri-state LEDs. The 25 pin breakout box allows any interface lead to be broken out.

HP 18180A: Combination RS-232C/V.24 and RS-449.

General Specifications

Weight: net, 5.7 kg (12.6 lb); shipping, 9.5 kg (21 lb).

Size: 11.2 H x 25.9 W x 28.6 cm D (4.4 x 10.2 x 11.3 in.).

Temperature: operating, 0°C to +55°C (+32°F to +131°F);** storage, -40°C to +75°C (-40°F to +167°F).

**Tape drive should only be operated from +5°C to +40°C (+41°F to +104°F).

Power Requirements: 100, 120, 220 or 240 Vac, -10% to +10%; 48 to 66 Hz, single phase; typical less than 15 VA, maximum less than 30 VA.

Ordering Information

| | Price |
|--|--------|
| HP 4951B Protocol Analyzer (does not include interface pod) | \$3595 |
| Option 001: Integral Tape Drive | \$850 |
| Option 003: Katakana JIS-7, and EBCDIK Data Code | \$250 |
| Option 100: Adds accessory HP 18173A | \$400 |
| Option 101: Adds accessory HP 18174A | \$400 |
| Option 102: Adds accessory HP 18180A | \$800 |
| Option 103: Adds accessory HP 18179A | \$550 |
| Option 104: Adds accessory HP 18178A | \$750 |
| Option 106: Adds accessory HP 18197A | \$1150 |
| Option 910: Service Manual and Extra Operating Manual | \$50 |
| Option 915: Service Manual | \$30 |
| Option 916: Extra Operating Manual | \$20 |

Accessories

| | |
|---|-------|
| HP 18173A: RS-232C/V.24 Interface Pod | \$400 |
| HP 18174A: RS-449/422A/423A Interface Pod | \$400 |
| HP 18179A: RS-232C/V.24 Interface with complete breakout box | \$550 |
| HP 18180A: Combination RS-232C/V.24 and RS-449/422A/423A Interface Pod | \$800 |
| HP 18190A: Soft Vinyl Carrying Case | \$125 |
| HP 98200A: Certified blank tape cartridges (set of five) | \$95 |

Software Accessories

| | |
|---|--------|
| HP 18178A: X.21 Interface Kit | \$750 |
| HP 18186A: SNA Analysis | \$500 |
| HP 18187A: DDCMP Decode/Simulate | \$450 |
| HP 18193A: X.25 Package | \$350 |
| HP 18197A: Combination X.21/RS-232C/V.24 Pod | \$1150 |
| HP 18201A: Async Terminal Emulator | \$250 |



DATA COMMUNICATIONS TEST EQUIPMENT

Protocol Analyzer

Model 4953A



HP 4953A

HP 4953A Protocol Analyzer

The HP 4953A combines portability with very high performance. With complete unattended remote control over any asynchronous data link, you can transport the problem and your expertise instead of your expert. To the Hewlett-Packard protocol analyzer family, the HP 4953A adds Cursor Timing for timing measurements at the touch of a softkey without programming, mnemonic labeled softkeys for easy setup of frame and packet tests, total remote operation, and tremendous future versatility. An extensive and growing library of application programs, many of which may co-reside in the up-to-324 Kbytes of application space, dramatically enhances the already-powerful HP 4953A. The auxiliary RS-232C/V.24 connector on the rear panel supports computer control (ask about the REMOTE application note), remote operation with another HP protocol analyzer, or printer output to any ASCII printer. For more information see the family summary on the preceding pages or the software listing following.

General Operating Characteristics

Protocols: X.25, X.75, HDLC, SDLC, SNA, BSC, BSC-framed X.25, DDCMP, CCITT#7, and user-definable character asynchronous or synchronous protocols.

Data Transfer Rates: 50 bps to 72 kbps using the HP 4953A's internal clock or an externally supplied clock.

Data Capture Speed: bit oriented protocols to 256 kbps.

Data Transmission Modes: synchronous, asynchronous, and synchronous NRZI.

Capture Memory: 64 Kbytes for storing data, timing, and interface lead status. Option 001 increases the capture memory to 256 Kbytes.

Remote: total control of up to 16 remote instruments.

Character Framing: 5,6,7, or 8 information bits plus parity.

Data Codes: ASCII, EBCDIC, Baudot, EBCD, and Transcode are provided. The user may quickly define other data codes and store them to tape for future use.

Error Checking: CRC-CCITT, CRC-16, CRC-12, CRC-6, and LRC.

Parity: Odd, Even, None, and Ignore.

Triggers: 63 triggers, consisting of character strings, errors, or interface lead transitions. Bit and character masking, and "not" characters are supported. Trigger events can be selectively displayed and stored to tape.

Tape Drive: cartridges store data, timing information, interface and lead status, menu configurations, custom data codes, and application programs. The entire contents of the buffer memory may be stored on a single data cartridge.

Display: high resolution 23 cm (9 in.) diagonal, 25-line by 80-character display. Double size characters are selectable.

Keyboard: full ASCII keyboard pivots and looks at any angle for convenient desk, bench, rack, or floor-standing operation.

RS-232C/V.24: for instrument control by computer or remote analyzer, separate from interface port. Direct graphics output of all normal sized displays to an HP 2671G, HP 2673A, or HP293X, 2932A, or 2934A printer is standard. General RS-232C/V.24 printer support is also standard. Remote transfer of data, menus, setups, status, application programs, and remote menu execution via RS-232C/V.24 are all standard features.

Timers and Counters: 5 each.

Timers: 65 535 ms max.; 1 ms resolution.

Counters: up to 65 535 counts.

Cursor Timing: direct display readout of the time between any two characters or lead transitions.

Self Test: extensive self test and functional verification routines will isolate failures to the board assembly level. Built-in signature analysis permits fault isolation to the component level.

Specifications

HP Class B Environmental Specifications

Relative Humidity: operating 5% to 95% at +40°C; storage, 5% to 90% at +65°C.

Temperature: operating, 0°C to +55°C (+32°F to +131°F); storage, -40°C to +75°C (-40°F to +167°F)**

** Tape drive should only be operated from +5°C to +40°C (+41°F to +104°F).

HP Class B Shock and Vibration Specifications: IEC 348, ANSI 395, CSA Safety Standards.

Altitude: operating, 4 600 m (15 000 ft); storage, 15 300 m (50 000 ft).

Primary Channel Clock Accuracy: 0.005%.

Dimensions: (overall excluding pouch): 41.2 L x 46.4 W x 19.6 cm H (16.25 x 18.25 x 7.75 in.); Rack height 17.8 cm (7 in.).

Weight: net, 15.5 kg (34 lb).

Power Requirements: 115/230 Vac + 10%-25%; 48 Hz to 66 Hz; single phase; 200 VA max.

Ordering Information

| | Price |
|--|----------|
| HP 4953A: Protocol Analyzer | \$12,000 |
| (does not include interface pods or service manual) | |
| Opt 001: Extended Memory | \$1,000 |
| Opt 003: Adds HP 18200A Katakana Character Set (JIS-8) | \$250 |
| Opt 100: Adds HP 18135A (RS-232C/V.24) | \$950 |
| Opt 101: Adds HP 18136A | \$950 |
| Opt 104: Adds HP 18137A | \$950 |
| Opt 105: Adds HP 18139A | \$950 |
| Opt 908: Rack Mount Kit | \$35 |
| Opt 915: Service Manual | \$95 |
| Opt 916: Additional Operating Manual | \$55 |
| Physical Interface Pods | |
| HP 18135A: RS-232C/V.24 Interface Pod | \$950 |
| HP 18136A: RS-449 Interface Pod | \$950 |
| HP 18137A: V.35 Interface Pod | \$950 |
| HP 18139A: MIL-188C Interface Pod | \$950 |
| Software and other Accessories | |
| HP 18140A: Breakout Box (for all interfaces) | \$505 |
| HP 98200A: Certified Blank Tape Cartridges (set of 5) | \$95 |
| HP 9211-2644: Transit Case | \$460 |
| HP 04953-62611: Option 001: Extended Memory Retrofit Kit | \$1,000 |
| HP 18153A: SNA Analysis | \$750 |
| HP 18154A: X.21 Interface Kit | \$1,250 |
| HP 18155A: BSC-framed X.25 Decode | \$450 |
| HP 18199A: CCITT#7/CCS7 Analysis | \$1,600 |



HP 4955A

HP 4955A Protocol Analyzer

The HP 4955A is a high level tool for R & D and manufacturing, as well as for network performance analysis. In addition to the standard capabilities provided within the protocol analyzer family, the HP 4955A offers BASIC programming, HP-IB control, a real-time clock, and dual tape drives. Troubleshooting is straightforward with the softkey driven menus. A datacomm-enhanced BASIC programming language is standard with the instrument and can be used for sophisticated analysis or for unique applications. BASIC uses many of the menu routines, maintaining softkey ease of use while giving you the capability to write your own programs as needed. The HP 4955A, combined with the X.25 Certification and Analysis System, provides you with a very powerful tool for certifying equipment for use in X.25 networks. Please refer to the software accessories section on page 132 for additional details.

General Operating Characteristics

Protocols: X.25, HDLC, BSC, SDLC, user defined character synchronous/asynchronous. Available software accessories supply custom display formats to decode SNA, BSC-framed X.25, DDCMP, X.21, and CCITT 7.

Data transfer rates: 50 bps to 72 kbps using internal clock. HP 4955A can properly frame data at higher rates using an external clock.

Data transmission modes: synchronous, asynchronous, and synchronous NRZI.

Capture memory: 256 Kbytes for storing data, timing, and interface lead status.

Character framing: 5,6,7, or 8 information bits plus parity.

Data codes: ASCII, EBCDIC, Baudot, EBCD, IPARS, Selectric, and Transcode are provided. The user may quickly define other codes using the supplied application program, and store them to tape for future use.

Error checking: CRC-CCITT, CRC-16, CRC-12, CRC-6 and LRC.

Parity: Odd, Even, None, and Ignore.

Triggers: 63, consisting of characters, errors, or interface lead transitions. External TTL pulse trigger-in and trigger-out ports are provided. Bit and character masking, and "not" characters are supported. Trigger events can be selectively displayed and stored to tape. Date and time are also stored for future reference.

Timers and Counters (5 of each).

Timers: 65535 ms max; 1 ms resolution and accuracy.

Counters: up to 10,000.

Date and time clock: battery backup.

Dual tape drives: cartridges store buffer data and timing information, menu configurations, custom data codes, application programs, and BASIC programs. The entire contents of the buffer memory may be stored on a single data cartridge.

Display: 23 cm (9 in.) diagonal, 25-line by 80-character display. Double size characters are selectable.

Keyboard: the full ASCII keyboard pivots and locks at any angle for convenient desk, bench, rack, or floor-standing operation.

HP-IB (IEEE-488-1978)

a. Direct hard copy output of any display to an HP 2671G, HP 2673A, HP 2932A, or HP 2934A printer.

b. Remote operation using an HP-IB controller.

Security: inhibit simulation and data recording capability.

Self test: extensive self-test and functional verification routines isolate failures to the board assembly level. Built-in signature analysis permits fault isolation to the component level.

Specifications

Primary channel clock accuracy: 0.005%.

Temperature: operating, 0°C to +55°C (+32°F to +131°F)*
storage, -40°C to +75°C (-40°F to +167°F).

* Tape drives should only be operated from +5°C to +40°C (+41°F to +167°F).

Altitude: Operating, 4600 m (15 000 ft);
Storage, 15 300 m (50 000 ft).

Dimensions (overall, excluding pouch).

Length: 654 mm (25.7 in.).

Width: 436 mm (17.2 in.).

Height: 201 mm (7.9 in.).

Rack Height: 177 mm (6.97 in.).

Weight: Net, 22 kg (49 lb);

Shipping, 32 kg (70 lb).

Power requirements: 110, 220, Vac -15% to +15%; 48 to 66 Hz single phase; 250 VA max.

HP-IB Interface Functions: SH1, AH1, T2, L2, SR1, RL1, PP0, DC1, DT0, C1, C2, C4, C27, and E2. For more on these codes, refer to the HP-IB section of this catalog.

Ordering Information

HP 4955A: Protocol Analyzer (includes HP 18135A, HP 18143A, HP 18144A) \$18,680

Opt 001: BASIC Programming Language add \$1,700

Opt 002: Deletes HP 18135A less \$950

Opt 003: Katakana Character Set (JIS-8) add \$250

Opt 004: Deletes second tape drive and pouch less \$300

Opt 908: Rack Mount Kit (HP 5061-0078) add \$35

Opt 910: Extra Operating Manual (HP 04955-90029) add \$55

Opt 915: Service Manual (HP 04955-90004) add \$95

Physical Interface Pods

Opt 916: Japanese Operating Manual (HP 04955-90026) add \$55

HP 18135A: RS-232C/V.24 Interface Pod \$950

HP 18136A: RS-449/422A/423A Balanced RS-422A drivers Interface Pod \$950

HP 18137A: V.35 Interface Pod \$1,150

HP 18138A: X.21 Interface Kit (used with HP 18136A) \$250

HP 18139A: MIL-188C Interface Pod \$950

Software and other Accessories

HP 18140A: Breakout Box (for all interfaces) \$595

HP 18141A: Service Kit \$750

HP 18142A: BASIC Programming Language Field Retrofit Kit \$1,500

HP 18143A: Training Guide (Included with HP 4955A) \$50

HP 18144A: Protocol Decode Pack (Included with HP 4955A) \$250

HP 18145A: Remote Testing Pack \$500

HP 18146A: CCITT#7 Decode \$500

HP 18151JA: X.25 DTE Certification and Analysis System \$1,500

HP 98200A: Certified Blank Tape Cartridge (set of 5) \$ 95

Transit Case: (HP 9211-2662) \$570

Retrofit Kit for Opt 003: (JIS-8) (HP 04955-62615) \$170

Retrofit Kit for Rev 2.0: System firmware (HP 04955-62616) \$170

One Day HP 4955A Training (+24A) \$1,475



DATA COMMUNICATIONS TEST EQUIPMENT

Protocol Analyzer Software Library

| Protocols: | 4951 | 4953 | 4955 |
|-------------------------|------|------|------|
| Async/Sync | | | |
| BSC | | | |
| SDLC | | | |
| HDLC | | | |
| SNA | New | New | |
| X.25 | | | |
| X.75 | | | |
| DDCMP | New | | |
| X.21 | New | | |
| BSC-X.25 | | New | |
| CCITT#7 | | New | |
| Applications: | | | |
| Async Terminal Emulator | New | | |
| Remote | | | |
| X.25 Packet display | New | | |
| Printer output | New | | |
| BASIC programming | | | |
| X.25 Certification | | | New |

software accessory standard product feature

X.25

HP 18193A - New - X.25 Package for the HP 4951

\$350

Provides Link and Packet level assisted string entry for building triggers and send strings and a Packet display. These features are standard in the HP 4953 and HP 4955.

HP 18151JA - New - X.25 DTE Certification Testing and Analysis System for the HP 4955

\$1500

Provides X.25 users with extensive certification tests to completely evaluate DTE conformance with the CCITT X.25 specification. Any problems discovered through the certification procedure can be quickly isolated using the HP 18151JA emulation and analysis tools. This software package is specifically designed for characterizing and troubleshooting X.25 packet-switching network software. It includes:

- X.25 Link level DTE certification
- X.25 Packet level DTE certification
- X.25 Link level DTE and DCE emulation

More than 700 individual certification test sequences are designed in accordance with National Bureau of Standards X.25 verification procedure for FS 1041/FIPS 100. Because the tests are written in HP 4955 BASIC, they can easily be modified for customized testing applications. Certifying X.25 equipment as it is developed helps eliminate potential problems interfacing with other X.25 equipment. Analysis with the Link level emulator allows easy Packet level testing by automatically handling the Link level. Together, the certification tests and analysis tools offer a powerful X.25 problem-solving system.

SNA

HP 18186A - New - SNA Analysis for the HP 4951

\$500

Presents SNA data in an easy-to-read format clearly displaying the TH, RU, and FMH with detailed sub-fields and high-level mnemonics. Supervisory frame suppression and specific link address monitoring efficiently utilize buffer space.

HP 18153A - New - SNA Analysis for the HP 4953

\$750

Presents SNA data in clear, easy-to-read, high-level terms, showing the TH, RU, and FMH for FID types 0,1,2,3,4, and F and the first 80 characters of data.

HP 18144A - Protocol Decode Pack for the HP 4955

standard

X.21

HP 18178A - New - X.21 Interface Kit for the HP 4951

\$750

Provides an X.21 interface pod and software for complete Monitor/Simulate of quiescent, call establishment, data transfer, and call clear phases.

HP 18197A - New - Combination X.21 and RS-232C/V.24 Interface Pod for the HP 4951

\$1150

Provides an X.21 and RS-232C/V.24 interface pod and software for complete Monitor/Simulate of quiescent, call establishment, data transfer, and call clear phases. X.21 bis is not supported.

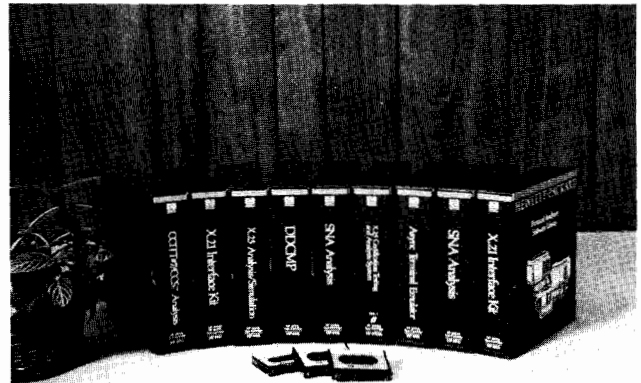

HP 18154A - New - X.21 Interface Kit for the HP 4953

\$1250

Provides X.21 software for complete Monitor/Simulate of quiescent, call establishment, data transfer, and call clear phases. Must be used with the HP 18136A RS-449 pod and option 001 extended memory.

HP 18138A - X.21 Interface Kit for the HP 4955

\$250

Provides a 15-pin X.21 network access cable and software to display X.21 data. Must be used with the HP 18136A RS-449 pod.

DDCMP

HP 18187A - New - DDCMP Decode/Simulate for the HP 4951

\$450

Provides software needed to Monitor and Simulate DDCMP. Automatic generation of header and data CRCs is done in Simulation.

HP 18144A - Protocol Decode Pack for the HP 4955

standard

CCITT#7/CCS7

HP 18199A - New - CCITT#7/CCS7 Analysis for the HP 4953

\$1000

FISU and LSSU suppression, automatic network frame counts and inter-frame timing measurements. User-definable mnemonics and field segmentation for portions of Level 4 allow for ongoing development of new fields and User Parts. Requires Option 001 extended memory.

HP 18146A - CCITT#7 Decode for the HP 4955

\$500

Provides post-processing software to decode and display CCITT#7 data. Custom TUP display formats are available.

BSC-Framed X.25

HP 18155A - New - BSC-framed X.25 Decode for the HP 4953

\$450

Provides a clear, easy-to-read format of the Link and Packet level mnemonics of BSC-framed X.25 along with the first 80 characters of information.

HP 18144A - Protocol Decode Pack for the HP 4955

standard

Remote

All HP protocol analyzers have the capability to remotely transfer data, setups, and user-written program menus via RS-232C/V.24, either directly or via external modems. The HP 4951 and HP 4953 have this remote capability built in. The HP 4953 can run the remote transfer with the remote site totally unattended. The HP 4955 has remote capabilities through the use of a software accessory.

HP 18145A - Remote Testing Pack for the HP 4955

\$500

Terminal Emulation

A protocol analyzer that acts like an asynchronous terminal allows field service technicians to send and receive mail from a main office computer, verify terminal problems, and configure intelligent devices without the need for a separate terminal.

HP 18201A - New - Async Terminal Emulator for the HP 4951

\$250



Data Network Testing

There are a wide variety of tests that can be made on a data communications system. Depending on the point in the system at which the tests are made, quite different philosophies and techniques apply.

Protocol analysis is usually concerned with overall network performance, determined through monitoring or simulating network software (protocol and/or data). Digital testing involves measuring modem-channel-modem efficiency in terms such as Bit Error Rate (BER) and Block Error Rate (BLER). Analog testing measures the tariffed and other key parameters of the transmission line itself.

The interrelationships of these measurement philosophies are complicated and difficult to understand. For example, how is envelope delay distortion of the line related to the BER or the throughput of the system? Generally speaking, the three measurement philosophies are related in a hierarchical fashion. Nonintrusive network monitoring by protocol analyzers gives an indication of overall performance and can often isolate problems to the component or section. When monitoring is insufficient, such as during software debugging or systems integration, protocol analyzers also can be used to simulate network components such as front-end processors or terminals. Once sectionalized, BER testers are used to verify and quantify the link dysfunction, and analog measurements determine which tariffed parameter is out of specification should the telephone line be the problem.

Combined protocol, digital, and analog tests can be used synergistically to restore the network quickly and efficiently. Protocol Analysis has been previously described. The next sections detail the analog and digital testing.

Digital Measurements

Data error analyzers are used to test the quality of both the modem and the transmission facility. They provide information about the modem and transmission line, but no information about the DTE they replace.

The overall quality of the link is indicated by its BER. A good link will have an error rate better than 1×10^{-5} per bit. This measurement will include the effect of both transmission line impairments and the modem's ability to overcome them. Modems vary widely in their sensitivity to line impairments. Low speed (less than 300 bps) and adaptively equalized modems are less sensitive than high speed (more than 4800 bps) and non-adaptively equalized modems.

Since data communications systems transmit data and control information in blocks, these instruments also measure BLER and Percent Error Free Seconds (%EFS). BER, BLER and %EFS can be used together to examine the statistics of the error mechanism.

If the BER and BLER are both high, and %EFS low, the impairment is random and probably due to noise. If the BER is high but the BLER and %EFS are low, the impairment is more bursty. This happens when lines are switched, synchronization is temporarily lost, or impulse noise is too high.

| | Basic Testing | | Conditioned Circuit Testing | | | | Additional Testing for Complete Troubleshooting | | | | Remote Automatic Testing | | Signaling | | | | | | | | |
|-----------------------|-----------------|--|--|------------------------|------|-------------------------|---|--------------------------------------|-----------------------------------|--------------|--------------------------|---------------|-------------|-----------------|------------|--------------|----------------|------------|--------------|-----------------|---------------|
| | Up to 2400 bps | Up to 9600 bps and ODS | C & D Conditioning — BELL M1020 & M1040 Conditioning — CCITT | | | | | | | | | | | | | | | | | | |
| | Loss Continuity | Signal/Noise Ratio Noise: Less vs. Free | Impulse Noise | Wideband Impulse Noise | P/AB | Envelope or Group Delay | Attenuation Distortion | Frequency Intermodulation Distortion | M/D or Intermodulation Distortion | Phase Jitter | Amplitude Jitter | Hits/Dropouts | Return Loss | CCITT Crosstalk | HP SYSTEMS | Master/Slave | Ring Generator | Loop Start | Ground Start | Loop Rev. Start | CM 1, II, III |
| BELL Recommendations | | 3551A 4935A 4945A 3776B 4937A 4938A | | | | | | | | | | | | | | | | | | | |
| CCITT Recommendations | | 3552A 4936A 3770B 3776A | | | | | | | | | | | | | | | | | | | |

Error rates are quantitative checks of the data communications system that can be made in a few minutes. If the system is bad, diagnostic measurements are provided to help isolate the problem. Dropouts, clock slips, error skew, jitter, and total peak distortion indicate some of the problems that can occur on a link. These measurements are made simultaneously with the error rate measurements and can be printed out in automatic unattended mode if desired.

Catastrophic failures can usually be found with self-tests and loop-back switches built into the modem. Data error analyzers can find failures that are not illuminated by internal self-tests.

Modem dynamics are another source of data transmission problems. Modern modems have automatic equalization circuits to compensate for telephone line distortions. It is important to let the equalization process settle, particularly with switched carrier modems, so data is not transmitted too soon.

Measurements that verify modem dynamics are RTS-CTS delay and modem start up tests such as ping-pong.

Analog Impairments Affect Performance

Analog impairments on the telephone line can significantly affect the efficiency of data communications. What the user notices is a slow down in throughput (because of frequent retransmission of blocks of data), garbled data or no data at all. These effects are a result of the line impairments so distorting to

the modem signal that the receiving modem cannot make correct decisions. So data bits and blocks are received in error.

The various modem types are susceptible to each impairment in differing degrees. Low speed modems generally use simple modulation schemes and are mostly affected by problems of *continuity*, *loss*, *signal-to-noise ratio*, and *impulse noise*.

As modem speeds increase, the modulation scheme becomes more complex and so they are more susceptible to other impairments. Two approaches are taken to minimize these effects. One is to select and condition leased telephone lines to eliminate significant impairments. The impairments of concern are *bandwidth reduction*, *envelope (or Group) delay distortion*, *non-linear (Inter-modulation) distortion*, *phase jitter*, *hits*, and *dropouts*.

The other approach can address a limited number of these with varying degrees of success. Automatic equalization is built into the modem itself. This can take care of *bandwidth reduction*, and *envelope (or Group) delay distortion* problems. There is no significant protection against the other impairments and cases of severe or rapidly changing *envelope (or Group) delay distortion* or *bandwidth reduction* may not be adequately compensated for either.



DATA COMMUNICATIONS TEST EQUIPMENT

Transmission Impairment Measuring Sets (TIMS)

Models 4935A, 4936A

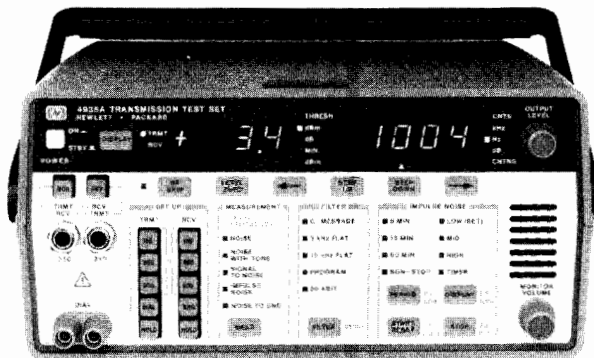

HP 4935A

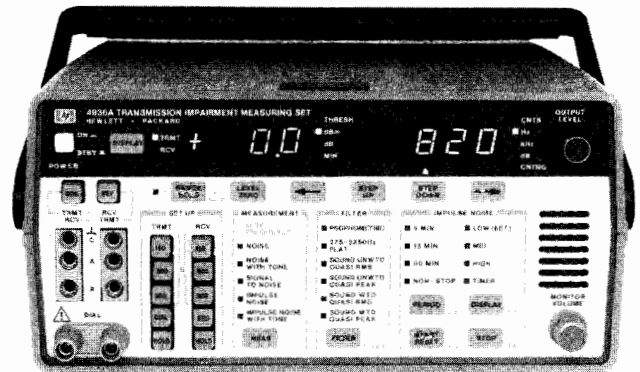

HP 4936A

Product Description

Qualify Circuits for Voice, Data or Program

The Hewlett-Packard 4935A and 4936A Transmission Impairment measuring Sets provide the basic analog tests to isolate faults and to qualify circuits for voice, data or broadcast transmission at frequencies up to 110 kHz. The HP 4935A is compatible with Bell standards and the HP 4936A is CCITT compatible. Both of these sets provide measurements of level versus frequency, noise and noise with tone using various noise filters, and three-level impulse noise. The HP 4935A performs the required tests to qualify the local loop for Digital Data Systems (DDS) up to 56 kbps. The Peak-to-Average-Ratio (P/AR) measurement option on the HP 4935A gives system users a powerful yet simple measure of the combined factors that effect the overall data transmission quality of the line. The P/AR measurement was developed by Bell Laboratories and is useful as a benchmark of a line's data transmission quality.

Telephone companies, PABX and other telecommunications equipment service people will find the HP 4935A and 4936A have the analog testing capability they need. Both instruments include standard dial and hold capabilities, independent transmit and receive impedances, level zero function, SF skip and complete unit annunciation.

Portable for Field Use

The HP 4935A and 4936A in their rugged polycarbonate cases weigh only 14 pounds with batteries, making them ideal for field applications.

Easy-to-Use Instruments Reduce Testing Time

Both the HP 4935A and 4936A are easy to use, allowing reduced training time, fewer operator errors and reduced testing times. The HP 4935A and 4936A guide you through the measurements by activating only the proper keys for each selection. Each selected function is indicated on its own LED and there is a beep when a key is pressed. Complete annunciation displays the selected measurement, proper units for each measurement, and error messages, if there is a problem with either the measurement or the instrument.

HP 4935S Transmission Test Set

The Hewlett-Packard 4935S Data Transmission Test Set combines the analog power of the HP 4935A TIMS with the digital testing capabilities of the HP 4925B Bit Error Rate Test Set (BERT) to give you a complete data service and installation tool in one portable package. The HP 4935S allows you to verify and troubleshoot most data links quickly and efficiently. Both analog transmission problems and modem problems can easily be isolated. The system weighs 17 pounds and is battery-powered, making it ideal for field installation and maintenance personnel.

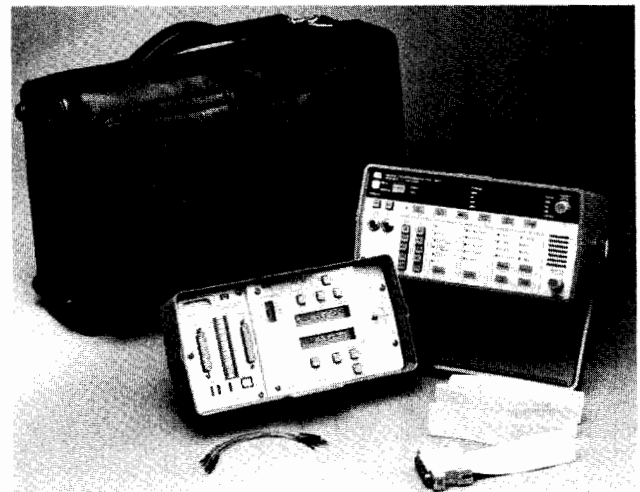

The HP 4935S includes the HP 4925B, the HP 4935A and a large carrying case.

HP 4925B Bit Error Rate Test Set

The HP 4925B Bit Error Rate Test Set (BERT) sits on the digital interface and measures the integrity of the data link to properly transmit and receive error-free data to 72 kbps. Digital testing allows you to perform bit error tests and data throughput analysis, and to test terminals, printers, and statistical multiplexers for proper operation. It is available with both the RS-232C and V.35 interfaces.

More Than Just A Bert

In addition to the standard bit and block error test, the HP 4925B measures errored seconds, percent error-free seconds, timing delay, and parity errors. Increased flexibility is afforded by a complete breakout box.

The HP 4925B adds the ability to frame data for testing character-oriented systems such as statistical multiplexers. With it, you can also transmit the FOX message to printers and terminals. Three separate start-up tests—half-duplex ping-pong, local modem loopback, and remote Bell 208B—enable dynamic testing of modems.

HP 4935A Specifications

Level and Frequency

Transmitter

Frequency range: 20 Hz to 110 kHz.

Resolution: ± 1 Hz to 100 kHz.
 ± 10 Hz, 110 kHz.

Level range: -40 to +13 dBm.

Level resolution: 0.1 dB.

Receiver

SF skip band: 2600 Hz ± 150 Hz.

Frequency range: 20 Hz to 110 kHz.

Resolution: ± 1 Hz to 10 kHz.
 ± 10 Hz, to 110 kHz.

Level range: -60 to +13 dBm.

Level accuracy: from -40 to +13 dBm.

20-50 Hz ± 1.0 dB.

50-200 Hz ± 0.5 dB.

200 Hz-15 kHz ± 0.2 dB.

15 kHz-85 kHz 0.5 dB.

Level resolution: 0.1 dB.

Noise Measurements

Range

Message circuit noise: 0 to 100 dBm.

Noise with tone: 10 to 100 dBm.

Noise to ground: 50 to 130 dBm.

Detector: quasi rms.

Notch filter: 50 dB rejection from 995 to 1025 Hz.

3 Level Impulse Noise

Threshold ranges @ 600 Ω :

Low: 30 to 109 dBm.

Mid: 4 dB above Low to 109 dBm.

High: 8 dB above Low to 109 dBm.

Range of tone: -40 to +13 dBm.

Peak to Average Ratio

Transmitted level range: -40 to 0 dBm.

Received level range: -40 to +3 dBm.

P/AR range: 0 to 120 P/AR units

Resolution: 1P/AR unit.

General

Impedances: 135 Ω , 600 Ω , 900 Ω .

Filters: C message

3 kHz flat

15 kHz flat

Program

50 kbit

HP 4936A Specifications

Level and Frequency

Transmitter

Frequency range: 20 Hz to 110 kHz.

Resolution: ± 1 Hz to 100 kHz.
 ± 10 Hz, 110 kHz.

Level range: -40 to +13 dBm.

Level resolution: 0.1 dB.

Stored frequencies: 404 Hz, 1004 Hz, 2804 Hz, 2713 Hz.

Stored frequencies: 300 Hz, 820 Hz*, 2000 Hz, 3000 Hz.

* 1020 Hz tone and notch available as option.

Receiver

Tone blanking: SF skips 2280 Hz ± 150 Hz.

Frequency range: 20 Hz to 110 kHz.

Resolution: ± 1 Hz to 10 kHz.
 ± 10 Hz, 110 kHz.

Level range: -70 to +13 dBm.

Level accuracy: from -40 to ± 13 dBm.

20-50 Hz: ± 1.0 dB.

50-100 Hz: ± 0.5 dB.

100 Hz-4 kHz: ± 0.1 dB.

4kHz-15 kHz: ± 0.2 dB.

15 kHz-85 kHz: ± 0.5 dB.

Level resolution: 0.1 dB.



Noise Measurements

Range

Noise: -90 to +10 dBm.

Noise with tone: -80 to +10 dBm.

Detector: quasi rms.

quasi peak - monitored by analog outputs.

Notch filter: 50 dB rejection from 800-855 Hz*.

*With optional 1020Hz tone, notch is same as HP 4935A.

3 Level Impulse Noise

Threshold ranges @ 600 Ω :

Low: -60 to 16 dBm.

Mid: 3 dB above Low to 16 dBm.

High: 6 dB above Low to 16 dBm.

Range of tone: -40 to +13 dBm.

General

Impedances: 150 Ω , 600 Ω , 900 Ω .

Filters: Psophometric (P.53)

275-3250 Hz Flat (0.71 impulse noise)

Sound unweighted (J.16)

Sound weighted (J.16)

Ordering Information

HP 4935A Transmission Impairment Measuring Set \$3295

Option 001: adds rechargeable battery pack \$375

Option 002: adds P/AR measurement in place of noise-to-ground \$390

Option 003: adds both battery pack and P/AR, deletes noise-to-ground \$430

Option 910: adds extra HP 4935A Operating and Service Manual \$25

HP 4936A Transmission Impairment Measuring Set \$3860

Option 001: includes 820 Hz tone with rechargeable battery pack \$495

Option 002: 1020 Hz tone 0

Option 003: includes 1020 Hz tone with rechargeable battery pack \$495

Option 910: adds extra HP 4936A Operating and Service Manual \$35

HP 4935S Data Transmission Test Set \$4615

Option 001: adds rechargeable battery pack to HP 4935A \$375

Option 002: adds P/AR measurement in place of noise-to-ground in HP 4935A \$300

Option 003: adds both battery pack and P/AR to HP 4935A, deletes noise-to-ground \$430

Option 101: adds RS-232C/V.24 interface to HP 4925B \$390

Option 102: adds V.35 interface and HP 18184A power module to HP 4925B \$570

Option 910: adds extra HP 4935A and HP 4925B Operating and Service Manuals \$60

Accessories

HP 18132A 19 inch rack-mount adapter for HP 4935A \$150

HP 18134A Soft vinyl carrying case for HP 4935A or HP 4935S \$125

HP 18172A Soft vinyl carrying case for HP 4925B \$85

HP 15512A Cable 1m length of 600 Ω balanced cable with a 3-pin audio connector (Siemens type) at each end (for the HP 4936A). \$75

HP 15513A Cable 1m length of 600 Ω balanced cable with a WECO 310 jack plug at each end (for the HP 4935A). \$60

HP 18161A Ladder Bracket \$25



DATA COMMUNICATIONS TEST EQUIPMENT

Data Error Analyzer, Bit Error Rate Test Set

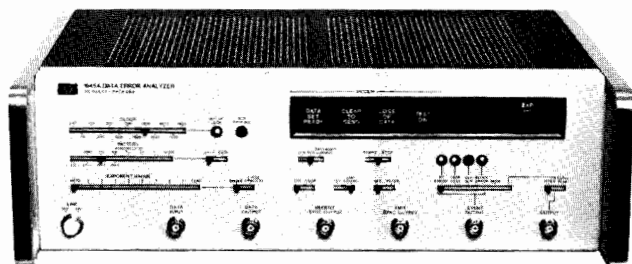

HP 1645A

HP 1645A Description

Hewlett-Packard's Model 1645A Data Error Analyzer quickly isolates data communications link problems through six simultaneous measurements. During test, the HP 1645A can be left totally unattended because it automatically maintains synchronization even in the presence of dropouts. For added convenience, the HP 1645A can be equipped with a printer for hard-copy recordings of long tests.

Bit-error and block-error rate tests are autoranged and displayed directly on an LED readout; there is no need to perform any calculation. Additionally, the HP 1645A measures jitter or total peak distortion (the sum effect of jitter and bias), counts the number of times carrier loss or dropouts occur, measures data error skew, and counts the number of clock slips resulting from phase hits or modem synchronization problems.

With all these measurements made during the same test interval, you'll be able to determine more precisely where your problem is.

HP 1645A Specifications

Transmitter and Receiver Bit Rate

Asynchronous Modem Operation: selectable 75, 150, 200, 300, 600, 1200, 1800, 2400, 3600, 4800, 7200, 9600 bps.

Synchronous Modem Operation: to 5 Mbps. (Modem supplies transmit and receive clocks).

Indicators

Out of lock; received data inverted; bit error; carrier loss; clock slip; block error; Data Set Ready (DSR); Clear To Send (CTS); loss of data; test on.

General

Power: 115 or 230 Vac, 48 to 440 Hz, 150 VA max.

Dimensions: 133 H x 425 W x 286 mm D (5.25 x 16.75 x 11.25 in.).

Weight: net, 8.2 kg (18 lb); shipping, 10.9 kg (24 lb).

Accessories Supplied: one 3 m (10 ft) RS-232C/V.24 interconnecting cable to connect the HP 1645A to the modem (HP P/N 01645-61605), one 2.3 m (7.5 ft) 3-wire power cord (HP P/N 8120-1378); one Operating and Service manual.

Ordering Information

HP 1645A Data Error Analyzer Price \$4465

Interfaces

HP 10387A: for Type 303 modems (with cable) \$700

HP 10388A: for CCITT V.35 (with cable) \$560

HP 10389A: Breakout Box (RS-232C/V.24) (with cable) \$390

HP 18062B: MIL-STD-188C interface \$285

HP 18063A: RS-449 interface (with cable) \$355

Accessories

HP 10233A: Printer interconnecting cable connects HP 1645A to HP 5150A printer. \$195

HP 4925B Description

More than a BERT

The HP 4925B is more than just a bit error rate test set. In addition to the standard bit and block error tests, the HP 4925B measures errored seconds, percent error-free seconds, timing delay, and parity errors over both RS-232C/V.24 and V.35. Now complete data testing to 72 kbps is available making the HP 4925B ideally suited for complete DDS testing.

Increased flexibility is afforded by a complete breakout box. You can manipulate and monitor individual signal lines on the RS-232C/V.24 interface or crosspatch any line from the DCE side of the interface to the DTE side of the interface.

In addition, the HP 4925B adds to its arsenal the ability to frame data for testing character-oriented systems. The HP 4925B also

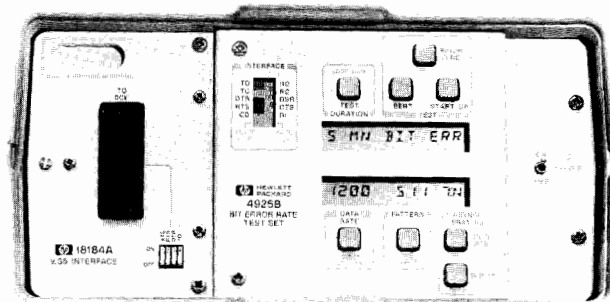

HP 4925B

transmits the FOX message to terminals and printers. Three separate startup tests enable dynamic testing of modems. This makes the unit extremely useful in isolating faults related to automatic equalization, receive carrier recovery, receive clock synchronization and initial recovery of received data. The startup tests include an end-to-end, half-duplex ping-pong test, a local modem loopback test and a test specifically designed to use the remote testing capabilities of the Bell 208B modem.

Intended primarily for field service installation and maintenance, the HP 4925B weighs only three pounds with batteries.

For operation with the V.35 interface, the HP 4925B is powered by a supplied AC power module accessory. This power module can also be used with the RS-232C/V.24 interface in fixed location or long term testing situations.

HP 4925B Specifications

Data Rates: 75, 110, 134.5, 150, 200, 300, 600, 1200, 1800, 2400, 3600, 4800, 7200, 9600, 14400, 19200 bps for asynchronous systems (framed and unframed) or synchronous systems where the HP 4925B provides the clock. Up to 72 kbps for synchronous systems.

Patterns: 63, 511, or 2047 bit pseudo-random binary sequence, FOX message.

Bit Error Testing: simultaneous detection of bit errors, block errors and errored seconds.

Parity Error Analysis: characters analyzed for odd or even parity errors.

FOX Message Transmission: use a 5-bit baudot code, 6-bit EBCD code, 7-bit ASCII code, or 8-bit EBCDIC code.

Character Oriented Network Testing

Data Levels: 5, 6, 7 or 8 bits per character.

Parity: Odd, Even, or None.

Detection and Annunciation of Dropouts and Clock Slips

RTS-CTS Delay Time

Resolution: 1 ms.

Accuracy: $\pm 4\%$ of reading.

Maximum Reading: 999 ms.

Startup Testing: end-to-end test, loopback test, Bell 208B modem test.

Power: six 9-volt alkaline transistor batteries; battery life exceeds 50 hours using RS-232C/V.24 only. AC module (HP 18185A) recommended for use with V.35 interface.

Weight: 1.5 kg (3 lb) with batteries.

HP 18183A Interface/Breakout Box (RS-232C/V.24): hard-wired activity indicators for TD, RD, TC, RC, DTR, DSR, RTS, CTS, CD, RI; one non-dedicated mark/space tri-state activity monitor.

HP 18184A V.35: interface provides the physical level interface for data circuits operating to 72 kbps.

Ordering Information

HP 4925B Bit Error Rate Test Set (does not include interface) Price \$1195

Option 001: Adds HP 18192A carrying case \$110

Option 101: Adds HP 18183A RS-232C/V.24 interface \$390

Option 102: Adds HP 18184A V.35 interface and HP 18185A power module \$570

Accessories

HP 18183A: RS-232C/V.24 interface \$390

HP 18184A: V.35 interface \$455

HP 18185A: Power module (No. America only) \$115

HP 18191A: Rack mount \$180

HP 18192A: Carrying case \$110



- Attenuation distortion
- Loss
- Message circuit noise
- Noise-with-tone
- Noise-to-ground
- Single frequency interference

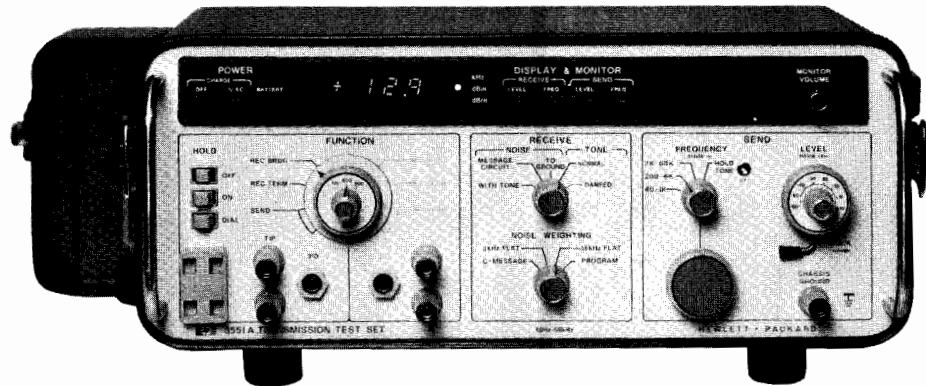

HP 3551A (North American)

HP 3551A/3552A Description

The HP 3551A/3552A Transmission Test Sets are rugged, portable test sets ideally suited for measurements on voice, program and data circuits up to 50 kbps. The HP 3551A is designed for use with North American Bell Standards, while the HP 3552A is designed for the CCITT standards. Both test instruments contain tests capable of measuring tone level, noise or frequency while simultaneously sending tone. Both level and frequency are fully autoranging.

These test sets can measure both 2-wire and 4-wire balanced circuits. The test sets may be powered by either AC line or internal rechargeable batteries and are suited for both inside and outside plant maintenance.

For frequency measurements, a four digit autoranging frequency counter is provided. The readout features 1 Hz resolution from 40 Hz to 10 kHz and 10 Hz resolution from 10 kHz to 60 kHz.

A convenient set of clip-on dial terminals for connecting a lineman's handset are provided. This allows a line connection to be dialed up and then held in an off-hook condition while making either a receive measurement or transmitting a signal on the line.

Noise measurements are made with a quasi rms detector and displayed in dBrn on the HP 3551A and dBm on the HP 3552A. Display rate is slowed to 2 per second to provide an analog feel of slowly changing noise levels. Both test sets are capable of measuring noise-with-tone, message with circuit noise, and noise-to-ground. Four switch selectable weighting networks are provided: 3 kHz, 15 kHz Flat and Program for both models plus a C-message with the HP 3551A and a Psophometric with the HP 3552A.

HP 3551A & 3552A Specifications

Receiver

Level Measurements

- Frequency range:** 40 Hz to 60 kHz.
- Dynamic range:** +15 dBm to -70 dBm.
- Resolution:** 0.1 dB.
- Accuracy:** at 25°C ± 10°C, temperature coefficient: ±0.005 dB/°C beyond this range.

| INPUT LEVEL (dBm) | FREQUENCY | | | | |
|-------------------|-----------|---------|---------|--------|---------|
| | 40 Hz | 100 Hz | 1 kHz | 16 kHz | 20 kHz |
| +15 | ±0.5 dB | ±0.3 dB | ±0.1 dB | ±2 dB | ±0.3 dB |
| -30 | | | ±0.3 dB | | |
| -70 | ±0.5 dB | | | | |

Receiver Accuracy Not Specified Below 500 Hz Or Below -65 dBm When Using 135 Ω Input.

Transmitter HP 3551A & 3552A

Frequency range: 40 Hz to 60 kHz.

Resolution: 1 Hz (40 Hz to 10 kHz), 10 Hz (10 kHz to 60 kHz).
Level range: +10 dBm to -60 dBm (40 Hz to 60 kHz). +6 dBm to -60 dBm. (1004 Hz fixed for HP 3551A; 800 Hz fixed for HP 3552A).

Resolution: 0.1 dB.

Accuracy: at 25°C ± 10°C, temperature coefficient: ±0.005 dB/°C beyond this range.

| OUTPUT LEVEL (dBm) | FREQUENCY | | | | |
|--------------------|-----------|---------|---------|---------|---------|
| | 40 Hz | 100 Hz | 1 kHz | 4 kHz | 60 kHz |
| +10 | ±0.5 dB | ±0.2 dB | ±0.5 dB | ±0.5 dB | ±0.5 dB |
| -30 | | | | | |
| -60 | ±1 dB | | | | |

Transmitter Accuracy Not Specified Below 500 Hz On 135 Ω or 150 Ω Output.

HP 3551A Noise Measurements

Dynamic Range

- Message circuit noise:** 0 dBrn to +85 dBrn.
- Noise-with-tone:** 10 dBrn to +85 dBrn.
- Noise-to-ground:** 40 dBrn to +125 dBrn.
- Resolution:** 1 dB.
- Detector type:** quasi rms responding.

HP 3552A Noise Measurements

Dynamic Range

- Message circuit noise:** -90 dBm to -5 dBm.
- Noise-with-tone:** -80 dBm to -5 dBm.
- Noise-to-ground:** -50 dBm to +35 dBm.
- Resolution:** 1 dB.
- Detector type:** quasi rms responding.

General

- Balanced impedances:** 135 Ω, 600 Ω, 900 Ω (HP 3551A).
- Balanced impedances:** 150 Ω, 600 Ω, 900 Ω (HP 3552A).
- Hold circuit:** 20 milliamps constant current. <0.2 dB holding loss, resistive fuse protection.
- Input/output protection:** blocks 300 V dc.
- Maximum longitudinal voltage:** 200 V rms.
- Battery supply:** >4 hours continuous operation on internal rechargeable batteries at 25°C. Recharge in 12 hours.
- Power requirements:** 100 V, 120 V, 220 V, 240 V ±10%; 48 Hz to 440 Hz; 15 VA.
- Temperature range:** 0°C to 55°C, operating; -20 °C to +65°C, storage.
- Size:** 133 mm H x 343 mm W x 254 mm D (5.25" x 13.5" x 10").
- Weight:** net, 6.6 kg (14.5 lb); shipping, 7.3 kg (16 lb).

Ordering Information

- HP 3551A Transmission Test Set
- HP 3552A Transmission Test Set (CCITT)

Price

- \$3500
- \$3600



DATA COMMUNICATIONS TEST EQUIPMENT

Transmission Impairment Measuring Set (TIMS)

Model 4945A

- Compatible with North American standards
- Complete testing of:
 - Voice grade data channels
 - Program channels
 - High speed digital channels
- 110 kHz bandwidth
- Portable package for field use
- Versatile I/O for systems use
- Master/Slave capability for end-to-end testing
- Automatic gain slope measurement
- Programmable sweep
- 5x display for distant viewing

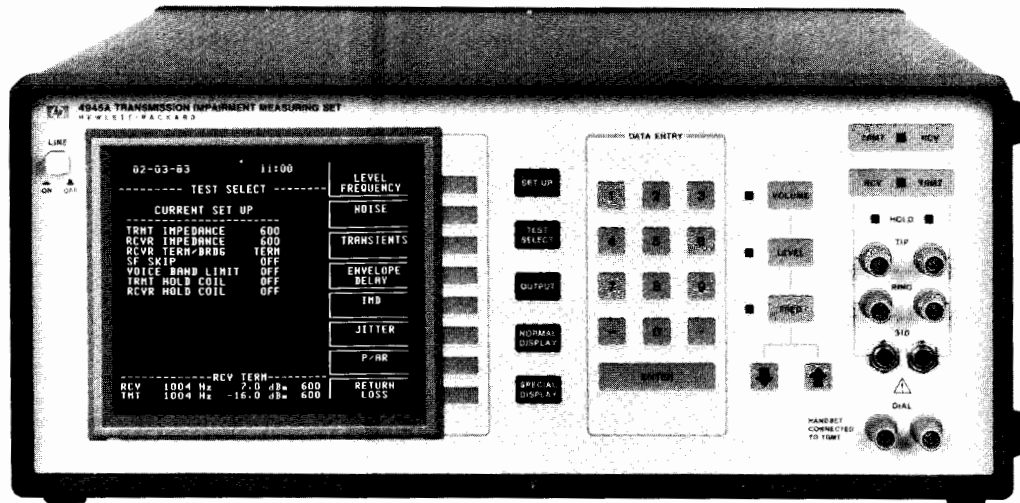

RS-232



HP 4945A

HP 4945A Product Description

The HP 4945A Transmission Impairment Measuring Set provides the complete set of measurements needed to quickly isolate faults and qualify circuits for voice, data or broadcast transmission up to 110 kHz. All measurements are compatible with current Bell standards including the ability to test local distribution loops for Digital Data Systems (DDS) to 56 kbps.

Softkeys Guide the User

All set-up selections, measurement selections and results are presented on the CRT display. Softkeys are the key to making the HP 4945A extremely flexible while maintaining ease of operation. All appropriate choices for a particular measurement or configuration are present, thus eliminating guesswork or nonsense configurations. Through softkeys, you are never more than two key presses away from a parameter change.

A Convenient Display

The CRT allows you to see more information than conventional segmented displays. All of the set-up conditions are presented in a logical, easy-to-understand format. The lower three status lines on the display always contain the important set-up information as well as the current level and frequency of both the transmitter and receiver. Some measurements, such as JITTER, have the "measure all" capability which allows simultaneous display of both amplitude and phase jitter in all three frequency bands (4-20 Hz, 20-300 Hz, 4-300 Hz).

Using the "Special Display" key, the measurement results are enlarged five times to facilitate viewing from a distance. This is ideal for central office or large data center applications where the equipment is not where the adjustment is made. And don't worry about the CRT in the field environment. HP's experience and rigid testing standards assure you of a reliable product for field use.

Complete Measurement Capability

The HP 4945A offers you all the measurements needed to install, troubleshoot, and maintain both voice and data circuits. These measurements are designed in accordance with Bell System Technical Reference 41009 and IEEE 743-1984. The list includes:

| | |
|-------------------------------|------------------------------|
| LOSS | 3 LEVEL IMPULSE NOISE |
| ATTENUATION DISTORTION | GAIN HITS |
| GAIN-SLOPE | PHASE HITS |
| MESSAGE CIRCUIT NOISE | DROPOUTS |

| | |
|-----------------------------------|-------------------------------------|
| NOTCHED NOISE | PEAK-TO-AVERAGE RATIO (P/AR) |
| SIGNAL-TO-NOISE RATIO | ENVELOPE DELAY DISTORTION |
| NOISE-TO-GROUND | 2-WIRE RETURN LOSS |
| AMPLITUDE JITTER | 4-WIRE RETURN LOSS |
| PHASE JITTER | |
| INTERMODULATION DISTORTION | |

| | | |
|--------------------|---------|--------------------------|
| 02-03-83 | 11:00 | AMPLITUDE JITTER (ON) |
| ----- JITTER ----- | | PHASE JITTER (ON) |
| 20-300 Hz | AMP | 20-300Hz |
| 20-300 Hz | PHASE | 4-300Hz |
| 4-300 Hz | AMP | 4-20Hz |
| 4-300 Hz | PHASE | MEASURE ALL |
| -----RCV TERM----- | | |
| RCV | 1004 Hz | 6.7 dBm 600 |
| TMT | 1004 Hz | -16.0 dBm 600 |

The CRT display provides more area for displaying useful data. Here, both phase and amplitude jitter in all three bands are simultaneously displayed along with the current receive and transmit status.

Master/Slave Capability

Master/Slave saves time and money by allowing you to control the remote (Slave) TIMS from the local (Master) TIMS. This HP-pioneered and patented technique allows the Master unit to completely control and collect data from the remote Slave unit over the lines under test. Master/Slave greatly reduces the time, coordination, and highly-skilled manpower needed for performing end-to-end tests. The Master/Slave technique used on the HP 4945A is also backward-compatible with the HP 4943A and HP 4944A.

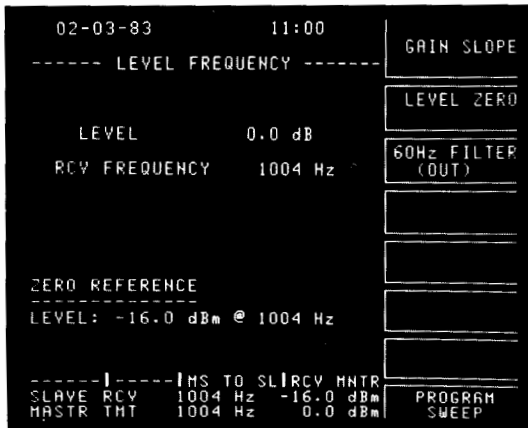

Master/Slave measurement results are displayed just like manual end-to-end results. The status lines indicate the direction of test (Master to Slave) and the current status of the Slave's receiver and Master's transmitter.

Systems Capability

The HP 4945A can be controlled by a computer or controller over three different interfaces. For the larger systems, HP-IB provides the speed and versatility needed to tie together many test instruments in a customized system. For those faced with the problem of the HP 4945A being distant from the controller, RS-232C provides a low-cost solution for control. With the addition of inexpensive modems, an HP 4945A can be controlled over dial or leased lines. If portable data collection is a must, HP-IL provides a low-cost portable solution with a handheld calculator, such as the HP-41C or HP-71B acting as the controller.

In addition, the HP 4945A can output measurement results directly to a printer without the need for a controller. This gives you hardcopy results from any HP-IB, RS-232C, or HP-IL printer.

Complete Self-Check and Calibration

Every time the HP 4945A is powered on, it executes a self-check which assures you that all the major blocks are functioning properly. There is also a built-in self-calibration mode. With the simple press of a softkey, the HP 4945A will calibrate itself, thus avoiding costly downtime and assuring you that the HP 4945A is operating at its peak performance. In addition, built-in self diagnostics quickly isolate and identify any problems thus reducing repair time and consequently downtime.

Specifications

For detailed specifications ask your local HP Sales Office for an HP 4945A TIMS Data Brochure.

General

Impedances: 135Ω, 600Ω, 900Ω, 1200Ω.

Power: 115/230 V ac + 11%–22%, 48 to 63 Hz, 150 W max.

Dimensions: 18.4 cm H x 45.1 cm W x 48.9 cm D (7.25" x 17.75" x 19.25").

Weight: 15 kg (33 lb).

Interfaces Available: HP-IB, RS-232C, HP-IL.

Level and Frequency

Transmitter

Frequency range: 20 Hz to 110 kHz.

Output level: –60 dBm to +13 dBm; 600Ω, 900Ω, 1200Ω.
–60 dBm to +5 dBm 135Ω.

Receiver

Range: –60 dBm to +13 dBm.

Noise Measurements

Transmitter: 1004 Hz fixed or quiet termination.

Receiver Range

Message circuit noise: 10 to 90 dBm

Noise-with-tone: 10 to 90 dBm

Noise-to-ground: 40 to 130 dBm

Signal-to-noise ratio: 10 to 45 dB

Weighting filters: C-message, 3 kHz Flat, Program, 15 kHz Flat, 50 kbit

Notch filter: 50 dB rejection from 995 to 1025 Hz.

Peak to Average Ratio

Transmitter

Signal spectrum: Per BSTR 41009

Range: –40 to 0 dBm.

Receiver

Level range: –40 to 0 dBm.

P/AR range: 0 to 120 P/AR units.

Jitter

Transmitter

See Noise Measurements.

Receiver

Amplitude jitter: 0 to 30% peak to peak

Phase jitter: 0 to 30 degrees peak to peak

Bandwidths: 20 to 300 Hz

4 to 300 Hz

4 to 20 Hz

Transients

Transmitter

See Noise Measurements or Quiet Termination.

Receiver

General: Count rate: 7, 8, 100 counts per second.

Count range: 0 to 9,999.

Timer: 1 to 9,999 minutes or continuous.

Phase hits: thresholds: 5° to 45° in 5° steps.

Gain hits threshold: 2 to 10 dB in 1 dB steps.

Drop outs: threshold –12 dB.

Impulse Noise Range

Low: 30 to 110 dBm.

Mid: 2, 3, 4, or 6 dB above Low.

High: 2, 3, 4, or 6 dB above Mid.

Envelope Delay

Transmitter

Level range: –40 to 0 dBm

Modulation: 83⅓ Hz

Receiver

Level range: –40 to +10 dBm

Measurement range: –3000 to 9000 microseconds.

Return Loss

Modes: ERL, SRL-High, SRL-Low, Sine Wave

2-Wire:

Range: 0 to 40 dB

Internal Hybrid 600Ω, 900Ω, in series with 2.16 μF capacitor, or external.

4-Wire:

Range: 0 to 50 dB.

Trans Hybrid Loss Compensation: –10 to 30 dB.

Ordering Information

HP 4945A TIMS

Options

101: adds HP 18162A HP-IB Module

102: adds HP 18163A RS-232C Module

103: adds HP 18165A HP-IL Module

104: adds HP 18169A 19" Rack Mount

105: adds HP 18170A Soft Vinyl Carrying Case

Accessories

HP 18162A HP-IB Module

HP 18163A RS-232C Module

HP 18165A HP-IL Module

HP 18169A 19" Rack Mount

HP 18170A Soft Vinyl Carrying Case

HP 18176A 23 inch Rack Mount

HP 9211-2650 Hard Transit Case

*The Non-Linear Distortion Technique is licensed under Hekimian Laboratories, Inc., USA Patent No. 3862380.

Price
\$14,950

\$500

\$500

\$350

\$75

\$210

\$505

\$505

\$355

\$80

\$210

\$160



DATA COMMUNICATIONS TEST EQUIPMENT

Network Circuit Access Test Set, Transmission Impairment Measuring Set

Models 4938A/4937A



HP 4938A/4937A

HP 4937S Network Access Transmission Test Set HP 4937S Product Description HP 4937S = HP 4937A + HP 4938A

A Transmission Test Set With Signaling

The HP 4937S Network Access Transmission Test Set provides transmission tests, supervisory signaling simulation, and network access capabilities for installation and maintenance of networks and PBXs. It is a field-service, portable test set designed for craft-level use. All the transmission measurements are compatible with current Bell standards.

One Instrument for Installation/Maintenance of PBXs and Networks.

The HP 4937S is an ideal field service test set for installation and maintenance of PBXs and networks. Traditionally, a technician needs three test sets for testing — a transmission test set, a return loss set, and a signaling set. The HP 4937S combines all the analog measurements and signaling simulation in one portable test set. The HP 4937A contains a set of voiceband transmission tests — level/frequency measurement, noise, and 2- and 4-wire return loss measurements. It also has the ability to seize and hold three types of loop circuits and three types of E/M lines. In addition, the HP 4937A simulates signaling both from the central office and from the PBX at the network interface.

The HP 4938A provides additional network access and margin testing capabilities. It includes access to 4-wire simplex leads, generating ringing signal, and providing access for loop current and ringing voltage measurement.

Easy-to-Use and Reliable

The HP 4937S is designed for craft-level use with minimum training. Each measurement is annunciated as you go through the selection. You only have to connect the line under test to one instrument for signaling and making transmission tests. All results are shown clearly on the LED displays. The instrument case is tough, durable, and designed for rugged field use.

HP 4937A Specifications

Level/Frequency

Transmitter

Level: -40 dBm to +13 dBm.

Frequency: 20 Hz to 9999 Hz.

Receiver

Level: -60 dBm to +13 dBm.

Frequency: 20 Hz to 9999 Hz.

Noise

Transmitter: quiet terminated

Receiver Level: 0 dBm to 99 dBm.

Filter: C-message, 3 kHz flat.

Noise with Tone

Transmitter Level: -40 dBm to +13 dBm.

Frequency: 1004 Hz fixed tone.

Receiver Level: 10 dBm to 99 dBm.

Filters: C-message, 3 kHz flat.

Notch Filter: 50 dB rejection.

Signal-to-Noise Ratio

Transmitter Level: -40 dBm to +13 dBm.

Frequency: 1004 Hz fixed tone.

Receiver Level: -40 dBm to +13 dBm.

Ratio Range: 10 dB to 45 dB.

Filters: C-message, 3 kHz flat.

Notch Filter: 50 dB rejection.

Noise-to-Ground

Transmitter: quiet terminated.

Receiver Level: 50 dBm to 99 dBm.

Filters: C-message, 3 kHz flat.

Return Loss

Return Loss, 2-Wire

Impedance: 600 and 900 ohms.

Signal Spectra: Echo return loss, singing return loss high, singing return loss low.

Transmitter Level: -26 dBm to -2 dBm.

Receiver Range: 0 to 40 dBm.

Return Loss, 4-Wire

Signal Spectra: Echo return loss, singing return loss high, singing return loss low.

Transmitter Level: -26 dBm to -2 dBm.

Receiver Range: 0 to 50 dB.

Transhybrid Loss Compensation: -29.9 to +29.9 dB.

Supervisory Signaling

E/M Signaling: Types I, II, III (both Originate and Terminate).

Battery: -48 Vdc current limited to 29 mA.

Loop Signaling: Loop start, Ground start, Loop Reverse Battery (both Originate and Terminate).

Battery: -48 Vdc current limited to 29 mA.

Hold Circuit: 2 each drawing 20 mA at a minimum voltage of 8.5 Vdc.

Wink: idle state, 100 ms; off-hook state, 200 ms.

General

Battery Supply (Optional): Typically 5 hours of continuous operation at +25°C. Complete recharging in 14 hours with unit in STBY.

Power Requirements: 100V, 120V, 220V, and 240 Vac +5%, -10%; 48-66 Hz.

Temperature Range: 0°C to +55°C, 0°C to +40°C with batteries, operating; -40°C to +75°C, -20°C to +45°C with batteries, storage.

Dimensions: 27.9W x 12.7H x 38cm L (11x5x15 in.)

Weight: 5.3 kg (12 lb), 7.6kg (17 lb) with batteries.

HP 4938A Specifications

Ringing Voltage Generator

Output Level: 86 Vrms

Frequencies: 20 Hz and 30 Hz.

Ring Trip Threshold: 17 mA typical.

Ringer Termination: REN-3 load, ring trip closure.

Loop Signaling Network: loop start, 430 ohms; ground start, 550 ohms from ring to ground.

4-Wire Network Access: 2 dual center-tapped simplex transformers.

Battery Simulator: 48 Vdc maximum current 100 mA.

General

Power Requirements: 120V +5, -10%; 60 Hz only.

Dimensions: 9.1H x 26.1L x 12.6 cm D. (3.6x10.3x4.9 in.)

Weight: 1.5 kg (3.2 lb)

Ordering Information

HP 4937S Network Access Transmission Test Set. \$5200

Option 001: Rechargeable Batteries. \$250

Option 002: Replace 900 ohms with 150 ohms. N/C

HP 4937A Transmission Impairment Measuring Set. \$4250

Option 001: Rechargeable Batteries. \$250

Option 002: Replace 900 ohms with 150 ohms. N/C

Option 910: Extra Operating & Service manual. \$27

HP 4938A Network Circuit Access Test Set. \$1050

Accessories

HP 18132A: 19-inch rack mount adaptor for HP 4937A. \$150

HP 15513A: 36-inch test cord with 310 male connector at each end. \$60

HP 18182A: 60-inch test cord with 310 male connector and double alligator clips. \$60

HP 18172A: Small soft vinyl carrying case for HP 4938A. \$85

HP 18190A: Large soft vinyl carrying case for HP 4937S. \$125

DATA COMMUNICATIONS TEST EQUIPMENT

Telephone Line Analyzer; Optional Data Line Analysis

Models 3770B, 3776A/B & Option 001

141



HP 3770B

- Compatible with CCITT Recommendation 0.81
- Makes all the maintenance measurements listed in CCITT Recommendation M.1060
- Optional slaving facilities

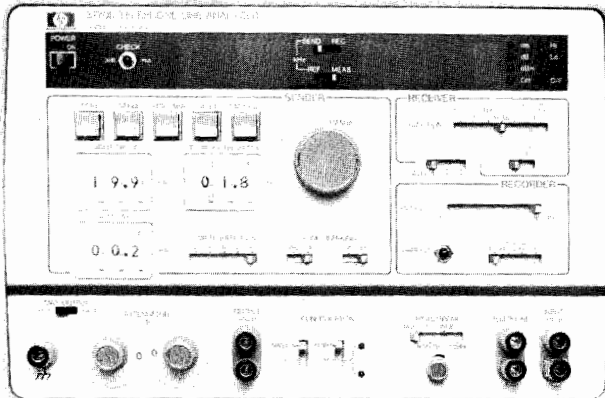

HP 3770B

HP 3770B Telephone Line Analyzer

The HP 3770B is designed for audio data line characterization to CCITT standards. The HP 3770B makes, in one combined unit, all of the routine maintenance measurements listed in CCITT Recommendation M.1060 for high speed data lines.

The HP 3770B measures group delay, attenuation distortion, and absolute level in the frequency range 200 Hz to 20 kHz. It has automatic ranging, zeroing, and synchronization, with simultaneous LED read-out of measurement result and frequency. The sender and receiver are combined in a single, rugged, portable unit.

The HP 3770B also measures weighted noise, noise-with-tone and impulse noise. A crosstalk measurement is available as an option. Further, an optional slave facility for group delay and attenuation distortion measurements allows the measurement results for both directions of transmission on a 4-wire circuit to be displayed at one end of the circuit. The measurements in both directions can be controlled from one end of the circuit, leaving the slave unit unattended.

The HP 3770B has X-Y recorder outputs to enable a permanent swept record of the measurements to be made. A suitable portable X-Y recorder can be supplied as an option. Pre-printed graph paper showing CCITT limits for group delay and attenuation distortion measurements can also be supplied.

The instrument also has a built-in telephone facility to allow voice communication in a 2- or 4-wire mode over the line or lines under test. An integral loudspeaker allows the operator to monitor either the receiver input or sender output.

HP 3776A/B Option 001

- CCITT and North American versions
- All measurements available at digital or analog interfaces
- Measurement sequence facility
- Direct output to printer or plotter

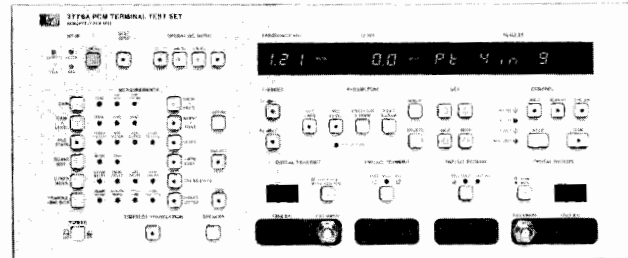

HP 3776A/B Option 001



HP 3776A/B PCM Terminal Test Sets

In mixed analog/digital networks, the HP 3776A/B make PCM related measurements and with Option 001 the measurement set is extended to include measurements of the parameters affecting voice frequency (4 kHz) data transmission. These measurements can be made at any suitable analog or digital (PCM) access point in the network.

Data Measurements - available in all modes A-A, A-D, D-A, D-D.

Frequency

Group Delay Distortion (HP 3776A only)

Envelope Delay Distortion

Absolute Delay

Phase Jitter (Choice of filters)

Transient (measured simultaneously)

Amplitude/Gain Hits

Phase Hits

Interruptions/Dropouts

Impulse Noise (3-level)

The HP 3776A/B have pre-programmed measurement parameters that can be used immediately, but users can also create their own measurement parameters and store them in non-volatile memory; either set can be selected as required. A sequence of measurements can be created, using a controller, and downloaded into the HP 3776A/B. This sequence is also stored in non-volatile memory and can be run independently by the instrument at any time.

Results are always available via the LED display on the front panel; however, measurement parameters and results can also be output directly to a printer or plotter via HP-IB. In plot mode multipoint measurement results are presented in a graphical format and can also be shown in relation to the standard measurement mask, if this facility has been selected by the user.

Additional details on the HP 3776A/B can be found on page 144.

Ordering Information

| | Price |
|--|----------|
| HP 3770B Telephone Analyzer | \$7,320 |
| HP 3776A PCM Terminal Test Set + Option 001 - CCITT | \$10,700 |
| HP 3776B PCM Terminal Test Set + Option 001 - North American | \$11,250 |



DATA COMMUNICATIONS TEST EQUIPMENT

15 Hz to 50 kHz Selective Voltmeter

Model 3581C

- Voice grade testing
- Wideband data circuit testing
- Single frequency interference
- Spectrum analysis



HP 3581C

Description

The HP 3581C Selective Voltmeter has found wide application in testing special service circuits in both inside and outside plant maintenance. The HP 3581C is used to do spectrum analysis, measure non-linear distortion (harmonic distortion) and to locate and measure unwanted spurious and induced tones. The unit can be operated from ac line or from optional internal batteries.

Specifications

Frequency range: 15 Hz to 50 kHz.

Display: 5 digit LED readout. Resolution: 1 Hz. Accuracy: ± 3.5 Hz.

Typical stability: ± 10 Hz/h after 1 hour. ± 5 Hz/ $^{\circ}$ C.

Automatic frequency control (AFC), hold-in range: ± 800 Hz.

Pull-in range: $> 5 \times$ bandwidth for 3 Hz to 100 Hz bandwidth; > 800 Hz for 300 Hz bandwidth for full-scale signal.

Lock frequency: center of passband ± 1 Hz.

Amplitude

Instrument Range

Linear: 30 V to 100 nV full scale.

Log: +30 dBm or dBV to -150 dBm or dBV.

Amplitude Accuracy*

| | Log | Linear |
|---|--------------|------------|
| 15 Hz-50 kHz, frequency response | ± 0.4 dB | $\pm 4\%$ |
| Switching between bandwidths | ± 0.5 dB | $\pm 5\%$ |
| Amplitude display | ± 2 dB | $\pm 2\%$ |
| Input attenuator | ± 0.3 dB | $\pm 3\%$ |
| Amplitude reference level, Most sensitive range | ± 1 dB | $\pm 10\%$ |
| All other ranges | ± 1 dB | $\pm 3\%$ |

Dynamic range: > 80 dB.

Noise sidebands: greater than 70 dB below CW signal. 10 bandwidths away from signal.

IF feedthrough: input level > 10 V: -60 dB; input level < 10 V: -70 dB.

Spurious responses: > 80 dB below input reference level.

Sweep

Scan width: 50 Hz to 50 kHz. These scans can be adjusted to cover a group of frequencies within the overall instrument range.

Sweep error light: this LED indicates a sweep that is too fast to capture full response.

*Note: these specifications cover the full temperature frequency and amplitude range, and represent worst case. Accuracy is significantly better for measurements not at the extremes.

External trigger: a short to ground stops normal sweep. Opening the short then enables a sweep.

Input

Unbalanced (UNBAL)

Impedance: 1 M Ω /40 pF.

Balanced/Bridged (BRDG)

Impedance: 10 k Ω .

Frequency response: 40 Hz-20 kHz, ± 0.5 dBm for signals < 20 dBm.

Balanced/Terminated (TERM)

Impedance: 600 Ω /900 Ω balanced.

Frequency response: same as balanced/bridging.

Input connector: accepts WECO 310 plug.

Output Characteristics

Tracking generator output (also known as BFO or tracking oscillator output). Switchable on rear panel to restored output (HP 3581C acts as a narrow band amplifier).

Range: 0 to 2 V rms.

Frequency response: $\pm 3\%$ 15 Hz to 50 kHz.

LO output: 100 mV signal from 1 MHz to 1.5 MHz as input is tuned from 0 to 50 kHz.

Output connector: WECO 310, for connection to tracking generator output or restored output. In addition to monitoring restored output with headphones, an internal speaker also provides an audio indication of signal content.

Restored output: acts as a narrow band amplifier.

X-Y recorder analog outputs: 0 to +5V $\pm 2.5\%$.

General

Operating temperature range: 0 $^{\circ}$ C to 55 $^{\circ}$ C.

Humidity: 95% relative, maximum at 40 $^{\circ}$ C.

Power requirements: 100 V, 120 V, 220 V, 240 V $+5\%$ -10%, 10 VA typical, 48 Hz to 440 Hz.

Size: 412.8 mm H x 203.2 mm W x 285.8 mm D (16 $\frac{1}{4}$ " x 8" x 11 $\frac{1}{4}$ ").

Weight: 11.5 kg (23 lb); Option 001, 13.5 kg (30 lb).

Accessory available: HP 7090A Measurement Plotting System.

Option 001: rechargeable battery: used to make floating measurements; 12 hours to fully charge. Also includes front panel dust cover.

Ordering Information

HP 3581C Selective Voltmeter

Opt 001: Battery Pack, dust cover

Opt 003: Rack Mount

Price

\$6,200

add \$700

add \$330



Introduction

Digital networks have advanced rapidly from the early days when junction PCM systems were used to increase inter-exchange capacity between switching centers. Key to this has been the development of integrated digital switching and transmission systems and the impact of technology, particularly in the area of codecs and subscriber line interface circuits. This trend towards Integrated Digital Networks (IDNs) and Integrated Services Digital Networks (ISDNs) has resulted in new testing needs and increased emphasis on characterizing performance of PCM conversion equipment and digital transmission links.

PCM Conversion Measurements

Today's IDNs are almost exclusively based on 64 kb/s PCM voice channels to one of two coding standards, CEPT A-law or Bell μ -law, both of which are now standardized by the CCITT. These coding standards both use 8 kHz speech sampling and 8-bit PCM companding to achieve high quality digitized voice transmission through 64 kb/s circuit-switched digital exchanges. Circuits can also carry multiplexed low-speed or wideband high-speed data with the result that future networks will carry a mixture of voice and data services via digital transmission systems. Initially, the majority of data carried by IDNs will be "conventional" analog modulated data from modems at customers' premises which is then PCM encoded at the nearest serving exchange switching center. In addition to dial-up data circuits through digital switches, an increasing number of leased non-switched circuits are provided at least in part, if not completely, via PCM transmission systems between switching offices.

These developments have resulted in an increased demand for measurements in the PCM signal of parameters affecting both voice and data services. This is especially true for automatic remote test systems such as the checking of circuits provided via digital access and cross-connect systems. The key to testing these circuits is the ability to measure PCM voice and analog data transmission performance at both analog and digital access points i.e. in a mixed analog/

digital network. HP's 3776 PCM Terminal Test set can make both PCM voice and analog data measurements in both analog and digital domains.

The HP 3776 has also made significant advances in the field of PCM measuring technology by implementing most of the measurements using digital signal processing. This allows comprehensive measurement capability to be integrated into a smaller, lower cost, more portable package than previously possible. When coupled with HP's computational products, the HP 3776 becomes a powerful system component of automated remote access and test systems for monitoring and maintaining mixed analog/digital networks.

The HP 3779 Primary Multiplex Analyzer has a complementary focus. Its internal intelligence provides major benefits: an exceptionally friendly front panel, built-in automatic measurement sequencing with limit-testing, and channel scanner and printer control. The HP 3779 is therefore optimized for R&D, production test and commissioning of line cards and PCM multiplexers/channel banks.

TDM Transmission Measurements

Digital transmission over cable, radio, satellite and, more recently, optical fibre is becoming an increasingly large proportion of inter-exchange and long haul transmission. As IDNs evolve and other services are added into the ISDN concept, transmission measurements have shifted from basic measures of bit error ratio and peak-peak jitter towards more thorough analysis of systems in terms of error performance or distribution with time. There is an increasing emphasis on evaluating "availability" of digital circuits. This requires more powerful analysis capability to be built into test instrumentation and the possibility of collecting large amounts of data for evaluation off-line in computers. HP is uniquely placed with advanced measuring and computational technology to provide measurement solutions for

these needs. A comprehensive range of error and jitter performance test equipment is now available covering bit rates from 1 kb/s to 170 Mb/s. Many special features are included for the three principal IDN digital transmission hierarchies now standardized by the CCITT.

The latest and most powerful instrument is the HP 3764A Digital Transmission Analyzer which is specifically designed for error and jitter performance measurements on 140 Mb/s links. Built-in analysis of availability and error distribution with real time are provided together with a choice of printer or cassette data capture media. An option of the instrument provides error performance testing and interfacing at the four standard bit rates of the CEPT digital hierarchy. Full HP-IB control also makes this instrument a powerful tool in automated production testing or digital network maintenance.

Jitter and Digital Networks

The increasing interest in and significance of timing jitter in digital networks has made this parameter of key importance in PCM/TDM measurements. This phenomenon has not been well understood until relatively recently, but is now recognized to be a major source of errors and other transmission impairments. HP offers a comprehensive range of jitter testing capability based on the HP 3785 Jitter Generator & Receiver for bit rates up to 50 Mb/s, and the HP 3764A Digital Transmission Analyzer for 140 Mb/s. Ease-of-use features such as built-in jitter tolerance mask sweeping and full HP-IB control make these instruments powerful tools in production test and field trial situations. A loop timing measurement in the HP 3776 PCM Terminal Test Set provides a quick field check of the most common causes of digital switching machine malfunction when working to loop-timed PCM multiplexers/channel banks.

Read on for a more detailed look at the comprehensive range of HP products for digital communications applications.

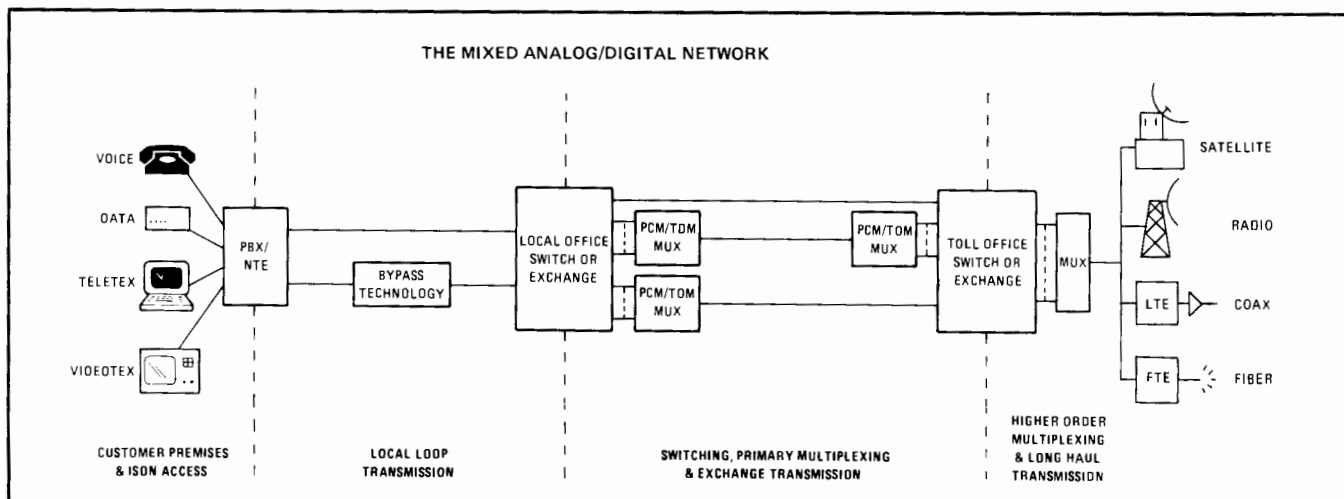



TELECOMMUNICATIONS TEST EQUIPMENT

PCM Terminal Test Set

Models 3776A, 3776B

- Analog and digital interfacing in CEPT/Bell/Japanese/CCITT networks
- Provides voice, PCM and data measurements in one instrument
- Direct output to printer or plotter

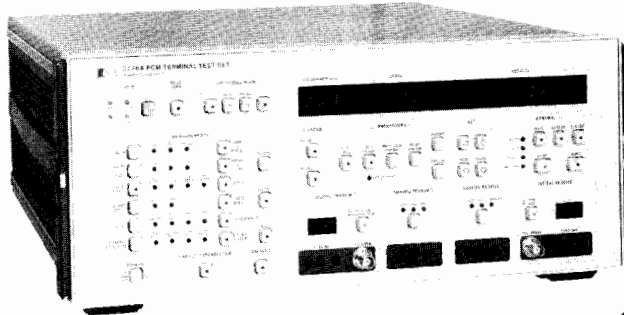

HP 3776A

The 3776A/B PCM Terminal Test Sets interface directly at the analog and digital level in mixed analog/digital networks. The HP 3776A is designed for CEPT/CCITT compatible networks while the HP 3776B is suitable for North American/Japanese/CCITT networks. Used in installation, commissioning and maintenance, the HP 3776A/B ensure optimum performance for each section (e.g., PCM channel bank, digital switching system or transmultiplexer) of the network.

One Instrument for Voice and Data Services

The HP 3776A/B provide comprehensive voice, PCM and data measurements for testing 4 kHz bandwidth analog and digital channels. They replace the collection of independent analog and digital test equipment previously used in a mixed system environment with one compact instrument. Facilities included are:

- Voice and PCM measurements in A-A, A-D, D-A or D-D modes
- Framing and signaling bits setting and monitoring
- Data measurements - on analog and digital circuits.

A summary of the measurements available is shown below:

| Standard Measurements | A-A | A-D | D-A | D-D |
|--|-----|-----|-----|-----|
| Gain | • | • | • | • |
| Digital mW gain | • | • | • | • |
| Level (including harmonic distortion) | • | • | • | • |
| Gain vs level (using tone) | • | • | • | • |
| Gain vs level (using noise - HP 3776A) | • | • | • | • |
| Gain vs level (using sync 2 kHz) | • | • | • | • |
| Gain vs frequency | • | • | • | • |
| Idle state (choice of filters) | • | • | • | • |
| Coder offset and peak codes | • | • | • | • |
| Noise with tone | • | • | • | • |
| Quantizing distortion (using tone) | • | • | • | • |
| Quantizing distortion (using noise - HP 3776A) | • | • | • | • |
| Intermodulation (using two tones) | • | • | • | • |
| Intermodulation (using four tones - HP 3776B)* | • | • | • | • |
| Digital Tx/Rx | • | • | • | • |
| Return loss 4W (ERL - HP 3776B) | • | • | • | • |
| Loop timing check | • | • | • | • |

*The non-linear distortion technique is licensed under Hekimian Laboratories, Inc., US Patent no. 3862380.

| Optional Data Measurements | A-A | A-D | D-A | D-D |
|---------------------------------------|-----|-----|-----|-----|
| Frequency | • | • | • | • |
| Group delay distortion (HP 3776A) | • | • | • | • |
| Envelope delay distortion | • | • | • | • |
| Absolute delay | • | • | • | • |
| Phase jitter (choice of filters) | • | • | • | • |
| Transients (measured simultaneously): | • | • | • | • |
| Amplitude/gain hits | | | | |
| Phase hits | | | | |
| Interruption/dropouts | | | | |
| Impulse noise (3 levels) | | | | |

- Simple measurement sequencing
- Full A-A, A-D, D-A, D-D measurement modes
- Built-in self test and measurement checking
- Optional Data Parameter Measurement

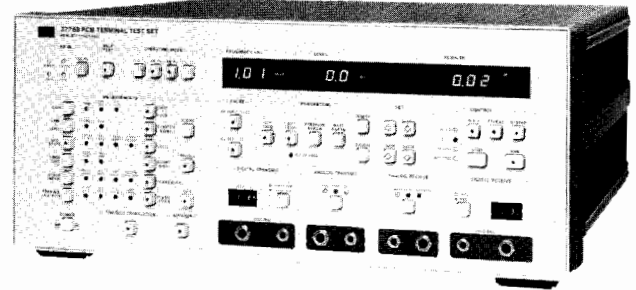

HP 3776B

Isolate Problems Quickly and Minimize Downtime

The HP 3776A/B provide convenient features to help reduce measurement set-up time. Hence more time can be spent isolating problems and restoring service with minimum downtime. These features are:

- Pre-programmed default measurement parameters
- User-modified measurement parameters held in non-volatile memory
- Measurement sequences can be downloaded from a controller to the HP 3776A/B and run independently.

Results Management

Measurement parameters and results are output directly to a printer or plotter via the HP-IB. Printed results are in a systematic, tabular format for easy analysis. In plot mode, multipoint measurement results are presented in a neat graphical format. Performance discrepancies can be spotted easily.

Features for Tomorrow's Networks

The HP 3776A/B have been designed keeping in mind the needs of tomorrow. Unique facilities provided for future use are:

- HP 3776A - Selection of 30 or 31 voice channel testing
- HP 3776B - Bell extended superframe (ESF) format & B8ZS line coding.

Specifications Summary

Full information and specifications are contained in the HP 3776A/B Data Sheet and HP 3776A/B Specifications Booklet.

Supply voltages: 115/240V ac +10%, -22%

Power consumption: 85W nominal

Size: 178 H x 425 W x 440 mm D (7 x 16.75 x 17.25 in.)

Weight: 15 kg (33 lb)

Temperature range: operating 0° to 55°C
storage -40° to 75°C

HP 3776A Options

- 001** - Adds data measurements. Price +\$1,540
- 002** - Replaces digital interface BNC connectors with 75 ohm Siemens 1.6/5.6 mm coaxial. Price N/C

HP 3776B Options

- 001** - Adds data measurements. Price +\$1,610
- 002** - Japanese measurement and connector requirements. Price N/C
- 004** - Interface connectors on standard instrument replaced by Trompeter triaxial type BJ77 located on rear panel. Price +\$215

Common Options

- 801** - Front panel cover (not available with front handle & rack flange options 907, 908, 909) Price +\$110
- 910** - Extra set of manuals Price +145

Ordering Information

- 3776A** PCM Terminal Test Set Price \$10,700
- 3776B** PCM Terminal Test Set Price \$11,250
- Transit Case HP 9211-2650: see page 750

TELECOMMUNICATIONS TEST EQUIPMENT

Primary Multiplex Analyzer; HP-IB Controlled Channel Selector

Models 3779C, 3779D, 3777A

145



HP 3779C/D

- Comprehensive PCM measurements.
- User-level keyboard programming.
- Direct control of printer and HP 3777As.

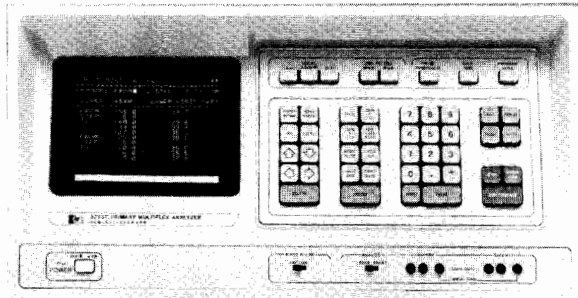

HP 3779C



HP 3779C/D Primary Multiplex Analyzer

The HP 3779C/D Primary Multiplex Analyzer (PMA) is an intelligent instrument for fast, comprehensive testing of PCM products.

Model 3779C tests voice channels to CEPT recommendations. The digital options test PCM equipment conforming to CCITT Rec. G.711 and G.732, i.e., 30 channels/32 time slots encoded using the A-law and multiplexed into a 2048 kb/s stream. A single channel TTL-compatible interface is available for codec and digital line card testing where clock and sync signals are separate from the PCM data.

Model 3779D tests voice channels to Bell recommendations. Digital options 001 and 003 test PCM equipment conforming to BSTR Pub 43801 and CCITT Rec. G.711 and G.733, i.e., 24 channels/24 time slots encoded using the u-law and multiplexed into a 1544 kb/s stream. A single channel TTL-compatible interface is also available on all options and is used exclusively on option 002 for u-law systems operating at 2048 kb/s.

The standard HP 3779C/D provides A-A and E-E (end-to-end) measurements. A-D, D-A and D-D capability is optional.

| Measurements | A-A | A-D | D-A | D-D | E-E |
|--|-----|-----|-----|-----|-----|
| Gain | • | • | • | • | • |
| High accuracy gain | • | • | • | • | • |
| Digital mW gain | • | • | • | • | • |
| Gain vs frequency | • | • | • | • | • |
| Gain vs level using noise (3779C only) | • | • | • | • | • |
| Gain vs level using tone | • | • | • | • | • |
| Gain vs level using sync 2 kHz | • | • | • | • | • |
| Coder offset | • | • | • | • | • |
| Peak codes | • | • | • | • | • |
| ICN weighted, 3 kHz flat & selective | • | • | • | • | • |
| Noise with tone | • | • | • | • | • |
| Quantizing distortion using tone | • | • | • | • | • |
| Quantizing distortion using noise (3779C only) | • | • | • | • | • |
| Intelligible crosstalk | • | • | • | • | • |
| Intermodulation using two tones | • | • | • | • | • |
| Intermodulation using four tones (3779D only)+ | • | • | • | • | • |
| Discrimination against out-of-band inputs | • | • | • | • | • |
| Spurious out-of-band outputs | • | • | • | • | • |
| Spurious in-band outputs | • | • | • | • | • |
| Return loss using swept tone (Tx & Rx) | • | • | • | • | • |
| Impedance balance (Tx & Rx) | • | • | • | • | • |
| Signal balance | • | • | • | • | • |
| E&M Signalling distortion | • | • | • | • | • |
| Tx-Rx | • | • | • | • | • |
| Tx-Rx codes | • | • | • | • | • |

In addition, an HP 3779C with D-A capability can automatically test multiplex alignment and alarm functions.

○ Capability provided by the user-definable Tx-Rx D-D measurements.

+ The Non-Linear Distortion technique is licenced under Hekimian Laboratories Inc, US Patent No. 3862380.

HP 3777A

- DC to 110 kHz.
- High quality relays.
- 2-wire/4-wire balanced switching.

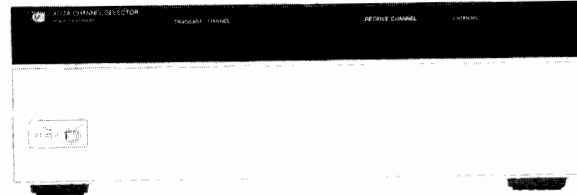

HP 3777A



Although measurement execution software is built-in, test values can be easily modified from the front panel. When selected, a measurement can be executed immediately or assembled with other measurements into a test sequence (stored in non volatile memory). Pass/fail conditions give simple but powerful control over the measurement process, e.g. branch, print on fail, etc.

By itself, the PMA can control a printer and HP 3777A Channel Selectors. However, when required, it can be readily subordinated to another HP-IB controller.

For details of a transit case accessory (Model 15514A) suitable for the HP 3779C/D, refer to page 150.

HP 3779C Options

- 001:** provides A-D, D-A, and D-D hardware and software; 2048 kb/s PCM interfaces are ternary rectangular with 75 ohm BNC connectors + \$2,040
- 002:** as Option 001 except PCM and clock connectors are 75 ohm Siemens 1.6/5.6 mm - \$2,040
- 003:** as Option 002 except PCM and co-directional clock connectors are 120 ohm Siemens 3-pin + \$2,040

HP 3779D Options

- 001:** provides A-D, D-A, and D-D hardware and software; 1544 kb/s PCM interfaces are bipolar rectangular with 100 ohm balanced WECO connectors + \$2,145
- 002:** provides A-D, D-A, and D-D hardware and software for u-law systems operating at 2048 kb/s; digital connections are via single channel interfaces only + \$2,145
- 003:** as Option 001 except PCM and clock connectors are BNC 75 ohm - \$2,145

Ordering Information

- HP 3779C Primary Multiplex Analyzer (CEPT) \$19,650
- HP 3779D Primary Multiplex Analyzer (Bell) \$22,820

HP 3777A Channel Selector

The HP 3777A is a 4-pole access switch for telecoms applications. It may be configured as a single 4-wire switch or as two, independent, 2-wire switches. Channel capacity is arranged by adding standard modules. Unselected channels are quiet terminated.

HP 3777A Options

| No. of Channels | Connectors | |
|-----------------|---------------|----------|
| | Siemens 3-pin | WECO 310 |
| 6 | Opt H07 | Opt H16 |
| 12 | Opt 002 | Opt 003 |
| 18 | Opt H13 | Opt H17 |
| 24 | Opt H14 | Opt 001 |
| 30 | Std | Opt H05 |

HP 3777A Channel Selector

\$4,280

TELECOMMUNICATIONS TEST EQUIPMENT

1 kb/s/50 Mb/s PCM/TDM Error Measuring Set for Field Use

Model 3780A

- Binary and code error measurements
- Internal crystal clocks and clock recovery
- Clock frequency offset generation and measurement
- Ternary coded and binary interfaces
- PRBS and WORD pattern generation and detection
- Printer and recorder outputs

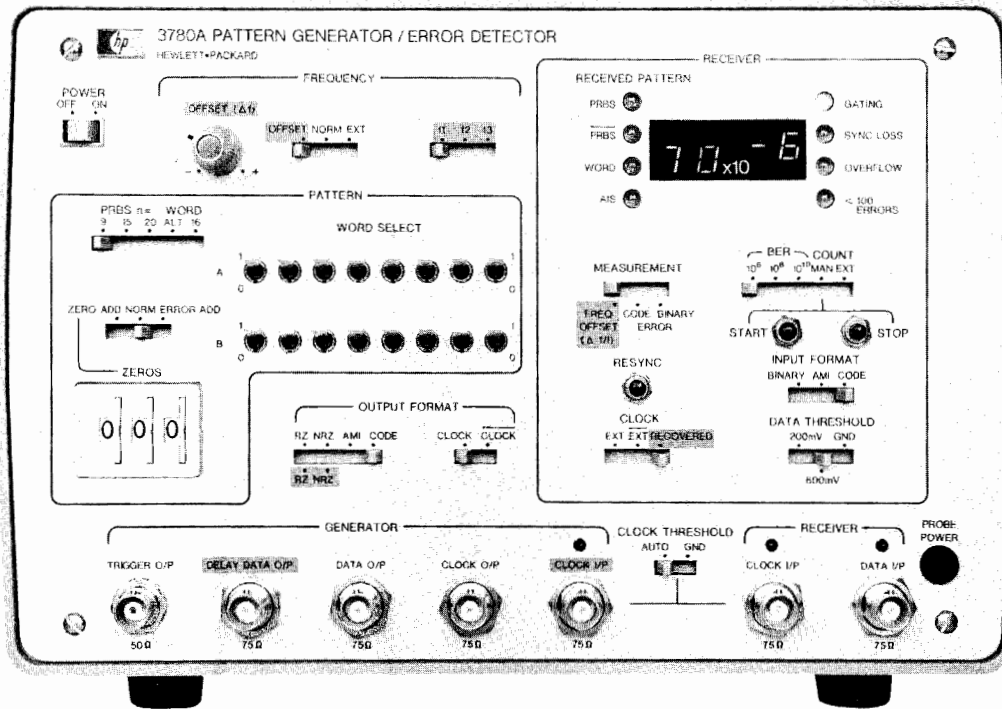

HP 3780A
Option 001

The HP 3780A Pattern Generator/Error Detector is a comprehensive error measuring set in one portable package. The instrument measures Binary Errors and Code Errors in digital transmission equipment operating at bit rates between 1 kb/s and 50 Mb/s. Frequency offset generation and measurement are also provided at the standard bit rates used in PCM/TDM transmission.

Binary errors are detected by stimulating the system with a test pattern and comparing the output bit-by-bit with a separate internally generated, error-free pattern. Code errors on interface or line coded information are detected during decoding into binary data. The errors can be counted over a chosen gating period and displayed directly as bit error ratio (BER) or total error count (COUNT).

Error measurements can be made with PRBS or WORD patterns and the receiver has automatic pattern recognition and synchronization. Alternatively, the reference pattern can be preset by the pattern switch which allows detection of systematic pattern errors. Zero add facilities allow investigation of regenerator clock recovery performance. This capability can be extended by the optional addition of programmable word and alternating word generation.

The clock frequency in the pattern generator can be offset and measured in the receiver. The offset is displayed as a fraction of the nominal crystal centre frequency. In addition, the offset of external clocks applied to the generator can be measured provided that the frequency is within 25 kHz of one of the installed crystal frequencies.

BER or COUNT results can be displayed directly by LED's on the front panel or monitored via a BCD printer and strip chart recorder. This makes the HP 3780A ideally suited for unattended long-term measurements. Monitoring, display, and recording of the Alarm Indication Signal (AIS) is now included.

The HP 3780A has been designed principally for use in field trials, commissioning, and maintenance of digital transmission terminal and link equipment. A new option has been added which provides 2²³-1 pattern capability and automatic equalization for in-station cabling for 2, 8 and 34 Mb/s systems.

Specifications

Measurements

Binary errors: closed loop bit-by-bit detection on any pattern produced by generator, excluding added zeros or alternating words.

Code errors: violations of coding rule detected on any pattern with AMI, HDB3, or HDB2 coding (optionally AMI, B6ZS, or B3ZS).

Frequency offset: measurement of fractional offset of generator clock output from installed crystal rates.

Options

Word/Connector Options

- | | Price |
|--|--------|
| 001: all words replaced by a 16-bit front panel programmable word | +\$230 |
| 002: Siemens 1.6 mm connectors | +\$85 |
| 003: combination of 001 and 002 | +\$290 |

Frequency Offset Option

- | | |
|--|--------|
| 099: frequency offset—measurement only; frequency offset generation deleted | -\$165 |
|--|--------|

Frequency/Codec Options

- | | |
|---|--------|
| Std: internal clock frequencies of 2048, 8448, and 1536 kHz; HDB3/HDB2 codec. | |
| 100: internal clock frequencies of 2048, 8448, and 34368 kHz; HDB3/HDB2 codec. | +\$235 |
| 101: internal clock frequencies of 1544, 6312, and 44736 kHz; B6ZS/B3ZS codec. | NC |
| 102: internal clock frequencies of 1544, 6312, and 3152 kHz; B6ZS/B3ZS codec. | NC |
| 103: internal clock frequencies of 2048, 8448, and 34368 kHz; 2 ²³ -1 pattern replaces 2 ⁹ -1; HDB3 codec. | +\$510 |
| 104: as option 103 but with Siemens 1.6 mm connectors | -\$585 |

HP 3780A Pattern Generator/Error Detector **\$7,130**

TELECOMMUNICATIONS TEST EQUIPMENT

Dedicated PCM/TDM Error Measuring Sets

Models 3781A, 3782A, 3781B, 3782B

147



HP 3781A/B

- Versatile selection of test patterns
- Internal jitter modulation
- Additional delayed data output

HP 3782A/B

- Binary and code error measurements
- Error ratio, error count, error seconds and error-free seconds displayed
- Powerful error distribution analysis

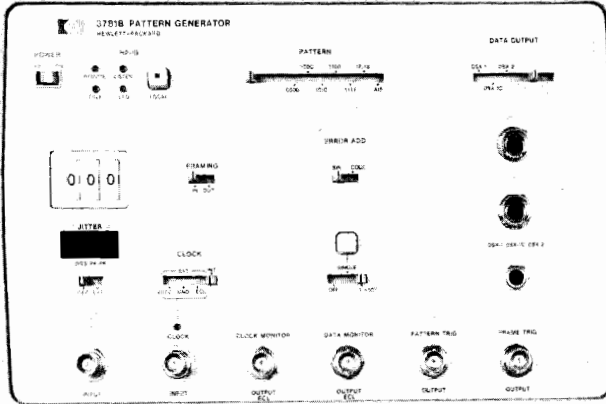

HP 3781B

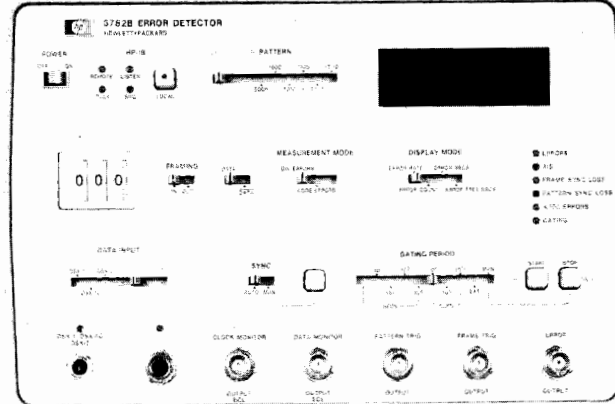

HP 3782B



The HP 3781A Pattern Generator and HP 3782A Error Detector form a high performance error measuring system which complements the existing HP 3780A Pattern Generator/Error Detector. Designed to conform with CEPT and CCITT standards, the HP 3781A/3782A provide four bit rates (up to 50 Mb/s) of the digital hierarchy in one compact system. Applications of the system are in R&D, field trial and production testing, especially where an automatic and remote measurement capability via the HP-IB is required.

In the HP 3781A, binary or code errors can be injected as single shot or at 10^{-3} or 10^{-5} rates into a wide range of PRBS and 16-bit WORD test patterns coded in AMI or HDB3. The test patterns provided include standard 2^9-1 , $2^{15}-1$, and $2^{23}-1$ bit PRBS to CCITT Recommendations, fully programmable 16-bit WORD, and two 8-bit WORDS which may be alternated under the control of an external signal. Zero substitution (up to 120 zeros) for PRBS patterns is included to examine, for example, the clock recovery performance of regenerators. 75 Ω unbalanced and 120 Ω balanced pseudo-ternary outputs and binary TTL monitor outputs are provided. A jitter modulation input facility is provided for simple oscillator connection, with direct LED display of pk-pk bits of jitter. This can be used to measure the input jitter tolerance of digital transmission equipment. A second data output with 12 bits delay provides adequate simulation of an independent sequence for thorough testing of 4 ϕ PSK digital radio systems. As an option, four extra data outputs coded in AMI or HDB3 can be included on the rear panel for driving adjacent radio channels.

The HP 3782A detects binary or code errors which can be displayed in the form of error ratio, error count, error seconds, and error-free seconds over a wide choice of gating periods. All four results are computed simultaneously over the same gating period. For ease of use there is a built-in automatic check for compatibility of switch position combinations. An error code flashes on the display if incompatibility is detected. When the monitor mode is used, the HP 3782A can be used for in-service monitoring of digital transmission links.

Measurement results are available on the HP-IB and a rear panel result threshold switch allows pre-selection of an error threshold above which results will be printed. This provides useful data reduction and a first order error distribution analysis. With a built-in real-time clock, results can be output with time, if required.

The HP 3781B Pattern Generator and HP 3782B Error Detector form a dedicated error measurement system for testing and evaluating the performance of Bell digital transmission terminal and link equipment, up to and including the DS-3 level in the digital hierarchy. The HP 3781B/3782B can be used in production testing, field installation, and maintenance of the Bell digital transmission system, including PCM/TDM transmission over cable, radio, satellite, and fibre optic links. The principal application is at the DS-3 level in the Bell digital hierarchy.

The HP 3781B/3782B are designed to interface at Bell System standard cross connect points with appropriate ternary coding and interface voltage levels at each hierarchical level. Interfacing at the DS-1C and DS-2 levels is limited to T1-C and T2 line systems. At the DS-3 level, a choice of four data formats is available. Alternatively, binary ECL interfaces can be used.

The HP 3781B Pattern Generator provides a selection of standard 2^9-1 , $2^{15}-1$, and $2^{20}-1$ bit PRBS and fixed WORD test patterns with a choice of single error or 1 in 10^5 error simulation on the digital data stream for normal measurements and troubleshooting. A pattern of 17 ones/15 zeros and zero substitution (up to 999 zeros) for PRBS patterns are included to examine phase sensitive circuitry such as clock recovery of regenerators. A jitter modulation input facility is provided for simple oscillator connection, with direct LED display of pk-pk bits of jitter. This can be used to measure the input jitter tolerance of digital transmission equipment. A second DS-3 output channel with 22 bits delay provides adequate simulation of an independent sequence for thorough testing of 4 ϕ PSK digital radio systems. As an optional extra, four DSX-3 BNC outputs on the rear panel can be included for driving adjacent radio channels.

The HP 3782B Error Detector detects any binary or code errors generated by the system under test. At the DS-3 level, it can perform in-service or out-of-service measurements of parity errors within the digital transmission system. The HP 3782B can measure simultaneously error rate, error count, error seconds, and error free seconds over a single gating period. When the DS-3 MON facility is used, in-service measurements (eg parity errors) of live traffic are possible. For ease of use, there is a built-in automatic check for compatibility of switch position combinations. An error code flashes on the display if incompatibility is detected. Hard copies of results can be obtained on a printer via HP-IB control, either in the "talk-only" or "addressable" modes. In addition, a preselectable error rate threshold and a real time clock allows selection for printing results which exceed a defined threshold (with local time, if required).

Ordering Information

HP 3781A Pattern Generator
HP 3782A Error Detector

Price

\$7,130
\$6,630

Ordering Information

HP 3781B Pattern Generator
HP 3782B Error Detector

Price

\$7820
\$7180



TELECOMMUNICATIONS TEST EQUIPMENT

Dedicated 150 Mb/s PCM/TDM Error Detection System

Models 3762A/3763A, 3764A

HP 3762A/3763A

- Binary bit-by-bit error detection
- Coded and binary operation
- Variable clock frequency offsets

HP 3762A

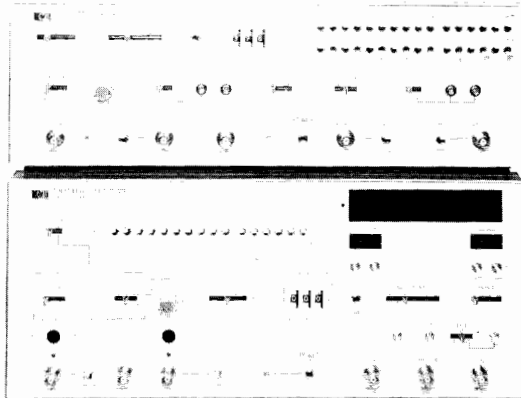

HP 3763A

HP 3762A Data Generator/3763A Error Detector

The HP 3762A Data Generator and HP 3763A Error Detector comprise a dedicated error rate measurement system for evaluating high-speed digital transmission equipment. Basically, there are two versions of the system available. One features CMI and binary data formats and is specifically intended for use in field commissioning and maintenance of digital radio (terrestrial microwave and TDMA satellite) systems. The other version, with CMI and ternary (HDB3 and B3ZS) data formats, is designed for digital multiplex and digital cable systems. Burst gating inputs allow the HP 3762A/3763A to be used in TDMA applications.

Specifications Summary

HP 3762A Data Generator

Internal clock: two crystal clocks in the range 30 to 150 MHz; crystals fitted in standard unit are 139.264 and 141.040 MHz; offset continuously variable up to ± 60 ppm.

External clock input: 1 kHz to 150 MHz; 75 ohm.

Patterns: $2^{10}-1$, $2^{15}-1$, and $2^{23}-1$ PRBS; two 10- or 16-bit programmable words; two 1010... repetitive patterns; two 8-bit words alternated by an external signal; PRBS patterns can be gated off for 1 to 999 clock periods after trigger pulse (zero substitution); error add facilities.

HP 3763A Error Detector

Data input: CMI, NRZ, or RZ formats; 75 ohm; DATA or $\overline{\text{DATA}}$; 12 dB fixed equalization at 70 MHz on CMI inputs with clock recovery.

External clock: as 3762A.

Patterns: all the patterns of the HP 3762A, including zero substitution, but excluding alternating words.

Count: totalizes errors over a selected gating period; internal period can be 10^6 , 10^8 , 10^{10} clock periods or 1 min to 24 h, repetitive or single shot, manual start/stop or external (ECL) control; result displayed as ABCD.

Measurement gating input: gates error and clock inputs to error counter, providing a measurement "window"; 50 ohm; ECL levels.

Frequency offset measurement: measures deviation of received bit rate from nominal rate; result displayed as $\pm \text{BCD} \times 10^{-6}$.

Printer output (rear panel): 8-4-2-1 BCD, 10-column output of result plus local time, if required, and flags; TTL print command pulse.

Recorder output (rear panel): constant current drive output of BER or COUNT result, with flags.

Ordering Information

HP 3762A Data Generator
HP 3763A Error Detector

Price

\$8,660
\$7,850

HP 3764A

- Full 140 Mb/s error measurement
- Jitter generation and measurement at 140 Mb/s
- Portable single-unit construction

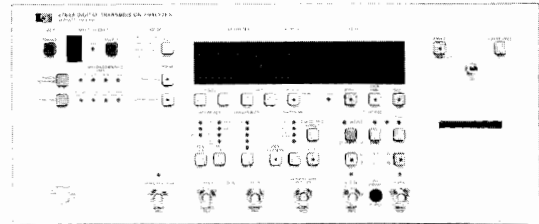

HP 3764A



HP 3764A Digital Transmission Analyzer

The HP 3764A Digital Transmission Analyzer is Hewlett-Packard's new product for analyzing the error performance of high speed digital transmission systems. Three versions of the HP 3764A are produced, each being designed to fulfill different operating requirements. This flexible approach allows the HP 3764A to provide substantial benefits in a wide range of applications, from design and development to commissioning and maintenance.

- **Standard HP 3764A** — this is a dedicated 140 Mb/s digital transmission analyzer with pattern generation, error detection and error analysis capabilities. The error analysis provision includes error performance measurements for testing the proposed Integrated Services Digital Networks (ISDN).
- **Multiple frequency version** — option 001 instruments provide the standard HP 3764A's measurement capability at the four main CEPT bit-rates of 2, 8, 34 and 140 Mb/s. This reduces the number of test sets required in multiple frequency environments.
- **Jitter version** — in addition to the standard HP 3764A's measurement capability option 002 instruments also provide jitter generation and timing jitter measurement at 140 Mb/s. This offers a cost-effective solution to 140 Mb/s testing requirements.

Specifications Summary

Generator Section

Clocks: internal clock 139.264 MHz; offset clocks + and - 15 ppm; external clock 1 kHz to 170 MHz.

Data outputs: CMI format at 139.264 Mb/s; Binary RZ or NRZ from 1 kb/s to 170 Mb/s, ECL levels, 75 ohm unbalanced.

Patterns: PRBS $2^{23}-1$; WORD, 1 to 16-bit fully programmable; ALT WORD, two 1 to 8-bit programmable words, crossover rate controlled by external signal; AIS, "all ones" pattern.

Receiver Section

Recovered clock: 139.264 ± 3 Mb/s.

Binary clock: 1 kHz to 170 MHz.

Data inputs: 75 ohm Terminated mode: Monitor mode; Binary, RZ or NRZ, ECL levels; External Error, ECL levels.

Measurements Performed

Error performance: % Availability, % ER \leq N, % EFS.

Errors: Error Ratio, Error Count, Error Seconds, Error Free Seconds.

Options

(Select one option only)

001: four internal frequencies.

002: jitter generation and measurement at 140 Mb/s.

Price

\$750

\$2,570

HP 3764A Digital Transmission Analyzer

\$9,630

TELECOMMUNICATIONS TEST EQUIPMENT

Dedicated PCM/TDM Jitter Generator and Receiver

Models 3785A, 3785B

149



- Jitter generation and measurement on data and clock
- Jitter specifications designed to CCITT recommendation 0.171
- Transient-free sweeping of internal CCITT defined jitter tolerance masks

- Single portable unit for up to 4 internal bit rates
- Built-in measurement filters to CCITT recommendations
- Comprehensive jitter analysis against real-time and jitter amplitude

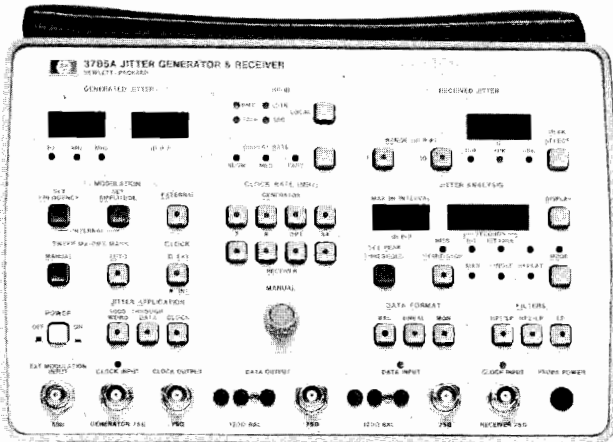

HP 3785A (2048, 8448, 34368 and, optionally, 25776 kHz)
CEPT

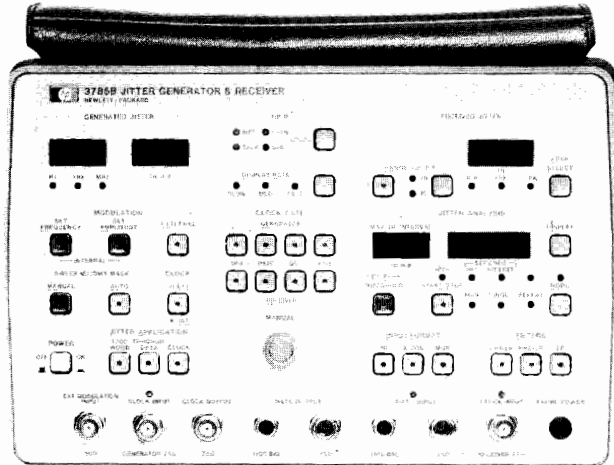

HP 3785B (DS-1, DS-1C, DS-2 and DS-3)
Bell



The HP 3785A/B Jitter Generator and Receiver is a dedicated jitter measurement system for testing and evaluating the performance of CEPT or Bell digital transmission terminal and link equipment up to and including the third level (34368 kb/s or DS-3) in the digital hierarchy. The HP 3785A/B can be used in production testing, field installation and maintenance of the CEPT or Bell digital transmission system including PCM/TDM transmission over cable, radio, satellite, and fiber optic links. The principal application is thorough testing to current CCITT Recommendations at each level in the digital hierarchy.

In addition to providing a comprehensive measurement capability which includes in-service jitter measurements, the microprocessor-controlled Jitter Generator and Receiver is easy to use with ergonomic layout of switches and connectors on the front panel. The instrument is designed to interface fully with the HP-IB, allowing bus-controlled operation and automatic measurement sequencing.

The Jitter Generator may be used to phase modulate an internally provided crystal clock, an externally applied clock (at a nominal digital hierarchy bit rate) or an externally applied data stream. Sinusoidal modulation is provided by an internal synthesizer whose amplitude and frequency can be set manually or swept, transient-free, through a CCITT shaped jitter tolerance mask programmed into the instrument. Alternatively, external modulating signals can be applied. The amplitude of generated jitter in unit intervals (U.I.) pk-pk and the frequency of internal modulation are in accordance with CCITT Recommendation 0.171 and are displayed on the front panel.

The modulated clock output can be applied to an external pattern generator such as the HP 3780A, 3762A, 3781A or 3782B. For jitter transfer function measurements, the CCITT standard 1000 repetitive pattern is provided within the HP 3785A/B. In addition, for demultiplexer jitter transfer function, jitter can be applied to an externally applied data stream which has the necessary framing and justification digits. Consult the data sheet for full technical specifications.

Consult the data sheet for full technical specifications.

Measurements

The Jitter Receiver offers six types of measurement:

- Absolute jitter amplitude in U.I. pk-pk
- Jitter peak, positive or negative
- Jitter hit count of the number of times received jitter exceeds a user-defined hit threshold in U.I. pk

- Jitter hit seconds count of the number of seconds in which one or more jitter hits occur
- Jitter hit-free seconds count of the number of seconds which are free of jitter hits
- Maximum absolute jitter amplitude in U.I. pk-pk is held during the jitter analysis gating period

Simultaneous measurement of all six parameters is possible with result display selection. In addition, the Receiver has a built-in interval timer and real-time clock to allow measurements of jitter distribution against time to be made.

The measurements can be made on clock or data inputs with or without internal filtering. Two high pass filters and one low pass filter as specified by CCITT are provided for each of the four bit rates. In addition, external filters can be connected between the demodulated jitter output and the measuring circuitry input. The demodulated jitter output can also be used to measure rms jitter amplitude on an external voltmeter or to display jitter spectrum on an external analyzer.

The clock reference for the jitter measurements can be internally derived from the applied data or clock via a narrow band phase-locked loop or externally derived from an applied reference.

The data input allows out-of-service or in-service measurements. The MON facility for in-service measurements has built-in additional gain to compensate for the flat loss at the protected monitor points.

HP-IB Operation

The capabilities of the HP 3785A/B can be enhanced by using the HP-IB to provide remote operation and automatic sequencing of results.

The HP-IB facility offers several principal features:

- Remote control of front panel switches and pushbuttons using programming codes
- Control codes which are set to default values on power-on and can be user-defined with the controller
- The ability to transfer all desired switch positions and masks onto a tape memory and reloaded back onto the instrument at a later time
- Output of the result data to a printer (eg HP 5150A Thermal Printer) or storage memory

Ordering Information

HP 3785A Jitter Generator and Receiver (CEPT)
HP 3785B Jitter Generator and Receiver (Bell)

Price
\$11,960
13,930

TELECOMMUNICATIONS TEST EQUIPMENT

PCM/TDM Accessories

Models 15507A, 15508B, 15508C, 15509A, 15509B, 15510A, 15511A, 15512A, 15513A, 15514A, 15515B, 15518A/B/C

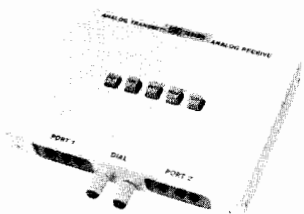

HP 15518A/B/C



HP 15509A

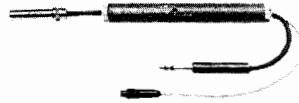

HP 15509B

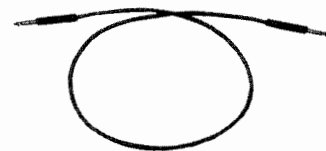

HP 15513A

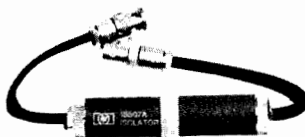

HP 15507A



HP 15510A

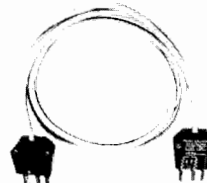

HP 15511A

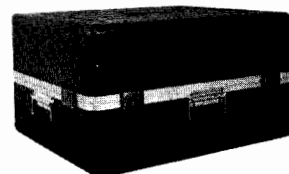

HP 15514A



HP 15508B



HP 15508C

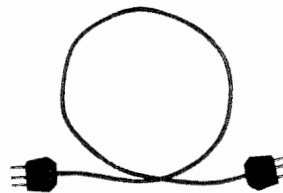

HP 15512A

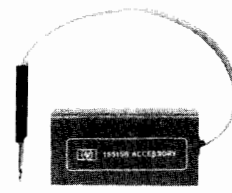

HP 15515B

HP 15507A Isolator

This unit provides isolation from longitudinal voltages which may appear on test connections to digital transmission equipment. It can also be used when the ground potential of the test equipment is different from that of the transmission equipment.

HP 15508B Converter (75 Ω unbal—110 Ω bal)

This unit provides a nominal 110 Ω balanced interface conversion from 75 Ω unbalanced interfaces on digital test equipment. This is required at the 1544 kb/s DS-1, 3152 kb/s DS-1C, and 6312 kb/s DS-2 levels of North American digital transmission systems.

HP 15508C Converter (75 Ω unbal—120 Ω bal)

The HP 15508C provides a nominal 120 Ω balanced interface conversion from 75 Ω unbalanced interfaces on digital test equipment. This may be required at the 2048 kb/s primary multiplex levels of European digital transmission systems.

HP 15509A Amplifier

This unit is designed to provide sufficient gain on a digital signal appearing at a standard digital equipment protected monitor point to trigger the Error Detector input. This is required to monitor in-service systems for code violations. Power for the HP 15509A is supplied from the error detector front panel PROBE POWER socket.

HP 15509B Amplifier

The HP 15509B is similar to the HP 15509A except that it is intended for operation at the DSX-1, DSX-1C, and DSX-2 monitor points of North American digital transmission systems.

HP 15510A 75 Ω Cable Accessory

The HP 15510A is designed to provide a protected monitor point to the HP 15509A input. This allows the Error Detector to monitor in-service systems (75 Ω) for code violations when the system monitor point is unprotected.

HP 15511A 120 Ω Cable Accessory

The HP 15511A is designed to provide a protected monitor point to the HP 15508C input and, subsequently, the HP 15509A input. This allows the Error Detector to monitor in-service systems (120 Ω) for code violations when the system monitor point is unprotected.

HP 15512A Cable

The HP 15512A is a 1 m length of 600 Ω balanced cable with a 3-pin audio connector (Siemens type) at each end.

HP 15513A Cable

The HP 15513A is a 1 m length of 600 Ω balanced cable with a WECO 310 jack plug at each end.

HP 15514A Transit Case

The HP 15514A is a transit case with moulded foam inserts for transporting the HP 3779 Primary Multiplex Analyzer.

HP 15515B Loop Holding Unit

Model 15515B is a loop holding unit which provides 24 mA loop holding current sinking. It is supplied with WECO connectors.

15518A/B/C Loop Holding Accessory

Models 15518A/B/C are loop hold accessories designed to satisfy the requirements of CCITT/Bell/Japanese network requirements and work with voice frequency instruments such as HP 3776A, HP 3776B, 3776B Opt 002 respectively. Two separate loop holding circuits are provided, each of which can sink a choice of 24, 60 or 100mA, loop holding currents. Also, a butt-in (telephone handset) can be connected to the HP 15518A/B/C to allow dial up of the remote end of a test circuit.

Ordering Information

| | Price |
|--|-------|
| HP 15507A Isolator | \$235 |
| HP 15508B Converter (75 Ω unbal—110 Ω bal) | \$205 |
| HP 15508C Converter (75 Ω unbal—120 Ω bal) | \$185 |
| HP 15509A Amplifier | \$310 |
| HP 15509B Amplifier | \$265 |
| HP 15510A 75 Ω Cable Accessory | \$84 |
| HP 15511A 120 Ω Cable Accessory | \$150 |
| HP 15512A Cable | \$75 |
| HP 15513A Cable | \$60 |
| HP 15514A Transit Case | \$535 |
| HP 15515B Loop Holding Unit | \$290 |
| HP 15518A/B/C Loop Holding Accessory | \$430 |

TELECOMMUNICATIONS TEST EQUIPMENT

General Information: Radio and FDM Carrier System Testing

151



FDM System Measurements

Frequency Division Multiplex (FDM) systems are the traditional method of transmitting a number of telecommunications channels over a single wideband transmission medium such as coaxial cable or microwave radio, each channel being allocated a unique part of the frequency spectrum. In narrow satellite or radio channels there might be only 12 or 24 telephone channels, whereas in a high capacity 12 MHz or 18 MHz system 2700 or 3600 channels can be transmitted simultaneously.

Hewlett-Packard supplies a comprehensive range of manual and automatic test-equipment, summarized in the table below, for FDM baseband, microwave radio and satellite systems.

FDM Measurements

The HP 3586A/B Selective Level Meter (SLM) and its companion Synthesizer/Level Generator the HP 3336A/B are specifically designed for manual measurements in manufacture, installation and maintenance. Both instruments incorporate synthesizer tuning for stability and resolution and provide absolute level accuracy of ± 0.2 dB (SLM) and ± 0.15 dB (Generator). The HP 3586A/3336A combination is optimized for testing to CCITT standards and the HP 3586B/3336B to Bell or North American standards.

Both HP 3586A/B and HP 3336A/B are HP-IB programmable and can be combined into a low-cost system with the HP-85F Personal Computer. This system, the HP 3046A/B, is simple to use and enables automatic multiple measurements and sequences to be set up using the stored FDM plans. Up to four test points can be accessed by means of an HP 3755A Access Switch Controller and HP 3754A Access Switch.

The HP 3746A SLMS, developed from the HP 3586A/B, has been optimized for FDM maintenance measurements, particularly in automatic network monitoring systems. Its built-in "intelligence" enables high speed scans of FDM signals using the internally stored FDM plans and limits which check for unacceptable levels. Group power measurements and hot-tone search provide rapid detection of high level signals (see Application Note AN 323). The HP 3746A has a built in access switch controller (similar to the facilities of the HP 3755A Access Switch Controller) to provide low-cost system integration with the HP 3754A, 3756A and 3757A Access Switches. The inter-

nal real-time clock allows limit violations to be logged on an external printer with the time of occurrence. All these facilities are available from the keyboard or programmable from a system controller.

The performance objectives for present day networks, and customer expectations, particularly business customers and data users, demand rapid fault location and analysis of system degradation. Hewlett-Packard offers two automatic monitoring systems designed round the HP 3746A SLMS: the HP 37050S system based on the HP 1000 A-Series Computer, and the HP 37051S based on the HP 9816S Personal Technical Computer. The HP 37051S is a low-cost measurement system for smaller networks providing control of up to six remote measurement subsystems, each with up to 45 access points. The software on the HP 9816S stores database information on the test points and allows a surveillance routine to be run continuously using sequence files. These can be interrupted at any time for demand measurements.

The computer-based HP 37050S system has all of these features and in addition can control up to 16 remote subsystems per computer and provides comprehensive data reduction and results reporting — for the larger system this is essential. The computer utilizes powerful Real-Time Executive (RTE) Operating System Software, so (unlike the HP 37051S) can provide simultaneous measurements at multiple sites and can support several users at local or remote terminals. The HP 37050S can be readily extended to cover a very large network by linking computers using DS/1000-IV Network Software.

Analog Radio Measurements

Radio measurements divide into two categories, qualitative baseband measurements and analytical IF and RF transmission measurements. IF transmission measurements, including group delay, amplitude flatness, differential gain and linearity, are used mainly for troubleshooting. The Hewlett-Packard Microwave Link Analyzers (MLAs) are equipped to make the full range of these measurements at 70/140 MHz IF (HP 3711A, 3712A). They are well established products with a very good reputation for reliability and accuracy essential for examining individual sections of the radio. Interpreta-

tion of MLA measurements and the relationship to white-noise testing is covered in Hewlett-Packard Application Note AN175-1, "Differential Phase and Gain at Work".

These MLA transmission measurements can be readily extended to RF interfaces using the high-performance HP 3730B Down Converter, and the HP 8620C Up Converter Simulator. In both these instruments the different microwave bands are covered by a range of plug-ins.

Baseband qualitative measurements such as white noise (NPR) testing can be carried out at IF interfaces using the HP 3717A 70 MHz Modulator/Demodulator. This is a compact, high-performance unit incorporating selected pre- and de-emphasis networks to CCIR and Bell standards.

Digital Radio Measurements

In common with other digital transmission systems, the overall performance measurement for digital radio is the bit-error-ratio (BER) performance (see page 143). To check the radio fade-margin, the carrier to noise ratio (C/N) is artificially degraded by adding noise and the BER is measured to plot the classical BER vs. C/N curve. The new HP 3708A Noise and Interference Test Set has been designed for this application and the test can be automated using the HP 3708S system operating on the HP 9816S Personal Technical Computer. Transmission impairments such as amplitude response and group-delay in the IF and RF sections can be evaluated with the HP Microwave Link Analyzers in the same way as analog radio.

NEW: I-Q Tutor, A Highly-Flexible Training Tool For Digital Communications

Imagine a practice "software workbench" which simulates a full digital communications system from voice channel through transmitter and on through demodulation. I-Q TUTOR runs on HP 9000 Model 216 or 236 Desktop Computers to display waveforms for modulations from BPSK to 16 QAM, and leads the user through various real-time tradeoffs of filter factors, S/N ratios, path fades, and non-linear performance of the high power amplifier. Ask for HP 11736A data sheet for a full description.

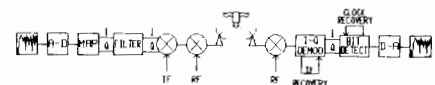

Typical display shows system schematic and waveforms through the system.

| | | MAINTENANCE/ MONITORING | INSTALLATION | MANUFACTURE |
|---------------------|--------------|----------------------------|---------------------------------|------------------------|
| FDM Measurements | Manual | HP 3586A/B, 3746A | HP 3586A/B, 3336A/B | HP 3586A/B, 3336A/B |
| | Automatic | HP 3046A/B, 3746A | HP 3046A/B, 3746A 3336A/B | HP 3046A/B |
| | Surveillance | HP 37050S, 37051S | — | — |



TELECOMMUNICATIONS TEST EQUIPMENT

Selective Level Measuring Set, HP-IB CRT Display

Models 3746A, 37461A

- Fast, accurate measurements on frequency division multiplex (FDM) systems
- Selective filters for pilot, channel and (optionally) group power and weighted noise measurements
- Automatic tuning to stored frequency plans with comparison of measured level to stored limits

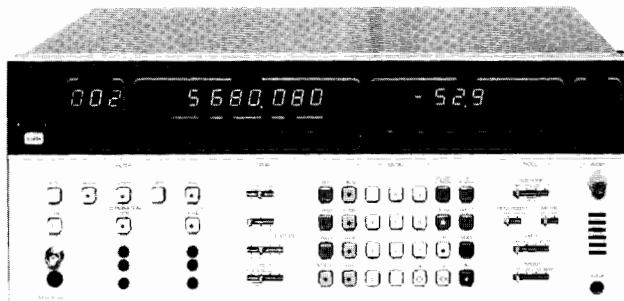

HP 3746A



HP 3746A Selective Level Measuring Set (50 Hz to 32 MHz)

The HP 3746A Selective Level Measuring Set (SLMS) is designed to make fast, accurate selective level measurements. A built-in frequency synthesizer gives accurate, stable tuning to the precise frequency at which the measurement is to be made. The HP 3746A can be tuned over its frequency range (50 Hz to 32 MHz) with a resolution of 1 Hz.

The SLMS measures true rms power between +20 dBm and -120 dBm with 1 dB, 0.1 dB, or 0.01 dB resolution. Fully auto-ranging attenuators and amplifiers simplify operation further by eliminating the need to set attenuators and add meter readings. Measurement results are automatically displayed to the selected resolution, in dBm or dB relative terms, on an LED display. The absolute accuracy of the measurement over wide level and temperature ranges is ± 0.25 dB.

Many benefits are derived from the purpose designed filters contained in the SLMS. The 38 Hz pilot filter has a flat top over 22 Hz, necessary for automatic tuning, and achieves high out-of-band rejection so that, for example, carrier leak can be measured on active systems. The channel filter is a flat-topped 3.1 kHz filter which can be used for measuring all signals in the voice channel and provides high out-of-band rejection. Optional weighted filters are available to make either true 'C'-message or CCITT psophometrically weighted noise measurements. These options also provide the following voice channel impairment measurements: single level impulse noise, phase jitter and noise-with-tone measurement. A 48 kHz filter for group power measurements is available by option to facilitate fast location of high level signals on a multiplex.

The HP 3746A is internally controlled by a microprocessor which provides many ease-of-use and time-saving features. As well as tuning exactly to an entered frequency, the SLMS can refer to CCITT or Bell multiplex frequency plans in its memory and automatically tune to the correct frequency at any level in the multiplex. Other frequency plans, as used for example on submarine cable or satellite links, can be installed to special order. Also, up to 145 unrelated frequencies can be stored in non-volatile memory and the SLMS programmed to scan through these frequencies. The comprehensive FDM plan and frequency storage capability of the SLMS eliminates the need for the

- Built-in access switch controller, real-time clock and frequency counter
- HP-IB controller for external printer, frequency synthesizer and companion display unit
- Versatile, efficient remote system device in computer-controlled HP-IB systems

operator to refer to FDM plan charts and tables. The SLMS can automatically step through pilots and supervisory tones, channels, group powers, carrier leaks, etc, across the baseband of a multiplex—comparing levels with pre-determined alarm limits and providing a print-out of limit violations on a separate printer. 250 pilot measurements can be made in about 2 minutes and 2700 channel powers can be measured in about 5 minutes.

Control of test point selection is provided by means of a built-in Access Switch Controller. This performs a function similar to the HP 3755A Switch Controller: control of HP 3754A, 3756A, or 3757A Switches to select 1 from a possible 1000 RF outputs. A 3-digit display on the SLMS front panel indicates the selected port. Another useful feature is the SLMS's integral Real-time Clock which can display time or date and holds the correct time even when the SLMS is switched off. If a printer is connected to the HP 3746A via the HP-IB, the SLMS can be configured to output measurement results to the printer together with the date and time at which each measurement is made.

The HP 3746A is fully programmable via the HP-IB, and can itself assume the role of system controller. In this mode, selectable by a rear panel switch, the SLMS can control a tracking Frequency Synthesizer (HP models 3330B, 3335A, 3336A/B are compatible), a 20- or 80-column Printer (for example, HP 5150A or 2631B), and a HP 37461A CRT Display. It is thus possible to assemble a self-contained test station for network maintenance and surveillance.

HP 3746A Options

| | |
|--|-------|
| 001: Siemens series 1.6/5.6 mm 75 Ω connectors | NC |
| 005: WECO 477B/223A (equivalent) connectors | \$65 |
| 011: 48 kHz group filter | \$695 |
| 012: tracking generator | \$279 |
| 014: high stability frequency reference | \$590 |
| 015: channel impairments—CCITT | \$375 |
| 016: channel impairments—North America | \$375 |
| 907: front handle kit | \$74 |
| 908: rack flange kit | \$42 |
| 909: rack and handle kit | \$99 |
| 910: extra set of manuals | \$100 |

Prices

HP 3746A Selective Level Measuring Set \$11,710

HP 37461A Display

The HP 37461A Display is a CRT-based display unit with integral processor and HP-IB interface. Under control of the HP 3746A SLMS, a graticule with labelled frequency and level axes is displayed and up to 256 measurement results can be plotted. This type of visual presentation enables speedy assessment of overall traffic loading, identification of spurious signals and detection of high level users.

For user convenience, both axes are labelled with values relating to the current measurement: the level (Y) axis is labelled with the upper limit, reference level and lower limit values (in dBm) calculated from the values held in the corresponding SLMS registers, while the frequency (X) axis is labelled with the start frequency and stop frequency for the current measurement scan.

HP 37461A Options

| | |
|----------------------------------|------|
| 907: front handle kit | \$71 |
| 908: rack flange kit | \$87 |
| 910: extra set of manuals | \$15 |

Prices

HP 37461A Display \$3,490

TELECOMMUNICATIONS TEST EQUIPMENT

Access/Distribution Switches and Controller, SLMS Accessories

Models 3754A, 3755A, 3756A, 3757A, 15580A, 15581B, 15582A, 15589A

153



- Select 1 from a possible 10 RF inputs/outputs
- Cascade up to 111 Switches to allow selection from 1000 inputs/outputs
- Mix different Switches for the most cost-effective solution

- Switches controllable from HP 3755A Switch Controller or HP 3746A SLMS
- Remote input selection using HP-IB (HP 3755A or 3746A)
- 75 Ω termination of unselected ports



HP 3754A

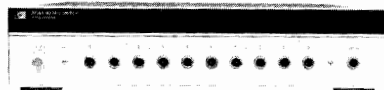

HP 3756A



HP 3757A

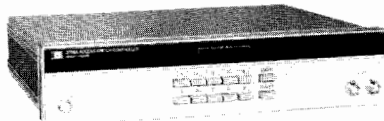

HP 3755A

The HP 3754A, 3756A and 3757A Switches and the 3755A Controller have been developed to meet the requirements of four main areas.

1. Frequency Division Multiplex (FDM) system surveillance and maintenance—the Switch arrangement is used in conjunction with a Selective Level Measuring Set (SLMS), such as the HP 3746A, to monitor pilot and traffic levels at various points in the multiplex. The HP 3746A SLMS can control the Access Switches directly without needing the HP 3755A Controller.
2. Production testing—where automatic selection or distribution of RF signals is required.
3. IF access and distribution—70 MHz IF signals can be switched using the HP 3756A for connection to the HP 3717A 70 MHz Modulator/Demodulator.
4. Access and distribution of digital communications signals up to 34 Mb/s (CEPT) or 44.7 Mb/s (DS-3).

HP 3754A 25 MHz Access Switch

The HP 3754A 25 MHz Access Switch is an ac-coupled, uni-directional, ten-input switch with a frequency range from 10 kHz to 25 MHz. The HP 3754A incorporates a virtual-ground amplifier—giving an insertion loss of $<\pm 0.1$ dB from 50 kHz to 20 MHz and high isolation across the whole frequency range. The isolation between any unselected input and the output is >85 dB and the isolation between any two inputs is >90 dB. In addition, pre-set gains of 1, 2 and 3 dB are internally selectable to compensate for losses in cables and equalizers.

HP 3756A 90 MHz Bi-directional Switch

The HP 3756A 90 MHz Switch is a dc-coupled, bi-directional, ten-way switch with a frequency range from dc to 90 MHz. The HP 3756A offers isolation of >80 dB between channels, and >75 dB between unselected input and output ports. It has an insertion loss of 1 dB with a flatness of $<\pm 0.2$ dB and >28 dB return loss.

HP 3757A 8.5 MHz Access Switch

The HP 3757A 8.5 MHz Access Switch is a low-cost, ac-coupled, uni-directional, ten-input switch with a frequency range of 10 kHz to 8.5 MHz. An option provides expanded frequency range from 200 Hz to 8.5 MHz. The HP 3757A has an insertion loss <0.1 dB from 10 kHz to 4 MHz and isolation of >95 dB between channels. In addition, pre-set gains of 1, 2 and 3 dB are internally selectable to compensate for losses in cables and equalizers. (The HP 3757A is powered from a ± 15 V dc supply.)

HP 3755A Switch Controller

The HP 3755A Switch Controller has a small, easy-to-operate keyboard with a 3-digit LED display to denote the input or output select-

ed. Each Switch (HP 3754A, 3756A or 3757A) is given a 1-digit code, to select the required port from up to 1,000.

The HP 3755A Switch Controller can be remotely controlled over the Hewlett-Packard Interface Bus (HP-IB) by a desk-top computer. If the HP 3746A is used as Switch controller, similar principles apply.

Active and Passive Probes

Models HP 15580A and 15581B High-Impedance Probes are used with the SLMS for bridging measurements. The HP 15580A is an “active” device powered from the SLMS having an insertion loss of 0 dB. Model HP 15581B is a passive probe having an insertion loss of 20 dB. The HP 15581B can also inject signals from a Level Generator at points where a high impedance source is required.

Specifications

| Parameter | HP 15580A | HP 15581B |
|---|---|--|
| Frequency Range | 20 kHz to 25 MHz | 10 kHz to 25 MHz |
| Insertion Loss | 0 dB ± 0.2 dB (50 kHz to 20 MHz) | 20 dB ± 0.2 dB (50 kHz to 20 MHz) |
| Tapping Loss (in 75 Ω system) | <0.15 dB (50 kHz to 20 MHz) | <0.25 dB (50 kHz to 20 MHz) |

Return Loss Kit

Model HP 15582A Return Loss Kit, with a suitable Level Generator, allows the SLMS to make return loss measurements from 10 kHz to 25 MHz.

Instrument Cart

HP Model 15589A is suitable for transporting the SLMS and its auxiliary equipment.

Ordering Information

| | |
|---------------------------------------|--|
| HP 3754A 25 MHz Access Switch | |
| HP 3755A Switch Controller | |
| HP 3756A 90 MHz Bi-directional Switch | |
| HP 3757A 8.5 MHz Access Switch | |
| HP 15580A Active Probe | |
| HP 15581B Passive Probe | |
| HP 15582A Return Loss Kit | |
| HP 15589A Instrument Cart | |

Price

| | |
|---------------------------------------|---------|
| HP 3754A 25 MHz Access Switch | \$2,350 |
| HP 3755A Switch Controller | \$2,190 |
| HP 3756A 90 MHz Bi-directional Switch | \$7,940 |
| HP 3757A 8.5 MHz Access Switch | \$920 |
| HP 15580A Active Probe | \$460 |
| HP 15581B Passive Probe | \$375 |
| HP 15582A Return Loss Kit | \$670 |
| HP 15589A Instrument Cart | \$780 |



TELECOMMUNICATIONS TEST EQUIPMENT

FDM Network Monitoring Systems

Models 37050S, 37051S

- Automated FDM network monitoring
- Multiple remote SLMS control
- Integral CCITT and Bell FDM plans

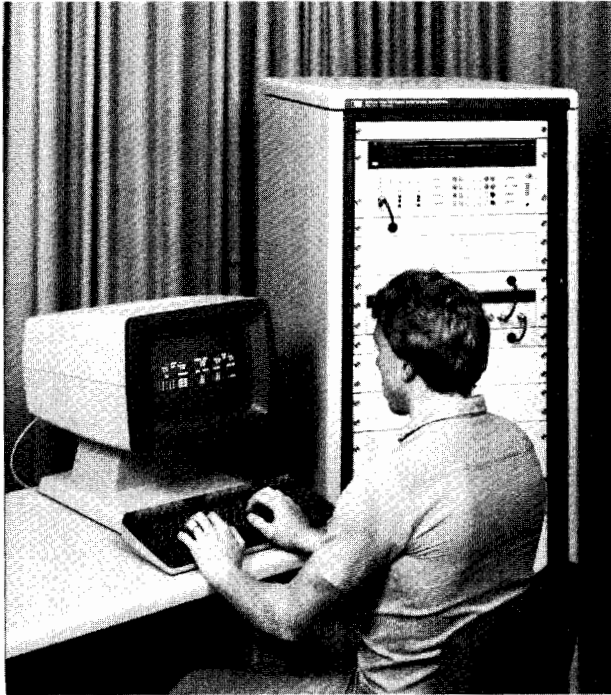

HP 37050S

The HP 37050S and 37051S provide the ability to monitor continually both Bell and CCITT Frequency Division Multiplex (FDM) networks.

These systems allow faults or deteriorations within an FDM network to be isolated and rectified in the shortest possible time. The HP 37050S has been designed to meet the demands of large, high capacity FDM networks, whereas the HP 37051S provides a low-cost solution for small FDM networks.

System Structure

Both systems use the extensive measurement capability and built-in intelligence (including FDM plans) of the HP 3746A Selective Level Measuring Set (SLMS). Expandable access switching arrangements using HP 3754A (25 MHz) or HP 3757A (8.5 MHz) switches enable each SLMS to monitor at a number of test points.

Both systems employ specialized software packages to control their operation and provide data base information, measurement routines and dedicated control software (e.g. time-scheduling routines).

Data Base Assistance

The HP 37050S and 37051S both incorporate a system data base to simplify system operation. Information detailing the required measurements and the test points at which they should be performed (e.g. test level, gain parameters) need only be entered once initially. This information is available to both the computer or manually initiated automatic measurements.

Comprehensive Measurements

Measurements supported by the systems include:

- Pilots
- Carrier Leaks
- Noise (Intersubgroup Slot, Channel)
- Power (Broadband, Channel, Group, Supergroup)
- Tones (Test, Signaling)
- Fast High Level Searches (FDM, Spectrum)
- Channel Impairments (Phase Jitter, Impulse Noise, Noise with Tone) — HP 37050S only

- Flexible configurations
- Fast, accurate measurements
- Concise result presentation

HP 37050S FDM Network Monitoring System

The HP 37050S is a flexible, automatic measurement system for use in the commissioning, monitoring, fault-finding and maintenance of FDM transmission networks.

The System operates under the direct control of an HP1000 A-Series Computer system which gathers measurement data concurrently from remote SLMS-based instrument subsystems. Up to 16 remote subsystems can be continuously monitoring network performance. Specialized result modes are provided that reduce the mass of data available to only that which is really relevant.

A number of User Terminals (VDU/keyboard) can be added to the HP 37050S to provide direct on-demand control of all measurements (e.g. for on-the-spot investigations of problems highlighted during automatic monitoring).

HP's Distributed Systems Network Software, DS/1000-IV, can be incorporated to allow two or more computer systems to be linked together. This facility enables an HP 37050S system to be expanded beyond 16 SLMSs.

HP 37016A FDM Network Monitoring Software

The HP 37016A Software is the power behind the HP 37050S and is used to control all the operations of the FDM Network Monitoring System. The software includes measurement programs and functional tests for verifying that the instruments at the remote sites function correctly.

HP 37051S FDM Measurement System

The HP 37051S is the ideal answer for the operator of a small FDM network who wishes to make measurements quickly at several remote, possibly unmanned, FDM installations and present the information obtained at one central location.

This system operates under the control of an HP 9816S Personal Technical Computer that provides sequential control of up to 6 remote SLMSs. Surveillance sequences can be created in which all the SLMSs are controlled in succession. User initiated measurements, temporarily interrupting any surveillance sequence, can be made to investigate a problem highlighted by surveillance.

HP 37051S operators retain the ability to later expand their monitoring system to the HP 37050S as their networks grow or needs change.

HP 37014B FDM Measurement Software

The HP 37014B Software controls the HP 37051S system providing measurement programs and also functional tests for verifying that the instruments at the remote sites function correctly.

Table 1. Monitoring Systems Summary

| | HP 37050S | HP 37051S |
|--|---------------------|------------------|
| Automated measurements (continuous and time-scheduled) | YES | YES |
| Measurements on-demand | YES | YES |
| Result storage capability | YES | YES |
| Maximum number of supported SLMSs per controller | 16 (simultaneously) | 6 (sequentially) |
| Maximum number of test points per SLMS | 999 | 45 |
| User Terminals | YES | NO |

Support Services

Full training programs for the HP 37050S and 37051S are available. All the individual components that make up these Systems (excluding data links) are designed and manufactured by Hewlett-Packard and are backed up by HP's worldwide support.

TELECOMMUNICATIONS TEST EQUIPMENT

Microwave Radio Noise and Interference Measurement System

Models 3708A, 3708S



HP 3708A

- Highly accurate wideband noise source covers all common microwave link IFs
- Tracking mode maintains constant C/N ratio under carrier fading conditions
- Broadband interference facility, with or without noise injection, stresses the radio deterministically

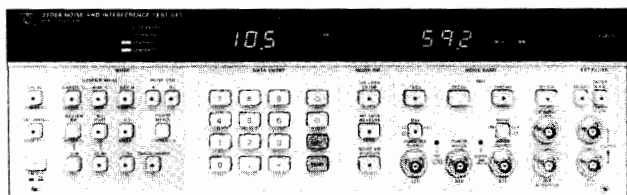

HP 3708A



HP 3708A Noise and Interference Test Set

The HP 3708A Noise and Interference Test Set offers an accurate, yet simple, method of simulating microwave radio fade conditions. Designed for operation in the IF section of a digital or FM microwave radio, HP 3708A will add calibrated levels of white noise and/or interference signals to the radio IF carrier. A built-in power meter and microprocessor control enables the radio IF carrier power to be sampled by the HP 3708A at the point of noise injection and the noise density adjusted automatically to maintain a constant carrier to noise ratio even in the presence of receiver carrier level variations. A simple, yet powerful interference test facility is also included in the HP 3708A, allowing an external broadband signal to be mixed with the radio IF carrier along with/instead of the injected noise. Additional capability provided within the instrument includes

- True RMS IF power meter
- High stability 0 dBm reference tone
- Direct noise bandwidth measurement.

HP 3708A Specifications Summary

Noise Generation

Outputs: "Noise only" or "noise + carrier (+ auxiliary interferer if desired)".

Absolute accuracy of noise power: ± 0.25 dB in range +6 to -10 dBm at $23 \pm 3^\circ\text{C}$.

Accuracy of carrier to noise power ratio: ± 0.35 dB over range: C = +1 to -5 dBm, C/N = 10 to 30 dB.

Maximum noise power output: +6 dBm "noise only" output. 0 dBm "noise + carrier" output.

Band-limiting filters: four fixed internal filters plus external filter facility with range 10 - 200 MHz.

Interference Signal Inputs

Auxiliary Interferer (i.e., in addition to Noise Injection)

Input: Broadband (10 to 200 MHz) fixed loss path (typically 15 dB) to IF output.

Interferer Only (i.e., Instead of Noise Injection)

Input: Broadband (10 to 200 MHz), acceptable signal level typically -30 dBm. Injection level determined by HP 3708A.

Accuracy of C/I power ratio: ± 0.35 dB in range C = +1 to -5 dBm, C/I = 10 to 30 dB, $23 \pm 3^\circ\text{C}$ for 70, 140 MHz (± 10 MHz) interferer.

Power Measurement

Absolute Accuracy: ± 0.05 dB at 0 dBm $23 \pm 3^\circ\text{C}$, 70/140 MHz after calibration using internal reference tone.

Resolution: 0.01 dB.

Options

Std: Signal connectors impedance, 75 ohms nominal unbalanced to GND. Reference tone oscillator frequency is 70/140 MHz.

001: Signal connectors impedance, 50 ohms nominal unbalanced to GND.

Special Options: Reference tone oscillator frequencies, other than the standard values, are available on a special order basis.

HP 3708A Noise and Interference Test Set \$13,400

HP 3708S

- Data base recall and editing of system setup parameters and measurement results
- Extensive graphics capability facilitates operation and measurement interpretation
- Complete range of Hewlett-Packard HP-IB compatible bit error ratio test sets supported

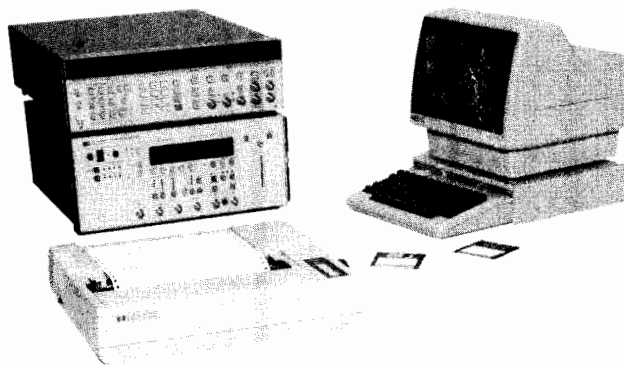

HP 3708S Noise and Interference Measurement System

The HP 3708S system enables computer-controlled automatic measurements to be made of microwave radio performance under simulated flat-fade conditions. The measurements are centered around an HP 3708A Noise and Interference Test Set to simulate flat fade (and/or interference) conditions with additional pattern generator and error detector to provide and monitor a known test pattern. All instruments are controlled by a single HP 9816S desktop computer via the HP-IB interface including extra configurable peripherals such as printer and pen plotter. The system is capable of performing BER versus C/N measurements both in the tracking and non-tracking modes of the HP 3708A, with the optional presence of interfering signals. Measurements of BER vs. Carrier/Interference ratio's are also supported. Versions of the HP 3708S system software (HP 3708) exist to support all current Hewlett-Packard bit error ratio test sets with HP-IB capability. The HP 3708S system is intended for production and maintenance where speed of testing, hard copy results and ease of use are all important factors.

HP 3708S System Configuration Summary

The HP 3708S system configuration basically consists of the following (plus miscellaneous accessories):

| Controller | Price |
|--|----------|
| HP 9816S Desktop computer (includes 512 kbytes of standard RAM, RAM-based BASIC and internal HP-IB interface). | \$5,105 |
| Plus: HP 98624A HP-IB plug-in module. | \$325 |
| HP 9122D dual 3.5 in. disc drive. | \$1,350 |
| Noise and Interference Test Set | |
| HP 3708A Noise and Interference Test Set. | \$13,400 |
| Bit-Error-Ratio Testers | |
| HP 3781A/3782A Pattern Generator and Error Detector. | \$13,760 |
| HP 3781B/3782B Pattern Generator and Error Detector. | \$15,060 |
| HP 3764A Digital Transmission Analyzer. | \$9,630 |
| Hard Copy Peripherals | |
| HP 82906A Printer. | \$780 |
| HP 7470A Plotter. | \$1,075 |
| System Software | |
| HP 37080A for use with HP 3781A/3782A. | \$2,500 |
| HP 37080B for use with HP 3781B/3782B. | \$2,500 |
| HP 37080C for use with HP 3764A. | \$2,500 |



TELECOMMUNICATIONS TEST EQUIPMENT

Selective Level Meter and Synthesizer

Models 3586A/B & 3336A/B

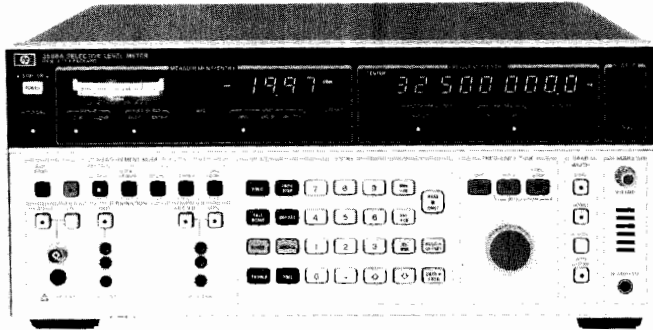

HP 3586A Selective Level Meter (CCITT)



General

The HP 3586A/B Selective Level Meters and HP 3336A/B Tracking Synthesizers offer the high performance necessary to meet the demanding requirements in the design, manufacture, commissioning and maintenance of Frequency Division Multiplex (FDM) systems. The HP 3586 and HP 3336 "A" models meet CCITT requirements, and the "B" models meet North American (Bell) standards. Both are fully programmable over the HP Interface Bus. The HP 3586A & B Selective Level Meter provides a unique combination of features, including wideband power and optional telephone impairment measurement of impulse noise, phase jitter, noise with tone, and signal-to-noise with tone ratio. The HP 3586A & B's wide frequency coverage to 32.5 MHz allows measurements to be made at both voice channel and carrier frequencies. Microprocessor control adds many ease-of-use features such as amplitude offset measurements of tone and noise level in units of dBmO, dBmCO, or dBpWO. Convenience features include simultaneous analog and digital level displays, precise frequency setting with HP's fractional N synthesized local oscillator, accurate frequency counter and tone measurements with automatic channel alignment for 800 Hz (CCITT) or 1004 Hz (Bell) test tone or carrier frequency reference.

The HP 3336 A/B Synthesizer/Level Generator is an excellent precision tracking signal source for the HP 3586A and B Selective Level Meter. When the Selective Level Meter and Synthesizer are in the tracking mode, the frequency of the synthesizer is automatically set to the frequency of the SLM. Frequency coverage is 10 Hz to 20.9 MHz, making the HP 3336 A and B useful for telephone circuit loop testing on most FDM systems, transfer function and distortion measurements in telecommunications manufacturing.

Carrier Frequency and Voice Channel

The HP 3586A & B can make both carrier frequency measurements to 32.5 MHz and voice channel measurements from 50 Hz to 100 kHz.

You can measure tone levels, idle channel noise or weighted noise at voice channel, then compare at carrier frequency.

Transmission Impairments

The Transmission Impairments capability permits phase jitter, weighted noise, noise-with-tone, signal-to-noise-with-tone ratio, and single level impulse noise measurements. The HP 3586A's capability to make these transmission impairment measurements at both FDM voice channel and carrier frequencies is unique.

Frequency and Amplitude Precision

The HP 3336 A/B provides frequency resolution of one microhertz (.000001 Hz) up to 100 kHz and one millihertz (.001 Hz) to 20.9 MHz. Level accuracy is ± 1.5 dB at full output over the full frequency range with ± 1.2 dB optional. Harmonic levels are more than 60 dB down up to 1 MHz and more than 50 dB down up to 20.9 MHz, performance not previously available in a synthesizer.

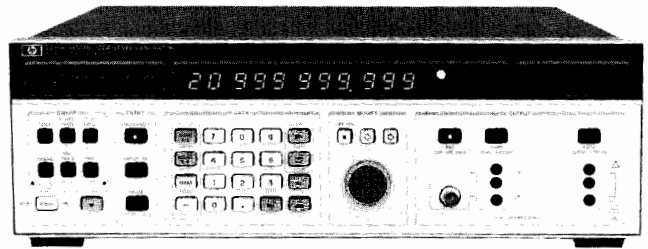

HP 3336A Synthesizer/Level Generator (CCITT)

FDM Testing

The flexible output section allows different connectors to be provided either by option or special request. Frequency entry is accomplished by keyboard or analog control for manual tuning or frequency stepping of any digit.

The Amplitude Blanking feature allows testing of operational FDM systems without disturbing adjacent channels while the frequency is changed. The output is blanked to less than -85 dBm until the next desired frequency is reached.

General Purpose Features

The HP 3336 A/B Synthesizer provides wide band sweep capability—sweep the full frequency range (or as little as two microhertz), log or linear, single or continuous. Single phase lock loop design means the sweep is phase continuous and you can modulate with AM to 50 kHz or PM to 5 kHz. Ten storage registers can be used to keep different test settings available for repetitive test. All necessary functions on the HP 3336 A/B can be remotely programmed by HP-IB control for automatic testing.

Designed-In Serviceability

The HP 3586 A/B Selective Level Meter and the HP 3336 A/B Synthesizer/Level Generator have been designed for reliable operation and excellent accessibility with many useful service features.

North American (Bell) and CCITT Requirements

The HP 3586A & B Selective Level Meter and HP 3336 A & B Synthesizer/Level Generator are designed to meet most world-wide connector and impedance requirements for both carrier and voice channel measurements. Special or regional connectors can be provided by option or special request.

Input Configuration

CCITT Requirements

| | |
|----------------------|--|
| HP 3586A SLM | 75 Ω /10 k Ω Unbalanced 150 Ω , 600 Ω /10 k Ω Balanced |
| HP 3336A Synthesizer | 75 Ω Unbalanced 150 Ω , 600 Ω Balanced |

North American (Bell) Requirements

| | |
|----------------------|---|
| HP 3586B SLM | 75 Ω /10 k Ω Unbalanced 124 Ω , 135 Ω , 600 Ω /10 k Ω Balanced |
| HP 3336B Synthesizer | 75 Ω Unbalanced 124 Ω , 135 Ω , 600 Ω Balanced |

Fully Programmable

HP-IB control is standard, allowing automatic operation to be controlled by a desktop calculator such as the HP Model 85B, HP 9816A, Series 200, or by a main frame computer, such as the HP 1000. FDM tests such as surveillance can be made from a remote location to reduce maintenance costs and increase troubleshooting efficiency. See page 159 for information on HP 3046 A/B selective level measuring system.

High Impedance Accessory Probes

Models HP 15580A and HP 15581B unbalanced high impedance probes and model HP 15576A balanced high impedance probe are available for use with the HP 3586A/B to facilitate bridging measurements.



Frequency

| Signal Input | HP 3586A | HP 3586B |
|------------------------|-------------------|-----------------|
| 75 Ω Unbalanced | 50 Hz to 32.5 MHz | |
| 124 Ω Balanced | | 4 kHz to 10 MHz |
| 135 Ω Balanced | | 4 kHz to 1 MHz |
| 150 Ω Balanced | 4 kHz to 1 MHz | |
| 600 Ω Balanced | 50 Hz to 108 kHz | |

The 124 Ω , 135 Ω , 150 Ω and 600 Ω inputs are usable over wider frequency ranges, but are not specified in under and overrange operation.

Frequency resolution: 0.1 Hz.

Center frequency accuracy: $\pm 1 \times 10^{-5}$ /year ($\pm 2 \times 10^{-7}$ /year with option 004).

Counter accuracy: ± 1.0 Hz in addition to center frequency accuracy for signals within the 60 dB bandwidth of the IF filter chosen or greater than -100 dBm (largest signal measured).

Frequency display: 9 digit LED.

Selectivity

3 dB Bandwidth, $\pm 10\%$

| HP 3586 (CCITT) | HP 3586B (N. American) |
|------------------------------|---------------------------|
| 20 Hz | 20 Hz |
| 400 Hz | 400 Hz |
| 3100 Hz | 3100 Hz |
| Psophometric Noise Weighting | C-Message Noise Weighting |

Adjacent channel rejection: 75 dB minimum at ± 2850 Hz, 3100 Hz BW.

Passband flatness: ± 0.3 dB.

Amplitude

Measurement range: $+20$ to -130 dBm.

Amplitude resolution: .01 dB.

Level accuracy: 10 dB autorange, low distortion mode, after calibration. 20 Hz and 400 Hz BW below -80 dBm.

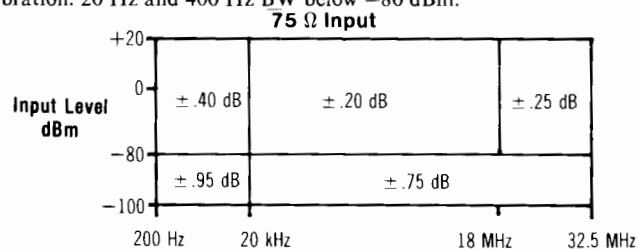

124 Ω Input (HP 3586B): ± 0.6 dB, 4 kHz to 10 kHz; $\pm .35$ dB, 50 kHz to 5 MHz; $\pm .50$ dB, 10 kHz to 50 kHz, and 5 MHz to 10 MHz for $+20$ to -80 dBm.

135 Ω /150 Ω Input (HP 3586A or B): ± 0.6 dB, 4 kHz to 10 kHz; $\pm .35$ dB 50 kHz to 1 MHz, $\pm .50$ dB 10 kHz to 50 kHz for $+20$ to -80 dBm.

600 Ω Input (3586 A/B): $\pm .35$ dB 200 Hz to 108 kHz for $+20$ to -80 dBm.

Level accuracy: 100 dB range (after calibration): add correction to 10 dB auto-range accuracy for dB below full scale. (Not required when in 10 dB autorange).

| dB Below Full Scale | Accuracy Correction |
|---------------------|---------------------|
| 0 to -20 dB | $\pm .25$ dB |
| -20 to -40 dB | $\pm .50$ dB |
| -40 to -80 dB | ± 2.0 dB |

Dynamic Range

Spurious Responses

Image rejection (100-132 MHz): -80 dBc.

IF rejection: 15625 Hz, -80 dBc; 50 MHz, -60 dBc.

Non-harmonic spurious signals: > 1600 Hz offset, -80 dBc; 300 Hz to 1600 Hz offset, -75 dBc.

Distortion

Harmonic distortion: -70 dB below full scale (> 4 kHz on 75 Ω and 600 Ω inputs), low distortion mode.

Intermodulation distortion: 60 dB below full scale, 200 Hz to 50 kHz offset; 70 dB below full scale, 50 kHz to 1 MHz offset.

Wideband power accuracy: after calibration, 100 dB range, averaging on, -45 to $+20$ dBm.

| ± 2.0 dB | ± 1.0 dB | ± 2.0 dB |
|--------------|--------------|--------------|
| 200 Hz | 20 kHz | 10 MHz |
| | | 32.5 MHz |

Noise Floor (full scale setting -35 to -120 dBm)

| Frequency | Bandwidth | Noise Level |
|---------------------|---------------------|-------------|
| 100 kHz to 32.5 MHz | 3100, 1740, 2000 Hz | -116 dBm |
| | 20 Hz, 400 Hz | -120 dBm |
| 10 kHz to 100 kHz | All | -105 dBm |

The noise floor for full scale settings of -30 to $+24$ dBm will be 80 dB below full scale for > 100 kHz, or 60 dB below full scale for < 100 kHz.

Signal Inputs

| HP Model | Impedance | Frequency | Mating Connector |
|----------|--------------------|-------------------|------------------|
| 3586A | 75 ohms unbalanced | 50 Hz to 32.5 MHz | BNC |
| | 150 ohms balanced | 4 kHz to 1 MHz | Siemens 3-prong |
| | 600 ohms balanced | 50 Hz to 108 kHz | 9 Rel 6 AC |
| 3586B | 75 ohms unbalanced | 50 Hz to 32.5 MHz | WECO 439/440A |
| | 124 ohms balanced | 4 kHz to 10 MHz | WECO 443A |
| | 135 ohms balanced | 4 kHz to 1 MHz | WECO 241A |
| | 600 ohms balanced | 50 Hz to 108 kHz | WECO 310 |

Connector Options

Opt 001 (HP 3586A): 75 ohms mates with Siemens 1.6/5.6 mm coaxial.

Opt 001 (HP 3586B): 75 ohms mates with WECO 358A. 124 ohms mates with WECO 372A.

(Contact local sales office for other special connectors.)

Return loss: -30 dB (50/75 Ω); -25 dB (600 Ω).

Balance

| Input | Frequency | Balance |
|------------------------------|------------------|----------|
| 124 Ω | 10 kHz to 10 MHz | -36 dB |
| 135 Ω or 150 Ω | 10 kHz to 1 MHz | -36 dB |
| 600 Ω | 50 Hz to 108 kHz | -40 dB |

Demodulated Audio Output

Output Level: 0 dBm into a 600 Ω load, adjustable.

Output Connector: mates with WECO 347A.

HP-IB Interface Functions: SH1, AH1, T6, TE0, L4, LE0, SR1, RL1, PP1, DC1, DT1, C1, C3, C28.

Additional Options

HP 3586A (CCITT)

Opt 001: 75 Ω input connector option. Siemens 1.6/5.6 mm coaxial connector replaces BNC.

Opt 004: High Stability Frequency reference 10 MHz oven stabilized reference oscillator improves frequency stability to $\pm 2 \times 10^{-7}$ /year.

HP 3586B (N. American)

Opt 001: 75 Ω and 124 Ω input connector option. Changes 75 Ω input connector to mate with WECO 358A and 124 Ω input to mate with WECO 372A.

Opt 004: High Stability Frequency reference. Same as Opt 004-HP 3586A.

Auxiliary Signal Inputs/Outputs

Tracking generator: 0 dBm rear panel tracking output.

External reference input: 1 MHz, 10 MHz or sub-harmonic input.

Reference output: 10 MHz, $+8$ dBm output.



TELECOMMUNICATIONS TEST EQUIPMENT

Selective Level Meter/Synthesizer

Models 3586A/B and 3336A/B (cont.)

Probe power: front panel dc output for HP active high impedance accessory probes.

HP-IB Interface Functions: rear panel interface meeting IEEE 488-1978 for remote operation. Used for tracking synthesizer interface. SH1, AH1, T6, L3, SR1, RL1, PP0, DC1, C0, E1.

Additional outputs: rear panel demodulated audio; phase jitter meter.

General

Operating Environment

Temperature: 0° to 55°C.

Relative humidity: 95%, 0° to 40°C.

Altitude: ≤15,000 ft; ≤4600 metres.

Storage Environment

Temperature: -40°C to 75°C.

Altitude: ≤50,000 ft; ≤15,240 metres.

Power: 100/120/220/240 V, +5%, -10% 48 to 66 Hz, 150 VA.

Weight: 23 kg (50 lb) net; 30 kg (65 lb) shipping.

Size: 177 mm H x 425.5 mm W x 466.7 mm D (7" x 16.75" x 18.38").

HP 3336 A & B Abbreviated Specifications

(See data sheet or manual for complete specifications)

Frequency

Frequency Range of Signal Outputs

| Signal Output | HP 3336A | HP 3336B |
|-----------------|-----------------------------|------------------------------|
| 75 Ω Unbalanced | 10 Hz to 20 999 999 999 MHz | |
| 124 Ω Balanced | | 10 kHz to 10 999 999 999 MHz |
| 135 Ω Balanced | | 10 kHz to 2 099 999 999 MHz |
| 150 Ω Balanced | 10 kHz to 2 099 999 999 MHz | |
| 600 Ω Balanced | 200 Hz to 109.999 999 kHz | |

All balanced outputs are usable over wider frequency ranges but are not specified in under and overrange operation.

Resolution: 1 μHz for frequencies < 100 kHz, 1 mHz for frequencies ≥ 100 kHz.

Aging rate (instruments without option 004): ±5 x 10⁻⁶/year (20° to 30°C).

Warm-up time: 30 minutes.

Amplitude

Range: 75 and 600 Ω outputs: -72.99 to +7.00 dBm.

124, 135 and 150 Ω outputs: -78.23 to +1.76 dBm.

Level accuracy, 20° to 30°C

| 75 Ω Output | | | 75 Ω Output with Option 005* | | |
|-------------|---------|---------------|------------------------------|--|----------|
| ±.15 dB | | | ±.12 dB | | |
| ±.25 dB | ±.30 dB | ±.35 dB | ±.16 dB | | |
| ±.30 dB | ±.35 dB | ±.40 dB | ±.18 dB | | |
| ±.35 dB | ±.40 dB | ±.45 dB | ±.22 dB | | |
| 10Hz | 10MHz | 10MHz 20.9MHz | 10 Hz | | 20.9 MHz |

*high accuracy attenuator

124 Ω output: 50 kHz to 10.9 MHz ±.15 dB -8.23 to 1.76 dBm, ±0.3 dB -18.23 to -8.24 dBm, ±.35 dB -38.23 to -18.24 dBm ±.4 dB -78.23 to -38.24 dBm.

135 Ω/150 Ω output: 10 kHz to 2.09 MHz, ±.17 dB -8.23 to +1.76 dBm, ±.32 dB -18.23 to -8.24 dBm, ±.37 dB -38.23 to -18.24 dBm, ±.42 dB -78.23 to -38.24 dBm.

600 Ω output: 200 Hz to 109.9 kHz, ±.30 dB -3.00 to +7.00 dBm/ ±.40 dB -13.00 to 2.99 dBm, ±.45 dB -33.00 to -12.99 dBm ±.50 dB -72.99 to -32.99 dBm.

1. Add ±.03 dB for 0° to 55°C operation.

2. Warm-up time is 30 minutes.

Amplitude blanking: < -85 dBm output during blanking

Spectral Purity

Phase noise: < -72 dB, HP 3336A and HP 3336B, for a 3 kHz band, 2 kHz either side of a 20 MHz carrier.

Harmonic level: -35 dB, 10 Hz to 30 Hz; -50 dB, 30 Hz to 50 Hz; -60 dB, 50 Hz to 1 MHz; -55 dB, 1 MHz to 5 MHz; -50 dB, 5 MHz to 20 MHz.

Spurious: all non-harmonically related signals will be more than 70 dB below the fundamental or -100 dBm (-115 dBm with option 005 except 150 or 600 Ω), whichever is greater.

Phase Offset

Range: ±719.9° with respect to arbitrary starting phase or assigned zero phase.

Resolution: 0.1°.

Increment accuracy: ±0.2°.

Ambient stability: ±1.0 degree of phase per degree C.

Frequency Sweep

Sweep time: linear sweep, 0.01 s to 99.99 s; single log sweep, 2 s to 99.99 s; continuous log sweep, 0.1 s to 99.99 s.

Maximum sweep width: specified frequency range of selected output.

Minimum sweep width: log sweep, 1 decade; linear sweep, minimum sweepwidth (Hz) = 0.1 (Hz/s) x sweep time(s).

Phase continuity: sweep is phase continuous over full frequency range.

Sweep flatness: ±0.15 dB, fast leveling, 10 kHz to 20 MHz, 0.03 s sweep time; ±0.15 dB, normal leveling, 50 Hz to 1 MHz, 0.5 s sweep time.

Amplitude modulation: modulation depth, 0 to 100%. Modulation frequency range, 50 Hz to 50 kHz.

Phase modulation: range, 0 to ±850°. Linearity, ±0.5% from best fit straight line. Modulation frequency range, dc to 5 kHz.

External leveling: input from an external voltage source to regulate the signal amplitude at a remote point.

HP-IB Interface Functions: rear panel interface meeting IEEE 488-1978 for remote operation. Used for tracking synthesizer interface. SH1, AH1, T6, L3, SR1, RL1, PP0, DC1, C0, E1.

Options

Option 001, HP 3336A/B Synthesizer/Level Generator

1.6/5.6 mm 75 Ω input, (HP 3336A). 75 Ω mates with WECO 358A, (HP 3336B). 124 Ω connector mates with WECO 372A, (HP 3336B).

Option 004, High Stability Frequency Reference

Aging rate: ±5 x 10⁻⁸/week after 72 hours continuous operation ±1 x 10⁻⁷/month after 15 days continuous operation.

Ambient stability: ±5 x 10⁻⁷ maximum, 0° to 55°C.

Option 005, high accuracy attenuator: improves level accuracy and spurious level. See main specifications.

General

Operating Environment

Temperature: 0° to 55°C.

Relative humidity: ≤85%, 0° to 40°C.

Altitude: ≤15,000 ft., ≤4600 metres.

Storage Environment

Temperature: -50° to +65°C.

Altitude: ≤50,000 ft., ≤15,240 metres.

Power requirements: 100/120/220/240 V, +5%, -10%, 48 to 66 Hz, 60 VA, (100 VA with all options), 10 VA standby.

Size: 132.6 mm high x 425.5 mm wide x 425.5 mm deep (5¼" x 16¾" x 16¾").

Weight: Net wt., 10 kg (22 lb). Shipping wt., 15.5 kg (34 lb).

Ordering Information

HP 3586A Selective Level Meter (CCITT)

Opt 001: 1.6/5.6 mm 75 Ω Connector

Opt 004: High Stability Frequency Reference

HP 3586B Selective Level Meter (N. American)

Opt 001: 75 Ω Connector mates with WECO 358A

and 124 Ω Connector mates with WECO 372A

Opt 004: Same as HP 3586A

HP 3336A Synthesizer/Level Generator (CCITT)

Opt 001: 1.6/5.6 mm 75 Ω Connector

Opt 004: High Stability Frequency Reference

Opt 005: High Precision Attenuator

HP 3336B Synthesizer/Level Generator (N. American)

Opt 001: 75 Ω WECO 358A, 124 Ω WECO 372A

Opt 004, 005: Same as HP 3336A

Price

\$10,300

add \$100

add \$750

\$10,300

add \$100

add \$750

\$4,900

add \$100

add \$650

add \$650

\$4,900

add \$100

TELECOMMUNICATIONS TEST EQUIPMENT

Selective Level Measuring System

Model 3046A/B

159



- Low cost FDM surveillance
- Stored CCITT or Bell FDM plans
- Synthesizer frequency accuracy

- 0.2 dB amplitude accuracy
- Voice channel impairments
- Plotting and storage of data



HP 3046B



Introduction

The HP 3046A/B systems are designed to automate measurements made on Frequency Division Multiplex (FDM) systems. These include tests such as pilot levels, carrier leaks and slot noise. The system, with all of its measurement power, requires no computer background to operate. Surveillance programs are configured simply by making choices from a series of measurement menus. The HP 3046A is designed for CCITT applications, while the HP 3046B meets North American (Bell) requirements.

This system is ideal for automating surveillance and routine maintenance on a local basis for small to medium capacity systems. Hewlett-Packard also provides automatic test equipment for large capacity FDM systems, using a distributed approach. See page 85-9.14 for a description of these automatic test systems. With a distributed system, remote selective level meters (SLMs) can be monitored from a central computer. With a local system such as the HP 3046A/B, each SLM computer is independent, making installation and operation easier, and the system more mobile.

System Configuration

A standard HP 3046A/B consists of an HP 3586A/B Selective Level Meter with Transmission Impairments and two copies of the appropriate system software, contained on data cartridges. An HP-85 desktop computer is also required and may be ordered as part of the system. A minimum controller configuration includes the HP-85B, a 82936A ROM Drawer, an 00085-15004 Matrix ROM and the 82937A HP-IB interface.

System software consists of FDM surveillance programs with stored CCITT (HP 3046A) or Bell (HP 3046B) plans, and system test software. The system test software can be used to verify proper

system operation and to help identify the faulty component in case of a failure.

For applications requiring a precision signal source, an HP 3336A/B Synthesizer/Level Generator can be added to the system. A 0 dBm tracking source is standard with the HP 3586A/B.

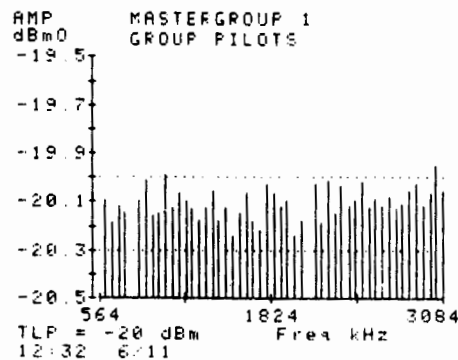

Tabular and Graphic Outputs

An automatic system will collect large amounts of data in a short time, making effective presentation of the results vital. In addition to a variety of tabular listing formats, the Selective Level Measuring



TELECOMMUNICATIONS TEST EQUIPMENT

Selective Level Measuring System

Model 3046A/B (cont.)

(SLM) System provides graphics—the ability to plot measured results. A plot of hundreds of data points can be analyzed in seconds, providing real insight into the condition of the system. With only a tabular listing, interpretation of hundreds of data points is difficult if not impossible. An active marker is provided to read the amplitude of any point on the graph to 0.01 dB resolution and to list FDM number and frequency.

Storage of Tests and Data

Tests are performed with an automatic system in much the same way they are done manually. First, the measurement parameters (frequency, bandwidth, etc.) are set, and then the measurement is made. The SLM System provides for storage of test parameters on the computer's built-in tape. With this feature often used test set-ups can simply be recalled from tape rather than having to be re-entered each time the test is run. In addition, a program can be stored in a file that will load and run when power to the computer is cycled. In this way a complicated series of tests can be run simply by turning the computer off and then on.

The system can also store measured data for future reference. Short term storage is automatic and has a capacity of 600 readings. This means that measured data can be retrieved any time after a test has been run. If an overnight test were run with only errors printed, this feature would allow printing or plotting of all the data in the morning.

Permanent storage on tape is also provided. This storage allows comparison of today's readings with those taken weeks or months earlier (limit is 600 readings). Data stored includes test limits, TLP, and the time of day and date when the measurement was made.

Timed Measurements

Every printout of test results includes time from turn on or time of day, and the date. The system also provides for delayed start of test and/or repetition of the test at timed intervals. This makes it easy to run a test at night or over a weekend and monitor system performance over time.

Provision for Custom Plans

An "array sweep" is available for testing of non-standard FDM plans. Each of four arrays has a capacity of 100 custom frequencies. Carrier tests can be performed at each test frequency, tested against limits and plotted or printed. Once an array of custom frequencies and the test at each is entered, it can be stored on tape for easy access.

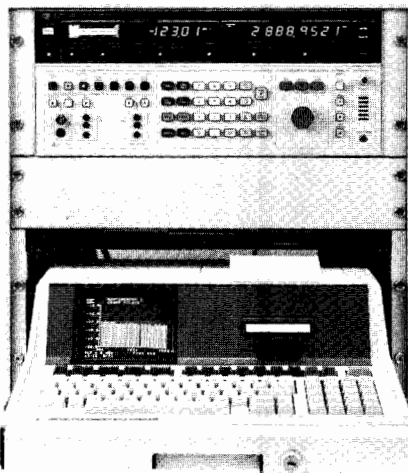

Option 400 cabinet with locking drawer

Recommended Accessories

Disk drive: A disk drive, such as the HP 82901M or HP 9121D provides much faster access to programs and data. This is highly recommended if the level of system interaction is expected to be high. These drives interface the system via HP-IB (HP-IB cable not supplied; ROM included with HP 85B computer only.)

Access switch: An access switch and switch controller can be added to the system with simple program modifications. The recommended controller is the HP 3755A, with several compatible switches available.

General

System Specifications

System accuracy specifications are identical to those of the HP 3586A/B and HP 3336A/B; see pages 157 and 158.

Measurement speed: 0.5 seconds/reading with no range change; 1.3 seconds/reading with range change; 3.3 seconds/reading with range change and Auto-cal.

System Performance

FDM Carrier Tests

Pilots

HP 3046A (CCITT): Group, Supergroup, Mastergroup, Super-mastergroup, and Hypergroup.

HP 3046B (North American): Group, Supergroup and Mastergroup pilots. Non-standard pilots can also be measured.

Carrier leaks: Channel, Group and Supergroup.

Test tones: 1010 Hz or 800 Hz (HP 3046A) or 1004 Hz (HP 3046B) and custom tones.

Signalling tones: 2600 Hz (HP 3046B)

Channel Noise and Slot Noise

HP 3046A: Flat or Psophometric weighting

HP 3046B: Flat or C-Message weighting

Other Tests

Transmission Impairments

Phase Jitter

Weighted Noise with 3100 Hz channel filter

Noise with Tone (notched noise)

Impulse noise can be measured and graphed over any period of time up to 90 minutes

Spot frequency: in the spot frequency mode, the HP 3046 can measure and print the level at a single frequency. The point to be measured can be defined by frequency or FDM number. Wide band power can also be measured and printed out in this mode.

System verification: the system verification program verifies operation of the HP 3586A/B and the HP 3336A/B, and can be used to locate the source of a hardware failure.

Physical Parameters

Temperature: 5 to 40°C

Relative humidity: 95%, 0 to 40°C

Altitude: ≤4600 metres, 15,000 feet

Ordering Information

| | Price |
|---|----------|
| HP 3046S Selective Level Measuring System | \$0 |
| By ordering the system instrumentation and controller under this model number, total system compatibility is insured. | |
| HP 3046A SLM System Instrumentation and Software (CCITT) | \$10,900 |
| HP 3046B SLM System Instrumentation and Software (Bell) | 10,900 |
| 001: Special Connector (HP 3586A/B Option 001) | \$100 |
| 004: High Stability Frequency Reference (HP 3586A/B Option 004) | \$750 |
| 100: Add HP 3336A/B Synthesizer/Level Generator | \$4,900 |
| 101: Special Connector (HP 3336A/B Option 001) | \$100 |
| 104: High Stability Frequency Reference (HP 3336A/B Option 004) | \$650 |
| 105: High Accuracy Attenuator (HP 3336A/B Option 005) | \$650 |
| 400: Locking Cabinet for Standard System | \$1,725 |
| 450: Locking Cabinet for System with Synthesizer | \$1,975 |
| 480: 220 V Operation | \$0 |
| HP 85B Controller configurations are priced beginning at | \$4,130 |
| Consult the HP 3046S System Configuration Guide for further details. | |

TELECOMMUNICATIONS TEST EQUIPMENT

70 MHz Modulator/Demodulator

Model 3717A



- Up to 5 pre-/de-emphasis networks
- Video and telephony inputs and outputs
- Service channel provided

- Built-in 15 dB open-ended attenuator
- Optional HP-IB control
- Optional balanced BB input and output

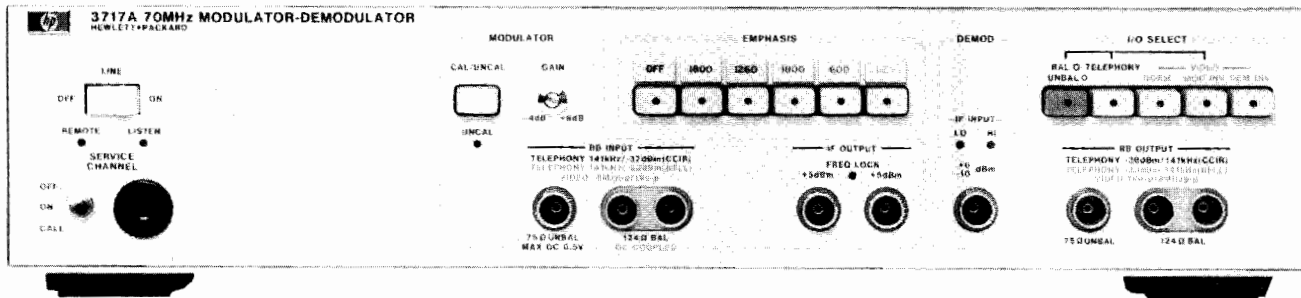

The HP 3717A 70 MHz Modulator/Demodulator can be used in microwave radio link systems to enable BB qualitative measurements to be made at non-demodulating repeater stations.

Standard measurement practice for the alignment and maintenance of microwave radio links involves two specific categories of tests, i.e. swept response measurements and BB qualitative measurements. Normal practice is to align a microwave radio initially by using swept response techniques such as those provided by an MLA. After these measurements have been completed successfully, qualitative measurements such as white noise loading, TV waveform testing, and BB frequency response are performed at the BB terminals of the microwave radio to verify operational performance.

However, the optimum swept response does not always produce the best possible qualitative figure. When this happens it may be necessary to isolate the faulty section by performing qualitative measurements from BB terminal stations to IF repeater stations, or vice versa. To do this, a high quality wideband test modulator or demodulator is required. The HP 3717A provides this capability.

Specifications Summary

Back-to-Back Performance (telephony)

BB Frequency Response (with or without emphasis)

50 Hz to 10 MHz: ± 0.2 dB.

50 Hz to 20 MHz: ± 3 dB.

Noise Loading Performance

At manual loading for all slots, 70 to 7600 kHz (1800 channels with emphasis): ≤ 25 pWOp (57 dB NPR).

Thermal: mod/demod is thermally dominated and will typically tolerate a 6 dB overload with no degradation.

Spurious Response

300 kHz to 10 MHz: ≤ -72 dBm0.

Back-to-Back Performance (video)

BB Frequency Response

5 Hz to 10 MHz: ± 0.2 dB.

Square wave tilt (50 Hz): $< 1.0\%$.

Diff. Gain (4.43 MHz)*: $\leq 0.7\%$.

Diff. Phase (4.43 MHz)*: $\leq 0.7^\circ$.

*Measured on an HP Microwave Link Analyzer with a test tone of 4.43 MHz.

Options

Connector Options—Select Any One.

Std: BNC

003: Siemens small.

004: commercial equivalent of WECO 477B balanced input.

Emphasis networks—up to five may be installed and should be specified with every order. Other emphasis networks are available to special order.

CCIR

011: 24 channel emphasis.

012: 60 channel emphasis.

013: 120 channel emphasis.

014: 300 channel emphasis.

015: 600 channel emphasis.

016: 960 channel emphasis.

017: 1260 channel emphasis.

018: 1800 channel emphasis.

021: 525 line emphasis.

022: 625 line emphasis.

023: 819 line emphasis.

Bell

031: Bell 600 channel emphasis.

032: Bell 900 channel emphasis.

033: Bell 1200 channel emphasis.

034: Bell 1500 channel emphasis.

035: Bell 1800 channel emphasis.

Miscellaneous options

100: HP-IB.

HP 3717A 70 MHz Modulator/Demodulator

Prices

N/C

(\$850)

+\$190

+\$190

+\$190

+\$190

+\$190

+\$190

+\$190

+\$190

+\$190

+\$190

+\$190

+\$190

+\$190

+\$190

+\$190

+\$190

+\$205

\$9640

TELECOMMUNICATIONS TEST EQUIPMENT

Microwave Link Analyzers and Accessories

Models 3711A/3712A, 3750A

- Test analog and digital radios
- Isolate and characterize causes of intermodulation distortion in wideband FM microwave radios
- Baseband and IF interfaces
- 70/140 MHz IF capability
- Selectable combinations of BB test tones

70/140 MHz IF MLA System

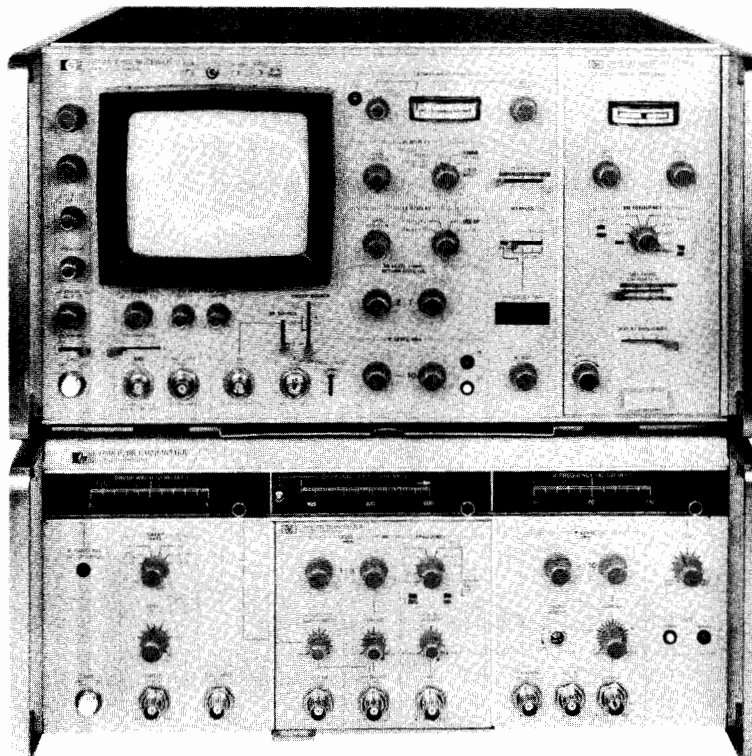

HP 3711A IF/BB Transmitter
 HP 3791B BB Transmitter (Plug-in)
 HP 3712A IF/BB Receiver
 HP 3793B Diff. Phase Detector (Plug-in)

The Microwave Link Analyzer (MLA) is available as a dual 70/140 MHz IF frequency HP 3711A/3712A system.

For microwave radio stations employing both 70 MHz and 140 MHz intermediate frequencies, the dual IF MLA is an economical way of providing a complete range of dedicated measurements at both IF's.

The HP 3711A/3712A isolates and characterizes causes of intermodulation distortion in wideband microwave radios. It has applications in both analog and digital radio systems. Measurements performed by the MLA include:

- BB power, gain, and loss
- IF power, gain, and loss
- modulator/demodulator deviation sensitivity
- modulator/demodulator linearity
- modulator/demodulator group delay
- swept IF amplitude response
- swept IF group delay
- swept IF return loss
- BB and IF differential gain (HF linearity)
- BB and IF differential phase (HF group delay)
- BB return loss

When used with the HP 8620C/86200 Series RF Sweeper system (equipped with the MLA interface option) and the HP 3730B RF Down Converter, the swept measurements of the basic MLA can be extended to RF. Pages 164 and 165 give further details about this RF instrumentation (HP 3730B and 8620C).

Apart from the dual 70/140 MHz IF capability, with the full range of measurements available at both frequencies, the HP 3711A/3712A MLA has many other refinements over earlier systems. These include an improved marker system, an IF input frequency counter, improved input sensitivity at -19 dBm, a slope control, a 16 dB dynamic display range, and X-Y Recorder facilities.

Another major contribution is the provision of an interface for the HP 8501A Storage-Normalizer. Use of this instrument with the HP 3711A/3712A MLA provides digital averaging and normalizing facilities. Further, measurement limit masks and adjustment instructions can be displayed on the MLA screen when a desk-top computing controller is used with the Storage-Normalizer.

A series of options are available with the MLA's, including:

- test-tone frequencies
- connectors
- balanced 124Ω baseband impedance
- sweep frequencies
- variable phase output of sweep signal

Connector Options

(HP 3711A/3791B/3712A only)

| Option | BNC | Siemens Large | Siemens Small | WECO 477B | WECO 560A |
|--------|-----|------------------|------------------|--------------|--------------|
| Std | • | | | | |
| 002 | | • | | | |
| 003 | | | • | | |
| 004 | | | | • | |
| 005 | | | | | • |

Test-Tone (BB) Options

(HP 3791B/3793B only)

| HP 3791B/ 3793B | Test-tone Frequencies | | | | | | | | | | | |
|-----------------------|-------------------------------|---------------------------------------|--------------------------------------|------------|-------------|-------------|-------------|-------------|-------------|-------------|--------------|---|
| | 83.333 250 & 500 kHz | 92.593 277.778 & 555.556 kHz | 55.556 92.593 & 277.778 kHz | 2.4 MHz | 3.50 MHz | 3.58 MHz | 4.43 MHz | 4.50 MHz | 5.60 MHz | 8.20 MHz | 12.39 MHz | |
| Options | | | | | | | | | | | | |
| 014 | • | | | • | • | | | | | • | • | • |
| 016 | • | | | • | | | | | • | • | • | • |
| 021 | | • | | • | | • | • | | | • | • | • |
| 022 | • | | | • | | • | • | | | • | • | • |
| 221 | | | • | • | | • | • | | | • | • | • |

Sweep Frequency Options (HP 3711A only)

| Option | 70 Hz | LINE | Opt | | | |
|--------|-------|------|-------|-------|--------|-------|
| | | | 70 Hz | 50 Hz | 100 Hz | 18 Hz |
| Std | • | • | • | | | |
| 006 | • | • | | • | | |
| 007 | • | • | | | • | |
| 015 | • | • | | | | • |

Miscellaneous Options

008 (HP 3711A only) Variable phase sweep output.

015 (HP 3793B only) Additional phase detector bandwidths of 90 and 180 Hz—must be used with 18 Hz sweep rate on HP 3711A IF/BB Transmitter.

020 (HP 3712A only) CRT graticule illumination.

908 (HP 3711A/3712A only) Rack mounting kit.

910 Extra manuals.

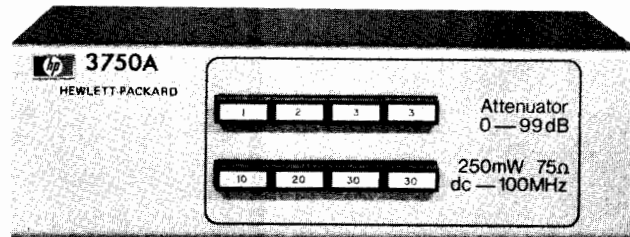

HP 3750A Attenuator

The Hewlett-Packard Model 3750A is a reliable, accurate, general-purpose 75 ohm attenuator for the frequency range 0 to 100 MHz. Eight push-button switches can select any value of attenuation between 0 and 99 dB, in 1 dB steps if necessary. +24 dBm can be accepted at the input which, because the attenuator is electrically symmetrical, can be either of the two 75 ohm female BNC connectors.

All the attenuator components, including the switches, are mounted on printed circuit boards to reduce the number of interconnecting leads and thus minimise stray capacitance and inductance. The printed circuit boards are made of a material with a controlled dielectric constant to minimise the return loss - and metal castings encase the printed circuit boards, screening them so that neither stray pick-up nor signal leakage is a problem. The result is a rugged, compact attenuator which, because of its small size can be used almost anywhere.

Specifications

Attenuation: 0 to 99 dB in 1 dB steps

Frequency range: 0 to 100 MHz

Impedance: 75 ohm

Accuracy: unit steps ±0.1 dB

decade steps ±0.2 dB

cumulative ±0.5 dB to 79 dB

±1.0 dB to 89 dB

±2.0 dB to 99 dB

Maximum input power: +24 dBm (250 mW)

Return Loss: 28 dB at either port when properly terminated

VSWR: 1.08:1

Insertion loss: 0.1 dB at 10 MHz

0.4 dB at 50 MHz

0.6 dB at 100 MHz

Ordering Information

70/140 MHz system (HP 3711A/3791B/3712A/3793B)

HP 3750A Attenuator

Price

\$19,350

\$645

TELECOMMUNICATIONS TEST EQUIPMENT

RF Down Converter

Model 3730B

- RF to IF frequency conversion
- 1.7 to 14.5 GHz frequency range
- Extends test capability of MLA's to RF
- 70 or 140 MHz IF output

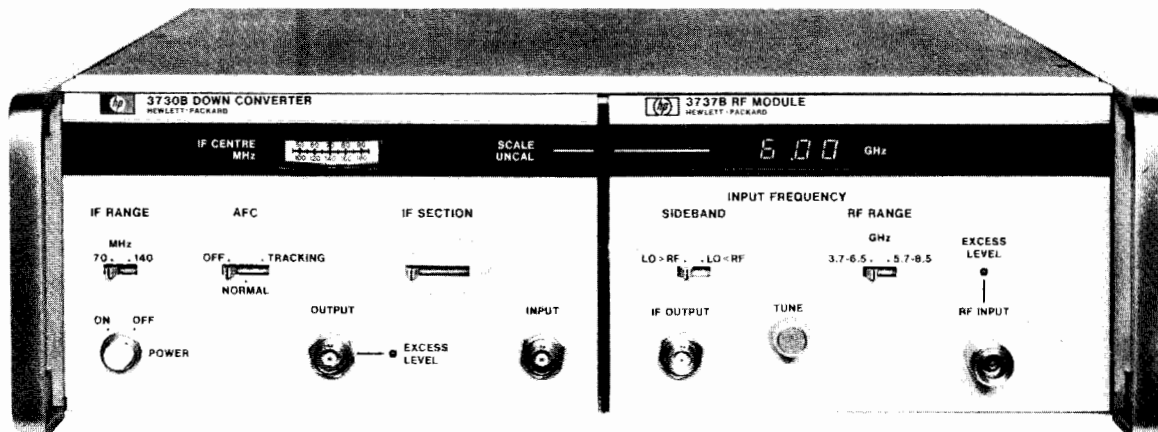

HP 3730B Option 010 Down Converter mainframe with HP 3737B RF Module plug-in

The HP 3730B Down Converter and plug-ins provide RF to IF conversion and RF test capabilities for Microwave Link Analyzers (MLA's). The 0.7 to 14.5 GHz RF range is accommodated by a series of local oscillator plug-ins, allowing easy tuning to the desired operating frequency.

The 3730B has dual IF capability which allows the Down Converter to interface with single 70 MHz or dual 70/140 MHz IF (eg HP 3711A/3712A) MLAs, or with wideband demodulators (eg HP 3717A) when white noise loading.

A tracking AFC and recovered sweep facility causes the local oscillator in the HP 3730B to track the incoming swept RF signal, thus almost eliminating the swept component of the IF signal. This feature is particularly useful in wideband applications. It allows the Down Converter to be used in conjunction with an Up Converter and a conventional MLA to perform RF to RF measurements over bandwidths of up to 250 MHz.

The tracking AFC facility also has advantages when operating over conventional measurement bandwidths of a Microwave Link Analyzer. Because of the effective sweep compression of the IF signal, the residual distortions of both the Down Converter and Microwave Link Analyzer receiver are reduced considerably.

Provision has been made for incorporating an isolator in the RF input of the Down Converter. The standard RF input circuit of the HP 3730B is broadband. However, for some measurement applications, introducing a narrow band isolator can provide substantial benefits, eg improved input return loss, reduced L.O. leakage, improved noise figure and increased input sensitivity.

On a microwave radio route containing a number of repeater stations, the local oscillator can be positioned above or below the carrier frequency and this can vary from repeater station to repeater station. This can cause difficulties when comparing MLA responses between stations due to frequency axis inversion of the swept response. Selecting upper or lower sideband operation on the HP 3730B overcomes this.

Lengthy runs of RF cable between the Down Converter and the RF test point can generate ripple responses which can mask the true measurement response. To avoid this problem, it is possible to remove the Down Converter plug-in and mount this directly onto a waveguide test point. The plug-in is then supplied with its power and mainframe control signals via an umbilical cable (HP 15609A). The plug-in's IF output is connected to either the HP 3730B or the measurement system, eg an MLA, via a cable of suitable length. This reduces the possibility of erroneous measurements as only IF signals are transmitted from the test point.

Option 010 of the HP 3730B incorporates an additional IF section, comprising a 25 dB fixed gain amplifier and a 30 dB stepped attenuator, to ensure that the IF signal level is sufficient to drive most MLA's when operating at RF input levels below -12 dBm. Note that no degradation of the residual performance specifications occurs when this option is fitted.

Specifications

HP 3730B + 3736B/7B/8B/9B

Residual Performance

| | 50 MHz Sweep Width at 70 MHz centre frequency | 100 MHz Sweep Width at 140 MHz centre frequency |
|-----------------------------------|---|---|
| Amplitude Response | 0.2 dB | 0.3 dB |
| Group Delay | 0.2 ns | 0.3 ns |
| Diff Gain (5.6 MHz test tone) | 0.3% | 0.5% |
| Diff Phase (5.6 MHz test tone) | 0.3° | 0.5° |

The residual specifications quoted are measured using the FM Sweep Input to reduce the residual contributions of the RF test source, and using storage normalizer techniques to remove MLA receiver contributions. Further improvements in the residual performance can be obtained by utilising the HP 3730B's unique tracking AFC facility.

Min RF input level: -15 dBm, typically (-40 dBm when Opt 010 is fitted), for correct operation of MLA; however, min input level dependent on input sensitivity of MLA and RF-IF gain conversion of Down Converter (HP 3711A/3712A MLA—min input sensitivity -19 dBm).

Size: 141 mm H x 425 mm W x 467 mm D (5.5 x 16.75 x 18.38 in.)

Power supply: 100, 120, 220, or 240V ac, +5 -10%; 48 to 66 Hz; consumption 100 VA max, including plug-in.

Weight: 11.9 kg (26 lb) net, including plug-in.

Temperature range: 0 to 55°C, operating.

Options

010: 25 dB fixed gain amplifier, with 30 dB (10 dB step) attenuator.

Prices

+\$1,285

Accessories

| | |
|---|-------|
| HP 15600A Isolator: 3.7 to 4.2 GHz. | \$635 |
| HP 15601A Isolator: 5.9 to 6.5 GHz. | \$600 |
| HP 15602A Isolator: 7.1 to 8.5 GHz. | \$535 |
| HP 15603A Isolator: 10.7 to 11.7 GHz. | \$730 |
| HP 15609A Remote Extender Cable: 3 metre umbilical cable. | \$400 |

Ordering Information

| | |
|-------------------------------------|----------|
| HP 3730B Down Converter | \$4,180 |
| HP 3736B RF Module 1.7 to 4.2 GHz | \$5,360 |
| HP 3737B RF Module 3.7 to 8.5 GHz | \$6,430 |
| HP 3738B RF Module 5.9 to 11.7 GHz | \$7,500 |
| HP 3739B RF Module 10.7 to 14.5 GHz | \$10,715 |

TELECOMMUNICATIONS TEST EQUIPMENT

RF Sweeper MLA Upconverter Simulation

Models 8350, 8620C, 86200 Series RF Plug-Ins

165



- MLA upconverter simulator options 0.5 to 18.0 GHz
- Use with MLA or as a general purpose sweeper
- Swept and CW RF source
- Test digital & analog microwave radio systems & components

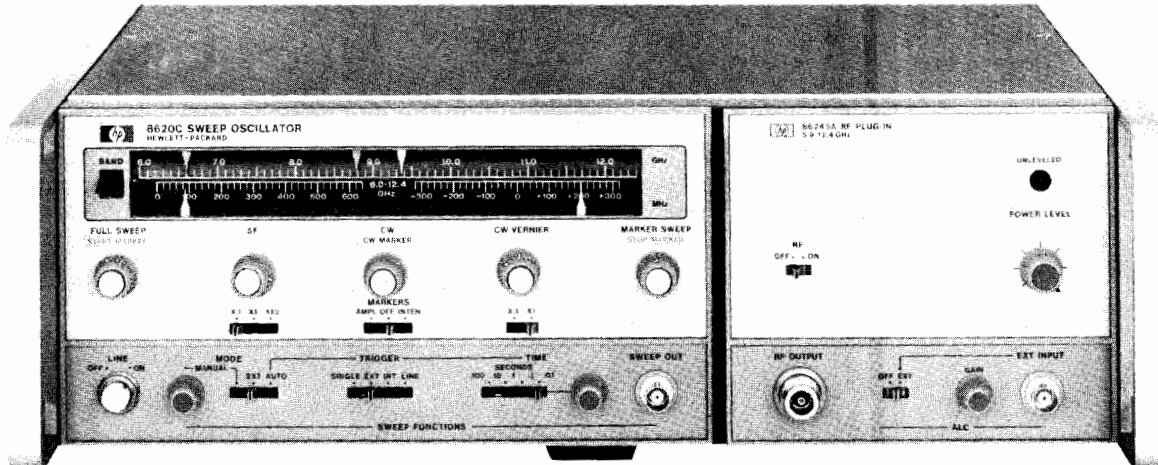

HP 8620C/86245A

Description

The HP 8620C Sweep Oscillator and HP 86200 Series of RF plug-ins provide a high performance, solid state source for Microwave Radio System tests via MLA Upconverter Simulation Options. These permit accurate RF-to-BB, RF-to-IF and RF-to-RF distortion measurements to be made with the HP 3700 Series MLA System. The plug-ins can also be used as standard sweeper plug-ins, with the only basic difference being modified FM circuitry. The RF-to-RF measurements must be made in conjunction with the HP 3730B RF Down Converter. This allows group delay, linearity, differential gain and phase measurements to be made on RF devices and components within the Microwave Radio System. The HP 8350 Sweep Oscillator Mainframe is also compatible with the HP 86200 series MLA option plug-ins through the use of the HP 11869A Adapter (see page 503).

Specifications

The HP 8620C/86200 Series MLA Upconverter Simulation Plug-ins are optimized for group delay, linearity, and differential gain and

phase over the specified frequency range. All plug-ins can be used with MLA sweep widths of 100 MHz (200 MHz with Option H42) or less. The following specifications supplement the standard HP 8620C system specifications (covered on pages 515-521).

Complementary Equipment

| | |
|--|--------------|
| HP 8350 Sweeper Mainframe | Price |
| HP 11869A Adapter | \$4,565 |
| HP 8620C Sweeper Mainframe (required) | \$405 |
| | \$3,865 |

To properly interface the HP 8620C/86200 Series plug-in to the item under test, the following are recommended for optimal performance:

| | |
|--|---------|
| HP 784C Directional Detector (1.7 – 12.4 GHz) | \$1,655 |
| Flatness over any 30 MHz: $< \pm 0.1$ dB | |
| Equivalent source match: typically ≤ 1.5 | |
| HP 11675B Leveling Cable Assembly (1.7 – 12.4 GHz) | \$655 |
| Group delay: ≤ 0.25 ns p-p (with 1.25 SWR at each end) | |

MLA Upconverter Simulation Plug-in Specifications (25°C)

| HP Model Number ¹ | MLA Option Number | MLA Freq. Range (GHz) | Group Delay (ns) p-p | Linearity (%) | Diff. Gain (%) | Diff. Phase (°) | FM Sens. (MHz/V) | Price W/MLA Option |
|------------------------------|-------------------|-----------------------|----------------------|---------------|------------------------|-----------------|------------------|--------------------|
| | | | @ 277.7 kHz | | @ 5.6 MHz ² | | | |
| | | | Across Any 30 MHz BW | | | | | |
| 86222A/B | H80 | 0.5–2.4 | <3 | <2.5 | <2.5 | <3 | N/S | \$7,025/8,475 |
| 86235A | 008 | 1.7–4.3 | <2 | <2.0 | <2.0 | <2 | +20 | \$6,080 |
| 86240C | — | 3.6–8.6 | <1 | <0.5 | <0.5 | <1 | +20 | \$7,525 |
| 86242D | 008 | 5.9–9.0 | <1 | <0.5 | <0.5 | <1 | +20 | \$6,180 |
| 86245A | 008 | 5.9–12.4 | <1 | <0.5 | <0.5 | <1 | +20 | \$8,980 |
| 86250D | 008 | 8.0–12.4 | <1 | <0.5 | <0.5 | <1 | +20 | \$6,280 |
| 86260A | H82 | 12.0–18.0 | <3 | <2.5 | <2.5 | <3 | N/S | \$6,680 |

¹Internal leveling is standard on all HP 86200 series plug-ins.

²Except HP 86222A/B & 86260A which are tested @ 2.4 MHz.

For applications requiring better distortion specifications, HP also offers plug-in systems which include a leveling cable and directional coupler. These systems are available in the following bands: 5.8–6.5 GHz, 7.0–8.6 GHz, 10.7–11.7 GHz, and 12.2–12.7 GHz. The system specifications are as follows:

Group delay @ 500 kHz: < 0.5 ns p-p

Linearity @ 500 kHz: $< 0.25\%$

Flatness: $< \pm 0.1$ dB

For more information consult your local HP Field Engineer.

The options shown after each plug-in provide the special MLA interface capability. Refer to pages 515–521 for details on other RF Sweeper plug-in specifications and options.

TELECOMMUNICATIONS TEST EQUIPMENT

Remote Access and Test System - RATES

Model 37100S

- Remotely test private circuits from a convenient central site without moving from the keyboard of a computer terminal.
- Dramatically improve the productivity of telephone maintenance operations by reducing troubleshooting and technician-travel time.
- Despatch repair technicians to fault locations with certainty.
- Obsolete existing time-intensive 'jack field' test methods.

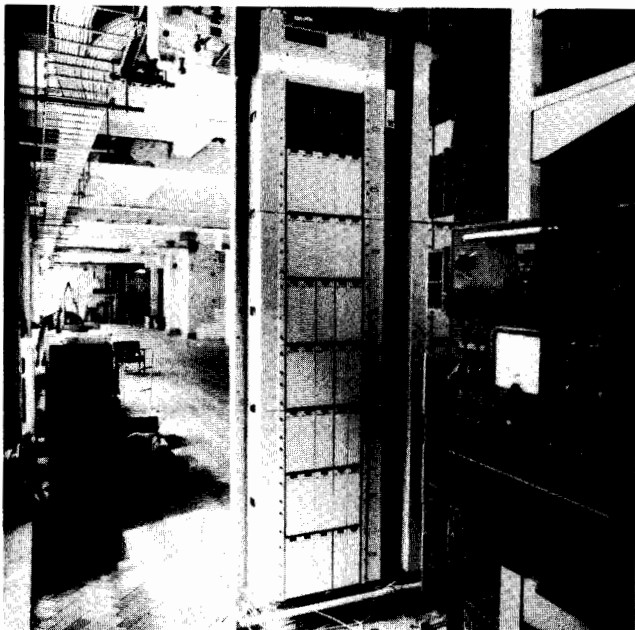

- Totally modular design means the system is suitable for a wide range of installation.
- User-friendly software means no special keyboard skills are required.
- Software generated reports and features which save time and effort.
- New compact low cost access and test equipment to better suit the smaller installation.



The HP 37100S Remote Access and Test System

The HP 37100S Remote Access and Test System (RATES) provides the hardware, software and support for nationwide testing and troubleshooting of voice frequency special service/private wire metallic telephone lines. Applications include testing of 2, 4, 6 or 8-wire private circuits configured as either point-to-point or conference circuits. These types of circuit can be accessed and tests carried out at the remote site under control of a central site operator. Any number of remote sites can be accessed allowing fault isolation to the particular line section or bridge leg causing the problem. This ability to rapidly test circuits reduces dramatically the time taken to restore faulty circuits. The RATES system has been designed to be modular at all levels providing solutions for the largest telephone company to the smallest end user. This modularity allows expansion throughout: additional circuits, extra test features and more test personnel are all easily accommodated.

How the System Operates

The RATES system uses the well proven HP 1000 A series range of computers as the system controller. The computer, driven by the applications software package (HP 37031A), controls the remote site access and test equipment using modem connection over dedicated or dial-up telephone lines. To ensure that data sent to or received from remote sites is unaffected by telephone line corruption, a specialized error handling protocol is used for all communications.

An operator using a terminal connected to the central site computer interacts with the applications software to carry out the required circuit tests. The applications software makes extensive use of graphics-style screen presentation to ensure a user-friendly man/machine interface which relates directly to the tests being performed.

Software Features to Save Time and Effort

Built into the software, as well as full control of the RATES hardware, are many other features which save both time and effort when using the system:

- **Tone Activated Loopback Device Control**
Single key press activation of tone activated Loopback Devices.
- **Soft Key Menu Driven**
The screen displayed function key labels show the available tests.
- **Sequences**
The series of keys to complete a test can be stored as a sequence.
- **Reports**
Reports can be produced to aid system installation, planning, turn-up and maintenance.
- **Diagnostic Routines**
Operator invoked routines quickly verify system availability.
- **Database-held Circuit Information**
All information to test a circuit is held in the computer system database.
- **Easy Data Loading**
A series of screen generated forms make entering information easy.
- **Activity Logging**
Operator and system activity are logged and can be viewed at any time.

- **Circuit Logs**

The results of operator tests on a circuit are placed in that circuit's log file, allowing instant reference anytime.

- **Circuit Log Archiving**

A comprehensive archiving system allows all log files to be transferred to cartridge tape.

- **Networking**

Using the DS 1000-IV Distributed Systems software the system can be expanded by having many computers interconnected to give a transparent distributed systems architecture.

Central Site Computer System

The central site computer system can be expanded at all levels. Additional terminals and additional remote site communications modems can all be easily accommodated. For applications with up to 14 operator terminals (typical), the HP 1000 A600+ Computer is recommended. For up to 24 terminals (typical), the more powerful A900 is required. The size of disc memory required is dependent on the number of circuits to be accessed and disc sizes range from 28 to 130 Mbytes. For very large systems more than one unit can be used.

Remote Measurement Site Hardware

The remote site equipment is available in two forms with differing physical size and feature set:

Series 30 RATES

For applications requiring basic access and test functions with low cost compact equipment, the Series 30 family of RATES modules is ideal. The Series 30 modules are 23 in. rack mounting and for sites requiring access to between 24 and 96 4-wire circuits the access and test functions are combined in the one module - the Access and Test Unit (ATU). Expansion is easily accommodated by installing Twin Access Modules (TAMs) which allow access to a further 24 - 192 4-wire circuits. Up to 7 TAMs can be 'chained' onto an ATU to give access up to 1440 4-wire circuits. A maximum of two test instruments can access a 'chain' simultaneously and access to a single circuit causes blockage to a further 95 (i.e. blockage is 1 in 96). The Series 30 equipment is fully compatible with other RATES equipment and where necessary a mixture can be used to give further site expansion to a maximum of 40300 4-wire circuits. The basic building blocks of the Series 30 family include:

HP 37130A Twin Access Module (TAM): 24 - 192 4-wire circuits

HP 37140A Access and Test Unit (ATU): access to 24 - 96 4-wire circuits with combined control measurement and test.

Series 50 RATES

The Series 50 RATES modules are designed for applications requiring a higher level of access activity and extra features not available in Series 30 equipment. These enhancements include:

- **Lower Blockage**

Up to 4 test instruments can be connected to a Series 50 module chain and a single access blocks access to only 23 circuits (i.e. blockage is 1 in 24).

- **A Split and Terminate Option (S&T)**

This allows conference circuit bridge legs to be isolated on a long term basis without continuous use of a test instrument (TMU).

- **A Loopback Oscillate & Terminate Option**

This operates independently of the TMU and is an invaluable aid to line section troubleshooting.

- **A Switch Settable Circuit Security Option**

Highly sensitive circuits can be made secure from system access using this option.

The Series 50 modules are 19 in. rack mounting and any site can be expanded from 24 to 43200 4-wire circuit access capacity. The basic access device is the Access Module (AM) giving access to 24 - 96 4-wire circuits. The control and test instrument, the Test and Measurement Unit (TMU), along with the AM gives the minimum Series 50 system size of 24 - 96 4-wire circuit access. Again, any combination of 2, 4, 6 or 8-wire circuits can be accommodated. Up to 15 AMs can be 'chained' together and up to 4 test instruments can simultaneously access the 'chain'. Further 'chains' and TMUs can be added by using the Chain Selector (CS). Chain Selectors allow up to 30 'chains' and 60 TMUs to be accommodated.

The basic building blocks of the Series 50 equipment include:

HP 37150A Access Module (AM): 24 - 96 4-wire with 1 in 24 blockage

HP 37160A Test and Measurement Unit (TMU): control, measurement and test unit

HP 37180A Chain Selector (CS): bus switching unit.

Test and Measurement Capability

The test capability of the Series 30 ATU and the Series 50 TMU is identical and includes the following:

- Multimeter measurements - dc/ac voltage and current resistance and capacitance
- Variable level and frequency source
- Flat or weighted level measurement
- Return Loss, ERL, SRL (High, Low)
- P/AR
- Comprehensive signaling emulation
- External instrument control (HP-IB)

As TMU features are provided on separate cards, only those that are required need be fitted - others can be added later. Although operation of the TMU/ATU is normally controlled from the central computer, each TMU/ATU can be driven in 'local mode' allowing use by repair technicians during installation and turn-up independently of the central computer.

Support Services

Hewlett-Packard offer support for the HP 37100S hardware and software to suit customer needs:

Training

A range of training courses is available which cater for system managers, system operators and system maintenance personnel.

Service Contracts

Service agreements and maintenance contracts are available to suit differing needs.

Engineering Support

Engineering backup is available from the HP Systems Engineering Organisation.

Software Subscription Services

Subscription services provide software updates and information on software enhancements.



VIDEO TEST EQUIPMENT

Video Measurement System & Set

Models 51810S, 51810 A/R

- High-throughput video testing
- Tasks separated for operator, test and QA managers
- Test results stored in database



The HP 51810S Video Measurement System

HP 51810S Video Measurement System

Over 60 parameters on NTSC baseband video signals are automatically measured using this computer-based test system. Signal-to-noise ratio, differential gain and phase, as well as other distortion measurements are among the tests it performs. Although intended primarily for production-testing of video products, the HP 51810S Video Measurement System will find applications in research and development, quality assurance, and broadcasting due to the wide variety of measurements it can make.

The HP 51810S is among the first high-volume manufacturing solutions available for final testing of video products. In keeping with the industry's growing demand for automatic test equipment, features like high test speed, ease of use, and a database for storing test results have been included. Separating tasks into test creation, test execution, and results evaluation, allows semi-skilled operators to run predefined tests easily, while providing full flexibility to quality assurance and test managers.

Along with advanced measurement software, the system combines new and existing hardware products. The new product, an HP 51810A or HP 51810R Video Measurement Set includes a Video Sync Separator and the Video Measurement Software. (The HP 51810R is a discounted version of the HP 51810A for multiple purchases.)

Powerful System Components

At the heart of the system is an HP 5180A Waveform Recorder, which captures and digitizes the video signal from the device under test. The HP 5180A is a high-fidelity, 10-bit digitizer, yielding chrominance amplitude resolutions up to 0.05 IRE. Combining digital interpolation schemes in software with a 20 MHz sampling rate, timing resolutions of 5 ns are obtained.

In addition to providing triggering signals to the waveform recorder, the Video Sync Separator (part of the Video Measurement Set) offers signal preprocessing on 1 volt, 75 ohm baseband video signals with a clamp, a subcarrier filter, an anti-aliasing filter and a times ten gain amplifier. The subcarrier filter is used for tests in which luminance information is not needed. Maximizing the voltage

resolution of the measurement, it allows the waveform recorder to capture the signal on the largest possible range. The gain amplifier is used for measuring noise on a quiet line. All of the functions of the sync separator are programmable via an HP-IB interface, and are changeable through the video-system-software menus.

The Video Measurement Software (also part of the Video Measurement Set) extracts gain, phase, timing, noise and distortion parameters from the digitized waveform, compares them to two preset limits - cautionary and alarm - and stores them for later analysis. Separating tasks in the software for three types of users - test manager, operator, and report manager - make the system quick to learn and easy to use.

Each of the hardware components in the system are powerful tools that can be used to solve other measurement problems. In addition to the Waveform Recorder and the Video Sync Separator, the system consists of an HP 9000 Model 217H computer with 2 megabytes of memory, an HP 9133H 20-megabyte Winchester disc drive, and optional printers and plotters. Other types of tests such as audio tests can be created using the same computer and waveform recorder by using leftover memory or adding additional memory to the system.

High-Throughput Testing

At typical production-test throughputs, this system automatically tests up to 250 products per hour. Contributing to its high speed are advanced assembly-coded, digital-signal-processing routines, which make single-line measurements throughout the video frame. Test speeds are also increased by incorporating an optimizer that orders and groups tests, eliminating redundant digitizing operations. Finally, high-speed data transfers to the computer are accomplished using a direct-memory-access (DMA) interface.

Within the software, "hooks" have been included for interfacing the system to other test equipment. Communication to a programmable generator, bar code reader, or a host computer are all possible. The system is conveniently equipped with both HP-IB and RS-232C interfacing abilities for these purposes.

Flexible, Yet Simple to Operate

To simplify operation, while retaining full flexibility, the three steps of testing - definition, execution, and evaluation - are structured for three types of users. The three users are the test manager, the operator, and the report manager. Each is provided with only the capabilities needed to perform their task.

- **The test manager** defines and orders tests, sets test limits and manages the database. Softkeys are used to select appropriate test definition information from menus. Data entry is checked to prevent entering inconsistent parameters. Most screens have HELP keys, informing the users what that screen is for and how to use it.
- **The operator** executes the tests defined by the test manager. After entering the serial number of the device to be tested, PASS or FAIL information is displayed on the screen. Two levels of test limits are reported: cautionary and alarm. (Limits are set by the test manager.) The operator can obtain quick, pre-formatted reports showing actual results or can proceed directly to testing the next unit.
- **The report manager** uses the database to analyze test results offline. Histograms, statistics and single or multiple device-test reports are all available with the standard software.

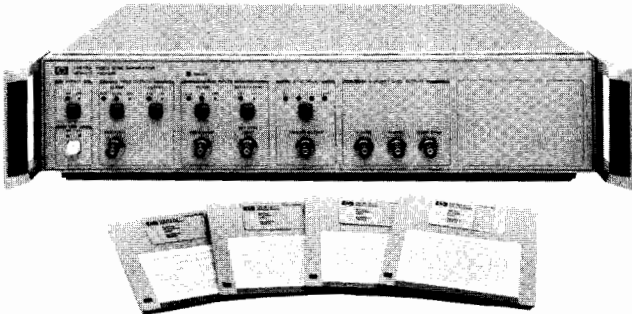

HP 51810A Video Measurement Set Convenient Modes Of Operation

Tests are selected by two methods. User-defined test groups are useful for manufacturing testing, and in device characterization where a well-thought-out test group is to be applied. "Quick Tests" are singly executed tests ideal for engineering applications. In both modes, tests can be programmed to run once, multiple times, or continuously. In addition, a delay between measurements is programmable for parameter trending over time. While running a user defined test group, the test manager has the choice of whether or not to store test results in the database.

Thousands of Test Results Stored

A database stores the HP 51810S test results for several thousand devices, depending on the length and number of the test groups defined. These results may be accessed easily for quality checking and process monitoring, by sorting on device serial number, date, failed parameter, and operator. Reports are defined by the report manager, which include histograms and statistics. Hard copies are easily obtained using any of several high quality HP plotters and printers.

Full Range of Standard Tests

All of the measurements that the system makes are based on standards set by the Electronic Industries Association (EIA RS-170-A and RS-250-B), the Network Transmission Committee (NTC-7) the Federal Communications Commission, and the International Radio Consultative Committee (CCIR). Below is a list of the tests performed. Several standard signals may be used for each test. An insertion gain test is performed at the user's request to calibrate out any system-gain errors.

• Differential Gain and Phase

While most test systems report only two answers for Differential Gain and Phase, the 51810S adds amplitude and phase measurements for each chrominance packet in the signal under test. Also included in this test are Burst-Amplitude, and Relative-Burst-Gain and Phase measurements.

• Gain-Frequency Distortion

By reporting the 6 packet amplitudes on an FCC multiburst or NTC-7 combination signal, the frequency response of the device under test can be obtained.

• Chrominance-Luminance Intermodulation

Both the reference luminance level, and the difference between the reference and each luminance level on a 3-level chrominance signal are reported.

• Chrominance-Luminance Gain/Delay Inequality

Also called "Relative Chroma Level and Relative Chroma Time" tests. Chrominance and luminance amplitudes and chroma delay are reported.

• Luminance Nonlinearity

Amplitude step differences for each level of a 5 or 10 step modulated staircase are reported.

• Chrominance Nonlinear Gain/Phase Distortion

Chroma amplitude of each of the 3 packets on a modulated pedestal or NTC-7 Combination signal are reported. Also, the normalized amplitude of the 20 IRE and 80 IRE packets are reported with the middle packet scaled to 40 IRE. The average phase of each packet is given relative to the color burst as well as the total phase deviation in absolute degrees.

• Color Bar Amplitude and Phase

All six color bar amplitudes and phases are reported for either the EIA, SMPTE, or FCC color bar signals.

• Dynamic Gain

Bar amplitude and sync amplitude in IRE are given, as well as sync amplitude as a percent of bar.

• Short/Line Time Waveform Distortion

Bar tilt and 2T pulse amplitude, and ringing amplitudes in 4 places are reported.

• Signal-to-Noise Ratio

Six different signal-to-noise ratio tests are available including SNR NTC-7, SNR CCIR, and four user-defined-weighting SNR measurements. Using the insertion gain test, noise is measured relative to actual signal power.

• Horizontal/Vertical Timing

Horizontal timing measurements (line 10 and above) include sync width, rise and fall times, front and back porch durations, blanking and breezeaway width, sync to setup time, and color cycles. On lines 1-9, vertical sync, serration, and equalizing pulse widths are measured.

• Waveform Monitor

A selected line of video is captured and displayed on the computer screen. Relative or absolute amplitude and timing information at any point is displayed using cursors controlled with softkeys. Zooming is accomplished using digital interpolation.

Ordering Information

This ordering guide lists the HP 51810S line items required for compatibility. It is not necessary to order any line item you already own. Contact an HP Sales Representative at your local HP Sales Office for assistance. (See page 774.)

| System Reference | Price |
|---|----------|
| HP 51810S Video Measurement System | |
| This system model number ensures coordination of shipments and compatibility of instruments and software. | 0 |
| Video Measurement Set (includes Video Measurement Software and Sync Separator) | |
| HP 51810A Video Measurement Set (first copy) | \$11,500 |
| HP 51810R Video Measurement Set (copies 2-n) | \$9,100 |
| Digitizer | |
| HP 5180A Waveform Recorder | \$18,600 |
| Mass Storage | |
| HP 9133H 20 MByte Winchester | \$2,740 |
| System Controller | |
| HP 9817H Computer | \$6,510 |
| OPT 001 1M Byte Memory | \$1,000 |
| HP 98257A 1M Byte Ram Board | \$2,000 |
| HP 98613A OPT 630 Basic 3.0 | \$860 |
| HP 98622A GPIO Interface | \$355 |
| System Controller Accessories | |
| HP 10833D HP-IB Cables, 0.5m (3 needed) | \$80 |
| HP 10875A DMA Cable | \$180 |
| Recommended Accessories | |
| Plotter (choose at least one) | |
| HP 7475A Graphics Plotter, OPT 002 | \$1,895 |
| HP 7470A Graphics Plotter, OPT 002 | \$1,095 |
| Printer (choose at least one) | |
| HP 2225A Thinkjet Printer | \$495 |
| HP 2686A Laserjet Printer | \$3,495 |



COMPUTER AIDED ENGINEERING

Introducing HP DesignCenter™

General Information

Hewlett-Packard has for many years been a leading supplier of computers and engineering workstations for measurement automation, data acquisition, automatic test, factory automation and many other technical applications.

Today, by combining its expertise in technical computers with its experience in state-of-the-art electronic design, HP supplies high-quality design systems to help improve the productivity of electronic, mechanical and software engineers.

HP's CAE/CAD/CAM offering is continually expanding as new products and enhancements are introduced at a rapid pace. The products described on the following pages represent only a small sample available at press time for this catalog. The reader is urged to contact the nearest Hewlett-Packard sales office for up-to-date information on HP's growing line of CAE/CAD/CAM solutions.

Why CAE/CAD/CAM?

During the past few years, several factors have influenced the typical product design process in ways that make the design engineer's task more demanding. Increasing global competition has compressed product development time as well as product life cycles, making the time saved in development even more critical than in the past.

The design task has also become more difficult due to the complexity of today's VLSI circuits, microprocessors, printed-circuit boards and electro-mechanical products. The engineer is caught between a more complex design task and less time in which to complete it.

In addition, the move to factory automation and increased emphasis on quality require absolute accuracy in designs from the engineer. Designs must be correct the first time, not only in terms of product description, but also in terms of process description (test procedures, documentation, etc.). In summary, there are more complex designs to be completed faster and more accurately by a limited number of skilled engineers.

The shorter the development time, the sooner the product goes to market and the longer the sales life of the product. A recent electronics industry study compared the impacts on product profitability of development costs, product costs and late product introduction.*

Sensitivity of Profits Over Product Life

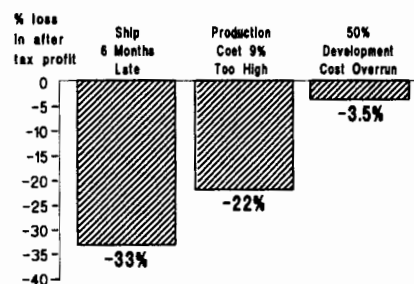

Using a representative high-growth market with 5-year product life, 12% annual price erosion, and 20% growth per year, an overrun of 50% in product development costs will decrease after-tax profits by 3.5%. In contrast, a production-cost overrun of only 9% results in a 22% decrease in after-tax profits. Even more significant, a six-month delay in introduction costs 33% of the after-tax profits.

(* Figure from Donald Reinstein, McKinsey & Co, Los Angeles, CA, Electronic Business, July 1983, P. 86. Copyright 1983, Cahners Publishing Company)

CAE/CAD/CAM A Strategic Decision

Purchase of any computer system is an important decision that requires looking beyond today's needs and currently available product features to expected future requirements and growth paths. This is especially true in CAE/CAD/CAM since the user's entire design-to-manufacturing cycle can be linked to the selection of a CAE vendor. With technology and design requirements changing at an ever-increasing pace, the strategic directions of alternative CAE vendors are an important factor in the selection process.

HP's product strategy is founded on a major corporate commitment to the CAE/CAD/CAM business. The company's engineering expertise, reputation for quality and experience in test, measurement and technical computing, as well as its respected worldwide support organization, all contribute to HP's position as a leading supplier of CAE/CAD/CAM solutions.

The foundation of HP's product offering is a family of networked technical workstations that bring computing power to the design engineer's workplace. HP's workstations reflect a commitment to industry standards, such as UNIX™ and Ethernet.™ The company's understanding of electronic, mechanical and software engineering is reflected not only in the products, but in the training and support behind them.

Along with the workstation platform, HP offers its own fully supported applications software solutions for electronic, mechanical and software engineering. We call this evolving family of solutions HP DesignCenter.

Complementing these HP-developed and supported CAE/CAD/CAM solutions is a wide range of third-party products that expand the application of the HP workstations.

By making these packages available on HP workstations, the company ensures that users have access to the widest possible ranges of solutions.

Introducing HP DesignCenter™

HP DesignCenter is an integrated design environment for electronic, mechanical and software engineers, where tasks can be planned, executed and managed more effectively. HP DesignCenter will include tools for data management, documentation and communication, not just design automation software. It runs on a family of powerful workstations which link, through industry-standard networks, to computers from HP and other vendors.

DesignCenter will help the individual design engineer by providing an integrated set of tools to speed the design process from idea to final production, while also improving overall quality. DesignCenter comes with the support, documentation and training to ensure productive use of design tools.

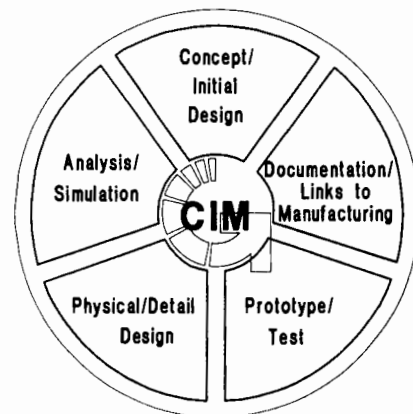

The process begins with concept/initial design and ends with final documentation and links to manufacturing. Except, as the diagram implies, the process does not really finish there; it repeats. Most designs are based on previous products and, in the ideal design process, experience gained from each design is passed on to future projects for continuous process improvement.



Concept/Initial Design

In this generic design process, the first stage refers to product concept, requirements definition, architectural decisions and initial functional design. Using a graphics workstation as an entry device, the designer creates a database which describes the product structure with sufficient accuracy and integrity for a computer to perform the next step: analysis and simulation.

Analysis/Simulation

In this step, the computer model of the product is exercised using algorithms that predict behavior of the finished product. The designer is able to "see" how the product will behave before it is created; performance problems can be corrected and "what if?" studies performed to optimize the design.

Physical/Detail Design

In the physical/detail design stage, the designer addresses the task of turning the computer model into a physically realizable product. Documentation and data files are created that describe how the product will be built, as opposed to how it will function.

Problems may occur at this stage that necessitate design changes; for example, physical limitations of the manufacturing process may be exceeded. In this case, design changes must be fed back to the previous steps and, if necessary, analyzed again to ensure that functional requirements are still met. Clearly, tight coupling between each step in the process is important for overall project management and quality control.

Prototype/Test

In the prototype/test phase a physical model of the product is built and tested to verify the process up to this point. Again, design changes may be required, so this stage must be linked to the rest of the process. Test results can reveal problems in design or in the production process, or even in the computer modeling algorithms. The ability to improve the accuracy of algorithms such as SPICE circuit models or finite element models is a benefit of closely coupling test with the design process.

Documentation/Links to Manufacturing

Although the diagram shows documentation/links to manufacturing as the final stage, it more accurately is a part of each step in the design process. To ensure a smooth start-up in production, the product should not come as a surprise to the manufacturing department; they should be involved throughout the design process. This is emphasized on the diagram by the design process being shown around a core labeled CIM for computer-integrated manufacturing.

Computer-Integrated Manufacturing

When fully developed, this process will make complete use of the core of the diagram shown here as CIM, for computer-integrated manufacturing. CIM includes three integrated levels; engineering automation (shown here), as well as factory floor automation and

planning and control systems. HP provides productivity-enhancing tools for all three levels and is moving toward a unified structure that will allow users to evolve into fully integrated design and manufacturing.

Today, the full capabilities of this "factory of the future" are not available anywhere. But portions of it are available now from HP with more on the way and increasing levels of integration as these processes evolve. DesignCenter is the foundation of this long-term CIM goal, and offers links between some of the design automation steps that can be used now.

HP DesignCenter, as it evolves, will increase engineering productivity at each step of the design process. It will include links between steps in the process to speed designs through the cycle with minimum rework. Feedback between steps will allow the whole process to be continuously improved, with the ultimate goal being a straight-through process in which each step is performed "right the first time".

Electronic CAE/CAD Products

As part of the DesignCenter offering, HP has a growing line of electronic CAE/CAD products. This includes a general-purpose design and drafting system (Engineering Graphics System) that has wide application in schematic capture and physical layout of printed circuit boards. HP EGS can transmit net list files to manufacturing equipment such as printed-circuit-board testers to ease the task of test development.

In the area of logical design and circuit simulation, HP is committed to providing an object-oriented database and artificial-intelligence-based software to provide schematic capture, circuit simulation and links to back-end physical-design tools. Please contact the nearest HP sales office for more information on new products in this area.

In the area of electronic test, HP is a leading supplier of logic analyzers, digitizing oscilloscopes, stimulus-response analyzers and other test instrumentation. Through extensive use of HP-IB (HP's implementation of IEEE 488), these products can be used in automated test systems, as well as in standalone applications to verify design prototypes or production processes.

With the increasing use of microprocessors in electronics, software design has become an integral part of the total electronic development process. With the HP 64000 microprocessor development system, the engineer can implement each step in the DesignCenter process for software development. Starting with the ability to enter source code in a variety of high-level languages, the 64000 user can compile and link the code and emulate the performance of the finished software product in the target system. The 64000 includes powerful hardware and software analysis tools to enable defects to be found and corrected early in the development cycle.

Mechanical CAD/CAM Products

For mechanical engineers, HP offers tools for capturing part geometry in a design database. 2-D, 3-D wireframe and solids modeling systems are available. In the area of analysis/simulation, links are provided between the design database and finite element models used for predicting dynamic or thermal behavior. Both HP-developed and popular third-party modeling packages are available.

HP's mechanical design systems include links to numerically controlled machine tools and have special utilities for plastic molding and sheet metal design. As with the electronics design process, HP has a strong offering of testing tools for mechanical engineers. Structural analysis instrumentation can perform multichannel vibration analysis on prototypes, and extract modal parameters from the measured data. These parameters can be compared with finite element model output and the results of this comparison used to improve the accuracy of the model or modify the product design.

Summary

Computer-aided engineering and design capabilities applied throughout the design cycle improve efficiency and quality at each step in the process and enhance communication and coordination between steps. With the increased capabilities and lower costs of technical workstations, peripherals, test equipment and application software, it is becoming feasible for every area of the factory to use these tools in collaboration so each can truly influence products in appropriate stages of design and development.

With the HP DesignCenter, an engineer will have access to a comprehensive offering of CAE/CAD/CAM solutions for electronic, mechanical and software development. Along with this comes the support, training and service that has distinguished Hewlett-Packard over the years, and that is so important to the successful use of these complex systems.

When the best solutions may be available through applications software from third parties and independent software vendors, HP cultivates relationships with other leaders in the market. This combination of the HP DesignCenter offerings complemented by renowned third-party products, provides the customer with the widest possible range of design automation solutions.

HP is committed to a technical and business relationship with CAE/CAD/CAM customers, which begins when the HP field engineer helps to define and analyze the customers' specific needs. This continues through system installation and implementation and extends through the life of the system and beyond as needs expand and new products become available.



The Hewlett-Packard 9000 Technical Workstation

The Hewlett-Packard technical engineering workstation — the HP 9000 — is a family of 16- and 32-bit computers. Aimed at helping engineers and scientists work more productively, the HP 9000's applications range from Computer-Aided Engineering (CAE) and Computer-Aided Design (CAD) to instrument control.

The HP 9000 is comprised of three computer series — the Series 200, Series 300, and the Series 500. Two other HP computers that are used in the technical market are the Integral PC and Vectra. With more than 150,000 of these computers installed worldwide, the company is one of the largest manufacturers and suppliers of technical and scientific engineering workstations.

The HP 9000 technical workstations are truly compatible computers—from the entry-level series 200 through the Series 300 to the top-of-the-line Series 500. All of these computers support common operating systems, programming languages, networking capabilities and peripherals.

The Series 200 and 300 are based on Motorola microprocessors. An MC 68000 16-bit computer chip is featured with the 200 while a choice of either a 16/32-bit MC 68010 or a full 32-bit MC 68020 is available for the 300.

The Series 500 is based on two Hewlett-Packard developed computer chips. When introduced in 1982, the company's microprocessor chip was the world's first full 32-bit single-chip CPU, and had more than 450,000 transistors in an area of approximately one-quarter of an inch square with an execution speed of one million instructions per second (MIPS). This Hewlett-Packard technology, called "NMOS III", led to the development of the second chip, a random-memory access (RAM) chip containing in excess of 600,000 individual transistors.

All three of these series features the HP-UX operating system, Hewlett-Packard's implementation of AT&T's UNIX* System V operating system.

The final computers are low cost solutions for the CAE/CAD market. Vectra, an IBM-PC compatible system, is based on an Intel 80286 microprocessor and the PC-DOS operating system, while the portable Integral features a Motorola 68000 CPU and the HP-UX operating system.

The Foundation For CAE/CAD

As the foundation for Hewlett-Packard's CAE/CAD product offerings, the HP 9000 family gives engineers flexibility and extensibility in their choice of computer power required to run their specific applications. Configuration flexibility — choices of displays, programming languages, internal memory capacity, peripherals — allows engineers to tailor a system to fit today's CAE/CAD needs as well as meet future requirements.

Measurement Automation

Hewlett-Packard's HP 9000 family of technical engineering workstations offer the kind of flexibility that makes it easy to build productivity into automating measurement, analysis and test system applications.

Computer-Aided Test

Using the HP 9000 in a Computer-Aided Test (CAT) systems improves diagnostic reporting and speed analysis. An HP 9000, such as the Series 300, coupled with high-speed data acquisition instruments, lets engineers capture and analyze transients in real-time, an alternative to statistical analysis.

Engineering Evaluation and Analysis

Engineers can use the HP 9000 to evaluate and analyze the performance of products under investigation and development. These computers, in conjunction with HP-UX operating system, are optimized to work with the more than 1,400 Hewlett-Packard instruments and peripherals via the company's HP-IB industry standard interface, making it easier to assemble instrument systems with higher speed, accuracy, repeatability and therefore, productivity.



HP 9000 FAMILY COMPARISON CHART

| Computer | Series 200 | Series 300 | Series 500 | Integral PC | Vectra |
|--------------------|----------------------------------|---|-----------------------------------|--------------------------|---|
| Microprocessor/CPU | Motorola 68000 | Motorola 68010/20 | Proprietary | Motorola 68000 | Intel 80286 |
| Operating System | HP BASIC, Pascal, HP-UX | HP BASIC, Pascal, HP-UX | HP BASIC, HP-UX | HP-UX | PC-DOS |
| Languages | BASIC, Fortran, C Compiler | BASIC, Fortran, C, Pascal | BASIC, Fortran 77, | BASIC, C | BASIC, GW BASIC Lattice or MS C Compiler Pascal |
| Memory | 256K RAM | 7.5M physical, 68010 - 16M virtual 68020 - 4 Gbytes Virtual | 512K RAM Expands to 10M | 512K RAM Expands to 5.5M | 256K RAM Expands to 3.6M |
| Mass Storage | Multiple Config. | Multiple Config. | Multiple Config. | Built-in 3 1/2" disc | Multiple Config. |
| Networking I/O | HP-IB, GPIB IEEE 802.3 | HP-IB HP-HIL RS-232 IEEE 802.3 | HP-IB IEEE 802.3 | HP-IB HP-HIL | HP-IB HP-IL HP-HIL RS-232C RS-422 |
| I/O slots | 4 | 4 - 8 | 4 - 8 | 2 | 7 |
| Display | 7in. to 14in. 25 lines X 80 col. | 12in. to 19in. 48 lines X 128 col. | 12in. to 19in. 26 lines X 80 col. | 9in. 24 lines X 80 col. | HP Touch 12in. 24 lines X 80 col. |
| Keyboard | Multiple config. | HP 46020 ASCII 8 function keys | ASCII standard others avail. | 90 key typewriter style | HP-HIL device port |

Manufacturing and Industrial Monitoring

Accurate monitoring of analog and digital signals is a key to manufacturing product quality. The HP 9000 combines computational speed and reliability for real-time data acquisition even in a harsh environment. Engineers can immediately spot trends or deviations in critical variables or processes.

Laboratory Monitoring and Analysis

Analytical procedures can be automated with the HP 9000. Using HP BASIC or Pascal programming languages, programs are easy to write and use. At the same time, engineers have a sophisticated means of data reduction and efficient management of samples, information and materials throughout the lab.

Design Automation

The second major area that the HP 9000 engineering workstation family is ideal for is the design automation market where engineers create software for CAE/CAD applications. To create this software, whether it is developed as an end-user product, for internal use by the developing company, or as the software for a turnkey system, the development system must be extremely flexible to precisely meet the designer's needs.

The HP 9000 is the answer for the OEM or ISV. The flexibility required by the designer is built into these engineering workstations.

With the HP 9000's modularity, engineers have a choice of computational power, color or black-and-white monitors, screen resolution, peripherals and accessories, allowing them to literally build the system they need. Total compatibility of all components guarantees that, regardless of how the system is structured, it will perform. Offering either 16/32-bit or full 32-bit processors, the HP 9000 is powerful and fast enough to meet the demands of any software design.

While flexibility, power and compatibility are the keys to the HP 9000 hardware for the applications software designer, they are also the keys to the UNIX operating system. UNIX is designed expressly for software developers and is the industry standard for 32-bit technical workstations. Hewlett-Packard's HP-UX is the company's implementation of this powerful operating system, and includes major enhancements and extensive debugging.

HP-UX is the operating system offered on the HP 9000 family, giving the designer the most advanced tool ever written for creating and modifying software. It is compatible with other major UNIX systems so contact with a virtually unlimited expanse of applications to port onto the HP 9000 is available.

Along with HP-UX, the HP 9000 runs Hewlett-Packard's BASIC and Pascal language systems as well as a large and continually growing base of "stand-alone" software. HP BASIC offers the friendliness of an interpreted language yet features exceptional operating speed, while HP Pascal is powerful, flexible and can help design engineers to fine-tune programs close to machine level. These languages also form another bridge of compatibility among the various models within the HP 9000 family.

CAE/CAD application often call for transfer of data between members of the design team, both in software development and end use. For this, the HP 9000 family of technical workstations, the company reinforces its commitment to the world of CAE/CAD applications. Using the HP 9000, design engineers enter a world of flexibility, compatibility, power and quality unmatched by any computer on the market today.

For more detailed information on the HP 9000 technical workstations please refer to page 65.



COMPUTER AIDED ENGINEERING

Technical Office Automation Software

For HP 9000 Series 200, 300 and the Integral PC

Research shows that engineers typically spend the majority of their time — 60% to 80% — planning, communicating and documenting their work — doing what HP calls Technical Office Automation. Using HP's Technical Office Automation software you can solve your documentation, analysis, and presentation needs and increase your productivity.

The following Technical Office Automation software is marketed, distributed, and fully supported by HP. Additional Technical Office Automation applications are available from the HP Plus program and are listed in the HP Technical Systems Software Solutions Catalog.

Technical Office Automation Software

HP 9000 Series 200 and 300* BASIC/Pascal Applications

Applications that include their own operating environment:

| | | |
|-------------|--|-------|
| HP 45462B+○ | Picture Perfect ® business graphics software for bar, pie, line and combined bar/line charts. | \$595 |
| HP 45463B+○ | Diagraph ® clip-art software for creating a variety of presentation aids, organizational charts, diagrams, forms, signs, word charts, and flow charts. | \$695 |
| HP 45480B+○ | Data Grapher/200 graphics software that turns numbers into charts and graphs. Files can be merged with HP TechWriter. | \$295 |
| HP 45537B | Graphics Editor/200 general purpose graphics software for creating charts and diagrams. Files can be merged with HP TechWriter. | \$445 |
| HP 45481B+ | Context MBA ® integrated software that performs spreadsheet modeling, word processing, business graphics, database management, forms, and telecommunications. | \$795 |

Applications that require Basic 3.0:

| | | |
|-----------|--|--------|
| HP 45538B | Text Editor/200 word processor for creating reports, memos and high quality letters. | \$275 |
| HP 98815A | Graphics Presentations/200 business graphics software for bar, line, and pie charts. | \$750 |
| HP 98817A | Project Management/200 software that analyzes PERT, CPM, and MPM network analysis and produces GANNT chart output. | \$500 |
| HP 98821A | Numerical Analysis math software provides seven commonly used analysis routines which may be added to application programs. | \$500 |
| HP 98820A | Statistics Library/200 provides an economical set of routines for data exploration, analysis and graphics display. | \$1500 |
| HP 98820B | Statistics Library/200 , Part I provides a basic library of general statistics. | \$925 |
| HP 98820C | Statistics Library/200 , Part II provides an advanced statistical analysis library. Part I required to run Part II. | \$750 |

*Requires Series 300 compatibility hardware.
+Not available for Model 226.
○Not available for Model 237.

Integral PC and HP 9000 Series 200 HP-UX Applications

| | | |
|-----------|--|--------|
| HP 45524G | MicroTrak ®/HP-UX project management software provides a critical path method scheduling system for managing complex projects. | \$775 |
| HP 45524H | MicroTrak ®/HP-UX. Multi-user version of HP 45524G. | \$1550 |
| HP 45515G | TK!Solver ®/HP-UX equation solving software solves complex math models using either your own design or specialized templates called TK!SolverPacks. | \$499 |
| HP 45515H | TK!Solver ®/HP-UX. Multi-user version of HP 45515G. | \$999 |

The following TK!SolverPacks are templates designed to work with TK!Solver (HP 45515G and HP 45515H):

| | | |
|-----------|--|--------|
| HP 45516G | TK!SolverPack ®/HP-UX Financial Management . | \$125 |
| HP 45517G | TK!SolverPack ®/HP-UX Mechanical Engineering . | \$125 |
| HP 45518G | TK!SolverPack ®/HP-UX Building Design & Construction . | \$125 |
| HP 45519G | TK!SolverPack ®/HP-UX Introductory Science . | \$125 |
| HP 45473G | Multiplan ®/HP-UX electronic spreadsheet provides financial modeling, forecasting and the calculation of engineering and scientific formulas. | \$345 |
| HP 45473H | Multiplan ®/HP-UX. Multi-user version of HP 45473G. | \$595 |
| HP 45420G | MemoMaker /HP-UX word processing for writing memos, business letters or reports. | \$195 |
| HP 45420H | MemoMaker /HP-UX. Multi-user version of HP 45420G. | \$395 |
| HP 45413G | Calculator /HP-UX provides the functionality of an HP Series 10 calculator with math, stat, trig and financial functions. | \$75 |
| HP 45413H | Calculator /HP-UX. Multi-user version of HP 45413G. | \$150 |
| HP 45438G | The Management Solution /HP-UX includes, MemoMaker/HP-UX, Multiplan/HP-UX and MicroTrak/HP-UX at a 15% savings over the combined list price of the three individual products. | \$1118 |
| HP 45438H | The Management Solution /HP-UX. Multi-user version of HP 45438G. | \$2159 |

For Series 300 HP-UX applications, contact your HP Sales Office.

Ordering Information

In the US, call toll-free (800) 538-8787; except in California, Alaska, or Hawaii call (408) 738-4133. Or contact your local Hewlett-Packard sales office or dealer.

©Context MBA is a trademark of Context Management Systems.
©Picture Perfect is a trademark of Computer Support Corporation.
©Diagraph is a trademark licensed to Computer Support Corporation.
©MicroTrak is a trademark of SofTrak Systems.
*TK!Solver and TK!SolverPacks are registered trademarks of Software Arts, Inc.
*Multiplan is a registered trademark of MicroSoft Corporation.



In today's technical computation and engineering design market, providing total hardware and software solutions to our customers is absolutely vital. To satisfy this need, Hewlett-Packard actively seeks out, and relies upon, the expertise of third party software suppliers to augment our selection of HP technical solutions.

Because the number of software products in this offering is quite large and constantly growing, we cannot list all of the products and prices here. However, HP provides a complete listing of these products—both HP and third party—in a quarterly Technical Systems Software Solutions Catalog available from HP's Computer Supplies Operation (CSO). Orders for single copies and annual subscriptions can be placed with your charge card by calling CSO directly (see Ordering Information below).

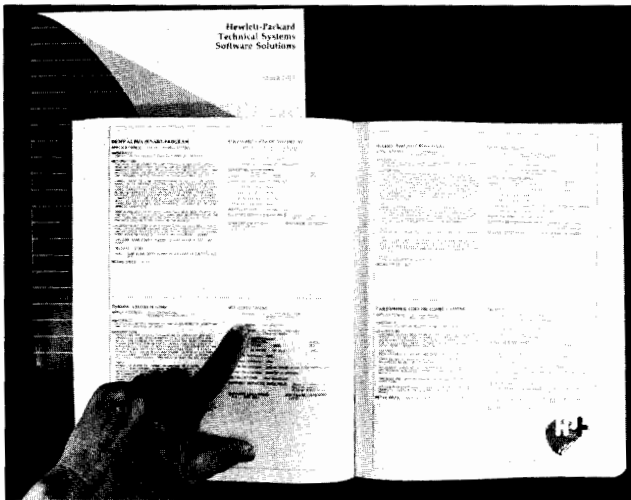

HP PLUS offers you software in three different categories: Listed, Referenced and Distributed. The Listed category is for the supplier with the lowest level of HP involvement in marketing his product. The Referenced category is for user proven software products. The Distributed category is for software which HP has elected to market, merchandise and sell.

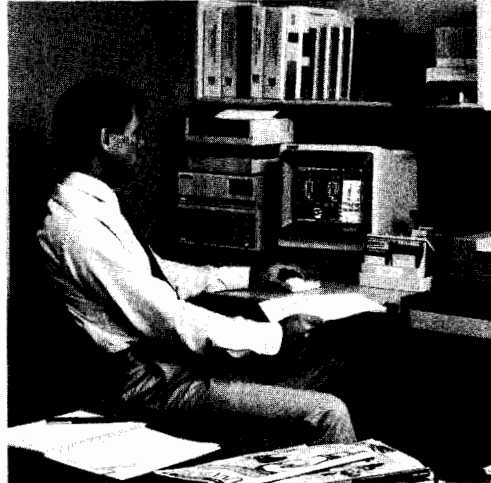

The HP 9000 Series 300 technical workstation provides the system and software design engineer with a flexible, high-performance, modular computer. Choose from a Motorola 68010 and 68020 CPU, four displays and the wide selection of HP peripherals, instrument and input devices.

Mechanical Engineering Solutions

HP has selected as marketing partners, creators of the leading applications software to link your design, drafting, analysis and manufacturing groups. HP third party software suppliers provide integrated solutions for 2D and 3D design, finite element analysis, solid modeling, geometric modeling, numerical control, computer aided test and tool path generation. These software solutions are widely known and used in the automotive, plastics molding, nuclear, aerospace, steel, computer manufacturing, AEC (architectural engineering and construction) and consumer products industries to name just a few.

Electrical Engineering Solutions

To round out our extensive proprietary Electrical Engineering and Computer Aided Testing offering, HP is working with third party suppliers to market software for logical design (schematic capture and simulation), physical design (IC and PC board layout) and microprocessor software development. Porting this software from third party sources to the appropriate HP hardware allows us to approach virtually all electrical engineering problems with complete solutions.

Software Engineering Solutions

Data Base Management Systems, FORTRAN and C programming environments, operating systems and utilities, compilers, debugging aids and documentation systems all are necessary parts of the programmer's tool kit. HP not only markets a large library of its own software engineering applications, it also helps merchandise numerous third party software packages in this area.

New software engineering capabilities that are available from HP third party vendors include relational data bases, artificial intelligence systems, assemblers, emulators, system documentors and software conversion aids.

Ordering Information

| | Price |
|-----------|--|
| 5957-4315 | Technical Systems Software Solutions Catalog (single issue) \$25.00 |
| 5957-8403 | Technical Systems Software Solutions Catalog (one year's subscription) \$80.00 |

Orders can be placed by calling CSO directly: (800) 538-8787 or (408) 738-4133 in California, Alaska and Hawaii.

The products included in this Technical Systems Software Solutions Catalog come from three sources:

1. Software submitted by third party suppliers to our HP PLUS Program which offers a vast "super market" of more than 750 technical software packages—from aerospace simulators to water utility operations. HP PLUS technical applications in such areas as civil engineering, petroleum exploration, earth sciences, process control, and math/statistics, all running on HP hardware, are available to solve a wide range of computational needs.

2. Software recruited from specially selected third party vendors who have developed software for particular markets associated with HP's Computer Aided Engineering strategy. HP is placing special emphasis on recruiting software vendors in the Mechanical, Electrical, and Software Engineering markets. Also included in this category are Technical Office Automation solutions—products that improve engineering productivity such as technical word processing, graphics presentation, data base management, spreadsheets, and numerical analysis solutions.

3. HP Proprietary Software, which offers you a broad selection of HP-proven technical applications, utilities, and complete solutions. Applications areas range from AC circuit simulation to statistical quality control and from engineering graphics systems to data communications software. Specific information on HP-created software can be found both in this General Products Catalog and in the Technical Systems Software Solutions Catalog mentioned above.

HP PLUS Program

To service its more than 250 independent technical software suppliers, HP relies on a vendor program called HP PLUS.



COMPUTER AIDED ENGINEERING

HP's Solution Support Program for CAE

Hewlett-Packard believes that CAE users would benefit the most from a comprehensive, integrated CAE solution. This solution is comprised of engineering workstations, peripherals, software and services tailored specifically to solve problems unique to your business and design engineering environment.

Solution support is not only important after purchasing the system, but in the investigative and evaluation stages as well. Thus our focus is on assisting you to

- investigate
- implement
- use
- adapt

the CAE/CAD system we have to offer.

HP uses a structured, *consultative* approach wherein a support representative helps you become self sufficient with the system in a well planned fashion. We work with you to evaluate your needs, present solutions to achieve your goals, gather appropriate resources and implement the entire project.

We know that you will be satisfied only when your initial objectives are met with *results* and you begin to see a return on your investment. Installation of the hardware and software alone does not lead to a fully productive system. Nor does a single training course. Achieving optimum system productivity could take several weeks or months and requires a full *curriculum* of education.

Our training courses are designed for your system manager, program developers and application users at different levels of expertise with the system. We even complement our training courses with expert guidance and consulting by our support representative, to steer you along the path to productivity. We feel that you will be self sufficient when you know how to adapt the system to your own evolving needs on an ongoing basis.

Hewlett-Packard has a wide range of support products and services that would apply to any serious user of our CAE/CAD solutions. These service products are applicable at specific periods during your Investigation, Implementation and Operation process. The following diagram will help you position and select the right service for your needs.

Range and Scope of Support for CAE/CAD

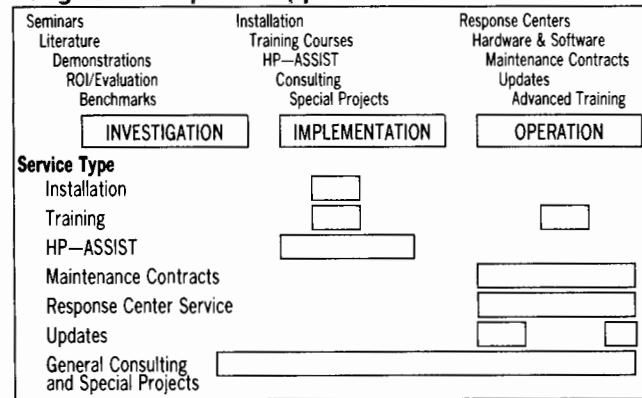

Support Products Available with Your CAE/CAD Solution

Our major service programs can be categorized as

- 1) Customer Education
- 2) HP-ASSIST
- 3) Consulting
- 4) Special Projects
- 5) Hardware and Software maintenance contracts.

Please see pages 759 to 767 for a detailed description of these programs. The following list and table illustrates the availability of support products with our CAE/CAD systems.

Customer Education

| HP 9000 HP-UX Systems | Days |
|---|------|
| 35073A HP-UX System Administration for Series 200 | 3 |
| 35128A Introduction to HP-UX | 5 |
| 35129A HP-UX System Administration for Series 500 | 3 |
| 35130A Programming in C language | 5 |



HP 9000 Language Systems

| | | |
|-----------------------------|--|---|
| 97005B | HP 9000 BASIC Upgrade for Series 500 | 3 |
| 98501A | BASIC Programming | 4 |
| 98502A | HP 9845 BASIC Operations and Programming | 5 |
| 98503A | BASIC I/O Programming | 4 |
| 98510A | Series 200 BASIC Operations and Programming | 5 |
| 98511A | Series 200 Pascal Operations and Programming | 5 |
| 98524A | HPL Operations and Programming | 5 |
| HP 9000 Applications | | |
| 98534A/X | HP-DRAFT at HP site/on-site | 4 |
| 98304A/X | Fundamentals of HP EGS at HP site/on-site | 3 |
| 98304B/Y | Advanced HP EGS at HP site/on-site | 2 |
| 98532X | HP-FE training course, on-site | 5 |
| 98363A+24D | HP ME Series 5/10 Fundamentals | 3 |
| 98365A+24D | Advanced concepts with HP ME Series 10 | 5 |

HP-ASSIST

| | |
|------------|--|
| 98360A+61A | Implementation Analysis for HP-DRAFT |
| 98360A+65A | Project Implementation Assistance for HP-DRAFT (Includes two seats in HP-DRAFT course #98534A) |
| 98360A+65B | Project Implementation Assistance for Shared Resource Manager used with HP-DRAFT |
| 98360A+65Z | Additional PIA units to HP-DRAFT ASSIST. |

Support Product Availability Matrix

| | Consulting | Installation | HP-ASSIST | AMS | RCS | SMS | WMMC | PMMC | FMCC | SMCC/BMMC | Training |
|-----------------------------|------------|--------------|-----------|-----|-----|-----|------|------|------|-----------|----------|
| HP EGS | • | | | • | • | • | | | | | • |
| HP ME Series 5/10 | • | • | • | • | • | • | | | | | • |
| HP DRAFT | | | | • | • | • | | | | | • |
| HP-FE | • | | | • | • | • | | | | | • |
| Languages/OS Series 200/300 | • | | | • | • | • | | | | | • |
| Languages/OS Series 500 | • | | | • | • | • | | | | | • |
| Series 200 | | • | | | | | • | • | • | | • |
| Series 300 | | • | | | | | • | • | • | | • |
| Series 500 | | • | | | | | • | • | • | | • |
| HP-Integral | | | | • | | | • | • | • | | • |

‡HP-UX only

New support products are continuously being added. Please contact your local sales office for availability details.

Software Description

HP-FE is a general purpose Finite Element system for linear structural and thermal analysis of 2D, axisymmetric and 3D structures and solids consisting of linear elastic materials with homogeneous isotropic and temperature-independent material properties.

The system is able to solve the majority of standard problems in structural mechanics and heat-transfer analysis assuming small displacements and small strain theory and a linear elastic material model. The system is well suited to analyzing medium sized problems encountered in real mechanical, electromechanical and civil engineering environments with a maximum of about 12,000 degrees of freedom.

HP-FE offers the advantages of simplified data preparation with

- Input in free format
- Input through the ME DesignCenter Series IO CAD system
- Powerful graphics capabilities for creation, automatic generation and verification of the Finite Element model
- Numerous output options to clearly display the results of an analysis

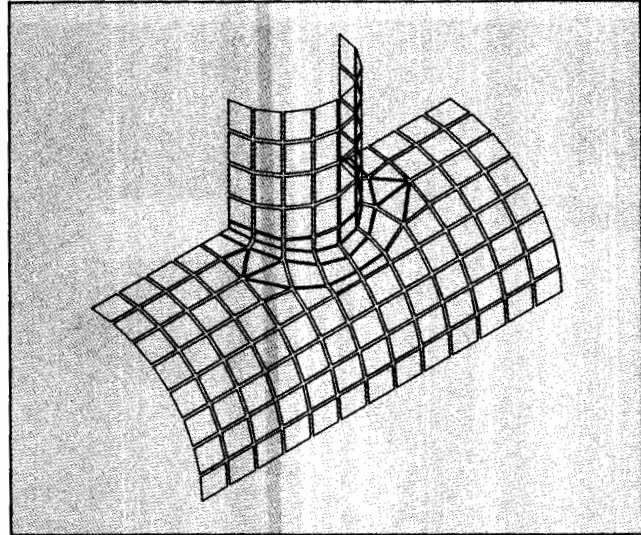

Mesh of Pipe Junction with Element Shrinkage

Types of Analysis

The extensive library of elements in HP-FE allows a structural model to be created for any shape. The analytical capabilities can be summarized as follows:

• Linear elastostatics

To solve for displacements, stresses, and reaction forces in linear elastic solids and structures subjected to applied structural and thermal loads.

• Linear dynamics:

- Mode frequency analysis

To extract natural frequencies and natural mode shapes (undamped free vibration forms and frequencies).

- Linear transient dynamic

To determine the time history solution of the response of a linear elastic structure to a transient dynamic load (general force excitation).

- Linear steady-state dynamic

To determine the steady-state response of a linear elastic structure to a time dependent, periodic force.

- Harmonic response analysis

To determine the steady-state response of a linear elastic structure to a set of harmonic loads of known frequency and amplitude.

• Linear heat transfer analysis:

To determine the steady-state or transient temperature distribution in 2 dimensional, and axisymmetric structures and solids due to temperature gradients and internal or external heat flux and heat sources.

Linear conduction and boundary convection conditions as well as internal heat generation may be considered. The calculated temperature distribution may then be used as input to a subsequent structural analysis.

Pre-Processor

An interactive and fully automatic 3D mesh generator for all element types is available to create Finite Element models. It will generate meshes automatically and display them for checking and modification by interactive editing.

The bandwidth optimizer (automatic node re-numbering) is an essential complement to the mesh generator. Its purpose is to reduce the bandwidth of the global stiffness matrix in order to improve the efficiency of the analysis by minimizing equation solution time and necessary storage capacity.

HP-FE provides an interactive graphics program to help the user to display and check the model in the most convenient way. The program permits rapid plotting of the model data on the graphics screen, plotter or graphics printer.

Post-Processor

HP-FE offers a number of output options within which a user selected subset can be printed or plotted based on the selection of load case, element group, and by element or node number range (e.g. displacements at selected nodes, stresses for selected elements).

Deformed shapes from a model corresponding to different load cases can be superimposed on the undeflected plot or displayed separately. All the features available in plotting the undeflected structural model also apply to the deformed mesh shape.

Specifications

| | |
|---|------|
| Maximum number of nodes: | 2000 |
| Maximum number of elements per group: | 500 |
| Maximum number of element groups: | 99 |
| Maximum number of load cases: | 24 |
| Maximum number of constraint equations: | 2000 |
| Maximum number of vibration modes: | 24 |
| Maximum number of contour lines: | 30 |
| Maximum number of material properties: | 100 |
| Maximum number of geometric properties: | 100 |
| Maximum number of combined load cases per combination equation: | 20 |
| Maximum number of suppressed nodes: | 700 |
| Maximum number of nodal forces/temperatures: | 1000 |
| Maximum number of prescribed displacements: | 1000 |
| Maximum number of load functions in dynamics: | 40 |

Ordering Information

HP 98353A

(designed to run on HP9000 Series 200 and 300)

Price

\$9,500



Introduction

HP Design Center Mechanical Engineering Series 10 is a 2D design and drafting system for mechanical engineering applications. It is also the core building block of a new generation of mechanical design solutions.

The system provides comprehensive design functionality which is presented to the user via a very friendly user interface. The interface has also been designed for maximum flexibility so that it can be customized to specific needs.

ME Series 10 runs on the complete range of HP 9000 series 300 engineering workstations under either the Pascal operating system or the HP-UX environment. These systems are complemented by the availability of both LAN and SRM networks.

Software Description

Functionality

ME Series 10 offers a powerful set of functions for complex mechanical part and assembly design as well as schematics. The result is high design efficiency with fast creation and modification of drawings.

Drafting features include:

- construction geometry
- an electronic "ruler" to emulate drawing board techniques
- viewport functions
- semi-automatic creation of isometric drawings
- functions for dimensioning according to international standards

Other capabilities ensuring high design productivity are:

- variation design features
- measurement of area properties
- parts, subassembly and assembly handling
- parts list generator

A high level macro language enables the user to tailor the system to his specific needs. All these design and drafting features are backed up by a filing system allowing easy storage of data.

User interface

Short learning cycles and friendly system handling are essential for engineering productivity. The ME Series 10 user interface is menu-driven and provides the ease-of-use beginners require together with customizing capabilities for the advanced user.

ME Series 10 offers a choice of 2 standard user interfaces optimized for the mechanical engineer and draftsman:

- a tablet/screen user interface is the ideal combination to offer functions directly accessible from the tablet, complemented by screen menu subfunctions.
- a screen-only version together with a "mouse".

Links to CAM and other applications

A major objective of CAD/CAM systems is the use of the same data throughout the design and manufacturing process. ME Series 10 meets this objective. Links to Finite Element analysis (e.g. to HP-FE) as well as to NC-programming are available. Additionally, direct access to the ME Series 10 design data is possible via external programs.

This open system concept allows for integrated and customized solutions to meet the growing needs of industry.

Ordering Information

HP 98365A ME Series 10 on HP 9000 Series 300, Pascal O.S. included, delivered on tape cartridge

HP 98366A ME Series 10 on HP 9000 Series 300 to run with HP-UX (O.S. not included) delivered on tape cartridge

Price

\$10,000

\$10,000

COMPUTER AIDED ENGINEERING/TEST

Dual-Channel, Dynamic Signal Analyzer 64 μ Hz to 100 kHz

Model 3562A

179



- Testing & analysis solutions for electronics, mechanics & electro-mechanical control systems.
- Network analysis
- Spectrum analysis
- Transient analysis
- Waveform recording
- Frequency response analyzer
- Modulation analysis
- Direct control of disc drives
- Direct control of HP-GL plotters

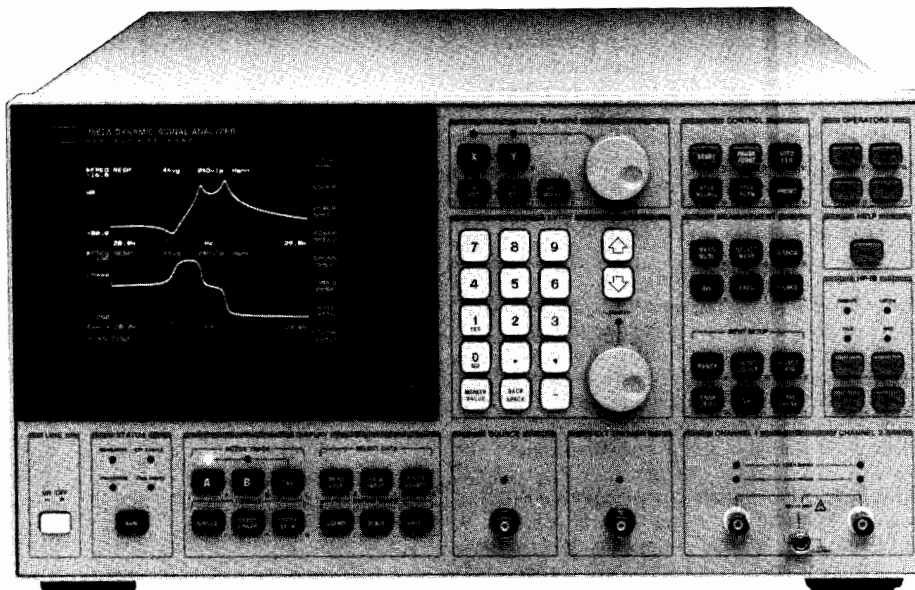

HP 3562A



The HP 3562A Dynamic Signal Analyzer is a dual-channel fast-Fourier transform-based network, spectrum and waveform analyzer which provides analysis capabilities in both the time and frequency domains. The dc-to-100 kHz frequency range, 150 dB measurement range and 80 dB dynamic range of the analyzer makes it a powerful solution for testing and analysis in electronics, mechanics and electro-mechanical control systems.

Two high performance input channels and a built-in signal source (noise and sine signals) address network analysis on the bench or in a test system. Zoom analysis with frequency resolution to 25.6 μ Hz plus a powerful AM, FM and PM demodulation function makes the HP 3562A a versatile spectrum analyzer. For transient or waveform analysis, signals can be sampled, digitized then stored in an internal memory, or directed via HP-IB to an external disc drive (without a computer). The stored waveforms can be recalled and analyzed in the time and frequency domains (baseband and zoom analysis).

Additional features include a full range of data analysis capabilities such as vector averaging, block-operation Waveform Math, a 40-pole/40-zero Curve Fitter and Frequency Response Synthesis. Front panel operations can be automated without a computer with built-in Auto Sequence programming, or with computers through complete HP-IB programmability. For documentation of results with hardcopy or mass storage, the HP 3562A can control digital plotters and external disc drives directly via HP-IB.

Network Analysis

Accurate, high resolution frequency response measurements of electronic and mechanical systems can be performed with Linear Resolution FFT, Logarithmic Resolution and Swept Sine analyzer. A built-in signal source provides a variety of random noise and sinewave signals to meet the requirements of the system under test.

Spectrum Analysis

On-line analysis of distortion, drift, modulation and phase noise can benefit from the speed and accuracy of the HP 3562A. High resolution measurements are typically 100 times faster than tuned spectrum analyzers — and, since the HP 3562A is an FFT-based analyzer, you can see transient events that a tuned analyzer would probably miss.

For complete specifications and pricing information see page 706.



COMPUTER AIDED ENGINEERING/TEST

Digital Vibration Test Control System

Model 5427A

- Random test flexibility for use with MIL, IEC, and other standards
- Automatic out-of-tolerance detection protects device under test

- Economical expansion for sine and transient control
- Ultra-high random control resolution: 512 lines standard (1024 lines optional)

Description

Closed-loop control of environmental and/or developmental vibration test stimuli for random, transient, and sine testing is available in the HP 5427A.

The basic HP 5427A Vibration Test Control system consists of: 2-channel (expandable to 4) analog-to-digital converter for processing feedback information; 21MX-E series, microcoded digital processor; HP 1335A Persistence CRT display; HP 2623A Graphics Terminal with built-in printer; pushbutton control unit; HP 9885M Flexible Disc storage unit; cabinet and programs for random control.

The HP 5427A is the ideal vibration control system for production vibration testing where random, transient and sine testing are required and offers a selectable set of analysis routines especially designed for easy operation by laboratory personnel. The following vibration test control capabilities apply to the HP 5427A.

System Operation

Random, sine and transient control follow the same logical operational phases. First, the appropriate disc is loaded and the test program or setup (envelope, alarm and abort limits, test time, calibrations, etc.) is loaded from disc storage in response to search codes or names. If a new program or modifications are desired, a friendly question-and-answer sequence is used. Once a new setup has been generated or changes made, it can be assigned a new name and stored for later use.

After a satisfactory setup is obtained, the operate phase allows control of the actual test via pushbuttons on the central control panel. Removable snap-on overlay panels clearly label buttons for the type of test desired. Choices of on-line displays and a save button allow saving of data for later plotting, including auxiliary PSD measurements during random control.

After the test, results and all saved data are available for review or documentation. The graphics terminal or an optional HP-IB compatible digital plotter provide fully labeled, report-quality plots of test results. In random control, fully labeled plots can be obtained while the test is running (open loop) using the terminal or an optional HP-IB plotter such as the HP 7470A.

Specification Summary

Random Control

Resolution: 64, 128, 256, or 512 lines (1024 lines optional)

Bandwidth: Δf to 5000 Hz

Loop time: <0.9s for 256 lines, 2500 Hz bandwidth, one control channel and full display

Dynamic range: >65 dB

Accuracy rms PSD accuracy: $\pm 2\%$

Control PSD accuracy: ± 1.0 dB (90% confidence level) Higher accuracies are typically achievable with increased control spectrum averaging.

Sine Control

Frequency range: 0.1 to 5000 Hz. Upper and Lower sweep frequency limits and starting frequency may be specified anywhere in the frequency range (resolution: 0.1 Hz).

Sweep rate: 0.001 to 100 octaves/minute log, 1 to 100,000 Hz/minute linear, operator selectable.

Harmonic components: >60 dB below full level fundamental output



HP 5427A

Sweep time accuracy: $\pm 0.25\%$ or ± 52 ms, whichever is greater

Amplitude accuracy: the greater of ± 2.5 mV or $\pm 1\%$ of specified reference value.

Output dynamic range: 72 dB

Transient Control

Classical reference waveforms: half-sine, terminal peak sawtooth, triangle or rectangle

Polarity: positive or negative

Duration range: 0.5 to 100 ms

Duration accuracy: $\pm 5\%$ for half-sine and terminal peak sawtooth at pulse baseline crossover points

Shock response spectrum synthesis: time domain waveforms are synthesized from a user-specified shock response spectrum (SRS) off-line in the setup mode

Resolution: $1/N$ octave, N is any integer from 1 to 9

Frequency range: 2 decades nominal, 2.6 decades maximum

Maximum frequency: $1/N$ th octave below 10,240 Hz

Ordering Information

HP 5427A Vibration Test Control System

Option 070 High resolution random (1024 lines)

Option 075 Transient control

Option 080 Sine control

Price

\$55,400

\$1205

\$3020

\$3020



HP EGS on HP 9000 Model 320

HP EGS Engineering Graphics System

Hewlett-Packard's Engineering Graphics System (HP EGS) continues to evolve to meet the demand for powerful, low-cost computer solutions within the engineering environment. HP EGS is a 2-D computer-aided design (CAD) system that helps the engineer create schematics, printed circuit (PC) board layouts, mechanical engineering drawings, and other engineering artwork. Developed for use on the HP 9000 Series 200 and 300 workstations and peripherals, HP EGS has numerous built-in design tools such as rat's nest generator, connect list compare, and materials list output to aid you in electrical and mechanical engineering design.

HP EGS functions expertly in stand-alone configurations or in a Shared Resource Management (SRM) system. The SRM can improve productivity by allowing several users to share data; it can save cost by allowing users to share peripherals. HP EGS is ideal for the novice with little knowledge of computers, and for the more experienced user who wants to develop custom applications.

Revision 2.1 HP EGS builds upon more than 2500 installations of earlier versions both inside HP's R&D labs and at client facilities, where 70% of all users report they routinely employ two or more of the multiple personalities.

Features and Capabilities

HP EGS is not just a simple computer-aided drafting system, but a flexible, multipurpose tool with several distinct drawing environments or personalities attuned to specific design needs. At the heart of HP EGS is the graphics editor, the tool used to generate drawings on the screen. You can enter all the drawing elements, numbers, and commands from a tablet menu or the screen, using a graphics tablet stylus or a mouse.

Drawings can be created using several elements—lines, circles, rectangles, polygons, arcs, text. Complex, frequently used shapes can be stored as library parts and called up as needed. Shapes on the screen can be altered with screen editing commands. It is possible to move, copy, delete, scale, rotate, or stretch lines and objects. New drawings can be created by modifying existing ones.

The specialized user environments, or personalities, in HP EGS efficiently address tasks in the following areas:

Electrical Engineering—used to draw printed circuit board artwork and circuit schematics

Mechanical Engineering—built with the isometric drawing capability that allows mechanical engineers and draftspeople to generate 2-D representations of 3-D drawings

General Drawing—geared for easy preparation of such general-purpose artwork as floor plans, telephone line layout, and pipeline schema



COMPUTER AIDED ENGINEERING

HP EGS Engineering Graphics System

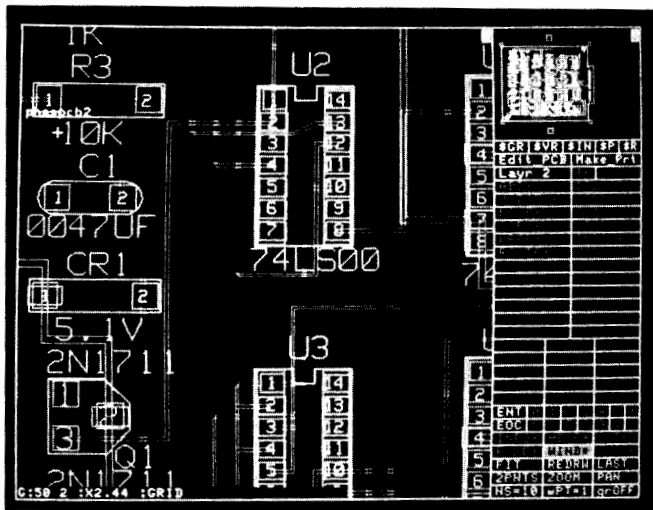

HP EGS Enhancements

Revision 2.1 HP EGS has a number of special tools that facilitate design—tools you'd expect to find in more advanced and expensive CAE/CAD systems. Among them:

Isometric mode—allows you to draw isometric views of objects or to show assembly operations on a single drawing.

Rat's nest generator—adds point-to-point connections between placed printed circuit board components based on a connection list from a schematic. Aids ready detection of congested areas.

Connect list compare—compares system-generated schematic and printed circuit board connect lists to ensure exactness.

Photoplotter/NC drill output (option)—converts HP EGS drawing information to the format required by a Gerber photoplotter or an Excellon numerical control drilling machine.

IGES pre/post processor (option)—translates drawing files into IGES (initial graphics exchange specification) format, making it possible to move them to other vendors' graphics systems, and back to the originating site.

GATHER command—lets you move segments of a drawing without losing connectivity.

Many other features designed into HP EGS contribute to its improved performance.

Three Specialized Personalities

Electrical Engineering Personalities

The Schematic Drawing and PC Board Layout Personalities in this software module now make it easy to turn engineering ideas into physical reality.

The Schematic Drawing Personality assists you in creating schematics of electronic designs much more rapidly than by manual methods. HP EGS is fast enough that you can always work with a current drawing. The symbol library for this personality contains such factory-defined sample elements as passive and active devices, digital devices, and package chips.

The PC Board Layout Personality allows you to create printed circuit board artwork for your electronic designs. This personality

makes the conversion from design into format suitable for a photoplotter or an NC drill machine. Another feature designed to further enhance HP EGS is the rat's nest generator which helps you make appropriate connections between placed components and a schematic connection list on the PC board using 'airlines.'

Mechanical Engineering Personality

Designed to assist engineers and draftspersons prepare 2-D mechanical drawings, this module dramatically reduces drawing time. You can use construction geometry techniques to create drawings; you can use construction lines while creating the drawing; and you can easily do isometric drawings. This easy-to-use personality expands to grow with your mechanical drawing requirements. The library for this personality is based on ANSI standard specifications.

General Drawing Personality

The easy-to-learn General Drawing Personality has the power of the other personalities to lend to a multitude of applications... from generating overhead slides, block diagrams, floor plans, project scheduling diagrams to any other general artwork.

General Drawing is where many new users begin to learn how to use HP EGS, and where many sophisticated users come to create their own environments.

HP EGS Options

HP TechWriter. Documenting your engineering tasks, writing reports, and developing presentation-quality materials that include illustrations consume a major portion of an engineer's time. HP EGS combines with HP TechWriter to deliver quality presentation materials.

This optional document editor works with the entire Series 200 and 300 family of workstations, and can be purchased separately from HP EGS. Using a picture processor, document editor, and lister, HP TechWriter electronically merges words with the pictures created by HP EGS.

Photoplotter/NC Drill Postprocessors. Printed circuit board designers often need to convert their designs into a format suitable for a photoplotter or an NC drill machine. HP's optional photoplot/NC drill feature makes the conversion for printed circuit boards designed on an HP EGS workstation. Output is in Gerber photoplotter and Excellon drill format, respectively. These ASCII formatted files can be ported to these machines in compatible magnetic tape or paper tape form. Standard data communications can also be used to move the files to these machines.

IGES Translators. Conforming to the initial graphics exchange specification (IGES), HP EGS IGES translators allow you to move HP EGS drawings to other CAD systems; or, you can move drawings from other systems to HP EGS. HP EGS can be used as a low-cost front end to your expensive CAD systems.

Large Digitizer. Some applications need the ability to digitize large drawings. HP EGS supports a Summagraphics Microgrid series E-size digitizer, the Model MG3548. Data transfer is accomplished via an RS-232 interface.

Ordering Information

| | | Price |
|--------|---|----------|
| 98305A | HP EGS 2.1 | \$10,000 |
| 98310A | HP EGS Photoplotter and NC Drill Tape Utilities, Right-to-use | \$3,000 |
| 98311A | HP EGS IGES Translators, Right-to-use | \$5,000 |
| 98819A | HP TechWriter 1.2, Right-to-use (Can be purchased separately) | \$795 |



Shorten the Design Cycle

Development of electronic products has changed drastically in the last decade. The advent of microprocessors was just the beginning. Technological advancements which are constantly lowering hardware prices and increasing performance are continuing at a staggering rate.

What does this mean to you? It may mean the software component of your product is now as significant as the hardware. Proper management of software development and system integration phases is now critical to producing a product.

Recently, an electronics industry article* compared the impact of development costs, product costs, and late product introduction. Using a representative high-growth market: 5-year product life, 12% annual price erosion,

and 20% growth per year, an overrun of 50% in a product's development costs will decrease after-tax profits by 3.5%. By contrast, a product-cost overrun of only 9% results in a 22% decrease in after-tax profits. But, even more significant, a six month delay in product introduction costs 33% of the after-tax profit.

Keeping a project on schedule is not as easy as adding more people. You know how difficult it is to find and train qualified people. And, too many people may actually throw the project further off schedule. The answer, of course, lies in higher productivity. Hardware and software designers need a design environment that helps them to be as productive as possible. Increased project complexity means that this environment must support project management as well, so that team efforts remain focused on objectives and progress is easily tracked.

Increase Productivity

The HP 64000 Logic Development System is an effective solution to shortening the microprocessor design cycle. It's the first sys-

tem to combine advanced software development, real-time emulation, sophisticated hardware/software analysis capabilities, and the power of the HP-UX** operating system.

Configuration flexibility combines with ease of operation and fast response to form a system that lets your people do their best work in the shortest time. Software project management tools running under the HP-UX operating system ensure smooth progress in the development cycle. Software engineers benefit from the tightly-coupled, high-level software development and analysis tools. Real-time performance analysis tools point to system bottlenecks, allowing significant improvements in performance in a fraction of the time of conventional techniques.

Powerful, interactive, yet, easy-to-use emulation and timing analysis speed hardware development. Since the HP 64000 system allows many engineers to share the same data base

*Figures from Donald Reinertsen, McKinsey & C. (Los Angeles, CA), *Electronic Business*, July, 1983, p. 66. ©1983, Cahners Publishing Company

**HP-UX is Hewlett-Packard's enhancement of the UNIX operating system. UNIX is a trademark of AT&T Bell Laboratories.



LOGIC DEVELOPMENT SYSTEMS

Advantages of an Integrated Approach

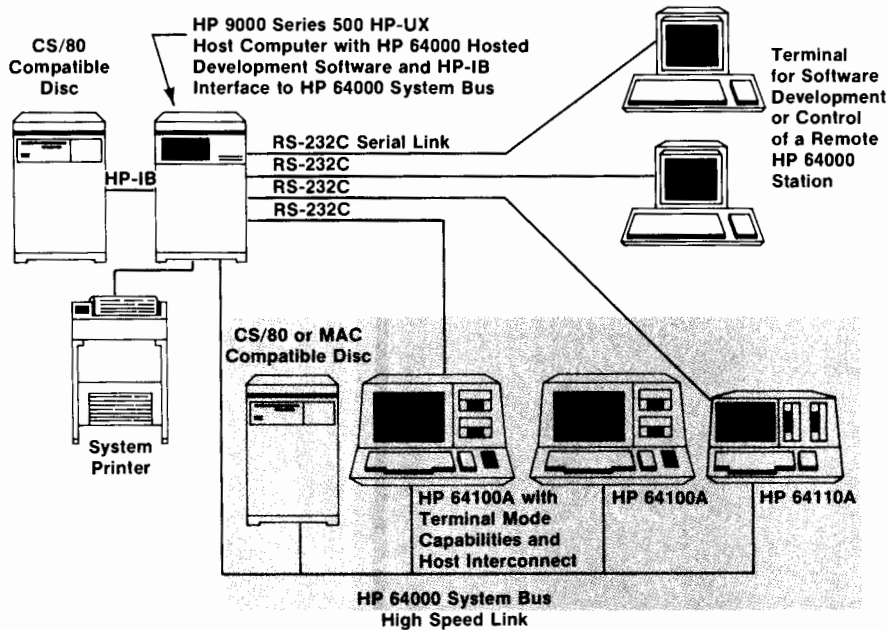

The HP 64000 logic development system is easily tailored to match your design environment. For small to medium-sized teams, up to six stations can be assembled in a single cluster (shaded area) with direct access to a central data-base. Larger teams are accommodated by adding a multi-user HP-UX computer to the high-speed HP 64000 system bus. Powerful networking links clusters to form a distributed development system to cover an entire lab.

and combines interactive tools for the hardware and software tasks, system integration (often the most time consuming development phase) is greatly enhanced. All this means product development schedules are shorter and better products get to market sooner.

In addition to complete development capability, this system also has tremendous flexibility to adapt to your development task . . . in your particular lab . . . to your unique approach. The HP 64000 system can include development stations (operating stand-alone or in clusters), HP 9000 series 200 and 500 multiuser computers running the HP-UX operating system, high performance HP peripherals, and advanced software; all configured for maximum productivity and cost effectiveness in your environment. The HP 64000 system can grow with your needs and provide complete assurance that your original investment is protected.

Work Stations

The heart of the HP 64000 system is the HP 64100A system workstation which contains a powerful, 16-bit computer, optimized for software development, emulation, and analysis. Stations are capable of performing stand-alone or in a cluster sharing high-performance peripherals. The peripherals are shared via a high-speed bus and proprietary networking software. An expensive network controller or file server is not required. Upgrading from a single station hard disc-based system to a multi-station system is as simple as connecting another productive station to the bus and turning it on.

Every station contains a card cage for the emulation and analysis subsystems that support the design team in each phase of the proj-

ect. The addition of powerful HP software tools such as compilers, assemblers, and linkers provides complete development capability for a wide variety of microprocessors. Syntax driven softkeys are the consistent, easy-to-learn interface to all these capabilities.

A System to Match Your Needs

Larger design environments can benefit from the inclusion of HP 9000 series general computers running the HP-UX operating system. The HP 9000 family of computers ranges from single user systems up to multi-user systems incorporating Hewlett-Packard's own state of the art 32-bit microprocessor. The computer connects directly to the HP 64000 system bus so that it shares the same data base with the development system. Access is provided from the computer terminals to the real-time execution and analysis environment of the HP 64000 stations, allowing them to be shared between several engineers.

The HP 9000 family of computers also offers extremely powerful networking capabilities that allow easy sharing of data from team to team, yet preserve team independence for project management purposes. They also accommodate a variety of physical layouts, whether the lab is across the hall from the engineer or across the country.

The HP-UX operating system provides software revision control systems and automatic compiling and linking to assure that the current version of a module is always being used. An electronic mail system and other communications software encourage and speed the sharing of information between teams as well as between team members.

HP 64000 software development and data communications software is also available to run on DEC VAX* series computers. This means that you can protect existing investments and still take advantage of all the power of the HP 64000 system.

The HP 64000 adds up to a system capable of solving all a team's development needs with enough flexibility to meet your organizational and budget requirements.

Tightly Integrated Tools Streamline the Software Design Cycle

The UNIX operating system, from which HP-UX is derived, was designed to be an ideal environment for software development. HP-UX, therefore, provides many tools for the software engineer. The hierarchical file structure allows easy organization of a project. Text processing utilities speed documentation. A system of "pipes" and "filters" allows the simple utilities the system provides to be combined together into powerful, yet easily understood commands. This flexibility allows an engineer to tailor the system to the task at hand. This can obviate many repetitive, tedious, and error-prone activities which hinder progress.

Another very important tool for enhancing the productivity of a software designer is high-level language. A designer can produce better documented, easier maintainable, and more transportable code using a high-level language in much less time than using assembly language.

*DEC VAX is a trademark of Digital Equipment Corporation.



An integrated set of modular development tools are well-suited to applications that require teams of designers. A common database enhances a smooth integration of all the components.

The HP 64000 development system allows the software designer to make maximum use of high-level languages. By integrating the synthesis and analysis tools into the same system a sophisticated data base generated by the compilers, assemblers, and linkers may be shared. This data base goes beyond merely providing global symbol information. HP 64000 logic analysis tools can access and display the original source lines in their trace listings, including comments. Data values can be referenced in the terms they were defined. Program flow can be analyzed on a procedure level rather than a machine code level. Analysis and debug can now be accomplished in terms of the source language, transparently, and in real-time. That means problems are found and solved sooner.

Many times a high-level language is avoided for projects with critical performance specifications. Hewlett-Packard is a pioneer in the development of nonintrusive performance analysis tools which address this problem. These tools allow development to be done quickly and efficiently in a high-level language. Overall system performance is then examined, bottlenecks and critical paths identified, modules are optimized and only where necessary (and that is the key), rewritten in assembly language. This optimization proceeds even to the assembly language level, assuring maximum performance. Performance analysis, done at real-time execution speed with no disturbance of the target system or its software, ensures that efforts are focused where they are the most productive.

Tightly Coupled Measurements Speed the Hardware Development Task

In-circuit emulation has become one of the most widely used tools in the development of microprocessor-based products. By replacing the microprocessor in the system under test, complete control, as well as a crystal clear window into the prototype system, is obtained. Faithfully emulating today's complex processors is critical. Otherwise, hours may

be wasted trying to solve a phantom problem introduced by the emulator, not the prototype system. Designers must trust the emulator so that time is spent productively debugging the target system and not the instrumentation.

Hewlett-Packard's emulation tools are up to the task. A wide variety of processors are supported so that the optimal processor can be selected for your project. All support real-time emulation, that is, they execute at the same speed as the processor. One of the most innovative tools in the industry, a user-definable emulator, is also available to support a proprietary processor or provide an early start on a new processor.

A pioneer in the field of logic analysis, Hewlett-Packard has combined its measurement expertise and its custom, integrated-circuit technology to add sophisticated logic analysis to the HP 64000 development system. An example is the powerful, 400 MHz timing/125 MHz state analyzer which makes use of the computing power of the station to provide advanced statistical information on the data it has captured. This does more than make the HP 64000 system development stations general-purpose logic analyzers. It allows engineers to use the analysis and emulation tools together as a system. Analysis and emulation modules interact over a high-speed bus to quickly pinpoint problems between multiple processors and subsystems. Not a patchwork connection of separate instruments, this capability is an intrinsic part of the HP 64000 system architecture.

All this is made possible by the modular design of the HP 64000 system stations, the hardware subsystems, and the self-configuring software. This means that the development station adapts to the needs of the moment. Whatever phase of the project, the appropriate capabilities are available. Several stations can even be combined into a single, extremely powerful measurement

system, when needed, to quickly solve the most complex problems and avoid costly delays. When schedules and budgets are tight, the HP 64000's adaptability means you get the most for your money.

Service, Support, Training

Hewlett-Packard has been a successful supplier of tools to the electronics industry for many years. During those years HP has earned an enviable reputation for customer satisfaction. There are two major reasons for this. First, the quality and reliability of the products Hewlett-Packard builds. Second, the wide spectrum of professional support available to our customers.

Reliability and serviceability are designed into Hewlett-Packard products. A comprehensive quality assurance program that begins with the original design specification has resulted in an extremely low failure rate for the HP 64000 system when compared to the rest of the computer industry. This is a major factor affecting the overall productivity of your designers, because if the development system isn't working, neither are your engineers.

HP also provides trained professionals who understand your development needs. A Customer Engineer performs on site installation and verification of equipment upon delivery. Systems Engineers answer technical questions and are available for applications assistance on a consulting basis. Training courses are available to bring your people up to speed quickly on the latest and most advanced development tools. Maintenance contracts are available that can be tailored to best suit your company's requirements. All this means you receive maximum return on your investment when you choose Hewlett-Packard.

Call your nearest Hewlett-Packard field office and find out how the HP 64000 system can help your next project come in ahead of schedule and under budget.



LOGIC DEVELOPMENT SYSTEMS

Software Design

Model 64000



HP 64000 Logic Development System

Software Development

The HP 64000 Software Design Center provides all of the advantages of an integrated approach to software development verification/analysis and system integration. There is, however, a strong trend towards the use of a central computer for software development, especially in large design environments where many engineers need access to the powerful software design and program management tools available with a UNIX or VMS operating system. Ideally, a design team should have an environment with the advantages of both the central computer and the tightly-coupled, development system integration and analysis tools. This "ideal" design is available in the HP 64000 Logic Development System. The tight coupling has been extended from the system integration and analysis tools of the HP 64000 work station to HP 9000 series 200 and 500 computers with HP-UX and DEC VAX series 11/7XX computers running the VMS system. This tight coupling is accomplished through a high-speed HP-IB link such that the computer and HP 64000 station operate as a unit. The result is a distributed processing, centrally controlled network where numerous users can be supported with low cost terminals while sharing the resources of the central computer and the emulation and analysis capabilities of an HP 64100 or 64110 workstation.

HP 64000 compatible C, PL/M, and Pascal cross compilers and cross assemblers have been developed for both the HP and DEC computers and their respective operating systems. In addition, a new remote access capability allows designers to access the emulation and analysis tools of an HP 64000 station from any of the terminals in the network.

Now, even larger design teams have the advantages of a tightly-coupled, integrated approach to software engineering. Software synthesis is accomplished efficiently using the fast, cross software tools

and program management tools under the powerful UNIX or VMS operating systems. The target processor's native code along with appropriate symbol table information is passed over the high-speed link to the HP 64000 station where software debugging can occur at the source code level and in real time. As software bugs are found, the context can immediately be changed to the source code editing environment where changes are made. As target hardware is developed, system integration and analysis can proceed and the software characterized and optimized — always at the source code level. The productivity of the entire design effort is greatly enhanced since design automation techniques are applied throughout the design process. Bugs are found earlier at less cost and documentation is maintained throughout the design cycle.

System Architecture

The fundamental unit of an HP 64000 System is the Development Station. Flexibility of the system architecture exists across two dimensions: within stations and between stations.

Within the station, the multiple bus structure is the key architectural feature. The operating system and station CPU communicate with the option-card slots via the development station bus. This bus carries address, data, and control signals from the host CPU and supplies power to all option cards. Cards which comprise a distinct subsystem, e.g., an emulation subsystem, communicate via separate high-speed subsystem buses. Another bus, the intermodule bus (IMB) is the link for interactive analysis modes. Since buses are not shared, the host system does not intrude on emulation or analysis operations to conduct "housekeeping" tasks, allowing real-time run modes and multitasking for the subsystems.

Functions for each development station are defined by the subsystems installed in the station. Subsystems reside on cards, and a single subsystem may require from one to five cards. Operating software is

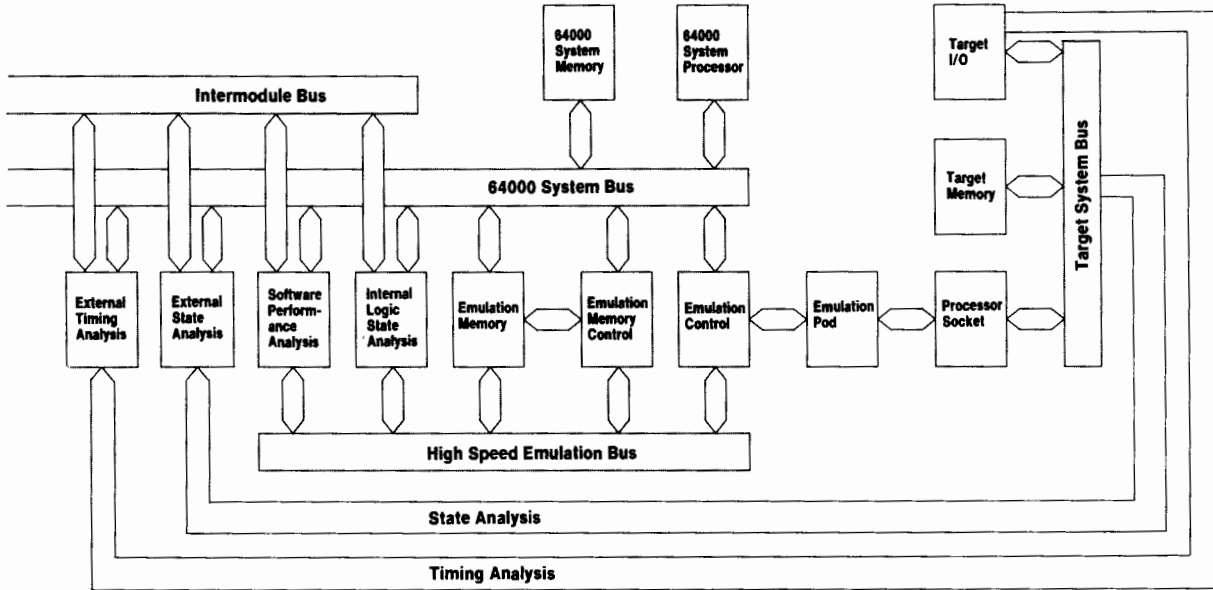

An advanced, flexible, dual-bus architecture is the key to real-time transparent emulation in the HP 64000 development system. The HP 64000 host processor communicates with installed subsystems over the system bus while emulation operates over a separate high-speed emulation bus. Other subsystems, such as performance analysis, emulation bus analysis, along with target system state and timing analysis can perform measurements without interfering with emulation activities.

Software Development Support Matrix

| Microprocessor | Emulation/Analysis | Assembler/Linker | Pascal Compiler | C Compiler | PL/M Compiler |
|---|--------------------|------------------|-----------------|------------|---------------|
| HP 9000, Series 200, 300, 500, HP-UX, DEC VAX, 11/7XX, VMS* | ■ | ■ | ■ | ■ | ■ |
| 8080/85 | ■ | ■ | ■ | ■ | ■ |
| 8048 Family | ■ | ■ | ■ | ■ | ■ |
| 8051 | ■ | ■ | ■ | ■ | ■ |
| 8086/88/186/188 | ■ | ■ | ■ | ■ | ■ |
| 6800 Family | ■ | ■ | ■ | ■ | ■ |
| 6809/09E | ■ | ■ | ■ | ■ | ■ |
| 6805 | ■ | ■ | ■ | ■ | ■ |
| 68000/010/08 | ■ | ■ | ■ | ■ | ■ |
| Z80 | ■ | ■ | ■ | ■ | ■ |
| Z8001/2 | ■ | ■ | ■ | ■ | ■ |
| NSC 800 | ■ | ■ | ■ | ■ | ■ |
| 9900 Family | ■ | ■ | ■ | ■ | ■ |
| TMS 320 | ■ | ■ | ■ | ■ | ■ |
| 6502 | ■ | ■ | ■ | ■ | ■ |
| 1750 | ■ | ■ | ■ | ■ | ■ |
| User Definable | ■ | ■ | ■ | ■ | ■ |

*DEC, VAX, and VMS are trademarks of Digital Equipment Corporation

stored on the mass storage device used for the configuration, and stations sharing common memory can all access the stored software. For example, in a cluster arrangement, all stations in the cluster can use any of the assemblers and compilers stored on the cluster's mass storage device.

Between stations, there are four basic arrangements. A system cluster, with hard disc, printer, and development stations, operates as a distributed processing network. Distributed processing takes advantage of the powerful host CPU resident in each development station, maintaining a high level of responsiveness even when extra stations are added, up to a total of six per cluster. For larger design programs with major software development demands, uniting the development system with an HP 9000 or other compatible computer via a high-speed link adds extra stations and extra capabilities. Typically, the

tools for writing software are housed in the computer, and object code and symbol tables are passed to development stations to take advantage of the simulation, integration, and optimization tools of the HP 64000 System. The special development aids can be accessed directly on a development station or remotely from a computer workstation. A third possibility is setting up a single development station as a benchtop instrument. A fourth basic setup with an RS-232 link defines a development station as a terminal for a host computer and an independent analysis/emulation instrument.

New products for the HP 64000 System are compatible with existing HP 64000 Systems that are maintained or updated to current status with Software Subscription Service. As applications change, the user can reconfigure an HP 64000 System to meet the new needs. On-going compatibility allows users to take advantage of enhancements and new subsystems as they become available.

Development Stations

Development stations are the user's interface to the Logic Development System. There are two stations, Model 64100A Development Station and the smaller, transportable Model 64110A Development Station. In use, the two stations are functionally the same, with an ASCII keyboard and eight syntax-driven softkeys to operate the installed subsystems. Each station contains:

- High-performance, 16-bit host processor
- Resident ROM and RAM memories for HP 64000 station CPU
- Card cage with five or ten slots for subsystem option cards
- RS-232-C (V.24) interface to access other clusters or computers

Model 64100A Development Station has ten slots to accommodate subsystem cards. An optional PROM programmer can be installed directly in the station, to the right of the keyboard; specific interfaces are available for most of the commonly used PROMs. Local mass storage can be added with Option 041 Dual Flexible Disc Drives. At least one station in an HP 64000 System cluster must have local mass storage as a means of entering operating software for the system and any subsystems. Local mass storage frees the station for stand-alone applications, and it also provides a convenient, economical means of storing and transferring work in progress.

Dual, flexible disc drives are standard for Model 64110A Development Stations. The transportable HP 64110A station has adjustable legs and a hinged keyboard, which makes it a logical choice for field and stand-alone uses. HP 64110A development station has five option card slots.

LOGIC DEVELOPMENT SYSTEMS

Software Evaluation and Verification

Model 64000



A broad selection of emulator subsystems ensures that there is HP 64000 System support for any of the most popular microprocessors. When a new design requires a different microprocessor, a new emulation subsystem can be installed readily.

Emulation

The HP 64000 Logic Development System offers a wide selection of emulators to support microprocessor-based product development. These emulators provide an essential link between the software development environment and the target system. Programs developed on the HP 64000 system or compatible computers are run on the emulator subsystem for real-time debug and analysis. Processor run controls in the emulator allow you to single-step, display, and modify memory. Modifications and improvements to software are made quickly and easily in the early design phases; emulation gives you the flexibility to experiment before committing a product to firmware. Features of an HP 64000 emulation subsystem include:

- Real-time emulation mode without inserted wait states
- Run-time controls for single cycling and register display
- Mapping memory blocks to emulation or target memory
- Simulated I/O using HP 64000 System resources
- High-speed emulation memory

Software modules can be evaluated as they are developed, rather than after both hardware and software are totally complete. Since much of the debugging is done as modules are added, there are far fewer problems in integrating hardware and software. The HP 64000 System emulators add one more dimension of user friendliness—all emulation commands are entered with directed-syntax softkeys from the development station keyboard.

The Logic Development System offers emulation subsystems for a variety of 8-bit and 16-bit microprocessors. Presently, emulators are available for the following processors:

| | | | |
|--------|------------|-------|----------|
| NSC800 | 6803 | 70108 | 8086 |
| Z80 | 6805/R/U/P | 70116 | 80C86 |
| Z8001 | 6808 | 8031 | 8088 |
| Z8002 | 6809 | 8035 | 80C88 |
| 6301 | 6809E | 8039 | 80186 |
| 6303 | 68A09 | 8048 | 80188 |
| 6800 | 68B09 | 8049 | 146805G2 |
| 68A00 | 68B09E | 8051 | 146805E2 |
| 68B00 | 68000 | 8080 | TMS32010 |
| 6801 | 68008 | 8085 | F9450 |
| 6802 | 68010 | | |

For microprocessors that are not presently supported with a dedicated HP 64000 System emulator, a custom emulator can be developed using Model 64274S User-Definable Emulator as a base. For ROM-based systems, there is a ROM Emulator, Model 64272S, to provide a controlled environment for software execution and analysis. Both user-defined emulators are powerful alternative tools for applications not served by processor-specific HP 64000 System emulators.

Emulation subsystems for the HP 64000 System consist of a control card and an emulator pod assembly. Memory for the emulator, ordered separately, requires at least two slots in the development station card cage, one for the control card and a second slot for the memory card. Emulation memory is implemented with high-speed static RAM; up to 1 Mbyte of emulation memory may be installed in increments of 32, 64, or 128 kbytes.

The emulation processor is run from two memories: emulation memory and target system memory. Memory is assigned to either memory by blocks of memory address space, but the processor runs as if only one memory existed. Blocks of memory addresses may be designated as RAM, ROM, or illegal. As code modules are completed, they can be tested on the emulator in combination with existing target system hardware.

One of the important advantages of an emulator is the control over the microprocessor during the development phase. The microprocessor can be run, halted, or single-stepped from the development station keyboard. During emulation, it is possible to examine the contents of the microprocessor memory and registers, modify the contents, and then continue the emulation run.

An emulation bus analyzer should be added to the subsystem to monitor activity on the emulator bus. Model 64302A analyzer provides real-time traces of address, data, and status/control signals. Displays may be in the microprocessor mnemonics or in an appropriate numerical base.

For multiprocessor applications, emulators may be used interactively with the Intermodule Bus (IMB). The IMB links emulation bus analyzers for cross-arming modes, and the IMB can also establish larger measurement systems for interactive emulators, timing analyzers, and/or state analyzers. When emulation and analysis subsystems reside in separate stations, an IMB extender (HP 64303A) is available for cross-station measurement systems.

Analysis

Analysis and system integration are major functions when designing and developing superior microprocessor-based products. The HP 64000 System offers five analysis subsystems to meet measurement needs for troubleshooting, debugging, and optimizing target systems. The HP 64302A Emulation Bus Analyzer is a basic real-time analyzer used with an emulation subsystem. As well as providing the displays and triggering conditions for the emulator, the HP 64302A analyzer is the emulator's access point for interactive emulation/analysis; in addition, it supports the High-Level Software Analyzer (HP 64330) for analysis in high-level programming languages of C and Pascal. The HP 64340 Real-time, High-level Software Analyzer is a hardware and software package that operates with an appropriate HP 64000 emulation subsystem. HP 64310A Software Performance Analyzer is also used with an emulator, providing overview measurements that aid in system-level evaluations. For complex problem solving, HP 64610S Logic Timing/State Analyzer and HP 64620S Logic State/Software Analyzer are high performance analyzers that may be used separately or interactively.

High-level Software Analysis

Two High-Level Software Analyzers offer HP 64000 System users an advanced, yet easy-to-use, feature set for analysis of programs written in Pascal or C. The analyzers are processor specific, for troubleshooting and debugging software written for the target microprocessor. Measurements are specified and displayed in the high-level context used in generating the software to simplify correlations between executing software and written programs. Two series are available: HP 64330 High-level Software Analyzers and HP 64340 Real-time, High-level Software Analyzers.

Basic features of these analyzers include:

- Measurements for global and detailed views of high-level software execution
- Variable values are displayed in their native data type (Boolean, integer, real, scalar, structured types, etc.)
- High compatibility with system cross compilers supports measurement specification using static and dynamic variable names, file, procedure, and function names, as well as high-level source line numbers
- Direct control over target system operation
- Command files speed measurement set-up and execution, facilitating automatic measurements

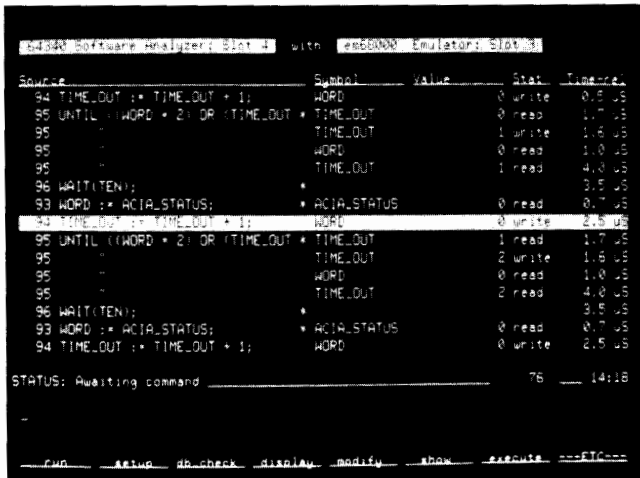

The HP 64340 Real-time, High-level Analyzer Trace Statements Measurement displays executed source lines along with the values of all variables referenced. A hierarchy of measurements streamline troubleshooting from a global view of module execution down to the detail of variable values.

- Additionally, the HP 64340 real-time, high-level analyzers offer:
- Module timing to detect anomalies and analyze performance
 - Counts of specified statements to verify software coverage
 - Sequencing, windowing, and measurement enable/disable to restrict analysis to specific software areas
 - Display any source files without exiting the analyzer for convenient comparisons to current source code
 - Time tagging of modules or statements as an elementary performance check
 - Interactive operation with other HP 64000 analysis and emulation subsystems

Both analyzers trace program and data flow in executing code. The HP 64330 adds no extra code to the software under test, but it does stop program execution periodically by inserting software traps to accommodate the analyzer. By contrast, in real-time mode, the HP 64340 is fully transparent to the system under test and it meets all criteria for real-time analysis: the processor is not halted, program execution is not stopped, and additional code traps are not added to the target software.

The HP 64330/64340 analyzers improve software engineering productivity with measurements that are relevant and convenient for troubleshooting software written in high-level programming languages. Presently, the HP 64330 supports 68000, 8086, 8088, 68008, 68010, 80186, and 80188 processors; the HP 64340 supports 68000, 68010, 80186, 8086, 8088, and 80188 processors.

Software Performance Analysis

Model 64310A Software Performance Analyzer provides overview measurements to aid in evaluating total system effectiveness of programs operating in real time. Global measurements let software designers determine where system resources are being used, in terms of execution times, memory usage, and interaction traffic. Software performance measurements aid in determining where to focus optimization efforts for maximum effect on system performance.

- Histogram displays for quick comparisons of software activity
- Tabular displays with continually updated means and standard deviations on current measurement
- Measurement modes of memory and program activity
- Measurement modes of event duration
- Measurement modes of intermodule linkages

Model 64310A analyzer is used with any of the processor-specific emulators for either 8-bit or 16-bit microprocessors. Up to three Software Performance Analyzers may be installed in a single station and

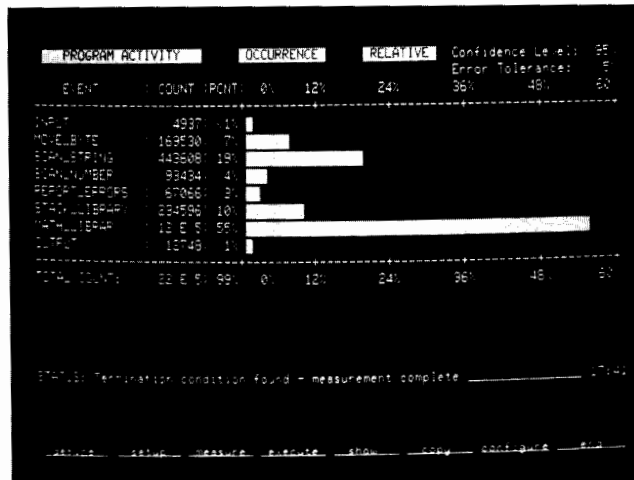

HP 64310A Software Performance Analyzer brings performance analysis measurements to design applications for microprocessor-based products. Six measurements quickly characterize total system performance, allowing the software designer to allocate available resources optimally.

they may be operated interactively through the intermodule bus (IMB). Each analyzer occupies one card slot. Software performance analysis is a powerful analytical tool once reserved for large main-frame computers, and now available for developing microprocessor products.

Logic State Analysis

Model 64620S Logic State/Software Analyzer offers real-time, transparent software analysis for microprocessor systems. A modular system, the Software Analyzer can be configured for 20 to 120 input channels. The HP 64620S analyzer supports analysis at all levels of complexity for microprocessor systems.

- Multiple trigger parameters using symbols, ranges, NOT, and "don't care" terms as well as file names and line numbers
- Selective data storage for edited state listings
- Powerful 15-level sequencer that may also be used to form one or two measurement windows
- Extensive symbolic tracing for quick setups and easy interpretation
- Real-time, nonintrusive analysis feature set supports debug for high-level programming languages
- Two software performance overview modes for code optimization
- Processor-specific interfaces and inverse assembly for easy hook-ups and state listings in the microprocessor mnemonics

An extensive feature set accommodates analysis of code written in high-level languages. An analyzer trace may contain source line numbers, high-level instructions together with comment fields, and assembly language lines. A listing of system activity in terms of high-level source lines together with the assembly-level language generated by the source lines resembles an expanded listing; this measurement is particularly useful when modifying code for quicker execution or more efficient use of program memory. When the HP 64620S analyzer includes the overview measurement capabilities, code modules that run too long or take too many lines of code can be quickly identified, rewritten, and tested again. Measurements may be specified by symbol names rather than address ranges or line numbers.

Preprocessors and inverse assemblers are available for a variety of microprocessors. Displays are automatically formatted and state listings are translated into the microprocessor mnemonics for convenient measurements.

The HP 64620S Software Analyzer subsystem is composed of a control card, one to three data acquisition cards, and general purpose probes or dedicated interfaces. There are two types of data acquisi-



LOGIC DEVELOPMENT SYSTEMS

System Integration

Model 64000

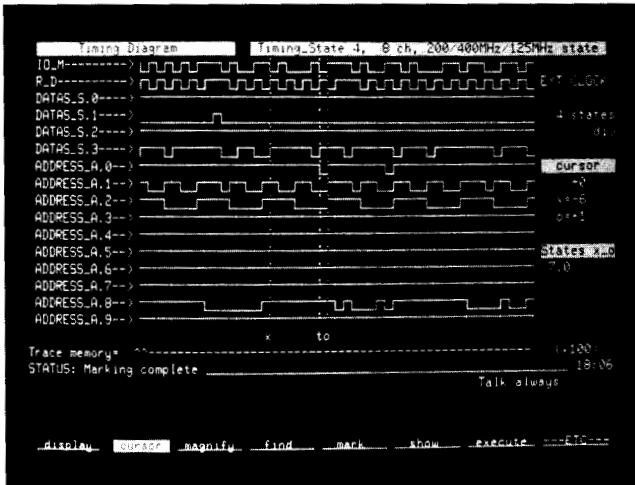

Model 64610S High-speed Timing/State Analyzer offers powerful, high-resolution, asynchronous and synchronous analysis with extensive postprocessing capabilities. Many triggering modes allow precise positioning of the display window to locate timing margin, state execution and interaction problems. Post-processing is also available to perform operations on acquired data.

tion cards: a card with 40 input channels and a card with 20 input channels and the overview circuits. The analyzer collects and stores data at data transfer rates up to 10 MHz. Analyzer memory is 256 states deep, with a 4096-state memory for the overview function.

Flexible triggering, a major strength of the Software Analyzer, is implemented with shared resources between trigger, store, and count functions. Trigger parameters may include values, ranges, "don't care" terms, NOT terms, file names, symbols, and line numbers. Events stored may include all states, or may be limited to only states of a specified type or within a defined range. Event or time interval counts can be made between stored states or from the trigger point to each stored state.

A sequencer may be used in conjunction with the trigger, store, and count functions. When the sequencer enables the trigger function, conditions specified for the sequencer must be met before the analyzer initiates a search for other triggering conditions. A basic sequence specification may have up to 15 sequence terms. Restart terms may be used with one or more of the sequence terms to define a state that reinitiates the search for a portion or all of the sequence.

At the highest level of analyzer control, the master enable condition enables or disables all other analyzer functions. The master enable may be a specific event, a sequence, or a stimulus from another analyzer across the intermodule bus.

Symbolic tracing is based on the symbol table created by the linker. Other user-defined labels may be added as needed. Symbols are alphanumeric names assigned to absolute addresses, ranges, or procedure names. All entries in the symbol table become part of a softkey set, saving time in setting up measurements.

Preprocessors and Interfaces

Preprocessors and interface modules tailor the HP 64620S Logic State/Software Analyzer for use with specific microprocessor systems. Preprocessors provide quick, convenient connections between target systems and the logic analyzer. Inverse assemblers translate collected state events into the processor mnemonics for easy reading and analysis. The interface software automatically sets formats for the logic analyzer to match inputs from the target system processor. Model 64650A General Purpose Preprocessor is used with a 60-channel HP 64620S Analyzer and replaces three HP 64635A data probes and one HP64636A clock probe. Control software and inverse assemblers are included with the processor specific interface modules that are installed in the preprocessor. The interface modules contain interface circuits and cabling to connect to the target system. Both processor specific and user-definable interface modules are available.

The user definable interface module includes hardware, chip sockets, and interface boards to create a wirewrap interface for processors not supported with a dedicated interface. A user-definable inverse assembler HP 64856A is also available for the general purpose interface.

The following preprocessor interfaces are available for the Model 64650A General Purpose Preprocessor:

| Processor | Interface Model Number |
|-----------------|------------------------|
| 8086/8088 | 64653A |
| 8085 | 64655A |
| 80286 | 64657A |
| 80186/80188 | 64658A |
| 6809/6809E | 64671A |
| 6800/6802 | 64672B |
| 68008 | 64673A |
| 68000/68010 | 64674A |
| Z8001 | 64680A |
| Z8002 | 64681A |
| Z80 | 64683A |
| NSC800 | 64690A |
| General purpose | 64651B |

Timing Analysis

Model 64610S High-speed Timing/State Analyzer subsystem offers powerful, high-resolution, asynchronous and synchronous analysis with extensive postprocessing capabilities. Many triggering modes allow precise positioning of the display window to locate timing margin, state, execution, and interaction problems. The analyzer's resources can be allocated to provide wide, fast, glitch, dual-threshold, and externally clocked measurements. Postprocessing adds another dimension to timing/state analysis with the ability to perform operations on acquired data, such as automated compare and statistical analysis of raw data. In the external clock mode, you have the ability to analyze the operation of high-speed logic in bit slice, microprogrammable, and state machines in real time. The HP 64610S analyzer offers powerful analysis that is easy to use.

- 8, 16, 24, or 32 channels of timing/state analysis
- Asynchronous sampling from 2 Hz to 400 MHz for excellent resolution
- Synchronous sampling to 125 MHz
- Compare level, range, and fault qualifications for state and timing listings
- Memory depth of 4060 samples in wide sample mode and 8140 samples in fast sample mode
- Glitch capture and trigger for glitches as narrow as 3 ns to quickly locate transients
- Dual threshold mode for checking transition times, loading problems, and noise margins

Model 64610S analyzer aids in quickly resolving timing problems in multichannel logic systems.

Each measurement mode provides a different view of the system under test. Wide sample mode is the most frequently used mode for standard timing analysis measurements from 2 Hz to 200 MHz. Fast sample mode captures asynchronous events at rates up to 400 MHz, and stores them in a memory 8140 samples deep. In glitch capture mode, a separate glitch detection circuit is activated whenever a signal crosses threshold two or more times in the same sample period resulting in completely asynchronous glitch monitoring. Dual threshold mode displays are three-level waveforms that show when the signal is above, below, or between threshold levels. This mode identifies marginal signals and slow transitions which are frequent causes for intermittent hardware problems.

Labels for single input lines or groups of lines identify the input source for easier interpretation of the display. Once defined, these user labels are added to the softkey set, making measurement setups and analysis much more convenient.

Speed, memory, and measurement modes give the Hardware Analyzer its power, but the finesse is a function of the versatile triggering parameters. Patterns, Boolean NOT conditions or a glitch on one or more lines can serve as trigger conditions. Transition triggering establishes a trigger point as a set of signals enter or leave a defined state. Time interval specifications can be defined for patterns, and the analyzer is triggered if the pattern persists longer than the defined time or if it does not persist long enough. When 16 channels are available, a

trigger on inputs of one probe pod can arm the analyzer to search for another trigger specification on the second probe pod, a sequential trigger.

The capability of storing and retrieving timing measurements quickly and simply is an enabling function for other postprocessing functions. Find and mark functions can locate and indicate the occurrence of a specified pattern across the entire 4000 or 8000 sample measurement. All occurrences of a marked time interval can be measured and the mean calculated automatically. New measurements may be compared to a stored measurement for automatic testing processes. Timing displays can be translated directly into state listings, together with the marked conditions and time interval measurements. In a two-step process, the analyzer can collect traces from one set of trigger specifications, pass the trace to the postprocessing functions where a second set of trigger specifications determines whether the trace is stored or discarded. Postprocessing functions are implemented by the HP 64610S analyzer operating software.

Microprogram Development Subsystem

Model 64276A/B/C

Model 64320S 25 MHz Logic State/Software Analyzer

The HP 64276 Microprogram Development Subsystem and the HP 64320S 25 MHz Logic State/Software Analyzer provide run control and real-time analysis for microprogrammable systems. As integrated subsystems of the HP 64000 Logic Development System, the HP 64276 and the HP 64320S add the power of run control and analysis to all phases of the design, development, and maintenance of microprogram-based products.

The Microprogram Development Subsystem consists of three components: a Run Control module, a Writable Control Store, and a 25 MHz Logic State/Software Analyzer. Run Control provides program flow control, clock control, and break event detection. Writable Control Store provides high-speed RAM for storing the microcode to be executed. A 25 MHz Logic State/Software Analyzer monitors system buses, trigger, store, and sequencing for locating problems in the microprogram.

The Microprogram Development Subsystem supports software development for a wide variety of microprogrammable processors and sequencers. Integration of the Microprogram Development Subsystem with other powerful HP 64000 analysis and emulation tools allows for interactive, cross-triggered measurements in complex multiprocessor environments.

Features

- Choice of clock control or real-time address jam at break detection offers flexible target system control
- Address ranging and two-level sequencing provide powerful break event specification
- Real-time, nonintrusive analysis of microprogrammed system activity reduces software development time
- Flexible user-definable microassembler provides support for a wide variety of microprogrammable devices
- Microcode source interleaved with analyzer trace data speeds software debugging
- Linking of separately assembled microcode modules accelerates software turnaround time
- MACRO instruction feature of the microassembler improves software engineering productivity
- Modular architecture permits specific Writable Control Store configurations for customized development tools
- Integration of Run Control and analysis capabilities simplify operation
- Interaction with other HP 64000 system emulators and analyzers provides real-time analysis in multiprocessor environments

In order to simplify the writing of your microcode, the HP 64861A User-definable Microassembler is available. With this software package, a microassembler can be created that supports MACROs, word widths up to 128 bits, linking, source code displayed with trace data, and errors issued for architecturally incorrect microwords. This microassembler, coupled with the Microprogram Development Subsystem and the state analyzer, provides you with the most comprehensive microprogram development system available.



The Microprogram Development Subsystem supports software development for a wide variety of microprogrammable and bit-slice processors and sequencers. Integration of this subsystem with other HP 64000 analysis and emulation tools offers interactive, cross-triggered measurements in multiprocessor environments.

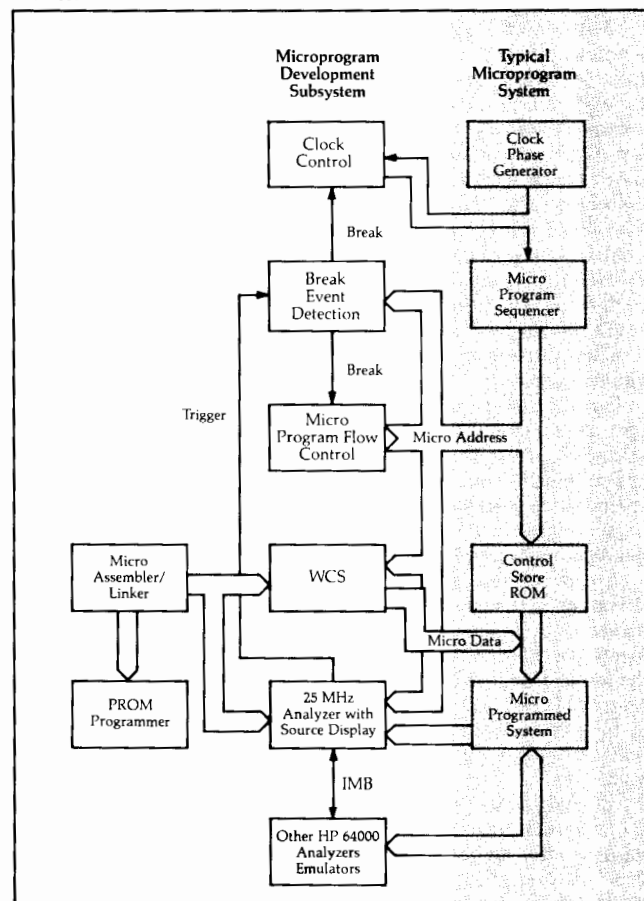

Typical microprogram system block diagram (shaded area) with interconnection to HP's Microprogram Development Subsystem. This flexible subsystem provides real-time nonintrusive analysis of microprogrammed system activity which reduces software development time.



LOGIC DEVELOPMENT SYSTEMS

Summary
Model 64000

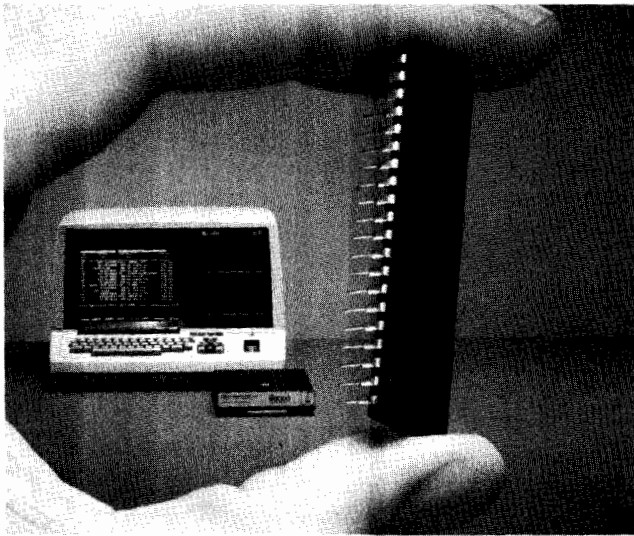

Model 64000 Logic Development System offers total support for all phases of developing microprocessor-based products.

Summary

Model 64000 Logic Development System is a complete system for developing microprocessor-based products. From the very first outlines for design specifications, through delivery to the customer, through modifications and updates, the HP 64000 System provides a common data base accessible by everyone associated with the product. Engineers and technicians working with the new product don't have to guess what should happen on the basis of out-of-date listings, inaccurate after-the-fact flowcharts, and scanty notes. They know. Final code and complete documentation can be passed on with the product as it moves to completion. Since there is a common user interface for all processes, there is no need to adapt to a new instrument for each major development phase. As an implementation of the "electronic workbench" the HP 64000 System supports microprocessor products through all phases of design, development, production, test, and redesign.

The HP 64000 System offers full microprocessor support: emulators, assemblers, C compilers, Pascal compilers, tailored for a wide selection of 8-bit and 16-bit processors. For debugging, integrating, and optimizing, five analyzers provide real-time, nonintrusive measurements to quickly locate problems and bottlenecks. The HP 64000 System is an integrated set of compatible tools that support microprocessor development from conception through obsolescence.

As a universal system, the HP 64000 System frees the user to select the optimum processor for each new product. With a dedicated development system, a processor is chosen first, and then support instruments are chosen to match the processor; economy may dictate that the same processors be used for subsequent products, forcing the designer to fit later applications to existing support equipment. Tooling up for a new microprocessor project with the HP 64000 System solution is a moderate add-on expense because the fundamental support already exists in the development stations, hard disc or flexible disc drives, and printer. With the universal HP 64000, it becomes practical to consider two or more processors, and even make comparisons through some breadboarding phases, before selecting the processor that best suits the application. Multiprocessor applications become feasible, even when the microprocessors come from different vendors. When a microprocessor is not supported by any of the HP 64000 development aids, user-defined kits are available to create new processor-specific emulators, assemblers, and inverse assemblers.

The HP 64000 is a friendly system, friendly in many dimensions. New users become proficient in little time, typically less than a day,

and experienced users progress quickly to take full advantage of the advanced applications of the HP 64000 System. Details of routine tasks are performed by the system, not the user. Yet, none of the functions are hidden; the display status line always describes current system activity, and error messages and commands are fully spelled out. Softkeys as implemented in the system are virtually self-explanatory; frequent references to manuals to decipher a code are eliminated. With softkeys, typing is used to create new code and text, and not for entering commands. Directed syntax displays the possible choices for the next command and avoids the inconvenience of entering a command string in the wrong sequence. Model 64000 Logic Development System encourages users to practice sound design and development techniques.

Selecting a Logic Development System

Model 64000 Logic Development System is a complex and dynamic family of microprocessor support tools. Consequently, it is recommended that an HP Field Engineer be contacted for a suggested system configuration that will fit your application. For a copy of our latest HP 64000 brochure, in the U.S., call 1-800-447-3282 (in Colorado call collect 590-3340). Outside the U.S., call your local HP sales office. Prices for selected components are listed below.

Ordering Information

| Model | Description | Price |
|----------|---|--------------------|
| 64070A | High-speed DEC VAX Interface | \$2700 |
| 64100A | Development Station | \$11,130 |
| Opt 041 | Dual Flexible Disc Drives | add \$2200 |
| 64110A | Transportable Development Station with flexible disc drives | \$11,150 |
| 64156S | Emulation Memory Subsystems 32 kbytes to 1024 kbytes | \$3140 to \$33,910 |
| 642XXS | Emulation Subsystem, 8-bit μ P | \$3200 to \$5600 |
| 642XXS | Emulation Subsystem, 16-bit μ P | \$4500 to \$8800 |
| 64276X | Microprogram Development Subsystem | \$7000 to \$13,800 |
| 64302A | 48-channel Emulation Bus Analyzer | \$2530 |
| 64310A | Software Performance Analyzer | \$3440 |
| 64320S | Logic State Software Analyzer for Microprogram Development Subsystem | \$6250 to \$13,250 |
| 6433XA | High-level Software Analyzer | \$3000 |
| 6434XX | Real-time, High-level Software Analyzer | \$12,000 |
| 64500S | PROM Programming Subsystem | \$1110 |
| Opt XXX | PROM specific Interface | add \$300 to \$500 |
| 64610S | High-speed, Timing/State Analyzer 200/400 MHz timing/125 MHz state 8 to 32 channels | \$7850 to \$23,350 |
| 64620S | Logic State/Software Analyzer 20 to 120 Channels | \$4350 to \$9610 |
| 64630S | Probe sets for HP 64620S Logic State/Software Analyzer 20 to 120 Channels | \$1620 to \$6680 |
| 64650A | General Purpose Preprocessor | \$3140 |
| 646XXA | Processor Specific Interfaces for use with HP 64650A GP Preprocessor | \$860 to \$2000 |
| 648XXA/S | Pascal & C Compilers, 8-bit, 16-bit | \$3000 to \$7000 |
| 648XXA | Assemblers/Linkers, 8-bit | \$600 to \$1600 |
| 648XXA | Assemblers/Linkers, 16-bit | \$1200 to \$2400 |
| 648XXA | Host Development Systems | \$3000 to \$5000 |
| 64851A | User-defined Assembler | \$1200 |
| 64856A | User-defined Inverse Assembler | \$1200 |

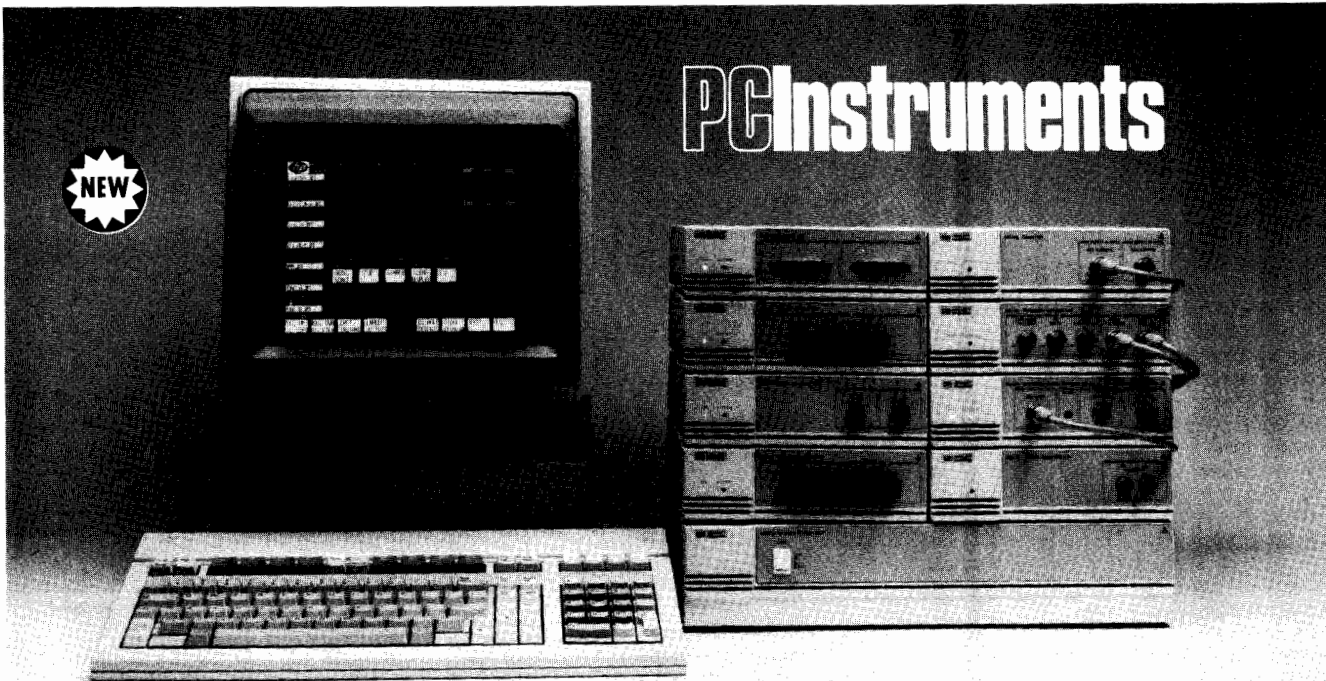

Introduction to PC-Controlled Instrumentation

The increased power of today's personal computers and their proliferation in the engineering workplace have made them increasingly attractive to industry as inexpensive, versatile controllers for test-and-measurement instruments.

Currently most PC-controlled test-and-measurement systems are based on HP-IB. A new and more novel approach is the personal-computer-instrument system.

Personal-computer instruments use a distinctive architecture in which the test-and-measurement instruments are tightly coupled to a personal computer at the system level. Redundant functions such as displays, user-interface and internal microprocessors are eliminated from the instruments and centralized in the personal computer. This allows a single-user interface to control these simpler and hence, more reliable instruments.

In addition to their automated-measurement capabilities, PC-controlled instruments offer low buy-in prices and the availability of numerous general-purpose personal-computer software packages. This makes them attractive for automating many repetitive testing functions, while still having the benefits of a general-purpose computer.

HP PC Instruments

HP PC Instruments link test and measurement devices to the HP Vectra PC, HP 150

Touchscreen and Touchscreen II, IBM PC, PC/XT, and PC/AT creating a more efficient, cost-saving way to program and perform test procedures, analyze and compare data, and record and plot results.

With PC Instruments, you can monitor and control up to eight instrument modules through the HP PC Instruments Bus (HP PCIB) for each HP PCIB interface card used. A second interface can also be added allowing control of up to 16 PC Instruments from a single computer.

PC Instruments consist of eight advanced instrumentation modules, each housed in a separate stackable plastic enclosure. Since the PC Instruments modules are located outside the personal computer, valuable expansion slots are conserved, and the instruments are removed from the noisy environment of the PC. The simple design of the modules allows easy access to the measurement terminals and easy expansion of the instrument system as necessary.

Isolated power is supplied by a separate external power pack provided with each module. This isolates all instrument modules from each other, and improves measurement capabilities by reducing the possibility of ground loops. An optional system power unit is available to house up to eight external power packs.

The PC Instruments system includes the following devices: Digital multimeter, digi-

tizing oscilloscope, function generator, universal counter, relay multiplexer, dual voltage digital-to-analog converter, digital input/output, and relay actuator. Typical applications include temperature measurement, multi-channel data logging, production test, incoming inspection, component evaluation, prototype test, subassembly test, process monitoring and control, and scientific research in chemistry, biology and other scientific and engineering fields.

Software Makes It Simple

Software is the key to PC Instruments power and flexibility. PC Instruments System Software makes it easy for you to use the system in both a manual and a programmed mode. For manual mode operation, the soft front panel duplicates the instrument-control panels of traditional instruments on your CRT screen. Because PC Instruments are programmed in Microsoft BASIC, it's easy to customize or develop your own application programs.

Optional HP data acquisition software provides simple menu-driven programs to get you up and running quickly for voltage scanning and temperature measurement applications. And add-on HP-IB Command Libraries are also available to turn your PC into a versatile HP-IB instrument controller that controls both PC Instruments and HP-IB instruments from the same BASIC program.



PC INSTRUMENTS

General Information

Manual Mode Simplicity

PC Instruments System Software generates an advanced soft front panel on your computer screen that duplicates the front panel of its traditional instrument counterpart. You interact with the panel as you would with any other instrument to set functions, ranges and values, and to take measurements. Monitor and control adjustments to each instrument are performed through the use of cursor keys, a mouse (on the HP Vectra PC, IBM PC, PC/XT, or PC/AT), or the HP Touchscreen.

The soft front panel, pictured to the right, consists of four fixed windows: 1) The **Interactive Instrument Window** displays the front panels of the instrument you are controlling; 2) The **System View Window** displays up to seven instruments and can be scrolled to reveal the status of all instruments in the system. This enables you to quickly compare data from several instruments; 3) The **Status Window** gives you feedback in the form of prompts and error messages about the instrument you are operating; and 4) **Softkeys** make it easy to set up your system and control the instruments. The Softkeys also enable you to store and recall instrument settings and get a hard copy of the information displayed on the screen.

PC Instruments can be easily interchanged between the System View Window and the Interactive Instrument Window through the use of cursor keys, a mouse or the HP Touchscreen. This enables you to more closely monitor and control test procedures, and to make instant changes where necessary. A Last Instrument Softkey allows you to quickly switch back and forth between two specific instruments.

Programmed Mode Productivity

High-Level Programming Commands

PC Instruments System Software enables you to create your own application programs in Microsoft BASIC to automate instruments. This results in a faster solution and more consistent results on repetitive tests. High-level, easy-to-remember commands, like OUTPUT and MEASURE, make it easy to program PC Instruments without referring to a programming guide.

State File Storage

PC Instruments increase your productivity by allowing you to automate your test and measurement tasks. The initial parameters of all the PC Instruments in your system can be set and stored on disc in one or more state files by simply touching the soft front panel. These state files can then be recalled and executed during a BASIC program with a single INITIALIZE SYSTEM command.

Versatile System Configuration

PC Instruments can be used in many configurations to meet your specific needs. You might, for instance, configure a system that includes three digital multimeters. You can assign your own names, such as "volts in," "temperature," and "pressure." You then program an instrument using its specific name throughout a program. This feature, along with "plain English" commands, makes your programs virtually self-documenting. Should your testing procedures or system configurations change in the future, you can easily rename the instruments.

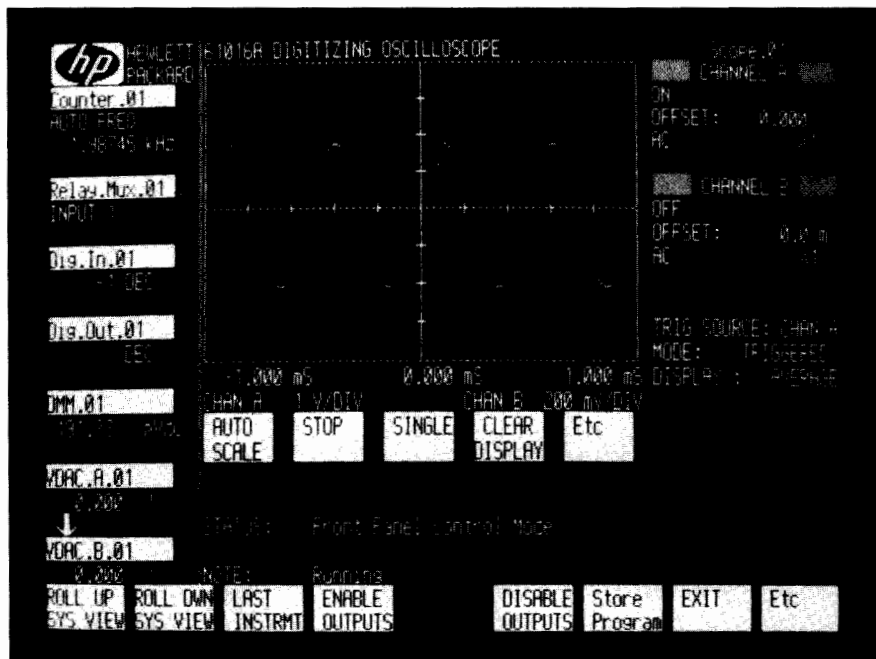

Programming Steps

To begin programming, the user exits the soft front panel which causes the system software to generate a shell program. This shell is a BASIC program skeleton that contains information about the configuration of the PC Instruments system.

The programmed mode is composed of these steps: 1) From DOS, enter the manual mode; 2) Set your instruments to the desired initial conditions and save each configuration in a state file using softkeys; 3) Save a program shell and exit manual mode; 4) Load BASIC and recall the program shell you just saved; 5) Key in your application program, inserting lines of your code into the shell. Make use of the PC Instruments commands and the configurations you saved as appropriate for your application; and 6) Save the program and run as required.

Linkage to Third-Party Software

The widely-used Data Interchange Format (DIF) and other utilities provide a pathway to a wealth of third-party software, such as 1-2-3™ by Lotus™. It gives you easy access to time-saving features such as graphics, database, spreadsheets, communications, and word processing, to help you work more efficiently. Thus data acquired from PC Instruments can easily be read into a spreadsheet, merged into a report, or plotted. The DIF conversion routine is standard with PC Instruments System Software.

Data Acquisition Software

HP Data Acquisition Software is also available to get you up and running quickly for common data acquisition applications, such as voltage scanning, thermocouple scanning, and analog recording. In addition, you can easily customize the program to meet your specific needs.

This menu-driven program also includes an engineering graphics utility for presenting

information in a simple listing, linear graph, or logarithmic plot form. Hard copy can be easily dumped to a graphics printer or an HP 7470A or 7475A plotter. The utility can also be merged into your own separate application program to provide easy-to-use graphics capabilities.

Control HP-IB Instruments

Separate HP-IB hardware and software turns your personal computer into a low-cost controller compatible with more than two thousand HP-IB (IEEE-488) instruments.

The HP-IB Command Libraries use a standard high-level command structure which makes programming easy. The HP Vectra PC, HP 150 Touchscreen and IBM PC HP-IB Command Libraries are compatible with the PC Instruments System Software. This allows you to control both PC Instruments and HP-IB instruments from the same BASIC program.

ASYST™ Scientific Software

ASYST Scientific Software is a programming language that integrates PC Instruments and HP-IB instruments with powerful analysis, statistics, and graphics capabilities common to most engineering and scientific applications. ASYST provides you with the power, precision, and flexibility previously found only on mainframe and minicomputers.

ASYST programs execute quickly in both the interactive and compiled modes. Fast numeric calculations are performed by utilizing the optional co-processors in the HP Vectra PC and the IBM PC, PC/XT, or PC/AT. In addition, all commands co-reside in memory.

Built-in analysis functions, like FFT and XY.AUTO.PLOT, reduce your application programming time by approximately 90 percent. These pre-programmed commands can be combined and modified to extend the system for custom applications.



HP 61010AA



HP 61011AA



HP 61012AA

PC Instruments Modules

PC Instruments General Specifications

The following specifications hold for all PC Instruments modules, except where noted otherwise.

Operating Temperature Range: 0°C to 40°C.

Storage Temperature Range: -40°C to +80°C.

Instrument Dimensions: L = 295 mm (11.62 in); W = 212 mm (8.35 in); H = 64.5 mm (2.54 in). Each instrument comes with a power pack which provides isolated power.

Power Pack Specifications: L = 110 mm (4.33 in); W = 90 mm (3.54 in); H = 64.5 mm (2.54 in); Wgt = 0.87 kg (1.91 lbs).

Input Voltage Domestic Power Pack: 120 Vac $\pm 12.5\%$, 57-63 Hz, 25 VA max.

Input Voltage International Power Pack(s): 100, 220 or 240 Vac, $\pm 12.5\%$, 47-66 Hz, 25 VA max.

PC Instruments meet IEC 348 standards.

HP 61010AA Digital I/O

The HP 61010AA Digital I/O can be used as both an input and an output device. It has 16 independent input lines and 16 independent output lines, which can be addressed as variable length words up to 16 bits long. The input and output connectors include two data control lines each. Both random asynchronous and synchronous transfers are available.

The instrument comes with two shrouded connectors for solder terminals. Accessory block (HP 14802A) allows easy screw termination.

User Connections: 16 input data bits; 2 input data control signals; 16 output data bits; 2 output data control signals.

Digital Input Data Characteristics

Input Voltage Range: ± 10 V max.

Input Impedance: 100 k ohm pullup resistor to +5 V.

Input Logic Threshold: Programmable to ± 10 V, Resolution = 80 mV, Accuracy = ± 160 mV.

Digital Output Data Characteristics

TTL Mode: $V_{ol} = 0.4$ V max @ $I_{ol} = 16$ mA max.

$V_{oh} = 2.4$ V min @ $I_{oh} = -4$ mA max.

Open Collector Mode: $V_{ol} = 0.4$ V max @ $I_{ol} = 16$ mA max.

$V_{ol} = 0.7$ V max @ $I_{ol} = 40$ mA max.

$V_{oh} = 12$ V max (pullup resistor to external supply).

Output Disabled Mode:

$I_{oz} = -5$ uA max (with output bit pulled down to ground).

$I_{oz} = 250$ uA max (with output bit pulled up to +12 V).

Data Control Signals

ODAV (Output Data Available): Same as output data bit.

ODAC (Output Data Accepted): $V_{il} = 0.0$ V to 0.4 V, $V_{ih} = 2.4$ V to 5.0 V (10 k ohm pullup resistor to +5 V); Minimum pulse width = 10 u.

IDAV (Input Data Available): $V_{il} = 0.0$ V to 0.4 V, $V_{ih} = 2.4$ V to 5.0 V (10 k ohm pullup resistor to +5 V); Minimum pulse width = 10 u.

IDAC (Input Data Accepted): Same as output data bit.

Data Transfer Time: Less than 50 ms (System limit with an OUTPUT or MEASURE statement).

Weight: 1.26 kg (2.78 lbs).

HP 61011AA Relay Multiplexer

The HP 61011AA Relay Multiplexer features break-before-make scanning of up to eight double-ended channels. The relays are bi-directional so that they may be used to send up to eight signals to a single destination, or distribute one source among eight output channels. The 61011AA can be teamed with a digital multimeter to provide thermocouple scanning. An onboard temperature reference allows accurate absolute temperature measurement.

The Relay Multiplexer comes with a plug-in screw terminal block for easy connection of user inputs and outputs.

User Connections: 8 Double-ended inputs; 1 Temperature reference voltage output; 1 Double-ended output.

Channel Select Time: Less than 65 ms (System limit with an OUTPUT statement, including automatic break-before-make).

Input Switching Characteristics

Max Voltage: 250 Vdc, 250 Vac rms, 350 Vac peak.

Max Current: (Per channel or module) 1 Amp dc, 1 Amp ac rms.

Max Power: (Per channel or module) 50 W dc, 250 VA ac.

Resistance (Input to Output): 1 ohm typical.

Thermal Offset (Input to Output): < 6 uV max.

Isolation Voltage Rating: 250 Vdc, 250 Vac rms, 350 Vac peak between any two input terminals or between an input and ground.

DC Isolation Resistance: ($< 40^\circ\text{C}$, 80% RH)

Open Channel $> 2 \times 10^8$ ohms

Channel-Channel $> 2 \times 10^8$ ohms

Channel-Ground $> 2 \times 10^8$ ohms

AC Characteristics (50 ohm termination):

| | 100 kHz | 1 MHz | 10 MHz |
|---------------------------------------|---------|---------|-----------|
| Crosstalk (input to input) (dB) | < -73 | < -53 | < -33 |
| Feedthrough (input to output) (dB) | < -73 | < -53 | < -33 |
| Insertion Loss (input to output) (dB) | < 0.2 | < 0.3 | < 0.5 |
| Capacitance | | | |
| (Open Channel, Channel to Channel) | | | < 5 pF |
| (Closed Channel) | | | < 25 pF |
| (Channel to Chassis) | | | < 50 pF |



PC INSTRUMENTS

Instrument Modules

Models 61013AA - 61015AA



HP 61013AA



HP 61014AA



HP 61015AA

General

Accuracy (at 23°C ± 5°C, 80% RH) All ac specifications given for a sine wave.

2.5 readings/second:

DC Volts: ±0.05% of reading ±4 counts.

AC Volts (45 Hz to 500 Hz): ±0.5% of reading ±50 counts.

AC Volts (30 Hz to 45 Hz, 500 Hz to 1 kHz): ±1% of reading ±50 counts.

Ohms: ±0.1% of reading ±4 counts (200, 2 k, 20 k, 200 k, 2 M ohm ranges). ±0.35% of reading ±4 counts (20 M ohm range).

12.5 readings/second:

DC Volts: ±0.05% of reading ±10 counts.

AC Volts (45 Hz to 500 Hz): ±0.5% of reading ±56 counts.

AC Volts (30 Hz to 45 Hz, 500 Hz to 1 kHz): ±1% of reading ±56 counts.

Ohms: ±0.1% of reading ±10 counts (200, 2 k, 20 k, 200 k, 2 M ohm ranges). ±0.35% of reading ±10 counts (20 M ohm range).

Accuracy (0°C - 40°C, 80% RH)

2.5 readings/second:

DC Volts: ±0.1% of reading ±8 counts.

AC Volts (45 Hz to 500 Hz): ±0.75% of reading ±100 counts.

AC Volts (30 Hz to 45 Hz, 500 Hz to 1 kHz): ±1.5% of reading ±100 counts.

Ohms: ±0.2% of reading ±7 counts (200, 2 k, 20 k, 200 k, 2 M ohm ranges). ±0.5% of reading ±12 counts (20 M ohm range).

12.5 readings/second:

DC Volts: ±0.1% of reading ±14 counts.

AC volts (45 Hz to 500 Hz): ±0.75% of reading ±106 counts.

AC Volts (30 Hz to 45 Hz, 500 Hz to 1 kHz): ±1.5% of reading ±106 counts.

Ohms: ±0.2% of reading ±13 counts (200, 2 k, 20 k, 200 k, 2 M ohm ranges). ±0.5% of reading ±18 counts (20 M ohm range).

Maximum Settling Time: DC: 150 ms (to 0.01%)

AC: 350 ms (to 0.1%)

Ohms: 75 ms (to 0.01%)

Maximum Measurement Rate: 12.5 readings/second (System limit with a MEASURE statement).

Programmable Measurement Rates: 2.5 readings/second or 12.5 readings/second.

Input Impedance: 10 M ohms minimum all dc ranges; 1 M ohms on all ac ranges.

Input Overvoltage Protection: 350 V peak (non-destructive).

Common Mode Rejection

DC Range 50/60 Hz NMR 50/60 Hz ECMRR* DC CMRR*

2.5/s >60 dB >120 dB >120 dB

12.5/s 0 dB >60 dB >120 dB

AC Range DC-60 Hz CMRR* DC CMRR*

2.5/s or 12.5/s >60 dB >120 dB

*With 1K in LO lead.

Isolation Voltage Rating: 250 Vdc, 250 Vac rms, 350 Vac peak between any input terminal and ground.

Weight: 1.02 kg (2.25 lbs).

HP 61014AA Function Generator

The HP 61014AA Function Generator generates sine waves, square waves, triangle waves, ramps and pulses. The function, frequency, amplitude and offset can be set programmatically. The burst feature allows you to program a discrete number of cycles ranging from 1 to 65536. Inputs for VCO and AM modulation are also provided.

Specifications: All specifications are given at full rated output into a 50 ohm load unless otherwise noted.

Symmetry Range for Sine, Square, Triangle Waves: 20% to 80% of duty cycle up to 500 kHz; 50% of duty cycle up to 5 MHz.

Sine Wave Distortion:

10 Hz to 50 kHz: All harmonics >40 dB below fundamental.

50 kHz to 5 MHz: All harmonics >30 dB below fundamental.

Square Wave Rise Time and Fall Time:

10% to 90% at 1 MHz: <50 ns (typical), <75 ns (maximum).

Triangle Linearity Error: <3% at 1 kHz.

Output Impedance: 50 ohms ±10%.

Flatness (Measured with respect to a 1 kHz sine wave reference):

10 Hz to 100 kHz: Better than ±3% (in a single output range).

100 kHz to 5 MHz: Better than ±18% (in a single output range).

Amplitude Characteristics

Amplitude range: 8 mV to 10 V p-p.

Resolution: 0.8 V to 10 V: 40 mV. below 0.8 V: 4 mV.

Offset: Programmable from -4 V to 4 V.

Offset Accuracy: ±5% ±0.2 V (function amplitude >0.1 V p-p).
±5% ±25 mV (function amplitude <0.1 V p-p).

Maximum Amplitude Including Offset: 5 V

Output Frequency Characteristics

Frequency Range: 0.5 Hz to 5 MHz.

Resolution: 0.5 Hz to 50 Hz: 0.1 Hz

50 Hz to 500 Hz: 1 Hz

500 Hz to 5 kHz: 10 Hz

5 kHz to 50 kHz: 100 Hz

50 kHz to 500 kHz: 1 kHz

500 kHz to 5 MHz: 10 kHz

Accuracy: ±4% of the maximum frequency in each of the ranges listed above.

External Modulation Characteristics

Amplitude Modulation:

Modulating signal: dc to >100 kHz. Carrier Envelope Distortion at 70% sine wave modulation with $f_c = 1$ MHz and $f_m = 1$ kHz: <2% typical.

VCO: The output frequency can be decreased from the maximum frequency associated with any given resolution: >100 to 1. The frequency versus voltage curve will be linear to within ±2% of maximum frequency associated with any given resolution.

Output Control Characteristics

Free Run Mode: Continuous Operation.

N-Burst Mode: The burst feature allows you to program a discrete number of cycles ranging from 1 to 65536.

Gate Mode: A logic zero applied to the gate input causes continuous operation. A logic one applied to the gate input will stop the output.

Sync Output: A TTL compatible square wave output at the frequency of operation.

Disable Output Mode: This command opens a relay in series with the output. The sync output remains operational.

Short Circuit Protection: A protection circuit reduces the signal to a safe level if the output is short circuited.

Weight: 1.56 kg (3.44 lbs).

HP 61015AA Universal Counter

The HP 61015AA Counter is a 100 MHz universal counter. It decodes commands from your computer, measures the input waveform, and returns the 8-digit measurement value back to the computer. Modes include frequency, period, and totalize for Channel A input. Channel B input is provided for frequency ratio and time interval measurement. Additional modes include auto-frequency and auto-period which use a reciprocal counting technique.

Input Frequency Limits

Input A (positive slope): 10 Hz to 100 MHz with prescaler.
10 Hz to 10 MHz without prescaler.

Input A (negative slope): 10 Hz to 90 MHz with prescaler.
10 Hz to 9 MHz without prescaler.

Input B (positive or negative slope): 10 Hz to 2.5 MHz.

Input Characteristics

Input A Sensitivity: 40 mV rms (10 Hz to 100 MHz).

Input B Sensitivity: 40 mV rms (10 Hz to 2.5 MHz).

Input Coupling: AC on both inputs.

Input Impedance: 1 M ohm (nominal) shunted by 30 pF.

Frequency (Input A)

Ranges: 10 Hz to 10 MHz (LSD = 10 Hz with 0.1 s gate time).

10 Hz to 10 MHz (LSD = 1 Hz with 1 s gate time).

10 Hz to 10 MHz (LSD = 0.1 Hz with 10 s gate time).

10 Hz to 100 MHz (LSD = 100 Hz with 0.1 s gate time).

10 Hz to 100 MHz (LSD = 10 Hz with 1 s gate time).

Resolution: ±LSD

Accuracy: ±LSD ±(time base error in ppm) x frequency.

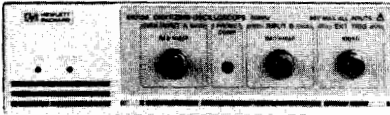

HP 61016AA

Auto-Frequency (Input A)

Range: 10 Hz to 100 MHz

Period (Input A)

Range: 400 ns to 0.1 s. Number of cycles of averaging (N) may be programmed from 1 to 1000 in decade steps.

LSD = 100 ns for 1 cycle averaging.

LSD = 10 ns for 10 cycle averaging.

LSD = 1 ns for 100 cycle averaging.

LSD = 0.1 ns for 1000 cycle averaging.

Resolution: \pm LSD.

Accuracy: \pm LSD \pm 1.4 x [(trigger error)/N] \pm (time base error in ppm) x period.

Auto-Period (Input A): Range: 10 Hz to 100 MHz.

Time Interval

Range: 250 ns to 10 s.

LSD Displayed: 100 ns.

Resolution: \pm LSD.

Accuracy: \pm LSD \pm START trigger error \pm STOP trigger error \pm (time base error in ppm) x (time interval).

Ratio

Range: Channel A: 10 Hz to 100 MHz.

Channel B: 10 Hz to 2.5 MHz.

LSD Displayed: 10 Hz to 10 MHz: 1 part in (A/B) x N.

10 Hz to 100 MHz: 1 part in (A/B) x N x 0.1.

Resolution: \pm LSD.

Accuracy: \pm 1 count of A \pm [(B trigger error) x (frequency A)]/N where N is the number of cycles of averaging for channel B input. N may be programmed from 1 to 1000 in decade steps.

Totalize (A)

Range: 10 Hz to 100 MHz.

Resolution: 10 Hz to 10 MHz: \pm 1 count.

10 Hz to 100 MHz: \pm 10 counts.

Time Base

Frequency: 10 MHz.

Time base error: \pm 10 ppm.

General

Trigger Error: $\frac{\sqrt{(80 \text{ uV})^2 + e_n^2}}{\text{input slew rate at trig. pt. (uV/s)}} \text{ (rms)}$

Where e_n is the rms noise in mV of the input for a 100 MHz bandwidth in Channel A and 10 MHz bandwidth in Channel B.

Maximum Measurement Rate: 10 readings/second (System limit with a MEASURE statement).

Operating Humidity Range: <80%.

Weight: 0.60 kg (1.31 lbs).

HP 61016AA Digitizing Oscilloscope

The HP 61016AA Digitizing Oscilloscope is fully programmable, providing such features as automatic scaling, auto trigger, self-calibration, and direct readout of delta voltage and delta time. Waveforms captured using sophisticated random repetitive sampling techniques can be saved and recalled for analysis. This 50 MHz scope has an external trigger input and delayed trigger capability.

Specifications

All specifications are valid after the instrument has reached a stable temperature, and self-calibration is performed.

Vertical

Bandwidth: 0 to 50 MHz with dc coupling; 10 Hz to 50 MHz with ac coupling.

Input Coupling: ac, dc.

Input RC: 1 Meg \pm 2% shunted by approx. 18 pF.

Max Input Voltage: \pm 40 V (dc + peak ac).

Range: 40 mV to 40 V.

Resolution: (trigger level set within vertical range and offset to zero).

| Vertical Range | Resolution |
|----------------|------------|
| 40 mV - 80 mV | 0.67 mV |
| 160 mV - 40 V | range/240 |

Gain Accuracy: \pm 3%.

Zero Offset Error: \pm 3% full scale \pm 3.0 mV.

| Offset Range: | Vertical Range | Offset Range |
|---------------|----------------|-------------------|
| | 40 mV - 4 V | \pm 1.5 x range |
| | 8 V - 16 V | \pm 12 volts |
| | 40 V | Not available |

Timebase

Range: 100 ns to 5 s in 1-2-5 sequence.

| Resolution: | Timebase | Resolution |
|-------------|-----------------|------------|
| | 100 ns - 200 ns | 1 ns |
| | 500 ns - 5 s | range/250 |

Delay Range: -0.5 to 250 x timebase range, with trigger referenced to center.

Trigger

Source: Either channel, pos or neg slope; or external trigger.

Range: \pm 2 x vertical range, limited to \pm 20 V.

Vertical Range

| Specification Sensitivity: | 40 mV - 1.6 V | 4 V - 40 V |
|----------------------------|---------------|--------------|
| (<10 MHz) | 15 mV | 400 mV |
| (>10 MHz) | 40 mV | 1.0 V |
| Level Accuracy: | \pm 3% | \pm 3% |
| | \pm 10% mV | \pm 250 mV |

External Trigger: 1 volt rising edge into 100 k ohms, with a rise-time <1 μ s.

Characteristics

Vertical:

Offset Accuracy: Zero offset error + gain error.

Noise: 1.5% of full scale or 2.4 mV, whichever is larger.

Single Marker Accuracy: Gain accuracy + zero offset error.

Dual Marker Accuracy: Gain accuracy.

Probe Scaling Factors: 1:1, 10:1.

Probe Compensation Signal: \approx 500 mV, 7 kHz square wave.

Trigger

Modes: Normal, Auto trigger, Auto level. Auto trigger mode will generate internal triggers at a 40 Hz rate in the absence of input trigger. Auto level will continuously adjust the trigger level to track the input signal with duty cycles between 30% and 70%.

Timebase

Delay Accuracy: \pm 0.02% \pm 0.4% of timebase range \pm 5 ns.

Single Marker Accuracy: Delay accuracy.

Dual Marker Accuracy: \pm 0.4% of timebase range \pm 2 ns.

Digitizer

A/D Resolution: 8 bits.

Digitizing Technique:

| Timebase Range | Acquisition Mode | Digitizing Rate |
|----------------|-------------------|--------------------|
| 100 ns - 50 us | Random Repetitive | (not applicable) |
| 100 us - 20 ms | Random Sequential | 5.814 kHz |
| 50 ms - 5 s | Flash Acquisition | 250/timebase range |

Throughput: 300 samples/s on 100 ns range. 700 samples/s on 200 ns to 100 us ranges, increasing to 2500 samples/s at 50 ms.

Measurements

Markers are provided for manual timing and voltage measurements. Automated measurements of the following waveform parameters can be made: Frequency, period, risetime, falltime, +width, -width, p-p volts, and overshoot. Waveforms can be saved and recalled for comparison.

Displays

Variable Persistence: This mode displays samples for a user set time, then erases them. The display time can be varied or set to infinite.

Average: Provides a display of the average of many samples. The averaging runs continuously, and can be set 1, 2, 4, 16, 32, 64, 128.

Autoscale

The Autoscale feature will display both channels with the proper vertical, trigger, and timebase setting. The coupling is set to ac,



PC INSTRUMENTS

Instrument Modules, Interfaces & Accessories, and Data Acquisition Software



HP 61017AA

and the delay is set to zero. Requires a duty cycle of 20% to 80%, an amplitude of >20 mV and a frequency >50 Hz.

Self Calibration

This feature calibrates the vertical, trigger, and timebase to the published specifications. A self calibration occurs when the instrument is first turned on, and can be requested by the user at any time. Calibration time is typically 3 seconds.

Weight: 1.40 kg (3.09 lbs).

HP 61017AA Relay Actuator

The HP 61017AA Relay Actuator provides programmable control of eight independent relay switches. Each channel can carry up to one ampere of current, and can switch up to 250 volts dc or ac rms.

The Relay Actuator comes with a plug-in screw terminal block for easy connection of user inputs and outputs.

User Connections: 8 independent single-pole channels.

Channel Select Time: Less than 40 ms (System limit with an OUTPUT statement).

Switching Characteristics

| | |
|-------------------------|---|
| Maximum Voltage: | 250 Vdc, 250 Vac rms, 350 Vac peak. |
| Maximum Current: | Per channel: 1 amp dc, 1 amp ac rms. Per module: 4 amp dc, 4 amp ac rms. |
| Maximum Power: | Per channel: 50 W dc, 250 VA ac Per module: 200 W dc, 1000 VA ac |

Resistance (per channel): 1 ohm typical.

Thermal Offset (per channel): <6 uV maximum.

Isolation Voltage Rating: 250 Vdc, 250 Vac rms, 350 Vac peak between any two input terminals or between an input and ground.

| | | | |
|---------------------------------|-----------------|----------------------------|--|
| DC Isolation Resistance: | (<40°C, 80% RH) | | |
| | Open Channel | > 2 x 10 ⁸ ohms | |
| | Channel-Channel | > 2 x 10 ⁸ ohms | |
| | Channel-Ground | > 2 x 10 ⁸ ohms | |

AC Characteristics (50 ohm termination):

| | 100 kHz | 1 MHz | 10 MHz |
|---------------------------------------|---------|-------|--------|
| Crosstalk (input to input) (dB) | <-73 | <-53 | <-33 |
| Feedthrough (input to output) (dB) | <-73 | <-53 | <-33 |
| Insertion Loss (input to output) (dB) | <0.2 | <0.3 | <0.5 |

Capacitance:

| | |
|------------------------------------|--------|
| (Open Channel, Channel to Channel) | < 5 pF |
| (Closed Channel) | <25 pF |
| (Channel to Chassis) | <50 pF |

Weight: 0.95 kg (2.09 lbs).

PC Instruments Interfaces and Accessories

HP 61060AA/HP 61061AA PC Instruments Interfaces

These products provide a link between the HP 150 Touchscreen (HP 61060AA) or the HP Vectra PC, IBM PC, PC/XT and PC/AT (HP 61061AA) and up to eight PC Instruments. They consist of a PCIB interface card, PC Instruments System Software, PC Instruments System Documentation, and two control cables. The interface card plugs into one of the accessory slots on the HP 150 Touchscreen and one of the long accessory slots on the HP Vectra PC and IBM PC. Maximum distance between computer and the instruments is 1.8 meters.

HP 61001A System Power Unit

The optional System Power Unit provides convenient, space-effective storage for the individual power packs of up to eight PC Instruments. Included in the unit are common mode and normal mode line conditioning, a line-spike suppression network, main fuse, PC Instruments system power switch, and two auxiliary unswitched outlets suitable for powering a personal computer and one peripheral. Used on the bench, the System Power Unit provides an ideal base for PC Instruments. It is also rack mountable.

HP 14801A PC Instruments Rack Shelf

The rack mounting kit allows up to four PC Instruments and four power packs to be mounted in standard 19-inch racks. Three blank panels are also included for use when racking fewer than four instruments.

HP 14802A Terminal Block

For use with Digital I/O. Allows easy screw terminations.

HP 5080-2064 Binder and Slipcase

Recommended for systems with more than three instrument modules. Provides neat storage for additional instrument manuals and application software documentation.

HP 10040A/HP 10021A Oscilloscope Probes

General: These miniature probes are recommended for use with the HP 61016AA Digitizing Oscilloscope. Each probe comes with a retractable hook tip, an IC probe tip adapter, an alligator clip, a 20 cm (8 in.) ground lead, eight color-coded indicator sleeves, a grounding spring, and an operating note. The probes have a one meter cable.

HP 10040A Oscilloscope Probe: Miniature Probe with a 10:1 division ratio and 9 pF shunt capacitance.

HP 10021A Oscilloscope Probe: Miniature Probe with a 1:1 division ratio and 36 pF shunt capacitance.

Data Acquisition Software

HP 14855AA, HP 150 Touchscreen Version

HP 14856AA, HP Vectra PC and IBM PC Version

HP's Data Acquisition Software is a menu-driven program that performs voltage scanning, thermocouple scanning, and analog recording. It also includes a graphics utility for presenting information in a simple listing, linear graph, or logarithmic plot form; and it can be easily modified to suit specific applications. The following describes the four applications that the package provides:

Voltage Scanner

The Voltage Scanner supports up to two Relay Multiplexers and one DMM. It scans up to 16 channels.

Scan Rate

List Mode: 8 seconds (for 16 channels). Tabular display of data collected.

Trend Mode: Graphical display of data collected. Post run: 6 seconds (for 16 channels). Collects all data and then plots it. Real Time: 2 seconds (for 3 channels). Collects and plots data at the same time.

Maximum Channel-to-Channel Delay

List Mode: 0.5 seconds.

Trend Mode: Post Run: 0.375 seconds. Real Time: 0.667 seconds.

Maximum Number of Samples: (Number of Scans) x (Number of Channels) ≤ 3000. (Total number of samples with no user modification of program.)

Thermocouple Scanner

The Thermocouple Scanner supports up to two Relay Multiplexers and one DMM. It scans up to 14 thermocouple inputs and provides compensation and linearization for T, J, E, R, K & S type thermocouples.

Scan Rate

List Mode: 25 seconds (for 14 channels).

Trend Mode: Post Run: 25 seconds (for 14 channels). Real Time: 5 seconds (for 3 channels).

Maximum Channel-to-Channel Delay

List Mode: 1.8 seconds.

Trend Mode: Post Run: 1.8 seconds. Real Time: 1.8 seconds.

Maximum Number of Samples: (Number of Scans) x (Number of Channels) ≤ 3000. (Total number of samples with no user modification of program.)

Temperature Errors: (Includes reference-junction error, thermal-off voltages, and linearization error; does not include DMM or transducer errors) = ±3.5° C.



Analog Recorder

The Analog Recorder supports up to three DMMs. It measures one, two, or three channels vs. time, and one or two channels vs. a third channel.

| | | |
|-------------------------|--------------------------|-------------|
| Sample Interval: | 1 channel vs. time | 1 second |
| | 2 channels vs. time | 1.5 seconds |
| | 3 channels vs. time | 2 seconds |
| | 1 channel vs. Channel 1 | 1 second |
| | 2 channels vs. Channel 1 | 1.5 seconds |

Maximum Channel-to-Channel Delay: (Time between successive measurements in one sample interval) = 0.1 second.

Maximum Number of Samples: 500 (Total number of samples with no user modification of program.)

Graphics Utility

The Graphics Utility has 2 Y-axes and plots linear, semi-log, and log-log graphs.

Common To All Applications

Timebase: Range: 1 second to 1800 seconds. Resolution: 1 second.

Plotters: Direct support of HP 7470A and HP 7475A plotters.

ASYST Scientific Software

HP 14858A

ASYST Scientific Software is a programming language that integrates HP-IB instruments with powerful analysis, statistics, and graphics capabilities. ASYST is designed to work in concert with the HP Vectra PC or IBM PC, PC/XT, and PC/AT to provide the scientist or engineer with straightforward, pre-programmed commands that can be used interactively, or combined and modified as needed.

Mathematical, graphics and statistical capabilities include basic mathematics operators, descriptive statistics, array manipulation and control, automatic plotting and color graphics support, a text editor, file I/O, and a built-in programming language.

Built-in analysis functions include eigenvalues, eigenvectors, polynomials, ANOVA, axonometric and contour plotting, least squares approximations, curve fitting, convolutions, integration, differentiation, smoothing, and fast Fourier transform.

HP-IB commands provide a "seamless" integration of instrument I/O with these analytical and graphics capabilities.

Graphics/Statistics/Analysis

Data Types: Single or double precision real, integer, or complex values (80-bit double precision); strings; named scalars or arrays. Automatic or user-controlled conversions in mixed expressions between integers, reals, and complex data types. Arrays may have up to 16 dimensions and be as large as 64K bytes apiece.

Arithmetic Operations and Special Functions: +, -, *, /, **, min, max, neg, abs, inv, sqrt, ln, exp, conj, sin, cos, tan, sec, csc, cot, sinh, cosh, tanh, sech, csch, coth, asin, acos, atan, asec, acsc, acot, asinh, acosh, atanh, asech, acsch, acoth. All arithmetic operators work directly (without loops) on all elements of an array. Mixed expressions of arrays and scalars, or arrays of differing dimensionality are permitted.

Statistical Functions: Mean; variance; mode; median; moments; standard deviation; cumulative distributions; Gaussian, Chi-square, Student-T distributions; random number generation; sort, sort and index.

Array Handling Functions: Subarrays, reversal of indices, transposition of dimension, lesser dimension subsets, individual elements, catenation, lamination, auto entry of array data, scrolling, format control of array data display, generalized inner and outer product, matrix multiplication.

Built-In Full-Screen Text Editor and Array Editor.

Graphics: Automatic line graphs, scatter plots, bar and pie charts, plotting with error bars. Options include: Color graphics, superposition of plots, multiple graphics windows, polar plots, autoscaling and data fitting, linear or logarithmic display along either axis, strip chart recorder emulation replotting of data subsets with a single keystroke, and support for digital plotters and high-resolution graphics.

Graphics Readout and Cursors: On-screen graphics cursors controlled by arrow keys, labeling at any location within the graphics area.

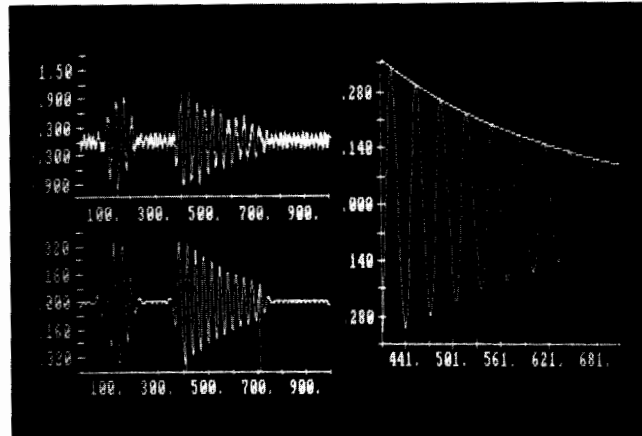

ASYST integrates analysis functions with graphics. On-screen cursors allow interactive selection of curve segments.

Control Structures: If... else... then, Begin... until, Begin... while... repeat, Case... of... endcase, Do... loop; Comparisons: =, <, >, ≤, ≥, ≥, not, and, or, xor.

Input/Output: Loading from standard text or arbitrary user-defined files, saving and loading workspace images to disk, direct array I/O to packed-binary disk files, ASCII, BASIC, and DIF-format files.

String Handling: String-to-number conversion, number-to-string conversion, string arrays.

Gamma, Bessel and Error Functions.

RS-232 Support.

Polynomial Mathematics and Evaluation: Polynomial multiplication, synthetic division, integration, differentiation, shifting, root extraction.

Advanced Graphics: Axonometric and contour plots. Plotting with hidden lines removed.

Vectors and Matrices: Matrix inversion, determinants, QR factorization and Gram-Schmidt orthogonalization.

Solutions to Simultaneous Equations.

Eigenvalues and Eigenvectors: Eigensystems of Hermitian matrices, spectral slicing, reduction of a general matrix to Hessenberg and triangular form.

Curve Fitting: Least squares polynomials, multilinear regressions, parametric and non-linear curve fitting, weighted least squares, exponential and logarithmic fits, orthogonal polynomials, R^2 (cross-correlation).

Non-Linear Regression.

Advanced Statistics: One- and two-way analysis of variance (ANOVA), F-tests.

Data Manipulation: Data smoothing, differentiation and integration, peak detection, convolutions and filtering.

Fast Fourier Transform, 2-D FFT, and Inverse FFT.

HP-IB Commands

Complete IEEE-488 Protocol: Device-dependent and device-independent commands, parallel and serial polling, synchronous and asynchronous operation, DMA acquisition.

Buffering: Array buffering of data. Buffering of device-dependent commands.

Real-time Synchronization: Triggering, clock-initiated acquisition, software synchronization.

ASYST Hardware Requirements

HP Vectra PC or IBM PC, PC/XT, or PC/AT.

DOS 2.0/2.1/3.0/3.1.

8087 or 80287 co-processor.

Two or more drives (including one double-sided 5¼" floppy drive).

512K memory (640K recommended).

IBM Color Graphics Board, Hercules Graphics Card, HP Enhanced Color Graphics Card.

HP-IB Interface Card (Required for HP-IB Commands)

Optional: HP Thinkjet Printer, IBM Graphics Printer, HP 7470A or 7475A plotter.

PC INSTRUMENTS

HP-IB Products

Models 14857AA and 61062AA

- Controls HP-IB instruments from an HP Vectra PC, HP 150 Touchscreen and IBM PC, PC/XT, or PC/AT.
- Operates with both BASIC and Pascal.

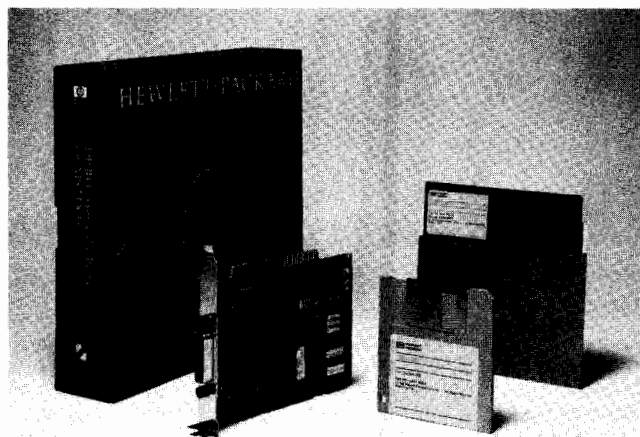

HP-IB Products

HP 14857AA HP-IB Command Library, HP 150 Touchscreen Version

HP 61062AA HP-IB Interface and Command Library, HP Vectra PC and IBM PC Version

The Hewlett-Packard HP-IB Command Library provides instrument control capability to personal computers that run MS-DOS. The following computers are supported: The HP Vectra PC, HP 150 Touchscreen and Touchscreen II, and the IBM PC, PC/XT, or PC/AT.

The HP-IB Command Library is compatible with PC Instruments System Software for the HP PC Instruments Bus (PCIB). This lets you control a combination of HP-IB instruments and PC Instruments from the same BASIC program.

A Single Command Set for BASIC and Pascal

The HP-IB Command Library lets you include commands in your BASIC or Pascal program to control HP-IB instruments. You learn only one set of commands for both BASIC and Pascal. Commands are implemented in BASIC as subroutine calls and in Pascal as function calls.

Six commands allow you to enter and output ASCII strings, real numbers, and arrays of real numbers. They are:

| | |
|-----------|---|
| IOENTER | Reads a single real number from a device. |
| IOENTERA | Fills an array with real numbers from a device. |
| IOENTERS | Enters an ASCII string from a device. |
| IOOUTPUT | Outputs a real number to a specified device. |
| IOOUTPUTA | Outputs an array of real numbers to a device. |
| IOOUTPUTS | Outputs an ASCII string to a device. |

These powerful commands take care of more than 80% of the HP-IB I/O tasks in most applications. They are easy to use and do not require a detailed knowledge of the IEEE-488 standard.

A built-in number builder and number formatter relieve the user of the need to convert data between string and numeric formats. This reduces the number of programming statements and the associated overhead.

- Controls HP-IB instruments and PC Instruments from the same BASIC program.
- Similar to HP-IB commands used on HP Series 200 and Series 80 computers.

Compatibility

Because the commands in the HP-IB Library are similar to those used on the HP Series 200 and Series 80 computers, a brief review of the instruction set is all that you need to get started with your applications.

System Performance

The performance of the HP-IB Command Library is compared below to that of other HP computers. The Nelson Benchmark shown here uses an HP 3437A Systems Voltmeter and an HP 3495A Relay Scanner to measure the voltage at each node of a biased resistor network. This benchmark represents a typical measurement loop in a small data acquisition system, and checks the ability of each computer to do quick reads of an HP-IB device as well as data conversion, looping and tolerance testing. These numbers are preliminary and for comparison purposes only.

| NOTE: ALL TIMINGS ARE IN MILLISECONDS | NELSON BENCHMARK | OUTPUT 1 BYTE | OUTPUT 255 BYTES | ENTER -12.34 | ENTER -1.234567E-06 |
|--|------------------|---------------|------------------|--------------|---------------------|
| HP Vectra PC with HP-IB Library | 230 ms. | 4 ms. | 6 ms. | 7 ms. | 8 ms. |
| HP 150 Touchscreen with HP-IB Library | 760 ms. | 13 ms. | 18 ms. | 20 ms. | 24 ms. |
| IBM PC/AT with HP-IB Library | 315 ms. | 6 ms. | 9 ms. | 9 ms. | 11 ms. |
| IBM PC/XT with HP-IB Library | 770 ms. | 15 ms. | 21 ms. | 24 ms. | 29 ms. |
| HP SERIES 200 (HP 9836 with BASIC 2.0) | 81 ms. | 1.5 ms. | 5.1 ms. | 1.9 ms. | 2.4 ms. |
| HP SERIES 80 (HP 86B) | 1,610 ms. | 40 ms. | 137 ms. | 29 ms. | 35 ms. |

System Requirements

The BASIC language implementation of the HP-IB Command Library requires Vectra BASIC Interpreter for the Vectra PC, GWTM-BASIC for the HP 150 Touchscreen or BASICA (version 2.0 or later) for the IBM PC family. The Pascal language implementation requires MSTM-Pascal (version 3.0 or later).

For Vectra PC and IBM PC applications, you must install the HP-IB interface card included with the 61062AA version of the Library.

The HP-IB Library requires a minimum of 256K bytes of memory. An additional 60K bytes of memory is recommended for the HP 150 Touchscreen version so that a program with HP-IB commands can be installed as an application under P.A.M.

| Computer | HP Vectra PC | HP 150 Touchscreen, Touchscreen Max, Touchscreen II | IBM PC, PC/XT, PC/AT |
|------------------|--------------------------|---|------------------------|
| Command Library | HP 61062AA | HP 14857AA | HP 61062AA |
| Mass Storage | Your Choice | Your Choice | Your Choice |
| Printer | Your Choice | Your Choice | Your Choice |
| HP-IB Cable | Your Choice | Your Choice | Your Choice |
| Operating System | Vectra DOS (HP 45951A) | MS-DOS 2.11 or Later | PC-DOS 2.1 or Later |
| BASIC Language | Vectra BASIC (HP 45952A) | GW BASIC (HP 45450D) | BASICA 2.0 or Later |
| Pascal Language | MS-Pascal | MS-Pascal | MS-Pascal |
| Memory Required | 256K | 256K (512K Recommended) | 256K |
| Interface Card | Included in HP 61062AA | Built In | Included in HP 61062AA |

MSTM-DOS, MSTM-Pascal, and GWTM-BASIC are trademarks of Microsoft Corporation.

Touchscreen Controller Packages

HP 45861A Touchscreen HP-IB Controller

The Touchscreen HP-IB Controller is a totally integrated personal-computer-based system that includes all of the PC accessories you need to control HP-IB (IEEE-488) instruments. It consists of an HP 150 Touchscreen II Base System, HP Touch Accessory, and the HP-IB Command Library, which gives you access to more than 2,000 HP-IB instruments. (Note: This package does not include GW BASIC or Pascal.)

The HP-IB Command Library for MS-DOS serves as a link between the office and the laboratory/production-test bench. It consists of a single command set implemented in both GW BASIC and Pascal, which is based on HP-IB functions used in the HP 9000 Series 200 and Series 80 computers (see page 200 for further HP-IB Command Library details).

The HP-IB Command Library is designed to be compatible with HP PC Instruments software, thus allowing control of both HP-IB instruments and PC Instruments from the same GW BASIC program.

HP 45862A Touchscreen PCIB Controller

The Touchscreen PCIB Controller is a bundled personal-computer-based system that includes all of the PC accessories you need to control PC Instruments.

It consists of an HP 150 Touchscreen II Base System, HP Touch Accessory, 384K RAM Memory Board, PC Instruments Interface, and GW BASIC. Users create an automated-instrument system by adding their selection of PC Instruments modules to the controller.

Ordering Information

Following are step-by-step instructions for configuring and ordering your PC Instruments system. Included are descriptions, ordering instructions and prices for individual instruments and accessories, and for bundled packages which offer ordering convenience and dollar savings.

To order PC Instruments products in the US Telephone 800-523-2121

Step 1: Refer to the configuration guide on page 202 for a listing of supported computer hardware and software, and order the equipment you need. Below is a partial listing of HP computers, software, and peripherals suitable for use with PC Instruments. Note that Microsoft BASIC (GW BASIC or BASICA) and a total of 640K RAM memory is required.

| | |
|--|--------|
| HP 45862A Touchscreen PCIB Controller | \$4935 |
| Includes: 150 Touchscreen II Base System | |
| HP Touch Accessory (user installable bezel) | |
| 384K RAM Memory Board | |
| PC Instruments Interface | |
| GW BASIC | |

Step 2: Choose from the following disc drives:

| | |
|--|--------|
| 9123D Dual 3 1/2" Microfloppy Disc Drive; 710 KB each drive* | \$715 |
| 9153A 10MB Winchester Disc with one 3 1/2" Microfloppy Disc Drive | \$1940 |
| 9133H 20MB Winchester Disc with one 3 1/2" Microfloppy Disc Drive | \$2740 |
| 9133L 40MB Winchester Disc with one 3 1/2" Microfloppy Disc Drive | \$4240 |

*Can only be used with 150 Touchscreen II due to power requirements. (9123D does not have its own power supply.)

Step 3: Select the following flexible discs for your personal computer:

| | |
|--|------|
| HP 92192A 3 1/2" Flexible Discs (box of 10). Double-sided microfloppy discs for use with the 150 Touchscreen and Touchscreen II PCs. | \$69 |
| HP 92190A 5 1/4" Flexible Discs (box of 10). Double-sided microfloppy discs for use with the HP Vectra PC or IBM PC, PC/XT and PC/AT. | \$58 |

Step 4: Select the correct PC Instruments Interface for your computer. You will not need this step if you have selected the PCIB Controller package unless you want more than eight modules on the system. One interface can control up to eight instrument modules. The System Software is included with the interface:

| | |
|--|-------|
| HP 61060AA PC Instruments Interface (HP 150 Touchscreen Version) | \$500 |
| HP 61061AA PC Instruments Interface (HP Vectra PC and IBM PC Version) | \$500 |

Up to two PC Instruments Interfaces can be accommodated by the HP Vectra PC, 150 Touchscreen II, IBM PC, PC/XT, or PC/AT. Only one PC Instruments Interface can be accommodated by the HP 150B Touchscreen. Each interface occupies one long slot in the computer's backplane.

Step 5: Select the type and quantity of instrument modules:

| | |
|--|--------|
| HP 61010AA Digital I/O | \$650 |
| HP 61011AA Relay Multiplexer | \$650 |
| HP 61012AA Dual Voltage DAC | \$800 |
| HP 61013AA Digital Multimeter | \$650 |
| HP 61014AA Function Generator | \$1500 |
| HP 61015AA Universal Counter | \$900 |
| HP 61016AA Digitizing Oscilloscope* | \$1500 |
| HP 61017AA Relay Actuator | \$650 |

*Up to five HP 61016AA oscilloscopes may be connected to a PC Controller if no other instruments are present on the PC Instruments Bus (PCIB).

Step 6: Select from these optional software packages:

| | |
|--|-------|
| HP 14855AA Data Acquisition Software (HP 150 Touchscreen Version) | \$400 |
| HP 14856AA Data Acquisition Software (HP Vectra PC or IBM PC Version) | \$400 |

Step 7: Choose from these optional PC Instruments Accessories:

| | |
|--|-------|
| HP 61001A System Power Unit | \$400 |
| Holds up to eight power packs, filters line current, and provides a central power switch. Can be rack mounted; support rails are recommended. | |
| HP 14801A Rack Shelf | \$200 |
| Allows you to mount up to four PC Instruments and their power supplies in a standard 19" instrument rack. Includes three blank front panels for use when fewer than four modules are to be racked. | |
| HP 14802A Terminal Block | \$150 |
| Allows easy screw termination of user connections to HP 61010AA Digital I/O. | |
| HP 5080-2064 Binder and Slipcase | \$15 |
| Empty binder and slipcase sized to fit PC Instruments manual pages. Recommended for systems consisting of more than three different PC Instruments modules. | |
| HP 10040A 10:1 Oscilloscope Probe | \$125 |
| HP 10021A 1:1 Oscilloscope Probe | \$75 |
| These miniature probes are recommended for use with HP 61016AA Digitizing Oscilloscope. | |

PC Instruments Packages

You can save over \$600 by ordering PC Instruments products in selected combinations. The following packages make it easy to order popular configurations. Just choose the right package for your needs, a PC Instruments Interface, and your computer. The Data Logging Packages have what you need to scan up to eight channels. The Electronic Bench Packages provide enough equipment to outfit an entire lab bench.

| | |
|---|--------|
| HP 61086AA Data Logging Package (HP 150 Touchscreen Version) | \$1600 |
| Includes: HP 61011AA Relay Multiplexer | |
| HP 61013AA Digital Multimeter | |
| HP 14855AA Data Acquisition Software | |



PC INSTRUMENTS

General Ordering Information; Required Hardware/Software

- HP 61087AA** Data Logging Package (HP Vectra PC and IBM PC Version) \$1600
 Includes: HP 61011AA Relay Multiplexer
 HP 61013AA Digital Multimeter
 HP 14856AA Data Acquisition Software
- HP 61088AA** Electronic Bench Package (HP 150 Touchscreen Version) \$6500
 Includes: HP 61011AA Relay Multiplexer
 HP 61012AA Dual Voltage DAC
 HP 61013AA Digital Multimeter
 HP 61014AA Function Generator
 HP 61015AA Universal Counter
 HP 61016AA Digitizing Oscilloscope
 HP 61001A System Power Unit
 HP 14855AA Data Acquisition Software
 HP 14857AA HP-IB Command Library for MS-DOS (HP 150 Touchscreen Version)
- HP 61089AA** Electronic Bench Package (HP Vectra PC and IBM PC Version) \$6600
 Includes: HP 61011AA Relay Multiplexer
 HP 61012AA Dual Voltage DAC
 HP 61013AA Digital Multimeter
 HP 61014AA Function Generator
 HP 61015AA Universal Counter
 HP 61016AA Digitizing Oscilloscope
 HP 61001A System Power Unit
 HP 14856AA Data Acquisition Software
 HP 61062AA HP-IB Command Library
 HP 5080-2064 Binder and Slipcase

HP-IB Products

Optional HP-IB products are available to turn your PC into an HP-IB instrument controller. (For use with or without PC Instruments.)

- HP 45861A** 150 Touchscreen HP-IB Controller \$3430
 Note: This package includes all of the PC accessories you need to control HP-IB Instruments except the BASIC or Pascal software.
 Includes: HP 150 Touchscreen II Base System
 HP Touch Accessory (user installable bezel)
 HP-IB Command Library for MS-DOS
- HP 14857AA** HP-IB Command Library (HP 150 Touchscreen Version) \$300
 The HP 14857AA is included in the HP 150 Touchscreen HP-IB Controller package. You will not need this if you have ordered the HP 45861A.
- HP 61062AA** HP-IB Command Library (HP Vectra PC and IBM PC Version) \$400
 The HP 61062AA contains both the software and an interface card which occupies one short slot in the computer's backplane.
- HP 10833D** HP-IB Cable, 1.6 ft (0.5m) \$80
HP 10833A HP-IB Cable, 3.3 ft (1.0m) \$80
HP 10833B HP-IB Cable, 6.6 ft (2.0m) \$90
HP 10833C HP-IB Cable, 13.2 ft (3.0m) \$100
 These cables are for use with the HP 14857AA and the HP 61062AA. One cable is needed for each HP-IB instrument in your system. Note that these cables are not required for use with any of the PC Instruments modules.
- HP 14858A Opt 001** ASYST Scientific Software \$1695
Opt 002 with HP-IB Commands add \$300
Opt 003 HP-IB Commands with HP-IB Interface Card add \$600

Required Computer Configuration and Supported Hardware

| | | | |
|---------------------------------------|--|---|--|
| COMPATIBLE COMPUTERS: | <ul style="list-style-type: none"> HP Vectra PC | <ul style="list-style-type: none"> HP 150B Touchscreen PC HP 150B Touchscreen MAX PC HP 150C Touchscreen II | <ul style="list-style-type: none"> IBM PC IBM PC/XT IBM PC/AT |
| AMOUNT OF MEMORY: | <ul style="list-style-type: none"> 640K RAM | <ul style="list-style-type: none"> 640K RAM | <ul style="list-style-type: none"> 640K RAM |
| SUPPORTED RAM: | <ul style="list-style-type: none"> HP 45973A 1/2MB Memory Expansion Card | <ul style="list-style-type: none"> HP 45632A 384K Memory Expansion Card | <ul style="list-style-type: none"> IBM Memory Expansion Card Quadram Quadboard™ (384K) |
| SUPPORTED DISC DRIVES: | <ul style="list-style-type: none"> HP 45811A 360KB internal flexible disc HP 45812A 1.2MB high-capacity internal flexible disc HP 45816A 20MB internal hard disc subsystem HP 9134H 20MB stand-alone hard disc | <ul style="list-style-type: none"> HP 9122D Dual 3 1/2" Microfloppy; 710 KB each drive HP 9123D Dual 3 1/2" Microfloppy; 710 KB each drive HP 9153D 10 MB Winchester with one 3 1/2" Microfloppy HP 9133H 20MB Winchester with one 3 1/2" Microfloppy HP 9133L 40MB Winchester with one 3 1/2" Microfloppy HP 9133D 14.8MB Winchester with one 3 1/2" Microfloppy | <ul style="list-style-type: none"> Dual flexible disc drive Winchester with flexible disc drive (standard IBM drive) |
| MONITOR: | <ul style="list-style-type: none"> Monochrome or color | <ul style="list-style-type: none"> Standard monochrome | <ul style="list-style-type: none"> Monochrome or color |
| SUPPORTED MONITORS: | <ul style="list-style-type: none"> HP 35731A 12" monochrome monitor HP 35741A 12" color monitor | <ul style="list-style-type: none"> N/A | <ul style="list-style-type: none"> IBM Color Monitor Princeton Graphics Systems HX-12 Sanyo DM8112CX (monochrome) |
| GRAPHICS ADAPTER: | <ul style="list-style-type: none"> HP 45984A Multimode Color Adapter | <ul style="list-style-type: none"> N/A | <ul style="list-style-type: none"> IBM Color Graphics Monitor Adapter |
| OPERATING SYSTEM: | <ul style="list-style-type: none"> HP 45951A Vectra DOS | <ul style="list-style-type: none"> MS-DOS 2.11 | <ul style="list-style-type: none"> DOS 3.0 |
| BASIC SOFTWARE: | <ul style="list-style-type: none"> HP 45952A Vectra BASIC Interpreter | <ul style="list-style-type: none"> HP 45450D GW BASIC | <ul style="list-style-type: none"> BASICA 2.0 or later version |
| Supported Computer Peripherals | | | |
| PRINTERS: | <ul style="list-style-type: none"> HP 2225C ThinkJet Printer | <ul style="list-style-type: none"> HP 2674A Internal Printer HP 2225A ThinkJet Printer | <ul style="list-style-type: none"> IBM Graphics Printer HP 2225C ThinkJet Printer |
| PLOTTERS: | <ul style="list-style-type: none"> HP 7470A Two pen plotter HP 7475A Six pen plotter | <ul style="list-style-type: none"> HP 7470A Two pen plotter HP 7475A Six pen plotter | <ul style="list-style-type: none"> HP 7470A Two pen plotter HP 7475A Six pen plotter |

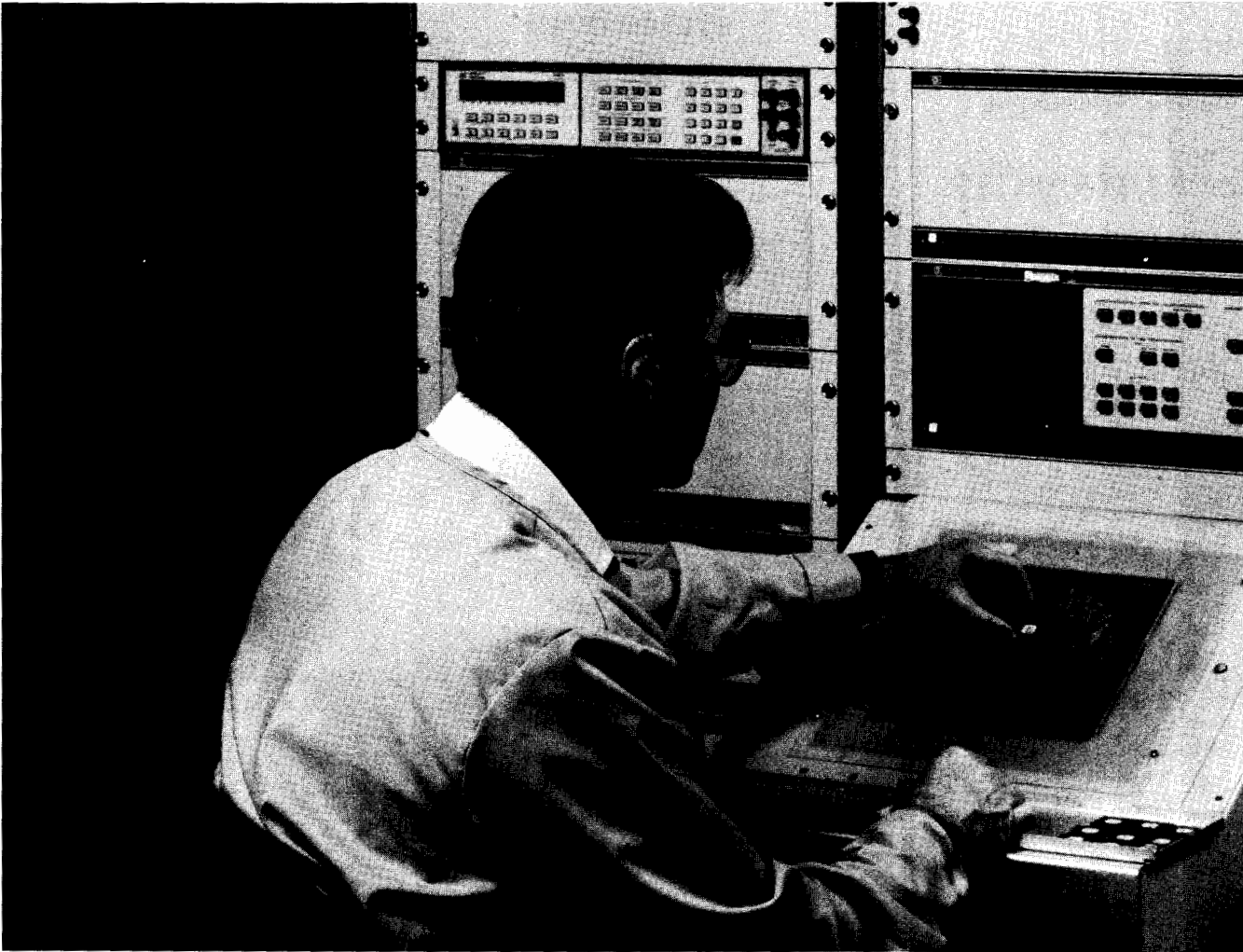

Hewlett-Packard's digital multimeters (DMMs) are carefully defined and designed with your needs in mind. As a result, we offer a wide range of DMMs with convenient, versatile performance features to meet your test, measurement, and data acquisition requirements. In some system applications, measurement speed is the most important requirement. Other applications require high accuracy, high resolution, and good noise rejection measurements. Often, the requirements are somewhere in between. HP offers both bench and system DMMs with a wide variety of speed and accuracy tradeoffs to fit your application.

HP's integrating DMMs offer the fastest reading rates available with powerline-related noise rejection. Integration selection (number of powerline cycles) is key to performance tradeoffs in HP's system DMMs. For example, reading rates are maximized by decreasing resolution and the number of powerline cycles. Conversely, accuracy and resolution are improved by increasing the number of powerline cycles. In short, HP allows you to choose the resolution, accuracy, and noise rejection needed, while maximizing measurement speed.

Quality and reliability are bywords of HP DMMs. From concept to implementation, every phase of designing and manufacturing DMMs like the HP 3468A/B and the HP 3478A have resulted in extremely reliable products.

These field-proven DMMs have lived up to their design expectations. In keeping with the precedent set by the HP 3468A/B and HP 3478A, the new HP 3457A Multimeter emphasizes quality and reliability while offering you performance and convenience rivaling that of competitive DMMs costing twice as much. Electronic, "no pots", calibration, designed-in serviceability, and self-test capabilities also keep repair time and costs to a minimum. Reliability of our products is so good that we now offer three years of hardware support for the HP 3437A, 3456A, 3457A, 3468A/B, and 3478A at a low incremental price that will surprise you. As a result of HP's commitment to quality, you can benefit by reducing your total cost of ownership when purchasing HP DMMs.

For system applications, you can increase throughput using DMMs like the HP 3456A. This system DMM is HP's throughput leader when you need to change functions and ranges often to obtain all of your measurements. The ability to change functions and ranges fast while taking measurements is a fairly realistic way of viewing measurement throughput. All of HP's system multimeters share this common strength to help you improve your throughput, and your profits.

Offering 3½ to 7½ digit resolution and excellent long term DC accuracy, the new HP 3457A offers you choices between high speed, low resolution (1350 3½ digit readings/sec) or low speed, high resolution (one 7½ digit reading every two seconds with

more than 160 dB effective common mode rejection) measurements. In DC Volts, the HP 3457A gives you 30 millivolt to 300 volt full scale ranging with a maximum resolution of 10 nanovolts. In addition to DC Volts, AC Volts, DC Current, AC Current, and Resistance functions, this multimeter has Frequency and Period functions, as well as two optional plug-in multiplexer assemblies. Complete programmability over HP-IB includes more than just measurements. Other features like Pass/Fail Limit testing, complete nonvolatile electronic calibration, and program memory are just a few of the many built-in programmable features of the HP 3457A. Flexible triggering and consistent timing even provide digitizing capabilities for audio bandwidth AC waveforms.

For low-cost HP-IB systems, the 3½ to 5½ digit HP 3478A provides five measurement functions—DC Volts, AC Volts, DC Current, AC Current, and Resistance—with the performance to meet many system requirements without putting a big dent in your instrumentation budget. The HP 3468A/B provides similar performance for bench applications. Both products are known for outstanding reliability, and are completely calibrated electronically. For the HP 3468A/B, calibration can be automated via a serial interface called HP-IL, the Hewlett-Packard Interface Loop, which also allows remote programmability using one of HP's HP-IL portable computers.



MULTIMETERS

SYSTEM DMMs

| HP Model | 3457A p.205 | 3456A p.210 | 3455A p.212 | 3437A p.213 | 3478A p.208 |
|--|--|--|--|---|---|
| GENERAL INFORMATION | | | | | |
| Digits of Resolution Base Price | 3½ to 6½ \$2800 | 3½ to 6½ \$3800 | 5½ to 6½ \$5100 | 3½ \$3000 | 3½ to 5½ \$995 |
| A/D CONVERSION METHOD | | | | | |
| | Multislope Integration | Multislope Integration | Multislope Integration | Successive Approximation | Multislope Integration |
| STANDARD FEATURES | | | | | |
| | 7 Functions Math, Electronic Calibration, | 3 Functions Math, Ratio, | 3 Functions Math | DC Volts 5k-(sample/sec) Data Acquisition | 5 Functions, Electronic Calibration |
| OPTIONAL FEATURES | | | | | |
| | Plug-in Multiplexers, 3 Yr. Hardware Support | Enhanced AC Accuracy, 3 Yr. Hardware Support | | | 3 Yr. Hardware Support |
| DC VOLTAGE | | | | | |
| Ranges Sensitivity 90 Day/1 Yr Best Full Scale Accuracy Max Readings Per Sec 60Hz/50Hz Modes at 3½ digits at 4½ digits at 5½ digits at 6½ digits | 30 mV to 300 V 10 nV 0.0019%/0.0027% | 100 mV to 1000 V 100 nV 0.0017%/0.0025% | 100 mV to 1000 V 1 µV 0.0051%/0.013% | 100 mV to 10 V 100 µV 0.19%/0.23% | 30 mV to 300 V 100 nV 0.0047%/0.0067% |
| | 1350/1350 1250/1250 360/312 53/45 | 330/290 330/290 210/180 48/40 | — — 24/22 6/5 | 5000/5000 — — — | 90/85 35/30 4.4/3.7 — |
| AC VOLTAGE | | | | | |
| Ranges | 30 mV to 300 V | 1 V to 1000 V | 1 V to 1000 V | — | 300 mV to 300 V |
| RESISTANCE | | | | | |
| Ranges | 30 Ω to 3 GΩ | 100 Ω to 1 GΩ | 100 Ω to 10 MΩ | — | 30 Ω to 30 MΩ |
| CURRENT | | | | | |
| DC Ranges Min/Max AC Ranges | 300 µA to 1.5 A 30 mA to 1.0 A | — — | — — | — — | 300 mA to 3 A 300 mA to 3 A |

BENCH DMMs

| HP Model | 3468A/B p.215 | 3466A p.214 | 3435A p.217 |
|--|--|--|---|
| GENERAL INFORMATION | | | |
| Digits of Resolution Base Price Rechargeable Battery Operation V & Ω Auto/Manual Ranging A/D Conversion Method AC Conversion Method | 3½ to 5½ \$750 — ✓ Multislope Integration True RMS | 4½ \$1000 ✓ ✓ Dual-Slope Integration True RMS | 3½ \$700 ✓ ✓ Dual-Slope Integration Average Responding |
| STANDARD FEATURES | | | |
| | 4-Wire Ohms, Electronic Calibration, HP-IL, Auto/Manual Current Ranging | AC+DC, Diode Test Ohms Zero Adjust | |
| OPTIONAL FEATURES | | | |
| | Rechargeable Battery Operation, 3 Yr Hardware Support | Touch-Hold Probe | Touch-Hold Probe |
| DC VOLTAGE | | | |
| Ranges Sensitivity 1 Yr Best Full Scale Accuracy Max Readings Per Sec | 300 mV to 300 V 1 µV 0.019% | 20 mV to 1200 V 1 µV 0.035% | 200 mV to 1200 V 100 µV 0.15% |
| | 32 | 4.7 | 4.7 |
| AC VOLTAGE | | | |
| Ranges | 300 mV to 300 V | 200 mV to 1200 V | 200 mV to 1200 V |
| RESISTANCE | | | |
| Ranges | 300 Ω to 30 MΩ | 20 Ω to 20 MΩ | 20 Ω to 20 MΩ |
| CURRENT | | | |
| DC Ranges AC Ranges | 3 A 300 mA to 3 A | 200 µA to 2 A 200 µA to 2 A | 200 µA to 2 A 200 µA to 2 A |

MULTIMETERS

3 1/2 to 6 1/2 Digit DMM with Extended Resolution to 7 1/2 Digits

Model 3457A



- Over 1350 Readings/sec at 3 1/2 Digits
- Seven Functions—dcV, acV, dcl, acI, Ohms, Frequency and Period

- Two Plug-in Multiplexer Options
- DC Sensitivity to 10 Nanovolts
- Outstanding Combination of Performance and Price

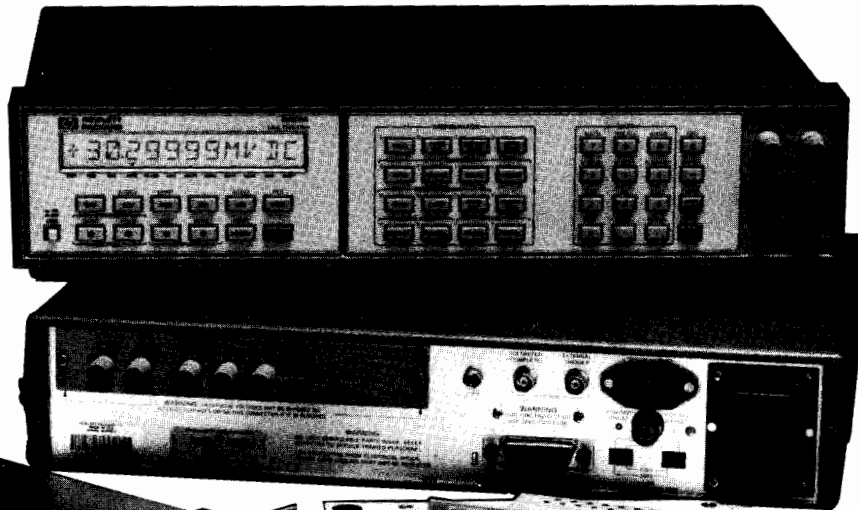

HP 3457A

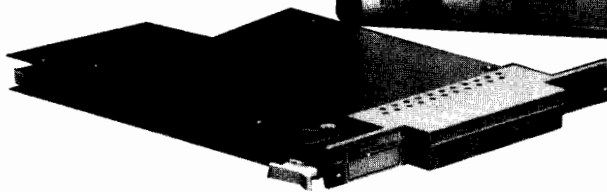

HP 44491A
Optional Relay Assembly



HP 44492A
Optional Relay Assembly



Description

The HP 3457A has seven functions with 3 1/2 to 6 1/2 digits of resolution extendable to 7 1/2 digits at reading rates from 1 reading every 2 seconds to 1350 rds/s and basic DC volts accuracy as good as 5 ppm. In addition, the input of the HP 3457A can be expanded up to ten channels with either of the optional plug-in multiplexer assemblies. On the bench, the front panel operation is extremely flexible and comprehensive. In systems, the Hewlett-Packard Interface Bus (HP-IB) is standard.

Powerful Measurement Management

The HP 3457A combines superb analog measuring capability with equally powerful measurement management. More than 1000 readings or whole measurement sequences can be stored in the HP 3457A for convenient and fast measurement throughput. The present dmm setup can be stored in the non-volatile state memory for convenient reconfiguration of the dmm.

Additional power from math functions can be obtained by using PASS/FAIL limit testing, NULL, SCALE, THERMISTOR linearization, and others. The power of total electronic calibration, including AC volts, makes it easy to maintain instrument performance.

System Features

Keeping with HP's long tradition of systems oriented digital multimeters, the HP 3457A has all the systems features you've come to expect plus more to make interfacing to your computer even easier—features like flexible formatting of ASCII, 16 bit binary, or 32 bit binary data and buffer memory so that you can take measurements with the HP 3457A while you're transferring the contents of its memory into your computer. In addition, you'll find the VOLTmeter

COMPLETE output and EXTERNAL TRIGGER input signals ideal for synchronizing other instrumentation with the HP 3457A. Finally, programmable front-rear terminal switching lets you measure two separate inputs without a scanner.

Hewlett-Packard Multimeter Language (HPML)

Another first for the HP 3457A DMM is an easy-to-use dmm language—HPML. Designed so that software written for today's multimeter will fit tomorrow's, HPML only asks you to define the parameters necessary to accomplish your measurement. For example, if you want to make a DCV measurement on a 9 volt signal with 0.01% resolution, the command sequence is "DCV,9,.01".

Two Multiplexer Options

Either one of two different multiplexer assemblies may be used with the HP 3457A so that up to ten signal channels may be scanned either sequentially or randomly. All of the functional capability offered through the normal front and rear input terminals is available for multiple inputs.

For measurement flexibility, the HP 44491A Armature Relay Multiplexer Assembly offers eight two-wire channels and two current/actuator channels. Under software control the eight two-wire channels can be reconfigured to four 4-wire ohm channels. The two current channels offer automatic make-before-break switching so that the path for current as high as 1.5 A is never broken. In addition, these two channels can be used as external device actuator channels. Each channel can switch up 250 V. The general purpose multiplexer can close a channel and make a measurement at a maximum rate of 33 channels per second.



MULTIMETERS

3¹/₂ to 6¹/₂ Digit DMM with Extended Resolution to 7¹/₂ Digits

Model 3457A (cont.)

For higher speed scanning, the HP 44492A Reed Relay Multiplexer Assembly offers ten two-wire channels. The HP 44492A is useful for switching dcV, acV, ac+dcV, two wire ohms, frequency and period measurement signals with a maximum amplitude of 125 V. The Reed Relay Multiplexer can close a relay and make a measurement at a maximum rate of 300 channels per second.

Abbreviated Technical Specifications

90 day, Tcal ± 5 deg. C

DC Voltage

| Range | Maximum Reading | Best 6 ¹ / ₂ Digit Accuracy ¹ ± (% Rdg + Cnts) | | | Input Resistance |
|---------|-----------------|--|-------------|--|------------------|
| | | % of Reading | Count Error | | |
| 30 mV | 30.03000 mV | 0.0040 | 365 | | 10 GΩ |
| 300 mV | 303.00000 mV | 0.0025 | 40 | | 10 GΩ |
| 3.0 V | 3.030000 V | 0.0017 | 7 | | 10 GΩ |
| 30.0 V | 30.30000 V | 0.0035 | 20 | | 10 MΩ |
| 300.0 V | 303.0000 V | 0.0050 | 7 | | 10 MΩ |

- After 1 hr warm-up, integration time 100 PLC. Tcal is the temperature of the calibration environment between 18 and 28 deg C.

DC Current

| Range | Maximum Reading | Best 6 ¹ / ₂ Digit Accuracy ¹ ± (% Rdg + Cnts) | | | Input Resistance |
|--------|-----------------|--|-------------|--|------------------|
| | | % of Reading | Count Error | | |
| 300 μA | 303.0000μA | 0.02 | 104 | | 1400Ω |
| 3 mA | 3.030000 mA | 0.02 | 104 | | 100Ω |
| 30 mA | 30.30000 mA | 0.02 | 104 | | 10Ω |
| 300 mA | 303.00000 mA | 0.07 | 204 | | 1Ω |
| 1.5A | 1.500000 A | 0.07 | 604 | | 0.1Ω |

- After 1 hr warm-up, integration time 100PLC. Tcal is the temperature of the calibration environment between 18 and 28 deg C.

Resistance (2 and 4 wire ohms)²

| Range | Maximum Reading | Best 6 ¹ / ₂ Digit Accuracy ¹ ± (% Rdg + Cnts) | | | Current Output |
|-----------------------|-----------------|--|-------------|--|----------------|
| | | % of Reading | Count Error | | |
| 30 Ohm | 30.30000 Ohm | 0.0065 | 315 | | 1 mA |
| 300 Ohm | 303.0000 Ohm | 0.0045 | 34 | | 1 mA |
| 3 kOhm | 3.030000 kOhm | 0.0035 | 6 | | 1 mA |
| 30 kOhm | 30.30000 kOhm | 0.0035 | 6 | | 100 μA |
| 300 kOhm | 303.0000 kOhm | 0.0040 | 7 | | 10 μA |
| 3 MOhm | 3.030000 MOhm | 0.0055 | 12 | | 1 μA |
| 30 MOhm | 30.30000 MOhm | 0.0250 | 80 | | 100nA |
| 300 MOhm ³ | 303.0000 MOhm | 0.60 | 1000 | | 100nA |
| 3.0 GOhm ³ | 3.030000 GOhm | 6 | 1000 | | 100nA |

- After 1 hr warm up, integration time 100 PLC. Tcal is the temperature of the calibration environment between 18 and 28 deg C.
- For two-wire ohms, add 200mOhms to count error specifications.
- For two-wire ohms only Accuracy is specified following autocal (ACAL), under stable conditions (±1 deg C).

Maximum Reading Rates (DCV, DCI, and Resistance up to 30 kOhm)²

| Power Line Cycles ³ | Maximum # of Digits | Readings per Second-60Hz (50Hz) | | |
|--------------------------------|--|---------------------------------|---------------|------|
| | | Auto Zero On | Auto Zero Off | NMR |
| .0005 | 3 ¹ / ₂ | 300 | 1350 | 0 |
| .005 | 4 ¹ / ₂ | 280 | 1250 | 0 |
| .1 | 5 ¹ / ₂ | 140 (128) | 360 (312) | 0 |
| 1.0 | 6 ¹ / ₂ | 26 (22) | 53 (45) | 60dB |
| 10 | 7 ¹ / ₂ ⁴ | 2.5 (2.0) | 4.8 (4.0) | 80dB |
| 100 | 7 ¹ / ₂ ⁴ | 25 (0.2) | 0.5 (0.4) | 90dB |

- Using Math HIRES mode.
- Reading rates are specified with zero delay, fixed range, display off, and front panel off. The output is to internal reading memory using single integer format and internal timer.
- Integration Time in Power Line Cycles (PLC).

Common Mode Rejection (dB): (1 kOhm unbalance in low lead) DC ECMR 140 dB; AC ECMR: <1 PLC, 76 dB; AC ECMR >1 PLC 156 dB, for 50, 60 Hz ±.08%.

AC Voltage: (RMS AC and RMS AC+DC)

ACV Bandwidth: 20 Hz to 1 MHz

Crest Factor: 3.5 to 1 at full scale

Common Mode Rejection: (1 kOhm unbalance in LO): >76 dB, DC to 60 Hz

Accuracy: (1 year)

| Range | Maximum Reading | (100 Hz to 20 kHz) Best 5 ¹ / ₂ Digit Accuracy ¹ ± (% Rdg + Cnts) | | | | Input Impedance |
|-------|-----------------|---|-------------|----------------------------|-------------|--------------------------------|
| | | AC Coupled % of Reading | Count Error | DC Coupled % of Reading | Count Error | |
| 30mV | 32.50000mV | 0.13 | 280 | 0.3 | 4000 | 1MΩ ±1% shunted by <90pF |
| 300mV | 325.0000mV | 0.13 | 280 | 0.3 | 4000 | |
| 3.0V | 3.250000 V | 0.13 | 280 | 0.3 | 4000 | |
| 30.V | 32.50000 V | 0.13 | 280 | 0.3 | 4000 | |
| 300V | 303.0000 V | 0.2 | 280 | 0.3 | 4000 | |

- Accuracy specified for sine wave inputs, >10% of range. DC component <10% of AC component after 1 hr warm-up and within one week of autocal. Integration time = 10 PLC. AC Band set to <400 Hz. DC coupled mode requires 2 hour warm-up.

AC Current (RMS AC and RMS AC+DC)

ACI Bandwidth: 20 Hz to 100 kHz Crest Factor: 3.5 to full scale

Accuracy: (1 year)

| Range | Maximum Reading | (100 Hz to 20 kHz) Best 5 ¹ / ₂ Digit Accuracy ¹ ± (% Rdg + Cnts) | | | |
|-------|-----------------|---|-------------|--------------|-------------|
| | | AC Coupled | | DC Coupled | |
| | | % of Reading | Count Error | % of Reading | Count Error |
| 30mA | 32.50000mA | 0.25 | 280 | 0.3 | 1600 |
| 300mA | 325.0000mA | 0.25 | 280 | 0.3 | 1600 |
| 1.0A | 1.000000 A | 0.35 | 280 | 0.4 | 1600 |

- Accuracy specified for sine wave inputs, >10% of range. DC component <10% of AC component after 1 hr warm-up and within one week of autocal. Integration time = 10 PLC. AC Band set to <400 Hz. DC coupled mode requires 2 hour warm-up.

Reading Rates (ACV and ACI)¹

| Power Line Cycles | Maximum # of Digits | Readings per Second .60 Hz (50 Hz) | |
|-------------------|---------------------|------------------------------------|-------------------------------|
| | | Input <400 Hz (Slow Response) | Input >400 Hz (Fast Response) |
| .0005 | 3 1/2 | 1 | 9.5 |
| .005 | 4 1/2 | 1 | 9.5 |
| .1 | 5 1/2 | 1 (1) | 9.25 (9.2) |
| 1 | 6 1/2 | 1 (1) | 7.25 (6.9) |
| 10 | 6 1/2 | 0.7 (0.65) | 2.0 (1.7) |
| 100 | 6 1/2 | 0.2 (0.17) | 0.25 (0.2) |

1. Reading rates are specified with preprogrammed delays, fixed range, and Auto Zero on.

Frequency and Period: Measures the frequency or period of the AC component of the AC or DC coupled voltage or current input. The counter uses a reciprocal counting technique to give constant resolution independent of input frequency.

Input Impedance: Refer to AC voltage and current specifications.

Frequency Range: 10 Hz to 1.5 MHz (voltage input)
10 Hz to 100 KHz (current input)

Period Range: .1 s to 667 ns (voltage input)
.1 s to 3.33 us (current input)

Sensitivity: 10 mV RMS or 100 μA RMS (sinewave)

Triggering: Triggers and counts on zero crossings

Accuracy: (1 year)

| Frequency | Period | ±% of Reading |
|-------------------|------------------|---------------|
| 10 Hz to 400 Hz | .1 s to 0.25 s | 0.05 |
| 400 Hz to 1.5 MHz | .025 s to 667 ns | 0.01 |

Maximum Reading Rate: 2.0 rdgs/s for integration time of 1 PLC, AC Band >400 Hz, delay zero and math off, and fixed range.

Memory: 2139 available bytes that can be partitioned into 3 segments, one devoted to storing measurements, one devoted to storing measurement subprograms, and one devoted to storing instrument states.

Math Functions: The HP 3457A performs the following math functions on the measurements—NULL, SCALE, OFFSET, RMS FILTER, SINGLE POLE FILTER, THERMISTOR LINEARIZATION, DB, DBM, % ERROR, PASS/FAIL LIMIT TESTING, and STATISTICS. Two math functions may be used at one time.

General Specifications

Operating Temperature: 0 to 55° C

Warmup Time: one hour to all specifications except where noted

Humidity Range: 95% R.H., 0 to 40° C

Storage Temperature: -40 to +75° C

Power: 100/120/240 V ±10%, 48 Hz - 66 Hz, 220 V, ±10%, 48 Hz to 66 Hz. Fused at .2A (115 V) or 0.08 A (230 V). <30 VA.

Size: 89 mm H (without removable feet) x 425mm W x 292mm D (3.5" x 16.75" x 11.5"). Height (with removable feet): 100 mm (4"). Allow 76mm (3") additional depth for wiring.

Net Weight: 5.05 kgm (11.1 lbs)

Shipping Weight: 9.3 kgm (20.5 lbs)

Plug-in Options

HP 44491A Armature Relay Multiplexer Assembly Input Characteristics: Eight two-wire armature relay channels and two current/actuator channels. Maximum voltage (terminal to terminal or terminal to chassis) -250 VDC, 250 VAC. Maximum current (per channel) -1.5 A DC or AC. Thermal Offset - 3μ V. Closed channel resistance (end of relay life) - <2 Ohms. Maximum switching and measurement speed - 33 channels/second.

Armature Relay (44491A)

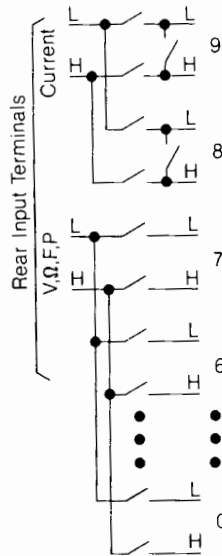

Reed Relay (44492A)

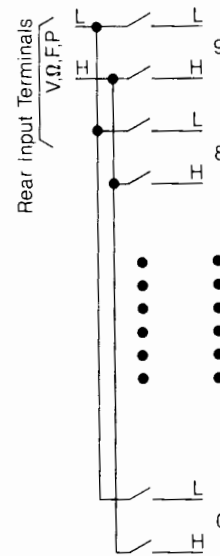

HP 44492A Reed Relay Multiplexer Assembly Input Characteristics:

Ten two-wire reed relay channels. Maximum voltage (terminal to terminal or terminal to chassis) - 125 V peak. Thermal offset - 3 μV. Closed channel resistance (end of relay life) - <4 Ohms. Specified for <100 kHz AC volts and frequency operation. Maximum switching and measurement speed - 300 channels/second.

Prices (U.S.A. List Prices Only)

| | |
|--|---------------|
| Model 3457A | \$2800 |
| *HP 44491A Armature Relay Multiplexer Assembly | \$450 |
| *HP 44492A Reed Relay Multiplexer Assembly | \$450 |
| Option 401: Side Handle Kit (P/N 5061-1171) | \$20 |
| Option 907: Front Handle Kit (P/N 5061-1170) | \$50 |
| Option 908: Rack Flange Kit (P/N 5061-1168) | \$30 |
| Option 909: Rack Flange and Front Handle Kit (P/N 5061-1169) | \$72 |
| Option 910: Extra Operating and Service Manual | \$75 |
| Option W30: Two years of additional hardware support | \$80 |
| Accessories: | |
| Extra Screw Terminal Connectors | |
| HP 44493A Screw Terminal Connector for HP 44491A includes strain relief and housing | \$60 |
| HP 44494A Screw Terminal Connector for HP 44492A includes strain relief and housing | \$60 |
| HP 34118 Test Lead Kit | \$25 |
| HP 11096B RF Probe, detects AC voltage up to 700 MHz | \$120 |
| HP 34111A High Voltage Probe, 1000 to 1, DC high voltage divider for up to 40 kVDC | \$150 |
| HP 44414A: Four Thermistor Pack | \$30 |
| 03457-10085 Calibration Software (85B Computer) | \$100 |
| 03457-10200 Calibration Software (200 Series Computer) | \$100 |

*Either option may be ordered and shipped separately without a HP 3457A mainframe. Unless otherwise specified, the optional plug-in accessories will be shipped with the HP 3457A mainframe.



MULTIMETERS

Low Cost 3½ to 5½ Digit HP-IB Multimeter

Model 3478A

- 5 measurement functions
- Up to 71 readings/s

- Electronic calibration
- 100 nanovolt resolution

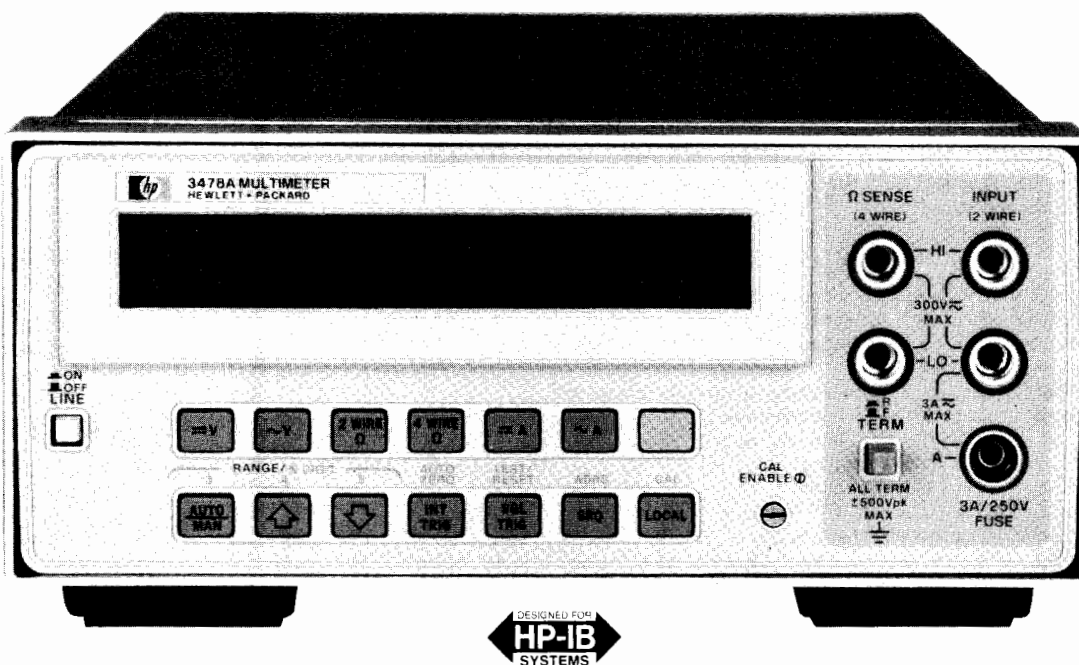

HP 3478A

Description

The HP 3478A provides a low cost, completely HP-IB programmable solution for system measurements. Selectable 3½ to 5½ digit resolution and 5 autoranging functions offer flexibility in automated testing. The HP 3478A can measure DCV, true RMS ACV, 2- and 4-wire ohms, and dc and ac current. Simple, fast electronic calibration eliminates all adjustments to provide a lower cost of ownership.

Performance

Selectable speed and resolution provide the right capability for your measurement. The HP 3478A can perform production tests or acquire experimental data at 90 readings/s with 3½ digit resolution, or take 35 readings/s with 130 dB of noise rejection using 4½ digits. The 5½ digit mode offers 100 nVdc and 100 μΩ resolution for precise measurements. True RMS with 300 kHz bandwidth and 4:1 crest factor provides reliable measurements of ac signals. Fast autoranging makes the first reading useful and accurate.

Designed for Systems

Switchable front/rear inputs permit flexible system connections. The Voltmeter Complete output and External Trigger input allow synchronization of the HP 3478A with a scanner for fast multiplexed measurements without the delay of software commands. The test program can automatically present messages or results on the alphanumeric liquid crystal display. The operator can then respond by pressing the HP 3478A's SRQ key to interrupt the controller and start the next test. Built-in self-test capability assures proper operation.

Electronic Calibration

Complete calibration of the HP 3478A is accomplished without any internal adjustment or removing the instrument's covers. The simple and fast electronic calibration procedure lowers the cost of ownership. You only need to connect standards to the HP 3478A and store calibration constants in the HP 3478A's non-volatile memory. Calibration can be done manually from the front panel or automatically using HP-IB.

Specifications

DC Voltage

Input Characteristics

| Range | Maximum Reading (5½ digit) | Resolution | | |
|--------|-------------------------------|------------|----------|----------|
| | | 5½ digit | 4½ digit | 3½ digit |
| 30 mV | ±30.3099 mV | 100 nV | 1 μV | 10 μV |
| 300 mV | ±303.099 mV | 1 μV | 10 μV | 100 μV |
| 3 V | ±3.03099 V | 10 μV | 100 μV | 1 mV |
| 30 V | ±30.3099 V | 100 μV | 1 mV | 10 mV |
| 300 V | ±303.099 V | 1 mV | 10 mV | 100 mV |

Input resistance: 30 mV, 300 mV, 3 V ranges: $> 10^{10} \Omega$
30 V, 300 V ranges: $10 \text{ M}\Omega \pm 1\%$

Maximum input voltage (non-destructive): Hi to Lo: 303 Vrms or 450 V peak; Hi or Lo to Earth Ground: $\pm 500 \text{ V peak}$

Measurement accuracy: $\pm(\%$ of reading + number of counts). Auto zero ON.

5½ Digit Mode

| Range | T _{Cal} * ±1°C | | T _{Cal} * ±5°C | |
|--------|-------------------------|-------------|-------------------------|------------|
| | 24 Hour | 90 Day | 90 Day | 1 Year |
| 30 mV | 0.025 + 40 | 0.0275 + 40 | | 0.035 + 40 |
| 300 mV | 0.004 + 4 | 0.005 + 5 | | 0.007 + 5 |
| 3 V | 0.003 + 2 | 0.004 + 2 | | 0.006 + 2 |
| 30 V | 0.004 + 3 | 0.005 + 4 | | 0.007 + 4 |
| 300 V | 0.004 + 2 | 0.005 + 2 | | 0.007 + 2 |

*T_{Cal} is the temperature of the environment where the HP 3478A was calibrated. Calibration should be performed with the temperature of the environment between 20°C and 30°C. 24 hour accuracy relative to calibration standards.

4½ and 3½ digit mode: accuracy is the same as 5½ digit mode for % of reading; use 1 count for number of counts on all ranges except 30 mV, use 4 counts.

Temperature coefficient: 0° to 55°C, 5½ digits, auto zero ON. ±(% of reading + number of counts)/°C

| Range | Temperature Coefficient |
|--------|-------------------------|
| 30 mV | 0.0028 + 5.0 |
| 300 mV | 0.0005 + 0.5 |
| 3 V | 0.0004 + 0.05 |
| 30 V | 0.0006 + 0.5 |
| 300 V | 0.0004 + 0.05 |

Noise rejection: in dB with 1 kΩ imbalance in Lo lead. AC rejection for 50, 60 Hz ± 0.1%. Auto zero ON.

| Display | AC NMR | AC ECMR | DC CMR |
|-----------|--------|---------|--------|
| 5½ digits | 80 | 150 | 140 |
| 4½ digits | 59 | 130 | 140 |
| 3½ digits | 0 | 70 | 140 |

Maximum Reading Rates (readings/s.)

| Line Frequency | Auto Zero and Display | Resolution | | |
|----------------|-----------------------|------------|-----------|-----------|
| | | 3½ digits | 4½ digits | 5½ digits |
| 60 Hz | Off | 90 | 35 | 4.4 |
| | On | 60 | 20 | 2.3 |
| 50 Hz | Off | 85 | 30 | 3.7 |
| | On | 50 | 17 | 1.9 |

AC Voltage (true rms)
Input Characteristics

| Range | Maximum Reading (5½ Digit) | Resolution | | |
|--------|----------------------------|------------|----------|----------|
| | | 5½ Digit | 4½ Digit | 3½ Digit |
| 300 mV | 303.099 mV | 1 µV | 10 µV | 100 µV |
| 3 V | 3.03099 V | 10 µV | 100 µV | 1 mV |
| 30 V | 30.3099 V | 100 µV | 1 mV | 10 mV |
| 300 V | 303.009 V | 1 mV | 10 mV | 100 mV |

Input impedance: 1 MΩ ± 1% shunted by <60 pF

Maximum Input Voltage (non-destructive):

Hi to Lo: 303 Vrms or 450 V peak

Hi or Lo to Earth Ground: ±500 V peak

Measurement accuracy: ±(% of reading + number of counts). Auto zero ON. 5½ digit display. Accuracy is specified for sinewave inputs only, >10% full scale.

1 Year, T_{Cal}* ±5°C

| Frequency | Ranges | | |
|---------------|-------------------------------|------------|------------|
| | 300 mV | 3 V, 30 V | 300 V |
| 20-50 Hz | 1.14 + 163 | 1.14 + 102 | 1.18 + 102 |
| 50-100 Hz | 0.46 + 163 | 0.46 + 103 | 0.5 + 102 |
| 100 Hz-20 kHz | 0.02 + 120 | 0.20 + 70 | 0.24 + 70 |
| 20-50 kHz | 0.38 + 205 | 0.26 + 140 | 0.42 + 140 |
| 50-100 kHz | 1.20 + 840 | 0.87 + 780 | 0.98 + 780 |
| 100-300 kHz | 10.1 + 3720 (30 V range only) | | |

Crest factor: >4:1 at full scale

Common mode rejection: with 1 kΩ imbalance in Lo lead, >70 dB, at 60 Hz

Maximum reading rates: 3½ or 4½ digits, 1.4 readings/s; 5½ digits, 1.0 readings/s. First reading is correct within 70 counts of final value when triggered coincident with step input. Add 0.6 second for each range change.

Resistance (2-wire Ω, 4-wire Ω)
Input Characteristics

| Range | Maximum Reading (5½ Digit) | Resolution | | |
|--------|----------------------------|------------|----------|----------|
| | | 5½ Digit | 4½ Digit | 3½ Digit |
| 30 Ω | 30.3099 Ω | 100 µΩ | 1 mΩ | 10 mΩ |
| 300 Ω | 303.099 Ω | 1 mΩ | 10 mΩ | 100 mΩ |
| 3 kΩ | 3.03099 kΩ | 10 mΩ | 100 mΩ | 1 Ω |
| 30 kΩ | 30.3099 kΩ | 100 mΩ | 1 Ω | 10 Ω |
| 300 kΩ | 303.099 kΩ | 1 Ω | 10 Ω | 100 Ω |
| 3 MΩ | 3.03099 MΩ | 10 Ω | 100 Ω | 1 kΩ |
| 30 MΩ | 30.3099 MΩ | 100 Ω | 1 kΩ | 10 kΩ |

Input protection (non destructive): Hi to Lo: ±350 V peak; Hi or Lo to Earth Ground: ±500 V peak.

Measurement accuracy: ±(% of reading + number of counts). Auto zero ON. 5½ digit display. 4-wire ohms.

| Range | T _{Cal} * ±1°C | T _{Cal} * ±5°C | |
|------------|-------------------------|-------------------------|------------|
| | 24 Hour | 90 Day | 1 Year |
| 30 Ω | 0.023 + 35 | 0.027 + 41 | 0.034 + 41 |
| 300 Ω | 0.0045 + 4 | 0.012 + 5 | 0.017 + 5 |
| 3 k-300 kΩ | 0.0035 + 2 | 0.011 + 2 | 0.016 + 2 |
| 3 MΩ | 0.0052 + 2 | 0.011 + 2 | 0.016 + 2 |
| 30 MΩ | 0.036 + 2 | 0.066 + 2 | 0.078 + 2 |

Current Through Unknown

| Range | 30 Ω | 300 Ω | 3 kΩ | 30 kΩ | 300 kΩ | 3 MΩ | 30 MΩ |
|---------|------|-------|------|--------|--------|------|--------|
| Current | 1 mA | 1 mA | 1 mA | 100 µA | 10 µA | 1 µA | 100 nA |

DC Current
Input Characteristics

| Range | Maximum Reading (5½ Digit) | Resolution | | |
|--------|----------------------------|------------|----------|----------|
| | | 5½ Digit | 4½ Digit | 3½ Digit |
| 300 mA | ± 303.099 mA | 1 µA | 10 µA | 100 µA |
| 3 A | ± 3.03099 A | 10 µA | 100 µA | 1 mA |

Maximum input (non-destructive): 3 A from <250 V source; fuse protected.

Measurement accuracy: ±(% of reading + number of counts). Auto zero ON. 5½ digit display.

| Range | T _{Cal} * ±5°C | |
|------------|-------------------------|-----------|
| | 90 Days | 1 Year |
| 300 mA | 0.11 + 40 | 0.15 + 40 |
| 3 A (<1 A) | 0.14 + 6 | 0.17 + 6 |
| 3 A (>1 A) | 1.0 + 30 | 1.0 + 30 |

Maximum burden at full scale: 1 V (3 A range), 0.1 V (0.3 A range)

AC Current (true rms responding)
Input Characteristics

| Range | Maximum Reading (5½ Digit) | Resolution | | |
|--------|----------------------------|------------|----------|----------|
| | | 5½ Digit | 4½ Digit | 3½ Digit |
| 300 mA | 303.099 mA | 1 µA | 10 µA | 100 µA |
| 3 A | 3.03099 A | 10 µA | 100 µA | 1 mA |

Maximum input: (non-destructive): 3 A from <250 V source; fuse protected.

Measurement accuracy: ±(% of reading + number of counts). Auto zero ON. 5½ digit display. Accuracy is specified for sinewave inputs only, >10% of full scale.

1 Year, T_{Cal}* ±5°C

| Frequency | Ranges | |
|-------------|------------|------------|
| | 300 mA | 3 A |
| 20-50 Hz | 1.54 + 163 | 2.24 + 163 |
| 50-1 kHz | 0.81 + 163 | 1.50 + 163 |
| 1 k-10 kHz | 0.72 + 163 | 1.42 + 163 |
| 10 k-20 kHz | 0.86 + 163 | 1.56 + 163 |

Maximum burden at full scale: 1 V (3A range)

General

Operating temperature: 0 to 55°C

Humidity range: 95% R.H., 0 to 40°C

Power: ac line 48 to 440 Hz; 86 to 250 V, 25 VA max.

Size: 102 mm H x 215 mm W x 356 mm D (4" x 8" x 14"); 3½ in. H without feet.

Weight: 3 kg (6.5 lb)

HP-IB Interface Functions: SH1, AH1, T5, TE0, L4, LE0, SR1, RL1, PP0, DC1, DT1, C0

Ordering Information

Price

Choose one N/C power option:

Opt 315: 100 V, 50 Hz; **Opt 335:** 220 V, 50 Hz

Opt 316: 100 V, 60 Hz; **Opt 336:** 220 V, 60 Hz

Opt 325: 120 V, 50 Hz; **Opt 345:** 240 V, 50 Hz

Opt 326: 120 V, 60 Hz; **Opt 346:** 240 V, 60 Hz

Opt 907: Front Handle Kit (HP P/N 5061-0088)

\$50.00

Opt 908: Rack Mount Kit (HP P/N 5061-0072)

\$52.50

Opt 910: Extra Manuals

\$21.50

HP 3478A Multimeter

\$995



MULTIMETERS

3 1/2 to 6 1/2 Digit DMM for Bench/System Applications

Model 3456A

- Up to 330 readings per second
- 100 nanovolt resolution
- Transfer standard performance

- 100 micro-ohm to 1.0 gigaohm measurement capability
- Offset compensated ohms (OC Ω)
- Fast AC

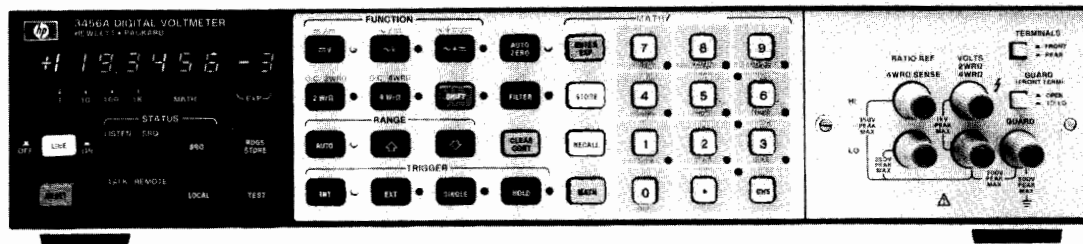

HP 3456A



Description

This microprocessor-based, fully guarded, integrating Digital Multimeter is designed for bench or systems. The HP Model 3456A measures DC, true RMS AC voltage and resistance.

Measurement speed and accuracy can be enhanced for a specific application, using the HP 3456A's selectable integration time (up to 100 power line cycles). An operator can select up to 330 readings/second for high speed bursts or one reading every fifteen minutes for periodic measurements. Resolution of 100 nanovolts at 48 readings/second (6 1/2 digits) to 10 microvolt resolution at 330 readings per second (3 1/2 or 4 1/2 digits) can be selected.

Transfer standard performance is assured with the HP 3456A. With good repeatability and 100 nanovolt sensitivity, accuracy on the ten volt range is $\pm 0.0008\% + 2$ counts over a 24-hour period at $23^\circ\text{C} \pm 1^\circ\text{C}$.

Four full-scale, true RMS AC voltage ranges are provided, with reading speeds up to 12 readings per second over a 10 Hz to 250 kHz frequency range. Best accuracy is 0.05%. Crest factor is greater than seven at full scale.

System DMM

Full programmability over HP-IB is standard on the HP 3456A. The front panel indicators on the HP 3456A display range, function and HP-IB status during remote operation. Also on the front panel is a SRQ (Service Request) button which can be used to flag or interrupt a computer. With the HP 3456A's program memory and reading storage capability, the HP 3456A can take measurements and store them while a computer performs some other task.

Another system feature of the HP 3456A is its hardware scanner advance capability for scanned or multiplexed system applications. As soon as the HP 3456A's measurement cycle is complete, a TTL signal is available to trigger a variety of switching instruments like the HP 3497A Data Acquisition/Control Unit to advance to their next channel. Up to 330 channels can be scanned per second without computer interaction.

Bench DMM

With a 2 ppm stability, the HP 3456A is a true transfer standard offering either 100 nanovolt sensitivity or 0.001% accuracy. Other standard features include fast autorange and easy-to-use math functions. The user can scale, limit test, null and make measurements in percent error, dB and dBm, as well as convert thermistor readings to degrees F and C. A statistics function key (STAT) enables the operator to improve the HP 3456A's sensitivity, resolution and accuracy by averaging. Averaging reduces random noise fluctuations and improves sensitivity by a factor of the square root of the number of measurements. For example, for low level signals after 100 measurements, the actual sensitivity of the HP 3456A is approximately 10 nanovolts instead of 100 nanovolts. In addition, STAT enables the

operator to recall the maximum (upper), minimum (lower), and variance.

Calibration of the HP 3456A is fast and convenient since all routine adjustments are accessible from a concealed door in the front panel. Should service be necessary, built-in diagnostics and PC Board modules make the HP 3456A easy to service.

Specifications

DC Voltage

Input Characteristics

| RANGE | MAXIMUM READING (5 1/2 digit) | RESOLUTION (6 1/2 digit) | RESOLUTION (5 1/2 digit) | RESOLUTION (4 1/2 digit) | INPUT RESISTANCE | MAXIMUM INPUT VOLTAGE |
|----------|-------------------------------|--------------------------|--------------------------|--------------------------|-----------------------|-----------------------|
| 0.1 V | .119999 V | 100 nV | 1 μV | 10 μV | $>10^{10} \Omega$ | ± 1000 V peak |
| 1.0 V | 1.19999 V | 1 μV | 10 μV | 100 μV | $>10^{10} \Omega$ | |
| 10.0 V | 11.9999 V | 10 μV | 100 μV | 1 mV | $>10^{10} \Omega$ | |
| 100.0 V | 119.999 V | 100 μV | 1 mV | 10 mV | 10 M $\Omega \pm 5\%$ | |
| 1000.0 V | 1000.00 V | 1 mV | 10 mV | 100 mV | 10 M $\Omega \pm 5\%$ | |

Guard to chassis: ± 500 V peak

Guard to low: ± 200 V peak

Measurement accuracy: \pm (% of reading + number of counts). Auto-zero on and filter off.

| RANGE | 24 hour: $23^\circ\text{C} \pm 1^\circ\text{C}$ | | 90 days: $23^\circ\text{C} \pm 5^\circ\text{C}$ | |
|-----------------------|---|---------------------|---|---------------------|
| | 6 1/2 digit (≥ 10 PLC) | 6 1/2 digit (1 PLC) | 6 1/2 digit (≥ 10 PLC) | 6 1/2 digit (1 PLC) |
| 0.1 V | .0022 + 24 | 0.0024 + 32 | 0.0026 + 24 | 0.0027 + 32 |
| 1.0 V | 0.0009 + 4 | 0.0012 + 5 | 0.0016 + 4 | 0.0017 + 5 |
| 10.0 V | 0.0008 + 2 | 0.0011 + 3 | 0.0015 + 2 | 0.0016 + 3 |
| 100.0 V | 0.0011 + 3 | 0.0014 + 4 | 0.0018 + 3 | 0.0019 + 4 |
| 1000.0 V ¹ | 0.0011 + 2 | 0.0013 + 3 | 0.0016 + 2 | 0.0017 + 3 |

¹Add .012 $\left(\frac{\text{Input Voltage}}{1000} \right)^2$ % to % of reading.

Filter ON: rejection is >60 dB at 50 Hz. Add 2 μV to uncertainty for .1 V, 1.0 V and 10 V range and 200 μV for 100 V and 1000 V range.

Response Time

Filter OFF: for preprogrammed settling times (0.0 seconds), error is $<0.0005\%$ of input voltage step.

Filter ON: for preprogrammed settling times (.65 seconds), error is $<.01\%$ of input voltage step.

NOISE REJECTION (dB) (1 k Ω unbalance in Lo)

| | AC ¹ NMR | AC ¹ ECMR | DC ECMR |
|--------------------------|---------------------|----------------------|---------|
| .01 PLC or .1 PLC | 0 | 90 | 140 |
| ≥ 1 PLC | 60 | 150 | 140 |
| ≥ 1 PLC with filter | 120 | 160 | 140 |

¹For 50, 60 Hz (depending on option) $\pm .09\%$



AC RMS Voltage (AC, AC + DC)

Input Characteristics

| RANGE | MAXIMUM READING | | | RESOLUTION | INPUT IMPEDANCE | MAXIMUM INPUT VOLTAGE |
|----------|-----------------|----------|----------|------------|-----------------------------------|---|
| | (5½ digit) | 6½ digit | 5½ digit | | | |
| 1.0 V | 1.19999 V | 1 µV | 10 µV | 100 µV | 1 MΩ ±.5% shunted by <90 pF | ±1000 V peak (700 V rms) 10 ⁸ VHZ |
| 10.0 V | 11.9999 V | 10 µV | 100 µV | 1 mV | | |
| 100.00 V | 119.999 V | 100 µV | 1 mV | 10 mV | | |
| 1000.0 V | 700.00 V | 1 mV | 10 mV | 100 mV | | |

Measurement accuracy: ±(% of reading + number of counts). Auto-zero on, >1% of scale, and dc component <10% of AC component.

90 days: 23°C ± 5°C

| Filter OFF Filter ON | FREQUENCY IN Hz | | | | | |
|--------------------------------|-----------------|-------------------|--------------------------|----------------------------|------------------------------|------------------------------|
| | 10 to 30 | 400-20k 30-20k | 20k to 50k 20k to 50k | 50k to 100k 50k to 100k | 100k to 250k 100k to 250k | 100k to 250k 100k to 250k |
| 6½ digit (≥1 PLC) ² | .47 + 450 | .07 + 730 | .17 + 1700 | .55 + 2900 | 5.0 + 6500 | |
| 5½ digit (.1 PLC) | .48 + 90 | .08 + 73 | .18 + 173 | .56 + 293 | 5.0 + 653 | |
| 4½ digit (.01 PLC) | .56 + 10 | .13 + 9 | .23 + 9 | .61 + 31 | 5.1 + 67 | |

¹Frequencies > 100 kHz are specified for 1.0 V and 10 V ranges only.

²Integration Time in Power Line Cycles (PLC). For 5½ digits, multiply counts by 0.1. For 4½ digits, multiply counts by 0.01.

Guard to chassis: ±500 V peak

Guard to low: ±200 V peak

DC component > 10% of ac component: (5½ digit) Add ±(.5% of Reading + 50 counts) to accuracy. For 6½ digit, multiply counts by 10. For 4½ digit, multiply counts by .1. For signals with no AC component, use the 1 kHz ac spec.

Crest factor: >7:1 at full scale.

Common mode rejection (1 kΩ Lo unbalance): >90dB DC to 60 Hz.

Auto-zero OFF: for stable environment ±1°C no accuracy change.

Response time: for preprogrammed settling times, error is <.1% of input voltage step.

Filter OFF: 0.06 seconds

Filter ON: .80 seconds

Resistance (2 WΩ, 4 WΩ, 2 WOCΩ, 4 WOCΩ)

Input Characteristics

| RANGE | MAXIMUM READING | | | RESOLUTION | CURRENT THROUGH UNKNOWN |
|--------|-----------------|----------|----------|------------|-------------------------|
| | (5½ digit) | 6½ digit | 5½ digit | | |
| 100 Ω | 119.999 Ω | 100 µΩ | 1 mΩ | 10 mΩ | 1 mA |
| 1 kΩ | 1199.99 Ω | 1 mΩ | 10 mΩ | 100 mΩ | 1 mA |
| 10 kΩ | 11.9999 kΩ | 10 mΩ | 100 mΩ | 1 Ω | 100 µA |
| 100 kΩ | 119.999 kΩ | 100 mΩ | 1 Ω | 10 Ω | 50 µA |
| 1 MΩ | 1199.99 kΩ | 1 Ω | 10 Ω | 100 Ω | 5 µA |
| 10 MΩ | 11.9999 MΩ | 10 Ω | 100 Ω | 1 kΩ | 500 nA |
| 100 MΩ | 119.999 MΩ | 100 Ω | 1 kΩ | 10 kΩ | ≤500 nA ¹ |
| 1 GΩ | 1000.00 MΩ | 1 kΩ | 10 kΩ | 100 kΩ | ≤500 nA ¹ |

¹Ohms source is a 500 nA current source in parallel with a 10 MΩ resistance.

Non-destructive overload: 350 V peak

Measurement accuracy: ± (% of reading + number of counts). Auto-zero on, filter off, and 4-wire ohms.

| RANGE | 24 hour: 23°C ±1°C | | 90 days: 23°C ±5°C | |
|--------|--------------------|------------------|--------------------|------------------|
| | 6½ digit (≥10 PLC) | 6½ digit (1 PLC) | 6½ digit (≥10 PLC) | 6½ digit (1 PLC) |
| 100 Ω | 0.003 + 24 | 0.003 + 32 | 0.004 + 24 | 0.004 + 32 |
| 1 kΩ | 0.002 + 4 | 0.003 + 5 | 0.003 + 4 | 0.004 + 5 |
| 10 kΩ | 0.002 + 4 | 0.003 + 5 | 0.003 + 4 | 0.004 + 5 |
| 100 kΩ | 0.002 + 2 | 0.003 + 3 | 0.003 + 2 | 0.004 + 3 |
| 1 MΩ | 0.006 + 2 | 0.006 + 3 | 0.007 + 2 | 0.007 + 3 |
| 10 MΩ | 0.041 + 2 | 0.041 + 3 | 0.042 + 2 | 0.042 + 3 |
| 100 MΩ | 1.3 + 1 | 1.3 + 1 | 1.8 + 1 | 1.8 + 1 |
| 1 GΩ | 11 + 1 | 11 + 1 | 16 + 1 | 16 + 1 |

Ratio

Type: DC/DC, AC/DC, or (AC + DC)/DC

Method: 4-wire with Volts Lo input common

$$\text{Ratio} = \frac{\text{Signal Voltage}}{\text{Ref. Hi Voltage} - \text{Ref. Lo Voltage}}$$

Signal measurement: Same as DC Volts, AC Volts, or AC + DC Volts

Reference measurement: automatically selects .1 V, 1 V, or 10 V DC. Volts range and a 0.0 ms. settling time. Filter is off.

Maximum Reference Voltages

Ref. Hi: ±12 V

Ref. Lo: ±9% of Ref. Hi

Ref. Hi-Ref. Lo: ±11.9999 V

Protection: ±340 V peak

Accuracy: total % signal error + total % reference error (same as .1 V, 1 V, or 10 V DC volts)

Reading Rate

Reading rates are with autorange, math, display and filter off. Output is to internal memory using internal trigger and packed mode. Packed output in place of internal memory adds 0.35 ms; ASCII output adds 2.3 ms per reading.

Rates vs. integration time and auto-zero: DC volts and 100 Ω thru 10 kΩ ranges with preprogrammed settling times (-0.0 s.). Also, AC or AC + DC volts and 100 kΩ thru 10 kΩ ranges with 0.0 s delay.

| INTEGRATION TIME IN POWER LINE CYCLES (PLC) | RATES (rdgs/second) | | | |
|---|---------------------|-------|--------------|-------|
| | Auto Zero OFF | | Auto Zero ON | |
| | 60 Hz | 50 Hz | 60 Hz | 50 Hz |
| 0.01 (4½ digit) | 330 | 290 | 210 | 180 |
| 0.10 (5½ digit) | 210 | 180 | 120 | 100 |
| 1.00 (6½ digit) | 48 | 40 | 25 | 20 |
| 10.00 (6½ digit) | 5.8 | 4.8 | 2.9 | 2.4 |
| 100.00 (6½ digit) | 57 | 47 | 29 | 24 |

Memory

Reading store: can store up to 350 readings.

can be recalled from HP-IB interface or front panel

Program memory: can execute an internal program which controls instrument configuration and measurement sequence. Program is input from the HP-IB interface with up to 1400 ASCII characters.

Memory size: total size is 1400 bytes. Memory used is 1 byte per ASCII character + 4 bytes per reading stored.

General

Operating temperature: 0 to 50°C

Warmup time: one hour to meet all specifications

Humidity range: 95% R.H., 0 to 40°C

Storage temperature: -40 to +75°C

Power: 100/120/220/240 V +5%, -10%, 48 Hz to 400 Hz line operation, 45 VA max.

Size: 88.9 mm H x 425.5 mm W x 527.1 mm D (3½" x 16¾" x 20¾")

Weight: net, 10.49 kg (23.13 lb.); shipping, 13.35 kg (29.38 lb.)

Ordering Information

Opt 050: Noise rejection for 50 Hz

Opt 060: Noise rejection for 60 Hz

Opt 907: Front handle kit, P/N 5061-0088

Opt 908: Rack flange kit, P/N 5061-0074

Opt 909: Rack flange and front handle kit, HP P/N 5061-0075

Opt 910: Extra operating & service manual

Opt H01: Enhanced AC accuracy

Opt W30: 3 year hardware support

HP 3456A Digital Voltmeter

Price

N/C

N/C

+\$50

+\$30

+\$72.50

+\$49.50

+\$200

+\$120

\$3955



MULTIMETERS

5 1/2 / 6 1/2 -Digit DVM with Auto Cal

Model 3455A

- DCV/ACV/Ohms
- Removable calibration reference

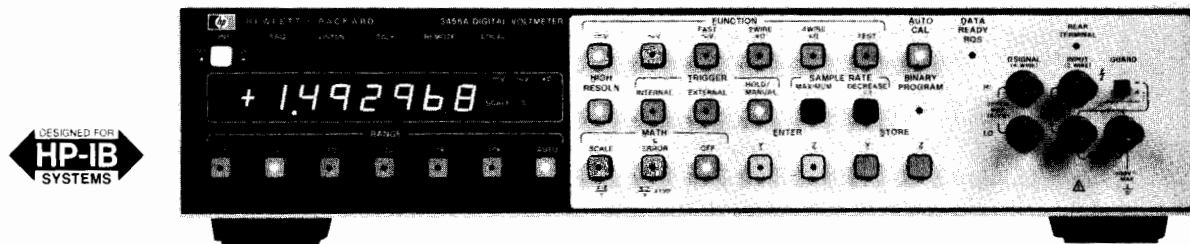

Description

Hewlett-Packard's 3455A Digital Voltmeter is a microprocessor controlled 5 1/2- or 6 1/2-digit integrating voltmeter for bench or systems applications. The standard instrument measures dc volts, ac volts, and resistance. HP-IB and auto or manual ranging are also standard.

Measuring Speed

The HP 3455A is fully guarded and has greater than 60 dB normal mode noise rejection at reading rates of up to 24 readings per second on all dc ranges. Ohms reading rates are up to 12 readings/second and an ac fast mode gives reading rates of up to 13 readings/second at frequencies above 300 Hz. (Readings/second given for 60 Hz operation and high resolution off.)

Performance

DC measurements can be made with up to 1 μV sensitivity. Ohms measurements are made with either a 2-wire and 4-wire mode. The High Resolution (6 1/2-digit) mode gives dc and ohms measurements with greater than 1 part per million resolution. The standard true rms converter gives ac measurements from 30 Hz to 1 MHz. Complex signals with crest factors of up to 7:1 at full scale can be measured.

Serviceability

Routine maintenance and calibration has been simplified with the removable reference assembly. Calibration of dc and ohms functions can be done by replacing the reference assembly with a recently calibrated one. Extra reference assemblies are available as HP 11177A.

Specifications

DC Voltage-Maximum Display

| Range | Hi Resolution OFF | Hi Resolution ON |
|-------|-------------------|------------------|
| 0.1 | ±0.149999 V | — |
| 1 | ±1.49999 V | ±1.499999 V |
| 10 | ±14.9999 V | ±14.99999 V |
| 100 | ±149.999 V | ±149.9999 V |
| 1000 | ±1000.00 V | ±1000.000 V |

Accuracy ± (% of reading + counts)

| 24 hrs: 23°C ± 1°C | | |
|---------------------|---------------------|--------------------|
| Range | High Resolution Off | High Resolution On |
| 0.1 V | 0.004 + 4 | — |
| 1 V | 0.003 + 1 | 0.003 + 4 |
| 10 V | 0.002 + 1 | 0.002 + 3 |
| 100 & 1000 V | 0.004 + 1 | 0.004 + 3 |
| 90 days: 23°C ± 5°C | | |
| Range | High Resolution Off | High Resolution On |
| 0.1 V | 0.007 + 4 | — |
| 1 V | 0.006 + 1 | 0.006 + 4 |
| 10 V | 0.005 + 1 | 0.005 + 3 |
| 100 & 1000 V | 0.007 + 1 | 0.007 + 3 |

Input resistance: 0.1 V through 10 V range: >10¹⁰ ohms. 100 V and 1000 V range: 10 megohm ±0.1% with Auto Cal. "off."

Maximum Input Voltage: High to low input terminals: ±1000 V peak; **Guard to chassis:** ±500 V peak; **Guard to low terminal:** ±200 V peak.

NMR at 50 or 60 Hz ±0.1%: >60 dB.

ECMR with 1 kΩ Unbalance in Lo at DC: >160dB;

AC Voltage (rms converter)

| Ranges: | Maximum display: |
|-----------|------------------|
| 1.00000 V | 1.49999 V |
| 10.0000 V | 14.9999 V |
| 100.000 V | 149.999 V |
| 1000.00 V | 1000.00 V |

Input Impedance

Front terminals: 2 MΩ ±1% shunted by less than 105 pf.

Rear terminals: 2 MΩ ±1% shunted by less than 90 pf.

Maximum Input Voltage

High to low terminals: ±1400 volts peak; 10⁷ VHz max.

Guard to chassis: ±500 V peak; **Guard to low terminal:** ±200 V peak.

Crest factor: 7:1 at full scale.

Performance (rms converter)

Accuracy: [± % of reading + counts] (ac coupled)

| Fast ACV | 300 Hz to 20 kHz | 20 kHz to 100 kHz | 100 kHz to 250 kHz | 250 kHz to 500 kHz | 500 kHz to 1 MHz |
|------------|------------------|-------------------|--------------------|--------------------|------------------|
| ACV | 30 Hz to 20 kHz | | | | |
| 90 days | | | | | |
| 23°C ± 5°C | 0.05 + 50 | 0.50 + 100 | 2.00 + 250 | 5.00 + 500 | 6.00 + 3100 |

Ohms

| Range | Maximum Display | |
|-------------|---------------------|--------------------|
| | High Resolution Off | High Resolution On |
| 0.100000 kΩ | 0.149999 kΩ | — |
| 1.00000 kΩ | 1.49999 kΩ | 1.499999 kΩ |
| 10.0000 kΩ | 14.9999 kΩ | 14.99999 kΩ |
| 100.000 kΩ | 149.999 kΩ | 149.9999 kΩ |
| 1000.00 kΩ | 1499.99 kΩ | 1499.999 kΩ |
| 10000.0 kΩ | 14999.9 kΩ | 14999.99 kΩ |

Accuracy ± (% of reading + counts) 4-wire kΩ

| 24 hours: 23°C ± 1°C | | |
|----------------------|---------------------|--------------------|
| Range | High Resolution Off | High Resolution On |
| 0.1 kΩ | 0.003 + 4 | — |
| 1 kΩ | 0.003 + 1 | 0.0025 + 4 |
| 10 kΩ | 0.005 + 2 | 0.0045 + 4 |
| 100 kΩ | 0.002 + 2 | 0.0020 + 5 |
| 1000 kΩ | 0.012 + 5 | 0.0120 + 4 |
| 10,000 kΩ | 0.10 + 5 | 0.1000 + 4 |
| 90 days: 23°C ± 5°C | | |
| Range | High Resolution Off | High Resolution On |
| 0.1 kΩ | 0.005 + 5 | — |
| 1 kΩ | 0.005 + 1 | 0.0035 + 5 |
| 10 kΩ | 0.007 + 2 | 0.0060 + 5 |
| 100 kΩ | 0.004 + 2 | 0.0035 + 6 |
| 1000 kΩ | 0.014 + 5 | 0.0135 + 5 |
| 10,000 kΩ | 0.100 + 5 | 0.1000 + 5 |

Maximum Reading Rates for Remote Operations. (Rdgs/s)

| Function | High Resolution ON | | High Resolution OFF | |
|----------------|--------------------|-------|---------------------|-------|
| | 50 Hz | 60 Hz | 50 Hz | 60 Hz |
| DCV | 5 | 6 | 22 | 24 |
| Ohms | 2.5 | 3 | 11 | 12 |
| ACV (rms) | | | 1.1 | 1.3 |
| Fast ACV (rms) | | | 12 | 13 |

General

Power: 100 V, 120 V, 240 V +5% -10%, 48-400 Hz; <60 VA.

Size: 88.9 H x 425.5 W x 527.1 mm D (3.5" x 16.75" x 20.75").

Weight: net, 9.38 kg (20.7 lb); shipping, 11.8 kg (26 lb).

Options

001: Average converter

HP 3455A Digital Voltmeter

Price

less \$100

\$5,340

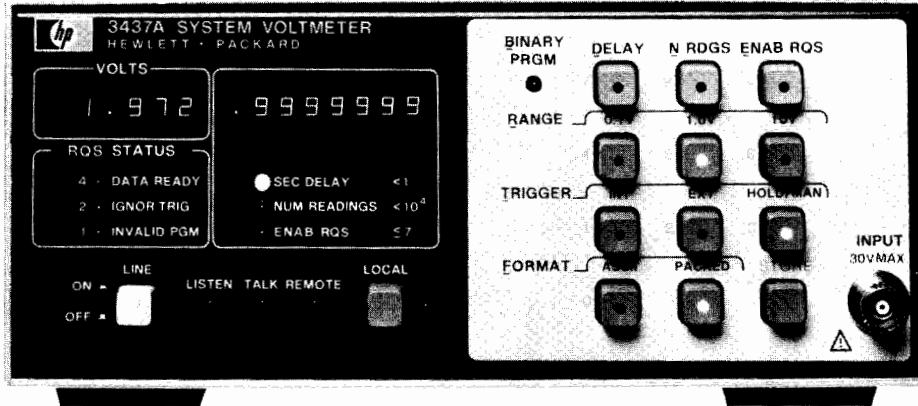

HP 3437A

Description

The Hewlett-Packard 3437A System Voltmeter is designed for systems. It is a 3½-digit, high-speed dc voltmeter with sample and hold. The standard unit measures dc volts, provides trigger delay, burst reading capability and Hewlett-Packard Interface Bus (HP-IB).

There are three dc floating input ranges: 0.1V, 1.0V and 10.0V full scale with a maximum display of "1998." Sample and Hold allow the HP 3437A to be an instantaneous reading voltmeter. The trigger delay can be set from 0.1µs to 1.0 second and the number of readings can be set from 0 to 9999 readings.

Typical Operation

Example: set Delay to 1 ms and Number of Readings is set to 1000. The HP 3437A will now take 1000 readings spaced 1 ms apart from one trigger.

Data Output

All front panel switches are programmable from the HP-IB. Two data output formats are available: (1) ASCII output (Serial ASCII characters) and (2) packed output (two 8-bit bytes on the HP-IB to send the complete reading).

Applications

Waveform analysis—The HP 3437A can be used to analyze a wide variety of waveforms. The delay and burst reading capability allows frequency, positive or negative peak values, RMS value and harmonic distortion to be measured. The accuracy of these measurements is comparable to more traditional measurement techniques.

Transient signal analysis—The HP 3437A is capable of measuring transient signals because of the wide bandwidth input (>1 MHz), high measuring speed and sample-and-hold.

Fast AC measurements—Sinusoidal signals of known frequency can be measured in less than one cycle of the signal. Very low frequency measurements can be made more quickly than with conventional techniques.

High speed scanning: multiple input measurement applications can be satisfied with the HP 3437A and the HP 3497A Data Acquisition/Control Unit. Reading rates of up to 4800 channels/second can be attained.

Data-Sheeted Systems

The HP 3437A is a component of the HP 3054A Automatic Data Acquisition and Control System. The HP 3054A includes the HP 3437A for high speed measurements, the HP 3456A Digital Voltmeter for high accuracy measurements and the HP 3497A Data Acquisition/Control Unit for multiplexing and control outputs. The HP 3054A includes an extensive software package to support the HP 3437A when used for thermocouple measurements, high speed scanning, and waveform digitization.

Specifications

DC Volts

| Ranges | Max. Display | Overload Reading |
|--------|--------------|------------------|
| 10 V | ±19.98 | ±99.99 |
| 1 V | ±1.998 | ±9.999 |
| 0.1V | ±1.998 | ±.9999 |

Ranging: manual or remote.

Performance

Static Accuracy (90 days, 23°C ±5°C)

10 V range: ±(0.05% of reading +1.6 counts).

Static Accuracy (1 year, 23°C +5°C) V range:

10 V range: ±(0.05% of reading +2 counts).

Static accuracy temperature coefficient (0°C–50°C):

±(0.002% reading +0.05 counts) /°C.

Input Characteristics



10 V range: R = 1 MΩ ±20%; C < 75 pF.

Maximum input voltage high to low on all ranges: < ±30 V peak.

Maximum voltage low to chassis: ±42 V peak.

Number of readings (N readings): 0 to 9,999.

Readings are not internally stored.

For N = 0 the HP 3437A operates in delay mode only.

Maximum reading rate (remote, N Rdgs. > 1, and a zero delay listener)

ASCII: 3600 readings/s.

Packed: 5700 readings/s.

Delay

N Rdgs. = 0 or 1

DELAY (setting): 0 to 0.999 999 sec. in 0.1 µs steps.

N Rdgs. > 1 (remote and a zero delay listener)

ASCII: 0.0002778 s ≤ DELAY ≤ 0.9999999 s.

PACKED: 0.0001754 s ≤ DELAY ≤ 0.9999999 s.

Minimum delay is a function of listener delay related by:

ASCII: 277.8 µs + listener delay.

PACKED: 175.4 µs + listener delay.

Accuracy (EXT. TRIG to DELAY OUT, 0°C to 50°C)

Delay offset: 100 ns ±25 ns (with <150 pF cable capacitance)

Delay accuracy: ±0.008% DELAY Setting + Delay offset.

Delay repeatability (jitter) for N Rdgs = 0 or 1

DELAY of 0 or 0.1 µs: 2 ns

DELAY of 0.2 µs to 50 ms: 10 ns + 0.0002% DELAY setting.

DELAY of >50 ms: ±110 ns.

Input Bandwidth (3 dB)

1 V and 10 V range: 1.0 MHz.

Settling Time

10 V range: 10 V range with 10 V step input:

Reading settles to within 30 mV of final value in 7.5 µs or to within 200 mV of final value in 700 ns.

General

Operating temperature: 0 to 55°C.

Storage temperature: -40°C to 75°C.

Humidity range: <95% R.H., 0°C to 40°C.

Power: 100 V, 120 V, 220 V, 240 V +5%, -10%, 48 Hz to 440 Hz line operation, <42 VA.

Size: 88.9 mm H x 212.7 mm W x 527.1 mm D (3½" x 8⅜" x 20¾").

Weight: net, 5.6 kg (12 lb 4 oz). Shipping, 7.6 kg (16 lb 12 oz).

HP-IB Interface Functions: SH1, AH1, T5, L4, SR1, RL1, PP0, DC1, DT1, C0, E1

HP 3437A System Voltmeter

\$3165



MULTIMETERS

4½ Digit Autoranging DMM

HP Model 3466A



HP 3466A

Description

The HP 3466A is a 4½ digit Multimeter with autoranging volts and ohms. Functional capability includes ACV, DCV, (ac + dc) V, ACI, DCI, (ac + dc) I, Ω , and diode test. AC measurements are true rms with selectable ac or dc coupling. Available with rechargeable batteries or ac power only, it has 1 μ V dc and 1 m Ω sensitivity with zero adjustment on lowest ranges to compensate for external offsets.

Specifications

DC Voltmeter

| Voltage Range | Maximum Display |
|---------------|-----------------|
| 20 mV | ± 19.999 mV |
| 200 mV | ± 199.99 mV |
| 2 V | ± 1.9999 V |
| 20 V | ± 19.999 V |
| 200 V | ± 199.99 V |
| 1200 V | ± 1199.9 V |

Maximum input: ± 1200 V maximum dc and peak ac.

Accuracy: (1 yr., 18 to 28°C)

| Range | \pm (% of reading + # of counts) |
|-------------------------|------------------------------------|
| 20 mV | (.05 + 3) |
| 200 mV | (.04 + 2) |
| 2 V \rightarrow 200 V | (.03 + 1) |
| 1200 V, <700 V input | (.035 + 1) |
| 1200 V, >700 V input | (.055 + 1) |

Input resistance: 10 meg Ω $\pm 0.5\%$ all ranges.

Input type: floating, 500 V maximum common to ground.

AC Voltmeter

AC converter: true-rms responding, true-rms calibrated

| Range | Maximum Display |
|--------|-----------------|
| 200 mV | 199.99 mV |
| 2 V | 1.9999 V |
| 20 V | 19.999 V |
| 200 V | 199.99 V |
| 1200 V | 1199.9 V |

Maximum input: (ac + dc): ± 1200 V dc; ± 1700 V (dc + peak ac), ac: ± 600 V dc; 1700 V (peak ac + dc), 10^7 V \cdot Hz.

Crest factor: 4:1 at full scale.

Accuracy (with display of $\geq 10\%$ of range): 1 yr., 18 to 28°C sinusoid waveform.

AC TRMS: (20 Hz to 100 kHz)

| Frequency Range | \pm (% of reading + # of counts) |
|-------------------|------------------------------------|
| 20 Hz to 30 Hz | (2 + 50) |
| 30 Hz to 50 Hz | (1 + 30) |
| 50 Hz to 10 kHz | (0.3 + 20) |
| 10 kHz to 20 kHz | (1 + 40) |
| 20 kHz to 100 kHz | (2 + 150) |

DC + AC TRMS: dc + (20 Hz to 100 kHz).

Ohmmeter

| Ohms Range | Maximum Display | Current Through Unknown | Accuracy: 1 yr., 18 to 28°C \pm (% of reading + # of counts) |
|-----------------|-------------------|-------------------------|--|
| 20 Ω | 19.999 Ω | 5 mA | .08 + 2 |
| 200 Ω | 199.99 Ω | 5 mA | .08 + 2 |
| 2 k Ω | 1.9999 k Ω | 1 mA | .03 + 1 |
| 20 k Ω | 19.999 k Ω | 100 μ A | .03 + 1 |
| 200 k Ω | 199.99 k Ω | 10 μ A | .03 + 1 |
| 2000 k Ω | 1999.9 k Ω | 1 μ A | .04 + 1 |
| 20 M Ω | 19.999 M Ω | 100 nA | .15 + 1 |

Input protection: 250 V rms or 350 V (dc + peak ac).

DC Current and True RMS AC Current

| Current Range | Maximum Display |
|---------------|----------------------|
| 200 μ A | ± 199.99 μ A |
| 2 mA | ± 1.9999 mA |
| 20 mA | ± 19.999 mA |
| 200 mA | ± 199.99 mA |
| 2000 mA | ± 1999.9 mA |

Maximum input: 2 A rms from < 250 V source (fuse protected).

DC Current Accuracy (1 yr., 18 to 28°C):

| Range | \pm (% reading + # of counts) |
|---------------------------|---------------------------------|
| 200 μ A through 20 mA | (.07 + 2) |
| 200 mA | (0.15 + 2) |
| 2000 mA | (0.5 + 2) |

AC current accuracy: (with display $\geq 10\%$ of range) 1 yr., 18°C to 28°C, sinusoid waveform.

AC TRMS: 20 Hz to 10 kHz.

| Range | Frequency | \pm (% of reading + # of counts) |
|--------------------|--------------|------------------------------------|
| 200 μ A–200 mA | 20 Hz–30 Hz | 2 + 50 |
| | 30 Hz–10 kHz | 0.9 + 35 |
| 2000 mA | 20 Hz–30 Hz | 2 + 50 |
| | 30 Hz–10 kHz | 1.2 + 20 |

(DC + AC) TRMS: dc + (20 Hz to 10 kHz).

Diode Test

Function: \rightarrow + (k Ω). **Range:** \rightarrow + (2k Ω).

Current source: 1 mA $\pm 1.5\%$.

Humidity: 95% RH at +40°C.

Power: ac line; 48–440 Hz; 86–250 V.

Battery: rechargeable lead-acid; 8 hours maximum continuous operation with full charge. Recharge time: 16 hours operating, 12 hours non-operating.

Size: HP 3466A: 98.4 mm H x 238.1 mm W x 276.2 mm D (3.88" x 9.38" x 10.88").

Weight: HP 3466A, 2.9 kg (6.31 lb); HP 3466A Opt 001, 2 kg (4.41 lb).

Ordering Information

HP 3466A Digital Multimeter. Standard configuration in a streamlined portable case with handle, ac line power, batteries and charger, and test leads.

HP 3466A Opt. 001, streamlined portable case, ac line power only. less \$75

HP 3466A Opt. 002, rack and stack case, ac line power only. (Rack mount kit not included.) less \$10

All orders must include one of the power options: 86–106 V Opt. 100; 190–233 V Opt. 210; 104–127 V Opt. 115; 208–250 V Opt. 230. N/C

Price

\$1090

less \$75

less \$10

N/C

- Five functions
- Electronic calibration
- 5½ to 3½ digits

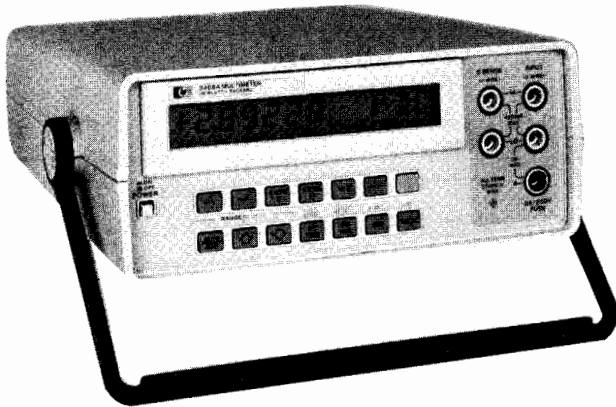

HP 3468A

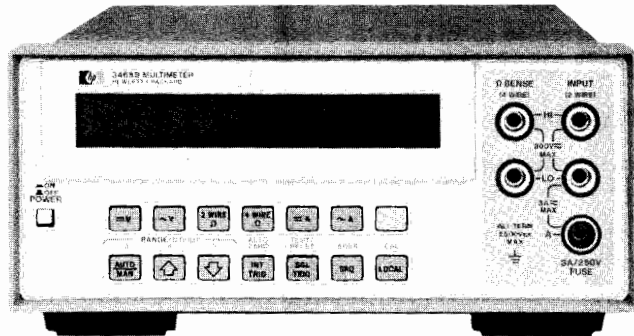

HP 3468B



Description

The HP Models 3468A/B are autoranging 5½ to 3½ digit DMMs, with the five functions of dc volts, true RMS ac volts, 2- and 4-wire ohms, dc current and true RMS ac current. They are low-cost, highly reliable DMMs which can be completely calibrated electronically, either manually from the front panel or remotely in an automatic calibration system. Remote calibration is made possible by the built-in HP-IL (Hewlett-Packard Interface Loop) interface which provides complete programmability of functions, ranges and modifiers.

The HP 3468A comes in a streamlined portable package with a handle for convenient carrying, whereas the HP 3468B comes in a plastic system case for easy rack mounting. Both are available with a rechargeable battery and battery charging circuitry for portable measurements.

High Performance

The HP 3468A/B have 5 functions with selectable 5½, 4½ or 3½ digit resolution. DC and true RMS ac voltage measurements are provided from 0.3 volt full scale range with 1 µV sensitivity up to 300 volts. The bandwidth of the true RMS ac converter is from 20 Hz to 100 kHz on all ranges and up to 300 kHz on the 30 V range. Either 2 or 4-wire ohms measurements can be selected with a maximum range of 30 MΩ. Both dc and true RMS ac current capability is provided up to 3 A. All functions on the HP 3468A/B incorporate a fast autoranging. The HP 3468A/B use an integrating analog to digital conversion technique for high noise rejection. The selectable 3½, 4½ or 5½ digits of resolution allows flexibility for choosing speed or noise rejection.

Electronic Calibration

Complete calibration of the HP 3468A/B is done electronically, either manually from the front panel or remotely in an automatic calibration system. There are no internal adjustments necessary. Complete calibration of all functions is done without removal of the instrument's covers, thus saving valuable time and reducing cost. The calibration procedure for the HP 3468A/B involves connecting a calibration standard to the input, then pressing three keystrokes to store one calibration constant in CMOS RAM for each range and function. When the HP 3468A/B make a measurement, each reading is corrected according to the calibration constants that have been stored.

The internal CMOS RAM used in the HP 3468A/B is powered by a lithium battery to create a non-volatile memory capable of holding the calibration constants for more than ten years.

HP-IL

The HP Models 3468A/B are fully programmable with HP-IL, a two-wire serial interface, and the HP-41C/CV handheld calculators or the more powerful HP Series 80 computers. HP-IL provides automatic measurements and adds computational power to these bench DMMs.

Battery

The optional battery pack includes a rechargeable battery and the battery charger circuitry for up to five hours of continuous measurements.

DC Voltage

Input Characteristics

| Range | Maximum Reading (5½ digit) | Resolution | | |
|-------|----------------------------|------------|----------|----------|
| | | 5½ digit | 4½ digit | 3½ digit |
| 0.3 V | ±0.301000 V | 1 µV | 10 µV | 100 µV |
| 3 V | ± 3.01000 V | 10 µV | 100 µV | 1 mV |
| 30 V | ± 30.1000 V | 100 µV | 1 mV | 10 mV |
| 300 V | ± 301.000 V | 1 mV | 10 mV | 100 mV |

Input resistance: 0.3 V, 3 V ranges: > 10¹⁰ Ω
30 V, 300 V ranges: 10 MΩ ± 1%

Maximum Input Voltage (non-destructive)

Hi to Lo: 301 Vrms or 450 V peak
Hi or Lo to Earth Ground: ±500 V peak

Measurement accuracy: ±(% of reading + number of counts). Auto zero ON. 5½ digits.

| Range | TCal*±1°C 24 Hour | TCal*±5°C | |
|-------|----------------------|-----------|-----------|
| | | 90 Day | 1 Year |
| 0.3 V | 0.005 + 4 | 0.009 + 5 | 0.02 + 5 |
| 3 V | 0.0035 + 2 | 0.007 + 2 | 0.018 + 2 |
| 30 V | 0.005 + 3 | 0.009 + 3 | 0.02 + 3 |
| 300 V | 0.0055 + 2 | 0.009 + 2 | 0.02 + 2 |

*TCal is the temperature of the environment where the 3468A/B was calibrated. Calibration should be performed with the temperature of the environment between 20°C and 30°C.



MULTIMETERS

5½ to 3½ Digit, HP-IL

HP Model 3468A/B

Temperature coefficient: 0°C to 55°C, 5½ digits, auto zero ON.
± (% of reading + number of counts)/°C.

| Range | Temperature Coefficient |
|-------------|-------------------------|
| 0.3 V, 30 V | 0.0008 + 0.5 |
| 3 V, 300 V | 0.0007 + .05 |

Noise rejection: in dB, with 1 kΩ imbalance in Lo lead. AC rejection for 50, 60 Hz ±0.1%. Auto zero ON.

| Display | AC NMR | AC ECMR | DC CMR |
|-----------|--------|---------|--------|
| 5½ digits | 80 | 150 | 140 |
| 4½ digits | 59 | 130 | 140 |
| 3½ digits | 0 | 70 | 140 |

Maximum reading rate with HP-85: 32 readings/second.
Maximum reading rate with HP-41CV: 2 readings/second.

Resistance (2-wire Ω, 4-wire Ω)

Input Characteristics

| Range | Maximum Reading (5½ digit) | Resolution | | |
|--------|----------------------------|------------|----------|----------|
| | | 5½ digit | 4½ digit | 3½ digit |
| 300 Ω | 301.000 Ω | 1 mΩ | 10 mΩ | 100 mΩ |
| 3 kΩ | 3.01000 kΩ | 10 mΩ | 100 mΩ | 1 Ω |
| 30 kΩ | 30.1000 kΩ | 100 mΩ | 1 Ω | 10 Ω |
| 300 kΩ | 301.000 kΩ | 1 Ω | 10 Ω | 100 Ω |
| 3 MΩ | 3.01000 MΩ | 10 Ω | 100 Ω | 1 kΩ |
| 30 MΩ | 30.1000 MΩ | 100 Ω | 1 kΩ | 10 kΩ |

Input protection (non-destructive): ± 350 V peak.
Measurement accuracy: ±(% of reading + number of counts). Auto zero ON. 5½ digit display. 4-wire ohms.

| Range | TCal* ±1°C 24 Hour | TCal* ±5°C | |
|-------------|--------------------|------------|-----------|
| | | 90 Day | 1 Year |
| 300 Ω | 0.004 + 4 | 0.012 + 4 | 0.017 + 5 |
| 3 kΩ-300 kΩ | 0.004 + 2 | 0.011 + 2 | 0.016 + 2 |
| 3 MΩ | 0.005 + 2 | 0.011 + 2 | 0.016 + 2 |
| 30 MΩ | 0.036 + 2 | 0.066 + 2 | 0.078 + 2 |

Current Through Unknown

| Range | 300 Ω | 3 kΩ | 30 kΩ | 300 kΩ | 3 MΩ | 30 MΩ |
|---------|-------|------|--------|--------|------|--------|
| Current | 1 mA | 1 mA | 100 μA | 10 μA | 1 μA | 100 nA |

Maximum open circuit voltage: 6.5 V

AC Voltage (true RMS responding) Input Characteristics

| Range | Maximum Reading (5½ digit) | Resolution | | |
|-------|----------------------------|------------|----------|----------|
| | | 5½ digit | 4½ digit | 3½ digit |
| 0.3 V | 0.301000 V | 1 μV | 10 μV | 100 μV |
| 3 V | 3.01000 V | 10 μV | 100 μV | 1 mV |
| 30 V | 30.1000 V | 100 μV | 1 mV | 10 mV |
| 300 V | 301.000 V | 1 mV | 10 mV | 100 mV |

Input impedance: 1 MΩ ±1% shunted by <60 pF.
Maximum input voltage (non-destructive): 301 Vrms or 450 V peak.
Measurement accuracy: ±(% of reading + number of counts) Auto zero ON. 5½ digit display. Accuracy is specified for sinewave inputs only, >10% of full scale.

1 Year, TCal ±5°C

| Frequency | Ranges | | |
|---------------|----------------------------------|------------|------------|
| | 0.3V | 3 V, 30 V | 300 V |
| 20-50 Hz | 1.14 + 163 | 1.14 + 102 | 1.18 + 102 |
| 50-100 Hz | 0.46 + 163 | 0.46 + 103 | 0.5 + 102 |
| 100 Hz-20 kHz | 0.29 + 163 | 0.26 + 102 | 0.33 + 102 |
| 20-50 kHz | 0.56 + 247 | 0.41 + 180 | 0.55 + 180 |
| 50-100 kHz | 1.74 + 882 | 1.05 + 825 | 1.26 + 825 |
| 100 k-300 kHz | 10.1 + 3720 (30 V range only) | | |

Crest factor: >4:1 at full scale.

DC Current Input Characteristics

| Range | Maximum Reading (5½ digit) | Resolution | | |
|-------|----------------------------|------------|----------|----------|
| | | 5½ digit | 4½ digit | 3½ digit |
| 3 A | ± 3.01000 A | 10 μA | 100 μA | 1 mA |

Maximum input (non-destructive): 3 A from <250 V source; fuse protected.

Measurement accuracy: ±(% of reading + number of counts). Auto zero ON. 5½ digit display.

| Range | TCal ±5°C | |
|-----------------|-----------|----------|
| | 90 Days | 1 Year |
| 3 A, <1 A Input | 0.14 + 6 | 0.17 + 6 |
| 3 A, >1 A Input | 1.0 + 30 | 1.0 + 30 |

AC Current (true RMS responding) Input Characteristics

| Range | Maximum Reading (5½ digit) | Resolution | | |
|-------|----------------------------|------------|----------|----------|
| | | 5½ digit | 4½ digit | 3½ digit |
| .3 A | 0.301000 A | 1 μA | 10 μA | 100 μA |
| 3 A | 3.01000 A | 10 μA | 100 μA | 1 mA |

Maximum input (non-destructive): 3 A from <250 V source; fuse protected.

Measurement accuracy: ±(% of reading + number of counts). Auto zero ON. 5½ digit display. Accuracy specified for sinewave inputs only, >10% of full scale.

1 Year, TCal ±5°C

| Frequency | Ranges | |
|-------------|------------|------------|
| | 0.3 A | 3 A |
| 20-50 Hz | 1.77 + 163 | 2.5 + 163 |
| 50-1 kHz | 1.1 + 163 | 1.8 + 163 |
| 1 k-10 kHz | 1.0 + 163 | 1.7 + 163 |
| 10 k-20 kHz | 1.14 + 163 | 1.84 + 163 |

General Information

Operating temperature: 0 to 55°C

Humidity range: 95% R.H., 0 to 40°C

Power: AC line 48 to 440 Hz, 86 to 250 V, (see configuration)

Battery: (Opt 001) Rechargeable lead-acid; minimum continuous operation for 5 hours at 25°C; recharge time is 16 hours with HP 3468A/B off and 36 hours with HP 3468A/B on.

Size: HP 3468A: 98.4 mm H x 238.1 mm W x 276.2 mm D (3.88 in. H x 9.38 in. W x 10.88 in. D). 3468B: 89 mm H x 213 mm W x 275 mm D (without feet), 3.5 in. H x 8.38 in. W x 10.83 in. D.

Weight: HP 3468A/B—2.1 kg (4.63 lb); HP 3468A/B with Opt 001—3.1 kg (6.83 lb).

Configuration: order one power and frequency option at no charge from below.

Opt 315: 100 V, 50 Hz; **Opt 335:** 220 V, 50 Hz

Opt 316: 100 V, 60 Hz; **Opt 336:** 220 V, 60 Hz

Opt 325: 120 V, 50 Hz; **Opt 345:** 240 V, 50 Hz

Opt 326: 120 V, 60 Hz; **Opt 346:** 240 V, 60 Hz

Ordering Information

HP 3468A DMM in Streamlined Portable Case with HP-IL and test probes.

Price
\$750

HP 3468B DMM in Rack and Stack Case with HP-IL and test probes.

\$750

Options and Accessories.

HP 3468A/B Option W30, add 3 year Extended Hardware Support

\$25

HP 3468A/B Option 001, add Rechargeable Battery Pack

\$148

HP 3468B Option 401, add Side Handle Kit

\$20

(HP P/N 5061-1171)

HP 3468B Option 907, add Front Handle Kit

\$50

(HP P/N 5061-1170)

HP 3468B Option 908, add Rack Mount Kit for a

\$52.50

Single Instrument (HP P/N 5060-0173)

HP P/N 5060-0174 Rack Mount Kit for rack mounting

\$62.50

two instruments side-by-side

MULTIMETERS

3 1/2 Digit, High Accuracy DMM

Model 3435A

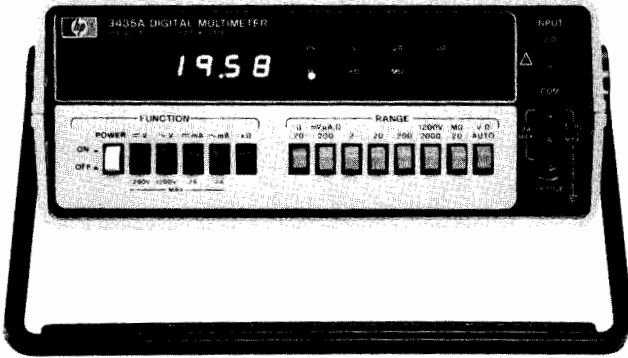

HP 3435A

Description

The HP 3435A is a 3 1/2 digit multimeter providing five functions of ACV, DCV, ACI, DCI and Ω . It is available with rechargeable batteries or ac line power only. The HP 34112A Touch-Hold probe provides "eyes-on" probing of ac and dc voltages by holding the HP 3435A display using a button on the probe. The HP 3435A case is rugged with a detent position carrying handle which is used also as a tilt stand.

Specifications

DC Voltmeter

| Ranges: | Maximum display: |
|---------|------------------|
| 200 mV | ± 199.9 mV |
| 2 V | ± 1.999 V |
| 20 V | ± 19.99 V |
| 200 V | ± 199.9 V |
| 1200 V | ± 1199 V |

Maximum input: 1200 V (dc + peak ac)
Accuracy: 1 year, 15 to 30°C.

| Range | Specifications |
|---------------|------------------------------------|
| 200 mV | $\pm(0.1\%$ of reading + 2 counts) |
| 2 V to 1200 V | $\pm(0.1\%$ of reading + 1 count) |

Temperature coefficient: (0 to 15°C and 30 to 55°C) $\pm(0.015\%$ of reading + 0.1 count)/°C.

Input resistance: 10 M Ω $\pm 1\%$.

Input type: floating, 500 V maximum common to ground.

Normal mode rejection: >40 dB at 50 Hz/60 Hz $\pm 0.1\%$.

Response time: <0.7 second to within 1 count of final value on one range. Add 1 second for each range change.

Effective common mode rejection: (1 k Ω unbalance) >120 dB at 50/60 Hz $\pm 0.1\%$.

AC Voltmeter

AC converter: avg. responding rms calibrated.

| Ranges: | Maximum display: |
|---------|------------------|
| 200 mV | 199.9 mV |
| 2 V | 1.999 V |
| 20 V | 19.99 V |
| 200 V | 199.9 V |
| 1200 V | 1199 V |

Maximum input: 1700 V (dc + peak ac), 10⁷ volt-Hz max.
Accuracy: (with display of ≥ 20 counts) 1 year, 15 to 30°C.

| Range | Specification |
|----------------|-------------------------------------|
| 30 Hz-50 Hz | $\pm(1.5\%$ of reading + 3 counts) |
| 50 Hz-20 kHz | $\pm(0.3\%$ of reading + 3 counts) |
| 20 kHz-100 kHz | $\pm(1.5\%$ of reading + 10 counts) |

Temperature coefficient: (0 to 15°C and 30 to 55°C) $\pm(0.04\%$ of reading + 0.2 count)/°C.

Input impedance: resistance: 5 M Ω . Shunt capacitance: <50 pF.

Ohmmeter

| Ranges | Maximum Display | Current Through Unknown |
|-----------------|------------------|-------------------------|
| 20 Ω | 19.99 Ω | 5 mA |
| 200 Ω | 199.9 Ω | 5 mA |
| 2 k Ω | 1.999 k Ω | 500 μ A |
| 20 k Ω | 19.99 k Ω | 50 μ A |
| 200 k Ω | 199.9 k Ω | 5 μ A |
| 2000 k Ω | 1999 k Ω | 500 nA |
| 20 M Ω | 19.99 M Ω | 50 nA |

Input protection: 250 V rms.
Accuracy: 1 year, 15 to 30°C.

| Range | Specifications |
|-------------------------------|-------------------------------------|
| 20 Ω | $\pm(0.5\%$ of reading + 12 counts) |
| 200 Ω -2000 k Ω | $\pm(0.2\%$ of reading + 2 counts) |
| 20 M Ω | $\pm(0.8\%$ of reading + 2 counts) |

Temperature coefficient: (0 to 15°C and 30 to 55°C)

| Range | Specifications |
|------------------------------|---|
| 20 Ω -2000 k Ω | $\pm(0.04\%$ of reading + 0.2 count)/°C |
| 20 M Ω | $\pm(0.18\%$ of reading + 0.2 count)/°C |

DC Current and AC Current

| Ranges: | Maximum display: |
|-------------|---------------------|
| 200 μ A | ± 199.9 μ A |
| 2 mA | ± 1.999 mA |
| 20 mA | ± 19.99 mA |
| 200 mA | ± 199.9 mA |
| 2000 mA | ± 1999 mA |

Maximum input: current: 2 A (fuse protected). Voltage: 250 V.
DC current accuracy: 1 year, 15 to 30°C.

| Range | Specifications |
|-----------------------|------------------------------------|
| 200 μ A to 200 mA | $\pm(0.3\%$ of reading + 2 counts) |
| 2000 mA | $\pm(0.6\%$ of reading + 2 counts) |

AC current accuracy: (with display of ≥ 20 counts)—1 year, 15 to 30°C.

| Current Range | 30 Hz | 50 Hz | 10 kHz |
|-----------------------|------------------------------------|------------------------------------|--------|
| 2000 mA | $\pm(2\%$ of reading + 5 counts) | $\pm(1.2\%$ of reading + 5 counts) | |
| 200 mA To 200 μ A | $\pm(1.7\%$ of reading + 5 counts) | $\pm(0.9\%$ of reading + 5 counts) | |

Frequency of Input Signal

General

Reading rate: 2.4 - 4.7/s depending on input level.

Ranging: automatic or manual on ACV, DCV and ohms. Manual only on ac & dc current.

Operating temperature: 0 to 55°C.

Humidity: 95% RH, +15 to +40°C.

Power: ac line: 48-440 Hz; 86-250 V (see ordering information). Battery: rechargeable lead-acid; 10 hours minimum continuous operation with full charge. Recharge time: 16 hours operating, 12 hours nonoperating.

Size: HP 3435A: 23.91 cm W x 9.84 cm H x 27.62 cm D (9.4" x 3.9" x 10.9").

Weight: HP 3435A: 2.41 kg (5.3 lb); HP 3435A Opt 001: 1.84 kg (4.1 lb).

Ordering Information

HP 3435A streamlined portable case with handle, ac line power. Batteries and charger included. **Price** \$790

HP 3435A Opt. 001, streamlined portable case, ac line power only. **Price** less \$65

HP 3435A Opt. 002, Rack and Stack case, ac line power only. (Rack mount kit not included.) **Price** less \$10

All orders must include one of the power options: 86-106 V Opt. 100; 190-233 V Opt. 210; 104-127 V Opt. 115; 208-250 V Opt. 230. **Price** N/C



MULTIMETERS

Voltmeter Accessories

Probes, Dividers, Carrying Cases

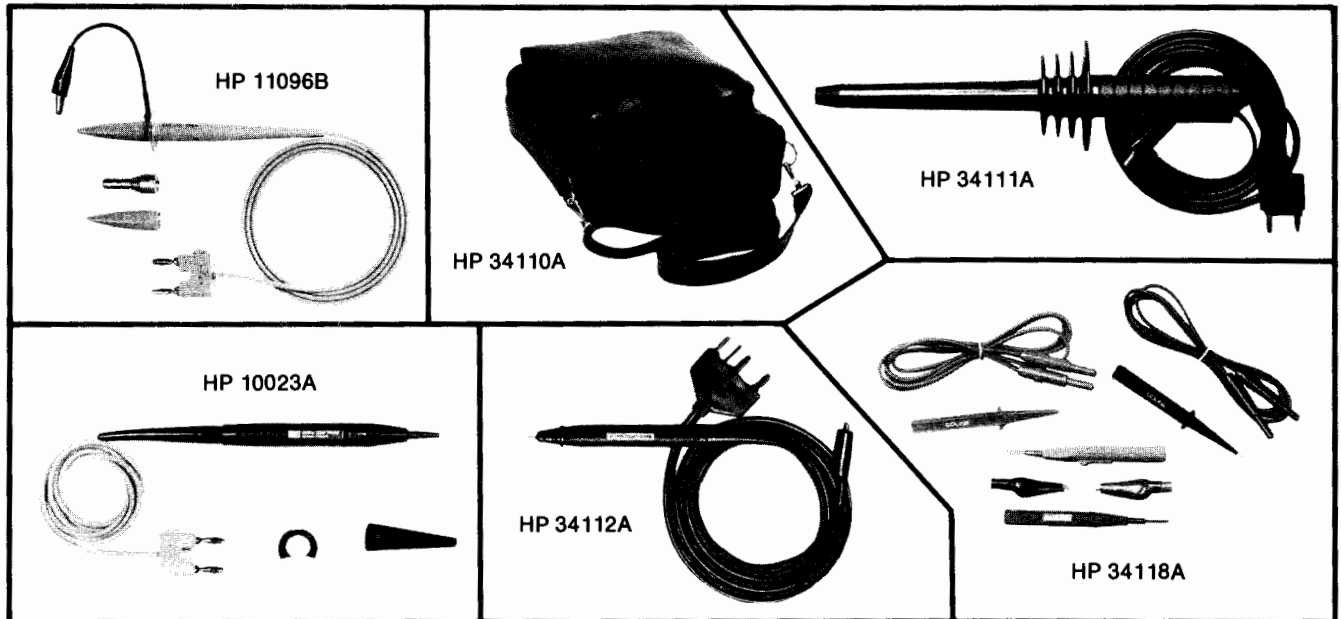

HP 10023A Temperature Probe

The HP Model 10023A Temperature Probe provides the fast, accurate temperature measurements needed in a wide variety of thermal design, diagnostic, and testing applications. Surface temperature measurements are read directly in degrees Celsius on general purpose digital multimeters having an input impedance of ≥ 10 megohms. A pencil-like probe tip easily accesses small components and a press-to-read switch makes measurements easy.

The probe is a self-contained temperature-to-voltage transducer with a forward-biased diode chip providing calibrated linear output of 1 mV/°C. The entire electronics assembly, including integrated circuits and battery is packaged in the probe barrel.

A standard dual banana plug output connector provides universal connection to digital voltmeters.

HP 10023A Specifications

Electrical

Measurement range: -55°C to $+150^{\circ}\text{C}$.

Output: 1 mV/°C.

Short term repeatability: $\pm 0.3^{\circ}\text{C}$ (minimum of 48 hrs).

Accuracy: $\pm 2^{\circ}\text{C}$ from 0°C to 100°C , decreasing linearly to $+2^{\circ}\text{C}$, -4°C at -55°C and $+4^{\circ}\text{C}$, -2°C at $+150^{\circ}\text{C}$.

Maximum voltage at tip: 600 V (dc + peak ac).

Tip capacitance to ground: approx 0.5 pF.

Thermal response: < 3 s to settle within 2°C of final reading (liquid measurement) for a 100°C temperature change.

DMM input R: ≥ 10 M Ω

General

Operating environment (probe tip to approx. 13 mm (0.5 in) from probe tip): temperature, -55°C to $+150^{\circ}\text{C}$; altitude, to 4600 m (15 000 ft); vibration, vibrated in three planes for 15 min each with 0.38 mm (0.015 in) excursion, 10 to 55 Hz.

Operating environment (probe body): temperature, 0°C to 60°C (battery limitation); humidity (non-condensing), to 95% relative humidity at $+40^{\circ}\text{C}$, altitude and vibration same as those for probe tip.

Overall length: approx 1.4 m (53 in).

Weight: net, 85 g (3 oz); shipping, 312 g (11 oz).

Battery life: approx 50 hr (varies with ambient temperature).

Accessories supplied: one replacement battery (HP 1420-0256), one sliding lock collar (HP 10023-23201), and one probe tip cover (HP 00547-40005).

Ordering Information

| Part Number | Description | Price |
|--------------------|--|-------|
| HP 10023A | Temperature Probe | \$330 |
| HP P/N 10023-60001 | Replacement tip, includes pre-calibrated tip and matching compensation network | \$120 |
| HP 11096B | High Frequency Probe | \$150 |

HP 11096B High Frequency Probe

Converts dc voltmeter with 10 M Ω input to high-frequency ac voltmeter. Works with any dc voltmeter with 10 M Ω input impedance.

HP 11096B Specifications

Voltage range: 0.25 to 30 Vrms.

Transfer Accuracy (when used with 10 M Ω \pm 10% dc voltmeter):

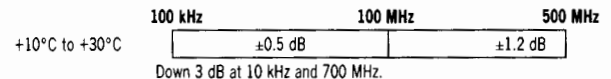

Response: peak responding. Calibrated to read rms value of sine wave.

Input impedance: 4 M Ω shunted by 2 pF.

Maximum input: 30 V rms ac; 200 V dc.

Accessories furnished: high-frequency adapter; straight tip; hook tip; ground lead.

HP 34110A Soft Vinyl Carrying Case

Carrying case for $\frac{1}{2}$ rack size instruments. Inside dimensions of 25.4 cm x 22.9 cm x 10.2 cm or 10 in D x 9 in W x 4 in H. Zipper flip top lid and zippered accessory pouch. Has shoulder carrying strap.

HP 34111A DC Hi-Voltage Probe

1000:1 divider will accept up to 40 kV. Input $Z = 10^9 \Omega$. Divider accuracy meets specifications when connected to 10 M Ω input resistance instrument.

Division Ratio Accuracy

| | |
|----------|---------|
| 0–20 kV | $< 4\%$ |
| 30–40 kV | $< 4\%$ |
| 20–30 kV | $< 2\%$ |

Divider has interchangeable hook and pointed tip.

HP 34112A Touch-Hold Probe

Allows user to hold DMM display by depressing button on probe body. Both ac and dc voltage up to 1200 V max. dc or ac RMS may be measured and held. Usable on the HP 3435A, HP 3438A, HP 3465A/B, and HP 3466A.

Ordering Information

| Part Number | Description | Price |
|-------------|---|-------|
| HP 34110A | Carrying Case for $\frac{1}{2}$ Rack Size Instruments | \$40 |
| HP 34111A | DC Hi-Voltage Probe | \$180 |
| HP 34112A | Touch-Hold Probe | \$70 |
| HP 34118A | Test Lead Kit | \$25 |

Selecting An Analog Voltmeter

Analog voltmeters are used for many applications from general purpose bench or field use to special needs of true rms ac detection.

For measurements involving dc applications, select the instrument with the broadest capability meeting your requirements. For ac measurements involving sine waves with only modest amounts of distortion (<10%), the average-responding voltmeter can perform over a bandwidth extending to several megahertz. For high-frequency measurements (>10 MHz), the peak-responding voltmeter with the diode-probe input is the most economical choice. Peak-responding circuits are acceptable if inaccuracies caused by distortion in the input waveform can be tolerated. For measurements where it is important to determine the effective power of waveforms that depart from a true sinusoidal form, the true rms-responding voltmeter is the appropriate choice.

Some analog voltmeters offer multiple functions such as dc and ac voltage plus resistance measurements.

Analog Voltmeter Accuracy

Before we can discuss meter accuracy, we must have a familiarity with the various meter scales available. Many instruments have meter scales marked in both volts and decibel (dB) units. It should be noted that dB and

voltage are complements of each other. That is, if a voltage scale is made linear, the dB scale on the same meter face will be logarithmic or nonlinear. Likewise, if the dB scale is made linear, the voltage scale becomes nonlinear. The term "linear-log scale" is applied to an instrument that has a linear dB scale and, therefore, a nonlinear voltage scale. Several different types of meter faces are illustrated in Figure 1.

Analog meters usually have nonlinearities and/or offsets present in the attenuators and amplifiers. The meter movement itself can have nonlinearities even with individually calibrated meter scales. Nonlinearities cause percent of reading errors, and offsets cause percent of full scale errors.

Looking at instrument specification sheets, accuracy specifications are usually expressed in one of three ways: 1. percent of the full-scale value, 2. percent of the reading, 3. (percent of reading + percent of full-scale). The first is probably the most commonly used accuracy specification. The second (percent of reading) is more commonly applied to meters having a logarithmic scale. The last method has been used more recently to obtain a tighter accuracy specification on a linear-scale instrument.

Hewlett-Packard uses the two-part accuracy specification to take advantage of the upper-scale accuracy and yet maintain a reasonable specification for the lower portion of the scale.

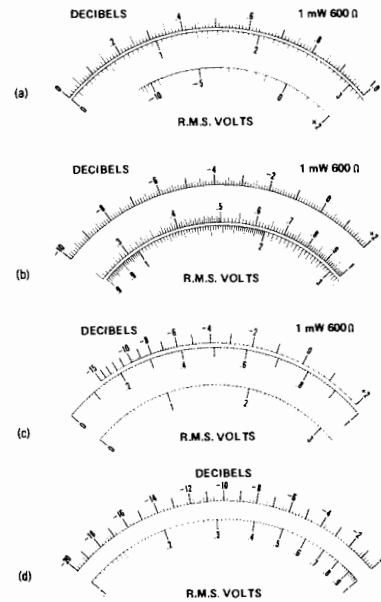

Figure 1. Four different types of meter scales available. (a) Linear 0-3 V and 0-10 V scales plus a dB scale. (b) Linear dB scale plus non-linear (logarithmic) voltage scales. (c) dB scale placed on larger arc for greater resolution. (d) Linear -20 to 0 dB scale useful for acoustical and communications applications.

Analog Voltmeter Selection Chart

| Model | AC VOLTMETERS | Voltage Range | Frequency Range; Typical Accuracy | Page |
|----------------------|---|--|---|------|
| HP 3400A | RMS VOLTMETER provides rms readings of complex signals. Has dc output for driving DVM's or recorders | 1 mV to 300 V (12 ranges) | 10 Hz to 10 MHz ±1% to ±5% | 220 |
| HP 400E HP 400 EL | HIGH ACCURACY AC VOLTMETER has dc output (±0.5%) for driving recorder | 1 mV to 300 V; -60 dB to +50 dB | 10 Hz to 10 MHz ±1% ±5% | 221 |
| HP 400F HP 400 FL | FAST-RESPONSE AC VOLTMETER 100 kHz low-pass filter ac amplifier | 100 μV to 300 V; -80 dB to +50 dB | 20 Hz to 4 MHz; ±1% to ±4% | 221 |
| HP 400GL | HIGH ACCURACY dB VOLTMETER 20 dB log scale (0 dB = 1 V) | -80 dB to +60 dB (8 ranges) | 20 Hz to 4 MHz; ±0.2 dB to 0.4 dB | 221 |
| HP 3406A | SAMPLING RF VOLTMETER provides true rms measurements when used with HP 3400A. Many accessories | 1 mV to 3 V (8 ranges) | 10 kHz to >1.2 GHz ±3% to ±13% | 223 |
| Model | MULTI-FUNCTION METERS | Voltage Range (Accuracy) | Resistance Range (Accuracy) | Page |
| HP 427A | BATTERY-OPERATED MULTI-FUNCTION METER has 10 MΩ dc input impedance and 10 MΩ/20 pF ac input impedance | dc: ±100 mV to 1000 V (±2%) 9 ranges ac: 10 mV to 300 V 10 Hz to 1 MHz (±2%) 10 ranges | 10 Ω to 10 MΩ mid-scale ±5%; from 0.3 to 3 on the meter scale (7 ranges) | 222 |
| HP 410C | VERSATILE VOLTMETER has 100 MΩ dc input impedance and 10 MΩ/1.5 pF ac impedance | dc: ±15 mV to ±1500 V (±2%) 11 ranges ac: 0.5 V to 300 V 20 Hz to >700 MHz (±3% at 400 Hz) 7 ranges | 10 Ω to 10 MΩ (center scale) 0 to midscale: ±5% or ±2% of midscale (whichever is greater) 11 ranges current: dc: ±1.5 μA to ±150 mA (±3%) | 222 |
| Model | CURRENT METERS | Current Range | Frequency Range | Page |
| HP 428B | dc MILLIAMMETER with clip-on probe eliminates direct connection | 1 mA to 10 A FS (9 ranges) | dc to 400 Hz | 223 |

MULTIMETERS

10 Hz to 10 MHz True RMS Voltmeter

HP Model 3400A

- 10 MHz bandwidth
- High crest factor for accurate pulse measurements
- Stable, linear dc output

- 1 mV full-scale sensitivity
- 10 MΩ input impedance
- Taut-band individually calibrated meter

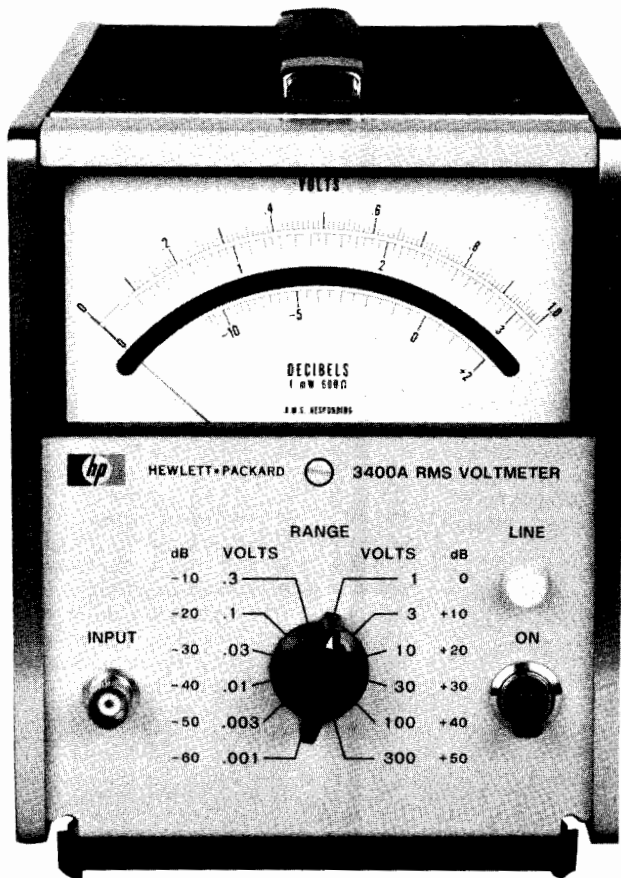

HP 3400A

Description

The Hewlett-Packard Model 3400A is a true root-mean-square (rms) voltmeter, providing a meter indication proportional to the dc heating power of the input waveform.

Six-decade frequency coverage makes the HP 3400A extremely flexible for all audio and most RF measurements and permits the measurement of broadband noise and fast-rise pulses.

Pulses or other non-sinusoids with crest factors (ratio of peak to rms) up to 10:1 can be measured full scale. Crest factor is inversely proportional to meter deflection, permitting up to 100:1 crest factor at 10% of full scale.

Permanent plots of measured data and higher resolution measurements can be obtained by connecting an X-Y plotter, strip chart recorder or digital voltmeter to the convenient rear-panel dc output. The dc output provides a linear 0 to 1 volt drive proportional to meter deflection.

Specifications

Voltage range: 1 mV to 300 V full scale, 12 ranges.

dB range: -72 to +52 dBm (0 dBm = 1 mW into 600Ω).

Frequency range: 10 Hz to 10 MHz.

Response: responds to rms value (heating value) of the input signal for all waveforms.

Meter accuracy: % of full scale (20°C to 30°C)*

| 10Hz | 50Hz | 1MHz | 2MHz | 3MHz | 10MHz |
|------|------|------|------|------|-------|
| ±5% | ±1% | ±2% | ±3% | ±5% | |

AC-to-DC converter accuracy: % of full scale (20°C to 30°C)*

| 10Hz | 50Hz | 1MHz | 2MHz | 3MHz | 10MHz |
|------|--------|------|------|------|-------|
| ±5% | ±0.75% | ±2% | ±3% | ±5% | |

* TC: ±0.1% from 0°C to 20°C and 30°C to 55 °C.

Crest factor: (ratio of peak to rms amplitude of input signal): 10 to 1 at full scale (except where limited by maximum input) inversely proportional to meter deflection (e.g., 20 to 1 at half-scale, 100 to 1 at tenth scale).

Maximum continuous input voltage: 500 V ac peak at 1 kHz on all ranges; 600 V dc on all ranges.

Input impedance: from 0.001 V to 0.3 V range: 10 MΩ shunted by <50 pF. From 1.0 V to 300 V range: 10 MΩ shunted by <20 pF. ac coupled input.

Response time: for a step function, <6 s to final value.

AC overload: 30 dB above full scale or 800 V p, whichever is less, on each range.

Output: negative 1 V dc into open circuit at full-scale deflection, proportional to meter deflection from 10–100% of full scale. 1 mA maximum; nominal source impedance is 1000Ω. Output noise <1 mV rms.

Power: 115 or 230 V ±10%, 48 to 66 Hz, 15 VA max.

Size: 159 H (without removable feet) x 130 W x 279 mm D (6.25" x 5.1" x 11"); ½ module.

Weight: net, 3.3 kg (7.3 lb). Shipping, 4.5 kg (10 lb).

Accessories furnished: 10110A Adapter, BNC to dual banana jack.

Accessories Available

| Accessories Available | Price |
|--|---------|
| HP 11170A Cable, 12 in., male BNC connectors | \$18.50 |
| HP 11170B Cable, 24 in., male BNC connectors | \$19.00 |
| HP 11170C Cable, 48 in., male BNC connectors | \$20.00 |
| HP 11002A Test lead, dual banana plug to alligator clips | \$20.00 |
| HP 11003A Test Leads, dual banana plug to probe and alligator clip | \$20.00 |
| HP 11076A Carrying Case | \$300 |

Ordering Information

HP 3400A Opt 001 spreads out the dB scale by making it the top scale of the meter. add \$40

Rear terminals in parallel with front panel terminals and linear log scale uppermost on the meter face are available on special order.

HP 3400A RMS Voltmeter

\$1630

MULTIMETERS

AC Voltmeter, 10 Hz to 10 MHz

HP Models 400E, EL, F, FL, GL

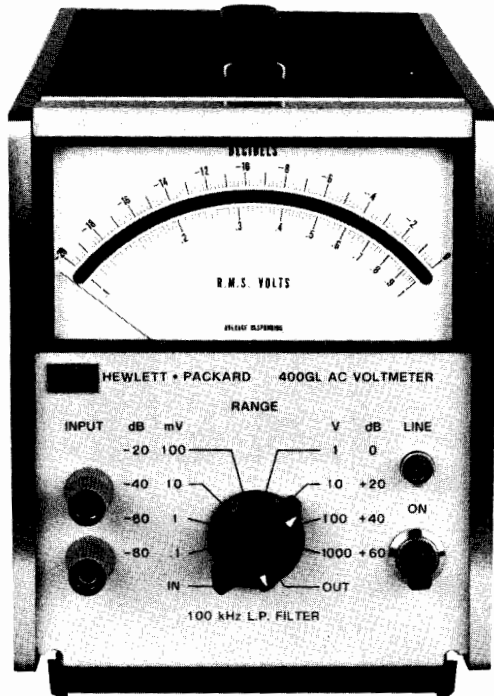

HP 400GL

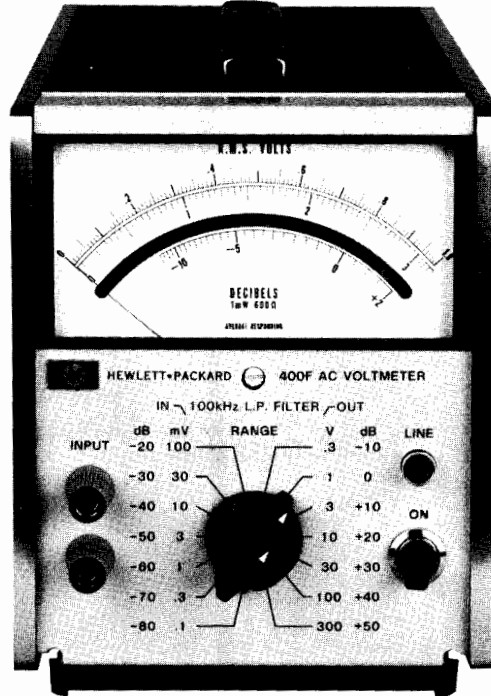

HP 400F

Specifications

| | HP 400E/EL* | HP 400F/FL* | HP 400 GL |
|-----------------|---|--|---|
| Voltage range | 1 mV to 300 V F.S. 12 ranges | 100 μ V to 300 V F.S. 14 ranges | -80 dB to +60 dB F. S. 8 ranges |
| Frequency range | 10 Hz-10 MHz | 20 Hz-4MHz | 20 Hz-4 MHz |
| Input impedance | 10 M Ω on all ranges <25 pF to <12 pF depending on ranges | 10 M Ω on all ranges <30 pF to <15 pF depending on ranges | 10 M Ω on all ranges <30 pF to <15 pF depending on ranges |
| Accuracy* | \pm (% reading + % range) 3 mV-300 V ranges 10 Hz-40 Hz; \pm (2.5 + 2.5) 40 Hz-2 MHz; \pm (1 + 0) 2 MHz-4 MHz; \pm (1.5 + 1.5) 4 MHz-10 MHz 3 mV range: \pm (2.5 + 2.5) 10 mV-3V range: \pm (3.0 + 2.0) for 4 MHz to 6 MHz \pm (3.75 + 3.75) for 6 MHz to 10 MHz 10 V-30 V: \pm (3.5 + 3.5) 1 mV range 10 Hz-40 Hz; \pm (2.5 + 2.5) 40 Hz-500 kHz; \pm (1 + 0) 500 kHz-4 MHz; \pm (2.5 + 2.5) | \pm (% reading + % range) (% reading) 300 μV-300 V ranges F 20 Hz-40 Hz; \pm (2 + 2) \pm 4 40 Hz-100 Hz; \pm (1 + 1) \pm 2 100 Hz-1 MHz; \pm (1/2 + 1/2) \pm 1 1 MHz-2 MHz; \pm (1 + 1) \pm 2 2 MHz-4 MHz; \pm (2 + 2) \pm 4 100 μV range 30 Hz-60 Hz; \pm (2 + 2) \pm 4 60 Hz-100 kHz; \pm (1 + 1) \pm 2 100 kHz-500 kHz; \pm (1 + 0.7) \pm 1, -8 | +60 dB range 20 Hz-40 kHz; \pm 0.4 dB 40 kHz-100 kHz; \pm 0.2dB -60 dB thru +40 dB ranges 20 Hz-40 Hz; \pm 0.4 dB 40 Hz-500 kHz; \pm 0.2 dB 500 kHz-2 MHz; \pm 0.4 dB 2 MHz-4 MHz; +0.2, -0.8 dB -80 dB range 30 Hz-60 Hz; \pm 0.4 dB 60 Hz-100 kHz; \pm 0.2 dB 100 kHz-500 kHz; + 0.2, -0.8 dB |
| Recovery | <2 s for 80 dB overload | | |
| Overload | **500 V rms ac, 300 V dc | | **1200 V rms max. input; 1000 V dc max. input |
| Calibration | Responds to average value of input; calibrated in rms value of sine wave. Scale -10 to +2 dB between ranges. 100 divisions on 0 to 1 scale. The dB scale reads -10 to +2 dB; 10 dB between ranges. | | Responds to average value of input; calibrated in rms value of sine wave. Linear -20 to 0 dB scale, 100 divisions. 20 dB per range. Log voltage scale. |
| Weight | Net, 2.7 kg (6 lb). Shipping, 4.1 kg (9 lb) | | |
| Size | 159 mm H (without removable feet) x 130 mm W x 297 mm D (6.25" x 5.13" x 11") | | |
| Power | AC: 115 or 230 V +10%, 48 to 440 Hz, 6 VA max. DC: External batteries: + and - voltages between 35 V and 55 V | | |
| Price: | HP 400E, \$1,090; HP 400 EL \$1,090 | HP 400F, \$1,090; HP 400 FL, \$1,090 | HP 400 GL, \$1,090 |

* NOTE: HP 400 EL same as HP 400E, and HP 400FL same as HP 400F, except for calibration.
Linear dB scale -10 dB to +2 dB, 10 dB between ranges. Log voltage scales 0.3 to 1 and 0.8 to 3, 120 divisions from -10 dB +2 dB. HP 400 FL accuracy is % of reading in dB only.

** AC overload voltage decreases with increasing frequency.

MULTIMETERS

General Purpose, Multi-Function Meters

HP Models 410C, 427A

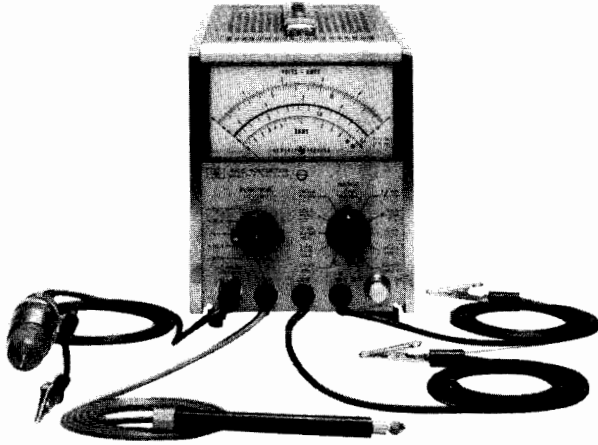

HP 410C with HP 11036A

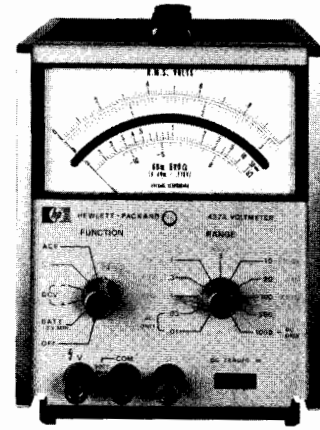

HP 427A

Description

HP's model 410C can be used for both dc current and voltage measurements as well as resistance measurements. With the supplied HP 11036A Plug-in Probe, ac voltages can also be measured.

Description

HP's model 427A is a portable multi-function meter valuable for measuring both ac and dc voltages and resistance. It will operate for more than 300 continuous hours on its internal battery. Option 001 provides both ac line and battery operation.

Specifications

| | | HP 410C | HP 427A | | | | | | | | | | | |
|----------------------|----------------------------|--|---|-----------|-------|--|--------------|--------------|------------------|-------------|-------------|------------------|--|--|
| DC Voltmeter | Voltage Range | ±15 mV to ±1500 V F.S. 11 ranges | ±100 mV to ±1000 V F.S. 9 ranges | | | | | | | | | | | |
| | Accuracy | ±2% of F.S. on any range | ±2% of F.S. on any range | | | | | | | | | | | |
| | Input Resistance | 100 MΩ ±1% on 500 mV range and above, 10 MΩ ±3% on 150 mV range and below | 10 MΩ | | | | | | | | | | | |
| AC Voltmeter | Voltage Range | 0.5 V to 300 V F.S. 7 ranges | 10 mV to 300 V F.S. 10 ranges | | | | | | | | | | | |
| | Frequency | 20 Hz to 700 MHz | 10 Hz to 1 MHz (> 500 MHz with HP 11096B High Frequency Probe) responds to average value, calibrated in rms | | | | | | | | | | | |
| | Response | AC probe responds to positive peak-above average value, calibrated in rms | | | | | | | | | | | | |
| | Accuracy | ±3% of F.S. at 400 Hz for sinusoidal voltages from 0.5V-300V rms | <table border="1"> <thead> <tr> <th rowspan="2">Frequency</th> <th colspan="2">Range</th> </tr> <tr> <th>0.01V to 30V</th> <th>100V to 300V</th> </tr> </thead> <tbody> <tr> <td>10 Hz to 100 kHz</td> <td>2% of range</td> <td>2% of range</td> </tr> <tr> <td>100 kHz to 1 MHz</td> <td></td> <td></td> </tr> </tbody> </table> | Frequency | Range | | 0.01V to 30V | 100V to 300V | 10 Hz to 100 kHz | 2% of range | 2% of range | 100 kHz to 1 MHz | | |
| Frequency | Range | | | | | | | | | | | | | |
| | 0.01V to 30V | 100V to 300V | | | | | | | | | | | | |
| 10 Hz to 100 kHz | 2% of range | 2% of range | | | | | | | | | | | | |
| 100 kHz to 1 MHz | | | | | | | | | | | | | | |
| Ohmmeter | Resistance Range | 10Ω to 10MΩ center scale, 7 ranges | 100Ω to 10mΩ center scale, 7 ranges | | | | | | | | | | | |
| | Accuracy | zero to midscale: ±5% of reading or ±2% of midscale, whichever is greater; ±7% from midscale to scale value of 2; ±8% from scale value of 2 to 3; ±9% from scale value of 3 to 5; ±10% from scale value of 5 to 10 | ±5% of reading (from 0.3 to 3 on scale) | | | | | | | | | | | |
| DC Ammeter | Current Range | ±1.5μA to ±150 mA F.S. 11 ranges | Not applicable | | | | | | | | | | | |
| | Accuracy | ±3% of F.S. on any range | | | | | | | | | | | | |
| Amplifier | | Maximum voltage gain of 100; output proportional to meter indication; 1.5 Vdc F.S. | Not applicable | | | | | | | | | | | |
| Weight | | Net, 3.6 kg (8 lb); shipping, 6.35 kg (14 lb) | Net, 2.4 kg (5.3 lb); shipping, 3.2 kg (7 lb) | | | | | | | | | | | |
| Size | | 159 mm H x 130 mm W x 280 mm D (6 1/2" x 5 1/8" x 11") | 159 mm H x 130 mm W x 203 mm D (6 1/2" x 5 1/8" x 8") | | | | | | | | | | | |
| Power | | 115 V or 230 V ±10%, 48 Hz to 440 Hz, 15 VA (24 VA with HP 11036A AC Probe) | > 300 hr operation on 22.5 V battery; Option 001: battery or ac line operation, rear panel selectable, 115 V to 230 V ±20%, 48 to 440 Hz, 0.7 VA | | | | | | | | | | | |
| Accessories | | Detachable power cord, HP 11036A AC Probe furnished standard | Refer to data sheet for available accessories | | | | | | | | | | | |
| Ordering Information | | Price | Price | | | | | | | | | | | |
| | HP 410C Voltmeter | \$2080 | HP 427A Voltmeter \$1235 | | | | | | | | | | | |
| | Option 002 (less ac probe) | less \$330 | Option 001 (ac power supply and battery) add \$80 | | | | | | | | | | | |



HP 428B

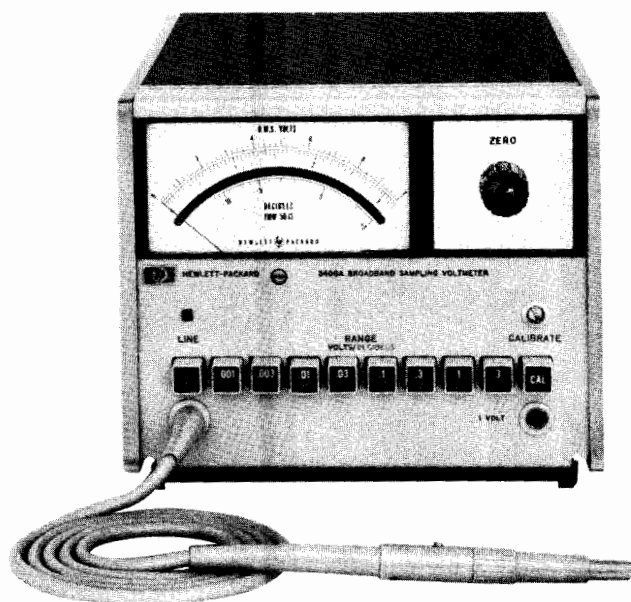

HP 3406A

Description

HP model 428B Clip-On Milliammeter measures direct current without interrupting your measured circuit or producing loading errors. DC current is measured by utilizing a clip-on transducer that converts the magnetic field around the conductor to an ac voltage proportional to dc current. This voltage is detected and displayed as direct current. Since no contact is made to the circuit, complete dc isolation is ensured.

Low frequency currents up to 400 Hz can also be measured by connecting an oscilloscope or voltmeter to the front panel output.

Specifications

- DC current range:** 1 mA to 10 A full scale, nine ranges.
- Accuracy:** $\pm 3\%$ of full scale ± 0.15 mA, from 0°C to 55°C (when instrument is calibrated to probe).
- Output:** variable linear output level with switch position for calibrated 1 V into open circuit (corresponds to full scale deflection).
- Frequency Range:** dc to 400 Hz (3 dB point).
- Power:** 115 or 230 V $\pm 10\%$, 48 to 440 Hz, 71 W.
- Probe insulation:** 300 V maximum.
- Probe tip size:** ≈ 0.5 in. (12.7 mm) by 0.66 in. (16.67 mm) aperture diameter 0.16 in. (3.97 mm).
- Size:** cabinet, 292 H x 191 W x 368 mm D (11.5" x 7.5" x 14.5").
- Weight:** net, 8.6 kg (17 lb); shipping, 10.9 kg (24 lb).

Accessories Available

- HP 3529A Magnetometer Probe:** this probe measures magnetic field strength and direction. The component of magnetic field sensed is parallel to the cylindrical axis of the probe.
- Range:** 1 mG to 10 G full scale, nine ranges. 1 mG = 1 mA conversion factor.
- Accuracy:** $\pm 3\%$ of full scale (0°C to +55°C) after calibration.
- Frequency Range:** dc to 80 Hz (3 dB point).
- Weight:** net, 0.45 kg (1 lb); shipping, 0.91 kg (2 lb).

Ordering Information

- HP 428B Analog Milliammeter
- HP 3529A Magnetometer Probe

Price
\$2175
\$270

Description

The HP model 3406A RF Voltmeter employs sampling techniques to achieve an extremely high bandwidth (10 kHz to 1.2 GHz) with high input impedance. Signals as small as 50 μ V can be resolved. Accessory probe tips enable the use of the HP 3406A in applications such as receivers, amplifiers and coaxial transmission lines.

Specifications

Voltage range: 1 mV to 3 V full scale in 8 ranges; decibels from -50 to +20 dBm (0 dBm = 1 mW into 50 Ω); average-responding instrument calibrated to rms value of sine wave.

Frequency range: 10 kHz to 1.2 GHz; useful sensitivity from 1 kHz to beyond 2 GHz.

Full-Scale Accuracy (%) with appropriate accessory (after probe is properly calibrated)

| 10 kHz | 20 kHz | 25 kHz | 100 kHz | 100 MHz | 700 MHz | 1 GHz | 1.2 GHz |
|----------|---------|---------|---------|---------|---------|----------|---------|
| ± 13 | ± 8 | ± 5 | ± 3 | ± 5 | ± 8 | ± 13 | |

Sample Hold Output

Provides ac signal whose unclamped portion has statistics that are narrowly distributed about the statistics of the input, inverted in sign (operating into >200 k Ω load with <1000 pF). Output is 0.316 V at f.s. on any range.

Meter

Meter scales: linear voltage, 0 to 1 and 0 to 3; decibel, -12 to +3. Individually calibrated taut-band meter.

General

- DC recorder output:** adjustable from 0 to 1.2 mA into 1000 ohms at full scale, proportional to meter deflection.
- Power:** 115V $\pm 10\%$, 48-440 Hz; 230V $\pm 10\%$, 48-66 Hz; 25 VA max.
- Size:** 159 mm H (without removable feet), x 197 mm W x 279 mm D (6.25" x 7.75" x 11"); $\frac{1}{2}$ module.
- Weight:** net, 5.4 kg (12 lb); shipping, 6.8 kg (15 lb).
- Accessories:** refer to data sheet.

Ordering Information
HP 3406A RF Voltmeter

Price
\$2970



ELECTRONIC COUNTERS

General Information

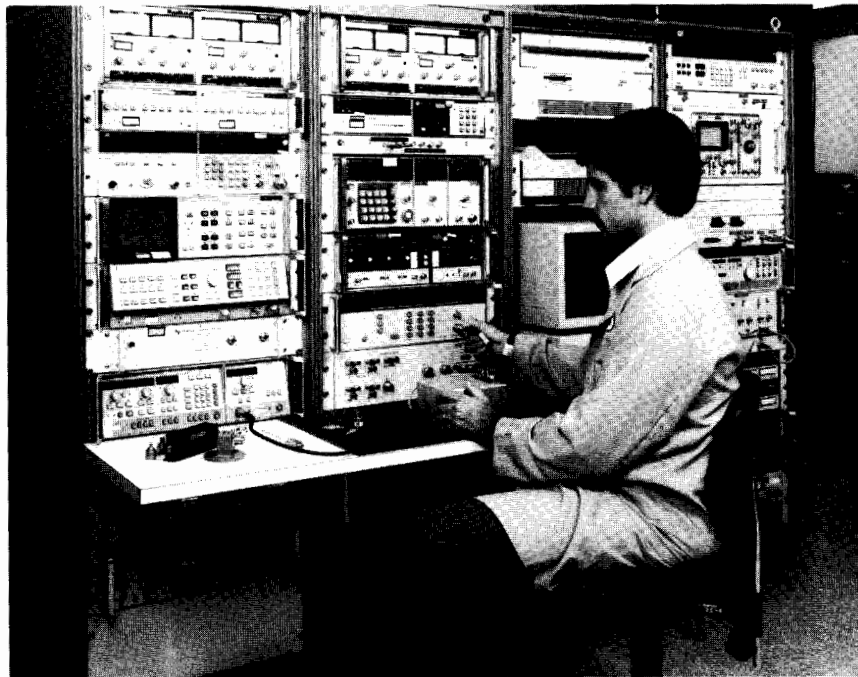

HP made-for-systems counters offer flexible solutions for automatic testing applications

The Strengths of a Counter

Save time and money

First, you get useful results, such as frequency, period and time interval without calculation. Then you get the lowest cost solution to frequency and time measurements. And finally, you get there with much less operator training.

Improve Manufacturing Productivity

The throughput, or rate of measuring, in a counter makes it the preferred choice in manufacturing. Hundreds, often thousands, of highly accurate measurements are provided each second.

A Counter for Your Needs

Choose from a wide range of cost-effective measurement solutions.

Frequency counters from the \$900, 225 MHz HP 5382A to the 110 GHz HP 5355A/5356D.

Universal counters, which add time interval measurement ability, from the \$550, 100 ns single shot HP 5314A to the 20 ps single shot HP 5370B.

Maximum flexibility with the high performance universal HP 5345A, and its pulsed microwave or millimeter plug-in companion 5355A with 5356A/B/C/D heads.

The Right Technique - Frequency Measurement

The **traditional** technique of counting the number of input cycles over a selected gate time gives you the advantage of a low cost at the expense of limited resolution at low frequencies - one hertz per second of gate time.

Reciprocal counting gives you the enhancement of significantly more useful digits of resolution at lower frequencies. For example, measuring 100 Hz with the HP 5384A, will give 8 digits in one second: a traditional counter would give only 3.

Interpolation gives you yet more useful digits of resolution. The HP 5370B will give at least 11 digits per second.

The Right Technique - Time Interval

Traditionally, time intervals have been measured by counting the instrument clock over the interval to be measured. With a 10 MHz clock, you would have 100 ns resolution. To get more resolution, you need a higher clock frequency, and so a more expensive counter. With a 500 MHz clock, you have 2 ns resolution.

Time interval averaging will give you greater resolution - 10 times for 100 measurements - at the expense of requiring a repetitive signal and much greater measurement time.

Interpolation gives you enhanced resolution at a lower cost, such as 2 ns single shot for only \$2800 in the HP 5334A. Interpolation can also emulate a 50 GHz clock to give you 20 ps single shot resolution, such as in the HP 5370B.

Let the Counter Give you More

Data reduction with built-in statistics and math functions, gives you useful information rapidly instead of inundating you with masses of raw data for later processing.

Pulse characterization, with built-in peak amplitude measurements and automatic trigger level setting, greatly speeds your analysis tasks. Math capabilities can then reduce the data to rise and fall times, slew rates, duty cycle or phase difference.

Reduced external circuitry results from built-in arming and gating, select the time interval of interest in complex waveforms, or profile a changing frequency.

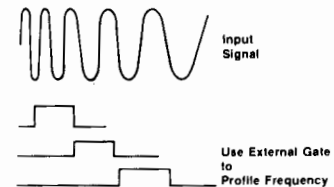

External gating of a frequency measurement lets you profile a signal with changing frequency.

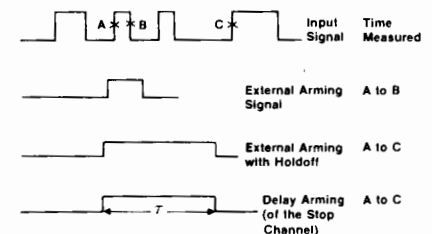

External arming, external arming with holdoff and built-in delay functions make it easy for you to pick out time intervals of interest.

Automatic Test Equipment

HP-IB is standard on many counters, and is an option on many others. Now you have accurate time and frequency information rapidly transferred to your system, thereby improving manufacturing productivity.

Here are some examples:

Counters such as the HP 5345A can provide frequency measurements to 500 MHz or single shot time interval measurements to 2 ns resolution at rates to 9000 measurements per second.

The HP 5370B can give you better than 100 ps accuracy at several hundred results per second, and 20 ps resolution measurements at up to 6000 measurements per second.

The HP 5334A offers you a systems solution of frequency or time interval to 2 ns resolution for only \$2800.

The HP 5316A gives universal counter capability for \$1900.

The HP 5351A gives 26.5 GHz frequency measurements at 80 readings per second for only \$6000.

See the selection guide on next page for more systems choices.

HP-IL gives you low-cost, portable automatic frequency measurement capability with the HP 5384A 225 MHz counter, or the 5385A 1-GHz counter.

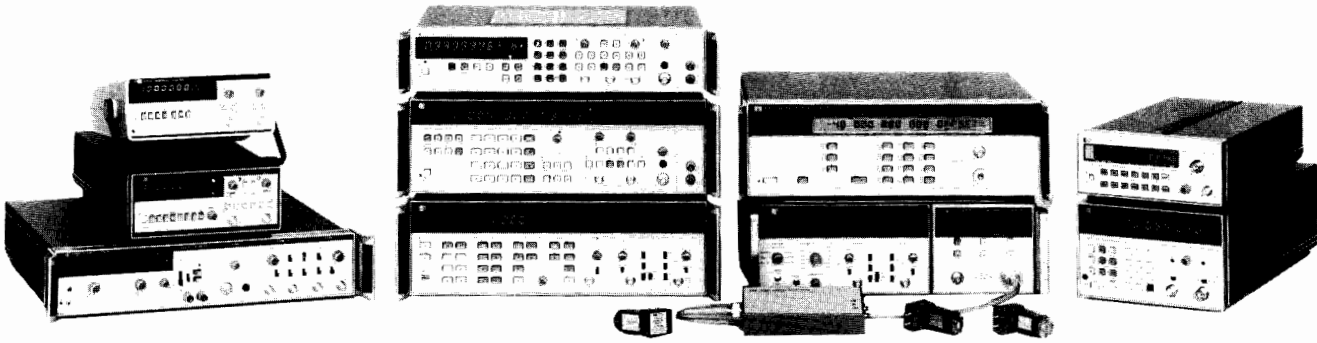

HP offers a wide selection of counters to fit your particular frequency and time measurement needs

Counter Selection Guide

| Model | Frequency A | Frequency B | Frequency C | Single Shot Time Interval | Display Digits | Resolution vs. Time | Sensitivity | HP-IB Readings/s | Enhanced Capabilities Available | Standard Price | Page |
|--|------------------|-----------------|-----------------|---------------------------|----------------|---------------------|-------------|------------------|---|----------------|------|
| Basic Frequency Counters | | | | | | | | | | | |
| 5382A | 10 Hz-225 MHz | | | | 8 | 1 Hz/s | 25 mV | | TCXO | \$900 | 236 |
| 5383A | 10 Hz-520 MHz | | | | 9 | 1 Hz/s | 25 mV | | TCXO | \$1200 | 236 |
| 5384A | 10 Hz-100 MHz | 50 MHz-225 MHz | | | 11 | 9 digits/s | 10 mV | 4 | Oven time base, battery, HP-IL | \$1400 | 235 |
| 5385A | 10 Hz-100 MHz | 90 MHz-1 GHz | | | 11 | 9 digits/s | 10 mV | 4 | Oven time base, battery, HP-IL | \$1700 | 235 |
| 5386A | 10 Hz-100 MHz | 90 MHz-3 GHz | | | 11 | 9 digits/s | 10 mV | 4 | Oven time base | \$2900 | 234 |
| Microwave And Millimeter CW Counters | | | | | | | | | | | |
| 5386A | 10 Hz-100 MHz | 90 MHz-3 GHz | | | 11 | 9 digits/s | -27 dBm | 4 | Oven time base | \$2900 | 234 |
| 5340A | 10 Hz-18 GHz | 10 Hz-250 MHz | | | 8 | varies | -35 dBm | 10 | Oven time base, limiter | \$12500 | 231 |
| 5342A | 500 MHz-18 GHz | 10 Hz-520 MHz | | | 11 | 1 Hz/s | -25 dBm | 10 | Oven time base, limiter, amplitude | \$650 | 228 |
| 5343A | 500 MHz-26.5 GHz | 10 Hz-520 MHz | | | 11 | 1 Hz/s | -33 dBm | 10 | Limiter, offset, totalize | \$7500 | 228 |
| 5350A | 500 MHz-20 GHz | 10 Hz-525 MHz | | | 11 | 1 Hz/s | -30 dBm | to 80 | Oven time base, limiter, math | \$5000 | 226 |
| 5351A | 500 MHz-26.5 GHz | 10 Hz-525 MHz | | | 11 | 1 Hz/s | -30 dBm | to 80 | Oven time base, limiter, math | \$6000 | 226 |
| 5352A | 500 MHz-40 GHz | 10 Hz-525 MHz | | | 11 | 1 Hz/s | -30 dBm | to 80 | Oven time base, math | \$10000 | 226 |
| 5356D | | 36 GHz-110 GHz | | | 11 | <2 Hz/s | -25/-10 dBm | to 9000 | Frequency averaging *needs 5345A, 5355A and mixers | \$4000* | 233 |
| Microwave And Millimeter Pulse Counters | | | | | | | | | | | |
| 5355A | 400 MHz-1.4 GHz | | 0-500 MHz | 2 ns | 11 | >8 digits/s | -15 dBm | to 9000 | Frequency profile, pulse width | \$5100 | 233 |
| 5356A | 1.5 GHz-18 GHz | 400 MHz-1.4 GHz | 0-500 MHz | 2 ns | 11 | 1 Hz/s | -25 dBm | to 9000 | Frequency profile, pulse width | \$1800 | 233 |
| 5356B | 1.5 GHz-26.5 GHz | 400 MHz-1.4 GHz | 0-500 MHz | 2 ns | 11 | 1 Hz/s | -20 dBm | to 9000 | Frequency profile, pulse width | \$2000 | 233 |
| 5356C | 1.5 GHz-40 GHz | 400 MHz-1.4 GHz | 0-500 MHz | 2 ns | 11 | <2 Hz/s | -15 dBm | to 9000 | Frequency profile, pulse width | \$2500 | 233 |
| 5356D | 36 GHz-110 GHz | 400 MHz-1.4 GHz | 0-500 MHz | 2 ns | 11 | <2 Hz/s | -25/-10 dBm | to 9000 | Frequency profile, pulse width | \$4000 | 233 |
| Basic Universal Counters | | | | | | | | | | | |
| 5314A | 10 Hz-100 MHz | | | 100 ns | 7 | 10 or 1 Hz/s | 25 mV | | Period, ratio, totalize, battery | \$550 | 251 |
| 5315A | .1 Hz-100 MHz | | 50 MHz-1 GHz | 100 ns | 8 | 7 digits/s | 10 mV | | Period, ratio, totalize, battery, oven TB | \$1100 | 248 |
| 5315B | .1 Hz-100 MHz | | 50 MHz-1 GHz | 100 ns | 8 | 7 digits/s | 10 mV | | Period, ratio, totalize, oven time base | \$1400 | 248 |
| 5316A | .1 Hz-100 MHz | | 50 MHz-1 GHz | 100 ns | 8 | 7 digits/s | 10 mV | 10 | Oven time base | \$1900 | 248 |
| Performance Universal Counters | | | | | | | | | | | |
| 5328B | 0-100 MHz | | 90 MHz-1.3 GHz | 10 ns | 8 | 1 Hz/s | 25 mV | to 500 | DVM, oven time base | \$4200 | 247 |
| 5334A | .001 Hz-100 MHz | .001 Hz-100 MHz | 90 MHz-1.3 GHz | 2 ns | 9 | 9 digits/s | 35 mV | to 140 | Auto pulse characterization | \$2800 | 242 |
| 5335A | .002 Hz-200 MHz | | 150 MHz-1.3 GHz | 2 ns | 12 | 9 digits/s | 25 mV | 15 | Auto pulse characterization, statistics | \$3900 | 244 |
| 5345A | 0-500 MHz | | (see 5355A) | 2 ns | 11 | >9 digits/s | 25 mV | to 9000 | External gate, frequency average | \$9000 | 241 |
| Precision Time Interval Counter | | | | | | | | | | | |
| 5370B | 0-100 MHz | | | 20 ps | 12 | >11 digits/s | 35 mV | to 6000 | Statistics, external gate | \$9500 | 237 |
| Enhancement Products | | | | | | | | | | | |
| HP 5363B Time Interval High Impedance Probes | | | | | | | | | | \$3800 | 240 |
| HP 5344A/S Source Synchronizer | | | | | | | | | | \$12500 | 230 |

ELECTRONIC COUNTERS

Low-Cost, High-Performance Microwave Frequency Counters

Models 5350A, 5351A, 5352A

- 10 Hz - 40 GHz
- 5-year calibration interval

- 80 outputs per second
- -30 dBm sensitivity
- 8-year mean-time-between-failures

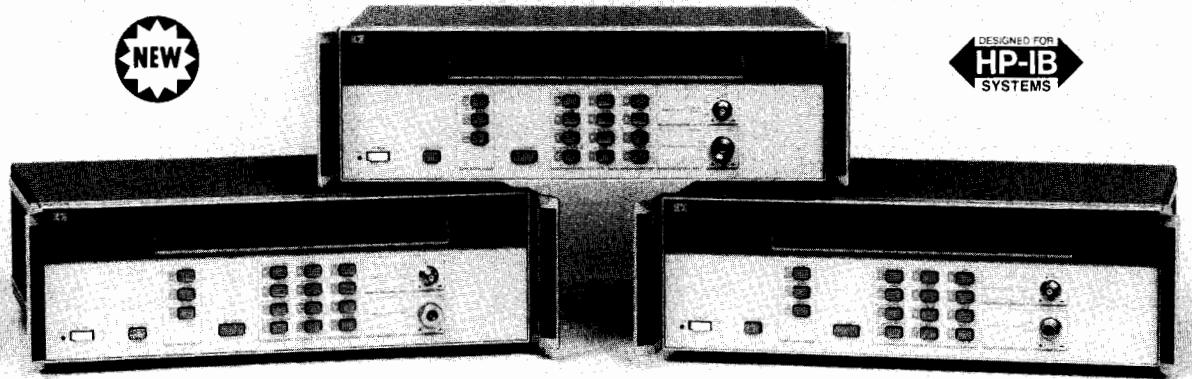

HP's lowest cost 20 GHz, 26.5 GHz and 40 GHz Microwave Counters

Description

Performance, ease of use and quality are key in the design of these new products. All the basic capability you will need for less cost.

Sensitivity is outstanding at -30 dBm through the use of Gallium Arsenide sampling circuits and integration of the microwave elements.

High speed data output, with over 80 readings-per-second, is ideal for systems applications, making increased productivity a reality.

Low cost of ownership comes from low parts count, high reliability and a design that reduces the temperature effects on components.

Extended calibration and long MTBF ensure maximum up time for your test station or engineering bench.

HP 5350A/5351A/5352A Specifications:

Input 1:

Frequency range: HP 5350A: 10 Hz to 20 GHz
 HP 5351A: 10 Hz to 26.5 GHz
 HP 5352A: 10 Hz to 40 GHz

Sensitivity:

HP 5350A/5351A: 500 MHz to 12.4 GHz; -25 dBm (-30 dBm typ @ 25°C);

Option 002 -24 dBm; Option 006 -22 dBm.

HP 5350/5351A: 12.4 GHz to 20 GHz -20 dBm (-25 dBm typical @ 25°C);

Option 002 -18 dBm; Option 006 -16 dBm.

Sensitivity Graph

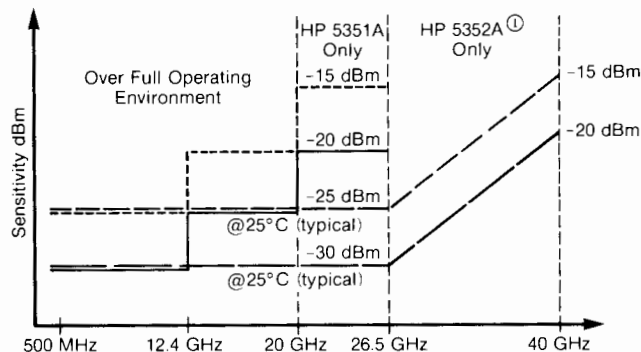

① HP 5352A Sensitivity dBm = $0.741 f(\text{GHz}) - 44.6$
 @ 25°C Sensitivity dBm = $0.741 f(\text{GHz}) - 49.6$

HP 5351A: 20 GHz to 26.5 GHz -15 dBm (-20 dBm typical @ 25°C);

Option 002 -12 dBm; Option 006 -10 dBm.

HP 5352A: 500 MHz to 26.5 GHz -25 dBm (-30 dBm typ @ 25°C); 26.5 GHz to 40 GHz linear decrease to -15 dBm (-20 dBm @ 25°C).

Maximum input: +7 dBm.

Damage level: +25 dBm; HP 5350A/5351A Option 006: 500 MHz to 6 GHz +39 dBm; 6 GHz to 18 GHz +36 dBm; 18 GHz to 26.5 GHz +34.8 dBm.

SWR (typical): 500 MHz to 10 GHz 2:1; Option 002/006 2.5:1
 10 GHz to 26.5 GHz 3:1; Option 002/006 3.5:1
 26.5 GHz to 40 GHz 3.5:1.

Coupling: DC to 50 ohm termination, AC to instrument.

Accuracy: ± 1 count \pm time base X frequency.

Residual stability: when counter and source use common 10 MHz time base or counter uses external higher stability time base, 1 LSD (.3 LSD typical) rms for resolution 1 Hz - 1 kHz at 25 degrees C: HP 5352A 1.4 LSD (.7 LSD typical) 26.5 - 40 GHz; LSD = least significant digit.

Resolution: selectable 1 Hz to 1 MHz.

FM Tolerance:

Maximum deviation: 20 MHz p-p; HP 5352A: 12 MHz.

Maximum FM rate: 10 MHz.

FM rate tolerance: Normal/low (see data sheet).

Normal: 1 MHz/s maximum drift rate.

Low: 80 kHz/s maximum drift rate.

FM Rate Tolerance Graph

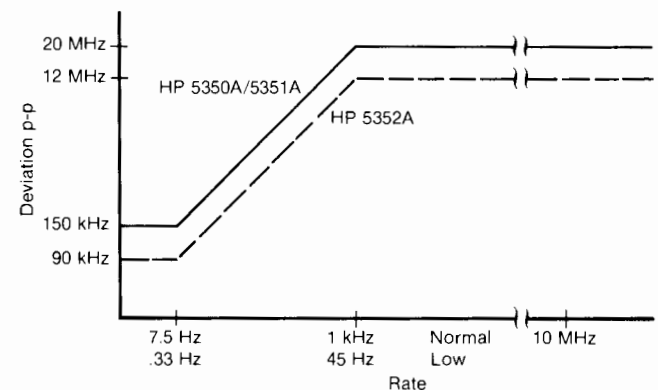

AM tolerance: any modulation index provided the minimum signal level is not less than the sensitivity specification.

Modes of Operation:

Automatic: automatic amplitude discrimination is used to determine and display the frequency.

Manual: center frequency must be entered to within ± 20 MHz of input frequency; ± 3 MHz below 1 GHz; increases measurement and data output rate.

Automatic amplitude discrimination: automatically measures the largest of all signals present, providing that signal is > 6 dB (typical) above any signal within 500 MHz; > 20 dB (typical) above any signal within 500 MHz to 20 (40) GHz.

Acquisition Time:

Automatic Mode:

Normal FM rate: 200 ms.

Low FM rate: 1300 ms.

Manual Mode: 40 ms after entering center frequency.

Input 2: HP 5350A/5351A/5352A.

Frequency range: 10 Hz to 525 MHz.

Mode of Operation:

50 ohm: 10 MHz to 525 MHz.

1M ohm: 10 Hz to 80 MHz.

Sensitivity: full operating environment:

50 ohm: 10 MHz to 525 MHz, 25mV rms; 15 mV typical @ 25°C;

1M ohm: 10 Hz to 80 MHz, 25mV rms; 15 mV typical @ 25°C;

Gate Time = 1/resolution: 1 ms minimum.

Resolution: selectable 1 Hz to 1 MHz.

High resolution: 1M ohm mode: 0.001 Hz for < 100 kHz input; 0.01 Hz for < 1 MHz input; 0.1 Hz for < 10 MHz input; 1 Hz for > 10 MHz input; 1 second gate.

Accuracy: ± 1 count

$$\left(\frac{\pm 1.4 \times \text{Trigger Error}^{(1)} \pm \text{Time Base}}{\text{Gate Time}} \right) \times \text{Frequency}$$

Impedance: selectable 1M ohm nominal shunted by < 70 pF or 50 ohm nominal.

Coupling: AC.

Connector: replaceable fuse, type BNC female.

Maximum input: 50 ohm: +10 dBm; 1M ohm: 1V rms.

Damage level: 50 ohm or 1M ohm DC - 5 kHz: 250V (DC + AC peak); > 5 kHz: 5.5V rms (+ 28 dBm) + 1.25×10^6 V rms/FREQ.

Panel label: 5.5V rms (+ 28 dBm).

Time base output: 10 MHz and 1 MHz, 2.4 V square wave AC coupled into 1k ohm: 1.5V p-p into 50 ohm; available from rear panel BNC connectors whenever the instrument has AC power connected.

External time base: 1, 2, 5 or 10 MHz, 0.7V min to 8V max. p-p sine wave or square wave into > 1 K ohm shunted by < 30 pF, via rear panel BNC connector. External reference automatically selected when signal is present.

Time Base (10 MHz)

| | TCX0 | Option 001 | Option 010 |
|--|------------------------------|-----------------------------|-----------------------------|
| Aging Rate | 1X10 ⁻⁷ per month | 5X10 ⁻¹⁰ per day | 2X10 ⁻⁸ per year |
| Short Term | 1X10 ⁻⁹ per s | 1X10 ⁻¹⁰ per s | 1X10 ⁻¹⁰ per s |
| Temperature 0 - 50 | 1X10 ⁻⁶ | 1X10 ⁻⁹ | 1X10 ⁻⁹ |
| Line 10% change | 1X10 ⁻⁷ | 1X10 ⁻¹⁰ | 1X10 ⁻¹⁰ |
| Warm up to $< 5 \times 10^{-9}$ @ 25°C | | 10 minutes | 10 minutes |

General

Display: segmented 24-character alphanumeric LCD (backlighted).

Keyboard: set-up stored in STBY mode.

Self-check: tests for correct circuit operation.

Diagnostics: front panel or HP-IB selectable, Display and Keyboard Lockout, Service Diagnostics and User Information.

Data output: over HP-IB bus; varies with Frequency and Resolution.

Manual mode: > 80 readings per second formatted at 10 kHz resolution, no math functions "DUMP MODE".

Math functions: result = measurement X scale + offset.

Offset: measurement is offset by entered value.

Scale: measurement is multiplied by entered value.

Smooth: displayed resolution is determined using exponential averaging; displays only stable digits.

Sample rate: variable from less than 50 ms between measurements to HOLD, which holds the display indefinitely or until trigger occurs.

Display rate: 1-2/s, variable over HP-IB.

Overload indication: "OVRLOAD" A user message.

Sleep mode: input 1 emissions reduced to < -70 dBm typical when sleep mode or input 2 is selected.

IF output: rear panel BNC provides 30 - 110 MHz down-converted microwave signal at > -20 dBm into 50 ohm, AC coupled.

HP-IB: functions and diagnostics are programmable; address-set at front panel, default switches on rear panel; teach/learn programming; IEEE 728 compatible command structure; function subset SH1, AH1, T5, RF1, RL1, PP0, DC1, DT1, C0, E1.

Reset/local: returns to local control.

Operation temperature: 0 degrees C to 50 degrees C.

Power requirements: 100 VA max

Line select: 100V (90-105 VAC rms; 47.5 - 440 Hz)

115/120 (104/126 VAC rms; 47.5 - 440 Hz)

220V (198-231 VAC rms; 47.5 - 66 Hz)

230/240V (207-252 VAC rms; 47.5 - 66 Hz)

Accessories furnished: power cord, manual

Size: 5 1/4" H X 16" W X 14" D / 33 mm H X 407 MM W X 358 mm D.

Weight: 24 lbs, / 11 kg.

Ordering Information

| | |
|---|-------------|
| Option 001 Oven Time Base | \$750 |
| Option 002 Rear Panel Inputs (HP 5350A/51A only) | \$300 |
| Option 006 Microwave Level Limiter (HP 5350A/51A only) | \$500 |
| Option 010 High Stability Oven Time Base | \$1,500 |
| Option 910 Additional Operating & Service Manual | \$40 |
| Option 908 Rack Mount Kit for use with front handles removed | \$55 |
| Option 913 Rack Mount Kit for use with supplied front handles | \$55 |
| Option W30 2 year extended hardware support | \$160 |
| Additional Equipment Available: | |
| Transit case | 9211-2643 |
| Waveguide (3" straight) adapter WR28-APC3.5 | 05356-20217 |
| Waveguide (3" straight) to coaxial adapter WR42-APC3.5 | 05356-20216 |
| Adapter - In series APC 3.5 Male to Male | 1250-1748 |
| Adapter - In series APC 3.5 Female to female | 1250-1749 |

| | |
|--|-----------------|
| HP 5350A 20 GHz Microwave Frequency Counter | \$5,000 |
| HP 5351A 26.5 GHz Microwave Frequency Counter | \$6,000 |
| HP 5352A 40 GHz Microwave Frequency Counter | \$10,000 |

(1) Trigger Error $\sqrt{e_i^2 + e_n^2}$ s rms

Input Slew Rate in V/s at Trigger Point
Where e_i = effective rms noise of counter's input channel (100 μ V typical)
 e_n = rms noise of the input signal for a 500 MHz bandwidth



ELECTRONIC COUNTERS

Automatic Microwave Counters

Models 5342A & 5343A

- Microprocessor controlled
- Automatic measurement to 18 GHz/26.5 GHz
- Wide FM tolerance

- Simultaneous display of input level
- High sensitivity
- Automatic or manual operation



HP 5342A

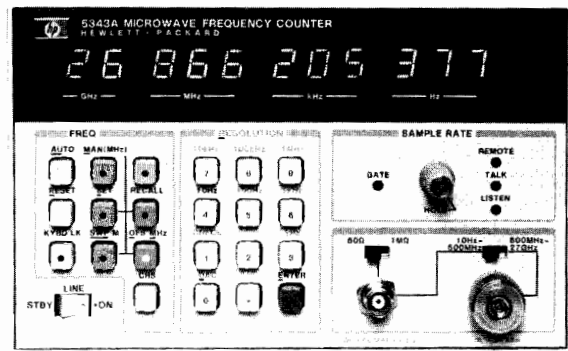

HP 5343A



Description

The HP 5342A and HP 5343A Microwave Counters provide Automatic Frequency Measurement up to 18 or 26.5 GHz in highly portable packages. The HP 5342A extends to 24 GHz optionally.

The powerful and versatile microprocessor controlled keyboards can accomplish offset tasks as a standard feature as well as providing user interactive diagnostic information. The eleven-digit display is sectionalized for easy readout to one hertz resolution.

Both units utilize the Harmonic Heterodyne down conversion technique which combines the best performance features of the Heterodyne Converter and Transfer Oscillator Techniques. Now Wide FM Tolerance is achievable along with high input sensitivity and automatic amplitude discrimination. This allows the counter to automatically measure the largest signal present within the counters' spectrum while ignoring all others.

Amplitude Measurements (option 002) (HP 5342A only)

Option 002 adds the ability to measure the input level of the incident sinewave signal. The instrument then displays this level in dBm. The eleven-digit LED display simultaneously presents frequency to 1 MHz resolution and amplitude to 0.1 dBm resolution. An added benefit from Option 002 is that dynamic range is extended so that frequency measurements to +22 dBm are accomplished. This extended dynamic range is also available without the amplitude measurement capability by ordering Option 003 (HP 5342A only).

FM Tolerance

The ability to measure a carrier frequency while being frequency modulated has broad appeal in the communications industry and elsewhere. The HP 5342A can tolerate 50 MHz peak-to-peak worst case FM in the wide mode, or the normal mode with accompanying faster acquisition time can be selected which gives 20 MHz peak-to-peak worst case FM. The HP 5343A offers a selection of three (3) acquisition times including a 200 ms "fast" acquisition time with 6 MHz peak-to-peak worst case FM tolerance.

Offset Functions

The power and versatility of the microprocessor controlled keyboard allows the user to perform offset functions by means of a few key strokes. Frequency values to 1 Hz resolution can be added to or subtracted from the measured frequency for IF offset application and also for monitoring variances about a given frequency. The HP 5343A also offers an $m \times \pm b$ mode for receiver testing where the measured local oscillator can be multiplied by the appropriate harmonic number. Adding the IF as an offset has the counter displaying the received frequency.

With Option 002 installed (HP 5342A) this offset capability can be applied to the amplitude measurements. These offset values can be recalled to the display at any time for reviewing.

Digital-to-Analog Converter (option 004)

The ability to convert any three consecutive displayed digits (frequency or amplitude) into an analog voltage output on the rear panel is added by Option 004. This makes the monitoring of microwave oscillator frequency drift easy to make with only a strip chart recorder.

Microwave Limiter (option 006)

High input level protection is available with Option 006. It provides built-in microwave limiter protection for CW input signals up to +39 dBm (8 watts). This option is very useful for high input level environments where expensive input circuitry of the counter could be damaged.

HP Interface Bus For Systems Use (option 011)

The full power of HP-IB (IEEE 488) is brought to fruition with the addition of Option 011. Front and rear panel controls can now be remotely programmed and measurement results can be outputted to HP-IB-compatible instruments, calculators, or computers. This interface also can select a given frequency in the manual mode and reduce acquisition time to typically less than 80 ms.

HP-IB interface functions: SH1, AH1, T1, L2, SL1, RL1, PP0, DC1, DT1, C0, E1.

HP 5342A Specifications

Signal Input

Input 1

Frequency range: HP 5342A: 500 MHz to 18 GHz

HP 5343A: 500 MHz to 26.5 GHz

Sensitivity: HP 5342A: 500 MHz to 12.4 GHz: -25 dBm

12.4 GHz to 18 GHz: -20 dBm

HP 5343A: 500 MHz to 12.4 GHz: -33 dBm

12.4 GHz to 18 GHz: -28 dBm

18.0 GHz to 26.5 GHz: -23 dBm

Maximum input: +7 dBm (See OPT 002, 003 for higher levels)

Impedance: 50 ohms, nominal

Connector: HP 5342A: Precision Type N female

HP 5343A: APC 3.5 male with collar

Damage level: +25 dBm, peak (See OPT 006 for +39 dBm -protection)

Coupling: dc to load, ac to instrument.

SWR: < 2:1, 500 MHz-10 GHz

< 3:1, 10 GHz-18 GHz/26.5 GHz

FM tolerance: switch selectable (rear panel)

- Wide:** 50 MHz p-p worst case
- Normal:** 20 MHz p-p worst case
- Narrow:** (HP 5343A only) 6 MHz p-p worst case

For Modulation Rates from dc to 10 MHz.

AM tolerance: any modulation index provided the minimum signal level is not less than the sensitivity specification.

Automatic amplitude discrimination: automatically measures the largest of all signals present, providing that signal is 6 dB above any signal within 500 MHz; 20 dB above any signal, 500 MHz–18 /26.5 GHz.

Modes of Operation

- Automatic:** counter automatically acquires and displays highest level signal within sensitivity range.
- Manual:** center frequency entered to within ±40 MHz of true value.

Acquisition Time

- Automatic Mode**
 - Narrow FM 200 ms worst case (HP 5343A only)
 - Normal FM 530 ms worst case
 - Wide FM 2.4 s worst case
- Manual mode:** 80 ms after frequency entered

Input 2

- Frequency range:** 10 Hz to 520 MHz direct count.
- Sensitivity:** 50 Ω: 10 Hz to 520 MHz: 25 mV rms. 1 M Ω: 10 Hz to 25 MHz: 50 mV rms.
- Impedance:** selectable 1 MΩ, <50 pF or 50 Ω nominal.
- Coupling:** ac.
- Connector:** type BNC female.
- Maximum input 50 Ω:** 3.5 V rms (+24 dBm) or 5 V DC, fuse protected
- 1 MΩ:** 200 V DC + 5 V rms

Time Base

- Crystal frequency:** 10 MHz.
- Stability**
 - Aging rate:** <1 × 10⁻⁷/month
 - Temperature:** < ±1 × 10⁻⁶ over the range 0°C to 50°C
 - Short term:** <1 × 10⁻⁹ for 1 second averaging time.
 - Line variation:** < ±1 × 10⁻⁷ for 10% change from nominal.
- Output frequency:** 10 MHz, ≥2.4 V square wave (TTL compatible) 1.5 p-p V into 50 Ω available from rear panel BNC.
- External time base:** requires 10 MHz, 3.0 V p-p sine wave or square wave into 1 kΩ via rear panel BNC connector. Switch selects either internal or external time base.

Optional Time Base (option 001)

- Crystal frequency:** 10 MHz.
- Stability**
 - Aging rate:** <5 × 10⁻¹⁰/day after 24-hour warmup
 - Temperature:** <7 × 10⁻⁹ over the range 0°C to 50°C
 - Short term:** <1 × 10⁻¹⁰ for 1 second averaging time
 - Line variation:** <1 × 10⁻¹⁰ for 10% change from nominal
 - Warm-up:** <5 × 10⁻⁹ of final value 20 minutes after turn-on, at 25°C.

Amplitude Measurement (opt 002) (HP 5342A only)

- Input 1**
 - Frequency range:** 500 MHz–18 GHz.
 - Dynamic range (frequency and level)**
 - 22 dBm to +22 dBm 500 MHz to 12.4 GHz
 - 15 dBm to +22 dBm 12.4 GHz to 18 GHz
 - Maximum operating level:** +22 dBm
 - Damage level:** +25 dBm, peak
 - Resolution:** 0.1 dBm
 - Accuracy:** ±1.5 dB (excluding mismatch uncertainty).
 - SWR:** <2:1 (amplitude measurement). <5:1 (frequency measurement).
 - Measurement time:** 100 ms + frequency measurement time.
 - Display:** simultaneously displays frequency to 1 MHz resolution and level. (Option 011 provides full frequency resolution on HP-IB).
- Input 2 (50 Ω impedance only)**
 - Frequency range:** 10 MHz–520 MHz.
 - Dynamic range (frequency and level):** –17 dBm to +20 dBm
 - Damage level:** +24 dBm.
 - Accuracy:** ±1.5 dB (excluding mismatch uncertainty).
 - SWR:** <1.8:1.
 - Measurement time:** 100 ms + frequency measurement time.
 - Display:** simultaneously displays frequency and input level.

Extended Dynamic Range (opt 003) (HP 5342A only)

- Frequency range:** 500 MHz to 18 GHz.
- Sensitivity:** 500 MHz to 12.4 GHz: –22 dBm
12.4 GHz to 18 GHz: –15 dBm
- Maximum operating level:** +22 dBm
- Dynamic range:** 500 MHz to 12.4 GHz: 44 dB
12.4 GHz to 18 GHz: 37 dB
- Damage level:** +25 dBm, peak
- SWR:** <5:1

Microwave Limiter (option 006)

- Input 1**
 - Frequency range:** HP 5342A: 500 MHz – 18 GHz
HP 5343A: 500 MHz – 26.5 GHz
 - Sensitivity:** HP 5342A: 500 MHz – 12.4 GHz: – 21 dBm
12.4 GHz – 18 GHz: – 15 dBm
HP 5343A: 500 MHz – 12.4 GHz: –30 dBm
12.4 GHz – 18 GHz: – 24 dBm
18 GHz – 26.5 GHz: – 18 dBm
 - Maximum operating level:** + 7 dBm
 - Damage level:** 500 MHz – 6 GHz: +39 dBm (8W)
6 GHz – 18 GHz: +36 dBm (4W)
(HP 5343A only) 18 GHz – 26.5 GHz: +34.8 dBm (3W)
 - SWR:** 2.5:1, 500 MHz – 10 GHz
3.5:1, 10 GHz – 18 GHz/26.5 GHz
 - Note:** Option 006 is incompatible with Option 002, Option 003, and Option 005 for HP 5342A. Please consult factory special to combine Options 005 and 006.

General

- Accuracy:** ±1 count ± time base error.
- Resolution:** front panel push buttons select 1 Hz to 1 MHz
- Display:** 11 digit LED display, sectionalized to read GHz, MHz, kHz, and Hz.
- Self-check:** selected from front panel pushbuttons displays 75 MHz for resolution chosen.
- Frequency offset:** selected from front panel pushbuttons. Displayed frequency is offset by entered value to 1 Hz resolution.
- Frequency multiply:** (HP 5343A only) (mx ±b) measured data is multiplied by any integer up to 99. Offset can then be added or subtracted. Front panel selectable.
- Totalize (HP 5343A only):** input 2 can totalize at rates up to 520 MHz. Readout on the fly is controlled by front panel or HP-IB.
- Sample rate:** variable from less than 20 ms between measurements to HOLD which holds display indefinitely.
- IF out:** rear panel BNC connector provides 25 MHz to 125 MHz output of down-converted microwave signal.
- Power requirements:** 100/120/220/240 V rms, +5%, –10%, 48–66 Hz; 100 VA max.
- Weight:** net 9.1 kg (20 lb.). Shipping 12.7 kg (28 lb.).
- Size:** 133 mm H x 213 W x 498 mm D (5.25" x 8.38" x 19.6").

Options and Accessories

| | Price |
|---|---------------|
| 001: High Stability Time Base | add \$750 |
| 002: Amplitude Measurement (HP 5342A Only) | add \$1600 |
| 003: Extended Dynamic Range (HP 5342A Only) | add \$650 |
| 004: Digital-To-Analog Converter | add \$400 |
| 005: Frequency Extension to 24 GHz (HP 5342A Only) | add \$500 |
| 006: Limiter Input Protection (+39 dBm) | add \$500 |
| 011: Digital Input/Output (HP-IB) (Cable Not Incl) | add \$550 |
| 908: Rack Mounting Adapter Kit | \$45 |
| HP K70-59992A: Rack Mounting Adapter Kit With Slot for access to front connectors from rear. | |
| HP 10842A: Extender Board Kit | \$500 |
| HP 5342A Frequency Counter | \$6500 |
| HP 5343A Frequency Counter | \$7500 |

ELECTRONIC COUNTERS

Microwave Source Synchronizer

Model 5344S

- Convenient CW lock
- High performance microwave counter
- Narrow band locked sweeps
- Wideband lock and roll

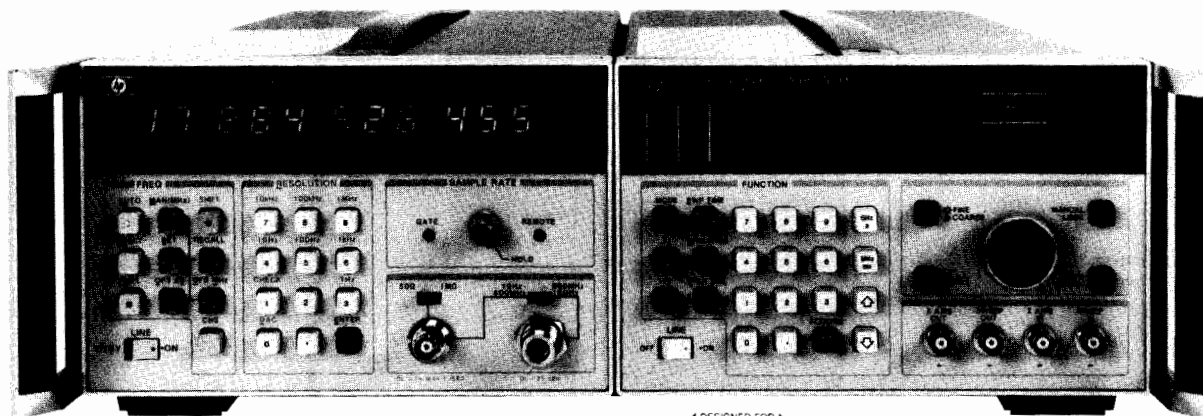

HP 5344S



Description

The HP 5344S Microwave Source Synchronizer phase locks your microwave signal to a high stability quartz oscillator in the HP 5344S. This greatly increases the frequency accuracy and repeatability of the microwave source in CW or swept operation. The long-term frequency stability (5×10^{-10} /day) of your source now becomes comparable to that of a microwave synthesizer but at a much lower cost. The HP 5344S is a full rack system consisting of the HP 5344A Source Synchronizer and the HP 5342A 18 GHz Microwave Counter with an Option 001 High Stability Timebase and Option 011 HP-IB Interface (HP's implementation of IEEE Standard 488). These two half rack instruments are mechanically and electrically integrated at the factory.

For applications requiring direct phase locked frequencies up to 26.5 GHz, the HP 5344S Option 043 is available which replaces the HP 5342A with the HP 5343A 26.5 GHz Microwave Counter.

HP 5344S Specifications

Lock Input

Frequency coverage: 500 MHz–18 GHz
500 MHz–26.5 GHz (HP 5344S Option 043)

Resolution: 1 Hz

Long-term stability: equal to timebase in counter

| | Standard (HP 5342A) | Option 043 (HP 5343A) |
|---------------------------|------------------------|--------------------------|
| Minimum Lock Level | | |
| 500 MHz–12.4 GHz | –22 dBm | –30 dBm |
| 12.4 GHz–18.0 GHz | –19 dBm | –25 dBm |
| 18.0 GHz–26.5 GHz | — | –20 dBm |

Lock time (typical): dependent on source. Typical times with HP 8350B/83592A source

Manual Lock: 900 ms
Auto Lock: 1.5 s

Apply to CW or LOCK/ROLL modes.
For CF/ Δ F or START/STOP add 300 ms.

Option 043: all lock times reduced by 400 ms

Accuracy (CW): equal to counter accuracy

Capture Range (manual mode)

CW or LOCK/ROLL (start frequency): ± 25 MHz for sources with FM sensitivity greater than or equal to 5 MHz/V. Five volts \times FM sensitivity for sources less than 5 MHz/V sensitivity.

FM output connector: rear panel BNC female

FM output drive: ± 10 V in series with 250 ohms

Polarity: automatic selection

Operating Modes

CW: Manual Lock—Source is manually tuned to within capture range of desired frequency

Auto Lock—Source is tuned automatically by the HP 5344S via the HP-IB to bring it into lock.

CW/ Δ F sweep (manual lock or auto lock): performs a phase continuous locked sweep from $CF - \frac{1}{2}\Delta F$ to $CF + \frac{1}{2}\Delta F$ in a sweep time defined by the user. Sweeps up to 40 MHz are available.

START/STOP sweep (manual lock or auto lock): performs a phase continuous locked sweep from START frequency to STOP frequency over a sweep time defined by the user. Sweeps up to 40 MHz are available.

Accuracy—CF/ Δ F and START/STOP modes

Start or Stop Frequencies: 1 kHz typical

Linearity: $\pm 0.05\%$ of sweep with respect to Sweep Out voltage (typical)

Resolution: 1 Hz for CF/ Δ F, START, and STOP frequencies

Sweep time: available in CF/ Δ F and START/STOP modes. Continuously adjustable from 10 ms to 100 s.

Marker frequencies: available in CF/ Δ F and START/STOP modes. Up to four frequency markers are settable across the sweep band.

LOCK/ROLL (manual lock or auto lock): sweep is phase-locked by the HP 5344S to a precise start frequency and then control is transferred to the sweeper to complete the sweep. The source determines sweep time, marker frequencies, and stop frequency.

General

Microwave counter specifications: refer to HP 5342A or 5343A data.

HP-IB interface functions: SH1, AH1, T1, L2, SL1, RL1, PP0, DC1, DT1, C1, E1

Operating temperature: 0°C to 50°C

Power requirements: 100/120/220/240 V rms, +5%, –10% 48–66 Hz; 125 VA max (HP 5344A) plus 100 VA max (HP 5342A)

Size: 133 mm H x 426 mm W x 498 mm D (5 $\frac{1}{4}$ " x 16 $\frac{3}{4}$ " x 19 $\frac{5}{8}$ ")

Weight: net, 18.7 kg (41 lb); shipping, 25.9 kg (57 lb)

Front handles: supplied with the instrument.

Ordering Information

Option 043: 26.5 GHz operation (HP 5343A microwave counter replaces the HP 5342A in the system) add \$900

Option 142: Deletes HP 5342A microwave counter less \$7,600

Option 908: Rack mounting flange kit for use upon removal of supplied front handles add \$25

Option 913: Rack mounting flange kit for use with supplied front handles add \$31

HP 5344S Microwave Source Synchronizer (18 GHz) \$11,500

ELECTRONIC COUNTERS

Automatic Microwave Counter

Model 5340A



- Single input 10 Hz to 18 GHz
- Automatic amplitude discrimination
- High sensitivity -35 dBm

- Optional extension to 23 GHz
- High AM and FM tolerance
- Exceptional reliability



HP 5340A



The HP 5340A Frequency Counter provides an easily used, versatile instrument for the direct measurement of frequencies from 10 Hz through 18 GHz via a single input connector. Utilizing microwave samplers incorporated in advanced phase-lock loops, this counter excels in many important specification parameters. It is therefore suited to a wide range of applications.

The exceptional sensitivity of this instrument enhances measurement in the microwave field, where signals are commonly low level and many times are connected via directional couplers or lossy devices. Wide tolerance of AM, FM, and residual noise insure accurate measurement of microwave carrier frequencies despite the presence of these deviations. Automatic amplitude discrimination allows the HP 5340A to choose the largest signal in a spectrum (250 MHz to 18 GHz) and measure only that signal's frequency, ignoring all others.

Access to the HP Interface Bus via Option 011 provides a particularly flexible system interface. The ability to program octave range via this input allows reduction of acquisition time to typically less than 40 ms. AN 181-1 describes the use of a calculator-controlled measurement system built around the HP Interface Bus for microwave component testing.

HP 5340A Specifications

Signal Input

Input 1

Range: 10 Hz to 18 GHz.

Symmetry: sinewave or squarewave input (40% duty factor, worst case).

Sensitivity: -30 dBm, 10 Hz to 500 MHz; -35 dBm, 500 MHz to 10 GHz; -25 dBm, 10 to 18 GHz.

Dynamic range: 37 dB, 10 Hz to 500 MHz; 42 dB, 500 MHz to 10 GHz; 32 dB, 10 GHz to 18 GHz.

Impedance: 50 Ω .

VSWR: <2:1, 10 Hz-12.4 GHz; <3:1, 12.4-18 GHz.

Connector: precision Type N.

Coupling: dc to load, ac to instrument.

Damage level: +30 dBm.

Total power (ac + dc) not to exceed 1 watt. See Option 006 for up to +39 dBm protection.

Acquisition time: <150 ms mean typical.

Input 2

Range: 10 Hz-250 MHz direct count.

Sensitivity: 50 mV rms, 150 mV p-p pulses to 0.1% duty factor; minimum pulse width 2 ns.

Impedance: 1 M Ω shunted by <25 pF.

Connector: type BNC female.

Coupling: ac

Maximum input: 200 V rms, 10 Hz to 100 Hz; 20 V rms, 100 Hz to 100 kHz; 2 V rms, 100 kHz to 250 MHz.

Automatic amplitude discrimination: automatically selects the strongest of all signals present (within 250 MHz to 18 GHz phase-lock range), providing signal level is: 6 dB above any signal within 200 MHz; 10 dB above any signal within 500 MHz; 20 dB above any signal, 250 MHz-18 GHz (typical performance).

Maximum AM modulation: any modulation index as long as the minimum voltage of the signal is not less than the sensitivity specification.

Time Base

Crystal frequency: 10 MHz.

Stability

Aging rate: < 3×10^{-7} per month.

Short term: < 5×10^{-10} rms for 1 second averaging time.

Temperature: < $\pm 2 \times 10^{-6}$ over the range of 0°C to 50°C.

Line variation: < $\pm 1 \times 10^{-7}$ for 10% line variation from nominal.

Output frequency: 10 MHz, ≥ 2.4 V square wave (TTL compatible) available from rear panel BNC.

External time base: requires 10 MHz approximately 1.5 V p-p sine wave or square wave into 1 k Ω via rear panel BNC. Switch selects either internal or external time base.

Optional time base (opt 001) aging rate: < 5×10^{-10} per day after 24 hour warm-up for less than 24 hour off-time.

General

Accuracy: ± 1 count \pm time base error.

Resolution: front panel switch selects 1 MHz, 100 kHz, 10 kHz, 1 kHz, 100 Hz, 10 Hz, or 1 Hz.

Display: eight digit LED with positioned decimal point and appropriate measurement units of kHz, MHz, or GHz.

Self check: counts and displays 10 MHz for resolution chosen.

Sample rate: controls time between measurements. Continuously adjustable from 50 ms typical to 5 seconds. HOLD position holds display indefinitely. RESET button resets display to zero and activates a new measurement.

HP-IB interface functions: SH1, AH1, T1, L2, SL1, RL2, PP0, DC1, DT1, C0, E1.

Operating temperature: 0°C to 50°C.

Power: 115 V or 230 V +5%, -10%, 48-66 Hz, 100 VA.

Weight: net, 11.3 kg (25 lb). Shipping, 14.1 kg (31 lb).

Size: 88.2 H x 425 W x 467 mm D (3.47" x 16.75" x 18.39").

Options

001: High Stability Time Base

002: Rear Panel Connectors

005: Frequency Extension to 23 GHz

006: Limiter Input Protection (+39 dBm)

011: Remote Programming-Digital Output (HP-IB)

908: Rack Flange Kit

Price

add \$750

add \$200

add \$600

add \$500

add \$550

add \$30

HP 5340A Frequency Counter

\$12,500

ELECTRONIC COUNTERS

Automatic Frequency Converter

Models 5355A and 5356A/B/C/D

- 110 GHz Pulse or CW Frequency
- -25 dBm Sensitivity
- 75 ns Minimum Pulse Width
- Fast Acquisition
- Precise Measurement Control

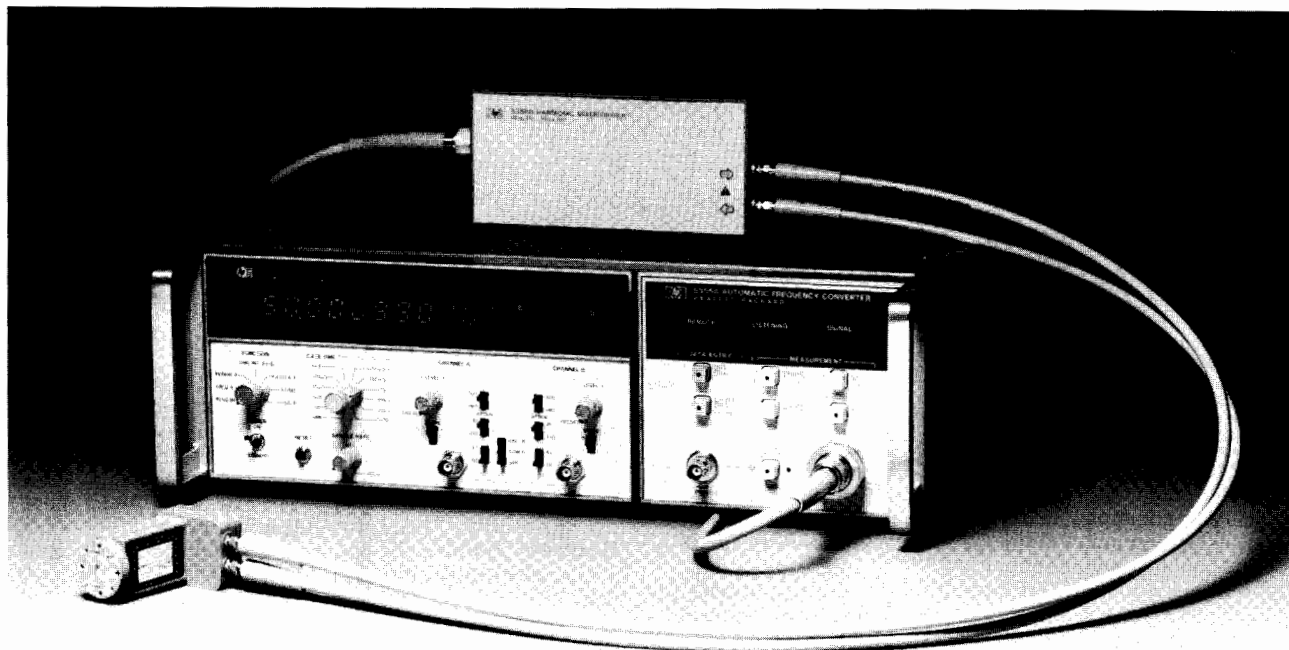

Extending the frequency range of a very versatile measurement solution.

HP 5355A automatic frequency converter/5345A counter, together with the HP 5356A, 5356B, 5356C and the new 5356D (11970 Mixer required) frequency converter heads, provide pulse and CW frequency measurement capability to 18/26.5/40/110 GHz. A 0.4-1.5 GHz prescaled input offers pulse and CW measurement for the lower microwave range even without one of the heads. The HP 5355A's internal microprocessor controls the measurement algorithm, computes the input microwave frequency, and displays it on the eleven digit HP 5345A display.

Superior pulsed RF performance is provided with selectable resolution to 100 Hz or better, with accuracy to 3 kHz. Internal pulse detection circuitry (Figure 1) sets the counter's gate for maximum resolution on widths as small as 75 ns. External gating (Figure 2) allows samples as small as 20 ns for performing dynamic frequency profiling of "CHIRPS" and other FM on the RF burst. This is also an excellent CW microwave counter, providing 1 Hz resolution in 1 second. Automatic amplitude discrimination and 60 MHz FM tolerance allows this counter to measure carrier frequencies in the most difficult transmitted signals.

Microprocessor control provides automatic operation and diagnostic routines for quick, easy failure isolation. The front panel keyboard provides user definable offsets including an $mx \pm b$ offset mode for receiver testing, where the local oscillator can be measured directly then multiplied by the appropriate harmonic number. Offsetting this by the receiver's IF allows the counter to conveniently display the tuned receiver frequency.

External gating capability via the rear panel gate control input allows determination of a point in real time, and for how long, the measurement is to be made. This measurement technique can be used to frequency average for improved resolution on pulsed RF signals (see Figure 3).

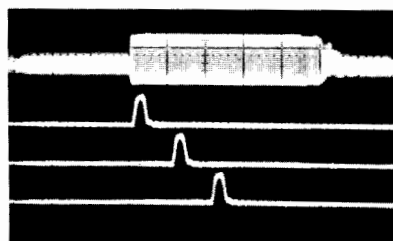
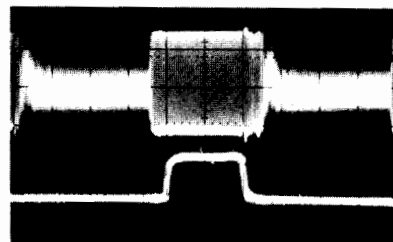

Figure 2

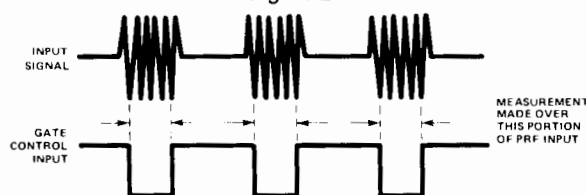

Figure 3. Frequency Averaging to Increase Resolution

Input Specifications (pulse and CW mode)

| | HP 5356A | HP 5356B | HP 5356C | HP 5356D ^① |
|-----------------|--------------|--------------|--------------|-----------------------|
| Frequency Range | 1.5-18 GHz | 1.5-26.5 GHz | 1.5-40 GHz | 36-110 GHz |
| Sensitivity: | | | | |
| 1.5-12.4 GHz | -20 dBm | -20 dBm | -25 dBm | — |
| 12.4-18 GHz | -15 dBm | -15 dBm | -20 dBm | — |
| 18-26.5 GHz | — | -15 dBm | -20 dBm | — |
| 26.5-34 GHz | — | — | -15 dBm | — |
| 34-40 GHz | — | — | -10 dBm | — |
| 36-110 GHz | — | — | — | -25 dBm ^① |
| Maximum Input: | | | | |
| 1.5-12.4 GHz | +5 dBm | +5 dBm | +5 dBm | — |
| 12.4-18 GHz | +5 dBm | +5 dBm | +15 dBm | — |
| 18-26.5 GHz | — | +5 dBm | +15 dBm | — |
| 26.5-40 GHz | — | — | +15 dBm | — |
| 36-110 GHz | — | — | — | +5 dBm |
| Damage Level* | +25 dBm peak | +25 dBm peak | +25 dBm peak | +24 peak +20 dBm |
| Impedance | 50 Ω NOMINAL | 50 Ω NOMINAL | 50 Ω NOMINAL | Waveguide |
| SWR: (TYPICAL) | | | | |
| 1.5-10 GHz | <2:1 | <2:1 | <2:1 | — |
| 10-18 GHz | <3:1 | <3:1 | <3:1 | — |
| 18-26.5 GHz | — | <3:1 | <3:1 | — |
| 26.5-34 GHz | — | — | <3:1 | — |
| 34-40 GHz | — | — | <5:1 | — |
| 36-110 GHz | — | — | — | <3:1 |
| Connector | N Male | SMA Male | APC 3.5 Male | ① |

*HP 5356A/B. See Option 006 for higher damage protection

CW Mode

| | HP 5356A/B/C Auto Mode | HP 5356A/B/C/D Man Mode | HP 5356D |
|--------------------------------|---|------------------------------|------------|
| ①FM Tolerance | 15 MHz p-p (60 MHz p-p in special FM mode) rate: dc-10 MHz | 80 MHz p-p rate: dc - 10 MHz | Fig. 4 |
| AM Tolerance | Any modulation index provided the minimum signal level is greater than the counter sensitivity. | | 50° |
| Multiple Signal Discrimination | Automatic Amplitude Discrimination (AAD). Automatically measures largest signal provided signal is 8 dB (TYPICAL) greater than any signal within 500 MHz and 20 dB (TYPICAL) greater than any signal over the full frequency range of the head. | | -15 dB TYP |
| Acquisition Time | HP 5356A/B = 400 ms HP 5356C = 1.4 s | 15 ms | ②200 ms |
| LSD Displayed | 1 Hz ÷ HP 5345A Gate Time | | |
| Resolution | ±2 x LSD ±10 ⁻¹⁰ rms x FREQ | | |
| Accuracy | ±2 x LSD ±1 x 10 ⁻¹⁰ rms x FREQ ± time base error x FREQ | | |

①Requires HP 11970 Q, U, V or W Harmonic Mixer. Sensitivity is mixer dependent 200 ms - 5 to +5 dBm, 500 ms -35 to -25 dBm

Input Specifications 5355A 0.4 - 1.6 GHz (condensed)

Sensitivity: -15 dBm

Maximum input: +5 dBm

Impedance: 50 ohm nominal

Damage level: +24 dBm peak (fuse in BNC connector)

Pulse width: 150 ns to 1 s

Pulse repetition rate: 100 Hz to 2 MHz

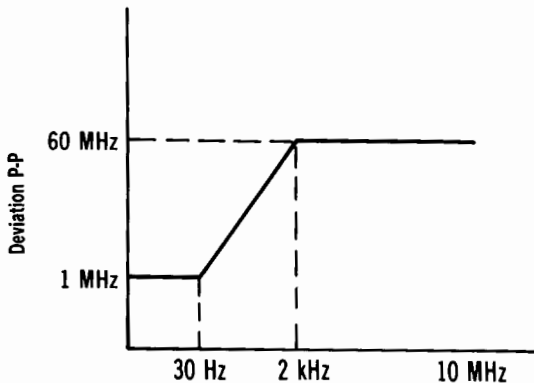

Figure 4 HP 5356D FM Tolerance

Pulse Mode

| | HP 5356A/B/C/D Input Auto Mode | HP 5356A/B/C/D Input Man Mode |
|---------------------------------|--|----------------------------------|
| FM Tolerance | 50 MHz p-p Chirp | 80 MHz p-p Chirp |
| Acquisition Time | <ul style="list-style-type: none"> HP 5356A/B/C Input Man Mode: 0 HP 5356A/B Input Auto Mode: 100 μs ÷ (EXT GATE WIDTH x PRF) + 650 ms for EXT GATE ≤ 100 μs (2 ÷ PRF) + 650 ms for EXT GATE > 100 μs HP 5356C Input Auto Mode: (8 ÷ PRF) + 1.55s + 100 μs ÷ (EXT GATE WIDTH x PRF) for EXT GATE ≤ 100s (10 ÷ PRF) + 1.55s for EXT GATE > 100 μs HP 5356D -5 to +5 dbm $2s + 2 \left(\frac{100 \mu s}{EXT GATE WIDTH \times PRF} \right) \text{ For EXT GATE } \leq 100 \mu s$ $2s + \frac{2}{PRF} \text{ For EXT GATE } > 100 \mu s$ <ul style="list-style-type: none"> HP 5356D -35 to -25 dbm $5s + 2 \left(\frac{100 \mu s}{EXT GATE WIDTH \times PRF} \right) \text{ For EXT GATE } \leq 100 \mu s$ $5s + \frac{2}{PRF} \text{ For EXT GATE } > 100 \mu s$ | |
| Pulse Width Min: | 100 ns | 75 ns |
| Max: | 20 ms | 20 ms |
| Pulse Repetition Frequency Min: | 50 Hz | 50 Hz |
| Min. (HP 5356D only) | 500 Hz | 500 Hz |
| Max: | 2 MHz | 2 MHz |
| Minimum On/OFF RATIO | 25 dB TYPICAL | |
| Maximum Video Feed-Through | 15 mV p-p TYPICAL for rf burst rise and fall times > 10 ns | |
| Minimum EXT GATE WIDTH | 20 ns | |
| LSD Displayed | 1 Hz ÷ HP 5345A GATE TIME | |
| Resolution | ±2 x LSD ±rms jitter* | |
| Accuracy | $\pm 2 \times LSD \pm rms \text{ jitter}^*$ $= \frac{.04}{EXT GATE WIDTH} \pm 3 \text{ KHz}$ $\pm \text{Time base error} \times FREQ$ | |

* rms jitter = 100 Hz rms + (1 ÷ √(HP 5345A GATE TIME) (EXT GATE WIDTH))

For EXT GATE signals generated by the HP 5355A, the EXT GATE WIDTH equals the input PULSE WIDTH minus 30 ns (TYPICAL) for the HP 5356A/B/C/D input and equals input PULSE width minus 65 ns (TYPICAL) for the HP 5355A 0.4-1.5 GHz input.

Ordering Information

| | |
|--|---------|
| HP 5356D 36-110 GHz Harmonic Mixer Driver | \$4,000 |
| Option 050 (HP 11970Q) 33-50 GHz Harmonic Mixer | \$1,650 |
| Option 060 (HP 11970U) 40-60 GHz Harmonic Mixer | \$1,850 |
| Option 075 (HP 11970V) 50-75 GHz Harmonic Mixer | \$2,250 |
| Option 110 (HP 11970W) 75-110 GHz Harmonic Mixer | \$2,250 |
| Option 005 (HP 5061-5458) Cables to connect HP 5356A to HP 11970Q/U/V or W | \$230 |
| HP 5355A Automatic Frequency Converter | \$6,100 |
| HP 5345A Electronic Frequency Counter | \$8,000 |
| HP 5356A 18 GHz Frequency Converter | \$1,800 |
| Option 001 High Pass Filter | \$200 |
| Option 006 Limiter | \$400 |
| HP 5356B 26.5 GHz Frequency Converter | \$2,000 |
| Option 001 18-26.5 GHz Waveguide (WR-42) | \$850 |
| Option 006 Limiter | \$400 |
| HP 5356C 40 GHz Frequency Converter | \$2,500 |
| Option 001 26.5-40 GHz Waveguide (WR-28) | \$750 |



ELECTRONIC COUNTERS

Low Cost Counters for Frequency Measurements

Model 5386A

- Frequency measurements to 3 GHz
- Up to 11 digits of resolution, 9 digits per second
- -27 dBm sensitivity
- HP-IB standard



The new HP 5386A offers both systems performance and portability

Description

The HP 5386A adds new value to your choice of basic frequency counters. This counter is ideal for production-test, calibration and laboratory applications where high performance at a low cost is essential. The half-rack-width package makes the HP 5386A economical on rack or bench space as well as portable. The twelve digit liquid crystal display has larger characters than other LED displays, and is easier to read in sunlight. Integrated design and extensive self-tests result in greater reliability, easier serviceability, and ultimately lower cost of ownership.

Performance

If your frequency measurement needs are below 3 GHz, the HP 5386A will provide you with the basic performance of traditional microwave counters, at about half the price. The HP 5386A measures frequencies from 10 Hz to 3 GHz with only two input ports, instead of the three ports found with other counters. The high-frequency input measures frequencies from 90 MHz to 3 GHz with -27 dBm sensitivity (10 mV rms). In addition, prescaling techniques offer peak-to-peak FM tolerance of at least 100 MHz for your communication applications. You can select the number of digits displayed from 3-to-11 to blank meaningless digits from an unstable signal source. The HP 5386A also solves your systems problems with full remote programmability standard and remote display capabilities. The high-stability timebase option will lengthen the required calibration period (for kHz accuracy at 3 GHz) from six months to a full year.

Application Areas

The HP 5386A fits well in the following application areas for local oscillator, IF, and radio transmitter frequency measurements:

- Military and private communications
- TACAN, DME, and Identify Friend or Foe
- Global Positioning System
- MDS Television

Condensed Specifications

Input channel A: 1M Ω / / 25 pF

Range: 10 Hz to 100 MHz

Sensitivity: 15mV rms sine wave 50 Hz to 100 MHz
25 mV rms sine wave 10 Hz to 50 Hz
45 mV pk-pk 5ns minimum pulse width

Dynamic range: 45mV to 4V pk-pk X attenuator setting

Attenuator: X1 or X20 nominal above 50 Hz input

Low pass filter: 100 kHz nominal 3 dB point

Manual trigger level: variable -0.1V to +0.1V X attenuator

Damage level X1: 10-200 Hz 350V (DC + AC peak)

0.2-420 kHz 170V (DC + AC peak)

0.42-10MHz (5 X 10⁷ Vrms Hz)/FREQ

>10MHz 5V rms

X20: <1MHz, Same as X1; >1MHz, 50V rms

Input channel B: 50 Ω nominal, VSWR 2.5, typical.

Range: 90 MHz to 3 GHz, prescaled

Coupling: AC

Sensitivity: 10mV rms (-27 dBm)

Dynamic range: 10mV rms to .5V rms (-27 dBm to +7 dBm)

Damage level: AC: +27 dBm, DC: \pm 5V

NOTE: Manual attenuator not active for channel B

Frequency A and B

Range channel A: 10 Hz - 100 MHz

Range channel B: 90 MHz - 3 GHz

LSD displayed: 10 Hz to 1 nHz

Period A

Range: 10 ns to 0.1 s

LSD displayed: .001 fs to 10 ns

Timebase:

Standard HP 5386A: TCXO, 10 MHz

Aging rate: <1 X 10⁻⁷/mo.

Temperature: <2 x 10⁻⁴, 0° to 40°C, ref. 25°C

Line voltage: <5 X 10⁻⁴ for \pm 10% variation

Oven Timebase (Option 004)

Aging rate: <3 X 10⁻⁷/mo. after 30 days continuous operation

Temperature: <1 X 10⁻⁷, 0° to 50°C, ref. 25°C

Line voltage: <2 X 10⁻⁴ for \pm 10% variation

I/O Interface

HP-IB Standard

Programmable functions: Frequency A, Frequency B, Period A

Programmable controls: ATTN A, FILTER A, MAN LEVEL A,

Gate Time

Display: Normal, Increment, Decrement (digits displayed); Remote,

Local

Data output: output will be maximum resolution/gate time

Format: 17 characters plus CR and LF

Rate: 4 readings/s maximum at 0.1 s gate

Interface Functions: SH1, AH1, T5, TE0, L4, LE0, SR1, RL1, PP0, DC1, DT1, C0, E1

General

Check: 10 MHz self-test

Gate times: 0.1, 1, or 10 seconds (nominal)

Display: 12-digit alphanumeric liquid crystal

Display digits (variable): frequency 3 to 11; period 3 to 8

Timebase output: 10 MHz, 25mV pk-pk (nominal) into 50 Ω

External timebase input: 10 MHz, 0.5V rms into 500 Ω

Operating temperature: 0° to 50°C

Power requirements

AC: selectable, 30 VA max, 115V +10%, -25%

230V +10%, -15% 48-66 Hz

115V \pm 10%, 380-420 Hz

Weight: Net, 3.4 kg (7 lbs. 8 oz.) Shipping 5.3 kg (11 lbs. 9 oz.)

Dimensions: 212.3 mm W X 88.1 mm H X 421.6 mm D (8 1/2 X 3 1/2 X 16 1/2 in.)

Options and Accessories

004 High Stability Ovenized Timebase \$500

910 Additional Operating/Service Manual \$20

Side Handle Kit: HP P/N 5061-0088 \$50

Rack Mount Kit (single), HP P/N 5061-0072 \$50

Rack Mount Kit (dual), HP P/N's 5061-0074 & 5061-0094 \$55

HP 5386A Frequency Counter 3.0 GHz

\$2,900

ELECTRONIC COUNTERS

Low Cost Counters For Frequency Measurements

Models 5384A, 5385A



- Rackable
- Stackable
- Portable



HP 5384A



HP 5385A

Description

The HP 5384A and HP 5385A are HP's lowest priced system counters. They provide outstanding measurement performance for bench, field, and system applications. The combination of wide frequency range, high resolution, high sensitivity, and HP-IB or HP-IL compatibility, puts the HP 5384A and HP 5385A in a class with instruments costing much more. The added feature of remote display extends the usefulness of these counters beyond that of simply making and displaying frequency measurements. User friendly messages, prompts, and measurement units can now be displayed.

Condensed Specifications

Input channel A (HP 5384A/85A): 1M ohm // 25pF

Range: 10 Hz to 100 MHz

Sensitivity: 15 mVrms sine wave 50 Hz to 100 MHz
25 mVrms sine wave 10 Hz to 50 Hz
45 mV pk-pk 5ns minimum pulse width

Dynamic range: 45 mV to 4 V pk-pk x attenuator setting

Attenuator: X1 or X20 nominal above 50 Hz input

Low pass filter: 100 kHz nominal 3 dB point

Manual trigger level: variable, -0.1 V to +0.1 V x attenuator

Damage level X1: 10-200 Hz 350 V (DC + AC peak)
0.2-420 kHz 170 V (DC + AC peak)
0.42-10 MHz (5 x 10⁷ Vrms Hz)/FREQ
> 10 MHz 5 Vrms

X20: < 1 MHz, Same as X1; > 1MHz, 50 Vrms

Input channel B (HP 5384A): 50 ohm

Range: 50 to 225 MHz

Sensitivity: 10 mVrms 50 to 200 MHz; 15 mVrms 200 to 225 MHz

Dynamic range: 10 mV to 1 Vrms

Manual attenuator: variable, X1 to X5 (0 to 14dB) nominal

Damage level: 350 V dc + 5 Vrms ac

Input channel B (HP 5385A): 50 ohm, fused

Range: 90 to 1000 MHz

Sensitivity: 10 mVrms (-27 dBm) 100-1000 MHz
15mVrms (-33dbm) 90-100 MHz

Dynamic range: 10 mV to 7 Vrms (-27 to +30 dBm)

Manual attenuator: variable, X1 to X18 (0 to 25 db) nominal

Damage level: ac > 1 MHz +30 dBm (7 Vrms)
ac < 1 MHz 2 Vrms, DC ± 5 V

Frequency A and B

Range channel A: 10 Hz-100 MHz

Range channel B: (HP 5384A) 50 MHz-225 MHz,
(HP 5385A) 90-1.0 GHz

LSD displayed: 10 Hz to 1 nHz

Period A

Range: 10 ns to 0.1 s

LSD displayed: .001 fs to 10 ns

Timebase: 10 MHz

Standard HP 5384A

Aging rate: < 3 x 10⁻⁷/mo.

Temperature: < 5 x 10⁻⁶, 0° to 50° C, ref. 25° C

Line voltage: < 1 x 10⁻⁷ for ± 10% variation.

TCXO (HP 5385A), Option 001 (HP 5384A)

Aging rate: < 1 x 10⁻⁷/mo.

Temperature: < 2 x 10⁻⁶, 0° to 40° C, ref. 25° C

Line voltage: < 5 x 10⁻⁸ for ± 10% variation.

Oven Timebase (Option 004)

Aging Rate: < 3 x 10⁻⁸/mo. after 30 days continuous operation.

Temperature: < 1 x 10⁻⁷, 0° to 50° C, ref. 25° C.

Line voltage: < 2 x 10⁻⁸ for ± 10% variation.

Battery operation: the instrument operates for 3 hours (typ.) with option 004. In STBY, the oven will operate continuously for 24 hours (typ.).

I/O Interface

HP-IB Standard, HP-IL Option 003

Programmable functions: Frequency A, Frequency B, Period A
Programmable controls: ATTN A, FILTER A, MAN LEVEL
A/B, Gate Time

Display: Normal, Increment, Decrement (digits displayed); Remote, Local

Data output: output will be maximum resolution/gate time

Format: 17 characters plus CR and LF

Rate: 4 readings/s maximum at 0.1 s gate

Battery Pack (Option 005)

Battery type: sealed lead-acid

Capacity: 4 hours (typ.) at 25° C without option 004.

Recharge time: 16 hours (typ.) in the standby mode.

Battery low annunciator: enabled 20 minutes prior to instrument shutdown nominally.

Battery save switch (rear panel): prevents discharge of internal battery by the oven timebase, option 004, during instrument standby (STBY).

Line failure protection: instrument automatically switches to battery in case of line failure.

Weight: option 005 adds 1.4 kg (3 lbs) to instrument weight.

General

Check: 10 MHz self-test

Gate times: 0.1, 1, or 10 seconds (nominal).

Display: 12-digit alphanumeric liquid crystal.

Display digits (variable): frequency 3 to 11; period 3 to 8.

Timebase output: 10 MHz, 25 mV pk-pk (nom.) into 50 ohms.

External timebase input: 10 MHz, 0.5 Vrms into 500 ohms.

Operating temperature: 0° to 50° C

Power Requirements

AC: selectable, 18 VA max. 115 V + 10%, -25%
230 V + 10%, -15% 48-66 Hz
115 V ± 10%, 380-420 Hz

DC: 9-15 V dc 1.0 A maximum

Weight: net, 2.2 kg. (4.8 lb). Shipping, 4.1 kg. (9 lb)

Dimensions: 238mm W x 98mm H x 276mm D (9 3/8 x 3 7/8 x 13 7/8 in.)

Options and Accessories

| Options and Accessories | Price |
|---|-------|
| 001 High Stability TCXO (HP 5384A)* | \$150 |
| 003 HP-IL I/O** | N/C |
| 004 High Stability Ovenized Timebase | \$500 |
| 005 Battery Pack | \$300 |
| 910 Additional Operating/Service Manual | \$20 |
| HP-IL Cable 1/2 Metre HP 82167A | \$6 |
| HP 5061-1171 Side Handle Kit | \$20 |
| HP 5060-0173 Rack Mount Kit (single) | \$52 |
| HP 5060-0174 Rack Mount Kit (dual) | \$52 |
| HP 34110A Vinyl Carrying/Operating Case | \$40 |

*TCXO timebase is standard with HP 5385A

**Option 003 deletes the HP-IB I/O interface.

| | |
|------------------------------------|--------|
| HP 5384A Frequency Counter 225 MHz | \$1400 |
| HP 5385A Frequency Counter 1.0 GHz | \$1700 |



ELECTRONIC COUNTERS

Low Cost Counters for Frequency Measurements

Models 5382A & 5383A

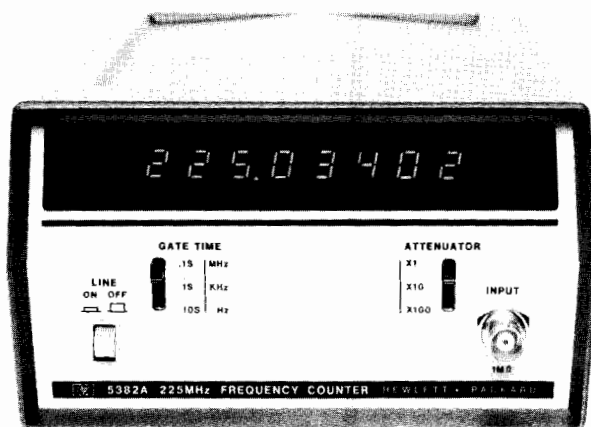

HP 5382A

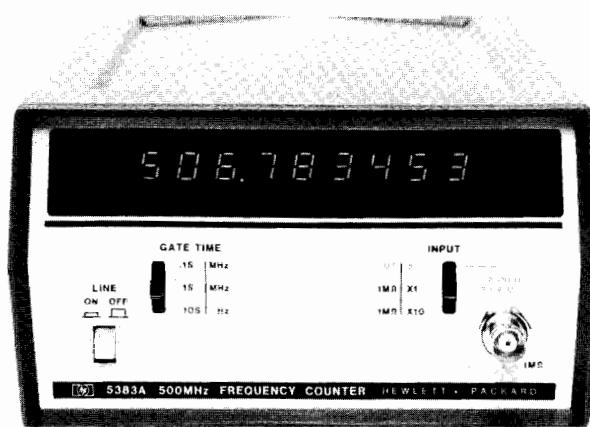

HP 5383A

Description

General

The HP 5382A and 5383A are a logical result of HP's long-standing leadership in frequency counter development. Leadership in quality, technology and efficient production procedures allows HP to offer a superb price/performance combination in these three precision instruments. These counters are designed to deliver reliable, high quality operation in such diverse areas as: production line testing, service and calibration (two-way radio and test equipment), frequency monitoring, education and training.

Resolution

The HP 5382A and 5383A employ the direct counting technique and, with 8 and 9 digits respectively, offer resolution of 10 Hz in 0.1 s., 1 Hz in 1 s and 0.1 Hz in 10 seconds.

Condensed Specifications

HP 5382A

Frequency range: 10 Hz to 225 MHz.

Sensitivity: 25 mV rms—30 Hz to 10 MHz.
50 mV rms—10 Hz to 225 MHz.

Input impedance: 1 M Ω , <40 pF.

Input attenuation: X1, X10, X100.

Accuracy: ± 1 count \pm time base error.

Resolution: direct count: 1 Hz in 1 second.

Gate time: 0.1 second, 1 second, 10 seconds.

Display: 8 LED digits, nonsignificant zero blanking.

Rear panel input: sensitivity: 250 mV rms.

Ratio: Rear Panel Input, 100 kHz to 10 MHz.

External frequency standard: Rear Panel Input, 10 MHz.

Time Base

Frequency: 10 MHz.

Aging: <0.3 ppm/month.

Temperature: ± 2.5 ppm 0°C to 40°C.

Line voltage: ± 0.5 ppm for 10% line change

TCXO Option

Opt 001: Temperature Compensated Crystal Oscillator time base

Frequency: 10 MHz.

Aging: <0.1 ppm/month.

Temperature: <1 ppm 0°C to 40°C.

Line voltage: ± 0.1 ppm for $\pm 10\%$ line change.

Note: time base output available for both HP 5382A and HP 5383A with Option 001.

HP 5383A

Frequency range: 10 Hz to 520 MHz.

Sensitivity:

1 M Ω : 25 mV rms—20 Hz to 10 MHz.

50 mV rms—10 Hz to 50 MHz.

50 Ω : 25 mV rms—20 Hz to 520 MHz.

Input impedance: selectable: 1 M Ω , <40 pF or 50 Ω .

Input attenuation: 1 M Ω \times 1, \times 10; 50 Ω \times 1—fuse protected.

Accuracy: ± 1 count \pm time base error.

Resolution: direct count: 1 Hz in 1 second.

Gate time: 0.1 second, 1 second, 10 seconds.

Display: 9 LED digits, nonsignificant zero blanking.

Display test: RESET function (activated with GATE TIME switch) illuminates all segments of all digits.

Rear panel input: sensitivity: 250 mV rms.

Ratio: Rear Panel Input, 100 kHz to 10 MHz.

External frequency standard: Rear Panel Input, 10 MHz.

Time Base Output

Frequency: 10 MHz.

Voltage: 200 mV p-p into 50 Ω load.

Control: active with Rear Panel Internal/External switch in internal position.

Time Base

Frequency: 10 MHz.

Aging: <0.3 ppm/month.

Temperature: ± 2.5 ppm 0°C to 40°C.

Line voltage: ± 0.5 ppm for $\pm 10\%$ line change.

HP 5380 Family General Data

Overflow: LED lamp indicator when most significant digit overflows.
Reset: manual selection of reset occurs when GATE TIME switch is between three normal positions.

Package: rugged, high strength metal case.

Operating temperature: 0°C to 40°C.

Power requirements: 100, 120, 220, 240, V rms (+5%, -10%)
48-440 Hz; 30 VA maximum.

Weight: net, 2.2 kg (4 $\frac{3}{4}$ lb). Shipping, 2.8 kg (6 lb).

Dimensions: 98 H x 160 W x 248 mm D (3.5" x 6.25" x 9.75").

Ordering Information

HP 5382A Frequency Counter

HP 5383A Frequency Counter

Opt 001: TCXO

Price

\$800

\$1100

add \$130

ELECTRONIC COUNTERS

Universal Time Interval Counter

Model 5370B



- 20 ps single shot resolution
- ± 100 ps accuracy achievable
- 6000 measurements/sec possible

- Built-in statistics functions
- Positive, zero and negative time
- Frequency and period to 100 MHz

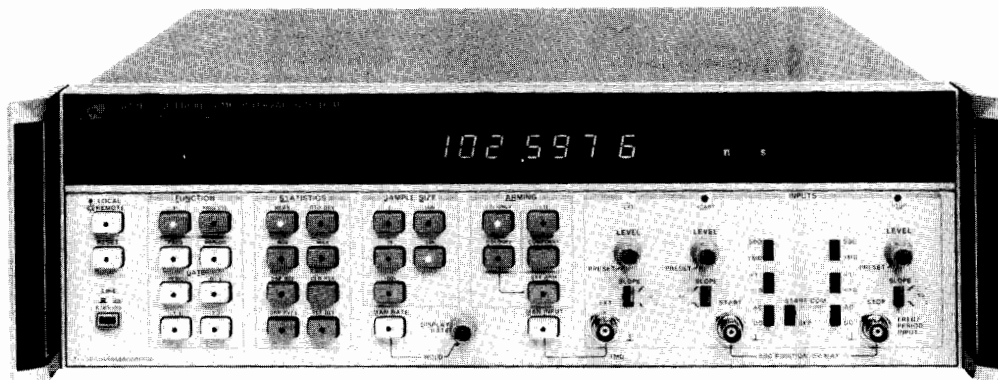

With the HP 5370B, you can make high-precision, time-interval measurements at up to 6000 measurements/sec, making it ideal for your production applications.



Increase Productivity with the HP 5370B's Precision and Measurement Speed

- IC Tester performance verification
- Fast IC characterization
- Disc drive manufacture
- Digital communications - jitter analysis
- Radar/laser ranging calibration
- Nuclear systems
- Calibration Labs

Use the full range of functions

Time Interval: you can get 20 ps single shot resolution on time intervals from zero to 10 s, including negative time (where the STOP channel event occurs before the START channel event).

Frequency: measure up to 100 MHz with 11 digits of resolution in one second. Choose gate times down to one period; use one period with average mode and access the powerful STATISTICS capabilities.

Period: measure period average from one to 100k samples and use STATISTICS.

Statistics: will reduce your external computations, reduce random errors and improve measurement throughput.

Sample size: you can select 1, 10, 1K, 10k or 100k samples from the front panel, or 1 to 16,777,215 samples over HP-IB. For the selected sample size you can compute:

- Mean
- Standard Deviation
- Minimum
- Maximum

Select the time interval you want from complex waveforms: use the extremely flexible arming and gating to select: +TI or \pm TI with internal arming, external arming - no hold-off, or with external arming - external hold-off.

Program all major capabilities of the HP 5370B over HP-IB:

- Data output rates:
- up to 6000 readings/second in fast binary mode - 165 μ s dead time
 - 10 to 20 readings per second fully formatted - 330 μ s dead time.

Condensed Specifications

Sensitivity: 100 mV p-p, 35 mV rms sine wave \times attenuator setting.

Impedance: selectable 1 M Ω /45 pF or 50 Ω nominal.

Trigger level: -2 V to +2 V, adjustable; 10 mV displayed resolution.

Trigger slope: independent selection of + or - slope.

Attenuators: $\div 1$ and $\div 10$ nominal.

Dynamic Range (preset)

50 Ω $\div 1$: 100 mV to 4 V p-p pulse; $\div 10$: 1 V to 7 V p-p pulse

1 M Ω $\div 1$: 100 mV to 4 V p-p pulse; $\div 10$: 1 V to 10 V p-p pulse

Dynamic range for rms sine wave is one-third of the above values.

Signal Operating Range

50 Ω $\div 1$: -4 V to +4 V; $\div 10$: -7 V to 7 V

1 M Ω $\div 1$: -4 V to +4 V; $\div 10$: -25 V to 10 V

Coupling: ac or dc switch selectable.

Minimum pulse width: 5 ns

Maximum Input

50 Ω $\div 1$: ± 7 V dc
7 V rms below 5 MHz
3.5 V rms (+24 dBm) above 5 MHz
 $\div 10$: ± 7 V dc, 7 V rms (+30 dBm)

1 M Ω $\div 1$: ± 350 V dc
250 V rms to 20 kHz decreasing to 3.5 V rms above 5 MHz
 $\div 10$: ± 350 V dc
250 V rms to 20 kHz decreasing to 35 V rms above 5 MHz

Common Input

All specifications are the same as for separate operation with the following differences:

Impedance: 1 M Ω becomes 500 k Ω shunted by <80 pF. 50 Ω same as in separate.

Sensitivity (preset)

50 Ω $\div 1$: 200 mV p-p, 70 mV rms; $\div 10$: 2 V p-p, 700 mV rms

1 M Ω : same as in separate

Dynamic Range (preset)

50 Ω $\div 1$: 200 mV to 5 V p-p pulse; $\div 10$: 2 V to 5 V p-p pulse

1 M Ω : same as in separate

Maximum Input

50 Ω ± 5 V dc or 5 V rms
1 M Ω same as in separate

Attenuators: becomes $\div 2$ and $\div 20$ for 50 Ω



ELECTRONIC COUNTERS

Universal Time Interval Counter

Model 5370B (cont.)

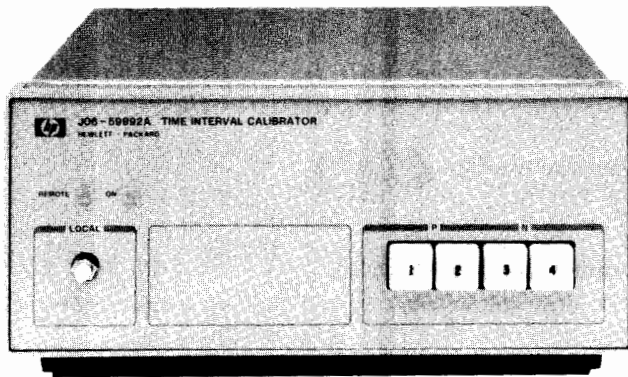

The J06-59992A Time Interval Calibrator gives you the ability to remove systematic errors from your measurement system, so that the 5370B can measure with uncertainties of $< \pm 100$ ps.

Time Interval Measurement

Range:

- \pm TI: -10 to +10 seconds, including zero
- +TI: 10 ns to 10 seconds

Accuracy:

The accuracy (uncertainty) in a time interval measurement is influenced by:

- 1) internal systematic uncertainty
- 2) trigger level timing error, for each edge
- 3) crystal oscillator aging
- 4) noise on the input signal
- 5) internal timing jitter

Factors 1, 2 and 3 can be significantly reduced by calibration - 1 and 2 by using the J06-59992A Time Interval Calibrator

Factors 4 and 5 can be significantly reduced by averaging: (by \sqrt{N} , where N is the number of measurements averaged).

Total Uncertainty

Add together the following:

- 1) Systematic uncertainty is:
 - 1 ns worst case, or
 - 400 ps typical, or
 - 20 ps typical after calibration
- 2) Trigger level timing error is:
 - read from graph 1 for each edge, or
 - 80 ps typical after calibration
- 3) Crystal aging influence is:
 - read from graph 2
- 4) Input signal noise influence is:
 - read from graph 3 for each edge
- 5) Internal timing jitter influence is:
 - 100 ps for up to 1 s intervals

Example:

Measure a time interval of 500 ns, from a 1V, 10 ns rise time edge to a 1V, 10 ns edge. Input signal noise (in a 500 MHz bandwidth) is 1mV. It is 1 year since oscillator calibration. The measurement will be made single shot.

- 1) is typically 400 ps
- 2) is 2 X 250 ps: 500 ps
- 3) is negligible
- 4) is 2 X 10 ps: 20 ps
- 5) is 100 ps

Total uncertainty is ± 1020 ps

Calibrate out systematic errors and you will reduce this to ± 200 ps. Average 100 readings in addition to calibration, and reduce to ± 100 ps.

Calibration is a simple procedure, which can be automated with HP-IB.

The Time Interval Calibrator, in conjunction with a suitable pulse generator, provides the counter with signals which will let you measure the systematic errors. Once measured, you simply subtract them from your results to make Time Interval or Pulse Width measurements with uncertainties of $< \pm 100$ ps.

Calibrate to the probe tips of the HP 5363B Time Interval Probes

The calibration works equally well when high impedance probes are needed to make your measurement.

Frequency and Period Measurement

Frequency range: 0.1 Hz to 100 MHz

Period range: 10 ns to 10 seconds

Internal gate times: 1 period, 0.01, 0.1, 1 second

External gate times: 20 ns to 10 seconds

Accuracy

The accuracy (uncertainty) in a frequency measurement is influenced by:

- 1) crystal oscillator aging
- 2) internal uncertainty
- 3) noise on the input signal.

Factor 1 can be reduced by calibration.

Factors 2 and 3 can be reduced by selecting longer gate times.

Total Uncertainty

Add together the following:

- 1) Crystal aging influence is:
 - read from graph 4
- 2) Internal uncertainty is:
 - read from graph 5
- 3) Input signal noise influence is:
 - read from graph 6

Example:

Measure a 1 MHz, 2V pk-pk sine wave. Input signal noise (in a 500 MHz bandwidth) is 1mV. It is 1 year since oscillator calibration. The selected gate time is 0.1 second.

- 1) is 180 mHz
- 2) is 1 mHz
- 3) is 3.2 mHz

Total uncertainty is 184 mHz

If you had calibrated the oscillator within the last month, this could be reduced to 19.2 mHz.

Select a one second gate time in addition to the recent calibration, and reduce this to 15.3 mHz.

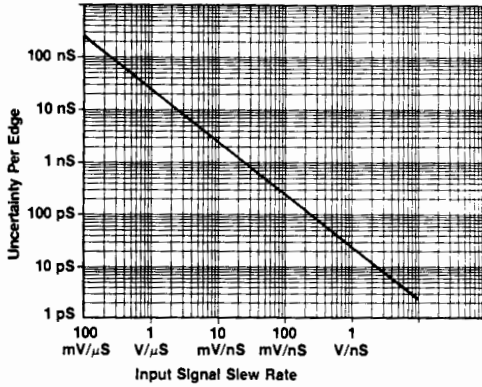

Graph 1. Trigger level timing error varies with input signal slew rate. Uncertainty is associated with both start and stop edges.

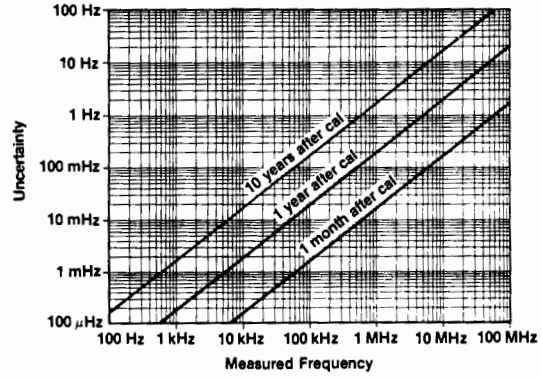

Graph 4. Time base crystal aging affects Frequency and Period measurements. You can further reduce the uncertainty by using an atomic frequency standard.

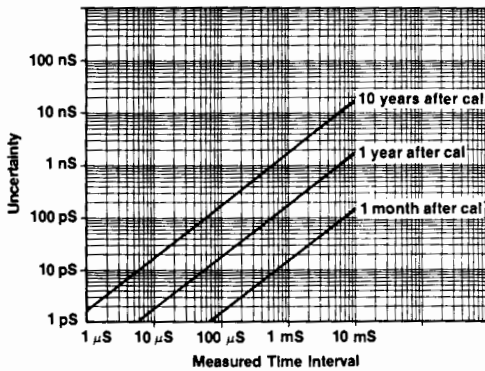

Graph 2. Time base crystal aging affects a time interval or pulse width measurement.

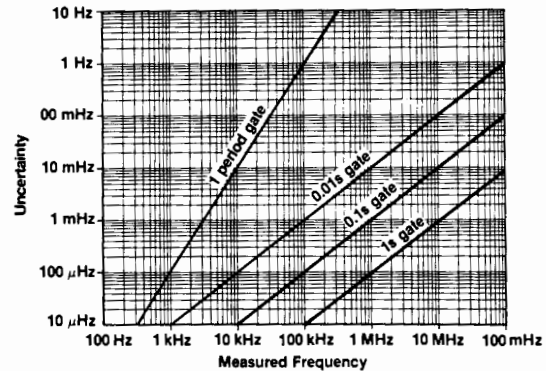

Graph 5. Internal uncertainties affect Frequency and Period measurements.

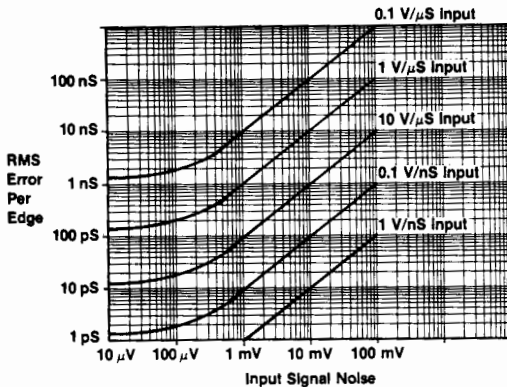

Graph 3. Noise on the input signal will add uncertainty to a time interval measurement. Averaging will reduce the effects of random noise.

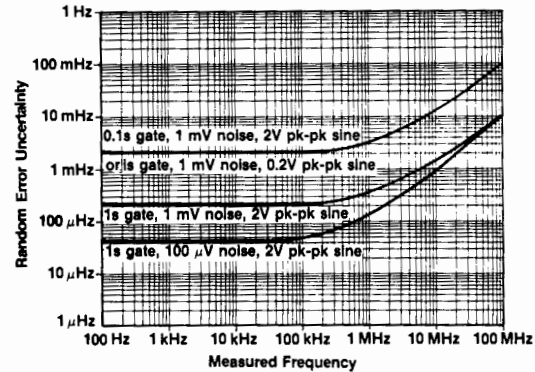

Graph 6. Noise on the input signal will add uncertainty to a Frequency or Period measurement. Longer gate times and averaging will reduce the effects of random noise.

General - 5370B

Display: 16 digits, suppressed leading zeros

Size: 133 H x 426 W x 521 mm D (5.25 x 16.75 x 20.5).

Weight: 14.55 kg (32 lbs.)

Power requirements: 100, 120, 220, or 240 V ac +5% -10%, 48 to 66 Hz, less than 250 VA.

Front handles: supplied with instrument

General - J06-59992A

Size: 102 H x 213 W x 295 mm D (4.0 x 8.38 x 11.6)

Weight: 3.0 kg (6.6 lbs)

Power requirements: 115 or 230 V ac +10% -15%, 48 to 66 Hz, 10 VA.

Ordering Information

J06-59992A Time Interval Calibrator

Option 908: (5370B Rack Flange Kit - without handles) \$33

Option 913: (5370B Rack Flange Kit - use with supplied front handles) \$30

HP 10870A: Service Kit Accessory \$650

HP 5370B Time Interval Counter

Price

\$3000

\$33

\$30

\$650

\$9,500



ELECTRONIC COUNTERS

Accessories

Models 5363B & 10855A & 10856A

- Precise trigger level setting
- Wide input dynamic range



HP 5363B



HP 5363B Time Interval Probes

Enhanced Counter Measurements

The HP 5363B provides the necessary input signal conditioning to allow a universal counter to make highly accurate and repeatable time interval measurements. Counters such as the HP 5345A, 5370B, 5335A, 5334A, and 5328B when teamed up with the HP 5363B can now make more accurate rise time, fall time, slew rate, propagation delay, and other complex measurements.

Wide Dynamic Range, Fine Trigger Level Settability

Greatly improved dynamic range allows the trigger point to be selected in 10 mV increments from -9.99 V to +9.99 V.

Minimized Circuit Loading

High impedance, low capacitance active probes minimize circuit loading and pulse distortion. Each probe contains two measurement channels, start and stop, so timing measurements on one waveform are possible. As example, the input/output rise (propagation delay) of a device can be measured between the probes.

Eliminate Systematic Timing Errors

Delays through probes, cables and inherent differential delays between a counter's input channels limit the absolute accuracy of time interval measurements.

A calibration procedure using the HP 5363B can equalize such systematic delays to set the counter to read 0.0 ns. This is possible with counters that can measure down to 0 ns like the HP 5370B, 5334A, and HP 5335A. For counters with a minimum time interval specification (HP 5345A and 5328B have 10 ns minimum capability), the HP 5363B can add a fixed offset of 10 ns to permit measurements of zero time interval.

Condensed Specifications

Operating range: ± 10 V

Minimum input voltage: ± 100 mV about trigger point

Damage level: ± 30 V

Voltage resolution: 10 mV

Impedance: 1 M ohm shunted by < 20 pF

Effective bandwidth: 350 MHz (1 ns rise time)

Minimum pulse width: 5 ns at ± 100 mV about trigger point

Output to counter: separate start/stop outputs; -0.5 V to +0.5 V into 50 ohm, slew rate through zero volts exceeds 0.25 V/ns

Delay compensation range: 2 ns adjustable about 0 ns or 10 ns

Power: 100, 120, 220, 240 Vac (+5-10%), 48-440 Hz; 40 VA max

Weight: net 3.0 kg (6.5 lb). Shipping 5.5 kg (12 lb)

Dimensions: 88.1 H x 212 W x 295 mm D (3.5" x 8.4" x 11.6").

Absolute Accuracy

$$\pm 1 \text{ ns} \pm \frac{\text{START TLA} + \text{START NTE}}{\text{START slew rate}} \pm \frac{\text{STOP TLA} + \text{STOP NTE}}{\text{STOP slew rate}}$$

where TLA denotes trigger accuracy and NTE denotes noise trigger error.

Noise trigger error: $\sqrt{(125 \mu\text{V})^2 + e_n^2}$ volts where 125 μV is the typical input noise on the HP 5363B and e_n is the input signal noise for a 350 MHz bandwidth.

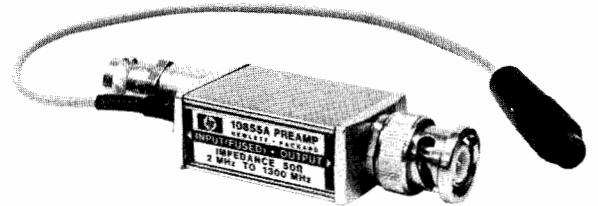

HP 10855A

HP 10855A 2-1300 MHz Preamp

The HP 10855A Preamp provides a minimum of 22 dB gain from 2 MHz to 1300 MHz to enhance measurements of very low-level signals. The ± 1.5 dB flat response reduces distortion in non-sinusoidal waveforms. The HP 10855A operates conveniently with a variety of HP measuring instruments having probe power outlets, or will work with the HP 1122A Probe Power Supply. The HP 5334A/5335A Option 030 and HP 5328B Option 031 counters all measure frequency to 1300 MHz and are compatible for use with the HP 10855A.

HP 10855A Specifications

Frequency range: 2 MHz-1300 MHz

Gain (minimum): 22 dB; 24 dB typical

Gain flatness across full frequency range: ± 1.5 dB

Noise figure: < 8.5 dB typical

Output power for 1 dB gain compression: 0 dBm

Harmonic distortion: -30 dB for -15 dBm output, typical

Output for < -66 dB harmonic distortion: -25 dBm, typical

VSWR: input and output, < 2.2

Impedance: 50 Ω nominal

Reverse isolation: > 45 dB

Maximum input: 3.5 V rms (+24 dBm), fuse protected

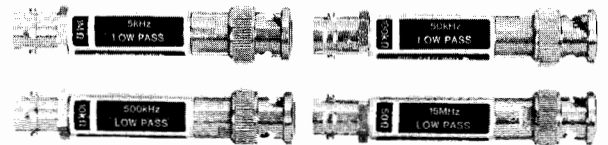

HP 10856A

HP 10856A Low Pass Filter Kit

The four low pass filters of the HP 10856A filter kit are recommended for use with any HP frequency counter to reduce high frequency noise or unwanted signals that cause frequency or period measurement errors. Further applications for the kit include reducing noise (trace fuzz) in oscilloscope and spectrum analyzer displays.

HP 10856A Specifications

| Cut Off Frequency (NOMINAL) | 5 KHz | 50 KHz | 500 KHz | 15 MHz |
|--------------------------------------|--------------|----------------|---------------|-------------|
| Input Impedance (NOMINAL) | 1 M Ω | 100 k Ω | 10 k Ω | 50 Ω |
| Signal Rejection, 100 MHz to 500 MHz | > 40 dB | > 40 dB | > 40 dB | > 20 dB |

Roll-off: 20 dB per decade.

Attenuation: $\times 2$, reduces signal voltage by a factor of 2.

Output impedance: for use with 1 M Ω input instruments.

Accessories Available

HP 10821A Probe Accessory Kit including 2 of each of the following: HP 10229A Hook Tip; HP 10218A BNC to Probe Adapter; HP 10100C 50 ohm Feedthrough termination; HP 1250-0655 BNC Tee to Probe Adapter; and HP 8710-0661 HP Probe tips (extra).

Price

\$130

HP 5363B Time Interval Probes

\$3800

HP 10855A 2-1300 MHz Preamp

\$550

HP 10856A Low Pass Filter Kit

\$250

ELECTRONIC COUNTERS

Our Fastest Systems Universal Counter

Model 5345A

241



- 500 MHz Direct Count, Conversion Plug-Ins to 110 GHz
- 2 ns Single Shot Resolution, 2 ps Averaged

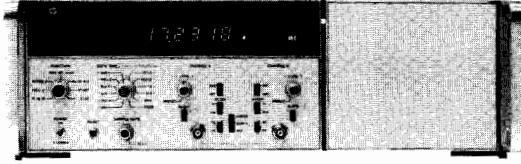

HP 5345A

HP 5345A Condensed Specifications

Frequency/Period Measurements

Range: 0.00005 Hz to 500 MHz.

Accuracy: $\pm \frac{2 \times 10^{-9}}{\text{gate time}}$ \pm trigger error \pm time base error.

Gate time: 1000 seconds to 100 nanoseconds in decade steps; <50 ns in MIN position.

Time Interval/Time Interval Average

Range: 10 ns to 20,000 s.

Minimum dead time: 10 ns

Trigger pulse width: 1 ns minimum width input at minimum voltage input.

Accuracy

Time interval: \pm trigger error \pm 2 ns \pm time base error.

Time Interval Averaging

$\frac{\text{trigger error} \pm 2 \text{ ns}}{\sqrt{\text{intervals averaged}}} \pm 0.7 \text{ ns} \pm$ time base accuracy

Not affected by harmonics of clock frequency.

Resolution

Time interval: 2 ns.

Time Interval Average

$\pm \frac{2 \text{ ns}}{\sqrt{\text{intervals averaged}}} \pm 2$ picoseconds.

Ratio B/A

Range: both channels accept dc to 500 MHz.

Accuracy: \pm LSD \pm trigger error.

Start/Stop

Range: both inputs dc to 500 MHz.

Modes: A, A \pm B determined by rear panel switch.

Scaling

Range: dc to 500 MHz.

Scaling factor: selectable by GATE TIME setting. Scaling factor equals GATE TIME setting/ 10^{-9} seconds.

Input: input signal through channel A.

Output: output frequency equals input frequency divided by scaling factor.

Input Channels A and B

Range: 0 to 500 MHz dc coupled 50 Ω and 1 M Ω ; 4 MHz to 500 MHz ac coupled, 50 Ω ; 200 Hz to 500 MHz ac coupled, 1 M Ω .

Impedance: selectable, 1 M Ω shunted by less than 45 pF or 50 Ω (nominal).

Sensitivity: X1, 25 mV rms sine wave and 75 mV peak-to-peak pulse. X10, 300 mV rms sine wave and 900 mV peak-to-peak pulse.

Dynamic range: 50 Ω & 1 M Ω : 25 mV to 300 mV rms sine wave (X1); 300 mV to 2.0 V rms (X10).

Trigger level: adjustable over ± 2.0 V dc.

Output: rear panel BNC connectors bring out CHAN A TRIG LEVEL and CHAN B TRIG LEVEL for convenient DVM monitoring.

- 25 mV Sensitivity to 500 MHz
- Up to 9000 readings/second over HP-IB

Common Input

Range: ac coupled 50 Ω , 4 MHz to 400 MHz; ac coupled 1 M Ω , 300 Hz to 400 MHz.

Impedance: 50 Ω remains 50 Ω ; 1 M Ω becomes 500 k Ω shunted by <80 pF.

Sensitivity: 50 Ω : 50 mV rms; 1 M Ω : No change.

Dynamic range: 50 Ω : 50 mV to 600 mV rms (X1); 600 mV to 4 V rms (X10); 1 M Ω : No change.

Time Base

Standard High Stability Oven

Frequency: 10 MHz

Aging rate: $< 5 \times 10^{-10}$ per day.

Short term: $< 1 \times 10^{-11}$ for 1 second average.

Temperature: $< 7 \times 10^{-9}$, 0°C to 55°C.

Opt 001

Frequency: 10 MHz

Aging rate: $< 3 \times 10^{-7}$ per month.

Short term: $< 2 \times 10^{-9}$ rms for 1 second

Temperature: $< 2 \times 10^{-6}$, 25°C to 35°C.
 $< 5 \times 10^{-6}$, 0°C to 55°C.

Line voltage: $< 1 \times 10^{-8}$, $\pm 10\%$ from nominal.

External frequency standard input: input voltage >1.0 V rms into 1 k Ω required from source of 1, 2, 2.5, 5 or 10 MHz $\pm 5 \times 10^{-8}$ ($\pm 5 \times 10^{-6}$ for opt. 001).

Frequency standard output: >1 V rms into 50 Ω at 10.0 MHz sine wave.

General

Display: 11 digit LED display and sign.

Measurement Speed

| Mode of Operation | Readings per Second |
|------------------------------------|---------------------|
| Normal Operation (Max sample rate) | 10 |
| Externally armed | 500 |
| Externally gated | 500 |
| Computer dump | 9,000 |

Overflow: asterisk is illuminated when display is overflowed.

Sample rate: continuously variable from <0.1 s to >5 s with front panel control. In HOLD position the last reading is maintained until the counter is reset.

External arm input: counter can be armed by a -1.0 V signal applied to the rear panel 50 Ω input.

External gate input: same conditions as for EXT ARM.

Gate output: >1 volt into 50 Ω .

Operating temperature: 0°C to 55°C.

Power requirements: 100/120/220/240 V rms $\pm 5\%$ -10% 48 to 66 Hz, maximum power 250 VA.

Weight: 17 kg (37 lb).

Size: 132.6 H x 425 W x 495 mmD (5.22" x 16.75" x 19.5").

HP 10590A Plug-In Adapter

The HP 10590A allows the user to interface any of the obsolete HP 5245 series of plug-ins (except the HP 5264A) to the HP 5345A counter.

Options and Accessories

| | Price |
|---|------------|
| 001: Room Temperature Time Base | less \$325 |
| 010: HP-IB Talk Only | add \$350 |
| 011: HP-IB includes remote programming | \$930 |
| 012: HP-IB similar to OPT 011, but also includes slope and trigger level controls | \$1610 |
| 908: Rack Flange Kit, HP 5060-8740 | \$22 |
| HP 10595A Board Extender Kit: For troubleshooting | \$750 |
| HP K13-59992A: State machine tester to aid troubleshooting the arithmetic processor | |
| HP K15-59992A: Standby power unit: Plug-in maintains oscillator operation without line voltage | |

Ordering Information

HP 10590A Plug-In Adapter

\$1200

HP 5345A Plug-In Counter

\$9000



ELECTRONIC COUNTERS

100 MHz Universal Counters

Model 5334A

- Two matched 100 MHz channels; optional 1.3 GHz channel C
- 9 digits per second resolution over the entire frequency range in one second
- 2 ns single shot time interval resolution
- Automatic rise/fall time, pulse width and peak amplitude measurements
- Store/recall of up to 10 front panel setups
- Complete HP-IB programmability including trigger levels

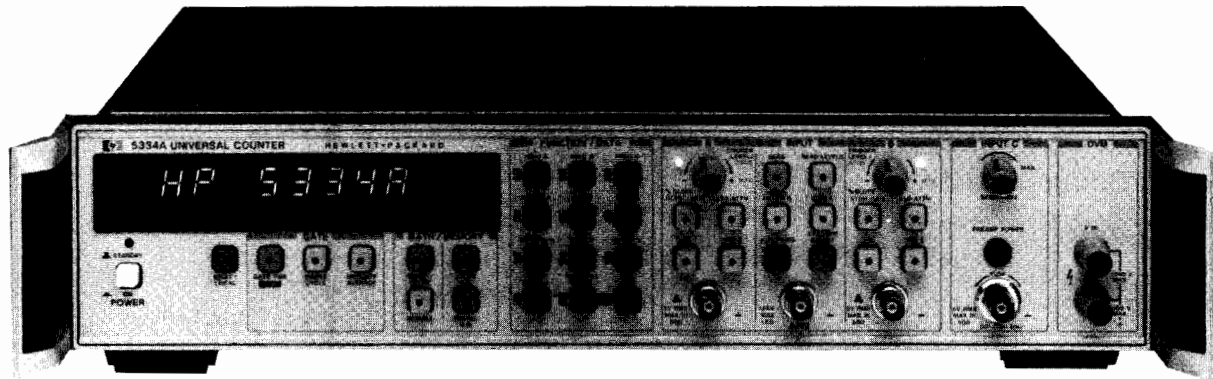

HP 5334A



The HP 5334A is a two-channel, 100 MHz Universal Counter with 9 digits in one second resolution and 2 ns single shot time interval resolution. Frequency, period, rise time, fall time, pulse width and peak amplitude may be measured automatically—all at the touch of a button. Options include a high-stability oven oscillator, a ± 1000 V DVM and a 1.3 GHz C-Channel.

Fully Programmable

Complete HP-IB capability standard is a first for counters in this class, opening up new possibilities for ATE applications. All front panel controls are programmable including input signal conditioning and trigger levels. Optional rear terminal inputs simplify cabling in rack-mounted systems.

Peak Amplitudes

The peak amplitude function adds a new dimension to universal counter applications. For any waveshape up to 20 MHz, the HP 5334A measures not only time and frequency, but also the maximum and minimum peak amplitudes of Channel A or B input signals. Often this function reduces the need for additional test equipment and gives a more complete picture of the input signal.

Input Signal Conditioning

In addition to automatic capability, independent selection of input signal conditioning provides flexibility for any application. Accurate triggering is ensured by selection of trigger slope, coupling, input impedance, attenuation, low pass filter, and variable sensitivity. Variable sensitivity may be used to widen the hysteresis band for measurements on noisy input signals.

Triggering Alternatives

The HP 5334A offers four alternatives for trigger level selection. Auto Trigger offers maximum convenience. The maximum and minimum peaks of the input signal are found automatically, and the optimum trigger point calculated. Auto Attenuator is enabled with Auto Trigger, ensuring correct counting by selecting the X10 attenuator when the input signal amplitude is greater than the input signal operating range.

The trigger levels may also be set manually over the range of -5.10 V to $+5.10$ V (-51.0 V to $+51.0$ V in X10 attenuation). Read Levels may be used to display the current trigger level control settings. Storing trigger levels from the front panel and programming trigger levels over HP-IB complete the alternatives for reliable and accurate triggering.

Store/Recall

Up to ten instrument setups including trigger levels may be stored in a nonvolatile memory and conveniently recalled. Sequencing through several complicated setups requires much less time and results in repeatable, exact measurement setups.

Math

Math functions let you view results in measurement units of your choice such as velocity, flow, or ppm. Normalize divides the measured value by a constant. Offset adds or subtracts the measured value by a constant.

External Arming

Synchronize a measurement to a real time event or events. Start arm is used alone to enable the start of a measurement, stop arm to enable the stop of a measurement. External gating is accomplished by arming both the start and stop of a measurement. This capability facilitates applications such as measuring the frequency within a pulsed RF signal and averaging for increased resolution, selecting a specific time interval within a pulse train, and selecting a portion of a pulse train to totalize.

The arm input and slope selection are conveniently located on the front panel and are programmable over HP-IB. The trigger level at which the arm signal will arm a measurement may be selected from -4 V to $+4$ V via a rear panel control.

Condensed Specifications

Input Characteristics (channels A and B)

Range

DC coupled: 0 to 100 MHz.

AC coupled: 1 M Ω , 30 Hz to 100 MHz. 50 Ω , 1 MHz to 100 MHz.

Sensitivity

15 mV rms sine wave to 20 MHz. 35 mV rms sine wave to 100 MHz.

100 mV peak-to-peak at a minimum pulse width of 5 ns.

Sensitivity can be continuously varied to 150 mV rms, (NOMINAL) using the TRIGGER LEVEL/SENS control in sensitivity mode. (Trigger levels set to 0 V NOMINAL.)

Dynamic Range (X1)

45 mV to 5 V peak-to-peak, to 20 MHz.

100 mV to 2.5 V peak-to-peak, to 100 MHz.

Signal operating range, dc: ± 5 V DC (X ATTN).

Trigger Level Range

Manual (auto trigger off): continuously adjustable over ± 5.1 V, displayed in 20 mV steps. In X10, ± 51 V displayed in 200 mV steps.

Preset: 0 V NOMINAL in Sensitivity Mode.

Auto Trigger

DC coupled: 100 Hz to 100 MHz.

AC coupled: 1M Ω , 100 Hz to 100 MHz. 50 Ω , 1 MHz to 100 MHz.

Coupling: ac or dc, switch selectable.

Trigger slope: independent selection of + or - slope.

Impedance: 1 M Ω NOMINAL shunted by <60 pf or 50 Ω NOMINAL, switch selectable.

Attenuator

Manual: X1 or X10 NOMINAL, switch selectable.

Auto: attenuator automatically switched when in Auto Trigger.

Low pass filter: 100 kHz NOMINAL, switchable in or out of Channel A.

External Arm

Minimum width: 50 ns.

Maximum transition time: 1 μ s.

Sensitivity: 500 mV peak-to-peak.

Signal operating range: -5 Vdc to +5 Vdc.

Slope: independent selection of START and STOP ARM slopes: +, -, or OFF.

Frequency A and Frequency B

Range: .001 Hz to 100 MHz.

LSD: (4ns/Gate Time) X FREQ.

Resolution

$$\pm \text{LSD} \pm \frac{(1.4 \times \text{Trigger Error} + 1 \text{ ns rms})}{\text{Gate Time}} \times \text{FREQ.}$$

Accuracy: \pm Resolution \pm Time Base Error \times FREQ.

Period A

Range: 10 ns to 10³ s, single shot. 10 ns to 10 s for 100 GATE AVERAGE.

LSD: (4 ns/Gate Time) \times PER.

Resolution

$$\pm \text{LSD} \pm \frac{(1.4 \times \text{Trigger Error} + 1 \text{ ns rms})}{\text{Gate Time}} \times \text{PER.}$$

Accuracy: \pm Resolution \pm Time Base Error \times PER.

Time Interval A to B

Range: -1 ns to 10³ seconds, single shot. -1 ns to 10s for 100 GATE AVERAGE.

LSD: 1 ns (100 ps using 100 GATE AVERAGE).

Resolution: \pm LSD \pm Start Trigger Error \pm Stop Trigger Error \pm 1 ns rms.

Accuracy: \pm Resolution \pm (Time Base Error \times TI) \pm Trigger Level Timing Error \pm Trigger Level Setting Error \pm 2 ns.

Time Interval Delay

Used with Time Interval A to B, a selectable delay can be inserted between START (Channel A trigger) and STOP (Channel B trigger). Electrical inputs during delay are ignored. Delay Range is 1 ms to 99.999 s (1 ms steps).

Ratio A/B

Range: .001 Hz to 100 MHz both channels.

LSD: 4 \times RATIO/(FREQ A \times Gate Time).

Resolution and Accuracy

$$\pm \text{LSD} \pm (\text{B Trigger Error/Gate Time}) \times \text{RATIO.}$$

Totalize A

Range: 0 to 10¹² -1.

LSD: 1 count of input signal.

Resolution and accuracy: \pm LSD.

Pulse Width A

Range: 5 ns to 10 ms.

LSD: 1 ns (100 ps using 100 GATE AVERAGE).

Resolution: \pm LSD \pm Start Trigger Error \pm Stop Trigger Error \pm 1 ns rms.

Rise/Fall Time A

Range: 30 ns to 10 ms.

Minimum amplitude: 500 mV peak-to-peak.

Dynamic range: 500 mV to 40 V peak-to-peak.

LSD: 1 ns (100 ps using 100 GATE AVERAGE).

Resolution: \pm LSD \pm Start Trigger Error \pm Stop Trigger Error \pm 1 ns rms.

Read Peak Amplitudes

Maximum and minimum peaks of Channel A or Channel B input are displayed.

Frequency range: DC, 100 Hz to 20 MHz.

Dynamic range: 0 V to 40 V peak-to-peak.

Resolution: \times 1: 20 mV. \times 10: 200 mV.

Time Base

Standard Crystal

Frequency: 10 MHz.

Aging rate: $<3 \times 10^{-7}$ per month.

Temperature: $<5 \times 10^{-6}$, 0 $^\circ$ to 50 $^\circ$ C.

Line voltage: $<1 \times 10^{-7}$ for 10 % change.

External input: rear panel BNC accepts 10 MHz, 500 mV to 5 V rms into 1 K Ω nominal shunted by <20 pf.

Time base output: 10 MHz, >500 mV rms sine wave into 50 Ω via rear panel.

Gate time range: 1 ms to 99.999 seconds in 1 ms increments.

Math

Display = (Measurement/Normalize) + Offset.

Entry range: $\pm 1 \times 10^{-10}$ to $\pm 9.999999999 \times 10^9$.

Single cycle: when enabled, one measurement is taken with each push of RESET key.

100 gate average: 100 gates accumulated and average displayed. This adds an additional digit of resolution.

Gate output: rear panel BNC drives TTL levels into 1 k Ω .

Hewlett-Packard Interface Bus

Programmable controls: all front panel controls and functions, except Option 030 Channel C sensitivity and power on/stby switch.

Trigger level: set Channel A or B from -5.1 V to +5.1 V in 20 mV steps (\times ATTN).

Other: Initialize, Transmit Error, High-Speed Output, Transmit Calibration Data, Device ID, and SRQ Mask.

Data Output

Normal operation: format: 19 characters plus CR and LF. Rate: Ten readings/second.

High speed output mode: format: 8 bytes of count data and Interpolator Start and Stop counts. Rate: up to 140 readings/second with 1 ms gate time.

Interface functions: SH1, AH1, T5, TE0, L4, LE0, SR1, RL1, PP0, DC1, DC1, C0, E2.

Options

Option 010 High Stability Time Base (Oven)

Frequency: 10 MHz.

Aging rate: $<5 \times 10^{-10}$ /day after 24-hour warm up.

Short term: $<5 \times 10^{-10}$ rms for a 1-second average.

Temperature: $<7 \times 10^{-9}$, 0 to 50 $^\circ$ C.

Line voltage: $<5 \times 10^{-10}$ for 10% change (2 minutes after change).

Warm up: within 5×10^{-9} of final value in 20 minutes.

Option 020 DC Digital Voltmeter

Range: 4 digits, autoranging, and autopolarity in ± 10 V, ± 100 V, ± 1000 V ranges.

Sensitivity and LSD: 100 μ V for ± 1 V reading. 1 mV for ± 10 V reading. 10 mV for ± 100 V reading. 100 mV for ± 1000 V reading.

Input type: floating pair.

Input resistance: 10 M Ω $\pm 1\%$.

Option 030 1300 MHz C Channel

Range: 90 MHz to 1300 MHz.

Sensitivity: 15 mV rms (-23.5 dBm) sine wave, 90 MHz to 1000 MHz. 75 mV rms (-9.5 dBm) sine wave, 1000 MHz to 1300 MHz.

Ordering Information

Option 010: Oven Oscillator \$800

Option 020: DVM \$500

Option 030: Channel C \$755

Option 050: Both option 020 and 030, order instead of both options separately. \$1255

Option 060: Rear Terminals \$100

Channel A, B and ARM in parallel with front inputs.

Options 020 and 030 at rear panel only.

Option 908: Rack Mount Kit for use without front handles. \$30

Option 913: Rack Mount Kit for use with supplied front handles. \$30

HP 5334A Universal Counter \$2800

ELECTRONIC COUNTERS

Our Highest Performance Universal Systems Counter

Model 5335A

- A high performance 200 MHz/2 ns Universal Counter
- Built-in automatic rise time, duty cycle, pulse width, slew rate and phase measurements
- Advanced automatic triggering capabilities
- HP-IB plus math and statistics functions standard



HP 5335A



Remarkable Automatic Measurement Power

The HP 5335A is an advanced universal counter with automatic measurement power built in. Designed either for bench or systems applications, the counter has 16 front-panel measurement functions, plus four "phantom" functions, all automatically selected by push button or by HP-IB. These twenty functions, plus greatly expanded arming and triggering capability, make the HP 5335A a most powerful universal counter. In addition, math and statistics features, matched Channel A and B input amplifiers, and HP-IB are all included in the standard unit, making the HP 5335A easily the most advanced universal counter available at its price.

Pulse Characterization Measurements

The HP 5335A possesses the expected universal measurements, and does them better than ever before. Beyond the expected measurement set, the HP 5335A has the ability to automatically measure waveform characteristics for various applications. Op amp characterization is one area where a number of measurements are needed to define the amplifier's performance. Using the HP 5335A and a signal source, rise and fall times, output slew rate, and propagation times can be measured with one test set-up. Also, duty cycle can be measured to see the distortion on a square wave through the amplifier due to different rising and falling slew rates. Phase measurements are also push-button selectable and automatically performed by the counter.

Complete Triggering Capability

To get good measurement results, a counter must properly trigger on the input signal. The HP 5335A employs both manual and automatic trigger modes to quickly and easily set the right trigger points.

Manual Triggering

The counter has a ± 5 Vdc range to help reduce input attenuator use for most input signals, including TTL.

Automatic Triggering

Two auto trigger modes help you trigger automatically. Just press *auto trig* or select auto trig on the HP-IB and the counter automatically selects 10%-90% rise/fall time trigger points, 50% phase trigger points, or the preset value of your choice. Then it tracks the signal's dc offset continuously to stay on the right trigger point. Option 040 allows programmability of trigger levels via HP-IB.

Trigger Level DVM

Built into the basic counter. Just press TRG LVL to see both input channel trigger levels displayed.

A Full Set of Universal Measurement Functions

In addition to waveform characterization features, the HP 5335A has an extremely wide set of measurement functions covering frequency, time, events and volts. These functions let you characterize signals quicker and more thoroughly than ever before possible.

Frequency

Frequency is the most common measurement performed by counters. The HP 5335A measures to 200 MHz in Channel A, 100 MHz in Channel B, and 1.3 GHz in its optional Channel C. Due to the counter's advanced design and reciprocal measurement technique, resolution is a constant 9 digits per second of gate time across its entire measurement range.

Time

In a universal counter, a time interval measurement equates to a stopwatch measurement started and stopped by unique events. Precision is dependent on the counter's circuitry.

To ensure precision, the HP 5335A has matched custom input amplifiers to greatly reduce trigger errors that might be produced if the start and stop signals were amplified differently. Further, the counter employs an analog interpolation technique that turns its 10 MHz clock into the equivalent of a 1 GHz time base. The HP 5335A is thus able to resolve single shot time interval measurements to better than 2 nanoseconds (100 ps with averaging). This analog interpolation eliminates the need found in some counters for a phase-modulated (jittered) time base for time interval average measurements.

Math and Statistics

Averaging techniques are often used to extend the resolution of a counter. For averaging, the HP 5335A provides sample sizes of $N = 100$ or $N = 1,000$. Best of all, averaging can be employed for all measurements except phase. In addition to mean, and selection of sample size, the counter takes standard deviations of the current measurement for the sample size selected.

Math functions are another built-in feature that provide operator convenience. These functions let you convert the display into direct indications of parameters like flow, speed, pressure, and temperature. Additionally, the counter remembers the offset, scale, and normalize factors for each measurement function.



Condensed Specifications

Input Characteristics (channel A and B)

Range

DC coupled, 0 to 100 MHz.

AC 1 M Ω , 30 Hz to 100 MHz.

AC 50 Ω , 200 kHz to 100 MHz.

NOTE: Channel A range 200 MHz when in Frequency A and Ratio modes.

Sensitivity (X1)

25 mV rms sinewave.

75 mV peak-to-peak pulse at minimum pulse width of 5 ns.

Dynamic Range (X1)

75 mV to 5 V peak-to-peak, to 100 MHz.

75 mV to 2.5 V peak-to-peak, >100 MHz.

Signal Operating Range (X1, DC)

-5 V dc to +5 V dc.

Trigger Level Range (X1)

Auto Trigger OFF

Preset: set to 0 V dc NOMINAL.

Adjustable: -5 V dc to +5 V dc.

Auto Trigger ON

Preset: set to nominal 50% point of input signal.

Adjustable: nominally between + and - peaks of input signal.

Auto Trigger (X1)

Range (50% duty cycle)

DC coupled, 30 Hz to 200 MHz.

AC 1 M Ω , 30 Hz to 200 MHz.

AC 50 Ω , 200 kHz to 200 MHz.

Minimum signal: 100 mV rms.

Duty cycle range: 10% to 90%.

Response time: 3 seconds, typical.

NOTE: Auto Trigger requires a repetitive signal.

Coupling: ac or dc, switchable.

Impedance: 1 M Ω , nominal, shunted by <35 pF or 50 Ω nominal, switchable. In COMMON A, 1 M Ω is shunted by <50 pF.

Attenuator: X1 or X10 nominal, switchable.

Slope: independent selection of + or - slope.

Channel input: SEPARATE or COMMON A, switchable.

Frequency A

Range: 0 to 200 MHz, prescaled by 2.

LSD Displayed

$\frac{1 \text{ ns}}{\text{Gate Time}} \times \text{FREQ.}$ (e.g. 9 digits in a second).

Resolution

$\pm (2 \times \text{LSD}) \pm 1.4 \times \frac{\text{Trigger Error}}{\text{Gate Time}} \times \text{FREQ.}$

Accuracy: $\pm (\text{Resolution}) \pm (\text{Time Base Error}) \times \text{FREQ.}$

Period A

Range: 10 ns to 10⁷ s.

LSD Displayed

$\frac{1 \text{ ns}}{\text{Gate Time}} \times \text{PER.}$ (e.g. 9 digits in a second).

Period average: user selects MEAN function, and n = 100, or n = 1,000.

Time Interval A \rightarrow B

Range: 0 ns to 10⁷ s.

LSD displayed: 1 ns (100 ps using MEAN).

Resolution: $\pm (2 \times \text{LSD}) \pm (\text{START Trigger Error}) \pm (\text{STOP Trigger Error})$.

Accuracy: $\pm (\text{Resolution}) \pm (\text{Time Base Error}) \times \text{TI} \pm (\text{Trigger Level Timing Error}) \pm (2 \text{ ns})$.

Gate mode: MIN only.

Time interval average: user selects MEAN function, and n = 100, or n = 1,000.

Time Interval Delay (holdoff)

Front panel Gate Adjust control inserts a variable delay between START and enabling of STOP. Electrical inputs during delay are ignored. Delay ranges are same as gate time ranges (100 μ s, to 4 s NOMINAL) for gate modes of Fast, Norm, and Manual.

Inverse Time Interval A \rightarrow B

Range: 10⁻⁷ to 10⁹ units/second

LSD Displayed, Resolution, and Accuracy are inverse of Time Interval A \rightarrow B specifications.

Rise and Fall Time A

Range: 20 ns to 10 ms transition with 50 Hz to 25 MHz repetition rates (50% duty cycle).

Minimum pulse height: 500 mV peak-to-peak.

Minimum pulse width: 20 ns.

Duty cycle range: 20% to 80%.

LSD Displayed and Resolution are same as Time Interval A \rightarrow B Specifications.

Pulse Width A

Range: 5 ns to 10⁷ s.

Trigger point range: 40% to 60% of pulse height.

LSD Displayed and Resolution are same as Time Interval A \rightarrow B specifications.

Duty Cycle A

Range: 1% to 99%, 0 to 100 MHz.

Trigger point range: 40% to 60% of pulse height.

LSD displayed: $\frac{1 \text{ ns}}{\text{PER}} \times 100\%$

NOTE: Constant duty cycle required during measurement.

Slew Rate A

Range: 50 V/s to 10⁸ V/s slew rate with 50 Hz to 25 MHz repetition rates (50% duty cycle). Minimum Pulse Height, Width, and Duty Cycle Range are same as Rise and Fall Time A.

Input mode: automatically set to COMMON A with 10% and 90% trigger levels.

Ratio A/B

Range: Channel A, 0 to 200 MHz (prescaled by 2).
Channel B, 0 to 100 MHz.

LSD displayed: $\frac{\text{RATIO}}{\text{FREQ} \times \text{Gate Time}}$ where FREQ is higher frequency after prescaling.

Totalize A

Range: 0 to 100 MHz.

LSD displayed: 1 count of input

HP-IB output: at end of gate.

Manual

Count reset: via RESET key.

HP-IB output: totalize data on-the-fly sent if Cycle mode set to Single. Input frequency range in this mode is 0 to 50 Hz nominal.

Gated

Count reset: automatic after measurement.

Phase A Rel B

Range: -180° to 360°, Range Hold off, or 0° to 360°, Range Hold on, with signal repetition rates of 30 Hz to 1 MHz.

Minimum signal: 100 mV rms.

LSD displayed: 0.1°.

Gate Time

Range: 100 ns to 10⁷ s.

LSD displayed: up to three digits with Ext. Arm Enable OFF, 100 ns when ON. MIN Gate Mode display zero.



ELECTRONIC COUNTERS

Our Highest Performance Universal Systems Counter

Model 5335A (cont.)

Trigger Level

Range: X1, +5 to -5 volts; X10, +50 to -50 volts.

Resolution: X1, 10 mV; X10, 100 mV.

Accuracy (X1): ±20 mV, ±0.5% of reading.

Time Base

Standard Crystal

Frequency: 10 MHz.

Aging rate: $< 3 \times 10^{-7}$ /month.

Temperature: $< 4 \times 10^{-6}$, 0 to 50°C.

Line voltage: $< 1 \times 10^{-7}$ for 10% change.

High stability crystal: see Option 010.

External time base input: rear panel BNC accepts 5 or 10 MHz, 200 mV rms into 1 kΩ; 5 V rms maximum.

Time base out: 10 MHz, >1 V p-p into 50 Ω via rear panel.

Statistics

Sample size: selectable between either $n = 100$ or $n = 1,000$ samples.

Std. dev.: displays a standard deviation of selected sample size.

Mean: displays mean estimate of selected sample size.

Smooth: performs a weighted running average and truncates unstable least significant digits from display.

Math

All measurement functions, with exception of GATE TIME, Totalize in Scale Mode, and TRIG LVL, may be operated upon by Math functions. Offset, Normalize, and Scale may be used independently or together as follows:

$$\text{Display} = \frac{\text{Measurement} + \text{Offset}}{\text{Normalize}} \times \text{Scale.}$$

Number value range: $\pm 1 \times 10^{-9}$ to $\pm 9 \times 10^9$.

Last display: causes value of previous display to Offset (negative value), Normalize, or Scale all subsequent measurements.

Measurement t-1: causes each new measurement to be Offset (negative value), Normalized, or Scaled by each immediately preceding measurement.

Hewlett-Packard Interface Bus

Programmable controls: all measurement functions, Math, Statistics, Reset, Range Hold, Ext. Arm Enable/Slope, Check, Gate Adj. (~ 1 ms to 1 s), Gate Open/Close (gate times to ∞), Gate Mode, Cycle, Preset, Slope, Common A, Auto Trigger.

Special functions: FREQ B, PULSE B, TIME B→A, TOT A-B, LEARN, MIN, MAX, all internal diagnostic routines.

Interface functions: SH1, AH1, TS, TEQ, L4, SL1, RL1, PP0, DC1, DT1, C0, E1.

Data output: fixed output format consisting of 19 characters plus CR and LF output is typically 8 ms.

Option 040: adds complete systems programmability; see column at right.

General

Gate: minimum, manual, or continuously variable (NORM/FAST) via Gate Adj. control.

NORM: 20 ms to 4 s NOMINAL.

FAST: 100 μs to 20 ms NOMINAL.

MIN: minimum gate time. Actual time depends on function.

MANUAL: each press opens or closes gate.

Cycle: determines delay between measurements.

NORM: no more than 4 readings per second, nominal.

MIN: updates display as rapidly as possible (~ 15 readings per second, depending on function).

SINGLE: one measurement taken with each press of button.

Arming: Ext. Arm Enable key allows rear panel input to determine Start and/or Stop point of a measurement. External gate defined by both Start and Stop armed. All measurements are armable except Manual Totalize, Phase, and Trigger Level.

Start arm: + or - slope of arm input signal starts measurement.

Stop arm: + or - slope of arm input signal stops measurement. When used, Start Arm must occur before Stop Arm.

Ext. arm input: rear panel BNC accepts TTL into 20 kΩ. Minimum Start To Stop Time: 200 ns.

Trigger level out: dc output into 1 MΩ via rear panel BNCs for Channel A and B; not adjusted for attenuators.

Accuracy at dc (X1): ±15 mV ±0.5% of TRIG LVL reading.

Gate out: TTL level into 50 Ω; goes low when gate open; rear panel BNC.

Range hold: freezes decimal point and exponent of display.

Reset: starts a new measurement cycle when pressed.

Check: performs internal self test and lamp test.

Display: 12-digit LED display in engineering format; exponent range of +18 to -18.

Operating temperature: 0 to 50°C.

Power requirements: 100, 120, 220, 240 VAC (+5%, -10%), 48-66 Hz; 130 VA max.

Weight: net, 8.8 kg (19 lb. 8 oz.). Shipping, 13.6 kg (30 lb.)

Dimensions: 425.5 mm W x 132.6 mm H x 345.4 mm D (16 3/4" x 5 1/4" x 13 1/2"), not including removable handles.

Options

Option 010: High Stability Time Base (oven)

Frequency: 10 MHz.

Aging rate: $< 5 \times 10^{-10}$ /day after 24 hour warm up.

Short term: $< 1 \times 10^{-10}$ rms for 1s average.

Temperature: $< 7 \times 10^{-9}$, 0 to 50°C.

Line voltage: $< 1 \times 10^{-10}$ for 10% change.

Warm-up: within 5×10^{-9} of final value in 20 minutes.

Option 020: DC Digital Voltmeter

Range: 4 digits, autoranging, autopolarity, in ±10, ±100, ±1000 V ranges.

Sensitivity: 100 μV, 1 mV, 10 mV, 100 mV for ±1 V, ±10 V, ±100 V, ±1000 V readings.

LSD displayed: same as sensitivity.

Input type: floating pair.

Input impedance: 10 MΩ ± 1%.

Option 030: 1.3 GHz C Channel

Input Characteristics

Range: 150 MHz to 1.3 GHz.

Sensitivity: 10 mV rms sinewave (-27 dBm) to 1 GHz. 100 mV rms sinewave (-7 dBm) to 1.3 GHz.

Frequency C

Range: 150 MHz to 1.3 GHz, prescaled by 20. LSD Displayed, Resolution, and Accuracy are same as Frequency A.

Ratio C/A

Range: channel A, 0 to 200 MHz.
channel C, 150 to 1300 MHz.

Option 040: Complete Systems Programmability

Adds remote selection of low pass filter, ac/dc coupling, X1-X10 attenuation, dc trigger level and input impedance for both Channel A and B.

Definitions

Duty cycle: percentage of time a signal is high or low, depending on Slope A setting. Trigger point is high/low dividing point.

$$\text{DUTY CY} = \frac{\text{PULSE}}{\text{PER}} \times 100\%.$$

Slew rate: effective slope between 10% and 90% points of rising or falling signal depending on Slope A setting.

$$\text{SLEW} = \frac{V_B - V_A}{T_I}$$

Phase: angle, with respect to B signal, between 50% points of channel A and B signals, trigger slopes selected by Channel A and B slope switches.

$$\text{PHASE} = (T_{I1} + T_{I2}) \div \left(\frac{2}{\text{PER}} \times 360^\circ \right)$$

T_{I1} is time between 50% points of A then B signals using slopes defined during Phase measurement.

T_{I2} is time between 50% points of A then B signals using complement slopes to T_{I1} .

Front handles: supplied with instrument.

Ordering Information

Option 010: Oven Oscillator

Option 020: DVM

Option 030: C Channel

Option 040: Expanded HP-IB Control

Option 908: Rack Flange Kit for use without handles

Option 913: Rack Flange Kit for use with supplied front handles

Price

add \$800

add \$550

add \$800

add \$750

add \$32

add \$35

5335A Universal Counter

\$3900

ELECTRONIC COUNTERS

100 MHz Universal Counters

Model 5328B

247



- 100 MHz and 1300 MHz
- 10 ns Time Interval
- T.I. Averaging to 10ps Resolution

- "Armed" Measurements
- DVM Option
- HP-IB Interface Standard

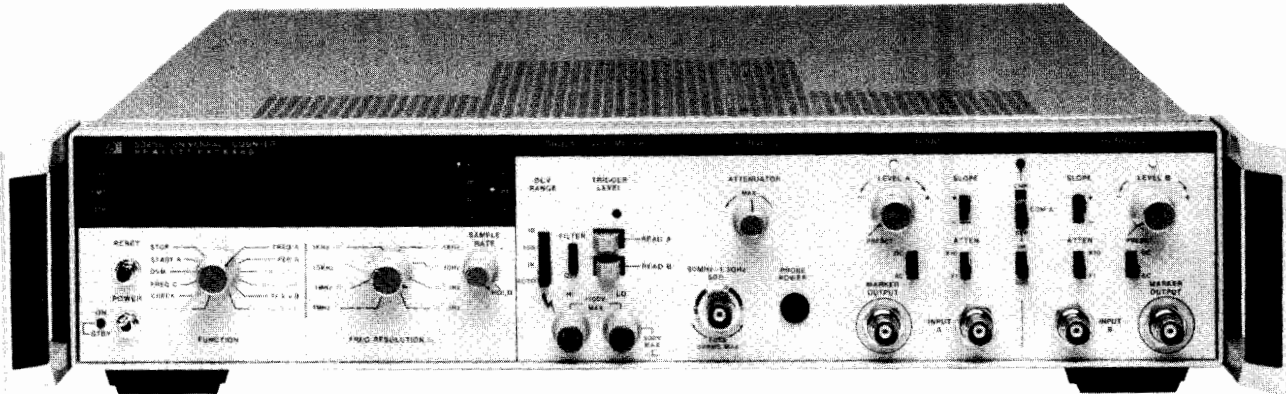

HP 5328B

Condensed Specifications

Input Characteristics

Sensitivity: 25 mV rms, to 40 MHz; 50 mV rms, 40 MHz-100 MHz.

Attenuators (nominal): X1, X10 switch selectable

Frequency A

Range: 0 to 100 MHz

Period A

Range: 100 ns to 10⁷s with resolution to 10 ns

Period Average A

Range: 100 ns to 10⁷s with resolution to 100 ps

Time Interval A → B

Range: 10 ns to 10⁷s with resolution to 10 ns

Time Interval Average A → B

Range: 0.1 ns to 1 s with resolution to 10 ps

Minimum Dead Time: 40 ns

Ratio B/A

Range: Channel A, 0 to 10 MHz; Channel B, 0 to 100 MHz

General

Display: 9 digit LED display, ninth digit used only with Channel C functions (FREQ. C, Ratio C/A).

Blanking: Suppresses leading zeros.

Storage: Holds reading between samples; can be overridden by rear panel switch.

Sample Rate: Variable from less than 2 ms between measurements to HOLD which holds display indefinitely.

Gate output: rear panel output: TTL levels.

Time base output: Rear panel output: TTL levels.

Check signal: Place function switch in FREQ A and universal module in CHECK (CHK). Counter should display 100 MHz ± 1 count.

Operating temperature: 0° to 50°C.

Power requirements: 100/120/220/240V rms, +5%, -10% (switch selectable), 48-66 Hz; 150 VA max.

Time Base Oscillators

Standard Crystal Oscillator

Frequency: 10 MHz

Ageing rate: < 3 x 10⁻⁷/month

Temperature: < 2.5 x 10⁻⁶, 0° to 50°C

Line voltage: < 1 x 10⁻⁷ for 10% change

Option 010: Oven Oscillator

Frequency: 10 MHz

Ageing rate: < 5 x 10⁻¹⁰/day after 24-hour warm-up

Short term: < 1 x 10⁻¹⁰ rms/s

Temperature: < 7 x 10⁻⁹, 0° to 50°C

Line voltage: < 5 x 10⁻⁹ for 10% variation

Warm-Up: Within 5 x 10⁻⁹ of final value in 20 minutes

Ext. freq. std. input: 30 kHz to 10 MHz signal of amplitude > 1.0V rms into 1 kΩ. Maximum input: 5V p-p. The external frequency

standard must be 10 MHz for Period Avg., T.I. Avg., Period (N=1), and T.I. (N=1).

Programmable functions: Functions, resolution, sample rate (maximum or manual control), arming, display modes, measurement modes, output mode, and reset commands. Trigger level, trigger slope, input impedance, coupling, separate/common/check, invert A and B, Trigger level is programmable in 10 mV steps in x1; 100 mV in x 10. Trigger level accuracy under remote control in x1: ± 35 mV.

HP-IB commands: responds to the following bus commands (see HP-IB Users Guides for definitions) - Unlisten, Untalk, Local Lock-out, Device Clear, Serial Poll Enable, Serial Poll Disable, Go to Local, Selected Device Clear, and Group Execute Trigger.

Service request (SRQ): if enabled, indicates end of measurement

Maximum data output rate: 500 readings/s

Option 021: High Performance Digital Voltmeter

Range: ± 10, ± 100, ± 1000 Vdc and Autorange

Sensitivity: 10 μV, 100 μV, 1 mV, 10 mV, 100 mV for measurement times of 10 s, 1 s 0.1 s, 10 ms, 1 ms respectively

Input type: floating pair

Impedance: 10 MΩ nominal

Maximum input: hi to low: ± 1100 V all ranges; low to chassis ground: ± 500 V

Trigger level measurements: 1 mV display resolution

Option 031: 1300 MHz C-Channel

Input Characteristics

Sensitivity: 20 mV rms sine wave (- 21 dBm)

Input protection: fused input

Maximum input: 5 Vrms, ± 5 Vdc

Frequency C

Range: 90 MHz to 1300 MHz, prescaled by 4 with resolution to 0.1 Hz.

Ratio C/A

Range: channel A, 0 to 10 MHz; channel C, 90 to 1300 MHz

Attenuation: continuously variable for optimum noise suppression

Options and Accessories

| Options and Accessories | Price |
|--|--------|
| 010: High Stability Time Base | \$ 800 |
| 021: High Performance DVM | \$ 800 |
| 031: 1300 MHz Channel C | \$ 900 |
| 050: DVM and Channel C | \$1700 |
| 908: Rack Flange Kit for use without front handles | \$ 30 |
| 913: Rack Flange Kit for use with supplied front handles | \$ 30 |
| HP 10855A Preamp | \$ 550 |
| HP 10856A Filter Kit | \$ 250 |
| HP 5363B Time Interval Probes | \$3800 |
| HP 5328B Universal Counter | \$4200 |
| Front handles: supplied with instrument | |



ELECTRONIC COUNTERS

Universal Counters

Models 5315A/B, 5316A

- Frequency, period, ratio, and totalize to 100 MHz
- Three versions: portable, rackable, or HP-IB
- 1 GHz capability available

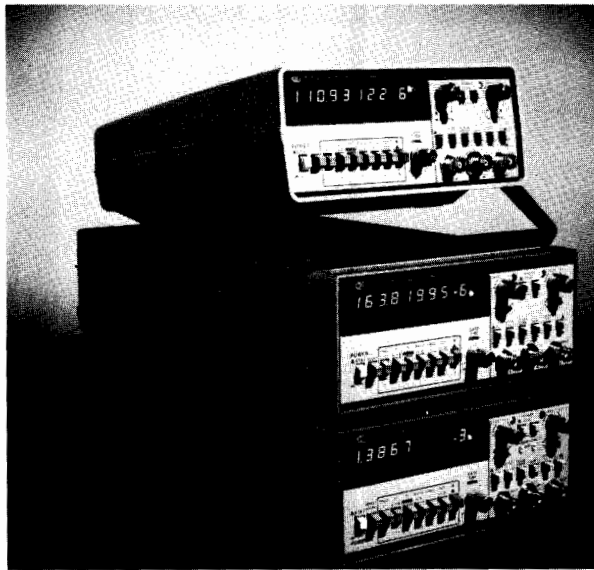

A Quiet Revolution in Capability . . .

HP's economical HP 5315A/B, and HP 5316A counters provide all the universal counter capability you've come to expect at much higher prices. That's because they use a unique custom circuit called the MRC (Multiple Register Counter) which packs counting and computing power into this popular counter series. To a user, the differences in operation from conventional direct models can be listed quickly: low frequency resolution is an outstanding 7 digits per second of gate time and reliability is extremely good due to the counter's low chip count. Also, the continuously adjustable gate time allows automatic selection of sample size for easy trade-offs between measurement time and resolution.

Much of the counter's performance is based on reciprocal counting techniques first pioneered in HP's high-performance HP 5360A computing counter, and the current HP 5345A Universal Counter. The use of these techniques coupled with HP's MRC and a microprocessor provides a quiet but powerful revolution in counter performance within the HP 5315A/B and HP 5316A. For example, this counter gives you its full 7-digits/second resolution over the range from 1 Hz to 100 MHz. This, simply stated, shows the power of the MRC and reciprocal counting.

High Performance, Low Price

In addition to its economy, the MRC counter offers a full set of universal counter measurements, and there are very few limitations to this capability. Increased accuracy in low-cost portable and system counters is also available with the oven oscillator option through improved temperature stability and lower aging rates.

Frequency to 100 MHz, C-Channel to 1.0 GHz

The MRC counter measures frequency to 100 MHz. Additionally the optional C-Channel measures to 1.0 GHz for both CW and pulsed RF signals as narrow as 60 ms. The C-Channel option is particularly useful in navigation and communications equipment testing due to this pulsed RF measurement feature.

- Uses reciprocal technique for full low-frequency resolution
- 100 ns time interval, 10 ps T.I. averaging
- Oven option for increased accuracy



HP 5316A

Time Interval to 100 ns, T.I. Averaging to 10 ps

The MRC counter provides three time measurement modes. Single-shot time interval allows measurements over a range of 100 ns to 100,000 seconds. This capability can be used to measure pulse width. Time interval averaging provides greater resolution for repetitive events. Finally, time interval delay avoids measurement of spurious signals by holding off the counter's trigger point by a precise, operator-selectable amount of time.

A Full Set of Measurements

Besides the frequency and time functions mentioned above, the MRC counter has other measurement functions that make it a truly impressive value:

Period A—allows single period measurements via Channel A.

Ratio A/B—allows frequencies to 100 MHz into both Channel A and B

A By B—totalizes the A input between 2 events on B channel

Totalize—a manually gated totalize mode of operation

Input Signal Conditioning Versatility

A full complement of input signal conditioning controls are provided for both channels. These include \pm slope, ± 2.5 Vdc trigger level, and ac/dc coupling. Other controls are a Separate/Common switch, and a 100 kHz low-pass filter for Channel A.

A Choice of Three Models

The MRC counter is available in three different versions: **HP 5315A**: a portable, light-weight unit best suited for field applications. This unit has a convenient carrying handle and optional battery power is available for up to 4 hours continuous operation. Despite its high impact plastic case, the HP 5315A possesses low RFI/EMC characteristics, making it equally suitable for bench use.



HP 5315B: a rackable, stackable counter that is designed to meet the most demanding RFI/EMC specs, the HP 5315B is intended primarily for rack mount use.

HP 5316A: this model possesses all the characteristics of both the HP 5315A and HP 5315B, and it has HP-IB capability built-in as standard equipment. It has low RFI, it is rackable, and it is functionally identical to the HP 5315A/B. In addition to programmable measurement functions, the user can also select dc trigger level and \pm slope under HP-IB control. Channel A and B trigger levels are brought out to the front panel on this unit for easy measurement with a DVM.

HP 5315A/B 5316A Condensed Specifications

Input Characteristics (channel A and channel B)

Range: dc coupled 0 to 100 MHz.

ac coupled 30 Hz to 100 MHz.

Sensitivity: 10 mV rms sine wave to 10 MHz.

25 mV rms sine wave to 100 MHz.

75 mV peak-to-peak pulse at minimum pulse width of 5 ns.

Sensitivity can be varied continuously up to 500 mV rms *NOMINALLY* by adjusting sensitivity control. In sensitivity mode, trigger level is automatically set to 0 V *NOMINAL*.

Dynamic Range

30 mV to 5 V peak-to-peak, 0 to 10 MHz.

75 mV to 5 V peak-to-peak, 10 to 100 MHz.

Coupling: ac or dc, switchable.

Filter: low pass, switchable in or out of Channel A. 3 dB point of 100 kHz *NOMINALLY*.

Impedance: 1 M Ω *NOMINAL* shunted by less than 40 pF.

Signal operating range: +2.5 Vdc to -2.5 Vdc.

Attenuator: X1 or X20 *NOMINAL*.

Trigger level: variable between +2.5 Vdc and -2.5 Vdc.

Slope: independent selection of + or - slope.

Common input: all specifications are the same for Common A except the following:

Sensitivity: 10 mV rms sine wave to 10 MHz; 25 mV rms sine wave to 50 MHz; 50 mV rms to 100 MHz; 150 mV peak-to-peak at a minimum pulse width of 5 ns.

Dynamic range: 30 mV to 5 V peak-to-peak to 10 MHz; 75 mV to 5 V peak-to-peak, 10-50 MHz; 150 mV to 5V peak-to-peak, 50-100 MHz.

Impedance: 500 k Ω *NOMINAL* shunted by less than 70 pF.

Damage Level

ac & dc \times 1:

dc to 2.4 kHz

250 V (dc + ac rms)

2.4 kHz to 100 kHz

6×10^5 V rms Hz/FREQ

>100 kHz

6 V rms

ac & dc \times 20:

dc to 28 kHz

500 V (dc + ac peak)

28 kHz to 100 kHz

1×10^7 V rms Hz/FREQ

>100 kHz

100 V rms

Frequency (channel A)

Range: .1 Hz to 100 MHz.

LSD displayed: 10 Hz to 1 n Hz depending upon gate time and input signal. At least 7 digits displayed per second of gate time.

Period

Range: 10 ns to 10^5 s.

LSD displayed: 100 ns to 1 fs depending upon gate time and input signal. At least 7 digits displayed per second of gate time.

Time Interval

Range: 100 ns to 10^5 s.

LSD displayed: 100 ns.

Time Interval Average

Range: 0 ns to 10^5 s.

LSD displayed: 100 ns to 10 ps depending upon gate time and input signal.

Number of intervals averaged (N): $N = \text{Gate Time} \times \text{FREQ.}$

Minimum dead time (stop to start): 200 ns.

Time Interval Delay (holdoff)

Front panel gate time knob inserts a variable delay of *NOMINALLY* 500 μ s to 30 ms between START (Channel A) and enabling of STOP (Channel B). Electrical inputs during delay time are ignored. Delay time may be digitally measured by simultaneously pressing T.I. Averaging, T.I. Delay and blue key.

Ratio

Range: 0.1 Hz to 100 MHz, both channels

LSD: $\frac{2.5 \times \text{Period A}}{\text{Gate Time}} \times \text{Ratio}$. (rounded to nearest decade)

Totalize

Manual

Range: 0 to 100 MHz.

A gated by B

Totalizes input A between two events of B. Instrument must be reset to make new measurement. Gate opens on A slope, closes on B slope.

Range: 0 to 100 MHz.

General

Standard Time Base

Frequency: 10 MHz

Aging rate: $< 3 \times 10^{-7}$ /mo.

Temperature: $\pm 5 \times 10^{-6}$, 0° to 50°C

Line voltage: $< 1 \times 10^{-7}$ for a $\pm 10\%$ variation.

Check: counts internal 10 MHz reference frequency over gate time range *NOMINALLY* 500 μ s to 30 ms.

Error light: LED warning light activated if logic error is found during instrument turn-on self-check.

Display: 8 digit LED display, with engineering units annunciator.

Overflow: only frequency and totalize measurements will overflow. In case of overflow, eight least significant digits will be displayed and front panel overflow LED will be actuated. All other measurements which would theoretically cause a display of more than 8 digits will result in the display of the 8 most significant digits.

Gate time: continuously variable, *NOMINALLY* from 60 ms to 10 s or 1 period of the input, whichever is longer.

Sample rate: up to 7 readings per second *NOMINAL* except in time interval mode, where it is continuously variable *NOMINALLY* from 250 ms to 10 s via Gate Time Control.

Operating temperature: 0° to 50°C.

Power requirements: 100, 120, 220, 240 V (+5%, -10%) 48-66 Hz; 15 VA maximum or 30 VA maximum (HP 5316A).

Weight: net, 2.2 kg (4 lbs. 12 oz.). Shipping, 4.1 kg (9 lbs).

Dimensions: 238 mm W x 98 mm H x 276 mm D (9 $\frac{3}{8}$ " x 3 $\frac{3}{4}$ " x 10 $\frac{7}{8}$ ").

Additional HP 5315B Specifications

Rack and stack metal case with rear panel, switchable AC power line module. Specifications same as HP 5315A except as follows:

Rack mount: HP 5061-0072 recommended.

Oscillator output: 10 MHz, 50 mV pk-pk into 50 Ω load, on rear panel.

External frequency standard input: 10 MHz, 1 V RMS into 500 Ω , on rear panel.

Dimensions: 212 mm W x 88 mm H x 345 mm D (8 $\frac{3}{8}$ " x 3 $\frac{1}{2}$ " x 13 $\frac{3}{4}$ ").

Weight: net, 3.2 kg (7 lbs. 2 oz.). Shipping, 4.5 kg (10 lbs.).



ELECTRONIC COUNTERS

Universal Counters

Models 5315A/B, 5316A (cont.)

Additional HP 5316A Specifications

Rack and stack metal case with rear panel, switchable ac power line module, Specifications same as HP 5315A except as follows:

Rack mount kit: HP 5061-0072 recommended.

Oscillator output: 10 MHz, 50 mV p-p into 50 Ω load on rear panel.
External frequency standard input: 1, 5, 10 MHz, 1 V rms into 500 Ω , or rear panel.

Trigger level output: $\pm 5\%$, ± 15 mV, over ± 2.0 VDC range at front panel connectors.

Dimensions: 212 mm W x 88 mm H x 415 mm D (8 3/8 x 3 1/2 x 16 1/2")

Weight: net, 3.9kg (8 lbs. 10 oz.). Shipping, 6.3kg (14 lbs.)

Hewlett-Packard Interface Bus

Programmable functions: Frequency A, Frequency A Armed by B, Totalize, A Gated by B, Ratio A/B, Time Interval Average A \rightarrow B, Time Int. Delay, Read Gate Time, Display Test, 10 MHz Check, Interface Test, Initialize, Reset, Wait State ON/OFF.

Programmable controls: Gate Time Command which sets long (60 ms to 10 s) or short (500 μ s to 30 ms) range; Trigger Level Commands which set Channel A and/or B slope (\pm) and Channel A and/or B trigger from -2.50 Vdc to $+2.50$ Vdc in steps of .01V.

Interface functions: Group Execute Trigger, Device Clear, Selected Device Clear, Interface Clear, Local, Remote, Local Lockout, Read Status (serial poll enable), Request Service.

Options

Opt. 001: High Stability Time Base (TCXO)

Frequency: 10 MHz.

Aging rate: $< 1 \times 10^{-7}$ /mo.

Temperature: $\pm 1 \times 10^{-6}$, 0° to 40°C.

Line voltage: $< 1 \times 10^{-8}$ for $\pm 10\%$ variation.

Opt. 002: battery (HP 5315A only)

Type: rechargeable lead-acid (sealed).

Capacity: TYPICALLY 4 hours of continuous operation at 25 °C.
Recharging time: TYPICALLY 16 hours to 98% of full charge, instrument non-operating. Charging circuitry included with Option. Batteries not charged during instrument operation.

Low voltage indicator: instrument turns itself off automatically when low battery condition exists. *Discharge* LED flashes slowly when this happens. *Discharge* LED is on whenever battery is supplying power to instrument. *Charge* LED indicates state of charge of battery during charging only and is on whenever battery is charged to 95% *NOMINAL* of capacity. *Charge* LED flashes when 90% *NOMINAL* of charge taken out is replaced. *Charge* LED is off if charge is less than 70% *NOMINAL* of capacity.

Line failure protection: instrument automatically switches to battery in case of line failure.

Weight: Opt. 002 adds 1.4 Kg (3 lbs.) to weight of instrument.

Option 003: C Channel

Input Characteristics

Range: 50 to 1000 MHz, prescaled by 10.

Sensitivity: 15 mV rms sinewave (-23.5 dBm) to 650 MHz. 75 mV rms sinewave (-9.5 dBm) to 1000 MHz.

Sensitivity can be decreased continuously by up to 20 dB *NOMINAL*, 50 to 500 MHz and 10 dB *NOMINAL*, 500 to 1000 MHz by adjusting sensitivity control. Trigger level is fixed at 0 V *NOMINAL*.

Dynamic range: 15 mV to 1 V rms (36 dB), 50 to 650 MHz. 75 mV to 1 V rms (20 dB), 650 to 1000 MHz.

Signal operating range: $+5$ V dc to -5 V dc.

Coupling: ac

Impedance: 50 Ω *NOMINAL* (VSWR, $< 2.5:1$ TYPICAL).

Damage level: ± 8 V (dc + ac peak), fuse protected. Fuse located in BNC connector.

Frequency (channel C) Range: 50 to 1000 MHz.

LSD displayed: 100 Hz to 1 Hz depending upon gate time. At least 7 digits per second of gate time.

Option 004: High Stability OVEN Time Base (HP 5315A only)

Frequency: 10 MHz

Aging rate: $< 3 \times 10^{-8}$ /mo*

Temperature: $\pm 1 \times 10^{-7}$, 0° to 50°C.

Line voltage: $< 1 \times 10^{-8}$, for a 10% variation.

Oven will operate continuously off of a fully charged battery for > 24 hours, typically, when in standby mode (no power applied, instrument OFF, and Freq. A button depressed).

(HP 5315B and HP 5316A)

Frequency: 10 MHz

Aging rate: $< 3 \times 10^{-8}$ /mo.**

Temperature: $\pm 2 \times 10^{-8}$, 0° to 50°C

Line voltage: $< 1 \times 10^{-9}$, for a 10% variation.

Ordering Information

| | HP 5315A | HP 5315B | HP 5316A | Price |
|---|----------|----------|----------|-----------|
| Option 001 TCXO Time Base | X | X | X | Add \$150 |
| Option 002 Battery Pack | X | | | Add \$300 |
| Option 003 C-Channel (1.0 GHz) | X | X | X | Add \$300 |
| Option 004 High Stability OVEN Time Base | X | | | Add \$460 |
| | | X | X | Add \$605 |

All HP 5315A orders must include one (1) of these line power options:

Option 100: 90-105 VAC

Option 120: 108-126 VAC

Option 220: 198-231 VAC

Option 240: 216-252 VAC

Price

N/C

N/C

N/C

N/C

HP 5315A Universal Counter

\$1100

HP 5315B Universal Counter

\$1400

HP 5316A Universal Counter

\$1900

* After 30 days continuous operation (ac power applied, in OFF or ON position).

** After 30 days continuous operation.

$< 5 \times 10^{-9}$ /mo., after 7 days continuous operation.

ELECTRONIC COUNTERS

Low Cost Universal

Model 5314A

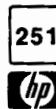

- 100 MHz
- 100 ns time interval
- Portable

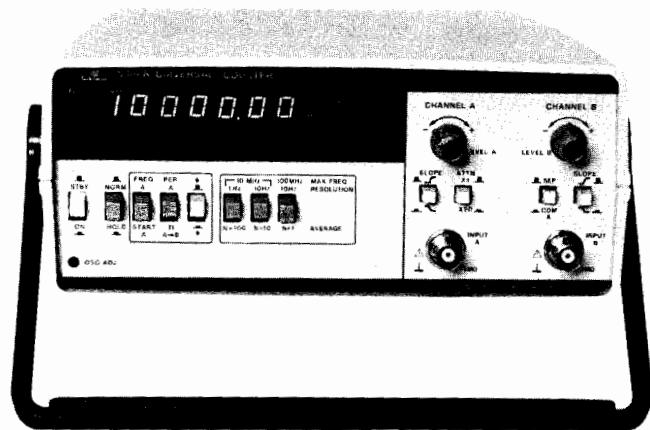

HP 5314A

The HP 5314A Universal Counter combines excellent performance and traditional HP quality at a very attractive price. This counter is designed to deliver reliable, high quality operation in such areas as: Production Test, Frequency Monitoring, Education, Training, Service and Calibration. Additionally, the optional battery (option 002) makes the HP 5314A especially attractive for field and portable applications.

Input Characteristics (channels A and B)

Range: CHANNEL A: 10 Hz to 10 MHz Direct.

1 MHz to 100 MHz Prescaled.

CHANNEL B: 10 Hz to 2.5 MHz.

Sensitivity: CHANNEL A: 25 mV rms to 100 MHz.

75 mV peak-to-peak at minimum pulse width of 5 ns (100 MHz range).

CHANNEL B: 25 mV rms to 2.5 MHz.

75 mV peak-to-peak at minimum pulse width of 200 ns.

Coupling: ac

Impedance: 1 MΩ NOMINAL shunted by less than 30 pF.

Attenuator: X1 or X20 NOMINAL (A channel only).

Trigger level: continuously variable \pm 350 mV times attenuator setting around average value of signal.

Slope: independent selection of + or - slope.

Channel input: selectable SEPARATE OR COMMON A.

Dynamic range: 75 mV p-p to 4 V p-p.

Frequency

Range: 10 Hz to 10 MHz direct count.

1 MHz to 100 MHz prescaled by 10.

Least significant digit (LSD) displayed: direct count 0.1 Hz, 1 Hz, 10 Hz switch selectable. Prescaled 10 Hz, 100 Hz, 1 kHz switch selectable.

Resolution: \pm LSD.

Accuracy: \pm LSD \pm (time base error) x Freq.

Period

Range: 10 Hz to 2.5 MHz.

LSD displayed: $\frac{100 \text{ ns}}{N}$ for N=1 to 1000 in decade steps of N.

Resolution: \pm LSD $\pm \frac{(1.4x \text{ TRIGGER ERROR})}{N}$

Accuracy: \pm LSD $\pm \frac{(1.4x \text{ TRIGGER ERROR})}{N}$

\pm (time base error) x Period.

Time Interval

Range: 250 ns to 1 s.

LSD displayed: 100 ns.

Resolution: \pm LSD \pm START trigger error \pm STOP trigger error.

Accuracy: \pm LSD \pm START trigger error \pm STOP trigger error \pm (time base error) x TI.

External arming required for START/STOP channels.

Ratio (A to B)

Range: 10 Hz to 10 MHz CHANNEL A.

10 Hz to 2.5 MHz CHANNEL B.

LSD displayed: 1/N in decade steps of N for N = 1 to 1000.

Resolution: \pm LSD \pm (B trigger error x Frequency A)/N.

Accuracy: \pm LSD \pm (B trigger error x Frequency A)/N.

Totalize

Range: 10 Hz to 10 MHz.

Resolution: \pm 1 count of input.

Totalize controlled by front panel switch.

General

Check: counts internal 10 MHz oscillator.

Display: 7 digit amber LED display with gate and overflow indication.

Max sample rate: 5 readings per second.

Operating temperature: 0° to 50 °C.

Power requirement: 115, +10%, -25%; 230 V, +9%, -17%; 48-66 Hz; 10 VA max.

Weight: 2.0 kg (4.4 lb.).

Dimension: 238 mm W x 98 mm H x 276 mm D (9 $\frac{3}{8}$ " x 3 $\frac{7}{8}$ " x 10 $\frac{7}{8}$ ").

Time Base

Frequency: 10 MHz.

Aging rate: < 3 parts in 10⁷ per month.

Temperature: < \pm 1 part in 10⁵, 0 to 50°C.

Line voltage: < \pm 1 part in 10⁷ for \pm 10% variation.

Options

Option 001 TCXO

Frequency: 10 MHz.

Aging rate: < 1 part in 10⁷ per month.

Temperature: < \pm 1 part in 10⁶, 0 to 40°C.

Line voltage: < \pm 1 part in 10⁸ for \pm 10% variation.

Option 002 Battery

Type: rechargeable lead-acid (sealed).

Capacity: typically 8 hours of continuous operation at 25 °C.

Recharging time: typically 16 hours to 98% of full charge, instrument non-operating. Charging circuitry included with option. Batteries not charged during instrument operation.

Battery voltage sensor: automatically shuts instrument off when low battery condition exists.

Line failure protection: instrument automatically switches to batteries in case of line failure.

Weight: option 002 adds typically 1.5 kg (3.3 lb.) to weight of instrument.

Definitions

Resolution: smallest discernible change of measurement result due to a minimum change in the input.

Accuracy: deviation from the actual value as fixed by universally accepted standards of frequency and time.

Trigger error:

$$\frac{\sqrt{(80\mu\text{V})^2 + e_n^2}}{\text{input slew rate at trigger point } (\mu\text{V/s})} \text{ (rms)}$$

Where e_n is the RMS noise of the input for a 100 MHz bandwidth in CHANNEL A and 10 MHz bandwidth in CHANNEL B.

Options

001 High Stability Time Base

Price

add \$150

002 Battery

add \$150

All orders must include one (1) of these line power options:

115: 86-127 V

N/C

230: 190-250 V

N/C

HP 5314A 100 MHz/100 ns Universal Counter \$550



FREQUENCY & TIME STANDARDS

General Information

Hewlett-Packard offers frequency standards and clocks which provide accurate frequency, time interval and timekeeping capabilities. Further, Hewlett-Packard standards provide means for comparing these quantities against national standards such as the National Bureau of Standards (NBS) and the U.S. Naval Observatory. Units of frequency or time cannot be kept in a vault for ready reference. They must be generated for each use, hence be regularly compared against recognized primary standards.

Frequency standards and clock systems manufactured by Hewlett-Packard are used for control and calibration at observatories, national centers for measurement standards, physical research laboratories, missile and satellite tracking stations, communication systems, radio navigation systems, manufacturing plants and radio monitoring and transmitting stations.

Types of Frequency Standards

At the present time, three types of frequency standards are in common use. These are:

1. The cesium atomic beam controlled oscillator.
2. The rubidium gas cell controlled oscillator, and
3. The quartz crystal oscillator.

Hewlett-Packard manufactures all three types of frequency standards. Of these three standards, the first is a primary frequency standard and the last two are secondary frequency standards. The distinction between a primary standard and a secondary standard is that the primary standard does not require any other reference for calibration; whereas the secondary standard requires calibrations both during manufacturing and at intervals during use depending on the accuracy desired.

Cesium Beam Frequency Standard

Cesium beam standards are in use wherever the goal is a very high accuracy primary frequency standard. In fact, the NBS frequency standard itself is of the cesium beam type. The cesium beam standard is an atomic resonance device which provides access to one of nature's invariant frequencies in accord with the principles of quantum mechanics. The cesium standard is a true primary standard and requires no other reference for calibration.

Rubidium Frequency Standard

Rubidium frequency standards feature a high order of both short-term and long-term frequency stability. These are both important in certain fields such as deep-space communications, satellite ranging, and doppler radar.

Rubidium standards are similar to cesium beam standards in that an atomic resonant element prevents drift of a quartz oscillator through a frequency lock-loop. Yet the rubidium gas cell is dependent upon gas mixture and gas pressure in the cell. It must be calibrated and then it is subject to a small degree of drift. The drift is typically 100 times less than the best quartz crystal standard.

TABLE 1 Comparison of Frequency Standards

| Standard | Principal construction feature | Principal advantage |
|---|---|---|
| Cesium Atomic Beam Resonator Controlled Oscillator. | Beam of free cesium atoms, spatially state selected, is subjected to a microwave signal at resonance frequency. | High intrinsic reproducibility and long-term stability. Designated as primary standard for definition of time interval. |
| Rubidium Gas Cell Resonator Controlled Oscillator. | Gas buffered resonance cell with optically pumped state selection. | Compact and light weight. High degree of short-term stability. |
| Quartz Crystal Oscillator. | Piezoelectrically active quartz crystal with electronic stabilization. | Very compact, light and rugged. Inexpensive. |

Quartz Crystal Oscillators

Quartz oscillators are used in virtually every frequency control application including atomic standards. The excellent short-term stability and spectral purity of the quartz oscillators used in Hewlett-Packard atomic standards contribute to the high quality of the output signal of these standards. For less demanding applications where some long-term drift can be tolerated, quartz oscillators are used as independent frequency sources.

Frequency Standards and Clocks

Frequency standards and clocks have no fundamental differences—they are based upon dual aspects of the same phenomenon. Time and frequency are intangible quantities which can be measured only with respect to some physical quantity. The basic unit of time, the second, is defined as the duration of 9,192,631,770 periods of transition within the cesium atom. Conversely an unknown frequency is determined by counting the number of cycles over the period of a second. The Master Clock at the U.S. Naval Observatory, one of the world's most accurate clocks, is made of an ensemble of more than a dozen Hewlett-Packard cesium beam frequency standards. The USNO directly controls the distribution of precise time and time interval (frequency) from Naval radio stations, Loran-C (operated by U.S. Coast Guard), Omega and Satellite Navigation Systems. Hewlett-Packard portable cesium standards, "flying clocks," are used to periodically check the synchronization between these stations and the Master Clock.

Hewlett-Packard cesium beam standards are widely used to drive precision clocks because of the extremely good long-term stability and reliability of this primary standard. If a quartz oscillator or other secondary standard is used, it must be evaluated for rate of drift and be corrected periodically.

Time Scale

The time interval of the atomic time scale is the International Second, defined in October 1967 by the Thirteenth General Conference of Weights and Measures. Since January 1972 the frequency offset between UTC and Atomic Time has been zero and the UTC time scale is kept in synchronism with the rotation of the earth to within ± 0.9 second by step-time adjustments of exactly 1 second, when needed (see Hewlett-Packard Application Note 52-2).

The U.S. National Bureau of Standards (NBS) and USNO provide the official basis for Standard Time for the United States. The UTC signal is broadcast from the NBS stations WWV and WWVB and by several other stations throughout the world. (See Hewlett-Packard Application Note 52-1, Fundamentals of Time and Frequency Standards, for a list of stations broadcasting time signals).

Standby Power Supplies

Minimum down-time, important for any system, is vital to a time standard. Its worth depends directly on continuity of operation. Noninterrupted operation is also important to ultra-precise quartz oscillators.

Hewlett-Packard standby power supplies ensure continued operation despite line interruptions, and operate over a range of ac line voltage to supply regulated dc to operate frequency standards and frequency dividers and clocks. The batteries in the supplies assume the full load immediately when ac power fails.

Hewlett-Packard Time and Frequency Standard

The Hewlett-Packard House Standard at the Santa Clara Division consists of an ensemble of five Hewlett-Packard Cesium Beam Standards each with the Option 004 High Performance Tube.

The standard is compared to the U.S. Naval Observatory Master Clock in Washington, D.C. by means of Loran C and TV Line 10 measurements through the USAS-TRATCOM satellite system. It is also compared with the U.S. National Bureau of Standards Frequency Standard (NBS FS) at Boulder, Colorado by means of Loran-C through the Naval Observatory. The frequency uncertainty of the standard is within a few parts in 10^{13} with respect to the standards maintained by the NBS and the USNO.

Time is maintained relative to the Naval Observatory and the National Bureau of Standards master clocks to an accuracy of better than ± 1.0 microseconds. This accuracy is verified with flying clock trips from the Naval Observatory to both Hewlett-Packard Santa Clara Division and Hewlett-Packard Geneva. Both locations have been designated U.S. Naval Observatory Time Reference Stations.

FREQUENCY & TIME STANDARDS

Atomic Frequency Standards

Models 5061A, 5065A

253



HP 5061A

- Improved accuracy $\pm 6 \times 10^{-12}$
- Primary standard
- Proven reliability

HP 5061A, Opt 004

- Accuracy $\pm 4 \times 10^{-12}$
- Settability $\pm 1 \times 10^{-13}$
- Time domain stability 5×10^{-12} (1 s avg)

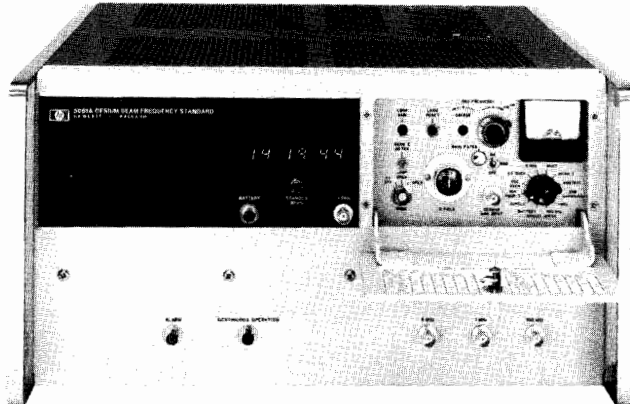

HP 5061A

HP 5061A Cesium Beam Standard

The first Hewlett-Packard Cesium Beam Standard, the HP 5060A, was introduced in 1964. This was followed in 1967 with the improved HP 5061A and in 1973 with the high performance beam tube option for the HP 5061A. Since this time the accuracy and reliability of Hewlett-Packard cesium beam standards has been demonstrated and these standards have become the world-wide standard for frequency and time keeping. The HP 5061A has provision for an optional digital divider and reliable, easy-to-read LED clock (Option 001) and for a battery with 1/2 hour standby power capacity with automatic charging (Option 002).

Reliability and warranty: over 60 million operation hours have proven the performance and reliability of Hewlett-Packard cesium beam standards in various world-wide applications. The units have provided dependable microsecond accuracy in aircraft, ship and fixed environments.

A three-year warranty on the HP 5061A standard cesium beam tube is provided as a result of proven field reliability over an extended period. This warranty includes replacement of the cesium beam tube if it should fail within the warranty period. Typically, beam tube life is longer than five years.

HP 5061A with Opt 004, High Performance Cesium Beam Tube

The Hewlett-Packard 5061A primary frequency standard with the Option 004 Cesium Beam Tube offers increased stability and accuracy in the instrument which has become the worldwide standard of frequency and time keeping since its introduction in 1967. Improvements in magnetic shielding, ruggedization and environmental performance permit improved performance and expansion of navigation and communication systems that have been made practical by the HP 5061A.

The design concept of the high performance beam tube includes unique HP designed dual beam optics with higher beam intensity to accomplish better short term stability and greater immunity to effects of shock and vibration. A 50 percent increase in resonance cavity length without change in the overall beam tube size contributes to better accuracy and settability because of the high Q of the narrower resonant line width. This tube retains the unique cesium standard feature of virtually no long term instability or aging.

The intrinsic accuracy is improved to $\pm 4 \times 10^{-12}$ which provides an excellent reference standard without need of calibration. If desired, as in many timekeeping applications, two or more units may be calibrated to determine the difference in rate or may be adjusted to the same frequency. With the improved settability specifications of 1×10^{-13} small changes in frequency are accomplished rapidly and accurately. A provision for degaussing the tube without adversely affecting the instrument operation allows removal of any residual magnetic field in the tube. This is important in achieving the settability performance.

The short term stability specification is improved by a factor of ten with this tube. The 5×10^{-12} (1 s avg.) performance compares very favorably with that of rubidium type standards which are noted for their excellent short term stability. An important advantage from the better short term stability is the capability to make measurements to 1 sigma precision of 1×10^{-12} in about one minute compared to the two hours required previously. The HP 5061A with the Option 004 High Performance Tube has the same high reliability as the HP 5061A with the standard tube. The new high performance tube is warranted for one year, but is designed to have the same long life as the standard tube.

HP 10638A Degausser

The HP 10638A Degausser is designed for use with the Option 004 High Performance Beam Tube to achieve settability of $\pm 1 \times 10^{-13}$ and reproducibility of $\pm 3 \times 10^{-12}$. The degausser removes residual magnetic fields in the beam tube which slowly decay and cause a small frequency change. The degausser should be used when initially setting up the HP 5061A with Option 004 or after the instrument has been moved or adjusted.

HP K34-59991A Broadband Linear Phase Comparator

The HP K34-59991A accurately compares the phase relationship of the output signals of two frequency standards having the same nominal frequency between 100kHz and 10MHz. The comparator output signal is suitable for driving a stripchart recorder, thus allowing long-term monitoring of the frequency standards' output differences. By using this comparator, very small frequency differences can be detected and adjustments can be made to the frequency standards to correct for timekeeping errors.

HP E21-5061A Flying Clock

The HP E21-5061A consists of a HP 5061A Cesium Beam Standard with Option 001 LED Clock and HP 5089A Power Supply joined together to make one portable unit. The power supply, which can be operated from 11 to 30 V dc, 85 to 255 V ac, will provide approximately 7 hours standby power (from sealed immobilized electrolyte lead calcium batteries) for the HP 5061A Cesium Beam Standard.

This wide range of operating power capabilities enable the HP E21-5061A to operate on local power in virtually any country in the world. The seven hours standby capability make it possible to travel where there is no power available and, of course, allow the HP E21-5061A to conveniently be transported between power sources and operated in almost any air or surface vehicle as a "flying clock" (see Hewlett-Packard Journal, August 1966 and December 1967).

The Option 004 tube, because of the improved shielding, offers a significant increase in accuracy under the varying earth's magnetic field conditions experienced by flying clocks and is a desirable addition to the HP E21-5061A. In addition, the better short term stability permits more accurate and rapid comparison of standards. The Option 002 Battery may also be added to increase standby capability.

FREQUENCY & TIME STANDARDS

Atomic Frequency Standards

Models 5061A, 5065A (cont.)

- Compact, high reliability, proven performance
- Long term drift rate $< 1 \times 10^{-11}$ /month
- Time domain stability $< 5 \times 10^{-13}$ (100 s, avg)

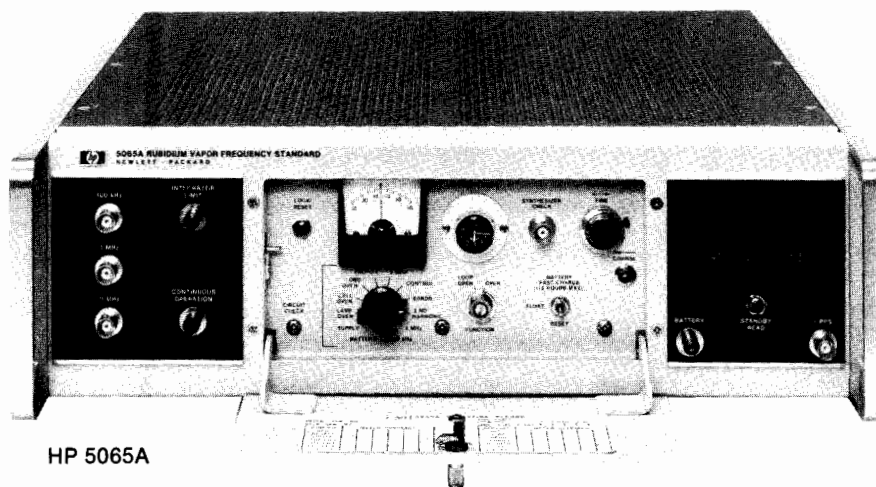

HP 5065A

HP 5065A Rubidium Frequency Standard

The HP 5065A is an atomic-type secondary frequency standard which uses a rubidium vapor resonance cell as the stabilizing element. As a result, it has long-term stability of better than 1×10^{-11} per month which exceeds that of high quality quartz oscillator frequency standards by 50 to 100 times. Furthermore, it has excellent short-term stability. These features contribute to its desirability as a coherent signal source, as a master oscillator for radio and radar systems where special requirements for stability and/or narrow bandwidth must be met, as a precision time keeper where the better performance of a cesium beam primary standard is not required, and as a house frequency standard for improved accuracy with fewer NBS calibrations compared to that required with quartz standards.

Front panel controls and circuit check meter of the HP 5065A are protected by a panel door. The magnetic field control provides fine frequency adjustment with which the frequency can be set to a precision of better than 2×10^{-12} without reference to a chart. The low noise quartz oscillator is phase-locked to the atomic frequency and provides the standard 5 MHz, 1 MHz, and 100 kHz outputs. The circuit check meter with selector switch monitors key voltages and currents for routine maintenance readings, calibration procedures, and fault finding.

The HP 5065A is designed for assured operation—to give the user confidence that the standard output signals are correct and locked to the atomic frequency. Logic within the unit maintains power to a “continuous” operation light on the front panel. If operation is interrupted, even momentarily, for any reason the light goes out and stays out until manually reset. An integrator limit light warns when the frequency correcting servo loop is approaching the limit of its dynamic range.

The HP 5065A is contained in a small-size package and is lightweight in comparison to a cesium beam standard. Additionally the rubidium resonance cell is much more frequency stable than quartz oscillators while subjected to shock and vibration, EMC, humidity, and magnetic field effects.

Reliability and warranty: the most significant module in the HP 5065A in terms of performance is the Rubidium Vapor Frequency Reference (RVFR). This temperature controlled, magnetically shielded unit includes the Rb gas cell and a photo sensitive detector

designed for maximum possible reliability. Field experience, including several million hours of operation, have demonstrated this reliability and the RVFR is now warranted for a period of three years. This increased warranty protects the owner in the event of random failure.

The Option 001 Digital Clock has an easy to read LED time-of-day display. The olive black upper panel provides a dark background around the readout for excellent contrast and readability. Initial clock setting is accomplished by means of pushbuttons easily accessible by removing the top cover. The LED display offers high reliability, freedom from errors due to mechanical shock, and performance over the full environmental range of the HP 5065A. A sync button on the digital divider permits automatic synchronization of this 1 PPS pulse to an external pulse. The clock 1 PPS is adjustable in decade steps from 1 μ s to 1 s, with respect to the synchronized reference, with 6 thumbwheel switches. A screwdriver adjustment allows fine continuous adjustment over a range of 1 μ s.

To conserve battery power, the display is not illuminated when ac power is not available. A STANDBY READ pushbutton below the display is used for readout when operating on the internal battery or external dc.

The Option 002 Standby Battery provides the HP 5065A with a minimum of 10 minutes standby power at 25°C. Switchover from line to battery is automatic so there is no interruption of operation if ac line power should fail. A front panel ac interruption light warns when ac power has failed or has been disconnected. Fast or float charging rates may be selected when ac power is available.

The Option 003 combines the Option 001 Clock and Option 002 Battery and should be specified if both Options 001 and 002 are required.

HP E21- 5065A Portable Time Standard

HP E21- 5065A Portable Time Standard is a complete system for precision timekeeping and for transporting time from one location to another. It consists of the HP 5065A Rubidium Standard with digital clock and divider (Option 001) and the HP 5089A Power Supply with 6 or more hours standby capability. The component units are held together by side bars, and the interconnecting cables are protected by a back cover.



Specifications

| Instrument: | HP 5061A Option 004 | | HP 5061A | | HP 5065A |
|--|---|---|--|---|--|
| Type of Standard: | Cesium | | Cesium | | Rubidium |
| Accuracy: maintained in magnetic field to 2 gauss and over temperature range of: | $\pm 7 \times 10^{-12}$ 0 to 50°C | $\pm 4 \times 10^{-12}$ $\pm 2.5^\circ\text{C}$ in range of 15 to 35°C | $\pm 1 \times 10^{-11}$ 0 to 50°C | $\pm 6 \times 10^{-12}$ $\pm 2.5^\circ\text{C}$ in range of 15 to 35°C | |
| Stability: | | | | | |
| Long Term: | $\pm 3 \times 10^{-12(1)}$ | | $\pm 5 \times 10^{-12(1)}$ | | $\pm 1 \times 10^{-11}/\text{month}$ |
| Short Term 5 MHz ⁽²⁾ : | Averaging time: 0.01 | | Averaging time: 0.01 | | Averaging time: 0.01 |
| | 1 | | 1.5 x 10 ⁻¹⁰ | | 1.5 x 10 ⁻¹⁰ |
| | 10 | | 5 x 10 ⁻¹⁰ | | 5 x 10 ⁻¹⁰ |
| | 100 | | 2.5 x 10 ⁻¹¹ | | 1.6 x 10 ⁻¹² |
| | 8.5 x 10 ⁻¹³ | | 8 x 10 ⁻¹² | | 5 x 10 ⁻¹³ |
| SSB Phase Noise Signal (1 Hz BW) Offset from signal: | Hz: 10 ⁻³ | -28 dB | -8 dB | -25 dB | |
| | 10 ⁻² | -48 dB | -28 dB | -52 dB | |
| | 10 ⁻¹ | -68 dB | -48 dB | -72 dB | |
| | 0 | -96 dB | -82 dB | -93 dB | |
| | 10 ¹ | -120 dB | -120 dB | -120 dB | |
| | 10 ² | -125 dB | -125 dB | -126 dB | |
| | 10 ³ | -140 dB | -140 dB | -140 dB | |
| Reproducibility ⁽⁴⁾ : | $\pm 3 \times 10^{-12(3)}$ | | $\pm 5 \times 10^{-12}$ | | |
| Settability (frequency) ⁽⁵⁾ : | $\pm 1 \times 10^{-13(3)}$ | | $\pm 7 \times 10^{-13}$ | | $\pm 2 \times 10^{-12}$ |
| Warm-up: | At 25°C 30 Min. | | At 25°C 45 Min. | | At 25°C 1 x 10 ⁻¹⁰ 1 hr. 5 x 10 ⁻¹¹ 4 hrs. |
| Sinusoidal Outputs: Output Voltage | 5 MHz, 1 MHz, 100 kHz, Front & Rear BNC 1 V into 50 ohms | | | | |
| Harmonic Distortion: (below rated output) | >40 dB | | >40 dB | | >40 dB |
| Non-Harmonic related output: (below rated output) | >80 dB | | >80 dB | | >80 dB |
| Under vibration or AC Mag Field: | >60 dB | | >60 dB | | >60 dB |
| Signal-to-Phase Noise Ratio in 30 kHz noise BW (1 and 5 MHz): | >87 dB | | >87 dB | | >87 dB |
| Environmental DC Magnetic Field Stability: | $< \pm 2 \times 10^{-13}$ | | $< \pm 2 \times 10^{-12}$ | | $< \pm 5 \times 10^{-12}$ |
| AC Magnetic Field: 50, 60 and 400 Hz $\pm 10\%$ | 2 Gauss Field $< 2 \times 10^{-12}$ for 2 Gauss peak | | 2 Gauss Field $< 2 \times 10^{-12}$ for 2 Gauss peak | | 1 Gauss Field $< 5 \times 10^{-12}$ for 1 Gauss peak |
| Temperature, operating with Option 001 or 002 Freq. change from 25°C: | 0 to 50°C $< 5 \times 10^{-12}$ | | 0 to 50°C $< 5 \times 10^{-12}$ | | 0 to 50°C $< 4 \times 10^{-11}$ |
| Temperature, non-operating without options: with Option 001: | -40°C to 75°C | | -40°C to 75°C | | -40°C to 75°C |
| with Option 002: | -40°C to 75°C | | -40°C to 75°C | | -40°C to 75°C |
| | -40°C to 50°C | | -40°C to 50°C | | -40°C to 50°C |
| NOTES: | | | | | |
| (1) For life of beam tube. | | | | | |
| (2) Short-term stability for the HP 5061A with both standard and high performance tubes is given for the normal loop time constant. For improved short-term stability in controlled environments the long time constant may be used. | | | | | |
| (3) With HP 10638A Degausser. | | | | | |
| (4) Degree to which an oscillator will produce the same frequency from one occasion to another without recalibration. | | | | | |
| (5) Degree to which frequency can be set to agree with a reference frequency. | | | | | |



FREQUENCY & TIME STANDARDS

Atomic Frequency Standards

Models 5061A, 5065A (cont.)

| Instrument | HP 5061A Opt 004 | HP 5061A | HP 5065A |
|---|--|---|--------------------------------------|
| Vibration: with isolators: | MIL-STD-167-1 MIL-T-21200 | MIL-STD-167-1 MIL-T-21200 | MIL-STD-167-1 |
| Shock: | MIL-E-5400, Class 1 (30G) | | |
| EMC: | 1-MIL-T-21200, C.1 | | MIL-T-21200, C.1 |
| General | MIL-STD-461, Notice 3, Class A | | |
| Power: AC: | 50, 60 or 400 Hz $\pm 10\%$, 115/230 V $\pm 10\%$ | | |
| DC: | 43 W 22 to 30 V 27 W | 43 W 22 to 30 V 27 W | 49 W 23 to 30 V 35 W |
| Option 001: add (AC/DC) | 10/7.5 W | 10/7.5 W | 10/7.5 W |
| Option 002: add (AC/DC) | 22/4.5 W | 22/4.5 W | 6/0 W |
| Option 010: add (AC/DC) | | | |
| Dimensions (H x W x D): mm: inches: | 221 x 425 x 416 8.7 x 16.7 x 16.4 | 221 x 425 x 416 8.7 x 16.7 x 16.4 | 133 x 425 x 416 5.2 x 16.7 x 16.4 |
| Weight: (lb/kg) | 70/31.8 | 67/30.5 | 34/15.4 |
| Option 001: add (lb/kg) | 2/0.9 | 2/0.9 | 2/0.9 |
| Option 002: add (lb/kg) | 5/2.3 | 5/2.3 | 3.5/1.6 |
| Option 001, Clock | | | |
| 1 PPS Outputs: Master: | Front & Rear BNC | Front & Rear BNC | Front & Rear BNC |
| Clock: | 10 V peak into 50 Ω load | | |
| Amplitude: | 20 μ s min | 20 μ s min | 20 μ s min |
| Width: | <50 ns | <50 ns | <50 ns |
| Rise Time: | <50 ns | <50 ns | <2 μ s |
| Fall Time: | | | |
| Jitter, pulse-to-pulse: | <1 ns, rms | <1 ns, rms | <5 ns, rms |
| Synchronization: | Automatic, 100 ns \pm 100 ns delay | Automatic, 100 ns \pm 100 ns delay | Auto., 10 \pm 1 μ s delay |
| Clock pulse adjustment range: | 1 μ s to 1 s | 1 μ s to 1 s | 1 μ s to 1 s |
| Clock display: | Solid State Digital | | |
| Option 002, Standby Power Supply Capacity at 25°C with Option 001 Clock: | 30 Minutes | 30 Minutes | 10 Minutes |
| Recharge, Fast/Float: | Automatic, fast charge | | Switch |

Ordering Information

| | |
|--|-------------|
| HP 5061A Cesium Beam Frequency Standard | \$32,200 |
| Opt 001: Clock | add \$3,000 |
| Opt 002: Standby Power Supply | add \$1,450 |
| Opt 003: Clock and Standby Power Supply | add \$4,400 |
| Opt 004: High Performance Beam Tube | add \$5,200 |
| Opt 908: Rack Flange Kit | add \$45 |
| HP E21-5061A Flying Clock | add \$5,775 |
| Consists of: HP 5061A with Opt 001 (not included in E21 price) and HP 5089A Standby Power Supply. | |
| Weight: 64 kg (141 lb). | |
| Size: 425 H x 405 W x 546 mm D (16.7" x 15.9" x 21.5") (includes handles). | |

Price

| | |
|--|-------------|
| HP 10638A Degausser | \$1,300 |
| Weight: 1.2 kg (3 lb). | |
| Size: 130 H x 77 W x 279 mm D (5.1" x 3" x 11"). | |
| HP 5065A Rubidium Frequency Standard | \$19,500 |
| Opt 001: Clock | add \$3,000 |
| Opt 002: Standby Power Supply | add \$700 |
| Opt 003: Clock and Standby Power Supply | add \$3,700 |
| Opt 908: Rack Flange Kit | add \$37 |
| HP E21-5065A Portable Time Standard | add \$5,775 |
| Consists of: HP 5065A with Opt 001 (not included in E21 price) and HP 5089A Standby Power Supply. | |
| Weight: 50 kg (110 lb). | |
| Size: 425 H x 405 W x 546 mm D (16.7" x 15.9" x 21.5") (includes handles). | |

FREQUENCY & TIME STANDARDS

Quartz Frequency Standard

Model 105B

257



- High spectral purity
- Well-buffered outputs
- Aging <math>< 5 \times 10^{-10}</math> per day

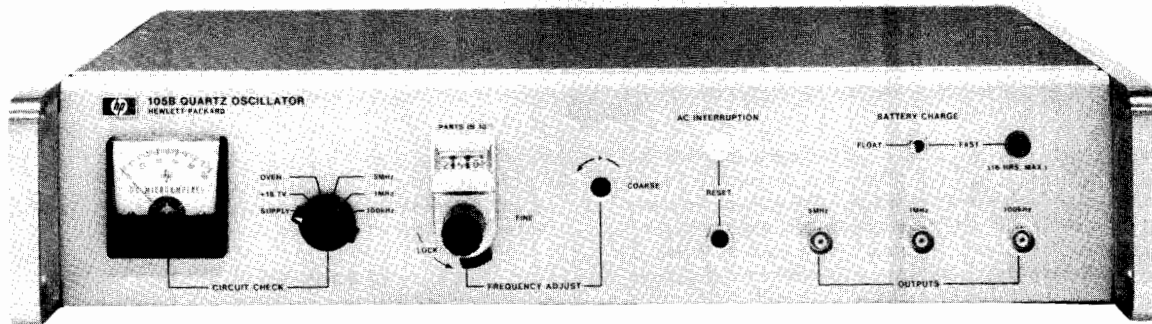

HP 105B

The HP 105B Quartz Oscillator provides state-of-the-art performance in precision frequency and time systems because of its excellent long and short term stability characteristics, spectrally pure output, unexcelled reliability, and ability to operate under a wide range of environmental conditions. The HP 105B fills a need for a small and economical yet highly stable precision quartz oscillator for frequency and time standards. The HP 105B can be operated from the ac line. It also has a built-in 8-hour standby battery for uninterrupted operation should line power fail. The 5 MHz, 1 MHz and 100 kHz buffered sinusoidal outputs have excellent short term stability (5 parts in 10^{12} rms for 1 s averaging time) and aging rate (<math>< 5</math> parts in 10^{10} per day).

The HP 105B features rapid warm-up. Typically, the oscillator will be within 5 parts in 10^9 of the final frequency in 15 minutes after an "off" period of 24 hours. The basis of these oscillators is an extremely stable "SC" cut quartz crystal developed by Hewlett-Packard. New technologies in the crystal mounting and packaging have resulted in a cleaner crystal which in turn has a lower aging rate. The crystal, oscillator and AGC circuit are all enclosed in a proportional oven which reduces the temperature effects on these components and circuits.

Particular care was taken to provide a spectrally pure 5 MHz output which, when multiplied high into the microwave region, provides signals with spectra only a few cycles wide. Spectra less than 1 Hz wide can be obtained in X-band (8.2 to 12.4 GHz). The stability and purity of the 5 MHz output make it suitable for doppler measurements, microwave spectroscopy, and similar applications where the reference frequency must be multiplied by a large factor.

Specifications

Outputs: 5 MHz, 1 MHz, 100 kHz; 1 V rms into 50 Ω front and rear connectors.

Clock output: 1 MHz or 100 kHz; 0.5 V rms into 1 k Ω , rear connector. Normally supplied wired for 1 MHz output.

Frequency Stability

Aging rate: <math>< 5 \times 10^{-10}</math> per 24 hours.

Short-term stability: for 5 MHz output only.

| τ (sec) | $\sigma\Delta f/f(2,\tau)$ |
|--------------|----------------------------|
| 10^{-2} | 1.5×10^{-10} |
| 10^{-1} | 1.5×10^{-11} |
| 10^0 | 5×10^{-12} |

Temperature: <math>< 2.5 \times 10^{-9}</math> total change 0°C to 50°C.

Load: $\pm 1 \times 10^{-10}$ open to short circuit, 50 Ω R, L or C load change.

Supply voltage: $\pm 5 \times 10^{-11}$ for 22–30 V dc from 26 V dc reference and for 115/230 V $\pm 10\%$.

Warm-up (at 25°C): to within 5×10^{-9} of final frequency in 15 min.

Distortion (5 MHz, 1 MHz, 100 kHz) Below Rated Output

Harmonic: >40 dB.

Non-harmonic: >80 dB.

Frequency Adjustments

Fine: $\pm 5 \times 10^{-8}$ range with digital dial reading parts in 10^{10} .

Coarse: 1×10^{-6} front panel screwdriver control.

Phase locking: external +5 V to –5 V allows $> 2 \times 10^{-8}$ frequency control for locking to external source.

Environmental

Temperature, operating: 0°C to +50°C.

Temperature, storage: –40°C to +50°C (+75°C without standby battery).

Altitude: 15.24 km (50,000 ft.).

Shock: MIL-T-21200 (30 Gs).

Vibration: MIL-STD-167 and MIL-T-21200.

Electromagnetic compatibility (EMC): MIL-I-6181D.

Standby supply capacity: 6 hours at 25°C ambient temperatures.

Power requirements: 115/230 V $\pm 10\%$, 50–400 Hz at 18 W (70 W warm-up) Add 1 W for float charge and 12 W for fast charge. 22–30 V dc at 8 W (16 W warm-up).

Size: 88 H x 425 W x 286 mm D (3 $\frac{1}{2}$ " x 16 $\frac{3}{4}$ " x 11 $\frac{1}{4}$ ").

Weight: 105B—net, 11 kg (24 lb). Shipping, 14 kg (31 lb).

Options

908: Rack Flange Kit

910: Extra manual

Price

add \$35

add \$19

HP 105B Quartz Oscillator

\$5800

FREQUENCY & TIME STANDARDS

Distribution Amplifier

Model 5087A

- Versatile with 3 input and 12 output channels
- Low noise, high stability, and isolation

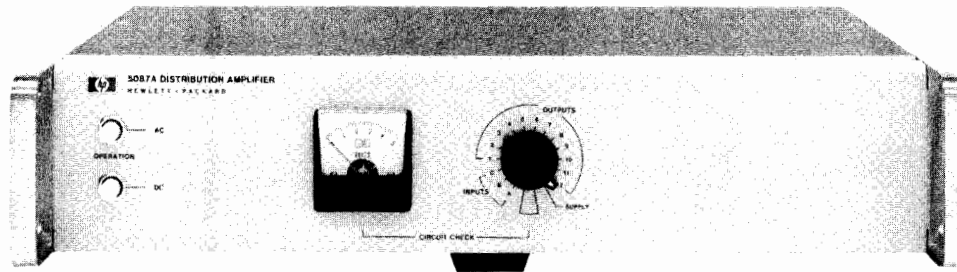

HP 5087A

The Hewlett-Packard 5087A Distribution Amplifier provides the isolation and flexibility required for distribution of the output of high quality frequency standards. Low distortion and excellent isolation make it ideal for providing multiple outputs from atomic or crystal frequency standards. The 3 input channels will accept 10 MHz, 5 MHz, 1 MHz or 100 kHz in any combination. The number of outputs for each channel is selectable up to a total of 12 outputs. The output levels are individually adjustable from 0 to 3 V rms. All input and output levels are monitored on a front panel meter.

The Distribution Amplifier features plug-in modular construction, short circuit isolation, exceptional phase stability, low noise and cross-talk, and uninterrupted switchover to standby dc in event of ac power failure.

The shielding around each input and output plug-in amplifier assures minimum noise and crosstalk. The tuned output amplifiers provide clean signals and high channel-to-channel isolation.

The instrument is designed for maximum versatility and can be supplied to meet a wide variety of special requirements. The standard configuration of input and output amplifiers is shown in Figure 1.

Several other commonly used configurations are also available and special combinations of the various input and output modules can be supplied. Input and output amplifiers can be added or the configuration easily changed at any time.

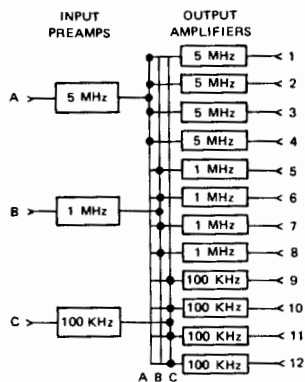

Figure 1. HP 5087A Distribution Amplifier with Option 031, Standard Configuration input and output amplifiers.

Specifications

- Inputs:** (up to three, rear panel BNC).
Frequencies: 10 MHz, 5 MHz, 1 MHz or 100 kHz.
Level: 0.3 to 3.0 V rms, 50 ohms.
- Outputs:** (up to 12 rear panel BNC).
Frequencies: 10 MHz, 5 MHz, 1 MHz or 100 kHz.
Level: 0–3 V into 50 ohms (screwdriver adjustment).
Harmonic distortion: >40 dB below rated output.
Non-harmonic distortion: >80 dB below rated output

Isolation

- Load** (open or short on any other channel)
Amplitude change: 0.1 percent.
Phase change: <0.1 ns at 5 or 10 MHz.
 <0.5 ns at 1 MHz.
 <5.0 ns at 100 kHz.

Injected signal: 1 V signal up to 50 MHz applied to any output except 10 MHz, will be down more than 60 dB in all other outputs; 10 MHz output channel will be down more than 50 dB.

SSB phase noise (5 MHz): >145 dB below signal in 1 Hz BW for frequencies > 1 kHz from carrier.

Short term stability degradation (5 MHz): < 1 x 10⁻¹² in 10 kHz band. (1 s average).

Environmental

- Temperature:** MIL-E-16400, Class 4.
Operating: 0–50°C; storage: –62° to +75°C.

Stability:

- Amplitude:** ±0.5 dB, 0° to 50°C.
Phase: <0.1 ns/°C., 5 and 10 MHz.

EMC: MIL-STD-461A.

Humidity: 95% at 40°C.

Vibration: MIL-STD-167.

Altitude: up to 30,000 ft.

Shock: MIL-T-21200, Class 1 and MIL-E-5400 (30 Gs).

General

- Power:** 115 or 230 V ±10%, 48 to 440 Hz, 20 VA, max, or 22–30 V dc, 500 milliamperes, max.
Dimensions: 88 H x 425 W x 286 mm D (3.5" x 16.7" x 11.3").
Weight: typical, Opt 031–Net 7 kg (15 lb).

Options

Normal Configurations (input and output amplifiers)

- | | Price |
|---|--------------|
| 031: 5, 1 and 0.1 MHz inputs and 4 outputs at each frequency | add \$1880 |
| 032: Single 5 MHz input and 12 outputs | add \$1650 |
| 033: Single 10 MHz input and 12 outputs | add \$1435 |
| 034: Single 5 MHz input, 4 each outputs at 5, 1 and 0.1 MHz | add \$1910 |

Special Configurations

Input Preamplifiers (up to 3 total)

- | | |
|--|-----------|
| 004: Input Preamplifier (0.1 to 10 MHz) | add \$70 |
| 005: 5 to 1 MHz Input Divider | add \$150 |
| 006: 1 to 0.1 MHz Input Divider | add \$200 |
| 011: 5 to 10 MHz Input Doubler | add \$225 |
| 013: 10 to 5 MHz Input Divider | add \$150 |
| 014: 10 to 1 MHz Input Divider | add \$250 |

Output Amplifiers (up to 12 total)

- | | |
|--------------------------------------|-----------|
| 001: 5 MHz Output Amplifier | add \$150 |
| 002: 1 MHz Output Amplifier | add \$150 |
| 003: 0.1 MHz Output Amplifier | add \$150 |
| 012: 10 MHz Output Amplifier | add \$150 |
| 908: Rack Flange Kit | add \$35 |

HP 5087A Distribution Amplifier Mainframe \$1800

FREQUENCY & TIME STANDARDS

Standby Power Supply

Model 5089A

259



- 15 ampere-hour capacity
- Maintenance free lead-calcium batteries
- Used in "Flying Clocks"
- Automatic recharge

HP 5089A

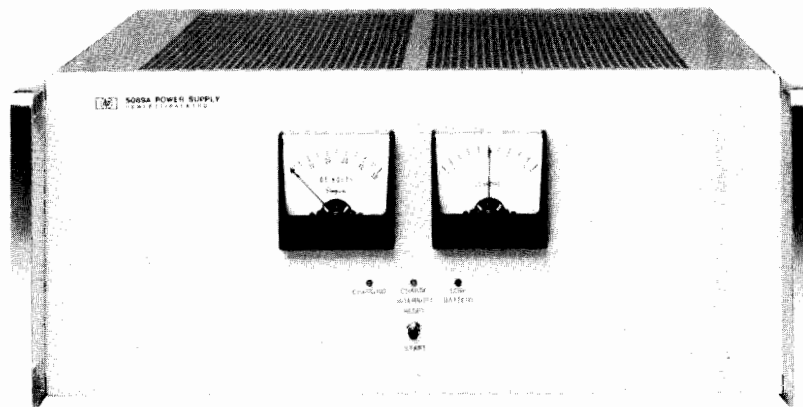

HP 5089A Standby Power Supply

The HP 5089A Standby Power Supply furnishes dc power to keep frequency or time standard systems operating during extended interruptions of ac line power. For applications where it is essential to maintain continuous operation and avoid loss of precise time, the use of a standby power supply is an absolute necessity. This unit is designed for use with the Hewlett-Packard Cesium Beam Standards, Rubidium Vapor Standards, Quartz Oscillators, and other equipment which will operate from 22 to 28 V dc. No switching is used in transferring power from line to battery operation and back again, thus assuring uninterrupted operation.

Versatility

The HP 5089A is an extremely versatile unit. It was designed both as a portable power supply for the HP 5061A and HP 5056A "flying clocks", and as a standby supply for stationary applications.

Portable Applications

Portable or "flying clock" applications require a power supply to operate from a wide range of power sources, along with the standby capability to maintain continuous operation where no external power is available. A special inverter permits operation from a 12V dc automobile battery. In addition, the 85 to 255 V ac, and 11 to 30 V dc capability enables the HP 5089A to operate from almost any power source in the world. The 15 ampere-hour standby batteries are the double sealed lead-calcium type, and thus are virtually spillproof. Mounting hardware is available to attach the HP 5089A to either the HP 5061A or the HP 5065A standards to make a portable frequency time standard package. These portable packages are available from Hewlett-Packard under HP E21-5061A and HP E21-5065A.

Stationary Applications

Stationary applications require long periods of power supply operation in a float or standby mode. Then when an ac supply failure occurs the supply must provide full standby capability. The charging circuits inside the HP 5089A are designed to charge the batteries in such a way that they will provide both long, trouble-free, reliable operation, and full standby power. After use, when ac power is restored, the HP 5089A will fully recharge its batteries. The double sealed batteries will not leak nor require maintenance of any kind. Thus, the HP 5089A allows you to add standby capability to your system with very little increase in maintenance costs.

Ease of Operation

In normal operation there is virtually no required operator intervention. The HP 5089A automatically maintains the batteries in a fully charged state, ready to supply standby power. Should regular line power fail, the HP 5089A will provide uninterrupted dc power (to the limit of its standby capacity) for your equipment. After normal operating power is restored, the HP 5089A will automatically recharge its batteries back to the standby level.

The HP 5089A tells you its operational status at a glance through three LED lamps: GREEN indicates the battery is being charged; YELLOW indicates there has been an ac line failure; a RED lamp lights when the battery is almost fully discharged. Two front-panel meters show battery voltage and charge/discharge current.

Batteries

The HP 5089A utilizes the "immobilized electrolyte" technology in its maintenance-free lead-calcium batteries. The lead-calcium grid gives these batteries longer life with better reliability than conventionally designed batteries. The batteries are double sealed to provide virtually leakproof, and thus maintenance-free operation.

HP 5089A Specifications

Input Voltage

AC charging: 85V to 130V ac rms, 48 to 440 Hz, 300 VA max
85V to 255V ac rms, 48 to 66 Hz, 300 VA max

DC operation: 11V to 30V dc, 110W max

Output voltage: 22V to 28V dc (nominal). 2A maximum.

Standby capacity: 15AH at +25°C when fully charged.

Recharge: complete recharge in 24 hours when operating from AC line.

External low battery voltage alarm: floating contact closure at rear panel barrier block for external visible or audible "low battery" warning. Contact rating is 30V dc at 2 amperes.

Operating Environment

Temperature: 0°C to 50°C

Humidity: up to 95% at 40°C (with no internal condensation)

Altitude: 4,600 metres (15,000 feet)

Storage Environment

Temperature: -40°C to +65°C

Humidity: up to 95% noncondensing

Altitude: 12,000 metres (40,000 feet)

Dimensions: 177mmH x 425mmW x 416mmD (7" x 16.7" x 16.4")

Weight: net weight 30.5kg (67 pounds)

Accessories Supplied

HP 05061-6091: AC Power Input Cable Assembly
HP 05089-60102: DC Power Input Cable Assembly
HP 05089-60101: DC Output Cable Assembly
HP 05060-0169: Extender Board Assy (Dual 25 Pin)

Options Available

Option 001: Spare AI Board Assembly (HP 05089-60001) \$700

Option 908: Rack Mounting Adapter Kit \$300

Option 910: Extra Operating and Service Manual \$10

HP 5089A Standby Power Supply

\$5000

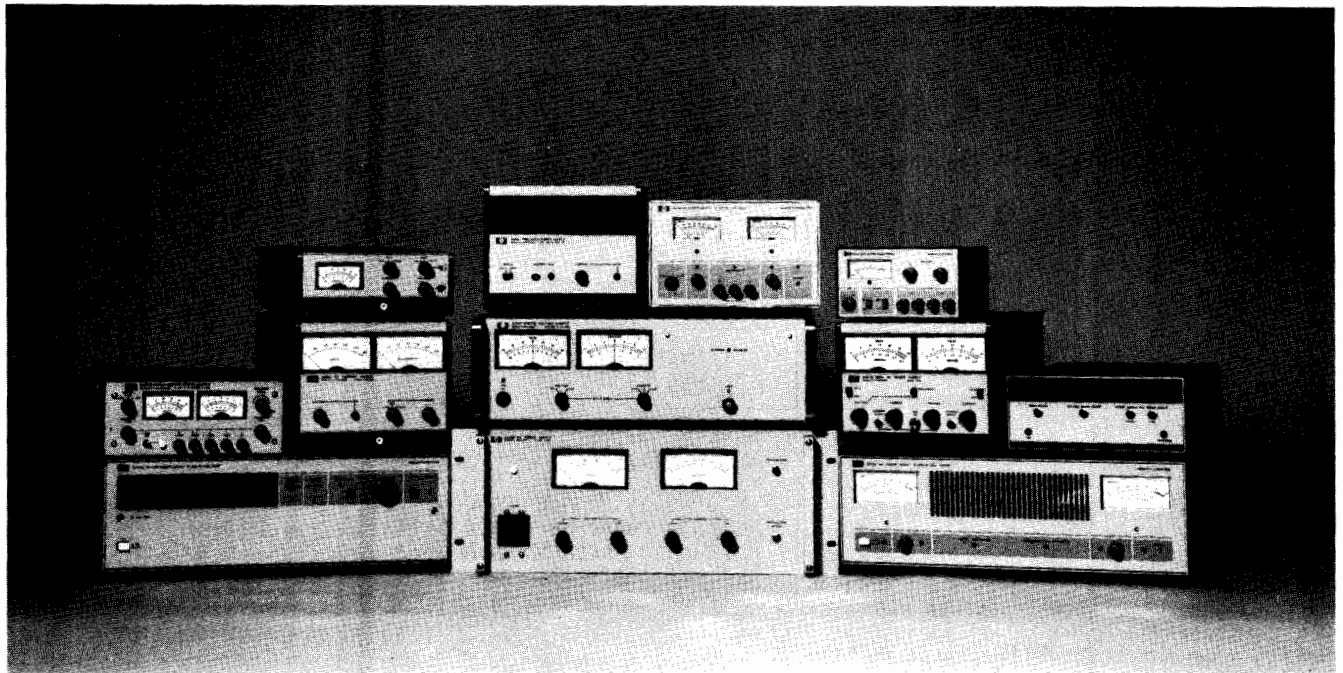

Introduction

Hewlett-Packard's extensive variety of power supplies serve a wide range of applications. For circuit and device development, there are laboratory supplies. For industrial needs, there are high power units. The HP-IB power sources manufactured by Hewlett-Packard are used in automated systems, and OEM Modular Power Supplies are designed for incorporation into other products. Through technological innovations, Hewlett-Packard strives to offer advanced capabilities, high reliability, and good value in both system and bench power supply families.

Regulation Techniques

The regulation technique used in a power supply defines its performance specifications, size, and efficiency. HP power supplies are designed using one of four proven regulation techniques: Series, SCR, SCR preregulator/series regulator, and switching.

Series regulation: this technique exhibits good regulation, low ripple and noise, and fast transient response. However, it is relatively inefficient. This results in greater power usage, large size, and more generated heat than the other methods. For this reason, series regulation is most useful for lower power units. These power supplies are used in laboratory and test applications, where stable, precise, dc power is needed.

SCR regulation: this technique is more efficient than series regulation, so the power supplies have lower power usage, smaller heat sinks, and less generated heat. However, the regulation (PARD ripple and noise) and transient response specifications are better with series regulation than with SCR regulation. Power supplies with SCR regulation are especially useful for high power industrial applications where fine regulation is not necessary and the lower cost/watt is important.

SCR preregulation/series regulator: this technique combines the best qualities of series and SCR regulation. As can be seen in the table, the operating specifications are much better than with SCR regulation. SCR preregulation does not detract from the excellent characteristic of series regulation, except for slower transient response. The efficiency is higher than that with series regulation, but not quite as high as with SCR regulation alone. These power supplies are used in laboratory and test applications similar to those of series regulated power supplies but at power levels greater than 75 watts.

Switching regulation: this technique provides high efficiency and operating specifications similar to series regulation (see table). These power supplies also tend to be small and lightweight.

Example Power Supply Comparison for a 40 V, 25 A, 1000 Watt Application

| Regulation Technique | HP Model Number | PARD (ripple and noise) rms/p-p | Load Effect | Load Transient Recovery | Typical Efficiency |
|-------------------------------|----------------------|---------------------------------|--|-------------------------|--------------------|
| Series with SCR preregulation | 6268B 40 V @ 30 A | 1 mV/5 mV | .01% + 200 μ V (4.2 mV at 40 V) | 50 μ s, 10 mV | 60% |
| Switching (autoranging) | 6012A 60 V @ 50 A | 5 mV/50 mV | .01% + 5 mV (9 mV at 40 V) | 2 ms, 100 mV | 75% |
| SCR | 6434B 40 V @ 25 A | 40 mV/500 mV | 40 mV | 200 ms, 200 mV | 70% |

Selecting a Power Supply

The tables on the next few pages list the dc power supplies in this catalog in output voltage order. For manual power supply operation, simply find those power supplies that correspond to the appropriate voltage and current levels and turn to the listed page numbers for further information.

For operation in an automatic system, power supplies must be chosen which can be controlled by the method you intend to use in your system, following the information in the tables.

HP-IB control usually provides the greatest level of system capability. The HP 59501B (page 281) is a special, isolated DAC which is used to configure many models into HP-IB systems. The Multiprogrammer (page 313) is a computer-controllable instrument subsystem that can be configured to provide power supply programming and many other system functions, including digital inputs and outputs, A/Ds, DACs, and event sensing.

New 1986 Power Supply Catalog

For more details concerning Hewlett-Packard power supplies, ask your HP sales representative for a *DC Power Supply Catalog*, or fill in the card at the back of this catalog.

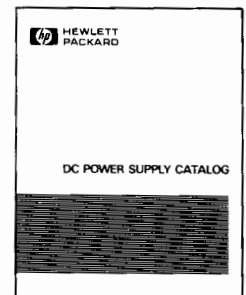

POWER SUPPLIES

Voltage Rating Index with remote control selection guide*



Multiple Output Systems Power Supplies: HP-IB Controlled Output Ratings and Combinations

| Output Channel | | Model and Number of Outputs per Model | | | |
|---------------------------------|--------------------------------|---------------------------------------|----------------------|----------------------|----------------------|
| Hi Range/ Low Range VOLTS | Hi Range/ Low Range AMPS | HP 6624A 4 OUTPUT | HP 6623A 3 OUTPUT | HP 6622A 2 OUTPUT | HP 6621A 2 OUTPUT |
| 0-20 0-7 | 0-2 0-5 | 2 | 1 | - | - |
| 0-50 0-20 | 0-0.8 0-2 | 2 | 1 | - | - |
| 0-20 0-7 | 0-4 0-10 | - | 1 | - | 2 |
| 0-50 0-20 | 0-1.6 0-4 | - | - | 2 | - |

See page 276 for full description and specifications

Voltage Rating Index with remote control selection guide

| Max. Volts (DC) | Max. Amperes (DC) | Type | HP Model | Page | GSA | Remote Control Methods* | | | | | | | | | | Remote Readback Methods for Output Voltage Current and Status | | | |
|-----------------|-------------------|--------------------------|----------|------|-----|-------------------------|---------|------------|------------------|-------|--------------------|---------|------------|------------------|-------|---|------------------|-------|--|
| | | | | | | for Output Voltage | | | | | for Output Current | | | | | | | | |
| | | | | | | Resistance | Voltage | HP 59501B* | Multiprogrammer* | HP-IB | Resistance | Voltage | HP 59501B* | Multiprogrammer* | HP-IB | Direct | Multiprogrammer* | HP-IB | |
| 6 | 1 | Triple Output (6, ±18 V) | 6235A | 266 | • | | | | | | | | | | | | | | |
| 6 | 2.5 | Triple Output (6, ±20 V) | 6236B | 266 | • | | | | | | | | | | | | | | |
| 6.7 | 30 | Autoranging | 6023A | 270 | | • | • | • | • | | • | • | • | • | | • | • | | |
| 6.7 | 30 | HP-IB Autoranging | 6033A | 278 | | • | • | • | | • | • | • | • | | • | | | • | |
| 7 | 120 | Autoranging | 6011A | 270 | | • | • | • | • | | • | • | • | • | | • | • | | |
| 7 | 120 | HP-IB Autoranging | 6031A | 278 | | • | • | • | | • | • | • | • | | • | | | • | |
| 7.5 | 5 | CV/CC | 6281A | 268 | • | • | • | • | • | | • | • | • | • | | | | | |
| 8 | 1000 | CV/CC | 6464C | 274 | • | • | • | • | • | | • | • | • | • | | | | | |
| ±10 | 0.01 | HP-IB DAC | 59501B | 281 | • | | | | | • | | | | | | | | | |
| 10 | 1 | CV/CC | 6214B | 265 | • | | | | | | | | | | | | | | |
| 10 | 10 | CV/CC | 6282A | 268 | • | • | • | • | • | | • | • | • | • | | | | | |
| 10 | 50 | CV/CC | 6259B | 272 | • | • | • | • | • | | • | • | • | • | | | | | |
| 10 | 100 | CV/CC | 6260B | 272 | • | • | • | • | • | | • | • | • | • | | | | | |
| 15 | 15.9 | Autoranging | 6023A | 270 | | • | • | • | • | | • | • | • | • | | • | • | | |
| 15 | 15.9 | HP-IB Autoranging | 6033A | 278 | | • | • | • | | • | • | • | • | | • | | | • | |
| 15 | 71 | Autoranging | 6011A | 270 | | • | • | • | • | | • | • | • | • | | • | • | | |
| 15 | 71 | HP-IB Autoranging | 6031A | 278 | | • | • | • | | • | • | • | • | | • | | | • | |
| 15 | 200 | CV/CC | 6453A | 274 | • | • | • | • | | | • | • | • | | | | | | |
| 16 or 18 | 600 or 500 | CV/CC | 6466C | 274 | • | • | • | • | • | | • | • | • | • | | | | | |

* An option may be required to program with the specified method.



POWER SUPPLIES

Voltage Rating Index with remote control selection guide* (Cont.)

| Max. Volts (DC) | Max. Amperes (DC) | Type | HP Model | Page | GSA | Remote Control Methods* | | | | | | | | | | Remote Readback Methods for Output Voltage Current and Status | | | | |
|-----------------|-------------------|---------------------------|----------|------|-----|-------------------------|---------|------------|-------------------|-------|--------------------|---------|------------|-------------------|-------|---|-------------------|-------|---|---|
| | | | | | | for Output Voltage | | | | | for Output Current | | | | | Direct | Multi programmer* | HP-IB | | |
| | | | | | | Resistance | Voltage | HP 59501B* | Multi programmer* | HP-IB | Resistance | Voltage | HP 59501B* | Multi programmer* | HP-IB | | | | | |
| 18 | 1 | Triple Output (18, ±20 V) | 6237B | 266 | • | | | | | | | | | | | | | | | |
| 18 | 0.2 | Triple Output (6, ±18 V) | 6235A | 266 | • | | | | | | | | | | | | | | | |
| 20 | 0.5 | Triple Output (6, ±20 V) | 6236B | 266 | • | | | | | | | | | | | | | | | |
| 20 | 0.5 | Triple Output (18, ±20 V) | 6237B | 266 | • | | | | | | | | | | | | | | | |
| 20 | 0.6 | Dual Outut (20, 20 V) | 6205C | 266 | • | • | • | • | • | • | • | • | • | • | • | • | • | • | • | • |
| 20 | 1.5 | CV/CC | 6200B | 265 | • | • | • | • | • | • | • | • | • | • | • | • | • | • | • | • |
| ±20 | ±2 | Bipolar PSA | 6825A | 283 | • | • | • | • | • | • | • | • | • | • | • | • | • | • | • | • |
| 20 | 2 | Precision Voltage | 6114A | 284 | • | • | • | • | • | • | • | • | • | • | • | • | • | • | • | • |
| 20 | 3 | CV/CC | 6284A | 268 | • | • | • | • | • | • | • | • | • | • | • | • | • | • | • | • |
| 20 | 3 | Dual Output (20, 20 V) | 6253A | 268 | • | • | • | • | • | • | • | • | • | • | • | • | • | • | • | • |
| 20 | 10 | Autoranging | 6023A | 270 | | • | • | • | • | • | • | • | • | • | • | • | • | • | • | • |
| 20 | 10 | HP-IB Autoranging | 6033A | 273 | | • | • | • | • | • | • | • | • | • | • | • | • | • | • | • |
| 20 | 10 | Autoranging | 6024A | 270 | • | • | • | • | • | • | • | • | • | • | • | • | • | • | • | • |
| 20 | 10 | CV/CC | 6263B | 272 | • | • | • | • | • | • | • | • | • | • | • | • | • | • | • | • |
| 20 | 10 | CV/CC | 6286A | 268 | • | • | • | • | • | • | • | • | • | • | • | • | • | • | • | • |
| 20 | 20 | CV/CC | 6264B | 272 | • | • | • | • | • | • | • | • | • | • | • | • | • | • | • | • |
| 20 | 50 | Autoranging | 6011A | 270 | | • | • | • | • | • | • | • | • | • | • | • | • | • | • | • |
| 20 | 50 | HP-IB Autoranging | 6031A | 278 | | • | • | • | • | • | • | • | • | • | • | • | • | • | • | • |
| 20 | 50 | Autoranging | 6012B | 270 | • | • | • | • | • | • | • | • | • | • | • | • | • | • | • | • |
| 20 | 50 | HP-IB Autoranging | 6032A | 278 | | • | • | • | • | • | • | • | • | • | • | • | • | • | • | • |
| 20 | 50 | CV/CC | 6261B | 272 | • | • | • | • | • | • | • | • | • | • | • | • | • | • | • | • |
| 25 | 0.2 | Dual Output (25,25 V) | 6234A | 265 | • | | | | | | | | | | | | | | | |
| 25 | 0.4 | CV/CC | 6216B | 265 | • | | | | | | | | | | | | | | | |
| 25 | 2 | Dual Output (25, 25 V) | 6227B | 268 | • | • | • | • | • | • | • | • | • | • | • | • | • | • | • | • |
| 30 | 1 | CV/CL | 6206B | 265 | • | • | • | • | • | • | • | • | • | • | • | • | • | • | • | • |
| 36 | 100 | CV/CC | 6456B | 274 | • | • | • | • | • | • | • | • | • | • | • | • | • | • | • | • |
| 36 | 300 | CV/CC | 6469C | 274 | • | • | • | • | • | • | • | • | • | • | • | • | • | • | • | • |
| 40 | 0.3 | Dual Output (40, 40 V) | 6205C | 266 | • | • | • | • | • | • | • | • | • | • | • | • | • | • | • | • |
| 40 | 0.75 | CV/CC | 6200B | 265 | • | • | • | • | • | • | • | • | • | • | • | • | • | • | • | • |
| 40 | 1 | Precision Voltage | 6114A | 284 | • | • | • | • | • | • | • | • | • | • | • | • | • | • | • | • |
| 40 | 1.5 | CV/CC | 6289A | 268 | • | • | • | • | • | • | • | • | • | • | • | • | • | • | • | • |
| 40 | 1.5 | Dual Output (40,40 V) | 6255A | 268 | • | • | • | • | • | • | • | • | • | • | • | • | • | • | • | • |
| 40 | 5 | CV/CC | 6266B | 272 | • | • | • | • | • | • | • | • | • | • | • | • | • | • | • | • |
| 40 | 5 | CV/CC | 6291A | 268 | • | • | • | • | • | • | • | • | • | • | • | • | • | • | • | • |
| 40 | 5.7 | Autoranging | 6024A | 270 | • | • | • | • | • | • | • | • | • | • | • | • | • | • | • | • |
| 40 | 10 | CV/CC | 6267B | 272 | • | • | • | • | • | • | • | • | • | • | • | • | • | • | • | • |
| 40 | 25 | CV/CC | 6434B | 274 | • | • | • | • | • | • | • | • | • | • | • | • | • | • | • | • |
| 40 | 30 | Autoranging | 6012B | 270 | | • | • | • | • | • | • | • | • | • | • | • | • | • | • | • |
| 40 | 30 | HP-IB Autoranging | 6032A | 278 | | • | • | • | • | • | • | • | • | • | • | • | • | • | • | • |

* An option may be required to program with the specified method.



| Max. Volts (DC) | Max. Amperes (DC) | Type | HP Model | Page | GSA | Remote Control Methods* | | | | | | | | | | Remote Readback Methods for Output Voltage Current and Status | | |
|-----------------|-------------------|------------------------|----------|------|-----|-------------------------|---------|------------|------------------|-------|--------------------|---------|------------|------------------|-------|---|------------------|-------|
| | | | | | | for Output Voltage | | | | | for Output Current | | | | | | | |
| | | | | | | Resistance | Voltage | HP 59501B* | Multiprogrammer* | HP-IB | Resistance | Voltage | HP 59501B* | Multiprogrammer* | HP-IB | Direct | Multiprogrammer* | HP-IB |
| 40 | 30 | CV/CC | 6268B | 272 | • | • | • | • | • | | • | • | • | • | | | | |
| 40 | 50 | CV/CC | 6269B | 272 | • | • | • | • | • | | • | • | • | • | | | | |
| 50 | 0.2 | CV/CC | 6218B | 265 | • | | | | | | | | | | | | | |
| 50 | 0.5 | Precision Current | 6177C | 285 | • | • | • | | | | • | • | • | | | | | |
| 50 | 0.8 | Precision Voltage | 6115A | 284 | • | • | • | • | • | | • | • | • | • | | | | |
| 50 | 1 | Dual Output (50, 50 V) | 6228B | 268 | • | • | • | • | • | | • | • | • | • | | | | |
| ±50 | ±1 | Bipolar PSA | 6824A | 283 | • | • | • | • | | | | | | | | | | |
| ±50 | ±1 | Bipolar PSA | 6826A | 283 | • | • | • | • | | | • | • | • | | | | | |
| ±50 | ±1 | Precision Voltage** | 6130C | 282 | • | | | | | • | | | | | • | | | |
| 50 | 4 | HP-IB Autoranging | 6002A | 280 | • | • | • | • | | • | • | • | • | | • | | | |
| ±50 | ±5 | Precision Voltage** | 6129C | 282 | • | | | | | • | | | | | • | | | |
| 60 | 0.5 | CV/CL | 6206B | 265 | • | • | • | • | | | | | | | | | | |
| 60 | 1 | CV/CC | 6294A | 268 | • | • | • | • | • | | • | • | • | • | | | | |
| 60 | 3.3 | Autoranging | 6024A | 270 | • | • | • | • | • | | • | • | • | • | | • | • | |
| 60 | 3.3 | HP-IB Autoranging | 6038A | 278 | • | • | • | • | | • | • | • | • | | • | | | • |
| 60 | 15 | CV/CC | 6274B | 272 | • | • | • | • | • | | • | • | • | • | | | | |
| 60 | 17.5 | Autoranging | 6012B | 270 | • | • | • | • | • | | • | • | • | • | | • | • | |
| 60 | 17.5 | HP-IB Autoranging | 6032A | 278 | • | • | • | • | | • | • | • | • | | • | | | • |
| 64 | 50 | CV/CC | 6459A | 274 | • | • | • | • | | | • | • | • | | | | | |
| 64 | 150 | CV/CC | 6472C | 274 | • | • | • | • | • | | • | • | • | • | | | | |
| ±100 | ±0.016 | Precision Current** | 6140A | 282 | • | | | | | • | | | | | • | | | |
| 100 | 0.1 | CV/CC | 6212B | 265 | • | | | | | | | | | | | | | |
| 100 | 0.25 | Precision Current | 6181C | 285 | • | • | • | | | | • | • | • | | | | | |
| 100 | 0.4 | Precision Voltage | 6115A | 284 | • | • | • | • | • | | • | • | • | • | | | | |
| ±100 | ±0.5 | Precision Voltage** | 6131C | 282 | • | | | | | • | | | | | • | | | |
| ±100 | ±0.5 | Bipolar PSA | 6827A | 283 | • | • | • | • | | | • | • | • | | | | | |
| 100 | 0.75 | CV/CC | 6299A | 268 | • | • | • | • | • | | • | • | • | • | | | | |
| 110 | 100 | CV/CC | 6475C | 274 | • | • | • | • | | | • | • | • | | | | | |
| 120 | 2.5 | CV/CC | 6443B | 274 | • | • | • | • | | | • | • | • | | | | | |
| 200 | 5 | Autoranging | 6010A | 270 | | • | • | • | • | | • | • | • | • | | • | • | |
| 200 | 5 | HP-IB Autoranging | 6030A | 278 | | • | • | • | | • | • | • | • | | • | | | • |
| 220 | 50 | CV/CC | 6477C | 274 | • | • | • | • | | | • | • | • | | | | | |
| 300 | 0.1 | Precision Current | 6186C | 285 | • | • | • | | | | • | • | • | | | | | |
| 300 | 35 | CV/CC | 6479C | 274 | • | • | • | • | | | • | • | • | | | | | |
| 320 | 0.1 | CV/CC | 6209B | 265 | • | • | • | • | | | • | • | • | | | | | |
| 440 | 25 | CV/CC | 6483C | 274 | • | • | • | • | | | • | • | • | | | | | |
| 500 | 20 | CV/CC | 6483C | 274 | • | • | • | • | | | • | • | • | | | | | |
| 600 | 1.5 | CV/CC | 6448B | 274 | • | • | • | • | | | • | • | • | | | | | |
| 600 | 15 | CV/CC | 6483C | 274 | • | • | • | • | | | • | • | • | | | | | |

* An option may be required to program with the specified method.

**An HP 59301A ASCII to parallel converter is required to operate this source on the HP-IB.

POWER SUPPLIES

Power Supply Terms and Specification Definitions

Power Supply Terms

Ambient temperature: the temperature of the air immediately surrounding the power supply.

Auto-parallel operation: a master-slave connection of the outputs of two or more supplies used for obtaining a current output greater than can be obtained from one supply.

Autorange power supply: a power supply that can provide maximum rated power over a wide range of voltage and current without external intervention to change range.

Auto-series operation: a master-slave connection of the outputs of two or more supplies used for obtaining a voltage greater than can be obtained from one supply.

Auto-tracking operation: a master-slave connection of two or more supplies each of which has one of its output terminals in common with one of the output terminals of all of the other supplies.

Complementary tracking: a master-slave interconnection of two supplies in which the voltage of the slave is equal to or proportional to that of the master and of opposite polarity with respect to a common point.

Compliance voltage: the output voltage of a power supply operating in the constant-current mode.

Constant-current (CC) power supply: a power supply that stabilizes output current with respect to changes in influence quantities. Thus, for a change in load resistance, the output current remains constant while the output voltage changes by whatever amount necessary to accomplish this.

Constant-voltage (CV) power supply: a power supply that stabilizes output voltage with respect to changes in influence quantities. Thus, for a change in load resistance, the output voltage remains constant while the output current changes by whatever amount necessary to accomplish this.

Constant-voltage/constant-current (CV/CC) power supply: a power supply that operates as a constant voltage power supply or a constant-current power supply depending on load conditions. It acts as a constant-voltage source for comparatively large values of load resistance and as a constant-current source for comparatively small values of load resistance.

Constant-voltage/current-limiting (CV/CL) power supply: a power supply similar to a constant-voltage/constant-current supply except that at comparatively small values of load resistance, its output current is limited instead of being stabilized.

Crowbar: see overvoltage protection.

Current limiting: the action of limiting the output current of a constant-voltage supply to some predetermined maximum value (fixed or adjustable) and automatically restoring the output voltage to its normal value when the overload or short circuit is removed. There are three types of current limiting: 1) by constant-voltage/constant-current crossover, 2) by decreasing the output voltage as the current increases, 3) by decreasing both voltage and current as the load resistance decreases (referred to as foldback or cutback current limiting).

Drift: the maximum change of an output voltage or current during an 8-hour period following a 30-minute warmup, with all influence and control quantities maintained constant during the warm-up time and the period of drift measurement. Drift includes both periodic and random deviations over the bandwidth from zero frequency (dc) to a specified upper frequency limit (usually 20 Hz).

Load effect: formerly known as load regulation, load effect is the change in the steady-state value of the stabilized output voltage or current resulting from a full-load change in the load current of a constant-voltage supply or the load voltage of a constant-current supply, with all other influence quantities maintained constant.

Load effect transient recovery time: the time interval between a specified step change in the load current of a constant-voltage supply (usually a full-load or 5-ampere change, whichever is smaller) or in the load voltage of a constant-current supply and the instant when the stabilized output quantity returns to and stays within the specified transient recovery band.

Master-slave operation: a method of interconnecting two or more supplies such that one of them (the master) serves to control the others (the slaves). The outputs of the slave supplies always remain equal to or proportional to the output of the master. The outputs of

the master supply and of one or more slaves may be connected in series, in parallel, or with just their negative or positive output terminals in common. (See also complementary tracking.)

Nominal value: the value that exists "in name only," not the actual value. For example, in the case of a power supply with a calibrated output control, the nominal value is the value indicated by the control setting. For a supply with a fixed output, the nominal output is the output indicated on the nameplate. The nominal value of a 120-volt \pm 10% line voltage is 120 volts.

Output impedance: the complex ratio of a sinusoidal voltage and sinusoidal current at the output terminals, the one being caused by the other and being of external origin.

Overcurrent protection: protection of the power supply and/or connected equipment against excessive output current.

Overtemperature protection: protection of the power supply or parts of it against temperatures exceeding specified values.

Overvoltage protection: protection of the power supply and/or connected equipment against excessive output voltage. Overvoltage protection is usually by means of a crowbar protection circuit, which rapidly places a low resistance shunt across the supply's output terminals to reduce output voltage to a low value if a predetermined voltage is exceeded. A supply equipped with an overvoltage crowbar must also be protected by a means of limiting or interrupting output current.

PARD (acronym for periodic and random deviation): the term PARD replaces the former term ripple and noise. PARD is the periodic and random deviation of a dc output voltage or current from its average value, over a specified bandwidth (20 Hz to 20 MHz) and with all influence and control quantities maintained constant.

Programming speed: the maximum time required for the programmed output voltage or current to change from a specified initial value (usually zero or maximum output) to a value within a specified tolerance band of a specified newly programmed value (for most models 99.9% or 0.1% of maximum output, respectively; 99% and 1% for the HP 6114A, 6115A, 6177C-6186C, and HP 6434B-6483C) following the onset of a step change in an analog programming signal, or the gating of a digital signal.

Remote control: also referred to as remote programming, remote control is the setting of the power supply voltage, current, or other function by means of an external control quantity such as a variable resistance, voltage, or current, or a digital signal.

Remote sensing: remote sensing, or remote error sensing, is a means by which a power supply monitors the stabilized voltage directly at the load using extra sensing leads. The resulting circuit action compensates for voltage drops in the load leads (up to a specified limit).

Resolution: for a bench supply, the smallest change in output voltage or current that can be obtained using the front panel controls. For a system supply, the smallest change that can be obtained using either the front panel controls or a computer.

Reverse voltage protection: protection of the power supply against reverse voltage applied at the output terminals.

Slave operation: see master-slave operation.

Source effect: formerly known as line regulation, source effect is the change in the steady-state value of the stabilized output voltage on current resulting from any change in the source voltage within its specified range, with all other influence quantities maintained constant. Source effect may be measured at any output voltage and current within rating.

Temperature effect coefficient: the maximum steady-state change in a power supply's output voltage or current per degree Celsius following a change in the ambient temperature within specified limits, with all other influence quantities maintained constant.

Voltage limiting: the action of limiting the output voltage of a constant-current supply to some predetermined maximum value (fixed or adjustable) and automatically restoring the output current to its normal value when the load conditions are restored to normal. There are two types of voltage limiting: 1) by constant-voltage/constant-current crossover, 2) by decreasing the output current as the voltage increases.

Warm-up time: the time interval after switching on a power supply until it complies with all performance specifications.

POWER SUPPLIES

Laboratory: Single & Multiple Output, 10W to 38W

Models 6200B-6218B and 6234A-6237B

265



- HP 6212B-6218B . . . 10 watts output
- Compact, impact-resistant stackable case
- Short-circuit proof

- HP 6200B-6209B . . . 30 watts output
- Auto series, parallel, and tracking
- Remote sensing

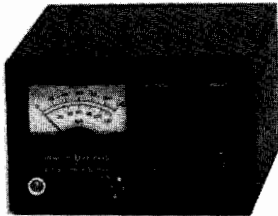

Single Output: HP 6212B-6218B

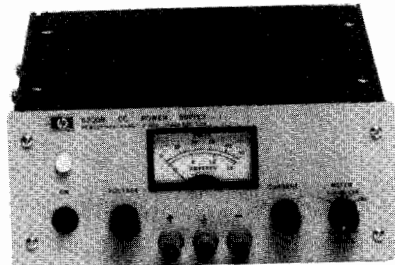

Single Output: HP 6200B-6209B

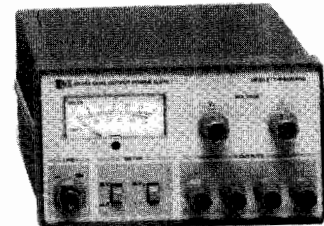

Dual Output: HP 6234A

Description—Single Output Models

Models 6212B-6218B

These popular low-cost CV/CC bench supplies are designed for general laboratory use and are equipped with front-panel mounted voltage and current controls, a combination volt/ammeter, and output binding posts. Output voltage and current are continuously variable, via coarse and fine controls from 0 to 15% above the maximum rated output. A switch selects either output voltage or current for display on the panel meter.

Load connections are made via three binding posts. Either the + or the - post may be grounded through an adjacent GND terminal or the supply may be operated floating at up to 300 volts above ground.

The supplies can also be operated as constant current sources with 500 μ A load regulation. All of these models can be connected in series or parallel.

The molded, impact-resistant case includes an interlocking feature for stacking several units vertically, thus minimizing bench space required for multiple supplies. Alternatively, up to three units can be mounted side by side in a 19" rack using Rack Mounting Kit HP 14521B. These supplies measure 86 H x 133 W x 368 mmD (3.40" x 5.25" x 8") and weigh 2 kg (4.4 lb).

Models 6200B-6209B

This series of low-cost bench supplies includes three models covering an output voltage range from 0–20 V to 0–320 V. All models are equipped with ten-turn voltage and current controls, (except the HP 6206B, which does not have a current control), volt/ampere meter, meter function/range switch, and front and rear output terminals. In addition, on the dual-range models (HP 6200B and 6206B), an output range switch permits the selection of either a high or a low output voltage range.

The constant voltage/current limiting supply, HP 6206B, is short-circuit protected by a fixed current limiting circuit which is activated at approximately 110% of rated load current. The current-limit point can be reduced by changing the value of a single internal resistor. For the constant voltage/constant current supplies, ten-turn current controls allow the current-limit point to be set to any value within the current rating. Using these controls the CV/CC supplies can also be operated as constant-current sources.

Units may be bench operated or rack mounted individually or in pairs using accessory rack mounting hardware.

All models in this group of supplies measure 89 H x 216 W x 317 mm D (3.50" x 8.50" x 12.50") and weigh 4.5 kg (10 lb).

Description—Dual Output Models

Model 6234A

Model 6234A is a low-cost, dual-output bench power supply with two independently adjustable and isolated power sources in one compact unit. Both of the dc power sources are of the constant voltage/current limit type with each output voltage being adjustable continuously over a 0 to 25 V range. The maximum current available per output is 0.2 A and is limited automatically to prevent overload.

The HP 6234A offers considerable flexibility to the user with output voltages that can be arranged to provide identical or different voltages in any polarity combination with respect to 0 or other common positive or negative voltage points. The outputs can also be connected in series to provide up to 50 V at 0.2 A. Both sources are fully isolated to permit either of the output terminals to be grounded.

With pushbutton switches, users can select either voltage or current for each output to be monitored on the unit's meter. Other features include two multiple-turn controls for precise voltage setting, regulation to 0.01%, and ripple and noise of less than 200 microvolts rms.

With dimensions of only 93 mm high, 157 mm wide and 210 mm deep (3.64" x 6.17" x 8.25"), the HP 6234A supply takes up a minimum amount of bench space. Its weight is 2.3 kg (5 lb). The unit can be powered from a 115 V or an optional 230 V, 47-63 Hz ac input, (Option 028).

Model 6205C

This low-cost bench supply is equipped with ten-turn output voltage controls, volt/ampere meter, meter function/ range switch, and front and rear output terminals. In addition, an output range switch permits the selection of either a high or a low output voltage range.

Model 6205C combines the versatility of a dual power supply with the flexibility of auto-parallel and auto-series operation to extend the output ratings of this supply to 20 V/1.2 A, 40 V/0.6 A, and 80 V/0.3 A. In addition, using the supply's auto-tracking capability, opposite



POWER SUPPLIES

Laboratory: Single & Multiple Output, 10W to 38W

Models 6200B-6218B and 6234A-6237B (cont.)

- Dual output to 24 watts
- Short-circuit proof
- Independent voltage controls
- Triple output to 38 watts
- Short circuit proof
- Tracking ± 20 volt outputs

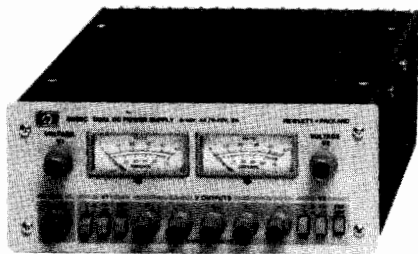

Dual Output: HP 6205C

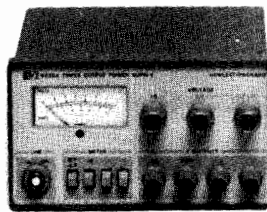

Triple Output: HP 6235A

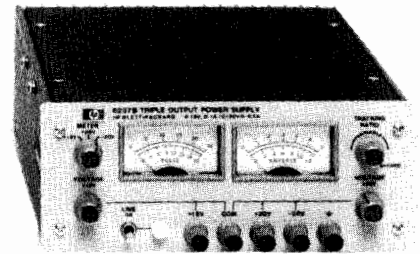

Triple Output: HP 6236B, 6237B

polarity voltages (± 20 V, ± 40 V) can conveniently be obtained from this one supply.

This constant voltage/current limiting supply is short-circuit protected by a fixed current limiting circuit which is activated at approximately 110% of rated load current. The current-limit point can be reduced by changing the value of a single internal resistor. Units may be bench operated or rack mounted individually or in pairs using accessory rack mounting hardware.

Description—Triple Output Models

HP 6235A

This compact, low-cost, three-in-one power supply is a handy addition to the lab bench where single or multiple voltages are needed for designing and testing breadboards and prototypes. The HP 6235A delivers three adjustable dc output voltages: 0 to +6 V at 1 A, 0 to +18 V at 0.2 A, and 0 to -18 V at 0.2 A. A single 0 to 36 volt output at 0.2 A can also be obtained by connecting across the +18 V and -18 V terminals.

The controls, meter, and binding posts are conveniently arranged on the front panel. One voltage control simultaneously adjusts the +18 V and -18 V outputs, which track one another and can be used to power operational amplifiers and other circuits requiring balanced positive and negative voltages. The supply's dual outputs have added versatility with an adjustable tracking ratio control (TRACK) that can set the negative output to a lower voltage than the positive output. Once the tracking ratio control has established a voltage ratio between the positive and negative outputs, the ratio remains constant as the +18 V voltage control is adjusted. A third control sets the 0 to +6 V output voltage.

The supply is a constant voltage/current limit type with each output voltage continuously adjustable over its range, while the maximum current available is automatically limited to prevent overloading. The power supply's outputs share a common terminal and are isolated from chassis ground so that any output terminal can be grounded if desired. Each output voltage or current can be quickly selected and monitored with the push-button meter switches.

Model 6235A measures 89 H x 157 W x 210 mm D (3.5" x 6.17" x 8.25") and weighs 2.3 kg (5 lb).

HP 6236B and 6237B

Microprocessors, digital and linear integrated circuits, and displays used in lab development frequently require triple output power supplies for operating prototypes. The HP 6236B and 6237B are valued additions to the design bench due to their multiple output voltages, small size, ease of operation and application-related performance.

These compact constant voltage/current limiting supplies combine 0 to ± 20 V tracking outputs rated at 0.5 A with a single output rated at 0 to +6 volts at up to 2.5 A in the HP 6236B, and 0 to +18 volts at 1 A in the HP 6237B.

Controls, meters, and binding posts are logically arranged on a neatly laid out front panel. One voltage control simultaneously adjusts the 20 V and -20 V outputs, which track within 1% to power operational amplifiers and circuits requiring balanced voltages. A tracking ratio control can disable the 1:1 tracking feature and set the negative output to a lower voltage than that of the positive output. Once the tracking ratio control has established a voltage ratio between the positive and negative outputs, the ratio remains constant as the ± 20 V voltage control varies both outputs. Another voltage control sets the 0 to +6 V (HP 6236B) or 0 to +18 V (HP 6237B) output.

All outputs are protected against overload and short-circuit damage by fixed current limiting circuits. For any overload condition, the +20 V and -20 V outputs in both models are limited to 0.55 A and the +18 V output in the HP 6237B is limited to 1.1 A. The overload protection circuit for the +6 V output in the HP 6236B has a current foldback characteristic that reduces the maximum available current from about 2.75 A at a 6 V terminal voltage to 1 A at zero volts (or short circuited). This foldback limiting characteristic maximizes the available current in the important 5 to 6-volt range while minimizing dissipation during overloads.

Another protective feature safeguards sensitive load circuitry by preventing an output voltage overshoot when the supply is turned on or off.

Separate dual-range panel meters allow both the voltage and current of any output to be monitored simultaneously. A three-position switch selects the output which the meters will monitor.

Both models measure only 89 H x 216 W x 319 mm D (3.5" x 8.5" x 12.5") and weigh 4.3 kg (9.5 lb).



Specifications

| RATINGS | | PERFORMANCE | | | | | | | GENERAL | |
|---|------------------------|-------------|------------------------|------------------------|-------------------------------------|-----------------------------|---|---|--------------------------|-------|
| DC Output | | HP Model | Load Effect | Source Effect | PAR rms/p-p | Control Mode and Resolution | Remote Control Coefficients | Power 115 V ac ± 10% | Options | Price |
| Volts | Amps | | | | | | | | | |
| SINGLE OUTPUT—10 WATTS | | | | | | | | | | |
| 0-10 | 0-1 | 6214B | 4 mV | 4 mV | 200 μ V/1 mV | CV/CC 5mV/75 μ A | ** | 48-440 Hz 0.3 A, 28 W | 28 | \$370 |
| 0-25 | 0-0.4 | 6216B | 4 mV | 4 mV | 200 μ V/1 mV | CV/CC 5mV/20 μ A | ** | 48-440 Hz 0.3 A, 28 W | 28 | \$370 |
| 0-50 | 0-0.2 | 6218B | 4 mV | 4 mV | 200 μ V/1 mV | CV/CC 10mV/10 μ A | ** | 48-440 Hz 0.3 A, 28 W | 28 | \$370 |
| 0-100 | 0-0.1 | 6212B | 8 mV | 4 mV | 200 μ V/1 mV | CV/CC 20mV/10 μ A | ** | 48-440 Hz 0.3 A, 28 W | 28 | \$450 |
| SINGLE OUTPUT—UP TO 30 WATTS | | | | | | | | | | |
| Dual range 0-20 or 0-40 | 0-1.5 0-0.75 | 6200B | 0.01% + 4 mV | 0.01% + 4 mV | 200 μ V/1 mV | CV/CC 10 mV/2 mA | 2000/V \pm 1% 0.5 k Ω /A \pm 10% or 1 k Ω /A \pm 10% | 48-440 Hz 0.9 A, 70 W | 11, 28 | \$600 |
| Dual range 0-30 or 0-60 | 0-1 0-0.5 | 6206B | 0.01% + 4 mV | 0.01% + 4 mV | 200 μ V/1 mV | CV/CL 10 mV/* | 3000/V \pm 1% | 48-440 Hz 1 A, 66 W | 11, 28 | \$600 |
| 0-320 | 0-0.1 | 6209B | 0.02% + 2 mV | 0.02% + 2 mV | 1 mV/40 mV | CV/CC 40 mV/200 μ A | 3000/V \pm 1% 150 k Ω /A \pm 10% | 48-63 Hz 1 A, 60 W | 28 | \$770 |
| DUAL OUTPUT—10 WATTS | | | | | | | | | | |
| Dual output 0-25 and 0-25 | 0.2 0.2 | 6234A | 0.01% + 1 mV | 0.01% + 1 mV | 200 μ V/1 mV | CV/CL | ** | 104-127 Vac 47-63 Hz 0.26A, 35 W | 28 | \$450 |
| DUAL OUTPUT—24 WATTS | | | | | | | | | | |
| Two dual ranges 0-20/0-40 and 0-20/0-40 | 0-0.6/0.3 0-0.6/0.3 | 6205C | 0.01% + 4 mV | 0.01% + 4 mV | 200 μ V/1 mV | CV/CL 10 mV/* | 2000/V \pm 1% | 48-440 Hz 0.5 A, 50 W | 11, 28 40 | \$650 |
| TRIPLE OUTPUT—13 WATTS | | | | | | | | | | |
| Triple output 0 to 6 and 0 to 18 and 0 to -18 | 0-1 0-0.2 0-0.2 | 6235A | 8 mV 10 mV 10 mV | 8 mV 15 mV 15 mV | 1 mV/5 mV 1 mV/5 mV 1 mV/5 mV | CV/CL | ** ** ** | 47-63 Hz 0.26 A, 35 W | 28 | \$480 |
| TRIPLE OUTPUT—35 WATTS* | | | | | | | | | | |
| Triple output 0 to +6 and 0 to +20 and 0 to -20 | 2.5 0.5 0.5 | 6236B | 0.01% + 2 mV | 0.01% + 2 mV | 350 μ V/1.5 mV | CV/CL 70 mV/* | ** | 104-127 Vac 47-63 Hz 1.2 A, 112 W | 100 120 220 240 | \$700 |
| TRIPLE OUTPUT—38 WATTS* | | | | | | | | | | |
| Triple Output 0 to +18 and 0 to +20 and 0 to -20 | 1 0.5 0.5 | 6237B | 0.01% + 2 mV | 0.01% + 2 mV | 350 μ V/1.5 mV | CV/CL 70 mV/* | ** | 104-127 Vac 47-63 Hz 1.2 A, 112 W | 100 120 220 240 | \$700 |

*fixed current limit

**remote control not available

★ac input voltage option must be specified when ordering

Option Descriptions

011: internal overvoltage protection crowbar. Protects delicate loads against power supply failure or operator error. Dual output models have dual crowbars.

HP 6200B, 6206B
HP 6205C

add \$100
add \$200

028: 230 Vac \pm 10%, single phase input. Consists of reconnecting power transformer taps, and other components where necessary.

NC

040: Multiprogrammer interface. Prepares HP 6205C power supplies for resistance programming by the HP 6940B or 6942A Multiprogrammer

add \$76

100: 87-106 Vac, 47-63 Hz, single phase input

NC

120: 104-127 Vac, 47-63 Hz, single phase input

NC

220: 191-233 Vac, 47-63 Hz, single phase input

NC

240: 208-250 Vac, 47-63 Hz, single phase input

NC

910: one additional operating and service manual is shipped with each power supply

HP 6200B-6237B

add \$5.10

Accessories

HP 14513A: rack kit for one HP 6200-6209B, 6236B, or 6237B supply

\$56

HP 14523A: rack kit for two of the above power supplies

\$30

HP 14521B: rack kit for one, two or three HP 6212B-6218B power supplies

\$85



POWER SUPPLIES

General Purpose: 25–200 W Output

Models 6227B–6299A

- Constant voltage/constant current operation
- Remote sensing and programming
- Auto-series, -parallel, & -tracking operation

- Front and rear output terminals
- Floating output—use as positive or negative source
- Bench or rack mounting



HP 6281A, 6284A, 6289A,
6294A, 6299A

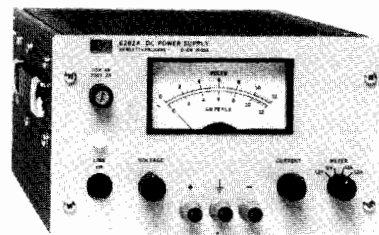

HP 6282A, 6286A,
6291A, 6296A

Description

HP 6281A–6299A Single Output

This series of medium-power constant voltage/constant current power supplies is available in two power ranges: 37–75 watts (packaged in 3½-inch high half-rack cases) and 100–200 watts (packaged in 5¼-inch high half-rack cases). All models except HP 6294A and 6299A have separate coarse and fine voltage and current controls that allow the voltage and current outputs to be varied from zero to the maximum rated values. The latter two models have ten-turn voltage controls. Crossover from constant voltage to constant current operation occurs automatically when the load current exceeds the value established by the current control settings. A four-position meter function switch selects either of two output voltage or output current ranges (X1, X0.1) for display on the panel meter.

The 37–75 watt models are of the series-regulated type. They have excellent regulation and ripple characteristics and include a special output-capacitor discharge circuit for improved programming speed. The 100–200 watt models employ a series-regulator/SCR-preregulator configuration to achieve the high efficiency necessary for a convection-cooled package of this size. They also have excellent regulation, low ripple and noise, and moderate programming speeds.

Specifications

| RATINGS | | | PERFORMANCE | | | | | | | |
|-----------|---------|----------|--------------|----------------|---------------|----------------|---------------|-------------|-------------------|----------------|
| DC Output | | HP Model | Load Effect | | Source Effect | | PAR (rms/p-p) | | Drift (stability) | |
| Volts | Amperes | | Voltage | Current | Voltage | Current | Voltage | Current | Voltage | Current |
| 0–7.5 | 0–5 | 6281A | 5 mV | 0.01% + 250 μA | 0.01% + 2 mV | 0.01% + 250 μA | 200 μV/1 mV | 4 mA rms | 0.1% + 2.5 mV | 0.1% + 12.5 mA |
| 0–10 | 0–10 | 6282A | 0.01% + 1 mV | 0.05% + 1 mA | 0.01% + 1 mV | 0.05% + 1 mA | 500 μV/25 mV | 5 mA rms | 0.1% + 2.5 mV | 0.1% + 25 mA |
| 0–20 | 0–3 | 6253A* | 0.01% + 4 mV | 0.01% + 250 μA | 0.02% + 2 mV | 0.01% + 250 μA | 200 μV/1 mV | 2 mA rms | 0.1% + 2.5 mV | 0.1% + 7.5 mA |
| 0–20 | 0–3 | 6284A | 0.01% + 4 mV | 0.01% + 250 μA | 0.01% + 2 mV | 0.01% + 250 μA | 200 μV/1 mV | 2 mA rms | 0.1% + 2.5 mV | 0.1% + 7.5 mA |
| 0–20 | 0–10 | 6286A | 0.01% + 1 mV | 0.05% + 1 mA | 0.01% + 1 mV | 0.05% + 1 mA | 500 μV/25 mV | 5 mA rms | 0.1% + 2.5 mV | 0.1% + 25 mA |
| 0–25 | 0–2 | 6227B* | 0.01% + 1 mV | 0.01% + 250 μA | 1 mV | 100 μA | 250 μV/4 mV | 250 μA/2 mA | 0.2% + 2 mV | 0.2% + 3 mA |
| 0–40 | 0–1.5 | 6255A* | 0.01% + 2 mV | 0.01% + 250 μA | 0.01% + 2 mV | 0.01% + 250 μA | 200 μV/1 mV | 500 μA rms | 0.1% + 2.5 mV | 0.1% + 4 mA |
| 0–40 | 0–1.5 | 6289A | 0.01% + 2 mV | 0.01% + 250 μA | 0.01% + 2 mV | 0.01% + 250 μA | 200 μV/1 mV | 500 μA rms | 0.1% + 2.5 mV | 0.1% + 4 mA |
| 0–40 | 0–5 | 6291A | 0.01% + 1 mV | 0.05% + 1 mA | 0.01% + 1 mV | 0.05% + 1 mA | 500 μV/25 mV | 3 mA rms | 0.1% + 2.5 mV | 0.1% + 12.5 mA |
| 0–50 | 0–1 | 6228B* | 0.01% + 1 mV | 0.01% + 250 μA | 1 mV | 100 μA | 250 μV/4 mV | 250 μA/2 mA | 0.2% + 2 mV | 0.2% + 1.5 mA |
| 0–60 | 0–1 | 6294A | 0.01% + 2 mV | 0.01% + 250 μA | 0.01% + 2 mV | 0.01% + 250 μA | 200 μV/1 mV | 500 μA rms | 0.1% + 2.5 mV | 0.1% + 2.5 mA |
| 0–60 | 0–3 | 6296A | 0.01% + 1 mV | 0.05% + 1 mA | 0.01% + 1 mV | 0.05% + 1 mA | 500 μV/25 mV | 3 mA rms | 0.1% + 2.5 mV | 0.1% + 7.5 mA |
| 0–100 | 0–0.75 | 6299A | 0.01% + 2 mV | 0.01% + 250 μA | 0.01% + 2 mV | 0.01% + 250 μA | 200 μV/1 mV | 500 μA rms | 0.1% + 2.5 mV | 0.1% + 2 mA |

*Models 6227B, 6228B, 6253A, and 6255A contain two identical, independently-adjustable power supplies.

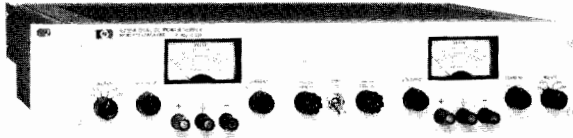

HP 6253A, 6255A

Each side of the dual supply can be operated as a constant voltage or constant current source, and each has its own crowbar for overvoltage protection. In the tracking mode, an overvoltage condition in either supply trips both crowbars. The power supply outputs are isolated up to 300 V from output to chassis or output to output.

Specifications—General

Load effect transient recovery: time, 50 μ s; level, 15 mV.

Meter accuracy: 3% of full scale.

Power: standard input voltage is 115 V ac \pm 10%. Order Option 028 for 230 V ac \pm 10% operation. Input power frequency, maximum input current, maximum power consumption are:

HP 6227B and 6228B, 48–63 Hz, 2.7 A, 260 W;
 HP 6253A, 48–440 Hz, 2.6 A, 235 W; HP 6255A, 48–440 Hz, 2.6 A, 235 W; HP 6281A, 48–440 Hz, 1.3 A, 118 W; HP 6282A, 57–63 Hz, 3.5 A, 200 W; HP 6284A, 48–440 Hz, 1.5 A, 128 W; HP 6286A, 57–63 Hz, 5.5 A, 320 W; HP 6289A, 48–440 Hz, 1.3 A, 110 W; HP 6291A, 57–63 Hz, 5.5 A, 280 W; HP 6294A, 48–440 Hz, 1.3 A, 114 W; HP 6296A, 57–63 Hz, 4.5 A, 250 W; HP 6299A, 48–440 Hz, 1.5 A, 135 W.

Size: 6227B, 6228B: 155 H x 197 W x 309.55 mm D (6 $\frac{3}{32}$ " x 7 $\frac{5}{32}$ " x 12 $\frac{3}{16}$ ").

HP 6253A, 6255A: 87 H x 483 W x 403 mm D (3 $\frac{1}{16}$ " x 19" x 15 $\frac{7}{16}$ ").
 HP 6281A, 6284A, 6289A, 6294A, 6299A: 87 H x 209 W x 398 mm D (3 $\frac{1}{16}$ " x 8 $\frac{3}{32}$ " x 15 $\frac{7}{16}$ ").

HP 6282A, 6286A, 6291A, 6296A: 131 H x 210 W x 435 mm D (5 $\frac{1}{32}$ " x 8 $\frac{1}{4}$ " x 17 $\frac{1}{16}$ ").

Option Descriptions

005: 50 Hz ac input: optimizes power supplies that require adjustment/modification for 50 Hz operation. N/C

010: Chassis slides. Enable convenient access to rack-mounted power supply for maintenance. add \$160



HP 6227B, 6228B

011: Internal overvoltage protection crowbar. Protects sensitive loads against power supply failure or operator error. Monitors the output voltage and places a virtual short circuit (conducting SCR) across load after preset trip voltage is exceeded.

HP 6281A, 6284A, 6289A, 6294A, 6299A

add \$125

HP 6282A, 6286A, 6291A, 6296A

add \$205

HP 6253A, 6255A

add \$205

028: 230 Vac \pm 10%, single-phase input. Factory modification reconnects the multi-tap input power transformer for 230 V operation.

N/C

040: Interfacing for Multiprogrammer operation. Prepares standard HP power supplies for resistance programming by the HP 6940B or 6942A. Price per output. add \$76

910: one additional operating and service manual shipped with the power supply

HP 6253A, 6255A, 6227B, 6228B

add \$7.50

HP 6281A, 6282A, 6284A, 6286A, 6289A, 6291A, 6294A, 6296A, 6299A

add \$5.10

Accessories

HP 14513A: 3.5 in. high rack kit for one HP 6281A, 6284A, 6289A, 6294A, 6299A \$56

HP 14523A: 3.5 in. high rack kit for two above supplies \$30

HP 14515A: 5.25 in. high rack kit for one HP 6282A, 6286A, 6291A, 6296A \$61

HP 14525A: 5.25 in. high rack kit for two above supplies \$35

HP 5060-8760: blank filler panel for HP 6227B, 6228B \$36

HP 5060-8762: adapter frame for rack mounting one or two HP 6227B, 6228B \$115

Specifications, continued

| REMOTE CONTROL FEATURES | | | | | | | | GENERAL | | | | | |
|--------------------------|---------------------------|---------------------|--------------------|------------|--------|--------------|--------|-------------|------------|---------------|---------------|----------------|--------|
| Resistance Coefficient | | Voltage Coefficient | | Speed, UP* | | Speed, DOWN* | | Overvoltage | | Weight | | | |
| Voltage | Current | Voltage | Current | NL | FL | NL | FL | Range | Margin | Net | Shipping | Options▲ | Price |
| 200 Ω /V \pm 1% | 200 Ω /A \pm 10% | 1 V/V \pm 1% | 0.2 V/A \pm 10% | 1 ms | 2 ms | 10 ms | 6 ms | 2.5–10 V | 4% + 2 V | 6.4 kg/14 lb | 7.2 kg/16 lb | 11, 28, 40 | \$850 |
| 200 Ω /V \pm 1% | 100 Ω /A \pm 10% | 1 V/V \pm 1% | 100 mV/A \pm 10% | 70 ms | 200 ms | 9 s | 40 ms | 1–13 V | 7% + 1 V | 11.3 kg/25 lb | 13.6 kg/30 lb | 5, 11, 28, 40 | \$1000 |
| 200 Ω /V \pm 1% | 500 Ω /A \pm 10% | 1 V/V \pm 1% | 0.33 V/A \pm 10% | 30 ms | 80 ms | 400 ms | 100 ms | 2.5–23 V | 4% + 2 V | 12.7 kg/28 lb | 17.7 kg/39 lb | 10, 11, 28, 40 | \$1350 |
| 200 Ω /V \pm 1% | 500 Ω /A \pm 10% | 1 V/V \pm 1% | 0.33 V/A \pm 10% | 30 ms | 80 ms | 400 ms | 100 ms | 2.5–23 V | 4% + 2 V | 6.4 kg/14 lb | 7.2 kg/16 lb | 11, 28, 40 | \$700 |
| 200 Ω /V \pm 1% | 100 Ω /A \pm 10% | 1 V/V \pm 1% | 100 mV/A \pm 10% | 150 ms | 150 ms | 9 s | 70 ms | 2–22 V | 7% + 1 V | 10.8 kg/26 lb | 13.1 kg/29 lb | 5, 11, 28 | \$1050 |
| 200 Ω /V \pm 1% | 500 Ω /A \pm 10% | 1 V/V \pm 1% | 5 V/A \pm 10% | 40 ms | 200 ms | 400 ms | 75 ms | 5–28 V | 7% + 1.5 V | 11 ka/24 lb | 12.9 kg/28 lb | 40 | \$1650 |
| 200 Ω /V \pm 1% | 500 Ω /A \pm 10% | 1 V/V \pm 1% | 0.66 V/A \pm 10% | 15 ms | 45 ms | 200 ms | 40 ms | 2.5–44 V | 4% + 2 V | 12.7 kg/28 lb | 17.7 kg/39 lb | 10, 11, 28, 40 | \$1350 |
| 200 Ω /V \pm 1% | 500 Ω /A \pm 10% | 1 V/V \pm 1% | 0.66 V/A \pm 10% | 15 ms | 45 ms | 200 ms | 40 ms | 2.5–44 V | 4% + 2 V | 6.4 kg/14 lb | 7.2 kg/16 lb | 11, 28, 40 | \$700 |
| 200 Ω /V \pm 1% | 200 Ω /A \pm 10% | 1 V/V \pm 1% | 200 mV/A \pm 10% | 275 ms | 275 ms | 13 s | 275 ms | 6–43 V | 7% + 1 V | 11.3 kg/25 lb | 12.7 kg/28 lb | 5, 11, 28 | \$1050 |
| 200 Ω /V \pm 1% | 1 k Ω /A \pm 10% | 1 V/V \pm 1% | 1 V/A \pm 10% | 50 ms | 350 ms | 1 s | 50 ms | 5–55 V | 7% + 1.5 V | 11 ka/24 lb | 12.9 kg/28 lb | 40 | \$1650 |
| 300 Ω /V \pm 1% | 1 k Ω /A \pm 10% | 1 V/V \pm 1% | 1 V/A \pm 10% | 25 ms | 80 ms | 2 s | 175 ms | 5–65 V | 4% + 2 V | 5.9 kg/13 lb | 6.8 kg/15 lb | 11, 28, 40 | \$750 |
| 300 Ω /V \pm 1% | 500 Ω /A \pm 10% | 1 V/V \pm 1% | 333 mV/A \pm 10% | 600 ms | 600 ms | 5 s | 200 ms | 9–66 V | 7% + 1 V | 11.3 kg/25 lb | 12.7 kg/28 lb | 5, 11, 28 | \$1050 |
| 300 Ω /V \pm 1% | 1 k Ω /A \pm 10% | 1 V/V \pm 1% | 1.3 V/A \pm 10% | 25 ms | 200 ms | 1.5 s | 200 ms | 20–106 V | 4% + 2 V | 5.9 kg/13 lb | 6.8 kg/15 lb | 11, 28, 40 | \$750 |

*UP = increasing output voltage. NL = No output load current. FL = Full rated output load current.



POWER SUPPLIES

Autoranging Power Supplies

Models 6010A, 6011A, 6012B, 6023A, and 6024A

- Complete front panel control/display
- Constant voltage/constant current operation
- Remote programming and sensing
- Autoranging output
- High efficiency, compact, and light weight
- Ten-turn voltage and current controls

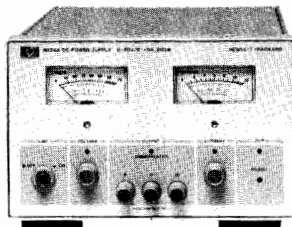

HP 6024A

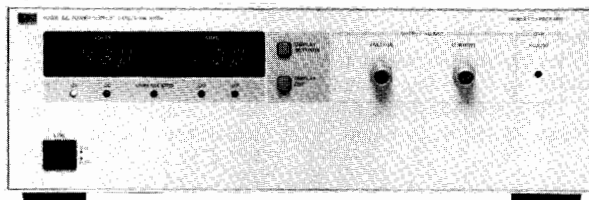

HP 6010A, 6011A, 6012B

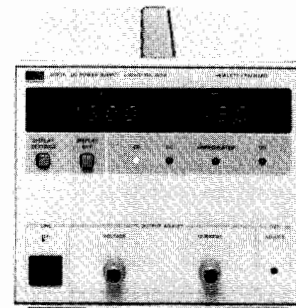

HP 6023A

Description

HP Models 6010A, 6011A, 6012B, and 6023A

This versatile family of dc power supplies provides laboratory grade performance along with many features to meet both laboratory and system needs.

Ten-turn front panel controls provide the means to precisely adjust the output voltage and current. The settings of these controls can be observed on the front panel meters by pressing the Display Settings button. This allows the current limit to be set when operating in the CV mode without shorting the output terminals and the voltage limit to be set when operating in the CC mode without opening the load leads.

Three and one-half digit front panel meters provide a convenient means for monitoring the output voltage and current. The accuracy of these meters allow them to replace external DVMs and monitor resistors in many applications that require monitoring of the power supply output.

The overvoltage protection (OVP) trip level can also be displayed on the front panel meters, allowing the trip level to be accurately adjusted without actually activating the OVP circuitry or disconnecting loads. In addition to the protection provided to the power supply and load by the OVP, these supplies also have protection against operating under excessive ac line or thermal conditions.

As autoranging power supplies, these units can operate at their maximum rated power over a wide and continuous range of voltage and current combinations. This often allows both present and future requirements to be satisfied with fewer supplies.

HP Model 6023A is stable when operating in the CC mode into inductive loads up to one henry. HP Models 6010A, 6011A and 6012B are stable when operating in the CC mode into inductive loads up to 100 mH, and a special modification is available for these three models to assure stability with loads up to ten henries.

System Features

The output voltage and current of these supplies can be remotely controlled with either 0-5 volt or 0-4000 ohm analog programming signals. The actual output levels can be monitored without complicated external circuitry by connecting DVMs to the buffered 0-5 volt monitor outputs. All programming and monitoring signals are referenced to the same common and are accessed through the rear panel barrier strip.

Either terminal may be grounded, or floated up to ± 240 volts from chassis ground for the HP 6011A, 6012B and 6023A, and ± 550 volts for the HP 6010A.

If more output voltage or current is needed than a single unit can provide, auto-series or auto-parallel configurations can be used. Up to four 1000-watt units, or up to two 200-watt units can be connected in auto-parallel, and any combination can be used in auto-series providing up to 240 volts total (550 Vdc for HP 6010A) from chassis ground including output voltage. Remote sensing can be used to maintain the CV load effect specification at the load with up to 0.5 volt drop per load lead and sense wires that are less than 0.2 ohm per lead. Operation is possible with up to 2.0 volts per lead; however, load effect specification may be degraded. For more system control and monitoring capabilities, see Option 002.

Specifications

| Ratings | | | | | | | | | Regulation | | | | 10% Change Transient Recovery |
|---------|---------|--------------------|----------------|----------------|----------------|----------------|----------------|----------|---------------|----------------|---------------|----------------|-------------------------------|
| Volts | Amperes | Autoranging Output | | | | | | HP Model | Load Effect | | Source Effect | | |
| | | V _i | P _i | V _o | P _o | V _s | P _s | | Voltage | Current | Voltage | Current | |
| 0-20 | 0-30 | 20V | 200W | 14V | 242W | 6.7V | 200W | 6023A | 0.01% +2mV | 0.01% +9mA | 0.01% +1mV | 0.01% +6mA | 1ms 50mV |
| 0-20 | 0-120 | 20V | 1000W | 14V | 1064W | 7V | 840W | 6011A | 0.01% +3mV | 0.01% +15mA | 0.01% +2mV | 0.01% +25mA | 2ms 100mV |
| 0-60 | 0-10 | 60V | 200W | 40V | 240W | 20V | 200W | 6024A | 0.01% +3mV | 0.01% +3mA | 0.01% +5mV | 0.01% +5mA | 1ms 75mV |
| 0-60 | 0-50 | 60V | 1000W | 40V | 1200W | 20V | 1000W | 6012B | 0.01% +5mV | 0.01% +10mA | 0.01% +3mV | 0.01% +10mA | 2ms 100mV |
| 0-200 | 0-17 | 200V | 1000W | 120V | 1200W | 60V | 1020W | 6010A | 0.01% +5mV | 0.01% +10mA | 0.01% +5mV | 0.01% +5mA | 2ms 150mV |

*See the generalized autoranging output characteristic curve.

HP Model 6024A

As an autoranging dc power supply, the HP 6024A can provide 200 watts over a wide and continuous range of voltage and current combinations, with maximums of 60 volts and 10/ampères. This provides greater flexibility than traditional power supplies that have only one maximum power point.

Ten-turn potentiometers provide precise control of the output voltage and current. The output levels can be observed on the separate front panel voltage and current meters. Terminals are available on both the front and rear panel for load connections.

The built-in OVP is adjustable from the front panel. Other protection features include over-temperature and high ac line detection.

The HP 6024A has many system oriented features. It can be remotely programmed with 0-5 volt or 0-2500 ohm analog signals. The output current can be easily monitored without an external shunt with the proportional 0-5 volt buffered monitor output. Remote sensing can be used to eliminate the effects of voltage drops in the load leads, and either terminal may be floated up to ± 240 volts from chassis ground. Several units can be combined in auto-series, auto-parallel, and auto-tracking configurations, further increasing the HP 6024A's flexibility.

For more system features, see Option 002.

General Specifications

Dimensions

HP 6010A, 6011A and 6012B: 132.6 mm H x 425.5 mm W x 516.4 mm D (5.2" x 16.75" x 20.33").

HP 6023A: 170.6 mm H x 208.8 mm W x 453.9 mm D (6.72" x 8.22" x 17.872").

HP 6024A: 133.4 mm H x 212.3 mm W x 415.33 D (5.25" x 8.36" x 16.35").

Ordering Information

Option Descriptions

002: provides extra programming and monitoring capabilities for system use. A card inserted into the power supply is accessible through a 37-pin connector on the rear panel. It provides easy access to the control and monitor signals available on standard units, as well as these additional features:

- OVP trip and reset
- power supply inhibit
- status bits indicating CV mode, CC mode, unregulated output, OVP tripped, overtemperature condition, and ac line drop-out
- remote programming via a 0-2 mA current sink
- bias supplies for your circuitry: +5 volts at 100 mA, +15 volts at 75 mA, and -15 volts at 75 mA.
- buffered 0-5 volt outputs representing both the output voltage and output current. (HP 6010A, 6011A, 6012B, and 6023A provide this feature standard, but HP 6024A only provides a scaled 0-5 volt output to represent the output current, not the output voltage.)
- programmable remote/local for use when programming with a current sink.

Price

\$330.00

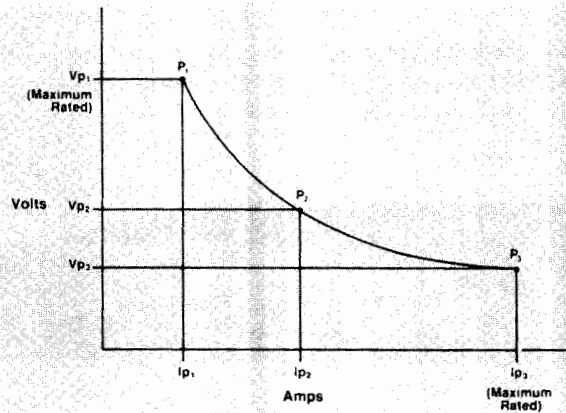

Generalized autoranging output characteristic curve

These features can all be taken advantage of with an HP 6940B or 6942A Multiprogrammer instrument sub-system configured with an HP 69520A or 69709A Power Supply Programming Card. The Multiprogrammer provides a cost-effective solution for controlling a group of power supplies, and also can provide many other digital and analog monitoring and control functions, all on the HP-IB. The voltage and current programming resolution available with either card is 1/1000th of full scale.

The features available with Option 002 can also be interfaced to your own external circuitry rather than an HP Multiprogrammer.

- 100:** 87-106 Vac, 48-63 Hz. HP 6024A Only! This option is for use in Japan only. The power supply output power is 75% of the output power available with the other line voltage options. For HP 6024A only. N/C
- 120:** 104 to 127 Vac, 48-63 Hz. N/C
- 220:** 191 to 233 Vac, 48-63 Hz. N/C
- 240:** 208 to 250 Vac, 48-63 Hz. N/C
- 800:** Rack-mount kit for two units side by side. This applies to HP 6023A and 6024A only.
 - HP 6023A \$72.00
 - HP 6024A \$70.00
- 908:** Rack-mount kit for a single unit. A blank filler panel is supplied when ordered for half rack width units.
 - HP 6010A, 6011A, 6012B \$30.00
 - HP 6023A \$80.00
 - HP 6024A \$53.50
- 910:** One extra operating and service manual shipped with each power supply.
 - HP 6023A, 6024A \$10.00
 - HP 6010A, 6011A, 6012B \$15.00

| PARD (rms/p-p) 20Hz-20MHz | | Programming Response Time | | | | | | | General* | | | | | | Price |
|------------------------------|---------|---------------------------|-----------|---------|-----------|------------|-------|---------|------------------|---------|---------|-----------|-----------------|--------|-------|
| | | UP | | | DOWN | | | | AC Input Current | | | | Weight kg (lbs) | | |
| | | Settling Band | Full Load | No Load | Full Load | Light Load | | 100 Vac | 120 Vac | 220 Vac | 240 Vac | Net | Shipping | | |
| Voltage | Current | | | | Time | Load | | | | | | | | | |
| 3 mV 30 mV | 15 mA | 5 mV | 100 ms | 100 ms | 200 ms | 500 ms | 50 Ω | — | 6.5 A | 3.8 A | 3.6 A | 8.6 (19) | 10.5 (23) | \$1550 | |
| 8 mV 50 mV | 120 mA | 30 mV | 300 ms | 300 ms | 500 ms | 1.5 sec | 50 Ω | — | 24 A | 15 A | 14 A | 16.8 (37) | 22.2 (49) | \$2200 | |
| 3 mV 30 mV | 5 mA | 60 mV | 200 ms | 200 ms | 300 ms | 600 ms | Open | 5.3 A | 5.3 A | 2.9 A | 2.7 A | 5.4 (12) | 7.3 (16) | \$1220 | |
| 8 mV 40 mV | 25 mA | 90 mV | 300 ms | 300 ms | 2.0 sec | 3.0 sec | 100 Ω | — | 24 A | 15 A | 14 A | 15.9 (35) | 21.3 (47) | \$2100 | |
| 22mV 50mV | 15mA | 300mV | 300ms | 300ms | 600ms | 3.5 sec | Open | — | 24 A | 15 A | 14 A | 16.3 (36) | 21.7 (48) | \$2200 | |

* An ac input option must be specified when ordering.



POWER SUPPLIES

General Purpose: 120-2000 W Output

Models 6259B-6274B

- Built-in overvoltage protection
- Constant voltage/constant current operation
- Remote programming and sensing

- Remote sensing
- Auto-series, -parallel, and -tracking operation
- $\leq 50 \mu\text{s}$ load transient recovery

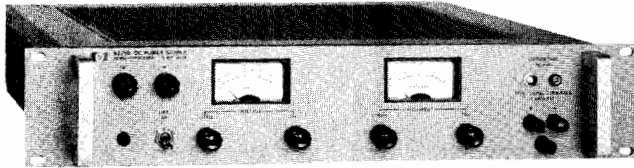

HP 6263B, 6266B, 6271B

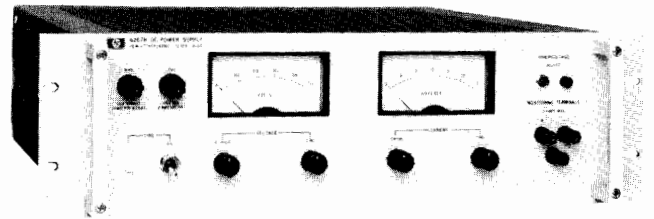

HP 6264B, 6267B

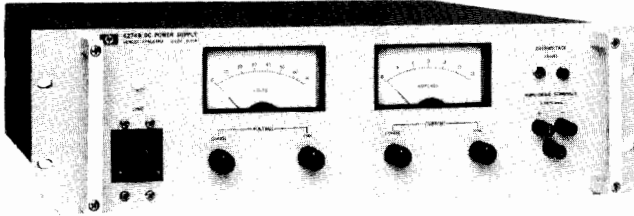

HP 6274B

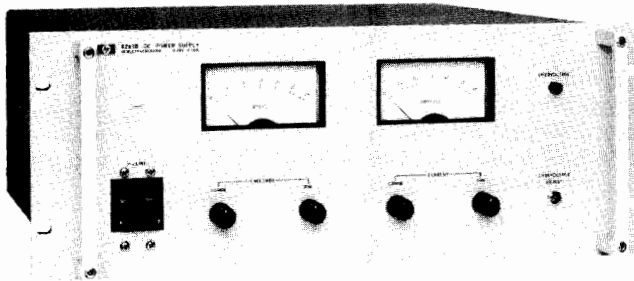

HP 6259B, 6260B, 6261B, 6268B, 6269B

Description

Models 6259B-6274B

This series of high-performance constant voltage/constant current supplies includes twelve models with output rating from 10 to 60 V. All models employ a transistor series-regulator/triac-preregulator circuit to achieve high efficiency, excellent regulation, low ripple and noise, and moderate programming speeds in a compact full-rack width package.

Separate coarse and fine voltage and current controls allow the voltage and current outputs to be varied from zero to the maximum rated value, crossover from constant voltage to constant current operation occurs automatically when the load current exceeds the value established by the current control settings.

Additional features include built-in overvoltage crowbar protection; remote error sensing; and auto-series, auto-parallel, and auto-tracking operation. The crowbar trip point adjustment and associated overvoltage indicator are conveniently located on the front panel.

Specifications†

| RATINGS | | | PERFORMANCE | | | | | | | |
|-----------|---------|----------|---------------------------|---------------------------|---------------------------|---------------------------|---------------------------------|-----------|---------------------------|---------------|
| DC Output | | HP Model | Load Effect | | Source Effect | | PAR (rms/p-p) | | Drift (stability) | |
| Volts | Amperes | | Voltage | Current | Voltage | Current | Voltage | Current | Voltage | Current |
| 0-10 | 0-50 | 6259B | 0.01% + 200 μV | 0.02% + 1 mA | 0.01% + 200 μV | 0.02% + 1 mA | 500 $\mu\text{V}/5 \text{ mV}$ | 25 mA rms | 0.03% + 2 mV | 0.03% + 10 mA |
| 0-10 | 0-100 | 6260B | 0.01% + 200 μV | 0.02% + 2 mA | 0.01% + 200 μV | 0.02% + 2 mA | 500 $\mu\text{V}/5 \text{ mV}$ | 50 mA rms | 0.03% + 2 mV | 0.03% + 20 mA |
| 0-20 | 0-10 | 6263B | 0.01% + 200 μV | 0.02% + 500 μA | 0.01% + 200 μV | 0.02% + 500 μA | 200 $\mu\text{V}/10 \text{ mV}$ | 3 mA rms | 0.03% + 500 μV | 0.03% + 6 mA |
| 0-20 | 0-20 | 6264B | 0.01% + 200 μV | 0.02% + 500 μA | 0.01% + 200 μV | 0.02% + 500 μA | 200 $\mu\text{V}/10 \text{ mV}$ | 5 mA rms | 0.03% + 500 μV | 0.03% + 6 mA |
| 0-20 | 0-50 | 6261B | 0.01% + 200 μV | 0.02% + 1 mA | 0.01% + 200 μV | 0.02% + 1 mA | 500 $\mu\text{V}/5 \text{ mV}$ | 25 mA rms | 0.03% + 2 mV | 0.03% + 10 mA |
| 0-40 | 0-5 | 6266B | 0.01% + 200 μV | 0.02% + 500 μA | 0.01% + 200 μV | 0.02% + 500 μA | 200 $\mu\text{V}/10 \text{ mV}$ | 3 mA rms | 0.03% + 500 μV | 0.03% + 3 mA |
| 0-40 | 0-10 | 6267B | 0.01% + 200 μV | 0.02% + 500 μA | 0.01% + 200 μV | 0.02% + 500 μA | 200 $\mu\text{V}/10 \text{ mV}$ | 3 mA rms | 0.03% + 2 mV | 0.03% + 3 mA |
| 0-40 | 0-30 | 6268B | 0.01% + 200 μV | 0.02% + 2 mA | 0.01% + 200 μV | 0.02% + 2 mA | 1 mV/5 mV | 20 mA rms | 0.03% + 2 mV | 0.03% + 5 mA |
| 0-40 | 0-50 | 6269B | 0.01% + 200 μV | 0.02% + 2 mA | 0.01% + 200 μV | 0.02% + 2 mA | 1 mV/5 mV | 25 mA rms | 0.03% + 2 mV | 0.03% + 10 mA |
| 0-60 | 0-15 | 6274B | 0.01% + 200 μV | 0.02% + 500 μA | 0.01% + 200 μV | 0.02% + 500 μA | 200 $\mu\text{V}/20 \text{ mV}$ | 5 mA rms | 0.03% + 2 mV | 0.03% + 5 mA |

†Refer to page 264 for complete specification definitions.

Auto-series, auto-parallel, and auto-tracking connections should ordinarily include no more than three supplies. If a specific application requires the use of more than three supplies in any of the three connections, consult your local HP Field Engineer for additional information.

All dc output, ac input, sensing, control, and programming connections are made to rear-panel terminals. Either the positive or negative output terminal may be grounded or the supplies may be operated floating at up to 300 volts above ground. Models 6263B, 6264B, 6266B and 6267B are convection cooled. All other models in this series employ cooling fans. Models which output more than 200 watts are equipped with terminal blocks for ac input and are not shipped with line cords.

Specification—General

Load effect transient recovery: time, 50 μ s; Level, 10 mV.

Resolution: voltage control, less than 0.02%; current control, less than 0.15%.

Temperature coefficient per °C: 0.01% of output plus 200 μ V.

Temperature ratings: operating, 0 to 55°C; storage, -40 to 75°C.

Remote control programming: these power supplies are capable of being programmed in constant voltage and constant current operation by using an external resistance or dc voltage with coefficients as shown in the table below.

Rear terminal wiring configurations for remote control operation are specified in the operating and service manual supplied with the power supply. For remote control programming procedures and timing considerations, contact your local HP field engineer.

Power: input voltage tolerance is $\pm 10\%$, 57-63 Hz. For other input voltage and frequency options available, see option listing in the specifications table below. Standard input voltage, maximum input current, and maximum power are:

- HP 6259B, 230 V ac, 6 A, 850 W;
- HP 6260B, 230 V ac, 12 A, 1600 W;
- HP 6263B, 115 V ac, 4.5 A, 350 W;
- HP 6266B, 115 V ac, 4 A, 325 W;
- HP 6268B, 230 V ac, 12 A, 1600 W;
- HP 6261B, 230 V ac, 12 A 1500 W;
- HP 6264B, 115 V ac, 8 A, 600 W;
- HP 6267B, 115 V ac, 8 A, 550 W;
- HP 6269B, 230 V ac, 18 A, 2500 W;
- HP 6274B, 115 V ac, 15 A, 1200 W;

AC line connections: three wire, five foot ac power cord included—HP 6263B and 6266B.

Three-terminal barrier strip provided on power supply for ac power connections—HP 6259B, 6260B, 6261B, 6264B, 6267B, 6268B, 6269B and 6274B.

Size

HP 6263B, 6266B: 83.7 H x 483 W x 479.4 mm D (3.296" x 19" x 18.875").

HP 6264B, 6267B, 6274B: 127 H x 483 W x 479.4 mm D (5.00" x 19" x 18.875").

HP 6259B, 6260B, 6261B, 6268B, 6269B: 173 H x 483 W x 479.4 mm D; (6.812" x 19" x 18.875").

Option Descriptions

005: 50 Hz ac input: optimizes power supplies that require adjustment/modification for 50 Hz operation. N/C

010: chassis slides. For access to rack mounted power supplies: HP 6263B, 6264B, 6266B, 6267B add \$86

HP 6274B, 6259B, 6260B, 6261B, 6268B, 6269B add \$160

016: Model 6260B only. 115 Vac $\pm 10\%$ single phase input. Consists of replacing power transformer and circuit breaker, and reconnecting bias transformer, RFI choke and fans. add \$120

022: voltage and current programming adjust. Allows the V and I programming coefficients and zero output to be conveniently adjusted to 0.1% accuracy via access holes in the rear panel. Consists of four potentiometers and resistors located inside the rear panel. add \$61

026: 115 Vac $\pm 10\%$, single phase input. Consists of replacing the input circuit breaker and reconnecting the power transformer, bias transformer, RFI choke, and fans. Models 6259B, 6261B and 6268B only. N/C

027: 208 Vac, $\pm 10\%$, single phase input. Consists of reconnecting power transformer taps, and other components where necessary. N/C

028: 230 Vac $\pm 10\%$, single phase input. Consists of reconnecting power transformer taps, and other components where necessary. N/C

040: Multiprogrammer interface. Prepares standard HP power supplies for resistance programming by the HP 6942A or 6940B Multiprogrammers. This option includes Option 022, special calibration, and protection check-out procedures (where required). add \$76

910: one additional operating and service manual shipped with each power supply. HP 6259B-6274B add \$7.50

Specifications, Continued

| REMOTE CONTROL FEATURES | | | | | | | | GENERAL | | | | | |
|-------------------------|-------------------------|-----------------|----------------------|-----------|--------|-------------|--------|-------------|----------|---------------|---------------|-----------------------|--------|
| Resistance Coeff. | | Voltage Coeff. | | Speed Up* | | Speed Down* | | Overvoltage | | Weight | | Options | Price |
| Voltage | Current | Voltage | Current | NL | FL | NL | FL | Range | Margin | Net | Shipping | | |
| 200 $\Omega/V \pm 1\%$ | 4 $\Omega/A \pm 10\%$ | 1 V/V $\pm 1\%$ | 10 mV/A $\pm 10\%$ | 70 ms | 70 ms | 200 ms | 100 ms | 2-12 V | 5% + 2V | 31.3 kg/69 lb | 35.3 kg/78 lb | 5, 10, 22, 26, 27, 40 | \$1775 |
| 200 $\Omega/V \pm 1\%$ | 2 $\Omega/A \pm 10\%$ | 1 V/V $\pm 1\%$ | 5 mV/A $\pm 10\%$ | 70 ms | 70 ms | 200 ms | 75 ms | 2-12 V | 5% + 2 V | 43.9 kg/97 lb | 48 kg/106 lb | 5, 10, 16, 22, 27, 40 | \$2105 |
| 200 $\Omega/V \pm 1\%$ | 100 $\Omega/A \pm 10\%$ | 1 V/V $\pm 1\%$ | 50 mV/A $\pm 10\%$ | 150 ms | 150 ms | 7 s | 350 ms | 2-23 V | 5% + 1 V | 15.4 kg/34 lb | 18.6 kg/41 lb | 5, 10, 22, 27, 28, 40 | \$1450 |
| 200 $\Omega/V \pm 1\%$ | 10 $\Omega/A \pm 10\%$ | 1 V/V $\pm 1\%$ | 25 mV/A $\pm 10\%$ | 140 ms | 140 ms | 10 s | 150 ms | 2.5-23V | 5% + 1 V | 21.3 kg/47 lb | 24.5 kg/54 lb | 5, 10, 22, 27, 28, 40 | \$1500 |
| 200 $\Omega/V \pm 1\%$ | 4 $\Omega/A \pm 10\%$ | 1 V/V $\pm 1\%$ | 10 m V/A $\pm 10\%$ | 150 ms | 150 ms | 250 ms | 250 ms | 2-23 V | 5% + 2 V | 35.3 kg/78 lb | 39.4 kg/87 lb | 5, 10, 22, 26, 27, 40 | \$1880 |
| 200 $\Omega/V \pm 1\%$ | 200 $\Omega/A \pm 10\%$ | 1 V/V $\pm 1\%$ | 100 mV/A $\pm 10\%$ | 275 ms | 275 ms | 13 s | 1.5 s | 2.5-45 V | 5% + 1 V | 15.4 kg/34 lb | 18.6 kg/41 lb | 5, 10, 22, 27, 28, 40 | \$1400 |
| 200 $\Omega/V \pm 1\%$ | 100 $\Omega/A \pm 10\%$ | 1 V/V $\pm 1\%$ | 50 mV/A $\pm 10\%$ | 275 ms | 275 ms | 13 s | 750 ms | 2.5-45 V | 5% + 1 V | 17.7 kg/39 lb | 20.8 kg/46 lb | 5, 10, 22, 27, 28, 40 | \$1450 |
| 200 $\Omega/V \pm 1\%$ | 6 $\Omega/A \pm 10\%$ | 1 V/V $\pm 1\%$ | 16.7 mV/A $\pm 10\%$ | 300 ms | 300 ms | 1 s | 650 ms | 4-45 V | 5% + 1 V | 34.4 kg/76 lb | 38.1 kg/84 lb | 5, 10, 22, 26, 27, 40 | \$1830 |
| 200 $\Omega/V \pm 1\%$ | 4 $\Omega/A \pm 10\%$ | 1 V/V $\pm 1\%$ | 10 mV/A $\pm 10\%$ | 350 ms | 350 ms | 1 s | 600 ms | 4-45 V | 5% + 1 V | 40.3 kg/89 lb | 44 kg/98 lb | 5, 10, 22, 27, 40 | \$1925 |
| 300 $\Omega/V \pm 1\%$ | 67 $\Omega/A \pm 10\%$ | 1 V/V $\pm 1\%$ | 33.3 mV/A $\pm 10\%$ | 600 ms | 600 ms | 40 s | 800 ms | 6-66 V | 5% + 1 V | 21.7 kg/48 lb | 24.5 kg/54 lb | 5, 10, 22, 27, 28, 40 | \$1600 |

*Up = increasing output voltage. NL = No output load current. FL = Full rated output load current



POWER SUPPLIES

General Purpose: 300—11,000 W Output

Models 6434B—6483C

- Outstanding value—low cost/watt
- Up to 75% efficiency at full output
- Constant voltage/constant current operation

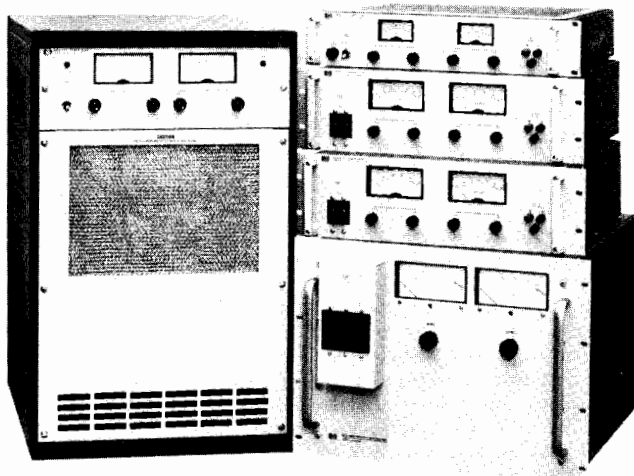

HP 6434B—6483C

Description

This series of SCR-regulated power supplies is designed for medium to high-power applications requiring a fixed or variable dc source with moderate regulation and ripple. For supplies with better regulation, faster response time, and lower ripple, see models HP 6259B—6274B on page 272.

Operating Features

All supplies in this series are of the constant voltage/constant current type. Large easy-to-read panel meters continuously monitor output voltage current.

Input and output power, remote sensing, remote programming, and auto-series, -parallel, and -tracking connections are made to bus bars and terminal blocks on the rear panel.

Specifications†

| RATINGS | | PERFORMANCE | | | | | | | |
|-------------------|---------------|-------------|----------------|---------------|----------------|---------------|--------------------------|----------------------------|---------------|
| DC Output | | HP Model | Load Effect | | Source Effect | | PARD Δ rms/p-p | Temperature Coefficient | Drift |
| Volts‡ | Ampers‡ | | Voltage | Current | Voltage | Current | | | |
| 0-8 | 0-1000 | 6464C | 0.05% + 5 mV | 0.1% + 1 A | 0.05% + 5 mV | 0.1% + 1 A | 80 mV/1 V | 0.03% + 100 μ V | 0.03% + 1 mV |
| 0-15 | 0-200 | 6453A | 0.2% + 10 mV†† | 1% or 2 A†† | 0.2% + 10 mV†† | 1% or 2 A†† | 150 mV rms | 0.05% + 2 mV | 0.25% + 10 mV |
| 0-16 or 18 | 0-600 or 500* | 6466C | 0.05% + 5 mV | 0.1% + 0.6 A | 0.05% + 5 mV | 0.1% + 0.6 A | 180 mV/1 V | 0.03% + 200 μ V | 0.2% + 1 mV |
| 0-36 | 0-100 | 6456B | 0.2% + 10 mV†† | 1% or 1 A†† | 0.2% + 10 mV†† | 1% or 1 A†† | 180 mV rms | 0.05% + 2 mV | 0.25% + 10 mV |
| 0-36 | 0-300 | 6469C | 0.05% + 5 mV | 0.1% + 0.3 A | 0.05% + 5 mV | 0.1% + 0.3 A | 180 mV/1 V | 0.03% + 400 μ V | 0.15% + 1 mV |
| 0-40 | 0-25 | 6434B | 40 mV | 200 mA | 18 mV | 200 mA | 40 mV/500 mV | 0.03% + 5 mV | 0.1% + 20 mV |
| 0-64 | 0-50 | 6459A | 0.2% + 10 mV†† | 1% or 0.5 A†† | 0.2% + 10 mV†† | 1% or 0.5 A†† | 160 mV rms | 0.05% + 2 mV | 0.25% + 10 mV |
| 0-64 | 0-150 | 6472C | 0.05% + 100 mV | 0.1% + 0.15 A | 0.05% + 100 mV | 0.1% + 0.15 A | 160 mV/2 V | 0.03% + 4 mV | 0.15% + 16 mV |
| 0-110 | 0-100 | 6475C | 0.05% + 100 mV | 0.1% + 0.1 A | 0.05% + 100 mV | 0.1% + 0.1 A | 200 mV/2 V | 0.03% + 5 mV | 0.15% + 20 mV |
| 0-120 | 0-2.5 | 6443B | 120 mV | 25 mA | 60 mV | 25 mA | 240 mV/400 mV | 0.03% + 20 mV | 0.1% + 60 mV |
| 0-220 | 0-50 | 6477C | 0.05% + 100 mV | 0.1% + 50 mA | 0.05% + 100 mV | 0.1% + 50 mA | 330 mV/2 V | 0.03% + 8 mV | 0.15% + 35 mV |
| 0-300 | 0-35 | 6479C | 0.05% + 100 mV | 0.1% + 35 mA | 0.05% + 100 mV | 0.1% + 35 mA | 330 mV/3 V | 0.03% + 11 mV | 0.15% + 45 mV |
| 0-440, 500 or 600 | 0-25, 20, 15* | 6483C | 0.05% + 100 mV | 0.1% + 35 mA | 0.5% + 100 mV | 0.1% + 35 mA | 600 mV/5 V | 0.03% + 20 mV | 0.15% + 80 mV |
| 1-600 | 5 mA-1.5 A | 6448B | 1 V | 40 mA | 600 mV | 15 mA | 600 mV/2 V | 0.03% + 100 mV | 0.1% + 300 mV |

† Refer to page 264 for complete specification definitions.

†† Specified for combined line and load regulation.

Δ For operation with a 50 Hz input (possible only with Option 005), the rms ripple and transient response specifications are increased by 50%.

* The output current rating is given in the same order corresponding with the voltage rating.

Protective Features

In addition to the overload protection inherent in constant voltage/constant current operation, there are many other built-in protective features included in these supplies. The features vary within the three model classifications as follows:

HP 6434B—6448B: (1) Reverse voltage protection. (2) Fused ac input.

HP 6453A, 6458B, 6459A: (1) AC line loss protection circuit monitors 3-phase input and cuts off SCR's and opens output bus if a phase drops out; operation resumes when ac input returns to normal. (2) 3-phase input circuit breaker. (3) Optional internal crowbar (Option 006) protects load from overvoltage condition.

HP 6464C—6483C: (1) High-temperature protection thermostat opens input to power transformer and lights front panel indicator if supply overheats. (2) Prolonged overload protection circuit is activated and lights front panel indicator if output current exceeds approximately 115% of maximum rating. (3) Optional internal crowbar (except on HP 6464C) protects load from overvoltage condition. (4) Turn-on circuit limits peak line current during start-up into low impedance loads. (5) Phase-balance circuit permits operation with line-to-line input voltage imbalance up to 8%. (6) Overcurrent and over-voltage circuits of master slave supplies used in auto-series, -parallel, or -tracking operation can be interlocked.

Auto-Series, -Parallel, -Tracking Operation

Supplies may be connected in auto-series, or auto-tracking (except HP 6448B and 6483C, which cannot be connected in auto-series).

Up to three lower-power models (HP 6434B—6448B) may be connected in any of the above configurations. Higher-power model (HP 6453A/6483C) interconnection should ordinarily include no more than two supplies.

Remote Programming

The voltage and current outputs of the supplies can be programmed by a remote resistance, or for most models, a remote voltage source. Programming speeds and coefficients are detailed in the specifications table.

AC Power Requirements

The ac power requirements vary with the three model classifications (see option listings). When powered from a 50 Hz source (possible with option 005), the rms ripple and transient response specifications increase by 50%. The p-p ripple specification is unchanged by line frequency.

§ Under light loading conditions, power supply may not meet all published specifications. The graph on the next page defines the permissible operating regions for CV and CC modes of operation.

For operation with a 50 Hz input (possible only with Option 005), output current is linearly derated from 100% at 40°C to 80% at 50°C.



POWER SUPPLY OUTPUT RESTRICTIONS AS A FUNCTION OF LOADING

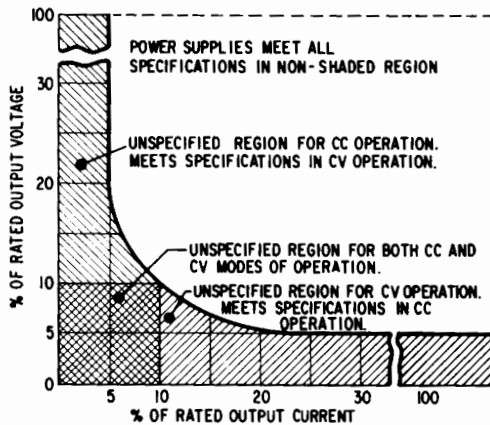

An ac input option must be specified when ordering.

Line Cords

Line cords are not supplied with models 6453A-6483C.

Size

- Model 6443B:** 89 H x 483 W x 445 mm D (3.5" x 19" x 17.5").
- Models 6434B, & 6448B:** 133 H x 483 W x 432 mm D (5.25" x 19" x 17").
- Models 6453A, 6456B, & 6459A:** 356 H x 483 W x 500 mm D (14" x 19" x 19.7").
- Models 6464C, 6466C, 6469C, 6472C, 6475C, 6477C, 6479C, & 6483C:** 705 H x 483 W x 715 mm D (27.75" x 19" x 28.12").

Option Descriptions

HP 6434B-6448B

- Std:** 115 V ac, ± 10%, single phase, 57-63 Hz
- 005:** realignment for 50 Hz operation
- 010:** chassis slides
- 027:** 208 V ac, ± 10%, single phase, 57-63 Hz
- 028:** 230 V ac, ± 10%, single phase, 57-63 Hz
- 910:** one extra operating and service manual shipped with each power supply

- Price**
- N/C
- N/C
- add \$160
- N/C
- N/C
- add \$10

HP 6453A, 6456B, 6459A

An ac input option must be specified when ordering.

- AC input connections are by means of a 4-conductor connector at rear of unit. A matching Hubbell No. 7413G plug (HP part number 1251-1570) is furnished.
- 001:** 208 V ac, ± 10%, 3-phase, 15.5 A/phase, 57-63 Hz N/C
- 002:** 230 V ac, ± 10%, 3-phase, 14 A/phase, 57-63 Hz N/C
- 003:** 460 V ac, ± 10%, 3-phase, 7 A/phase, 57-63 Hz add \$100
- 005:** realignment for 50 Hz operation N/C
- 006:** overvoltage protection crowbar
- HP 6453A, 6459A** add \$495
- HP 6456B** add \$650
- 010:** chassis slides add \$255
- 031:** 380 V ac, ± 10%, 3-phase, 8.5 A/phase, 57-63 Hz add \$150
- 032:** 400 V ac, ± 10%, 3-phase- 8.0 A/phase, 57-63 Hz \$150
- 910:** one extra operating and service manual shipped with each power supply. \$10

HP 6464C-6483C

An ac input option must be specified when ordering.

- AC input connections are by means of enclosed 4-wire terminal block
 - 001:** 208 V ac, ± 10%, 3-phase, 55 A/phase, 57-63 Hz N/C
 - 002:** 230 V ac, ± 10%, 3-phase, 50 A/phase, 57-63 Hz N/C
 - 003:** 460 V ac, ± 10%, 3-phase, 25 A/phase, 57-63 Hz add \$255
 - 005:** realignment for 50 Hz operation N/C
 - 006:** internal overvoltage protection crowbar
 - HP 6477C, 6479C, 6483C** add \$395
 - HP 6466C** add \$580
 - HP 6469C** add \$515
 - HP 6472C, 6475C** add \$465
 - 023:** rack mounting attachments for standard 19" rack add \$130
 - 031:** 380 V ac, ± 10%, 3-phase, 30 A/phase, 57-63 Hz add \$255
 - 032:** 400 V ac, ± 10%, 3-phase, 28.5 A/phase, 57-63 Hz add \$255
 - 040:** prepares power supply to be programmed with resistance by an HP 6940B or 6942A. add \$100
 - 910:** one extra operating and service manual shipped with each power supply. add \$15
- Accessory**
- 14545A:** casters for HP 6464C-6483C—set of four \$86

Specifications, continued

| REMOTE CONTROL | | | | | | | | | | GENERAL | | | | |
|----------------|---------|----------------------------------|------------------------|-------------------------|----------------------|---------------------|-------|-------|-------|---------|------------|-----|-------------------------------|---------|
| Resolution | | Load Transient Recovery Δ | Resistance Coefficient | | Voltage Coefficient† | | Up | | Down | | Net Weight | | Options | Price |
| V | C | | Voltage | Current | Voltage | Current | NL | FL | NL | FL | Kg | lb | | |
| 8 mV | 1 A | 100 ms, 500 mV | 200 $\Omega/V \pm 2\%$ | 1 $\Omega/A \pm 2\%$ | 1 V/V $\pm 1\%$ | 6.2 mV/A $\pm 7\%$ | 1.6 s | 0.6 s | 6 s | 0.1 s | 235 | 518 | 1, 2, 3, 5, 23, 31, 32, 40 | \$8700* |
| 65 mV | 1 A | 50 ms, 150 mV | 200 $\Omega/V \pm 2\%$ | 1 Ω/A | 0.4 V/V | 30 mV/A | 1 s | 0.5 s | 20 s | 0.2 s | 108 | 238 | 1, 2, 3, 5, 6, 10, 31, 32 | \$4400* |
| 18 mV | 0.5 A | 100 ms, 500 mV | 200 $\Omega/V \pm 2\%$ | 1.66 $\Omega/A \pm 2\%$ | 1 V/V $\pm 1\%$ | 10.3 mV/A $\pm 7\%$ | 1.6 s | 0.6 s | 15 s | 0.2 s | 226 | 500 | 1, 2, 3, 5, 6, 23, 31, 32, 40 | \$8600* |
| 90 mV | 0.5 A | 50 ms, 300 mV | 200 $\Omega/V \pm 2\%$ | 2 Ω/A | 166 mV/V | 60 mV/A | 1 s | 0.5 s | 60 s | 0.5 s | 108 | 238 | 1, 2, 3, 5, 6, 10, 31, 32 | \$4000* |
| 36 mV | 0.3 A | 100 ms, 500 mV | 200 $\Omega/V \pm 2\%$ | 3.33 $\Omega/A \pm 2\%$ | 1 V/V | 20.6 mV/A $\pm 7\%$ | 1.6 s | 3 s | 20 s | 0.5 s | 226 | 500 | 1, 2, 3, 5, 6, 23, 31, 32, 40 | \$8000* |
| 10 mV | 12.5 mA | 200 ms, 200 mV | 200 $\Omega/V \pm 2\%$ | 12 Ω/A | 1 V/V | ** | 0.3 s | 1.2 s | 75 s | 1.2 s | 30.4 | 67 | 5, 10, 27, 28 | \$1800 |
| 100 mV | 0.25 A | 50 ms, 600 mV | 300 $\Omega/V \pm 2\%$ | 4 Ω/A | 94 mV/V | 120 mV/A | 1 s | 0.5 s | 45 s | 0.7 s | 108 | 238 | 1, 2, 3, 5, 6, 10, 31, 32 | \$4000* |
| 64 mV | 0.15 A | 100 ms, 750 mV | 300 $\Omega/V \pm 2\%$ | 6.7 $\Omega/A \pm 2\%$ | 1 V/V $\pm 3\%$ | 41.2 mV/A $\pm 7\%$ | 1.4 s | 2.5 s | 55 s | 0.7 s | 226 | 500 | 1, 2, 3, 5, 6, 23, 31, 32, 40 | \$8000* |
| 22 mV | 0.1 A | 100 ms, 1 V | 300 $\Omega/V \pm 2\%$ | 10 $\Omega/A \pm 2\%$ | 1 V/V $\pm 3\%$ | 62 mV/A $\pm 7\%$ | 1.5 s | 2 s | 80 s | 0.7 s | 226 | 500 | 1, 2, 3, 5, 6, 23, 31, 32 | \$8000* |
| 30 mV | 1.3 mA | 200 ms, 600 mV | 300 $\Omega/V \pm 2\%$ | 120 Ω/A | 1 V/V | ** | 0.5 s | 2 s | 210 s | 2 s | 14 | 31 | 5, 10, 27, 28 | \$1350 |
| 44 mV | 50 mA | 100 ms, 2 V | 300 $\Omega/V \pm 2\%$ | 20 $\Omega/V \pm 2\%$ | 1 V/V $\pm 3\%$ | 124 mV/A $\pm 7\%$ | 1.5 s | 2 s | 95 s | 1 s | 226 | 500 | 1, 2, 3, 5, 6, 23, 31, 32 | \$8000* |
| 60 mV | 35 mA | 100 ms, 3 V | 300 $\Omega/V \pm 2\%$ | 28.6 $\Omega/A \pm 2\%$ | 1 V/V $\pm 3\%$ | 177 mV/A $\pm 7\%$ | 1.5 s | 2 s | 75 s | 1.6 s | 226 | 500 | 1, 2, 3, 5, 6, 23, 31, 32 | \$8000* |
| 60 mV | 25 mA | 100 ms, 5 V | 300 $\Omega/V \pm 2\%$ | 40 $\Omega/A \pm 2\%$ | 1 V/V $\pm 3\%$ | 0.25 V/A $\pm 7\%$ | 1.5 s | 2 s | 120 s | 2 s | 226 | 500 | 1, 2, 3, 5, 6, 23, 31, 32 | \$8400* |
| 60 mV | 0.75 mA | 200 ms, 3 V | 300 $\Omega/V \pm 2\%$ | 600 Ω/A | 1 V/V | ** | 0.2 s | 1 s | 45 s | 2 s | 27.6 | 61 | 5, 10, 27, 28 | \$1750 |

Δ For operation with a 50 Hz input (possible only with Option 005), the rms ripple and transient response specifications are increased by 50%.
 **This feature is not available.
 *An ac input option must be specified when ordering these 3-phase models.
 †Special Option J30 must be ordered with models 6434B-6448B and 6466C-6483C to be programmed with an HP 59501B Power Supply Programmer. Contact your local HP Field Engineer for ordering instructions.



POWER SUPPLIES

Multiple Output Linear System Power Supplies

Models 6621A, 6622A, 6623A and 6624A

- 2, 3 or 4 Independent Isolated Outputs per Model
- 160 Watts Total Output Power per Model
- HP-IB Programming of Voltage and Current
- HP-IB Measurement of Voltage and Current
- Full Local Control or Local Lockout
- Programmable Overvoltage and Overcurrent Protection

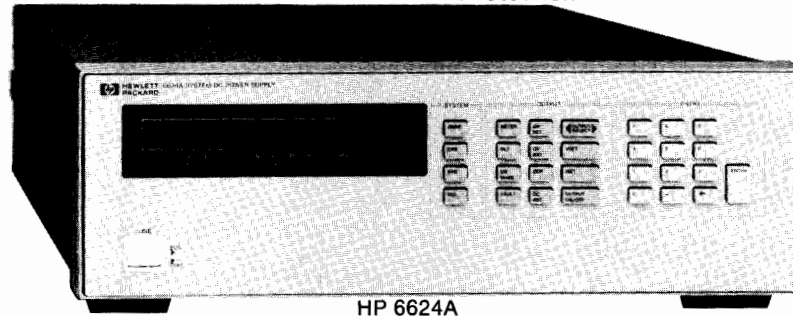

HP 6624A

Description

These HP-IB multiple output series regulated system power supplies feature a combination of intelligence, performance and low price which makes them the choice for power systems applications.

Four models, each offering a total of 160 watts output power, offer a variety of output combinations of 40 and 80 watts with voltages up to 50 volts and currents to 10 amps. Each output can produce power in two ranges (see fig. 1). For example, model 6622A has two 80 watt outputs. Each of these can produce 80 watts at either 20 volts or 50 volts. When operating below 20 volts, each output can source or sink up to 4 amps. When operating between 20 volts and 50 volts, it can source or sink up to 1.6 amps. Output combinations include:

- 6621A - 2 outputs at 80 watts, either 0-7 or 0-20 volts
- 6622A - 2 outputs at 80 watts, either 0-20 or 0-50 volts
- 6623A - 1 output at 80 watts, 0-7 or 0-20 volts; 1 at 40 watts, 0-20 or 0-50 volts; 1 at 40 watts, 0-7 or 0-20 volts
- 6624A - 4 outputs at 40 watts: two at 0-7 or 0-20 volts and two at 0-20 or 0-50 volts

The built-in interface is tailored to the power supply, resulting in simpler programming. Specifications supplied with these power supplies already take both the power supply and programming interface into account as a system. Self-contained measurement and readback capabilities eliminate the need for scanning the output or using a separate DVM.

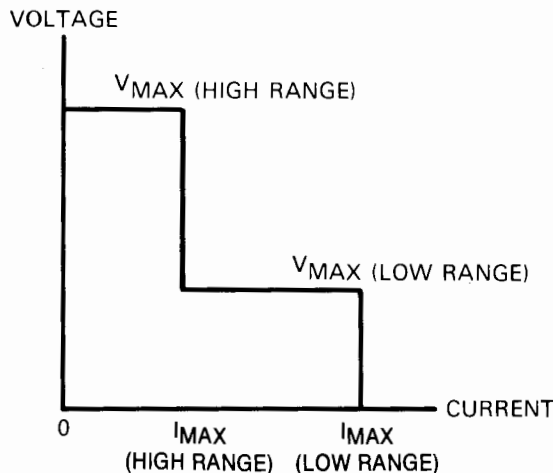

Fig 1. Output Characteristic Curve for HP 662X Series Power Supplies

Programming Capabilities

These power supplies share the programming command set of the higher power models 6030A-6038A programmable power supplies. (see page 278) The following functions are implemented:

- Output Voltage and Current Programming
- Output Voltage and Current Measurement and Readback
- Present and Accumulated Status Readback
- Programmable Service Request Mask
- Programmable Overcurrent Protection
- Programmable Overvoltage Protection
- Storage and Recall of Programmed Value Sets (all outputs)
- Echo Queries of Programmable Functions/Settings
- Output Channel Enable/Disable
- Programming Syntax Error Detection
- Reprogramming Delay Time for Service Request Mask

Operating voltage and current range is selected programatically, with the last parameter programmed (voltage or current) determining the range. No separate command is required to switch output range.

Programmed command processing time is typically 7 milliseconds. Slewing time to within settling band is additional.

Protection Features

Local lockout capability enables the programmer to disable all front panel controls over the HP-IB except the channel select (to allow display of the output voltage and current of any channel.)

Protection against overcurrent conditions is provided by either the current limit or overcurrent protection. Current limit will prevent the output current from exceeding a programmed value, while overcurrent protection will disable the supply if that value of current is reached. Current limit is always active, while overcurrent protection can be enabled or disabled.

As an example of its use, consider testing PC board subassemblies with a programmable power supply. A shorted component would cause current to be drawn from the power supply at the current limit value, possibly burning the board. Enabling overcurrent protection would cause the power supply to disable itself when the current limit value is reached, thus minimizing damage.

Output Ratings And Combinations

| OUTPUT | CHANNEL | NUMBER OF OUTPUTS PER MODEL | | | |
|----------------------------|-----------------------------|-----------------------------|---------------------|---------------------|---------------------|
| | | 6624A (4 output) | 6623A (3 output) | 6622A (2 output) | 6621A (2 output) |
| Hi Range Volts/ Amps | Low Range Volts/ Amps | | | | |
| 0-20/ 0-2 | 0-7/ 0-5 | 2 | 1 | - | - |
| 0-50/ 0-0.8 | 0-20/ 0-2 | 2 | 1 | - | - |
| 0-20/ 0-4 | 0-7/ 0-10 | - | 1 | - | 2 |
| 0-50/ 0-1.6 | 0-20/ 0-4 | - | - | 2 | - |



Protection against output overvoltage conditions is also provided. Normally, the power supply voltage will not exceed the programmed voltage setting. Programmable overvoltage protection guards your load against hardware faults by disabling and down-programming the power supply output if the programmed overvoltage setting is exceeded. A crowbar circuit is activated and shorts the output under these conditions.

This series also provides protection from unregulated output in the event of line voltage dropout and also guards against overtemperature conditions. The output is disabled when either of these conditions exists.

A service request can be generated to inform the controller in the event of any user-defined combination of overvoltage, overcurrent, overtemperature or mode change.

Fault trips which disable the output can be reset over the HP-IB.

Software Calibration And Selftest

With this series of power supplies, calibration is performed without removing the instrument's cover. All that is required is a shunt, a dvm, a controller and a few lines of code. Simple commands instruct the power supply to go to preset adjustment points, where voltages or currents are read with the dvm and shunt. Then the readings are sent to the power supply, which adjusts its calibration. Calibration is maintained through line voltage cycling.

Calibration integrity can be assured by using a jumper inside the box which, when removed, will prevent the supply from accepting calibration commands.

These supplies also have considerable selftest capability, which is exercised at power on and upon receipt of the selftest command over the HP-IB. Running selftests over the HP-IB will not cause the output to change.

System Configuration

This series of power supplies offers a number of significant benefits in the area of simplicity and flexibility of system configuration.

A convenient rear panel line voltage module allows switching of input line voltage without removing the covers. (The line voltage option determines line cord plug configuration.)

For applications which require different combinations of voltage and current for different loads, the dual range full power feature will be useful (see fig. 1). If this is not enough, two outputs can be combined in parallel or series combinations for more power at a given voltage or current level.

Where a precisely regulated voltage is required at the load, remote sensing at the load can be used. This capability will compensate for load lead IR drops of up to 1 volt per load lead. Add 1mV to the load effect specification for each 200 μ V drop in the negative load lead when remote sensing.

All outputs of these power supplies are isolated for up to 240 volts dc from chassis ground and each other.

For applications which require a hardware trip signal separate from the HP-IB remote disable, terminals are provided on the rear panel barrier block of each output which provide bidirectional overvoltage protection trip capability. These terminals can be used to

monitor for an OVP trip signal, strapped together to disable all outputs when one OVP is tripped or used as a remote disable separate from the HP-IB.

These models can sink as well as source current. This means that downprogramming without a load takes the same time as upprogramming. Quick discharging of reactive loads is another benefit resulting from this capability.

Front Panel Control

To aid in system program development, the following capabilities of these power supplies are controllable from the front panel:

- Output Channel Select (Controls and Display)
- OVP Setting
- Overcurrent Protection Enable
- Storage and Recall of Programmed Settings
- Voltage Setting
- Current Setting
- SRQ Mask Delay Time
- Output Enable/Disable
- OVP, OCP Reset
- Local

The alphanumeric LCD display will normally display output voltage and current for the channel selected. When programming from the front panel, the function being programmed and the present value will be displayed. Fault conditions will be spelled out in alpha characters. Output channel is indicated by an annunciator.

Changing the HP-IB address is done from the front panel, using the address key and the numeric keypad.

General Specifications

HP-IB interface functions: SH1, AH1, T6, L4, SR1, RL1, PP1, DC1, DT0. For more information on these codes, refer to the HP-IB section of this catalog.

Safety agency compliance: This series of power supplies is designed to comply with the following regulatory standards: IEC 348, VDE 0411, UL 1244, ANSI C39.5, and CSA Electrical Bulletin 556B.

Dimensions (all models): 132.6 mm H x 425.5 mm W x 497.8 mm D. (5.22 in. H x 16.75 in. W x 19.6 in. D)

Input current: 100 VAC 120 VAC 220 VAC 240 VAC
(max.rms, all models) 6.3 A 5.4 A 3.0 A 3.0 A

WEIGHTS kg(lb) (all models): NET 17.4(38) SHIPPING 22.7(50)

Prices And Option Descriptions

| | |
|---|----------|
| 6621A: Dual output system power supply. | \$2700 |
| 6622A: Dual output system power supply. | \$2700 |
| 6623A: Triple output system power supply. | \$3200 |
| 6624A: Quad output system power supply. | \$3700 |
| (NOTE: Line voltage option (100, 120, 220 or 240) must be specified) | |
| 100: 87- 106 Vac, 47-66 Hz. (for Japan only) | N/C |
| 120: 104-127 Vac, 47-66 Hz. | N/C |
| 220: 191-233 Vac, 47-66 Hz. | N/C |
| 240: 209-250 Vac, 47-66 Hz. | N/C |
| 908: Rack Mount Kit for one unit. | add \$30 |
| 910: One each extra operating and service manuals. (Operating manual only is shipped with standard unit.) | add \$30 |

Output Channel Specifications (READ ACROSS FROM PREVIOUS PAGE)

| HP-IB OUTPUT SETTINGS | | | | HP-IB MEASUREMENT READBACK ACCURACY (25 \pm 5 $^{\circ}$ C) | | | | PARD (p-p/rms) | | REGULATION | | | | PROGRAMMING SPEED | | |
|-----------------------|---------|------------------------------------|-----------------|---|---------------|------------------|----------|----------------|---------|----------------|----------------|---------------|---------|-------------------|--------------|---------------|
| RESOLUTION | | ACCURACY (25 \pm 5 $^{\circ}$ C) | | VOLTAGE | | CURRENT | | VOLTAGE | | LOAD EFFECT | | SOURCE EFFECT | | TIME CONSTANT | SLEWING TIME | SETTLING BAND |
| VOLTAGE | CURRENT | VOLTAGE | CURRENT | VOLTAGE | CURRENT | VOLTAGE | CURRENT | VOLTAGE | CURRENT | VOLTAGE | CURRENT | VOLTAGE | CURRENT | | | |
| 6 mV | 25 mA | 19 mV + 0.06%* | 50 mA + 0.16%* | 20 mV + 0.05%* | 10 mA + 0.1%* | 3 mV/500 μ V | 1 mA rms | 2 mV | 1 mA | 1 mV + 0.01%FS | 1 mA + 0.06%FS | 250 μ S | | 2 mS | 20 mV | |
| 15 mV | 10 mA | 50 mV + 0.06%* | 20 mA + 0.16%* | 50 mV + 0.05%* | 4 mA + 0.1%* | 3 mV/500 μ V | 1 mA rms | 2 mV | 0.5 mA | 1 mV + 0.01%FS | 1 mA + 0.06%FS | 750 μ S | | 6 mS | 50 mV | |
| 6 mV | 50 mA | 19 mV + 0.06%* | 100 mA + 0.16%* | 20 mV + 0.05%* | 20 mA + 0.1%* | 3 mV/500 μ V | 1 mA rms | 2 mV | 2 mA | 1 mV + 0.01%FS | 1 mA + 0.06%FS | 250 μ S | | 2 mS | 20 mV | |
| 15 mV | 20 mA | 50 mV + 0.06%* | 40 mA + 0.16%* | 50 mV + 0.05%* | 8 mA + 0.1%* | 3 mV/500 μ V | 1 mA rms | 2 mV | 1 mA | 1 mV + 0.01%FS | 1 mA + 0.06%FS | 750 μ S | | 6 mS | 50 mV | |

*% of setting.



POWER SUPPLIES

Autoranging System Power Supplies

Models 6030A, 6031A, 6032A, 6033A, and 6038A

- HP-IB programming of voltage and current
- Readback of voltage, current and status
- Overvoltage and overcurrent protection

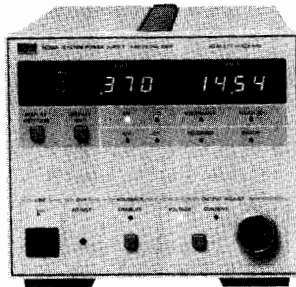

HP 6033A, 6038A

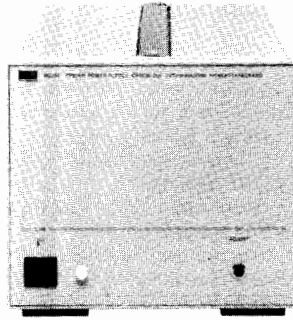

HP 6033A and 6038A
with Opt 001

- Optional CIIL programming
- Built-in self-test and diagnostics
- Up to 1200 watts output
- Full local control enable/disable

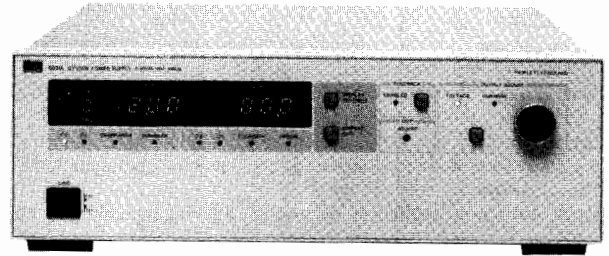

HP 6030A, 6031A and 6032A



Description

These HP-IB CV/CC dc power supplies have many productivity-oriented features which make them easy to program, integrate into systems and use.

A conventional power supply subsystem capable of monitoring and controlling power supply voltage and current requires a variety of hardware in addition to the actual supply. These new power supplies, however, have built-in capabilities which eliminate the need for D/A programmers, DVMs, and associated auxiliary circuitry. Fewer instruments mean less rack space, easier calculation of system specifications, quicker configurations, higher system reliability, more rapid troubleshooting, and simpler software. As autoranging power supplies, these models can provide a wide and continuous range of voltage and current combinations at the maximum rated power. This often allows both present and future requirements to be satisfied with fewer supplies, also reducing the number of instruments in the system.

Front Panel Control

Most of the extensive programmable instruction set can be simulated with front panel controls, thus facilitating design and debugging of system hardware and software. During system operation, if local control is not needed, the front panel controls can be disabled with a computer command. If operator interaction is required, a computer command can place limits on the output voltage and current available. Often, control and monitoring via the front panel is very useful during system development, but not needed afterwards. If the system is reproduced without further development, power supplies without front panel controls and meters (Option 001) can then be used. Ordering your power supplies with Option 001 significantly decreases the cost.

Specifications

| Ratings | | | | | | | | | Regulation | | | | 10% Change Transient Recovery |
|---------|---------|--------------------|----------------|----------------|----------------|----------------|----------------|----------|---------------|----------------|----------------|----------------|--|
| Volts | Amperes | Autoranging Output | | | | | | HP Model | Load Effect | | Source Effect | | |
| | | V ₁ | P ₁ | V ₂ | P ₂ | V ₃ | P ₃ | | Voltage | Current | Voltage | Current | |
| 0-20 | 0-30 | 20V | 200W | 14V | 242W | 6.7V | 200W | 6033A | 0.01% +2mV | 0.01% +9mA | 0.01% +1.3V | 0.01% +6mA | 1ms / 50mV |
| 0-20 | 0-120 | 20V | 1000W | 14V | 1064W | 7V | 840W | 6031A | 0.01% +3mV | 0.01% +15mA | 0.01% +2mV | 0.01% +25mA | 2ms / 100mV |
| 0-60 | 0-10 | 60V | 200W | 40V | 240W | 20V | 200W | 6038A | 0.01% +3mV | 0.01% +5mA | 0.01% +2mV | 0.01% +2mA | 1ms / 75mV |
| 0-60 | 0-50 | 60V | 1000W | 40V | 1200W | 20V | 1000W | 6032A | 0.01% +5mV | 0.01% +10mA | 0.01% +3mV | 0.01% +10mA | 2ms / 100mV |
| 0-200 | 0-17 | 200V | 1000W | 120V | 1200W | 60V | 1020W | 6030A | 0.01% +5mV | 0.01% +10mA | 0.01% +5mV | 0.01% +5mA | 2ms / 150mV |

*See the generalized autoranging output characteristic curve.

Protection Features

Because of the delicate nature of most loads, these system power supplies provide several different types of protection. Since they are CV/CC supplies, both the output voltage and current will be automatically limited to the programmed values. If reaching a programmed value indicates an undesirable condition, the power supply can be instructed to automatically down-program to zero output. For example, if the programmed current limit is reached while testing a PC board assembly, it may indicate a shorted component. In this case, the FOLDBACK feature, if enabled, would be able to serve as an overcurrent protection circuit and down-program the power supply automatically. FOLDBACK can be enabled and reset over the HP-IB.

The built-in overvoltage protection circuit is adjustable with a front panel control. The set trip level can be displayed on the front panel meter and also can be read back over the HP-IB, thus making adjusting the level easy. The OVP circuit, once tripped, can be reset over the HP-IB.

Production procedures sometimes require the operator to adjust the output voltage or current of a power supply locally with the front panel controls. If this is done, programmed levels can be set to limit the available adjustment range to a safe margin.

Potentially harmful conditions, such as overtemperature and high or low ac input, will trigger the power supply to automatically down-program to zero output. When these conditions occur, or the FOLDBACK or OVP circuits trip, LEDs on the front panel light to indicate the failure. This status can also be read back to the computer over the HP-IB and can be used to generate interrupts.

Programmable Features

Below are the parameters which can be programmed on the HP 6030A — 6038A and the information which is available for readback over the HP-IB. All of these features are included with the standard user-friendly programming language.

Programmable Functions

Output Voltage
Output Current
Output Disable/Enable
Soft Voltage Limit
Soft Current Limit
Group Trigger
Foldback Mode
Device Clear
Interrupt Mask
Interrupt Delay
Preset Power Supply States
Self-Test
Local Lockout

Readback Functions

Programmed Voltage
Programmed Current
Actual Voltage
Actual Current
OVP Trip Level
Soft Voltage Limit
Soft Current Limit
Foldback Mode
Present Status
Accumulated Status
Interrupt Mask
Programming Error Codes
Self Test Error Codes
Output Disable/Enable
Device ID

For added flexibility now a CIIL programming language, Option 700, is available.

System Configuration

If your application requires more power than the output capability of a single unit, you can use an auto-series connection for greater output voltage or an auto-parallel connection for greater output current. Any combination of models is possible with two units used in auto-parallel or up to 240 volts (550 volts for the HP 6030A) total output for auto-series connections. In addition, up to four 1000 watt models may be connected in autoparallel. For example, if you need 200 amperes at 6 volts, a cost-effective solution would be to use an HP 6031A as the master power supply and an HP 6011A as the slave in an auto-parallel configuration. See page 270 for more information about the HP 6011A, a non-HP-IB dc power supply.

Remote sensing can be used to maintain the CV load effect specification at the load with up to 0.5 volt drop per load lead, and sense wires which are less than 0.2 ohm per lead. Operation is possible with up to 2.0 volts drop per lead; however, the load effect specification may be degraded.

Either terminal may be grounded, or may be floated up to ± 240 (± 550 volts for the HP 6030A) volts from chassis ground.

Analog programming inputs and monitoring terminals are provided on the rear panel in addition to the HP-IB programming capabilities. Zero to full scale voltage or current can be programmed with either 0-5 volt voltage signals, or 0-4000 ohm resistance signals. The monitoring terminals present 0-5 volt buffered signals which are proportional to the output voltage and current.

HP models 6030A, 6031A, 6032A, and 6038A are stable when operating in CC into inductive loads up to 100 mH, and the HP 6033A and 6038A can handle up to 1 H. A special modification is available for HP Models 6030A, 6031A and 6032A to ensure stable operation when operating into inductive loads up to 10 H.

General Specifications

HP-IB interface functions: SH1, T6, AH1, L4, SR1, RL1, PP1, DC1, DT1. For more on these codes, refer to the HP-IB section of this catalog.

Specifications cont.

| PARD (rms/p-p) 20 Hz-20 MHz | Remote Control | | | | | | General | | | | | | |
|--------------------------------|----------------|---------|----------|------------------|------------------|---------|---------|---------|-------------------|----------|----------|--------|--|
| | Resolution | | Accuracy | | AC Input Current | | | | Weight - kg (lbs) | | Price | | |
| | Voltage | Current | Voltage | Current | 100 Vac | 120 Vac | 220 Vac | 240 Vac | Net | Shipping | | | |
| 3mV/30mV | 15mA/- | 5mV | 7.5mA | 0.035% +9mV | 0.15% +20mA | 6.0A | 6.5A | 3.8A | 3.6A | 9.6(21) | 11.4(25) | \$2400 | |
| 8mV/50mV | 120mA/- | 5mV | 30mA | 0.035% +15mV | 0.25% +250mA | 24A | 24A | 15A | 14A | 17.2(38) | 22.7(50) | \$3100 | |
| 3mV/30mV | 5mA/- | 15mV | 2.5mA | 0.035% +40mV | 0.085% +10mA | 6.0A | 6.5A | 3.8A | 3.6A | 9.6(21) | 11.4(25) | \$2400 | |
| 8mV/40mV | 25mA/- | 15mV | 12.5mA | 0.035% +40mV | 0.2% +85mA | 24A | 24A | 15A | 14A | 16.3(36) | 21.8(48) | \$3100 | |
| 22mV/50mV | 15mA/- | 50mV | 4.25mA | 0.035% +145mV | 0.2% +25mA | 24A | 24A | 15A | 14A | 16.3(36) | 21.7(48) | \$3100 | |

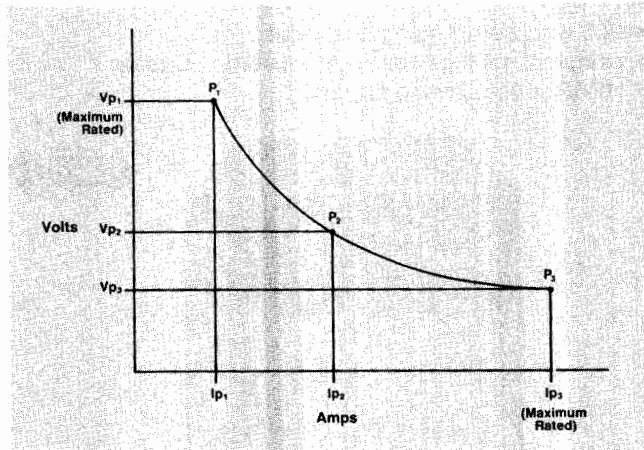

Generalized autoranging output characteristic curve

Dimensions: HP 6033A and 6038A: 170.6 mm H x 208.8 mm W x 453.9 mm D (6.72" x 8.22" x 17.872")

HP 6030A, 6031A and 6032A: 132.6 mm H x 425.5 mm W x 516.4 mm D (5.2" x 16.75" x 20.33")

Option Descriptions

- 001:** Front panel which has only line switch, line indicator, and OVP adjust. less \$300
- 100:** 87-106 Vac, 48-63 Hz. This option is for use in Japan only. The power supply output power is 75% of the output power available with the other line voltage options. N/C
- 120:** 104-127 Vac, 48-63 Hz. N/C
- 220:** 191-233 Vac, 48-63 Hz. N/C
- 240:** 208-250 Vac, 48-63 Hz. N/C
- 700:** CIIL programming language add \$500
- 800:** Rack mount kit for two units side by side. This applies to HP 6033A and 6038A only. add \$ 75
- 908:** Rack mount kit for a single unit. A blank filler panel is supplied when this option is ordered with HP 6033A and 6038A.
HP 6033A and 6038A add \$ 80
HP 6030A, 6031A and 6032A add \$ 30
- 910:** One extra operating and service manual shipped with each power supply. add \$ 15

POWER SUPPLIES

200 Watt System Power Supply

Model 6002A

- 200 watt autoranging dc output
- Constant-voltage/constant-current operation
- HP-IB programming option

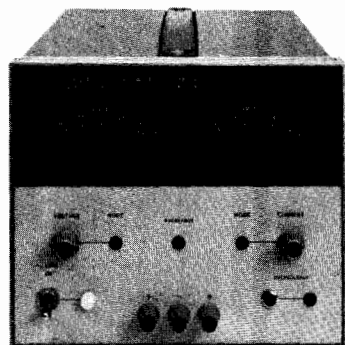

HP 6002A



Description

The HP 6002A dc power supply offers an exceptional combination of performance and flexibility. It employs a unique control concept which provides for an autoranging output with the performance characteristics of linear regulation. The HP 6002A is a 200 watt CV/CC power supply, which may be remotely programmed via the HP-IB when equipped with Option 001.

As an autoranging power supply, the HP 6002A can provide 200 watts over a wide range of voltage and currents without external intervention. This allows it to take the place of multiple conventional power supplies. For example, the HP 6002A can replace both a 50 volt, 4 ampere supply and a 20 volt, 10 ampere supply.

Autoranging Output Characteristic

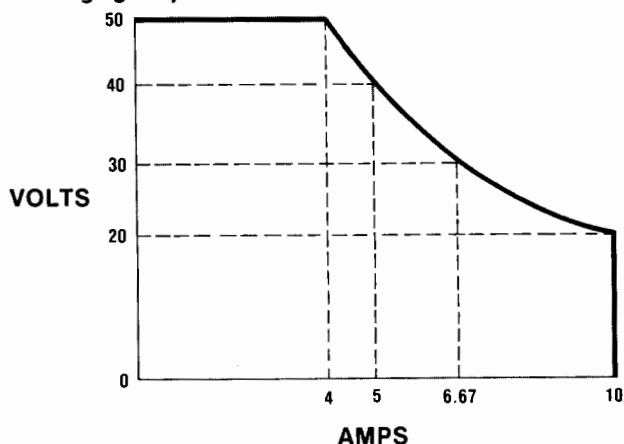

System Features/Remote Control

Analog programming of output voltages and current can be accomplished through the use of remotely controlled resistance or voltage applied to rear panel terminals. Additional control terminals are provided for remote load voltage sensing, auto-series or parallel operation, and for remotely activating the crowbar circuit. A pulse output from the crowbar terminal indicates the overvoltage circuit has been self-activated. A voltage step change appearing on terminal indicates a changeover to or from constant-current operation.

HP-IB Option

Digital programming via Option 001 permits control of output voltage or current by the Hewlett-Packard Interface Bus (HP-IB). Two programmable ranges allow better resolution below 10 volts or 2 amperes. The selection of HP-IB control of either voltage or current is done by rear panel switches. The IEEE 488 interface functions supported by the HP 6002A with Option 001 are basic listener (L2) and acceptor handshake (AH1). Complete explanation of these interface functions is available in the IEEE Std. 488-1978.

- Built-in overvoltage protection crowbar
- CV/CC operating status indicators
- Remote analog programming and sensing

Specifications

DC output: voltage and current output can be adjusted over the ranges indicated by front panel controls, analog programming, or an optional HP-IB interface.

Voltage: 0–50 V. **Current:** 0–10 A.

Maximum 200 watts output from 20 V to 50 V.

Load effect: constant-voltage, 0.01% +1 mV. Constant-current, 0.01% +1 mA.

Source effect: CV, 0.01% +1 mV; CC, 0.01% +1 mA.

PARD (ripple and noise): rms/p-p, 20 Hz to 20 MHz; CV, 1 mV/10 mV; CC, 5 mA rms.

Temperature coefficient: CV, 0.02% +200 μ V/°C; CC 0.02% +5 mA/°C.

Drift: CV, 0.05% +1 mV/8 h; CC, 0.05% +5 mA/8 h.

Load transient recovery: 100 μ s for output voltage to recover within 15 mV of nominal voltage setting following a load current change of 50% to 100% or 100% to 50% of full load current.

Response time: maximum time for output voltage to change between 0 to 99.9% or 100% to 0.1% of maximum rated output voltage. Up Programming: no load, 100 ms; full load, 100 ms. Down Programming: no load, 400 ms; full load, 200 ms.

Overvoltage protection: trip voltage adjustable from 2.5 V to 60 V.

DC output isolation: 150 V dc.

Power: 100, 120, 220, or 240 V ac (–13%, +6%), 48-63 Hz.

Temperature rating: 0°C to 55°C operating, –40°C to +75°C storage. Supply is cooled by built-in fan.

Size: 180 H x 212 W x 422 mm D (6.97" x 8.36" x 16.6").

Weight: net, 14.5 kg (32 lb); shipping, 15.9 kg (35 lb).

HP-IB Option

Programmable ranges: high: 0–50 V or 0–10 A,
low: 0–10 V or 0–2 A.

Programming speed: same as response time.

Accuracy: hi range: CV, 0.2% +25 mV; CC, 0.2% +25 mA.
lo range: CV, 0.2% +10 mV; CC, 0.2% +25 mA.

Resolution: hi range: CV, 50 mV; CC, 10 mA. (12 bit)
lo range: CV, 10 mV; CC, 2 mA. (12 bit)

Isolation: 250 volts dc from bus data lines to power supply.

Accessories

HP 5061-0060: rack mounting adapter kit for one HP 6002A **Price** \$80.00

HP 5061-0094: cabinet lock-together kit to connect two HP 6002As **Price** \$38.00

HP 5061-0078: rack flange kit to mount 2 locked HP 6002As **Price** \$35.00

Options

001: HP-IB interface **Price** add \$560.00

910: one extra operating and service manual **Price** add \$7.50

HP 6002A Autoranging DC Power Supply **Price \$1950**

POWER SUPPLIES

Digital Programmable: HP-IB Programmer

Model 59501B

281



- HP-IB power supply control
- HP-IB-to-power-supply isolation
- Programmable range

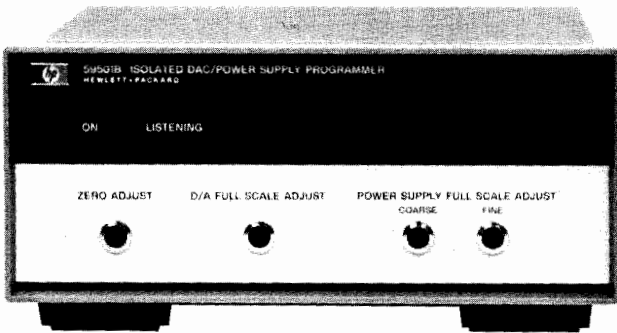

HP 59501B



Description

The HP 59501B is an isolated digital-to-analog converter designed to provide a convenient interface between the Hewlett-Packard Interface Bus and HP power supplies. With the HP 59501B, a wide range of dc voltages and currents becomes automatically controllable via the HP-IB. With proper wiring, the built-in isolation devices protect other instrumentation on the HP-IB from damage that could be caused by power supply outputs. In addition, an internal control circuit holds the output level near zero until programmed data is received. A programmable High/Low range control improves resolution by ten-to-one.

Power supply control is accomplished through the HP 59501B's programmable output voltage and programming network (see below). By making the appropriate connections between the 59501B's rear terminals and the remote programming terminals on the supply, the output voltage (or current) of the supply can be programmed from zero to its full rated output. The HP 59501B front panel controls provide fast and easy calibration of power supply outputs. The Zero Adjust enables the user to correct for small offsets in power supply response to programmed inputs. The Power Supply Full Scale Adjust (part of programming network) enables the user to set the maximum output desired from the power supply when the HP 59501B is programmed to its maximum value. For example, this adjustment would normally be used to calibrate the maximum programmable output of a 320Vdc power supply to 320 volts. However, it could also be used to set the maximum to 200 volts.

The HP 59501B also can be used directly as a low level dc signal source. Unipolar and bipolar output modes are available with output voltages programmable from zero to 9.99 volts, or minus 10.0 to plus 9.98 volts. Output current up to 10 milliamperes is available and is automatically limited to protect the HP 59501B and user equipment. The HP 59501B produces a full scale voltage change in approximately 250 μ s from the time the digital data is received.

- Programmable 10-volt dc output
- Unipolar/bipolar operation
- Fast digital to analog conversion

Specifications

Digital to Analog Converter

DC output voltage: programmable in high or low ranges within the voltage limits shown below. Output mode is unipolar or bipolar and is selected by a rear panel switch.

Unipolar: 0 to 9.99 V (low range, 0 to 9.999 V).

Bipolar: -10 to +9.98 V (low range, -1 to +0.998 V).

DC output current: 10 mA maximum.

PARD (ripple and noise): 2 mV rms/10 mV p-p.

Resolution: unipolar, 10 mV (low range, 1 mV). Bipolar, 20 mV (low range, 2 mV).

Accuracy: specified at 23°C \pm 5°C.

Unipolar: 0.1% +5 mV (low range, 0.1% +1 mV).

Bipolar: 0.1% +10 mV (low range, 0.1% +2 mV).

Stability: change in output over 8 hour interval under constant line, load, and ambient following a 30 minute warm-up. Stability is included in accuracy specification measurements over the temperature range indicated.

Unipolar: 0.04% + 0.5 mV (low range, 0.04% +0.1 mV).

Bipolar: 0.04% + 1 mV (low range, 0.04% +0.2 mV).

Temperature coefficient: unipolar, 0.01%/°C +0.5 mV/°C (low range, 0.1%/°C +0.1 mV/°C). Bipolar, 0.01%/°C +0.5 mV/°C (low range, 0.01%/°C +0.1 mV/°C).

Zero adjust: plus or minus 250 millivolts.

D/A full scale adjust: plus or minus 5%.

Programming speed: the time required for output to go from zero to 99% of programmed output change is 250 μ s (measured with resistive load connected to output terminals).

Power Supply Programming

Programming network specifications: in the following specifications, M represents the calibrated full scale value of the supply being programmed and P is the actual programmed output. The full scale value (M) can be any value within the supply's output range and is calibrated with the HP 59501B programmed to its maximum high range output.

Accuracy: specified at 23°C \pm 5°C.

Unipolar: 0.05% M +0.25% P (low range, 0.01% M + 0.25% P).

Bipolar: 0.1% M +0.25% P (low range, 0.02% M +0.25% P).

Isolation: 600 V dc between HP-IB data lines and output terminals.

Temperature coefficient: 0.005% M/°C + 0.015% P/°C (low range, 0.01% M/°C +0.015% P/°C).

Programming resolution: 0.1% M (low range, 0.01% M).

Programming speed: D/A programming speed plus the programming speed of the power supply.

General

Temperature range: operation, 0 to 55°C; storage, -40 to 75°C.

Power: 100, 120, 220, or 240 Vac (+6% -13%) 47-63 Hz, 10 VA (selectable on rear panel).

Size: 101.6 H x 212.9 W x 294.6 mm D (4" x 8.38" x 11.6").

Weight: net, 1.82 kg (4 lb); shipping, 2.27 kg (5 lb).

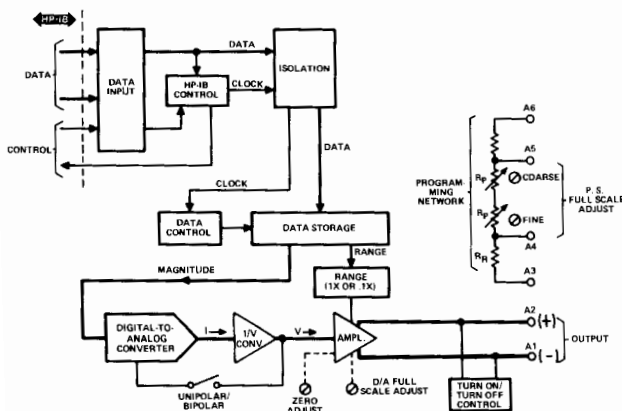

Several programming notes are available to assist in operating the HP 59501B Power Supply Programmer with the HP desktop computers. For more on free publications, see page 757.

Accessories

HP 5060-0173: rack mounting adapter kit for one HP 59501B Price \$52

HP 5060-0174: rack mounting adapter kit to connect two HP 59501B's \$52

Ordering Information

HP 59501B HP-IB Isolated D/A Power Supply Programmer Price \$760



POWER SUPPLIES

Precision Bipolar System Supplies

Models 6129C-6131C & 6140A

- HP-IB compatible options P05 and J99 with HP 59301A
- Fast, accurate, high resolution programming
- Bipolar output

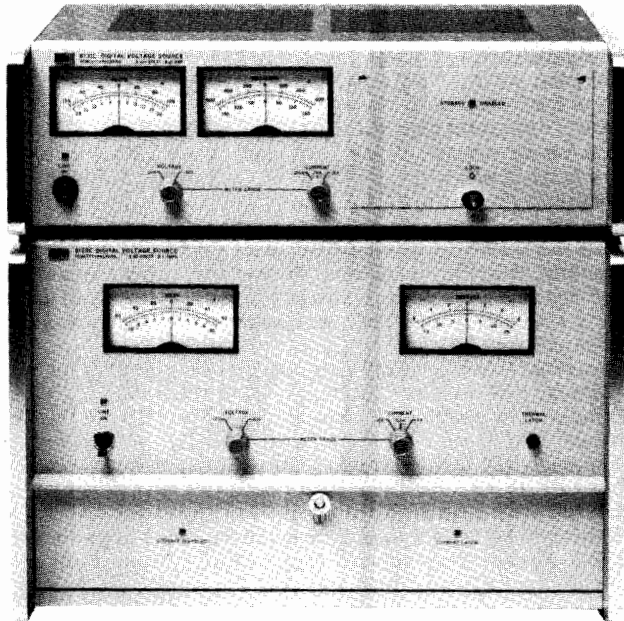

HP 6131C (top) & 6129C

Description

The family of Precision Bipolar System Supplies consists of three voltage sources (HP 6129C, 6130C and 6131C) and one current source (HP 6140A). They provide easy, fast and accurate programming of their dc outputs, with many features oriented specifically towards efficient integration in automatic systems.

HP-IB

These system power supplies, when ordered with either option P05 or J99, may be programmed on the HP-IB via the HP 59301A ASCII to parallel converter.

Isolation

All digital inputs are completely isolated from the analog outputs.

Programmable Current Limit (Voltage Source)

Valuable loads can be protected by a user programmable current latch. Output power goes to zero when the latch circuit is tripped. The reaction time to the latch can be adjusted, if desired, to avoid tripping when reprogramming with a capacitive load. There is also a fixed current limit at 110% of rated current output.

Current Monitoring Terminals (Voltage Sources)

A voltage is available at the rear barrier strip which is proportional to the output current.

Analog Input

An ac signal may be injected into the output amplifier to simulate various noise and ripple conditions.

Precision Bipolar System Current Source

The HP 6140A Current Source has features which correspond to the voltage sources. It has a programmable voltage limit, voltage monitoring terminal, as well as isolation, HP-IB options, and analog input capabilities.

Accessories Furnished

HP 1251-0086 50-contact rear plug.
HP 5060-7948 Plug-in extender board for voltage source.
HP 5060-7948/5060-7982. Two plug-in extender boards for current source.

- Current sink or source
- Programmable current latch (on voltage sources) or voltage limit (on current sources)
- Isolated output

Specifications

| | Binary Instruments Option J20 & P05 | | BCD Instruments Option J99 | |
|-----------------|--|-------------------|-------------------------------|------------------|
| | X1 Range | X10 Range | X1 Range | X10 Range |
| HP 6129C | | | | |
| Output | ±16.384 V, 5 A | ±50.00 V, 5 A | ±9.999 V, 5 A | ±50.00 V, 5 A |
| Accuracy | 1.5 mV | 15 mV | 1.5 mV | 15 mV |
| Resolution | 0.5 mV | 5 mV | 1 mV | 10 mV |
| HP 6130C | | | | |
| Output | ±16.384 V, 1 A | ±50.00 V, 1 A | ±9.999 V, 1 A | ±50.00 V, 1A |
| Accuracy | 1 mV | 10 mV | 1 mV | 10 mV |
| Resolution | 0.5 mV | 5 mV | 1 mV | 10 mV |
| HP 6131C | | | | |
| Output | ±16.384 V, 0.5 A | ±100.00 V, 0.5 A | ±9.999 V, 0.5 A | ±99.99 V, 0.5 A |
| Accuracy | 1 mV | 10 mV | 1 mV | 10 mV |
| Resolution | 0.5 mV | 5 mV | 1 mV | 10 mV |
| HP 6140A | | | | |
| Output | ±16.384 mA, 100 V | ±163.84 mA, 100 V | ±9.999 mA, 100 V | ±99.99 mA, 100 V |
| Accuracy | 1 µA ±0.01% | 10 µA, ±0.01% | 10 µA, ±0.01% | 10 µA, ±0.01% |
| Resolution | 0.5 µA | 5 µA | 1 µA | 10 µA |

Options

AC Power Option

028: transformer tap change for 230 V ac ±10%, single-phase input on HP 6130C and 6131C.
(HP 6129C and 6140A are 115/230 switch selectable.)

Price

N/C

Standard Interface Options*

P05: 16 bit binary programming format with modifications to interface to the HP 59301A and be programmed on the HP-IB. In addition to power supply modifications, a cable to connect the supply to the HP 59301A and programming documentation are included.

add \$150

J99: 4 digit BCD programming format, otherwise similar to Opt. P05. A cable, and programming documentation, are included.

add \$150

J20: 16 bit binary interface for HP 12661A I/O programmer card for Hewlett-Packard computers.

N/C

Accessories Available

HP 14533B: Pocket programmer permits manual programming of all input functions by switch closure.

\$370

HP 14534A: Pocket programmer extension cable (3 ft).

\$170

HP 14535A: HP computer interface kit includes HP 12661A computer I/O card, HP 14539A cable, verification software and RTE Driver. Up to eight PBSS's may be controlled from one HP 14535A.

\$1725

HP 14536A: Chaining cable connects an additional PBSS to the existing chain of PBSS's.

\$295

Ordering Information

An interface option must be ordered.

HP 6129C: Digital Voltage Source

\$6600

Opt 908: Rack Flange Kit

add \$50

HP 6130C, 6131C: Digital Voltage Source

\$3800

Opt 908: Rack Flange Kit

add \$37.50

HP 6140A: Digital Current Source

\$6600

Opt 908: Rack Flange Kit

add \$37.50

Opt 910: One extra operating and service manual shipped with each power supply

\$15

POWER SUPPLIES

Special Purpose: DC Power Supply/Amplifiers

Models 6824A-6827A

- High speed remote programming
- Overload protection
- Wide-band response

- Bipolar voltage
- Current sink or source

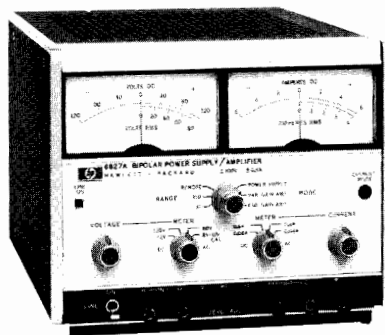

HP 6825A-6827A

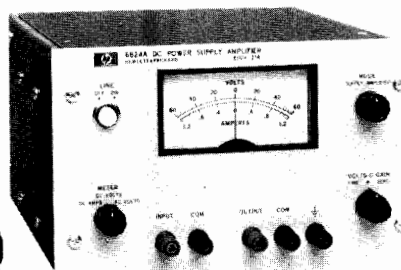

HP 6824A

Description

The Power Supply/Amplifier is a general-purpose instrument useful in any laboratory engaged in research and development of electronic systems, circuitry, or components. The unit can be operated in one of two basic operating modes: power supply or amplifier. Terminals at the rear permit access to various internal control points to further expand the operational capabilities of the instrument. The resulting flexibility lends the Power Supply/Amplifier to an almost unlimited number of applications.

Models 6825A Through 6827A

These models feature dual-range output and constant-voltage/constant-current operation. Output voltage and current as a dc supply, or gain as a power amplifier, are remotely controllable and are compatible with Hewlett-Packard Multiprogrammer Systems.

As a dc power supply, the unit can furnish a bipolar, constant-voltage or constant-current output. It can be remotely programmed with a resistance, voltage, or current and its high speed programming characteristics adapt it to a wide variety of laboratory and production testing applications. The supply can sink, as well as source, current permitting it to serve as a variable load device.

As a direct-coupled power amplifier, each unit offers a signal-to-noise ratio of approximately 80 dB at full output with low distortion and a frequency response up to 40 kHz in the fixed gain mode.

Model 6824A

Although this model does not provide quite the level of performance and flexibility of Models 6825A through 6827A, it is lower in cost and is suitable for many applications.

As a power supply, this unit offers constant-voltage/current-limiting operation, remote programming, and auto-series, auto-parallel operation.

As a power amplifier, the unit exhibits a high signal-to-noise ratio with a 20 dB gain from dc to 10 kHz. It is useful in servo systems, as a pulse or oscillator amplifier, for motor control, and a variety of other applications.

General Specifications

Temperature: operating, 0 to 55°C; storage, -40 to +75°C.

Power: HP 6824A, standard input voltage is 104-127 V ac, 48-63 Hz. Order Option 028 for 230 V ±10% operation. HP 6825A, 6826A, 6827A, switchable, 100, 120, 220, or 240 V ac, -13% +6%, 48-63 Hz, 150 W.

Size: HP 6824A, 131 H x 209 W x 303 mm D (5¹/₂" x 8⁷/₃₂" x 11¹⁵/₁₆"). HP 6825A, 6826A & 6827A, 155 H x 198 W x 316 mm D (6¹/₃₂" x 7²⁵/₃₂" x 12⁷/₁₆").

Weight: HP 6824A, 7.7 kg (17 lb); 6825A, 6826A & 6827A, 8.2 kg (18 lb).

Specifications

| RATINGS | | POWER SUPPLY PERFORMANCE | | | | | | POWER AMPLIFIER PERFORMANCE | | | | | | | | |
|------------------------------------|------------------------|--------------------------|---------------|----------|--------------------|-------------|------------|-----------------------------|--------------|---------------|-------------------------------|---------------|---------------------------|--------|---------|--------|
| DC Output | | HP Model | PAR (rms/p-p) | | Transient Recovery | | Resolution | | Voltage Gain | | Frequency Response, +1, -3 dB | | Distortion at full output | | Options | Price |
| Volts | Amperes | | Voltage | Current | Time | Level | Voltage | Current | Fixed | Variable | Fixed Gain | Variable Gain | 100 Hz | 10 kHz | | |
| -5 V to +5 V -20 V to +20 V | 0-2.0 A Both Ranges | 6825A | 10/30 mV | 5/15 mA | 100 μs | 20 mV | 40 mV | 6 mA | 1X 4X | 0-2X 0-8X | dc-40 kHz | dc-15 kHz | 0.1% THD | 0.5% | 9 | \$1950 |
| -5 V to +5 V -50 V to +50 V | 0-1.0 A Both Ranges | 6826A | 6/35 mV | 0.8/5 mA | 100 μs | 50 mV | 100 mV | 3 mA | 1X 10X | 0-2X 0-20X | dc-40 kHz | dc-15 kHz | 0.1% THD | 0.5% | 9 | \$1950 |
| -10 V to +10 V -100 V to +100 V | 0-0.5 A Both Ranges | 6827A | 10/50 mV | 0.4/5 mA | 100 μs | 100 mV | 200 mV | 1.5 mA | 2X 20X | 0-4X 0-40X | dc-30 kHz | dc-15 kHz | 0.1% THD | 1% | 9 | \$1950 |
| -50 V to +50 V | 0-1.0 A | 6824A | 10 mV rms | - | 100 μs | 0.02% +5 mV | - | - | - | 0-10X | - | dc-10 kHz | 0.1% THD | - | 9,28 | \$1200 |

Options Descriptions

028: 230 V ac ± 10%, single phase input

910: one additional manual shipped with each power supply

HP 6824A, add \$5.10
HP 6825A, 6826A, 6827A add \$15

Prices

N/C

Accessories

HP 5060-8762: adapter frame for rack mounting one or two HP 6825A-6827A units \$115

HP 5060-8760: blank filler panel to be used with above units \$36

HP 14515A: rack mounting kit for one HP 6824A \$61

HP 14525A: rack mounting kit for two HP 6824As \$35



POWER SUPPLIES

Special Purpose; Precision Voltage Sources

Models 6114A and 6115A

- 0.025% output voltage accuracy
- Pushbutton voltage control
- Five minute warm-up



HP 6114A & 6115A

Description

HP Models 6114A and 6115A

These 40-watt precision power supplies are high-accuracy instruments designed for use as low-cost calibrators, working voltage standards, systems reference supplies, or high-performance lab supplies. They are ideal for applications where an accurate, highly stable, and easy-to-use source of dc voltage is required.

Output Ratings

Both models feature automatic dual-range operation. For example, the HP 6114A can supply 0-20V at 0-2A, and 20-40V at 0-1A, without manual range switching. Automatic output current range crossover occurs when the supply is providing greater than one-half of the maximum rated output voltage.

Output Voltage Controls

Pushbutton voltage controls allow the output voltage to be set rapidly and accurately. The setting is displayed in large, easy-to-read numerals. A four-digit pushbutton switch increases or decreases the output voltage in unit steps, and the switches go directly from "9" to "0" without backing down. A fifth digit, set via a separate front-panel control, provides output voltage resolution of 200 μ V.

The output voltage accuracy is 0.025% (250 ppm) plus 1 mV — for example, at 40 volts output, the output voltage of Model 6114A is accurate within ± 11 mV. This accuracy is attained after only five minutes' warmup, thus making these supplies especially suitable as portable calibrators.

Output Current Controls

A front-panel current control allows the maximum output current of these supplies to be set to any desired value within the maximum rating. Using this control, the supplies can be operated as constant-current sources with 0.01% current regulation. A current mode indicator (a light-emitting diode) immediately lights when the supply is operated in the gross current limit region or when the output current level established by the setting of the front-panel control is reached. When the indicator is lighted, the output voltage is uncalibrated, but the front panel voltmeter continues to indicate the output voltage with an accuracy of 2%. A ten-turn current control with a three-digit graduated dial provides 2 mA current resolution.

Remote Programming

Models 6114A and 6115A are designed to be programmed with either the HP Multiprogrammer or the HP-IB Isolated D/A Power Supply Programmer. Interfacing for Multiprogrammer operation is included as a standard feature in these models; therefore, the addition of Option 040 is not required. See pages 281 and 313 for additional information on digital programming interfaces for power supplies. Both supplies can also be remote programmed by means of an external voltage or resistance.

The output capacitor can be disconnected to reduce current surges, thereby improving the performance of the supply as a constant-current source; this also increases the programming speed by approximately an order of magnitude. Note, however, that some capacitance

- May be used with HP-IB Power Supply Programmer
- Overvoltage and overcurrent indicators
- Built-in overvoltage crowbar

at the load may be required to maintain power supply stability under all loading conditions when the output capacitor is disconnected.

Overvoltage Protection

A built-in overvoltage protection circuit (an SCR crowbar) monitors the output and reduces the output voltage and current to zero whenever a preset voltage limit (adjustable from the front panel) is exceeded. This feature provides a convenient method of limiting the maximum output voltage supplied to voltage-sensitive loads.

Specifications

DC Output: voltage and current output can be adjusted over the range indicated by front-panel controls or analog programming.

HP 6114A: 0-20 volts, 0-2 amperes

20-40 volts, 0-1 amperes

HP 6115A: 0- 50 volts, 0-0.8 amperes

50-100 volts, 0-0.4 amperes

Both models feature automatic dual-range operation, which eliminates manual range switching.

Load effect: constant-voltage deviation, 0.0005% + 100 μ V; constant-current deviation, 0.01% + 500 μ A.

Source effect: over the rated input voltage range: constant-voltage, 0.0005% + 100 μ V; constant-current, 0.005% + 40 μ A.

PARD (ripple and noise): rms/p-p, 20 Hz to 20 MHz; CV 40 μ V/200 μ V, CC 200 μ A/1 mA.

Temperature coefficient: CV, 0.0001% + 15 μ V/ $^{\circ}$ C; CC, 0.02% + 50 μ A/ $^{\circ}$ C.

Drift: CV, 0.0015% + 15 μ V per 8 hours, 0.0075% + 30 μ V per 90 days.

Output voltage accuracy: output voltage accuracy obtained from front-panel controls at $23 \pm 3^{\circ}$ C at any ac line voltage and load current within rating and following a five-minute warm-up: 0.025% + 1.0 mV.

Resolution: front-panel voltage control, 200 μ V; front-panel current control, 2 mA.

Output impedance: typical value is approximated by 0.05 m Ω in series with 3 mH.

Load transient recovery time: less than 50 μ s is required for output voltage (constant voltage operation) to recover within 50 mV of the nominal output level following a change in output current equal to the current rating of the supply.

Remote programming speed: up programming of voltage at full load: HP 6114A, 1.75s; HP 6115A, 4.5s. Down programming, no load: HP 6114A, 350 ms; HP 6115A, 500 ms.

Overvoltage protection crowbar: adjustable front-panel screw-driver control from 0.5 to 45 volts on the HP 6114A and 0.5 to 110 volts on the HP 6115A.

Power: 104-127 or 208-254 Vac (switchable), 48-440Hz, 150 VA max.

Temperature rating: operating, 0 to 50 $^{\circ}$ C; storage, -40 to +75 $^{\circ}$ C.

Size: 197 mm W x 165 mm H x 337mm D (7.75" x 6.5" x 13.25")

Weight: 7.7 kg (17 lb) net, 9.5 kg (21 lb) shipping.

Accessories

5060-8762: adapter frame for rack mounting one or two 1/2 rack width units. This frame applies to HP 6114A, 6115A

5060-8760: blank filler panel. This 1/2 rack width panel applies to HP 6114A, 6115A

Price

\$115

\$36

Ordering Information

HP 6114A Precision Power Supply

HP 6115A Precision Power Supply

Price

\$1650

\$1650

POWER SUPPLIES

Special Purpose: Precision Constant Current Sources

Models 6177C, 6181C & 6186C

285



- Continuously variable voltage limit
- Output useful to micro-ampere region

- High output impedance—no output capacitor

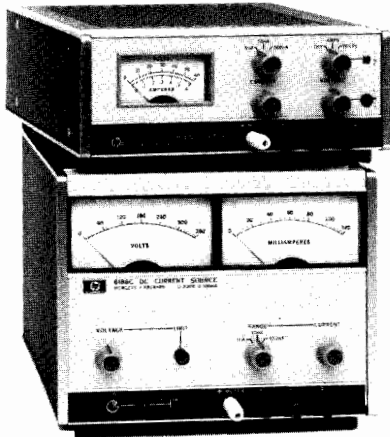

HP 6177C, 6181C

HP 6186C

voltage to vary from zero to maximum.

Source effect (line regulation): less than 25 ppm of output + 5 ppm of range switch setting for any change in the line voltage between 104 and 127 V ac at any output current and voltage within rating.

Load effect transient recovery: less than 800 μ s for recovery to within 1% of nominal output current following a full load change in output voltage. (On HP 6186C, recovery time for 100 mA/10 mA/1 mA ranges is 1 ms/1.6 ms/4 ms, respectively.)

Temperature coefficient: output change per degree C is less than 75 ppm of output current +5 ppm of range switch setting.

Drift (stability): less than 100 ppm of output current +25 ppm of range switch setting. Stability is measured for eight hours after one hour warm-up under conditions of constant line, load, temperature, and output setting.

Resolution: 0.03% of range switch setting.

Temperature rating: operating 0, to 55°C; storage, -40 to +75°C.

Accessories

HP 5060-8764: rack adapter for rack mounting one or two HP 6177C or 6181C supplies \$130

HP 5060-8762: rack adapter for rack mounting one or two HP 6186C supplies \$115.00

HP 5060-8530: filler panel for HP 6177C, 6181C \$49

HP 5060-8760: filler panel for HP 6186C \$36

Options

028: 230 Vac \pm 10%, single-phase input. N/C

910: one additional operating and service manual add \$7.50

Ordering Information

HP 6177C, 6181C Constant Current Source \$1300

HP 6186C Constant Current Source \$2000

Description

These solid-state constant-current sources are ideal for semiconductor circuit development, component testing, and precision electroplating applications.

Their high-speed remote programming characteristics make these supplies useful in testing and sorting semiconductors, resistors, relays, meters, etc. The ability to superimpose ac modulation on the dc output permits the supplies to be used for measurement of dynamic or incremental impedance of circuit components.

Specifications

Load effect (load regulation): less than 25 ppm of output + 5 ppm of range switch setting for a load change which causes the output

| Model | | HP 6177C | HP 6181C | HP 6186C |
|---|---|--|---|--|
| Output Current †† | | 0-500 mA | 0-250 mA | 0-100 mA |
| Voltage Compliance Δ | | 0-50 V dc | 0-100 V dc | 0-300 V dc |
| Output Ranges | A | 0-5 mA | 0-2.5 mA | 0-1 mA |
| | B | 0-50 mA | 0-25 mA | 0-10 mA |
| | C | 0-500 mA | 0-250 mA | 0-100 mA |
| AC Input | | 115V ac \pm 10%, 48-63 Hz; 0.6 A, 55 W at 115 V ac For 230 V ac see Option 028 | 115 V ac \pm 10%, 48-63 Hz; 0.6 A, 55 W at 115 V ac For 230 V ac see Option 028 | 115/230 V ac, 48-63 Hz; 0.9 A, 90 W at 115 V ac 115/230 V ac switch |
| Constant Current | Voltage Control (accuracy: 0.5% of output current +.04% of range) | Range A | 200 mV/mA | 1 V/mA |
| | | Range B | 20 mV/mA | 100 mV/mA |
| | | Range C | 2 mV/mA | 10 mV/mA |
| Remote Programming | Resistance Control (accuracy: 1% of output current +0.04% of range) | Range A | 400 ohms/mA | 2 k Ω /mA |
| | | Range B | 40 ohms/mA | 200 ohms/mA |
| | | Range C | 4 ohms/mA | 20 ohms/mA |
| Voltage Limit Remote Programming | Voltage Control (Accuracy: 20%) | | 1 V/V | 1 V/V |
| | | Resistance Control | 870 ohms/V | 435 ohms/V |
| | | Accuracy | 25% | 25% |
| Typical Output Impedance (R in parallel with C)* | Range A | R = 330 Meg, C = 500 pF | R = 1330 Meg, C = 10 pF | R = 10,000 Meg, C = 900 pF |
| | Range B | R = 33 Meg, C = 0.005 μ F | R = 133 Meg, C = 100 pF | R = 1,000 Meg, C = 700 pF |
| | Range C | R = 3.3 Meg, C = 0.05 μ F | R = 13.3 Meg, C = 1000 pF | R = 100 Meg, C = 1500 pF |
| PARD (Ripple and Noise): rms/p-p (20 Hz to 20 MHz) with either output terminal grounded | Range A | 1.6 μ A rms/40 μ A p-p | 0.8 μ A rms/20 μ A p-p | 0.2 μ A rms/5 μ A p-p |
| | Range B | 16 μ A rms/200 μ A p-p | 8 μ A rms/100 μ A p-p | 2 μ A rms/50 μ A p-p |
| | Range C | 160 μ A rms/1 mA p-p | 80 μ A rms/500 μ A p-p | 20 μ A rms/500 μ A p-p |
| Programming Speed: from 0 to 99% of range switch setting with a resistive load **(Output Current Modulation) | | 6 ms | 6 ms | 10 ms |
| Dimensions: | | 7.75" (W) x 3.44" (H) x 12.38" (D) 197 mm (W) x 88 mm (H) x 315 mm (D) | 7.75" (W) x 3.44" (H) x 12.38" (D) 197 mm (W) x 88 mm (H) x 315 mm (D) | 7.75" (W) x 3.44" (H) x 12.38" (D) 197 mm (W) x 158 mm (H) x 315 mm (D) |
| Weight: (Net/Shipping) | | 4.53 kg (10 lb)/5.9 kg (13 lb) | 4.53 kg (10 lb)/5.9 kg (13 lb) | 5.9 kg (13 lb)/7.7 kg (17 lb) |

* This network is a simplified representation of a complex network. The formula $Z = R_X / \sqrt{R^2 + X_C^2}$ is used for frequencies up to 1 MHz by substituting the values given for R and C. Above 1 MHz, the output impedance is greater than the formula would indicate.

** Output current can be modulated 100% up to 50 Hz; percent modulation decreases

linearly to 10% at 500 Hz.

†† For operation above 40°C the maximum output current must be reduced linearly to 80% of rating at 55°C (maximum temperature).

Δ Minimum voltage obtainable with voltage limit control is 0.5 V.

DATA ACQUISITION, CONTROL & TEST

General Information

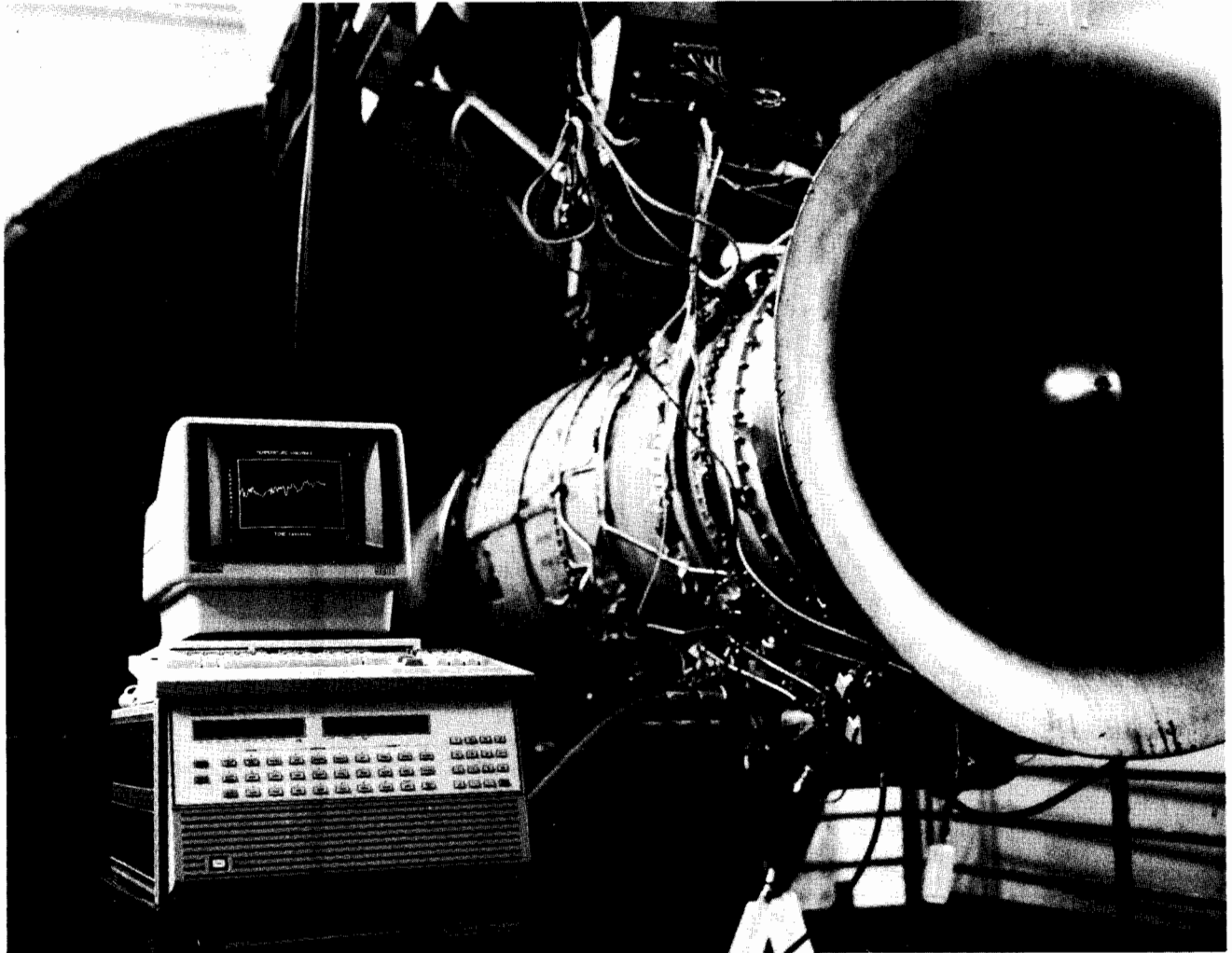

The new HP 3852S Data Acquisition/Control System has extensive system software, and can make measurements at rates up to 100 kHz.

No industry is perfect. In order to stay competitive we all need to be more productive, offering products and services of higher quality. One obvious way is through automation. But automation by itself is not the answer—it takes the commitment of a company familiar with computer-based systems to help you overcome the problems encountered in an automation project.

HP is a major pioneer in computer-based data acquisition systems. We have listened to our customers' likes, dislikes, and frustrations, and the result is a number of systems targeted not only for Data Acquisition, but for Electronic Product Test as well. Now you can choose the system with attributes most suitable for your individual needs; from the battery powered HP 3421A/71B system to the new versatile HP 3852S.

Test

In an electronic test situation, the product is often tested to design standards from a well-known list of variables. There is a need for signal multiplexing, matrix switching and R.F. switching, as well as a need for stimulating the device under test either through a D/A converter or signal generator.

Addressing the electronic test category are the HP 3488A Switch/Control Unit, the HP 3457A Digital Multimeter and the HP 6940/6942/6944 Multiprogrammer Series of products. HP also has complete systems for Electronic Test: the HP 6901S and the ATS/1000 integration service. Integration on ATS/1000 ranges from simple racking and cabling, to writing of system software.

Data Acquisition

A Data Acquisition system can find itself in very different situations, from an R&D Lab to a factory floor control environment.

Each situation places a different degree of importance upon the features of the system.

For instance, a research lab needs accuracy, ease of configuration and versatility, while a factory floor application calls for NEMA cabinets, control algorithms and distributed intelligence.

As you can see from the charts, HP has a wide selection of systems with varying degrees of speed, accuracy and intelligence, each designed to produce the best performance available for your allotted budget.

System and Software

The quality of Data Acquisition software is just as important as the quality of the hardware. Few of us are programming experts, so HP has produced a wide variety of software tools that match the ability of the programmer.

For simple data logging chores the HP 3054DL, 3056DL and 3055S have menu-driven software. For more complex applications, each of these systems has a path to versatile subroutine software.

For the utmost in software versatility, this year HP is introducing the HP 44456A computer-aided test software, using the new HP 3852A Data Acquisition/Control Unit and the new HP Series 300 computer family.

Support

Hewlett-Packard's system contribution doesn't end with the sale. We also offer a wide variety of training courses, both for the user and the service technician. In certain cases, customized support contracts and consulting time are also available. Contact your local HP sales office for specific information.

Instrument Intelligence

In test applications, the instrument may operate stand alone from the computer and only report exceptions to the test limits. In Data Acquisition and Control applications, it may be desirable for the instrument to operate separately from the computer to protect against computer or I/O link failure. Some products rely on powerful microprocessors that can operate independently of the main computer. Other products utilize dedicated card handshaking to provide additional capability.

Environment

Consideration of the operating environment is a very important step in choosing a data acquisition or test system. An application can require that a system operate in hot, dusty and corrosive environments. In addition, the electrical environment should also be considered in regard to the amount of electrical noise (both common and normal mode) present in the area.

All Hewlett-Packard instruments are designed to operate in moderately harsh environments and the HP 2250 Measurement and Control Processor is available in a NEMA-12 rated enclosure for industrial installations.

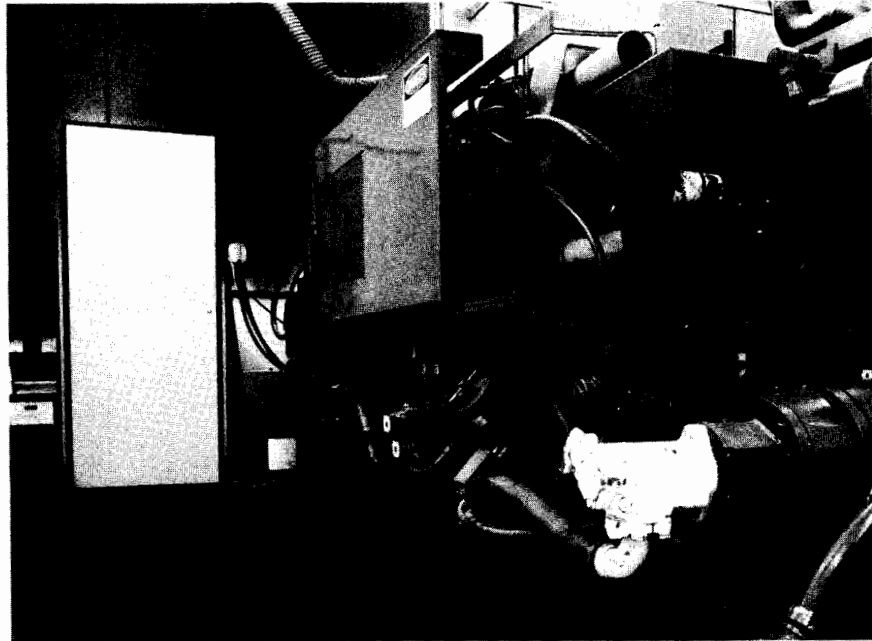

The HP 2250A Automation Processor and HP Control/1000 Products have the stand alone intelligence needed for control applications.

Integrated Systems

Integrated systems can save you a great deal of time and effort, both in hardware consolidation and in software design. Let HP do the hard part, and reap the benefits in faster design of experiments.

For further information on HP's front-ends and systems, consult the following catalog pages. Technical brochures, programming notes and tutorial application notes are also available.

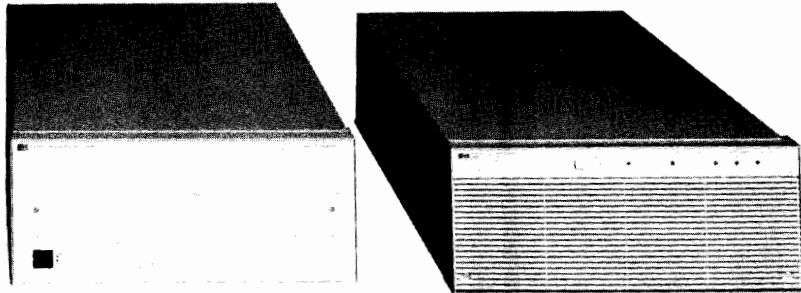

The Multiprogrammer series of front ends are an excellent match for production test applications.

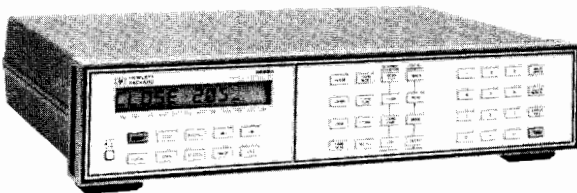

Use the HP 3488A Switch/Control Unit for RF and matrix switching as well as digital I/O.

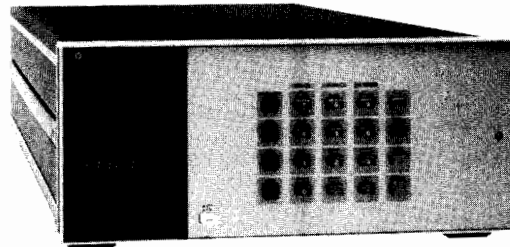

The versatile HP 3497A has an integrating 5 1/2 digit DVM and a whole family of plug-in cards. It is an excellent choice for data acquisition.

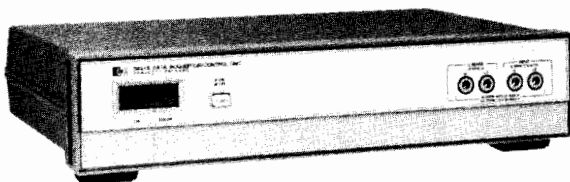

The low-cost HP 3421A operates on batteries with 30-channel capacity and a built-in 5 1/2 digit DVM.

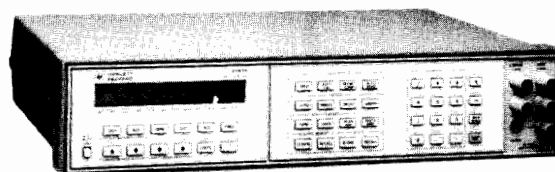

The HP 3457A Digital Multimeter has a 10-channel scanner for small benchtop experiments.



DATA ACQUISITION, CONTROL & TEST

General Information (cont.)



The new HP 3055S has personal computer data logger software to drive either the HP 3421A or 3497A.

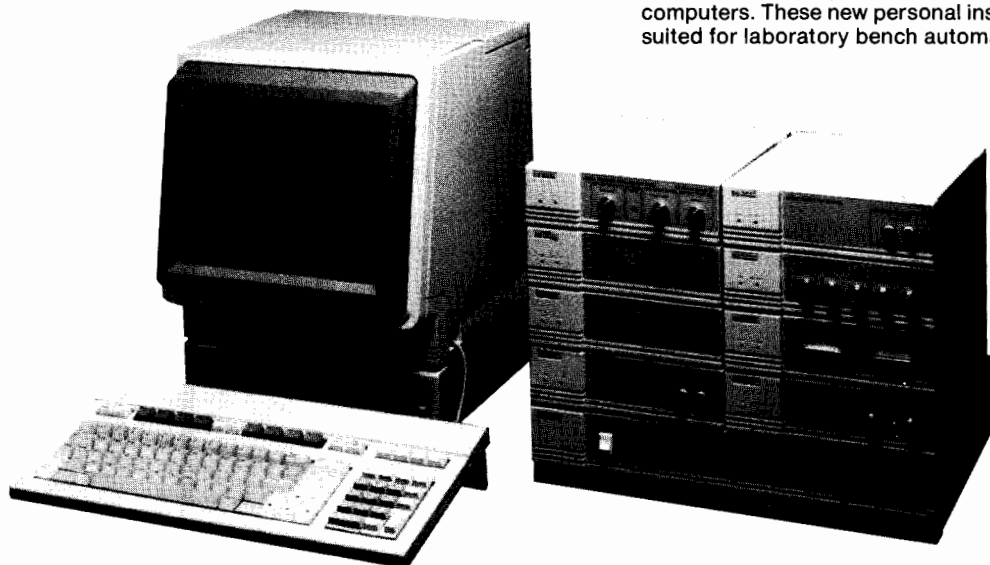

HP has a new, compact solution for users of personal computers. These new personal instruments are well suited for laboratory bench automation.

| Product | Catalog Page | Systems | Technical Brochure |
|--|--------------|---|---|
| Data Acquisition HP 2250 Measurement & Control Processor | 308 | 2250A 2250H 2250L PMC/1000 | 5953-6978 5953-2848 |
| HP 3421A Data Acquisition Control Unit | 290 | 3056DL 3421A/71B 3055S | 5953-7000 5953-7007 5953-7000 |
| HP 3497A Data Acquisition Control Unit | 296 | 3054A 3054S 3054C 3055S 3054DL 3497A PMC/1000 | 5952-8897 5952-8862 5952-8865 5953-7000 5952-8862 5953-6911 5953-2848 |
| HP 3852A Data Acquisition Control Unit | 300 | 3852S | 5953-7004 5953-7005 |
| Test HP 3488A Switch/Control Unit | 311 | | 5953-6956 |
| HP 3457A DMM | 205 | | 5953-6992 |
| HP 61010AA/61061AA | 193 | PC Instruments | 5952-4124 |
| HP 6940B | 320 | | 5952-4077 |
| HP 6942A | 316 | HP 6901S | 5952-4089 |
| HP 6944A | 315 | | 5952-4090 5952-4110 |

| Product | Accuracy | Readings Per Second | Sensitivity | Resolution (Bits Plus Sign) |
|--|---------------|---------------------|---------------------------|-----------------------------|
| Data Acquisition HP 2250 Measurement & Control Processor | 0.7% | 50,000 | 2 μ V | 14 Bits |
| HP 3421A Data Acquisition/Control Unit | 0.01% | 4* 35* | 1 μ V | 18 Bits 11 Bits |
| HP 3497A Data Acquisition Control Unit | 0.007% | 50* 300* | 1 μ V 100 μ V | 17 Bits 10 Bits |
| HP 3852A Data Acquisition Control Unit | 0.01% .01% | 100,000 1600* | 10 μ V 1 μ V | 12 Bits 18 Bits |
| Test HP 3488A Switch/Control Unit | | | | |
| HP 3457A DMM | .002% | 48* 1350* | .01 μ V 10 μ V | 20 Bits |
| HP 61011A/6013A | 0.1% | 2.5* | 10 μ V | 11 Bits |
| HP 6940B | 0.2% | 20,000 7* | 50 μ V 10 μ V | 12 Bits |
| HP 6942A | 0.27% | 500,000 | 50 μ V | 12 Bits |
| HP 6944A | 0.27% | 500,000 | 50 μ V | 12 Bits |

*Integrating A/D Converter for excellent noise rejection.

The requirements for speed and accuracy vary with application. For data acquisition applications where electrical noise is prevalent, HP has integrating A/D converters that reject powerline related noise. For high speed applications, there are several systems to choose from.

- Up to 60 channels
- Graphics
- Data stored on tape
- Menu and subroutine software

- Adaptive data logging
- User definable functions
- Choose from 18 separate functions

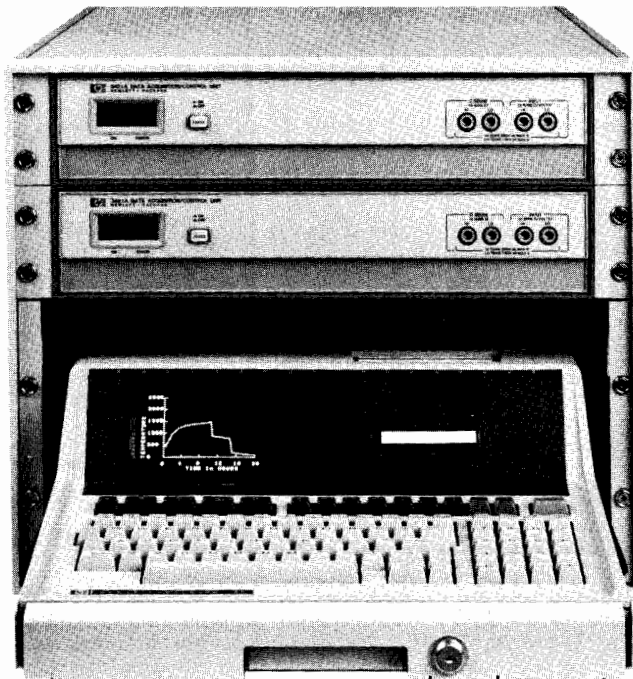

HP 3056DL



Description

The HP 3056DL Data Logger merges the measurement capabilities of up to two HP 3421A Data Acquisition/Control Units with the programming versatility of the HP-85B computer. It comes in an attractive locking cabinet with two dedicated software packages and all necessary cables.

The Hardware

Each HP 3421A Data Acquisition/Control Unit used in the HP 3056DL Data Logger has the accuracy and resolution for critical applications. The basic accuracy is .01%, with a 5½ digit A/D Converter, a sensitivity of one microvolt, signal conditioning for thermocouples, DCV, ACV, Ohms, and Frequency. Each has a scanning capacity of up to 30 channels as well as 30-reading storage buffer. The HP 3421A assures you of precise transducer measurements at a surprisingly low price.

The HP-85B Personal Computer communicates with the HP 3421A via either HP-IL or HP-IB. The HP-85B has the data logging features you need all in a single integrated package: keyboard, magnetic tape drive, graphics printer and CRT.

The Software

Two levels of software come with each HP 3056DL Data Logger. The HP 3056DL Menu Software is ideal for the first-time user, yet powerful enough for an expert.

For the BASIC programmer, there are measurement subroutines in the HP 3056DL software. Integrate these subroutines into your own programming material to get the optimum speed and efficiency from the data logger.

User Definable Functions

There are no less than 17 separate functions to choose from:

- DCV
- 2-Wire Ohms
- Thermocouples: J, K, T, E, R, S
- 2-Wire RTD
- ACV
- 4-Wire Ohms
- 4-Wire RTD
- Digital Read
- Frequency
- 2.2K Thermistor
- Actuate
- 4-20 mA

Each function is selected simply by pressing the appropriate key on the HP-85B computer.

When the 17 available functions are not adequate, you can generate your own linearization equation: $mX+B$, a 5th order polynomial, or even a BASIC subroutine that you write yourself.

Adaptive Data Logging

When a specified channel exceeds its measurement limits, you can instruct the system to print, display a warning, or jump to a completely different measurement routine. For instance, you can scan slowly while the process you are monitoring is stable, and then adapt the scanning rate when an out-of-limit condition occurs. This "adaptive scanning" philosophy makes efficient use of data storage space and computer time.

Ordering Information

HP 3056S includes the HP 3056DL Data Logger plus the HP 85B Controller.

Input Assembly Options

| | |
|---|-------|
| 020: 8 Channel Multiplexer/2 Channel Actuator Assembly | \$346 |
| 021: 9 Channel Multiplexer/1 Channel Actuator Assembly | \$346 |
| 022: 10 Channel Multiplexer Assembly | \$346 |
| 040: Breadboard Assembly, connector block | \$89 |
| 050: Digital Assembly, connector block | \$346 |

Power Line Options

315-346: Options for 100 V/50 Hz through 240 V/60 Hz

Systems Options

| | |
|---|------------|
| 201* : add HP-IB interface to the HP 3421A (allows the use of EITHER HP-IB or HP-IL) | \$250 |
| 202* : two HP 3421As (both HP-IL) for up to 60 channel capacity | \$1482 |
| 203* : two HP 3421As (both HP-IB) for up to 60 channel capacity | \$2174 |
| 400: delete 16 in. cabinet, locking drawer | Less \$988 |
| 910: extra set of HP 3056DL manuals, pre-recorded tape cartridge | \$296 |

Computer

Order the HP-85B. To operate the HP 3056DL software, you must have all items (HP-85B, ROM drawer, HP-IB or HP-IL, Advanced Programming ROM).

| | |
|---|--------|
| HP-85B Computer with CRT, keyboard, tape drive graphics, 32K memory, I/O ROM, mass storage ROM | \$3265 |
| HP 82936A ROM Drawer | \$45 |
| HP 82937A HP-IB Interface | \$395 |
| HP 82938A HP-IL Interface | \$295 |
| HP 00085-15005 Advanced Programming ROM | \$165 |

HP 3056DL Data Logger

Includes one HP 3421A Data Acquisition/Control Unit with 5½ digit DVM, VDC, VAC, Ω, Counter, 30-reading storage, HP-IL Interface, sliding drawer and cabinet, software levels 1 and 2. Computer is ordered separately or as part of the HP 3056S.

\$2767

* Select no more than one

DATA ACQUISITION, CONTROL & TEST

Data Acquisition/Control Unit

Model 3421A

- Up to 30 differential channels, 56 single-ended channels
- Electronic calibration for repeatable answers
- Built-in 5½ digit A/D converter with 1 μ V sensitivity
- HP-IL (standard) and HP-IB (optional) with rear panel switch
- Optional 12 volt battery power
- "Sleep mode" for extended battery life in remote locations
- Front terminals for convenient DCV, ACV, 2 & 4-wire ohms, frequency and temperature
- Display shows channels closed, digital states and self-test conditions

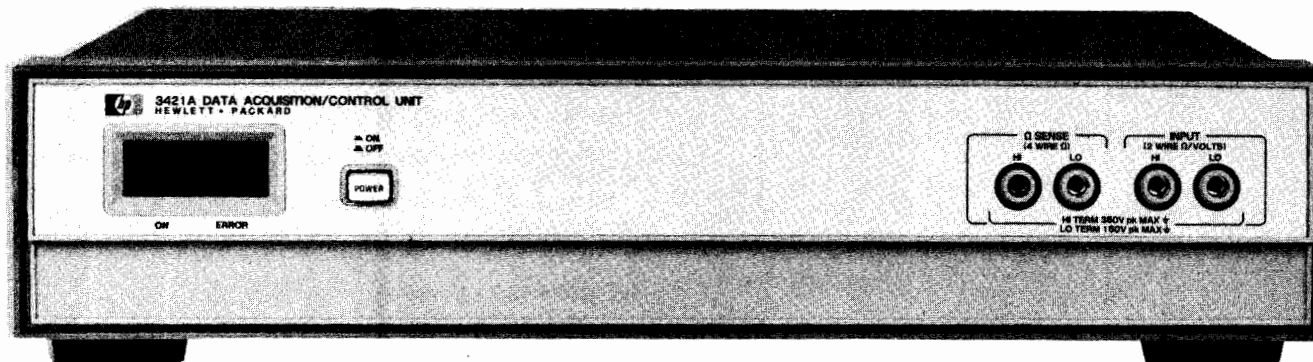

HP 3421A



Description

The HP 3421A Data Acquisition/Control Unit is the instrument that beats the high cost of data logging. Use it for that small data acquisition project with the assurance that it will quickly pay its own way.

The HP 3421A scans up to 30 channels, measuring DCV, ACV, 2- and 4-wire Ohms, Frequency, and Temperature. It also reads and writes digital information and stores up to 30 analog readings. The standard HP 3421A comes with an HP-IL interface for battery-powered flexibility or optionally HP-IB for more computational power.

Up to three of the following assemblies may be added to the HP 3421A mainframe:

- 10-channel analog multiplexer/actuator assembly with thermocouple compensation
- 8-bit input/8 bit output digital assembly
- Breadboard assembly for custom circuitry

Measurement Integrity

With its 5½, 4½, 3½ digit A/D converter, the HP 3421A can resolve 1 μ V out of 300 mV to monitor thermocouples and other low-level transducers. Or it can read higher level signals by auto-ranging up to 300 volts dc.

System Versatility

Each HP 3421A can scan up to 30 differential channels or 56 single-ended channels of analog information. The HP 3421A is battery-powered with latching relays that will not change state when the ac line power is removed. Battery power gives the HP 3421A its own uninterruptible power supply.

All functions are remotely programmable via either HP-IL or HP-IB. Use HP-IL with the HP 71B handheld calculator as a self-contained battery-powered data logger, or use HP-IB with the HP 85B Personal Computer for more programming performance.

The HP-71B handheld computer can turn on the HP 3421A Data Acquisition/Control Unit, trigger it to scan a list of 30 channels, instruct a mass memory to store all 30 readings and then power down the entire system until the next time interval passes.

The HP 3421A is not limited to portable applications. It is equally useful in laboratory situations, where its 0.01% accuracy, 1 microvolt sensitivity and 5½ digit resolution assure you of reliable answers.

Digital inputs, actuator outputs and a breadboard assembly give the laboratory designer a great deal of instrument flexibility while HP-IB compatibility adds the option of a more powerful instrument controller.

Special HP 71B ROM

Exceptional convenience for workstation and field use of the HP 3421A is provided by a special ROM (HP 82479A) for the powerful HP-71B Handheld Computer.

Composed of independent software modules, the Data Acquisition Pac implements a: (1) FRONT PANEL - more than just an HP 3421A front panel, with 14 measurement functions; analog and digital channel controls; and linearization for popular thermocouples, thermistors and RTD's for temperature measurements; (2) STRIP CHART - driving the HP 2225B to simulate strip chart recording; (3) MONITOR - continuously showing the state of measured parameters relative to preset limits on a large screen video display; (4) DATA LOGGER - simplicity of menu-driven software to perform data acquisition and storage, and react to out-of-limit measurements; (5) REPORT PROGRAM - perform minimal statistical, graphical and tabular analyses on collected data; (6) DATA TRANSFER - format and transfer collected data to the ASCII HPAF environment for more extensive data analyses.



The HP-71B is a full function technical BASIC language computer, with over 250 keywords. The Data Acquisition Pac ROM adds over 40 keywords specifically designed to ease data collection tasks. This combination yields an extremely powerful data acquisition capability for portable applications.

The HP 85B System (The HP 3056DL)

The HP 3421A can also be combined with the HP-85B Personal Computer for even easier and more powerful data logging. Dedicated software enhances the system with Menu programming, Subroutine programming, instrument panel emulation and graphic analysis. It makes data logging as easy as answering a few questions on the CRT display.



HP 3421A Mainframe Specifications

The HP 3421A mainframe comes with:

- A 5½, 4½, and 3½ digit integrating A/D converter
- Thermocouple compensation
- Type T thermocouple linearization built in
- HP-IL
- 30-reading storage buffer
- LCD 30 channel display with power and error indicators
- Electronic calibration
- Rechargeable battery
- High level command set

All specifications apply for relative humidity less than 85% at 30 degrees C.

DC Voltage

Ranges: 300 mV, 3 V, 30 V, 300 V, Autorange

Basic accuracy: ±(.009% reading + 3 counts); 5½ digits

Reading rates: 2 to 35 readings/second

Resistance

Ranges: 300 Ω, 3 kΩ, 30 kΩ, 300 kΩ, 3 MΩ, 30 MΩ; Autorange

Basic accuracy: ±(.012% reading + 3 counts); 5½ digits

Reading rates: 2 to 35 readings/second

AC Voltage

Ranges: 3 V, 30 V, (300 V with HP 44469A divider)

Converter type: averaging

Resolution: 3½ or 4½ digits

Basic accuracy: 4½ digits: ±(0.5% reading + 60 counts), 45 Hz to 500 Hz; ±(1% reading + 60 counts), 30 Hz to 1 kHz; providing the input voltage is at least 10% of range.

Counter

The counter is part of the mainframe circuit, and is multiplexed through the channel relays.

Resolution: 65,535 counts

Frequency: 1 Hz to 10 kHz

Modes: frequency, totalize

Thermocouple Thermometer

Type T thermocouple linearization is built in. For other thermocouple types, the reference junction temperature is available on each multiplexer assembly.

Option 020, 021, 022 Multiplexer/Actuator Assemblies

The configuration of multiplexer and actuators depends on the option you order. Option 020 has 8 multiplexer/2 actuator channels; Option 021 has 9 multiplexer/1 actuator channels; Option 022 has 10 multiplexer channels. The actuators are capable of switching 252 Vac. One HP 3421A mainframe can hold up to 3 assemblies.

Option 040 Breadboard Assembly

The breadboard assembly is convenient for constructing custom circuitry. It comes complete with a manual describing the circuit that enables the HP 3421A to communicate directly with an 8-bit microprocessor.

Option 050 Digital I/O Assembly

Option 050 has 8 isolated input lines and 8 isolated output lines for both monitoring and controlling external digital devices.

Option 201 HP-IB

The Option 201 adds an HP-IB interface to the HP 3421A. Interface functions: SH1, AH1, T6, TE0, LE0, L4, SR1, RL0, PP0, DC1, DT1, C0. For more on these codes, see the HP-IB section of this catalog.

Option 214 12 Volt Power Assembly

This optional assembly provides the necessary isolation and regulation to allow use of a 12 volt automotive battery or system to recharge or charge while in use the batteries of the HP 3421A, HP 71B Handheld Computer, and peripherals such as the HP 9114A Portable 3½" Microfloppy and HP 2225B Thinkjet Personal Printer. Option 214 is mutually exclusive with Option 201 (HP-IB).

Ordering Information

Input and I/O Assembly Options

| | Price |
|--|-------|
| 020: 8 Channel Multiplexer/2 Channel Actuator Assembly | \$346 |
| 021: 9 Channel Multiplexer/1 Channel Actuator Assembly | \$346 |
| 022: 10 Channel Multiplexer Assembly | \$346 |
| 040: Breadboard Assembly with connector block | \$89 |
| 050: 8 bit in, 8 bit out Digital I/O Assembly with connector block | \$346 |
| 201: add HP-IB interface. Allows use of EITHER an HP-IB or HP-IL controller | \$250 |
| 214: add 12 volt power assembly. Cannot be added if opt 201 is specified | \$330 |

Power and Frequency Options

| | |
|---|-----|
| 315-346: Line power options from 100 V/50 Hz–240 V/60 Hz | N/C |
|---|-----|

Rack Mount and Manual Options

| | |
|------------------------------------|------|
| 401: Side Handle Kit | \$20 |
| 907: Front Handle Kit | \$50 |
| 908: Rack Mount Kit | \$30 |
| 909: Rack Mount with Handle | \$75 |
| 910: Extra Manuals | \$74 |

Field Installation Kits*

| | |
|---|-------|
| HP 44462A: 8-Channel Multiplexer/2 Channel Actuator Assembly with thermocouple compensation, connector block | \$346 |
| HP 44463A: extra connector block for above | \$35 |
| HP 44464A: Breadboard Assembly with connector block | \$89 |
| HP 44465A: 8 bit in, 8 bit out digital I/O assembly with connector block | \$330 |
| HP 44466A: Extra connector block for digital or breadboard assembly | \$15 |
| HP 44469A: Seven 10:1 dividers for measuring 300 Vac | \$15 |

Accessories

| | |
|--|-------|
| HP 2225B: Thinkjet Personal Printer (HP-IL) | \$495 |
| HP 9114A: Portable 3½" Microfloppy (HP-IL) | \$795 |
| HP 11340A: 20-metre HP-IL Cable | \$40 |
| HP 11340B: 50-metre HP-IL Cable | \$100 |
| HP 11340C: 100-metre HP-IL Cable | \$200 |
| HP 82161A: Digital Cassette Drive (HP-IL) | \$450 |
| HP 82162A: Printer/Plotter (HP-IL) | \$450 |
| HP 82402A: Dual HP-IL Adapter | \$50 |
| HP 82479A: HP-71 Data Acquisition Pac ROM | \$195 |

HP 3421A Data Acquisition/Control Unit \$1,532

* Field installation is recommended to be performed only by service trained personnel.

DATA ACQUISITION, CONTROL & TEST

Automatic Data Acquisition/Control System

HP Model 3054S/HP Model 3054A

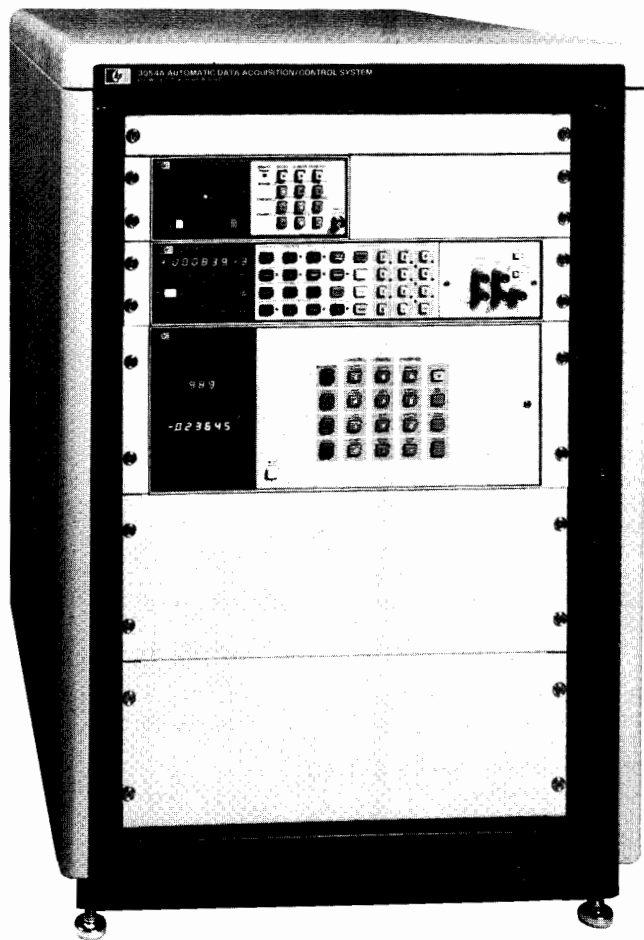

HP 3054S/A



Description

The HP 3054S/A is a computer-based automatic data acquisition and control system. The HP 3054S/A combines speed, precision and a variety of control functions with full computation and analysis capabilities. The HP 3054S/A offers flexibility, convenience, and performance to solve many data acquisition applications.

The system has the flexibility to make a wide variety of measurements, including outputs of thermocouples, strain gages, RTDs, flow meters, and other transducers. The HP 3054S/A also has digital inputs and outputs, voltage and current D/A converters for precision closed-loop control.

The HP 3054S/A offers the convenience of using instrumentation that is designed as a system. To help the user get started fast, the measuring system is rack-mounted and pretested. System specifications represent the summation of all instrument errors. An Introductory User's Guide is part of the system documentation package which enables the user to quickly learn how to use the system for his or her application.

The HP 3054S/A system performs by combining speed, accuracy and computational power. Measurement rates, from 4800 readings/second (60 Hz operation) to 48 readings/second, are possible with resolutions from 3½ digits to 6½ digits. DC measurements of low level transducers can be made with 100 nanovolt resolution with greater than 150 dB of noise rejection. An HP desktop computer or mini-computer will automate the system, store data, linearize transducers, and provide computation and analysis.

- Improve productivity in research and manufacturing
- Low cost data acquisition
- Precision transducer measurements and analysis
- 1000 analog channels and 1360 digital points
- Control functions for closed-loop applications



HP 217

The HP 3054S/A system is a powerful yet economical system for transducer measurements. By adding a graphics plotter, system measurements can be plotted for analysis, documentation, and presentation. Recommended plotters include the 6-pen HP 7475A, and the 2-pen HP 7470A.

System Configuration

The HP 3054A system includes an HP 3497A Data Acquisition/Control Unit, an HP 3456A Digital Voltmeter and an HP 3437A System Voltmeter. The HP 3054S system includes an entire HP 3054A plus a desktop computer (HP 85B, HP Series 200 or HP 7825B) and selected peripherals.

The HP 3497A Data Acquisition/Control Unit is the instrument that provides the analog multiplexing, digital monitoring, and control functions using plug-in assemblies. The 20 Channel Reed Relay Assembly provides low level guarded switching with $<2 \mu\text{V}$ of thermal offset. An isothermal connector is provided as an option to this assembly for thermocouple compensation. An FET multiplexer assembly provides fast scanning and high reliability. Digital input and output assemblies are available for monitoring and control. And you get specialized measurement and control using the Reciprocal Counter Assembly and the programmable D/A Converter Assemblies. Up to five of these optional plug-in assemblies can be contained in the HP 3497A mainframe. Expansion to more than five assemblies is provided by the HP 3498A Extender. Each HP 3498A can hold ten more assemblies. A total of thirteen extenders can be supported by one HP 3497A mainframe, giving a maximum of 1000 analog channels and 1360 digital channels.

System timing is accomplished through the non-volatile real time clock in the HP 3497A.

The optional DVM assembly for the HP 3497A has $1 \mu\text{V}$ sensitivity, 5½ digit resolution, integration, and guarding—capability previously available only on stand-alone system DVMs. (See page 296).

The HP 3456A Digital Voltmeter is a 3½ to 6½ digit integrating voltmeter with high accuracy, 100 nanovolt sensitivity, and speed to 330 readings/second. Its dc and true rms ac voltage and resistance measurement capability reduce the amount of signal conditioning necessary. The HP 3456A can detect 100 nanovolt changes in 100 mV signals at speeds of 48 readings/second. This capability is necessary for measuring thermocouples with the HP 3054S/A system to better than 0.01°C resolution. Common mode rejection of 140 dB makes the HP 3054S/A system particularly suited for repeatable low level measurements in the presence of noise.

The built-in memory of the HP 3456A can store both readings and sequences of measurement commands. The HP 3456A can store internally up to 350 readings or up to 1400 ASCII programming characters or combinations of both readings and programming characters.

The HP 3437A System Voltmeter is a high speed 3½ digit dc voltmeter that provides precisely timed sample and hold readings. Use it to analyze repetitive signals up to 1 MHz or transients down to 1 ms. in a fraction of the time required by conventional means. Use it with Option 030 FET Multiplexer Assembly to scan sequential channels at up to 4800 channels per second (60 Hz operation).

Power and Performance in Desktop Computers

A choice of computers with the HP 3054S/A provides a wide range of capability and performance for automating data acquisition applications. The desktop computers supported with the HP 3054S/A are the HP 85B, HP Series 200 and HP 9825B. The computers automate the system by controlling the instruments and gathering the data over HP-IB. All of these computers offer easy interaction to greatly simplify the writing and editing of programs. The friendly languages of the computers and the HP 3054S/A software package make it easy to get started. The presentation of data is very versatile when using a computer and external peripherals. Transducer data can be converted to engineering units, statistical analyses of the data can be performed, and graphical representations of the data can be produced. The individual capabilities of each computer—such as speed, memory size, and output devices—should be considered for the different data acquisition applications.

Software and Documentation

The system software is an integral part of the HP 3054S/A Automatic Data Acquisition/Control System. Specially written software and documentation packages are supplied for each of the computers. This complete software package greatly simplifies programming and enables the user to get started fast.

The complete software and documentation package supplied with the HP 3054S/A includes:

- operational verification programs
- system sub-programming routines
- typical application programs

The system verification/diagnostic programs can be used to verify that the system is in operating condition at the time of installation. The programming of the HP 3054S/A is most effectively accomplished by combining the system sub-program with other system operations. Sample application programs are also provided for assistance in developing functional software.

Racks and Cabinets

Other cabinets may be chosen besides the standard 30" rack for the HP 3054S/A. A 16" case is offered as a compact and portable package for the HP 3054S/A. A desk provides rack space for the instrument and a table top for software development. The 56" cabinet provides space for additional equipment and future expansion.

For more information on the HP 3054S/A, contact your nearest HP Sales Office.

System Options

Input Assemblies for the HP 3497A

| | Price |
|---|-------|
| 010: 20 Channel, Low Thermal Relay Multiplexer Assembly | \$600 |
| 020: Relay Multiplexer Assembly with Thermocouple Compensation | \$750 |
| 030: 20 Channel FET Multiplexer Assembly | \$750 |
| 050: 16 Channel, Isolated, Digital Input/Interrupt Assembly | \$550 |
| 060: Reciprocal Counter Assembly | \$600 |
| 070: 10 Channel, 120Ω Strain Gage/Bridge Assembly | \$900 |
| 071: 10 Channel, 350Ω Strain Gage/Bridge Assembly | \$900 |

Output Assemblies for the HP 3497A

| | |
|--|--------------|
| 110: 16 Channel Actuator/Digital Output Assembly | \$750 |
| 115: 8 Channel High Voltage Actuator | \$550 |
| 120: ±10V Dual D/A Converter Assembly | \$1000 |
| 130: 0 to 20 mA or 4 to 20 mA Dual D/A Converter Assembly | \$1000 |
| 140: Breadboard card for custom designs | \$148 |
| 230: U.S. Clock Format for the HP 3497A (month:day:hour:minute:second) | N/C |
| 231: European Clock Format for the HP 3497A (day:month:hour:minute:second) | N/C |
| 260: Delete Keyboard and Display on HP 3497A | less \$360 |
| 261: Delete HP 3437A SVM and HP-IB cable | less \$3,236 |
| 262: Delete HP 3456A DVM and HP-IB cable | less \$4,026 |
| 280: Add 5½ digit DVM and current source for the HP 3497A. NOTE: Only one DVM may be deleted from system, unless optional HP 3497A DVM assembly is added. | \$1,650 |
| 298: Add HP 3498A Extender and connecting cables | \$2,100 |

Cabinet Options for HP 3054A

| | |
|--|--------------|
| 400: Delete 30" cabinet; rack-mounting hardware supplied | less \$2,174 |
| 416: Add 16" combining case with power strip; delete 30" cabinet | less \$1,186 |
| 456: Add 56" cabinet with fan and power strip; delete 30" cabinet | \$296 |
| 490: Add HP 44530A systems desk with fan, power strip, and 23" rack space; delete 30" cabinet | \$889 |
| 495: Field wiring termination panel; fits 30" (standard) and 56" (opt 456) cabinets only | \$600 |
| 496: Add locking drawer, 8" high, for 85A | \$494 |
| 498: Add locking drawer, 18" high | \$642 |

Software and Documentation Options for HP 3054A

| | |
|--|-----|
| 841: Complete HP 3054S System Documentation—85B | N/C |
| 842: Complete HP 3054S System Documentation—HP 9825B | N/C |
| 800: Complete HP 3054S System Documentation—Series 200 (BASIC 2.0) on 3½" flexible disc | N/C |
| 801: Complete HP 3054S System Documentation—Series 200 (BASIC 2.0) on 5¼" flexible disc | N/C |
| 802: Complete HP 3054S System Documentation—HP 9817/9837 (BASIC 3.0) | N/C |
| 804: Complete HP 3054S System Documentation—HP 9826A (HPL) | N/C |

Basic HP 3054A System

\$13,339

DATA ACQUISITION, CONTROL & TEST

Data Loggers

HP Model 3054S/HP Model 3054DL

- 5½ Digit measurement
- Graphics

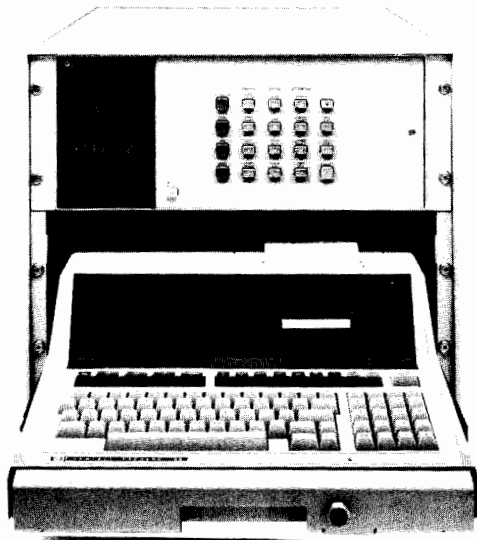

Description

The HP 3054DL consists of a precise measurement unit housed inside an attractive locking cabinet. When you add the computational capability of the 85B scientific computer, the combination becomes more than just a data logger—it becomes a complete scientific measurement station with data and program storage, graphics and excellent measurement performance the HP 3054S.

The measurement unit contains a 5½ digit digital voltmeter with a dc current source for ohms measurements as well as a 5-slot mainframe for optional plug-in assemblies. Each slot accepts either a counter, a low-thermal multiplexer, a thermocouple multiplexer, a digital input card or a digital output (alarm relay) card. Advanced noise-rejection techniques such as Multi-Slope Integration and Tree Switching compliment the 1 microvolt sensitivity of the voltmeter.

The HP 85B computer is not only a system controller, it is a full function BASIC language scientific computer with data analysis capabilities, graphics CRT and printer, and a built-in tape cartridge for both data and program storage.

Temperature measurements, whether made with thermocouples, RTD's or thermistors, are all specified in terms of total system accuracy. The thermocouple reference junction is located on the connector block and is read automatically via the data logger software.

Resistance can be measured in a 4-wire configuration to eliminate the effects of lead wire resistance.

The reciprocal counter accepts logic-level inputs and can operate in either a period measurement mode or a totalize mode.

Digital inputs and digital (alarm relay) outputs are available for monitoring switch positions and controlling external devices.

Graduated software

The program, or "software" that instructs the measurement unit is stored on a magnetic tape cartridge in the HP 85B computer. This software flexibility allows you to choose any one of the three programming methods that fits your need best:

- Level 1: Menu entry . . . no programming language required
- Level 2: Line entry . . . no computer language required . . . just enter data logger information
- Level 3: Subroutine . . . enter a short BASIC program that uses prewritten subprograms.

- Data analysis
- Graduated software

Graphic presentation is the key to understanding the data. From the graphic display to the program flexibility to the precise measurement capability, the 3054S is the complete data logger.

HP 3054S/DL Specifications

The following specifications include all contact resistances, contact voltages and DVM errors. Accuracy specifications apply when the HP 3054S is in an ambient environment of 23°C ± 5°, <85% R.H. Temperature coefficients are applied when the ambient temperature is 0 to 18°C or 28 to 50°C.

DC voltmeter (use option 010 or 020)

Ranging: auto or fixed range

A/D technique: integrating

Maximum input voltage: hi to lo: ±120 V peak

Lo to guard: ±170 V peak

Any terminal to chassis: ±170 V peak

| Range | Maximum Reading | Resolution | Accuracy (90 days) (%Rdg.+Counts) | Temperature Coefficient (%Rdg.+Counts)/°C | Z _{in} |
|-------|-----------------|------------|-----------------------------------|---|-------------------|
| .1 V | .119999 | 1 μV | .007 + 5 | .00025 + .15 | >10 ¹⁰ |
| 1 V | 1.19999 | 10 μV | .006 + 2 | .0002 + .02 | >10 ¹⁰ |
| 10 V | 11.9999 | 100 μV | .006 + 1 | .0002 + .01 | >10 ¹⁰ |
| 100 V | 119.999 | 1 mV | .006 + 1 | .00025 + .03 | 10 MΩ ±0.5% |

For >90 days, add 10 ppm/month to accuracy

Normal mode rejection: 60 dB (50 or 60 Hz ± .1%)

Effective common mode rejection

AC: 150 dB (50 or 60 Hz ±.1%)

DC: 104 dB (100 channels)

Ohmmeter (use option 010 or 020)

Type: 2-wire or 4-wire

Current source: floating

| Range | Maximum Reading | 1 Count Resolution | Current Through Unknown | Accuracy (90 days) (%Rdg.+Counts) | Temperature Coefficient (%Rdg.+Counts)/°C |
|--------|-----------------|--------------------|-------------------------|-----------------------------------|---|
| 100 Ω | 119.999 | 1 mΩ | 1mA | .032 + 5 | .0028 + .15 |
| 1 kΩ | 1.19999 | 10 mΩ | 100 μA | .032 + 5 | .0028 + .15 |
| 10 kΩ | 11.9999 | 100 mΩ | 10 μA | .032 + 5 | .0028 + .15 |
| 100 kΩ | 119.999 | 1 Ω | 10 μA | .031 + 2 | .0027 + .02 |

For >90 days, add 20 ppm/month to basic accuracy

Note: the HP 3054S system includes the entire HP 3054DL (with selected options) plus certain system peripherals.

Options

Option # (choose up to 5 total option cards—HP 3054DL capacity is 5 slots)

| Option # | Price |
|---|--------|
| 010: 20 channel guarded input relay card | \$600 |
| 020: 19 channel guarded input relay card with thermocouple compensation. Measures JKERST thermocouples or dc volts | \$750 |
| 050: 16 channel optically isolated digital input | \$550 |
| 060: Frequency counter, totalizer | \$600 |
| 110: 16 channel digital output actuator relay card | \$750 |
| 115: 8 channel high voltage actuator | \$550 |
| 230: Clock format: Mo:Day: Hr:Min:Sec | N/C |
| 231: Clock format: Day:Mo: Hr:Min:Sec | N/C |
| 260: Delete scanner display and controls | -\$360 |
| 400: Delete locking cabinet with sliding drawer | -\$900 |
| 841: Add Level 3 software for custom data acquisition programs | \$410 |
| 910: Extra set of Level 1 & 2 software (one set comes with HP 3054DL at no charge) | \$200 |
| Computer (order both items to complete the 3054S) | |
| HP 85B: Personal Computer with integrated screen, tape and printer. Built-in I/O ROM included. Must order HP 82937A HP-IB I/O Card separately. | \$3265 |
| HP 82937A: HP-IB Interface for use with Series 80 personal computer. | \$395 |
| HP 3054DL: Includes 5½ digit DVM, current source, real time clock, HP-IB interface, sliding drawer and cabinet, software Levels 1 & 2, and pre-initialized data tape | \$5829 |

DATA ACQUISITION, CONTROL & TEST

Automatic Data Acquisition/Control System

HP Model 3054C

295



- Precise measurement and analysis
- Execute multiple programs simultaneously
- Communicate to other computers in a distributed network

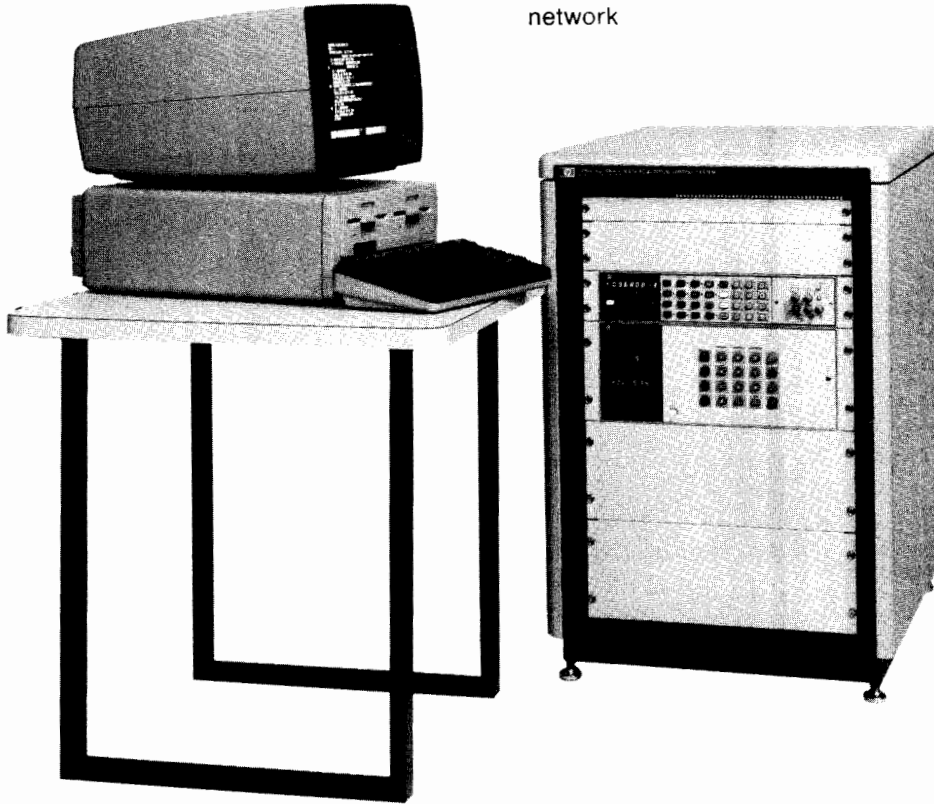

HP 3054C



Description

The HP 3054C Automatic Data Acquisition/Control System combines precise instrumentation with the power and versatility of HP 1000 computers. The HP 3054C is similar to the HP 3054A system except that the HP 3054C supports software compatible with the HP 1000 series of computers. The HP 1000 series of computers give you increased analysis capabilities and can be used to create multitasking, distributed data acquisition and control networks. Distributed systems allow you to control instruments with one computer while another computer in the network analyzes or processes the data. The multitasking capability of the HP 1000 allows any computer in the network to simultaneously control instruments with one program while another program performs other, possibly unrelated, tasks.

Instrumentation

The HP 3054C consists of a HP 3497A Data Acquisition/Control Unit and a HP 3456A Digital Voltmeter. The HP 3497A is a card cage instrument that can be custom configured to meet your needs. Assemblies are available for A/D conversion, multiplexing, strain gage/bridge completion, digital inputs/interrupts, counting, actuator outputs, and voltage and current D/A outputs. The HP 3456A is a very precise voltmeter and has the resolution and noise rejection required for measuring low levels in a noisy system environment.

Computers

The HP 3054C software package is compatible with the HP 1000A, E, and F series of computers. These computers offer the maximum flexibility in system design allowing you to match the size and power of the computer or computer network to your application. All of these computers execute similar real-time operating systems but offer different feature sets and performance levels. For more HP 1000 computer selection information, see the A, E, & F series section under Computers and Peripherals.

Software

The HP 3054C software package consists of over 35 subroutines that can be used as building blocks to create a useful measurement program. The subroutines allow the user to write sophisticated programs without knowing instrument programming codes. Included in the HP 3054C software package are linearization programs for most thermocouples, 120 and 350 ohm strain gages, thermistors and RTDs. The routines include error trapping to locate and identify system problems.

System Configuration

The HP 3054C consists of the following. The computer, other computer peripherals and computer operating systems are ordered separately.

HP 3054C

Instruments

HP 3497A Data Acquisition/Control Unit

HP 3456A Digital Voltmeter

Software and Documentation

HP 3054C Software package consisting of measurement, conversion, utility and HELP routines.

Rack/Integration

30" rack (shown) is standard. Other racks are available. Integration includes HP-IB cables, instrument connecting cables and test assemblies.

Verification/Installation

The HP 3054C is installed and tested with the HP 1000 computer at the customer's site.

Ordering Information

**Basic HP 3054C Automatic Data Acquisition/
Control System**

Price

\$11,017



DATA ACQUISITION, CONTROL & TEST

Data Acquisition/Control Unit

HP Model 3497A

- Relay multiplexing
- DVM
- FET multiplexer
- Real time clock
- Bridge completion
- Digital inputs/outputs
- Counter
- Programmable D/As
- Optional RS-232C interface

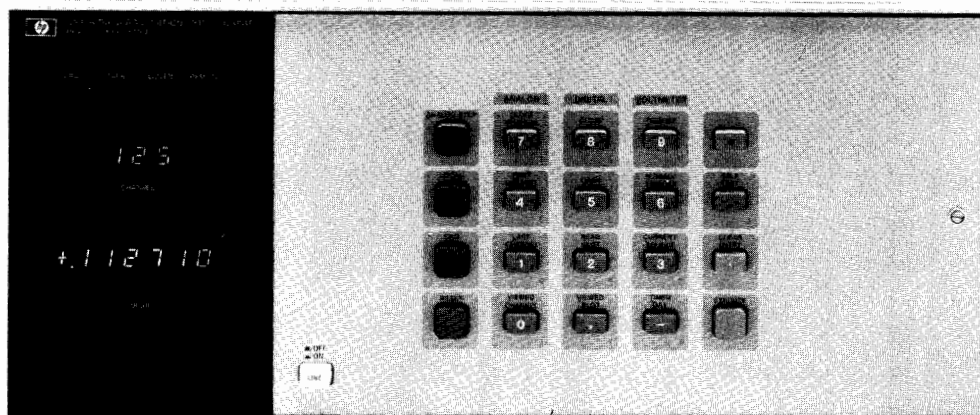

HP 3497A



Description

The HP 3497A Data Acquisition/Control Unit combines the capabilities of several instruments and is a basic building block of an automatic data acquisition and control system. The HP 3497A will be used in an HP-IB automated system and can be viewed as a precision measurement and control computer peripheral.

The HP 3497A has been designed to be a very versatile and very powerful instrument. A basic HP 3497A consists of a mainframe that includes a front panel keyboard and display, a non-volatile real time clock, and an HP-IB interface. Available as an option is a 5½ digit integrating digital voltmeter and current source that occupies a dedicated slot in the HP 3497A chassis. Capability is added to the HP 3497A by using any combination of plug-in assemblies. Available plug-in assemblies are:

- Relay Multiplexers with or without thermocouple compensation
- FET Multiplexer
- Digital Input/Interrupt
- Counters
- Strain gage/bridge completion
- Actuators
- Programmable voltage and current D/As
- Breadboard Assembly

Up to 5 assemblies can be added to a HP 3497A and the HP 3498A Extender chassis can hold up to 10 more plug-in assemblies.

High Performance

The HP 3497A DVM can resolve 1 microvolt signals and is ideal for the precise measurement of the outputs of thermocouples, strain gauges and other transducers. Included on the DVM is a programmable current source that allows four-terminal resistance measurements. The multiplexer assemblies switch 3 wires (Hi, Lo, and Guard) and add less than 2 microvolts of thermal offset to the measured signal.

Flexible Hardware Configuration

The HP 3497A card cage can hold 5 of any combination of the plug-in assemblies. This allows the multiplexing of up to 100 3-wire inputs to the DVM in a single HP 3497A or a single HP 3497A might contain 60 multiplexer channels, 16 digital inputs, 16 actuator outputs, and a DVM. By using the HP 3498A Extender, up to 1000 analog channels and 1360 digital channels can be controlled, all at a single bus address.

Ease of Use

The HP 3497A keyboard and display make the HP 3497A very easy to use and makes debugging of a HP 3497A based system easy. The calibration adjustments for the HP 3497A DVM are located behind a

hinged front panel; this allows complete calibration of the DVM without removing it from the test rack. Connections to all of the HP 3497A assemblies are made using screw terminals, thereby eliminating the need for soldering.

Automatic Data Acquisition and Control Systems

The HP 3497A is an integral part of the HP 3054A/C Automatic Data Acquisition and Control Systems. The HP 3054A consists of a HP 3456A Digital Voltmeter for high accuracy measurements, a HP 3437A Systems Voltmeter for high speed measurements and an HP 3497A for multiplexing, digital I/O and control. The HP 3054A includes software compatible with the HP 85 and Series 200 computers. The HP 3054C is similar to the HP 3054A but it does not include the HP 3437A and the software is compatible with the HP 1000 series of computers. The HP 3497A is also a part of the HP 3054 DL data logger.

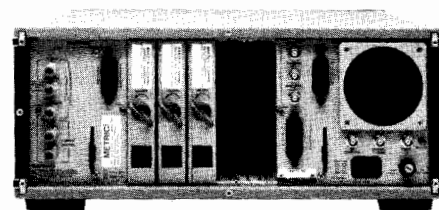

Real Time Clock

The HP 3497A mainframe includes a quartz-referenced, non-volatile, real-time clock. In addition to providing timing data, the clock can measure elapsed time, interrupt at a presettable time, and output a programmable pulse train.

Clock Format

Month:Day:Hours:Minutes:Seconds (U.S. Format)

Day:Month:Hours:Minutes:Seconds (European Format)

| Modes | Max. Time | Resolution | Accuracy |
|---------------------|-------------------------|------------|-------------------------|
| Real Time Mode: | 1 year | 1 second | ±(.005% of time + .1 s) |
| Elapsed Time Mode: | 10 ⁶ seconds | 1 second | ±(.005% of time + .1 s) |
| Time Alarm Mode: | 24 hours | 1 second | ±(.005% of time + .1 s) |
| Time Interval Mode: | 24 hours | 1 second | ±(.005% of time + .1 s) |
| Timer Output Mode: | 1 second | 100 μs | ±.02% of time |

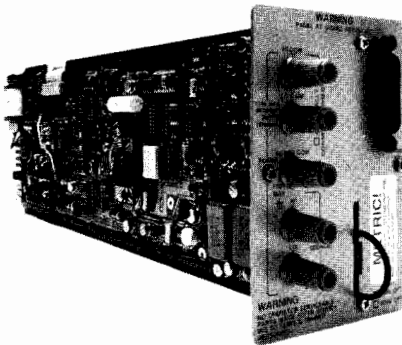

Option 001—5½ Digit DVM and Current Source

The HP 3497A DVM assembly is a systems quality, 5½ digit, 1 microvolt sensitive dc voltmeter. The DVM is fully guarded and uses an integrating A/D conversion technique; this yields excellent common and normal mode noise rejection.

Included on the DVM assembly is a three level programmable current source. The current source, when used simultaneously with the DVM, can be used to make high accuracy four terminal resistance measurements with 1 milliohm resolution. Maximum speed is 300 readings per second in 3½ digit mode.

Voltmeter Specifications

| Range | Max. Display | 5½ Digit Resolution | Accuracy 90 Days, 23°C ± 5°C 5½ Digits | Input Z |
|---------|--------------|---------------------|--|-------------------|
| .10 V | ±.119999 | 1 μV | ±(.007% RDG + 3 counts) | 10 ⁹ Ω |
| 1.0 V | ±1.19999 | 10 μV | ±(.006% RDG + 1 count) | 10 ⁹ Ω |
| 10.0 V | ±11.9999 | 100 μV | ±(.006% RDG + 1 count) | 10 ⁹ Ω |
| 100.0 V | ±119.999 | 1 mV | ±(.006% RDG + 1 count) | 10 ⁹ Ω |

Maximum Input Voltage

High to low: 120 V peak
Low to guard: 170 V peak
Guard to chassis: 170 V peak

Current Source

Accuracy: 90 days

| Range | 23°C ± 5°C |
|--------|------------|
| 10 μA | 2.5 nA |
| 100 μA | 25.0 nA |
| 1 mA | 250 nA |

Compliance: > +15 volts

Isolation voltage: 170 volts peak

General Information

Maximum Reading Rate: (readings/second)

| Auto Zero | 60 Hz Operation Digits Displayed | | | 50 Hz Operation Digits Displayed | | |
|-----------|-------------------------------------|-----|-----|-------------------------------------|-----|-----|
| | 5½ | 4½ | 3½ | 5½ | 4½ | 3½ |
| ON | 25 | 100 | 150 | 20 | 83 | 125 |
| OFF | 50 | 200 | 300 | 40 | 166 | 250 |

Delay: 0 to 99.9999 seconds in 100 μs steps

Buffer size: packed format: 100 readings; ASCII format: 60 readings

Number of readings per trigger: 1 to 999

Measurement Speeds

For the HP 3497A DVM and the relay multiplexer, speeds are given for measurements on random channels (using software channel selection) and sequential channels (using external hardware increment). Speeds include I/O times to the indicated computers.

60 Hz Operation (50 Hz operation)

| | Number of Digits Selected | 85 | Computer | | |
|--|---------------------------|-----------|----------|----------|----------|
| | | | 9826* | 1000L | 1000E,F |
| Sequential Channels using external increment | 5½ digits | 39 (33) | 39 | 39 (25) | 30 (25) |
| | 4½ digits | 97 (88) | 103 | 108 (79) | 88 (79) |
| | 3½ digits | 112 (107) | 123 | 127 (99) | 107 (99) |

| Random Channels using software | Number of Digits Selected | 85 | Computer | | |
|--------------------------------|---------------------------|----------|-----------|----------|---------|
| | | | 9826* | 1000L | 1000E,F |
| | | | 5½ digits | 13 (11) | 27 |
| | 4½ digits | 14 (11) | 51 | 31 (28) | 35 (30) |
| | 3½ digits | 14 (11) | 55 | 33 (29) | 35 (32) |

*9826 speeds for BASIC operating system

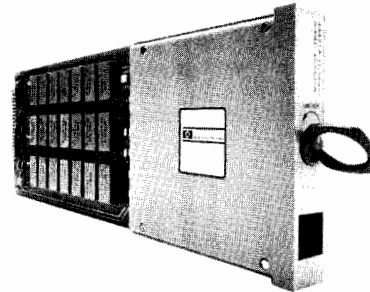

Option 010—20 Channel Relay Multiplexer

This assembly uses reed relays to multiplex signals to the DVM or other instruments. Each assembly switches 20 channels, each channel consists of HI, Lo, and Guard lines. Two channels may be closed per assembly and relays may be closed in a random sequence or incremented between programmable limits. The low thermal offset of the relays make it suitable for measuring the outputs of strain gage and other transducers. Each channel can be configured with a filter or current shunt for additional flexibility.

Input Characteristics

Maximum input voltage: <170 V peak between any two input terminals

Maximum current: 50 mA per channel non-inductive

Maximum power: 1 VA per channel

Thermal offset: direct switched, <1 μV differential; tree switched, <2 μV differential

Closed Channel Resistance

In series: 100 Ω ±10% in High, Lo and Guard

Relays contacts only: <1 Ω per contact

Open channel isolation: >10¹⁰ Ω (Hi to Lo, 40°C, <60% R.H.)

Maximum switch rate: 475/second (using hardware increment)

Rated switch life at 1 VA: 10⁷ operations

All Relays are Break-Before-Make

Option 020—Relay Multiplexer with Thermocouple Compensation

The option 020 assembly uses the same relay multiplexer as option 010 but incorporates a special isothermal connector block to allow thermocouple compensation. Two types of compensation (selectable by the user) are available. A temperature-dependent voltage is generated for software compensation; this voltage is then used in a computer program to compensate the thermocouple voltage. Hardware compensation involves inserting a voltage in the measurement circuit that automatically compensates the thermocouple voltage.

Reference Junction Compensation Comparison

| | Software | Hardware |
|---|-------------|---|
| Compatible Thermocouples | Any mixture | One of the following types: B,E,J,K,R,S,T |
| Measurement channels available per assembly | 19 | 20 |
| Reference junction compensation accuracy (23°C ± 5°C) | 0.1°C | |



DATA ACQUISITION, CONTROL & TEST

Data Acquisition/Control Unit (cont.)

Model 3497A

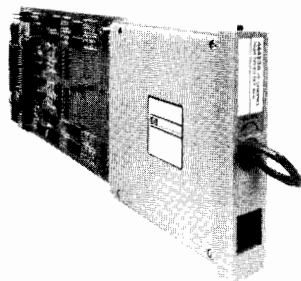

Option 030—20 Channel FET Multiplexer Assembly

The option 030 assembly is used to multiplex input signals to a DVM in a manner similar to option 010. The option 030 assembly provides high speed, low level multiplexing. Maximum signal levels are 12 volts peak between any high, low or guard input and any other guard input, guard common or chassis ground.

Maximum sequential scanning rate: 4800 readings/s (at 60 Hz) using an HP 3437A Voltmeter and HP Series 200 computer; 4000 readings/s at 50 Hz power.

Bias currents: sourced by either high or low to guard

| | 0-28°C | 28-55°C |
|------------------------------------|---------|---------------------------------------|
| Channel closed: | ±300 nA | Current doubles every 15°C above 28°C |
| Channel open: | ± 15 nA | |
| From each deselected FET assembly: | ± 15 nA | |

Differential offset voltage: includes effects of bias currents and series resistance. Does not include effects of voltmeter bias and noise currents.

| | 0-28°C | 28-55°C |
|--------------------------------------|--------|--|
| ±1.4 mV | | Add ±140 $\mu\text{V}/^\circ\text{C}$ for each degree above 28°C |
| ±0.15 mV per deselected FET assembly | | Add ±15 $\mu\text{V}/^\circ\text{C}$ above 28°C for each selected FET assembly |

Series resistance for each input: intrinsic resistance of the FET switch (when ON) plus series protection resistor.

| | 0-55°C |
|-----------|-----------|
| High, low | 5500 Ohms |
| Guard | 3500 Ohms |

Maximum current: ±1 mA per channel

Option 050—16 Channel Isolated Digital Input/Interrupt

The option 050 assembly can sense up to 16 channels of digital data. The first 8 channels can also be used as interrupt lines to detect transient signals. The assembly can accept a wide range of input levels and all functions and masks are fully programmable. A five-volt supply is provided for driving external contact closures and open collector outputs.

Input Signal Characteristics

| Input Level | Low Voltage Maximum | High Voltage Minimum | Maximum Input Voltage Between High & Low Terminals | Minimum Input Current |
|-------------|---------------------|----------------------|--|-----------------------|
| 5 V | 0.8 V | 2.4 V | 30 V | 400 μA |
| 12 V | 3.0 V | 7.0 V | 42 V | 1 mA |
| 24 V | 6.0 V | 13.0 V | 42 V | 2 mA |

Maximum voltage: ±170 V peak between any terminal and chassis

Logic polarity: positive true (negative true is jumper selectable)

Interrupt Mode (bits 0-7)

Minimum pulse width: 100 microseconds

Triggering: each interrupt line is individually programmable for positive or negative edge triggering.

Masking: each interrupt line may be enabled or disabled using a programmable mask.

Option 060—100 kHz Reciprocal Counter

This option can be used to measure mechanical and low frequency electronic signals. The counter can measure the period of signals up to 100 kHz and the pulse width of signals down to 18 μs . The counter can also count up or down from a programmable start point. It can accept a wide variety of input signals including CMOS, open collector TTL and passive contact closures.

Input Signal Characteristics Input Levels

| Input Level Range | V(Lo) (Maximum) | | V(Hi) (Minimum) | |
|-------------------|-----------------|---------|-----------------|---------|
| | Isolated | Non-iso | Isolated | Non-iso |
| 5 V | 1.0 V | 1.0 V | 4.2 V | 4.2 V |
| 12 V | 1.8 V | 2.7 V | 10.3 V | 8.0 V |
| 24 V | 2.6 V | 6.0 V | 18.4 V | 16.5 V |

(5 V level is standard, 12 and 24 volt levels are jumper selectable. Other voltages can be accepted using customer supplied resistors.)

Input circuit: switch selection of optically isolated or non-isolated input. Non-isolated input has 19.5 k Ω minimum input impedance.

Maximum isolation voltage: 170 V peak between any terminal and ground. Isolated mode only.

Period Mode

Maximum input frequency: 100 kHz

Minimum on time: 5 μs

Minimum off time: 5 μs

Range Characteristics

| Range | Least Significant Digit (LSD) | |
|--------------|-------------------------------|-------------------|
| | HP-IB | Display |
| 9999.999 s | 1 ms | 10 ms |
| 99.99999 s | 10 μs | 100 μs |
| 0.9999999 s | 100 ns | 1 μs |
| .099999999 s | 10 ns | 1 μs |

Accuracy: ±(.01% of reading + 2 LSDs + Trigger Error)

Pulse Width

Minimum start to stop time: (pulse width): 18 μs

Minimum stop to start time: 18 μs

Range Characteristics

| Range | Least Significant Digit (LSD) | |
|-------------|-------------------------------|-------------------|
| | HP-IB | Display |
| 9999.999 s | 1 ms | 10 ms |
| 99.99999 s | 10 μs | 100 μs |
| 0.9999999 s | 1 μs | 1 μs |
| .09999999 s | 1 μs | 1 μs |

Accuracy: ±(0.1% of reading + Trigger Error + (2 LSDs or 18 μs , whichever is greater)).

Totalize/Down Count Mode

Maximum input frequency: 100 kHz

Minimum pulse width: 5 μs

Range: 0 to 999,999

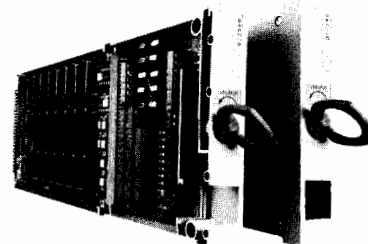

Option 070—120 Ohm Strain Gage/Bridge Completion Assembly

Option 071—350 Ohm Strain Gage/Bridge Completion Assembly



The option 070/071 assemblies may be used to provide bridge completion for measuring strain gages, RTDs pressure sensors and load cells. Each card uses an internal shared half bridge and can complete 10 channels of 1/4 and 1/2 and full bridges in any combination. When used with a +5 V excitation supply (such as the HP 6214A) and the HP 3497A DVM, the assembly provides 0.1 μE sensitivity with 1 μE accuracy. Provisions are made for shunt calibration and checking gage leakage and lead resistance.

Specifications

| Bridge Type | Sensitivity (excitation voltage at 5 volts) | | Accuracy | |
|-------------|---|--------------|--------------------------|----------------------|
| | HP 3497A DVM | HP 3456A DVM | Range at Best Resolution | 90 Day 23°C ± 5°C |
| 1/4 | .4 μE | .04 μE | 42400 μE | 25 μE |
| 1/2 | .2 μE | .02 μE | 21200 μE | 5 μE |
| Full | .1 μE | .01 μE | 9500 μE | 1 μE |

Excitation Supply Requirements

V max: 5.4 Vdc; **I (out):** 250 mA per 10 channels (120 ohm gages)

Option 110—16 Channel Actuator

Option 115—8 Channel High Voltage Actuator

Option 110 consists of 16 mercury wetted form C (single pole-double throw) relays. Each relay can be individually closed and can switch 1A at 100V. The actuator assembly can be used to switch test fixture power or to actuate alarm bells. This flexibility of this assembly allows it to be used as a digital output or matrix switch.

Option 115 is an 8 channel high voltage actuator assembly that can switch voltages up to 252 Vrms and currents up to 2 amperes. The Option 115 assembly is ideal for switching power line voltages to small motors, alarm bells and lights, motor starters and solenoids.

Option 110 and 115 Specifications

| | Option 110 | Option 115 |
|--------------------|----------------|-----------------------|
| Switch Form | C | A |
| Contact Type | Mercury Wetted | Dry |
| Number of channels | 16 | 8 |
| Maximum Voltage | 100 V Peak | 252 Vrms 48 Vdc |
| Maximum Current | 1 A | 2 Arms or dc |
| Maximum Power | 100 VA | 500 VA ac 60 VA dc |

Option 120—Dual Voltage D/A

Option 130—Dual Current D/A

Option 120 consists of two 0 to ±10 V programmable voltage sources. These sources can be used to provide a programmable test stimulus or to control voltage programmed devices like power supplies and VCOs.

Option 130 consists of two 0 to 20 mA or 4 to 20 mA programmable current sources. These sources, especially when using the 4 to 20 mA range, can be used as transmitters in industrial current loops and can drive up to 600 ohms of total loop resistance.

Option 120 Specifications

- Output:** 13 bits including polarity
- Least significant bit:** 2.5 mV
- Output range:** -10.2375 V to +10.2375 V
- 90 day accuracy:** ±.070% of programmed value ±4.0 mV
- Maximum output current:** 15 mA (output within specifications)

Option 130 Specifications

- Output:** 12 bits
- Least significant bit:** 5 μA (0 to 20 mA range)
4 μA (4 to 20 mA range)
- Output range:** 0 to 20.475 mA or 4 to 20.380 mA (each source jumper selectable)
- 90 day accuracy:** ±0.07% of programmed value ±10.0 μA
- Compliance voltage:** 12.0 volts

Option 140 Breadboard Card

Option 140 is a breadboard card compatible with the HP 3497A cardage. Using this card, HP 3497A users can construct special purpose assemblies that communicate with the HP 3497A backplane.

Option 232—RS232C Interface

Option 232 to the HP 3497A deletes the standard HP-IB interface and adds an RS232C (CCITT/V.24) compatible interface. The option 232 interface is also compatible with the new RS423 (CCITT/V.10) version of the RS449 interface.

The option 232 interface allows you to remotely locate the 3497A. HP technical brochure part number 5952-8884 contains additional information on HP 3497A option 232.

Option 298—HP 3498A Extender

The HP 3498A Extender chassis allows low cost expansion of HP 3497A-based systems. Each HP 3498A can hold up to ten HP 3497A plug-in assemblies. Use of one or more HP 3498As requires a HP 3497A (for control); all required connecting cables are supplied with the HP 3498A.

Number of slots per HP 3498A: 10

Maximum number of added analog multiplexer channels (options 010, 020): 900 channels (45 assemblies)

Maximum number of added non-analog acquisition assemblies (options 050, 060, 110, 120, 130): 85 assemblies

Maximum number of HP 3498As per HP 3497A: 13

General

HP-IB Interface functions: SH1, AH1, T5, L4, SR1, RL1, PP0, DC1, DT1, C0, E1

Size (HP 3497A or HP 3498A): 190.5 mm H x 428.6 mm W x 520.7 mm D (7 1/2" x 16 7/8" x 20 1/2").

Net weight: HP 3497A, 20.4 kg (45 lb) and 3498A, 20.4 kg (45 lb) with assemblies in all slots.

Shipping weight: HP 3497A and HP 3498A maximum with assemblies in all slots are 26.3 kg (58 lb.)

Operating temperature: 0°C to 55°C

Non-operating temperature: -40°C to 75°C

Humidity: to 95% at 40°C except as noted

Operating power: switch selection of 110, 120, 220 and 240 volts ±10%, 48-66 Hz, 150 VA 3497A and 3498A.

Ordering Information

Price

Each HP 3497A can hold one DVM assembly (Opt 001) and up to 5 plug-in assemblies. Each HP 3498A (Opt 298) can hold 10 additional plug-ins. To order plug-ins without a mainframe, order as 444XXX Field Installation Kits as shown below.

Required on Every Order:

- A Clock Format (Option 230 or 231)
- A Power Line Frequency and Voltage (Options 315 through 346)

| | |
|--|------------|
| Opt 001 or 44420A: 5 1/2 Digit DVM and Current Source | \$1,650 |
| Opt 010 or 44421A: 20 Channel Relay Multiplexer Assembly | \$600 |
| Opt 020 or 44422A: Relay Multiplexer Assembly with thermo-couple compensation | \$750 |
| Also order one of the following no charge options for thermo-couple compensation: Option A20 for software compensation. Option B20, E20, J20, K20, R20, S20 or T20 for hardware compensation of types B,E,J,K,R,S or T. Software compensation works with any of these types. | |
| Opt 030 or 44423A: 20 channel FET Multiplexer Assembly | \$750 |
| Opt 050 or 44425A: 16 channel Isolated Digital Input/Interrupt Assembly | \$550 |
| Opt 060 or 44426A: 100 kHz Reciprocal Counter | \$600 |
| Opt 070 or 44427A: 120 Ohm Strain Gage/Bridge Completion Assembly | \$900 |
| Opt 071 or 44427B: 350 Ohm Strain Gage/Bridge Completion Assembly | \$900 |
| Opt 110 or 44428A: 16 Channel Actuator/Digital Output Assembly | \$750 |
| Opt 115 or 44431A: 8 Channel High Voltage Actuator Assembly | \$550 |
| Opt 120 or 44429A: Dual Output Voltage DAC Assembly | \$1,000 |
| Opt 130 or 44430A: Dual Output Current DAC Assembly | \$1,000 |
| Opt 140 or 44432A: Breadboard Card | \$130 |
| Opt 230: Clock Format (Month:Day:Hours:Min:Second) | N/C |
| Opt 231: Clock Format (Day:Month:Hours:Min:Second) | N/C |
| Opt 232: Delete HP-IB Interface, add RS232C Interface | \$210 |
| Opt 260: Delete Keyboard and Display | less \$360 |
| Opt 298: Add HP 3498A Extender & connecting cables | \$2,100 |

HP 3497A Data Acquisition/Control Unit \$3,000

DATA ACQUISITION, CONTROL & TEST

Data Acquisition and Control System

HP Model 3852S

- System Software
- Command Storage
- Reading Storage
- Integrating DVM
- High Speed DVM
- Complete Set of I/O

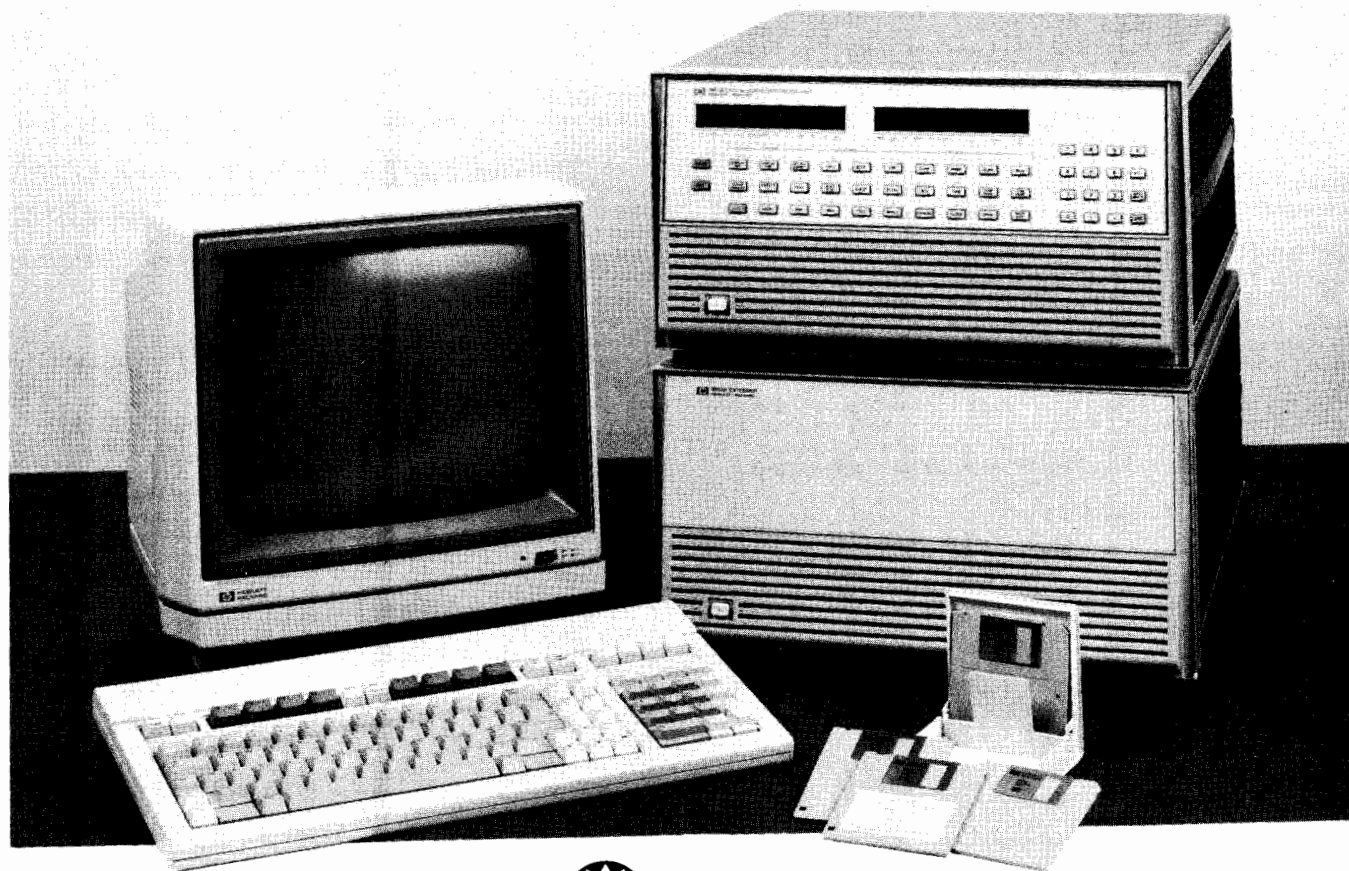

Optional Controller



HP Model 3852S

With the HP 3852S Data Acquisition and Control System you get capable hardware plus system software to create a powerful data acquisition system that you can easily configure to your needs. With this system, you'll find that data acquisition and control is fast and easy. A full keyboard with two displays means easy checkout of system wiring. Plug-in voltmeters and input/output accessories with removable terminal modules for field wiring speed up system configuration. You'll have powerful system software for fast and easy start-up using a tool set of capabilities needed in data acquisition such as data analysis, presentation, distribution and archiving.

The HP 3852S Data Acquisition and Control System consists of an HP 3852 mainframe, optional HP 3853 extenders, a selection of plug-in voltmeters, multiplexers and input/output accessories, an optional Series 200 or 300 computer and system software. You can choose any combination of these capabilities. The HP 3852 Data Acquisition and Control Unit has a full keyboard with displays, a power supply and a controller module built-in. Eight slots are available for plug-in accessories. If more slots are needed, add up to seven extenders with 10 slots per extender.

High Performance

You can use the HP 3852S to perform accurate, low-level and noise-rejecting measurements as well as high speed measurements.

You can resolve 1 microvolt signals with the Integrating DVM and make scanned readings at up to 100,000 readings per second with the High Speed DVM. In a single card-cage product, you can make a wide range of measurements. Both system voltmeters interface to transducers directly or through a variety of multiplexer accessories. The voltmeters have built-in current sources for measuring resistive transducers. You can even insert shunt resistors in multiplexer accessories and measure current.

Flexible Hardware Configuration

You can use the HP 3852S to configure exactly the system you need. The HP 3852S consists of an HP 3852 Data Acquisition & Control Unit (mainframe), plus an HP 3853 extender if needed. Voltmeter and I/O plug-in accessories can be placed in any slot of the mainframe or extenders. If you need racks, both a 76.2 cm (30 inch) and a 142.24 cm (56 inch) rack (48.26 cm (19 inch) wide) are available. An HP Series 200/300 computer and system software for the Series 200/300 computer complete the system with easy-to-use but powerful tools for data acquisition.

Intelligent Computer Front End

Use the HP 3852 Data Acquisition and Control Unit with any HP-IB (IEEE-488) computer. While not a "stand-alone" instrument, it has considerable built-in intelligence which frees the computer to handle other tasks. This built-in intelligence increases the speed with which data is collected and decisions made. Download your user routines from the computer. Use the computer to call a routine or let one routine call another. A number of BASIC constructs such as FOR . . . NEXT, IF . . . THEN . . . ELSE and WHILE are built into the HP 3852 as are the capabilities for conversion of data to user units, transducer linearizations and execution of user stored routines. Limit and alarm capabilities are also included. Channel lists (of channels in random order) can be downloaded and scanned with a single powerful command. The HP 3852 can unpack any data stored in the "packed" mode prior to transferring the data over HP-IB to a computer.

System Software-HP 44456A/B

Becoming a computer expert is a lengthy process; one that can interfere with your valuable time when you are trying to get a data acquisition project completed. That's why we've designed friendly and powerful system software to help you get running quickly. With the HP 44456A/B System Software, you'll have a "tool kit" to assist in developing your specific application programs. This "tool kit" consists of callable BASIC subprograms that help with the following tasks:

- System configuration/verification,
- Data storage and retrieval (memory management),
- High speed data acquisition,
- Data manipulation and analysis,
- Data presentation and real-time graphics,
- Process control,
- Task scheduling,
- Data distribution.

But the system software does more than supply you with tools. It helps you learn the use of your new tools. A tutorial utility program helps you learn to use each tool to achieve a complete solution to your problem. You can either talk directly to the HP 3852S via an HP-IB interface, talk through the system software tool kit, or both. This intermixing of BASIC instructions, HP 3852S commands, and software tool kit instructions means you get the ultimate in system customization without having to be a computer expert.

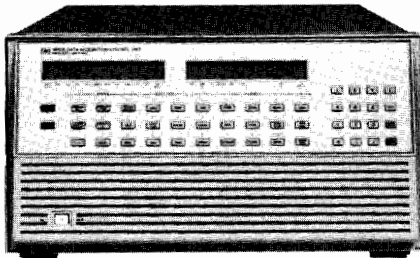

HP 3852 Data Acquisition & Control Unit

The HP 3852 Data Acquisition & Control Unit is a cardcage mainframe for the system. As a computer front end for measuring voltages and transducer signals, it must normally be linked to a computer via HP-IB but it does have a keyboard and display for local operation. With its built-in intelligence and memory, it can often run with minimal communications with the computer.

Features

- Full alphanumeric keyboard.
- Commands are keyboard executable.
- Two displays: command entry and results.
- Eight I/O slots.
- Any accessory in any slot.
- Interrupts from any slot.
- Multiple voltmeters allowed.
- Real time clock.
- Built-in pacer.

Intelligence

BASIC constructs:

FOR . . . NEXT
IF . . . THEN . . . ELSE
WHILE

User routines

Callable by computer or by another routine.

Time Alarms

Limit Checking

Real-time or post-processing

Conversion to user units

Temperature linearizations:

Thermocouples, Thermistors, and RTD's

Any type of measurement can be stored

Packed data can be unpacked before transmission over HP-IB

Uses a Motorola 68000 uP

Memory

Usable for program and data storage

4,000 bytes standard

1/4 MByte and 1 MByte expansions

Expansion cards fit into controller module and, therefore, don't use up a mainframe slot.

Memory used per rdg/

no. of rdgs (using standard memory)

| Storage format | High Speed DVM | Integrating DVM ⁽¹⁾ |
|----------------|----------------------|--------------------------------|
| integer | 2 bytes (2,000 rdgs) | 2 bytes (2,000 rdgs) |
| packed | 2 bytes (2,000 rdgs) | 4 bytes (1,000 rdgs) |
| real | 8 bytes (500 rdgs) | 8 bytes (500 rdgs) |

(1) for all resolutions

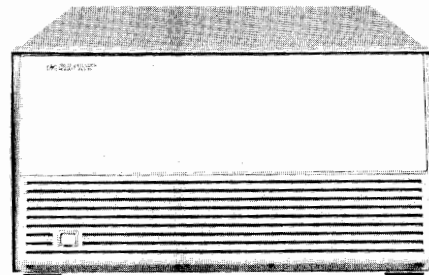

HP 3853 Extender

The HP 3853 Extender gives you additional slots for plug-in I/O accessories. All functions of the mainframe are available in the extender, including interrupts. You can use voltmeters in the extender and multiple voltmeters can be used. Extenders do not have a keyboard, a display or a controller assembly.

Number of slots: 10

Max Extenders per Mainframe: 7

Max distance from Mainframe: The sum of the cable lengths to all extenders must not exceed 25 meters.*

Connecting Cables:

Analog cable: Needed if analog voltages are switched between the extender and the mainframe or another extender.

Digital cable: Always needed.

*Count either analog or digital cable lengths, not both.

Racks

Choose system racks in 76.20 cm (30 inch) and 142.24 cm (56 inch) sizes. You can order these racks with the HP 3852 and HP 3853(s) installed in a standard configuration. When racks are ordered, the HP 3852 will be installed in the topmost location and as many extenders as have been ordered and will fit, will be installed below the mainframe. The 30" rack will hold a maximum of three and the 56" rack a maximum of six mainframes and extenders. For large systems requiring two or more racks, the mainframe and extenders will be first loaded into the 30 inch rack (if ordered) with any extra units going into any remaining racks that are ordered. Plug-in I/O accessories are shipped in individual boxes whether or not the hardware is rack mounted. This allows you to install the accessories where you want them.

When ordering racks, specify option 908 rack mounting hardware or 909 rack mounting hardware and front handle kit for each HP 3852 or 3853 you plan to have installed in the racks.



DATA ACQUISITION, CONTROL & TEST

Data Acquisition and Control System (cont.)

Model 3852S



Accessory Descriptions

HP 44701A 5 1/2 Digit Integrating Voltmeter

Use the Integrating Voltmeter for voltage and current (with shunt) measurements of DC or AC and 2 or 4-wire ohms measurements using its built-in current source. Offset compensated ohms and auto zero are built in. The voltmeter is guarded for common mode noise rejection and integrating for normal mode noise rejection. Integration time is software selectable for a number of power line cycles (NPLC) from 0.0005 to 0.1 which yields 3 1/2 to 5 1/2 digits of resolution. An extended precision mode is available for 1 or 16 power line cycles, resulting in 6 1/2 digit resolution. In this mode, it is advisable to do subsequent averaging of the data.

DC Accuracy: \pm (% of reading + number of counts)
(auto zero on, rear terminals or backplane)
90 Days, 23°C \pm 5°C, RH < 85%

| Range | % of Reading | # of Counts | | | | |
|--------|--------------|-------------|-------|-----|-------|--------|
| | | NPLC: | 1, 16 | 0.1 | 0.005 | 0.0005 |
| 30 mV | 0.010 | | 600 | 80 | 20 | 6 |
| 300 mV | 0.008 | | 60 | 10 | 4 | 4 |
| 3 V | 0.008 | | 8 | 4 | 4 | 4 |
| 30 V | 0.008 | | 30 | 7 | 4 | 4 |
| 300 V | 0.008 | | 7 | 4 | 4 | 4 |

Resistance Accuracy¹: \pm (% of reading + number of counts)
(Auto zero on, 4-wire ohms, rear terminals or backplane)
90 Days, 23°C \pm 5°C, RH < 85%

| Range | % of Reading | # of Counts | | | | | Max Lead Resistance ¹ |
|-------|--------------|-------------|-------|-----|-------|--------|----------------------------------|
| | | NPLC: | 1, 16 | 0.1 | 0.005 | 0.0005 | |
| 30 | 0.015 | | 600 | 80 | 20 | 6 | 3k Ω |
| 300 | 0.015 | | 60 | 10 | 4 | 4 | 3k Ω |
| 3 k | 0.015 | | 60 | 10 | 4 | 4 | 3k Ω |
| 30 k | 0.015 | | 8 | 4 | 4 | 4 | 30k Ω |
| 300 k | 0.015 | | 10 | 4 | 4 | 4 | 30k Ω |
| 3 M | 0.015 | | 17 | 7 | 5 | 5 | 30k Ω |

¹For lead resistance in current source or voltage sense leads \leq 3k Ω or full scale of Range, not to exceed 30 k Ω .

AC Accuracy: AC measurements are made with a peak detector calibrated in RMS, intended to measure sine waves. The voltmeter is accurate only when the input voltage is greater than 10% of full scale.
90 days, 23°C \pm 5°C, 45-500 Hz
NPLC = 1 (6 1/2 digits)
All Ranges (0.2, 2, 20, 200 V)
 \pm 0.5% of reading + 600 counts

Reading Rate: 1.5 seconds/reading

Note: Changing to the AC volts function requires approximately 2 seconds.

Noise Rejection:

NMR = normal mode rejection (line frequency = 50 or 60 Hz \pm 0.09%)

ECMR = effective common mode rejection (1000 Ω unbalance in low lead)

| AC NMR (dB) (50 or 60 Hz) | | NPLC = 1 (6 1/2 Digits) 60 dB | | |
|----------------------------|-----------------|----------------------------------|---------------|----------------|
| | | \leq 20 Ch | \leq 100 Ch | \leq 1540 Ch |
| AC ECMR (dB) (50 or 60 Hz) | 20 ch relay mux | 145 | 140 | 128 |
| | 20 ch FET mux | 128 | 120 | 110 |
| DC ECMR (dB) | 20 ch relay mux | 120 | 104 | 95 |
| | 20 ch FET mux | 100 | 86 | 66 |

RH < 85% @ 25°C

For NPLC < 1 subtract 60 dB from all AC numbers (no normal mode noise rejection)

20 Ch Relay and FET Multiplexers are HP 44705A, 8A, 9A, and 10A.

Integration period in line cycles:

1 cycle = 16.7 mS for 60 Hz power

1 cycle = 20 mS of 50 Hz power

HP 44702A 13 Bit High Speed Voltmeter

You can use the High Speed Voltmeter for high speed readings of DC voltage or current (with shunt), or 2 and 4-wire ohms measurements using a built-in current source. Resolution is 12 bits plus sign with autoranging at up to 100,000 readings per second for readings of DCV, 2-wire ohms and 4-wire ohms over the dedicated ribbon cable. You can also auto zero the voltmeter. Analog input is via any multiplexer accessory through the instrument's analog backplane or via dedicated ribbon cable with up to six (eight in an extender) 24 channel FET multiplexer accessories to achieve 100,000 readings per second. 8 K readings can be stored in the standard buffer or 64 K readings with enhanced memory. Readings can be stored to main-frame memory or to a GPIO port that allows reading storage direct to a computer. The high speed voltmeter has balanced inputs. This means that each input has an equal impedance to ground so that a common mode noise signal is seen equally by both high and low inputs. Since the voltmeter measures only the voltage difference between high and low, this provides good common mode noise rejection.

Voltmeter Accuracy: \pm (% of reading + Number of Counts)
Auto zero on, RH < 85%

| | Range | |
|-------------------------|--------|-------------------------|
| | 40 mV | 0.32, 2.56, 10.24 Volts |
| 90 days, 23°C \pm 5°C | 0.05+4 | 0.05+2 |

Autoranging: The High Speed Voltmeter can autorange at full speed of 100,000 readings per second for scanned static signals. Proper autoranging is not guaranteed if the signal changes at > 6 volts/sec.

Resistance Accuracy: 23°C \pm 5°C, 90 days
 \pm % of reading + counts

| Resistance Ranges: | 10 k | 100 kohm | 1 Mohm | Temperature Co-Efficient (all currents) ² |
|-------------------------------|--------|-------------|------------|--|
| Current Source ¹ : | 1 mA | 100 μ A | 10 μ A | |
| Voltmeter Range | | | | |
| 40 mV | 0.07+4 | 0.07+4 | 0.07+4 | 0.005 +0.05 |
| 320 mV | 0.07+2 | 0.07+2 | 0.07+2 | 0.003+0.05 |
| 2.56 V | 0.07+2 | 0.07+2 | 0.07+2 | 0.003+0.05 |
| 10.24 V | 0.07+2 | 0.07+2 | 0.07+2 | 0.003+0.05 |

¹Compliance: \pm 10.24 V

Output Resistance: > 10⁸

Current Source Accuracy: 2% of full range

²Add this error for temperatures outside of 18-28°C.



Effective Common Mode Rejection:

ECMR = effective common mode rejection
(To voltmeter rear panel, 1000 Ω unbalance
in low lead, DC to 60 Hz, <85% RH @
28°C)

| DC-60 Hz Range | No. of Channels ≤24 ECMR (dB) | Max CMR Volts |
|-------------------|-------------------------------------|------------------|
| 40 mV | 90 | ±10.24 |
| 320 mV | 80 | |
| 2.56 V | 70 | |
| 10.24 V | 70 | |

HP 44705A, 6A, 8A Relay Multiplexers

You can use the Relay Multiplexer accessories for low or high level measurements where accuracy and noise rejection are important and scanning speed is below 500 channels per second. Use the HP 44705A accessory to switch high, low and guard on all 20 Channels for maximum common mode noise rejection. The HP 44708A is similar but adds thermocouple compensation so any of the 20 channels can be used for thermocouple measurements. You can use many thermocouple types and mix types on a card. You can also check the integrity of your thermocouples by making two wire ohms measurements with offset compensated ohms. (The HP 44708A does not measure four-wire ohms.) One-pole, low pass filters can be installed in each channel of the HP 44705A and 44708A accessories for additional normal mode rejection. This is particularly useful for low-level signals such as thermocouples. The space for the low pass filter can also be used for a voltage divider to lower input voltages for improved relay life.

The HP 44706A gives you 60 single ended voltage measurements, providing high channel count as low cost per channel. For single ended measurements only high is switched and all low and guard connections are tied together on the accessory. As a result, less common mode noise rejection is provided than on the accessories which switch low and guard on all channels.

The tables below summarize the Relay Multiplexer configurations:

| | No. of Channels | Meas Volts | Space for 1 Shunt | 2-wire ohms | 4-wire T/C ohms | T/C Comp | Space for LP Filter |
|-----------|-----------------|------------|-------------------|-------------|-----------------|----------|---------------------|
| HP 44705A | 20 | * | * | * | * | * | * |
| HP 44706A | 60 | * | * | * | * | * | * |
| HP 44708A | 20 | * | *1 | * | * | * | * |

¹Use of current shunt not recommended because heating can affect T/C measurement accuracy.

| | No. of Channels | Peak Volts ¹ | DC Offset | Max Scan Rate | Switch HI, Lo, Guard | Switch HI Only |
|-----------|-----------------|-------------------------|-------------|---------------|----------------------|----------------|
| HP 44705A | 20 | 170 | 2 μ V | 450 | * | * |
| HP 44706A | 60 | 42 | 100 μ V | 450 | * | * |
| HP 44708A | 20 | 170 | 2 μ V | 450 | * | * |

¹If the analog backplane is not discharged between measuring high voltages, the difference between maximum voltage and minimum voltage of the channels must be used to calculate relay contact voltage.

HP 44709A, 10A, 11A, 12A, 13A FET Multiplexers

You can use FET Multiplexers to measure low level signals. Common mode noise must be low enough that total voltages (signal plus noise) do not exceed 10 volts peak. FETs are valuable when high scanning speeds are needed and when relay lifetime could create a maintenance problem.

For applications requiring good guarding for common mode noise rejection, the HP 44709A and HP 44710A provide switching of voltmeter high, low, and guard on each of 20 channels. HP 44709A is a 20 channel FET multiplexer which uses the same software commands as the 20 channel relay multiplexer. The HP 44710A has thermocouple compensation capability. Space is provided to add a low pass, noise rejecting filter to each channel of the HP 44709A, 10A, 11A, and 13A accessories. This space can also be used to add a voltage divider to measure higher than ±10.24 volts.

For higher speeds with less guarding, the HP 44711A, 12A and 13A series of 24 and 48 channel FET multiplexers provide a dedicated ribbon cable connection to the High Speed Voltmeter to achieve 100,000 readings per second. Up to six of these multiplexers can be connected with ribbon cable to a single High Speed Voltmeter in the mainframe and up to 8 in an extender. These accessories can also scan using the HP 3852 analog backplane but at lower scanning rates.

The tables below summarize the FET multiplexer configurations:

| | No. of Channels | Meas Volts | Space for 1 Shunt | 2-Wire Ohms | 4-Wire Ohms | T/C Comp | Space for LP Filter |
|-----------|-----------------|------------|-------------------|-------------|-------------|----------|---------------------|
| HP 44709A | 20 | * | * | * | * | * | * |
| HP 44710A | 20 | * | *1 | * | * | * | * |
| HP 44711A | 24 | * | * | * | * | * | * |
| HP 44712A | 48 | * | * | * | * | * | * |
| HP 44713A | 24 | * | *1 | * | * | * | * |

¹Use of current shunt not recommended because heating can effect T/C measurement accuracy.

| | Peak Volts | Ch/Sec Max Scan Rate | | Switch HI, Lo, Guard | Switch HI & Lo | Switch HI Only |
|-----------|------------|----------------------|--------------|----------------------|----------------|----------------|
| | | Backplane | Ribbon Cable | | | |
| HP 44709A | ±10.24 | 600 | N/A | * | * | * |
| HP 44710A | ±10.24 | 600 | N/A | * | * | * |
| HP 44711A | ±10.24 | 600 | 100,000 | * | * | * |
| HP 44712A | ±10.24 | 600 | 100,000 | * | * | * |
| HP 44713A | ±10.24 | 600 | 100,000 | * | * | * |

Max Signal Current: ±1 mA

Closed Channel on Resistance: High or Low: 3.0 k Ω
Guard: ±3.2 k Ω

¹HP 44709A and 44710A accessories only.

Max Bias Currents: (with the channel at 0 volts with respect to chassis) Bias currents are sourced by the accessory from high and low to chassis. ± number of nA (0-28°C/0-55°C)

| | Into Transducer or Backplane | | Into Backplane | |
|--------------------------------|------------------------------|--------------|--|--|
| | Channel Closed | Channel Open | Channel Open Tree Switch Closed ¹ | Max Differential Offset Voltage ² |
| High or Low Guard ³ | 5/45 | 2/11 | 2/11 | 20 μ V/230 μ V |
| | 65/770 | 6/110 | 65/670 | |

¹Channels all open but tree switch closed.

²Differential offset voltage between HI and Low with source resistance < 1k Ω ; RH < 85% @ 28°C

³HP 44709A, 44710A accessories only.

HP 44715A Five Channel Counter/Totalizer

The Counter/Totalizer accessory helps you measure five channels of low level AC (25 mV rms) or digital inputs with frequencies up to 200 kHz. Each of the five channels is software settable to an isolated or non-isolated input. Both isolated and non-isolated inputs can be connected to transducers and software commands used to multiplex the counter channel between the two inputs. This means that up to 10 inputs can be measured by one counter accessory in some applications. This accessory can be used in any of four configurations:

- 5 channel frequency
- 5 channel totalize
- 1 two-channel measurement and 3 one-channel measurement
- 2 two-channel measurement and 1 one-channel measurement

You can let the counter pull interrupts from any channel and autorange on period and frequency measurements. You can preset any channel for a totalizing measurement. For isolated inputs, select input levels of 5, 12, or 24 Volt DC. Non-isolated inputs can be selected to be TTL or low level AC. Positions are provided on the accessory to install a one pole low pass filter in each channel for noise rejection. The terminal module supplies non-isolated pull-up voltage for use in measuring contact closures. Finally, you can select a debounce time (common to all channels) to prevent false counts.

The types of measurements you can make with the counter are:



DATA ACQUISITION, CONTROL & TEST

Data Acquisition and Control System (cont.)

Model 3852S

One Channel Measurements

Frequency
Totalize
Circular totalize¹

Two Channel Measurements

Up/down count
Circular up/down count¹
Gated totalize
Circular gated count¹
Counts and direction
Circular counts and direction¹
Quadrature count
Ratio of count on two channels
Period
Delayed period

¹Circular count (also called modulo N) allows you to count to a preset limit and then wrap around to zero.

HP 44721A 16 Channel Digital Input with Totalize and Interrupt

Use this accessory to read the input levels for 16 digital input channels. The accessory provides isolated inputs for jumper selectable input levels of 5, 12, 24, or 48 volts. Any channel can be set to pull an interrupt. Each channel can totalize at up to 500 Hz. Channels are hardware debounced to prevent erroneous readings being taken on inputs that are still changing after a logic level transition. You can choose one of three selectable debounce times. Five volts is available on the accessory for use in measuring dry contacts. When the 5 volt supply is used, the channel is no longer isolated.

Each channel can be independently set for voltage and function. Debounce time is selectable but common to all channels.

| Nominal Voltage | Threshold Voltage | | Nominal Input Current @ Vnominal |
|-----------------|-------------------|------|----------------------------------|
| | Min | Max | |
| 5 | 1 | 4 | 0.5 mA |
| 12 | 2.5 | 9.5 | 1.3 mA |
| 24 | 7.0 | 17.0 | 2.8 mA |
| 48 | 14 | 31 | 5.8 mA |

HP 44722A 8 Channel AC Digital Input with Totalize and Interrupt

This is the 16 Channel Digital Input Accessory with a different terminal module that allows for higher AC or DC input voltages. Functional capability of this accessory is the same as the DC Digital Input Accessory except for higher voltage capacity and a fixed debounce. The debounce allows the accessory to read an AC line voltage that is cycling at up to 10 times a second.

Number of Channels: 8

| Nominal Input Voltage (RMS) | Threshold Voltages | | Input Current @ Nominal Volts |
|-----------------------------|--------------------|--------|-------------------------------|
| | Min | Max | |
| 24 V | 5.5 V | 16.5 V | 1.7 mA |
| 120 V | 30 V | 90 V | 1.1 mA |
| 240 V | 65 V | 185 V | 1.1 mA |

Max Input Voltage: AC: 250 Vrms or 354 V peak
DC: 250 Vrms

AC frequency range: 47 to 470 Hz

HP 44724A 16 Channel Digital Output

Use the open drain Digital Output accessory to control low level DC devices or to drive logic levels when used with an external power supply and external pull-up resistors.

Vmax (off state): 55 V DC

Current leakage (off state): 0.25 mA per channel at 55 V DC

Maximum sink current: 500 mA DC per channel

TTL Compatibility: 200 mA/channel with Vout < 0.4 volts

On resistance: < 1.5Ω

Maximum switch rate: 1200 transitions/sec

Inductive load protection: transient absorber on main board

Maximum reverse polarity current: 500 mA DC per channel

Fuse protection: 1 A (on terminal module)

Isolation: 250 Vrms (354 V peak) channel-to-channel or channel-to-chassis

HP 44725A 16 Channel General Purpose Switch

This accessory lets you switch moderate voltage and current levels. Use it as a low level actuator or as a switch to route low level signals in an experiment. The switches are single pole, double throw (SPDT), Form-C relays. They are low noise, break before make and they return to their normally closed positions at power down.

Vmax: 30 V DC, 42 V AC

I_{max}: 1.5 A RMS AC or DC

Sum of I²_{rms}: < 24

Response time: 15 msec

Switch rate: 20 per sec

Thermal offset: 5 microvolts

Total Contact R: 175 mΩ

Switch life: 10⁵ at full load, 10⁸ at minimum load

Isolation: DC: 10⁹ Ω across SW, Ch to Ch, Ch to earth

AC: 10 pF open contacts, 5 pF Ch to Ch, 30 pF Ch to earth

Crosstalk: ¹100 kHz: 73 dB

1 MHz: 53 dB

10 MHz: 33 dB

Minimum load²: Vmin = 100 mV DC

Imin = 100 μA DC

¹measured from an excited channel to an adjacent channel that is terminated with 50 Ω

²needed for contact cleaning

HP 44727A, B, C 4 Channel Digital to Analog Converters

These accessories provide analog voltages or currents which you can use to test or control devices. Each digital to analog converter (DAC) channel can be either voltage or current and channels have remote sense capabilities for providing accurate voltages at the test point. Channels are re-configured from voltage to current or current to voltage by moveable jumpers. The accessory can be ordered in three configurations to make re-calibration unnecessary in most cases. DAC channels are isolated and can be connected in parallel for current or in series for voltage (up to ±170V peak). If a mainframe or extender were filled with DACs and each DAC were set for 20 mA output on all four channels, the drain on the instruments power supply would exceed its capacity. For this reason, there is a limitation on the number of DACs that can be used in the mainframe or extender.

Ordering Configurations:

HP 44727A 4 Ch Voltage DAC

HP 44727B 4 Ch Current DAC

HP 44727C 2 Ch Voltage/2 Ch Current DAC

Protection: Channel-to-channel or channel-to-chassis: ±170 V peak

Settling Time: 75 msec

Voltage

Ranges: 0 to 10.235 Vdc or -10.235 V to 10.235 V

Resolution: 2.5 mV (12 bits + sign)

Accuracy (90 day): ±0.05% of reading + 2.5 mV < 2.5Ω in sense leads; 18 - 28°C

Max Output Current: 20 mA

Current

Ranges: 0 - 20.16 mA or 4 - 20.16 mA

Resolution: 2.5μA (13 bits)

Accuracy (90 day): ±0.05% of rdg + 5μA (0 to 500 Ωload; 18 - 28°C)

HP 44728A 8 Channel Relay Actuator

This actuator lets you switch AC or DC power. The switches are Form C relays which are break before make and return to their normally closed position at power down.

Vmax: 30 V DC, 250 V RMS AC

I_{max}: 2 A DC, 3 A RMS AC in any channel. The sum of the squares of the currents in each channel should be < 26 (for any type of load).

V_{Amax}: 60 W DC, 750 VA AC per channel

Response time: 15 msec

Switch Rate: one switch each 2 seconds

Total resistance: 200 mΩ per channel

Switch life: 10⁵ cycles at full load

Snubber circuit leakage: 1.0 mA per channel @ 250 VAC

HP 44729A 8 Channel AC Power Controller

Use the power controller to switch AC power. It switches on at the zero voltage crossing and off at the zero current crossing. This switching technique is best for long device life and low transient generation. Each channel has a relay and solid state switch in parallel to provide an exceptional combination of switch life and low on resistance.

Off Voltages: 12 to 250 Vrms

Off leakage: 0.5 mA

Maximum load: 2.5 Amp per channel (3.0 Amp is allowed if the accessory is limited to 16 Amps total)

On resistance: < 0.125 Ω @ 3 A; < 0.2 Ω @ 100 mA

Surge current: 50 Amp non repetitive

Switch life: 5 x 10⁶

Max Switch Speed: 10 per second per channel. Not for continuous operation. Specifications apply for < 3 switches per second. For speeds > 3 per minute, external filtering may be necessary to comply with VDE Standard 0875 emission limits.

Max Response Time: On: 30 msec; Off: 34 msec

Isolation: Channel-to-channel; channels share a common neutral
Channel-to-chassis: 354 Volts Peak



Ordering Information

To order, specify an HP 3852S System with the appropriate software, controllers, mainframes, extenders, plug-in accessories, racks etc. The HP 3852S itself has no cost, each component of the system is priced individually. Extra terminal modules for field wiring can be ordered as well. The accessory numbers for terminal modules are the same as the number for the accessories they are used with, but with a "T" suffix added to the number. For example, to order just an extra terminal module for the HP 44705A Relay Multiplexer, order an HP 44705AT.

| HP 3852S System Components | Price |
|--|------------|
| HP 3852A Data Acquisition and Control Unit | \$3,600.00 |
| Opt 001 Mainframe Extended Memory - 256 kbyte ¹ | 600.00 |
| Opt 002 Mainframe Extended Memory - 1 MByte ¹ /order Opt 001 or Opt 002 | \$2,000.00 |
| Opt 907 Front Handle Kit | 85.00 |
| Opt 909 Rack Mounting Hardware and Front Handle Kit | 140.00 |
| Opt 910 Extra Set of HP 3852A/3853A Documentation | 200.00 |
| HP 3853A Extender | 2400.00 |
| Opt 001 4-Meter Digital Cables Instead of 1 Meter Cables | |
| Opt 907 Front Handle Kit | 85.00 |
| Opt 908 Rack Mounting Hardware | 55.00 |
| Opt 909 Rack Mounting Hardware and Front Handle Kit | 140.00 |
| Opt C01 Add specified length Analog Cable (delete standard cable) | |
| Opt C02 Add specified length Digital Cable (delete standard cable) | |
| Opt K01 Specified length Analog Cable (field kit) | |
| Opt K02 Specified length Digital Cable (field kit) | |
| HP 44701A 5½ Digit Integrating Voltmeter | 1500.00 |
| HP 44702A ³ 13 Bit High Speed Voltmeter - 100 kHz (8 kReadings memory) | 2500.00 |
| HP 44702B ³ 13 Bit High Speed Voltmeter - 100 kHz (64 kReadings memory) | 3000.00 |
| HP 44703A ¹ Mainframe Extended Memory Card - 256 kByte | 600.00 |
| HP 44703B ¹ Mainframe Extended Memory Card - 1 MByte | 2000.00 |
| HP 44703C High Speed Voltmeter Extended Memory Card - 56 kReadings (for HP 44702A voltmeter) | 550.00 |
| HP 44705A 20 Channel Relay Multiplexer | 750.00 |
| HP 44706A 60 Channel Single Ended Relay Multiplexer | 900.00 |
| HP 44708A 20 Channel Relay Mux with Thermocouple Compensation | 850.00 |
| HP 44709A 20 Channel FET Multiplexer | 800.00 |
| HP 44710A 20 Channel FET Multiplexer with thermocouple Compensation | 900.00 |
| HP 44711A 24 Channel High Speed FET Multiplexer | 900.00 |
| HP 44712A 48 Channel High Speed Single Ended FET Multiplexer | 1050.00 |
| HP 44713A 24 Channel High Speed FET Mux with Thermocouple Compensation | 1000.00 |
| HP 44715A 5 Channel Counter/Totalizer (200 kHz) | 950.00 |
| HP 44721A 16 Channel Digital Input with Totalize and Interrupt | 650.00 |
| HP 44722A 8 Channel AC Digital Input with Totalize and Interrupt | 650.00 |
| HP 44724A 16 Channel Digital Output (Open Drain) | 650.00 |
| HP 44725A 16 Channel General Purpose Switch | 750.00 |
| HP 44727A ³ 4 Channel Voltage DAC | 1200.00 |
| HP 44727B ³ 4 Channel Current DAC | 1200.00 |
| HP 44727C ³ 2 Channel Volts; 2 Channel Current DAC | 1200.00 |
| HP 44728A 8 Channel Relay Actuator | 600.00 |

| | |
|---|---------|
| HP 44729A 8 Channel Power Controller | 900.00 |
| HP 44736A Breadboard | 350.00 |
| HP 447-T Extra Terminal Module (see note under Ordering Information) | |
| HP 44740A ² 76.2 cm (30") Rack with 110V power panel and instrument installed | 2200.00 |
| HP 44740B ² 76.2 cm (30") Rack with 220V power panel and instrument installed | 2200.00 |
| HP 44741A ² 142.24 cm (56") Rack with 110V power panel and instrument installed | 2500.00 |
| HP 44741B ² 142.24 cm (56") Rack with 220V power panel and instrument installed | 2500.00 |
| HP 44495A Field Wiring Terminal Panel (not installed in rack) | 600.00 |
| HP 44456A BASIC 3.0/4.0 System Software on 3½ inch flexible disc (for HP 9000 Series 200/300 Computers) | 1750.00 |
| HP 44456B BASIC 3.0 System Software on 5¼ inch flexible disc (for HP 9000 Series 200 Computers) | 1750.00 |
| HP 44456R License to reproduce one copy of system software (includes manuals) | 1000.00 |
| HP 44744A 2 meter GPIO Cable for High Speed Voltmeter | 250.00 |
| HP 44744B 4 meter GPIO Cable for High Speed Voltmeter | 300.00 |

The following service and support products and courses are available:

| | |
|---|--|
| HP 44743A Plug-in Accessory service module (backplane extender) | |
| HP 44743B Power supply service module (backplane extender) | |
| HP 44743C Test and Calibration software (HP 85A/B Tape) | |
| HP 44743D Test and calibration software (HP Series 200, 5.25" disc) | |
| HP 44743E Test and calibration software (HP Series 200, 3.5" disc) | |
| HP 44743F Service Kit. Includes same test and calibration software as in HP 44743C, D, and E. Also includes diagnostic terminal modules for all plug-in accessories, test cables, an HP 44743A and 44743B. Kit comes in a service kit suitcase. | |
| HP 44743G Suitcase for spare plug-in modules | |
| HP 50011A HP-IB Course for Series 200 | |
| HP 50015A Data Acquisition & Control Fundamentals Course | |
| HP 50016A HP-IB Course for HP 1000 | |
| HP 50600B Instrument Application Services (consulting). | |

The following HP products can be included on an HP 3852S order when the System Software HP 44456A/B is ordered:

| | |
|---|--|
| HP 9000 Series 200 and 300 Computers | |
| HP 216 Personal Technical Computer | |
| HP 217 Personal Modular Computer | |
| HP 236 Technical Computer (not the HP 236C) | |
| HP 220 Modular Computer | |
| HP 310 Technical Computer | |
| HP 320 Technical Computer | |

Also, HP printers, plotters, flexible or hard disc drives or other peripherals supported by the HP Series 200 and 300 computers, can be ordered as part of your HP 3852S Data Acquisition and Control System.

¹Use only one per mainframe.
²Specify Option 908 or 909 for any HP 3852As and 3853As you order with a rack.
³Power limitations dictate no more than 2 high-speed DVMS in a mainframe, or 3 per extender. DACs are limited to 4 per mainframe, 5 per extender. See HP 3852S Data Book (P/N 5953-7005) for details.



DATA ACQUISITION, CONTROL & TEST

Data Logger

HP Model 3055S

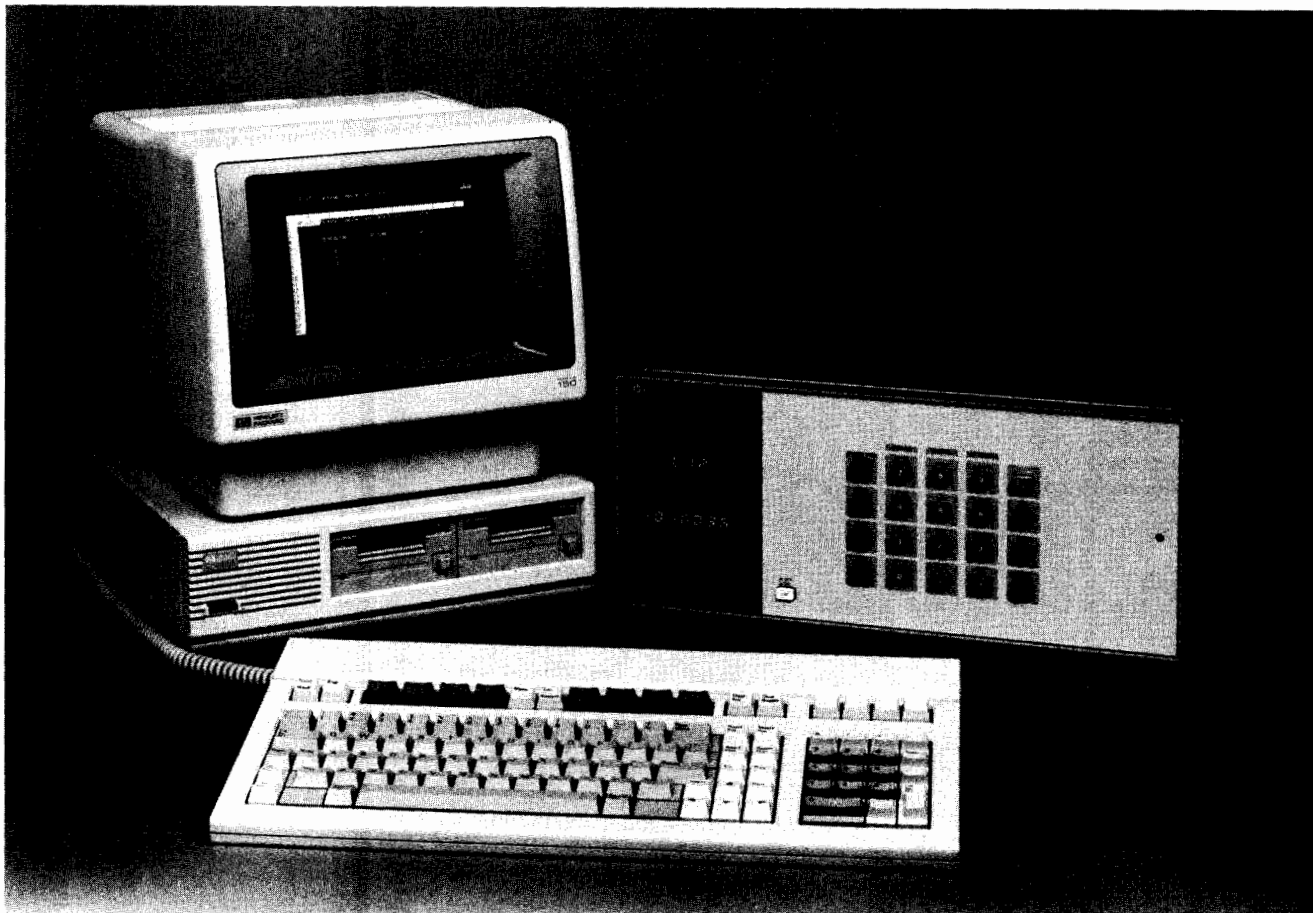

HP Model 150 with Model 3497A



Description

The HP Model 3055S is a family of data acquisition products that brings Hewlett-Packard's measurement expertise to the Personal Computer market.

A comprehensive data acquisition system, the HP 3055S will run on the HP Touchscreen I or II, HP Touchscreen MAX I or II, IBM® PC, IBM PC/XT™ and IBM PC/AT™. The HP 3055S includes two new data acquisition software packages for two popular HP data acquisition front ends.

The Hardware

The HP 3055S gives you a choice of two front ends to connect to your Personal Computer; either the HP 3497A or the HP 3421A.

The HP 3421A Data Acquisition/Control Unit is ideally suited for those small to medium channel applications that require accurate measurements at an affordable cost.

The HP 3421A has three slots that can hold any combination of three permanently installed optional assemblies; multiplexer/actuator, digital I/O, and breadboard. Each HP 3421A can be

configured for up to 30 channels of voltage, resistance, frequency or thermocouple measurements.

The HP 3497A Data Acquisition/Control Unit is ideally suited for those medium to large channel applications that require high performance, versatility and ease of use. It has five slots that can hold any combination of 12 optional plug-in assemblies.

These assemblies plug into the HP 3497A card cage for quick and easy expansion and configuration changes, without removing the covers. Up to 100 analog channels can be installed in the HP 3497A, and each HP 3498A extender can hold another 200 analog channels.

Common HP 3421A and HP 3497A Features

| | |
|-------------------------|---------------------------|
| Isolated inputs/outputs | Low thermal relays |
| Integrating A/D | DCV, Resistance |
| 5½ digit resolution | Digital input/output |
| 1 µV sensitivity | Thermocouple compensation |
| Autorange, autozero | Differential inputs |
| HP-IB | Actuators |



The Software

Menu Operation

Use the HP 3055S's menu operation to quickly set up your experiment, acquire data, store and analyze the results with minimal effort. The HP 3055S menu operation supports either one HP 3497A or two HP 3421As.

Gather data on up to 100 channels, check limits, activate alarms, store, print and analyze the data—all by pressing softkeys on the CRT menu or entering alphanumeric responses.

Functions supported include:

| | |
|------------------|----------------------------------|
| DCV | Resistance (2- or 4-wire) |
| Digital Read | Actuators |
| RTD (100 Ohm) | Thermocouples (J, K, T, E, R, S) |
| mX+B | Thermistors (2.2k Ohm) |
| BASIC subroutine | Polynomial (5th order) |

Powerful analysis routines such as channel vs channel, channel vs time and statistics/histogram are available for analyzing the data you have gathered.

Subroutines:

The HP 3055S also provides temperature conversion subroutines that the user can call from a custom mainline program. This gives the advanced user the versatility to write a complex BASIC program using the HP 3055S subroutines as building blocks. The user can expand the system up to 1000 analog and 1360 digital channels and add other HP-IB instruments by writing a custom BASIC program.

Link to LOTUS 1-2-3™:

A utility program is also provided for converting the HP 3055S data to LOTUS 1-2-3™ format for further analysis. This means you can add the data you have acquired from the HP 3055S with data from other sources into a spreadsheet for manipulation and graphical display.

The Computer

| HP Touchscreen I or II HP Touchscreen MAX I or II | IBM® PC, IBM® PC/XT, IBM® PC/AT |
|--|--|
| Requirements: 256k RAM MS™-DOS 2.1 or higher GW™-BASIC Dual 3½ inch disc drives or 3½ inch with hard disc HP-IB I/O library (HP 14857) Graphics Printer | Requirements: 256k RAM PC-DOS 2.1 or higher (with BASICA) Graphics Monitor Card Dual 5¼ inch disc drives or 5¼ inch with hard disc HP-IB card & library (HP 61062) Graphics Printer |

Applications

Applications for the HP 3055S include product R&D, product test, process monitoring, energy management and scientific research.

The HP 3055S can be used for the design of new products such as engines, solar collectors and batteries, and in controlling and recording the oven temperature vs time in product test applications. The HP 3055S can also monitor the temperature and pressure of a process, and actuate alarms when limits are exceeded.

Energy management applications in greenhouses and small buildings can be solved by the HP 3055S since it can monitor temperature and turn on heaters, blowers and fans by controlling external relays.

Scientific research applications in chemical labs, for example, can use the HP 3055S to eliminate manual data reduction and examine cause and effect relationships.

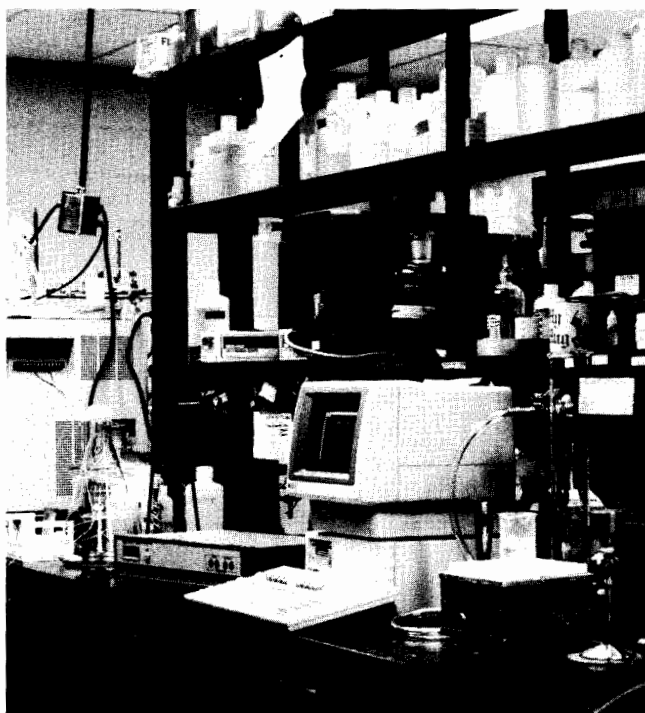

Ordering Information

For a complete system, order an HP 3055S and select an HP Personal Computer, a Data Acquisition Front End (either an HP 3421A or HP 3497A) and the appropriate Data Acquisition Software package.

Personal Computer

| | |
|-----------------------|--------|
| HP Touchscreen | \$3495 |
| HP Touchscreen MAX | \$5495 |
| HP Touchscreen II | \$3845 |
| HP Touchscreen MAX II | \$5070 |
| GW™-BASIC | \$ 395 |

Data Acquisition Front End

(Order either one HP 3497A or up to two HP 3421As. The options listed are supported by the menu driven portion of the HP 3055S software. All other options can be accessed from a user written BASIC program.)

HP 3421A \$1450

Options

| | |
|---|--------|
| 020: 8 Channel Multiplexer/2 Channel Actuator | \$ 330 |
| 021: 9 Channel Multiplexer/1 Channel Actuator | \$ 330 |
| 022: 10 Channel Multiplexer | \$ 330 |
| 050: 8 Channel Digital I/O | \$ 330 |
| 201: HP-IB (required) | \$ 250 |

HP 3497A \$3000

Options

| | |
|--|--------|
| 001: DVM and Current Source (required) | \$1650 |
| 010: 20 Channel Relay Multiplexer | \$ 600 |
| 020: Relay Multiplexer with T/C Compensation (A20) | \$ 750 |
| 050: 16 Channel Digital Input | \$ 550 |
| 110: 16 Channel Digital Output/Actuator | \$ 750 |
| 115: 8 Channel High Voltage Actuator | \$ 550 |

Data Acquisition Software

| | |
|---|--------|
| HP 44451A (HP 3421A/HP Touchscreen software) | \$ 400 |
| option 003 (add HP 14857 plus HP-IB cable) | \$ 380 |
| HP 44451B (HP 3421A/IBM® PC software) | \$ 400 |
| option 005 (add HP 61062 plus HP-IB cable) | \$ 480 |
| HP 44457A (HP 3497A/HP Touchscreen software) | \$ 500 |
| option 003 (add HP 14857 plus an HP-IB cable) | \$ 380 |
| HP 44457B (HP 3497A/IBM® PC software) | \$ 500 |
| option 005 (add HP 61062 plus an HP-IB cable) | \$ 480 |



DATA ACQUISITION, CONTROL & TEST

Measurement and Control Processor

Model 2250

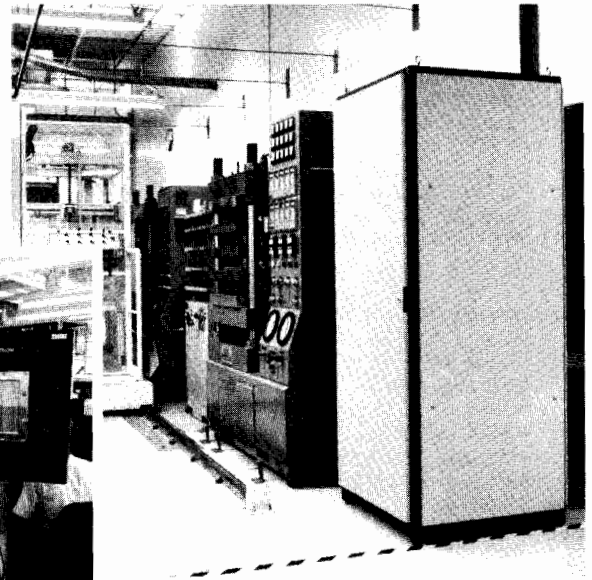
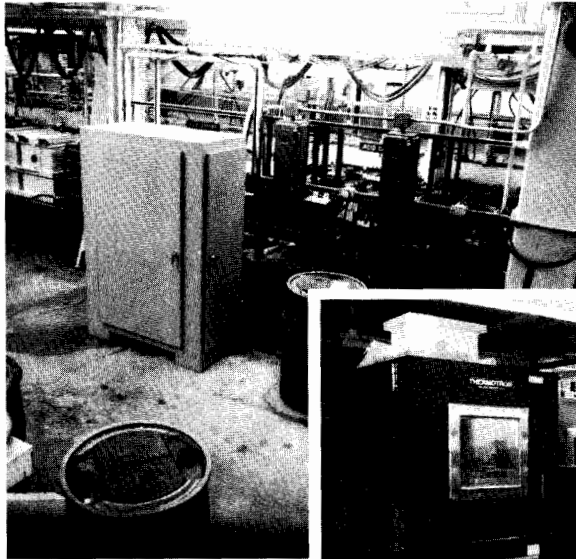

System Description

The HP 2250 Measurement and Control System provides a powerful solution to today's demanding laboratory and industrial automation applications. The HP 2250's modular hardware structure gives you the versatility of selecting only the product you need for a cost-effective solution to your specific automation problem—yet you have the flexibility to expand your capabilities as your automation needs grow.

The HP 2250 operates in conjunction with a host HP 1000 or HP 200 series computer via the HP-IB, Hewlett-Packard Interface Bus, our implementation of IEEE Standards 488-1978. A single HP-IB cable connection is all that is required to link your computer to the HP 2250, creating a high-performance automation system. For those applications that require the HP 2250 to be remotely located, a coaxial cable or fiber optic HP-IB extender is available to extend the computer/HP 2250 link up to 1000 metres.

The HP 2250 has a built-in LSI microcomputer and MCL/50 firmware, a software command set consisting of over 100 applications oriented mnemonic commands that can be used in many combinations to optimize measurement and control operations. MCL/50 Measurement and Control language software is easy to learn and use, allowing users to program their applications and control all HP 2250 function cards without intervention from the host computer. This decoupled operation facilitates a simpler and faster implementation of your automation solution and results in more predictable and repeatable performance.

Measurement and control applications exist in many different environments, and the modular HP 2250 hardware is designed with the flexibility to meet the diverse requirements of these applications. A comprehensive set of high performance analog and digital function cards are available to interface to the broad range of sensors and actuators commonly found in laboratory and industrial environments today. Additionally, most function cards include provisions for on-board signal conditioning modules that permit accurate and reliable interfacing in demanding industrial applications. Also provided are convenient industrialized field wiring assemblies accommodating up to 10 AWG wire.

System Features

- High-performance analog measurement capability includes:
 - 14 bit resolution
 - accuracy specified from 0 to 40° C
 - 50,000 samples per second average throughput to disc*
 - isolated voltage and current outputs
 - paced sampling.
- Wide range of function cards are available with 45 separate plug-on signal conditioning modules.

*For High level signals, not using HP-IB extenders.

- Digital output relay is modularized to allow individual relay replacement.
- HP MCL/50 high level command set enables task multiplexing and computer decoupled operation.
- Solid-state output relay digital design is ruggedized to enable mechanical relay replacement in most operations.
- Fully integrated systems or components available separately for custom cabinet installations.

Control/1000

For more processing power, it is possible to upgrade the built-in microcomputer to an A-Series HP 1000 Computer. In this configuration, nearly all HP 2250 system features are retained while the capacity for more memory, faster computations, networking and database management are added. MCL/50 is replaced by Control/1000 software (HP 91823A) which is callable from application programs written in Fortran, Pascal or "C". Contact your local Hewlett-Packard sales office for detailed configuration information.

HP 2250A Industrial Measurement and Control System

The HP 2250A is a complete measurement and control system in an industrialized enclosure. This system is designed for applications ranging from local machine to large process control in industrial environments. Field wiring and the electronic assemblies are accessed through separate doors and all doors are lockable.

The HP 2250A contains one HP 2104B Processor Unit and up to two HP 2251B Measurement and Control Units. The HP 2104B provides local intelligence for computer-decoupled operation and MCL/50 command interpretation and execution. The HP 2104B communicates with the function cards in the HP 2251B over a dedicated high speed bus. Each HP 2251B contains slots for up to 8 I/O cards.

Features

- Integrated measurement and control system in an industrialized NEMA-12 rated enclosure
- Removable metal access plates for field wiring conduit installation.
- Capacity for up to 16 I/O function cards.
- Floor standing.
- Separate lockable compartments for electronics and field wiring.
- Convenient and well labeled field wiring interface.

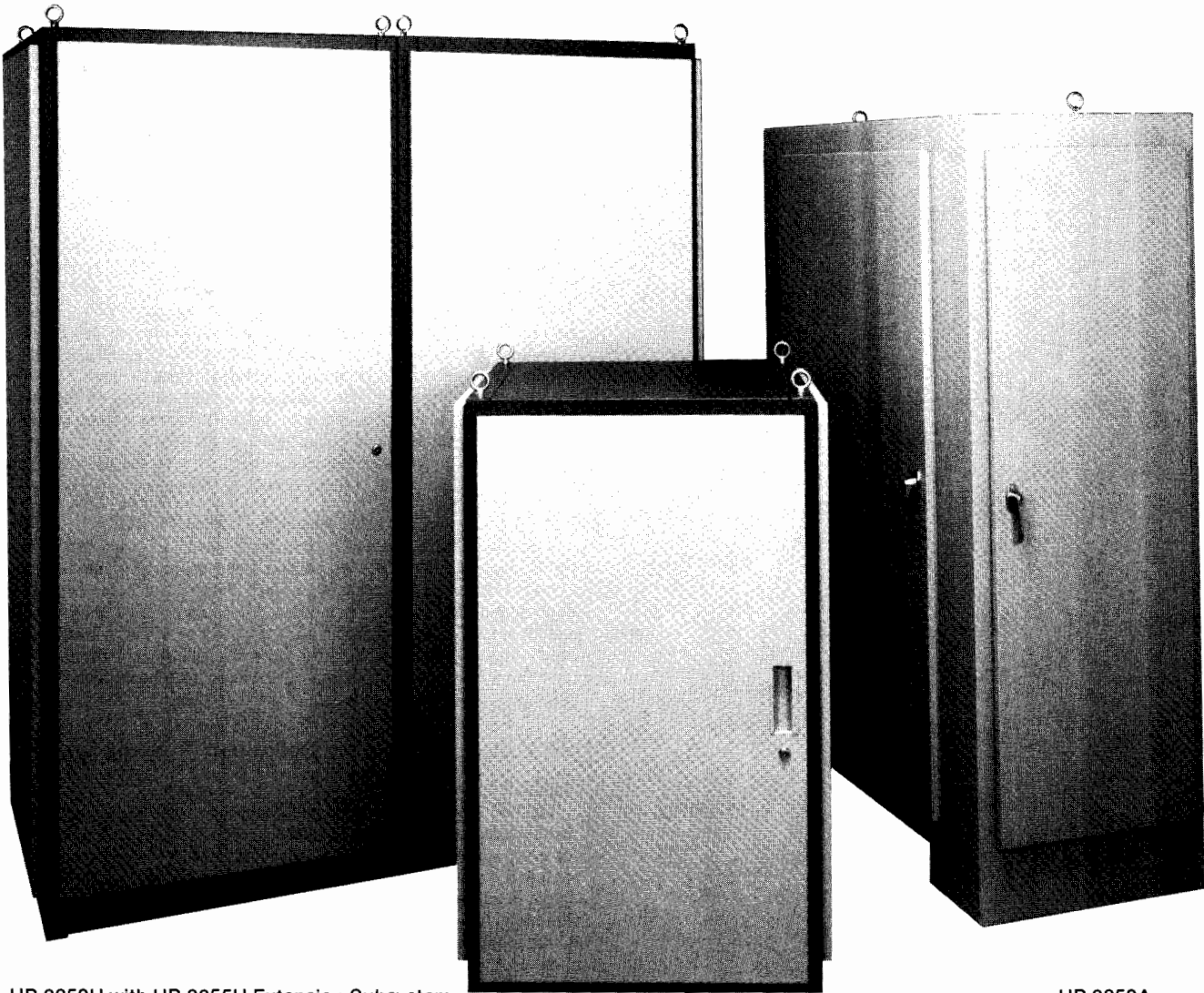

HP 2250H with HP 2255H Extension Subsystem

HP 2250L

HP 2250A

HP 2250H Measurement and Control System

The HP 2250H is a complete measurement and control system in an upright cabinet. This system is appropriate for high point count applications in laboratory and less harsh industrial environments.

The HP 2250H contains one HP 2104B and up to two HP 2251B's just like the HP 2250A. However, as many as three HP 2255H expansion subsystems can be easily attached to one HP 2250H to provide a total of eight HP 2251Bs. This allows up to 64 I/O function cards to be controlled from one HP 2104B. In a maximal configuration as many as 1920 analog input points or 2048 digital I/O points are available in one system.

Features

- Integrated measurement and control system in an upright cabinet.
- Capacity for up to 16 I/O function cards.
- HP 2255H expansion subsystems allowing 64 I/O function card capacity.
- Convenient and well labeled field wiring interface.

HP 2250L Mobile Measurement and Control System

The HP 2250L is a complete measurement and control system in a small mobile cabinet. This system is designed for small laboratory or industrial applications and temporary data acquisition and control projects that require frequent movement of equipment.

The HP 2250L contains one HP 2104B and one HP 2251B, which provides capacity for up to 8 I/O function cards. A maximal configuration of this system could provide up to 240 analog input points or 256 digital I/O points.

Features

- Integrated measurement and control system in a small mobile cabinet.
- Capacity for up to 8 I/O function cards.

- Convenient and well labeled field wiring interface.

Ordering Information

The HP 2250S is an ordering convenience that simplifies purchasing an HP 2250 system with an HP Series 200 desktop computer. Contact your local Hewlett-Packard sales office for details.

| | Price |
|--|----------|
| HP 2250A Industrial Measurement and Control System | \$16,712 |
| HP 2250H Measurement and Control System | \$15,723 |
| HP 2255H Measurement and Control Subsystem | \$ 8,500 |
| HP 2250L Mobile Measurement and Control System | \$15,080 |
| HP 2104B Processor Unit | \$ 7,812 |
| HP 2251B Measurement and Control Unit | \$ 2,274 |
| HP 25501D 16-Channel High Speed ADC Input Card | \$ 4,351 |
| HP 25502B 32-Channel High Level FET Multiplexer Input Card | \$ 2,769 |
| HP 25503D 32-Channel Low Level FET Multiplexer Input Card | \$ 3,313 |
| HP 25503E 32-Channel Low Level FET Multiplexer with Thermocouple Reference Connector | \$ 3,758 |
| HP 25504D 16-Channel Relay Multiplexer Input Card | \$ 3,362 |
| HP 25504E 16-Channel Relay Multiplexer with Thermocouple Reference Connector | \$ 3,857 |
| HP 25510D 4-Channel Voltage/Current DAC Output Card | \$ 2,522 |
| HP 25511B 32-Channel Digital Input Card | \$ 1,582 |
| HP 25512B 4-Channel Counter Input Card | \$ 1,829 |
| HP 25513B 32-Channel Digital Output Card | \$ 1,100 |
| HP 25514B 16-Channel Digital Relay Output Card | \$ 1,450 |
| HP 25515B 4-Channel Pulse Output Card | \$ 1,700 |
| HP 25516B 16-Channel In/16-Channel Out Digital Multi-function Card | \$ 1,300 |
| HP 91823A Control/1000 Software | \$ 3,250 |



DATA ACQUISITION, CONTROL & TEST

A-Series Measurement & Control Cards

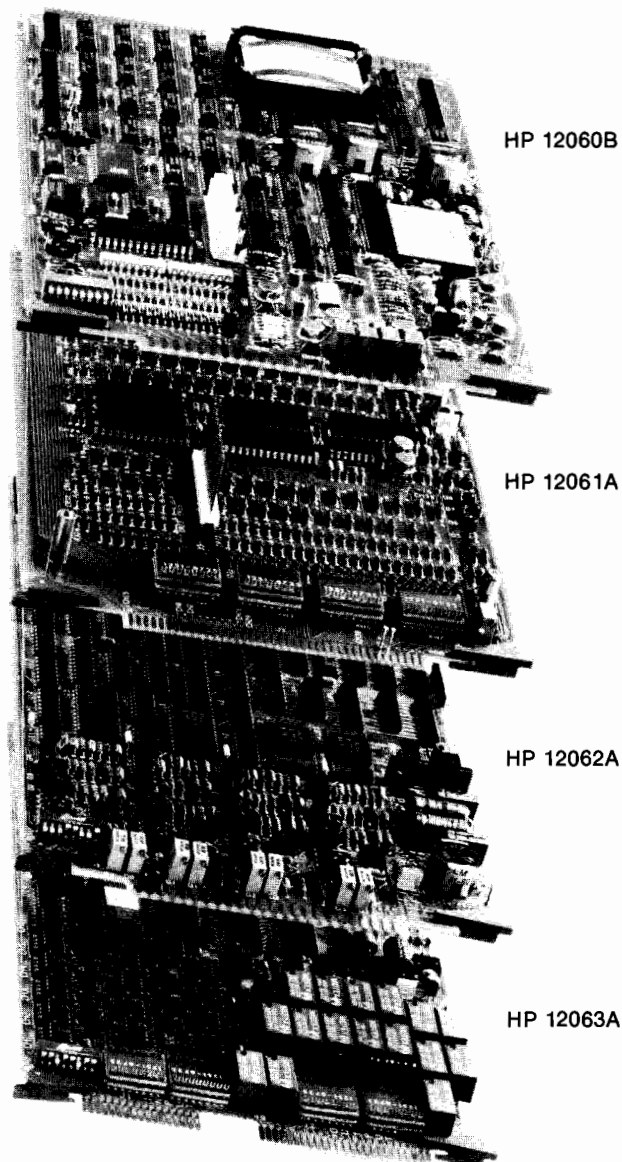

HP 12060B

HP 12061A

HP 12062A

HP 12063A

Description

The HP 12060B, 12061A, 12062A, and 12063A are plug-in cards for HP 1000 A-Series Computers. They provide low cost, high performance, analog and digital I/O for use in distributed measurement and control applications. The A-series product in which these cards are used must have a 25 kHz power supply. Hood connectors with each card allow users to build cables for connection to their applications.

12060B 8 Channel Analog Input Card

The HP 12060B is capable of acquiring up to 55,000 readings per second with 12-bit resolution. Auto scanning or single-channel sampling is possible to 55 kHz. Provisions for external pacing/trigging of sampling and scanning is provided. The HP 12060B includes four programmable full scale ranges from plus or minus 1.28 V to plus or minus 10.24 V. Maximum resolution is 0.625 mV on the 1.28 V range. A separate "zero reference" on the card allows the user to measure actual offset due to temperature drift, and correct readings on all channels for higher accuracy. The card has 8 differential channels.

HP 12061A 32 Channel Analog Input Expansion Card

The HP 12061A provides 32 additional differential inputs for the HP 12060B card. The HP 12061A card fastens directly onto the HP 12060B card, creating a two-board unit that occupies two I/O slots in an HP 1000 A-series computer. Programming information is passed from the HP 12060B directly to the HP 12061A; analog signals on the additional 32 channels are in turn passed back to the HP 12060B for digitizing. The HP 12061A includes removable plug-in headers so the user can add current sense resistors for current loop measurements. These headers allow the board to be adapted to the specific application without soldering components directly on the board and are easily removable for repair purposes.

HP 12062A 4 Channel Analog Output Card

The HP 12062A Analog Output Card provides 4 independent bipolar voltage outputs. Remote sensing per channel provides accurate output voltages to compensate for long distances of field wiring. Undedicated digital outputs may be used in pen up/down control, CRT display, or X-Y plotters. DMA compatibility provides fast analog updates on a per-channel basis or between channels. Programmable time delay between DMA updates provides signal reconstruction capability with a full power bandwidth of 20 kHz.

HP 12063A 32 Channel Digital Multifunction Card

Input Characteristics

The HP 12063B provides 16 fully isolated digital inputs via voltage threshold opto-couplers. Input voltage levels are selectable by the user for each channel by installing the appropriately valued resistors on removable plug-in headers (8 resistors per header = 8 channels). These headers allow the board to be adapted to the specific application without soldering components directly on the board, and are easily removed for repair purposes. Plug-in opto-couplers (supplied) allow user selection of ac or dc coupling for each channel by merely installing the opto-coupler in the ac position or dc position. For ac coupling, a plug-on jumper is provided for each channel to select 60 Hz ac filtering of the rectified input if desired.

Event Detection

In addition to status, any input may be user programmed to function as an interrupt to be generated on the rising edge or falling edge of the input or both (whichever occurs first). This capability is easily activated by the user via loading the appropriate pattern into the three registers. The on-card microprocessor takes over to cause the interrupt to be generated when that event occurs. User programming is required to service the interrupt.

Debounce Delay

The same microprocessor also provides the user-programmable debounce delay up to 246 ms on any input when monitoring contact closures and may be used in both status mode and event sense mode.

Output Characteristics

Sixteen form C (SPDT) relay outputs are provided on the same card. Both the normally open (NO) and normally closed (NC) contacts are available to users. Two removable headers allow for arc suppression devices to be added by the user for *each channel* without soldering directly to the board. Each header handles 8 output channels. Plug-on jumpers select the arc suppression across the NO or NC contacts. An on-card isolated power supply derived from the 25 kHz ac supply in the A-Series processor provides coil power for the relays. This technique minimizes any coupling of relay contact noise in the computer itself.

Ordering Information

| Part Number | Price |
|---|--------|
| HP 12060B 8 Channel Analog/Digital Converter | \$1795 |
| HP 12061A 32 Channel Analog Input Expansion | \$895 |
| HP 12062A 4 Channel Digital/Analog Converter | \$1295 |
| HP 12063A 32 Channel Digital Multifunction Card | \$1645 |

DATA ACQUISITION, CONTROL & TEST

Low Cost, Versatile HP-IB Switching

Model 3488A

311



- DC—300 MHz signal switching
- Matrix, multiplexer, & general purpose relays
- Digital I/O control & actuation

- Up to 50 channels
- 40 configuration storage registers
- 6 switch & control modules

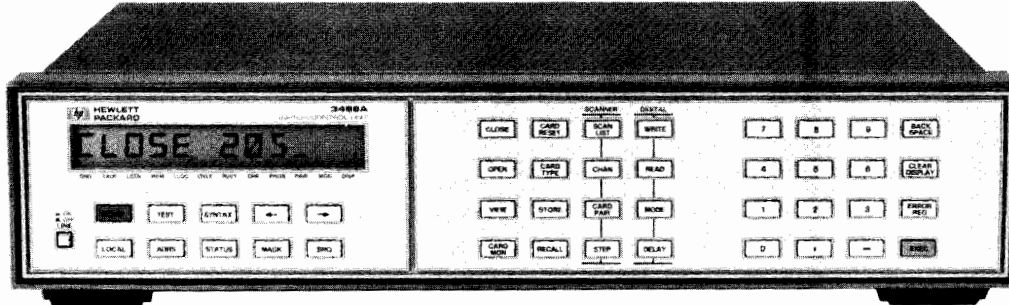

HP 3488A



Description

The HP 3488A Switch/Control Unit brings versatile, HP-IB programmable switching to tests requiring multi-channel measurements. The HP 3488A provides signal switching with the integrity and isolation needed for high performance test systems in production. It also offers a flexible, low cost interconnection solution for automating experiments on the bench and for development testing in the lab. The HP 3488A is designed to hold any combination of up to 5 of the following optional switch and control modules:

- 10 Channel Relay Multiplexer
- 10 Channel General Purpose Relay
- Dual 4 Channel VHF Switch
- 4 x 4 Matrix Switch
- 16 Bit Digital Input/Output
- Breadboard

Flexible Switching

The HP 3488A offers an economical approach to switching flexibility through plug-in modules. The user can select the right combination of switching functions to meet both performance and budget requirements. Testing is simplified by having one solution for connections of low level DVM inputs, high level dc and ac power, and VHF signals to 300 MHz. Additional devices such as microwave relays and programmable attenuators are easily controlled with digital I/O functions. Custom circuitry can also be implemented on breadboard modules.

Versatile Performance

The HP 3488A can store up to 40 complete switch configurations for convenient recall in automated test programs. Switch operation can be with multiple relay closures or with selectable channels in a break-before-make mode. Break-before-make closures and recallable complete switch configurations can be combined in a programmable scan list. The HP 3488A uses removable screw terminal connectors that provide easily interchangeable wiring configurations for each test. Built-in self-test capability assures proper operation.

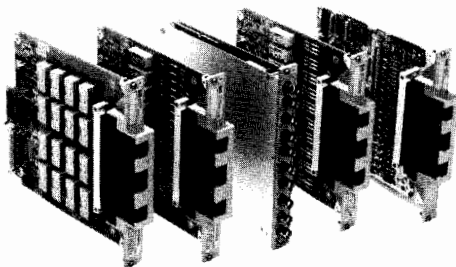

Multiplexer (Opt. 010/HP 44470A)

Option 010 is a 10 channel multiplexer for scanning or multiple signal connections. Channels switch 2 wires (Hi & Lo) with 2PST relays for DVM inputs and other signals up to 250 V and 2A. This module can also be used to multiplex signals to other switching functions such as the matrix module.

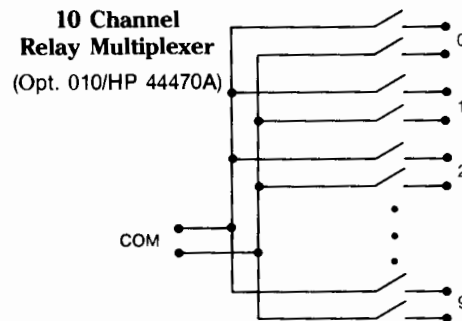

General Purpose Relay (Opt. 011/HP 44471A)

This module consists of 10 SPST independent relays for general signal switching and control of external devices. The quality connections provided make this module ideal for switching signals when multiplexing isn't required or for supplying switchable power to the device under test.

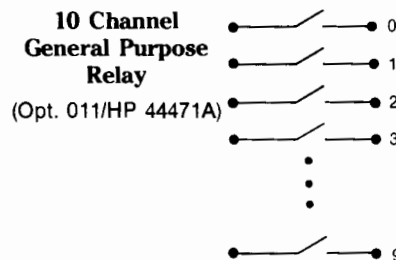

Matrix Switch (Opt. 013/HP 44473A)

Option 013 offers highly flexible switching with a 4 x 4, 2 wire matrix. Any combination of 4 input channels may be connected to any combination of 4 output channels. Each cross point or node in the matrix uses a 2PST relay to switch 2 lines (Hi & Lo) at a time. Multiple 4 x 4 modules can be connected to form larger matrices. Multiplexers can be used in conjunction with this module to effectively expand the number of inputs and outputs of the matrix.



DATA ACQUISITION, CONTROL & TEST

Model 3488A

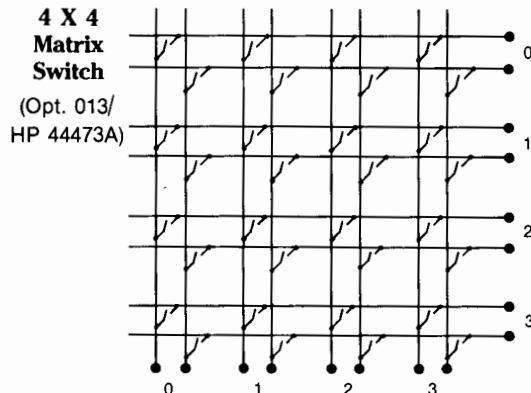

VHF Switch (Opt. 012/HP 44472A)

The VHF module provides broadband switching capability for high frequency and pulse signals. The 2 independent groups of bidirectional 1 x 4 switches can be used for signals from dc to 300 MHz. All channels have 50 ohm characteristic impedance and are break-before-make within a group of 4 channels. Each group is isolated from the other and from ground to prevent ground loops. Excellent isolation makes this module ideal for high frequency signal analyzer measurements requiring a large dynamic range.

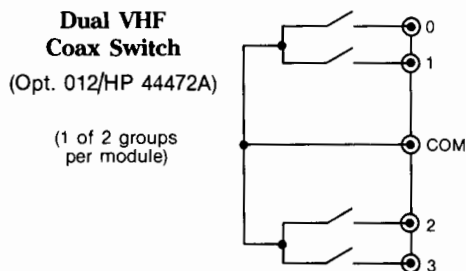

Digital I/O (Opt. 014/HP 44474A)

This module offers 16 very flexible bidirectional I/O lines and 4 TTL compatible handshake lines for sensing and control of external devices. The digital inputs can be used to sense contact closures to ground. Each channel provides current sinks for remote switching of external relays such as the HP 33311 series of coaxial switches.

Breadboard (Opt. 015/HP 44475A)

The breadboard module provides a convenient way to implement custom circuits and special functions that interface directly with the HP 3488A's backplane control signals.

Specifications for Opt. 010/HP 44470A Multiplexer, Opt. 011/HP 44471A General Purpose Relay, and Opt. 013/HP 44473A Matrix Switch Modules

Input Characteristics

Maximum voltage (terminal-terminal or terminal-chassis): 250 V dc, 250 Vac rms, 350 Vac peak
Maximum current: 2A dc, 2A ac rms
Maximum power: 60 W dc, 500 VA ac
Thermal offset: < 3 μ V

DC Isolation (40°C, 60% RH)

Channel-channel, open channel: > $10^{11} \Omega$

AC Isolation/Performance

| (50 Ω termination) | 100 kHz | 1 MHz | 10 MHz |
|---------------------------|---------|-------|--------|
| Insertion Loss (dB) | <0.30 | <0.35 | <0.90 |
| Crosstalk (dB) | <-73 | <-53 | <-33 |

Specifications For Opt. 012/HP 44472A VHF Switch Module

Input Characteristics

Maximum Voltage

Center-center, center-low: 250 Vdc, 30 Vac rms, 42 Vac Peak
 Low-chassis, low-low: 42 V dc

Maximum current (per channel): 30 mA dc, 300 mA ac rms

Thermal offset: <15 μ V per channel

Characteristic impedance: 50 Ω

AC Isolation/Performance

| | 30 MHz | 100 MHz | 300 MHz |
|-----------------------------|--------|---------|---------|
| Crosstalk (dB) Chan-Chan | <-100 | <-85 | <-65 |
| Group-Group | <-85 | | |
| Insertion Loss (dB) | <0.5 | <0.75 | <1.25 |
| VSWR | <1.06 | <1.12 | <1.43 |

All channels break-before-make within a group of 4 channels.

Specifications for Opt. 014/HP 44474A Digital I/O Module

I/O Lines

Maximum voltage = +30 Vdc (line-chassis)

Output characteristics: V (high) \geq 2.4 V; V (low) \leq 0.4V

I (low) maximum = 125 mA @ V (low) \leq 1.25 V; fused at 250 mA.

Input characteristics: V (high) \geq 2 V; V (low) \leq 0.8 V

External increment: advances HP 3488A to next programmed configuration on falling edge of TTL pulse.

Channel closed: indicates completion of new configuration; TTL pulse.

General Specifications

Environmental

Temperature: 0 to 55°C; humidity: 95%, 0 to 40°C

Power: 86-132 V/195-250 V, switch selectable; 48 - 440 Hz; 18 VA.

Interface: SH1AH1T6TE0L4LE0SR1RL1PP0DC1DT1E2

Size: 89 mm H (without feet) x 425 mm W x 292 mm D (3.5" x 16.75" x 11.5"). Allow 76 mm (3") additional depth for wiring.

Weight: net: 8.5 kg (18.5 lb). Shipping: 16 kg (36.5 lb).

Connectors (all modules except option 012/HP 44472A VHF switch): Removable screw terminal connector. Each terminal accepts 18-26 gauge (16-40 mils) wire, with strain relief for wiring. Option 012/HP 44472A VHF Switch: BNC connectors.

Ordering and Configuration Information

| Switch Modules-Includes Terminal Connectors | Price |
|--|---------|
| Opt. 010/HP 44470A: 10 Channel Relay Multiplexer Module | \$395 |
| Opt. 011/HP 44471A: 10 Channel General Purpose Relay Module | \$395 |
| Opt. 012/HP 44472A: Dual 4 Channel VHF Switch Module | \$595 |
| Opt. 013/HP 44473A: 4x4 Matrix Switch Module | \$495 |
| Opt. 014/HP 44474A: 16 Bit Digital Input/Output Module | \$395 |
| Opt. 015/HP 44475A: Breadboard Module | \$168 |
| Rack Mounting and Manuals | |
| Opt. 401: Side Handle Kit (HP P/N 5061-1171) | \$20 |
| Opt. 907: Front Handle Kit (HP P/N 5061-1170) | \$50 |
| Opt. 908: Rack Flange Kit (HP P/N 5061-1168) | \$30 |
| Opt. 909: Rack Flange with Handles (HP P/N 5061-1169) | \$72 |
| Opt. 910: Extra Operating & Service Manuals | \$75 |
| HP 3488A Switch/Control Unit | \$1,385 |

DATA ACQUISITION, CONTROL & TEST

Multiprogrammer: Versatile Basic Building Block for System Integration.

313



Models 6940B, 6942A, and 6944A

- Isolated power supplies for analog functions
- Mainframe extenders for increased I/O capacity
- Broad range of I/O instrumentation cards

- Easy-to-use, menu-driven software
- Large range of user/application documentation

Introduction

Hewlett-Packard Multiprogrammer products provide solutions for a variety of data acquisition, control and test applications. The application flexibility is due to the architectural features of these products. The plug-in Multiprogrammer I/O cards allow card-to-card communication, isolated inputs and external triggering and provide a wide range of functions. The HP 6940B coupled with the Multiprogrammer Series I I/O cards offers low-cost solutions when operated on the GP-IO Bus. The HP 6942A Multiprogrammer and the Series II I/O cards are a medium-performance, medium-speed, HP-IB solution. For applications requiring a higher level of performance and more speed, the HP 6944A Series 200 Multiprogrammer should be considered for use with the Series II I/O cards.

The I/O cards have many benefits. Multiple-card configurations can be established that provide instrument-like functions. For example: high-speed scanning and multiple simultaneous-buffered analog-to-digital converters. Other features provide precise crystal-controlled timing or pacing of I/O operations. This allows the modular construction of instrumentation functions such as frequency measurement, time interval measurement and programmable pulse generation. The card-to-card communication feature allows the I/O operation of the Multiprogrammer to operate independently of the computer. The computer is then free to perform other tasks until it receives an interrupt from the Multiprogrammer. If the application requires the process to control data acquisition, it can be accomplished via the external trigger feature. This feature allows the process to time or pace operations independently of the computer. In addition, I/O data can be stored in the Multiprogrammer's plug-in memory system, allowing high-speed operation of other tasks the computer must perform.

HP 6944A Features

- Data transfer rate of 180,000 readings/second
- Dedicated interface (HP 98633A) to HP Series 200 computers
- Direct to disc at 180K words/second
- HP 14751A CAT programming package
- HP Multiprogrammer Series II I/O cards

HP 6942A Features

- Data transfer rate 18,000 readings/second
- HP-IB interface
- HP 14750A CAT programming package
- HP Multiprogrammer Series II I/O cards

HP 6940B Features

- Front panel control
- GP-IO or optional HP-IB interfacing
- Data transfer rate 20,000 readings/second
- HP multiprogrammer Series I I/O cards
- Temperature measurement capability

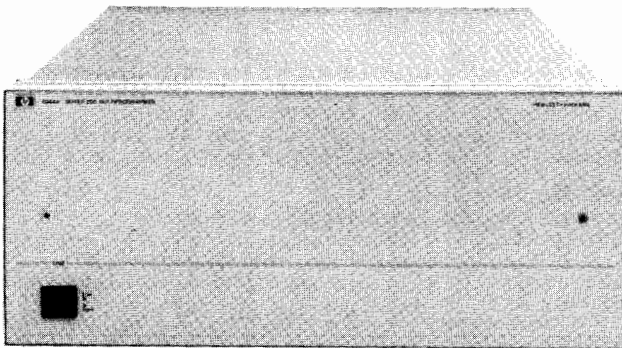

HP 6944A

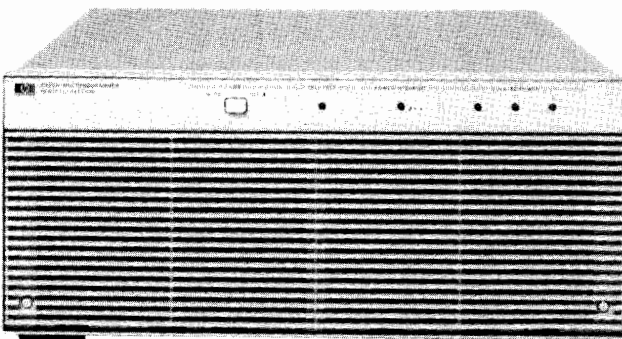

HP 6942A

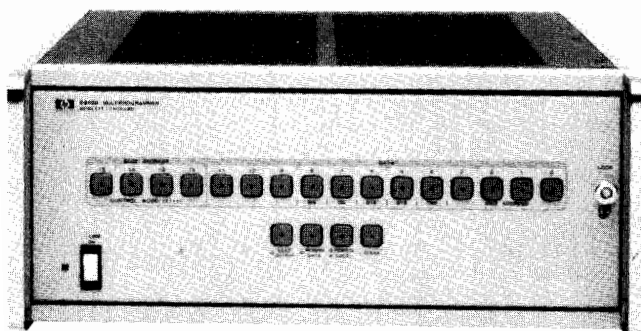

HP 6940B

DATA ACQUISITION, CONTROL & TEST

Multiprogrammer: Measurement & Analysis System

Model 6901S

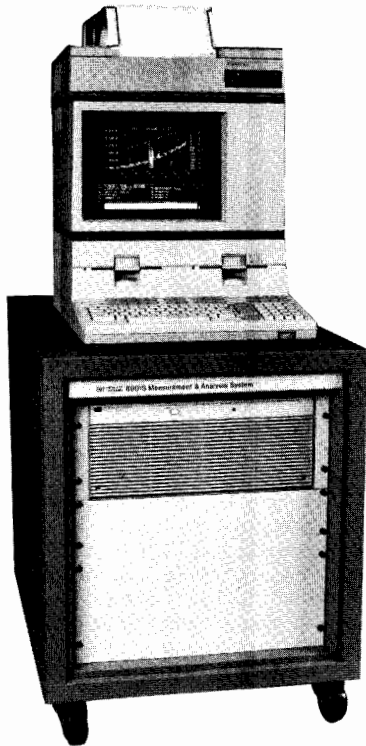

HP 6901S

Description

Hewlett-Packard's 6901S Measurement and Analysis System is a fully integrated, high speed scanning system for measuring multiple channels of voltage, current or resistance. It's a complete, ready-to-use solution which improves productivity by allowing a user to begin making measurements immediately. It also retains the flexibility to be customized for individual applications.

Easy to Use

A comprehensive software package makes the HP 6901S easy to use—for many applications, *no* software writing is required. Friendliness is enhanced via the use of descriptive menus. Sequencing of menus is controlled by the HP 6901S general-purpose mainline program.

The system comes fully assembled in a desk-height rack which provides a convenient work surface for any of the HP Series 200 Computers. User connections are easily made with a screwdriver to a factory-wired termination panel in the rear of the rack.

Hardware Features

The standard HP 6901S will scan 1 to 64 single-ended, analog channels at up to 25,000 channels per second, or up to 100 scans per second with programmable limit checking. (A scan is one complete pass through every channel.) By adding additional scanning cards, the standard system can scan up to 256 channels, or up to 768 channels with user-supplied termination panels. Options for double-ended and 4-wire scanning are also available.

As shipped, the HP 6901S will measure signals in the ± 10.23 volt range with 12-bit resolution. ± 1.023 volt and ± 102.3 millivolt ranges are switch selectable.

Software Features

The HP 6901S software includes one burst and three continuous scanning modes:

- Burst mode is used for applications requiring high speed scanning for up to 4096 readings.
- Limit mode is used to look at data before and after the occurrence of an out-of-limit condition on any channel. Both high and low limits are programmable for each channel.
- Strip chart mode produces a continuous hard copy record to indicate long term change.
- Running statistics mode outputs a statistical summary of long-term tests.

The HP 6901S graphics utilities support the following types of outputs: multichannel plotting, histogram plotting, cumulative distribution plotting, and tabular listings. Interactive graphics are provided within each plotting utility for extracting and analyzing the important information from the plots. The system also supports the HP

2671G Graphics Printer and three HP graphics plotters for hard copies and overhead transparencies.

Four of the HP Series 200 Computers can be specified with the HP 6901S. These are the Model 16S, 26S, 36S and 36CS computers.

Easy to Customize

Both the HP 6901S hardware and software can be easily customized for the customer with special needs. The standard system software makes use of many separate utilities, all of which are available to the user. Each one is written in BASIC and can be accessed by the user by modifying the mainline program.

The HP 6901S is also easily customized by users with special hardware needs. By using the HP 14750A CAT Programming Package, included with the system, a variety of HP Multiprogrammer Series II I/O Cards can be added to the system. This family of 24 cards, described on pages 317 and 318, performs many functions. This type of customization makes the HP 6901S a partially integrated solution to a broad range of automatic test, data acquisition, and control needs.

Specifications

Maximum Scanning Rates (single-ended only)

Burst mode: 25 kHz (channels/second), ± 10 V, ± 1 V ranges; 14 kHz, ± 100 mV range. Buffer Size: 4096 words

Limit mode: 100 Hz (scans/second) with limit checking on up to 30 channels.

Strip chart mode: 1 Hz (scans/second) for any 8 channels.

Running statistics mode: 5 scans/second average for up to 16 channels with no more than 400 milliseconds between successive readings on any one channel.

Minimum Out-of-Limit Condition Duration of an Input Signal In Limit mode: 10 ms for 100 Hz scanning rate.

Slots available for Multiprogrammer cards: 16 (the standard system uses five of these.) Up to seven HP 6943A Multiprogrammer Expanders can be added external to the rack.

Operating temperature range (HP 6901S): 10–40°C.

Dimensions (HP 6901A): 725 mm high x 600 mm wide x 900 mm deep, (28.6 in high x 23.7 in wide x 35.6 in deep).

Power (HP 6901A): 100/120/220/240 Vac (selectable), +5%, -10%, 47 to 63 Hz, 600 VA.

Weight (HP 6901A): net, 81.7 kg (180 lb); shipping, 107 kg (235 lbs)

Ordering Information

Price

| | |
|--|--------------|
| Step 1: Specify the HP 6901S | |
| HP 6901S Measurement & Analysis System | N/C |
| Step 2: Order two RAM Boards and one Computer | |
| Two HP 98256A 256 kbyte RAM boards @ \$1,060 | \$2,120 |
| HP 9836CS Computer | \$17,660 |
| HP 9836S Computer | \$14,630 |
| HP 9826S Computer | \$11,605 |
| HP 9816S Computer, Option 630 | \$5,550 |
| HP 9888A Bus Expander (required for HP 9816S only) | \$3,130 |
| HP 9121D 3½-in Dual Flexible Disc Drives (HP 9816S only) | \$1,775 |
| HP 10833A HP-IB Cable; 1 m (3.3 ft) (HP 9816S only) | \$81 |
| HP 98612A BASIC Extensions 2.0, Option 630 (HP 9816S only) | \$505 |
| Step 3: Specify HP 6901A with one media option | |
| HP 6901A Scanning Subsystem | \$17,500 |
| Opt 630: 3½-in flexible discs | N/C |
| Opt 655: 5¼-in flexible discs for HP 9826/9836 | N/C |
| Step 4: Options 1, 2, or 3 may be ordered as alternatives to the 64 channel FET scanner. Order as many expansion options as required. | |
| Opt 001: Substitute 16-Channel FET | less \$950 |
| Opt 002: Substitute 16-Channel Double Ended Relay | less \$500 |
| Opt 003: Substitute 16-Channel 4-wire Ohms Scanner | add \$1,575 |
| Opt 004: Add 16 FET Channels | add \$675 |
| Opt 005: Add 64 FET Channels | add \$1,625 |
| Opt 006: Add 16 Double Ended Relay Channels (may only be ordered with opt. 002 or 003) | add \$1,125 |
| Opt 007: Add 16 4-Wire Ohms Scanning Channels (may only be ordered with opt. 003) | add \$2,250 |
| Opt 008: Right to copy software (deletes SW) | less \$2,000 |
| Step 5: Select peripherals required for hard copy (HP 2671G Printer, and HP 9872C, 9872T, 7470A Plotters) | |

DATA ACQUISITION, CONTROL & TEST

Multiprogrammer: Versatile Building Block Approach to Systems

Model 6944A

315



- Data transfer rate 180,000 readings/second
- Dedicated interface (HP 98633A) to HP Series 200 Computers

- Direct-to-disc transfer rate of 180,000 words/second
- HP 14751A CAT programming package
- HP Multiprogrammer Series II I/O cards

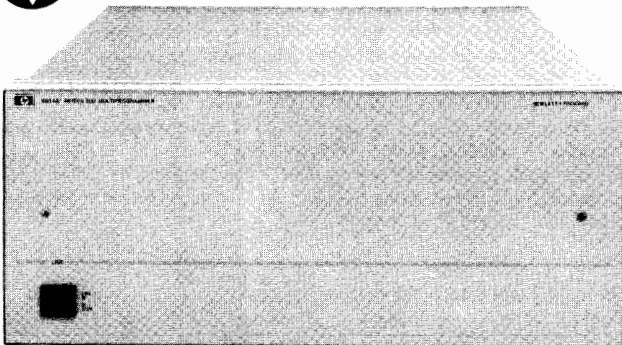

HP 6944A

Description

The HP 6944A Series 200 Multiprogrammer is a high-speed data acquisition and control system designed exclusively for use with HP Series 200 computers. The HP 6944A capitalizes on the HP Series 200 computer architecture by using the dedicated HP 98633A Multiprogrammer Interface and the HP 98620B DMA Controller to achieve high-speed data transfers.

The powerful HP Multiprogrammer Series II I/O cards provide a broad variety of I/O functions for the HP 6944A. These cards allow the user to configure the HP 6944A to implement many instrumentation functions such as high-speed scanning, analog waveform synthesis, limit checking and transient analysis.

The HP 6944A is programmed exclusively with the HP 14751A Computer Aided Test Programming Package. This software package effectively couples the flexible hardware architecture of the HP 6944A with the BASIC language system of the HP Series 200 Computers. The friendliness of this system is such that the system programmer only needs to be able to program in BASIC. The control statement are english-like and closely linked to the application by a list of "Names" supplied by the user. An easy-to-use, menu-driven configuration process correlates the user-assigned "Names" to the system's I/O functions automatically from the BASIC program. The software, through the same menu-driven process, then leads the system programmer through the hardware configuration. The net result is fast program development, self documenting, and the ability to maintain different configuration files on one disc.

Features

The primary features of the HP 6944A evolve around the architecture of the HP 6944A, HP Series 200 Computers, and the Multiprogrammer Series II I/O cards.

The key feature of the HP 6944A is high-speed data transfer. With the HP 6944A, HP 69759A 500 kHz A/D, HP 69791A/92A High-Speed Memory I/O System, and the HP 98620B DMA Controller Card, data may be transferred to an HP Series 200 Computer at rates of 180,000 readings/second. Without the HP 98620B DMA Controller Card, transfer rates of nine kilowords/second are achieved.

A second key feature of the HP 6944A is its ability to unburden the HP Series 200 Computer from controlling each I/O task of the HP 6944A. This allows the HP Series 200 Computer time to perform numerical analysis or manage other instruments during these time periods.

HP 6944A Specifications

Plug in I/O card positions: Maximum of 15 plug-in output or input cards per mainframe. Removable rear cover provides access to card slots.

Computer interface: The HP 6944A is connected to an HP Series 200 Computer via the HP 98633A Multiprogrammer Interface Card and HP 14704A, B or C cable.

Extender units: Up to eight HP 6944A Series 200 Multiprogrammers can be "linked" to the Series 200 via one HP 98633A Multiprogrammer Interface Card by using HP 14704A, B or C Interface Cables.

Maximum length of a link: A link of up to eight HP 6944A Series 200 Multiprogrammers can be nine metres long, maximum. This maximum length is the sum of the lengths of all the HP 14704A, B or C Interface Cables in the link.

Power supplies: All necessary power supplies for up to 16 I/O cards are built into each HP 6944A frame. Three ± 18 V supplies are isolated from each other and from ground, and are available for powering isolated I/O card circuits.

Cooling: Built-in forced air cooling draws air in through the side vents and exhausts air through the rear cover.

Operating temperature range: 0 degrees C to +55 degrees C.

Power: 100/120/220/240 Vac (switch, selectable), +5% to -10%, 47 to 63 Hz, 650 VA.

Dimensions: 177.0 mm high x 425.5 mm wide x 597.0 mm deep (7.0 in high x 16.25 in wide x 23.5 in deep).

Weight (without I/O cards): Net, 21 kg (46 lb); shipping, 28.6 kg (63 lb).

Ordering Information

Price

Step 1: Select the necessary quantity of HP 6944As.

HP 6944A Series 200 Multiprogrammer \$3700

Option 908: rack mount kit

Option 910: extra operating and service manual

Step 2: Select the HP Series 200 Multiprogrammer Interface Card for HP 6944A.

HP 98633A Multiprogrammer Interface Card \$350

Step 3: Select number and lengths of cables required for connecting HP 98633A Interface to first frame.

An additional cable is needed for each HP 6944A frame used as an extender.

HP 14704A Multiprogrammer Interface Cable, 1 m (3.3 ft) \$100

HP 14704B Multiprogrammer Interface Cable, 2 m (6.6 ft) \$110

HP 14704C Multiprogrammer Interface Cable, 4 m (13.2 ft) \$130

Step 4: Select HP 14751A to receive necessary CAT software and documentation (mandatory).

Select the option appropriate for the system controller.

HP 14751A Computer Aided Test Programming Package \$2000

Option 630: software provided on 3 1/2" flexible discs

Option 655: software provided on 5 1/4" flexible discs

Option 910: extra set of documentation

HP 14751R: right to reproduce HP 14751A CAT programming package (documentation provided) \$1000

DATA ACQUISITION, CONTROL & TEST

Multiprogrammer: Versatile Automatic Test, Data Acquisition and Control

Model 6942A

- Action-oriented instructions
- Isolated analog inputs and outputs
- Built-in self test

- Overlapped input and output
- Internal or external pacing
- Easy to configure

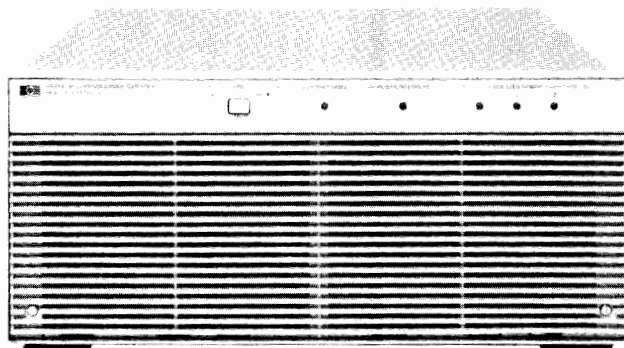

HP 6942A



The Multiprogrammer Performs Operations in Parallel

With this one instrument you can control several processes at once. And, while you are controlling the processes, the Multiprogrammer can also be watching for interrupt conditions. The internal microprocessor manages all the parallel operations and monitors the alarm lines; when the operations have completed or if an alarm condition occurs, the Multiprogrammer interrupts the controller.

How does the HP 6942A Connect With Your Controller?

The HP 6942A Multiprogrammer interfaces with your controller (desktop or minicomputer) using the HP-IB, Hewlett-Packard's implementation of IEEE Standard 488 and the identical ANSI Standard MC1.1. Data and status readback make use of the extended bus addressing features of the HP-IB.

Programming Flexibility

Mnemonic, action-oriented instructions make the HP 6942A Multiprogrammer simple to learn and use. For instance, the output instruction "OP" works with all output cards. When you send an instruction, the internal microprocessor checks which type of card you are addressing and automatically converts the data to the proper format for that card. You select the units with which you want to program each card. Whether you want to use volts, millivolts, amps, degrees, feet, or any other units, the Multiprogrammer does the converting for you.

Mainframe Memory Unburdens The Controller

The mainframe memory of the HP 6942A will accept up to 76 instructions from the controller at one time. This leaves your controller free for other processing activities while the Multiprogrammer works on the I/O operations. This mainframe memory may also be used to collect up to 1440 data readings and hold them until the controller is free to take them. (For even more data storage, up to 1 Meg words of data may be stored using the HP 69741A and HP 69792A Memory System Cards.

Real Time Clock

Built-in real-time clock gives you time-of-day readings and pacing of measurements. The clock detects which power line frequency you are using, 50 Hz, or 60 Hz, and automatically synchronizes itself to this frequency. The range of the clock is 65,534 days, with resolution to a tenth of a second.

Computers and Documentation

The HP 6942A can be operated with a wide variety of computers, including the HP Series 80, Series 200, Series 1000, 9825, and 9845 computers. Documentation packages are available for all of these computers. Each one contains a User's Guide with programming examples, a utility program tape or flexible disc, operating and service manuals, and a binder to hold this material. One no-charge documentation option must be specified to select the documentation appropriate for your computer.

Accessories

HP 14700A extender kit: this kit contains the transmission boards which go into the master mainframe (HP 6942A) and the last extender mainframe in the chain.

HP 14701A intermediate extender kit: when more than two mainframes are in a chain, the card in this kit must be used in each intermediate extender mainframe.

HP 14702A chaining cable: this is the cable which chains together the master and extender mainframes. One cable is required for each extender mainframe. Length: 1.5 m (5 ft).

HP 14703A card edge connector: extra connectors for the I/O cards may be ordered in addition to the one supplied with each I/O card.

HP 6942A/6943A Specifications

Plug-in I/O card positions: maximum of 16 plug-in output or input cards per mainframe. Removable rear cover provides access to card slots.

Computer interface (HP 6942A only): the Multiprogrammer is connected to a controller via the Hewlett-Packard Interface Bus (HP-IB), Hewlett-Packard's implementation of IEEE Std. 488.

Real time clock (HP 6942A only): the built-in real time clock is automatically synchronized with the 50/60 Hz ac power line frequency. The clock is read and set with data in the form of days, hours, minutes and seconds with a resolution of 0.1 second.

Extender interface kits (HP 6943A only): each HP 6943A Extender requires one HP 14700A or 14701A Interface Kit and one HP 14702A Chaining Cable for operation with the HP 6942A.

Maximum number of mainframes per chain: up to seven HP 6943A Multiprogrammer Extenders may be placed in a chain with one HP 6942A Multiprogrammer.

Maximum chain length: a chain of mainframes can be up to 152 meters (500 feet) long. This maximum length is the sum of the lengths of all HP 14702A Chaining Cables used in one chain.

Power supplies: all power supplies for up to 16 I/O cards are built-in including three ± 18 V supplies isolated from each other and from the ground.

Cooling: built-in forced air cooling draws air in through the front panel and exhausts air through the ventilated rear cover.

Front panel indicators: five light emitting diodes on the front panel indicate power supply and self-test status.

Operating temperature range: 0°C to 55°C.

Power: 100/120/220/240 Vac (selectable), +5%, -10%, 47 to 63 Hz, 600 VA.

Dimensions: 177.0 mm high x 425.5 mm wide x 597.0 mm deep, (6.969 in. high x 16.250 in. wide x 23.500 in. deep).

Weight (without I/O cards): net, 20 kg (45 lb); shipping, 27 kg (60 lb).

Accessories furnished: PC board Extender Card (HP Part No. 5060-2792).

Ordering Information

| | Price |
|--|--------|
| Opt 010-386: One Set Documentation/Software | N/C |
| Opt 410-786: Extra Documentation/Software | \$101 |
| Opt 908: Rack Flange Kit | \$40 |
| Opt 910: Extra Manual | \$30 |
| HP 14700A Extender Interface Kit | \$505 |
| HP 14701A Extender Interface Kit | \$405 |
| HP 14702A Chaining Cable | \$255 |
| HP 14703A Spare Card Connector | \$40 |
| HP 14711A Field Service Kit | \$2525 |

| | |
|--|---------------|
| HP 6942A Multiprogrammer | \$4400 |
| HP 6943A Multiprogrammer Extender | \$3300 |

DATA ACQUISITION, CONTROL & TEST

Multiprogrammer Series II I/O Cards

Models 69700A-69793A



Multiprogrammer Series II I/O Cards for the HP 6944A/S, 6942A/S and 6901S

For a complete description of the Multiprogrammer Series II I/O Cards, ask for publication 5952-4090.

| | Functions | Applications | Cards Used |
|-------------|--|--|---|
| STIMULUS | <p>Programmable DC Voltage and Current</p> | The output voltage (up to 250V) and current (up to 1000A) of forty different HP power supplies can be programmed to provide bias in automatic test systems or control of electromechanical process equipment. | Resistance Output, HP 69700A-69706A; Power Supply Control, HP 69709A. |
| | <p>Digital-to-Analog Conversion</p> | Twelve-bit voltage DAC's provide outputs for strip chart, x-y, and analog tape recorders as well as control of analog programmable instruments and stimulus of units under test. Control process equipment with 4-20 mA output. | Voltage DAC, HP 69720A; Current DAC, HP 69721A. |
| | <p>Analog Waveform Synthesis</p> | The Memory card can continually supply pre-loaded data to the D/A card at rates of up to 100 kHz. Special waveforms may be loaded into the Memory card from the computer and used as stimuli for test and processes. The analog output is isolated from digital ground. | Memory card, HP 69790B; 69791A, 69792A Voltage DAC, HP 69720A; or Current DAC, HP 69721A. |
| MEASUREMENT | <p>Voltage, Current, and Resistance Measurements</p> | A/D converters may be used to measure voltages from $\pm 50\mu\text{V}$ to $\pm 100\text{V}$ in the presence of 250 V of common-mode noise. Connecting a resistor across the input permits current measurements for 4-20 mA current loops used in process control. Combine the A/D with the current DAC for resistance measurements. | High Speed ADC, HP 69751A, HP 69759A |
| | <p>Frequency Measurements</p> | The Pulse Counter card accumulates counts over a precise time interval when a Timer card is connected to the enable line of the Counter. The program divides the count by the time interval to measure frequencies from 1 MHz to less than 0.001 Hz. | Counter, HP 69775A; Timer HP 69736A. |
| | <p>Pulse Counting Preset Up/Down</p> | The Counter may be preset to any value within the count range of 0 to 65,535 and can cause an interrupt when it rolls over. The Counter may be enabled and disabled by pulses or levels. The computer may read the count without disturbing the counting process. | Counter, HP 69775A. |
| | <p>Offline Analog Acquisition</p> | Differential or single-ended signals may be digitized at rates up to 500 kHz by the A/D, and stored in the Memory system. Each Memory system can store up to one megawords. The digitizing process can take place independent of other Multiprogrammer activity. | High Speed ADC, 69751A; Memory cards, 69790B, 69791A/69792B. |
| | <p>Scanner Systems</p> | Analog measurements from up to 960 channels may be acquired at 25,000 readings per second depending upon the scanner system configuration. Random access to any channel, as well as continuous scanning, are easily accomplished. (See Application Note AN316-3.) | Cards used: Scan Control, HP 69750A; FET Scanners, 69752A or 69755A; Relay Scanner, HP 69754A; High Speed ADC HP 69751A; Memory card HP 69790B, or 69791A/92A |
| CONTROL | <p>Digital Output and Switching</p> | Sixteen-bits of data in TTL, open collector, or SPST relay-contact form provide digital control of instruments and indicators. AC power, up to 6, can be switched to 12 loads with a HP 69731B, and HP 14570A AC Power Controller. | Digital Output, HP 69731B; Relay Output, HP 69730A; AC Power Controller, HP 14570A. |
| | <p>Digital Input</p> | Digital input cards accept 16-bits of data from digital measuring instruments, push-buttons, switches, relays, and other digital devices in the form of logic levels or contact closures. Digital data sources with more than 16-bits of data use several digital input cards. | Digital Input, HP 69771A; Isolated Digital Input, HP 69770A. |
| | <p>Stepping Motor Control</p> | The Stepping Motor card can produce from 1 to 32767 pulses at either of two outputs (CW or CCW) to control motor translators. Output pulses are also used for pulse-train update of supervisory control stations. The pulse rate (motor speed) is also programmable. | Pulse Train/Stepping Motor, HP 69735A. |
| | <p>Time and Frequency Reference</p> | Crystal controlled timing pulses, programmable from 1 μs to 18 hours, may be used as a time-base reference for control, measurement, and data acquisition. Period, duty cycle, and number of pulses are all programmable. | Timer, HP 69736A or Pulse Train, HP 69735A. |
| ALARM | <p>Level Detecting</p> | When signals cross preset levels, the Digital Input card can trigger the interrupt card to interrupt the computer. The alarm trigger levels can be programmed with the D/A or fixed with resistors. | Digital Input HP 69771A; Interrupt card, HP 69776A. |
| | <p>Event Sensing</p> | A digital word may be used to trigger quick computer response with the interrupt card. The computer responds to the interrupt with a software routine. The interrupt may also cause immediate local response by triggering a preloaded output card. | Interrupt card, HP 69776A. |



DATA ACQUISITION, CONTROL & TEST

Multiprogrammer Series II I/O Cards

| | |
|---|-----------|
| HP 69752A 64 Channel FET Scanner Card Scans 64 single-ended channels (± 10.24 V input signal range) at up to 25,000 readings per second. Cards cascable to 960 channels in a single mainframe. | \$1,210 |
| HP 69755A 16 Channel FET Scanner Card Same as 69752A, except scans 16 channels. | \$555 |
| HP 69754A 32 Channel Relay Scanner Card Scans 32 single-ended (16 double-ended) channels with a ± 100 V input signal range at speeds up to 1000 readings per second (625 readings double-ended). Switches currents up to 50 mA. | \$910 |
| HP 69750A Scan Control/Pacer Card Provides all pacing and control functions for the scanner cards listed above. One required for each group of scanner cards (maximum of 15 cards—see data sheet for further clarification). | \$655 |
| HP 69709A Power Supply Control Card Used for full system control of 6024A and 6012A Autoranging Power Supplies. | \$960 |
| HP 14728A Buffered A/D Cable Used to connect 69751A and 69790B in a buffered A/D configuration. | \$225 |
| HP 69700A-69706A Resistance output cards: the output of each of these cards is a programmable resistance value. Twelve mercury wetted relay contacts close across binary weighted precision resistors in a series string. The cards are designed to program the voltage or current output of an HP power supply with option 040. | \$555-605 |
| HP 69720A D/A voltage converter card: provides a high speed, bipolar output voltage programmable from -10.240 V to $+10.235$ V up to 5 mA load current. | \$705 |
| HP 69721A D/A current converter card: provides a bipolar -20.480 mA to $+20.475$ mA current output. | \$910 |
| HP 69730A Relay output card: provides sixteen independent, normally open, mercury wetted relay contacts. Contacts rated at 100 Vdc; or 1 Amp; and 28 VA. | \$555 |
| HP 69731B Digital output card: provides sixteen TTL or CMOS compatible outputs, or sixteen 100 mA open-collector switches. | \$405 |
| HP 69735A Pulse train output/stepping motor control card: generates up to 32767 pulses at a programmable frequency. | \$505 |
| HP 69736A Timer/pacer card: outputs a programmable pulse from one microsecond to eighteen hours or a programmable square wave. | \$505 |
| HP 69751A A/D converter card: this card measures bipolar dc voltages in one of four ranges, ± 100 mV, ± 1 V, ± 10 V, or ± 100 V, with 12 bit resolution at up to 33,000 readings per second. | \$960 |
| HP 69770A Isolated digital input card: breaks the path of potential ground loops with an optically coupled isolator in each of the sixteen digital input lines. | \$655 |
| HP 69771A Digital input/analog comparator card: monitors up to sixteen contact closures, switches, TTL signals, CMOS signals, or analog signals. The switching threshold can be set to any value between ± 9.5 volts by a screwdriver-adjustable potentiometer on the card or may be externally programmed. | \$605 |
| HP 69775A Counter/totalizer card: counts contact closures, TTL or CMOS logic level pulses, or analog waveform transitions in the range of 0 to 65,535. | \$730 |
| HP 69776A Interrupt card: compares up to sixteen logic level or contact closure inputs with a sixteen-bit reference word and interrupts for =, \neq , <, > conditions. | \$555 |
| HP 69790B Memory card (occupies 2 I/O slots): provides 4096 16-bit words for use with the DAC cards or the ADC cards or for other input/output tasks that need to run independent of other Multiprogrammer or computer tasks. Several Memory cards may be used to implement truly simultaneous operations. | \$1,315 |
| HP 69793A Breadboard card: the generalized grid area on this card may be used for mounting custom circuits. | \$150 |

HP 69759A - 500 kHz A/D

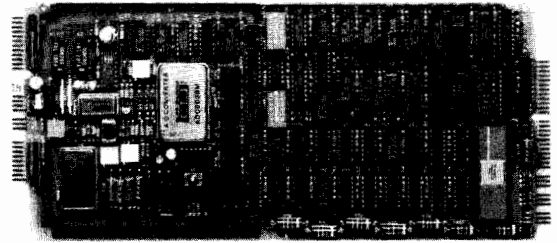

The HP 69759A 500 - kHz A/D converter measures bipolar voltages in four programmable ranges, ± 100 V, ± 10 V, ± 1 V, and ± 100 mV. The digitized values may be read directly by the controller or transferred into HP 69791A and HP 69792A memory buffer cards available for the Multiprogrammer system. Use of memory buffers permits simultaneous digitization of as many as 40 independent signal channels at rates up to 500 kHz per channel. Scanning subsystems designed specifically to work with the HP 69759A card provide additional measurement flexibility and permit expansion up to 7168 channels. Timebase and triggering functions may be added using other Multiprogrammer cards to form a complete analog measurement system that is precisely tailored to the requirements of the specific application.

Application Note 316-5, Data Capture, describes several ways that the HP 69759A can be used with other Multiprogrammer cards to solve several different applications. These descriptions include cable diagrams and program listings for both the HP 14751A and the HP 6942A native instructions.

HP 69759A - \$2300

HP 69791A/92 - Memory System

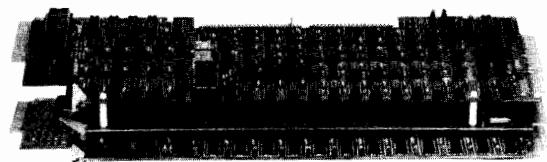

The HP 69791A and HP 69792A Memory Cards form a buffer used to perform input and output tasks without intervention from the controller. A memory card buffer can be used for inputs or outputs, or both. Data can be acquired at up to 760 kilowords/second or sent at up to 400 kilowords/second.

A memory card buffer has one HP 69791A Memory Card and up to five HP 69792A Memory Expansion Cards for a maximum memory size of 1M (1,048,576 16-bit words). The HP 69791A holds 64k (65,536 16-bit words) and the HP 69792A holds 192k (196,608 16-bit words). The memory card buffer functions as a single memory, regardless of how many HP 69792As are added.

The memory card subsystem can be used with the HP 69751A or HP 69759A A/D cards to input digitized analog measurements. Up to eight HP 69759A A/D Cards can be multiplexed into a single HP 69791A/69792A memory buffer. The A/Ds can be triggered by the same timebase for truly simultaneous readings which are then stored in sequential memory locations. This reduces memory costs and the number of mainframe slots required.

HP 69791A - \$2000
HP 69792A - \$1500

DATA ACQUISITION, CONTROL & TEST

Multiprogrammer: Computer Aided Test System

Models 6942S/14750A and 6944S/14751A

319



- Easy to use menu entry
- Faster software development
- Improved HP 6942A performance

Description

The new HP 6944S and the HP 6942S are easy to use computer-aided test systems that improve productivity by enabling you to implement your testing requirements more quickly. This is achieved through the use of two new software packages. The HP 14750A is a powerful CAT programming package which replaces the standard two-letter mnemonics of the HP 6942A Multiprogrammer. The HP 14751A is the standard programming language for the new HP 6944A Series 200 Multiprogrammers.

These systems are friendly and easy to use. Mnemonic-type language is not needed to program the HP 6944A. In addition, the HP 14750A will increase the performance speed of the HP 6942A. These CAT programming packages support all of the Multiprogrammer Series II I/O cards and several multiple-card functions. (Support for the HP 69759A and HP 69791A using the HP 14750A is currently under development. For further details, see your HP field engineer.) The HP 6942S and HP 6944S systems consist of: the desired Multiprogrammer mainframe, the appropriate CAT programming package.

CAT Programming Package

The CAT programming package is a comprehensive collection of software routines that provide the ATE system designer with a high-performance linkage between the BASIC language and Multiprogrammer hardware. Both friendliness and higher performance are combined in the software through an architecture which optimizes total system performance.

Friendliness is achieved by replacing traditional "computer language" statements with test-oriented commands. Communication with all supported instrumentation is via "functional names", chosen by the user, which have a close relationship with the function performed. For example, in the menu below, the name "value", is used to program a HP 69720A Voltage D/A Converter. This lets you program in terms that are familiar to you resulting in programs which are virtually self-documenting. Friendliness is further enhanced by convenient menu entries, which make it easy to enter all function names and parameters.

The CAT programming package reduces the amount of software written by the user thus speeding program development. Productivity is improved by shortening test development time. To create test software, the user enters functional names and other data into a series of menus. Then a program is written in HP-enhanced BASIC to handle all sequencing, computational, and decision-making operations. Whenever a stimulus, acquisition or control function is desired, the BASIC program is instructed to call a routine from the CAT programming package.

Features

Some of the CAT programming package features are highlighted in a menu below. The timeout feature can generate an error if an operation has not completed in a specified time. Since the error can be trapped like any other BASIC error, corrective action can be programmed to occur automatically. Limit-checking prevents out of range values from being executed, and data conversion permits programming with user specified units. Initial values can also be specified and, at run time, sent to all instrumentation with a single command.

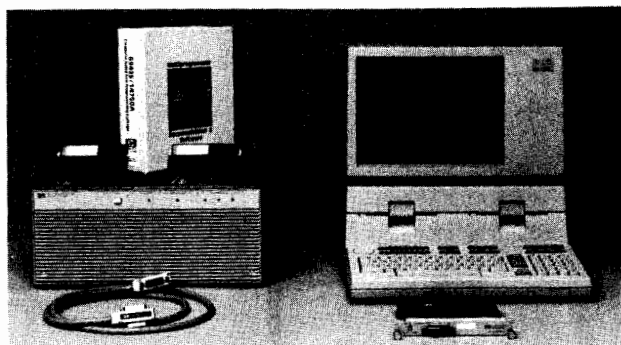
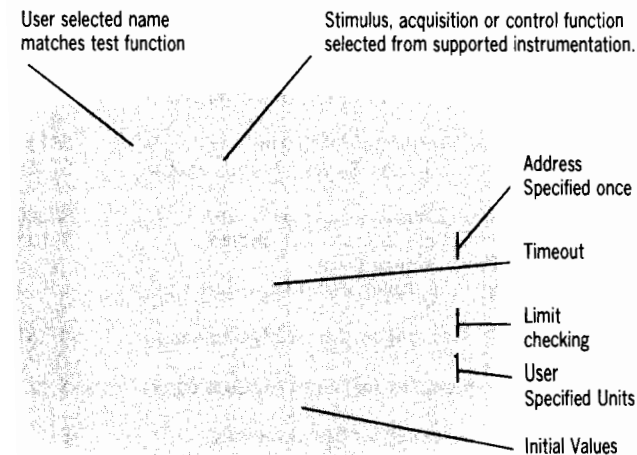

Multiprogrammer Series II I/O Cards

The CAT programming package supports the Multiprogrammer Series II I/O card functions, described on pages 317 and 318, and four popular multiple-card functions. These include combinations such as using a high-speed scanner, A/D, and memory card together. In addition, the HP 3478A 5½-digit Multimeter is supported for applications requiring high-accuracy and high-resolution measurements.

HP 6942A Multiprogrammer

The Multiprogrammer is a high-performance mainframe that provides the necessary interface for up to sixteen plug-in cards. Optional HP 6943A Multiprogrammer Extenders can be added to a system to further expand its capabilities. Up to seven Extenders, each holding up to sixteen plug-in cards, can be chained to one mainframe.

HP 6944A Series 200 Multiprogrammer

The new HP 6944A Series 200 Multiprogrammer is a high-speed mainframe that provides the necessary interface for up to sixteen plug-in cards. The HP 98633A Multiprogrammer interface must be used to operate the HP 6944A. Up to eight HP 6944A Multiprogrammers may be operated from one HP 98633A Multiprogrammer interface.

System Performance Specifications

Note: Specified times are for the HP 9826 and HP 9836 configurations. Actual times for the HP 9816 may be slightly slower.

| Mainframe | HP 6942A | HP 6944A |
|-------------------------------|-------------|-------------|
| Interface | HP 98624A | HP 98633A |
| CAT Programming Package | HP 14750A | HP 14751A |
| Single Data Point Input | 1.9 ms | 1.5 ms |
| Single Data Point Output | 2.1 ms | 1.4 ms |
| Scaling to User Units | add 0.35 ms | add 0.35 ms |
| Interrupt Response Time | 13.7 ms | 13.7 ms |
| Maximum Block Transfer Input | 12,500 | 180,000* |
| Maximum Block Transfer Output | 18,000 | 30,000 |

*HP 98620A DMA controller required.

Product Selection Guides

To order the HP 6942S or HP 6944S, it is recommended that the appropriate technical data sheet be used in conjunction with the Multiprogrammer Series II I/O card technical data sheet.

| Title | Data Sheet Number |
|---|-------------------|
| HP 6942S Computer Aided Test System | 5952-4092 |
| HP 6944S HP Series 200 Multiprogrammer System | 5952-4110 |
| Multiprogrammer Series II I/O Cards | 5952-4090 |

Ordering Information

| Item | Price |
|---|--------|
| HP 14750A Computer Aided Test Programming Package | \$2510 |
| Opt 630 3½" Flexible Discs | N/C |
| Opt 655 5¼" Flexible Discs for 9826/9836 | N/C |
| Opt 910 Extra Set of Documentation | \$ 75 |
| HP 14750R Right to Reproduce HP 14750A CAT Programming Package (Interface and Documentation provided) | \$1500 |
| HP 14751A Computer Aided Test Programming Package | \$2000 |
| Opt 630 3½" Flexible Discs | N/C |
| Opt 655 5¼" Flexible Discs for 9826/9836 | N/C |
| Opt 910 Extra Set of Documentation | \$ 75 |
| HP 14751R Right to Reproduce HP 14751A CAT Programming Package (Documentation provided) | \$1000 |



DATA ACQUISITION, CONTROL & TEST

Multiprogrammer: Versatile Building Block Approach to Systems

Model 6940B

- Front panel control
- GPIO or HP-IB
- Data transfer rate 20,000 readings/second

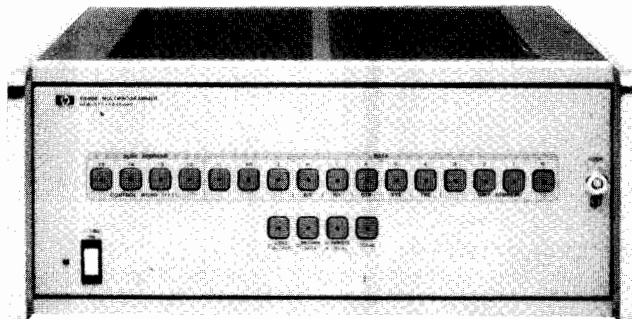

HP 6940B

Description

The HP 6940B Multiprogrammer is a low-cost, medium-speed data acquisition and control system designed to be used with controllers or computers via the GP-IB, a 16-bit parallel interface bus. The HP 6940B is supported by a full complement of I/O cards. These I/O cards provide a broad range of instrumentation functions for acquisition, stimulus, measurement and control.

The HP 6940B is programmed by a set of word formats and octal coding. There are three word formats: a control word that selects the operating mode, a data word used to select and control output cards, and an address word to select and control an input card.

The HP 6940B may also be used as an HP-IB product. This requires an HP 59500A Multiprogrammer Interface Kit. This kit provides conversion of the HP-IB format to 16-bit parallel format.

Features

A full-feature, front-panel switch register permits manual programming of all Multiprogrammer output, input and control functions. Fault isolation or manual system checkout of the computer, multiprogrammer or external devices is accomplished from the front panel.

Another feature of the HP 6940B is isolation of analog cards. Isolation from system ground is provided on analog cards. The HP 6940B has four isolated bias power supplies available to independently power the output circuitry of up to four groups of cards.

The HP 6940B Multiprogrammer has the capability of growing to meet the user's needs. Up to 15 HP 6941B extenders can be added to the system, allowing up to 240 I/O slots to be programmed from a single computer interface. The HP 6941B Multiprogrammer Extender has a blank front panel and all interfacing is provided in the HP 6940B Multiprogrammer.

Specifications

Plug-in I/O card position: Maximum of 15 plug-in input or output cards per mainframe.

Computer Interface: Can be interfaced using the GP-IO, which requires an I/O slot of the computer and a GP-IO interface card. An HP 59500A Multiprogrammer Interface Kit is required for use on the HP-IB.

Extender Units: Up to 15 HP 6941B extenders can be chained together to create 240 programmable I/O slots. Extenders may be separated from one another by up to 30 metres.

Data transfer rate: 20,000 readings/second using the GP-IO interface.

Cooling: Natural convection

Operating temperature range: 0 to +55 degrees Celsius.

Power: 100/120/220/240 Vac (selectable), +5%, -10%, 48 to 440 Hz, 230 watts.

Dimensions: 172.2 mm high x 425.4 mm wide x 539.8 mm deep (6.78 in high x 16.75 in wide x 21.25 in deep).

Weight (without I/O cards): 15.9 kg (35.0 lb) net, 19.5 kg (43.0 lb) shipping.

- Temperature measurement capability
- Multiprogrammer Series I I/O cards

Ordering Information

Step 1 - Select controller

| Controller | ROM HP P/N | Description |
|------------|--------------|--|
| HP-85B | | HP-IB: Option 085 GP-IO: Option 185 |
| HP-86B | 00087-15003* | HP-IB: Option 085 GP-IO: Option 185 |
| HP-87XM | 00087-15003* | HP-IB: Option 085 GP-IO: Option 185 |
| HP 9826A | N/A | BASIC: Option 026 HPL: Option 126 |
| HP 9836A | N/A | Option 036 |
| HP 1000 | N/A | Option 010 |

*Requires HP 8936A ROM drawer.

Step 2 - Select interface

| Interface | GP-IO | HP-IB |
|-----------|-------------------|---|
| HP-85B | HP 6940B Opt 185 | HP 59500A and HP-85B Opt 007 |
| HP-86B* | HP 6940B Opt 185 | HP 59500A |
| HP-87XM* | HP 6940B Opt 185 | HP 59500A |
| HP 9826A | HP 98622A Opt 003 | HP 59500A, includes 2-metre HP-IB cable |
| HP 9836A | HP 98622A Opt 003 | HP 59500A |
| HP 1000A | HP 14550B | HP 59500A and HP 59310B |

*When ordering an HP-86B or HP-87XM and using HP-IB interface, an HP-IB cable must be ordered.

Step 3 - Determine I/O card set

Select I/O functions from Series I I/O cards (See page 321).

Step 4 - Select number of mainframes

| | Price |
|---|--------|
| HP 6940B - holds up to 15 I/O cards plus one | \$2500 |
| HP 69351C voltage regulator card. | |
| Option 10: HP-1000 | N/C |
| Option 85: HP-85B HP-IB | N/C |
| Option 185: HP-85B GP-IO | \$ 605 |
| Option 026: HP 9826A BASIC | N/C |
| Option 126: HP 9826A HPL | N/C |
| Option 036: HP 9836A BASIC | N/C |
| Option 136: HP 9836A HPL | N/C |
| Option 908: Rack Mount Hardware for | \$ 40 |
| HP 6941B Extender, additional 15 I/O slots | \$2100 |
| Option 908: Rack Mounting Hardware | \$ 40 |
| HP 14541A Extender Cable; one for each HP 6941B | \$ 125 |

Step 5 - Determine accessories

| | |
|--|--------|
| HP 59500A Multiprogrammer Interface; required for each HP 6940B on the HP-IB | \$1300 |
|--|--------|

Accessories

| | |
|---|--------|
| HP 14540A Main Input Cable Assembly, 3.6 m (12 ft) | \$ 255 |
| HP 14541A Chaining Cable, HP 6940B to HP 6941B | \$ 125 |
| HP 14550B Multiprogrammer Interface Kit for the HP 1000 | \$1820 |
| HP 14551A Service Kit for the HP 6940B | \$1715 |
| HP 14555A Connector Kit for Series I Multiprogrammer I/O cards | \$ 20 |
| HP 14556A Software Library for the HP 9825A | \$ 200 |
| HP 14557A Power Supply Interconnect Cable for the HP 69520A Programming Card | \$ 135 |
| HP 14558A Termination Panel; with 40 dual-screw terminals | \$ 125 |
| HP 14560A Cable Assembly for Series I I/O cards; 15 conductors | \$ 81 |
| HP 14561A Cable Assembly for Series I I/O cards; 30 conductors | \$ 125 |
| HP 14562A Cable Assembly for Series I analog I/O cards; two shielded conductors | \$ 35 |

DATA ACQUISITION, CONTROL & TEST

Multiprogrammer: Series I I/O Cards for HP 6940B and 6941B

321



Power Supply Programming

HP 69500A-69513A Resistance Programming Cards

\$355-\$405

HP 69500A is supplied without resistors. The HP 69501A-69506A are single output, 12-bit resolution cards designed to program a single HP power supply equipped with Option 040. The HP 69510A-69513A are dual-output cards with six-bit resolution designed to program the current output of HP power supplies equipped with Option 040.

HP 69520A Power Supply Programming Card

\$455

Provides full system control of HP 6023A, 6024A and HP 6011A, 6012A autoranging power supplies. Requires HP 14557A interconnect cable.

Temperature Measurement

HP 69423A Low Level A/D and Scanner Card

\$705

Six channels of thermocouples or other low-level dc sources in the range of ± 20 mV can be measured with resolution of 5 μ V. A seventh channel is used to read the temperature of the isothermal input terminal block. An HP 69351C Voltage Regulator Card is required to provide the regulated isolated bias voltage to the HP 69423A. One HP 69351C will support up to four analog input cards.

Analog Input

HP 69336B High Speed Scanner Card

\$455

This card features a FET multiplexer with 16 single-ended voltage input channels that can be scanned at 20,000 channels/second. Input voltage range is ± 10.24 volts with 100 V isolation from data common. Several cards can be cascaded to provide up to 224 channels.

HP 69422A High Speed A/D Card

\$705

The High Speed A/D Card measures bipolar dc voltages in one of four ranges, ± 100 mV, ± 1 V, ± 10 V, and ± 100 V. The three lower ranges are switch selectable. The ± 100 V input range is connected to an on-board divide-by-ten attenuator. Data conversion rate is 33,000 readings/second.

Analog Output

HP 69321B D/A Voltage Converter Card

\$455

This model provides a high-speed (33 kHz), bipolar output voltage (± 10.24 volts at 5 mA) that is the analog of the digital input data. Dual-rank storage, a feature that allows all D/A cards in a system to change their outputs simultaneously, is provided on the HP 69321B.

HP 69322A Quad D/A Voltage Converter Card

\$605

This D/A card provides four individually programmable, bipolar output voltages (-10.24 V to $+10.22$ V at 5 mA, 16 kHz maximum) that are the analog of the digital data input. Two of the 12 data-bits address the DACs, and the remaining ten data-bits provide the digital input data.

HP 69370A D/A Current Converter Card

\$655

This model provides a high-speed (33 kHz), constant-current output (0 to 20.475 mA at up to 10.5 V) that is the analog of the digital data input. Dual-rank storage, a feature that allows all D/A models in the system to change their outputs simultaneously, is provided on the HP 69370A.

HP 69351C Voltage Regulator Card

\$200

The Voltage Regulator Card provides four regulated, isolated bias supplies for the analog models and is inserted into the voltage regulator slot of the HP 6940B and HP 6941B. The HP 69351C is required for proper operation of the analog input and output models. It will support up to four of these models.

Digital Input

HP 69430A Isolated Digital Input Card

\$255

This card employs photoisolators to provide up to 100 V RMS isolation between the 12 data lines and chassis ground. The model is designed to monitor only circuits that are active. This model may be ordered with any of three different logic options. One of these options must be specified when ordering this model:

Option 069: negative-true TTL logic levels

Option 073: positive-true TTL logic levels

Option 088: positive-true Hi level = ± 12 to 25 V.

HP 69431A Digital Input Card

\$255

The Digital Input Card provides 12 data lines that can be used to monitor contact closure or logic levels referenced to ac earth ground. Gate/flag circuitry provides the HP 69431A with the interface to the computer interrupt system. An option must be specified when ordering this model.

Option 069: negative-true TTL logic levels

Option 073: positive-true TTL logic levels

Option 070: positive-true Hi level = 6 to 14 volts

Digital Output

HP 69331B Digital Output Card

\$255

This model is a general-purpose, 12-bit card with power-on preset, system enable/disable, and gate/flag capabilities. The output lines are jumper selectable for TTL or +12 volt logic levels. The HP 69331B digital output is shipped with TTL logic level configuration.

HP 69332A Open Collector Output Card

\$150

This card is similar to the HP 69331B except it can switch up to 30 volts dc and currents up to 40 mA. The HP 69332A open collector output card is designed to drive lamps and relay coils utilizing an external dc power source. The outputs of the HP 69332A may be random at power-on.

HP 69433A Relay Output with Readback Card

\$305

The relay card provides 12 independent SPST, mercury-wetted, normally-open contact pairs. The HP 69433A also allows the computer to examine the status of the relay coil drive circuits, before and after the contacts are changed. No external handshaking is available with this product.

Functional

HP 69335A Stepping Motor Control Card

\$225

This model can be programmed to generate from 0 to 2047 square-wave pulses at either of two output terminals. The user may also configure the card to generate 0 to 4095 square-wave pulses. An 11-bit binary data word specifies the total steps and Bit-12 specifies direction of rotation.

HP 69435A Pulse Counter Card

\$200

This card will count pulses, up or down, with a maximum square-wave input frequency of 200 kHz. Carry and borrow pulses are generated so that the HP 69435A may be cascaded for greater counting capabilities.

HP 69602A Timer/Pacer Card

\$405

The Timer/Pacer Card provides a full programmable, crystal-controlled time base that can be used to pace Multiprogrammer I/O operations or generate accurate one-shot pulses. The HP 69602A coupled with the HP 69435A can satisfy requirement for frequency measurement (maximum of 200 kHz). Time interval measurement (10 μ s to 34 minutes) and time of day (2.8 minutes to 1084 years).

Interrupt

HP 69434A Event Sense Card

\$505

The Event Sense Card monitors up to 12 external contact closures and interrupts the computer when one or more contacts change state with respect to the 12 reference bits stored on the card. Jumpers allow for reconfiguration to provide four logical arguments: equal to, not equal to, greater than, or less than.

HP 69436A Process Interrupt Card

\$405

This card provides an interrupt to the computer when any one or more of the 12 data lines being monitored change state. The HP 69436A has TTL and open collector compatible edge detectors and can detect any logic transition lasting 100 nanoseconds or longer.

Breadboard

HP 69280A Breadboard Card

\$100

The Breadboard Card provides a generalized grid pattern for mounting custom circuitry. The HP 69280A plugs into the HP 6940B and HP 6941B, allowing access to the data lines and power supply lines of the Multiprogrammer backplanes.

HP 69380A Breadboard Output Card

\$150

This breadboard card is similar to the HP 69280A and has output storage buffer circuits that allow the Multiprogrammer backplane output data to drive external or custom circuits. A large portion of the printed circuit board has a plated grid and general-purpose circuit pattern.

HP 69480A Breadboard Input Card

\$150

The Breadboard Input Card is identical to the HP 69380A, except the on-board logic is the input buffer gates for driving the Multiprogrammer backplane.



DATA ACQUISITION, CONTROL & TEST

Multiprogrammer Technical Publications

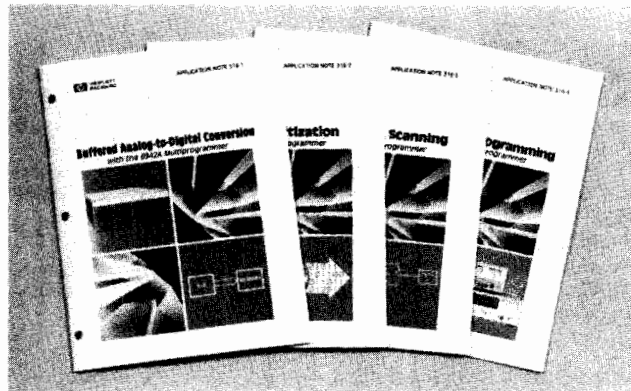
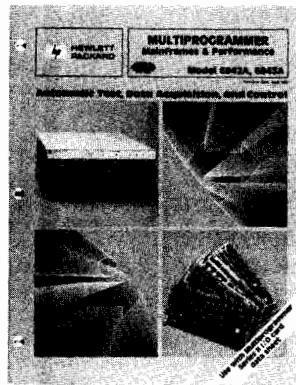
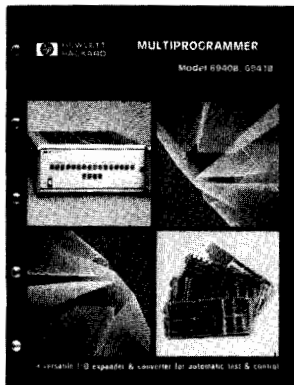

Technical Data

In addition to a broad range of products for integration of data acquisition, control and test systems, Hewlett-Packard provides a selection of technical literature as further support of the Multiprogrammer products. These technical brochures provide detailed operating specifications of the Multiprogrammer product family and are extremely helpful in configuring the best Multiprogrammer package for your application. Other literature available are Product Notes describing a specific product application and Application Notes.

This technical literature will provide information to help you choose the right Multiprogrammer products for your application. The Product Notes augment the Operating and Service Manuals and provide additional information on product configurations and actual applications. The Application Notes are more specific "how to" information aimed at a specific application and product configuration.

This technical literature is provided at no charge upon request. Ask your local Hewlett-Packard field engineer, or use the card at the rear of this catalog.

| Publication Title | Publication Number |
|---|------------------------|
| Multiprogrammer Model 6940B, 6941B | 5952-4077 |
| Multiprogrammer Mainframes & Performance Models 6942A, 6943A | 5952-4089 |
| Multiprogrammer Series II I/O Cards Models 69700A-69793A | 5952-4090 |
| Measurement & Analysis System Model 6901S | 5952-4093 |
| Computer Aided Test System Models 6942S, 147501A | 5952-4092 |
| HP Series 200 Multiprogrammer System Models 6944S, 6944A, 14751A | 5952-4110 5952-4110 |

Product Notes

A series of product notes is available for the Multiprogrammers. The first two, 6940B-1 and 6940B-2, are product oriented, and describe how to use particular Multiprogrammer cards. The others are product "Application Stories" which describe how Multiprogrammer customers have implemented specific applications.

6940B-1 Scanning with the 6940B Multiprogrammer

Describes use of the HP 69336B FET scanning card for high-speed data acquisition.

6940B-2 Power Supply Control

Describes use of the HP 69520A power supply programming card to control HP autoranging power supplies.

6940B-3 Subassembly Testing

Details Ford Motor Company's use of a building block approach to increase the flexibility of Ford's systems testing while reducing cost and design times.

6940B-4 Automating Manual Equipment

Describes the implementation of the HP 6940B in a radiation monitoring system.

6940B-5 Basic Research

Describes the interfacing of an HP 6940B and HP 9845A to a scanning electron beam microscope.

6940B-6 Product Evaluation

Describes the use by BF Goodrich of the HP 6940B to test the true effectiveness of tires for the different ice, snow, soil and load conditions.

6942A-1 Production Line Testing

Describes Solitron Devices Inc. use of the HP 6942A for hybrid device testing.

6942A-2 Heavy Industry

Describes Northwest Culvert Company's use of the HP 6942A to control metal pipe production and improve process control.

6942A-3 Instrument Control

Describes the use of an HP 6942A to control RF test equipment in an automatic modem test system.

6942A-4 Research and Development

Describes the use of an HP 6942A as control and data acquisition system for a heavy oil pump development test rig.

6942A-5 Materials Evaluation

Describes the use of an HP 6942A to automate the measurement of fluid viscosities.

14570A-1 Burn-In

Describes the use of an HP 14570A AC power controller in testing for equipment reliability with AC power cycling.

Application Notes

A new series of application notes introduces a beginner to computer aided test, and makes it easier for any user to implement the most common HP 6942A Multiprogrammer configurations. Each of the notes contains a comprehensive study of an application, and includes theory, wiring information, and software listings for the basic functions. Information on advanced techniques is also provided. Although the programming information is oriented toward the HP 9826A and HP 9836A computers, the concepts are discussed in a general way that allows application to other computers. Copies of these application notes are available through your local HP sales office.

AN316-0 Introduction to Computer Aided Test

This introductory note is designed to take a computer aided test novice through the steps of evaluating, planning, and implementing a sample computer aided test system.

AN316-1 Buffered Analog-to-Digital Conversion

A buffered A/D allows the HP 6942A to acquire data rapidly, and store it without computer intervention. Additional buffered A/D's can be used to make measurements simultaneously from many channels. This note describes how to configure the HP 69751A A/D converter and the HP 69790B memory card with the HP 14728A cable for this application.

AN316-2 Waveform Digitization

The HP 6942A can also function as a logic analyzer for analog signals. It can store a pre-determined block of voltage readings occurring before, during or after an external event. This capability makes the HP 6942A useful for digitizing transients, and recording events with long propagation delays.

AN316-3 High-Speed FET Scanning

High speed data acquisition from many channels is easily accomplished with the Multiprogrammer scanner system consisting of an HP 69750A or HP 69755A scanner cards. This note covers sequential and random access scanning methods.

AN316-4 Power Supply Programming

Full system control of a power supply, including output voltage and current readback, is possible with a single Multiprogrammer card. The HP 69709A power supply control card is designed for control of HP 6023, HP 6024A, HP 6011, and HP 6012A power supplies equipped with Option 002.

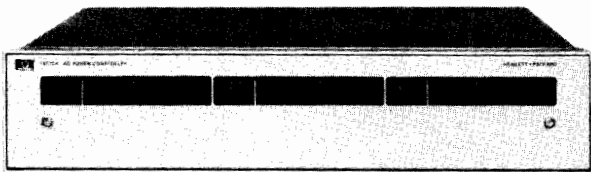

HP 14570A AC Power Controller

The HP 14570A is a high-reliability and low-EMI alternative to relays or conventional solid-state switches for controlling AC power. Up to 12 AC loads can be switched under computer control. Both 115 and 230 Vac loads of up to six amps can be controlled from a single unit. Primary uses include switching AC power to instruments, power supplies, motors, and devices under test. It is also useful for burn-in, power cycling, and process control applications.

Feature Summary

- 12 AC power switches
- Switches up to 6 amps rms
- Low-noise
- Handles inductive loads
- True zero-crossing switching
- Short-circuit protection
- 115 and 230 volt AC outputs
- Rated for 2 million operations
- Quick-disconnect AC plugs
- Designed to meet UL, IEC & CSA
- 6940B, 6942A or TTL Control
- AC line filtering

Specifications

Line voltage: 115 or 230 Vac, +15%, -22%

Line frequency: 47 to 63 Hz

Isolation voltage: 1500 Vac rms

Maximum current (rms): up to 6 Amps per switch (at any lagging power factor*), with each group of four switches limited to 15 Amps.

* Loads with a leading power factor, such as power-factor correction capacitors, should not be switched with the HP 14570A.

Maximum current (peak): 100 Amps per switch for less than 1 ms (non-repetitive). 20 Amps per switch continuously, subject to rms limitations.

Minimum load current: 20mA

Off-state leakage: 2 mA through the external load

Maximum switching rate: 0.5 Hz

Turn-On delay: 6 to 30 ms. Turns on at zero voltage.

Turn-Off delay: 14 to 34 ms. Turns off at zero current.

Input characteristics: 1 kΩ pull-up resistors to +5 V

Logic-High Level (Off) = 3.5 to 5.25 V

Logic-Low Level (On) + -0.5 to 1.50 V

Required drive: negative-true, open collector; 5 mA maximum current sink at logic-low level

Dimensions: 80 mm x 425 mm x 425 mm (3 1/2" x 16 3/4" x 16 3/4")

Weight: 9.5 kg (21 lbs)

HP 14570A Options

| | |
|--|--------|
| 040: HP 69331B card & cable for use with HP 6940B | \$ 355 |
| 042: HP 69731B card & cable for use with HP 6942A | \$ 505 |
| 050: Underterminated cable for use with other sources | \$ 91 |
| HP 14570A AC Power Controller | \$1770 |

Training

HP 50004A: HP 6942A Multiprogrammer User's Course

Description

This three-day introduction to the Multiprogrammer teaches a person how to use the HP 6942A to make measurements and perform stimulus/response or control for automation applications. An overview of the HP-85 Personal Computer is followed by lectures, discussions, and lab exercises which provide experience in programming the HP 6942A in the BASIC language. Experience is gained in using the memory card, real time clock, and data formatting/conversion capabilities of the Multiprogrammer.

At least one-third of the class time is devoted to hands-on lab exercises using the HP-85 controller. You will write practice programs which are readily adaptable to other HP-IB* controllers and using the information gained, you will improve your Multiprogrammer application skills.

The HP 50004A HP 6942A Multiprogrammer User's Course is offered at HP training centers around the world. Please contact your local HP Sales Office for dates, locations, and enrollment information. Lodging and meals are the responsibility of the student.



HP 6944A, HP 6942A, and HP 6940B Service Kits

The HP 14711D Field Service Kit is a service aid for the HP 6944A Series 200 Multiprogrammer. It provides customers with the parts needed to minimize down time.

The Model 14711D contains pre-tested HP 6944A mainframe printed circuit assemblies in a lightweight case. A two meter transmission case is included along with space for small parts and software discs.

Defective boards, which are replaced by boards from the HP 14711D, can be sent to the local HP Service Center for repair.

The HP 14711A Field Service Kit is a service aid for the HP 6942A Multiprogrammer. It provides board exchange capability for users with a need for the shortest possible downtime.

The 14711A case contains seven pretested mainframe PC assemblies which can replace defective PC assemblies in the HP 6942A. Twelve additional slots can be filled by the user with spare I/O cards.

Troubleshooting information needed to isolate a malfunctioning mainframe PC assembly can be found in the *HP 6942A Installation and Assembly Level Service Manual* (HP P/N 06942-90006). Interpretation of errors reported by defective I/O cards can be found in Appendix B of the *HP 6942A User's Guide*.

Defective boards, which are replaced by boards from the 14711A, can be sent to the local HP Service Center for repair.

The HP 14551A Multiprogrammer Service Kit for the Hewlett-Packard Model 6940A/B Multiprogrammer subsystems is designed to be used with an HP computer in the HP 1000 series, a HP 9825A desktop computer, or by the HP 6940B operating alone in the LOCAL mode.

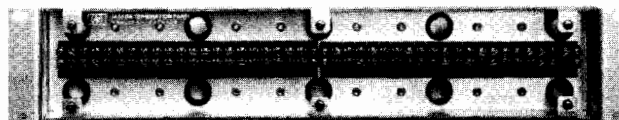

HP 14558A Termination Panel

The HP 14558A Termination Panel is an accessory for Multiprogrammer systems to facilitate field wiring to the I/O cards. The HP 14558A allows the user to bring the edge connections of the Multiprogrammer I/O cards out to a screw-terminal barrier strip. The field wiring may be brought to this rack-mounted barrier strip to complete the connection. This is an alternative to soldering the field wiring directly to the card edge connectors which are supplied with the I/O cards.

Specifications

Terminals: Two 20-position barrier blocks provide a total of 40 pairs of #6 screw terminals at 0.38-inch (9.5 mm) center-to-center spacing. Terminals accept #6 crimped terminations up to 0.31 inches (7.9 mm) wide and are equipped with rising surface clamp screws that also accept unterminated wire up to #14 AWG.

Current Rating: 20A

Voltage Rating: 250 volts dc or ac

Net Weight: 0.8 kg (2 lbs)

Dimensions: 88 mm high x 482.6 mm wide x 36.6 mm deep (3.47 in high x 19.00 in wide x 1.44 in deep)



DATA ACQUISITION, CONTROL & TEST

Automatic Test Systems

Integration Services, Model 9400 Switches

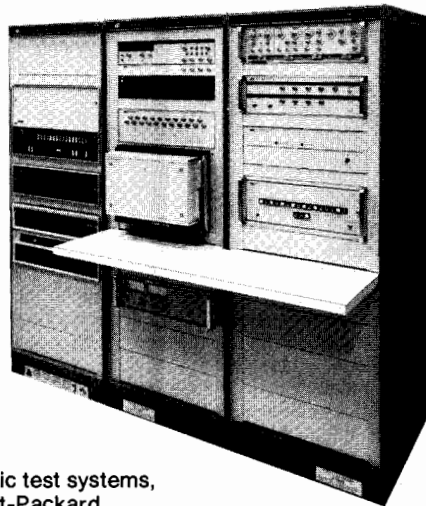

Customized automatic test systems, integrated by Hewlett-Packard

ATS/1000 Integration Services

Previously, when building an automatic test system, users had only two choices: purchase an already-assembled "turn-key" system or purchase computers and instruments separately and assemble them on their own. As a result of our experience with more than 1000 HP automatic test system installations worldwide, HP offers two categories of system-building assistance, called ATS/1000 Integration Services.

An automatic test system can be purchased at various levels of completion, depending on how much assistance the user desires. At the lowest level, called Racking and Cabling Service, HP consolidates the equipment, designs cabinet layout and power distribution, then installs the equipment in cabinets. The user assumes responsibility for software configuration and testing.

With the highest level of service, Configuration/System Test, the user receives a fully-integrated, fully-installed system, ready for developing application programs. HP consolidates the equipment, installs it in cabinets, configures the operating software, and checks out the system on-site.

Integration service prices vary, depending on the complexity and size of the system. A typical system that contains \$100,000 of instrumentation typically requires \$30,000 to \$40,000 of integration services to be fully configured and tested.

Ordering Information

HP 93283A ATS Racking and Cabling Service

HP 93284A ATS Configuration/System Test Service

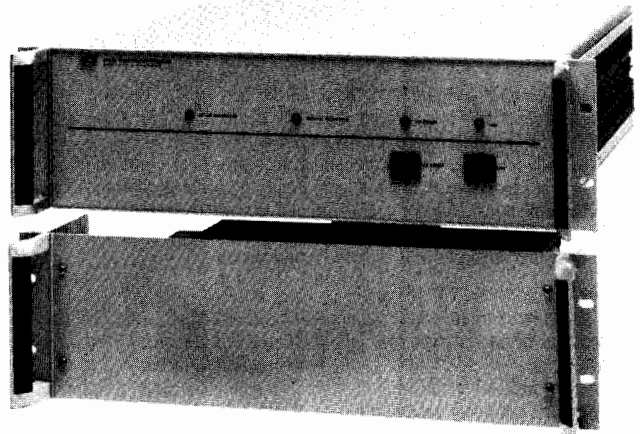

HP 9411B Switch Controller



Switches for Automatic Test

HP-IB switch products used in HP automatic test systems are available individually for HP 1000 system users who manufacture their systems in-house or those who have complex switching requirements in their HP 1000-based automated test systems. These switches provide a commercially-available solution for connecting the system to the unit-under-test (UUT). Three types of switching units are available, all controlled by a single HP 9411B Switch Controller that provides micro-processor control of multiple switch mainframes.

- **HP 9411B Switch Controller** \$8,000
 The HP 9411B is for use on HP 1000 Computer Systems and is controlled via the HP-IB. It provides control logic and relay power for the switch mainframes. It performs comprehensive self-test and fault isolation of all signal relays in the HP 9412A and 9414A switch cards.
- **HP 9412A Modular Switch** \$14,700
to \$47,000
 Provides high-density, multi-function switching of signals up to 10 MHz. A built-in 1768-pin (34 x 52) matrix interface panel improves signal performance and eliminates "spider web" cabling. The HP 9412A accommodates five types of switch cards in any combination up to a total of 25 cards.
- **HP 9413A VHF Switch** \$3,700
to \$11,000
 Provides modular, flexible high-frequency switching of pulse and video signals up to 500 MHz. The HP 9413A accommodates up to 12 coaxial switch modules.
- **HP 9414A Matrix Switch** \$13,400
to \$48,000
 Provides maximum flexibility for switching signals up to 10 MHz. Designed for high-density, high-performance switching, the HP 9414A allows any UUT pin to be switched to any instrument in the system. The 16-input matrix can be configured in 30-pin increments (UUT pins) up to 120 pins. A distribution bus allows several instruments to share four of the 16 matrix inputs, thus minimizing switching requirements.



Component and Semiconductor-Parameter Measurement

Component Measurement

An impedance-measuring instrument measures impedance characteristics of electronic components, materials and circuits. HP impedance instruments provide:

1. A broad product line, to fit each application;
2. Full evaluation of impedance characteristics under conditions of varying frequency, test-signal level and DC bias.
3. High-precision, high-resolution impedance measurement, with error correction for test-lead or test-fixture effects.

Impedance-measuring instruments can be divided into two general categories: LCR meters and impedance analyzers. The LCR meter primarily measures the inductance, capacitance and resistance of a test device. The impedance analyzer, in addition to all of the functions of the LCR meter, measures the impedance and phase of the test device, and makes detailed analysis of the impedance measurement.

The major applications of impedance-measurement instruments are in electronic-component materials manufacture and electronic equipment manufacture (electronic component users). **Table 1** shows the type of evaluation and the functions required according to instrument application.

Impedance measurements can be divided into two general categories:

1. Tests of whether the test device functions properly under application conditions and
2. Tests under conditions stipulated by MIL or IEC standards.

When type 1 measurements are conducted in an R&D department, the purpose is to shorten development time through careful

| Application Area | Component/Material Manufacturer | | Component User | |
|--------------------------------|---|---|---------------------|--|
| | R&D and QA | Production | Incoming Inspection | R&D |
| Major Requirements | Verify that device has sufficient performance | Perform GO/NO GO testing based on MIL, IEC, etc. | | Evaluate devices/circuits under actual working conditions |
| Required Measurement Functions | Multi-function/General Purpose <ul style="list-style-type: none"> • Wide freq. range • Auto freq. sweep • Variable signal level and DC Bias • Multi-parameter • High accuracy and resolution | High Speed/Single Function <ul style="list-style-type: none"> • High Speed • Fixed frequency level and DC Bias • Single parameter | | Multi-function/General Purpose <ul style="list-style-type: none"> • High frequency resolution • Auto freq. sweep • Variable signal level & DC Bias • Multi-parameter • High accuracy and resolution |
| HP Product Offering | HP 4194A HP 4192A HP 4192A HP 4191A HP 4191A HP 4193A HP 4193A HP 4274A/4275A HP 4274A/4275A HP 4276A/4277A HP 4271B HP 4271B HP 4261A/4262A HP 4342A HP 4328A HP 4329A | | | |
| Objects for Test | Materials <ul style="list-style-type: none"> • Magnetic materials • Dielectric materials • High polymers • Optical materials (fibers, etc.) • Semiconductor materials • etc. | Components <ul style="list-style-type: none"> • Capacitors • Inductors • Transformers • Magnetic heads • Piezo electrics • Cables • Resonators • Sensors • Hybrid ICs • Filters • etc. | | Equipment <ul style="list-style-type: none"> • VTRs • Audio/video products • TVs • Communication equipment • Computers • etc. |

Table 1. Component-measurement applications and HP products.

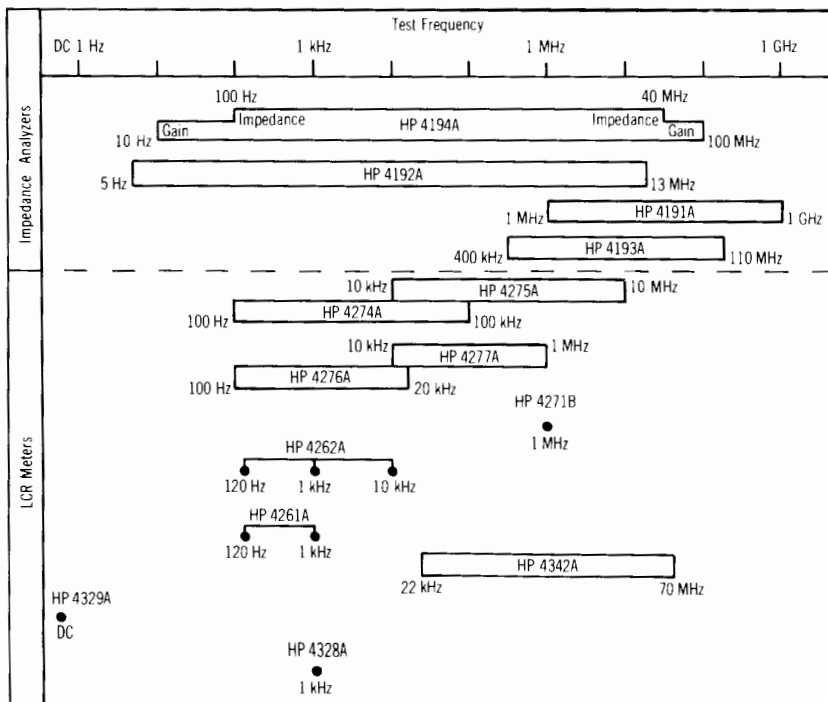

Table 2. HP Component-measurement products vs. test frequency.

evaluation. Therefore, a multi-function, general-purpose instrument for the measurement of many characteristics is required, such as an impedance analyzer or high-resolution LCR meter.

Type 2 measurements are conducted for go/no-go tests in manufacturing or incoming inspection. The measurement data are fed back to vendors or manufacturing processes for correction and improvement. Because of volume, test costs must be minimized. Therefore, a high-speed, single-function instrument may be used. Sorting and interpreting test results may be required, so an LCR meter with a comparator option can be used.

Table 2 shows HP's line of instruments arranged according to measurement frequency and performance. Test frequencies of these instruments range from 5 Hz to 1 GHz, and some have fixed MIL/IEC standard frequencies between 1 kHz and 1 MHz.

Since the time that HP introduced the first digital LCR meter, the company has continued to create high-performance impedance-measurement instruments. Because of this effort, it is now possible for virtually anyone to make the most difficult impedance measurements with ease and great accuracy.



COMPONENT & SEMICONDUCTOR MEASUREMENT

General Information

Parametric Measurement

Semiconductor Parametric Measurement

Semiconductor parametric measurement instruments are used for measuring and evaluating the electrical characteristics of semiconductors.

Competition within the semiconductor field is fierce, and major goals are: developing new products rapidly, improving yield and reducing costs.

HP semiconductor parametric measurement instruments provide:

1. Precise, high-resolution measurements for accurate and reliable evaluation and
2. Automated operation from measurement through analysis.

Semiconductor measurement applications vary widely, from device R&D to large-volume manufacture on mass-production lines. Measurement equipment must fit the measurement functions required.

In R&D, parametric testers make comprehensive physical and electrical evaluations of new materials, prototype devices and evaluation test patterns. As the integration and performance of semiconductors advance, measurement instruments must have the expandability to adapt to the high resolution and precision demanded by new evaluation methods.

For production departments, parametric testing helps stabilize new processes for mass production and helps make process yield improvements. Functional testing is used mostly in outgoing inspection. Cost reduction for both types of test requires high-speed, multiple-pin measurements and reduced downtime. The yield of new VLSI devices is less than 10 percent, and bad devices must be discarded. The accurate parametric testing pro-

| Device Type | No. Of Pins | M O S | | | | | Bipolar | | | | | | | |
|---|-------------|------------------|-----|----------|-----|----------------|------------------|-------------|-------------|----|----|-----|-----|------|
| | | DLTS | C-t | C-V | I-V | DC | AC | Func-tional | Func-tional | AC | DC | I-V | C-V | DLTS |
| | | | | | | | | | | | | | | |
| Diodes ● Junction ● Schottky ● MIS | 2 | HP 4280A | | | | | HP 4280A | | | | | | | |
| | | HP 4274A/4275A | | HP 4140B | | HP 4274A/4275A | | | | | | | | |
| | | HP 4061A | | | | | HP 4061A | | | | | | | |
| | | HP 4064A | | HP 4064A | | HP 4064A | | | | | | | | |
| Transistor | 4 | HP 4145A | | | | | HP 4145A | | | | | | | |
| | 6/12 | HP 4063A | | | | | HP 4063A | | | | | | | |
| Test Pattern | 12-48 | HP 4145A /4085M | | | | | HP 4145A /4085M | | | | | | | |
| | | HP 4062B | | HP 4062B | | HP 4062B | | | | | | | | |
| ICs | 12-128 | HP 81800S | | | | | HP 81800S | | | | | | | |
| | | HP 9430 (Memory) | | | | | HP 9430 (Memory) | | | | | | | |

Table 3. HP Semiconductor-measurement instruments by device and measurement type.

vided by HP parametric testers can help improve processes and raise yields.

Parametric measurements are generally divided into capacitance (C) and DC, AC, and functional measurements. The following summarize each type of measurement.

1. Capacitance measurements include, primarily, capacitance vs voltage (C-V), capacitance vs time (C-t) and deep-level transient spectroscopy (DLTS) measurements. These capacitance measurements require correct measurement timing and good capacitance measurement resolution.

2. DC measurements measure the DC current vs voltage (I-V). DC parameter evaluation is based on I-V curve evaluation (eg. threshold voltage, breakdown voltage, leakage current). These measurements require high speed and resolution.

3. AC measurements evaluate the dynamic characteristics of the semiconductor device. With a digital IC, timing measurements such as rise time and propagation delay are the primary ones, so timing resolution is important. Determining the AC gain characteristics of linear ICs requires a wide dynamic range over a wide frequency band.

4. Functional testing evaluates the input/output operation and digital characteristics of semiconductor devices, especially logical devices. This measurement creates an input/output truth table and determines whether the desired output is attained or not.

Table 3 shows HP's semiconductor parametric-test line according to the purpose of the device being measured.

Table 4 shows the parametric measurements required by each application area, with the HP parametric-measurement products that apply.

| | | Lab/R&D | | | Production | | User |
|--------------|-------------|---------------------|---------------------|----------------|---------------------|---------------------------|---------------------|
| | | Base Technology | Process Development | Circuit Design | Process Engineering | Testing/Quality Assurance | Incoming Inspection |
| C | C-V | • | • | | • | | |
| | C-t | • | • | | | | |
| | DLTS | • | • | | | | |
| D | I-V | • | • | • | • | | |
| | Parameter | • | • | • | • | • | |
| AC Parameter | | | | • | • | • | |
| Functional | | | | • | • | • | |
| Instruments | C-V | HP 4274A/4275A | HP 4280A | | | | |
| | | HP 4140B | HP 4145A | | | | |
| | | HP 4141B | HP 4141B | | | | |
| | I-V | HP 4145A & HP 4085M | HP 4061A | | | | |
| | | HP 4063A | HP 4063A | | | | |
| Systems | I-V/ C-V | HP 4064A | HP 4064A | | | | |
| | | HP 4062B | HP 4062B | | | | |
| | Functional | HP 81800S | HP 81800S | | | | |
| | | HP 9430 (Memory) | HP 9430 (Memory) | | | | |

Table 4. Measurements and HP instruments/systems by application area.

CAD Software for Parameter Extraction

HP recently introduced TECAP (Transistor Electrical Characterization and Analysis Program), used with the company's parametric-measurement equipment. This software package greatly simplifies the task of using mathematical models in circuit design. It measures real devices and computes the parameters needed for circuit-simulation programs such as SPICE.

Semiconductor Productivity Network (SPN)

HP is a leading supplier of automation systems to semiconductor manufacturers. SPN is made up of modules of software and hardware for applications such as WIP tracking, engineering data collection and analysis, process control, planning, accounting, and other functions. A new module, TC-10, collects and formats tester data for the SPN engineering-analysis system to help improve process and product quality.

Digital Circuit Test and Memory Test

The HP 81800S Digital Circuit Test System and the new HP 9430 Memory Test System logically complement the line of semiconductor test equipment described earlier. Thus one can choose a dedicated system to optimize the measurement tasks.

Digital Circuit Test System

Digital circuit complexity ranges from simple logic gates to PC-board systems of large computers. Irrespective of the application and complexity, all digital circuit blocks can be characterized by their logic function and their input and output parameters.

The HP 81800S represents a high speed, high performance hardware verification system for digital ICs. It includes stimulus and response units, standard HP controller, software, testhead and a comprehensive set of accessories. Thus it enables its users to characterize individual circuits by analyzing the response to specific stimulation.



HP 81800S Digital Circuit Test System

In addition to testing the logic function, specific to each digital circuit type, it also measures the physical parameters which apply to all circuits. These parameters include

- setup times,
- hold times,
- propagation-delay times, and
- signal levels/glitches.

The HP 81800S system is optimized to perform "at-speed" functional and AC-parametric tests, due to its high data rate (50 MHz) and its high resolution (100 ps, 10 mV).

VLSI characterization. With the design cycles for VLSI circuits, custom ICs, semi-custom ICs and gate arrays being decreased considerably, the immediate design verification and testing of prototypes can cause bottlenecks in the design cycle. The HP 81800S benchtop system, incorporating a simple operating concept combined with software routines for measurement automation, fits exactly in engineering applications.

Volume Testing. High speed and low test cost are conflicting demands for volume testing of commodity devices as fast as SSI and MSI circuits. The HP 81800S' test head, compatible with standard industry handlers and wafer probers, provides clean DUT interfacing. Its configurability for both high

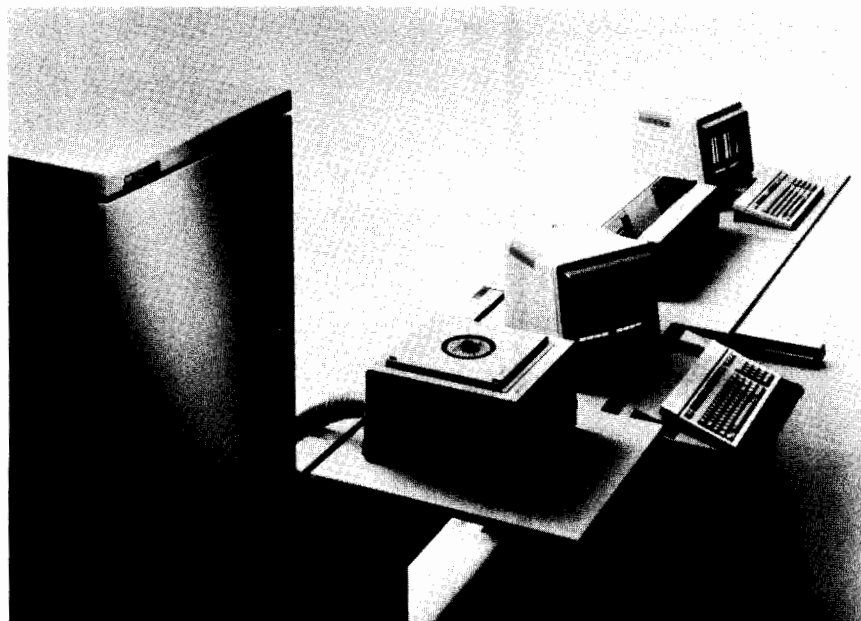

HP 9430 Memory Test System

and low pin counts, coupled with fast set-up times, optimizes equipment investment, while the high system data rate of 50 MHz successfully addresses the speed issue.

HP 9430 Memory Test System

Based on Hewlett-Packard's traditional expertise in designing and manufacturing of ICs, high-quality test equipment and computers, the new HP 9430 Memory Test System was created. It is a general-purpose memory tester that provides a versatile and economical solution for testing the most common memory devices in manufacturing and incoming inspection. The system makes major hardware and software contributions in concert with flexibility for changing device complexity.

Design Goals. In addition to quality and compactness, high performance and a convenient user interface were primary design goals for the HP 9430.

Built-in quality ranges from the system's careful design to comprehensive production-test procedures. As result, a one year interval for calibration and preventive maintenance provide maximum up-time of the HP 9430.

Compactness refers to both the system's small footprint due to the single card-cage design, and its autonomy due to the integrated system computer and disc mass storage. The HP 9430 is a complete stand-alone tester, independent from an external host.

Even in networked configurations, there is the benefit of off-loading the host, thus improving the overall network performance. The built-in controller, furthermore, allows simultaneous operation of up to four workstations. Programs can be developed or edited even while devices are being tested.

Excellent pulse performance and timing accuracy lead to more thorough and precise memory characterization for improved yields and also help optimize test strategies and processes. The HP 9430 has a driver/comparator skew of better than ± 400 ps and edge placements within ± 600 ps. In conjunction with its sustained long-term stability,

the system helps to improve yield and throughput.

The HP 9430's extremely versatile algorithmic pattern generator produces virtually any pattern at a 10-MHz cycle rate. The system has an expandable modular design, so that upgrading to a 16-Mword address range or to 12 data/8 clock channels is easy.

Software Architecture. To improve engineering productivity, the HP 9430's modular and application-oriented software speeds up the learning curve and reduces to 50 percent or better the test-programming effort required to reach test execution.

By means of individual modules, the various tasks for developing test programs are logically grouped together. This means that test parameters for pin assignment, pattern types, timing information and descrambling data are set up in independent editors. They form easy-to-handle and universal building blocks for faster program generation and better readability. In addition, they can be used repeatedly when creating new test programs and can simplify the adaptation to different device types.

Application-oriented programming sets the user free from the burden of learning tester-specific codes. Functional and device-related terms are used instead. Program development at the application level greatly increases engineering efficiency.

Hardware simulation techniques eliminate the need to have actual access to the tester hardware when debugging files. Thus the user can stay in the software environment much longer before tester hardware resources need to be used.

An interactive debugger acts as a further time saver because program modifications can be carried out without time-consuming recompilation of the entire program.

The HP 9430 Memory Test System combines excellent accuracy and long-term stability with high software productivity, leading to more dependable test results and data correlation and increased engineering productivity. Thus the user company becomes more cost effective and competitive.



COMPONENT & SEMICONDUCTOR MEASUREMENT

Impedance/Gain-Phase Analyzer

Model 4194A

- Flexible Measurement, Computation and Analysis Capabilities on a Color Graphic Display
- Fully Programmable
- High Accuracy and Wide Range
 Impedance Measurement:
 100Hz to 40MHz, 0.1mohm to 1.6Mohm, 0.17%
 Gain-Phase Measurement:
 10Hz to 100MHz, -107dBm to +15dBm, 0.1dB
 resolution

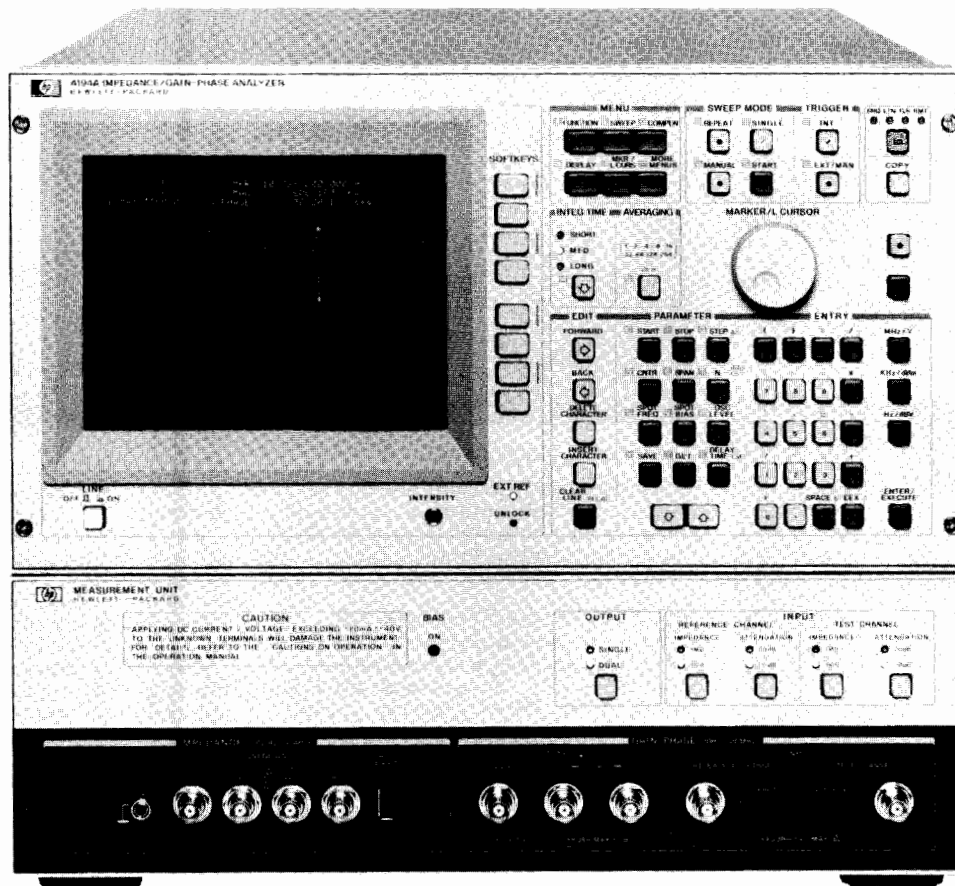

HP 4194A



Description

The HP 4194A Impedance/Gain-Phase Analyzer is an integrated solution for efficient measurement and analysis or go/no-go testing of components and circuits. Detailed impedance and transmission characteristics including secondary parameter derivations can be simply and quickly evaluated or tested. The HP 4194A can contribute to improving engineering productivity and reducing test cost. The analyzer is flexible and has wide measurement capabilities in both impedance and transmission measurements, plus it is fully programmable using Auto Sequence Programming (ASP). Desired measurements and computations, including graphics analysis, can be programmed simply by storing front panel keystroke operations, allowing you to customize measurement, computation and analysis functions. The HP 4194A also features high accuracy and error elimination functions to ensure reliable measurements.

Wide Range Accurate Measurement

Featuring a wide test frequency range of 100Hz to 40MHz for impedance measurements and 10Hz to 100MHz for gain-phase measurements, the HP 4194A will satisfy a wide spectrum of needs. You can perform device measurements under actual operating conditions by varying the test frequency, test signal level, and dc bias. You can improve the quality of your devices with the HP 4194A's accurate measurements.

Quick Analysis

The HP 4194A makes high speed measurements, (approximately 4.5ms per point), displays results on a color CRT, and performs parameter analysis of components and circuits quickly and efficiently; substantially reducing development and evaluation time. The analysis function not only provides you with impedance and transmission characteristics, but also allows you to determine secondary parameters. Using the marker and line cursor functions, you can obtain the resonating frequency of resonators and the pass band width of band pass filters quickly. Additionally, the equivalent circuit analysis function allows you to obtain the four equivalent circuit element values of a piezoelectric resonator or the self-inductance, lead reactance, and stray capacitance of inductors.



Easy Operation and Expandability

The HP 4194A has been designed to enhance user productivity through ease of operation. Device evaluation, from measurement and graphics display to analysis and hardcopy, can be performed with a few keystrokes. To control the analyzers measurement, analysis, and other functions without the aid of an external controller, the HP 4194A is equipped with an Auto Sequence Program (ASP) function. Program creation and editing can be accomplished quickly and easily with HP 4194A's front panel keys. Additionally, you can use the ASP to develop your own functions, such as alternating the sweep to evaluate filters, finding the 3dB pass band width of a band pass filter, and also to make automatic measurements.

Specifications

Impedance Measurements

Measurement Parameters: $|Z|$, $|Y|$, θ , R, X, G, B, L, C, D, Q. 20 parameter combinations are available.

Test Frequency: 100Hz - 40MHz (CABLE LENGTH: 0m), 100Hz - 15 MHz (CABLE LENGTH: 1m), 1mHz resolution.

OSC Level: 10mV - 1Vrms (≤ 10 MHz), 10mV - 0.5Vrms (> 10 MHz) (UNKNOWN terminal open), 0.1dB (about 1%) resolution

DC Bias: 0 - ± 40 V, 10mV resolution

Measurement terminal: 4 - terminal pair configuration

Auto Zero Compensation: Automatic compensation for residual impedance and stray admittance of a test fixture.

Measurement Range and Maximum Resolution:

| Measurement Parameter | Range | Max Resolution |
|-----------------------|-----------------------------------|-----------------|
| Z , R, X | 100 $\mu\Omega$ to 1.6 M Ω | 100 $\mu\Omega$ |
| Y , G, B | 1 nS to 10 S | 1 nS |
| θ | $\pm 180^\circ$ | 0.01 $^\circ$ |
| L | 100 pH to 1 KH | 100 pH |
| C | 0.1 fF to 10 mF | 0.1 fF |
| D | 0.0001 to 10 | 0.0001 |
| Q | 0.1 to 1000 | 0.1 |

Basic Measurement Accuracy: 0.17%

Level Monitor: Monitor test voltage across and current through the DUT

Gain-Phase Measurements

Measurement Parameters: Tch/Rch (dB, Linear Ratio), Tch, Rch (V, dBm, dBV), θ (degree, rad), τ

Tch = Test Channel, Rch = Reference Channel, τ = Group Delay

Measurement Frequency: 10Hz - 100MHz, 1mHz resolution

Aperture Frequency Range (Group Delay Measurements): 0.5% - 100% of frequency span

OSC Level: -65dBm - +15dBm, 0.1dB resolution

Measurement Range:

Tch/Rch: 0 - ± 120 dB, 0.001dB resolution

Tch, Rch: -107dBm - -5dBm (0dB Attenuator)
-87dBm - +15dBm (20 dB Attenuator)
0.001dB resolution

θ : $\pm 180^\circ$ (can display phase continuously with the phase scale expansion function), 0.01 $^\circ$ resolution

τ : 0.1ns - 1s, 0.1ns resolution

Basic Measurement Accuracy:

Tch/Rch: 0.1dB, 0.5 $^\circ$

Tch, Rch: 0.35dBm

θ : 0.5 $^\circ$

Level Monitor: Monitor the input level of the Rch and Tch in units of dBm, dBV and Volts.

Common Specifications

Trigger Mode: Internal, External and Manual

Sweep Capability:

Sweep Parameter: Frequency, OSC Level, DC Bias (impedance measurements only)

Entry: START/STOP or CENTER/SPAN

Sweep Type: LIN, LOG, ZERO SPAN (DC Bias: LIN or ZERO SPAN only)

Number of Measurement Points: 2 to 401 points

Sweep Functions: Partial Sweep, Expand Markers Sweep, Program Points Measurement

Display

CRT: 7.5 inch color CRT

Display Mode: Rectangular (X-A & B), Rectangular (A-B), Table

Display Control: Autoscale, Superimpose and Storage

Analysis

Maker: Single, Delta, Double Makers

Line-Cursor: Line-Cursor, Delta-Line Cursor

Equivalent Circuit Function: Approximation, Simulation

Arithmetic Operation

Data Register Manipulation: Use arithmetic operations and functions to manipulate data registers.

GO/No-Go Limits

Programming

Auto Sequence Program (ASP): Control the HP 4194A's operation with an internal program language. ASP Programs can be entered using the front panel keys or downloaded from HP-IB.

Program Memory Size: 20kBytes of non-volatile memory

Copy: Dump, Plot, Print Mode

Save/Get: Save up to five kinds of data and measurement conditions in non-volatile memory.

General Specifications

Operating Temperature and Humidity: 0 $^\circ$ C - 40 $^\circ$ C, $\leq 95\%$ RH at 40 $^\circ$ C

Storage Temperature: -30 $^\circ$ C - +60 $^\circ$ C

Safety: Based on IEC - 348, UL - 1244

Power: 100, 120, 220V $\pm 10\%$, 240V - 10% + 5%, 48 - 66Hz, 400VA (max)

Dimensions: 425 (W) x 375 (H) x 620(D) mm

Weight: Approximately 37kg (net)

Reference Data

Typical Measurement Speed:

Impedance: Approximately 4.5ms/point

Gain-Phase: Approximately 4ms/point

Accessories Furnished

HP 16047D: Direct Coupled Test Fixture

HP 8120-1838: 30cm BNC Cable (2ea) (OPT.350)

HP 04194-61640: 30cm BNC Cable (2ea) (OPT.375)

HP 8120-1839: 60cm NNC Cable (OPT.350)

HP 04194-61641: 60cm NNC Cable (OPT.375)

HP 1250-0080: BNC Adapter

Accessories Available

HP 16085A: Terminal Adapter, used with HP 16092A, \$380

HP 16093A/B or HP 16451A.

HP 16086A: Accessory Kit \$1,450

HP 16092A: Spring Clip Fixture \$420

HP 16093A/B: Binding Post Fixture \$160/170

HP 16034B: Test Fixture for Chip Component (<3MHz) \$320

HP 16047A: Direct Coupled Test Fixture (≤ 13 MHz) \$210

HP 16047C: Direct Coupled Test Fixture \$270

HP 16048A: Test Leads with BNC Connector (≤ 15 MHz) \$250

HP 16048B: Test Leads with RF Miniature (≤ 15 MHz) \$250

HP 16048C: Test Leads with Alligator Clips (<100kHz) \$330

HP 16065A: External Bias Fixture (± 200 VDC, ≤ 2 MHz) \$700

Ordering Information **Price**

4194A Impedance/Gain-Phase Analyzer \$19,800

Opt 350*: 50 Ohm System \$0

Opt 375*: 75 Ohm System \$0

Opt 001: High Stability Frequency Reference \$800

*Must select either OPT.350 or 375

COMPONENT & SEMICONDUCTOR MEASUREMENT

LF Impedance Analyzer (5 Hz to 13 MHz)

Model 4192A

- 5 Hz to 13 MHz variable measuring frequency
- Gain-phase measurement: amplitude, phase, group delay
- Floating or grounded devices
- Impedance measurement: $|Z|$ • $|Y|$ • θ • R • X • G • B • L • C • D • Q • Δ • $\Delta\%$
- Standard HP-IB

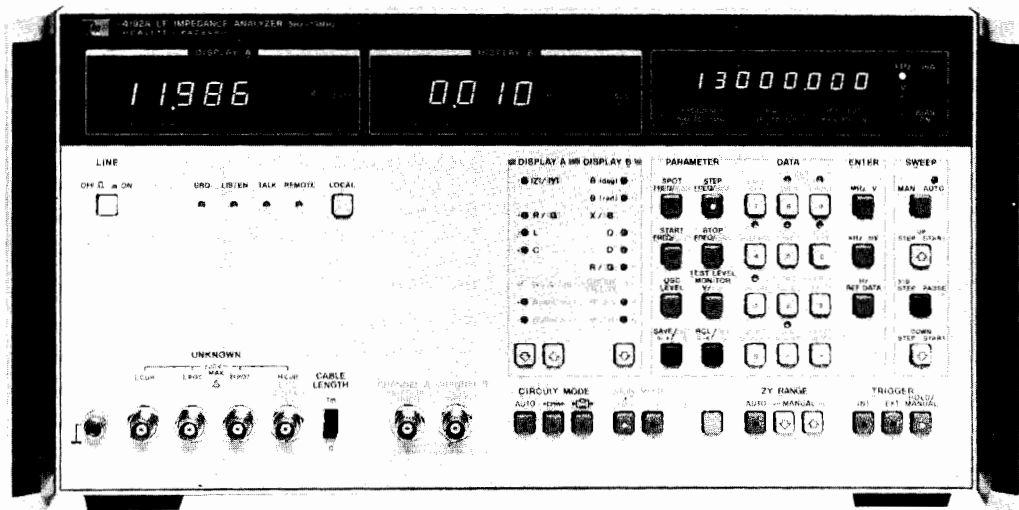

HP 4192A (shown with Opt. 907 handles)



Description

The HP 4192A LF Impedance Analyzer performs both network analysis and impedance analysis on devices such as telecommunication filters, audio/video electronic circuits, and basic electronic components. Both floating and grounded devices can be tested.

Automatic Swept Frequency Measurement of All Impedance Parameters

The HP 4192A can measure 11 impedance parameters ($|Z|$, $|Y|$, θ , R, X, G, B, L, C, D, Q) over a wide range $|Z|$: 0.1 m Ω to 1 M Ω ; $|Y|$: 1 nS to 10 S).

The built-in frequency synthesizer can be set from 5 Hz to 13 MHz with a maximum resolution of 1 mHz. This feature allows accurate characterization of high Q devices such as crystals. Test signal level is variable from 5 mV to 1.1 V with 1 mV resolution. Also, an internal dc bias voltage source provides ± 35 V at 10 mV increments. Thus, the HP 4192A can evaluate components and entire circuits near actual operating conditions.

Specifications (complete specifications on data sheet)

Measuring signal (23 $\pm 5^\circ$ C)

Frequency range: 5 Hz to 13 MHz

Frequency step: 0.001 Hz (5 Hz to 10 kHz), 0.01 Hz (10 kHz to 100 kHz), 0.1 Hz (100 kHz to 1 MHz), 1 Hz (1 MHz to 13 MHz).

Frequency accuracy: ± 50 ppm

OSC level: 5 mV to 1.1 Vrms variable into 50 Ω (amplitude-phase measurement) or open circuit (impedance measurement).

OSC level step: 1 mV (5 mV to 100 mV), 5 mV (100 mV to 1.1 V).

OCS level accuracy: 5 Hz to 1 MHz: $\pm(5 + 10/f)\%$ of setting ± 2 mV where f is in Hz. 1 MHz to 13 MHz: $\pm(4 + 1.5 \times F)\%$ of setting ± 2 mV where F is in MHz.

Level monitor (impedance measurement): current through or voltage across sample can be monitored

Control: spot and sweep via front panel or HP-IB

Measuring Mode

Spot measurement: at specific frequency (or dc bias)

Swept measurement: manual or automatic sweep from START to STOP frequency (or dc bias) at selected STEP frequency (or dc bias) rate

Sweep mode: linear or logarithmic (frequency only)

Recorder outputs: output dc voltage proportional to each measured value, and frequency or dc bias.

Maximum output voltage: ± 1 V

Output voltage accuracy: $\pm 0.5\%$ of voltage ± 20 mV

Key status memory: 5 sets of measuring conditions can be stored and recalled at any time.

HP-IB data output and remote control: standard

Self-test: automatic introspective testing

Trigger: internal, external or manual

Amplitude—Phase Measurement

Parameter measured: relative amplitude B-A (dB) and phase θ (degrees or radians), B-A and group delay, absolute amplitude A (dBm or dBV) or B (dBm or dBV), and deviation (Δ , $\Delta\%$) of all parameters

Reference amplitude: 0 dBV = 1 Vrms, 0 dBm = 1 mW (with 50 Ω termination)

OSC output resistance: 50 Ω

Channels A and B: input impedance: 1 M Ω $\pm 2\%$, shunt capacitance: 25 pF ± 5 pF

Display Range and Resolution

B-A: 0 to ± 100 dB*, 0.001 dB (0 to ± 20 dB), 0.01 dB (± 20 to ± 100 dB)

θ : 0 to $\pm 180^\circ$, 0.01 $^\circ$

Group delay: 0.1 ns to 19 s, max. resolution 4½ digits

A or B: $+0.8$ to -100 dBV*, 0.001 dB (> -20 dB), 0.01 dB (≤ -20 dB), $+13.8$ to -87 dBm, 0.001 dB (> -20 dBm), 0.01 dB (≤ -20 dBm)

Measuring accuracy (23 $\pm 5^\circ$ C): specified at BNC unknown terminals after 30 minute warmup (test speed: normal or average)

B-A (relative amplitude) and θ (phase) Measurement

Determined by sum of channel A and B accuracies given below (accuracy of each channel changes according to absolute input level)

*Accuracy of relative and absolute gain measurements is specified from 0 dB to ± 80 dB.

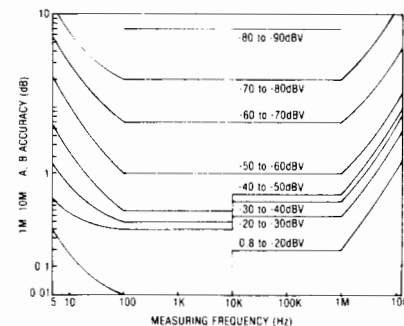

FIGURE 1: GAIN MEASUREMENT ACCURACY

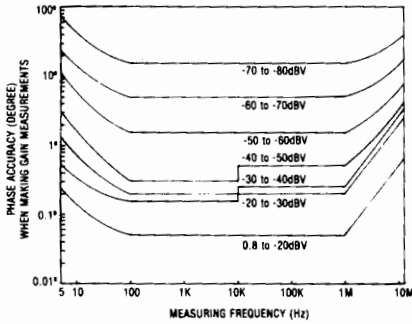

FIGURE 2: PHASE ACCURACY WHEN MAKING GAIN MEASUREMENTS

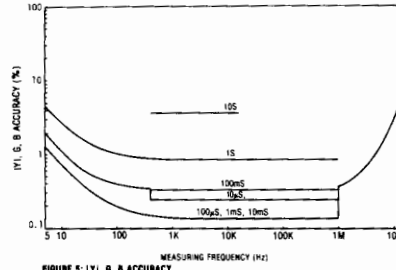

FIGURE 5: |Y|, G, & ACCURACY

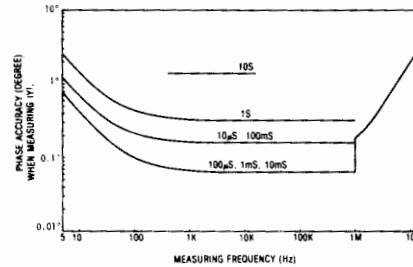

FIGURE 6: PHASE ACCURACY WHEN MEASURING |Y|

Impedance Measurement

Parameter measured: $|Z| - \theta$, $|Y| - \theta$, R-X, G-B, L-D • Q • R • G, C-D • Q • R • G and deviation (Δ , $\Delta\%$) of all parameters

Display: 4½ digits, max. display 12999 counts, 19999 for L & C.

Circuit mode: series equivalent circuit (—□—) and parallel equivalent circuit (—□—). Automatic selection available.

Auto ZERO adjustment: automatic normalization of the readout offset due to residuals of the test fixture by pushbutton operation (at spot frequency)

Measuring range and accuracy ($23 \pm 5^\circ\text{C}$): specified at BNC unknown terminals after 30 minute warmup when OSC level is more than 0.1 V and when auto ZERO adjust is performed (test speed: normal or average). Accuracy given below is only valid when the measured value is equal to full scale of each range.

$|Z| - \theta$, R - X measurement: range: $|Z|$, R, X: 0.1 m Ω to 1.2999 M Ω ; θ : -180.00° to $+180.00^\circ$. Accuracy: R accuracy ($D \geq 10$); X accuracy ($D < 1$)

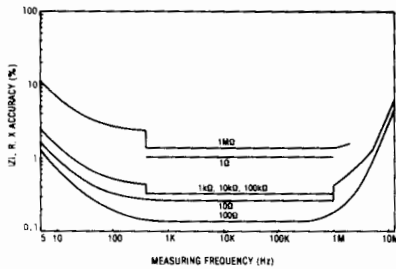

FIGURE 3: |Z|, R, X ACCURACY

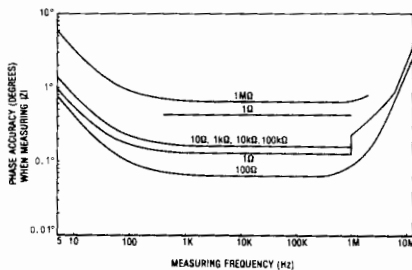

FIGURE 4: PHASE ACCURACY WHEN MEASURING |Z|

$|Y| - \theta$, G - B measurement: range: $|Y|$, G, B: 1 nS to 12.999 S; θ : -180.00° to $+180.00^\circ$. Accuracy: G accuracy ($D > 1$); B accuracy ($D \leq 0.1$).

L - D • Q, C - D • Q measurement: (automatically calculated from measured Z/Y values)

| Parameter | Measuring Range* | Basic Accuracy |
|-----------|-------------------|--|
| L | 0.01 nH to 1000 H | 0.27% |
| C | 0.1fF to 199** mF | 0.15% |
| D(1/Q) | 0.0001 to 19.999 | 0.001 (C-measurement) 0.003 (L-measurement) |

*Varies with measuring frequency except for D(1/Q)

**Accuracy of C ranges over 100 mF is not specified.

Internal dc bias: standard (impedance measurement only)

Voltage range: -35 V to $+35\text{ V}$, 10 mV step

Setting accuracy ($23 \pm 5^\circ\text{C}$): 0.5% of setting + 5 mV

Bias control: spot and swept, using front panel controls or HP-IB

General

Measuring Time (high speed mode)

B-A and θ , A or B: 88 to 127 ms ($\geq 400\text{ Hz}$)

Impedance parameters: 58 to 91 ms ($\geq 1\text{ kHz}$)

Test Level Monitor Range (impedance measurement)

Voltage: 5 mV to 1.1 V

Current: 1 μA to 11 mA

Operating temperature: 0 to 55°C , $\leq 95\%$ RH at 40°C

Power: 100, 120, 220 V $\pm 10\%$, 240 V + 5% to -10% , 48 to 66 Hz, 150 VA max.

Size: 425.5 mm W x 235 mm H x 615 mm D (16.75" x 9" x 22.6").

Weight: approx. 19 kg (41.9 lb)

Furnished accessories and parts: HP 16047A test fixture, HP 11048C 50 Ω feed thru terminations (2 ea.), power splitter, HP 11170A BNC cables (2 ea.), BNC adapter

Accessories available

HP 16095A Probe Fixture

HP 16096A 2-port Component Test Fixture

HP 16097A Accessory Kit

HP 16047C Test Fixture

HP 16048B Test Leads (miniature connector)

HP 16048C Test Leads with alligator clip

HP 4274A/4275A's test fixtures/leads are usable with

HP 4192A

Price

\$450

\$900

\$1,500

\$270

\$250

\$330

HP 4192A LF Impedance Analyzer

\$11,590

COMPONENT & SEMICONDUCTOR MEASUREMENT

RF Impedance Analyzer

Model 4191A

- 1-1000 MHz variable test frequency with sweep capability
- Direct reading of $|Z| - \theta$, $|Y| - \theta$, $|\Gamma| - \theta$;
L • C - R • G • D • Q
R - X, G - B, $\Gamma_x - \Gamma_y$
- High resolution—4½ digit max
- Wide measuring range—1 m Ω - 100 k Ω ($|Z|$)
- Versatile, easy-to-use test fixtures

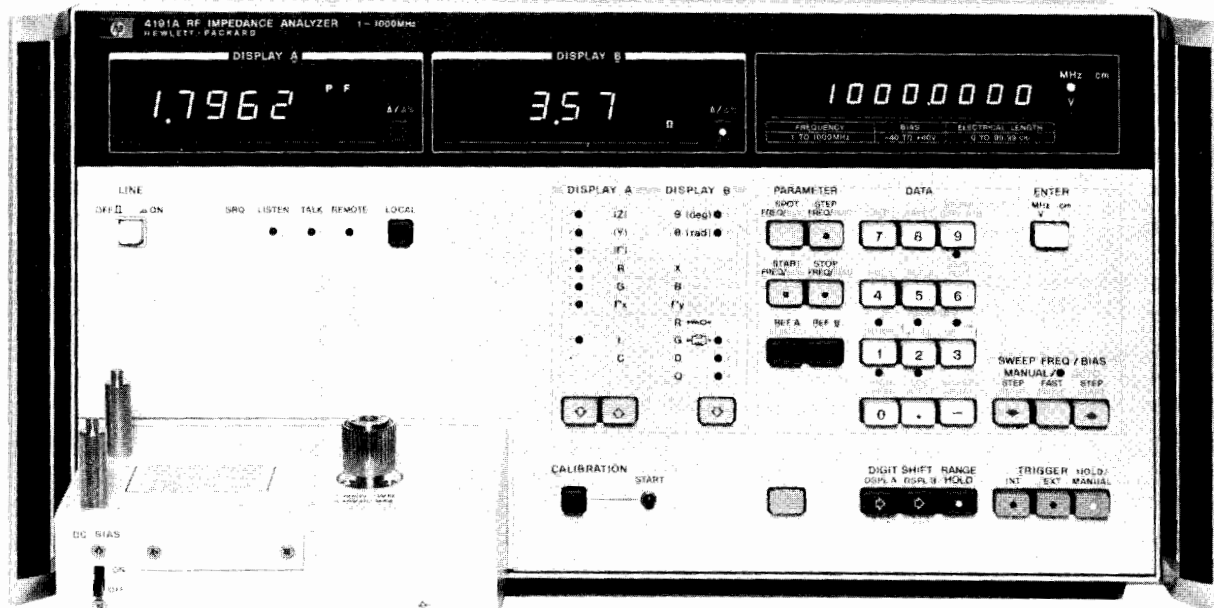

HP 4191A (Shown with Opt 907 Handles)



Description

The HP 4191A RF Impedance Analyzer measures 14 parameters with a maximum resolution of 4½ digits. The internal synthesizer provides variable frequencies from 1 MHz through 1000 MHz covering the UHF, VHF and video bands with automatic sweep capability. An internal dc bias supply with auto sweep function covers the voltage range of ± 40 V in 10 mV steps.

The HP 4191A permits reliable measurements over a wide measuring range. Its outstanding repeatability, frequency response and accuracy are made possible by unique error correction capability and specially designed test fixtures. These features allow the HP 4191A to be used in evaluation of electronic materials, components and circuitry.

The internal synthesizer provides a maximum resolution of 100 Hz (Opt 002) with an accuracy of 3 ppm, allowing small changes in the resonant frequency of the device under test to be easily detected. The swept frequency capability aids in the analysis of frequency characteristics of the device.

Two complete front panel settings (parameter selection and the sweep control) can be stored in a non-volatile memory and recalled at any time with a single key operation. This, together with the standard HP-IB interface, makes the HP 4191A extremely efficient either as a stand-alone or systems instrument.

These unique features permit very wide applications in: (1) semiconductor testing such as surface state evaluation at high frequencies (C-V/G-V and conductance G/ω - ω) characteristics), and the input/output impedance evaluation of diodes and transistors, (2) resonator, filter, and magnetic and dielectric materials testing, (3) evaluation of LCR components such as high frequency chip and leaded components, and (4) testing of communications related components such as cables, connectors, etc.

Specifications

Parameter measured: $|Z| - \theta$, $|Y| - \theta$, $|\Gamma| - \theta$

R - X, G - B, $\Gamma_x - \Gamma_y$

L - R • G • D • Q, C - R • G • D • Q

Display: 4½ digit, max display 19999 counts

Deviation Measurement (deviation from stored reference)

Δ : -19999 to +19999 counts

$\Delta\%$: -1999.9 to +1999.9%

Measuring Signal ($23 \pm 5^\circ\text{C}$)

Frequency range: 1 MHz to 1000 MHz

Frequency step: Standard: 100 kHz, 1-500 MHz
200 kHz, 500-1000 MHz

Opt 002: 100 Hz, 1-500 MHz

200 Hz, 500-1000 MHz

Frequency accuracy: ± 3 ppm

Signal level (into 50 Ω): -20 ± 3 dBm

Frequency control: spot and swept

Measuring Mode

Spot measurement: at specific frequency (or dc bias)

Swept measurement: manual or automatic sweep from start to stop frequency (or dc bias) at step frequency (or dc bias) rate in linear or logarithmic form.

Auto Calibration

Automatic error compensation referenced to connected terminations (0 Ω , 50 Ω , 0 S)

Calibration frequency: 51 frequencies including start and stop frequencies.

Electrical length compensation: automatic compensation for electrical length of test fixtures.



Compensating range: 0 to 99.99 cm.

DC Bias

Internal dc Bias

Voltage range: -40 to +40 V, 10 mV step

Setting accuracy: 0.1% of setting +10 mV

Bias control: spot and swept

External dc Bias

Voltage range: -40 to +40 V

Max allowable current: 100 mA

Key status memory: 2 sets of measuring conditions can be stored and recalled at any time. These conditions are kept in storage even when LINE is turned off.

Ranging: Auto/Range hold

Trigger: Internal, External or Manual

Self-test: automatic internal program test

HP-IB data output and remote control: standard

Measuring Range, Resolution and Accuracy

Specified at APC-7 UNKNOWN connector for reflect coefficient measurement at measuring frequency and ambient temperature (0 - 55°C) where calibration is performed after the warm-up time of 40 minutes. Refer to General Information for temperature coefficient and typical measuring range/resolution and accuracies of other measuring parameters (see data sheet for detailed specifications).

$|\Gamma| - \Theta/\Gamma_x - \Gamma_y$ Measurement

Measuring Range

$|\Gamma|, \Gamma_x, \Gamma_y$: 0.0001 to 1.0000

Θ : 0° to $\pm 180.00^\circ$ (0 to $\pm \pi$ rad.)

$|\Gamma|, \Gamma_x, \Gamma_y$ resolution: 0.0001

**REFERENCE DATA (NOT SPECIFIED)
TYPICAL ACCURACY**

Y(S) Z(Ω)

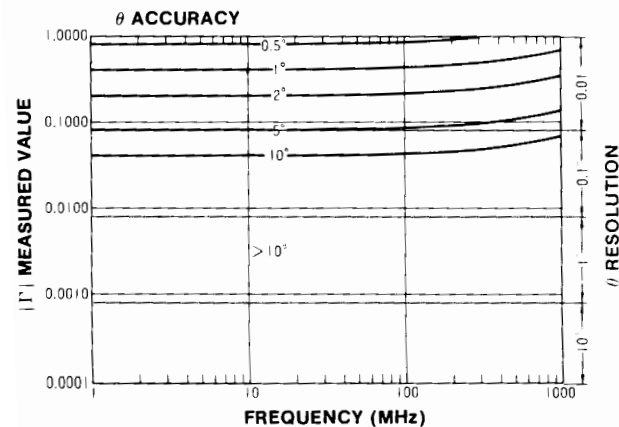
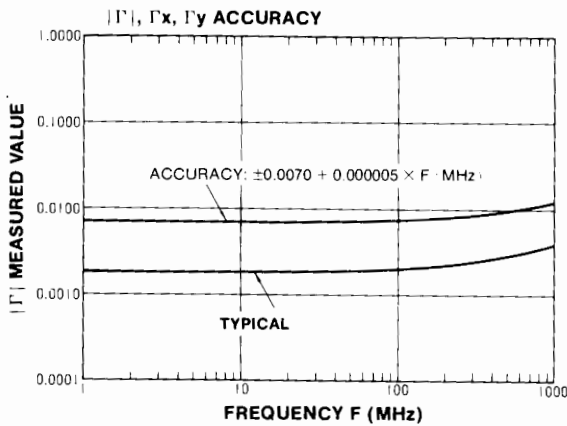
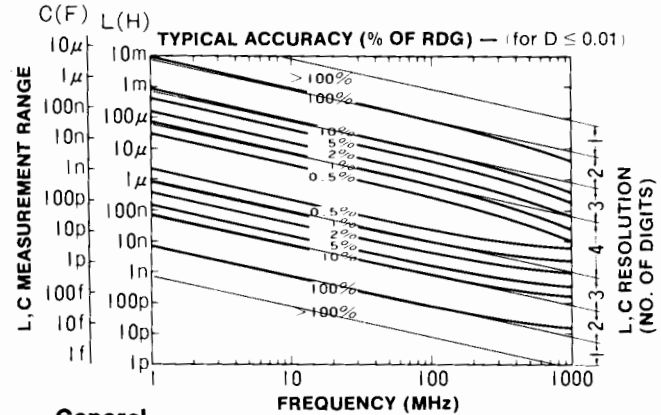
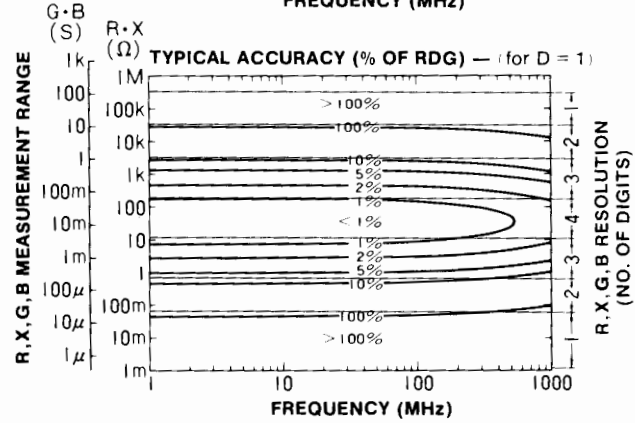
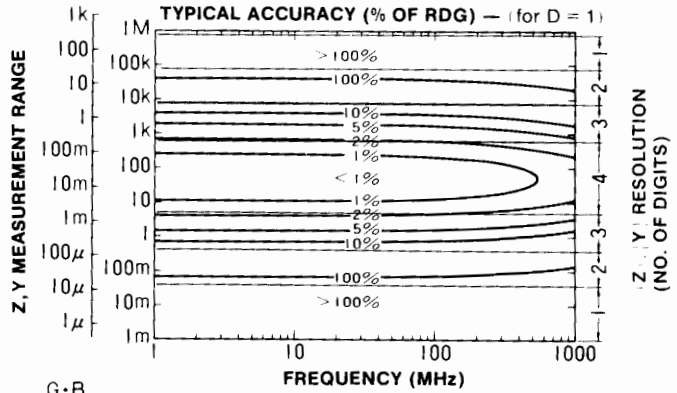

General

Temperature coefficient for $|\Gamma|$: 0.0001/°C (23 ± 5°C)

Measuring time: <800 ms or <250 ms (high speed mode)

Frequency switching time: ≤ 200 ms

Temperature: 0 - 55°C, < 95% RH

Power: 100, 120, 220 V ± 10%, 240 V + 5% - 10%, 48 - 66 Hz, 150 VA max.

Size: 425.5 mm W x 230 H x 574 mm D (16.75" x 9" x 22.6")

Weight: approx. 24 kg (52.8 lb)

Accessories furnished: accessory case (with reference terminations included).

Accessories Available

| Accessories Available | Price |
|-------------------------------------|-------|
| HP 16091A Coaxial Test Fixture | \$430 |
| HP 16092A Spring Clip Test Fixture | \$420 |
| HP 16093A Binding Post Test Fixture | \$160 |
| HP 16093B Binding Post Test Fixture | \$170 |
| HP 16094A Probe Fixture | \$140 |

Options

002: 100 Hz/200 Hz resolution synthesizer \$1,650

004: Recorder Outputs \$420

HP 4191A RF Impedance Analyzer \$14,320



COMPONENT & SEMICONDUCTOR MEASUREMENT

Vector Impedance Meter (400 kHz to 110 MHz)

Model 4193A

- 400 kHz to 110 MHz spot or swept frequency
- Measure impedance magnitude (10 m Ω to 120 k Ω) and phase (-180.0° to $+180.0^\circ$)
- Test components in-circuit and out-of-circuit
- Fixtures include low-grounded probe, spring clip fixture and binding post fixture
- Standard HP-IB and analog outputs

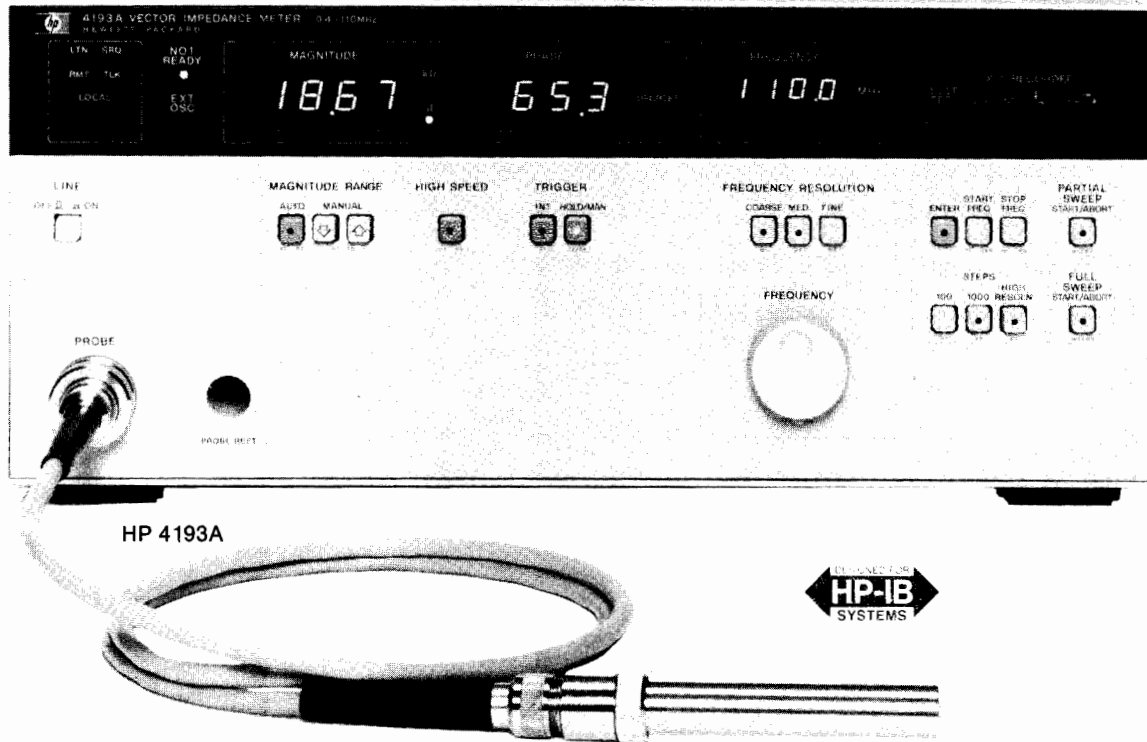

Description

The HP 4193A Vector Impedance Meter measures impedance magnitude and phase. An internal oscillator provides test signals from 400 kHz to 110.0 MHz. The test signal is constant current between 10 μ A and 100 μ A, depending on $|Z|$ range.

Reliable and Accurate Impedance Measurement

The HP 4193A can measure and display impedance magnitudes from 10 m Ω to 120 k Ω . Impedance phase is displayed from $+180.0^\circ$ to -180.0° . Accuracy is as good as 3.0% of reading (magnitude) and 3.2° (phase).

Also, the HP 4193A's $3\frac{1}{2}$ digit resolution makes it easy to see small changes in measurement results during adjustment procedures, for example.

Frequency Sweep for Complex Component Testing

When testing complex components like ceramic resonators, it is useful (1) to sweep frequency to get the big picture and (2) identify critical impedance points such as the series resonant point. This requires both swept measurement and measurements at individual "spot" frequencies. The HP 4193A can do both.

The HP 4193A can be tuned to any individual frequency from 400 kHz to 110.0 MHz with maximum resolution of 1 kHz. If greater frequency resolution is required, it can be provided by connecting an external synthesized source such as the HP 3335A or HP 8656B to the HP 4193A EXT OSC input.

Flexible internal frequency sweep is an exciting HP 4193A feature. Frequency can be swept linearly over any portion of the HP 4193A frequency range—or swept logarithmically over the entire 400 kHz to 110.0 MHz range.

Test In-Circuit and Out-of-Circuit Components

Several test fixtures help adapt the HP 4193A to your device under test. For example, the handy L-ground probe is useful for in-circuit

testing. The HP 16099A Test Fixture Adapter and three associated fixtures help connect to out-of-circuit devices of various sizes and shapes.

Easy to Use—Both Manually and Under HP-IB Control

The HP 4193A front panel is amazingly simple. In just a few minutes you can become an expert operator. This is a big time saver over most other impedance meters which are usually much more difficult to operate. Plus, the HP 4193A has standard HP-IB, making it a good choice for automated testing in R&D, incoming inspection, production and product assurance.

Specifications

Test Signal Output Specifications

Test signal is output from the furnished low-ground probe.

Frequency range: 400 kHz to 110.0 MHz

Frequency Resolution

400 kHz to 9.999 MHz: 1 kHz resolution

10.00 MHz to 99.99 MHz: 10 kHz resolution

100.0 MHz to 110.0 MHz: 100 kHz resolution

Frequency accuracy: $\pm 0.01\%$ of setting after calibration.

Frequency stability: ± 100 ppm per month (0 to 55 $^\circ$ C)

Frequency Control

Spot: spot frequency is set using coarse, medium and fine controls

Full sweep: logarithmic sweep at 43 points over full range of 400 kHz to 110 MHz

Partial sweep: linear sweep from selected START to STOP frequency. Number of steps is selected as 100, 1000 or "HIGH RESOLN". When "HIGH RESOLN" steps are selected, the operator must also select "coarse", "medium" or "fine" resolution.

EXT OSC: increase frequency resolution by connecting an external frequency synthesizer such as the HP 3335A or HP 8656B.

Input signal level: 0 dBm to +5 dBm

Input impedance: 50 ohms ± 10%

Frequency range: 400 kHz to 110 MHz

Test level: constant current source

| Z Range | Current in μA ±20% |
|----------|-----------------------|
| 10 Ω | 100 |
| 100 Ω | 100 |
| 1 kΩ | 100 |
| 10 kΩ | 50 |
| 100 kΩ | 10 |

Impedance Measurement Specifications

Input configuration: low-grounded probe (furnished)

Residual Impedance of Probe (at probe tip)

Resistance: <0.55 Ω

Inductance: <(4.9 + 10/f) nH where f is measuring frequency in MHz

Parallel Capacitance: <0.11 pF

Digital display of impedance: 3½ digits

|Z|: 0 to 1999 counts (0 to 120 counts on 100 kΩ range)

θ: -1800 to +1800 counts (-180 to +180 counts on 100 kΩ range)

Measurement trigger: internal, external, and manual

Measurement range control: auto, hold, and manual

Measurement Range

|Z|: Five decade ranges: 10 Ω, 100 Ω, 1 kΩ, 10 kΩ, 100 kΩ

minimum |Z| (sensitivity): 10 mΩ

maximum |Z|: 120 kΩ

θ: One range: -180.0° to +180.0°

Recorder output: dc voltage proportional to measured |Z|, θ and measurement frequency.

Output voltage: accuracy specification for all recorder output voltages is ±(1% + 20 mVdc)

|Z|: 0 Vdc (0000 display counts) to +1 Vdc (1999 display counts)

θ: -1 Vdc (-180.0°) to +1 Vdc (+180.0°)

Frequency

Full sweep: 0 Vdc (400 kHz) to +1 Vdc (110 MHz), log sweep

Partial sweep: 0 Vdc (START frequency) to +1 Vdc (STOP frequency), linear sweep

HP-IB remote control and data output: standard

Self-test: standard

General Information

Test Signal Output

Frequency settling time: 5 ms to 400 ms. Best case is when (Δf/f)% is less than 10% (below 10 MHz) and less than 1% (above 10 MHz).

Signal Purity

Spurious: -60 dBc (dBc is dB below carrier)

Harmonics: -30 dBc

Residual FM: measured in a 100 Hz band centered on the carrier

400 kHz to 1 MHz: 40 Hz p-pFM

1 MHz to 110 MHz: 100 Hz p-pFM

Impedance Measurement

Measuring speed: assumes range is fixed; recorder output is OFF

HI SPEED: approximately 150 ms per measurement

NORMAL: approximately 1 s per measurement

Ranging time: approximately 400 ms per range plus one measuring interval (e.g., 1 s in normal mode)

Temperature coefficient at 23°C ± 5°C

|Z|: 2 mΩ/°C

θ: 0.02°/°C

|Z| and θ Measurement Accuracy: in the Table below, "f" is in MHz

| Range | Accuracy | Measuring Frequency in Megahertz | | |
|--------------|-------------|---|--|---|
| | | 0.4 | 1 | 10 |
| 10 Ω Range | Z Accuracy | ±[(5.7 + 0.56/f)% rdg + 9 counts] | ±(6.3% rdg + 6 counts) | ±[(4.5 + 0.18f)% rdg + 4 counts] |
| | θ Accuracy | ±(1.7 + 1.8/f + $\frac{35}{ Z \text{ counts}}$) deg | ±(3.3 + 0.20f + $\frac{35}{ Z \text{ counts}}$) deg | |
| 100 Ω Range | Z Accuracy | ±[(2.4 + 0.56/f)% rdg + 4 counts] | ±(3.0% rdg + 4 counts) | ±[(2.6 + 0.037f)% rdg + 4 counts] |
| | θ Accuracy | ±(1.5 + 1.9/f + $\frac{35}{ Z \text{ counts}}$) deg | ±(3.3 + 0.035f + $\frac{35}{ Z \text{ counts}}$) deg | |
| 1 kΩ Range | Z Accuracy | ±[(3.2 + 0.56/f)% rdg + 4 counts] | ±(3.7% rdg + 4 counts) | ±[(2.7 + 0.11f)% rdg + 4 counts] |
| | θ Accuracy | ±(1.6 + 1.8/f + $\frac{35}{ Z \text{ counts}}$) deg | ±(3.3 + 0.11f + $\frac{35}{ Z \text{ counts}}$) deg | |
| 10 kΩ Range | Z Accuracy | ±[(2.9 + 0.56/f)% rdg + 4 counts] | ±[(3.2% + 0.29f)% rdg + 4 counts] | ±[(0.74 + .53f)% rdg + 4 counts] |
| | θ Accuracy | ±(1.8 + 1.9/f + $\frac{35}{ Z \text{ counts}}$) deg | ±(3.1 + 0.53f + $\frac{35}{ Z \text{ counts}}$) deg | ±(8.3 + 0.01f + $\frac{35}{ Z \text{ counts}}$) deg |
| 100 kΩ Range | Z Accuracy | ±[(3.3 + 0.56/f)% rdg + 4 counts] | Not specified | |
| | θ Accuracy | ±(3.0 + 1.9/f + $\frac{35}{ Z \text{ counts}}$) deg | | |

Guideline for Use of the |Z| and θ Accuracy Table

- "f" is in MHz.
- "rdg" is display reading, for example, 50.0 ohms.
- "counts" is display counts in the |Z| display.
- "deg" is degrees of arc.

Example: calculate the |Z| and θ accuracy for a device which gives HP 4193A readings of |Z| = 50.0 Ω and θ = -45.0°. Assume an 0.9 MHz test frequency 100 Ω range, and normal measuring speed.

$$|Z| = 50.0 \Omega \pm [(2.4 + \frac{0.56}{0.9}) \% \text{ of rdg} + 4 \text{ counts}]$$

$$|Z| = 50.0 \Omega \pm [(2.4 + \frac{0.56}{0.9}) * \frac{50.0 \Omega}{100} + 0.4 \Omega]$$

$$|Z| = 50.0 \Omega \pm 1.91 \Omega$$

$$\theta = -45.0^\circ \pm (1.5 + \frac{1.9}{0.9} + \frac{35}{|Z| \text{ counts}}) \text{ deg}$$

$$\theta = -45.0^\circ \pm (1.5 + \frac{1.9}{0.9} + \frac{35}{500}) \text{ deg}$$

$$\theta = -45.0^\circ \pm 3.68^\circ$$

Operating temperature/humidity: 0 to 55°C, ≤95% RH @ 40°C. Note that measurement error in 0°C to 55°C temperature range is typically double the error in the 23°C ± 5°C range.

Power: 100/120/220 V ±10%, 240 V -10% to +5%, 48 to 66 Hz, 150 VA max

Size: 426 mm W x 178 mm H x 498 mm D, (16.75" x 7" x 19.6").

Weight: 18 kg (40 lb)

Accessories furnished: low-ground probe kit includes probe, spare pins, spare clips, BNC adapter, component mounting adapter, probe socket and accessory case.

Accessories Available

HP 16099A Test Fixture Adapter (used with HP 16092A and HP 16093A/B) \$300

HP 16092A Spring Clip Fixture (used with HP 16099A) \$420

HP 16093A Binding Post Fixture (used with HP 16099A) \$160

HP 16093B Binding Post Fixture (used with HP 16099A) \$170

HP 4193A Vector Impedance Meter \$7,380



COMPONENT & SEMICONDUCTOR MEASUREMENT

Multi-Frequency LCR Meters

Models 4274A & 4275A

Model 4274A

- Test frequencies – 100 Hz to 100 kHz
- Test signal level – 1 mV to 5 Vrms
- High resolution – 5½ digit: D=0.00001

- Measure L/C – D/Q/ESR/G; $|Z| - \theta$, R-X/B/L/C; Δ LCRZ, $\Delta\%$
- 0.1% basic accuracy

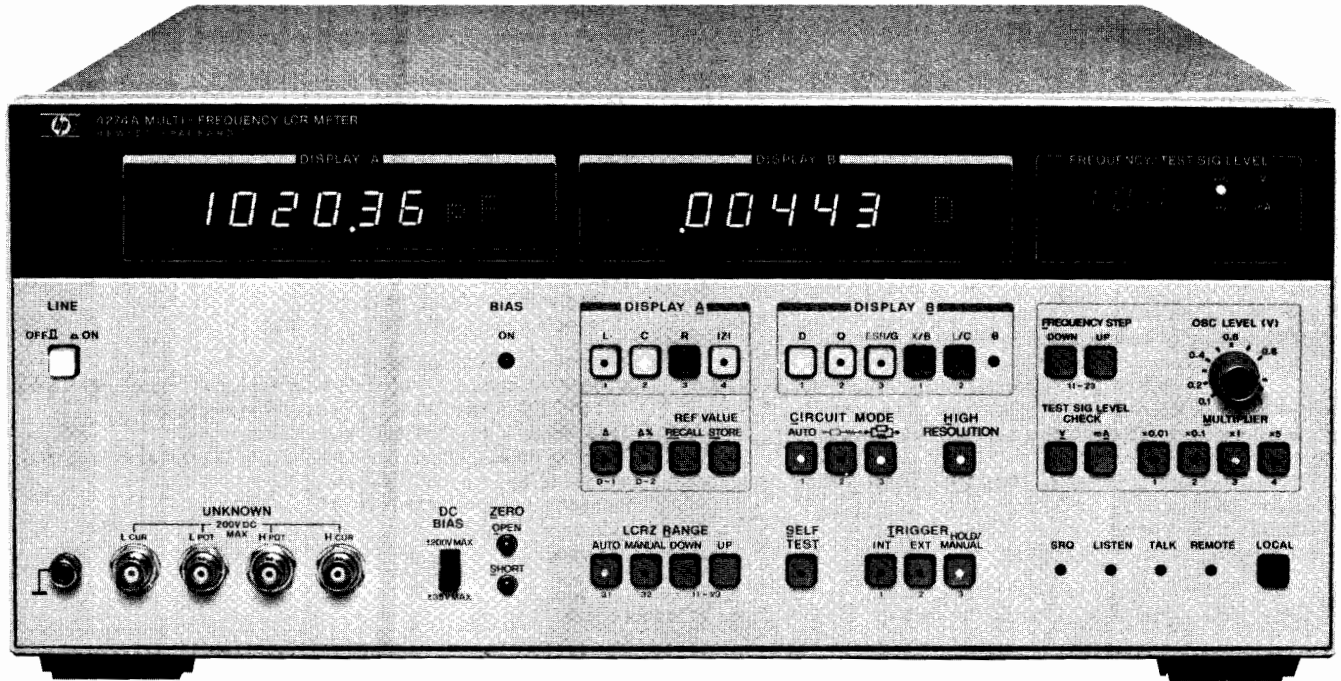

HP 4274A



Description

The HP 4274A and HP 4275A Multi-frequency LCR Meters are recent additions to Hewlett-Packard's new generation of microprocessor-based impedance measuring instrumentation. Both instruments offer a new measuring concept for the evaluation of LCR components, complex components, electronic circuits "tested under actual working conditions", and semiconductor materials. A measurement under conditions similar to the intended use contributes to the improvements in quality and reliability of electronic components, devices and circuits.

Multi-Frequency Capability

To insure the high reliability in circuits and devices, it is most important that they be tested and evaluated at test signals similar to those of actual operating conditions.

The HP 4274A covers the wide frequency range of 100 Hz to 100 kHz in 11 spot frequencies and the HP 4275A has 10 spot frequencies from 10 kHz to 10 MHz, in 1-2-4 step sequence with 1-3-5 as an option. This feature produces the frequency characteristics of components or devices. In addition, two optional special frequencies (for example, 455 kHz and 10.7 MHz) are available within the frequency range of each instrument. This wide frequency range selection offers evaluation of circuit design with a continuously variable test signal over the range of 1 mV to 5 Vrms (to 1 Vrms for the HP 4275A), and with internal dc bias optionally available with 1 mV maximum resolution. The test voltage or current values can be monitored on the 3-digit display for accurately setting the actual conditions under which the device-under-test will operate.

Multi-Parameter Measurements

The HP 4274A and HP 4275A measure equivalent series resistance (ESR), impedance ($|Z|$), phase angle (θ), reactance (X), susceptance (B), and conductance (G), in addition to the conventional L,C,R,D and Q parameters in certain combinations with a dual 5½ digit display, and an HP-IB standard for systems integration.

This wide selection of 11 parameters provides for more accurate evaluation of electronic materials or components with high measurement speed for most needed combined parameters; for example, the C-G measurement of semiconductors, an R-X measurement in circuit design, or the C-ESR or $|Z| - \theta$ measurement of tantalum capacitors.

In addition, a deviation measurement capability ($\Delta, \Delta\%$) for the L,C,R, and $|Z|$ functions displays the difference between the actual value and a stored reference, either as a difference value or in percent. Deviation applications include, for example, a temperature dependence measurement of devices in environmental tests.

Reliable Measurements with 5½ Digit Resolution

The HP 4274A and HP 4275A measure only the value of the component and/or device under test, with 5½ resolution and 0.1% basic accuracy by reducing the possibility of errors due to self or mutual inductance, stray capacitance and/or residual inductance in the test leads or test fixture used. This measurement is obtained by a state-of-the-art four terminal pair configuration and a built-in automatic ZERO-offset capability to compensate for these errors.

Model 4275A

- Test frequencies – 10 kHz to 10 MHz
- Test signal level – 1 mV to 1 Vrms
- 0.1% basic accuracy

- High resolution – 5½ digit; $D=0.00001$
- Measure L/C – D/Q/ESR/G; $|Z| - \theta$,
R-X/B/L/C; $\Delta LCRZ$, $\Delta\%$

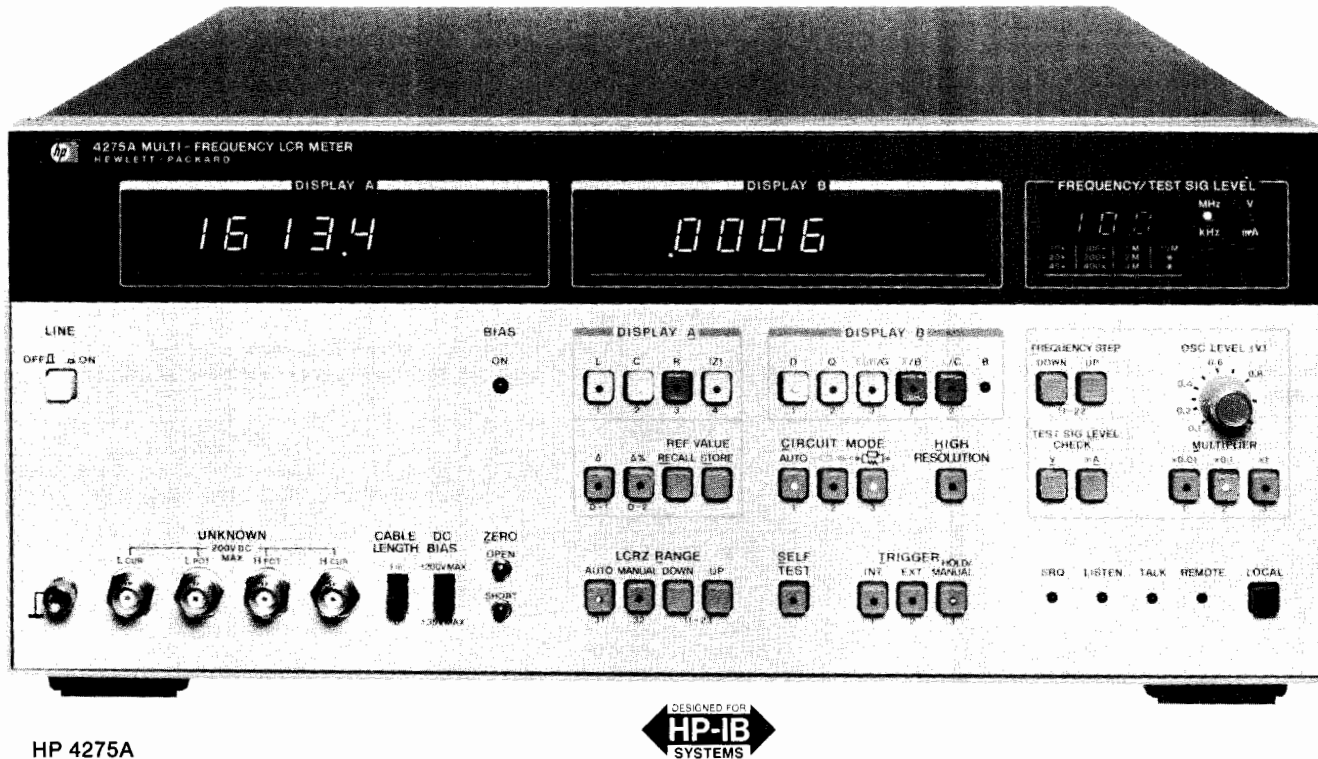

HP 4275A

The fast measurement speed, high resolution, and high accuracy can make major contributions for the component manufacturer and user who is concerned about reducing his costs, improving quality, and throughput efficiency. In these areas, the HP 4274A and the HP 4275A are ideal for D-measurements of film capacitors or insulation material (with the high resolution of 0.00001), the C-G measurements of semiconductors (with maximum resolutions of 0.01 fF, 0.01 nS, respectively), and for the low impedance measurement of aluminum electrolytic capacitors (with a maximum resolution of 0.001 m Ω).

Automatic Semiconductor and Component Measurements with HP-IB

Integrating the HP 4274A and the HP 4275A into an HP-IB controlled system is an excellent method for improving efficiency and cost savings both in the laboratory and on the production line. These automatic measurement systems are assembled by connecting the HP-IB cables between the instruments to be utilized for a specific task.

A system built around the HP 4274A and/or HP 4275A allows the user to obtain useful data for many diverse applications. For example, the evaluation of semiconductors based on the frequency dependence of its C-V characteristics that requires a wide range and fast measurement speeds is easily accomplished with these instruments. The four-terminal pair input configuration and the automatic zero offset capability insures that the measured data is accurate, even in a systems environment.

Sample Applications Semiconductor Measurements

The evaluation of a semiconductor can be done with a C-V or G-V measurement with the multi-spot frequencies featured in the HP

4274A and HP 4275A, (with C resolution of 0.01 fF and G resolution of 0.01 nS), their two programmable bias sources (maximum resolution 1 mV) and their continuously variable test signal levels (from 1 mVrms).

Of significant use is the evaluation of the doping process and the measurement of the characteristics of MOS or bipolar semiconductor materials which employ a C or G measurement with varying dc bias voltage.

A sample plot of a semiconductor measurement is shown in the figure below. Such measurements at high speed can offer high reliability and high throughput efficiency in the semiconductor manufacturing processes.

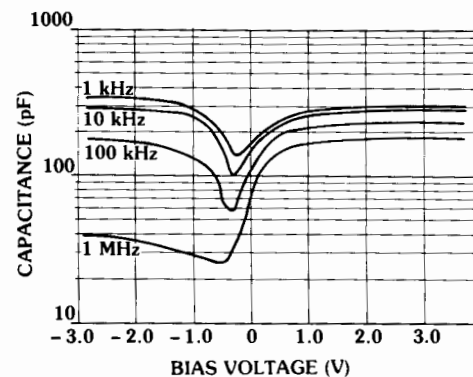



COMPONENT & SEMICONDUCTOR MEASUREMENT

Multi-Frequency LCR Meters

Models 4274A & 4275A (cont.)

Common Specifications (HP 4274A & HP 4275A)

Parameters Measured

| | | |
|-----------------------|-----------------------------------|--|
| L: inductance | Q: =1/D | θ : phase angle |
| C: capacitance | ESR: equivalent series resistance | Δ : deviation for L, C, R, Z |
| R: resistance | G: conductance | $\Delta\%$: % of deviation |
| Z: impedance | X: reactance | Test frequency |
| D: dissipation factor | B: susceptance | Test signal level (voltage or current) |

Parameter Combinations

| Display A | Display B | |
|-----------|-------------|-----------|
| | | |
| L | D / Q / ESR | D / Q / G |
| C | | |
| R | X / L | B / C |
| Z | θ | |

Measurement Frequencies, Test Signal Levels, and Full Scale Range

| MODEL | HP 4274A | HP 4275A |
|-------------------------|--|---|
| Measurement frequencies | 100 Hz–100 kHz, 11 spots (100 Hz, 120 Hz, 200 Hz, 400 Hz, 1 kHz, 2 kHz, 4 kHz, 10 kHz, 20 kHz, 40 kHz, 100 kHz; $\pm 0.01\%$) | 10 kHz–10 MHz, 10 spots (10 kHz, 20 kHz, 40 kHz, 100 kHz, 200 kHz, 400 kHz, 1 MHz, 2 MHz, 4 MHz, 10 MHz; $\pm 0.01\%$) |
| Test signal levels | 4-ranges (1 mVrms–5 Vrms) continuously variable | 3-ranges (1 mVrms–1 Vrms) continuously variable |
| Full scale range | | |
| L | 100.00 nH – 1000.0 H | 100.00 nH – 10.00 H |
| C | 1.0000 pF – 1.00 F | 1.0000 pF – 100.00 μ F |
| R, Z , ESR, & X | 100.00 m Ω – 10.000 M Ω | 1.0000 Ω – 10.000 M Ω |
| D | 0.00001 – 9.9999 | 0.00001 – 9.9999 |
| Q (1/D) | 0.01 – 9900 | 0.01 – 9900 |
| G & B | 1.0000 μ S – 100.00 S | 1.0000 μ S – 10.00 S |
| θ | 0 – $\pm 180^\circ$ | 0 – $\pm 180^\circ$ |

Accuracy (HP 4274A only): typical C–D, L–D, R–X and |Z|– θ measurement accuracy values are given below.

| FREQUENCY RANGE | C-D/Q | L-D/Q | R-X | Z – θ |
|-----------------|---|---|--|--|
| | D-range: 0.00001–9.9999 Q-range: 0.01–9900 (=1/D) (C & D accuracies apply only when C: full scale and D: ≤ 0.1) | D-range: 0.00001–9.9999 Q-range: 0.01–9900 (=1/D) (L & D accuracies apply only when L: full scale and D: ≤ 0.1) | (R accuracies apply only when R: full scale) (X accuracies apply only when R: 1/10 of full scale and X: full scale) | θ -range: -180° – $+180.00^\circ$ (Z & θ accuracies apply only when Z : full scale) |
| 100 Hz | C: 1000 pF–1000 mF, 0.1% + 3 D: 0.33% + 0.0008 + 1 | L: 100 μ H–10 kH, 0.1% + 3 D: 0.33% + 0.0013 + 1 | R: 100 m Ω –10 M Ω , 0.1% + 3 X: 100 m Ω –10 M Ω , 0.1% + 13 | Z : 100 m Ω –10 M Ω , 0.1% + 3 θ : $\pm 0.1^\circ$ |
| 120 Hz | | | | |
| 200 Hz | C: 1000 pF–1000 mF, 0.1% + 2 D: 0.32% + 0.0007 + 1 | L: 100 μ H–10 kH, 0.1% + 3 D: 0.32% + 0.0012 + 1 | R: 100 m Ω –10 M Ω , 0.1% + 3 X: 100 m Ω –10 M Ω , 0.1% + 13 | Z : 100 m Ω –10 M Ω , 0.1% + 3 θ : $\pm 0.1^\circ$ |
| 400 Hz | C: 100 pF–100 mF, 0.14% + 1 D: 0.34% + 0.0013 + 1 | L: 100 μ H–10 kH, 0.1% + 3 D: 0.31% + 0.0011 + 1 | R: 100 m Ω –10 M Ω , 0.1% + 3 X: 100 m Ω –10 M Ω , 0.1% + 13 | Z : 100 m Ω –10 M Ω , 0.1% + 3 θ : $\pm 0.1^\circ$ |
| 1 kHz | C: 100 pF–100 mF, 0.1% + 3 D: 0.33% + 0.0008 + 1 | L: 10 μ H–1000 H, 0.1% + 3 D: 0.33% + 0.0013 + 1 | R: 100 m Ω –10 M Ω , 0.1% + 3 X: 100 m Ω –10 M Ω , 0.1% + 13 | Z : 100 m Ω –10 M Ω , 0.1% + 3 θ : $\pm 0.1^\circ$ |
| 2 kHz | C: 100 pF–100 mF, 0.1% + 2 D: 0.32% + 0.0007 + 1 | L: 10 μ H–1000 H, 0.1% + 3 D: 0.32% + 0.0012 + 1 | R: 100 m Ω –10 M Ω , 0.1% + 3 X: 100 m Ω –10 M Ω , 0.1% + 13 | Z : 100 m Ω –10 M Ω , 0.1% + 3 θ : $\pm 0.1^\circ$ |
| 4 kHz | C: 10 pF–10 mF, 0.14% + 1 D: 0.34% + 0.0013 + 1 | L: 10 μ H–1000 H, 0.1% + 3 D: 0.31% + 0.0011 + 1 | R: 100 m Ω –10 M Ω , 0.1% + 3 X: 100 m Ω –10 M Ω , 0.1% + 13 | Z : 100 m Ω –10 M Ω , 0.1% + 3 θ : $\pm 0.1^\circ$ |
| 10 kHz | C: 10 pF–10 mF, 0.1% + 3 D: 0.33% + 0.0008 + 1 | L: 1 μ H–100 H, 0.1% + 3 D: 0.33% + 0.0013 + 1 | R: 100 m Ω –10 M Ω , 0.1% + 3 X: 100 m Ω –10 M Ω , 0.1% + 13 | Z : 100 m Ω –10 M Ω , 0.1% + 3 θ : $\pm 0.1^\circ$ |
| 20 kHz | C: 10 pF–10 mF, 0.1% + 2 D: 0.32% + 0.0007 + 1 | L: 1 μ H–100 H, 0.1% + 3 D: 0.32% + 0.0012 + 1 | R: 100 m Ω –10 M Ω , 0.1% + 3 X: 100 m Ω –10 M Ω , 0.1% + 13 | Z : 100 m Ω –10 M Ω , 0.1% + 3 θ : $\pm 0.1^\circ$ |
| 40 kHz | C: 1 pF–1000 μ F, 0.14% + 1 D: 0.34% + 0.0013 + 1 | L: 1 μ H–100 H, 0.1% + 3 D: 0.31% + 0.0011 + 1 | R: 100 m Ω –10 M Ω , 0.1% + 3 X: 100 m Ω –10 M Ω , 0.1% + 13 | Z : 100 m Ω –10 M Ω , 0.1% + 3 θ : $\pm 0.1^\circ$ |
| 100 kHz | C: 1 pF–1000 μ F, 0.1% + 3 D: 0.33% + 0.0008 + 1 | L: 100 nH–10 H, 0.1% + 3 D: 0.33% + 0.0013 + 1 | R: 100 m Ω –10 M Ω , 0.1% + 3 X: 100 m Ω –10 M Ω , 0.1% + 13 | Z : 100 m Ω –10 M Ω , 0.1% + 3 θ : $\pm 0.1^\circ$ |

(Conditions: Warm-up time ≥ 30 minutes, environment temperature: $23^\circ\text{C} \pm 5^\circ\text{C}$). Refer to technical data sheet for accuracy details.

Displays: dual 5½-digit and single 3-digit; maximum display 199999 (full scale and overrange in high resolution mode), and 4½-digit: maximum display 19999 in normal mode. (Number of digits depends on measurement frequency, test level, and range).

Circuit modes: series equivalent circuit and parallel equivalent circuit. Automatic selection available in AUTO mode.

Deviation measurement: difference between recallable stored reference and displayed is deviation value (count or percent).

Display range: -199999 to $+199999$ counts in AUTO range. -199999 to $+199999$ counts in MANUAL range (the sample should be measurable at the selected range).

Percent display range: -199.99% to $+199.99\%$

Ranging: AUTO or MANUAL (UP/DOWN).

Trigger: internal, external or manual.

Measurement terminals: four-terminal pair with guard.

Auto zero adjustment: automatic normalization of the readout offset due to residuals of the test fixture by pushbutton operation.

Normalization range: C < 20 pF, L < 2000 nH, R < 0.5 Ω , G < 5 μ S.

Self test: automatic operational verification check indicates pass or fail condition.

HP-IB data output and remote control: standard.

Memory back-up for storing measurement conditions: standard.

Accuracy (HP 4725A only): typical C-D, L-D, R-X and $|Z|-\theta$ measurement accuracy values are given below.

Range: full scale range, accuracy: % of reading + counts (D accuracy: % of reading + absolute D value + count).

| Frequency Range | C - D/Q | L - D/Q | R - X | $ Z - \theta$ |
|-----------------|--|--|--|---|
| | D-range: 0.00001 - 9.9999 Q-range: 0.01-9900 (= 1/D) (C & D accuracies apply only when C: full scale and D: ≤ 0.1) | D-range: 0.00001 - 9.9999 Q-range: 0.01 = 9900 (= 1/D) (L & D accuracies apply only when L: full scale and D: ≤ 0.1) | (R accuracies apply only when R: full scale) (X accuracies apply only when R: 1/10 of full scale and X: full scale) | θ -range: $-180.00^\circ - +180.00^\circ$ (Z & θ accuracies apply only when Z: full scale) |
| 10 kHz | C: 10 pF - 100 μ F, 0.1% + 3 D: 0.33% + 0.008 + 1 | L: 10 μ H - 100H, 0.1% + 3 D: 0.33% + 0.0013 + 1 | R: 1000 m Ω - 10 M Ω , 0.1% + 3 X: 1000 m Ω - 10 M Ω , 0.1% + 13 | $ Z $: 1000 M Ω - 10 m Ω , 0.1% + 3 θ : $\pm 0.1^\circ$ |
| 20 kHz | C: 10 pF - 100 μ F, 0.1% + 2 D: 0.32% + 0.0007 + 1 | L: 10 μ H - 100 H, 0.1% + 3 D: 0.32% + 0.0012 + 1 | R: 1000 m Ω - 10 M Ω , 0.1% + 3 X: 1000 m Ω - 10 M Ω , 0.1% + 13 | $ Z $: 1000 M Ω - 10 m Ω , 0.1% + 3 θ : $\pm 0.1^\circ$ |
| 40 kHz | C: 1 pF - 10 μ F, 0.14% + 1 D: 0.34% + 0.0009 + 1 | L: 10 μ H - 100 H, 0.1% + 3 D: 0.31% + 0.0011 + 1 | R: 1000 m Ω - 10 M Ω , 0.1% + 3 X: 1000 m Ω - 10 M Ω , 0.1% + 13 | $ Z $: 1000 M Ω - 10 m Ω , 0.1% + 3 θ : $\pm 0.1^\circ$ |
| 100 kHz | C: 1 pF - 10 μ F, 0.1% + 3 D: 0.33% + 0.0008 + 1 | L: 1 μ H - 10 H, 0.1% + 3 D: 0.33% + 0.0013 + 1 | R: 1000 m Ω - 10 M Ω , 0.1% + 3 X: 1000 m Ω - 10 M Ω , 0.1% + 13 | $ Z $: 1000 M Ω - 10 m Ω , 0.1% + 3 θ : $\pm 0.1^\circ$ |
| 200 kHz | C: 10 pF - 10 μ F, 0.1% + 2 D: 0.32% + 0.0007 + 1 | L: 1 μ H - 1000 mH, 0.2% + 3 D: 0.53% + 0.0023 + 1 | R: 1000 m Ω - 1 M Ω , 0.2% + 3 X: 1000 m Ω - 1 M Ω , 0.2% + 13 | $ Z $: 1000 M Ω - 1 m Ω , 0.2% + 3 θ : $\pm 0.1^\circ$ |
| 400 kHz | C: 1 pF - 1000 nF, 0.14% + 1 D: 0.34% + 0.0009 + 1 | L: 1 μ H - 1000 mH, 0.2% + 3 D: 0.51% + 0.0021 + 1 | R: 1000 m Ω - 1 M Ω , 0.2% + 3 X: 1000 m Ω - 1 M Ω , 0.2% + 13 | $ Z $: 1000 M Ω - 1 m Ω , 0.2% + 3 θ : $\pm 0.1^\circ$ |
| 1 MHz | C: 1 pF - 1000 nF, 0.1% + 3 D: 0.33% + 0.0008 + 1 | L: 100 nH - 100 mH, 0.2% + 3 D: 0.55% + 0.0025 + 1 | R: 1000 m Ω - 1 M Ω , 0.2% + 3 X: 1000 m Ω - 1 M Ω , 0.2% + 13 | $ Z $: 1000 M Ω - 1 m Ω , 0.2% + 3 θ : $\pm 0.1^\circ$ |
| 2 MHz | C: 10 pF - 100 nF, 0.3% + 3 D: 0.55% + 0.0025 + 1 | L: 1 μ H - 10 mH, 0.5% + 5 D: 1.0% + 0.0033 + 1 | R: 10 Ω - 100 k Ω , 0.5% + 5 X: 10 Ω - 100 k Ω , 0.5% + 15 | $ Z $: 10 Ω - 100 k Ω , 0.5% + 5 θ : $\pm 0.2^\circ$ |
| 4 MHz | C: 1 pF - 10 nF, 1% + 20 + 0.002 pF D: 3.3% + 0.01 + 1 | L: 1 μ H - 10 mH, 1% + 5 D: 2.0% + 0.0063 + 1 | R: 10 Ω - 100 k Ω , 2% + 7 X: 10 Ω - 100 k Ω , 2% + 105 | $ Z $: 10 Ω - 100 k Ω , 2% + 7 θ : $\pm 0.8^\circ$ |
| 10 MHz | C: 1 pF - 10 nF, 2% + 20 + 0.002 pF D: 4% + 0.011 + 1 | L: 100 nH - 1 mH, 2% + 7 D: 3.1% + 0.002 + 1 | R: 10 Ω - 100 k Ω , 2% + 7 X: 10 Ω - 100 k Ω , 2% + 105 | $ Z $: 10 Ω - 100 k Ω , 2% + 7 θ : $\pm 0.8^\circ$ |

(Conditions: Warm-up time ≥ 30 minutes, environment temperature: $23^\circ\text{C} \pm 5^\circ\text{C}$). Refer to technical data sheet for accuracy details.

General Information

Test Signal Level Monitor

| Model | Range | | Accuracy |
|----------|------------------------|--------------------------|---|
| | Voltage | Current | |
| HP 4274A | 0.001 V - 5.00 Vrms | 0.001 mA - 100 mArms | \pm (3% of reading + 1 count) |
| HP 4275A | 0.001 V - 1.00 Vrms | 0.001 mA - 10.0 mArms | \pm (3% of reading + 1 count) at < 1 MHz \pm (10% of reading + 2 counts) at ≥ 1 MHz |

Measurement time: (typical) 140-180 ms (> 1 kHz); 140-210 ms ≤ 1 kHz (measurement time depends on range, sample value and offset adjustment value).

Z - θ measurement time: 170-210 ms > 1 kHz; 170-240 ms ≤ 1 kHz.

High resolution mode: approximately 8 times the normal measurement time.

Auto ranging time: 100 ms - 300 ms per range change.

Options

Opt 001: 0 to ± 35 internal dc bias

| Range | Steps | Accuracy |
|-----------------------|-------|---------------------------------|
| \pm (.000 - .999) V | 1 mV | \pm (0.5% of reading + 2 mV) |
| \pm (1.00 - 9.99) | 10 mV | \pm (0.5% of reading + 4 mV) |
| \pm (10.0 - 35.0) | 0.1 V | \pm (0.5% of reading + 20 mV) |

Control: HP 16023B dc Bias Controller or remote control with HP-IB

Opt 002: 0 - ± 99.9 V internal dc bias (for C ≤ 0.1 μ F)

Range: \pm (00.0 - 99.9) V, 0.1 V steps

Accuracy: \pm (2% of reading + 40 mV)

Control: same as Opt 001

External dc bias: ± 200 V maximum.

Bias monitor: rear panel BNC connector monitors internal or external input bias.

Opt 004: frequency steps in 1-3-5 sequence.

Special Options

One or two arbitrary test frequencies for each instrument are available. For more details, please contact nearest HP sales office.

Selectable Frequency Range

HP 4274A: 100 Hz to 100 kHz to $\pm 0.1\%$. If two frequencies are added, at least one frequency must satisfy the following equation: $f = 1200/N$ kHz where N is an integer from 12 to 12000.

HP 4275A: 10 kHz to 10.7 MHz $\pm 0.1\%$.

Accessories

HP 16047A: Direct coupled test fixture. Furnished accessory with the HP 4274A and HP 4275A.

HP 16023B: dc Bias Controller, for control of dc bias \$300

Opt 001 or 002 Internal Bias Supply. Control range 0 to ± 99.9 V by setting thumbwheel switch.

HP 16034B: Test Fixture for chip components \$320

HP 16047B: Test Fixture with safety cover \$600

HP 16047C: Test Fixture for high frequencies \$270

HP 16048A: Test leads, BNC \$250

HP 16048B: Test leads, RF miniature \$250

HP 16048C: Test leads with alligator clips \$330

Options

Opt 001: 0 to ± 35 internal dc bias, max resolution; 1 mV steps \$745

Opt 002: 0 to ± 99.9 V internal dc bias, resolution: 100 mV steps. \$690

Opt 004: Frequency steps in 1-3-5 sequence N/C

Ordering Information

HP 4274A 100 Hz - 100 kHz Multi-Frequency LCR Meter \$8200

HP 4275A 10 kHz - 10 MHz Multi-Frequency LCR Meter \$9000

COMPONENT & SEMICONDUCTOR MEASUREMENT

LCZ Meters

Models 4276A & 4277A

Model 4276A

- 3-digit frequency setting: 100 Hz to 20 kHz (801 spots)
- High speed measurements (1 kHz): 95 ms/meas (4-digit display resolution); 60 ms/meas (3-digit display resolution)
- Measure L/C-D/Q/ESR/G, $|Z| - \theta$, high speed L/C
- 10-bin component sorting-comparator (OPT. 002)
- 0.1% basic accuracy over impedance range of 100 m Ω to 10 M Ω

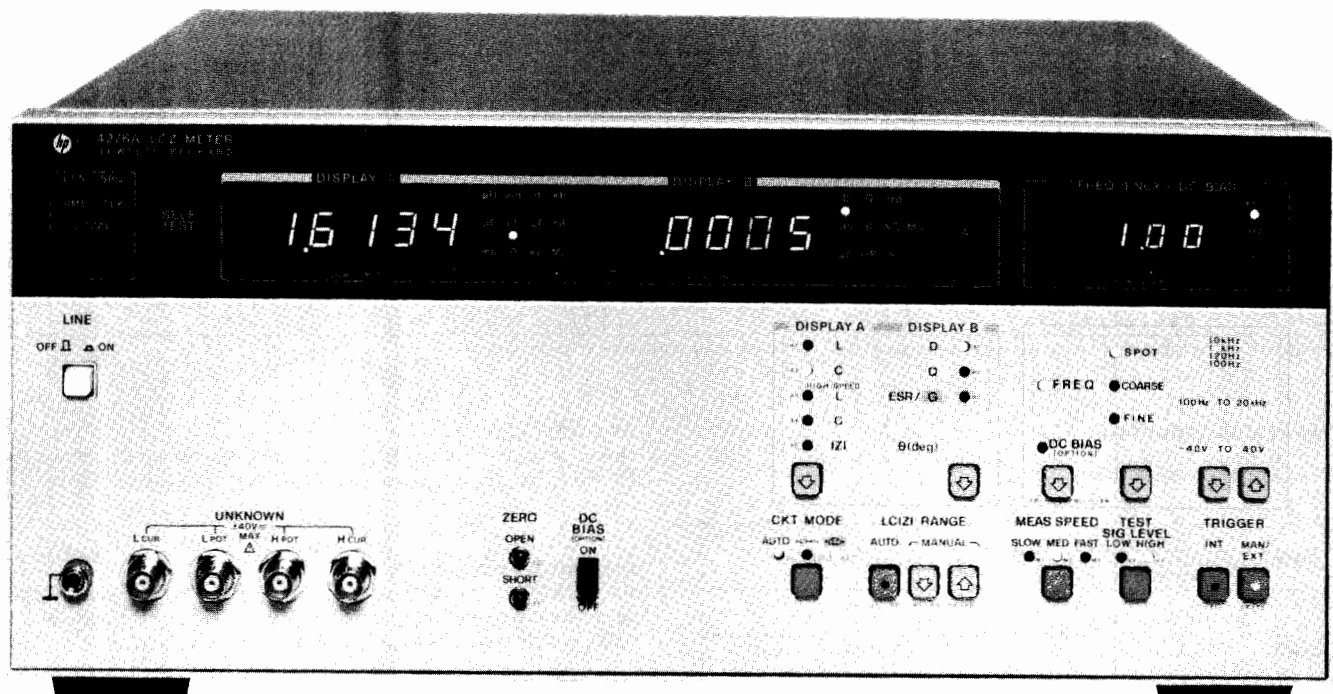

HP 4276A



Description

HP's 4276A and 4277A LCZ Meters are general purpose impedance measuring instruments designed to measure circuit components such as capacitors and inductors using frequency and dc bias conditions identical to those of the intended application. Both HP 4276A and HP 4277A feature variable test frequency (100 Hz - 20 kHz and 10 kHz - 1 MHz respectively), optional dc bias variable from 0 to ± 40 V, multiple parameters (L • C • |Z| • D • Q • ESR • G • θ) with fully automatic high speed measurements, and $4\frac{1}{2}$ digit resolution. The HP 4276A has an impedance range of 100 m Ω to 10 M Ω and the HP 4277A 10 Ω to 1 M Ω .

Both instruments are ideal for production line, quality control, and circuit design applications, and are versatile enough for stand-alone use or systems use under HP-IB control (standard). An optional comparator for 10-bin sorting with measurement time of less than 100 ms make the HP 4276A/4277A a good choice for production line testing of discrete components.

Variable Test Parameters: Frequency, Bias, Signal Level

HP's 4276A and 4277A offer variable test frequency, optional internal dc bias, and selectable test signal level (HIGH and LOW). This makes it possible to measure components under conditions almost identical to those of the intended circuit.

The HP 4276A (100 Hz to 20 kHz) and the HP 4277A (10 kHz to

1 MHz) provide 801 and 701 test frequencies, respectively. Test frequencies of both instruments are linearly spaced along a logarithmic scale. The most commonly used test frequencies for production line measurements—100 Hz, 120 Hz, 1 kHz and 1 MHz, all of which are specified in MIL/IEC standards are included. Frequency setting resolution is 3 digits.

Both instruments feature selectable test signal levels—1 V/50 mV (Cp) (HP 4276A) and 1 V/20 mV(Cp) (HP 4277A)—and both can be equipped with an optional internal dc bias source that is variable from 0 to ± 40 V in 10 mV (0 to 10 V) or 100 mV (10 to 40 V) steps. Thus, bias conditions that suit the measurement and the DUT can be selected, an important consideration for semiconductor C-V measurements.

The features described above satisfy most impedance measurement requirements for component development and circuit design. HP-IB enhances these features.

High Speed Measurements

The HP 4276A and HP 4277A provide high speed measurements with $3\frac{1}{2}$ to $4\frac{1}{2}$ digits resolution. The time required for a C-D measurement, for example, is 95 ms (4-digit) or 60 ms (3-digit) at 1 kHz, and 70 ms (4-digit) or 60 ms (3-digit) at 1 MHz. Even at 120 Hz, a measurement time of 170 ms (4-digit) or 150 ms (3-digit) is possible. Also, when the instrument is set to high speed L or high speed C measurement mode, measurement time is 45 ms (4-digit) or 35 ms (3-digit) at 1 kHz (if D is less than 0.002), and 40 ms (4-digit) or 30 ms (3-digit) at 1 MHz (if D is less than 0.01).

Model 4277A

- 3-digit frequency setting: 10 kHz to 1 MHz (701 spots)
- High speed measurements (1 MHz): 70 ms/meas (4-digit display resolution); 60 ms/meas (3-digit display resolution)
- Measures L/C-D/Q/ESR/G, $|Z| - \theta$, high speed L/C
- 10-bin component sorting-comparator (opt. 002)
- 0.1% basic accuracy over impedance range of 10 Ω to 1 M Ω

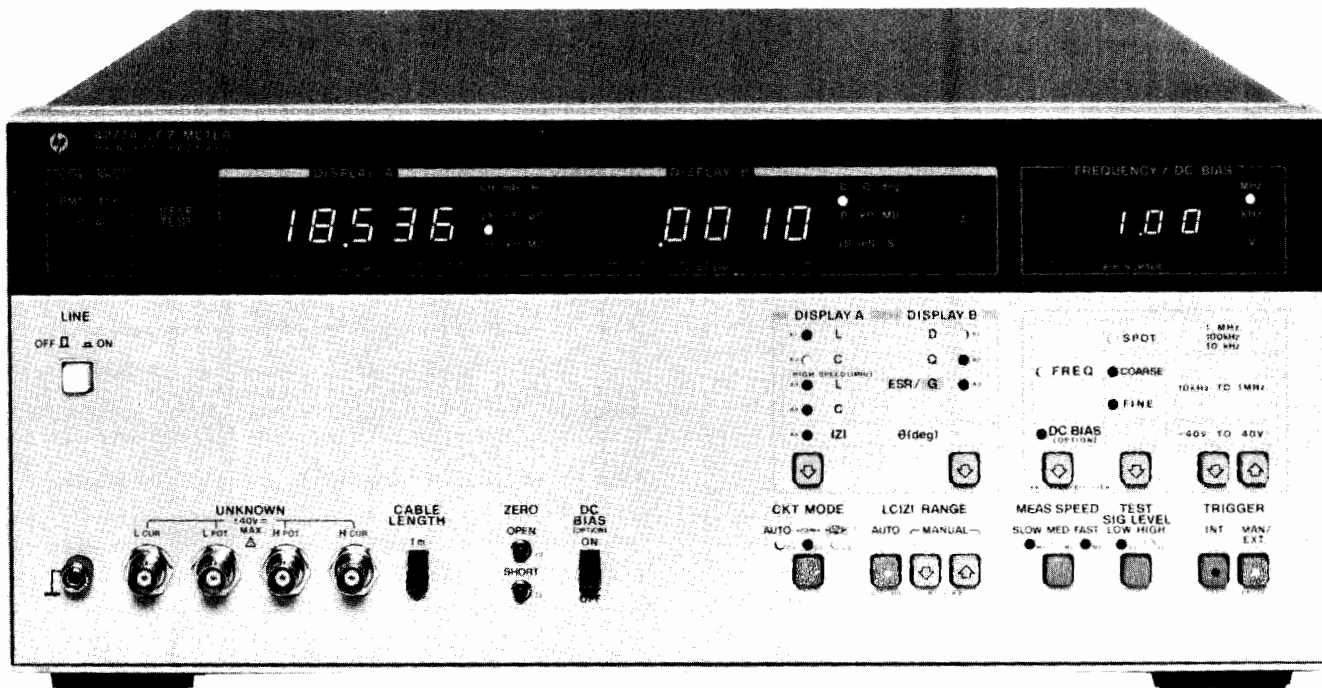

HP 4277A



Such high speeds considerably improve the efficiency and increase the throughput of high volume measurements such as outgoing inspection on the production line and incoming inspection by component end users. If an HP-IB system is configured, measurement efficiency is further improved because HP-IB is capable of packed binary data output format, which can be processed much faster than the usual ASCII format. Even when the HP-IB capability is not used, the HP 4276A/4277A can increase production line throughput if the optional comparator is used.

Optional Ten-Bin Component Sorting

A 10-bin comparator (option 002) is available. Nine sets of bin limits (high and low) can be input for L, C or $|Z|$. Also, high and low limits for D, Q, ESR, or G can be set to provide go/no-go testing.

Multiple bin sorting is especially beneficial on the production line and in incoming inspection. Test costs can be significantly reduced using the HP 4276A/4277A's high speed measuring capability. When the optional handler interface is used for automatic component sorting, measurement efficiency is better than that when using HP-IB. This is because time for data handshake is not needed.

Output data from the handler interface is at TTL or open collector level, which improves system noise immunity. Particularly,

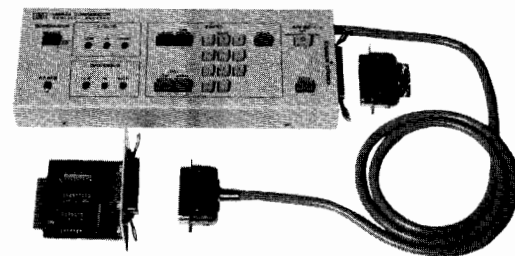

Option 002 Comparator

three lines—external trigger and measurement complete signals—are photo-isolated, so a reliable sorting system free from noise can be constructed.

Measurement reliability is improved by other comparator features such as front panel lock-out and auto zeroing of fixture residuals.

Plus, all comparator functions can be HP-IB controlled. So a fully automatic component sorting system can be constructed for use in outgoing/incoming inspection.

Specifications (Refer to data sheet for complete specifications)
Common to HP 4276A and HP 4277A

Parameters measured: C-D•Q•ESR•G
L-D•Q•ESR•G
high speed L, high speed C
 $|z| - \theta$ and Δ (deviation for any parameter)

Display: 4½ digits (max), maximum display 19999



COMPONENT & SEMICONDUCTOR MEASUREMENT

LCZ Meters

Models 4276A & 4277A (cont.)

Measurement circuit modes: Auto, Parallel, and Series

Frequency control modes: SPOT (100 Hz, 120 Hz, 1 kHz, 10 kHz, 100 kHz, 1 MHz), COARSE (10 freq./decade), and FINE (max. freq. resolution).

Test Signal Level (unknown terminal open)

| | HIGH | LOW |
|----------|-------------------|---------------------------|
| HP 4276A | 1 Vrms \pm 10%* | 50 mV \pm 20%*(Cp only) |
| HP 4277A | 1 Vrms \pm 10% | 20 mV \pm 15% |

*at 1 kHz only

Output impedance: 100 Ω

Ranging modes: Auto and Manual (up-down)

Trigger: Internal, External or Manual

Measurement terminals: 5-terminal (HP 4276A)

4-terminal pair (HP 4277A)

Measurement speed modes: FAST, MED, and SLOW

Offset adjustments: front panel OPEN and SHORT adjustments to compensate for residual impedance and stray admittance of the test fixture.

Test frequencies: HP 4276A - 100 Hz to 20 kHz \pm 0.01% (801 points)

HP 4277A - 10 kHz to 1 MHz \pm 0.01% (701 points)

Step Frequency

| Test Frequency | Step Frequency |
|------------------|----------------|
| 100 Hz-200 Hz | 1 Hz |
| 202 Hz-500 Hz | 2 Hz |
| 505 Hz-1 kHz | 5 Hz |
| 1.01 kHz-2 kHz | 10 Hz |
| 2.02 kHz-5 kHz | 20 Hz |
| 5.05 kHz-10 kHz | 50 Hz |
| 10.1 kHz-20 kHz | 100 Hz |
| 20.2 kHz-50 kHz | 200 Hz |
| 50.5 kHz-100 kHz | 500 Hz |
| 101 kHz-200 kHz | 1 kHz |
| 202 kHz-500 kHz | 2 kHz |
| 505 kHz-1 MHz | 5 kHz |

Compensation Frequencies

HP 4276A: 100, 200, 500, 1k, 2k, 5k, 10k, 16k, 20 kHz

HP 4277A: 10k, 20.2k, 50.5k, 100k, 202k, 505k, 700k, 900k, 1 MHz

Compensation at other frequencies is automatically done using second degree interpolation.

Offset Ranges

| | HP 4276A | HP 4277A |
|-------|--|---|
| OPEN | C \leq 20 pF G \leq 0.2 μ S | C \leq 20 pF G \leq 2 μ S |
| SHORT | Z \leq 2 Ω | L \leq 2 μ H R \leq 2 Ω |

HP-IB Interface

Remote control: all front panel control settings and HP 16064A (comparator) settings can be controlled using HP-IB.

Data output: parameter measured, equivalent circuit, display status, measured values and decision output of comparator.

Output format: ASCII and packed binary.

Self test: checks HP 4276A/4277A's basic operation.

Measurement accuracy and range: specified at the front panel unknown connectors when all of the following conditions are satisfied:

- (1) warmup time \geq 30 min.
- (2) test signal level is set to HIGH (1 Vrms)
- (3) measurement speed mode: MED or SLOW
- (4) ambient temperature is 23°C \pm 5°C
- (5) cable length switch is set to Om (HP 4277A)
- (6) OPEN and SHORT adjustments have been made
- (7) D \leq 0.1 (L-D•Q, C-D•Q, and |Z| - θ measurements)
D \leq 0.002 (HP 4276A) high speed L/C measurement
D \leq 0.01 (HP 4277A)

Accuracies given in Tables 1 through 6 are read as \pm (% of reading + number of counts) for L, C, and |Z|, and \pm (number of degrees + number of counts) of θ .

C-D/C-Q (1/D) measurement accuracy: accuracies for C measurements are given in Table 1 (frequencies other than 100, 120, 1k, and 1 MHz) and Table 2 (100, 120, 1k and 1 MHz only). The HP 4277A's C accuracies in the tables are for the full scale value of each C range.

High Speed C Measurements can be made under the following conditions

| | Test Frequency | Measurement Range | D |
|----------|-----------------|--|--------------|
| HP 4276A | All frequencies | All ranges except for the two highest ranges at each frequency | \leq 0.002 |
| HP 4277A | 1 MHz | 1 pF - 10 nF | \leq 0.01 |

(Refer to the HP 4276A/4277A data sheet for complete accuracy specifications, including D/Q accuracies)

L-D/L-Q (1/D) Measurement: accuracies for L measurements are given in Table 3 (for frequencies other than 1k, 10k, 100k, and 1 MHz) and Table 4 (for 1k, 10k, 100k, and 1 MHz). The HP 4276A's L accuracies given in the tables are for the full scale value of each L range.

High Speed L Measurement can be made under the following conditions

| | Test Frequency | Measurement Range | D |
|----------|-----------------|--|--------------|
| HP 4276A | All frequencies | All ranges except for the two highest ranges at each frequency | \leq 0.002 |
| HP 4277A | 1 MHz | 1 μ H - 100 μ H | \leq 0.01 |

(Refer to the HP 4276A/4277A data sheet for complete accuracy specifications, including D/Q accuracies)

|Z| - θ Measurement: accuracies for |Z|/ θ measurements are given in Table 5 (HP 4276A) and Table 6 (HP 4277A). Accuracies given in the tables are for the full scale value of each |Z| range.

DC Bias

Internal dc bias (opt.): 0 to \pm 40 V

| Bias Voltage | Voltage Step | Accuracy (at 23 \pm 5°C) |
|------------------|--------------|---------------------------------|
| -40.0 to -10.0 V | 0.1 V | \pm (1% of reading + 35 mV) |
| -9.99 to -0.01 V | 0.01 V | \pm (1% of reading + 10 mV) |
| 0.00 to 9.99 V | 0.01 V | \pm (0.3% of reading + 10 mV) |
| 10.0 to 40.0 V | 0.1 V | \pm (0.5% of reading + 35 mV) |

Output resistance: 1020 Ω \pm 10% (HP 4276A)

1040 Ω \pm 10% (HP 4277A)

Control: front panel or via HP-IB

External dc bias via rear panel: 0 to \pm 40 V

Continuous Memory (approx. two weeks)

Memory contents: all front panel key settings, excluding BIAS, offset values, reference for deviation and comparator limit data.

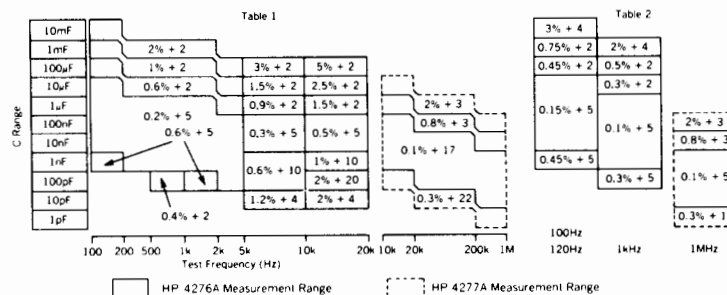

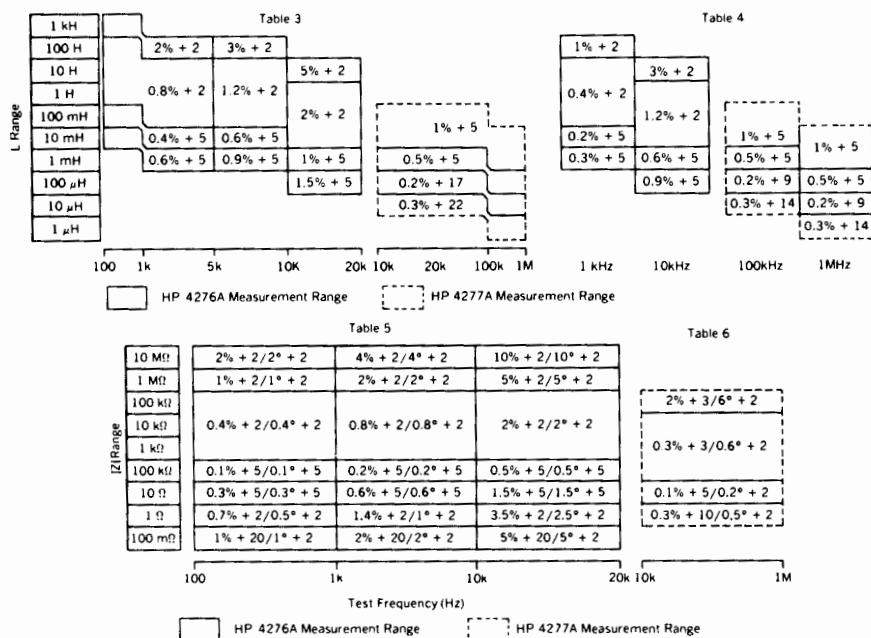

General Measurement Time (Typical)

HP 4276A (circuit mode set to AUTO, and test signal level set to HIGH)

Capacitance measurement: applicable to all ranges except for highest range when measuring low loss capacitors of full scale value.

Inductance measurement: applicable to all ranges except for lowest range when measuring low loss inductors of full scale value.

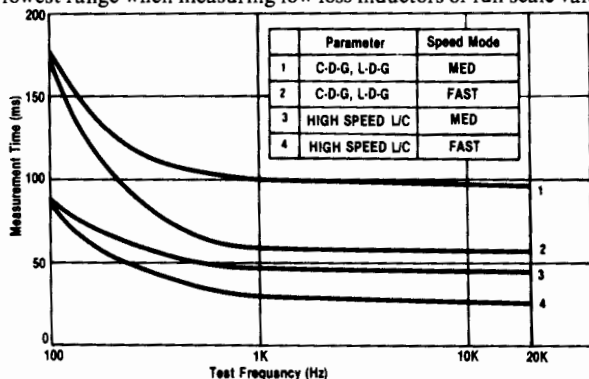

HP 4277A (circuit mode set to AUTO)

Capacitance measurement: applicable to parallel C ranges when measuring low loss capacitors of full scale value.

Inductance measurement: applicable to series L ranges when measuring low loss inductors of full scale value.

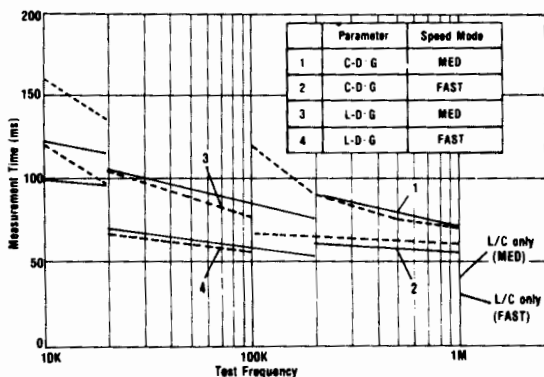

Operating temperature and humidity: 0° to 55°C, ≤ 95% RH at 40°C.

Power requirements: 100/120/220 Vac ±10%, 240 V + 5% - 10%; 48 to 66 Hz.

Power consumption: 65 VA max (HP 4276A); 75 VA max (HP 4277A).

Size: 188 mm H x 426 mm W x 422 mm D (7 1/2" x 16 3/4" x 16 2/3").

Weight: approx. 8.5 kg (18.7 lb).

Options

Opt 001: Internal dc bias, 0 to ±40 V, max resolution 10 mV/100 mV.

Opt 002: 10-bin sorting for L/C/|Z| and go/no-go testing for D/Q, interfaced with component handler, usable only with HP 4276A/4277A.

Limit data input: high and low limits using comparator numerical keys or HP-IB

Limit setting range: 00000 to 19999

Decision output: BIN number, LED (high/in/low), or HP-IB

Handler interface: (negative true)

Output signal: (open collector or TTL)

Decision outputs: BIN number, high/in/low

Index: analog measurement complete, photo isolated

Measurement complete: full measurement complete, photo isolated

Input signal: (open collector or TTL)

External trigger: photo isolated

Accessories

Furnished accessories: HP 16047A Direct Coupled Test Fixture

Accessories Available

- HP 16034B:** Tweezer Type Test Fixture for Chip Components \$320
- HP 16047C:** Test Fixture \$270
- HP 16048A:** Test Leads, BNC (1m) \$250
- HP 16048B:** Test Leads, RF Miniature (1m) \$250
- HP 16048C:** Test Leads, with Alligator chips (1m) \$330
- HP 16048D:** Test Leads, BNC (2m) \$330
- HP 16064A:** Retrofit Kit for Comparator (HP 4276A/HP 4277A, Opt 002) \$600
- HP 16065A:** External DC Bias Test Fixture (≤200 V) \$700

Options

- 001:** Internal DC Bias \$165
- 002:** Comparator \$580

Ordering Information

- HP 4276A** LCZ Meter \$3,850
- HP 4277A** LCZ Meter \$5,500

Price
N/C

Price
\$3,850
\$5,500



COMPONENT & SEMICONDUCTOR MEASUREMENT

Digital LCR Meters

Models 4261A and 4262A

- Automatic balancing, ranging & circuit mode selection
- Test frequencies: HP 4261A, 120 (100) Hz and 1 kHz
HP 4262A, 120 (100) Hz, 1 kHz and 10 kHz
- Versatile accessories and options
- High reliability

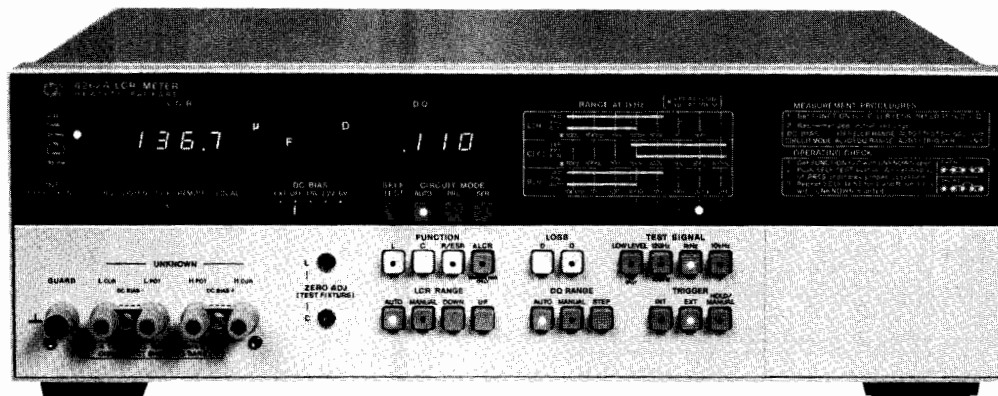

HP 4262A



HP 4261A

Description

The HP 4261A and HP 4262A are 3½ digit LCR meters that meet today's requirements for component measurements. Both instruments feature fully automatic operation over wide measuring ranges. Simply select the measuring functions and one of the test frequencies, then insert the device to be measured. The instrument does the rest—automatically selecting the proper measuring range and equivalent circuit mode. The HP 4261A and HP 4262A basic features are summarized in the table below.

| | HP 4261A | HP 4262A |
|---------------------|---------------------|--|
| Test Frequency | 120 (100) Hz, 1 kHz | 120 (100) Hz, 1 kHz, 10 kHz |
| Signal Level | 1 V, 50 mV (Cp) | 1 V, 50 mV (Cp) |
| Parameters Measured | C-D L-D R | C-D • Q L-D • Q R (ESR) Δ (Deviation) |
| HP-IB | No | Yes (opt.) |
| Digital Comparison | No | Yes (opt.) |
| BCD Output | Yes (opt.) | Yes (opt.) |

In addition to automatic measurements, the HP 4261A and HP 4262A provide high accuracy (0.2% reading), internal dc bias, and series and parallel equivalent circuit modes.

These relatively low cost and easy-to-use LCR meters are capable of a wide range of applications—measuring electrolytic/ceramic capacitors, filter coils, pulse transformers, internal resistance of dry cells and semiconductor junction capacitance, as well as ordinary LCR components. Extended features of these reliable instruments include optionally available HP-IB (HP 4262A) and BCD (HP 4261A) data output capabilities and a comparator option which is convenient for production line applications.

Specifications (refer to data sheet for complete specifications) Measurement ranges and accuracies: see table on next page. Accuracy applies over a temperature range of 23°C ±5°C (at 0° to 55°C, error doubles). 10 kHz and Q specifications are given only for the HP 4262A.

| | HP 4261A | HP 4262A | |
|-----------------------------|--------------------------------|------------------------------------|--------------|
| Parameters measured | L-D, C-D R | L-D • Q, C-D • Q R (ESR), Δ LCR | |
| Display | 3½ digits max. display 1900 | 3½ digits max. display 1999 | |
| Test frequency | 120 (100) Hz, 1 kHz ±3% | 120 (100) Hz, 1 kHz 10 kHz ±3% | |
| Test signal level (typical) | 1 V, 50 mV (Cp mode only) | | |
| DC bias | Int | 1.5 V, 2.2 V, 6 V ±5%, selectable | |
| | Ext | 0 to +30 V | 0 to +40 V |
| Equivalent circuit modes | auto, parallel, series | | |
| Ranging modes | LCR | auto, manual | |
| | DQ | D only — fixed | auto, manual |
| Trigger | internal, external, manual | | |
| Measuring terminal | 5-terminal configuration | | |

Deviation measurement (HP 4262A): displays the difference between a stored value (that is, measured value when Δ LCR switch is depressed) and subsequent measured data.

Offset adjustments (HP 4262A): front panel adjustments to compensate for stray capacitance and residual inductance of the test fixture.

C: 0 to 10 pF

L: 0 to 1 μH

Self-test (HP 4262A): automatically checks the HP 4262A's basic functions.

General

Measuring time (typical): for a 1000 count measurement on a low loss component on a fixed range:

1 kHz, 10 kHz: C/L 220-260 ms, R 120-160 ms

120 (100) Hz: C/L 900 ms, R 700 ms

Ranging Time

1 kHz, 10 kHz: 180 ms/range step

120 (100) Hz: 670 ms/range step

Reading rate: INT (internal trigger) approximately 30 ms between end of measurement cycle and start of the next cycle. EXT (external trigger) measuring cycle is initiated by a remote trigger input.

C-D/C-Q Measurement

| Range | C | 120 (100) Hz | 1000 pF | 10.00 nF | 100.0 nF | 1000 nF | 10.00 μF | 100.0 μF | 1000 μF | 10.00 mF | |
|--------------------------------|---|------------------------|---|----------|---------------------|----------|----------|----------|------------------------------|------------------------------|----------|
| | | 1 kHz | 100.0 pF | 1000 pF | 10.00 nF | 100.0 nF | 1000 nF | 10.00 μF | 100.0 μF | 1000 μF | 10.00 mF |
| | | 10 kHz | 10.00 pF | 100.0 pF | 1000 pF | 10.00 nF | 100.0 nF | 1000 nF | 10.00 μF | 100.0 μF | |
| | | D | 0.001 to 1.900 (HP 4261A), 0.001 to 19.9 (HP 4262A) | | | | | | | | |
| | | Q ^{*1} | 0.050 to 1000 (4 ranges, HP 4262A) | | | | | | | | |
| C Accuracy ^{*2} | | 0.2% + 1 ^{*3} | | | | | | | | | |
| | | At 120 (100) Hz, 1 kHz | | | 0.3% + 2 | | | | 0.5% + 2 | 1% + 2 ^{*4} | |
| | | At 10 kHz | | | | | | | 1% + 2 | 5% + 2 | |
| D (1/Q) Accuracy ^{*2} | | 0.2% + (2 + 200/Cx) | | | | | | | At 120 (100) Hz, 1 kHz | | |
| | | 0.5% + (2 + 200/Cx) | | | | | | | At 10 kHz | | |
| | | At 120 (100) Hz, 1 kHz | | | 0.3% + (2 + Cx/500) | | | | 1% + (5 + $\frac{Cx}{500}$) | | |
| | | At 10 kHz | | | 0.5% + (2 + Cx/500) | | | | 1% + (5 + $\frac{Cx}{500}$) | 5% + (5 + $\frac{Cx}{500}$) | |

*1 Calculated as the reciprocal of D.
^{*2} ±(% of reading + number of counts), Cx is capacitance readout in counts. Accuracies in this table apply when D < 1.900.
^{*3} Add 0.2 pF for HP 4261A.
^{*4} (5% + 2 counts) at 1 kHz.

L-D/L-Q Measurement

| Range | L | 120 (100) Hz | 1000 μH | 10.00 mH | 100.0 mH | 1000 mH | 10.00 H | 100.0 H | 1000 H | |
|--------------------------------|---|------------------------|---|----------|------------------------|----------|----------|------------------------|------------------------------|--------|
| | | 1 kHz | 100.0 μH | 1000 μH | 10.00 mH | 100.0 mH | 1000 mH | 10.00 H | 100.0 H | 1000 H |
| | | 10 kHz | 10.00 μH | 100.0 μH | 1000 μH | 10.00 mH | 100.0 mH | 1000 mH | 10.00 H | |
| | | D | 0.001 to 1.900 (HP 4261A), 0.001 to 19.9 (HP 4262A) | | | | | | | |
| | | Q ^{*1} | 0.050 to 1000 (4 ranges, HP 4262A) | | | | | | | |
| L Accuracy ^{*2} | | At 120 (100) Hz, 1 kHz | | | 0.3% + 2 | | | 1% + 2 | | |
| | | At 10 kHz | | | | | | 1% + 2 | 5% + 2 | |
| | | 0.3% + 2 | | | 0.2% + 2 ^{*3} | | | At 120 (100) Hz, 1 kHz | | |
| D (1/Q) Accuracy ^{*2} | | At 120 (100) Hz, 1 kHz | | | 0.3% + (3 + Lx/500) | | | 1% + (3 + Lx/500) | | |
| | | At 10 kHz | | | 0.5% + (3 + Lx/500) | | | 1% + (3 + Lx/500) | 5% + (5 + $\frac{Lx}{500}$) | |
| | | 0.2% + (3 + 200/Lx) | | | | | | At 120 (100) Hz, 1 kHz | | |
| | | 0.5% + (3 + 200/Lx) | | | | | | At 10 kHz | | |

*1 Calculated as the reciprocal of D.
^{*2} ±(% of reading + number of counts), Lx is inductance readout in counts. Accuracies in this table apply when test signal level is 1 V and D < 1.900.
^{*3} Add 0.2 μH for HP 4261A.

R (ESR)^{*1} Measurement

| Range | 120 (100) Hz | 1000 mΩ | 10.00 Ω | 100.0 Ω | 1000 Ω | 10.00 kΩ | 100.0 kΩ | 1000 kΩ | 10.00 MΩ | |
|------------------------|--------------|------------------------|---------|---------|--------|----------|----------|---------|----------|--|
| | | 1 kHz | | | | | | | | |
| | | 10 kHz | | | | | | | | |
| Accuracy ^{*2} | | 0.3% + 2 ^{*3} | | | | | | | | |
| | | 0.2% + 1 | | | | | | | | |

*1 ESR measuring range is from 1 mΩ to 19 kΩ (typical). These values vary depending on the series capacitance or inductance value of the device under test.
^{*2} ±(% of reading + number of counts).
^{*3} (5% + 2 counts) on 10.00 MΩ range at 10 kHz.

| | HP 4261A | HP 4262A |
|------------------------------------|---|--|
| Operating temperature and humidity | 0°C to 55°C ≤95% RH at 40°C | |
| Power requirements | 100/120/220/240 V ± 10% | 100/120/220 V ± 10%, 240 V + 5% -10%, 48-66 Hz |
| Power consumption | 48-66 Hz ≤25 VA | ≤55 VA |
| Size | 134 H x 213 W x 422 mm D (5 • 3/8" x 8 • 3/8" x 16 • 3/8") | 147 H x 426 W x 345 mm D (5 • 3/4" x 16 • 3/4" x 13 • 3/4") |
| Weight (approx.) | 7.5 kg (16.51 lb) | 8 kg (17.51 lb) |

Options Available

| Option | HP 4261A ^{*1} | HP 4262A ^{*2} |
|--------|--|------------------------|
| 001 | BCD data output (L/C/R and D simultaneously) | BCD data output |
| 002 | BCD data output (L/D, C/D, R alternately) | — |
| 003 | BCD remote control | — |
| 004 | — | Digital comparator |
| 101 | — | HP-IB |

*1 Options 001 and 002 are mutually exclusive.
^{*2} Option combinations 101/001 and 101/004 cannot be ordered.

Accessories available: **HP 16061A:** test fixture, direct couple, 5-terminal; **HP 16062A:** test leads with alligator clips, 4-terminal (for low impedance measurements); **HP 16063A:** test leads with alligator clips, 3-terminal (for high impedance measurements).

Ordering Information (4261A)

| Item | Price |
|---|----------------|
| HP 16061A Test Fixture, Radial/Axial lead devices | \$160 |
| HP 16062A Test Leads, 3-wire | \$90 |
| HP 16063A Test Leads, 4-wire | \$85 |
| Opt 001: BCD Output (Simultaneous) | \$185 |
| Opt 002: BCD Output (Alternately) | \$160 |
| Opt 003: BCD Remote Control | \$80 |
| Opt 010: 100 Hz Test Frequency | N/C |
| Opt 910: Extra Manual | \$23 |
| HP 4261A Digital LCR Meter | \$2,420 |

Ordering Information (HP 4262A)

| Item | Price |
|--|----------------|
| Opt 001: BCD Output | \$320 |
| Opt 004: Digital Comparator | \$800 |
| Opt 010: 100 Hz Test Frequency | N/C |
| Opt 101: HP-IB Interface | \$545 |
| Opt 907: Front Handle Kit | \$55 |
| Opt 908: Rack Flange Kit | \$32.50 |
| Opt 909: Rack/Handle Kit | \$80 |
| Opt 910: Extra Manual | \$29 |
| HP 16061A Test Fixture for Radial/Axial Lead Devices | \$160 |
| HP 16062A Test Cables, 3-wire | \$90 |
| HP 16063A Test Cables, 4-wire | \$85 |
| HP 4262A Digital LCR Meter | \$3,240 |



COMPONENT & SEMICONDUCTOR MEASUREMENT

Q Meter

Model 4342A

- Frequency range: 22 kHz to 70 MHz
- Q range: 5 to 1000

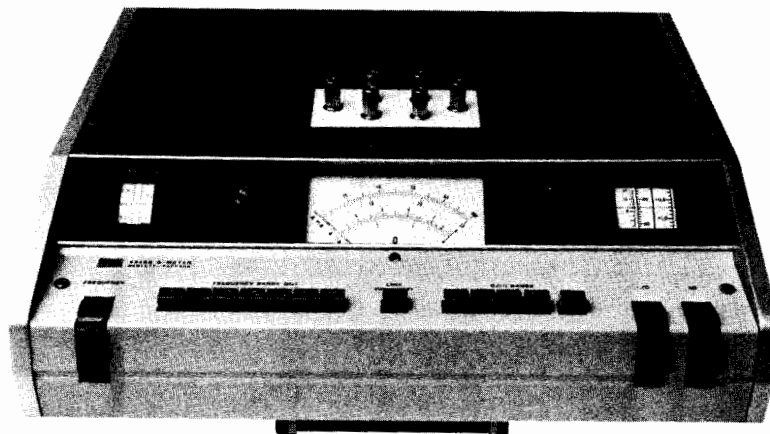

HP 4342A

Description

The direct-reading expanded scale of the HP 4342A permits measurement of Q from 5 to 1000 and readings of very small changes in Q resulting from variation in test parameters. The HP 4342A is solid state with the elimination of specially matched, fragile thermocouple components.

The HP 4342A will measure dissipation factor and dielectric constant of insulating materials. The Q meter can measure coefficient of coupling, mutual inductance, and frequency response of transformers. RF resistance, reactance, and Q of resistors and capacitors can also be determined.

Pushbutton operation of frequency range and Q/ Δ Q range selection provides straightforward measurement. Automatic indication of meter scales, frequency dials and frequency multipliers are featured, adding to simplicity and reading speed.

Specifications

RF Characteristics

RF range: 22 kHz to 70 MHz in 7 bands: 22 to 70 kHz, 70 to 220 kHz, 220 to 700 kHz, 700 to 2200 kHz, 2.2 to 7 MHz, 7 to 22 MHz, 22 to 70 MHz.

HP 4342A Opt 001: 10 kHz to 32 MHz in 7 bands: 10 to 32 kHz, 32 to 100 kHz, 100 to 320 kHz, 320 to 1000 kHz, 1 to 3.2 MHz, 3.2 to 10 MHz, 10 to 32 MHz.

RF accuracy: $\pm 1.5\%$ from 22 kHz to 22 MHz; $\pm 2\%$ from 22 MHz to 70 MHz; $\pm 1\%$ at "L" point on frequency dial.

HP 4342A Opt 001: $\pm 1.5\%$ from 10 kHz to 10 MHz; $\pm 2\%$ from 10 MHz to 32 MHz; $\pm 1\%$ at "L" point on frequency dial.

RF increments: approximately 1% resolution.

Q Measurement Characteristics

Q range: 5 to 1000 in 4 ranges: 5 to 30, 20 to 100, 50 to 300, 200 to 1000.

Q accuracy: % of indicated value: (at 25°C)

| Q Freq. | HP 4342A & HP 4342A Opt. 001 | HP 4342A |
|----------|------------------------------|---------------|
| | 22 kHz-30MHz | 30 MHz-70 MHz |
| 5-300 | ± 7 | ± 10 |
| 300-600 | ± 10 | ± 15 |
| 600-1000 | ± 15 | ± 20 |

Q increments: upper scale, 1 from 20 to 100; lower scale, 0.5 from 5 to 30.

Δ Q range: 0 to 100 in 4 ranges: 0 to 3, 0 to 10, 0 to 30, 0 to 100.

Δ Q accuracy: $\pm 10\%$ of full scale.

Δ Q increments: upper scale, 0.1 from 0 to 10; lower scale, 0.05 from 0 to 3.

Inductance Measurement Characteristics

L range: 0.09 μ H to 1.2 H, direct reading at 7 specific frequencies.

L accuracy: $\pm 3\%$ after substitution of residuals (approx. 10 nH).

Resonating Capacitor Characteristics

Capacitor range: main dial, 25 to 470 pF, vernier dial, -5 to $+5$ pF.

Capacitor accuracy: main dial, $\pm 1\%$ or 1 pF, whichever is greater; vernier dial, ± 0.1 pF.

Capacitor increments: main dial, 1 pF from 25 to 30 pF, 2 pF from 30 to 200 pF, 5 pF from 200 to 470 pF; vernier dial, 0.1 pF.

General

Rear Panel Outputs

Frequency monitor: 170 mV rms min. into 50 Ω .

Q analog output: 0 to 1 V ± 50 mV dc after 15 minutes warmup, proportional to meter deflection. Output impedance approximately 1 k Ω .

Over limit signal output: contact closure at the rear panel. Relay contact capacity 0.5 A/15 VA.

Over limit display time: selectable, 1 s or continuously on, after limit exceeded.

Temperature range: 0°C to 50°C.

Power: 115 or 230 V $\pm 10\%$, 50-400 Hz, approximately 40 VA.

Size: 138 mm H x 425 mm W x 414 mm D (5 $\frac{7}{16}$ " x 16 $\frac{3}{4}$ " x 16 $\frac{1}{16}$ ").

Weight: net, 14 kg (31 lb); shipping, 18.45 kg (41 lb).

Accessories Available

HP 16014A series loss test adaptor: designed for measuring low-value inductors and resistors and high-value capacitors.

HP 16451A Dielectric Test Adapter: designed for measuring the dielectric constant, capacitance and dissipation factor of insulating materials.

HP 16462A Auxiliary Capacitor: designed to extend the Q and L measurement capability of the HP 4342A Q Meter. It is especially useful for measuring small inductors at low frequencies.

HP 16470A Reference Inductors: A range of 20 inductors (any of which can be supplied separately) which can be used with the HP 4342A Q Meter when measuring the RF characteristics of capacitors, resistors, or insulating materials.

HP 16470B Stable Inductors: A set of 4 inductors (any of which are separately available) which can be used to compensate indicated Q values and/or instrumental variation in the maintenance of the HP 4342A Q Meter. They are usable over a range of 800 kHz to 50 MHz with excellent long-term temperature stability.

Options and Accessories

Opt 001: Frequency Range (10 kHz - 32 MHz) \$230

Opt 910: Extra Manual \$21

HP 16014A Series Loss Test Adaptor \$110

HP 16451A Dielectric Test Adapter \$330

HP 16462A Auxiliary Capacitor \$420

HP 16470A Reference Inductors, set of 20 \$1600

HP 16470B Stable Inductors, set of 4 \$950

HP 16470C Complete set of 24 Inductors (HP 16470A + HP 16470B) \$2500

HP 4342A Q Meter

\$4,600

COMPONENT & SEMICONDUCTOR MEASUREMENT

Milliohmmeter/High Resistance Meter

Model 4328A/4329A

347



- 20 $\mu\Omega$ resolution on 1 m Ω range
- Four terminal measurement
- Low test voltage



- Wide range: 500 k Ω to $2 \times 10^{16} \Omega$
- Selectable test voltages: 10 V to 1000 V

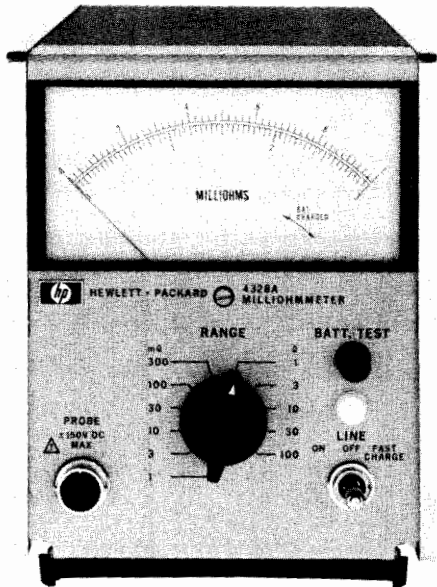

HP 4328A

Description

HP's 4328A Milliohmmeter is a high sensitivity portable instrument for measurement of low resistances. The 1 m Ω to 100 Ω measuring range and 20 $\mu\Omega$ resolution make the HP 4328A ideal for measuring the contact resistance of switches, relays, and connectors and the resistivity of conductors and semiconductors. Series reactances of up to twice the full scale resistance will not affect the accuracy. The maximum voltage across a sample, with the instrument at the proper range, is less than 200 μV peak. Even at incorrect range settings, the voltage across the sample will not exceed 20 mV peak.

The special probes that allow four-terminal measurement in two probes are furnished with the HP 4328A.

The basic HP 4328A is line operated but Opt 001 permits operation from rechargeable batteries for 15 continuous hours.

Specifications

Range: 0.001 to 100 ohms full scale in a 1, 3 sequence.

Accuracy: $\pm 2\%$ of full scale. No additional error is caused by series reactance of samples up to two times full scale.

Measuring frequency: 1000 Hz ± 100 Hz.

Voltage across sample: 200 μV peak at full scale.

Maximum voltage across sample: 20 mV peak.

Superimposed dc: 150 V dc maximum (external source).

Recorder output: 0.1 V dc output at full scale, output resistance approx. 1 k Ω .

Applied current (mA): constant by range, 150/(full scale value in milliohms).

General

Power requirements: 115/230 V $\pm 10\%$, 50 to 60 Hz, 1.5 VA.

Weight: 3.2 kg (7 lb).

Size: 155 mm H x 130 mm W x 280 mm D (6 $\frac{1}{2}$ " x 5 $\frac{1}{8}$ " x 11").

Accessories furnished: HP 16005A Probe, HP 16006A Probe, HP 16007A/B Test Leads and HP 16143A Probe Cable.

Ordering Information

HP 4328A Milliohmmeter

Opt 001: Rechargeable battery operation

Opt 910: extra manual

Price

\$1550

\$90

\$15

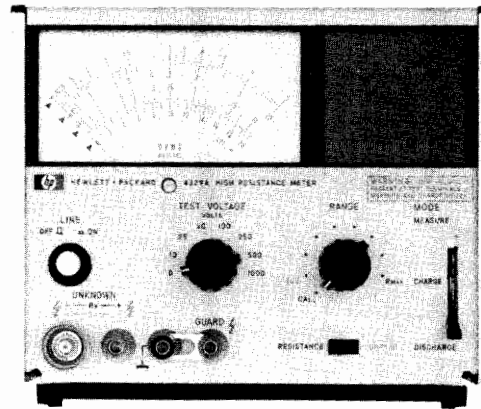

HP 4329A

Description

The HP 4329A is a solid-state insulation resistance meter designed for easy, accurate and direct readings of the very high resistance values typically found in synthetic resins, porcelain, insulating oils and similar materials. It is also useful for measurements in electrical components such as capacitors, transformers, switches and cables. Seven fully regulated dc test voltages (between 10 and 1000 Vdc) are provided as test sources.

The HP 4329A is instantly convertible from ungrounded-to-grounded-sample operation via a simple relocation of the front panel ground strap from "guard" to "+" position.

The HP 4329A also has a current measurement capability. Minute currents as low as 0.05 pA can be readily measured.

The HP 16008A Resistivity Cell, designed for use with the HP 4329A, can safely, rapidly and conveniently measure the volume and surface resistivity of sheet insulation materials (maximum sample size: 125 mm W x 125 mm D x 7 mm H).

Specifications

Resistance Measurement

Range: 500 k Ω to $2 \times 10^{16} \Omega$. (Depends on the test voltage).

Accuracy: total accuracy is determined by test voltage and range used. At low resistance end of each scale, accuracy is $\pm 3\%$, near center scale $\pm 5\%$, and near the specified upper limit on the meter scale (a quarter of full scale), accuracy is $\pm 10\%$. Accuracy is not specified above these limits. On all voltage ranges, if multiplier is set to Rmax., an additional $\pm 3\%$ is included.

Test voltages: 10 V, 25 V, 50 V, 100 V, 250 V, 500 V and 1000 V $\pm 3\%$.

Current Measurement

Range: 5×10^{-14} to 2×10^{-5} A in 8 ranges.

Accuracy: $\pm 5\%$ of full scale deflection (there can be an additional $\pm 3\%$ error at the top decade).

General

Recorder output: 0 to 100 mV dc, proportional to meter deflection; 1 k Ω output resistance.

Power: 115/230 V $\pm 10\%$, 50-60 Hz, approximately 3 VA.

Size: 155 mm H x 198 mm W x 204 mm D (6 $\frac{1}{2}$ " x 7 $\frac{25}{32}$ " x 8 $\frac{25}{32}$ ").

Weight: 3.5 kg (7.7 lb).

Accessory furnished: HP 16117A Low Noise Test Leads.

Accessory available: HP 16008A Resistivity Cell.

Ordering Information

HP 16008A Resistivity cell

HP 4329A High resistance meter

Opt 910: extra manual

Price

\$750

\$1985

\$15

COMPONENT & SEMICONDUCTOR MEASUREMENT

Standard Capacitor Set and Decade Capacitor

Models 16380A, 16380C, 4440B

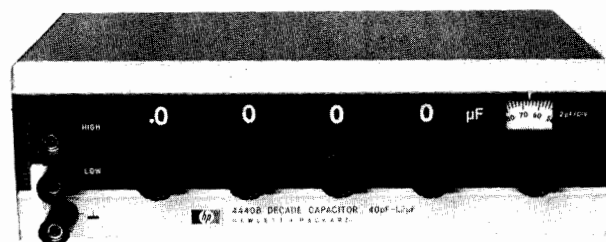
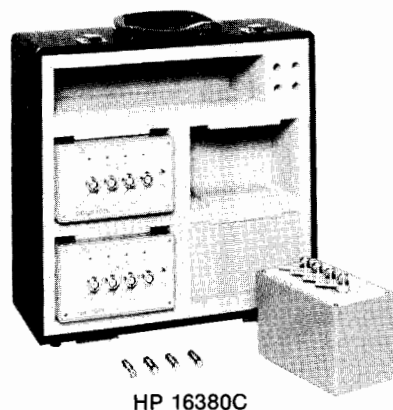
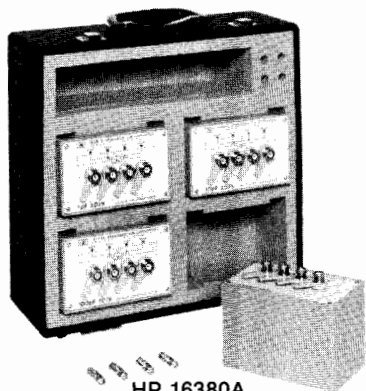

HP 16380A, HP 16380C Description

The HP 16380A and HP 16380C are precision standard capacitor sets that cover the range of 1 pF to 1 μF in decade steps. The HP 16380A consists of four discrete air-dielectric capacitors with nominal values of 1 pF, 10 pF, 100 pF, and 1000 pF. Similarly, the HP 16380C consists of four discrete capacitors, but with solid dielectrics and with nominal values of 0.01 μF, 0.1 μF, and 1 μF.

Both the HP 16380A and HP 16380C are furnished with test certification of 0.01% calibration accuracy. Capacitance stability with respect to time varies from capacitor to capacitor but is specified in the range of +/-50 or +/-300 ppm/year.

The HP 16380A and HP 16380C both have the four-terminal pair configuration to allow direct connection to any of Hewlett-Packard's many four-terminal pair impedance measuring instruments. The HP 16380A/C can be easily adapted to two-, three-, and five-terminal configurations.

HP 16380A, 16380C Specifications (valid at 1

kHz, 23±5°C)

HP 16380A

| Capacitance | 1 pF | 10 pF | 100 pF | 1000 pF |
|----------------------|-------------------------------------|-------|-------------|---------|
| Nominal Accuracy | | | ±0.1% | |
| Calibration Accuracy | | | ±0.01% | |
| Stability | | | <300 ppm/yr | |
| Dissipation Factor | | | <0.0001 | |
| Dimensions | 112 mm (H) x 142 mm (W) x 88 mm (D) | | | |
| Weight | 8.0 kg (includes case) | | | |

HP 16380C

| Capacitance | 0.01 μF | 0.1 μF | 1 μF |
|----------------------|-------------------------------|---------|------------|
| Nominal Accuracy | | | ±0.1% |
| Calibration Accuracy | | | ±0.01% |
| Stability | | | <50 ppm/yr |
| Dissipation Factor | <0.0004 | <0.0005 | <0.0007 |
| Dimensions | 117 mm (H)x142 mm(W)x88 mm(D) | | |
| Weight | 6.3 kg (includes case) | | |

HP 4440B Description

The Hewlett-Packard 4440B Decade Capacitor is a high accuracy instrument providing usable capacitances from 40 pF to 1.2 μF. Its 0.25% accuracy makes it an ideal aid for circuit design or as a working standard.

The use of silvered-mica capacitors in all four decades provides higher accuracy, lower dissipation factor and good temperature coefficient. An air capacitor vernier provides 100 pF (from 40 pF to 140 pF) with resolution of 1 pF. Capacitors are housed in a double shield in such a way that increased capacitance from two terminals to three terminals is held to 1 pF.

4440B Specifications

Capacitance: 40 pF to 1.2 μF in steps of 100 pF with a 40 pF to 140 pF variable air capacitor providing continuous adjustment to better than 2 pF between steps.

Direct reading accuracy: ±(0.25% + 3 pF) at 1 kHz for three-terminal connection.

Resonant frequency: typical values of the resonant frequency are 450 kHz at 1 μF, 4 MHz at 0.01 μF and 40 MHz at 100 pF

Dissipation factor: for C ≥ 1040 pF, 0.001 max. at 1 kHz.
for C < 1040 pF, 0.005 max. at 1 kHz.

Temperature coefficient: < +70 ppm/°C.

Insulation resistance: 5 GΩ minimum, after 5 minutes at 500 V dc.

Maximum voltage: 42 Vdc or 30 Vrms.

Weight: net, 2.5 kg (5½ lb); shipping, 3.6 kg (8 lb).

Size: 76 mm H x 264 mm W x 152 mm D (3" x 11" x 6").

Ordering Information

| Model | Description | Price |
|-----------|---|--------|
| HP 16380A | Standard Capacitor Set (1 pF, 10 pF, 100 pF, 1000 pF) | \$2600 |
| HP 16380B | Standard Capacitor Set (0.01 μF, 0.1 μF, 1 μF) | \$3000 |
| HP 4440B | Decade Capacitor | \$1050 |

COMPONENT & SEMICONDUCTOR MEASUREMENT

Semiconductor Parametric Test System

Model 4062B

349



- Precise, high speed probed wafer measurements
- 1pA resolution at all 48 pins

- Easy to program with Probing Pattern Generator
- Virtual front panel simplifies operation

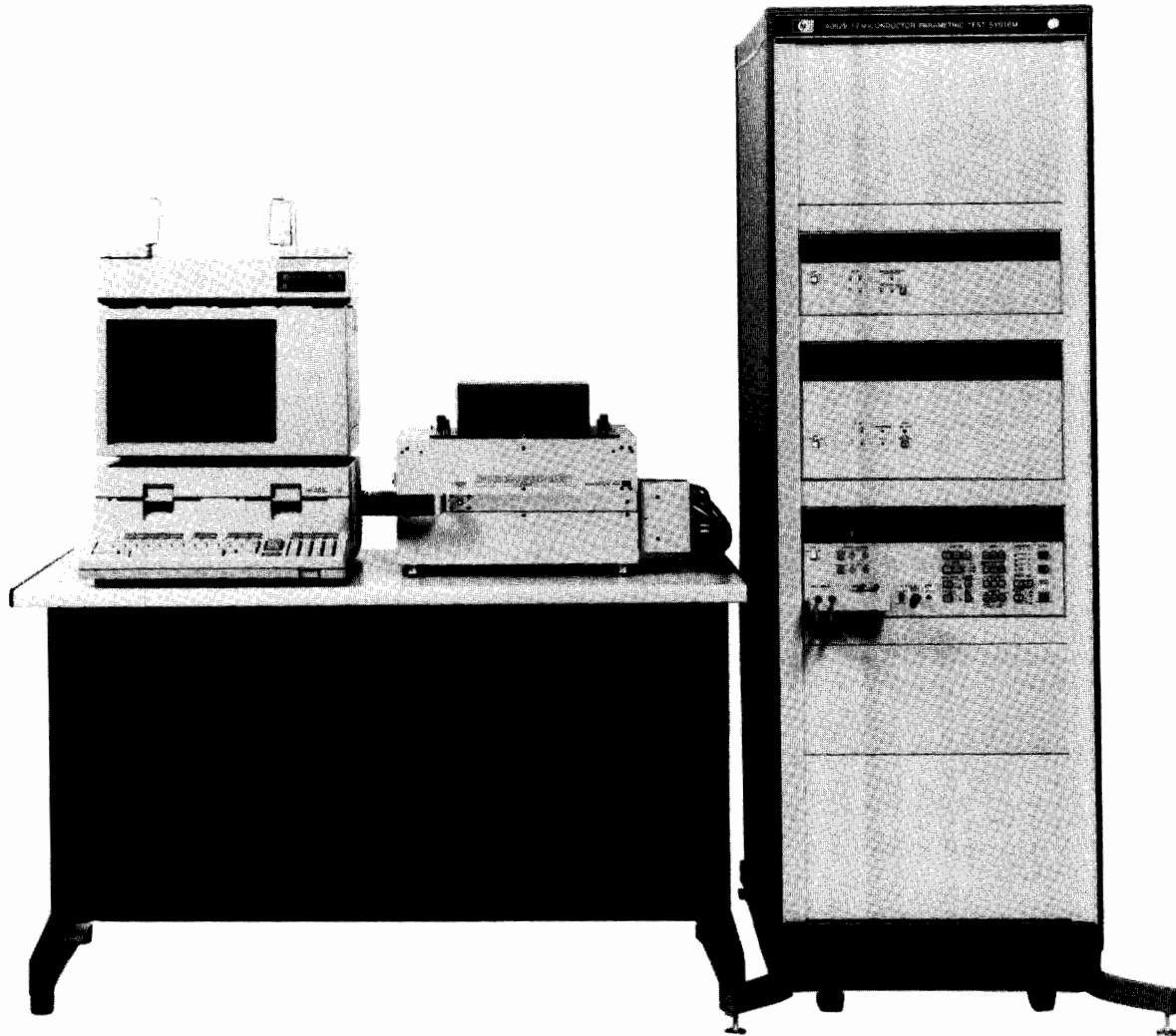

HP 4062B

(System controller, printer and tables are sold separately.)

Description

The HP 4062B Semiconductor Parametric Test System will help you improve IC yield and quality in production plus increase engineering efficiency. The system measures DC voltage/current and 1 MHz capacitance/conductance of wafers with high resolution and speed.

Precise 1pA and 1fF measurements are performed using a low noise switching matrix with up to 48 DUT pins. All specifications are guaranteed on these DUT pins. High speed measurement units provide fast throughput of high resolution measurements for wafer process monitoring and evaluation. Highly reliable measurements

performed on wafers can be fed back to design and process engineers to improve your IC yield and quality.

The HP 4062B is programmed with the simple and powerful HP BASIC. Parameter measurements such as threshold voltage or current gain can be made by a two line program using the HP 4062B's measurement utility subprograms. Prober control software is supplied to allow users to easily operate a wafer prober with the HP 4062B. The system software features an extensive program library that includes statistical analysis, trend charts, and the Virtual Front Panel (VFP) for convenient manual measurement. The HP 4062B will help you reduce software development time and increase engineering efficiency with easy programming.

COMPONENT & SEMICONDUCTOR MEASUREMENT

Semiconductor Parametric Test System

Model 4062B

Vth Measurements

Sample Program Using TIS

```

100 !
110 Connect (Smu1, D)
120 Connect (Smu2, G)
130 Connect (Gnd, S, Sb)
140 Force_v(D, Vd, Vrange, Vlimit)
150 Set_bsearch(G, D, 4, Va, Vb, Ith)
160 Search (Vth)
170 !

```

Sample Program Using Utility Library

```

60 !
70 Set_tr (S, G, D, Sb)
80 Vth=FNVth4(Ith, Vd, Va, Vb)
90 !

```

High speed, high resolution measurements

The HP 4062B can perform high speed measurements with 1 pA resolution. Measurement speed is important to customers, especially on production lines. The HP 4062B's switching matrix is designed to eliminate the effects of noise and reduce leakage current while minimizing stray capacitance. The system's measurement instruments were specially developed for high speed, high resolution measurements. Therefore, the total measurement speed, including data transfer, is very high. For example, Vth (threshold voltage) measurement takes approximately 140 ms.

Reliable measurements

The switching matrix, test leads and test fixtures are designed specifically for use in a parametric test system to ensure precise high speed measurements and to guarantee the performance of each measurement instrument in the system. The HP 4062B's specifications are guaranteed up to the DUT pins, so the HP 4062B provides practical high speed measurements with 1 pA resolution. In addition, the HP 4062B is easy to maintain and is set up for on-site service to minimize down time.

System Configuration

- DC Source/Monitor (HP 4141B)
- Switching Matrix (48-pin configuration)
- Switching Matrix Controller
- 1 MHz C Meter/C-V Plotter (HP 4280A)
- Rack Cabinet (HP 29402C)

Easy to program

Using the furnished measurement library - e.g., threshold voltage and current gain - you can perform measurements with a one or two line program. You can also quickly create probing programs using the interactive probing pattern generator furnished with the HP 4062B.



The HP 4062B's Test Instruction Set (TIS) makes programming easy. TIS programs execute very quickly, ensuring high speed measurement. Also furnished is software for statistical analysis of measurement data. This software allows you to create wafer maps, trend charts, and Scattergrams. In addition, a networking solution is available. SPN data file creation software (Opt. 401) can transform HP 4062B data files into files compatible with HP's SPN data format so that you can manage large volumes of data for total factory control.

Software Library

Virtual Front Panel (VFP) Test Instruction Set (TIS)

- Switching matrix control
- DC measurements
- Capacitance measurements
- Timing control
- Prober control
- System initialization

Graphics Library

- C-V graph
- I-V (linear-linear) graph
- I-V (linear-log) graph

Parameter Measurement Library

- Resistivity (2-wire or 4-wire)
- Breakdown voltage
- DC current gain
- Drain current
- Threshold voltage (4 kinds)
- Lateral diffusion effect (ΔL and ΔW)

Auto Prober Control Library

- Probing pattern generation
- Probing control

Data Processing Library

- Data file creation
- Wafer map
- Histogram
- Scatter plot
- Trend chart

Diagnostic Program

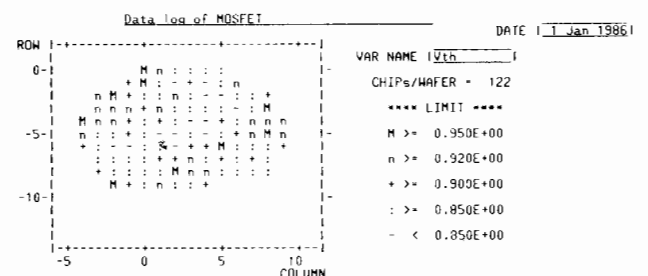



Specifications

Switching Matrix

Number of pins (to DUT): 48 pins (standard) with options for 12, 24 and 36 pins.

Number of ports (to instrument): 9 ports

High Resolution Source and Monitor Unit: 1 port

Source and Monitor Units: 3 ports

Ground: 1 port

C Measurement: 2 ports

Auxiliary: 2 ports

Maximum allowable voltage between ports: 220 Vdc

Maximum allowable current at pins: 500 mA_{dc}

Maximum stray capacitance between pins: 6 pF

DC Source and Monitor Units

High resolution source and monitor unit (SMU1*): 1 unit

Output/Measurement Range: Current, ± 1 pA - ± 100 mA, Basic Accuracy, 0.3%; Voltage, ± 1 mV - ± 100 V, Basic Accuracy, 0.1%

Source and monitor units (SMU2-4*): 3 units

Output/Measurement Range: Current, ± 100 pA - ± 100 mA, Basic Accuracy, 0.3%; Voltage, ± 1 mV - ± 100 V, Basic Accuracy, 0.1%

Ground unit: 1 unit

Output Voltage: OV; Accuracy, ± 2 mV

Current Range: ± 500 mA

Voltage source (Vs): 2 units

Output Range: 1 mV - ± 20 V; Basic Accuracy, 0.5%

Voltage monitor (Vm): 2 units

Measurement Range: ± 100 μ V - ± 20 V, Basic Accuracy, 0.2%

*SMU 1-4: Each SMU can function either as a dc voltage source/current monitor or as a dc current source/voltage monitor.

Capacitance-Conductance Measurements

Test frequency: 1 MHz ± 0.01 %

OSC level: 30 mV_{rms} ± 20 % and 10 mV_{rms} ± 20 %

Measurement range: (Maximum resolution to full scale)

C: 0.001 pF - 1.2 mF; basic accuracy, 0.5%

G: 0.01 μ S - 12 mS; basic accuracy, 1.5%

DC bias voltage for capacitance measurements: ± 100 V

Reference Data

Command Execution Time

Connect (Relays): 8ms

DC Source/Monitor¹:

Force (Current or Voltage): 10ms

Measure (Current or Voltage): 14ms

Sequential Force/Measure: 23ms

Binary Search²: 100ms (10 iterations)

Linear Search²:

80 - 100ms (10 point sweep)

440 - 640ms (100 point sweep)

1. When integration time is short and range is not InA/10nA. Does not include wait time set by user.
2. This command searches a specified measurement value by repetitive halving of the force voltage/current range.
3. This command searches a specified measurement value by using linear sweep.

General Specifications

Operating temperature range: 10°C - 40°C, ≤ 70 % RH at 40°C

Permissible temperature change: ≤ 1 °C/5 minutes

Air cleanliness: class 100,000 or higher clean room required

Power requirements: 100 V, 120 V, 200 V ± 10 %; 240V $+5$ % - 10 %; 48-66 Hz, 510 VA max.

Dimensions: cabinet, 535 mm(W) x 1635 mm(H) x 770 mm(D); switching matrix, 406 mm(W) x 210 mm(H) x 380mm (D)

Weight: cabinet with instruments, approximately 200 kg; switching matrix, approximately 25.3 kg

Accessories Furnished

HP 16066A: Test Fixture Adapter

HP 16067A: 24 pin DIP Low Leakage Fixture

HP 16068A: 48 pin DIP Low Leakage Fixture

HP 16069A: Universal Low Leakage Fixture

HP 16070A: General Purpose Dip Fixture

HP 16071A: Universal Fixture

HP 16072A: Personality Board (for connecting probe card)

HP 16075A: Relay Test Adapter

HP 16076A: System Test Module

HP 16077A: Extension Cable Fixture

System Controller

Required Controller: HP 9000 Series 200 Model 236A, 236C, 236S or 236CS

System Language: BASIC 3.0

Memory Size: ≥ 832 K byte

Interface: In addition to standard HP-IB, 2 HP-IB interface Cards (HP 98624A) are required.

Prober Interface

Automatic wafer probers used with the HP 4062B must be equipped with HP-IB capability. Hardware for mounting the switching matrix on the prober is also required. Contact the prober manufacturer for details concerning necessary mounting hardware.

Accessories Available

| Accessories Available | Price |
|--|---------|
| HP 16262B OPT. 502: EG 2001X Control Software | \$2,500 |
| OPT. 521: TSK 6000A Control Software | \$2,500 |
| HP 16262C OPT. 401: SPN Data File Creation Software | \$1,650 |

Ordering Information

| | |
|--|-----------|
| HP 4062B Semiconductor Parametric Test System (does not include controller) | \$78,600 |
| OPT. 050/060: For 50/60Hz Line Frequency ¹ | N/C |
| OPT. 100/120/220/240: For 100/120/220/240 Line Voltage ² | N/C |
| OPT. 001: 12-pin Configuration (delete 36 pins) | \$-14,400 |
| OPT. 002: 24-pin Configuration (delete 24 pins) | \$-9,600 |
| OPT. 003: 36-pin Configuration (delete 12 pins) | \$-4,800 |
| OPT. 004: Additional Pin Board | \$400 |
| OPT. 011: SMU Board | \$1,000 |
| OPT. 102: Delete 4280A | \$-8,380 |
| OPT. 110: Delete Test Fixtures for Packaged Devices | \$-3,480 |
| OPT. 401: SPN Data File Creation Software | \$1,650 |
| OPT. 501: EG 1034X Control Software ³ | \$0 |
| OPT. 502: EG 2001X Control Software ³ | \$0 |
| OPT. 521: TSK 6000A Control Software ³ | \$0 |
| OPT. 920: Extra System Library | \$320 |

¹Must select OPT. 050 or 060 according to the power line frequency used.

²Must select OPT. 100, 120, 220 or 240 according to the power line voltage used.

³Must select OPT. 501, 502 or 521.

NOTE: Refer to HP 4062B data sheet for details

COMPONENT & SEMICONDUCTOR MEASUREMENT

Semiconductor Parameter Analysis System

Model 4063A

- 1fA, 10 μ V and 1fF resolution through a wafer prober
- Wide variety of application programs
- Easy menu-driven operation
- Powerful programming tools

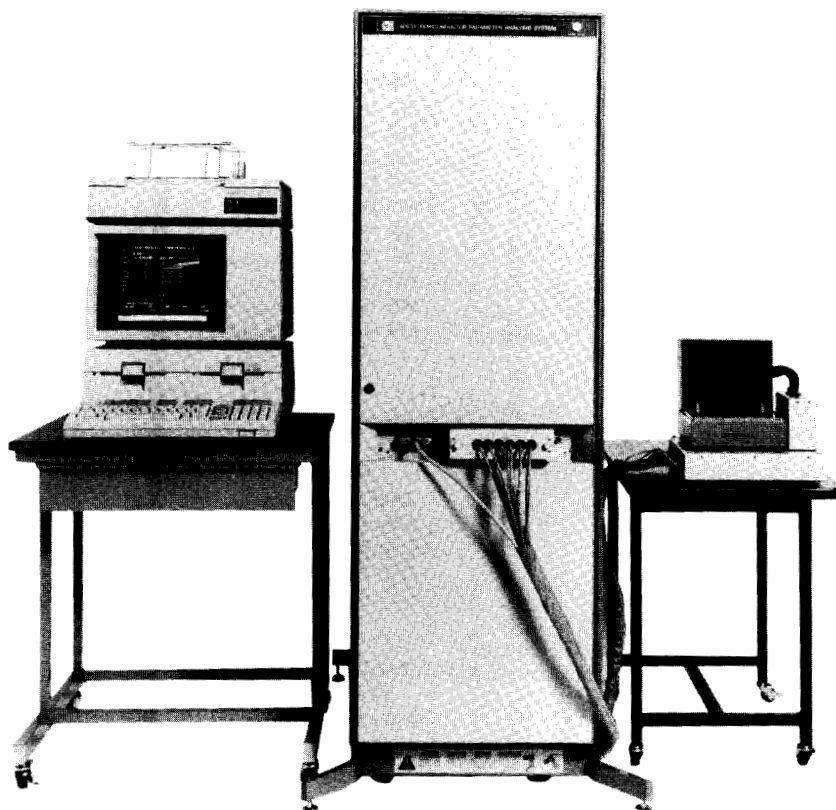

HP 4063A

(System controller, printer and tables are sold separately.)

Description

The HP 4063A offers plenty of advantages and benefits for applications in the semiconductor development lab. You can use the system to reduce your semiconductor development time and cost, ensure the accuracy and reliability of your measurements, and eliminate the long start-up times characteristic of other test systems.

The HP 4063A is the first semiconductor parameter analysis system capable of stable 1fA resolution measurements of wafer devices. Since precise measurements of wafer devices is possible, evaluation results can be fed back to control the semiconductor process. The result is that semiconductor development time and cost can be reduced.

Precise 1fA and 10 μ V DC measurements plus 1fF capacitance measurements at 1 MHz are performed through the HP 4063A switching matrix. All these measurements can be made at any one of the 6 (standard) or 12 (option) switching matrix DUT channels. That means you can make measurements with a single probing to ensure accuracy and reliability.

The entire system is controlled by menu-driven software. This simplifies operation so that you can become an expert operator quickly. The system includes a wide selection of application programs so that you can begin measurements as soon as the system is installed. This will virtually eliminate the long start-up time characteristic of other test systems.

Precise, high resolution measurements

The dedicated instrumentation provides a wide measurement range, high resolution, and high accuracy. Measurement instruments are designed for high resolution, while the switching matrix, test leads and test fixtures are designed for low noise. Since accuracy is specified at the end of Measurement Cable (HP 16146A), highly reliable measurements are ensured. Thus, the HP 4063A can perform 1fA/10 μ V/1fF resolution measurements on a wafer. Examples of the kinds of measurements requiring high resolution are leakage current and resistivity.

System configuration

Digital Voltmeter (HP 3456A)
 pA meter/DC Voltage Source (HP 4140B)
 DC Source/Monitor (HP 4141B)
 1 MHz C Meter/C-V Plotter (HP 4280A with OPT.001)
 Switching Matrix
 Switching Matrix Controller
 Rack Cabinet (HP 29402C)

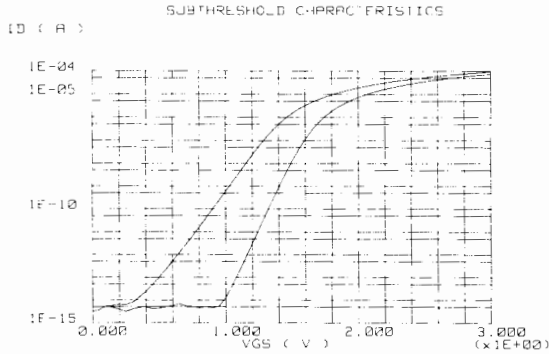

Ready to use

The HP 4063A's system software is menu driven, Page oriented - both operation and programming - to simplify system operation. Application programs require only measurement setup conditions, and can be used to obtain various characteristic curves and parameters, such as hFE-Ic and quasi-static C-V, as well as DLTS measurements (option). So you can begin measurement and analysis as soon as the 4063A is installed.

Application Package

The following programs are furnished with the 4063A. These are easy to execute with a few keystrokes.

MOSFET DC Characteristics: Drain Characteristics, Subthreshold Characteristics, Body Effect, Parameter Measurements.

Bipolar Tr. DC Characteristics: Collector Characteristics, $I_C/I_B - V_{BE}$ Characteristics, hFE - I_C Characteristics, Parameter Measurements.

MOS Diode Capacitance Characteristics: 1 MHz C-V Characteristics, C-t Characteristics/Zerbst Analysis, Pulsed C-V Characteristics/Doping Profile, Ideal C-V characteristics, Quasi-Static C-V Characteristics, Ideal Quasi-Static C-V Characteristics, Surface State Distribution.

Junction Diode Capacitance Characteristics: 1 MHz C-V Characteristics, Doping Profile.

DLTS (OPT. 301): DLTS Signal Plot (MOS/Junction Diode), Arrhenius Plot (MOS/Junction Diode), Surface State Distribution (MOS Diode).

SPN Data File Creation (OPT. 401)

Wafer devices sequential measurement and data analysis (OPT. 411)

Easy to operate and program

All system operations are controlled by virtual front panels designed for convenience, flexibility and expandability of operations. Measurement conditions can be set easily by filling-in-the blanks using softkeys. Eight display modes, including three-dimensional graphs, histograms and wafer maps, are available. Each display mode has various analysis functions for quick evaluation of measurement results. In addition, you can create your own programs using the HP 4063A's powerful programming tool, TSP (Test Sequence Programming), which includes a utility library. TSP will help you improve your programming efficiency. A networking solution is also available. SPN data file creation software (OPT. 401) can transform HP 4063A's data files into files compatible with HP's SPN data format in order to manage test data for analysis.

Specifications

Switching Matrix

Number of DUT channels: 6 (standard) or 12 (optional)

Number of AUX terminals: 2

Connection method: guarded Kelvin connection

Maximum voltage between DUT Channels when switch is open: ± 200 Vdc

Maximum ground-referenced voltage at DUT Channel: ± 100 Vdc

Maximum current at DUT channel: 500 mA

DC Measurements

Source and Monitor: 4 units

Output Measurement Range: current, 0 A to ± 100 mA, 0.3% basic accuracy, 1 pA max resolution; voltage, 0 to ± 100 V, 0.1% basic accuracy, 1 mV max resolution.

Ground Unit

Output Voltage: 0 V ± 7 mV

Low Current Measurements

Measurement Range: 0 A to ± 19.99 mA, 0.5% basic accuracy, 1 fA max resolution

Voltage Source for Low Current Measurements

Output Modes:



Output Range: 0 to ± 100 V, 10 mV max resolution

High Resolution Voltage Measurements

Measurement Range: 0 V to ± 200 V, 0.0078% basic accuracy, 10 μ V max resolution

Voltage Source: 2 units

Output Range: 0V to ± 20 V, 0.5% basic accuracy, 1 mV max resolution

Capacitance-Conductance Measurements

Test Frequency: 1 MHz $\pm 0.01\%$

OSC Level: 30 mVrms $\pm 30\%$ and 10 mVrms $\pm 30\%$

Measurements Range:

C: to 1.2 nF, 0.35% basic accuracy, 1fF max resolution

G: to 11 mS, 0.55% basic accuracy, 10 nS max resolution

dc Bias Source: 0 to ± 100 V

Temperature Measurements

Available Thermocouples: Type K,T,E,J,R,KP vs AU-0.07% Fe

Number of Thermocouple connection Terminals: 3 (High, Low, Guard)

Voltmeter for temperature measurements: same as that for high resolution dc voltage measurements.

Measurement Range: -200°C to $+400^\circ\text{C}$, 0.1 $^\circ\text{C}$ resolution

General Specifications

Operating Temperature Range: 10°C to 40°C , $\leq 70\%$ RH at 40°C

Power Requirements: 750 VA max (standard system)

Dimensions: 535mm W x 1635mm H x 800mm D

Additional cabinet will be added for options 301, 302, or 311.

Weight: approximately 230 kg (standard)

Accessories Furnished

HP 16145A: Interconnection Cable Set

HP 16146A: Measurement Cable

HP 16147A: Test Fixture

HP 16148A: Test Leads

HP 16079A: System Test Module

System Controller

Required Controller: HP 9000 Series 200 model 236C/236CS/236A/236S Personal Technical Computer

Accessories Available

| Accessory | Price |
|---|----------|
| HP 16073A: Personality Board | \$ 190 |
| HP 16263A Opt.401: SPN data file creation software | \$ 1,650 |
| HP 16264A Opt.054: Electroglas 2001X prober control software | \$ 2,200 |

Ordering Information

HP 4063A Semiconductor Parameter Analysis System \$84,600

(does not include controller)

Opt.050/060:¹ for 50/60 Hz Line frequency N/C

Opt.100/120/220/240:² for 100/120/220/240 V N/C

line voltage

Opt.301: DLTS measurement \$7,800

Opt.302: Current bias for DLTS \$2,500

Opt.311: 12-channel configuration \$25,700

Opt.351: Add rack cabinet (for OPT.301, 302) \$3,600

Opt.352: Add rack cabinet (for OPT.311) \$3,600

Opt.401: SPN data file creation software \$1,650

Opt.501: Electroglas 1034X prober control software \$2,200

Opt.502: Electroglas 2001X prober control software \$2,200

Opt.521: TSK A-PM 3000/6000 prober control software \$2,200

Opt.611: SI 5500 temperature controller control software \$500

(for DLTS)

Opt.801: Extra SMU board \$1,000

Opt.910: Extra system library \$200

1. Must select OPT.050 or 060 according to the power line frequency used.

2. Must select OPT.100, 120, 220 or 240 according to the power line voltage used.

COMPONENT & SEMICONDUCTOR MEASUREMENT

DLTS Analysis System

Model 4064A

- Furnished with DLTS, C-V/C-t application programs
- Easy, menu-driven operation
- 1fF capacitance resolution, 10 μ s time resolution

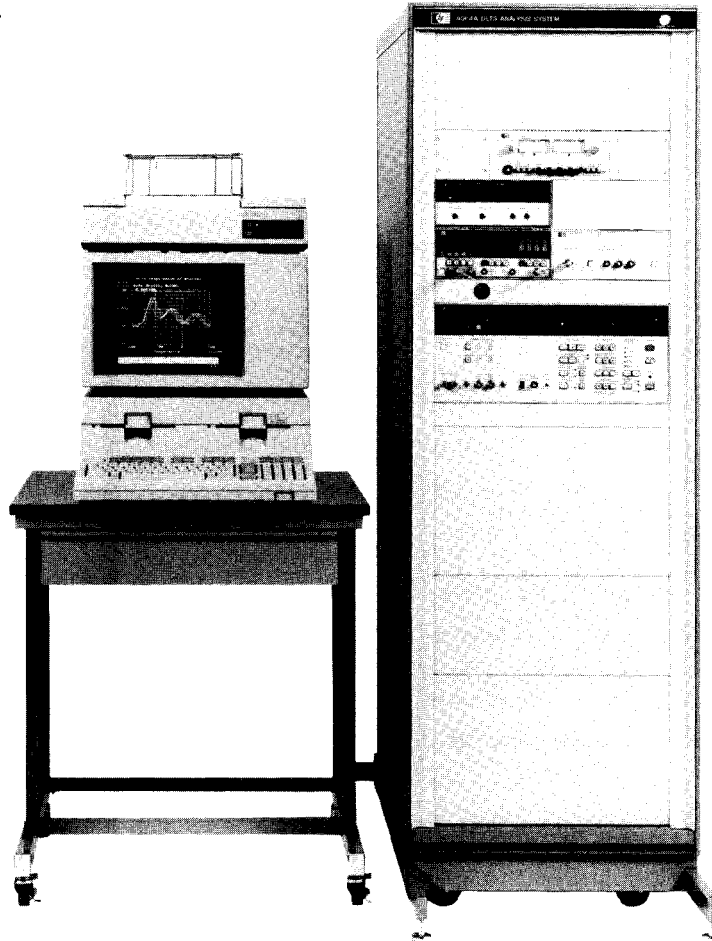

HP 4064A with OPT. 302
(System controller, printer and table are sold separately.)

Description

DLTS measurements which once required considerable time and labor can now be performed easily with the HP 4064A, a temperature controller, and a cryostat. Once measurement conditions are set using the 4064A's menus and softkeys, you can perform everything from DLTS measurements to DLTS signal plots, Arrhenius plots, and capture cross section calculations. You can obtain multiple DLTS signal plots with a single temperature sweep to make a large amount of data available in a short period of time. After your system is installed, start making measurements by using the 4064A's extensive set of application programs, which include such functions as Doping Profiles and Zerbst Analysis.

DLTS Measurement Software

With its menu-driven operation and softkeys, the HP 4064A software features ease of use that does not require special programming skills.

Once the measurement conditions are set, DLTS measurement can be performed and DLTS signals can be plotted. A unique feature of the HP 4064A DLTS measurement software is the execution of an Arrhenius plot which is displayed with automatically calculated trap levels, trap densities and capture cross section parameters. The HP

4064A DLTS measurement software also provides Surface State Distribution, important for MOS diode evaluation.

Measurements obtained over a wide trap level range are highly sensitive and stable because of the HP 4064A's 1fF capacitance resolution and 10 μ s time resolution.

The HP 4064A's option 302 allows you to apply a pulse voltage with currents up to 100mA to perform PN junction majority and minority carrier trap evaluations.

C-V/C-t Measurement Application

In addition to DLTS measurements, application programs are furnished with the HP 4064A. Designed for easy operation, these programs obtain a number of capacitance characteristics, for example, Flat-Band Voltage, Surface Charge Density, and Substrate Impurity Concentration, Doping Profile from the 1MHz C-V characteristics and Zerbst Analysis from the C-t Characteristics.

Test Sequence Programming

You can use the 4064A's Test Sequence Programming function to write your own custom application programs. This feature allows you to expand into new areas and to develop new test methods, like Isothermal Capacitance Transient Spectroscopy (ICTS).



Application Programs

DLTS Measurements:

DLTS Signal Plot (MOS, junction diode)

Arrhenius Plot (MOS, junction diode):

Trap level, capture cross section, trap concentration

Surface State Distribution (MOS diode)

MOS Diode Capacitance Characteristics:

1MHz C-V Characteristics:

Flat band voltage/capacitance, Oxide layer thickness, Surface state charge density, Oxide layer capacitance, Impurity concentration of the substrate, Threshold voltage, Fermi potential

C-t Characteristics/Zerbst Analysis:

Surface generation velocity, Minority carrier generation lifetime

Pulsed C-V Characteristics/Doping Profile

Ideal C-V Characteristics

Junction Diode Capacitance Characteristics:

1MHz C-V Characteristics

Doping Profile

System Configuration

1MHz C Meter/C-V Plotter (HP 4280A with Option 001)

Pulse Generator (HP 8112A)

External Bias Adapter (HP 16083B)

Rack Cabinet (29402C)

Specifications

Specifications are defined at the end of the HP 16081A test leads (furnished accessory).

1MHz Capacitance Measurements

Measurement functions: C, G, C & G, C-V, G-V, C & G-V, C-t, G-t, C & G-t

Test frequency: 1MHz $\pm 0.01\%$

Test signal level: 30mVrms $\pm 15\%$, 10mVrms $\pm 15\%$

C and G measurement range, resolution:

C: 0-1.2nF (to 900pF for EXT FAST bias)

Maximum resolution is 1fF (10fF for FAST measurement speed)

G: 0-7mS (to 5mS for EXT FAST bias)

Maximum resolution is 10nS (100nS for FAST measurement speed)

Accuracy:

| Bias Mode | Range | | Accuracy ^{1, 2} | |
|-----------|-----------------------|---|--------------------------|---|
| | | | | $\pm(\% \text{ of rdg} + \text{capacitance/conductance})$ |
| Int | 10 pF/ 100 μ S | C | | $\pm\{0.3\%^4 + 8 \text{ fF}^3 + (0.4 \times \text{Gr}) \text{ fF}\}$ |
| | | G | | $\pm\{0.4\%^4 + 80 \text{ nS}^3 + (110 \times \text{Cr}) \text{ nS}\}$ |
| or Ext | 100 pF/ 1 mS | C | | $\pm\{0.3\%^4 + 30 \text{ fF}^3 + (0.4 \times \text{Gr}) \text{ fF}\}$ |
| | | G | | $\pm\{0.4\%^4 + 300 \text{ nS}^3 + (110 \times \text{Cr}) \text{ mS}\}$ |
| Slow | 1 nF/ 10 mS | C | | $\pm\{0.8\%^4 + 300 \text{ fF}^3 + (1.2 \times \text{Gr}) \text{ fF}\}$ |
| | | G | | $\pm\{1.9\% + 3\mu\text{S}^3 + (150 \times \text{Cr}) \text{ nS}\}$ |
| Ext Fast | 10 pF/ 100 μ S | C | | $\pm\{0.9\%^4 + 23 \text{ fF}^3 + (2.3 \times \text{Gr}) \text{ fF}\}$ |
| | | G | | $\pm\{1.2\%^4 + 230 \text{ nS}^3 + (160 \times \text{Cr}) \text{ nS}\}$ |
| | 100 pF/ 1 mS | C | | $\pm\{0.9\%^4 + 130 \text{ fF}^3 + (2.3 \times \text{Gr}) \text{ fF}\}$ |
| | | G | | $\pm\{1.2\%^4 + 1.3\mu\text{S}^3 + (160 \times \text{Cr}) \text{ nS}\}$ |
| | 1 nF/ 10 mS | C | | $\pm\{3.1\%^4 + 2.3 \text{ pF}^3 + (5.1 \times \text{Gr}) \text{ fF}\}$ |
| | | G | | $\pm\{4.4\% + 23\mu\text{S}^3 + (240 \times \text{Cr}) \text{ nS}\}$ |

Gr: Measured conductance (μ S), Cr: Measured capacitance (pF)

1. Accuracy is specified at 23°C $\pm 5^\circ\text{C}$. Error doubles at 10°C-40°C.

2. Accuracy is specified for the following conditions: C & G or C & G-V measurement function, floating mode, MED or SLOW measurement speed, test signal level is 30mVrms, after zero calibration, high resolution off, stray capacitance guard <5pF.

3. Multiply by 10 for FAST or MED measurement speed and 10mVrms test signal level.

4. Add 0.1% for 10mVrms test signal level.

DC Bias

Voltage setting range: 0 to $\pm 100\text{V}$

Pulse Bias

Amplitude setting range: 0 to 7.00V

Maximum Current: $\pm 6\text{mA}$

C-t Measurements

Hold time (th) and delay time (td) setting range, resolution:

| Setting Range | Resolution |
|--|-------------|
| $10\mu\text{s} \leq \text{th}, \text{td} \leq 65\text{ms}$ | 10 μ s |
| $65\text{ms} < \text{th}, \text{td} < 1\text{s}$ | 500 μ s |
| $1\text{s} \leq \text{th}, \text{td} < 10\text{s}$ | 1ms |
| $10\text{s} \leq \text{th}, \text{td} \leq 32\text{s}$ | 10ms |

Option 302 Current Bias

Voltage setting range: 0 to 9.99V

Maximum current: $\pm 100\text{mA}$

General Specifications

Operating Temperature: 10°C-40°C; relative humidity $\leq 70\%$ (at 40°C)

Storage Temperature: -40°C to +70°C

Power Requirements: 90-105V, 108-126V, 198-233V, 216-250V, 48-63Hz

Maximum Power: 400VA

Warm Up Time: ≥ 30 minutes

Dimensions (mm): approximately 533(W) x 1632(H) x 762(D)

Weight: approximately 160kg (standard)

Accessories Furnished

HP 16081A: Test Leads, 1 ea.

HP 04064-61608: Extension Cable (1.5m), 2 ea.

HP 1250-0080: BNC Adapter, 2 ea.

HP 04064-61000: Test Capacitor Set, 1 ea.

System Controller:

Applicable Controllers: HP 9000 Series 200 model 236C, 236CS, 236A, or 236S

Required Memory Capacity: 1.8 Mbytes RAM memory

Interfaces: One 98624A HP-IB Interface Card, one 98623A BCD Interface Card when using YEW 2572.

Thermometer and Temperature Controller:

Use a thermometer or a temperature controller that has control software supplied with the 4064A (see options 611 or 651).

Ordering Information

4064A DLTS Analysis System (does not include controller) **Price** \$28,000

Opt. 100/120/220/240:¹ 100/120/220/240 V line voltage \$0

Opt. 302: Current bias for DLTS \$2,500

Opt. 611: Control software for the Scientific Instruments Model 5500 Temperature Controller \$550

Opt. 651:² Yokogawa Hokushin Electric (YEW) Type 2572 Digital Thermometer installation kit (includes control software, rack mount kit, and BCD cable) \$900

1. Must specify one of these options according to the power line voltage.

2. Must order one 98623A BCD Interface with the system controller.



COMPONENT & SEMICONDUCTOR MEASUREMENT

Semiconductor/Component Test System

Model 4061A

- Ready to use—supplied with 7 turn-key application pacs
- Reliable impedance and current measurements with one probing
- Productivity improvement through accurate and fast measurement over wide range

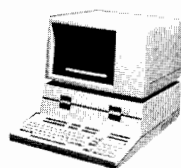

DESIGNED FOR
HP-IB
SYSTEMS

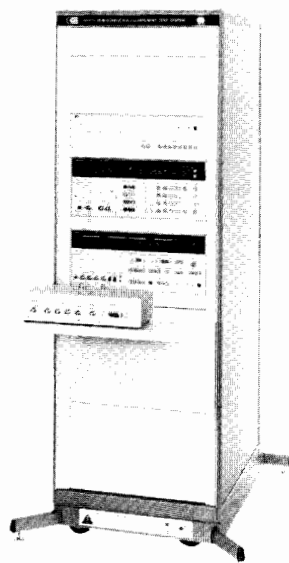

HP 4061A

Description

The HP 4061A Semiconductor/Component Test System is a dedicated system for making efficient, automatic evaluation of the fundamental characteristics of semiconductor and electronic components required in R & D and production areas. This system employs reliable, accurate measurements and high speed data processing to perform more reliable evaluations with speed and less manpower. The HP 4061A is supplied with 7 sophisticated applications programs and is flexible in both software and hardware. Thus, the system can output measurement results in nearly any required data format.

The switching subsystem, designed especially for use with the HP 4061A, allows both impedance and current measurement without changing DUT connection. Using this new switching subsystem, and by making impedance measurements, the HP 4061A performs evaluation of Doping profile, Oxide capacitance, Flat band condition, Threshold voltage, Surface charge, and Minority carrier life time/surface generation velocity. The HP 4061A also measures leakage current and reverse/forward current-voltage characteristics. Surface state density evaluation, using both high (e.g., 1 MHz) and low frequency (Quasi-static) C-V measurements and data processing are also possible by making modifications to system software.

The system offers significant improvement in both yield and quality in production through fast and reliable measurements and evaluations. It is also a valuable evaluation tool for the development of new materials and devices. The HP 4061A provides the flexibility to meet the future measurement requirements of the electronics industry.

System Configuration

HP 4140B pA Meter/DC Voltage Source
HP 4275A Multi-frequency LCR Meter
Switching Subsystem
HP 29402C 56-inch Rack Cabinet

Furnished Application Software

Semiconductor high/low frequency C-V characteristics, I-V characteristics, C-t characteristics and Zerst analysis, Impedance Frequency/Bias characteristics, Ideal C-V curve.

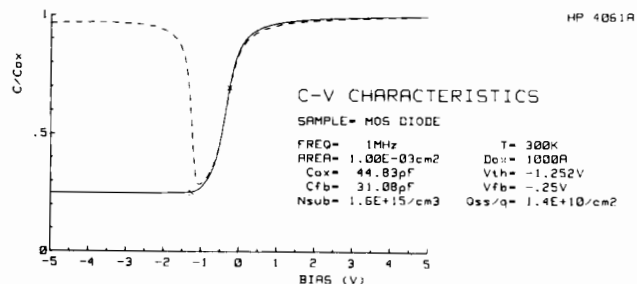

Specification

For detailed specifications on each of the instruments used in the HP 4061A, refer to the individual data sheets.

Switching Subsystem

The switching subsystem consists of a switch control module and switching module with interconnecting cables.

Function: Switches connection from DUT to either Multi-frequency LCR Meter or the pA Meter/DC Voltage source.

System Measurement Range (only deviations from individual instrument specifications are listed.)

Impedance Measurements (HP 4275A)

Frequency range: ≤ 1 MHz

Measurement parameters: C-G

Capacitance: ≤ 2000 pF (with $D \leq 0.1$)

***Accuracy:** (accuracy of HP 4275A) $\times 1.5 + \Delta C$ (at $23^\circ\text{C} \pm 5^\circ\text{C}$).

$$\Delta C = 1.4 \times 10^{-3} C \times f^2 \text{ (pF)} + 5 \text{ counts}$$

Conductance: $\leq 12\text{mS}$ ($D \leq 0.1$)

***Accuracy:** (accuracy of 4275A) $\times 1.5 + \Delta G$ (at $23^\circ\text{C} \pm 5^\circ\text{C}$)

$$\Delta G = 6 \times 10^{-3} C \times f \text{ (S)} + 5 \text{ counts}$$

* f: frequency in MHz

Cx: Measured capacitance value in pF

At 5°C to 40°C , ΔC and ΔG doubles. Example: Assuming $C_x = 1000$ pF and $f = 1$ MHz, $C = (1.4 \times 10^{-3} \cdot 10^3 \cdot (1)^2) \text{ pF} + 5 \text{ counts} = 1.4 \text{ pF} + 5 \text{ counts}$

Current Measurements (HP 4140B)

Accuracy: (accuracy of HP 4140B) $\times 1.5 + 5$ counts

After one-hour warmup and at DUT terminal of switching module

Impedance Measuring Section (HP 4275A)

See the HP 4275A's page.

Current Measurement Section (HP 4140B)

See the HP 4140B's page.

General Information

Operating temperature: 5°C to 40°C , $\leq 70\%$ RH at 40°C

Power: 100, 120, 220, and 240V, $+5\%$ to 10% , 48 to 66 Hz, 520 VA

Size: 535mm W x 1635 mm H x 770 mm D (21" x 64.4" x 30.3").

Weight: Approximately 125 kg (275 lbs).

System Controller

HP 9000 Series 200 Model 226A/236A/226S/236S Personal Technical Computer

Ordering Information

HP 4061A Semiconductor/Component Test System (does not include controller) **Price** \$27,190

Opt. 001: ± 100 V dc Bias for HP 4275A N/C

Opt. 002: 1-3-5 Frequency Steps for HP 4275A N/C

Opt. 026*: System library for HP 9826A/S controller N/C

Opt. 036*: System library for HP 9836A/S controller N/C

*Must order either OPT. 026 or 036.

NOTE: Refer to HP 4061A data sheet for details

COMPONENT & SEMICONDUCTOR MEASUREMENT DC SOURCE/MONITOR



Model 4141B

- High speed measurements down to the pA range
- High reliability at low cost

- High accuracy and resolution
V: $\pm 100\mu\text{V}$ — $\pm 100\text{V}$, 0.1%
I: $\pm 50\text{fA}$ — $\pm 100\text{mA}$, 0.3%

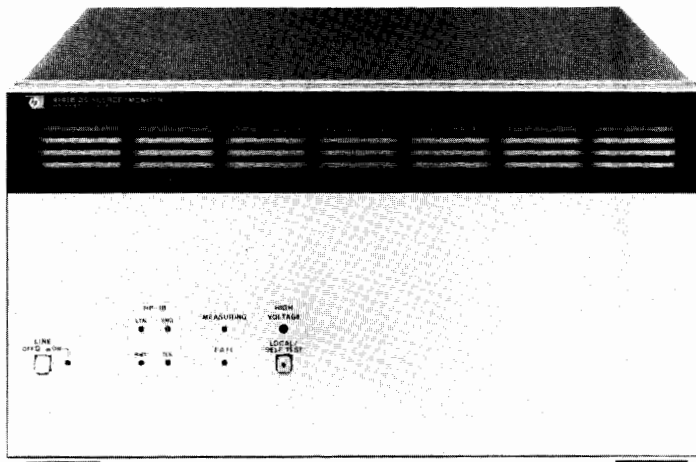

HP 4141B



Description

The HP 4141B DC Source/Monitor is designed for use as a system component in user-designed semiconductor I-V or DC parametric test systems. With its wide DC measurement range, high resolution, high-speed measurement capabilities, remote sensing, and high accuracy, the HP 4141B will contribute towards quality improvement and increased measurement throughput in the lab or on the production line.

High Speed Measurements with High Resolution

Four source/monitor units (SMU's) coupled with two voltage-source units (Vs's), two voltage monitor units (Vm's), and one ground unit (GNDU) make the HP 4141B equivalent to twenty one instruments. A stand-alone instrument capable of measuring dc parameters, the HP 4141B features high resolution measurements (50fA/100 μV) and a built-in timing controller. Typical time for a current or voltage measurement, which includes data transfer, is approximately 25ms. A swept measurement (51 points) takes approximately 490ms. High accuracy and high speed measurements, especially in the low current range, are exclusive features of the HP 4141B.

High Reliability

The HP 4141B's high reliability significantly simplifies maintenance and reduces maintenance costs. To reduce system down time, the HP 4141B is designed for on-site service. Performance verification and diagnostics software for user troubleshooting is also available.

Specifications

Measurement Unit

Source and monitor units (SMU): 4 channels (Kelvin connection) Each SMU can be programmed to source voltage and monitor current, or conversely to source current and monitor voltage.

SMU Range, Resolution and Accuracy

| Voltage range | Resolution | Accuracy | Max. Current |
|-----------------------|-------------------|-------------------------------------|----------------------------|
| $\pm 20\text{V}$ | 1mV | 0.1% + 0.05% | 100mA |
| $\pm 40\text{V}$ | 2mV | | 50mA |
| $\pm 100\text{V}$ | 5mV | | 20mA |
| Current Range | Resolution | Accuracy | Max. Voltage |
| $\pm 100\text{mA}$ | 100 μA | 0.3% + (0.1 + 0.2 x Vout*/100)% | 20V (I > 50mA) |
| $\pm 10\text{mA}$ | 10 μA | | 40V (20mA < I \leq 50mA) |
| $\pm 1000\mu\text{A}$ | 1 μA | | 100V (I \leq 20mA) |
| $\pm 100\mu\text{A}$ | 100nA | | |
| $\pm 10\mu\text{A}$ | 10nA | | |
| $\pm 1000\text{nA}$ | 1nA | | |
| $\pm 100\text{nA}$ | 100pA | 0.5% + (0.1 + 0.2 x Vout*/100)% | |
| $\pm 10\text{nA}$ | 10pA | 1% + (0.1 + 0.2 x Vout*/100)% + 5pA | |
| $\pm 1000\text{pA}$ | 1pA ** | | |

*Vout is the SMU output voltage, in volts.

**Max. Measurement Resolution is 50fA.

1. Accuracy specifications are given as % of reading when measuring or % of setting when reading.
2. Accuracy tolerances are specified at 23°C \pm 5°C, after a 40-minute warm-up, with AUTO CAL on, and are specified at the rear panel connector terminals referenced to SMU common. Tolerances double for the extended temperature range of 10°C to 40°C.

Output/Measurement resolution: Voltage - 4 1/2 digits
Current - 4 digits

Voltage source units (Vs): 2 channels

Voltage Range, Resolution, and Accuracy

| Output voltage range | Resolution | Accuracy | Max. Current |
|----------------------|------------|------------------------|--------------|
| $\pm 20\text{V}$ | 1mV | 0.5% of setting + 10mV | 10mA |

Voltage monitor units (Vm): 2 channels

Voltage Range, Resolution and Accuracy

| Measurement voltage range | Resolution | Accuracy |
|---------------------------|-------------------|------------------------|
| $\pm 2\text{V}$ | 100 μV | 0.5% of reading + 10mV |
| $\pm 20\text{V}$ | 1mV | 0.2% of reading + 10mV |

Ground Unit: 1 channel (kelvin connection)

Current range: $\pm 500\text{mA}$

General Specifications

Operating Temperature Range: +10°C to +40°C, $\leq 70\%$ RH at 40°C. Permissible temperature change $\leq 1^\circ\text{C}/5\text{min}$, Maximum wet-bulb temperature is 29°C.

Power requirements: 100/120/220V $\pm 10\%$, 240V-10%+5%, 48 to 66Hz, 240/VA max.

Dimensions: Approximately 426mm (16.77in)W x 235mm (9.25in)H x 612mm (24.1in)D

Weight: Approximately 19kg (41.5 lbs)

Accessories Furnished

HP 04085-61651 Interconnect Cable Assembly

HP 04141-60001 Connector Plate

HP 04145-61630 BNC Cable (3m) 4ca.

Accessories Available

HP 16058A Test Fixture

HP 16059A Adapter (Using with 16058A)

Price

\$2,100

\$420

Ordering Information

4141B DC Source/Monitor

Opt.001: Extra SMU Board

Opt.050/060: *50Hz/60Hz Line Frequency

Price

\$15,300

\$1,000

\$0

*Must select Opt. 050 or 060 according to the power line frequency used.



COMPONENT & SEMICONDUCTOR MEASUREMENT

Semiconductor Parameter Analyzer

Model 4145A

- Fully automatic, high speed dc characterization of semiconductor devices and materials
- Four programmable stimulus/measurement units capable of high resolution, wide range sourcing and sensing . . . I: 1 pA~100 mA, V: 1 mV~100 V
- Built-in graphics analysis functions
 - marker and cursor provide direct numeric readouts
 - line function for automatic calculation of line gradient and X,Y axes intercept values
- Built-in flexible disc drive for permanent storage of user programs and measurement results

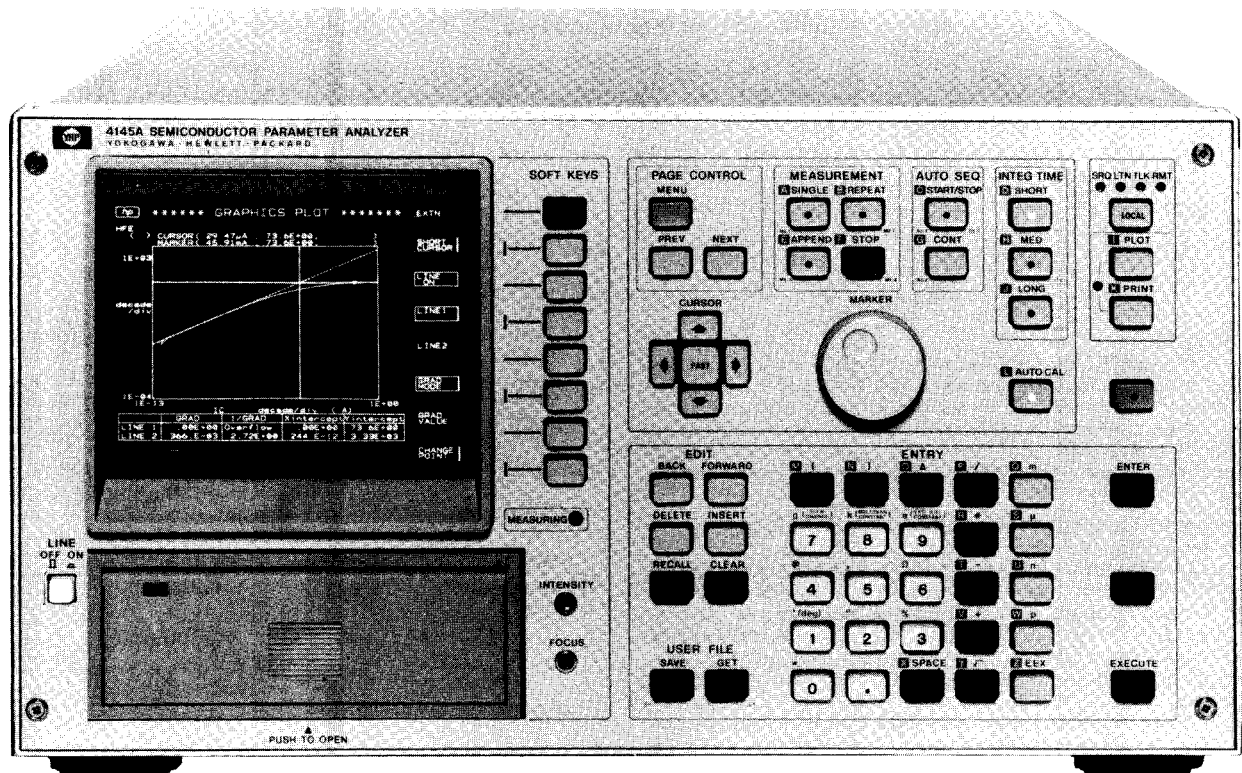

HP 4145A



Description

Designed for production line and laboratory use, the HP 4145A is the electronics industry's first stand-alone instrument capable of complete dc characterization of semiconductor devices and materials. It stimulates voltage and current sensitive devices, measures the resulting current and voltage responses, and displays the results in a user-selectable format (graph, list, matrix or schmo) on a built-in CRT display. An on-board programmable calculator provides real-time calculation of voltage/current dependent parameters, such as the current gain (h_{FE}) and transconductance (g_m) of transistors, which also can be displayed on the CRT. A number of powerful graphic analysis tools—marker, cursor, line function, interpolation—enhance the HP 4145A's basic capabilities and provide fast, accurate analysis of semiconductor devices, leading to increased production yields and improved device quality.

Four built-in stimulus/measurement units (SMUs) are the heart of the HP 4145A. Each SMU can be independently programmed to function as either a voltage source/current monitor or a current source/voltage monitor. Thus, a bipolar transistor, for example, can be completely characterized in common-base, common-emitter, and common-collector configurations without changing connections—only changing the SMUs' operating modes is required. The HP 4145A is also equipped with two voltage sources and two voltage monitors for measurements on devices having more than four terminals, such as ICs.

The HP 4145A can be controlled from the front panel, via the HP-IB (standard), or by measurement setups stored on flexible discs.

Displayed information—measurement setups, auto-sequence programs, measurement results—can be dumped directly onto an external digital printer/plotter to obtain publication quality hard copies. Also, measurement results can be sent via the HP-IB to a computer for further processing.

Auto Sequence Programs

Measurement programs stored on a HP 4145A flexible disc can be linked by an auto sequence program, making it possible to perform a series of measurements with just one keystroke.

Four User-Selectable Display Formats to Suit the Evaluation

Measurement results can be displayed in one of four display formats: GRAPHICS, LIST, MATRIX or SCHMOO. After measurement has been made and the results displayed, the softkeys can be used to access various analysis functions for complete device evaluation. These functions include MARKER for numeric readout of measured value at any point along a plotted curve, CURSOR for numeric readout of value at any graphic point and for line positioning, STORE /RECALL for overlay comparisons, AUTO SCALE for optimum graphic scaling, and LINE FUNCTION for direct readout of line gradient and X-Y axes intercept values.

COMPONENT & SEMICONDUCTOR MEASUREMENT

Switching Matrix
Models 4145A, 4085M



HP 4145A Specifications

Stimulus measurement unit (SMU): four SMUs are built into the HP 4145A. Each SMU can be programmed to source voltage and monitor current, or conversely to source current and monitor voltage.

Output/measurement resolution: voltage, 4 1/2 digits; current, 4 digits

Maximum capacitive load: 1000 pF

SMU Range, Resolution and Accuracy

| Voltage Range | Resolution | Accuracy ^{1,2} | Max. Current |
|---------------|------------|----------------------------|--------------|
| ±20 V | 1 mV | ±(0.1% of reading + | 100 mA |
| ± 40 V | 2 mV | 0.05% of range + | 50 mA |
| ± 100 V | 5 mV | 0.4 Ω × I _{out}) | 20 mA |

| Current Range | Resolution | Accuracy ^{1,2} | Max. Voltage |
|---------------|------------|---|---|
| ± 100 mA | 100 μA | ±[0.3% + (0.1 + 0.2 × V _{out} /100)%] | 20 V (I > 50 mA) 40 V (20 mA < I ≤ 50 mA) 100 V (I ≤ 20 mA) |
| ± 10 mA | 10 μA | | 100 V |
| ±1000 μA | 1 μA | | |
| ± 100 μA | 100 nA | | |
| ± 10 μA | 10 nA | | |
| ±1000 nA | 1 nA | ± [0.5% + (0.1 + 0.2 × V _{out} /100)%] | |
| ± 100 nA | 100 pA | | |
| ± 10 nA | 10 pA | ±[1% + (0.1 + 0.2 × V _{out} /100)% + 5 pA] | |
| ±1000 pA | 1 pA* | | |

I_{out} is SMU output current in amps.

V_{out} is SMU output voltage in volts.

*50 fA resolution in current monitor mode.

- Accuracy specifications are given as ±% of reading or setting value ±% of range.
- Accuracy tolerances are specified at 25°C ±5°C, after a 40 minute warm-up time, with AUTO CAL on, and specified at the rear panel connector terminals referenced to SMU common. Tolerances are doubled for the extended temperature range of 10°C to 40°C.

Voltage Sources (Vs) Characteristics: 2 units

Voltage Output Range, Resolution and Accuracy

| Output Voltage Range | Resolution | Accuracy | Max. Output Current |
|----------------------|------------|----------------------------|---------------------|
| ±20 V | 1 mV | ±(0.5% of setting + 10 mV) | 10 mA |

Voltage Monitors (Vm) Characteristics: 2 units

Voltage Measurement Range, Resolution and Accuracy

| Measurement Voltage Range | Resolution | Accuracy |
|---------------------------|------------|----------------------------|
| ± 2 V | 100 μV | ±(0.5% of reading + 10 mV) |
| ±20 V | 1 mV | ±(0.2% of reading + 10 mV) |

No. of Measurement Steps: 512 for a single VAR 1 sweep, Max. 570 for a multiple sweep

Analysis

Calculation: two user functions can be input and keyboard calculations can be done using the following 11 operators: +, -, *, /, √, EXP, LOG, LN, ** (power), ABS (absolute) and Δ (differential).

Analysis functions: overlay comparison with STORE/RECALL, Marker, Interpolate, Cursor, Auto scale, Zoom function (←→, →←, ↑↓, ↓↑), Line and Move Window.

General Specifications

Operating temperature range: +10°C to +40°C; ≤70% RH at 40°C, permissible temperature change ≤1°C/5 min.

Power requirements: 100/120/220 V ±10%; 240 V - 10% + 5%; 48 to 66 Hz; 270 VA max.

Dimensions: 426 mm W x 235 mm H x 612 mm D (16.75" x 9.06" x 24.1").

Weight: 27 kg (59 lb) approximately.

Accessories Furnished

- HP 16058A Test Fixture
- HP 04145-61501 Disc Set
- HP 04145-60001 Connector Plate
- HP 04145-61622 Triaxial Cable (3m), 4 ea.
- HP 04145-61630 BNC Cable (3m), 4 ea.
- HP 04145-61623 Shorting Connector

Ordering Information

HP 4145A Semiconductor Parameter Analyzer

Opt.050/060: 50Hz/60Hz Line Frequency

Price

\$19,300

N/C

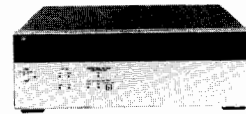

Switching Matrix Controller

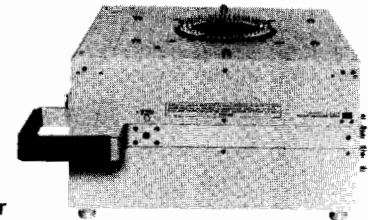

Switching Matrix

HP 4085M

HP 4085M Description

Combining the HP 4085M switching matrix with the HP 4145B Semiconductor Parameter Analyzer produces a 1 pA, 1 mV switching system capable of 48-pin high resolution semiconductor testing.

A design which minimizes both noise and leakage current means exceptional built-in dc measurement capabilities and the realization of 1 pA resolution measurements at any one of the 48 pins.

The software included with the system makes it possible to freely switch any one of the eight instrument ports to any one of the test pins from the system controller. A number of fixtures are available for wafer and various packaged device measurements. The HP 4085M retains the HP 4145B's full measurement capabilities to obtain highly reliable wide range dc parameter measurements.

Specifications

Switching Matrix

DUT Pins: From 12 to 48 pins can be installed.

Instrument Ports:* Eight instrument ports are included.

Low Leakage SMU Port: 1 ea. (Port 1)

SMU Ports : 3 ea. (Port 2 - 4)

Vs Ports : 2 ea. (Vs Port 1 and 2)

Vm Ports : 2 ea. (Vm Port 1 and 2)

*SMU: Stimulus Measurement Unit

Vs : Voltage Source

Vm : Voltage Monitor

Maximum Voltage between Instrument Ports: ±220 Vdc

Maximum Current at each DUT Pin: ±500 mA dc

General Specifications

Power Requirement: 100/120/220 V ±10%, 240 V + 5% - 10%, 48 - 66 Hz, 130 VA max.

Dimensions: 426 (W) x 134 (H) x 432 (D) mm (Switching Matrix Controller),

406 (W) x 210 (H) x 380 (D) mm (Switching Matrix)

Weight: Approx. 25.3 kg (56 lbs) (Switching Matrix Controller), Approx. 8 kg (18 lbs) (Switching Matrix)

System Controller

Required Controller: HP 9000 Series 200 Desktop Computers (model 216S or 236A/S).

Required Memory Size: >320 KByte.

Language System: BASIC 2.0 or later version

Ordering Information

HP 4085M Switching Matrix (does not include controller) \$34,100

Opt. 001: 12-pin system \$-14,400

Opt. 002: 24-pin system \$-9,600

Opt. 003: 36-pin system \$-4,800

Opt. 004: Add one pin \$400

Opt. 016:* 3 1/2" system software disc \$0

Opt. 036:* 5 1/4" system software disc \$0

* Must order either OPT. 016 or OPT. 036

Refer to the 4085M data sheet for details.

COMPONENT & SEMICONDUCTOR MEASUREMENT

pA Meter/DC Voltage Source Model 4140B

- 3 basic semiconductor measurements: I, I-V and quasi-static C-V
- Two programmable voltage sources
- Basic accuracy: 0.5%
- High resolution: 0.001×10^{-12}
- HP-IB standard

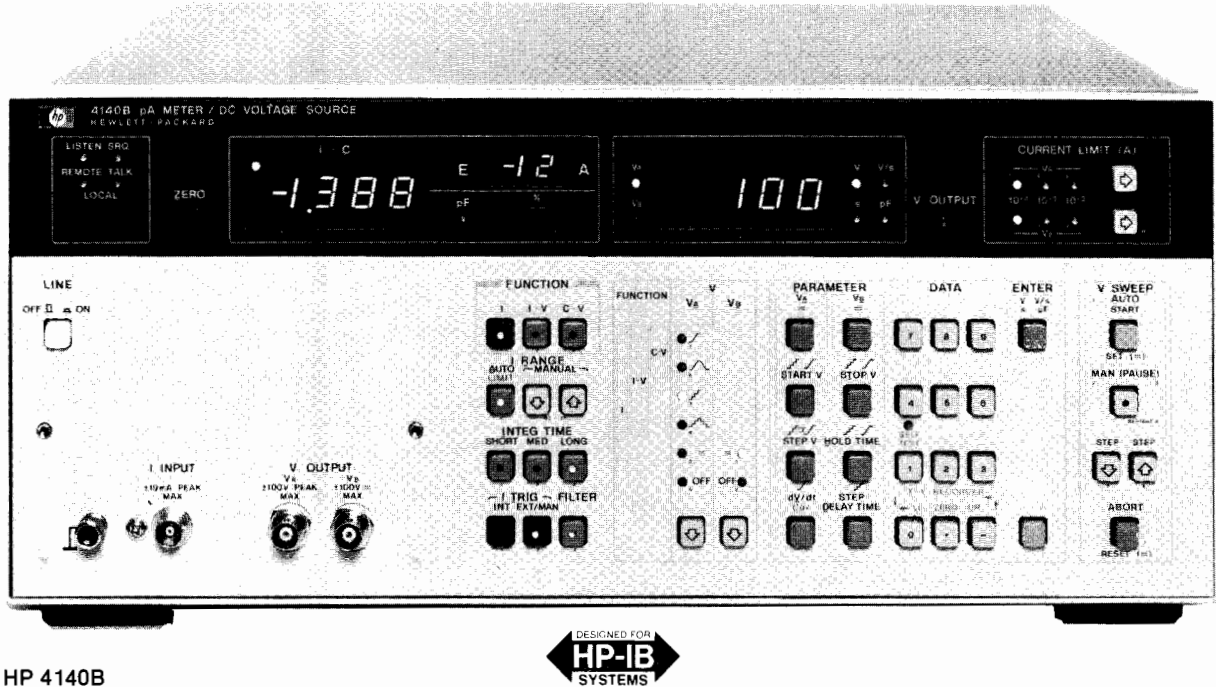

HP 4140B

Description

The HP 4140B pA Meter/DC Voltage Source is another in Hewlett-Packard's new generation of Component Measurement instrumentation. It consists of an extremely stable picoampere meter and two programmable dc voltage sources, one of which operates as a ramp and staircase generator as well as a dc source. These features make the HP 4140B ideal for making dc characteristic measurements such as leakage current, current-voltage characteristics and quasi-static C-V measurements required by the semiconductor industry for new product development and for improving production yields. It is equally useful in measurements of electronic components and materials to determine leakage currents or insulation resistances.

The HP 4140B can contribute to the development, production and quality control of semiconductor devices and to the improvement in the reliability of electronic components and equipment.

Stable pA Measurements

Stable picoampere measurements can be made with the HP 4140B with a maximum resolution of 10^{-15} A. This is made possible by a new measurement technique in conjunction with an offset current capability, low noise test leads, and an electrostatic and light shielded test fixture. These features provide both stable and fast picoampere measurements.

This measurement technique is very useful in making small leakage current measurements and determining dc parameters of semiconductor devices or measuring the insulation resistance and leakage current for dielectric absorption measurements necessary in the analysis of capacitors or insulation materials.

Synchronized I-V Measurements

The HP 4140B makes automatic, synchronized current-voltage measurements that have required a large instrumentation system in the past.

The two voltage sources in the HP 4140B operate over a range of -100 V to +100 V with a maximum resolution of 10 mV. One operates only as a stable dc source while the other generates a staircase voltage, a precise ramp or a stable dc level.

By adding precise, programmable timing capability, we can now make fast, accurate I-V and C-V measurements. Device stabilization times, (time between the applied voltage and the subsequent current

measurement) can now be programmed from the front panel of the HP 4140B or via the HP-IB bus.

Quasi-Static C-V Measurements

Automatic quasi-static C-V measurements are easily accomplished by the ramp voltage capability of the HP 4140B. This measurement is highly significant in evaluating basic semiconductor characteristics.

The HP 4140B operates over a capacitance range of 0.1 pF to 1999 pF with a dc voltage ramp rate of 1 mV/s to 1 V/s in 1 mV/s increments. Capacitance, which is calculated from the measured current divided by the ramp rate, can also be provided as a percent of the capacitance of the oxide film (C_{ox}) over a range of 0.0 to 199.9%. By providing the output voltage at each capacitance measurement point, we have the dc (quasi-static) C-V characteristics of the device under test.

HP-IB Capability

Interfacing the HP 4140B to an HP-IB system improves measurement efficiency and takes advantage of its high speed (approx 5 ms) measurement rate. Such a system will minimize measurement time of dc parameters of semiconductors and the insulation resistance and leakage current of electric components and materials. This allows rapid feedback to production for fast evaluation of a new device in the development stage.

Specifications

Measurement functions: I, I-V and C-V

Voltage sources: two separate sources (V_A and V_B)

V_A : ± 100 V programmable source/function generator

V_B : ± 100 V programmable dc voltage source

Measurement Function/Source Selection

| Function | V_A | V_B |
|----------|-------|----------|
| I | | --- (DC) |
| I-V | | --- |
| C-V | | (DC) |

Voltage sweep: auto or manual (pause)

Current Measurements

Displays: current, 3½ digits with 2 character annunciator. Voltage, 3½ digits.

Measurement range: $\pm 0.001 \times 10^{-12} \text{A}$ to $1.000 \times 10^{-2} \text{A}$ full scale in 11 ranges.

Overrange capability: 99.9% on all ranges.

Range selection: auto (lowest current range is selectable) and manual

Measurement Accuracy/Integration Time

| Range | Accuracy* ± (% of rdg. + counts) | Integration Time** (ms) | | |
|---------------------|-------------------------------------|-------------------------|--------|------|
| | | Short | Medium | Long |
| $10^{-2} - 10^{-9}$ | 0.5 + 2 | 20 | 80 | 320 |
| 10^{-10} | 2 + 2 | | | |
| 10^{-11} | 5 + 3 | 80 | 320 | 1280 |
| 10^{-12} | 5 + 8 | 160 | 640 | 2560 |

* Accuracy for long integration time. 23°C ± 5°C. humidity ≤ 70%. For short and medium integration time, see reference data section.

** Integration times specified at 50 Hz. For 60 Hz operation, multiple time by 1.2.

Zero offset: cancels leakage current of test leads or test fixtures.

Offset range: 0 to $\pm 100 \times 10^{-15} \text{A}$.

Trigger: INT, EXT and HOLD/MAN

Input terminal: triaxial

Capacitance-Voltage (C-V) Measurement

Measurement ranges: 0.0 pF – 100.0 pF and 200 pF – 1000 pF full scale in two ranges; 99.9% overrange

Ranging: auto

% C: capacitance change of device under test is displayed as a percent of the set value of the oxide capacitance ($C_{ox} = 100\%$)

% C range: 0.0% – 199.9%

Cox setting ranges (2 ranges): 0.1 pF – 199.9 pF and 200 pF – 1999 pF

Capacitance calculation accuracy: accuracy is dependent on accuracy of both the current measurement and ramp voltage.

Zero offset: cancels stray capacitances of test fixtures and test leads.

Offset range: 0 to 100 pF

High speed I data output: available with HP-IB interface only. Outputs current measurement data at 4 ms intervals (max rate).

DC Voltage Sources

Output Modes, V_A and V_B

| Function | V _A | V _B |
|----------|----------------|----------------|
| I | | --- |
| I-V | | --- |
| C-V | | (DC) |

Voltage ranges (V_A and V_B): 0 to $\pm 10.00 \text{V}$ and 0 to $\pm 100.0 \text{V}$ in 2 ranges, auto range only.

Maximum current: 10 mA, both sources.

Voltage sweep: auto and manual (pause), up/down step in manual (pause) mode. Sweep abort standard.

Operating Parameter Setting Ranges

Start voltage and stop voltage: 0 – $\pm 10.00 \text{V}$, 0.01 V steps; 0 – $\pm 100.0 \text{V}$, 0.1 V steps

Step voltage: 0 – $\pm 10.00 \text{V}$, 0.01 V steps; 0 – $\pm 100.0 \text{V}$, 0.1 V steps

Hold time: 0 – 199.9 seconds in 0.1 s increments; 0 – 1999 seconds in 1.0 s increments

Step delay time: 0 – 10.00 seconds in 0.01 s increments; 0 – 100.0 seconds in 0.1 s increments

Ramp rate (dV/dt): 0.001 V/s – 1.000 V/s in 0.001 V/s increments

Accuracy (at 23°C ± 5°C)

Output voltage: $\pm 10 \text{V}$, $\pm(0.07\% + 11 \text{mV})$; $\pm 100 \text{V}$, $\pm(0.09\% + 110 \text{mV})$

Linearity: typically 0.5%, 0 – $\pm 10 \text{V}$; < 5%, > 10 V.

Current limit: 100 μA , 1 mA and 10 mA, $\pm 10\%$ (V_A and V_B)

Output terminals: BNC; L-GND

Reference Data

Current Measurement

Current Measurement Accuracy*

| Range | Integration Time | |
|---------------------|------------------|---------|
| | Short | Medium |
| $10^{-2} - 10^{-8}$ | 0.5 + 3 | 0.5 + 2 |
| 10^{-9} | 0.5 + 3 | 0.5 + 3 |
| 10^{-10} | 2 + 4 | 2 + 3 |
| 10^{-11} | 5 + 10 | 5 + 4 |
| 10^{-12} | 5 + 20 | 5 + 10 |

* ± (% of rdg. + counts), 23°C

Current ranging times: 20 ms to 7.76 s. (longer ranging time needed for large changes in input signal level, especially on lowest current ranges).

*When FILTER is on, current ranging time increases 60 ms (50 Hz power line) or 50 ms (60 Hz power line)

Warm-up time: ≥ 1 hour

Common mode rejection ratio: ≥ 120 dB (≤ 2 counts)

Analog Output I, C and V_A

Accuracy: $\pm(0.5\% + 20 \text{mV})$

Low pass filter: 3 position: OFF, 0.22 s $\pm 20\%$ and 1s $\pm 20\%$ applied to both V_A and I/C data outputs

Pen lift output: TTL low level ($\leq 0.8 \text{V}$) during sweep period in I-V and C-V functions

Recorder output scaling: pushbutton scaling of lower left and upper right limits of X-Y recorder

HP-IB Interface

Remote controlled functions: measurement function, current range, integration time, I data output trigger, voltage sweep controls, current limit, V_A and V_B voltages, zero (offset), self test and parameter settings (voltages, sweep/hold/delay times)

Data Output

- Measured data (I, C and V_A),
- Voltage setting (V_A and V_B),
- Parameter settings

General Information

Power: 100, 120, 220, V $\pm 10\%$, 240 V +5% – 10%; 48-66 Hz, 135 VA max

Size: 426 mm W x 177 mm H x 498 mm D (16.5" x 7" x 19.6")

Weight: 14.4 kg (31.7 lb)

Accessories Furnished

HP 16053A test leads: consists of one triaxial cable, two each BNC-BNC cables and one connection plate with mating female panel-mount connectors. Cables are one meter in length.

HP 16055A test fixture: for general device measurements. Provides electrostatic and light shielding for stable pA measurements.

Accessories Available

HP 16054A connection selector: provides a simple method to select appropriate connection of low lead for the pA meter section.

HP 16056A current divider (10:1): for use only on the 10 mA range to extend the measurement capability to 100 mA.

Ordering Information

| Accessories | Price |
|--|----------------|
| HP 16053A Test Leads (furnished) | N/C |
| HP 16054A Connection Selector | \$280 |
| HP 16055A Test Fixture (furnished) | N/C |
| HP 16056A Current Divider (10:1) | \$150 |
| Options | |
| Opt 907 Front Handle Kit (HP P/N 5061-0090) | \$65 |
| Opt 908 Rack Flange Kit (HP P/N 5061-0078) | \$35 |
| Opt 909 Rack & Handle Kit (HP P/N 5061-0084) | \$90 |
| Opt 910 Extra Manual | \$47 |
| HP 4140B pA Meter/DC Voltage Source | \$7,950 |

COMPONENT & SEMICONDUCTOR MEASUREMENT

1 MHz C Meter/C-V Plotter

Model 4280A

- Built-in sweepable dc bias source and timer for C-V (Capacitance-Voltage)/C-t (Capacitance-Time) measurements
- High speed C-t measurements with minimum measurement interval of 10 ms (10 μ s if an external pulse generator is used)
- Basic C measurement accuracy: 0.1%
- Test lead extension up to 5 m
- 5½-digit display resolution (option) for C measurement

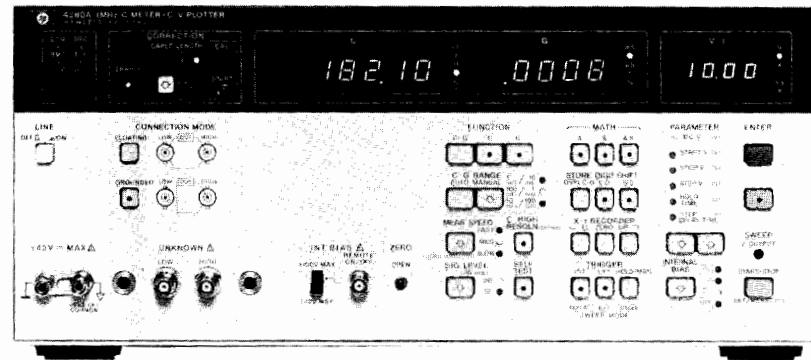

HP 4280A



Description

HP's 4280A 1 MHz C Meter/C-V Plotter measures the capacitance and conductance of semiconductor devices and materials as functions of applied voltage (C-V) or time (C-t). The HP 4280A consists of a precision 1 MHz C-G meter, a programmable dc bias source that can be swept in staircase fashion, and accurate timing control.

C-V and C-t Measurements

The HP 4280's internal dc bias source has a range of 0 V to ± 100 V with 1 mV resolution on the most sensitive range. Various measurement parameters for C-V and C-t measurements—hold time (bias pulse width) and delay time (measurement interval)—can be manually set from the front panel. Or these parameters can be set under program control via the HP-IB. Settable range for C-t measurement interval is 10 ms to 32s with a best case resolution of 10 μ s. If an external pulse generator is used, however, measurement intervals as short as 10 μ s can be set. Up to 9999 readings can be set for a C-t measurement. These capabilities make it possible for the HP 4280A to measure the C-t characteristics of virtually any device.

High Speed C-t Measurement

A special sampling integration technique employed in the HP 4280A provides measurement intervals as short as 10 μ s using an external pulse generator, such as the HP 8112A or HP 8160A, to provide the bias pulse. Short measurement interval makes the HP 4280A applicable to Deep Level Transient Spectroscopy (DLTS) measurements, which are commonly used to analyze the physical characteristics of semiconductors.

Precision, High Resolution Measurements

The HP 4280A measures capacitances up to 1.900 nF, over three ranges, with 0.001 pF resolution on the most sensitive range. Conductance up to 12 mS can be measured with a maximum resolution of 10 μ S.

C and G measurements are made at 1 MHz. AC signal level is selectable between 10 mVrms or 30 mVrms, suitable for semiconductor measurements. Basic measurement accuracy is 0.1%. Maximum display resolution is 4½ digits. With Option 001, however, display resolution for capacitance is 5½ digits.

The accuracy and resolution of the HP 4280A satisfy the stringent requirements of laboratory and R and D measurements, which require the detection of minute changes in device characteristics.

Probed Measurements On Wafers

HP's 4280A has an automatic error correction function that makes

it possible to use test leads up to 5 m long (HP P/N 8120-4195). The HP 4280A can measure either floating or grounded devices. Thus, the HP 4280A can be connected to a wafer prober and still provide stable, accurate C and G measurements.

Easy, Low Cost Systemization

HP-IB is standard on the HP 4280A. So, a process evaluation system or a lab automation system capable of evaluating the physical characteristics of semiconductor devices can be easily constructed.

The HP 4280A is equipped with analog outputs to allow users to plot device characteristics on an X-Y recorder or large screen display.

Specifications (refer to data sheet to complete specifications)

Measurement functions: C, C-V and C-t

| Basic Function | Function | Available Internal dc Bias Function |
|----------------|----------------------------|-------------------------------------|
| | Selection | |
| C | C only, G only C-G only | OFF, ∞ (DC) |
| C-V | C-V G-V C & G-V | |
| C-t | C-t G-t C & G-t | OFF, ∞ (DC), OFF |

C Measurement

Test Signal

Frequency: 1 MHz $\pm 0.01\%$

OSC level: 30 mVrms or 10 mVrms $\pm 10\%$

Measurement terminals: two-terminal-pair configuration (High, Low and Guard).

Connection mode: sets connection configuration between DUT (floating/grounded) and measurement circuit.

Ranging: auto or manual

Error Compensation

Cable length: 0 m, 1 m or 0–5 m. The standard cable (HP P/N 8120-4195) up to 5 m can be internally compensated.

Zero open: compensate stray capacitance and conductance at the test fixture.

External error compensation: compensate errors by external computer to eliminate other error factors not listed above.

Measurement speed: FAST, MED or SLOW

Trigger: Internal, External or Hold/Manual

Internal dc bias mode: OFF or ∞ (DC)



Measurement Range/Resolution/Accuracy

| Range ¹ | Resolution ² | Max. Display ³ | Accuracy ⁴ ±(% of rdg + counts) | |
|-------------------------|-------------------------|---------------------------|---|----------------------------|
| | | | OSC: 30 mV | OSC: 10 mV |
| 10 pF/100 μS | 0.001 pF 0.01 μS | 19.000 pF 120.00 μS | ±(0.1% + 5) ±(0.2% + 5) | ±(0.2% + 5) ±(0.3% + 5) |
| 100 pF/1 mS | 0.01 pF 0.1 μS | 190.00 pF 1.2000 mS | ±(0.1% + 3) ±(0.2% + 3) | ±(0.2% + 3) ±(0.3% + 3) |
| 1 nF/10 mS ⁵ | 0.1 pF 0.001 mS | 1.9000 nF 12.000 mS | ±(0.1% + 3) ±(1.2% + 3) | ±(0.2% + 3) ±(1.2% + 3) |

¹ 100 pF/1 mS and 1 nF/10 mS ranges only in grounded measurement.

² When measurement speed is set to FAST (10 mV/30 mV) or MED (10 mV), resolution and Max. display become 1 digit less (3½ digit display).

³ Approx. 50 pF at 100 pF/1 mS range and 1.76 nF at 1 nF/10 mS range in grounded measurement. Error correction to offset residuals will reduce maximum value which can be measured.

⁴ Accuracy is specified at UNKNOWN terminals and at the end of HP 16082A Test Leads (1 m) after warm-up > 30 min., at temperature 23°C ± 5°C, zero open calibration is performed, and CORRECTION is enabled. Front panel settings are C-G, FLOATING and 0 m or 1 m (CABLE LENGTH). Some errors will be added at other settings (refer to data sheet). C accuracy is specified when D < 0.05 and G accuracy is specified when counts of C < 1/100 of range. Error double at 0°C-55°C.

⁵ Add 0.1% of rdg for C and 0.2% of rdg for G when HP 16082A is used.

C-V Measurement

Function: measures C-V, G-V or C & G-V characteristics using internal staircase bias.

Measurement speed: FAST, MED or SLOW

C-t Measurement

Function: measures C-t, G-t or C & G-t characteristics using internal and/or external pulse bias source.

Internal measurement mode: Burst or Sampling Mode automatically selected.

Burst mode: apply one pulse then make repetitive measurement with specified time interval between measurements.

Sampling mode: repeated pulse with single samples between pulses. Delay between application of measure voltage and sample can be specified.

Measurement speed: FAST or MED

DC Bias Source

Output Mode: , , , (DC) or OFF

Output Voltage Range/Resolution/Accuracy

| Voltage Range | Resolution | Accuracy* ±(% of setting + volts) |
|---------------|------------|--------------------------------------|
| ±1.999 V | 1 mV | ±(0.2% + 0.01 V) |
| ±19.99 V | 10 mV | ±(0.1% + 0.02 V) |
| ±100.0 V | 100 mV | ±(0.1% + 0.1 V) |

*at 23°C ± 5°C, at 0°C - 55°C error doubles

Staircase Sweep Parameter Settings (C-V Basic Function Only)

Start/stop voltage: 0 V-±100 V (max. 1 mV resolution)

Step voltage: 0 V-200 V (max. 1 mV resolution)

Hold/step delay time (th/td): 3 ms-650s (max. 1 ms resolution)

Pulse Bias Parameter Settings (C-t basic function only)

DC/pulse/measurement voltage: 0 V-±100 V (max. 1 mV resolution)

Number of readings: 1-9999

Hold time (th): max. 10 μs resolution

Internal bias: 10 ms-32 s

Ext bias slow: 50 μs-32 s

Ext bias fast: 10 μs-32 s

Delay time (td): 10 μs-32 s (max. 10 μs resolution)

Burst Mode

| Function | Meas. Speed | Block Mode | Non Block Mode | |
|------------|-------------|------------|----------------|-------------|
| | | | Data Format | |
| | | | Binary | ASCII |
| C-t G-t | FAST | 10 ms-32 s | 20 ms-32 s | 150 ms-32 s |
| | MED | | | |
| C & G-t | FAST | 50 ms-32 s | | 200 ms-32 s |
| | MED | | 100 ms-32 s | 250 ms-32 s |

Sampling Mode

Ext bias slow: 200 μs-5 s

Ext bias fast: 10 μs-5 s

Math functions: displays measured C/G values as differential values (Δ), % ratio (%) or differential % (Δ%) of the reference value.

Other

HP-IB: not just IEEE-488, but the hardware, documentation and support that delivers the shortest path to a measurement system.

Data output format: ASCII or Binary

Block mode output: can make C-V/t characteristics measurement and store measured data (C-V/t or G-V/t Function: 680 data, C & G-V/t Function: 400 data) into the internal data buffer. Then, packed data can be output.

Recorder Output

Output voltage: ±10 V for C, G and V/t data

Accuracy: ±(% of output voltage + V)

C or G: ±(0.5% + 20 mV)

V or t: ±(0.15% + 40 mV)

Self test: verifies normal measurement operations (not including calibration)

Options

Option 001: High Resolution Offset Capacitance Measurement

Function: increase C measurement resolutions by one digit with offset reference value.

C offset range: 0 pF-1023 pF (1 pF increment). C offset value can be set by measured data or numeric key.

General Specifications

Operating temperature range: 0°C to 55°C; 95% RH at 40°C

Power requirements: 100/120/220 V ±10%, 240 V + 5% - 10%; 48 to 66 Hz; 140 V A max.

Dimensions: 426 mm W x 177 mm H x 498 mm D (16.5" x 7" x 19.5")

Weight: 15.3 kg (33.7 lb)

Accessories Furnished

HP 16080A: Direct Coupled Test Fixture

Reference Data

Measurement Time

| MEAS SPEED | Measurement Function | | |
|------------|----------------------|-----------|-----------|
| | C-G | C | G |
| FAST | 30 (70) | 10 (30) | 10 (30) |
| MED | 70 (110) | 40 (60) | 35 (55) |
| SLOW | 400 (440) | 270 (290) | 220 (240) |

When measured values are displayed on the front panel and the recorder outputs are used, measurement times in parentheses apply.

Residual L-R compensation: error compensation for residual L-R (max. 19 μH/190 Ω) is available using an external controller.

Internal DC Characteristics of High and Low Unknown Terminals (Without DC Bias)

Maximum offset voltage: ±1 mV

Maximum allowable current: 100 mA

Internal DC Bias

Settling time (99.9% of final value): 0.05 × voltage swing (V) + 1.7 (ms)

Maximum output current: ±6 mA

Hold time/step delay time/th/td: 0.02% (basic accuracy)

Response time of the EXT SLOW bias circuit (99.9% of final value): 100 μs

Option 001

C offset accuracy: ±(2% of reference value + 0.5 pF) can be compensated by CORRECTION ENABLE key.

Ordering Information

| | Price |
|--|-------|
| Opt 001 C-High Resolution (not field installable) | \$335 |
| HP 16081A Test Leads, 2 m double shielded, BNC | \$550 |
| HP 16082A Test Leads, 1 m, BNC | \$190 |
| HP 16083A Pulse Bias Noise Clipper | \$280 |

HP 4280A 1 MHz C Meter/C-V Plotter

\$8380

COMPONENT & SEMICONDUCTOR MEASUREMENT

Parameter Extraction Software

HP 94445A TECAP Software

- Shortens IC Design Time
- Improves Circuit Designs
- Lowers Chip Costs

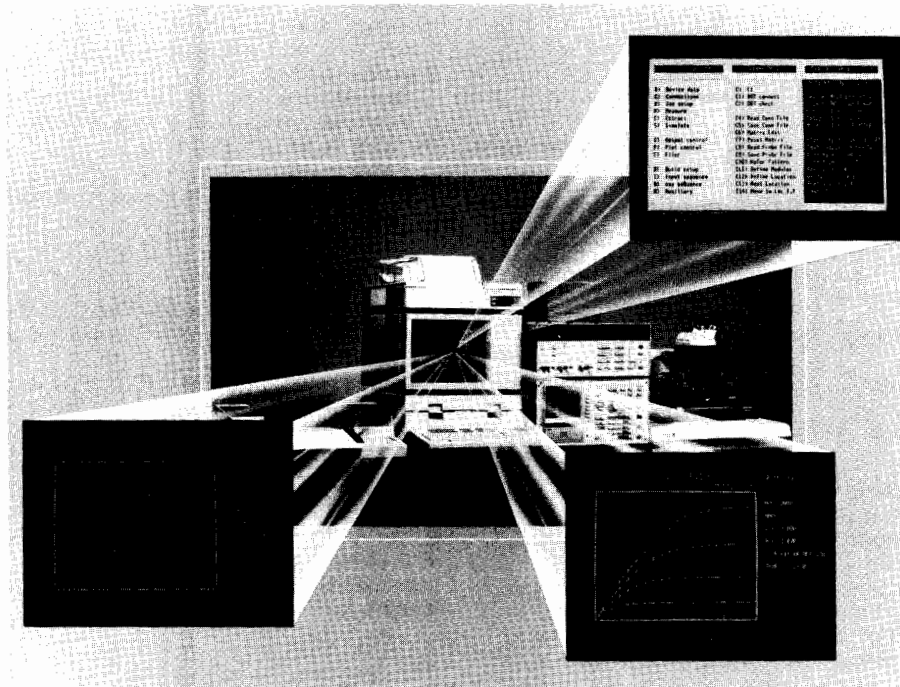

POWERFUL TECAP SOFTWARE REDUCES SEMICONDUCTOR DESIGN TIME

TECAP Bridges the Gap Between Engineering and Production

You need accurate transistor model parameters to generate precise circuit simulations for IC design. TECAP - Transistor Electrical Characterization and Analysis Program - gives you these model parameters quickly and easily. TECAP shortens your IC design cycle and saves valuable engineering and production resources.

TECAP system hardware performs I-V and C-V measurements on your developmental wafers or discrete transistors. TECAP software transforms the measured data into transistor model parameters. Because the model parameters precisely match your particular fab technology, they provide the most accurate basis for circuit simulation and yield better IC designs.

Because you begin wafer fabrication with a superior design, only minimal adjustments may be necessary at this stage. You save valuable engineering and production resources by eliminating wasteful fab runs.

Powerful Yet Friendly

The TECAP software uses the computing power of the HP 9000 Series 200 PASCAL workstations. The software, written in PASCAL 3.0, is menu-driven and requires no programming expertise. The program is simple to learn and commands don't have to be memorized. TECAP offers the user a unique "integrated" solution, where measurements, parameter extraction, device simulation, and plotting routines are included in one unified program.

The complete set of commands and configuration information may be saved or retrieved from a disc. You can create macro command sequences to execute many tasks with the touch of one key. These tools let you create a customized, turnkey system to enhance your design capability.

TECAP Gives You The Technical Advantage

TECAP can model sub-micron geometry transistors using the UCB Level 1,2,3 MOS transistor models. Developed at the University of California, Berkeley, these models can simulate second-order effects such as channel-length modulation and offer direct compatibility with the UCB SPICE circuit simulator program. For bipolar analysis, TECAP supports the well-proven Ebers-Moll and Gummel-Poon model equations. These equations take second-order effects into account and also offer direct compatibility with the UCB SPICE circuit simulator.

With TECAP, you can enter your OWN model equations into the program to be compatible with your proprietary circuit simulator or new processes. HP gives you access to the needed TECAP code modules and step-by-step documentation for quick insertion of your model. TECAP provides you with the ideal interactive environment you need to effectively develop and test your new model equations.

TECAP's optimizer precisely extracts model parameters from measured data by evaluating a non-linear, least-squares fit algorithm (Levenberg-Marquardt). After computing the model parameters, you can use the one-transistor device simulator to verify accuracy. The simulator takes into account the external resistances of the transistors and solves an admittance matrix to give you meaningful, practical simulations.

Choose The System That's Right For You

TECAP supports a wide range of measurement hardware. The HP 4145A Semiconductor Parameter Analyzer is used for I-V measurements and the HP 4280A C-meter takes care of C-V measurements. TECAP can also run on the HP 4062B or HP 4063A Semiconductor Parametric Test Systems. TECAP also supports automatic wafer probers, switching matrices, disc drives, printers, and plotters to give you increased flexibility.

You can depend on HP to provide you with worldwide application consulting, hardware support services, and software support services to maintain your TECAP system and keep it working for you.

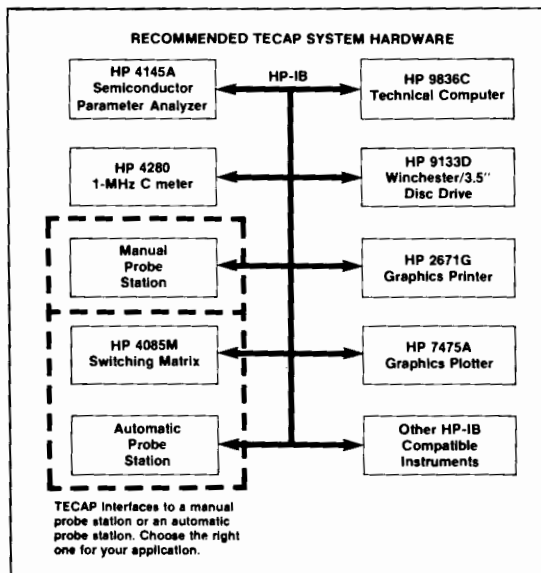
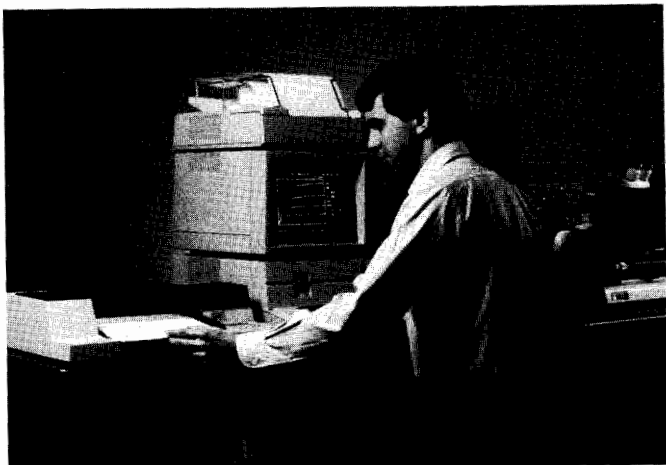

Operating Characteristics

Operating system: HP Series 200 Pascal 3.0
Media: 3.5" double-sided microfloppy or 5.25" minifloppy
Memory required: 2 megabytes
Data space: up to 18,432 measured and simulated data points
Measurement: voltage, current, capacitance
Extraction:

Interactive parameter optimization

- Levenberg-Marquardt algorithm for non-linear, least-squares fit
- constrained optimization
- simultaneous optimization of up to 15 parameters for a set of 1024 data points, maximum
- compatible with user-implemented models

Pre-defined parameter extraction

- initial value estimation
- automatic optimization of model parameters

UCB level 2 MOSFET model

- classical parameters
- short-channel parameters
- narrow-width parameters
- saturation parameters
- external resistances
- junction capacitances

UCB bipolar model

- external resistances
- junction capacitances

Early voltages

- forward and reverse

Gummel parameters

- forward and reverse

Simulation: voltage, current capacitance
 eight nodes maximum (4 device terminals plus 4 series resistances)
Available models: UCB MOS Level 1,2,3

- UCB Bipolar
- Diode
- PN Junction Capacitance
- MOS Gate Capacitance
- Classical MOS

compatible with user-defined models
 interactive simulation

User-definable models

User-definable instruments

User-definable switch matrix

User-definable prober

User-definable commands

User-definable macros

- 6 maximum
- 8 maximum
- 1 maximum
- 1 maximum
- 15 maximum
- 14 maximum

Ordering Information

Software:

HP 94445A TECAP Software (Volume discounts are available. Please contact your local sales office for more information.) 20,000

Hardware:

HP 4145A Semiconductor Parameter Analyzer 19,300
HP 4280A 1 MHz C Meter/C-V Plotter 8,380
HP 9836C Series 200 Technical Computer 15,590
HP 98615B PASCAL 3.0 Language System N/C
HP 98257A 1 Megabyte RAM (2 required) 3,300
HP 98635A Floating Point Math Card (optional) 975
HP 98620B DMA Controller Card (optional) 500
HP 9133D Winchester/3.5" Microfloppy Combination System (optional) 3,345
HP 2671G Graphics Printer (optional) 1,640
HP 7475A 6-Pen Graphics Plotter (optional) 1,895
HP 10833 A/B/C/D HP-IB Cables (1 required per instrument and peripheral. A-1m, B-2m, C-4m, D-0.5m) 80-100

Support:

For information on the support services available, please contact your local HP Sales Office.

Other Supported Hardware

Measurement Equipment:

HP 4063A Semiconductor Parameter Analysis System 84,600
HP 4062B Semiconductor Parametric Test System 78,600
HP 4275A Multi-Frequency LCR Meter (Opt. 001) 9,000
HP 4085M Switching Matrix 34,100

Controllers:

HP 9836A Series 200 Technical Computer 12,470
HP 9817A Personal Modular Computer 3,495

Printers:

HP 2225A ThinkJet Personal Printer 495
HP 2673A Intelligent Graphics Printer 2,240
HP 9876A Thermal Graphics Line Printer 6,080

Probe Stations: (must be ordered from the manufacturer)

Rucker & Kolls Model 681A Probe Station (IEEE-488 External Control)
 Rucker & Kolls Model 1032 Probe Station (IEEE-488 Option)
 Electroglas Model 1034X Probe Station (IEEE-488 Option D)
 Electroglas Model 2001X Probe Station (IEEE-488 Option)

366



COMPONENT & SEMICONDUCTOR MEASUREMENT

Memory Test System

Model 9430

- High accuracy and stability
- Compact design
- Low programming costs
- Hardware independent program development
- Multi User System



HP 9430 MEMORY TEST SYSTEM

Description

The HP 9430 Memory Test System is the result of years of experience in IC design, and in the manufacturing of high quality test equipment and computers. This general-purpose memory test system is designed for high performance, reliability, and long-term stability. It is a versatile and economic solution for testing most common semiconductor memories in manufacturing and end-user environments. Whatever your devices are, it delivers measurement results very accurately and efficiently.

In addition, system flexibility allows easy upgrading to meet both your present and future test requirements. Your initial investment is thus well protected.

The system software sets new standards in user friendliness. It makes programming and operation of the HP9430 an easy task, cutting down operating costs and by increasing the productivity of the system programmer.

As described in the following pages, the HP9430 is a complete system. A standard HP computer is an integral part of the memory tester. This permits operation in both stand-alone, and networked environments. The multi-user, multi-tasking capability supports simultaneous operation of terminals and a variety of peripherals, without sacrificing throughput in production test.

COMPONENT & SEMICONDUCTOR MEASUREMENT

Memory Test System

Model 9430

367



- +/- 400ps Driver Skew
- +/- 1,8 ns Overall Timing Accuracy
- 16 MWords Address Range

- Application oriented Programming
- Independent Software Modules
- Graphics Capabilities

Hardware



Accuracy/Stability

The HP 9430 offers excellent pulse performance and timing accuracy to make test results and data correlation more dependable. Data Driver skew better than +/-400 ps and an Edge placement within +/-600 ps characterize the typical performance in a normal environment. You can easily verify access times with the system Overall Timing Accuracy (OTA) of typically +/- 1.8 ns. This is usually found only in larger and more expensive systems.

The system is ideally suited for non critical environmental conditions. Its worst case specifications are valid for a temperature window of $\pm 10^{\circ}$ C within the specified operating range of $+10^{\circ}$ to $+40^{\circ}$ C.

Timing System

256 timing cycles can be simultaneously stored, eliminating the need for reloads. Cycle boundary crossing into the next cycle is possible, and 26 timing edges allow generation of complex waveforms. The period is in a range of 96 ns to 32 us, with a resolution of 500 ps.

Pattern Generation

Patterns of the N, N3/2, N2 and other types can be generated through an Algorithmic Pattern Generator for up to 16 MWords and 12 data bits at a 10 MHz cycle rate. A standard Pattern Library is included with the system. Optionally available are a one Megabit truth table RAM for ROM testing and a catch RAM for enhanced error control and bit mapping.

Reliability by design

Built-in quality provides maximum availability of the HP 9430 to perform testing tasks throughout the year. A one year interval for calibration and preventive maintenance is the result of careful design, tight component monitoring, and comprehensive production test procedures. An exhaustive diagnostic program verifies proper system performance down to board level. Typically this takes less than 4 minutes without the need for extra hardware.

Compactness

The controller, mass storage and a single card cage for all main frame boards are contained in one cabinet. The result is a reduced component count, low system complexity, improved reliability and simplified service.

Software

Multi User System

An HP 9000 series 200 computer is part of the HP 9430 system. The system does not depend upon an external host computer. This computer and the HP-UX¹ operating system offer all the capabilities of a modern multi-user system. Up to four work stations for simultaneous program development and testing are supported. The standard computer memory size of 1 MByte can be increased to 7,68 MByte, depending on the operating needs.

Modularity

The system software consists of independent modules, which highly reduces program complexity. The Configurable Command Level (CCL) serves as the main user interface. It provides menus for access to all modules in order to set up parameters and programs which are subsequently linked into a complete test program. With CCL, users do not need knowledge of HP-UX¹ to develop test programs and to run them on the HP 9430.

CCL screens can be configured to match different user needs. Special operator panels, for example, can be developed for users who do not need access to programming functions.

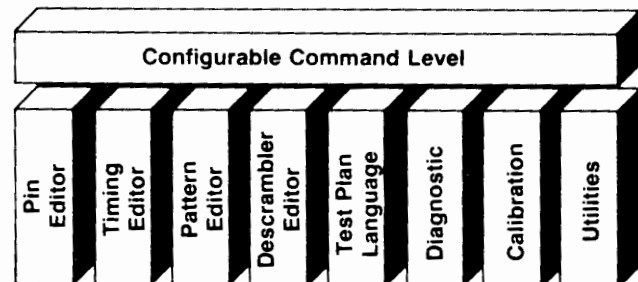

Hardware independent program development

The software modules include simulation and error checking features. Thus programs can be developed close to their final structure without use of the actual tester hardware. This saves costs, since the system can run in the production environment with test engineers developing programs at the same time.

Test Program Debugging

The interactive Test Plan Language Debugger gives detailed information about the hardware status during a program run and allows a programmer to modify the hardware settings. This feature reduces error fixing time and eliminates the need to recompile the entire program during test program debugging.

Data Analysis

The HP 9430's software capabilities are complemented by a set of Data Analysis functions which allow effective use of all test data collected during a memory device test. The following reports can be set up and displayed to analyse measurement results: X-Y Graph, Shmoo Plot, Wafer Map, Bit Map, Table Listing, Bar Chart.

¹HP-UX is derived from the UNIX System.
UNIX is a trademark of AT&T Bell Laboratories

Memory Test System

Model 9430

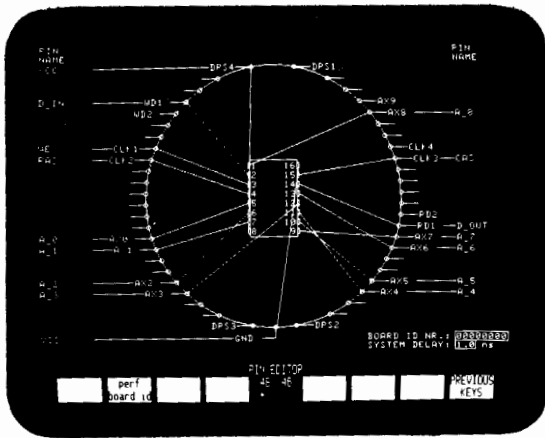

Pin Editor Graphic

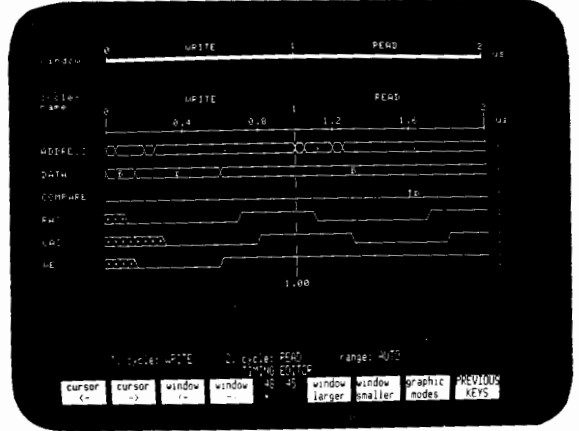

Timing Editor Graphic

| LAST CYCLE: | WRITE | DATA: | DO .. DO | ADDRESS: | X0 .. X3 | Y0 .. Y3 | | |
|-------------|-------|---------|----------|----------|----------|----------|---------|---------|
| LAST DATA: | Y x | OH | Y x | 4H | Y x | 8H | Y x | CH |
| Y x | OH | 1 1 1 1 | 1 1 0 0 | 0 0 0 0 | 0 0 0 0 | 0 0 0 0 | 0 0 0 0 | 0 0 0 0 |
| Y x | 4H | 1 1 1 1 | 1 1 0 0 | 0 0 0 0 | 0 0 0 0 | 0 0 0 0 | 0 0 0 0 | 0 0 0 0 |
| Y x | CH | 1 1 1 1 | 1 1 0 0 | 0 0 0 0 | 0 0 0 0 | 0 0 0 0 | 0 0 0 0 | 0 0 0 0 |
| Y x | CH | 1 1 1 1 | 1 0 0 0 | 0 0 0 0 | 0 0 0 0 | 0 0 0 0 | 0 0 0 0 | 0 0 0 0 |
| Y x | CH | 1 1 1 1 | 1 0 0 0 | 0 0 0 0 | 0 0 0 0 | 0 0 0 0 | 0 0 0 0 | 0 0 0 0 |
| Y x | CH | 1 1 1 1 | 1 0 0 0 | 0 0 0 0 | 0 0 0 0 | 0 0 0 0 | 0 0 0 0 | 0 0 0 0 |

Pattern Editor Graphic

```

(set reference levels and enable comparison of d_out)
set_reference(comp_ref, 0.8 * V, 2.4 * V, no_wait);
set_reference(addr_ref, 0.7 * V, 2.5 * V, no_wait);
set_reference(data_ref, 0.7 * V, 2.5 * V, no_wait);
set_reference(clock_ref, 0.7 * V, 2.5 * V, no_wait);
close_relay(d_out, comparator, min_wait);
mask_comparator(d_out, enabled);

(Nominal functional test)
failure_threshold(); (Stop test after 1 error)
write ("Nominal functional test");
test_digital("nominal", "march", stop_on_fail, 3 * s);
IF digital_failure
  THEN BEGIN
    write("FAILED !");
    GOTO 10;
  END;
THEN;
write("passed !");
IF key_pressed(exit_key) THEN GOTO 10;

(Long cycle test)
failure_threshold(); (Stop test after 1 error)
write ("Long cycle test");
  
```

Test Plan Language

Graphic display

Access to Pin Editor, Pattern Editor, Descrambler Editor, Timing Editor, Text Editor and Debugger is provided by the Configurable Command Level via softkeys. The programming editors support a graphics function for visual feedback of data entry. Available graphic displays are pin connections, pattern execution and timing diagrams.

The graphics features of the editors help significantly to reduce program development time.

Application oriented programming

The software has been designed to be transportable and hardware independent.

User defined names (RAS, CAS, WE, for example) are used instead of predefined machine terms for the hardware during program development.

Functional block addressing, such as "PMU", "SUPPLY", rather than register addressing is applied throughout the software.

This makes test programs easily readable and reduces their complexity and redundancy.

Networking

Hewlett Packard is committed to the IEEE 802.3 or Ethernet based LAN 9000, an HP AdvanceNet Product. This international Local Area Network standard was adopted to facilitate communication with non HP computer equipment. The HP 9430 system controller provides a straight-forward interface to such a network.

The UNIX¹ to UNIX Copy Protocol (ucp) is another effective method for integrating the HP 9430 in any UNIX-based network via RS 232C.

Support

A number of support services are available to ensure optimum system use. Site preparation and system installation help to minimize the startup time with the purchase of each HP 9430 System. In addition, a two week user training course is provided at an HP Customer Support Center near you.

Besides interactive training, a comprehensive documentation package assists you in using the system efficiently. All manuals have detailed reference information and sample programs to speed-up the learning curve.

¹UNIX is a trademark of AT&T Bell Laboratories

Response Center Support with telephone assistance, regular software updates, and a news letter are free for the first year of system operation. These services are valuable tools to provide you with professional application and programming support and to maximize system productivity.

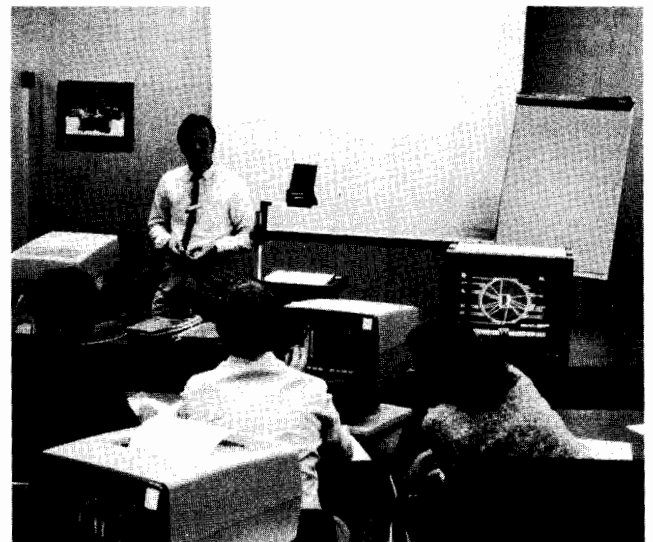

Ordering Information

HP 9430 Memory Test System
(Depends upon tester configuration)

Price

From \$110,000

COMPONENT & SEMICONDUCTOR MEASUREMENT

Digital Circuit Test System

Model 81800S

369



- At-speed functional test
- AC parametric verification
- Easy-to-use

- 50 MHz data rate
- 100 ps/10 mV resolution
- Software library

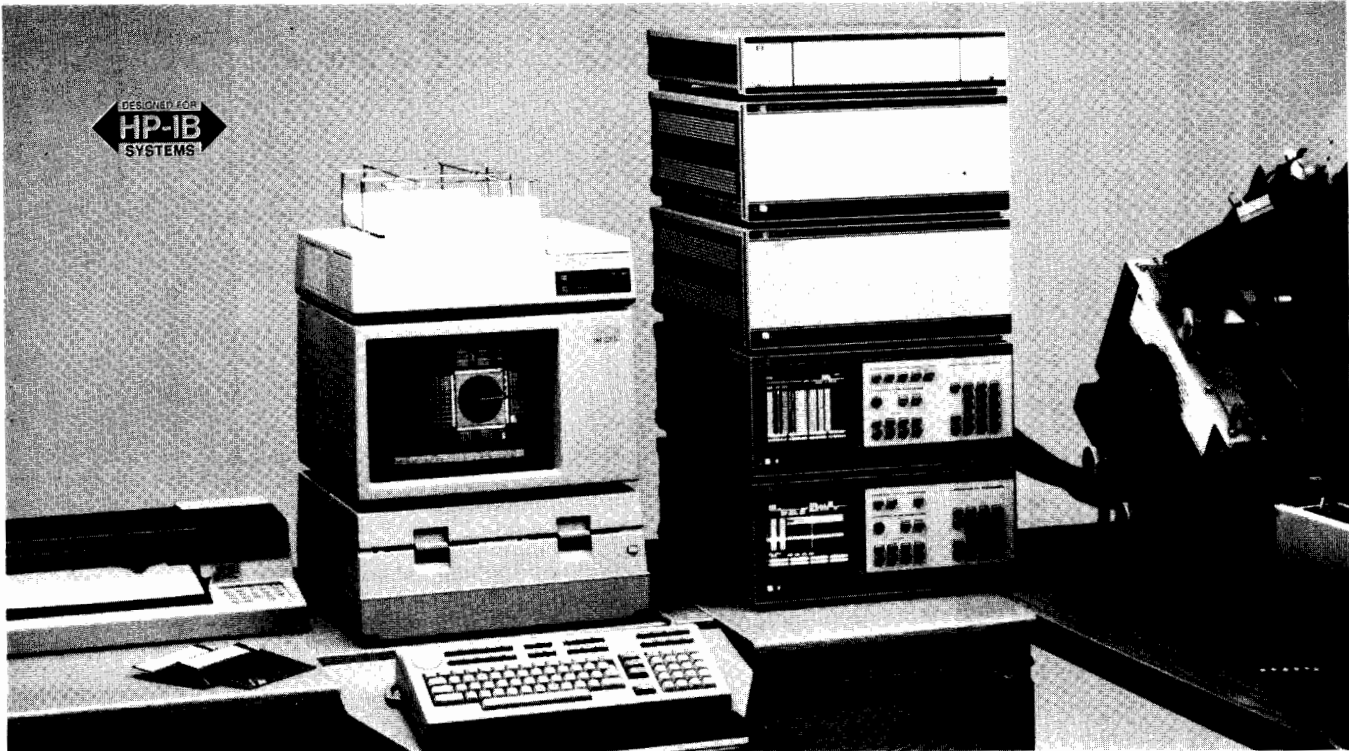

A 50 MHz Test System for Automated Testing of Digital IC's, Boards and Modules

The HP 81800S Digital Circuit Test System presents a proven solution for testing digital hardware to the standards set in R&D. It offers high speed (50 MHz), high resolution (100 ps, 10 mV) in a low-cost, easy-to-use benchtop workstation for full characterization of IC's, boards and modules at operational speed.

Design verification testing involves the stimulation of a set of input pins with a known set of input vectors and capturing vectors from a set of output pins to verify the logical integrity of a design. Furthermore it includes also the parametric evaluation of chip hardware to precisely characterize the timing and level parameters of the IC.

It is necessary to test both at the proposed chip's operational speed ("at-speed") and at lower speeds. Low-speed testing can give information about design or stuck-at types of faults, while at-speed testing can contribute to the detection of nonclassical faults as well as the identification of timing and loading problems.

The HP 81800S system addresses all of the above mentioned objectives. It provides stimulus (Data Generator HP 8180A) and response (Data Analyzer HP 8182A) units, device under test (DUT) interfacing (Testhead HP 15425A, Performance Board HP 15424A), software (HP 81800A), standard HP controller (Series 200) and a comprehensive set of accessories. Its clean DUT interfacing gives you 50 ohm technology right up to the test pins for accurate, repeatable characterization. It also is compatible with standard industry handlers and wafer probers.

Under computer control it is easy to set up new tests so that a single HP 81800S system can test a variety of IC's. The software helps you to perform complex tests and it simplifies test program development.

The system incorporates full HP-IB capabilities thus enhancing the universality of the workstation as a powerful engineering tool.

Applications

The HP 81800S system is optimized to perform 'at-speed functional' and 'ac parametric' tests.

The 'at-speed functional' tests verify correct operation of IC's in the framework of the specified characteristics. All limit values of set-up and hold times, input and output levels are programmed for a test. The result is 'passed' or 'failed'.

The 'ac parametric' test, measures parameters such as set-up time, hold time propagation delay etc.

The two major groups doing these tests, IC manufacturers and IC users (equipment manufacturers), have different reasons for performing them:

The IC Manufacturers

Whether manufacturing commercially or captively, newly-developed IC's must be characterized so that the process can be optimized, and the sales specifications established. This refers to various development stages like basic circuit cell, prototype evaluation and quality assurance. The HP 81800S also is well suited in production test for specific devices to obtain feedback for the chip's quality.

The Equipment Manufacturers

For the manufacturer of high-quality equipment who wants to reduce PC-board test and warranty cost, IC test has to be performed already during product development. A precise characterization gives information of the actual IC parameters like propagation delay, maximum clock frequency, setup and hold times, at-speed output swing or dynamic input hysteresis.

This knowledge of the discrepancies between the actual parameters and the specifications gives valuable recognition in materials engineering for component approval, in incoming evaluation, in R&D department for product development, in production engineering and in quality assurance.

The HP 81800S is a very user-friendly system fitting into these target application areas.

COMPONENT & SEMICONDUCTOR MEASUREMENT

Digital Circuit Test System

Model 81800S (cont'd)

| Applications | | Design Evaluation | Production Test | Quality Control | Incoming Evaluation |
|-------------------|-------------|-------------------|-----------------|-----------------|---------------------|
| Devices | Application | | | | |
| VLSI/LSI Circuits | | • | | • | • |
| SSI/MSI Circuits | | • | • | • | • |
| Boards/Modules | | • | | • | • |

Parameters of interest

Timing Parameters

have to be verified to assure error-free operation of synchronous devices (e.g. RAM's, latches) and asynchronous ones.

To measure the setup and hold times, the Data Generator HP 8180A delivers the functional pattern with the appropriate timing parameters, represented by delay and width. At the same time the Data Analyzer HP 8182A recognizes the errors which occur due to these parameters being different from the expected values.

To measure the propagation delay, the HP 8182A Analyzer samples the circuit output data at a delay after the system clock. To obtain the required precision for these measurements the HP 81800S provides a timing resolution of 100 ps for the data generator's period, for individual delay and width of timing (RZ) and clock channels, for the data analyzer's sampling point placement and the real time compare window.

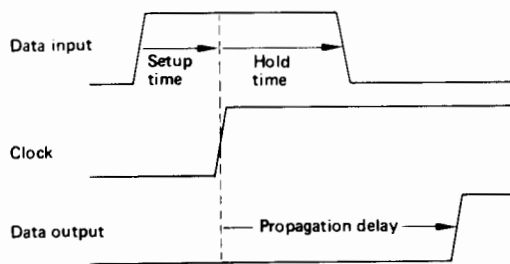

The timing parameters limiting a circuit's maximum data rate.

Level Parameters

have to be recorded at the device's operational speed. The HP 8180A Data Generator delivers independently programmable high and low levels for individual channels to stimulate even mixed logic circuits (dynamic input characteristics). The HP 8182A Data Analyzer offers one or two thresholds per channel, also programmable independently, to address the output swing characteristics at-speed getting high, low or intermediate states.

Both stimulus and response units provide a high 10 mV resolution to obtain accurate level information.

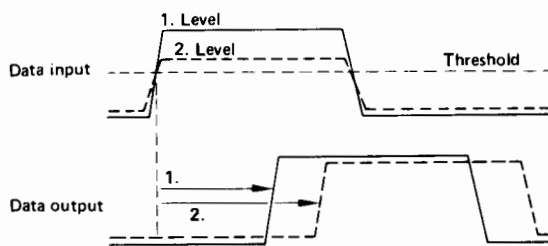

Different propagation delays depending on input threshold overdrive.

Glitches

which could be caused by internal propagation delay mismatching or high frequency crosstalking, can be identified by the 'glitch detector' feature of the Data Analyzer. Distinguishing automatically between troublesome glitching during 'data valid', and unimportant ones during 'data change', is possible with the 'real time window compare' feature offered by the HP 8182A.

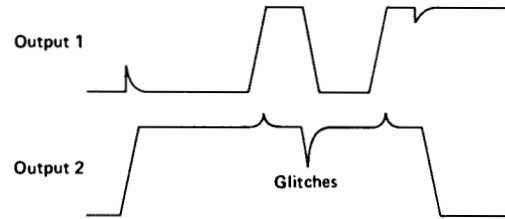

Crosstalking causes output instability.

Automatic Test

Testing is a costly phase in the implementation of digital circuits. It involves a considerable amount of time to set up the test equipment for debugging a chip generating the required test patterns, providing the expected data and comparing them with the received data. Even while testing small quantities of any particular chip automatic test methods will save time and money.

The HP 81800S system incorporates a standard HP series 200 controller and a software package (HP 81800A) thus increasing the convenience and the speed of use. The desktop computer acts as focus of all communications. It provides the HP-IB interface bus to control the involved test equipment (generator, analyzer, test-head and other devices); furthermore it offers a set of standard interfaces, like the RS-232-C interface to communicate to hosts.

Using the HP 81800S, a general procedure can be outlined for the testing of a circuit. The test program on the series 200 controller transfers the test vectors to the data generator, expected data vectors - if used - are loaded into the analyzer. After inserting the DUT the user can be prompted to input the test parameters. The test results can be stored on a local disk file. The entire operation is controlled by the computer.

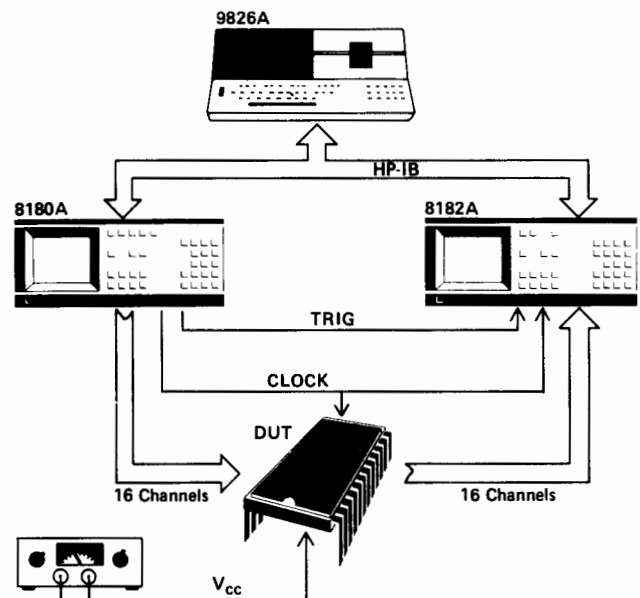

Setup for an automatically performed IC measurement.

System Components

Feature Summary of the HP 8180A/8181A Data Generator

1 Hz - 50 MHz Data Rate

8 - 64 NRZ channels

up to 128 NRZ channels with parallel operations of two systems

up to 8 RZ channels, two clocks

100 ps resolution for width and delay of RZ channels and clocks

1 kbit memory/channel, non-volatile

-2 V to +17 V into open (-2 to +5.5 V into 50 ohm with 10 mV resolution)

<3.5 ns transition times for TTL, typically 1.5 ns for ECL

comfortable data pattern editing, convenient softkey operation

HP-IB implementation

tristate capabilities

Feature Summary of the HP 8182A Data Analyzer

1 Hz - 50 MHz Data Rate

(synchronous and asynchronous)

8 - 32 channels

up to 64 channels with parallel operation of two systems

1 kbit memory/channel, non volatile

delayable sampling point

with respect to the active clock slope with 100 ps resolution

real time window compare

with 100 ps resolution for window width and placement

real glitch detection and storage

comfortable compare pattern editing; convenient softkey operation

HP-IB implementation

The HP 15424A Performance Board

The HP 15424A Performance Board offers high-quality connection and convenient adaptability to a Device Under Test (DUT). The product consists of a printed circuit motherboard, a device-dedicated, exchangeable DUT board and a kit containing connectors, screws, spacers etc. The whole package is designed to provide maximum flexibility for user configurations, and is assembled and configured by the user, according to his requirements.

The board has been designed with 50 ohm strip-line signal paths to ensure high-speed pulse performance, and has a hollow center for wafer probing applications. Pads for relays, connectors, termination and user-defined circuits are provided. 84 pins allow the user to connect 57 single and 27 dual-directional HP 8180/81/82A channels to the board. The exchangeable DUT boards are compatible with industry standards. Additional DUT boards are supplied as separate items.

Pulse Performance

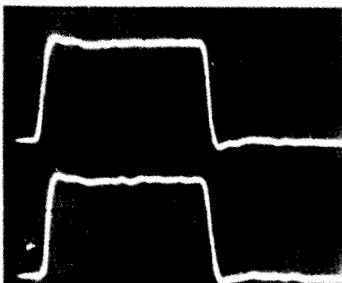

Signal as output
from HP 8180A

Signal as received
at the DUT board

Scale: 10 ns/div. (horiz.)
1 V/div. (vert.)

The HP 15425A Test Head

The HP 15425A Test Head provides a convenient, clean and reliable DUT interface for applications where a cabinet based construction is required. The industrial standard size cabinet simplifies interfacing to IC handlers and wafer probers for production and incoming evaluation applications. HP-IB controlled relays on the HP 15424A Performance Board allow switching between the HP 81800S system channels for ac-parametric testing and dc-parametric measurement units (e.g. HP 4140B or HP 4145A). A board identification can be performed by reading address bits via the HP-IB interface thus allowing automatic test setups for particular chips.

The Test Head is supplied in a metal case and consists of the Performance Board, with connectors for the HP 81800S already fitted. The cabinet can hold up to 6 tri-state pods HP 15413A (4 channels each). Strain relief clamps for all cables keep connections unaffected when Test Head is manipulated.

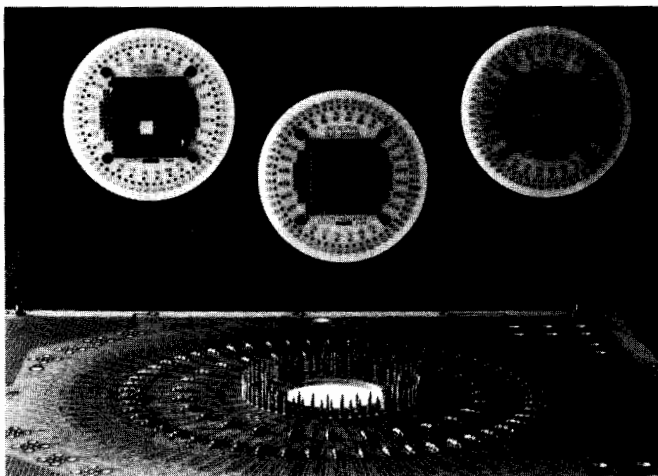

The System Controller

The HP 81800S digital circuit test system is automated by an HP 9000 Series 200 computer. This standard controller enhances the universality of the test system offering additional mass storage devices (disks, tape drives) and documentation capabilities (printers, plotters), all interfaced via the HP-IB interface bus. It also provides other standard interfaces like the RS-232-C for host communication.

The open system architecture allows to perform other tasks than pure testing. It gives access to the BASIC system for individual programming or using commonly available software.

The HP 81800A Software Pac

The HP 81800A Software Pac reduces the software development time for the HP 81800S system by providing programs and subroutines which enable the user to perform measurements with a minimum of programming effort. With the Software Pac, the user can easily expand the HP 81800S Digital Circuit Test System to utilize the controller capabilities of an HP Series 200 computer for mass storage, documentation, and measurement automation of appropriate peripheral instruments.

The HP 81800A Software Pac is composed of two parts:

The 'Ready-to-Run' Program

strongly improves the utilization of the HP 81800S system hardware. The program consists of interactive, softkey driven modules which guide the unexperienced user to create his own library of simple automated test sequences. Greatest flexibility is achieved by storing patterns and parameter settings in dedicated files, which can be accessed in any combination by any test sequence. In addition, management of an extended data base is facilitated, and documentation aids are provided.

'Library' Subprograms

offer full programming flexibility for tailored measurement solutions. The test program language is BASIC. A library of test-oriented subprograms is provided thus reducing the programming tasks to a minimum. Utilities for assisting program development considerably improves the efficiency of writing application programs and testplans.

Customer Training HP 81800A + 24A

A one day course is available to ensure fast familiarization with the Generator and Analyzer operation and programming. This training course is recommended for all users because it shortens the starting time considerably. (see page 761.)

Ordering Information

For easy configuration of a complete HP 81800S system, please, ask for the Ordering Guide. It supplies you with all required details by simply checking several steps. It enables you to consider all possible combinations of instruments, options and accessories including the Series 200 controller and its peripherals.

Cross Reference

For more technical details of HP 8180A Data Generator and HP 8182A Data Analyzer, please, refer to the catalogue's section Data Generators/Data Analyzers. In these pages (468, 469) you will also find a detailed list of the HP 81800S accessories.



DIGITAL CIRCUIT TESTERS

Logic Troubleshooting System

Model 55005S

- Automated digital troubleshooting using signature analysis
- Automatic test construction and documentation generation
- Backtrace and signature matching troubleshooting modes
- No programming or device libraries required

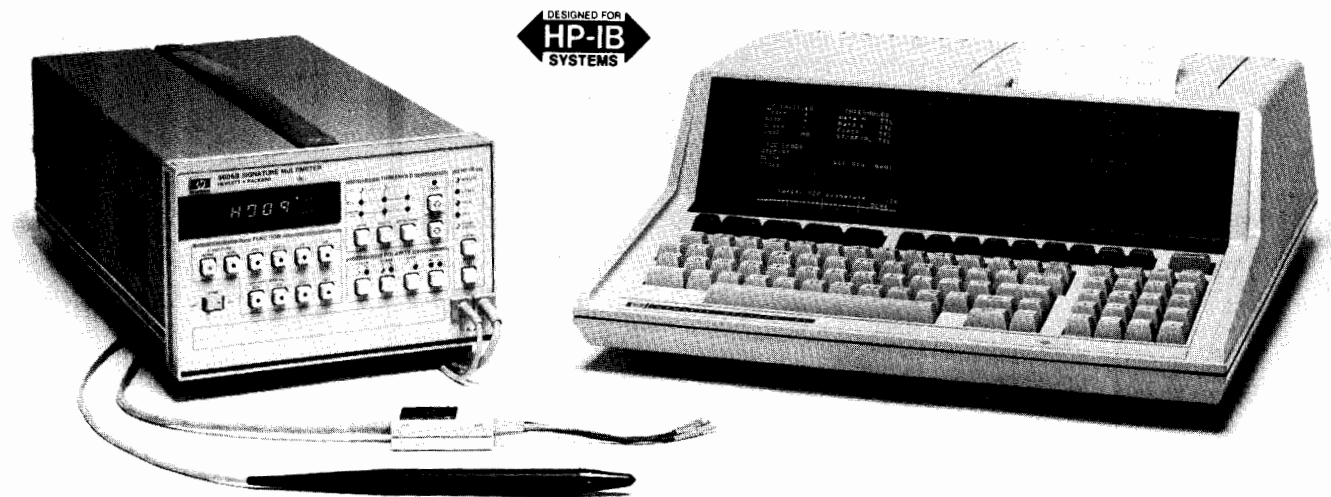

HP 55005S Logic Troubleshooting System

Description

The HP 55005S Logic Troubleshooting System represents a significant advance in automated digital test construction, documentation, and directed troubleshooting using Signature Analysis. It consists of an HP 85 Computer, HP 5005B Signature Multimeter, system software, optional flexible disc drive, and optional printer. These components together provide a significant productivity improvement when applied to troubleshooting digital products.

Test Construction

Circuit characterization is greatly simplified by the HP 55005S's LEARN mode. All information necessary for troubleshooting a product is generated during the signature collection phase of LEARN mode. The operator only needs to know the device number, input/output status of each device pin, and the circuit connection points. Automatic signature collection, through the HP 5005B Signature Multimeter, and directed softkey inputs provide the data required to build a troubleshooting data base. This eliminates the requirement for device libraries or special programming.

Test construction utilizes the data base compiled in the LEARN mode. Signature and circuit connection information comprise the basic lists for backtrace and signature matching modes of troubleshooting. These lists are automatically generated by the HP 55005S software.

Documentation

Troubleshooting a digitally based product requires sound documentation. The HP 55005S system generates a complete set of documentation for effective Signature Analysis troubleshooting. Three forms of printed documentation, or reports, can be generated by the HP 55005S system. Two of these reports, report-by-part and report-by-node, list the correct signatures for each respective circuit point. These reports comprise the basic documentation found in products designed for Signature Analysis troubleshooting. A third report, the troubleshooting tree, provides an innovative way to perform manual backtracing through a circuit. This troubleshooting tree provides a

means, by following through a set of special signature lists, to backtrace systematically through a circuit.

Troubleshooting

Major improvements in troubleshooting productivity translate into recurring manufacturing and service savings. Two troubleshooting modes in the HP 55005S provide these productivity improvements for both highly skilled technicians and lower skill level personnel.

Higher skill level operators benefit from the HP 55005S's ability to indicate if a probed signature matches a correct signature existing in the unit under test's data base. This allows the operator to troubleshoot a product efficiently using knowledge of the circuit's operation, technical experience and intuition. Enhanced productivity results from this extension of the technician's efficiency.

A guided backtrace mode in the HP 55005S aids the lower skill level person in troubleshooting digital products. All probing and measuring is controlled by the software program. The operator repeatedly probes the circuit, as directed by the controller, until the HP 55005S system locates the faulty node. A full report printout of probing history, location of the faulty node, and circuit points connected to the bad node occurs upon locating the fault. This report can then assist a technician in repairing the circuit assembly.

Configuration

Three system configurations (development, troubleshooting, and basic configuration) cover a variety of troubleshooting applications. Service support engineering, manufacturing, and field service organizations can select a system configuration which meets their exact needs. A full development system, for example, could support the troubleshooting procedure and documentation generation requirements found in a service support group. Manufacturing and field service would benefit from the cost savings and optimized performance available in the troubleshooting system configuration. Each system offers the flexibility to upgrade to higher performance configurations when the need arises.

The HP 55005S system is priced from \$9,700.

DIGITAL CIRCUIT TESTERS

373



Signature Multimeter, Combines Counter and Multimeter Functions with Signature Analysis

Model 5005A/B

- Digital and analog measurement capability optimized for digital troubleshooting
- Easy to use single probe measurement of logic signals, voltage, and frequency
- 25 MHz, multiple logic family signature analysis with qualified clocking mode
- Compact and portable (HP 5005A)

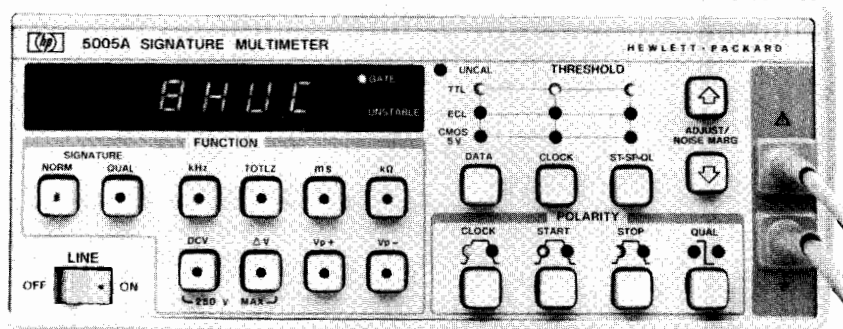

HP 5005A Signature Multimeter

Description

Total checkout of a digital system often requires characterizing both digital data activity and analog signal parameters. A typical troubleshooting procedure may specify a digital multimeter for checking power supplies and circuit board integrity (shorts and opens), a universal counter to measure clock frequencies and time intervals between signals, and a means to verify the analog integrity of active digital signals. The HP 5005 Signature Multimeter offers, in a single instrument, a measurement set optimized for these types of digital troubleshooting applications.

Two versions, the HP 5005A for manual applications and the HP 5005B for automatic test system applications, share common performance capabilities. Their feature set includes:

- Field proven Signature Analysis (for multiple logic families).
- Digital multimeter (DC volts, resistance and differential voltage).
- Frequency counter (frequency, totalize, time interval).
- Voltage threshold (upper voltage peak, lower voltage peak).
- Multifunction probe.

Signature Analysis

HP's patented Signature Analysis technique enables the HP 5005 to generate a compressed, four digit "fingerprint" or signature of the digital data stream at a logic node. Any fault associated with a device connected through the node will force a change in the data stream and, consequently, produce an erroneous signature.

Specific features of the HP 5005 Signature Analyzer include:

- Multiple logic family compatibility—preset threshold levels for TTL, CMOS, and ECL or adjustable thresholds (+12.5 V to -12.5 V) assure coverage of a wide variety of logic device types.
- 25 MHz clock frequency—extends Signature Analysis to high speed circuits such as CRT controllers.
- Qualified signature mode—speeds fault isolation in complex products by windowing signature collection to specific modules or devices without requiring major test setup changes. This simplifies the engineering involvement in hardware and software testability and accelerates test procedure preparation.

Digital Multimeter

Certain digital problems result from analog circuit failures: a low power supply voltage, an open or shorted circuit path, a faulty A/D or D/A converter. Each may contribute to a system failure. The HP 5005 contains a 4½ digit dc voltmeter, ohmmeter, and differential voltmeter, each with performance geared toward analog measurements necessary in digital troubleshooting.

The implementation of each multimeter function emphasizes simplicity and convenience. Automatic internal self calibration and auto-ranging maximize troubleshooting efficiency by eliminating unnecessary interaction with the instrument. Improvements in display interpretation also aid troubleshooting. The ohmmeter, for example, when measuring an open circuit, produces an "OPEN" indication on the display rather than the typical overload display.

Frequency Counter

The counter within the HP 5005 provides totalize and frequency measurements to 50 MHz, and time interval measurements to 100 nanosecond resolution. Intended to extend the digital troubleshooting capabilities of the Signature Analysis (synchronous measurements), the counter functions provide the ability to characterize one-shots and timers through time interval measurement; test interrupt lines, reset lines, and asynchronous communication interfaces (RS-232) through totalize; and verify clock and clock driver circuitry through frequency measurement.

Voltage Threshold

Logic level degradation is a common and troublesome malfunction in digital products. Isolating this failure typically requires displaying and interpreting the waveform. The HP 5005's peak voltage measurement mode provides a simple, direct method of measuring logic high and logic low voltage of active digital signals.

The peak voltage measurement mode allows the HP 5005 to characterize and display either the greatest (positive peak) or lowest (negative peak) voltage measured at the probe. Selection of either positive peak or negative peak mode displays the appropriate measured threshold for comparison against the specifications of the logic family.



DIGITAL CIRCUIT TESTERS

Signature Multimeter, Combines Counter and Multimeter Function with Signature Analysis

Model 5005A/B (cont.)

- Complete HP-IB programmability of every function
- Measurement trigger switch in probe
- Rack and stack enclosure (HP 5005B)
- Programmable audible beeper

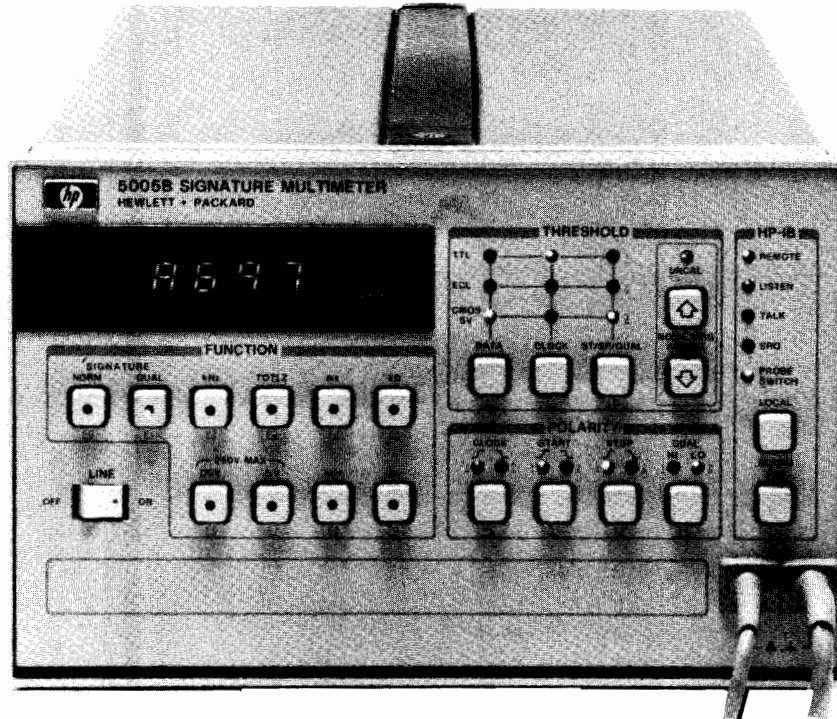

HP 5005B Programmable Signature Multimeter



Multifunction Probe

Several measurement functions incorporated into a single instrument can provide optimal troubleshooting efficiency only when each function is easy to use. The operator, when troubleshooting, must be able to measure the analog signal parameters and digital functional characteristics of a node without requiring time consuming and error-prone probe or instrument setup changes. The HP 5005 multifunction probe solves this problem by providing automatic access to the Signature Analyzer, multimeter, and counter functions through a single probe. All signal multiplexing to the appropriate measurement function is accomplished inside the HP 5005.

This efficient probing scheme becomes particularly important in automatic applications. The HP 5005B takes advantage of the several functions available in the multifunction probe. A switch, located on the side of the probe, allows the operator to trigger automatic measurement. The instrument controller can then characterize both the analog parameters and functional digital operation of a circuit node while the operator probes the same point. This greater automatic measurement efficiency translates into increased troubleshooting productivity.

HP-IB Programmability

Complete programmability makes the HP 5005B an ideal choice for automatic digital testing and troubleshooting. Every HP 5005B measurement and control function can be programmed through the HP-IB interface. This flexibility allows the automatic test system designer full access to the many measurement functions in the instrument.

Simplified programming enhances the automatic testing and troubleshooting productivity improvements inherent in the HP 5005B. Straightforward commands and data output formats aid in accelerating test program development. A measurement trigger switch located in the probe allows direct operator communication to the controller. Audible feedback, supplied by the beeper in the HP 5005B, can then indicate the completion of the measurement cycle. This closed-loop communication (controller-to-operator) aids in improving troubleshooting efficiency.

Portability

The HP 5005A offers a compact portable solution for manual troubleshooting of digitally based products. Its compact package, complete measurement capabilities, and multifunction probe make it invaluable as a bench or field service tool. This complete measurement set, combined into a single instrument, insures you always having the necessary troubleshooting capabilities in hand.

The identical feature set between the HP 5005A and HP 5005B also simplifies going from automatic to manual troubleshooting procedures. Consistent front panel function key arrangements and performance specifications allow direct translation of test or troubleshooting procedures. Your investment in an automatic procedure provides an additional return when expanding into a manual troubleshooting environment.



HP 5005A/B Specifications

Signature

Display: 4 digits. Characters 0-9, ACFHPU.

Fault detection accuracy: 100% probability of detecting single-bit errors; 99.998% probability of detecting multiple-bit errors.

Minimum gate length: 1 clock cycle (1 data bit) between START and STOP.

Maximum gate length: no limit.

Minimum timing between gates: 1 clock cycle between STOP and START.

Data Probe Timing

Setup time: 10 ns (data to be valid at least 10 ns before selected clock edge.)

Hold time: 0 ns (data to be held until occurrence of selected clock edge.)

START, STOP, QUAL Timing

Setup time: 20 ns (signals to be valid at least 20 ns before selected clock edge.)

Hold time: 0 ns (signals to be held until occurrence of selected clock edge.)

CLOCK Timing

Maximum clock frequency: 25 MHz.

Minimum pulse width: 15 ns in high or low state.

Quality mode: allows data clock qualification by an external signal. DATA probe input impedance ≈ 50 k Ω to the average value of "0" and "1" threshold settings (± 6 V max); 15 pF.

START, STOP, CLOCK, QUAL input impedance ≈ 100 k Ω ; 15 pF.

Front panel indicators: flashing GATE light indicates detection of valid START, STOP, CLOCK conditions. Flashing UNSTABLE light indicates a difference between 2 successive signatures, and possible intermittent faults.

Frequency

Display: 5 digits.

Ranges: 100 kHz, 1 MHz, 10 MHz, 50 MHz, autoranged.

Resolution: 1 LSD (1 Hz on 100 kHz range).

Accuracy: $\pm 0.01\%$ of reading ± 1 count.

Minimum pulse width ≈ 10 ns in high or low state.

Gate time ≈ 1 s, fixed.

Input impedance ≈ 50 k Ω to the average value of "0" and "1" threshold settings (± 6 V max); 15 pF.

Totalizing

Display: 5 digits.

Range: 0-99,999 counts.

Resolution: 1 count.

Maximum input frequency ≈ 50 MHz, with a minimum pulse width of 10 ns, and minimum pulse separation of 10 ns.

Minimum START/STOP pulse width ≈ 20 ns.

DATA input impedance ≈ 50 k Ω to the average value of "0" and "1" threshold settings (± 6 V max); 15 pF.

START, STOP input impedance ≈ 100 k Ω ; 15 pF.

Time Interval

Display: 5 digits.

Ranges: 10 ms, 100 ms, 1 s, 10 s, 100 s, autoranged.

Resolution: 1 count (100 ns on 10 ms range).

Accuracy $\pm 0.01\%$ of reading ± 2 counts.

Minimum START/STOP pulse width ≈ 20 ns.

START, STOP input impedance ≈ 100 k Ω ; 15 pF.

Resistance

Display: 4 or 5 digits, depending on range.

Ranges: 30 k Ω , 300 k Ω , 1 M Ω , 3 M Ω , 10 M Ω , autoranged.

Accuracy: (at 15°C–30°C).

| RANGE | FULL SCALE | ACCURACY | DISPLAY RESOLUTION |
|----------------|-------------------|---------------------------------------|--------------------|
| 30 k Ω | 29,999 k Ω | $\pm 1\%$ of reading ± 2 Ω | 1 Ω |
| 300 k Ω | 299,99 k Ω | $\pm 1\%$ of reading | 10 Ω |
| 1 M Ω | 999.9 k Ω | $\pm 1\%$ of reading | 100 Ω |
| 3 M Ω | 2999. k Ω | $\pm 10\%$ or reading | 1 k Ω |
| 10 M Ω | 10000. k Ω | $\pm 10\%$ of reading | 10 k Ω |

Input impedance ≈ 20 k Ω to ± 2 V

DC Voltage

Display: 4½ digits.

Ranges: ± 25 V, ± 250 V, autoranged; referenced to earth ground.

Accuracy: (at 15°C–30°C).

| RANGE | ACCURACY | RESOLUTION |
|-----------------------|-------------------------------------|------------|
| 25 V | $\pm 0.1\%$ of reading ± 2 mV | 1 mV |
| 250 V (<100 V) | $\pm 0.25\%$ of reading ± 20 mV | 10 mV |
| 250 V (≥ 100 V) | $\pm 0.25\%$ of reading ± 20 mV | 100 mV |

Input impedance ≈ 10 M Ω .

Differential Voltage

Reading: reads input voltage present at the probe and displays difference between it and voltage at the time ΔV key was depressed.

Specifications: same as for DCV, above. Voltage range is determined by larger of 2 compared voltages.

Peak Voltage

Display: 3½ digits.

Range: 0– ± 12 Vp.

Resolution: 50 mV.

Accuracy: $\pm 2\%$ of reading $\pm 5\%$ of p-p signal ± 100 mV.

Minimum peak duration ≈ 10 ns.

Maximum time between peaks ≈ 50 ms.

Input impedance ≈ 100 k Ω ; 15 pF.

Signature Analyzer Logic Thresholds

Preset thresholds: TTL, ECL, CMOS.

Adjustable thresholds: each preset threshold can be adjusted.

Range: ± 12.5 V, in 50 mV steps.

Accuracy: $\pm 2\%$ of setting, ± 2 V

Logic threshold circuitry is operative during NORM, QUAL, kHz, TOTLZ and ms measurements.

General

Data probe tip: acts as high-speed logic probe in the NORM, QUAL, kHz and TOTLZ modes. Lamp indicates high, low, bad-level and pulsing states.

Minimum detected pulse width is 10 ns.

Data Probe Protection

Continuous Overload

DCV, ΔV , k Ω modes only: ± 250 V ac/dc.

All other modes: ± 150 V ac/dc, 20 V rms at input frequencies > 2 MHz.

Intermittent overload: ± 250 V ac/dc, up to 1 min, for all modes.

Timing Pod Protection

Continuous overload: ± 100 V ac/dc, 20 V rms at input frequencies > 2 MHz.

Intermittent overload: ± 140 V ac/dc, up to 1 min.

Auxiliary power supply: three rear-panel connectors supply 5 V at 0.7A total for accessories (HP 5005A only)

Operating temperature: 0°C to $+55$ °C.

Power: selectable 100 V, 120 V, 220 V or 240 V ac line ($+5\%$ – -10%), HP 5005A–48–440 Hz, 35 VA maximum.

HP 5005B–48–66 Hz, 35 VA maximum.

Weight: HP 5005A–Net: 3.5 kg (8.0 lb.) Shipping: 10 kg (22.5 lb.).

HP 5005B–Net: 5.5 kg (12.0 lb.) Shipping: 8.7 kg (19 lb.).

Size: HP 5005A–90 mm H x 215 mm W x 410 mm D (3½" x 8½" x 16"), excluding handle.

HP 5005B–133 mm H x 212 mm W x 432 mm D (5¼" x 8¾" x 17"), excluding handle.

Ordering Information

HP 5005A Signature Multimeter

Option 910 Additional manual

HP 5005B Signature Multimeter

Option 910 Additional Manual

Price

\$2,900

\$35

\$4,000

\$40



DIGITAL CIRCUIT TESTERS

Signature Analyzer, A Digital Troubleshooting Tool

Model 5006A

- Reduce warranty and service support costs
- Full at-speed testing of digital products

- Reduce comparisons to documentation with composite signature
- Compare signatures in groups with signature memory

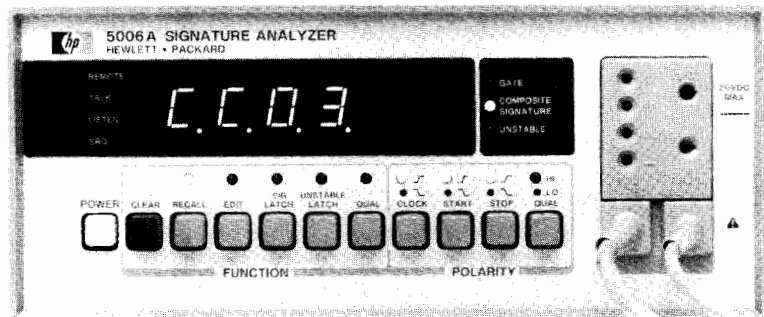

HP 5006A



The Technique

Signature Analysis is a fast and accurate troubleshooting method for digital circuits. Fault finding is reduced to tracing signal flow and comparing measured signatures to those recorded on paper or in a computer. Troubleshoot with Signature Analysis by probing the circuit, reading the display and comparing to the known good signature. A signature is a cyclic redundancy code (CRC) used as an error detection check on blocks of data. Test patterns may be generated within a circuit or stimulated externally.

Programmability Means Efficiency

The HP 5006A is completely programmable using the optional HP-IB interface. Upgrade production test and troubleshooting systems to include digital troubleshooting by adding the HP-IB option.

Signatures compress the necessary troubleshooting information of a bit stream into 16 bits. Instead of entire bit streams, only signatures need be compared to detect bit errors in the unit under test.

Time Savers

Composite signature and signature memory save time for the troubleshooter who does not have a computer-aided system. Composite signature is the binary sum of individual signatures. The HP 5006A computes it for any grouping of digital signals (i.e., bus or IC). Only one "composite" signature need be compared to documentation if all signals for that group are good.

Signatures are stored in the HP 5006A memory after the probe switch is pushed. The memory stores the last 32 signatures probed. Individual signatures can now be compared in groups instead of after each probe by reviewing the memory in the RECALL mode.

HP 5006A Specifications

General

Display: 4 digits. Characters 0-9, ACFHPU.

Fault detection accuracy: 100% probability of detecting single-bit errors; 99.998% probability of detecting multiple-bit errors.

Composite signature: maximum number of signatures: No limit.

Sums all signatures, triggered by probe switch, following depression of CLEAR key, or power-up.

Signature memory: signatures recallable by probe switch: The last 32 signatures triggered by probe switch.

Timing

Clock: maximum frequency: 25 MHz. Minimum clock time: 15 ns in high or low state.

Probe: setup time: 10 ns with 0.2V overdrive. (Data to be valid at least 10 ns before selected clock edge.) Hold time: 0 ns. (Data to be held after occurrence of selected clock edge.)

Start, stop, qualifier: setup time: 20 ns with 0.2V overdrive. (Data to be valid at least 20 ns before selected clock edge.) Hold time: 0 ns. (Data to be held until occurrence of selected clock edge.) Minimum gate length: 1 clock cycle (1 data bit) between START and STOP.

Maximum gate length: no limit.

Minimum timing between gates: 1 clock cycle between STOP and START.

Input Impedance

Probe: 50k Ω to ground nominal.

Pod: 100k Ω to ground nominal.

Overload Protection

Probe: $\pm 150V$ continuous.

$\pm 250V$ intermittent.

250V ac for 1 minute.

CMOS sense: 20V dc maximum.

Pod: $\pm 20V$ continuous.

$\pm 140V$ intermittent.

$\pm 140V$ ac for 1 minute.

TTL Thresholds

Probe: Logic one: 2V + .2-.3. Logic zero: 0.8V +.3-.2

Pod: 1.4 V ± 6

CMOS Thresholds

Logic one: 70% of sensed voltage.

Logic zero: 30% of sensed voltage.

Display and Indicators

Signature: four seven-segment digits with decimal point.

Lamps: Key Status: Recall, edit, signature latch, unstable latch, qualify mode, timing polarities. Programmable: Remote, talk, listen, SRQ. (Option 040). Status: Composite signature, gate, unstable.

Probe: logic levels indicated: High, low, open and pulsing. Minimum pulse width: 10 ns.

Other

Selectable power: 115V +10%–25% ac line, 48-440 Hz.

230 V +10–15% ac line, 48-66 Hz. 25VA maximum.

Operating environment: temperature: 0-55°C. Humidity: 95% RH at +40°C. Altitude: 4600m (15,000 ft).

Size: 89 mm high x 216 wide 279 mm deep. (3-1/2 in. x 8-1/2 in. x 11 in.)

Net weight: 2.4 kg (5.3 lbs). Shipping weight: 4.1 kg (9 lbs)

Options and Accessories

Option 40: HP-IB Interface

Option 910: Additional Manual

HP 5060-0173 Half Rack Mount Kit

HP 5006A Signature Analyzer

Price

\$300

\$16.50

\$64

\$1100

DIGITAL CIRCUIT TESTERS

Logic Probes

Models 545A & 10525E

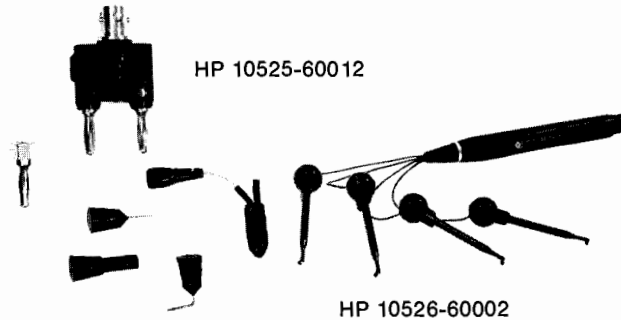
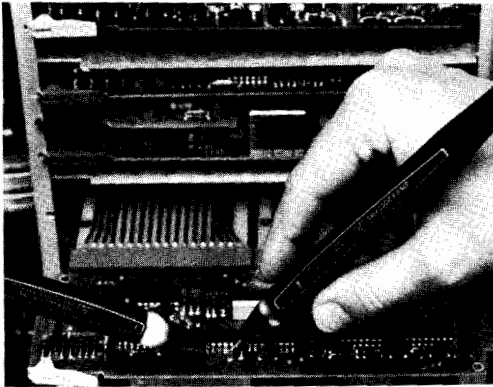
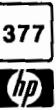

545A/546A

Logic Probes

Logic Probes greatly simplify tracing logic levels and pulses in IC circuits to find nodes stuck HIGH or LOW, intermittent pulse activity, and normal pulse activity. That's because they instantly show whether the node probed is high, low, bad level, open circuited, or pulsing.

Logic Probes require a simple connection to the circuit under test's power supply, and they're ready to use. The strain-relieved power cord, and line-voltage protected tip insure long life and durability. High input impedance protects against circuit loading, not just in the HIGH state, but for logic LOWs as well.

HP 545A TTL/CMOS Logic Probe

The HP 545A Logic Probe contains all the features built into other HP probes, plus switch-selectable, multi-family operation and built-in pulse memory. Employing straightforward one-lamp display the HP 545A operates from 3 to 18 volts in CMOS applications or from 4.5 to 15 V dc supplies in the TTL mode while maintaining standard TTL thresholds.

The probe's independent, built-in pulse memory and LED display help you capture hard to see, intermittent pulses. Just connect the probe tip to a circuit point, reset the memory, and wait for the probe to catch those hard to find glitches. The memory captures and retains a pulse until reset.

The hand-held HP 545A is light, rugged, overload protected, and very fast: 80 MHz in TTL, 40 MHz in CMOS. It also employs handy power supply connectors that enable you to easily hook up to supply voltage almost anywhere in the unit under test.

ECL Logic Probe

The HP 10525E Logic Probe extends time-proven, cost-saving logic probe troubleshooting techniques to high-speed ECL logic. Its high speed circuitry stretches single shot phenomena so that single pulses as narrow as 5 nanoseconds may be observed.

The HP 10525E may be powered directly from any -5.2 volt source and its high input impedance minimizes circuit loading.

Accessories included: BNC to alligator clips, ground clip.

Accessories Available

| | Price |
|---|--------|
| HP 00545-60104 Tip Kit for HP 545A Probe, 546A Pulser | \$50 |
| HP 10525-60012 Tip Kit for HP 10525E Probe, | \$65 |
| HP 10827A BNC to Y Adapter | \$9.25 |

HP 545A Probe Specifications

Input current: $\leq 15 \mu\text{A}$ (source or sink).

Input capacitance: $\leq 15 \text{ pF}$.

Logic thresholds

*TTL: Logic one $2.0 + 0.4$, -0.2 V . Logic zero $0.8 + 0.2$, -0.4 V .

CMOS: 3-10 V dc supply

Logic one: $0.7 \times V_{\text{supply}} \pm 0.5 \text{ V dc}$.

Logic zero: $0.3 \times V_{\text{supply}} \pm 0.5 \text{ V dc}$.

CMOS: $\geq 10-18 \text{ V dc}$ supply.

Logic one: $0.7 \times V_{\text{supply}} \pm 1.0 \text{ V dc}$.

Logic zero: $0.3 \times V_{\text{supply}} \pm 1.0 \text{ V dc}$.

Input minimum pulse width: 10 ns using ground lead (typically 20 ns without ground lead).

Input maximum pulse repetition frequency:

TTL, 80 MHz. CMOS, 40 MHz.

Input overload protection: $\pm 120 \text{ V}$ continuous (dc to 1 kHz); ± 250 for 15 seconds (dc to 1 kHz).

Pulse memory: indicates first entry into valid logic level; also indicates return to initial valid level from bad level for pulse $\geq 1 \mu\text{s}$ wide.

Power Requirements

TTL: 4.5 to 15 V dc*.

CMOS: 3 to 18 V dc.

Maximum current: 70 mA.

Overload protection: $\pm 25 \text{ V dc}$ for one minute.

Accessory included: ground clip.

* $\pm 5\pm 10\% \text{ V dc}$ power supply; usable to $+15 \text{ V dc}$ with slightly increased logic low threshold.

HP 10525E ECL Probe Specifications

Input impedance: 12 k Ω in both the high and low state.

Logic one threshold: $-1.1 \text{ V} \pm 0.1 \text{ V}$.

Logic zero threshold: $-1.5 \text{ V} \pm 0.1 \text{ V}$.

Input minimum pulse width: 5 ns.

Input maximum pulse repetition frequency: 50 MHz (typically 100 MHz at 50% duty cycle).

Input overload protection: ± 70 volts continuous, 200 volts intermittent, 120 V ac for 30 seconds.

Power requirements: $-5.2 \text{ V} \pm 10\%$ at 80 mA; supply overload protection for voltages from -7 to $+400$ volts.

Ordering Information

HP 545A Logic Probe
HP 10525E Logic Probe

Price

\$150
\$300

DIGITAL CIRCUIT TESTERS

Logic Pulsers, Digital Current Tracer

Models 546A, 547A

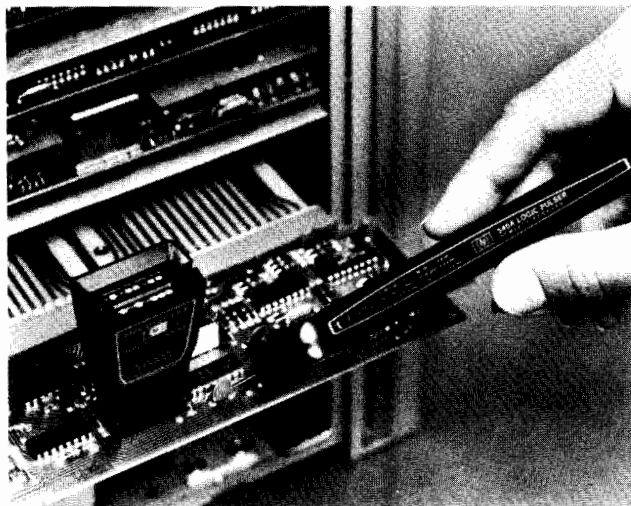

HP 546A/546A

Logic Pulser

The Logic Pulser solves the problem of how to pulse IC's in digital circuits. Merely touch the Pulser to the circuit under test, press the pulse button and all circuits connected to the node (outputs as well as inputs) are briefly driven to their opposite state. No unsoldering of IC outputs is required. Pulse injection is automatic, high nodes are pulsed low and low nodes, high, each time the button is pressed.

Ability to source or sink up to 0.65 amperes insures sufficient current to override IC outputs in either the high or low state. Output pulse width is limited so the amount of energy delivered to the device under test is never excessive. Additionally, the Pulser output is three-state so that the circuit under test is unaffected until the Pulser is activated.

HP 546A Logic Pulser

Automatic polarity pulse output, pulse width, and amplitude make for easy multi-family operation when you use the HP 546A Logic Pulser. But, the real surprise comes when you code in one of its six ROM-programmable output patterns (single pulses; pulse streams of either 1, 10, or 100 Hz; or bursts of 10 or 100 Hz; or bursts of 10 or 100 pulses). This feature allows you to continually pulse a circuit when necessary, or it also provides an easy means to put an exact number of pulses into counters and shift registers. Used with our multi-family IC Troubleshooters, the HP 546A acts as both a voltage and current source in digital troubleshooting applications.

HP 546A Pulser Specifications

Output

| Family | Output Current | Pulse Width | Typical Output Voltage | |
|---------|----------------|-------------|---------------------------------|-----------|
| | | | HIGH | LOW |
| TTL/DTL | ≤650 mA | ≥0.5 μs | ≥3 V dc | ≤0.8 V dc |
| CMOS | ≤100 mA | ≥5.0 μs | ≥(V _{supply} - 1 V dc) | ≤0.5 V dc |

Power supply requirements: TTL; 4.5 to 5.5 V dc at 35 mA, CMOS; 3 to 18 V dc at 35 mA, protected to ±25 V dc for 1 min.

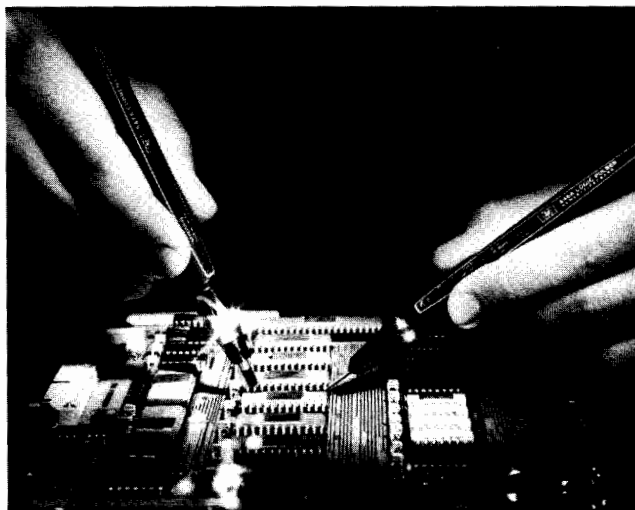

HP 547A/546A

Digital Current Tracer

The HP 547A Current Tracer precisely locates low-impedance faults in digital circuits by locating current sources or sinks. For example, on a bad node the Tracer can verify that the driver is functioning and also show where the problem is by tracing current flow to the source or sink causing the node to be stuck. The Tracer is designed to troubleshoot circuits carrying fast rise-time current pulses. The Tracer senses the magnetic field generated by these signals in the circuit and displays transitions, single pulses, and pulse trains using a simple one-light indicator. Because it is not voltage sensitive, the Tracer operates on all logic families having current pulses exceeding 1 mA, including CMOS, where even lightly loaded outputs can have up to 2 to 3 mA of instantaneous charging current.

To use the Tracer, align the dot on its tip at a reference point, usually the output of a node driver. Set the sensitivity control to indicate the presence of ac current activity. As you probe from point to point or follow traces, the lamp will change intensity; when you find the fault the Tracer will indicate the same brightness found at the reference point.

HP 547A Current Tracer Specifications

Input

Sensitivity: 1 mA to 1 A.

Frequency response: light indicates single-step current transitions; single pulses ≥50 ns in width; pulse trains to 10 MHz (typically 20 MHz for current pulses ≥10 mA).

Risetime: light indicates current transitions with risetime ≤200 ns at 1 mA.

Power Supply Requirements

Voltage: 4.5 to 18 V dc.

Input current: ≤75 mA.

Maximum ripple: ±500 mV above 5 V dc.

Overvoltage protection: ±25 V dc for one minute.

Accessories Available

HP 00545-60104: Tip Kit for HP 546A Pulser, 545A Probe
 HP 10526-60002: Multi-Pin Stimulus Kit
 HP 10827A BNC to Y Adapter

Price

\$50
 \$70
 \$9.25

Ordering Information

HP 546A Logic Pulser \$200
 HP 547A Digital Current Tracer \$410

DIGITAL CIRCUIT TESTERS

Logic Clip, Logic Comparator

Models 548A & 10529A

379

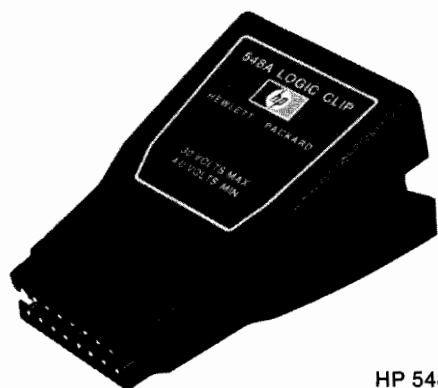

HP 548A

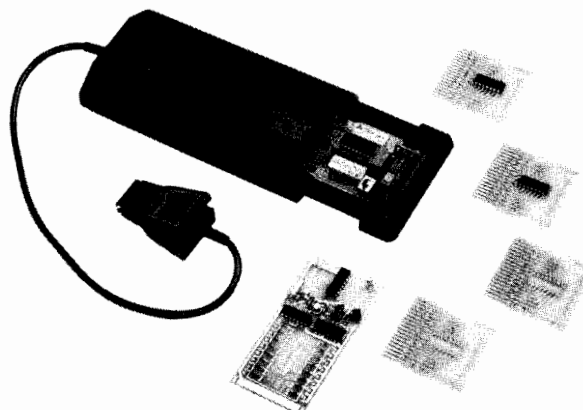

HP 10529A

Logic Clip

The Logic Clip is an extremely handy service and design tool which clips onto dual-in-line package (DIP) ICs, instantly displaying the states of up to 16 pins. Each of the clip's 16 LEDs independently follows level changes at its associated pin. Lit diodes are logic High, extinguished diodes are Low.

The Logic Clips's real value is in its ease of use. It has no controls to set, needs no power connections, and requires practically no explanation as to how it is used. The clip has its own gating logic for locating ground and V_{CC} pins and its buffered inputs reduce circuit loading.

The Logic Clip is much easier to use than either an oscilloscope or a voltmeter when you are interested in whether a circuit is in the high or low state, rather than its actual voltage. The Clip, in effect, is 16 binary voltmeters, and the user does not have to shift his eyes away from his circuit to make the readings.

The intuitive relationship of the input to the output—lighted diode corresponding a high logic state—greatly simplifies the troubleshooting procedure. The user is free to concentrate his attention on his circuits, rather than on measurement techniques. Also, timing relationships become especially apparent when clock rates can be slowed to about 1 pulse per second.

When used in conjunction with the Logic Pulser, the Logic Clip offers unparalleled analysis capability for troubleshooting sequential used to inject pulses between gates allowing it to supply signals to the IC under test absolutely independent of gates connected to the IC. All outputs may then be observed simultaneously on the Logic Clip. Deviations from expected results are immediately apparent as the Pulser steps the IC through its truth table.

HP 548A Multi-Family Logic Clip

Fully automatic and protected to 30 V dc, and employing bright individual LEDs in its display, the HP 548A brings multi-family operation to the HP line of IC Troubleshooters. The Clip can be externally powered, if desired, using a simple power connector.

HP 548A Specifications

Input threshold: $(\geq 0.4 \pm 0.06 \times \text{Supply Voltage}) = \text{Logic High}$.

Input impedance: 1 CMOS load per input.

Input protection: 30 V dc for 1 minute.

Supply voltage: 4-18 V dc across any two pins.

Auxiliary supply input: 4.5 to 20 V dc applied via connector. Supply must be ≥ 1.5 V dc more positive than any pin of IC under test.

Supply current: <55 mA.

HP 548A Logic Clip

\$200

Logic Comparator

The HP 10529A Logic Comparator clips onto powered TTL or DTL ICs and detects functional failures by comparing the in-circuit test IC with a known good reference IC inserted in the Comparator. Outputs of the particular IC to be tested are selected via 16 miniature switches which tell the Comparator which pins of the reference IC are inputs and which are outputs. Any logic state difference between the test IC and reference IC is identified to the specific pin(s) on 14- or 16-pin dual in-line packages on the Comparator's display. A lighted LED corresponds to a logic difference. Intermittent errors as short as 300 nanoseconds (using the socket board) are detected, and the error indication on the Comparator's display is stretched for a visual indication. A failure on an input pin, such as an internal short, will appear as a failure on the IC driving the failed IC; thus a failure indication actually pinpoints a malfunctioning node. A test board is supplied to exercise all of the circuitry, test leads, and display elements to verify proper operation.

HP 10541A: twenty additional blank reference boards; identical to the 10 boards provided with the Logic Comparator.

HP 10541B: twenty preprogrammed reference boards. The 10541B includes the following ICs: 7400, 7402, 7404, 7408, 7410, 7420, 7430, 7440, 7451, 7454, 7473, 7474, 7475, 7476, 7483, 7486, 7490, 7493, 74121, 9601.

HP 10529A Comparator Specifications

Input threshold: 1.4 V nominal (1.8 V nominal with socket board), TTL or DTL compatible.

Test IC loading: outputs driving Test IC inputs are loaded by 5 low-power TTL loads plus input of Reference IC. Test IC outputs are loaded by 2 low-power TTL loads.

Input protection: voltages < -1 V or > 7 V must be current limited to 10 mA.

Supply voltage: 5 V $\pm 5\%$, at 300 mA.

Supply protection: supply voltage must be limited to 7 V.

Maximum current consumption: 300 mA.

Sensitivity

Error sensitivity: 200 ns with reference board or 300 ns with socket board. Errors greater than this are detected and stretched to at least 0.1 second.

Delayed variation immunity: 50 ns. Errors shorter than this value are considered spurious and ignored.

Frequency range: maximum operational frequency varies with duty cycle. An error existing for a full clock cycle will be detected if the cycle rate is less than 3 MHz.

Accessories included: 1 test board; 10 blank reference boards; 1 programmable socket board; 1 carrying case.

Accessories Available

HP 10541A: Twenty Blank Reference Boards

Price

\$100

HP 10541B: Twenty Pre-programmed Boards

\$300

HP 10529A Logic Comparator

\$700

DIGITAL CIRCUIT TESTERS

Logic Troubleshooting Kits

Models 5011T, 5021A, 5022A, 5023A & 5024A

- Complete multi-family kits
- Stimulus-response capability
- In-circuit fault finding



HP 5011T

- In-circuit analysis
- Dynamic and static testing
- Multi-pin testing

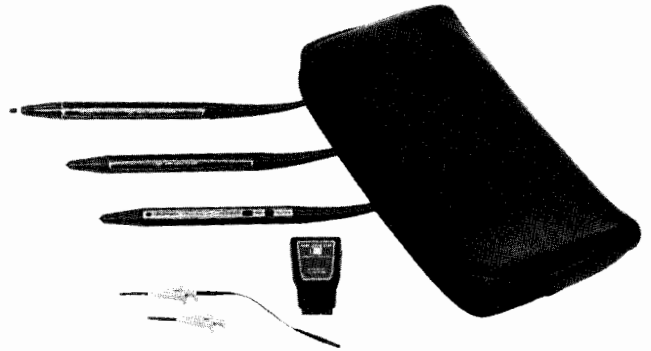

HP 5022A

| FAULT | STIMULUS | RESPONSE | TEST METHOD |
|---|---------------------|-----------------------|--|
| Shorted Node ¹ | Pulser ² | Current Tracer | <ul style="list-style-type: none"> • Pulse shorted node • Follow current pulses to short |
| Stuck Data Bus | Pulser ² | Current Tracer | <ul style="list-style-type: none"> • Pulse bus line(s) • Trace current to device holding the bus in a stuck condition |
| Signal Line Short to Vcc or Ground | Pulser | Probe, Current Tracer | <ul style="list-style-type: none"> • Pulse and probe test point simultaneously • Short to Vcc or Ground cannot be overridden by pulsing • Pulse test point, and follow current pulses to the short |
| Supply to Ground Short | Pulser | Current Tracer | <ul style="list-style-type: none"> • Remove power from circuit under test • Disconnect electrolytic bypass capacitors • Pulse across Vcc and ground using accessory connectors provided • Trace current to fault |
| Internally Open IC | Pulser ² | Probe | <ul style="list-style-type: none"> • Pulse device input(s) • Probe output for response |
| Solder Bridge | Pulser ² | Current Tracer | <ul style="list-style-type: none"> • Pulse suspect line(s) • Trace current pulses to the fault • Light goes out when solder bridge passed |
| Sequential Logic Fault in Counter or Shift Register | Pulser | Clip | <ul style="list-style-type: none"> • Circuit clock de-activated • Use Pulser to enter desired number of pulses • Place Clip on counter or shift register and verify device truth table |

1. A node is an interconnection between two or more IC's.
2. Use the Pulser to provide stimulus or use normal circuit signals, whichever is most convenient.

Used individually, each of HP's IC Troubleshooters provide their own unique and important troubleshooting function. Together they become invaluable stimulus-response testing partners that help pinpoint faults and ensure fast non-destructive repair of digital circuits.

To help you take advantage of the usefulness of the IC Troubleshooters, HP has packaged them into kits which offer both ordering convenience, and cost savings. Also, applications information is available, such as AN 163-2, "New Techniques of Digital Troubleshooting", to help users derive maximum benefit from these instruments.

The table shows a series of typical node and gate faults and the combination of tools used to troubleshoot the circuit. As with all sophisticated measuring instruments, operator skill and circuit knowledge are key factors once the various clues or "bits" of information are obtained using the IC Troubleshooters.

To accomplish troubleshooting at the node and gate level, both stimulus (Pulser) and response (Probe, Tracer, Clip and Comparator) instruments are needed. Moreover, instruments with both voltage and current troubleshooting capability help isolate electrical faults where the precise physical location is hard to identify.

The HP 547A Current Tracer, the latest and most sophisticated of these troubleshooters, lets you "see" current flow on nodes and buses that otherwise appear stuck at one voltage level. Used with the HP 546A Pulser, stimulus-response testing is now also possible in the current domain.

IC Troubleshooter Kits Ordering Information

| Kit | H mm (in) | W mm (in) | D mm (in) | Net Wt kg (lbs, oz) | Ship Wt kg (lbs, oz) |
|----------|-------------|------------|-------------|---------------------|----------------------|
| HP 5011T | 82.6 (3.25) | 203 (8) | 311 (12.25) | 1.49 (3.5) | 2.11 (4.11) |
| HP 5021A | 64 (2.5) | 146 (5.75) | 298 (11.75) | 0.51 (1.2) | 0.62 (1.6) |
| HP 5022A | 64 (2.5) | 146 (5.75) | 298 (11.75) | 0.65 (1.7) | 0.76 (1.11) |
| HP 5023A | 225 (8.88) | 200 (7.88) | 337 (13.25) | 1.63 (3.10) | 2.19 (4.14) |
| HP 5024A | 64 (2.5) | 146 (5.75) | 298 (11.75) | 0.60 (1.5) | 0.71 (1.9) |

Accessories Available

| | |
|--|-------|
| HP 00545-60104: Tip Kit for HP 545A Probe, and 546A Pulser | \$50 |
| HP 10525-60012: Tip Kit for HP 10525E Probe | \$65 |
| HP 10526-60002: Multi-pin Stimulus Kit for Logic Pulsers | \$70 |
| HP 10529-60006: External Reference Kit for HP 10529A Comparator | \$420 |
| HP 10541A: Twenty blank reference boards for HP 10529A Comparator | \$100 |
| HP 10541B: Twenty pre-programmed reference boards for HP 10529A Comparator | \$300 |

IC Troubleshooter Kits Selection Guide

| HP MODEL | 545A TTL/CMOS Probe | 546A TTL/CMOS Pulser | 547A TTL/CMOS Current Tracer | 548A TTL/CMOS Clip | 10529A TTL Comparator | PRICE \$ |
|-----------|---------------------|----------------------|------------------------------|--------------------|-----------------------|----------|
| 5011T Kit | X | X | | X | X | 1220 |
| 5021A Kit | X | X | | X | | 540 |
| 5022A Kit | X | X | X | X | | 940 |
| 5023A Kit | X | X | X | X | X | 1630 |
| 5024A Kit | X | X | X | | | 740 |

DIGITAL CIRCUIT TESTERS

Digital Education Courses, Microprocessor Lab

Model 5035T, 5036A

381



- Complete introductory course in practical digital electronics.

- Covers hardware, software and troubleshooting in one course.

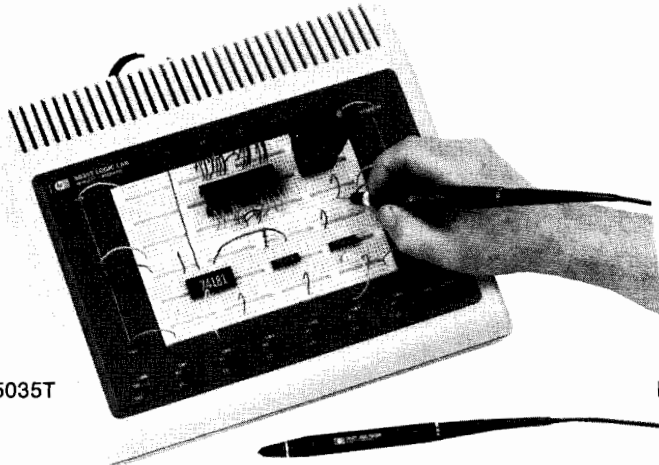

HP 5035T

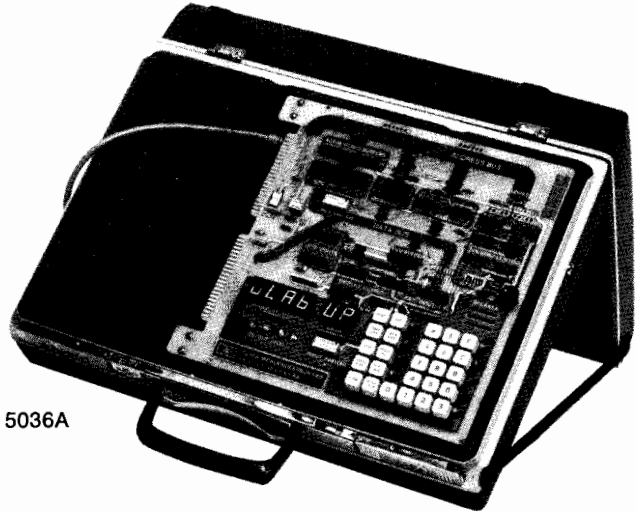

HP 5036A

HP 5035T Complete Logic Lab

Learn logic . . . the practical way. The HP 5035T Logic Lab combines theory and lab so you'll learn digital logic quickly, enjoyably, and memorably. Start by building simple circuits and work up to a complete digital clock. Logic labs have been adopted by schools, industrial firms and individuals who want to keep up with the changing world of electronics, and enjoy doing it.

HP 5035T Lab Includes

Mainframe with removable breadboard (see below)

"Practical Digital Electronics"—An Introductory Course

- Complete textbook
- 26 Experiment Workbook

TTL/DTL Test Instruments

- HP 545A Logic Probe
- HP 546A Logic Pulser
- HP 548A Logic Clip

Wire and Component Kit

- 32 TTL, MSI, LSI ICs
- 285 Pre-stripped Wires
- 4 Large LED Numerical Displays
- IC Remover

Logic Lab Mainframe

The Logic Lab Mainframe brings convenience and flexibility to breadboarding by allowing solderless connection of new circuit ideas. Fully self-contained, the mainframe has a 5-volt 1-amp power supply, two clocks, four LED indicators, six data switches, two 5-volt BNC connectors, and a handy removable breadboard. To use it, just connect circuits using standard 24-gauge wire, then power up either one or several breadboards to verify new circuit ideas quickly and easily before incurring PC board layout and rework charges.

Accessories Available

| | Price |
|--|--------------|
| HP 1258-0121: Additional breadboard assembly | \$80 |
| HP 1540-0258: Heavy duty, padded vinyl carrying case | \$97.50 |
| HP 05035-60006: Wire interconnect kit | \$41 |
| HP 10656A: Set of 10 "Practical Digital Electronics", An Introductory Course—Text and Lab Workbook | \$230 |
| HP 10657A: Additional component and wire kit | \$200 |

HP 5035T Complete Logic Lab **\$1400**

HP 5036A Microprocessor Lab

Staying Current with Technology

The microprocessor presents a repair problem due to its complexity, and because it is used in so many diverse products. Little imagination is required to anticipate field repair problems with microprocessor-based products like traffic controllers, typesetters, POS terminals, medical instrumentation, etc.

There are scientists and engineers who can contribute to solving this problem by learning about both the hardware and software in microprocessor systems, and there is a virtual army of technicians who need to learn to troubleshoot them. The HP 5036A Microprocessor Lab provides both the hardware and software basics and vital troubleshooting information needed to solve the microprocessor puzzle.

The HP 5036A course book, *Practical Microprocessors*, covers both hardware and software in detail in separate chapters containing summaries, hands-on experiments and quizzes. Once these chapters are completed, the course builds up to a series of troubleshooting experiments employing recommended troubleshooting instruments that challenge the user and reinforce microprocessor operating concepts. The book also contains information on the use of oscilloscopes, signature analyzers, logic analyzers, and logic probes for troubleshooting microprocessor-based products.

HP 5036A Major Features

- Color PC board graphics illustrate system block diagrams to enhance learning.
- Multiple-experiment troubleshooting chapter highlights IC Troubleshooters such as HP 545A Probe, 546A Pulser, 547A Current Tracer and HP Signature Analyzers.
- Plug-in jumpers create real hardware faults that allow realistic troubleshooting practice.
- Complete resident software.
- Dual 5-volt power supplies, plus edge connectors for expandability.
- LED monitors on all data, address, status and output lines.

Recommended Accessories for Troubleshooting Experiments

| | Price |
|------------------------------------|--------------|
| HP 5024A Logic Troubleshooting Kit | \$740 |
| HP 5006A Signature Analyzer | \$1100 |

HP 5036A Microprocessor Lab and Power Supply mounted in briefcase, plus *Practical Microprocessors* text and lab book, in English (German, French and Italian editions are available in those countries). **\$1250**



CIRCUIT TEST SYSTEMS

Production Testing of Electronic Printed Circuit Board Assemblies

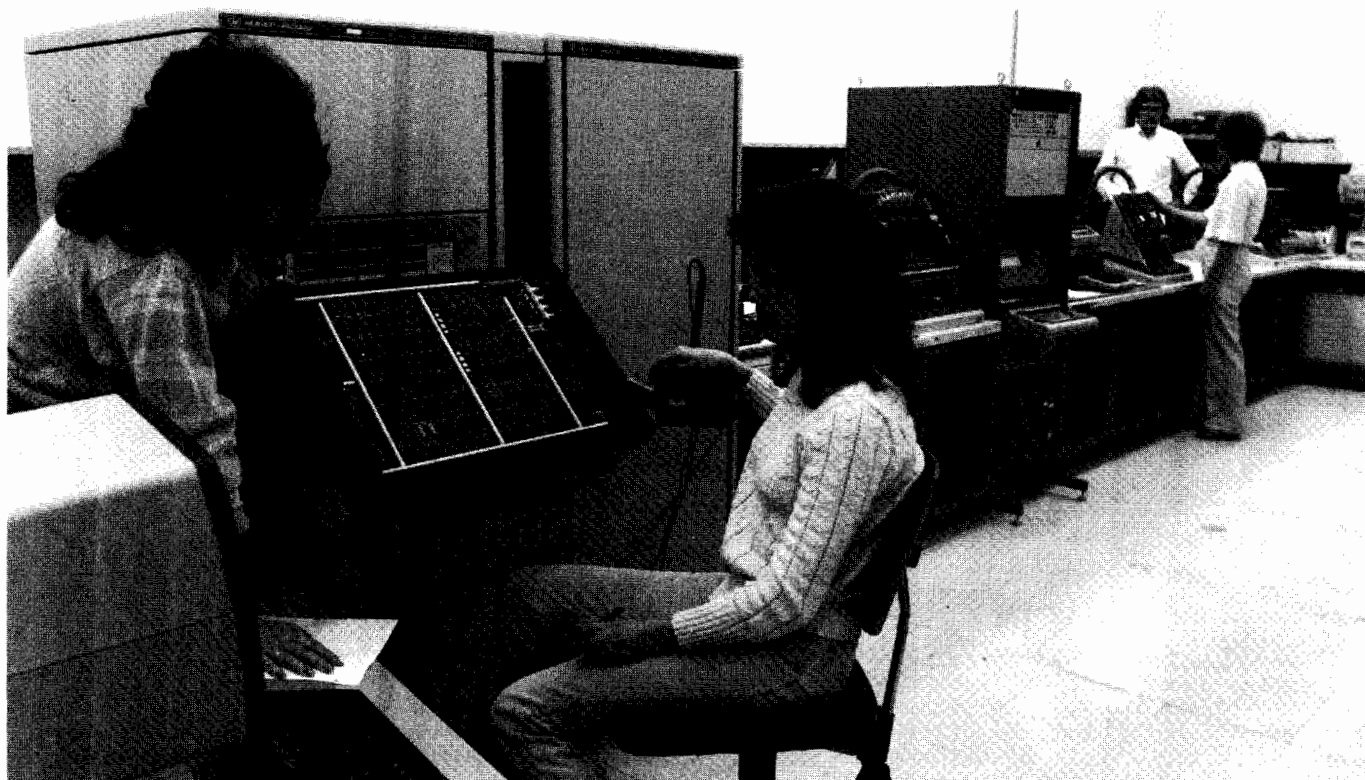

Technological advances and increased worldwide competition are placing new demands on production managers to cut costs, increase productivity and improve product quality. Automatic test equipment has become a key factor in achieving these goals. The implementation of a cost effective ATE solution requires careful assessment of the particular production environment in which it will be used.

Fault Identification

The cost of finding a fault or failure in electronic equipment increases by a factor of ten at each stage of the production process. A fault detected at board test could cost \$5—at final assembly the cost could exceed \$50. If this defective unit reached your customer, it could cost \$500 or more. While the economic costs are high, the intangible costs can be even greater. Defects at the board level could cause bottlenecks, disrupting the smooth flow of boards through production process. Failures that remain undetected until final test can lead to late deliveries and nonlinear shipments. If this same failure reached the field, it could undermine customer goodwill and your company's reputation for quality.

Since the cost of fault identification increases dramatically at each step in production, you must catch faults as early as possible. Extensive incoming inspection of parts is not necessarily the answer. Your real goal is high turn-on rates in final test. To achieve this goal requires boards that are defect free. High yield PC boards are a function of good parts and good processes.

A number of problems can occur during

the PC board assembly process that cannot be eliminated at incoming inspection. Typical problems are open traces, solder splashes, wrong or misloaded parts, poor solder joints, and parts damaged during the assembly process. If board level testing is omitted, these process faults would lead to unacceptably low turn-on rates in final test. Even with a good board yield of 60%, a simple product with only five boards would fail 90% of the time. Clearly, the best place for thorough testing is at the board level because it is the first opportunity to locate faults across the entire fault spectrum.

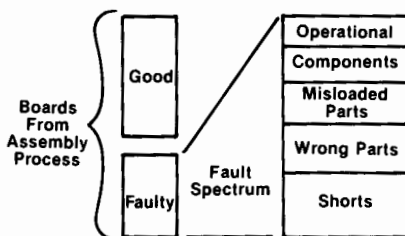

The Board Test Advantage

Automatic board test equipment will save you money by increasing productivity and improving product quality. Productivity is increased by replacing labor-intensive manual testing with computer-aided testing. Component level diagnostics provided by ATE reduces rework costs. As production through-

put increases, so does your plant capacity.

ATE will also help to achieve your quality goals. Higher quality products will lower warranty costs and preserve customer goodwill. Automatic testing provides critical feedback necessary to diagnose quality problems in your production process and correct them. This allows you to build quality into your product, not test it in.

Your production operation is unique. To determine if ATE will make sense in your application, you must compare the total cost of ownership with the savings accrued by using ATE. Return on investment calculations often show that the test equipment will pay for itself in a year or less.

Choosing a Circuit Board Tester

There are no simple answers to selecting an automatic board test system. You must consider such factors as: production yield, test yield, process induced fault spectrum, production volume, board type, and anticipated new products. If ATE makes sense, you must then consider the level of support you will require from the ATE vendor.

Three general types of loaded board testers are presently being used in the electronics industry. They are in-circuit, functional and combinational in-circuit/functional testers. The in-circuit test system locates faults by checking components and circuitry without energizing the entire board. Functional testers isolate faults by exercising the board in a manner that simulates its use in the final product. Combinational testers perform in-circuit evaluation before powering the board for functional testing.

In-circuit Board Testers

In-circuit testers access all nodes on the PC board through a bed-of-nails fixture. Spring loaded pins contact the internal points on the loaded board. Components can be isolated using an electrical guarding technique and then tested for value, placement, and component type. In-circuit testers are well suited for detecting manufacturing and workmanship-related faults which can account for up to 80% of all faults.

Program generation on an in-circuit tester is simple and straightforward. Most of these test systems have automatic program generators that automatically develop the in-circuit portion of the test plan. Since the tests are component level only, the actual function of the PC board is irrelevant. The tester steps through the test plan from component to component and evaluates specific characteristics of each device. This technique provides excellent diagnostic resolution at the component level.

Functional Board Testers

Functional test systems emulate the electrical environment of the board under test. Stimulus sources act as input signals to the circuit, while detectors measure the output and compare it with the expected response. The primary goal of the functional test system is to verify the dynamic performance of the complete circuit under test. Most dedicated functional test systems are simulator-based and provide a fast go/no go indication on the board under test. Since all tests are performed at the board-edge connector, fault isolation is more difficult and time consuming than with the bed-of-nails fixture used for in-circuit testing.

Combinational Test Systems

Individually, in-circuit and functional testers have advantages and disadvantages. Combining these measurement techniques provides a complementary approach to board testing. The spectrum of faults not covered by in-circuit testing is usually covered by functional test capability.

Advances in test technology have led to the development of test systems that perform both in-circuit and functional testing. They combine the best of both techniques into a single system. Test systems that blend in-circuit and functional test capability can not only check for shorts and component errors, but can also verify the dynamic performance of the circuit under test.

These combined test systems are ideal for boards that have nodes that can be accessed with a bed-of-nails fixture, whether analog, digital or hybrid. Test capabilities of these systems can include analog in-circuit, analog functional, digital in-circuit, digital functional, and shorts testing.

Digital In-circuit Testing

Digital in-circuit testing electrically isolates each IC on the board while it is tested. This technique requires that the test system take control of the chip's inputs by overdriving the outputs of "upstream" devices. Overdriving without careful analysis of these digital tests can potentially cause failure during testing or latent failures due to device degradation.

After over three years research, HP determined that to minimize the potential for device damage, each individual IC test should be analyzed. This is due to the variety of configurations in which a device can be used.

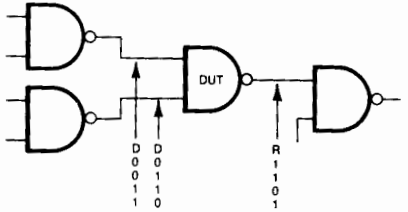

HP's "Safeguard In-circuit" analysis software looks at each test as it is created. It considers device parameters such as package type, power dissipation, and overdrive voltages and currents to minimize the damage potential. To further reduce the potential for

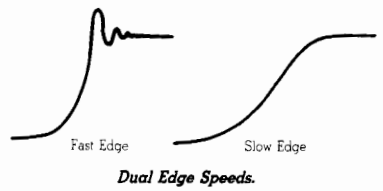

device damage, two driver edge speeds are available to reduce voltage overshoot. If the chance of excessive temperature rise exists, a cooldown time is automatically imposed. After all these precautions are taken, if the potential for damage still exists, the programmer receives a warning message.

Digital Functional Testing

There are basically two forms of digital functional testing: high speed digital functional testing and static pattern testing. HSDFT tests the circuit "at speed", emulating the dynamic operation of the circuit under test. Signature Analysis is an HSDFT test method consisting of a high speed digital stimulus and a synchronous measurement technique. Long data strings are compressed into a four character hexadecimal string called a signature. These DUT signatures are then compared to those learned from a known good board.

Static pattern testing consists of applying a test pattern at the input of a printed circuit board and measuring the response at the output. If the tester has access to internal circuit nodes, the output of each individual device can be tested.

Test systems can access the board under test in several ways. The first is via the board-edge connector. Used primarily with the static pattern test technique, this method gives a fast go/no go indication for the circuit under test. Component level fault isolation, if available, is usually through the use of a program-directed probing technique. A second method uses a bed-of-nails fixture to access every circuit node, providing simple component level diagnostics. The same is true for the combined edge connector/bed-of-nails fixturing method.

Test patterns for functional test systems can be generated manually or by a simulator. Manual generation is usually limited to simple circuits. The output of computer aided design (CAD) systems can be used to simplify the manual process. The two basic types of simulators used to generate functional test patterns are those that are an integral part of the functional tester and the off-line simulator. Simulator outputs are generally required for comprehensive testing of large, complex digital circuits.

Advanced Analog In-circuit Testing

All HP in-circuit testers use advanced techniques that allow component isolation in even the most difficult circuit configurations. For example, a 0.01 μ F capacitor can be measured to an accuracy of 4% even when in parallel with a 1000 ohm resistor. This is made possible by our 6-wire guarding and phase synchronous detection. Added features such as remote sensing, extended guarding, and extra digit greatly expand the precision measurement capabilities of HP's board test systems.

Extended Guarding

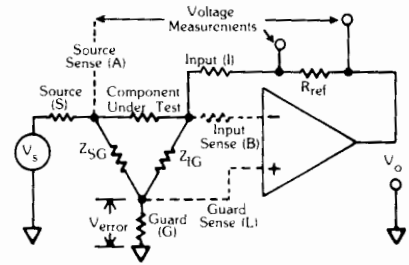

Analog Functional Testing

Functional testing enhances in-circuit test results and can significantly increase board test system yields. Each HP board test system with in-circuit capability also has standard sources and detectors to provide functional testing. Optional instrumentation can easily be added via the HP-IB interface. Active analog functional testing finds faults not detected with in-circuit testing and allows tuning and circuit adjustments by system operators.

HP's Testing Techniques

Since each production process is unique, your specific process may require several of the measurement capabilities listed above. HP's Circuit Test product line offers a wide range of board test systems, each providing at least two of these testing techniques. Analog in-circuit and functional testing capabilities are available in the HP 3061A, HP 3062A and HP 3065 board test systems. The HP 3062A provides static pattern and high speed digital functional testing. Digital in-circuit testing with "Safeguard In-circuit" analysis is provided on the HP 3065 family. The DTS-70 is a simulator-based digital functional tester with analog functional testing capability.



CIRCUIT TEST SYSTEMS

Production Testing of Electronic Printed Circuit Board Assemblies (cont.)

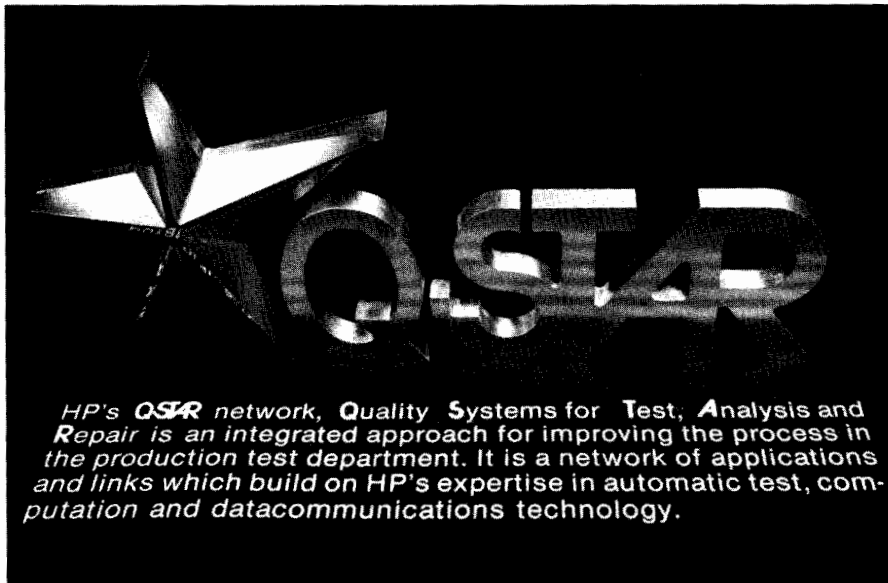

HP's Q-STAR network, Quality Systems for Test, Analysis and Repair is an integrated approach for improving the process in the production test department. It is a network of applications and links which build on HP's expertise in automatic test, computation and datacommunications technology.

Maintaining Control of the Manufacturing Process

Automatic testing in the production test area is not the total solution to productivity or product quality. There must be an overall strategy for linking computer-aided solutions throughout the entire manufacturing facility. The HP Manufacturer's Productivity Network (MPN) is an integrated strategy for providing products and services that link the four major areas in a facility. They include operations, administration, engineering and production. Timely communication among these areas is essential if control of the manufacturing facility is to be maintained.

The HP Q-STAR network (Quality Systems for Test, Analysis and Repair) is a significant addition to the HP MPN in the production test area. It provides productivity and product quality enhancements in the test area with multiple links to other MPN quadrants. HP Q-STAR was developed on the premise that a network is more than a hardware link. It must also provide applications software to form a framework for using board test data to improve product quality as well as provide feedback to improve the manufacturing process.

HP Q-STAR resides on the HP 3065 Board Test System and takes advantage of its unique cluster architecture that allows users to access common peripherals and data bases. Several new application packages have been added to enhance the standard HP 3065 software. These include paperless repair, CAD-HP 3065 interfacing, and test reporting using Statistical Quality Control (SQC) methods.

Paperless Repair/Reporting

Paperless repair/reporting with bar code reader capability automates the data flow between the test and repair areas and provides board tracking through the test/repair cycle. Failure information by board serial number can be stored for retrieval by repair operators using a terminal keyboard or a bar code reader. This test/repair data can be used to identify "looping" boards and result in increased

productivity in the repair process. The same data base can be analyzed and provide timely feedback to improve the production process. PPR is a standard feature on the HP 3065 Board Test Systems.

Test Statistics Reporting

Analysis of data obtained in the test/repair loop is the job of HP Q-STATS, another standard feature of the HP 3065. The statistical analysis turns raw data into usable information required by programmers, test engineers and managers. For example, producibility reports provide a statistical measure of the quality and repeatability of a test. This is a clear indication of how well the test will perform in the production process.

HP Q-STATS provides production management information in several different formats based on Statistical Quality Control concepts. Tabular reports highlight production parameters such as yield, volume of boards tested, and average wait, test and repair times. Pareto charts provide more detailed information such as board failures by component designator. These reports can be used as they are, or can be easily tailored to meet user format requirements

CAD-ATE Interfacing

In every in-circuit board test system, a description of the circuitry, or topology of the board to be tested, must be entered into the test system before a test plan can be generated. Computer Aided Design (CAD) systems are widely used in the design of the boards and contain much of the data required by the test system. Standard CAD outputs such as netlists and parts lists can be formatted and used instead of manually entering each component and interconnect. Once the topology information is in the test system, component values and tolerances must be entered manually. At this point, most in-circuit test systems have an automatic program generator that generates the basic test plan.

HP provides a unique solution for extracting data from the CAD systems for use on the HP 3065 Board Test System. Instead of relying on a CAD vendor to supply a post-processor to format the CAD files, the standard outputs are read into the HP 3065 and reformatted there. Using a software package called HP CAD-VANTAGE, board test data can be extracted from custom CAD systems as well as commercial systems.

After the transferred data is formatted in the HP 3065, it is entered into the forms entry package. Parameters such as component values, tolerances and failure messages can then be entered into this menu-driven package. Once the data is complete, the HP 3065's program generator, IPG-II, automatically generates a complete in-circuit test for the board in a fraction of the time required using the manual entry mode. In addition, the board description may be transferred to other HP board testers for test program generation on those systems.

Linked Solutions

These applications require supported links to be useful. The HP 3065 provides high speed links for networking a number of test clusters together to share files and resources. A single "copy" command can transfer remote files as well as local files over HP's proven Distributed Systems (DS) link.

For links beyond the HP 3065 environment, HP has provided a number of new software capabilities. HP 3062 Data Link Utilities enables an HP 3065 to communicate with HP 3061/2 systems over the HP-IB (IEEE-488) interface. The Q-STAR environment is open to a wide variety of computer systems used in Computer Aided Manufacturing (CAM). New software provides access to the HP 3065's RS-232 ports for custom communications with virtually any computer system via hardwired or modem links.

Standard HP 3065 software also uses ISO's HDLC packet switched protocol, BYSYNC communication or standard ASCII record transfers to link to HP 1000, 3000 and desktop computers. Modem interfaces allow remote communications and support for the X.25 international packet switched standard provides true global network capability for the HP 3065 Board Test Family.

Is ATE the Answer?

Can automatic board test equipment save you money? Again, there are no simple answers. Chances are that it can if any of the following conditions exist in your plant: high PC volume, complex boards, backlogs in production test, low turn-on in final assembly, high in-process inventory and high warranty costs. HP's sales representatives can help you characterize your production operation by comparing the cost of testing or not testing at each level of the process. They are available to help you answer your ATE questions.

CIRCUIT TEST SYSTEMS

Board Test Application Services



- Custom fixtures, board test software and library test software
- Fast turnaround
- High quality solutions
- Local installation

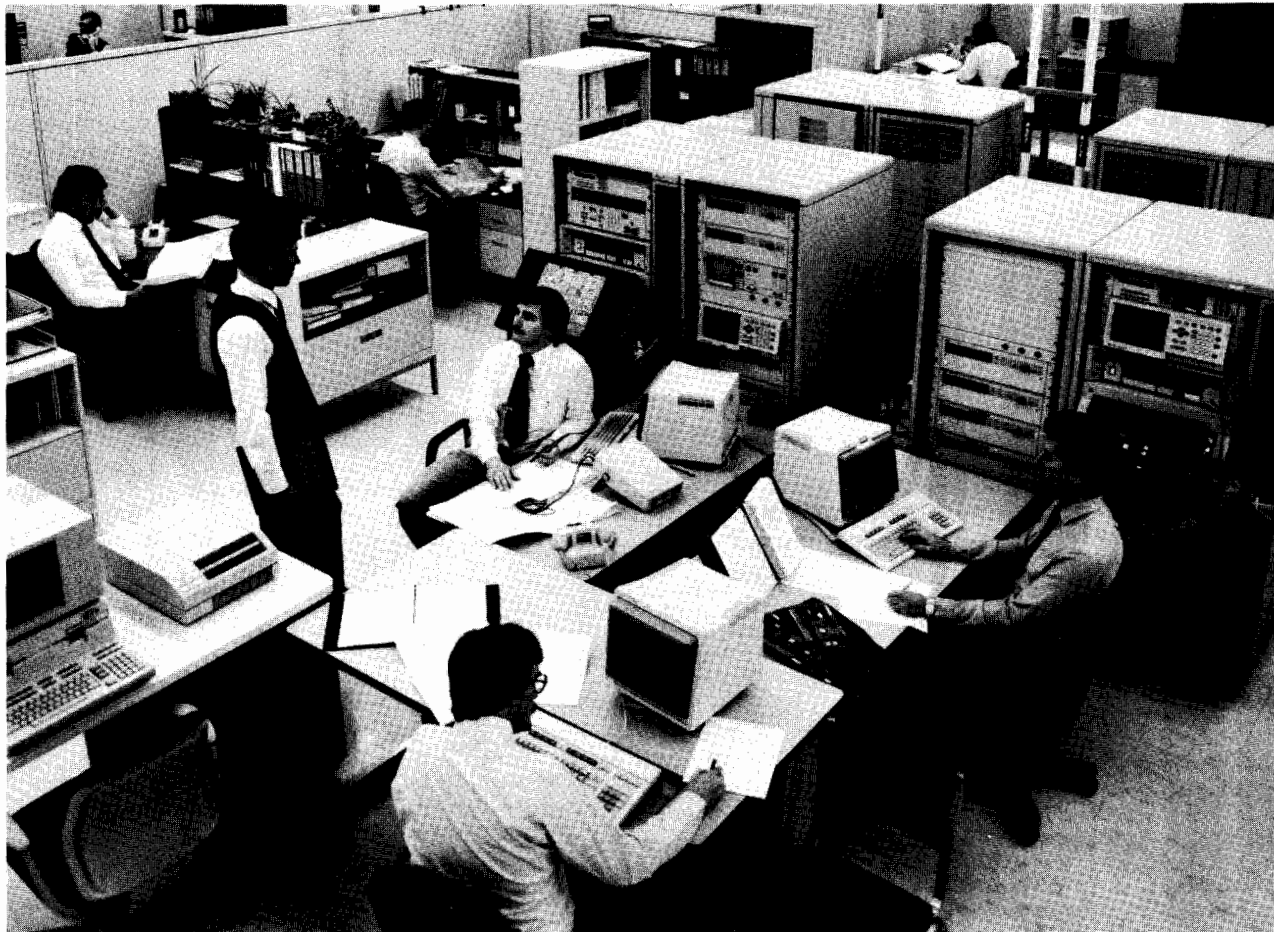

Custom board test application services are available through HP's SupportNet team of Application Centers and your local Application Engineer. By using the SupportNet team, you can benefit from the economies of scale provided by a centralized programming and fixturing staff in the Centers, and have the assistance of near-by Application Engineers to help define your requirements, and to install and support custom programs when they are completed.

The SupportNet team offers a broad range of custom fixtures and programs tailored to fit your exact needs. HP is able to offer these services at economical prices by taking advantage of the hundreds of man-years of experience of SupportNet personnel, combined with significant capital investments in automated assembly, programming stations and test equipment.

Custom Fixtures

Custom fixtures may be ordered for any of HP's board test systems. The fixtures can be built from one of HP's high-quality fixture kits, or from a kit brand of your choice. To provide a fixture built to your exact needs, you may select from a number of options including special probe types, unique fixture plate milling and special damming of the fixture vacuum. You may also choose to have specialized electronics built into the fixture or custom interfaces built for programmable instrumentation.

HP also maintains an on-going monitoring program for special fixtures developed by third parties including dual-access and dual-stage fixtures.

Custom Programs

Custom in-circuit board test software is available for the HP 3061A, 3062A, and 3065 board test systems. This software includes data entry, shorts and opens tests, in-circuit testing of digital ICs using the HP 3065 digital device library and specific functional tests for various circuit components. It may optionally include library test development of digital ICs—either commercial or custom—not yet in the HP 3065 device library, or these tests can be ordered separately.

These programs include a complete, personalized documentation package and on-site installation by your HP Application Engineer.

Ordering Information

HP 44810A Custom Fixture-Built from Small HP Kit
HP 44811A Custom Fixture-Built from Large HP Kit
HP 44812A Custom Fixture-Built from Dual HP Kit
HP 44813A Custom Fixture-Special Design
HP 44820A Custom In-Circuit Board Test Program
HP 44830A In-Circuit Library Test Program

Price

Quote
Quote
Quote
Quote
Quote
Quote

CIRCUIT TEST SYSTEMS

In-Circuit/Functional Test Systems

Model 3061A/3062A



Description

The HP 3061A and HP 3062A test systems combine excellent in-circuit fault isolation with functional testing capability to maximize PC board yields. Both incorporate advanced measurement and interface technology based on years of experience within HP and field proven in the HP 3060A.

The HP 3061A Board Test System has been optimized for analog PC board testing. It combines advanced analog in-circuit and analog functional test capabilities with high speed shorts/opens testing.

The HP 3062A Board Test System adds both digital static and digital functional testing to analog testing capabilities of the HP 3061A. You can choose the system that is right for your specific production test needs.

System Controllers

You may select from four system controllers, the HP Model 36, HP Model 26, HP Model 20, or HP Model 16. Software written on one model is directly compatible with the others. The HP Model 26 and 36 computers have built-in floppy disc drives for convenient programming. Additional hard disc drives can be added. The HP Model 16's low cost and small physical size makes it an ideal controller for dedicated test applications. The HP Model 20 Box Computer is rack mounted and offers a low cost alternative to the HP Model 26 and 36. It has a 15-slot card cage for additional interfaces and memory expansion.

Advanced Analog In-Circuit Testing

The HP 3061A/3062A advanced analog in-circuit testing finds faults over a wide variety of components, measurement values, and tolerances. Advanced six-wire guarding methods make accurate measurements possible, even in cases of severe parallel shunting. Programmers may select a variety of guarding methods to optimize throughput and/or accuracy for specific production requirements.

This test technique assures you of consistent measurement results from board-to-board and between systems. For example, you can off-load analog testing from one tester to another during peak production periods and get the same test results. HP analog in-circuit testing techniques mean flexible, consistent, and accurate measurements from your testers.

Analog Functional Testing for Higher Yields

Analog functional testing enhances the results of in-circuit testing and significantly increases PC board yields. Yields of 85-90% using analog in-circuit test methods may be increased to 95-98% with the addition of functional testing. The standard HP 3061A/3062A gives the user a wide range of measurement test tools for full functional testing. If additional functional test capability is required, HP-IB instrumentation from Hewlett-Packard may be easily added for your specific functional test needs.

Digital Functional Testing

The HP 3062A tests digital PC boards containing a wide range of logic devices including microprocessors. The testing of micro-processor-based circuits with bus-structured devices, large memories, and dynamic memory devices often presents difficult test problems. Functional testing of your microprocessor boards is reduced to a manageable task using Signature Analysis (SA).

Digital Static Pattern Testing tests circuits of medium complexity. This technique stimulates digital circuits and compares the measured response to an expected response. Using advanced analog testing and static pattern testing, hybrid circuits such as A to D's and phase lock loops can be thoroughly tested.

Software for Your Programmers

Test development times are reduced to a minimum through the use of HP's high-level languages and automatic program generator. The system software includes the following:

- Board Test Language (BTL200)-BTL200 controls complex system functions including setup, measurement, response and data evaluation. On-line editing and immediate execution makes the testing of complex circuit configurations a simple task.
- In-Circuit Program Generator (IPG200)-IPG200 automatically generates the analog in-circuit test program from the circuit description entered by the programmer. It analyzes the circuit for parallel paths and automatically selects optimum guarding locations. IPG200 then prints out a measurement analysis of each component, the test program, and fixture documentation. Once the fixture is built, verification software helps to check for construction errors.
- Software Development Package (DFT200)-DFT200 software development package aids the user in entering and debugging programs using the Signature Analysis (SA) technique. DFT200 combines stimulus and SA measurement routines into a final efficient test program. This means faster program execution and high PC board throughput.

Quality Through Data Analysis

HP 3061A/3062A Test Systems accumulate data required for statistical evaluations of your production process. HP-supplied programs can analyze the data or you can write your own data analysis programs easily using HPL statements. Analysis of your failure information will isolate problems in your manufacturing process.

HP Support

Qualified systems engineers are located near your facility to provide you with applications and programming support. Customer Engineers support your system on a worldwide basis through the use of locally-placed system service kits. But, that's still not the whole story. Complete user training courses are taught for each system. To enhance the learning process, these training courses are offered at 14 Hewlett-Packard training locations throughout the world.

Ordering Information

HP 3061A Board Test System
(depending on configuration)
HP 3062A Board Test System
(depending on configuration)

Price

Starts at \$75,000

Starts at \$110,000

CIRCUIT TEST SYSTEMS

Board Test Family

Model 3065



- Digital/Analog In-Circuit Testing
- Low programming costs

- Multiple test stations
- Guaranteed 99% Uptime Service

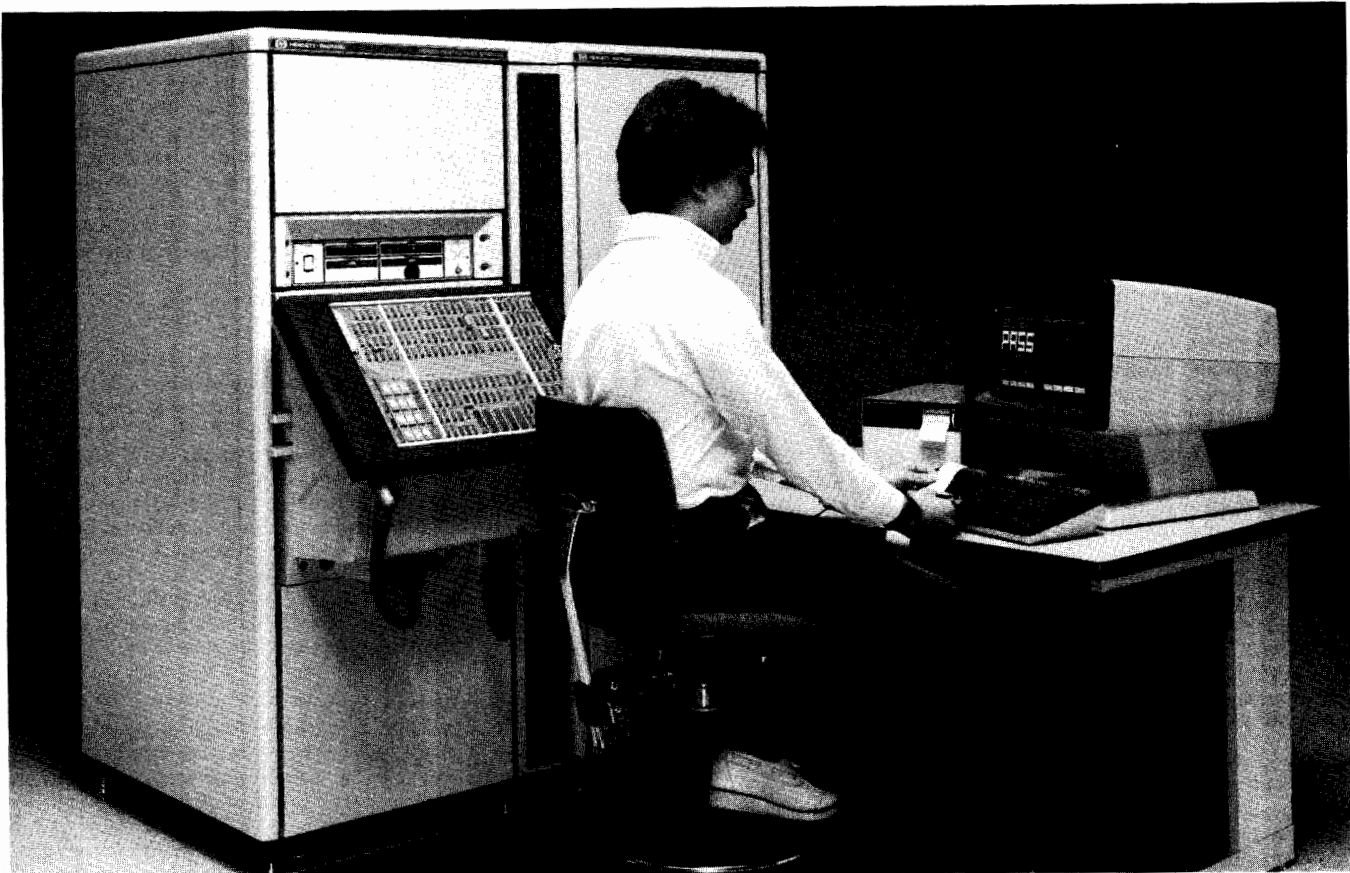

Description

The HP 3065 Board Test Family is the result of years of experience in automatic testing and advanced computer technology. It combines high speed digital in-circuit testing with our proven 6-wire analog in-circuit and analog functional measurement capabilities. In addition, the HP 3065's distributed intelligence architecture allows a single system controller to support multiple test stations, multiple programming stations and a variety of peripherals without sacrificing high throughput in production test.

The HP 3065's family concept and modular design allows configurations to meet today's testing requirements and still provides flexibility for future expansion. A basic HP 3065 test system consists of a system controller and a test station. A total of three system controllers and three test stations are available, allowing a board test system to be configured to your specific testing needs.

Controllers

The HP 3065 family has a total of three system controllers providing a wide selection of price/performance tradeoffs. All include specialized HP minicomputers, each with different operating speeds, memory capacity and peripheral handling capabilities.

The HP 3065C System Controller provides up to two megabytes of internal memory and a 132Mb fixed disc drive. A single controller supports up to three test stations and three programming stations simultaneously. If fewer than three test stations are required, up to two additional programming stations may be added. Used exclusively as a test development center, the HP 3065C can support a total of six programming stations. Test stations and programming stations can be located up to 90 meters from the system controller.

The HP 3065CL uses an HP A600+ based controller with 2Mb of internal memory and a 55Mb fixed disc drive. It supports one test station

and two additional terminals to be used for programming and/or repair stations located up to 90 meters from the controller. The test station is adjacent to the controller.

The third controller in the HP 3065 family is the HP 3065CX. This HP A900 based controller provides 3.0Mb of internal memory and a 132Mb fixed disc drive. It can support three test stations and up to eleven programming/repair stations simultaneously. All can be located up to 90 meters from the controller.

Digital/Analog Test Stations

Three test stations are available in the HP 3065 family. As in the case of the system controllers, they offer the user a choice of price and performance. All three test stations provide state-of-the-art in-circuit testing to isolate both component and process induced faults on PC board assemblies. Each scanner has 22 slots for analog, digital, hybrid and general purpose relay cards providing up to 1408 analog or 1320 hybrid points.

The HP 3065H test station provides digital and analog in-circuit and analog functional testing capabilities. Digital in-circuit tests use a distributed control structure to apply test patterns at programmable rates up to 2.5 MHz on all digital and hybrid pins. Analog in-circuit tests use six-wire guarding, phase synchronous detection, extra digit and enhance measurement modes to measure a wide range of components and component values. Analog functional tests are made with internal sources and detectors or a variety of external instrumentation via the HP-IB interface. An equipment bay is provided in addition to the measurement bay to allow the addition of up to eight programmable digital DUT power supplies and/or functional test instruments.

The HP 3065HL is a single bay test station with the same user interface as the HP 3065H. It supports dedicated analog and digital cards as well as the hybrid card. The test station provides four fixed DUT

CIRCUIT TEST SYSTEMS

Board Test Family

Model 3065 (cont.)

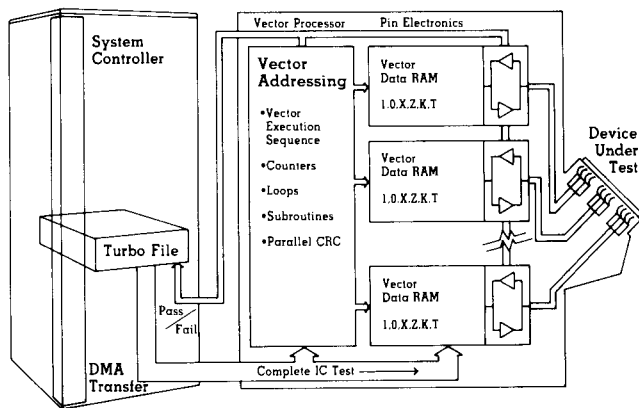

The HP 3065's architecture downloads an entire digital test from the system controller to the test station electronics in one DMA transfer. A Vector Processor microcomputer in each HP 3065 test station sequences test vectors stored in the RAM behind the pins.

power supplies with the capability to add two programmable supplies. Digital pattern application rates are programmable up to 5 MHz on the hybrid card pins; 2.5 MHz on the dedicated digital pins. Analog functional testing capability is available, but no equipment bay is provided for the HP-IB instruments.

The HP 3065HX is a two bay test station similar to the HP 3065H. The major difference is the new Vector Processor Card that allows digital test patterns to be applied at a 5 MHz rate when using the hybrid pin electronics. Dedicated digital cards operate at 2.5 MHz. The equipment bay provides space for eight programmable DUT power supplies and functional test instruments.

Compatibility/Modularity

The HP 3065 family concept and modular design allow the user to configure a board test system to meet today's complex testing requirements and still provide flexibility for future expansion. The compatibility of software and hardware makes it possible to configure up to five test systems based on testing requirements and price considerations.

Test programs and fixtures used on the HP 3065C/H test system are compatible with the new controller/test station combinations. This protects the large investment in time and equipment when additional testing capacity is required.

Improved Performance

Hardware and software enhancements on the HP 3065 family have made significant improvements in tester performance, especially in the areas of throughput, ease of programming and faster test plan generation. This reduces the amount of time required to get the product out of the lab and into the final assembly.

Throughput

Digital throughput is usually incorrectly equated to test pattern applications rates. In reality, actual test times are a very small portion of the total time required to test a digital device. With test vectors being applied at MHz rates, it takes less than 50 microseconds for most IC tests. Conventional testers incur overhead times of 50 to 750 milliseconds reading data from the disc, downloading test data to the hardware, reading the received data, and comparing the results with the expected pattern. In most cases, overhead varies with IC complexity. The HP 3065's digital throughput is virtually independent of device complexity.

The HP 3065 uses efficient software and a distributed intelligence hardware design to minimize overhead times. Each test station has its own bit-slice microcomputer, the Vector Processor, plus RAM and control electronics to provide up to 5 MHz test vector rates on all digital and hybrid pins.

The HP 3065 System Controller reads multiple device tests into a "turbo" file in its memory during a single disc access. Then using

Direct Memory Access (DMA), the system controller downloads complete device tests from the "turbo" file to the test station one at a time. Test sequence information is loaded into the Vector Processor memory and unique test vectors are loaded into the RAM behind the pins.

Vector Processor

The Vector Processor controls the real-time digital test execution for each test station. Using a pipeline architecture, the Vector Processor eliminates overhead time between test vector applications. As tests are executed, pin electronics supporting each test pin makes a pass/fail decision in hardware by comparing the received data with the expected pattern. The instant a failure is detected, a fail bit is returned to the Vector Processor. The system controller detects this failure and immediately initiates the DMA transfer of the next complete device test.

Pin Electronics

Each bi-directional test pin is supported by local RAM. This RAM is used to store only unique test vectors required to test a device. Each of these vectors may be applied as many times as necessary by the Vector Processor to completely test the DUT. The RAM also supports the HP 3065's K (keep the previous state) and T (toggle the previous state) vector states in addition to the traditional 1, 0, X and Z. This derivative mode and the unique vector storage give the HP 3065 an equivalent of 4k random vector storage and almost unlimited algorithmic vector capability. Using these techniques, data compression of 150:1 and greater can be achieved.

By reducing the amount of data that must be transferred and minimizing or eliminating overhead times inherent in the test process, the typical HP 3065 overhead time averages less than 25 milliseconds.

Faster Program Generation

Test development costs can be the major on-going cost of owning a board test system. The HP 3065 helps control these costs by providing a unique software environment to increase programmer productivity and reduce test development costs. From data entry to test execution, the HP 3065 is fast and easy to use.

Since Computer Aided Design (CAD) systems often contain board topology information, the HP 3065 can link to these systems to retrieve this data. Non-technical personnel can add to CAD data using the HP 3065 forms entry package. If CAD system data is not available, the entire circuit description can be entered easily into the fill-in-the-blank forms package.

Once the circuit description is entered, the HP 3065's In-circuit Program Generator (IPG-II) creates an in-circuit test plan for all analog and digital components—automatically. Tests for all analog components are automatically generated, including guarding required to eliminate the effects of the surrounding circuitry. Digital IC tests are selected from the HP 3065's library of more than 4000 part numbers and automatically modified to reflect specific applications of digital devices on the board under test.

IPG-II easily accommodates engineering changes after the board is in production. In addition to entering the production changes, the existing fixture wiring information can be entered. IPG-II will use this data to produce a new wirelist to minimize fixture rewiring.

The outputs of IPG-II are fixture wiring information and a test plan that calls the shorts tests, executes the analog test, and calls the digital IC tests. A test generation summary is also provided. On a digital board with over 200 ICs and 100 analog components, IPG-II produced a test plan with 90% working tests without debug. This translates to faster test turn-on and lower test costs.

"Safeguard In Circuit" Analysis

Digital in-circuit testing electrically isolates a device on a PC board while it is being tested. This technique requires that the test system takes control of the chip's inputs by overdriving the outputs of "upstream" devices. Overdriving these devices without careful analysis can potentially cause device damage or degradation. HP spent three years researching the causes of device damage and found the major causes to be overdrive current, excess temperature rise and voltage

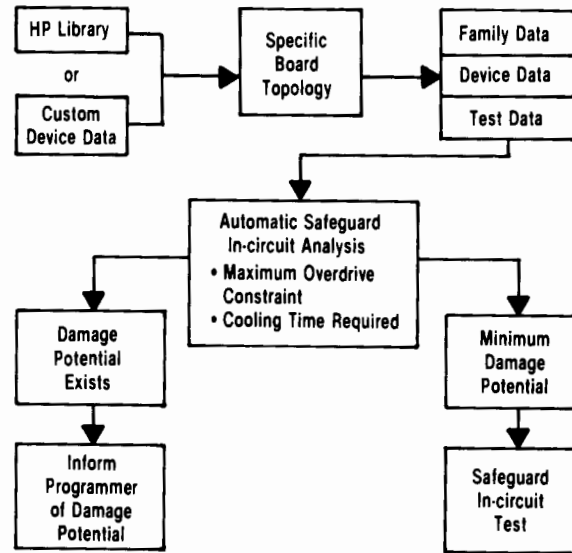
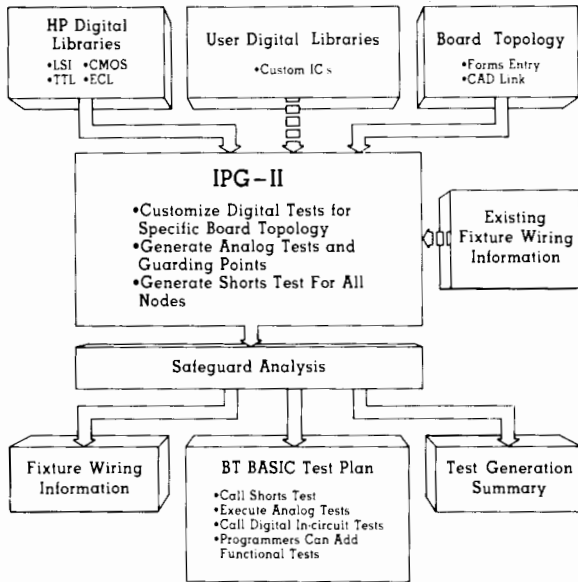

IPG-II is HP's second generation in-circuit program generator. Requiring only a board topology as input, IPG-II uses digital libraries and the circuit description to generate the entire in-circuit test plan.

overshoot. It was determined that the circuit configuration as well as the device parameters contribute to potential IC damage.

HP's "Safeguard In-circuit" analysis package automatically evaluates all digital tests to minimize the potential for device damage or degradation. The analysis considers device parameters such as package type, device family, power dissipation, and voltage/current handling capabilities as well as circuit topology. It then selects minimum levels necessary to overdrive logic states, yet maintain adequate noise margins. It also selects the appropriate edge speed to minimize overshoot; fast edge for fast TTL and ECL logic families, slow edge for CMOS to prevent latchup.

If cumulative heating is a problem, "Safeguard In-circuit" imposes a cooldown time between tests. This is particularly important during debug since it may be necessary to loop on a test or series of tests. The cooldown period occurs during the overhead time, therefore it has minimal effect on digital throughput.

Networking for Productivity

HP brings the Manufacturer's Productivity Network into your test department. With the introduction of the new Q-STAR network (Quality Systems for Test, Analysis and Repair), the HP 3065 has the multi-link capability to become an integral part of your facility networking plans. HP Q-STAR provides productivity and quality enhancements within the test department with multiple links to the other MPN quadrants. More than just a hardware link, Q-STAR provides application software to improve production testing as well as timely feedback to improve the manufacturing process.

HP Q-STAR takes advantage of the unique cluster architecture of the HP 3065 Board Test System that allows users to access common peripherals and data bases. Application packages include paperless repair, statistical test reporting (Q-STATS) and interfacing to CAD Systems (CAD-VANTAGE). HP's MPN, in conjunction with Q-STAR, provide the strategy and the tools to help you maximize control of your manufacturing facility.

Protect Your Investment

In order to protect your investment in the production test area, many factors must be considered. Three of the most important considerations are system flexibility, compatibility and service.

Keep Pace with Technology

The modularity and flexibility of the HP 3065 family allows the user to keep pace with board test technology. An ongoing enhancement program in both the software and hardware areas has produced

The HP 3065's Safeguard In-circuit analysis package automatically evaluates each digital test as it is created. Whenever the potential for damage is identified, the programmer is notified and test execution is prohibited.

advances such as the new vector processor card that applies test patterns at a 5 MHz rate and the hybrid cards that provide up to 1320 hybrid scanner test points. Two new system controllers and two new test stations have been added, allowing customers to select the price and performance for their particular testing needs.

Since the introduction of the HP 3065, several major software packages have been introduced, including Paperless Repair/Reporting and quality statistical data collection and reporting (Q-STATS). These were added to the system software at no cost. CAD-VANTAGE is another major enhancement that is offered to the HP 3065 user.

System Compatibility

Perhaps the most important factor in protecting your investment in the production test area is system compatibility. The HP 3065 family of testers provides this protection. Test programs and fixtures developed on the original system (HP 3065C/H) work on the new controller/test station combinations. Programs written on a system with dedicated analog and digital scanner cards will work on a system with hybrid scanner cards as well. Therefore, training, test programs and fixtures are not abandoned when additional test capacity is needed.

In addition, all future enhancements to the HP 3065 Board Test Family will be compatible with test programs developed on the new test systems. The new vector processor and hybrid cards will serve as a base for the planned enhancements.

99% Guaranteed Uptime Service

In the U.S., HP is offering a 99% Guaranteed Uptime Service program on the HP 3065 Board Test Family. This is made possible by the excellent reliability record of the HP 3065 and HP's outstanding support organization.

In addition, HP offers a complete worldwide solution to your application, hardware and software needs. HP's SupportNet is a team of HP engineers and technicians that provide custom fixtures and programs for HP board test customers. This and other hardware and software support services help get your test system up and running fast and keep it operating at peak efficiency.

HP 3065 Board Test Family

For an informative brochure on the HP 3065 Board Test Family and/or more information on the 99% Guaranteed Uptime Service program, call 1-800-634-8378.

Prices start at \$163,000.

HP 44539A

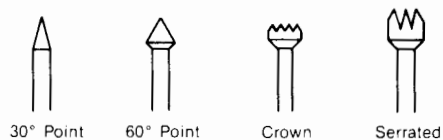
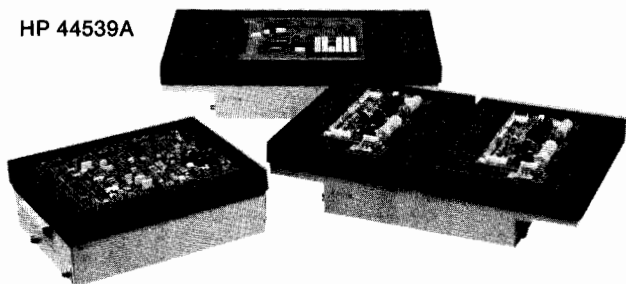

Fixturing Products

Description

The vacuum-actuated test fixtures have a dual vacuum plate design that creates a guided probe system. The spring probes are equipped to allow wire-wrap interconnections, and are easily replaceable. A patch panel interfaces the probes to HP 306X Board Test Systems' relay matrix. The entire lightweight fixture is enclosed by a molded plastic case, eliminating the possibility of accidental damage or contamination. An optional extender and breadboard kit allows you to add your own custom test circuitry to the fixture.

Performance

Special attention has been paid to the design of the fixturing products to ensure performance. The patch panel is made of a material that exhibits very high isolation resistance. This means leakage currents are kept low and will not significantly affect in-circuit measurements. In addition, the spring probes exhibit low series resistance and can handle up to three amperes of current.

Attention has been paid not only to electrical performance but to mechanical performance as well. For example, the fixture has been designed to significantly reduce vacuum requirements. Low leakage probe sockets together with an improved vacuum seal made of durable thermoplastic rubber help achieve an air-tight construction. The improved vacuum seal serves to muffle the acoustic noise level for smooth, quiet operation.

The fixture kits are designed for ease of assembly and modification. No adhesives are required at any point in the assembly process. The test head is hinged and can be locked in either the down position or the up position for easy access to wiring. Once assembly is completed, a fixture verification software package aids you in debugging the initial construction and is also useful for repairing and troubleshooting the kits already in production.

Test Fixture Available in Three Sizes

There is a kit for relatively small boards up to a size of 25.4 x 33 cm (10" x 13"). For larger boards, a kit that will accommodate sizes up to 33 x 55.9 cm (13" x 22") is available. In addition, a dual fixture kit is also available which allows you to increase your throughput by testing boards in tandem. Each side of the dual fixture will accept a small size PC board. All three of the fixturing products are fully compatible with HP 306X Board Test Systems, and are available as either options or accessories.

Fixture Construction Kit Parts

Probes

Four probe styles are available, each with two different ranges of spring tension. The probes can be ordered with sixty degree single-point tip (HP 44561L and 44561H), star or crown-point tip (HP 44563L and 44563H), serrated multi-point tip (HP 44562L and 44562H) and spear point tip (HP 44564L and 44564H). The high force (8 oz. spring tension) probes are recommended except for high pin density applications. In these applications, low force (4 oz. spring tension) probes should be used. Each option contains 100 probes.

Sockets

HP sockets (HP 44574A) are specially designed for low air leakage and reliability. The sockets have 0.54" diameter barrel which accepts most standard probes.

Patch Panel Plugs

Six patch panel plugs are available to meet your specific fixture building needs. Single (HP 44589S and 44589SW) and dual plug (HP 44590D and 44590DW) versions are available pre-wired and with wirewrap posts or posts only. The pre-wired 5-plug (HP 44592A) is used for HP 3065 systems digital nodes. It features twisted pair wires for quick and easy wiring of 4 digital nodes. HP 44591A DUT PWR Pin plugs are required for HP 3065 digital pulser power requirements. These plugs are specially designed to fit the HP 3065 system scanner board.

Extenders

Height extenders are available for the standard fixture (HP 44560S) and for the large or dual fixture (HP 44560D). These extenders add 7.6 cm (3") of vertical height. A 12.7 cm x 17.8 cm (5" x 7") breadboard is available for either extender.

Assembly tool kit—HP 44572A option 003 contains the hardware and tools needed to assemble HP test fixtures. One tool kit is needed for each assembly station.

Spare parts kit—HP 44573A contains spare parts for constructing or modifying an HP test fixture.

Ordering Information

| | Price |
|--|-------|
| HP 44538A Standard Test Fixture Kit | \$655 |
| HP 44539A Large Test Fixture Kit | \$830 |
| HP 44540A Dual Test Fixture Kit | \$990 |
| HP 44560S Standard Extender | \$170 |
| HP 44560SA Standard Extender Angled to 45° | \$150 |
| HP 44560D Large/Dual Extender | \$250 |
| HP 44560DA Large/Dual Extender, Angled to 45° | \$150 |
| HP 44572A Assembly Tool Kit | \$125 |
| HP 44573A Spare Parts Kit | \$90 |
| Option 001 Fixture Verification Software Package | \$225 |

Probes

| | |
|---|-------|
| HP 44561L LF Single (60°) point 100 per bag | \$150 |
| HP 44561H HF Single (60°) point 100 per bag | \$150 |
| HP 44562L LF Serrated Head 100 per bag | \$170 |
| HP 44562H HF Serrated Head 100 per bag | \$170 |
| HP 44563L LF Star 100 per bag | \$95 |
| HP 44563H HF Star 100 per bag | \$95 |
| HP 44564L LF Spear (30°) point 100 per bag | \$95 |
| HP 44564H HF Spear (30°) point 100 per bag | \$95 |

Sockets

| | |
|--------------------------------------|------|
| HP 44574A Socket (.054" dia. barrel) | \$60 |
|--------------------------------------|------|

Patch Panel Plugs

| | |
|---------------------------------------|-------|
| HP 44589S Single Plug w/wirewrap tail | \$60 |
| HP 44589SW Single Plug pre-wired | \$115 |
| HP 44590D Dual Plug w/wirewrap tail | \$160 |
| HP 44590DW Dual Plug pre-wired | \$185 |
| HP 44591A HP 3065 DUT Power Pin Kit | \$65 |
| HP 44592A HP 3065 Dr/Rv 5-plug | \$505 |

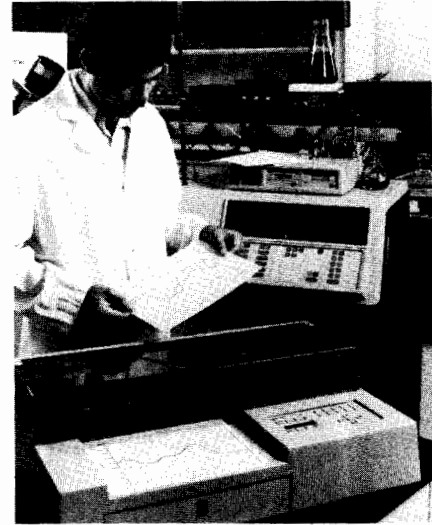

Introduction

Whenever you measure and collect data with accuracy and precision, you need precise hardcopy records of your results. A hardcopy graphics device can improve your measurement system: plots provide permanent post-test results for analysis and documentation purposes and can be filed and retrieved as needed; output can be presented on overhead transparencies for effective communication during training sessions or meetings; and plots take less time than manual graphing and less money than scope camera film.

Recording Analog Data

For measurements made from analog input signals, HP offers two solutions. HP offers a family of traditional X-Y recorders, plus the 7090A Measurement Plotting System, a versatile measurement graphics instrument. The HP 7090A is a recorder that captures signals up to 3 kHz and plots annotated results on paper.

Recording Digital Data

Hewlett-Packard has two solutions for obtaining hardcopy records from digital data input. Both the HP 7090A and HP's graphics plotters (HP 7475A and 7550A), with the appropriate hardware and software, can draw grids, annotate charts, and use many line types and colors to differentiate data.

Whether your application is manufacturing, engineering, education, or medicine, HP offers the products and performance features to meet your hardcopy graphics requirements. Check the table on pages 392 through 395 to help choose the best device for your HP instrument.

Measurement Plotting System

The HP 7090A Measurement Plotting System is a new concept that provides a significant measurement advantage as well as unparalleled flexibility in hardcopy graphics. Functionally, the HP 7090A can replace traditional analog recorders in most applications, and, in addition, add significant and unique measurement and graphics capabilities. With its three input channels, dc to 3 kHz bandwidth, six-pen plotting system, and HP-IB interface, the HP 7090A goes beyond the capabilities of any single recorder or plotter.

The HP 7090A replaces traditional analog recorders; it offers superior dynamic performance and accuracy; 41,000 calibrated ranges; a 30 msec to 24-hour time base; 6 triggering modes with up to 100 percent pre-trigger capture; the ability to annotate with date, time, and setup conditions; and the ability to draw axes and grids which correspond to the recorded data.

X-Y Recorders

X-Y recorders plot graphs from low-frequency analog signals. There are three factors to consider in selecting an X-Y recorder: static performance, dynamic performance, and specific features that are important for your particular application.

Static performance: static performance relates to a recorder's response to dc voltages and very low frequency input signals. It includes accuracy and resolution. Accuracy and resolution are trace functions of the electronic and mechanical characteristics of the recorder and also its dynamic performance. The type of input signal will determine the range of sensitivity required.

Dynamic performance: dynamic performance is a function of slewing speed and acceleration. Slewing speed, the maximum pen speed attainable by the pen along either axis, contributes when recording high amplitude, low frequency signals. Acceleration, the peak pen acceleration, contributes to the recording of low amplitude, high frequency signals. High dynamic performance is essential to the capture of rapid, transient signal inputs.

Graphics Plotters

Graphics plotters provide multi-color, professional quality hardcopy for digital data input. Selection is based on line quality, speed, output size, intelligence features, available software, interface, and budget considerations.

Line quality and speed: all HP plotters provide optimal line quality with a high mechanical resolution of 0.001 inches and a repeatability of 0.004 inches. These specifications assure smooth lines and characters. They perform at high speeds and allow speed adjustment for writing on different media.

Output size: your application will determine the output size required. Notebook size (8.5 x 11 in.) color plots are ideal for reports and overhead transparencies. Use them to summarize data, identify trends, compare results, and highlight exceptions. The larger 11 x 17 inch plots are especially useful for time lines, PERT charts, schematics, engineering drawings, and other applications where you need to show visual detail.

Intelligence and software: HP plotters feature built-in HP-GL (Hewlett-Packard Graphics Language) commands to control a large number of plotter functions. This plotter intelligence frees your system's CPU for other jobs and simplifies the user's programming task. Graphics software packages are available for use on all of HP's graphics plotters. See page 97 for more details.

PLOTTERS & RECORDERS

Recorder/Plotter Selection Guide

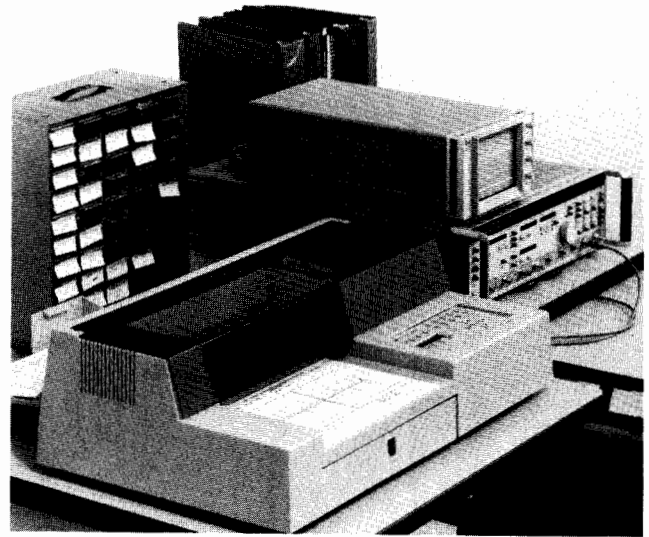
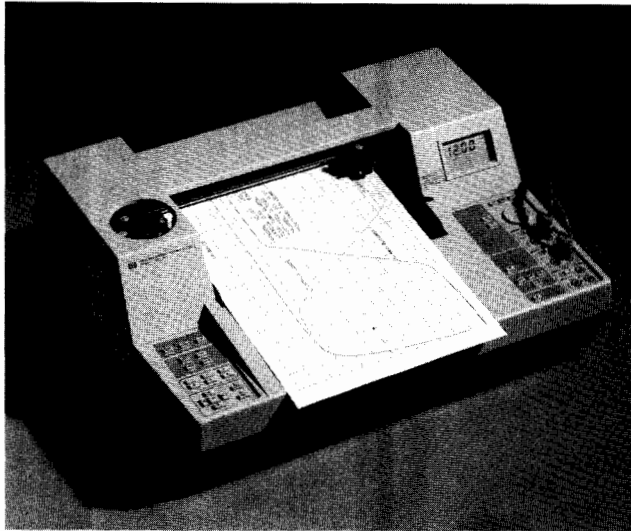

Recommended Solutions

In the following pages, you will find a selection guide listing the graphics output devices suited to your instrument system - one of our three graphics plotters, one of our four X-Y recorders, or the HP 7090A Measurement Plotting System. The HP 7090A is not only a high-quality plotter, but also a recorder that captures signals up to 3 kHz.

HP instruments designed with micro-processors can control plotting from front-panel buttons or menu-driven softkeys. These instruments allow you to send graphics data directly from your instrument to a plotter. If your instrument has this capability, it will be listed with a "direct to plotter" output capability.

Other HP instruments require the appropriate controller and software in order to send graphics output to the plotter. These devices are indicated by "indirect to plotter" output capability. If the system includes or requires a particular controller, that controller is indicated. Plotter software support is also indicated. Consult your local sales representative for controller information or software updates.

Features

X-Y Recorders

- Choice of four models — HP 7015B, 7035B, 7045B, and 7046B
- One-pen and two-pen models
- Electrostatic holddown
- Disposable pens
- Sturdy construction

HP 7475A Graphics Plotter

- 6 pens
- 210 x 297 mm (8½ x 11 in.) and 297 x 420 mm (11 x 17 in.) media capability
- Paper and overhead transparency film, manual media loading
- Multi-color fiber-tip pens
- HP-IB or RS-232-C/CCITT V.24 interface
- 38.1 cm/s (15 in./s) maximum pen speed
- 1024 byte I/O buffer size

HP 7550A Graphics Plotter

- 8 pens
- 210 x 297 mm (8½ x 11 in.) and 297 x 420 mm (11 x 17 in.) media capability
- Paper and overhead transparency film, automatic media loading
- Vellum and polyester film, manual media loading
- Multi-color fiber-tip, roller-ball, and liquid-ink drafting
- HP-IB and RS-232-C/CCITT V.24 interface
- 80 cm/s (31.5 in./s) maximum pen speed
- 1024 byte default I/O buffer size
- 12,800 byte available I/O buffer size

HP 7090A Measurement Plotting System (in plotter mode)

- 6 pens
- 210 x 297 mm (8½ x 11 in.) and 297 x 420 mm (11 x 17 in.) media capability
- Paper and overhead transparency film
- Multi-color fiber-tip pens
- HP-IB interface
- 38.1 cm/s (15 in./s) maximum pen speed
- 1000 word I/O buffer size



X-Y Recorder and Graphics Plotter Selection Guide for HP Instruments

| HP Instrument | Output Capability* | Plotter Software Support | X-Y Recorder Outputs | | Recommended HP Models |
|--|---|---|--------------------------------|---|----------------------------------|
| | | | Voltage | Penlift | |
| PC Instruments | Indirect to plotter | Data Acquisition Software: HP 150, HP 14855A; IBM PC, HP 14856A | | | 7475A |
| 141T Spectrum Analyzer System | Direct to recorder | | X -5 to 5 V Y 0 to -8 V | YES (14 V pen up, 0 V pen down) | 7090A 7015B |
| 415E SWR Meter | Direct to recorder | | Y 0 to 1 V | NO | 7090A 7045B |
| 432A/B/C 436A/438A Power Meters | Direct to recorder | | Y 0 to 1 V | NO | 7090A 7045B |
| 853A Spectrum Analyzer Display | Direct to recorder Direct to plotter (LO) | Front-panel controls select graticule and/or trace (no annotation) | X -5 to 5 V Y 0 to .8 V | YES (15 V pen up, 0 V pen down) | 7090A 7045B 7475A 7550A |
| 1040A UV/VIS LC Detector | Indirect to plotter | HP 1040A opt. 631 software available | | | 7475A 7550A |
| 1090A Liquid Chromatograph | Indirect to plotter. System includes HP 85B | HP software included | | | 7475A |
| 1347A HP-IB Display | direct to plotter (LO) (using dedicated plotter port) | Program command or front-panel control duplicates screen image onto plotter | | | 7475A 7550A |
| 1980B/S Oscilloscope Measurement Systems (with 19860A Digital Waveform Storage and 19811A Plot/Sequence ROM) | Direct to plotter (LO) or indirect to plotter | Menu-driven softkeys provide graticule, trace, and/or annotation; HP 19800A Waveform Measurement Library software also available | | | 7475A 7550A |
| 2250S Data Acquisition/ Control System | Indirect to plotter | HP PMC/1000 software available | | | 7475A |
| 3046A/B/S Selective Level Measuring Systems | Indirect to plotter | Customer software required | | | 7475A |
| 3047A/S Spectrum Analyzer Systems | Indirect to plotter | HP software included with 3047S | | | 7475A 7550A |
| 3054A/C/DL/S Data Acquisition Systems | Indirect to plotter | Customer software required for 3054C/DL | | | |
| 3056DL/S Data Acquisition Systems | Indirect to plotter | Customer software required | | | 7475A |
| 3314A Function Generator | Direct to recorder | | X -5 to 5 V | YES | 7090A 7045B |
| 3325A Synthesizer/Function Generator | Direct to recorder | | X 0 to 10 V | YES TTL | 7090A 7045B |
| 3326A Two Channel Synthesizer | Direct to recorder | | X 0 to 10 V | YES-TTL | 7090A |
| 3335A Synthesizer/Level Generator | Direct to recorder | | X 0 to 10 V | NO | 7090A 7045B |
| 3336A/B/C Synthesizer/Level Generator | Direct to recorder | | X 0 to 10 V | YES TTL | 7090A |
| 3350A/3357A/B Lab Automation System | Indirect to plotter. System includes HP 1000 | HP 19135C C/PLOT/3350 software available | | | 7475A 7550A |
| 3421A Data Acquisition/ Control Unit | Indirect to plotter | Customer software required | | | 7475A |
| 3497A/S Data Acquisition/ Control System | Indirect to plotter | Customer software required | | | 7475A |
| 3561A Dynamic Signal Analyzer | Direct to plotter (05) or indirect to plotter | Front-panel control duplicates screen image to plotter. Software similar to 3577, also adds annotation | | | 7475A 7550A |
| 3562A Dynamic Signal Analyzer | Direct to plotter or indirect to plotter | Front-panel control duplicates screen image to plotter. Software similar to 3577, also adds annotation | | | 7475A 7550A |
| 3575A Gain/Phase Meter | Direct to recorder | | Y1 10 mV/degree Y2 10 mV/dB | NO | 7090A 7046B |
| 3577A Network Analyzer | Direct to plotter (LO) or indirect to plotter | Front-panel control duplicates screen image to plotter. Menu-driven software provides selectable graticule, trace, annotation, pen number, line type. | | | 7475A 7550A |
| 3580A Spectrum Analyzer | Direct to recorder | | X 0 to 5 V Y 0 to 5 V | YES Contact closure to ground during sweep | 7090A 7045B |
| 3581A Wave Analyzer 3581C Selective Voltmeter | Direct to recorder | | X 0 to 5 V Y 0 to 5 V | YES Contact closure to ground during sweep | 7090A 7045B |
| 3582A/S Spectrum Analyzer | Direct to recorder Indirect to plotter | 3)Customer software required | X 0 to 5.25 V Y 0 to 5.25 V | YES Contact closure during sweep | 7090A 7045B 7475A |
| 3585A Spectrum Analyzer | Direct to recorder Indirect to plotter | HP software available | X 0 to 10 V Y 0 to 10 V | YES TTL | 7090A 7045B 7475A |

*"Indirect to plotter" requires an appropriate controller and software. "Direct to plotter" may require an address of 05 or L0 (listen only).



PLOTTERS & RECORDERS

Recorder/Plotter Selection Guide

| HP Instrument | Output Capability "Indirect to plotter" requires an appropriate controller and software. | Plotter Software Support | X-Y Recorder Outputs | | Recom- mended HP Models |
|--|---|---|---|---------------------------------------|--------------------------------------|
| | | | Voltage | Penlift | |
| 3586A/B/C Selective Level Meter | Indirect to plotter | Customer software required | | | 7475A |
| 3708S Noise and Interference Test System | Indirect to plotter | HP software available | | | 7475A |
| 3712A MLA Receiver | Direct to recorder | | X -5 to 5 V Y -5 to 5 V | YES | 7090A 7015B |
| 3770B Telephone Analyzer | Direct to recorder (Special graph paper available) | | X 0 to 5 V Y -5 to 5 V | NO | 7090A |
| 3776A/B PCM Terminal Test Set | Direct to recorder or Direct to plotter (LO) | | | | 7090A 7475A 7550A |
| 3780A Error Measuring Set | Direct to recorder | | Y 0 to 1 mA into 10Kohm max | NO | 7090A |
| 4061A/S Semiconductor Component Test System | Indirect to plotter | HP software included with 4061S | | | 7475A |
| 4062B/S Semiconductor Parametric Test System | Indirect to plotter | Customer software required | | | 7475A |
| 4063A/S Semiconductor Parametric Analysis System | Indirect to plotter | HP software included | | | 7475A 7550A |
| 4064A/S DLTS Analysis System | Indirect to plotter | HP software included | | | 7475A 7550A |
| 4140B pA Meter/DC Voltage Source | Direct to recorder Indirect to plotter | Customer software required | X -10 to 10 V Y -5 to 5 V | YES | 7090A 7045B 7475A |
| 4145A Semiconductor Parameter Analyzer | Direct to plotter (LO) | Front-panel controls select trace and/or graticule, fixed characters | | | 7475A 7550A |
| 4191A RF Impedance Analyzer (with Option 004) | Direct to recorder | | X 0 to 1 V Y1 0 to 1 V Y2 0 to 1 V | NO | 7090A 7046B |
| (Option 004 not required) | Indirect to plotter | Customer software required | | | 7475A |
| 4192A LF Impedance Analyzer | Direct to recorder | | X -1 to 1 V Y -1 to 1 V | YES TTL (low level at pen down) | 7090A 7045B |
| | Indirect to plotter | Customer software required | | | 7475A |
| 4193A Vector Impedance Meter | Direct to recorder | | X 0 to 1 V Y1 0 to 1 V Y2 -1 to 1 V | YES | 7090A 7046B |
| | Indirect to plotter | Customer software required | | | 7475A |
| 4194A Impedance Gain-Phase Analyzer | Direct to plotter | Front-panel control duplicates screen image to plotter. Graticule, traces are selectable | | | 7475A 7550A |
| 4280A 1 MHz C Meter/C-V Plotter | Direct to recorder Indirect to plotter | HP software available | X -10 to 10 V Y -10 to 10 V | YES | 7090A 7045B 7475A |
| 5180A Waveform Recorder 5182A Waveform Recorder Generator | Direct to recorder Direct to plotter (LO) or Indirect to plotter | Front panel controls provide fixed graticule, trace, annotation; 51800A Waveform Measurement Library also available | X -1 to 0 V Y -1 to 0 V | YES (0 V and 5 V) | 7090A 7045B 7475A 7550A |
| 5390A Frequency Stability Analyzer | Indirect to plotter | HP software provides graticule, trace, and characters | | | 7475A |
| 54100A Digitizing Oscilloscope | Direct to plotter | | | | 7475A 7550A |
| 54200A Digitizing Oscilloscope | Direct to plotter | | | | 7475A 7550A |
| 5427A Digital Vibration Test Control System | Direct to plotter (05) | Front-panel controls select fixed-format graticule, trace, and/or characters | | | 7475A 7550A |
| 55286S/88S Dimensional Metrology Analysis Systems | Indirect to plotter. System includes HP 85 | Menu-driven software provides fixed-format plots with graticule and characters, selectable trace, title block, and vertical scale | | | 7475A |
| 5987A/96A GCMS Systems | Indirect to plotter. System includes HP 1000 or Series 200 | HP 59974A and 59872A software available | | | 7475A 7550A |
| 6901S Measurement and Analysis System | Direct to plotter (05) | Menu-driven software provides fixed-format plots with graticule and characters, selectable trace | | | 7475A |
| 6940B/42A Multiprogrammers | Indirect to plotter | Customer software required | | | 7475A |
| 6942S Computer Aided Test System | Indirect to plotter | Customer software required | | | 7475A |
| 6944A/S Multiprogrammer | Indirect to plotter | Customer software required | | | 7475A |
| 7100 Series Modular Spectrum Analyzers | Direct to plotter | | | | 7475A 7550A |
| 8116A Pulse/Function Generator (with Option 001) | Direct to recorder | | X 0 to 10 V (1.5 V/decade) | YES TTL | 7090A 7045B |
| 8165A Programmable Signal Source (with Option 002) | Direct to recorder | | X 0 to 2.99 V (1 V/decade) | NO | 7090A 7045B |
| 8340A Synthesized Sweeper | Direct to recorder | | X 0 to 10 V | YES | 7090A 7045B |
| 8350B Sweep Oscillator | Direct to recorder | | X 0 to 10 V | YES | 7090A 7045B |



| HP Instrument | Output Capability "Indirect to plotter" requires an appropriate controller and software. | Plotter Software Support | X-Y Recorder Outputs | | Recom- mended HP Models |
|--|---|---|--|--|----------------------------------|
| | | | Voltage | Pen/Ink | |
| 8405A Vector Voltmeter | Direct to recorder | | Y1 0 to 1 V Y2 -5 to 5 V | NO | 7090A 7046B |
| 8410B Network Analyzer System — The following plug-ins are part of the 8410B system: | | | | | |
| 8412A Phase-Magnitude Display | Direct to recorder | | Y1 50 mV/dB Y2 10 mV/degree | NO | 7090A 7046B |
| 8414A Polar Display | Direct to recorder | | X -2.5 to 2.5 V Y -2.5 to 2.5 V | NO | 7090A 7045B |
| 8408B/S Automatic Network Analyzer | Indirect to plotter | HP software duplicates screen image onto plotter | | | 7475A 7550A |
| 8450/51A Diode Array Spectrophotometers | Direct to plotter | Selectable graticule, trace, and characters | | | 7475A 7550A |
| 8505A Network Analyzer | Direct to recorder Indirect to plotter | HP software provides graticule, trace, and characters | X 0 to 7.5 V Y -1.25 to 1.25V | YES 200 mA current sink | 7090A 7045B 7475A 7550A |
| 8507D/S Automatic RF Network Analyzer System | Indirect to plotter | HP software provides graticule, trace, and characters | | | 7475A 7550A |
| 8510A Network Analyzer | Direct to plotter | Front-panel controls select graticule, trace characters, pen and quadrant | | | 7475A 7550A |
| 8557A/58B/59A Spectrum Analyzers | Direct to recorder | | X -5 to 5 V Y 0 to .8 V (with 853A and 180 mainframes) | YES (15 V pen up, 0 V pen down) | 7090A 7045B |
| With 853A Display | Direct to plotter | | | | 7475A |
| 8565A Spectrum Analyzer | Direct to recorder | | X -5 to 5 V Y 0 to .8 V | YES (15 V pen up, 0 V pen down) | 7090A 7045B |
| 8566B/S/68B/S Spectrum Analyzers | Direct to recorder Direct to plotter | HP 85862/63 software packages available | X 0 to 10 V Y 0 to 10 V | YES (15 V pen up, 0 V pen down) | 7090A 7475A |
| 8569B Spectrum Analyzer | Direct to recorder Direct to plotter | Front-panel controls select graticule, trace, and/or characters | X -5 to 5 V Y 0 to .8 V | YES (15 V pen up, 0 V pen down) | 7090A 7045B 7475A 7550A |
| 8620C Sweep Oscillator | Direct to recorder | | X 0 to 10 V | YES (5 V pen up) | 7090A 7045B |
| 8642A/B Synthesized Signal Generator | Direct to recorder | | X 0 to 10 V | YES-TTL | 7090A |
| 8660C Synthesized Signal Generator | Direct to recorder | | X 0 to 8 V | YES (with Option H24) | 7090A 7045B |
| 8662A/63A/73B/C/D Synthesized Signal Generators | Direct to recorder | | X 0 to 10 V | YES TTL | 7090A 7045B |
| 8683A/B/D/84A/B/D Signal Generators | Direct to recorder | | X 0 to 10 V | NO | 7090A |
| 8750A Storage-Normalizer | Direct to recorder | | X 0 to 1 V Y -4 to 4 V | YES (open collector driver, 20 V max) | 7090A 7045B |
| 8754A Network Analyzer | Direct to recorder | | X 0 to 1 V Y -4 to .4 V | YES (5 V pen up, 0 V pen down) | 7090A 7045B |
| 8755S Scalar Network Analyzer System | Direct to recorder | | Y -4 to 4 V X 0 to 10 V | YES (open collector driver, 20 V max) | 7090A 7045B |
| 8757A/S Automatic Scalar Network Analyzer | Direct to plotter | HP 8757A has softkeys with custom plot capability. HP 8757S has menu-driven software. | | | 7475A 7550A |
| 8756A/S Automatic Scalar Network Analyzer | Direct to plotter | 8756A provides menu-driven softkeys, 8756S has menu-driven software to select graticule, trace, and/or characters (rev. 1 does not include 7550A in ID table) | | | 7475A 7550A |
| 8900C/D Peak Power Meter | Direct to recorder | | Y 0 to 1 V | NO | 7090A |
| 8903B Audio Analyzer | Direct to recorder Indirect to plotter | Customer software required* | X 0 to 10 V Y 0 to 10 V | YES | 7090A 7015B 7475A |
| 8953A/S Transceiver Test System | Indirect to plotter | Customer software required* | | | 7475A |
| 8955A/S RF Test System | Indirect to plotter | Customer software required* | | | 7475A |
| 8970A Noise Figure Meter | Direct to recorder Indirect to plotter | Customer software required* | X 0 to 6 V Y 0 to 6 V | YES TTL | 7090A 7045B 7475A |

PLOTTERS & RECORDERS

Measurement Plotting System

Model 7090A

- Floating and guarded inputs
- DC to 3 kHz bandwidth, 33.3 kHz sampling rate
- 3 channels with simultaneous sampling
- 12-bit resolution, 1 k buffer/channel
- 6 trigger modes with up to 100% pre-trigger capture
- Full programmability and data transfer over HP-IB

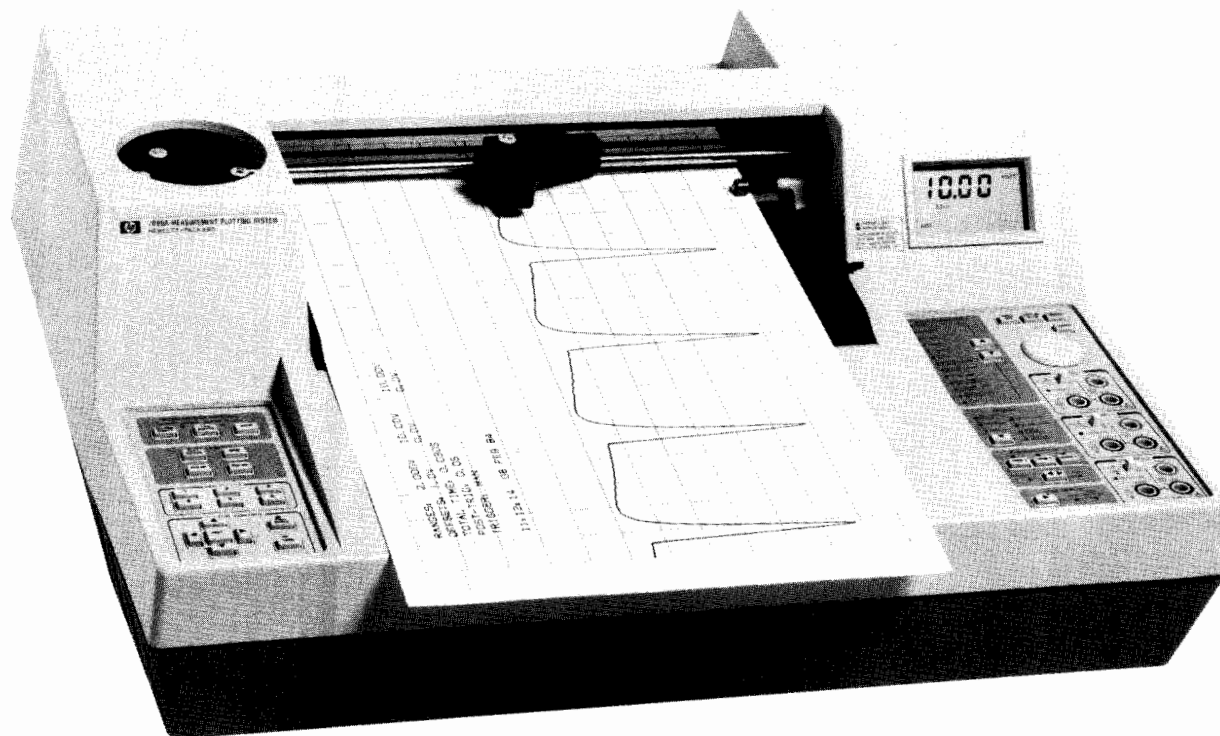

HP 7090A

The HP 7090A is designed for low-frequency (< 3 kHz) measurement, analysis, and documentation. The 7090A merges several technologies - waveform recording, digital plotting, analog recording, and automated measurement - to provide a powerful solution to a broad range of measurement applications. It significantly increases the ability to measure and display low-frequency phenomena and substantially improves real-time recording and digital plotting . . . all in one low-cost system.

Signal Capture

Simultaneous sampling on each of three channels, 12-bit resolution, bandwidth of dc to 3 kHz (33.3 k samples/s maximum), and 1000 word memory per channel allow high resolution measurement, storage, and display.

Flexible Triggering

The HP 7090A has six trigger modes which allow virtually any signal change to initiate signal capture, even decaying repetitive signals such as faults in a power line voltage, or in a transducer's carrier. Combined with pre-trigger capability, these trigger modes make the HP 7090A Measurement Plotting System ideal for turn-on/off characterization, fault monitoring and mechanical motion analysis.

A System Component

All panel functions are programmable via the HP-IB interface. Data can be transferred from the internal 1 k-buffers or streamed in real time from the analog-to-digital converters at up to 500 points/s. In addition, the menu-driven HP 17090B Measurement Graphics Software package is available for HP 9000 Series 200

computers (BASIC 3.0 only). The software allows easy data manipulation, storage and retrieval, and system integration.

Versatile Capabilities

As the name implies, the HP 7090A Measurement Plotting System is also a high performance digital plotter. It is ideal for a graphics dump from a smart instrument (e.g. from an HP 8569B Spectrum Analyzer) or as part of an HP-IB system; you can also use the HP 7090A to take an X-Y dump from an analog instrument (e.g. from an HP 141T Spectrum Analyzer System). With the HP 7090A, hand annotation is unnecessary. The 7090A annotates setup conditions, date and time, selected data points from memory, and trigger information. It draws user-defined axes and grids, eliminating the need for pre-printed graph paper. The HP 7090A even lets you plot overhead transparencies for technical presentations.

Applications

Analog Recording: Electrical, chemical, mechanical and medical fields all benefit from recording real-time X-Y and Y-T relationships. As an analog recorder, the HP 7090A has sensitivity to 5 mV full scale and 41,000 calibrated ranges for easy and quick calibration to measurement units. The HP 7090A's superior dynamic performance and high sensitivity provide users the versatility and accuracy required in laboratory environments.

Capturing Low Frequency Electrical Transients: General diagnostic monitoring (such as looking for relative timing sequences) and fault monitoring (capturing pre-trigger data for intermittent

failure analysis) are natural applications for the HP 7090A. Measuring Phase Relationships: The simultaneous sampling on all channels is ideal for measuring current/voltage phase relationships in power systems.

Analog Instrument/Digital System Link: The HP 7090A can integrate an analog instrument into an HP-IB system; the HP 7090A, with a controller can digitize output voltages from analog instruments for HP-IB system data entry.

Mechanical and Electromechanical Testing: Applications in which transducers convert velocity, acceleration, force, temperature or torque to voltage are a good fit for the HP 7090A. These applications have a maximum output frequency below 3 kHz. The HP 7090A's flexible trigger capabilities make it useful for one-shot electromechanical events such as clutch and mechanism engagements.

Electromechanical Control Systems: The HP 7090A can measure the response of a system to a stimulus; a typical use would be exciting the system with a step function and using the measured response to determine damping ratio and the natural frequency of the control system.

Material Testing: The HP 7090A can record classic stress-strain curves, particularly those obtained from destructive testing. The data is stored in a buffer, so even though the sample has been destroyed, the data can be viewed and rescaled in several different ways.

Automatic Test: When linked to an HP 9000 Series 200 computer, the HP 7090A is a good, inexpensive learning tool for small companies considering automatic test systems. Applications include environmental and production line testing and proof of performance records.

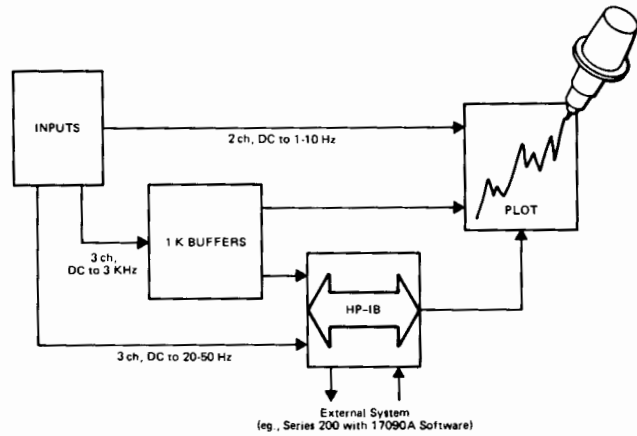

Possible data flow paths for the HP 7090A Measurement Plotting System.

Measurement Graphics Software

Combining an HP 7090A, an HP 9000 Series 200 computer and the HP 17090B Measurement Graphics Software produces a powerful menu-driven system for measurement, data manipulation, and data storage and retrieval. The menu-driven software, written in BASIC 3.0 for Series 200 computers, takes advantage of the HP 7090A's capabilities as a system component. No programming is necessary; once the HP 7090A is loaded with paper and pens and connected to the controller using an HP-IB cable, just load the software. All HP 7090A functions can be controlled by the computer.

Program Capabilities: There are six main functional areas of Measurement Graphics Software:

- Measurement Setup
- Measurement
- Display
- Annotation
- Data Manipulation
- Storage and Retrieval

The HP 17090B software helps you use the HP 7090A's features easily and effectively plus, it provides storage, annotation and data transformation options not available on the HP 7090A unit alone.

Friendly, Menu-driven Interface: Each menu allows the user to view several parameters simultaneously. Series 200 softkeys and cursor-control knob minimize keyboard input. The "help" softkey displays the available choices and ranges for each parameter setting.

System Requirements: Measurement Graphics Software is written in BASIC 3.0 and requires a minimum of 216 K of RAM after the operating system is loaded; however, 433 K is recommended for optimum program speed. The software is designed for use with an HP 9000 Series 200 computer and an HP 7090A Measurement Plotting System. The software is supplied on two 3.5 in. microfloppy or 5.25 in. minifloppy discs and is accompanied by a user's manual.

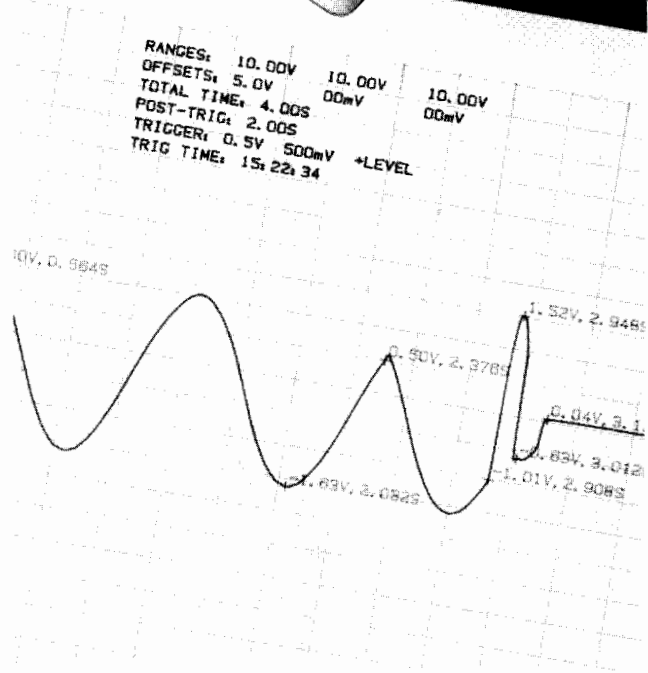
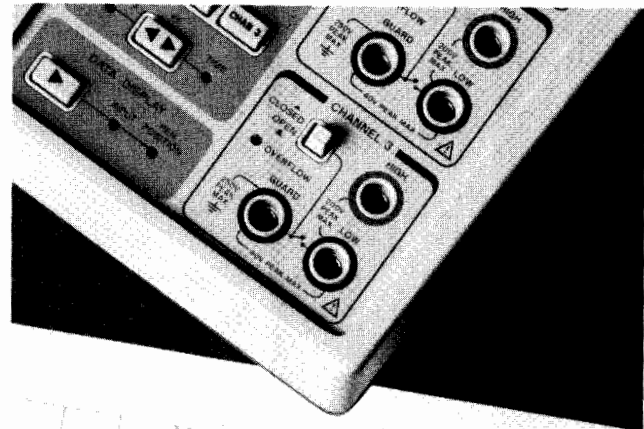



PLOTTERS & RECORDERS

Measurement Plotting System

Model 7090A (cont)

Specifications

Inputs:

| | |
|-----------------------------|---|
| Number of channels | 3 |
| Type of input | floating, guarded |
| Sensitivity | 5 mV to 100 V full scale |
| Sensitivity ranges | 41,000 |
| Zero offset | ±2 full scale or ±100 V maximum |
| Zero offset ranges | approximately 5% or range steps |
| Input impedance | 1 Mohm, shunted by 45 pf (Nominal) |
| Maximum input voltage | 200 V, dc or peak |
| Maximum source resistance | 10 kohm |
| Common mode rejection ratio | 140 dB dc; 100 dB ac @ 60 Hz with 1 kohm unbalance in LOW terminal and most sensitive range (at 25 C) |

Electrical accuracy (@ 25 C, ±1 scale offset maximum):

| | |
|-------------------------|---|
| Constant inaccuracy | |
| 1 V to 100 V range | ±0.15% of range |
| 5 mV to 500 mV range | increases from ±0.15% of range @ 500 mV to ±0.26% of range @ 5 mV |
| Reading inaccuracy | ±0.055% of reading |
| Temperature coefficient | |
| Constant inaccuracy | |
| 1 V to 100 V range | ±0.012% of range/degree C |
| 5 mV to 500 V range | increases from ±0.012% or range/degree C @ 500 mV to ±0.044% of range/degree C @ 5 mV |
| Reading inaccuracy | ±0.01% of reading/degree C |

Timebase

| | |
|------------------|-----------------------------|
| Buffer mode | |
| Range | 30 milliseconds to 24 hours |
| Number of ranges | 4,700 |
| Direct mode | |
| Range | 1 second to 24 hours |
| Number of ranges | 3,700 |
| Accuracy | ±0.1% |

Dynamic Performance

| | |
|-------------------------|--|
| Slewing Speed (Nominal) | |
| Direct mode | 127 cm/s (50 in./s) |
| Plotting mode | 75 cm/s (30 in./s) |
| Acceleration (Nominal) | 2 g constant |
| Bandwidth (≥3dB) | 3 kHz for all full scale ranges ≥ 20 mV 2.6 kHz for all full-scale ranges < 20 mV |
| Peak capture | 250 μ at fastest timebase range |

Memory per Channel

| | |
|------------|------------|
| Size | 1000 words |
| Resolution | 12-bits |

Trigger Characteristics

| | |
|------------------|--|
| Internal Trigger | Inside or outside window to capture decaying repetitive signals, inside resets with each reverse transition; Above or below level, selectable over the full-scale range in 1.0% of range increments (NOMINAL); Source, channel 1 |
| External Trigger | BNC connector, TTL level or contact closure to ground |
| Manual Trigger | Available from front-panel controls |
| Display | Up to 100% pre-trigger capture, up to 24 hour post-trigger delay before measurement start |

Supplemental Characteristics

| | |
|------------------|--|
| Writing System | 6-pen carousel with automatic pen capping Fiber-tip pens for paper or transparencies |
| Digital Plotting | Intelligence: over 40 HP-GL instructions; five built in character sets including ANSI ASCII, HP 9825, French/German, Scandinavian, |

| Media | Spanish/Latin America Front-panel controls: P1, P2; pen position cursors; pen selection Interface modes (user selectable): listen only; listen/talk Types: paper, overhead transparency film Sizes (switch-selectable): A4/A (210 x 297 mm, 8.5 x 11 in.); A3/B (297 x 420 mm, 11 x 17 in.) | | | | | | | | | | | | | | | |
|---------------------------------|--|--------|-------|--------|-----------|-------|-------|------------------------|-------|-------|------------|------|-------|-------------------------|------|-------|
| Programming | HP-IB control of all recorder and plotter functions Software lockable front panel | | | | | | | | | | | | | | | |
| Scope Output | Allows use of X-Y oscilloscope to preview buffer contents Connectors: 2 BNC, vertical and horizontal Output: -10 V to 10 V (0 V corresponds to origin on chart); refreshed every 15 ms Resolution: 10-bit Allows panel display of dc voltage levels on selected channel input Sampling rate: 1/sec (NOMINAL) Allows cursor to move pen along plotted buffer data on selected channel, value shown on display, and coordinate pair can be printed at selected points. | | | | | | | | | | | | | | | |
| Digital Voltmeter (DVM) Mode | BNC connector, TTL level or contact closure to ground | | | | | | | | | | | | | | | |
| Pen Position Data Display | Max. sampling rate: 33.3 k samples/s Max. streaming rate over HP-IB: | | | | | | | | | | | | | | | |
| External Pen Lift Control | | | | | | | | | | | | | | | | |
| Analog-to-digital | | | | | | | | | | | | | | | | |
| | <table> <thead> <tr> <th></th> <th>ASCII</th> <th>Binary</th> </tr> </thead> <tbody> <tr> <td>1 channel</td> <td>167/s</td> <td>500/s</td> </tr> <tr> <td>1 channel plus trigger</td> <td>143/s</td> <td>333/s</td> </tr> <tr> <td>3 channels</td> <td>59/s</td> <td>167/s</td> </tr> <tr> <td>3 channels plus trigger</td> <td>59/s</td> <td>167/s</td> </tr> </tbody> </table> | | ASCII | Binary | 1 channel | 167/s | 500/s | 1 channel plus trigger | 143/s | 333/s | 3 channels | 59/s | 167/s | 3 channels plus trigger | 59/s | 167/s |
| | ASCII | Binary | | | | | | | | | | | | | | |
| 1 channel | 167/s | 500/s | | | | | | | | | | | | | | |
| 1 channel plus trigger | 143/s | 333/s | | | | | | | | | | | | | | |
| 3 channels | 59/s | 167/s | | | | | | | | | | | | | | |
| 3 channels plus trigger | 59/s | 167/s | | | | | | | | | | | | | | |
| Real-time Clock | Functions: second, minute, hour, day, year Controls: front-panel set, battery (lithium) backup Accuracy: ±4 sec/day @ 25 C Operating temperature: 0-55 C Source: 100, 120, 220, 240 V ac -10%, +5% Frequency: 48-66 Hz Consumption: 140 W | | | | | | | | | | | | | | | |
| Environmental Power Requirement | Height: 205.5 mm (8.1 in.) Weight: 575.0 (22.6 in.) Depth: 465.0 (18.3 in.) Net: 15.7 kg (34.5 lbs) Shipping: 23.6 kg (18.3 lbs) | | | | | | | | | | | | | | | |
| Size | | | | | | | | | | | | | | | | |
| Weight | | | | | | | | | | | | | | | | |

Accessories Supplied

| | Part Number |
|------------------------------------|-------------|
| Interfacing and Programming Manual | 07090-90001 |
| Operator's Manual | 07090-90002 |
| Pocket Guide | 07090-90004 |

An assortment of pens and media are also shipped with each HP 7090A unit sold. Paper size and power cord are determined by destination.

Ordering Information

| | Price |
|---|-----------|
| 10833A or 45529A HP-IB (IEEE-488) 1-meter cable | \$81.00 |
| 10833B or 45529B HP-IB (IEEE-488) 2-meter cable | \$91.00 |
| 7090A Measurement Plotting System | \$4400.00 |
| Option 910 (duplicate set of manuals) | \$100.00 |
| 17090B Measurement Graphics Software | |
| Option 630 (3.5 in. disc size) | \$700.00 |
| Option 655 (5.25 in. disc size) | \$700.00 |

PLOTTERS & RECORDERS

Low-Cost, General Purpose X-Y Recorders, Time Base

Models 7015B, 7035B, 17108A



- Full capability

- Precision recording

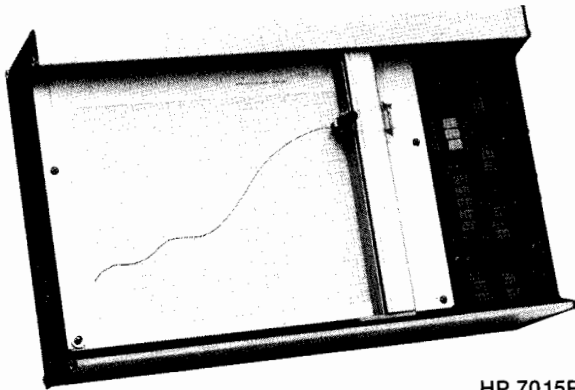

HP 7015B

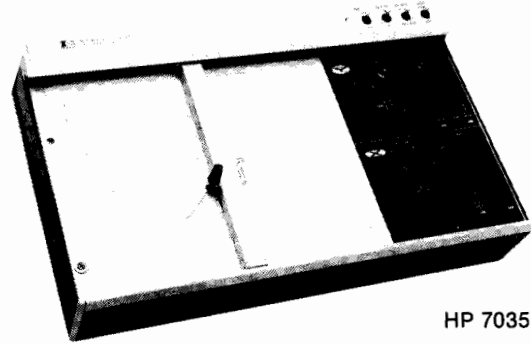

HP 7035B

For 35 years, the Hewlett-Packard family of X-Y recorders has been bringing performance, reliability, and service to lab environments all over the world. These recorders are manufactured in the HP tradition of quality, and designed to help you make recordings easily and accurately.

HP 7015B: a low-cost recorder for applications that require high dynamic performance, medium sensitivity, and A4/A-size output.

HP 7035B: a general purpose laboratory recorder for applications that require low dynamic performance, medium sensitivity, and A-size output.

HP 7045B and 7046B: high performance recorders for applications that require very high dynamic performance, high sensitivity, and A4/A- or A3/B-size output.

All HP X-Y recorders have electrostatic holddown for silent, trouble-free grip. And they use disposable pens for crisp, clean traces and one-step replacement of ink, tip, and color.

Model 7015B X-Y Recorder

The HP 7015B is a low-cost, one-pen X-Y recorder that allows charting on paper sizes up to ISO A/4 or 216 x 280 mm (8.5 x 11 in.). The unit is mounted in a sturdy case made from a single casting, assuring mechanical alignment and long life, even in rugged environments. The HP 7015B provides recording for a wide range of laboratory uses where there is a need for full capability at a reasonable cost.

The HP 7015B has a full complement of capabilities. The standard features include an internal time base with sweep selections from 5 seconds to 15 minutes. The time base provides automatic pen control and accepts remote triggering from sweep start and reset.

Also included are matched input filters, remote pen lift, and TTL-level remote control. The HP 7015B accepts TTL-level and low current (5mA) contact closure for easy interface with external equipment.

Model 7035B X-Y Recorder

The HP 7035B is the ideal recorder for general lab use. Compact in design, the HP 7035B is well adapted to rack mounting with the addition of only two optional wing brackets. It features floating guarded

inputs to help eliminate the common mode voltage effects that are troublesome when recording from low-level sources.

Input connectors on the HP 7035B accept both open wire and plug-type connectors. In addition, the recorder provides five calibrated ranges (0.4 mV/cm to 4 V/cm) for each axis; signal scaling for full-scale deflection, and high-impedance (1 megohm, except for the first two ranges).

Model 17108A Time Base

The HP 17108A is a self-contained time base that operates on either axis of the HP 7035B. By simply plugging in the HP 17108A, the HP 7035B is provided with five sweep seconds from 0.2 s/cm to 20 s/cm (0.5 to 50 s/in.). This module, powered by a single self-contained battery, is controlled by its own six-position range switch and three-position mode switch.



HP 17108A Option 002 mounted on recorder.

HP 17108A Specifications

Sweep seconds: 0.2, 0.4, 2, 4, 20 s/cm (0.5, 1, 5, 10, 50 s/in.)

Accuracy: 5% of recorder full scale

Linearity: 0.5% of full scale (20°C to 30°C)

Output voltage: 0 to 1.5 V

Power: replaceable mercury battery (100 h)



PLOTTERS & RECORDERS

Low Cost, General Use X-Y Recorder (cont'd)

Models 7015B, 7035B

HP 7015B and 7035B Specifications

Performance Specifications

| | HP 7015B | HP 7035B |
|-----------------------------------|---|---|
| Type of input | Floating binding posts or circuit board rear connector | Floating guarded signal pair; rear connector |
| Input ranges | 5, 50, 500 mV/cm (0.01, 0.1, 1 V/in.) | 0.4, 4, 40, 400 mV/cm; 4 V/cm (1, 10, 100 mV/in.; 1 V/in.) |
| Input resistance | 1 M Ω constant on all ranges | 100 k Ω on 4 mV/cm (10 mV/in.) and potentiometric or essentially infinite at null on 0.4 mV/cm (1 mV/in.) |
| Source resistance | 10 k Ω maximum on all ranges | 20 k Ω maximum on most sensitive range; no restrictions on other ranges |
| Accuracy | $\pm 0.3\%$ of full scale on most sensitive range (includes linearity and resettability) plus $\pm 0.2\%$ of deflection when on other ranges; temp. coefficient $\pm 0.02\%$ per $^{\circ}\text{C}$ | $\pm 0.2\%$ of full scale |
| Deadband Common mode rejection | $\pm 0.2\%$ of full scale 100 dB dc, 90 dB ac with 1 k unbalanced in HI terminal CMR decreases 20 dB per decade step in attenuation | 130 dB dc, 100 dB ac with 1 k Ω between the negative input and guard connection CMR decreases 20 dB per decade step in attenuation |
| Normal mode rejection | Greater than 50 dB at 60 Hz (40 dB/decade rolloff above 60 Hz) | Greater than 30 dB at 60 Hz; then 18 dB/octave |

Dynamic Performance Specifications

| | | |
|---------------------------------------|---|------------------------------------|
| Slewing speed | Greater than 50 cm/s (20 in./s) | 50 cm/s (20 in./s) nominal at 115V |
| Acceleration peak Y-axis X-axis | 2.5 g's (2540 cm/s ² or 1000 in./s ²) 1.3 g's (1270 cm/s ² or 500 in./s ²) (with internal filters switched out) | Not specified |
| Maximum overshoot | 2% of full scale | Not specified |

Offset Specifications

| | |
|-------------|--|
| Zero offset | Zero may be placed anywhere on the writing area or electrically off scale up to one full scale from zero index |
|-------------|--|

Time Base Specifications

| | | |
|--------------------|---|---|
| Time base | Six speeds: 0.1, 0.5, 1, 5, 10, 50 s/cm (0.5, 1, 5, 10, 50, 100s/in.) remote sweep start and reset via TTL level or contact closure | Optional external time base (HP 17108A) |
| TIME BASE ACCURACY | 1.5% ± 0.1 per $^{\circ}\text{C}$ | $\pm 5\%$ of recorder full scale |

General Specifications

| | | |
|--------------|---|---|
| Power | Switch selectable for 100, 120, 220, 240 Vac +5 -10%; 47.5 to 440 Hz; 70 VA maximum | 115 or 230 V $\pm 10\%$; 50 to 60 Hz; approx. 45 VA |
| Pen lift | Electric (remote via TTL level or contact closure) | Electric pen lift capable of being remotely controlled |
| Writing area | 18 x 25 cm (7 x 10 in.) | |
| Weight | Net 7.2 kg (16 lb) | Net 8 kg (18 lb) |
| Size | 267 H x 432 W x 135 mm D (10.5 in. x 17 in. x 5 in.) | 265 H x 445 W x 121 mm D (10.5 in. x 17.5 in. x 4.8 in.) |

HP 7015B Options
001 Metric calibration
908 Rack Mount

Price
N/C
\$30

HP 17108A Options
002 HP 17108A Metric calibration

N/C

HP 7035B Options
001 Metric Calibration
908 Rack Mount

N/C
\$35

Ordering Information

HP 7015B Lab X-Y recorder \$2200
HP 7035B General Purpose X-Y recorder \$2500
HP 17108A Time base plug-in \$490

PLOTTERS & RECORDERS

High Performance General Use X-Y Recorders

Models 7045B, 7046B

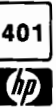

- Dynamic performance
- High sensitivity

- A4/A or A3/B paper size
- Choice of one-pen or two-pen models

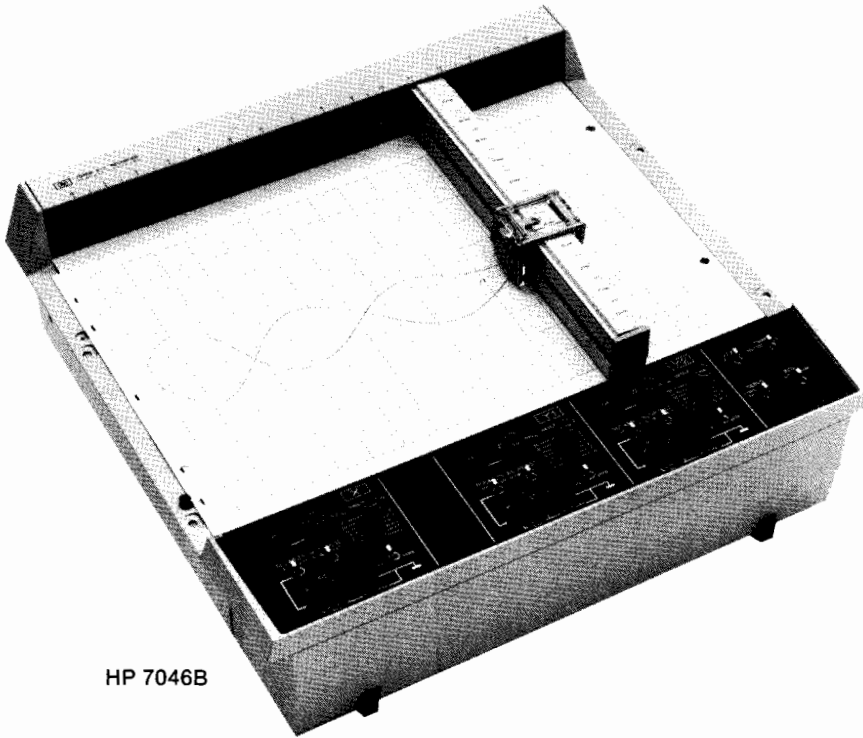

HP 7046B

The HP 7045B offers exceptional slewing speed and acceleration on both X- and Y-axes. This high dynamic performance allows the HP 7045B to faithfully reproduce a wide range of fast-changing signals.

The HP 7046B offers high dynamic performance in a two-pen model. And both Y-axes have virtually no overshoot, allowing accurate plotting of two variables against a third.

Both the one-pen (X or T vs Y) HP 7045B and the two-pen (X or T vs Y1 & Y2) HP 7046B offer the same quality features.

Very High Dynamic Performance

With a combination of high slewing speed and acceleration, these recorders can capture fast, changing signals that an ordinary recorder might miss. For example, the HP 7045B will, typically, record a signal from dc to 10 Hz at 2 cm peak-to-peak amplitude on either axis.

TTL Remote Control

With TTL or simple contact closure to ground, a rear connector offers easy interface to measurement systems. TTL provides remote control of sweep, start and reset, pen lift, servo mute, and chart hold. Pen lift, the most important action to be controlled remotely, is also available from a convenient rear-mounted banana jack connector.

Wide Chart Size Range

The HP 7045B and 7046B accept ISO A3, ISO A4, ANSI B, ANSI A, and any size under the maximum limit (A3/B-size). With this flexibility, these recorders can fill a variety of charting needs.

User-oriented Features

These recorders are precision instruments that are easy to use. The polarity reverse switch eliminates the need to reverse input leads. The response switch allows recorder response to be slowed to simplify setup. A separate rear connector provides a convenient remote pen lift control connection. And built-in hardware simplifies table or rack mounting.

Does your application require maximum general-use capability? Do you need two pens to draw two or three simultaneous variables? . . . **Choose the HP 7046B**

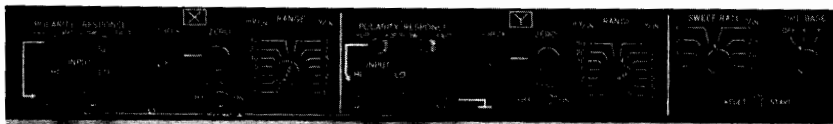

Do you have multi-users and many applications, need fast pen response but have no need to plot two simultaneous Y variables? . . . **Choose the HP 7045B**

PLOTTERS & RECORDERS

High Performance General Use X-Y Recorders

Models 7045B, 7046B (cont'd)

HP 7045B and 7046B Specifications

Performance Specifications

| | HP 7045B | HP 7046B |
|-----------------------|--|----------|
| Type of input | Front and rear input. Floating, guarded. Polarity reversal switch on front panel. | |
| Input ranges | 0.25, 0.5, 1, 2.5, 5, 10, 25, 50, 100, 250, 500 mV/cm. 1, 2.5, 5 V/cm. (0.5, 1, 2, 5, 10, 20, 50, 100, 200, 500 mV/in. 1, 2, 5, 10 V/in.) Continuous vernier between ranges. | |
| Input resistance | 1 megohm constant on all ranges | |
| Source resistance | 10 kΩ maximum on all ranges | |
| Accuracy | ±0.2% of full scale (includes linearity and deadband) at 25°C. Temp coefficient ±0.01% per °C | |
| Range Accuracy | ±0.2% of full scale ±0.2% of deflection (includes linearity and deadband) at 25°C. Temp coefficient ±0.01% per °C. | |
| Deadband | 0.1% of full scale | |
| Common mode rejection | 110 dB and 90 dB ac (exceeds 130 dB dc and 110 dB ac under normal lab environmental conditions) with 1 k Ω between HI and LO terminals. CMV applied between ground and LO, and attenuator on most sensitive range. CMR decreases 20 dB per decade step in attenuation. | |
| Normal mode rejection | Internal filter not available | |

Dynamic Performance Specifications

| | | |
|--------------------------|---|--|
| Slewing speed | 97 cm/s (38 in./s) typical under normal lab conditions. 76 cm/s (30 in./s) minimum. | |
| Acceleration peak-Y axis | 7620 cm/s ² (3000 in./s ²) | 6350 cm/s ² (2500 in./s ²) |
| -X axis | 5080 cm/s ² (2000 in./s ²) | 3800 cm/s ² (1500 in./s ²) |
| Overshoot | 1% of full scale maximum. | |

Offset Specifications

| | |
|-------------|---|
| Zero offset | Zero may be placed anywhere on the writing area or electrically off scale up to one full scale from zero index. |
|-------------|---|

Time Base Specifications

| | |
|--------------------|---|
| Time base | 8 speeds: 0.25, 0.5, 1, 2, 5, 10, 25, 50 s/cm (0.5, 1, 2, 5, 10, 20, 50, 100 s/in.) |
| Time base accuracy | 1.0% at 25°C. Temp coefficient at ±0.1%/C° |

General Specifications

| | | |
|--------------|---|---|
| Power | 100, 120, 220, 240 Vac +5 -10%; 48 to 440 Hz; 230 VA | 100, 120, 220, 240 Vac +5 -10%; 48 to 440 Hz; 230 VA |
| Pen lift | Electric (remote via TTL level) | |
| Writing area | 25 x 38 cm (10 x 15 in.) | |
| Weight | Net 13.7 kg (30 lb) | Net 16 kg (35 lb) |
| Size | 400 H x 483 W x 165 mm D (15.8" x 19" x 6.5"). | 441 H x 483 W x 173 mm D (17.4" x 19" x 6.8"). |

HP 7045B Options

| | |
|------------------------|--|
| 001 Time base | |
| 002 Event marker | |
| 006 Metric calibration | |

Price

| |
|-------|
| STD. |
| \$170 |
| N/C |

HP 7046B Options

| | |
|------------------------|--|
| 001 Time base | |
| 002 Event marker | |
| 007 Metric calibration | |

Price

| |
|-------|
| STD. |
| \$170 |
| N/C |

Ordering Information

| | |
|--|--|
| HP 7045B Very high speed recorder | |
| HP 7046B 2-pen, very high speed recorder | |

Price

| |
|--------|
| \$3500 |
| \$4800 |

PLOTTERS & RECORDERS

Four and Eight-Channel Oscillographic Recorders

Models 7414A, 7418A & 8800 Series Signal Conditioners



- Thermal writing for low maintenance
- Z-fold paper for easy review/storage

- Available in benchtop configuration, mobile cart, upright cabinet

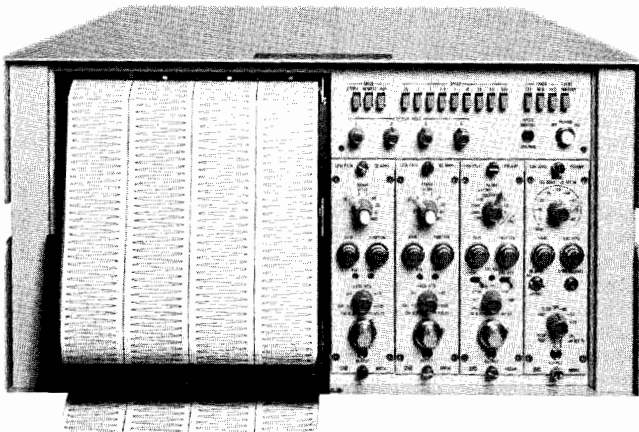

HP 7414A

HP 7414A 4-Channel and 7418A 8-Channel Oscillographic Recorders provide permanent reproducible records of multichannel, real-time data. A complement of HP 8800 Series Plug-in Signal Conditioners results in a system capable of meeting many measurement requirements in a reliable, versatile manner.

Thermal writing tips feature long stylus life and rectilinear presentations. A Z-fold chart paper pack loads easily, allows for convenient data review and storage. Two markers are supplied. The timer marker can be selected for one-second or one-minute marks. The event marker can be activated remotely or by front panel pushbutton.

HP 7414A, 7418A, 8800 Series Plug-in Specifications

HP 7414A General Specifications

Chart speeds: 0.25, 0.5, 1.0, 2.5, 10, 25, 50, 100 mm/s. Speed regulation $\pm 1\%$. Paper weave less than 0.5 mm. Speed selected via front panel pushbuttons. Optional speeds in mm/min.

Limiting: electrical limiting keeps stylus within channel.

Markers: event (local or remote control) between ch 3 and 4. (Timer (1 min or 1 s selectable) between ch 1 and 2.

Chart paper: four 40 mm wide channels each with 50 div; time lines every 1 mm; heat sensitive Z-fold Permapaper[®] with green grid lines available in packs of 500 sheets, each 30 cm (12"). (HP part number 9270-0878).

Paper loading: no threading required.

Remote operation: rear panel connector provides for remote chart drive and event marker activation.

Power: 115/230 V ac $\pm 10\%$, 60 Hz, 350 VA (includes plug-ins) 50 Hz optional.

Size: 266.7 H x 482.6 W x 577.9 mm D (10 $\frac{1}{2}$ " x 19" x 22 $\frac{3}{4}$ "). Projection: 76.2 mm (3") from rack front.

Weight: net, 50.5 kg (112 lb); shipping, 59.5 kg (132 lb).

HP 7418A General Specifications

Chart speeds: 0.5, 1, 2.5, 5, 10, 25, 50, 100, 200 mm/s. Speed regulation $\pm 1\%$. Paper weave less than 0.5 mm. Speed selected via front panel pushbuttons (or remote). Optional speeds in mm/min.

Chart paper: eight 40 mm wide channels each with 50 divisions; time lines every 1 mm. Heat sensitive Chemical Thermal Paper standard for all system recorders except option 050. Permapaper[®] for Option 050 recorders only. Chemical Thermal Paper available in packs of 400 sheets, each 30.1 cm (12") long x 40.2 cm (15.8") wide (HP part number 9270-0563 red grid). Permapaper available in packs of 500 sheets, each 30.1 cm (12") long x 40.2 cm (15.8") wide (HP part number 9270-0946 green grid).

Remote operation: rear panel connector provides for chart drive and event marker, optional extra markers. Remote connector supplies -20 V.

Power: 115/230 V ac $\pm 10\%$, 60 Hz. Recorder only 575 VA; system plug-ins 695 VA.

Size: rack: 266.7 H x 482.6 W x 577.9 mm D (10 $\frac{1}{2}$ " x 19" x 22 $\frac{3}{4}$ "). Projection: 76.2 mm (3") from front of rack.

Weight: 50 kg (110 lb) including driver amplifiers.

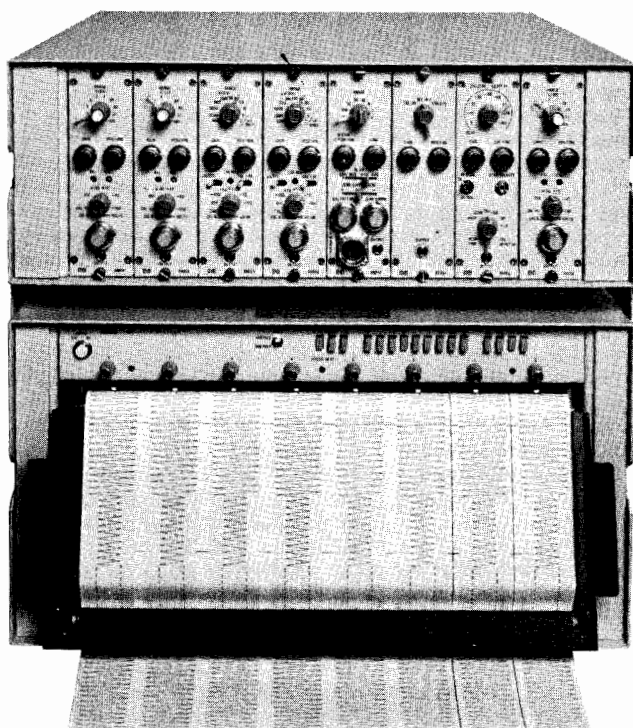

HP 7418A with Options 030 and 003

PLOTTERS & RECORDERS

Four and Eight-Channel Oscillographic Recorders

Models 7414A, 7418A & 8800 Series Conditioners (cont.)

- Plug-in versatility for HP 7414A/7418A

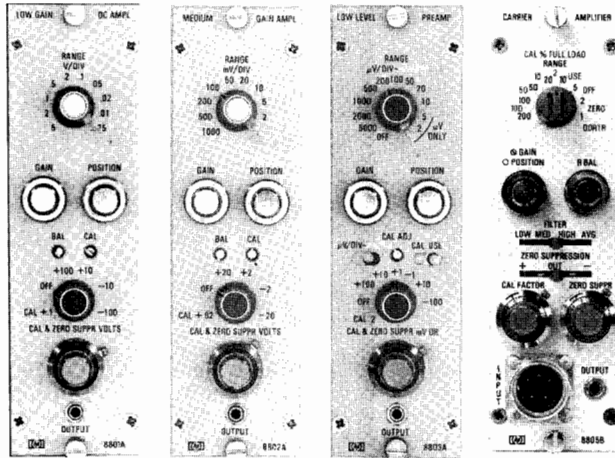

HP8801A HP 8802A HP 8803A HP 8805B

HP 8801A Low Gain DC Amp

Input ranges: 5, 10, 20, 50, 100, 200, 500, 1000, 2000, 5000 mV/div; accuracy $\pm 1\%$.

Max sensitivity: 5mV/div (gain 20).

Max fs input: 250V.

Input circuit & input frequency range: resist. 500 k Ω $\pm 1\%$ each side bal to gnd; parallel with approx. 100 pF

Rise time (10 div, 10-90%, 4% overshoot): 5 ms.

Calibration (referred to input): 100 mV, $\pm 1\%$, internal.

Output frequency response (-0.5 dB at 50 div): 50 Hz.

Zero suppression: ± 10 and ± 100 V for single-ended or diff. signals. 10-T pot sets precise values of zero suppression voltages; ± 50 V max suppress on 5, 10, 20 mV/div ranges; max error of suppression $\pm 0.5\%$ of suppression range, and 1% of indicated suppression.

Output noise, max (less trace width): 0.2 div, p-p.

Zero drift, 20° to 40°C, 103 to 127 V (less trace width): temp—1.25 div/10°C, 0.5 div/hr, constant ambient. Line voltage—0.15 div.

Common mode rejection and tolerance: 48 dB min, dc to 150 Hz; ± 50 V max on other ranges for $< 1\%$ change in differential sensitivity.

Output linearity (less trace width): 0.25 div, after calibration for zero error to center scale $+20$ div.

HP 8802A Medium Gain DC Amp

Input ranges: 1, 2, 5, 10, 20, 50, 100, 200, 500, 1000 mV/div; accuracy $\pm 1\%$.

Max sensitivity: 1 mV/div (gain 100).

Max fs input: 50 V.

Input circuit and input frequency range: resist 180 k Ω $\pm 1\%$, each side bal to gnd, parallel with approx 100 pF.

Rise time (10 div, 10-90%, 4% overshoot): 5 ms.

Calibration (referred to input): 20 mV, $\pm 1\%$, internal.

Output frequency response (-0.5 dB at 50 div): 50 Hz.

Zero suppression: ± 2 V and 20 V for single-ended or differential signals; 10-T pot sets precise values of zero suppression voltages; ± 12.5 max suppression on 1, 2, 5 mV/div ranges; max error of suppression $\pm 0.5\%$ of suppression range and 1% of indicated suppression.

Output noise, max (less trace width): 0.2 div, p-p.

Zero drift, 20° to 40°C, 103 to 127 V (less trace width): same as HP 8801A.

Common mode rejection and tolerance: 48 dB min dc to 60 Hz, 1000 mV/div range; 48 dB min. dc to 150 Hz other ranges ± 12.5 V on 1, 2, 5 mV/div ranges; ± 125 V on 10, 20, 50 mV/div ranges; ± 500 V max other ranges for less than 1% change in differential sensitivity.

Output linearity (less trace width): same as HP 8801A.

HP 8803A High Gain DC Amp

Input ranges: 1, 2, 5, 10, 20, 50, 100, 200, 500, 1000, 2000, 5000 μ V/div; 10, 20, 100, 200, 500, 1000, 2000, 5000 mV/div; accuracy $\pm 1\%$ on 5000 μ V/div to 20 μ V/div ranges, $\pm 2\%$ on 10 μ V/div to 1 μ V/div; accuracy of x 1000 attenuator $\pm 1\%$.

Max sensitivity: 1 μ V/div (gain 100,000)

Max fs input: 250 V.

Input circuit and input frequency range: 1 M Ω min on μ V range, independent of gain; 5 M Ω on mV range; floating and guarded.

Rise time (10 div, 10-90%, 4% overshoot): 5 ms. 6% overshoot.

Calibration (referred to input): 200 μ V $\pm 1\%$ internal on μ V/div range; 200 mV $\pm 1\%$ internal on mV/div range.

Output frequency response (-0.5 dB at 50 div): 50 Hz.

Zero suppression: μ V ranges ± 1 , ± 10 , ± 100 mV; mV ranges ± 1 , ± 10 , ± 100 V, 10-T pot sets precise values of zero suppression voltages; accuracy $\pm 1\%$ suppression range.

Output noise, max (less trace width): 1.5 mm p-p at 1 μ V/div; 0.1 div, p-p min gain.

Zero drift, 20% to 40%, 103 to 127 V (less trace width): temp— μ V range 1 Ω V/10° referred to input, ± 0.26 div/10° C for 0 output & ± 0.65 div/10° C for fs output. mV range, 1 mV/10° C referred to input, ± 0.26 div/10° C for 0 output. Line voltage 0-0.07 div; fs 0.35 div.

Common mode rejection and tolerance: μ V range, max source unbal of 1 k Ω ; 160 dB min at dc, 120 dB min at 60 Hz; mV range, max source unbal of 500 k Ω ; 100 dB min at dc, 60 dB min at 60 Hz dc. 300 V pk; 60 Hz. 1 μ V/div, 10 V rms; 2 μ V/div, 20 V rms; 5 μ V/div, 50 V rms; 10 μ V/div and 10 mV/div, 100 V rms; 20 μ V to 5000 μ V/div and 20 mV to 5000 mV/div, 200 V rms.

Output linearity (less trace width): 1 mV range 0.35 div, others 0.25 div after calibrating for zero error at center scale and $+20$ div.

HP 8805 Carrier Preamp

Input ranges: X1, 2, 5, 10, 20, 50, 100, 200; accuracy $\pm 2\%$.

Max sensitivity: 10 μ V rms/div (gain 10,000 rms ac to dc)

Max fs input: 100 mV rms.

Input circuit and input frequency range: input impedance—HP 8805B 1 M Ω $\pm 10\%$; single-ended. Min load resistance across excitation 100 Ω . Max impedance in series with input (transducer output impedance) 5 k Ω . Excitation—floating source 5 V rms nominal at 2400 Hz $\pm 2\%$. Internal switch allows use with full or half bridge transducer.

Rise time (10 div, 10-90%, 4% overshoot): 5.6 ms.

Calibration (referred to input): 2% $\pm 0.02\%$ of transducer fs output. Adjust by Cal Factor control; accuracy ± 55 μ V/V out of 10mV/V, switchable Cal voltage to 2%, 10%, 50%, or 100% $\pm 1\%$ of fs.

Output frequency response (-0.5 dB at 50 div): 50 Hz.

Zero suppression: 0-100% of transducer full load rating, for transducers having Cal Factor up to 10 mV/V at full load, 10-T pot with calibration dial; accuracy—1 dial div $\pm 0.5\%$ of suppress range. Zero Supp Polarity switch, Separate R Bal control allows bucking of in-phase unbal to ± 3 mV/V regardless of Cal Factor.

Output noise, max (less trace width): approx. 0.2 div, p-p.

Zero drift, 20% to 40%, 103 to 127 V (less trace width): temp—0.45 div/10° C; Line voltage—0.25 div.

Common mode rejection and tolerance: quadrature rejection and tolerance: > 40 dB. Tolerance error: $< \pm 2\%$ fs when quadrature voltage equal to twice in-phase signal required for center to edge deflection on chart. Automatic C Balance permits bucking of transducer's quad unbalance of up to ± 5 mV/V.

Output linearity (less trace width): 0.4 div after calibrating for zero error at center scale and $+20$ div.

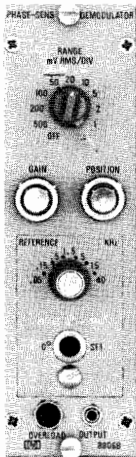

HP 8806B
Opt. 002

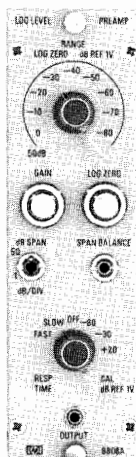

HP 8808A



HP 8815A
Opt. 002

HP 8806B Phase Sensitive Demodulator

Must be purchased with minimum of one of the four available options.

Input ranges: sig input—0.5, 1, 2.5, 10, 20, 50, 100, 200, 500 mV/div; $\pm 1\%$, 50 Hz to 10 kHz; $\pm 2\%$, 10 kHz; $\pm 3\%$, 20 kHz to 40 kHz. Reference voltage—3 to 20 rms, 20 to 133 V rms.

Max sensitivity: 0.5 mV rms/div (gain 200 rms ac to dc).

Max fs input: 25 V rms full scale.

Input circuit and input frequency range: signal input:—transformer isolated, floating point and guarded; resistance approx 1 M Ω . Reference input: differential, transformer coupled; resistance approx 500 k Ω each side to ground, may be used single ended. 50 Hz to 40 kHz in 6 bands with variable frequency plug-in (Opt. 002); 60 Hz (Opt. 003), 400 Hz (Opt. 004) and 5 kHz (Opt. 005) fixed frequency phase shifter plug-in; special order phase shifter plug-ins 50 Hz to 40 kHz. Note: must order with frequency plug-in.

Rise time (10 div, 10-90%, 4% overshoot): 5 ms (5 kHz ref).

Calibration (referred to input): 1 V rms internal at carrier reference frequency; $\pm 1\%$ 50 Hz to 10 kHz; $\pm 2\%$ 10 kHz to 20 kHz; $\pm 3\%$ 20 kHz to 40 kHz.

Zero suppression: none. Phase shifter plug-ins allow control of reference phase over 360°. Fixed frequency: 0° to 90° dial; 2° graduations; any of 4 quadrants by panel switches; dial accuracy within $\pm 3^\circ$. Variable frequency: adjust thru 360°.

Output noise, max (less trace width): 7 μ V x square root of frequency response, referred to input.

Zero drift, 20° to 40°C, 103 to 127 V (less trace width): temp: 0.5 div/10°C; Line voltage: 0.25 div.

Common mode rejection and tolerance: CM: >40 dB up to 10 kHz 500 V rms, max. Quadrature tolerance: equal to amplitude of a fs, in-phase signal.

Output linearity (less trace width): 0.4 div after calibrating for zero error at center scale and +20 div.

HP 8808A Log Level Preamp

Input ranges: 50 dB span: bottom scale -80, -70, -60, -50, -40, -20, -10, and 0 dB below 1 V (i.e. 100 μ V, 320 μ V, 1, 3.2, 10, 32, 100, 320 mV and 1V). 100 dB span bottom scale -80, -70, -60, and -50 dB below 1 V.

Max sensitivity: 100 μ V rms sine wave corresponds to bottom scale output, -80 dB below 1 V.

Max fs input: 320 V rms.

Input circuit and input frequency range: single ended, resistance 1 M Ω min. 5 Hz to 100 kHz for <3 dB down from the midband level on "Slow" response range; 500 Hz to 100 kHz on "Fast" response range.

Rise time (10 div, 10-90%, 4% overshoot): fast, 20.5 rms (875 dB/s); slow, 2 s (9 dB/s).

Calibration (referred to input): internal from oscillator at approx 500 Hz. -80, -30, and ± 20 dBV = dB ref. to 1 V (100 μ V, 32 mV and 10 V) -80 +20 dBV internally adjustable: -30 dBV accuracy ± 0.25 dB (at 115 V line at 25°C).

Output noise, max (less trace width): 50 dB range: 0.8 div, p-p, 100 dB range: 0.4 div, p-p (max noise at bottom of recording chart).

Output linearity (less trace width): departure from log characteristics 50 dB: 1.25 div, 100 dB: 1 div, after calibrating for zero error at lower and upper ends of printed coordinates.

HP 8809A Signal Coupler

Input ranges: continuously adjustable from 20 to 50 mV/div.

Max sensitivity: 30 mV/div (gain 3.33).

Max fs input: 0 to +2.5 V or 0 to -2.5 V.

Input circuit and input frequency range: switch selected: 1500 Ω $\pm 2\%$ or 100 k Ω min, incremental; single ended.

Rise time (10 div, 10-90%, 4% overshoot): 5 ms.

Calibration (referred to input): 600 mV $\pm 2\%$, internal.

Output frequency response (-0.5 dB at 50 div): 50 Hz.

Output noise, max (less trace width): 0.1 div, p-p.

Zero drift, 20° to 40°C, 103 to 127 V (less trace width): temp: 0.4 div/10°C at 30 mV sensitivity. Line voltage: 0.3 div.

Common mode rejection and tolerance: 50,000: 1 at dc.

Output linearity (less trace width): 0.4 div after calibrating for zero error at center scale and +20 div.

HP 8815A Opt 002 General Purpose Integrator

Sensitivity ranges: 0.2, 0.5, 1, 2, 5. Sensitivity setting of 1 results in the following integrator outputs:

Seconds integrator: 1 volt per volt-second input (0.1 volt-seconds per recorded division, or 5 volt-seconds full scale).

Minute integrator: 1 volt per 60 volt-seconds input (6 volt-seconds per recorded division or 300 volt-seconds full scale). For other sensitivity settings, divide the above volt-second values by the sensitivity switch setting.

Offset control: ± 2.8 volts referred to input. Can be used with switch-selectable rectifier to rectify (or ignore) portions of roughly sinusoidal inputs.

Drift: seconds integrator, ± 5 mV/s, referred to output; minute integrator, ± 15 mV/min., referred to output.

PLOTTERS & RECORDERS

Four and Eight-Channel Oscillographic Recorders

Models 7414A, 7418A & 8800 Series Signal Conditioners (cont.)

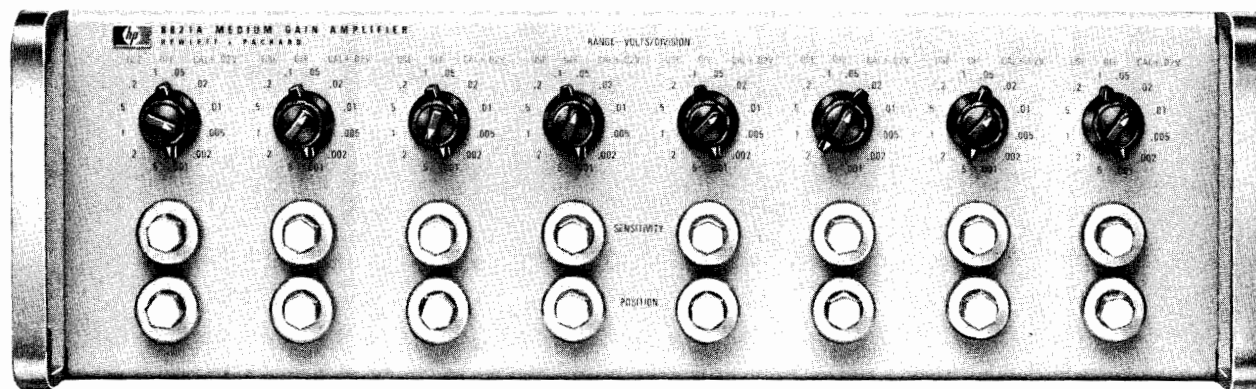

HP 8821A

HP 8821A Eight Channel Bank Amplifier

Max sensitivity: 0.001 V/div (Amplifier Gain 100).

Max fs input: 250 V (edge to edge).

Input ranges (attenuation): 0.001, 0.002, 0.005, 0.010, 0.020, 0.050, 0.1, 0.2, 0.5, 1, 2, 5 V/div. Attenuator accuracy (dc) 1/2% on 0.001 to 0.050 V/div ranges; 1% on 0.1 to 5 v/div ranges.

Input circuit: balanced, floating and guarded, 9 MΩ constant for all gain settings (0.001 to 0.050 V/div); 4.5 mΩ each side to ground (0.1 to 5 V/div).

Common mode rejection: 100 dB at 60 Hz, 0.001 V/div sensitivity, 1 kΩ source unbalance decreases to 66 dB at 0.05 V/div, 66 dB at 60 Hz, 0.01 to 5 V/div sensitivity. 1 kΩ source unbalance.

Common mode tolerance: ±20 V on 0.001 to 0.05 V/div ranges (6 most sensitive); ±250 V on 0.1 to 5 V/div ranges (6 least sensitive).

Frequency response: dc to <0.5 dB down at 50 Hz (50 div, p-p). dc to <3 dB down at 200 Hz (10 div p-p).

Rise time (10 div, 10-90%, 4% overshoot): <6 ms.

Output linearity (less trace width): linear within ±0.25 div. after setting mechanical zero of stylus to within ±1 div. of chart center and calibrating for zero error at center scale and ±20 div.

Drift, 20° to 40°C, 115 V ±10%. 60 Hz (less trace width): temp., <0.55%/10°C; line voltage, <±0.2 div.

Calibration: +0.02 V ±1% on 6 most sensitive ranges. Simulates +2 V ±2% at input on 6 least sensitive ranges.

Temperature rating: operating, 0°C to +55°C; storage, -40°C to 75°C.

Ordering Information

HP 7414A 4-channel Oscillographic Recorder

Opt 001: rack mount kit with slides and mounting hardware; delete case.

Opt 008: 50 Hz operation

Opt 015: extra Event Marker, between channels 2 & 3

Opt 025: 60:1 speed reduction (50 Hz), requires Opt 008

Opt 026: 60:1 speed reduction (60 Hz)

Opt 054: installed in mobile cart. Rack space: 53 cm (21 in.). Cart height: 102 cm (40.75 in.). Includes paper takeup drawer.

HP 7418A 6 to 8-channel Oscillographic Recorder

Opt 001: 6 channel Hot-tip Thermal Recorder only; includes takeup tray. Plug-in preamplifiers require Opt 030 Power Supply; for 8-channel Bank Amplifiers (Power Supply included) select Opt 031 or 032

Price

\$9449

N/C

N/C

\$111

\$480

\$480

\$1475

\$12082

less \$625

Opt 002: rack mount kit \$354

Opt 003: bench-top configuration \$540

Opt 004: 160 cm (63 in.) rack space cabinet. Cabinet height: 177 cm (72.5 in.). Includes paper takeup drawer. \$2999

Opt 006: Portable Cart with 71 cm (28 in.) rack space, includes Opt. 002. Cart height: 126 cm (50.5 in.). \$1779

Opt 008: 50 Hz operation N/C

Opt 009: 230 Vac operation N/C

Opt 014: extra Event Marker between channels 4 & 5 \$101

Opt 015: extra Event Marker between channels 5 & 6 \$101

Opt 025: 60:1 speed reduction (50 Hz), requires Opt 008 \$712

Opt 026: 60:1 speed reduction (60 Hz) \$712

Opt 030: HP 8848A plug-in Preamplifier Power Supply, required for operation of HP 8800 preamplifiers \$2616

Opt 032: HP 8821A 8-channel Medium Gain Bank Preamplifier \$5333

Opt 035: rack mount kit for HP 29400 series cabinet \$313

Opt 050: recorder equipped for permapaper operation only N/C

HP 8801A Low Gain Preamplifier \$762

HP 8802A Medium Gain Preamplifier \$813

HP 8803A High Gain Preamplifier \$2073

HP 8805B Opt 012 Carrier Preamplifier without Harmonic Filter \$1576

HP 8806B Phase Sensitive Demodulator Preamplifier. Requires one of following plug-ins: \$1545

Opt 002: Variable Frequency Phase Shifter plug-in, 50 Hz to 40 kHz \$510

Opt 003: 60 Hz Phase Shifter plug-in \$379

Opt 004: 400 Hz Phase Shifter plug-in \$354

Opt 005: 5 kHz Phase Shifter plug-in \$303

HP 8808A Logarithmic Preamplifier \$1727

HP 8809A Signal Coupler Preamplifier \$445

HP 8815A Opt 002 General Purpose Integrator \$1621

Opt 003: Sample and hold (for digital display read-outs) \$241

HP 8821A Medium Gain Bank Preamplifier (8-channel) \$5333

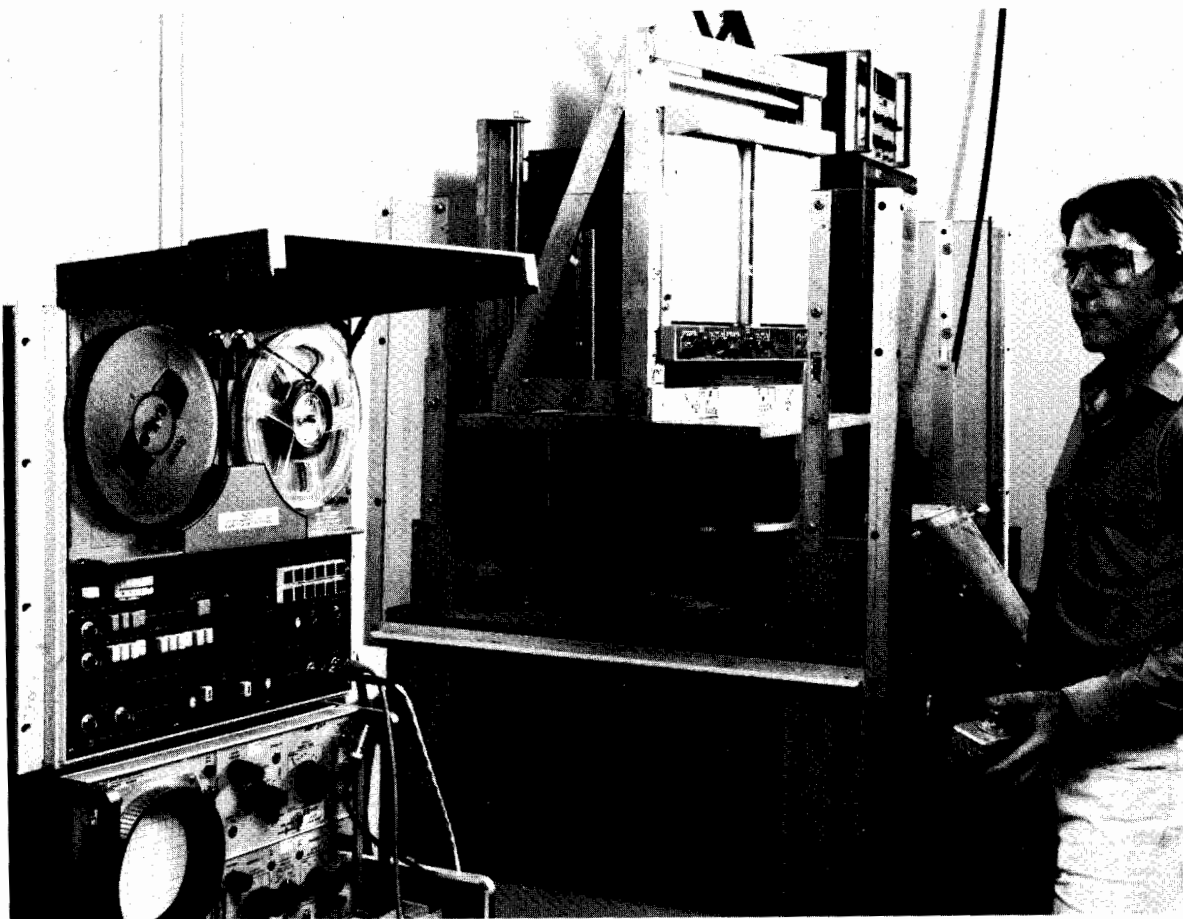

Introduction

Instrumentation tape recorders (ITRs) are used to record, store, and reproduce test data for many and varied applications. The main reasons for using ITRs are economy, accurate data recording and reproduction, and long-term data storage. ITRs manufactured by Hewlett-Packard are 4 or 8-channel recorders using 1/4-inch tape. They are designed specifically for applications under 64 kHz. ITR recording provides nondestructive reproduction so data can be reproduced repeatedly without degrading the quality, and time-base can be contracted or expanded. Data is contracted by using faster tape speeds to reproduce slow-speed data or expanded by doing the reverse to produce, for example, lower frequency data for use on a graphics recorder.

ITR Characteristics

Direct record/reproduce electronics: direct electronics accept frequencies above 100 Hz (approximate) and record the amplitude of the input signal on the tape as a proportional magnetic flux intensity. Because direct electronics require a "linear" relationship, changing tape type generally necessitates the re-equalization of each direct channel. Direct electronics also require that each recorded tape be degaussed (erased) fully before being reused.

FM record/reproduce electronics: FM electronics accept very low frequencies, including dc. In FM, the amplitude of the input signal is recorded as a frequency deviation from a "center" frequency, the maximum input amplitude being recorded as a 40% deviation. Because amplitude is converted to a frequency, FM tends to be insensitive to tape drop-outs, but sensitive to speed irregularities such as flutter. With FM, tape types can be changed without re-equalizing the channel. Since FM records to saturation, tape can be reused without degaussing with only a small (10 to 15 dB) loss in signal-to-noise ratio.

Common frequency range: FM and direct have a common segment of the frequency range in which either type of electronics can function. On Hewlett-Packard's ITRs this range is approximately 100 Hz to 5 kHz. The advantages of using direct electronics in this range are high frequency response at slow tape speeds and a general insensitivity to flutter. The advantages of FM are dc response and a general insensitivity to tape drop-outs.

Tape speed control: the tape speed is usually controlled by a phase-lock servo system in one of two ways. The more common method uses the servo system to control the

rotational speed of the tape capstan, employing a tachometer mounted on the capstan's shaft to monitor the speed. With this method, tape speed control is limited to approximately $\pm 0.2\%$, because of capstan irregularities, tape slippage, and tape stretching. The less common but more precise method uses a frequency reference placed on one track during recording as the speed reference for the phase-lock servo during reproduce. Tape servo generates a reproduce speed that is virtually identical to the record speed; the time difference between events in record and reproduce is indicated by the time base error specification (which assumes continuous phase-lock operation). The time base error figure represents a short-term specification, because drop-outs, etc., may cause momentary loss of phase lock.

Flutter: this is a short-term tape speed variation. It produces time base perturbations in direct electronics and noise in FM.

Signal-to-noise ratio: this is the ratio of maximum to minimum recordable amplitude expressed as a voltage ratio in dB. Basically, it represents the usable dynamic range.

Tape selection: it is recommended that instrumentation tape such as Ampex 797 always be used. Use of other quality tape may adversely affect head wear, signal-to-noise ratio, etc.



PLOTTERS & RECORDERS

Instrumentation Tape Recorders and Degausser

Models 3964A, 3968A, and 13064A Degausser

- Continuing savings by recording on 1/4-inch tape
- Choice of 4 or 8-channel recorders
- Selection of FM or direct electronics
- Six tape speeds, including 15/32 ips
- Remote control (TTL or optional HP-IB)
- Switch selection of tach or tape servo

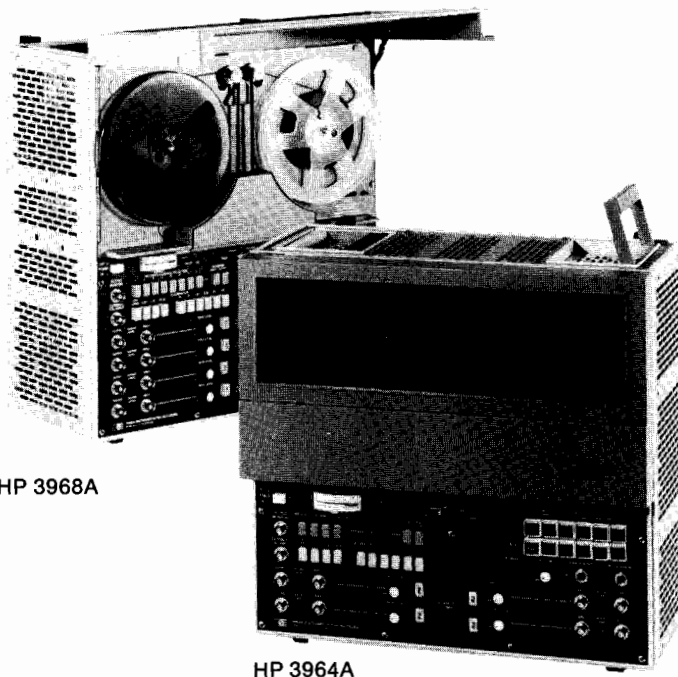

HP 3968A

HP 3964A

HP 3964A and 3968A ITRs, HP 13064A Degausser

The 4-channel HP 3964A and 8-channel HP 3968A are quality instrumentation tape recorders (ITRs) that provide cost-saving operation by using 1/4-inch tape for a wide variety of recordings. Medical versions of the HP 3964A and 3968A (Options 009 and 010) are available. These versions include a UL 544 medical listing making them useful in hospitals, medical offices, and research facilities.

The HP 13064A bulk tape degausser erases a complete roll of tape cleanly in seconds. A thoroughly clean tape is necessary to obtain maximum signal-to-noise ratio.

Both the HP 3964A and the HP 3968A are precision-built ITRs with features that cut costs, enhance the usefulness of the units, and simplify recording tasks in laboratory, medical, production, and field use.

HP 3964A, 3968A Features

Cost-saving 1/4-inch tape: provides continuing savings for the life of the recorder. By using 1/4-inch tape, rather than 1/2-inch tape, users can save over 50 percent on tape costs.

AC/DC calibrator: provides an internal voltage source that simplifies the set up of input and output levels for each data channel. Six voltages, ac or \pm dc, can be pushbutton selected, applied, and monitored to check out each channel. In addition, there is an external connector to allow the use of scopes or other monitoring devices.

Tach or tape servo control: tach-servo and tape-servo systems are switch selectable.

Flutter compensation: improves the signal-to-noise ratio in FM by up to 12 dB in a vibrating environment. When switched on, flutter-generated noise introduced during record and reproduce is subtracted from all FM data channels during reproduce to improve performance. One FM channel is used for flutter compensation; this same channel can also be used for tape servo control, saving a data channel for recording when both flutter compensation and tape servo are required.

Voice capability: provides voice annotation capability on the fourth channel of the HP 3964A or the eighth channel of the HP 3968A, using the press-to-talk microphone. The voice channel accepts data only, voice only, or data with a voice interrupt. Microphone, speaker, and headphone jack are provided with both recorders.

FM electronics-to-electronics (e-e) mode: transfers the input signal automatically to output, bypassing the record/reproduce heads. This occurs when tape is below record/reproduce speed or in Fast Forward, Rewind, or Stop mode. E-E allows the unit to be set and calibrated without using tape.

Instrumentation Tape Recorder Notes

These technical application notes are available, at no charge, from your Hewlett-Packard sales office:

| Topic | Application Note No. | HP Part Number |
|--------------------------------------|----------------------|----------------|
| Dropouts | 213-1 | 5952-2841 |
| Crosstalk | 213-2 | 5952-2844 |
| Interchannel Time Displacement Error | 213-3 | 5952-2848 |
| Magnetic Tape Recording Handbook | 89 | 5952-2820 |

HP 3964A, 3968A Transport Specifications

Tape width: 1/4 inch (6.3 mm)

Reel size: standard 7-inch (18 cm) plastic reel, totally enclosed by reel cover

Heads

HP 3964A: One 4-track record and one 4-track reproduce

HP 3968A: One 8-track record and one 8-track reproduce

| Tape Speed* (ips) | 15 | 7 1/2 | 3 3/4 | 1 7/8 | 1 5/16 | 1 5/32 |
|-----------------------------|---------|---------|-----------|----------|----------|----------|
| Flutter (% p-p) | 0.35 | 0.35 | 0.40 | 0.50 | 0.70 | 1.5 |
| Time base error (μ s)* | ± 4 | ± 5 | ± 7.5 | ± 15 | ± 25 | ± 50 |
| Start time (s) (typical) | 3 | 1.5 | 0.9 | 0.5 | 0.5 | 0.5 |
| Tape speed accuracy (s) | 0.2 | 0.2 | 0.2 | 0.2 | 0.2 | 0.2 |

*Tape servo operation

Tape motion controls: pushbutton selectable Forward Record, Reverse Record, Forward Play, Reverse Play, Fast Forward, Fast Rewind, and Stop

EOT sensing: tape drive stops automatically at the end of tape (EOT)

Reel revolution counter: 4-digit counter with pushbutton reset

FM Record/Reproduce Specifications¹

| Tape Speed (ips) | Passband ² (Hz) | Signal-to-noise ³ Ratio | |
|---------------------|-------------------------------|---------------------------------------|----------|
| | | HP 3964A | HP 3968A |
| 15 | dc-5000 | 48 | 46 |
| 7 1/2 | dc-2500 | 48 | 46 |
| 3 3/4 | dc-1250 | 48 | 46 |
| 1 7/8 | dc-625 | 46 | 46 |
| 15/16 | dc-312 | 44 | 44 |
| 15/32 | dc-156 | 40 | 40 |

- Based on use of Ampex 797 tape or equivalent
- Frequency response over passband is ± 1.0 dB referenced to 10% of upper band edge frequency
- Signal measured with carrier deviation $\pm 40\%$ of upper passband without flutter compensation. Output filters of reproduce amplifiers selected for constant amplitude response. May also be selected for linear phase (transient) response

Flutter compensation: can improve signal-to-noise by up to 4 dB under static conditions and as much as 12 dB under conditions of vibration. Selected by rear panel switch.

Distortion: total harmonic distortion $< 1.2\%$ @ 15 to 1 7/8 ips, $< 2\%$ @ 15/16 to 15/32 ips.

Linearity: $\pm 1.0\%$ of peak-to-peak output for best straight line through zero at $\pm 40\%$ deviation

DC drift: $\pm 0.1\%$ (max) of full scale output per $^{\circ}\text{C}$

Input level: 1 V to 30 V (peak-to-peak); continuously adjustable

Input impedance: 100 k Ω nominal, shunted by < 100 pF single-ended

Output level: 1 to 5 V (peak-to-peak); continuously adjustable

Load impedance: minimum load impedance 660 Ω

Direct Record/Reproduce Specifications¹

| Tape Speed (ips) | Passband (± 3 dB) ² | | S/N Ratio (dB) ³ | |
|---------------------|-------------------------------------|--------------|-----------------------------|----------|
| | HP 3964A | HP 3968A | HP 3964A | HP 3968A |
| 15 | 70-64000 Hz | 500-64000 Hz | 38 | 36 |
| 7 1/2 | 50-32000 Hz | 250-32000 Hz | 38 | 36 |
| 3 3/4 | 50-16000 Hz | 100-16000 Hz | 38 | 36 |
| 1 7/8 | 50-8000 Hz | 100-8000 Hz | 38 | 36 |
| 15/16 | 50-4000 Hz | 100-4000 Hz | 38 | 35 |
| 15/32 | 50-2010 Hz | 100-2000 Hz | 37 | 35 |

- Based on the use of Ampex 797 tape or equivalent
- Reference to 10% of upper band edge
- Referenced to a 500 Hz sine wave with a maximum of 1% third harmonic distortion when reproduced at 3 3/4 ips

Input level: 1 V to 30 V (p-p); continuously adjustable

Input impedance: 100 k Ω nominal, single-ended

Output level: 0.5 to 5 V (p-p); continuously adjustable

Load impedance: minimum load impedance 600 Ω

Calibrator: internal signal source, peak ac and \pm dc levels of 0, 1.0, 1.414, 2.5, 5.0, and 10.0 volts $\pm 2\%$

Meter modes: peak ac or dc, input or output

HP 3964A, 3968A General Specifications

Size

HP 3964A: 400 H x 427 W x 256 mm D (15.7" x 16.8" x 10.1")

HP 3968A: 445 H x 427 W x 256 mm D (17.5" x 16.8" x 10.1")

Weight: HP 3964A, 29.5 kg (65 lb); HP 3968A, 31.3 kg (69 lb)

Power requirements: 100, 120, 220, or 240 V, $\pm 5\%$, -10% , 48-66 Hz; 110 W average

Temperature: storage, -40°C to 75°C ; operating, 0°C to 55°C ; tape limit, 10°C to 40°C

Altitude: storage, 15240 m (50000 ft); operating, 4500 m (15000 ft)

Humidity: the system, excluding tape limitations, will operate from 10% to 95% RH (25°C to 40°C), non-condensing

Shock: 30 g maximum (11 ms) non-operating

Mounting: rack mounting kit for equipment racks, 19-inch



HP 13064A

HP 13064A Tape Degausser Specifications

Tape size: 1/4-inch (6.33 mm) tape on reels up to 10 1/2 inch (266 mm) in diameter

Erase: 60 dB minimum

Duty cycle: one minute ON, three minutes OFF

Size: 67 H x 133 W x 171 mm D (2.6" x 5.25" x 6.75")

Weight: approximately 4.3 kg (9.5 lb)

Power requirements: 115 V ac $\pm 10\%$, 50-60 Hz (Opt 001); 230 V ac $\pm 10\%$, 50-60 Hz (Opt 002)

HP 3964A, 3968A Options

Record/Reproduce Channel Data Card Options

Option provides one data card. Specify one option for each channel, up to 4 for HP 3964A, up to 8 for HP 3968A.

001 FM data card, standard \$480

030 FM data card, medical (must order Opt 009 or 010) \$480

002 Direct data card, standard \$450

031 Direct data card, medical (must order Opt 009 or 010) \$450

Medical ITR Options

009 Medical version with white paint \$500

010 Medical version with standard paint \$430

Other Options

Specify no more than one of each option per mainframe

003 Rear panel with BNC input/output connectors for each channel.

HP 3964A \$95

HP 3968A \$125

004 Locking knob set (screwdriver adjustable) \$50

005 Metric speed annotation on pushbuttons N/C

007 HP-IB remote control of speeds and mode \$470

024 Loop adapter (accommodates 5 to 30-ft loop) \$975

026 Slides for 19 in. racks \$135

027 Slides for HP cabinets \$195

041 IRIG servo reference frequency \$225

070 Overlap. For two units. Provides automatic play/record commands for second recorder when first unit tape is low \$380

HP 3964A \$95

HP 3968A \$125

004 Locking knob set (screwdriver adjustable) \$50

005 Metric speed annotation on pushbuttons N/C

007 HP-IB remote control of speeds and mode \$470

024 Loop adapter (accommodates 5 to 30-ft loop) \$975

026 Slides for 19 in. racks \$135

027 Slides for HP cabinets \$195

041 IRIG servo reference frequency \$225

070 Overlap. For two units. Provides automatic play/record commands for second recorder when first unit tape is low \$380

Ordering Information

HP 3964A 4-channel instrumentation tape recorder \$8065

HP 3968A 8-channel instrumentation tape recorder \$10,370

HP 13064A Tape degausser (specify Option 001 for 115 V ac or 002 for 230 V ac, N/C for options) \$155

HP 13107A Transit case for HP 3964A \$480

HP 13106A Transit case for HP 3968A \$480



LOGIC ANALYZERS

State, Timing, Analog, And System Performance Analysis

Model 1631A/D, 1630A/D/G

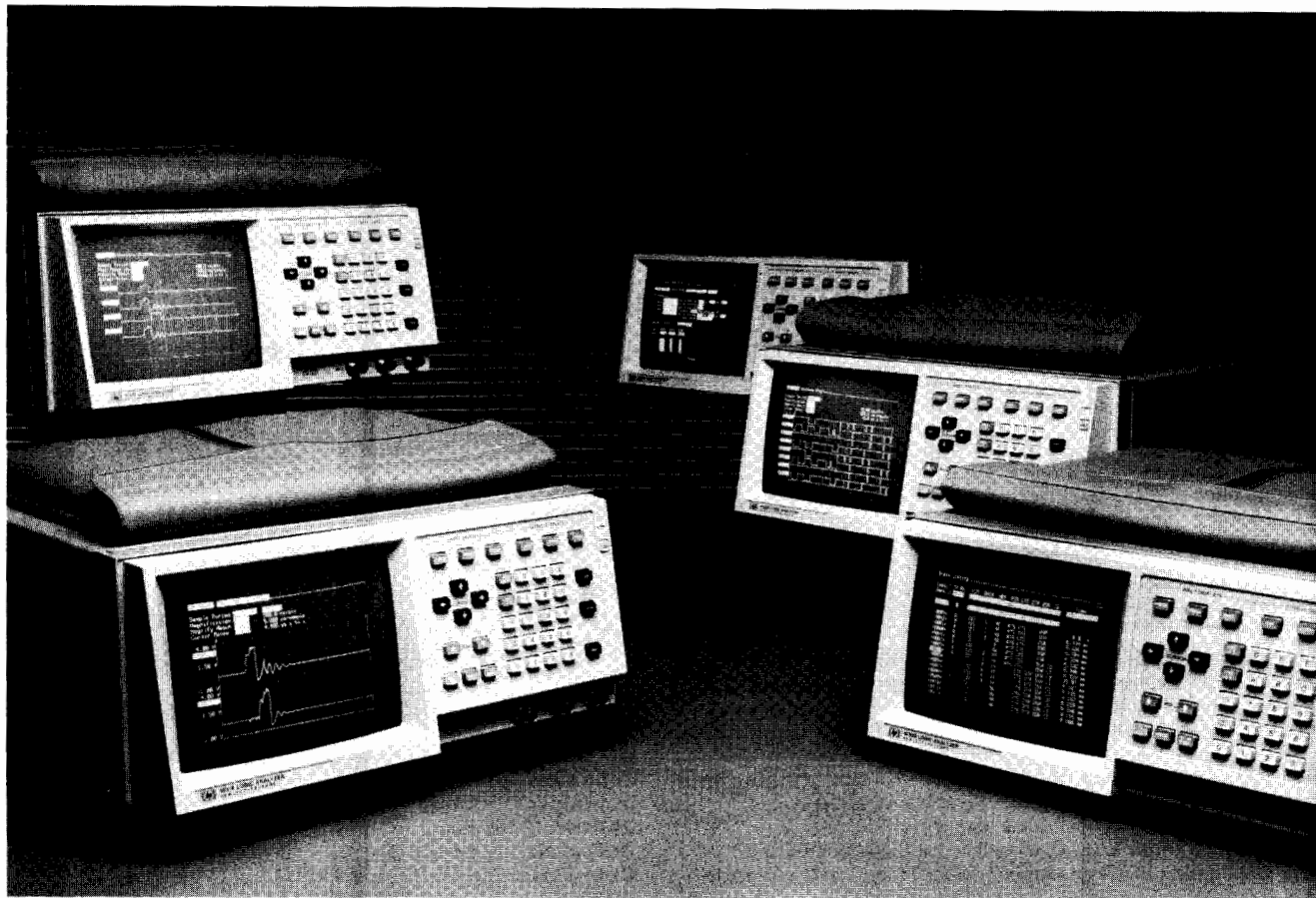

Hewlett-Packard provides a complete line of high-performance logic analyzers to help you design and troubleshoot today's systems.

Indispensable Tools For Digital Design And Test

Powerful

- Timing, state, analog (HP 1631A/D), and software performance analysis all in one low-cost instrument.
- Trigger measurements on combinations of glitches, edges, voltage levels (HP 1631A/D) and patterns so you can quickly track down hard-to-find problems.

Versatile

- Each instrument within the family can be upgraded, providing a range of price/performance solutions.
- Preprocessors, disassemblers, and down-loadable programs tailor the HP 1630 and HP 1631 for a variety of microprocessors and communication buses.
- Built-in HP-IB and HP-IL interfaces allow for both manual and automatic testing applications and for sending data to an external printer or disc drive.

Easy to Use

- A menu architecture guides you through each step in the measurement process. All choices are clearly shown, and prompt and error messages help eliminate setup guesswork.
- Data can be displayed in eight different formats, including microprocessor mnemonics, relocatable addresses, and user-defined labels.

Multi-function Tool

Combining up to five logic analysis functions in one benchtop instrument, the HP 1630/1631 may be your single most important tool for digital-product design, development, and testing.

- Timing analysis at 100 MHz to check hardware and status signals.
- State analysis at 25 MHz to trace program and software flow.
- Analog analysis at 200 megasamples/second to verify data voltage and time parameters.
- Performance analysis to optimize code.
- Interactive state/timing/analog (HP 1631A/D) analysis to integrate systems, circuits and code.

Flexibility, high performance, and reliability make the HP 1630 and 1631 logic analyzers an excellent value.

Preprocessor/Interface Modules

Because digital design and test involves more than just a logic analyzer, Hewlett-Packard provides a complete line of preprocessor and interface modules for HP 1630 and HP 1631 logic analyzers that simplify data interpretation and interconnections.

- Microprocessor preprocessors - direct connection to eight and 16-bit microprocessor systems. Please see page 416.
- Bus preprocessors - non-intrusive monitoring plus inverse assembly for easy interpretation of RS-232C/V.24, RS-449, and HP-IB data buses. Please see page 416.
- Minicomputer interfaces - eliminate loading, clocking, and demultiplexing problems. Please see page 416.

| HP 1630A | | HP 1630D | | HP 1630G | | HP 1631A | | | HP 1631D | | |
|----------|--------|----------|--------|----------|--------|----------|--------|--------|----------|--------|--------|
| State | Timing | State | Timing | State | Timing | State | Timing | Analog | State | Timing | Analog |
| 35 | — | 43 | — | 65 | — | 35 | — | 2 | 43 | — | 2 |
| — | 8 | — | 16 | — | 8 | — | 8 | 2 | — | 16 | 2 |
| 27 | 8 | 35 | 8 | 57 | 8 | 27 | 8 | 2 | 35 | 8 | 2 |
| — | — | 27 | 16 | — | — | — | — | 2 | 27 | 16 | 2 |

LOGIC ANALYZERS

Logic Analyzer With Scope

Model 1631A/D

411



- Built-in two-channel digitizing oscilloscope—50 MHz bandwidth and 200 megasample/second digitizing rate
- Up to 43 state channels and 16 timing channels

- System performance analysis for global view of system activity
- Interactive measurements
- Automatic time-interval measurements

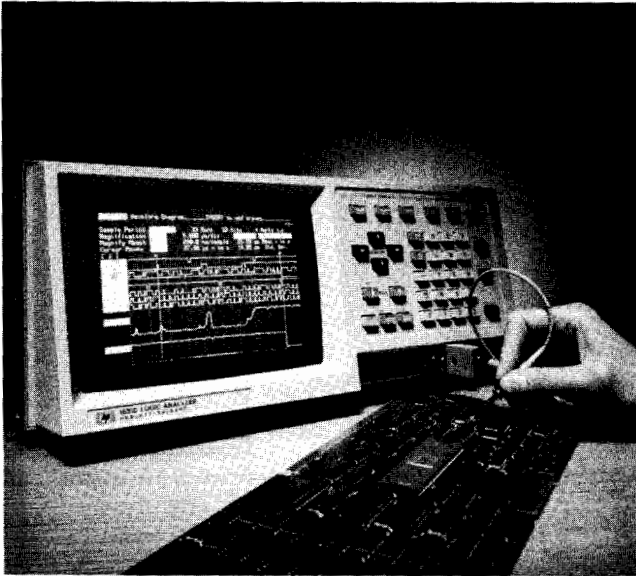

The new HP 1631A/D is a full-featured logic analyzer with a built-in digitizing oscilloscope, enabling the digital hardware designer to make the cross-domain measurements needed to troubleshoot and characterize systems.

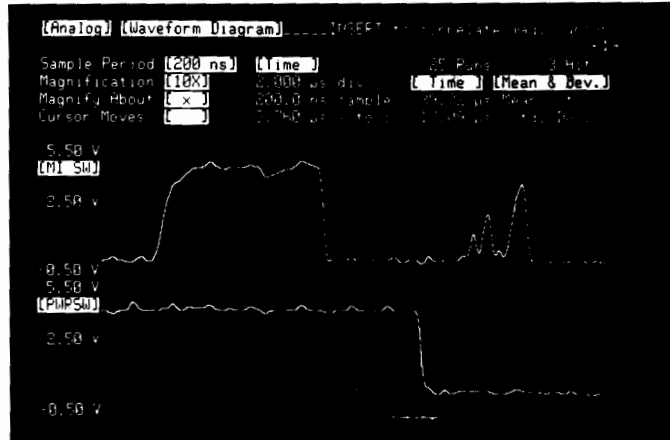

With a built-in oscilloscope, the HP 1631A/D provides two channels of analog analysis plus automatic time-interval measurements.

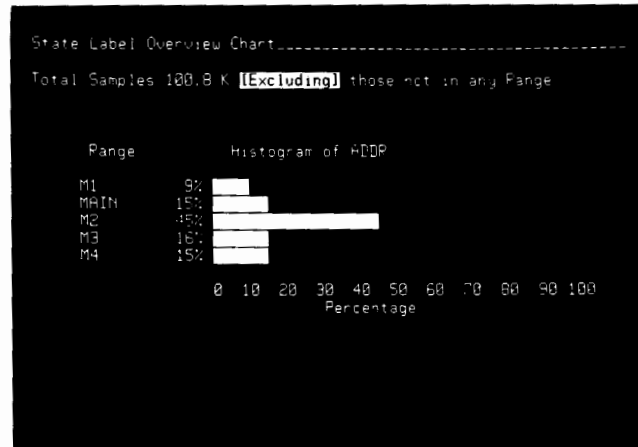

The HP 1631A/D's system performance analysis mode helps engineers locate problems in program flow, hardware execution, and system activity.

Analog Waveform Analysis

Analog waveform analysis provides simultaneous display of up to two channels User-definable labels, wide magnification range, and direct readout of time and voltage between cursors are available.

State Analysis

State listings and waveforms provide displays and windowing of address, data, status, and control line activity. Selectable display modes include binary, octal, decimal, hexadecimal, ASCII, relocation, user-defined mnemonics, and microprocessor-specific mnemonics. You can assign labels, and display and/or trigger on code in terms of relocatable or absolute addresses, or mnemonics.

Timing Analysis

Timing waveform diagrams provide simultaneous display of up to 16 channels, with user-definable labels. Wide magnification range, glitch display, and direct readout of time between cursors are available.

System Performance Analysis

Time interval and event histograms let you view system hardware/software activity or specific modules for performance evaluation. Out-of-spec conditions or bottlenecks in program flow or hardware execution stand out. In addition, the display shows measurement data, including the minimum, maximum, average value, and total measurement time.

HP 1631A/D Logic Analyzer . . .

The One With The Scope

The HP 1631A/D provides a digitizing oscilloscope and a logic analyzer in one low-cost instrument. It offers analog, timing, state, and system performance analysis capabilities function separately or interactively to serve the needs of digital design and test engineers.

The A and D models differ only in state/timing channel width. The HP 1631A provides up to 35 state channels, eight timing channels, and two analog channels. The HP 1631D provides up to 43 state channels, 16 timing channels, and two analog channels.

The One Tool For Every Phase Of Digital Design And Test

A 50 MHz digitizing oscilloscope

- 200 megasample/second digitizing rate for capturing single-shot waveforms
- Two simultaneous channels
- Single-shot time intervals to ± 1.5 ns

A complete logic analyzer

- 100 MHz timing analyzer
- Time-interval accuracy to ± 1.5 ns
- 25 MHz state analyzer
- Performance analysis for a global view of the system

Interactive measurements

- Arming and triggering with timing correlation
- Sophisticated triggering features
- Automatic time-interval measurements

LOGIC ANALYZERS

Logic Analyzer With Scope

Model 1631A/D

Complete Logic Analysis In A 16-bit Environment

Interactive: State and Analog

Full state analyzer indexing can arm analog waveform acquisition.
Full analog triggering can arm state data acquisition.

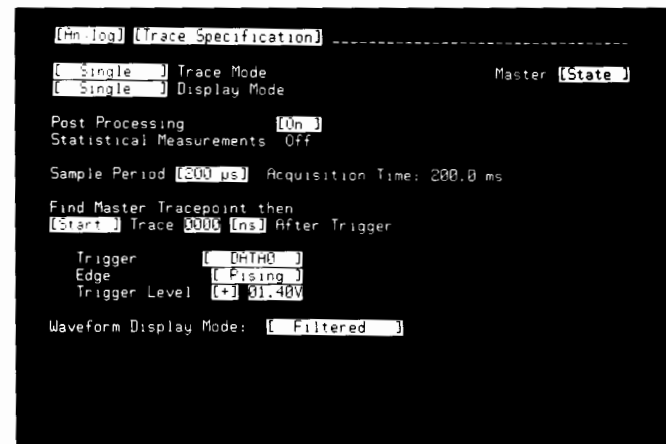
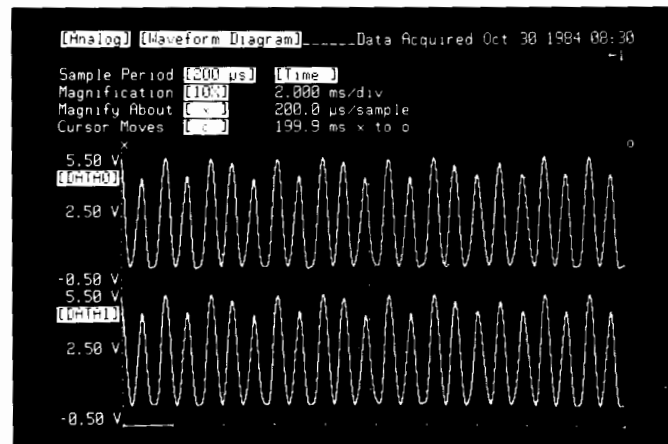
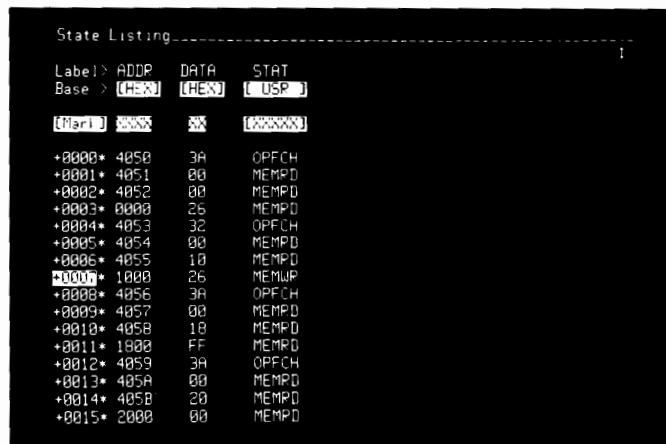

Interactive: State And Timing

Full state analyzer indexing can arm timing waveform acquisition.
Full timing analyzer indexing can arm state data acquisition.

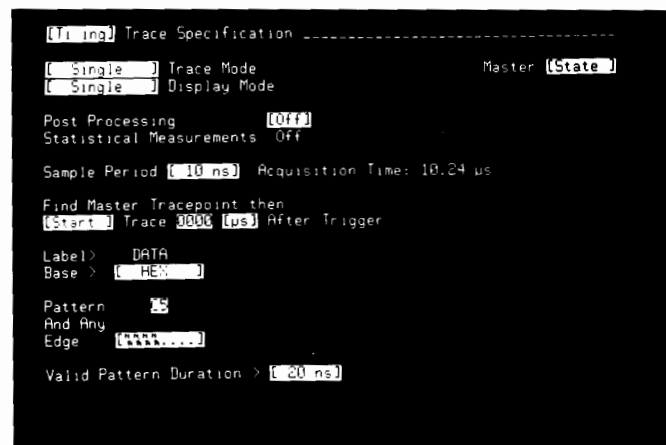
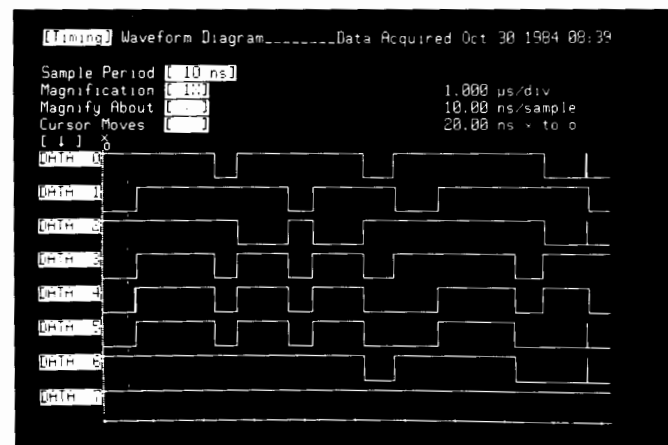

Analog Post-processing

Automatic time-interval measurements are provided through analog X and O cursors, with statistical calculations to enhance accuracy. A search-and-then-stop mode stops waveform acquisition when user-definable trigger conditions are met.

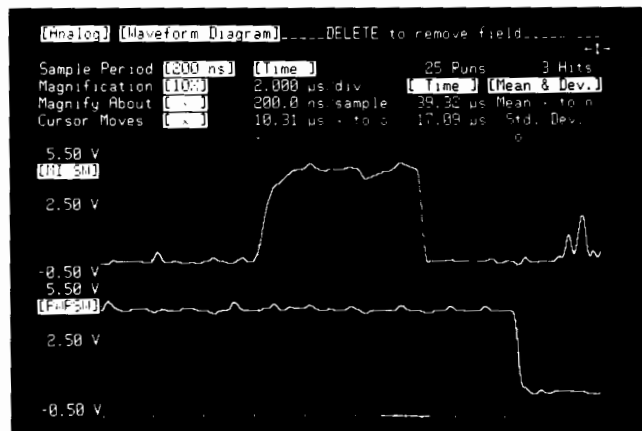

Timing Post-processing

Automatic time-interval measurements are provided through timing X and O cursors, with statistical calculations to enhance accuracy. A search-and-then-stop mode stops timing data acquisitions when user-definable trigger conditions are met.

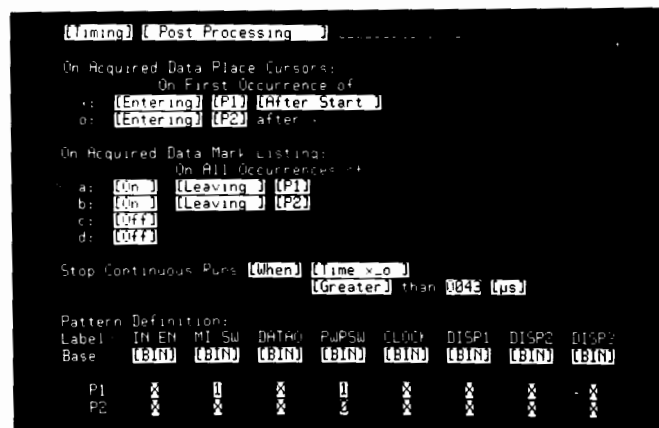
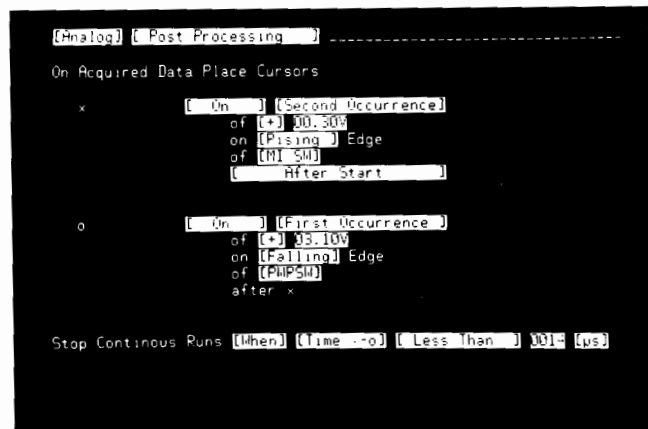
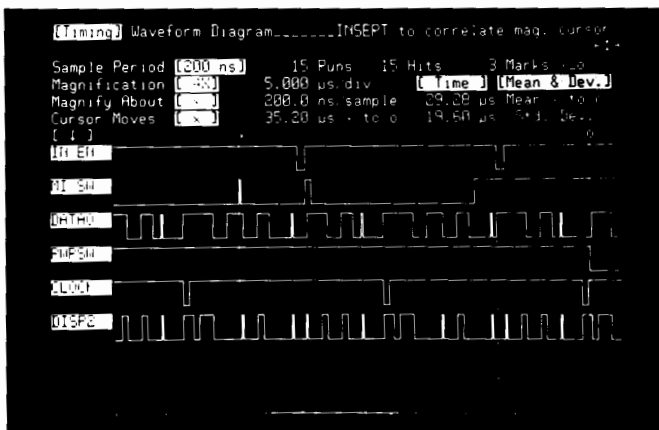

Inverse Assembly

Displaying program activity in inverse assembly can save many hours in test and debug. No more time-consuming or error-prone conversions from hex because measurement listings appear just as you wrote them, making them easy to compare to source-code listings.

Preprocessor/Interface Modules

HP provides a complete line of microprocessor preprocessors that tailor the HP 1631A/D to specific microprocessors. Preprocessor interface modules contain circuitry that properly formats data, and they provide connection via a microprocessor socket. Software supplied with preprocessors performs inverse assembly for state displays in the selected microprocessor's mnemonics.

A bus preprocessor available for analyzing RS-232C/V.24, RS-449, and HP-IB data bus, and minicomputer interface modules are also available for use with HP logic analyzers.

For more details on these preprocessor/interface modules, please refer to page 416.

LOGIC ANALYZERS

General-purpose Family

Models HP 1630A, 1630D, and 1630G

- Provides state, timing, and system performance analysis in one instrument
- Timing post-processing
- Interactive measurements
- Full compare mode (HP 1630G)

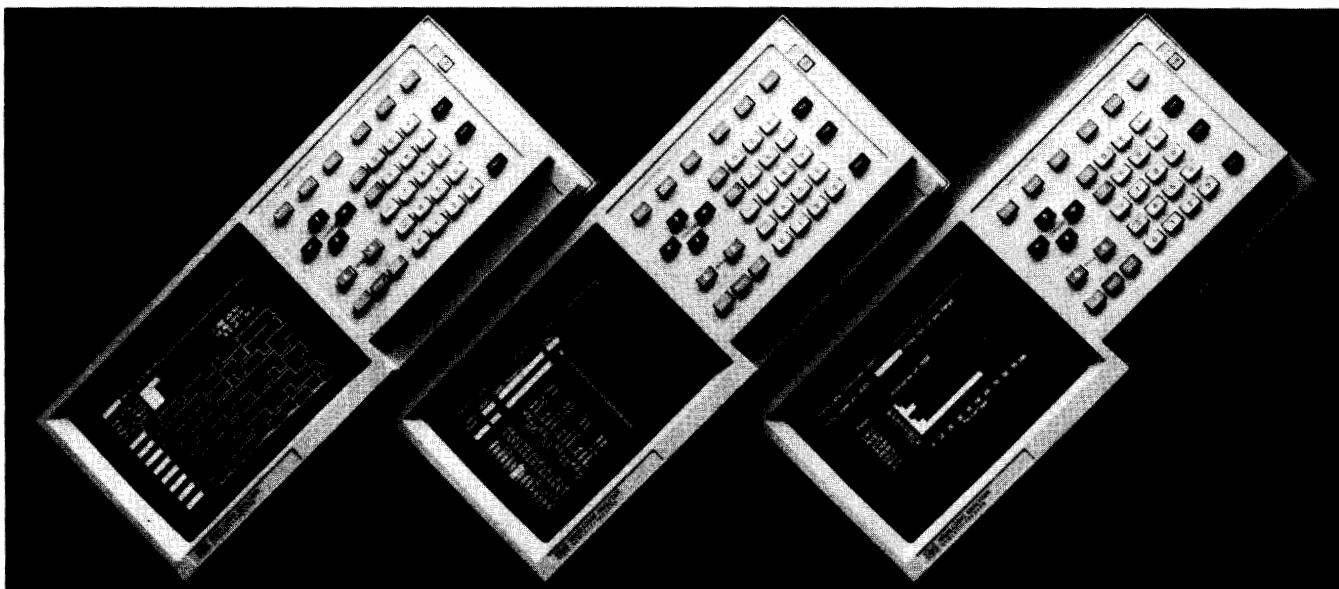

General-purpose Tool For The Modern Designer

The HP 1630 family of logic analyzers consists of three models designed to meet the needs of digital design and test engineers.

The A and D models differ only in channel width—the HP 1630A has 35 channels, and the HP 1630D has 43 channels. The HP 1630G has 65 channels, and additional system performance features for time tagging, time-positional charting, and module linkage histograms.

State Analysis

State listings and waveforms provide displays and windowing of address, data, status, and control line activity. Selectable display modes include binary, octal, decimal, hexadecimal, ASCII, relocation, user-defined mnemonics, and microprocessor-specific mnemonics. You can assign labels, and display and/or trigger on code in terms of relocatable or absolute addresses, or mnemonics.

- 25 MHz speed
- Up to 65 channels (HP 1630G)
- 1k memory
- Three clocks
- Demultiplexing
- Full compare mode

Timing Analysis

Timing waveform diagrams provide simultaneous display of up to 16 channels, with user-definable labels that speed and simplify data evaluation. Wide magnification range, unique glitch display, and direct readout of time between cursors let you quickly adjust parameters to match the application.

- Speeds to 100 MHz
- Up to 16 channels (HP 1630D)
- 1k memory
- Glitch triggering

Timing Post-processing

Automatic time-interval measurements are provided with X and O cursors, with statistical calculations to enhance accuracy. A search-and-then-stop mode, which is called post-processing, stops timing data acquisition if your system violates a timing or sequence condition.

System Performance Analysis

Meeting system throughput requirements often requires a global look at overall system activity. Time interval, event, and module linkage histograms let you view system hardware and software activity or specific modules of code for performance evaluation.

Out-of-spec conditions or bottlenecks stand out. The display shows measurement data, including the minimum, maximum, average, and total measurement time.

- Time-interval histogram - eight ranges, 1 μ s resolution
- State label histogram - eight labels, maximum count $2^{63}-1$
- Time-positional histogram - 1023 time buckets, 1.023 μ s to 205 ks duration
- Module linkage histogram - eight definable events, eight links

Interactive Measurements

The HP 1630A/D/G's interactive measurement capability allows you to determine whether your system problems are software errors or hardware malfunctions.

- Trigger on state and view timing data
- Trigger on timing and view state data
- Time tags for real-time measurements between states (HP 1630G)

Preprocessors

A wide selection of preprocessors tailors the HP 1630 logic analyzers to specific microprocessors. Preprocessor interface modules contain circuitry that properly formats data, and they provide connection via a microprocessor socket. Software supplied with preprocessors performs inverse assembly for state displays in the selected microprocessor's mnemonics. For more details on HP's preprocessors and interface modules, please refer to page 416.

Inverse Assembly

Program activity displayed in inverse assembly can save many hours in test and debug. No more time-consuming or error-prone conversions from hex because now your measurement listings appear just as you wrote them, making them easy to compare to source-code listings.

Fast, Reliable Storage of Setups And Data

HP-IB and HP-IL are standard on the HP 1630A/D/G. These interfaces allow the logic analyzer to communicate with a variety of computers, test equipment, and peripherals. A small investment in an HP disc drive allows you to store setups and data. The HP 1630A/D/G can use the HP 9121S/D and HP 9122S/D disc drives as the mass storage device.

Hardcopy Output Simplifies Documentation

With the HP 2225A ThinkJet printer, you can quickly obtain a copy of any HP 1630A/D/G display. Instead of time-consuming hand documentation or inconvenient photography, simply push the PRINT button. In seconds, you have a complete record for your lab notebook.

HP 1630A: For Eight-bit Analysis

With its 35 channels, the HP 1630A is an economical solution for designs involving eight-bit microprocessors, most of which require 24 channels for address and data.

The HP 1630A provides a cost-effective solution and uncompromised measurement performance. In addition to state and timing analysis, the HP 1630A also offers system performance analysis with complete time-interval histogramming, glitch triggering and capture, and post-processing.

Most state analyzers offer many levels of triggering, and require you to string the levels together to trigger on the precise term of interest. The HP 1630A provides four powerful resource terms (a, b, c, d) plus the ≠ of each term, and NO STATE and ALL STATES triggering. You may assign an address, data, or status value to any combination of resource terms. Each time the HP 1630A captures a bus transaction, it automatically tests to see whether that term is to be stored, and whether it is a trigger point or a restart term. Therefore, the HP 1630A accomplishes in one level what most other analyzers require three or more levels to accomplish.

For designs requiring 16-bit microprocessors, you can easily upgrade your HP 1630A to either an HP 1630D or HP 1630G.

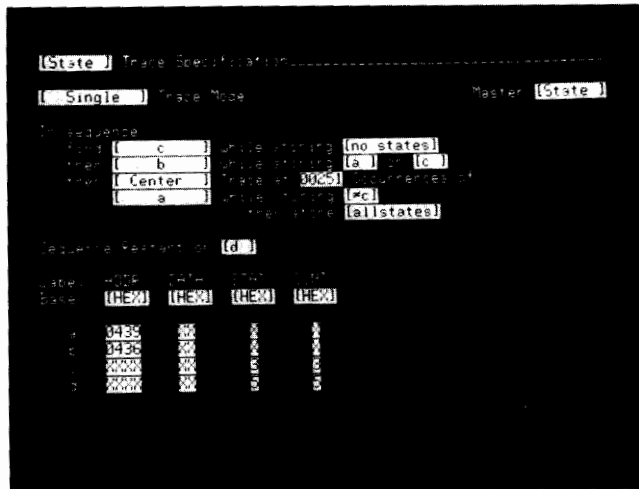

State trace specifications can be easily set up with the HP 1630A/D/G's flexible resource terms.

HP 1630D: 16-bit hardware analysis

The HP 1630D facilitates hardware analysis and debug of 16-bit microprocessors. The HP 1630A's measurement capability is also available in the HP 1630D, but with additional state and timing channels to meet the needs of 16-bit microprocessors. Total channel count is increased to 43, where eight or 16 of the channels can be used for high-speed timing analysis. Glitch triggering and capture are also increased to eight channels.

Finding hardware problems in complex digital systems requires a logic analyzer that has flexible triggering. The ability to trigger the timing analyzer from the state analyzer, or vice versa, is critical.

In addition to triggering on patterns from one to 16 channels wide, you can define a simultaneous occurrence of a pattern and a positive or negative edge to assure data registration precisely on entering or exiting the specified pattern. You can also specify a pattern and a glitch on one or more channels. You can trigger on just edges or glitches, and you can define the valid pattern duration.

X and O cursors can be moved anywhere on or off screen. You can magnify the trace around either cursor for greater visual resolution. Time intervals are displayed on-screen, independent of magnification and sample period.

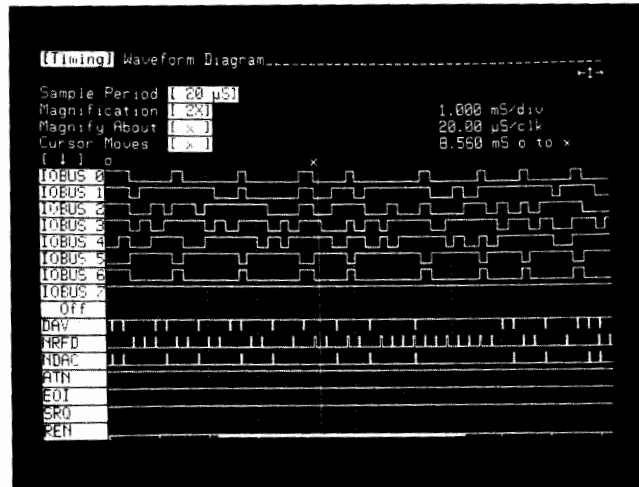

The HP 1630D captures and displays up to 16 channels of timing data with each having unique labels.

HP 1630G: 16-bit software analysis

With up to 65 channels of state analysis, eight of which can be used for high-speed timing analysis, the HP 1630G is essential for engineers developing 16-bit microprocessor-based products. To verify state execution time, a real-time clock measures the actual time between states, the total time, or the number of unstored states between states in the state listing.

After the functional design is complete, the overall performance of the system must be evaluated to ensure that the system is operating efficiently. The HP 1630G's extensive system performance analysis provides qualified histogramming that shows all acquired states of just-executed instructions; module histograms that show the execution time of a subroutine or module; intermodule linkage histograms that show software traffic patterns to determine which module or subroutine is calling another; and time-positional measurements that produce a time-varying profile of system activity where the x-axis is time and the y-axis is the number of calls to a given routine.

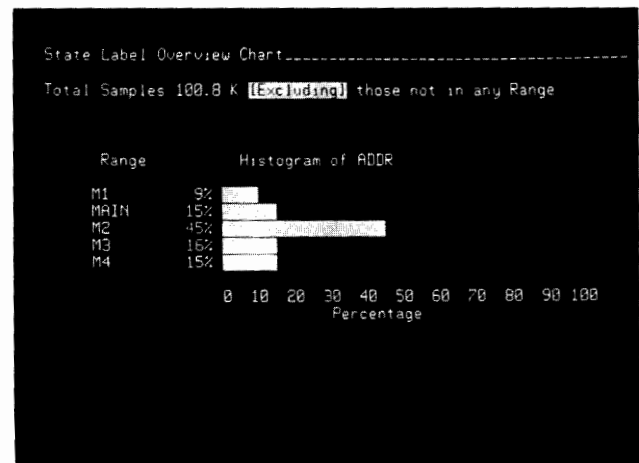

A variety of system analysis measurements assist in optimizing the performance of a microprocessor-based system.

LOGIC ANALYZERS

Preprocessors And Interface Modules

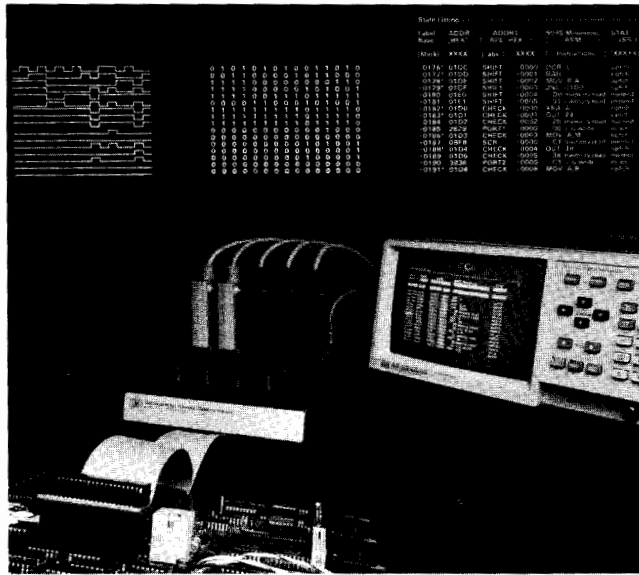

Because digital design and test involves more than just a logic analyzer, HP offers a wide selection of preprocessors and interface modules that simplify data interpretations and interconnections.

Preprocessors And Interfaces

Preprocessors and interface modules tailor the HP 1631A/D and HP 1630A/D/G logic analyzers for use with specific microprocessor systems. Preprocessors provide quick, convenient connections between target microprocessor systems and logic analyzers.

Inverse assemblers translate collected state events into the microprocessor mnemonic for easy reading and analysis. The interface software automatically sets formats for the logic analyzer to match inputs from the microprocessor under test.

General-purpose Interface Module

The HP 10269B general-purpose interface module provides the mechanical and electrical interface between HP logic analyzers and a microprocessor or bus preprocessor. Control software and inverse assemblers are provided on a 3 1/2-inch disc that is supplied with each preprocessor. This disc is compatible with the HP 9121S/D and HP 9122S/D disc drives.

Microprocessor Preprocessors

| Microprocessor | HP Preprocessor Model No. |
|-----------------|---------------------------|
| 8086/8088 | 10305B |
| 8085 | 10304B |
| 80286 | 10312B |
| 80186/80188 | 10306B |
| 6809/6809E | 10308B |
| 6800/6802 | 10307B |
| 68008 | 10310B |
| 68000/68010 | 10311B |
| Z8001 | 10301B |
| Z8002 | 10302B |
| Z80 | 10300B |
| NSC800 | 10303B |
| General purpose | 10320A |

User-definable Interfaces

For custom interfaces where no active components are required, the HP 10320A user-definable interface module provides a wire-wrapped printed-circuit board, wire-wrap pins, cable connectors, and a design manual.

For interfaces requiring active components, order both the HP 10320A and HP 10321A. The HP 10321A includes additional chip sockets, wire-wrapping pins, and an assortment of passive and active components for buffering and demultiplexing.

Connection between the HP 10320A or HP 10321A and the target system is accomplished by selecting one of the three dual in-line connectors shown below.

| Dual In-line Connector | HP Model Number |
|------------------------|-----------------|
| 40-pin | 10322A |
| 48-pin | 10323A |
| 64-pin | 10324A |

User convenience is enhanced by demultiplexing address and data signals on the interface board and with user labels in the logic analyzer. State, timing, and analog (HP 1631A/D) labels and symbols can be loaded into the logic analyzer to simplify data interpretation and reduce measurement errors.

Minicomputer Interfaces

Connecting HP logic analyzers to minicomputers is facilitated through minicomputer interfaces for three of the most popular minicomputer buses:

- HP 10275A PDP-11 UNIBUS Interface
- HP 10276A LSI Q-BUS Interface
- HP 52126A MULTIBUS Interface

The interface boards plug into the respective buses. A ribbon cable extending from the board can either be connected to the logic analyzer, or for convenience through the HP 10320A with an HP 10269B general-purpose interface.

Switches on each interface board qualify information routed to the logic analyzer or preprocessor by the selected activity type. Any combination of monitored activities may be selected for a logic analysis measurement.

| Computer Activity | HP 10275A | HP 10276A | HP 52126A |
|-------------------|-----------|-----------|-----------|
| Reads | X | X | X |
| Writes | X | X | X |
| Interrupt vectors | X | X | |
| DMA transfers | X | X | |
| Refresh activity | | X | |
| I/O transfers | | | X |

Bus Preprocessors . . . Non-intrusive Monitoring Plus Inverse Assembly

The HP 10342B bus preprocessor captures bus activity and provides inverse assembly for RS-232C/V.24, RS-449, and HP-IB buses. This bus analysis tool combines the power of a logic analyzer with the convenience of a preprocessor, yielding a truly easy-to-use instrument.

Simply select the appropriate operating modes from the front of the HP 10342B, press run on your logic analyzer, and you will obtain a listing of your bus activity. The inverse assembler configures and assigns labels to the lines used in the logic analyzer.

The HP 10342B, which is compatible with all HP logic analyzers, uses the timing analyzer to display the condition of the handshake lines when a character is received. Easy access to an oscilloscope for high-resolution timing measurements can be made by connecting any of the input signal lines to one of the three probe sockets located on the front panel of the HP 10342B.

Inverse Assembly

The HP 10342B is supplied with a 3 1/2-inch disc inverse assembler that converts data and status into standard text for easy interpretation.

In the HP-IB mode, all data, handshake, and status lines are monitored and states displayed. For RS-232C/V.24 and RS-449, data and five handshake lines are monitored and displayed. Four of the handshake lines are synchronous with the serial controller. The fifth is asynchronous with the carrier detect, but is sampled each time a character is sent to the analyzer.

Ordering Information

Please refer to page 419 for details.



HP 1630A/D/G, 1631A/D Specifications

Memory

Data acquisition: 1024 words.

Compare: 16 words, HP 1630A/D, 1631A/D; 16 or 1024 words, HP 1630G.

Memory search: all patterns within a label set may be marked or separately displayed.

State Analysis Mode

Clocks

Clock edges: for each of three ORed clocks, select either or both edges; separate edges of one clock may be selected for multiplexed modes.

Repetition rate, single phase: 25 MHz for single edge of single clock; 20 MHz for any combinations of ORed clocks and edges.

Repetition rate, multiplexed: master clock must follow slave clock by at least 10 ns and precede next slave clock by at least 50 ns.

Pulse width: ≥ 10 ns at threshold.

Setup time: ≥ 20 ns.

Hold time: zero.

Data Indexing

Resources: four terms, including the Boolean NOT of each term, ALL patterns or NO pattern; terms may be used as often as needed.

Trigger: up to four resource terms in sequence; final sequence term may use up to four ORed resource terms.

Restart: up to four ORed terms to reinitiate sequence search.

Store qualifiers: up to four ORed resource terms; may be separately defined for each term in the trigger sequence.

Occurrence: to 59 999; applies to final sequence term only.

Compare: width of analyzer by 16 words; trace until "equal to" or "not equal to" with each compare word matched to all 1024 words in memory; compare words may contain "don't care" terms.

Full compare (HP 1630G only): the compare file is the full 1024 states of memory.

Timing Analysis Mode

Clock

Range: 10 ns to 500 ms in 1, 2, 5 sequence.

Accuracy: $\pm 0.01\%$.

Glitch: min detectable glitch, 5 ns width at threshold; with glitch detection on, number of timing channels is halved.

Data Indexing

Asynchronous pattern: 20 ns to 1 ms in 1, 2, 5 sequence with accuracy $\pm 20\%$ or 15 ns, whichever is greater; glitch or edge ANDed with asynchronous pattern.

Maximum time delay: approx 2^{18} times the sample period, to 9999 s max.

Cursors: time between dual cursors (x and o) displayed to accuracy of one sample period.

Expansion: X1 to X40 in 1, 2, 4 sequence; standard display shows entire 1k memory at X1.

Analog Analysis Mode (HP 1630G)

Channel 1 And 2 (Vertical)

Probe factors: 1:1, 10:1, or 50:1 probe attenuation factors may be entered to scale the HP 1631A/D to input voltages at the probe tip

Range: 40 mV to 2.5 V full-scale

Bandwidth (-3 dB dc-coupled): dc to 50 MHz

Dc gain accuracy: $\pm 2.5\%$ of full-scale

Analog-to-digital conversion (ADC) resolution: ± 1 LSB, which is $\pm 1.6\%$ of full-scale

Transition time: ≤ 5.25 ns, 20% to 80% of full-scale

Trigger

Sources: channel 1, channel 2, or external trigger input

Edge: rising or falling edge may be selected for any source

Time Base (Horizontal)

Sample period: 5 ns to 500 ms in a 1-2-5 sequence

Range: 125 ns to 500 s full-scale (10 divisions)

Time base accuracy

Sample period: $\pm 0.01\%$

Time-interval measurement accuracy (equal rise and fall times): single-shot, ± 1.5 ns for 5 ns sample period, ± 1 sample period for sample periods of 10 ns or greater; continuous, ± 1.5 times sample period, based on 100 averages

Delay tracepoint: equals trigger plus delay; tracepoint can be delayed from 0 to about 260k sample periods after the trigger

Analog Operating Conditions

Digitizer: two channels are digitized simultaneously

Digitizing technique (real-time digitizing): all data points are digitized at equal selectable increments in time on each acquisition

Digitizing rate: selectable, 2 samples/second to 200 megasamples/second

Voltage resolution: 6 bits, 1 part in 64

Acquisition memory: 1024 samples, 6 bits/channel, 2 channels; up to 1000 samples are used for display; magnifier allows full-screen display from 1000 samples to 25 samples; the entire 1024 sample record can be accessed via HP-IB and HP-IL.

Interactive State/Timing/Analog Analysis Mode

Acquisition: analog, timing, and state data acquisition occur simultaneously

Arming: either of the three analyzers can be master while the remaining two are slave

Master state: the waveform analyzer and the timing analyzer can be simultaneously armed by the full data indexing capability of the state analyzer

Master timing: the waveform analyzer and the state analyzer can be simultaneously armed by the full data indexing capability of the timing analyzer

Master analog (HP 1631A/D): the timing analyzer and the state analyzer can be simultaneously armed by the full analog indexing capability of the waveform analyzer.

Tracepoint alignment: analog, timing, and state acquisition data can be correlated in time

Mixed display: timing channels can be displayed on the same screen with analog channels; the tracepoint and time/div are common to timing and analog in this display mode, and set by the timing analyzer

Software Performance Analysis and Overview Modes

XY Chart: all 1024 events/samples for any label group can be displayed as a chart of order of occurrence by magnitude; max and min vertical limits are user-specified.

Time interval histogram: measures time between start and stop events defined for up to eight time ranges.

Time range: min size, 1 μ s.

Display: histogram; min, max, average, and last time reading; total elapsed time; number of samples.

Resolution: for four-bit label group, 250 ns or 0.1% of reading, whichever is greater.

State histogram: sampled occurrence count of events in a label group for up to eight total user-defined ranges or values.

Max count: $2^6 - 1$.

Resolution: $\pm 0.01\%$.

Time-positional histogram (HP 1630G only): shows the number of occurrences of an event over time. A time unit is defined, and the analyzer counts the occurrences of a specified event in that time unit. The measurement can be repeated for up to 1023 equal-sized time units.

Typical accuracy of first time unit: -250 ns to $+500$ ns, $+/-0.01\%$ of specified width.

Typical accuracy of subsequent time units: $+/-0.01\%$ of specified width.

Linkage histogram (HP 1630G only): shows up to eight module links. A link is defined as a specific state followed immediately by another specific state with no intervening states. Store qualification can be used to acquire states selectively. The measurement can be started on completion of a sequence of up to three resource terms, with restart and occurrence capabilities such as state data indexing.

Max number of definable events: 8.

Max number of definable links: 8.

Max count: $2^6 - 1$.

LOGIC ANALYZERS

Specifications And Characteristics

Models 1631A/D, 1630A/D/G, 10342B

Measurement Aids

Cursors: two cursors (X and O) are provided for making voltage and time measurements on displayed waveforms. Both absolute and differential values are provided for voltage measurements. Dual cursor time measurements can be made between two points on the same waveform or between two points on different waveforms.

Cursor statistics: X to O cursor statistics are provided for continuous voltage and time measurements: max, min, mean and standard deviation. Single cursor voltage statistics can be obtained between two points on the same waveform or between two points on different waveforms (time only).

Cursor placement: both X and O cursors can be uniquely specified with respect to the tracepoint or acquisition start, by selection of channel 1 or 2, rising or falling edge, voltage level, hold or delay time.

State/Timing/Analog Inputs

State/Timing Probe Inputs

RC: 100k ohm, $\pm 2\%$ shunted by approximately 5 pF at probe body

Minimum swing: 600 mV p-p

Minimum input overdrive (above pod threshold): 250 mV or 30% of input amplitude, whichever is greater

Maximum voltage: ± 40 V, peak

Threshold voltage: -9.9 V to $+9.9$ V in 0.1 V increments

Accuracy: 2.5%, ± 120 mV

Dynamic range: ± 10 V about threshold

Analog Inputs (HP 1631A/D): channel 1, channel 2, external trigger

Input coupling: dc

Input RC: 1 megohm $\pm 2\%$, shunted by approximately 14 pF

Maximum safe input voltage: ± 40 V (dc + peak ac)

General Characteristics

Labels

Input channel labels: up to eight state, up to 16 timing, user-defined, five-character labels may be assigned bit patterns in any configuration up to 65 (HP 1630G) bits/label. Bits may be used in more than one label and need not be contiguous.

User field: all labels with four bits or less allow mnemonics to be assigned to specific patterns. Primary use is to identify such functions as read, write, opcode, etc.

Relocatable field: up to sixteen module starting locations may be specified, allowing trigger parameters to be based on module names, plus an offset value.

Time-of-day clock: a 24-hour clock prints out the time of data collection on all stored records.

Activity markers: provided in the format display for identifying active inputs.

Non-volatile memory (HP 1630G): the HP 1630G has 8k of EEPROM for internally storing a disassembler. One setup configuration of the instrument can also be stored.

HP-IB Outputs

An HP-IB connector, along with an eight-position switch, is located on the rear panel. Five positions on the switch are used to determine the address, two positions are used to determine "talk-only" for hardcopy and system controller modes.

HP-IL Outputs

An HP-IL connector is located on the rear panel for interfacing.

Programmability

All instrument configurations and acquisition data may be remotely programmed via the HP-IB (IEEE-488) or HP-IL.

Rear-panel BNC Outputs

One BNC output is located on the rear panel with a TTL output. High is ≥ 2 V into 50 ohms; low is 0.4 V into 50 ohms. The BNC can be programmed from the keyboard to provide the following signals: pulse on state tracepoint, high until state tracepoint, low until state tracepoint, high on last sequence, constant high, constant low, high on timing pattern, probe compensation (HP 1631A/D), and positive edge on analog trigger (HP 1631A/D). A second BNC is located on the rear panel to provide +5 V for the HP 10269B general-purpose probe interface.

Operating Environment

Temperature: 0° to 55° C (+32° to 131° F)

Humidity: up to 95% relative humidity at +40° C

Altitude: to 4600 m (15 000 ft)

Vibration: vibrated in three planes for 15 minutes each with 0.3 mm excursions, 5 to 55 Hz.

Weight: all models ~30 lbs (13.6 kg) net; all models ~40 lbs (18.1 kg) shipping

Power: 115/230 Vac, -22% to $+10\%$; 300 W max; 48-66 Hz

Size: 190 x 426 x 447 mm (7.5 x 16.8 x 17.6 in)

Product Support Package

HP 1630-68705: HP logic analyzer support package

HP 5957-7306: HP logic analyzer service training

Accessories Supplied

One operating manual, one 2.3 m (7.5 ft) power cord, plus the following probes:

| HP Model # | 10271A | 10272A | 10273A | 10017A |
|------------|--------|--------|--------|--------|
| 1630A | 3 | 1 | — | — |
| 1630D | 3 | 2 | — | — |
| 1630G | 3 | 1 | 3 | — |
| 1631A | 3 | 1 | — | 2 |
| 1631D | 3 | 2 | — | 2 |

HP 10342B Operating Characteristics

RS-232C (V.24)/449

Asynchronous

Data transfer rates (bits/second): 50, 75, 110, 134.5, 150, 300, 600, 1200, 1800, 2000, 2400, 3600, 4800, 7200, 9600 or 19 200

Parity: Odd, even, or none

Bits per character: 6-bit transcode

7-bit ASCII

8-bit ASCII

8-bit EBCDIC

Stop bits per character: 1, 1.5, 2

Synchronous

Data transfer rate: to 72k bits/second

Format: Bit-oriented protocols (BOP)

Synchronous data link control (SDLC)

High-level data link control (HDLC)

X.25 packet mode

Standard network access protocol (SNAP)

Hewlett-Packard data link control (HPDLC)

Burroughs data link control (BDLC)

LOGIC ANALYZERS

Specifications And Characteristics

Models 10342B, 10269B



Advanced data communication control procedure (ADCCP)
 Character-oriented protocols (COP)
 Binary synchronous communication (BSC)
 Digital data communications message protocol (DDCMP)

Selectable: 6, 7, or 8 bits per character
 Transmit clock source: data terminal equipment (DTE) or data communications equipment (DCE). Internally selectable on pc-board.

General

Inputs: Three provided: RS-232C (V.24), RS-449, and HP-IB
Outputs: Three mini-probe sockets can be connected to any of the input lines via jumper wires
Signal line loading: RS-232C/449, 1 standard load; HP-IB, 1 LS load (loading at the end of the supplied ribbon cables)
Power requirement: +5 V at 0.65 A

HP 10269B Specifications

Channel width: HP 10269B, 9 probe sockets, 65 data channels, and 3 clock channels.

Qualified clock rate: 25 MHz max.

Input

Impedance: 100 kΩ < 20 pF at interface module connector.
Maximum: ±40 Vdc.
Dynamic range: threshold ±10 V in 0.1 V increments.
Minimum clock pulse width: 10 ns.

Setup and Hold Times

Setup time: 20 ns min.
Hold time: zero.

Power

Power available for interface module: 1.0 A max at +5 Vdc, supplied by HP 1630 Logic Analyzer.

Environmental

Temperature: operating, 0° to +55° C (+32° to +131° F); non-operating, -40° to +75° C (-40° to +167° F).
Humidity: to 90% at +40° C, noncondensing.
Altitude: operating, 4600 m (15 000 ft); nonoperating, 15 300 m (50 000 ft).

Ordering Information

Logic Analyzers

| | Price |
|------------------------|--------------|
| HP 1630A (35 channels) | \$8600 |
| HP 1630D (43 channels) | \$10,630 |

| | |
|---|----------|
| HP 1630G (65 channels) | \$12,100 |
| HP 1631A (35 channels, plus two analog) | \$11,000 |
| HP 1631D (43 channels, plus two analog) | \$13,000 |

Support Products

| | |
|---|--------|
| HP 10269B general-purpose probe interface | \$460 |
| HP 10330A HP 1630A/D to HP 1631A/D upgrade kit | \$3000 |
| HP 10331A HP 1630A/D to HP 1631A/D upgrade kit, includes ROMs to update for disc-based mass storage | \$3500 |
| HP 10340A HP 1630A/D to HP 1630G upgrade kit | \$3450 |

Preprocessors/Interfaces

Microprocessor Preprocessors - note, inverse assembly is provided on 3/2-inch disc

| | |
|---------------------------------|--------|
| HP 10300B Z80 interface | \$860 |
| HP 10301B Z8001 interface | \$960 |
| HP 10302B Z8002 interface | \$960 |
| HP 10303B NSC800 interface | \$1000 |
| HP 10304B 8085 interface | \$860 |
| HP 10305B 8086/8088 interface | \$1210 |
| HP 10306B 80186/80188 interface | \$2000 |
| HP 10307B 6800/6802 interface | \$1100 |
| HP 10308B 6809/6809E interface | \$1100 |
| HP 10310B 68005 interface | \$1100 |
| HP 10311B 68000/68010 interface | \$1300 |
| HP 10312B 80286 interface | \$2000 |

Bus Preprocessors

| | |
|---|--------|
| HP 10342B bus preprocessor (RS-232C/V.24, RS-449, HP-IB) including inverse assembly | \$1200 |
|---|--------|

Minicomputer Interfaces

| | |
|---|-------|
| HP 10275A PDP-11 UNIBUS interface board | \$460 |
| HP 10276A LSI-11 Q-BUS interface board | \$510 |
| HP 52126A MULTIBUS interface board | \$350 |

User-definable Interfaces

| | |
|--|-------|
| HP 10320A user-definable interface module | \$250 |
| HP 10321A microprocessor interface kit for the HP 10320A | \$225 |

Connectors

| | |
|---|-------|
| HP 10322A 40-pin dual in-line package connector for the HP 10320A | \$400 |
| HP 10323A 48-pin dual in-line package connector for the HP 10320A | \$460 |
| HP 10324A 64-pin dual in-line package connector for the HP 10320A | \$560 |

OSCILLOSCOPES & WAVEFORM ANALYZERS

HP Digitizing Oscilloscopes

Hewlett-Packard Digitizing Oscilloscopes

The primary reason for selecting a digitizing oscilloscope over more conventional varieties is its ability to store the waveform information in a relatively inexpensive digital memory. After digital storage, you can (at your leisure) analyze the data or use it for other purposes. The process of selecting a digitizing oscilloscope is identical to that of selecting a conventional one. The major question that needs to be asked is will the instrument capture the waveform of interest, and, after storage, can it be recalled and analyzed in the desired way?

One of the fundamental parameters is the sample rate and/or bandwidth upper limit. Simplified selection criteria might be to select a product from the chart below that has a sample rate specification of at least two times the bandwidth of the waveform you wish to capture for single-shot measurements. For repetitive measurements it is necessary that the bandwidth of the instrument exceed that of the signal; how much it exceeds depends on the measurement accuracy needed.

The number of bits or resolution (dynamic range) and timing resolution are also important criteria. The particular application involved helps determine the need for

resolution. For example, if the signals being measured are digital, the corresponding parameters of interest are rise time, pulse width, overshoot, etc. Vertical resolution of 6-7 bits (approximately 1%) is all that is required. More important is the timing resolution of the instrument to obtain accurate timing measurements. If, however, the signal being measured is a complex modulated analog signal such as a floppy disc head signal or video signal, resolution in the 10-12 bit range is important because frequency domain analysis is desired in addition to time domain.

A third selection criteria is the memory length of the instrument. Memory length

When you need to . . .

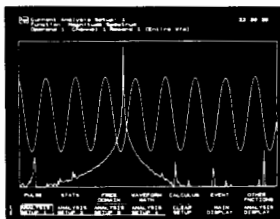

get high resolution measurements and wish to overlay displays

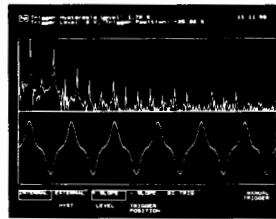

measure disc signals and do FFT's

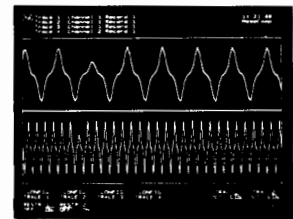

zoom the captured signal, and show where dropout trigger caught the dropout

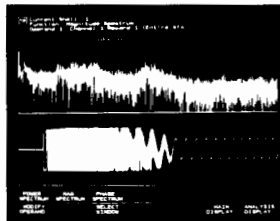

capture a transient and display its FFT

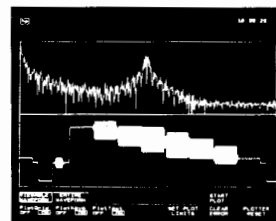

record a VIDEO line and display it in frequency and time

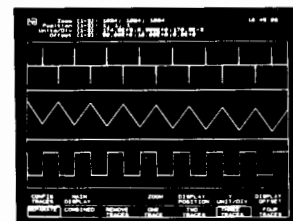

automatically differentiate and integrate the incoming signal

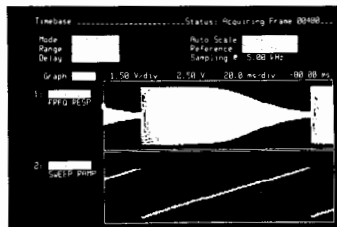

observe gain versus frequency

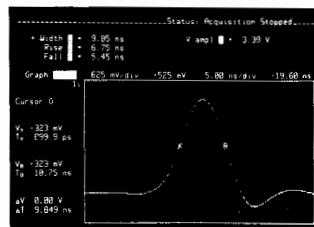

capture fast single-shot or low-repetition rate events

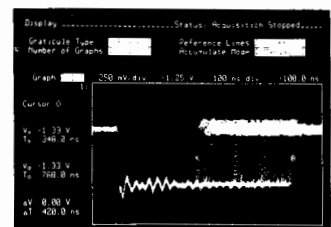

measure worst-case conditions

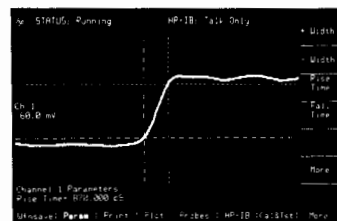

measure sub-nanosecond rise times

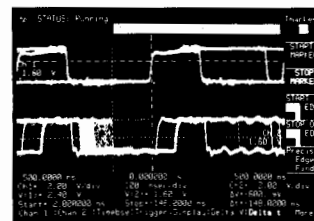

view pre-trigger information

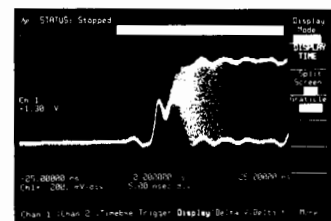

measure worst-case conditions

simply describes how long an event (how many samples) can be captured, although there are a variety of techniques to capture long waveforms or non-continuous events using burst time base or adaptive sample rate (a feature of the HP 5183T,U). In general, long events such as looking for a dropout on a sector of disc require lots of memory.

A final selection criteria is whether the capture technique is single shot or repetitive. Repetitive techniques give higher bandwidths while sacrificing the ability to capture single-shot transients.

The HP 54100A,D, HP 54110D and HP 54200A,D Digitizing Oscilloscopes are opti-

mized for (but not limited to) capturing digital signals. The HP 54100A,D has a 1 GHz bandwidth and uses a repetitive measurement technique. The HP 54110D is the same instrument but has a full-color screen. The HP 54200A,D has a 50 MHz bandwidth and captures at 200M samples/s single shot. Both instruments offer full digital word triggering capabilities.

The HP 5183T,U and HP 5180T,U are optimized for (but not limited to) transient waveform capture and resultant analysis both in the time and frequency domain. These products are characterized by exceptional resolution and dynamic range, long

memories, and built-in analysis features for complete characterization of complex modulated signals. The HP 5180T,U has a 10-MHz bandwidth and captures 10 bits single shot at 20M samples/s. The HP 5183T,U has a 1-MHz bandwidth and captures 12 bits single shot at 4M samples/s.

The chart below will help you to identify various waveform characteristics and the product that will capture your waveform and result in best value. The chart also leads you to the page where the specific product is discussed in more detail.

When you need to . . . (cont.)

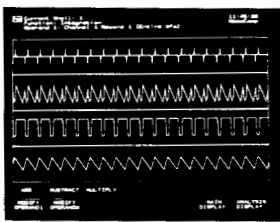

do waveform math or record and display four channels simultaneously

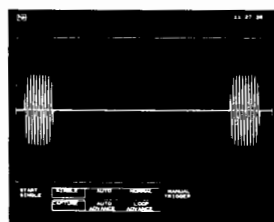

use Adaptive Sample Rate for capturing a sonar signal

HP 5183T,U Precision Digitizing Oscilloscope

- 1 MHz bandwidth
- 4M samples/s
- 12-bit resolution
- 512K memory

(see page 422)

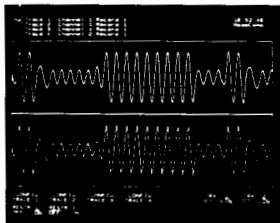

accurately reconstruct a signal when approaching the Nyquist rate

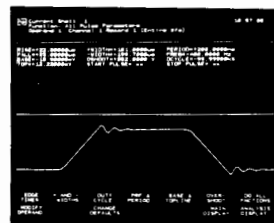

get complete pulse parametrics

HP 5180T,U Precision Digitizing Oscilloscope

- 10 MHz bandwidth
- 20 M samples/s
- 10-bit resolution
- 16K memory

(see page 422)

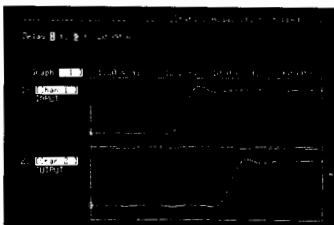

capture two channels simultaneously

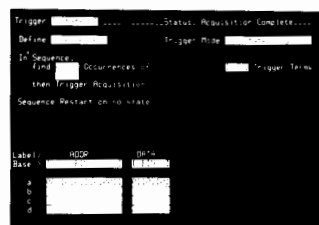

trigger an oscilloscope on a logic word or sequence of logic words

HP 54200A,D Digitizing Oscilloscope

- 50 MHz bandwidth
- 200 M samples/s
- 6-bit resolution
- 1K memory

(see page 434)

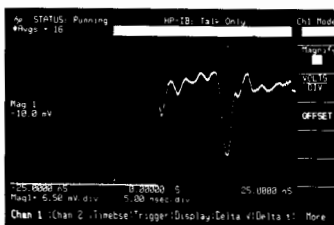

measure small reflections on a large signal

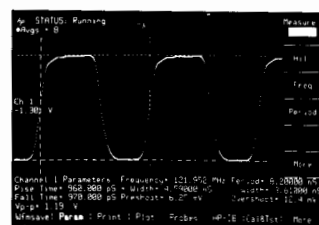

measure pulse parameters automatically

HP 54100A,D & HP 54110D Digitizing Oscilloscopes

- 1 GHz bandwidth
- 40 M samples/s
- 7-bit resolution
- 1K memory

(see page 430)



OSCILLOSCOPES & WAVEFORM ANALYZERS

Precision Digitizing Oscilloscope

Models 5183T,U & 5180T,U

- 12-bit resolution, 4 megasamples per second
- 2 differential channels, 72 dB dynamic range
- Up to 512k words memory, enhanced triggering
- Calibration to probe tip

- 10-bit resolution, 20 megasamples per second
- 2-channel operation, 60 dB dynamic range
- 16k words memory
- Post- and pre-trigger capability

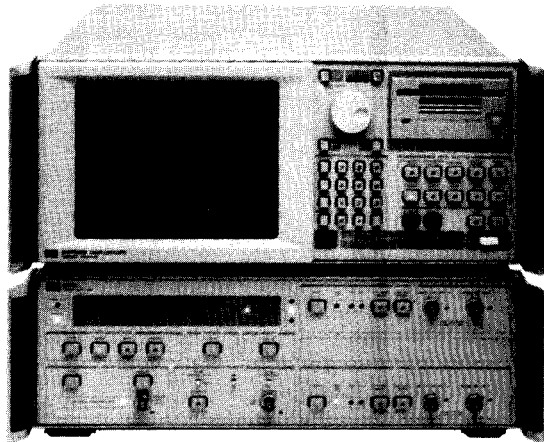

HP 5183T, 2 differential channels (HP 5183U, 4 differential channels—not shown)
(see page 425 for more information on the recorder section)

DESIGNED FOR
HP-IB
SYSTEMS



HP 5180T, 2 differential channels (HP 5180U, 4 differential channels—not shown)
(see page 426 for more information on the recorder section)

Precision Digitizing Oscilloscope

The oscilloscope has been one of the fundamental engineering tools for many decades. It is a general purpose instrument, which provides the same measurement answers as racks of instrumentation. Voltage, frequency, phase and many more parameters can be measured using an oscilloscope, but it usually involves laborious human intervention to count graticules and interpret data. Also, until the storage scope, most transient measurements could not be performed.

With the advent of digitizing oscilloscopes, the tedium involved in taking data from a waveform has been vanquished. The production line no longer needs the single, dedicated instruments, customized to take a voltage or time measurement. The digitizing scope can "capture" the waveform, and preprocess the signal to provide single number answers so that the technician or computer can make simple "go" or "no go" decisions. Waveforms can be stored enabling characterization and correlation between runs.

Accuracy unrealized by oscilloscopes is obtained by this new series of precision digitizing oscilloscopes. Procuring measurements with standard analog oscilloscopes produces approximately 30 dB of resolution; the HP 5183T,U and 5180T,U precision digitizing oscilloscopes have 72 dB and 60 dB of resolution respectively.

Built-in Analysis Package

HP precision digitizing oscilloscopes provide many analysis features. This gives the designer, technician or automatic data acquisition system the freedom to get the information they need in real time without resorting to the use of sophisticated external software to manipulate the data.

Precision Pulse Measurements

These oscilloscopes provide pulse measurements according to the IEEE-194 standard. The designers can also define their own pulse characterization environment. Risetime or falltime are provided with the touch of a finger in the analysis menu. Positive and negative

pulse widths along with duty cycle and amplitude are other statistics available. Also included at a single touch are overshoot and undershoot.

Real Time Conversion to Frequency Domain

With the introduction of the precision digitizing oscilloscope, the designer can now do some frequency domain analysis with the same instrument that does the time domain analysis. Both domains can be observed and characterized simultaneously. An FFT is performed on the time record using either a Hann, Uniform, Flat Top or user defined window. The magnitude and the phase spectrums can then be computed and displayed independently using the flexibility of the instruments.

Waveform Math and Calculus

Two waveforms can be manipulated mathematically by adding, subtracting or multiplying them together. This gives the designer the ability to experiment quickly with modulation, performing experiments on raw data before breadboarding is done. Afterwards, the data can be gathered from the actual circuit and compared against the theoretical data, and all this is accomplished without the aid of external computational equipment.

Incoming signals, or waveforms in memory can be integrated or differentiated, resulting in a waveform that lets the designer bypass special purpose hardware or computer programming. The DC drift of a circuit is easily quantifiable using integration in the analysis feature set. High frequency components of a signal are easily identifiable by integrating an incoming signal and placing it either underneath the signal, or combining the two traces into one display.

Waveform Reconstruction means Readable Displays

A common complaint when using digitizing oscilloscopes, is that the representation of the data is not always optimum. The following two figures show the same waveform; the top waveform has used the waveform reconstruction algorithm, built into the HP 5183T,U and 5180T,U, and the bottom waveform shows the data with the recon-

struction feature turned off. The top graph is also the representation that would be viewed on a storage oscilloscope.

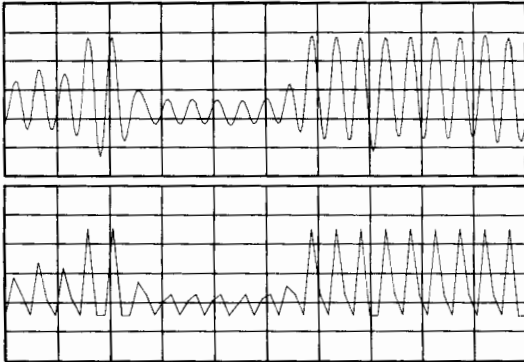

Reconstruction gives designers a truer representation of the data, allowing them to continue thinking in the analog time domain.

Flexibility in Data Presentation

These digitizing oscilloscopes are extremely friendly as bench top instruments. One to four traces can be displayed, with the designer determining what the traces consist of and how they are displayed. As with analog oscilloscopes, continuous or single-shot waveforms, incident at the inputs can be displayed. Here the similarity with analog scopes ends; the precision digitizing oscilloscope can also display waveforms stored in memory, or signals that have been processed using the analysis functions inside the scopes. The HP 5183T,U and 5180T,U can display analyzed data and the original measurement continuously as the signals are digitized. Once the waveform has been digitized, the display can be manipulated by zooming in on an interesting section, or changing the gain and offset to show more fine details.

Permanent Copies of Waveforms

The HP 5183T,U and 5180T,U provide two ways to create permanent copies of waveforms, or processed signals. With the optional internal floppy disc, up to 250 1K records can be stored. In addition to

storing captured and processed waveforms, the entire state of the instrument can be stored so that complex series of instrument setups can be recalled at a touch, leaving the designer or technician to concentrate on the device under test, and not setting up instruments. The waveforms are formatted in Hewlett-Packard's LIF directory, permitting the recorded disc to be used with any of the HP 9000 series 200 computers. In addition to storing the binary waveform, each file is time stamped.

Hardcopies of the display can also be created without the aid of a controller. This series of precision digitizing oscilloscopes can operate most HP plotters (see the data sheet for a complete list of the supported plotters).

Precision Measurements with Cursors

Two cursors are provided for making accurate measurements. A reference level, settable by the operator, is used to make voltage measurements; timing measurements are taken with respect to the trigger point. The difference between two cursors is also available for voltage, timing, frequency and decibels. Measurements using the delta cursors feature can be made on a single trace, or between two different traces being displayed.

Quick timing, frequency, voltage and power analysis can be accomplished using a single cursor. Once the cursor is placed on the desired waveform, the minimum and maximum can be determined with a single touch. A single keystroke places the cursor on the next minimum, maximum, or zero crossing which reveals waveform details without the user having to perform a tedious search.

Battery Backed up Instrument Settings

Four instrument settings may be stored, but five can be recalled. The fifth memory location contains the instrument environment that was present before the last recall, which means that a complex instrument setting won't be overwritten by accident. This gives the designer or technician the ability to determine the exact instrument settings, and then auto-sequence through five different test setups. The ram that stores the front panel settings along with the internal clock is backed up by a lithium battery.

Common Analysis Features

Pulse characterization

Rise time, fall time, baseline, topline
+ width, - width, overshoot, period
frequency and duty cycle

Voltmeter

Peak to peak, rms and period rms

Frequency Domain

Power spectrum, phase spectrum and magnitude spectrum

Available windows

Uniform, Hann and Flat Top

Waveform math

Add, subtract and multiply

Calculus

Integrate and differentiate

Frequency Counter

Average frequency and event crossing

Miscellaneous functions

Minimum hold, maximum hold and extract

Cursor functions

Waveform maximum, waveform minimum, next maximum, next minimum, next crossing, next positive crossing and next negative crossing

Display functions

X zoom, X position, Y gain, Y offset,
reconstruction and dot or line mode

Plotting

Plot waveforms with most HP plotters

Mass storage

Using 3.5 inch floppy discs, when option 035 is installed

See pages 425 - 426 for more information on the recorder sections.



OSCILLOSCOPES & WAVEFORM ANALYZERS

ATE for Waveform Measurement Applications

- ATE that Boosts Productivity
- A powerful pre-processor that produces not only raw data but complete answers
- Capture and analyze your signals automatically
- Store captured data and instrument setups digitally for instant recall of results and measurement setup at a later time
- Monitor and control your signals automatically

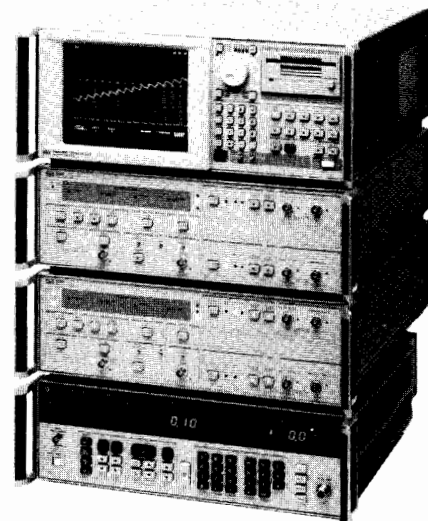

Boost Productivity by Interfacing your Digitizing Oscilloscope to an HP Technical Computer

Hewlett-Packard Digitizing Oscilloscopes are designed to enhance ATE applications and are powerful pre-processors. They provide raw measurement data or complete answers to your technical systems computer.

Hewlett-Packard Technical Computers provide complete measurement instrument control and have the power to perform analysis needed for scientific and engineering problems. The HP 5183T/U and HP 5180T/U Digitizing Oscilloscopes are compatible with all HP-IB Technical computers and are easy to program. HP technical computers provide an excellent match for these instruments. With the power of HP's PRO-BASIC or the compiled speed of PASCAL, or FORTRAN, you can easily perform many complex measurements, with minimal programming. The Series 200 computers are also optimized for instrument control, with superb I/O capabilities, and high-level language support of typically difficult interface management functions.

Configure your Waveform Measurement System with Ease

Complete automation of your waveform measurements, with a digitizing oscilloscope and a scientific computer, will boost your productivity, and minimize setup time, programming time and systems down-time. Perform high-speed data acquisition and signal processing with ease. All front panel controls of the waveform analyzer section are easily programmed via the HP-IB bus with a simple character code logically related to the front panel. Programming is further simplified by many automatic functions in the digitizing oscilloscopes and the teach learn functions, that let the computer learn the instrument's setup and later reprogram it easily.

Flexible Data Transfer Modes and Data Presentation

It is easy to read or write data to the HP 5183T/U's or the HP 5180T/U's memory. Data can be transferred in either direction over HP-IB in a variety of formats such as a fast binary format or a friendly ASCII format. Flexible data transfer means that it's easy for you to capture data, then store it on computer tape or disc. Or you can process the data using a host of time and frequency algorithms. Besides displaying the results on the analyzer's touchscreen or the computers CRT, waveforms can be plotted on a variety of HP-GL plotters.

Replace Custom Test Setups for ATE Flexibility

Replace inflexible custom-test setups with an HP Digitizing Oscilloscope and an HP Technical Computer. No need to buy or design

special hardware. For example, testing floppy disc media and drive electronics on the production-test line are easily automated using a Digitizing Oscilloscope with a Technical Computer. Results can be tailored to the application and can be displayed in familiar terms. Permanent digital storage of the measurement data and instrument setups with the floppy disc option provide confidence and accurate repeatability of measurements.

Ordering Information

HP 5183T Digitizing Oscilloscope 2 CH includes waveform analyzer, two-channel recorder section, software and interconnect cables **Price** \$23,100

Options

| | |
|---------------------------------|---------|
| Option 010 Oven Oscillator | \$1,000 |
| Option 035 Floppy Disc | \$1,200 |
| Option 301 Adaptive Sample Rate | \$1,900 |
| Option 512 512K Word Memory | \$3,800 |

HP 5183U Digitizing Oscilloscope 4 CH includes waveform analyzer, 2 two-channel recorder sections, software and interconnect cables **Price** \$34,200

Options

| | |
|---------------------------------|---------|
| Option 010 Oven Oscillator | \$1,000 |
| Option 035 Floppy Disc | \$1,200 |
| Option 301 Adaptive Sample Rate | \$3,800 |
| Option 512 512K Word Memory | \$7,600 |

HP 5180T Digitizing Oscilloscope 2CH includes waveform analyzer, two-channel recorder section, software and interconnect cables **Price** \$31,400

Option

| | |
|------------------------|---------|
| Option 035 Floppy Disc | \$1,200 |
|------------------------|---------|

HP 5180U Digitizing Oscilloscope 4CH includes waveform analyzer, 2 two-channel recorder sections, software and interconnect cables **Price** \$50,000

Option

| | |
|------------------------|---------|
| Option 035 Floppy Disc | \$1,200 |
|------------------------|---------|

Accessories

| | |
|--|-------|
| HP 1008A Testmobile | \$850 |
| Option 002 Storage shelf and lower cabinet | \$115 |

To ensure coordination of shipments and compatibility of instruments and peripherals such as printers, plotters, and disc drives, it is important that you request the appropriate Data Sheets and Ordering Guides from your local sales office. Please see page 774.

OSCILLOSCOPES & WAVEFORM ANALYZERS

Recorder Section

Model 5183T,U

425



- Differential inputs
- Adaptive Sample Rate
- Dropout trigger

- 256K word per channel optional memory
- Complete calibration to probe tip
- Configurable as two or four channels

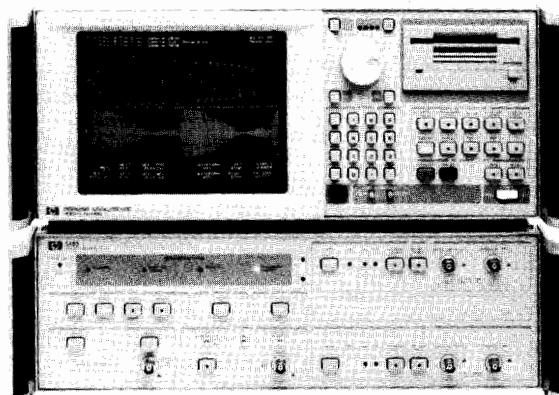

HP 5183T

Unbeatable measurement resolution & accuracy

The HP 5183T,U provides many features unavailable from any other digitizing oscilloscope. Trigger features allow data acquisition that was previously either impossible, or required complex external trigger circuitry. The optional 512K word memory allows long continuous records to be acquired. Adaptive Sample Rate gives the benefit of catching glitches that would ordinarily escape detection. The burst timebase feature allows samples to be gathered in packets of samples as small as 1 sample per trigger point. Calibration is now possible out to the probe tip providing greater absolute accuracy.

Enhanced trigger capability

As with the other Hewlett-Packard waveform recorders, post- and pre-triggering are available. This permits viewing of the trigger point, the events leading up to the trigger point, or events that occur long after the trigger has occurred. Dropout trigger provides the capability to trigger on the absence of a signal. This means that the HP 5183T,U can be used to monitor a signal source such as a power main. The recorder can be configured with auto advance to capture up to 256 1K records showing dropouts, when Option 512 is installed.

Sequential trigger is used in the following manner. A trigger event occurs at the external trigger input. Then, when a user defined delay elapses, the recorder will wait for the proper internal trigger and record in the operator defined environment. This can be used for recording signals such as a specific sector on a magnetic disc, using the index pulse as the external trigger, and the approximate delay to the proper sector.

Composite trigger allows the trigger circuitry to be or'ed together internally. Composite trigger is also available in four channel operation, with two recorder sections being used together. This allows the designer to set up triggering conditions for the channels, and whichever event occurs first, will cause synchronous triggering and sampling in all channels.

High frequency trigger will cause the recorder to trigger on a glitch, or any other high frequency component in the waveform. This is only available with the optional Adaptive Sample Rate.

Adaptive Sample Rate (ASR)

ASR provides rapid sampling only when it is needed. With this option, the recorder will sample at a slow speed until high frequency energy is detected. As this occurs, the timebase will speed up to capture the high frequency signal, returning to the slower speed when the high frequency ceases. This means that for many input signals, the memory can appear to be up to 30 Mbytes, when the optional 512K word memory is used.

Summary of Specifications*

Channel A and B inputs

Maximum sensitivity (nominal): 50 μ V
Input attenuator ranges: 100 mV to 50 V (Full scale)
Input offset voltage: \pm 200% of input attenuator range
Amplifier bandwidth (nominal): (-1 dB) 1 MHz, (-2 dB) 3 MHz with filter (10 pole), (-4 dB) 1 MHz, (-65 dB) 3 MHz
Input impedance (nominal): 1 M Ω in parallel with 45 pF
CMRR at 10 kHz: 60 dB
Damage level: \pm 5 V DC plus peak AC on 100 mV to 1 V ranges
400% of range DC plus peak AC or 2 V to 50 V ranges

Dynamic performance after calibration

Harmonic and spurious distortion: \geq 65 dBc
Effective bits: 10.0 bits

Triggering

Internal trigger: level and sensitivity selectable over input voltage range.

External trigger: level selectable over \pm 5V

Internal source: drop-out, sequential, composite, or high frequency trigger (with option 301)

Measurement control: auto, normal, single, manual trigger

Settable: level, hysteresis, position, drop out delay, delay from external trigger (sequential trigger)

Slope: \pm and bittrigger (internal only)

Trigger position: - 100% to + 6400% of record length

Timebase

Internal timebase: 4 MHz internal timebase allows sample rates between 250 ns and 1 s, in 250 ns increments

External timebase: 1, 4 or 10 MHz

External encode: DC to 2.1 MHz or 1.9 MHz to 4 MHz

Memory

Size: 65,536 words per channel, or 262,144 words per channel when Option 512 is installed

Segmentation: memory can be configured as a single 131,072 word record for channel A, or between 1 to 64 equal length records for channel A and B.

When Option 512 is installed, memory can be configured as a single 524,288 word record for channel A, or between 1 and 256 equal length records for channel A and B

ASR (Adaptive Sample Rate): Slows timebase by a 1:64 rate when high frequency energy is not present; Option 301

*See HP 5183T Recorder Section Data Sheet for more information



OSCILLOSCOPES & WAVEFORM ANALYZERS

Waveform Recorder, 20 M sa/s, 10 Bits, 16K Word Memory

Model 5180A

- 16K memory records up to 32 waveforms
- High quality samples

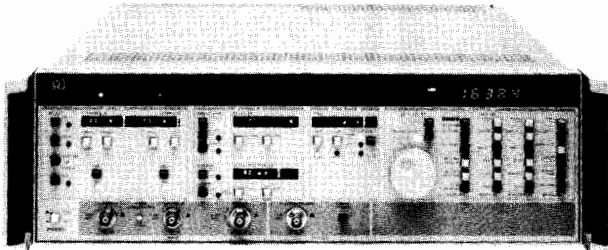

High Quality Samples Every 50 Nanoseconds

Signal processing requires high quality input data. Hewlett-Packard's 5180A Waveform Recorder digitizes and stores single-shot or repetitive signals. Voltage waveforms are digitized at sampling rates up to 20 M sa/s (50 ns/sample). Each voltage sample is encoded into a 10-bit word and stored into the memory. These precise voltages (and times) can be read from the front panel with cursors.

Excellent dynamic performance (please read HP Product Note 5180-2) means the ADC does not break up for higher input frequencies. Therefore, your signal is accurately represented for analysis (and replay; see the next pages for description of the HP 5182A Waveform Recorder/Generator).

Accurately Digitize Transients - The shape of fast attack and decay single-shot waveforms is preserved because the higher frequency components are accurately digitized. The digital trigger is precisely settable ensuring reliable triggering with no drift. Selectable hysteresis eliminates false triggering due to noise.

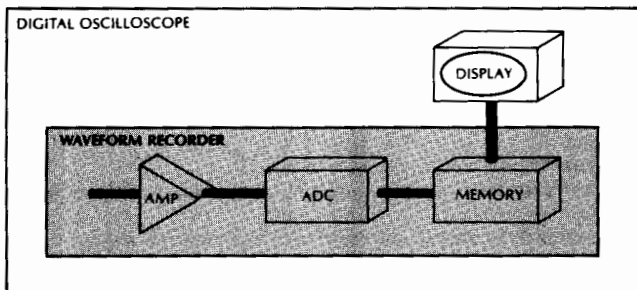

View Single-shot or Repetitive Signals Quickly

The HP 5180A controls external XYZ displays and hardcopy devices to show the contents of memory records without the need for a computer. Zoom and Gain features expand displayed waveforms horizontally or vertically to look in detail at a selected portion of a waveform. Dual trace capability puts two waveforms on an external display for visual comparison. Digital plotters and printers are controlled by HP-IB. There are two methods of transferring data from the HP 5180A to a computer for analysis: HP-IB and DMA. Direct Memory Access (DMA) can transfer data at a rate up to 1 million words/second, depending on the computer.

The HP 5180A can begin recording a signal at one sampling rate and then switch to another. The switch point is selectable. Set one timebase at a faster sample rate to record more detail, and set the other at a slower rate to conserve memory space. Two transients may be recorded simultaneously using the HP 5180A's input CHOP mode.

The HP 5180A is fully programmable over HP-IB for automated operations.

- High speed repetitive signal acquisition
- Accurately digitize transient signals
- Up to 1 million words/s. data transfer

Summary of HP 5180A Specifications*

Channel A and B Inputs

Maximum sensitivity: 200 μ V

Input attenuator range: \pm 100 mV to \pm 10 V (full scale).

Input offset voltage: \pm selected Voltage Range.

Amplifier bandwidth (-3 dB): dc to 40 MHz (dc coupling).
10 Hz to 40 MHz (ac coupling).

Input impedance (NOMINAL): 1 M Ω || 40 pF (10 V range).
1 M Ω || 35 pF (other ranges).

Damage level: \pm 12 V above 1 kHz.

Dynamic Performance (at 1 MHz)

Harmonic and spurious distortion: -50 dBc

Effective bits: 7.8

Triggering

Internal trigger: level and sensitivity selectable over input voltage range.

External trigger: level selectable over \pm 2.5 V range.

Trigger position: -100% to +9999% of memory.

Timebase

Internal timebase: 20 MHz internal timebase allows sample rates between 50 ns and 50 ms in a 1-2-5 sequence.

External timebase: external timebase signals between 1 MHz and 20 MHz may be used. Internal divide ratio between 1 and 10⁶ in a 1, 2, 5 sequence.

Memory

Size: 16,384 10-bit words.

Segmentation: memory may be divided into 1, 2, 4, 8, 16, or 32 equal-length records.

Outputs

XYZ CRT monitor outputs: X, Y deflection voltages (NOMINAL) -1 to 0V into 50 Ω . X requires 1 MHz bandwidth input; Y requires 5 MHz bandwidth input. Z voltage (NOMINAL) is 0 to 2 V into 1 k Ω (0 to 1V into 50 Ω), selectable positive or negative going blanking pulse. Z requires 1.25 MHz bandwidth input.

HP-IB: all front panel function values selectable via HP-IB. Data I/O in ASCII or binary; maximum 3 Kbyte/second rate, depending on controller. "Talk only" to HP-GL plotters available even if no controller is used.

DMA: direct memory access allows fast parallel data transfer; maximum 1M word/second, depending on controller.

General

Operating temperature: 0°C to 55°C.

Power requirements: 100/120/220/240 volts +5%, -10%; 48 to 66 Hz. Max power dissipation 500 VA.

Weight: 22 kg (48 lb) net; 25 kg (53 lb) shipping.

Size: 142 mm H x 426 mm W x 574 mm D (5 $\frac{5}{8}$ " x 16 $\frac{3}{4}$ " x 23").

Accessories

| Accessories | Price |
|---|---------|
| HP 10871B Service Kit (for HP 5180A) | \$3,600 |
| HP 10872A Parallel Interface (DMA Interface for use with HP 5180A and HP 9825/35/45 controller) | \$750 |
| HP 10873A Rack Mount Kit (for HP 5180A) | \$90 |
| HP 10874A Slide Mount Kit (for HP 5180A) | \$150 |
| HP 10875A 4.8m DMA Cable | \$180 |
| HP 10875B 1.0m DMA Cable | \$180 |
| Option 910: Additional Manual | \$170 |

*See HP 5180A Waveform Recorder Data Sheet for more information.

HP 5180A Waveform Recorder

\$18,600

OSCILLOSCOPES & WAVEFORM ANALYZERS

Waveform Measurement System

Models 5180S, 51800A

427



- Automatic measurements
- Universal measurement solutions
- Modular software
- Increase test design productivity
- Choose standard measurements
- Add custom tests

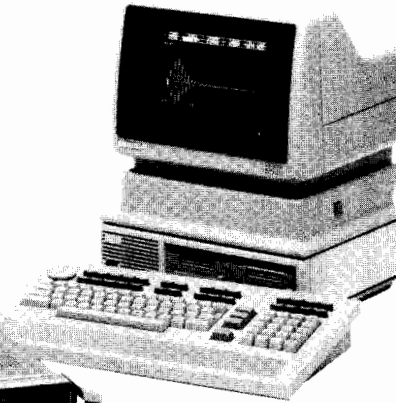
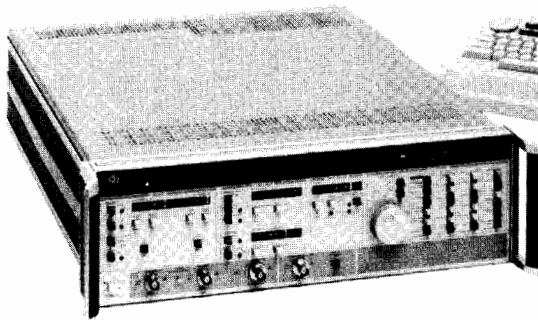

Automatic Time Domain Measurements

Make time domain measurements on single-shot or repetitive waveforms with the HP Model 51800A Waveform Measurement Library. The library is a collection of programs designed to make measurements on signals captured by the HP 5180A Waveform Recorder and HP 5182A Waveform Recorder/Generator. Instruments are controlled by sub-programs. All you do is chain them together to make the measurements you need.

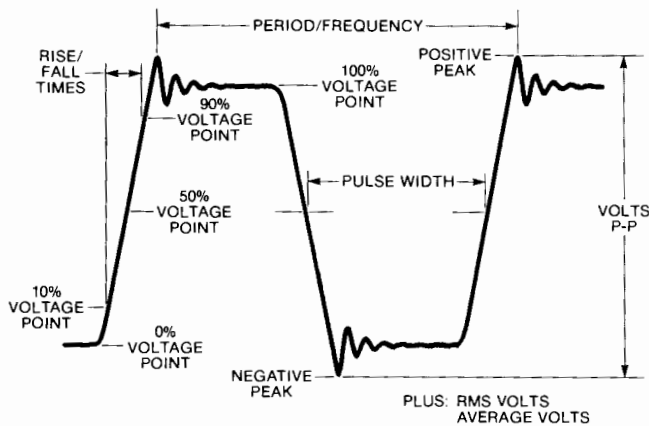

Realize the Power of a Waveform Recorder by Interfacing It to an HP Series 200 Technical Computer

Because the signal has been digitized and stored, it can now be sent to a computer for analysis and then to a disc for permanent storage. Frequency, Period, Pulse Width, Rise/Fall Time, Volts rms and Volts p-p are some of the many standard measurement programs.

Automate With HP-IB

All front-panel functions are remotely controllable with HP-IB including complete front-panel "teach" and "learn" strings. HP-IB I/O Functions: SH1, AH1, T5, L3, SR1, RL1, PP0, DC1, DT1, C0, E1

Transfer Data Fast With DMA

Waveform data can be sent to and from a computer about 100 times faster than HP-IB using Direct Memory Access (DMA). As many as 100 records (1K word) per second can be sent to an HP 9826 Technical computer. For more information, call your local sales office (see page 774) for a free copy of Application Note A/N 313-8 on using DMA with an HP 9826 Technical Computer and HP 5180A Waveform Recorder.

Reduce Programming Time by Chaining Preprogrammed Subroutines From The HP 51800A Waveform Measurement Library

No programming is required to run the Measurement Program. Start taking measurements on repetitive waveforms the day the software arrives. Assemble your own program for infrequent and non-periodic waveforms from the library subprograms. For example, frequency is measured with one subprogram, while waveform comparisons are performed by another.

Since instrument control is done by subprograms, you can concentrate on the results you need, saving the time of learning how to program the instrument. Write your own program by chaining subroutines to make measurements, store waveforms on disc, print or plot results, and perform utility functions.

Three programs help you construct your own measurement programs faster. The example MAIN program includes everything a program needs to work with a waveform recorder and the library subprograms. The two other programs are an autoloader and comment stripper.

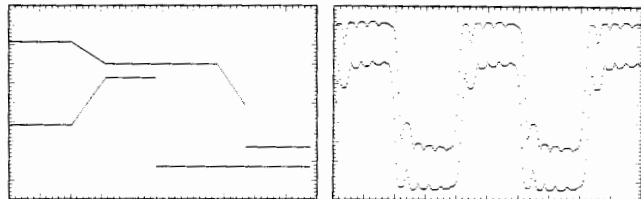

Specify Arbitrary Test Limits

Set limits like those shown above on the left from a set of endpoints that you input. Thus any arbitrary shape can be defined as the limit waveform.

You can also compare waveforms from units under test to the limits set by a known good signal as seen above on the right. This saves time by not having to measure every parameter and allows the computer to make qualitative decisions.

Ordering Information

HP 5180S Waveform Measurement System

Price

N/C

To ensure coordination of shipments and compatibility of instruments, computers and software, use the system model number when ordering the individual components, including peripherals such as printers and plotters. Obtain an HP 51800A Data Sheet and an HP 5180S Ordering Guide from your local sales office. See page 774.

HP 51800A Waveform Measurement Library

\$1,000



OSCILLOSCOPES & WAVEFORM ANALYZERS

Waveform Recorder/Generator, 20 MHz, 10 Bits, 16K Word Memory

Model 5182A



- 16K Nonvolatile waveform memory
- Fully programmable via HP-IB
- Quickly transfer waveforms to/from computer
- Easily simulate complex, real signals
- Record single-shot, replay repetitively

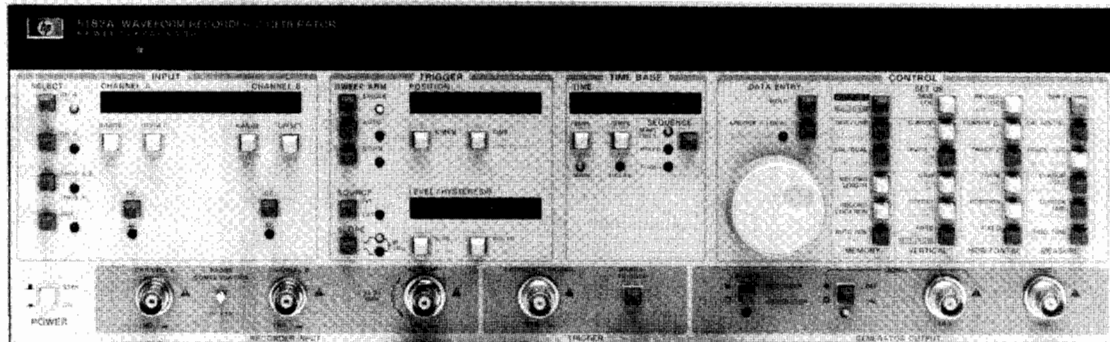

Duplicate Infrequent Waveforms Whenever You Need Them

Get an "instant replay" of your single shot signal when you buy a HP 5182A Waveform Recorder/Generator. Also create repetitive signals by playing back a single recording over and over again with no time gap between replays.

Now you can test your circuits with the actual signal you record rather than a theoretical one. "What if" testing can be done by adding a computer to modify and store the waveforms. An HP Series 200 Technical Computer, HP 9111A Graphics Tablet and an HP 5182A comprise the HP 5182S Waveform Generation System.

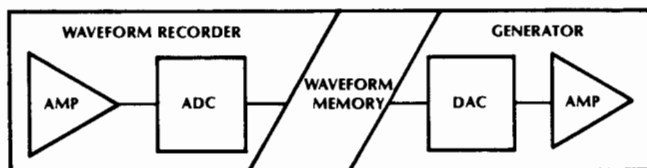

A Waveform Recorder/Generator is a High Speed Digital "Tape" Recorder

The "tape" is silicon memory. At 20M samples per second, it can store 819 μ s, 819 seconds at 20 samples per second. This digitized waveform can be played back once, or over and over again with no time gap. For example, you can accurately store 16 separate lines of video, or a single sector of data from a floppy disc drive. The video signal can generate color bar patterns to test video circuits. The disc signal can be used to test read-recovery circuits.

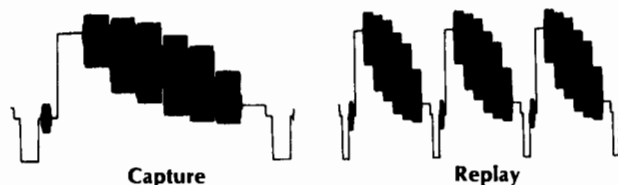

Capture and Save in the Field, Replay on the Bench

Continuous (battery backed up) waveform memory allows you to record up to 32 waveforms on site. Remove the power and carry the HP 5182A back to the lab. Now you can play them back to test your circuits or for further analysis. Attach the HP 5182A to an HP Series 200 Technical Computer and you can store the waveforms on disc, process them further and modify them for "what if" testing.

Simulate Expensive, Single-Shot Experiments

Some experiments can be very time consuming and expensive to repeat, for example: biomedical experiments, measurements of explosions, and propagation experiments such as radar and sonar. With the HP 5182A you can capture the signal accurately, when it occurs. Then, switch to generator mode, and you're ready to replay it, any time you need it.

A sync pulse is generated once per playback cycle for synchronizing other equipment.

Specifications Generator Section

For accessories and specifications of the recorder section, please see page 427.

Peak Output Voltage (for Full-Scale Waveform) Into 50 Ohms:

| Range | Vernier Range | | Vernier Step Size |
|--------|---------------|---------|-------------------|
| | Min | Max | |
| 5.12V | 52 mV | 5.12V | 40 mV |
| 512mV | 52 mV | 512 mV | 4 mV |
| 51.2mV | 5.2 mV | 51.2 mV | 0.4 mV |

Max. output voltage into open circuit: 10V (NOMINAL).

Output Offset: $-5.12V$ to $+5.11V$ in 10 mV steps into 50 ohms.

AC Performance: Noise: -65 dBc

Harmonic Distortion (DC to 1MHz): -48 dBc

Spurious (Sample Rate Related): -40 dBc TYPICAL

Output Risettime: 100ns max. (10% to 90%).

Amplifier Bandwidth (-3 dB): 10MHz (NOMINAL)

DC Performance (10 bits resolution per sample)

Differential Nonlinearity: <1 LSB (Monotonic)

Integral Nonlinearity: <3 LSB

Offset Accuracy: 100mV (20-30°C)

Absolute Accuracy: 1% of p-p full scale range (20-30°C)

Internal Trigger: Output automatically triggered when armed.

External Trigger: Slope, level, hysteresis, width, impedance, coupling and maximum input same as for Recorder. (See page 427).

Insertion Delay: 250ns max.

Time Base Modes

Main Only: Available in Single, Auto, and Normal Sweep Arm modes.

Mixed (Main, Delay): Available in Single and Normal Sweep Arm modes.

Memory Size: 16384 10-bit words; Segmentation: 1,2,4,8,16 or 32 equal length blocks. Generation: Data may be generated from any memory block. Within any one block, a portion of the waveform may be generated by setting the starting point and stopping point. An even number of points is always output.

Sync Output: Voltage: 0 to $-0.75V$ NOMINAL into 50 ohms, Pulse Width: One sample interval with the falling (first) edge active (or approximately 100 μ s when the sync pulse is past the stop position, and Sweep Arm is Single or Normal). Position: Settable from first point in the record to the last point. If the sync position is set outside the limits of the Start and Stop Position markers, the output record is extended to include the Sync Position by assigning a dc voltage (equal to the nearest Start/Stop Position marker) to the waveform between the Start/Stop Position marker and the sync position.

HP 5182 A Waveform Recorder/Generator

\$23,000

OSCILLOSCOPES & WAVEFORM ANALYZERS

Waveform Generation System

Models 5182S, 51820A

429



- Save time storing and recalling waveforms
- Quickly modify and utilize waveforms
- Save time when generating arbitrary waveforms
- No programming necessary

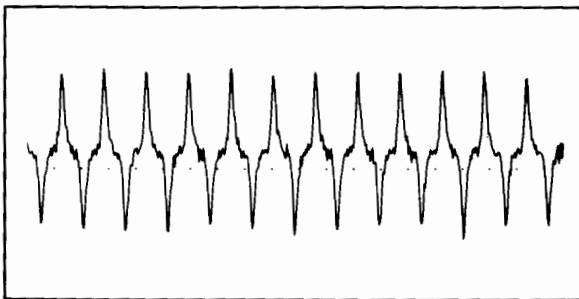
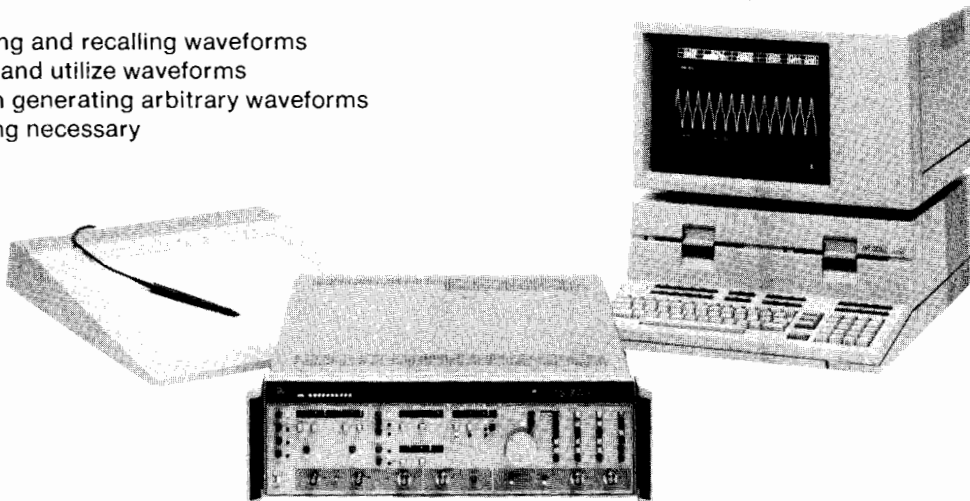

This signal was recorded from a floppy disc read head.

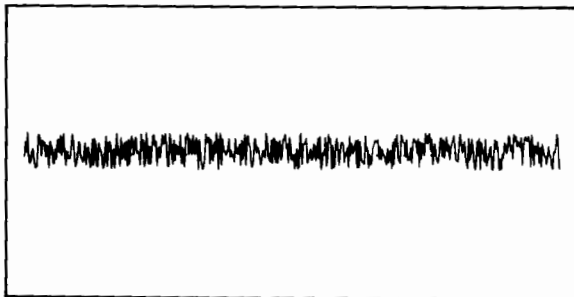

Combined with noise generated from built-in function . . .

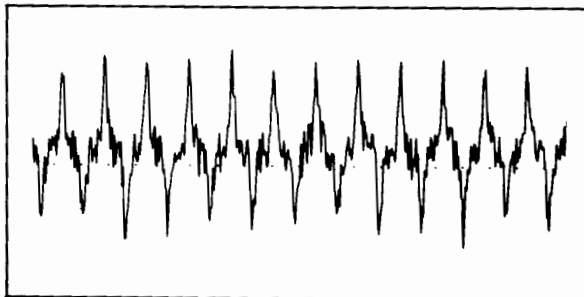

It is used to test the sensitivity of read recovery circuits.

Save Time Generating Specialized Waveforms

The HP 51820A Software is a powerful set of tools for creating specialized waveforms. Modify captured waveforms or define new ones with the HP 9111A graphics tablet (part of the HP 5182S system). Simply press a SOFTKEY to send waveforms to the HP 5182A for replay or disc for storage. Since the HP 51820A is a complete package (no programming is required), you are productive immediately.

The software is driven by a main menu and three submenus: draw, process and I/O. Because it's only two levels deep, you won't get lost in multiple levels of menus.

Waveform Capture, Modification and Playback

Modify waveforms you've captured and play them back into the device you are testing. Rather than waiting for a glitch to occur randomly, you can draw one and see the circuit response immediately.

Waveforms can also be modified by processing. Simple functions like offset and gain are built into the SOFTKEY MENU. There are also SOFTKEYS for adding or multiplying two waveforms together.

More complicated processing like calculus and convolution can be accomplished by modifying the user-equation subroutines. Four SOFTKEYS are reserved for your own equations. The Software comes with the equations programmed to generate sine waves, triangle waves, square waves and random noise.

Arbitrary Waveform Generation

There are three ways to create the waveforms you need. You can recall waveforms from the library, including sine waves, square waves, $\text{SIN}(X)/X$, Gaussian pulses, exponentials and more. You can calculate waveform samples with equations. Third, you can draw or trace waveforms with the graphics tablet. Choose the method that will get you the signal you need in the shortest time.

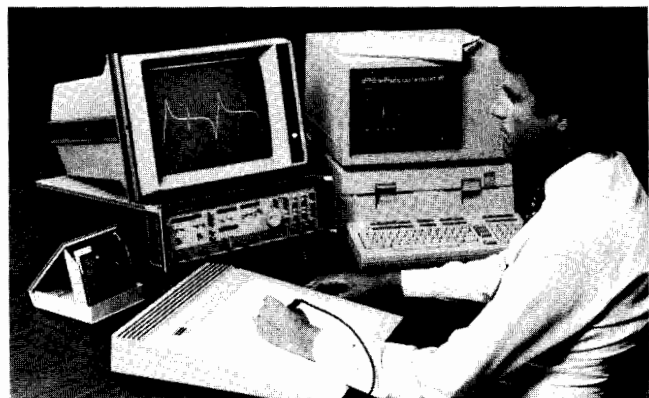

Draw, trace, or edit waveforms with friendly software and graphics tablet. Waveforms can also be generated by equations.

Ordering Information

HP 5182S Waveform Generation System

Price
N/C

To ensure coordination of shipments and compatibility of instruments, computers and software, use the system model number when ordering individual components including peripherals such as printers and plotters. Obtain HP 51820A and HP 51800A Data Sheets and a HP 5182S Ordering Guide from your local sales office. See page 774.

HP 51820A Waveform Generation Software

\$1000

OSCILLOSCOPES & WAVEFORM ANALYZERS

Digitizing Oscilloscopes

Models 54100A/D, 54110D

- 1 GHz bandwidth
- Automatic pulse parameter and time interval measurements
- Digital storage
- Available with color or monochrome display
- Flexible probing solution
- Pre-trigger viewing
- Logic triggering capability

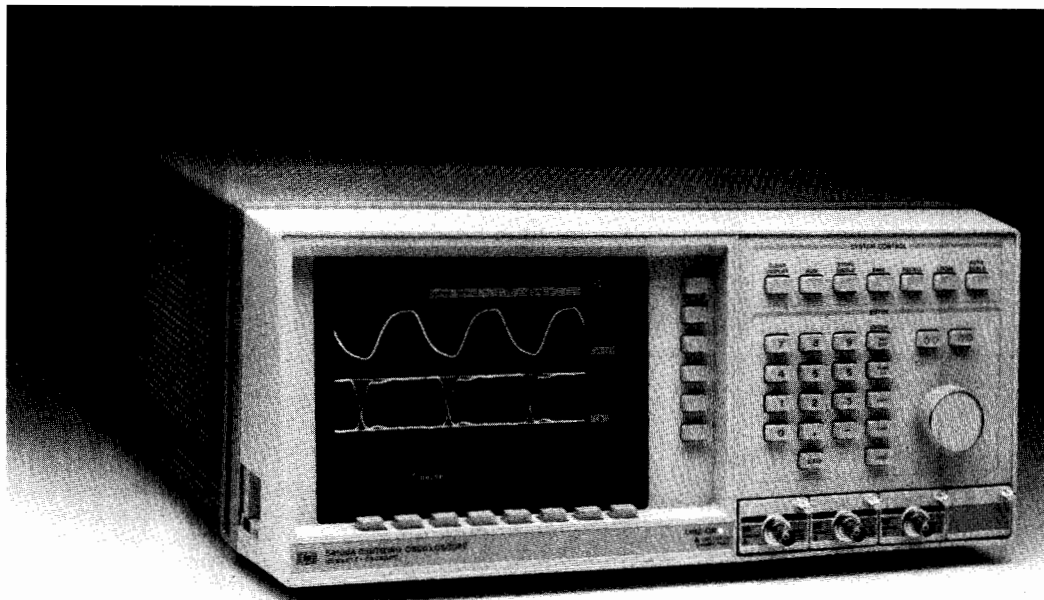

HP 54100A General-purpose Oscilloscope

From dc To ECL . . . Now In Color!

In the HP 54100A/D and HP 54110D Digitizing Oscilloscopes, Hewlett-Packard combines an innovative oscilloscope architecture with state-of-the-art technologies, creating a general-purpose oscilloscope for engineers involved with digital design and test. The HP 54100A/D and HP 54110D simplify analog time-domain measurements: they can make the measurements needed when working with the most recently-developed logic families, and it can make standard measurements faster and more accurately than conventional oscilloscopes can.

Measurement Performance for High-Speed Logic Design

- 350 ps rise time.
- Stable triggering on pulses 1 ns wide.
- 100 ps/div time base.
- 40 megasample/sec digitizing rate.

Digital Storage

- Bright, stable display of low duty-cycle signals.
- Retain waveforms as long as desired for worst-case analysis.
- Fade-free, non-blooming display.
- Store as many waveforms as needed for comparison or reference.
- Make measurements after signal is acquired. This is especially useful on single-shot signals or infrequent error conditions.
- Waveform data available over the HP-IB.
- Signal averaging for noise rejection and increased resolution.

Automatic Measurements

- Automatic edge finders save time, eliminate uncertainty, and reduce operator error in time-interval measurements.
- Measure pulse parameters automatically, without a controller.
- Markers indicate where the measurement was made, providing confidence in measurement results.

Pre-trigger Display

- Find causes of events.
- Displayed time can be any time before or after the trigger, and is not limited to one screen width before the trigger. Time intervals

can be measured with a resolution of parts per million, before and after the trigger.

Stable, Precise, Accurate Time Base

- Stability of 0.1 parts per million allows you to measure small time increments over a large time range with minimal jitter.
- With 0.002% time base linearity, 50 ps aperture jitter, and 10 ps resolution, you can measure critical timing parameters in high-speed logic circuits confidently.
- Channel-to-channel skew calibration allows you to measure time intervals accurately at the probe tips.

Triggering on Complex Digital Waveforms

- Logic pattern triggering allows you to trigger on the complex events found in typical digital systems.
- Trigger holdoff can be specified by events or by time for stable triggering on long, complex sequences of events.
- Independent trigger threshold adjustments for each channel. No need to reset the trigger level each time you switch from one trigger source to another.

Easy-to-Use

- Pressing the Auto-Scale button automatically sets up the time base, sensitivity, offset, and trigger for a stable display over a wide range of input signals.
- Save up to ten front panel setups in non-volatile memory; simplify a sequence of repeated measurements quickly.
- Instant hardcopy with either a pen plotter or a graphics printer eliminates time-consuming, expensive photography.

Simplified Programming

- Simple, logical, structured programming mnemonics make programs easy to edit, easy to understand, and easy to modify for new applications.
- Measurement-oriented, English-like mnemonics.
- Complies with the recommendations of IEEE standard 728-1982, *Recommended Practice for Code and Format Conventions*.

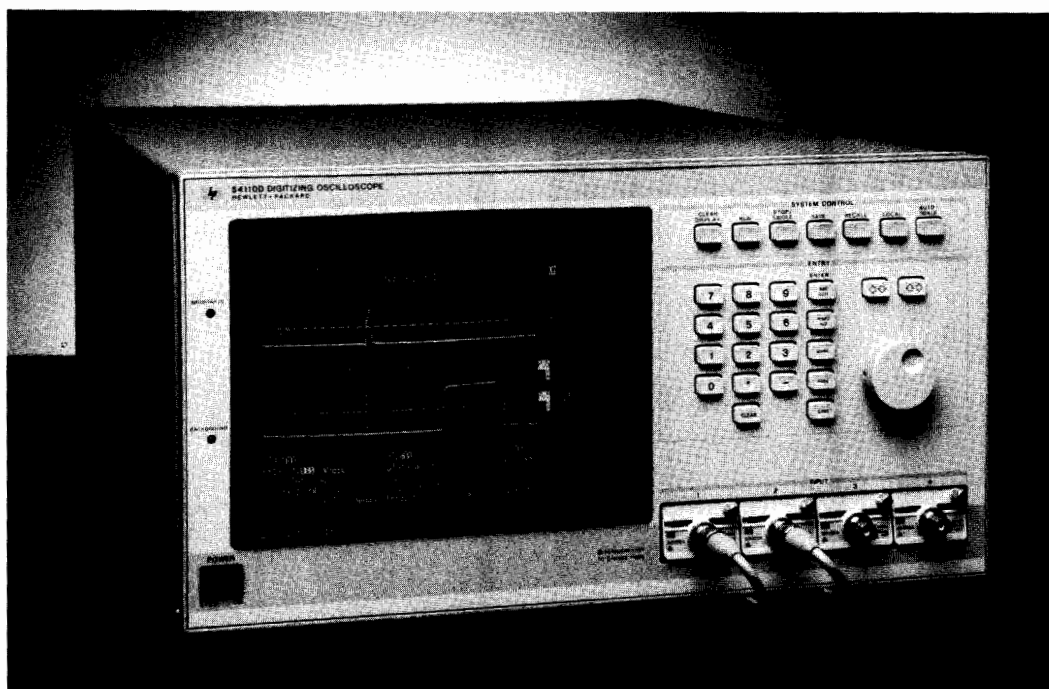

HP 54110D - Color 1 GHz Digitizing Oscilloscope

Configurable Inputs

- 50 ohm inputs and probes for a wide variety of environments, without the expense of amplifier plug-ins.
- 1 GHz active miniature probes for densely-packed, high-speed logic circuits.
- 1 megohm probes for circuits sensitive to resistive loading.
- 50 ohm BNC inputs for measurements where terminated lines are important.
- 3-megohm 100:1 probes for extended dynamic range.

The HP 54100D/54110D - Extensive Logic Triggering

The HP 54100D and HP 54110D adds the following triggering features to the basic capabilities of the HP 54100A.

Fourth Input

The HP 54100D and HP 54110D has four inputs: two are vertical channels, and two are trigger inputs. The HP 54100A has three inputs; two vertical channels and one trigger input.

Pattern Trigger

In the HP 54100D/54110D's pattern trigger mode, each of the four inputs can be selected as high, low, or don't care. In the HP 54100A, the pattern selection is limited to the three inputs. The additional bit in the pattern specification extends the usefulness of pattern triggering to more complex data buses.

Time-Qualified Pattern

In addition to triggering on entering or exiting the specified pattern, the HP 54100D/54110D can be set to trigger when a specified pattern is present for less than or greater than a specified duration, from 10 ns to 5 seconds. Applications include glitch detection, triggering on timing violations, and capturing bus hangup conditions.

Pattern With Clock

The HP 54100D/54110D can be set to trigger on an edge of either polarity on any one of the four inputs, when a specified pattern exists at the other three inputs. This is useful when it is necessary to synchronize the display to a system clock and detect a system state.

Delayed Trigger

The HP 54100D/54110D can be set up to arm on an edge on any one of its four inputs, then trigger on an edge on any other input after a specified time or after a specified number of edges. The delay time can be varied from 20 ns to 5 seconds. The edge count can be set from

1 to 99999999. The delay-by-events mode is particularly useful in systems where the data rate fluctuates or jitters, as in a disc drive. You could use the delay-by-events mode to arm on the index pulse in a disc drive, then trigger on a data pulse anywhere around the track. This stabilizes the display on a particular pulse.

Color Oscilloscope Improves User Productivity

The HP 54110D is a digitizing oscilloscope with a 1 GHz repetitive bandwidth and a full-color, high-resolution (368 vertical, 576 horizontal) display. In addition to the present feature set of the HP 54100D, the HP 54110D provides waveform math functions (i.e., A+B, A-B, Invert A, and A versus B) and semi-automatic channel-to-channel time-interval measurements. It also provides four additional memories, allowing automatic measurements on stored waveforms.

Color As A Measurement Tool

The HP 54110D can display a high-resolution, flicker-free color representation of the rapidly changing data inherent in the design and test of high-speed logic circuits and when working in high-speed data communications. With the nine-inch raster display, the user can work with as many as nine colors at one time, selecting these nine from a total of 4096 available. For convenience, a default nine-color palette was designed to provide optimum viewing for users in standard laboratory environments.

The addition of color through the HP 54110D is expected to make further productivity improvements in applications performed manually as well as those involving automated measurements. Color can be combined with intensity, line types, and modulation to create easier, faster measurements with fewer errors than with a monochrome oscilloscope.

Adding color to an instrument such as an oscilloscope aids the user in four ways:

- it helps in differentiating between overlapping, superimposed, or similar waveforms;
- it helps in associating displayed information with corresponding data or waveforms;
- it can be used to emphasize displayed information; and
- the user can choose colors and their use to compensate for color blindness, ambient conditions, or special test requirements.



OSCILLOSCOPES & WAVEFORM ANALYZERS

Digitizing Oscilloscopes

Models 54100A/D, 54110D

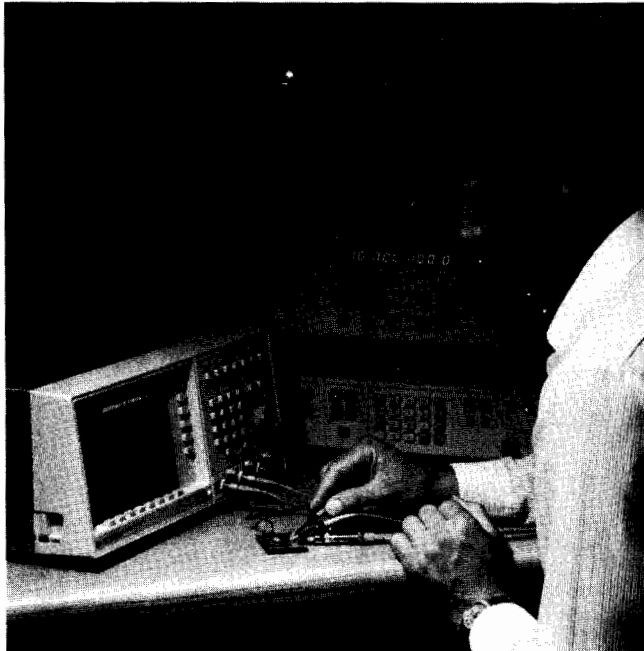

For The Digital Designer's Bench Save Time and Reduce Errors in Complex Measurement Setups

Automate a sequence of measurements on your design bench, without a controller, with the HP 54100A/D/54110D's save and recall keys, to save time and reduce errors. Step through a series of complex measurements by pressing only two keys for each new setup. Increase confidence in measurement correlation by not spending time between measurements changing setups.

Measure Pulse Parameters Automatically

The HP 54100A/D/54110D automatically locates and measures pulse features. Markers indicate where the measurement was made, so you are confident that the measurement was valid.

Store Multiple Waveforms for Comparison or Reference

With the HP 54100A/D/54110D, you can easily store waveforms by pressing a button. Because each waveform is stored exactly as it is displayed, many waveforms can be stored in each of the HP 54100A/D/54110D's two waveform storage memories. Stored waveforms are overlaid, facilitating precise visual comparisons between stored waveforms, or from a stored waveform to a live waveform. The time and voltage markers can be used for quantitative measurements on stored waveforms.*

Logic Family Presets

ECL and TTL presets scale the vertical gain, offset, and trigger levels for the selected logic family. This saves time in setting up for a measurement.

Document Results

Active as well as stored waveforms, setup conditions, and measurement results can be printed or plotted for instant, low-cost documentation. HP printers provide report-quality hardcopy for articles or printed reports at minimal cost, and without the delay of photographic reproduction.

Hold That Waveform!

When the input signal is removed, the display is retained on-screen. The display can also be frozen by pressing the Stop button. This is useful when it's difficult to hold the probe on a test point, or to see the oscilloscope screen and the test point simultaneously. You can also capture rapidly-changing or transient signals for viewing and analysis. You can use the markers to make measurements on the stored waveform; you can print or plot the captured waveform at leisure.

*The HP 54110D has four additional memories that allow the user to make automatic measurements on stored waveforms.

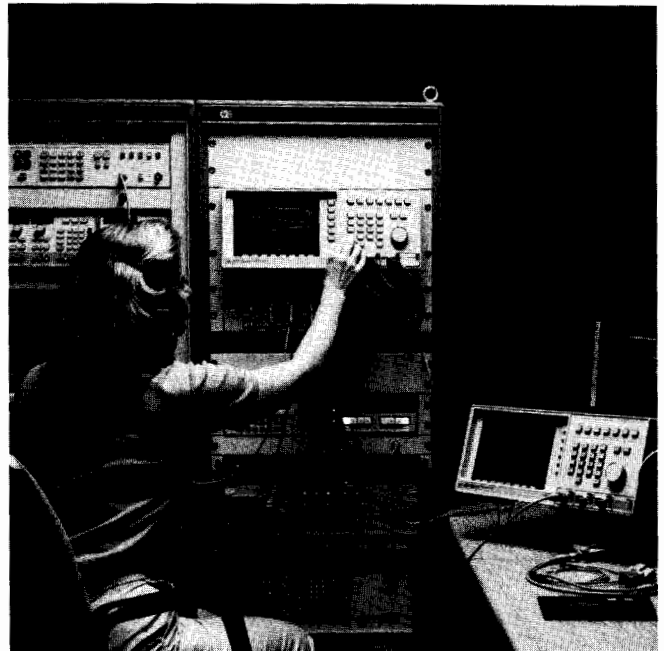

For Computer-aided Test Applications Simplified Programming

Easily understood, English-like commands with a logical structure facilitate programming with minimum documentation, and they can simplify editing or modifying programs.

Save Setups in the HP 54100A/D/54110D's Memory

Speed up tests by storing setups in local memory. At execution time, simply recall the desired setups.

Data Or Measurements—Whichever You Need

Complete waveform data are available for analysis in a variety of formats. If you need to measure pulse parameters or time intervals, the HP 54100A/D/54110D can make these measurements automatically. This simplifies your program and reduces traffic on the HP-IB.

Select the Kind of Data You Need

- Program the HP 54100A/D/54110D to acquire the data in the format you need and transmit it as a binary block quickly and efficiently.
- Use the averaged data mode when the signal is noisy and you must analyze small reflections or perturbations.
- Select the envelope mode when you need to know the waveform's minimum and maximum values over a period of time; for example, when capturing soft errors that occur only once every million or more bits.
- Use the pixel format when you need to analyze every sample acquired on an eye pattern to detect random timing.

Automate Probing

Connect up to 16 probes to your circuit, then select any one or two at a time with the HP 54300A probe multiplexer. No need to move probes between measurements. You can be confident that all of your measurements were made under identical conditions because you didn't have to shut off power to the circuit under test, disturb test points by moving probes, or restart the test program. The time saved can be a significant portion of the time required to test a complex circuit with many measurements on each of several nodes.

You can cascade HP 54300A (page 443) probe multiplexers to two levels for probing up to 128 points. You can store multiplexer setups in the HP 54300A's non-volatile memory in up to 100 lists of up to 100 steps each (3700 steps max), which you can then step through manually by pressing a button on the front panel or automatically under HP-IB control.



Specifications - HP 54100A/D, HP 54110D

Inputs

| | HP 54002A | HP 54001A | HP 54003A |
|---|-------------------|------------------------------|--|
| | 50 Ω input | 1 GHz miniature active probe | 1 M Ω input, with 10:1 probe attached |
| Maximum input voltage | 5 V rms | 20 V peak | 20 V peak |
| Coupling | dc | dc | dc |
| Input capacitance (nominal) | N/A | 2 pF | 8 pF |
| Input resistance (nominal) | 50 Ω | 10 k Ω | 1 M Ω |
| Bandwidth (-3dB) | dc to 1 GHz | dc to 1 GHz | dc to 300 MHz |
| Transition time (10% to 90%) | ≤ 350 ps | ≤ 350 ps | ≤ 1.2 ns |
| System bandwidth with HP 54100A/D, 54110D (-3 dB) | dc to 1 GHz | dc to 700 MHz | dc to 300 MHz |
| System transition time with HP 54100A/D, 54110D (10% to 90%) | ≤ 350 ps | ≤ 400 ps | ≤ 1.2 ns |
| Division ratio | 1:1 | 10:1 $\pm 3\%$ | 10:1 $\pm 3\%$ |

Vertical (Voltage)

The following apply when the HP 54100A/D is used with the HP 54002A 50 ohm input pod.

Bandwidth (-3 dB): dc to 1 GHz; these specifications apply over ambient temperature range of +15° C to +35° C.

Transition time (10% to 90%): ≤ 350 ps

Deflection factor (full-scale=8 divisions): 10 mV/div to 1 V/div in 1-2-5 steps.

DC accuracy, single voltage marker: $\pm 3\%$ of full-scale $\pm 2\%$ of offset; when driven from a 50 ohm source.

DC delta voltage accuracy using voltage markers on the same channel: $\pm 1\%$ of full-scale $\pm 3\%$ of reading, when driven from a 50 ohm source.

DC Offset

Range: $\pm 1.5 \times$ full-scale (referenced to center screen).

Magnifier: expands displayed signal vertically from 1 to 16 times; adjustable in 0.5% steps.

Inputs: two inputs, configurable with HP 54000-series pods.

Horizontal (Time)

Deflection Factor (full-scale is 10 divisions): 100 ps/div to 1 sec/div.

Delay (Time Offset)

Pre-trigger range: up to -200 ms or -10 divisions, whichever is greater.

Post-trigger range: up to +1 second or +10 divisions, whichever is greater.

Time Base Accuracy

Single-channel: (100 ps $\pm 2 \times 10^{-5} \times$ delta T reading)

Channel-to-channel: (200 ps $\pm 2 \times 10^{-5} \times$ delta T reading)

RMS Jitter: (50 ps + $5 \times 10^{-7} \times$ delay setting)

Trigger

The following apply when the HP 54100A/D, 54100D is used with the HP 54002A 50 ohm input pod.

| Trigger Source | Vertical Channel 1 or 2 | Trigger Input 3 (HP 54100D, 54110D: Trig In 3 or 4) |
|----------------------------|---------------------------|---|
| Trigger level range | $\pm 2 \times$ full-scale | ± 2 V |
| Trigger sensitivity | | |
| dc to 100 MHz | 0.12 \times full-scale | 40 mV |
| 100 to 500 MHz | 0.24 \times full-scale | 50 mV |

Trigger Source: channel 1, channel 2, trigger 3 input (HP 54100D/54110D, trigger 4 input).

Trigger 3 Input (HP 54100D, 54110D, trigger 4 input): configurable with HP 54000-series pods.

Operating Characteristics

Digitizer

Resolution: 7 bits (1 part in 128).

Effective resolution can be extended up to approx 10 bits by using magnification and averaging.

Digitizing rate: up to 40 megasamples/s. Vertical

Input protection: a relay opens when applied voltage exceeds rated input for input pod in use (see "Inputs").

Horizontal

Delay between channels: difference in delay between channels can be nulled out in 10 ps steps up to 10 ns to compensate for differences in input cables or probe length.

Reference location: the reference point can be located at the left edge, center, or right edge of the display. The reference point is that point where the time is offset from the trigger by the delay time.

Display

Data display resolution: 500 points horizontally by 256 points vertically.

Data display formats

Split screen: each channel display is four divisions high.

Full screen: the 2 channels are overlaid. Each channel display is eight div high.

Display modes

Variable persistence: the time that each data point is retained on the display can be varied from 200 ms to 10 seconds, or it can be displayed indefinitely.

Averaging: the number of averages can be varied from 1 to 2048 in powers of 2. On each acquisition, 1/n times the new data is added to (n-1)/n of the previous value at each time coordinate. Averaging operates continuously; the average does not converge to a final value after n acquisitions.

Graticules: full grid, axes with tic marks, or frame with tic marks.

Display colors (HP 54110D): a default color selection is set up in the instrument. Different colors are used for display background, channel 1/ function 1, channel 2/ function 2, background and high-lighted text, advisories, markers, and memories. If desired, the user may change the colors used from the front panel or over the HP-IB.

Ordering Information

HP 54100A

HP 54100D

HP 54110D color display

Price

\$17,600

\$19,300

\$21,000

Input Pods And Probes

HP 54001A 1 GHz miniature active probe pod

\$750

HP 54002A 50 ohm BNC input pod

\$130

HP 54003A 1-megohm, 10:1 probe pod

\$550

OSCILLOSCOPES & WAVEFORM ANALYZERS

200 Megasample/Second Digitizing Oscilloscope

Model 54200A/D

- Dual 200 megasample/second digitizers, allowing 50 MHz single-shot capture
- Pre-trigger viewing
- Continuously updated, automatic waveform measurements
- Up to 27 channels of state triggering
- Infinite variable persistence
- Instant hardcopy output

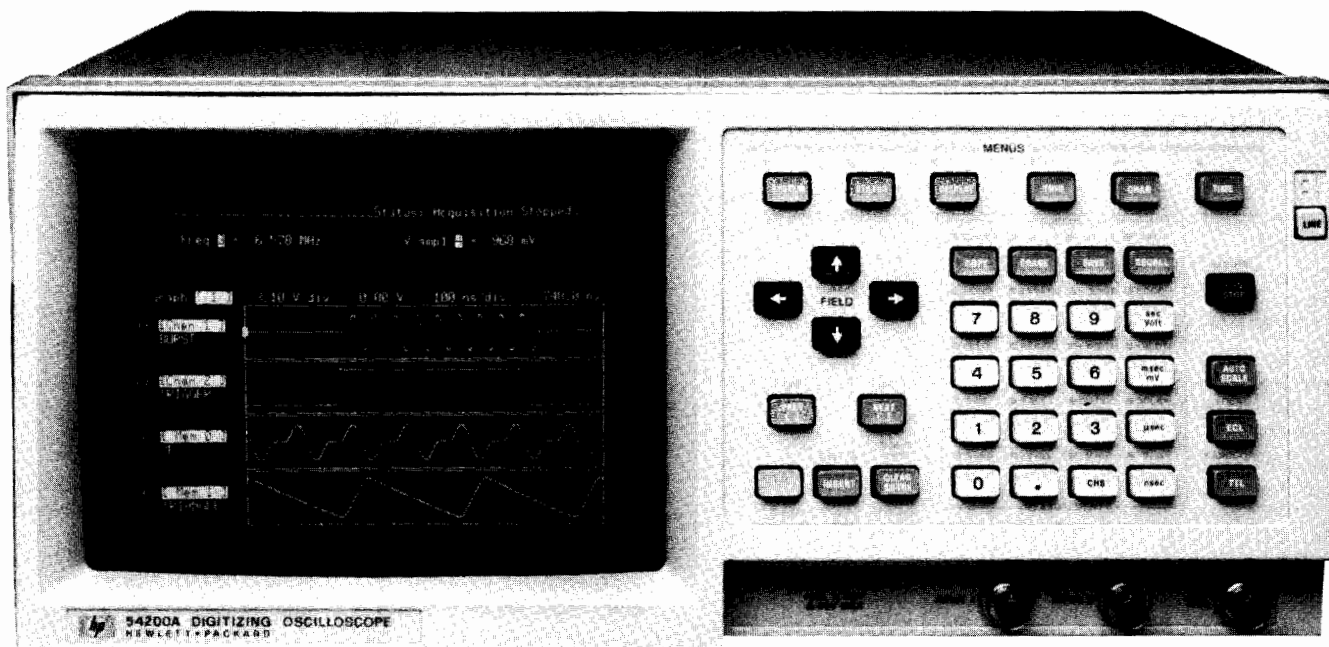

HP 54200A

Capture And Analyze Single-shot And Repetitive Waveforms

The second in HP's new digitizing oscilloscope product line, the HP 54200A/D is a fully programmable, 200 megasample/second digitizing oscilloscope, ideal for capturing high-speed single-shot events.

The HP 54200A/D is particularly useful to designers of digital and analog systems who must deal with transient fault conditions. Transients as narrow as 10 nanoseconds can be captured easily.

With its 50 MHz bandwidth and a variety of automatic measurement capabilities, the HP 54200A/D is also useful as a general-purpose oscilloscope, and is designed to be a friendly, powerful addition to the designer's electronic bench as well as to ATE systems.

The HP 54200D model provides sophisticated triggering modes similar to those available in logic analyzers. Both the HP 54200A and HP 54200D are priced below comparable digitizing oscilloscopes and waveform analyzers. They offer greater performance than analog storage oscilloscopes that are similarly priced.

High Performance

The HP 54200A/D's dual 200 megasample/second digitizers and pre-trigger storage capability deliver exceptional waveform acquisition performance on single-shot and repetitive waveforms.

Convenient Operation Simplifies Circuit Problems

The HP 54200A/D simplifies waveform capture and analysis with logic presets, dc offsets, display selections, automatic measurements, time windowing, time/voltage cursors, and instant hardcopy output. These features equip the engineer with the tools needed to pinpoint and analyze difficult circuit problems.

Versatility In Both Benchtop And ATE Systems

High-speed data acquisition, coupled with automatic waveform scaling, automatic measurements, and full programmability can improve the productivity of bench-top users and increase throughput in automatic test system applications.

The HP 54200D model adds the powerful and flexible triggering capability of logic analyzers to the analog triggering of oscilloscopes. State patterns of up to 27 bits wide, with up to four definable sequence terms may be used as trigger qualification.

The HP 54200D also incorporates bit fault modes that trigger the oscilloscope when an extra bit is detected in a serial data stream. With the complex triggering capability of logic analyzers and the powerful waveform capture and analysis capability of digitizing oscilloscopes, the HP 54200D is a versatile debugging tool for engineers involved in system design and integration.



With the HP 54200A/D, you can easily capture, analyze, and document transient events that cause problems.

Serving The Needs Of Design Engineers Product Development

The HP 54200A/D's dual high-speed digitizers, digital storage, and pre-trigger features enable an engineer to capture those hard-to-find circuit turn-on problems.

Instrument setups can be accomplished in seconds using Auto-Scale, save/recall memories, and ECL and TTL presets. Accumulate, envelope, and average modes are used to show worst-case signal variations and signals buried in noise. The HP 54200D's state triggering capability allows the position of the acquisition window to be based on microprocessor activity and eases system integration tasks. Documentation needs are fulfilled with hardcopy output directly to a printer or plotter.

Product Characterization

The tedious and time-consuming task of prototype characterization and documentation using an analog scope can now be replaced with a semiautomatic or fully-automatic test system.

When design changes are made, they can be evaluated quickly and efficiently, thereby minimizing project delays and cost overruns.

More complete characterizations are possible since the task is automated and can be run 24 hours a day when necessary.



The HP 54200A/D's two 200 megasample/second A/D converters provide two-channel simultaneous acquisition without sacrificing sample rate.

Providing High Throughput In Production Test Areas Semiautomated Test

The HP 54200A/D's ease-of-use and built-in automatic features make it equally at home in testing applications where computer control is not required but measurement throughput and repeatability are important. Auto-Scale, setup memories, and logic presets provide the use with multiple methods to acquire and display waveforms quickly.

Twelve built-in automatic measurements take operator error out of the picture and provide fast, repeatable measurements every time.

Documentation requirements can also be fulfilled without the use of a computer since the HP 54200A/D can output acquired waveforms and measurement results directly to HP-GL printers and plotters.

Automated Test Systems

Throughput is a major consideration when choosing equipment for automated testing. The HP 54200A/D's high-speed A/Ds capture waveform data in a single sweep, eliminating time-consuming repetitive sampling methods that take forever on fast, low duty-cycle signals. The HP 54200A/D can compute waveform measurements internally, eliminating the need to transfer raw waveform data to the controller. This simplifies program writing and reduces data transfer and computation times.

OSCILLOSCOPES & WAVEFORM ANALYZERS

200 Megasample/Second Digitizing Oscilloscope

Model 54200A/D

The HP 54200D: Flexible Triggering For Today's Digital Systems

State Trigger Inputs

The HP 54200D model uses three HP 10271A ten-channel probes to input 27 channels of state trigger and three clocks. These inputs can be used in a multiplexed configuration on microprocessor systems with multiplexed buses.

Normal

The normal mode provides state triggering that is similar to that in the HP 1630A/D logic analyzer. Up to four unique state patterns of up to 27 bits each may be qualified on in a user-defined sequence. The last state can be an ORed or ANDed combination of up to four state patterns and can be specified to occur from one to 59 999 times before satisfying a complete state sequence. Up to four ORed sequence restart terms allow you to restart the complete sequence if the restart term occurs before the proper sequence is completed. Upon satisfying a sequence specification, the HP 54200D can be defined to trigger immediately, or trigger on the next valid analog trigger.

Qualified

The qualified mode enables the user to perform digital delay triggering, which is very useful for triggering on a serial bit string. One application involves triggering on the nth sector pulse on a disc after an index pulse. Simply qualify on the index pulse, and define the sequence to trigger after the nth occurrence of any state.

Missing Bit

The HP 54200D can detect a missing bit in a string of serial data, and trigger the acquisition. A reference clock provided by the user is compared with the input serial data. There must be one data bit transition in the serial data within each reference clock cycle. If the data bit is missing, the HP 54200D detects it and triggers the acquisition on the next reference clock edge. When in this mode, the last state in the sequence specification can be defined to search for up to 59 999 missing bits.

Extra Bit

The extra bit mode operates similarly to the missing bit mode. If more than one data bit transition occurs within any reference clock cycle, the HP 54200D detects it and triggers the acquisition according to the state sequence specification.

Precise Triggering In Microprocessor-based Systems

With the increased use of microprocessors in today's electronic products, using oscilloscopes as general-purpose troubleshooting tools has become an increasingly difficult or impossible task. The limited triggering capability of oscilloscopes has prevented their use in applications where digital buses (i.e., address, data, and control) must be used as trigger qualification. One solution has been to use a logic analyzer to qualify on a pattern or sequence of patterns, and then trigger an oscilloscope. This method is quite cumbersome and in many cases does not work because the event has already occurred by the time the oscilloscope triggers.

The HP 54200D overcomes these problems by combining the state triggering capability of logic analyzers with a high-speed digitizing oscilloscope to provide a tool that excels in digital/digital and digital/analog circuit and system measurement environment.

Complete Documentation With Ease

When your measurement needs include hardcopy output for reports, lab notebooks, presentations, or records, the HP 2225A ThinkJet printer provides high contrast paper copies in seconds, at the press of a button. With the same resolution as the HP 54200A/D's display, you get a perfect picture every time. The HP 54200A/D can output waveforms as well as instrument setup information.

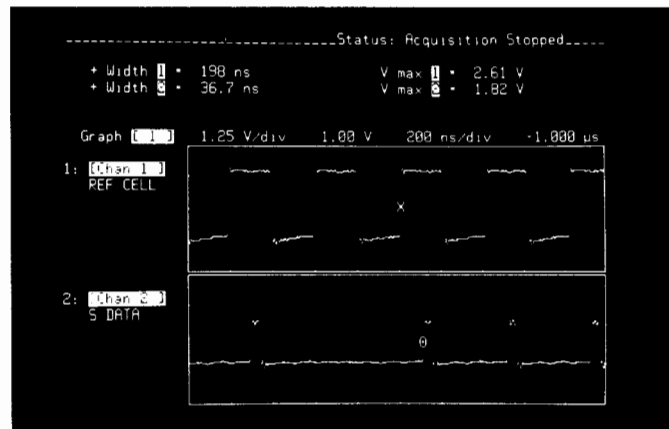

The missing-bit mode allows circuit faults to be captured quickly

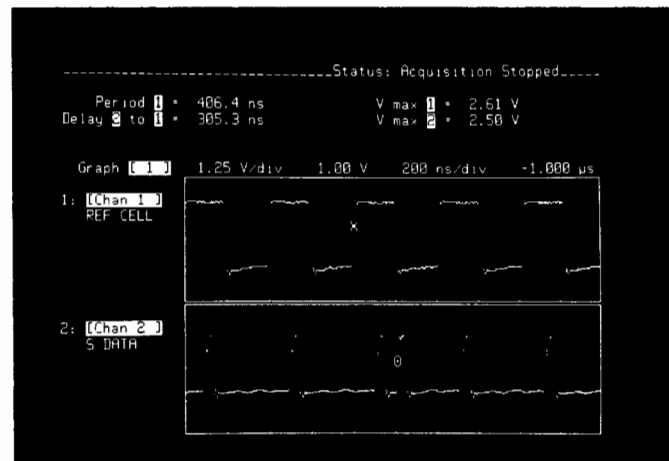

The extra-bit mode makes finding elusive glitches a snap.

Specifications - HP 54200A/D

Channels 1 And 2 (Vertical)

Bandwidth (-3 dB)

dc-coupled: dc to 50 MHz
ac-coupled: 10 Hz to 50 MHz

Transition time: ≤ 7 ns (10% to 90%)

Range: 40 mV to 40 V full-scale, calibrated with two-digit resolution

Gain accuracy: $\pm 2\%$ of full-scale (applies within $\pm 10^\circ\text{C}$ of auto-calibration temperature)

Analog-to-digital conversion (ADC)

Accuracy: $\pm 1.6\%$ of full-scale (can be improved with averaging)

Dc offset accuracy

| Channel range | Offset accuracy |
|-----------------|---------------------------------|
| 40 mV to 390 mV | $\pm 1\%$ of offset ± 5 mV |
| 400 mV to 40 V | $\pm 1\%$ of offset ± 50 mV |

Dc offset range/resolution

| Channel range | Offset range | Offset resolution |
|-----------------|--------------|-------------------|
| 40 mV to 390 mV | ± 2 V | Approx. 1.2 mV |
| 400 mV to 40 V | ± 20 V | Approx. 12 mV |

Voltage Measurement Accuracy (dc)

Single cursor (X to O): gain accuracy + ADC accuracy + offset accuracy

Dual cursor: gain accuracy + 2 (ADC accuracy) (X to O measurements on same waveform)

Input Coupling: ac or dc

Input RC: 1 megohm $\pm 2\%$, shunted by approx. 14 pF

Maximum Input Without Distortion (maximum input voltage without distortion for frequencies > 20 MHz is 20 V peak-to-peak)

| Channel range | Input (dc + peak ac) |
|-----------------|----------------------|
| 40 mV to 390 mV | ± 2 V |
| 400 mV to 40 V | ± 20 V |

Time Base (Horizontal)

Range: 50 ns to 10 s full-scale (10 divisions), in a 1-2-5 sequence

Time Base Accuracy

Single and dual cursors: ± 2 ns or $\pm 0.2\%$ of time range, whichever is greater (dual cursor specifications apply for measurements made on the same or simultaneously-acquired waveforms)

Delay (Time Offset)

Pre/post Trigger Range:

| Time range | Pre-trigger range | Post-trigger range |
|--------------------|-------------------------|----------------------------|
| 50 ns to 5 μ s | Up to 5 μ s | Up to 1 ms |
| 10 μ s to 10 s | Up to 1 screen diameter | Up to 260 screen diameters |

Pre/post Trigger Resolution: adjustable in steps of 0.1 (coarse) and 0.004 (fine) screen diameters, or the least significant digit, whichever is greater

Accuracy: ± 1 sample clock period

Trigger (Analog)

Sources: channel 1, channel 2, or external trigger input

Sensitivity: $\frac{1}{8}$ of full-scale

Level Range/Resolution:

| Full-scale range | Trigger range | Trigger resolution |
|------------------|---------------|--------------------|
| 40 mV to 390 mV | ± 2 V | Approx. 2.4 mV |
| 400 mV to 40 V | ± 20 V | Approx. 24 mV |

Level Accuracy:

| Trigger range | Level accuracy |
|-----------------|---------------------|
| 40 mV to 390 mV | $\pm 2\% \pm 5$ mV |
| 400 mV to 40 V | $\pm 2\% \pm 50$ mV |

External Trigger Input: bandwidth, transition time, input coupling, input RC, input range, maximum safe input voltage - same as channel 1 and 2 inputs

HP 54200D Only

State Trigger Mode

Clock Repetition Rate

Single phase - 25 MHz maximum with single clock and single edge specified; 20 MHz maximum with any ORed combination of clocks and edges

Multiplexed - master-slave clock timing; master clock must follow slave clock by at least 10 ns and precede next slave clock by 50 ns or more

Clock Pulse Width: ≥ 20 ns at threshold

Setup Time: ≥ 20 ns, the time data must be present prior to the clock transition

Hold Time: 0 seconds, the time data must be present after the clock transition

Operating Characteristics - HP 54200A/D

Digitizer

Digitizing Technique: real-time digitizing; all data points are acquired on a single acquisition

Digitizing Rate: 100 samples/second to 200 megasamples/second (determined by time base range setting)

Resolution: 6 bits; 1 part in 64; effective resolution may be increased by using data filtering/averaging

Acquisition Record Length: 1001 samples (1000 intervals)

Channel 1 And 2 Inputs (Vertical)

Probe Factors: 1:1, 2:1, 5:1, 10:1, 20:1, 50:1, or 100:1 probe may be entered to scale the HP 54200A/D to represent voltages as seen by the probe tips

Channel Isolation: 50 dB from dc to 50 MHz

Timebase (Horizontal)

Expand Mode: X and O cursors can be used to window an area of interest and expand it to full screen

Reference Location: the reference point can be positioned at the left edge, center, or right edge of the display. The reference point is that point where the time is offset from the trigger point by the delay time

Trigger (Analog)

Level Range

Track Mode: maintains the same voltage range as the internal trigger source selected (tracks either channel 1 or 2)

Adjust Mode: vertical scaling of the trigger display channel may be adjusted within specified ranges independent of the internal channels (1 and 2)

vertical scaling

| Internal channel 1 or 2 range | Trigger channel adjust range |
|-------------------------------|------------------------------|
| < 390 mV | 40 mV to 4.0 V |
| ≥ 400 mV | 400 mV to 40 V |

Edge: positive or negative slope may be selected for any source

Ordering Information

HP 54200A digitizing oscilloscope

HP 54200D digitizing oscilloscope, with state triggering

Price

\$7860

\$9800



OSCILLOSCOPES & WAVEFORM ANALYZERS

Oscilloscope Measurement System

Models 1980B, 1965A, 19860A, 1950A, 19800/19801

- Fully HP-IB programmable
- Digital waveform storage
- Gated universal counter
- Application software
- Front panel calibration
- Auto-scope automatically scales waveforms
- CRT test for operator instructions
- Two-channel expansion module

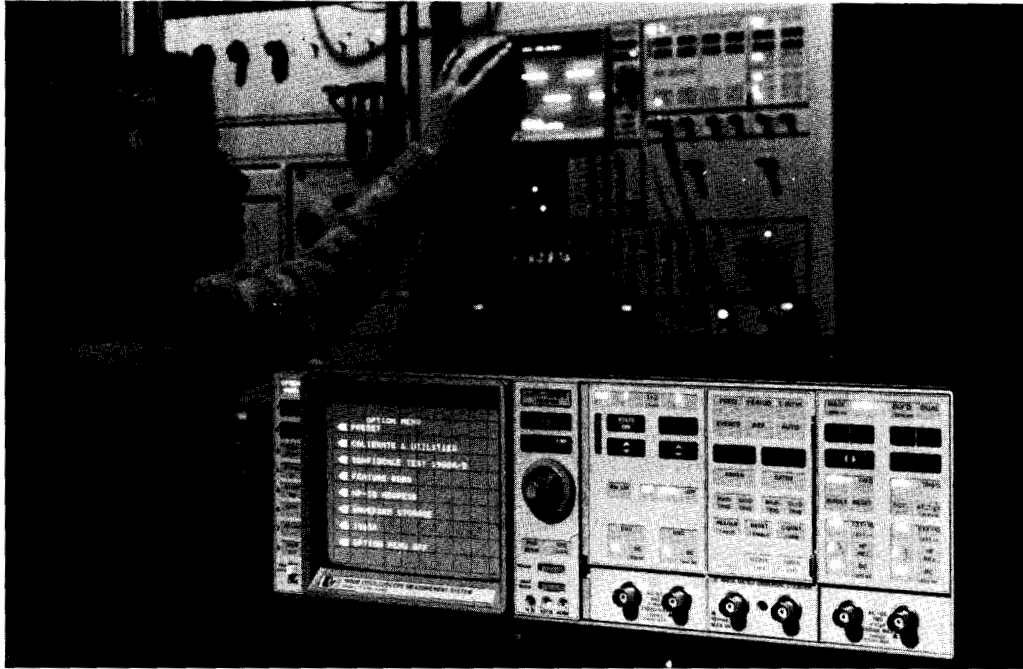

The HP 1980 System Description

In the 1980 system, Hewlett-Packard has integrated many components that together provide complete waveform-measurement solutions.

HP's 1980 system combines a programmable oscilloscope, waveform digitizer, universal counter, and programmable analog comparators to provide versatile measurement capability. Combining these instruments into a single measurement system not only reduces your test system assembly time, but it also increases the quality of measurements and saves money by reducing the number of instruments you need to purchase. Linked together with HP's computers, software, and support, the HP 1980 system increases the productivity of developing, maintaining, and operating test systems.

The HP 1980B Oscilloscope Measurement System

The HP 1980B Oscilloscope Measurement System is a fully HP-IB programmable, two-channel, 100 MHz oscilloscope. It features continuously-calibrated verniers, with 2 mV/div deflection factors and two independent 5 ns/div sweeps. Measurement capabilities can be expanded by adding internal options and plug-in expansion modules. In addition, the HP 1980 has these special features:

- The Auto-Scope function autoranges trigger levels, deflection factors, and sweep speeds to display input signals. It provides a one keystroke setup for most signals.
- Continuously calibrated verniers replace the standard 1-2-5 vernier sequence, providing exceptional versatility in viewing and measuring time-domain waveforms.
- Save/Recall registers can be used to save up to eight complete instrument states for recall in repetitive measurement procedures.
- Calibration can be performed on-site without removing covers and requires little or no test equipment. Internal reference signals are provided and complete, step-by-step instructions are displayed on the CRT.

The HP 1950A Two-Channel Expansion Module

The HP 1950A adds two 100 MHz vertical channels to the HP 1980. It features continuously-calibrated variable deflection factors from 2 mV/div to 10 V/div and a delta voltage function.

The HP 1980's Trigger Flag

Trigger Flag, a standard measurement feature of the HP 1980, accesses the HP 1980's trigger circuits and uses them as programmable analog trigger comparators to make static and dynamic tests. It can make a variety of measurements, including voltage and timing tolerances tests, random noise tests, envelope and burst measurements, and static-state testing.

The HP 1965A Gated Universal Counter Expansion Module

The HP 1965A adds a fully-programmable, 100 MHz universal counter to the HP 1980 system. By merging oscilloscope and counter technologies, the HP 1965A makes counter measurements (i.e., frequency, period, time interval, and events) and automatic pulse-parameter measurements (i.e., rise/fall time, pulse width, duty cycle, propagation delay, and phase shift) with accuracy up to 500 picoseconds and ± 10 picosecond resolution. The HP 1965A simplifies measurements requiring complex gating or triggering by using the HP 1980's vertical signal conditioning, time bases, and trigger circuitry.

The HP 19860A Digital Waveform Storage

Internally installed in the HP 1980, the HP 19860A adds digital waveform storage to the system. The HP 19860A can digitally store up to two waveforms with 10-bit vertical resolution over the entire 100 MHz bandwidth of the HP 1980. Waveforms are acquired in single-shot mode (sampling rate is 50 k-samples/second) or repetitive mode (100 MHz bandwidth). Additional flexibility is provided through programmable sample density and averaging.

The Waveform Measurement Library

HP's HP 19800A/B and HP 19801A/B/C Waveform Measurement Library (i.e., Series-1980 application software) automates time-domain measurements. The software consists of first-day measurement capability, a flexible subprogram structure, and easy-to-use tools for developing specific application programs. Other HP software products can extend the system's measurement capabilities. For example, the Waveform Analysis Package when used with the Waveform Measurement Library can perform fast Fourier transforms on the waveform data captured by the HP 1980 system.

By performing waveform characterization and waveform comparison, this software provides an extremely versatile set of time-domain measurements. With the software package, the 1980 system can automatically characterize waveform parameters such as peak-to-peak voltage, rms voltage, frequency, pulse width, rise time, and fall time. Waveform comparison is a measurement technique that allows a computer to perform qualitative time-domain measurements. To perform a waveform comparison, the waveform must be compared to limits established for it. These limits can be derived from an ideal waveform generated by a computer or from a known "good" waveform. In this way, the computer, not the operator, can make the necessary judgments.

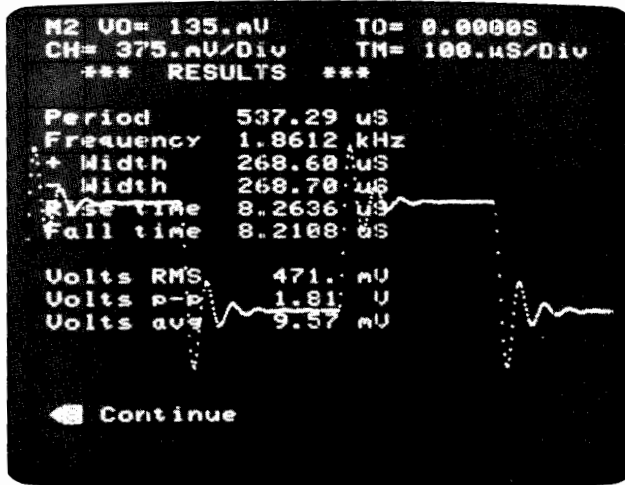

HP 19860A waveform characterization—the HP 19860A Digital Waveform Storage option and the HP Waveform Measurement Library can automatically characterize waveform parameters. This photo shows measurement results from the first-day Automatic Waveform Measurement Program. The program accounts for the ringing on the waveform when measuring parameters such as rise time and fall time. This program provides first-day measurement results without requiring any additional programming.

HP 1980 System Accessories

HP provides several accessories for the HP 1980 system. The HP 19811A Plot/Sequence ROM memorizes up to 6 sequences of 25 keystrokes that are executed when enabled. Any key sequence can be initiated when you press a pushbutton on an HP 1008XA probe, send a command over HP-IB, or set a timer in the HP 1965A. Additionally, the HP 19811A can send waveforms stored by the HP 19860A to a plotter in stand-alone configurations. A complete line of testmobiles and miniature probes is also available.

Improving Quality Through HP Automation

A test system based on the HP 1980 System and an HP computer can improve the quality of time-domain measurements. For example, the computer can automatically set up the HP 1980's front panel, eliminating operator errors. Measurements usually made by counting graticule lines can be made without operator intervention. In addition, the computer can make comparison measurements on waveforms, maintaining quality and reducing the required skill level of the operator. HP's Waveform Measurement Library is the software that accesses these capabilities to improve the quality of measurements.

HP 1980 SYSTEM - CORE OF A TEST SYSTEM

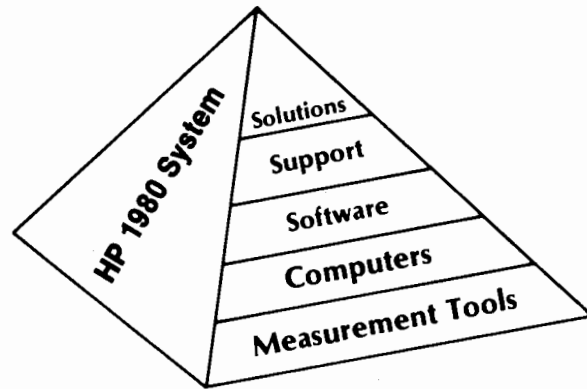

The HP 1980—A Test System's Central Measurement Device

The various components of the HP 1980 system together provide a very extensive set of time-domain measurement capabilities. There are two main categories of measurements that the HP 1980 system can make—characterization and comparison. The system can characterize waveform parameters including peak-to-peak voltage, rms voltage, frequency, pulse width, rise time, and fall time. The system also performs waveform comparisons, a measurement technique that allows a waveform to be tested against specified tolerance limits. The HP 1980 system's flexible measurement capability can improve the quality of measurements in automatic, semiautomatic, and manual environments.

Increasing Test System Throughput

The productivity of a test system can be evaluated by its measurement throughput. There are several steps associated with a measurement: after a waveform from a unit under test is connected to a test system, the instruments must be set up to view or store the waveform. Next, the measurement tools gather and transfer data to a computer for analysis. Together, these steps determine the throughput of a system. Because the HP 1980 and an HP computer provide automatic setup, acquisition, and analysis capabilities, they can increase the throughput of your test system.

The HP 1980 system is designed to increase measurement throughput of systems in automatic, semiautomatic, and manual environments. The HP 1980 system is ideal for automatic applications, because it provides full programmability, flexible measurement capability, and the application software needed to automate time-domain measurements. In semiautomatic applications, the HP 1980 system with an HP computer can increase throughput by automatically setting up its front panel and guiding an operator through a test procedure via text on the CRT. Manual applications can also benefit from features such as Auto-Scope and Save/Recall registers.

HP's Complete Product Support

HP provides many services to help you be successful integrating the HP 1980 into a test system. In addition to product notes that discuss specific measurements, a Waveform Measurement Seminar is available that teaches you how to get the best results from the HP 1980 system. Also, HP's System Engineering Organization can provide consulting services and can help you to develop programs for your particular application.

OSCILLOSCOPES & WAVEFORM ANALYZERS

Oscilloscope Measurement System

Models 1980B, 1965A, 19860A, 1950A, 19800/19801

HP 1980B Specifications

Operating Modes

Voltage vs time (V vs T); channel 1 vs 2 (1 vs 2); monitor mode for logic state display with HP Model 1607A (X-Y-Z).

Vertical Display Modes (V vs T)

Channel 1; channel 2; channels 1 and 2 displayed on alternate sweeps (ALT); channels 1 and 2 displayed by switching between channels at approx 400 kHz rate with blanking during switching (CHOP); automatic selection of alternate for sweep speeds >1 ms/div and chop for sweep speeds ≤1 ms/div (AUTO-CHOP/ALT); channel 1 plus 2 algebraic addition (1 + 2), channel 1 and/or 2 may be inverted; and either main or delayed trigger signal.

Vertical Amplifiers (2)

Bandwidth: 3 dB down from a 5 div reference signal (0° to +40°C).

DC-coupled: dc to 100 MHz in 50 Ω and 1 MΩ input modes.

AC-coupled: <10 Hz to ≥100 MHz.

Bandwidth limit: limits upper bandwidth to approx 20 MHz.

Input coupling: ac, dc, 50 Ω (dc), ground. Ground position disconnects input connector and grounds amplifier input.

Input RC: ac or dc, 1 MΩ ±2% shunted by approx 16 pF; 50 Ω(dc), 50 Ω ±3%.

Maximum input voltage: 50 Ω, 5 V rms; 1 MΩ, ac or dc coupled, 250 V (dc + peak ac) at ≤1 kHz.

Deflection factor: range, 2 mV/div to 10 V/div; accuracy, ±3%; 3 digits of resolution.

Vertical position: range, baseline can be adjusted ±15 major div from center graticule line (possible 10 div off-screen); accuracy, ±(2% of reading + 0.3 major div).

ΔV (channel 1 or 2): range, ±15 times the deflection factor selected for that channel; accuracy, ±4% (for a Δ≤10 major div).

Channel 1 + 2

Amplifier: bandwidth and deflection factors are unchanged.

Differential (channel 1-2 or channel 2-1): CMRR is at least 20 dB from dc to 20 MHz with common mode signal amplitude equivalent to 10 div and one channel adjusted for optimum rejection.

Trigger view: displays internal or external trigger signal for either main or delayed sweep.

Horizontal Display Modes (V vs T)

Main, main intensified, delayed, and dual. Dual simultaneously displays main intensified and delayed sweep.

Main and Delayed Time Bases

Range: 5 ns/div to 1 s/div; 3 digits of resolution.

Accuracy*

| Speed | Accuracy* |
|--|-----------|
| 5 ns/div to 9.99 ns/div (center 8 div) | ±3% |
| 10 ns/div to 9.99 ms/div (first 10 div) | ±3% |
| 10 ms/div to 1 s/div (first 10 div) | ±4% |

*Within ±10°C of the temperature at which the instrument was calibrated. For temperatures beyond the ±10°C range and within 0° to +55°C, add 1% and 2% from 0.5 s/div to 1 s/div.

Sweep Delay

Time delay: range, 0 to 9.9999 s; resolution, displayed, 5 digits; HP-IB, 100 ps at any delay, possible 11 digits.

Accuracy*

| Sweep Speed | Delay or Time Interval | |
|-------------------------|--|--|
| | <200 μs | ≥200 μs |
| 5 ns/div to 9.99 ns/div | ±(2 ns + 0.1% of reading) | ±(0.05% of reading) |
| ≥10 ns/div | ±(2 ns + 0.1% of reading + 1% of dly'd s/div x 10 div) | ±(0.05% of reading + 1% of dly'd s/div x 10 div) |

*Within one hour of a delay self-calibration and in constant ambient temperature.

Delay jitter: 0.002% of delay time; at 10 MHz ±10 kHz, 0.01% of delay time.

Time interval (ΔT): in intensified, dual, or delayed horizontal display modes, a zero time reference can be set anywhere in the delay range and a ΔT measurement made from that point.

Resolution, accuracy: same as time delay.

Frequency (1/ΔT): calculates and displays reciprocal of time interval measurement; resolution, same as ΔT. As frequency increases, insignificant digits are truncated; accuracy, same as time delay.

Digital delay: range, 0 to 10⁸ - 1 events; resolution, 1 event; maximum rep rate, 15 MHz with a 50% duty cycle.

Triggering (main and delayed time bases)

Main Time Base

Triggered: specified level and slope generates a sweep.

Auto-triggered: baseline displayed in absence of a trigger signal; triggering is same as triggered above approx 10 Hz.

Single: sweep occurs once with same triggering as triggered mode.

Delayed Time Base

Auto-sweep after delay: delayed sweep starts at end of delay time.

Triggered sweep after delay: sweep can trigger after delay.

Digital delay: delayed sweep starts a specified number of events after start of main sweep.

Sources: selectable from channel 1, channel 2, enhancement module, or external. Line frequency triggering for main sweep only. Main and delayed independently selectable.

Internal Trigger Level

Range: ±20 major divisions from center horizontal graticule line.

Resolution: 0.02 major divisions; coarse or fine slew rates.

Accuracy: ±(3% of reading + 0.4 major div).

External Trigger Level

Range: ±1.2 V from ground reference; in ÷ 10, ±12 V.

Resolution: ÷ 1, 2 mV; ÷ 10, 20 mV; coarse or fine slew rates.

Accuracy: ±(3% of reading + 40 mV); ÷ 10, ±(3% of reading + 400 mV).

Line Trigger Level

Range: ±20 relative units.

Resolution: steps of 0.02; fine or coarse slew rates.

Slope: positive or negative slope within trigger signal range.

Sensitivity

Internal: <10 mV/div, at least 1.4 div from dc to 25 MHz increasing to 3 div at 100 MHz; ≥10 mV/div at least 0.7 div from dc to 25 MHz increasing to 1.5 div at 100 MHz.

External: ÷ 10, at least 500 mV p-p from dc to 25 MHz increasing to 1.2 V p-p at 100 MHz; ÷ 1, at least 50 mV p-p from dc to 25 MHz increasing to 120 mV p-p at 100 MHz.

Coupling (internal and external): ac, attenuates signals <10 Hz; dc, direct coupled; HF rej, attenuates signals above approx 35 kHz; LF rej, attenuates signals below approx 35 kHz.

External Trigger Inputs (main and delayed)

Input RC: ac or dc, 1 MΩ ±2% shunted by approx 15 pF; 50 Ω (dc), 50 Ω ±3%.

Maximum input voltage: 50 Ω (dc), 5 V rms; 1 MΩ, ac or dc coupled, 250 V (dc + peak ac) at ≤1 kHz.

1 vs 2 Operation

Bandwidth: Y-axis (channel 1), same as channel 1 in V vs. T; X-axis (channel 2), dc to 4 MHz.

Phase difference: ≤3° dc to 100 kHz.

Deflection factors: same as Vertical Amplifiers.

Cathode-Ray Tube and Controls

Type: post-accelerator, approx 22 kV accelerating potential, aluminum P31 phosphor.

Graticule: 10 x 10 div internal graticule; 0.2 subdivision markings on major horizontal and vertical axes; 10 x 12 cm display area.

Trace and character intensity: adjustable in relative steps of 1 from 0 to 99.

General

Bus compatibility: as defined in IEEE Std 488-1978 is SH1, AH1, T5, TE0, L3, LE0, SR1, RL1, PP0, DC0, DT1, C0, and E2.

HP-IB interface functions: SH1, AH1, T5, TE0, L3, LE0, SR1, RL1, PP0, DC0, DT1, C0, and E2. (See HP-IB section of this catalog.)



HP 1980B Specifications (cont.)

Power: 100, 120, 220, 240 Vac, +5 to -10%; 48 to 440 Hz; 300 VA max with expansion module and plug-in ROMs, standard, 200 VA max.

Weight: net, approx 18.2 kg (40 lb). Shipping, approx 24.1 kg (53 lb).

Dimensions: (HP 1980A) 278 H x 213 W x 543 D mm (10.9 x 8.4 x 21.4 in); (HP 1980B) 143 H x 427 W x 543 D mm (5.6 x 16.8 x 21.4 in).

Operating environment: temperature, 0° to +55 °C; humidity, to 95% relative at +40° C; altitude, to 4 600 m (15 000 ft); vibration, vibrated in three planes for 15 min each with 0.38 mm (0.015 in) excursion, 10 to 55 Hz.

Accessories furnished: one blue light filter HP P/N 01980-02701; one 2.3 m (7.5 ft) power cord; one expansion module panel cover, HP P/N 01980-24106; two Operating/Programming Manuals; one service manual; one binder with divider tabs; two HP 10081A, 10:1 divider probes approx 2 m (6 ft) long.

HP 1950A Specifications

Vertical Display Modes

Channels 3 and 4 independently selected; channel 3 vs 4; channel 3 + 4; either or both channels may be inverted.

Vertical Amplifiers

Bandwidth: same as HP 1980.

Input RC: same as HP 1980, channels 1 and 2.

Deflection factors: 2 mV/div to 10 V/div, ±3%, 3 digit resolution.

ΔV (Channel 3 or 4): same as HP 1980, channels 1 and 2.

General

Operating environment: same as HP 1980A/B.

Weight: net, approx 1.5 kg (3.3 lb). Shipping, 2.2 kg (4.8 lb).

Power: supplied by HP 1980.

Accessories furnished: one operating and service manual; two HP 10081A, 10:1 divider probes, approx 2 m (6.6 ft) long.

HP 1965A Specifications

Frequency A

Range: 100 mHz to 100 MHz

Note: refer to Triggering for minimum pulse-width requirements.

LSD Displayed: $\frac{10 \text{ ns}}{\text{sample time}} \times \text{frequency}$ (9 digits maximum)

Unarmed and Armed Modes

Resolution: $\pm(2 \times \text{LSD}) \pm 1.4 \times \frac{\text{trigger error}}{\text{sample time}} \times \text{frequency}$

Accuracy: \pm resolution \pm time base error \times frequency

Gated Mode

Resolution: $\pm \frac{\text{period resolution}}{\text{period}} \times \text{frequency}$

Accuracy: $\pm \frac{\text{period accuracy}}{\text{period}} \times \text{frequency}$

** Refer to period—gated mode specifications.

Period A

Range: 10 ns to 10 s

LSD displayed: $\frac{10 \text{ ns}}{\text{sample time}} \text{ period}$ (9 digits maximum)

Unarmed and Armed Modes

Resolution: $\pm(2 \times \text{LSD}) \pm 1.4 \times \frac{\text{trigger error}}{\text{sample time}} \times \text{period}$

Accuracy: \pm resolution \pm time base error \times period

Gated Mode

Resolution: $\pm \frac{10 \text{ ns} + (1.4 \times \text{trigger error})}{N \times \sqrt{\text{sample time}/(\text{period} \times N)}}$

Accuracy: \pm resolution \pm (time base error \times period) $+$ $\frac{4 \text{ ns}}{N}$

Where N is the number of cycles gated per sweep.

Time Interval A→B

Range: \pm -10 ps to \pm -10 s.

LSD displayed: $\frac{10 \text{ ns}}{\sqrt{\text{# of averages}}}$

| Number of Averages | LSD |
|--------------------|--------|
| 1 | 10 ns |
| 100 | 1 ns |
| 10 000 | 100 ps |
| 1 000 000 | 10 ps |

Resolution: \pm -LSD \pm -start trigger error/ $\sqrt{\text{(of averages)}}$
 \pm -stop trigger error/ $\sqrt{\text{(of averages)}}$

Accuracy: \pm -resolution \pm -time base error \times time interval
 \pm -trigger level timing error \pm - systematic error

RATIO A/B

Range: 10E-9 to 10E9

Resolution: \pm - $\frac{\text{period B}}{\text{sample time}} \times \text{ratio} \pm$ - $\frac{\text{trigger error}}{\text{sample time}} \times \text{ratio}$

Accuracy: same as Resolution

Events A (Gated)

Range: 0 to 1000 megabits

Events A During B

Range: 0 to 1000 megabits

Minimum time between B pulses: 75 ns

Totalize A

Range A: 0 to 1000 megabits

LSD: 1 count of input

Resolution: \pm -LSD

Accuracy: same as Resolution

Totalize A + B

Range: 0 to 2000 megabits

LSD: 1 count of input

Resolution: \pm -LSD

Accuracy: same as Resolution

Totalize A - B

Range: -1000 megabits to 1000 megabits

Display: continuous update for input repetition rates up to 5 MHz; beyond 5 MHz, display is updated when measurement is completed.

LSD: 1 count of input

Resolution: \pm -LSD

Accuracy: same as Resolution

Auto-Parameters

Repetition rate: 15 Hz to 20 MHz, such that period - time parameter > 35 ns.

Note: time parameter is parameter being measured, except the time parameter for duty cycle is pulse width, and time parameter for phase shift is propagation delay.

Maximum input undershoot + overshoot: 10%

Minimum peak-to-peak amplitude: 3 divisions and 35 mV

Resolution: \pm -LSD \pm -start trigger error/ $\sqrt{\text{# of averages}}$ \pm -stop trigger error/ $\sqrt{\text{# of averages}}$

Time parameter accuracy: \pm -resolution \pm -(time base error \times time interval) \pm -auto trigger error \pm -systematic error

Note: systematic error for rise time, fall time, pulse width, and duty cycle is 1 ns. Systematic error for propagation delay and phase shift is 2 ns.

Auto-trigger error: \pm - $\frac{1\% \text{ of input p-p voltage}}{\text{slew rate at start trigger point}}$

\pm - $\frac{1\% \text{ of input p-p voltage}}{\text{slew rate at stop trigger point}}$

Time Base

Standard high stability, temperature-compensated crystal oscillator.

Frequency: 10 MHz

Aging rate: <1 part in 10E7 per month

Short term: <1 part in 10E9 rms for one-second average; <2 parts in 10E6, 0° C to 55° C

External time base input: front-panel BNC accepts 10 MHz 1 V rms to 10 V rms into 50 Ω. Time base selected to external via soft key selection.

Triggering

Minimum \pm - pulse widths: main = 5.0 ns (100 MHz maximum); delayed = 6.25 ns (80 MHz maximum)

Definitions

Systematic error: timing error due to propagation delays between start(A) and stop(B) trigger paths.

Common source (main-to-main or delayed-to-delayed): 500 ps

Dual source with equal vertical sensitivities: 1 ns

Dual source with unequal vertical sensitivities: 2 ns.



OSCILLOSCOPES & WAVEFORM ANALYZERS

Oscilloscope Measurement System

Models 1980B, 1965A, 19860A, 1950A, 19800/19801 (cont.)

HP 19860A Digital Waveform Storage Specifications

Vertical

Analog bandwidth: dc to 100 MHz; ac coupled lower limit is <10 Hz; 3 dB down from a 5 div reference; 0° to 40°C.

Acquisition window: $\geq \pm 4.5$ div from center horiz graticule line.

Matching of data to CRT graticule lines:¹ $\pm 2\%$ of full scale.

Matching of Digitized to Real Time Traces¹

| Sine Wave, Percent of Full-Scale | | |
|----------------------------------|-------------|-------------|
| 10 Hz | 1 kHz | 1 MHz |
| $\pm 1.5\%$ | $\pm 1.5\%$ | $\pm 2.5\%$ |

Excludes first data point. In repetitive mode, trigger rep rate must be 1 Hz or faster. In single sweep mode, trigger must occur within 1 s of digitize command, otherwise exclude first five data points. Data for this specification is acquired using the Auto-Cal default mode of a full Auto-Cal.

Absolute accuracy of data: \pm (accuracy of vertical channel + matching of digitized trace to real-time trace + matching of data to graticule line).

DC offset: <0.2 div from real-time trace at time of data acquisition.

¹Full scale is ten divisions.

RMS Noise²

| Waveform Storage Mode | 2 mV/div to 9.99 mV/div | 10 mV/div to 10 V/div |
|------------------------|-------------------------|-----------------------|
| Normal | 0.75% | 0.5% |
| 8 Averages or Filtered | 0.4% | 0.25% |

²Measured by grounding the vertical input, digitizing, and calculating the RMS value of the data.

Horizontal

Acquisition window: main horizontal display mode (main s/div x 10 div); in intensified and delayed (delayed s/div x 10 div). In intensified and delayed, the acquisition window can be delayed 0 to 9.9999 s from main trigger point.

Time offset from real-time trace: $-(\leq 30 \text{ ns})$.

Timing accuracy: $\pm(2 \text{ ns} + 0.2\%$ of the acquired time window).

Jitter: 0.002% of delay time + 1 ns; at 10 MHz $\pm 10 \text{ kHz}$, 0.01% of delay time + 1 ns.

Operating Characteristics

Repeatability of data: approx 2% for waveforms acquired within 8 hours and within 20°C to 30°C. To optimize repeatability of waveform data, use either a minimum of 8 averages or filtered mode, for signals <100 Hz use dc or 50 Ω dc input coupling.

Vertical resolution: 10 bits, approx 0.1% of full scale.

Auto-Cal: pre-acquisition calibration of sampling efficiency that also sets offset and gain data correction factors. Offset and gain factors are used for post-acquisition data correction to match a digitized trace to a real time trace.

Sample density: selectable 1, 3, 6, 11, 21, 51, 101, 251, 501 points at any sweep speed.

Minimum time between points: repetitive, 100 ps, clocked by HP 1980 delay generator; single-shot, 19.8 μs , clocked by HP 1980 processor clock.

Acquisition mode: repetitive, 999 $\mu\text{s}/\text{div}$ to 5 ns/div, two sweeps per point; single-shot, 1 s/div to 1 ms/div, one sweep per waveform.

Averaging: each sample point may be averaged 2, 4, 8, 16, 32, or 64 times in repetitive mode to reduce noise; N + 1 sweeps required per point, where N = number of averages.

Filter: approx 1 MHz low pass filter selectable in single-shot.

Cursors: start and stop cursors for memories (M1 and M2) to measure voltage from center graticule line, time from main trigger point, or ΔV and ΔT measurements on stored waveforms.

General

Operating environment: same as HP 1980B.

Weight: net, 0.4 kg (13 oz). Shipping, 0.9 kg (2 lb).

HP 19800A/B, 19801A/B/C Description

Series HP 1980 Application Software is available for HP Series 80 computers (HP 19801A/B/C) and HP Series 200 computers (HP 19800A/B). Application software is available for the HP Series 1000 computers through the HP Plus program; contact your local HP Sales Office for more details.

Measurement Programs

Automatic waveform measurement program: automatically characterizes many different kinds of waveforms, displays measurement results, and can plot waveforms for permanent records. This program uses Trigger Flag and the HP 19860A Digital Waveform Storage.

User-interactive waveform measurement program (HP 19800 only): provides interactive menus allowing you to characterize waveform parameters, control waveform data bases, and obtain hardcopy output of results or waveforms. Measurements include pulse parameters and two-channel time intervals. This program uses Trigger Flag and the HP 19860A Digital Waveform Storage.

Universal counter measurement program (HP 19800 only): automatically characterizes waveform parameters using the HP 1965A. Trigger levels for rise time, fall time, and pulse width measurements are determined by digitally storing trigger view and determining top and base using a histogram.

Gated time interval measurement program (HP 19800 only): leads user through the process of making a gated time interval measurement with the HP 1965A. Measurement setups can be saved and recalled at a later time.

Library Subprograms

1. The waveform characterization subprograms perform a wide range of parametric time-domain measurements by using the data captured by both the HP 19860A and Trigger Flag.

2. The waveform comparison subprograms perform limit test on waveform parameters to determine whether a given waveform is acceptable according to a specified set of tolerances.

3. The waveform setup subprograms reduce test times and eliminate operator setup errors by automatically setting up the HP 1980A/B. Within this group is a subprogram that automatically re-scales the waveform if there is insufficient information within the waveform data for the measurement.

4. The waveform data management subprograms control the HP 19860A and direct the movement of waveform data records. With these subprograms, permanent records of key waveforms can be made. Accessing these records eliminates needless repetition and simplifies the documentation of procedures and results.

5. The general utilities subprograms simplify the development of application programs. For example, they initialize the system, help debug programs being developed, manage instrument setup data, output results and plot waveforms onto HP graphics printers and plotters.

6. The HP 1965A subprograms set up and control the counter functions. They also perform statistical analysis on measurement results.

Ordering Information

HP 1980S Oscilloscope Measurement System

Use the system model number when ordering a system mainframe with expansion modules, enhancements, and computer products. Any model number can also be ordered individually. Using the system model ensures coordination of shipments and compatibility of instruments, computers, and software

| | Price N/C |
|--|--------------|
| HP 1980B Oscilloscope Measurement System (rack) | \$10,600 |
| HP 1950A 100 MHz Two-channel Expansion Module | \$2,800 |
| HP 1965A 100 MHz Gated Universal Counter | \$2,550 |
| HP 19811A Plot/Sequence ROM | \$500 |
| HP 19860A Digital Waveform Storage | \$3,000 |
| HP 19800A/B Waveform Measurement Library | \$1,020 |
| HP 19801A/B/C Waveform Measurement Library | \$1,020 |
| HP 19807A Service Extender for expansion modules | \$530 |

- Expand Input Capability Of 50Ω Instrumentation
- Your choice 50Ω, 10kΩ & 1 MΩ Input Pods

- Fully HP-IB Programmable, Plus Convenient Front-panel Control
- Internal Non-volatile Memory

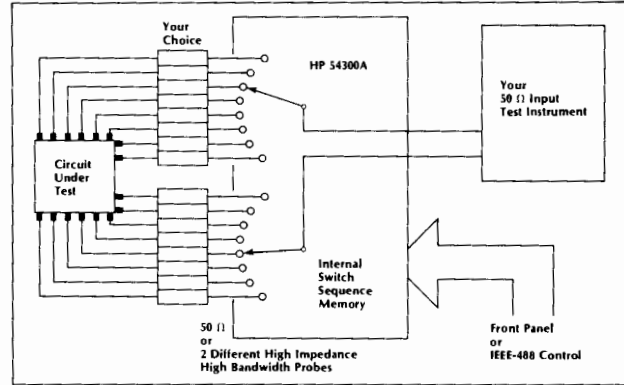
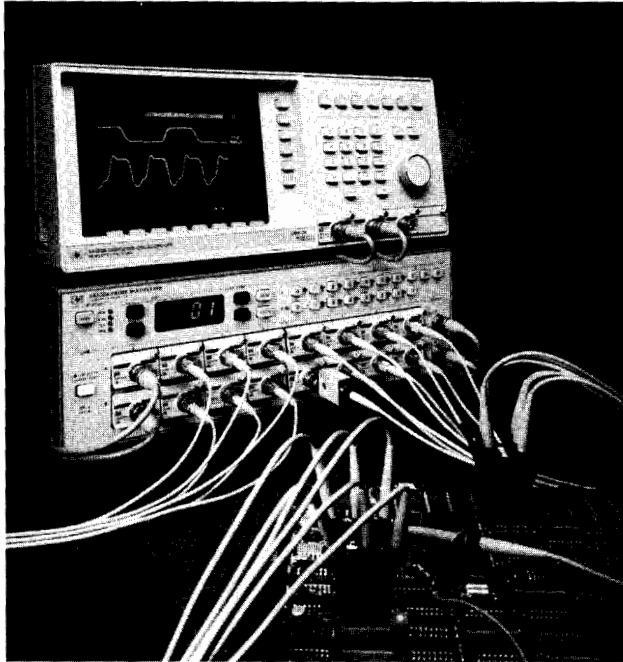

The HP 54300A's configurable inputs and HP-IB programmability make it a powerful addition to your bench or ATE system.

HP 54001A 1 GHz Active Mini-probe Pod

This pod, with its built-in probe, offers 1 GHz bandwidth with 10kΩ/2 pF input loading. It uses HP's mini-tip probe for easy access in compact circuits, and features both high-bandwidth and high-impedance at the probe tip. This probe is ideal for making high-speed logic measurements, where high bandwidth is needed and probe capacitance is a significant factor in loading the test circuit.

HP 54002A 50Ω BNC Pod

This pod should be used with terminated 50Ω systems. Output from the multiplexer using this pod is <2 dB down at >1 GHz. The 54002A is also useful with divider probes such as the HP 10020A.

HP 54003A 300 MHz 1 MΩ Probe Pod

This pod, with a 10:1 detachable mini-tip probe, has 1 MΩ resistive and 8 pF capacitive loading. It is valuable when resistance is a more significant loading factor than capacitance, such as in operational amplifier measurements. If desired, the probe may be removed from its pod to provide a 1 MΩ approximately 10 pF BNC input.

Fully Programmable For Automated Testing

All functions that can be controlled from the HP 54300A front panel can also be controlled over the HP-IB. Simple, English-like commands are used with an optional format that is compatible with the command language of the HP 3488A switch/control unit.

The HP 54300A command set is simple, but complete. Even information such as the type of input pod that is being used or the total number of switch closures that have occurred on a given switch pole may be obtained over the bus. This information is useful in determining whether the correct pods have been inserted for a particular automatic program, or to indicate when switch replacement is due. The HP 54300A is a powerful complement to other HP programmable instruments and HP computers for automated testing of high-frequency circuits.

Ordering Information

| | Price |
|---|--------------|
| HP 54300A dual 8:1 probe multiplexer | \$6800 |
| Includes one operating and programming manual. Each HP 54300 accepts up to 16 input pods in any combination. Pods must be ordered separately. | |
| Opt. 908 Rackmount flange kit | \$32.50 |
| HP 54001A 1 GHz miniature active probe pod | \$750 |
| HP 54002A 50 BNC input pod | \$130 |
| HP 54003A 1M 10:1 probe pod | \$550 |

For information on other probes and probing accessories, please refer to the section on the HP 54100A/D digitizing oscilloscope, page 430.

The HP 54300A probe multiplexer expands the input capability of the HP 54100A/D digitizing oscilloscope, or any 50Ω input instrument, simplifying delicate high-frequency connections.

The Multi-Input Tool For 50Ω Instrumentation

The HP 54300A is a programmable, dual eight-to-one probe multiplexer designed to expand the input capability of instrumentation with 50Ω inputs. The unique strength of this multiplexer is its configurability. The user may select from three different input pods: two high-frequency, high-impedance probes, or a 50Ω BNC input for terminated line applications.

The HP 54300A features full HP-IB programmability as well as simple front-panel control. It has internal non-volatile memory for storing lists of switching steps. Switch lists can be advanced step-by-step from a front-panel button, over the HP-IB (i.e., IEEE-488) or for data logging applications, through a TTL pulse entered at the rear panel.

Automate Complex Measurements

The HP 54300A is ideal for delicate situations where high-frequency connections must be maintained and probes cannot be conveniently moved from one connection to another. Complex measurements can be automated by using the multiplexer's 16 inputs, switching one or two of them at a time into the test instrument, under computer control. In situations requiring more than 16 inputs, HP 54300A multiplexers may be cascaded in series to give a total of 128 inputs.

Your Choice Of Inputs

Configurable inputs is one of the HP 54300A's strongest contributions. It accepts all of the input pods designed for the HP 54100A/D 1 GHz digitizing oscilloscope.



OSCILLOSCOPES & WAVEFORM ANALYZERS

Accessories

Camera, Testmobiles

HP 197B Camera

The HP 197B is a versatile, general-purpose instrument for cathodray tube photographic recording. The camera features lift-off mounting and swing-away hinging by pressing a single latch release button. Interchangeable film backs enable capture of CRT display information on a complete spectrum of Polaroid® or conventional sheet, pack, or roll film. All controls are located outside of the camera for easy reading and fast adjustment during setup. A low-angle viewing port provides a direct view of the display through a flexible facemask while the camera is in the photographic position.

Camera Mounting

On initial order, the HP 197B can be configured, with different camera adapters, to mount directly on a variety of instruments. Each camera adapter is attached to the camera body with a piano hinge and is an integral part of the camera. The HP 197B includes an HP 10376A adapter that directly interfaces to HP 1700-series oscilloscopes with 8 x 10 division CRTs. The HP 197B option 002 includes an HP 10378A adapter that directly interfaces to HP 180-series oscilloscopes. Model 197B Option 006 includes an HP 10375A adapter which directly interfaces with the majority of HP small-screen CRT displays.

By using camera bezel adapters, various camera configurations can be adapted to other instruments not directly compatible with the camera adapter. For mounting a variety of cameras to instruments both current and those no longer in production, refer to the HP 197B Camera Data Sheet. Copies of the 197B Data Sheet can be obtained from your local HP field office or by writing: Inquiries Manager, Hewlett-Packard Company, 1820 Embarcadero Road, Palo Alto, California 94303.

*Registered Trademark of Polaroid, Inc.

*Registered Trademark of Graflex, Inc.

HP 197B Characteristics

Reduction ratio: continuously adjustable from 1:1 to 1:0.7. Reference scale provided on focus plate.

Lens: 75 mm, f/1.9 high transmission lens; aperture, f/1.9 to f/16.

Shutter speeds: 1/30, 1/15, 1/8, 1/4, 1/2, 1, 2, 4 seconds, Time and Bulb; shutter has a sync contact closure output for triggering external equipment and an input jack for remote operation.

Camera back: 83 mm x 108 mm (3.25 in x 4.25 in) Polaroid® pack back.

Mounting: lift on/off mounting with positive lock, swing-away hinging to left.

Viewing: low-angle, direct viewing through a flexible facemask.

Shutter open indicator: illuminated whenever shutter is open.

Ultraviolet illumination: light source and lens filter provide graticule illumination and photographic speed enhancement.

Focus: adjustable with lock; split-image focusing plate provided.

Size: 267 H x 194 W x 356 mm D (10.5 in x 7.6 in x 14 in).

Weight: net, 4.5 kg (10 lb); shipping, 7.3 kg (16 lb).

Power: switch selectable 115 Vac $\pm 10\%$ or 230 Vac $\pm 10\%$, 48 to 66 Hz*, 10 VA max.

Accessories furnished: comb. split image focusing plate reduction ratio scale, 2.3 m (7.5 ft) power cord, and instruction manual.

Ordering Information

HP 197B Camera

| | Price |
|--|--------------|
| 001: deletes ultraviolet illumination feature | \$1495 |
| 002: replaces HP 197B adapter with HP 10378A adapter. | less \$50 |
| 006: replaces HP 197B adapter with HP 10375A adapter. | N/C |
| 007: meets UL listing requirements for medical and dental electronic equipment. | N/C |
| 009: Camera Bezel Adapter for HP 1745A and HP 1746A oscilloscopes. | add \$15 |
| 910: additional manual | add \$20 |
| 10367A Camera Bezel Adapter for HP 182T | add \$6.10 |
| Ultraviolet Light Kit (P/N 00197-69507) for field installation of ultraviolet illumination feature. | \$102 |
| | \$190 |

*Camera operates from 48 to 440 Hz, but does not meet the ac line to chassis leakage requirements of UL 544 listing above 66 Hz.

Testmobiles: Save Bench Space, Easily Moved

Hewlett-Packard testmobiles offer convenient portability for your oscilloscopes or instrumentation systems. The top tray on these testmobiles may be tilted to position your instrument for easy operation. The selection of testmobiles range from a basic model such as the HP 1006A, designed to hold a single oscilloscope or other instrument, to a testmobile such as the HP 1008A or HP 1117B that can be adapted to provide a complete mobile test system. Refer to the testmobile/instrument compatibility chart for assistance in selecting the testmobile that will best fit your requirements.

HP 1007A, HP 1008A Description

These versatile testmobiles provide a sturdy, lightweight, stable platform for your oscilloscope or instrumentation system (see compatibility chart). Large angled wheels with a wide track move quietly and smoothly over most surfaces. The top trays are table-top height and can be tilted to a convenient viewing angle between 30° above and 30° below the horizontal position with a total of seven detent positions in 10° increments. The caps on each side rail are designed to hold three probes conveniently to reduce the possibility of damaging probes not in use.

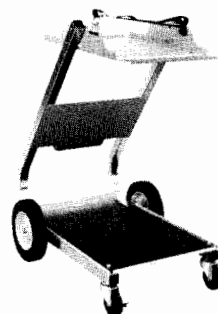

HP 1006A

HP 1006A Description

This is a sturdy general purpose testmobile for cabinet style oscilloscopes and other instruments (see compatibility chart). The tilt tray adjusts $\pm 30^\circ$ in 10° increments. A base tray and an accessory rack add space for other instruments and accessories; and a convenient bracket holds three HP probes. Large rear wheels allow easy movement and locking front casters hold the testmobile in position. A five outlet power strip accessory is available for mounting under the tilt tray or beneath the accessory rack.

HP 1007A, HP 1008A Options

Many options are available so that the HP 1007A or HP 1008A can be easily tailored to your specific requirements. Refer to the option photographs with description to select the testmobile best suited to your requirements. Options apply to both the HP 1007A and HP 1008A. Option 008, U.S.-only five outlet power strip, is also available for convenient instrument operation.

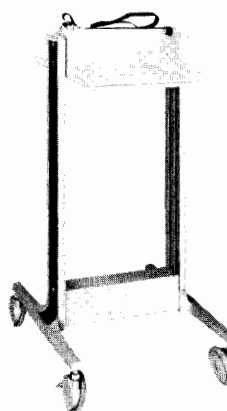

Basic Testmobile

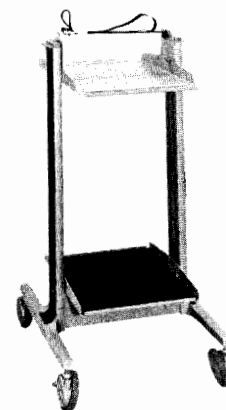

Opt 001: storage shelf load limit: 18 kg (40 lb).

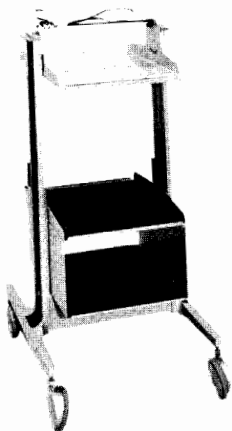

Opt 002: storage shelf and lower cabinet; load limit 18 kg (40 lb) each.

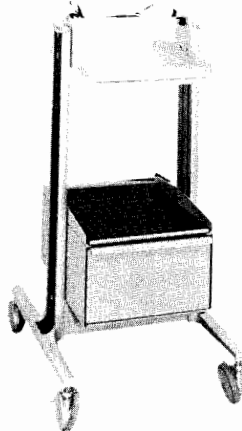

Opt 003: 15 cm (6 in) lockable drawer with shelf on top; load limit 11 kg (25 lb) in drawer and 18 kg (40 lb) on shelf.

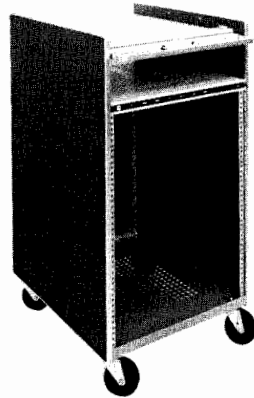

HP 1117B

HP 1117B Description

The HP 1117B provides a mobile test station for cabinet and rack model instruments, with tilt tray angles from -15° to +30° in 7½° increments for easy viewing. In addition, other instruments can be mounted in the standard EIA racks of the lower compartment. Rack mounting height is 62.2 cm (24½ in), depth is 58.4 cm (23 in), and power distribution is provided with a built-in four outlet power strip. Optional accessory drawers 7.6 cm (3 in) and 20.3 cm (8 in) deep are available to provide convenient storage space. The drawers may be installed in many vertical positions of the lower compartment, allowing room for other rack-mounted equipment.

Specifications

(see testmobile data sheet for complete specifications)

| | HP 1006A | HP 1007A | HP 1008A | HP 1117B |
|-----------------------|-----------------|-----------------|-------------------------|-------------------------|
| Height | 841 mm (33¼ in) | 930 mm (36½ in) | 930 mm (36½ in) | 1003 mm (39½ in) |
| Overall width | 502 mm (19¾ in) | 584 mm (23 in) | 759 mm (29¾ in) | 511 mm (20¼ in) |
| Width of tray | 322 mm (12½ in) | 321 mm (12½ in) | 473 mm (18½ in) | |
| Tilt tray angle | ±30° | ±30° | ±30° | -15° to +30° |
| Weight | net | 11.8 kg (26 lb) | 11 kg (25 lb) | 13 kg (28 lb) |
| | shipping | 14.5 kg (32 lb) | 19 kg (41 lb) | 22 kg (48 lb) |
| Max load on tilt tray | | 23 kg (50 lb) | 34 kg (75 lb) | 45 kg (100 lb) |
| | below tilt tray | 23 kg (50 lb) | see option descriptions | see option descriptions |
| | | | | 56.7 kg (125 lb) |

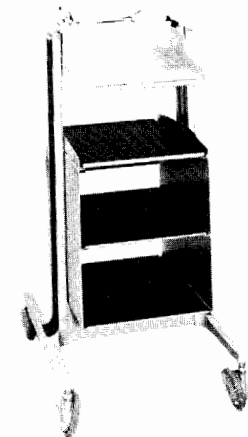

Opt 004: two storage cabinets with shelf on top; combined load limit, cabinets and shelf, 45 kg (100 lb).

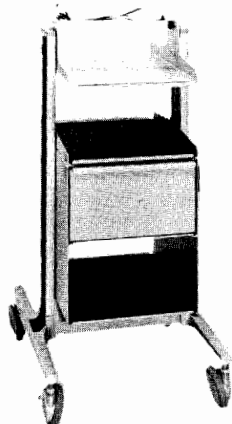

Opt 005: storage cabinet and drawer in upper position with shelf on top; load limit 18 kg (40 lb) each on shelf and in cabinet, 11 kg (25 lb) in drawer.

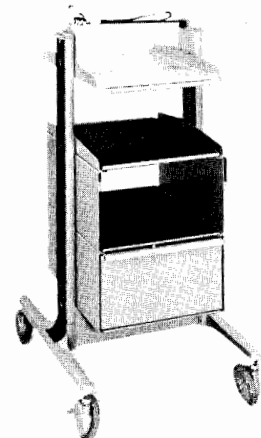

Opt 006: storage cabinet with shelf on top and drawer in lower position; load limit 18 kg (40 lb) each on shelf and in cabinet, 11 kg (25 lb) in drawer.

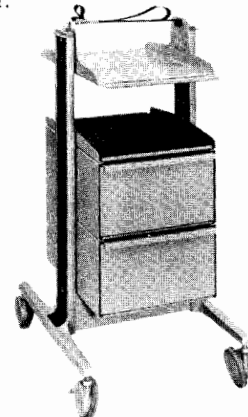

Opt 007: two lockable drawers with shelf on top; load limit 18 kg (40 lb) on shelf, 11 kg (25 lb) each drawer.

Optional Accessories

Price

| | |
|--|---------|
| HP 10475A 7.6 cm (3 in) drawer for HP 1117B testmobile | \$200 |
| Weight: net, 4.1 kg (9 lb); shipping, 5.9 kg (13 lb). | \$225 |
| HP 10476A: 20.3 cm (8 in) drawer for HP 1117B testmobile | |
| Weight: net, 5.4 kg (11 lb); shipping, 8.2 kg (18 lb). | \$32 |
| HP 01008-61201 Probe Pod Holder holds three small Logic Analyzer probe pods such as HP 10230 and HP 10248 | \$175 |
| HP 01008-68701 Rack Mount Kit for HP 1008A, 13.3 cm (5¼ in) high for mounting under the tilt tray | \$92.50 |
| HP 01007-60008 Power Strip kit adds Opt 008 power strip to all versions of HP 1006A, HP 1007A, HP 1008A testmobiles | |

Ordering Information

| | | |
|--|-----------|------------|
| HP 1006A Testmobile | | \$450 |
| Opt 008 Power Strip | | add \$50 |
| HP 1007A, HP 1008A Testmobiles (HP 1007A) | | (HP 1008A) |
| for option descriptions) | \$750 | \$850 |
| Opt 001: storage shelf | add \$40 | add \$45 |
| Opt 002: storage shelf, lower cabinet | add \$100 | add \$115 |
| Opt 003: storage shelf, locking drawer | add \$175 | add \$195 |
| Opt 004: two storage cabinets, shelf | add \$170 | add \$180 |
| Opt 005: upper drawer, lower storage | add \$220 | add \$265 |
| Opt 006: lower drawer, upper storage | add \$220 | add \$265 |
| Opt 007: two locking drawers | add \$290 | add \$350 |
| Opt 008: power strip (5 outlet) | add \$50 | add \$50 |

HP 1117B Testmobile (includes power strip) \$950



OSCILLOSCOPES & WAVEFORM ANALYZERS

Variable Persistence Storage Analog Oscilloscope

- 200 cm/ μ s variable persistence and stored writing rate
- Minimum blind time, auto-intensity circuit
- Dual-channel, 5 mV/div to 100 MHz
- Third-channel trigger view and selectable input impedance

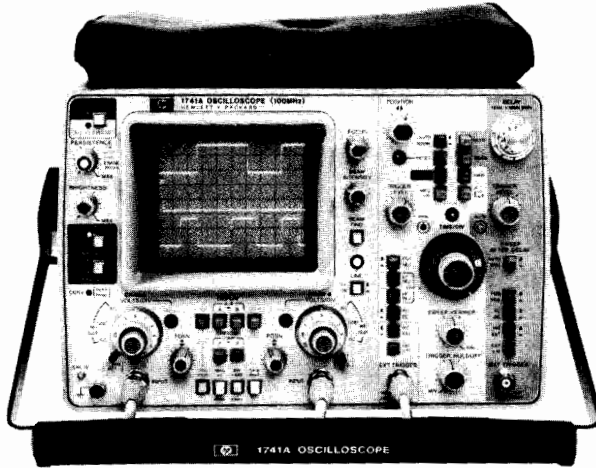

HP 1741A 100 MHz analog variable persistence storage oscilloscope—the “one-oscilloscope” solution.

General-purpose Oscilloscope For Storage Applications

The HP 1741A 100 MHz variable persistence storage oscilloscope functions as a general-purpose instrument as well as serving specialized storage markets. It maintains a fast variable persistence writing speed of 200 cm/ μ s while retaining the minimum blind time found in conventional analog oscilloscopes. Its other standard features include third-channel trigger view, selectable input impedance, and convenient, easy-to-use storage controls.

The HP 1741A's 200 cm/ μ s writing speed is available in both variable persistence and single-shot storage modes.

A “One-oscilloscope” Solution

The HP 1741A provides a “one oscilloscope” solution to the many measurements encountered daily. Its versatility results from the many operating modes available—from minimum persistence, which approximates conventional operation, to continuous persistence settings, and automatic storage. The adjustable persistence control allows you to match signal and persistence characteristics, resulting in excellent display characteristics over a wide range of conditions.

Clear Display of Virtually Any Signal

Low repetition rate signals at fast sweep speeds produce very low light output on conventional analog CRTs and normally require the use of a viewing hood to obtain a viewable display. The HP 1741A's variable persistence mode solves this problem by integrating several sweeps to amplify the light output, producing bright, clear traces. This “light-integrating” capability helps eliminate flickering displays, which result from low repetition rates and slow sweep speed signals.

Simplified Operation

Conveniently grouped variable persistence storage controls, front-panel color coding, LED indicators, and automatic operating modes make the HP 1741A a very functional storage oscilloscope.

Additional features include selectable input impedance (1 megohm, 50 ohm) for both general-purpose probing and high-fidelity, high-frequency signal capture with the built-in 50 ohm impedance matching.

Non-blooming Traces

An auto-intensity circuit permits sharp, flicker-free, non-blooming traces to be obtained in the variable persistence modes under almost all operating conditions. There is a variety of settings available in the variable persistence mode. However, there is an easily set reference position that provides a viewable trace: intensity—max, persistence—min, brightness—min. From this position, intensity can be increased as necessary.

Automatic “Snapshots”

The auto-erase mode periodically takes individual “snapshots” of an input signal. In this mode, persistence is internally set to maximum, and the persistence control regulates how frequently a new “snapshot” is captured and displayed.

Single-shot Capture

The auto-store mode makes single-shot events easy to capture and reduces the possibility of recording the wrong event by automatically switching to the normal trigger mode. The oscilloscope automatically switches from a “write” mode to a “store” mode after the sweep of the single-shot event for maximum trace retention time. A “store” LED indicates that the event is captured, one press of the Store/Display button displays the stored trace.

Third-channel Trigger View

With third-channel trigger view either the internal or external trigger signal can be displayed. Timing analysis can be done with the three channels of information because the trigger channel is displayed with a specified delay of ≤ 3.5 ns relative to the two vertical channels.

A view of the trigger waveform verifies that the correct trigger source and level are being used. Also, it's possible to avoid portions of the trigger waveform that contain irregularities and reflections.

Triggered A Vs. B Option 002

The delay line commonly found in modern high-bandwidth oscilloscopes introduces significant phase error in A vs. B plots for signals above 200 kHz. Option 002 adds a variable delay line in the horizontal axis. This eliminates phase error and enables the HP 1741A to produce matched phase response up to the 5 MHz bandwidth of the horizontal deflection system.

| Feature | HP 1741A |
|-----------------------------|---|
| Bandwidth | 100 MHz |
| Risetime | ≤ 3.5 ns |
| Writing rate | 200 cm/ μ s |
| Sweep speed with X10 | 5 ns/div |
| Sensitivity | 1 mV & 2 mV to 30 MHz; 5 mV to 100 MHz |
| Auto-intensity | Standard |
| 50 ohm/high-impedance input | Standard |
| Third-channel trigger view | Standard |
| DMM | Optional |

Ordering Information

HP 1741A analog variable persistence oscilloscope
Option 002 triggered A vs. B

Price

\$6400.
\$225.

FREQUENCY, FUNCTION & WAVEFORM SYNTHESIZERS

General Information



Signal sources are described by various names: oscillators, audio signal generators, synthesizers, function generators, etc. The names are typically associated with the application area. A signal generator is an oscillator that has modulation capability. Synthesizers are sine-wave sources generated digitally, using a process known as "fractional N", which gives them excellent frequency stability. The term oscillator refers exclusively to a sinusoidal source while a function generator always provides additional wave shapes, most often square waves, triangle waves and, increasingly, arbitrary waveforms.

Technological progress has lowered the cost of digitally derived sources. Hence, synthesizers are increasingly being used in place of oscillators. Synthesizers offer the user two important benefits, the ability to digitally enter frequency very precisely and extremely stable frequency output. In addition, function generators and arbitrary waveform generators are becoming digitally derived, which has tended to blur the traditional definitions of these products.

Source Summary

| Type | HP Model | Frequency Range | Page |
|--------------------------------|------------|-----------------|-----------|
| Function Generator | 3312A | 100Hz - 10MHz | 462 |
| | 3314A | 100Hz - 10MHz | 463 |
| Pulse/Function Generator | 8111A | 100Hz - 10MHz | 461 |
| | 8116A | 100Hz - 10MHz | 458 |
| Synthesizer/Function Generator | 3325A | 100Hz - 10MHz | 452 |
| | 3326A (DC) | 100Hz - 10MHz | 454 |
| | 8165A | 100Hz - 10MHz | 458 |
| Synthesizer/Level Generator | 3335A | 100Hz - 10MHz | 456 |
| | 3336A/B/C | 100Hz - 10MHz | 457 & 156 |

Frequency Range: 1μHz, .01mHz, .1mHz, 1mHz, .01Hz, .1Hz, 1Hz, 10Hz, 100Hz, 1kHz, 10kHz, 100kHz, 1MHz, 10MHz, 100MHz



FREQUENCY, FUNCTION & WAVEFORM SYNTHESIZERS

General Information (con't)

FUNCTION GENERATOR SUMMARY

| | Function Generators | Arbitrary Waveform/Function Generators | | Pulse/Function Generators | | Synthesizer/Function Generators | | | |
|----------------------------|---------------------|--|---|---------------------------|-----------------------|---|--------------------------------|-------------|-------------------|
| | HP Models | 3312A | 3314A | 8770A | 8111A | 8116A | 3325A | 3326A | 8165A |
| Frequency | | | | | | | | | |
| Min | 0.1 Hz | 1.0 mHz | DC | 1.0 Hz | 1.0 mHz | 1 μ Hz | DC | 1 mHz | |
| Max | 13 MHz | 20 MHz | 50 MHz | 20 MHz | 50 MHz | 21 MHz-sine 11 MHz-square 11 kHz-triangle | 13 MHz | 50 MHz | 20 MHz-pulse/ramp |
| Waveforms (symmetry) | | | | | | | | | |
| Sine | 20-80% | 5-95% | Full | 10-90% | 10-90% | 50% | 50% | 50% | |
| Square | 20-80% | 5-95% | Arbitrary | 10-90% | 10-90% | 50% | 1-99% | 20, 50, 80% | |
| Transition time | <20 ns | <9 ns | Waveform | <10 ns | <6 ns | <20 ns | <15 ns | <5 ns | |
| Triangle | 20-80% | 5-95% | | 10-90% | 10-90% | 50% + ramp | — | 20, 50, 80% | |
| Output (into 50 Ohms) | | | | | | | | | |
| Amplitude (p-p) | 10 V | 10 V | 2 V | 16 V | 16 V | 10 V | 10 V | 20 V | |
| DC Offset | ± 5 V | ± 5 V | — | ± 8 V | ± 8 V | ± 5 V | ± 5 V | ± 5 V | |
| Output Impedance- Ω | 50 | 50 | 50 | 50 | 50 | 50 | 50 | 50/1000 | |
| Modes | | | | | | | | | |
| Counted Burst | — | 1 to 1999 | Full | 1 to 1999 | 1 to 1999 | — | — | 1 to 1999 | |
| Gate | int/ext | int/ext | Arbitrary | ext | ext | — | — | ext | |
| Phase Lock | — | ± 200 deg | Waveform | — | — | — | — | ext | |
| Trigger | int/ext | int/ext | | ext | int/ext | — | int/ext | ext | |
| Arbitrary | — | 150 vectors | | — | — | — | — | — | |
| Modulation/Sweep | | | | | | | | | |
| AM | int/ext | ext | Full | — | ext | ext | int/ext | option | |
| FM | int/ext | ext | Arbitrary | — | ext | PM | int/ext PM | ext | |
| PWM | — | — | Waveform | — | ext | — | — | — | |
| VCO | int/ext | ext | HP 11775A | ext | ext | — | — | ext | |
| Lin Sweep | int/ext | int | | — | — | int | int | — | |
| Log Sweep | — | int | | — | option | int | discrete | option | |
| Programmability | — | HP-IB | HP-IB | — | HP-IB | HP-IB | HP-IB | HP-IB | |
| Catalog page | 462 | 463 | 450 | 461 | 459 | 452 | 454 | 458 | |
| Notes | 50% above 1 MHz | also 1/2 cycle bursts | Requires HP Series 200 Controller | 50% above 1 MHz | 20-80% above 1 MHz | 40 Vp-p to 1 MHz option | internal output combiner | | |

Function Generators

The function generator is a versatile, multi-waveform signal source capable of very wide frequency coverage.

The HP 3312A, HP 3314A, HP 3325A and HP 3326A offer a complete set of functions including sine, square, triangle, ramp and even arbitrary waveforms (HP 3314A). For extended pulse capabilities, the HP 8111A and HP 8116A Pulse/Function Generators include precise timing waveforms.

In addition to this complete set of waveforms, Function Generators include versatile modulation capabilities such as amplitude, frequency, phase, pulse width and VCO control.

The Function Generator is an indispensable, general-purpose signal source for production testing, instrument repair, and the electronics laboratory. Diverse fields of applications in which the function generator is being used include medical research, education, chemical, communications, geophysics, industrial control, military and aerospace.

Frequency Synthesizers

Today's measurement needs are placing increasingly stringent requirements on signal sources for greater frequency resolution and stability. Narrowband component testing, satellite and terrestrial communications, local oscillator and automatic test systems are only a few of the many applications that con-

tinually require higher precision sources.

Square waves, triangle waves, and pulses are signals typically associated with non-synthesized sources. This situation is changing. Precision signals of these types are finding important applications in mechanical, civil and environmental engineering.

Increased amplitude accuracy and resolution are also requirements in many applications. The telecommunications industry's Frequency Division Multiplex (FDM) systems require high amplitude accuracy and resolution (0.01 dB) as well as high frequency resolution and stability. These requirements are becoming commonplace in R&D and production test environments.

Frequency Synthesis Techniques

Traditional approaches to indirect synthesis techniques require a phase-locked loop for every decade of frequency resolution. This method provides adequate performance, but many component parts leads to an expensive product. However, a new technique has been developed by Hewlett-Packard that allows a single phase-locked loop to offer multidigit resolution. The process is called Fractional Frequency Synthesis or Fractional N—a method of relating the VCO frequency to the crystal reference by other than an integer N. Up to 11 digits of frequency resolution can be achieved from a single phase-locked loop with this new technique. Significant cost savings and increased reliability result.

Signal Quality

The common specifications that describe signal sources include frequency range and resolution, amplitude range and resolution, distortion and stability.

Additional specifications that are pertinent to the synthesizer are phase noise and spurious content. Phase noise describes the short-term frequency stability of a signal source. It is typically specified as single sideband spectral density or integrated (total) phase noise. Spurious signals are discrete, nonharmonically related signals appearing in the output.

Synthesizers

Hewlett-Packard offers a wide range of high quality frequency synthesizers and synthesized signal generators covering the frequency range of dc to 26 GHz. In addition to being high performance synthesized signal sources, they incorporate many additional features which allow them to fulfill the needs of either bench or programmable applications.

The combined frequency ranges of the HP 8656B, 8660A/C, 8662A, 8663A, 8672A and 8673B,C, and D Synthesized Signal Generators span 10 kHz to 26 GHz. These generators couple the frequency accuracy and stability of synthesizers with the modulation capability and precise, calibrated, wide-range level control of high quality signal generators. In addition, each of these

FREQUENCY, FUNCTION & WAVEFORM SYNTHESIZERS

General Information (con't)

449



generators offers HP-IB remote control of frequency, level and modulation.

Synthesized Level Generators

The HP 3335A is a synthesized level generator covering the range of 200 Hz to 80 MHz. This instrument is ideal as a stand-alone generator with synthesizer stability or as a companion generator for the HP 3745A/B SLMS and HP 3586A/B/C Selective Level Meters. It offers the traditional range of connectors and output impedances, balanced and unbalanced, required by the telecommunications industry. The HP 3336A/B/C is a 21-MHz synthesized level generator with a similar set of telecommunications features. It, too, is ideal as a stand-alone generator or as a companion for HP's 3586A/B/C Selective Level Meters. For more information on these generators, refer to the Telecommunications section of this catalog.

Sweep Capability

The HP 3325A, 3326A, 3330B, 3335A, 3336A/B/C, 8660C, 8662A, 8663A, and 8673B, C and D are among the most linear

sweepers ever built. Keyboard control of microprocessors gives these instruments digital control of sweep start/stop frequencies and sweep times.

Synthesizer/Function Generator

The HP 3325A is a function generator whose functions are derived from a primary synthesized oscillator. It provides a high purity synthesized sine wave from 0.000001 Hz to 21 MHz, precision square waves to 11 MHz, linear ramps and triangle waveforms to 11 kHz, 11 digit resolution (1 μ Hz < 100 kHz), wideband phase-continuous sweep, and HP-IB programmability. The low price makes the HP 3325A an excellent choice for automatic test systems or bench applications.

The HP 3326A is a two-channel synthesizer with internal modulation, sine and square waves, and four operating modes including two-phase, two-tone, two-channel, and pulse. Discrete sweep and nonvolatile storage of instrument states make the HP 3326A an ideal choice for ATE applications, where high-performance and versatility are important.

Arbitrary Waveform Synthesizer

The new HP 8770A Arbitrary Waveform Synthesizer offers a significant advance in waveform generation for DC-50 MHz applications. Relying on state-of-the-art digital technology for its digital-to-analog output converter, the HP 8770A provides 125 million waveform samples per second (8 ns, e.g. 50 MHz bandwidth), with 12-bit amplitude resolution (0.025%). The completely arbitrary waveform is constructed mathematically using an HP 9000 Series 200 Desktop Computer (HP 9816, 9836, 9836C) and HP 11775A Waveform Generation Software. This powerful software uses the newly-developed Waveform Generation Language (WGL) which provides a flexible application-oriented tool to mathematically construct any user-required waveform. The available 128K word memory is further enhanced by memory conservation or "re-use" modes. The HP 8770A makes applications such as hard-disc signal simulation, ATE, and EMP pulse testing possible with just one generator.

| HP Model | Frequency Range | Frequency Resolution | Frequency Stability | Level Range dBm - 50 Ω | Level Resolution | Remote Control | Other Features* | Page |
|-----------|---|--|---|-------------------------------|--|--------------------------------------|---|----------|
| 3325A*** | DC-21 MHz (sine) DC-11 MHz (square) | 0.000001 Hz or 0.001 Hz (11 digits) | 5 x 10 ⁻⁶ /yr | -56.02 to +23.98 (sine) | 0.01 dB or 0.001 mV to 0.01 V (4 digits) | All functions | 8, 11, 12, 13 | 452 |
| 3326A | DC-13 MHz | 0.000001 Hz or 0.001 Hz (11 digits) | 5 x 10 ⁻⁶ /yr | -56.02 dBm to +23.98 dBm | 0.01 dB or 0.001 mV to 0.01V (4 digits) | All functions | 8, 11, 12, 13, 18 | 454 |
| 8770A | DC to 50 MHz | ---- | 5 x 10 ⁻¹⁰ /day | -110 to +13 | 12 bit 1.4096 | All functions | Fully Arbitrary Waveform | 450 |
| 3335A | 200 Hz-80 MHz | 0.001 Hz | 10 ⁻⁹ /day | -87 to +13 | 0.01 dB (4 digits) | All functions | 2, 3, 8 | 456 |
| 3336A/B/C | 10 Hz - 21 MHz | 0.001 Hz or 11 digits | 1.5 x 10 ⁻⁹ /day | -71 to +8 | 0.01 dB | All functions | 8, 11, 12, 13 | 156, 457 |
| 8656B | 100 kHz to 990 MHz | 10 Hz | 10 ⁻⁹ /day | -127 to +13 | 0.1 dB | Freq., ampl. & modulation | 8, 14 | 449 |
| 8660A/C** | 10 kHz to 2600 MHz | 1 Hz or 2 Hz (10 digits) | 3 x 10 ⁻⁹ /day | -146 to +13 | Local: 10-dB steps plus Vernier remote: 1-dB steps | Freq., ampl. & modulation | HP 8660A 5, 7, 8 HP 8660C 3, 5, 7, 8 | 532 |
| 8642A/B | 100 kHz to 1050 MHz (A) 100 kHz to 121 MHz (B) | 1 Hz | 2 x 10 ⁻⁹ /yr (1x10 ⁻⁹ /day opt.) | -140 to +20 | 0.1 dB | All functions | 3, 4, 12, 13, 14 | 526 |
| 8662A** | 10 kHz - 1280 MHz | 0.1 Hz or 0.2 Hz (11 digits) | 5 x 10 ⁻¹⁰ /day | -139.9 to +13 | 0.1 dB (4 digits) | Freq., ampl., modulation & sweep | 3, 8, 14 | 529 |
| 8663A** | 10 kHz to 2560 MHz | 0.1 Hz or 0.2 Hz (11 digits) | 5 x 10 ⁻¹⁰ /day | -129.9 to +16 | 0.1 dB | Freq., ampl., modulation & sweep | 3, 8, 14, 15 | 529 |
| 8671A | 2 to 6.2 GHz | 1 kHz | 5 x 10 ⁻¹⁰ /day | >+8 | — | Freq., FM modulation | 8, 9 | 546 |
| 8672A | 2 to 18 GHz | 1, 2, 3 kHz | 5 x 10 ⁻¹⁰ /day | -120 to +2 (+7 optional) | Local: 10-dB steps plus Vernier remote: 1-dB steps | Frequency, amplitude, and modulation | 8, 10 | 547 |
| 8672S | 10 MHz to 18 GHz | 1, 2, 3 kHz | 5 x 10 ⁻¹⁰ /day | -120 to +2 (+7 optional) | Local: 10-dB steps plus Vernier remote: 1-dB steps | Frequency, amplitude, and modulation | 8, 16 | 546 |
| 8673B | 2 to 26.5 GHz | 1, 2, 3, 4 kHz | 5 x 10 ⁻¹⁰ /day | -100 to +8 | Local: 10-dB steps plus Vernier remote: 1-dB steps | Frequency, amplitude, and modulation | 8, 10 | 545 |
| 8673E | 2 to 18 GHz | 1, 2, 3 kHz | 1.5 x 10 ⁻⁹ /day | -120 to +8 | Local: 10-dB steps plus Vernier remote: 1-dB steps | Frequency, amplitude, and modulation | 8, 16 | 548 |
| 8673C | 50 MHz to 18 GHz | 1, 2, 3 kHz | 5 x 10 ⁻¹⁰ /day | -100 to +2 | Local: 10-dB steps plus Vernier remote: 1-dB steps | Frequency, amplitude, and modulation | 8, 16, 17 | 539 |
| 8673D | 50 MHz to 26.5 GHz | 1, 2, 3, 4 kHz | 5 x 10 ⁻¹⁰ /day | -100 to +5 | Local: 10-dB steps plus Vernier remote: 1-dB steps | Frequency, amplitude, and modulation | 8, 16, 17 | 539 |
| 8165A | 1 mHz to 50 MHz | 4 digits | 1 x 10 ⁻⁶ /day | 10.0 mV to 20 Vp-p | 3 digits | Modulation & trigger | 3, 8, 10 | 458 |

*Other features: (1) 10⁻⁹/day freq. stability optional, (2) 5 x 10⁻¹⁰/day, (3) digital freq. sweep, (4) digital ampl. sweep, (5) internal AM/FM, Φ M, (6) external AM, (7) 3 x 10⁻⁹/day stability Opt. 001, (8) HP-IB, (9) external FM, (10) external AM & FM, (11) 5 x 10⁻⁹/week stability optional, (12) external AM & Φ M, (13) phase-continuous sweep, (14) internal & external AM & FM, (15) independent and simultaneous A, FM, PM and pulse modulation, (16) external AM, FM, and pulse modulation, (17) harmonically-related spurious < -60 dBc, (18) The HP 3326A is a two-channel synthesizer with internal modulation, square waves, discrete (user-defined) frequency sweep, and four operating modes including two-phase, two-tone, pulse, and two-channel.

**The HP 8660A/C, 8662A, 8663A and 8672A are synthesized signal generators. They are discussed in detail in the section labeled "Signal Generators."

***The HP 3325A Synthesizer/Function Generator includes squarewaves, positive and negative ramps, and triangle waveforms in addition to sinewaves.



FREQUENCY, FUNCTION & WAVEFORM SYNTHESIZERS

Arbitrary Waveform Synthesizer System, DC-50 MHz

Models 8770S, 8770A, 11775A

- A new source of "real-life" signals to 50 MHz
- New standard for generating arbitrary waveforms
- Quick and easy "what if" testing
- Accurate margin tests with user-defined distortions
- 125 MHz sample rate
- 12 bit resolution, 128K word memory

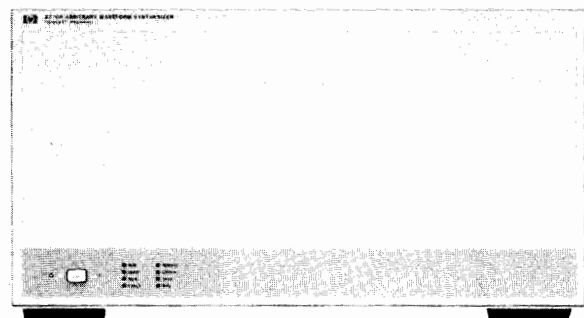
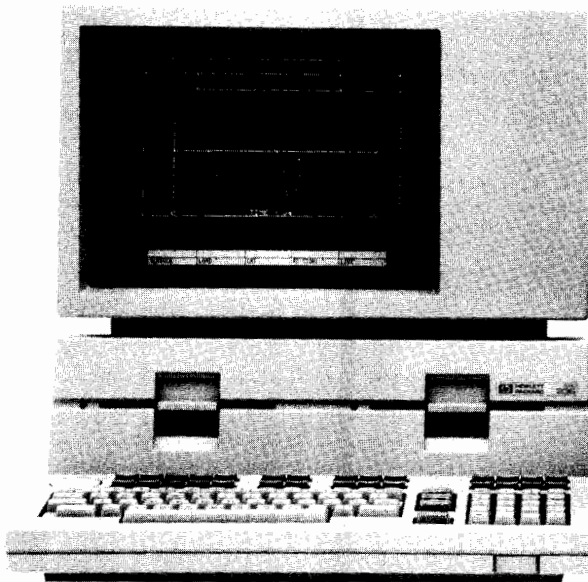

Complete Waveform Generation/Capture/Modification Systems

The HP 8770S is a complete system for the generation of arbitrary waveforms, DC to 50 MHz. The system can also be expanded to become a complete waveform development station. Waveforms created by the HP 11775A and generated by the HP 8770A can be viewed and captured by other instruments. The data can be brought back into the HP 11775A for modification of the original waveform. Now it becomes easy to perform "what if" testing quickly to more accurately determine a device's performance to actual signal conditions.

Providing Waveforms of Any Shape to 50 MHz

The HP 8770A Arbitrary Waveform Synthesizer and HP 11775A Waveform Generation Software set the new performance standard for providing "real-life" complex test signals. The HP 8770A offers capabilities not available before for accurate and efficient tests of rigid disc drives and other high speed serial logic systems, receiver systems and video system developments.

Generate Real-life Signals

Waveforms created with the HP 11775A software and generated from the HP 8770A can represent not only ideal test signals, but signals with precise amounts of distortions or noise added to represent true operating conditions. All signal parameters, including user-defined noise and distortions, are under complete control allowing for quick changes to meet new test demands. Regardless of your application, the use of precise, complex test signals will improve the evaluation of your circuits or systems.

Margin Tests Made Easy

Now you can quickly identify faulty or marginal systems at an early stage with signals containing varying amounts of distortion. Use signals from the HP 8770S to find many potential failures early and thus eliminate costly problems later on.

Complete Signal Control

The HP 8770A reproduces signals from waveform samples updated every 8 ns and thus allows change of signal parameters very rapidly. The 12-bit words give the HP 8770A's output high amplitude resolution. The internal clock phase-locks to a crystal oscillator and

provides a time-base with synthesizer accuracy. Special output circuits guarantee low harmonic and spurious signal levels to meet the needs of the most demanding application. A 110 dB RF attenuator allows signal power to be precisely set at any level desired. In addition, the HP 8770A has an amplitude accuracy of 2% (without attenuation) for added confidence in your quality control at any stage of development.

Powerful Software Speeds Waveform Creation

The HP 11775A Waveform Generation Software operates on the HP 216 and 236 technical computers. The HP 11775A is optimized for the easy creation and modification of waveform sample data defining the desired analog waves subsequently generated by the HP 8770A. Exact and precise waveforms can be quickly created using a command set that operates similar to a hand-held calculator. Glitches, noise or distortions can be added in precise amounts to waveforms to simulate real signal conditions for more accurate tests. Double your power by using the internal FFT routine to modify and create waveforms in the frequency domain. Create new, personalized commands out of existing commands to further increase waveform creation and modification efficiency.

Complex Signals Made Easy

Previously, the more complex a signal was, the more costly and difficult it was to produce. Fortunately, this is not the case with the HP 8770S. The HP 8770S can generate complex signals as easily as a signal generator generates a sine wave. Multi-tone signals, exponentially growing/decaying signals, irregular signals, pulses with jitter or truly arbitrary waveforms are quickly generated when samples of the desired waveforms are loaded into the HP 8770A memory. The HP 8770S can generate many signals without the need for external modulation sources, and at the same time you can add precise non-linearities or distortions to completely test a device's response and reduce development times.

Complete ATE Fit

Because of its versatility, the HP 8770S can simplify many of your test equipment requirements for providing complex signals. The HP 8770A has a complete HP-IB command set for full automatic control and easy downloading of waveform data previously defined by the HP 11775A software or by other means. Digital data representing waveform samples can be downloaded through either HP-IB, or through Direct-Memory-Access (DMA). Trigger outputs are also available to help waveform capture devices lock onto specific parts of test waveforms of special interest.

Build Waveform Libraries for Complete Tests

Any HP-IB computer can control the HP 8770A and download previously defined waveform data. Generate a library of test waveforms with the HP 11775A software and then download them to the HP 8770A from the computer in your ATE system for use in your applications.

Meet New Test Signal Requirements Quickly

The versatility of the HP 8770S assures that you will have the test signals needed to meet future needs. To generate new waveforms, waveform data need only be created with the software and then downloaded into the HP 8770A for immediate generation, or saved for later use and for distribution to multiple stations. The large 128K word memory of the HP 8770A ensures that even the most complex waveforms can be completely defined and generated.

Sequencing Stretches Memory

With most arbitrary waveforms, certain parts of the waveform often repeat themselves and quickly fill up even the largest arbitrary waveform generator memory. This leaves less memory to define the rest of the desired test signal. The HP 8770A avoids this problem by programming sections of memory (packets) to be repeated any number of times and in any order. This sequencer capability frees large amounts of memory to give greater flexibility when defining the rest of the desired test signal. Many test signals can also be stored simultaneously in the memory and accessed at any time with the sequencer.



The HP 8770S offers complex waveform synthesis up to 50 MHz bandwidths.

Performance Characteristics

Peak Output Signal: 2 V p-p into 50 ohms

Attenuator: 110 dB in 10 dB steps

DC Performance

Resolution: 12 bits per sample

Differential Non-linearity: <1 LSB typical

Integral Non-linearity: <2 LSB typical

Absolute Accuracy (20-30° C): ±2% of full scale

Sine Wave Performance

Frequency Range: DC to 50 MHz

Time Base: Internal 10 MHz (< 5x10⁻¹⁰/day aging rate after 24 hour warm-up)

Clock Rate: 125 MHz internal or 10 - 130 MHz external input

Harmonic Distortion: < -50 dBc

Spurious & Non-linear Distortion: < -60 dBc for signals <30 MHz
< -50 dBc for signals >30 MHz

Two-Tone Linearity (124 KHz separation): < -57 dBc

SSB Phase Noise @ 10 MHz: < -125 dBc/Hz @ 10 kHz offset typical

Dynamic Range: 72 dB plus 110 dB step attenuator

Amplitude Flatness (without attenuation): ±0.5 dB

Amplitude Stability: ±0.02 dB typical @ 20° C after 24 hour warm-up

Risetime: 8 ns (10% to 90%) typical

Output Markers: Memory Scan Start

Packet Start

Sequence Start

Memory Address Equal

HP-IB Interface Codes: SH1, AH1, T5, TE0, LE0, L3, SR1, RL1, PP1, DC1, DT1, C0

General

Operating Temperature: 15 - 40°C

Power: 300 VA

Weight: Net, 23.6 kg (52 lb), Shipping, 29.5 kg (65 lb)

Size: 235 H x 425.5 W x 622 mm D (9.25" x 16.75" x 24.5")

Ordering Information

Price

HP 8770S Waveform Synthesizer System

To ensure coordination of shipments and compatibility of instruments, computers and software, use the system model number when ordering individual components. Obtain the HP 8770A and HP 11775A Data Sheet and an HP 8770S Ordering Guide from your local sales office.

HP 8770A Arbitrary Waveform Synthesizer

To be

Announced

N/C

To be

Announced

Option 002: 75 ohm Output Impedance

HP 11775A Waveform Generation Software

(5.25" Diskettes Standard)

Option 630: 3.5" Diskettes Only

N/C

FREQUENCY, FUNCTION & WAVEFORM SYNTHESIZERS

1 μ Hz to 21 MHz Synthesizer/Function Generator

Model 3325A

- Synthesizer
- Function generator
- Sweeper
- Programmable

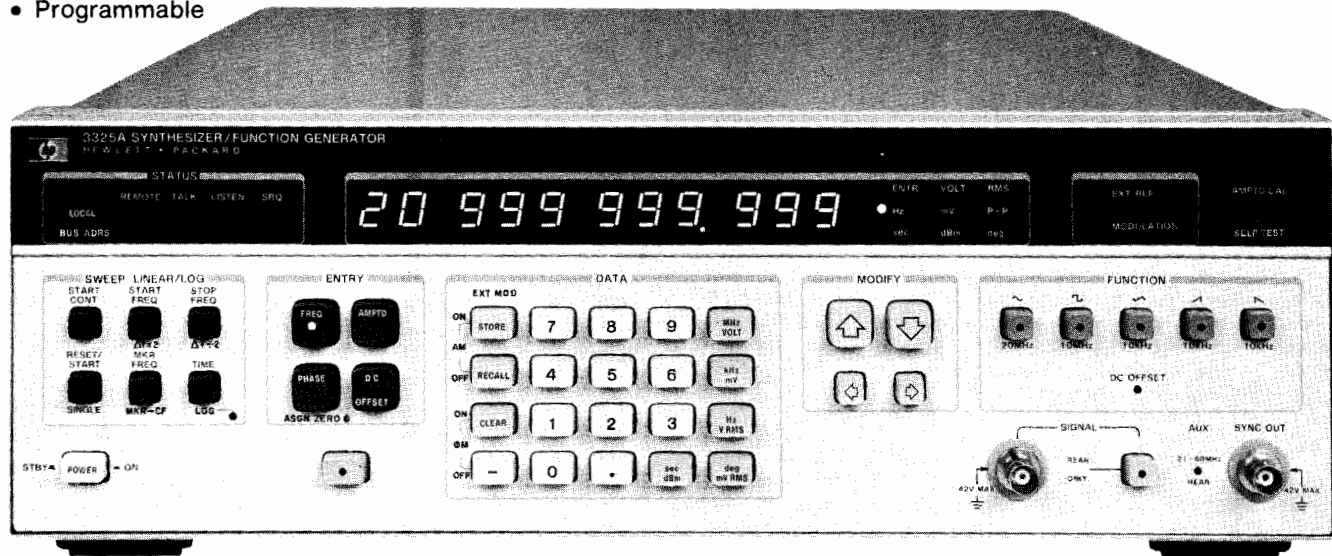

HP 3325A



Description

The HP 3325A Synthesizer/Function Generator is an uncompromising, high performance synthesizer with 11 digit resolution, a function generator with precision waveforms, a wideband sweeper, and a fully programmable systems instrument.

Synthesizer

The HP 3325A is first with microhertz resolution below 100 kHz along with frequency coverage from .000001 Hz to 20.999 999 999 MHz. Signal purity, accuracy and stability are as good or better than earlier stand-alone HP synthesizers. Harmonics are 65 dB down below 50 kHz and you can externally modulate with AM and PM.

Function Generator

The HP 3325A is also a high performance function generator providing precision waveforms with synthesizer accuracy and resolution. Squarewaves to 10.999 999 999 MHz have 20 ns rise and fall times. Triangles and ramps with .05% linearity are available up to 10.999 999 999 kHz. All waveforms can be dc and phase offset.

A Wideband Sweeper

A major contribution is wideband phase continuous sweep, covering up to the full frequency range of each waveform. Sweep log or linear, single or continuous without the phase discontinuities usually associated with synthesizers. Phase lock loop testing is made easier.

Make convenient swept frequency network measurement on filters, amplifiers or any passive or active network. Use the TTL marker to check the frequency of points of interest on a swept frequency display desired. Use the convenient "zoom" functions $\Delta F \times 2$ and $\Delta F \div 2$ to quickly change the frequency span for the display desired.

Fully Programmable

All necessary functions are programmable on the HP-IB, including frequency, amplitude, all functions, phase and dc offset, modulation, all sweep parameters, amplitude cal and self-test, making the HP 3325A a very versatile and powerful addition to automatic test systems. The isolated interface combined with floating outputs and inputs and talk mode make the HP 3325A easy to use in Automatic Test Systems.

More Features

The phase of the output can be changed $\pm 719.9^\circ$ with 0.1° resolution. The phase is advanced (or retarded) with respect to the starting

phase. Two HP 3325A units can be phase locked together for dual phase output applications.

DC offset is capable of ± 4.5 Vdc on the standard instrument. The high voltage option (Opt 002) allows ac voltages up to 40 Vpp and ac + dc up to ± 18 V total (ac peak + dc).

Ten storage registers can be programmed with ten different combinations of function/parameter settings from the front panel, stored and then recalled.

The HP 3325A can display 11 digits of frequency and 4 digits of volts or millivolts from 1 mV to 10 volts peak to peak. Conversion to RMS or dBm is simple with the touch of a button.

New Technology

The HP 3325A provides unprecedented performance per dollar thanks to several major contributions from advances in HP technology. A single loop Fractional-N synthesis technique allows synthesizer accuracy with 11 digits of resolution and, as an added bonus, phase continuous frequency sweep. Fewer parts and integrated circuit technology make the difference. A unique method of triangle and ramp waveform generation provides excellent linearity. Add microprocessor control and Hewlett-Packard Interface Bus (HP-IB) operation and the result is more performance, flexibility and versatility on the bench or in automatic test systems than previously available, and at a lower cost.

Specifications

Refer to the HP 3325A data sheet for complete specifications.

Waveforms

Sine, Square, Triangle, negative and positive Ramps.

Frequency Range

Sine: 1 μ Hz to 20.999 999 999 MHz

Square: 1 μ Hz to 10.999 999 999 MHz

Triangle/ramps: 1 μ Hz to 10.999 999 999 kHz

Resolution: 1 μ Hz, < 100 kHz

1 mHz \geq 100 kHz

Aging rate: $\pm 5 \times 10^{-6}$ /year, 20° to 30°C

Warm-up time: 20 minutes to within specified accuracy

Main Signal Output (all waveforms)

Impedance: 50 Ω

Connector: BNC; switchable to front or rear panel, nonswitchable with option 002, except by internal cable change.

Amplitude

Range: 1 mV to 10 V p-p in 8 amplitude ranges, 1-3-10 sequence (10 dB steps), into 50 Ω load.

| Function | Sine | | Square | | Triangle/Ramps | |
|-----------------|----------|---------|----------|---------|----------------|---------|
| | min | max | min | max | min | max |
| Units Displayed | | | | | | |
| peak-peak | 1.000 mV | 10.00 V | 1.000 mV | 10.00 V | 1.000 mV | 10.00 V |
| rms | 0.354 mV | 3.536 V | 0.500 mV | 5.000 V | 0.289 mV | 2.887 V |
| dBm (50 Ω) | -56.02 | +23.98 | -53.01 | +26.99 | -57.78 | +22.22 |

Resolution: 0.03% of full range or 0.01 dB (4 digits).

Amplitude Accuracy (without dc offset, relative to programmed amplitude and accuracy)

Sinewave Amplitude Accuracy

1 mHz to 100 kHz: ±0.1 dB, ≥3 Vpp; ±0.2 dB, <3 Vpp
100 kHz to 20 MHz: ±0.4 dB, ≥3 Vpp; ±0.6 dB, 0.1 to 3 Vpp

Squarewave Amplitude Accuracy

1 mHz to 100 kHz: 1%, ≥3 Vpp; 2.2%, <3 Vpp
100 kHz to 10 MHz: 11.1%, ≥3 Vpp; 13.6%, <3 Vpp

Triangle Amplitude Accuracy

1 mHz to 2 kHz: 1.5%, ≥3 Vpp; 2.7%, <3 Vpp
2 kHz to 10 kHz: 5%, ≥3 Vpp; 6.2%, <3 Vpp

Sinewave Spectral Purity

Phase noise: -60 dB for a 30 kHz band centered on a 20 MHz carrier (excluding ±1 Hz about the carrier) with high-stability option 001 installed.

Spurious: all non-harmonically related output signals will be more than 70 dB below the carrier (60 dB with dc offset), or less than -90 dBm, whichever is greater.

Sinewave harmonic distortion: harmonically related signals will be less than the following levels (relative to the fundamental) at full output for each range:

| Frequency Range | Harmonic Level |
|-------------------|----------------|
| 0.1 Hz to 50 kHz | -65 dB |
| 50 kHz to 200 kHz | -60 dB |
| 200 kHz to 2 MHz | -40 dB |
| 2 MHz to 15 MHz | -30 dB |
| 15 MHz to 20 MHz | -25 dB |

Squarewave Characteristics

Rise/fall time: ≤20 ns, 10% to 90% at full output

Overshoot: ≤5% of peak to peak amplitude, at full output

Settling time: <1 μs to settle to within .05% of final value.

Phase Offset

Range: ±719.9° with respect to arbitrary starting phase or assigned zero phase

Resolution: 0.1°

Accuracy: ±0.2°

DC Offset

Range: dc only (no ac signal): 0 to ±5.0 V/50 Ω.

dc + ac: Maximum dc offset ±4.5 V on highest range, decreasing to ±4.5 mV on lowest range.

Resolution: 4 digits

Sinewave Amplitude Modulation

Modulation depth at full output for each range: 0-100%

Modulation frequency range: dc to 400 kHz (0-21 MHz carrier frequency)

Sensitivity: ±5 V peak for 100% modulation

Sinewave Phase Modulation

Range: ±850°, ±5 V input

Modulation frequency range: dc -5 kHz

Frequency Sweep

Sweep Time

Linear: 0.01 s to 99.99 s

Logarithmic: 2 s to 99.99 s single, 0.1 s to 99.99 s continuous

Maximum sweep width: full frequency range of the main signal output for the waveform in use, except minimum log start frequency is 1 Hz.

Phase continuity: sweep is phase continuous over the full frequency range of the main output.

Auxiliary Inputs and Outputs

Reference input: for phase-locking HP 3325A to an external frequency reference signal from 0 dBm to +20 dBm into 50 Ω. Reference signal must be a subharmonic of 10 MHz from 1 MHz to 10 MHz.

Auxiliary frequency output: 21 MHz to 60.999 999 999 MHz, under range coverage to 19.000 000 001 MHz, frequency selection from front panel; 0 dBm; output impedance 50 Ω.

Sync output: square wave with V (high) ≥1.2 V, V (low) ≤0.2 V into 50 Ω.

X-Axis drive: 0 to >+10 V dc linear ramp proportional to sweep frequency, linearity, 10-90%, ±0.1% of final value.

Sweep marker output: high to low TTL compatible voltage transition at selected marker frequency.

Z-Axis blank output: TTL compatible voltage levels capable of sinking 200 mA from a positive source.

1 MHz reference output: 0 dBm output for phase-locking additional instruments to the HP 3325A.

10 MHz oven output: 0 dBm internal high stability frequency reference output for phase-locking HP 3325A. (Opt. 001 only)

HP-IB Interface Functions: SH1, AH1, T6, L3, SR1, RL1, PP0, DC1, DT0, C0, E1.

Recommended Accessory: HP 7090A Measurement Plotting System.

Option 001 High Stability Frequency Reference

Aging rate: ±5 × 10⁻⁸/week (72-h warm up); ±1 × 10⁻⁷/month (after 15 days continuous operation).

Ambient stability: ±5 × 10⁻⁸ (0° to +55°C).

Warm-up time: reference will be within ±1 × 10⁻⁷ of final value 15 minutes after turn-on for an off time of less than 24 hours.

Option 002 High Voltage Output

Frequency range: 1 μHz to 1 MHz

Amplitude

Range: 4.00 mVpp to 40.00 Vpp (500 Ω, < 500 pF load).

Accuracy and Flatness at Full Output

Sine, square, and triangle waves: ±2% at 2 kHz

Ramps: ±2% at 500 Hz

Flatness: ±10% relative to programmed amplitude

Sinewave distortion: harmonically related signals will be the same as the standard instrument to 1 MHz

Maximum output current: 80 mA_{pp}.

Output impedance: < 2 Ω at dc, < 10 Ω at 1 MHz

DC offset range: 4 times the specified range of the standard instrument.

General

Operating environment

Temperature: 0°C to 55°C.

Relative humidity: 95%, 0°C to 40°C.

Altitude: ≤ 15,000 ft.

Storage temperature: -40°C to +75°C.

Storage altitude: ≤ 50,000 ft.

Power: 100/120/220/240 V, +5%, -10%, 48 to 66 Hz; 90 VA, 120 VA with all options; 10 VA standby.

Weight: 9 kg (20 lb) net; 14.5 kg (32 lb) shipping.

Size: 132.6 H x 425.5 W x 497.8 mm D (5.25" x 16.75" x 19.63").

Ordering Information*

| | Price |
|---|-----------|
| HP 3325A Frequency Synthesizer | \$4300 |
| Opt. 001 High Stability Frequency Reference | add \$750 |
| Opt. 002 High Voltage Output | add \$250 |
| Opt 907 Front Handle Kit (standalone orders P/N HP 5061-0089) | \$55 |
| Opt 908 Rack Flange Kit (standalone orders P/N HP 5061-0077) | \$32.50 |
| Opt 909 Rack Flange and Handle Combination Kit (standalone orders P/N HP 5061-0083) | \$80 |

*HP-IB cable not supplied. See page 121.

FREQUENCY, FUNCTION & WAVEFORM SYNTHESIZERS

Two-Channel Synthesizer, DC to 13 MHz

Model 3326A



HP 3326A



The HP 3326A Two-Channel Synthesizer combines two independent synthesizers, flexible modulation, and control circuitry into a single, powerful package. This single instrument can provide precise phase offset, two-tone sweep, fast frequency switching, internal modulation, and pulse signals for bench or systems use.

Complete Two-Phase Solution

The HP 3326A can provide two signals whose phase is adjustable and calibrated anywhere in its 13 MHz frequency range without an external phasemeter.

Self-calibration can be performed internally or externally and yields accuracy of ± 0.2 degrees below 100 kHz. Phase can be set with 0.01 degree resolution at all frequencies. Using its unique phase-calibration circuitry, calibrated multi-phase signals are easily achieved with two or more HP 3326As.

Powerful Two-Tone Capability

The HP 3326A is the single-source answer for producing a wide variety of broadband two-tone signals. Its two channels can be offset up to ± 100 kHz, either in the CW mode or while sweeping.

Channel amplitudes and functions (sine or square) can be selected independently and provided from separate outputs or through the built-in signal combiner. Low sinewave distortion (harmonics are at least -70 dBc below 100 kHz) makes low-distortion intermodulation measurements a simple task.

Versatile ATE Source

With two complete synthesizers in a single instrument, rack space and power are conserved. Features like internal amplitude and phase modulation, two-tone, and pulse modes allow this one instrument to do the job of several sources.

All functions, modes, and parameters of the HP 3326A are completely programmable over the HP-IB. Maximum accuracy is ensured with amplitude/phase calibrations that can be enabled, disabled and initiated under remote control.

High Performance Modulation and Pulses

Precise amplitude and phase modulation is easy with both channels of the HP 3326A. Each channel can be used with simultaneous AM and PM, or one channel can modulate the other. Amplitude modulation frequency is dc to 100 kHz and envelope distortion is better than -46 dB.

In the pulse mode both pulse and pulse-complement outputs are provided. Symmetry range is 1% to 99% and is settable in 0.1% increments. In addition, both pulse amplitudes and their offsets are independently controllable.

Other Features

The HP 3326A has a host of convenience features to speed and simplify signal generation. Nine complete setup states can be stored in nonvolatile memory, along with automatic storage of the power-off state. A discrete sweep mode is available to generate from 2 to 63

frequency pairs with dwell times individually selectable for each frequency and each channel. Several flexible triggering modes allow hardware or software triggers to initiate frequency, amplitude, or phase changes, and sweeps.

DC offset is available in all modes, and all outputs are floating. Frequency resolution is 11 digits, and all sweeps and frequency changes are phase-continuous.

Specifications

For complete specifications refer to the HP 3326A data sheet.

Operating Modes

Two Channel: Channels A and B are independent

Two-Phase: Channels A and B are the same frequency, with calibrated phase offset between the two signals

Two-Tone: Channel B frequency offset 0 to 100 kHz from channel A frequency

Pulse: Channel B is the complement of Channel A

Frequency (Waveforms are Sine, Square, Pulse, and DC)

Range: 0 Hz to 13 MHz

Resolution: 1 μ Hz below 100 kHz, 1 mHz at and above 100 kHz

Stability: $\pm 5 \times 10^{-6}$ /year, 20° to 30°C. See also option 001, High Stability Frequency Reference.

Accuracy: $\pm 5 \times 10^{-6}$ of selected value, 20° to 30°C, at time of calibration with standard frequency reference

Sinewave Spectral Purity

Harmonics: Harmonically related signals will be less than the following levels relative to the fundamental, or < -90 dBm, whichever is greater:

| | 10 Hz | 50 kHz | 100 kHz | 1 MHz | 13 MHz |
|------------|-------|---------|---------|---------|---------|
| +23.98 dBm | ----- | ----- | ----- | ----- | ----- |
| | | -80 dBc | -70 dBc | -55 dBc | -30 dBc |
| +13.98 dBm | ----- | ----- | ----- | ----- | ----- |
| | | -80 dBc | -80 dBc | -65 dBc | -50 dBc |
| -56.02 dBm | ----- | ----- | ----- | ----- | ----- |

Integrated Phase noise: -66 dBc (Option 001 only, for a 30 kHz band centered on a 10 MHz carrier excluding ± 1 Hz about the carrier)

Main Signal Outputs (Channels A & B, All Waveforms Unless Noted)

Connectors: Front panel BNC female

Impedance: 50 Ω ; output may be floated to ± 42 V peak

Sync A: TTL level squarewave at Channel A frequency.

Output Amplitude (Sine Mode)

Range: 1 mVpp to 10 Vpp in 8 ranges without DC offset. See also option 002 High Voltage Output

Units: Volts peak-peak, Volts rms, dBm (50 Ω), dBV



Resolution: 0.1% of full range for peak-peak entry
0.3% of full range for rms entry
0.01 dB for dBm or dBV entry

Accuracy: Relative to programmed value after self-calibration

| | 0.001 Hz | 100 kHz | 1 MHz | 13 MHz |
|------------|----------|---------|---------|--------|
| +23.98 dBm | ----- | ----- | ----- | ----- |
| | ±0.1 dB | ±0.3 dB | ±0.6 dB | |
| +3.98 dBm | ----- | ----- | ----- | ----- |
| | | | ±0.8 dB | |
| -36.02 dBm | ±0.2 dB | ±0.5 dB | ----- | ----- |
| | | | ±1.0 dB | |
| -56.02 dBm | ----- | ----- | ----- | ----- |

Squarewave and Pulse Characteristics

Rise/fall time: ≤15 ns, 10% to 90% at full output
Overshoot: ≤5% of peak-to-peak amplitude at full output
Pulse width range: 1% to 99% of period or 20 ns, whichever is greater
Pulse width resolution: 0.1% of period
Pulse width accuracy: ≤±1% of period ±20 ns
Amplitude accuracy: ±2%, 0.001 Hz to 100 kHz

DC Offset

Range: (See also option 002, high voltage output)
DC only: 0 to ±5 V
DC+AC: DC+AC peak ≤5V; Max. DC offset is affected by AC range, Maximum is 4.5 V decreasing to 4.5 mV on lowest range
Resolution: 3 digits
Accuracy: (After self-calibration)
DC only: ±75 mV
DC+AC: (Sinewave) 10 Hz to 1 MHz: ±2% of range
1 MHz to 13 MHz: ±5% of range

Phase Offset

(Channel A vs B in Two-Phase mode)
Range: ±720 degrees
Resolution: 0.01 degree
Accuracy: After self-calibration, for equal-level sinewaves 1 V to 10 V peak-peak

| | |
|------------------|--------------|
| 0.1 Hz to 10 Hz | ±0.5 degrees |
| 10 Hz to 100 kHz | ±0.2 degrees |
| 100 kHz to 1 MHz | ±0.3 degrees |
| 1 MHz to 13 MHz | ±2.0 degrees |

Amplitude Modulation

Specifications apply to Channel A and Channel B with external modulation or to Channel A internal modulation with Channel B as the modulation source. External modulation is allowed in all modes; internal modulation is allowed only in the two-channel mode.
Waveforms: Sine, square, or (external only) pulse
Frequency Range: Carrier: DC to 13 MHz
Modulation: DC to 100 kHz
Modulation Depth: 0 to 100%

Phase Modulation

Specifications apply to Channel A and Channel B with external modulation or to Channel A internal modulation with Channel B as the modulation source. External modulation is allowed in all modes; internal modulation is allowed only in the two-channel mode.
Waveforms: Sine, square, or (external only) pulse
Frequency Range: Carrier: DC to 13 MHz
Modulation: DC to 5 kHz
Phase Deviation: 0° to 360°

Frequency Sweep

Sweep Types: Linear, discrete
Sweep Forms: Triangle, ramp
Sweep Time: 5 ms to 1000 s
Sweep Elements (Discrete): 2 to 63 frequency pairs and dwell times, user defined; dwell times = 5 ms to 1000 s/element
Maximum Sweep Width: 13 MHz

Output Combiner

Channel A and B are combined on the Channel A output. B output is off. Combiner may be used in the two-channel, two-phase, and two-tone modes. DC offset is automatically set to 0 V.

Frequency Range: DC to 13 MHz
Return Loss: >20 dB

Auxiliary Outputs (All Connectors are Rear-Panel BNC)

10 MHz reference: +3 dBm output to phase lock other instruments to the HP 3326A
10 MHz oven output: +3 dBm oven-stabilized frequency reference (option 001 only)
X-axis drive: Linear ramp proportional to sweep time
Z-axis blank: TTL low during sweep
Sweep Marker: TTL low at selected marker frequency in sweep
20-33 MHz LO: >100 mV square wave output offset 20 MHz from Channel B output

Auxiliary Inputs (All Connectors are Rear-Panel BNC)

Reference Input: For phase-locking to an external frequency reference. Signal of 1,2,5, or 10 MHz, ±10 ppm, 0 to +20 dBm
External Trigger Input: TTL level to initiate linear or discrete sweep on high to low transition
Channel A and B external phase calibration inputs
Channel A and B external amplitude modulation inputs
Channel A and B external phase modulation inputs

HP-IB Remote Control

Compatible with IEEE Standard 488-1978
Interface Functions:
SH1,AH1,T6,L4,SR1,RL1,PP0,DC1,DT1,C0,E1

Option 001 High Stability Frequency Reference

Stability: ±5×10⁻⁸/week after 72 hours continuous operation
±1×10⁻⁷/month after 15 days continuous operation

Option 002 High Voltage Output

Multiplies the output level by 4 and expands the allowable DC offset range. Specifications apply to both channels in all modes with the internal combiner off.
Frequency range: DC to 1 MHz
Output impedance: <2 Ω, DC to 50 kHz; <10 Ω, 50 kHz to 1 MHz
Amplitude range: 4 mV to 40 V_{pp} into >1k Ω, <200 pF load without DC offset (must be entered in peak-to-peak units only)
DC offset: ±20 V, independent of amplitude range. DC + AC peak must not exceed 20 V

Option 003 Rear Terminal Outputs

Provides Channel A and B main outputs only on rear panel BNC's. Front panel main outputs are removed. Specifications unchanged.

General

Power: 100/120/220/240 V, +5%, -10%, 48 to 66 Hz; 120 VA, 150 VA with all options, 10 VA standby
Weight: 27 kg (60 lb) net, 37 kg (81 lb) shipping
Dimensions: 177 mm H x 425.5 mm W x 497.8 mm D (7" x 16³/₄" x 19⁵/₈")

Accessories Available

HP 15507A Isolator: For isolation of signal ground between frequency reference and instrument input/output
HP 9211-2656 transit case for protection in transportation and storage

Ordering Information

| | Price |
|---|------------|
| HP 3326A Two-Channel Synthesizer | \$9200 |
| Option 001 High Stability Frequency Reference | add \$650 |
| Option 002 High Voltage Output | add \$300 |
| Option 003 Rear Terminal Outputs | N/C |
| Option 907 Front Handle Kit | \$60 |
| Option 908 Rack Flange Kit | \$35 |
| Option 909 Rack Flange and Handle Combination Kit | \$90 |
| Option 910 Extra Operating Manual | add \$100 |
| Option 914 Delete Service Manual | less \$115 |



FREQUENCY, FUNCTION & WAVEFORM SYNTHESIZERS

Synthesizer/Level Generator 200 Hz to 81 MHz

Model 3335A

- 1 mHz resolution
- High spectral purity
- Precision amplitude control
- Program storage
- HP-IB

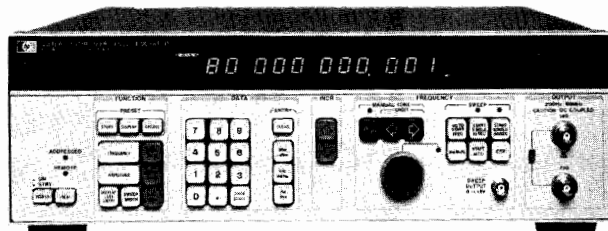

HP 3335A



Description

Covering a frequency range of 200 Hz–81 MHz, the HP 3335A Synthesizer/Level Generator has performance characteristics that make it ideally suited for the telecommunications industry, as well as for traditional synthesizer applications, including testing of Frequency Division Multiplex (FDM) equipment and R & D and production testing of communications systems. It features precision level control, millihertz resolution, high spectral purity, internal frequency sweep, HP-IB programmability and numerous user conveniences.

Internal Storage

Up to 10 different front panel settings (frequency, level, ϕ incr, etc.) can be stored in internal memory registers for later recall. The DISPLAY key allows viewing of register contents without altering the synthesizer output.

Precision Amplitude

Increasing channel capacity of Frequency Division Multiplex (FDM) systems is continually placing more stringent requirements on the testing of transmission parameters. To meet these performance standards, the HP 3335A incorporates a state-of-the-art attenuator resulting in attenuator accuracies of up to ± 0.025 dB over the 81 MHz frequency range.

HP-IB Programmability

IEEE STD 488-1978 Definition SH1, AH1, T6, L3, SR1, RL1, PP0, DC1, DT0, C0, E1.

Frequency Stability

The HP 3335A synthesizes its output frequency from an internal temperature-controlled crystal oscillator which provides $\pm 1 \times 10^{-8}$ /day frequency stability ($\pm 5 \times 10^{-10}$ is optional). The HP 3335A can also be phase-locked to any external frequency standards.

Automatic Frequency Sweep

The HP 3335A combines the precision frequency accuracy and stability of a synthesizer with the time-saving convenience of a digital sweeper.

SLMS - Tracking Generator

The HP 3335A operates as a tracking generator with the HP 3746A/B Selective Level Measuring Set (SLMS), or the HP 3586A/B/C Selective Level Meter for automatic or semi-automatic testing of FDM systems. For closed-loop tracking where the HP 3335A and HP 3746A/B are in the same location, the frequency of the generator is controlled by the microprocessor in the SLMS.

Options

Standard: equipped with switch-selectable 50 Ω and 75 Ω outputs (BNC connectors).

001: High-stability frequency reference

002/004: Equipped with 75 Ω unbalanced and 124 Ω and 135 Ω balanced connectors per table.

| Option | Fits WECO Type | Spacing | Accepts WECO Type | |
|--------------|----------------|--------------|---------------------------------|--------------|
| 75 Ω | 002 004 | 477B 560A | N/A 358A 439A/440A | |
| 124 Ω | 002 004 | 477B 560A | 16 mm (.625") 12.7 mm (0.5") | 372A 443A |
| 135 Ω | 002/004 | 223A | 16 mm (.625") | 241A |

003: 75 Ω unbalanced BNC output and 150 Ω balanced output using a pair of BNC connectors at 20 mm (0.80 in.) spacings.

Abbreviated Specifications

(For complete specifications, refer to the HP 3335A data sheet.)

Frequency Range

Standard: 200 Hz–81 MHz;

Opt. 002/004: 75 Ω , 200 Hz–81 MHz; 124 Ω , 10 kHz–10 MHz; 135/150 Ω , 10 kHz - 2 MHz.

Opt. 003: 75 Ω , 200 Hz–81 MHz; 150 Ω , 10 kHz - 2 MHz

Frequency resolution: .001 Hz.

Stability, long term: $\pm 1 \times 10^{-8}$ /day; $\pm 1 \times 10^{-7}$ /month.

Opt. 001 (high stability frequency reference)

Aging rate: $\pm 5 \times 10^{-10}$ /day; $\pm 2 \times 10^{-8}$ /month; $\pm 1 \times 10^{-7}$ /year

Warmup: Within 5×10^{-9} of final value 20 minutes after turn-on at 25°C.

Spectral Purity

Harmonic distortion: 200 Hz–10 MHz: < -45 dBc; 10 MHz–81 MHz; < -40 dBc

Phase noise (30 kHz band, excluding ± 1 Hz, centered on the carrier): 9.9 MHz: < -63 dBc; 20 MHz; < -70 dBc; 40 MHz: < -64 dBc; 81 MHz: < -58 dBc

Spurious: nonharmonically related signals: the greater of -75 dBc or -125 dBm (50/75 Ω), -97 dBm (124 Ω), -68 dBm (135/150 Ω)

Amplitude Range

Standard: 50 Ω : +13.01 dBm to -86.98 dBm; 75 Ω : +11.25 dBm to -88.74 dBm.

Opt. 002/004: 75/124/135 Ω : +11.25 dBm to -88.74 dBm

Opt. 003: 75/150 Ω : +11.25 dBm to -88.74 dBm

Signal balance (124 Ω , 135 Ω , 150 Ω balanced outputs): > 60 dB at 100 kHz

Resolution: 0.01 dB

Absolute level accuracy (max. output at 100 kHz, 20°C to 30°C): 50/75 Ω ± 0.05 dB; 124/135/150 Ω : ± 0.1 dB

Flatness (relative to 100 kHz, full amplitude): 50/75 Ω : 1 kHz – 25 MHz: ± 0.07 dB; 200 Hz - 81 MHz: ± 0.15 dB. 124 Ω : 10 kHz - 10 MHz: ± 0.15 dB, 10 kHz - 10 MHz ± 0.4 dB; 135/150 Ω : 10 kHz - 2 MHz: ± 0.18 dB

Attenuator:

Range: 0 to 98 dB in 2 dB steps

Accuracy: (1 year)

50 Ω :

| ATTENUATION | FREQUENCY |
|-------------|---------------|
| 0 to 38 dB | ± 0.25 dB |
| 40 to 58 dB | ± 0.3 dB |
| 60 to 98 dB | ± 0.9 dB |

75 Ω :

| ATTENUATION | FREQUENCY | |
|-------------|--------------|---------------|
| | 200Hz | 25 MHz 80 MHz |
| 0 to 18 dB | ± 0.4 dB | ± 1.5 dB |
| 20 to 58 dB | ± 0.9 dB | ± 2.5 dB |
| 60 to 98 dB | ± 2.0 dB | ± 5.0 dB |

Options

001: Hi-stability reference $\pm 5 \times 10^{-10}$ /day

002: Connector option (75/124/135 Ω)

003: Connector option (75/150 Ω)

004: Connector option (75 Ω , miniature WECO on 124/135 Ω)

Price

add \$1210

add \$550

add \$350

add \$550

HP 3335A Synthesizer/Level Generator

\$10,100

FREQUENCY, FUNCTION & WAVEFORM SYNTHESIZERS

Synthesizer/Level Generator

Model 3336C

457

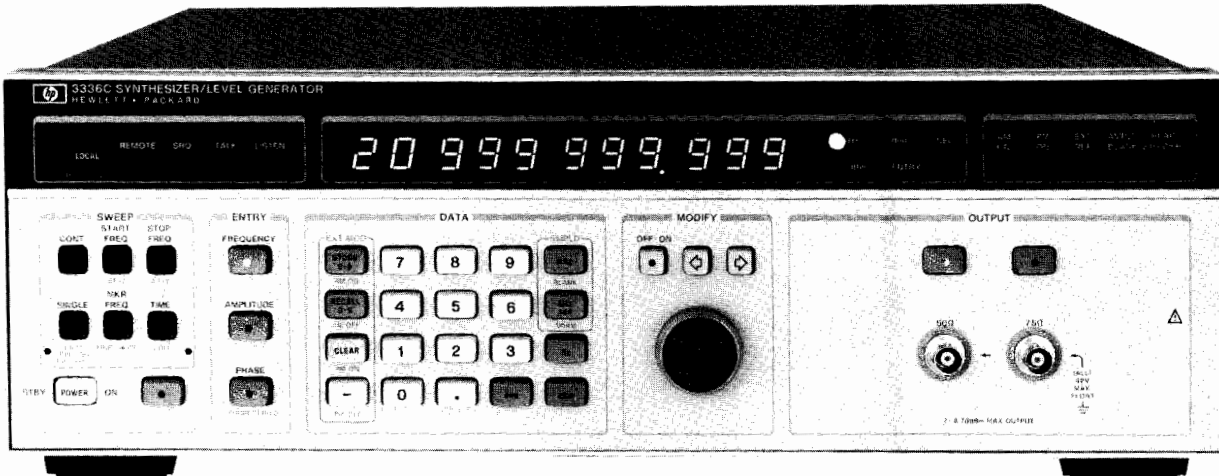

HP 3336C



Description

Covering a frequency range of 10 Hz to 20.999 MHz, the HP 3336C is designed for traditional synthesizer applications as well as R&D and production testing of systems or components. It features precision level control, high spectral purity, optional frequency stability of $\pm 5 \times 10^{-8}$ /week, internal frequency sweep and numerous user conveniences. All models include HP-IB.

Precision Frequency Measurements

Major advances in HP technology have provided a single loop, fractional-N synthesis technique which allows synthesizer accuracy with 11 digits of resolution, with completely phase continuous frequency sweep over any of the instrument's frequency ranges. Microhertz resolution below 100 kHz allows precise frequency measurements over a range of 10 Hz to 20.999 999 999 MHz. Harmonics are below -60 dBc over the range from 50 Hz to 1 MHz (-50 dBc to 20 MHz), with spurious signals below -70 dBc or -100 dBm in the standard instrument, -115 dBm with an option. Integrated Phase Noise is -64 dBc (30 kHz BW).

± 0.05 dB Amplitude Accuracy

New HP attenuator technology coupled with custom designs in leveling loops and thermal converters produce amplitude accuracies seen only in instruments at much greater cost. The fast leveling loop makes extremely flat sweeps possible at high sweep speeds. External leveling is also available for those custom applications where a control loop is desired.

Other Features

Models HP 3336 A & B are also available for the telecommunications industry. See page 000. All three models (the HP 3336A, B & C) have 10 storage registers; amplitude blanking capability during frequency switching; linear or logarithmic phase continuous sweep capabilities; RPG (rotary pulse generator) to simplify modification of any digit in the display; phase offset capability; output connector and impedance flexibility; AM and PM modulation; and many other features. Refer to the data sheet for complete information.

Abbreviated Specifications

Frequency

Range: 10 Hz to 20.999 999 999 MHz

Resolution: 1 μ Hz for frequencies < 100 kHz, 1 mHz for frequencies ≥ 100 kHz

Aging rate: $\pm 5 \times 10^{-6}$ /year (20° to 30°C)

Warm-up time: 30 minutes to within specified accuracy

Amplitude

Range: 50 Ω : -71.23 to $+8.76$ dBm; 75 Ω : -72.99 to 7.00 dBm

Absolute accuracy: ± 0.05 dB, 20° to 30°C (for the top 9.99 dB of amplitude range at 10 kHz), ± 0.08 dB, 0° to 55°C

Flatness: 50/75 Ω , ± 0.1 dB (± 0.07 dB with option 005) referenced to 10 kHz.

Attenuator Accuracy: (instruments without option 005)

10 Hz 1 MHz 10 MHz 20.9 MHz

| | | | |
|----------------|--------------|--------------|--------------|
| 10 to 19.99 dB | ± 1 dB | ± 1.5 | ± 2 dB |
| 20 to 39.99 dB | ± 1.5 dB | ± 2 dB | ± 2.5 dB |
| 40 to 79.99 dB | ± 2 dB | ± 2.5 dB | ± 3 dB |

Note: Amplitude Accuracy is the sum of the Absolute Accuracy and, as necessary, Flatness and Attenuator Accuracy.

Phase Offset

Range: $\pm 719.9^\circ$ with respect to arbitrary reference phase.

Amplitude Modulation

Modulation depth: 0 to 100%

Modulation frequency range: 50 Hz to 50 kHz

Envelope distortion: < -30 dB to 80% modulation (1 kHz modulating freq.)

Phase Modulation

Range: 0° to $\pm 850^\circ$

Linearity: $\pm 0.5\%$ from best fit straight line

Modulation frequency range: dc to 5 kHz

Input sensitivity: ± 5 V peak for 850° phase shift (170°/volt)

Frequency Sweep

Sweep time: Linear; 0.01 s to 99.99 s. Single Log; 2 s to 99.99 s. Continuous Log; 0.1 s to 99.99 s.

Maximum sweep width: specified frequency range of selected output

Minimum sweep width: Log; 1 decade. Linear; minimum BW (Hz) = .1 (Hz/s) x Sweep Time (s)

Phase continuity: phase is continuous over full frequency range.

Sweep flatness: fast leveling ± 0.15 dB, 10 kHz to 20 MHz, .03 s

Sweep time: normal leveling; ± 0.15 dB, 50 Hz to 1 MHz, 0.5s sweep time.

HP-IB Interface Functions: SH1, AH1, T6, L3, SR1, RL1, PP0, DC1, DT0, C0, E1.

General

Operating Environment

Temperature: 0° to 55°C

Relative humidity: $\leq 85\%$, 0° to 40°C

Altitude: $\leq 15,000$ ft, (4600 metres)

Storage temperatures: -50° to $+65^\circ$ C

Storage altitude: $\leq 50,000$ ft, (15,240 metres)

Power requirements: 100/120/220/240 V, $+5\%$, -10% , 48 to 66 Hz, 60 VA, (100 VA with all options), 10 VA standby

Size: 132.6 mm H x 425.5 mm W x 497.8 mm D, (5.2" x 16.8" x 19.6")

Weight: net, 10 kg. (22 lb). Shipping, 15.5 kg. (34 lb)

Ordering Information

HP 3336C Synthesizer/Level Generator (General Purpose) \$4700

Opt 004 High Stability Frequency Reference add \$650

Opt 005 High Accuracy Attenuator add \$650

Opt 907 Front Handle Kit add \$55

Opt 908 Rack Flange Kit add \$32.50

Opt 909 Rack Flange and Handle Kit add \$80

Price



FREQUENCY, FUNCTION & WAVEFORM SYNTHESIZERS

50 MHz Programmable Signal Source

Model 8165A

- Pulse/function capability
- Sine, triangle, square to 50 MHz
- Pulses and ramps to 20 MHz
- Trigger, gate and counted burst
- Synthesizer stability, precision amplitude
- Storage of operating parameters

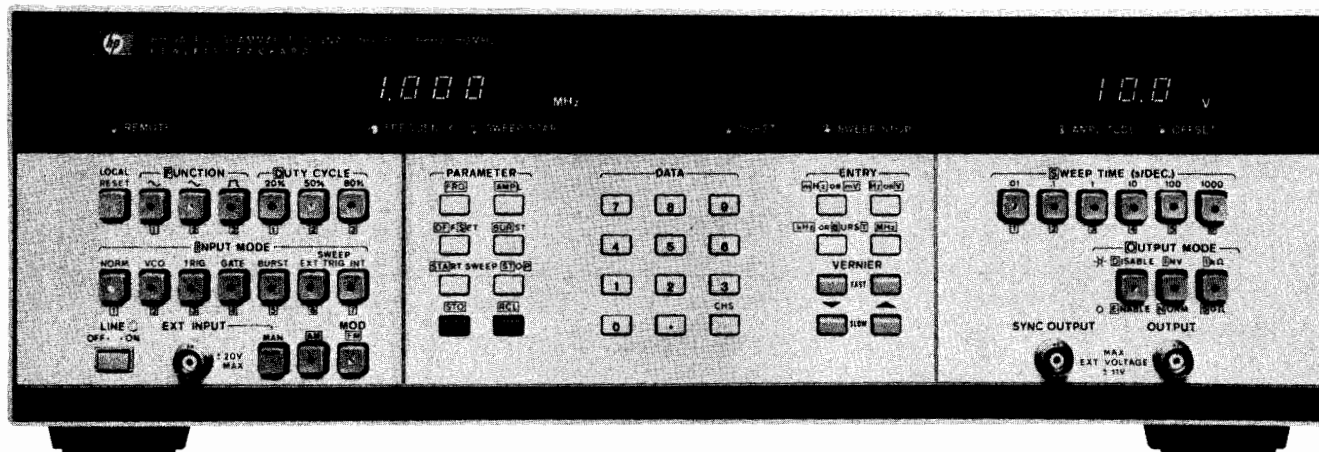

Picture shows 8165A with option 002, AM and Logarithmic Sweep.

Versatility and Simplicity for Systems and Bench

The HP 8165A Programmable Signal Source is a versatile function generator with good accuracy and many trigger features. Microprocessor control assures rapid, accurate setup whether programming locally or via HP-IB.

Operating Set Storage

Ten complete sets of operating information can be stored and recalled. In the event of power failure, battery back up retains all data plus the active settings.

Stability and Resolution

Very stable frequency is ensured with phase lock loop techniques and internal crystal reference. The four-digit frequency display means a 1 μ Hz resolution in the 1 to 9.999 MHz range.

Specifications

Waveforms and Frequency Range

Sine, square, triangle (50% duty cycle): 1.000 mHz to 50.00 MHz.

Pulse/ramp (20, 80% symmetry): 1.000 mHz to 19.99 MHz.

Haversine/havertriangle: please inquire for special option.

Output Characteristics

Range: amplitude and offset independently variable within ± 10 V window.

Source impedance: selectable 50 Ω $\pm 1\%$ or 1 k Ω $\pm 10\%$

Amplitude: 10.0 mVpp to 10.0 Vpp (50 Ω into 50 Ω)
2.00 Vpp to 20.0 Vpp (1 k Ω into 50 Ω)

| Accuracy | Sine V Vrms | Square | Triangle (50%) | Ramp (20%-80%) | Pulse (20%-80%) |
|---------------|----------------|-----------|-------------------|-------------------|--------------------|
| <1kHz | $\pm 3\%$ | $\pm 2\%$ | $\pm 3\%$ | $\pm 3\%$ | $\pm 2\%$ |
| 1kHz-4.99MHz | $\pm 3\%$ | $\pm 2\%$ | $\pm 3\%$ | $\pm 5\%$ | $\pm 2\%$ |
| 5 MHz-19.9MHz | $\pm 8\%$ | $\pm 5\%$ | $\pm 10\%$ | $\pm 10\%$ | $\pm 5\%$ |
| 20MHz-50MHz | $\pm 8\%$ | $\pm 5\%$ | +5% to -20% | - | - |

Offset: 0 ± 10 mV to ± 5.00 V (50 Ω into 50 Ω)

0 ± 20 mV to ± 10.0 V (1 k Ω into 50 Ω)

Accuracy: $\pm 1\%$ programmed value $\pm 1\%$ signal Vpp ± 20 mV.

Sine Characteristics

Distortion: total harmonic distortion (THD) for fundamental up to 1 MHz: $\pm 1\%$.

Harmonic signals: (fundamental 1-10 MHz): ≤ -36 dB

Harmonic signals: (fundamental above 10 MHz): ≤ -30 dB.

Non-harmonic: ≤ -40 dB.

Square/Pulse Characteristics

Transition times: (10% to 90%): ≤ 5 ns (50 Ω into 50 Ω), ≤ 7 ns (1 k Ω into 50 Ω)

Preshoot/Overshoot/ringing: $\leq \pm 5\%$ (50 Ω into 50 Ω), $\pm 10\%$ (1 k Ω into 50 Ω).

Triangle/Ramp Characteristics

Linearity: (10% to 90%): $\leq \pm 1\%$ ($\leq \pm 5\%$ above 5 MHz).

Operating Modes

Norm (continuous phase locked), **VCO** (external sweep voltage), **Trig** (ext or man. one-shot), **Gate, Burst** (1-9999 counted cycles), **Frequency Modulation**

HP-IB: control and learn capability for all modes and parameters.

Interface functions*: SH1, AH1, T6, L4, SR1, RL1, PP0, DC0, DT1, C0, E1.

General

Memory: non volatile. 10 addressable locations plus one for active operating state. Each location can store a complete set of operating parameters and modes.

Power: 100/120/220/240 Vrms; $\pm 5\%$, -10%; 48 to 66 Hz, 200 V A max.

Operating temperature: 0° to 50°C

Weight: net 12 kg (26.5 lbs). Shipping 16 kg (35.3 lbs).

Size: 133 H x 426 W x 422 mm D (5.2" x 16.8" x 16.6").

Ordering Information

| | Price |
|--|-------------|
| HP 8165A Programmable Signal Source** | \$6790 |
| Opt 002: AM and logarithmic sweep | add \$850 |
| Opt 003: Rear Panel Connectors | N/C |
| Opt 907: Front Handle Kit (Part No HP 5061-0089) | add \$55 |
| Opt 908: Rack Mounting Kit (Part No HP 5061-0077) | add \$32.50 |
| Opt 909: Opt 907, 908 combined (Part No HP 5061-0083) | add \$80 |
| Opt 910: additional Operating and Service Manual | add \$70 |

*For more on these codes refer to the HP-IB section of this catalog.

**HP-IB cables not supplied, see page 121.

FREQUENCY, FUNCTION & WAVEFORM SYNTHESIZERS

1 mHz–50 MHz Pulse/Function Generator

Model 8116A



- Sine, triangle, square, haversine functions and dc
- 1 mHz–50 MHz, 32 Vpp for all waveforms
- Variable (10 ns min) pulse width, 6 ns transitions
- Wide range of operating capability
- Self-prompting operating concept
- Error recognition and self test



Picture shows 8116A with Option 001, Burst and Logarithmic Sweep.

The fully programmable HP 8116A features pulse as well as function generator capabilities in one small unit. A broad 1 mHz–50 MHz band for all waveforms and a wide choice of operating and modulating modes assure high flexibility. These factors, plus good repeatability, make the HP 8116A a sound, long-term investment.

Unique Operating Concept Saves Engineering Time

HP's custom IC's have made it feasible to put the many HP 8116A capabilities into such a small volume. Handling is simplified by a unique, microprocessor-controlled, operating concept which ensures a clear overview of the compact front panel at all times. When the mode and waveform have been selected, illuminated labels show which parameters must be set. There's no clutter, no confusion.

Auto vernier. In normal mode, the HP 8116A's auto-vernier increments any desired parameter continuously until a stop signal is applied. This means that thresholds can be measured automatically, without a controller.

Level or amplitude programming. The HP 8116A's output can be programmed in terms of high and low levels or in terms of amplitude and offset. Consequently a direct, automatic, conversion is always feasible so that the HP 8116A can be programmed in the same terms as the device is specified.

Safe limit. Devices can be protected by the limit feature. This prevents the output from exceeding a given magnitude.

Rectangular Waveforms

For applications such as laser diodes or dc motors, square waves can be programmed for constant duty cycles from 10% to 90%. For digital test, or for simulating very low duty-cycle events, pulse width can be programmed down to 10 ns. Square wave and Pulse modes provide clean 6 ns edges that are ideal for many technologies. Pulse width modulation and pulse recovery capability are available in Pulse mode.

Sine and Triangle Functions

10% to 90% duty cycle, programmable in 1% steps, provides ramps and asymmetrical sine waves for testing VCO's, servos, amplifier linearity and industrial process control systems. Haversine functions,

available in External Trigger, Gate and Burst modes, extend the applications to areas such as telephone line and vibration testing.

Modulation

All waveforms can be amplitude or frequency modulated. VCO operation allows frequency variation over two decades with an external voltage; consequently transducer output can be conditioned for mag tape recording, or frequency-shift keying or linear sweep can be carried out.

Option 001

10 1/2-decade log sweep. Sweep mode covers the wide 1 mHz – 50 MHz band in a single up sweep. Test setups require no more than an X-Y recorder or scope because all necessary control signals are available. The HP 8116A sweeps can be internally triggered, if desired.

Accurate, counted bursts. A preprogrammed number of cycles of any waveform can be generated in Burst mode. With sine, triangle and square functions, bursts can be triggered internally as well as externally.

Hold capability. For material stress testing, low frequency functions can be held at instantaneous levels. Hold is controlled by an external signal.

Low-Cost Automation for Bench and Systems

Powerful capability, small size and wide specified temperature range make the HP 8116A a good choice for automatic test systems. Also, the low cost means that it's now realistic to automate those routine bench jobs and leave more time for design. Comfortable software features such as easy syntax and flexible format contribute to rapid system design.

Operating Confidence

There's reliance in the HP 8116A's output because proper operation is always ensured by the instrument's error detector. This helps the user to recover from an incorrect front panel or programming operation by indicating the offending parameter. Also, the built-in test and diagnosis feature verifies correct function each time the instrument is switched on.



FREQUENCY, FUNCTION & WAVEFORM SYNTHESIZERS

1 mHz–50 MHz Pulse/Function Generator

Model 8116A (cont.)

Specifications

Specifications apply with 50-ohm load and temperatures in the range 0°C to 55°C.

Functions

Sine, triangle, ramp, square, pulse, haversine, havertriangle, dc.

Timing

Frequency

Range: 1 mHz to 50 MHz (3-digit resolution).

Accuracy¹ (pulse mode, 50% d/c): $\pm 3\% \pm 0.3$ mHz below 100 kHz, $\pm 5\%$ above 100 kHz.

Jitter (pulse mode, 50% d/c): $< 0.1\% + 100$ ps.

Stability: $\pm 2\%$ (1 hour), $\pm 5\%$ (24 hours).

Duty cycle:

(sine, triangle, square, haversine, havertriangle).

Range: 10% to 90% (20% to 80% above 1 MHz), 2-digit resolution.

Accuracy¹: ± 0.5 digits (± 3 digits above 1 MHz).

Pulse Width

Range: 10.0 ns to 999 ms (3-digit resolution).

Accuracy¹: $\pm 5\% \pm 2$ ns.

Jitter: $< 0.1\%$ ($0.2\% + 200$ ps for width ≤ 10 μ s).

Output Characteristics

(voltages double into high impedance).

Amplitude

Range: 10.0 mVpp to 16.0 Vpp (3-digit resolution).

Accuracy¹: $\pm 5\%$ (at 1 kHz for sine and triangle).

Flatness (sine): $\pm 3\%$ ($\pm 5\%$ above 1 MHz, $+5 -15\%$ above 10 MHz).

Flatness (triangle): $\pm 3\%$ ($\pm 5\%$ above 1 MHz, $+5 -25\%$ above 10 MHz).

Offset and dc Mode

Range: 0.00 to ± 7.95 V (0 to ± 795 V mV for amplitude < 100 mVpp).

Resolution: 3 digits.

Accuracy¹: 0.5% of setting $\pm 1\%$ of ampl ± 40 mV ($+2$ mV if ampl < 100 mVpp, ± 20 mV in dc mode).

Distortion (sine, normal mode, 50% duty cycle).

Total harmonic distortion (10 Hz–50 kHz): $< 1\%$ (-40 dB)*.

Harmonic related signals (50 kHz–1 MHz): < -34 dB.

(1 MHz–50 MHz): < -23 dB*.

*May increase by 3 dB below 10°C and above 45°C.

Non-linearity (triangle, ramp, 100 mHz–1 MHz):

$< \pm 3\%$.

Pulse and Square Wave Characteristics

Transitions: < 6 ns.

Pulse perturbations: $< \pm 5\% \pm 2$ mV.

Output impedance: 50 ohm $\pm 5\%$.

Operating Modes

Normal, trigger*, gate*, external width.

Additional Modes in HP 8116A Option 001

Logarithmic Up Sweep (for all waveforms).

Range: Start and stop frequencies selectable up to full range (1 mHz–50 MHz).

Sweep time: selectable in 1-2-5 sequence from 10 ms to 500 seconds per decade.

Sweep repetition: continuous sweeps (internal sweep) or externally triggered.

Counted Burst* (for all waveforms).

Burst length: 1 to 1999 cycles.

Burst repetition: internally triggered at selectable intervals from 100 ns to 999 ms (except in Pulse mode), or externally triggered, up to 40 MHz.

*Selectable (-90°) start-phase for haversine, havertriangle.

Control Modes

Frequency modulation: $\pm 5\%$ max deviation.

Sensitivity: 1 V for 1% deviation.

Modulating frequency: dc to 20 kHz.

Amplitude Modulation

Sensitivity: ± 2.5 V for 100% mod. ($+2.5$ V to -7.5 V for DSBSC).

Modulating frequency: dc to 1 MHz.

¹Applies from 15°C to 35°C, %-error increases 0.05 per °C outside this range.

Pulse Width Modulation

Range: 10 ns to 1 s in 8 non-overlapping decade ranges.

Max. width ratio: 10:1.

Sensitivity: ± 9 V for 1:10 ratio.

Voltage-Controlled Oscillator

Range: 2 decades in range 1 MHz–50 MHz.

Sensitivity: 0.1 V to 10 V for 2 decades.

Modulating frequency: dc to 1 kHz.

Auxiliary Modes

Manual: simulates external input.

1 cycle (option 001): triggers single output cycle in Trigger, Gate and Ext Burst modes.

Auto vernier: continuous vernier which can be remotely or manually stopped.

Limit: programmable maximum output levels to protect DUT.

Complement: selectable normal/complement output.

Disable: relay disconnects output.

Auxiliary Inputs and Outputs

External Input

Threshold: ± 10 V adjustable.

Max input voltage: ± 20 V.

Sensitivity: 500 mVpp.

Min pulse width: 10 ns.

Input impedance: 10 k Ω typ.

Trigger slope: positive, negative and off.

Control Input

Max input voltage: ± 20 V.

Input impedance: 10 k Ω typ.

Trigger Output

Output levels: 0/2.4 V typ.

Output impedance: 50 ohm typ.

X-Output (Option 001) for sweep X-Y recording (rear panel).

Output levels: 0 V (= start frequency) to 10 V max.

Slope: 1.5 V per sweep decade.

Marker Output (Option 001) for sweep (rear panel).

Output levels: TTL

Leading edge: positive at selected marker frequency.

Hold Input (Option 001), rear panel.

Input levels: TTL

Leading edge: positive transition causes HP 8116A output ($f < 10$ Hz) to hold at instantaneous level. Output droop 0.01% per second.

Max input voltage: ± 20 V

HP-IB Capability

All manual key operations are programmable. Talk mode provides learn, status byte and error report capabilities.

Memory

Battery-backup RAM retains current operating state.

General

Repeatability: factor 4 better than accuracy.

Environmental

Storage temperature: -40°C to $+70^\circ\text{C}$.

Operating temperature: 0°C to 55°C .

Humidity: 95% RH, 0°C to 40°C .

Power: 100/120/220/240 V rms; $+5\%$, -10% ; 48 to 440 Hz; 120 VA max.

Weight: net, 5.9 kg (13 lb). Shipping, 8.0 kg (18 lb).

Size: 89 H x 212.3 W x 422 mm D (3.5" x 8.36" x 16.6").

Ordering Information

HP 8116A Programmable Pulse/Function Generator*

Opt 001: Burst and Logarithmic Sweep

Opt 910: Extra Operating & Service Manual

HP 5061-9701: Bail Handle Kit

HP 5061-9672: Rack Mount Kit (single HP 8116A)

HP 5061-9674: Rack Mount Kit (two instruments)

HP 5061-9694: Lock Link Kit (for use with

HP 5061-0074)

Prices

\$3500

add \$400

add \$40

\$38

\$49

\$30

\$25

*HP-IB cables not supplied, see page 121.

FREQUENCY, FUNCTION & WAVEFORM SYNTHESIZERS

1 Hz–20 MHz Pulse/Function Generator

Model 8111A



- Sine, triangle, square, haversine functions
- 20 MHz, 32 Vpp for all waveforms
- Variable duty cycle or pulse width

- Trigger, gate, VCO and optional burst
- Digital display for all parameters
- Error recognition

Picture shows 8111A with Option 001, Counted Burst.



The HP 8111A combines pulse generator and function generator capabilities in a single, compact unit. Triggered operation for all waveforms, and the ability to define rectangular waveforms in terms of pulse width or duty cycle, are examples of the HP 8111A's versatility.

Saves Space and Equipment

Small size and manifold capability make the HP 8111A an ideal source for service and bench. Digital display, error detector and good repeatability assure high operating confidence. This reduces the need for output monitoring and consequently saves equipment.

Flexible

Operating modes include VCO which permits frequency-shift keying and dc-to-frequency conversion as well as sweep and FM applications. Option 001's Burst mode simplifies tone burst generation and digital preconditioning by generating a precise number of waveform cycles. An "extra cycle" feature activated after a burst allows critical events to be examined.

Pulse mode's variable width down to 25 ns and clean 10 ns transitions provide useful digital test capability. High analog flexibility is assured because all waveforms can be generated in trigger, gate and burst modes. Adjustable duty cycle up to 999 kHz means that CRT sawtooth waveforms and rectangular signals for dc motor control can be simulated.

Specifications (50-ohm load resistance)

Waveforms

sine, triangle, ramp, square, pulse, haversine functions.

Timing

Frequency

Range: 1.00 Hz to 20.0 MHz (3-digit resolution).

Accuracy (50% duty cycle): 5% ($\pm 10\%$ below 10 Hz).

Jitter: $< 0.1\% + 50$ ps.

Stability: $\pm 0.2\%$ (1 hour), $\pm 0.5\%$ (24 hours).

Duty Cycle (sine, triangle, square, haversine functions):

| | Calibrated | Variable (below 1 MHz) |
|-------------|---------------|--|
| Range: | 50% nominal | 10% to 90%. |
| Resolution: | 2 digits | 2 digits. |
| Accuracy: | ± 1 digit | ± 6 digits (± 3 in range 20 to 80%). |

Pulse Width

Range: 25.0 ns to 100 ms (3-digit resolution).

Accuracy: $\pm 5\% \pm 2$ ns.

Output Characteristics

(voltages double into high impedance)

Amplitude

Range: 1.60 mVpp to 16.00 Vpp ($3\frac{1}{2}$ digit resolution).

Accuracy: $\pm 5\%$ (at 1 kHz for sine and triangle).

Flatness (sine, triangle): $\pm 3\%$ ($+10\%$, -15% above 1 MHz).

Offset

Range: 0.00 mV to ± 8.00 V (3-digit resolution).

Accuracy: $\pm 0.5\%$ setting $\pm 1\%$ ampl ± 20 mV

(ampl ≥ 160 mVpp),

$\pm 0.5\%$ setting $\pm 1\%$ ampl ± 1 mV

(ampl < 160 mVpp).

Distortion: THD (1 Hz–1 MHz) $< 3\%$ (-30 dB); harmonics (1 MHz–20 MHz) < -26 dB. Distortion may increase by 3 dB below 10°C and above 45°C .

Linearity (triangle): $< \pm 3\%$ ($< \pm 1\%$ below 1 MHz)

Pulse and Squarewave Performance

Transitions: < 10 ns.

Perturbations: $< \pm 5\%$ ($< \pm 10\%$ below 0.16 Vpp).

Output impedance: ± 50 ohm $\pm 5\%$.

Modes

normal, trigger*, gate*, VCO and (Option 001) burst*.

*Adjustable start-phase for haversine, haversintriangle

VCO range: 2 decades, ext. signal 0.1 V to 10 V (dc to 1 kHz).

Burst length: 1 to 1999 periods for all waveforms.

General

Repeatability: factor 2.5 better than accuracy.

Environmental

Storage temperature: -40°C to $+75^\circ\text{C}$.

Operating temperature: 0°C to 55°C .

Humidity: 95% RH, 0°C to 40°C .

Power: 100/120/220/240 V rms; $+5\%$ – 10% ; 48 to 440 Hz; 70 VA max.

Weight: net, 4.6 kg (10 lb). Shipping, 6.6 kg (15 lb).

Size: 89 H x 212.3 W x 345 mm D ($3.5'' \times 8.36'' \times 13.6''$).

Ordering Information

HP 8111A Pulse/Function Generator

Opt 001: Burst

Opt 910: Extra Operating and Service Manual

HP 5061–9701: Bail Handle Kit

HP 5061–9672 Rack Mount Kit (single HP 8111A)

HP 5061–9674 Rack Mount Kit (two instruments)

HP 5061–9694 Lock Link Kit (for use with HP

5061–0074)

Price

\$1965

add \$370

add \$38

\$38

\$49

\$30

\$25

FREQUENCY, FUNCTION & WAVEFORM SYNTHESIZERS

Function Generator

Model 3312A

- Two function generators in one instrument
- AM-FM, sweep, trigger, gate and burst

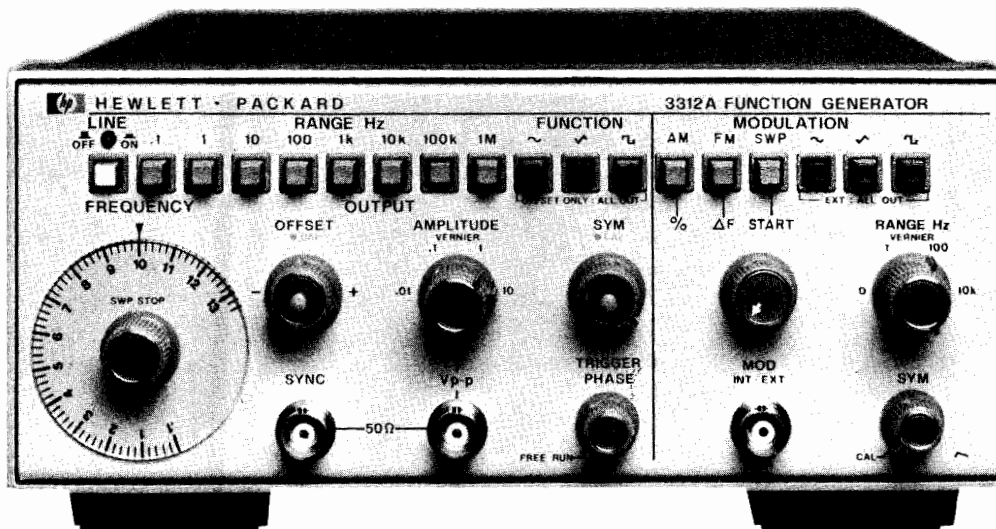

HP 3312A

Description

Hewlett-Packard's 3312 A Function Generator combines two separate, independent function generators with a modulator section in one compact instrument.

The main generator can—via pushbutton control—be triggered by the modulation generator to provide sweep functions, AM, FM or tone burst.

Ten V p-p into 50 Ω provides adequate power for most applications. The output attenuator has a range of more than 10,000:1 so clean low-level signals from 10 V to 1 mV p-p into 50 Ω can be obtained. The main generator includes dc offset up to 10 volts p-p into 50 Ω.

The HP 3312A is an effective low cost solution for generating a multitude of functions.

Specifications

Output waveforms: sine, square, triangle, ± ramp, pulse, AM, FM, sweep, triggered and gated.

Frequency Characteristics

Range: 0.1 Hz to 13 MHz in 8 decades ranges.

Dial accuracy: ±5% of full scale. Unspecified in Uncal Mode.

Square wave rise or fall time (10% to 90%): <20 ns.

Aberrations: <10%.

Triangle linearity error: <1% at 100 Hz.

Variable symmetry: 80:20:80 to 1 MHz.

Sine wave distortion: <0.5% (-46 dB) THD from 10 Hz to 50 kHz. (10 kHz range maximum). >30 dB below fundamental from 50 kHz to 13 MHz, at full-rated output.

Output Characteristics

Impedance: 50 Ω ± 10%.

Level: 20 V p-p into open circuit, >10 V p-p into 50 Ω at 1 kHz.

Level flatness (sine wave): <±3% from 10 Hz to 100 kHz at full rated output (1 kHz reference). <±10% from 100 kHz to 10 MHz.

Attenuator: 1:1, 10:1, 100:1, 1000:1 and >10:1 continuous control.

Attenuator error: <5%.

Sync output: impedance: 50 Ω ± 10%, >1 V p-p square wave into open circuit. Duty cycle varies with symmetry control.

DC offset: variable up to ± 10 volts. Instantaneous ac voltage + Vdc offset cannot exceed ± 10 V (open circuit) or ± 5 V (terminated 50 ohm).

Modulation Characteristics

Types: internal AM, FM, sweep, trigger, gate or burst; external AM, FM, sweep, trigger, gate or burst.

Waveforms: sine, square, triangle, ramp or variable symmetry pulse.

Frequency range: 0.01 Hz to 10 kHz.

Output level: >1.0 V p-p into 10 kΩ.

Amplitude Modulation

Depth: 0 to 100%.

Modulation frequency: 0.01 Hz to 10 kHz (internal). DC to >1 MHz (external).

Carrier 3 dB bandwidth: <100 Hz to >5 MHz.

Carrier envelope distortion: <2% at 70% sine wave modulation with $f_c = 1$ MHz, $f_m = 1$ kHz.

External sensitivity: <10 V p-p for 100% modulation.

Frequency Modulation

Deviation: 0 to ±5% (internal).

Modulation frequency: internal: 0.01 Hz to 10 kHz; external: DC to >50 kHz.

Distortion: <-35 dB at $f_c = 10$ MHz, $f_m = 1$ kHz, 10% modulation.

Sweep Characteristics

Sweep width: >100:1 on any range.

Sweep rate: 0.01 Hz to 10 kHz, 90:10 ramp, and 0 Hz Range (provides manual setting of "Sweep Start" without modulation generator oscillating).

Sweep mode: repetitive linear sweep between start and stop frequency settings. Retrace time can be increased with symmetry -control.

Ramp output: 0 to >-4 p-p into 5 kΩ.

Gate Characteristics

Start/stop phase range: +90° to -80°.

Frequency range: 0.1 Hz to 1 MHz (useful to 10 MHz).

Gating signal frequency range (external): dc to 1 MHz, TTL compatible.

External Frequency Control

Range: 1000:1 on any range.

Input requirement: with dial set at 10, 0 to -2 V ±20% will linearly decrease frequency >1000:1. An ac voltage will FM the frequency about a dial setting within the limits $(0.1 < f < 10) \times$ range setting.

Linearity: 0.5% of Fmax for $F_{max} \leq 1$ MHz 5.0% of Fmax for $F_{max} > 1$ MHz. Deviation is from a best fit straight line. VCO frequency span ≤ 100:1.

Input impedance: 2.8 kΩ ±5%.

General

Operating temperature: 0°C to +55°C; specifications apply from 0°C to 40°C.

Storage temperature: -40°C to +75°C.

Power: 100 V, 120 V, 220 V, 240 V +5%, -10%, switchable; 48 Hz to 440 Hz; ≤25 VA.

Size: 102 mm H x 213 mm W x 377 mm D (4" x 8.4" x 14.8").

Weight: net, 3.8 kg (8.4 lb). Shipping, 5.9 kg (13 lb).

HP 3312A Function Generator

\$1,450

FREQUENCY, FUNCTION & WAVEFORM SYNTHESIZERS

1 MHz to 20 MHz Function Generator with Arbitrary Waveforms

Model 3314A

463



- Lin/Log sweeps
- AM/FM/VCO
- Phase lock xN and $\div N$

- Gate and counted burst
- 1/2 cycle mode
- Arbitrary waveform generator



HP 3314A

HP 3314A Multi-Waveform Generator

The HP 3314A is a Function/Waveform Generator with the precision and versatility to produce numerous waveforms. Its feature set includes accurate sine, square, and triangle waves, with ramps and pulses available using variable symmetry. Additional features include counted bursts, gate, lin/log sweeps, AM, FM/VCO, dc offset, and phase lock. For increased versatility, the Arbitrary waveform mode allows a countless number of user defined waveforms. Since complete programmability is provided, all of these capabilities are available for ATE systems, as well as bench applications.

Precise Functions

The HP 3314A provides sine, square, and triangle waveforms from 0.001 Hz to 19.99 MHz with an amplitude range of 0.01 mV to 10 Vp-p into 50 ohms, with optional 30 Vp-p into > 500 ohms.

Continuous waveforms are provided with high accuracy and low distortion, with frequency accuracy on the upper ranges of 0.01% and sine distortion < -55 dBc to 50 kHz.

Pulses and ramps are provided to 2 MHz using the variable symmetry control over the full 5% to 95% symmetry range. This provides narrow pulses with 9 ns rise/fall times for digital circuit testing, and positive or negative ramps for amplifier testing and process control.

Independent dc offset to ± 5 V (into 50 ohms) can be added to any ac signal. A post-attenuator summing technique is used providing large ac signals with small offsets and vice versa.

Burst and Gate

The HP 3314A's N Cycle burst mode generates an integer number of complete cycles at each trigger. Bursts of 1 to 1999 cycles are possible for use in applications ranging from sonar testing to digital circuits. Variable symmetry and start/stop phase can be used to produce single ramps and haversaws.

Like burst mode, gate mode can be triggered internally or externally. In gate, the HP 3314A output consists of complete cycles, pulses or Arb's which start when the trigger is true, and stop after the trigger goes false. In gate and burst modes, the full frequency range applies for sine, square, triangle, pulse, and ramp waveforms.

New 1/2 Cycle and "Integer" Phase Lock Modes

The new 1/2 Cycle burst mode allows simulation of specialized signals found in electronics. At each trigger, alternating 1/2 cycles of sines or triangles are produced. With the addition of variable start/stop phase and symmetry, pulses with variable rise/fall time and overshoot can be produced. Repetition rate, 1/2 cycle frequency, symmetry, and phase can be set independently to produce a variety of waveforms.

The $\text{Fin} \times N$ $\text{Fin} \div N$ modes provide powerful phase locking capability. With "integer" phase lock, fractions or multiples of the reference signal can be provided, and ± 200 deg of phase offset is available. Since the HP 3314A phase locks to the plus or minus edge of the trigger signal, it can lock to a variety of signals such as sines, squares, pulses, ramps, and others—with complete control of output function, symmetry, N, phase, amplitude and offset.

Modulation and Sweep

Complete AM, FM/VCO modulation give the HP 3314A versatile signal modifying capabilities. With 100 kHz bandwidths, AM and FM/VCO can be used separately or simultaneously to produce a multitude of waveforms.

Multi-frequency measurements can be made with the HP 3314A's sweep capabilities. Linear, logarithmic, and manual sweep make measurements of filters, amplifiers, and other networks convenient and accurate. X drive, marker, and trigger output signals are also provided.

Arbitrary Waveforms

For specialized low frequency applications, the HP 3314A's Arbitrary (ARB) waveform mode lets you create custom waveforms as a series of voltage ramps or vectors. Values are easy to enter from the front panel using the modify knob as a "pencil" and an oscilloscope as a "pad". For remote programming, use a desktop or mainframe computer to calculate the values, then program them using the HP-IB. Arb waveforms are automatically stored in non-volatile memory for quick recall.

Two Sources in One

A square wave trigger source is included for generation of complex waveforms with a single HP 3314A. The 0.5 MHz to 500 kHz internal trigger is useful in gated, burst, and phase locked waveforms. This signal is provided as an output for synchronizing the HP 3314A to other devices.

Source for your System

Because all front panel controls are programmable, the HP 3314A's precision and versatility can be utilized in automated test systems.

System efficiency can be improved with standard features such as Service Request (SRQ) interrupt capability and buffered transfer mode.

In production test environments, the HP 3314A's Query commands can be used when an operator and computer are sharing control of the instrumentation. Parameters can be read from the HP 3314A into the computer where its computational capabilities can be utilized.

FREQUENCY, FUNCTION & WAVEFORM SYNTHESIZERS

1 mHz to 20 MHz Function Generator with Arbitrary Waveforms

Model 3314A (cont.)

Arbs Made Easy

With complete control of each vector, the modify knob is used as a "pencil" to draw the waveform on an oscilloscope.

1. After ~20 unit vectors have been inserted, use modify to set the marker, VMKR, to #1. Then set the height of #1 to 400.

2. Press V LEN and use modify to set the length to 3.

3. Press V HGT twice, and set the height of #2 to -190.

4. Continue to use V HGT and V LEN to create the desired waveform, and INS (insert) or DEL (delete) vectors as needed. Amplitude and frequency can now be set without affecting the vector values. Waveform parameters are automatically stored in non-volatile memory while they are being created.

5. Later, if a slightly different waveform is needed, just use the marker to select an individual vector, and modify its height and length without affecting the height and length of other vectors!

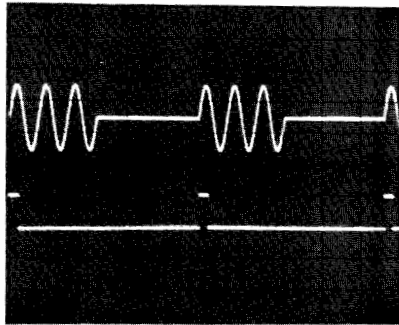
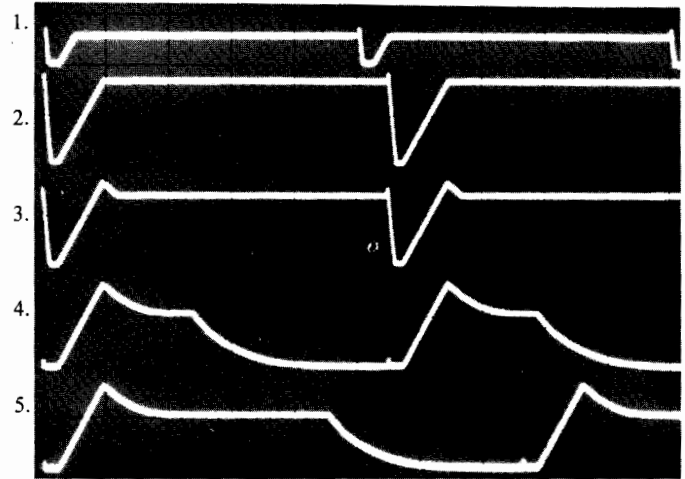

Counted burst with ext. trigger

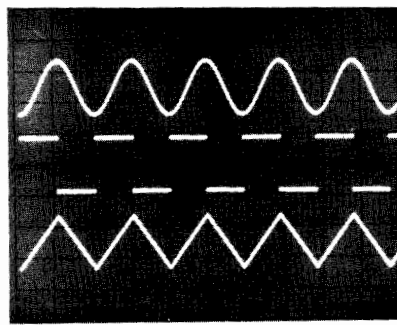

Sine, square, and triangle to 20 MHz

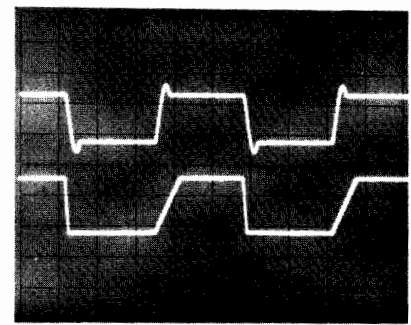

1/2 cycle mode simulating overshoot and variable rise/fall pulses

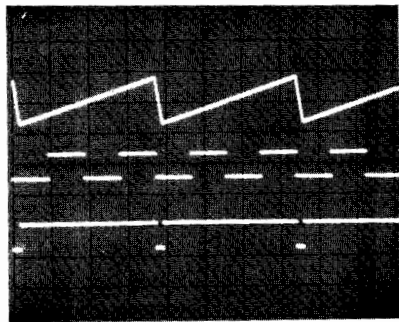

Ramp output phase locked to internal trigger. Shown with sync output.

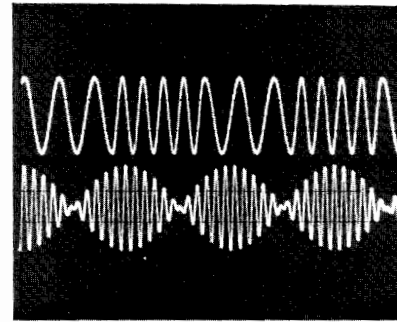

FM and AM (suppressed carrier)

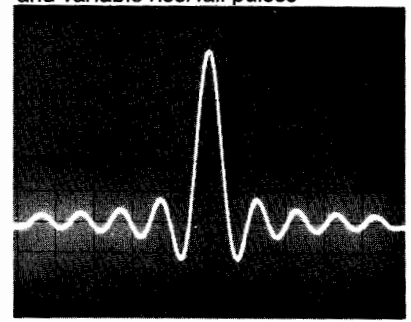

$\frac{\text{sine } x}{x}$ using ARB's

Specifications

Frequency

Frequency range: 0.001 Hz to 19.99 MHz-sine, square and triangle waveforms, 0.001 Hz through 2 MHz range when symmetry \neq 50%

Resolution: 3 1/2 digits

Frequency Accuracy

| HP-IB # | Range | Minimum Frequency | | Maximum Frequency | Accuracy |
|---------|---------|-------------------|-----------|-------------------|--|
| | | Range Hold | Autorange | | |
| 1 | 2 Hz | .001 Hz | .001 Hz | 1.999 Hz | $\pm(0.4\% \text{ setting} + 0.2\% \text{ range})$ |
| 2 | 20 Hz | 0.01 Hz | 1.50 Hz | 19.99 Hz | |
| 3 | 200 Hz | 0.01 Hz | 15.0 Hz | 199.9 Hz | $\pm(0.2\% \text{ setting} + 0.1\% \text{ range})$ |
| 4 | 2 kHz | 0.01 kHz | 150. Hz | 1999. Hz | |
| 5 | 20 kHz | 0.01 kHz | 1.50 kHz | 19.99 kHz | |
| 6 | 200 kHz | 0.01 kHz | 15.0 kHz | 199.9 kHz | |

Synthesized

| | | | | | |
|---|--------|----------|----------|-----------|---|
| 7 | 2 MHz | 0.01 kHz | 150. kHz | 1999. kHz | $\pm(0.01\% \text{ setting} + 50 \text{ ppm/year})$ |
| 8 | 20 MHz | 0.01 MHz | 1.50 MHz | 19.99 MHz | |

Accuracy applies in the Free Run mode, with VCO Off, and Symmetry = 50% (Fixed)

Amplitude

Amplitude range: 1.0 mVp-p to 10 Vp-p into 50 Ω

Resolution: 3 1/2 digits

| HP-IB # | Range | Minimum | Maximum | Step Attenuator |
|---------|--------|---------|----------|-----------------|
| 1 | 10 mV | 1.0 mV | 10.00 mV | 60 dB |
| 2 | 100 mV | 10.0 mV | 100.0 mV | 40 dB |
| 3 | 1 V | .100 V | 1.000 V | 20 dB |
| 4 | 10 V | 1.00 V | 10.00 V | 0 dB |

Absolute Amplitude Accuracy

$\pm(1\% \text{ of display} + 0.035 \text{ Vp-p})$, sine and square wave

$\pm(1\% \text{ of display} + 0.06 \text{ Vp-p})$, triangle

Amplitudes: 1.00 Vp-p to 10.00 Vp-p (Range 4)

Frequency: 10 kHz, Autorange ON

Flatness-sine wave: relative to 10 kHz, 1.00 V to 10.0 V (Range 4)

| 20 Hz | 50 kHz | 1 MHz | 19.99 MHz |
|--------|--------|--------|-----------|
| .07 dB | .33 dB | 1.5 dB | |



Frequency Sweep

| | Range (decades) | Start Freq | Stop Freq | Sweep Time |
|--------|-----------------------|------------|------------|------------------------|
| linear | 0 to 2 | ≥.001 Hz | ≤19.99 MHz | 7.2 ms to 1999 s/sweep |
| log | 1 to 7 (integer only) | ≥0.2 Hz | ≤19.99 MHz | 40 ms to 1999 s/decade |

Manual Sweep

Modify knob tunes between start and stop frequencies. X drive follows sweep.

X Drive Start/Stop Voltage

-5 V to +5 V into 1 kΩ load

Z Axis Output

Blanking Pulse, > +5 V

Baseline, 0V ± 1 V

Marker Pulse, < -5 V into 1 kΩ load

Modulation Inputs

| | Bandwidth | Sensitivity | Range | Z |
|-----|-------------------|--|----------------------|-------|
| AM | dc to 100 kHz | 2 Vp-p for 100% -1 Vdc for suppressed carrier | >100% | 10 kΩ |
| FM | 100 Hz to 100 kHz | ±1 Vp for ±1% of range deviation | 1% of Freq. range | 10 kΩ |
| VCO | dc to 100 kHz | 10%/volt | +1 to -10V | 10 kΩ |

Waveform Characteristics

Sine Harmonic Distortion

Individual harmonics will be below these levels, relative to the fundamental. Offset = 0V. Function Invert = OFF. Range Hold = OFF.

| | | | |
|-------|---------|----------|-----------|
| 20 Hz | 50 kHz | 1490 kHz | 19.99 MHz |
| | -55 dB* | -40 dB | -25 dB |

*add 4 dB for ambient temperature 0 to 5°C and 45 to 55°C, 20 Hz to 50 kHz

Square Wave Rise/Fall Time

< 9 ns, 10% to 90% at 10 Vp-p output

N Integer

N = 1 to 1999, Preset to 1
For Phase-lock $F_{in} \div N$, $F_{in} \times N$
or N CYCLE (counted burst)

Function Invert

Inverts ac portion of signal outputs
Sine, square, triangle, ramp, pulse, and ARBs
Does not affect Sync and Trigger outputs or dc offset setting

Phase

Phase Offset—Phase Lock Modes

Resolution: 0.1°
Range: ±199.9°
Accuracy: ±2° (50 Hz to 15 kHz)
Phase Offset is Referenced to
signal output for $F_{in} \div N$
signal input for $F_{in} \times N$

Start/Stop Phase—Burst Modes

Resolution: 0.1°
Range: ±90.0° for frequencies to 19.99 MHz
Accuracy: ±3° (applies from .001 Hz to 1 kHz)

Trigger

Internal Trigger

Range: .002 ms (500 kHz) to 1999 s (0.5 mHz) square wave.
Period Accuracy:
± (0.01% + 50 ppm/year) of displayed interval (excluding sweep intervals)

Trigger output: low <0.5 V, high > 2.5 V; output resistance 1 kΩ

External Trigger

For Gate, N Cycle, ½ Cycle, $F_{in} \times N$, $F_{in} \div N$, and external sweep triggers

Frequency range: 50 Hz to 20 MHz

Trigger slope: selectable, positive or negative

Trigger level: Selectable to 0 V or +1 V

Trigger level hysteresis: ±0.15 V

Input resistance = 1 kΩ

Symmetry

Symmetry range: 5% to 95% of period

Frequency range: 2 Hz to 2 MHz ranges

Arbitrary Waveforms

Output consists of a series of voltage ramps called vectors. Arbitrary waveforms can be composed of 2 to 150 vectors. A maximum of 160 vectors can be stored in six available storage registers with a minimum of 2 vectors per waveform (#1 and return-to-start vectors).

Waveform Parameters

| Key | Range | Description |
|--------|--------------------|---|
| Δt | 0.2 ms to 19.99 ms | sets the time value for each unit of V LEN (length) |
| V HGT | 0 to ±1999 | sets the relative height of an individual vector |
| V LEN | 1 to 127 | sets the length in time of an individual vector in integral multiples of Δt |
| V MKR | 1 to 150 | marker is used to select an individual vector |
| INS | | insert is used to add a vector before the marker location |
| DEL | | deletes the vector at marker location |
| FREQ | .002 Hz to 2.5 kHz | $F_{req} = \frac{1}{\Delta t(VLEN_1 + VLEN_2 + \dots + VLEN_n)}$ |
| AMPTD | .01 mV to 10 Vp-p | sets amplitude window for ARB waveform |
| OFFSET | 0 to ±5 Vdc | offsets the ARB waveform independent of AMPTD setting |
| PHASE | +90° to -90° | sets wave start/stop voltage within the window defined by AMPTD |

Marker output: located on Z axis rear panel connector

Sync output: low during the return-to-start vector

Gate mode: allows external gating of ARB output-complete ARB waveforms only

Option 001 - Voltage Multiplier

Simultaneous ×3 amplitude output on rear panel (into >500 Ω).

30 Vp-p max, dc to 1 MHz.

General

Specifications Apply When

Main signal output terminated into 50 ± 0.1 Ω

Warm-up > 30 minutes

Within ±5°C and 24 hours of last internal calibration

Temperature: 0 to 55°C

Relative humidity: <95% at 40°C

Altitude: <15,000 ft

Storage temperature: -40 to +75°C

Power

100/120/220/240 V + 5% -10%, 48 to 66 Hz

90 VA maximum

Weight: net, 7.3 kg (16 lb). Shipping, 10.5 kg (23 lb).

Dimensions: 132.6 mm (5.22 in.) H x 212.3 mm (8.36 in.) W x 419.0 mm (16.50 in.) D

HP-IB

IEEE Standard 488-1978 abbreviated definition

SH1 AH1 T6 TE0 L3 LE0 SR1 RL1 PP0 DC1 DT1 C0 E2

Accessories Included

HP 11048C 50 Ω feed-through termination

50 ±0.1 Ω

Accessories

Transit case for one HP 3314A

HP P/N9211-2677

Ordering Information

HP 3314A Function Generator

Option 001: simultaneous X3 output

Price

\$4,200

add \$250



DATA GENERATORS & DATA ANALYZERS

General Information:

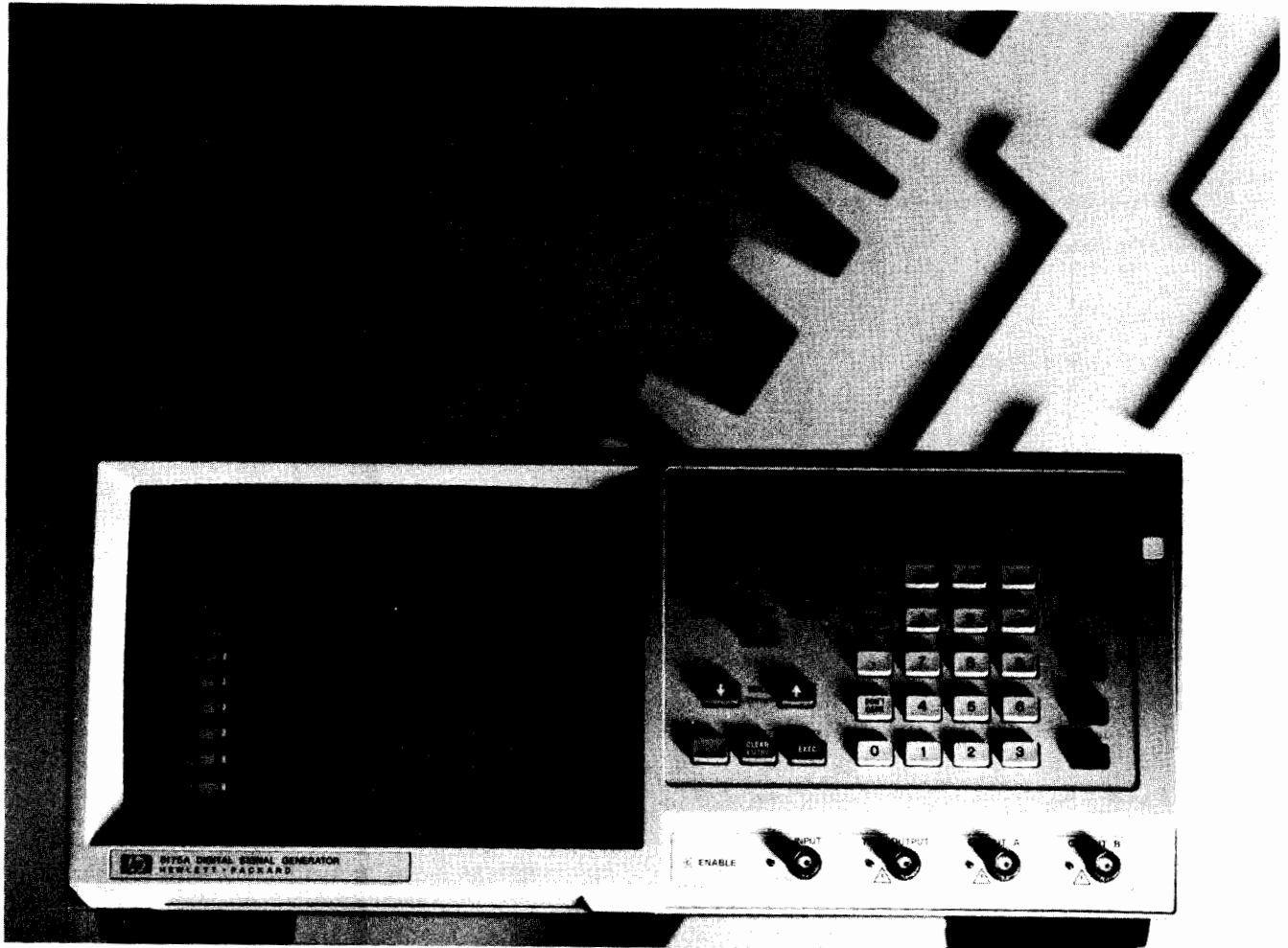

Engineering Efficiency

HP's data generators and data analyzers are engineering tools which enhance and, at the same time, simplify the evaluation of digital hardware. Enhanced because at-speed testing assures performance. Simpler because bench-top transportability plus front panel and HP-IB access mean quick set-up and fast response to engineering problems. Variable parameters and programmable data save time and equipment because they make dedicated solutions and unwieldy arrays of many different instruments unnecessary.

Independence

Data generators and analyzers functionally test digital devices under real conditions independent of supporting hardware or large test systems. Models with variable timing and levels permit characterization, are convenient and need no additional equipment.

Project times are consequently shortened because parallel development is feasible, and problems are detected earlier in design and production engineering phases. Equipment accessibility makes QA and materials engineering less dependent on other areas, and at-speed module testing enhances system assurance.

Long term investment is ensured through flexibility. Pulse performance and choice of levels ensure suitability for all common logic families, and quality connectors mean swift adaptation to an IC, IC prototype, breadboard, board, module, etc., with specified performance at the device.

Separate packaging saves equipment and promotes mobility because the generators and analyzers can be paired to match input and output needs. Also, separate use is feasible for either multi-channel output devices which are essentially stimulus-independent, or multi-

channel input devices with "simple" outputs which can be affectively monitored with an oscilloscope or voltmeter.

Comprehensive

Multi-channel requirements are met by the HP 8175A, 8170A, 8180/81A and 8016A.

The HP 8175A combines a very versatile feature set (e.g. programmable pattern durations, looping and branching capability, interaction with a DUT) with high performance in terms of speed (50MHz parallel, 100MHz serial) and timing accuracy. This makes it the ideal digital stimulus for fast, at-speed testing in digital environments. While the HP 8175A serves as a universal digital stimulus, an 1630/31 family logic analyzer is an excellent response tool in timing and state analysis. Operational convenience is stressed through the same front panel and operating concept. For lower speed applications the HP 8170A features hand-shake data generation up to 2 Mbit.

Highest requirements for pin-counts, timing and driver resolution and accuracy are met by the HP 8180/81A Data Generator. Together with the HP 8182A Data Analyzer, providing high resolution synchronous data sampling and analysis, a software pac, performance board, and test head an entire measurement system can be configured. Parameters such as setup, hold and propagation times and sensitivity are measured directly making it the ideal solution for parametric digital IC design and test. Excellent timing capabilities and high signal performance are also true for the 8 channels wide HP 8016A thus making it a low-cost alternative to the HP 8180/81A.

Serial generators include the HP 8018A, e.g. for PCM and similar applications, and the sub-nanosecond HP 8080A system.

DATA GENERATORS & DATA ANALYZERS

467

General Information:
Data Generator Selection Chart



SELECTION CHART

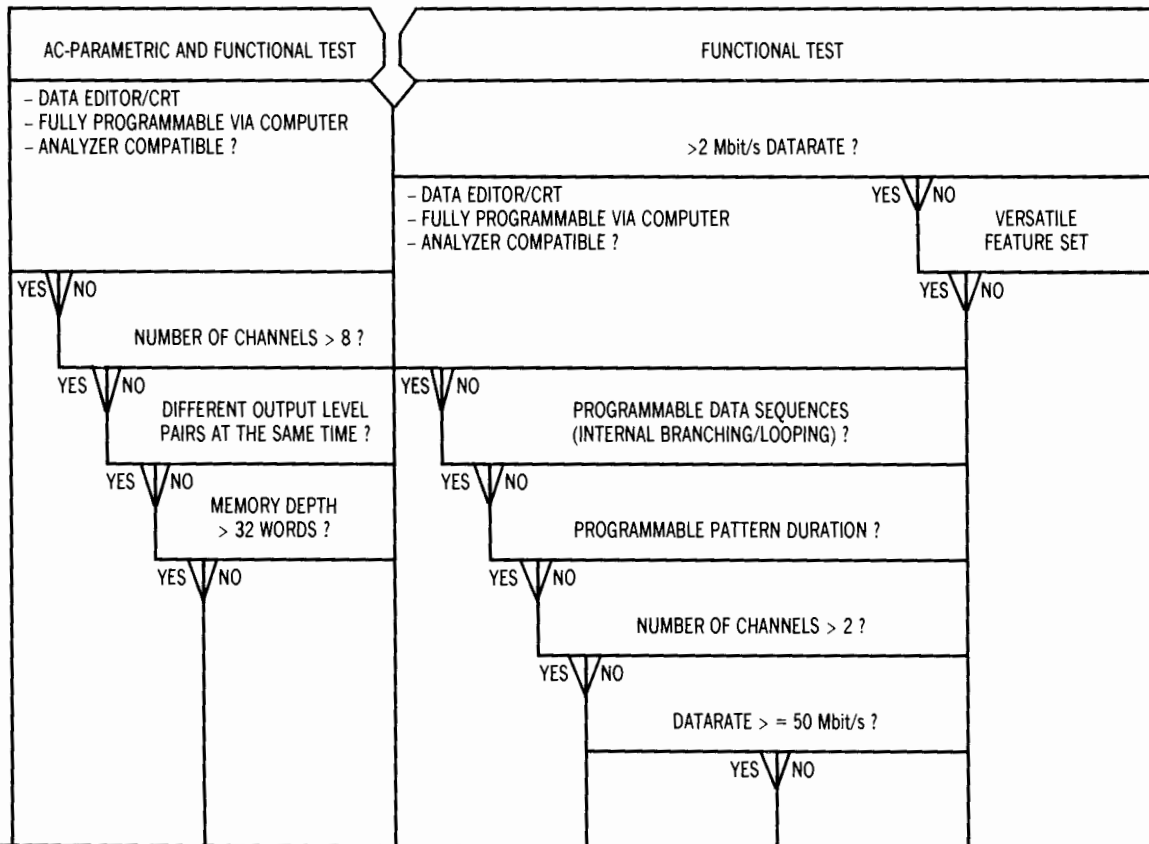

| MODEL | 8180A (8181A) | 8016A | 8175A | 8080A D01, D02, D03 | 8018A | 8170A |
|---|---|--|---|--|----------------------------------|---|
| DATARATE (Mbit/s) | 50 | 50 | 50 PARALLEL 100 SERIAL | 300 | 50 | 2 |
| NUMBER OF CHANNELS | 8 PARALLEL (16 OPT.) (128 WITH EXTENSION) | 8 PARALLEL | 24 PARALLEL OR 2 SERIAL | 1 SERIAL (2 SERIAL) | 2 SERIAL | 16 PARALLEL |
| MEMORY DEPTH (PATTERNS) | 1024 | 32/8 CH., 64/4 CH., 128/2 CH., 256/1 CH. | 1024 PARALLEL 8096 SERIAL | 64 SERIAL | 1024/2 CHANNEL 2048/1 CHANNEL | 2048/16 CH, 4096/8 CH |
| VARIABLE DELAY AND WIDTH | 0...999 ms (8 CH.) | 0...1 us (4 CH.) DELAY 10 ns...1 us WIDTH POTENTIOMETER | 20...40 ns, (4 CH.) DELAY ONLY | NO | NO | NO |
| RESOLUTION | 100 ps | 100 ps | 100 ps | NO | NO | NO |
| RZ/NRZ | RZ/NRZ | RZ/NRZ | NRZ | RZ/NRZ | RZ/NRZ | NRZ |
| PATTERN DURATION | NO | NO | 20 ns...9.9 s | NO | NO | NO |
| RESOLUTION | NO | NO | 10 ns | NO | NO | NO |
| OUTPUT LEVELS (HL=HIGH LEVEL, LL=LOW LEVEL) | TTL,ECL,VAR -1...+17 V (HL) -2...+16 V (LL) (HIGH IMPEDANCE) | TTL,ECL,VAR 1...2.5 V (HL TTL) -0.9...1.1 V (HL ECL) AMPLITUDE VAR. 0.3...1 V (ECL) POTENTIOMETER | TTL,ECL,TRI STATE VAR 2.4...9.9 V (HL) | D01: 0.2...2 V D02, D03: 0.6...1.2 V PEAK TO PEAK OFFS. D01: +/- 1.0 V, D02/D03: +/- 1.2V POTENTIOMETER | ECL,VAR 1.25...15 V | TTL,VAR 3...15 V (HL) -0.5...+0.4 V(LL) |
| RESOLUTION | 10 mV (50 OHM), 20 mV (10 KOHM) | POTENTIOMETER | 100 mV | POTENTIOMETER | POTENTIOMETER | POTENTIOMETER |
| 50 OHM SOURCE IMPEDANCE | YES | YES | NO | YES | YES | NO |



DATA GENERATORS & DATA ANALYZERS

Data Generator/Analyzer System

Models 8180A, 8181A, 8182A

- Digital ac parametric and functional characterization
- 50 MHz, 1 kbit/channel
- Direct measurements, 100 ps/10 mV resolution

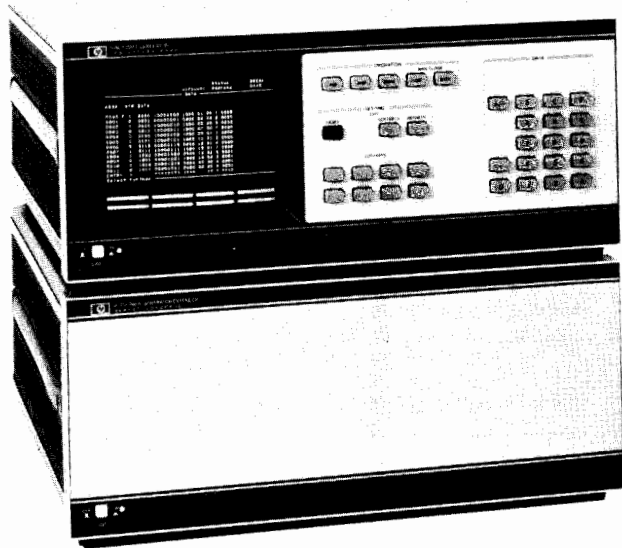

Upper: HP 8180A Data Generator
Lower: HP 8181A Data Generator Extender
Up to 64* channels with HP 8180A and two 8181A's.

- Variable sampling point delay in synchronous operation
- Real-time data comparison
- Convenient softkey operating concept with live keyboard

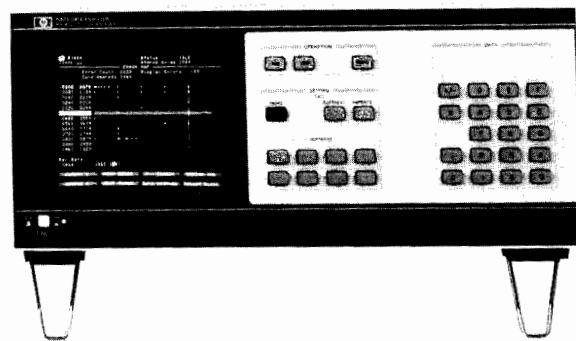

HP 8182A Data Analyzer (up to 32* channels)

* Number of channels can be doubled by parallel operation.

An Affordable Engineering Tool for At-Speed Characterization of Digital Hardware.

This compact, benchtop system is designed for manual and automatic engineering investigations on all types of digital hardware. It also upgrades ATS to at-speed testing. Features such as the same high resolution for generator and analyzer, and matched control signals, guarantee the viability of these measurements. Modularity promotes cost-effectivity because the number of channels can be increased without loss of speed or memory.

The same guided operating concept speeds familiarization, and common HP-IB syntax and free format accelerate programming. Live keyboards give rapid parameter access without changing software. Data entry is simplified by the predefined patterns and extensive edit features. Mixed logic needs are solved because up to 6 different levels can be assigned to any number of individual channels.

Data Generator

Timing capabilities include individual delay and width on two clock channels for dual-phase applications, and on RZ data channels for setup and hold time measurements. HP 8181A Extender group delay allows separate timing of e.g. simulated address signals.

High-speed pulses and clean shape provide performance for all common logic. Variable, high resolution levels allow worst-case conditions to be measured. The segmentable memory allows initialization and looping of data (upon an external signal) to be set up.

Data Analyzer

In addition to at-speed analysis, comparison and glitch detection, the HP 8182A also measures multichannel output timing like propagation delays because the sampling point is variable. For investigations in e.g. the setup/hold interval, a real-time compare mode examines data stability throughout a programmable window: any deviation from the expected state is displayed and error signals permit operations such as 'stop on error' for trapping sporadic faults.

Specifications

Specifications apply for operating temperatures from 0°C to 50°C.

HP 8180A/8181A Data Generator/Extender

Memory and Channels

Memory depth: 1024 bit/channel

Number of channels: up to 64 using HP 8180A with two HP 8181A Extenders. Up to 128 channels with 2 sets of equipment in parallel operation.

HP 8180A Channels

RZ (return-to-zero) channels: independent variable delay and width in each of up to 8 channels.

NRZ (non-return-to-zero) channels: Up to 16 channels minus the number of RZ channels. Fixed timing.

Strobe channel: NRZ data or clock. Fixed timing

Clock channels: independent delay and width in each of 2 channels. Clock 1 can be selected to run continuously in Break state (see 'Cycle modes').

HP 8181A Channels

NRZ: up to 24 channels. Fixed timing within an Extender, group delay with respect to HP 8180A.

Memory Loading

Codes: bin, oct, hex, dec (address codes: oct, hex, dec).

Entry: Keyboard or HP-IB.

Displayed channel order: user-defined.

Line edit: insert, delete, macro.

Channel edit: clear, set, copy, prbs, counts, entry mask.

Cycle Modes

Single, Auto, Initialization + Auto, Gated, Initialization + Gated. (Initialization data is output at the beginning of the first cycle only).

Break state: implemented by manual or external BREAK command or by strobe channel bit. Data is held at current address. Manual or external RUN command cause same cycle to continue.



Cycle Modes (Cont.)

Stop state: implemented by manual or external STOP command. Data is held at current address and the cycle is terminated. Manual or external RUN command trigger a new cycle.

Timing

Clock period: 20 ns to 950 ms (1.05 Hz to 50 MHz). Ext clock 0 to 50 MHz.

Delay

(relative to strobe channel): 0.0 ns to 950 ms, max 90% period -18ns.

Width: 10.0 ns to 950 ms, max 90% period -8ns.

Skew: ≤ 2 ns for NRZ channels and RZ channels programmed for zero delay.

Resolution: 3 digits (best case 100 ps).

Accuracy: $\pm 5\%$ of programmed value ± 1 ns.

Jitter: $\leq 0.2\% + 100$ ps (+ additional 50 ps for delay and width).

Outputs

Output impedance: 50 Ohm

Data and clock: 4 different high level / low level pairs can be defined and assigned to any number of individual outputs. Each channel has independent normal / complement switching. Common 'off'.

Read-out: can be selected for 50 Ohm or high impedance load (common selection for all channels).

| | 50 Ohm load | High-impedance load |
|--------------------|------------------|----------------------------|
| High level: | -1.50 to +5.50 V | -1.00 to +17.0 V |
| Low level: | -2.00 to +5.00 V | -2.00 to +16.0 V |
| Resolution: | 3 digits (10 mV) | 3 digits (best case 20 mV) |
| Amplitude: | 0.5 to 5.5 V | 1.0 to 17 V |

Transitions:

10% to 90% (3 + |0.2 ampl|) ns (3 + |0.5 ampl|) ns

20% to 80% at ECL levels: 1.5 ns

Strobe: ECL/TTL selectable

HP 8182 Data Analyzer

Memory and Channels

Memory depth: 1024 bit/channel

Number of channels: up to 32. Can be doubled by parallel operation of two HP 8182A's.

Expected data memory: 1024 bit/channel, segmentable.

Codes: bin, oct, hex (address code: dec).

Entry: Keyboard, HP-IB or read-in from DUT.

Displayed channel order: user-defined.

Line edit: word mask (don't care), insert, delete.

Channel edit: clear, set, copy, mask (don't care), exchange.

Modes

Analysis / store-and-compare: synchronous sampling with variable analog sampling point delay or asynchronous sampling. Comparison with expected data, if required.

Displays: state list, timing diagram, or error map.

Glitch detection: down to 5 ns. Memory depth is halved when glitch detection is selected.

Trigger condition: can be selected to start or stop analysis.

Real-time compare: comparison of actual with expected data throughout a time window. Window has variable analog delay and width. Real-time and latched error output signals are provided.

Display: error map.

Trigger conditions: starts comparison.

Timing

External clock: 0 to 50 MHz.

Delay

(relative to external clock): 0.0 ns to 1 s, max 95% period - 1 ns

Compare window width: 10.0 ns to 1 s, max 95% period - 9 ns

Channel skew: ≤ 2 ns

Resolution: 3 digits (best case 100 ps).

Accuracy: $\pm 5\%$ of programmed value ± 1 ns.

Internal clock: 1 Hz to 50 MHz (1-2-5) steps.

Inputs

Data: 6 different thresholds or dual threshold pairs can be defined and assigned to any number of individual inputs.

Clock: programmable threshold and selectable slope (positive, negative, both).

Input impedance: 1 MOhm, < 7 pF.

Control signals: (100 kOhm / 50 Ohm selectabel input impedance)

Trigger arm and ext stop signals: independent programmable thresholds and selectable slope (positive, negative, don't care).

Trigger qualifier and clock qualifier signals: independent programmable threshold and selectable levels (high, low, don't care).

Threshold range: -10.0 to +10.0 V.

Dynamic range: threshold ± 10 V.

Resolution: 3 digits (best case 10 mV).

Trigger

Trigger arm, word and qualifier, digital filter (1 to 16), clock and qualifier, delay (0 to 65535).

Ordering Information

| | Price |
|---|----------|
| HP 8180A Data Generator* (includes 8 NRZ channels) | \$15,900 |
| Opt 001 4 additional NRZ channels | \$2,300 |
| Opt 002 4 additional RZ channels | \$5,500 |
| HP 8181A Data Generator Extender (includes 8 NRZ channels) | \$9,400 |
| Opt 001 4 additional NRZ channels | \$2,300 |
| HP 8182A Data Analyzer* (includes 8 channels) | \$15,800 |
| Opt 001 8 additional channels | \$5,100 |

*HP-IB cables not included

HP 8180A/8181A/8182A Accessories

| | |
|---|---------|
| HP 15406A 8182A clock probe (supplied) | \$105 |
| HP 15407A 8182A cable set with probes for 4 data channels (supplied) | \$370 |
| HP 15408A 5 plug-on grabbers with ground leads (supplied with 8182A and 15413A) | \$75 |
| HP 15409A 5 plug-on BNC adaptors | \$75 |
| HP 15410A 5 plug-on SMB adaptors | \$75 |
| HP 15411A 5 plug-on coax open-end adaptors | \$60 |
| HP 15413A Tri-State Pod | \$850 |
| Each Pod includes a set of grabbers (HP 15408A) | |
| HP 15414A Tri-State Unit 4-24 channels, levels programmable via 8180A/8181A, selectable inhibit conditions | \$2120 |
| HP 15415A 5 plug-on miniprobes (for HP 10024A IC test clip) | \$75 |
| HP 15416A cable for parallel operation of 2 each HP 8182A | \$55 |
| HP 15421A cable for parallel operation of 2 each HP 8180A | \$55 |
| HP 15422A 8180A cable set for clock 1, clock 2 and strobe (supplied) | \$85 |
| HP 15423A 8180A/81A cable set for 4 data channels (supplied) | \$105 |
| HP 15424A Performance Board | \$1300 |
| HP 15425A Test Head | \$4300 |
| HP 15426A 20 solder-in receptacles (supplied) | \$70 |
| HP 15427A DUT Board | \$100 |
| HP 15428A | \$240 |
| 20 dual-in-line relays for use with HP 15425A Test Head, maximum current 250 mA | |
| HP 81800A Software Pac for series 200 controller | \$1,300 |

Information

For more detailed information the following publications are available: Product Brochure (5952-9548), Application Note (5952-9549), HP 8180A/81A Technical Data (5952-9550), HP 8182A Technical Data (5952-9551), HP 15413A/14A Technical Data (5952-9556), HP 15424A/25A Technical Data (5952-9562), HP 81800A Software Pac (5952-9558), Ordering Guide (5952-9563).

Please refer also to chapter Components & Semiconductor Measurement for detailed information of Digital Circuit Test System HP 81800S (page 369).



DATA GENERATORS & DATA ANALYZERS

50 MHz Digital Signal Generator

Model 8175A

- 24 channels/1Kbit ea/50 Mbit ea
2 channels/8Kbit ea/100 Mbit ea
- Virtual Memory Expansion
255 memory segments sequencing
- Programmable Pattern Durations
20 ns to 9.99s range/10 ns res.
- Interaction with DUT
8 Bit Trigger/8 Flags
- Most logic families
TTL/CMOS/ECL/variable
- Manual and automated operation
CRT, mass storage, hardcopy, HP-IB

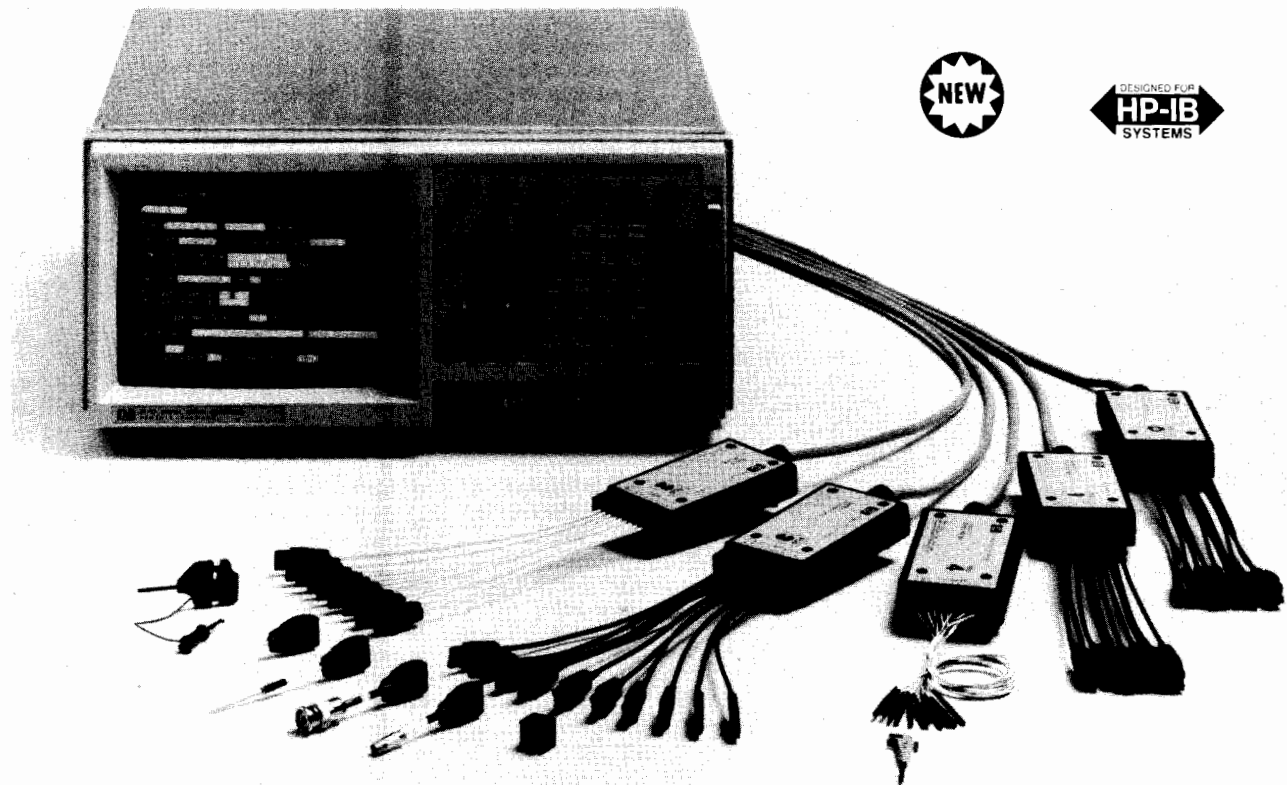

HP 8175A with output pods (15461A/15462A), trigger pod (15463A) and accessories (left to right: 15408A, 15411A,

15415A, 15409A, 15410A, 15429A, 10230-62101; 15429A and 10230-62101 are standard, others are optional). Not shown: detachable pouch on top of instrument for accessories storage.

The HP 8175A delivers high-speed parallel and serial data with programmable patterns, adequate for at-speed testing of most of present and future logic circuits. Individually Programmable Pattern Durations permit complex timing set-ups for simulation of extreme, asynchronous timings without wasting memory. Virtual Memory Expansion allows very long data sequences by branching to up to 255 user-definable memory segments. Interaction with a device under test provides for simulation of a wide range of data paths in digital systems. Output pods provide the appropriate levels for most logic families and flexible interface adaptors ensure the specified signal quality at the probe tip, a precondition for reliable results.

A Fine Timing option (opt. 001) enhances the timing resolution provided with Programmable Pattern Durations in order to delay four channels with 100ps steps.

Operational convenience is stressed through a large, menu driven CRT, a comprehensive data editor including waveform graphics and the capability to directly access (via HP-IB) a printer for documentation and a flexible disc drive for use as a test data library.

In *Engineering Test*, this versatile feature set provides early simulation of not yet available elements, speeding design cycles through reduced integration time at the circuit and system level.

In *Production Test* and *Incoming*, automated at-speed testing at the module and system level results in early failure detection, thus reducing production cost and improving quality.

Combining the HP 8175A Digital Signal Generator with a HP 1630/31 family logic analyzer results in a complete Stimulus - Response measurement system. For more information on the HP 1630/31 family logic analyzers refer to the respective pages in this catalog.

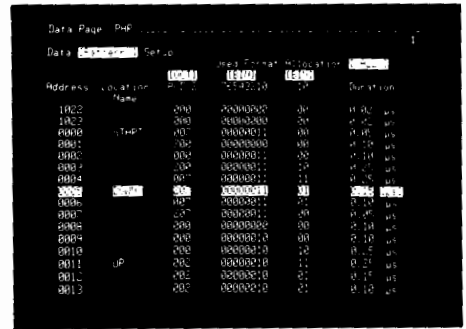

Data Page: Pattern Set-Up

Data can be entered and displayed in various codings. Channels to be displayed can be selected. Comprehensive data editing support is provided. For instance, segments of data can be moved or copied to other memory addresses or, data segments can be 'block modified'. Easy exchanging of data between channels avoids having to rearrange probes at the test fixture. Also fixed patterns such as up and down counters with selectable start and stop address are loaded with a few keystrokes.

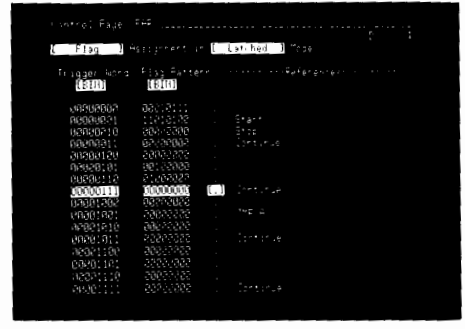

Control Page: Flag Assignment

This example shows how trigger words can be assigned to initiate certain output flags. The patterns marked with an asterisk (*), for instance 00000001, would always initiate flags, in this case the pattern 11010100. Note that in parallel status control functions can be performed (like START, STOP, CONTINUE, JUMP A/JUMP B, TRI-STATE ON/OFF).

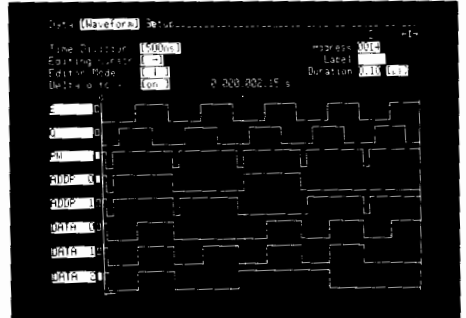

Data Page: Waveform Set-Up

All codings from the Pattern Set-Up page will be automatically converted into a timing diagram when switching to this page. Or, the data can be set-up from scratch or easily edited in terms of waveforms. User-definable labels identify 8 or 16 channels on one screen. Zooming the waveforms permits precise positioning of cursors and relative time calculations between pulse edges.

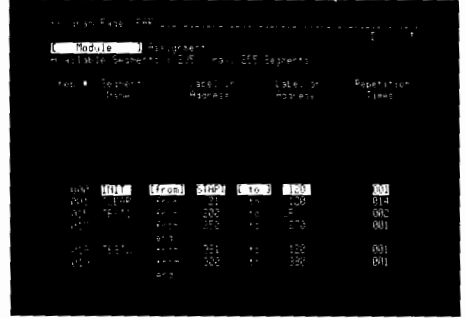

Program Page: Segment Assignment

This page gives an example of how pattern sequencing can be defined. Up to 255 segments of data memory can be defined by first and last addresses or labels in the 0000 to 1023 address range. During data execution the segments are real-time sequenced in the given order thus expanding the memory depth virtually far beyond the physical depth of 1024 data patterns.

Ordering Information

- HP 8175A Digital Signal Generator** \$15000
- incl. 4 ea 15462A (TTL/CMOS Data Pods) +1 ea 15463A (Trigger Pod)
- Options:**
- Opt. 001** Fine Timing; 4 channels, 100 ps delay \$1100
- Opt. D04** Deletes standard pod set (order pods separately) \$-4950
- Opt. 908** Rack Flange Kit (PN 5061-9678) \$35
- Opt. 910** Additional Operating / Programming / Service Manual \$110
- Opt. 916** Additional Operating and Programming Manual \$35
- Pods:**
- HP 15461A** ECL POD (fixed Ecl levels, includes 1 ea HP 15429A) \$800
- HP 15462A** TTL/CMOS Pod (progr. High Level, incl. 1 ea HP 15429A) \$1100
- HP 15463A** Trigger Pod (includes lead set and probe tip) \$550
- Adaptors for HP 15461A and HP 15462A:**
- HP 15408A** plug-on grabbers with ground leads, 5 ea \$75
- HP 15409A** plug-on BNC adaptors, 5 ea \$75
- HP 15410A** plug-on SMB adaptors, 5 ea \$75
- HP 15411A** plug-on coax open-end adaptors, 5 ea \$60
- HP 15415A** plug-on miniprobe, useable with HP 10024A IC clip, 5 ea \$75
- HP 15429A** solder-in receptables (standard accessory, 5x2 ea) \$40
- HP PN 15463-63201** lead set (for HP 15463A, standard accessory) \$65
- HP PN 10230-62101** probe tip (10 ea necessary for HP 15463A) \$3
- HP 15430A** cable for master-slave operation of 2 ea HP 8175A \$75
- HP 10062A** Protective Cover (protects front cover) \$75
- Recommended Peripherals:**
- HP 2225A** ThinkJet (inkjet graphics printer) \$495
- HP 9122D** dual, double-sided 3.5 inch flexible disc drive \$1390
- HP 10833A/D** 1 meter (3.3ft)/0.5 meter (1.6ft) HP-IB cable \$80



DATA GENERATORS & DATA ANALYZERS

50 MHz Digital Signal Generator

Model 8175A (cont.)

Specifications and Characteristics

Specifications apply for operating temperatures from 0 C to 55 C.

Parallel / Serial Data Generator

Number of channels: 24 parallel, 2 serial

Bits per channel: 1024 parallel, 8192 serial

Max. NRZ Bit rate per ch.: 50 Mbit/s parallel, 100 Mbit/s serial

Pattern Duration (with internal clock):

In *Parallel* mode the duration of each individual pattern is programmable. In *Serial* mode the duration of the data bits is programmable with successive bits always having the same duration. The duration is equal for all channels.

Range/Resolution:

| | |
|-----------------------------|---------------|
| (10)*, 20 ns - 9.99 μ s | / 10 ns |
| 10 μ s - 999 μ s | / 1 μ s |
| 1 ms - 99.9 ms | / 100 μ s |
| 0.1 s - 9.99 s | / 10 ms |

* 10 ns in serial mode with fixed timing

Accuracy:

- $\pm 0.05\%$ of progr. duration ± 2.5 ns (asynchronous start)
- $\pm 0.5\%$ of progr. duration ± 2.5 ns (synchr. start, clock calibration)
- $\pm 3.0\%$ of progr. duration ± 2.5 ns (synchr. start, no clock cal.)

Jitter (max.): 0.1% of progr. value + 150ps

Pattern Duration (with external clock): Period of ext. clock x m

| | |
|---------------------------|---------------------|
| m (Range) | / Resolution: |
| (1)2** to 999 | / 1 period |
| 1 000 to 99 900 | / 100 periods |
| 100 000 to 9 990 000 | / 10 000 periods |
| 10 000 000 to 999 000 000 | / 1 000 000 periods |

** Min. Pattern duration in parallel mode 20ns, in serial mode 10ns.

Clock

The clock has a programmable period. It is available on line 7 of the pod for the output flags. In serial mode an additional Clock is available providing a pulse at every bit.

Period (with internal clock):

Range / Resolution: 20ns - 9.99 μ s / 10ns; 2 μ s - 999 μ s / 1 μ s

Accuracy:

- $\pm 0.05\%$ of progr. value $\pm 2.5\mu$ s (asynchronous start)
- $\pm 0.5\%$ of progr. value $\pm 2.5\mu$ s (synchr. start, clock cal.)
- $\pm 3\%$ of progr. value $\pm 2.5\mu$ s (synchr. start, no clock cal.)

Period (with external clock): Period of external clock x m

Range: m = 2,3,4 . . . 999, 1000, 1100, 1200, . . . 99 900

Skew (maximum time difference between the leading or trailing data bit edges of the same memory address with Fine Timing off)

across ECL pods: ≤ 6 ns; typical ≤ 3 ns

across TTL/CMOS pods: ≤ 7 ns; typical ≤ 3 ns

Option 001 Fine Timing (can be retrofitted in HP service office)

Parallel Data Generator

Channels: 0,1,2 and 3 of pod 0

Delay (Range/Resolution): 20 ns to 40 ns / 100 ps

Accuracy: $\pm 5\%$ of progr. value ± 1 ns

Serial Data Generator

Channels: 0 and 2 of pod 0

Delay (Range/Resolution): 0 ns to 20 ns / 100 ps

Accuracy: $\pm 5\%$ of progr. value ± 2 ns

General

Dimensions (mainframe): 190mm high, 426mm wide, 584mm deep

Weight: Net 17.5kg (38.8lb)

Power: 115/230 Vac; -22% $+10\%$; 48-66 Hz; 630 VA max.

HP 15462A TTL/CMOS Pod (Data Or Flag Output Pod)

Number of channels: 8

Max. Bit rate per channel: 50 Mbit/s NRZ

Low level: ≤ 0.7 V

High level (Range/Resolution): 2.4 V - 9.9 V / 100mV

Accuracy: $\pm 5\%$ of programmed value ± 300 mV

(into open; pattern duration > 50 ns)

Programmed high level is valid for all pods, high level can also track an external voltage applied to an individual pod.

Transition times (into open): ≤ 3 ns + high level x 1.2ns/V

(into 50 pF): ≤ 9 ns + high level x 1.8ns/V

Fan-out per channel (typical): 10 LS TTL

Overshoot, ringing (into open): $\leq 20\%$ of amplitude

Max. external voltage at outputs: -3 V / $+10$ V

Disable/enable characteristics (Tri-State)

T(on), T(off): ≤ 30 ns

Leakage current: ≤ 20 uA

Residual capacitance: ≤ 40 pF

Tri-State input at the output pod (TRIS):

Impedance (typical): 10 k Ω /50 pF

Threshold: 35% of programmed or external high level

Max. ext voltage at inputs (TRIST, HIL): 0 V to 10 V

HP 15461A ECL Pod (Data Or Flag Output Pod)

Number of channels: 8

Max Bitrate per channel: 100 Mbit/s NRZ

Low level: ≤ -1.60 V

High Level: ≥ -1.02 V

Fan-out per channel (typical): 5 ECL

Transition times (20% - 80%; into 22pF): ≤ 3 ns

Overshoot, ringing: $\leq 20\%$ of amplitude

Max. external voltage at outputs: ± 5 V

Enable/disable characteristics (ECL common LOW):

T(On), T(Off): ≤ 15 ns

Enable/disable input

Impedance: 60 k Ω / 50 pF

Threshold: ECL compatible

Max. ext. voltage at input (EN): 0V to -5 V

HP 15463A Trigger Pod (Trigger Word Input Pod)

This pod is used for external status and output flag control.

Max. clock rate: 25 MHz

Impedance: 100 k Ω / 5 pF typ.

Threshold (Range/Resolution): -9.9 V to 9.9 V / 100mV

Accuracy: $\pm 2.5\%$ ± 120 mV

Min. overdrive: 250 mV or 30% of input amplitude, whichever is greater

Min. swing: 600 mVpp

External Input (BNC)

This connector can be used to start / stop datacycling with selectable transitions.

Impedance: 10 k Ω / 50 pF

Threshold (Range/Resolution): -9.9 V to $+9.9$ V/100 mV

Accuracy: $\pm 5\%$ of progr. value ± 250 mV

Min. swing: 600 mV pp

Min. overdrive: 250 mV or 30% of input amplitude

Max. input voltage: ± 20 V

External Clock (BNC)

Clock rate (Range): DC to 100 MHz

All other specifications see External Input (BNC).

External Reference (BNC)

Input characteristics: LS TTL compatible

DATA GENERATORS & DATA ANALYZERS

9-Bit Parallel, 32-Bit Serial, 50 MHz Word Generator

Model 8016A



- 2 complementary outputs per channel, RZ/NRZ formats
- Variable RZ width, 4 delay channels
- Channel serializer
- TTL/ECL output levels selectable

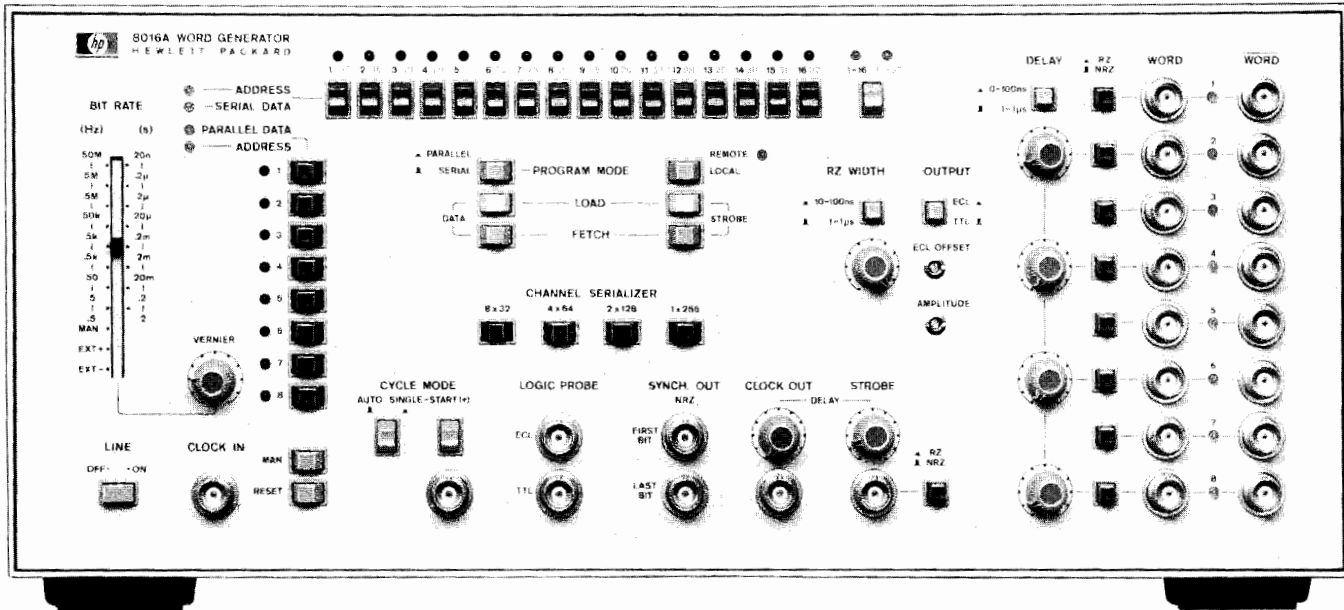

HP 8016A

The HP 8016A is a 9-channel data generator capable of serialization up to 256 bits. For the digital designer the HP 8016A is a natural companion to multichannel data display devices such as logic analyzers. As a bench or systems component, the HP 8016A provides programmable digital patterns plus adjustable timing parameters necessary for testing ICs and circuit boards.

Functional Test

Bit pattern programmability combined with fast cycle time (50 MHz clock) make the HP 8016A especially effective in simulating worst case conditions, e.g. high speed IC testing. The HP 8016A saves time in component evaluation environments because test setups can be rapidly built and reconfigured to meet the demands of testing small quantities of a wide variety of IC types.

Parametric Test

Complete testing of digital circuits and systems requires not only digital patterns for functional test but control of the analog parameters of the pulses as well. Adjustable pulse widths, levels, and interchannel delays contribute to measurements such as setup and hold times, clock pulse width sensitivities, and system sensitivity to propagation delay variations. To meet these testing requirements, the HP 8016A includes 6 independent delay circuits. Output levels of the HP 8016A's 50 Ω output amplifiers are selectable for ECL or TTL test specifications and can be adjusted. In addition, a choice of RZ or NRZ formats with variable RZ pulse width is provided.

Specifications

Data capacity: 8 data channels plus 1 strobe channel, each 32 bits. 8 data channels can be serialized as four 64-bit channels, two 128-bit channels or a single 256-bit channel.

Data loading: address channel, enter 32 serial bits in that channel. Alternatively, address parallel word, enter (max 8) bits in that word. Addressing/entry by pushbuttons/LEDs or via HP-IB (option 001).

Data Outputs: (50 Ω source into 50 Ω load).

Format: independent RZ/NRZ selection in each channel.

RZ width: single continuous adjustment in ranges 10-100 ns, 0.1-1 μ s.

Width jitter: $\leq 0.2\% + 50$ ps

Complement: simultaneous normal and complement outputs for each channel.

Delay: channels 2, 4, 6, 8 can be delayed independently within the ranges 0-100 ns, 0.1-1 μ s with respect to odd channels.

Jitter: $\leq 0.1\% + 5$ ps

Skew (undelayed): ± 1 ns

Levels: ECL/TTL selectable

Transition times: ≤ 3.0 ns (ECL ≤ 2.5 ns)

Bit Rate

Internal: 0.5 Hz to 50 MHz.

External: dc to 50 MHz, or manual.

Data Cycling

Auto: Sequence recycles continuously.

Single cycle: Sequence is triggered/gated by external pulse/level.

General

Operating temperature: 0°C to +50°C.

Power: 100/120/220/240 Vrms; +5%, -10%; 48 Hz to 66 Hz, 200 VA (maximum)

Weight: net, 14.5 kg (32 lb). Shipping 16 kg (35.3 lb).

Size: 177 H x 426 W x 422 mm D (7" x 16.8" x 16.6").

Ordering Information

HP 8016A Word Generator

Opt 001: HP-IB for data loading*

Opt 907: Front Handle Kit (Part No. HP 5061-0090)

Opt 908: Rack Flange (Part No. HP 5061-0078)

Opt 909: Opt 907, 908 combined (Part No. HP 5061-0084)

Opt 910: Additional Operating and Service Manual

*HP-IB cables: Refer to page 121.

Price

\$8700

add \$800

add \$65

add \$35

add \$90

add \$48



DATA GENERATORS & DATA ANALYZERS

Logic Pattern Generator

Model 8170A

- 32k memory
- 8 bit/16 bit parallel output

- 2 wire/3 wire handshake capability
- Internal and external addressing

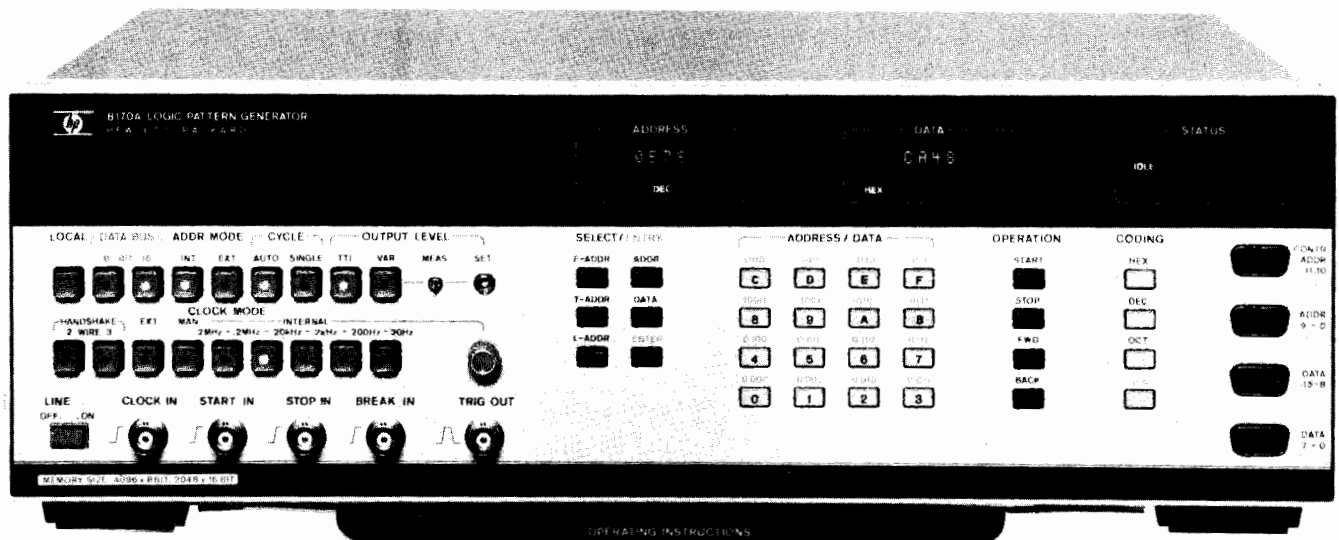

HP 8170A



Parts, memories and peripherals can be verified at all stages in design and production because the HP 8170A allows testing in isolation from the system. Busses or devices can be stimulated synchronously or asynchronously with data from the HP 8170A's memory. Address outputs (Option 002) allow writing into a RAM for subsequent comparison on e.g. a logic analyzer. In external address mode, software can be setup, verified and modified in the HP 8170A before committing ROM's.

The HP 8170A memory can be programmed manually, via HP-IB or by selecting one of the fixed patterns. User codes can be used directly because conversion is handled automatically.

Specifications

Memory: 32 kbit, 8- or 16-bit width, selectable. Freely programmable or selectable patterns (Set/reset/prbs/count up/down).

Address Modes

Internal: ascending sequence between user-defined addresses.

External: 10-line address plus 4 enable lines. Max rate 2 Mbit/s.

Clocking

Internal: 20 Hz to 2 MHz in 5 ranges.

External: dc to 2 MHz.

Manual: forward/backward data stepping.

Handshake: 2-wire/3-wire (IEEE 488) selectable.

Cycle Modes (applies to Int Address mode)

Auto cycle: data cycled continuously.

Single cycle: data is cycled once per Start In command.

Outputs

Data: 8 or 16 lines, selectable. Pos/neg true selectable.

Control: data Valid. Pos/neg true selectable.

Status: 2 lines indicate whether data is clocked, static or off.

Levels: TTL or adjustable +3 V to +15 V.

Address (via Opt 002 pod): 10 lines, +2.4 V true, +0.5 V false.

Inputs

Address: 10 lines (12 lines in Opt 001).

Control: ready for Data and data accepted lines.

Enable: 4 lines.

Levels: high +2.0 V, low +8.0 V.

Remote control: HP-IB, RS-232C (CCITT V.24).

HP-IB

Interface functions: SH1, AH1, L4, SR1, RL1, T5, PP0, DC0, DT0, C0.

General

Power: 100/120/220/240 V rms; +5%, -10%; 48-66 Hz, 110 VA max.

Operating temperature: 0°C to 55°C.

Weight: net 11 kg (24.3 lbs). Shipping 15 kg (33.2 lbs).

Dimensions: 133 H x 426 W x 422 mm D (5.2" x 16.8" x 16.6").

Ordering Information

| | Price |
|---|--------------|
| HP 8170A Logic Pattern Generator** | \$6,700 |
| Opt 002: Address Driver Pod (HP 15452A) | add \$470 |
| Opt 907: Front Handle Kit (HP part number 5061-0089) | add \$55 |
| Opt 908: Rack Mount Kit (HP part number 5061-0077) | add \$32.50 |
| Opt 909: Opt 907, 908 combined (HP p/n 5061-0083) | add \$80 |
| Opt 910: Extra Operating and Service Manual | add \$70 |
| HP 15457A Pod Connector (Pods can be easily plugged into DUT when this accessory is wired in) | add \$65 |
| HP 15459A 1.5 m pod extension cable | add \$190 |

Supplied Accessories

| | |
|--|-------|
| HP 15453A Address input pod | \$320 |
| HP 15454A Control Pod | \$320 |
| HP 15455A Data Pod (D0-D7) | \$320 |
| HP 15456A Data Pod (D8-D15) | \$320 |
| HP 15458A Snap-on Assembly (one per pod) | \$150 |
| HP 10230-62101 Hook-on Clip | \$3 |

*For more on these codes refer to the HP-IB section of this catalog.

**HP-IB cables not furnished, see page 121.

DATA GENERATORS & DATA ANALYZERS

50 MHz Serial Data/PRBS Generator

Model 8018A



- 2048 bit, dual channel memory
- Variable word and pattern length
- TTL, ECL, CMOS compatible
- Programmable, prbs and mixed data

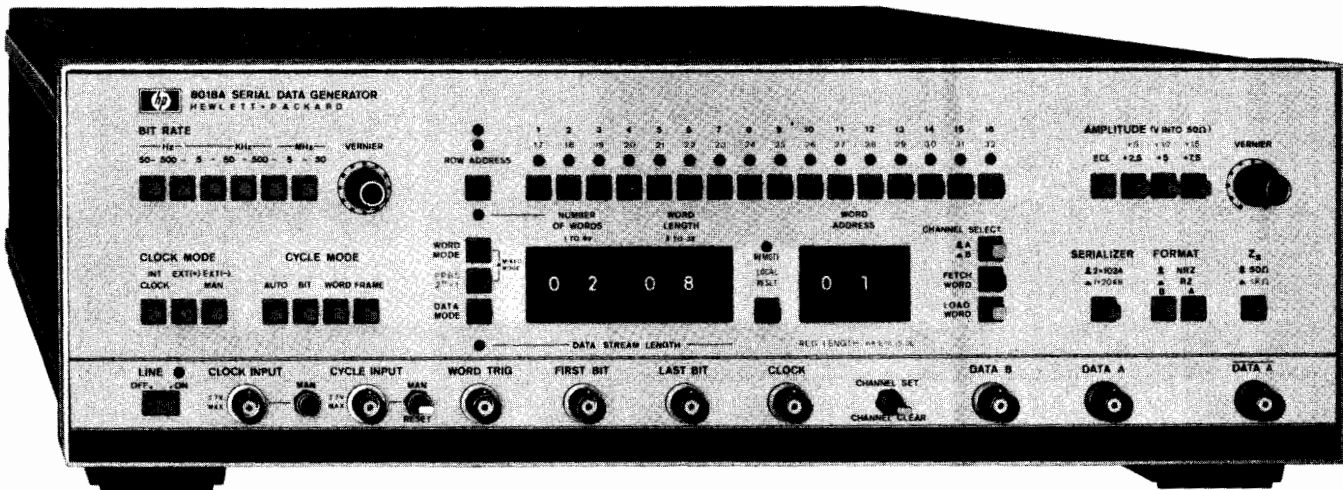

HP 8018A

With 2048 programmable bits, and a choice of pseudo-random binary sequences (prbs) ranging to over 1 Mbits, the HP 8018A is a powerful stimulator for serial digital systems and devices requiring high bit rate and fast pulses. Even preamble-data-postamble data link patterns are feasible by combining prbs and programmed data. Useful synch outputs simplify testing by locking scope or analyzer to unique points in the data stream.

For data link patterns, mixed mode inserts a prbs after each odd word.

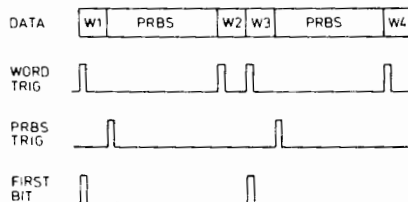

For dual-channel applications, the memory splits so that the outputs have independent 1 Kbits of data.

A high performance output amplifier adds to the HP 8018A's wide applicability. It delivers clean, 6 ns pulses with repetition rates from dc to 50 Mb/s. Output amplitude is variable up to 15 volts into 50 Ω. This enables you to directly drive logic circuits ranging from TTL to CMOS. Output levels for emitter-coupled-logic (ECL) are also provided.

To handle patterns for repetitive tests more conveniently, data can be loaded via HP-IB (Option 001).

Specifications

Data Capacity and Modes

Programmable memory: 2 channels, each 1 kbit, serializable. Thumbwheel switches define data stream length or frame length (N words of Mbits), and set up synch signals accordingly.

Prbs: pseudo-random binary sequences of 511, 1023, 32767 and 1048575 bits. Synch pulse at beginning of sequence.

Mixed: prbs is inserted after every odd-numbered programmable word.

Data Outputs

Channel A: simultaneous normal and complement outputs. ECL levels or variable +15 V amplitude. Selectable 50 Ω/1 kΩ output impedance, RZ/NRZ format.

Data length: up to 1024 bit or (serialized with B data) 1025 to 2048 bit.

Transitions (50 Ω into 50 Ω): ≤ 6 ns (ECL ≤ 5 ns)

Preshoot, overshoot, ringing: ≤ 10% (ECL ≤ 15%)

Channel B: normal output, 2.4 V (50 Ω into 50 Ω), up to 1024 bits, RZ/NRZ selectable.

Bit Rate

Internal: 50 Hz to 50 MHz (40 MHz in Mixed mode), jitter 0.2%

External: dc to 50 MHz (40 MHz in Mixed mode) or manual.

Data Cycling

Auto: sequence recycles continuously.

Bit: bits are triggered/gated by external pulses/level.

Word: words are triggered/gated by external pulses/level.

Frame: sequence is triggered/gated by external pulses/level.

Manual: switch triggers single bits/words/frame.

General

Power: 100/120/220/240 V rms; +5%, -10%; 48 to 440 Hz. 230 V A max.

Temperature range: 0°C to 50°C.

Weight: net 12 kg (26.5 lbs). Shipping 16 kg (35.3 lbs).

Size: 133 H x 426 W x 422 mm D (5.2" x 16.8" x 16.6").

Ordering Information

HP 8018A Serial Data Generator

Opt 001: HP-IB for data loading*

Opt 907: Front Handle Kit (Part No. HP 5061-0089)

Opt 908: Rack Flange Kit (Part No. HP 5061-0077)

Opt 909: Opt. 907, 908 combined

(Part No. HP 5061-0083)

Opt 910: Extra Operating and Service Manual

* HP-IB cables: refer to page 121.

Price

\$4700

add \$700

add \$55

add \$32.50

add \$80

add \$38

PULSE GENERATORS

General Information

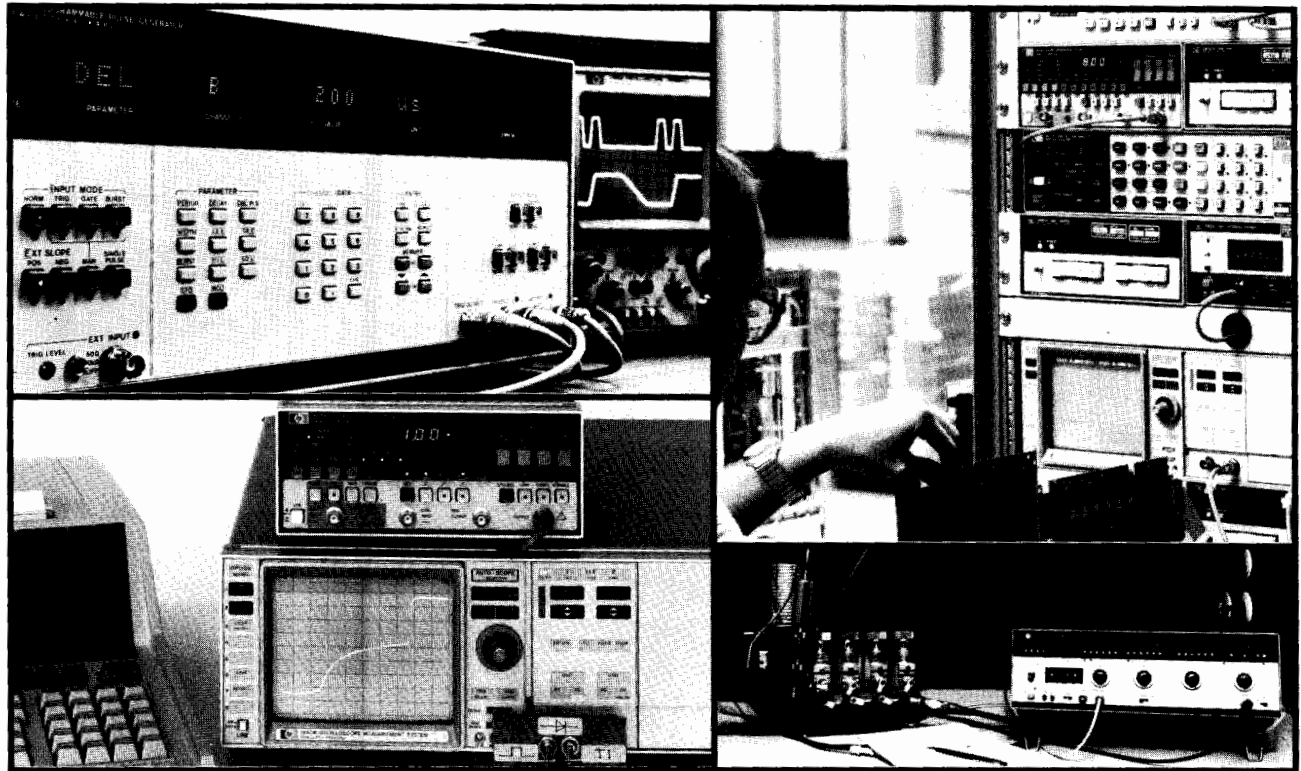

Analog and Digital Test

HP's *pulse generators* range from simple, inexpensive units to high performance, microprocessor-based instruments offering precision pulse generation. Depending on model, variable clock speeds to 1 GHz and variable amplitudes up to 100 V are available.

Pulse parameters are independently variable for thorough characterization and worst-case testing. Variable pulse transitions permit parametric analysis like trigger circuit hysteresis, and the fastest settings are ideal for at-speed logic test and amplifier transient investigations.

Pulse/function generators combine pulse capability with all features expected of a function generator. The benefits are high flexibility for analog requirements plus an entry into logic test.

Operating Comfort

Clear front panel layout, guided parameter selection, and error detection and recovery features, mean quick familiarization and rapid, error-free use. In addition, great emphasis is placed on ruggedness, reliability and serviceability. The generators are developed and produced using high quality standard components and custom-designed ICs. Resultant technical benefits are, for exam-

ple, broad operating temperature range and clean 50-Ohm output impedance.

Selectable polarity, complement and offset help make hook-up simpler and, for further flexibility, *inverters*, *adders* and *splitters* are available (page 488*).

Complex waveform capability allows glitches, ringing and multi-level signals to be simulated. Constant numbers of pulses, unaffected by other parameters are available in HP's counted burst mode.

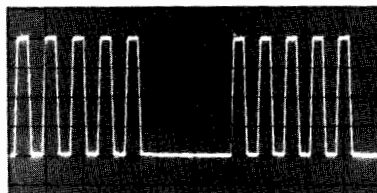

Bench and Automatic Test

A new generation of very versatile models offer good repeatability and high operating comfort for fast, accurate testing. These instruments also offer HP-IB which makes bench automation a reality for time-consuming tests. Setup time is a minimum because the syntax is simple and uses the same command sequence as the front panel.

Straight-forward syntax helps develop ATS software quickly; good repeatability and error reporting eliminate the need for software measurement loops. Specified performance over the entire 0°C to 55°C operating temperature range guarantees reliability in system racks.

Time Synthesis (page 489*)

Time Synthesizers are mainly used in radar and laser ranging, component and circuit testing, and precise triggering and calibrating applications. They give a precisely timed output pulse with an accurate, adjustable delay which may be incremented in steps as small as 50 pico-seconds. A fixed, virtually jitter-free insertion delay allows phase locking to equipment under test.

Logic Capability

CMOS: HP 8011A, 8015A, 8111A, 8112A, 8116A, 8160A

TTL: HP 8012B, 8013B, 8015A, 8111A, 8112A, 8116A, 8160A.

LS-TTL: HP 8082A, 8161A

ECL: HP 8082A (0.7 ns), 8080A (0.5 ns/0.2 ns, depending on configuration), HP 8161A (0.9 ns). Figures in brackets are the equivalent ECL switching time, 20% to 80% of amplitude.



Pulse Generator Selection Chart

| HP Model Page | Pulse Generators | | | | | | | | | | | Pulse/Function Generators | | |
|---|------------------|-----------|-----------|-----------|-----------|-----------|-----------|--------------|----------------------------|----------------------------|----------------------------|----------------------------|----------------------------|----------------------------|
| | 214B 483 | 8005B 484 | 8011A 484 | 8012B 485 | 8013B 485 | 8015A 486 | 8082A 487 | 8080A 488 | HP-IB SYSTEMS 8112A 478 | HP-IB SYSTEMS 8160A 480 | HP-IB SYSTEMS 8161A 480 | HP-IB SYSTEMS 8111A 461 | HP-IB SYSTEMS 8116A 459 | HP-IB SYSTEMS 8165A 458 |
| Timing | | | | | | | | | | | | | | |
| Max frequency (MHz) | 10 | 20 | 20 | 50 | 50 | 50 | 250 | 300/1000 | 50 | 50 | 100 | 20 | 50 | 50 |
| Transition time (ns) | 15 | 10 var | 10 | 5 var | 3.5 | 6 var | 1 var | 0.8/0.3 | 5 var | 6 var | 1.3 var | 10 | 6 | 5 |
| Var width (ns) min | 25 | 25 | 25 | 10 | 10 | 10 | 2 | Sp Opt | 10 | 10 | 4 | 25 | 10 | 10 |
| Square/duty cycle (%) | 1-10 | Sq | Sq | Sq | Sq | Sq | Sq | Sq | 1-99 | | | 10-90 | 10-90 | 20/50/80 |
| Variable delay | • | • | | • | • | • | • | • | • | • | • | | | |
| Output (max values are quoted: see specifications for conditions). | | | | | | | | | | | | | | |
| Amplitude (V) | 100 | 10 | 16 | 10 | 10 | 30 | 5 | 4/2.4 | 32 | 20 | 5 | 32 | 32 | 20 |
| Offset/Window (V) | | ±4/±10 | | ±2.5/±7.5 | ±2.5/±7.5 | ±28/±16 | ±2/±5 | ±2/±4 | ±16/±16 | ±20/±20 | ±5/±5 | ±16/±16 | ±16/±16 | ±10/±10 |
| Format | +/- | | | | | | | | | | | | | |
| • = positive, negative, symmetrical, normal and complement formats. | | | | | | | | | | | | | | |
| Outputs | 1 | + and - | 1 | 1 | + and - | 2 | 1 | Configurable | 1 | 2-chan option | 2-chan option | 1 | 1 | 1 |
| Additional outputs | | TTL | | | | TTL | Compl | | | | Compl | | | |
| Operating Modes | | | | | | | | | | | | | | |
| Trigger | • | • | • | • | • | • | • | • | • | • | • | • | • | • |
| Ext width | | | | • | • | • | • | • | • | • | • | • | • | • |
| Gate | • | • | | • | • | • | • | • | • | • | • | • | • | • |
| Ext burst | Option | | Option | | | Option | | | | | | Option | Option | • |
| Int burst | | | | | | | | | | | | | Option | |
| Double pulse | • | • | | • | • | • | • | • | • | • | • | • | • | • |
| Control (Modulation) Modes | | | | | | | | | • | | | • | • | • |

Pulse Generator Definitions

Time Reference Point: Median (50% amplitude point on pulse edge).

Pulse Period: The time interval between the leading edge medians of consecutive trigger output pulses.

Trigger Delay: Interval between trigger point of input signal and the trigger output pulse's leading edge median. Applies in trigger, external width, gate and burst modes.

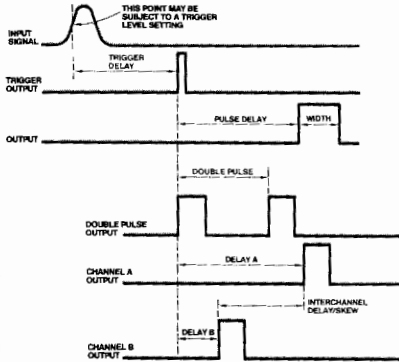

Pulse Delay: Interval between leading edge medians of trigger output pulse and output pulse.

Double Pulse: Interval between leading edge medians of the double pulse.

Interchannel Delay/Skew: Interval between corresponding leading edge medians.

Pulse Width: Interval between leading- and trailing-edge medians.

Additional Information for Pulse Generators with Variable Transition Times

Pulse Width: The specified and displayed value is that obtained with fastest edges; essentially equal to the interval from the start of the leading edge to the start of the trailing edge.

By designing so that the pulse edges turn about their start points, the interval from leading edge start to trailing edge start stays unchanged* when transition times are varied. This is more convenient for programming and the width display is easy to interpret.

*In practice, start points may shift with change in transition time.

Delay: The specified and displayed value is that obtained with the fastest leading edge. For a slower edge, the actual delay exceeds the displayed delay by the combined shift of start-point and median.

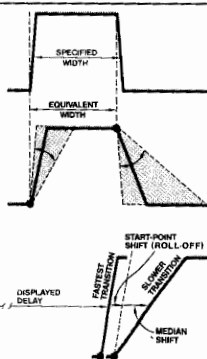

Transition Time: Interval between the 10% and 90% amplitude points on the leading/trailing edge.

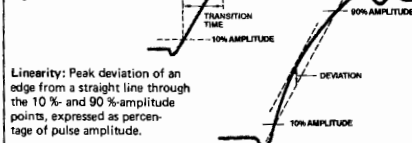

Linearity: Peak deviation of an edge from a straight line through the 10% and 90% amplitude points, expressed as percentage of pulse amplitude.

Jitter: Short-term instability of one event with respect to another. Unless stated otherwise, value is p-p, expressed as a percentage of the main parameter.

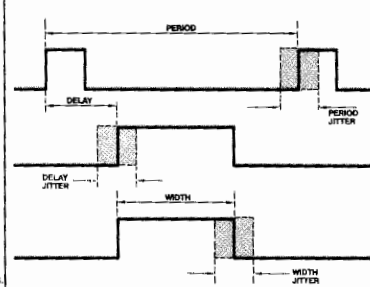

Stability: Long-term average instability, expressed as percentage of main parameter over a specific time duration, e.g. hour, year. Excludes jitter.

Pulse Level: High level and low level. Any limitation is expressed by an amplitude specification.

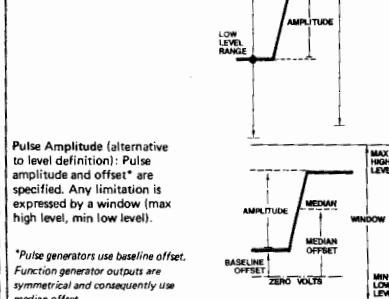

Pulse Amplitude (alternative to level definition): Pulse amplitude and offset* are specified. Any limitation is expressed by a window (max high level, min low level).

*Pulse generators use baseline offset. Function generator outputs are symmetrical and consequently use median offset.

Preshoot, Overshoot, Ringing: Preshoot and overshoot are peak distortions preceding/following an edge. Ringing is the positive peak and negative peak distortion excluding overshoot, on pulse top or base. A combined preshoot overshoot, ringing specification of e.g. ± 5% implies:

- Overshoot/undershoot < 5%,
- Largest pulse-top oscillation < ± 5%, of pulse amplitude.

Settling Time: Time taken for pulse levels to settle within level specification, measured from 90% point on leading edge.

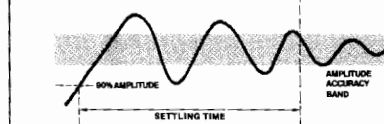

Duty Cycle: Percentage ratio of pulse width to period. In pulse/function generators, this term is also used to define sine and triangle symmetry.

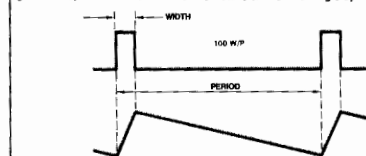

Output Impedance/Resistance: Effective pulse source impedance/dc resistance.

Reflection Coefficient: Reflection at pulse generator output expressed in percent of incident pulse amplitude. (Test pulse edges correspond to generator's fastest transitions).

Repeatability: When an instrument operates under the same environmental conditions, and with the same settings, the value of a parameter will lie within a band inside the accuracy window. Repeatability defines the width of this band.

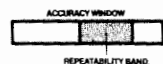

HP-IB Programming Times

Listen Time: The time an instrument occupies the bus to receive and verify a message. The NRFD signal is active during this period.

Settling Time: The time taken by the instrument to execute an HP-IB message, and for the output to settle within the accuracy specification, NRFD inactive.

Execution Time: The sum of Listen Time and Settling Time.

Talk Time: The time an instrument occupies the bus to output a specified string. Output data is typically instrument error status, or current or stored parameters.



PULSE GENERATORS

Programmable Low Cost Pulse Generator

Model 8112A

- Full pulse capability
- Modulation
- Ramps and haversines
- Width/duty cycle
- Device protection
- Error recognition and self test

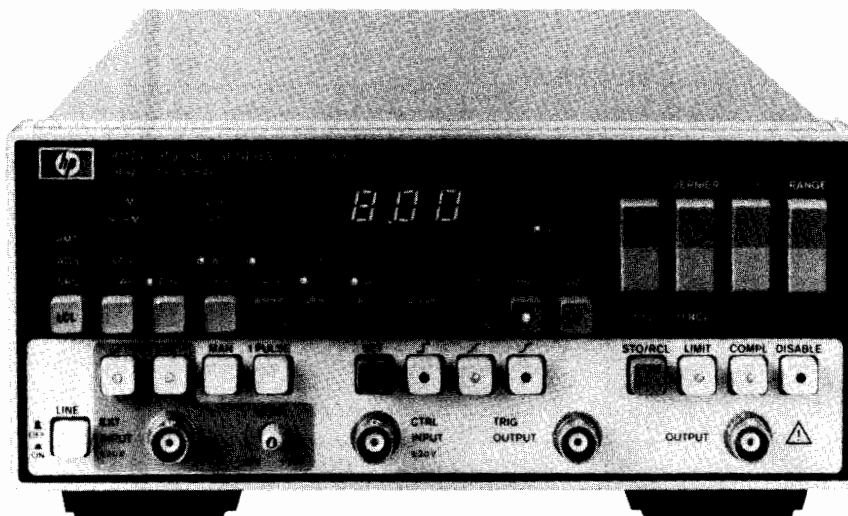

HP 8112A



The HP 8112A is fully programmable 50 MHz pulse generator with 5 ns transitions and 32 V_{pp} (into open circuit) max output amplitude. All pulse parameters are variable including delay and double pulse spacing.

Besides the comprehensive trigger modes, external modulation capabilities extend applicability. 3-level signals and upper level, width, period and delay-modulated signals are available. These can be combined with the trigger modes so that complex real-life signals like modulated bursts are simulated easily.

Step response and trigger hysteresis measurements require fast transitions or sawtooth signals as obtained in the HP 8112A's linear transition mode—either fixed 5 ns or variable from 6.5 ns. The new cosine transitions, also variable from 6.5 ns, mean that band-filtered signals are now just as simple to obtain.

Sensitive devices are protected by programming output limits and the upper level can be controlled by the device supply. Also, constant energy or constant width can be programmed.

Dual channel operation is feasible by operating HP 8112A's in a master/slave combination.

For really easy operation a green button gives error-free settings. A new softkey operating concept plus detailed error recognition make the HP 8112A's powerful versatility easy to handle.

Specifications

Specifications apply with 50-ohm load, and temperatures in the range 0°C to 55°C.

Timing (specifications apply for min transition times)

Period: 20.0 ns to 950 ms.

Delay: 65.0 ns to 950 ms.

Double pulse: 20.0 ns to 950 ms.

Width: 10.0 ns to 950 ms.

Accuracy: ± 5% of progr value ± 2 ns (delay: ± 4 ns).

Duty cycle: 1% to 99% (Min: 10 ns. Max: period - 10 ns).

Accuracy: ± 10% of progr value.

Pulse Characteristics (voltages double when driving into open circuit)

Levels

High level: -7.90 V to 8.00 V.

Low level: -8.00 V to 7.90 V.

Accuracy: ± 1% of progr value ± 3% amplitude ± 40 mV.

Settling time: 100 ns + transition time.

Transition times

Fixed: 5 ns

Linear and Cosine: 6.5 ns to 95.0 ms (max edge ratio 1:20 within a 1.5-decade range. Ranges overlap by 0.5 decade).

Accuracy: ± 5% of programmed value ± 2 ns.

Preshoot, overshoot, ringing: ± 5% ± 10 mV (variable transitions), ± 10% ± 10 mV (fixed transitions).

Output resistance: 50 ohm ± 5%.

Operating modes: Normal, Trigger, Gate, Ext Width (pulse restoration), Ext Burst (1 to 1999 pulses).

Control (Modulation) Modes

Period, delay, width covered in 8 non-overlapping decades (max input frequency 8 kHz.).

High level: -8 V to +8 V, independent of progr low level (min input transition 200 μs).

General

HP-IB: all keys programmable. Learn, status and error reporting capability. Interface functions: SH1, AH1, T6, L4, SR1, RL1, PP0, DC1, DT1.

Memory: retains current operating state. 9 store/recall locations, 1 fixed set of parameters.

Repeatability: factor 4 better than accuracy.

Environmental

Storage temperature: -40°C to +65°C.

Operating temperature: 0°C to 55°C.

Humidity: 95% RH, 0°C to 40°C.

Power: 100/120/220/240 V rms; +5%; -10%; 48 to 440 Hz; 120 VA max

Weight: net, 5.9 kg (13 lb). Shipping, 8.0 kg (18 lb).

Size: 89 H x 212.3 W x 450 mm D (3.5" x 8.36" x 17.7").

Ordering Information

HP 8112A Programmable Pulse Generator* \$4775

Opt 910 Extra Operating and Service Manual add \$48

HP 5061-9701 Bail Handle Kit \$38

HP 5061-9672 Rack Mount Kit (single HP 8112A) \$49

HP 5061-9674 Rack Mount Kit (two instruments) \$30

HP 5061-9694 Lock Link Kit (for use with HP 5061-0074) \$25

* HP-IB cables not supplied, see page 121

Prices

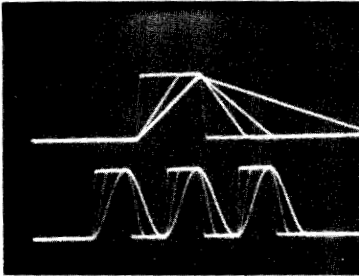

Linear Transitions

(upper trace) supply everything from fast pulses through trapezoids to ramps and triangles. These solve the stimulus requirements for such diverse applications as transient response evaluation Schmitt trigger hysteresis measurements,

component stress characterization and materials testing. Variable transition times allow digital devices to be tested under the exact conditions specified by the IC manufacturer. Also, reflections caused by mismatch can be reduced by increasing the transition times.

Cosine-Shaped Transitions

Selectable cosine edges reduce signal bandwidth for transmission line testing. As shown in the lower trace in the above photograph, even haversines (which are ideal for simulating radar and similar signals) can be generated when the pulse width is set equal to transition time.

Counted Burst Mode

The external signal (upper trace) triggers a counted number of output pulses which can be used for clocking digital devices to an exact condition. The External signal can also be used to **trigger** single or double pulses, or to **gate** the output.

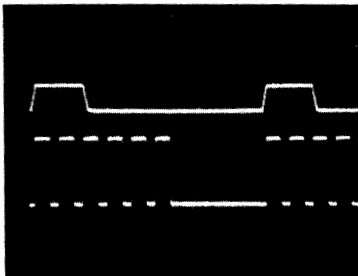

External Width Mode

The clean lower trace has been recovered from the noisy signal applied to the HP 8112A's External Input.

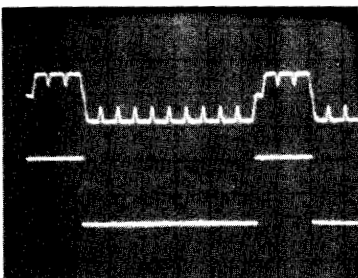

Flexible Transition Time Handling

allows excessive settings so that noise spikes (like those in the upper trace) as well as triangular waveforms can be generated.

Delay Control Mode

Phase Modulated signals can be simulated by controlling delay with an external voltage. The lower trace shows the effect on a double-pulse signal.

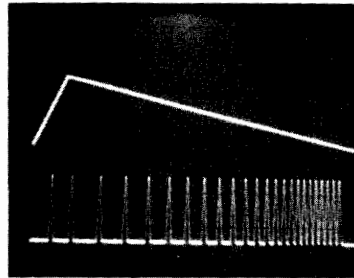
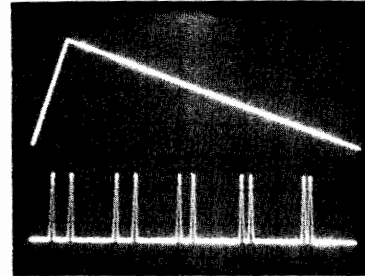

Period Control

PLL tracking accuracy and settling time can be evaluated with the period-modulated signals (lower trace) generated in the Period Control mode.

Width Control

As shown in the lower trace, PWM control signals can be simulated in this mode. As in the other timing control modes, the dynamic range is 1:10.

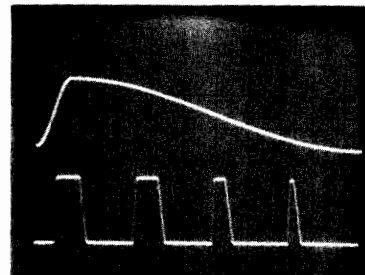

Dual-Edge Triggering

Both edges can be selected for triggering as well as just positive or negative. The lower trace shows how a magnetic storage device signal can be simulated by applying a signal (upper trace) simultaneously as external trigger and high-level control voltage.

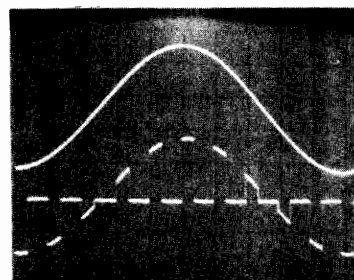
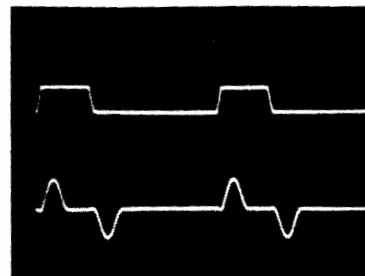

High-Level Control

In addition to producing 3-level signals like that in the previous photograph, high-level control mode can be used for simulating PAM signals and also for protecting CMOS.



PULSE GENERATORS

Programmable Precision Pulse Generators

Models 8160A, 8161A

- 50 MHz repetition rate
- 6.0 ns variable transition time
- 20 V output amplitude
- 1-3% pulse parameter accuracy
- Full dual channel capability (option 020)
- 1 year recalibration period

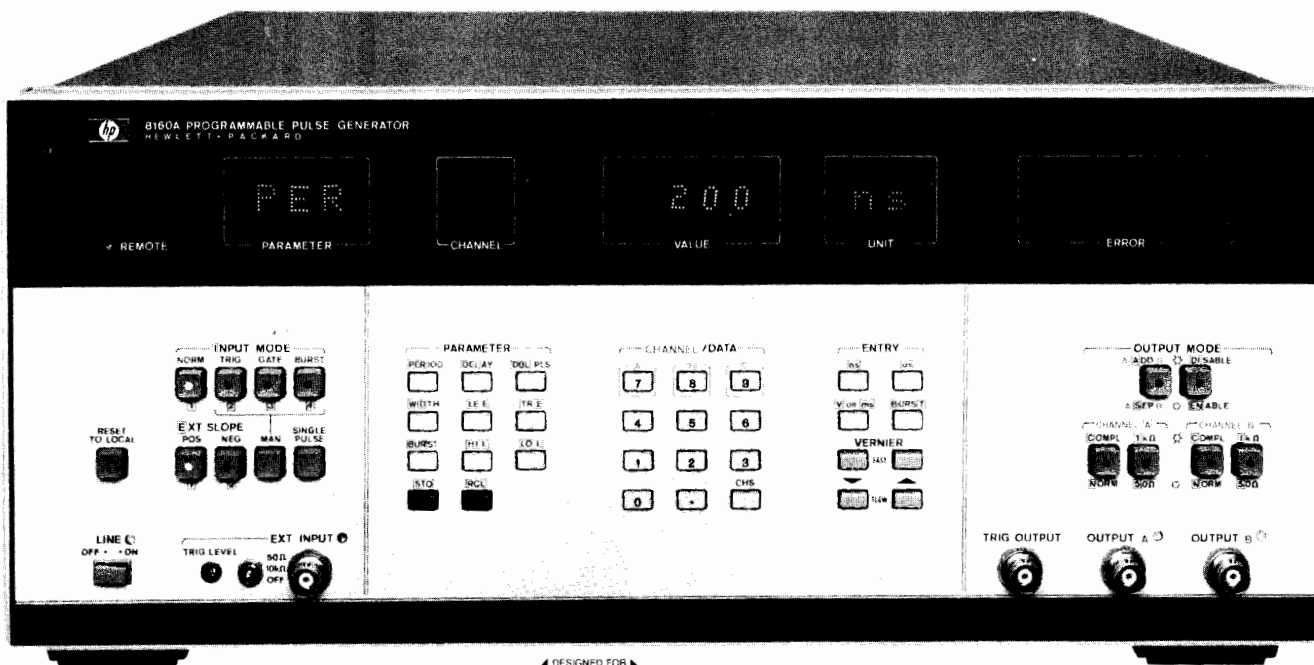

Picture shows 8160A
with Option 020, Dual Channel

- 100 MHz repetition rate
- 1.3 ns variable transition time
- 5 V amplitude
- 1-3% basic timing accuracy
- Full dual channel capability (option 020)
- 1 year recalibration period

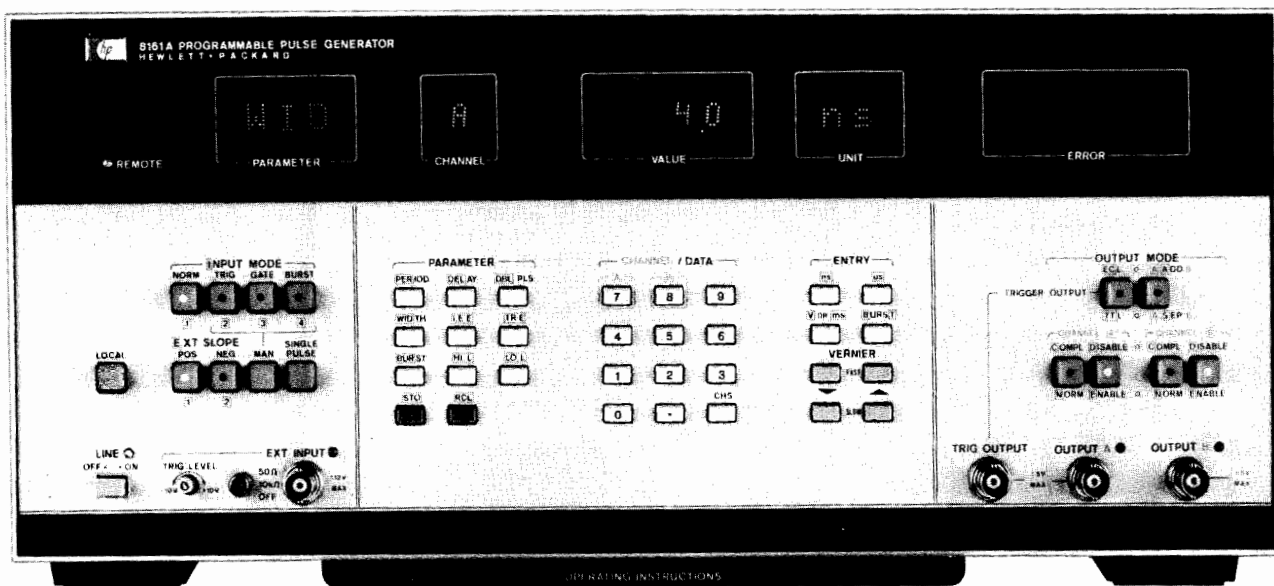

Picture shows 8161A
with Option 020, Dual Channel

The HP 8160A and 8161A are fully programmable pulse generators designed for high performance applications on the bench and in automatic test systems. Operation is made easy because the pulse parameters are controlled independently and do not inter-react. Dual channel options permit synchronous or complex waveforms to be generated. With its 50 MHz repetition rate, 20 V output, and 6 ns variable transition times, the HP 8160A is a general purpose pulse generator. The HP 8161A covers the high end of technology with its 100 MHz, 5 V and 1.3 ns variable transition times. Measured between the 20% to 80% amplitude points, these transitions are faster than 1 ns and meet ECL requirements.

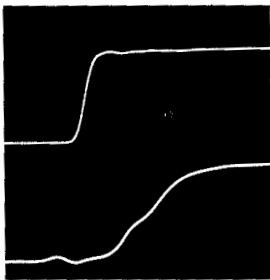

HP 8161A input pulse (upper) and ECL memory output pulse (lower).

Combining high programming accuracy with microprocessor-based control capabilities, pulses can be set up without a measuring instrument. Pulse parameters are entered and displayed numerically, and generated with a basic timing accuracy of 1-3%, depending upon parameter.

An easy-to-use HP-IB interface brings high-accuracy pulses to automatic test. All parameters and operating modes are remotely programmable using straight-forward command sequences. Faster, easier program generation and reduced software costs are direct benefits.

Precision Pulse Generation

Both models provide precision control over all parameters of their output pulses. The HP 8160A's leading and trailing edge transition times may be independently programmed down to 6 ns. The HP 8161A's transitions have a common control from 1.3 ns to 5 ns, and are independent above 5 ns. Variable transition times are indispensable when digital IC's need to be characterized: either the IC's data sheeted input transition time is required, or the IC's functioning range with various transitions needs to be evaluated.

Direct entry of the high and low levels of the output pulse enables easy adjustment to the logic levels concerned. Pulse width is variable from 4 ns (HP 8161A) or 10 ns (HP 8160A) to 1 s, giving a wide range of duty cycle programmability. Delay shifts the output pulse in relation to the trigger output or, in double pulse mode, defines the pulse spacing.

In the dual-channel versions, double pulse can be selected in either or both channels. This means, for example, that simultaneous clock and data signals can be generated.

Complex Signals

Independent pulse parameters plus individual programmability of the Option 020's dual outputs are augmented by the A ADD B mode. Summation allows complex signals to be precisely and easily set up. Here are some examples:

Applications such as radar coincidence circuits and special codes in communications require 3- and 4-level signals. These are conveniently generated by combining channel A and channel B pulses.

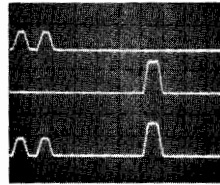
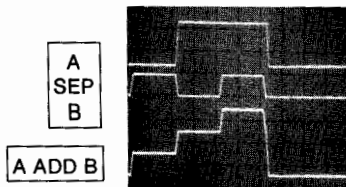

A critical test for digital circuits and IC's is its glitch and noise sensitivity, which can be easily performed with the A ADD B mode.

A
SEP
B

A
ADD
B

Transponder circuits need accurate delays, often with respect to a double-pulse interrogation signal. In the HP 8160A, this is arranged by operating one channel in double pulse mode and setting up the transponder delay in the other.

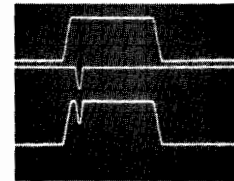

Counted Burst

Using Burst Mode, a predetermined number of pulses is generated independent of frequency. Bursts from 0 to 9999 pulses in length may be produced, and can be triggered via an external signal manually or with an HP-IB command.

Wide Temperature Range for System Reliability

The HP 8160A's and 8161A's 0-50°C operating range ensures calculable performance. Indeed, temperatures will generally be between 20-40°C where there is no derating factor.

User Features

Fast, Reliable Setup

Microprocessor control promotes highly accurate pulses. Parameters are directly entered via the instrument's keyboard, and are then displayed on numeric LED's with 3-digit resolution.

In bench applications, the vernier controls give a fine adjust capability to "tweak-in" any pulse parameter. You can increment or decrement the selected parameter either in single steps or at speed.

Error detection by the microprocessor further simplifies pulse setup by solving the old problem of incompatible settings. Should pulse width exceed pulse period, for example, the microprocessor indicates a TIMING error. All possible mis-settings are detected and the type of error is indicated to aid rapid correction.

HP-IB Programming

Microprocessor control over all interface functions makes remote programming as easy and straight-forward as manual control. The instruments employ keystroke programming so that data entry via the HP-IB is an exact simulation of manual entry. Bus commands for each front panel key simply replace manual keystrokes.

Parameter Storage

Complete parameter and mode information for 9 independent instrument set-ups can be stored. Waveforms may be stored and recalled either manually or via the HP-IB.

By utilizing a single command to recall an entire instrument set-up, controller time is saved. In simple repetitive testing applications, storage of test waveforms gives a high degree of user convenience without an external controller.

PULSE GENERATORS

Programmable Precision Pulse Generators

Models 8160A, 8161A (cont.)

Learn Mode

When interrogated by the system controller, the instruments output a character string to the interface bus. This string completely describes the pulser's current set-up or any one of its stored parameter sets. Using Learn Mode, you can enter and try out waveforms manually and then automatically transfer them via the HP-IB to the controller for storage in a program.

Verification Software for the 8160A

Test system accuracy is guaranteed by accessory software which verifies the HP 8160A's performance standards. The software is fully documented and comes recorded on a cassette suitable for HP Model 9825A Desktop Computer.

In the event of a failure, downtime is minimized because the software also delivers diagnostic information to accelerate repair and calibration.

Specifications

(50-ohm source into 50-ohm load). Standard instruments are single channel. Option 020 provides independent dual channels with common pulse period.

| Timing (with minimum transitions) | HP Model 8160A | HP Model 8161A |
|---|---|---|
| Period Range: Accuracy: Max Jitter: | 20 ns to 999 ms. ±3% of progr value ±0.3 ns (period < 100 ns); ±2% of progr value (period ≥ 100 ns). 0.1% of progr value + 50 ps. | 10 ns to 980 ms. ±3% of progr value ±0.5 ns (period < 100 ns); ±2% of progr value (period ≥ 100 ns). 0.1% of progr value + 50 ps. |
| Delay, Double Pulse, Width Delay Range: Double Pulse Range: Width Range: Accuracy: Max Jitter: | 0.0 ns to 999 ms. 20.0 ns to 999 ms. 10.0 ns to 999 ms. ±1% of progr value ±1 ns. 0.1% + 50 ps (≤999 ns); 0.05% (999 ns < - ≤9.99 μs); 0.005% (>9.99 μs). | 0.0 ns to 990 ms. 8.0 ns to 990 ms. 4.0 ns to 990 ms. ±1% of progr value ±1 ns. 0.1% + 50 ps (≤999 ns); 0.05% (999 ns < - ≤9.99 μs); 0.005% (>9.99 μs). |
| Output Characteristics Output levels High Level Range: Low Level Range: Amplitude: Level Accuracy: Settling Time: | 50 Ω into 50 Ω -9.89 V to 9.99 V. -9.99 V to 9.89 V. 0.10 V min, 9.99 V max. ±1% of progr value ±1% of ampl ±50 mV. 40 ns. | 50 Ω into open or 1 kΩ into 50 Ω -19.7 V to 19.9 V -19.9 V to 19.7 V 0.2 V min, 19.9 V max |
| Transition Times (10 - 90% amplitude) Leading Edge: Trailing Edge: Accuracy: Linearity: | 6.0 ns to 9.99 ns. 6.0 ns to 9.99 ns. ±3% of progr value ±1 ns. ±3% for transitions > 30 ns. | 1.3 ns to 900 μs. 1.3 ns to 900 μs. ±10% of progr value ±1 ns. ±5% for transitions > 30 ns. |
| Preshoot, Overshoot, Ringing: | ±5% of ampl ±10 mV. | ±5% of ampl ±10 mV (may increase to ±10% of ampl ±10 mV for transitions < 2.5 ns). |
| A ADD B: | Adds channel A and B outputs (Opt 020 only). | Adds channel A and B outputs (Opt 020 only). |
| Output Format: | Normal/Complement Selectable. (Independently selectable in each channel in Option 020.) | Simultaneous Normal and Complement Outputs. (Independently selectable in each channel in Option 020.) |
| Source Impedance: | 50 ohm/1 kohm selectable. | 50 ohm. |

Operating modes: Normal, Trigger, Gate, Ext Burst (0-9999 pulses).

HP-IB capability: all modes and parameters can be programmed. Talk mode for status, error messages, stored parameters.

Memory: 9 programmable locations*,
1 location for active operating state*,
1 location with fixed parameter set.

Capacity: 1 complete operating state per location.
*Battery back-up for power-off storage

General

Recalibration period: 1 year.

Repeatability: factor 2 better than specified accuracy.

Operating temperature: 0°C to 50°C (Specifications apply from 20°C to 40°C. Accuracy derating factors for 0°C to 20°C and 40°C to 50°C).

Power: 115/230 V ac + 10%, -22%, 48-66 Hz; 675 VA max.

Weight: net 20.8 kg (46 lbs). Shipping 25 kg (55 lbs).

Size: 178 H x 426 x 530 mm D (7" x 16.8" x 20.9").

Ordering Information

Price

| | HP 8160A | HP 8161A |
|---|----------|----------|
| HP 8160A/8161A Programmable Pulse Generator* | \$12,530 | \$14,850 |
| Opt 001: Rear panel inputs and outputs | N/C | N/C |
| Opt 020: Second channel (Rate common) | \$6,320 | \$6,680 |
| Opt 907: Front handle kit (P/N HP 5061-0090) | \$65 | \$65 |
| Opt 908: Rack flange kit (P/N HP 5061-0078) | \$35 | \$35 |
| Opt 909: Opt 907, 908, combined (P/N HP 5061-0084) | \$90 | \$90 |
| Opt 910: Additional Operating Manual | \$120 | \$150 |
| 08160-39910 Verification Software (HP 8160A only). | \$200 | — |

* HP-IB cables not supplied, see page 121

PULSE GENERATORS

Fast, High Power Pulse Generator

Model 214B

483



- High power 100 V, 2 A output
- 10 MHz repetition rate

- Constant duty cycle
- Counted pulse burst option

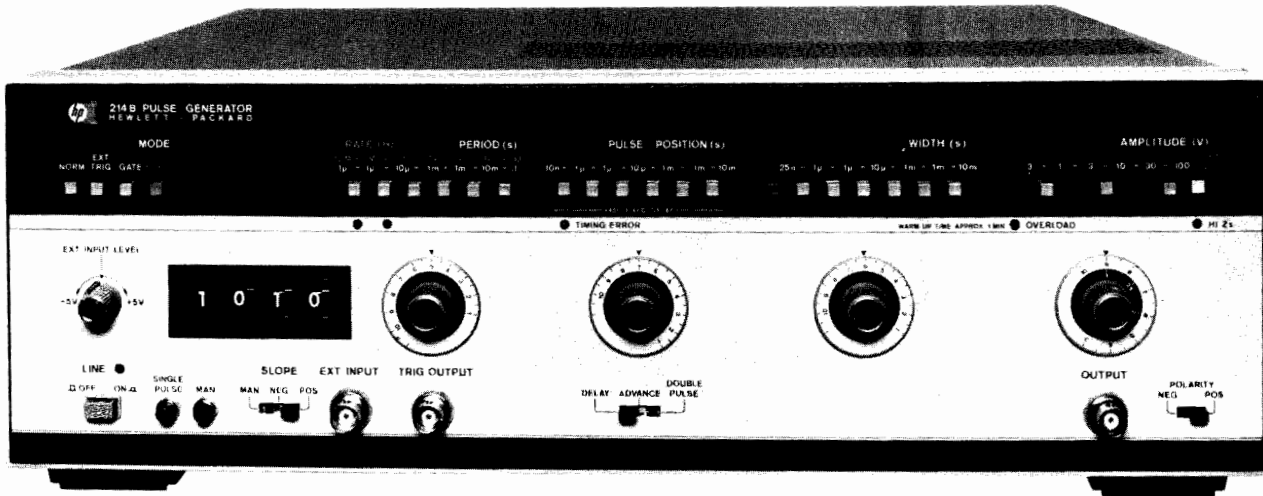

Picture shows 214B with Option 001, Counted Burst.

The HP 214B pulse generator employs semiconductor technology for high power pulse generation at up to 10 MHz repetition rate. Delivering 100 V pulses with 15 ns risetimes, the HP 214B meets the speed demands of today's applications.

State-of-the-art VMOS FETS used as current sources for the output amplifier tubes enable pulse width to be specified down to 25 ns. The HP 214B is thus well-equipped for low duty cycle applications such as laser diode pulsing or transient simulation.

When changing duty cycle threatens destruction to the device under test, the HP 214B Constant Duty Cycle (CDC) mode provides device protection. In CDC operation the duty cycle, hence power, remains constant as frequency is varied. The HP 214B is itself protected against excessive duty cycles via an overload protect circuit.

Easy operation is assured by the timing error indication. Calibrated dials enable fast accurate adjustments. Operating into unmatched loads, clean pulse shape is guaranteed by the low reactance 50 Ω source impedance. Pulse distortions such as preshoot and overshoot are specified as 5% at all amplitudes.

Specifications

Timing

Repetition rate: 10 Hz to 10 MHz in 6 ranges. In 30 V - 100 V amplitude range, maximum rep. rate is 4 MHz. Calibrated vernier provides continuous adjustment within ranges. **Vernier accuracy:** $\pm(10\%$ of setting + 1% full scale). **Period Jitter:** $\leq 0.1\%$ + 300 ps.

Pulse delay/advance: pulse can be delayed/advanced with respect to the trigger output from 10 ns to 10 ms (\pm fixed delay of 45 ns) in 5 ranges. Calibrated vernier provides continuous adjustment within ranges. **Vernier accuracy:** $\pm(10\%$ of setting + 1% full scale) + fixed delay. **Position Jitter:** $\leq 0.1\%$ + 500 ps

Maximum pulse position duty cycle: $\geq 50\%$

Double pulse: 5 MHz maximum in all ranges except 30 V - 100 V range which is max. 2 MHz. Minimum separation is 100 ns.

Pulse width: 25 ns to 10 ms in 6 decade ranges. Calibrated vernier provides continuous adjustment within ranges. **Accuracy:** $\pm(10\%$ of setting + 1% full scale) + 5 ns. **Width Jitter:** $\leq 0.1\%$ + 500 ps.

Max. duty cycle: $\geq 10\%$ for 30 - 100 V range. $\geq 50\%$ all other ranges.

Constant duty cycle mode (disabled in ext. trigger mode): duty cycle of output pulse remains constant as the period is varied. The duty cycle limits in this mode are typically 8% fixed for the 10 M - 1 MHz range (max. 4 MHz); 2.5% to 10% for 1 MHz - .1 MHz range; .25% to 10% for .1 MHz - 10 kHz range; 0.1% for all other ranges. Calibrated vernier provides continuous adjustment within ranges.

Accuracy: $\pm(15\%$ of setting + 1% of full scale).

Trigger Output

Amplitude: $\geq +5$ V (50 ohm into open circuit).

Pulse width: 10 ns typical.

External Operating Modes

External Input (impedance 10 k ohm, dc coupled)

Repetition rate: dc to 10 MHz. **Sensitivity:** 500 mVpp, dc coupled.

Slope: pos. or neg. **Trigger level:** +5 V to -5 V adjustable.

Maximum input level: ± 100 V. **Trigger pulse width:** ≥ 10 ns.

EXT TRIG mode: an output pulse is generated for each input pulse.

GATE mode: gate signal turns on rep. rate generator synchronously. Last pulse always completed.

BURST mode (optional): preselected number of pulses generated on receipt of trigger signal. **Number of pulses:** 1 to 9999. Minimum spacing between bursts: 200 ns.

Manual: pushbutton can be used for triggering single pulses (EXT TRIG mode), generating gate signals (GATE mode) or triggering pulse bursts (BURST mode).

Output

Amplitude: 0.3 V to 100 V in 5 ranges. Calibrated vernier provides adjustment within ranges. **Vernier accuracy:** $\pm 10\%$ of setting.

Source impedance: fixed 50 Ω nominal on ranges up to 10 V. Selectable 50 Ω nominal or HI-Z on 10 - 30 - 100 V ranges (with 50 Ω / 50 Ω impedance, amplitude decreases to 5 - 15 - 50 V).

Polarity: pos. or neg. selectable.

Transition times: ≤ 15 ns for leading and trailing edges.

Pulse top perturbations: $\leq \pm 5\%$ of amplitude.

General

Operating temperature: 0°C to 55°C.

Power: 100/120/220/240 Vrms; +5%, -10%, 48 to 66 Hz, 360 VA max.

Size: 133 mm H x 426 mm W x 422 mm D (5.2" x 16.8" x 16.6").

Weight: net 13.6 kg (30 lb). Shipping 15.6 kg (34.3 lb).

Ordering Information

HP 214B Pulse Generator

Opt 001: Counted Burst

Opt 907: Front Handle Kit (part number HP 5061-0089).

Opt 908: Rack Mount Kit (part number HP 5061-0077).

Opt 909: Opt 907, 908 Combined (part number HP 5061-0083).

Opt 910: extra Operating and Service Manual

Prices

\$3820

add \$475

add \$55

add \$32.50

add \$80

add \$33

PULSE GENERATORS

20 MHz Pulse Sources

Models 8005B, 8011A

- Dual outputs, +10 V and -10 V
- TTL output
- Gating, square wave, double pulse modes

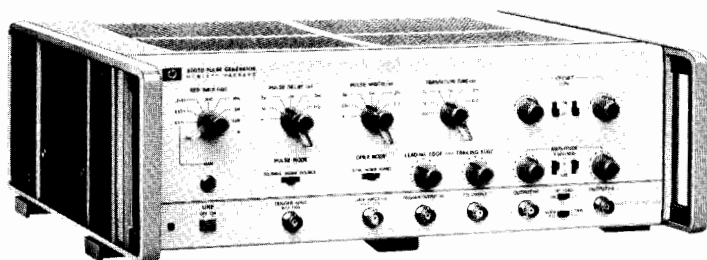

HP 8005B

The HP 8005B is a general purpose, triple output pulse generator. This instrument has all parameters variable and produces simultaneous pos. and neg. pulses. It also has a TTL output with all parameters variable except amplitude. This feature, together with the normal/complement facility, greatly improves the ease of operation.

HP 8005B Specifications

Pulse Characteristics

Transition times: ≤ 10 ns to 2 s. Edges independently variable.
Non-linearity: for transition times >30 ns, $< 4\%$ of pulse amplitude.
Preshoot, overshoot, ringing: $< 5\%$ of pulse amplitude.
Pulse width: < 25 ns to 3 s. **Jitter:** $< 0.1\%$ of setting + 50 ps.
Max. duty cycle: $> 80\%$ (0.3 Hz - 1 MHz), $> 50\%$ (1-20 MHz).
Square wave: 0.15 Hz - 10 MHz.
Pulse delay: < 100 ns to 3 s. **Jitter:** $< 0.1\%$ of setting + 50 ps.
Pulse outputs: simultaneous pos., neg. and TTL outputs.
Pulse amplitude: 300 mV to 10 V.
Output protection: max. external voltage ± 10 V.
Source impedance: 50 ohms $\pm 10\%$ or high impedance selectable.
TTL compatible output: +4.6 V norm. or comp. 50 Ω impedance.

Repetition Rate and Trigger

Repetition rate: 0.3 Hz to 20 MHz in 5 ranges. **Jitter:** $< 0.1\%$ + 50 ps.
Double pulse: 10 MHz max. Simulates 20 MHz.
Trigger output: $> +2$ V ampl. across 50 ohms. **Width:** > 6 ns.

External Operating Modes

External Triggering (dc to 20 MHz)

Delay: approx. 35 ns trig. input to trig. output.
Maximum input: ± 10 V. **Sensitivity:** sine 2 Vpp.
Impedance: approx. 1k ohms, dc coupled. **Pulses:** ± 1 Vpeak.
Input pulse width: ≥ 10 ns.

Gating

Synchronous: gate signal turns on repetition rate. Last pulse is always completed.

Asynchronous: gate signal controls output of rate generator.

Gate Input (impedance 1 k ohms dc coupled)

Amplitude: 2 V to 20 V (max.). **Polarity:** negative.

General

Operating temperature: 0°C to 55°C .
Power: 115/230 V rms; +10%, -15%; 48 to 440 Hz, 180 VA max.
Weight: net 7 kg (15.5 lb). Shipping 9 kg (20 lb).
Size: 130 H x 426 W x 290 mm D (5.1" x 16.8" x 11.4").

Ordering Information HP 8005B, 8011A

| | |
|---|-------------|
| HP 8011A Pulse Generator | \$1090 |
| Opt 001: Pulse Burst | add \$370 |
| Opt 910: extra Operating and Service Manual | add \$20 |
| HP 15179A (for HP 8011A): Adapter frame, Rack mount for 1 or 2 units, includes blank panel for single-unit operation. | \$205 |
| HP 8005B Pulse Generator. | \$2960 |
| Opt 908: Rack Flange Kit (part number HP 5060-8740). | add \$37.50 |
| Opt 910: extra Operating and Service Manual. | add \$28 |

- Repetition rate 0.1 Hz to 20 MHz
- Positive/negative/symmetrical output
- Normal/complement switch



Picture shows 8011A with Option 001, Burst.

The HP 8011A is a versatile, reliable, low cost pulse generator. This compact instrument features an uncomplicated design using high quality components to ensure long, dependable service. Ease of operation results from the logical and simple front panel layout. These qualities and the many pulse formats available emphasize the HP Model 8011A's cost-effectiveness in a wide application range.

HP 8011A Specifications

Pulse Characteristics (50 ohm source/load impedances)

Transition times: < 10 ns fixed.
Overshoot, ringing and preshoot: $< \pm 5\%$ of pulse amplitude. May increase to 10% at counter-clock wise positions of amplitude vernier.
Pulse width: 25 ns to 100 ms in four ranges. Vernier provides continuous adjustment within each range.
Width jitter: $< 0.1\%$ + 50 ps on any width setting.
Maximum duty cycle: $> 50\%$ (100% using pulse complement)
Maximum output: 8 V. With internal 50 Ω and external Hi-Z or internal Hi-Z/external 50 Ω , then 16 V max.
Attenuator: 3-step attenuator provides the ranges 0.25 V - 1 V - 4 V - 16 V. Vernier provides continuous adjustment within each range.
Source impedance: 50 $\Omega \pm 10\%$ shunted by 30 pF, except in 4 V - 16 V range which is 50 Ω /Hi-Z, switch selectable.
Polarity/format: pos., neg., or sym./norm. or compl., switch select.

Repetition Rate and Trigger

0.1 Hz to 20 MHz in 5 ranges. Vernier provides continuous adjustment within each range. **Period jitter:** $< 0.1\%$ + 50 ps of per. setting.
Square Wave: 0.05 Hz to 10 MHz.
Trigger output: dc coupled 50 Ω (typ.) source delivering $\geq +1$ V into 50 Ω (can increase to +5 V). **Trigger pulse width:** 20 ns ± 10 ns.

External Operating Modes

Input impedance: 50 $\Omega \pm 10\%$. **Trigger polarity:** positive.
Maximum input: ± 5 V. **Sensitivity:** 1 V.
Manual: front panel pushbutton for generating single pulse.
Repetition rate: 0 to 20 MHz. In square wave, output frequency is half the input frequency.
Trigger source: manual or ext. signal. Min. ext. signal width 20 ns.
Pulse burst mode (option 001): preselected number of pulses generated on receipt of trigger.
Burst trigger source: man. or ext. signal. Min. signal width 25 ns.

General

Operating temperature: 0°C to 55°C .
Power: 100/120/220/240 V rms; +5%, -10%; 48 Hz to 440 Hz, 70 VA max.
Weight: net, 4 kg (9 lb). Shipping, 6.5 kg (14.6 lb).
Dimensions: 126 H x 200 W x 280 mm D (5" x 7.9" x 11").

PULSE GENERATORS

50 MHz Pulse Sources

Models 8012B & 8013B

485



- Variable transition times down to 5 ns
- ± 10 V amplitude; selectable source impedance
- Ideal for testing TTL

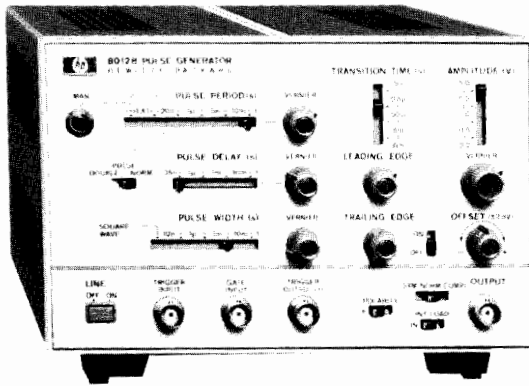

HP 8012B

- Fixed 3.5 ns transition times
- 10 V amplitude; selectable source impedance
- 2 outputs

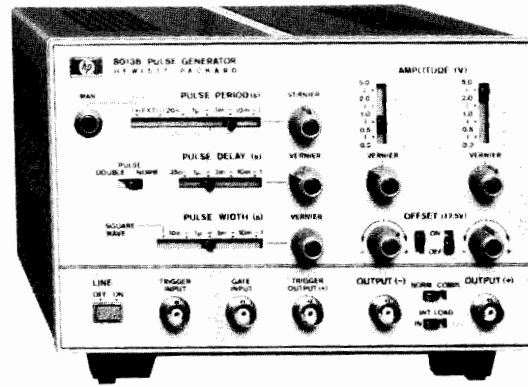

HP 8013B

The HP 8012B and 8013B are at the top of their class for versatility, ease of operation and wide range of application. They provide the ideal solution to almost all digital logic testing problems with fixed 3.5 ns transition times on the HP 8013B and variable transition times down to 5 ns on the HP 8012B. The well-composed layout of the front panel controls (horizontal controls for horizontal parameters, vertical controls for vertical parameters) enables output pulses to be set up quickly and accurately with minimum risk of incompatible settings. Both models feature normal and complement outputs and a switchable internal 50 ohm source.

Pulse delay: <35 ns to 1 s (with respect to trigger output) in four ranges; vernier provides continuous adjustment within ranges.
Delay jitter: <0.1% + 50 ps on any setting.

Repetition Rate and Trigger

1 Hz to 50 MHz in four ranges, continuous adjustment within ranges.

Period jitter: <0.1% + 50 ps on any rate setting.

Square wave: 0.5 Hz to 25 MHz in four ranges. Duty cycle 50% $\pm 5\%$ up to 1 MHz, tolerance increases to $\pm 15\%$ at 25 MHz.

Trigger output: > +1 V across 50 Ω , 16 ns ± 10 ns wide.

External Triggering

0 to 50 MHz; for square wave output, frequency divided by factor 2.

Trigger input: sine waves 1.5 V p-p (about zero) or pulses >0.8 V either polarity, >7 ns wide. Maximum input ± 7 V.

Impedance: 50 $\Omega \pm 10\%$, dc coupled.

Delay: 25 ns ± 8 ns leading edge trig. input to trig. output.

Manual: pushbutton for single pulse.

Gating

Synchronous gating: gating signal turns generator "on". Last pulse is completed even if the gate ends during pulse.

Gate input: dc-coupled; voltage at open connector approx. +1.8 V. Shorting current ≤ 12 mA. Input impedance $\approx 160 \Omega$

Gate input signal: voltage >+1.5 V or resistor > 1 k Ω to ground enables rep. rate generator. Voltage <+0.8 V or resistor <160 Ω disables rep. rate generator. Input TTL compatible, max. ± 5 V.

External Width and RZ

External width: output pulse width determined by width of drive input signal. Amplitude, transition times selectable. Trigger output independent of external width input signal.

RZ mode: external drive input switched to delay generator. Period determined by period of drive input signal. Delay, amplitude and width selectable.

Input signal: >+1 V, >7 ns wide. Max. ± 5 V. 50 Ω dc coupled.

General

Operating temperature: 0°C to 55°C.

Power: 100/120/220/240 V rms; +5%, -10%; 48 to 400 Hz, 100 VA max.

Weight: net, 4kg (8.8 lb). Shipping, 6.5 kg (14.6 lb).

Size: 126 H x 200 W x 280 mm D (5 x 7.9 x 11 in.)

Ordering Information

HP 8012B Pulse Generator

Opt 910: extra operating and service manual

HP 8013B Pulse Generator

Opt 910: extra operating and service manual

HP 15179A Adapter frame. Rack mounting for 1 or 2

units, includes blank panel for single-unit requirements

Prices

\$1750

add \$20

\$1650

add \$13

\$205

Specifications

Pulse Characteristics

| Parameter | HP Model 8012B | | HP Model 8013B | |
|------------------|---|---------------|---|---------------|
| | Int. load IN | Int. load OUT | Int. load IN | Int. load OUT |
| Transition times | 5 ns–0.5s 4 ranges, Verniers provide separate control of both edges within ranges up to max. ratios of 100:1 or 1:100. | 6 ns–0.5s | 3.5 ns fixed | 5 ns fixed |
| Source impedance | 50 ohms $\pm 10\%$ shunted by typically 20 pF | >50 ohms | 50 ohms $\pm 3\%$ shunted by typically 20 pF | >50 ohms |

| Parameter | HP Models 8012B/8013B | |
|-------------------|--|--|
| | Internal load IN | Internal load OUT |
| Overshoot ringing | $\pm 5\%$ of pulse amplitude | May increase to $\pm 10\%$ when amplitude is between 0.4–4 V |
| Maximum output | 5 V across 50 ohms, 10 V across open circuit. Short cct. protection. | 10 V across 50 ohms, Short cct. protection. |
| Attenuator | 4-step, reduces output to 0.2 V. | 4-step, reduces output to 0.4 V. |
| DC offset | ± 2.5 V across 50 ohms. Independent of amplitude settings. | DC offset switched off. |

Linearity (HP 8012B): for transition times >30 ns, maximum straight line deviation is 5% of pulse amplitude.

Preshoot: < $\pm 5\%$ of pulse amplitude.

Pulse width: < 10 ns to 1 s in four ranges. Vernier provides continuous adjustment within ranges.

Width jitter: <0.1% + 50 ps on any width setting.

Maximum duty cycle: >75% from 1 Hz to 10 MHz, decreasing to $\geq 40\%$ at 50 MHz. Up to 100% in COMPL mode.

Polarity: HP 8012B; positive or negative selectable, NORM/COMPL/SYM selectable; HP 8013B, one positive + one negative channel, NORM/COMPL selectable.

PULSE GENERATORS

50 MHz, Dual Output

Model 8015A

- Two independent ± 16 V outputs
- Additional TTL output
- Remote control and counted burst options
- Complex waveforms

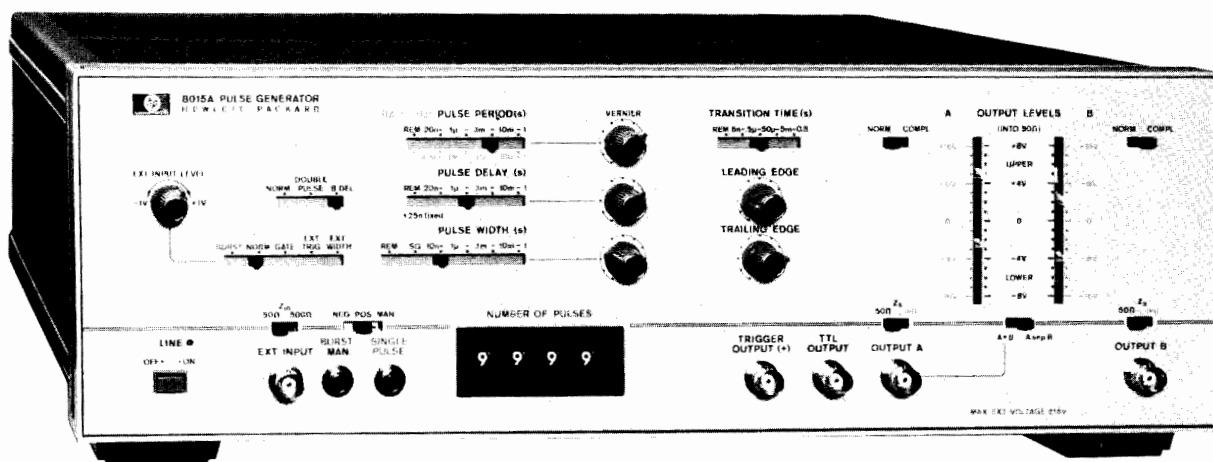

Picture shows 8015A with Option 002, Burst

Offering B Delay mode in addition to variability of all pulse parameters, the HP 8015A is ideal for analyzing critical timing conditions, or generating 2-phase clocks.

A + B mode gives a 30 V output within a ± 16 V window. Combined with B Delay mode, three-level signals, special codes or simulated biomedical signals can be generated.

Option 002 Burst mode generates an exact number of pulses by means of an internal counter.

Direct access to either or both output amplifiers (Option 007) converts to MOS/CMOS levels. Alternatively, high-level tracking capability ensures that clock and data signals follow the supply, and thus safeguards CMOS devices.

For use in automatic test, Option 003 allows all pulse parameters to be controlled remotely.

Specifications

Timing

Repetition rate: 1 Hz to 50 MHz (square wave and double pulse to 25 MHz, A + B mode to 40 MHz, B delay 20 MHz).

Width: 10 ns to 1 s or square wave.

Delay: 20 ns to 1 s (both channels, interchannel or double pulse).

Jitter: 0.1% + 50 ps.

Output (50 Ω Output Impedance into 50 Ω termination. Voltages double in 50 Ω / 1 k Ω or 1 k Ω / 50 Ω operation).

Magnitude: 1 V to 8 V amplitude (2 V to 16 V in A + B mode).

High level: -7 V to +8 V. **Low level:** -8 V to +7 V.

Transition times: 6 ns to 0.5 s in four ranges, independent leading/trailing vernier adjustment.

Non-linearity: 5% for transitions > 30 ns.

Preshoot, overshoot and ringing: 5%.

A + B mode: sum of channel A and channel B outputs.

Complement: independently selectable.

Impedance: 50 Ω / 1 k Ω , independently selectable.

Trigger Input

Impedance: 50 Ω / 500 Ω selectable.

Level: adjustable +1 V to -1 V (50 Ω), +10 V to -10 V (500 Ω).

Slope: + or - selectable.

Auxiliary Outputs

TTL: 50 Ω output impedance, timing as channel A.

Trigger output: 1 V, 50 Ω into 50 Ω .

Option 002 Burst Mode

Burst length: 1-9999 pulses, selectable.

Pulse repetition rate: 1 Hz to 40 MHz.

Burst trigger: trigger input.

Minimum burst separation: 200 ns.

Option 003 Remote Control

Timing ranges: TTL or contact closure.

Timing verniers: current, voltage or resistor programming.

Output levels: voltage programming.

Burst: BCD, TTL/contact closure.

Option 007 Amplifier and Tracking Modes

Dual Amplifier Mode

Gain: 0.8 to 6.4.

Frequency response (-3 dB): 0 to 80 MHz.

Upper Level Tracking Mode

Upper level: input voltage $\pm 5\%$.

Lower level: 0 V ± 250 mV.

Settling time: 400 μ s to $\pm 5\%$ of final value.

General

Operating temperature: 0°C to 55°C.

Power: 100/120/220/240 V rms; +5%, -10%; 48 to 440 Hz, 180 VA max.

Weight: net, 11 kg (24.26 lb). Shipping, 14.7 kg (32.4 lb).

Size: 133 H x 426 W x 346 mm D (5.2" x 16.75" x 13.6").

Ordering Information

HP 8015A Pulse Generator

Opt 002: Pulse Burst

Opt 003: Remote Control

Opt 007: Dual Amplifier and Level Tracking modes

Opt 907: Front Handle Kit (Part No. HP 5061-0089)

Opt 908: Rack Flange Kit (Part No. HP 5061-0077)

Opt 909: Opt. 907, 908 combined

(Part No. HP 5061-0083)

Opt 910: Additional Operating and Service Manual

Price

\$4450

add \$700

add \$1600

add \$470

add \$55

add \$32.50

add \$80

add \$38

PULSE GENERATORS

250 MHz Fast Pulse Source

Model 8082A



- < 1 ns variable transition times
- Ultra-clean 50 ohm source
- Switch-selectable ECL levels
- Dual ± 5 V outputs

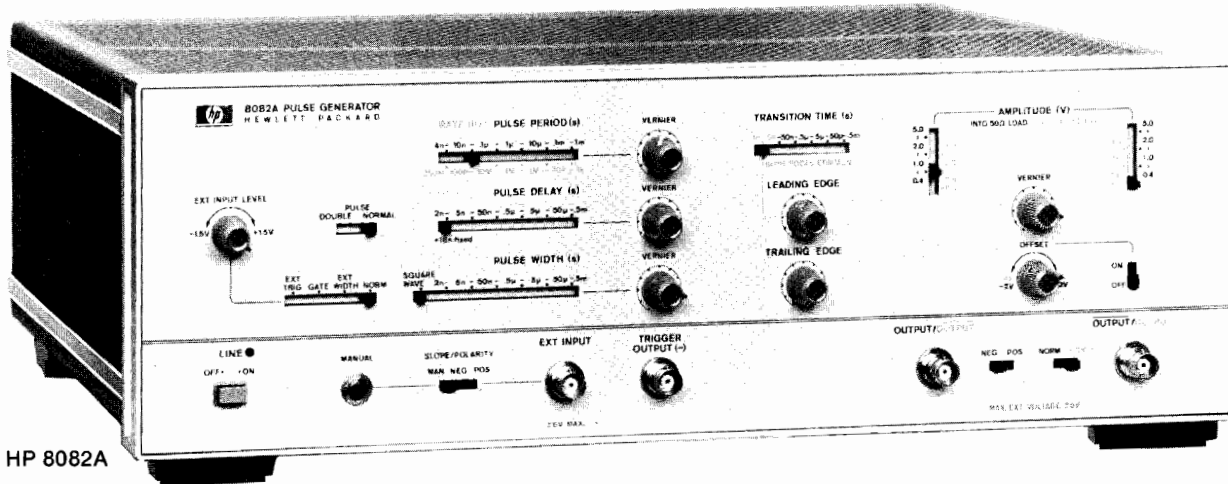

HP 8082A

The HP 8082A is Hewlett-Packard's fastest pulse generator with all pulse parameters variable. With repetition rates to 250 MHz, transition times down to 1 ns and amplitudes to 5 V, the HP 8082A is ideally suited for state-of-the-art TTL and ECL logic designs. Using the HP 8082A, you can rapidly test logic circuits under all operating conditions by simply varying pulse parameters. Although a highly sophisticated instrument, the HP 8082A is still easy to operate because of its logical front panel layout and switch selectable ECL output levels. Another feature that contributes to ease of operation is the square wave mode. You can, for example, carry out toggle rate tests in this mode up to 250 MHz without having to worry about pulse duty cycle.

Hybrid IC's, manufactured by Hewlett-Packard, are used extensively in the design of the HP 8082A. These ICs eliminate the need for fans, reduce power consumption and enable a low reactance 50 ohm source impedance to be used. This source impedance absorbs 98% of reflections from signals up to 4 V amplitude.

Specifications

Pulse Characteristics (50 Ω source and load impedance)

Transition times: <1 ns - 0.5 ms (10% to 90%) in 6 ranges. <750 ps (20% to 80%). Leading/trailing edges controlled together on fastest range, independently variable over 1:10 ratio on other ranges.

Overshoot and ringing: $\leq \pm 5\%$ of pulse amplitude may increase to $\pm 10\%$ with amplitude vernier CCW.

Preshoot: $\leq \pm 5\%$ of pulse amplitude.

Linearity: linearity aberration for both slopes $\leq 5\%$ for transition times >5 ns.

Output: maximum amplitude is 5 V from 50 Ω into 50 Ω . Maximum output voltage is ± 5 V (amplitude + offset).

Offset: ± 2 V, into 50 Ω .

DC-source impedance: 50 $\Omega \pm 5\%$.

Reflection coefficient: reflection is 2% typical for steps with 1 ns rise time applied to output connector on all amplitude ranges except 5 V range. On the 5 V range, the reflection may be 15%.

Output protection: cannot be damaged by open or short circuits or application of ext. ≤ 6 V or ± 200 mA independent of control settings.

Attenuator: two separate three step-attenuators reduce the outputs to 1 V. Vernier is common for both outputs and reduces the output to 0.4 V minimum. A further position provides ECL-compatible outputs (-0.9 V to -1.7 V typ. open circuit).

Timing

Repetition rate: 250 MHz to 1 kHz in 6 ranges.

Period jitter: <0.1% of setting +50 ps.

Delay: 2 ns - 0.5 ms in 6 ranges plus typ. 17 ns fxd. with respect to trigger output. Duty cycle >50%.

Delay jitter: <0.1% of setting +50 ps.

Double pulse: up to 125 MHz max. (simulates 250 MHz).

Pulse width: <2 ns - 0.5 ms in 6 ranges.

Width jitter: <0.1% of setting +50 ps.

Width duty cycle: >50%.

Square wave: delay and double pulse are disabled, max. Rep. Rate 250 MHz. Duty cycle is 50% $\pm 10\%$ up to 100 MHz, 50% $\pm 15\%$ for >100 MHz.

Trigger output: negative going Square Wave (50% duty cycle typ.) >500 mV from 50 Ω into 50 Ω . Internal 50 Ω can be switched off by slide-switch on PC-board. Amplitude up to 1 V into 50 Ω up to 200 MHz.

Trigger output protection: cannot be damaged by short circuit or application of external ± 200 mA.

External Operating Modes

External Input

Input impedance: 50 $\Omega \pm 10\%$, dc coupled.

Maximum input: ± 6 V.

Trigger level: adjustable -1.5 V to +1.5 V.

Slope control: positive, negative or manual selectable. In the manual position all ext. functions can be controlled by push button. Button pushed in simulates an "on-signal."

Sensitivity: sine-wave >200 mV p-p pulses >200 mV.

Repetition rate: 0 to 250 MHz.

External-Controlled Modes

External trigger: there is approximately 7 ns delay between the external input and the trigger output. Rep. rate is externally controlled (is triggered by external signal). Trigger output provides the pulse-shaped input signal.

Synchronous gating: gating signal turns rep. rate generator on. Last pulse normal width even if gate ends during pulse.

External width: output pulse width determined by width of drive input. Rep. rate and delay are disabled. Trigger output provides shaped input signal.

General

Operating temperature: 0°C to 55°C.

Power: 100/120/220/240 Vrms; +5%, -10%; 48-440 Hz. 85 VA max.

Weight: net, 7.9 kg (17.44 lb). Shipping 8.9 kg (19.63 lb).

Size: 133 mm H x 426 W x 345 mm D (5.2" x 16.75" x 13.6").

Ordering Information

HP 8082A Pulse Generator Price \$4985

Opt 907: Front Handle Kit (part number HP 5061-0089) add \$55

Opt 908: Rack Flange Kit (part number HP 5061-0077) add \$32.50

Opt 909: Opt 907, 908 Combined (part number HP 5061-0083) add \$80

Opt 910: Additional Operating and Service Manual add \$28



PULSE GENERATORS

Configurable Pulse/Data Stimuli

HP 8080A Series

Example: HP 8080A SO4

- 1 GHz, 300 ps transitions
- Interchannel delay

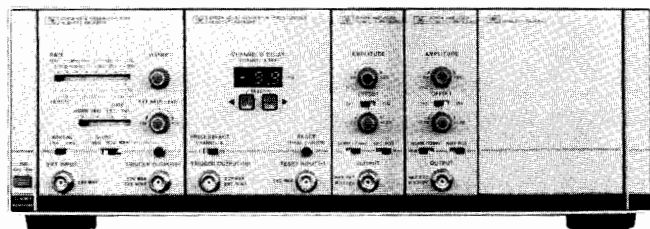

| | | | |
|-------------------------------|--------------------------------|--|-----------------------------|
| HP 8091A Rate Generator | HP 8092A Delay Generator | CHA CHB HP 8093A Output Amplifiers | HP 15400A Blank Panel |
|-------------------------------|--------------------------------|--|-----------------------------|

Example: HP 8080A DO1

- 300 MHz, 800 ps transitions
- Manually programmable data

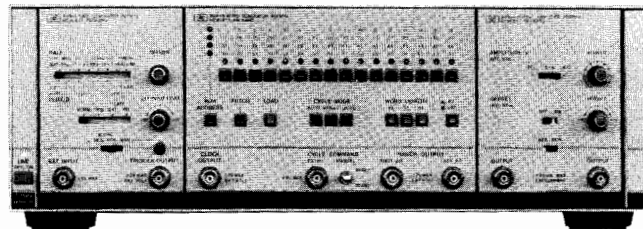

| | | |
|----------------------------|----------------------------|------------------------------|
| HP 8081A Rate Generator | HP 8084A Word Generator | HP 8083A Output Amplifier |
|----------------------------|----------------------------|------------------------------|

Research and development in advanced technologies such as subnanosecond ICs, fiber optics and nucleonics, require fast pulses for thorough characterization. The HP 8080A can, for example, generate simultaneous 1 GHz clock and simulated NRZ data for testing today's fastest memories, or complementary data with up to 64 bits and fast 300 ps edges for state-of-the-art communication devices. Cost-effectivity is promoted because the HP 8080A's modular structure allows performance and capability to be tailored to the requirement.

Two examples are shown here. Full details of these and all other factory-systemized configurations are in the data sheet. Individual modules are also available for special applications or for extending an existing configuration. Ask for the systemizing and adjustment guidelines.

Leading Characteristics (50-ohm load)

HP 8080A SO4

Timing

Repetition rate: 100 Hz – 1 GHz.

Interchannel delay: ± 9.9 ns in 0.1 ns steps.

Channel B divider: 0.5 f selectable for simulating NRZ data.

Width: Square wave.

Modes: Int, Ext Width, Gate, Manual.

Independent 50-ohm Outputs

Amplitude: 0.6 V to 1.2 Vpp.

Offset: ± 1.2 V.

Transitions times (10% to 90%): <300 ps.

Polarity: selectable

Format: Normal/Complement selectable

HP 8080A DO1

Timing

Repetition rate: 10 Hz–300 MHz.

Width: square wave (RZ) or NRZ.

Modes: Int, Ext/Manual Width.

Data cycle modes: Ext/Man Single and Gated Cycle, Auto Cycle.

Data: Serial, 16/32/64 bit selectable.

Simultaneous Normal and Complement 50-ohm Outputs

Amplitude: 0.2 V to 2 V.

Offset: ± 1 V.

Transition times (10% to 90%): <800 ps.

Polarity: selectable.

General

Operating temperatures: 0°C to 55°C.

Power: 115/230 V rms; +10%, -22%; 48 to 66 Hz, 200 VA max.

Weight: (typical, HP 8080A Mainframe plus full complement of modules) 9.4 kg (16.6 lbs) net; 19.7 kg (43.3 lbs) shipping.

Size: (HP 8080A Mainframe): 133 H x 426 W x 422 mm D (5.24" x 16.77" x 16.61").

Ordering Information

| | |
|--|------------------|
| HP 8080A Mainframe | \$2,440 |
| Opt 907: Front handle kit | add \$55 |
| Opt 908: Rack flange kit | add \$32.50 |
| Opt 909: Opt 907, 908 combined | add \$80 |
| Opt S01: (HP 8081/83A, 2 x HP 15400A) | add \$3,080 |
| Opt S02: (HP 8081/93A, 2 x HP 15400A, 15401A) | add \$4,090 |
| Opt S03: (HP 8091/93A, 2 x HP 15400A, 15401A) | add \$7,220 |
| Opt S04: (HP 8091/92A, 2 x HP 8093A, 15400A) | add \$13,100 |
| Opt D01: (HP 8081/83/84A) | add \$6,575 |
| Opt D02: (HP 8081/84/93A, 15401A) | add \$7,585 |
| Opt D03: (HP 8081/84A, 2 x HP 8093A) | add \$9,970 |
| HP 8081A 300 MHz Rate Generator module | \$1,485 |
| HP 8083A 300 MHz Output Amplified module | \$1,485 |
| HP 8084A 300 MHz Word Generator module | \$3,605 |
| HP 8091A 1 GHz Rate Generator module | \$4,615 |
| HP 8092A 1 GHz Delay Generator module | \$3,555 |
| HP 8093A 1 GHz Output Amplifier module | \$2,440 |
| Opt H01: Special Option for variable-width operation with HP 8092A | Price on inquiry |
| Additional manuals: Opt 910, per module | add \$28 |

Accessories Available

| | |
|--|-------|
| HP 15400A Blank Panel, ¼ mainframe width | \$55 |
| HP 15401A Blank Panel, ½ mainframe width | \$55 |
| HP 15402A BNC Feedthru panel, ½ width | \$265 |

Pulse Generator Accessories



| | |
|---|-------|
| HP 15104A/15115A Pulse Adder/Splitter dc to 2 GHz | \$105 |
| HP 15116A Pulse Inverter 3 MHz to 2 GHz | \$265 |
| HP 15115A Pulse Splitter/Inverter 3 MHz to 2 GHz | \$210 |

PULSE GENERATORS

High Resolution Time Synthesizer

Model 5359A

489



- Precise digital delays 0-160 ms
- 50 ps increments
- Jitter < 100 ps

- Programmable
- Fully synchronous to external trigger
- Automatic calibration

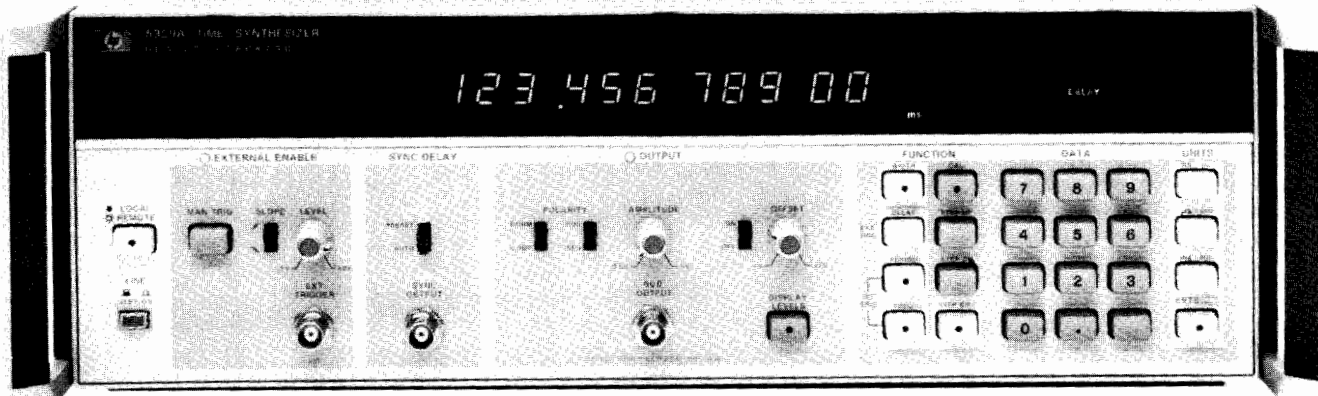

HP 5359A



The HP 5359A Time Synthesizer produces two extremely precise, low jitter time delays. These delays, T_d and T_w , are individually selectable by means of the keyboard, in 50 ps or greater steps to generate delays of up to 160 ms.

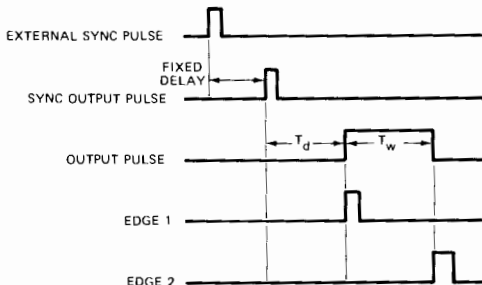

The HP 5359A has many applications and may be used for the calibration of Radar, Loran, DME and Tacan Systems, or for precision generation of delayed sweeps in oscilloscopes, and for extremely accurate "time positioning" control of external gates on frequency counters. In component and circuit test, the instrument may be used for extremely accurate delay line simulation.

Condensed Specifications

Modes

External trigger mode: the delays from the sync out to the beginning of the output pulse, and the width of the output pulse, are selected.

Internal trigger mode: the "period" or "frequency", and the width of the output pulse, are selected.

Range

Delay T_d : 0 ns to 160 ms.

Width T_w : 5 ns to 160 ms (width & delay \leq 160 ms).

Period: 100 ns min or width + 85 ns; 160 ms max.

Frequency: same as corresponding "period".

Repetition rate: 10 MHz max.

Accuracy: ± 1 ns \pm time base error (± 100 ps \pm time base error after external calibration).

Insertion delay: fixed at < 150 ns; selectable as < 50 ns for delays > 100 ns.

Jitter: typical 100 ps rms; maximum 200 ps rms (delays to 10 ms)

External trigger input: -2 V to + 2 V slope selectable.

Sync output: 1 V - 50 Ω ; 5 V - 1 M Ω . Width 35 ns nominal.

Output Pulse

Amplitude: 0.5 V to 5 V into 50 Ω .

Polarity: positive or negative.

Offset: -1 V to 1 V, or OFF.

Transition time: < 5 ns.

External voltage must not be applied. Offset and Amplitude voltage into 50 Ω may be displayed.

EDGE 1 OUTPUT (rear panel): occurs in Sync with leading edge of output pulse (same spec. as Sync out).

EDGE 2 OUTPUT (rear panel): occurs in Sync with falling edge of output pulse (same spec. as Sync out).

Events mode: substitutes external input (to 100 MHz) for the internally counted clock (delay and width must both be specified in terms of events instead of time).

Triggered frequency mode: the same as internal frequency mode except the output is a burst beginning in synchronism with an external trigger signal, and continues for the duration of this signal.

Calibrate mode: performs an internal calibration to remove the effects of internal delay differences.

External probes: provides outputs to control the HP 5363B probes and accepts inputs from the probes to include external devices in the calibration loop.

HP-IB: All controls except trigger levels are programmable as standard.

Time Base

High Stability Oven Oscillator

Frequency: 10 MHz

Aging: $< 5 \times 10^{-10}$ /day

Temperature: $< 2.5 \times 10^{-9}$, 0°C to 50°C

Line voltage: $< 1 \times 10^{-10}$, $\pm 10\%$ from nominal

Size: 133 H x 426 W x 521 mm D (5.25" x 16.75" x 20.50").

Weight: 30 lbs.

Power requirements: 100, 120, 220, or 240 Vac +5% -10%, 48 to 66 Hz, less than 250 VA

Front handles: supplied with instrument.

Options and Accessories

908: Rack Flange Kit for use without handles

add \$32.50

913: Rack Flange Kit for use with supplied handles

add \$35

HP 10870A: Service Kit

add \$655

HP 5359A Time Synthesizer

\$10,000



AMPLIFIERS

Microwave Amplifier

Model 11975A

- 2 GHz to 8 GHz wideband frequency coverage
- 40 milliwatts (+16 dBm) output power
- Adjustable, calibrated power level

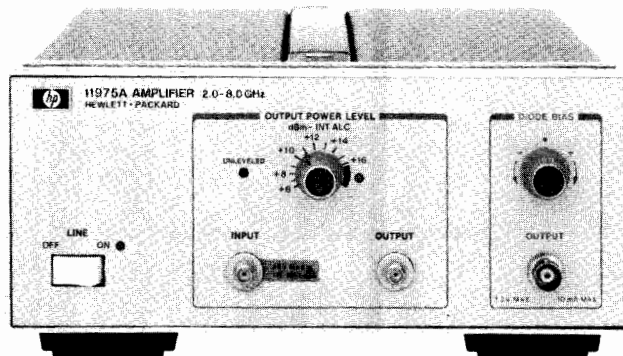

HP 11975A

Convenient Microwave Amplifier

The HP 11975A is a general purpose microwave amplifier which offers versatility, convenience, and reliability at an economical price. Combining state-of-the-art GaAs FET technology with a regulated power supply and control circuits makes this amplifier a complete tool for lab and production.

Broadband, Leveled Power

The amplifier delivers up to 40 milliwatts (+16 dBm) of leveled power for broadband input signals from 2 to 8 GHz. With ± 1 dB frequency response and ± 2 dB absolute power accuracy, the HP 11975A provides calibrated power for fixed or swept frequency needs.

Versatile Features

The HP 11975A has many features designed for general purpose use:

Automatic level control (ALC): output power is normally leveled unless the ALC switch (rear panel) is OFF or less than minimum input power required for leveling is available. An unlevelled light indicates the non-ALC condition.

Adjustable output power: calibrated output power can be adjusted from +6 to +16 dBm. An uncalibrated light indicates when greater than +16 dBm is present at the output connector.

Diode bias: positive or negative bias current needed for some harmonic mixers is provided by a separate connector and control knob.

Applications

- The HP 11975A supports many general purpose testing needs:
- As an LO booster and isolation amplifier, the HP 11975A improves mixer performance and testing.
 - As a pre-amplifier, the HP 11975A increases counter sensitivity and improves spectrum analyzer noise figure.
 - As an LO line driver for a harmonic mixer (such as an HP 11517A or HP 11970), the HP 11975A increases sensitivity, improves frequency response, and reduces gain compression.

Specifications

Frequency Specifications

Frequency range: 2.0 to 8.0 GHz in one band.

Output Specifications

Distortion

Harmonics (2nd and 3rd): < -20 dBc for $P_{out} \leq +16$ dBm.

Non-harmonics: < -60 dBc typical for $P_{out} \leq +16$ dBm.

Third order intercept (ALC OFF): +25 dBm typical.

1 dB gain compression (ALC OFF): +18 dBm typical.

Noise figure: 13 dB typical.

Output Power (ALC ON)

Power level control: single turn knob with 11 calibrated divisions in 1 dB steps; spring loaded detent for uncalibrated power above +16 dBm.

- Automatic level control (ALC)
- Diode bias supply for harmonic mixers

Power range: +6 dBm to +16 dBm.

Absolute power accuracy: ± 2.0 dB; ± 1.5 dB typical.

Frequency response: ± 1.0 dB; ± 0.5 dB typical.

Uncalibrated power range: +16.75 dBm to +19 dBm typical; uncalibrated light warns of high level.

Reverse isolation: > 40 dB typical at +16 dBm output.

Output Connection

Connector: SMA female.

Impedance: 50 ohm nominal.

SWR: 1.7:1, ALC ON; 2.5:1 typical, ALC OFF.

Short circuit protection: continuous.

Input Specifications

Minimum input power: minimum power for leveling.

Small signal gain: gain with less than minimum input for leveling or with ALC switch OFF (rear panel).

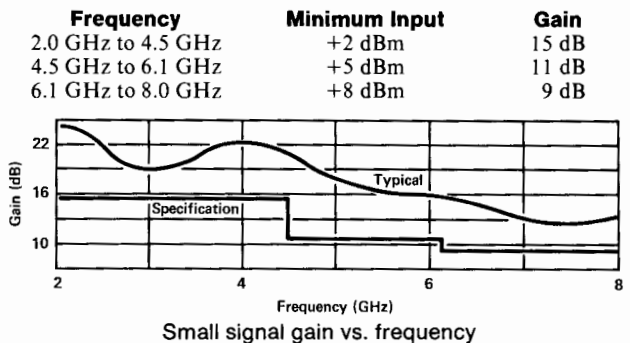

Input Connection

Connector: SMA female.

Impedance: 50 ohm nominal.

SWR (ALC OFF): 2.7:1 typical.

Maximum input: = +30 dBm (1 watt); ± 35 Vdc.

Diode Bias Specifications

Bias control: five turn knob for positive and negative current adjustment with 10 μ A resolution.

Current range: 0 to ± 10 mA typical for single diode load.

Output Connection

Connector: BNC female.

Maximum voltage: ± 3 Vdc typical.

Short circuit protection: ≤ 11 mA @ 25° C.

General Specifications

Power requirements: 100, 120, 220, or 240 Vac (user selectable), +5%, -10%; 48 to 440 Hz; less than 36 VA; convection cooled.

Environmental: per MIL-T-28800C, Type III, Class 5, Style E.

Temperature: operating 0° to +55° C; storage -40° to +75° C.

EMI: conducted and radiated interferences are in compliance with methods CEO3 and REO2 of MIL STD 461A and CISPR Pub. 11 (1975).

Weight: net, 3.04 kg (6.8 lb). Shipping, 5.45 kg (12.2 lb).

Size: 102 H \times 213 W \times 297 mm D (4.0" \times 8.4" \times 11.7").

Ordering Information

HP 11975A Amplifier

Opt 001: Type N Female Connectors

Opt 907: Front Handles

Opt 910: Extra Operating and Service Manual

Rack Mounting Kit: (HP P/N 5061-0072)

Price

\$4,100

add \$100

add \$50

add \$5

add \$53



AMPLIFIERS

Microwave Amplifier

Model 8349B



- Continuous 2 to 20 GHz coverage
- 15 dB gain to 18.6 GHz

- 100 milliwatts across 2 to 18.6 GHz
- < 13 dB typical noise figure



HP 8349B

The HP 8349B microwave amplifier delivers increased microwave power performance across a 2 to 20 GHz frequency range. This general-purpose broadband power amplifier is designed for maximum reliability and configured for the greatest convenience in interfacing with Hewlett-Packard's microwave sources, namely the HP 8350 or HP 8620C sweep oscillators, the HP 8340A/8341A synthesized sweepers, and the HP 8672A or 8673 synthesized signal generators.

Providing 100 mW (+20 dBm) of unlevelled output power from 2 to 18.6 GHz, 50 mW (+17 dBm) from 18.6 to 20.0, the HP 8349B offers one of the broadest operating bandwidths available from a solid-state power amplifier. This general-purpose, broadband power performance is achieved using a GaAs FET design of multiple stages. This multiple stage design provides more than 15 dB of gain from 2 to 18.6 GHz, and more than 12 dB of gain from 18.6 to 20.0 GHz.

The HP 8349B can also provide externally leveled output power without using an external coupler and detector, since these components are built-in and are compatible with Hewlett-Packard microwave sources. The HP 8349B is also equipped with an output power display. This display minimizes the need for an external power meter and enhances the amplifier's utility; for example the HP 8349B can be placed at the end of a long RF cable where the microwave output needs to be amplified, leveled and monitored.

Naturally, the versatile power control features of the microwave source (e.g., calibrated power, power sweep, power slope and remote power control via the Hewlett-Packard Interface Bus) can be accurately transmitted through the HP 8349B during external leveling operations.

The HP 8349B also has a built-in source module interface, enabling it to provide the HP 83550 series millimeter-wave source modules with the DC bias and control signals they need for proper operation. Using the HP 8349B and a millimeter source module extends the capabilities of any HP microwave source operating in the 11 to 20.0 GHz range to the millimeter-wave frequencies.

Applications

The broadband power of the HP 8349B is ideal in a number of applications that require high power, whether in a versatile bench-top arrangement or in a dedicated rack-mount system. In antenna testing, the HP 8349B can be placed at the end of long RF cables, delivering high power right to the device under test. In EW/ECM systems, the HP 8349B can be combined with the HP 8340A, HP 8341A opt. 006 (pulse modulation), or the HP 8673A synthesized signal generator to provide high power pulses with little degradation in pulse performance. The HP 8349B is also an excellent choice as a microwave driver for TWTs, high power amplifiers, or mixers. And with a typical noise figure of < 13 dB, the HP 8349B is often used as a pre-amplifier for spectrum analyzers and frequency counters.

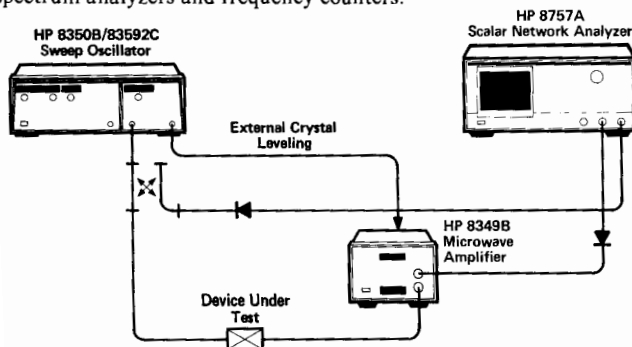

Extended Dynamic Range Configuration

The dynamic range of a scalar network analyzer measurement system is limited by the maximum output power of the microwave source and the sensitivity of the detectors. Using the illustrated configuration, the effective dynamic range of a scalar analyzer system is typically extended by > 20 dB by combining the calibrated dynamic range of the reference detector (R) with that of the transmission detector (B) in a ratio measurement (B/R). The HP 8349B makes this possible by extending the external crystal leveling power control of the microwave source. Hewlett-Packard Application Note 327-1 discusses this application in detail, and shows how typically > 80 dB of dynamic range can be achieved from 2 to 20 GHz using the HP 8349B amplifier, the HP 8350B/83592C sweep oscillator and the HP 8756A or HP 8757A scalar network analyzer.

RF susceptibility tests can also greatly benefit from the high quality amplifying characteristics of the HP 8349B.

Frequency Specifications

Range: 2.0-20 GHz

Output and Input Specifications (25°C ± 5°C)

Minimum Output Power (25°C ± 5°C): +5dBm input

| Frequency Range (GHz) | Output | |
|-----------------------|------------------|-------------------|
| | Leveled | Unleveled |
| 2.0 to 18.6 | 19 dBm (80mW) | 20 dBm (100mW) |
| 18.6 to 20.0 | 16 dBm (40mW) | 17 dBm (50mW) |

Power Flatness (Leveled): ±1.25 dB

1 dB Compression Point: +21 dBm, nominal

Minimum Small Signal Gain (at -5 dBm input): 15 dB, 2 to 18.6 GHz
12dB, 18.6 to 20 GHz

Noise Figure: < 13 dB, typical

Impedance (Input and Output): 50 ohms, nominal
SWR

| Frequency Range (GHz) | Input | Output | |
|-----------------------|-------|---------|---------------------|
| | | Leveled | Unleveled (typical) |
| 2.0 to 5.0 | ≤2.8 | ≤2.5 | ≤4.8 |
| 5.0 to 11.0 | ≤2.8 | ≤2.5 | ≤3.8 |
| 11.0 to 18.0 | ≤2.8 | ≤2.5 | ≤3.2 |
| 18.0 to 20.0* | ≤2.8 | ≤2.5 | ≤3.2 |

*SWR from 18.0 to 20.0 GHz is typical

Maximum Continuous Input, to the input or output ports:
+27 dBm (RF), ±10V (DC)

Spectral Purity

Harmonics: (at + 20 dBm output) < -20 dBc, 2.0 to < 11.0 GHz.
< -30 dBc, 11.0 to 20.0 GHz typical.

Non-Harmonic Spurious: ≤ -55 dBc.

Third Order Intercept: + 33 dBm, nominal.

Pulse Transmission Capability

Rise/Fall Time: Typically < 10 ns.

Delay Time (input to output): Typically < 8 ns.

General

Reverse Isolation: > 50 dB, typical

RF Input/Output Connectors: Type N Female

Size: 133 H x 214 W x 366 mm D (5.2" x 8.36" x 13.6")

Weight: Net, 7 kg (15 lb); shipping, 14 kg (31 lb).

Ordering Information

HP 8349B 2 to 20 GHz Microwave Amplifier

Opt 001 Rear Panel RF Input/Output

Opt 002 Rear Panel RF Input with Front Panel RF

Output

Opt 910 Extra Service Manual

Price

\$7,000

add \$100

add \$100

add \$15



AMPLIFIERS

RF Amplifiers

Models 8447A/D/E/F

- Wide band (multi-decade)
- Low noise
- Flat response

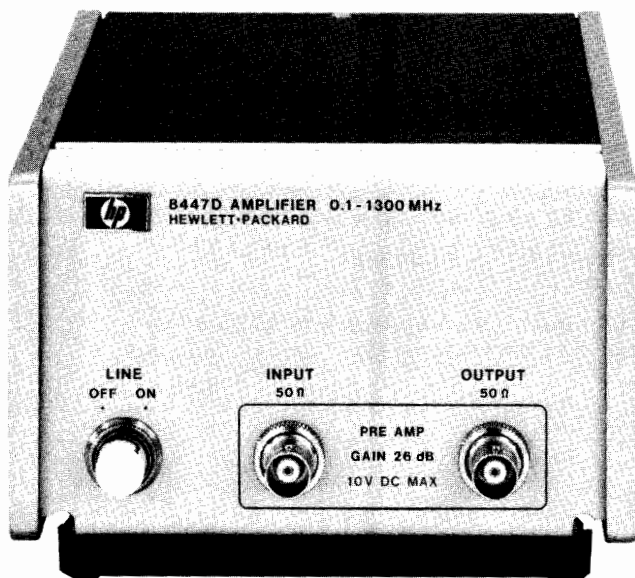

HP 8447D

The HP 8447 series of general purpose amplifiers offers high reliability and the convenience of a small, lightweight package.

High Performance

These low noise, high gain amplifiers provide the flat frequency response and low distortion required for a wide range of uses. They can be used to improve the sensitivity of counters, spectrum analyzers,

RF voltmeters, EMI meters, power meters and other devices, or to increase the maximum power available from a signal generator or sweeper.

Broadband Frequency Coverage

The HP 8447 series offers an amplifier for nearly every application in the 100 kHz to 1.3 GHz frequency range. The amplifiers' wide bandwidths are compatible with other wideband instruments used for making measurements involving broadband spectra.

Options

Standard connectors are BNC (f) on all amplifiers.
 Option 010 N (f) connectors on single channel amplifier.
 Option 001 Dual channel amplifier, BNC (f) connectors.
 Option 011 Dual channel amplifier, N (f) connectors.
Note: dual channel amplifiers are ideal for dual channel systems such as oscilloscopes or network analyzers. Channels may also be cascaded for increased small-signal gain.

General

Weight: net, 1.56 kg (3.4 lb). Shipping, 2.30 kg (5.1 lb).
Size: 85.8 H x 130 W x 216 mm D (3.4" x 5.1" x 8.5").
Power requirements: 110 or 230 V ac ± 10%, 48-440 Hz, 15 watts.

Ordering Information

Price

| | |
|---|--------|
| HP 8447A Preamp | \$1075 |
| Opt 910: Extra Operating and Service Manual (HP 8447A) | \$2 |
| HP 8447D Preamp | \$1100 |
| HP 8447E Power Amp | \$1225 |
| HP 8447F Preamp-Power Amp | \$1875 |
| Opt 910: Extra Operating and Service Manual (HP 8447D/E/F) | \$4 |

Specifications

| | HP 8447A Preamp | HP 8447D Preamp | HP 8447E Power Amp | HP 8447F Preamp-Power Amp |
|--|--------------------------|---|----------------------------|---|
| Frequency Range | 0.1-400 MHz | 100 kHz-1.3 GHz | 100 kHz-1.3 GHz | 100 kHz-1.3 GHz |
| Typical 3 dB Bandwidth | 50 kHz-700 MHz | 50 kHz-1.4 GHz | 50 kHz-1.4 GHz | 50 kHz-1.4 GHz |
| Gain (Mean, per channel) | 20 dB ± 0.5 dB at 10 MHz | >26 dB (20°C-30°C) | 22 dB ± 1.5 dB (20°C-30°C) | |
| Gain Flatness Across Full Frequency Range | ±0.5 dB | ±1.5 dB | ±1.5 dB | ↑ HP 8447D AND 8447E COMBINED IN A SINGLE PACKAGE ↓ |
| Noise Figure | <5 dB | <8.5 dB | <11 dB typical | |
| Output Power for 1 dB Gain Compression | >+6 dBm | >+7 dBm typical | >+15 dBm | |
| Harmonic Distortion | -32 dB for 0 dBm output | -30 dB for 0 dBm output (typical) | -30 dB for +10 dBm output | |
| Typical Output for <-60 dB Harmonic Distortion | -25 dBm | -30 dBm | -20 dBm | |
| VSWR | <1.7 | <2.0 input <2.2 output 1-1300 MHz | <2.2 1-1300 MHz | |
| Impedance | 50 Ω | 50 Ω | 50 Ω | |
| Reverse Isolation | >30 dB | >40 dB | >40 dB | |
| Maximum DC Voltage Input | ±10 V | ±10 V | ±10 V | |
| Options Available | 001 | 001, 010, 011 | 010 | |
| Option Prices | add \$600 | add \$650, \$100, \$1000 | add \$100 | add \$385 |

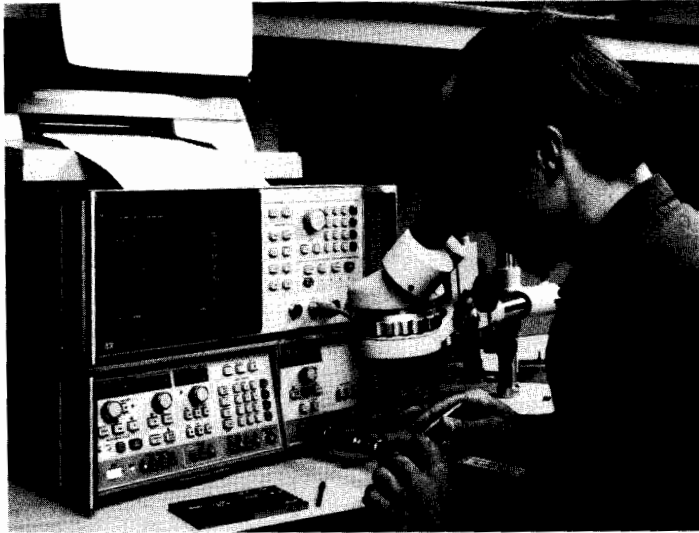

Sweep Oscillators

Sweep oscillators are important in a number of applications where the characteristics of a device or system must be determined over a continuous range of frequencies. By replacing laborious point-by-point techniques, swept measurements increase the speed and convenience of broadband testing. The continuous frequency characterization of the unknown device or system also eliminates the chance of missing important information between frequency points. Swept techniques are applicable in all phases of design, manufacture, and maintenance.

Hewlett-Packard Sweep Oscillators

Hewlett-Packard sweepers cover the entire frequency spectrum from dc to 60 GHz. Self-contained, multi-octave sweepers cover the frequency range to 110 MHz. The HP 8620 and HP 8350 family of solid state oscillators provide a versatile choice of configurations—single band, straddle band, or very wide band plug-ins. The HP 8340A (10 MHz to 26.5 GHz) and the HP 8341A (10 MHz to 20.0 GHz) are broadband synthesizers that combine the excellent stability, frequency accuracy, and phase noise of a synthesizer with the versatile characteristics of a sweep oscillator. And for coverage in the millimeter-wave frequency range, the HP 83550-series frequency multipliers effectively extend the excellent performance of Hewlett-Packard's sweep oscillator family to the 26.5-40 GHz (HP 83554A), 33-50 GHz (HP 83555A), and 40-60 (HP 83556A) millimeter-wave frequency ranges.

A chart of the complete frequency coverage of Hewlett-Packard's line of sweep oscillators is shown on page 495.

Sweep Oscillator Features

Sweep Flexibility

Every HP sweeper has several different sweep modes available for setting the frequency limits of the instrument. A full band or independently adjustable start/stop frequency sweep can be selected. Alternately, a marker sweep or a symmetrical F sweep about the desired center frequency can be chosen. And switching from one sweep mode to another is a simple pushbutton operation.

In the auto mode the sweep retriggers automatically. A manual sweep is also available, a real convenience for calibrating displays such as X-Y recorders. An external trigger is provided as well for applications where the sweeper must be synchronized to other instrumentation or remotely controlled. Sweep times from 0.01 to more than 100 seconds can be selected.

Marker capability, both Z-axis intensity dots and RF pips, are available on HP sweepers to note important measurement frequencies. Two or more independent markers are offered on all sweepers with up to five markers on the HP 8340A/41A as well as the HP 8350 mainframe. Crystal markers are also offered on the HP 86222B, 83522A, and 83525A/B RF plug-ins.

Another powerful feature available on the HP 8340A/41A and 8350 sweeper mainframe is Save/Recall Mode where up to nine complete front panel states can be stored in memory and later recalled when the measurement is repeated. This saves considerable time when repetitive tests are required.

Power Output and Leveling

Power output is continuously adjustable at the front panel over approximately a 10 dB range of all plug-ins. Built-in attenuators are also available on most plug-ins for greater power control. Internal or external leveling is employed to obtain (1) a constant power output and (2) a good source match (low VSWR). This ensures high accuracy when making swept measurements.

The HP 8340A/41A and 83500 series of plug-ins for the HP 8350 offer calibrated output power and internal leveling as standard features. Power is calibrated over a 15 dB range (40 dB for the HP 8340A/41A) with 0.1 dB resolution (programmable to 0.02 dB); with an internal step attenuator, the calibrated range is extended to 85 dB (130 dB on the HP 8340A/41A).

When higher output is required, the HP 8349B microwave amplifier can be driven by the RF output of the sweeper to provide a full +20 dBm of output power from 2 to 18.6 GHz, +17 dBm from 18.6 to 20.0 GHz. The amplifier is capable of at least 15 dB of gain

to 18.6 GHz, 12 dB of gain to 20 GHz, and can be easily leveled via its built-in directional detector and the automatic level control (ALC) circuitry of the sweeper.

Power as well as frequency can be swept with the HP 8340A/41A or the HP 8350 and 83500 series plug-ins using the Power Sweep function. This means that both the frequency response and power response of level sensitive devices like transistors and amplifiers can be measured using the same test set-up. Using the power sweep function the 1 dB gain compression can easily be measured at a CW frequency. Also, the ability to alternate between two successive sweeps allows a swept measurement of the 1 dB gain compression point.

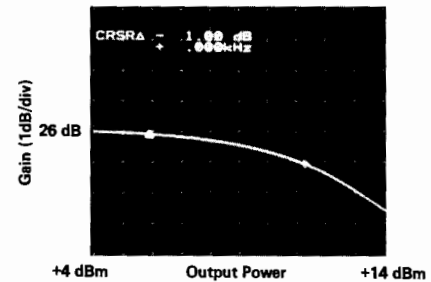

Power Sweep Measurement

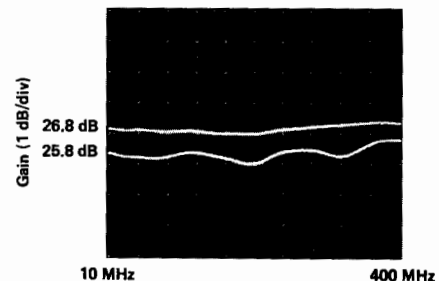

Alternate Sweep Measurement

Modulation

Modulation capabilities further extend the sweeper's usefulness both as a sweeper and a signal generator for signal simulations. Most Hewlett-Packard sweep oscillators offer versatile FM and AM capabilities which are

SWEEP OSCILLATORS

General Information (cont.)

useful for a variety of tests on communication receivers. The flexible FM capability allows remote analog frequency programming, important for many applications.

External pulse modulation is available on many of the HP 83500/86200 series plug-ins. These plug-ins also accept the 27.8 kHz square wave modulation required by the HP 8755, 8756A and 8757A scalar network analyzers directly, eliminating the need for an external modulator. The HP 8350 mainframe will supply the 27.8 kHz square wave modulation directly to the plug-in.

The HP 8340A and 8341A opt. 006 synthesized sweepers have extensive modulation capability, providing both internal pulse and AM modulation. The pulse modulation capability works for pulse widths as narrow as 100 ns, having rise and fall times less than 25 ns and an on/off ratio of greater than 80 dB. The AM is dc coupled and has a 3 dB bandwidth of 100 kHz. The maximum modulation depth varies with available output power but it is never less than 90%. In addition, the HP 8340A and 8341A opt. 006 may simultaneously pulse and amplitude modulate the RF to simulate the effect of antenna scan on a pulse modulated signal.

MLA Compatibility

In communications applications where up-converter simulation is required in conjunction with the HP Microwave Link Analyzer, several of the plug-ins have been selected to provide this capability as an option in frequency ranges from 500 MHz to 18 GHz. Group delay of less than 1 nanosecond and linearity of better than 0.5% over 30 MHz across most of the frequency range permit very accurate RF to RF, RF to IF and RF to BB distortion measurements. See page 150 for more information.

Programming

The HP 8340A/41A, 8350 mainframe and 83500 series plug-ins offer total HP-IB control of all front panel functions. Not only CW frequencies, but sweeps, markers, power levels, etc., can be remotely programmed via the HP-IB. This means there are no limitations to designing customized automatic systems for either component or system testing. The HP 8620C solid state sweeper mainframe offers optional HP-IB programming capability.

In many applications a computer can be used to assimilate data from a network analyzer (HP 8756A/57A or 8510). With automatic systems the computer can completely set up the measurement, sweep width, markers, power level, etc., and then document the measurement results in a printed or plotted format. For operations requiring a minimum of user interactions specification comparisons can be made for automatic "go/no-go" testing.

An example of this computer-aided test is the HP 85015B system software for the HP 8756A/57A scalar network analyzers. This software package allows you to configure and store complete measurements and measurement setups as well as customized output formats. The HP 85016B system software includes all the features of the HP 85015B and includes fault location capabilities that

allow the automated scalar measurement system to locate faults in transmission media. Refer to page 604.

Covering Millimeter-wave Frequencies

The new HP 83550-series millimeter-wave source modules answer the growing need for high-performance sweep oscillators in the millimeter-wave frequency ranges. The source modules are frequency multipliers that effectively extend the excellent performance of HP sweep oscillators covering the 11 to 20 GHz range to the 26.5 to 40 GHz (HP 83554A), the 33 to 50 GHz (HP 83555A), and the 40 to 60 GHz (HP 83556A) millimeter-wave frequency ranges.

To use the HP 83550-series source modules with existing HP microwave sources, the HP 8349B amplifier is necessary to provide the +17 dBm of output power and, through a built-in source module interface, the DC bias and control signals the source modules need for proper operation. Another solution for a microwave driver in applications that incorporate the HP 8350B is the new HP 83550A, an 8 to 20 GHz RF plug-in that provides +20 dBm to 18.6 GHz and +18 dBm, 18.6 to 20 GHz. This plug-in also has a built-in source module interface to drive the millimeter-wave source modules directly.

Digital Sweeping Synthesizers

The HP 3325A, 3330B, 3335A, 8642A/B, 8660C, 8662A/63A, and 8673B/C/D combine the precision frequency accuracy and stability of a synthesizer with the time saving convenience of a sweeper. Instead of analog sweeps, however, these units provide a digital sweep. The digital sweep is a progression of discrete CW frequencies that can be stepped through at a specified rate. Parameters such as start/stop/center frequencies, sweep width, frequency step and sweep time are entered and executed through a convenient keyboard or remote programming. Some additional features are phase-continuous linear/log sweep in the HP 3325A and amplitude sweeping in steps as small as 0.01 dB in the HP 3330B. This, in conjunction with frequency sweeping, can provide a comprehensive family of curves.

Sweeper Applications

Sweepers are an integral part of many kinds of test applications. Their versatility and extensive feature set make them the perfect choice for scalar/vector network analysis, noise figure measurements, frequency translation measurements, signal simulation and many other applications. The sweepers you will find in this book are designed to be compatible with all relevant measurement solution from HP.

Sweepers are used extensively with swept scalar network analyzers to characterize the amplitude responses of broadband devices or with vector network analyzers when the amplitude and phase characteristics of the device (i.e. s-parameters) are needed. Examples of such analyzers are the HP 8756A and HP 8757A scalar network analyzers and the HP 8510A vector network analyzer. The HP 8340A/41A and HP 8350B sweepers can be controlled by these analyzers via a private "system interface bus." This

makes use of the sweepers full programmability and creates synergistic performance; for instance, the ability to save and recall complete system setups and not just one instrument's.

Some applications require special characteristic of a microwave sweep oscillators. For measurements requiring low harmonics, the HP 83592C RF plug-in for the HP 8350 sweep oscillator mainframe offers -55 dBc harmonic suppression from 3.5 to 20 GHz. For applications that require high power, the new HP 83550A offers +20 dBm of leveled output power to 18.6 GHz, +18 dBm from 18.6 to 20 GHz.

For scalar measurements requiring more dynamic range, the HP 8349B microwave amplifier can be used to extend the dynamic range from 76 dB to typically > 90 dB.

For measurements that require an entirely spurious-free environment and phase information, sweepers may be used with vector network analyzers such as the HP 8510A. Extremely high performance vector measurements can be made with the HP 8340A/41A and the HP 8510. For less demanding applications, the HP 8350B/83500 series sweepers can be used with the HP 8510. For instance, the HP 8350B/83522A can be used with the HP 8510 to make RF measurements with greater than 90 dB of dynamic range from 45 MHz to 2.4 GHz.

Noise figure measurements above 1500 MHz can be made using the HP 8970A noise figure meter with either the HP 8340A/8341A or the HP 8350 serving as the local oscillator. With this equipment noise figure and gain measurements can be made

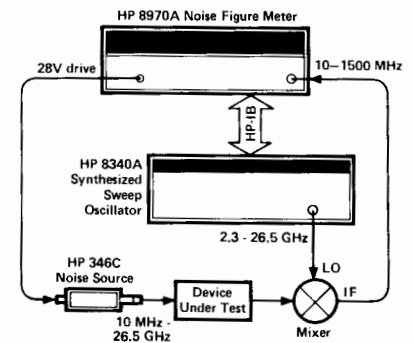

on microwave components such as amplifiers, transistors or mixers. The HP 8340A/41A can also be used as a microwave LO in an HP 8902S and 8952S measurement systems that makes several important measurements on microwave sources.

Two-tone sweep testing of devices such as mixers and receiver front ends requires two signals offset from each other by the IF. This is accomplished by phase-locking the difference frequency of two sweep oscillators to a very stable source. The sweepers may then be swept across the band of interest.

The modulation and built-in attenuator features of Hewlett-Packard sweep



oscillators make them useful in many traditional CW signal generator applications. The excellent stability, phase noise, frequency range and modulation capability of the HP 8340A and 8341A make them well suited for most of these applications. In addition, accuracy, linearity, and flatness of the broadband plug-ins like the HP 83590A, 83594A, 83595A, 83592 A/B/C, 86290 B/C, 83525 A/B, 86222 A/B, and 83522A make them more than adequate in many applications requiring a general purpose CW generator.

For wideband applications these RF plug-ins feature performance that rivals octave band oscillators in the areas of frequency purity and accuracy, harmonics, flatness, and power.

For a complete discussion of swept frequency measurements the following application notes and others are available from your local Hewlett-Packard sales office.

- AN 155-2 "100 dB Dynamic Range Measurements Using the 8755 Frequency Response Test Set"
- AN 183 "High Frequency Swept Measurements"
- AN 187-6 "Frequency Performance of the 8620C Sweep Oscillator Under Remote Programming"

- AN 312-1 "Configuration of a Two-tone Sweeping Generator"
- AN 327-1 "Extending Dynamic Range of Scalar Transmission Measurements Using the HP 8756A or HP 8755C Scalar Network Analyzer"
- AN 329 "Performance Characteristics of HP Microwave Signal Sources-A Comparison"
- PN 8340A-1 "Increasing Frequency Switching Speed on the HP 8340A Synthesized Sweeper"
- PN 8340A-5 "60 GHz Frequency Coverage Using the HP 8340A Synthesized Sweeper and the WJ 1204-4X Frequency Extender"
- PN 8340A-6 "Reduced Harmonic Distortion Using the Integra TMF-1800H Tracking Filter with the HP 8340A Synthesized Sweeper"
- PN 8340A-7 "Microwave Noise Figure Measurements Using the 8340A Synthesized Sweeper with the HP 8970A Noise Figure Meter"
- PN 8350-1 "Using the HP 8350A Sweep Oscillator with the Wiltron 560 Scalar Network Analyzer"
- PN 8350-2 "Improved Frequency Accuracy by Calibrating HP 83590 Series RF Plug-ins to HP 8350A Sweep Oscillator Mainframe"
- PN 8350-3 "A Penlift Dwell Circuit for the

- HP 8350 Sweep Oscillator"
- PN 8350-4 "Pulse Modulation Characteristics of the HP 83500 Series Sweep Oscillator RF Plug-ins"
- PN 8350-5 "60 GHz Frequency Coverage Using the HP 8350A Sweep Oscillator and WJ 1204-4X Frequency Extender"
- PN 8350-6 "Reduced Harmonic Distortion Using the Integra TMF-1800H Tracking Filter with the HP 8350 Sweep Oscillator"
- PN 8350-7 "Microwave Noise Figure Measurements Using the HP 8350A Sweep Oscillator with the HP 8970A Noise Figure Meter"
- PN 8350-8 "Leveling the HP 8350B Sweep Oscillator with an HP 430 Series Power Meter"
- PN 8349-1 "Achieving Calibrated Output Power With The HP 8350 Sweep Oscillator/8349 Broadband Amplifier Combination"
- PN 8620C-1 "Using the HP 8620C Sweep Oscillator with the Wiltron 560 Scalar Network Analyzer"
- PN 8756A-1 "Automating the 8756A Scalar Network Analyzer"
- PN 8756A-3 "How to use the HP 5344S Source Synchronizer with the HP 8350B Sweep Oscillator and the HP 8756A Scalar Analyzer"

Sweep Oscillator—Summary Chart

| Frequency Range* | Model Number | | | Frequency | | | | | | | | | | | | | |
|---|--|--|--|-----------|-------|--------|---------|-------|-------|-------|-------|--------|--------|--------|--------|--------|--------|
| | 8350 Series | 8620 Series** | Other Sweepers | 100 kHz | 1 MHz | 10 MHz | 100 MHz | 1 GHz | 2 GHz | 4 GHz | 8 GHz | 12 GHz | 18 GHz | 26 GHz | 40 GHz | 50 GHz | 60 GHz |
| 0.1 Hz-13 MHz 10 Hz-21 MHz 1 μHz-21 MHz 1 mHz-50 MHz 200 Hz-80 MHz 10 kHz-1280 MHz 10 kHz-2600 MHz | | | 3312A 3336A/B/C 3325A 8165A 3335A 8662A 8660C | ← | ← | ← | ← | ← | ← | ← | ← | ← | ← | ← | ← | ← | ← |
| 100 kHz-110 MHz 100 kHz-1 GHz 100 kHz-2 GHz 100 kHz-2.56 GHz 10 MHz-1.3 GHz 10 MHz-2.4 GHz 10 MHz-8.4 GHz 10 MHz-20 GHz 10 MHz-26.5 GHz 50 MHz-18.6 GHz 50 MHz-26.5 | 83522A 83525A/B 83592A/B/C 83595A | 86220A 86222A/B | 8601A 8642A 8642B 8663A 8341A 8340A 8673C 8673D | ← | ← | ← | ← | ← | ← | ← | ← | ← | ← | ← | ← | ← | ← |
| 1.7-4.3 GHz 2-8.4 GHz 3.6-8.6 GHz 2-18.6 GHz 2-20 GHz 2-22 GHz 2-26.5 GHz | 83540A/B 83590A 83594A | 86235A 86240A/B 86240C 86290B/C 86290B Opt H08 | 8673A | | | | | | ← | ← | ← | ← | ← | ← | ← | ← | ← |
| 3.2-6.5 GHz | | 86241A | | | | | | | ← | ← | | | | | | | |
| 5.9-9.0 GHz 5.9-12.4 GHz 7-11 GHz 7.5-18.6 GHz 8-12.4 GHz 8-20 GHz | 83545A 83550A | 86242D 86245A 86250D Opt H08 86251A 86250D | | | | | | | | ← | ← | ← | ← | ← | ← | ← | ← |
| 10-15.5 GHz 12.4-18 GHz 17-22 GHz 18-26.5 GHz 26.5-40 GHz | 83570A 83572A/B | 86260B 86260A 86260C | | | | | | | | | ← | ← | ← | ← | ← | ← | ← |
| 26.5-40 GHz*** 33-50 GHz*** 40-60 GHz*** | | | 83554A 83555A 83556A | | | | | | | | | | | | ← | ← | ← |

*Other Special Frequency Ranges Can Be Provided Upon Request.

**HP 86200 Series RF Plug-ins are usable with the HP 8350A Mainframe via the HP 11869A Adapter. HP 83500 Series Plug-ins are not usable in the HP 8620C Mainframe.

***The HP 83550-series millimeter-wave source modules are frequency multipliers that require a microwave input. See pages 512-514.

SWEEP OSCILLATORS

Synthesized Sweepers

Models 8340A, 8341A

- 1 to 4 Hz frequency resolution
- Low spurious and phase noise
- 100 ns pulse width capability (optional on HP 8341A)
- +10 dBm to -110 dBm calibrated output (optional on HP 8341A)
- Complete analog sweeper
- DC to 100 kHz amplitude modulation

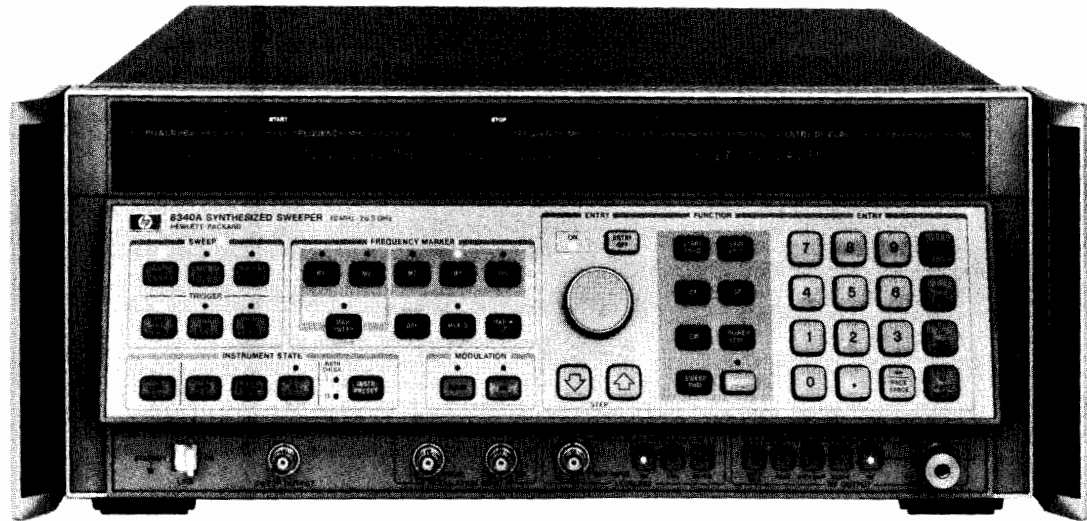

HP 8340A



HP 8340A/8341A Synthesized Sweepers

The HP 8340A and 8341A Synthesized Sweepers deliver the combined high-performance of a synthesizer and a broadband sweep oscillator in one instrument that is completely controllable via the Hewlett-Packard Interface Bus (HP-IB). This efficient combination of performance and versatility is ideal for manual or automatic test systems and in many cases enables the HP 8340A/41A to replace a sweep oscillator, a frequency counter, an RF synthesizer, and a microwave synthesizer.

Synthesizer Precision and Spectral Purity

The synthesized broadband frequency coverage (10 MHz to 26.5 GHz on the HP 8340A and 10 MHz to 20 GHz on the HP 8341A) and the precise 1 to 4 Hz frequency resolution (depending on the frequency band of the HP 8340A or 8341A) are generated by indirect synthesis techniques. These techniques enable the HP 8340A/41A to achieve the same low single-sideband phase-noise performance as the HP 8672A and HP 8673 series of Synthesized Signal Generators. The HP 8340A/41A long-term stability is also outstanding at 1×10^{-9} /day (see specification on following page for more information).

The HP 8340A/41A also feature CW switching times of better than 50 ms (typically <35 ms). Additionally, a "Fast Phase-lock" programming command can be used to reduce typical CW switching times to between 11 and 22 ms (depending on frequency step size and absolute frequency value).

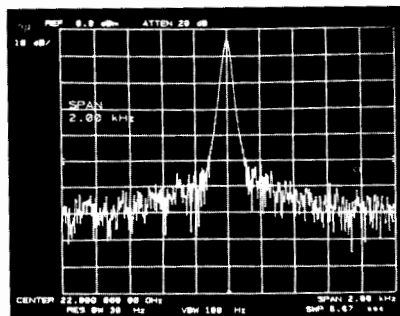

Spectrum Analyzer photo of HP 8340A signal at 22 GHz.

Swept Capability

Analog sweep widths as narrow as 100 Hz or as broad as the full frequency range of the HP 8340A or 8341A permit rapid and thorough testing of any device within their broad frequency ranges. To simplify swept measurements, five frequency markers are provided along with useful marker functions such as marker sweep, marker to center frequency (MKR-CF), and marker difference. Direct compatibility with the HP 8510, 8756A/57A, 8410 and 8755 Network Analyzers also enhances the HP 8340A/41A's swept capability.

Pulse and AM Modulation

The high performance pulse modulators of the HP 8340A and the HP 8341A Opt 006 offer >80 dB ON/OFF ratio and <25 ns rise and fall times. Pulse amplitudes are leveled for pulse widths as narrow as 100 ns. The HP 8340A/HP 8341A also feature dc-coupled AM modulation with a 3 dB bandwidth of 100 kHz and a minimum depth of 90%. Pulse and amplitude modulation can be used simultaneously to simulate antenna scan patterns.

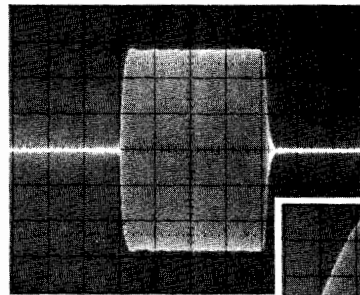

HP 8341A Opt 006 pulse performance at 3 GHz. Pulse width = 200 ns.

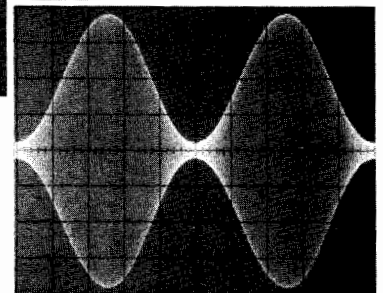

HP 8340A AM performance at 22 GHz. AM rate is 50 kHz and depth is 90%.



Output Power

The HP 8340A/41A provide high output power which can be controlled down to -110 dBm (opt. 001 or 004 on the HP 8341A) with 0.05 dB resolution. High power resolution is complemented by outstanding accuracy and flatness, as shown on the following page of specifications. The HP 8340A/41A also feature power sweep capability with >20 dB dynamic range for complete characterization of level-sensitive devices.

Usability and Programmability

The ENTRY DISPLAYS of the HP 8340A/41A always show the active functions and their current values, which can be easily changed via the data entry keyboard, the step keys or the knob. This friendly and responsive interaction with the user makes the HP 8340A/41A very easy instruments to operate. Complete HP-IB programmability also enables the HP 8340A/41A to effectively interact with computers via simple-to-use programming codes (for example, a CW frequency of 5 GHz can be programmed by: CW 5 GZ). Other HP-IB enhanced features, such as the "Fast Phase-lock" command, let users easily and fully exploit the powerful capabilities of the HP 8340A/41A.

Network Analyzer Companions

Besides being excellent stand-alone general purpose sources, the HP 8340A and HP 8341A are also ideal sources for precision microwave network analysis. Examples of this are the HP 8340A/41A with the HP 8510 and HP 8756A/57A network analyzers. The HP 8510 vector network analyzer brings tremendous measurement capability to the microwave engineer that was never before available. A significant portion of this capability depends on the stability, signal purity and source/analyzer interface of the sweeper used. An example of this high performance is shown in Figure 1 where a single device under test was measured seven times with seven completely different HP 8510/8340A test systems. The repeatability (system to system) is remarkable. When the HP 8512A or 8514A 500 MHz to 18 GHz test sets are used with the HP 8510, the 10 MHz to 20 GHz HP 8341A is the recommended source and when the HP 8513A or 8515A 45 MHz to 26.5 GHz test sets are used, the 10 MHz to 26.5 GHz HP 8340A is recommended.

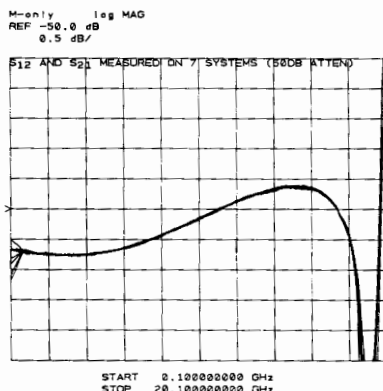

Both the HP 8340A and HP 8341A can also be teamed with the HP 8756A and HP 8757A scalar network analyzers for precision scalar analysis, for instance, magnitude-only applications where data at accurate frequencies is needed. In addition to this frequency accuracy, the HP 8340A/8341A have a "phase-locked sweep." For sweep widths of $n \times 5$ MHz or less (n = frequency band number), one of the phase-locked loops is swept producing synthesizer class frequency accuracy and stability in a continuous sweep. As an example, see Figure 2 where an 832 MHz SAW resonator is swept over a width of 400 kHz by the HP 8341A with less than 60 Hz of residual FM.

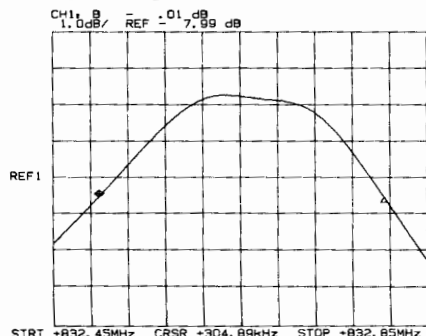

The HP 8341A is particularly well suited for scalar analysis because of its excellent performance for the price. Previously, if greater frequency

accuracy and stability was required of a swept source, the sweeper was combined with a source-locking counter or simply stopped and counted in CW mode. Now with the 10 MHz to 20 GHz HP 8341A, you can obtain the highest quality frequency accuracy, stability, and phase noise along with an analog sweeper. The HP 8341A has all this built into a single easy-to-use instrument at a price comparable to a broadband sweeper/source-locking counter combination.

HP 8340A/8341A Specifications

(see technical data sheet for complete specifications)

HP-IB Interface Functions

The following codes describe the HP-IB electrical capabilities of the HP 8340A/41A using IEEE Std 488-1978 mnemonics: SH1, AH1, T6, TE0, L4, LE0, SR1, RL1, PP0, DC1, DT1, C0, C1, C2, C3, C28, E1.

Frequency

CW Mode (and Manual Sweep)

Frequency Range: HP 8340A, 10 MHz to 26.5 GHz
HP 8341A, 10 MHz to 20.0 GHz

Frequency Resolution:

1 Hz, 0.01 to <7.0 GHz
2 Hz, 7.0 to <13.5 GHz
3 Hz, 13.5 to <20.0 GHz
4 Hz, 20.0 to 26.5 GHz (HP 8340A only)

Accuracy: Same as time base.

Time Base:

Internal 10 MHz time base.
Aging Rate: less than 1×10^{-9} /day and 2.5×10^{-7} /year after 30 day warm-up.
Temperature Effect: typically $<1 \times 10^{-8}$ SUP10/ $^{\circ}$ C.
Line Voltage Effect: typically $<1 \times 10^{-8}$ SUP11/ $\pm 10\%$ line voltage change.

Switching time: <50 ms to be within specified frequency resolution (PEAK function off).

(Fast Phase Lock Mode reduces typical switching time to <20 ms).

Frequency Bands: For bands 0 and 1, the output is derived from the fundamental frequency of the internal 2.3 to 7.0 GHz YIG-tuned oscillator ($n = 1$). For bands 2 (7.0-13.5 GHz), 3 (13.5-20 GHz), and 4 (20.0-26.5 GHz), the output is derived from the 2nd, 3rd, or 4th harmonic of the oscillator ($n = 2, 3, \text{ or } 4$).

Swept Mode

Center Frequency/Sweep Width (ΔF)

Range: HP 8340A: 10.00005 MHz to 26.4999995 GHz (**center frequency**); 100 Hz to 26.49 GHz (**sweep width**), HP 8341A: 10.00005 MHz to 19.99999995 GHz (**center frequency**), 100 Hz to 19.99 GHz (**sweep width**).

Resolution: approximately 0.1% of sweep width (ΔF).

Readout Accuracy: (sweep time > 100 ms)

$\Delta F \leq n \times 5$ MHz: $\pm 1\%$ of indicated sweep width (ΔF). \pm time base accuracy.

$n \times 5$ MHz $< \Delta F < n \times 100$ MHz: $\pm 2\%$ of indicated sweep width (ΔF). $\Delta F \geq n \times 100$ MHz: $\pm 1\%$ of indicated sweep width (ΔF), or ± 50 MHz, whichever is less.

Where n = harmonic multiplication number (1 to 4). Refer to Frequency Bands description above.

Start/Stop Frequency

Range: HP 8340A: 10 MHz to 26.4999999 GHz (Start); 10.0001 MHz to 26.5 GHz (Stop) HP 8341A: 10 MHz to 19.9999999 GHz (Start)

10.0001 MHz to 20.0 GHz (Stop)

Resolution: same as Center Frequency/Sweep Width.

Readout Accuracy: with respect to sweep out voltage (sweep time > 100 ms): same as Center Frequency/Sweep Width Mode.

Frequency Markers

All 5 markers are independently variable and have the same specifications.

Range: HP 8340A: 10 MHz to 26.5 GHz.
HP 8341A: 10 MHz to 20.0 GHz.

Resolution: same as Center Frequency/Sweep Width.

Readout Accuracy: same as Center Frequency/Sweep Width.

Readout Accuracy in MKR Δ Mode: same as Center Frequency/Sweep Width.

Swept Frequency Accuracy (of any frequency covered by the sweep): same as Center Frequency/Sweep Width Mode.



SWEEP OSCILLATORS

Synthesized Sweepers (cont.)

Models 8340A, 8341A

Spectral Purity

Specifications apply to CW mode and all swept modes unless otherwise stated.

Spurious Signals (expressed in dB relative to the carrier level (dBc) at ALC level of 0 dBm).

Harmonics (up to 26.5 GHz) of output frequency: < -35 dBc
Subharmonics and Multiples Thereof (up to 26.5 GHz) of output frequency:

- < -25 dBc, 7.0 to < 20.0 GHz
- < -20 dBc, 20.0 to 26.5 GHz (HP 8340A only)

Non-Harmonically related spurious (CW and Manual Sweep mode only):

- < -50 dBc, 0.01 to < 2.3 GHz
- < -70 dBc, 2.3 to < 7.0 GHz
- < -64 dBc, 7.0 to < 13.5 GHz
- < -60 dBc, 13.5 to < 20.0 GHz
- < -58 dBc, 20.0 to 26.5 GHz (HP 8340A only)

HP 8340A Single-Sideband Phase Noise (dBc/1 Hz Noise BW, CW Mode, all power levels)

| Frequency Range (GHz) | Offset from Carrier | | | | |
|-----------------------|---------------------|--------|-------|--------|---------|
| | 30 Hz | 100 Hz | 1 kHz | 10 kHz | 100 kHz |
| 0.01 to < 2.3 | -64 | -70 | -78 | -86 | -107 |
| 2.3 to < 7.0 | -64 | -70 | -78 | -86 | -107 |
| 7.0 to < 13.5 | -58 | -64 | -72 | -80 | -101 |
| 13.5 to < 20.0 | -54 | -60 | -68 | -76 | -97 |
| 20.0 to 26.5 | -52 | -58 | -66 | -74 | -95 |

HP 8341A Single-Sideband Phase Noise (dBc/1 Hz Noise BW, CW Mode, all power levels)

| Frequency Range (GHz) | Offset from Carrier | | | | |
|-----------------------|---------------------|--------|-------|--------|---------|
| | 30 Hz | 100 Hz | 1 kHz | 10 kHz | 100 kHz |
| 0.01 to < 2.3 | - | -67 | -75 | -83 | -107 |
| 2.3 to < 7.0 | - | -67 | -75 | -83 | -107 |
| 7.0 to < 13.5 | - | -61 | -69 | -77 | -101 |
| 13.5 to < 20.0 | - | -57 | -65 | -73 | -97 |

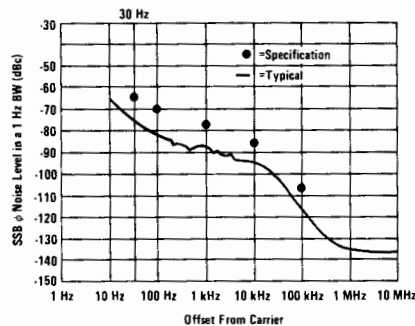

Typical HP 8340A Phase Noise performance from 2.3 to 7.0 GHz.

Typical Residual FM in CW Mode: $< n \times 60$ Hz rms

Typical Residual FM in Swept Mode:

$\Delta F > n \times 5$ MHz: $< n \times 25$ kHz rms.

$\Delta F \leq n \times 5$ MHz: same as CW Mode.

Where n = harmonic multiplication number (1 to 4). Refer to Frequency Bands description above.

RF Output

Output Power Range

HP 8340A Maximum Levelled Power (0°C to +35°C)

| Frequency Range | Specified | Typical |
|----------------------|-----------|---------|
| 0.01 to < 2.3 GHz | +10.0 dBm | +12 dBm |
| 2.3 to < 7.0 GHz | +12.0 dBm | +16 dBm |
| 7.0 to < 13.5 GHz | +10.0 dBm | +12 dBm |
| 13.5 to < 20.0 GHz | + 9.0 dBm | +11 dBm |
| 20.0 to < 23.0 GHz | + 3.0 dBm | + 5 dBm |
| 23.0 to 26.5 GHz | + 1.0 dBm | + 3 dBm |

HP 8341A Maximum Levelled Power (0°C to +35°C)

+10 dBm, 0.01 to 20.0 GHz

Minimum Settable Power: HP 8340A, -110 dBm, 0.01 to 26.5 GHz; HP 8341A, $- 20$ dBm, 0.01 to 20.0 GHz.

RF Off: When the RF key is turned off, the POWER dBm display will read OFF and a 0 dBm signal out of the RF connector will typically be attenuated to a level of < -100 dBm. Additional attenuation of the signal may be achieved by using the internal step attenuator.

Output Power Resolution

ENTRY DISPLAY: 0.05 dB

POWER dBm Display: 0.1 dB

HP 8340A Output Power Accuracy (0°C to +55°C)

| Output Level Range | Frequency Range (GHz) | | |
|----------------------------------|-----------------------|---------------|--------------|
| | 0.01 to < 2.3 | 2.3 to < 20 | 20 to 26.5 |
| +20 to +10 dBm | - | ± 1.8 dB | ± 2.3 dB |
| +10 to -9.95 dBm | ± 0.9 dB | ± 1.5 dB | ± 2.0 dB |
| -10 to -19.95 dBm | ± 1.2 dB | ± 2.0 dB | ± 2.5 dB |
| -20 to -49.95 dBm | ± 1.5 dB | ± 2.3 dB | ± 2.8 dB |
| -50 to -79.95 dBm | ± 1.8 dB | ± 2.6 dB | ± 3.1 dB |
| -80 to -100 dBm | ± 2.1 dB | ± 2.9 dB | ± 3.4 dB |
| -100 to -110 dBm (typically) | ± 2.9 dB | ± 3.7 dB | ± 4.2 dB |

HP 8341A Output Power Accuracy

| Output Level Range | Frequency Range (GHz) | |
|--------------------|-----------------------|--------------|
| | 0.01 to < 2.3 | 2.3 to 20 |
| +20 to -10 dBm | - | ± 1.6 dB |
| +10 to -10 dBm | ± 0.9 dB | ± 1.3 dB |
| -10 to -20 dBm | ± 1.7 dB | ± 2.1 dB |

Accuracy specifications include power level variations with frequency and temperature (i.e. flatness, which is given below).

HP 8340A Flatness (Internally levelled)

| Output Level Range | Frequency Range (GHz) | | |
|----------------------------------|-----------------------|---------------|--------------|
| | 0.01 to < 2.3 | 2.3 to < 20 | 20 to 26.5 |
| +20 to +10 dBm | - | ± 1.2 dB | ± 1.7 dB |
| +10 to -9.95 dBm | ± 0.6 dB | ± 1.1 dB | ± 1.6 dB |
| -10 to -19.95 dBm | ± 0.9 dB | ± 1.6 dB | ± 2.1 dB |
| -20 to -49.95 dBm | ± 1.2 dB | ± 1.9 dB | ± 2.4 dB |
| -50 to -79.95 dBm | ± 1.4 dB | ± 2.2 dB | ± 2.7 dB |
| -80 to -100 dBm | ± 1.7 dB | ± 2.5 dB | ± 3.0 dB |
| -100 to -110 dBm (typically) | ± 1.9 dB | ± 3.1 dB | ± 3.6 dB |

HP 8341A Flatness (internally levelled)

| Output Level Range | Frequency Range (GHz) | |
|--------------------|-----------------------|--------------|
| | 0.01 to < 2.3 | 2.3 to 20 |
| +20 to +10 dBm | - | ± 1.0 dB |
| +10 to -10 dBm | ± 0.6 dB | ± 0.9 dB |
| -10 to -20 dBm | ± 0.8 dB | ± 1.5 dB |

Output Level Switching Time: typically < 10 ms to be within ± 0.1 dB of final value with no attenuator change (internal leveling only).

Stability with Temperature: typically ± 0.01 dB/°C.

Output Impedance: 50Ω nominal.

Source SWR (internal leveling only):

Typically $< 1.3:1$, 0.01 to < 2.6 GHz.

Typically $< 1.6:1$, 2.3 to < 18.0 GHz.

Typically $< 2.0:1$, 18.0 to 26.5 GHz. (20.0 GHz for HP 8341A)

Power Sweep

Range:

Displayed: 0 to 40 dB/sweep
Actual: At least 10 dB at any given frequency (at least 20 dB in DECOUPLED mode; see Figure 2 below).

Resolution: 0.05 dB/sweep

Accuracy:

Starting Power Level: Same as Output Power Accuracy Power Sweep Width and Linearity:

Resolution: 0.05 dB/sweep

Slope Compensation

Calibrated Range: 0 to 0.4 dB/GHz

Resolution: 0.001 dB/GHz

External Leveling

XTAL allows the HP 8340A/41A to be externally leveled by crystal detectors of positive or negative polarity.

METER allows power meter leveling with any HP power meter.

Range: 500 μ V (-66 dBV) to 2V (+6 dBV) for **XTAL** or **METER** modes.

Accuracy: leveled voltage is shown in **ENTRY DISPLAY** in dBV. Accuracy of actual voltage at EXT INPUT relative to the displayed value is as follows:
 ± 0.5 dB, ± 0.2 mV.

Loop bandwidth: nominally 30 kHz in **XTAL** mode, 0.7 Hz in **METER** mode.

Input Impedance: nominally 1 M Ω .

Pulse Modulation

Specifications apply only to CW frequencies. Pulse modulation is standard in the HP 8340A and available as option 006 in the HP 8341A.

ON/OFF Ratio: >80 dB.

Rise (T_R) and Fall (T_F) Times: ≤ 25 ns.

Minimum Internally Leveled RF Pulse Width (T_{RF}): ≤ 100 ns.

Minimum Unleveled RF Pulse Width: typically <25 ns.

Pulse Repetition Frequency:

100 Hz to 5 MHz (when internally leveled)

Typically dc to 20 MHz in non-leveled operation

Maximum Peak Power: same as CW and swept modes. See **RF OUTPUT** specifications.

Accuracy of Internally Leveled RF Pulse (V_p) (relative to CW level)

| Pulse Width | Frequency Range (GHz) | | |
|------------------------------|-----------------------|--------------|--------------|
| | 0.01 to 0.4 | 0.4 to <2.3 | 2.3 to 26.5* |
| 100 to <200 ns | — | +3/-0.3 dB | +1.5/-0.3 dB |
| 200 to <500 ns | — | +1.5/-0.3 dB | ± 0.3 dB |
| ≥ 500 ns | — | ± 0.3 dB | ± 0.3 dB |
| 1 to <2 μ s (typically) | +3/-0.3 dB | — | — |
| 2 to <5 μ s (typically) | +1.5/-0.3 dB | — | — |
| ≥ 5 μ s (typically) | ± 0.3 dB | — | — |

*20.0 GHz for HP 8341A opt. 006

Settling Time: Settling time states the typical amount of time needed for the internally leveled RF pulse amplitude to be within 10% of its final value after a change in the pulse amplitude has been initiated. In the HP 8340A/41A, for pulse widths <10 μ s, settling time is the greater of 70 μ s or the time to generate 7 pulses. For pulse widths ≥ 10 μ s, settling time is 70 μ s divided by the duty cycle. Settling time can be reduced by pressing **SHIFT AM**, which effectively increases the ALC bandwidth. **SHIFT AM** also has the effect of causing some degradation in the pulse envelope as well as raising the minimum pulse repetition frequency from 100 Hz to 1 kHz.

Overshoot, Ringing (V_{OR}/V_p): <15% typically.

Pulse Width Compression ($T_V - T_{RF}$): ± 5 ns typically.

Delay Time (T_D): 50 ns typically.

Video Feedthrough (V_F/V_p):

- <100%, 0.01 to <0.4 GHz
- <5%, 0.4 to <2.3 GHz (for output power levels $\leq +8$ dBm)
- <0.2%, 2.3 to 26.5 GHz (20.0 GHz for HP 8341A opt. 006)

Sidebands caused by a pulse input when PULSE is OFF: typically <-50 dBc with a 30 kHz squarewave input from .01 to 7.0 GHz.

Pulse Input: TTL compatible. (Open circuit is TTL high level and keeps RF on). Damage level +12V, -20V.

Pulse Definitions:

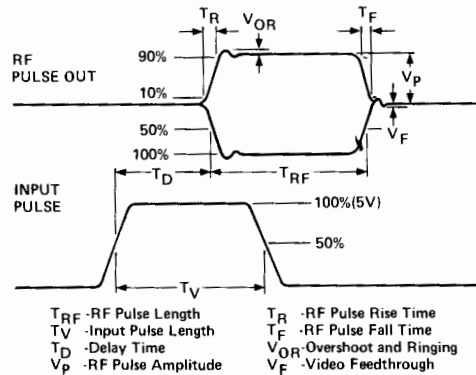

Amplitude Modulation

Specifications below apply when the HP 8340A/41A are internally leveled, for waveforms whose envelope peak is at least 1 dB below maximum specified power.

AM Depth: 0-90%. Actual available depth will be greater than this in many cases and is determined by the difference of the maximum leveled power available at frequency of interest and -30 dBm.

AM Sensitivity: (at a 1 kHz rate and 30% depth) 100%/V $\pm 5\%$. AM depth is linearly controlled by varying input level between 0 and ± 1 V peak. Nominal input impedance is 600 Ω .

AM Bandwidth (30% Depth, PULSE off): dc coupled, 3 dB point >100 kHz.

AM Frequency Response (Flatness) Relative to a 1 kHz Rate at 30% depth (PULSE off): ± 0.20 dB, dc to 10 kHz.

Distortion: typical values are given in Figure 3 below.

Incidental ϕM in Peak Radians (Rates ≤ 10 kHz, 30% Depth): <0.4 typically

Incidental FM: Incidental $\phi M \times$ Modulation Frequency.

AM Input Impedance: nominally 600 ohms.

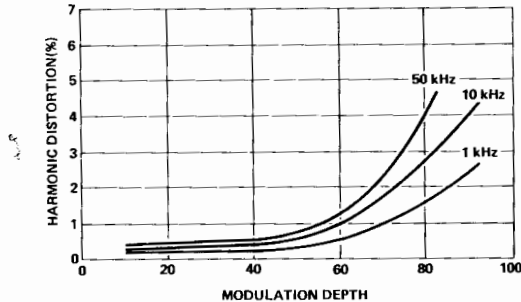

Figure 3. Typical HP 8340A AM distortion for various modulation rates and depths.

Ordering Information

| | | |
|--|--------------|--------------|
| HP 8340A Synthesized Sweeper | Price | \$69,100 |
| Option 001 Front Panel RF Output Without Attenuator | | less \$2,000 |
| Option 004 Rear Panel RF Output With Attenuator | | add \$200 |
| Option 005 Rear Panel RF Output Without Attenuator | | less \$1,800 |
| Option 006 Delete Pulse Modulation | | less \$4,000 |
| Option 007 Relaxed Phase Noise Specifications | | less \$3,500 |
| Option 910 Extra Operating and Service Manual | | add \$400 |
| HP 8341A Synthesized Sweeper | | \$44,000 |
| Option 001 Front Panel RF Output With Attenuator | | add \$2,000 |
| Option 002 +13 dBm Output Power, 2.3 to 18.6 GHz | | add \$4,000 |
| Option 004 Rear Panel RF Output With Attenuator | | add \$2,200 |
| Option 005 Rear Panel RF Output Without Attenuator | | add \$200 |
| Option 006 Pulse Modulation | | add \$4,000 |
| Option 007 Improved Phase Noise Specifications | | add \$3,500 |
| Option 910 Extra Operating and Service Manual | | add \$400 |
| Common Options | | |
| Option 806 Rack Mount Slide Kit | | add \$110 |
| Option 850 HP 8410B/C Interface Cable | | add \$100 |
| Option 908 Rack Flange Kit | | add \$35 |
| Option 913 Rack Flange Kit for Instruments With Front Handles | | add \$40 |
| Option 914 Delete Service Manual | | less \$350 |
| 08340-60134 Support Kit | | add \$650 |

SWEEP OSCILLATORS

Model 8350 Series: 10 MHz to 40 GHz

Model 8350 Series

- Versatile microprocessor-controlled mainframe
- Single-band, straddle-band and broad band plug-ins
- 10 MHz to 40 GHz in two plug-ins
- 10 mW output power to 26.5 GHz
- Total HP-IB programmability

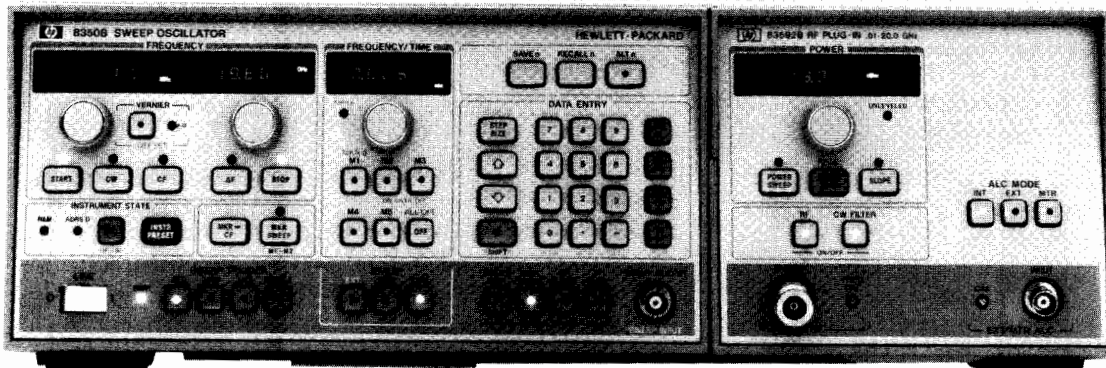

HP 8350B



HP 8350 System

The HP 8350 is a powerful general-purpose source for swept microwave measurements, wideband CW signal generation and automatic testing. It incorporates the efficiency of microprocessor control with state-of-the-art YIG-tuned oscillators and GaAs FET amplifiers to produce a high performance sweep oscillator system ideally suited for either manual or automatic measurements.

You can easily configure a source to meet your application's frequency coverage and power requirements. Just combine the versatile HP 8350 mainframe with any of the 32 standard RF plug-ins (see table at right) and you are ready to make measurements. Both the advanced HP 83500 series plug-ins and the existing HP 86200 series plug-ins (via the HP 11869A adapter) are accepted by the HP 8350 mainframe.

HP 8350 Mainframe

The HP 8350 has been designed to include many features that not only speed and simplify measurements but also improve accuracy. In addition, it is compatible with HP network analyzers, counters, noise figure meters, power meters, and microwave link analyzers to provide complete solutions.

All function values (sweep limit frequencies, marker frequencies, etc.) are indicated on high resolution digital displays. Function values are easily modified using the appropriate knob, step keys, or data entry keyboard.

Five independent, continuously variable markers are available to note your measurement frequencies. The active marker frequency or the difference frequency between any two markers is read easily from high resolution digital display. You can also use marker sweep to zoom in on a particular frequency span while retaining your original sweep limits.

Another particularly useful feature in making repetitive measurements is the HP 8350's Save/Recall Mode. Once the sweeper has been set for a particular measurement, all front panel settings (HP 8350 and HP 83500 series plug-in) can be *Saved* and later *Recalled* to repeat the measurement by accessing one of nine internal storage registers.

In the past, HP-IB programming of sweepers was limited to a series of CW frequencies. With the HP 8350 all front panel functions, e.g. sweeps, markers, sweep time, even output power (HP 83500 series plug-ins) can be programmed. This means there are no limitations in designing your own customized test systems. Utilizing the Learn Mode function, the HP 8350 becomes a "talker" as well as "listener" on the bus, transferring all manually entered front panel controls to the computer.

Full compatibility with both the HP 8510 and the HP 8410C Network Analyzers, the HP 8756A and the HP 8757A Scalar Network Analyzers are provided for convenient vector and scalar measurements with the HP 8350. The HP 5343A Counter can be combined with the HP 8350 to measure Start, Stop, or marker frequencies with up to 100 kHz accuracy while sweeping. Improved frequency accuracy and stability may be achieved by using the HP 5344S Source Synchronizer with the HP 8350 to phase-lock the RF output. Microwave

noise figure measurements may be made using the HP 8350 with the HP 8970A Noise Figure Meter. In addition, the HP 8350B, with an appropriate plug-in driving the HP 8349B microwave amplifier, provides up to +20 dBm of output power across a 2 to 20 GHz range.

HP 83500 Series Plug-Ins

Broadband frequency coverage from 10 MHz to 40 GHz with high output power is provided in the HP 83500 series RF plug-ins. One plug-in, the HP 83595A, operates over the entire 10 MHz to 26.5 GHz range without sacrificing frequency accuracy (± 12 MHz at 26.5 GHz). The HP 83592C, 10 MHz to 20 GHz RF plug-in has -55 dBc harmonics and subharmonics from 2 to 20 GHz. The HP 83550A provides +20 dBm of output power from 8.0 to 18.6 GHz, +18 dBm from 18.6 to 20.0 GHz and also has a built-in source module interface to drive the HP 83550-series millimeter-wave source modules. The 18 GHz to 26.5 GHz band is filled by the HP 83570A RF plug-in and boasts a 10 mW power level (comparable to most BWOs). The millimeter-wave bands are covered by the HP 83550-series millimeter-wave source modules, frequency multipliers that provide coverage in the 26.5 to 40 GHz (HP 83554A), 33 to 50 GHz (HP 83555A), and 40 to 60 GHz (HP 83556A) bands by effectively extending the characteristics of an 11 to 20 GHz microwave source to the millimeter frequency range.

The HP 83500 series plug-ins offer output power level control previously unavailable on a swept source. Power level control is calibrated with 0.1 dB resolution and up to 80 dB range (with Opt 002 attenuator). Calibrated power sweeps are available for characterizing device performance as a function of power. Slope and internal leveling controls are standard on all units. The HP 83500 series plug-ins (except the HP 83572A/B) are also capable of power meter leveling with the HP 432A/B/C, 436A, and 438A power meters.

All HP 83500 series front panel functions are HP-IB programmable including power level. This means your automatic test systems can now characterize a device both as a function of frequency and input power level.

HP 86200 Series Plug-Ins

Simply combining the HP 86200 series plug-in (including the one you may already own) with an HP 11869A Adapter makes all the convenient digital controls, markers, and HP-IB capability of the HP 8350 immediately available to you. The HP 86200 series are a particularly attractive plug-in choice when economical single-band operation is desired with the HP 8350 mainframe. For measurements with HP Microwave Link Analyzers, specially characterized HP 86200 series plug-ins can be used with the HP 8350 to create an upconverter for communications distortion measurements.

The HP 86290B/C plug-ins cover the 2-18 GHz frequency range with 10 mW and 20 mW of output power respectively. Frequency accuracy at 18 GHz is 20 MHz, exceeding that available on most single-band plug-ins. Both HP 83500 series and HP 86200 series plug-ins compatible with the HP 8350 mainframe are summarized in the table below. Note that the HP 11869A Adapter is required with all HP 86200 series plug-ins.



HP 11869A

HP 86290B

HP 83540A



| | HP Model number | Frequency range (GHz) | Leveled power output | Frequency accuracy (MHz) | Complete specifications on page |
|------------------------|-----------------|-----------------------|----------------------|--------------------------|---------------------------------|
| Broad-band Plug-ins | 83595A | 0.01-26.5 | 2.5 mW | ±12 | 504 |
| | 83594A | 2-26.5 | 2.5 mW | ±12 | 504 |
| | 83592A/B | 0.01-20 | 10 mW/20 mW* | ±10 | 504 |
| | 83592C | 0.01-20 | 4 mW | ±10 | 504 |
| | 83590A | 2-20 | 10 mW | ±10 | 504 |
| | 83525A/B | 0.01-8.4 | 20 mW/10 mW | ±12 | 506 |
| | 83522A | 0.01-2.4 | 20 mW | ±5 | 506 |
| | 86222A/B | 0.01-2.4 | 20 mW | ±10 | 518 |
| | 86290B | 2-18.6 | 10 mW | ±30 | 517 |
| 86290C | 2-18.6 | 20 mW | ±30 | 517 | |
| Straddle-band Plug-ins | 83540A/B | 2-8.4 | 40 mW/20 mW | ±12 | 508 |
| | 86240A | 2-8.4 | 40 mW | ±20 | 519 |
| | 86240B | 2-8.4 | 20 mW | ±20 | 519 |
| | 86240C | 3.6-8.6 | 40 mW | ±20 | 519 |
| | 86251A | 7.5-18.6 | 10 mW | ±20 | 519 |
| | 83550A | 8.0-20.0 | 100 mW/50 mW** | ±20 | 508 |
| Single-band Plug-ins | 86220A | 0.01-1.3 | 10 mW | ±10 | 520 |
| | 86235A | 1.7-4.3 | 40 mW | ±20 | 520 |
| | 86241A | 3.2-6.5 | 3.2 mW | ±30 | 520 |
| | 86242D | 5.9-9 | 10 mW | ±35 | 520 |
| | 83545A | 5.9-12.4 | 50 mW | ±20 | 520 |
| | 86245A | 5.9-12.4 | 50 mW | ±40 | 520 |
| | 86250D | 8.0-12.4 | 10 mW | ±40 | 520 |
| | 86260B | 10-15.5 | 10 mW | ±50 | 520 |
| | 86260A | 12.4-18 | 10 mW | ±50 | 520 |
| | 86260C | 17-22 | 10 mW | ±50 | 520 |
| | 83570A | 18-26.5 | 10 mW | ±30 | 510 |
| | 83572A | 26.5-40 | 1.6 mW (Opt 001) | ±100 | 510 |
| | 83572B | 26.5-40 | 4 mW (Opt 001) | ±100 | 510 |

NOTE: The HP 11869A Adapter is required to interface HP 86200 series plug-ins with the HP 8350B mainframe.

*HP 83592B: 20 mW to 18.6 GHz.

**HP 83550A: 100 mW to 18.6 GHz.



SWEEP OSCILLATORS

Model 8350 Series: Mainframe

Model 8350B

- Accurate, high resolution, digital displays
- Five markers with marker Δ and marker sweep
- Save/recall 9 complete front panel states

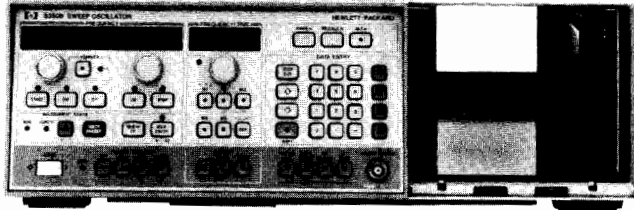

HP 8350B



HP 8350B

Sweep Oscillator applications are greatly enhanced by the features of the HP 8350B. Along with the traditional swept and CW frequency functions, the HP 8350B adds extensive marker capabilities, versatile data entry and complete HP-IB programmability. Besides the popular HP 83500-series RF plug-ins, the HP 8350B also accepts the HP 86200-series plug-ins via the HP 11869A adapter. And the HP 8350B is directly compatible with such measurement systems as the HP 8510A/8410C vector network analyzers and the HP 8756A/8757A scalar network analyzers. Frequency accuracy is easily enhanced by using the HP 5343A counter to count the START, STOP, or ACTIVE MARKER frequencies. For even more frequency accuracy and stability the HP 5344S source synchronizer may be used to phase-lock the RF output.

The HP 8350B has three methods of changing function values: control knobs, keyboard entry, or step key entry.

Five markers are available with the HP 8350B. These markers, combined with the high resolution digital readout, make the accurate location of important frequency responses easy. A key marker feature, marker Δ , computes the difference between any two markers. The markers can modify the center frequency (marker \rightarrow CF) or the START/STOP frequency (Marker Sweep). These expanded marker capabilities simplify sophisticated measurements.

A necessity in making repetitive measurements or automatic tests is the Save/Recall feature. Once the HP 8350B controls have been set for a particular measurement, all of the front panel controls can be "Saved" in a memory location and later "Recalled" when the measurement is repeated. This feature supplies nine memory locations, each storing a complete front panel set-up. Nonvolatile memory is included so that all memories are retained even when line power is removed.

The HP 8350B makes "simultaneous" comparison of two separate frequency ranges or power levels easy via the alternate sweep mode. When the alternate sweep mode is activated, the HP 8350B alternates between the current front panel setting and any stored memory setting on successive sweeps. The output from this function may be processed through a network analyzer such as the HP 8756A or the HP 8757A and viewed on a two channel display.

All front panel controls (except the ac line switch) may be programmed or controlled via the HP-IB. The HP 8350B may interact as a listener or as a talker on the HP-IB. As a talker the HP 8350B is capable of outputting the manually entered front panel information to a controller.

A self test is performed at turn on or whenever the instrument pre-set function is activated. This function verifies that the HP 8350B is functioning properly. If there is a problem, error codes are displayed on the front panel to help locate the problem quickly to the board and component level.

- Accepts all HP 83500 series plug-ins
- Total HP-IB programmability

HP 8350B Specifications

Instrument Control

Control knobs, step keys and data entry keyboard: all instrument parameters whether time, frequency or power may be set three ways: control knobs, keyboard entry, or step keys.

Frequency Control Functions

Range: determined by RF plug-in unit used.

Linearity: refer to RF unit specifications.

START/STOP sweep: sweeps up from the START frequency to the STOP frequency.

CF/ Δ F Sweep: sweeps symmetrically upward, centered on CF.

Δ F: frequency width of sweep continuously adjustable from zero to 100% of frequency range.

Δ F Accuracy: refer to RF unit specifications.

CF Accuracy: refer to RF unit specifications.

CF Resolution: 0.00038% (262,144 points across band).

Δ F Resolution: 0.1% of full band (1024 points across band)

0.012% of band for $1/8$ of band or less

0.0015% of band for $1/64$ of band or less.

Display resolution: 5 digits.

CW operation: single frequency RF output.

CW accuracy: refer to RF unit specifications.

CW resolution: same as CF.

Vernier: adjusts CW frequency or swept center frequency up to 0.05% of RF plug-in band being swept.

Vernier resolution: 4 ppm (64 points between each CW point; 262,144 points across band).

Offset: allows the CW frequency or center frequency to be offset by any amount up to the full range of the plug-in.

Resolution: same as CF.

Accuracy: refer to RF unit specifications.

Frequency markers: five frequency markers are independently adjustable and fully calibrated over the entire sweep range. Amplitude or intensity markers available.

Resolution: 0.4% of selected sweep width (256 points/sweep).

Accuracy: refer to frequency accuracy.

Marker output: rectangular pulse, typically -5 volts peak available from the POS Z BLANK connector on rear panel.

Marker sweep: RF output is swept between Marker 1 and Marker 2.

Marker \rightarrow CF: causes the CW or the swept center frequency to equal the frequency of the active marker.

Sweep and Trigger Modes

Internal: sweep recurs automatically.

Line: sweep triggered by ac power line frequency.

External trigger: sweep is actuated by external trigger signal.

Single: selects mode and triggers a single sweep.

Sweep time: continuously adjustable from 10 ms to 100 seconds.

Manual sweep: front panel controls provide continuous manual adjustment of frequency between end frequencies.

External sweep: sweep is controlled by external signal applied to front or rear panel SWP OUTPUT/SWP INPUT connector.

Sweep output: direct-coupled sawtooth, zero to approximately ± 10 volts, at front or rear panel concurrent with swept RF output.

Instrument State Storage

Save n/recall n: up to 9 different front panel settings can be stored in the HP 8350B via the Save n (n = 1 through 9) function. Settings can be recalled randomly or in sequence.

Alt n: causes the RF output to alternate on successive sweeps between the current front panel setting and a setting stored in memory.

Instrument State

Instrument preset: sets the front panel of the HP 8350B into a pre-determined state. It also causes an internal analog and digital self-test to occur. If internal errors or failures are detected they are indicated via error codes.

Modulation

External AM: refer to RF unit specifications.

Internal AM: square wave modulation available at all sweep speeds. Factory preset to 27.8 kHz although selectable to 1000 Hz or 27.8 kHz. On/off ratio, refer to RF unit specifications.

External FM: refer to RF unit specifications.

Phase-lock: refer to RF unit specifications.

Remote Programming (HP-IB)

The HP 8350B has both input and output capability. The HP-IB address can be displayed on the front panel and is selectable (any number from 0 to 31). All front panel controls except the ac line power switch are programmable.

Frequency resolution: same as CF/ΔF plus vernier.

Power resolution: see HP 83500 Series Plug-ins.

Output mode functions: the HP 8350B can output to a controller an instrument state message that describes the present instrument status.

HP-IB interface functions: SH1, AH1, T6, L4, SR1, RL1, PPO, DC1, DT1, CO, EI.

General Specifications

Nonvolatile memory: continuous memory that retains the contents of all instrument state storage registers, the HP-IB address, and current instrument state when ac line power is off.

Blanking

RF: when enabled, RF turns off during retrace and remains off until next sweep.

Display: POS Z BLANK; direct-coupled rectangular pulse approximately +5.0 volts during retrace and bandswitch points of sweep. NEG Z BLANK; direct-coupled rectangular pulse approximately -5.0 volts coincident in time with RF blanking.

Pen Lift: output to control the pen lift function of XY recorder at end point of sweep.

Counter trigger (CNTR TRIG): output for controlling the external trigger input of the HP 5343A Frequency Counter.

Stop sweep: input for stopping the progress of a forward sweep, used with HP 5343A Frequency Counter.

Program connector: additional control of and information on the HP 8350B instrument state is provided via a 25 pin rear panel connector.

HP 8410C interface cable: permits multi-octave operation of HP HP 8410C Network Analyzer with HP 8350B.

Operating temperature range: 0°C to +55°C.

Power: 100, 120, 220 or 240 volts ±10%, 50 to 60 Hz (Option 400, 60 to 400 Hz). Approximately 270 volt-amperes including RF unit.

Weight (not including RF unit): Net 16.5 kg (36.4 lb). Shipping 22.7 kg (50 lb).

Dimensions: 425 mm wide, 133.3 mm high, 422 mm deep (16.75" x 5.25" x 16.6").

Ordering Information

HP 8350B Sweep Oscillator Mainframe²

Options

| Options | Price |
|--|-------------|
| 400: 400 Hz Power Line Frequency Operation | add \$200 |
| 803: HP 5343A Interface Cables | add \$60 |
| 850: HP 8410C Source Control Cables | add \$100 |
| 908: Rack Mount Kit | add \$32.50 |
| 910: Extra Manual | add \$80 |
| 913: Rack Flange Kit for Instruments with Front Handles | add \$35 |

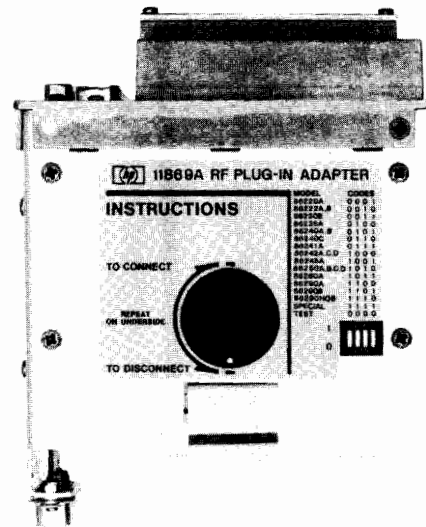

HP11869A

HP 11869A Adapter

The HP 11869A adapter provides the electrical and mechanical interface between the HP 8350 and 86200 series plug-ins. All of the HP 8350's standard operating features, including HP-IB remote programming, are available. However, specific plug-in functions (output power level, RF on/off, etc.) cannot be controlled or remotely programmed by the HP 8350 mainframe.

Plug-ins With Rear Panel RF Output

Option 004 allows the adapter to be used with HP 86200-series plug-ins that are equipped with rear panel RF output.

Plug-ins Compatible With The HP 11869A Adapter

The HP 11869A adapter attaches to the back of the HP 86200 series plug-in and is equipped with a switch for setting the specific interface code for the plug-in being used.

The following plug-ins will operate in the HP 8350 by using the HP 11869A.

| | |
|--------------------------------------|---|
| HP 86220A (0.01-1.3 GHz) | HP 86245A (5.9-12.4 GHz) |
| HP 86222A/B (0.01-2.4 GHz) | HP 86250A/B/C/D (8.0-12.4 GHz) ¹ |
| HP 86230B ¹ (1.8-4.2 GHz) | HP 86251A ³ (7.5-18.6 GHz) |
| HP 86235A (1.7-4.3 GHz) | HP 86260A (12.4-18.0 GHz) |
| HP 86240A/B (2.0-8.4 GHz) | HP 86260B (10.0-15.5 GHz) |
| HP 86240C (3.6-8.6 GHz) | HP 86260C (17.0-22.0 GHz) |
| HP 86241A (3.2-6.5 GHz) | HP 86290A ¹ (2.0-18.0 GHz) |
| HP 86242A/C/D (5.9-9.0 GHz) | HP 86290B/C (2.0-18.6 GHz) |

HP 11869A Adapter

\$405

Options

| | |
|---|-----------|
| 004: Extension Cables for Plug-ins with Rear Panel RF Output | add \$200 |
| 006: Type N Aux Out Interface Connector for HP 86251A and 86290A ¹ /B/C | add \$200 |

¹Models 86230B, 86290A, and 86250A/B/C are obsolete. However, existing models can interface to HP 8350B mainframe via the HP 11869A adapter.

²For transit cases see page 750

³Requires a special PROM for the HP 11869A, which is shipped with every HP 86251A.



SWEEP OSCILLATORS

Model 8350 Series: Broadband RF Plug-Ins

Models 83595A, 83592A/B/C, 83594A, 83590A

- Calibrated output power with 0.1 dB resolution
- +13 dBm from 0.01 to 18.6 GHz
- 12 MHz frequency accuracy at 26.5 GHz

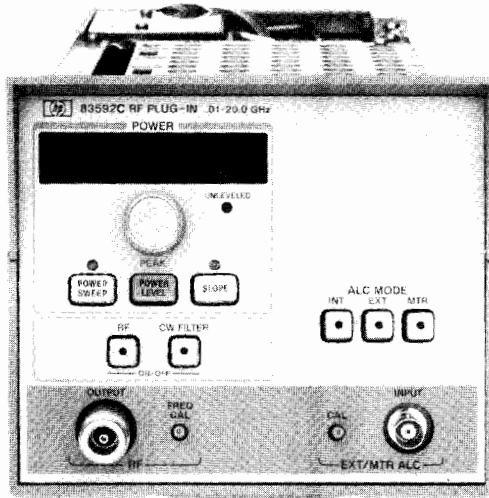

HP 83592C



The six HP 83590 series plug-ins feature wideband frequency coverage as exemplified by the HP 83595A which covers 0.01–26.5 GHz in a single sweep. While the HP 83590 series feature broadband sweeps, they still maintain narrowband precision. The frequency output exhibits excellent stability and accuracy. At 26.5 GHz the HP 83595A maintains an accuracy of ± 12 MHz. The HP 83592B does not sacrifice power for broadband high frequency coverage; the output power is internally leveled for a minimum +13 dBm (to 18.6 GHz) output with ± 0.9 dB flatness. The HP 83592C provides a clean test signal with -55 dBc harmonic and subharmonic levels to maximize dynamic range. Power output capabilities have been expanded to provide power sweep and slope control. In addition, the HP 83590 series plug-ins are completely HP-IB programmable.

The most outstanding feature of the HP 83590 series plug-ins is their broad frequency range. Innovative technology is used to create this precision frequency range. The principle behind this technology is the Switched YIG Tuned Multiplier circuit (SYTM). The YTM circuit uses the output of a fundamental oscillator to drive a high-efficiency multiplier that has been integrated with a tracking YIG filter in order to create and select high order harmonics to be used as output frequencies.

A figure of merit for the HP 83590 series is their flat output power over the entire frequency range. The output power is internally leveled within 0.9 dB for a minimum output power of 10 dBm, with a displayed resolution of 0.1 dB. The power level may be controlled to a minimum settable power level of -5 dBm. This level may be extended to -75 dBm on the HP 83592A/B and HP 83590A with Option 002 (70 dB Step Attenuator) or to -60 dBm on the HP 83592C, the HP 83595A and HP 83594A with Option 002 (55 dB Step Attenuator).

Since power parameters are critical to high frequency measurements, the HP 83590 Series (along with all HP 83500 series plug-ins) offer many modes of power output. In addition to a single power output, the HP 83590 Series offer a Power Sweep function. The Power Sweep function sweeps a power range for characterizing level sensitive devices like amplifiers and transistors. The Slope mode is supplied to provide compensation for cable or test set losses. In all these modes the power output is internally monitored and leveled. If preferred, the power may be externally leveled. The HP 83590 Series plug-ins are capable of power meter leveling with the HP 432A/B/C, 436A, and 438A power meters.

HP-IB programmability is an essential feature when one of the HP 83590 series is used in automatic test systems. For example, the automated tests of amplifiers for gain compression are possible. These plug-ins are completely programmable, which means the power mode may be selected and the power level may be set with .02 dB resolution.

- -55 dBc harmonics and subharmonics from 3.5 to 20 GHz
- Internal leveling and slope standard
- HP-IB

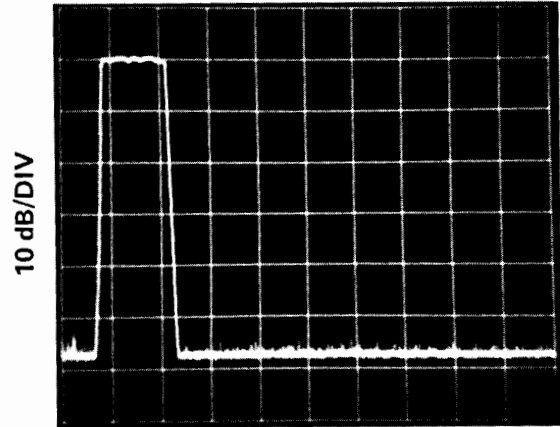

2.0 GHz

1.8 GHz/DIV

20.0 GHz

General Specifications

Sweep time (minimum): 10 ms for a single band (Bands 0, 1, 2, 3, 4). 25 ms for full band (HP 83590A, 83592A/B).

Switch points: HP 83595A, 83592A/B/C: Internal bands are 0.01–2.4 GHz, 2.3–7.0 GHz, 6.9–13.5 GHz, 13.4–20.0 GHz and 19.9–26.5 GHz (HP 83595A only). Broadband switch points are at approximately 2.4 GHz, 7.0 GHz, 13.5 GHz and 20.0 GHz (HP 83595A only). HP 83594A, 83590A: Internal bands are 2.0–7.0 GHz, 6.9–13.5 GHz, 13.4–20.0 GHz and 19.9–26.5 GHz (HP 83594A only). Broadband switch points are at approximately 7.0 GHz, 13.5 GHz and 20.0 GHz (HP 83594A only).

Auxiliary output: HP 83595A, 83592A/B/C: Rear panel 2.3–7.0 GHz fundamental oscillator output, nominally 0 dBm. HP 83594A, 83590A: Rear panel 2.0–7.0 GHz fundamental oscillator output, nominally 0 dBm.

Frequency reference output: (1 V/GHz or 0.5 V/GHz internal switch selectable, rear panel BNC output): HP 83595A, 83592A/B/C: nominal 1 V/GHz (0.01–19 GHz) ± 25 mV; nominal 0.5 V/GHz (full frequency coverage) ± 25 mV. HP 83594A, 83590A: nominal 1 V/GHz (2–19 GHz) ± 25 mV; nominal 0.5 V/GHz (full frequency coverage) ± 25 mV.

RF output connector: HP 83595A, 83594A: Type APC 3.5 male. HP 83592A/B/C, 83590A: Type N female.

Weight: net, 6.0 kg (13.2 lb); shipping, 9.2 kg (20 lb).

Improved Network Measurement Capabilities

These plug-ins are compatible with the:

- HP 8510 Network Analyzer
- HP 8410 Network Analyzer
- HP 8757A Scalar Network Analyzer
- HP 8756A Scalar Network Analyzer
- HP 8970A Noise Figure Meter
- HP 8709A Phase-Lock Synchronizer
- HP 5344S Source Synchronizer

Output Characteristics

Impedance: 50 Ω nominal.

VSWR: <1.9:1

Power Sweep (with option 002 Power Sweep cannot cross an attenuator step)

Calibrated range: HP 83590A, 83592A/B/C: >10 dB (15 dB typical); HP 83594A, 83595A: 9 dB.

Accuracy (including linearity): $<\pm 1.5$ dB typical.

Resolution: 0.1 dB.



Slope Compensation (with option 002 Slope cannot cross an attenuator step).

Calibrated range: up to 0.5 dB/GHz (10 dB over full range).

Linearity: <0.3 dB typical.

Resolution: 0.1 dB/GHz.

Attenuator Accuracy (\pm dB referenced from the 0 dB setting, HP 83590A, 83592A/B only).

| Frequency Range (GHz) | Attenuator Setting (dB) | | | | | | |
|-----------------------|-------------------------|-----|-----|-----|-----|-----|-----|
| | 10 | 20 | 30 | 40 | 50 | 60 | 70 |
| 0.01-12.4 | 0.6 | 0.7 | 0.9 | 1.8 | 2.0 | 2.2 | 2.3 |
| 12.4-18.0 | 0.7 | 0.9 | 1.2 | 2.0 | 2.3 | 2.5 | 2.8 |
| 18.0-20.0 | 0.9 | 1.5 | 2.5 | 3.0 | 3.2 | 3.3 | 3.5 |

Modulation Characteristics

External AM

Frequency response: typically 100 kHz.

Input impedance: approximately 10 k Ω .

Range of amplitude control: typically 15 dB.

Sensitivity: 1 dB/V typical.

Maximum input: 15 V.

Pulse In (HP 83595A and 83592A/B/C only)

TTL Compatible: Logic high = RF on, logic low = RF off.

0.01 to 20.0 GHz: Squarewave modulation up to 30 kHz.

On/Off Ratio: \geq 30 dB below specified maximum leveled power.

0.01 to 2.5 GHz

Rise/Fall Time: typically 50 ns.

Minimum Pulse Width

Leveled: 1 μ sec.

Unleveled: typically 200 ns.

2.5 to 20 GHz

Rise/Fall Time: typically 10 ns.

Minimum Pulse Width

Leveled: typically 1 μ s.

Unleveled: typically 100 ns.

External FM

Maximum Deviations for Modulation Frequencies

DC to 100 Hz: \pm 75 MHz.

100 Hz to 1 MHz: \pm 7 MHz.

1 MHz to 2 MHz: \pm 5 MHz.

2 MHz to 10 MHz: \pm 1 MHz.

Sensitivity

FM Mode: -20 MHz/V typical.

Phase-lock mode: -6 MHz/V typical.

Input impedance: 2 k Ω nominal.

Frequency response (DC to 2 MHz): \pm 3 dB.

Ordering Information

Price

| | |
|---|-------------|
| HP 83590A 2.0 to 20 GHz RF Plug-in | \$17,700 |
| Option 002: 70 dB Step Attenuator | add \$1,305 |
| Option 004: Rear Panel RF Output | add \$200 |
| HP 83592A 0.01 to 20 GHz RF Plug-in | \$20,500 |
| Option 002: 70 dB Step Attenuator | add \$1,305 |
| Option 004: Rear Panel RF Output | add \$200 |
| HP 83592B 0.01 to 20 GHz (13 dBm) RF Plug-in | \$26,580 |
| Option 002: 70 dB Step Attenuator | add \$1,305 |
| Option 004: Rear Panel RF Output | add \$200 |
| HP 83592C 0.01 to 20 GHz (-55 dBc harmonics) RF Plug-in | \$26,580 |
| Option 002: 55 dB Step Attenuator | \$1,305 |
| Option 004: Rear Panel RF Output | \$200 |
| HP 83594A 2.0 to 26.5 GHz RF Plug-in | \$22,820 |
| Option 002: 55 dB Step Attenuator | add \$1,305 |
| Option 004: Rear Panel RF Output | add \$200 |
| HP 83595A 0.01 to 26.5 GHz RF Plug-in | \$29,085 |
| Option 002: 55 dB Step Attenuator | add \$1,305 |
| Option 004: Rear Panel RF Output | add \$200 |

| | HP 83592A/B/C HP 83590A (excluding Band 0) | | | | | HP 83595A HP 83594A (excluding Band 0) | | | | | |
|---|--|--|--|--|---|--|--|---|---|---|---|
| | Band ^A 0 | Band ^A 1 | Band 2 | Band 3 | Full ^A Band | Band 0 | Band ^A 1 | Band 2 | Band 3 | Band 4 | Full ^A Band |
| | .01-2.4 | 2.4-7.0 | 7.0-13.5 | 13.5-20 | .01-20 | .01-2.4 | 2.4-7.0 | 7.0-13.5 | 13.5-20 | 20-26.5 | .01-26.5 |
| Frequency Characteristics Accuracy: (25°C \pm 5°C) CW Mode: (MHz) Typically: (MHz) All Sweep Modes (100ms Sweep Time): (MHz) Linearity: Typ. (MHz) | \pm 5 \pm 2 \pm 15 \pm 2 | \pm 5 \pm 2 \pm 20 \pm 2 | \pm 10 \pm 3 \pm 25 \pm 4 | \pm 10 \pm 4 \pm 30 \pm 6 | \pm 10 \pm 4 \pm 50 \pm 10 | \pm 5 \pm 2 \pm 15 \pm 2 | \pm 5 \pm 2 \pm 20 \pm 2 | \pm 10 \pm 3 \pm 25 \pm 4 | \pm 10 \pm 4 \pm 30 \pm 6 | \pm 12 \pm 5 \pm 35 \pm 10 | \pm 15 \pm 5 \pm 50 \pm 15 |
| Stability With Temperature: Typically (MHz/°C) With 10% Line Voltage Change: (kHz) With 10 Power Level Change: (kHz) With 3:1 Load VSWR: (kHz) With Time (after 1 hour warmup at the same frequency) Typically (kHz) Residual FM (20 Hz-15kHz bandwidth, peak): (kHz) | \pm 0.2 \pm 50 \pm 200 \pm 100 \pm 100 \pm 100 \pm 100 | \pm 0.2 \pm 50 \pm 200 \pm 100 \pm 100 \pm 100 \pm 100 | \pm 0.4 \pm 100 \pm 400 \pm 200 \pm 200 \pm 200 \pm 200 | \pm 0.6 \pm 150 \pm 600 \pm 300 \pm 300 \pm 300 \pm 300 | \pm 0.6 \pm 150 \pm 600 \pm 300 \pm 300 \pm 300 \pm 300 | \pm 0.2 \pm 50 \pm 200 \pm 100 \pm 100 \pm 100 \pm 100 | \pm 0.2 \pm 50 \pm 200 \pm 100 \pm 100 \pm 100 \pm 100 | \pm 0.4 \pm 100 \pm 400 \pm 200 \pm 200 \pm 200 \pm 200 | \pm 0.6 \pm 150 \pm 600 \pm 300 \pm 300 \pm 300 \pm 300 | \pm 0.8 \pm 200 \pm 800 \pm 400 \pm 400 \pm 400 \pm 400 | \pm 0.8 \pm 200 \pm 800 \pm 400 \pm 400 \pm 400 \pm 400 |
| Output Characteristics Maximum Leveled Power ^B : (mW) (25°C) Opt 002 | 10,(20) ^B 10,(16) ^B | 10,(20), ^A (4) ^C 7,(14) ^B , ^A (3,2) ^C | 10,(20), ^A (4) ^C 6,3,(14) ^B , ^A (2,5) ^C | 10,(2,5) ^C 5,(1,4) ^C | 10,(2,5) ^C 3,2,(1,4) ^C | 10 10 | 10 7 | 10 6.3 | 10 5 | 2.5 1.25 | 2.5 1.25 |
| Power Level Accuracy (Internally Leveled): (dB) Minimum Settable Power: (dBm) With Opt 002 Remote Programming Resolution Displayed: (dB) Settable (dB) | \pm 1.5 -5 -75,(-60) ^E 0.1 .02 | \pm 1.3 -5 -75,(-60) ^E 0.1 .02 | \pm 1.3 -5 -75,(-60) ^E 0.1 .02 | \pm 1.4 -5 -75,(-60) ^E 0.1 .02 | \pm 1.5 -5 -75,(-60) ^E 0.1 .02 | \pm 1.5 -5 -60 0.1 .02 | \pm 1.3 -5 -60 0.1 .02 | \pm 1.3 -5 -60 0.1 .02 | \pm 1.4 -5 -60 0.1 .02 | \pm 1.7 -5 -60 0.1 .02 | \pm 1.8 -5 -60 0.1 .02 |
| Power Variation (Max. Rated Pwr) Internally Leveled: (dB) Externally Leveled (Excludes Coupler/Detector Variation) (For Negative Crystal Detector and Power Meter: (dB) With Temperature: (dB/°C) | \pm 0.9 \pm 2 0.1 | \pm 0.7 \pm 2 0.1 | \pm 0.7 \pm 2 0.1 | \pm 0.8 \pm 2 0.1 | \pm 0.9 \pm 2 0.1 | \pm 0.9 \pm 2 0.1 | \pm 0.7 \pm 2 0.1 | \pm 0.7 \pm 2 0.1 | \pm 0.8 \pm 2 0.1 | \pm 0.9 \pm 2 0.1 | \pm 1.0 \pm 2 0.1 |
| Residual AM in 100 kHz Bandwidth: (dBc) | \pm 50 | \pm 50 | \pm 50 | \pm 50 | \pm 50 | \pm 50 | \pm 50 | \pm 50 | \pm 50 | \pm 50 | \pm 50 |
| Spurious Signals Harmonically Related: (dBc) Typically: (dBc) Non-Harmonics: (dBc) | \pm 25,(20) ^{B,F} \pm 35 ^F \pm 25 | \pm 25, \pm (-55) ^F \pm 40, \pm (-60) ^F \pm 50, \pm (-55) ^F | \pm 25, \pm (-55) ^F \pm 35, \pm (-60) ^F \pm 50, \pm (-55) ^F | \pm 25, \pm (-55) ^F \pm 35, \pm (-60) ^F \pm 50, \pm (-55) ^F | \pm 25 \pm 35 \pm 50 ^G | \pm 25 \pm 35 \pm 40 \pm 45 \pm 50 | \pm 25 \pm 35 \pm 40 \pm 45 \pm 50 | \pm 25 \pm 35 \pm 40 \pm 45 \pm 50 | \pm 25 \pm 35 \pm 40 \pm 45 \pm 50 | \pm 25 \pm 35 \pm 40 \pm 45 \pm 50 | \pm 20 \pm 35 \pm 40 \pm 45 \pm 50 |

^A Band 1 on the HP 83590A and the HP 83594A covers 2.0-7.0 GHz, and Full Band on the HP 83590A and 83594A covers 2-20 GHz and 2-26.5 GHz.

^B HP 83592B only.

^C HP 83592C only.

^D 0.5 dB lower with Opt 004.

^E HP 83592C only; \pm 25 dBc (0.01-1.4 GHz)

\pm 45 dBc (1.4-2.4 GHz)

\pm 50 dBc (2.4-3.5 GHz)

\pm 55 dBc (3.5-7.0 GHz)

^F HP 83592C \pm 35 dBc (0.01-1.4 GHz); \pm 50 dBc (1.4-2.4 GHz)

^G With HP 83592 A/B/C (0.01 - 20GHz): -25 dBc

SWEEP OSCILLATORS

Model 8350 Series: Broadband RF Plug-Ins (cont.)

Models 83522A, 83525A and 83525B

- 10 MHz–2.4 GHz and 10 MHz–8.4 GHz in one continuous sweep
- Calibrated output power
- Power sweep

- 1, 10, and 50 MHz crystal markers
- HP 83525B with < -45 dBc harmonics from 2–8.4 GHz
- Complete HP-IB programmability

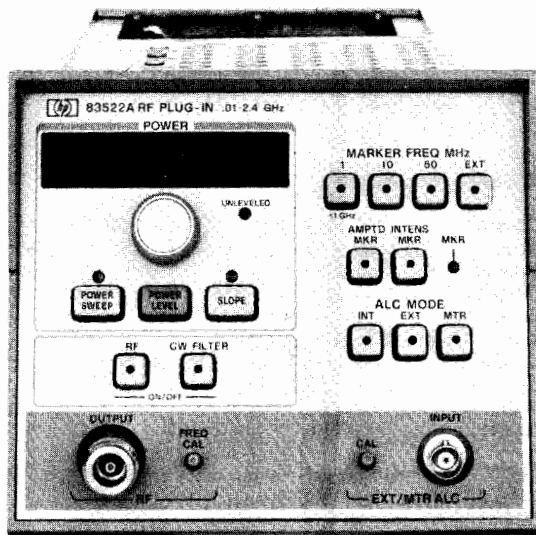

HP 83522A

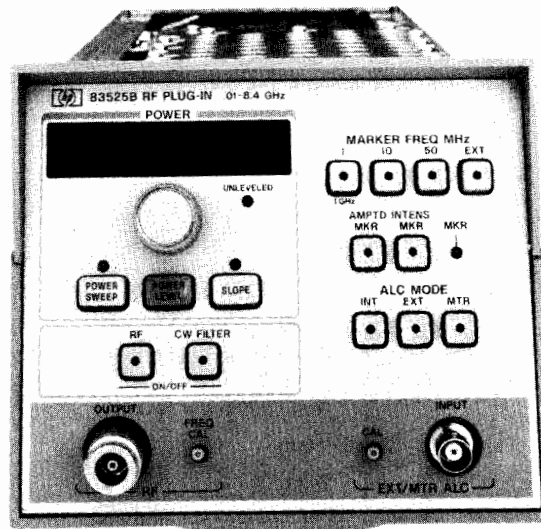

HP 83525B



Broadband frequency measurements may be made with the HP 83522A (10 MHz to 2.4 GHz) plug-in and the HP 83525A/B (10 MHz to 8.4 GHz) plug-in. These plug-ins have similar functions as well as individual merits which are described below.

HP 83522A

The HP 83522A uses a heterodyne circuit to provide high performance 10 MHz to 2.4 GHz frequency coverage. This frequency range is covered in one continuous sweep having excellent frequency characteristics. Frequency accuracy is maintained within 5 MHz and the linearity is within 1 MHz over the full band. The power output is internally leveled to ± 0.25 dB flatness over the entire 10 MHz to 2.4 GHz range while maintaining a power level ≥ 13 dBm.

HP 83525A/B

The HP 83525A/B cover the frequency range of 10 MHz to 8.4 GHz with excellent frequency stability, accuracy, and output power. This wide frequency range is created by automatically switching two bands together with a PIN diode switch. The lower frequency band covers 0.01–2.1 GHz which results from a heterodyne circuit. The upper frequency band is produced by a 2–8.4 GHz YIG oscillator. This 0.1 GHz frequency overlap is provided to enable smooth, narrowband sweeps around the switch point. On a full band sweep (10 MHz to 8.4 GHz) the band discontinuity at the switch point is typically < 8 MHz. The HP 83525A/B maintain excellent frequency parameters with a lower band accuracy within ± 5 MHz and an upper band accuracy within ± 12 MHz. Full band frequency linearity is ± 3 MHz while the lower band maintains a linearity of ± 2 MHz.

The HP 83525A plug-in, with its extremely broad frequency range, does not sacrifice power. This plug-in provides at least +13 dBm of output power while being internally leveled to a flatness of ± 1 dB.

The HP 83525B plug-in provides the same outstanding specifications as the HP 83525A plus 45 dBc harmonics for maximum dynamic range in RF component and system measurements.

HP 83522/83525 Common Features

Crystal Marker Capability

A powerful feature offered by the HP 83522A and the HP 83525A/B is Crystal Marker capability. This capability provides harmonic markers at 10 or 50 MHz intervals over the full range of the HP 83522A and below 2 GHz with the HP 83525A/B. In addition, 1 MHz harmonic markers are available below 1 GHz with all three

plug-ins. These markers may be seen as either intensity spots or amplitude dips. The amplitude markers are compatible with the HP 8756A and 8757A Scalar Network Analyzers. These crystal markers simplify and speed up precision frequency measurements.

Power Output

The HP 83522A and the HP 83525A/B plug-ins have a calibrated output power range of typically 15 dB that may be extended to > 80 dB with Option 002 (70 dB attenuator). The output power level accuracy is within 1 dB on the HP 83522A and within 1.5 dB on the HP 83525A/B. The front panel digital resolution enables the power to be manually set to a 0.1 dB resolution. The power may be remotely HP-IB programmed to 0.02 dB resolution.

In addition to a single power output, these plug-ins offer a Power Sweep function. The Power Sweep function sweeps a power range for characterizing level sensitive devices like amplifiers and transistors. The Slope mode is supplied to provide compensation for cable or test set losses.

Programmability

The HP 83522A and the HP 83525A/B are completely programmable plug-ins. This infers that the power level, power mode (Power Sweep, Slope, etc.), crystal markers and other plug-in functions may be externally controlled via the HP-IB. Programmability is a key feature for automatic test systems or production environments requiring multiple, repetitive tests.

Network Measurements

Increased dynamic range scalar measurements can be made using either the HP 83522A or the 83525A with the HP 8756A or the HP 8757A Scalar Network Analyzer. In the AC detection mode, the dynamic range is increased by internally modulating the RF output with the required 27.8 kHz square wave (produced by the HP 8350). This causes the output to be modulated before it is passed through the output amplifier, thereby avoiding modulation of the amplifier noise. The advantage of increased dynamic range is complemented by the simple interface between the sweep oscillator and the HP 8756/8757A. In addition, these plug-ins are directly compatible with the HP 8510 and the HP 8410s' Network Analyzer, for vector and scalar measurements, the HP 8970A Noise Figure Meter for noise level analysis, and the HP 5344S Source Synchronizer for phase-lock applications.



Frequency Characteristics

| Range | HP 83522A | HP 83525A/B | |
|---|--|--|---|
| | 0.01-2.4 GHz | 0.01-8.4 GHz | |
| | | 0.01-2 GHz | 2-8.4 GHz |
| Accuracy* (25°C ±5°C) CW Mode: Typically: All Sweep Modes Linearity Typically: | ±5 MHz ±1.5 MHz ±15 MHz ±1 MHz | ±5 MHz ±1.5 MHz ±15 MHz ±2 MHz | ±12 MHz ±3.5 MHz ±20 MHz ±3 MHz |
| Stability With Temperature: Typically With 10% Line Voltage Change: With 10 dB Power Level Change: With 3:1 Load SWR: With Time (in 10 minute period after one hour warmup at the same frequency setting): Typically Residual FM (20 Hz-15 KHz Bandwidth), peak: | ±200 kHz/°C ±20 kHz ±100 kHz ±10 kHz ≤±100 kHz ≤5 kHz | ±200 kHz/°C ±20 kHz ±100 kHz ±10 kHz ≤±100 kHz ≤5 kHz | ±200 kHz/°C ±20 kHz ±100 kHz ±1 MHz ±250 kHz ≤±200 kHz ≤7 kHz |

Output Characteristics

| | HP 83522A | HP 83525A/B | |
|--|--|--|---|
| | 0.01-2.4 GHz | 0.01-2 GHz | 2-8.4 GHz |
| Maximum Leveled Output Power (25°C ± 5°C) With Option 002 | +20 mW +20 mW | +20 mW +20 mW | +20 mW/10 mW +20 mW/10 mW |
| Power Level Accuracy (Internally Leveled): Attenuator Accuracy (per 10 dB step, typical): Calibrated Range: With Option 002: Resolution (displayed): Remote Programming (Settable): | ±1 dB ±0.3 dB 15 dB 85 dB 0.1 dB ±0.01 dB | ±1.5 dB ±0.3 dB 15 dB 85 dB 0.1 dB ±0.01 dB | ±1.5 dB ±0.3 dB 15 dB 85 dB 0.1 dB ±0.01 dB |
| Power Variation (Max. Rated Pwr) Internally Leveled: Externally Leveled (Excludes Coupler/Detector Variation) For Negative Crystal Detector and HP 432A/B/C Power Meter: With Temperature: | ±0.25 dB ≤±0.1 dB ±0.02 dB/°C | ±1 dB ≤±0.1 dB ±0.02 dB/°C | ±1 dB ≤±0.1 dB ±0.02 dB/°C |
| Residual AM in 100 kHz Bandwidth: | <-50 dBc | <-50 dBc | <-50 dBc |
| Spurious Signals Harmonics (for 10 mW output pwr): Typical: Non-Harmonics: Typical: | <-25 dBc <-30 dBc <-25 dBc <-30 dBc | <-25 dBc** <-30 dBc <-30 dBc <-35 dBc | <-25 dBc/ 45 dBc <-30 dBc/50 dBc <-60 dBc <-60 dBc |
| Output VSWR (internally leveled) | <1.5 | <2.0 | <1.6 |

Unleveled indicator: lights when RF power level is set too high to permit leveling over sweep range selected.

Impedance: 50 Ω nominal

Power Sweep

Calibrated range: 15 dB

Accuracy (including linearity): <±1.5 dB typical

Resolution: 0.1 dB

Slope Compensation

Calibrated range: up to 5 dB/GHz (10 dB over full range, typically 15 dB)

Linearity: <0.2 dB typical

Resolution: 0.01 dB/GHz

Modulation Characteristics

External AM

Frequency response: 100 kHz typically

Input impedance: Approximately 10 kΩ

Range of amplitude control: 15 dB typically

Sensitivity: 1 dB/V typically

Maximum input: 15 V

Pulse modulation: (HP 83525A/B, 2-8.4 GHz)

Rise/fall time: 20 ns typically

Minimum pulse width: Leveled: 1 μs (HP 83525A), 5 μs (HP 83525B) typically
Unleveled: 100 ns typically

*When calibrated using internal crystal markers and FREQ CAL adjustment.

**83525A harmonics <- 20 dBc for 20 mW output power.

Internal AM

Selectable (by internal jumper in HP 8350) to 1 kHz or 27.8 kHz square-wave modulation. 27.8 kHz modulation guarantees operation with HP 8755 Frequency Response Test Set.

On/Off Ratio: ≥30 dB (>40 dB above 2 GHz)

External FM

Maximum Deviations for Modulation Frequencies

DC to 100 Hz: ±7.5 MHz

100 Hz to 1 MHz: ±7 MHz

1 MHz to 2 MHz: ±5 MHz

2 MHz to 10 MHz: ±1 MHz

Sensitivity

FM Mode: -20 MHz/V typical

Phase-lock mode: -6 MHz/V typical

Input impedance: 2 kΩ nominal

Frequency response (dc to 2 MHz): ±3 dB

Crystal Marker Capability

Internal crystal markers: Harmonic markers of 10 and 50 MHz are available over the full range of the HP 83522A and below 2 GHz with HP 83525A/B. 1 MHz harmonic markers are available below 1 GHz with the HP 83522A and 83525A/B. Markers are output as intensity spots through the POS Z BLANK connector on the HP 8350 or as amplitude dips on the RF output.

Accuracy of center frequencies (25°C): ±5 x 10⁻⁶

Typical Marker Width Around Center Frequency

1 MHz Markers: ±100 kHz

10 MHz Markers: ±200 kHz

50 MHz Markers: ±300 kHz

Temperature stability: ±2 x 10⁻⁶/°C typical

External marker input: generates amplitude or Z-axis marker when sweep frequency equals external input frequency.

Frequency range: .01 to 2.4 GHz (2.0 GHz for HP 83525A/B)

Marker width: ±300 kHz

Marker indicator light: LED lights when coincident with crystal or external marker for accurate CW calibration.

General Specifications

Sweep Time (minimum over full band)

HP 83522A (.01-2.4 GHz): 10 ms

HP 83525A/B (.01-8.4 GHz): 17 ms

Switch points (HP 83525A/B only): low band .01-2.1 GHz, high band 2.0-8.4 GHz. Internal band switch point at 2.0-2.1 GHz.

Frequency reference output: nominal 1 V/GHz (over full sweep range); ±10 mV rear panel BNC output.

RF Output connector: type N female

Weight: net, 4.5 kg (10 lb); shipping, 7.7 kg (17 lb)

Improved Network Measurement Capabilities

The HP 83522A and 83525A/B are compatible with the:

HP 8510 Network Analyzer

HP 8410 Network Analyzer

HP 8757A Scalar Network Analyzer

HP 8756A Scalar Network Analyzer

HP 8970A Noise Figure Meter (frequencies >2 GHz)

HP 8709A Phase-lock Synchronizer

HP 5344S Source Synchronizer

Ordering Information

HP 83522A (+13 dBm) .01-2.4 GHz RF Plug-in

Price

\$8,170

Options

002: 70 dB Step Attenuator

add \$1,005

004: Rear Panel RF Output

add \$200

HP 83525A (+13 dBm) .01-8.4 GHz RF Plug-in

\$13,540

HP 83525B (+10 dBm) .01-8.4 GHz RF Plug-in

\$15,540

Options

002: 70 dB Step Attenuator

add \$1,105

004: Rear Panel RF Output

add \$200



SWEEP OSCILLATORS

Model 8350 Series: RF Plug-Ins

Models 83540A, 83540B, 83545A, and 83550A

- HP 83540A: 40 mW internally leveled 2–8.4 GHz output
- HP 83545A: 50 mW internally leveled 5.9–12.4 GHz output
- HP 83540B: <−45 dBc harmonics 2–8.4 GHz output
- HP 83550A: 100 mW internally leveled 8–18.6 GHz output, built in source module interface
- Calibrated output power with 0.1 dB resolution
- Power sweep
- Complete HP-IB programmability

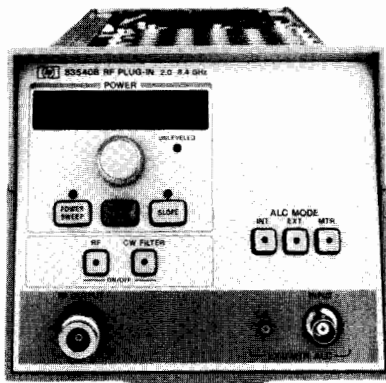

HP 83540B

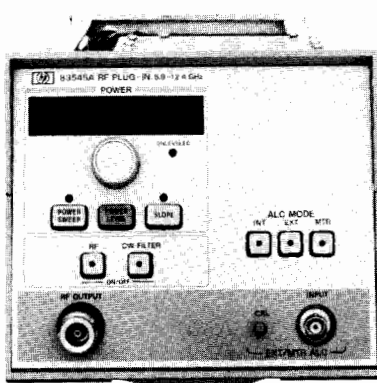

HP 83545A



HP 83550A



HP 83540A/B

High power, high performance, straddle band frequency coverage from 2–8.4 GHz is provided by the HP 83540 plug-ins. The output power is leveled at a minimum of +16 dBm from the HP 83540A and +13 dBm from the HP 83540B with variations less than ± 1 dB. The calibrated power output range is 15 dB which may be extended to >80 dB with Option 002 (70 dB step attenuator). These plug-ins also feature power sweep which allows real time power response measurements to be made in a single test. Another power function is slope compensation which adjusts for high frequency cable or test set losses. All plug-in features are completely HP-IB programmable. The frequency outputs are accurate to $< \pm 15$ MHz while maintaining a full band linearity typically within 0.1%. In addition to its sweeper functions, the HP 83540 is also directly compatible with the HP 8756A and 8757A scalar network analyzers and the HP 8510 and HP 8410C vector network analyzers.

The HP 83540B gives emphasis to signal purity with 45 dBc harmonics for extended dynamic range in precision RF scalar measurement systems.

HP 83545A

The HP 83545A plug-in features high performance 5.9–12.4 GHz frequency coverage with exceptionally high output power. The output power is internally leveled to at least +17 dBm, with power variations less than ± 0.6 dB. The calibrated output power has a range of 15 dB that is expandable to >80 dB with option 002 (70 dB step attenuator). A power sweep function is available for power response measurements. In addition, the HP 83545 provides slope compensation and complete HP-IB programmability. The frequency output is accurate to ± 20 MHz with excellent stability and linearity (typically 0.1%). Network analysis is simplified since the HP 83545 provides 27.8 kHz internal modulation for direct compatibility with the HP 8756A and 8757A scalar network analyzers and it is also directly compatible with the HP 8510 and 8410C network analyzers.

HP 83550A

The HP 83550A is a new, high power 8.0–20.0 GHz plug-in that provides +20 dBm of output power to 18.6 GHz and +18 dBm of output power from 18.6 to 20.0 GHz. This high output power is internally leveled with variations of less than ± 1.25 dB. The output power has a range of at least 18 dB that is expandable to >68 dB with option 002 (50 dB step attenuator) and the frequency output is accurate to ± 20 MHz.

The HP 83550A is also equipped with a source module interface that allows it to be used as a microwave driver for the HP millimeter-wave source modules. These modules are frequency multipliers that effectively extend Hewlett-Packard's microwave sources like the HP 83550A to the millimeter-wave frequency range. Currently these source modules cover the 26.5–40.0 GHz (HP 83554A), the 33.0–50.0 GHz (HP 83555A), and the 40.0–60.0 GHz (HP 83556A) millimeter-wave frequency bands. The HP 83550A is the perfect microwave driver for these source modules as it can directly supply the +17 dBm of output power from 11 to 20 GHz these source modules need and also supplies the DC bias and control signals through the source module interface.

The HP 83550A is directly compatible with the HP 8756A and 8757A scalar network analyzers and the HP 8510A and 8410C vector network analyzers.

General Specifications

RF output connector: type N female

Sweep time (minimum over full band): 10 msec

Weight: HP 83540A/B, HP 83545A, HP 83550A: net, 4.5 kg (10 lb); shipping, 7.7 kg (17 lb)

Improved Network Measurement Capabilities

The HP 83540A/B, 83545A, and 83550A are compatible with the:

- HP 8510 Vector Network Analyzer
- HP 8410 Vector Network Analyzer
- HP 8755 Scalar Network Analyzer
- HP 8756A Scalar Network Analyzer
- HP 8757A Scalar Network Analyzer
- HP 8970A Noise Figure Meter
- HP 8709A Phase-lock Synchronizer
- HP 5344S Source Synchronizer



Frequency Characteristics

| | HP 83540A | HP 83540B | HP 83545A | HP 83550A |
|--|--|--|---|--|
| Range: | 2-8.4 GHz | 2-8.4 GHz | 5.9-12.4 GHz | 8-20 GHz |
| Accuracy (25°C + 5°C) CW Mode: Typical: All Sweep Modes (for sweep times >100 msec): | ±15 MHz ±3.5 MHz ±20 MHz | ±12 MHz ±3.5 MHz ±20 MHz | ±20 MHz ±10 MHz ±35 MHz | ±20 MHz — ±50 MHz |
| Stability With Temperature: With 10% Line Voltage Change: With 10 dB Power Level Change: With 3:1 Load SWR Change: With Time: (in 10 minute time period after one hour warmup at the same frequency setting: Residual FM: (20 Hz-15 kHz bandwidth) peak | ±200 kHz/°C ±20 kHz ±1 MHz ±250 kHz ±200 kHz <9 kHz | ±200 kHz/°C ±20 kHz ±1 MHz ±250 kHz ±200 kHz <7 kHz | ±1.2 MHz/°C ±40 kHz ±1.5 MHz ±250 kHz ±200 kHz <15 kHz | ±1 MHz/°C ±150 kHz* ±500 kHz ±500 kHz ±1 MHz* <25 kHz |

Output Characteristics

| | | | | |
|--|--|--|--|--|
| Maximum Leveled Power: (25°C+5°C) | >40 mW | >20 mW | >50 mW | >100 mW, 8-18.6 GHz >60 mW, 18.6-20 GHz |
| With Opt. 002 | >32 mW | >16 mW | >40 mW | >50 mW, 8-18.6 GHz >30 mW, 18.6-20 GHz |
| Power Variation (at max rated power) Internally Leveled: Unleveled: Typically Externally Leveled (Excluding coupler and detector variations): Crystal Detector or Power Meter: Power Level Accuracy: Option 002: (at 0 dB attenuator step) Power Sweep Calibrated Range: Accuracy (including linearity): typical Resolution: Slope Compensation Calibrated Range (max): Maximum Allowable Power Difference: Linearity: Typical Resolution: | <±1 dB <±2 dB <±0.1 dB <±1.5 dB <±1.7 dB >15 dB ±1.5 dB 0.1 dB 5 dB/GHz 10 dB <0.2 dB 0.01 dB | <±1 dB <±2 dB <±0.1 dB <±1.5 dB <±1.7 dB >15 dB ±1.5 dB 0.1 dB 5 dB/GHz 10 dB <0.2 dB 0.01 dB | <±0.6 dB <±3 dB <±0.1 dB <±1 dB* <±1 dB* >15 dB ±1.5 dB 0.1 dB 5 dB/GHz 10 dB <0.2 dB 0.01 dB | <±1.25 dB — <±0.1 dB* <±1.5 dB <±1.7 dB >18 dB ±1.5 dB 0.1 dB 5 dB/GHz 18 dB — 0.01 dB |
| Spurious Signals: (Below fundamental at specified max power) Harmonically Related: Non-Harmonics: Source VSWR: 50 ohms nominal impedance Internally leveled: Unleveled: Typically Residual AM in 100 kHz Bandwidth: | <-20 dBc <-60 dBc <1.6 <2.5 <-50 dBc | <-45 dBc <-60 dBc <1.6 <2.5 <-50 dBc | <-17 dBc, 5.9-7 GHz <-30 dBc, 7-12.4 GHz <-60 dBc <1.6 <2.5 <-50 dBc | <-15 dBc, 8-11 GHz <-20 dBc, 11-20 GHz <-50 dBc <2.5 <3.8, 8-11 GHz <3.2, 11-20 GHz <-50 dBc |
| Modulation Characteristics External FM Maximum Deviations DC to 100 Hz: 100 Hz to 1 MHz: 1 MHz to 2 MHz: 2 MHz to 6 MHz: 6 MHz to 10 MHz: Sensitivity: Nominal FM Mode: Phase-lock Mode: | ±75 MHz ±7 MHz ±5 MHz ±1 MHz ±1 MHz -20 MHz/V -6 MHz/V | ±75 MHz ±7 MHz ±5 MHz ±1 MHz ±1 MHz -20 MHz/V -6 MHz/V | ±75 MHz ±7 MHz ±5 MHz ±1.5 MHz ±1.5 MHz -20 MHz/V -6 MHz/V | ±75 MHz ±13.5 MHz ±13.5 MHz ±13.5 MHz — -20 MHz/V -6 MHz/V |
| External AM Input Impedance: nominal Frequency Response: Typical Range: Typical Pulse Modulation Rise/Fall Time: Typical Minimum Pulse Width Leveled: Typical Unleveled: Typical Square Wave Response On/Off Ratio: Typical Symmetry: Typical | 33 kohms 100 kHz 15 dB 20 nsec 1 usec 100 nsec >30 dB 40/60 | 33 kohms 100 kHz 15 dB 20 nsec 5 usec 100 nsec >30 dB 40/60 | 33 kohms 100 kHz 15 dB 15 nsec 1 usec 100 nsec >40 dB 40/60 | 33 kohms 100 kHz 20 dB 25 nsec 1 usec 25 nsec >30 dB 45/55 |
| Internal AM Selectable to 1 kHz or 27.8 kHz square wave On/Off Ratio: | >30 dB | >30 dB | >30 dB | >30 dB |

*Denotes typical values

Ordering Information

| | | |
|------------------------------------|--------------|--|
| HP 83540A 2-8.4 GHz Plug-in | Price | |
| 002: 70 dB Step Attenuator | \$9,780 | |
| 004: Rear Panel RF Output | add \$1,105 | |
| 004: Rear Panel RF Output | add \$200 | |
| 910: Extra Manual | add \$40 | |
| HP 83540B 2-8.4 GHz Plug-in | \$10,280 | |
| 002: 70 dB Step Attenuator | add \$1,105 | |
| 004: Rear Panel RF Output | add \$200 | |
| 910: Extra Manual | add \$40 | |

HP 83545A 5.9-12.4 GHz Plug-in

| | |
|-----------------------------------|-------------|
| 002: 70 dB Step Attenuator | \$9,780 |
| 004: Rear Panel RF Output | add \$1,105 |
| 910: Extra Manual | add \$200 |
| | add \$40 |

HP 83550A 8-20 GHz Plug-in

| | |
|-----------------------------------|-------------|
| 002: 50 dB Step Attenuator | \$15,000 |
| 004: Rear Panel RF Output | add \$1,305 |
| 006: Rear Panel AUX OUT | add \$200 |
| 910: Extra Manual | add \$450 |
| | add \$40 |



SWEEP OSCILLATORS

Model 8350 Series: RF Plug-Ins (cont.)

Models 83570A, 83572A and 83572B

- HP 83572B offers 5 mW minimum unlevelled 26.5-40 GHz output
- HP 83570A offers 10 mW internally leveled 18-26.5 GHz output
- HP 83570A offers low frequency auxiliary output for easy counting and phase-locking
- Calibrated output power with 0.1 dB resolution
- Power sweep
- Complete HP-IB programmability

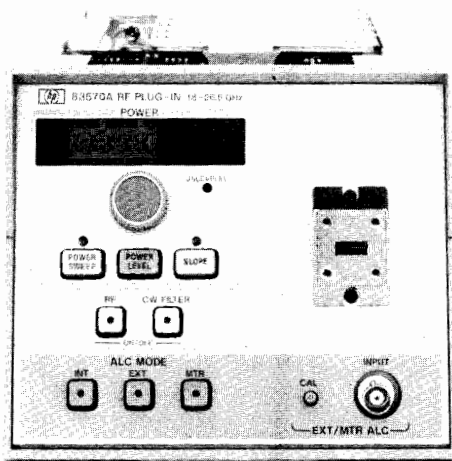

HP 83570A

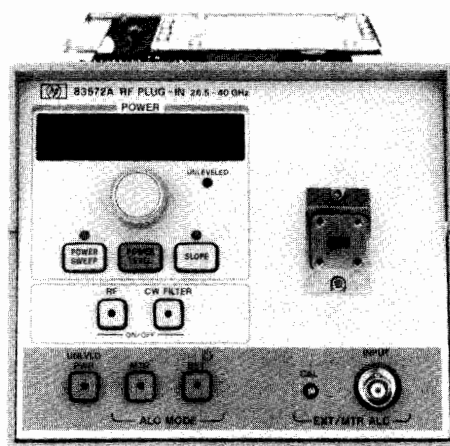

HP 83572A

HP 83570A

Now precision measurements to 26.5 GHz are possible with the solid state HP 83570A plug-in. The HP 83570A plug-in maintains a minimum leveled output power of 10 dBm which is comparable to the output power of Backward Wave Oscillators. Power is internally leveled to a flatness ± 1.4 dB. At the output, power losses are minimized with a waveguide output connector (a coaxial output connector may be made using the HP K281C adapter). Full range coverage of the HP 83570A extends from 18 GHz to 26.5 GHz. This frequency range maintains a 30 MHz frequency accuracy and 0.1% linearity. With high frequency coverage, complete HP-IB programmability and outstanding leveled output power, the HP 83570A plug-in, combined with the many features of the HP 8350 mainframe adds a new dimension to microwave measurements above 18 GHz.

The output power has a calibrated range of 11 dB which can be extended with external attenuators such as the HP 8495K. The power level may be manually set to a 0.1 dB resolution, or the power level may be remotely HP-IB programmed to a 0.02 dB resolution. In addition to a single output power, the HP 83570A also has a power sweep function. This function sweeps the power from one level to another. Another important feature that the HP 83570A offers is slope compensation. This compensates for high frequency power losses in external tests by attenuating the power at lower frequencies.

Scalar measurements at high frequencies may be easily made since the HP 83570A provides internal 27.8 kHz modulation required to interface with the HP 8756A or the HP 8757A Scalar Network Analyzer in the AC detection mode. In addition to simplifying the interface circuitry, internal modulation reduces connection losses which are critical at high frequencies.

The high output power and HP-IB programmability also make the HP 83570A ideal for use with the HP 8410 Network Analyzer and HP K8747A Test Set when making vector network measurements from 18 to 26.5 GHz. The +10 dBm output power is required for proper operation of HP K8747A mixers.

HP 83572A/B

The HP 83572A/B RF Plug-in extends the frequency coverage from 26.5 GHz to 40.0 GHz. The plug-ins offer minimum unlevelled output power of 7 dBm (HP 83572B), and 3 dBm (HP 83572A) for maximizing the dynamic range of passive device measurements. Option 001 provides 6 dBm (HP 83572B), and 2 dBm (HP 83572A) calibrated externally leveled output power for regulated power control during swept and CW operations. The HP 83572 offers 100 MHz frequency accuracy and 0.2% linearity. With high frequency coverage, complete HP-IB programmability and outstanding leveled output power, the HP 83572 plug-ins extend the HP 8350 mainframe capabilities above 26.5 GHz.

The output power has calibrated range of 7 dB (HP 83572A) and 11 dB (HP 83572B). The power level may be manually set to a 0.1 dB resolution, or it may be remotely HP-IB programmed to a 0.01 dB resolution. The HP 83572 also features Power Sweep which allows real time power response measurements of active devices. Another important feature is slope compensation which compensates for system/cable losses at high frequencies.

Scalar measurements at high frequencies may be easily made since the HP 83572 provides internal 27.8 kHz modulation (Option 006) required to interface with the HP 8756A or the HP 8757A Scalar Network Analyzer in the AC detection mode. In addition to amplifying the interface circuitry, internal modulation reduces connection losses which are critical at high frequencies.

The high output power and HP-IB programmability also make the HP 83572 ideal for use with the HP 8410 Network Analyzer and HP R8747B Test Unit when making vector network measurements from 26.5 to 40.0 GHz.

Output Characteristics

RF Power Leveling

Unleveled: selected by front panel switch; refer to chart for figures. Standard for HP 83572A/B.

Internal: selected by front panel switch; refer to chart for figures. Standard for HP 83570A.

External

Crystal detector: approximately -10 to -200 mV for specified leveling at rated output; for use with negative polarity detectors such as HP 422 Series Crystal detectors.

Calibrated crystal detector (option 001): approximately -10 to -200 mV for specified leveling at rated output; for use with negative polarity detectors such as HP 422 Series Crystal detectors. SHIFT DET switch selects internal calibration for an external coupler, a crystal detector, and a BNC cable, all included in Option 001 of HP 83572.

Power meter input: switch selects proper compensation for HP 432A/B/C Power Meters.

Indicator: front panel indicator lights when RF power becomes unleveled. Residual AM in 100 kHz Bandwidth: <-50 dBc.

Impedance: 50 Ω nominal

Power Sweep

Calibrated range

HP 83570A: ≥ 11 dB.

HP 83572A/B (option 001 only): ≥ 7 dB, typical.

Accuracy: ± 1.5 dB typical.

Resolution: 0.1 dB

Slope compensation

Calibrated range

HP 83570A: up to 5 dB/GHz (10 dB max, typically 11 dB).

HP 83572A/B (option 001 only): Up to 5 dB/GHz (7 dB max).

Linearity: < 0.2 dB.

Resolution: 0.1 dB/GHz

General Specifications

Sweep Time (minimum over full band)

HP 83570A (18-26.5 GHz): 10 ms

HP 83572A/B (26.5-40.0 GHz): 10 ms.

RF Output Connector

HP 83570A type WR42 waveguide.

HP 83572A/B type WR28 waveguide.

Auxiliary output: (HP 83570A) real panel 9-13.25 GHz fundamental oscillator output, nominally 0 dBm.

Weight: net 5.4 kg (12 lbs). Shipping 8.7 kg (19 lbs).

Improved Network Measurement Capabilities

The HP 83570A is Compatible with the

HP 8756A Scalar Network Analyzer**

HP 8757A Scalar Network Analyzer**

HP 5344S Source Synchronizer

HP 8410 Network Analyzer using the K8747A Test Set

The HP 83572A/B are Compatible with the

HP 8756A Scalar Network Analyzer**

HP 8757A Scalar Network Analyzer**

HP 8410 Network Analyzer using the R8747B Test Set

Ordering Information

HP 83570A 18-26.5 GHz RF Plug-in (Internal leveling standard) **Price** \$11,985

HP 83572A 26.5-40.0 GHz RF Plug-In \$14,540

Opt 001: Calibrated External Leveling add \$1,605

Opt 006: Internal Pulse and Square Wave Modulation capability add \$1,805

HP 83572B 26.5-40.0 GHz RF Plug-in \$17,500

Opt 001: Calibrated External Leveling add \$1,600

Opt 006: Internal Pulse and Square Wave Modulation capability add \$1,800

Frequency Characteristics

| | HP 83570A | HP 83572A/B |
|--|-------------|-------------|
| Range | 18-26.5 GHz | 26.5-40 GHz |
| Accuracy (25°C ± 5°C) | | |
| CW Mode: | ± 30 MHz | ± 100 MHz |
| Typical: | ± 20 MHz | ± 20 MHz |
| All Sweep Modes: | ± 55 MHz | ± 150 MHz |
| Linearity typically: | ± 15 MHz | ± 50 MHz |
| Stability | | |
| With Temperature: | 800 kHz/°C | ± 8 MHz/°C |
| With 10% Line Voltage Change: | ± 80 kHz | ± 1 MHz |
| With 10 dB Power Level Change: | + 1 MHz | ± 200 kHz |
| With 3:1 Load SWR: | ± 500 kHz | ± 100 kHz |
| With Time: (in 10 minute time period after one hour warmup at the same frequency setting, typical) | ± 400 kHz | ± 4 MHz |
| Residual FM: (in 20 Hz-15 kHz bandwidth, CW mode): | < 30 kHz | < 60 kHz |

Output Characteristics

| | | |
|---|------------|-------------------|
| Maximum Leveled Power (25°C ± 5°C): | > 10 mW | > 2 mW (5 mW)* |
| Minimum Unleveled Power (25°C ± 5°C): | | 1.0 dB less |
| Opt. 001 (at output of external leveling coupler): | | 1.5 dB less |
| Opt. 006 (at waveguide output of plug-in): | | |
| Power Level Accuracy: Typical | | |
| Internally leveled: | ± 1.8 dB | ± 1.5 dB |
| Externally Leveled (Opt. 001): | | ± 1.5 dB |
| Resolution (displayed): | 0.1 dB | 0.1 dB |
| Remote Programming (settable) | ± 0.01 dB | ± 0.01 dB |
| Power Variation (At max. rated power) | | |
| Internally Leveled: | < ± 1.4 dB | < ± 3 dB |
| Unleveled: Typically | < ± 2 dB | |
| Externally Leveled (Excluding coupler and detector variation): | | |
| Crystal Detector or Power Meter | < ± 0.1 dB | < ± 0.2 dB |
| Spurious Signals: (Below fundamental at specified maximum power) | | |
| Harmonically Related: | < -25 dBc | < -50 dBc |
| Non-Harmonics: | < -50 dBc | < -50 dBc |
| Source VSWR: 50 Ω nominal impedance | | |
| Internally leveled: | < 2.5 | < 1.5 |
| Externally leveled (Opt. 001) | | |
| Modulation Characteristics | | |
| External FM | | |
| Maximum Deviations for Modulation Frequencies | | |
| DC to 100 Hz: | ± 75 MHz | ± 150 MHz |
| 100 Hz to 200 kHz: | | ± 3.5 MHz |
| 100 Hz to 1 MHz: | ± 7 MHz | |
| 1 MHz to 2 MHz: | ± 5 MHz | |
| 2 MHz to 10 MHz: | ± 1.5 MHz | |
| Sensitivity: Nominal | | |
| FM Mode: | -20 MHz/V | -20 MHz/V |
| Phase-lock Mode: | -6 MHz/V | -6 MHz/V |
| External AM | | |
| Frequency Response: | | |
| Typically | 100 kHz | 10 kHz |
| Range of Amplitude Control (typically) | | |
| Internally Leveled: | 11 dB | - |
| Option 001 (externally leveled): | - | 7 dB (11 dB)* |
| Unleveled: | - | 30 dB |
| Sensitivity: | 1 dB/V | 1 dB/V (Opt. 001) |
| Input Impedance: Approx. | 30 kΩ | 30 kΩ |

Internal Square Wave Modulation (Option 006 of HP 83572A/B) 1 kHz or 27.8 kHz square wave modulation selectable by internal jumper in HP 8350B. The 27.8 kHz modulation ensures operation with Hewlett-Packard scalar network analyzers.

On/Off Ratio: > 25 dB > 20 dB
Symmetry: 40/60 45/55

| External Pulse and Square Wave Modulation*** | | |
|--|---------|-----------|
| Pulse Input: TTL compatible | | |
| Rise/Fall Time: | 20 ns | 300/50 ns |
| Minimum RF Pulse: Width (Typically) | | |
| Internally Leveled: | 1 us | - |
| Unleveled: | 100 ns | 500 ns |
| Modulation Rate: | - | 0.5-1 MHz |
| On/Off Ratio: | > 25 dB | > 26 dB |

*HP 83572B only

**Requires HP 83572A/B Option 006

***HP 83572A/B Option 006, unleveled output



SWEEP OSCILLATORS

Model 8350 Series: Millimeter-Wave Source Modules

Models 83554A, 83555A and 83556A

- 26.5 to 60 GHz frequency range
- Internally-leveled high output power
- Can be driven by many HP microwave sources
- Source module remotable up to a meter length
- Low entry cost

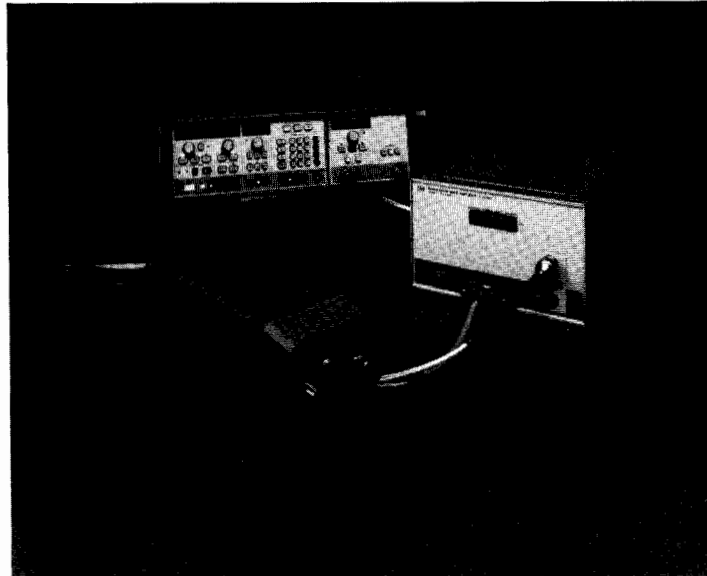

HP 83550 Series Millimeter-wave Source Modules

The three HP 83550 series millimeter-wave source modules provide a simple approach to extend the frequency range of 11 to 20 GHz sources to cover 26.5 to 40 GHz (HP 83554A), 33 to 50 GHz (HP 83555A) and 40 to 60 GHz (HP 83556A) bands. The HP 83550 series source modules offer internally-leveled high output power, full waveguide band frequency coverage, and the high frequency accuracy and resolution of the driving microwave source.

As shown in Figure 1, there are two basic ways of configuring a millimeter-wave source to best suit your specific needs. Your choice can range from a sweep oscillator (HP 8350B/83550A) to a sophisticated synthesized sweeper (HP 8341A/8349B).

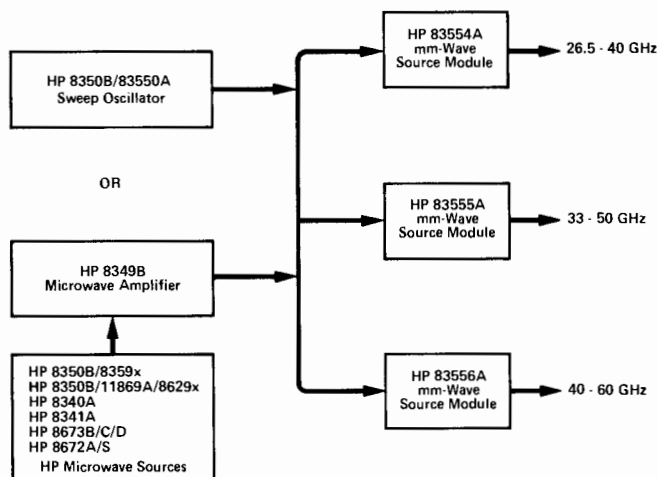

Frequency Precision and Spectral Purity

An advantage of using frequency multiplication to generate millimeter-wave signals is that the module output translates many of the capabilities and features of the microwave source driver. The frequency accuracy and resolution are multiplied by a factor of two

or three depending on whether the drive frequency is doubled or tripled. For example, a millimeter-wave source based on the HP 8341A/8349B will have frequency resolution of 6 Hz from 26.5 to 40 GHz, and 9 Hz from 33 to 50 GHz.

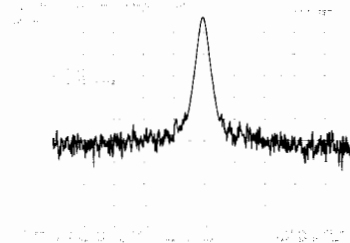

Spectrum Analyzer Photo of HP 8340A/8349B/83556A Signal at 50 GHz.

The HP 83550 series source modules offer harmonic and sub-harmonic suppression of < -30 dBc in the 26.5 to 40 GHz band and < -20 dBc from 33 to 50 GHz and 40 to 60 GHz bands. The high stability and low phase noise characteristics of the HP 8340A/41A or HP 8673/72 synthesizers (combined with the required HP 8349B amplifier) are also essentially translated through the source modules and are available for a variety of signal simulation applications.

High Output Power

Internally-leveled output power from the source modules is rated at +8 dBm for the HP 83554A, +5 dBm for the HP 83555A and +3 dBm for the HP 83556A. This high output power can permit the source module to serve as a mixer LO in some applications, and also expands the available dynamic range in frequency response measurements.

Pulse, AM and FM Modulation

The high performance pulse modulators of the HP synthesized sources offer > 80 dB ON/OFF ratio and < 25 ns (HP 83554A) or < 50 ns (HP 83555A, 83556A) rise and fall times. Pulse amplitudes are leveled for pulse widths as narrow as 1 μ s.

The HP 8340A/41A also feature dc-coupled AM with a 3 dB bandwidth of 100 kHz. Pulse and amplitude modulation can be used to simultaneously simulate antenna scan patterns.

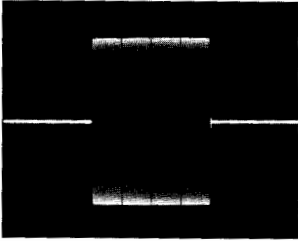

HP 8340A/8349B/83554A Pulse Performance at 35 GHz. Pulse width = 5 μ s.

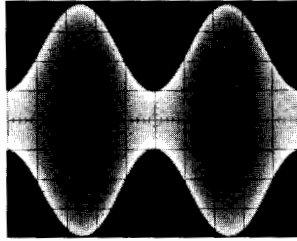

HP 8341A/8349B/83554A AM Performance at 30 GHz. AM rate is 17 kHz and depth is 70%.

FM rates between 100 Hz and 10 MHz may be applied to the HP 8673/72 synthesizer input to achieve deviations up to 20 MHz (HP 83554A) and 30 MHz (HP 83555A, 83556A) at millimeter-wave frequencies.

Operational Simplicity

Simple front panel operations let you enter a display multiplier, so that the actual output frequency of the source module may be entered and displayed directly on the microwave source driver. The output power of the source module is displayed on the HP 83550A or the HP 8349B power display (depending on your millimeter-wave source configuration) and can be controlled again from the microwave driver.

In addition, the small size of the HP 83550-series source modules allows you to use them even on a crowded benchtop. Two flexible cables (a source module interface cable and an RF cable) are provided with the source modules to connect the microwave source driver to the source module. These cables permit you to place the source module up to 1 meter from the driving source. This allows you to bring your source to your test system instead of the other way around.

This combination of performance and versatility, plus total HP-IB programmability (via the microwave source driver), makes the HP millimeter-wave sources ideal in many automatic test or bench applications.

All at a Lower Cost

The HP 83550-series source modules combines performance and quality with a low cost of entry. This is possible because the source modules are backward-compatible with existing HP microwave sources. Thus, you can generate a full waveguide band of millimeter-wave frequencies for just the cost of the HP 8349B and a source module. Also, the cost of ownership to you is reduced even further by the two-year warranty on the microcircuits of the HP 83550-series source modules and the HP 8349B microwave amplifier.

HP 8340A/41A, 8673B/C/D, 8672A/S Synthesizer Sources Related Specifications

Frequency

Resolution: 2 (HP 83554A) or 3 (HP 83555A, 83556A) times the resolution of the input frequency

Accuracy: Same as time base.

Time Base: Internal 10 MHz time base. Aging rate: less than 1×10^{-9} /day and 2.5×10^{-7} /year after 30 day warm-up (HP 8340A/41A only); less than 5×10^{-10} /day after a 24-hour warm-up (HP 8673/72 only).

Spectral Purity

Single-Sideband Phase Noise: Same as input signal plus 6 dB (HP 83554A) or 10 dB (HP 83555A, 83556A)

Pulse Modulation (HP 8340A/41A and 8673B/C/D only)

ON/OFF Ratio: Typically > 80 dB.

Minimum Uneveled RF Pulse Width: Typically < 100 ns.

Amplitude Modulation (HP 8340A/41A and 8673B/C/D only)

Rates (3 dB BW): Typically DC to 100 kHz (HP 8340A/41A only); Typically 20 Hz to 100 kHz (HP 8673B/C/D only).

Sensitivity: Typically 30%/V (HP 8673B/C/D only) and 100 %/V.

Frequency Modulation (HP 8673B/C/D and 8672A/S only)

Maximum Deviations: Follows input with 2 (HP 83554A) or 3 (HP 83555A, 83556A) times the deviation.

Output Sensitivity: 2 (HP 83554A) or 3 (HP 83555A, HP 83556A) times the input sensitivity.

HP 8350B/83550A, 8350B/83590-series Related Specifications

Frequency

Resolution: 2 (HP 83554A) or 3 (HP 83555A, 83556A) times the resolution of the input frequency

Accuracy and Stability: 2 (HP 83554A) or 3 (HP 83555A, 83556A) times the accuracy and stability of the input frequency

Pulse Modulation

ON/OFF Ratio (Typically): > 60 dB (83550A).

Minimum Uneveled RF Pulse Width: Typically < 100 ns.

Amplitude Modulation

Rates (3 dB BW): Typically DC to 100 kHz.

Sensitivity: Typically 1 dB/V.

Frequency Modulation

Maximum Deviations: Follows input with 2 (HP 83554A) or 3 (HP 83555A, 83556A) times the deviation.

Output Sensitivity: 2 (HP 83554A) or 3 (HP 83555A, HP 83556A) times the input sensitivity.

HP 83554A Output Characteristics

| | HP 8350B/83550A | HP 8350B/ 83590 Series/8349B | HP 8340A/8349B, HP 8341A/8349B | HP 8673B/C/D/8349B, HP 8672A/S/8349B | HP 8350B/11869A/ 86290B/C/8349B |
|--|---|--|---|---|------------------------------------|
| Maximum Levelled Power (25°C±5°C) | +8 dBm, 26.5-37.2 GHz +7 dBm, 37.2-40.0 GHz -10 dBm | +8 dBm, 26.5-37.2 GHz +7 dBm, 37.2-40.0 GHz -5 dBm | +8 dBm, 26.5-37.2 GHz +7 dBm, 37.2-40.0 GHz -10 dBm | +8 dBm, 26.5-37.2 GHz +7 dBm, 37.2-40.0 GHz -10 dBm | +8 dBm, 26.5-37.2 GHz |
| Minimum Settable Power: | | | | | 0 dBm |
| Power Level Accuracy ¹ (25°C±5°C) | | | | | |
| Internally Levelled: | ±1.75 dB | ±1.75 dB | ±1.75 dB | ±1.75 dB | ±1.75 dB |
| Power Flatness (at max levelled power) | | | | | |
| Internally Levelled: | ±1.25 dB | ±1.25 dB ² | ±1.25 dB | ±1.25 dB ³ | ±2.5 dB ² |
| Source Output VSWR | | | | | |
| Internally Levelled: | <1.9 | <1.9 | <1.9 | <1.9 | <1.9 |
| Uneveled: Typically | <3.0 | <3.0 | <3.0 | <3.0 | <3.0 |
| Spectral Purity Specifications | | | | | |
| Spurious Signals (expressed in dB relative to the carrier level (dBc)). | | | | | |
| Harmonically related spurious: | <-30 dBc | <-30 dBc | <-30 dBc | <-30 dBc | <-30 dBc |
| Non-harmonically related spurious: | <-50 dBc | <-50 dBc | <-50 dBc | <-50 dBc | <-50 dBc |

¹Specified with respect to HP 83550A or HP 8349B power display. Includes power level flatness.

²1V/GHz output must be changed to 0.5V/GHz. Refer to HP Service Notes 8359x-8, 86290B-5 and 86290C-4.

³To achieve specified performance the existing units may need modifications. (Consult your local HP Sales or Service Office for further information).

MM-Wave Source Modules

Models 83554A, 83555A and 83556A

| HP 8355 Series Output Power Specifications | HP 8350B/83550A | HP 8350B/ 83590 Series/8349B | HP 8340A/8349B HP 8341A/8349B | HP 8673B/C/D/8349B, HP 8672A/S/8349B | HP 8350B/11869A/ 86290B/C/8349B |
|--|-----------------|---------------------------------|----------------------------------|---|------------------------------------|
| Maximum Levelled Power (25°C±5°C) | +5 dBm | +5 dBm | +5 dBm | +5 dBm | +5 dBm |
| Minimum Settable Power: | -10 dBm | -5 dBm | -10 dBm | -10 dBm | 0 dBm |
| Power Level Accuracy¹ (25°C±5°C) | | | | | |
| Internally Levelled: | ±2.25 dB | ±2.25 dB | ±2.25 dB | ±2.25 dB | ±2.25 dB |
| Power Flatness (at max levelled power) | | | | | |
| Internally Levelled: | ±1.75 dB | ±1.75 dB ² | ±1.75 dB | ±1.75 dB ³ | ±2.5 dB ² |
| Source Output VSWR | | | | | |
| Internally Levelled: | <1.9 | <1.9 | <1.9 | <1.9 | <1.9 |
| Unlevelled: Typically | <3.0 | <3.0 | <3.0 | <3.0 | <3.0 |
| Spectral Purity Specifications | | | | | |
| Spurious Signals (expressed in dB relative to the carrier level (dBc)). | | | | | |
| Harmonically related spurious: | <-20 dBc | <-20 dBc | <-20 dBc | <-20 dBc | <-20 dBc |
| Non-harmonically related spurious: | <-50 dBc | <-50 dBc | <-50 dBc | <-50 dBc | <-50 dBc |

¹Specified with respect to HP 83550A or HP 8349B power display. Includes power level flatness.

²1V/GHz output must be changed to 0.5V/GHz. Refer to HP Service Notes 8359x-8, 86290B-5 and 86290C-4.

³To achieve specified performance the existing units may need modifications. (Consult your local HP Sales or Service Office for further information.)

| HP 8355 Series Output Power Specifications | HP 8350B/83550A | HP 8350B/ 83590 Series/8349B | HP 8340A/8349B HP 8341A/8349B | HP 8673B/C/D/8349B, HP 8672A/S/8349B | HP 8350B/11869A/ 86290B/C/8349B |
|--|-----------------|---------------------------------|----------------------------------|---|------------------------------------|
| Maximum Levelled Power (25°C±5°C) | +3 dBm | +3 dBm | +3 dBm | +3 dBm | +3 dBm |
| Minimum Settable Power: | -10 dBm | -5 dBm | -10 dBm | -10 dBm | 0 dBm |
| Power Level Accuracy¹ (25°C±5°C) | | | | | |
| Internally Levelled: | ±2.25 dB | ±2.25 dB | ±2.25 dB | ±2.25 dB | ±2.25 dB |
| Power Flatness (at max levelled power) | | | | | |
| Internally Levelled: | ±1.75 dB | ±1.75 dB ² | ±1.75 dB | ±1.75 dB ³ | ±2.5 dB ² |
| Source Output VSWR | | | | | |
| Internally Levelled: | <1.9 | <1.9 | <1.9 | <1.9 | <1.9 |
| Unlevelled: Typically | <3.0 | <3.0 | <3.0 | <3.0 | <3.0 |
| Spectral Purity Specifications | | | | | |
| Spurious Signals (expressed in dB relative to the carrier level (dBc)). | | | | | |
| Harmonically related spurious: | <-20 dBc | <-20 dBc | <-20 dBc | <-20 dBc | <-20 dBc |
| Non-harmonically related spurious: | <-50 dBc | <-50 dBc | <-50 dBc | <-50 dBc | <-50 dBc |

¹Specified with respect to HP 83550A or HP 8349B power display. Includes power level flatness.

²1V/GHz output must be changed to 0.5V/GHz. Refer to HP Service Notes 8359x-8, 86290B-5 and 86290C-4.

³To achieve specified performance the existing units may need modifications. (Consult your local HP Sales or Service Office for further information.)

General Safety Information

Minimum Input Power Level into RF Input Cable: +17 dBm (50 mW)

Maximum Input Power Level into Source Module RF Input Connector: +27 dBm.

Waveguide Output Connector

HP 83554A: EIA size WR 28 waveguide; JAN UG-599 flange.

HP 83555A: EIA size WR 22 waveguide; JAN UG-383 flange.

HP 83556A: EIA size WR 19 waveguide; JAN UG-383 flange.

Weight: Net, 1.7 kg (4 lb).

Dimensions

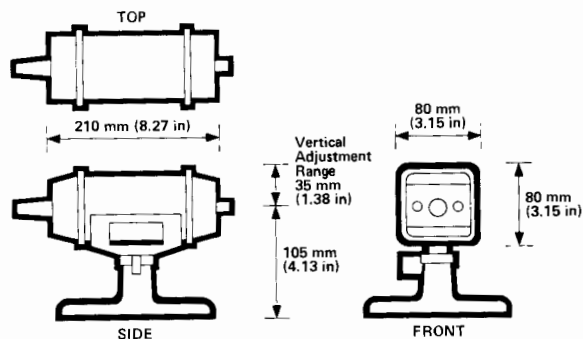

Furnished with Each Source Module: Operating and Service Manual, Type-N RF cable (also available as HP Part No. 5061-5359), Module Base Assembly (also available as HP Part No. 83556-60010).

Optional Accessories

| | |
|---|---------|
| HP 83554A 26.5-40.0 GHz MM-Wave Source Module | \$5,000 |
| Opt 910: Extra Manual | \$1,500 |
| HP 83555A 33.0-50.0 GHz MM-Wave Source Module | \$5,000 |
| Opt 910: Extra Manual | \$1,500 |
| HP 83556A 40.0-60.0 GHz MM-Wave Source Module | \$5,000 |
| Opt 910: Extra Manual | \$1,500 |



HP 8620C with HP 86222B, 86290B

HP 8620 System

The Hewlett-Packard HP 8620 solid state sweeper system offers the flexibility of the HP 8620C mainframe in addition to a choice of singleband, multiband, straddle-band, and broadband plug-ins. The HP 8620 system also offers high output with solid state reliability—greater than 10 mW leveled to 22 GHz.

The fundamental oscillators used in the plug-ins and modules are YIG tuned transistor or bulk effect circuits. YIG tuning results in exceptional tuning linearity, low noise, and low spurious content; it also allows frequency modulation at high rates and wide deviations with low distortion.

The HP 8620C has many features which are highly useful in stringent applications. With convenient functionally grouped controls and lighted pushbutton indicators the mainframe offers extreme ease of operation and flexibility. In addition, it can be a completely HP-IB programmable source, an indispensable feature for automatic systems and signal simulation applications.

HP 86222A/B Plug-In (10 MHz to 18.6 GHz)

Now the 10 MHz to 18.6 GHz frequency range can be covered with just two plug-ins—the HP 86222A/B and 86290B/C. Besides their broad frequency range these plug-ins offer many special features including unique crystal markers in the HP 86222B and better than ± 30 MHz frequency accuracy in a HP 86290B/C even at 18 GHz.

HP 86240A/B Plug-In (2 to 8.4 GHz)

Covering more than an octave of frequencies the HP 86240A/B span 2 to 8.4 GHz and the HP 86251A spans from 7.5 to 18.6 GHz with major advances in power output and signal purity. The HP 86240A offers more than 40 mW while the HP 86251A provides over 10 mW of leveled output across the full band. All three plug-ins deliver a high quality test signal of low harmonic content with the HP 86240B providing harmonics of >45 dBc. This can be very important when making measurements across more than one octave.

HP 86290B/C Plug-In (10 MHz to 22 GHz)

The HP 86200 series of plug-ins covers both ends of the frequency spectrum from 10 MHz to 22 GHz with a choice of more than eleven plug-ins.

Plug-In Choice for HP 8350 Sweep Oscillator

The entire line of HP 86200 series plug-ins can be used in the HP 8350 Sweep Oscillator mainframe by using the HP 11869A Adapter.

TYPICAL UNLEVELED POWER OUTPUT

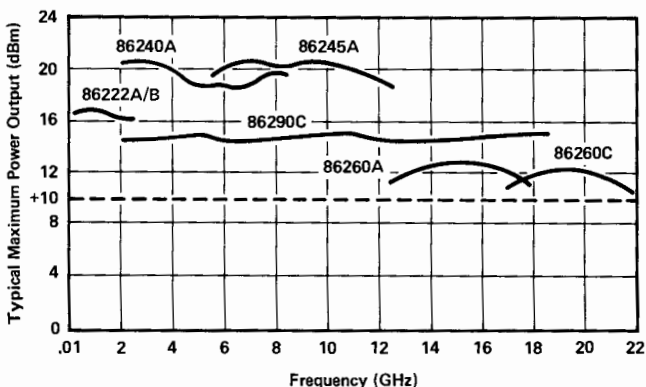

SWEEP OSCILLATORS

Model 8620 Series: Mainframe

Model 8620C

- Optional BCD or HP-IB programming
- 3 markers

- 100% ΔF capability, fully calibrated

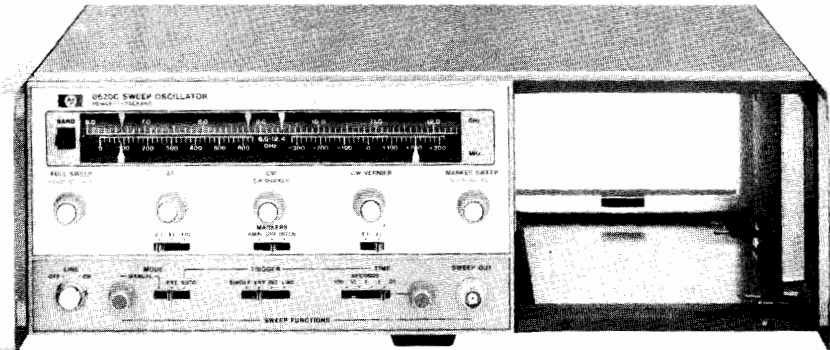

HP 8620C

The HP 8620C offers many features as standard equipment. For example, up to four separate bands and their respective frequency scales can be selected with a band select lever to the left of the dial scale. Pushbuttons, concentrically located in the frequency control knobs, light when actuated to indicate the sweep function in use. The sweep functions available are: FULL SWEEP, MARKER SWEEP, CW/ ΔF and CW. Three markers are available, controlled by the START MARKER, STOP MARKER, and CW MARKER knobs.

The HP 8620C is fully and continuously calibrated for any ΔF sweep width. The sweep is symmetrical about the CW MARKER setting and three continuously variable ΔF ranges are available by using the range switch below the ΔF knob. This allows calibrated sweep widths of up to 1%, 10% or 100% of full band.

When in CW/ ΔF or CW modes, the CW VERNIER knob allows for excellent frequency resolution. In terms of improved frequency resolution the vernier increases the effective length of the dial scale to 7.5 metres (300 inches).

Another feature is the capability to fully program the sweeper. The standard HP 8620C includes inputs for band selection, sweep function selection, and analog frequency control. In addition to this, a more flexible digital frequency programming option is available to control the HP 8620C via the HP-IB (Option 011).

8620C Specifications

Frequency

Frequency range accuracy and linearity: determined by band select lever and RF plug-in installed.

Sweep Functions

FULL SWEEP: sweeps the full band as determined by the plug-in and the band select lever.

MARKER SWEEP: sweeps from START MARKER to STOP MARKER frequency settings: up to the full range of the plug-in can be set to sweep either up or down in frequency.

ΔF Sweep: sweeps symmetrically upward in frequency, centered on CW setting, CW vernier can be activated for fine control of center frequency.

Width: continuously adjustable and calibrated from zero to 1%, zero to 10%, or zero to 100% of frequency band.

CW operations: single-frequency RF output controlled by CW MARKER knob selected by depressing pushbutton in CW MARKER control.

CW vernier: calibrated directly in MHz about CW setting. CW vernier activated by pushbutton in CW vernier control. Zero to $\pm 0.5\%$ or zero to $\pm 5\%$ of full bandwidth, selectable with front panel switch.

Frequency markers: three constant width frequency markers are fully calibrated and independently adjustable over the entire range in FULL SWEEP function, controlled by START MARKER, STOP MARKER, and CW MARKER controls. In ΔF sweep START and STOP MARKERS are available, and in MARKER SWEEP the CW MARKER is available. Front panel switch provides for the selection of either amplitude or intensity markers (amplitude modulating the RF output or Z-axis modulating the CRT display).

Marker output: rectangular pulse, typically -5 volts peak available from Z-axis BNC connector on rear panel. Source impedance, approximately 1000 ohms.

Sweep Modes: auto, manual and external

Sweep time: continuously adjustable from 0.01 to 100 seconds.

Sweep triggers: line, internal, external and single.

Sweep output: direct-coupled sawtooth, zero to approximately +10 volts, at front panel BNC connector, concurrent with swept RF output.

Modulation

External AM, FM and phase-lock capability; internal 1000 Hz square wave AM modulation available.

Remote Control

Remote band select: frequency range can be controlled remotely by three binary contact closure lines available at rear panel connector.

Remote Frequency Programming, Opt 011 (HP-IB) Functions

Band: manual enable or remote control of up to four bands.

Mode: seven modes are selectable, including digital control in three modes with a resolution of 10,000 points.

HP-IB interface functions

SH0, AH1, T0, L2, SR0, RL2, PP0, DC0, DT0, C0, E1.

General

Blanking

RF: with blanking switch enabled, RF automatically turns off during retrace, and remains off until start of next sweep.

Display (Z-AXIS/MKR/PEN LIFT output): direct-coupled rectangular pulse approximately +5.0 volts coincident in time with RF blanking is on rear panel.

Negative (negative blanking output): direct-coupled rectangular pulse approximately -5.0 volts coincident in time with RF blanking.

Pen lift: for use with X-Y recorders having positive power supplies. Transistor-switch signal is available on Z-AXIS/MKR/PEN LIFT connector. This signal is also available on the programming connector.

Furnished: 2.29 m (7½-foot) power cable with NEMA plug and calibration scale. With Option 011, an HP-IB connector/adaptor are included.

Power: 100, 120, 220, or 240 volts +5 –10%, 50 to 400 Hz. Approximately 140 watts.

Weight: (not including RF unit): Net, 11.1 kg (24 lb). Shipping 13.4 kg (30 lb).

Size: 132.6 mm H x 425 mm W x 337 mm D (5.29" x 16.75" x 13.25").

Ordering Information

HP 8620C Sweep Oscillator Mainframe

Opt 011: HP-IB Frequency Programming

Opt 007: Rear Sweep Out

Opt 820: 8410C Interface Cable

Opt 908: Rack Flange Kit

Price

\$3,865

add \$955

add \$75

add \$50

add \$37.50

SWEEP OSCILLATORS

Model 8620 Series: Broadband RF Plug-Ins

Models 86290B and 86290C



- +13 dBm 2 to 18.6 GHz with HP 86290C
- ±30 MHz frequency accuracy at 18.6 GHz

- Compatible with HP 8350 mainframe via HP 11869A adapter

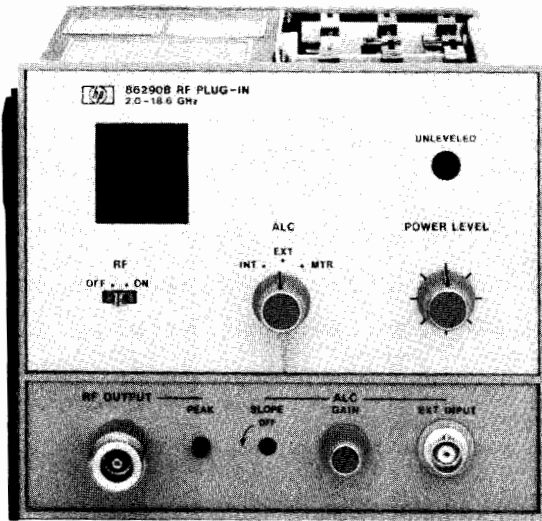

HP 86290B

The HP 86290B/C broadband plug-ins offer a continuous sweep from 2 to 18.6 GHz for broadband swept testing. In addition, higher frequency resolution is achieved by covering the 2 to 18.6 GHz range in three individual bands of 2 to 6.2, 6 to 12.4, 12 to 18.6. The HP 86290C offers outstanding electrical performance, producing >20 mW swept output over the 2 to 18.6 GHz range along with excellent linearity and low spurious and harmonic content. For scalar measurements in the AC detection mode, the 27.8 kHz square wave modulation from the HP 8756 or the HP 8757 Scalar Network Analyzers is accepted directly through the EXTERNAL AM input. When performing phase/amplitude network analysis the interfacing between the sweeper and the HP 8410C Network Analyzer permits the HP 8410C to automatically phase lock over multi-octave sweeps for continuous swept 2 to 18.6 GHz phase and amplitude measurements.

Specifications with Plug-In Installed in an HP 8620C Mainframe

Frequency Characteristics

| | Band 1 | Band 2 | Band 3 | Band 4 |
|---|--------|--------|---------|--------|
| Range: (GHz) HP 86290B/C | 2-6.2 | 6-12.4 | 12-18.6 | 2-18.6 |
| Accuracy (25°C) | | | | |
| CW mode (or >100 ms sweep time): (MHz) | ±20 | ±30 | ±30 | ±100 |
| Remote programming: (typ.) | ±2.5 | ±2.5 | ±3.5 | — |
| All sweep modes: (MHz) | ±30 | ±40 | ±40 | ±80 |
| Marker: (MHz) | ±30 | ±30 | ±30 | ±80 |
| Linearity (MHz) typ.: | ±8 | ±8 | ±8 | ±30 |
| Frequency Stability | | | | |
| With temperature: (MHz/°C) | ±0.5 | ±1.0 | ±1.5 | ±2.0 |
| With 10% line voltage change: (kHz) | ±100 | ±100 | ±100 | ±100 |
| With 10 dB power level change: (MHz) | ±0.6 | ±1.2 | ±1.8 | ±1.8 |
| With 3:1 load VSWR, all phases: (kHz) | ±100 | ±200 | ±300 | ±300 |
| With time (in 10 minute period after 30 minute warmup): typically (kHz) | ±300 | ±600 | ±900 | ±900 |
| Residual FM (20 Hz -15 kHz bandwidth CW mode): (kHz peak) | <10 | <20 | <30 | <30 |

Output Characteristics

Maximum Levelled Power (25°C)

HP 86290B: +10 dBm, (Opt. 004: +9.5 dBm)

HP 86290C: +13 dBm, (Opt. 004: +12.5 dBm)

Power level control range: >10 dB

| | Band 1 | Band 2 | Band 3 | Band 4 |
|--|--------|--------|--------|--------|
| Power Variation (Max Rated Pwr) | | | | |
| Internally levelled: (dB) | ±0.7 | ±0.7 | ±0.8 | ±0.9 |
| Externally levelled (excluding coupler and detector variation) | | | | |
| Crystal detector: -20 to -250 mV for specified leveling at rated output: (dB) | ±0.15 | ±0.15 | ±0.15 | ±0.15 |
| Power meter: internal leveling amplifier with compensation for HP models 432A/B/C provided: (dB) | ±0.15 | ±0.15 | ±0.15 | ±0.15 |
| With temperature, typically (dB/°C) | ±0.1 | ±0.1 | ±0.1 | ±0.1 |

Residual AM in 100 kHz BW: <-55 dBc.

Spurious Signals

Harmonically related signals: <-25 dBc.

Non-harmonics: <-50 dBc.

Impedance: 50Ω nominal.

SWR: <1.9 internally levelled.

RF output connector: type N female.

Modulation Characteristics

External AM

Input impedance: approximately 10kΩ.

Frequency response: typically 100 kHz levelled.

Square Wave Response

On/Off ratio: >30 dB.

Symmetry: 40/60.

Attenuation for +5V input: >30 dB.

Internal AM (1000 Hz)

Square-wave on/off ratio: >25 dB.

RF blanking on/off ratio: >30 dB.

External FM

Maximum Deviations for Modulation Frequencies

DC to 100 Hz: ±75 MHz.

100 Hz to 2 MHz: ±5 MHz.

Sensitivity (typically)

FM mode: -20 MHz/V.

Phase-lock mode: -6 MHz/V.

General

Sweep time (min): 10 ms single bands, 60 ms on 2 to 18.6 GHz band.

Auxiliary output: rear panel 2 to 6.2 GHz fundamental oscillator output, nominally -10 dBm.

Slope control: front panel control allowing compensation for frequency dependent test setup losses.

Peak control: front panel control for peaking power over desired frequency range.

Frequency reference output: nom. 1 V/GHz (2-18.6 volts) ±35 mV rear panel BNC output.

Weight: net, 4.4 kg (9.6 lb); shipping, 5.9 kg (13 lb).

Ordering Information

HP 86290B 2 to 18.6 GHz +10 dBm (10 mW) plug-in \$15,300 (internal leveling standard)

HP 86290C 2 to 18.6 GHz +13 dBm (20 mW) plug-in \$19,810 (internal leveling standard)

Opt 004: rear panel RF output

add \$200



SWEEP GENERATORS

Model 8622A and 8622B RF Plug-ins (cont.)

Models 8622A and 8622B

- 10 MHz to 2.4 GHz CW or continuous swept frequency coverage
- Internally leveled, with 70 dB step attenuator

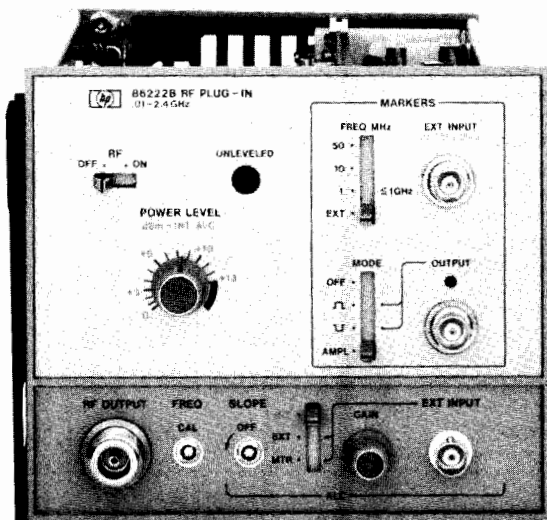

HP 86222B

The HP 86222A and 86222B RF plug-ins can provide CW or continuous swept 10 MHz to 2.4 GHz frequency coverage. Power output is calibrated from 0 to +13 dBm in 1 dB increments with ± 0.25 dB flatness and excellent linearity (2 MHz) over the entire 0.01 to 2.4 GHz range. For applications demanding precise frequency identification, the HP 86222B offers a crystal marker system which provides a comb of markers at 1, 10 or 50 MHz. Markers may be displayed as intensified spots on a CRT or as amplitude dips on the RF output (often useful for XY recordings). In addition, when the output frequency is coincident with a 50, 10 or 1 MHz comb of the internal crystal oscillator, a front panel LED lights for independent CW frequency calibration (75 kHz accuracy at 1 GHz). For scalar measurements in the AC detection mode, the 27.8 kHz square wave modulation from the HP 8756A or the HP 8757A Scalar Network Analyzer is accepted directly through the external AM input. For phase/magnitude network analysis the interfacing between the sweeper and the HP 8410C Network Analyzer permits the HP 8410C to automatically phase-lock over multi-octave sweeps.

Specifications with Plug-in Installed in an HP 8620C Mainframe

Frequency range: 10 MHz to 2.4 GHz

Range: 10 MHz to 2.4 GHz.

Accuracy (25°C)

CW mode: ± 10 MHz.

Remote programming: typically ± 1.5 MHz.

All sweep modes: ± 15 MHz (>100 ms sweep time). Accuracy of HP 86222B may be enhanced to better than ± 200 kHz through use of crystal markers.

Linearity: typically ± 2 MHz.

Stability

With temperature: ± 500 kHz/°C.

With 10% line voltage change: ± 20 kHz.

With 10 dB power level change: ± 100 kHz.

With 3:1 load SWR, all phases: ± 10 kHz.

With time (after 1-hour warm-up): typically ± 100 kHz/10 min.

Residual FM: (20 Hz -15 kHz bandwidth; FM switch in NORM; CW Mode): <5 kHz peak.

Output Power and Leveling

Maximum leveled power (25°C): >20 mW (+13 dBm); typically >+15 dBm.

Power level accuracy (internal leveling only): ± 1 dB.

Attenuator Opt 002: add ± 0.2 dB/10 dB step.

Power Variation (at max. rated power)

Internally Leveled

0.01 to 2.4 GHz: ± 0.25 dB.

Stability with temperature: typically ± 0.02 dB/°C.

- 10 MHz to 2.4 GHz CW or continuous swept frequency coverage
- Internally leveled, with 70 dB step attenuator
- Crystal markers at 1, 10 or 50 MHz
- Square wave modulation from HP 8756A or HP 8757A

Externally Leveled (excluding coupler and detector variation)

Crystal detector: (-10 to -100 mV at rated output): ± 0.1 dB.

Power meter (with HP 432A/B/C series power meters): ± 0.1 dB.

Residual AM in 100 kHz BW: < -50 dBc.

Spurious Signals (below fundamental)

Harmonics: < -25 dBc at +13 dBm; typically < -30 dBc at +10 dBm.

Non-Harmonics

0.01 to 2.3 GHz: < -30 dBc at +13 dBm; typically < -40 dBc at +10 dBm.

2.3 to 2.4 GHz: < -25 dBc at +13 dBm; typically < -35 dBc at +10 dBm.

Broadband noise in 100 kHz bandwidth: typically < -70 dBm.

Impedance: 50 Ω nominal.

SWR: <1.5 internally leveled.

Slope control: allows variable compensation for frequency dependent losses in test set-up.

RF output connector: type N female.

Modulation Characteristics

External AM

Input impedance: approximately 10 k Ω .

Frequency response: typically 150 kHz.

Square Wave Response

On/Off ratio: >30 dB.

Symmetry: 40/60, for > 10 dBm output power.

Attenuation for +6 V input: >30 dB.

Internal AM

1 kHz square-wave On/Off ratio: >30 dB.

RF blanking On/Off ratio: >30 dB.

External FM

Maximum Deviations for Modulation Frequencies

DC to 100 Hz: ± 75 MHz.

100 Hz to 1 MHz: ± 5 MHz.

1 MHz to 2 MHz: ± 2 MHz.

Sensitivity (typically)

FM mode: -20 MHz/V.

Phase-lock mode: -6 MHz/V.

Crystal Markers (available with Model 8622B only)

Internal crystal markers: harmonic markers of 10 and 50 MHz usable over full 0.01 to 2.4 GHz range and 1 MHz markers usable 0.01 to 1 GHz. Positive (+) or negative (-) voltage output pulses can be selected to Z-axis intensify a scope trace; or RF amplitude pips can be selected (at maximum sweep speed, pulse width optimized for approximately 10 markers/sweep).

Accuracy of center frequencies (25°C): $\pm 5 \times 10^{-6}$.

Typical Marker Width Around Center Frequency

1 MHz markers: ± 75 kHz.

10 MHz markers: ± 200 kHz.

50 MHz markers: ± 300 kHz.

Temperature stability: typically $\pm 2 \times 10^{-6}/^\circ\text{C}$.

Marker output

Pos. intensity mode: nominally >3 V.

Neg. intensity mode: nominally -3 to -8 V, internally adjustable.

Amplitude mode: typically 0.5 dB, internally adjustable.

General

Weight: net, 2.5 kg (5.5 lb); shipping, 4 kg (9 lb).

Ordering Information

HP 86222A 0.01-2.4 GHz RF Plug-In (internal leveling standard)

HP 86222B 0.01-2.4 GHz RF Plug-In with Crystal and External Markers (internal leveling standard)

Opt 002: 70 dB Step Attenuator (10 dB steps)

Opt 004: Rear Panel RF Output

Model

86222A

86222B

Opt 002

Opt 004

Weight

Net



Models 86240A, 86240B, 86240C and 86251A

...
...
...
...

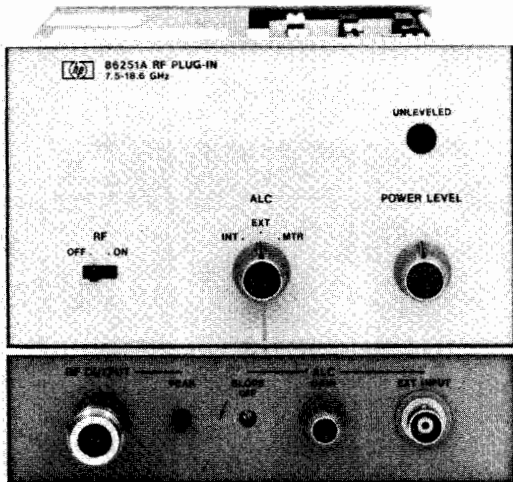

HP 86251A

The HP 86251A excels in meeting the most stringent of swept or CW source requirements for precise Radar and ECM component measurements. Covering the essential frequency bands with one continuous sweep, the HP 86251A is ideal for testing active devices like multioctave TWTs or RF memories as well as passive devices like filters or isolators.

The HP 86240A/B are designed for high power and superior performance with the HP 86240A delivering 40 mW of RF output power and the HP 86240B offering 45 dBc harmonics (typically <- 50 dBc). For precise RF power level control, internal leveling and slope control are also available.

The HP 86240C can be used for MLA Upconverter Simulation as well as a general purpose sweeper. It is optimized for group delay of

less than 1 ns peak-to-peak over 30 MHz, linearity better than 0.5% and power output up to 40 mW. It has 10 MHz FM bandwidth, flat to ± 1.5 dB for noise loading applications, power control and internal leveling. For further information on MLA Upconverter Simulation refer to the Telecommunications Test Equipment section on page 165.

Specifications
with Plug-In Installed in an HP 8620C Mainframe

- Frequency:** ...
- Linearity:** typically $\pm 0.1\%$.
- Residual FM** (in 20 Hz -15 kHz bandwidth, FM switch in NORM, CW Mode): <9 kHz peak, <30 kHz peak for HP 86251A.
- Reference output:** dc-coupled voltage proportional to RF frequency, voltage approximately 1 V/GHz.
- Internal Leveling:** selected by front panel switch; refer to RF plug-in specifications.
- Source SWR:** 50 Ω nominal impedance.
- Internally leveled:** <1.6 SWR for HP 86240. <1.9 SWR for HP 86251A.
- Unleveled:** typically 3 SWR.
- RF output connector:** type N female.

- External FM** (maximum deviation for modulation frequencies)
 - DC to 100 Hz:** ± 100 MHz
 - 90 kHz to 10 MHz:** ± 1.5 MHz
 - Frequencies response, dc to 10 MHz:** ± 1.5 dB
 - Nominal Sensitivity**
 - FM mode:** +20 MHz/volt
 - Upconverter mode:** +20 MHz/volt

General:
Weight: Net, 2.3 kg (5 lb); shipping, 3.2 kg (7 lb) for HP 86240A/B/C. Net, 4.4 kg (9.6 lb); shipping, 5.9 kg (13 lb) for HP 86251A.

- Options:**
- 002:** 70 dB Step Attenuator (HP 86240A/B/C only)
- 004:** Rear Panel RF Output

| | HP 86240A | HP 86240B | HP 86240C | HP 86251A |
|--|--------------------------------|-----------------|--------------------------------|-------------|
| FREQUENCY | | | | |
| Frequency Range (GHz): | 2.0-8.4 | 2.0-8.4 | 3.6-8.6 | 7.5-18.6 |
| Frequency Accuracy: (25°C) | | | | |
| CW Mode (MHz) | ± 25 | ± 25 | ± 25 | $\pm 60^1$ |
| CW Remote Programming typically (MHz): | ± 3.5 | ± 3.5 | ± 3.5 | |
| All Sweep Modes (for sweep time > 100 ms) (MHz): | ± 40 | ± 50 | ± 35 | ± 60 |
| POWER OUTPUT | | | | |
| Maximum Leveled Power (25°C) (mW): | >40 | >20 | >40 | >10 |
| With Option 002 (mW): | >40 | >20 | >40 | |
| Power Variation: (At Max Rated Power) | | | | |
| Unleveled (Typically) (dB): | < ± 6 | < ± 6 | < ± 6 | < ± 5 |
| Internally Leveled: | < ± 2 | < ± 2 | < ± 2 | < ± 0.8 |
| Externally Leveled (Excluding Coupler and Detector Variation) Crystal Detector and Power Meter (dB): | < ± 0.1 | < ± 0.1 | < ± 0.1 | ± 0.15 |
| Spurious Signals: (dB below fundamental at specified maximum power) | | | | |
| Harmonics: | <-20 (@20 mW) <-16 (@40 mW) | <-45 (Typ <-50) | <-20 (@20 mW) <-16 (@40 mW) | <-40 |
| Nonharmonics: | <-60 | <-60 | <-60 | <-50 |
| Plug-in: | | | | |

¹CW mode installed in HP 8350 mainframe or remote programming in HP 8620C: ± 20 MHz.

SWEEP OSCILLATORS

Model 8620 Series: Single Band RF Plug-Ins

Model 86200 Series and 11869A Adapter

- 10 MHz to 22 GHz coverage
- >50 mW from 5.9 to 12.4 GHz
- Compatible with HP 8350 mainframe via HP 11869A adapter

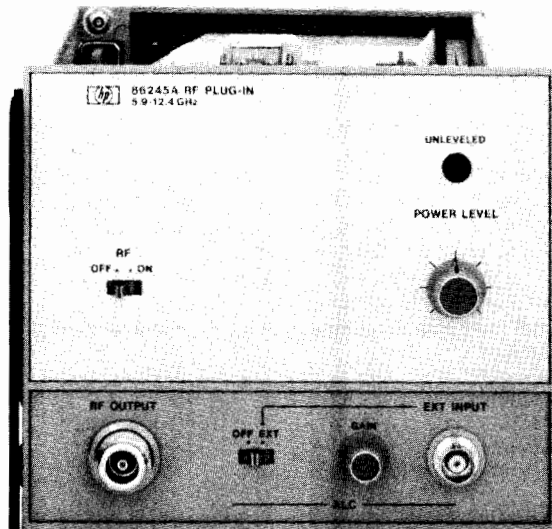

HP 86245A

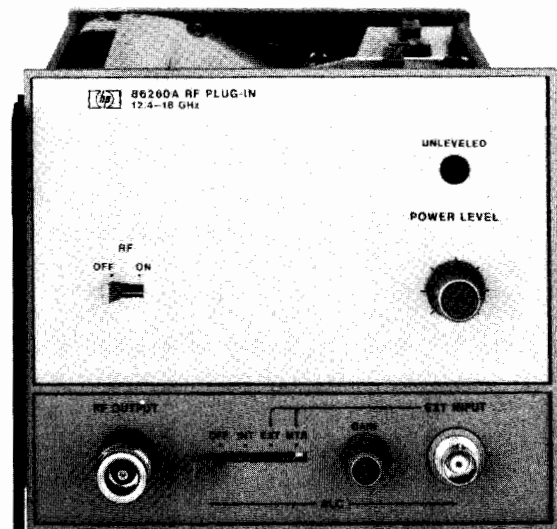

HP 86260A

HP 86200 Series

The HP 86200 series plug-ins feature a wide choice of bandwidths and power specifications for covering the 10 MHz to 22 GHz frequency range. The HP 86222A/B 10 MHz to 2.4 GHz plug-ins, the HP 86240A/B/C 2 GHz to 8.6 GHz plug-ins, and the HP 86290B/C 2 GHz to 18.6 GHz plug-ins cover multi-octave frequency ranges with exceptional frequency precision and RF output characteristics. See preceding pages for specifications on these plug-ins. For octave band applications, smaller range plug-ins covering, for instance, 5.9 GHz to 12.4 GHz are available with optional capability to operate as up-converters for MLA measurements. Internal leveling is standard on all HP 86200 series plug-ins.

HP 11869A Adapter

The HP 86200 series can be used in the HP 8350 Sweep Oscillator mainframe with the addition of the HP 11869A Adapter. The HP 11869A provides the electrical and mechanical interface between the HP 86200 plug-in and the HP 8350 so that digital control of the plug-in is possible. All of the performance and features of the HP 8350 Sweep Oscillator mainframe are available when using the HP 86200 plug-ins and HP 11869A Adapter. For more information on the HP 11869A see page 503.

Specifications

With Plug-In Installed in an HP 8620C Mainframe

Frequency linearity: typically $\pm 1\%$.

Frequency reference output: typically 1 V/GHz dc-coupled voltage is available for referencing or phase-locking external equipment to the plug-in or for multi-octave operation with an HP 8410C.

RF power leveling: internal dc-coupled leveling amplifier and PIN modulator provided.

Internal, standard: selected by front panel switch; refer to RF plug-in specifications.

External

Crystal input: approximately -20 to 250 mV for specified leveling at rated output; for use with negative polarity detectors such as HP 780 Series Directional Detectors, HP 423A/B and 8470 Series Crystal Detectors.

Power meter input: leveling amplifier with compensation for HP 432A power meter included internally in all plug-ins except the HP 86241A.

Indicator: front panel indicator lights when RF power level is set too high to permit leveling over entire selected sweep range or when operating in unlevelled mode.

Residual AM in 100 kHz bandwidth: < -50 dBc.

External AM

Frequency response: typically dc to 100 kHz unlevelled, dc to 50 kHz leveled (at maximum leveled power).

Input impedance: approximately 5000 ohms.

RF output connector: type N Female.

HP 8350 Compatibility: the HP 11869A Adapter provides the electrical and mechanical interface so that the HP 86200 series plug-ins can be used in the HP 8350 Sweep Oscillator mainframe. For more information see the section on HP 11869A Adapter page 503.

Weight: net, 2.3 kg (5 lb); shipping, 3.2 kg (7 lb).

Options

002: 70 dB attenuator in 10 dB steps

004: rear panel RF output

Price

See model number add \$200

Upconverter simulation options: options are available which guarantee compatibility with the HP Microwave Link Analyzer. For further information on these plug-ins refer to the Telecommunications Test Equipment Section beginning on page 165.

Single Band Plug-Ins

Refer also to Broadband Models 86222A/B (0.01-2.4 GHz), 86240A/B/C (2-8.4 GHz), 86251A (7.5-18.6 GHz), and 86290B/C (2-18.6 GHz)

| Specifications with plug-in installed in HP 8620C | HP 86220A | HP 86235A | HP 86241A | HP 86242D | HP 86245A | HP 86250D | HP 86260B | HP 86260A | HP 86260C |
|--|--|-------------|--|-------------|-------------------------------------|-------------|----------------------|---------------------|---------------------|
| Frequency range¹ (GHz): | 0.01-1.3 | 1.7-4.3 | 3.2-6.5 | 5.9-9.0 | 5.9-12.4 | 8.0-12.4 | 10.0-15.5 | 12.4-18.0 | 17.0-22.0 |
| Frequency accuracy CW mode (MHz): | ±10 | ±20 | ±30 | ±35 | ±40 | ±40 | ±50 | ±50 | ±50 |
| Remote programming typically (MHz): | ±6.0 | ±2.5 | ±10.5 | ±5.0 | ±20 | ±20 | ±25 | ±25 | ±25 |
| All sweep modes (sweep time >100 ms) (MHz): | ±15 | ±30 | ±33 | ±40 | ±50 | ±50 | ±70 | ±70 | ±70 |
| Stability: With Temperature: | ±600 kHz/°C | ±500 kHz/°C | ±650 kHz/°C | ±750 kHz/°C | ±1.2 MHz/°C | ±1.2 MHz/°C | ±5.4 MHz/°C | ±5.4 MHz/°C | ±5.4 MHz/°C |
| With 10% Line Voltage Change: | ±20 kHz | ±40 kHz | ±30 kHz | ±40 kHz | ±40 kHz | ±40 kHz | ±180 kHz | ±180 kHz | ±180 kHz |
| With 10 dB Power Level Change: | ±20 kHz | ±1 MHz | ±1 MHz | ±1.5 MHz | ±1.5 MHz | ±1.5 MHz | ±6 MHz | ±6 MHz | ±6 MHz |
| With 3:1 Load SWR Change, all Phases: | | ±250 kHz | | ±250 kHz | ±250 kHz | ±250 kHz | | | |
| With Time (after warm-up): Typ/10 min. | ± 200 kHz | ± 200 kHz | ± 200 kHz | ± 600 kHz | ± 600 kHz | ± 600 kHz | | ± 450 kHz | |
| Residual FM (20 Hz -15 kHz BW, FM switch in NORM) CW mode (kHz peak): | <5 | <7 | <7 | <15 | <15 | <15 | <25 | <25 | <25 |
| Maximum leveled power¹ (mW): | 10 | >40 | >6.3(3.2-6 GHz) >5(6-6.5 GHz) | >10 | >50 | >10 | >10 | >10 | >10 |
| Power variation Internally leveled (dB): | <±0.5 | <±2 | <±0.8 | <±0.5 | <±0.6 | <±0.5 | <±0.7 | <±0.7 | <±0.7 |
| Externally leveled (dB) (excluding coupler & detector variation): | N/A | <±0.1 | <±0.1 | <±0.1 | <±0.1 | <±0.1 | <±0.1 | <±0.1 | <±0.1 |
| Spurious signals: (dB below fundamental, at specified max power) Harmonics: | <-25(10-750 MHz) <-30(750-1300 MHz) | <-20 | <-16(3.2-3.8 GHz) <-20(3.8-6.5 GHz) | <-30 | <-17(5.9-7 GHz) <-30(7-12.4 GHz) | <-30 | <-25 | <-25 | <-25 |
| Nonharmonics: | <-40 | <-60 | <-60 | <-60 | <-60 | <-60 | <-50 | <-50 | <-50 |
| Source SWR: (50 Ω nom. Internally leveled) | <1.3 | <1.6 | <1.6 | <1.6 | <1.6 | <1.6 | <1.6 | <1.6 | <1.6 |
| External FM: Max deviations (MHz) for modulation frequencies: DC-100 Hz: | ±15 | ±75 | ±25 | ±150 | ±150 | ±150 | ±150 (DC-200 kHz) | ±75 (DC-200 kHz) | ±75 (DC-200 kHz) |
| DC-1 MHz: | ±0.5 | ±5 | ±2 | ±7 | ±7 | ±7 | ±5(200 Hz-200 kHz) | ±5(200 Hz-200 kHz) | ±5(200 Hz-200 kHz) |
| Sensitivity (nom. MHz/V): | +3.5 | -20/-6 | -6 | -20/-6 | -20/-6 | -20/-6 | -20/-6 | -20/-6 | -20/-6 |
| AM: Internal 1 kHz Square wave On/Off ratio & EXT AM sensitivity To -10 V (dB): | >35 | >40 | >25 | >40 | >40 | >40 | >25 | >25 | >25 |
| EXT AM Response compatible with 8756A/8757A Mod drive signal: | No | Yes | No | Yes | Yes | Yes | No | No | No |
| Price: Plug-in: | \$3810 | \$5075 | \$4575 | \$5175 | \$7975 | \$5275 | \$6125 | \$5675 | \$9280 |
| Opt 002 (70 dB Atten.): | +\$750 | +\$850 | N/A | N/A | N/A | N/A | N/A | N/A | N/A |

¹ Special frequency band and high power outputs available on request.

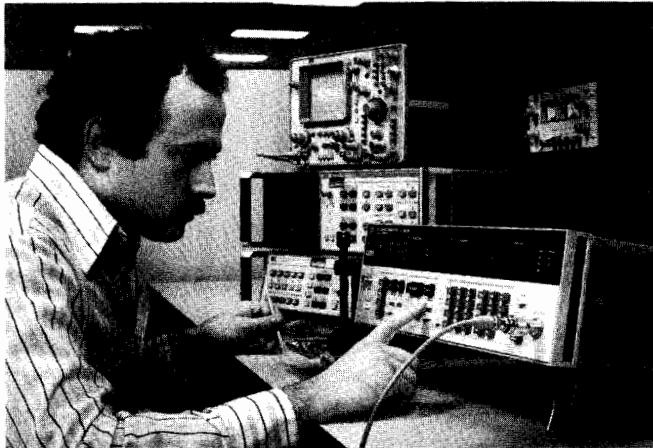

Hewlett-Packard offers a complete line of signal generators from 10 kHz to 60 GHz. Each includes the following: 1) Accurately calibrated variable frequency, 2) accurately calibrated variable output level, and 3) wide modulation capability.

HP has recently introduced ultra-high-speed digital technology for synthesizing fully-arbitrary waveforms with signal components up to 50 MHz. This capability gives you a highly-flexible method of precise signal generation for traditional VHF system tests on receivers as well as components.

In addition, the remarkable performance now available in generating arbitrary waveforms with 125 million sampling points per second and 12-bit amplitude resolution makes the generator ideal for many other important applications like computer disk signal simulations, EMP (Electro-Magnetic Pulse) simulations, and a highly-flexible signal source for automatic test systems. Signal fidelity exhibits <-60 dBc spurious and <-50 dBc harmonics. The 128K word memory provides for long, complex waveforms.

The HP 8770A Arbitrary Waveform Synthesizer depends on a special high-speed digital-to-analog converter at its output. The waveform is described mathematically from the keyboard/display of an HP 200-Series Desktop Computer (HP 9816, 9836, 9836C), using a special waveform generation software set (HP 11775A) optimized for the creation of arbitrary waveforms.

Completely arbitrary waveforms may be generated as well as simple CW signals, two-tone or multiple tone simulations as well as any type of AM, FM, Φ M or pulse modulation.

Synthesized Signal Generators

Collectively covering a frequency range from 10 kHz to 26.5 GHz, these versatile programmable signal generators are used in a wide variety of automated systems and high performance applications.

The HP 8662A covers 10 kHz to 1280 MHz with calibrated output from +13 to -140 dBm. The HP 8663A shares the frequency synthesis circuitry of the HP 8662A and covers 100 kHz to 2560 MHz with calibrated levels from +16 to -130 dBm. Both

generators feature extremely low phase noise and spurious while maintaining fast frequency switching. The low phase noise close to the carrier (-112 dBc/Hz at a 100 Hz offset) optimizes the HP 8662A and 8663A for critical low noise applications like local oscillator substitution and multiplication to microwave frequencies. In addition, the low noise at typical channel spacings (-132 dBc/Hz at 10 kHz offset) allows both in-channel and out-of-channel measurements to be made under programmable control. The HP 8662A has AM and FM. The HP 8663A offers AM, FM, Φ M, and pulse modulation and a 10 Hz to 99.9 kHz modulation oscillator. Both the HP 8662A and 8663A feature precision digital sweep and full HP-IB programmability.

The HP 8642A (0.1 to 1057.5 MHz) and HP 8642B (0.1 to 2115 MHz) offer excellent spectral purity at carrier offsets beyond 10 kHz. Both share the same SAW resonator-based synthesis block diagram and differ primarily in frequency coverage. With SSB phase noise of -134 dBc/Hz at 20 kHz offset from a 1 GHz carrier and -100 dBc nonharmonic spurious, these generators are ideally suited to perform the most stringent of out-of-channel measurements on high performance RF communications receivers. Output levels from +20 dBm down to -140 dBm with ± 1 dB absolute level accuracy down to -127 dB allow these generators to drive high level mixers and pinpoint receiver sensitivity. RF leakage is specified at 0.5μ V for confidence in low level tests. AM, FM, Φ M and pulse modulation insure compatibility with most RF communications systems. AM is suited for avionics VOR and ILS systems and FM specifies 0.03% THD and typically 50 dB stereo separation. Frequency and amplitude sweep simplify device characterization.

The HP 8642A/B set a new standard for improved up-time in large ATE systems applications. A two-year recommended calibration interval, built-in diagnostic hardware and software and on-site repair and calibration contribute to improved ATE system productivity by keeping the HP 8642A/B up and running instead of out for repair.

The HP 8656B, an economical programmable RF signal generator, provides synthesized signals from 0.1 to 990 MHz. The HP

8656B offers a wide range of standard features, including 10 Hz resolution, full keyboard control, reverse power protection to 50W, and HP-IB programmability.

The HP 8656B features a new long-life output attenuator and ± 1.0 dB level accuracy for increased measurement accuracy and repeatability. Its low RF leakage permits testing of RFI-susceptible devices and its phase adjustment feature allows characterization of phase sensitive devices. The HP 8656B's flexible modulation, including simultaneous and FM rates from dc to 100 kHz, permits digital squelch tone tests as well as most communication receiver tests. Separate increment keys provide rapid and easy setting of frequency, output and modulation. Because HP-IB is standard and frequency changes can be made in 150 ms, the HP 8656B is a cost-effective solution for in-channel measurements and an ideal general-purpose RF source for other applications.

The HP 8660A/C is a particularly versatile synthesized signal generator family, offering two mainframes and a variety of RF and modulation plug-ins. The HP 8660A mainframe utilizes thumbwheel switches for frequency selection. The HP 8660C has a more versatile keyboard control featuring synthesized digital sweep and frequency-step capability. Both HP-IB and BCD programming interfaces are available.

Three plug-in RF sections provide separate frequency ranges: 10 kHz to 110 MHz, 1 MHz to 1300 MHz, and 1 MHz to 2600 MHz. Output levels are calibrated over >140 dB range. Five different modulation plug-ins provide versatile combinations of AM, FM, Φ M, and pulse modulation.

The HP 8340A (10 MHz to 26.5 GHz) and HP 8341A (10 MHz to 20 GHz) offer the same excellent CW performance as the HP 8670 series. They also have a high-performance sweep oscillator, providing wide and narrow band continuous analog sweeps. Other features include 1 to 4 Hz frequency resolution, high-quality internal pulse and amplitude modulation, and calibrated output power from +12 to -110 dBm. (Pulse modulation and 90 dB step attenuator are optional on the HP 8341A.)

The HP 8670 series of microwave synthesizers and the HP 8340A and HP 8341A synthesized sweepers cover five frequency ranges for measurement flexibility and broadband frequency coverage. They also feature good spectral purity and stability, versatile modulation, and full HP-IB programmability for signal simulation applications.

The HP 8671A is a synthesizer only, covering 2 to 6.2 GHz with a minimum output of +8 dBm and external FM capability. The HP 8672A is a 2 to 18 GHz AM/FM generator with calibrated output from +3 to -120 dBm (+8 dBm with Option 008). The HP 8672S provides all the capability of the HP 8672A, plus extended frequency coverage from 10 MHz to 18 GHz and internal high-quality pulse modulation. Both the HP 8672A and S use knob-entry for frequency set.



The HP 8673B spans 2 to 26.5 GHz, with +8 to -100 dBm output level. Internal pulse modulation as well as external metered AM and FM allow complex signal simulation. Frequency and amplitude entry are digital keyboard entry.

The HP 8673E has all the features of the B-model except for frequency coverage of 2 to 18.6 GHz. Output range is +8 to -120 dBm.

The HP 8673D has all the performance of the HP 8673B, with extended frequency coverage from 50 MHz to 26.5 GHz, and harmonically related spurious outputs <-60 dBc from 2 to 26.5 GHz. Output power is >+5 dBm across the operating band. The HP 8673C offers the same performance from 50 MHz to 18.6 GHz.

Solid-State, Mechanically Tuned Generators

Solid-state mechanically tuned generators combine fundamental oscillators with solid-state circuitry to yield excellent spectral purity for modern performance requirements.

HP 8680 Series Solid-State Signal Generators

The HP 8680 series solid-state signal generators are designed to meet the stringent requirements of modern microwave radar and communications testing. The HP 8683A and 8684A are optimized for communications receiver applications and feature low-distortion AM and FM, high spectral purity, and ±2.5 dB output level accuracy.

The HP 8683B and 8684B add +10 dBm output power (standard) and high performance internal pulse modulation for radar/EW applications. An internal pulse generator provides wide ranges of rate, width and delay, and a custom pulse modulator yields >80 dB on/off ratio and <10 ns rise/fall times.

The HP 8683D and 8684D are extended-frequency versions of the HP 8683B and 8684B employing internal frequency doublers. Both are also capable of wideband FM for satellite communication applications. Peak deviations of ±10 MHz at dc to 10 MHz rates make these products suitable for DBS receiver testing.

HP 8640B Series High Performance

The performance leader of the RF mechanically tuned family is the HP 8640B signal generator, covering 450 kHz to 550 MHz. Frequency coverage can be extended to 1024 MHz with an internal doubler (Option 002), and an optional built-in audio oscillator extends the CW range down to 20 Hz (Option 001). The HP 8640B provides wide output level range from +19 to -145 dBm. High performance AM and FM and low phase noise at typical receiver channel spacings makes the HP 8640B an ideal generator for a wide variety of receiver measurements.

The HP 8640B with built-in counter has the ability to count external signals at frequencies up to 550 MHz and to phase-lock the generator's RF output to the counter time base for frequency stability of better than 5×10^{-8} /hour.

For avionics, navigation and communications applications, the HP 8640B Option 004 can be combined with suitable external modulation sources for testing ILS, VOR, and VHF communications receivers.

Signal Generator Summary

| Frequency Range | HP Model | Characteristics | Page |
|---|---|---|------|
| 0 to 50 MHz | 8770A Arbitrary Waveform Synthesizer | Fully-arbitrary waveform. Output 125 million points per second (50 MHz). 12-Bit amplitude resolution (.025%), 2% amplitude accuracy. Operates from HP 200-Series Desktop Computer. | 450 |
| 0.5 to 1024 MHz | 8640B, 8640B Opt. 004 Signal Generators | Calibrated and leveled output from +19 to -145 dBm. AM, FM, and external pulse modulation. Built-in counter and phase lock capability. Avionics option available (Opt. 004). | 535 |
| 0.1 to 1057.5 MHz 0.1 to 2115 MHz | 8642A, 8642B Synthesized Signal Generators | High spectral purity. 1 Hz frequency resolution. ±1 dB absolute output level accuracy. AM, FM, ΦM and pulse. Sweep. On-site repair. | 526 |
| 0.1 to 990 MHz | 8656B Synthesized Signal Generator | ±1.0 dB absolute level accuracy from +13 to -127 dBm in 0.1 dB steps. Calibrated AM and FM. Frequency resolution of 10 Hz. Time base aging rate of ±2 ppm/year. | 524 |
| 0.01 to 1280 MHz | 8662A Synthesized Signal Generator | Low noise. 0.1 Hz frequency resolution, 5×10^{-10} /day stability. Calibrated and leveled output from +13 to -140 dBm. Digital sweep. Completely HP-IB programmable. AM/FM modulation. | 529 |
| 0.1 to 2560 MHz | 8663A Synthesized Signal Generator | Low noise. 0.1 Hz frequency resolution, 5×10^{-10} /day stability. Calibrated and leveled output from +16 to -130 dBm. Digital sweep. Completely HP-IB programmable. AM, FM, ΦM, pulse modulation. | 529 |
| 0.01 to 110 MHz 1 to 1300 MHz 1 to 2600 MHz | 8660A, 8660C Synthesized Signal Generators | 1 Hz frequency resolution, 3×10^{-9} /day stability. Calibrated and leveled output from +13 to -146 dBm. HP-IB and BCD programmable. AM, FM, ΦM, pulse modulation. Plug-ins determine frequency range and modulation capability. | 532 |
| 0.8 to 2.4 GHz 1.8 to 4.5 GHz | 8614A, 8616A Signal Generators | Output +10 (HP 8616; +3 dBm above 3 GHz) to -127 dBm into 50 ohms, leveled below 0 dBm. Internal square-wave; external pulse, AM and FM. Auxiliary RF output. | 542 |
| 2.3 to 6.5 GHz 5.4 to 12.5 GHz | 8683/84 A,B Signal Generators | High spectral purity, stability. ±2.5 dB absolute level accuracy from +10 to -110 dBm (0 dBm, A models). AM, FM standard. High perf. internal pulse modulator and pulse generator with B models. Portable, rugged (19.1 kg). | 540 |
| 2.3 to 13 GHz 5.4 to 18 GHz | 8683/84 D Signal Generators | Same as B model except with wideband frequency coverage. DC coupled FM with ±10 MHz deviations available. -3dBm standard output power in doubled frequency band. +10 dBm available with option 001. | 540 |
| 2 to 6.2 GHz | 8671A Synthesizer | 1 kHz frequency resolution, 5×10^{-10} /day stability, +8 dBm minimum output. Completely HP-IB programmable. Ext. FM. | 548 |
| 2 to 18.0 GHz | 8673E Synthesized Signal Generator | 1 to 3 kHz frequency resolution, 1.5×10^{-9} /day stability. +8 to -120 dBm output. Pulse, amplitude and frequency modulation. Digital sweep. Completely HP-IB programmable. | 546 |
| 2 to 18 GHz | 8672A Synthesized Signal Generator | 1 to 3 kHz frequency resolution, 5×10^{-10} /day stability. Calibrated and leveled output from +3 to -120 dBm. Completely HP-IB programmable. Metered external AM and FM. | 544 |
| 0.01 to 18 GHz | 8672S Synthesized Signal Generator | 1 to 3 kHz frequency resolution, 5×10^{-10} /day stability. Internal pulse modulator. Calibrated and leveled output from +2 to -120 dBm. Metered external AM and FM. Completely HP-IB programmable. | 548 |
| 0.05 to 18.6 GHz 0.05 to 26.5 GHz | 8673C 8673D Synthesized Signal Generators | Harmonics and sub-harmonics <-60 dBc. 1 to 3 kHz resolution, C-model; 1 to 4 kHz, D-model; +2 to -100 dBm output, C-model; +5 to -100 dBm, D-model. Pulse amplitude and frequency modulation. Digital sweep. Completely HP-IB programmable. | 547 |
| 0.01 to 20 GHz | 8341A Synthesized Sweeper | 1-3 Hz frequency resolution, 1×10^{-9} /day stability. +10 to -20 dBm output. Amplitude modulation. Continuous analog sweep with spans from 100 Hz to 19.99 GHz completely HP-IB programmable. | 543 |
| 2 to 26.5 GHz | 8673B Synthesized Signal Generator | 1 to 4 kHz frequency resolution, 5×10^{-10} /day stability. +8 to -100 dBm output. Pulse, amplitude, and frequency modulation. Digital sweep. Completely HP-IB programmable. | 544 |
| 0.01 to 26.5 GHz | 8340A Synthesized Sweeper | 1 to 4 Hz frequency resolution, 1×10^{-9} /day stability. +12 to -110 dBm output. Pulse and amplitude modulation. Continuous analog sweep with spans from 100Hz to 26.49 GHz. Completely HP-IB programmable. | 543 |
| 18 to 26.5 GHz 26.5 to 40 GHz | 938A, 940A Frequency Doublers | Driven by 9 to 13.25 GHz, 13.25 to 20 GHz sources (HP 8690, 8672A, 8672S, 8673B, 8673D, 8340A, 8350A, and 8620 series). 100 dB precision attenuator. | 542 |
| 26.5 to 40 GHz 33 to 50 GHz 40 to 60 GHz | 83554A, 83555A, 83556A Millimeter-Wave Source Modules | Effectively extends the performance of an 11 to 20 GHz microwave source (HP 8672A/S, 8673B/C/D, 8340A, 8341A, 8350B, 8620C) to the millimeter-wave frequency ranges. | 512 |



SIGNAL GENERATORS

Synthesized Signal Generator

Model 8656B

- 100 kHz to 990 MHz
- ± 1.0 dB absolute level accuracy
- Amplitude offset and phase adjustment capability
- 150 millisecond frequency switching speed
- Versatile simultaneous modulation including dc FM
- Fully HP-IB programmable

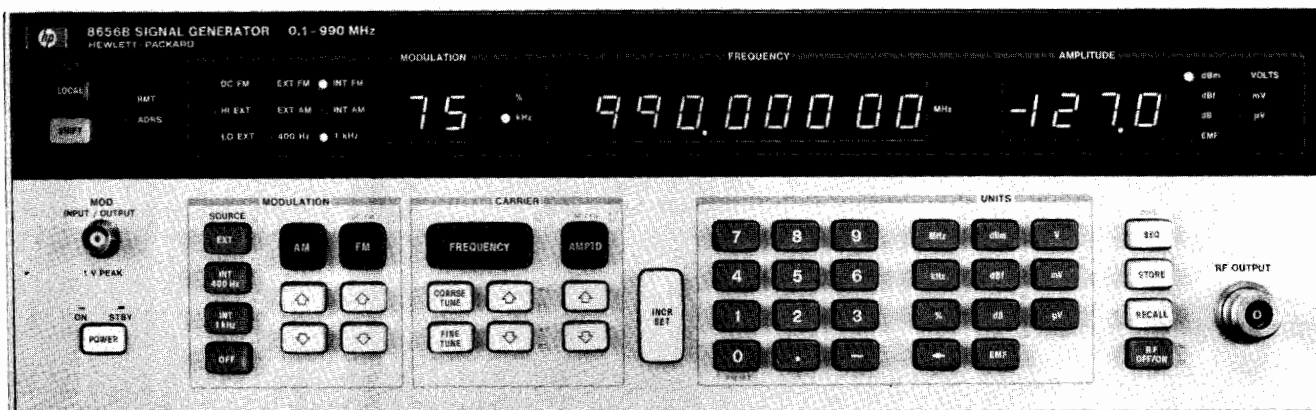

HP 8656B



Description

The HP 8656B is a programmable synthesized signal generator that offers exceptional value through a powerful combination of performance, quality and economy.

Frequency

The HP 8656B provides frequency coverage from 0.1 to 990 MHz (with underrange to 10 kHz). This wide range covers the IF and LO frequencies as well as the RF frequencies of most receivers. It also allows testing in a variety of communication systems including the 800 MHz FM mobile band and some telemetry bands. For automated testing, the 150 ms frequency switching speed of the HP 8656B (specified to be within 100 Hz of the final frequency) increases throughput. Frequency resolution of 10 Hz allows convenient setting of increments including narrow channel spacings, while characterization of phase sensitive devices is made easier with the help of the phase increment/decrement feature. The standard internal reference has an aging rate of 2 ppm/year. Improved stability and accuracy can be achieved by adding the optional 1×10^{-7} /day high stability time base (Option 001) or using an external reference of 1, 5 or 10 MHz.

Output

The new output attenuator of the HP 8656B has been designed with high volume automatic test system use in mind. The 8656B also features ± 1.0 dB absolute level accuracy and 0.1 dB resolution for accurate receiver sensitivity tests, circuit characterization and R&D applications. The output levels are calibrated from +13 dBm (over-range to +17 dBm) to -127 dBm and may be set and displayed in any one of 14 convenient units including dBm, volts, dB μ V or Vemf. The output level can also be offset to compensate for cable and/or other losses external to the generator, or turned on or off with a dedicated key. Shielding keeps leakage at $< 1.0 \mu$ V for testing RFI susceptible devices, and standard resettable reverse power protection for up to 50 watts guards against accidental damage from transmitters.

Modulation

The HP 8656B's versatile modulation capabilities include simultaneous and mixed modulation modes (AM/AM, FM/FM and AM/FM) from internal (1 kHz and 400 Hz) and external sources. AM is ac coupled while FM can be either ac or dc coupled. The new, patented dc coupling technique used in the HP 8656B provides exceptional long term stability (< 10 Hz/hour) and center frequency accuracy (± 500 Hz) eliminating the need for retuning in the dc FM mode. For calibrated external modulation, a 1V peak signal is required, and HI/LO annunciators on the HP 8656B indicate when the external signal is within 5% of the correct amplitude.

Ease of Operation

A microprocessor-based controller provides a broad range of operating features for simple, but efficient control. Keyboard data entry uses a function/data/units format, and all function entries are made using a left-to-right keystroke sequence. All information entered is visible via LED displays and annunciators. Modulation, frequency, and level functions can be individually incremented by step sizes that are set by convenient keyboard entries. In addition, resolution control keys allow coarse and fine tuning of frequency in decade steps.

Up to ten front-panel setups can be stored and recalled. A sequence function allows you to cycle through stored setups at the touch of a key or via remote control. The microprocessor also makes troubleshooting aids available at the front panel, enhancing the serviceability of the HP 8656B.

HP-IB Programmability

Full HP-IB programmability is standard in the HP 8656B. Each programming command has an easy-to-remember, two-character, alpha-numeric HP-IB code that is also labeled next to each key. All functions are quickly and easily programmed using the same function/data/units format as in the manual mode.



HP 8656B Specifications

Frequency

Range: 100 kHz to 990 MHz (8 digit LED display).

Frequency underrange: 10 kHz with uncalibrated output (typical).

Resolution: 10 Hz.

Accuracy and stability: same as internal time base.

Time Base Characteristics

| Typical Characteristics | Standard Time Base | Option 001 Time Base |
|---------------------------------------|--|-------------------------|
| Aging Rate | ±2 ppm/year | 1x10 ⁻⁷ /day |
| Frequency | 50 MHz | 10 MHz |
| External Reference Input (rear panel) | Accepts any 1, 5, or 10 MHz (±0.002%) frequency standard at a level >0.15 Vrms into 50 ohms. | |

Frequency switching speed (to be within 100 Hz of final frequency): <150 ms.

Phase Offset: adjustable via HP-IB or from the front panel in nominal 1 degree increments.

Spectral Purity

Spurious Signals (≤ +7 dBm output levels)

Harmonics: < -30 dBc.

Non-harmonic spurious (greater than 5 kHz from carrier in CW mode): < -60 dBc.

Sub-harmonics: none.

Residual FM

| Post Detection Noise Bandwidth | Frequency Range (MHz) | | | |
|--------------------------------|-----------------------|--------------|------------|------------|
| | 0.1 to 123.5 | 123.5 to 247 | 247 to 494 | 494 to 990 |
| 0.3 to 3 kHz | <7 Hz rms | <2 Hz rms | <4 Hz rms | <7 Hz rms |
| 0.05 to 15 kHz | <15 Hz rms | <4 Hz rms | <8 Hz rms | <15 Hz rms |

Residual AM (0.05 to 15 kHz post detection noise bandwidth): <-75 dBc.

SSB Phase Noise (CW only)

| Offset from Carrier | 0.1 to 123.5 MHz (dBc/Hz) | 123.5 to 247 MHz (dBc/Hz) | 247 to 494 MHz (dBc/Hz) | 494 to 990 MHz (dBc/Hz) |
|---------------------|---------------------------|---------------------------|-------------------------|-------------------------|
| 20 kHz | <-114 | <-126 | <-120 | <-114 |

Output

Level range (into 50 ohms): 13 dBm to -127 dBm (3½ digit LED display; uncalibrated output to 17 dBm).

Resolution: 0.1 dB.

Absolute level accuracy: <±1.0 dB; 123.5 to 990 MHz

<±1.5 dB; f_c < 123.5 MHz, levels > +7 dBm and <-124 dBm.

Level flatness (100 kHz to 990 MHz): ±1.0 dB at an output level setting of 0.0 dBm.

Reverse power protection: protects signal generator from application of up to 50 watts (from a 50Ω source) of RF power to 990 MHz into generator output; dc voltage cannot exceed 25V.

Amplitude Modulation (2 digit LED display)

AM depth¹: 0 to 99% to +7 dBm and 0 to 30% to +10 dBm.

Resolution: 1%.

AM rate: internal 400 Hz and 1 kHz, ±3%; external (1 dB bandwidth), 20 Hz to 40 kHz.

AM distortion (at internal rates): <1.5%, 0-30% AM; <3%, 31-70% AM; <4%, 71-90% AM.

Indicator accuracy (for depths <90% internal rates and levels <+7 dBm)¹: ≤±(2% + 4% of reading).

Incidental phase modulation (at 30% AM depth and internal rates): <0.3 radian peak.

Frequency Modulation (2 digit LED display)

FM Peak Deviation

| Center Frequency | Maximum Peak Deviation | |
|--|---|---------|
| | AC Mode | DC Mode |
| 0.1 to 123.5 MHz | The lesser of 99 kHz or 4000 x rate (Hz) | 99 kHz |
| 123.5 to 247 MHz | 50 kHz or 1000 x rate (Hz) | 50 kHz |
| 247 to 494 MHz | 99 kHz or 2000 x rate (Hz) | 99 kHz |
| 494 to 990 MHz | 99 kHz or 4000 x rate (Hz) | 99 kHz |
| FM not specified for $f_c - (\Delta f_{pk}) < 100$ kHz | | |

Resolution: 100 Hz for deviations less than 10 kHz; 1 kHz for deviations greater than 10 kHz.

FM rate: internal 400 Hz and 1 kHz, ±3%; external (1 dB BW), dc coupled, dc to 50 kHz; ac coupled, 20 Hz to 50 kHz.

Center frequency accuracy in dc FM mode: <±500 Hz.

Center frequency stability in dc FM mode: <10 Hz/hour.

FM distortion (internal rates and ≥3 kHz peak deviations): <0.5%.

Indicator accuracy¹: ±5% of reading at internal rates.

Incidental AM (for center frequency ≥500 kHz, peak deviation <20 kHz and internal rates): <0.1%.

Remote Programming

Interface: HP-IB (Hewlett-Packard's implementation of IEEE - 488).

Interface functions implemented: SH0, AH1, T0, L2, SR0, RL1, PP0, DC1, DT0, C0 and E1. (For more on these functions, refer to the HP-IB section of this catalog.)

General

Operating temperature range: 0° to +55° C.

Leakage: conducted and radiated interference is within the requirements of methods CE03 and RE02 of MIL STD 461B, FTZ 1115. Furthermore, RF leakage of less than 1.0 μV is induced in a two-turn loop, 2.5 cm in diameter, held 2.5 cm away from the front surface.

Power requirements: 100, 120, 220, or 240 Vac; +5%, -10%; 48 to 440 Hz, 125 VA maximum.

Weight: net, 18.2 kg (40 lb); shipping, 23.6 kg (52 lb).

Size: 133 H x 425 W x 520 D mm (5.25 x 16.75 x 20.5 inches). HP System II module size: 5¼ H x 1 MW x 17 D. For cabinet accessories, see page 744.

Rack slides and transit case: HP part numbers are: slide kit, 1494-0018; tilt slide kit, 1494-0025; full module transit case, 9211-2661.

Ordering Information

| | |
|---|------------------------|
| HP 8656B Signal Generator ² | Price \$6500 |
| Option 001: High stability time base | add \$850 |
| Option 002: Rear panel input and output | add \$175 |
| Option 907: Front handle kit | add \$55 |
| Option 908: Rack flange kit | add \$32.50 |
| Option 909: Rack flange and front handle kit | add \$80 |
| Option 910: Extra operating & service manual | add \$85 |

¹AM depth and FM deviation are further limited by Indicator Accuracy specifications.

²HP-IB cables not supplied, see page 121 for description and prices.

Models 8642A and 8642B

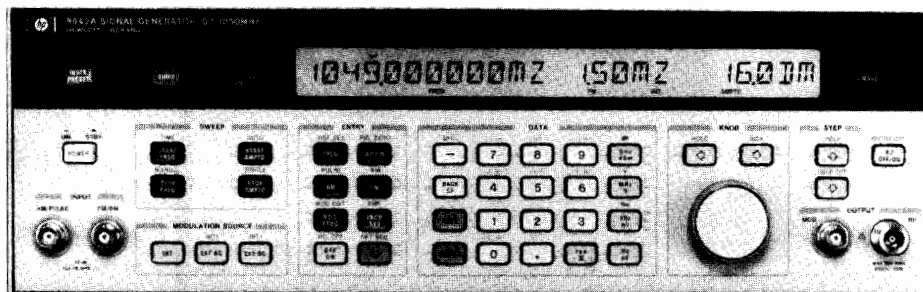

HP 8642A

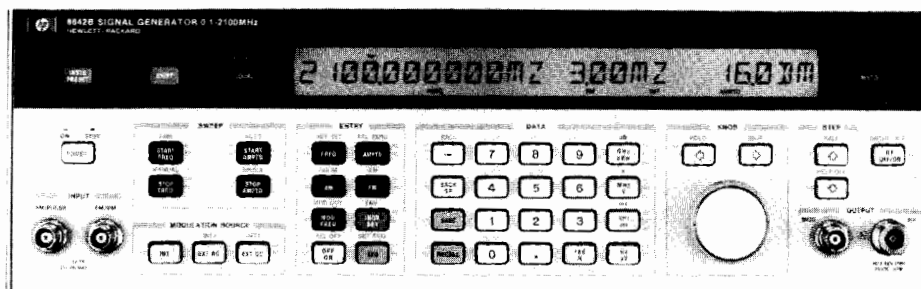

HP 8642B

HP 8642A/B Synthesized Signal Generators

The HP 8642A and HP 8642B synthesized signal generators are high performance programmable signal generators intended for the most demanding out-of-channel RF receiver measurements and other stringent RF applications. The HP 8642A covers the frequency range from 100 kHz to 1057.5 MHz and the HP 8642B covers the frequency range from 100 kHz to 2115 MHz. The two generators are otherwise very similar.

The HP 8642A/B improve the state-of-the-art in SSB phase noise at typical receiver adjacent channel spacings over the cavity tuned HP 8640B signal generator. This improvement is made possible through the use of high-Q Surface Acoustic Wave resonator oscillators operating near 800 MHz. SSB phase noise at 20 kHz offset from a 1 GHz carrier is -134 dBc/Hz, approximately 6 dB lower than the HP 8640B. The HP 8642A/B are an ideal choice to characterize selectivity on high performance receivers up to 1 GHz or 2 GHz. Furthermore, their advanced control features simplify measurements on the bench and in ATE systems.

Nonharmonic spurious are held to below -100 dBc on the HP 8642A/B up to 1 GHz and to below -94 dBc on the HP 8642B above 1 GHz. These two generators allow receiver spurious rejection tests to be fully automated with the utmost confidence in test results. In the HP 8642A/B design, high performance mixers reduce typical synthesizer spurious, and rigid die castings with resilient RF gasketing provide up to 140 dB of circuit isolation to ensure low spurious content on the output.

Absolute output level accuracy is ± 1 dB down to -127 dBm (0.1 μ V). In R&D or on the production line, the HP 8642A/B will accurately measure receiver sensitivities. Excellent output level repeatability is obtained with a high reliability attenuator specifically

designed for continuous ATE system use. At any output level setting, the attenuator can be fixed and level varied up or down 10 dB in a transient free manner.

Up to +20 dBm is available from the HP 8642A/B to perform a variety of high level measurements, often eliminating the need for external amplifiers.

In ATE system use, this extra power is available to overcome cabling losses. Using the relative amplitude feature, the display can be offset to show correct output level at the end of the cable.

In receiver design, there is sufficient output power to drive high level mixers and perform receiver blocking tests. Intermodulation measurements can be made with high confidence since intermodulation distortion products on the HP 8642A/B are specified.

The HP 8642A/B offer AM, FM, Φ M and pulse modulation across their full frequency ranges with a unique dual output section to improve modulation characteristics at lower carrier frequencies.

The HP 8642A/B, like their predecessor the HP 8640B, use an RF divider output chain to obtain lower frequency coverage with improved spectral purity. However, the HP 8642A/B can, on demand, switch in a separate heterodyne (HET) output section below 132.2 MHz to obtain improved modulation performance over the divided output.

For testing FM mobile radios, the HP 8642A/B have built-in 750 μ s preemphasis (FM PRE) to simplify receiver audio flatness tests. Simultaneous modulation capability allows two-tone modulation tests.

A low distortion internal modulation oscillator can be used to modulate the HP 8642A/B up to 100 kHz rates or as a stand-alone audio source. The output, available at the front panel, is programmable both in frequency and level providing an independent audio oscillator.



Fit for ATE System Use

To improve instrument availability or "uptime", the HP 8642A/B have been designed to reduce failures and simplify the service procedure in the event of a failure. When used in ATE systems, the HP 8642A/B will improve overall system up-time, thus leading to increased productivity.

Recommended Calibration Interval

The recommended calibration interval for the HP 8642A/B is two years, the result of a quality design, environmental-type testing and stringent production control. This means the HP 8642A/B will be more available for critical measurements, not out for calibration. When calibration is necessary, the HP 8952A Signal Generator Test System can automatically verify most warranted specifications for the HP 8642A/B in less than 20 minutes.

On-site Repair and Recalibration

The HP 8642A/B can be repaired and recalibrated on site in typically less than two hours. The fourteen internal modules that make up the HP 8642A/B all have rigid I/O specifications allowing a module-exchange repair strategy. Faulty modules can be quickly isolated using internal diagnostic hardware and software. A replacement module can be easily fitted and calibration data transferred to the instrument's main memory with a simple front-panel key sequence. Calibration and adjustments are primarily made electronically with ROM memory ICs and D/A converters.

Advanced Meter Features

Convenient control features help save time when putting the HP 8642A/B to work in systems. By using the "HELP" feature, special function codes and associated operational descriptions can be displayed by the alphanumeric back-lit liquid crystal display. It is easy to scroll through these descriptions with the knob or the UP/DOWN keys. The "HELP" feature eliminates the need to check manuals or pull-out cards by providing easy access to all special functions.

Through the LCD, messages in English clearly show instrument state and inform users of entry errors to help write programs that run smoothly from the start.

HP 8642A/B Specifications

Frequency

Range: 100 kHz to 1057.5 MHz, HP 8642A; 100 kHz to 2115 MHz, HP 8642B.

Bands: Both generators cover their ranges in one continuous span. However, many other specifications are dependent on carrier frequency. To simplify such specifications, the HP 8642A and 8642B carrier frequency ranges are divided into bands shown in the table below.

| Band | Carrier Frequency (MHz) | Band | Carrier Frequency (MHz) |
|------|-----------------------------|------|-------------------------|
| 10 | 1057.500001-2115 (HP 8642B) | 4 | 16.523438- 33.046875 |
| 9 | 528.750001-1057.5 | 3 | 8.261719- 16.523437 |
| 8 | 264.375001- 528.75 | 2 | 4.130860- 8.261718 |
| 7 | 132.187501- 264.375 | 1 | 0.1 - 4.130859 |
| 6 | 66.093751- 132.1875 | HET | 0.1 -132.1875 |
| 5 | 33.046876- 66.09375 | | |

Resolution: 1 Hz, 0.1 Hz with special function.
Stability: same as reference oscillator.

Intermodulation Distortion

Typical stability, standard: aging rate: ± 2 ppm/year.
Stability, option 001: $< 10^{-9}$ /day aging rate after 8 days warm-up.

Spurious Emissions

Residual FM; CW, AM or Angle Modulation $\leq 1/3$ Maximum Peak Deviation:

| Carrier Frequency | Post Detection Bandwidth, kHz | |
|--------------------|-------------------------------|---------------------|
| | 0.3 to 3 (Hz rms) | 0.05 to 15 (Hz rms) |
| band 10 (HP 8642B) | < 5 | < 9 |
| band 9 | < 2 | < 5 |
| band 8 | < 1.2 | < 2 |
| bands 1 thru 7 | < 1 | < 1.2 |
| band HET | < 3.5 | < 5 |

SSB Phase Noise; CW, AM, or Angle Modulation $< 1/60$ Maximum Peak Deviation:

| Carrier Frequency Band | SSB Phase Noise 20 kHz Offset dBc/Hz | SSB Phase Noise Floor 200 kHz Offset dBc/Hz |
|------------------------|--------------------------------------|---|
| 10 | -125 | -134 |
| 9 | -134 | -143 |
| 8 | -137 | -144 |
| 7 | -141 | -144 |
| 6 | -144 | -145 |
| 5 | -145 | -145 |
| 4 | -146 | -147 |
| 3 | -147 | -148 |
| 2 | -148 | -149 |
| 1 | -137 | -138 |
| HET | -125 | -137 |

Residual AM: $< 0.01\%$ AM rms, 0.3 to 3 kHz post-detection BW.

Spurious

| Type of Spurious | HP 8642A/B Bands 1-9 and HET | HP 8642B Band 10 |
|--|------------------------------|------------------|
| Harmonics | | |
| Output Level $\leq +10$ dBm | -30 dBc | -25 dBc |
| Output Level $\leq +16$ dBm | -20 dBc | -20 dBc |
| Sub-harmonics | none | -45 dBc |
| Non-harmonics, > 10 kHz from the carrier | -100 dBc ¹ | -94 dBc |

Output

Level range: from maximum available to -140 dBm (0.023 μ V).
Maximum Level Available:

| | HP 8642A | HP 8642B |
|-----------------|----------------|----------------|
| +20 dBm (2.24V) | bands 1 thru 7 | bands 1 thru 7 |
| +19 dBm (2.00V) | n/a | bands 8 & HET |
| +18 dBm (1.78V) | bands 8 & HET | n/a |
| +17 dBm (1.58V) | n/a | band 9 |
| +16 dBm (1.41V) | band 9 | band 10 |

Resolution: 0.1 dB.
Absolute accuracy: ± 1 dB, output level ≥ -127 dBm.
Flatness: $\leq \pm 0.75$ dB, +10 dBm output level.
Impedance: 50 ohms nominal.
SWR: $< 1.5:1$ for output levels < 0 dBm;
 $< 2.0:1$ for output levels ≥ 0 dBm.
Reverse power protection: 50W, from a 50 Ω source 50 Vdc, HP 8642A;
25W, 50 Vdc, HP 8642B.

Third order intermodulation: < -55 dBc at +12 dBm, two generators 25 kHz apart into a resistive combiner. Typically decreases 10 dB for every 5 dB of combined level decrease.

Available calibration units: V, mV, μ V, dBm, and EMF. REL ZERO or REF SET can be used to obtain settings such as dB μ V, dBEMFV, dBf, etc.

Amplitude Modulation

AM depth: 0 to 99.9%, output level $\leq +10$ dBm.
AM resolution: 0.1%.
AM indicator accuracy at 1 kHz rate and up to 90% AM:
 $\pm (3.5\%$ of setting $+1\%$ AM), HP 8642A/B bands 1-8 and HET, HP 8642B band 9.
 $\pm (5\%$ of setting $+1\%$ AM), HP 8642B band 9, HP 8642B band 10.

AM distortion at 1 kHz rate:

| Depth, % | Distortion | |
|----------|---|--|
| | HP 8642A/B bands 1-8 HP 8642B band 9 | HP 8642B band 9 HP 8642A/B band HET |
| 0 to 30 | $< 1\%$ | $< 2\%$ |
| 30 to 70 | $< 2\%$ | $< 4\%$ |
| 70 to 90 | $< 4\%$ | $< 6\%$ |

AM 3 dB bandwidth, depth $\leq 90\%$:
External dc/ac coupling: dc/20 Hz to 100 kHz, bands 1 and 5 thru 10; dc/20 Hz to 20 kHz, bands 2,3,4.

Internal: same as external ac.
Incidental phase modulation at 1 kHz rate and 30% AM: < 0.2 radians peak.
¹Not specified in HET band.

SIGNAL GENERATORS

Synthesized Signal Generators

Models 8642A and 8642B (cont.)

Frequency Modulation

Maximum FM deviation:

| Carrier Frequency Band | Maximum Deviation DC Coupled | Maximum Deviation AC Coupled or Internal |
|------------------------|------------------------------|--|
| 10 | 3 MHz | (the smaller of) 3 MHz or $f_{mod} \times 2160$ |
| 9 | 1.5 MHz | 1.5 MHz or $f_{mod} \times 1080$ |
| 8 | 750 kHz | 750 kHz or $f_{mod} \times 540$ |
| 7 | 375 kHz | 375 kHz or $f_{mod} \times 270$ |
| 6 | 187 kHz | 187 kHz or $f_{mod} \times 135$ |
| 5 | 93.8 kHz | 93.8 kHz or $f_{mod} \times 67.5$ |
| 4 | 46.9 kHz | 46.9 kHz or $f_{mod} \times 33.75$ |
| 3 | 23.4 kHz | 23.4 kHz or $f_{mod} \times 16.88$ |
| 2 | 11.7 kHz | 11.7 kHz or $f_{mod} \times 8.44$ |
| 1 | 93.8 kHz | 93.8 kHz or $f_{mod} \times 67.5$ |
| HET | 1.5 MHz | 1.5 MHz or $f_{mod} \times 1080$ |

FM resolution: 0.7% of setting or 0.0004% of maximum deviation, whichever is larger.

FM indicator accuracy:

$\pm(5\%$ of setting +10 Hz).

Rates dc to 100 kHz, external dc coupling.

Rates 20 Hz to 100 kHz, external ac and internal.

FM distortion: 4% for maximum dc coupled deviation, 2% for 1/2 maximum dc deviation, 0.4% for 1/10 maximum dc coupled deviation, rates 20 Hz to 100 kHz.

FM 3 dB bandwidth:

External dc/ac coupling: dc/20 Hz to 200 kHz.

Internal: dc/20 Hz to 200 kHz.

Incidental AM: 0.2%, 20 kHz peak deviation, 1 kHz rate, >400 kHz carrier frequency.

Carrier frequency offset when entering FM or phase modulation modes: AC and internal: none; DC: <500 Hz, HP 8642A/B; <1 kHz, HP 8642B band 10.

Phase Modulation

Maximum phase deviation:

| Carrier Frequency Band | Maximum Deviation (Radians) |
|------------------------|-----------------------------|
| 10 | 200 |
| 9 | 100 |
| 8 | 50 |
| 7 | 25 |
| 6 | 12.5 |
| 5 | 6.25 |
| 4 | 3.13 |
| 3 | 1.56 |
| 2 | 0.78 |
| 1 | 6.25 |
| HET | 100 |

Phase modulation accuracy: $\pm(5\%$ of setting +0.09 radians), 1 kHz rate.

Phase modulation resolution: 0.7% of setting or 0.0004% of maximum deviation, whichever is greater.

Phase modulation distortion: <0.4%, 1 kHz rate.

Phase modulation 3 dB bandwidth: 20 Hz to 15 kHz, internal and external ac. DC to 15 kHz, external dc.

Pulse Modulation (for output levels $\leq +15$ dBm)

Pulse on/off ratio: >40 dB, HP 8642A/B; >85 dB, HP 8642B band 10.

Rise/fall time: <400 ns 10% to 90%.

Maximum repetition frequency: 100 kHz.

Minimum pulse width: 2 μ s.

Nominal peak input threshold level: 1.5V.

Internal Modulation Oscillator

Rates: 20 Hz to 100 kHz.

Frequency resolution: 1% of setting.

Frequency accuracy: 2% of setting.

Output level range: 0 to 3V peak into 600 ohms.

Output level resolution: 4 mV.

Distortion: >0.5V peak: <0.02 kHz to 15.8 kHz; <0.15%, >15.8 kHz.

Output level accuracy: $\pm(4\%$ +15 mV) within 1 second.

Output impedance: 600 ohms $\pm 10\%$.

Frequency Sweep

Digitally stepped sweep:

Start-stop sweep: sweeps between two selected endpoints in a linear step-wise manner. Endpoints can be anywhere within the frequency range of the instrument.

Phase continuous sweep:

Start-stop sweep: instrument sweeps between two selected endpoints in a linear, phase continuous manner.

Maximum span: up to 400 kHz, HP 8642A/B; up to 800 kHz, HP 8642B band 10.

X axis output: 0 to 10 Vdc, $\pm 10\%$.

Z axis output: TTL positive true for crt display blanking during retrace.

Remote Programming

Interface: HP-IB (Hewlett-Packard's implementation of IEEE-488-1978).

Functions controlled: all functions controlled from the front panel or over HP-IB from 00 to 30 (5 bit decimal equivalent).

Interface function: listener, talker, and controller.

HP-IB interface functions implemented: SH1, AH1, T5, TE0, L3, LE0, SR1, RL1, PP1, DC1, DT1, C1, C3, C28, E2.

General

Operating temperature range: 0° to 55° C.

Storage temperature: -55° C to +75° C.

Leakage: conducted and radiated interference is within the requirements of MIL STD 462B method CE03 and RE02. Interference is also within the standards set by FTZ 1115. Also, RF leakage of <0.5 μ V is induced in a two turn loop 2.5 cm in diameter, held 2.5 cm away from any surface for output levels ≤ 0 dBm.

Power requirements: 100V, 120V, 220V, or 240V; +5%, -10%; 48 to 440 Hz; 300 VA max.

Dimensions: 133H X 425W X 617D mm (5.25 X 16.75 X 24.3 inches).

HP System II module size: 5 1/4 H X 1M W X 23D.

Weight: Net 32.7 kg (71.5 lb); shipping 43 kg (95 lb).

Supplemental Characteristics

Spectral Purity

Measured SSB Phase Noise at 1 GHz

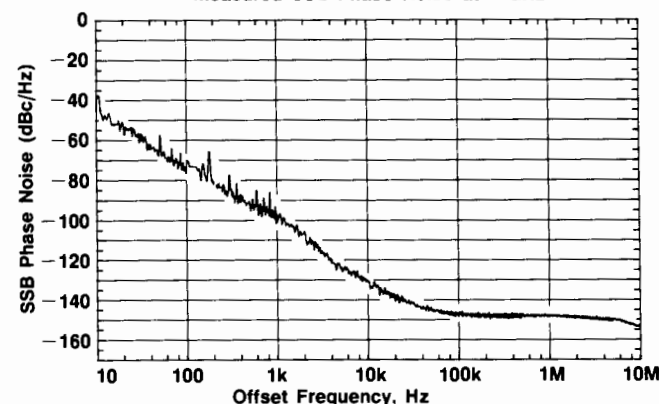

Ordering Information

| Item | Price |
|--|------------|
| HP 8642A Synthesized Signal Generator | \$21,000 |
| HP 8642B Synthesized Signal Generator | \$28,000 |
| Option 001: High stability time base | \$1,500 |
| Option 002: Rear panel inputs and outputs | \$150 |
| Option 710: On-site repair manual | \$72 |
| Option 907: Front handle kit | \$55 |
| Option 908: Rack flange kit | \$32 |
| Option 909: Front handle kit & rack flange kit | \$80 |
| Option 910: Extra manual | \$210 |
| Option 914: Delete service manual | less \$175 |
| Option W03: 90 day on-site warranty conversion | \$0 |
| Option W30: Three-year extended hardware support: | |
| HP 8642A | \$975 |
| HP 8642B | \$1350 |
| HP 11801A: On-site repair kit for HP 8642A | \$20,000 |
| HP 11801B: On-site repair kit for HP 8642B | \$26,500 |
| HP 11801C: On-site repair kit for HP 8642A and 8642B | \$28,000 |

SIGNAL GENERATORS

Synthesized Signal Generators

Models 8662A, 8663A

529



- 10 kHz to 1280 MHz frequency range
- < -147 dBc/Hz SSB phase noise at 10 kHz offset
- 0.1 Hz frequency resolution

- 100 kHz to 2560 MHz frequency range
- AM/FM/ØM/pulse in one generator
- Internal variable modulation oscillator

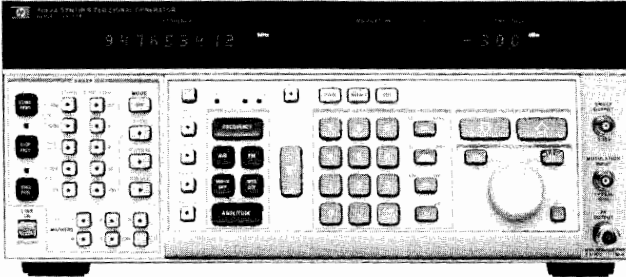

HP 8662A

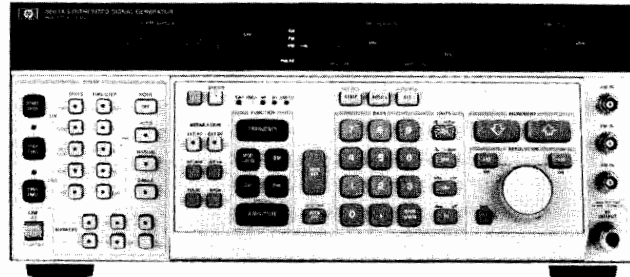

HP 8663A



HP 8662A Synthesized Signal Generator

The HP 8662A derives exceptional RF performance from an indirect frequency synthesis technique that results in frequency resolution of 0.1 Hz from 10 kHz to 640 MHz and 0.2 Hz from 640 MHz to 1280 MHz.

Output level accuracy is held to ± 1 dB using microprocessor correction. This makes the HP 8662A an ideal generator for performing precise receiver sensitivity tests either manually or in automated systems.

The HP 8662A offers versatile phase-locked AM/FM using either internal 400 Hz and 1 kHz rates or externally applied modulating signals, which can be either dc or ac coupled. Several different modes of simultaneous modulation (such as AM + FM or FM + FM) are possible.

Exceptional Spectral Purity

The key contribution of the HP 8662A is spectral purity. Fast-tuning, switched-inductance, voltage-controlled oscillators combined with a low noise reference multiplication chain result in very low SSB phase noise, especially at small offsets from the carrier. The phase noise at 20 kHz to 50 kHz offsets is comparable to that of the best cavity-tuned fundamental oscillators. Such excellent noise performance makes possible complete automation of receiver out-of-channel measurements.

With its excellent long and short-term frequency stability, high output power, fine frequency resolution, and broad frequency range the HP 8662A also meets the requirements of the most critical low noise local oscillator applications. In addition, its fast frequency switching and sweep capabilities also permit its use in many frequency agile and swept local oscillator applications.

An advanced microprocessor-based controller allows convenient keyboard control of all HP 8662A functions. For example, all functions can be incremented and decremented in any user-defined step size within the resolution of the synthesizer using the increment keys and the knob. Up to nine full front panel setups can be stored in the HP 8662A's memory and recalled for later use in any user-defined sequence at the touch of a pushbutton. This permits time-saving semi-automation of generator operation in production setups where the generator must perform many different tests.

Precision Digital Sweep

Fast frequency switching combined with microprocessor control gives the HP 8662A a powerful sweep capability. Automatic, single, and manual modes are available for both linear and logarithmic sweeps with user-selectable step size and number of steps. Five different sweep speeds can be chosen and up to five amplitude or Z-axis markers can be set. All sweep parameters can be controlled with full synthesizer resolution.

HP 8663A Synthesized Signal Generator

The HP 8663A provides all the features and the exceptional spectral purity of the HP 8662A with increased frequency range and modulation capability.

Broad Frequency Range

The HP 8663A utilizes the complete frequency synthesis portion of the HP 8662A with the addition of an internal frequency doubler to achieve a broad frequency range of 100 kHz to 2560 MHz in a single instrument. In the HP 8663A, the exceptional spectral purity of the HP 8662A is maintained up to 1280 MHz. Above this, phase noise is typically increased 6 dB to a level of -124 dBc/Hz at 10 kHz offset from a 2.5 GHz carrier. High output power of +16 dBm (with over-range to 19.9 dBm) is available for efficiently driving frequency translators when low noise microwave signals are needed. Combined with a microwave synthesizer such as the HP 8673A, full frequency coverage from 100 kHz to 26 GHz is possible.

Flexible Modulation

Complete modulation capability across a wide carrier frequency range is the key contribution of the HP 8663A. AM and FM characteristics are similar to those offered in the HP 8662A. The HP 8663A adds high performance pulse and biphasic modulation with wide bandwidth linear phase modulation available with option 002. For complete flexibility the HP 8663A option 002 has the capability to simultaneously provide AM+FM+pulse+phase modulation across its entire frequency range. AM, FM, and linear phase are either AC or DC coupled while biphasic and pulse are DC coupled. This modulation flexibility assures exact signal simulation when testing complex systems such as those involving pulsed doppler radar and electronic warfare. An internal 100 kHz sinusoidal modulation synthesizer phase locked to the 10 MHz time base is standard. Microprocessor flexibility allows the sweep functions to be applicable to the internal audio synthesizer, as well as the RF synthesizer, making applications involving swept modulation possible with a single instrument.

Similarity to the HP 8662A

Because the HP 8663A has been designed to be upward compatible with the HP 8662A, the two generators have identical control and performance characteristics for those functions that are common. Either generator can be combined with the HP 11729A Microwave Converter and the HP 3047A Phase Noise Measurement System to perform microwave phase noise measurements simply and quickly.

SIGNAL GENERATORS

Synthesized Signal Generators

Models 8662A, 8663A (cont.)

HP 8662A Specifications

Frequency
Range: 10 kHz to 1280 MHz (1279.9999998 MHz).
Resolution: 0.1 Hz (0.2 Hz above 640 MHz).
Accuracy and stability: same as reference oscillator.
Internal reference oscillator: 10 MHz quartz oscillator. Aging rate $< 5 \times 10^{-10}$ /day after 10 day warm-up (typically 24 hrs in normal operating environment).

Spectral Purity

Residual SSB Phase Noise in 1 Hz BW ($320 \leq f_c < 640$ MHz)

| Offset from Carrier | | | | |
|---------------------|----------|----------|----------|----------|
| 10 Hz | 100 Hz | 1 kHz | 10 kHz | 100 kHz |
| -100 dBc | -112 dBc | -121 dBc | -131 dBc | -132 dBc |

SSB broadband noise floor in 1 Hz BW at 3 MHz offset from carrier: < -146 dBc for f_c between 120 and 640 MHz at output levels above +10 dBm.

Spurious Signals

| | Frequency Range (MHz) | | | | |
|---|-----------------------|------------|------------|------------|-------------|
| | 0.01 to 120 | 120 to 160 | 160 to 320 | 320 to 640 | 640 to 1280 |
| Spurious non-harmonically related ^{1,2} | -90 dBc | -100 dBc | -96 dBc | -90 dBc | -84 dBc |
| Sub-harmonically related ($\frac{1}{2}, \frac{3f}{2}$, etc.) | none | none | none | none | -75 dBc |
| Power line (60Hz) related or microphonically generated (within 300 Hz) ³ | -90 dBc | -85 dBc | -80 dBc | -75 dBc | -70 dBc |
| Harmonics | < -30 dBc | | | | |

Output

Level range: +13 to -139.9 dBm (1V to 0.023 μ V_{rms} into 50 Ω).
Resolution: 0.1 dB.
Absolute level accuracy (+15° to +45°C): ± 1 dB between +13 and -120 dBm, ± 3 dB between -120 and -130 dBm.
SWR: typically from 1.5 to 1.8 depending on output level and frequency.
Reverse power protection: typically up to 30W or ± 8 Vdc.

Amplitude Modulation

Depth: 0 to 95% at output levels of +8 dBm and below (+10 dBm in uncorrected mode). AM available above these output levels but not specified.
Resolution: 1%, 10 to 95% AM; 0.1%, 0 to 9.9% AM.
Incidental PM (at 30% AM): 0.15-640 MHz, < 0.12 radian peak; 640-1280 MHz, < 0.09 radian peak.
Incidental FM (at 30% AM): 0.15-640 MHz, $< 0.12 \times f_{mod}$; 640-1280 MHz, $< 0.09 \times f_{mod}$.
Indicated accuracy: $\pm 5\%$ of reading $\pm 1\%$ AM. Applies for rates given in table below, internal or external mode, for depths $\leq 90\%$.
Rates and Distortion with Internal or External Modulating Signal

| Frequency range | AM rate | AM Distortion | | |
|-----------------|------------|---------------|-----------|-----------|
| | | 0-30% AM | 30-70% AM | 70-90% AM |
| 0.15-1 MHz | dc-1.5 kHz | 2% | 4% | 5.75% |
| 1-10 MHz | dc-5 kHz | 2% | 4% | 5.75% |
| 10-1280 MHz | dc-10 kHz | 2% | 4% | 5.75% |

Frequency Modulation

FM rates (1 dB bandwidth): external ac, 20 Hz to 100 kHz; external dc, dc to 100 kHz.

FM deviation: from 25 to 200 kHz depending on carrier frequency.
Indicated FM accuracy: $\pm 8\%$ of reading plus 10 Hz (50 Hz to 20 kHz).
FM resolution: 100 Hz for deviations < 10 kHz, 1 kHz for deviations ≥ 10 kHz.
Incidental AM (AM sidebands at 1 kHz rate and 20 kHz deviation): < -72 dBc, $f_c < 640$ MHz; < -65 dBc, $f_c \geq 640$ MHz.
FM distortion: $< 1.7\%$ for rates < 20 kHz, $< 1\%$ for rates < 1 kHz.
Center frequency accuracy and long term stability in AC mode: same as CW mode.

Supplemental Characteristics

Typical SSB Phase Noise

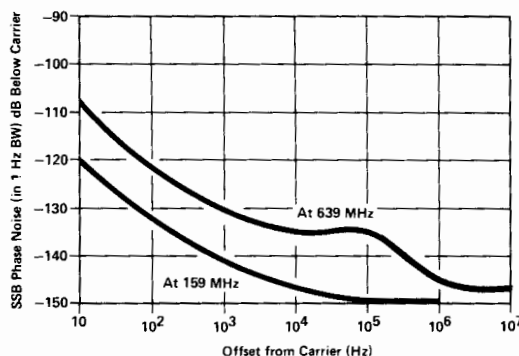

Frequency switching speed: From 420 μ sec to 12.5 msec, depending on the programming mode.

HP 8663A Specifications

The HP 8663A signal generator is related to the HP 8662A in both concept and structure. The HP 8662A concept of an extremely low phase noise signal source incorporating signal generator modulation capabilities and output characteristics is carried even further by the HP 8663A. While maintaining high spectral purity, the HP 8663A offers increased frequency range to 2560 MHz, increased output level to +16 dBm, and the addition of phase and pulse modulation. The result is a highly flexible and powerful signal generator that utilizes and extends the proven circuitry of the HP 8662A. Thus, the HP 8662A and HP 8663A share many of the same specifications as shown below:

Frequency

Range: 100 kHz to 2560 MHz (2559.9999996 MHz)
Resolution: 0.1 Hz ($f_c < 640$ MHz)
 0.2 Hz ($640 \text{ MHz} \leq f_c < 1280$ MHz)
 0.4 Hz ($f_c \geq 1280$ MHz)

Accuracy, stability, and internal reference oscillator: identical to HP 8662A.

Spectral Purity

Residual SSB phase noise in 1 Hz BW ($320 \leq f_c < 640$ MHz): identical to HP 8662A.
Typical SSB phase noise: identical to the HP 8662A for f_c between 100 kHz and 1280 MHz (see graph). For f_c between 1280 and 2560 MHz, the noise will be approximately 12 dB higher than the 639 MHz curve on the "typical SSB phase noise" graph.
Spurious signals: identical to HP 8662A except for f_c between 1280 and 2560 MHz the spurious non-harmonics are -78 dBc, the sub-harmonically related ($f/2, 3f/2$, etc.) are -40 dBc, and the power line (60 Hz) or microphonically generated spurious are -65 dBc.
Harmonics: < -30 dBc, $\leq +13$ dBm output, < -25 dBc, +13 dBm to +16 dBm output, $f_c < 1280$ MHz; < -25 dBc, $f_c \geq 1280$ MHz

Output

Level range: +16 dBm to -129.9 dBm
Resolution: 0.1 dB
Absolute level accuracy (+15° to +45°C): ± 1 dB, +16 dBm to -119.9 dBm; ± 3 dB for -120 dBm and below.
SWR: < 1.5

Depth: 0 to 95% at levels of +10 dBm and below

Resolution: 0.1%

Incidental FM (at 30% AM): identical to HP 8662A except: $<0.3 \times f_{\text{mod}}$ for $1280 \leq f_c < 2560$ MHz

Indicated accuracy: $\pm 6\%$ of reading $\pm 1\%$ AM (400 Hz and 1 kHz, depth 90%)

AM Bandwidth (1dB)

DC to >1.5 kHz, $0.15 \text{ MHz} \leq f_c < 1 \text{ MHz}$;

DC to >5 kHz, $1 \text{ MHz} \leq f_c \leq 10 \text{ MHz}$;

DC to >10 kHz, $f_c > 10 \text{ MHz}$;

External dc coupling.

External ac coupling or internal; low frequency coupling is 20 Hz.

Distortion (400 Hz and 1 kHz): $<2\%$ (0–30% AM)

$<4\%$ (30–70% AM)

$<6\%$ (70–90% AM)

FM rates (1 dB bandwidth): external ac, 20 Hz to 100 kHz, external dc, dc to 100 kHz.

Maximum allowable peak deviation: identical to HP 8662A for f_c between 100 kHz and 1280 MHz. Up to 400 kHz for f_c between 1280 and 2560 MHz.

Indicated FM accuracy (50 Hz to 20 kHz): $\pm 9\%$ of setting +10 Hz.

FM resolution: 100 Hz to 1 kHz depending on f_c and deviation setting.

Incidental AM (AM sidebands at 1 kHz rate and 20 kHz deviation)

< -72 dBc ($10 \leq f_c < 640$ MHz)

< -65 dBc ($640 \leq f_c < 2560$ MHz)

FM distortion: $<1.25\%$ (400 Hz and 1 kHz rates)

$<1.75\%$ (rates less than 20 kHz)

Maximum peak phase deviation: from $\pm 25^\circ$ for f_c between 120 and 160 MHz up to $\pm 400^\circ$ for f_c between 1280 and 2560 MHz.

Maximum rate: from 10 kHz for f_c between 0.15 and 10 MHz up to 10 MHz for f_c between 250 and 2560 MHz.

Phase deviation resolution: 1° ($0.1 \leq f_c < 640$ MHz)

2° ($640 \leq f_c < 1280$ MHz)

4° ($1280 \leq f_c < 2560$ MHz)

Phase modulation distortion: 10% at maximum rate

Biphase modulation is available on the standard HP 8663A for f_c less than 640 MHz and available for all f_c with option 002.

Deviation: $\pm 90^\circ$

Carrier null when modulated with 1 MHz, 50% duty cycle square wave: > 25 dBc.

Modulation input required: TTL positive true. The internal modulation oscillator can be used for 50% duty cycle modulation. External input is on rear panel.

Pulse on/off ratio: >80 dB (50–2560 MHz)

Pulse rise/fall time: <250 ns (50–120 MHz); <780 ns (120–640 MHz); <100 ns ($f_c \geq 640$ MHz)

Pulse Repetition Frequency (50% duty cycle):

Internal: 10 Hz to 99.9 kHz

External: 10 Hz to 2 MHz, $50 \text{ MHz} < f_c < 640 \text{ MHz}$

10 Hz to 5 MHz, $f_c > 640 \text{ MHz}$

Internal Modulation Oscillator

Rates: 10 Hz to 99.9 kHz

Frequency resolution: 3 digits

Frequency accuracy: same as reference oscillator.

Output level (available on rear panel): 1 volt peak into 600Ω

Output impedance: 600Ω

Flatness (referenced to 1 kHz): $\leq \pm 1\%$

Distortion: $<1\%$

Remote programming: the HP-IB interface is standard on the HP 8662A and HP 8663A signal generators. All functions controlled from the front panel with the exception of the line switch are programmable with the same accuracy and resolution as in manual mode.

Operating temperature range: 0° to $+55^\circ\text{C}$.

Leakage: meets radiated and conducted limits of MIL STD 461A methods RE02 and CE03 as well as VDE 0871.

Power requirements: 115 (90-126) V or 230 (198-252) V; 48 to 66 Hz; 450 VA max.

Weight: HP 8662A: net 30 kg (65.5 lb.). Shipping 36 kg (80 lb.).

HP 8663A: net 33.8 (74 lb.). Shipping 40 kg (88 lb.).

Size: HP 8662A: 178 mm H x 425 mm W x 572 mm D ($7'' \times 16.75'' \times 22.5''$)

HP 8663A: 178 mm H x 425 mm W x 642 mm D ($7'' \times 16.75'' \times 25.3''$)

Note: depth includes front panel depth of 45 mm ($1.75''$).

HP 8662A 1280 MHz Signal Generator⁶

Option 001: Rear panel RF output and mod input

Option 003: Specified SSB phase noise for 640 MHz output

Option 907: Front Handle kit

Option 908: Rack flange kit

Option 909: Rack flange & front handle kit

Option 910: Extra operating & service manual

HP 11721A External frequency doubler for operation

to 2.56 GHz (HP 8662A only)

HP 8663A 2560 MHz Signal Generator⁶

Option 001: Rear panel RF output and mod inputs

Option 002: Wideband linear phase modulation

Option 003: Specified SSB phase noise for 640 MHz output.

Option 907: Front handle kit

Option 908: Rack flange kit

Option 909: Rack flange & front handle kit

Option 910: Extra operating & service manual

HP 11714A Service Support Kit (required for servicing HP 8662A/8663A)

¹In the remote mode it is possible to have microprocessor clock related spurious signals spaced 3 MHz apart at an absolute level of typically less than -145 dBm.

²Spurious signals can be up to 3 dB higher in the dc FM mode.

³At a 50 Hz line frequency, power line or microphonically related spurious signals may be up to 3 dB higher and appear at offsets as high as 1 kHz from the carrier.

⁴Due to automatic leveling loop bandwidth changes, brief (30 msec) level inaccuracies may occur when switching through 150 kHz and 1 MHz RF output frequencies.

⁵Pulse modulation is available for $f_c < 50$ MHz but is unspecified.

⁶HP-IB cables not supplied, see page 121 for description and prices.



SIGNAL GENERATORS

Synthesized Signal Generators

Models 8660A and 8660C

- 10 kHz to 2600 MHz
- Synthesizer stability and accuracy
- 1 Hz resolution (2 Hz above 1300 MHz)

- Ten digit display
- Calibrated output over > 140 dB range
- AM, FM, Φ M, or pulse modulation

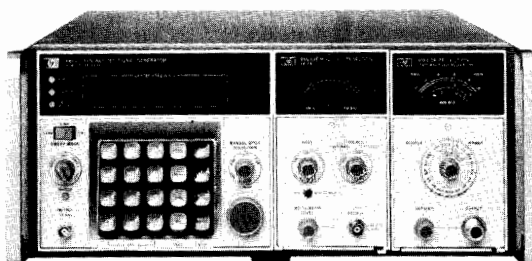

HP 8660C

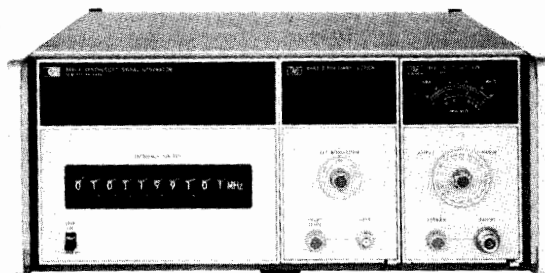

HP 8660A

HP 8660A, 8660C Synthesized Signal Generators

System Concept

The HP 8660 is a modular solid-state plug-in system. Each system includes: 1) a programmable synthesized signal generator mainframe, 2) an RF section plug-in, and 3) a modulation section. Synthesized accuracy and stability along with complete programmability make the HP 8660 ideal for most automated receiver and component testing situations.

Mainframes

There are two mainframes, the HP 8660A and HP 8660C which both offer a BCD or optional HP-IB interface and operation from an internal or external frequency reference. The HP 8660A mainframe uses thumbwheel switches to select CW output frequencies. The HP 8660C mainframe provides direct keyboard entry of CW frequencies. Added capabilities of the HP 8660C include digital sweep, frequency stepping, control of frequency with a tuning knob, and a ten-digit numerical display.

Plug-In RF Sections

The HP 86601A (0.01 – 110 MHz), HP 86602B (1 – 1300 MHz), and HP 86603A (1 – 2600 MHz) are the three RF section choices. The HP 11661B Frequency Extension Module (mainframe option 100) must be used with the HP 86602B and HP 86603A and is installed internal to an HP 8660 mainframe. When using the HP 8660A mainframe, the HP 86603A plug-in must be ordered with option 003.

Plug-In Modulation

There are five modulation sections to choose from. The HP 86631B Auxiliary Section provides external AM and pulse modulation. The HP 86632B offers AM and FM and utilizes a free-running VCO to provide high FM deviations and rates while the HP 86633B provides AM and phase locked FM. The HP 86634A offers high performance phase modulation with rates to 10 MHz while the HP 86635A provides both FM and phase modulation. (The HP 86634A and HP 86635A must be used with option 002 RF Section.)

HP 8660A, 8660C Mainframe Specifications

Frequency accuracy and stability: CW frequency accuracy and long term stability are determined by internal reference oscillator (3×10^{-8} /day), or by external reference.

Reference Oscillator

Internal: 10 MHz quartz oscillator. Aging rate less than ± 3 parts in 10^8 per 24 hours after 72 hours warm-up (± 3 parts in 10^9 per 24 hours, Option 001).

External: rear panel switch allows operation from 5 MHz or 10 MHz frequency standard at a level between 0.5 and 2.5 Vrms into 170 ohms.

Reference output: rear panel BNC connector provides output of reference signal selected at level of at least 0.5 Vrms into 170 ohms.
Digital sweep (HP 8660C): auto, single, or manual. Selectable speeds 0.1, 1, or 50 seconds.

Remote Programming

Functions

HP 8660A: all front panel frequency and output level (and most modulation functions) are programmable.

HP 8660C: CW frequency, frequency stepping (STEP], STEP], output level, and most modulation functions are programmable. Note: digital sweep is NOT programmable.

Programming Input

Connector type: 36-pin Cinch type 57 (mating connector supplied). 24-pin Cinch type 57 for optional HP-IB interface (mating connector NOT supplied).

Logic: TTL compatible (negative true).

Switching time: less than 5 ms to be within 100 Hz of any new frequency selected. (Less than 100 ms to be within 10 Hz.)

General

Operating temperature range: 0 to +55°C.

Power: 100, 120, 220, or 240 volts +5%, -10%, 48-66 Hz; approximately 350 watts.

Weight (mainframe only): net 23.2 kg (51 lb). Shipping, 28.6 kg (63 lb).

Supplemental Characteristics

Typical Single Sideband Phase Noise

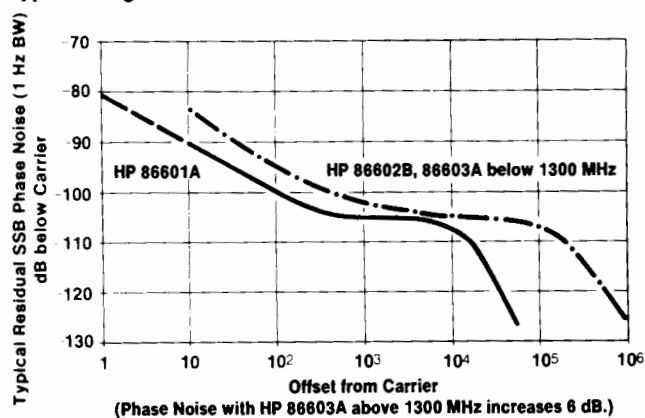

10 kHz to 110 MHz

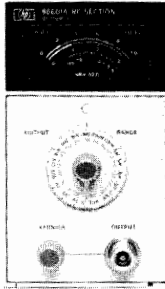

HP 86601A

1 MHz to 1300 MHz

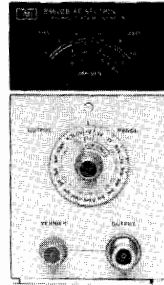

HP 86602B (HP 11661B required)

1 MHz to 2600 MHz

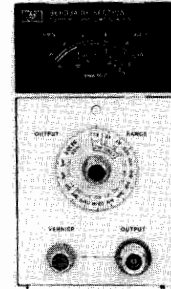

HP 86603A (HP 11661B required)

RF Section Specifications (installed in HP 8660A or HP 8660C mainframe)

| | | HP 86601A | HP 86602B (requires HP 11661B) | HP 86603A (requires HP 11661B) | |
|----------------------------|--|--|--|---|--|
| FREQUENCY CHARACTERISTICS | Frequency Range | 0.01–110 MHz (109.999999 MHz) | 1–1300 MHz (1299.999999 MHz) | 1–2600 MHz (2599.999998 MHz) | |
| | Frequency Resolution | 1 Hz | 1 Hz | 2 Hz | |
| | Harmonics | ≤−40 dBc | ≤−30 dBc (<−25 dBc above +3 dBm) | ≤−20 dBc ¹ | |
| | Spurious Non Harmonically Related | ≤−80 dBc | ≤−80 dBc below 700 MHz ≤−80 dBc above 700 MHz within 45 MHz of carrier ≤−70 dBc above 700 MHz >45 MHz from carrier | ≤−74 dBc within 40 MHz of carrier ¹ ≤−64 dBc >45 MHz from carrier ≤−64 dBc | |
| | Power Line Related (CW, AM, φM only) ² | ≤−70 dBc | ≤−50 dBc on +10 dBm range ≤−70 dBc | | |
| | Signal To Phase Noise Ratio (CW, AM, φM only) ² | >50 dB | >45 dB | >39 dB | |
| OUTPUT CHARACTERISTICS | Output Level (into 50Ω) | +13 dBm to −146 dBm | +10 to −146 dBm | +10 to −136 dBm +7 to −136 dBm ³ | |
| | Output Accuracy (local and remote) | ±1 dB, +13 to −66 dBm ±2 dB, −66 to −146 dBm | ±1.5 to −76 dBm ±2.0 to −146 dBm | ±2.5 dB to −76 dBm ³ ±3.5 dB to −136 dBm | |
| | Flatness (output level variation with frequency) | <±0.75 dB | <±1.0 dB | <±2.0 dB (1–2600 MHz) | |
| | Impedance | 50Ω | | | |
| MODULATION CHARACTERISTICS | AM Modulation Depth | 0 to 95% | 0 to 90% ⁴ | 0 to 50% ⁴ | |
| | 3 dB Bandwidth: | 0–30% | 200 Hz, CF<0.4 MHz 10 kHz, 0.4≤CF<4 MHz 100 kHz, CF≥4 MHz | 10 kHz, CF<10 MHz 100 kHz, CF≥10 MHz | 10 kHz |
| | | 0–70% | 125 Hz, CF<0.4 MHz 6 kHz, 0.4≤CF<4 MHz 60 kHz, CF≥4 MHz | 6 kHz, CF<10 MHz 60 kHz, CF≥10 MHz | N/A |
| | | 0–90% | 100 Hz, CF<0.4 MHz 5 kHz, 0.4≤CF<4 MHz 50 kHz, CF≥4 MHz | 5 kHz, CF<10 MHz 50 kHz, CF≥10 MHz | N/A |
| | Distortion, ⁵ THD at 30% AM at 70% AM at 90% AM | | <1%, 0.4–110 MHz <3%, 0.4–110 MHz <5%, 0.4–110 MHz | <1% <3% <5% | <5% N/A N/A |
| | | FM Rate | dc to 1 MHz with HP 86632B 20 Hz to 100 kHz with HP 86633B | dc to 200 kHz with HP 86632B and HP 86635A 20 Hz to 100 kHz with HP 86633B | |
| | | Maximum Deviation (peak) | 1 MHz with HP 86632B 100 kHz with HP 86633B | 200 kHz with HP 86632B and HP 86635A 100 kHz with HP 86633B | 400 kHz w/HP 86632B, 86635A 200 kHz w/HP 86633B |
| | Distortion, THD (at rates up to 20 kHz) | <1% up to 200 kHz dev. <3% up to 1 MHz dev. | <1% up to 200 kHz dev. | <1% up to 400 kHz dev. | |
| | PULSE | Pulse Rise/Fall Time | 200 ns | 50 ns | |
| | | ON/OFF Ratio (with pulse level control at max.) | >50 dB | >40 dB | >60 dB |
| φM ⁶ | φM Rate | N/A | dc to 1 MHz with HP 86635A dc to 1 MHz for CF <100 MHz dc to 10 MHz for CF ≥100 MHz with HP 86634A | | |
| | Maximum Peak Deviation | N/A | 0 to 100 degrees | 0 to 200 degrees | |
| | Distortion, THD | N/A | <5% up to 1 MHz rates <7% up to 5 MHz rates <15% up to 10 MHz rates | | |
| GENERAL | Weight | Net 5 kg (11 lb) Shipping 6.8 kg (15 lb) | Net 4.1 kg (9 lb) Shipping 5.5 kg (12 lb) | Net 5 kg (11 lb) Shipping 6.4 kg (14 lb) HP 11661B: Net 2.3 kg (5 lb); shipping 2.7 kg (6 lb) | |

¹For output levels +3 dBm and below; slightly higher +3 to +7 dBm.
²Measured in a 30 kHz band centered on the carrier excluding a 1 Hz band centered on the carrier.
³For +3 to +7 dBm output levels, output accuracy and flatness will be slightly degraded (above 1300 MHz only)

⁴For RF output level meter readings from +3 dB to −6 dB and only at +3 dBm and below.
⁵Applies only at 400 Hz and 1 kHz rates with output meter set between 0 and +3 dB. At −6 dB meter setting the distortion approximately doubles.
⁶Phase modulation is only possible with Option 002 RF Sections.



SIGNAL GENERATORS

Synthesized Signal Generators

Models 8660A & 8660C (cont.)

Pulse/AM

AM/High Deviation FM

AM/φ Locked FM

Phase Modulation

φM/FM

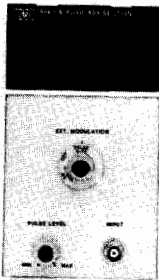

HP 86631B

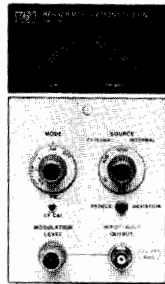

HP 86632B

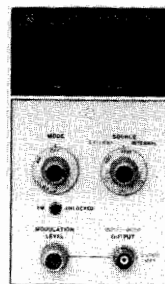

HP 86633B

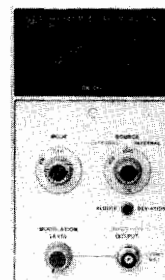

HP 86634A

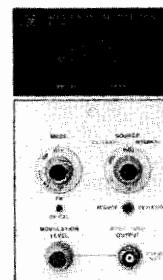

HP 86635A

Modulation Section Specifications

| | | HP 86631B | HP 86632B | HP 86633B | HP 86634A | HP 86635A |
|---|---|--|---|---|---|---|
| | Functions | Ext. Only | Int. and Ext. | Int. and Ext. | — | — |
| AM | Indicated Accuracy (at 400 and 1000 Hz rates) | — | ±5% of full scale With HP 86601A RF Section: ±7%, center frequency ≥100 MHz. With HP 86603A RF Section: ±10%, center frequency ≥1300 MHz. | — | — | — |
| FM | Functions | — | Int. and Ext., FM CF CAL | Int. and Ext. | — | Int. and Ext., FM CF CAL |
| | Center Frequency Long Term Stability | — | Typically less than 200 Hz/hr | Same as in CW Mode (3×10^{-8} /day) | — | Typically less than 200 Hz/hr |
| | Indicated Accuracy (up to 20 kHz rates) | — | ±5% of full scale | | — | ±5% of full scale |
| Pulse | Functions | Ext. Only | — | — | — | — |
| φM | Functions | — | — | — | Int. and Ext. | Int. and Ext. |
| | Indicated Accuracy (15°C to 35°C) | — | — | — | ±5% of full scale up to 100 kHz rates ±8% of full scale up to 2 MHz rates ±15% of full scale up to 10 MHz rates | |
| Meter | | — | 0—100% AM 0—10, 100, 1000 kHz FM Pk. Dev. (0—20, 200, 2000 kHz FM for CF ≥1300 MHz) | 0—100% AM 0—10, 100 kHz FM Pk. dev. (0—20, 200 kHz FM for CF ≥1300 MHz) | 0—100° Peak φM (0—200° for CF ≥ 1300 MHz) | 0—10, 100, 1000 kHz FM, 0—100° Pk φM (0—20, 200, 2000 kHz FM, 0—200° Pk. φM for CF ≥1300 MHz) |
| Internal Modulation Source Output | | None — | 400 Hz and 1 kHz ±5% 200 mV minimum into 10 kΩ. Available at front panel BNC connector | | | |
| Input Impedance | | 50Ω Pulse 600Ω AM | 600Ω | 600Ω | 50Ω | 600Ω |
| Weight | | Net, 1.4 kg (3 lb) Shipping, 2.3 kg (5 lb) | Net, 2.7 kg (6 lb) Shipping, 4.1 kg (9 lb) | Net, 2.7 kg (6 lb) Shipping, 4.1 kg (9 lb) | Net, 1.8 kg (4 lb) Shipping, 3.2 kg (7 lb) | Net, 2.7 kg (6 lb) Shipping, 4.1 kg (9 lb) |

Ordering Information:

HP 8660A Synthesized Signal Generator Mainframe \$10,500

HP 8660C Synthesized Signal generator Mainframe \$12,500

Options for HP 8660A, 8660C

Option 001: ±3 × 10⁻⁹/day internal reference oscillator add \$210

Option 002: no internal reference oscillator less \$300

Option 003: operation from 50 to 400 Hz line add \$158

Option 004: 100 Hz frequency resolution (200 Hz above 1300 MHz) less \$350

Option 005: HP-IB programming interface \$150

Note: HP-IB cables not supplied, see page 742.

Option 009: (HP 8660A only) LED display indicates selected frequency in 1-2-4-8 BCD code add \$210

Option 100: HP 11661B factory installed inside main frame add \$5,100

Option 908: Rack Flange Kit \$40

HP 86601A 0.01–110 MHz RF Section \$6,500

Price

\$10,500

\$12,500

HP 86602B 1–1300 MHz RF Section \$1,500

HP 86603A 1–2600 MHz RF Section \$2,000

Note: HP 86602B and 86603A RF sections require an HP 11661B for operation.

Option 001: no RF output attenuator (all RF Sections) \$1,500

Option 002: adds phase modulation capability (HP 86602B, 86603A only) \$1,500

Option 003: allows operation of HP 86603A with HP 8660A mainframe \$1,500

HP 11661B Frequency Extension Module \$1,500

HP 86631B Auxiliary Section \$1,500

HP 86632B AM/FM Modulation Section \$2,500

HP 86633B AM/FM Modulation Section \$2,500

HP 86634A φM Modulation Section \$2,500

HP 86635A φM/FM Modulation Section \$2,500

HP 11672A Service Accessory Kit \$1,000

HP 11707A Test Plug-in \$2,000

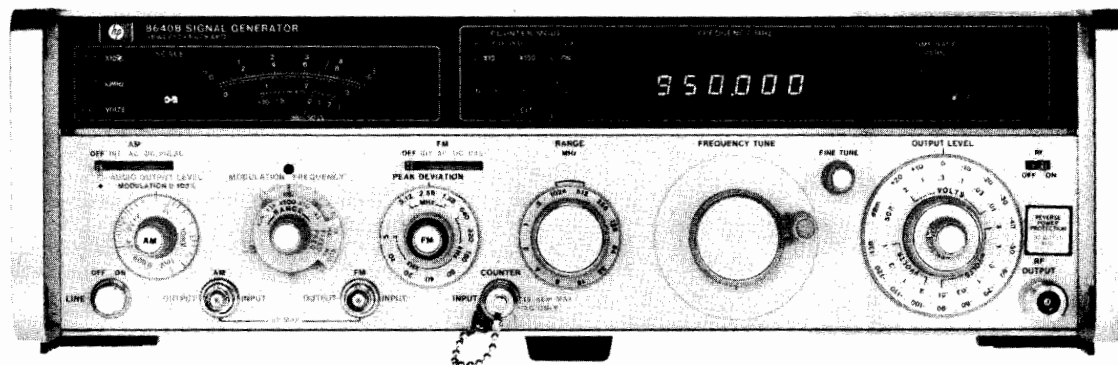

HP 8640B (with Option 001, 002, 003)

HP 8640B Signal Generator

The HP 8640B Signal Generator covers the frequency range 500 kHz to 512 MHz (450 kHz to 550 MHz with band overrange) and can be extended to 1024 MHz with an internal doubler (Opt 002). Using the HP 11710B Down Converter, the HP 8640B frequency range can be extended down to 10 kHz. An optional audio oscillator (Opt 001) is also available with a frequency range of 20 Hz to 600 kHz. This broad coverage, together with calibrated output and modulation, provides for complete RF and IF performance tests on virtually any type of HF, VHF, or UHF receiver.

A solid state generator, the HP 8640B has an output level range of +19 to -145 dBm (2V to 0.013 μ V) which is calibrated, metered, and leveled to within ± 0.5 dB across the full frequency range of the instrument.

The HP 8640B generator provides AM, FM, and pulse modulation for a wide range of receiver test applications. This modulation is calibrated and metered for direct readout under all operating conditions.

A reverse power protection option (Opt 003) is available to eliminate instrument damage due to accidental transmitter keying. This module protects against up to 50 watts of applied power and automatically resets upon removal of the reverse power.

Noise performance of the HP 8640B is extremely low beyond 10 kHz offsets. The high-Q cavity oscillator has been optimized with use of a low-noise microwave transistor for spectrally pure output signals. At a 20 kHz offset from the carrier, SSB phase noise is < -130 dBc for carrier frequencies from 230 to 450 MHz, and rises to -122 dBc at 550 MHz. The SSB phase noise level decreases by approximately 6 dB for each division of the output frequency down to the

broadband noise floor of better than 140 dB/Hz. This exceptional noise performance is also preserved during FM modulation and in the phase-locked mode.

Frequency Counter

The internal 6-digit counter displays the output frequency and can also be used to count external input signals from 20 Hz to 550 MHz. This eliminates the need for a separate frequency counter in many measurement systems.

Phase-Locked Mode

At the push of a button, the HP 8640B built-in phase lock synchronizer locks the RF output frequency to the crystal time base used in the counter. In this locked mode, the output stability is better than 5×10^{-8} /hr and the spectral purity and FM capability of the unlocked mode are preserved. For higher stability, it is possible to lock to an externally applied 5 MHz standard. Two HP 8640Bs can also be locked together for various 2-tone measurements.

In the phase locked mode, increased resolution is available by using the $\frac{1}{2}$ digit increment button. For example, 500 Hz resolution is possible for frequencies between 100 and 1000 MHz.

FM Modulation

In the phase locked mode, full FM capability is preserved down to modulation rates of 50 Hz. The narrow bandwidth of the phase lock loop (< 5 Hz) provides for FM modulation up to 250 kHz rates and insures no degradation in noise from the unlocked mode. This crystal stability, coupled with the precision modulation and low noise, makes the HP 8640B ideal for testing narrowband FM or crystal-controlled receivers.



SIGNAL GENERATORS

Precision, High Stability, AM-FM VHF Signal Generator

Model 8640B (cont.)

HP 8640B Specifications

(See technical data sheet for complete specifications.) All specifications apply over the nominal frequency ranges and over the top 10 dB of the output level vernier range unless otherwise specified.

Frequency

Range: 500 kHz to 512 MHz in 10 octave ranges (to 1024 MHz with Option 002 internal frequency doubler).

Ranges and range overlap: ranges extend approximately 10% below and 7% above the nominal frequency ranges shown below.

| Frequency ranges (MHz) | | |
|------------------------|--------|-----------|
| 0.5-1 | 8-16 | 128-256 |
| 1-2 | 16-32 | 256-512 |
| 2-4 | 32-64 | 512-1024 |
| 4-8 | 64-128 | (Opt 002) |

Fine Tuning

Unlocked: >1000 ppm total range.

Locked mode: >±20 ppm by varying internal time base vernier.

Internal Counter Resolution (unlocked)

| Frequency Ranges (MHz) | Normal Mode | Expand X10 | Expand X100 |
|------------------------|-------------|------------|-------------|
| 0.5-1 | 10 Hz | 1 Hz | 0.1 Hz |
| 1-16 | 100 Hz | 10 Hz | 1 Hz |
| 16-128 | 1 kHz | 100 Hz | 10 Hz |
| 128-1024 | 10 kHz | 1 kHz | 100 Hz |

Optimum Counter Resolution When Phase-Locked

| Frequency Ranges (MHz) | With 6 Digits | +1/2 Digit |
|------------------------|---------------|------------|
| 0.5-0.9999995 | 1 Hz | 0.5 Hz |
| 1.0-9.999995 | 10 Hz | 5 Hz |
| 10.0-99.99995 | 100 Hz | 50 Hz |
| 100.0-999.9995 | 1 kHz | 500 Hz |
| 1000-1024 | 10 kHz | 5 kHz |

Accuracy: 6½ digit LED display with X10 and X100 expand; accuracy depends on internal or external reference used.

Stability (after 2 hour warmup)

Normal: <10 ppm/10 min.

Locked: <0.05 ppm/hr.

Restabilization Time After Frequency Change

Normal: <15 min.

Locked: <1 min. after relocking to be within 0.1 ppm of steady state frequency.

Output

Range: 10 dB steps and 18 dB vernier provide the following output power settings into 50Ω.

| Frequency Range (MHz) | HP 8640B | With Option(s) | | |
|--------------------------|-----------------|-------------------|-------------------|-----------------|
| | | 002 | 003 | 002/003 |
| 0.5 to 512 | +19 to -145 dBm | +18.5 to -145 dBm | +18.5 to -145 dBm | +18 to -145 dBm |
| 512 to 1024 (Option 002) | | +13 to -145 dBm | | +12 to -145 dBm |

Level Flatness (referred to output at 50 MHz and applies to 1V range and for top 10 dB of vernier range)

| Frequency Range (MHz) | HP 8640B | With Option(s) | | |
|--------------------------|----------|----------------|----------------------|--------------------|
| | | 002 | 003 | 002/003 |
| 0.5 to 64 | ±0.5 dB | ±0.75 dB | +0.75 dB -1.25 dB | +1.0 dB -2.0 dB |
| 64 to 512 | | ±1.0 dB | | |
| 512 to 1024 (Option 002) | | ±1.5 dB | | ±2.0 dB |

Level accuracy: (worst case as indicated on level meter) ±1.5 dB to ±4.5 dB depending on level, frequency, and options installed.

Spectral Purity

Harmonics (at 1 volt, +10 dBm output range and below)

>30 dB below fundamental, 0.5 to 512 MHz.

>12 dB below fundamental, 512 to 1024 MHz (Option 002).

Spurious Output Signals (excluding frequencies within 15 kHz of the signal whose effects are specified in residual AM and FM)

| Frequency Range (MHz) | Subharmonically Related | Non-harmonically Related |
|--------------------------|-------------------------|--------------------------|
| 0.5 to 512 | <-100 dBc | <-100 dBc |
| 512 to 1024 (Option 002) | <-20 dBc | |

¹dBc = dB below the carrier.

Residual AM (averaged rms): 0.3 to 3 kHz post-detection noise bandwidth <-85 dBc.

Residual FM (averaged rms): 0.3 to 3 kHz post-detection noise bandwidth. (CW and up to 1/8 maximum allowable peak deviation.)

0.5 to 512 MHz: <5 Hz.

512 to 1024 MHz: <10 Hz.

Measured SSB noise (typical): in graph below, triangular markers indicate specified limits.

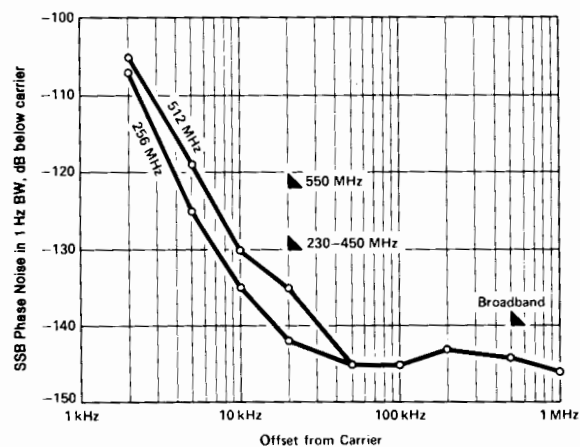



Modulation

General

Types: internal AM and FM; External AM, FM, and PULSE; simultaneous AM and FM or PULSE and FM.

Internal modulation sources (independently adjustable output level is available at front panel):

Standard

Frequency: fixed 400 Hz and 1 kHz, $\pm 3\%$.

Output level: 10 mV to 1V rms into 600 Ω .

Optional (internal variable audio oscillator Option 001):

Frequency: variable 20 Hz to 600 kHz, $\pm 15\%$ plus fixed 400 Hz and 1 kHz $\pm 3\%$.

Output level: 1 mV to 3V rms into 600 Ω .

Amplitude Modulation

Depth

0.5 to 512 MHz: 0 to 100% for output levels from +13 dBm and below.

512 to 1024 MHz: 0 to 100% for output levels of +7 dBm and below, excluding the top 6 dB of output vernier range.

AM rates: INT and EXT ac, 20 Hz to AM 3 dB bandwidth; EXT dc, dc to AM 3 dB bandwidth.

AM 3 dB Bandwidth

| Frequency Ranges | 0 to 50% AM | 50 to 90% AM |
|------------------|-------------|--------------|
| 0.5 to 2 MHz | 20 kHz | 12.5 kHz |
| 2 to 8 MHz | 40 kHz | 25 kHz |
| 8 to 512 MHz | 60 kHz | 50 kHz |
| 512 to 1024 MHz | 60 kHz | 50 kHz |

AM Distortion (at 400 Hz and 1 kHz rates)

| Frequency Ranges | 0 to 30% AM | 30 to 50% AM | 50 to 90% AM |
|------------------|-------------|--------------|--------------|
| 0.5 to 512 MHz | <1% | | <3% |
| 512 to 1024 MHz | <10% | <20% | |

External AM Sensitivity (400 Hz and 1 kHz rates)

0.5 to 512 MHz: (0.1 \pm 0.005)% AM per mV peak into 600 Ω with AM vernier at full clockwise position.

512 to 1024 MHz: nominal 0.1% AM per mV peak into 600 Ω with AM vernier at full clockwise position.

Indicated AM Accuracy (400 Hz and 1 kHz rates using internal meter)

0.5 to 512 MHz: \pm (5.5% of reading + 1.5% of full scale) from 0 $^\circ$ to 50 $^\circ$ C.

512 to 1024 MHz: not specified; each generator can be individually calibrated using operating manual procedure.

Peak Incidental Phase Modulation (at 30% AM)

0.5 to 128 MHz: <0.15 radian.

128 to 512 MHz: <0.3 radian.

512 to 1024 MHz: <0.6 radian.

Peak incidental frequency deviation: equals peak incidental phase deviation x modulation rate.

Pulse Modulation¹

| | Frequency Ranges (MHz) | | | | | |
|------------------------------------|---|------------|------------------|------------------|------------------|----------------------|
| | 0.5-1 | 1-2 | 2-8 | 8-32 | 32-512 | 512-1024 |
| Rise and Times Fall | <9 μ s | <4 μ s | <2 μ s | <1 μ s | | <1 μ s (typical) |
| Pulse Repetition Rate | 50 Hz to 50 kHz | | 50 Hz to 100 kHz | 50 Hz to 250 kHz | 50 Hz to 500 kHz | |
| Pulse Width Minimum ² | 10 μ s | | 5 μ s | 2 μ s | | |
| Pulse ON/OFF ratio at max. vernier | >40 dB | | | | | >60 dB |
| Peak Input Required | Nominally +0.5V (5V max). Sinewave or pulse return to zero into 50 Ω | | | | | |

¹Pulse performance degrades below 500 Hz repetition rates.

²For level accuracy within 1 dB of CW (>0.1% duty cycle).

Frequency Modulation

Deviation: maximum allowable deviation equals 1% of lowest frequency in each nominal output frequency range.

| Frequency Range (MHz) | Maximum Peak Deviation (kHz) |
|-----------------------|------------------------------|
| 0.5-1 | 5 |
| 1-2 | 10 |
| 2-4 | 20 |
| 4-8 | 40 |
| 8-16 | 80 |
| 16-32 | 160 |
| 32-64 | 320 |
| 64-128 | 640 |
| 128-256 | 1280 |
| 256-512 | 2560 |
| 512-1024 | 5120 |

FM 3 dB bandwidth: internal and external ac, 20 Hz to 250 kHz; external dc, dc to 250 kHz. (Locked mode: FM above 50 Hz only.)

FM Distortion (at 400 Hz and 1 kHz rates)

<1% for deviations up to 1/8 maximum allowable.

<3% up to maximum allowable deviation.

External FM sensitivity: 1 volt peak into 600 Ω yields maximum deviation indicated on PEAK DEVIATION switch with FM vernier at full clockwise position.

Indicated FM accuracy (400 Hz and 1 kHz rates from 15 $^\circ$ to 35 $^\circ$ C, using internal meter): \pm (7% of reading + 1.5% of full scale).

Incidental AM (at 400 Hz and 1 kHz rates)

0.5 to 512 MHz: <0.5% AM for FM up to 1/8 maximum allowable deviation; <1% AM for FM at maximum allowable deviation.

512 to 1024 MHz (Opt 002): <1% AM for FM up to 1/8 maximum allowable deviation; <7% AM for FM deviations up to maximum allowable.

Counter

External RF Input

Frequency range: 1 Hz to 550 MHz.

Sensitivity: \geq 100 mV rms into 50 Ω , ac only.

Resolution: 6-digit LED display.

| Mode | Normal | Expand X10 | Expand X100 |
|------------|--------|------------|-------------|
| 0-10 MHz | 100 Hz | 10 Hz | 1 Hz |
| 10-550 MHz | 10 kHz | 1 kHz | 100 Hz |

External reference input: 5 MHz, nominally >0.5V p-p (5V maximum) into 1 k Ω .

Internal Reference (after 2 hr warm-up and calibration at 25 $^\circ$ C)

Aging rate: <0.05 ppm/hr; <2 ppm/90 days.

Temperature Drift

< \pm 2 ppm from 15 $^\circ$ to 35 $^\circ$ C.

< \pm 10 ppm from 0 $^\circ$ to 50 $^\circ$ C.

Typical overall accuracy (within 3 months of calibration and from 15 $^\circ$ to 35 $^\circ$ C): \pm 2 ppm.

General

Operating temperature range: 0 $^\circ$ to 55 $^\circ$ C.

Power requirements: 100 or 120 volts (+ 5%, -10%) from 48 to 440 Hz; or 220 or 240 volts (+5%, -10%) from 48 to 66 Hz. 175 VA max (Option 002: 190 VA max).

Weight: net, 20.8 kg (46 lb). Shipping, 24.1 kg (53 lb).

Size: 140 H x 425 W x 476 mm D (5.5" x 16.75" x 18.75").

Ordering Information

8640B Signal Generator

Option 001: internal variable audio oscillator, 20 Hz to 600 kHz

Option 002: internal doubler 512-1024 MHz

Option 003: reverse power protection

Option 004: avionics option

Option 908: rack mount kit

Option 910: extra operating and service manual

Price

\$9950

add \$352.00

add \$1005.00

add \$352.00

add \$1505.00

add \$37.50

add \$100



Model 8640B Option 004

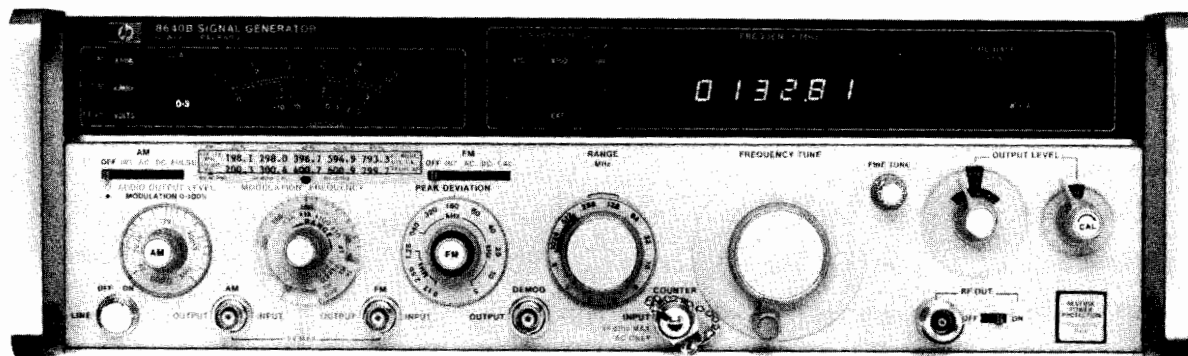

HP 8640B Option 004 (with Options 001, 003)

HP 8640B Avionics Option 004 Signal Generator

The Hewlett-Packard Model 8640B Option 004 NAV/COM Signal Generator is an HP 8640B AM/FM Signal Generator specially adapted for testing ILS (Marker Beacon, Localizer and Glide Slope), VOR and VHF communications receivers used throughout the aviation industry. VOR, LOCALIZER and VHF communications frequencies (108 to 136 MHz) are available on one frequency band for rapid channel selection. GLIDE SLOPE (329 to 335 MHz) and MARKER BEACON (75 MHz) frequencies are also easily set using the 6-digit LED display.

The HP 8640B Option 004 provides highly stable, spectrally pure RF signals for testing narrow-channel, crystal controlled receivers. For avionics testing, external audio generators are required to provide the composite modulation. Designed with versatile AM and FM modulation, Option 004 features low distortion modulation when used with suitable, external VOR/ILS Audio Generators.

Operation and specifications of the HP 8640B Option 004 are the same as the Standard HP 8640B AM/FM Signal Generator with the following additions:

One front panel BNC connector provides demodulated output from the RF peak detector for precise AM settings. A choice of combined ac/dc at 1V rms or ac only at 5V rms is provided.

To ensure the best possible demodulated output linearity, Option 004 combines a 10 dB step attenuator and a 1 dB step attenuator with a vernier. This provides output levels from +15 dBm to -142 dBm (1.3 V to 0.018 μ V). The output level can be read directly from the attenuator dial in 1 dB steps or from the front panel meter in dBm or volts.

External AM input impedance of 2 k Ω allows compatible operation with old and new generations of external audio generators.

The HP 8640B Option 004 provides flat AM response and minimum phase shift at 30 Hz and 9960 Hz as well as constant group delay between 9 kHz and 11 kHz for accurate VOR and ILS testing.

HP 8640B Option 004 Specifications

(These specifications apply to HP 8640B Option 004 in addition to standard HP 8640B specifications. See HP 8640B AM/FM Signal Generator technical data for complete specifications.)

Noise: SSB broadband noise floor greater than 1 MHz offset from carrier: < -130 dBc.

Range: +15 dBm to -142 dBm (1.3V to 0.018 μ V).

Attenuators: a 10 dB step attenuator plus a 1 dB step attenuator with vernier allow selection of any output level over the full output level range.

Vernier: >2 dB continuously variable from a CAL detent position.

Level flatness (referred to 190 MHz and for +10 to -10 dBm without Option 003): $< \pm 0.75$ dB from 0.5 to 512 MHz; $< \pm 0.5$ dB from 108 to 336 MHz.

Level Accuracy

| Output Level (dBm) | +15 to -10 | -10 to -50 | -50 to -142 | With Option 003 |
|--|--------------|--------------|--------------|---|
| Total Accuracy as Indicated on Level Meter | ± 1.5 dB | ± 2.0 dB | ± 2.5 dB | Add ± 0.5 dB except from 108 to 336 MHz |

Demodulated output (output vernier in CAL position, 108 to 118 and 329 to 336 MHz and 20% - 80% AM): an internal selector switch allows selection of ac only or ac and dc at the demodulated output.

AC only output: directly proportional to AM depth (90 to 150 Hz modulation frequency).

% AM equals: $(20 \pm 0.6)\%$ per V rms, 0 $^\circ$ to 55 $^\circ$ C; $(20 \pm 0.4)\%$ per V rms, 20 $^\circ$ to 30 $^\circ$ C; $(20 \pm 0.2)\%$ per V rms (using the DEMOD CAL label provided).

AC and dc output: ac output voltage is directly proportional to AM depth (90 to 150 Hz modulation frequency). dc output equals (1.41 ± 0.01) V dc with vernier in CAL position.

% AM equals: $(100 \pm 3)\%$ per V rms, 0 $^\circ$ to 55 $^\circ$ C; $(100 \pm 2)\%$ per V rms, 20 $^\circ$ to 30 $^\circ$ C; $(100 \pm 1)\%$ per V rms (using the DEMOD CAL label provided).

External input impedance: nominally 2 k Ω .

Frequency response: $< \pm 0.04$ dB from 90 Hz through 150 Hz (108 to 118 and 329 to 335 MHz.); $< \pm 0.1$ dB, 9 kHz through 11 kHz (108 to 118 MHz).

Phase Shift From Audio Input to Demodulated Output (108 to 118 MHz, AM EXT DC mode)

30 Hz $< \pm 0.01^\circ$; 30 Hz to 10 kHz $< \pm 3^\circ$; 9 kHz to 11 kHz $< \pm 2^\circ$.

HP 8640B Signal Generator with Avionics Option 004

Option 001: Internal variable audio oscillator, 20 Hz to 600 kHz

Option 002: not available with Option 004

Option 003: Reverse power protection

Option 908: Rack mount kit

Option 910: Extra Operating and Service Manual

SIGNAL GENERATORS

Accessories, Frequency Doublers

Models 11509A, 11687A, 11690A, 11710B, 11721A

539



HP 11687A 50-75Ω Adapter



HP 11687A



HP 11509A

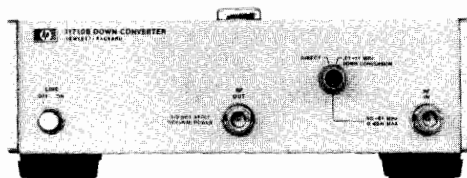

HP 11710B



HP 11690A



HP 11721A

HP 11509A Fuseholder

Accidental burnout of attenuators in HP 8640 and HP 8654 Signal Generators can be prevented by using this fuse element between the signal generator and a transceiver. The fuseholder has a frequency range of dc to 480 MHz, insertion loss of ≤ 1 dB, SWR of ≤ 1.35 (50 Ω load), and Type N connectors. Ten extra fuses are furnished.

HP 11687A 50-75 Ω Adapter

This 50-75 Ω Adapter with Type N connectors is recommended for use with HP 8640, 8642, 8654, 8660, 8656, and 8662 Signal Generators for measurements in 75 Ω systems. The voltage calibration on the output level meter is unaffected by use of the adapter, but 1.76 dB must be subtracted from the dB scale on the meter to determine the output in dBm into 75 Ω . Frequency range is dc to 1300 MHz.

HP 11690A Frequency Doubler

The HP 11690A extends the frequency range of all HP 8640 series Signal Generators by doubling the 256-512 MHz frequency band up to 1024 MHz (to 110 MHz with band overrange). All HP 8640s indicate the correct doubled output frequency on a dial or counter when the 512-1024 MHz range is selected. The HP 11690A will also perform well with any source meeting the input requirements of 200-550 MHz at +10 to +19 dBm. Conversion loss is < 13 dB, output flatness has < 4 dB total variation, and the first and third input harmonics are suppressed > 20 dB. Connectors are BNC.

HP 11710B Down Converter

The HP 11710B Down Converter is an accessory for the HP 8640 and HP 8654 series signal generators. Frequency inputs from 50.01 to 61 MHz are down converted to the 10 kHz to 11 MHz range respectively. The output level and modulation functions of the HP 8640 and HP 8654 remain calibrated. A straight-through selection switch allows the input to pass through unchanged, and thus minimizes the necessity to move cables when testing. Option 001 provides rails and semi-rigid coax for combining the HP 11710B with an HP 8654A,B Signal Generator.

HP 11710B Specifications

Input
Down-conversion mode: 50.01 to 61.00 MHz at ≤ 0 dBm.
Straight-through mode: 0.01 to 1100 MHz (dc coupled).

Down-Converted Output

Frequency range: 10 kHz to 11 MHz.
Level range: 0 to -107 dBm
Level flatness: RF source flatness ± 0.5 dB (referred to 4.0 MHz).
Total level accuracy: ± 1 dB plus input level accuracy).
Harmonics: > 35 dB below the carrier (dBc).
Intermixing spurious: > 60 dBc.
Local oscillator feed-through (50 MHz): < -100 dBm.

Internal Reference Characteristics

Time base output: 1 MHz or 5 MHz selectable, nominally $> 0.5V$ p-p into 500 Ω . This will drive an HP 8640B external time base input.
Typical overall accuracy: (within 3 months of calibration and from 15°C to 35°C): ± 2 ppm.

General

Operating temperature range: 0° to 55°C.
Power requirements: 100, 120, 220, 240V (+5%, -10%), 48 to 440 Hz; 25 VA maximum.
Weight: net, 3.2 kg (7 lb); shipping, 4.5 kg (9 lb).
Size: 102 H \times 266 W \times 295 mm D (4" \times 10.5" \times 11.6"). ½ MW \times 4 H \times 11 D System 1 Module.

HP 11721A Frequency Doubler

The HP 11721A Doubler is an ideal accessory for extending the usable frequency range of signal generators, frequency synthesizers, or other signal sources. Operating on input frequencies of 50 MHz to 1300 MHz, it provides a doubled output in the range of 100 MHz to 2600 MHz. The HP 11721A will work well with any RF source with an output in the range 50 to 1300 MHz.

The 50 Ω passive circuit of the HP 11721A offers low conversion loss, low spurious, and excellent flatness over its entire frequency range when operated above +10 dBm.

HP 11721A Specifications

Input frequency range: 50 to 1300 MHz.
Output frequency range: 100 to 2600 MHz.
Conversion loss (+13 dBm input, 50 to 1280 MHz): < 15 dB.
Spurious referenced to desired output frequency f (+13 dBm input with harmonics < -50 dBc, 50 to 1280 MHz): $f/2$, -15 dB; $3f/2$, -15 dB.
Input SWR: 1.5 typical.
Input/output impedance: 50 Ω nominal.
Operating temperature range: 0° to +50°C.
Connectors: input, type N male; output, type N female.
Size: 161 L \times 30 W \times 20.5 mm H (6 3/8" \times 1 3/16" \times 13/16").
Weight: net, .02 kg (0.5 lb); shipping, 0.4 kg (1 lb).

Ordering Information

| Ordering Information | Price |
|--|--------------|
| HP 11509A Fuseholder | \$175.00 |
| HP 11687A 50 Ω -75 Ω Adapter | \$195.00 |
| HP 11690A Frequency Doubler | \$227.00 |
| HP 11710B Down Converter | \$1805.00 |
| Option 001: Combining Kit | add \$150.00 |
| Option 910: Extra operating & service manual | add \$3.50 |
| HP 11721A Frequency Doubler | \$450.00 |



SIGNAL GENERATORS

Solid-State Microwave Signal Generators

Models 8683/8684A,B,D

- Portable signal generators with high performance modulation
- Wide frequency ranges from 2.3-18 GHz
- Wideband FM for satellite video ± 10 MHz peak deviation
- dc-10 MHz rates

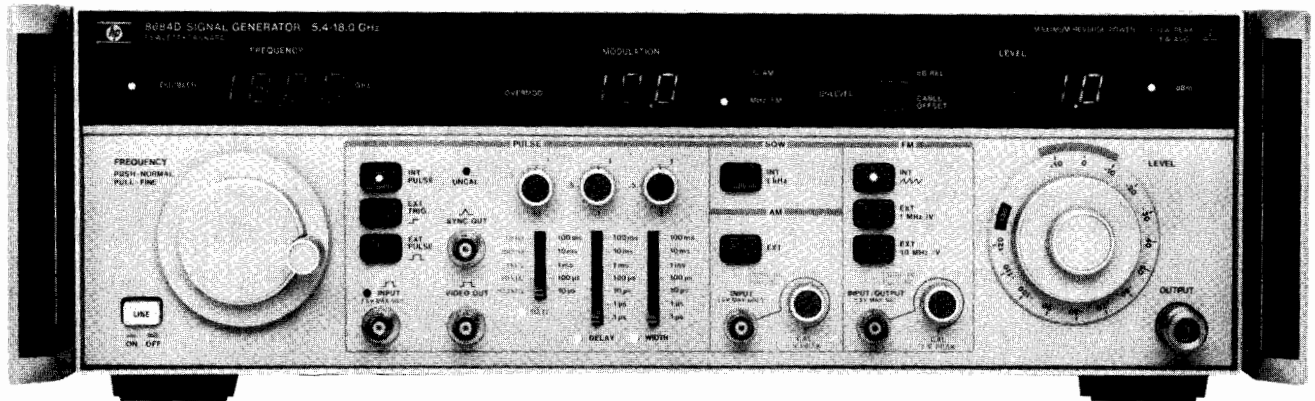

HP 8684D

HP 8683/8684 Microwave Signal Generators

The HP 8683 and 8684 are rugged portable signal generators designed for demanding benchtop and field maintenance environments. Operating in four overlapping frequency ranges, with a choice of features including a high performance internal pulse generator, the family provides a wide range of benefits for various radar, communications and electronic warfare applications.

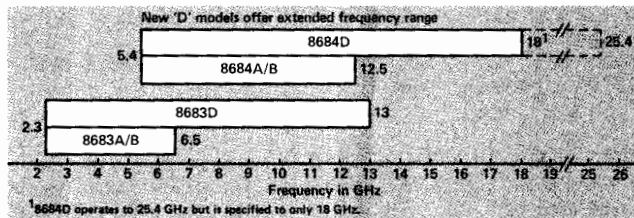

Clean, Stable, Cavity-Tuned Oscillator

At the heart of each signal generator is a mechanically tuned cavity oscillator. State-of-the-art electronics teamed with sophisticated mechanical design provide excellent frequency stability, spectral purity and quick warm-up times necessary for accurate measurements. With low spurious outputs and a low noise floor, the HP 8683 and 8684 are excellent for receiver sensitivity measurements and out-of-channel communications receiver measurements where high performance at low signal levels is required.

Microprocessor-Enhanced Measurement Accuracy

Characteristics of microwave components such as oscillators, amplifiers, and attenuators vary considerably with frequency and power level. An internal microprocessor effectively compensates for these variations, providing accurate output level in dBm, dB relative to a user-selected power level, or power level with a specified cable offset. These conveniences translate to faster measurements and reduced possibility of operator error in interpreting observations.

Reliability and Serviceability

The HP 8683 and 8684 were designed with high reliability and serviceability as major considerations. The instruments exceed rigorous military specifications (MIL-T-28800C Class V) for operating and non-operating temperature, humidity, condensation, shock and vibration, and EMI. The instruments success in these tests is an indication that they are rugged enough to provide accurate, reliable measurements in environments where many instruments would fail. For added reliability in the A and B models Option 002 may be selected for reverse power protection. With this option the possibility of instrument failure due to operator error is substantially reduced, allowing for as much as 10 watts average or 2000 watts peak reverse power with no

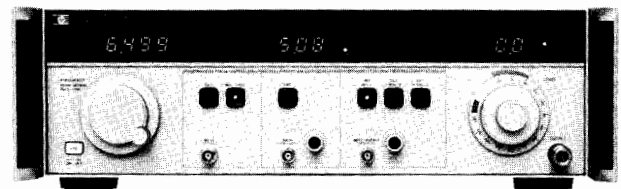

HP 8683A

damage to the instrument. The reliability of these generators is reflected in a demonstrated MTBF in excess of 20,000 hours.

Confidence in signal generator performance is provided by diagnostic tests which automatically execute at turn-on and monitor most critical nodes prior to entering the operation mode. If a failure is detected, in most cases it can be isolated to at least the circuit function level with the aid of the front panel display. The generators' open, accessible internal design and complete service manuals result in excellent serviceability, minimizing repair time if a failure should occur.

HP 8683/8684 A,B,D Features

A variety of modulation capabilities, frequency ranges, and power specifications are available in the HP 8683/8684 Microwave Signal Generator family.

Sharing the same rugged dependable design with the rest of the family, the A models provide AM and FM for conventional communications applications in an affordable package. All A models are specified to have maximum output power of 0 dBm throughout their frequency range; however, if required, Option 001 may be selected to provide +10 dBm output power.

The B and D models add a high performance pulse modulator and internal pulse generator for the simulation of a wide variety of sophisticated radar transmissions. Simultaneous FM and pulse allow chirping, while simultaneous AM and pulse allow simulation of antenna scan patterns. Of course, basic receiver sensitivity and AGC measurements can also be made easily.

For users with multi-band, broadband or general purpose applications, the D models, with twice the frequency coverage of the A and B models, offer exceptional performance, versatility and economy in a single box. Not only is frequency coverage increased, but in doubled mode, FM peak deviation is also doubled to 10 MHz at dc to 10 MHz rates making possible the direct test of satellite video receivers. If required, the high-power Option 001 may be selected to boost maximum output power in the frequency-doubled bands from -3 dBm to the +10 dBm level already provided in the main bands. By combining



proven, rugged, dependable design with the versatility of twice the frequency coverage and wideband FM, the D models offer cost-effective, high performance solutions to radar and communications receiver test problems.

| Distinguishing features of the A, B, & D models | | | |
|---|---------|---------|------------------------------|
| | A | B | D |
| Output Power | 0 dBm | +10 dBm | +10 dBm, -3 dBm ¹ |
| Opt 001 Power | +10 dBm | N/A | +10 dBm ¹ |
| Internal Pulse Generator/Modulator | No | Yes | Yes |
| FM Deviation (DC To 10MHz Rate) | 5 MHz | 5 MHz | 10 MHz ¹ |

¹ These specifications for the doubled mode

HP 8683A/B/D, HP 8684A/B/D Specifications

Frequency Specifications

Range

HP 8683A/B: 2.3–6.5 GHz.

HP 8683D: 2.3–13.0 GHz.

HP 8684A/B: 5.4–12.5 GHz.

HP 8684D: 5.4–18.0 GHz.

Resolution: HP 8683, 5 MHz using a 4 digit LED display; HP 8684, 10 MHz using a 3 1/2 digit LED display.

Calibration accuracy: HP 8683A/B/D, $\pm 1.25\%$ <4.0 GHz, $\pm 0.75\%$ 4.0 to 6.5 GHz; HP 8683D x2 band, $\pm 1.25\%$ 6.5 to 8.0 GHz, $\pm 0.75\%$ >8 GHz; HP 8684A/B/D, $\pm 1.25\%$ 5.4 to 9.0 GHz, $\pm 0.75\%$ 9.0 to 12.5 GHz; HP 8684D x2 band, $\pm 1.25\%$ 12.5 to 18.0 GHz.

Stability (typical)

vs. time (20 min. after turn-on): <30 kHz/min.

vs. time (60 min. after turn-on): <100 kHz/hr.

vs. temperature (0 to 55° C): HP 8683, <15 MHz; HP 8684, <30 MHz.

vs. line voltage (transients of +5%/-10%): <20 ppm.

Spectral Purity

Harmonics (<18GHz, at specified max output): <-25 dBc.

HP 8683/84D harmonics are unspecified in x2 frequency band.

Fundamental feedthrough (at specified max. output): HP 8683D, <-25 dBc 6.5–9.5 GHz; HP 8684D, <-25 dBc 12.5–18.0 GHz. Not specified for D models with Option 001.

Spurious (non-harmonically related): <-80 dBc; typ, <-90 dBc.

Residual FM (50 Hz to 15 kHz post detection BW): <5 kHz peak. HP 8683/84D in doubled band: <10 kHz peak.

Single-sideband phase noise (avg. rms, 1 Hz BW, 10 kHz offset from carrier, typical): HP 8683A/B, <-72 dBc; HP 8683D, <-66 dBc; HP 8684A/B, <-65 dBc; HP 8684D, <-59 dBc.

Residual AM (avg. rms, 300 Hz to 15 kHz post detection BW): <0.15%.

Output Specifications

Range (leveled into 50Ω): HP 8683/84A, 0 to -130 dBm; HP 8683/84A opt. 001 and HP 8683/84B, +10 to -130 dBm; HP 8683/84D, +10 to -130 dBm (main band), -3 to -130 dBm (x2 band), +10 dBm in x2 bands available with Option 001.

Resolution: 0.1 dB using a 3 1/2 digit LED display.

Accuracy: ± 2.5 dB from maximum specified output power to -110 dBm (to -100 dBm in x2 bands); ± 3.5 dB to -120 dB. Typ. ± 0.9 dB at -100 dBm. Option 002 affects level accuracy ± 0.5 dB.

Flatness (power level >-10 dBm): ± 1.0 dB.

Reverse power protection: the standard models typically accept 1 watt avg. or 100 watts peak power with no damage resulting. Option 002 (on A and B models only) increases this protection to 10 watts avg. or 2kW peak.

Auxiliary output: rear panel, typically >-15 dBm into 50Ω, prior to AM, pulse, or frequency doubling; source impedance approx. 50Ω.

Modulation Specifications

Types: internal and external AM, FM, and Pulse (except HP 8683/84A). Simultaneous AM, FM, Pulse.

Metering: 3-digit LED, selectable for % AM or FM deviation.

Amplitude Modulation

Depth (1 kHz rate): 0-70%.

Rates (3 dB BW at 40% depth): dc to 10 kHz (dc coupled); 50 Hz to 10 kHz (ac coupled).

Distortion (THD): <10% at 40% depth and 1 kHz rate.

Indicated AM accuracy (depth 50%, 1 kHz rate): $\pm 5\%$ of full scale.

Incidental FM (30% AM depth): <15 kHz peak to peak. (<30 kHz p-p in doubled band, HP 8683/84D.)

Internal AM: fixed 1 kHz nom. square wave with 50 $\pm 5\%$ duty cycle.

Frequency Modulation

Peak deviation: HP 8683/84 A/B, ± 5 MHz; HP 8683/84D, ± 5 MHz (main); ± 10 MHz (x2 band).

Rates (3 dB BW): dc to 10 MHz, 100 Hz to 10 MHz (ac coupled).

Distortion: <5% at 100 kHz rate and <1 MHz peak deviation.

Indicated accuracy (typ., 10 MHz/V range): $\pm 10\%$ of full scale, deviations <5 MHz, 100 kHz rate.

Incidental AM (rate <100 kHz, peak deviation <1 MHz): <6%.

Internal FM: FM sawtooth with a fixed sweep rate of 1 kHz nom. and variable deviation up to ± 5 MHz (± 10 MHz for D models, x2 bands).

Phase lock input: typical sensitivity of -5 MHz/V.

Pulse Modulation

HP 8683/84 B/D Internal Pulse Generator

Rate: 10 Hz to 1 MHz continuously adjustable in 5 ranges.

Width: 50 ns to 100 ms continuously adjustable in 7 ranges.

Delay (time between sync out and video out): <50 ns to 100 ms in 7 ranges with continuous adjustment within ranges.

Accuracy: calibration accuracy is 20% of full scale.

HP 8683/84 B/D External Pulse Input Requirements

Rate: 0 to 1 MHz.

Width: >100 ns.

Level: on >+1.0 V peak; off <+0.4 V peak.

HP 8683/84 B/D RF Pulse Specifications

Rise/fall time: <10 ns.

On/off ratio: >80 dB.

Minimum pulse width: <100 ns.

Maximum pulse repetition frequency: >1 MHz.

Peak pulse power: ± 0.5 dB of level set in CW mode.

General

Operating temperature range: 0° to 55° C.

EMI: MIL-STD-461, VDE0871, CISPR Pub. 11.

Safety: meets the requirements of IEC 348.

Power: 100, 120, 220 or 240V, +5%, -10%; 48 to 66 Hz; (Opt. 003 adds 400 Hz operation at 100 or 120 V); <200 VA max.

Dimensions: 145 H x 457 W x 472 mm D (5.7" x 18" x 18.6").

Weight: HP 8683, 17.9kg (39 lb) net, 23.4 kg (51 lb) shipping; HP 8684, 16.5 kg (36 lb) net, 22.0 kg (48 lb) shipping.

Ordering Information

HP 8683A Microwave Signal Generator

Price

HP 8684A Microwave Signal Generator

\$12,030

Option 001: +10 dBm output power, HP 8683/84 A

\$12,030

add \$1500

HP 8683B Microwave Signal Generator

\$15,030

HP 8684B Microwave Signal Generator

\$15,030

HP 8683D Microwave Signal Generator

\$19,000

Option 001 +10 dBm in x2 band, HP 8683D

add \$3000

HP 8684D Microwave Signal Generator

\$19,000

Option 001: +10 dBm in x2 band, HP 8684D

add \$5000

Option 002: Reverse power protection

(except D models)

add \$725

Option 003: 400 Hz line frequency

operation (all models)

add \$180

Option 910: Extra operating and

service manual

add \$25

Option 913: Rack mounting flange kit

add \$35

HP 11727A Support kit

\$475

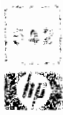

Models 8614A, 8616A, 938A, 940A, 11720A

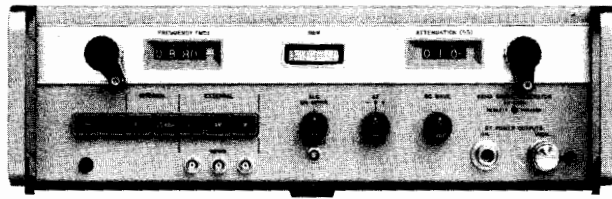

HP 8614A

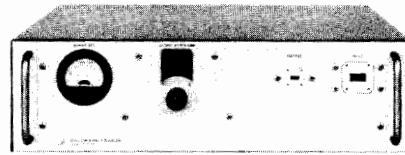

HP 938A

HP 8614A, 8616A Signal Generators

The HP 8614A and 8616A Signal Generators provide stable, accurate signals from 800 to 2400 MHz (HP 8614A) and from 1800 to 4500 MHz (HP 8616A). Both frequency and attenuation are set on direct-reading digital dials. Selectable functions include CW, leveled output, square-wave modulation, and external AM, FM and pulse modulation. Modulation can be accomplished simultaneously with or without leveling.

The HP 8614A and 8616A can also be used with companion modulators, HP 8403A modulators and HP 8730-series PIN modulators to provide 80 dB pulse on/off ratio (see last page, this section). In addition, TWT amplifiers can be used with these generators to provide high power levels.

Frequency range: direct reading within 2 MHz, 800 to 2400 MHz. (HP 8614A), 1800 to 4500 MHz (HP 8616A)

Vernier: ΔF control has a minimum range of 1.0 MHz for fine tuning.

Frequency calibration accuracy (0 dBm & below): ± 10 MHz (8616A). ± 5 MHz (8614A).

Frequency stability: approximately 50 ppm/ $^{\circ}C$ change in ambient temperature, less than 2500 Hz peak residual FM; 30 ppm change for line voltage variation of $\pm 10\%$.

RF output power: +10 dBm (0.707 V) to -127 dBm into 50 Ω load, (+3 dBm to -127 dBm from 3000 to 4500 MHz). Output attenuation dial directly calibrated in dBm from 0 to -127 dBm. A second uncalibrated output (approximately -3 dBm) is provided on front panel.

Output impedance: 50 Ω ; SWR <2.0.

Internal square wave: 950 to 1050 Hz. Square wave can be synchronized with a +1 to +10 V signal at PULSE input.

External pulse: 50 Hz to 50 kHz; 2 μs rise time, +20 to +100 V peak input.

External AM: dc to 1 MHz, >20 dB range.

External FM: front-panel connector capacity-coupled to repeller of klystron; four-terminal rear-panel connector (Cinch-Jones type S304AB) is dc-coupled to repeller of klystron.

Power source: 115 or 230 V $\pm 10\%$, 50 to 60 Hz, approximately 130 W.

Size: cabinet, 141 H x 425 W x 467 mm D (5.5" x 16.75" x 18.4"); rack mount, 133 H x 416 W x 483 mm D (5.2" x 16.4" x 19").

Weight: net, 19.5 kg (43 lb). Shipping, 22.7 kg (50 lb).

Accessory furnished: HP 11500A Cable Assembly.

HP 8614A Signal Generator (800-2400 MHz)

HP 8616A Signal Generator (1800-4500 MHz)

HP 8614A and 8616A Options

Option 001: External modulation input connectors on rear panel in parallel with front-panel connectors; RF connectors on rear panel only.

Option 908: Rack mounting flange kit

Option 910: Extra operating and service manual

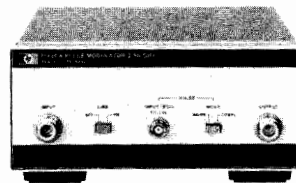

HP 11720A

HP 938A, 940A Frequency Doubler Sets

The HP 938A Doubler supplies power from 18 to 26.5 GHz and HP 940A from 26.5 to 40 GHz when driven by 9 to 13.25 GHz and 13.25 to 20 GHz sources respectively.

These frequency doubler sets consist of broadband harmonic generators suitably mounted in a waveguide section, a power monitor, a broad stopband low-pass filter, and a precision attenuator.

Frequency range: HP 938A, 18 to 26.5 GHz; HP 940A, 26.5 to 40 GHz.

Conversion loss: less than 18 dB at 10 mW input.

Output power: approximately 0.5-1 mW when used with typical HP signal generators; input power 100 mW maximum.

Output monitor accuracy: ± 2 dB.

Output attenuator accuracy: $\pm 2\%$ of reading or ± 0.2 dB whichever is greater.

Attenuator range: 100 dB.

Size: 137 H x 489 W x 457 mm D (5.4" x 19.25" x 18").

Weight: net, 9 kg (20 lb). Shipping, 11.8 kg (26 lb).

HP 11720A Pulse Modulator

The HP 11720A Pulse Modulator is a high performance microwave pulse modulator covering the range of 2 to 18 GHz. Because of this wide frequency coverage, it can be used to increase the modulation capabilities of many microwave sources (sweepers or signal generators) and eliminate the need for several individual modulators in broadband applications.

Frequency range: 2 to 18 GHz.

ON/OFF ratio: >80 dB.

Rise and fall times: <10 ns.

Insertion loss: <6 dB, 2 to 12.4 GHz; <10 dB, 2 to 18 GHz.

Power: 100, 120, 220, 240 V +5, -10%; 48-400 Hz; 25 VA max.

Weight: net, 2.6 kg (6 lb). Shipping, 3.5 kg (8 lb).

Size: 101 mm H x 212 mm W x 290 mm D (4.0" x 8.4" x 11.4").
1/2 MW x 3 1/2 H x 11 D System II Module.

HP 938A or 940A Frequency Doubler

Option 910: Extra operating & service manual

HP 11503A Flexible Waveguide P-Band

HP 11504A Flexible Waveguide X-Band

HP 11720A Pulse Modulator

Option 910: Extra manual



SIGNAL GENERATORS

Synthesized Sweepers

Models 8340A, 8341A

543



• Frequency resolution: 1 Hz resolution
 • Frequency range: 100 kHz to 10 GHz
 • Complete test system for measuring (optional on HP 8341A)

- +10 dBm to -110 dBm calibrated output (optional on HP 8341A)
- Complete analog sweeper
- DC to 100 kHz amplitude modulation

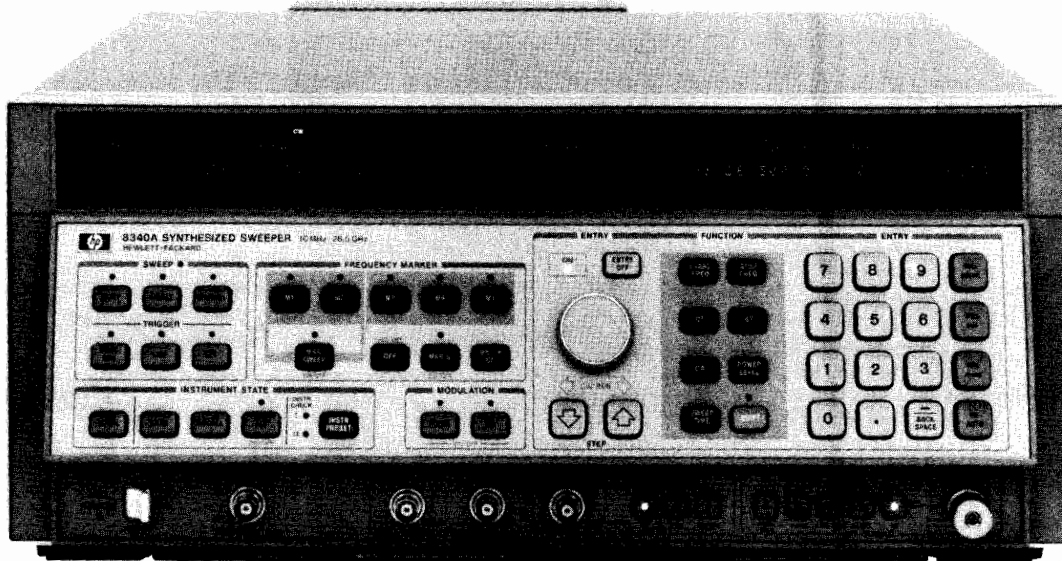

HP 8340A



HP 8340A/41A Synthesized Sweepers

The HP 8340A/41A synthesized sweepers deliver the combined high-performance of a synthesizer and a broadband sweep oscillator in one efficient instrument that is completely controllable via the Hewlett-Packard Interface Bus (HP-IB). This efficient combination of performance and versatility is ideal for manual or automatic test systems and enables the HP 8340A/41A to replace a sweep oscillator, a frequency counter, an RF synthesizer, and a microwave synthesizer.

Frequency Precision and Spectral Purity

The synthesized broadband frequency coverage and the precise 1 to 4 Hz frequency resolution (depending on the frequency band of the HP 8340A/41A) are generated by indirect synthesis techniques. These techniques enable the HP 8340A/41A to achieve the same low single-sideband phase noise performance as the HP 8672A and 8673 series Synthesized Signal Generators.

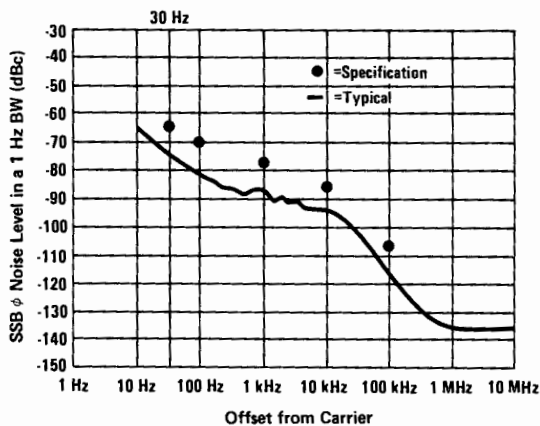

Typical HP 8340A Phase Noise performance from 2.3 to 7.0 GHz.

Stepped CW Switching Times

The HP 8340A/41A feature CW switching times of better than 50 ms (typically <35 ms). Additionally, a Fast Phase-lock programming command can be used to reduce typical CW switching times to be-

tween 11 and 22 ms (depending on frequency step size and absolute frequency value).

Output Power

The HP 8340A and the HP 8341A Opt 001 provide high output power which can be varied all the way down to the minimum level (-110 dBm) with 0.05 dB resolution.

The HP 8340A/41A also feature power sweep capability with >20 dB dynamic range for complete characterization of level-sensitive devices.

Pulse and AM Modulation

The HP 8340A and the HP 8341A Opt 006 have a high-performance pulse modulator with an ON/OFF ratio >80 dB and rise and fall times <25 ns. Pulse amplitude is leveled and can be as narrow as 100 ns. The HP 8340A/41A also feature dc-coupled AM modulation with a 3 dB bandwidth of 100 kHz and a minimum depth of 90%. And with the HP 8340A and the HP 8341A Opt 006, pulse and amplitude modulation can be used simultaneously.

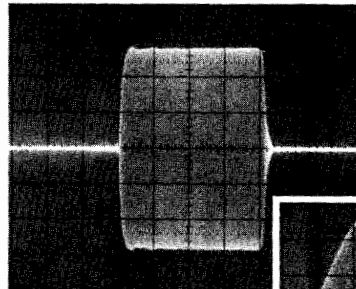

HP 8340A/41A Opt 006 pulse performance at 3 GHz. Pulse width=200 ns.

HP 8340A AM performance at 22 GHz. AM rate is 50 kHz and depth is 90%

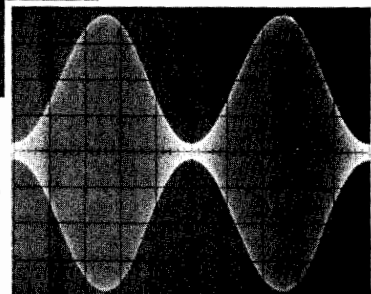

For additional ordering and performance information about the HP 8340A and 8341A, refer to page 496.

SIGNAL GENERATORS

Synthesized Signal Generators

Models 8673B, 8672A

- 2 to 26.5 GHz frequency range
- 1 to 4 kHz frequency resolution
- Low spurious and phase noise
- +8 to -100 dBm calibrated output
- Internally leveled pulse modulation
- Metered AM/FM

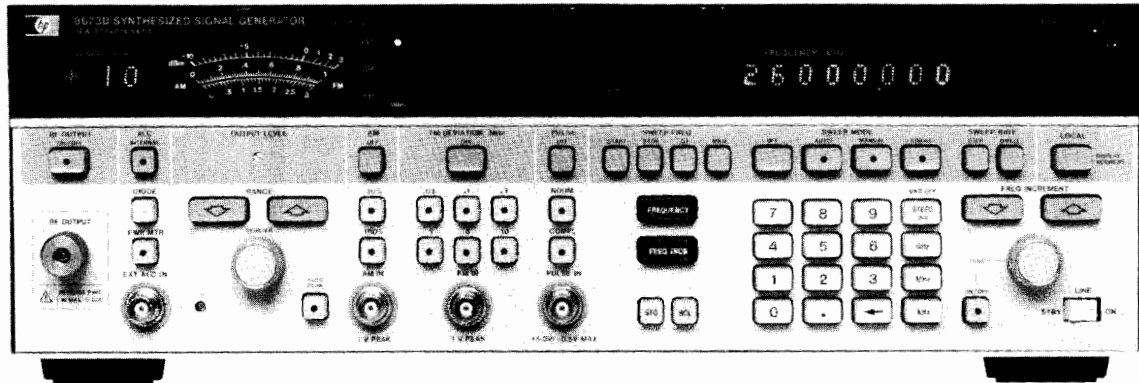

HP 8673B



HP 8673B, 8672A Synthesized Signal Generators

The HP 8673B and 8672A Synthesized Signal Generators deliver precise microwave signals over the 2.0 to 26.0 GHz and 2.0 to 18.0 GHz frequency ranges respectively. The generators feature a compact solid-state package (133mm, 5.25 in. high), calibrated and leveled output power, AM/FM modulation capability, and full programmability. The HP 8673B further features internally leveled pulse modulation and microprocessor-enhanced control facilitating digital sweep.

Excellent Spectral Purity

For LO applications and many tests on radar and microwave communication systems, the HP 8672A and 8673B provide extremely stable frequencies. Output signals are derived by multiplying a fundamental 2.0 to 6.6 GHz - 1 kHz resolution YIG-tuned oscillator $\times 1$, $\times 2$, $\times 3$, or $\times 4$ to yield resolutions of 1 to 4 kHz depending upon band of operation. Indirect synthesis phase-locks the YIG-tuned oscillator to a 10 MHz quartz crystal reference providing excellent long and short term stability (frequency drift $< 5 \times 10^{-10}$ per day). Phase-locked loop responses are optimized to allow the HP 8672A/73B generators to exhibit the lowest possible single-sideband phase noise.

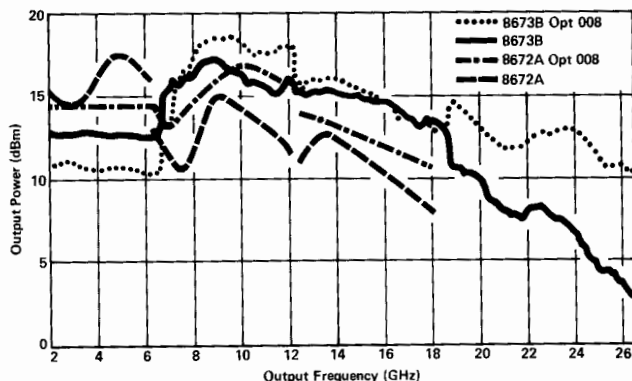

Figure 1. Maximum power typically available from HP 8673B, 8673B Option 008, 8672A, and 8672A Option 008 instruments at 25°C.

Wide Dynamic Output Range

For broadband component and receiver testing applications, the HP 8673B and 8672A deliver exceptionally flat power outputs across their full frequency ranges. For receiver sensitivity measurements, power is internally (or externally) leveled and calibrated to -120 dBm on the HP 8672A and to -100 dBm on the HP 8673B. Maximum available power varies with frequency as shown in Figure 1. The HP 8672A Option 008 raises the guaranteed HP 8672A maximum output to +8 dBm from a standard +3 dBm. HP 8673B output power is guaranteed to be at least +8 dBm up to 18 GHz and 0 dBm up to 26 GHz (+7 dBm with option 008).

Internally Leveled Pulse Modulation

The HP 8673B features an internal pulse modulator that provides high-quality pulse modulation over the entire 2.0 to 26.0 GHz range. The modulation is done before the frequency multiplication allowing the peak pulsed power to be leveled and calibrated to within typically ± 1 dB of the set level referenced to CW. ON/OFF ratios > 80 dB and rise/fall times < 35 ns make the HP 8673B ideal for use in pulsed radar test systems. Externally supplied TTL level drive signals determine pulse rates up to 1 MHz and leveled pulse widths as narrow as 100 ns.

Calibrated AM/FM Modulation

To expand the versatility of the HP 8672A and 8673B in receiver testing applications, AM/FM capability is included. AM depth at rates up to 100 kHz can be accurately set using the front panel meter. Six ranges of metered FM are available at rates and peak deviations up to 10 MHz. Both AM depth and FM deviation are linearly controlled by varying the externally supplied modulating input voltage up to 1 V peak.

Full Programmability and Digital Sweep

The HP 8673B and 8672A both provide full programmability of all front-panel functions for automatic test system applications. Over HP-IB, output level can be controlled in steps as fine as 1 dB (HP 8672A) and 0.1 dB (HP 8673B). In addition, the HP 8673B uses an internal microprocessor that facilitates convenient keyboard control, easy HP-IB program code generation following front-panel keystroke sequences, and digital sweep. Sweep spans can be set over the entire frequency range with variable rates, step sizes, and selectable markers available. Sweep outputs needed for compatibility with scalar and network analyzers are provided on the HP 8673B rear panel.



- 2 to 18 GHz frequency range
- Low spurious and phase noise
- Metered AM/FM

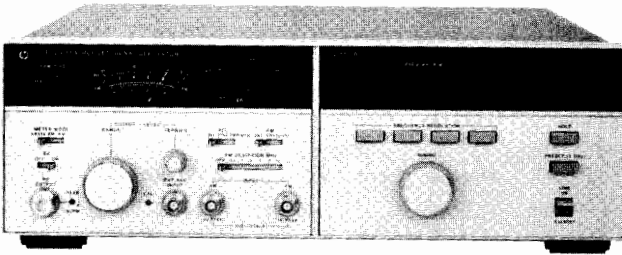

HP 8672A

HP 8672A, 8673B Specifications

(HP 8672A and 8673B specifications are identical except for additional HP 8673B specifications *in italic type*.)

Frequency Characteristics

Frequency range: 2.0–18.0 GHz (18.599997 GHz overrange).

2.0–26.0 GHz (26.5 GHz overrange).

Frequency bands: band 1, 2.0–6.2 GHz; 2.0–6.6 GHz
band 2, 6.2–12.4 GHz; 6.6–12.3 GHz
band 3, 12.4–18.0 GHz; 12.3–18.6 GHz
band 4, 18.6–26.0 GHz.

Frequency resolution: 1 kHz in Band 1, 2 kHz in Band 2, 3 kHz in Band 3, 4 kHz in Band 4.

Time base: internal 10 MHz ($<5 \times 10^{-10}$ /day aging rate) or external 5 or 10 MHz.

Frequency switching time: <15 ms (<20 ms) to be within specified resolution, all bands.

Spectral Purity

Single-sideband phase noise (1 Hz BW, CW mode):

| F _c | Offset from F _c | | | | |
|----------------|----------------------------|---------|---------|---------|----------|
| | 10 Hz | 100 Hz | 1 kHz | 10 kHz | 100 kHz |
| Band 1 | -58 dBc | -70 dBc | -78 dBc | -86 dBc | -110 dBc |
| Band 2 | -52 dBc | -64 dBc | -72 dBc | -80 dBc | -104 dBc |
| Band 3 | -48 dBc | -60 dBc | -68 dBc | -76 dBc | -100 dBc |
| Band 4 | -46 dBc | -58 dBc | -66 dBc | -74 dBc | -98 dBc |

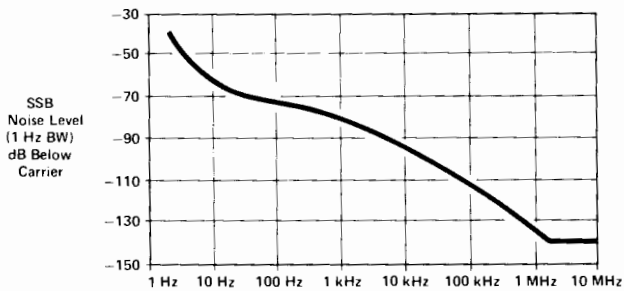

Figure 2. Typical HP 8672A & 8673B single-sideband phase noise performance using the internal standard, Band 1.

Harmonics (up to maximum frequency, output level meter readings <0 dB on 0 dBm range and below): <-25 dBc, <-40 dBc.

Sub-harmonics and multiples thereof: <-25 dBc, Bands 1–3; <-20 dBc, Band 4.

Spurious (CW and AM modes)

Non-harmonically related: <-70 dBc, Band 1; <-64 dBc, Band 2; <-60 dBc, Band 3; <-58 dBc, Band 4.

Power line related and fan rotation related within 5 Hz below line frequency and multiples thereof:

| F _c | Offset from F _c | | |
|----------------|----------------------------|-----------------|----------|
| | <300 Hz | 300 Hz to 1 kHz | >1 kHz |
| Band 1 | -50 dBc | -60 dBc | -65 dBc |
| Band 2 | -44 dBc | -54 dBc | -59 dBc |
| Band 3 | -40 dBc | -50 dBc | -55 dBc |
| Band 4 | -38 dBc | -48 dBc | -53 dBc |

Output Characteristics

Output level (+15°C to +35°C): +3 to -120 dBm; +8 to -100 dBm up to 18 GHz, +4 to -100 dBm up to 22 GHz, 0 to -100 dBm up to 26 GHz.

Flatness (0 dBm range, +15°C to +35°C): ± 0.75 dB through Band 1, ± 1.0 dB through Band 2, ± 1.25 dB through Band 3, ± 1.75 dB through Band 4.

Remote programming output level resolution: 1.0 dB; 0.1 dB.

Source impedance: 50 ohms nominal.

Pulse Modulation (HP 8673B)

ON/OFF ratio: >80 dB.

Rise/fall times: <35 ns.

Minimum leveled pulse width: <100 ns.

Pulse repetition frequency: dc–1 MHz.

Maximum peak power: same as in CW mode.

Peak level accuracy (relative to CW, +15°C to +35°C): ± 1.5 dB.

Pulse modulation input requirements: normal mode, positive-true TTL levels; complement mode, negative-true TTL levels.

Video feedthrough: typically <-50 dBc.

Amplitude Modulation

Rates (3 dB BW, 30% depth): 10 Hz–100 kHz; 10 Hz–50 kHz (Option 008); 20 Hz–100 kHz.

Sensitivity: 30%/V, 100%/V ranges. Max. input 1 V peak into 600 Ω .

Frequency Modulation

Peak deviation (max.): the smaller of 10 MHz or $f_{mod} \times 5$, Band 1; 10 MHz or $f_{mod} \times 10$, Band 2; 10 MHz or $f_{mod} \times 15$, Band 3; 10 MHz or $f_{mod} \times 20$, Band 4.

Sensitivity: 30, 100, 300 kHz/V and 1, 3, 10 MHz/V ranges.

Max. input 1 V peak into 50 Ω .

Rates (3 dB BW typical): 30, 100 kHz/V ranges: 50 Hz to 10 MHz; 300 kHz/V and 1, 3, 10 MHz/V ranges: 1 kHz to 10 MHz.

Digital Sweep Characteristics (HP 8673B)

Sweep function: start/stop or ΔF (span) sweep.

Sweep modes: manual, auto, or single sweep.

Step size: maximum of 9999 frequency points per sweep; minimum step size equals frequency resolution.

Dwell time: set from 1 to 255 ms per frequency.

Markers: 5 independent, settable frequency markers.

Sweep outputs: 0 to +10 V ramp start to stop; 1 V/GHz ramp (18 V maximum); Z-axis blanking/markers; tone marker; penlift.

Remote Programming

All functions HP-IB programmable except line switch. The HP 8673B can output over the interface frequency and output level settings, error/malfunction codes, and operational status codes.

Interface functions:

HP 8673B: SH1, AH1, T5, TE0, L3, LE0, SR1, RL1, PP1, DC1, DT1, C0, E1.

HP 8672A: SH1, AH1, T6, TE0, L4, LE0, SR1, RL0, PP2, DC1, DT0, C0, E1.

General

Operating temperature range: 0°C to +55°C.

Power: 100, 120, 220, 240 V, +5%, -10%, 48–66 Hz; 400 VA max.

Weight: net, 27 kg (60 lb), 29 kg (64 lb). Shipping, 32.5 kg (72 lb), 34.5 kg (76 lb).

Size: 133 mm H x 425 mm W x 603 mm D (5.25" x 16.75" x 23.75").

Ordering Information

| | Price |
|--|-------------------|
| HP 8673B Synthesized Signal Generator | \$47,030 |
| HP 8672A Synthesized Signal Generator | \$38,030 |
| Option 001: Delete RF output attenuator | -\$600 |
| Option 002: Delete reference oscillator | -\$550, \$735 |
| Option 003: Operation at 400 Hz line | +\$250, \$460 |
| Option 004: Rear panel RF output | +\$75 |
| Option 005: Rear panel RF output without RF attenuator | -\$525 |
| Option 006: Chassis slide kit | +\$45, \$75 |
| Option 008: +8 dBm (+7 dBm) output level | +\$4,100, \$7,000 |
| Option 907: Front panel handle kit | +\$55 |
| Option 908: Rack mounting flange kit | +\$33 |
| Option 909: Front panel handle kit plus rack mounting flange kit | +\$80 |
| Option 910: Extra operating and service manual | +\$35 |
| HP 11712A Support Kit (for HP 8672A) | \$800 |
| HP 11726A Support Kit (for HP 8673B) | \$1,005 |



SIGNAL GENERATORS

Synthesized Signal Generators

Model 8673E

- 2 to 18 GHz
- +8 to -120 dBm calibrated output
- 0.1 dB resolution, digitally displayed

- AM/FM/Pulse Modulation
- Low spurious and phase noise
- 1 to 3 kHz frequency resolution



HP 8673E



HP 8673E Synthesized Signal Generator

The HP 8673E is a synthesized signal generator that delivers value-oriented performance in precise microwave signal simulation. It is optimized for applications requiring high performance signal generation in the 2.0 to 18.0 GHz frequency range while also providing 128 dB dynamic output range. The HP 8673E includes the necessary modulation features required in a full performance microwave synthesizer.

Exceptional Output Performance

The HP 8673E provides frequency coverage from 2.0 to 18.0 GHz with resolution of 1, 2, or 3 kHz depending upon frequency band. Optimized for output level flexibility, power is internally (or externally) leveled and calibrated from -120 dBm to +8 dBm. Adding to your measurement convenience, the output level is displayed on the front panel with 0.1 dB resolution with a digital display.

Flexible Modulation

As a full performance synthesized signal generator, the HP 8673E includes amplitude, frequency, and pulse modulation capability. AM depth up to 75% at rates up to 10 kHz is ideal for most applications. The HP 8673E features two types of FM: locked and unlocked operation. In the locked mode, operation is like other synthesizers providing up to 3 MHz deviation that is dependent upon modulation index. The unlocked mode allows up to 10 MHz deviation at rates as low as 50 Hz. Internally leveled pulse modulation over the entire 2 to 18 GHz range with ON/OFF ratios >70 dB is available with any externally supplied TTL-level input signals. Output pulses will have rise/fall times typically less than 50 ns.

Many More Features

The HP 8673E includes many more features including excellent spectral purity and a YIG-tuned oscillator phase-locked to a 10 MHz quartz crystal reference. Full HP-IB and digital sweep capability identical to the HP 8673B/C/D is also included. Listed below is a brief summary of specifications.

HP 8673E Specifications

Frequency Characteristics

| | |
|-------------------------|--|
| Frequency range: | 2.0 - 18.0 GHz (1.95 - 18.6 GHz overrange) |
| Resolution: | 1 kHz, 2.0 - 6.6 GHz |
| | 2 kHz, 6.6 - 12.3 GHz |
| | 3 kHz, 12.3 - 18.0 GHz |

Spectral Purity

Single-sideband phase noise (1 Hz BW, 1 kHz offset, CW mode): ≤ -60 dBc

Harmonics: ≤ -40 dBc at +3 dBm

Subharmonics and multiples thereof: -35 dBc at +3 dBm

Output Characteristics

Output level (+15°C to +35°C): +8 to -120 dBm

Resolution: 0.1 dB, digital display

Pulse Modulation

ON/OFF ratio: ≥ 70 dB

Rise/fall times: < 50 ns, typical

Pulse repetition frequency: 50 Hz to 1 MHz

Minimum duty cycle: < 0.0001 for leveled performance

Amplitude Modulation

Depth: 0 to 75%, at 0 dBm maximum carrier level, 15°C to 35°C

Rate (30% depth): 10 Hz - 10 kHz, ± 3 dB

Sensitivity: 30%/V and 100%/V ranges

Frequency Modulation

| Deviation Range | Rate (± 3 dB BW) | Maximum Peak Deviation |
|---------------------|--------------------------|--|
| 30 kHz/V | 100 Hz - 2 MHz | the smaller of 3 MHz or: $f_{\text{mod}} \times 5$, 2.0 - 6.6 GHz $f_{\text{mod}} \times 10$, 6.6 - 12.3 GHz $f_{\text{mod}} \times 15$, 12.3 - 18.0 GHz |
| 100 kHz/V | 100 Hz - 2 MHz | |
| 300 kHz/V | 3 kHz - 2 MHz | |
| 1 MHz/V | 3 kHz - 2 MHz | |
| 3 MHz/V | 3 kHz - 2 MHz | |
| 10 MHz/V (unlocked) | 50 Hz - 2 MHz, (typical) | 10 MHz |

Digital Sweep Characteristics

Identical to HP 8673B/C/D

Remote Programming

All functions HP-IB programmable except line switch.

Interface functions: SH1, AH1, T5, TE0, L3, LE0, SR1, RL1, PP1, DC1, DT1, C0, E1

General

Operating temperature range: 0°C to +55°C

Power: 100, 120, 220, 240V, +5%, -10%; 48-66Hz; 400 VA max

Weight: 29 kg (64 lb.) net

Size: 620 mm D x 425 mm W x 146 mm H (24.4" x 16.8" x 5.7")

Ordering Information

| | |
|---|-------------|
| HP 8673E Synthesized Signal Generator | \$36,500.00 |
| Option 907: Front panel handle kit | 55.00 |
| Option 908: Rack mounting flange kit | 32.50 |
| Option 909: Front panel handle with rack mounting flange kit | 80.00 |
| Option 910: Extra manual | 85.00 |

SIGNAL GENERATORS

Synthesized Signal Generators

Models 8673C and 8673D



- 10 MHz to 26.5 GHz frequency range
- < -60 dBc harmonics/subharmonics
- Low SSB phase noise and spurious outputs

- $+5$ to -100 dBm calibrated output
- 1 to 4 kHz frequency resolution
- Leveled pulse modulation/AM/FM

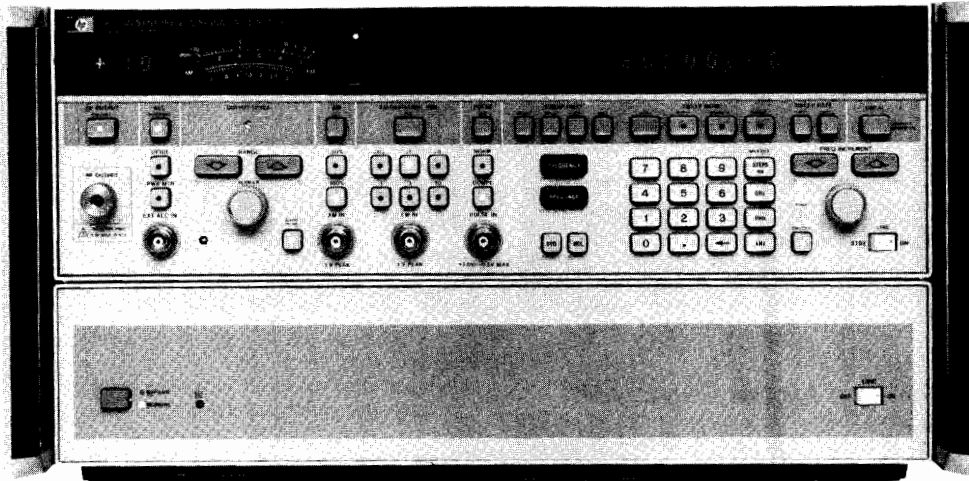

HP 8673D



HP 8673C and 8673D Synthesized Signal Generators

Designed as versatile microwave test sources for broadband receiving systems, the HP 8673C and 8673D Synthesized Signal Generators offer precise signal simulation capability in the 50 MHz to 26.5 GHz frequency range. The generators deliver spectrally pure frequencies, with harmonically related spurious outputs < -60 dBc above 1.2 GHz. Internal solid state amplifiers guarantee that adequate levels will be delivered to the system under test, even after the signal has passed through a number of automatic test system switching paths. Output is leveled and calibrated to a low level of -100 dBm, and maximum leveled output is specified to be at least $+5$ dBm across the HP 8673D operating band. High performance pulse modulation (> 80 dB ON/OFF ratios, < 40 ns rise/fall times) is delivered via external video modulating signals, as are amplitude and frequency modulation. Simultaneous modulation is possible to simulate complex environments. All operating parameters are HP-IB programmable.

For source applications limited to Ku band and below, the HP 8673C offers 50 MHz to 18.6 GHz frequency coverage, with $+5$ dBm levels to 16 GHz, and $+2$ dBm to 18.6 GHz.

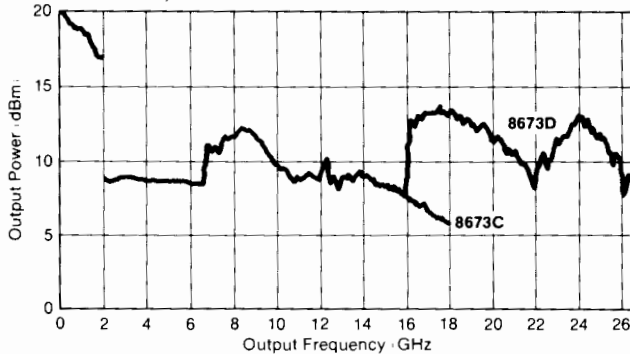

Figure 1. Maximum power typically available from the HP 8673C and 8673D at 25°C

HP 8673C and 8673D Specifications

(HP 8673C and D specifications are identical to HP 8673B specifications with the following exceptions and/or additions.)

Frequency Characteristics

Frequency range

HP 8673D: 50 MHz–26.0 GHz (10 MHz–26.5 GHz overrange);

HP 8673C: 50 MHz–18.6 GHz (10 MHz–18.6 GHz overrange).

Frequency bands: band 0, 50 MHz–2.0 GHz.

Frequency resolution: 1 kHz in Band 0.

Frequency switching time: < 50 ms to be within specified resolution, all bands.

Spectral Purity

Single-Sideband Phase Noise (1 Hz BW, CW mode):

| F _C | Offset from F _C | | | | |
|----------------|----------------------------|---------|---------|---------|----------|
| | 30 Hz | 100 Hz | 1 kHz | 10 kHz | 100 kHz |
| Band 0 | -64 dBc | -70 dBc | -78 dBc | -86 dBc | -105 dBc |

Harmonics (up to maximum frequency, output level meter readings < 0 dB on 0 dBm range and below): < -40 dBc, 50 MHz–1.2 GHz; < -60 dBc, 1.2–26.0 GHz.

Subharmonics and multiples thereof: < -60 dBc.

Spurious (CW and AM modes)

Non-harmonically related: < -60 dBc, Band 0.

Power line related and fan rotation related within 5 Hz below line frequency and multiples thereof:

| F _C | Offset from F _C | | |
|----------------|----------------------------|-----------------|-----------|
| | < 300 Hz | 300 Hz to 1 kHz | > 1 kHz |
| Band 0 | -50 dBc | -60 dBc | -65 dBc |

Output Characteristics

Output level ($+15^\circ\text{C}$ to $+35^\circ\text{C}$): $+11$ to -100 dBm, 50 MHz to 2 GHz; $+5$ to -100 dBm, 2 to 22 GHz; $+6$ to -100 dBm, 22–26 GHz ($+2$ to -100 dBm, 8673C 16–18.6 GHz).

Fatness (0 dBm range, $+15^\circ\text{C}$ to $+35^\circ\text{C}$): ± 0.5 dB through Band 0.

Pulse Modulation

Rise/fall times: < 20 ns, Band 0.

Frequency Modulation

Peak deviation (max.): the smaller of 10 MHz or $f_{\text{mod}} \times 5$, Band 0.

Remote programming

Interface functions: SH1, AH1, T5, TL0, L3, LE0, SR1, RL1, PP1, DC1, DT1, C0, E1.

General

Power: 100, 120, 220, 240V, $+5\%$, -10% , 48–66 Hz; 500 VA max.

Weight: net, 42.4 kg (94 lb). Shipping, 46.5 kg. (103 lb).

Size: 613 mm D x 425 mm W x 234 mm H (24.1" x 16.8" x 9.2").

Ordering Information

HP 8673C Synthesized Signal Generator

HP 8673D Synthesized Signal Generator

Option 001: Delete RF output attenuator

Option 002: Delete reference oscillator

Option 003: Operation at 50/60/400 Hz line

Option 004: Rear panel RF output

Option 005: Rear panel RF out without attenuator

Option 006: Chassis slide kit

Option 908: Rack mounting flange kit

Option 913: Rack flanges for standard front handles

Option 910: Extra operating and service manual

Price

\$55,000

\$67,000

less \$600

less \$735

add \$460

add \$75

less \$525

add \$75

add \$55

add \$45

add \$60

SIGNAL GENERATORS

Synthesized Signal Generator, Synthesized Source

Models 8672S, 8671A

- 10 MHz–18 GHz frequency range
- Internal pulse modulator
- HP-IB programmability

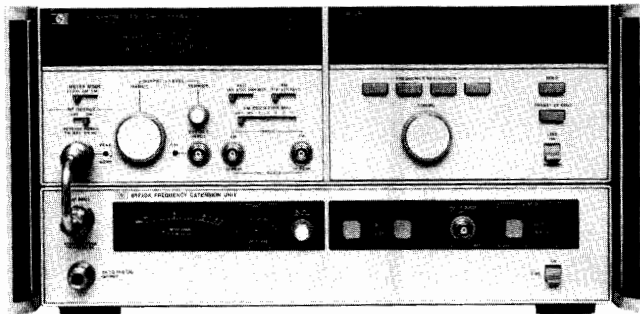

HP 8672S

HP 8672S Synthesized Signal Generator

The HP 8672S Synthesized Signal Generator consists of an HP 8672A Synthesized Signal Generator and an HP 86720A frequency extension unit. The HP 86720A uses a heterodyne technique to extend the frequency coverage of a standard HP 8672A to a lower limit of 10 MHz. As a single 9-inch high package, the HP 8672S features 10 MHz to 18 GHz single-knob continuous frequency tuning, calibrated CW output power, and an internal pulse modulator allowing high-quality pulse modulation over the entire 10 MHz to 18 GHz frequency range. All front-panel functions, with the exception of the line switches, are HP-IB programmable.

Specifications for the HP 8672S are identical to those of a stand-alone HP 8672A for the 2 to 18 GHz frequency range with the exception of a 1 dB decrease in maximum output power and no AM modulation available below 2 GHz.

Existing HP 8672A Signal Generators can be retrofitted to the HP 8672S configuration by ordering the HP 86720A Frequency Extension Unit and an HP 11731A or 11732A Frequency Extension Retrofit Kit.

HP 8672S Specifications

(Specifications for the HP 8672S are identical to those of the standard HP 8672A with the following exceptions.)

Frequency Characteristics

Frequency range: 10 MHz–18.0 GHz (18.599997 GHz overrange).

Frequency resolution: 1 kHz to 6.2 GHz, 2 kHz to 12.4 GHz, 3 kHz to 18.0 GHz.

Non-harmonic spurious: < -60 dBc, 10 MHz–1.999999 GHz.

Power line and fan rotation related spurious: 10 MHz–6.2 GHz, same as HP 8672A 2.0–6.2 GHz.

Single-sideband phase noise (1 Hz BW, CW mode): 10 MHz–6.2 GHz, same as HP 8672A 2.0–6.2 GHz.

Output Characteristics

Output level: +13 dBm to -120 dBm, 0.01–2.0 GHz; +2 dBm (+7 dBm, Opt. 008) to -120 dBm, 2.0–18.0 GHz.

Total indicated meter accuracy: 0.01–2.0 GHz, same as HP 8672A 2–6.2 GHz degraded by 0.5 dB; 2.0–18.0 GHz, HP 8672A degrades by 0.25 dB.

Level flatness: same as HP 8672A degraded by ± 0.25 dB.

Modulation Characteristics

Frequency modulation: 0.01–2.0 GHz, same as HP 8672A 2–6.2 GHz.

Pulse modulation: >80 dB ON/OFF ratio; <15 ns rise/fall times; peak pulsed power within 1.0 dB of level selected in CW mode for 0.01–2 GHz, uncalibrated for 2.0–18.0 GHz.

General

Programming: all functions HP-IB programmable except line switches and meter mode.

Interface functions: SH1, AH1, T6, TL0, L4, LE0, SR1, RL0, PP2, DC1, DT0, C0, E1.

Operating temperature range: 0 to +55°C (+15 to +35°C for specified performance).

Size: 222 H x 425 W x 620 mm D (8.8" x 16.8" x 24.4").

- 2–6.2 GHz frequency range
- Low spurious and phase noise
- +8 dBm minimum output power

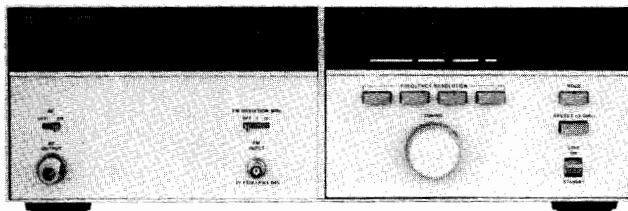

HP 8671A

HP 8671A Synthesizer

The HP 8671A Microwave Frequency Synthesizer covers the frequency range of 2.0 to 6.2 GHz in 1 kHz steps with excellent stability and spectral purity. It is well suited for most LO applications that require state-of-the-art performance as well as broadband capability.

HP 8671A Specifications

(Specifications for the HP 8671A are identical to those of the standard HP 8672A 2.0–6.2 GHz with the following exceptions.)

Frequency Characteristics

Harmonics: < -15 dBc.

Output Characteristics

Power (uneveled): +8 dBm (min.), +15 to +35 °C.

Flatness: <6 dB total variation across full frequency band.

Amplitude Modulation

Not available.

Frequency Modulation

Sensitivity: 50 kHz/V and 5 MHz/V ranges; max input 2 V peak.

General

Programming interface functions: SH1, AH1, T6, TE0, L4, LE0, SR1, RL0, PP2, DC1, DT0, C0, E1.

Weight: net, 24 kg (53 lb). Shipping, 29.5 kg (65 lb).

Ordering Information

| Ordering Information | Price |
|--|--------------|
| HP 8672S Synthesized Signal Generator | \$55,000 |
| Option 001: Delete RF output attenuator | less \$600 |
| Option 002: Delete reference oscillator | less \$550 |
| Option 003: Operation at 50/60/400 Hz line | add \$250 |
| Option 004: Rear panel RF output | add \$150 |
| Option 005: Rear panel RF output without RF attenuator. | less \$450 |
| Option 006: Chassis slide kit | add \$80 |
| Option 008: +7 dBm output level | add \$4,100 |
| Option 009: Delete internal pulse modulator | less \$1,100 |
| Option 010: Delete pulse modulator and step attenuator | less \$1,700 |
| Option 908: Rack flange kit | add \$55 |
| Option 913: Rack flanges for standard front panel handles. | add \$45 |
| Option 910: Extra operating and service manuals | add \$60 |
| HP 86720A Frequency Extension Unit | \$17,000 |
| HP 11731A Frequency Extension Retrofit Kit | \$1,000 |
| HP 11732A Frequency Extension Retrofit Kit | No Charge |
| HP 8671A Microwave Frequency Synthesizer | \$23,500 |
| Option 002: No internal reference | less \$550 |
| Option 003: Operation at 50/60/400 Hz line | add \$250 |
| Option 005: Rear panel RF output | add \$75 |
| Option 006: Chassis slide kit | add \$45 |
| Option 907: Front panel handle kit | add \$55 |
| Option 908: Rack mounting flange kit | add \$33 |
| Option 909: Front panel handle plus rack mounting flange kit | add \$80 |
| Option 910: Extra operating and service manual | add \$33 |
| HP 11712A Support Kit | \$800 |

SIGNAL GENERATORS

PIN Modulators, Pulse Driver

Models 8730 Series, 8403A

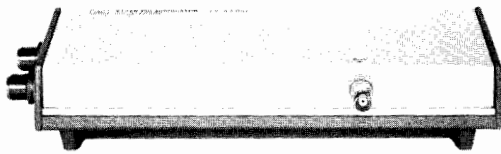

HP 8730B Series

HP 8730 Series PIN Modulators

With HP 8730 series PIN Modulators, signal sources, including klystrons, can be pulse-modulated, leveled or amplitude-modulated with sinusoidal and complex waveforms. Fast rise times, low incidental FM and a nearly constant impedance match to source and load are typical of these absorption-type modulators.

HP 8403A Modulator

The HP 8403A provides complete control of the PIN modulators, supplying the appropriate modulation wave shapes and bias levels for fast rise times, rated on/off ratios and amplitude modulation. An internal square-wave and pulse modulator with PRF of 50 Hz to 50 kHz and adjustable pulse width and delay also provide square wave and pulses for general pulse applications. For applications requiring an absorption-type modulator plus controls in a single unit, a PIN modulator can be installed inside the HP 8403A, for any specified frequency range.

HP 8403A Specifications

Output Characteristics (available separately at front panel).
For driving HP 8730 PIN modulators: AM and pulse output, pulse output specially shaped for optimum RF rise and decay times.
For general pulse applications: positive dc-coupled pulse 25 to 30 volts in amplitude, approximately symmetrical about 0 volt; no AM signal.

Modulation

Internal Square Wave

Frequency: variable from 50 Hz to 50 kHz.
Symmetry: better than 45/55%.

Internal Pulse

Repetition rate: variable from 50 Hz to 50 kHz.
Delay: variable from 0.1 μ s to 100 μ s, between sync out pulse and RF output pulse.
Width: variable from 0.1 μ s to 100 μ s.

HP 8730 Series Specifications

| | HP 8731B | HP 8732B | HP 8733B | HP 8734B | HP 8735B | HP 8731B-H10 ⁶ |
|--|------------|-------------------|------------|------------|------------------|---------------------------|
| Frequency range (GHz) | 0.8-2.4 | 1.8-4.5 | 3.7-8.3 | 7.0-12.4 | 8.2-12.4 | 0.4-1.2 |
| Dynamic range (dB) | 80 | 80 | 80 | 80 | 80 | 35 |
| Max. residual atten. (dB) ¹ | <2.0 | <3.5 ² | <3.0 | <5.0 | <5.0 | <2.0 |
| Typical rise time (ns) ³ | 30 | 30 | 30 | 30 | 30 | 40 |
| Typical decay time (ns) ³ | 20 | 20 | 20 | 20 | 20 | 30 |
| SWR, min. attenuation | 1.6 | 1.6 ⁴ | 2.0 | 2.0 | 2.0 | 1.5 ⁷ |
| SWR, max. attenuation | 2.0 | 2.0 | 2.2 | 2.2 | 2.2 | 2.0 ⁷ |
| Forward bias input resistance (ohms) | 100 | 100 | 100 | 100 | 100 | 300 |
| RF connector type | N(f) | N(f) | N(f) | N(f) | W/G ⁵ | N(f) |
| Weight, net kg (lb) | 2.5 (5.5) | 2.7 (6.0) | 1.4 (3.0) | 1.4 (3.0) | 1.4 (3.0) | 2.5 (5.5) |
| shipping kg (lb) | 3.3 (7.3) | 3.5 (7.8) | 1.9 (4.2) | 1.9 (4.2) | 1.9 (4.2) | 3.3 (7.3) |
| Dimensions | | | | | | |
| Height, mm (in) | 57 (2.25) | 57 (2.25) | 57 (2.25) | 57 (2.25) | 57 (2.25) | 57 (2.25) |
| Width, mm (in) | 124 (4.9) | 124 (4.9) | 83 (3.25) | 83 (3.25) | 83 (3.25) | 124 (4.9) |
| Depth, mm (in) | 289 (11.4) | 289 (11.4) | 311 (12.3) | 311 (12.3) | 267 (10.5) | 289 (11.4) |
| Prices | \$1625 | \$1710 | \$1850 | \$1850 | \$1850 | \$1625 |

Maximum ratings: maximum input power, peak or CW: 1 W; bias limits: +20 V, -10 V.
 Bias polarity: negative voltage increases attenuation.
 RF: radiated leakage limits are below those specified in MIL-I-6181D at input levels <1 mW; at all input levels radiated interference is sufficiently low to obtain rated attenuation.

1. With +5 V bias.
 2. 4 dB, 4 to 4.5 GHz.
 3. Driven by HP 8403A Modulator.
 4. 2.0 SWR, 4 to 4.5 GHz.

5. Fits 1 x 1/2 in. (WR 90) waveguide.
 6. External high-pass filters required.
 7. Excluding high-pass filters.

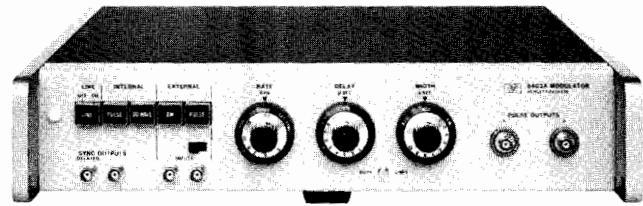

HP 8403A

External Sync

Signal: 5 to 20 volts peak, + or -, pulse or sine wave.
Input impedance: approximately 2000 ohms, dc-coupled.

Trigger Out

Sync out: simultaneous with or 0.1 to 100 μ s in advance of RF pulse, as set by delay control.
Delayed sync out: simultaneous with output pulse.
Amplitude: approximately -2 volts.
Source impedance: approximately 330 ohms.

External Pulse

Amplitude and polarity: 5 volts to 20 volts peak, + or -.
Repetition rate: maximum average PRF, 500 kHz/s.
Input impedance: approximately 2000 ohms, dc-coupled.
Width: minimum 0.1 μ s; maximum 1/PRF -0.4 μ s.

Amplitude Modulation (with HP 8730 series)

Frequency response: dc to approximately 10 MHz (3 dB).
Sensitivity: approximately 10 dB/volt with HP 8730A series; approximately 20 dB/volt with HP 8730B series.
Input impedance: approximately 1000 ohms.

General

Power: 115 or 230 volts \pm 10%, 50 to 400 Hz, approximately 10 watts.
Size: 96 H x 425 W x 467 mm D (3.75" x 16.73" x 18.4").
Weight: net, 7.4 kg (16.5 lb). Shipping, 9 kg (20 lb).

Ordering Information

HP 8403A Modulator

Price
\$2570

Options

002: HP 8731B PIN Modulator installed in HP 8403A add \$1525
004: HP 8732B PIN Modulator installed in HP 8403A add \$1600
006: HP 8733B PIN Modulator installed in HP 8403A add \$1725
008: HP 8734B PIN Modulator installed in HP 8403A add \$1725
009: Input and Output Connectors on rear panel add \$50
908: Rack flange kit add \$35.00
910: Extra Manual add \$7.50

MILLIMETRE WAVE TESTING

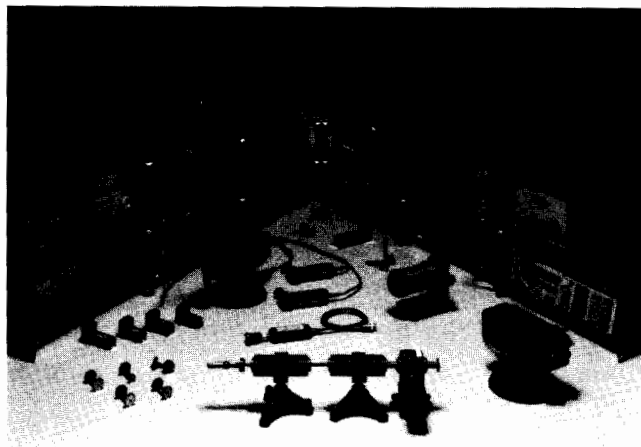

Figure 1. New HP millimeter-wave product line includes spectrum analyzers, scalar and vector network analyzers, frequency counters, power meters, sweepers and synthesizers, and a full line of waveguide measurement accessories.

Introduction

Hewlett-Packard now addresses measurements to 60 GHz and beyond with an offering of spectrum analyzers, vector and scalar network analyzers, signal sources, power meters, frequency counters, and a complete line of waveguide measurement accessories. In most cases, this new millimeter-wave test equipment is based around an existing piece of HP microwave test equipment.

HEWLETT-PACKARD MILLIMETER-WAVE PRODUCT LINE

| FREQUENCY RANGE | 26.5 to 40 GHz | 33 to 50 GHz | 40 to 60 GHz | 50 to 75 GHz | 75 to 110 GHz |
|---------------------------------|----------------|--------------|--------------|--------------|---------------|
| Signal Sources | | | | | |
| Signal Analysis | | | | | |
| Vector Network Analysis | | | | | |
| Scalar Network Analysis | | | | | |
| mm-Wave Measurement Accessories | | | | | |
| Power Measurements | | | | | |
| Frequency Counting | | | | | |

Available Now

In Development

Figure 2. Synopsis of HP's mm-wave product line, including frequency extensions currently under development.

As shown in Figure 2, HP's new line of millimeter-wave test equipment includes power meters to 50 GHz, vector and scalar network analyzers, sweepers and synthesizers, and measurement accessories to 60 GHz, and spectrum analyzers and frequency counters to 110 GHz. Also indicated is the commitment to extend the entire line to 110 GHz.

Millimeter-Wave Signal Sources

Hewlett-Packard offers three millimeter-wave source modules (see Figure 3) that produce high power, high quality signals covering the full waveguide bands of 26.5 to 40 GHz, 33 to 50 GHz, and 40 to 60 GHz. These source modules are efficient frequency multipliers that translate 50 mW microwave signals in the 11 to 20 GHz range to millimeter-wave signals. The source for the microwave input signal can be either the new HP 83550A 8 to 20 GHz, +20 dBm RF plug-in for the HP 8350B sweep oscillator, or any other HP 11 to 20 GHz microwave source driving the new HP 8349B 2 to 20 GHz power amplifier.

Convenience and Economy

Because the source module is small, light in weight, and connected to the microwave driver via flexible cables, it can be placed right at the waveguide input (rather than requiring that the waveguide be run to the source).

Also, since the module is an extension of a lower frequency microwave source, its cost is quite low relative to other source alternatives. And of course, the microwave driving source can be productively used for other microwave applications when not in use with the module.

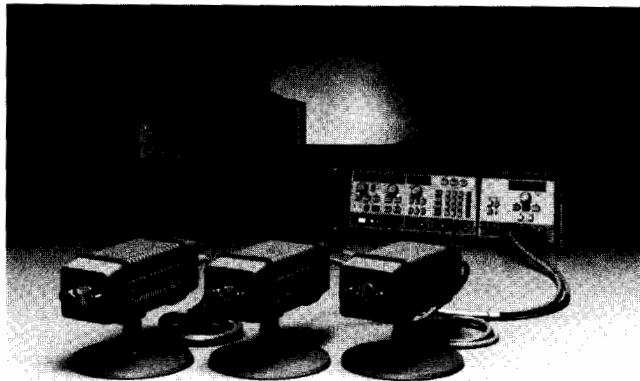

Figure 3. HP millimeter-wave source modules include the HP 83554A (26.5 to 40 GHz), HP 83555A (33 to 50 GHz), and HP 83556A (40 to 60 GHz).

Translate the High Performance of Your Microwave Source

With the source modules, the characteristics of your microwave source are translated to millimeter-wave frequencies. For millimeter-wave swept testing, the features of the HP 8350-series sweep oscillator including all sweep modes, calibrated leveled power and, full programmability, are all available.

When highest frequency accuracy, stability, and spectral purity are needed, a microwave synthesizer can be used as the driving source. For instance, with the HP 8341A synthesized sweeper, you can achieve 9 Hz of frequency resolution at 60 GHz, and typically -70 dBc/Hz SSB phase noise at 35 GHz (in a 1 Hz BW 10 kHz away from the carrier). Similarly, the sophisticated (AM, FM or pulse) modulation of a synthesized signal generator like the HP 8673 series or the HP 8341A/40A can be translated up to millimeter-wave frequencies.

Signal Analysis

To extend your millimeter-wave signal analysis capability to 110 GHz, HP offers a line of external harmonic mixers. The mixers, along with the multi-band millimeter-wave capability of the new HP 71000 spectrum analyzer (see Figure 4), the high performance of the HP 8566B and economy of the HP 8569B spectrum analyzers offer a wide range of millimeter-wave signal analysis capability.

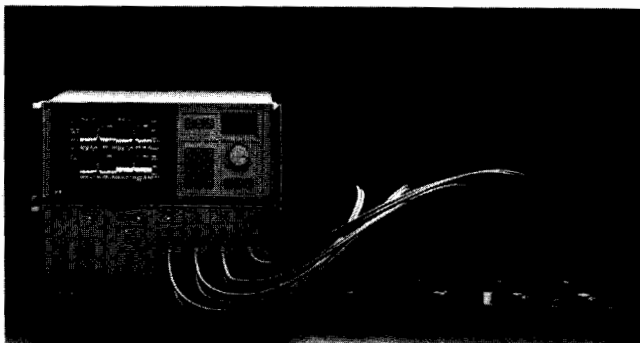

Figure 4. HP 71000 millimeter-wave spectrum analyzer with four HP 11970 series mixers measuring 26.5 to 110 GHz on four simultaneous displays.

Easy to Use

Because the HP 11970 and 11971 series mixers do not require DC bias and its associated adjustments, measurements can be made quickly and easily. Signal frequencies are easy to determine using these mixers with the high-performance signal identification functions in both the HP 8566B and new HP 71000 spectrum analyzers, providing fast, reliable results.

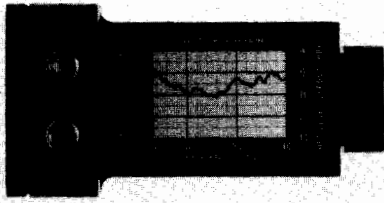

Figure 5. Each harmonic mixer's conversion loss is plotted versus frequency and mounted on the body of the unit.

High Performance

Each individual mixer is characterized by a plot of conversion loss versus frequency which is mounted on the body of the unit (see Figure 5). By removing the conversion loss characteristics of the mixer from the amplitude measurement (using a simple down-loadable program in the HP 71000 or 8566B or a manual IF gain adjustment on the HP 8569B), calibrated amplitude measurements are possible with a spectrum analyzer at millimeter-wave frequencies. In addition, these harmonic mixers have excellent sensitivity, offering typically -104 dBm at 44 GHz and -93 dBm at 94 GHz (HP 11970 series in a 1 kHz resolution BW).

Vector Network Analysis

Now the powerful HP 8510 microwave vector network analyzer can be extended to operate at millimeter-wave frequencies (see Figure 6). All of the HP 8510 system measurement capabilities available at microwave frequencies are now obtainable to 60 GHz. Optionally, the ability to view the response of a test device as a function of time is also available.

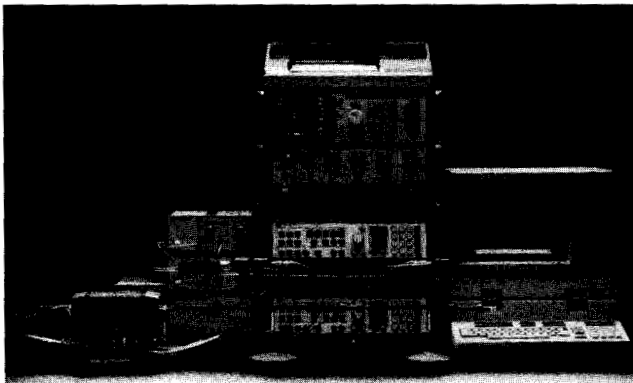

Figure 6. HP 8510 millimeter-wave network analyzer for the 26.5 to 40 GHz frequency band.

Wide Dynamic Range

With 80 to 100 dB of dynamic range, measuring the transmission loss of a high rejection filter or the return loss of a small signal device isn't limited by the test system.

Simple to Use

An HP 8510 millimeter-wave system provides a new level of measurement convenience. The mobility of the test ports means you can quickly connect and measure your device rather than spend time adapting to the requirements of the test system.

Precision with Speed

Using the HP 85129A millimeter-wave system software pac, the HP 8510 millimeter-wave system is capable of measurements with speed and accuracy. Measurement speeds range from 7 seconds for 51 synthesized frequency points to just under a minute for a full 401 points of error-corrected measurements. Meaningful resolutions of 0.05 dB and 0.1 degrees phase are easily achieved. Accuracy enhancement further improves measurement uncertainty by reducing the level of systematic errors. Effective directivity and source match are typically 38 to 45 dB and 35 to 40 dB, respectively.

Configuration Summary

All of the details for configuring and operating an HP 8510 millimeter-wave system are thoroughly documented in HP Product Note 8510-1A. For ordering convenience, kits of the components necessary to configure the test set portion of the system are offered. System software and a complete line of calibration devices are also available.

Scalar Network Analysis

Scalar network measurement systems covering 26.5 to 60 GHz include calibrated detectors, analyzers, sources, and millimeter-wave accessories and take advantage of all the capability and productivity enhancements built into the systems for microwave use.

Choose from two HP scalar network analyzers—the HP 8756A or the HP 8757A. The HP 8757A is the ideal choice for most millimeter-wave measurements. Using the Q85026A and U85026A detectors, the HP 8757A can measure in either AC or DC detection modes, allowing you to optimize your measurement dynamic range for each device. For multi-port devices, use the optional fourth detector input to measure four independent device parameters simultaneously. In addition, the HP 8757A, with its 9 inch diagonal vector display, can generate limit lines that permit pass/fail testing—ideal for the production environment. For measurements above 60 GHz, use the HP 85025C (HP 8757A only) and 11664C detector adapters with your millimeter-wave detectors and source.

Frequency Counters

Hewlett-Packard extends its frequency measuring capability to millimeter-wave frequencies with the addition of the HP 5352A 40 GHz CW counter and the HP 5356D harmonic mixer driver (which translates the existing HP 5345/55/56 series CW and pulse microwave counter to millimeter-wave frequencies via the HP 11970 series harmonic mixers) for frequency coverage to 110 GHz.

The HP 5352A 10 Hz to 40 GHz CW counter provides reliable performance and ease of use at a low price for microwave and millimeter-wave frequency measurements. A rugged APC-3.5 male input connector is used to cover a broad 500 MHz to 40 GHz range. Alternatively, a 3.5 mm coax to WR-28 waveguide adapter could be used for measurements in 26.5 to 40 GHz waveguide. Dynamic range at 40 GHz is 22 dB and resolution is 1 Hz. Operation is enhanced by data manipulation features (e.g. math functions and offset capability), and full programmability.

The HP 5356D harmonic mixer driver extends the line of HP 5345A/5355A/5356 series microwave frequency counters to 110 GHz. With this extension comes the capability to measure both CW and pulsed millimeter-wave signals. Using the 36 to 50 GHz band as an example, 32 dB dynamic range with 48 MHz FM tolerance (at rates of dc to 10 MHz) is available in CW mode and a signal with a maximum 80 MHz FM chirp and 75 ns minimum pulse width can be measured in pulse mode.

Power Meters

The accuracy in power measurements at microwave frequencies has now been extended into the millimeter-wave region. Paired with the HP 438A, 436A, or 435B power meters, the new HP R8486A and Q8486A thermocouple waveguide power sensors exhibit stable, well-matched performance allowing you to accurately measure power in the frequency ranges of 26.5 to 40 GHz and 33 to 50 GHz respectively.

These millimeter-wave power sensors have the capability to normalize the sensor/meter combination to the 50 MHz, 1mW reference signal contained within the power meters. The accuracy of your power measurements is further assured by traceability to NBS standards.

Millimeter-Wave Measurement Waveguide Accessories

Accompanying HP's broad range of millimeter-wave instrumentation is a full line of millimeter-wave measurement accessories. These accessories make up the components necessary to configure practical millimeter-wave measurement systems in the 26.5 to 40 GHz, 33 to 50 GHz, and 40 to 60 GHz waveguide bands. Accessories in the line include variable attenuators, frequency meters, couplers, isolators, detectors, terminations, fixed attenuators and assorted adapters, bends, twists and straights.

MICROWAVE TEST EQUIPMENT

Microwave Measurements and Products



Microwave measuring techniques

Hewlett-Packard offers a complete line of microwave coaxial and waveguide measuring equipment. Measuring systems can be assembled from this equipment to make accurate reflection and transmission measurements on other components such as filters, mixers, cables, etc. Signal characteristics such as frequency, power, or spectral content may be measured using other associated equipment.

HP equipment capability ranges from inexpensive systems for point-by-point, narrow-band work to powerful analyzers which furnish dynamic displays of error-corrected network scattering parameters across wide frequency bands. Equipment selection and measuring techniques depend primarily on the accuracy, speed, and cost requirements of the application.

Some applications require complete phase and amplitude characterization of microwave components. These vector measurements are usually made in design labs to aid in component design or in evaluating performance to phase specifications. Such phase measurements require relatively sophisticated equipment and techniques.

But the majority of microwave measurements made in production, test, maintenance, and calibration require only amplitude (scalar) characteristics. Scalar test procedures are popular because they are straightforward, easy-to-use, and low cost, yet yield an excellent measure of the quality of the test part.

More detailed information is available in the Coaxial & Waveguide Measurement Accessories Catalog & Microwave Measurement Handbook, literature number 5952-8262.

Confidence in Component Performance

The performance of every unit manufactured is verified on an error-correcting automatic network analyzer that has been calibrated with standards that are directly or indirectly traceable to the National Bureau of Standards. This means you can be assured that the product you receive has been properly tested and meets the specifications you expect.

MICROWAVE TEST EQUIPMENT

Adapters, Waveguide Stands, Air Lines

Models 281A/B/C, 292A/B, 11515/6/A, 11540 Series, 11566/7/A, 11588A, 11606A

553



HP K281C



HP X281A



HP MX292B



HP 11566A



HP 11515A



HP 11606A

HP 11545-11548A

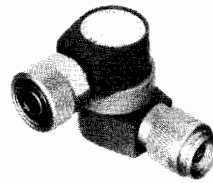

HP 11588A

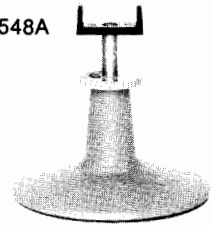

HP 11540A

HP 281A/B/C, 292A/B, 11515A/6A Coax and Waveguide Adapters

HP 281A/B Adapters transform waveguide transmission line into 50-ohm coaxial line. The HP 281C family has improved SWR.

HP 292A/B Waveguide-to-Waveguide Adapters connect two different waveguide sizes with overlapping frequency ranges. HP 11515A/16A adapt circular to rectangular flanges in K-band and R-band.

HP 281A/B/C Specifications

| HP Model | SWR | Frequency Range (GHz) | Waveguide Size EIA | Coaxial Connector | W/G Flange UG-() U | Price |
|------------|------|-----------------------|--------------------|-------------------|---------------------|-----------|
| S281A | 1.25 | 2.60-3.95 | WR284 | N Female | 584 | \$210 |
| G281A | 1.25 | 3.95-5.85 | WR187 | N Female | 407 | \$190 |
| J281A | 1.25 | 5.30-8.20 | WR137 | N Female | 441 | \$160 |
| H281A | 1.25 | 7.05-10.0 | WR112 | N Female | 138 | \$140 |
| X281A | 1.25 | 8.20-12.4 | WR90 | N Female | 135 | \$120 |
| X281B | 1.25 | 8.20-12.4 | WR90 | APC-7 | 135 | \$285 |
| Option 013 | | | | N Female | | less \$15 |
| X281C | 1.05 | 8.20-12.4 | WR90 | APC-7 | 135 | \$335 |
| Option 012 | | | | N Male | | less \$15 |
| Option 013 | | | | N Female | | less \$15 |
| P281B | 1.25 | 12.4-18.0 | WR62 | APC-7 | 419 | \$230 |
| Option 013 | | | | N Female | | less \$15 |
| P281C | 1.06 | 12.4-18.0 | WR62 | APC-7 | 419 | \$360 |
| Option 012 | | | | N Male | | less \$15 |
| Option 013 | | | | N Female | | less \$15 |
| K281C | 1.07 | 18.0-26.5 | WR42 | APC-3.5 (f) | 597 | \$400 |
| Option 012 | | | | APC-3.5 (M) | | N/C |

HP 292A/B, 11515A, 11516A Specifications

| HP Model | Frequency Range (GHz) | SWR | W/G Size Flange | to | W/G Size Flange | Price |
|----------|-----------------------|------|-----------------|----|-----------------|-------|
| HX292B | 8.2-10.0 | 1.05 | WR 112 UG-51/U | | WR 90 UG-39/U | \$210 |
| MX292B | 10.0-12.4 | 1.05 | WR 75 Cover | | WR 90 UG-39/U | \$270 |
| MP292B | 12.4-15.0 | 1.05 | WR 75 Cover | | WR 62 UG-419/U | \$210 |
| NP292A | 15.0-18.0 | 1.05 | WR 51 Cover | | WR 62 UG-419/U | \$210 |
| NK292A | 18.0-22.0 | 1.05 | WR 51 Cover | | WR 42 UG-595/U | \$210 |
| 11515A | 18.0-26.5 | - | WR 42 UG-425/U | | WR 42 UG-595/U | \$210 |
| 11516A | 26.5-40.0 | - | WR 28 UG-381/U | | WR 28 UG-599/U | \$210 |

HP 11588A Swivel Adapter, 11606A Rotary Air Line

The HP 11606A Rotary Air Line and the HP 11588A Swivel Adapter are capable of a full 360° of rotation. A combination of the air line and the adapter permits rigid coax movement in three dimensions. Even the most awkwardly shaped devices can be easily connected or disconnected in a coax system with the aid of these components. Insertion loss is <0.5 dB and uncertainty due to rotation is -57 dB.

HP 11566A, 11567A Air Line Extension

Impedance: 50 ohms.

Frequency: dc-18 GHz.

Reflection coefficient: 0.018 + (0.001 x frequency in GHz).

Connector: APC-7.

Length: 11566A, 102.5 mm (4 in.); 11567A, 202.5 mm (8 in.).

Shipping weight: 0.45 kg (1 lb).

HP 11540 Series Waveguide Stand, Waveguide Holders

The HP 11540A Waveguide Stand locks HP waveguide holders at any height from 70 to 133 mm (2.75 in. to 5.25 in.). The waveguide holders are offered in five sizes to hold waveguide covering frequencies from 22 to 40 GHz.

HP 11588A, 11606A Specifications

| HP Model | Frequency Range GHz | SWR | Connectors | Dimensions mm (in) | Shipping Weight kg (lb) | Price |
|----------|---------------------|-----|-------------|--|-------------------------|-------|
| 11588A | DC-12.4 | 1.1 | APC-7(m)(f) | 42 x 59 x 30 (1 1/8 x 2 3/16 x 1 1/16) | 0.28 (10 oz.) | \$550 |
| 11606A | DC-12.4 | 1.1 | APC-7(f) | 100 x 19 (4 x 3/4) | 0.45 (1 lb) | \$450 |

Ordering Information

| | Price |
|--|-----------|
| HP 11566A Air line extension | \$275 |
| HP 11567A Air line extension | \$320 |
| HP 11540A Waveguide stand | \$60 |
| HP 11545A X-Band, | each \$40 |
| HP 11546A P-Band, 11547A K-Band, 11548A R-Band | each \$40 |
| Waveguide holders | |



MICROWAVE TEST EQUIPMENT

Millimetre Waveguide Accessories, 33 to 60 GHz

Models Q/U 382A, Q/U 422A, Q/U 532A, 292 Series

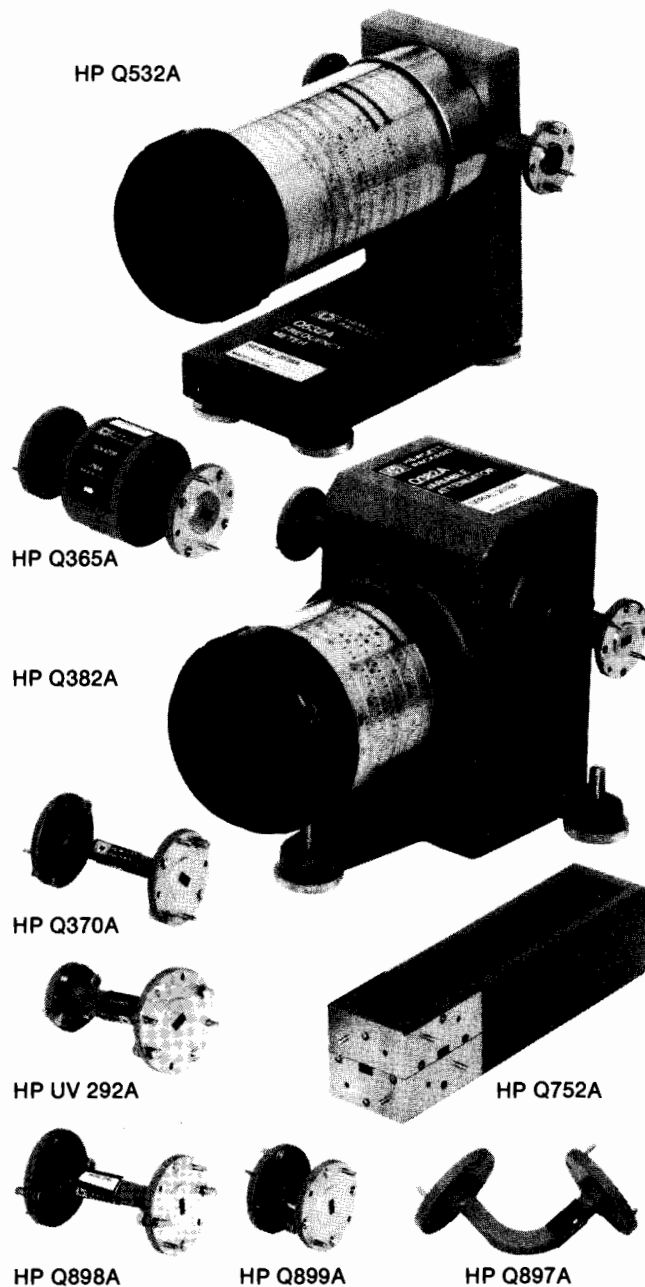

HP Q532A

HP Q365A

HP Q382A

HP Q370A

HP UV 292A

HP Q898A

HP Q899A

HP Q897A

HP Q752A

Millimetre-Wave Waveguide Measurement Accessories

To complement our broad range of millimetre-wave instrumentation, Hewlett-Packard offers a full line of waveguide accessories - virtually everything you need to assemble millimetre-wave measurement systems in the Q and U waveguide bands.

Performance of every unit is verified in a specially configured mm-wave Automatic Network Analyzer that has been calibrated with standards that are directly or indirectly traceable to the National Bureau of Standards.

HP 382A Millimetre-Wave Variable Attenuators

The HP Q382A and U382A rotary vane Waveguide Attenuators provide a thoroughly reliable, true standard of attenuation for use as precision calibrators in your laboratory, or for direct comparison measurements. Attenuation accuracy is within $\pm 2\%$ of dial reading in dB or ± 0.1 dB, whichever is greater. This includes both calibration error and frequency response.

HP 382A Variable Attenuator Specifications

| HP Model | Frequency Range (GHz) | Accuracy | Attenuation Range (dB) | Waveguide & Equivalent Flange | Price |
|----------|-----------------------|---|------------------------|-------------------------------|--------|
| Q382A | 33-50 | $\pm 2\%$ of reading or 0.1dB (whichever greater) | 0-50 | WR-22 UG-383/U | \$1800 |
| U382A | 40-60 | | | WR-19 UG-383/U (Mod.) | \$1840 |

HP 422A Millimetre-Wave Detectors

The HP Q422A and U422A are general purpose waveguide detectors. They use Low-Barrier Schottky diodes, especially fabricated with low video impedance and low junction capacitance. The detectors combine high sensitivity with flat frequency response and low SWR. They can be used with the HP 415E SWR meter or common oscilloscopes and voltmeters.

HP 422A Detector Specifications

| HP Model | Frequency Range (GHz) | SWR (Max) | Low Level Sensitivity (mV/uW) | Max. Input Power | Output Polarity | Waveguide & Equivalent Flange | Video Connector | Price |
|----------|-----------------------|-----------|-------------------------------|------------------|-----------------|-------------------------------|-----------------|--------|
| Q422A | 33-50 | 2.0 | 0.25 | 100mW | Negative | WR-22 UG-383/U | SMA(f) | \$ 980 |
| U422A | 40-60 | 2.0 | 0.20 | 100mW | Negative | WR-19 UG-383/U (Mod.) | SMA(f) | \$1150 |

Options

Opt. 003 Positive Polarity No Charge

HP 532A Millimetre-Wave Frequency Meters

The HP 532A Frequency Meters are direct reading, absorption-type meters that provide a quick, easy, and accurate way of measuring frequency in Q and U waveguide bands. They have calibration marks every 20 MHz for high resolution. They are also designed to be virtually backlash-free for high repeatability.

HP 532A Frequency Meter Specifications

| HP Model | Frequency Range (GHz) | Overall Accuracy (%) | Calibration Increments | Waveguide & Equivalent Flange | Price |
|----------|-----------------------|----------------------|------------------------|-------------------------------|--------|
| Q532A | 33-50 | 0.12 | 20 MHz | WR-22 UG-383/U | \$1680 |
| U532A | 40-60 | 0.15 | 20 MHz | WR-19 UG-383/U (Mod.) | \$1740 |

HP 292A Millimetre-Wave Waveguide Adapters

The HP 292A Waveguide Adapters are short sections of waveguide, carefully tapered from one size waveguide to the next. The prefix designates the waveguide bands for which the adapter is specified. For example, HP QU292A connects Q-band to U-band.

HP 292A Waveguide Adapter Specifications

| HP Model | Frequency Range (GHz) | SWR (Max.) | Typical Insertion Loss (dB) | W/G Size Flange | To WG/Size Flange | Price |
|----------|-----------------------|------------|-----------------------------|-----------------------|-----------------------|-------|
| RQ292A | 33-40 | 1.15 | 0.1 | WR-28 UG-381/U | WR-22 UG-383/U | \$380 |
| QU292A | 40-50 | | | WR-22 UG-383/U | WR-19 UG-383/U (Mod.) | \$380 |
| UV292A | 50-60 | | | WR-19 UG-383/U (Mod.) | WR-15 UG-385/U | \$405 |

MICROWAVE TEST EQUIPMENT

Millimetre Waveguide Accessories, 33 to 60 GHz

Models Q/U 365A, Q/U 370 A/B/C, Q/U 752 A/C/D, Q/U 897-899, Q/U 910A, Q/U 920A

555



HP 365A Millimetre-Wave Waveguide Isolators

The HP Q and U365A Isolators use a Faraday-rotation-type design consisting of a section of waveguide containing low-loss ferrite material and impedance matching elements. A permanent magnet supplies the external magnetic bias field to the ferrite core. This results in excellent broadband isolation ratios of at least 25 dB along with low SWR and insertion loss.

HP 365A Waveguide Isolator Specifications

| HP Model | Frequency Range (GHz) | SWR (Max.) | Maximum Insertion Loss (dB) | Minimum Isolation (dB) | Maximum Input Power (Avg.) | Waveguide & Equivalent Flange | Price |
|----------|-----------------------|------------|-----------------------------|------------------------|----------------------------|-------------------------------|-------|
| Q365A | 33-50 | 1.4 | 1.5 | 25 | 1.5W | WR-22 UG-383/U | \$850 |
| U365A | 40-60 | 1.4 | 1.8 | | | WR-19 UG-383/U (Mod.) | |

HP 370A/B/C Millimetre-Wave Fixed Attenuators

The HP Q and U 370 Fixed Attenuators offer precise attenuation, flat frequency response, and low SWR. Their ruggedness, reliability, and small size make them ideal for bench systems applications. They are also useful for general purpose applications, like the reduction of power levels to sensitive components and systems.

HP 370A/B/C Fixed Attenuator Specifications

| HP Model | Frequency Range (GHz) | SWR (Max) | Max. Input Power | Attenuation | Attenuation Accuracy | Waveguide & Equivalent Flange | Price |
|----------|-----------------------|-----------|-----------------------|-------------|----------------------|-------------------------------|-------|
| Q370A | 33-50 | 1.2 | .5W Avg. 100W Peak | 3dB | ±0.3dB | WR-22 | \$310 |
| Q370B | | | | 6dB | ±0.6dB | UG-383/U | |
| Q370C | | | | 10dB | ±0.3dB | | |
| U370A | 40-60 | 1.2 | .5W Avg. 100W Peak | 3dB | ±0.3dB | WR-19 | \$325 |
| U370B | | | | 6dB | ±0.6dB | UG-383/U (Mod.) | |
| U370C | | | | 10dB | ±0.6dB | | |

HP 910A Millimetre-Wave Fixed Terminations

The Q910A and U910A Fixed Loads cover a frequency range of 33 to 50 and 40 to 60 GHz respectively. Their low SWR specification make them ideal for precise measurements of small reflections in transmission lines.

HP 910A Fixed Terminations Specifications

| HP Model | Frequency Range (GHz) | SWR (Max.) | Max. Input Power | Waveguide & Equivalent Flange | Price |
|----------|-----------------------|------------|------------------|-------------------------------|-------|
| Q910A | 33-50 | 1.03 | 1.0W Avg. | WR-22 UG-383/U | \$225 |
| U910A | 40-60 | 1.04 | 1.0W Avg. | WR-19 UG-383/U (Mod.) | \$225 |

HP 752A/C/D Millimetre-Wave Directional Coupler

The HP Q752A/C/D and U752A/C/D Directional Couplers feature exceptionally high directivity of at least 36 dB, low SWR of 1.1 or better, and a smooth coupling variation of no more than +0.7 dB. When connected in a reflectometer configuration, their high directivity and low SWR will ensure accurate measurements of reflection and/or transmission. To sample or monitor power, these couplers provide flat frequency response and low SWR which allows you to accurately measure incident or reflected power levels.

The directivity, the most important parameter of a coupler, is typically better than 40 dB for these couplers.

HP 752A/C/D Directional Coupler Specifications

| HP Model | Frequency Range (GHz) | Coupling (dB) | Mean Coupling Accuracy | Coupling Variation (dB) | Minimum Directivity (dB) | Max. Input Power | Waveguide & Equivalent Flange | Price |
|----------|-----------------------|---------------|------------------------|-------------------------|--------------------------|------------------|-------------------------------|-------|
| Q752A | 33-50 | 3 | ±0.7 dB | ±0.7 | 36 | 1W | WR-22 UG-383/U | \$900 |
| Q752C | | 10 | | | | 5W | | |
| Q752D | | 20 | | | | 50W | | |
| U752A | 40-60 | 3 | ±0.7 dB | ±0.7 | 36 | 1W | WR-19 UG-383/U (Mod.) | \$950 |
| U752C | | 10 | | | | 5W | | |
| U752D | | 20 | | | | 50W | | |

HP 897A/B, 898A/B, 899 A/B Millimetre-Wave Waveguide Accessories

HP offers a number of E- and H-Plane bends, twists, and straight sections necessary for assembling waveguide measurement systems. The HP Q and U 897 A/B are E-Plane and H-Plane bends of 90 degrees. The HP Q and U 898A/B twists can be specified for either right rotation (A-Model) or left rotation (B-Model) of 90 degrees. The HP Q and U 899A/B are straight sections available in 2.5 and 5.0 cm lengths.

HP 897A/B, 898A/B, 899A/B Waveguide Accessories

| HP Model | Description | Frequency Range (GHz) | SWR (Max.) | Waveguide & Equivalent Flange | Price |
|----------|---|-----------------------|------------|-------------------------------|-------|
| Q897A B | Bend (H-Plane) (E-Plane) | 33-50 | 1.1 | WR-22 UG-383/U | \$145 |
| Q898A B | Twist (90° R.H.) (90° L.H.) | | | | \$150 |
| Q899A B | Straight (2.5 cm, 1 in) (5.0 cm, 1 in) | | | | \$140 |
| U897A B | Bend (H-Plane) (E-Plane) | 40-60 | 1.1 | WR-19 UG-383/U (Mod.) | \$145 |
| U898A B | Twist (90° R.H.) (90° L.H.) | | | | \$150 |
| U899A B | Straight (2.5 cm, 1 in) (5 cm, 2 in) | | | | \$140 |

HP 920A Millimetre-Wave Sliding Shorts

The Q920A and U920A are low-loss sliding shorts for waveguide systems operating from 33 to 60 GHz. They can be used with waveguide tees as variable shunt reactances for tuning or impedance matching applications. They are also valuable as reference impedances for reflectometer systems.

HP 920A Sliding Shorts Specifications

| HP Model | Frequency Range (GHz) | Reflection Coefficient | Adjustment (at lowest frequency) | Waveguide & Equivalent Flange | Price |
|----------|-----------------------|------------------------|----------------------------------|-------------------------------|-------|
| Q920A | 33-50 | >.98 | 5/8 λ | WR-22 UG-383/U | \$405 |
| U920A | 40-60 | >.98 | 5/8 λ | WR-19 UG-383/U (Mod.) | \$405 |



MICROWAVE TEST EQUIPMENT

Coaxial Fixed Attenuators

Models 8491A/B, 8492A, 8493A/B/C, 8498A, 11581/2/3A/3C, 33340A/B/C

- Flat frequency response
- Low SWR
- Specifications traceable to NBS

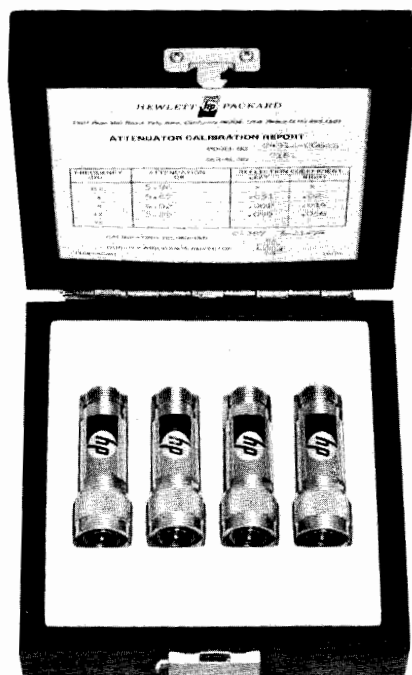

HP 11581A

HP 8491A/B, 8492A, 8493A/B/C Fixed Attenuators

Hewlett-Packard coaxial fixed attenuators provide precision attenuation, flat frequency response, low SWR over broad frequency ranges at low prices. Attenuators are available in nominal attenuations of 3-dB and 6-dB, also 10-dB increments from 10 dB to 60 dB. These attenuators are swept-frequency tested to ensure meeting specifications at all frequencies. Calibration points are provided on a nameplate chart attached to each unit.

HP 11581A, 11582A, 11583A/C Attenuator Sets

A set of four Hewlett-Packard attenuators—3, 6, 10 and 20 dB—are furnished in a handsome walnut accessory case. The HP 11581A set consists of HP 8491A Attenuators; the HP 11582A set, HP 8491B Attenuators; the HP 11583A set, HP 8492A Attenuators; and the HP 11583C set, HP 8493C Attenuators. The set includes calibration reports certified traceable to the National Bureau of Standards, containing both the attenuation and the reflection coefficients for each attenuator at four frequencies for the HP 11581A (dc, 4, 8, 12.4 GHz) and five frequencies for the HP 11582A and HP 11583A (dc, 4, 8, 12.4, 18 GHz). By specifying option 890, calibration data is given at 26 frequencies (HP 11581A) or 42 frequencies (HP 11582A and 11583A). The HP 11583C set includes option 890 calibration data. See next page for exact frequency lists.

These sets are ideal for calibration labs or where precise knowledge of attenuation and SWR is desired.

HP 8498A High Power Attenuator

The HP 8498A Option 030 is designed to meet the needs of high power attenuation applications in the RF and microwave frequency range. It is specified from dc to 18 GHz at 25 watts average, 500 watts peak, from dc to 5.8 GHz and 125 watts peak from 5.8 to 18 GHz. Available only in a 30 dB model (option 030), the unit offers low SWR (<1.30 at 18 GHz) and good accuracy (± 1 dB at 18 GHz). The unit also features 'human engineered' cooling fins that prevent operator burns even under continuous maximum input power conditions.

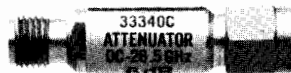

HP 33340C

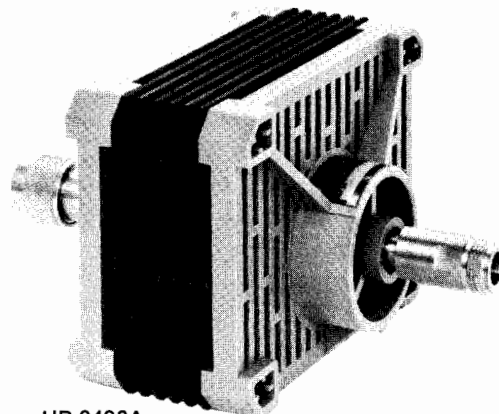

HP 8498A
Option 030

Option 890 Calibration Data

Extensive calibration data is available on HP attenuators at low cost. When option 890 is specified for the fixed attenuators or microwave step attenuators, standardized calibration data in frequency steps no larger than 500 MHz is provided over the frequency range of the units. This data is generated from measurements made on an HP 8542 Automatic Network Analyzer and features excellent accuracy (traceable to NBS) and low cost. Data is given for attenuation and the SWR (reflection coefficient for the HP 8493C) of each port and is provided in a protective plastic envelope.

Calibration data has important uses in applications such as RF substitution measurements and test system verification. Using the actual calibration data rather than data sheet specifications allows the attenuation uncertainty to be reduced 60% or more. Also, the calculated mismatch uncertainty for a test system is lower if the actual SWR data for the attenuators is used. Similar calibration data is used in HP production areas to verify the performance of manual and automated test systems. For automated system checkout, the calibrated unit is tested and the results are compared to the previously stored calibration data. If the differences are within the measurement uncertainty, proper operation is ensured. For step attenuators, the calibration data can be used in automated test systems to more accurately characterize a device's characteristics. By storing the calibration data for the individual steps, the measurement results can be adjusted by the actual amount of attenuation (for example, when a nominal 10 dB step is actually 9.6 dB).

The calibration data frequencies, prices, and ordering information for fixed attenuators are on the next page, and the same information for step attenuators is on page 558.

HP 33340A/B/C Fixed Attenuators

The HP 33340A, 33340B and 33340C are Coaxial Fixed Attenuators intended for OEM and systems use. Frequency range specifications are dc—12.4 GHz, dc—18 GHz and dc—26.5 GHz respectively. These OEM attenuators are similar to the HP 8493 series Attenuators.

For more information regarding the HP 33340 series refer to the data sheet (5952-8279).

Ordering Information

HP 33340A Coaxial Fixed Attenuator
Option 890
HP 33340B Coaxial Fixed Attenuator
Option 890
HP 33340C Coaxial Fixed Attenuator
Option 890

Price
\$85
add \$20
\$110
add \$25
\$238
add \$40



HP 8491A/B series



HP 8492 series



HP 8493A/B/C series

Ordering Example

Include appropriate frequency range/connector and attenuation designations from the ordering example below with every attenuator order.

Calibration Data

Include "Option 890" or "Option 894" in addition to attenuation option when ordering calibration data.

| HEWLETT PACKARD CALIBRATION REPORT | | | | |
|--|------------------|------------|-------------------|--|
| MODEL: 8493B OPT 806/890 | SER NO: 82521 | | TECHNICIAN: 33886 | |
| DATE: 11-06-83 | | | | |
| MEAS SYSTEM: 8542B SYSTEM A | | | | |
| PORT IDENTIFICATION: With the label facing the user, PORT 1 is on the left and PORT 2 is on the right. | | | | |
| FREQUENCY (MHz) | ATTENUATION (dB) | SWR PORT 1 | SWR PORT 2 | |
| 100.00 | 5.84 | 1.004 | 1.009 | |
| 300.00 | 5.85 | 1.005 | 1.009 | |
| 500.00 | 5.86 | 1.005 | 1.009 | |
| 700.00 | 5.85 | 1.005 | 1.010 | |
| 900.00 | 5.87 | 1.006 | | |
| 1000.00 | 5.86 | | | |
| 1250.00 | 5.89 | | | |
| 1500.00 | 5.91 | | | |
| 1750.00 | | | | |
| 2000.00 | | | | |

Option 890 Example

8491B Option 010 Option 890 or 894

Connectors and Frequency Range

- 1A:** Type N (m,f), dc-12.4 GHz
 - 1B:** Type N (m,f), dc-18 GHz
 - 2A:** APC-7, dc-18 GHz
 - 3A:** SMA (m,f), dc-12.4 GHz
 - 3B:** SMA (m,f), dc-18 GHz
 - 3C:** APC 3.5 (m,f), dc-26.5 GHz
 - 8A:** Type N (m,f), dc-18 GHz
- 8498 is available in a 30 dB model only

Attenuation

- 003:** 3 dB
- 006:** 6 dB
- 010:** 10 dB
- 020:** 20 dB
- 030:** 30 dB
- 040:** 40 dB*
- 050:** 50 dB**
- 060:** 60 dB**

* Not available for HP 8493A/B ** Not available for HP 8493C

Ordering Information

- HP 11581A** 3, 6, 10, 20 dB HP 8491A set
- Option 890** Calibration Data
- HP 11582A** 3, 6, 10, 20 dB HP 8491B set
- Option 890** Calibration Data
- HP 11583A** 3, 6, 10, 20 dB HP 8492A set
- Option 890** Calibration Data
- HP 11583C** 3, 6, 10, 20 dB HP 8493C set
- Option 890** Calibration Data

Price

- \$525
- Add \$90
- \$650
- Add \$110
- \$1,200
- Add \$100
- \$1,320
- Incl.

HP 8491A/B, 8492A, 8493A/B/C, 8498A, Option 890 Specifications

| HP Model | Frequency Range GHz | SWR Maximum | Maximum input Power | Attenuation Accuracy | | | | | | | | Connector | Price (Specify option) |
|---------------------|---------------------|--|--|----------------------|-------------------|--------------------|--------------------|--------------------|--------------------|--------------------|--------------------|------------------|------------------------|
| | | | | 3 dB (Option 003) | 6 dB (Option 006) | 10 dB (Option 010) | 20 dB (Option 020) | 30 dB (Option 030) | 40 dB (Option 040) | 50 dB (Option 050) | 60 dB (Option 060) | | |
| 8491A 3-30 dB | dc-12.4 | dc-8 GHz: 1.2 8-12.4 GHz: 1.3 | 2 W Avg. 100 W Peak | ±0.3 dB | ±0.4 dB | ±0.6 dB | ±0.6 dB | ±1 dB | — | — | — | N(m,f) | \$115 |
| | | | | — | — | — | — | — | ±1.5 dB | ±1.5 dB | ±2 dB | | \$165 |
| 8491B 3-30 dB | dc-18 | dc-8 GHz: 1.2 8-12.4 GHz: 1.3 12.4-18 GHz: 1.5 | 2 W Avg. 100 W Peak | ±0.3 dB | ±0.4 dB | ±0.6 dB | ±0.6 dB | ±1 dB | — | — | — | N(m,f) | \$140 |
| | | | | ±0.4 dB | ±0.5 dB | ±1.0 dB | — | ±1.5 dB | ±1.5 dB | ±2 dB | \$200 | | |
| 8492A 3-30 dB | dc-18 | dc-8 GHz: 1.15 dc-12.4 GHz: 1.25 12.4-18 GHz: 1.35 | 2 W Avg. 100 W Peak | ±0.3 dB | ±0.4 dB | ±0.6 dB | ±0.6 dB | ±1 dB | — | — | — | APC-7 | \$265 |
| | | | | ±0.4 dB | ±0.5 dB | ±1.0 dB | — | ±1.5 dB | ±1.5 dB | ±2 dB | \$330 | | |
| 8493A 3-20 dB | dc-12.4 | dc-8 GHz: 1.2 8-12.4 GHz: 1.3 | 2 W Avg. 100 W Peak | ±0.3 dB | ±0.4 dB | ±0.6 dB | ±0.6 dB | — | — | — | — | SMA (m,f) | \$115 |
| | | | | — | — | — | — | ±1 dB | — | — | — | | |
| 8493B 3-20 dB | dc-18 | dc-8 GHz: 1.2 8-12.4 GHz: 1.3 12.4-18 GHz: 1.5 | 2 W Avg. 100 W Peak | ±0.3 dB | ±0.4 dB | ±0.6 dB | ±0.6 dB | — | — | — | — | SMA(m,f) | \$140 |
| | | | | ±0.4 dB | ±0.5 dB | ±1.0 dB | ±1 dB | — | — | — | \$140 | | |
| 8493C | dc-26.5 | dc-8 GHz: 1.1 8-12.4 GHz: 1.15 12.4-26.5 GHz: 1.25(1.27 Opt. 006) | 2 W Avg. 100 W Peak | ±0.5 dB | ±0.6 dB | ±0.3 dB | ±0.5 dB | ±0.7 dB | ±1.0 dB | — | — | APC 3.5 (m,f) | \$275 |
| | | | | dc-18 GHz | ±0.6 dB | ±0.5 dB | ±0.6 dB | ±1.0 dB | ±1.3 dB | | | | |
| 8498A Option 030 | dc-18 | dc-2 GHz: 1.1 2-12.4 GHz: 1.2 12.4-18 GHz: 1.35 | 25 W Avg. 500 W Peak (dc-7 GHz) 125 W Peak (7-18 GHz) 500 watt-µs max. per pulse | — | — | — | — | ±1 dB | — | — | — | N(m,f) | \$950 |

| Option 890 Calibration Data | HP Models | | Calibration Frequencies (MHz) | | | | Option 890 Price |
|--------------------------------|-------------------------------|--|---|--|--|--|------------------|
| | | 8491A, 8493A | 100, 500, 1000, every 500 MHz to 12000, 12400. (26 frequencies) | | | | |
| | 8491B, 8492A, 8493B, 8498A | Same as above plus 12500 to 16000 8493B, 8498A in 500 MHz steps, 16000 to 18000 in 250 MHz steps. (42 frequencies) | | | | | add \$25 |
| | 8493C | Every 500 MHz 2 GHz to 18 GHz, every 250 MHz 18 GHz to 26.5 GHz (67 frequencies) | | | | | add \$40 |
| Option 894 Calibration Data | 8492A | | Same as HP 8492A Option 890 plus 110, 580, 1050 and 1520 MHz. | | | | add \$30 |
| | 8493C | | Same as HP 8493C Option 890 plus 100, 110, 500, 580, 1000, 1050, 1500 and 1520 MHz. | | | | add \$50 |



MICROWAVE TEST EQUIPMENT

Coaxial Step Attenuators

Models 355 Series, 8494/5/6/7 Series, 11713A, 11716A/B, 11717A

- Excellent repeatability
- Manual and programmable
- Calibration data available

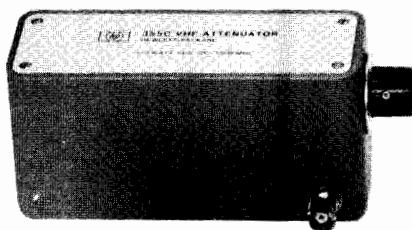

HP 355C

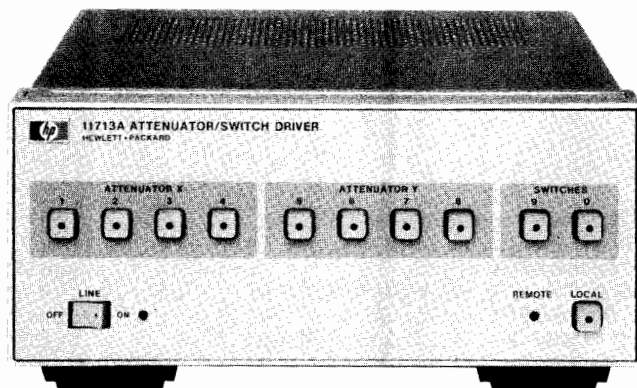

HP 11713A



HP 355C/D/E/F Manual and Programmable Step Attenuators, dc to 1000 MHz

Precision attenuation from dc to 1000 MHz is available with these Hewlett-Packard attenuators. HP 355C/E provide 0 to 12 dB in 1-dB steps and HP 355D/F provide 0 to 120 dB in 10-dB steps. For the HP 355E and 355F models, attenuation programming is done through a 7-pin connector. All standard models are equipped with BNC connectors.

HP 8494A/B/G/H, 8495A/B/D/G/H/K, 8496A/B/G/H, 8497K Manual and Programmable Step Attenuators, dc to 26.5 GHz

Four attenuation ranges are available: 0 to 11 dB in 1-dB steps (HP 8494), 0 to 70 dB in 10-dB steps (HP 8495), 0 to 110 dB in 10-dB steps (HP 8496) and 0 to 90 dB in 10 dB steps (HP 8497). There is choice of three connectors: Type N (f), SMA (f), and APC-7 (APC-3.5 on HP 8495D/K and 8497K only). Manual and programmable versions are available as well as coverage of three frequency ranges (dc-4 GHz, dc-18 GHz, and dc-26.5 GHz). Calibration data (SWR and attenuation) is available on the HP 8494/5/6/7 models as option 890. The data is generated by an automatic network analyzer test system and is given for each step of the attenuator at 14 frequencies (dc-4 GHz models), 47 frequencies (dc-18 GHz models), or 72 frequencies (dc-26.5 GHz); see frequency lists on next page. This data is very useful for improving measurement accuracy in manual and automated test systems.

Each attenuator consists of three or four attenuation sections connected in cascade. Attenuator sections are inserted and removed by cam-actuated "edge line" contacts. These contacts are gold-plated leaf-springs that ensure long life (over a million steps) and high repeatability (typically 0.03 dB).

The G, H, and K programmable models offer the same high performance as the manual models with the addition of fast switching solenoids. Attenuation programming is done through a 12-pin con-

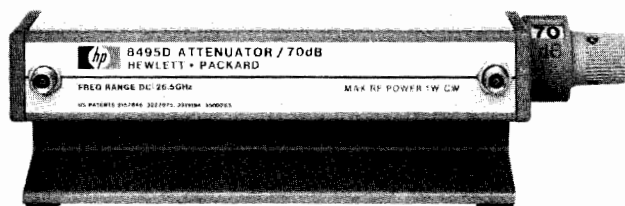

HP 8495D option 004

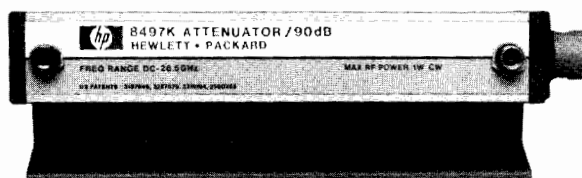

HP 8497K option 004

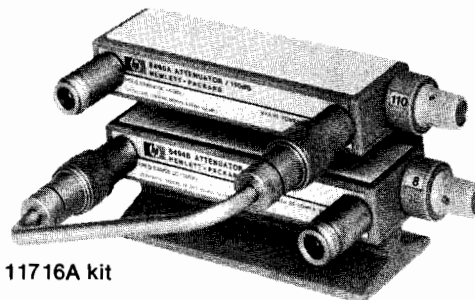

HP 11716A kit

ductor. For ease of connection to the driving circuit, each attenuator is provided with a five-foot cable assembly that includes the mating connector. With the HP 11713A Attenuator Driver, the attenuators are easily integrated into a Hewlett-Packard Interface Bus (HP-IB) automated system.

HP 11716A/B Interconnection Kit

Convenient interconnection of 1-dB and 10-dB models is provided with the HP 11716A/B. These kits provide a rigid RF cable, mounting bracket, and screws to connect any pair of HP 8494/5/6 attenuators in series (see picture above). Attenuators must be ordered separately.

Equivalent versions of these attenuators for incorporation in equipment (i.e., "OEM") are available under model numbers HP 33320, 33321, 33322 and 33323. See following pages.

HP 11713A Attenuator/Switch Driver

This instrument has all of the necessary features to provide HP-IB control of up to two programmable attenuators of the HP 8494/5/6/7 or HP 33320/1/2/3 series and concurrently up to two electro-mechanical Switches (e.g., HP 8761B or 33311 series). Alternatively, the HP 11713A can be used to supply +24 V common and ten pairs of transistor switches (total current less than 1.25A) to control up to ten relays. The HP 11713A includes an integral power supply with short circuit protection that can simultaneously provide 125 milliamps at 24 volts to all contacts for control of the attenuators and switches, so no external power supply is needed. For convenience in connecting HP 8490 or HP 33320-series Attenuators, two 5-foot cables with appropriate connectors are supplied.

A local mode and front-panel push buttons allow switches and attenuator sections to be operated manually. Switching time for the drivers is less than 10 milliseconds.

Ordering Information

| | Price |
|---|--------|
| HP 11713A Attenuator/Switch Driver | \$1610 |
| HP 11716A Interconnection Kit for Type N (f) Connectors | \$190 |
| HP 11716B Interconnection Kit for APC-7 Connectors | \$270 |
| HP 11717A Attenuator/Switch Rack Mount Support Kit | \$45 |

How to Order the HP 8494/5/6/7 Series Attenuators

Each order must include basic model number, suffix letter, and connector option.

Optional calibration data.

HP 8494 A Option 001 Option 890

- 4 (1 dB step, 11 dB max)
- 5 (10 dB step, 70 dB max)
- 6 (10 dB step, 110 dB max)
- 7 (10 dB step, 90 dB max)

- A (Manual, dc—4 GHz)
- B (Manual, dc—18 GHz)
- D (Manual, dc—26.5 GHz)*
- G (Programmable, dc—4 GHz)
- H (Programmable, dc—18 GHz)
- K (Programmable, dc—26.5 GHz)*

- 001 (N-Female)
- 002 (SMA Female)
- 003 (APC-7)
- 004 (APC-3.5 Female)*

* Option 004 is only available on 'D' and 'K' models.

HP 355 Series, 8494/5/6/7 Series Specifications

| HP Model and (Switching Mode) | Frequency Range (GHz) | Incremental Attenuation (dB) | SWR Maximum (50 Ω Nominal) | Insertion Loss (0 dB setting) | Attenuation Accuracy | Power Rating, Minimum Life | Solenoid Voltage Speed Power | Size, Shipping Weight | Connector Options Available | Price | | |
|---|---|------------------------------|--|---|---|--|---------------------------------|---|---|------------------|--|------------------------|
| 355C (Manual) | dc—1 | 0—12 1 dB steps | dc—0.25 GHz: 1.2 dc—0.5 GHz: 1.3 dc—1.0 GHz: 1.5 | 0.11 dB + 1.39 dB/GHz | ±0.1 dB @ 1000 Hz ±0.25 dB: dc—0.5 GHz ±0.35 dB: dc—1.0 GHz | 0.5 W avg 350 W peak 0.6 million steps | — 15—18 V <65 ms 3.0 W | 67 H × 70 W × 152 mm D (2.6" × 2.75" × 6") 1.4 kg (3 lb) | BNC (f) See Note 1 | \$350 \$645 | | |
| 355E (Programmable) | | | | | | | | | | | | |
| 355D (Manual) | dc—1 | 0—120 10 dB steps | dc—0.25 GHz: 1.2 dc—0.5 GHz: 1.3 dc—1.0 GHz: 1.5 | 0.11 dB + 1.39 dB/GHz | ±0.3 dB @ 1000 Hz ±1.5 dB to 90 dB, and ±3 dB to 120 dB @ 1 GHz | 0.5 W avg 350 W peak 0.6 million steps | — 15—18 V <65 ms 3.0 W | 67 H × 70 W × 152 mm D (2.6" × 2.75" × 6") 1.4 kg (3 lb) | BNC (f) See Note 1 | \$350 \$645 | | |
| 355F (Programmable) | | | | | | | | | | | | |
| 8494A (Manual) | dc—4 | 0—11 1 dB Steps | 1.5 | 0.6 dB + 0.09 dB/GHz | ±0.2 dB: 1—2 dB ±0.3 dB: 3—4 dB ±0.4 dB: 7—10 dB ±0.5 dB: 11 dB | 1 W avg 100 W peak 10 μs max. 1 million steps | — 20—30 V <20 ms 2.7 W | 43 H × 73 W × 159 mm D (1.7" × 2.9" × 6.2") 0.9 kg (2 lb) | 001 002 003 See Note 2 | \$700 \$1,070 | | |
| 8494G (Programmable) | | | | | | | | | | | | |
| 8494B (Manual) | dc—18 | 0—11 1 dB steps | dc—8 GHz: 1.5 dc—12.4 GHz: 1.6 dc—18 GHz: 1.9 | 0.6 dB + 0.09 dB/GHz | dc—12.4 GHz ±0.3 dB: 1—2 dB ±0.4 dB: 3—4 dB ±0.5 dB: 5—6 dB ±0.6 dB: 7—10 dB ±0.7 dB: 11 dB dc—18 GHz ±0.7 dB: 1—5 dB ±0.8 dB: 6—9 dB ±0.9 dB: 10—11 dB | 1 W avg 100 W peak 10 μs max. 1 million steps | — 20—30 V <20 ms 2.7 W | 43 H × 73 W × 159 mm D (1.7" × 2.9" × 6.2") 0.9 kg (2 lb) 43 H × 73 W × 142 mm D (1.7" × 2.9" × 5.6") | 001 002 003 See Note 2 | \$890 \$1,365 | | |
| 8494H (Programmable) | | | | | | | | | | | | |
| 8495A (Manual) | dc—4 | 0—70 10 dB steps | 1.35 | 0.4 db + 0.07 dB/GHz | ±1.7% of setting or ±0.4 dB, whichever is greater | 1 W avg 100 W peak 10 μs max. 1 million steps | — 20—30 V <20 ms 2.7 W | 43 H × 73 W × 130 mm D (1.7" × 2.9" × 5.1") 0.9 kg (2 lb) | 001 002 003 See Note 2 | \$500 \$895 | | |
| 8495G (Programmable) | | | | | | | | | | | | |
| 8495B (Manual) | dc—18 | 0—70 10 dB steps | dc—8 GHz: 1.35 dc—12.4 GHz: 1.5 dc—18 GHz: 1.7 | 0.4 dB + 0.07 dB/GHz | ±3%: dc—12.4 GHz ±4%: dc—18 GHz % in dB from Atten. Setting | 1 W avg 100 W peak 10 μs max. 1 million steps | — 20—30 V <20 ms 2.7 W | 43 H × 73 W × 130 mm D (1.7" × 2.9" × 5.1") 0.9 kg (2 lb) | 001 002 003 See Note 2 | \$655 \$1,000 | | |
| 8495H (Programmable) | | | | | | | | | | | | |
| 8495D (Manual) | dc—26.5 | 0—70 10 dB steps | dc—12.4 GHz: 1.6 12.4—18 GHz: 1.9 18—26.5 GHz: 2.2 | 0.5 dB + 0.13 dB/GHz | ±3%: dc—12.4 GHz ±4%: dc—18 GHz ±7%: dc—26.5 GHz % in dB from Atten. Setting | 1 W avg 100 W peak 10 μs max. 1 million steps | — 20—30 V <20 ms 2.7 W | 43 H × 52 W × 159 mm D (1.7" × 2.1" × 6.2") 0.9 kg (2 lb) | 004 APC-3.5 See Note 2 | \$980 \$1,445 | | |
| 8495K (Programmable) | | | | | | | | | | | | |
| 8496A (Manual) | dc—4 | 0—110 10 dB steps | 1.5 | 0.6 dB + 0.09 dB/GHz | ±1.7% of setting or ±0.4 dB, whichever is greater | 1 W avg 100 W peak 10 μs max. 1 million steps | — 20—30 V <20 ms 2.7 W | 43 H × 73 W × 159 mm D (1.7" × 2.9" × 6.2") 0.9 kg (2 lb) | 001 002 003 See Note 2 | \$700 \$1,070 | | |
| 8496G (Programmable) | | | | | | | | | | | | |
| 8496B (Manual) | dc—18 | 0—110 10 dB steps | dc—8 GHz: 1.5 dc—12.4 GHz: 1.6 dc—18 GHz: 1.9 | 0.6 dB + 0.09 dB/GHz | ±3%: dc—12.4 GHz ±4%: dc—18 GHz % in dB from Atten. Setting | 1 W avg 100 W peak 10 μs max. 1 million steps | — 20—30 V <20 ms 2.7 W | 43 H × 73 W × 159 mm D (1.7" × 2.9" × 6.2") 0.9 kg (2 lb) | 001 002 003 See Note 2 | \$890 \$1,365 | | |
| 8496H (Programmable) | | | | | | | | | | | | |
| 8497K (Programmable) | dc—26.5 | 0—90 10 dB steps | dc—6 GHz: 1.25 6—12.4 GHz: 1.45 12.4—18.0 GHz: 1.6 18.0—26.5 GHz: 1.8 | 0.6 dB + 0.09 dB/GHz | ±0.3 dB at 6 GHz 10 dB attenuation to ±2.8 dB at 26.5 GHz 90 dB attenuation. See Data Sheet 5952-8278 for details. | 1 W avg 100 W peak 10 μs max. 1 million steps | 5 V or 24V | 43 H × 52 W × 143 mm D (1.7" × 2.1" × 5.6") 0.9 kg (2 lb) | 004 APC-3.5 See Note 2 | \$1800 | | |
| Option 890 Calibration Data | Option 890 Frequency List (MHz) | | | | | Models | | | Option 890 Price | | | |
| | DC to 4 GHz Models: 100, 300, 500, 700, 900, 1000, 1250, 1500, 1750, 2000, 2500, 3000, 3500, 4000 | | | | | DC to 26.5 GHz Models every 500 MHz 2 to 16 GHz every 250 MHz 16 to 26.5 GHz | | | 8494A/G, 8496A/G, 33320A/G, 33322A/G 8495A/G, 33321A/G | | | add \$130 add \$110 |
| | DC to 18 GHz Models: Same as above to 4000 MHz, every 500 MHz to 16000 (plus 12400 MHz), every 250 MHz from 16000 to 18000. | | | | | 8494B/H, 8496B/H, 33320B/H, 33322B/H 8495B/H, 33321B/H 8495D/K, 8497K | | | add \$170 add \$150 add \$250 | | | |
| Note 1: 355C/D/E/F connector options (BNC (f) standard) Option 001 N(f) Option 005 TNC(f) Option 007 Transistor protection (355E/F only) | | | | Price add \$25 add \$10 add \$55 | Note 2: 8494/5/6/7 orders must specify connector option. See ordering example above. Option 001 N(f) Option 002 SMA(f) Option 003 APC-7 Option 004 APC-3.5 (HP 8495D/K, 8497K only) | | | | N/C N/C add \$50 N/C | | | |

MICROWAVE TEST EQUIPMENT

Variable Attenuators and OEM Step Attenuators

Models 375 Series, 382 Series, 33300 Series, 33320 Series

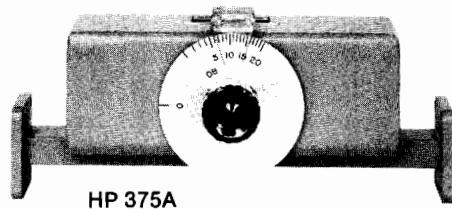

HP 375A

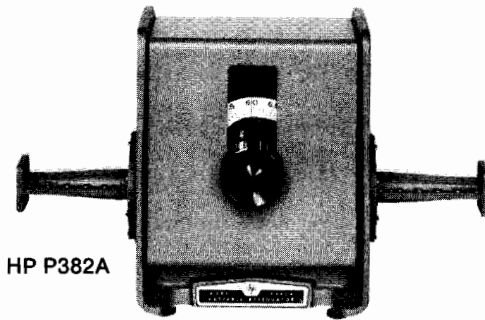

HP P382A



HP 33300A



HP 33321H



HP 33323K

HP 33300 Series, 33320 Series OEM Step Attenuators

HP 33300 series Step Attenuators provide wideband programmable signal level control. Magnetic latching solenoids switch individual attenuating elements into and out of contact with a 50-ohm transmission line. C/D models have separate indicator contacts and A/B models have no indicator contacts. Three three-digit connector options (OXY) must be specified. X is the input connector, Y is the output connector, first digit is always 0. See specifications table for option numbers.

HP 33320 series Step Attenuators are compact versions of the HP 8494/5/6/7 bench Attenuators on page 558 (same specifications) and are configured for designing into microwave systems and instru-

ments. Manual or electrically-actuated versions are available. The manual models take less than 1.5 square inches of panel space. OEM quantity discounts are available for HP 33300 and 33320 series.

HP 375, 382 Series Waveguide Attenuators

Operation of these HP 382 series rotary-vane, continuously-variable Attenuators depends on a mathematical law rather than on the resistivity of the attenuator card. They are direct-reading and provide accurate attenuation from 0 to 50 dB (60 dB for S382C) regardless of temperature and humidity.

HP 375A series variable flap Attenuators consist of a short slotted section of waveguide in which a matched resistive strip is inserted.

HP 33300 Series, 33320 Series Specifications

| HP Model | Freq Range (GHz) | Mode | Range | Remarks | Price |
|---------------|--------------------------|--------|-------------------------|--|----------------------------|
| 33300 A/B C/D | dc-18 | Prog. | 0-70 dB 10 dB steps | A&C models 12-15 V | \$1200 \$1250 |
| 33301 A/B C/D | dc-18 | Prog. | 0-42 dB 6 dB steps | B&D models 24-30 V | \$1200 \$1250 |
| 33304 A/B C/D | dc-18 | Prog. | 0-11 dB 1 dB steps | Connector options available: | \$1575 \$1635 |
| 33305 A/B C/D | dc-18 | Prog. | 0-110 dB 10 dB steps | 0: N(f), 1: N(m) 2: 7mm(f), 3: 7mm(m) 5: SMA(f), 6: SMA(m) | \$1585 \$1635 |
| 33320A B | dc-4 dc-18 | Manual | 1-11 dB 1dB steps | Specifications identical to 8494 series page 558 | \$ 680 \$ 870 |
| 33320G H | dc-4 dc-18 | Prog. | | SMA(f) connectors | \$1050 \$1345 |
| 33321A B D | dc-4 dc-18 dc-26.5 | Manual | 0-70 dB 10 dB steps | Specifications identical to 8495 series page 558 | \$ 480 \$ 635 \$ 975 |
| 33321G H K | dc-4 dc-18 dc-26.5 | Prog. | | SMA (f) connectors (APC-3.5 on D/K) | \$ 875 \$ 980 \$1425 |
| 33322A B | dc-4 dc-18 | Manual | 0-110 dB 10 db steps | Specifications identical to 8496 series page 558 | \$ 680 \$ 870 |
| 33322G H | dc-4 dc-18 | Prog. | | SMA (f) connectors | \$1050 \$1345 |
| 33323K | dc-26.5 | Prog. | 0-90 dB 10 dB steps | Specifications identical to 8497K page 558 APC-3.5 only | \$1785 |

HP 375A, 382 Series Specifications

| HP Model | Frequency Range (GHz) | Accuracy | Attenuation Range (dB) | Waveguide & Equivalent Flange | Price |
|----------|-----------------------|---|------------------------|-------------------------------|--------|
| S382C | 2.6-3.95 | ±1% of reading or 0.1 dB whichever greater ±2% above 50 dB | 0-60 | WR 284 UG-584/U | \$4375 |
| G382A | 3.95-5.85 | ±2% of reading or 0.1 dB whichever greater | 0-50 | WR 187 UG-407/U | \$3080 |
| J382A | 5.3-8.2 | ±2% of reading or 0.1 dB whichever greater | 0-50 | WR 137 UG-441/U | \$2475 |
| H382A | 7.05-10.0 | ±2% of reading or 0.1 dB whichever greater | 0-50 | WR 112 UG-138/U | \$2475 |
| X382A | 8.2-12.4 | ±2% of reading or 0.1 dB whichever greater | 0-50 | WR 90 UG-135/U | \$1485 |
| P382A | 12.4-18.0 | ±2% of reading or 0.1 dB whichever greater | 0-50 | WR 62 UG-419/U | \$1485 |
| K382A | 18.0-26.5 | ±2% of reading or 0.1 dB whichever greater | 0-50 | WR 42 UG-597/U | \$2475 |
| R382A | 26.5-40.0 | ±2% of reading or 0.1 dB whichever greater | 0-50 | WR 28 UG-599/U | \$2450 |
| X375A | 8.2-12.4 | ±1 dB, ±2 dB | 0-20 | WR 90 UG-39/U | \$ 715 |
| P375A | 12.4-18 | ±1 dB, ±2 dB | 0-20 | WR 62 UG-419/U | \$ 715 |

MICROWAVE TEST EQUIPMENT

Transmission Reflection Test Sets, Power Splitters, Power Dividers

Models 8721A, 8502A/B, 11850A/B, 11667A/B, 11636A/B

561

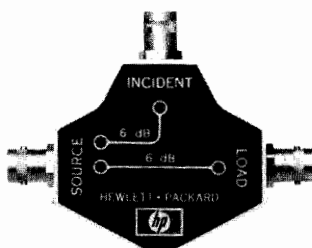

HP 8721A

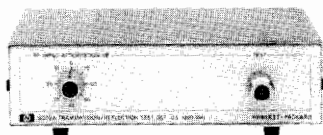

HP 8502A

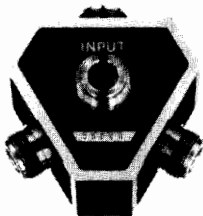

HP 11850A

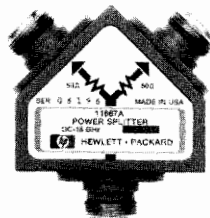

HP 11667A



HP 11636A



HP 11667A Power Splitter (Type N) HP 11667B Power Splitter (APC-3.5)

These two-way, two-resistor splitters provide good input and output source match in ratio measurement and source leveling applications. The HP 11667A operates from dc to 18 GHz with output match >17 dB and tracking <0.25 dB. The HP 11667B operates from dc to 26.5 GHz and has output source match >18 dB and tracking <0.4 dB. Detailed specifications are on page 601.

HP 11636A/B Power Dividers/Combiners

The HP 11636A/B are two-way, three-resistor power dividers for use in non-ratio measurements. They can also be used as power combiners for combining two independent signals. They are ideal for fault location measurements made with the HP 8757S and the HP 85016A software.

Frequency Range

HP 11636A: DC to 18 GHz.

HP 11636B: DC to 26.5 GHz.

Impedance: 50 ohms nominal.

Insertion loss: 6 dB nominal.

| | DC-10 GHz | DC-18 GHz | DC-26.5 GHz |
|--|--|-----------|-------------|
| Input SWR | | | |
| HP 11636A | <1.25 | <1.35 | |
| HP 11636B | <1.22 | <1.29 | <1.29 |
| Output SWR (non-ratio measurements) | | | |
| HP 11636A | <1.25 | <1.35 | |
| HP 11636B | <1.22 | <1.29 | <1.29 |
| Output Tracking (between output arms) | | | |
| HP 11636A | <0.4 dB | <0.5 dB | |
| HP 11636B | <0.25 dB | <0.25 dB | <0.5 dB |
| Typical Phase Tracking (between output arms) | | | |
| HP 11636A | 2° | 2° | |
| HP 11636B | 2° | 2.5° | 3° |
| Maximum Input Power | | | |
| HP 11636A | +30 dBm | | |
| HP 11636B | +27 dBm | | |
| Connectors | | | |
| HP 11636A: | Type N male input port, female output ports. | | |
| HP 11636B: | APC-3.5 female on all ports. | | |
| Dimensions | | | |
| HP 11636A: | 42 H x 45 W x 18 mm D (1.64 x 1.75 x 0.69 in.) | | |
| HP 11636B: | 40 H x 47 W x 10 mm D (1.6 x 1.9 x 0.4 in.) | | |
| Weight | | | |
| HP 11636A: | net, 0.14 kg (0.31 lb); shipping, 0.45 kg (1 lb) | | |
| HP 11636B: | net, 0.06 kg (0.13 lb); shipping, 0.14 kg (0.3 lb) | | |

Description

Accurate broadband measurements of transmission and reflection parameters are highly dependent on the device used to separate signals for the measurement. Some devices separate the reflected and transmitted signals and some split power for ratio and comparison measurements.

HP 8721A Directional Bridge

HP 8721A Option 008 75 Ohm Version

Frequency range: 0.1 - 110 MHz.

Directivity: >40 dB, 1 - 110 MHz, typically >30 dB, 0.1 - 1 MHz.

Load port match: >30 dB (VSWR <1.07).

Transmission arm: Nominal loss, 6 dB. Frequency response, <0.2 dB.

Coupling arm: Nominal coupling, 6 dB. Frequency response, <0.6 dB.

Maximum input power: +20 dBm.

Weight: net, 0.55 kg (0.25 lb); shipping, 1.1 kg (0.5 lb).

Size: 59 H x 39 W x 123 mm D (1.5 x 1 x 3.13 in.).

HP 8502A 50 Ohm Transmission Reflection Test Set

HP 8502B 75 Ohm Transmission Reflection Test Set

The HP 8502 contains a power splitter and directional bridge that permits simultaneous transmission and reflection measurements with over 35 dB directivity from 500 kHz to 1.3 GHz. The HP 8502A Option H26 allows 50 ohm transmission/reflection measurements up to 2600 MHz. Detailed specifications on the HP 8502A and HP 8502B appear on page 622.

HP 11850A 50 Ohm Power Splitter

HP 11850B 75 Ohm Power Splitter

These three-way power splitters are designed for ratio measurements from dc to 1.3 GHz. One output port provides the reference and the other two output ports can be used for independent transmission measurements. They provide 0.1 dB tracking and >32 dB output match. Detailed specifications are on page 622.

Ordering Information

| | Price |
|--|-----------|
| HP 8721 Directional Bridge | \$325 |
| Option 008: 75 Ohm Version | add \$50 |
| HP 8502A 50 Ohm Transmission Reflection Test Set | \$3,010 |
| Option H26: 4 to 2600 MHz | add \$505 |
| HP 8502B 75 Ohm Transmission Reflection Test Set | \$3,410 |
| HP 11850A 50 Ohm Power Splitter | \$805 |
| Option H26: dc to 2.6 GHz | add \$100 |
| HP 11850B 75 Ohm Power Splitter | \$1,405 |
| HP 11667A Power Splitter (DC - 18GHz) | \$930 |
| Option 001: Type N Male Input, Type N Female Outputs | N/C |
| Option 002: Type N Female Input, APC-7 On Outputs | add \$75 |
| HP 11667B Power Splitter (DC - 26.5 GHz) | \$950 |
| HP 11636A Power Divider (DC - 18 GHz) | \$400 |
| HP 11636B Power Divider (DC - 26.5 GHz) | \$950 |



MICROWAVE TEST EQUIPMENT

Coaxial Single and Dual-Directional Couplers

Models 770 Series, 790 Series, 11691D, 11692D

- Broadband coverage
- High directivity
- Close tracking

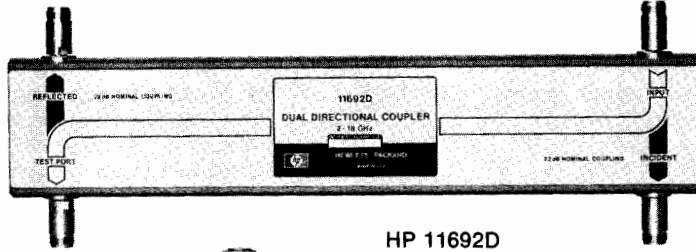

HP 11692D

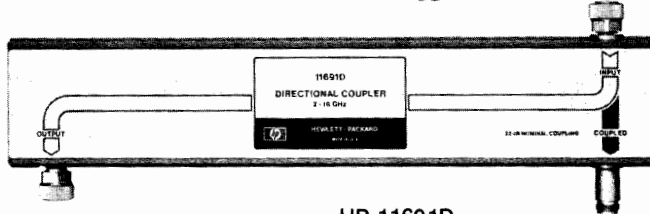

HP 11691D

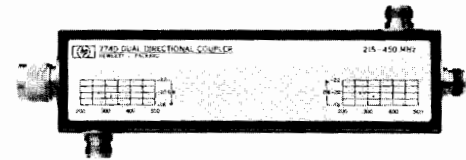

HP 774D

HP 779D Directional Coupler

The HP 779D spans more than two octaves from 1.7 to 12.4 GHz with excellent directivity. With increased coupling factors (typically 24 dB), the HP 779 is useful down to 500 MHz. Upper frequency usefulness extends to 18 GHz with directivity reduced to about 15 dB. Various connector options are available.

HP 790 Series Directional Couplers (octave bands)

The HP 790 Directional Couplers are ultra-flat, high directivity couplers which are ideal for power-monitoring applications in coaxial systems. Output coupling (ratio of output power from main and auxiliary arms) is specified rather than a coupling factor. Thus, no correction factor is required to account for insertion loss in the main arm.

HP 11691D Directional Coupler

The HP 11691D is an ultra-wide-band single directional coupler covering 2 to 18 GHz with high directivity. It is useful as a power monitoring or leveling coupler, or for making reflection measurements. Couplers are preferred over broadband bridges in reflectometer applications in situations where the power level of the source is limited, or where simultaneous measurement of return loss and insertion loss is desired.

HP 779D, 790 Series, 11691D Specifications

| HP Model | Frequency Range (GHz) | Mean Output Coupling (dB) | Output Coupling Variation (dB) | Minimum Directivity (dB) | Equivalent ¹ Source Match | Price |
|----------|-----------------------|---------------------------|--------------------------------|-----------------------------------|--------------------------------------|--------|
| 779D | 1.7-12.4 | 20 ± 0.5 | ±0.75 | 1.7-4 GHz: 30 4-12.4 GHz: 26 | 1.2 | \$1075 |
| 796D | 0.96-2.11 | 20 ± 0.5 | ±0.2 | 30 | 1.13 | \$675 |
| 797D | 1.9-4.1 | 20 ± 0.5 | ±0.2 | 26 | 1.16 | \$675 |
| 798C | 3.7-8.3 | 10 ± 0.3 | ±0.3 | 20 | 1.25 | \$750 |
| 11691D | 2-18 | 22 Nominal | ±1.0 | 2-8 GHz: 30 dB 8-18 GHz: 26 dB | 1.2 | \$1530 |

| | | | | | | |
|--|--|--|--|--|--|-------------------|
| HP 796D-798C Standard connectors Primary Line: N(f), N(m) Auxiliary Arm: N(f) | | | | | | |
| HP 779D Standard connectors Primary Line: N(m) input, N(f) output; auxiliary arm: N(f) | | | | | | |
| Option 010: Primary Line: N(f) input, N(m) output; auxiliary output: N(f) Other options: APC-7 on any or all ports | | | | | | N/C Contact HP |
| HP 11691D Standard connectors Primary line: APC-7, APC-7; Auxiliary Arm: N(f) | | | | | | |
| Option 001: All N(f) | | | | | | less \$30 |
| Option 005: All APC-7 | | | | | | add \$25 |

¹ Apparent SWR at the output port of a coupler when used in a closed-loop leveling system.

HP 774D-777D Dual-Directional Couplers (octave bands)

The economical HP 774D-777D Couplers cover frequency spreads of more than two-to-one, each centered on one of the important VHF/UHF bands. With their high directivity and a mean coupling accuracy of ±0.5 dB, these couplers are ideal for reflectometer applications. Furthermore, the close tracking of the auxiliary arms makes these couplers particularly useful for reflectometers driven by sweep oscillators such as the HP 8350B with its appropriate plug-in. Power ratings are 50 W average, 500 W peak.

HP 778D, 11692D Dual-Directional Couplers (multi-octave bands)

These couplers are ideal for swept-frequency reflectometer testing of broadband coaxial components. The HP 778D covers 100 MHz to 2 GHz and the HP 11692D covers 2 to 18 GHz. High directivity and close tracking of the auxiliary arms are featured. Various connector options are available. Both couplers handle 50 W average power. Peak power: HP 778D, 500 W; HP 11692D, 250 W.

HP 774D, 775D, 776D, 777D, 778D, 11692D Specifications

| HP Model | Frequency Range (GHz) | Nominal Coupling (dB) | Maximum Coupling Variation (dB) | Minimum Directivity (dB) | SWR Primary Line Maximum (50Ω Nom.) | Price |
|-------------------|-----------------------|-----------------------|---------------------------------|---|-------------------------------------|--------|
| 774D | 0.215-0.450 | 20 | ±1 | 40 | 1.15 | \$800 |
| 775D ¹ | 0.450-0.940 | 20 | ±1 | 40 | 1.15 | \$800 |
| 776D ¹ | 0.940-1.90 | 20 | ±1 | 40 | 1.15 | \$800 |
| 777D | 1.90-4.0 | 20 | ±0.4 | 30 | 1.2 | \$950 |
| 778D | 0.10-2.0 | 20 | ±1.5 | 0.1-1 GHz: 36 ² 1-2 GHz: 32 | 1.1 | \$950 |
| 11692D | 2.0-18.0 | 22 | ±1 incident to test port | 2-8 GHz: 30 8-18 GHz: 26 ² | 2-12.4 GHz: 1.3 12.4-18 GHz: 1.4 | \$2730 |

| | | | | | | |
|--|--|--|--|--|--|-----------|
| HP 774D-777D Standard connectors Primary Line: N(m), N(f) Auxiliary Arm: N(f), N(f) | | | | | | |
| HP 778D Standard connectors Primary Line: N(m), N(f); Auxiliary Arms: N(f), N(f) | | | | | | |
| Option 011: Primary Line, APC-7, N(f) | | | | | | add \$25 |
| Option 012: Primary Line, N(m), N(f) | | | | | | N/C |
| HP 11692D Standard connectors Primary line: N(f), APC-7; Auxiliary Arms: N(f), N(f) | | | | | | |
| Option 001: Primary Line, N(f), N(f) | | | | | | less \$15 |
| Option 002: Primary Line, N(f), N(m) | | | | | | less \$15 |

¹ Maximum auxiliary arm tracking: 0.3 dB for HP 776D; 0.5 dB for HP 777D

² 30 dB, 0.1 to 2 GHz, input port.

³ 24 dB with Type N connector on the test port.

MICROWAVE TEST EQUIPMENT

Coaxial Directional Detectors and Waveguide Directional Couplers

Models 780 Series, 752 Series

563



- Flat frequency response
- Low equivalent source match
- High directivity to >40 dB

- Low SWR
- Coverage to 40 GHz

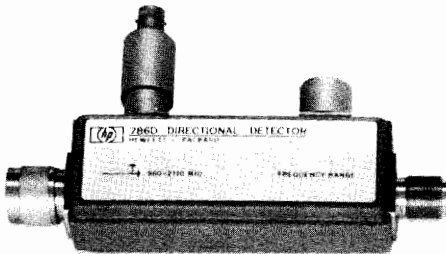

HP 786D

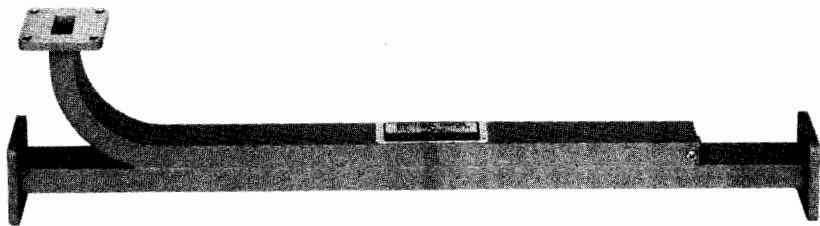

HP X752A

HP 780 Series Directional Detectors

The HP 780 series Detectors are directional couplers with built-in crystal detectors. The couplers have flat frequency response and good directivity, while the detectors have good frequency response plus high sensitivity. The configuration of the directional detector reduces the number of ambiguities over the standard system of separate coupler and detector and makes possible tighter correlation between main-arm power and detected signal. The directional detector is well suited for sweep oscillator leveling and can also be used to monitor power with a voltmeter or oscilloscope.

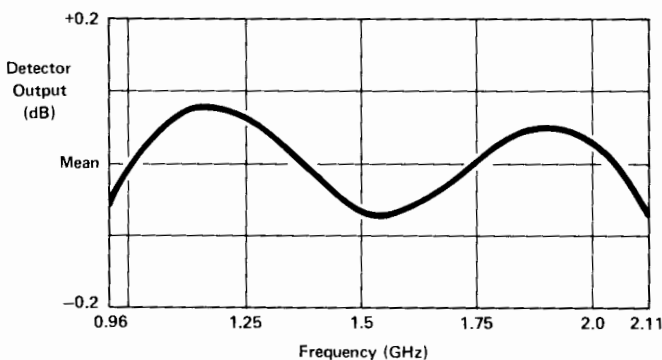

Figure 1. Typical HP 786D Frequency Response.

HP 780 Series Specifications

Standard Connectors

Output: all models, N(f).

Input: HP 786D-788C, N(m); HP 789C, N(f).

| HP Model | Frequency Range (GHz) | Frequency ¹ Response | Equivalent ² Source Match | Price |
|----------|-----------------------|---------------------------------|--------------------------------------|--------|
| 786D | 0.96-2.11 | ±0.2 | 1.13 | \$800 |
| 787D | 1.9-4.1 | ±0.2 | 1.16 | \$800 |
| 788C | 3.7-8.3 | ±0.3 | 1.25 | \$1000 |
| 789C | 8-12.4 | ±0.5 | 1.25 | \$1350 |

¹Includes coupler and detector variation with frequency as read on a meter calibrated for square-law detector (e.g., HP 415E).

²Apparent SWR at the output port of the directional detector when used in a closed-loop leveling system.

HP 752 Series Waveguide Directional Couplers

The HP 752 series Couplers are specified to meet a wide variety of microwave applications. Every coupler has a minimum directivity of 40 dB over its entire frequency range. Each coupler is swept-frequency tested to ensure that the main guide SWR and directivity specifications are accurate. Performance characteristics are unaffected by humidity, temperature, and time, making these units especially useful in microwave "standards" measurements.

The HP 752 Couplers are an essential part of many waveguide measurement systems. Attenuation measurements, reflectometer set-ups, power measurements, source leveling and network analysis are just a few areas in which these couplers are used.

HP 752 Series Specifications

| HP Model | Frequency Range (GHz) | Nominal Coupling (dB) | Mean Coupling Accuracy (dB) | Maximum Coupling Variation (dB) | Minimum Directivity (dB) | Waveguide & Flange | Price |
|----------|-----------------------|-----------------------|-----------------------------|---------------------------------|--------------------------|--------------------|-------|
| X752A | 8.2-12.4 | 3 | ±0.4 | ±0.5 | 40 | WR90 UG-135/U | \$680 |
| X752C | 8.2-12.4 | 10 | ±0.4 | ±0.5 | 40 | | \$680 |
| X752D | 8.2-12.4 | 20 | ±0.4 | ±0.5 | 40 | | \$680 |
| P752A | 12.4-18.0 | 3 | ±0.4 | ±0.5 | 40 | WR62 UG-419/U | \$680 |
| P752C | 12.4-18.0 | 10 | ±0.4 | ±0.5 | 40 | | \$680 |
| P752D | 12.4-18.0 | 20 | ±0.4 | ±0.5 | 40 | | \$680 |
| K752A | 18.0-26.5 | 3 | ±0.7 | ±0.5 | 40 | WR42 UG-595/U | \$825 |
| K752C | 18.0-26.5 | 10 | ±0.7 | ±0.5 | 40 | | \$825 |
| K752D | 18.0-26.5 | 20 | ±0.7 | ±0.5 | 40 | | \$825 |
| R752A | 26.5-40.0 | 3 | ±0.7 | ±0.5 | 40 | WR28 UG-599/U | \$890 |
| R752C | 26.5-40.0 | 10 | ±0.7 | ±0.5 | 40 | | \$890 |
| R752D | 26.5-40.0 | 20 | ±0.7 | ±0.6 | 40 | | \$890 |



MICROWAVE TEST EQUIPMENT

Coaxial Crystal Detectors

Models 420C, 423A/B, 8470A/B, 8471A, 8472A, 8473B/C, 33330B/C

- Flat frequency response
- High burnout protection

- Low SWR
- Field replaceable detector elements



HP 33330B



HP 8470B Opt 012



HP 423A



HP 8470A



HP 423B



HP 8470B



HP 8472A



HP 8471A

HP 423B, 8470B, 8473B/C, 33330B/C Low Barrier Schottky Diode (LBSD) Detectors

The low-barrier Schottky diode (LBSD) detectors are a state-of-the-art addition to the HP family of high performance detectors. Various models provide coverage to 12.4, 18, and 26.5 GHz and input connectors are Type N, APC-7, or APC-3.5 depending on frequency range. Output connector is BNC (f) except for the HP 33330B/C (SMC).

Matched pairs (Opt 001), square-law load (Opt 002), and positive polarity output (Opt 003) are available for most models.

HP 420C, 423A, 8470A, 8471A, 8472A Point-Contact Detectors

These point-contact detectors have been widely used for many years and provide high performance at an economical price. The HP 8470A, 8470A Opt 012, and 8472A provide APC-7, Type N, and SMA connector versions to 18 GHz. Matched pairs are available for applications requiring close detector tracking, and the HP 423A and 8470A can be supplied with video loads for optimum conformance to square law.

Coaxial Crystal Detector Specifications

| HP Model | Frequency Range (GHz) | Frequency Response (dB) | SWR Maximum (500 Nom.) | Low Level Sensitivity | Maximum Input (Peak or Average) | Short-Term Maximum Input (<1 min.) | Option 001 Matched Pair (order 2 units for each pair) | Options Available | Input Connector | Output Connector | Price |
|---------------|-------------------------------|---|---|---|---------------------------------|------------------------------------|---|-------------------|-----------------|------------------|-------|
| 420C | 0.01-12.4 Point Contact | ±2 | 2.0 | >0.15 mV/μW | 100 mW | 0.1 watt | ±1 dB | 001 003 | N (m) | BNC (f) | \$140 |
| 423B | 0.01-12.4 LBSD | ±0.2/octave to 8 GHz ±0.3 overall | <1.15 to 4 GHz <1.3 to 12.4 GHz | >0.5 mV/μW | 200 mW | 1 watt | ±0.2 dB to 12.4 GHz | 001 002 | N (m) 003 | BNC (f) | \$270 |
| 423A | 0.01-12.4 Point Contact | ±0.2/octave to 8 GHz ±0.5 overall | <1.2 to 4.5 GHz <1.35 to 7 GHz <1.5 to 12.4 GHz | >0.4 mV/μW | 100 mW | 0.1 watt | ≥0.2 dB to 8 GHz ±0.3 dB to 12.4 GHz | 001 002 003 | N (m) | BNC (f) | \$220 |
| 8470B | 0.01-18.0 LBSD | ±0.2/octave to 8 GHz ±0.3 to 12.4 GHz ±0.6 to 18 GHz | <1.15 to 4 GHz <1.3 to 15 GHz <1.4 to 18 GHz | >0.5 mV/μW | 200 mW | 1 watt | ±0.2 dB to 12.4 GHz ±0.3 dB to 18 GHz | 001 002 003 | APC-7 | BNC (f) | \$330 |
| 8470B Opt 012 | | | | | | | | | N (m) | | |
| 8470A | 0.01-18.0 Point Contact | ±0.2/octave to 8 GHz ±0.5 to 12.4 GHz ±1.0 to 18 GHz | <1.2 to 4.5 GHz <1.35 to 7 GHz <1.5 to 12.4 GHz <1.7 to 18 GHz | >0.4 mV/μW | 100 mW | 0.1 watt | ±0.2 dB to 8 GHz ±0.3 dB to 12.4 GHz ±0.6 dB to 18 GHz | 001 002 003 | APC-7 | BNC (f) | \$260 |
| 8470A Opt 012 | | | | | | | | | N (m) | | |
| 8473B | 0.01-18.0 LBSD | ±0.2/octave to 8 GHz ±0.6 to 18 GHz | <1.2 to 4.0 GHz <1.5 to 18 GHz | >0.5 mV/μW | 200 mW | 1 watt | ±0.2 dB to 12.4 GHz ±0.3 dB to 18 GHz | 001 003 | APC-3.5 (m) | BNC (f) | \$310 |
| 8473C | 0.01-26.5 LBSD | ±0.6 to 20 GHz ±1.5 with a -3.5 dB slope, 20 to 26.5 GHz | <1.2 to 4 GHz <1.5 to 18 GHz <2.2 to 26.5 GHz | >0.5 mV/μW to 18 GHz >0.18 mV/μW to 26.5 GHz | 200 mW | 1 watt | ±0.2 dB to 12.4 GHz ±0.3 dB to 18 GHz ±0.5 dB to 26.5 GHz | 001 003 | APC-3.5 (m) | BNC (f) | \$360 |
| 8472A | 0.01-18.0 Point Contact | ±0.2/octave to 8 GHz ±0.5 to 12.4 GHz | <1.2 to 4.5 GHz <1.35 to 7 GHz <1.5 to 12.4 GHz <1.7 to 18 GHz | >0.4 mV/μW | 100 mW | 0.1 watt | ±0.2 dB to 8 GHz ±0.3 dB to 12.4 GHz ±0.6 dB to 18 GHz | 001 003 | SMA (m) | BNC (f) | \$245 |
| 33330B | 0.01-18.0 LBSD | ±0.6 | <1.2 to 4.0 GHz <1.5 to 18 GHz | >0.5 mV/μW | 200 mW | 1 watt | ±0.2 dB to 12.4 GHz ±0.3 dB to 18 GHz | 001 003 | APC-3.5 (m) | SMC (m) | \$302 |
| 33330C | 0.01-26.5 LBSD | ±0.6 to 20 GHz ±1.5 with a -3.5 dB slope 20 to 26.5 GHz | <1.5 to 18 GHz <2.2 to 26.5 GHz | >0.5 mV/μW to 18 GHz Degrades to 0.18 mV/μW at 26.5 GHz | 200 mW | 1 watt | ±0.3 dB to 18 GHz ±0.5 dB to 26.5 GHz | 001 003 | APC-3.5 (m) | SMC (m) | \$337 |
| 8471A | 100 kHz-1.2 GHz Point Contact | ±0.6 (typical) ±0.1/100 MHz | 1.3 (typical) 50Ω | >0.35 mV/μW | 3 Vrms | 3 Vrms | No | 004 005 006 | BNC (m) | BNC (f) | \$100 |

Options

Option 001: Matched response. Must order two (2) option 001s for a pair of detectors with matched frequency response.

Option 002: Optimum square law load.

Option 003: Positive polarity output.

HP 8471A

004: positive output

005: 75 ohm negative output

006: 75 ohm positive output

N/C
add \$10
add \$10

| Point Contact Detectors | | | | Low Barrier Schottky Diodes | | | |
|-------------------------|----------|----------|----------|-----------------------------|----------|----------|----------|
| HP Model | Opt. 001 | Opt. 002 | Opt. 003 | HP Model | Opt. 001 | Opt. 002 | Opt. 003 |
| 420C | add \$20 | n/a | N/C | 423B | add \$25 | add \$25 | add \$35 |
| 423A | add \$25 | add \$25 | N/C | 8470B | add \$25 | add \$25 | add \$35 |
| 8470A | add \$25 | add \$25 | N/C | 8472B | add \$25 | n/a | add \$35 |
| 8472A | add \$20 | n/a | N/C | 8473B | add \$25 | n/a | add \$35 |
| | | | | 8473C | add \$25 | n/a | add \$35 |
| | | | | 33330B | add \$20 | n/a | add \$30 |
| | | | | 33330C | add \$20 | n/a | add \$30 |

MICROWAVE TEST EQUIPMENT

Waveguide Crystal Detectors; Frequency Meters

Models 422A, 424A, 532 Series, 536A, 537A

565

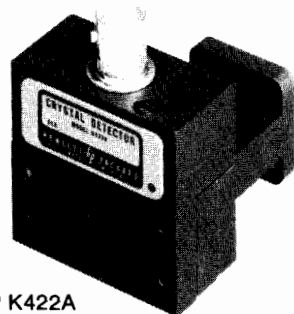

HP K422A

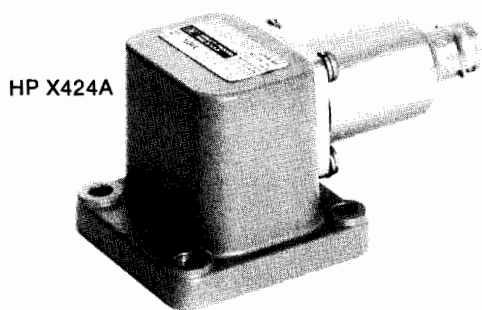

HP X424A

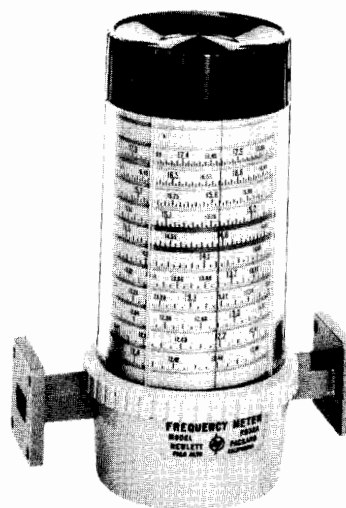

HP P532A

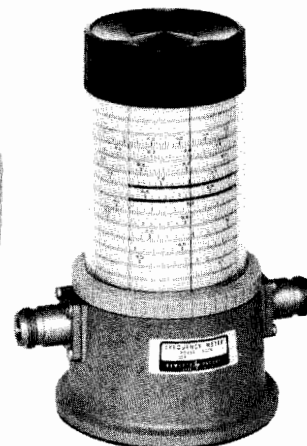

HP 537A

HP 422 Series, 424 Series Crystal Detectors

The HP 422A and 424A families of Crystal Detectors combine high sensitivity with flat frequency response and low SWR to provide waveguide band coverage from 8.2 to 40 GHz. They deliver between 0.2 and 0.4 mV/ μ W output at low level and handle 100 mW peak input. SWR ranges from 1.35 at H-band to 3 at R-band.

For reflectometer applications in which both flat frequency response and square-law characteristics are important, these models can be supplied as matched pairs (Option 001) and with optimum square-law loads (Option 002).

HP 422 Series, 424 Series Waveguide Crystal Detector Specifications

| HP Model | Frequency Range (GHz) | Frequency Response (dB) | Option 001 Matched Response (dB) | Option 003 Positive Polarity Output Available | Waveguide & Equivalent Flange | Price |
|----------|-----------------------|-------------------------|----------------------------------|---|-------------------------------|-------|
| X424A | 8.2-12.4 | ± 0.3 | ± 0.3 dB | Yes | WR90 UG-135/U | \$300 |
| P424A | 12.4-18.0 | ± 0.5 | ± 0.5 dB | Yes | WR62 UG-419/U | \$340 |
| K422A | 18.0-26.5 | ± 2 | ± 1 dB | N/A | WR42 UG-595/U | \$800 |
| R422A | 26.5-40.0 | ± 2 | ± 1 dB | N/A | WR28 UG-599/U | \$800 |

Option 001: Matched response. Must order two (2) option 001's for a pair of detectors with matched frequency response.

Option 002: optimum square-law load.

Option 003: positive polarity output.

Option Prices

| HP Model | Opt. 001 | Opt. 002 | Opt. 003 |
|----------|----------|----------|----------|
| K422A | add \$45 | add \$20 | N/A |
| P424A | add \$20 | add \$20 | N/C |
| R422A | add \$45 | add \$20 | N/A |
| X424A | add \$20 | add \$20 | N/C |

HP 532 Series, 536A, 537A Frequency Meters

These direct-reading frequency meters measure frequencies from 8.2 to 40 GHz in waveguide and from 960 MHz to 12.4 GHz in coax quickly and accurately. Their long scales and numerous calibration marks provide high resolution which is particularly useful when measuring frequency differences or small frequency changes. Frequency is read directly in GHz so neither interpolation nor charts are required.

The instruments comprise a special transmission section with a high-Q resonant cavity which is tuned by a choke plunger. A 1 dB or greater dip in output indicates resonance; virtually full power is transmitted off resonance. Overall accuracy of each frequency meter includes allowance for 0 to 100 percent relative humidity and temperature variation from 13 to 33°C.

HP 532 Series, 536A and 537A Specifications

| HP Model | Frequency Range (GHz) | Overall Accuracy (%) | Calibration Increment (MHz) | W/G-Coax Equivalent Flange (Connector) | Price |
|----------|-----------------------|---|-----------------------------|--|--------|
| 536A | 0.96-4.20 | 0.96 to 1 GHz: 0.22 1 to 4.2 GHz: 0.17 | 2 | Coax Type N(f) | \$1600 |
| 537A | 3.7-12.4 | 0.170 | 10 | Coax Type N(f) | \$1200 |
| X532B | 8.20-12.4 | 0.080 | 5 | WR90 UG-39/U | \$1155 |
| P532A | 12.4-18.0 | 0.100 | 5 | WR62 UG-419/U | \$1155 |
| K532A | 18.0-26.5 | 0.110 | 10 | WR42 UG-595/U | \$1540 |
| R532A | 26.5-40.0 | 0.120 | 10 | WR28 UG-599/U | \$1540 |



MICROWAVE TEST EQUIPMENT

Slotted Lines, Carriage, Probes, SWR Meter

Models 415E, 442B, 444A, 447B, 809C, 810B Series, 816A

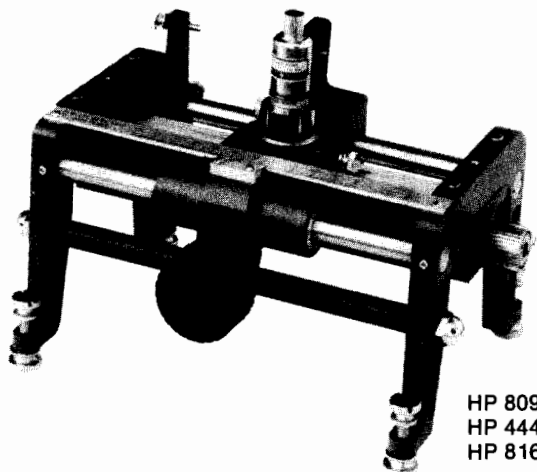

HP 809C
HP 444A
HP 816A Opt 011

HP 809C Slotted Line Carriage

The HP 809C carriage operates with the HP 816A coaxial slotted section and the HP 810B waveguide slotted sections. It is compatible with the HP 442B, 444A, and 447B coaxial probes. The carriage has a centimeter scale with a vernier reading to 0.1 mm, and provision is also made for mounting a dial gauge if more accurate probe position reading is required.

HP 810B Series, HP 816A Slotted Sections

The HP 810B waveguide and HP 816A coaxial slotted sections are used with the HP 809C carriage. The HP 810B waveguide sections accept the HP 444A untuned probe or the HP 442B probe. The HP 816A coaxial line accepts the HP 447B probe.

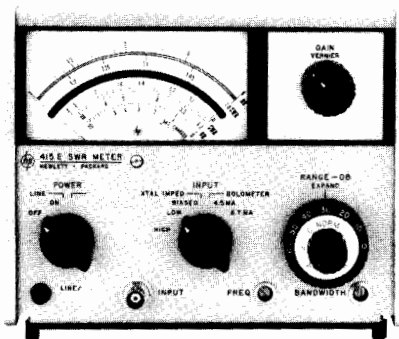

HP 415E



HP 442B



HP 447B

HP 415E SWR Meter

HP 415E SWR Meter is a low noise, 1000 Hz tuned amplifier and voltmeter, calibrated in dB and SWR. Designed for use with square law detectors, it measures SWR, attenuation, and gain directly from metered scales, or drives an X-Y recorder for RF substitution measurements. Front panel INPUT switch selects unbiased low (50-200 Ω) or high (2500-10,000 Ω) impedance crystal, biased crystal (1 V into 1 k Ω), or low or high current bolometer (4.5 or 8.7 mA \pm 3% into 200 Ω).

An internal precision 60 dB attenuator allows the HP 415E to operate over a 70 dB range in 10 or 2 dB steps, with ± 0.05 dB accuracy for a 10 dB step; maximum cumulative error between any two 10 dB steps is ± 0.1 dB. Sensitivity is 0.15 μ V rms for full scale deflection at maximum bandwidth (1 μ V rms on high impedance crystal input).

Continuously adjustable bandwidth can be adjusted from 15 Hz for maximum sensitivity at CW frequencies to 130 Hz for swept frequency uses. An optional rechargeable battery pack provides up to 36 hours of continuous operation for portable use.

Weight: Net 4 kg (9 lb); shipping 5.8 kg (13 lb).

Power: 115-230 V $\pm 10\%$, 50-400 Hz, 1 VA.

Dimensions: 155Hx190Wx279mm D(6 $\frac{3}{32}$ x7 $\frac{25}{32}$ x11 in.)

HP 810B Series, HP 816A Specifications

| HP Model | Frequency Range (GHz) | SWR Residual | WG & Flange or Coax Conn. | Remarks | Price |
|----------|-----------------------|-------------------|---------------------------|---|-----------|
| X810B | 8.2-12.4 | 1.01 | WR 90 UG-135/U | Use with HP 809C carriage & HP 444A Probe | \$1000 |
| P810B | 12.4-18.0 | 1.01 | WR 62 UG-419/U | | \$770 |
| 816A | 1.8-18.0 | 1.02-1.04 (APC-7) | Coaxial APC-7 N(f) | 11512A N (m) Short 11565A APC-7 Short | \$1070 |
| Opt 011 | | | Both APC-7 | furnished. Use with HP 809C Carriage | Add \$25 |
| Opt 022 | | 1.04-1.06 N(f) | N(m), N(f) | HP 447B Probe | Less \$15 |

HP 442B, 444A, 447B Probes/Adapters

The HP 442B fits the HP 809C carriage and provides sampled RF at a Type N jack.

The HP 444A is an untuned probe for 2.6-18 GHz for use with the HP 809C carriage or other $\frac{3}{4}$ inch (19 mm) mounting hole and the HP 810B waveguide sections. HP 447B is similarly used with the HP 809C and the HP 816A coaxial section for 1.8 to 18 GHz.

Ordering Information

| | |
|---|-----------|
| HP 442B RF probe | \$300 |
| HP 444A Untuned probe | \$300 |
| HP 447B Detector probe | \$415 |
| HP 809C Slotted line carriage | \$980 |
| HP 415E SWR Meter | \$2105 |
| Opt 001: rechargeable battery installed | add \$105 |
| Opt 002: rear panel input connector | add \$25 |

- Precision loads and shorts for measurements to 40 GHz



HP 909A



HP 11512A



HP 909D

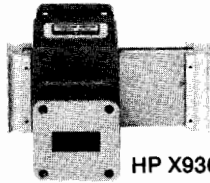

HP X930A



P X914B



HP X910B

HP 905A, 911A, 911C Coaxial Sliding Loads

The HP 905A, and 911A are movable, low reflection 50 Ω loads for precision measurements. The HP 905A is supplied with three interchangeable connectors, N-male, N-female and APC-7. The HP 911A is supplied with SMA male and female.

The HP 911C is a sliding load designed for 3.5 mm coaxial transmission lines and uses the APC-3.5 connector. This permits mode-free operation to 26.5 GHz. The HP 911C is furnished with interchangeable male and female connectors in a carrying case.

HP 905A, 911A, 911C Specifications

| HP Model | Frequency Range (GHz) | Load SWR | Power Rating | Length (mm) In. | Shipping Weight | Price |
|----------|-----------------------|-------------------------------------|---------------------|-----------------|--------------------|--------|
| 905A | 1.8-18 | 1.05 | 1 W avg. 5 kW pk | (440) 17.25 | (1.4 kg) 3 lb | \$635 |
| 911A | 2-18 | 1.1, 2-4 GHz; 1.05, 4-18 GHz | 1 W avg. 5 kW pk | (380) 14.87 | (1.4 kg) 3 lb | \$620 |
| 911C | 2-26.5 | 1.2, 2-10 GHz; 1.07, 10-26.5 GHz | 1 W avg. 5 kW pk | (266) 10.5 | (1.7 kg) 3.8 lb | \$1130 |

HP 908A, 909A/C/D/E Coaxial Fixed Terminations (50 and 75 Ω)

The HP 908A, 909A and 909D Terminations are low reflection loads for terminating 50 Ω coaxial systems in their characteristic impedance. The HP909C (50 Ω) and HP909E (75 Ω) are precision ultra low reflection terminations intended for use as calibration standards.

HP 908A, 909A/C/D Specifications

| HP Model | Frequency Range (GHz) | Impedance (ohms) | SWR | Power Rating | Connector | Price |
|----------------------------------|-----------------------|------------------|---|-----------------------|--|--------------|
| 908A | dc-4 | 50 | 1.05 | ½ W avg. 1 kW pk | N male | \$100 |
| 909A | dc-18 | 50 | 1.05: 0-4 GHz 1.1: 4-12.4 GHz 1.25: 12.4-18 GHz | 2 W avg. 300 W pk | APC-7 | \$175 |
| 909A Option 012 Option 013 | dc-18 | 50 | 1.06: 0-4 GHz 1.11: 4-12.4 GHz 1.3: 12.4-18 GHz | 2 W avg. 300 W pk | Opt. 012 N male Opt. 013 N female | Less \$15 |
| 909C | dc-2 | 50 | 1.005 | ½ W avg. 100 W pk | APC-7 | \$302 |
| 909C Option 012 Option 013 | dc-2 | 50 | 1.01 | ½ W avg. 100 W pk | Opt. 012 N male Opt. 013 N female | Less \$25 |
| 909C Option 200 | dc-2 | 50 | 1.005 | ½ W avg. 100 W pk. | Must be ordered with Opt. 012 N (m) or Opt. 013 N(f) | N.C. |
| 909C Option 201 | dc-2 | 50 | 1.01 | ½ W avg. 100 W pk. | Must be ordered with Opt. 012 N(m) | less \$20 |
| 909D | dc-26.5 | 50 | 1.07: dc-4 GHz 1.12: 4-12.4 GHz 1.22: 12.4-26.5 GHz | 2 W avg. 100 W pk | APC-3.5 male | \$250 |
| 909D Option 011 | dc-26.5 | 50 | 1.07: dc-4 GHz 1.12: 4-12.4 GHz 1.22: 12.4-26.5 GHz | 2 W avg. 100 W pk. | Opt. 011 APC-3.5 female | N.C. |
| 909D Option 040 | dc-26.5 | 50 | 1.02: dc-4GHz 1.12: 4-12.4GHz 1.22: 12.4-26.5GHz | 2W avg. 100 W pk. | APC-3.5 male Opt. 011 APC-3.5 female | \$15 |
| 909E | dc-2 | 75 | 1.01 | ½ W avg. 100 W pk. | N(m) | \$257 |

HP 920B, X923A, X930A Waveguide Shorts

The HP 920B is a movable short, adjustable through at least half a wavelength at the low end of the band. The HP X923A is also a movable short, but is adjustable through about two wavelengths at 8.2 GHz.

The HP X930A is a shorting switch. SWR is less than 1.02 in the "through" position and greater than 124 in the "short" position.

HP 920B, X923A, X930A Specifications

| HP Model | Frequency Range (GHz) | Waveguide Size EIA | Price |
|----------|-----------------------|--------------------|-------|
| X923A | 8.2-12.4 | WR90 | \$510 |
| P920B | 12.4-18 | WR62 | \$560 |
| K920B | 18.0-26.5 | WR42 | \$765 |
| R920B | 26.5-40.0 | WR28 | \$700 |
| X930A | 8.2-12.4 | WR90 | \$800 |

HP 910A/B, 914A Waveguide Fixed and Movable Terminations

The HP 910A/B are fixed terminations for waveguide systems. The HP 914A/B are similar to the HP 910A/B, except that their absorptive elements are movable and locking plungers control the position of the elements.

HP 910A/B, 914A/B Specifications

| HP Model | Frequency Range (GHz) | SWR | Power Rating | Type | Waveguide Size (EIA) | Price |
|----------|-----------------------|-------|--------------|---------|----------------------|-------|
| X910B | 8.2-12.4 | 1.015 | 1 watt | fixed | WR90 | \$235 |
| P910A | 12.4-18 | 1.02 | 1 watt | fixed | WR62 | \$225 |
| X914B | 8.2-12.4 | 1.01 | 1 watt | sliding | WR90 | \$535 |
| P914A | 12.4-18 | 1.01 | ½ watt | sliding | WR62 | \$535 |
| K914B | 18-26.5 | 1.01 | ½ watt | sliding | WR42 | \$765 |
| R914B | 26.5-40 | 1.01 | ½ watt | sliding | WR28 | \$700 |

HP 11511A, 11512A, 11565A Coaxial Shorts

These shorts are used for establishing measurement planes for known reflection phase and magnitude in 50 Ω and 75 Ω coaxial systems for various connectors.

Ordering Information

| Model | Price |
|--|-------|
| HP 11511A N-female short (50 ohm) | \$50 |
| HP 1250-1531 N-female short (75 ohm) | \$19 |
| HP 11512A N-male short (50 ohm) | \$50 |
| HP 1250-1530 N-male short (75 ohm) | \$32 |
| HP 11565A APC-7 short (50 ohm) | \$100 |
| HP 0960-0054 SMA-female short (50 ohm) | \$25 |
| HP 0960-0055 SMA-male short (50 ohm) | \$21 |

MICROWAVE TEST EQUIPMENT

Filters, Mixers, and Tuners

Models 360 Series, 362 Series, 870A, P932A, 10514A, 10534A

- Effective elimination of undesirable signals
- Low insertion loss through passband
- Correct waveguide discontinuities
- Measure microwave frequencies



HP X362A

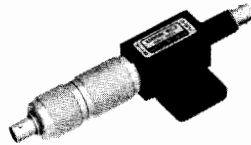

HP P932A



HP 360D

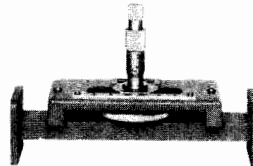

HP X870A



HP 10514A

HP 360 Series Coaxial Low Pass Filters, HP 362 Series Waveguide Low Pass Filters

These Hewlett-Packard low-pass filters facilitate microwave measurements by eliminating undesirable signals (such as harmonics) from the measurement system. Suppression of such signals is particularly important in applications such as broadband reflection and transmission measurements or slotted line measurements where harmonics generated by the signal source could otherwise impair measurement accuracy.

HP X870A, P870A Waveguide Slide-Screw Tuners

Waveguide slide-screw tuners are used primarily for correcting discontinuities or for "matching" waveguide systems. HP X870A covers 8.2-12.4 GHz in WR 90 waveguide and HP P870A covers 12.4-18.0 GHz in WR 62 waveguide. Both can correct a SWR of 20 to a value of 1.02, with a maximum loss of 2 dB.

HP P932A Harmonic Mixer

This mixer can be used for frequency measurements and phase lock applications from 12.4 to 18 GHz. It accepts stable VHF signals from 100 to 1000 MHz and provides broadband, high sensitivity mixing with microwave signals from 12.4 to 18 GHz in WR 62 waveguide. With 0 dBm input signal it provides 0.4 mV p-p output.

HP 10514A, 10534A Double Balanced Mixers

These mixers are excellent in a variety of mixing applications as well as AM, pulse, and square-wave modulation applications. The careful balancing of the hot carrier diodes in the HP 10514A and 10534A provides excellent output suppression of the local oscillator and input frequencies. Frequency ranges are 0.2-500 MHz for the HP 10514A and 0.05-150 MHz for the HP 10534A. Connectors are BNC.

Ordering Information

| | Price |
|--|-------|
| HP X870A Waveguide tuner | \$800 |
| HP P870A Waveguide tuner | \$830 |
| HP P932A Waveguide harmonic mixer | \$885 |
| HP 10514A Double Balanced Mixer (0.2-500 MHz) | \$168 |
| HP 10534A Double Balanced Mixer (0.05-150 MHz) | \$121 |

HP 360 Series Coaxial Filter Specifications

| HP Model | Cut-off Frequency (MHz) | Insertion Loss | Rejection | Impedance | SWR Maximum | Connectors | Overall Length mm (in) | Shipping Weight kg (lb) | Price |
|----------|-------------------------|--|--|-----------|-----------------------------------|------------|------------------------|-------------------------|-------|
| 360A | 700 | Less than 1 dB below 0.9 times cut-off frequency | Greater than 50 dB at 1.25 times cut-off frequency | 50 Ω | <1.6 to within 100 MHz of cut-off | N (m,f) | 276 (10.9) | 0.9 (2) | \$400 |
| 360B | 1200 | | | 50 Ω | | N (m,f) | 183 (7.2) | 0.9 (2) | \$400 |
| 360C | 2200 | | | 50 Ω | <1.6 to within 200 MHz of cut-off | N (m,f) | 274 (10.8) | 0.9 (2) | \$330 |
| 360D | 4100 | | | 50 Ω | <1.6 to within 300 MHz of cut-off | N (m,f) | 187 (7.4) | 0.45 (1) | \$330 |

HP 362 Waveguide Low Pass Filter Specifications

| HP Model | Passband (GHz) | Stopband (GHz) | Passband Insertion Loss | Stopband Rejection | SWR Maximum | Waveguide Size | Equivalent Flange | Length mm (in) | Shipping Weight kg (lb) | Price |
|--------------------|----------------|----------------|-------------------------|--------------------|-------------|----------------|-------------------|----------------|-------------------------|--------|
| X362A | 8.2-12.4 | 16-37.5 | <1 dB | At least 40dB | 1.5 | WR 90 | UG-39/U | 136 (5.4) | 0.9 (2) | \$1150 |
| P362A | 12.4-18.0 | 23-54 | | | 1.5 | WR 62 | UG-419/U | 94 (3.7) | 0.37 (13 oz) | \$1150 |
| K362A ¹ | 18.0-26.5 | 31-80 | | | 1.5 | WR 42 | UG-595/U | 64 (2.5) | 0.15 (5.3 oz) | \$975 |
| R362A ¹ | 26.5-40.0 | 47-120 | <2 dB | >35 dB | 1.8 | WR 28 | UG-599/U | 42 (1.7) | 0.11 (4 oz) | \$975 |

¹Circular Flange Adapters: For K-Band, specify HP 11515A (UG-425/U). For R-Band, specify HP 11516A (UG-381/U).

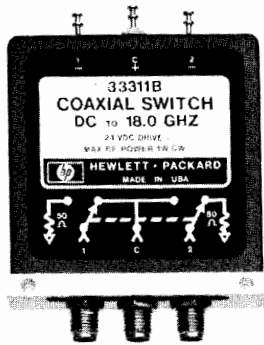

HP 33311B

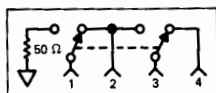

HP 33312B



HP 33313B
Wiring Diagrams

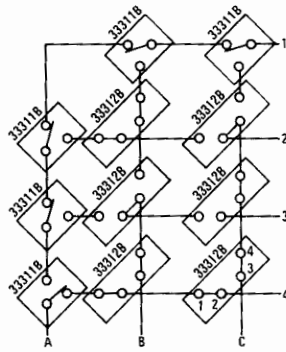

Typical Matrix Application

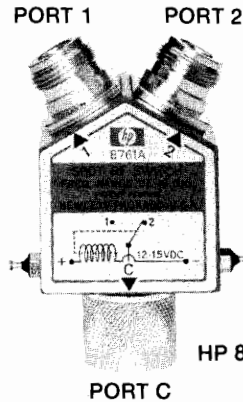

HP 8761A Option 001

HP 33311B/C Coaxial Switches

The HP 33311B and 33311C are high-isolation, single-pole, double-throw Coaxial Switches with excellent reliability, repeatability, and performance. They are designed for use in 50 Ω systems and have internally-switched 50 Ω terminations which results in all ports being matched. The switches are controlled by magnetic latching solenoids and switching current is automatically cut off when switching is complete.

HP 33312B, 33313B Coaxial Switches

HP 33312B (4-port) and 33313B (5-port) Coaxial Switches are highly-flexible components useful for a variety of automated microwave switching applications. They can serve as "transfer switches" to insert or remove a component from a signal path. They can switch from a calibration "through-path" to insert a device-under-test at a system test port. Finally, they can be used as shown above as an intersection matrix switch element. HP 33312B features one internal 50-ohm load to terminate an inactive port, while HP 33313B brings all 5 ports to 5 connectors. Insertion loss, SWR, isolation, and solenoid drive power are all similar to the HP 33311B/C Switches. Ask for Application Note 332 for more information on MW switching.

HP 8761A/B Coaxial Switches

The HP 8761 is a single-pole, double-throw Coaxial Switch with low standing-wave ratio, low insertion loss, and excellent isolation from dc to 18 GHz. Mechanically, the switch is a break-before-make type controlled by a latching solenoid. Any of seven coaxial connectors, or a 50-ohm termination, may be specified for each port.

HP-IB Compatible

The HP 33311B/C, 33312B, 33313B, and the 8761A/B Switches can be remotely controlled by the HP-IB with either the HP 11713A Attenuator/Switch Driver or the HP 59306A Relay Actuator. See the catalog index for page reference.

HP 33311B/C, 33312B, 33313B Specifications

Frequency Range

HP 33311B/12B/13B: dc to 18 GHz.

HP 33311C: dc to 26.5 GHz.

SWR (50 ohm characteristic impedance)

HP 33311B/12B/13B: <1.25, dc to 12.4 GHz; 1.5, 12.4 to 18 GHz.

HP 33311C: <1.3, dc to 10 GHz; <1.5, 10 to 16 GHz; <2.3, 16 to 26.5 GHz.

Insertion Loss

HP 33311B/12B/13B: <0.25 dB, dc to 2 GHz; <0.5 dB, 2 to 18 GHz.

HP 33311C: <0.25 dB, dc to 2 GHz; <0.5 dB, 2 to 10 GHz; <0.8 dB, 10 to 16 GHz; <1.4 dB, 16 to 26.5 GHz.

Isolation

HP 33311B/12B/13B: >90 dB, dc to 18 GHz.

HP 33311C: >90 dB to 12.4 GHz; >85 dB, 12.4 to 18 GHz; >50 dB, 18 to 26.5 GHz.

RF Connectors

HP 33311B/12B/13B: SMA female.

HP 33311C: (3) APC-3.5 female (SMA compatible).

Power: 1 W average, 100 W peak (10 μs duration).

Solenoid voltage (dc or pulsed): 24 volts. Diode protected to reduce voltage transients.

Switching speed: <30 ms (including settling time).

Life: >1,000,000 switchings.

Size: 54 H x 53 W x 14 mm D (2.13" x 2.13" x 0.56") excluding connectors and solenoid terminals.

Weight: net, 88 gm (0.2 lb). Shipping, 220 gm (0.5 lb).

Options: 011, 5-volt solenoid voltage. (HP 33311B/12B/13B only)

HP 8761A/B Specifications

Characteristic impedance: 50 ohms.

Frequency range: dc to 18 GHz.

Standing-Wave Ratio

| Frequency | SWR | | |
|-------------|-------------|-------------|-------------|
| | 7-mm | N | SMA |
| dc-12.4 GHz | 1.15 (1.20) | 1.20 (1.25) | 1.30 (1.30) |
| dc-18 GHz | 1.20 (1.25) | 1.25 (1.30) | 1.35 (1.35) |

SWR in parenthesis applies to switch with built-in termination

Insertion loss: <0.5 dB, dc to 12.4 GHz; <0.8 dB, dc to 18 GHz.

Isolation: >50 dB, dc to 12.4 GHz; >45 dB, dc to 18 GHz.

Power: 10 W average, 5 kW peak; built-in termination rated at 2 W average, 100 W peak.

Switching energy: 1.5 W for 20 ms (permanent magnet latching).

Solenoid voltages (dc or pulsed): 12 to 15 V, HP 8761A; 24 to 30 V, HP 8761B.

Switching speed: 35 to 50 ms (including settling time).

Life: >1,000,000 switchings.

Size: 41 H x 38 W x 38 mm D (1.6" x 1.5" x 1.5") excluding connectors and solenoid terminals.

Weight: net, 140 to 220 gm (0.3 to 0.5 lb). Shipping, 220 to 300 gm (0.5 to 0.7 lb).

How to Order HP 8761A/B Switches

Specify solenoid voltage and connectors (including built-in 50-ohm termination) by the alphabetic suffix on the switch model number and the appropriate three-digit option number.

A Model: 12-15 V Connector Option Number 0 0 1
B Model: 24-30 V (See table) Port 1 Port 2 Port C

| Option Code | Connector Type | Option Code | Connector Type |
|-------------|----------------------------|-------------|-----------------------|
| 0 | N (f) | 4 | APC-7 for UT-250 Coax |
| 1 | N (m) | 5 | SMA (f) |
| 2 | APC-7 w/Threaded sleeve | 6 | SMA (m) |
| 3 | APC-7 w/Coupling nut | 7 | 50Ω Termination |

Ordering Information

HP 8761A/B order must include option number

HP 8761A/B Coaxial Switch (quantity 1-9) Each \$295

HP 8761A/B Coaxial Switch (quantity 10-24) Each \$285

HP 8761A/B Coaxial Switch with 50-ohm termination add \$35

HP 33311B Coaxial Switch (quantity 1-9) Each \$570

HP 33311B Coaxial Switch (quantity 10-24) Each \$540

HP 33312B Coaxial Switch (quantity 1-9) Each \$615

HP 33312B Coaxial Switch (quantity 10-24) Each \$585

HP 33313B Coaxial Switch (quantity 1-9) Each \$655

HP 33313B Coaxial Switch (quantity 10-24) Each \$620

HP 33311C Coaxial Switch (quantity 1-9) Each \$750

HP 33311C Coaxial Switch (quantity 10-24) Each \$710

Option 011, 5v solenoids for HP 33311B/12B/13B N/C

FIBER OPTIC TEST EQUIPMENT

General Information



Probably the most remarkable fact about the evolution of fiber optics has been their rapid market growth. Design work began some twenty years ago, with trial projects carrying live telephone traffic being installed ten years later. Today, optical fibers are mass-produced for many applications worldwide.

Technical Background

In general, all fiber optic systems incorporate the following elements: light source (LED or laser), optical fiber and receiving device (PIN-diode or APD) - all of which are linked by connectors or splicers. There exists a huge variety of systems for digital or analog applications, for point-to-point or network configurations, for short distance or long-haul connections; illustrating the great versatility of fiber optic technology.

Light Sources

Light Emitting Diodes (LED's) are primarily used in short (10km max.) systems with bit rates below 100MHz. Their transmission capacity is limited by a broad emission spectrum and a low coupling efficiency. LED advantages are simple drive electronics, good reliability and low price.

Semiconductor lasers, on the other hand, feature a narrow spectral width and an excellent coupling efficiency, yielding transmission capacities 10 to 100 times higher than LEDs. Thus, lasers permit the realization of repeaterless data transmission over great distances.

Optical Fibers

Inside the fiber propagating light is totally reflected at the core/cladding boundary due to corresponding differences in the refractive indices.

Fibers employed as transmission media fall into three categories:

Step-Index Fibers. The refractive indices of core and cladding change in the form of a step function. Step-index fibers have a comparatively simple manufacturing process and are suitable for short distance connections with low data rates. Their low bandwidth can be attributed to multimode dispersion, caused by the difference in total path lengths within the waveguide.

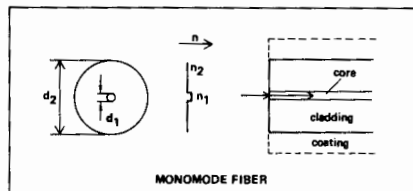
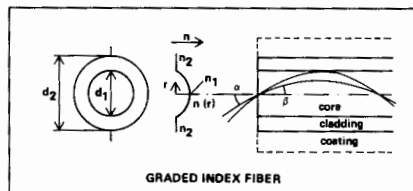
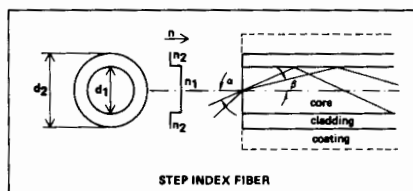

Graded Index Fibers. These feature a core having a non-uniform cross-sectional refractive index, which usually approximates a parabolic curve. The profile of these fibers reduces dispersion considerably, thus yielding bandwidths of 1 GHz x km. Graded index fibers are frequently used in systems where medium data rates with superior transmission quality is demanded.

Monomode Fibers. Installed when the fastest data handling rates are required. Monomode fibers feature bandwidths of up to several Gigabits. For this reason, they tend to be used typically in long-haul telecommunications systems where a high data handling capacity is mandatory.

The construction of the monomode fiber is similar to that of the step-index fiber; the difference being that the core is so small (approximately 8 μ m), that only one mode can propagate - thereby eliminating multimode dispersion.

Receiving Devices

Photodetectors, such as PIN-diodes, and Avalanche Photodiodes (APD's) convert the light back into an electrical signal for further processing. Today, the majority of short-haul optical systems employ the PIN diode as the receiving element because it exhibits a large bandwidth (Gigabits). This property is combined with favorable linearity and high stability. When increased sensitivity is of concern (long-haul systems for instance), the APD is preferred. Owing to its non-linearity, this device is appropriate for purely digital applications, while the PIN diode can be used in both analog and digital systems.

Wavelengths

Short wavelengths (800 to 850 nm), despite typical fiber attenuation properties of 4 dB/km, are easier to handle and more economical to implement than long wavelengths. For this reason, shorter wavelengths are popular in commercial systems, where short distances and low transmission capacities prevail (e.g. local area networks, computer interfaces, military equipment and industrial electronics).

Greater wavelengths (around 1300 nm), are employed chiefly in long-haul telecommunication systems. In this application, the significantly reduced attenuation properties (0.6dB/km) translate directly into greater transmission distances.

A number of projects are currently investigating the feasibility of transmissions in the 1550 nm range, where losses as low as 0.2 dB/km are expected to be achieved soon.



Fiber Optic Test Environments

HP's line of fiber optic test equipment offers new measurement capabilities for laboratory and manufacturing engineers in a number of different application areas.

Computers

The increasing sophistication of computers and their distributed services, prompted by the need for greater data handling capabilities and higher memory densities, has resulted in a demand for fiber optic systems. Major application areas include the mutual interfacing of central processors, the linking of them to peripheral devices, and the data transmission within the mainframe. Reduced bit errors - free from environmental interference - are assured.

Local Area Networks

The development of Local Area Networks has been stimulated by the availability of low-cost, intelligent, digital terminal hardware and the trend towards distributed data acquisition and processing. Here also, optical fibers serve as the transmission medium in networks which may be configured as ring, star or bus structures. Such systems are primarily installed in business environments to support office operations, manufacturing facilities or private automatic branch exchanges; they all take advantage of the absence of crosstalk, electromagnetic interference and echoes - often a problem in twist-pair and coax systems.

Industrial Electronics

Industrial environments represent an ideal market for numerous fiber optic applications. Examples include power plants, railroad networks and the metal industry, where data acquisition, control and process signals need to be transmitted, without being affected by high energy fields.

Some automobile and aircraft manufacturers have begun to install optical fibers instead of copper cables to increase safety and reliability, and to save weight.

Fiber optic sensors are gaining importance in hazardous environments to monitor chemical, biological and physical processes.

Telecommunications

The telecommunications industry has traditionally been the sphere of greatest interest and highest investment for fiber optics technology. The majority of resources are employed to investigate, design and install new information transfer and processing equipment; long-haul transmission systems (submarine fiber optic cables linking continents, for example), and networks in high-traffic environments.

Measurement Tasks

Designers, manufacturers and end-users of fiber optic components, modules or systems face a large variety of measurement tasks. These tasks range from purely physical measurements, such as fiber geometry or numerical aperture, to system performance tests in the time or frequency domains.

In design and production, fiber optic systems require stimuli for the thorough evaluation of individual system elements. The stimuli may be employed to characterize the effect of passive components in the signal path, with all signal parameters being selectable, so that lifelike conditions can be simulated. Furthermore, the stimulus is often used in lieu of the existing light source for system optimization or for measuring the receiver's critical parameters at absolute limits.

Testing the sensitivity of receivers or defining pulse response demands a stimulus like the HP 8150A Optical Signal Source. With the aid of this instrument, the user can perform parametric tests at calibrated optical levels, under fully-specified and precisely-controlled conditions.

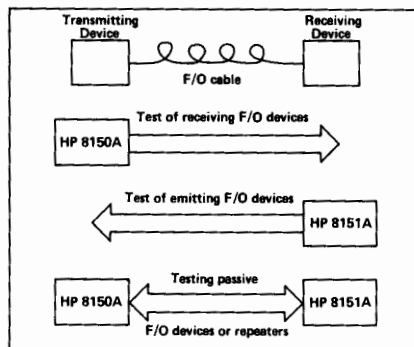

The HP 8150A and HP 8151A can be used to evaluate fiber optic devices, modules and systems.

Undoubtedly one of the most important and commonly performed measurement is that of optical power levels. The transmission of energy from one point in the system to another makes the verification of power levels during design, manufacturing and operational cycles essential. Such tests determine the magnitude of power emitted by a light source (laser, LED), and the power lost due to connectors, splices and fiber inhomogeneities. Hence, optical power meters tend to be the most widely used instruments for general purpose applications.

The HP 8151A Optical Pulse Power Meter is an excellent tool for verifying analog and digital power level parameters in terms of peak and average power.

HP's Fiber Optic Test Solutions

Hewlett-Packard's fiber optic test equipment extends testing in the optical domain from functional checkout to parametric performance analysis in the lab, production testing, incoming inspection and quality assurance.

The HP 8150A Optical Signal Source

The HP 8150A delivers accurate and repeatable, calibrated signals for evaluating the performance of fiber optic components and receivers. Its main element is an electrical-to-optical transducer which can be modulated by signals from DC to 250 MHz. This large bandwidth, coupled with variable transducer gain, caters for major network requirements, industrial links and a number of short-haul telecommunication systems.

The HP 8150A offers an output power range between 1 nW and 2 mW. Thus, very small, attenuated signals for receiver sensitivity testing can be generated in addition to the higher outputs required for overall systems test.

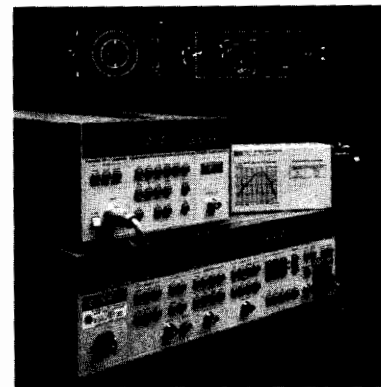

HP's fiber optic test equipment offers new ways to perform parametric tests with reliable and repeatable results.

The HP 8151A Optical Pulse Power Meter

The HP 8151A performs precise power measurements, enabling the user to perform comprehensive characterization of fiber optic components and transmitters. Its unique peak and average power level measurement capability allows the user to determine the upper and lower power levels of optical signals.

A new dimension in optical power measurements is added by the HP 8151A's 250 MHz transducer. Its electrical output signal corresponds directly to the optical input, and can be applied to an oscilloscope or other instruments for the accurate evaluation of real-time signals.

For interfacing the HP 8151A to the optical source to be characterized, an optical head is required. The HP 81511A is for use with short wavelengths, while the HP 81512A covers long wavelength applications.

The HP 81519A Optical Receiver

This instrument is a high-performance opto-electric converter with a bandwidth of 400 MHz and excellent linearity. It can be used as an interface to standard electronic test equipment or as a general purpose transducer in fiber optic measurement setups.

Accessories

For fast, simple adaptation to the device/system under test, a range of accessories complements the above products.

FIBER OPTIC TEST EQUIPMENT

Optical Signal Source

Model 8150A

- E/O transducer capability with 250 MHz bandwidth
- Calibrated output power levels from 1 nW to 2 mW
- Built-in modulator (50 MHz)
- Wavelength 850 nm \pm 15 nm

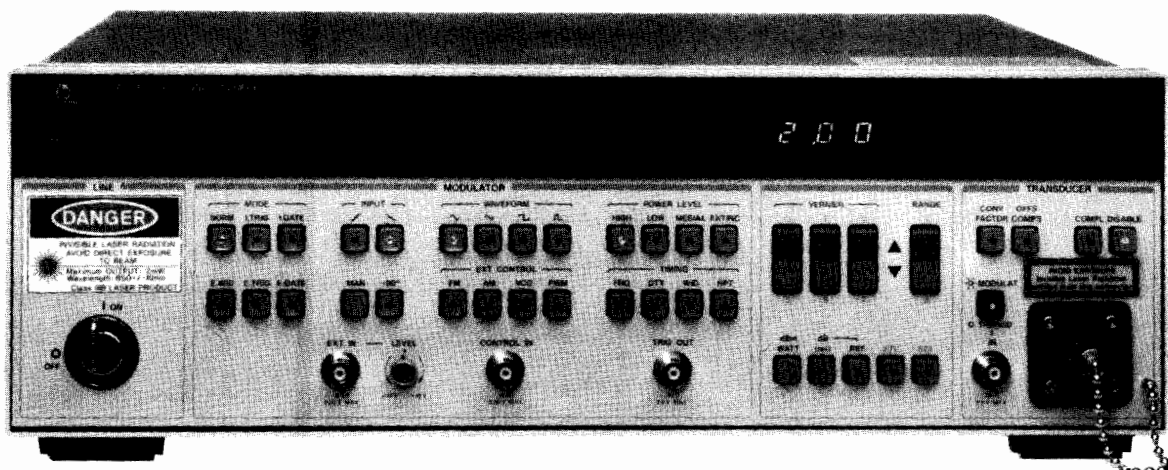

HP 8150A



The HP 8150A is a universal light stimulus for the parametric testing of fiber optic components and systems having an 850 nm operating wavelength. The instrument's transducer permits the conversion of both digital and analog electrical signals into their optical equivalents, up to a frequency of 250 MHz (-3 dB optical). The internal modulator features additional capabilities which allow the HP 8150A to function as pulse/function generator with an optical output.

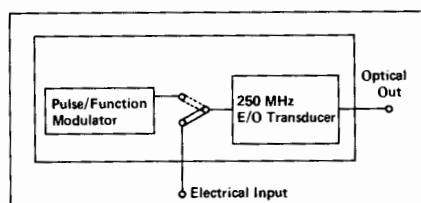

HP 8150A Blockdiagram

Calibrated output levels

The HP 8150A's calibrated optical output levels are selectable by simply programming the desired values in the 1 nW to 2 mW wide dynamic range. This facilitates design verification and manufacturing testing, such as the performance evaluation of optical components and receivers, where repeatable and reliable results are essential. Since level parameter specifications refer directly to the open end of the 2 m pigtail fiber, the user has access to well-defined signal conditions at the optical output port with which to perform reliable measurements.

To maintain signal fidelity and calibration accuracy, multiple feedback loops control the optical path. Additionally, the instrument's laser diode always operates within its linear region. This feature contributes to extended lifetime and waveform purity.

Transducer

In the transducer operating mode, the HP 8150A can be adapted to the user's needs in terms of absolute power levels, with its gain being adjustable from 1.80 nW to 1.80 mW per Volt of electrical input. Transition times of less than 2 ns ensure the generation of clean, high-speed digital signals up to a frequency of 250 MHz. Its large bandwidth and optical power range make the HP 8150A a suitable tool for testing large optical systems.

Modulator

The modulator operating mode offers a straightforward method for generating accurate, calibrated, repeatable power levels, by simply programming high or low power values at the frontpanel, or via the HP-IB, to a resolution of three digits. In addition, the mesial power level (50% amplitude level) and extinction ratio values of signals are selectable, allowing the user to simulate the attenuation effects of fiber optic systems. A rearpanel monitor output allows the user to view the electrical signal responsible for modulating the transducer, via an oscilloscope. The internal modulator further offers the choice of various waveforms with adjustable duty cycles and true pulses with variable width. A host of other features, such as FM, AM and VCO, together with externally and internally activated operating modes contribute to the versatility of the HP 8150A as a stimulus for fiber optic system and automated bench applications.

Traceability and safety

The specifications of the HP 8150A are traceable to the NBS and other national standard bureaus, such as PTB etc. The instrument is equipped with a frontpanel high-quality Diamond optical output connector, which ensures repeatable measurement results and prevents signal degradation, even after a large number of connections. The optical output has a numerical aperture of 0.2, and fiber dimensions of 50/125 μ m (graded index), thereby offering easy adaptation for testing most fiber optic systems.

A set of features is provided in order to meet international safety regulations. The secured optical output connector, for example, interrupts laser emission immediately the fiber is disconnected. The ON/OFF safety key, remote interlock facility and appropriate safety labelling are other standard HP 8150A features which help eliminate hazards to the operator.



HP 8150A Specifications

Optical characteristics

Wavelength: 850 nm \pm 15 nm
Output: 50/125 μ m graded index, multimode; N.A. 0.2

Transducer mode

Conversion range: 1.80 nW/V to 1.80 mW/V
Stability: \pm 0.05 dB (12h, $\Delta T < \pm 2^\circ\text{C}$)
Accuracy: \pm 1 dB opt @ 30 Hz sine
Electrical input swing: 0.1 V_{pp} to 1.0 V_{pp}
Electrical input window: - 0.5 V to + 0.5 V
Input impedance: 50 Ohm
Offset compensation range: - 1.2 V to + 1.2 V

| Signal-to-noise | 10 Hz to 10 MHz | 10 MHz to 400 MHz |
|---------------------------|-----------------|-------------------|
| Input 1 V _{pp} | > 27 dB opt | > 15 dB opt |
| Input 0.1 V _{pp} | > 17 dB opt | |

Bandwidth: dc to 170 MHz (@ - 1.5 dB opt),
to 250 MHz (@ - 3.0 dB opt)
Flatness: \pm 0.25 dB opt (1 Hz to 99.9 kHz),
 \pm 0.5 dB opt (100 kHz to 9.99 MHz),
 \pm 1.5 dB opt (10 MHz to 170 MHz)
THD: \leq 17 dB opt (10 Hz to 49.9 kHz), \leq 2%
Harmonic signals (input 0.1 to 0.8V_{pp}):
 \leq 15 dB opt below fundamental (50 kHz to 999 kHz)
 \leq 10 dB opt below fundamental (1 MHz to 170 MHz)
Pulse response: < 2.0 ns; perturbations: < 15% of amplitude

Modulator mode (using internal pulse/function generator)

Output power
High level: 1.18 nW to 2.00 mW; **Low level:** 1.00 nW to 1.01 mW
Mesial level: 1.09 nW to 1.10 mW;
Extinction ratio: 1.18 to 10.0
Accuracy High/Low/Mesial level: \pm 1.0 dB opt @ 30Hz
Accuracy Extinction ratio: \pm 20% @ 30 Hz
Flatness (Sine): \pm 0.4 dB opt (1 Hz to 99.9 kHz),
 \pm 0.75 dB opt (100 kHz to 9.99 MHz),
 \pm 1.0 dB opt (10 MHz to 50 MHz)

Timing parameters of internal modulator

Frequency
Range: 1 mHz to 50 MHz (3-digit resolution)
Accuracy* (pulse mode, 50% d/c): \pm 3% below 100 kHz,
 \pm 5% above 100 kHz
Jitter (pulse mode, 50% d/c): < 0.2% + 300 ps
Stability: \pm 0.2% (1 hour), \pm 0.5% (24 hours)
Duty cycle (Sine, Triangle, Square, Haversine, Havertriangle)
Range: 10% to 90% (20% to 80% above 1 MHz, 50% above 10 MHz)
Resolution: 1% steps
Accuracy: \pm 0.5 digits (\pm 3 digits above 1 MHz)
Pulse width
Range: 10.0 ns to 950 ms (3 digit resolution)
Accuracy: \pm 5% of setting \pm 2ns
Jitter: 0.3% + 300 ps (0.2% for width \geq 10 us)
Repetition time for internal trigger/internal gate
Range: 100 ns to 950 ms (3 digit resolution)
Accuracy: \pm 5% of setting \pm 5 ns
*Applies from 15°C to 35°C, error increases 0.05% per °C outside this range

Waveform characteristics

Sine (Normal mode, 50% d/c, Extinction ratio 1.18 to 5.00)
THD: \leq - 15 dB opt = < 3% (10 Hz to 49.9 kHz)
Harmonic signals:
< - 13 dB opt below fundamental (50 kHz to 999 kHz),
< - 10 dB opt below fundamental (1 MHz to 50 MHz)
Triangle/Ramp non-linearity: \pm 5%
Pulse and Squarewave
Transition times (10% to 90%): < 4 ns
Perturbations: < \pm 10% of amplitude

Operating modes

Normal, Ext. Trigger*/Gate*/Width, Int. Trigger*/Gate*
*Selectable (- 90°) start phase for haversine/havertriangle

Control Modes

Frequency Modulation: \pm 5% max. deviation

Sensitivity: 1 V for 1% deviation
Modulating frequency: dc to 20 kHz
(dc to 3 kHz for frequencies > 10 MHz)

Amplitude Modulation
Sensitivity: \pm 2.5 V for 100% mod.
(+ 2.5 V, - 7.5 V for DSBSC)

Modulating frequency: dc to 1 MHz
Pulse Width Modulation
Range: 10 ns to 1 s in 8 non-overlapping decade ranges; max. width ratio 1:10
Sensitivity: \pm 6.5 V typ. for ratio 1:10
Modulating Frequency: dc to 20 kHz
Voltage Controlled Oscillator
Range: 2 decades with 0.1 V to 10 V
Modulating frequency: dc to 1 kHz

Auxiliary modes

Watt/dBm: power can be displayed as 'Watt' or 'dBm'
dB rel: for setting power relative to selected reference
STO/RCL: 8 complete operating states can be stored and recalled
Man: simulates external input
Compl: selectable normal/complement signal output
Disable: shutter interrupts optical signal path

Auxiliary inputs and outputs

External input
Threshold: \pm 10 V adjustable
Max. input voltage: \pm 20 V; input impedance: 10 kohm
Sensitivity: 500 mV_{pp}
Min. pulse width: 10 ns
Trigger slope: selectable pos./neg./off
Control input
Max. input voltage: \pm 20 V; input impedance: 10 kohm
Trigger output
Output levels: 0 to 2.4 V into 50 ohm (4.8 V into open)
Output impedance: 50 ohms
Monitor output (rearpanel)
Signal shape corresponds to optical output signal. Amplitude is proportional to actual extinction ratio (EXR), but not correlated to the absolute output power level.
Output levels (Into 50 Ohms): 0 to 1 V (EXR = 10)
0.45 to 0.55 V (EXR = 1.18)
Output impedance: 50 ohms

HP-IB capability

All manual key operations except trigger level can be programmed. Talk mode provides learn, status byte and error report capabilities. Interface functions: SH1, AH1, T6, L4, SR1, RL1, PP0, DC1, DT1, C0.

General

Recalibration period: 1 year
Repeatability: factor 4 better than accuracy
Environmental
Storage temperature: - 40°C to + 65°C
Operating temperature: 0°C to + 55°C
Humidity: 95% R.H., > 0°C to + 40°C
Power: 100/120/220/240 Vrms; +5%, - 10%. 48 - 66 Hz, 140 VA
Weight: net 121.5 kg (27 lbs), shipping 16.5 kg (36.3 lbs)
Size: 133H x 426W x 422D mm (5.2" x 16.8" x 16.6")

Ordering information

| | Prices |
|---|---------------|
| HP 8150A Optical Signal Source | \$12900 |
| Opt 907: Front handle kit (stand-alone orders; HP P/N 5061-0089) | \$55 |
| Opt 908: Rack mount kit (stand-alone orders; HP P/N 5061-0077) | \$32.50 |
| Opt 909: Rack flange and handle combination kit (stand-alone orders: HP P/N 5061-0083) | \$80 |
| Opt 910: Extra operating and service manual | \$60 |
| HP 81500C: F/O cable Diamond HFS1/pigtail (supplied with instrument) | \$190 |
| HP 15457A: Cleaning kit (supplied with instrument) | \$40 |

For other fiber optic cables, see 'Fiber Optic Test Accessories' on page 575



FIBER OPTIC TEST EQUIPMENT

Optical Pulse Power Meter

Model 8151A with 81511A/81512A

- Peak and average power measurements
- Accuracy $\pm 2.5\%$
- O/E transducer capability



HP 81510A

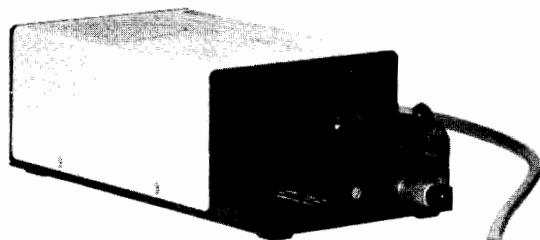

HP 81511A



HP 8151A



The HP 8151A, in combination with the HP 81511A/81512A Optical Heads, is a response measuring instrument for the level characterization of fiber optic components, modules and systems. In addition to performing average power measurements, the HP 8151A allows the user to accurately determine upper and lower peak power levels - important in digital applications. This feature is also useful for applications where non-repetitive or non-identical signals need to be evaluated, or where threshold levels are to be determined. The instrument's versatility is further enhanced by capabilities which allow the user to measure the amplitude, mesial power and extinction ratio of a signal.

The instrument's transducer has a frequency range of 250 MHz, and outputs an electrical signal which corresponds directly to the optical input waveform. The transducer output can be applied to other instruments for further processing, or displayed on an oscilloscope, for example. By using the transducer, timing related measurements as functions of optical power (e.g. propagation delay versus power) are possible.

HP-IB programmability is a standard feature of this instrument, thereby giving the user total remote control of all power meter functions.

HP 81511A and HP 81512A Optical Heads

These products complement the operation of the HP 8151A Optical Pulse Power Meter. The HP 81511A Optical Head is for use at operating wavelengths between 550 and 950 nm (calibrated for 850 nm), and the HP 81512A for use between 950 and 1750 nm (calibrated for 1300 nm). It should be noted that the HP 8151A cannot be operated without an optical head. All heads carry interface adapters for fiber connectors (Standard 'Diamond', optional NEC/D3, and others) and bare fibers. The manual microdrive facilitates the optimum coupling of the fiber end to the PIN diode in the head. The HP 8151A's frontpanel trend meter assists in determining this coupling position.

A calibration grid on top of each optical head indicates any typical correction factors to be entered into the HP 8151A for operating wavelengths other than that at which the head is calibrated. Thus, the HP 8151A can be adapted to operate at any wavelength in the 550 to 1750 nm range.

HP 8151A Specifications

Optical characteristics of HP 81511A/81512A Optical Heads

Wavelength range HP 81511A: 550 to 950 nm, cal for 850 nm

HP 81512A: 950 to 1750 nm, cal for 1300 nm

Maximum core diameter: HP 81511A: 200 μ m; HP 81512A: 100 μ m

Optical power measurements

Parameters measured: high, low, and mesial power levels, amplitude, extinction ratio, average power

Measurement range: HP 81511A: +10 dBm to -60 dBm; HP 81512A: 0 dBm to -50 dBm

Resolution: 3 digits (watts), 1 pW min., 4 digits (dB), 0.01 dB min.

Accuracy: (applies to linear display in Watt, rel. to calibration)

| Range | Hi/Lo Peak Power | Average Power |
|------------------|---------------------------------------|--|
| (dBm) | \pm (of read + counts) | \pm (of read + counts) |
| +10 ¹ | 0.3dB _{opt} +5 | 0.1dB _{opt} +5 |
| 0 | 0.3dB _{opt} +30 ² | 0.1dB _{opt} +5 |
| -10 | 0.35dB _{opt} +50 | 0.1dB _{opt} +5 |
| Bandwidth | | |
| -20 | 0.2dB _{opt} +10 | 0.1dB _{opt} +5 |
| -30 | 0.2dB _{opt} +10 | 0.1dB _{opt} +5 |
| -40 | 0.2dB _{opt} +20 ² | 0.15dB _{opt} +10 ² |
| -50 | 0.2dB _{opt} +50 ² | 0.2dB _{opt} +50 ² |
| -60 ¹ | 0.3dB _{opt} +80 ¹ | 0.2dB _{opt} +50 ¹ |

1) not valid for HP 81512A 2) better specifications for HP 81511A

Transducer (opto-electric conversion)

Actual waveform depends on measurement range. Calibrated for 850nm (HP 81511A)/1300nm (HP 81512A).

Conversion Accuracy (for 30Hz squarewave)

| Range [dBm] | Conversion Factor DC | Accuracy of Conversion | Bandwidth w/o Lowpass | rms Noise [dBm] |
|------------------|----------------------|---|------------------------|------------------|
| +10 ¹ | 1V/10mW ¹ | $\pm 0.3\text{dB}_{\text{opt}} \pm 10\text{mV}^1$ | DC-250MHz ² | -20 ¹ |
| 0 | 1V/1mW | $\pm 0.3\text{dB}_{\text{opt}} \pm 10\text{mV}$ | DC-250MHz ² | -20 ³ |
| -10 | 1V/1mW | $\pm 0.35\text{dB}_{\text{opt}} \pm 20\text{mV}$ | DC-250MHz ² | -30 |
| -20 | 1V/10uW | $\pm 0.3\text{dB}_{\text{opt}} \pm 20\text{mV}$ | DC-10kHz | -40 ³ |
| -30 | 1V/1uW | $\pm 0.3\text{dB}_{\text{opt}} \pm 20\text{mV}$ | DC-6kHz | -50 ³ |
| -40 | 1V/1uW | $\pm 0.3\text{dB}_{\text{opt}} \pm 20\text{mV}$ | DC-1kHz ² | -60 ³ |
| -50 | 1V/10nW | $\pm 0.3\text{dB}_{\text{opt}} \pm 50\text{mV}^3$ | DC-1kHz ² | -60 ³ |
| -60 ¹ | 1V/1nW | $\pm 0.3\text{dB}_{\text{opt}} \pm 20\text{mV}^1$ | DC-4kHz ² | -70 ¹ |

1) for HP 81511A only 2) 150MHz for HP 81512A 3) better specifications for HP 81511A

Pulse response

Transition time: ≤ 2 ns full b/w (≤ 3 ns for HP 81512A)

Perturbations: $\leq 10\%$ of amplitude

HP-IB capability

Interface functions: SH1, AH1, T6, L4, SR1, RL1, PP0, DC1, DT1, C0

General

Recalibration period: 1 year

Environmental

Storage temperature: -40°C to +70°C

Operating temperature: 0°C to +55°C.

Humidity: 95% R.H., > 0°C to +40°C

Power: 100/120/220/240 Vrms; +5%, -10%, 48 to 66 Hz, 100 VA max.

Weight HP 8151A: net 8 kg (17.5 lbs), shipping 10 kg (22 lbs)

HP 81511A: net 1.3 kg (2.9 lbs), shipping 2 kg (4.4 lbs)

HP 81512A: same as for HP 81511A

Size HP 8151A: 140H x 220W x 530D mm (5.7" x 9" x 21.6")

HP 81511A: 60H x 96W x 200D mm (2.5" x 3.9" x 8.2")

HP 81512A: same as for HP 81511A

Ordering information

HP 8151A Optical Pulse Power Meter

Opt 910: Extra operating and service manual

Rack Mount options see Datasheet

Opt 907: Front handle kit

(stand-alone orders HP P/N 5061-0089)

Opt 908: Rack mount kit

(stand-alone orders HP P/N 5061-0057)

HP 81511A Optical Head 550 to 950 nm

HP 81512A Optical Head 950 to 1750 nm

Note: The HP 8151A cannot be used without an optical head and connector adapter. For connector adapters and cleaning kit, see 'Fiber Optic Test Accessories' on page 575

Price

\$6300

\$ 60

\$ 55

\$32.50

\$2600

\$4200



- Calibrated O/E conversion
- dc to 400 MHz bandwidth
- ± 0.3 dB opt conversion accuracy

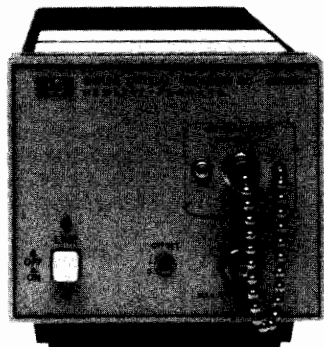

HP 81519A

The HP 81519A is a linear transducer which converts optical signals into their electrical equivalents. The instrument is designed as a front-end interface to conventional electronic test equipment and as a general purpose receiving device for testing fiber optic modules and systems.

The Optical Receiver employs a PIN diode as receiving element and is calibrated for operation at a wavelength of 850 nm, with an operational range between 550 to 950 nm. The characteristic curve on top of the instrument indicates transducer gain in this range.

With the wide demodulation frequency band of DC to 400 MHz and an intrinsic transition time of less than 1.1 ns, the HP 81519A is a valuable tool for testing fiber optic devices in computer, local area network and aerospace applications. When operating in conjunction with other equipment, measurements such as pulse response and bandwidth in the time and frequency domains can be performed accurately. Connecting the HP 81519A to an oscilloscope, for example, makes performance analysis an easy task. In addition, the adjustable offset compensation feature allows the user to conveniently adapt the instrument's operating range to any optical input condition between 0 and 1 mW.

HP 81519A Specifications

Optical characteristics

Wavelength range: 550 to 950 nm, cal for 850 nm

Input: Adapts to core diameters up to 80 μm ; N.A. ≤ 0.2

Input swing: 1 mW (min. low level 0 mW, max. high 1.5 mW)

Input connector: Diamond HFS1; connector uncertainty: ± 0.1 dB

Transducer characteristics

Conversion, opto/electric

Conversion gain: -1 V/mW

Accuracy: ± 0.3 dB opt ± 10 μW (@ 30 Hz)

Small signal bandwidth: dc to 400 MHz (@ -3.0 dB opt)

Flatness of conversion: ± 0.35 opt (dc to 150 MHz)

NEP: < 700 nW (rms); **Distortion:** typ < -20 dB opt (40 dB el.)

Output (into 50 Ohm)

Range: $+0.5$ V to -0.5 V; Output impedance: 50 Ohm $\pm 2\%$

Response

Intrinsic risetime: ≤ 1.1 ns; Perturbations: $< 10\%$ of ampl.

General

Environmental

Storage temperature: -40°C to $+70^\circ\text{C}$

Operating temperature: 0°C to $+55^\circ\text{C}$

Humidity: 95% R.H., $> 0^\circ\text{C}$ to $+40^\circ\text{C}$

Power: 115/230 Vrms, $+10\%$, -22% , 48 to 66 Hz, 16 VA max.

Weight: net 1.7 kg (3.6 lbs), shipping 2.4 kg (5 lbs)

Size: 95H x 105W x 345D mm (3.8" x 4.3" x 13.6")

Fiber Optic Test Accessories

Interface cables

A set of interface cables which enable easy connection of the HP 8150A to the device under test is available. One end of the 2 m optical cable is terminated with the standard Diamond HFS1 (this end connects to the HP 8150A). The other end can be selected from the following:

| Cable Configuration | Model No. | Price |
|---------------------------------|------------|-------|
| Diamond to HFS1 | HP 81500A | \$370 |
| Diamond to NEC D4 | HP 81500B | \$230 |
| Diamond to Amphenol 906 | HP 81500E | \$350 |
| Diamond to Diamond HFS-24 (SMA) | HP 81500F | \$350 |
| Diamond to FC | HP 81500G | \$500 |
| Diamond to F & G 3702 | HP 81500J | \$350 |
| Diamond to Stratos 430 | HP 81500K | \$350 |
| Diamond to AMP/SMA | HP 81500N | \$350 |
| Diamond to Pigtail | HP 81500C* | \$190 |

*50/125 μm , G.I. supplied with HP 8150A

Connector adapters

Exchangeable adapters, for use with HP 81511A/81512A Optical Heads simplify fiber connection. This is achieved by a receptacle that serves as a plug-in for cables with a mating connector. Or, if the user prefers, bare fiber adapters can be employed. The table below indicates adapter types available or in preparation.

| Adapter Configuration | Model No. | Price |
|-------------------------------|-------------|-------|
| Diamond HFS1 | HP 81510A | \$200 |
| NEC D4 | HP 81510B | \$100 |
| Amphenol 906 | HP 81510E | \$100 |
| HP SMA | HP 81510F | \$100 |
| NTT/FC | HP 81510G | \$100 |
| Western Electric | HP 81510H | \$100 |
| F&G | HP 81510J | \$100 |
| Stratos 430 | HP 81510K | \$100 |
| AMP/SMA | HP 81510N | \$100 |
| Blank | HP 81510Z* | \$ 40 |
| Pigtail 50/125 μm | HP 81510C** | \$170 |
| Pigtail 200/250 μm | HP 81510D | \$170 |
| Optical Base Plate | HP 81510Q | \$ 60 |

*Can be customized by user **Supplied with HP 81511A/81512A

HP 5040-9346 Connector Adapter Case

The case conveniently holds up to six connector adapters for safe storage. The wooden box is lined with foam cushion which is custom-formed to fit the adapter dimensions.

HP 15475A Cleaning Kit

The kit consists of cleaning brush, tissue and tape etc. to clean the optical surfaces of fibers and lenses. It is supplied in a plastic carrying case. This kit is supplied with the HP 8150A Optical Signal Source.

HP 9300-1094 Safety Glasses

For eye protection from possible ocular hazards resulting from exposure to high-intensity, short wavelength laser emissions.

Ordering information

| | Price |
|---|--------|
| HP 81519A Optical Receiver | \$2700 |
| Opt 910: extra operating and service manual | \$ 20 |
| HP 15475A Cleaning Kit | \$ 40 |
| HP 5040-9345 Connector Adapter Case | \$ 75 |
| HP 9300-1094 Safety Glasses | \$ 246 |

POWER METERS

Power Measurements

Average Power Measurements

At microwave frequencies, power is the best measure of signal amplitude because, unlike voltage and current, power remains constant along a lossless transmission line. For this reason, power meters are almost indispensable for microwave measurements. Typical applications include monitoring transmitter power levels, calibrating signal generators, leveling signal sources, and measuring transmission characteristics of unknown devices.

To satisfy the requirements of this broad range of applications Hewlett-Packard has developed a family of general purpose microwave power meters and power sensors. The power sensors use a diode, thermocouple, or thermistor as the power sensing element, and it is important to understand the merits of each of these sensors before choosing a particular power meter.

Power Meters and Sensors

Hewlett-Packard makes five average-reading power meters. The HP 438A is a dual channel power meter designed for ATE systems applications. The HP 435B and the 436A are analog and digital meters, which are designed to operate with HP's line of thermocouple and diode power sensors. The HP 432 power meters are designed to operate with HP's line of thermistor mounts: the HP 432A is an analog power meter, and the HP 432B is digital with BCD output.

Thermocouple power sensors are generally preferred for measuring power because they exhibit lower SWR and wider dynamic range than previously used thermistor elements. Low SWR is directly responsible for superior accuracy since mismatch errors are lower.

Thermocouple sensors (HP 8481, 8482, 8483, 8485A, R8486A, Q8486A) are available from 100 kHz to 50 GHz and range from -30 dBm to +44 dBm. The HP 8484A diode sensor operates with the same meters and extends the input level down to -70 dBm. This sensor uses a Low-Barrier Schottky Diode to achieve exceptional 100 pW (-70 dBm) sensitivity and low noise and drift. Because the diode is always operated in its square law region (voltage out power in), the HP 8484A can be used to measure the true power of complex as well as CW waveforms.

Thermistor power sensors (HP 478A, 486A series) operate with the HP 432A and 432B power meters. Since these power meters are based on balanced bridge principles, they are used whenever a direct dc-substitution technique is required. In addition, waveguide thermistor mounts are available from 8.20 to 40 GHz.

Peak Power Measurements

A frequent requirement in microwave work is the measurement of peak power in a periodic pulse. Rather than calculate peak power from an average power measurement, it would be more convenient to measure peak power directly. Hewlett-Packard produces two versatile instruments that accurately and conveniently measure peak power from 50 MHz to 18 GHz, and from 0 dBm to + 20

dBm on pulses with widths from 100 nanoseconds to CW.

The HP 8900C is an economical analog power meter calibrated in watts and dBm. The HP 8900D has an easy to read 3½ digit display calibrated in watts. Both of these peak power meters work with the HP 84811A peak power sensor that conveniently detaches from the meters for storage, recalibration, or replacement.

The HP 8900C/D meters feature two modes of operation, Direct and Compare. In the Direct mode, the meter automatically measures and displays the maximum RF power.

In the Compare mode, an oscilloscope and a meter front panel control are used to measure power at arbitrary points on the pulsed waveform. In this mode, the detected pulse train and an accurate reference line, supplied by the HP 8900C/D, can be simultaneously displayed on the oscilloscope CRT. The front panel control moves the reference line up or down with respect to the detected waveform. The user can then measure power at any desired point on the waveform by simply moving the reference line to that point.

Automatic Systems to Calibrate Power Sensors and Attenuators

Power sensors and attenuators, in most cases, are the standards against which signal levels are compared. For this reason, it is essential that they be periodically recalibrated to maintain measurement integrity. Power sensors and attenuators are calibrated by either a highly accurate and fast, but expensive automatic network analyzer or by an economical, manual, but slow and tedious system. There is very little calibration capability offered in between. But now, HP offers an automatic power sensor and attenuator calibration system, the HP 436A-E40. The heart of this system is a power meter based reflectometer controlled by the HP-85 computer.

Calibration systems similar to the HP 436A-E40 have been in use for several years at key Hewlett-Packard calibration laboratories throughout the world.

Figure 1 shows the system configuration. In operation, for power meter calibration, test signals are standardized against a specially calibrated power sensor standard. The sensor to be calibrated is compared against the standardized signals and a calibration chart is plotted.

The system is also ideal for attenuation calibration. The accuracy and linearity of power meters plus the low SWR of power sensors offer attenuation accuracy surpassed only by error correcting automatic network analyzers.

The reports for Cal Factor and attenuation are printed in either tabular or graph form and they include the calibration uncertainty. Coaxial power sensors and attenuators can be calibrated from 100 MHz to 26.5 GHz in 3 bands, 100 MHz to 2 GHz, 2 to 18 GHz, and 18 to 26.5 GHz. Waveguide thermistor sensors can be calibrated in X, P, and K bands.

Literature

Application Note 64-1, *Fundamentals of RF and Microwave Power Measurements*, deals with the general theory of microwave power measurements. It covers the basic principals of measurement, calculation of measurement uncertainty, traceability, etc.

Application Note 64-2, *Extended Applications of Automatic Power Meters*, discusses an automatic power meter system for measuring attenuation gain saturation and the calibration factor of power sensors.

Application Note 196, *Automated Measurements using the 436A Power Meter*, contains several typical uses of the 436A with the HP-IB interface bus. All of these applications notes and a coaxial and waveguide catalog are available without charge. See page 757.

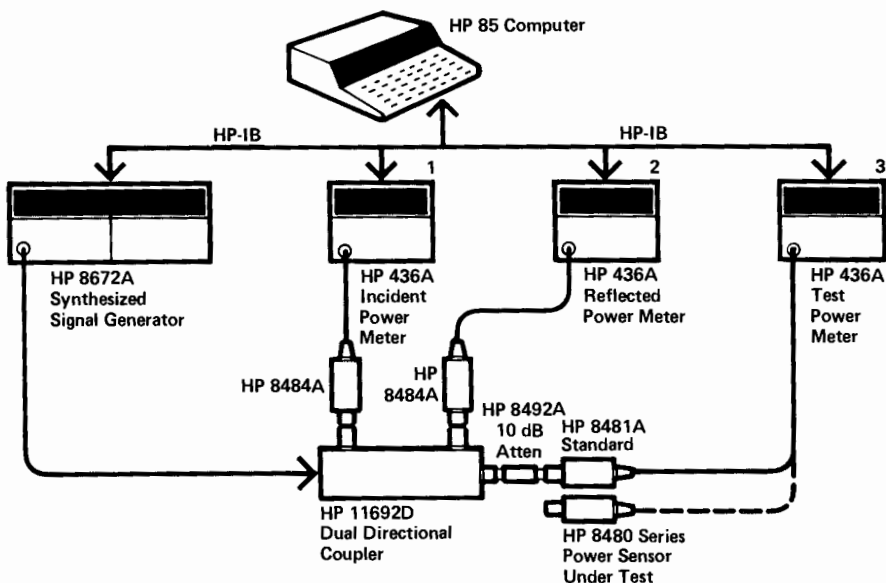
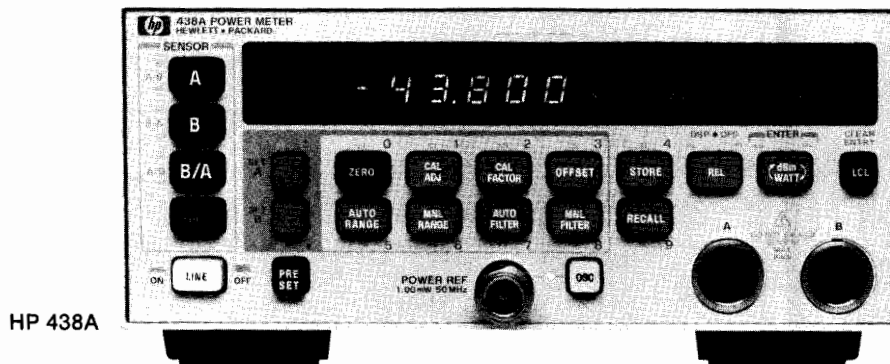

Figure 1. Power sensors and attenuators calibration system.



- Ideal for ATE applications
- Dual power sensors
- Innovative ratio & difference measurements



DESIGNED FOR
MATE
SYSTEMS



HP 438A

The HP 438A Power Meter is a dual channel power meter designed specifically for ATE systems. The compact front panel is designed to save space in rack mounted systems, while the dual channel design allows simple measurements of the ratio and difference of power levels from two separate sensors. Compatible with the HP 8480 series of thermocouple and diode sensors, the power and frequency range of the meter extends from -70 dBm to 44 dBm and from 100 kHz to 50 GHz.

Important measurement contributions are a programmable digital filter for optimizing resolution and measurement speed, independent offset (in dB) values for each channel, 0.001 dB resolution available, and a power difference mode for displaying absorbed power in transmission lines. Up to 19 different operating states of the meter can be stored into non-volatile memory for later recall.

The programmable digital averaging filter gives the user control over the inherent tradeoff between speed and accuracy. The AUTO filter mode is usually adequate for fully settled readings with 0.01 dB resolution. Less digital averaging leads to faster but noisier readings, if speed is the critical issue.

The Hewlett-Packard Interface Bus (HP-IB) capability is standard on the HP 438A with programming codes printed on the front panel for easy reference. For U.S. Air Force MATE (Modular Automatic Test Equipment) system applications, Option 700 provides the HP 438A with the internal capability to be controlled by the MATE language CIIL (Control Interface Intermediate Language). All measurement modes are programmable including zeroing, calibration, and Cal Factor. Complete interrupt capability with flexible SRQ operation optimizes the efficiency of program execution in automatic systems.

HP 438A Specifications

Frequency range: 100 kHz to 26.5 GHz (depending on power sensor used).

Power range: -70 dBm to +44 dBm (100 pW to 25 W), sensor dependent. Uses HP 8480 series power sensors; see sensor specs for details.

Operating temperature range: 0 -55°C.

Instrumentation Accuracy

Single channel, linear mode: ±0.5%.

Log mode: ±0.02 dB.

Dual channel, linear mode: ±1%.

Log mode: ±0.04 dB.

Zeroing: automatic, ±0.5% full scale on most sensitive range.

Power Reference

Power output: 1.00 mW. Factory set to ±0.7%, traceable to the U.S. National Bureau of Standards.

Accuracy: ±1.2% worst case (±0.9% rss) for 1 year.

Connector: front panel type N female (also on rear panel, Opt 002).

Meter Adjustments

Cal factor: values from 1% to 150% in 0.1% steps can be entered to account for sensor frequency response. Sensor calibration: automatic self calibration to 1.00 mW.

General

Display: four digit display (five digits in high resolution mode) with 20% over-range capability on all ranges. Annunciators to indicate measurement mode, Cal Factor, offset value, fixed or automatic range and filter values, and error conditions.

Recorder output: linearly proportional to power in watts. One volt corresponds to full scale; 1kΩ output impedance, BNC rear panel female connector.

Line voltage: 100, 120, 220 or 240 Vac +5% -10%. 100 and 120 volts, 48 to 66 Hz and 300 to 440 Hz. 220 and 240 volts, 48 to 66 Hz only.

Power requirements: 65 VA, 35 watts, maximum.

Weight: net, 5.9 kg (13 lb). Shipping, 9.1 kg (20 lb).

Dimensions: 89 mmH x 213 mmW x 418 mmD (3.5 x 8.4 x 16.8 in).

HP-IB interface codes: SH1, AH1, T5, TE0, L4, LE0, SR1, RL1, PPI, DC1, DT1, C0.

Accessories

Furnished: HP 11730A, 2 each, 1.5 metre (5 ft) power sensor cables. Power cable, 1 each, 2.4 metres (7.5 ft). Mains plug matches destination requirements.

Available: To select non-standard lengths for power sensor cables, select option 004 (delete sensor cables) and order as required from HP 11730A-F, power sensor cables. Lengths are available from 1.5 metres (5 ft) to 61 metres (200 ft).

HP 11730A-F Power Sensor Cables

The HP 11730 series power sensor cables are for use with the HP 435B, 436A, and 438A power meters and the HP 8480 series thermocouple and diode power sensors. These cables are designed to reduce RFI effects on low power readings with an improved shielding design in the cable itself. Cables may be ordered individually or in pairs in any combination desired for single and dual channel measurements.

The HP 11730A cable is the standard cable for the HP 435B, 436A, and 438A (2 cables shipped) meters. To order a non-standard cable, select Option 004 for the meter in question, and order the desired cable from below.

Ordering Information

| | Price |
|--|--------------|
| HP 438A Dual Channel Power Meter | \$4900 |
| Option 002: Rear panel sensor connectors (in parallel with front panel) and additional reference oscillator with rear panel output. | +\$325 |
| Option 700: Internal MATE programming | +1000 |
| Option 004: Delete power sensor cables | -\$146 |
| Option 910: Additional manual | \$25 |
| HP 11730A 1.5 metre (5 ft) sensor cable | \$75 |
| HP 11730B 3.0 metre (10 ft) sensor cable | \$85 |
| HP 11730C 6.1 metre (20 ft) sensor cable | \$105 |
| HP 11730D 15.2 metre (50 ft) sensor cable | \$165 |
| HP 11730E 30.5 metre (100 ft) sensor cable | \$215 |
| HP 11730F 61.0 metre (200 ft) sensor cable | \$355 |



POWER METERS

Thermocouple Power Meter

Model 436A

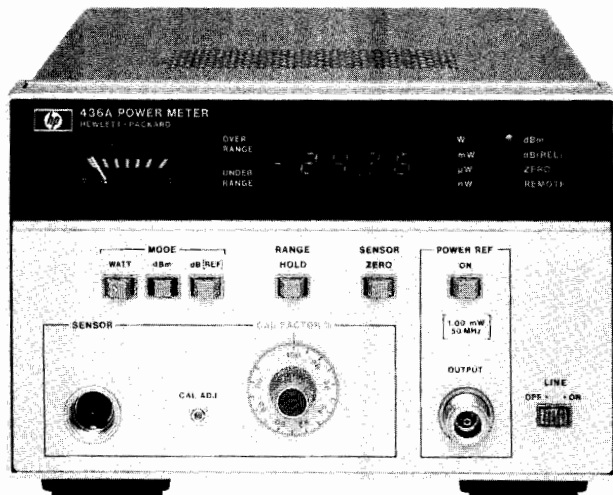

HP 436A



HP 436A Power Meter

The HP 436A Power Meter is a general purpose digital power meter intended for manual and automatic RF and microwave power measurements. It is compatible with the entire series of HP 8480 Power Sensors. Depending on which power sensor is used, the HP 436A can measure power from -70 dBm (100 pW) to $+44$ dBm (25W) at frequencies up to 50 GHz.

The logically organized and uncluttered front panel, and the convenience of push-button operation and digital display make the HP 436A both easy to interpret and easy to use in any application. The auto ranging capability allows for "hands-off" operation.

The HP 436A measures either absolute or relative power. It displays absolute power in either watts or dBm, and relative power in dB.

The HP 436A Power Meter also features optional programmability; the Hewlett-Packard Interface Bus (HP-IB) interface is available. This interface allows full remote control of all power meter functions (CAL function can be programmed to either 100 percent or the CAL factor which has been manually set on the front panel). This option may be added by the user at a later time.

HP 436A Specifications

Frequency range: 100 kHz to 50 GHz (depending on power sensor used).

Temperature range: 0–55°C.

Power Range (display calibrated in watts, dBm, and dB relative to reference power level).

With HP 8481A, 8482A, 8483A, 8485A, R8486A, Q8486A sensors: 50 dB with 5 full-scale ranges of -20 , -10 , 0, 10, and 20 dBm (10 μ W to 100 mW).

With HP 8481B or 8482B sensors: 44 dB with 5 full-scale ranges of 10, 20, 30, 40, and 44 dBm (10 mW to 25 W).

With HP 8481H or 8482H sensors: 45 dB with 5 full-scale ranges of 0, 10, 20, 30 and 35 dBm (1 mW to 3 W).

With HP 8484A sensor: 50 dB with 5 full-scale ranges of -60 , -50 , -40 , -30 , and -20 dBm (1 nW to 10 μ W).

Accuracy Instrumentation

Watt mode: $\pm 0.5\%$.

dBm mode: ± 0.02 dB ± 0.001 dB/°C.

dB (REL) mode¹: ± 0.02 dB ± 0.001 dB/°C.

¹ Specifications are for within range measurements. For range-to-range accuracy add another ± 0.02 dB.

Zero: automatic, operated by a front-panel switch.

Zero set: $\pm 0.5\%$ of full scale on most sensitive range, typical; ± 1 count on other ranges.

Zero carry over: $\pm 0.2\%$ of full scale when zeroed on the most sensitive range.

Power reference: internal 50 MHz oscillator with Type N female connector on front panel (or rear panel, Option 003 only).

Power output: 1.0 mW. Factory set to $\pm 0.7\%$ traceable to the National Bureau of Standards.

Accuracy: $\pm 1.2\%$ worst case ($\pm 0.9\%$ rss) for one year.

Supplemental Characteristics

Noise (typical, at constant temperature, peak change over any one-minute interval): 20 pW (HP 8484A); 40 nW (HP 8481A, 8482A, 8483A, 8485A, R8486A, Q8486A); 40 μ W (HP 8481B, 8482B); 4 μ W (HP 8481H, 8482H).

Drift (1 hour, typical, at constant temperature after 24-hour warm-up): 20 pW (HP 8484A); 10 nW (HP 8481A, 8482A, 8483A, 8485A, R8486A, Q8486A); 10 μ W (HP 8481B, 8482B); 1 μ W (HP 8481H, 8482H).

Response time typical, measured at recorder output, 0 to 99% of reading:

Range 1 (most sensitive range) < 10 seconds.

Range 2 < 1 second.

Ranges 3 through 5 < 100 milliseconds.

CAL factor: 16-position switch normalizes meter reading to account for calibration factor. Range 85% to 100% in 1% steps.

CAL adj: front-panel adjustment provides capability to adjust gain in meter to match power sensor in use.

Recorder output: linearly proportional to indicated power with 1 volt corresponding to full scale and 0.316 volts to -5 dB; 1 k Ω output impedance, BNC connector.

RF blanking: open collector TTL; pulls low during meter zeroing. Useful for turning off RF input to sensor during auto-zeroing. BNC connector.

Display: four-digit display with 20% over-range capability on all ranges; analog uncalibrated peaking meter to show fast changes.

Power consumption: 100, 120, 220, or 240 V (+5%, -10%), 48 to 66 Hz, and 360 to 440 Hz; < 20 V \cdot A (< 23 V \cdot A with option 022).

HP-IB Function codes: AH1, C0, DC2, DT0, LEO, PP0, RL2, SH1, SR0, T3, TE0. (For more on these codes refer to the HP-IB section in this catalog.)

Weight: net, 4.5 kg (10 lb). Shipping, 5.5 kg (12 lb).

Size: 134 H x 213 W x 279 mm D (5.2" x 8.4" x 11.0").

Accessories

Furnished: HP 11730A, 1.5 m (5 ft) cable for power sensor; 2.3 m (7.5 ft) power cable. Mains plug shipped to match destination requirements.

Available: To select non-standard lengths for power sensor cables, select option 004 (delete sensor cables) and order as required from HP 11730A-F, power sensor cables. Lengths are available from 1.5 metres (5 ft) to 61 metres (200 ft). To rack mount one HP 436A by itself, order HP 5061-9657 Rack Mount Adapter Kit.

Ordering Information

| Ordering Information | Price |
|---|-----------|
| HP 436A Power Meter | \$2900 |
| Option 003: Reference oscillator output on rear panel only. | no charge |
| Option 004: Delete power sensor cable | less \$73 |
| Option 022: Digital input/output, fully compatible with HP Interface Bus (HP-IB) | add \$500 |
| Option 908: Kit for rack mounting one HP 436A | \$35 |
| Option 910: Extra operating and service manual | add \$25 |

POWER METERS

Thermocouple Power Meter, Range Calibrator

Models 435B, 11683A

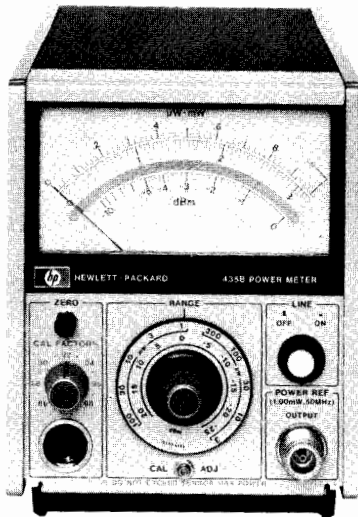

HP 435B

HP 435B Power Meter

The HP 435B Power Meter is an analog power meter, compatible with the entire series of HP 8480 Power Sensors. Depending on which sensor is used, the HP 435B can measure power from -65 dBm to +44 dBm, full scale, at frequencies from 100 kHz to 50 GHz. This versatile instrument also features <1% instrumentation uncertainty, low noise and drift, auto-zero, recorder output, optional battery operation, and long cable options up to 61 m (200 ft).

HP 11683A Range Calibrator

The HP 11683A Calibrator is specifically designed for use with the HP 435B, 436A and 438A Power Meters. It allows verification of full-scale meter readings on all ranges, as well as meter tracking. Simply connect the cable between the power meter and calibrator. The CAL ADJ control on the power meter is used to set the meter to full scale on the 1 mW range. The calibrator and meter are then stepped through the other ranges verifying accuracy within $\pm 1\%$ plus noise and drift. The HP 11683A also has a polarity switch which tests the Auto-Zero circuit.

HP 435B Specifications

Frequency range: 100 kHz to 26.5 GHz (depending on power sensor used).

Temperature range: 0 -55°C.

Power Range (calibrated in watts and dB in 5 dB steps).

With HP 8481A, 8482A, 8483A, 8485A, R8486A or Q8486A: -25 dBm (3 μ W) to +20 dBm (100 mW) full scale.

With HP 8481B or 8482B: +5 dBm (3 mW) to +44 dBm (25 W) full scale.

With HP 8481H or 8482H: -5 dBm (0.3 mW) to +35 dBm (3 W) full scale.

With HP 8484A: -65 dBm (300 pW) to -20 dBm (10 μ W) full scale.

Accuracy

Instrumentation: $\pm 1\%$ of full scale on all ranges.

Zero: automatic, operated by front-panel switch.

Zero set: $\pm 0.5\%$ of full scale on most sensitive range, typical.

Zero carryover: $\pm 0.5\%$ of full scale when zeroed on the most sensitive range.

Power reference: internal 50 MHz oscillator with Type N female connector on front panel (or rear panel, Option 003 only).

Power output: 1.00 mW. Factory set to $\pm 0.7\%$ traceable to the National Bureau of Standards.

Accuracy: $\pm 1.2\%$ worst case ($\pm 0.9\%$ rss) for one year.

Supplemental Characteristics

Noise (typical, at constant temperature, peak change over any one-minute interval): 20 pW (HP 8484A); 40 nW (HP 8481A, 8482A, 8483A, 8485A, R8486A, Q8486A); 40 μ W (HP 8481B, 8482B); 4 μ W (HP 8481H, 8482H).

Drift (1 hour, typical, at constant temperature after 24-hour warm-up): 40 pW (HP 8484A); 15 nW (HP 8481A, 8482A, 8483A, 8485A, R8486A, Q8486A); 15 μ W (HP 8481B, 8482B); 1.5 μ W (HP 8481H, 8482H).



HP 11683A

Response Time (typical, measured at recorder output, 0 to 99% of reading):

| | |
|--------------------------------|--------------------|
| Range 1 (most sensitive range) | <10.0 seconds |
| Range 2 | <3.8 seconds |
| Range 3 | <1.3 seconds |
| Ranges 4 to 5 | <500 milliseconds. |

Cal factor: 16-position switch normalizes meter reading to account for calibration factor; range 85% to 100% in 1% steps.

Recorder output: linearly proportional to indicated power with 1 volt corresponding to full scale; 1 k Ω output impedance, BNC connector.

RF blanking output: provides a contact closure to ground. Used for turning off RF input to sensor during auto-zeroing. BNC connector.

Cal adj: front-panel adjustment provides capability to adjust gain of meter to match power sensor in use.

Power consumption: 110 or 120 V (+5%, -10%), 48 to 66 Hz and 360 to 440 Hz; also 220 or 240 V (+5%, -10%), 48 to 66 Hz only: <20V \cdot A.

Weight: net, 2.7 kg (5.9 lb). Shipping, 4.2 kg (9.2 lb).

Size: 155 H x 130 W x 279 mm D (6.3" x 5.1" x 11").

Accessories

Furnished: HP 11730A, 1.52 m (5 ft) cable for the power sensor; 2.3 m (7.5 ft) power cable (mains plug shipped to match destination requirements).

Available (See page 577).

To select non-standard lengths for power sensor cables, select option 004 (delete sensor cables) and order as required from HP 11730A-F, power sensor cables. Lengths are available from 1.5 metres (5 ft) to 61 metres (200 ft).

HP 11076A: Carrying case.

HP 5060-8762: Rack adapter frame (holds three instruments the size of the HP 435B).

Combining Cases (See page 748).

HP 1051A: 286 mm (11.25 in.) deep.

HP 1052A: 416 mm (16.4 in.) deep.

These combining cases accept $\frac{1}{3}$ -module Hewlett-Packard instruments for bench use or rack mounting.

HP 11683A Range Calibrator

Calibration functions: outputs corresponding to meter readings of 3, 10, 30, 100 and 300 μ W; 1, 3, 10, 30, and 100 mW.

Calibration uncertainty: $\pm 0.25\%$ in all ranges.

Power: 100, 120, 220, or 240 Vac +5%, -10%, 48 -440 Hz, less than 10 V \cdot A.

Weight: net, 1.13 kg (2.5 lb). Shipping, 1.9 kg (4.2 lb).

Size: 89 H x 133 W x 216 mm D (3.5" x 5.25" x 8.5").

Ordering Information

| | |
|----------------------------|--------|
| HP 11683A Range Calibrator | Price |
| HP 435B Power Meter | \$750 |
| HP 435B Options | \$1380 |

001: Rechargeable battery installed provides up to 16 hours of continuous operation add \$100

002: Input connector placed on rear panel in parallel with front add \$25

003: Parallel sensor inputs front and rear panels, reference oscillator output on rear panel. add \$25

004: Delete power sensor cable less \$73

910: Extra operating and service manual add \$7.50

POWER METERS

Power Sensors

Models 8481A/B, 8481H, 8482A/B, 8482H, 8483A, 8484A, 8485A, R/Q 8486A, 11708A

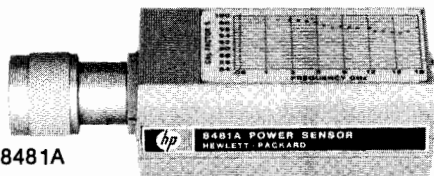

HP 8481A

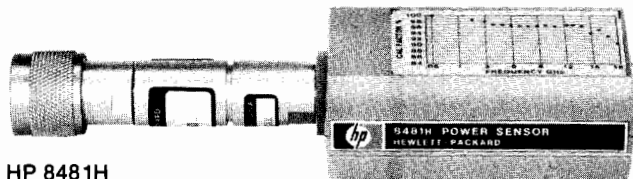

HP 8481H

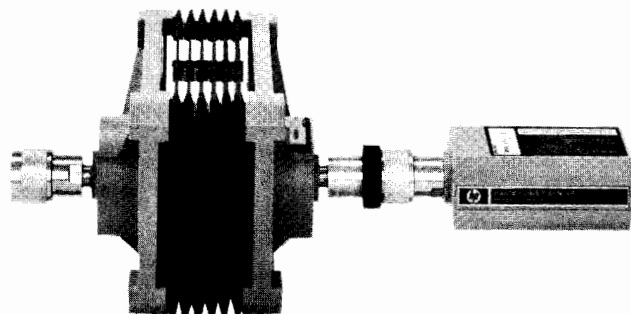

HP 8481B

HP 8480 Series Power Sensors

The HP 8480 series of Power Sensors have been designed for use with the HP 435B, 436A, and 438A Power Meters. They feature wide frequency and power ranges in addition to very low SWR.

The power measurement range of these sensors is from 0.1 nW to 25 watts. With just three sensors a power measurement range of 114 dB can be achieved.

Wide Frequency Range for Many Applications

Power measurements can be made over a frequency range of 100 kHz to 50 GHz. The six frequency ranges covered with these units are 10 MHz to 18 GHz, 100 kHz to 4.2 GHz, and 50 MHz to 26.5 GHz, in 50 Ω sensors and 100 kHz to 2 GHz, with the 75-ohm sensor, and 26.5 to 40 GHz and 33 to 50 GHz in Waveguide.

Low SWR for Low Measurement Uncertainty

The HP 8481/82/83/85/86 series of sensors use a silicon monolithic thermocouple as the sensing element. The small physical size of the thermocouple enables the sensors to have a very low SWR even at 50 GHz. A low SWR reduces mismatch uncertainty error, typically the largest single source of error in power measurements. The HP 8484A sensor uses a crystal detector for higher sensitivity and low SWR.

Individually Calibrated for More Confidence in Results

Each sensor is individually calibrated, traceable to the National Bureau of Standards. A control on the meter compensates for power sensor Cal Factor at any frequency. A precise automatic network analyzer printout for Cal Factor and reflection coefficient in magnitude and phase is supplied with the HP 8481A/B/H, 8484A, and 8485A. This means you can significantly reduce mismatch uncertainty by calculating the mismatch error.

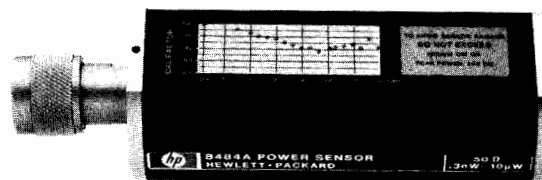

HP 8484A

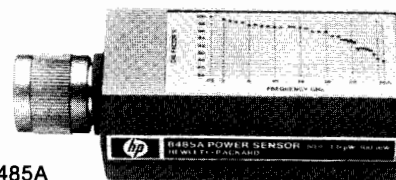

HP 8485A

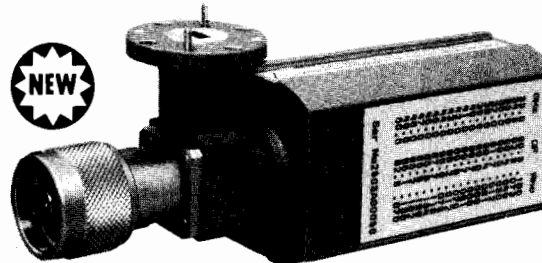

HP Q8486A

High Power Sensors to 25 Watts

The HP 8481B and 8482B High Power Sensors both have a power range of 1 mW to 25 watts. The HP 8481B covers a frequency range of 10 MHz to 18 GHz and the HP 8482B has a frequency range of 100 kHz to 4.2 GHz.

Previous methods of measuring high power levels usually required adding a separate attenuator in front of a low power sensor. With the HP 8481/82B power sensors, the attenuator and sensor are combined into one unit. This reduces mismatch uncertainty error and improves accuracy by including the attenuator in the measured Calibration Factor curves. In addition, light-weight, heat-dissipating fins on the attenuator prevent burns.

Medium Power Sensors to 3 Watts

The HP 8481H measures power from 100 μ W to 3 watts over a frequency range of 10 MHz to 18 GHz. The HP 8482H measures power from 30 μ W to 3 watts over a frequency range of 100 kHz to 4.2 GHz.

Standard Sensors to 100 mW

The HP 8481A, 8482A, 8483A, and 8485A Power Sensors all measure power over a range of 1 μ W to 100 mW. The HP 8481A is a 50-ohm sensor with a frequency range of 10 MHz to 18 GHz. The HP 8482A is a 50-ohm sensor with a frequency range of 100 kHz to 4.2 GHz. The HP 8485A is a 50-ohm sensor with a frequency range of 50 MHz to 26.5 GHz. The HP 8483A is a 75-ohm sensor and covers a frequency range of 100 kHz to 2 GHz.

High Sensitivity Sensors

The HP 8484A measures power from 0.1 nW to 10 μ W over a frequency range of 10 MHz to 18 GHz. It is furnished with the HP 11708A 50 MHz reference attenuator for precise calibration with 1 mW power meter reference oscillator. Noise and drift have been reduced to less than 5% of full scale on the 300 pW range (only 15 pW) when it is used with the HP 435B power meter. Noise and drift are even less with the HP 436A and 438A power meters.

Millimeter-Wave Power Sensors

The HP R8486A and Q8486A Thermocouple Waveguide Power Sensors measure true, average power from 1 μ W to 100 mW over the frequency ranges of 26.5 to 40 GHz (R-band) and 33 to 50 GHz (Q-band).



HP 8480 Series Specifications

| HP Model (Nominal Impedance) | Frequency Range | Power Range | Maximum Power | Power Linearity ² | Maximum SWR (Reflection Coefficient) | Size mm (in.) | | RF Connector | Price |
|---------------------------------|-----------------|--|--|------------------------------|---|---------------------------------------|--------------|---------------------------------|-------------|
| | | | | | | Shipping Weight kg (lb) | | | |
| 8481A (50 Ω) | 10 MHz-18 GHz | 1 μW to 100 mW | 300 mW avg. 15 W peak 30 W • μs (per pulse) | +10 to +20 dBm +2, -4% | 10 MHz - 30 MHz: 1.40 (0.166) 30 MHz - 50 MHz: 1.18 (0.083) 50 MHz - 2 GHz: 1.10 (0.048) 2 - 12.4 GHz: 1.18 (0.083) 12.4 - 18 GHz: 1.28 (0.123) | 30 x 38 x 105 (1.2 x 1.5 x 4.1) | 0.5 (1) | N(m) | \$630 |
| Option 001 | | | | | | | | APC-7 | add \$25 |
| 8481B (50 Ω) | 10 MHz-18 GHz | 0-35°C: 1 mW-25W; 35°C-55°C: 1 mW-20 W | 0-35°C: 30 W avg. ¹ 35°C-55°C: 25 W avg. 10 MHz-5.8 GHz 500 W peak 5.8-18 GHz 125 W peak 500 W • μs (per pulse) | +35 to +44 dBm ±4% | 10 MHz - 2 GHz: 1.10 (0.048) 2-12.4 GHz: 1.18 (0.083) 12.4-18 GHz: 1.28 (0.123) | 83 x 114 x 248 (3.25 x 4.5 x 9.75) | 1.5 (3.2) | N(m) | \$1402 |
| 8481H (50 Ω) | 10 MHz-18 GHz | 100 μW to 3W | 3.5 W avg. 100 W peak 100W • μs (per pulse) | +25 to +35 dBm ±5% | 10 MHz - 8 GHz: 1.20 (0.091) 8-12.4 GHz: 1.25 (0.110) 12.4 - 18 GHz: 1.30 (0.130) | 30 x 38 x 149 (1.2 x 1.5 x 5.9) | 0.5 (1) | N(m) | \$770 |
| 8482A (50 Ω) | 100 kHz-4.2 GHz | 1.0 μW to 100 mW | 300 mW avg. 15 W peak 30 W • μs (per pulse) | +10 to +20 dBm +2, -4% | 100-300 kHz: 1.60 (0.231) 300 kHz - 1 MHz: 1.20 (0.091) 1 MHz - 2 GHz: 1.10 (0.048) 2-4.2 GHz: 1.30 (0.130) | 30 x 38 x 105 (1.2 x 1.5 x 4.1) | 0.5 (1) | N(m) | \$580 |
| 8482B (50 Ω) | 100 kHz-4.2 GHz | 0-35°C: 1 mW-25 W; 35°C-55°C: 1 mW-20 W | 0-35°C: 30 W avg. ¹ 35°C-55°C: 25 W avg. 500 W peak 500 W • μs (per pulse) | +35 to +44 dBm ±4% | 100 kHz - 2 GHz: 1.10 (0.048) 2 GHz - 4.2 GHz: 1.18 (0.083) | 83 x 114 x 248 (3.2 x 4.5 x 9.7) | 1.5 (3.2) | N(m) | \$1352 |
| 8482H (50 Ω) | 100 kHz-4.2 GHz | 100 μW to 3W | 3.5 W avg. 100 W peak 100 W • μs (per pulse) | +25 to +35 dBm ±5% | 100 kHz-4.2 GHz: 1.20 (0.091) | 30 x 38 x 149 (1.2 x 1.5 x 5.9) | 0.5 (1) | N(m) | \$740 |
| 8483A ³ (75 Ω) | 100 kHz-2 GHz | 1.0 μW to 100 mW | 300 mW avg. 10 W peak 30 W • μs (per pulse) | +10 to +20 dBm +2, -4% | 100-600 kHz: 1.80 (0.286) 600 kHz - 2 GHz: 1.18 (0.083) | 30 x 38 x 105 (1.2 x 1.5 x 4.1) | 0.5 (1) | N(m) 75 Ω | \$580 |
| 8484A ⁴ (50 Ω) | 10 MHz-18 GHz | 0.1 nW to 10 μW | 200 mW avg. 200 mW peak | -30 to -20 dBm ±1% | 10-30 MHz: 1.40 (0.166) 30 MHz - 4 GHz: 1.15 (0.070) 4-10 GHz: 1.20 (0.091) 10-15 GHz: 1.30 (0.130) 15-18 GHz: 1.35 (0.149) | 36 x 44 x 133 (1.4 x 1.7 x 5.2) | 0.5 (1) | N(m) | \$880 |
| 8485A (50 Ω) | 50 MHz-26.5 GHz | 1 μW to 100 mW | 300 mW avg. 15 W peak 30 W • μs (per pulse) | +10 to +20 dBm +2, -4% | 50 MHz-100 MHz: 1.15 (0.070) 100 MHz-2 GHz: 1.10 (0.048) 2-12.4 GHz: 1.15 (0.070) 12.4-18 GHz: 1.20 (0.091) 18-26.5 GHz: 1.25 (0.111) | 30 x 38 x 95 (1.2 x 1.5 x 3.7) | 0.5 (1) | APC-3.5(m) | \$900 |
| R8486A (Waveguide) | 26.5-40 GHz | 1 μW to 100 mW | 300 mW avg. 15 W peak 30W • μs pulse | +10 to +20 dBm +2, -4% | 1.4 (0.167) | 30 x 38 x 126 (1.2 x 1.5 x 50) | 0.4 (0.9) | Waveguide Flange UG-599/U | \$1500 |
| Q8486A (Waveguide) | 33-50 GHz | 1 μW to 100 mW | 300 mW avg. 15 W peak 30W • μs pulse | +10 to +20 dBm +2, -4% | 1.5 6/(0.200) | 30 x 38 x 126 (1.2 x 1.5 x 50) | 0.4 (0.9) | Waveguide Flange UG-383/U | \$1750 |

¹For pulses greater than 30 W the maximum average power (Pa) is limited by the energy per pulse (E) in W • μs according to Pa = 30-0.02E.

²Negligible deviation except for those power ranges noted.

³Includes HP 1250-0597 adapter from 75 Ω type N to 50 Ω type N for calibration.

⁴The HP 11708A 30 dB attenuator for calibrating against a 0 dBm, 50 MHz power reference is shipped with the HP 8484A.

Uncertainty of Calibration Factor Data for HP 8482A and 8483A

| Frequency (MHz) | Sum of Uncertainties (%) ¹ | | | | Probable Uncertainties (%) ² | | | |
|--------------------|--|-------|--------|--------|--|-------|--------|--------|
| | HP Model | | | | HP Model | | | |
| | 8482A | 8482B | 8482H | 8483A | 8482A | 8482B | 8482H | 8483A |
| 0.1 | ±2.3 | ±5.7 | ±3.3 | ±2.6 | ±1.3 | ±2.8 | ±1.6 | ±1.5 |
| 0.3 | 2.2 | 5.7 | 3.2 | 2.5 | 1.2 | 2.8 | 1.6 | 1.4 |
| 1.0 | 2.2 | 5.7 | 3.2 | 2.5 | 1.2 | 2.8 | 1.6 | 1.4 |
| 3.0 | 2.2 | 5.7 | 3.2 | 2.5 | 1.2 | 2.8 | 1.6 | 1.4 |
| 10.0 | 2.5 | 5.7 | 3.5 | 3.0 | 1.3 | 2.8 | 1.6 | 1.6 |
| 30.0 | 2.6 | 5.7 | 3.6 | 3.1 | 1.4 | 2.8 | 1.7 | 1.6 |
| 50.0 | 0(ref) | 2.7 | 0(ref) | 0(ref) | 0(ref) | 2.7 | 0(ref) | 0(ref) |
| 100.0 | 3.1 | 5.6 | 4.1 | 3.9 | 1.6 | 3.3 | 1.9 | 2.0 |
| 300.0 | 3.1 | 5.6 | 4.1 | 3.9 | 1.6 | 3.3 | 1.9 | 2.0 |
| 1000.0 | 2.7 | 5.7 | 3.7 | 3.7 | 1.4 | 3.3 | 1.7 | 2.0 |
| 2000.0 | 2.7 | 5.5 | 3.7 | 3.9 | 1.4 | 3.1 | 1.7 | 2.1 |
| 4000.0 | 2.8 | 5.5 | 3.8 | — | 1.5 | 3.1 | 1.8 | — |

Uncertainty of Calibration Factor Data for HP 8481A/B, 8484A 8485A³

| Frequency (GHz) | Sum of Uncertainties (%) ¹ | | | | | Probable Uncertainties (%) ² | | | | |
|--------------------|--|-------|-------|-------|-------|--|-------|-------|-------|-------|
| | HP Model | | | | | HP Model | | | | |
| | 8481A | 8481B | 8481H | 8484A | 8485A | 8481A | 8481B | 8481H | 8484A | 8485A |
| 0.1 | ±3.1 | ±6.4 | ±4.1 | ±4.4 | — | ±1.6 | ±3.0 | ±1.9 | ±1.9 | — |
| 2 | 2.7 | 5.8 | 3.7 | 4.0 | ±3.6 | 1.4 | 3.1 | 1.7 | 1.8 | ±2.1 |
| 4 | 2.8 | 5.8 | 3.8 | 4.1 | — | 1.5 | 3.1 | 1.8 | 1.8 | — |
| 6 | 2.8 | 5.8 | 3.8 | 4.1 | 4.0 | 1.5 | 3.1 | 1.8 | 1.8 | 2.3 |
| 8 | 3.2 | 6.0 | 4.2 | 4.6 | — | 1.7 | 3.2 | 2.0 | 2.0 | — |
| 10 | 3.6 | 6.2 | 4.6 | 5.1 | 4.7 | 1.9 | 3.5 | 2.2 | 2.2 | 2.7 |
| 12 | 3.9 | 7.8 | 4.9 | 6.5 | — | 2.1 | 4.1 | 2.4 | 2.8 | — |
| 14 | 4.8 | 7.9 | 5.8 | 7.4 | 5.6 | 2.6 | 4.1 | 2.8 | 3.2 | 3.2 |
| 16 | 5.2 | 8.0 | 6.2 | 7.8 | — | 2.9 | 4.2 | 3.0 | 3.4 | — |
| 18 | 5.8 | 8.3 | 6.8 | 8.4 | 5.9 | 3.2 | 4.3 | 3.4 | 3.7 | 3.6 |
| 22 | — | — | — | — | 6.8 | — | — | — | — | 3.7 |
| 26.5 | — | — | — | — | 7.3 | — | — | — | — | 4.0 |

¹Includes uncertainty of reference standard and transfer uncertainty. Directly traceable to NBS.

²Square root of sum of the individual uncertainties squared (RSS).

³For R/Q8486A uncertainty data see the data sheet (5953-6482).



POWER METERS

Thermistor Power Meters & Power Meter Calibrator

Models 432A/B, 8477A

- Automatic zero
- High accuracy

- Recorder outputs, analog & digital
- Long cable options

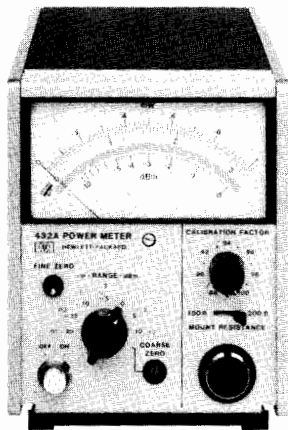

HP 432A

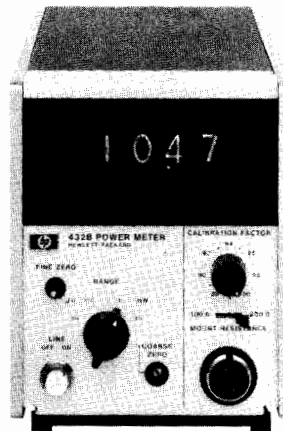

HP 432B

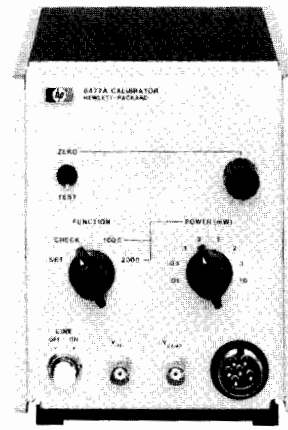

HP 8477A

HP 432A/B Power Meters

High accuracy—no thermoelectric error: high accuracy over a wide temperature range is featured on the HP 432 Power Meters. By measuring the output voltage of the thermistor bridges, and computing the corresponding power, even higher accuracy of $\pm 0.2\% \pm 0.5 \mu\text{W}$ can be obtained.

Accuracy can be maintained on even the most sensitive range because the error due to thermoelectric effect is reduced to a negligible level.

Calibrated mounts: each thermistor mount is furnished with data stating the Calibration Factor* and Effective Efficiency* at various frequencies across the operating range. For easy and accurate power measurements, the front panel of the HP 432 contains a calibration factor control, calibrated in 1% steps from 88% to 100%, that compensates for losses in the mount and eliminates the need for calculation.

Instrument type: automatic, self-balancing power meter for use with temperature-compensated thermistor sensor.

*"Calibration Factor" and "Effective Efficiency" are figures of merit expressing the ratio of the substituted signal measured by the power meter to the microwave power incident on and absorbed by the sensor.

Specifications (partial)

Power Range

HP 432A: seven ranges with full-scale readings of 10, 30, 100, and 300 μW , 1, 3, and 10 mW; also calibrated in dBm from -20 dBm to +10 dBm full scale in 5 dB steps.

HP 432B: four ranges with full-scale readings of 10 and 100 μW , and 1 and 10 mW.

Noise: less than 0.25% of full scale peak (typical).

Response time: at recorder output, 35 ms time constant (typical).

Fine zero: automatic, operated by front panel switch.

Zero carryover: less than 0.50% of full scale when zeroed on most sensitive range.

Meter

HP 432A: taut-band suspension, individually calibrated, mirror-backed scales. Milliwatt scale more than 108 mm (4.25 in.) long.

HP 432B: three digits with one digit overrange. 20% overrange capability on all ranges.

Calibration factor control: 13-position switch normalizes meter reading to account for the thermistor sensor calibration factor. Range 100% to 88% in 1% steps.

Thermistor sensor: thermistor sensors are required for operation of the HP 432A/B. For microwave sensors HP 478B, 8478B and 486 series see page 583.

Recorder output: proportional to indicated power with 1 volt corresponding to full scale. 1 k Ω output impedance.

BCD output: 8, 4, 2, 1 code: "1" positive. TTL compatible logic. Operates with HP 5150A, Opt 002 (BCD) Digital Recorder. "Print" and "Inhibit" lines available. (HP 432B only.)

Power Consumption

HP 432A: 115 or 230 Vac $\pm 10\%$, 50 to 400 Hz, 1.5 watts.

HP 432B: 115 or 230 Vac $\pm 10\%$, 50 to 400 Hz, 1.0 watts.

Weight

HP 432A: net, 2.3 kg (5.5 lb). Shipping, 4.6 kg (10 lb).

HP 432B: net, 3 kg (6.5 lb). Shipping, 4.8 kg (10.5 lb).

Size: 130 W x 155 H x 279 mm D (5.2" x 6.1" x 11.0").

HP 8477A Power Meter Calibrator

The HP 8477A Calibrator is specifically designed for use with the HP 432 Power Meter. It allows you to verify full-scale meter readings on all ranges, and meter tracking. Simply connect three cables between the power meter and calibrator; no charts or additional instruments are required.

Power: 115 or 230 Vac $\pm 10\%$, 50 to 400 Hz, 3 watts.

Ordering Information

| | Price |
|---------------------|--------------|
| HP 432A Power meter | \$1225 |
| HP 432B Power meter | \$2100 |

HP 432A/B Options

| | |
|---|--------------|
| 001: rechargeable battery installed, provides up to 20 hours continuous operation (HP 432A only) | add \$105 |
| 002: input connector placed on rear panel in parallel with front | add \$25 |
| 003: input connector on rear panel only | add \$10 |
| 009: 3.1 m (10 ft) cable for 110- Ω or 200- Ω sensor | add \$30 |
| 010: 6.1 m (20 ft) cable for 100- Ω or 200- Ω sensor | add \$55 |
| 011: 15.2 m (50 ft) cable for 100- Ω or 200- Ω sensor | add \$105 |
| 012: 30.5 m (100 ft) cable for 100- Ω or 200- Ω sensor | add \$155 |
| 013: 61 m (200 ft) cable for 100- Ω or 200- Ω sensor | add \$260 |
| 100: 100 Vac operation, 48-66 Hz | no charge |
| 910: extra operating and service manual | add \$5 |
| HP 8477A Power Meter Calibrator | \$830 |

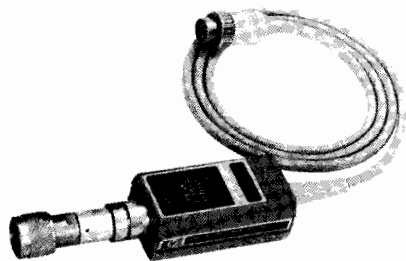

HP 84811A



HP 478A



HP 8478B

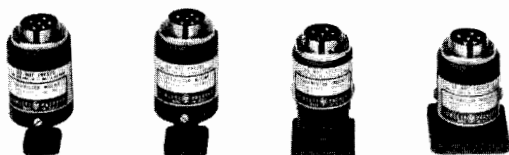

HP 486 Series

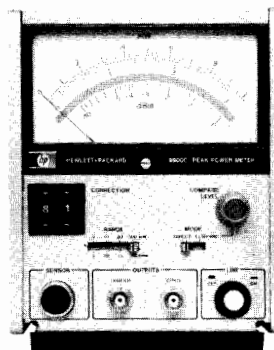

HP 8900C

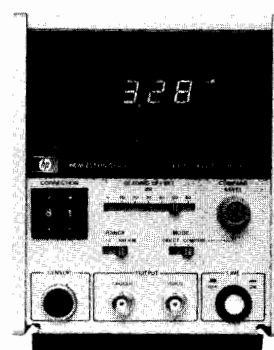

HP 8900D

HP 8900C/D Peak Power Meters

The HP 8900C and 8900D Peak Power Meters directly display the peak power of RF pulses over a 100 MHz to 18 GHz frequency range. Measurements can be made on pulses with widths from 1 μ s (100 ns in Compare mode) to CW, and repetition rates from 100 Hz (0 Hz in Compare mode) to 100 kHz.

The HP 8900C is an economical analog meter calibrated in watts and dBm. The analog display with its large, easy-to-read scale makes it simple to peak or null pulsed power systems. The HP 8900D has a high resolution 3 1/2 digit digital display calibrated in watts. The direct reading display and range annunciators make the digital version a good choice for production and field applications where unambiguous or frequent readings are required.

HP 8900C/D Peak Power Meters Specifications

Frequency range: 100 MHz to 18 GHz.

Dynamic range: 20 dB (0 to +20 dBm).

HP 8900C: 4 ranges of 3, 10, 30 and 100 mW full scale.

HP 8900D: 2 ranges of 10 and 100 mW full scale.

Pulse Response

Direct Mode

Pulse width: 1 μ s to CW.

Repetition rate: 100 Hz to 100 kHz.

Compare Mode

Pulse width: 100 ns (typical) limited by rise time specification.

Repetition rate: 0 to 100 kHz.

Rise time: 75 ns.

Fall time: 125 ns (as measured on video output).

Power consumption: 100 and 120 Vac +5, -10%, 48 -66 Hz and 360-440 Hz; 220 and 240 Vac +5, -10%, 48 -66 Hz.

| Meter Accuracy | CW | Pulse | Transfer Accuracy CW to Pulse |
|----------------|--------------|---------------|----------------------------------|
| Direct | ± 0.2 dB | ± 0.35 dB | ± 0.2 dB |
| Compare | ± 0.2 dB | ± 0.25 dB | ± 0.1 dB |

HP 84811A Peak Power Sensor Specifications

Power range: 0 to +20 dBm (1 mW to 100 mW).

Frequency range: 100 MHz to 18 GHz.

SWR: 100 MHz to 12 GHz < 1.5. 12 GHz to 18 GHz < 2.0.

Maximum peak power: +24 dBm (250 mW) for 5 minutes.

Connector type: N (male).

Calibration: every 2 GHz from 2 to 10 GHz. Every 1 GHz from 11 to 18 GHz.

Operating temperature: 0 to +55°C.

Calibration accuracy: (+10 to +40°C), ± 0.7 dB/0.1 to 12 GHz. ± 1.0 dB to 18 GHz. 0-10°C and 40-55°C: add ± 0.2 dB.

Ordering Information

HP 8900C Analog peak power meter

HP 8900D Digital peak power meter

HP 84811A Peak power sensor

Price

\$1950

\$2450

\$750

Temperature Compensated Thermistor Mounts

High efficiency and good RF match are characteristic of the HP 478A and 8478B coaxial and 486A series waveguide Thermistor Mounts. Used in conjunction with the HP 432 Power Meter they provide high accuracy even in routine power measurements. These thermistor mounts are temperature-compensated for low drift, even in the presence of thermal shocks, permitting measurement of microwave power as low as one microwatt. Each mount contains data showing Calibration Factor and Effective Efficiency at six frequencies, directly traceable to the National Bureau of Standards at those frequencies where NBS provides calibration service.

HP 486, 478, 8478B Specifications

| HP Model | Frequency range, GHz | Maximum SWR | Operating Resistance (Ohms) | Price |
|--------------------|----------------------|--|-----------------------------|-------|
| 478A | 10 MHz to 10 GHz | 1.75, 10 to 25 MHz 1.3, 25 MHz to 7 GHz 1.5, 7 to 10 GHz | 200 | \$325 |
| 8478B ¹ | 10 MHz to 18 GHz | 1.75, 10 to 30 MHz 1.35, 30 to 100 MHz 1.1, 0.1 to 1 GHz 1.35, 1 to 12.4 GHz 1.6, 12.4 to 18 GHz | 200 | \$530 |
| X486A | 8.20 to 12.4 | 1.5 | 100 | \$420 |
| P486A | 12.4 to 18.0 | 1.5 | 100 | \$460 |
| K486A ² | 18.0 to 26.5 | 2.0 | 200 | \$580 |
| R486A ² | 26.5 to 40.0 | 2.0 | 200 | \$640 |

¹Option 011: furnished with APC-7 RF connector add \$25
²Circular flange adapters:
 K-band (UG-425/U) HP 11515A \$210
 R-band (UG-381/U) HP 11516A \$210

HP 84811A Peak Power Sensor

The HP 84811A Peak Power Sensor works with the HP 8900C/D Peak Power Meters to measure the peak power of RF pulses. It is supplied with a 4 foot flexible cable to easily reach the pulse source being measured. Any sensor can be used with any meter. The HP 84811A also conveniently detaches from the meter for storage, recalibration or replacement.

NOISE FIGURE METER

Noise Measurements

Noise Figure

Modern receiving systems must often process very weak signals, and noise added by the receiving system components often determines whether or not an input signal can be processed properly. Noise figure is the figure of merit used to express how well a system and its components can process weak signals. It expresses the degradation in the S/N ratio as the signal passes through the system. Noise figure is unique and universal; it may be determined for transistors, amplifiers, mixers and entire systems. Considering the S/N ratio, it is often more economical to reduce the noise figure of the receiving system components than it is to increase the signal by increasing transmitted power or antenna gain.

Noise figure may also be expressed as the ratio of total output noise power (at a source temperature of 290K) compared to the output noise power if there were no noise added by the device under test (DUT), that is, a noise-free DUT. Consider the representation of the noise power at the output of a DUT vs. the temperature of the source impedance at the DUT input.

$$N_p = N_a + kGBT_s$$

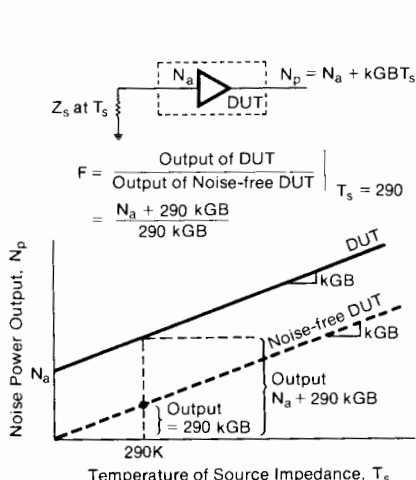

Figure 1. Available noise power and noise figure.

Figure 1 is a graph of the equation. In the equation, N_a is the noise added by the DUT, k is Boltzmann's constant, G is the gain of the DUT, B is bandwidth in Hz, and T_s is the temperature of the source termination in Kelvins. Thermal agitation energy of the source impedance causes movement of the free-charge in that impedance. Energy of the moving charge that occurs within the bandwidth of the DUT masquerades as input signal, gets processed by the DUT, and contributes to power output. At absolute zero, there is no thermal energy transferred from the source impedance and the only power at the output is noise added by the DUT, N_a . As the source temperature increases, the power output increases in accordance with the gain-bandwidth product and with Boltzmann's constant (which can be thought of as a conversion factor between two expressions for energy — kelvin temperature and joules). Noise figure is concerned with the behavior of the DUT compared to a noise-free DUT for a source temperature of 290K as shown in Figure 1. Noise figure is often expressed in dB by

$$F(\text{dB}) = 10 \log F$$

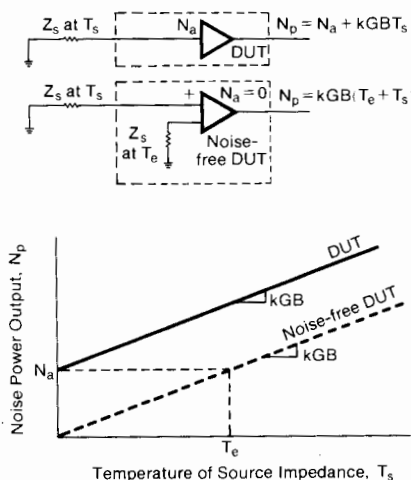

Figure 2. Available noise power & effective input noise temperature.

Effective Input Noise Temperature — (T_e)

Another figure of merit, the effective input noise temperature T_e , gives the noise performance without reference to a standard source temperature (290K). It is therefore commonly used for satellite system work where source temperatures are usually much lower than 290K. Once again the DUT output is compared to the output if no noise were added by the DUT (Figure 2). T_e is the source temperature necessary for the source of the noise-free DUT to produce the same output noise power as the added noise of the actual DUT. For convenience, the DUT may be modeled as a noise-free DUT with an extra source impedance at temperature T_e .

Noise Figure Measurement

Noise figure meters measure two points along the straight-line for the DUT (Figure 3), and then display the corresponding noise figure. The two source temperatures correspond to the noise source being turned on (for T_h) and off (for T_c). The cold temperature of

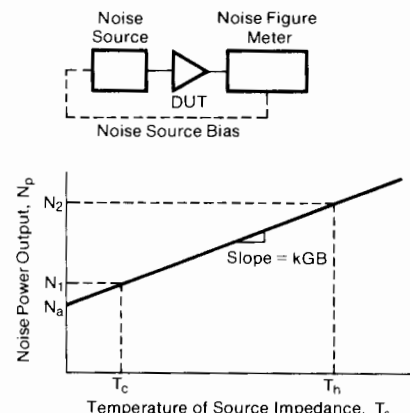

Figure 3. Available noise power and noise figure measurement.

a noise source usually corresponds to the ambient temperature. The hot temperature of a noise source is specified indirectly by its excess noise ratio (ENR), which is given by

$$\text{ENR} = 10 \log \frac{T_h - 290}{290}$$

Before the microprocessor was employed in noise figure meters, several simplifying assumptions had to be made about the noise measurements for the analog circuits of the noise figure meter to display the noise figure. Increasing the measurement accuracy meant backing out the effect of those assumptions with a myriad of calculations and often further measurements. Assumptions commonly made included that T_c was equal to 290K, that T_h was constant at all frequencies, and that the added noise of the measurement system had a negligible effect on the measurement result.

A modern, microprocessor-controlled noise figure meter, the HP 8970A, eliminated those assumptions. It allows variable values of the T_c and it uses a stored table of ENR values at 20 or more frequencies for the particular noise source being used. The noise figure meter automatically interpolates among the stored ENR values for the proper value at each measurement frequency. Through system calibration, the HP 8970A measures the noise contribution of the measurement equipment and sets a gain reference. It can then correct for the noise figure of the measurement system and calculate and display the noise figure and gain of the DUT alone.

The microprocessor also adds a lot of needed conveniences. Examples include the display of effective input noise temperature, T_c , or of noise figure, simultaneous gain measurement, and correction of measurement results for adapter loss.

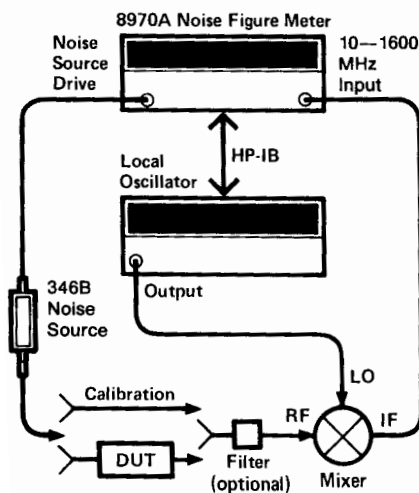

Figure 4. Swept microwave amplifier measurement.

10 MHz to 26.5 GHz Noise Figure Measurement

The HP 8970A can be tuned or swept anywhere between 10 and 1600 MHz. For testing devices and components with output frequencies above 1600 MHz, down conversion to the 10 to 1600 MHz range is necessary (see Figure 4). For measurements on amplifiers from 2 to 26.5 GHz, adding a suitable, commercially available, double-balanced mixer and a suitable LO (such as the HP 8672, 8673, 8340, or 8350) to the HP 8970A and its companion HP 346 series noise sources is all that is necessary. (For mixer and receiver measurement, see Product Note 8970A-1 mentioned below.) Since most low-noise LO's do not extend below 2 GHz, a different technique is often required from 1.6 to 2 GHz (single sideband, discussed in the next section). Through system calibration, the HP 8970A corrects for the noise contribution of the mixer, LO, and the HP 8970A. In Figure 4, the HP 8970A sends frequency commands over the interface bus (HP-IB) to tune the LO across the frequency band of interest. Thus, no external controller is necessary for error-corrected, swept, microwave measurements.

Single Sideband vs. Double Sideband

When an ordinary mixer is used in the setup of Figure 4, all measurements are double sideband. (LO/Noise-source mixing provides two bands, upper and lower sideband, that will convert to the IF). Since the self-calibration and measurement are both double sideband, the HP 8970A will display the correct noise figure and gain. For double sideband measurement, it is best to have a low IF, since the measurement is like an average of upper and lower sideband values.

If double sideband measurement is inappropriate, such as when the DUT response varies rapidly with frequency or in the 1.6 to 2 GHz range mentioned above, a single sideband measurement must be made. For these cases a high IF is best, so that the unwanted sideband may be easily filtered.

For 1.6 to 2 GHz amplifier measurements, for example, one method is to fix the LO to a proper frequency (such as 2.4 GHz), sweep the HP 8970A input (such as from 800 to 400 MHz), and the lower test sideband will sweep from 1.6 to 2 GHz. The upper sideband (sweeping from 2.8 to 3.2 GHz) may be filtered easily (an HP 360C works well). Another method uses a swept LO and an appropriate high fixed IF, with the HP 8970A controlling the external LO. In either case, the HP 8970A displays the measurement frequency during the sweep (1.6 to 2 GHz) and the microprocessor takes care of all of the control chores automatically.

Noise Figure Measurement Applications

Hewlett-Packard's noise figure measurement equipment is exceptional in a variety of applications. It exhibits the following benefits in these applications.

Amplifiers: 1) Simultaneous noise figure and gain measurement, 2) Results automatically corrected for ENR variations, ambient temperature, and mixer, LO, and IF noise contributions, 3) Real-time, swept, corrected output to oscilloscope for easy tuning (display is digitally stored), 4) Automatic control of an external LO for measurements above 1600 MHz without a separate computer.

Transistors: the above benefits, plus: 1) Easy real-time tuning for best noise figure and gain, 2) Real-time tuning to actual transistor F_{min} without second stage effects, 3) Easy single-sideband measurement (high HP 8970A IF makes filtering easy), 4) Low mismatch effects (the HP 346A features virtually identical impedance for T_h and T_c), 5) Easy to program for automatic systems.

Receivers and mixers: 1) Simultaneous measurement of gain (conversion loss) and noise figure, 2) Tunable and swept IF from 10 to 1600 MHz, 3) No external IF gain needed, 4) Automatic ENR correction, even for broadband sweeps, 5) Effects of LO power, IF power, and IF frequency changes on noise figure are easily observed, 6) Easy to program.

Literature

Product Note 8970A-1, Applications and Operation of the 8970A Noise Figure Meter, describes the HP 8970A and many of its applications in more detail. It is both an introduction to the HP 8970A and a summary reference manual.

Product Note 8350A-7, Microwave Noise Figure Measurements Using the 8350A Sweep Oscillator with the 8970A Noise Figure Meter, describes measurements with this popular combination of equipment.

Programming Note 8970A/HP 85-1, Introductory Operating Guide for the 8970A Noise Figure Meter with the HP-85 Personal Computer, shows the ease of programming the noise figure meter, local oscillator, and computer for automatic system using BASIC.

Application Note 57-1, Fundamentals of RF and Microwave Noise Figure Measurements, explains the theory behind noise figure and its measurement. This note includes an extensive glossary of noise related terms.



NOISE FIGURE METER

Automatic Noise Figure Meter, Noise Sources

Models 8970A, 346A/B/C

- Accurate and simple, swept or CW measurements.
- Automatic operation, 10 MHz—26.5 GHz.
- Second stage correction.
- Display of both noise figure and gain.
- Calibrated display on oscilloscope or recorder.
- Powerful special function enhancements.

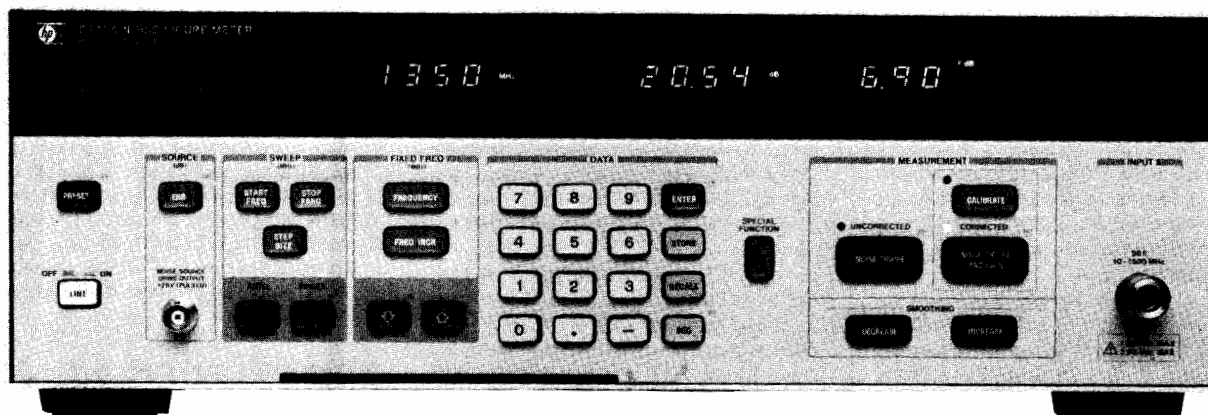

HP 8970A

HP 8970A Noise Figure Meter

With the HP 8970A automatic noise figure meter, accurate and repeatable noise figure measurements are now easy. RF and microwave (with an external local oscillator) measurements from 10 MHz to at least 26.5 GHz are equally simple; any IF between 10 and 1600 MHz may be used. The ENR (Excess Noise Ratio) calibration table of the noise source may be stored in the HP 8970A, and a properly interpolated value is automatically used at each frequency. Automatic second stage correction makes accurate noise figure readings possible even for low gain devices. The HP 8970A's dynamic range allows it to measure either gain up to at least 40 dB (higher in some cases) or loss to -20 dB, with no external attenuation or amplification required.

Microprocessor and Controller Functions

The HP 8970A takes the mystery out of noise figure measurement. It uses a microprocessor to make the myriad calculations and corrections necessary for truly accurate, convenient and flexible noise figure measurement. The HP 8970A also acts as a controller to external HP-IB local oscillators (such as the HP 8673 synthesized signal generator or HP 8350 sweep oscillator) so that swept, broad-band microwave measurements of amplifiers, mixers, and transistors are essentially as simple as RF measurements.

In addition to acting as controller for an HP-IB local oscillator at microwave frequencies, the HP 8970A is fully programmable. Virtually all front panel buttons and functions are accessible over HP-IB, which is Hewlett-Packard's enhanced implementation of IEEE-488.

Simple Calibration and Second Stage Correction

Accuracy is greatly enhanced because the HP 8970A measures its own noise figure (and that of the rest of the measurement system) at up to 81 points. It stores this information, interpolates if necessary, and corrects for it to remove second stage (measurement system) effects. The 8970A also measures the gain of the device under test (DUT).

Display

The HP 8970A has an LED digital front panel display. For swept display of noise figure and gain on an oscilloscope, or x-y recorder, rear panel BNC connectors are available. Either display mode is easily and accurately scaled from the HP 8970A from the front panel to any resolution desired. The swept oscilloscope display allows the design engineer to optimize his DUT in real time for both corrected noise figure and gain. The noise figure display is easily changed from noise figure to effective noise temperature (T_e) if desired, or Y factor.

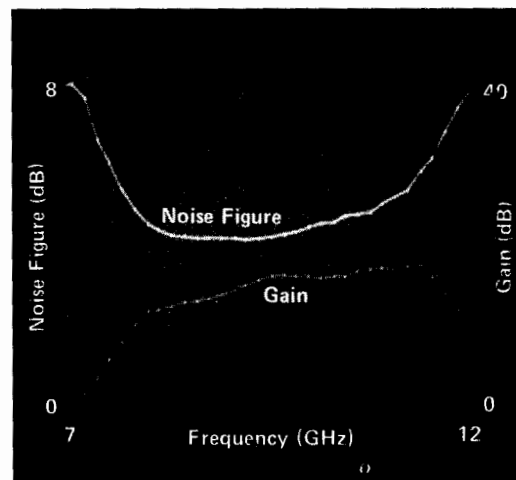

Typical oscilloscope display of amplifier.

Front Panel and Special Functions

The HP 8970A front panel buttons control the number entry, calibration, and measurement functions. STORE, RECALL, and SEQ buttons allow up to 9 front panel settings to be stored and sequenced automatically or manually to save set-up time. Smoothing INCREASE and DECREASE buttons are used to average up to 512 readings before display, to eliminate flicker and increase accuracy.

The simple front panel control of the HP 8970A satisfies many noise figure measurement needs. In addition, for those who may need even greater measurement power, there are more than 150 special functions that are easily selected via a numerical code and the SP button. Two examples are hot-cold measurements and automatic compensation for losses at the input of the DUT. One special function is a catalog that quickly indicates the current special function status. Three pull-out cards serve as a mini-reference manual to the instrument, including most of the special functions, the HP-IB formats and codes, and typical measurement setups. A complete set of service-oriented special functions can also be accessed.

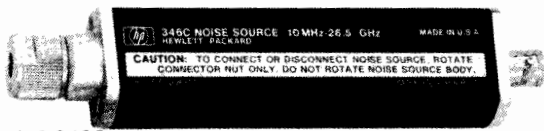

HP 346C

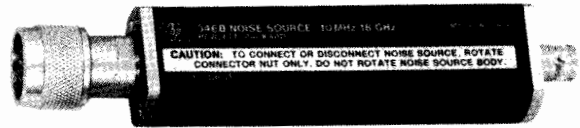

HP 346B (option 001)

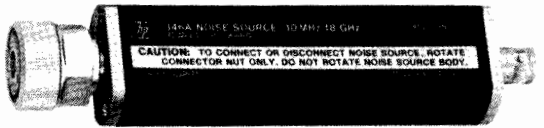

HP 346A (option 002)

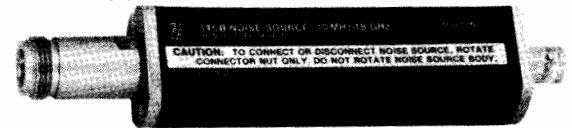

HP 346B (option 004)

Noise Figure Measurement Repeatability and Accuracy

A very troublesome noise figure measurement problem is repeatability. For example, a vendor's system may not measure the same noise figure as his customer's. This is much less of a problem with the HP 8970A. Using randomly selected HP 8970As, HP 346Bs, mixers, and local oscillators, superimposed plots of a single DUT are routinely within 0.1 dB of each other.

The HP 8970A internal circuitry is so accurate and linear that instrumentation uncertainty is less than ±0.1 dB. With the ±0.1 dB ENR uncertainty of the HP 346B at most frequencies, and the uncertainties due to mismatch, total root-sum-square measurement uncertainties of less than ±0.25 are easily attainable.

HP 346A/B/C Broadband Noise Sources

The ideal companion to the HP 8970A is the HP 346 family of noise sources. These noise sources, covering the microwave frequency range up to 26.5 GHz as well as the UHF and IF ranges, make it unnecessary to maintain a different noise source for each frequency band. Each source has individually calibrated values of ENR at cardinal frequencies printed on its label (see illustration) for easy loading into the HP 8970A. The low SWR of each noise source reduces a major source of measurement uncertainty—re-reflections of test signals. The variety of connectors available reduces the need for degrading accuracy with connector adapters.

The HP 346 family of noise sources are designed for a broad range of measurement applications. The HP 346C covers the broadest frequency range, 10 MHz to 26.5 GHz. The HP 346B has a high excess noise ratio, low SWR, and a variety of connectors to make it a general purpose noise source. The HP 346A is especially designed for accurately characterizing the noise figure of DUTs which do not include an isolator at the input, such as GaAsFETs and many UHF amplifiers. Without an isolator such devices can change gain during the noise figure measurement and thereby cause large errors in measuring noise figure. The HP 346A has a very small change in reflection coefficient (<0.01) from ON to OFF to minimize the gain changes. The ENR is large enough (~5.2 dB) to accurately measure noise figures of low noise GaAsFETs and UHF amplifiers.

HP 346 Partial Specifications

(See technical data sheet for complete specifications.)

Frequency range: 10 MHz to 18 GHz for HP 346A/B; 10 MHz to 26.5 GHz for HP 346C.

Excess noise ratio (ENR) limits: HP 346A: 4.5 to 6.5 dB
 HP 346B: 14 to 16 dB
 HP 346C: 12 to 16 dB (10 MHz to 12 GHz) and 14 to 17 dB (12.0 to 26.5 GHz).

Maximum SWR (reflection coefficient) on and off:

HP 346A/B: 10 to 30 MHz — 1.3 (0.13)
 30 to 5000 MHz — 1.15 (0.07)
 5 to 18 GHz — 1.25 (0.11).

HP 346C: 10 MHz to 18 GHz — 1.25 (0.11)
 18 to 26.5 GHz — 1.35 (0.15).

Power required: 28 ± 1 Vdc.

Dimensions: 140 H x 21 W x 30 mm D (5.5" x 0.8 x 1.2").

Weight: net, 0.108 kg (3.5 oz). Shipping, 0.5 kg (1 lb).

8970A Partial Specifications

(See technical data sheet for complete specifications.)

Noise figure measurement range: 0 to 30 dB.

Noise figure instrumentation uncertainty: ±0.1 dB for 0 to 55°C.

Noise figure resolution: 0.01 dB (0.001 dB over HP-IB).

Gain measurement range: -20 to at least 40 dB.

Gain instrumentation uncertainty: ±0.2 dB.

Gain resolution: 0.01 dB (0.001 dB over HP-IB).

Frequency range: tunable from 10 to 1600 MHz.

Tuning accuracy: (from 10 to 40°C) ± (1 MHz + 0.01 × freq.), 6 MHz maximum.

Frequency resolution: 1 MHz.

Noise figure: (for input power levels below -60 dBm) <7 dB + 0.003 dB/MHz.

Maximum operating input power: -10 dBm.

Maximum net external gain: 80 dB between noise source and HP 8970A RF input.

Noise source drive: 28.0 ± 0.1 volt.

HP-IB capability: SH1, AH1, T5, L4, SR1, RL1, PP0, DC1, DT1, C1, C3, C28, E1.

Operating temperature: 0°C to 55°C.

Storage temperature: -55°C to 75°C.

Power: 100, 120, 220, or 240 V (+5, -10%); 48-66 Hz; 150 VA maximum.

Dimensions: 146 H x 425 W x 476 mm D (5.75" x 16.8" x 18.8").

Weight: net, 15.5 kg (34 lb). Shipping, 18.5 kg (40 lb).

| FREQ GHz | ENR dB | FREQ GHz | ENR dB | FREQ GHz | ENR dB |
|----------|--------|----------|--------|----------|--------|
| 0.01 | 5.31 | 0.01 | 15.18 | 0.01 | 13.35 |
| 0.10 | 5.57 | 0.10 | 15.49 | 0.01 | 13.43 |
| 1.0 | 5.36 | 1.0 | 15.26 | 1.0 | 15.49 |
| 2.0 | 5.17 | 2.0 | 15.17 | 2.0 | 13.52 |
| 3.0 | 5.02 | 3.0 | 14.93 | 3.0 | 13.35 |
| 4.0 | 4.90 | 4.0 | 14.86 | 4.0 | 13.29 |
| 5.0 | 4.97 | 5.0 | 14.91 | 5.0 | 13.57 |
| 6.0 | 4.94 | 6.0 | 14.83 | 6.0 | 13.80 |
| 7.0 | 4.99 | 7.0 | 14.90 | 7.0 | 14.04 |
| 8.0 | 5.09 | 8.0 | 15.05 | 8.0 | 14.33 |
| 9.0 | 5.25 | 9.0 | 15.25 | 9.0 | 14.55 |
| 10.0 | 5.36 | 10.0 | 15.39 | 10.0 | 14.77 |
| 11.0 | 5.28 | 11.0 | 15.43 | 11.0 | 15.04 |
| 12.0 | 5.21 | 12.0 | 15.50 | 12.0 | 15.16 |
| 13.0 | 5.02 | 13.0 | 15.41 | 13.0 | 15.37 |
| 14.0 | 4.93 | 14.0 | 14.93 | 14.0 | 15.42 |
| 15.0 | 4.96 | 15.0 | 15.51 | 15.0 | 15.56 |
| 16.0 | 4.99 | 16.0 | 15.55 | 16.0 | 15.66 |
| 17.0 | 5.04 | 17.0 | 15.62 | 17.0 | 15.86 |
| 18.0 | 5.05 | 18.0 | 15.66 | 18.0 | 16.22 |
| | | | | 20.0 | 16.49 |
| | | | | 25.0 | 16.17 |
| | | | | 25.5 | 15.60 |

HP 346A HP 346B HP 346C

Example labels of 346 Noise Sources

Ordering Information

- HP 8970A Noise Figure Meter \$10,300
- Option 907: Front panel handle kit add \$43
- Option 908: Rack mounting flange kit add \$25
- Option 909: Both options 907 and 908 add \$65
- Option 910: Extra operating and service manual add \$25
- HP 346A Noise Source \$1,500
- HP 346B Noise Source \$1,400
- HP 346C Noise Source \$1,900
- Option 001 (HP 346A/B only): Type N (male) connector N/C
- Option 002 (HP 346A/B only): APC-7 connector add \$25
- Option 004 (HP 346A/B only): Type N (female) connector N/C

NETWORK ANALYZERS

Complete Characterization of Linear Networks

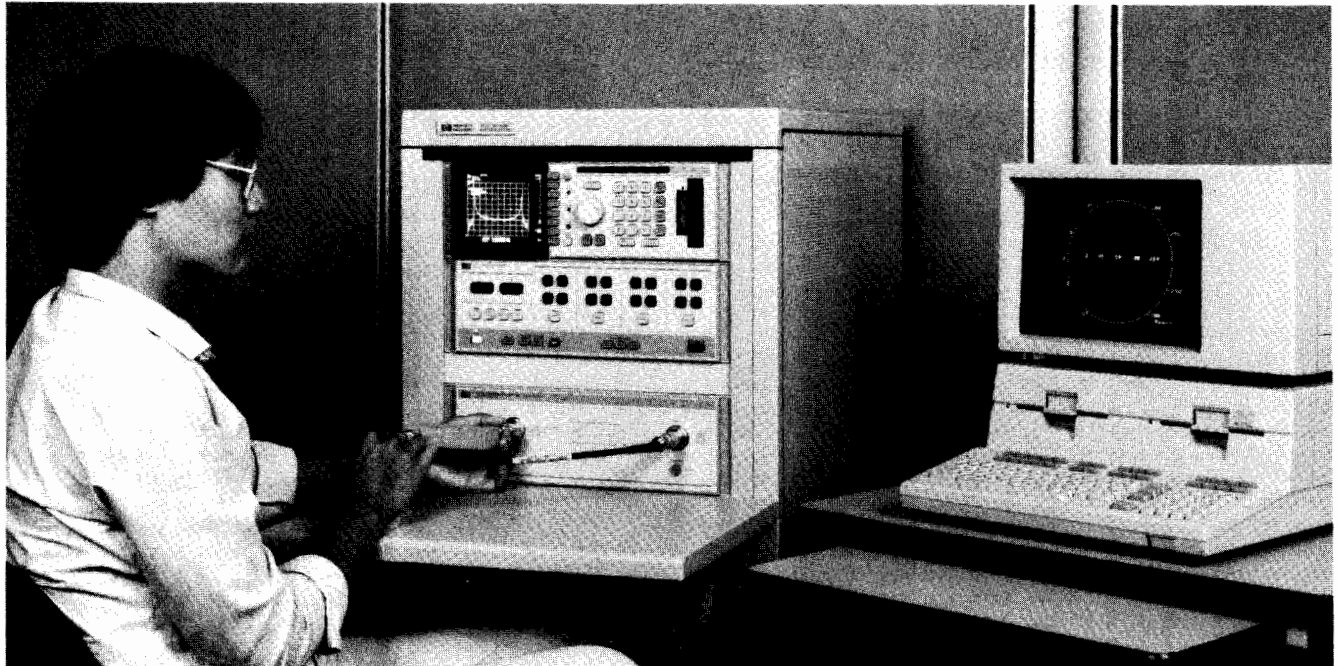

Why Network Analysis?

Characterizing the behavior of linear networks that will be stimulated by arbitrary signals and interfaced with a variety of other networks is a fundamental problem in both synthesis and test processes. For example, the engineer designing a multi-component network must predict with some certainty the final network performances from knowledge of the individual components. Similarly, a production manager must know allowable tolerances on the products manufactured and whether the final products meet the specified tolerances. Network analysis offers a solution to these problems through complete description of linear network behavior in the frequency domain. Additionally, some network analyzers offer the capability to transform measurement data, taken in the frequency domain, to the time domain providing further insight into the behavior of linear networks.

Network analysis accomplishes the description of both active and passive networks by creating a data model of such component parameters as impedances and transfer functions. However, these parameters not only vary as a function of frequency but are also complex variables in that they have both magnitude and phase. Until the advent of the modern network analyzer, phase was difficult to measure at CW frequencies and often involved laborious calculations; these measurements were accomplished by conventional oscilloscopes at lower frequencies and slotted lines at microwave frequencies. However, swept network analyzers now measure magnitude and phase (the total complex quantity) as a function of frequency with less difficulty than conventional CW measurements. Impedance and transfer functions can then be conveniently displayed on a swept CRT, as in Figure 1, X-Y recorder, or computer controlled peripherals such as a printer and/or a plotter. HP computers also combine with network analyzers to give new levels of speed and accuracy in swept measurements that could only be attained previously by long calculations at CW frequencies.

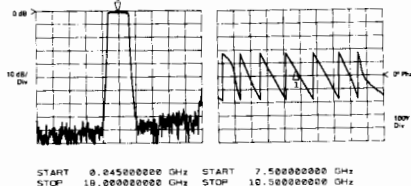

Figure 1. 45 MHz to 18 GHz measurement of magnitude and phase in a single sweep.

Thus, network analysis satisfies the engineering need to characterize the behavior of linear networks quickly, accurately, and completely over broad frequency ranges. In design situations, this minimizes the time required to test new designs and components, allowing more time to be spent on the design itself. Likewise, production test times may be minimized while reducing the uncertainties surrounding the test. Hewlett-Packard manufactures a full line of scalar network analyzers (magnitude only) and vector network analyzers (both magnitude and phase).

What Is Network Analysis?

Network analysis is the process of creating a data model of the transfer and/or impedance characteristics of a linear network through stimulus-response testing over the frequency range of interest. All network analyzers in the HP product line operate according to this definition.

Creating a data model is important in that actual circuit performance often varies considerably from the performance predicted by calculations. This occurs because the perfect circuit element doesn't exist and because some of the electrical characteristics of a circuit may vary with frequency.

At frequencies above 1 MHz lumped elements actually become "circuits" consisting of the basic elements plus parasitics like stray capacitance, lead inductance, and unknown absorptive losses. Since parasitics depend on the individual device and its construction they are almost impossible to predict. Above

1 GHz component geometries are comparable to a signal wavelength, intensifying the variance in circuit behavior due to device construction. Further, lumped-element circuit theory is useless at these frequencies and distributed-element (or transmission-line) parameters are required to completely characterize a circuit.

Data models of both transfer and impedance functions must be obtained to completely describe the linear behavior of a circuit under test. At lower frequencies, h , y , and z -parameters are examples of transfer and/or impedance functions used in network description; at higher frequencies, S -parameters are used to characterize input-output impedances and transfer functions. Therefore, a network analyzer must measure some form of a circuit's transfer and impedance functions to achieve its objective of complete network characterization. Figure 2 shows an example of a swept impedance measurement.

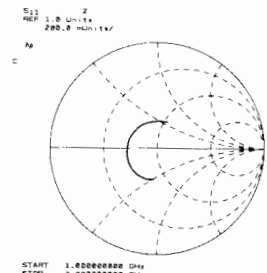

Figure 2. Input impedance of microcircuit amplifier is read directly with Smith Chart overlay for Polar Display.

Network analysis is generally limited to the definition of linear networks. Since linearity constrains networks stimulated by a

sine wave to produce a sine wave output, sine wave testing is an ideal method for characterizing magnitude and phase response as a function of frequency. In non-linear measurements phase is often meaningless and amplitude has to be defined with respect to individual frequency components. For non-linear measurements, refer to the sections on spectrum analyzers, wave analyzers (signal analyzers) and vector modulation products in this catalog.

Network Analyzers

Hewlett-Packard network analyzers are instruments that measure transfer and/or impedance functions of linear networks through sine wave testing. A network analyzer system accomplishes these measurements by configuring its various components around the device under test. The first requirement of the measurement system is a sine wave signal source to stimulate the device under test. Since transfer and impedance functions are ratios of various voltages and currents, a means of separating the appropriate signals from the measurement ports of the device under test is required. Finally, the network analyzer itself must detect the separated signals, form the desired signal ratios, and display the results.

Signal Sources and Signal Separation

In the general case, any sine wave source meeting the network analyzer's specifications can be used to stimulate the device under test. For CW measurements a simple oscillator may suffice; for greater CW frequency accuracy a signal generator or synthesizer may also be desirable. If the analyzer is capable of swept measurements, great economies in time can be achieved by stimulating the device under test with a sweep oscillator or sweeping synthesizer. This allows quick and easy characterization of devices over broad frequency ranges. Some network analyzers will operate only with a companion source that both stimulates the device under test and acts as the analyzer's local oscillator.

At low frequencies it is not particularly difficult to separate the appropriate voltages and currents required for transfer and impedance function measurements. Signal separation is merely the process of establishing the proper shorts, opens, and connections at the measurement ports of the device under test. As frequencies increase, the problem of signal separation usually involves traveling waves on transmission lines and becomes correspondingly more difficult. Hewlett-Packard manufactures test sets (often called "transducers") applicable for separating the appropriate traveling waves in a variety of high frequency measurements.

Broadband and Narrowband Detection

After the desired signals have been obtained from the test set (or transducer) they must be detected by the network analyzer; HP network analyzers can use one of two detection methods. Broadband detection accepts the full frequency spectrum of the input signal while narrowband detection involves

tuned receivers that convert CW or swept RF signals to a constant IF signal. There are certain advantages to each detection scheme.

Scalar network analyzers usually employ broadband detection techniques. Broadband detection reduces instrument cost by eliminating the IF section required by narrowband analyzers but sacrifices noise and harmonic rejection. However, noise is not a factor in many applications, and careful measurement techniques, using filters, can eliminate harmonic signals that would otherwise preclude accurate measurements. Broadband systems are generally source independent while some narrowband systems require companion tracking sources. Finally, broadband systems can make measurements where the input and output signals are not of the same frequency, as in the measurement of the insertion loss of mixers and frequency doublers. Narrowband systems cannot make these measurements.

Vector network analyzers normally employ narrowband detection techniques. Narrowband detection makes a more sensitive low noise detection of the constant IF possible. This allows increased accuracy and dynamic range for frequency selective measurements (as compared to broadband systems) and high resolution through IF substitution using precision IF attenuators. Source dependent narrowband systems utilize a companion tracking source not only to stimulate the device under test, but also to produce a signal offset from the RF by a fixed frequency for tuning the analyzer's constant IF.

Signal Processing and Display

Once the RF has been detected, the network analyzer must process the detected signals and display the measured quantities. All HP network analyzers are multi-channel receivers utilizing a reference channel and at least one test channel; absolute signal levels in the channels, relative signal levels (ratios) between the channels, or relative phase difference between channels can be measured depending on the analyzer. Using these measured quantities, it is possible to either display directly as shown in Figure 2, or compute the magnitude and phase of transfer or impedance functions.

Magnitude measurements fall into two categories, relative and absolute; absolute measurements involve the exact signal level in each channel while relative measurements involve the ratios of the two signal channels. Absolute measurements are usually expressed in voltage (dVB) or in power (dBm). The units dVB are derived by taking the log ratio of an unknown signal in volts to a one volt reference. Similarly, dBm is the log ratio of unknown signal power to a one milliwatt reference.

Relative ratio measurements are usually made in dB, which is the log ratio of an unknown signal (Test Channel) with a chosen reference signal (Reference Channel). This allows the full dynamic range of the instrumentation to be used in measuring variations of both high and low level circuit responses. For example, 0 dB implies the two signal levels have a ratio of unity while ± 20 dB im-

plies a 10:1 voltage ratio between two signals.

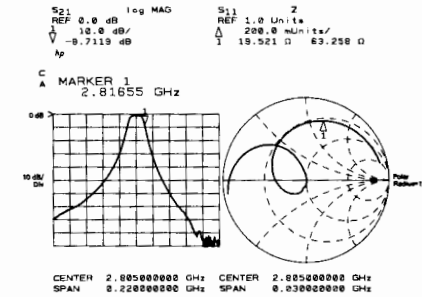

Figure 3. Simultaneous measurement of transmission response and passband reflection coefficient.

All network analyzer phase measurements are relative measurements with the reference channel signal considered to have zero phase. The analyzer then measures the phase difference of the test channel with respect to the reference channel.

Measurement results at CW frequencies may be displayed on analog meters, LEDs or computer controlled printers. Swept frequency measurements of amplitude and phase may be displayed versus frequency on CRTs, digital plotters or X-Y recorders. Insertion Loss is displayed in two different ways in Figure 4. The addition of digital storage and normalization to network analyzer CRTs ensures flicker-free traces and removal of frequency response errors for fast, real-time displays of test device responses versus frequency.

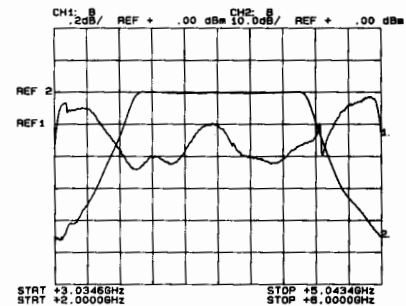

Figure 4. Simultaneous measurement of filter passband and skirts using alternate sweep.

Low Frequency Network Analysis

Networks operating at frequencies below 10 MHz are generally characterized by measuring the gain and phase changes through the network and the associated input and output impedances; h, y, and z-parameters as well as other lumped-component models are typical analytical and computational tools used to represent these measurements. The first derivative of phase with respect to frequency, group delay, is an important measurement of distortion in communication systems. Hewlett-Packard produces a broad line of instrumentation capable of measuring all of these parameters.

Phase information complements amplitude data in the measurement of low frequency parameters. Phase is more sensitive to



NETWORK ANALYZERS

Complete Characterization of Linear Networks (cont.)

network behavior and it is a required component of complex impedance and transfer functions. For instance, phase is required to determine the frequency of network resonances (poles) and anti-resonances (zeros). This is because the phase shift of a network transfer function is exactly zero at the frequency of resonance. Phase information is also vital in circuit design, particularly loop design, where phase margins are critical.

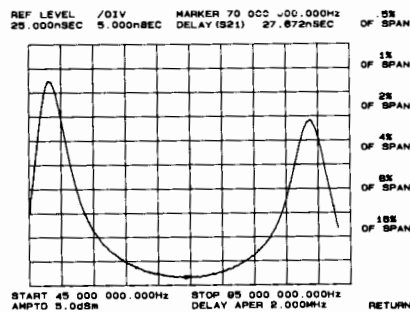

Figure 5. Direct measurement of group delay with digital readout at marker.

Phase data is also required to measure delay distortion or group delay of networks. Delay distortion occurs when different frequency components of a complex waveform experience nonlinear phase shifts as they are transmitted through a network. Group delay is a measure of this distortion and is defined as:

$$T_g = - \frac{d\theta}{d\omega}$$

There are several techniques for measuring group delay; the most common techniques are phase slope, amplitude modulation, frequency modulation, and frequency deviation. Most HP network analyzers can make measurements with at least one of these techniques while several analyzers measure and display group delay directly. Choice of a group delay measurement technique is dependent on the particular device under test and the resolution required.

An alternative method for measuring phase distortion is deviation from linear phase or differential phase. Deviations from linear phase can be measured by introducing enough electrical length in the network analyzer's reference channel to linearize a device's phase shift. Once this has been accomplished it is possible to observe any variations in phase shift linearity at high resolution. Since group delay is the derivative of phase ($d\theta/d\omega$), nonlinearities in phase shift correspond directly to changes in a device's group delay. Figure 6 shows deviation from linear phase and group delay. Introduction of electrical length in the measurement channel may be accomplished by physically adding cable, or it may be accomplished electronically on some network analyzers.

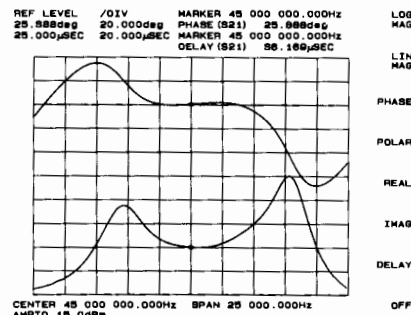

Figure 6. Two independent techniques for measuring filter phase distortion.

At lower frequency (typically ≤ 50 kHz) digital signal analysis using Fast Fourier Transformations (FFT) can also be used to determine the magnitude and phase of transfer characteristics. This subject is treated in the signal analyzers section of this catalog.

High Frequency Network Analysis

Measurements of voltages and currents become more and more difficult as frequency increases. Consequently, h, y, and z parameters lose their usefulness at high frequencies. High frequency network behavior can be better described using transmission line theory in terms of forward and reverse travelling waves. Thus, travelling waves make a logical replacement for voltages and currents in high frequency measurements.

Scattering parameters or S-parameters were developed to characterize linear networks at high frequencies. S-parameters define the ratios of reflected and transmitted traveling waves measured at the network ports. A two-port device is modeled with S-parameters in Figure 7. S_{11} is the complex re-

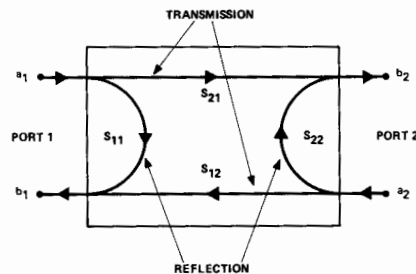

Figure 7. S-parameter model for a two-port linear network.

flexion coefficient at port 1 and is the ratio of b_1/a_1 , if $a_2 = 0$ (port 2 terminated in its characteristic impedance). S_{21} is the complex transmission coefficient from port 1 to port 2, b_2/a_1 , if $a_2 = 0$. The "a" and "b" signals represent the amplitude and phase of the incident and emerging or reflected traveling waves. By reversing the ports and terminating port 1 in its characteristic impedance, S_{22} and S_{12} can be similarly defined. From these definitions, the following equations can be derived:

$$\begin{aligned} E r_1 &= S_{11} E i_1 + S_{12} E i_2 \\ E r_2 &= S_{21} E i_1 + S_{22} E i_2 \end{aligned}$$

where incident signals act as independent variables determining the signals leaving the network. The definition of an S-parameter can be easily extended to multipoint networks; measurement is also easily accomplished by terminating additional ports in their charac-

teristic impedances. Thus, S-parameters completely describe linear network behavior in the same manner as low frequency parameters.

S-parameters offer numerous advantages to the microwave engineer because they are both easy to use and easy to measure. They are easy to measure because the device is terminated in its characteristic impedance, allowing swept broadband frequency measurement without tuning, enhancing the stability of active devices, and permitting a test set up to be used for different devices. The design process is simplified because S-parameters are directly applicable to flow graph analysis. HP network analyzers and the appropriate test sets will measure and directly display S_{21} or S_{12} as gain or attenuation and S_{11} or S_{22} as reflection coefficient, return loss or impedance. Figure 8 shows measurements of both S_{21} and S_{11} . Also, S-parameters may be directly related to h, y, and z-parameters through algebraic transformations.

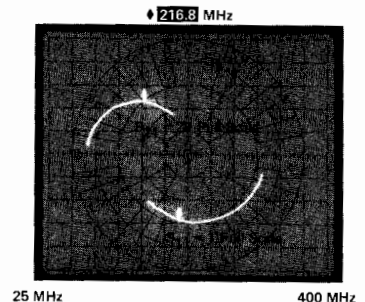

Figure 8. Simultaneous measurement of transistor S-parameters.

Additional Capabilities

Precision design work and manufacturing tolerances demand highly accurate measurements, but most errors in network measurements are complex quantities that vary as a function of frequency. By characterizing and virtually removing these systematic errors, measurement accuracies are improved by several orders of magnitude. Hewlett-Packard now offers network analyzers with built-in, high-speed computational hardware that can perform the complex mathematics required for sophisticated error correction. In many cases, this improvement in accuracy is provided in real time, permitting operator adjustment to the network being characterized while maintaining a high level of measurement accuracy. Other network analyzers, when combined with HP desktop computers into measurement systems, also offer accuracy enhancement through error correction.

Adding the computational capabilities of a digital computer can complement the network analyzer's versatility through simplifying and speeding measurements, data processing, and accuracy enhancement. Hewlett-Packard has combined network analyzers and computers into measurement systems and now offers some analyzers that may be easily interfaced with HP desktop computers through the Hewlett-Packard Interface Bus.

Computer controlled network analyzers can be programmed to set up and make many measurements automatically. The measurement process is further accelerated by the computer's ability to store, transform, sum-



marize, and output data in a variety of formats to a number of peripherals. These capabilities make the computer controlled network analyzer ideal for both computer aided design or automatic production testing.

Network Analyzer Product Line

Hewlett-Packard offers a complete line of network analyzers capable of measurements through the 1 Hz to 40 GHz frequency range. Further information and detailed specifications on individual network analyzers are available on the following pages (see matrix on page 593 for specific page numbers).

HP 3575A

The HP 3575A measures phase and amplitude or gain. With the HP 3575A, the complete response picture is available at a reasonable cost from a single instrument, over an 80 dB range, from 1 Hz to 13 MHz. The HP 3575A uses a broadband measurement technique, which is attractive because the measurement is not constrained by internal tracking source or dedicated external device. The HP 3575A is not dependent on the wave shape, thus measurements can be made on a variety of waveforms such as triangle and square waves.

HP 3577A/3577S

The HP 3577A network analyzer is a combination of superb measurement performance and outstanding network analysis capabilities. The broadband 5 Hz to 200 MHz measurement capability is provided by precise analog design. The accuracy and display flexibility are the result of digital signal processing. Simplicity of operation is the benefit of innovative microprocessor control.

Use the internal synthesized source from 5 Hz to 200 MHz with 0.001 Hz resolution and settability. Measure with 100 dB of dynamic range and 0.02 dB and 0.2 degree dynamic accuracy. Make critical low level measurements with -130 dBm sensitivity in the 1 Hz resolution bandwidth. Move the display marker to resolve points of interest to 0.001 dB and 0.005 deg. Automatic measurements are easy with the HP 3577A's simple programming codes that minimize software development time.

Characterize magnitude/phase performance such as insertion loss/gain, attenuation, group delay, or input/output power. Make simultaneous reflection/transmission measurements with the HP 35677A/B S-parameter test set. Measure reflection quantities such as reflection coefficient, return loss, or impedance. Make higher accuracy reflection measurements possible with built-in vector error correction. Simultaneous transmission and reflection measurements can also be made from 5 Hz - 200 MHz using the cost-effective HP 35676A/B Reflection/Transmission Test Kit.

The HP 3577S Network Analyzer System includes the HP 3577A, HP 35677A/B, HP Model 9000 Series 200 Computer, HP 35678A/B Calibration Kit, and HP 35675A Accuracy Enhancement Software. The HP 3577S offers full 12-term error correction for all s-parameter measurements, conversions from s-parameters to h, y, or z parameters, and convenient disc storage of data and error-correction sequences.

Application areas include communications, crystal filter testing, amplifier and component characterization as well as sonar and disc drive testing.

HP 8405A

The HP 8405A vector voltmeter is a dual-channel RF millivoltmeter and phasemeter. It reads the absolute voltages on either of two channels and simultaneously determines the phase relationship between them. CW measurements can be made over the frequency range 1 MHz to 1 GHz.

Besides its use as a voltmeter, applications of the HP 8405A include:

- 1) Transmission measurements (gain, loss, phase shift and return loss) in 50 Ω systems.
- 2) Group delay and amplitude modulation index.
- 3) In-circuit probing.
- 4) S-parameters in 50 Ω systems.

Application Notes 77-3, 77-4, and 91 are available for more detail on the above measurements.

HP 8754A

The HP 8754A is a completely integrated stimulus/response system for testing a wide variety of networks (such as filters, amplifiers, and attenuators) in the 4 to 2600 MHz frequency range. By combining a swept source, three channel tuned receiver, and polar/rectilinear CRT display into a single compact package, outstanding performance can be achieved at an economical price. Magnitude, phase, polar reflection coefficient and impedance are all measured directly over 80 dB of spurious free dynamic range. Frequency accuracy is provided by a crystal marker system and, since three receiver inputs are available, network transmission and reflection parameters can be measured simultaneously. Additionally, a complete line of 50 Ω and 75 Ω power splitters, transmission/reflection test sets, and S-parameter test sets, is available. A high impedance probe can also be used if necessary, and an external signal generator can be used directly to characterize narrowband devices such as crystal filters.

HP 8505A/8507D

The HP 8505A network analyzer provides measurement capability from 500 kHz to 1.3 GHz. Three RF input ports, each with 100 dB of dynamic range, make possible simultaneous network measurements of reflection

and transmission parameters. Two independent yet identical display channels are each capable of displaying magnitude, phase, deviation from linear phase and group delay of either the transmission or reflection characteristics of an RF network. These parameters can be displayed in rectangular, in polar coordinates or both formats at the same time. The swept source, which is an integral part of the analyzer, offers extreme frequency flexibility through seven different modes of operation.

The HP 8507D is an automatic network analyzer using the HP 8505A with HP-IB interface and one of the HP 9816S, 9826S, or 9836S computers. The HP 8507D is well suited for laboratory applications because of the accuracy enhancement software available with the system. The HP 8507D is also well suited for manufacturing applications where fast, repeatable testing is necessary. Test data can also be reformatted and outputted to an external plotter for permanent documentation.

HP 8410C/8408B

The HP 8410C network analyzer system measures the transmission and reflection characteristics of linear networks in the form of gain, attenuation phase shift, reflection coefficient, normalized impedance and S-parameters in the frequency range of 110 MHz to 18 GHz.

The HP 8410C is a ratiometer using both reference and test signal inputs; consequently, the sweeper output must be divided into channels. This is accomplished by a "Test Set" whose other major function can be to provide the switching required for making transmission and reflection measurements with minimum or no changes in the measurement setup. Hewlett-Packard offers test sets covering various frequency ranges and switching functions.

Another major instrument required in the HP 8410 measurement system is a unit for the detection and display of the IF amplitude and phase. Two plug-in displays (for the HP 8410C mainframe) are available for this purpose: a phase-gain display for displaying log amplitude and phase versus frequency; and a polar display for displaying amplitude and phase in polar coordinates.

The HP 8410C is capable of swept measurements over multi-octave bands through 18 GHz. Measurements of more than 60 dB of attenuation and 40 dB of gain are possible.

The HP 8408B is a low cost, automatic network analyzer system based on the HP 8410C network analyzer, the HP 8350B sweeper and the HP 85B desktop computer. Using automatic error correction techniques, primarily in reflection, the HP 8408B offers the capability of making more accurate measurements than with the HP 8410C manual system.



NETWORK ANALYZERS

Complete Characterization of Linear Networks (cont.)

HP 8510A/8510T

The HP 8510 series microwave vector network analyzers provide complete measurement capability for characterization of linear networks from 45 MHz to 26.5 GHz. Full feature systems operating to 60 GHz can be customer configured. Two independent, yet identical, display channels can be used to view the log/linear magnitude, phase, or group delay response of a test device. The display channels may be viewed individually or simultaneously with measurement results presented in either a rectangular or polar/smith chart format. Powerful trace math, data averaging, smoothing, and electrical delay functions provide performance improvement and measurement flexibility. Internal, non-volatile, storage of instrument front panel states, calibration sets, and measurement data is available. A built-in tape cassette unit extends the storage capacity. Measurement results may be printed or plotted directly to a compatible peripheral without the need of an external computer. The system is completely programmable through the Hewlett-Packard Interface Bus.

An internal, high-speed computer controls all aspects of system operation and data processing, and provides the powerful capability to perform the complex mathematics required for vector error correction. Frequency response, one port, and full two port measurement calibrations are available. System speed is such that measured data is error-corrected, yet displayed in virtual real time, allowing for operator adjustment of the test device while retaining a high level of measurement accuracy.

Optionally, transformation of measured data from the frequency domain to the time domain is available, providing the ability to view the response of a test device as a function of time. The time domain response presents the individual responses of a network as a function of time (or distance), permitting identification of specific discontinuities within the test device. Individual responses can be isolated within settable "gates," and viewed in the frequency domain without the effect of the responses outside the gate.

A total measurement system comprises a source (either the HP 8350 series sweep oscillators or HP 8340A/8341A synthesized sweepers) and one of four broadband test sets. The test sets provide either reflection/transmission or full S-parameter measurement capability. The S-parameter test sets include test channel attenuators and bias networks for application in active device characterization. All four test sets include an integrated three- or four-channel frequency converter. The HP 8511A is a four-channel frequency converter covering the 45 MHz to 26.5 GHz frequency range, and it can be combined with a customer supplied test setup for customized test requirements. Additionally, a complete line of calibration/verification kits, test port return cables, and other measurement accessories are available.

The HP 8510T network analyzer system provides, under one model number, the highest performance network measurement system available. Covering 45 MHz to 26.5 GHz, it includes the HP 8515A S-parameter test set and HP 8340A synthesized sweeper in a four foot high mobile rack along with a comprehensive array of standards, verification kits, and accessories. Also, included are system installation and one year on-site warranty.

Scalar Network Analyzers

Scalar (magnitude only) network analyzers use economical broadband diode detectors for swept frequency measurements. These detectors, along with broadband bridges, permit transmission and reflection measurements from 10 MHz to 26.5 GHz with one system. Because many devices can be sufficiently characterized by magnitude versus frequency measurements, the need for complex, costly phase measuring circuitry in the network analyzer is eliminated. A scalar measurement system usually consists of a scalar network analyzer, sweep oscillator, detectors and a signal separation device (such as a directional coupler or bridge). In addition, many scalar systems utilize computers for automatic testing and data collection. Scalar network analyzers have enjoyed wide acceptance in research and development, manufacturing and field service testing applications.

HP 8757A/8757S

The HP 8757A is Hewlett-Packard's highest performance scalar network analyzer. It can make swept frequency transmission and reflection measurements from 10 MHz to 60 GHz. Each of the three (or optionally four) detector inputs can be displayed independently in an absolute power measurement mode (A, B, C or R) or in a ratio measurement mode (A/R, B/R, C/R or any other combination). A built-in trace memory for each channel enables normalized measurements that can be saved with the front panel settings in the SAVE/RECALL registers.

Alongside the CRT are several keys whose functions are defined in the HP 8757A internal memory. These "soft keys" make a large number of measurement functions available without adding front panel complexity. For example, the "open/short cal" soft key guides the user through the steps involved in an open/short calibration for reflection measurements. The plot soft key allows the user to plot the output to an HP-IB plotter of the CRT trace, graticule and annotation.

Soft keys allow the user to make any measurements that have previously required a computer. For example, the cursor soft keys enable the user to measure the 3 dB (or any other value) frequencies of a band limited device. Another soft key allows the user to specify limit lines that appear on the CRT for simple pass/fail testing. After the device under test has been adjusted, measurement results can be plotted and titled using the plot soft keys.

Add a computer for fully automated transmission and reflection testing. All functions and front panel controls are programmable via the HP-IB with simple 3 letter codes. In addition to complete programmability, the HP 8757A can output data back to a computer very fast. A 401 point trace of measurement data can be transmitted in 35 milliseconds.

The HP 8757S automatic scalar network analyzer system is an ordering convenience that consists of all the instruments and accessories needed for automated measurements of insertion loss or gain, return loss, SWR, and power. The system is based on the HP 8757A scalar network analyzer and is controlled by an HP 9000 series 200 computer over the HP-IB. Also included in the system are a sweep oscillator, a high directivity (40 dB) directional bridge, detectors, accessories, and the HP 85015A or HP 85016A system software.

The HP 85015A system software allows the user to configure and run automatic scalar measurements with simple menu selections. No programming is needed to perform, display, plot or print scalar measurements.

The HP 85016A transmission line test software enables the user to completely characterize coaxial cables and waveguide runs. Measure insertion and return loss of the transmission line, calculate an inverse Fast Fourier Transform, and plot return loss versus distance to locate bad connections and faults.

HP 8756A/8756S

The HP 8756A is also a microprocessor based scalar analyzer that measures swept frequency transmission and reflection. Its "soft keys" offer a subset of the functions defined for the new HP 8757A described above. The 3 detector inputs can be displayed on either of two display channel in a power measurement mode or ratio measurement mode. A built-in trace memory for each channel enables normalized measurements to be made at any resolution or offset. A fully annotated graphics CRT displays the measurement trace, scale per division, input being measured, and start and stop frequencies (when using an HP 8350B, 8341A or 8340A sweep oscillator).

The HP 8756A uses an ac detection scheme to reduce the effects of RFI, noise, and time and temperature drift. The HP 11664 detectors described above are also compatible with the HP 8756A, as are the directional bridges, power splitters, and other measurement accessories.

All functions and front panel controls of the HP 8756A are programmable via the HP-IB. With an HP 9000 series 200 computer, the HP 8756S automatic scalar network analyzer can make fully automated transmission and reflection measurements. The HP 85015A and HP 85016A software products are completely compatible with the HP 8756S.



Network Analyzer Product Line Summary

| HP Model | Frequency Range | Source | Measurement Capabilities |
|--|----------------------|--|--|
| 3577A Network Analyzer Page 605 | 5 Hz to 200 MHz | Synthesized Source | Transfer functions, magnitude/phase, insertion loss/gain, attenuation, electrical length, gain compression. Group Delay, Deviation from Linear Phase HP-IB Programmable |
| 3577S Network Analyzer System Page 610 | 100 KHz to 200 MHz | Synthesized Source | All the capabilities of the HP 3577A, in addition to full 12-term vector error correction, conversion from s-parameters to h, y, or z parameters, and convenient disc storage of device data, calibration data, and instrument states. |
| 3582A Spectrum Analyzer Page 701 | 20 mHz to 25.599 kHz | Built-in source that is selectable as either random or pseudorandom. The noise signal is automatically band-limited and band-translated to match the analysis. | Transfer function amplitude and phase. Coherence function. Transient capture and analysis. |
| 3575A Gain Phase Meter Page 612 | 1 Hz-13 MHz | None | Gain, Phase and Amplitude Low Frequency Analysis |
| 8405A Vector Voltmeter Page 617 | 1 MHz-1 GHz (CW) | HP 3200B Oscillator, VHF Signal Generators, HP 8654 (UHF), and HP 8640 A/B | Voltmeter Transfer Functions, Impedance in 50 Ω systems Group Delay, Amplitude Modulation Index S-parameters in 50 Ω systems |
| 8754A Network Analyzer Page 614 | 4-2600 MHz | Swept source included external source usable. | Magnitude and phase transmission coefficient reflection coefficient and return loss S-parameters, impedance. |
| 8505A RF Network Analyzer Page 618 | 500 kHz-1.3 GHz | Swept Source Included | Complex Transfer functions—Gain/Loss or S-parameters Complex Impedance—T, Return Loss, R_{\pm} jX Distortion—Group Delay, Deviation from Linear Phase Digital Readout of Data while sweeping Frequency Counter included HP-IB with Learn Mode |
| 8507S Automatic Network Analyzer Page 624 | 500 kHz-1.3 GHz | Swept Source Included | HP 8507D Network Analyzer Subsystem HP 85011A System Software HP 9816, 9817, 9826, or 9836 Computer Automatic Measurements with Data Formatting and Graphics. Error corrected measurements. |
| 8756A Scalar Network Analyzer Page 603 | 10 MHz-60 GHz | HP 8350 or 8620 Series Sweep Oscillators, HP 8340A/8341A Synthesized Sweeper | Scalar Transmission/Reflection Measurements 50 Ω Coax Measurements 10 MHz-26.5 GHz 75 Ω Coax Measurements 10 MHz-2.4 GHz Waveguide Measurements 26.5 GHz-60 GHz Open/Short Averaging, Normalization, Averaging Storage Registers, HP-IB Programmable |
| 8756S Automatic Scalar Network Analyzer Page 603, 604 | 10 MHz-60 GHz | HP 8350 Series Sweep Oscillators, HP 8340A/8341A Synthesized Sweeper | Automatic Scalar Transmission/Reflection Measurements Custom configurable test sequences Automatic data collection and storage HP 9816, 9817, 9826 or 9836 Computer |
| 8757A Scalar Network Analyzer page 596 | 10 MHz-60 GHz | HP 8350 or 8620 Series Sweep Oscillators, HP 8340A or 8341A Synthesized Sweepers | Scalar Transmission/Reflection Measurements 50 Ω Coax Measurements 10 MHz-26.5 GHz 75 Ω Coax Measurements 10 MHz-2.4 GHz Waveguide Measurements 26.5 GHz-60 GHz Open/Short Averaging, Normalization, Averaging, Limit Testing Storage Registers, HP-IB Programmable |
| 8757S Automatic Scalar Network Analyzer Page 594, 604 | 10 MHz-60 GHz | HP 8350 or 8620 Series Sweep Oscillators, HP 8340A or 8341A Synthesized Sweepers | Automatic Scalar Transmission/Reflection Measurements Custom configurable test sequences Transmission line testing with fault location HP 9816, 9817, 9826 or 9836 Computer |
| 8410C Network Analyzer Page 632 | 110 MHz-18 GHz | HP 8350, 8620 Series Sweep Oscillators | Transmission/Reflection Characteristics, S-parameters 50 Ω Coax Measurements 110 MHz to 18 GHz Continuous Multioctave Measurements with HP 8620 and 8350 Series Sweepers DC Bias for Semiconductor Measurements |
| 8408S Automatic Network Analyzer Page 637 | 110 MHz-18 GHz | HP 8350 or 8620 Series Sweep Oscillators | Automatic Transmission/Reflection Measurements Full Error Correction in Reflection Measurements Tracking Error Correction in Transmission Measurements HP 8410C Network Analyzer System HP 85F Desktop Computer |
| 8510 Series Network Analyzer Page 626 | 45 MHz to 60 GHz | HP 8350 Series Sweep Oscillators HP 8340A, 8341A Synthesized Sweepers | Transmission/Reflection Characteristics S-parameters Active device characterization Full error correction in real time Time domain capability Full HP-IB programmability |

NETWORK ANALYZERS

Automatic Scalar Network Analyzer System (10 MHz to 60 GHz)

Model 8757S

- Measure insertion loss or gain, VSWR, and power
- Customize automatic tests without programming
- Plot and display data
- Troubleshoot waveguide and coax

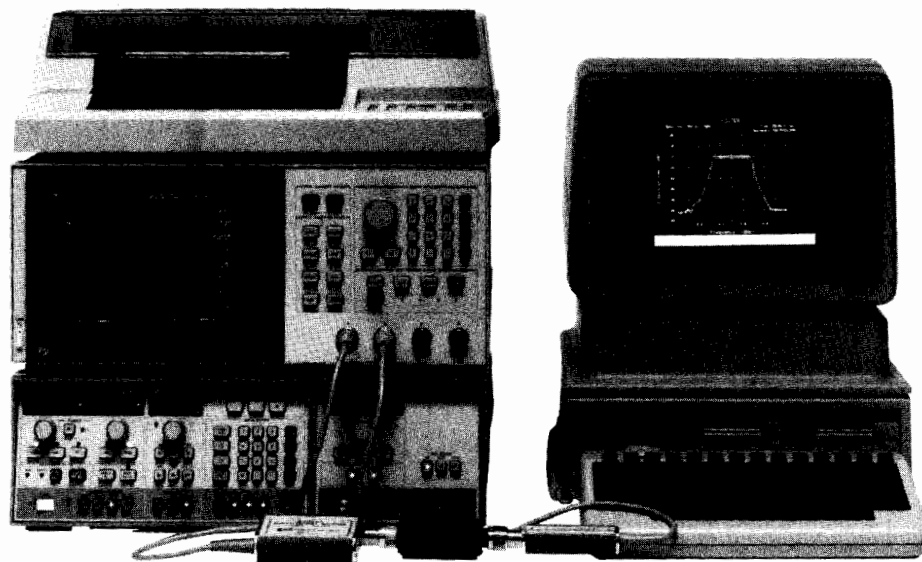

HP 8757S

The HP 8757S is a complete automatic scalar network analyzer for measurements of insertion loss or gain, return loss, and power from 10 MHz to 60 GHz. The system is based on the HP 8757A scalar network analyzer and is controlled by an HP 9000 series 200 computer (HP 9816, 9817, 9826, or 9836) over the Hewlett-Packard Interface Bus (HP-IB). Also included in the system are a swept source (HP 8350B sweep oscillator with RF plug-in or HP 8340A/8341A synthesized sweeper), a high directivity (40 dB) directional bridge, detectors, accessories, and the HP 85015B or 85016B system software. All analyzer and source controls are completely programmable.

Increase Productivity

The HP 85015B system software saves time and money in scalar measurements, and allows you to increase throughput without any programming. The simple menus and soft keys guide you through the measurement process. Informative "help" messages are always available for extra guidance. Frequently performed measurements may be saved for future use on the computer disc. When these test configurations are later recalled, the system is completely programmed with frequency limits, measurement channels, calibration data... everything you need to perform and display scalar measurements. The chances for operator error are greatly reduced, and repeatable, accurate data is ensured.

Troubleshoot Transmission Lines

The HP 85016B transmission line test software adds accurate fault location to the system. In addition to the frequency response of waveguide runs and coaxial cables, plot return loss data as a function of distance along the line. Locate bad connections and faults that cause reflections in the frequency range of interest.

Flexible Plot and Print Formats

Plot or print data and CRT graphics in your choice of formats without any programming. Select automatic scaling of either the vertical or horizontal axes (or both). Customize your own plot configuration with or without labels, grid lines, limit lines, and out-of-spec indicators. Plot up to four plots on a single page or print the data in the format you find most useful.

Easy to Use

In either manual or automatic operation, the HP 8757S is easy to operate. The fully annotated HP 8757A CRT is the system's control center with convenient display of frequency, power, and scaling parameters. Manual measurements can be easily controlled with the front panel function keys. With the system software and the entire HP 8757S system, even complex scalar measurements can be performed with ease.

High Performance

Each component of the HP 8757S is a high performance instrument in its own right. Together they form a very high performance automatic scalar network analyzer.

The HP 8757A scalar network analyzer offers 76 dB of dynamic range (+16 to -60 dBm) in three (or optionally four) independent inputs (A, B, (C), and R) when used with the HP 11664A/E detectors. Single inputs or ratio combinations of the inputs can be displayed on any of four independent display channels. Using AC modulation and detection, the HP 8757A provides excellent performance in the presence of unmodulated noise and spurious signals. The HP 11664 detectors cover the range from 10 MHz to 40 GHz and the HP 11664C detector adapter can be used with waveguide detectors for higher frequency operation. The HP 85025 AC/DC detectors cover the range from 10 MHz to 26.5 GHz and offers the choice between AC and DC detection. In DC mode, the HP 85025 detectors can be used to provide excellent swept power measurements (dBm).

New HP Q/U 85026 detectors extend the frequency coverage over the Q (33-50 GHz) and U (40-60 GHz) waveguide bands.

Test signals are provided by the HP 8350B sweep oscillator with an RF plug-in or by the HP 8340A/8341A synthesized sweepers. All source front panel functions are fully programmable via HP-IB and are also easy to use in manual applications. Frequency and power entries can be made with a knob, a numeric keypad, or with increment and decrement keys. Up to nine independent front panel settings may be saved or recalled at the touch of a key or through HP-IB.

System Specifications

ACCURACY

Transmission Loss or Gain Measurement Accuracy: Transmission loss or gain measurements are made relative to a 0 dB reference point established at calibration. The measurement accuracy is equal to the uncertainty due to the change in power level, called dynamic accuracy, plus mismatch uncertainty. The frequency response errors of the source, detectors, bridge and power splitter may be removed via calibration.

Dynamic Power Accuracy ($25 \pm 5^\circ\text{C}$):

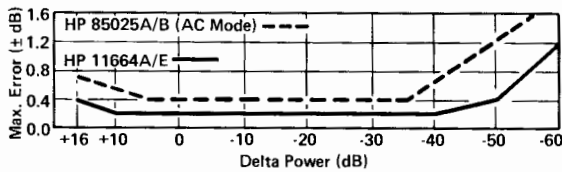

Absolute Power Measurement Accuracy: This specification is useful for determining the accuracy of power measurements in dBm when using the HP 85025A/B detectors in the DC mode. Absolute power measurements are not made after a "through" calibration, thus the total uncertainty is the sum of the detector frequency response, power accuracy, and mismatch uncertainties.

Absolute Power Accuracy (HP 85025A/B detectors in DC mode, detector offsets removed via power meter cal, $25 \pm 5^\circ\text{C}$):

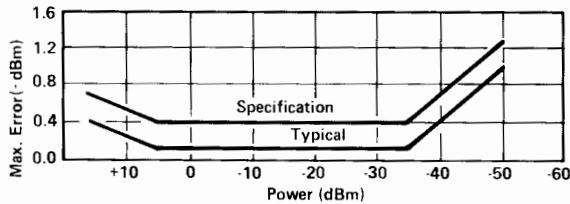

Detector Frequency Response (HP 85025A/B detectors, $25 \pm 5^\circ\text{C}$):

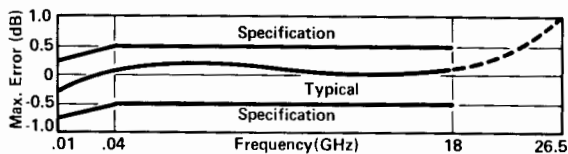

DYNAMIC RANGE (on all HP 8757A detector inputs):

| Detector | Range |
|---------------|----------------|
| HP 11664A/E | +16 to -60 dBm |
| HP 11664D | +10 to -50 dBm |
| HP 85025A/B | |
| AC mode | +16 to -55 dBm |
| DC mode | +16 to -50 dBm |
| HP Q/U 85026A | |
| AC mode | +10 to -45 dBm |
| DC mode | +10 to -40 dBm |

Reflection Measurement Accuracy: Uncertainties due to calibration error and the frequency response of the source, detectors and bridge are removed via open/short averaging. The remaining uncertainties are primarily the sum of directivity uncertainty, effective source match uncertainty, and dynamic power accuracy. As shown in the graphs below, directivity is the dominant error term when measuring small reflected signals (high return loss) and source match is dominant when measuring large reflected signals (low return loss).

The Effect of Effective Source Match on Reflection Uncertainty:

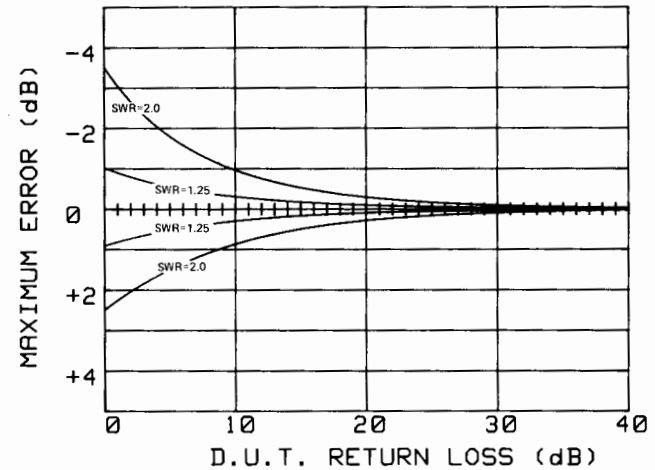

The Effect of Directivity on Reflection Uncertainty:

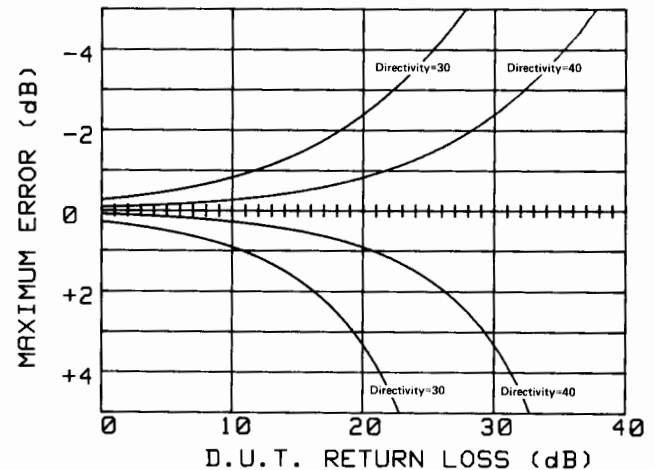

Dynamic Power Accuracy (HP 85027/20 bridges, $25 \pm 5^\circ\text{C}$):

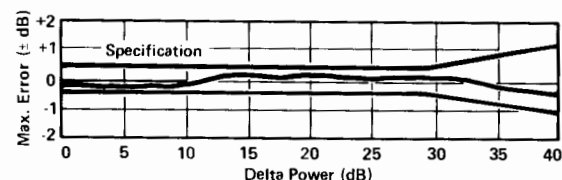



NETWORK ANALYZERS

Scalar Network Analyzer, 10 MHz to 60 GHz

Model 8757A

- 76 dB dynamic range
- Accurate swept power measurements (dBm)
- 40 dB directivity bridges
- Four independent display channels
- Limit testing built in
- Save/recall setup and cal data
- Direct plotter output

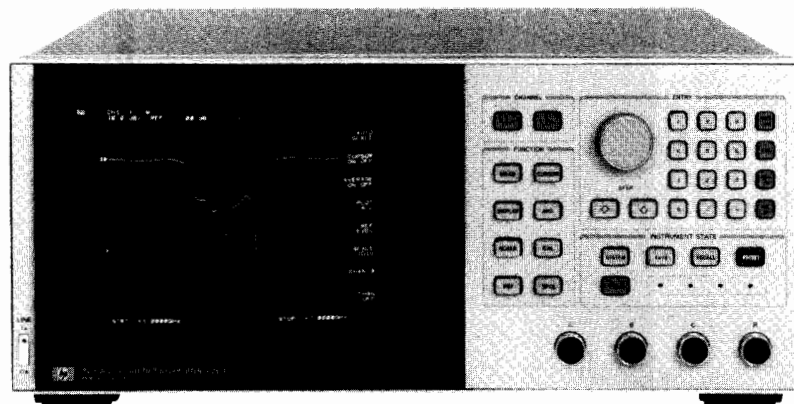

HP 8757A Option 001

Description

Measure insertion loss or gain, return loss, SWR, and power quickly and accurately with the new HP 8757A scalar network analyzer. With high performance detectors and directional bridges and a companion HP source and digital plotter, the HP 8757A becomes the basis of a complete measurement system with superb performance.

Performance

The HP 8757A features 76 dB of dynamic range (-60 dBm to $+16$ dBm) when used with the HP 11664A/E detectors. With square wave modulation and detection (AC), the HP 11664 detectors enable reliable, drift-free measurements from 10 MHz to 40 GHz. With the new HP 85025 AC/DC detectors, make scalar measurements with or without modulation. In DC mode (no modulation), use the HP 85025A/B to make accurate swept-frequency measurements of power (dBm).

High directivity bridges (>40 dB) covering RF and microwave frequencies help produce excellent measurement results. Using the HP 85020A/B and 85027A/B/C directional bridges, make accurate measurements of reflection and transmission parameters simultaneously.

Calibrate your test system, and make normalized measurements with 0.01 dB vertical resolution. Select the optimum horizontal resolution for your application, by choosing 101, 201, 401, 801, or 1601 data points. Lower resolution allows faster sweep times. Calibrate with full 1601 point resolution over your frequency range. Then zoom in on a narrower frequency span and retain calibration. The HP 8757A interpolates the calibration data automatically.

Easy to Use

With a combination of simple front panel keys and powerful menu-driven soft keys, the HP 8757A allows you to set up the system and make accurate measurements fast. Menus appear on the display, and you control them with the front panel soft keys. The soft keys give you powerful capabilities without adding front panel complexity. Press "Cal" and let the menu guide you through calibration procedures. Press "Autoscale" to bring your measurement into view quickly. Activate the "Cursor" and dial it to any point on your data trace for an accurate high resolution reading of magnitude (and frequency with the HP 8350B/8340A/8341A). Measurements are fast and easy.

Productivity Without a Controller

The HP 8757A increases productivity in scalar measurements even without a controller. Decrease the time it takes you to set up and make measurements, while improving the quality of the results.

Enter your own limit lines for easy comparison of measurement results to upper and lower specification limits. Or use these lines as

your own reference calibration and remove the frequency responses of devices that are inserted after calibration.

Four independent display channels add new capabilities to the system. Each channel can display the data taken from any of the three (or optionally four) detector inputs. Each channel can display a single input (A, B, (C), R) or a ratio combination of two inputs (A/R, B/R, A/B, etc.). With four inputs, measure multi-port devices or characterize several devices simultaneously. Or compare the response of the test device to the stored response of your "reference" device.

When used with the HP 8350B sweep oscillator or the HP 8340A/8341A synthesized sweepers, the HP 8757A acts as a system controller by managing the source via the "8757 System Interface." Using this interface the HP 8757A can extract frequency information and annotate the display. When used alone, the HP 8757A can save and recall up to nine front panel states in non-volatile memory, complete with calibration or measurement data, limit lines, and plot labels. With the system interface and a companion HP source, the HP 8757A can save and recall not only its own front panel state, but the source's as well. Configure often repeated measurements only once. Then just recall that set-up and connect your device.

Combining the HP 8757A with an HP 8350B/8340A/8341A also enables the useful "alternate sweep" function, which allows you to sweep different frequency ranges or power levels and display them both in real time.

The HP 8757A can adapt to any sweep ramp input in the 0-10 V range, such as a 2-5 V ramp. Test voltage-controlled oscillators and attenuators, using your test voltage ramp to drive the HP 8757A display. Plot output power or attenuation versus tuning voltage.

Document Your Results

The HP 8757A also uses the "8757 System Interface" to drive an HP-IB digital plotter or "ThinkJet" printer. Plot what appears on the CRT or define your own plot and plot size. Get crisp, permanent, annotated plots without a controller.

Millimeter Wave Measurements

Extended scalar measurements to millimeter-wave frequencies with the HP 8757A and the waveguide detector for your frequency range. For swept frequency measurements from 26.5 to 40 GHz, choose the HP 11664D waveguide detector. The new HP Q85026A and U85026A detectors offer fully calibrated scalar measurements in the frequency bands 33-50 GHz (Q) and 40-60 GHz (U). Add an HP millimeter-wave source and waveguide coupler for a complete scalar measurement system to 60 GHz. Above 60 GHz use your own waveguide detector with either the HP 85025C (AC/DC) or 11664C (AC only) detector adapters.

NETWORK ANALYZERS

8757/8756 System Accessories

Models 8757A, 85027A/B/C, 85020A/B

597



HP 8757A Specifications

Amplitude Characteristics

Independently controlled for each channel.

Reference offset: offset level adjustable in 0.01 dB increments from -70 to +20 dBm (power measurement) or -90 to +90 dB (ratio measurement).

Display characteristics

Resolution

Vertical: 0.003 dB (power measurement)
0.006 dB (ratio measurement)
0.01 dB for "Display Cursor"

Horizontal: 101, 201, 401, 801, or 1601 data points

Sweep time/number of traces: minimum sweep time and maximum number of display traces depend on horizontal resolution.

| Number of Points | Minimum Sweep Time | Number of Traces |
|------------------|--------------------|------------------|
| 101 | 50 ms | 4 |
| 201 | 100 ms | 4 |
| 401 | 200 ms | 4 |
| 801 | 200 ms | 2 |
| 1601 | 200 ms | 1 |

Modulation Requirements (for HP 11664 detectors and HP 85025/26 detectors in AC mode):

Square-wave amplitude modulation

Frequency 27,778±20 Hz

≥30 dB on/off ratio

45% to 55% symmetry

Averaging: 2,4,8,16,32,64,128, or 256 traces may be averaged.

Normalization: traces are stored and normalized with the highest resolution, independent of display scale/division or offset. Calibration data can be saved and recalled with instrument states, and is interpolated when the frequency span is decreased.

HP-IB Characteristics

Transfer formats: Data may be transferred either as ASCII strings (nominally six characters per reading) or as 16 bit integers (most significant byte first). Readings may be taken at a single point, or an entire trace may be transferred at once.

Transfer speed:

ASCII format, 401 point trace: 500 ms typical.

ASCII format, point: 10 ms typical.

Binary format, 401 point trace: 30 ms typical.

Binary format, point: 7 ms typical.

System Interface

Description: the HP 8757A system interface is a dedicated HP-IB port used exclusively by the HP 8757A to control and extract information from a swept source and a digital plotter or "Thinkjet" printer.

Swept sources: HP 8350B with RF plug-in, HP 8340A/8341A synthesized sweeper, or any source that provides a sweep ramp in the range of 0-10 volts.

Plotters: HP 7470A, 7475A, 7550A, 7090A

General Specifications

Power requirements: 48 to 62 Hz, 115/230 V ±10%, typically 100 watts.

Dimensions: 178 H x 425 W x 482 mm D (7.0 x 16.75 x 19.0 in.).

Weight: net, 21 kg (46 lb); shipping, 33 kg (73 lb).

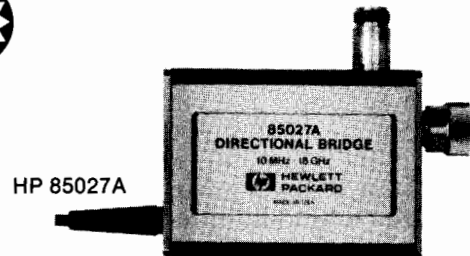

HP 85027A

• 40 dB Directivity

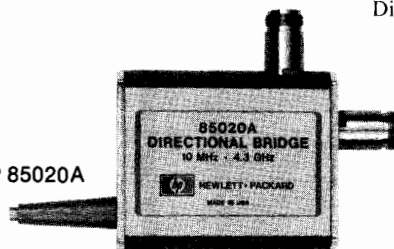

HP 85020A

Directional Bridges

The HP 85020A/B and HP 85027A/B/C are directional bridges designed especially for the HP 8757A, 8756A and 8755C scalar network analyzers. Each bridge features outstanding directivity and test port match in a compact, rugged package.

Within each bridge, one zero-bias Schottky diode detector measures the return loss of the test device. Ratio measurements can be made by adding a power splitter (HP 11667A/B) and detector (HP 11664 series or HP 85025 series).

HP 85027A/B/C Directional Bridges

The HP 85027 series directional bridges are designed to operate with the HP 8757, 8756 and 8755 scalar network analyzers for reflection measurements from 10 MHz to 26.5 GHz. A switch on the HP 85027 series bridges allows the user to configure them for operation with the HP 8757 or the HP 8756 and 8755 scalar network analyzers.

When used with the HP 8757A scalar network analyzer, the HP 85027 series bridges allow the user to choose the measurement mode that best suits the application. Use the bridge's AC mode (modulated RF) for measurements in the presence of undesired signals such as broadband noise or electromagnetic interference. Or choose the bridge's DC mode (unmodulated RF) to measure the return loss of modulation sensitive devices such as amplifiers with gain control circuits. Use the companion HP 85025 series detectors for AC and DC measurement versatility or the HP 11664 series detectors for AC only measurements.

High (40 dB) directivity and excellent test port match ensure accurate reflection measurements over a broad swept frequency range. The HP 85027B bridge operates from 10 MHz to 26.5 GHz and has an SMA compatible, precision APC-3.5 test port connector. The HP 85027A/C bridges operate from 10 MHz to 18 GHz. The HP 85027A has a rugged APC-7® test port connector and the HP 85027C has a precision Type-N connector.

Measuring SMA devices

Hewlett-Packard recommends using the HP 85027A bridge and an APC-7 to APC-3.5 adapter for measuring SMA devices from 10 MHz to 18 GHz. For SMA measurements to 26.5 GHz, HP recommends using APC-3.5 to APC-3.5 adapters (included with the HP 85027B bridge) to preserve the HP 85027B output connector.

HP 85027A/B/C Specifications

Frequency Range

HP 85027A: 0.01 to 18 GHz.

HP 85027B: 0.01 to 26.5 GHz.

HP 85027C: 0.01 to 18 GHz.

*APC-7 is a U.S. registered trademark of the Bunker Ramo corporation

NETWORK ANALYZERS

8757/8756 System Accessories (con't)

Models 85027A/B/C, 85020A/B, 85025A/B, Q/U85026A, 85025C, 11664A

Nominal impedance: 50 ohms.

Input Connector

- HP 85027A: Type-N Female.
- HP 85027B: APC-3.5 Female.
- HP 85027C: Type-N Female.

Output Connector

- HP 85027A: APC-7.
- HP 85027B: APC-3.5 Female.
- HP 85027C: Type-N Female.

Maximum power to input port: +23 dBm.

Directivity

- HP 85027A: 0.01 to 0.04 GHz: 36 dB.
0.04 to 18 GHz: 40 dB.
- HP 85027B: 0.01 to 0.04 GHz: 36 dB.
0.04 to 20 GHz: 40 dB.
20 to 26.5 GHz: 36 dB.
- HP 85027C: 0.01 to 12.4 GHz: 36 dB.
12.4 to 18 GHz: 34 dB.

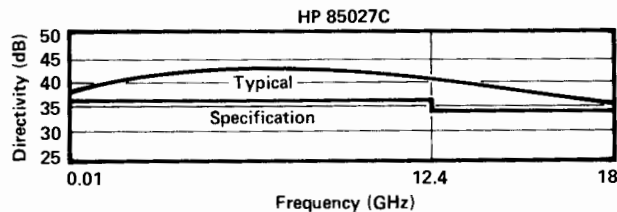
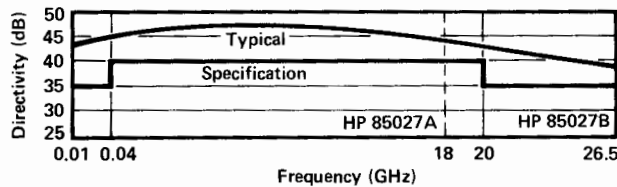

Test Port Match (SWR)

- HP 85027A/C: 0.01 to 8.4 GHz: 1.15.
8.4 to 12.4 GHz: 1.25.
12.4 to 18 GHz: 1.43.
- HP 85027B: 0.01 to 8.4 GHz: 1.15.
8.4 to 20 GHz: 1.43.
20 to 26.5 GHz: 1.75.

Typical Input Port Match (SWR)

- HP 85027A/C: 0.01 to 8.4 GHz: <1.22.
8.4 to 18 GHz: <1.33.
- HP 85027B: 0.01 to 8.4 GHz: <1.22.
8.4 to 20 GHz: <1.33.
20 to 26.5 GHz: <1.93.

Typical Insertion Loss

- HP 85027A/B/C: 6.5 dB at 10 MHz.
8.0 dB at 18 GHz.
- HP 85027B: 10 dB at 26.5 GHz.

Typical minimum input power (for a 40 dB return loss measurement): +7 dBm at 18 GHz.

Dimensions: 26 H x 124 W x 118 mm D (1.0 x 4.9 x 3.9 in).

Weight: net, 0.6 kg (1.3 lb); shipping, 2.4 kg (5.2 lb).

HP 85020A/B Directional Bridges

The economical HP 85020A/B directional bridges also offer high (40 dB) directivity and excellent port match at RF (to 4.3 GHz) frequencies. For 50 ohm measurements choose the HP 85020A. The HP 85020B is designed for 75 ohm environments. Both RF bridges have Type-N connectors.

HP 85020A/B Specifications

Frequency Range

- HP 85020A: 0.01 to 4.3 GHz.
- HP 85020B: 0.01 to 2.4 GHz.

Nominal Impedance

- HP 85020A: 50 ohms.
- HP 85020B: 75 ohms.

Connectors: Type-N Female.

Maximum power to input port: +23 dBm.

Directivity

- HP 85020A: 0.01 to 3 GHz: 40 dB.
3 to 4.3 GHz: 34 dB.
- HP 85020B: 0.01 to 2.4 GHz: 40 dB.

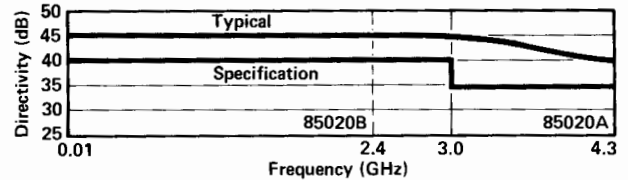

Test Port Match (SWR)

- HP 85020A: 0.01 to 3 GHz: 1.20.
3 to 4.3 GHz: 1.25.
- HP 85020B: 0.01 to 1.3 GHz: 1.25.
1.3 to 2.4 GHz: 1.39.

Typical Input Port Match (SWR)

- HP 85020A: 0.01 to 4.3 GHz: 1.25.
- HP 85020B: 0.01 to 2.4 GHz: 1.25.

Typical insertion loss: 6.5 dB.

Typical minimum input power (for a 40 dB return loss measurement): +4 dBm.

Dimensions: 26 H x 110 W x 118 mm D (1.0 x 4.3 x 3.9 in).

Weight: net, 0.5 kg (1.2 lb); shipping, 2.3 kg (5 lb).



HP 85025A



HP U85026A



HP 85025C



HP 11664A

Detectors

Use the HP 85025 and 85026 series detectors to measure either modulated (AC) or unmodulated (DC) microwave signals. The HP 11664 series detectors operate in AC mode only.

HP 85025A Detector

Function: Designed specifically to use with the HP 8757A scalar network analyzer, the HP 85025A detects either a modulated (AC) or an unmodulated (DC) microwave signal. In AC mode, the HP 85025A detects the envelope of the 27.8 kHz modulated microwave signal. In DC mode, the HP 85025A measures the microwave power directly. The user can change modes via HP 8757A softkey selection.

Frequency Range: 10 MHz to 18 GHz.

Return Loss (25 ± 5 C):

- 10 MHz to 40 MHz: 10 dB.
- 40 MHz to 4 GHz: 20 dB.
- 4 GHz to 18 GHz: 17 dB.

Frequency Response: (25 ± 5 C):

- 10 MHz to 40 MHz: +0.25 dB, -0.75 dB.
- 40 MHz to 18 GHz: ±0.5 dB.

Impedance: 50 ohms nominal.

Maximum Input Power: +20 dBm (100 mW), 10 VDC.

Connector: Type-N Male (Option 001: APC-7).

Dimensions: Cable length is 1.22 m (48 in.).

Weight: Net 0.24 kg (0.5 lb). Shipping 1.0 kg (2.2 lb).

NETWORK ANALYZERS

8757/8756 System Accessories (con't)

Models 85025B, Q/U 85026A, 85025C, 11664A/C/D/E

599



HP 85025B Detector

Note: The specifications above for the HP 85025A apply for the HP 85025B except as noted below.

Frequency Range: 10 MHz to 26.5 GHz.

Return Loss ($25 \pm 5^\circ \text{C}$):

10 MHz to 40 MHz: 10 dB.

40 MHz to 4 GHz: 20 dB.

4 GHz to 18 GHz: 17 dB.

18 GHz to 26.5 GHz: 12 dB.

Frequency Response: ($25 \pm 5^\circ \text{C}$):

10 MHz to 40 MHz: ± 0.8 dB.

40 MHz to 18 GHz: ± 0.5 dB.

18 MHz to 26.5 GHz: ± 1.0 dB typical.

Test Port Connector: APC-3.5 Male

HP Q/U 85026A Detectors

Function: The HP Q/U 85026A detectors are calibrated waveguide detectors designed specifically for operation with the HP 8757A. They detect either a modulated (AC) or unmodulated (DC) millimeter-wave signal. Operation with the HP 8756A requires an adapter (HP Part No. 5061-5369) and is limited to AC only operation.

Frequency range:

HP Q85026A, 33 to 50 GHz.

HP U85026A, 40 to 60 GHz.

Return loss: ≥ 12 dB.

Dynamic range:

AC mode, +10 to -45 dBm.

DC mode, +10 to -40 dBm.

Frequency response: $< \pm 2.0$ dB.

EIA Waveguide Size:

HP Q85026A, WR-22.

HP U85026A, WR-19.

Cover Flange: UG-383.

Dimensions: Cable length is 1.22 m (48 in.).

Weight: Net 0.24 kg (0.5 lb.). Shipping 1.0 kg (2.2 lb.).

HP 85025C Detector Adapter

Function: The HP 85025C matches the HP 8757A to most standard low barrier (zero-biased) crystal, silicon, and gallium arsenide detectors for scalar measurements above 60 GHz. A softkey calibration sequence calibrates the HP 8757A to your detector for an accurate display of power level.

Compatible Scalar Analyzer: HP 8757A only, firmware Revision 2.0 or higher. For scalar measurements with the HP 8756A or 8755C use the HP 11664C detector adapter.

Maximum Measurable Input: ± 3 volts peak.

Maximum Allowable Input: ± 10 volts peak.

Connector: SMA male.

Dimensions: Cable length is 1.22m (48 in.).

Weight: Net 0.24 kg (0.5 lb.). Shipping 1.0 kg (2.2 lb.).

HP 11664A Detector

Function: The HP 11664 series detectors detect the envelope of the 27.8 kHz modulated RF signal to be displayed on the scalar network analyzer.

Frequency Range: 10 MHz to 18 GHz.

Frequency Response:

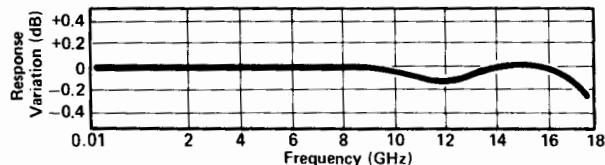

Return Loss (-60 to $+10$ dBm, 15 to 35°C):

10 MHz to 40 MHz: ≥ 10 dB

40 MHz to 4 GHz: ≥ 20 dB

4 GHz to 12 GHz: ≥ 18 dB

12 GHz to 18 GHz: ≥ 16 dB

Impedance: 50 ohms nominal.

Maximum Input Power: $+20$ dBm (100 mW).

Test Port Connector: Type N-Male.

Option 001: APC-7.

Dimensions: Cable length is 1.22 m (48 in.).

Weight: Net 0.17 kg (0.4 lb). Shipping 0.9 kg (2 lbs).

HP 11664E Detector

(Note: The specifications above for the HP 11664A apply for the HP 11664E except as noted below.)

Frequency Range: 10 MHz to 26.5 GHz.

Frequency Response: (-10 dBm, $25 \pm 5^\circ \text{C}$):

10 MHz to 18 GHz: ± 0.5 dB.

10 MHz to 26.5 GHz: ± 1.0 dB

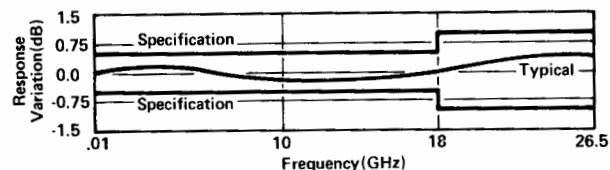

Return Loss (-60 to $+10$ dBm, $25 \pm 5^\circ \text{C}$):

10 MHz to 40 MHz: ≥ 10 dB.

40 MHz to 6 GHz: ≥ 20 dB.

6 GHz to 20 GHz: ≥ 16 dB.

20 GHz to 26.5 GHz: ≥ 12 dB (-60 to -10 dBm).

Test Port Connector: APC-3.5 Male

HP 11664D Detector

Function: The HP 11664D detects AC modulated signals in the frequency range of 26.5 to 40 GHz.

Frequency Range: 26.5 to 40 GHz.

Frequency Response: (0 dBm, $25 \pm 5^\circ \text{C}$):

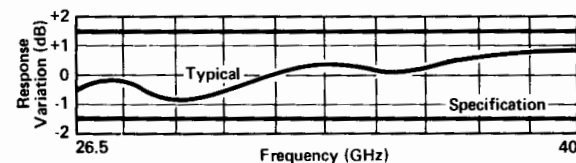

Return Loss: ≥ 12 dB (-50 to $+10$ dBm, $25 \pm 5^\circ \text{C}$).

Maximum Input Power: $+16$ dBm (40 mW).

Test Port Connector: EIA size WR-28 rectangular waveguide (mates with UG-599/U cover flange).

Dimensions: Cable length is 1.22 m (48 in.).

Weight: Net 0.24 kg (0.5 lb). Shipping 1.0 kg (2.2 lbs).

HP 11664C Detector Adapter

Function: The HP 11664C matches the HP 8757A/56A/55C to most standard crystal, silicon, and gallium arsenide detectors via two screwdriver adjustments. One adjustment sets the adapter's amplifier gain to the correct power level indication on the scalar network analyzer. The second adjustment matches the input impedance of the adapter to the load impedance of the detector. Together, the square law to linear transition region of the detector is optimized for the HP 8757A/56A/55C. Positive or negative bias ($\pm 50 \mu \text{A}$) can be selected by two internal switches.

Frequency Range: Depends on the external detector used.

Maximum Input: 5 V peak.

Connector: BNC Male.

Dimensions: Cable length is 1.22 m (48 in.).

Weight: Net 0.17 kg (0.4 lb). Shipping 0.9 kg (2 lbs).

NETWORK ANALYZERS

8757/8756 System Accessories (con't)

Models 11679A/B, 85023A/B/C/D, 85022A, 85015B, 85016B, 11668A, 11678A

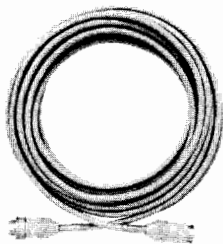

HP 11679A



HP 85023C

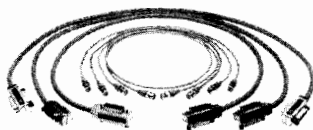

HP 85022A



HP 11668A



HP 11678A

HP 11679A/B Extension Cables

Function: These cables extend the distance between the scalar network analyzer and the detector or bridge to a maximum of 200 feet without degradation of performance.

HP 11679A: 7.6 m (25 ft) extension cable: \$105
HP 11679B: 61 m (200 ft) extension cable: \$355

HP 85023A/B/C/D Verification Kits

The HP 85023A/B/C/D system verification kits each contain a set of precision components used to perform a system verification procedure for the HP 8757S/56S scalar network analyzer system. This procedure, which is in the HP 8757A/56A Operating and Service Manuals, checks system installation and can be used as a daily functional test.

Choose a system verification kit to match your device under test. For APC-7 applications, select the HP 85023A. If you are measuring SMA or APC-3.5 devices, choose the HP 85023B. For 50 ohm, Type-N applications, select the HP 85023C. These kits (HP 85023A/B/C) all include an open, short, 10 dB fixed attenuator, 50 ohm termination, and a source to directional bridge adapter of the corresponding connector type. The HP 85023D verification kit, for 75 ohm Type-N measurements, consists of a short, a 75 ohm termination, a 50 ohm 10 dB fixed attenuator and two HP 11852A 50 to 75 ohm minimum loss pads (for 50/75 ohm impedance conversion).

Frequency range: HP 85023A/C, dc to 18 GHz.

HP 85023D, dc to 1.3 GHz.

HP 85023B, dc to 26.5 GHz.

Connector type: HP 85023A, APC-7.

HP 85023B, APC-3.5.

HP 85023C, Type-N, 50 ohm.

HP 85023D, Type-N, 75 ohm.

Characteristic impedance: HP 85023A/B/C, 50 ohm.

HP 85023D, 75 ohm.

Weight: net, 0.5 kg (1.2 lb); shipping, 1.2 kg (2.9 lb).

HP 85022A System Cable Kit

The HP 85022A contains all the BNC and HP-IB cables to connect an HP 8350B sweep oscillator (or HP 8340A synthesized sweeper), an HP Series 200 computer, and a printer to the HP 8757A or 8756A. This kit contains 3 one-metre HP-IB cables (HP 10833A), 3 two-foot BNC cables (HP 11170B), and 1 four-foot BNC cable (HP 11170C).

BNC connectors: N-Male, N-Male.

BNC impedance: 50 ohm.

Weight: net, 0.5 kg (1.2 lb); shipping, 1.2 kg (2.9 lb).

HP 85015B System Software for HP 8757S/8756S

Save frequently performed measurement procedures and calibration data for future use. Measure insertion loss, gain, power and reflection coefficient. The HP 85015 allows you to customize your test sequence and then print or plot the output in your choice of formats. The HP 85015 includes four system discs and a data disc for either 5.25 inch or 3.5 inch disc drives. Choose the option that corresponds to your computer configuration.

Weight: net, 0.5 kg (1.2 lb); shipping, 1.2 kg (2.9 lb).

For further information see page 604.

HP 85016B Transmission Line Test Software for HP 8757S/8756S

Add accurate transmission line fault location to the HP 85015A/B system software. In addition to frequency response, plot return loss of cables and waveguides as a function of distance. The HP 85016B includes four system discs and one data disc for either 5.25 inch or 3.5 inch disc drives. Choose the option that corresponds to your computer configuration.

Weight: net, 0.5 kg (1.2 lb); shipping, 1.2 kg (2.9 lb).

For further information see page 604.

HP 11668A High Pass Filter

The HP 11668A high pass filter accessory is recommended when making measurements on active devices that have gain below 50 MHz. Use of the HP 11668A, placed after the HP 11665B, reduces the modulator drive feedthrough from 8 mV to 1 mV and prevents possible amplifier saturation. Use of the HP 11668A filter is not necessary for passive measurements since the feedthrough from the HP 11665B is -65 dBm and causes no degradation in system performance.

Frequency range: 50 MHz to 18 GHz.

| | Insertion Loss | Return Loss |
|---------------|----------------|--------------|
| 50-100 MHz | ≤ 2.5 dB | ≥ 12 dB |
| 100 MHz-8 GHz | ≤ 1.0 dB | ≥ 16 dB |
| 8-12 GHz | ≤ 1.0 dB | ≥ 14 dB |
| 12-18 GHz | ≤ 1.5 dB | ≥ 14 dB |

Maximum input: +27 dBm.

Connectors: N-female, N-male.

Weight: net, 0.13 kg (5 oz); shipping, 0.28 kg (10 oz).

HP 11678A Low Pass Filter Kit

Description: the HP 11678A low pass filter kit contains five filters. Low pass filters reduce harmonics generated by the RF source when making precision measurements.

Frequency Range (low pass filters, cutoff frequency fc)

HP 11668A: 2.8 GHz.

HP 11689A: 4.4 GHz.

HP 11684A: 6.8 GHz.

HP 11685A: 9.5 GHz.

HP 11686A: 13.0 GHz.

Insertion loss: < 1.1 dB at 0.95 fc.

Rejection (at 1.25 fc): greater than 40 dB.

Impedance: 50 ohm normal.

Connectors: N-Female, N-Male.

Weight: net, 0.44 kg (1 lb); shipping, 1.2 kg (2.9 lb).

Service Products

HP 8757+02B/8756+02B Onsite Installation (where available)

Be sure your HP 8757S or 8756S automatic scalar network analyzer system is operating from the start by having an HP Customer Engineer configure your system at your site. After you have unpacked the equipment the HP Customer Engineer will assemble and verify the operation of your system.

HP 8757S+23B/8756S+23B Onsite Service (where available)

Increase your total system uptime by ordering onsite service. An HP Customer Engineer will come to your site to perform all repairs for one year.

NETWORK ANALYZERS

8757/8756 System Accessories (cont.)

Models 11667A/B, 11636A/B, 11665B, 11679A/B, 11852A

601

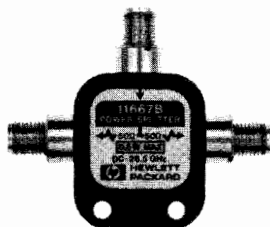

HP 11667B

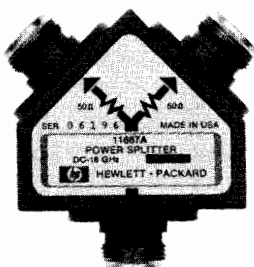

HP 11667A



HP 11665B

Connectors:

HP 11667A: N-female on all ports.

HP 11667B: APC-3.5 female on all ports.

Dimensions:

HP 11667A: 46 H x 52 W x 19 mm D (1.8 x 2.0 x 0.7 in).

HP 11667B: 40 H x 47 W x 10 mm D (1.6 x 1.9 x 0.4 in).

Weight:

HP 11667A: net, 0.14 kg (0.31 lb); shipping, 0.22 kg (0.5 lb).

HP 11667B: net, 0.06 kg (0.13 lb); shipping, 0.14 kg (0.3 lb).

HP 11636A/B Power Dividers

The HP 11636A/B power dividers/combiners are recommended when making wideband comparison measurements without ratioing, and in fault location measurements with the HP 8757S/85016. Detailed specifications are on page 561.

Other Signal Separation Devices

Many other signal separation devices are available from HP for use with the HP 8757A, 8756A and 8755C. Coaxial couplers from 0.1 to 18 GHz are available with the HP 770 series, the 790 series, and the HP 11692. Higher directivity HP 752 series waveguide couplers can also be used with the HP 8757A, 8756A or 8755C with the addition of appropriate HP 281 series waveguide-to-coax adapters.

HP 11667A/B Power Splitter

The HP 11667A/B power splitters are recommended when making wideband ratio measurements using the HP 8757A, 8756A or 8755C scalar network analyzer. These two-resistor type splitters provide excellent output SWR at the auxiliary arm when used for source leveling or ratio measurement applications. The tracking between output arms over a frequency range from dc to 18 GHz allows wideband measurements to be made with a minimum of uncertainty.

Frequency Range:

HP 11667A: DC to 18 GHz.

HP 11667B: DC to 26.5 GHz.

Impedance: 50 ohms nominal.

Insertion Loss: 6 dB nominal.

| | DC to 4 GHz | DC to 8 GHz | DC to 18 GHz | DC to 26.5 GHz |
|--|----------------|----------------|-----------------|-------------------|
| Input SWR: | | | | |
| HP 11667A: | ≤1.15 | ≤1.25 | ≤1.45 | |
| HP 11667B: | ≤1.22 | ≤1.22 | ≤1.22 | ≤1.29 |
| Equivalent Output SWR: (leveling or ratio measurements) | | | | |
| HP 11667A: | ≤1.10 | ≤1.20 | ≤1.33 | |
| HP 11667B: | ≤1.22 | ≤1.22 | ≤1.22 | ≤1.22 |
| Output Tracking: (between output arms) | | | | |
| HP 11667A: | ≤0.15 dB | ≤0.20 dB | ≤0.25 dB | |
| HP 11667B: | ≤0.20 dB | ≤0.20 dB | ≤0.20 dB | ≤0.25 dB |
| Typical Phase Tracking: (between output arms) | | | | |
| HP 11667A: | 0.5 deg | 1.5 deg | 3.0 deg | |
| HP 11667B: | 1.5 deg | 1.5 deg | 1.5 deg | 2.5 deg |
| Maximum Input Power: | +27 dBm. | | | |

11665B Modulator

Function: absorptive on-off modulator designed for and powered by the HP 8757A, 8756A or 8755C scalar network analyzers.

| Frequency Range | Return Loss On and Off | Insertion Loss On Off |
|-----------------|------------------------|-----------------------|
| 15-40 MHz | ≥10 dB | ≤7.0 dB ≥35 dB |
| 40 MHz-4 GHz | ≥15 dB | ≤3.2 dB ≥35 dB |
| 4-8 GHz | ≥12 dB | ≤3.8 dB ≥40 dB |
| 8-12.4 GHz | ≥8 dB | ≤4.3 dB ≥45 dB |
| 12.4-18 GHz | ≥8 dB | ≤5.0 dB ≥45 dB |

Modulator drive feedthrough: ≤8 mV (peak) at 27.8 kHz at either port when powered by the HP 8757A, 8756A or 8755C. Reduced to ≤1 mV (peak) using the HP 11668A. (See HP 11668A High Pass Filter).

Drive current: nominally +50 mA in On condition, -50 mA Off condition.

Weight: net, 0.17 kg (6 oz); shipping, 0.9 kg (2 lb).

HP 11852A 50 ohm/75 ohm Minimum Loss Pad

The HP 11852A is a low SWR minimum loss pad required between 75 ohm devices and 50 ohm sources and detectors. For more information, see page 623.



NETWORK ANALYZERS

Ordering Information

Models 8757/8756

Ordering Information

The HP 8757S Automatic Scalar Network Analyzer is ordered with multiple line items to give you maximum flexibility in specifying a system that meets your needs. This ordering guide lists the HP 8757S line items required for software compatibility. It is not necessary to order any line item you already own. Consult your local HP Sales Office if you would like assistance.

HP 8757S Scalar Network Analyzer System

This system model number ensures coordination of shipments and compatibility of instruments and software.

Analyzer

| | |
|----------------------------------|----------|
| HP 8757A Scalar Network Analyzer | \$11,000 |
| Opt. 001 Fourth detector input | \$1,500 |

Sweep Oscillators (choose either HP 8350B with an RF Plug-in 8340A or 8341A)

| | |
|---|----------|
| HP 8350B Sweep Oscillator Mainframe | \$4,565 |
| HP 83522A 0.01-2.4 GHz RF Plug-in | \$8,170 |
| HP 83592A 0.01-20 GHz RF Plug-in | \$20,500 |
| HP 83595A 0.01-26.5 GHz RF Plug-in | \$29,085 |
| Other RF Plug-in (see HP 8350B catalog entry for model and options) | |
| HP 8341A 0.01-20 GHz Synthesized Sweeper | \$44,000 |

Directional Bridges (choose at least one)

| | |
|---|---------|
| HP 85027A 0.01-18 GHz, APC-7, 50 ohm | \$2,500 |
| HP 85027B 0.01-26.5 GHz, APC-3.5 female, 50 ohm | \$2,800 |
| HP 85027C 0.01-18 GHz, Type-N female, 50 ohm | \$2,500 |
| HP 85020A 0.01-4.3 GHz, Type-N female, 50 ohm | \$950 |
| HP 85020B 0.01-2.4 GHz, Type-N female, 75 ohm | \$1,050 |

Detectors (choose at least one)

| | |
|--|----------|
| HP11664A 0.01-18 GHz, Type-N male | \$430 |
| Opt. 001 APC-7 connector | add \$25 |
| HP 11664E 0.01-26.5 GHz, APC-3.5 male | \$680 |
| HP 11664D 26.5-40 GHz, WR-28 waveguide | \$1,100 |
| HP 11664C Detector Adapter | \$255 |
| HP 85025A 0.01-18 GHz, Type-N male | \$850 |
| Opt. 001 APC-7 connector | add \$50 |
| HP 85025B 0.01-26.5 GHz, APC-3.5 male | \$950 |
| HP Q85026A 33-50 GHz, WR-22 waveguide | \$1,700 |
| HP U85026A 40-60 GHz, WR-19 waveguide | \$1,700 |
| HP 85025C Detector Adapter | \$500 |

System Verification Kits (choose at least one)

| | |
|---------------------------|-------|
| HP 85023A APC-7, 50 ohm | \$520 |
| HP 85023B APC-3.5, 50 ohm | \$655 |
| HP 85023C Type-N, 50 ohm | \$415 |
| HP 85023D Type-N, 75 ohm | \$685 |

Filter Kits

| | |
|-------------------------------|---------|
| HP 11668 High Pass Filter Kit | \$555 |
| HP 11678 Low Pass Filter Kit | \$1,380 |

System Cable Kit

| | |
|----------------------------|-------|
| HP 85022A System Cable Kit | \$355 |
|----------------------------|-------|

Computer (choose one)

| | |
|---|----------|
| HP 9816S Series 200, Model 16S Computer (select option) | \$5,150 |
| Opt. 630 for use with HP 9121D/22D Disc Drive | N/C |
| HP 9826S Series 200, Model 26S Computer | \$11,555 |
| HP 9836S Series 200, Model 36S Computer | \$14,420 |
| HP 98256A 256K byte Memory Board | \$830 |
| HP 98257A 1M byte Memory Board | \$3,300 |

Disc Drives (one required for HP 9816S)

| | |
|--|---------|
| HP 9121D 3.5 inch Dual Flexible Disc Drive | \$1,190 |
| HP 9122D 3.5 inch Dual Flexible Disc Drive | \$1,390 |

Software (choose one option)

| | |
|--|---------|
| HP 85015B System Software for HP 8757S | \$2,000 |
| Opt. 630 for HP 9816S Computer with HP 9121D/22D Disc Drive | N/C |
| Opt. 655 for either HP 9826S or 9836S Computer | N/C |
| HP 85016B Transmission Line Test Software for HP 8757S | \$4,500 |
| Opt. 630: For HP 9816S Computer with HP 9121D/22D Disc Drive | N/C |
| Opt. 655: For either HP 9826S or 9836S Computer | N/C |

Recommended Accessories

Printer (choose at least one)

| | |
|--|---------|
| HP 2673A Intelligent Graphics Printer | \$2,240 |
| HP 2932A Opt 046 Impact Graphics Printer | \$2,545 |

Plotter (choose at least one)

| | |
|---|---------|
| HP 7470A Opt. 002 Two-pen Graphics Plotter (8.5" x 11") | \$1,095 |
| HP 7550 Eight-pen Vector Plotter (11" x 17") | \$3,900 |

Optional Accessories (for ratio and/or modulation measurements)

| | |
|--|----------|
| HP 11636A Power Divider DC to 18 GHz | \$400 |
| HP 11636B Power Divider DC to 26.5 GHz | \$950 |
| HP 11665B Modulator | \$605 |
| HP 11667A Power Splitter DC to 18 GHz | \$930 |
| Opt. 001 N-male on input port; N-female on output ports: | N/C |
| Opt. 002 N-female on input port; APC-7 on output ports: | add \$75 |

| | |
|---|-------|
| HP 11667B Power Splitter DC to 26.5 GHz | \$950 |
| HP 11852A 50 to 75 ohm Minimum Loss Pad | \$205 |

Service and Support Products

| | |
|--|-------|
| HP 8757S+02B Onsite Installation (where available) | \$630 |
| HP 8757S+23B Onsite Service (where available) | |

Compatible HP 8350B Plug-ins

(HP 86200 series plug-ins require the HP 11869A adapter for use with the HP 8350)

| HP Model Number | Frequency Range (GHz) | Power Out (mW) | Price |
|-------------------------------------|-----------------------|----------------|----------|
| 83595A | 0.01-26.5 | 2.5 | \$29,085 |
| 83592A | 0.01-20.0 | 10 | 20,500 |
| 83592B | 0.01-20.0 | 20 | 26,580 |
| 83592C | 0.01-20.0 | 4 | 26,580 |
| 83525A | 0.01-8.4 | 20 | 13,540 |
| 83525B | 0.01-8.4 | 10 | 15,540 |
| 83522A | 0.01-2.4 | 20 | 8,170 |
| 83594A | 2.0-26.5 | 2.5 | 22,820 |
| 83590A | 2.0-20.0 | 10 | 17,700 |
| 83550A | 8.0-20.0 | 60 | 15,000 |
| 83540A | 2.0-8.4 | 40 | 9,780 |
| 83540B | 2.0-8.4 | 20 | 10,280 |
| 83545A | 5.9-12.4 | 50 | 9,780 |
| 83570A | 18.0-26.5 | 10 | 11,985 |
| 83572A** | 26.5-40.0 | 2 | 14,540 |
| 83572B** | 26.5-40.0 | 5 | 17,500 |
| 83554A*** | 26.5-40.0 | 5 | 8,000 |
| 83555A*** | 33.0-50.0 | 3.2 | 8,000 |
| 83556A*** | 40.0-60.0 | 2 | 8,000 |
| 86222A | 0.01-2.4 | 20 | 5,520 |
| 86222B | 0.01-2.4 | 20 | 6,970 |
| 86220A* | 0.01-1.3 | 10 | 3,810 |
| 86235A | 1.7-4.3 | 40 | 5,075 |
| 86290B | 2.0-18.6 | 10 | 15,300 |
| 86290C | 2.0-18.6 | 20 | 19,810 |
| 86240A | 2.0-8.4 | 40 | 6,575 |
| 86240B | 2.0-8.4 | 20 | 7,720 |
| 86240C | 3.6-8.6 | 40 | 7,525 |
| 86241A* | 3.2-6.5 | 3.2 | 4,575 |
| 86245A | 5.9-12.4 | 50 | 7,975 |
| 86242D | 5.9-9.0 | 10 | 5,175 |
| 86250D | 8.0-12.4 | 10 | 5,275 |
| 86251A | 7.5-18.6 | 10 | 10,780 |
| 86260B* | 10.0-18.6 | 10 | 6,125 |
| 86260A* | 12.4-18.0 | 10 | 5,675 |
| 86260C* | 17.0-22.0 | 10 | 9,280 |
| 8620C sweep oscillator mainframe | | | 3,865 |
| 8350B sweep oscillator mainframe | | | 4,565 |
| 11869A adapter for HP 86200 plug-in | | | 280 |

* Requires HP 11665B modulator.

** Requires Option 006 for internal 27.8 kHz modulator.

*** Source module, requires a 11-20 GHz swept source.

NETWORK ANALYZERS

Scalar Network Analyzer, 10 MHz to 40 GHz

Model 8756A/S

603



- High (40 dB) directivity bridges
- "Autoscale" for fast measurements
- Full HP-IB programmability

- Fully annotated digital display
- Nine "Save/Recall" registers
- Direct digital plot capability

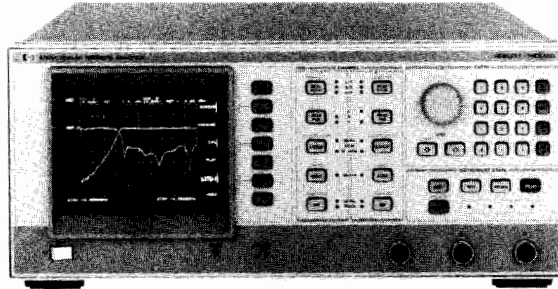

HP 8756A



Description

Measure insertion loss and gain, return loss, and absolute power quickly and accurately with the HP 8756A scalar network analyzer. These scalar measurements can be performed over a broad 10 MHz to 40 GHz frequency range. The HP 11664 diode detectors and AC modulation make accurate, reliable, and drift-free measurements. High-directivity directional bridges covering RF and microwave frequencies produce excellent reflection measurements. The HP 85020 and 85021 bridges, HP 11664 detectors and other scalar accessories are described on pages 597 through 602.

Easy-to-Use

The HP 8756A features two independent display channels with separate controls. Complete measurements can be performed using only five control keys for each channel.

Make even faster measurements with one key—the "Autoscale" key. Press it and the built-in microprocessor chooses the optimum scale and reference level to display your measurement. Use the convenient display cursor to read out magnitude and frequency at each data point.

For Automatic or Manual Systems

When used with the HP 8350B sweep oscillator or HP 8341A/8340A synthesized sweepers, the HP 8756A acts as a system controller by managing the other instruments through the "8756 System Interface." Using the system interface, the HP 8756A extracts frequency information from the sweeper and uses it to annotate the digital display.

When used alone, the HP 8756A can save and recall up to nine front-panel states. With the HP 8350B or 8340A/41A, it saves and recalls not only its own front-panel state, but the sweeper's as well.

Another benefit of the HP 8756A/8350B combination is "Alternate Sweep"; the ability to sweep two different frequency ranges or power levels and display them simultaneously.

System control also extends to an HP-IB digital plotter. The HP 8756A can directly plot the CRT's image onto a plotter such as the HP 7475A or 7470A. Crisp, permanent, annotated plots can be created just by selecting the Plot soft key.

Programmability Features

Since all of the controls of the HP 8756A are completely programmable, computer-controlled automatic systems can make full use of the HP 8756A and its built-in features. Order the HP 8756S automatic scalar network analyzer system and choose the configuration of source, analyzer, computer, and peripherals for your needs. Add the HP 85015B system software for custom testing and storage of data and measurement configurations.

Specifications

Function: The HP 8756A processes and displays the demodulated 27.8 kHz signals from the HP 11664 detectors and the HP 85020 or 85021 bridges.

Dynamic range: +10 dBm to -50 dBm in all three inputs (A, B, and R).

Dynamic accuracy: dynamic accuracy of a single channel measurement using HP 11664A/B/E Detector. Measurement taken over +10 to -50 dBm at 25°C and at 50 MHz.

±(0.1 dB + 0.01 dB/dB) from +10 to -40 dBm.

±(0.2 dB + 0.02 dB/dB) from -40 to -50 dBm.

Scale resolution: 0.1, 0.2, 0.5, 1, 2, 5, 10, or 20 dB per division. Independently controlled for each measurement channel.

Reference offset: offset level adjustable in 0.01 dB increments from -70.00 to +20.00 dBm (absolute) or -90.00 to +90.00 dB (ratio).

Resolution

Vertical: 0.006 dB for display.

0.01 dB for "Display Cursor."

Horizontal: 401 points.

Sweep time: minimum sweep time ≥ 150 ms.

Averaging: 2, 4, 8, 16, 32, 64, 128, or 256 traces may be averaged. Independent control of each display channel.

Normalization: traces are stored and normalized to 0.006 dB resolution, independent of scale/division or offset. The horizontal resolution is 401 points.

Transfer formats: data may be transferred as either ASCII strings (nominally 6 characters per reading) or as 16 bit integers. Readings may be taken at a single point or as an entire 401 point measurement trace.

Transfer Speed

ASCII format, trace: 800 ms typical.

ASCII format, point: 10 ms typical.

Binary format, trace: 35 ms typical.

Binary format, point: 5 ms typical.

Description: the HP 8756A System Interface is an HP-IB port used exclusively by the HP 8756A to control and extract information from a sweep oscillator and a digital plotter.

Sweep oscillators: HP 8350B with RF plug-in, HP 8340A/8341A synthesized sweep oscillators.

Plotters: HP 7470A Opt. 002, HP 7475A Opt. 002, HP 7550A Opt. 002, HP 9872C.

Power requirements: 48 to 62 Hz, 115/230V ±10%, typically 100 watts.

Dimensions: 178 H x 425.5 W x 451 mm D (7.0 x 16.75 x 17.75 in.).

Weight: Net, 15 kg (33 lb). Shipping, 20 kg (44 lb).

Ordering Information

HP 8756A scalar network analyzer

Price

\$8,500



NETWORK ANALYZERS

Scalar Network Analyzer Software for the HP 8757S/8756S

Models 85015B, 85016B

- Custom tests without programming
- Friendly menu operation
- Measure insertion and return loss
- Plot or store data
- Test coax and waveguide
- Locate faults in transmission lines

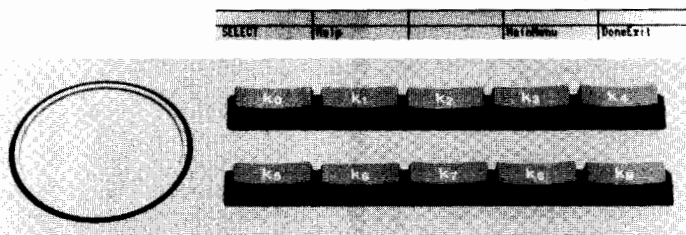

Using the HP 85015B system software for the HP 8757S/8756S, you can create and run complete scalar measurements without programming. The software guides you all the way from setup to output. Just make your selections using the computer's knob and softkeys. The software makes all the necessary settings on the scalar analyzer and source to provide fast, accurate measurements that can be stored for later reference.

Easy To Learn

Use the BASIC mode to get up to speed quickly on the software's operation. It prompts you with a few simple questions, then sets up your source and analyzer automatically. The software prompts you to make all the connections necessary for calibration and measurement sequences, then automatically plots the data on the CRT display. For a permanent record, send the plot to a graphics plotter with a single keystroke.

Use The Analyzer CRT

With the HP 8757, use the scalar analyzer as the control center for your measurements. The analyzer knob and softkeys control the software menus which appear on the CRT of the HP 8757A, instead of the computer's.

Customized Measurement Setups

Use the GENERAL and ADVANCED modes to access more of the software's powerful features. Define up to 4 measurements in one sequence. Specify particular power levels for your test device and enter your specification limits as point, line, or sloped limits. These limit lines allow simple pass/fail testing, or real time adjustment to within the spec limits.

Then output the data using your own customized format with labels, limit lines and "out-of spec" indicators. Make up to 4 plots on a single page. Store the data on computer disc for archival purposes, then recall it later for further analysis.

The software makes it easy to save your configuration, complete with all the parameters you've specified and the calibration data. When you want to run this test later, just recall the configuration and connect the device. The software recalls cal data, plot formats, labels, limit lines . . . everything you need to run complete automated tests.

Test Transmission Lines

The HP 85016B transmission line test software provides all the capability of the HP 85015B plus fault location for complete testing of coax and waveguide transmission lines. Test frequency response (insertion and return loss), then find faults (mismatches) that affect the signals in your frequency range. Troubleshoot your ECM, radar or communication system quickly and without guesswork.

Fault location is accomplished using frequency domain reflectometry, a technique that uses frequency domain reflection data and the inverse Fast Fourier Transform to characterize reflection as a function of distance. This enables you to locate impedance mismatches resulting from bad connections or faulty cables.

Ordering Information

Each software package comes with 5 discs, including a data disc. Order the option that corresponds to your computer configuration. The HP 85015B/16B can run on either BASIC 2.0 or BASIC 3.0 and require 1½ Mbytes of RAM memory.

| | Price |
|--|-------------|
| HP 85015B system software | \$2000 |
| Opt. 630: 3.5 inch discs | N/C |
| Opt. 655: 5.25 inch discs | N/C |
| Opt. 100: upgrade from HP 85015A | less \$500 |
| HP 85016B transmission line test software | \$4500 |
| Opt. 630: 3.5 inch discs | N/C |
| Opt. 655: 5.25 inch discs | N/C |
| Opt. 100: Upgrade from HP 85015A | less \$1500 |

NETWORK ANALYZERS

Audio/IF/RF Network Analyzer, 5 Hz to 200 MHz

Model HP 3577A

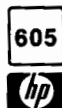

- High speed/high accuracy measurements
- .001 dB, .005 degree, 1 ps, .001 Hz resolution
- Built-in three-term error correction plus normalization
- Magnitude, phase, polar, real, imaginary, and group delay display modes
- Convenience features including direct plotter control and vector math functions

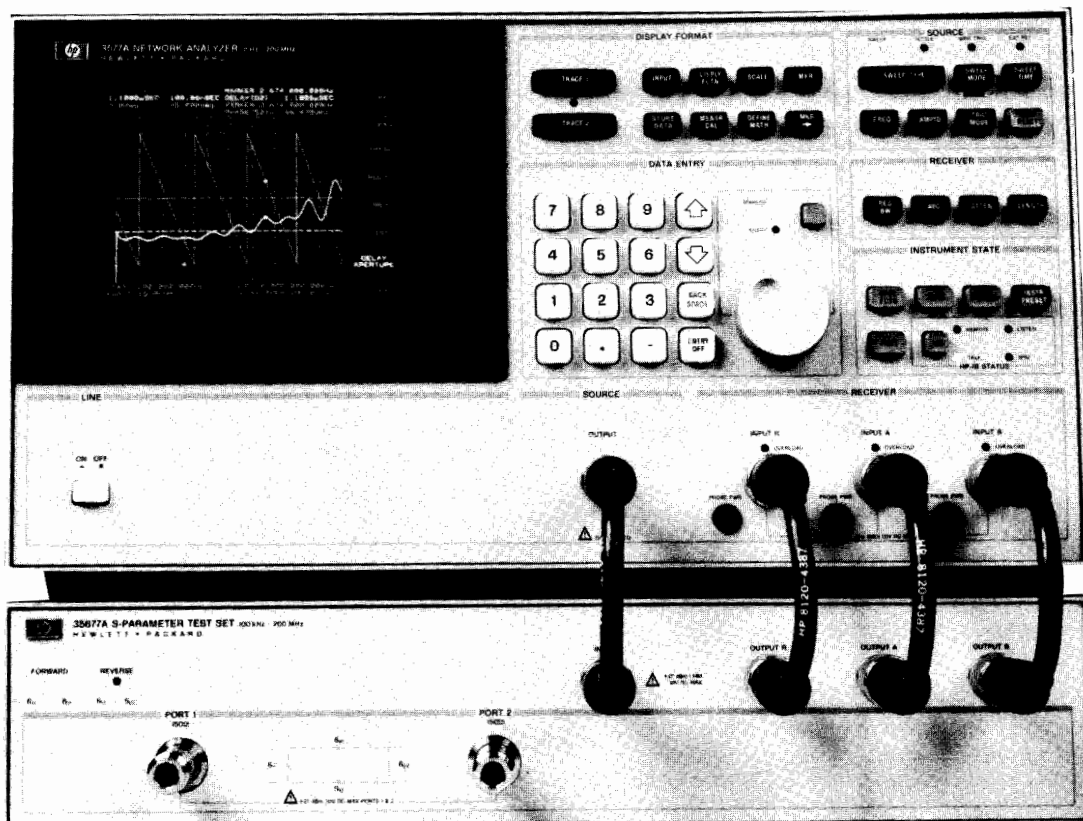

HP 3577A



Introduction

The HP 3577A Network Analyzer provides cost-effective, high performance network measurements from 5 Hz to 200 MHz for higher productivity in design and production. The companion HP 35677A/B S-Parameter Test Sets and full line of accessories ensure a complete measurement solution. Innovative analog and digital design are combined for superb accuracy, resolution and operational simplicity.

Convenient soft-key selection of measurement functions allows you to quickly measure transfer functions, magnitude/phase, insertion loss/gain, attenuation, electrical length and gain compression. In addition, measurement of phase distortion parameters such as group delay and deviation from linear phase can be made with high resolution. With the HP 3577A's flexible receiver input impedances, you can measure in either 50- Ω or high impedance (1 M Ω) environments. Use the HP 35677A or HP 35677B S-Parameter Test Sets with the HP 3577A to make reflection measurements such as return loss, reflection coefficient and impedance in 50- Ω or 75- Ω systems, while simultaneously displaying transmission parameters.

With the addition of an HP 9000 Series 200 Computer and appropriate system software, the HP 3577A becomes the hub of a powerful network measurement solution, the HP 3577S Network Analyzer System. A full description of the HP 3577S begins on page 610.

High Performance Measurements below 200 MHz

The HP 3577A Network Analyzer is designed to offer unprecedented measurement performance at audio, baseband, and IF frequencies below 200 MHz. Resolution specifications of .001 dB, .005 degree, 1 ps and .001 Hz make the HP 3577A ideally suited both for critical R&D applications and as a calibration standard for production systems. Very fast measurement speeds are made possible by state-of-the-art digital signal processing technology. Moreover, each input has its own precision analog receiver, thus eliminating the need for multiplexed signals.



NETWORK ANALYZERS

Audio/IF/RF Network Analyzer, 5 Hz to 200 MHz

HP Model 3577A (cont.)

Versatility and Convenience

User-defined Vector Math functions operate on measured data, constants and functions to present measurement results in the form you need. Multiple Display Formats with electronic graticules provide accurate display in rectangular, polar or Smith chart coordinates. Frequency Sweep (Logarithmic, Linear or Alternate) and Amplitude Sweep capabilities meet measurement needs in a wide range of applications. Accessories such as S-Parameter Test Sets, Power Splitters, Minimum Loss Pad, Cables, Calibration Kits, Transistor Fixtures, Adapters, and Current and Voltage Probes ensure a complete solution to your measurement needs.

The built-in autoscale functions put the measurement on the screen quickly with a full scale display. Digital Display Markers with Marker → Min or Max and Marker Offset capabilities provide accurate, high resolution readout of data points on a fully annotated dual trace display. Direct Digital Plot (using an HP graphics plotter without a computer) of displayed traces, graticule, annotation and marker data provides quick, cost-effective hard copy of measurement results. Non-volatile Save/Recall Memory of five front panel instrument states is convenient for making rapid and repeatable measurements.

Similarly, trace data can be stored in magnitude and phase format in any one of four data registers. Since data is stored with full accuracy and resolution, it can be rescaled as needed.

Measurement Display Modes

Magnitude, phase, polar, real, imaginary, and delay modes are directly accessible from the soft key display menu. Input data, stored data and user-defined constants can then be combined using built-in vector math functions (+, -, *, /) to create arbitrary measurement display modes. As an example, a feedback amplifier can be mathematically analyzed by measuring its open loop gain, storing the data, and then adjusting a complex variable which represents the amount of feedback in the closed-loop gain equation.

High-Performance Group Delay Measurements

The HP 3577A measures group delay directly by dividing the measured phase changes across a selected frequency aperture by the aperture value. The frequency aperture can be set from 0.5% to 16% of span with annotation directly in Hertz, thus allowing the user to change span and still retain the same effective smoothing.

Sophisticated measurements of both magnitude and phase distortion in communication systems can be made.

Cables and transmission lines can be tested for maximally flat delay with a resolution of up to 1 psec.

Noise Reduction

Noise reduction in the HP 3577A is accomplished by Vector Noise Averaging and/or selectable Resolution Bandwidth filters. With the proper use of these two noise reduction methods, greater than 130 dB dynamic range can typically be achieved.

Built-in Error Correction

Three-term Vector Error Correction in the HP 3577A is used to remove the effects of directivity, frequency response, and source mismatch from one-port measurements. Similarly, vector normalization enhances the accuracy of two-port measurements at the push of a button. These powerful accuracy enhancement routines can be used to cancel the repeatable error introduced by cable and test fixtures. Moreover, the HP 3577A can be easily upgraded to an HP 3577S Network Analyzer System with full twelve-term Vector Error Correction, as the need for uncompromising measurement accuracy arises.

HP-IB Programmability

The HP 3577A is fully programmable over the Hewlett-Packard Interface Bus. Simple programming codes minimize the time it takes to develop control software for automatic measurements. Quickly access a single point or an entire 401-point trace in either fast binary or ASCII modes. Customize the built-in vector display via the HP-IB to draw test limit lines, operator instructions or connection diagrams.

HP 3577A Network Analyzer Abbreviated Specifications

Source

Frequency

Range: 5 Hz to 200 MHz

Resolution: 0.001 Hz

Amplitude: $\pm 5 \times 10^{-8}$ /day, 0 to 55°C

Range: +15 dBm to -49 dBm (1.26Vrms to 793 μ Vrms: 2dBV to -62 dBV) into a 50 Ω load

Resolution: 0.1 dB

Accuracy: ± 1 dB at +15 dBm and 100 kHz. Below +15 dBm, add the greater of ± 0.02 dB/dB or 0.2 dB

Flatness: 1.5 dBp-p from 5 Hz to 200 MHz

Impedance: 50 Ω ; >20 dB return loss at all levels

RF Output Connector: 50 Ω Type N female

Sweep Types: Linear, alternate, cw and log frequency; log amplitude

Sweep Time: 100 ms/span to 200 ms/span for frequency sweep; 1 ms/step to 16 s/step for amplitude sweep.

Sweep Modes: Continuous, single, manual

Trigger Modes: Free run, immediate, line, external

Receiver

Full Scale Input Level: -13 dBV from 10 kHz to 200 MHz with internal 20 dB attenuators ON (0dBm at 50 Ω)

Input Characteristics

Frequency Range: 5 Hz to 200 MHz

Inputs: Three receiver inputs (A, B and R)

Input Impedance: Selectable 50 Ω with > 25 dB return loss, or 1 M Ω in parallel with approximately 30 pF

Input Connectors: 50 Ω Type N female

Resolution Bandwidth: Selectable 1 kHz, 100 Hz, 10 Hz, or 1 Hz
Sensitivity (Due to noise and internal crosstalk between source and receiver inputs):

| Resolution Bandwidth | 30 kHz - 200 MHz (50 Ω) 30 kHz - 20 MHz (1 M Ω) | |
|----------------------|--|-------------------------------|
| | Internal 20 dB Attenuator ON | Internal 20 dB Attenuator OFF |
| 1 Hz | -110 dBm | -130 dBm |
| 10 Hz | -110 dBm | -130 dBm |
| 100 Hz | -105 dBm | -125 dBm |
| 1 kHz | -95 dBm | -115 dBm |

Crosstalk: >100 dB isolation between inputs.

Electrical Length/Reference Plane Extension: Provides equivalent electrical line length, or delay at inputs A, B and R.
Range: -3 x 10⁸m to +3 x 10⁸m or +1 s to -1 s

Resolution: 5 digits or 0.1 cm (3.3 ps) whichever is greater

Accuracy: ± 0.1 cm or $\pm 0.02\%$ whichever is greater.

Magnitude Characteristics

Range: Full Scale Input to Sensitivity

Resolution

Marker: 0.001 dB (log); 5 digits (linear)

Display: 0.01 dB/div to 20 dB/div (log absolute); 0.01 dB/div to 200 dB/div (log ratio); 0.1 nV/div to 10 V/div (linear absolute); 10^{-10} /div to 10^{20} /div (linear ratio)

Display Units: dB, dBm, dBV, V, and linear ratio.

Accuracy (at 100 kHz, 25°C, and Full Scale Input)

Absolute (A, B, R): ± 0.2 dB

Ratio (A/R, B/R, A/B): ± 0.15 dB (50 Ω); ± 0.2 dB (1 M Ω).

Dynamic Accuracy:

| Error | | Input Level Relative to Full Scale Input |
|----------------------|---------------|--|
| Resolution Bandwidth | | |
| 1 kHz, 100 Hz, 10 Hz | 1 Hz | |
| ± 0.04 dB | ± 0.04 dB | 0 dB to -10 dB |
| ± 0.02 dB | ± 0.02 dB | -10 dB to -50 dB |
| ± 0.05 dB | ± 0.05 dB | -50 dB to -60 dB |
| ± 0.15 dB | ± 0.25 dB | -60 dB to -80 dB |
| ± 0.75 dB | ± 0.75 dB | -80 dB to -90 dB |
| ± 0.75 dB | ± 3.00 dB | -90 dB to -100 dB |

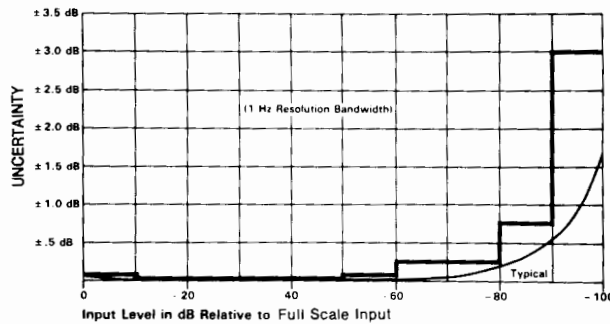
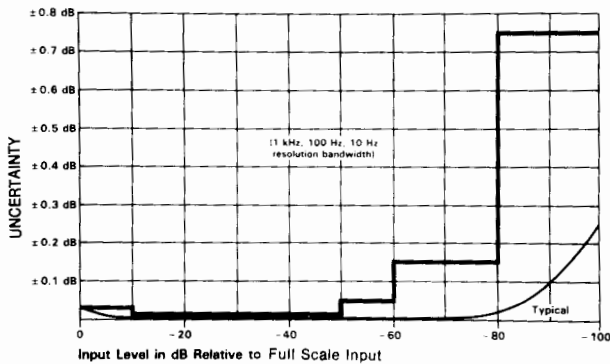

Frequency Response (when driven from a 50 Ω source and with 50 Ω receiver input impedance)

Absolute (A,B,R): 0.3 dBpp from 20 Hz to 20 MHz; 0.6 dBpp from 5 Hz to 200 MHz

Ratio (A/R, B/R, A/B): 0.3 dBpp from 20 Hz to 20 MHz; 0.4 dB from 5 Hz to 200 MHz

Reference Level

Range: -207 dBm to +33 dBm (-220 dBV to +20 dBV) (Log absolute); -400 dB to +400 dB (log ratio); 0 V to 10 V (linear absolute); 0 to 10^{20} (linear ratio)

Resolution: 0.001 dB (log); 5 digits (linear)

Stability

Temperature: Typically $< \pm 0.02$ dB/ $^{\circ}$ C

Time: Typically $< \pm 0.05$ dB/hour at 25 $^{\circ}$ C

Phase Characteristics (A/R, B/R, A/B)

Range ± 180 deg.

Resolution

Marker: 0.005 deg (0.001 rad)

Display: 0.01 deg/div to 200 deg/div (0.00018 rad/div to 3.49 rad/div)

Accuracy (at 100 kHz, 25°C, and Full Scale Input): $\pm 2.0^{\circ}$

Dynamic Accuracy:

| Error | Input Level Relative to Full Scale Input |
|---------------|--|
| ± 4 deg | 0 dB to -10 dB |
| ± 2 deg | -10 dB to -50 dB |
| ± 5 deg | -50 dB to -60 dB |
| ± 1.5 deg | -60 dB to -80 dB |
| ± 7.5 deg | -80 dB to -100 dB |

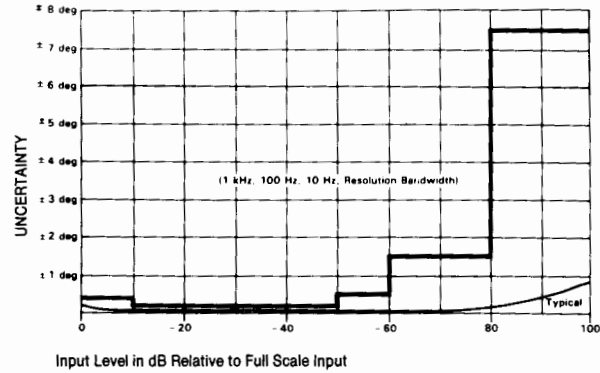

Reference Level Resolution: 0.01 $^{\circ}$

Temperature Stability: Typically $< \pm 0.05$ deg/ $^{\circ}$ C.

Time Stability: Typically $< \pm 0.05^{\circ}$ /hour at 25 $^{\circ}$ C

Polar Display Characteristics

Range, Resolution, Display Units, Dynamic Accuracy, Frequency Response, Uncertainty, Crosstalk, Reference Level, and Stability specifications are the same as the corresponding magnitude and phase characteristics.

Full Scale Magnitude Range

Absolute (A,B,R): 0.1 nV to 10V

Ratio (A/R, B/R, A/B): 10^{-10} to 10^{20}

Real, Imaginary Display Characteristics

Range, Dynamic Accuracy, Frequency Response, Uncertainty, Crosstalk, Stability specifications are the same as the corresponding magnitude and phase characteristics.

Resolution

Marker: 5 digits

Display: 0.1 nV/div to 10V/div for absolute; 10^{-10} to 10^{20} for ratio

Reference Level

Range: ± 10 V for absolute; $\pm 10^{20}$ for ratio

Resolution: 5 digits

Delay Display Characteristics

Normalized Accuracy: $\frac{\text{Dynamic Phase Accuracy}}{360 \times \text{Aperture [Hz]}} + 2\text{nS}$

Reference Level

Range: $\pm 10^3$ s

Resolution: 5 digits



NETWORK ANALYZERS

Audio/IF/RF Network Analyzer, 5 Hz to 200 MHz

HP Model 3577A (con't.)

General Display Characteristics

Annotation: Start/stop, center/span or CW frequency, source level, scale/div, reference level, delay aperture, marker data, and soft key functions.

Graticules: Rectangular logarithmic and linear, polar, and Smith. All graticules are electronically generated.

Traces: Two simultaneous traces may be present with a rectangular graticule. One trace with polar or Smith graticules.

Markers: Each trace has one main marker and an offset marker. Markers indicate data at corresponding trace coordinates in the same units as used to set the Reference Level. Markers can be used to modify certain display parameters. Marker resolution is the same as horizontal display resolution.

Rectangular Graticule: 0% to 100% full scale deflection in 0.05% increments.

Polar/Smith Chart Graticule: ± 500 deg in 0.001 deg increments.

Calibration

Transmission: Both traces can be normalized to measured data with full accuracy and resolution.

Reflection: Corrects for directivity, frequency response and source match errors.

Noise Averaging

Type: Exponentially weighted vector averaging on successive sweep data.

Averaging Factor: Selectable 1 (off), 4, 8, 16, 32, 64, 128, 256.

Linear Phase Slope Compensation: Provides linear phase slope offset of $-72,000^\circ/\text{span}$ to $+72,000^\circ/\text{span}$.

Programming Characteristics

Capability: Remote programming via the Hewlett-Packard Interface Bus (HP-IB). The HP 35677A/B S-Parameter Test Sets are programmable through the HP 3577A interface only.

Interface Functions: SH1, AH1, T5, TE0, L4, LE0, SR1, RL1, PP1, DC1, DT1, C0, E1. For more on these codes refer to the HP-IB section of this catalog.

Output Data Transfer Time: 401 data points (single parameter) can be transferred directly to an HP 200 series computer in Basic language as follows:

ASCII mode: Typically 1500 ms.

Binary Floating point mode: Typically 160 ms.

Graphics Capabilities: 12 lines of text with 40 alphanumeric characters per line, and high resolution line vectors can be displayed through HP-IB commands.

General Characteristics

External Reference Frequency Input

Frequency: 10 MHz/N. N is an integer from 1 to 100.

Level: 0 dBm ± 10 dB, nominal.

Impedance: 50 Ω , nominal.

Connector: BNC female, rear panel.

Reference Frequency Output

Frequency: 10 MHz.

Level: Typically 0 dBm.

Impedance: 50 Ω , nominal.

Connector: BNC female, rear panel.

External Trigger: Triggers on negative TTL transition or contact closure to ground.

Connector: BNC female, rear panel.

Plotter Control: Directly compatible with HP-IB graphics plotters that use Hewlett-Packard Graphics Language (HP-GL) with listen only capability. HP 7470A, HP 7475A, HP 7550A, HP 7090A

Save/Recall: Front panel setups can be stored in non-volatile memory locations 1 through 5. Last state is saved when power is removed.

Operating Conditions

Temperature: 0°C to +55°C.

Relative Humidity: <95% at 40°C.

Altitude: <4,572m (15,000 ft).

Non-Operating Conditions

Temperature: -40°C to +75°C.

Altitude: <15,240m (50,000 ft).

Power: 115V + 10%, -25% (47 Hz to 440 Hz), or 230 V + 10%, -15% (47 Hz to 66 Hz), 450 VA maximum.

Weight: 31 kg (67 lb) net; 41 kg (90 lb) shipping.

Dimensions: 222 mm H x 426 mm W x 578 mm D (8.75 in. x 16.75 in. x 22.75 in.).

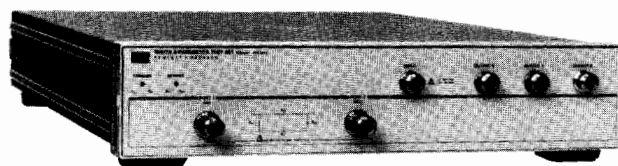

HP 35677A/B S-Parameter Test Sets

While test setups can be constructed from discrete RF components such as power dividers, directional bridges, cables, pads, etc., it is usually much easier to use a fully integrated test set such as the HP Model 35677A/B.

The test set contains the hardware required to make transmission and reflection measurements in both the forward and reverse directions. The only setup required is to connect the device under test to the two measurement ports; the HP 3577A Network Analyzer controls the switching functions, so that even reverse measurements can be made without changing device connections. The HP 35677A is used for 50 Ω systems and the HP 35677B is used for 75 Ω systems.

HP 35677A/B S-Parameter Test Set Specifications

Frequency Range: 100kHz to 200MHz

Test Port Impedance

HP 35677A: 50 Ω .

HP 35677B: 75 Ω .

Directivity: >40 dB.

Frequency Response

Transmission (S₂₁, S₁₂): ± 1 dB, $\pm 5^\circ$.

Reflection (S₁₁, S₂₂): ± 1 dB, $\pm 5^\circ$.

Port Match

Test Ports 1, 2: HP 35677A, >26dB; HP 35677B, >24 dB.

Test Ports 1, 2 open/short ratio: HP 35677A, $< \pm 0.75$ dB magnitude and $< \pm 5^\circ$ phase; HP 35677B, $< \pm 1$ dB magnitude and $< \pm 7.5^\circ$ phase.

Input Port: >20 dB return loss.

Output Ports A, B, and R: >26 dB return loss.

Test Port Isolation: >100 dB.

Insertion Loss

RF Input to Test Port 1 or 2: HP 35677A, typically 13 dB; HP 35677B, typically 19 dB.

RF Input to Output Ports A, B, or R: HP 35677A, typically 19 dB; HP 35677B, typically 31 dB.

Test Port Reciprocity:

Transmission (S₂₁, S₁₂): Typically $< \pm 0.5$ dB magnitude and $< \pm 5^\circ$ phase.

Reflection (S₁₁, S₂₂): Typically $< \pm 0.5$ dB magnitude and $< \pm 5^\circ$ phase.

Incident Power Ratio (Test Port 1 to Test Port 2): Typically $< \pm 1.5$ dB.

RF Input Maximum Operating Level: +25 dBm or ± 30 Vdc.

RF Input Damage Level: +27 dBm or ± 30 Vdc.

Port 1 or 2 Damage Level: +27 dBm or ± 30 Vdc.



Connectors

Input Port and Output Ports A, B, and R: 50Ω Type N female.
Test Ports 1 and 2: HP 35677A, 50Ω Type N female; HP 35677B, 75Ω Type N female.
DC Bias Inputs: BNC female, rear panel.
DC Bias Range: Typically ± 30 Vdc and ± 20 mA with some degradation of RF specifications; 200 mA damage level.

Accessories Supplied

4 ea. 190 mm (7.5 in.) 50Ω cables with Type N male connectors for connection to HP 3577A (HP Part No. 8120-4387).
 1 ea. Test Set interconnect cable to HP 3577A (HP Part NO. 35677-61620).
 1 ea. Rear Panel Lock Foot Kit (HP Part NO. 5061-0099).
 1 ea. Service Manual (HP Part No. 35677-90010).

Recommended Accessories

HP 35677A: HP 35678A 50Ω Type N Calibration Kit; HP 35679A 50 Type N Test Port Extension Cables.
HP 35677B: HP 35678B 75Ω Type N Calibration Kit; HP 35679B 75 Type N Test Port Extension Cables.

General Characteristics

Programming: The HP 35677A/B are completely controlled through the HP 3577A using the HP 3577A interconnect cable. All programming is accomplished through the HP 3577A HP-IB interface.

Power: All power is obtained through the HP 35677A interconnect cable.

Weight: 6 kg (13 lb) net; 12 kg (25 lb) shipping.

Dimensions: 90mm H x 426mm W x 584mm D (3.5 in. x 16.75 in. x 22.75 in.). Add 1/8 inch to depth to include front panel connectors.

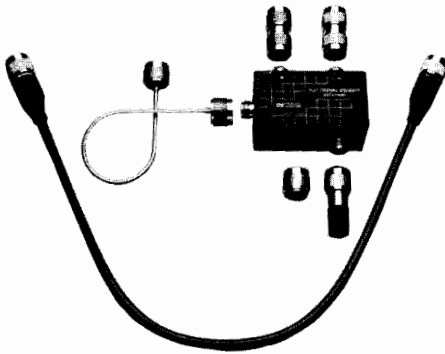

HP 35676A/B Reflection/Transmission Test Kits

Low frequency and broadband measurements with the HP 3577A are greatly simplified with the HP 35676A/B Reflection/Transmission Test Kits. Operating in conjunction with internal calibration routines in the HP 3577A, the test kits provide all the measurement capabilities required for reflection, transmission, and impedance measurements throughout the entire 5 Hz to 200 MHz frequency range. Separate versions are available for 50Ω (HP 35676A) or 75Ω (HP 35676B) environments. Each HP 35676A/B Reflection/Transmission Test Kit contains a precision resistive divider, 50Ω (HP 35676A) or 75Ω (HP 35676B) reference load, coaxial short, carrying case, and all cables and hardware necessary for basic measurements with the HP 3577A Network Analyzer.

HP 35676A/B Operating Characteristics*

Test Port Impedance: 50 \pm 2% typical (HP 35676A)
 75 \pm 2% typical (HP 35676B)
Insertion Loss (source input to test output): 10 \pm 1 dB typical
Equivalent Directivity: 40 dB typical
Equivalent Source Match: 30 dB typical (HP 35676A)
 25 dB typical (HP 35676B)

Ordering Information

HP 3577A Network Analyzer

| | Price |
|--|-----------------|
| HP 3577A Network Analyzer | \$24,000 |
| Option 907: Front Handle Kit | add \$75 |
| Option 908: Rack Mount Kit | add \$40 |
| Option 909: Rack Mount and Front Handle Kit | add \$100 |
| Option 910: Extra Operating and Service Manuals | add \$240 |
| 03577-84401: Service Accessory Kit for HP 3577A | \$250 |

Accessories for 50 Ohm Systems

| | |
|--|---------|
| HP 35677A 50 Ohm Reflection/Transmission Test Kit | \$1,250 |
| HP 35677A 50 Ohm S-Parameter Test Set | \$3,600 |

| | |
|--|----------|
| Option 907: Front Handle Kit | add \$49 |
| Option 908: Rack Mount Kit | add \$25 |
| Option 909: Rack Mount and Front Handle Kit | add \$60 |
| Option 910: Extra Operating and Service Manuals | \$45 |

| | |
|--|---------|
| HP 35678A 50 Ohm Type N Calibration Kit | \$750 |
| HP 35679A 50 Ohm Type N Port Extension Cables | \$500 |
| HP 11525A APC-7 to 50 Ohm Type N Adapter | \$158 |
| HP 11850A 50 Ohm 3-Way Power Splitter | \$805 |
| HP 11853A 50 Ohm Type N Accessory Kit | \$230 |
| HP 11854A 50 Ohm BNC Accessory Kit | \$195 |
| HP 11600B TO-18/TO-72 Transistor Fixture | \$1,505 |
| HP 11602B TO-5/TO-12 Transistor Fixture | \$1,505 |
| HP 11858A Transistor Fixture Adaptor | \$980 |

Accessories for 75 Ohm Systems

| | |
|--|---------|
| HP 35676B 75 Ohm Reflection/Transmission Test Kit | \$1,500 |
| HP 35677B 75 Ohm S-Parameter Test Set | \$3,600 |

| | |
|--|----------|
| Option 907: Front Handle Kit | add \$49 |
| Option 908: Rack Mount Kit | add \$25 |
| Option 909: Rack Mount and Front Handle Kit | add \$60 |
| Option 910: Extra Operating and Service Manuals | add \$45 |

| | |
|--|---------|
| HP 35678B 75 Ohm Type N Calibration Kit | \$1,400 |
| HP 35679B 75 Ohm Type N Port Extension Cables | \$1,650 |
| HP 11850B 75 Ohm Power Splitter | \$1,405 |
| HP 11852A 50 Ohm to 75 Ohm Minimum Loss Pad | \$205 |
| HP 11855A 75 Ohm Type N Accessory Kit | \$230 |
| HP 11856A 75 Ohm BNC Accessory Kit | \$330 |

*Typical, 5 Hz - 200 MHz, assuming proper calibration with supplied accessories.

NETWORK ANALYZERS

Model HP 3577S Network Analyzer System

- Twelve-term error correction
- Conversion from S-Parameters to H, Y, or Z-Parameters
- Convenient disc storage/recall of device, setup, and calibration data

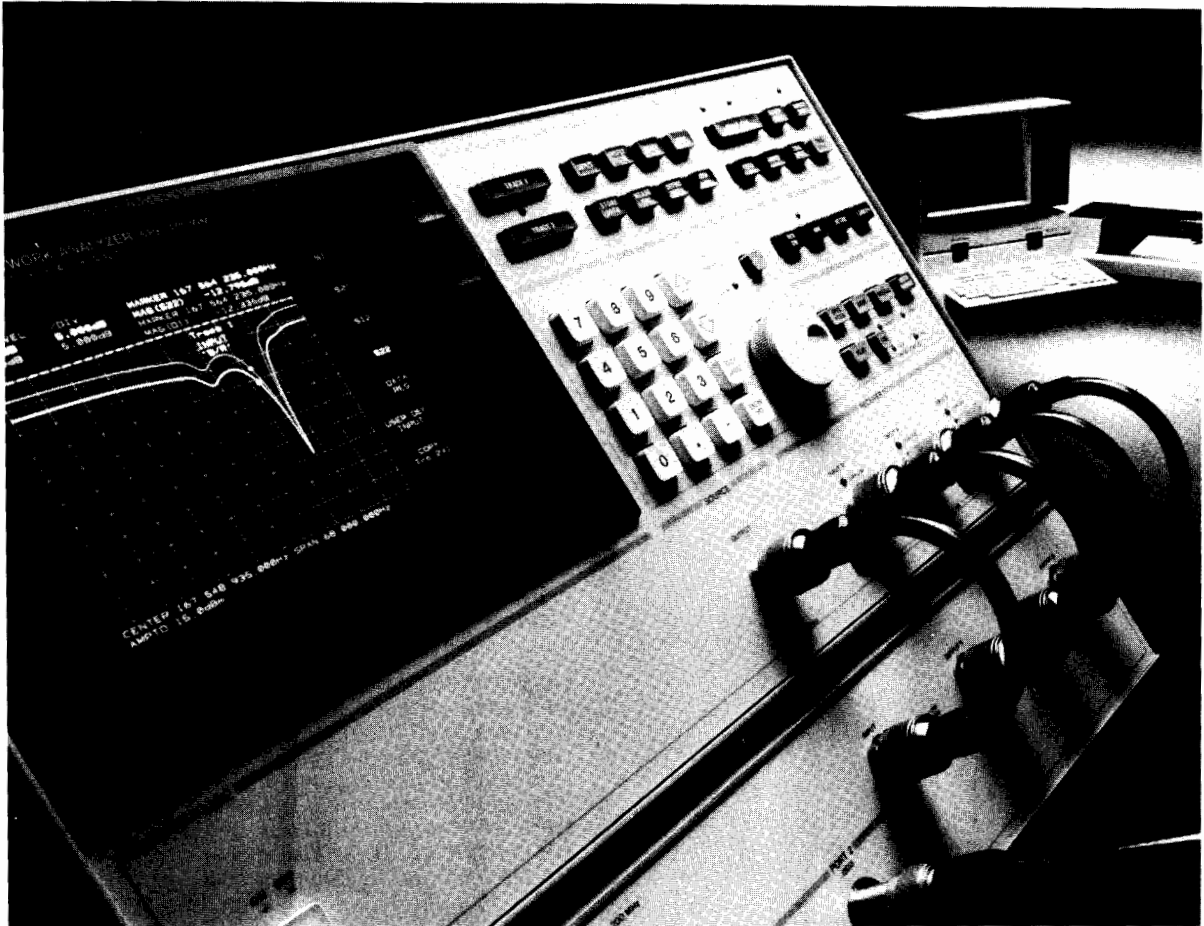

Introduction

The HP 3577S Network Analyzer System brings full two port twelve-term error correction to the HP 3577A Network Analyzer and its companion HP 35677A/B S-Parameter Test Set. Although the HP 3577S is a turn key system, it is also the natural foundation for an automated network analysis workstation with expanded capability. The HP 3577S can be integrated with other instrumentation and software to obtain customized solutions to difficult measurement and productivity problems.

Each HP 3577S system includes the HP 3577A Network Analyzer, HP 35677A/B S-Parameter Test Set, HP Model 9000 Series 200 Computer, HP 35678A/B Calibration Kit, and HP 35675A Accuracy Enhancement Software plus various accessories and peripherals.

Accurate measurements can be made inside environmental chambers and at remote test fixtures. Repeatable errors due to the effects of cables and connectors are removed from the measurement results by the HP 35675A error correction routines. Even the repeatable errors contributed by custom text fixtures can be eliminated, provided that compatible short, thru and reference terminations are available.

Parameter Conversion

Error corrected s-parameters are converted to accurate hybrid (h), admittance (y), or impedance (z) parameters by the HP 35675A system software. The appropriate parameter set can then be selected for the device under test. For example, transistor parameters are easily characterized using h parameters and the optional HP 11600B/11602B Transistor Test Fixtures.

Storage/Recall of Device Data, Calibration Data, and Instrument States

Measurements can be repeated without having to setup and recalibrate the system. Fast, convenient setup is accomplished by recalling previously stored error coefficients and instrument settings from disk memory. This feature is especially helpful when switching among several test fixtures or when linking a series of sweeps together to increase resolution. The number of configurations stored is limited only by the capacity of the storage media.

Device measurement data can also be stored for later retrieval, archived or, with a small programming effort, accumulated in a data base for analysis using your own statistical techniques.

Accuracy Enhancement

For each measurement, the entire system is first characterized by successively measuring an open and the short, thru, and reference terminations furnished in the HP 35678A/B Calibration Kit. Twelve-term vector error coefficients derived from the measurement of these known impedances are then used to correct subsequent s-parameter measurements. Eight-term partial error correction can be invoked when measuring the transmission parameters of well-matched devices; in such cases faster measurements can be made without a significant loss of accuracy.

Output

There is an output mode for every need. Test results can be most quickly evaluated by testing or plotting device data on the computer display. Permanent documentation is then obtained by transferring the displayed measurement results to an HP Graphics Printer such as the HP ThinkJet 2225A. Similarly, report quality graphs can be generated by one of HP's many graphics plotters.

HP 3577S Network Analyzer System Characteristics

Frequency Range: 100 KHz to 200 MHz

System Impedance: 50Ω (with HP 35677A)
75Ω (with HP 35677B)

Connector Type: Type N female

Typical Output Power Range:

+2 dBm to -62 dBm (with HP 35677A)
-4 dBm to -68 dBm (with HP 35677B)

Typical DC Bias:

+30V DC and 20 mA with some degradation of RF specification; 200 mA damage level. (DC bias voltages for the device under test can be applied via the rear panel of the HP 35677A/B.)

Error Correction:

One and two port 8 - or 12 - term

Typical Performance (401 point, 12 term mode):

Calibration: 2 minutes; includes time to connect devices
Measurement plus correction: 30 seconds

Required Memory: 350K bytes for HP 35675A
Accuracy Enhancement Software

Basic: HP 35675A Accuracy Enhancement Software will run on BASIC v. 2.0, 2.1, or 3.0

HP Model 9000 Series 200 Computers

The HP 35675A Accuracy Enhancement Software will work with any HP Model 9000 Series 200 computer, as will the HP-IB-equipped HP 3577A. An HP 3577S Network Analyzer System can therefore be easily configured to suit individual needs. Some recommended system configurations are listed at the end of this section.

Ordering Information

HP 3577S Network Analyzer System \$0

Specify this system reference number to insure coordination of shipments and guarantee compatibility of instruments and software.

A complete HP 3577S Network Analyzer System includes HP 3577A, HP 35677A/B, HP 35678A/B, and a properly configured HP 9000 Series 200 Computer. IT IS NOT NECESSARY TO ORDER COMPONENTS ALREADY OWNED.

| | |
|---|----------|
| HP 3577A Network Analyzer | \$24,000 |
| HP 35675A Accuracy Enhancement Software | \$ 1,500 |
| HP 35677A 50 Ohm S-Parameter Test Set | \$ 3,600 |
| HP 35678A 50 Ohm Type N Calibration Kit | \$ 750 |
| HP 35679A 50 Ohm Type N Port Extension Cables | \$ 500 |

| | |
|---|----------|
| HP 35677B 75 Ohm S-Parameter Test Set | \$ 3,600 |
| HP 35678B 75 Ohm Type N Calibration Kit | \$ 1,400 |
| HP 35679B 75 Ohm Type N Port Extension Cables | \$ 1,650 |
| HP 11600B 50 Ohm TO-18/TO-72 Transistor Fixture | \$ 1,505 |
| HP 11602B 50 Ohm TO-5/TO-12 Transistor Fixture | \$ 1,505 |
| HP 11858A 50 Ohm Transistor Fixture Adaptor | \$ 980 |

Please consult the HP 3577A Ordering Information on page 609 for more information concerning options and accessories for your HP 3577S System.

HP 9000 Series 200 Computer Systems Configured for HP 3577S

| | | |
|-----------------------------|---|----------|
| 9816S / Option 001 | Model 216 Personal Technical Computer Includes Basic 3.0 and 1.02 Mbyte memory. Requires HP 9122D or HP 9125S flexible disc drive. | |
| Option 630: | For use with HP 9122D Disc Drive | \$ 8,500 |
| Option 650: | For use with HP 9125S Disc Drive | \$ 8,500 |
| 9817H / Option 001: | Personal Modular Computer Includes 3.0 and 1.02 Mbyte memory. Requires HP 981613A Basic 3.0 Language System and HP 9122D or HP 9125S flexible disc drive. | \$ 9,030 |
| 9920S / Option 001: | Technical Modular Computer Includes Basic 3.0 and 1.2 Mbyte memory. Requires HP 9122D or HP 9125S flexible disc drive. | |
| Option 630: | For use with HP 9122D Disc Drive | \$10,520 |
| Option 650: | For use with HP 9125S Disc Drive | \$10,520 |
| 9826S / Option 001: | Model 226 Technical Computer Includes Basic 3.0, 1.02 Mbyte memory and internal 5/4 inch flexible disc drive. | \$14,075 |
| 9836S / Option 001: | Model 236 Technical Computer Includes Basic 3.0, 1.02 Mbyte memory and dual internal 5/4 inch flexible disc drives. | \$16,940 |
| 9836CS / Option 001: | Model 236 Color Computer Includes 1.02 Mbyte memory. Requires HP 98613A Basic 3.0 Language System and HP 9122D or HP 9125S flexible drive. | \$20,030 |
| 9837H / Option 001: | Technical Computer | \$17,020 |

Computer Peripherals

| | |
|---|---------|
| HP 9122D Dual 3.5" Disc Drive | \$1,270 |
| HP 9125S Single 5.25" Flexible Disc Drive | \$1,200 |
| HP 98256A Additional 256K Memory Board | \$820 |
| HP 98635A Floating Point Math Card | \$975 |

For complete ordering information, prices, delivery, and available options, contact your local HP sales representative.

NETWORK ANALYZERS

Gain/Phase Meter

Model 3575A

- dBV, dB ratio and degrees from 1 Hz to 13 MHz

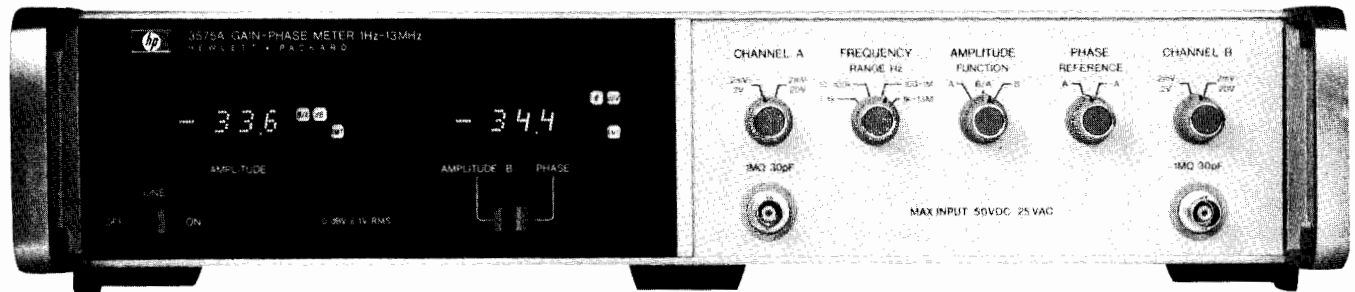

HP 3575A Option 001 dual panel meters

Description

The HP 3575A Gain-Phase Meter is a versatile two-channel analyzer which can measure and display the absolute amplitude level or amplitude ratio of signals present at the inputs. In addition, the HP 3575A can measure the phase relationship of the two signals. This analyzer is a broadband detector, which is easy to use because no frequency tuning is required.

Since a dedicated tracking source is not required to operate with the HP 3575A, a wide selection of stimuli is possible. This flexibility coupled with a variety of possible amplitude, gain and phase outputs (LED display, analog outputs, and optional BCD) gives you a wide choice of cost/results tradeoffs. For example, you may wish to manually plot your network response data on a Bode diagram in which case a low cost sinewave oscillator stimulus may be used. For easier, quicker results you may select the HP 7090A plotter and let the instruments plot your response. You may use a calculator or computer to control a programmable stimulus source and the HP 3575A to provide automatic measurements. Here you have a wide range of computation and output possibilities.

Phase

The phase relationship of two signals is indicated over a range of ± 192 degrees with 0.1 degree resolution. A unique logic circuit (patent) design allows the HP 3575A to make stable phase measurements in the presence of noise. This feature minimizes the error to less than two degrees for a signal-to-noise ratio of 30 dB. One of three band limiting filters may be selected to get further noise rejection.

The HP 3575A is also capable of measuring the phase relationship of a variety of waveforms, such as square waves and triangle waves. Even harmonic and in-phase odd harmonic components of these signals cause no phase measurement error. For out-of-phase odd harmonic signal-to-harmonic ratios of 40 dB, measurement errors are less than 0.6 degree as shown in Figure 1.

Amplitude

The amplitude of either channel or the ratio of the two can be measured over an 80 dB dynamic range and 100 dB measurement range. Resolution is 0.1 dB. Results are displayed in dBV for channel amplitude and dB for ratio measurements. Digit blanking and channel overload annunciators will turn on if the maximum allowable signal level at either channel input is exceeded.

Readout

The standard three-digit LED display may be selected by the operator to indicate the amplitude of channel A or B, gain or phase. A second three-digit LED display is optionally available for simultaneous display of amplitude and phase readings. Lighted annunciators identify the measurement function, units and remote status.

Programmable

Two programmable options both offer full control of front panel functions and BCD output of information (amplitude, ratio or phase) contained in both digital displays. The two options give the user a choice of negative true or positive true outputs.

Applications

The HP 3575A can solve network analysis problems in the 1 Hz to 13 MHz frequency range where complex measurements (gain or phase or both) are required. A few of the many measurements it can make are gain and phase response of feedback systems, envelope delay and return loss of transmission lines, complex impedance of components, and insertion loss of mixers and frequency doublers. Bode plots and Nichols charts are useful graphical tools for analyzing many of these response data.

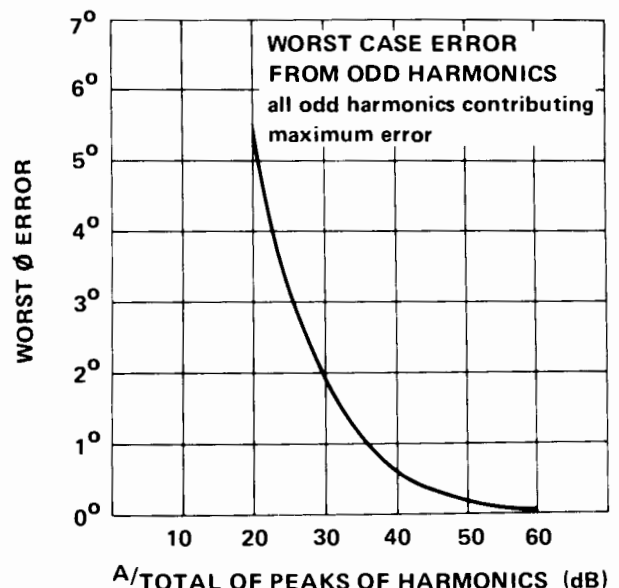
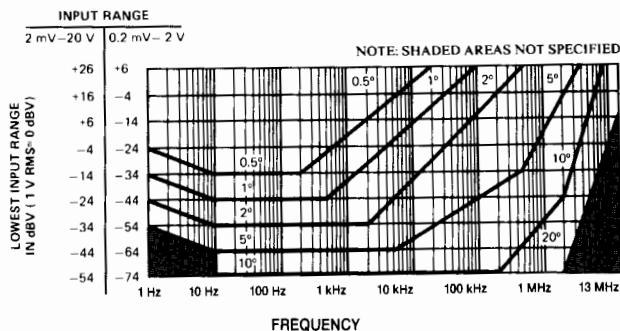

Figure 1. Worst case error from odd harmonics.

Specifications

Phase Accuracy*



*Conditions: Temperature: $25^{\circ}\text{C} \pm 10^{\circ}\text{C}$; Frequency range switch on lowest applicable range; Analog Output accuracy (rear panel).

Input signal range: 200 μV rms to 20 V rms.

Harmonic Rejection

Even harmonics: no error.

Odd harmonics: (in phase) no error.

Odd harmonics: (out of phase) 0.57° worst case error when total odd harmonic distortion is 40 dB below the fundamental.

Noise tolerance: 2° error for a 10 kHz, 1 V sine wave on one channel. One volt sine wave added to Gaussian noise (limited to a 1 MHz bandwidth and 30 dB S/N ratio) on the other channel. The 100 Hz to 1 MHz frequency range was used.

Display

Range: $\pm 180^{\circ}$ with 12° of overrange.

Resolution: 0.1° .

Panel meter accuracy: ± 3 counts (0.3 degrees/dB/dBV). The panel meter error must be added to the phase and amplitude errors to obtain the display error.

Inputs

Impedance: 1 M Ω 30 pF.

Protection: ± 50 V dc, 25 V rms.

Response Time to Achieve 95% of Final Reading

| Frequency Range | Time |
|------------------|-------|
| 1 Hz to 1 kHz | 20 s |
| 10 Hz to 100 kHz | 2 s |
| 100 Hz to 1 MHz | 0.2 s |
| 1 kHz to 13 MHz | 20 ms |

Rear terminal inputs are available as a special (HP 3575A-C09). Digital (Opt. 002). 0, +5 V; ground true. Twelve lines to fully program all functions.

Outputs

Analog

Phase: 10 mV/degree.

Amplitude: 10 mV/dB or dBV.

Output impedance: 1 k Ω

Digital (Opt 002): 0, +5 V; ground true. 31 output lines (1-2-4-8 BCD).

Digital readout: $3\frac{1}{2}$ digits with sign and annunciators. Four readings per second, fixed.

Amplitude Accuracy*

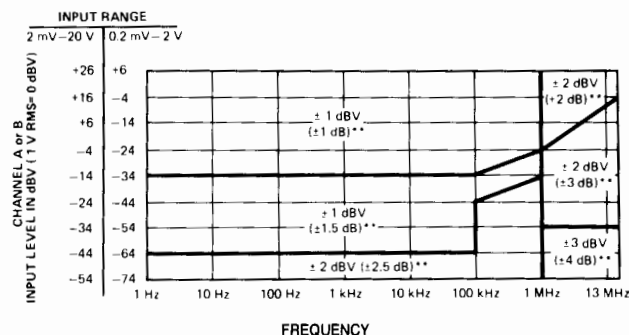

*Conditions: Temperature: $25^{\circ}\text{C} \pm 10^{\circ}\text{C}$; accuracy applies to dB V and ratio measurements with the same frequency on both channels; for ratio measurements, the lowest level channel determines accuracy; analog output accuracy (rear panel).

**Ratio (B/A) tolerances

Amplitude functions: A dBV, B dBV or B/A dB.

Amplitude reference: (A dBV, B dBV) 1 V rms = 0 dBV.

Display

Range: A dBV, B dBV: -74 dBV to $+26$ dBV (in two ranges). B/A dB: -100 to $+100$ dB. (Both input signals must be within the range of 0.2 mV rms to 20 V rms)

Resolution: 0.1 dBV, 0.1 dB.

General

Power: 115 V/230 V $\pm 10\%$, 48 Hz to 440 Hz, 40 VA.

Weight: net, 8.3 kg (18.4 lb). Shipping, 11.3 kg (25.8 lb).

Size: 88 H x 425 W x 337 mm D (3.47" x 16.75" x 13.25").

Accessories furnished: extender boards, line cable and 50-pin connector (Opt 002 and 003 only).

Recommended Accessories: HP 7090A Measurement Plotting System.

Options

001 Dual panel meters: HP's 3575A Opt 001 is equipped with two digital readouts and two analog outputs for simultaneous amplitude and phase readings. This option has no additional measurement capability over the standard instrument.

Dual analog outputs: rear panel BNC connectors provide dc output voltages that correspond to the respective panel meter readings.

001: Dual Readout add \$630

002/003 Programmable: HP 3575A Opt 002 and Opt 003 are equipped with dual panel meters and dual analog outputs (same as Opt 001) plus BCD outputs and complete remote control capability. Opt 002 has negative true output levels and Opt 003 has positive true output levels. BCD information from the HP 3575A (Opt 002) can be read by the HP 9800 series HP Desktop Computers with appropriate interfacing.

002: Programmable (negative true output levels) add \$1100

003: Programmable (positive true output levels) add \$1100

908: Rack Flange Kit add \$35

910: Extra Product Manual add \$50

HP 3575A Gain/Phase Meter

\$4950



NETWORK ANALYZERS

RF Network Analyzer, 4 MHz to 1300 MHz (optional to 2600 MHz)

Model 8754A

- Integrated source, receiver, and display
- H26 option covers 4 to 2600 MHz
- Three inputs, two measurement channels
- 80 dB dynamic range

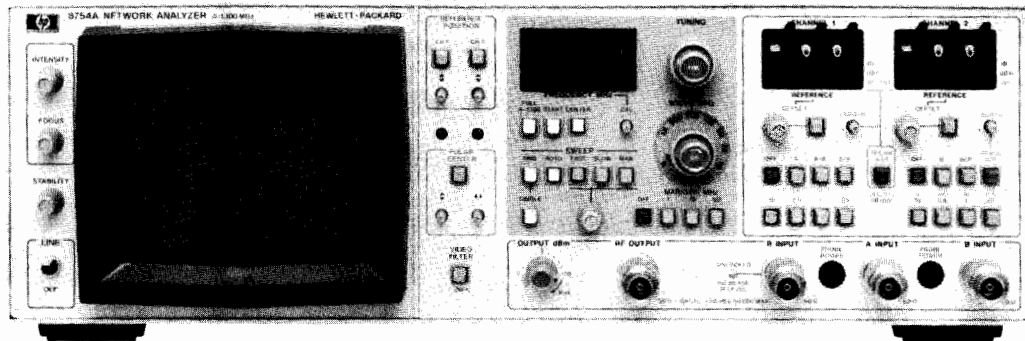

HP 8754A

Description

The HP 8754A is a complete stimulus/response test system which combines a 4-1300 MHz swept source, three-input narrowband, tuned receiver, and both rectilinear and polar displays in a compact package. The convenient built-in source incorporates digital display of the start or center frequency, the ability to sweep all or any portion of the 4-1300 MHz range, and crystal markers at 1, 10, or 50 MHz intervals to enable accurate frequency calibration and measurement. The receiver provides 80 dB dynamic range in two independent measurement channels to allow simultaneous measurement of any two transmission or reflection parameters using a single test setup. Measurements of absolute power, magnitude ratio, phase angle, and reflection coefficient (or return loss) are displayed on the fully calibrated CRT with resolutions up to 0.25 dB and 2.5 degrees per major division. With these features the HP 8754A offers a new level of operating convenience and technical performance to swept magnitude and phase measurements in laboratory, production, and field testing applications at an economical price.

A comprehensive line of 50-ohm and 75-ohm test sets allow you to tailor your test setup for a specific measurement using the minimum of equipment, or to provide the maximum in versatility for a wide range of applications. Signal separation devices include the HP 11850 Power Splitter for precision transmission measurements, the HP 8502 Transmission/Reflection Test Set for simultaneous transmission and reflection measurements, the HP 8748A S-Parameter Test Set to measure both forward and reverse S-Parameters. Matched cable sets, precision adapters, and transistor fixtures provide convenient, reliable connections to the test device. Adding the HP 8750A Storage Normalizer provides flicker-free rectilinear displays regardless of sweep rate. The HP 8750A will automatically store and subtract out the frequency response of a test set or cable if necessary, eliminating the need to use a grease pencil when making normalized measurements. For applications that require exceptional frequency accuracy and stability, the HP 8754A may be used with external sources such as the HP 8660, 8662A, 8663A or 8640 Signal Generators.

Coverage to 2600 MHz

The HP 8754A Option H26 provides an economical solution for magnitude and phase measurements to 2600 MHz. Frequency coverage to 2600 MHz is obtained by adding an external frequency doubler (supplied with Option H26) to the RF source output and engaging the "DOUBLER" pushbutton on the front panel. The external frequency doubler doubles the RF output frequency while the

"DOUBLER" pushbutton changes the phase lock circuitry that enables the receiver to lock onto and track signals up to 2600 MHz. In this doubled mode of operation it is necessary to multiply the indicated frequency settings by two for a proper reading. The frequency span between the 1, 10 and 50 MHz crystal markers is also doubled but their excellent accuracy and stability are unaffected. The performance of the source and doubler combination is specified from 100 MHz to 2600 MHz although it is usable down to 8 MHz.

A comprehensive line of 50-ohm 2600 MHz test sets and accessories allow you to tailor your test setup for a specific measurement. For the maximum in versatility, use the HP 8748A Option H26 S-Parameter Test Set which allows characterization of forward and reverse S-Parameters without physically reversing the device. Other test sets include the HP 8502A Option H26 Transmission/Reflection Test Set for simultaneous transmission and reflection measurements and the HP 11850A Option H26 Power Splitter for transmission measurements. Matched cable sets, adapters and transistor fixtures with coverage up to 2600 MHz are also available for connections to test devices.

HP 8754A Network Analyzer Specifications

Frequency range: 4 to 1300 MHz. Option H26 coverage is 4 to 2600 MHz; 4 to 1300 MHz in normal mode, 100 to 2600 MHz in doubled mode (usable down to 8 MHz).

Sweep modes: linear full sweep (4 to 1300 MHz or 8 to 2600 MHz in doubled mode) and calibrated sweep widths with variable start or center frequency.

Sweep widths: selectable sweep width ranges from 1 to 1000 MHz (2 to 2000 MHz with Option H26) in a 1, 2, 5 sequence, plus CW. A vernier allows continuous adjustment of sweep width within each range and calibration to internal crystal makers.

Spectral Purity (+10 dBm RF output level)

Residual FM (swept and CW): ≤ 7 kHz rms (10 kHz bandwidth).

Harmonics: -28 dBc.

Output power range: 0 to +13 dBm typical, ± 0.5 dB flatness. Option H26 100 to 2600 MHz: (measured at the output of the doubler with +10 dBm at the input, frequency doubler has approx. 14 dB of conversion loss).

Residual FM (swept or CW): ≤ 14 kHz rms (10 kHz bandwidth).

Harmonics: Second typically -15 dBc, Third typically -25 dBc.

Output power range: 0 to +13 dBm typical, ± 0.5 dB flatness.

Receiver

Frequency: 4 MHz to 1300 MHz. Option H26 ("DOUBLER" pushbutton engaged): 8 to 2600 MHz.

Input channel: two test inputs (A and B) and one reference (R) input.

Input connectors: type-N Female, 50 ohms nominal impedance.

Input port match: ≥ 20 dB Return Loss (1.22 SWR).

Option H26:

1300 to 2000 MHz: ≥ 13 dB Return Loss (1.58 SWR).

2000 to 2600 MHz: ≥ 9 dB Return Loss (2.10 SWR).

Maximum input level: 0 dBm at R, A, B inputs.

Damage level: +20 dBm (50 Vdc).

Noise level: < -80 dBm at A and B inputs.

Minimum R input level: -40 dBm (≥ -40 dBm required to operate R input phase-lock).

Crosstalk between channels: > 83 dB.

Error Limits:

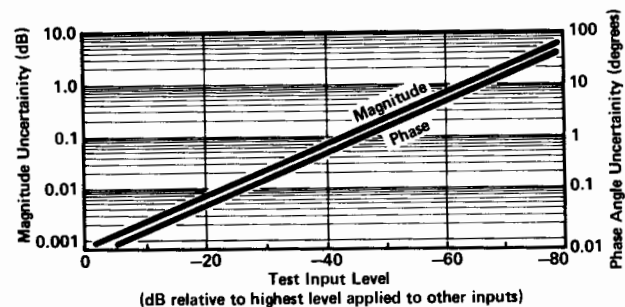

Magnitude frequency response (flatness)

Absolute (A,B): ± 1 dB.

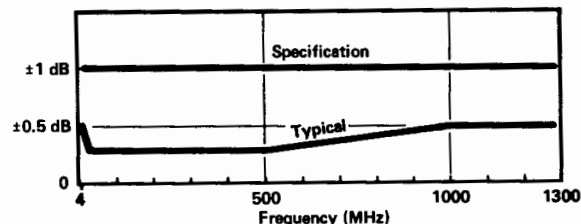

Ratio (A/R, B/R): $\leq +0.3$ dB.

Option H26: 8 to 2000 MHz: $\leq \pm 0.7$ dB.

8 to 2600 MHz: $\leq \pm 1.3$ dB.

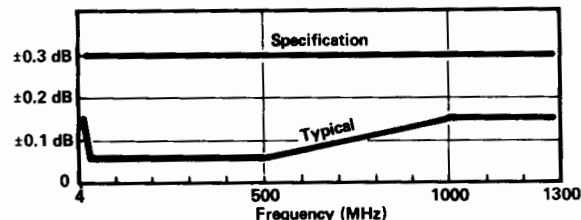

Magnitude dynamic accuracy: ± 0.3 dB from 0 to -50 dBm, ± 0.5 dB from -50 to -60 dBm, ± 1 dB from -60 to -70 dBm, ± 2.5 dB from -70 to -80 dBm.

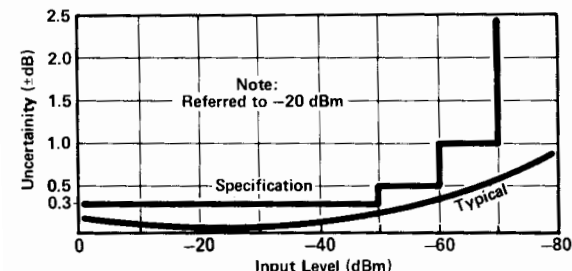

Magnitude reference offset range: ± 199 dB in 1 dB steps. Vernier provides variable offset for calibration.

Absolute power measurements (A, B, and R): typically ± 0.5 dBm at 0 dBm, 50 MHz input.

Phase frequency response: $\pm 2.5^\circ$ (typically $\pm 1^\circ$); Option H26 1300-2600 MHz, $\pm 5^\circ$.

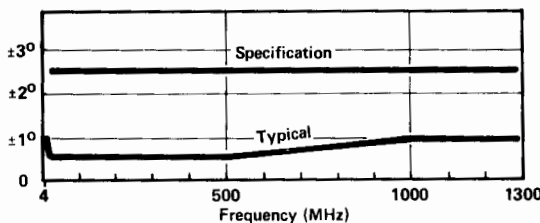

Phase range: $\pm 180^\circ$.

Phase dynamic accuracy: $\pm 2^\circ$ from 0 to -50 dBm, $\pm 4^\circ$ from -50 to -70 dBm.

Phase reference offset range: $\pm 199^\circ$ in 1° steps. Vernier provides variable offset for calibration.

Electrical length adjustment range: typically 0 to 16 cm length for transmission phase; typically 0 to 8 cm reference plane extension for reflection measurements. Option H26 (to 2600 MHz) typically up to 8 cm for transmission phase; up to 4 cm for reflection.

Display

Measurement functions: CRT displays either polar trace or Channel 1 and Channel 2 rectilinear traces.

Reference position: independent reference lines for Channel 1 and Channel 2 and polar center can be set to any position for calibration.

Video filter: typically 100 Hz (10 kHz without filter).

Graticule size: rectilinear 10 cm by 8 cm; polar 8 cm in diameter.

Smith chart overlays: 2, 1, 0.2 and 0.1 full scale (furnished).

CRT photography: Tektronix C-5B Oscilloscope Camera is recommended (UV illumination will not excite P39 CRT phosphor for graticule exposure).

Resolution: 10, 2.5, 1, 0.25 dB magnitude per major division. 90, 45, 10, 2.5 degrees phase per major division.

Accuracy: $\pm 2\%$ ± 0.05 division for rectilinear trace. Within 2.5 mm for polar trace.

General

Sweep output: -5 V to $+5$ V.

External sweep inputs: 0 to 10 V nominal.

X-Y Recorder/External CRT Output

Horizontal and vertical: 0.1 V/div.

Penlift/blinking: $+5$ V Blanking and Penlift.

External marker input: typically -13 dBm RF signal produce a marker at the frequency of the RF signal.

Magnitude/phase output: -10 mV/degree and -100 mV/dB.

Probe power: Two $+15$ Vdc and -12.6 Vdc.

Storage-Normalizer interfaces: directly compatible with the HP 8750A Storage-Normalizer. HP 8501A Storage-Normalizer requires a single internal adjustment for compatibility.

Programming connector: outputs include magnitude/phase and sweep outputs and inputs described above as well as measurement mode selection by TTL levels or contact closures.

External source: the HP 8754A sweep-out voltage is provided to frequency modulate (sweep) an external signal generator for narrow-band measurement applications. A sweep input is provided to synchronize the CRT display for use with an externally swept source (HP 8620 and 8350 series).

Temperature

Operating: 0° to 55° C except where noted.

Storage: -40° C to $+75^\circ$ C.

EMI: VDE 0871/0875 and CISPR publication 11.

Safety: conforms to the requirements of IEC 348.

Power: selection of 100, 120, 220 and 240 V $\pm 5\%$ -10% . 48 to 66 Hz, 20 VA max.

Size: 425.5 mm W x 133 mm H x 505 mm D (16 $\frac{3}{4}$ " x 5 $\frac{1}{4}$ " x 19 $\frac{7}{8}$ ".)

Weight: net, 16.8 kg (37 lb); shipping, 19 kg (42 lb).

NETWORK ANALYZERS

RF Network Analyzer

Model 8754A (cont.)

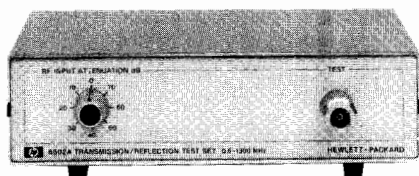

HP 8502A

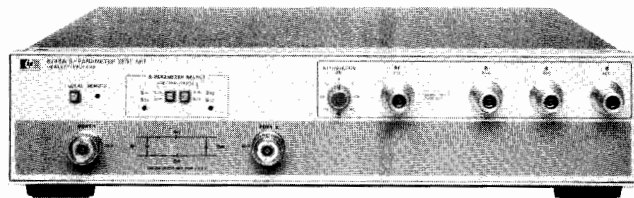

HP 8748A

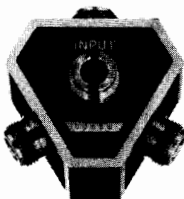

HP 11850A

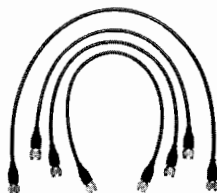

HP 11851A

HP 8748A 50 Ohm S-Parameter Test Set Specifications

Frequency Range: 4 to 1300 MHz. Option H26: 4 to 2600 MHz.

Directivity: ≥ 40 dB.

Option H26: 4 to 1300 MHz, ≥ 35 dB.

1300 to 2600 MHz, ≥ 30 dB.

Frequency Response¹:

Transmission (S_{21} , S_{12}): ± 1 dB, $\pm 8^\circ$.

Option H26 (2600 MHz frequency range):

4 to 1300 MHz: ± 1 dB, $\pm 8^\circ$.

1300 to 2600 MHz: ± 1.5 dB, $\pm 15^\circ$.

Reflection (S_{11} , S_{22}): ± 2 dB, $\pm 15^\circ$.

Option H26 (2600 MHz frequency range):

4 to 1300 MHz: ± 2 dB, $\pm 15^\circ$.

1300 to 2600 MHz: ± 3 dB, $\pm 20^\circ$.

Port Match²:

Test Port 1 and 2: ≥ 26 dB Return Loss (≤ 1.11 SWR).

Test Port 1 and 2 open/short ratio: ± 0.75 dB and $\pm 6^\circ$ from 4 to 1000 MHz, ± 0.9 dB and $\pm 7.5^\circ$ from 1000 to 1300 MHz.

Option H26:

Test Port 1 and 2:

4 to 1300 MHz, 22 dB Return Loss.

1300 to 2600 MHz, 17 dB Return Loss.

Test Port 1 and 2 open/short ratio:

4 to 1300 MHz: ± 1.2 dB, $\pm 10^\circ$.

1300 to 2600 MHz: ± 1.5 dB, $\pm 15^\circ$.

Insertion Loss:

Input to Test Port 1 or 2: 13 dB nominal.

Input to Port A, B or R: 19 dB nominal.

Option H26: same

Maximum Operating Level: +20 dBm.

RF Attenuator Range: 0 to 70 dB in 10 dB steps.

Test Port Connectors: APC-7.

DC Bias Input Range: ± 30 Vdc, ± 200 mA.

Includes: cables for connection to HP 8754 and Reference Plane Extension Cable Kit.

Recommended Accessory: HP 11857A Test Port Extension Cables, HP 11608A Transistor Fixture, or HP 11600B, 11602B Transistor Fixtures.

Power: 20Vdc, supplied from HP 8754 via interface cable (included).

Size: 432mmW x 90mmH x 495mmD (17" x 3½" x 19½").

Weight: net, 9.1 kg (20 lb); shipping, 11.3 kg (25 lb).

HP 8502A 50 Ohm Transmission/Reflection Test Set

HP 8502B 75 Ohm Transmission/Reflection Test Set

General: the HP 8502 contains a power splitter and directional bridge that permits simultaneous transmission and reflection measurements.

Detailed specifications on the HP 8502A and 8502B appear on page 622. The HP 8502A Option H26 is intended as an accessory to the HP 8754A Option H26 and allows 50 ohm transmission/reflection measurements up to 2600 MHz. For interconnections from the HP 8502 to the HP 8754A use the HP 11851A RF Cable Set. The major specifications of the HP 8502A option H26 are:

Frequency Range: 4 to 2600 MHz.

Directivity:

4 to 1300 MHz: ≥ 35 dB.

1300 to 2600 MHz: ≥ 30 dB.

Frequency Response:

Transmission:

4 to 1300 MHz: ≤ 0.9 dB, $\leq \pm 10^\circ$.

1300 to 2600 MHz: $\leq \pm 1.5$ dB, $\leq \pm 15^\circ$.

Reflection:

4 to 1300 MHz: $\leq \pm 1.8$ dB, $\leq \pm 10^\circ$.

1300 to 2600 MHz: $\leq \pm 3.0$ dB, $\leq \pm 15^\circ$.

Port Match:

Test Ports:

4 to 1300 MHz: ≥ 22 dB Return Loss (≤ 1.17 SWR).

1300 to 2600 MHz: ≥ 17 dB Return Loss (≤ 1.33 SWR).

Test Port Open/Short Ratio:

4 to 1300 MHz: $\leq \pm 1.2$ dB, $\leq \pm 10^\circ$.

1300 to 2600 MHz: $\leq \pm 1.5$ dB, $\leq \pm 15^\circ$.

Reference and Reflection Port:

4 to 1300 MHz: ≥ 22 dB (≤ 1.17 SWR).

1300 to 2600 MHz: ≥ 17 dB (≤ 1.33 SWR).

Input Port

4 to 1300 MHz: ≥ 20 dB (≤ 1.22 SWR).

1300 to 2600 MHz: ≥ 12 dB (≤ 1.67 SWR).

HP 11850A 50 Ω Three-Way Power Splitter

HP 11850B 75 Ω Three-Way Power Splitter

General: one output port provides the reference output and the other two output ports can be used for independent transmission measurements. Use the HP 11851A RF Cable Set for interconnections. Detailed specifications on page 622.

HP 11851A RF Cable Set

General: three 61 cm (24 in.) 50 Ω cables, phase matched to $\pm 4^\circ$ and one 86 cm (34 in.) 50 Ω cable. Used with HP 8502A/B and 11850A/B. Detailed specifications on page 623.

HP 11857A APC-7 Test Port Extension Cables

General: two precision 50 Ω cables phase matched to $\pm 2^\circ$ to connect test device between HP 8748A test ports. Detailed specifications on page 623.

Transistor Fixtures

General: three transistor fixtures can be used with the HP 8748A. The HP 11600B and 11602B require use of the HP 11858A Transistor Fixture Adapter. The HP 11608A transistor fixture connects directly to the HP 8748A. Detailed specifications on pages 634 and 636.

Adapter Kits

General: the HP 11853A, 11854A, 11855A, and 11856A accessory kits are available to provide precision Type N and BNC adapters and calibration standards for use with the HP 11850A/B, 8502A/B, and 8748A test setups. Detailed specifications on page 623.

¹ \pm degrees, specified as deviation from linear phase.

² Effective port match for ratio measurements.

Ordering Information

| | Price |
|---|-------------|
| HP 8754A Network Analyzer | \$15,500 |
| Opt H26: 4-2600 MHz | add \$1,825 |
| Opt 908: Rack Flange Kit | add \$32 |
| Opt 910: Extra Manual | \$75 |
| Opt 913: Rack Mount Kit | add \$35 |
| HP 11850A 50 Ω Three-Way Power Splitter | \$800 |
| Opt H26: 4-2600 MHz (50 Ω) | add \$100 |
| HP 11850B 75 Ω Three-Way Power Splitter | \$1,400 |
| HP 8502A 50 Ω Transmission/Reflection Test Set | \$3,000 |
| Opt H26: 4-2600 MHz (50 Ω) | add \$500 |
| HP 8502B 75 Ω Transmission/Reflection Test Set | \$3,400 |
| HP 11851A RF Cable Set | \$950 |
| HP 11857A Test Port Extension Cables | \$1,000 |
| HP 8748A 50 Ω S-Parameter Test Set | \$8,150 |
| Opt 907: Front Handle Kit | add \$50 |
| Opt 908: Rack Flange Kit | add \$30 |
| Opt 909: Rack Mount Flange/Front Handle Kit | add \$72 |
| Opt H26: 4-2600 MHz (50 Ω) | add \$1,950 |

NETWORK ANALYZERS

Vector Voltmeter

Model 8405A

617



- Accurate voltage and phase measurement
- 1 to 1000 MHz
- 50/75 Ω coaxial measurements

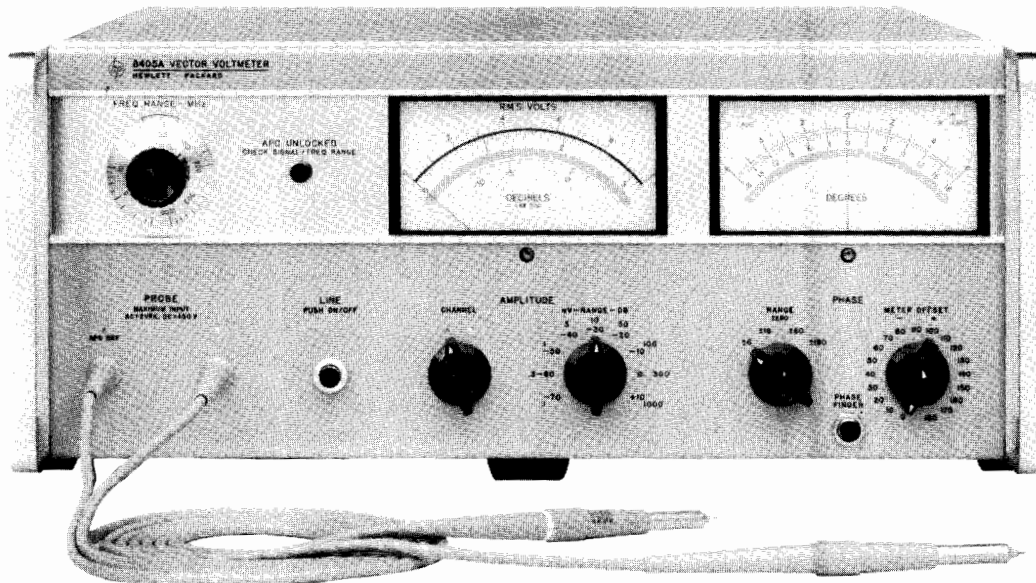

HP 8405A

The HP 8405A Vector Voltmeter measures voltage vectors described by both magnitude and phase. This capability makes the HP 8405A a unique instrument for about any design and test application in the frequency range 1 to 1000 MHz.

In addition to absolute voltage measurements, capabilities include insertion loss and computed group delay of bandpass filters and other transmission devices, gain and phase margin of amplifiers, complex impedance of mixers, antennas, matching the electrical lengths of cables, s-parameters of transistors, amplitude modulation index, RF distortion measurements and in-circuit probing. Simultaneous 50/75 ohm coaxial transmission and reflection measurements can be made using the HP 8502A/B transmission/reflection test set, and 50/75 ohm coaxial high resolution transmission comparison measurements can be made using the HP 11850A/B three-way power splitter. The HP 11852A 50-to-75 ohm minimum loss pad can be used to adapt the HP 11536A 50 ohm tee to a 75 ohm environment.

The HP 8405A achieves this measurement versatility through its two-channel capability enabling voltage magnitude measurements in either channel, thus allowing ratio measurements and phase difference measurements between the two channels. Gain or loss in excess of 90 dB and phase measurements with 0.1° resolution over a 360° phase range are possible.

Accuracy is achieved through the 1 kHz bandwidth entailing response only to the fundamental frequency of the input signal. Also, phase-locked coherent sampling to translate 1 to 1000 MHz RF signals to 20 kHz IF signals enables accurate detection of voltage magnitude and phase. Automatic phase-locked tuning makes it possible to select the one of 21 overlapping octave ranges which contains the input signal frequency by simply rotating a switch.

Specifications

Frequency range: 1 MHz to 1 GHz in 21 overlapping octave bands; tuning automatic within each band.

Isolation between channels: 1 to 300 MHz, >100 dB; 300 to 1,000 MHz >80 dB.

Maximum input: ac, 2 V peak; dc, ± 50 V.

Input impedance (nominal): 0.1 M Ω shunted by 2.5 pF; 1 M Ω shunted by 2 pF when HP 11576A 10:1 Divider is used; 0.1 M Ω shunted by 5 pF when HP 10216A Isolator is used. AC coupled.

Voltage Range (rms)

| Channel | 1 - 10 MHz | 10 - 500 MHz | 500 - 1000 MHz |
|---------|----------------------|----------------------|----------------------|
| A | 1.5 mV - 1.0 V | 300 μ V - 1.0 V | 500 μ V - 1.0 V |
| B | <100 μ V - 1.0 V | <100 μ V - 1.0 V | <100 μ V - 1.0 V |

Voltmeter ranges: 100 μ V to 1 V rms full scale in 10 dB steps.

Voltage ratio accuracy: 1-200 MHz, 0.2 dB for -60 to 0 dB ranges and 0.5 dB for -70 dB and +10 dB ranges; 200-1000 MHz, 0.2 dB for -60 to -10 dB ranges, 0.5 dB for -70 dB and 0 dB ranges and 1.5 dB for +10 dB range.

Phase range: 360° indicated on zero-center meter with end-scale ranges of $\pm 180^\circ$, $\pm 60^\circ$, $\pm 18^\circ$, and $\pm 6^\circ$.

Phase resolution: 0.1° at any phase angle.

Phase meter offset: $\pm 180^\circ$ in 10° steps.

Phase accuracy: $\pm 1.5^\circ$ (equal voltage Channel A and B).

Accessories furnished: two HP 11576A 10:1 Dividers, two HP 10216A Isolators, two HP 10218A BNC Adapters, six ground clips for HP 11576A or 10216A; six replacement probe tips.

Bandwidth: 1 kHz.

Power: 115 or 230 V $\pm 10\%$, 50 to 60 Hz, 35 W.

Weight: net, 13.9 kg (31 lb); shipping, 16.3 kg (36 lb).

Size: 177 H x 425 W x 467 mm D (7.0" x 16.75" x 18.38").

HP 11570A Accessory Kit

50 Ω Tee: HP 11536A: for monitoring signals on 50 Ω transmission lines without terminating line. Kit contains two with type N RF fittings.

50 Ω Power splitter: HP 11549A: all connectors Type N female.

50 Ω Termination: HP 908A: for terminating 50 Ω coaxial systems in their characteristic impedance.

Shorting plug: HP 11512A: Shorting Plug, Type N male.

Ordering Information

HP 8405A Vector Voltmeter

Opt 002: linear dB scale

HP 11570A Accessory Kit (measurement in 50 Ω systems only)

Price

\$5,690

add \$25

\$955

NETWORK ANALYZERS

RF Network Analyzer, 500 kHz to 1.3 GHz

Model 8505A

- 100 dB of dynamic range
- Digital readout of data with analog display
- Direct group delay and deviation from linear phase
- High performance sweep oscillator
- Complete family of 50 Ω and 75 Ω test sets
- Digital storage and normalization

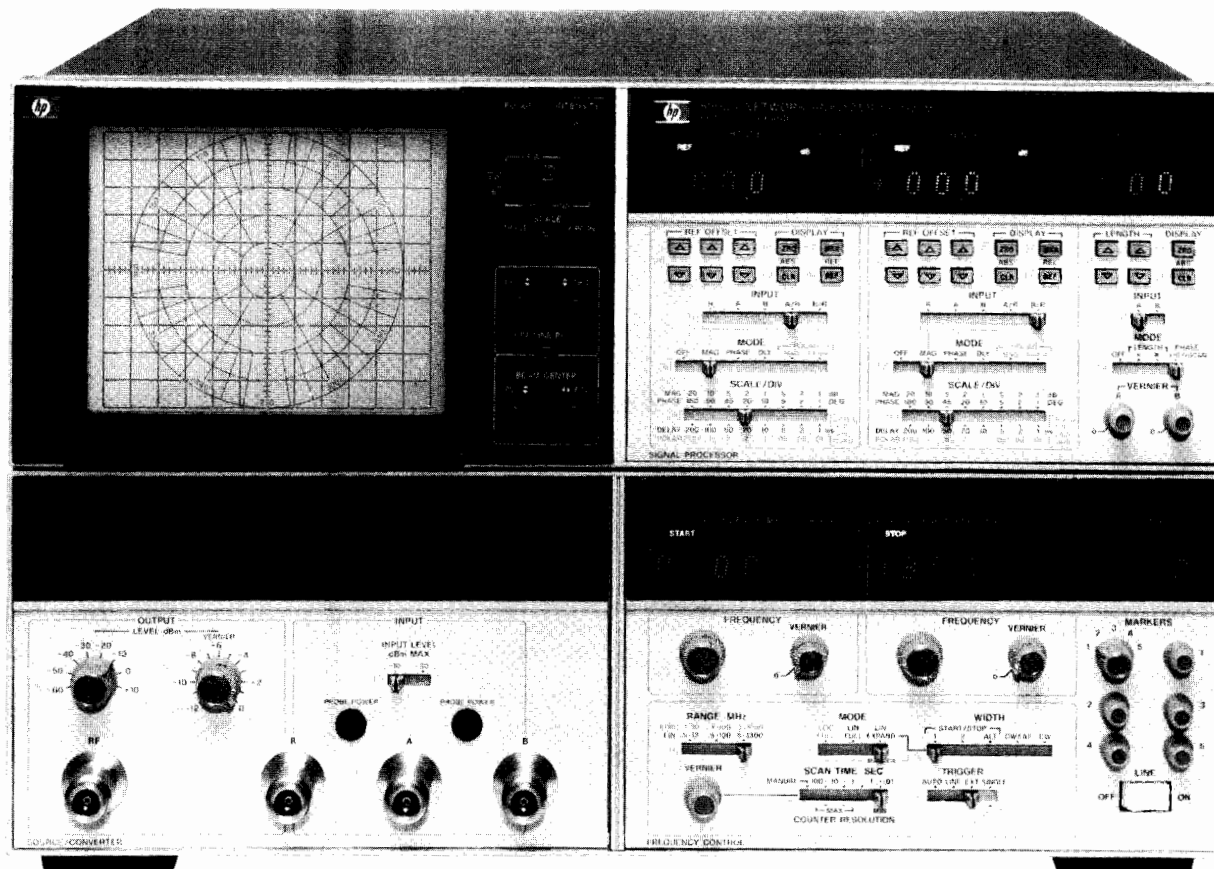

HP 8505A



The HP 8505A is a high performance RF network analyzer operating over the 500 kHz to 1.3 GHz frequency range. It accurately and easily measures complex impedance, transfer functions and group delay of coaxial components and semiconductors. Because both magnitude and phase are measured, it is possible to completely characterize the linear behavior of either active or passive networks.

Since magnitude and phase can be measured and displayed over 100 dB of dynamic range (-10 to -110 dBm), it is a simple process for the HP 8505A to measure transmission loss of high rejection devices such as filters or gain and return loss of small signal devices like amplifiers. Distortion parameters like group delay, deviation from linear phase, and deviation from constant amplitude are measured in an equally straightforward manner. Group delay is measured and displayed directly to resolutions of 1 ns per major division using a new linear FM measurement technique. A unique new electrical line stretcher compensates for the linear phase shift of the device under test so that phase non-linearities may be examined at high resolution (1° per major division). Amplitude deviations with frequency can be similarly observed to resolutions 0.1 dB per major division with clear, crisp trace stability. In addition, it is possible to read out swept amplitude, phase and delay digitally at any one of five continuously variable markers with resolutions of 0.01 dB, 0.1°, and 0.1 ns respectively.

Many of the HP 8505A's high performance features and operating conveniences are derived from the fact that it is a completely integrated system including both the sweep oscillator and receiver. The basic instrument also includes a built-in frequency counter, polar and rectangular displays on the same CRT, the new electronic line stretcher, group delay measurement, and frequency selective digital readings of swept amplitude, phase and delay. The frequency counter with resolutions up to 100 Hz adds further precision to the measurements by allowing frequency as well as amplitude, phase and delay to be read out at any of the five markers. The HP 8505A is fully programmable in a straightforward fashion using the Hewlett-Packard Interface Bus (HP-IB operation is standard). The user can configure a customized automatic system or for convenience HP offers a fully configured system, the HP 8507D. (See pages 624 and 625.)

Companion instruments include the HP 11850A Three Way Power Splitter for high resolution transmission comparison measurements, the HP 8502A Transmission/Reflection Bridge for simultaneous transmission and reflection measurements, and the HP 8503A S-parameter Test Set for complete characterization of two port devices in a single test set-up. The HP 8501A Storage-Normalizer adds digital storage, normalization, signal averaging, increased resolution, and graphics to HP 8505A measurements.



HP 8505A Specifications

Source

Frequency Characteristics

Frequency range: 500 kHz to 1.3 GHz in three ranges, 500 kHz to 13 MHz, 500 kHz to 130 MHz and 500 kHz to 1.3 GHz.

Swept frequency accuracy: $\pm 1\%$ of range for linear sweep.

CW frequency accuracy: ± 2 counts \pm time-base accuracy.

Frequency stability: better than $\pm 0.01\%$ of reading $\pm 0.01\%$ of frequency range over 10 minutes after warm-up.

Frequency counter characteristics: frequency counter measurements are made at any one of five continuously variable marker positions without interrupting the swept RF signal.

Resolution (least significant digit)

| Frequency Range (MHz) | 0.5 to 13 | 0.5 to 130 | 0.5 to 1300 |
|-----------------------|-----------|------------|-------------|
| 10 ms Sweep time | 10 kHz | 100 kHz | 1 MHz |
| 100 ms Sweep time | 1 kHz | 10 kHz | 100 kHz |
| >1 second Sweep time | 100Hz | 1 kHz | 10 kHz |

Counter accuracy: ± 2 counts \pm time-base accuracy.

Marker frequency accuracy: $\pm 0.002\%$ of scan width \pm counter accuracy. Measured in CW $\pm \Delta F$.

Time-base accuracy: ± 5 ppm ± 1 ppm/ $^{\circ}\text{C}$ ± 3 ppm/90 days.

Output Characteristics

Output power range: +10 dBm to -72 dBm.

Attenuator accuracy: ± 1.5 dBm over 70 dB range.

Vernier accuracy: ± 1 dB.

Leveling: ± 0.5 dB from 500 kHz to 1.3 GHz.

Impedance: 50 Ω ; ≥ 16 dB return loss at -10 dBm output level (<1.38 SWR).

Residual FM

| Frequency Range (MHz) | 0.5 to 13 | 0.5 to 130 | 0.5 to 1300 |
|-----------------------|-------------|-------------|--------------|
| Residual FM | 50 Hz rms | 200 Hz rms | 2 kHz rms |
| Bandwidth | 20 Hz-1 kHz | 20 Hz-1 kHz | 20 Hz-10 kHz |

Harmonics: >25 dB below main signal at +10 dBm output level.

Sub-harmonics and spurious signals: below -50 dBm at +10 dBm output level.

General Characteristics

Sweep modes: linear Full, Log Full, Start/Stop 1, Start/Stop 2, Alternate, CW $\pm \Delta F$, and CW.

Sweep times: 10 ms to 100 s in decade ranges.

Trigger modes: auto, line sync., single scan or external sync.

RF Output connector: type N female.

Receiver

Frequency range: 500 kHz to 1.3 GHz.

Input Characteristics

Input channels: three channels (R, A, and B) with 100 dB dynamic range.

Damage level: +20 dBm or ≥ 50 V dc.

Noise (average, 10 kHz BW): -110 dBm from 10 to 1300 MHz; -100 dBm from 2 to 10 MHz; -95 dBm from 0.5 to 2 MHz.

Impedance: 50 Ω ; ≥ 20 dB return loss (<1.22 SWR). Typically >26 dB return loss (<1.11 SWR).

Magnitude Characteristics

Absolute frequency response (A, B, R): ± 1.5 dB.

Ratio frequency response (A/R, B/R): ± 0.3 dB from 0.5 MHz to 1.3 GHz.

Dynamic accuracy: ± 0.01 dB/dB from -20 to -40 dBm; ± 0.2 dB from -10 to -50 dBm; ± 0.5 dB from -50 to -70 dBm; ± 1.0 dB from -70 to -90 dBm; ± 2.0 dB from -90 to -100 dBm; ± 4.0 dB from -100 to -110 dBm.

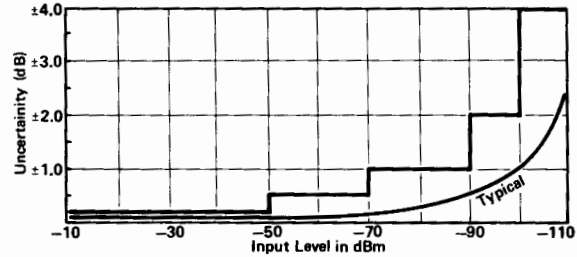

Crosstalk error limits: >100 dB isolation between inputs.

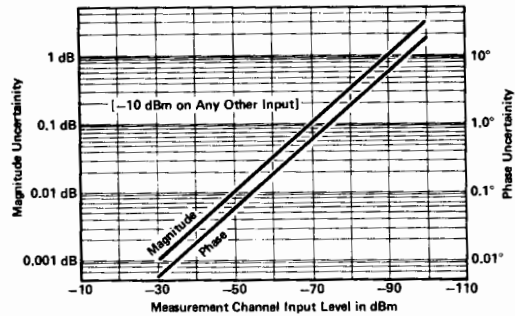

Reference offset range: ± 199.9 dB.

Reference offset accuracy: ± 0.03 dB ± 0.003 dB/dB of offset.

Marker measurement resolution: 0.01 dB over any <10 dB range; 0.1 dB over any ≥ 10 dB range.

CRT display resolution: 0.1 dB to 20 dB/division in 1, 2, 5 sequence.

Phase Characteristics

Frequency response: $\pm 3^{\circ}$ from 500 kHz to 750 MHz; $\pm 5^{\circ}$ from 750 MHz to 1.3 GHz.

Range: $\pm 180^{\circ}$.

Accuracy: $\pm 0.01^{\circ}$ /degree for $\pm 170^{\circ}$; $\pm 0.01^{\circ}$ /degree $\pm 0.5^{\circ}$ for $\pm 180^{\circ}$.

Dynamic accuracy (in 10 kHz Bandwidth): $\pm 0.02^{\circ}$ /dB from -20 to -40 dBm; $\pm 0.5^{\circ}$ from -10 to -50 dBm; $\pm 1^{\circ}$ from -50 to -70 dBm; $\pm 3^{\circ}$ from -70 to -90 dBm.

Crosstalk: see amplitude crosstalk specification.

Reference offset accuracy: $\pm 0.3^{\circ}$ $\pm 0.5\%$ of offset.

Marker measurement resolution: $\pm 0.1^{\circ}$ over <100 $^{\circ}$ range and 1° for $\geq 100^{\circ}$ range.

CRT display resolution: 1° to 180° per division in 8 steps.

Polar characteristics: frequency Response, Dynamic Response, Reference Offset and Marker Measurement specifications are the same as magnitude and phase characteristics.

CRT display accuracy: actual value is within less than 3 mm circle of the displayed value.

Tracking between dB offset controls and polar full switch positions: ≤ 0.2 dB.

Full scale magnitude range: 1 to 0.01 in a 1, 0.5, 0.2 sequence.

Delay Characteristics

Frequency response: ± 1 ns from 1 MHz to 1.3 GHz.

Delay accuracy:¹ $\pm 3\%$ of reading ± 3 units (Units = 1ns for 0.5 to 1300 MHz range, 10 ns for 0.5 to 130 MHz range, and 100 ns for 0.5 to 13 MHz range.).

¹ ± 3 units may be calibrated out with thru connection.



NETWORK ANALYZERS

RF Network Analyzer, 500 kHz to 1.3 GHz (cont.)

Model 8505A

Range Resolution and Aperture

| Frequency Range (MHz) | 0.5 to 13 | 0.8 to 130 | 4.0 to 1300 |
|--|--------------------|----------------|-----------------|
| Range | 0 to 80 μ s | 0 to 8 μ s | 0 to 800 ns |
| Resolution | | | |
| CRT: | 100 ns | 10 ns | 1 ns |
| Marker: | 100 ns | 10 ns | 1 ns |
| Marker with Delay scale/Div Switch set to: | 10 ns (<1 μ s) | 1 ns (<100 ns) | 0.1 ns (<10 ns) |
| Aperture ¹ | 7 kHz | 20 kHz | 200 kHz |

Reference offset range: ± 1999 dB.

Reference offset accuracy: ± 0.3 units $\pm 0.3\%$ of offset.

Electrical Length/Ref. Plane Extension Characteristics Calibrated Electrical Length Range and Resolution²

| Frequency Range (MHz) | 0.5 to 13 | 0.5 to 130 | 0.5 to 1300 |
|-----------------------|--------------|--------------|---------------|
| Range X1 | ± 19.9 m | ± 1.99 m | ± 19.9 cm |
| X10 | ± 100 m | ± 10 m | ± 1 m |
| Resolution X1 | 10 cm | 1 cm | 0.1 cm |
| X10 | 1 m | 10 cm | 1 cm |

Calibrated electrical length accuracy: $\pm 3\%$ of reading $\pm 1\%$ of range.

Linear phase substitution (degrees/scan) range: $\pm 1700^\circ$ per scan with 0° offset.

$$\frac{\pm 1.4 \text{ km}}{\text{scan width (MHz)}} \quad \text{or} \quad \frac{\pm 4.7 \mu\text{s}}{\text{scan width (MHz)}}$$

Linear phase substitution resolution: 10°

Linear phase substitution accuracy: $\pm 3\%$ of reading $\pm 10^\circ$ / scan.

Phase compensation linearity: $< 0.2\%$ of phase slope inserted.

General Characteristics

RF input connectors: type N female.

Display bandwidth: selectable IF bandwidths of 10 kHz and 1 kHz. A video filter position is also provided.

CRT overlays: Smith Charts (2, 1, 0.5, 0.2, 0.1 full scale), Log Charts (10 MHz, 100 MHz and 1000 MHz).

CRT photography: HP 197A Opt 006 camera or HP 197A with HP 10375A Bezel Adapter required to fit HP 8505A display. A CRT illumination control is provided.

Auxiliary Outputs

Channel 1 and 2 outputs: 0.25 V/display division.

Sweep output: 0.25 V/display division.

Pen lift: dc coupled, 200 mA current sink.

Programming

The HP 8505A has a remote programming interface using the Hewlett-Packard Interface Bus with Learn Mode. One 0.5 m (HP 10833D) HP-IB cable included.

Power: selection of 100, 120, 200 or 240 V $+5\%$ -10% , 50 to 60 Hz, approximately 275 watts.

Size: 279 H x 426 W x 553 mm D (11 x 16.75 x 21.75 in.).

HP 8505A Opt 005 Specifications (phase-lock operation)

Source

Frequency Characteristics

Modes (HP 8505A): CW and CW $\pm \Delta F$ only.

Range and Resolution (HP 8505A and 8656B):

(Total frequency range is 500 kHz to 990 MHz)

| | HP 8656B Frequency Ranges (MHz) | HP 8505A Frequency Range MHz | | |
|--|-----------------------------------|------------------------------|-----------------|----------------|
| | | 0.5 to 13 | 0.5 to 130 | 0.5 to 1300 |
| CW Resolution (set on HP 8656) | All freq. ranges | 10 Hz | 10 Hz | 10 Hz |
| $\pm \Delta F$ Resolution (set on HP 8505) | All freq. ranges | 1 Hz | 10 Hz | 100 Hz |
| Max +/- ΔF | 0.5-123.5 123.5-247 247-990 | 1.3kHz | 13kHz 13 kHz | 50kHz 99kHz |

Range and Resolution (HP 8505A and 8642B):²

(Total frequency range 500 kHz to 1300 MHz)

| | HP 8642B Frequency Ranges (MHz) | HP 8505A Frequency Range MHz | | |
|--|----------------------------------|------------------------------|------------|--------------------|
| | | 0.5 to 13 | 0.5 to 130 | 0.5 to 1300 |
| CW Resolution (set on HP 8642) | All freq. ranges | 1 Hz | 1 Hz | 1 Hz |
| $\pm \Delta F$ Resolution (set on HP 8505) | All freq. ranges | 1 Hz | 10 Hz | 100 Hz |
| Max +/- ΔF ³ | 0.5-132 ¹ 132-1300 | 1.3 kHz | 13 kHz | 130 kHz 130 kHz |

Typical system residual FM: the residual FM of a phase-locked HP 8505A approaches that of the HP 8642A/B or 8656B.

Output Characteristics

Power output, harmonics, spurious outputs, RF noise, etc. are determined by the HP 8642A/B or the HP 8656B.

Receiver

Magnitude and phase characteristics are unchanged with the exception of the dynamic range specification.

Delay Characteristics

Accuracy: $\pm 3\%$ of reading ± 3 units. Units: 1 μ s for 0.5-1300 MHz; 10 μ s for 0.5-130 MHz; 100 μ s for 0.5-13 MHz.

Range, resolution and aperture: (HP 8642A/B or 8656B) (HP 8505A indicated units x 1000)

| | 8505 Frequency Range (MHz) | | |
|--|----------------------------|--------------|---------------|
| | 0.5-13 | 0.5-130 | 0.5-1300 |
| Range | 0-80 ms | 0-8 ms | 0-800 μ s |
| Resolution: | | | |
| CRT & Digital Marker | 100 μ s | 10 μ s | 1 μ s |
| Digital Marker with Delay Switch Setting | 10 μ s | 1 μ s | 100 ns |
| Delay Switch Setting | <1 ms | <100 μ s | <10 μ s |
| Aperture ⁴ | 1.5 kHz | 2.0 kHz | 4.0 kHz |

Electrical Length Characteristics

Accuracy: $\pm 3\%$ of reading $\pm 3\%$ of range.

Calibrated electrical length, range, and resolution⁵: (HP 8642A/B or 8656B): (HP 8505A digital readouts $\times 1000$) give electrical length 1000 times larger and resolution divided by 1000.

General Characteristics

RF Inputs

L.O. drive input level: 10 dBm ± 2 dB (Rear panel BNC).

RF drive input level: 0 dBm ± 2 dB (Rear panel BNC).

Tunable FM output: ± 1.3 V maximum (rear panel BNC with output level controlled by $\pm \Delta F$ control on front panel of HP 8505A). ± 1.3 V output is obtained independent of the frequency range switch setting.

Capture range of phase-lock loop: 100 kHz (0.5-13 MHz range); 400 kHz (0.5-130 MHz range); 4 MHz (0.5-1300 MHz range).

Standard/phase-lock operation: rear panel switch can disable all phase-lock circuitry when using the instrument in its standard (non phase-lock) operating mode.

¹Heterodyne band.

²HP 8642A and the HP 8505A have a total frequency range of 500 kHz to 1057.5 MHz. Resolution and ΔF performance is the same as the HP 8642B.

³Max deviation for the HP 8642A/B exceeds 1 MHz for various frequency bands.

⁴Typical measurement Aperture using linear FM modulation technique.

⁵Vernier provides continuous adjustment of electrical length. Calibrated Electrical Length Linearity: $\Delta \theta = 0.7\% \times 1.2 \text{ f (MHz)} \times 1 \text{ (metres)}$.

NETWORK ANALYZERS

RF Network Analyzer: Storage Normalizer

Model 8501A

621

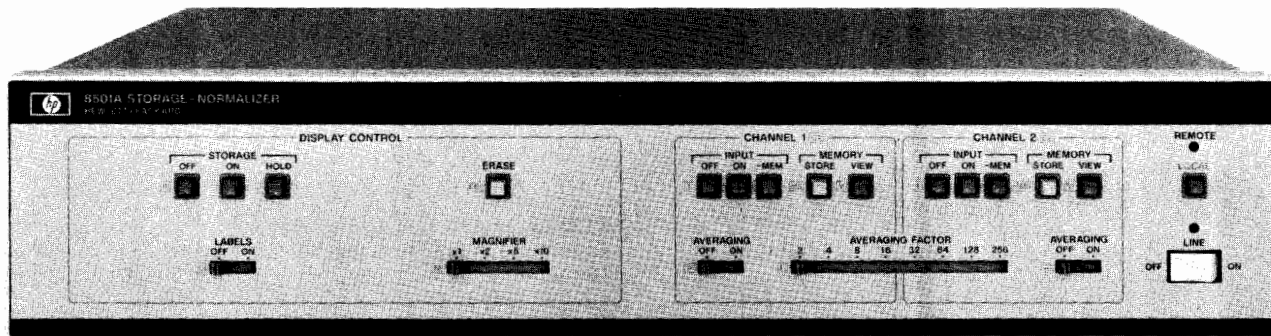

HP 8501A



Description

The HP 8501A high performance Storage-Normalizer is a dedicated accessory that extends the measurement capability of your HP 8505A RF Network Analyzer (500 kHz to 1.3 GHz). Flicker-free displays with digital storage and CRT annotation of major control settings provide convenient easy documentation. Using normalization, frequency response errors are simply removed. In addition, the HP 8501A can digitally average signals to dramatically improve signal-to-noise ratios and magnify the display for high accuracy measurements. With a desktop computing controller, computer graphics capability is added to the HP 8505A for displaying corrected data, operator messages, or computer programs.

HP 8501A Specifications

Display

Rectangular Displays

Horizontal display resolution: two display channels, 500 points per channel (0.2% of full scale, 0.24 mm).

Vertical display resolution: 500 points displayed full scale (0.2% of full scale) plus a 50% overrange (250 points) both above and below full screen.

Polar Displays

Display resolution: two display channels, 250 points per polar display (0.2% of full scale, 0.2 mm in X and Y).

Display tracking: visual offsets between direct HP 8505A and stored displays are approximately $\pm 1/2$ CRT minor division (± 1 mm).

Horizontal input sweep times: 100 s max/10 ms min.

Conversion time: 10 ms max for 500 ± 2 data points (20 μ s per point).

Display refresh time: nominally 20 ms depending upon information displayed.

Line generator: a line generation technique is used to connect points on a CRT display, yielding a smooth continuous trace.

Markers: all five markers are also available in the digital display mode.

Output

Auxiliary outputs XYZ: (BNC female connectors on rear panel).

X—1 V full screen, 83 mV/div (12 div).

Y—1 V full screen, 100 mV/div (10 div).

Z—1 volt blanks display, +2 volts unblank display. (Signal compatible for all HP CRT displays such as 1332, 1304, or 1310).

Offsets: the X, Y, and polar display offsets can be adjusted over a $\pm 10\%$ range of screen by means of potentiometers on the rear panel of the HP 8501A.

Labeling interface: all major control settings of the HP 8505A, the HP 8503A and phase-lock indication are displayed on the CRT.

HP-IB Interface

HP-IB Interface Capabilities

Remote Programming

Learn mode: this feature provides the ability to output the current instrument state to a computing controller.

Input data: data for graphics or other purposes can be sent to the HP 8501A at a rate of:

ASCII mode: 600 points per second.

Binary mode: 10000 points per second.

Output data: data can be read from the HP 8501A at a rate of:

ASCII mode: 800 points per second.

Binary mode: 9000 points per second.

Graphics: data for graphics can be read into the HP 8501A and viewed in two types of displays.

Text displays: 22 lines of text with 54 characters per line can be displayed on the CRT.

Vector display: lines can be drawn on the display between any two points with a resolution of 432 points in X and 360 points in Y (nominal).

General

Display Controls

Storage off: the HP 8501A is bypassed so the display returns to normal analog operation.

Storage on: turns on digitally stored display.

Storage hold: the current display is not updated and is frozen for CRT photography or further analysis.

Erase: display and memory are erased.

Labels: switches all display labeling on or off.

Magnifier: expands the display by a factor of 1, 2, 5, or 10.

Processing Functions (channel 1 and 2)

Input off: display of channel 1 (2) is blanked.

Input on: channel 1 (2) measurement is displayed.

Input mem: the difference between the channel 1 (2) measurement and the stored memory content is displayed (normalization).

Memory store: the current measurement is stored in memory.

Memory view: the stored memory content is displayed.

Averaging: the data averaging function for channel 1 (2) is switched on or off.

Averaging factor: the degree of averaging is selectable from 2, 4, 8 ... to 256. The current averaged trace is always displayed and updated at the sweep rate.

Local: returns the HP 8501A control to the front panel from remote HP-IB control.

Includes: 0.5 m HP-IB cable and the processor interconnect cable.

Accessories: the HP 11864A Accessory Kit provides the labeling interface boards and connectors for retrofitting the HP 8505A. Labeling interface now standard on the HP 8505A.

Power: selection of 100, 120, 220, or 240 V $\pm 5\%$ -10%, 50 to 60 Hz and < 140 VA (< 140 watts).

Size: 90 H x 426 W x 534 mm D (3.5" x 16.75" x 21.0").

Weight: net, 12.25 kg (27 lb); shipping, 14 kg (31 lb).



NETWORK ANALYZERS

RF Network Analyzer, 500 kHz to 1.3 GHz (cont.)

Models 8503A/B, 8502A/B, 11850A/B, 11851A-11858A, 11857B, 1121A

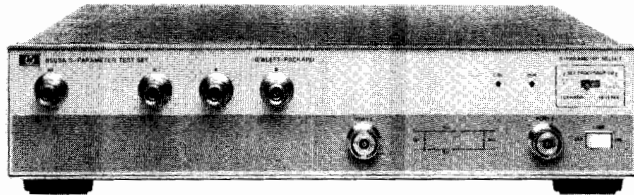

HP 8503A

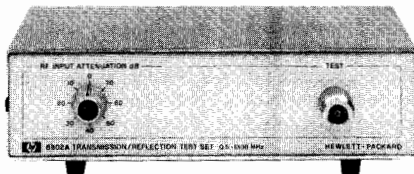

HP 8502A

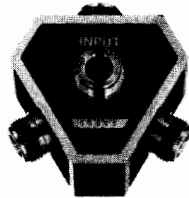

HP 11850A

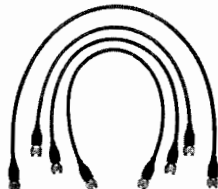

HP 11851A

HP 8502A 50 Ω Transmission/Reflection Test Set HP 8502B 75 Ω Transmission/Reflection Test Set

Frequency range: 500 kHz to 1.3 GHz.

Impedance: HP 8502A, 50 Ω ; HP 8502B, 75 Ω .

Directivity: ≥ 40 dB.

Frequency Response

Transmission: $\leq \pm 0.8$ dB and $\leq \pm 8^\circ$.

Reflection: $\leq \pm 1.5$ dB and $\leq 15^\circ$ from 0.5–1300 MHz; $\leq \pm 10^\circ$ from 2–1300 MHz.

Port Match

Test port: ≥ 26 dB return loss from 2–1300 MHz (≥ 24 dB for HP 8502B); ≥ 20 dB return loss from 0.5–2 MHz (≥ 18 dB for HP 8502B).

Test port open/short ratio: ± 0.75 dB and $\pm 6^\circ$ from 2–1000 MHz (± 0.9 dB and $\pm 7.5^\circ$ for HP 8502B); ± 0.9 dB and $\pm 7.5^\circ$ from 1000–1300 MHz; ± 1.25 dB and $\pm 10^\circ$ from 0.5–2 MHz.

Reference and reflection ports: ≥ 25 dB return loss from 2–1000 MHz; ≥ 23 dB return loss from 0.5–1300 MHz.

Input port: ≥ 23 dB return loss.

Nominal Insertion Loss

Input to test port: 13 dB (HP 8502A), 19 dB (HP 8502B).

Input to reference port: 19 dB (HP 8502A), 19 dB (HP 8502B).

Input to reflection port: 19 dB (HP 8502A), 31 dB (HP 8502B).

Maximum operating level: +20 dBm.

Damage level: 1 watt CW.

RF attenuator range: 0 to 70 dB in 10-dB steps.

Connectors test port: 50 Ω Type N Female for HP 8502A and 75 Ω Type N Female for HP 8502B; all other RF ports 50 Ω Type N Female; Bias input, BNC Female.

DC bias input: ± 30 V dc and ± 200 mA.

Includes: HP 8502B includes 50 Ω /75 Ω minimum loss pad.

Recommended accessory: HP 11851A RF Cable Kit for either HP 8502A or 8502B.

Size: 61.5 H x 101 W x 204 mm D (2.44" x 7.5" x 8.0").

Weight: net, 1.7 kg (3.25 lb); shipping, 3.1 kg (7 lb).

HP 8503A 50 Ω S-Parameter Test Set

HP 8503B 75 Ω S-Parameter Test Set

Frequency range: 500 kHz to 1.3 GHz.

Impedance: HP 8503A, 50 Ω ; HP 8503B, 75 Ω .

Directivity: ≥ 40 dB.

Frequency Response

Transmission (S_{12} , S_{21}): ± 1 dB, $\pm 12^\circ$ from 0.5–1300 MHz.

Reflection (S_{11} , S_{22}): ± 2 dB, $\pm 20^\circ$ from 0.5–1300 MHz; $\pm 15^\circ$ from 2–1300 MHz.

Port Match

Test ports 1 and 2: ≥ 26 dB return loss from 2–1300 MHz (≥ 24 dB for HP 8503B), ≥ 20 dB return loss from 0.5–2 MHz (≥ 18 dB for HP 8503B).

Test port 1 and 2 open/short ratio: $\leq \pm 0.75$ dB and $\pm 6^\circ$ from 2–1000 MHz (± 0.9 dB and $\pm 7.5^\circ$ for HP 8503B); $\leq \pm 0.9$ dB and 7.5° from 1000–1300 MHz; ± 1.25 dB and $\pm 10^\circ$ from 0.5–2 MHz.

Reference and return ports: ≥ 23 dB return loss from 2–1000 MHz; ≥ 20 dB return loss from 0.5–2 MHz and 1000–1300 MHz.

RF input port: 20 dB return loss from 0.5–1300 MHz.

Maximum operating level: +20 dBm.

Damage level: 1 watt CW.

Connectors: test ports, 50 Ω APC-7 for HP 8503A and 75 Ω Type-N Female for HP 8503B; all other RF connectors, 50 Ω Type-N Female; Bias inputs BNC Female.

DC bias input: 30 V dc, ± 200 mA.

Includes: four 19 cm (7.5") cables for connection to HP 8505A.

Recommended accessory: HP 11857A 50 Ω Test Port Extension Cables or HP 11857B/C 75 Ω Test Port Extension Cables.

Programming: programming via HP-IB; 0.5 m HP-IB cable included.

Power: 100, 120, 220, or 240 V +5%–10%, 50 or 60 Hz; approx. 10 watts (15 watts for HP 8503B).

Size: 90 H x 426 W x 553 mm D (3.5" x 16.75" x 21.0").

Weight: net, 9.1 kg (20 lb); shipping, 11.3 kg (25 lb).

Accessories

HP 11850A 50 Ω Power Splitter

HP 11850B 75 Ω Power Splitter

Frequency range: dc to 1.3 GHz.

Impedance: HP 11850A, 50 Ω ; HP 11850B, 75 Ω .

Tracking between any two output ports: ≤ 0.1 dB and $\leq 1.5^\circ$.

Equivalent source match (ratio or leveling): ≥ 32 dB return loss (≤ 1.05 SWR).

Input port match: ≥ 20 dB return loss.

Nominal insertion loss: 9.54 dB for HP 11850A; 7.78 dB for HP 11850B.

Frequency response absolute: input to output ≤ 0.2 dB.

Maximum operating level: +20 dBm.

Burn-out level: ≥ 1 watt CW.

Connectors: HP 11850A, 50 Ω Type N female; HP 11850B, three outputs 75 Ω Type N female; RF input, 50 Ω Type N female.

Recommended accessory: HP 11851A RF Cable Kit.

Includes: HP 11850B includes three 50 Ω /75 Ω Minimum Loss Pads

Size: 46 H x 67 W x 67 mm D (1.88" x 2.63" x 2.63").

Weight: net, 1.8 kg (4 lb); shipping, 3.1 kg (7 lb).

HP 11851A RF Cable Kit

General: three 610 mm (24 in.) 50 Ω cables phase matched to 4° at 1.3 GHz and one cable 860 mm (34 in.). Connectors are Type N Male. Recommended for use with HP 8502A/B Transmission/Reflection Test Set and HP 11850A/B Power Splitter.
Weight: net, 0.91 kg (2 lb); shipping, 1.36 kg (3 lb).

HP 11852A 50 Ω/75 Ω Minimum Loss Pad

General: the HP 11852A is a low SWR minimum loss pad required for transmission measurements on 75 Ω devices with HP 8505A receiver (50 Ω).

Frequency range: dc to 1.3 GHz.

Insertion loss: 5.7 dB.

Return loss: 75 Ω side, 50 Ω side terminated: typically ≥34 dB (≤1.04 SWR). 50 Ω side, 75 Ω side terminated: typically ≥30 dB (≤1.06 SWR).

Typical flatness: ≤0.1 dB from dc to 1.3 GHz.

Maximum input power: 250 mW (+24 dBm).

Connectors: 50 Ω Type N female and 75 Ω Type N male.

Size: 14 D x 70 mm L (0.56" x 2.75").

Weight: net, 0.11 kg (4 oz); shipping, 0.26 kg (9 oz).

HP 11853A 50 Ω Type N Accessory Kit

General: the HP 11853A furnishes the RF components required for measurement of devices with 50Ω Type N Connectors using the HP 11850A, 8502A, or 8503A (8503A also requires the HP 85032A). Kit contains a Type N Female short, a Type N Male short, two Type N Male barrels, two Type N Female barrels and storage case.

Weight: net, 0.91 kg (2 lb); shipping, 1.36 kg (3 lb).

HP 11854A 50 Ω BNC Accessory Kit

General: the HP 11854A furnishes the RF components required for measurement of devices with 50Ω BNC Connectors using the HP 11850A, 8502A, or 8503A (8503A also requires the HP 85032A). Kit contains two Type N Male to BNC Female adapters, two Type N Male to BNC Male adapters, two Type N Female to BNC Female adapters, two Type N Female to BNC Male adapters, a BNC Male short and storage case.

Weight: net, 1.13 kg (2½ lb).

HP 11855A 75 Ω Type N Accessory Kit

General: the HP 11855A provides the RF connecting hardware generally required for measurement of devices with 75 Ω Type N connectors using the HP 8502B, 8503B or 11850B. Kit contains two 75 Ω Type N Male barrels, two Type N Female barrels, a 75 Ω Type N Female short, a 75 Ω Type N Male short, a 75 Ω Type N Male termination, and storage case.

Weight: net, 0.91 kg (2 lb); shipping, 1.36 kg (3 lb).

HP 11856A 75 Ω BNC Accessory Kit

General: the HP 11856A provides the RF connecting hardware generally required for measurement of devices with 75 Ω BNC connectors using the HP 8502B, 11850B, or 8503B. Kit contains two Type N Male to BNC Female adapters, two Type N Male to BNC Male adapters, two Type N Female to BNC Female adapters, two Type N Female to BNC Male adapters, a BNC Male short, a 75 Ω BNC Male termination, and storage case.

Weight: net, 0.91 kg (2 lb); shipping, 1.36 kg (3 lb).

HP 11857A 50 Ω APC-7 Test Port Extension Cables

General: two precision 61 cm (24 in.) cables, phase matched to 2° at 1.3 GHz for use with HP 8503A S-parameter test set. Connectors are 50 Ω APC-7.

Weight: net, 0.91 kg (2 lb); shipping, 2.3 kg (5 lb).

HP 11857B 75 Ω Type N Test Port Extension Cables

General: two precision 61 cm (24 in.) cables, phase matched to 2° at 1.3 GHz for use with HP 8503B S-parameter test set. One cable has 75 Ω Type N Male connectors on both ends; the other has one Type N Male and one Type N Female connector.

Weight: net, 0.91 kg (2 lb); shipping, 2.3 kg (5 lb).

HP 11858A Transistor Fixture Adapter

General: the HP 11858A adapts the HP 11600B and 11602B transistor fixtures (vertical test port configuration) to the HP 8503A S-parameter test set. Connectors are APC-7.

Weight: net, 0.91 kg (2 lb); shipping, 1.36 kg (3 lb).

Ordering Information

| | Price |
|--|--------------|
| HP 8505A* RF Network Analyzer | \$40,370 |
| Opt 005: Phase Lock | \$1,505 |
| Opt 908: Rack Mounting Kit (for use without front handles) | \$50 |
| Opt 910: Extra Manual | \$150 |
| Opt 913: Rack Mounting Kit | \$62 |
| HP 8503A* 50 Ω S-Parameter Test Set | \$7,170 |
| Opt 908: Rack Mounting Kit (for use without front handles) | \$30 |
| Opt 910: Extra Manuals | \$12 |
| Opt 913: Rack Mounting Kit | \$30 |
| HP 8503B* 75 Ω S-Parameter Test Set | \$7,270 |
| Opt 908: Rack Mounting Kit (for use without front handles) | \$30 |
| Opt 910: Extra Manual | \$12 |
| Opt 913: Rack Mounting Kit | \$30 |
| HP 8501A* Storage Normalizer | \$7,770 |
| Opt 908: Rack Mounting Kit (for use without front handles) | \$30 |
| Opt 910: Extra Manual | \$25 |
| Opt 913: Rack Mounting Kit | \$30 |
| HP 8502A 50 Ω Transmission/Reflection Test Set | \$3,010 |
| Opt 910: Extra Manual | \$6 |
| HP 8502B 75 Ω Transmission/Reflection Test Set | \$3,410 |
| Opt 910: Extra Manual | \$6 |
| HP 11850A 50 Ω Power Splitter | \$805 |
| HP 11850B 75 Ω Power Splitter | \$1,405 |
| HP 11851A RF Cable Kit | \$955 |
| HP 11852A 50 Ω to 75 Ω Minimum Loss Pad | \$205 |
| HP 11853A 50 Ω Type N Accessory Kit | \$230 |
| HP 11854A 50 Ω BNC Accessory Kit | \$195 |
| HP 11855A 75 Ω Type N Accessory Kit | \$230 |
| HP 11856A 75 Ω BNC Accessory Kit | \$330 |
| HP 11857A 50 Ω APC-7 Test Port Extension Cables | \$1,005 |
| HP 11857B 75 Ω Type N Test Port Extension Cables | \$1,455 |
| HP 11858A Transistor Fixture Adapter | \$980 |
| HP 11864A Labeling Interface Kit | \$945 |

*Front Handles are standard



NETWORK ANALYZERS

Automatic Network Analyzer System, 500 kHz to 1.3 GHz

Model 8507S

- Improve productivity in lab and factory
- Accuracy enhancement
- Ease of operation via HP-IB
- HP 9816S, 9826S or 9836 Computer
- Learn mode
- Graphics transfer to computer

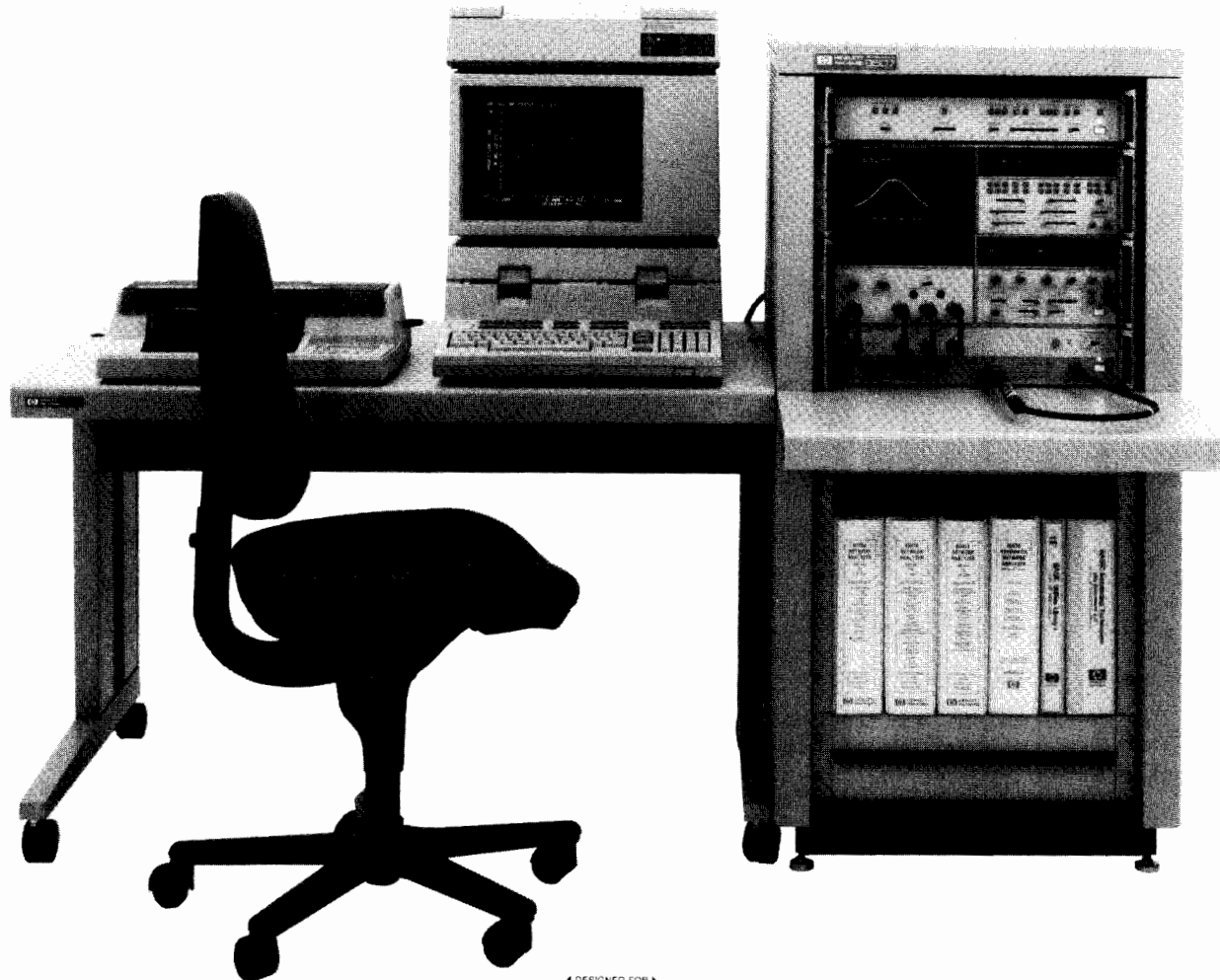

HP 8507S



Description

The HP 8507S is an Automatic Network Analyzer System based on the HP 8505A Network Analyzer that is controlled by one of the HP Series 200 computers (HP 9816, 9826S, 9836S, or 9836CS). Mating this versatile, easy-to-use desktop computer with the completely programmable network analyzer produces a powerful RF network measurement tool for both lab and production use.

Cost Effective Solutions

In laboratory applications, engineers gain greater circuit insight via the speed and ease with which the HP 8507S accumulates and summarizes data. Use the HP 85011A Software for accuracy enhancement and data output formatting or program the instruments yourself with easy to use HP-IB commands. With only a few hours training, engineers with no previous programming experience have been able to write customized programs that solve specialized measurement problems. In production environments, the HP 8507S can dramatically reduce the time and cost of making complicated limit tests on all types of components. Testing programs with built-in operator instructions can minimize training cost, ensure uniform test procedures and eliminate subjective decisions.

Simplicity and Flexibility of HP-IB

Configuration of the standard HP 8507S is a simple matter since it is programmed via the Hewlett-Packard Interface Bus. For example, perhaps your RF measurement application requires a programmable power supply for transistor biasing or a digital voltmeter. Simply choose an instrument from the selection of HP-IB programmable instruments and add it to your HP 8507S using universal HP-IB cables.

It is equally easy to get started making measurements since the HP 8507S comes with software (HP 85011A) that complements the Hewlett-Packard hardware. Included are programs for 8 or 12 term accuracy enhancement and general network analyzer applications. In addition, a system check-out program is provided.

Learn Mode Operation

The "Learn" mode of operation has extended traditional automatic operation to a new level of operator convenience. The desktop computer can accept (Learn) a data string from the network analyzer that defines all of the manually set front panel control settings. This is accomplished by a single keystroke. Once stored in the desktop computer (or permanently recorded on a flexible disc) this data string can then be used to automatically return the network analyzer to its exact original test conditions. And this can all be done without the operator ever writing a single program line!

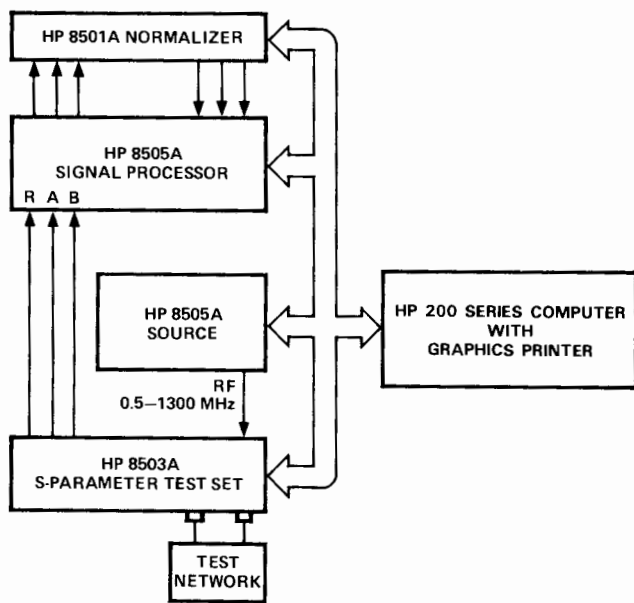
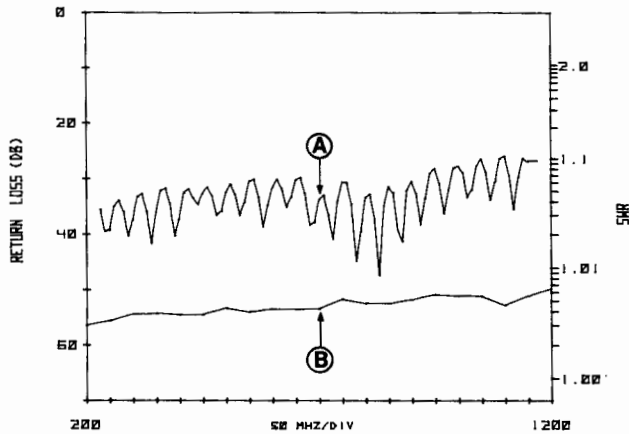

HP 8507S Calibration Kits

HP 85031A Verification and APC-7 Calibration Kits

Included with HP 8507D. Contains Precision APC-7 Load, APC-7 Short, and two verification standards.

HP 85032A Type N Calibration Kit

For use with HP 8507S. Contains 2 APC-7 to N-Male Adapters, 2 APC-7 to N-Female Adapters, 1 N-Male Load, 1 N-Female Load, 1 N-Female Short, 1 N-Male Short.

HP 85033A SMA Calibration Kit

For use with HP 8507S. Contains 2 APC-7 to SMA-Male Adapters, 2 APC-7 to SMA-Female Adapters, 1 SMA-Male Load, 1 SMA-Female Load, 1 SMA-Female Short, and 1 SMA-Male Short.

Accuracy Enhancement

The HP 85011A System Software permits frequency tracking, mismatch, and directivity errors to be characterized by applying known standards. These stored system errors are then removed from the measurement of the unknown to provide a degree of accuracy exceeding that possible with the standard HP 8505A.

An Example

The plots on the left show the result of software accuracy enhancement. Curve A depicts raw measurements on a 50 dB return loss termination at the end of a six-foot RG 214 cable—a typical application problem in testing in temperature chambers. Curve B shows the results after calibrating at the end of the cable—a 25 dB improvement.

Data in the Form you Need

With the desktop computers, it is a simple matter to obtain customized printed or plotted outputs. Or you may want to store data on tape for later analysis. Data can be analyzed or statistically summarized directly, bypassing the laborious and error-prone task of manually recording and re-entering data. Data reformatting such as converting return loss to SWR or S-parameters to Y-parameters can be accomplished also.

HP 8507S Automatic Network Analyzer

Ordering Information

System Reference

HP 8507S Automatic Network Analyzer \$0

This system reference number ensures coordinated delivery and compatibility of instrument and software

Network Analyzer Subsystem

HP 8507D Network Analyzer Subsystem \$59,925

Includes: HP 8505A Network Analyzer
HP 8501A Storage Normalizer
HP 8503A S-Parameter Test Set
HP 85031A APC-7 Calibration Kit
Systems Cabinet and Cables
System Checkout prior to shipment

Opt. 002: Delete Systems Cabinet less \$900

Opt. 005: Add HP 8505A Phase Lock \$1,500

Opt. 910: Extra Set of Manuals \$330

Calibration Kits

HP 85031A APC-7 Calibration Kit (included with HP 8507D) \$850

HP 85032A 50Ω Type-N Calibration Kit \$1,040

HP 85033A SMA Calibration Kit \$750

Computers (choose one)

HP 9816S Series 200, Model 16S Computer (select option) \$5,150

Note: When using Basic 3.0 the HP 9816S will need at least an additional 256K Byte memory board.

Opt. 630 for use with HP 9122D Disk Drive N/C

Opt. 650 for use with HP 9125S Disk Drive N/C

HP 98256A 256K Byte Memory Card \$1,050

HP 98257A 1M Byte Memory Card \$3,300

HP 9817H Series 200 Model 217H Computer \$6,510

Opt. 001 Substitutes 1M Byte Memory Board for 2-256 K Byte Boards add \$1,640

HP 9826S Series 200, Model 26S Computer \$11,000

HP 9836S Series 200, Model 36S Computer \$14,000

HP 9836CS Series 200, Model 36CS Computer \$17,000

Disk Drives (one required for HP 9816S)

HP 9122D 3.5 inch Dual Flexible Disk Drive \$1,270

HP 9125S 5.25 inch Single Flexible Disk Drive \$1,185

Software (choose one option)

HP 85011A Rev 2.0 System Software for HP 8507D \$500

Opt. 630 for HP 9816S Computer with HP 9122D Disk Drive N/C

Opt. 655 for either HP 9826S or 9836S Computer N/C

Printer (choose one)

HP 2673A Thermal Graphics Printer \$2,240

HP 2932A Impact Graphics Printer Opt. 046 \$2,495

HP 2225A Think Jet Graphics Printer \$495

HP 2671G Thermal Graphics Printer \$1,540

System Furniture

HP 92214B Work Station Table \$440

HP 92209C Ergonomic Chair \$390

Plotters

HP 7470A Opt. 002 Two Pen Plotter \$1,095

HP 7475A Opt. 002 Six Pen Plotter \$1,895

HP 7550A Eight Pen Plotter \$3,900

NETWORK ANALYZERS

Microwave Network Analyzers, 45 MHz to 60 GHz

8510 Series

- 45 MHz to 60 GHz frequency range
- "Real Time" error-corrected measurements
- 50 dB effective directivity, 40 dB effective source and load match
- 80 dB to 100 dB dynamic range
- 0.001 dB, 0.01 degree, 0.01 nanosecond measurement resolution
- Time domain analysis

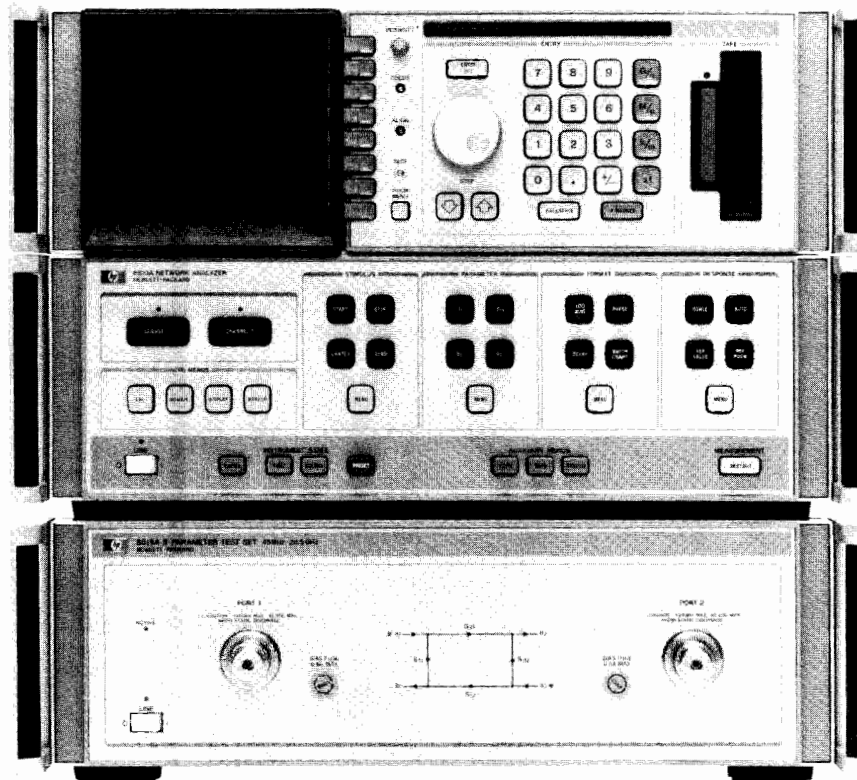

HP 8510A

Description

The HP 8510 series microwave vector network analyzers provide a complete solution for characterizing the linear behavior of either active or passive networks over the 45 MHz to 26.5 GHz frequency range. A complete system comprises the HP 8510A network analyzer, one of four HP 851XA broadband test sets, and a compatible RF source. For millimeter-wave measurement needs, complete systems operating to 60 GHz can be customer-configured.

The test sets are offered in one of two measurement test setup configurations. The reflection/transmission test sets provide the capability to simultaneously measure the complex reflection and transmission characteristics of a test device. The S-parameter test sets offer a single test setup solution for complete characterization of two-port devices. Each measurement presented on the CRT display consists of 51, 101, 201, or 401 discrete points of data, and when the system source is a synthesizer, the frequency of each data point is synthesized.

Measurement results can be displayed on one of two completely independent, yet identical, channels. The channels may be displayed individually, or simultaneously, with results presented in either logarithmic/linear magnitude, phase, or group delay format on rectangular or polar coordinates. Direct measurement of normalized impedance is possible with the Smith chart format. The value and frequency of any one data point can be read with one of five independent markers. The entire measurement trace can be copied directly to a plotter, such as the HP 7470A, 7475A, or 7550A without the need of an external computer. Also, a list of the trace values can be sent to a printer such as the HP 9876A or 2225A.

Powerful measurement enhancement functions are also available. Data averaging can be employed to effectively narrow the receiver IF

bandwidth, extending dynamic range and reducing signal-to-noise ratio. Trace smoothing aids in the interpretation of measurement results and is used to control the aperture of group delay measurements. The equivalent of an electronic line stretcher is available with the electrical delay function.

Built-in storage provides the capability to save and recall up to eight different front panel states, eight separate measurement calibrations, and four separate measurements in nonvolatile memory. Extension of the internal storage capacity is practically limitless via the built-in tape cassette unit.

All the functions of the HP 8510 system are completely programmable from an external computer through the Hewlett-Packard Interface Bus. Also, measurements can be transferred to a computer in one of four data transfer formats. CRT graphics, such as limit lines, can be written to the HP 8510 to aid in test procedures. The built-in tape drive can, as well, be used to provide permanent storage of CRT graphics.

High Performance

Along with the capability to completely characterize a microwave network with a single connection over the extremely broad 45 MHz to 26.5 GHz frequency range, the HP 8510 system offers wide dynamic range. Depending on the test set used, 80 dB to 100 dB of dynamic range is available. The precision IF processing and detection system contributes as little as ± 0.05 dB and ± 0.5 degree measurement uncertainty at a level of 50 dB below the reference. Meaningful resolutions of 0.001 dB, 0.01 degree, and 0.01 nanosecond are easily achievable.

"Real Time" Error Correction

The fundamental accuracy limitations in most microwave measurements are due primarily to uncertainties associated with systematic errors in the microwave hardware (directivity, mismatch, frequency response, etc.). The HP 8510A's built-in, high speed computer provides the capability to characterize and effectively remove the impact of systematic errors through accuracy enhancement techniques. Effective directivity is improved to 50 dB, and effective source and load match to better than 40 dB. The data processing speed of the system is such that a fully error-corrected, 401 point trace of data is updated in under one second. This virtual "real time" display of error-corrected data means that you can easily adjust your test device while it's being measured, with the assurance that you are viewing the data at the highest possible accuracy.

Hewlett-Packard supplies kits of measurement calibration standards for precision 7 mm, precision 3.5 mm, and Type N connector interfaces. The HP 8510 system, also, provides the capability to measure devices in other coaxial interfaces, and waveguide, given the proper calibration standards.

Time Domain Analysis

The HP 8510 (with option 010) has the capability of displaying the time domain response of a network, obtained by computing the Inverse Fourier Transform of the frequency domain response. The time domain response displays the reflection coefficient of the network versus time, which displays the magnitude and location of each individual discontinuity, or else the transmission coefficient versus time, which displays each individual transmission path.

The HP 8510 offers two time domain modes. The Low Pass mode provides the traditional Time Domain Reflectometer (TDR) measurement capability and gives the response of the network to a (mathematically simulated) step or impulse stimulus. This mode gives information of the type of impedance (R, L, or C) present at a discontinuity. The Band Pass time domain mode, which has only the impulse stimulus, may be used over any frequency range to give the time domain response of frequency-selective devices (such as waveguide).

Gating is another powerful time domain feature that may be used to selectively isolate a single response in time and then convert just that response back to the frequency domain. For reflection measurements, this provides the capability to view the return loss of individual portions of a microwave component without disturbing the actual circuit. For transmission measurements, one can view the frequency and time domain responses of individual transmission paths.

The HP 8510A time domain capability can give great insight into the design of microwave components. Another useful application is cable fault location. Gating can be used in a variety of applications such as removing fixturing residuals or removing the effects of multipath and ground clutter in antenna measurements.

Compatible Sources

The HP 8340A and 8341A synthesized sweepers with the HP 8510 provide the best, most accurate measurements, regardless of the parameter selected. They combine a high resolution synthesizer with a broadband sweeper to cover the full frequency range of the HP 8510. With the HP 8340A you obtain 4 Hz resolution at 26.5 GHz for CW frequencies, phase locked narrowband (<5 MHz) sweeps, and fully synthesized start frequencies for broadband sweeps.

The HP 8350B sweep oscillator family is also fully compatible with the HP 8510. Coupled with this versatile sweeper mainframe, you can choose from a wide variety of RF plug-ins.

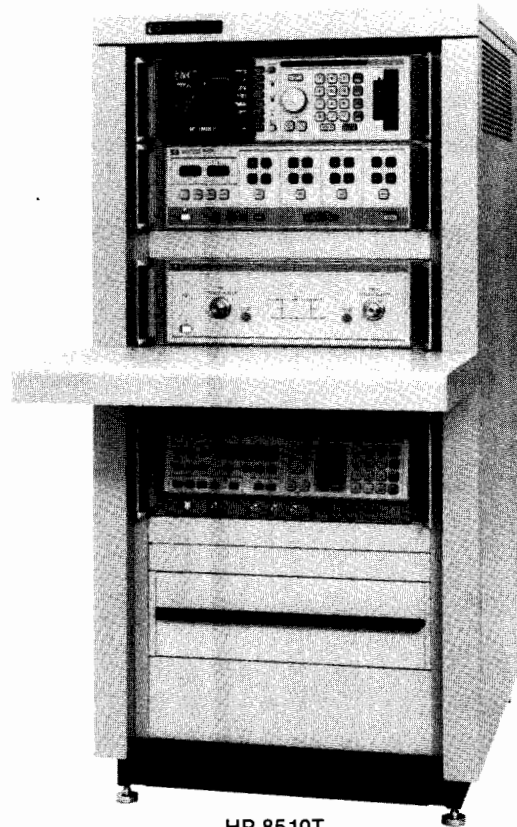

HP 8510T

HP 8510T Network Analyzer System

The HP 8510T is the highest performance system in the HP 8510 series. It provides, under one model number, everything needed to make precision measurements in the 45 MHz to 26.5 GHz frequency range. The system includes the HP 8510A with option 010, the 8515A S-Parameter Test Set, and an HP 8340A Synthesized Sweeper with options 005, 006, and 007. A comprehensive array of test and measurement accessories including the HP 85050A 7 mm Calibration Kit, HP 85051A 7 mm Verification Kit, HP 85052A 3.5 mm Calibration Kit, along with RF return cables and adapters, are supplied. The instruments are installed in the portable HP 85043A system rack.

When you purchase HP 8510T you not only obtain a high performance network measurement system, you are also provided with the total solution. Included with the HP 8510T are an impressive array of support products including on-site maintenance for one year, installation, and calibration at no extra charge.

HP 85043A System Rack

The HP 85043A System Rack is a rack standing only 123.7 cm (48.7") high with a width of 60.0 cm (23.6") and a depth of 80.0 cm (31.5"). Complete with support rails and ac power distribution (suitable for 50 to 60 Hz, 100-240 Vac), it includes rack mounting hardware for all instruments. Thermal design is such that no rack fan is needed.

NETWORK ANALYZERS

Test Sets

Models 8511A, 8512A, 8513A, 8514A, 8515A

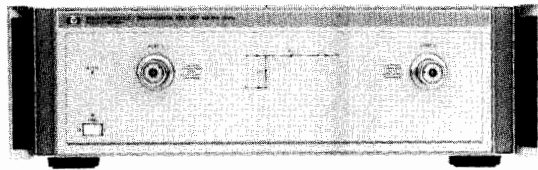

HP 8512A

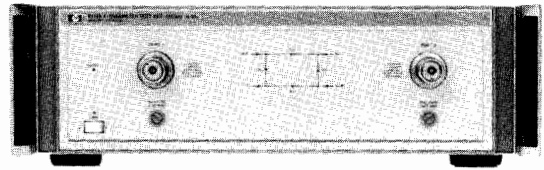

HP 8514A

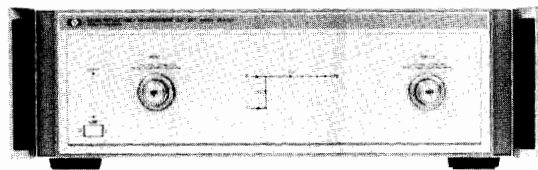

HP 8513A

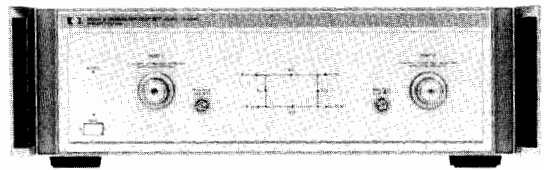

HP 8515A

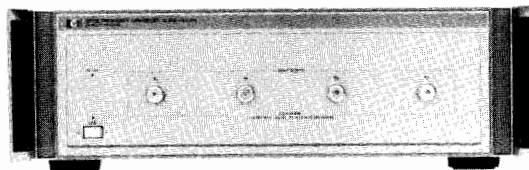

HP 8511A

HP 8512A Reflection/Transmission Test Set

The HP 8512A Reflection/Transmission Test Set provides the capability to simultaneously measure the complex reflection and transmission characteristics of a test device from 45 MHz to 18 GHz in transmission and 500 MHz to 18 GHz in reflection. Reflection measurements to 45 MHz are achievable with some loss (about 30dB) in dynamic range. An HP 8512A-based system offers very broad dynamic range with the highest accuracy available. The test ports have rugged precision 7-mm connectors and may be adapted to other interfaces with the appropriate precision adapters. The test set includes an integrated three-channel frequency converter.

HP 8513A Reflection/Transmission Test Set

The HP 8513A Reflection/Transmission Test Set provides the capability to simultaneously measure the complex reflection and transmission characteristics of a test device over the 45 MHz to 26.5 GHz frequency range. An HP 8513A-based system offers the capability to measure a network across an extremely wide frequency range with just one connection, over a wide dynamic range with high accuracy. The test ports are a special, ruggedized, version of the precision 3.5-mm connector interface that is completely compatible with any connector in the 3.5 mm family. The test set includes an integrated three-channel frequency converter.

HP 8514A S-Parameter Test Set

The HP 8514A S-Parameter Test Set provides the capability to measure all four S-parameters of a two port device with a single connection over the 500 MHz to 18 GHz frequency range. Measurements to 45 MHz are achievable with some loss (about 30 dB) in dynamic range. The S-parameter test set architecture is ideal for measuring two-port devices where it is not convenient to physically reverse the device to measure the reverse parameters, or for networks that need to be adjusted while being measured with full error-correction employed. The test ports have rugged precision 7-mm connectors

and may be adapted to other connector interfaces with the appropriate precision adapters. Along with an integrated, four-channel frequency converter, the test set includes two 90-dB step attenuators for changing the incident power level at the test port and two bias networks for applying dc bias to the test port center conductor in active device test applications.

HP 8515A S-Parameter Test Set

The HP 8515A S-Parameter Test Set provides the capability to measure all four S-parameters of a two-port device with a single connection over the 45 MHz to 26.5 GHz frequency range. The S-parameter test set architecture is ideal for measuring two port devices where it is not convenient to reverse the device to measure the reverse parameters, or for networks that need to be adjusted while being measured with full error-correction employed. The test ports are a special, ruggedized, version of the precision 3.5 mm interface that is completely compatible with any connector in the 3.5 mm family. Along with an integrated, four-channel frequency converter, the test set includes two 90-dB step attenuators for changing the incident power level at the test port and two bias networks for applying dc bias to the test port center conductor in active device test applications.

HP 8511A Frequency Converter

The HP 8511A is a four-channel frequency converter covering the 45 MHz to 26.5 GHz frequency range. An HP 8510A/8511A combination results in a system that can be customized to unique test requirements with the addition of customer-supplied test setup hardware. Examples include multi-port device measurements and antenna characterization. Each of the four inputs operates over the full dynamic range of the system, from 85 dB to 100 dB. Isolation between channels is typically greater than 100 dB. Dynamic accuracy is better than ± 0.05 dB and ± 0.2 degree at a test channel level of -50 dBm.

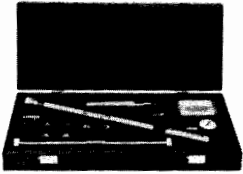
Models 85050A, 85051A, 85052A, 85053A, 85054A, 85130A, 85131A/B, 85132A/B

HP 85050A

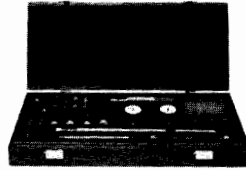

HP 85052A

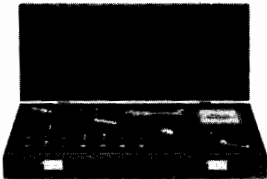

HP 85054A



HP 85051A



HP 85053A



HP 85130A

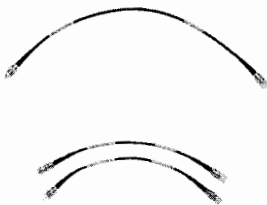

HP 85131A/B



HP 85132A/B

Calibration Kits

Error-correction procedures require that the systematic errors in the measurement system be characterized by measuring known devices (standards) on the system over the frequency range of interest. The calibration kits in the HP 8510 family contain precision standard devices to characterize the systematic errors of the HP 8510 system. Hewlett-Packard offers several calibration kits in various connector interfaces that are compatible with the HP 8510.

HP 85050A 7 mm Calibration Kit

The HP 85050A 7 mm Calibration Kit contains a set of precision calibration standards used to calibrate the HP 8510 system for measurements of devices with precision 7-mm connectors. The calibration standards include open and short circuits, and fixed and sliding terminations. Also included are a precision 7-mm connector gage and tools for verifying and maintaining the connector interfaces.

Option 010: Adds a precision 30-cm beadless airline that is useful in time domain applications.

Option 020: Deletes precision 7-mm connector gage and tools.

HP 85052A 3.5 mm Calibration Kit

The HP 85052A 3.5 mm Calibration Kit contains a set of precision calibration standards used to calibrate the HP 8510 system for measurements of devices with 3.5-mm connectors (precision 3.5 mm or SMA). The calibration standards include open and short circuits, and fixed and sliding terminations. Also included are precision 7-mm to 3.5-mm adapters. Connector gages are supplied for verifying critical mechanical tolerances of the 3.5-mm connector interface.

Option 010: Adds precision 15-cm beadless airline that is useful in time domain applications.

Option 020: Deletes precision 3.5-mm connector gages.

HP 85054A Type N Calibration Kit

The HP 85054A Type N Calibration Kit contains a set of precision calibration standards used to calibrate the HP 8510 system for measurements of devices with Type N connectors. The calibration standards include open and short circuits, and fixed and sliding terminations. Also included are precision 7-mm to Type N adapters.

Verification Kits

Measuring known devices, other than the calibration standards, is a straightforward way of verifying that the HP 8510 system is operating properly. Hewlett-Packard offers verification kits that include standard devices, with data, for verifying the error-corrected measurement performance of the HP 8510 system.

HP 85051A 7 mm Verification Kit

The HP 85051A 7 mm Verification Kit contains a set of precision devices, with data, used to verify the error-corrected performance of the HP 8510 system. The devices have precision 7-mm connectors and include 20-dB and 50-dB attenuators, a 10-cm beadless airline, and a 10-cm beadless stepped impedance airline (25 ohms nominal).

HP 85053A 3.5 mm Verification Kit

The HP 85053A 3.5 mm Verification Kit contains a set of precision devices, with data, used to verify the error-corrected performance of the HP 8510 system. The devices have precision 3.5-mm connectors and include 20-dB and 40-dB attenuators, a 7.5-cm beadless airline, and a 7.5-cm beadless stepped impedance airline (25 ohms nominal).

Test Port Return Cables

Hewlett-Packard offers a variety of high quality RF cables that are used to return the transmitted signal to the test set when measuring two-port devices.

HP 85131A 3.5 mm Test Port Return Cable

The HP 85131A is a single test port return cable for use with either the HP 8513A or 8515A test sets (when connecting the device directly to Port 1).

Frequency Range: dc to 26.5 GHz

Length: 91 cm (36 in.)

VSWR: 1.22:1, typical

Connectors: Special 3.5 mm, and precision 3.5 mm (female)

HP 85131B 3.5 mm Test Port Return Cable Set

The HP 85131B is a pair of test port return cables for use with the HP 8515A test set. The device is connected between the cables during measurement.

Frequency Range: dc to 26.5 GHz

Length: 66 cm (24 in.) each

VSWR: 1.22:1, typical

Connectors: Special 3.5 mm, and precision 3.5 mm (one male, or female)

HP 85132A 7 mm Test Port Return Cable

The HP 85132A is a single test port return cable for use with either HP 8512A or 8414A test sets (when connecting the device directly to Port 1). When used with the HP 85130A adapter set, the HP 85132A can also be used with the HP 8513A and HP 8515A test sets when measuring devices with precision 7-mm connectors.

Frequency Range: dc to 18 GHz

Length: 91 cm (86 in.)

VSWR: 1.2:1, typical

Connectors: Precision 7 mm

HP 85132B Test Port Return Cable Set

The HP 85132B is a pair of test port return cables for use with the HP 8514A test set. The device is connected between the cables during measurement. When used with the HP 85130A adapter set, the HP 85132A set can also be used with the HP 8515A set when measuring devices with precision 7-mm connectors.

Frequency Range: dc to 18 GHz

Length: 66 cm (24 in.) each

VSWR: 1.2:1, typical

Connectors: Precision 7 mm

HP 85130A Special 3.5 mm to 7 mm Adapter Set

The HP 85130A kit contains a set of precision special 3.5-mm to 7-mm adapters used for converting the test ports of the HP 8513A and 8515A test sets to a precision 7-mm interface. The HP 85132A or 85132B cables are used as the test port return cables when the HP 85130A adapters are connected to the test set.

NETWORK ANALYZERS

Accessories (cont.)

8510 Series

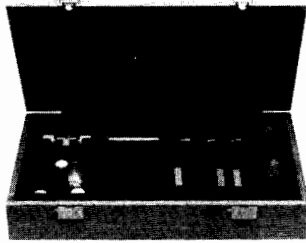

HP 85041A



HP 8717B

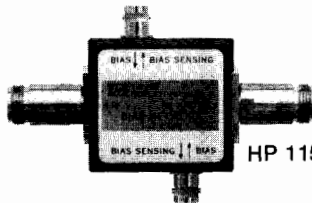

HP 11590B



HP 11612A



HP 11635A

Active Device Test

Hewlett-Packard offers an extensive array of accessories designed for the needs of active device test and measurement, including fixtures, bias supplies, bias networks, and application software.

HP 85041A Transistor Test Fixture Kit

The HP 85041A Transistor Test Fixture (TTF) kit is a comprehensive measurement system for testing and characterizing stripline packaged microwave transistors. Only useful when used with the HP 85014A Active Device Measurement software.

Frequency Range: dc to 18 GHz

Transistor Package Inserts: 70 mil and 100 mil

Verification Devices: Short and through circuits

Connectors: precision 7 mm

Accessories Supplied: fixture stand, torque tool, tweezers, and lid opening tool

HP 8717B Transistor Bias Supply

The HP 8717B transistor bias supply provides manual or automatic biasing for transistor testing. This supply 8717B has two meters for independently monitoring current and voltage. Bias connections are conveniently selected for all transistor configurations with a front panel switch.

Voltage Ranges: 1,3,10,30,100 V

Current Ranges: 0.1,0.3,1,3,10,30,100,300,1000 mA

Accuracy: 4% of full scale for both current and voltage

Option 001: programmable D/A converter

Option 011: programming cable for HP Series 200 computers

HP 11590B Bias Network

The HP 11590B is a rugged, broadband bias network. This bias network provides dc bias to the center conductor of a coaxial line which can be connected to the device under test while blocking DC bias from the RF circuit.

Frequency Range: 0.1 to 12.4 GHz (Option 001, 1.0 to 18.0 GHz)

Maximum insertion loss: 1.0 dB, 0.1 - 1.0 GHz

0.8 dB, 1.0 - 12.4 GHz

1.2 dB, 12.4 - 18.0 GHz (Option 001)

Minimum return loss: 16 dB, 0.1 - 1.0 GHz

19 dB, 1.0 - 12.4 GHz

14 dB, 12.4 - 18.0 GHz (Option 001)

Maximum Bias Current: 0.5 A, each bias port

Maximum Bias Voltage: 100 V

Connectors: BNC for dc bias; type N female for RF (Option 001, precision 7 mm)

HP 11612A Bias Network

The HP 11612A is an insertable, extremely broadband bias network with excellent port match and low insertion loss. This bias network provides dc bias to the center conductor of a coaxial line which can be connected to the device under test while blocking DC bias from the RF circuit.

Frequency Range: 45 MHz to 26.5 GHz

Insertion loss: 0.8 dB, 45 MHz - 12.4 GHz

(max) 1.3 dB, 12.4 - 26.5 GHz

Minimum return loss: 20 dB, 45 MHz - 8.0 GHz

18 dB, 8.0 - 18.0 GHz

14 dB, 18.0 - 26.5 GHz

Maximum Bias Current: 0.5 A

Maximum Bias Voltage: 40 V

Connectors: SMB snap-on for dc bias; precision 3.5 mm for RF

HP 11635A Bias Decoupling Network

The HP 11635A bias decoupling network is a recommended accessory for prevention of bias oscillations when biasing microwave bipolar transistors with any HP bias network or s-parameter test set. Installing the HP 11635A between the bias supply and the base bias network prevents low frequency oscillations.

Application Software

Hewlett-Packard offers several application software packages that complement the HP 8510 system providing automated calibration and measurement capability. Software is available for HP 200 Series desktop computers with either BASIC 2.0 or 3.0 operating systems on both 3 1/2" and 5 1/4" disc media.

HP 85014A Active Device Measurement Application Pac

The HP 85014A software pac provides the capability to the HP 8510 system for measurement of RF and microwave transistors. Features include automated device biasing with the HP 8717B bias supply, system calibration, and de-embedding of s-parameters when using the HP 85041A transistor test fixture. It is also usable with other HP transistor fixtures as well as user-designed fixtures. Plotted and listed output of device S, H, Y, and Z parameters, as well as the device Amplifier Summary and Termination Summary are provided. Also available is the capability to store and retrieve s-parameter data in formats suitable for computer aided design applications.

HP 85013A Basic Measurements Application Pac

The HP 85013A software pac provides the capability to automate the HP 8510 system for applications where the system is required to emulate the user interface of the HP 8409 series automatic network analyzers. All the features of the HP 8409 series operating system are provided for including the capability to measure up to 401 related (Start/Stop/Step) or unrelated (individual CW) frequency points.



Millimeter-Wave Measurements

The HP 8510A network analyzer is the solution for your vector measurement needs at millimeter-wave frequencies. With a variety of standard HP products, you can configure a complete network analyzer system that provides vector measurement capability in the 26.5 GHz to 40 GHz, 33 GHz to 50 GHz, or 40 GHz to 60 GHz waveguide bands. Because the architecture uses two HP 8340A-series synthesized sources, utilizing one to provide the RF stimulus and the other to act as LO for frequency conversion to the HP 8510 IF frequency of 20 MHz, 80 dB to 100 dB of dynamic range is easily achieved.

The HP 85129A software pac automates system operation but leaves all the powerful features of the HP 8510 accessible at the front panel, including built-in error correction and optional time domain capability.

Support Products

Hewlett-Packard offers a complete group of support products specifically tailored to achieve maximum HP 8510 productivity. Several of these products are described below.

HP 8510A + 24D Basic Measurements Using the HP 8510 Network Analyzer System

With two enrollments included in the purchase price of the HP 8510A, this three day, lab intensive training course introduces students to the operation of the HP 8510 system including error-correction and time domain fundamentals. The training course provides the opportunity for users to accelerate on the basic operation learning curve, allowing maximum utilization of the system to be achieved in a shorter time.

HP 8510T + 23N On-Site System Installation (where available)

The HP 8510T+23N provides for complete installation of the HP 8510 system in either table top or racked configurations. Included are pre-installation inspection, on-site installation, and verification. Also included is a retrofit of one customer owned HP 8350 series sweep oscillator for HP 8510 compatibility.

HP 8510T + 23A Basic System Maintenance and Calibration (where available)

The HP 8510T+23A provides complete on-site maintenance and calibration support for an HP 8510 system. Included are next-day on-site response when repairs are needed, preventive maintenance, and on-site calibration performed twice a year with NBS (or other standard agency) traceable devices.

Ordering Information

| Analyzer | Price |
|-----------------------------------|-------------|
| HP 8510A Network Analyzer | \$33,500 |
| Option 010 Time Domain Capability | add \$9,500 |

Test Sets (choose at least one)

| | |
|--|----------|
| HP 8512A R/T Test Set (0.5 to 18.0 GHz) | \$17,300 |
| HP 8513A R/T Test Set (45 MHz to 26.5 GHz) | \$25,000 |
| HP 8514A S-Parameter Test Set (0.5 to 18.0 GHz) | \$28,000 |
| HP 8515A S-Parameter Test Set (45 MHz to 26.5 GHz) | \$37,200 |
| HP 8511A Frequency Converter (45 MHz to 26.5 GHz) | \$17,300 |

Sources (choose either the HP 8340A/8341A or the HP 8350B with an RF Plug-in)

| | |
|--|----------|
| HP 8340A 0.01 to 26.5 GHz Synthesized Sweeper (with options 005, 006, 007) | \$59,800 |
| HP 8341A 0.01 to 20.0 GHz Synthesized Sweeper (with option 005) | \$44,200 |
| HP 8350B Sweep Oscillator (choose one of these recommended plug-ins) | \$ 4,565 |
| HP 83592A 0.01 to 20.0 GHz (with option 004) | \$20,700 |
| HP 83595A 0.01 to 26.5 GHz (with option 004) | \$29,285 |

For ordering convenience, HP offers a complete line of kits that combine many of the instruments and components into several easy-to-order model numbers. To allow you to take full advantage of the HP 8510's built-in error-correction capabilities, a line of waveguide calibration kits are also available.

Millimeter-Wave HP 8510 Network Analyzer Kits*

| Frequency Range (GHz) | 26.5 to 40 | 33 to 50 | 40 to 60 |
|-----------------------|---------------------------|------------|------------|
| Test Set Kit | HP R11643A | HP Q11643A | HP U11643A |
| Calibration Kit | HP R11644A | HP Q11644A | HP U11644A |
| LO/IF Interface Kit | HP 85100A (1 per HP 8510) | | |
| Software | HP 85129A (1 per HP 8510) | | |

*In addition to an HP 8510 and the kit items listed, system configuration requires two HP 8341A option 005 synthesized sweepers, one HP 8349B option 002 amplifier, one millimeter-wave source module and one HP Model 9000 Series 200 computer (minimum 0.5 megabyte RAM).

Calibration Kits (choose one for each connector type to be used)

| | |
|----------------------------------|-------------|
| HP 85050A 7 mm Calibration Kit | \$3,000 |
| Opt. 010 30 cm beadless airline | add \$1,100 |
| Opt. 020 delete connector tools | less \$750 |
| HP 85052A 3.5 mm Calibration Kit | \$4,850 |
| Opt. 010 15 cm beadless airline | add \$1,100 |
| Opt. 020 delete connector tools | less \$750 |
| HP 85054A Type N Calibration Kit | \$1,950 |

Verification Kits

| | |
|-----------------------------------|---------|
| HP 85051A 7 mm Verification Kit | \$2,400 |
| HP 85053A 3.5 mm Verification Kit | \$2,600 |

Test Port Return Cables (choose at least one)

| | |
|--|---------|
| HP 85131A 3.5 mm Test Port Return Cable | \$850 |
| HP 85131B 3.5 mm Test Port Return Cable Set | \$1,600 |
| HP 85132A 7 mm Test Port Return Cable | \$700 |
| HP 85132B 7 mm Test Port Return Cable Set | \$1,350 |
| HP 85130A Special 3.5 mm to 7 mm Adapter Kit | \$575 |

Transistor Test Accessories

| | |
|--|-----------|
| HP 85041A Transistor Test Fixture Kit | \$5,000 |
| HP 8717B Transistor Bias Supply | \$4,415 |
| (when used with HP 85014A software must order) | |
| Opt. 001 Programming Capability | add \$670 |
| Opt. 011 Programming Cable | add \$250 |
| HP 98622A GPIO Interface | \$355 |
| HP 11590B Bias Network | \$775 |
| HP 11612A Bias Network | \$700 |
| HP 11635A Bias Decoupling Network | \$275 |

Millimeter-Wave Network Analyzer Kits

| | |
|----------------------------------|----------|
| HP 85100A LO/IF Interface Kit | \$13,000 |
| HP R11643A WR-28 Test Set Kit | 14,000 |
| HP Q11643A WR-22 Test Set Kit | 15,000 |
| HP U11643A WR-19 Test Set Kit | 16,500 |
| HP R11644A WR-28 Calibration Kit | \$3,600 |
| HP Q11644A WR-22 Calibration Kit | 3,850 |
| HP U11644A WR-19 Calibration Kit | 4,200 |

System Rack

| | |
|-----------------------|---------|
| HP 85043A System Rack | \$2,300 |
|-----------------------|---------|

Software (choose one option)

| | |
|--|---------|
| HP 85013A Basic Measurements Application Pac | \$950 |
| Opt. 630 3 1/2" disc | N/C |
| Opt. 655 5 1/4" disc | N/C |
| HP 85014A Active Device Measurements Application Pac | \$3,000 |
| Opt. 630 3 1/2" disc | N/C |
| Opt. 655 5 1/4" disc | N/C |
| HP 85129A 8510A Millimeter-wave Measurement Software | \$800 |

Support Products

| | |
|---|-----------------|
| HP 8510A + 24D User Course | \$1,100/student |
| HP 8510T + 23N On-site Installation (where available) | \$600 |
| HP 8510T + 23A On-site Service (where available) | |

Systems

| | |
|----------------------------------|-----------|
| HP 8510T Network Analyzer System | \$162,000 |
|----------------------------------|-----------|

NETWORK ANALYZERS

Microwave Network Analyzer, 110 MHz to 18 GHz

Model 8410 Series

- Economical vector performance
- Measures all network parameters
- Multioctave swept frequency measurements
- Eliminate harmonic and spurious responses

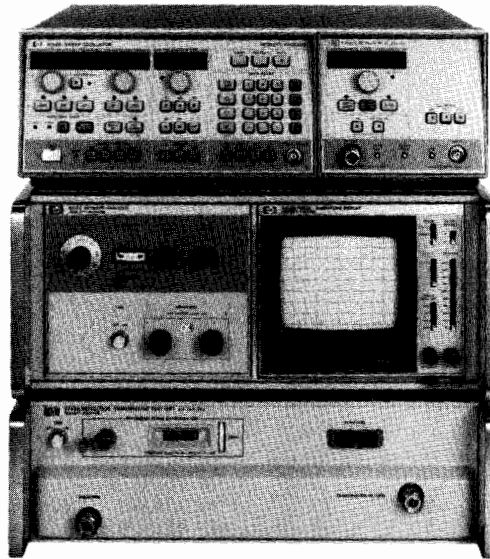

Receiver

The HP 8410C network analyzer and HP 8411A harmonic frequency converter comprise the nucleus of the swept-frequency system which provides magnitude and phase measurement capability from 110 MHz to 18 GHz in coax. Automatic frequency locking allows continuous multioctave sweeps. Frequency conversion from RF to IF gives high sensitivity and greater than 60 dB dynamic range, free of spurious and harmonic responses. Calibrated IF substitution makes possible accurate gain or insertion loss measurements.

Displays

The HP 8412B Phase/Magnitude Display displays magnitude and phase versus frequency. The HP 8414B Polar Display provides a polar plot of magnitude and phase. These displays are interchangeable plug-ins for the HP 8410C mainframe. The HP 8418B Auxiliary Display Unit can be added to provide simultaneous rectilinear and polar display capability.

Sources

Although the HP 8410C can produce octave-width sweeps using any swept source, continuous multi-octave sweeps limited only by the frequency range of the test set are possible with the HP 8620C or 8350B Sweep Oscillators.

Test Sets

The HP 8745A, 8743B, 8746B, and 85040B test sets contain all the necessary splitters and couplers required to provide stimulus to the device under test and route the reference and reflected or transmitted signals to the receiver. Accessories allow the test sets to be configured for active and passive coaxial measurements as well as for semiconductor measurement applications.

System Ordering Convenience

HP 8410S systems enable ordering a complete network analyzer system, except for source, using a single model number. Each option has been configured for making general measurements on coaxial or semiconductor devices. The HP 8410S systems enable the operator to view a real time CRT display over octave or multioctave bands with a dynamic range of 60 dB amplitude and 360° phase. Multioctave, continuous network measurements over the frequency range of 2 to 18 GHz are possible when the HP 8410C is used with the HP 8620C or 8350B Sweep Oscillator.

The HP 8410S systems' upper frequency limit for coaxial and semiconductor measurements is 12.4 GHz; however, individual instruments may be ordered that will expand coaxial measurement capability to 18 GHz (option 018 instruments).

HP 8410S Network Analyzer Systems

| GENERAL PURPOSE MEASUREMENTS | | | | | | | | | | | | | |
|---|------------|--------------------------------|----------|----------|----------|----------|-----------|-----------|-----------|-----------|-----------|-----------|----------|
| All HP 8410S Systems Include the Following Instrument Model Numbers: HP 8410C, 8411A, 8412B, 8414B, 11609A, and 8750A opt. 003 | | | | | | | | | | | | | |
| Frequency Range | Option No. | Measurement Port Configuration | HP 8743B | HP 8745A | HP 8746B | HP 8717B | HP 11600B | HP 11602B | HP 11608A | HP 11604A | HP 11610B | HP 11650A | Price |
| 0.11 to 2 GHz | 110 | Coaxial (APC-7) | | X | | | | | | X | | X | \$37.405 |
| 0.11 to 12.4 GHz | 310 | Coaxial (APC-7) | X | X | | | | | | X | X | X | \$46.030 |
| 2 to 12.4 GHz | 210 | Coaxial (APC-7) | X | | | | | | | | X | X | \$34.045 |
| SEMICONDUCTOR CHARACTERIZATION | | | | | | | | | | | | | |
| 0.11 to 2 GHz | 400 | T018/T072 Packages | | X | | X | X | | | | | | \$38.660 |
| 0.11 to 2 GHz | 401 | T05/T012 Packages | | X | | X | | X | | | | | \$38.660 |
| 0.5 to 12.4 GHz | 500 | Stripline | | | X | X | | | X | | | | \$41.815 |

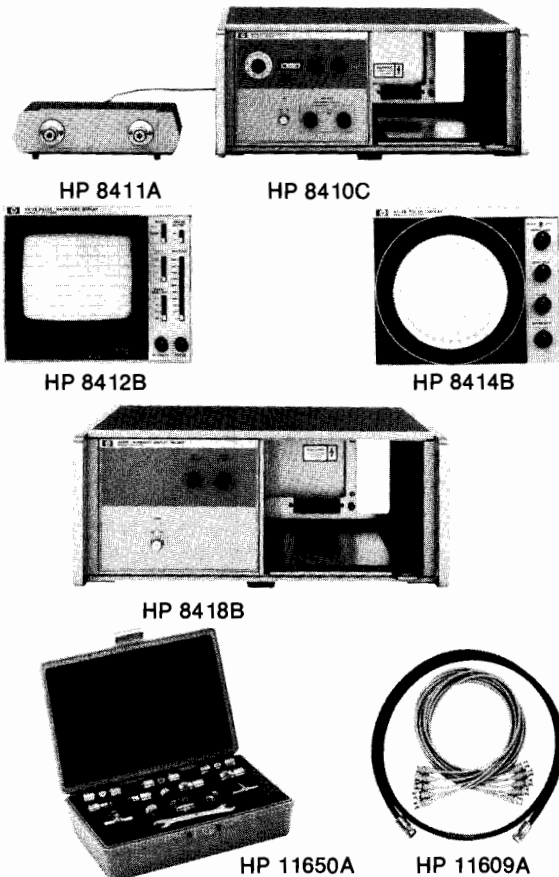

Specifications

HP 8410C/8411A Network Analyzer

Function: HP 8411A converts RF signals to IF signals for processing in HP 8410C mainframe. HP 8410C is the mainframe for display plug-in units. Mainframe includes tuning circuits (octave bands or multioctave bands when used with HP 8620C or 8350B sweep oscillator), IF amplifiers and precision IF attenuator. HP 8410C allows injection of an external local oscillator used in automatic applications to lock the HP 8410C receiver to an external source such as the HP 3335A.

HP 8410C frequency range: 0.11 to 18 GHz.

HP 8411A frequency range: 0.11 to 12.4 GHz.

Opt 018: 0.11 to 18 GHz.

HP 8411A input impedance: 50 ohms nominal. SWR <1.5, 0.11 to 2.0 GHz; <2.0, 2.0 to 16.0 GHz; 3, 6.0 to 18.0 GHz.

Channel isolation: >65 dB, 0.1 to 6 GHz; >60 dB, 6 to 12.4 GHz; >50 dB, 12.4 to 18 GHz.

Magnitude Range

Reference channel: -18 to -35 dBm, 0.11 to 12.4 GHz; -18 to -25 dBm from 12.4 to 18.0 GHz.

Test channel: -10 to -75 dBm from 0.11 to 12.4 GHz; -10 to -68 dBm from 12.4 to 18 GHz.

Maximum RF input to either channel: 50 mW.

IF gain control: 69 dB range in 10 dB and 1 dB steps with a maximum cumulative error of ± 0.2 dB.

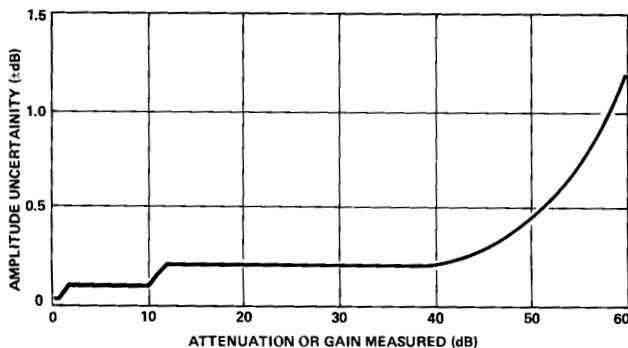

Phase

Phase range: 0 to 360°

Control: vernier control $\leq 90^\circ$

Connectors (HP 8411A): APC-7.

Power: 115 or 230 V $\pm 10\%$, 50-60 Hz, 70 watts (includes HP 8411A).

Weight

HP 8410C: net, 14.9 kg (33 lb); shipping, 18.5 kg (41 lb).

HP 8411A: net, 3.2 kg (7 lb); shipping, 4.5 kg (10 lb).

Size

HP 8410C: 191 H x 425 W x 467 mm D (7.5" x 16.75" x 18.38").

HP 8411A: 67 x 228 W x 143 mm D (2.63" x 9" x 5.63") exclusive of connectors and cable.

HP 8412B Phase-Magnitude Display

Function: plug-in CRT display unit for HP 8410C. Displays relative amplitude in dB and/or relative phase in degrees between reference and test channel inputs versus frequency. Programmable 180° phase offset by ground closure.

Amplitude

Range: 80 dB display range with selectable resolutions of 10, 2.5, 1 and 0.25 dB/division.

Accuracy: 0.08 dB/dB from midscreen.

Phase

Range: $\pm 180^\circ$ display range with selectable resolutions of 90, 45, 10, and 1°/division.

Accuracy: 0.065°/degree from midscreen.

Phase offset: 0.3°/20° step cumulative <3°.

Power: 23 watts supplied by mainframe.

Weight: net, 7.8 kg (17 lb); shipping, 10 kg (22 lb).

Size: 152 H x 186 W x 395 mm D (6" x 7.28" x 15.56") excluding front panel knobs.

HP 8414B Polar Display

Function: plug-in CRT display unit for HP 8410C. Displays amplitude and phase data in polar coordinates on 5-in. cathode ray tube.

Range: normalized polar coordinate display; magnitude calibration 20% of full scale per division. Scale factor is a function of IF setting on HP 8410C. The beam center function is controllable by an external contact closure.

Accuracy: error circle on CRT ± 3 mm.

Power: 35 watts supplied by mainframe.

Weight: net, 5.8 kg (13 lb); shipping, 8.1 kg (18 lb).

Size: 152 H x 186 W x 395 mm D (6" x 7.28" x 15.56") excluding front panel knobs.

HP 8418B Auxiliary Display Holder

Function: the HP 8418B auxiliary display holder provides power for operating of the HP 8412B or the 8414B display units. Used in conjunction with the HP 8410C network analyzer, it provides the capability of viewing amplitude and phase readout in both rectangular and polar coordinates simultaneously. Includes a remotely programmable 0-70 dB IF attenuator required for autoranging in automatic applications.

Weight: net, 11.2 kg (25 lb); shipping, 19.7 kg (44 lb).

Size: 177 H x 483 W x 450 mm D (6.97" x 19" x 17.13").

HP 11650A Accessory Kit

Function: accessories normally used for transmission and reflection tests with the HP 8745A and 8743B.

Weight: net, 1.34 kg (3 lb); shipping, 2.23 kg (5 lb).

HP 11609A Cable Kit

Function: interconnecting cables normally required for network measurements using the HP 8410C network analyzer.

Weight: net, 0.9 kg (2 lb); shipping 1.36 kg (3 lb).

Ordering Information

| Item | Price |
|-----------------------------------|-----------|
| HP 8410C mainframe | \$7,775 |
| Opt 908: Rack Flange Kit | add \$25 |
| HP 8411A Frequency Converter | \$5,520 |
| Opt 018: 0.11 to 18 GHz | add \$550 |
| HP 8412B Phase-Magnitude Display | \$4,110 |
| HP 8414B Polar Display | \$3,865 |
| HP 8418B Auxiliary Display Holder | \$3,710 |
| Opt 908: Rack Flange Kit | add \$25 |
| HP 11650A Accessory Kit | \$1,605 |
| HP 11609A Cable Kit | \$150 |

NETWORK ANALYZERS

Test Sets and Accessories

Model 8410 Series



HP 8745A

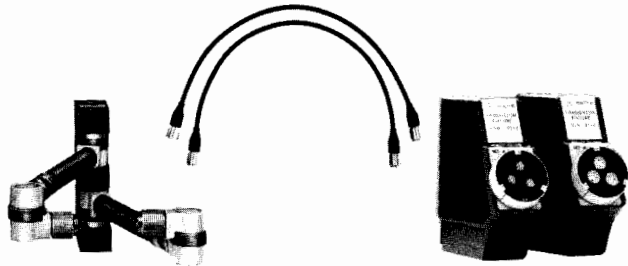

HP 11604A

HP 11602B HP 11600B

HP 8745A S-Parameter Test Set

Function: wideband RF power splitter and reflectometer with calibrated line stretcher. Pushbutton operated for either forward or reverse transmission or reflection measurements with network analyzer.

Frequency range: 100 MHz to 2 GHz.

Impedance: 50 ohms nominal.

Source reflection coefficient: ≤ 0.057 , 0.11 to 2.0 GHz.

Termination reflection coefficient: < 0.10 , 100, to 200 MHz; < 0.063 , 200 MHz to 2.0 GHz.

Directivity: ≥ 36 dB, below 1 GHz; ≥ 32 dB, 1 to 2 GHz.

Reference plane extension: 0 to 15 cm for reflection; 0 to 30 cm for transmission.

Maximum RF power: 2 watts.

Connectors: RF input type N female; all other connectors APC-7; Option 001, type N female.

Remote programming: ground closure.

Power: 115 or 120 V $\pm 10\%$, 50 to 400 Hz, 40 watts.

Weight: net, 15.4 kg (34.25 lb); shipping, 18.0 kg (40 lb).

Size: 140 H x 425 W x 654 mm D (5.50" x 16.75" x 25.75").

HP 11604A Universal Extension

Function: mounts on front of HP 8745A; connects to device under test. Rotary air-lines and rotary joints connect to any two port geometry.

Frequency range: dc to 2 GHz.

Impedance: 50 ohms nominal.

Reflection coefficient: 0.035.

Acc. included: semi-rigid coax. cable, HP Part #11604-20021.

Weight: net, 1.8 kg (4 lb); shipping, 2.2 kg (5 lb).

Size: 127 H x 32 W x 267 mm D (5" x 1.25" x 10.50").

HP 11600B/11602B Transistor Fixtures

Function: mounts on front of HP 8745A S-parameter test set; holds devices for S-parameter measurements in a 50 ohm, coax circuit. Other devices also fit the fixture (tunnel diodes, etc.).

Transistor Base Patterns

Model 11600B: accepts TO-18/TO-72 packages.

Model 11602B: accepts TO-5/TO-12 packages.

Calibration references: short circuit termination and a 50 ohm through-section.

Frequency ranges: dc to 2 GHz.

Impedance: 50 ohms nominal.

Reflection coefficient: < 0.05 , 100 MHz to 1.0 GHz; < 0.09 , 1.0 to 2 GHz.

Connectors: hybrid APC-7; Option 001, type N female.

Weight: net 1.1 kg (2.38 lb); shipping, 1.8 kg (4 lb).

Size: 152 H x 44 W x 229 mm D (6" x 1.75" x 9").

HP 11857A 50 Ω APC-7 Test Port Extension Cables

General: two precision 61 cm (24 in.) cables, for use with HP 8745A S-parameter test set. Connectors are 50 Ω APC-7.

Weight: net, 0.91 kg (2 lb); shipping, 2.3 kg (5 lb).

HP 8410S Opt 110 Specifications

Function: the HP 8410S option 110 measurement system configuration is described on page 632. Following are specifications describing measurement capabilities of the HP 8410C/8411A when used with the HP 8745A/11604A over the frequency range of 110 MHz to 2 GHz.

Frequency range: 0.11 to 2.0 GHz.

RF input: 20 dB range between +5 dBm and -12 dBm.

Source reflection coefficient: ≤ 0.067 , 0.11-2.0 GHz.

Termination reflection coefficient: ≤ 0.11 , 100-200 MHz; ≤ 0.07 , 200-2000 MHz.

Directivity: ≥ 28 dB 0.11-1.0 GHz; ≥ 27 dB 1.0-2.0 GHz.

Insertion loss, RF input to test port: 4 dB nominal.

Frequency Response

Transmission: typically $\leq \pm 0.35$ dB amplitude and $\leq \pm 5^\circ$ phase.

Reflection: typically $\leq \pm 0.06$ magnitude and $\pm 5^\circ$ phase with a short on the test port.

Transmission measurement accuracy: (see common performance specifications).

Reflection measurement accuracy (using HP 8414B): sources of error included in the accuracy equations are directivity, source match, and polar display accuracy.

Magnitude Accuracy

$\rho_u = \pm(0.0398 + 0.03 \rho_L + 0.067 \rho_L^2)$ 0.11-1.0 GHz.

$\rho_u = \pm(0.0447 + 0.03 \rho_L + 0.067 \rho_L^2)$ 1.0-2.0 GHz.

ρ_u = magnitude uncertainty.

ρ_L = measured reflection coefficient magnitude.

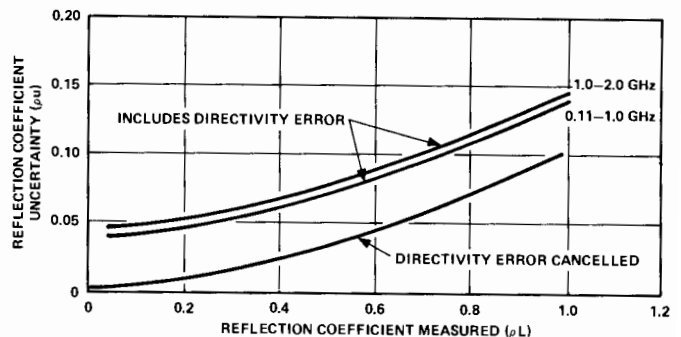

Phase Accuracy

$\Phi_u = \sin^{-1} \rho_u / \rho_L$ for $\Phi_u < 90^\circ$.

Φ_u = phase uncertainty.

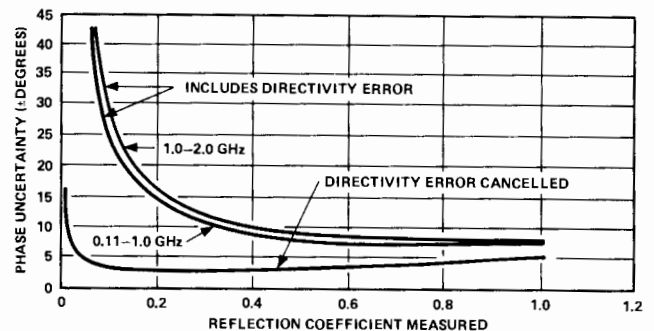

See HP 8410S network analyzer systems table for price and instrument breakdown.

Ordering Information

| | Price |
|--|-----------|
| HP 8745A Test Set | \$8,930 |
| Opt 001: Type N Test Port Connectors | N/C |
| Opt 908: Rack Flange Kit | \$25 |
| HP 11604A Universal Arm Extension | \$2,710 |
| HP 11600B/11602B Transistor Fixtures | \$1,505 |
| Opt 001: Type N Female Connectors | less \$30 |
| HP 11857A 50 Ω APC-7 Test Port Extension Cables | \$1,005 |

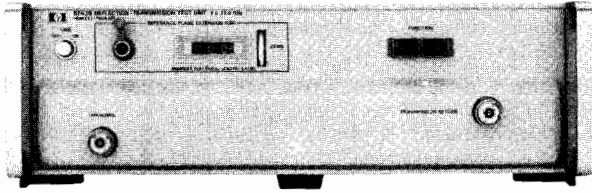

HP 8743B

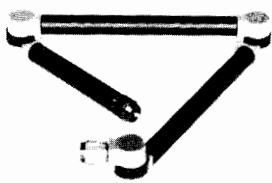

HP 11605A

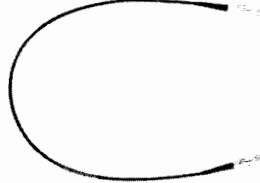

HP 11610B

HP 8743B Reflection/Transmission Test Unit

Function: wideband RF power splitter and reflectometer with calibrated line stretcher. Pushbutton operated for either transmission or reflection measurement with network analyzer. Designed for use with the HP 11610B test port extension cable.

Frequency range: 2 to 12.4 GHz (Opt 018: 2 to 18 GHz).

Impedance: 50 ohms nominal.

Source reflection coefficient: ≤ 0.09 , 2.0 to 8.0 GHz; ≤ 0.13 , 8.0 to 12.4 GHz; < 0.2 , 12.4 to 18 GHz.

Termination reflection coefficient: ≤ 0.13 in reflection mode, 2.0 to 12.4 GHz; ≤ 0.2 in transmission mode, 2.0 to 12.4 GHz; typically < 0.2 , 12.4 to 18 GHz.

Directivity: ≥ 30 dB, 2.0 to 12.4 GHz; ≥ 18 dB, 12.4 to 18 GHz.

Reference plane extension: 0 to 15 cm for reflection; 0 to 30 cm for transmission.

Connectors: RF input, type N female; all other connectors APC-7.

Remote programming: ground closure.

Power: 115 or 230 V $\pm 10\%$, 50-400 Hz, 15 W.

Weight: net, 12.1 kg (29 lb); shipping, 15.3 kg (34 lb).

Size: 140 H x 425 W x 467 mm D (5.50" x 16.75" x 18.38").

HP 11610B Microwave Cable

Function: a high quality semirigid coaxial cable used with the network analyzer at frequencies up to 18 GHz. It is designed for applications which require excellent magnitude and phase repeatability from connection to connection. The cable exhibits minimum change in transmission characteristics when flexed during normal use. The HP 11610B is the recommended transmission return cable for use with the HP 8743B and the HP 8746B.

Frequency range: dc to 18 GHz.

Impedance: 50 ohms nominal. Reflection coefficient of ports < 0.14 .

Insertion loss: < 0.7 dB + 0.12 dB/GHz.

Stability with three repeated flexings: < 0.3 dB, < 0.5 degrees + 0.12 degrees/GHz change.

Connectors: APC-7.

Length: 1.07 m (42 inches).

HP 11605A Flexible Arm

Function: mounts on front of HP 8743B test set; connects to device under test. Rotary air-lines and rotary joints connect to any two-port geometry. Primarily intended for use with existing HP 8743As but can be used with HP 8743B (HP 11610B recommended for use with HP 8743B).

Frequency range: dc to 12.4 GHz (Opt 018, 2 to 18 GHz).

Impedance: 50 ohms nominal. Reflection coefficient of ports: ≤ 0.11 , dc to 12.4.

Opt 018: ≤ 0.23 , 2.0 to 12.4 GHz; ≤ 0.31 , 12.4 to 18 GHz.

Connectors: APC-7.

Weight: net, 1.8 kg (4 lb); shipping, 2.7 kg (6 lb).

Length: 257 mm (10.09") closed; 648 mm (25.50") extended.

HP 8410S Opt 210 Specifications

Function: the HP 8410S Option 210 measurement system configuration is described on page 632. Following are specifications describing measurement capabilities of the HP 8410C/8411A when used with the HP 8743B/11610B over the frequency range of 2 GHz to 12.4 GHz.

Frequency range: 2.0 to 12.4 GHz.

RF input: 20 dB range between +12 dBm and -5 dBm.

Source reflection coefficient: ≤ 0.09 , 2-8 GHz; ≤ 0.13 , 8-12.4 GHz.

Termination reflection coefficient: ≤ 0.09 , 2-8 GHz; ≤ 0.13 , 8-12.4 GHz.

Directivity: ≥ 30 dB, 2-12.4 GHz.

Insertion loss, RF input to test port: 20 dB nominal.

Frequency Response

Transmission: typically $< \pm 0.5$ dB amplitude and $< \pm 5^\circ$ phase.

Reflection: typically $< \pm 0.09$ magnitude and $< \pm 6^\circ$ phase, with a short on the unknown port.

Transmission Measurement accuracy (see Common Performance Specifications).

Reflection measurement accuracy (using HP 8414B): sources of error included in the accuracy equations are directivity, source match, and polar display accuracy.

Magnitude Accuracy

$\rho_u = \pm(0.0316 + 0.03 \rho_L + 0.09 \rho_L^2)$ 2-8 GHz.

$\rho_u = \pm(0.0316 + 0.03 \rho_L + 0.13 \rho_L^2)$ 8-12.4 GHz.

ρ_u = magnitude uncertainty.

ρ_u = measured reflection coefficient magnitude.

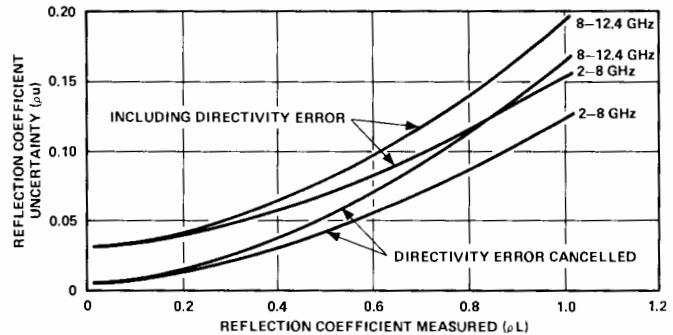

Phase Accuracy

$\Phi_u = \sin^{-1} \rho_u / \rho_L$ for $\Phi_u < \pm 90^\circ$.

Φ_u = phase uncertainty.

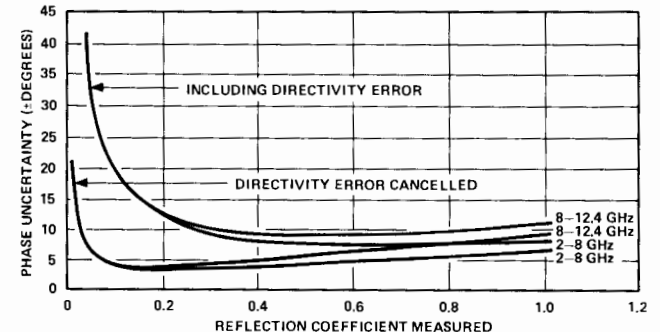

See HP 8410S network analyzer systems table for price and instrument breakdown.

Ordering Information

HP 8743B Reflection/Transmission Test Unit

Opt 018: 2 to 18 GHz

Opt 908: Rack Flange Kit

HP 11610B Microwave Cable

HP 11605A Flexible Arm

Opt 18: 0.11 to 18 GHz

Price

\$7,320

add \$800

add \$25

\$655

\$2,135

add \$880

NETWORK ANALYZERS

Test Sets and Accessories (cont.)

Model 8410 Series

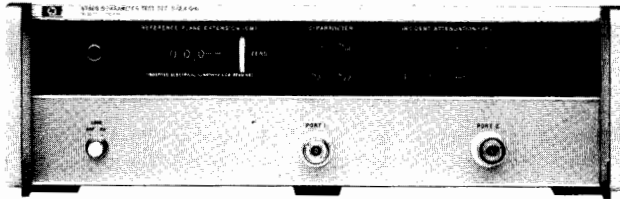

HP 8746B



HP 11608A

HP 8746B S-Parameter Test Set

Function: wideband RF power divider and reflectometer with calibrated line stretcher and a selectable 0-70 dB incident signal attenuator. Provides internal bias for completely characterizing two port active devices.

Frequency range: 0.5 to 12.4 GHz.

Source and termination reflection coefficient: ≤ 0.13 .

Directivity: ≥ 30 dB, 0.5 to 4.0 GHz; ≥ 26 dB, 4.0 to 12.4 GHz.

Incident attenuation: 0-70 dB in 10 dB steps $\pm 5\%$.

Reference plane extension: adds 0 to 15 cm for reflection, 0 to 30 cm for transmission.

Remote programming: ground closure.

Transistor biasing: via 36-pin connector.

Connectors: input type N female, test ports APC-7.

Opt 001: provides 10 dB higher power level at the test port.

Power: 115 or 230 V $\pm 10\%$, 48 to 440 Hz, 110 VA max.

Weight: net, 16.1 kg (35 lb); shipping, 19.1 kg (42 lb).

Size: 140 H x 425 W x 467 mm D (5.5" x 16.75" x 18.38").

HP 11608A Transistor Fixture

Function: provides the capability of completely characterizing stripline transistors. A through-line microstrip and bolt-in grounding structure machineable by customer is included.

Frequency range: dc to 12.4 GHz.

Reflection coefficient: < 0.05 , dc to 4 GHz; < 0.07 , 4.0 to 8.0 GHz; > 0.15 , 8 to 12.4 GHz.

Package Styles

Opt 003: 0.205 inch diameter packages.

Calibration references: option 003 only, short circuit termination and a 50-ohm through-section.

Connectors: APC-7 hybrid.

Weight: net, 0.9 kg (2 lb); shipping, 1.4 kg (3 lb).

Size: 25 H x 143 W x 89 mm D (1" x 5.63" x 3.5").

HP 8410S Opt 500 Specifications

Function: the HP 8410S option 500 measurement system configuration is described on page 632. Following are specifications describing measurement capabilities of the HP 8410C/8411A when used with the HP 8746B/11608A over the frequency range of 500 MHz to 12.4 GHz.

Frequency range: 0.5 to 12.4 GHz.

Transistor dc bias selection; front panel slide switches establish proper dc biasing for both Bi-polar and FET transistors. The voltage and current controls operate independently and are continuously adjustable over a current range of 0 to 500 mA and a voltage range of 0 to 30 Vdc.

RF input: 20 dB range between +12 and -5 dBm.

Incident attenuation range: 0 to 70 dB in 10 dB steps.

Source reflection coefficient: (typically) ≤ 0.132 , 0.5 to 4.0 GHz; ≤ 0.135 , 4.0 to 8.0 GHz; ± 0.141 , 8.0 to 12.4 GHz.

Termination reflection coefficient: (typically) < 0.139 , 0.5 to 4.0 GHz; < 0.148 , 4.0 to 8.0 GHz; ± 0.170 , 8.0 to 12.4 GHz.

Directivity: ≥ 28 dB, 0.5 to 4.0 GHz; ≥ 24 dB, 4 to 8.0 GHz; ≥ 23 dB, 8.0 to 12.4 GHz.

Frequency response: (typically) < 0.5 dB, ± 7 degrees, 0.05 to 4.0 GHz; < 0.75 dB, ± 7 degrees, 4.0 to 8.0 GHz; < 1.25 dB, ± 7 degrees, 8.0 to 12.4 GHz.

Transmission measurement accuracy: (see Common Performance Specifications).

Reflection measurement accuracy: sources of error included in the accuracy equation are directivity and source match.

Magnitude Accuracy

$\rho_u = \pm(0.04 + 0.08 \rho_L + 0.13 \rho_L^2)$ 0.5 to 4.0 GHz.

$\rho_u = \pm(0.06 + 0.09 \rho_L + 0.135 \rho_L^2)$ 4.0 to 8.0 GHz.

$\rho_u = \pm(0.074 + 0.098 \rho_L + 0.14 \rho_L^2)$ 8.0 to 12.4 GHz.

ρ_u = magnitude uncertainty.

ρ_L = measured reflection coefficient magnitude.

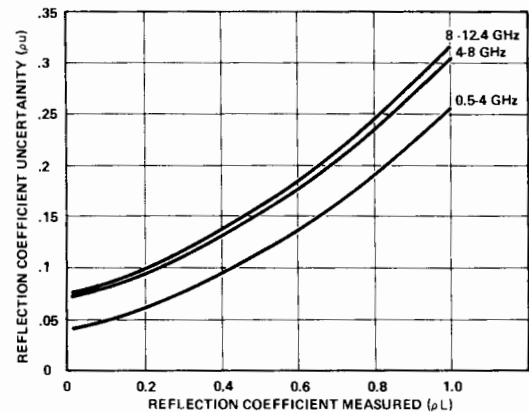

Phase Accuracy

$\Phi_u = \sin^{-1} \rho_u / \rho_L$ for $\Phi_u < 90^\circ$.

Φ_u = phase uncertainty.

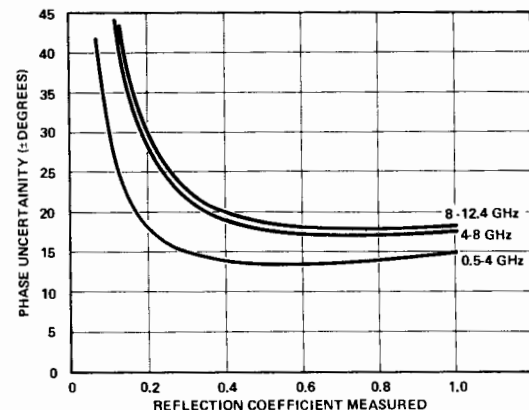

See HP 8410S network analyzer systems table for price and instrument breakdown.

Ordering Information

HP 8746B Test Unit

Opt 001: Large Signal

Opt 908: Rack Flange Kit

HP 11608A Transistor Fixture Customer Machineable

Opt 003: 0.205 inch diameter package style

Price

\$12,740

N/C

add \$25

\$1,705

add \$450

NETWORK ANALYZERS

Automatic Network Analyzer System, 500 MHz to 18 GHz

Model 8408S



- 40 dB effective directivity
- Economical reflection and transmission measurements

- 8-term vector error-correction
- Friendly, easy-to-use

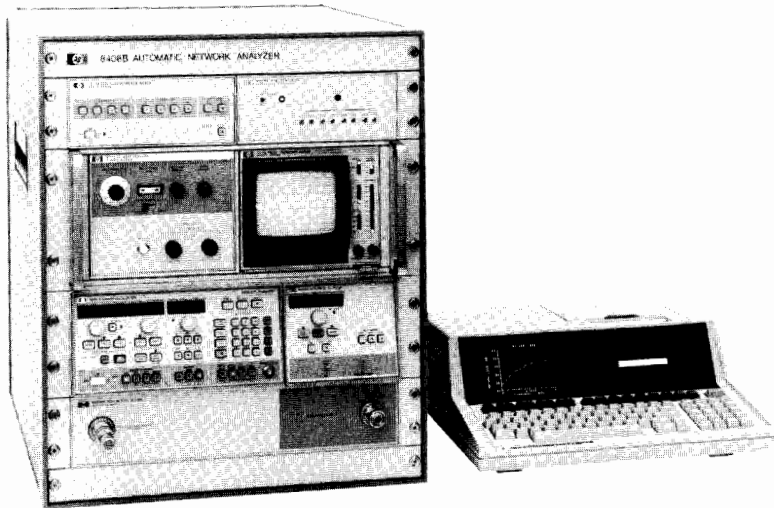

HP 8408S

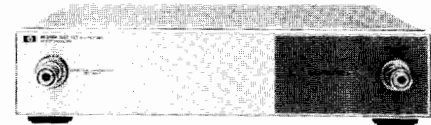

HP 85040B

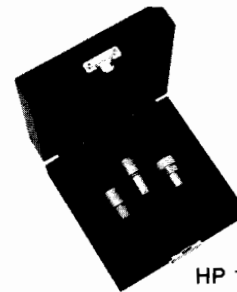

HP 11866A

Description

The HP 8408S Automatic Network Analyzer is a complete microwave network measurement system composed of a network analyzer (receiver), reflection/transmission test set, programmable source, computing controller, and accuracy enhancement pac for making vector error-corrected measurements. The HP 8408S system is fully assembled and integrated at the factory. All accessories and cables necessary for making transmission and reflection measurements are supplied with the system, including calibration standards for measurements in APC-7.

Utilizing a single broadband source and test set, this system measures return loss and transmission (magnitude and phase) over the 500 MHz to 18 GHz frequency range. To verify that the proper connections have been made or to adjust the test device, a real-time CRT display of swept magnitude and phase is provided over the selected frequency range. The test set is a one-path reflection transmission. The HP 85040B Test Set is a low cost test set designed for automatic systems. When used with the HP 11873A Accuracy Enhancement Pac in the HP 8408S system, measurements can be made from 500 MHz to 18 GHz with an effective system directivity better than 40 dB.

The HP 8408S makes vector error-corrected measurements by initially measuring several calibration standards in order to quantify and store the repeatable system errors. Then at each measurement frequency the measured data is enhanced by using an 8-term error correction model that effectively removes these system errors.

The HP 11873A Accuracy Enhancement Pac provided with the system allows the user to immediately make measurements at up to 100 frequencies. The software guides the user via simple prompts through the initial setup, calibration, measurement, and output sequences in order to simplify system operation. After measuring the test device, the data can be displayed in a tabular listing, plotted versus frequency in a rectangular format, or plotted in a polar format. Direct the output to the CRT or the internal thermal printer for hard copy results. By adding a graphics plotter, system measurements can be plotted for analysis, documentation, and presentation. Recommended plotters include the 8-pen HP 7550A, the 6-pen HP 7475A, and the 2-pen HP 7470A.

HP 85040B 0.5-18 GHz Reflection/Transmission Test Set

The HP 85040B is a reflection/transmission test set designed for automatic systems, specifically the HP 8408B Automatic Network Analyzer. Switching between transmission and reflection is done with

an external 24-Volt signal from the HP 11713A Attenuator/Switch Driver via a cable supplied with the HP 85040B.

Frequency range: 0.5 to 18 GHz (0.1 to 18 GHz transmission only)

Impedance: 50 ohms nominal.

Maximum Operating Level (with HP 8411A installed)

RF Input: +8 dBm.

Test port: +10 dBm.

Transmission return: -10 dBm, +17 dBm damage level.

Connectors: RF input type N female; all other RF connectors APC-7.

Source reflection coefficient: <0.2.

Directivity: >24 dB, 0.5 to 8 GHz; >20 dB, 8 to 18 GHz.

Typical Insertion Loss

RF In to RF Out: <9 dB.

RF Out to HP 8411A (Reflection Mode): <38 dB, 0.5 to 2 GHz; <31 dB, 2 to 18 GHz.

HP 11866A APC-7 Calibration Kit

Function: a 50 Ω (>52 dB return loss 2 GHz) termination, a short circuit and a shielded open circuit are used with automatic network analyzers to quantify directivity, source math, and frequency tracking errors.

Weight: net 0.57 kg (1.25 lb); shipping, 0.91 kg (2.0 lb).

Size: 50.8 H x 127 W x 127 mmD (2.0" x 5.0" x 5.0").

Ordering Information

| System Reference | Price |
|-------------------------------------|-------|
| HP 8408S Automatic Network Analyzer | \$0 |

Network Analyzer Subsystem

| | |
|--|---------------|
| HP 8408B Network Analyzer Subsystem 0.5-18 GHz | \$59,415 |
| Option 001: 2-18 GHz only | less \$2,800 |
| Option 003: Delete Sweep Oscillator Plug-in | less \$20,700 |

Computer

| | |
|-------------------------------|---------|
| Model 85B Personal Computer | \$3,495 |
| HP 82936A ROM Drawer | \$45 |
| HP 00085-15002 Print/Plot ROM | \$195 |
| HP 00085-15004 Matrix ROM | \$195 |
| HP 82937A HP-IB Interface | \$395 |

| | |
|---|---------|
| HP 11866A APC-7 Calibration Kit | \$440 |
| HP 85040B 0.5-18 GHz Reflection/Transmission Test Set | \$5,010 |



NETWORK ANALYZERS

Storage-Normalizer

Model 8750A

- Digital storage and normalization
- Simple CRT photos and x-y recordings
- Use with HP network and spectrum analyzers

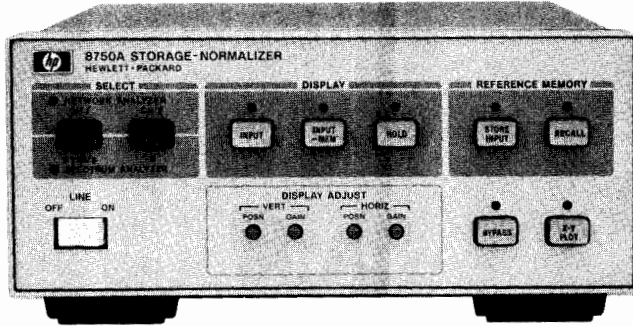

HP 8750A

With HP's versatile 8750A Storage-Normalizer, you can make your network analyzer or spectrum analyzer measurements faster, easier, and more accurately through the simple addition of digital storage and normalization. This useful instrument accessory is directly compatible via a single interface cable with the following Hewlett-Packard instruments; the HP 8755 Scalar Network Analyzer, the HP 8410/8412B, the HP 8754A and the HP 8505A Networks Analyzers and HP 8557A, 8558B, 8565A and 8559A Spectrum Analyzers. A special I/O adapter (opt 001 or opt 002) is available for interfacing instruments (like HP 140 Series Spectrum Analyzers) that are not directly compatible with the HP 8750A. An external oscilloscope can then be used for digitally stored and normalized displays. (The HP 8750A is not compatible with the HP 8414B Polar Display or the polar mode of the HP 8505A or the HP 8754A.)

In network analyzer applications, digital storage always yields a flicker-free display of the complete device response, facilitating easy adjustment of test devices under slow sweep conditions. Measurement accuracy is also improved since frequency response errors can be automatically removed through digital normalization. This effectively eliminates the need to manually record calibration traces on a CRT or x-y recorder and allows high resolution measurements of attenuator, amplifier, or filter passband flatness.

In spectrum analyzer applications, the HP 8750A's digital storage feature simplifies many difficult tests requiring slow scan times such as high resolution modulation measurements. Drift tests are also easy since two traces, a stored reference and the current input, can be displayed simultaneously.

Hard copy documentation can be obtained quickly and easily since data can be frozen on the CRT for straightforward CRT photography or output to an x-y recorder at a constant 30 second sweep rate.

Supplemental Performance Characteristics

Display

Horizontal memory resolution: two display channels, 256 points per channel (0.4% of full scale, 8 bit word)

Vertical memory resolution: 512 points displayed full scale (0.2% of full scale, 10 bit word) plus a 50% overrange (256 points) both above and below full screen.

Horizontal input sweep rates: 100 s max./10 ms min.

Display refresh rate: 6 ms.

Video Detection

Network analyzer: average detection (20 kHz).

Spectrum analyzer: peak detection.

Input/Output

A/D Horizontal Input

Network analyzer: 0 to 10 V nominal. Offset ± 0.5 V and Gain Adjust for 6 to 15 V sweep.

Spectrum analyzers: ± 5 V nominal. Offset ± 0.5 V and Gain Adjust for ± 4.5 to ± 5.5 V.

A/D Vertical Input

Network analyzer: ± 1 V min. and ± 2 V max, with continuous gain adjustment. Offset ± 0.3 V.

Spectrum analyzer: 0 to 0.8 V or 0 to -0.8 V. Offset ± 0.1 V and Gain Adjust $\pm 10\%$.

D/A Horizontal Output

Network analyzer: gain adjustment for 1 to 3 V peak. Offset adjustment $+0.5$ to -1.5 V.

Spectrum analyzer: gain adjustment for 1 to 3 V peak. Offset $+0.5$ to -1.5 V.

D/A Vertical Output

Network analyzer: same as Vertical Input with $\pm 10\%$ adjustment range.

Spectrum analyzer: same as Vertical Input with $\pm 10\%$ adjustment range.

X-Y Recorder Outputs

Horizontal range and accuracy: 0 ± 20 mV to 1 V nominal, settable within $\pm 3\%$ of full scale. BNC female output (rear panel).

Vertical range and accuracy: ± 4 V $\pm 3\%$ BNC female output (rear panel).

Sweep time: 30 s per displayed trace.

Penlift output: BNC female (rear panel with open collector-driver 20 V maximum.)

Controls

Select: LED display indicates network or spectrum analyzer operation depending on the plug-in interface card.

Display

Input: initiates digital storage.

Input-mem (input minus memory): stored Reference trace is subtracted from input data (normalization).

Hold: freezes display for CRT photos or further analysis.

Reference Memory

Store input: current input trace is stored as Reference.

Recall: displays stored Reference trace.

Bypass: bypasses HP 8750A so display is returned to conventional analog operation.

X-Y Plot: initiates X-Y plots.

General

Interface cards: the HP 8750A is supplied with two general plug-in interface cards, one for use with the HP Spectrum Analyzers listed above and one for use with the HP 8407A/8412B and 8505A Network Analyzer. When the HP 8750A is to be used primarily with an 8755C Scalar Network Analyzer, HP 8350B/8620C sweep oscillator, HP 8410C/8412B Network Analyzer, or the HP 8754A Network Analyzer, calibration and adjustment of the HP 8750A to these instruments can be greatly simplified by ordering one of the plug-in interface cards dedicated to these instruments (Opt. 003 and 004). All offset and gain adjustments are significantly reduced. When Opt. 003 or 004 are ordered, the two general interface cards are also included, so you have the flexibility to change your test set-up at any time.

Power: selection 100, 120, 220, or 240 V $+5\%$ -10% . 48 to 440 Hz and < 20 VA (< 20 watts).

Size: 102 H x 212 W x 280 mm D (4" x 8.4" x 11.2").

Weight: net, 2.72 kg (6.1 lbs); shipping, 5.0 kg (11 lbs).

Ordering Information

HP 8750A Storage-Normalizer

Price

\$2,355

Opt 001: BNC Interface Adapter (Deletes direct interface cable)

N/C

Opt 002: BNC Interface Adapter (Retains direct interface cable)

add \$180

Opt 003: HP 8755C or 8412B/8620C Plug-in Interface Card

add \$150

Opt 004: HP 8754A Plug-in Interface Card

add \$150

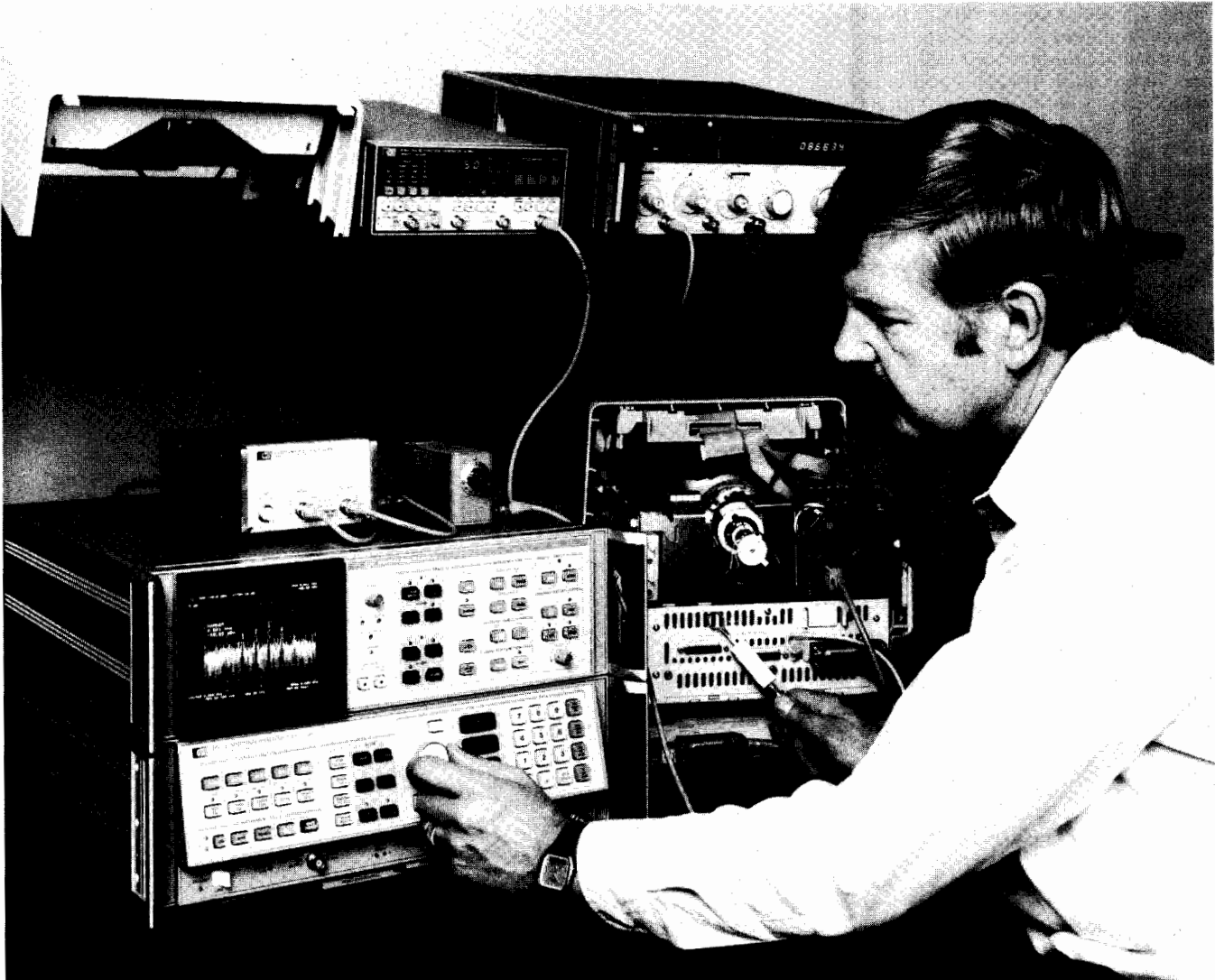

Analysis of signals in the frequency domain is an important measurement concept which is widely used for providing electrical and physical system performance information. Several examples will illustrate some important applications where signal analyzers are useful.

Mechanical Measurements

Noise and vibration levels are of major concern to manufacturers and users of mechanical structures such as aircraft, automobiles, and bridges. With an appropriate motion-to-electrical signal transducer the spectrum analyzer or the Fourier analyzer can examine vibration signals in the frequency domain. This makes it possible to monitor and analyze vibration components of rotating machines associated with unbalance, worn bearings or worn gears, and to identify a structure's natural modes of vibration.

Communications

In the fields of telecommunications, the spectrum, modulation, wave and audio analyzers provide vital operational performance verification of transceivers and multiplex systems. Unwanted signals such as carrier leak signals, out-of-band noise, and cross modu-

lated signals must be identified. System gain, loss, distortion and pilot tone measurements must also be made. These measurements are discussed in more detail in the Telecommunications Test Equipment section of this catalog.

Electronic Testing

Finally, in the general field of electronics, there are four primary uses for the signal analyzer. First, the analyzer is used to identify and measure signals which result from nonlinear effects in the process of amplification, filtering, and mixing. Second, the purity of signal sources is commonly observed. Third, the modulation analyzer serves a special purpose in analyzing modulated communication signals by measuring and displaying RF power, frequency and modulation characteristics. Fourth, the signal analyzer with a companion tracking generator is used as an amplitude-only network analyzer for frequency response measurements of filters, amplifiers, and many other types of networks.

Basic Analyzers

This section discusses the definition and use of several types of instruments for fre-

quency response signal analysis: spectrum analyzers, digital Fourier analyzers, wave analyzers, distortion analyzers, audio analyzers, modulation analyzers and measuring receivers.

Each of these instruments measures basic properties of a signal in the frequency domain, but each uses a different technique. The spectrum analyzer is a swept receiver that provides a visual display of amplitude versus frequency. It shows on a single display how energy is distributed as a function of frequency, displaying the absolute value of Fourier components of a given waveform. The Fourier analyzer uses digital sampling and transformation techniques to form a Fourier spectrum display that has phase as well as amplitude information. The wave analyzer is the true tuned voltmeter, showing on a meter the amplitude of the energy in a specific frequency window which is tunable over a specific frequency range. The distortion analyzer performs an almost reciprocal function to that of the wave analyzer. It collectively measures the energy outside a specific bandwidth tuning out the fundamental signal and displaying the energy of the har-

SIGNAL ANALYZERS

Wave, Distortion, Modulation, Spectrum and Fourier Analyzers (cont.)

monics and other distortion products on a meter. The audio analyzer performs the same measurement function as a distortion analyzer but also includes the additional measurement functions of SINAD, signal to noise ratio, frequency count, true rms DVM and dc DVM. The modulation analyzer tunes to the desired signal and recovers the entire modulation envelope of AM, FM and phase modulation for processing and display. The measuring receiver adds to the capabilities of the modulation analyzer the ability to very accurately measure signals down to -127 dBm.

Different Views

Figure 1 shows a graphical representation of the way five of the analyzers view a signal and one harmonic. The time domain scan of the signal is presented in Figure 1a. $A(t)$ is the complex voltage waveform as it would be viewed on an oscilloscope. The dashed lines represent the vector components of the signal: $A_1(t)$, the fundamental and $A_2(t)$ the second harmonic. In Figure 1b the spectrum analyzer displays the frequency spectrum showing both vector components and their amplitude relationship.

The Fourier analyzer uses digital signal processing techniques to extract both the amplitude and phase information about each spectral component. Conceptually the Fourier analyzer can be viewed as measuring a large number (up to 2048) of parallel filters as shown in Figure 1c. These filters are actually very specialized digital filters so that precise, repeatable results can be obtained. With this arrangement of parallel filters the complete display is generated in the time that it takes to analyze the lowest frequency component. HP Fourier analyzers presently cover the range of dc to 100 kHz.

The wave analyzer in Figure 1d measures the amplitude and frequency of the signal in the frequency window to which it is tuned. This window can be moved to measure the amplitude of the second harmonic, thereby making a precise comparison with the fundamental. This technique is practical from 15 Hz to above 32 MHz.

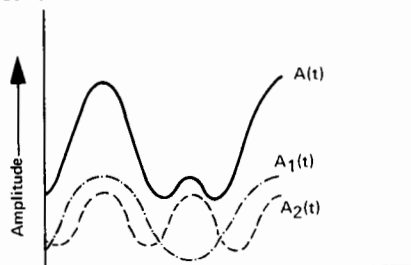

Figure 1a. Waveform t

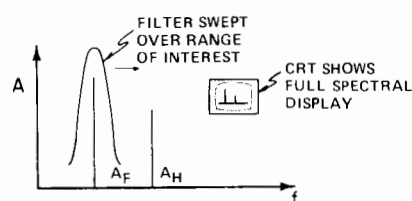

Figure 1b. Spectrum analyzer

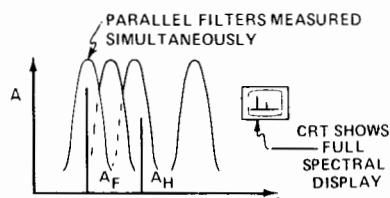

Figure 1c. Fourier analyzer

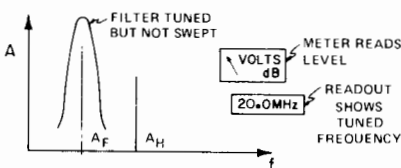

Figure 1d. Wave analyzer

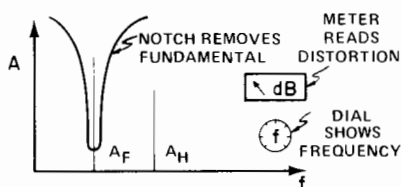

Figure 1e. Distortion analyzer

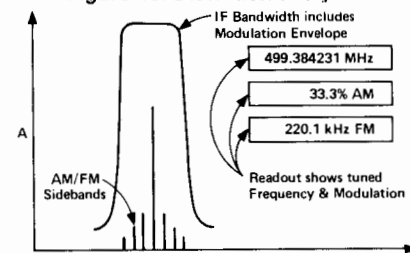

Figure 1f. Modulation analyzer

The distortion analyzer as pictured in Figure 1e rejects the fundamental to which it has been tuned and measures the energy everywhere else within the instrument's frequency spectrum. Distortion, as a percentage or in dB down from the fundamental, is displayed directly on a meter. Hewlett-Packard distortion analyzers cover 5 Hz to 600 kHz.

The modulation analyzer of Figure 1f and the measuring receiver tune to a desired frequency just as the wave analyzer does. Their IF bandwidths and detection systems are designed to pass the entire modulation envelope so that percent modulation, distortion, residual and peak deviation measurements can be made. All close-in spectral components are combined in the measurement.

The following section considers each instrument technique, showing the particular strength and flexibility of each.

Hardcopy Records

Signals and harmonics can be reproduced on printers and plotters for analysis, comparisons, and documentation. Report quality hard copy saves time and money when graphical representations are needed for reports or presentations. For more information, see the X-Y Recorder and Graphics Plotter Selection Guide for HP Instruments in the Recorders, Plotters & Printers section of this catalog.

Spectrum Analyzers

To display useful information about a frequency scan, a spectrum analyzer must be sensitive, frequency stable, free of spurious

responses over a wide band, and have calibrated accuracy in the CRT display. The examples which follow best demonstrate the wide variety of information which can be measured on the spectrum analyzer.

Measurements with the Spectrum Analyzer

CW signal: the most basic spectrum analysis measurement is the single CW signal.

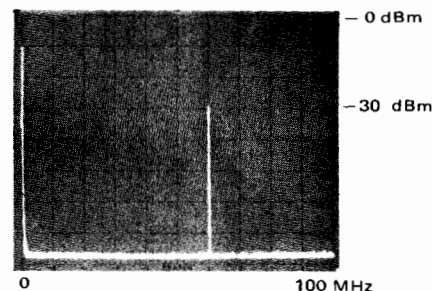

Pictured is a -30 dBm signal at 60 MHz. The zero frequency indicator is at the far left graticule line.

Spectral purity of a CW signal: one very important oscillator signal measurement is spectral purity. This 70 MHz carrier has power line related sidebands (± 60 Hz) which are 65 dB down.

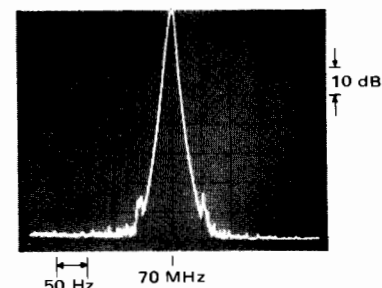

Such sidebands may result from power supply ripple. The 50 Hz/division spectrum analyzer scan and the 10 Hz analyzer bandwidth provide the high degree of resolution required to see these sidebands.

Frequency conversion products: the spectrum analyzer is well suited for frequency conversion measurements such as the output of a balanced mixer as shown.

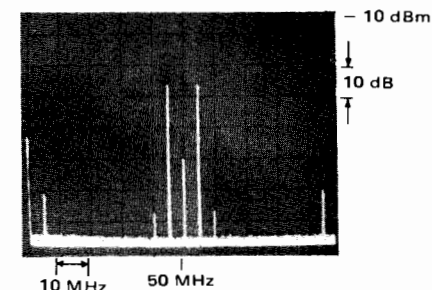

With the 50 MHz local oscillator input at 0 dBm and a 5 MHz, -30 dBm mixer signal, two sidebands at 45 MHz and 55 MHz result. The sidebands are -36 dBm, giving the mixer a 6 dB conversion loss. The local oscillator has 60 dB isolation and the 5 MHz signal has 41 dB isolation. Second order distortion products at 40 and 60 MHz are 40 dB below the desired mixer outputs.

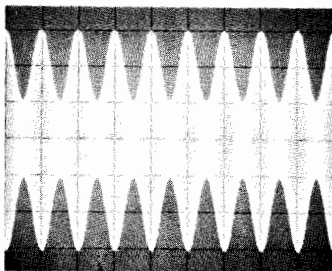

Oscilloscope

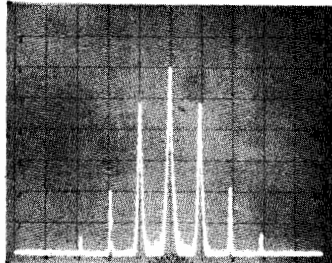

Spectrum Analyzer

Amplitude modulation: percent amplitude modulation is often more easily measured with the spectrum analyzer than it is with the oscilloscope. This is especially true for low level modulation.

With the oscilloscope time display, percent modulation, M , is measured as a ratio of the signal's dimensions: $M = 100 (6-2)/(6+2) = 50\%$. In the spectrum analyzer display, whose vertical calibration is 10 dB/division, the carrier and sidebands differ by 12 dB, the voltages in the sidebands are $1/4$ of that of the carrier and again, $M = 50\%$. At the same time the second and third harmonic distortion of the sidebands can be measured at 28 and 44 dB respectively.

Frequency modulation: information transmitted by FM can be characterized by the spectrum analyzer.

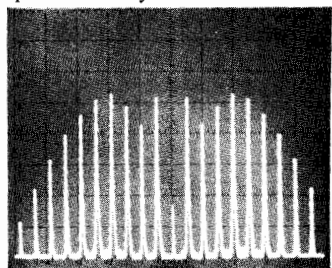

20 kHz Low Deviation FM

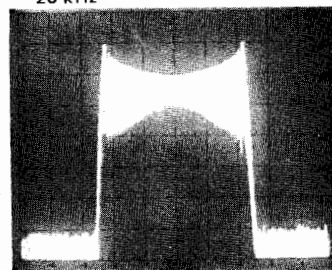

0.5 MHz High Deviation FM

Low deviation FM is applied to a 60 MHz carrier in the first photo. The deviation has been adjusted for the second carrier null ($M = 5.52$). The sideband spacing is 10 kHz, the modulation frequency; therefore, $\Delta f_{\text{peak}} =$

$5.52 \times 10 \text{ kHz} = 55.2 \text{ kHz}$.

The second photo is an example of a high deviation FM. The transmission bandwidth is 2.5 MHz.

Pulsed CW power: by viewing the spectra of a repetitive RF pulse on the spectrum analyzer, pulse width, average and peak power, occupied bandwidth, and duty cycle can be determined.

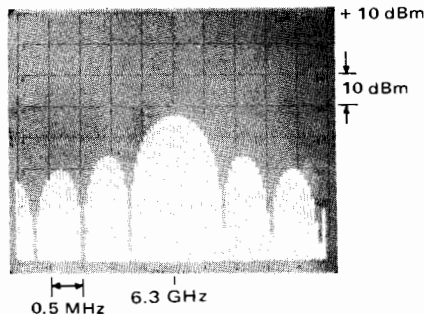

From the spectral output shown the pulse's complete characteristics are determined: 6.3 GHz RF at 0 dBm, pulsed at 50 kHz rate. The pulse width is 1.3 μs .

EMI: Spectrum analyzers have long been a useful tool in the evaluation of electromagnetic interference (EMI). They are valuable for preliminary design troubleshooting and qualification testing. The spectrum analyzer's ability to display wide frequency spans provides "quick look" capability for locating EMI "hot spots." The high performance spectrum analyzers (HP 8566B and HP 8568B) offer full programmability, allowing automatic EMI measurements. With the addition of the Quasi-Peak Adapter (HP 85650A), these analyzers can make quasi-peak measurements used in commercial EMI tests.

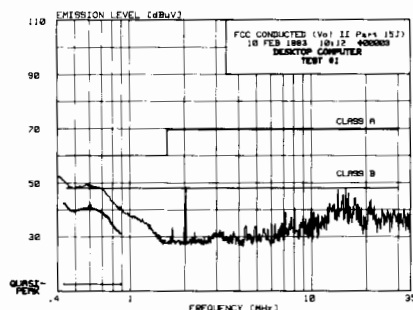

Plot of FCC conducted emissions test using peak and quasi-peak detection

Noise: spectrum analysis is effective in measuring impulse noise, random noise, carrier to noise ratio, and amplifier noise figure.

Phase noise: the short term frequency fluctuations of a sine wave source can be measured directly as phase modulation sidebands. Hewlett-Packard spectrum analyzers with narrow resolution and synthesized internal frequency sources can make many phase noise measurements directly. Bandwidth corrections, analyzer corrections, data averaging and setup calibration factors can be accounted for by Hewlett-Packard microprocessor-controlled spectrum analyzers. All instrument controls, data transfer and data reduction can be handled by easy-to-write software for Automatic Spectrum Analyzers.

Frequency response: using a tracking signal source and a spectrum analyzer the frequency response of filters can be displayed with ease.

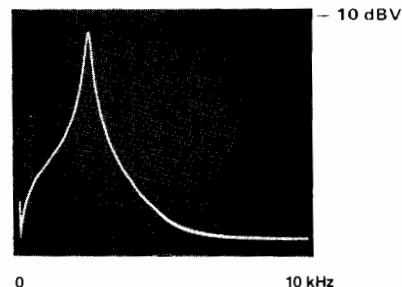

In this case, an audio filter used in a communications system is being measured. Since the input reference level to the filter is -13 dBV, the insertion loss at 2.4 kHz is 4 dB. Extremely high Q devices can be measured with this system.

Spectrum Analyzer Capabilities

To be useful in making measurements in the frequency domain, the analyzer must be capable of making quantitative measurements. Specifically, an analyzer must:

1. make absolute *frequency* measurements
2. make absolute *amplitude* measurements
3. operate over a *large amplitude dynamic range*
4. have *high resolution* of frequency and amplitude
5. have *high sensitivity*
6. provide means of *observing, preserving, and recording* its output in a convenient and rapid manner by using variable persistence, digital storage and adaptive sweep. Hewlett-Packard spectrum analyzers excel in these six measures of performance. Let us consider each of these performance standards in greater detail.

Absolute frequency measurements: frequency readout accuracy depends upon the tuning and readout techniques employed, as well as the stability of the spectrum analyzer's frequency reference. The absolute frequency accuracy read off the slide-rule type of frequency dial is approximately 1% of full scale. Synthesized local oscillators allow accuracies to $\pm 4 \text{ Hz}$ at 1500 MHz in narrow frequency spans. When the spectrum analyzer is used in conjunction with a tracking generator (a source whose frequency is the same as the analyzer tuning frequency) accuracy much better than 1% can be achieved by counting the generator output.

Extended frequency capabilities: the frequency range of microwave spectrum analyzers can be extended to the millimeter frequency bands where waveguide transmission lines are required. This frequency extension is accomplished by using external harmonic mixers to convert the millimeter signal frequency down into the range of the spectrum analyzer. Hewlett-Packard Harmonic Mixers provide a high level of performance for measurements in these millimeter frequency bands from 18 to 60 GHz. Their characteristics include excellent absolute amplitude accuracy and low conversion loss, the latter providing high sensitivity. In addition, no mixer bias is required, allowing full waveguide band measurements to



SIGNAL ANALYZERS

Wave, Distortion, Modulation, Spectrum and Fourier Analyzers (cont.)

be made easily and accurately. The non-biased feature also makes these mixers highly suitable for fully automatic systems, since there is no need to adjust a bias current over the frequency range to achieve the best flatness. For more information on millimeter measurements, refer to page 697.

Absolute amplitude measurements: all Hewlett-Packard spectrum analyzers are absolutely calibrated for amplitude measurements. This means the spectrum analyzer indicates to the user what the log/reference level or linear sensitivity is regardless of control settings. Either a warning light or CRT message indicates an uncalibrated condition, making operation of the analyzer easy and foolproof.

Microprocessor controlled analyzers feature built-in calibration routines which account for changes in analyzer controls such as the resolution bandwidth and RF attenuator.

Dynamic range: the dynamic range of a spectrum analyzer is defined as the difference between the input signal level and the average noise level or distortion products, whichever is greater. Hence, dynamic range can be either distortion limited, noise limited or display limited. Hewlett-Packard micro-processor controlled analyzers can be set to ensure that distortion products of on-screen signals will be below a certain level.

Frequency and amplitude resolution: frequency resolution is the ability of the analyzer to separate signals closely spaced in frequency. The frequency resolution of an analyzer is a function of three factors: 1) minimum IF bandwidth, 2) IF filter shape factor, 3) spectrum analyzer stability.

The minimum IF bandwidth ranges down to 1 Hz on Hewlett-Packard spectrum analyzers.

One way to define IF filter shape factor is the ratio of 60 dB bandwidth to 3 dB bandwidth. Filter shape factor specifies the selectivity of the IF filter. Hewlett-Packard spectrum analyzers have IF filter shape factors as low as 5:1.

Analyzer frequency stability also limits resolution. The residual FM (short term stability) should be less than the narrowest IF bandwidth. If not, the signal would drift in and out of the IF pass band. Hewlett-Packard analyzers have excellent stability. Low frequency and microwave frequency models are available with residual FM <1 Hz, enabling the measurement of noise sidebands. The stabilization circuitry is completely automatic and foolproof. No signal recentering, manual search, or checking is required.

Amplitude resolution is a function of the vertical scale calibration. Hewlett-Packard analyzers offer both log calibration for observing large amplitude variations (10, 5, 2 and 1 dB/div) and linear calibration for observing small amplitude variations.

Sensitivity: sensitivity is a measure of an analyzer's ability to detect small signals, and is often defined as the point where the signal level is equal to the noise level or $(S+N)/N=2$. Since noise level decreases as the bandwidth is decreased, sensitivity is a function of bandwidth. The maximum attainable sensitivity ranges from -150 dBm to -125 dBm with Hewlett-Packard analyzers.

Variable persistence, digital storage, and adaptive sweep: high resolution and sensitivity both require narrow bandwidths and consequently slow sweep rates. Because of these slow sweeps, both digital display and variable persistence are virtually indispensable in providing a bright, steady flicker-free trace.

The digital storage feature on Hewlett-Packard analyzers covering audio to microwave frequency ranges make measurements and CRT photography simple. It gives the CRT display a dot matrix connected by line generators for an unbroken and uniform intensity scan. In addition, the microprocessor controlled analyzers feature CRT annotation to completely describe the data characteristics displayed.

On low frequency analyzers, adaptive sweep effectively speeds the measurement times. On the very slow sweep times (required when using the 1 Hz bandwidth), adaptive sweep allows the scan to sweep rapidly when no signals occur and slow down when a signal is above a preset level. The measurement time savings can be greater than 20:1.

Tracking Preselector

The only way to simultaneously avoid spurious, multiple, harmonic and image responses is to filter the RF signal through a tracking preselector. This is an electronically tuned bandpass filter that automatically tracks the analyzer's tuning. A preselector improves the spurious-free range of the analyzer from 70 dB to 100 dB.

Tracking Generator

A tracking generator expands the measurement capability of the spectrum analyzer by providing a signal source which tracks the tuning frequency of the analyzer. The source/receiver combination can be used to measure insertion loss, frequency response, return loss and allow precision frequency counting.

It helps make these additional measurements with increased distortion-free dynamic range, sensitivity and selectivity. The tracking generator is also an excellent stable sweeping generator. The residual FM varies from <1 Hz to <200 Hz for Hewlett-Packard tracking generators.

Automatic Spectrum Analyzers

The measurement capability of a spectrum analyzer can be greatly enhanced by allowing a desktop computer to control instrument functions and record frequency and amplitude information. Data can be gathered and processed into a variety of formats at a very rapid rate. Through comprehensive self-calibration, automatic spectrum analysis offers amplitude accuracy of up to ± 0.4 dB with 0.01 dB resolution. User cost savings are realized through faster measurements, lower operator skill requirements, and unattended operation capability.

Further discussion of computer based automatic spectrum analysis can be found on page 667.

Frequency Stability Analysis

Frequency stability and spectral purity are important parameters when characterizing most signal sources. Long term stability or

frequency drift due to aging or temperature effects is generally measured with a precision frequency counter such as the HP 5345A; random fluctuations in frequency or period can also be measured in the time domain, using an electronic counter and the Allan Variance technique.

Another measure of frequency stability is the phase spectral density. The most common method of making this measurement is to phase-lock the unknown to a clean reference source, mixing the two signals together in a phase detector and analyzing the low frequency output on a wave or spectrum analyzer. This technique allows the phase noise sidebands to be measured in the absence of the carrier, and can result in measurement sensitivities of -170 dBc or better.

Analog spectrum analyzers are required for noise measurement at high offset frequencies (above 25kHz). However, at lower offsets (below approximately 100 Hz), their bandwidths become large in comparison to the frequencies being measured. In these cases, the use of FFT-based spectrum analyzers becomes necessary.

Insuring the accuracy of a phase noise measurement can be quite a problem. Non-ideal phase detectors and amplifiers will introduce measurement errors, and the phase-locked loop used to control the reference source will attenuate the noise signal at certain frequencies.

The HP 3047A Phase Noise Measurement System contains both a conventional and an FFT spectrum analyzer, and allows measurement of phase noise sidebands over the offset frequency range 0.02 Hz to 40 MHz. Phase detectors are provided for carriers from 5 MHz to 18 GHz, and require only an appropriate external reference source such as the HP 8662A. An extensive software package handles all operator interface, graphics and data storage, as well as complete error characterization and correction. Overall accuracy is an excellent ± 2 dB. -170 dBc sensitivity is provided by a special low noise input amplifier. The HP 3047A Phase Noise Measurement System is described on page 710.

Fourier Analyzers

The Fourier analyzer uses digital signal processing techniques to provide measurement capability over and above that of a swept spectrum analyzer. Some of these include the precise measurement of random signals obscured by noise, measurement of the joint properties or relationships of two or more signals, measurements of statistical properties of signals, and measurements of very low frequency (e.g. below 5 Hz) or very closely spaced (e.g. less than 1 Hz) signals.

Fourier analyzers are based on the calculation of the Discrete Fourier Transform using a highly efficient algorithm known as the Fast Fourier Transform. As shown in Figure 2, this algorithm calculates the magnitude and phase of each frequency component from a block of time domain samples of the input signal.

The block diagram that is involved is shown in Figure 3. First, the input signal is filtered to remove out-of-band components. Next, the input is sampled and digitized at

regular Δt intervals until a full block of samples called a time record has been collected. The processor then executes the desired series of computations on the time data to produce the frequency domain results. These results, which are stored in memory, can be analyzed on a CRT display, plotted, or processed further to provide the user additional useful information.

$$X(k \Delta f) = \sum x(n \Delta t) e^{-j2\pi(n)k/N}$$

EACH FREQUENCY POINT IS COMPOSED OF A MAGNITUDE AND PHASE VALUE

EACH FREQUENCY POINT CONTAINS INFORMATION FROM ALL TIME DOMAIN SAMPLES

COMPLEX FACTOR

Figure 2

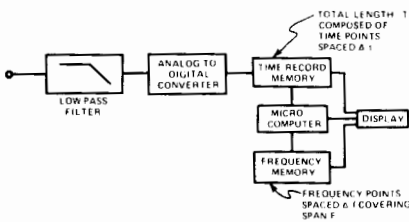

Figure 3

When two or more input channels are provided, signals can be sampled simultaneously. The processor can then additionally compute joint properties of the signals. This is useful for characterizing the transfer function of a linear device and for investigating cause/effect relationships.

The digital nature of Fourier analysis insures *high accuracy, stability and repeatability*. In addition, there are several specific advantages that are achieved.

Low Frequency Coverage

The Fourier transform calculates equally spaced frequency components from DC to the maximum frequency. By simply varying the sample rate it is possible to make measurements down to a few micro Hertz. For such low frequency measurements, the laws of physics dictate a long observation time. Since the Fourier transform simultaneously calculates all frequency points from one set of observation points, a one to two order of magnitude speed improvement over a swept measurement is possible.

High Frequency Resolution

By digitally translating a band of frequencies down to DC it is possible to provide very high frequency resolution over the entire range. This technique, known as Band Selectable Fourier Analysis, can provide resolution of a few millihertz as shown in Figure 4. Here a 5 Hz band of frequency located at 3 kHz is analyzed showing 0.48 Hz sidebands over 20 dB down.

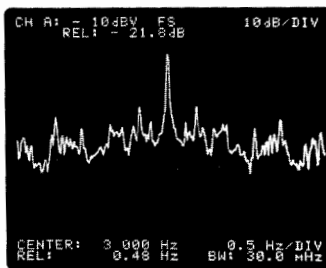

Figure 4

Direct Transfer Function Measurements

With simultaneous sampling of both the input and output of an electrical, mechanical, or acoustical system, it is possible to directly characterize transfer functions. Since the Fourier analyzer measures the frequency components simultaneously, energy must also be provided at these frequencies. This can be done with a broadband white noise signal, a pseudorandom noise signal or an impulse. Results presented in magnitude/phase or real/imaginary format help quickly illustrate the performance characteristics of a system.

The measurement of the coherence function can additionally provide a measure of the validity of a transfer function. It can distinguish portions of the output power that are not directly caused by the input, but may instead be due to additive noise, distortion products, or unmeasured inputs.

Systems Compatibility

Since the Fourier analyzer is basically all digital, interfacing to a computing controller or other digital peripherals is relatively simple. Remote programming and data input/output can considerably expand the range of potential applications.

Fourier Analyzer Applications

The versatility and performance of the Fourier analyzer make it an ideal tool for a variety of applications as a few specific examples will illustrate.

In the general area of electronics, the Fourier analyzer functions as a very high performance spectrum and network analyzer. It can be very useful for measuring phase noise or for characterizing filters.

In the field of communications, the Fourier analyzer can be very useful for characterizing audio signals, such as modems and touch tone signals.

When combined with a microphone the Fourier analyzer can be useful in characterizing acoustic devices, such as loud speakers.

With a motion transducer the Fourier analyzer can be used to analyze the vibration signatures of rotating machines. This can be very useful in helping to establish scientific maintenance policies.

The transfer function of a mechanical structure can illustrate how the structure responds to vibration inputs. This is extremely important in optimizing the design of structures that will be subjected to substantial vibration.

Wave Analyzers/SLMs

Wave analyzers are known by several different names: frequency selective voltmeter, carrier frequency voltmeter, and selective level meter. These names describe the instrument's function rather well.

As mentioned in the introduction to this section, a wave analyzer can be thought of as a finite bandwidth window filter which can be tuned throughout a particular frequency range.

Signals will be selectively measured as they are framed by the frequency window. Thus, for a particular signal, the wave analyzer can indicate its frequency (window position) and amplitude. Amplitude is read on an analog meter; frequency is read on either a mechanical or electronic readout.

The uses of wave analyzers can be categorized into three broad areas: 1) amplitude measurement of a single component of a complex frequency system, 2) amplitude measurement in the presence of noise and interfering signals, and 3) measurement of signal energy appearing in a specified, well defined bandwidth.

Wave Analyzer/SLM Considerations

Frequency Characteristics

Range: should be selected with the future in mind as well as present requirements.

Accuracy and resolution: should be consistent with available bandwidths. Narrow bandwidths require frequency dial accuracy to place the narrow window in the proper position for measurement. Accuracy of instruments with selectable bandwidths is determined by the basic center frequency accuracy of the IF bandwidth filters in addition to the local oscillator frequency accuracy.

Readout: usually an LED display.

Stability: frequency stability is important when using narrow bandwidths and for long term signal monitoring. Stability is best achieved with automatic frequency control (AFC) or frequency synthesis. AFC locks the local oscillator to the incoming signal and eliminates any relative drift between the two. A frequency synthesized local oscillator allows frequency accuracy of $<1 \times 10^{-5}$ with 0.1 Hz resolution.

Sweep: some instruments are equipped with sweep to allow use as a spectrum analyzer. Readout is a CRT or X-Y recorder.

Amplitude Characteristics

Range: the amplitude range is determined by the input attenuator and the internal noise of the instrument. Sensitivity is defined as the lowest measurable signal equal to the noise level for a unity signal-to-noise ratio (often called tangential sensitivity). Sensitivity will vary with bandwidth and input impedance.

Dynamic range: defined as the dB ratio of the largest and smallest signals that can be simultaneously accommodated without causing an error in the measurement.

Attenuators: the amplitude range switch is an attenuator in the input and IF stages. Intermodulation distortion is lowest when the input amplifier has the minimum signal applied and the IF gain is greatest. Conversely the internal noise, important when making sensitive measurements, is lowest with maximum input signal and lowest IF gain. Newer instruments use auto-ranging techniques.

Accuracy: amplitude accuracy is a function of frequency, input attenuator response, IF attenuator performance, calibration oscillator stability and accuracy, and meter tracking. Often specifications are expanded to separately describe each contributor.

Readout: amplitude readout is usually a meter calibrated in dB and/or volts or a LED digital display. Linear voltage meters are used to allow the user to see down into the noise at the bottom of the scale. Digital readouts are often used with an analog meter to aid in tuning to signals. Expanded scale meters allowing expansion of any 1 or 2 dB portion of the scale into a full scale presentation allow resolution of input level changes of a few hundredths of a dB while LED displays



SIGNAL ANALYZERS

Wave, Distortion, Modulation, Spectrum and Fourier Analyzers (cont.)

allow 0.01 dB resolution. This is useful when the wave analyzer is used as a sensitive indicator in bridge or comparison measurements. The expanded scale meter is included in some instruments and is an optional accessory on others.

Input Characteristics

Impedance: may be high impedance bridging input or terminating impedance to match standard transmission lines. High frequency measurements require matched systems to avoid error-producing standing waves on interconnecting cables. The measure of impedance accuracy is usually return loss or reflection coefficient ($RL=20 \log \rho$). In low frequency instruments, percent accuracy is used. High input impedance instruments are usually poorer in high frequency and noise performance and are usually low frequency instruments. High impedance at high frequencies is accomplished by using a bridging probe to place the impedance at the point of measurement. The probe may be active with unity gain or passive with 20-30 dB insertion loss.

Input arrangement: input may be balanced to ground or unbalanced. Communications system usage typically requires balanced input. Standard 600 and 135/150 Ω balanced inputs are limited in frequency to less than 1 MHz and 124 Ω balanced to less than 10 MHz in most instruments. The impedance may be balanced to ground with the center point grounded or may be completely isolated from ground. Unbalanced inputs do not have frequency range limitations.

Network Analysis Application

Frequency response testing: with its tracking generator output, the wave analyzer is particularly useful for measuring filter and amplifier frequency responses. If a notch filter is being measured, for example, a narrow band measurement like that provided by a wave analyzer is essential for obtaining acceptable accuracy. A broadband technique will lead to some misleading results. For example, a notch filter may be driven with a flat oscillator and the response measured with a broadband voltmeter. The notch filter will reject the oscillator's fundamental tone, but pass its harmonics which are in the voltmeter's measurement range. Thus, an error results. If the voltmeter were frequency selective, like a wave analyzer, the harmonics would be rejected and the true level of the notch would be measured. Accurate and fast measurements can be made because Hewlett-Packard wave analyzers track and detect on the tracking generator frequency.

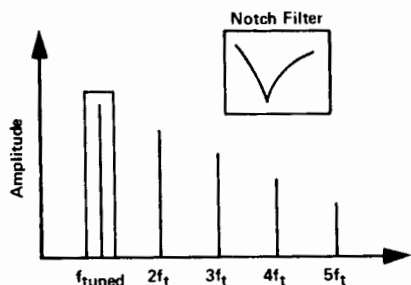

Only signal detected by wave analyzer. For example, the notch of a filter can be accurately measured to its full depth.

Distortion, Audio Analyzers

Harmonic distortion is one of many types of distortion created in communications equipment, audio and ultrasonic sound systems. Nonlinear elements in amplifiers cause harmonic related frequencies from a pure tone stimulus to be created at the output. Hence, to a listener, a poor reproduction quality becomes apparent. The total of these frequency components present in a signal, in addition to the fundamental frequency, can be measured quickly and easily with Hewlett-Packard distortion and audio analyzers.

The ratio of these frequency components to the amplitude of the fundamental is the total harmonic distortion (THD) as defined by the following equation (1):

$$THD = \frac{\sqrt{\sum (\text{harmonics})^2}}{\text{fundamental}}$$

The Hewlett-Packard distortion and audio analyzers consist of a narrow band rejection filter and broadband detector. Before the fundamental is rejected, the analyzer first measures the amplitude of the fundamental, all the harmonic components, and noise. Then the rejection filter is employed to remove the fundamental. The ratio of the two measurements is an approximation of equation (1) above and is defined by the following equation (2):

$$THD = \frac{\sqrt{\sum [(\text{harmonics})^2 + (\text{noise})^2]}}{\sqrt{\sum [(\text{fundamental})^2 + (\text{harmonics})^2 + (\text{noise})^2]}}$$

An approximation error of 1/2% can be expected for the THD levels of 10%. However, distortion levels as high as 10% are seldom encountered in most measurement situations. The harmonic content of the stimulus source must not be more than a third of the distortion expected to be caused by the system under test.

Audio Analyzers

The Audio Analyzer performs several basic low frequency measurements in addition to distortion, making it a general purpose audio test set. The audio analyzer includes the SINAD function for testing mobile radio receiver sensitivity. It contains a low distortion audio oscillator for stimulus response testing in combination with its distortion analyzer. It contains a true rms voltmeter and dc voltmeter for accurate measurement of complex waveform levels. Swept ac level and swept distortion measurements can be made when using the audio analyzer with a suitable X-Y recorder. Signal/noise ratio measurements are performed automatically when using the internal source and rms voltmeter. A reciprocal frequency counter is also included that continuously counts the frequency of the input signal.

These basic capabilities provide a general purpose instrument that represents high value in three major applications areas: 1) General audio component characterization, 2) radio transceiver audio measurements, 3) HP-IB systems. The Audio Analyzer provides sophisticated measurement capa-

bilities with significantly reduced operator interaction.

True Harmonic Distortion Measurements

The Hewlett-Packard desktop computer controlled automatic spectrum analyzers provides a rapid means of measuring true harmonic distortion levels. The fundamental and its harmonic components are rapidly measured one at a time and the distortion is computed by applying equation (1). In production test situations, distortion calculations can be stored on tape for future reference and/or plotted for hard copy needs. Limit testing can also be applied.

Modulation Analyzers/Measuring Receivers

A modulation analyzer is a precision receiver designed to detect the entire modulation envelope of a signal under test. It can measure and display the carrier characteristics of RF frequency and power as well as AM, FM and phase modulation characteristics such as AM depth, peak deviation, residual modulation, and various ratios associated with them. The modulation analyzer also faithfully recovers the actual modulating signal for further analysis such as distortion testing.

Applications for modulation analyzers and measuring receivers include transmitter testing, signal generator calibration and RF signal characterization. The precision receiver capability allows comprehensive testing of the transmitter. All phases of design, production test, and maintenance of transmitters and their modules and subassemblies are applications. Because the measuring receiver can measure very low RF signal levels (to -127 dBm) as well as modulation and RF frequency, it is ideal for metrology and calibration labs for signal generator and attenuator calibration.

Capabilities

The unique measurement capabilities of modulation analyzers are easily shown on system tests with multiple-mode modulations such as simultaneous AM and FM. For example, if both amplitude and frequency modulation are present on a signal, a complex modulation spectrum is produced. To demonstrate this, an HP 8640B Signal Generator was 46.5% amplitude modulated with a 5 kHz triangular wave and 4.5 kHz peak frequency modulated with a 5 kHz sine wave simultaneously. The picture below shows the resulting signal as seen on a spectrum analyzer.

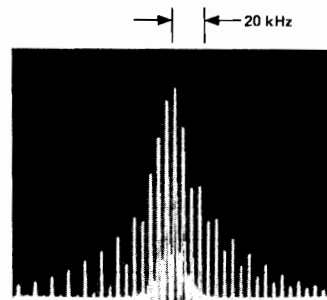

Spectrum Analyzer display of simultaneous AM (46.5%) and FM (4.5 kHz pk deviation) modulation.

Unequal, complex sidebands result and little data can be deduced. However, since a modulation analyzer faithfully recovers both modulation signals in independent detection systems insensitive to each other, it is easy to separate and read directly the various modulation components involved.



Modulation Analyzer displays of RF signal parameters.

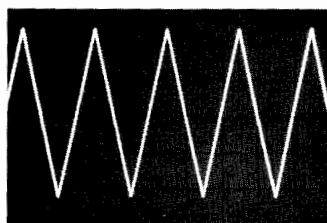

Recovered 5 kHz AM input signal viewed on oscilloscope.

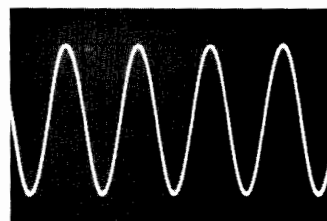

Recovered 5 kHz FM input signal.

In addition, since the modulation analyzer handles the full complex modulation envelope, it measures and displays RF power and average frequency of the entire signal. The readings are all available at the push of a button.

The independent detection systems demodulate the waveforms. If further analysis is desired, the modulation analyzer characterizes audio signal level, frequency and distortion of both internally demodulated audio signals and external audio signals.

Since the AM and FM detection systems are independent and highly insensitive to each other, incidental modulation measurements can be made with high precision. For example, even with 90% amplitude modulation, the FM demodulator will accurately in-

dicade incidental FM. Such capability is valuable for design of oscillators, modulators, mixers and other components. It is very difficult to separate multiple modulation effects on spectrum analyzer displays because the effects are combined.

The HP 8901A/B Modulation Analyzers contain selectable filters to provide commonly used system characteristics for low-pass and high-pass filtering and FM de-emphasis. Thus measurement of transmitter modulation frequency response doesn't require additional equipment. Selectable detectors, including peak hold, allow measurements such as transmitter modulation limiting to be made very easily.

The measuring receiver can also serve as a high sensitivity, selective frequency counter and power meter. Since the superheterodyne design allows high sensitivity amplification of low level modulated signals, frequency counting of signals as low as -100 dBm is possible with good rejection of other signals.

Display and computational conveniences speed typical transmitter measurements and improve confidence in results. For example, ratio keys allow any measurement to be expressed in % or dB relative to any other measured or key-entered value. Such computations are valuable in applications such as mobile FM measurements, where hum and noise is expressed relative to an industry standard of 60% of maximum allowable deviation.

Display and computational conveniences speed typical transmitter measurements and improve confidence in results. For example, ratio keys allow any measurement to be expressed in % or dB relative to any other measured or key-entered value. Such computations are valuable in applications such as mobile FM measurements, where hum and noise is expressed relative to an industry standard of 60% of maximum allowable deviation.

Signal Analyzers Selection Guide Spectrum Analyzers

| Frequency Range | Amplitude Calibration Range | Bandwidths | | HP Model Description | HP Companion Instruments | Page |
|---|-----------------------------|------------|---------|---|---|------------|
| | | Min | Max | | | |
| 0.02 Hz-25.6 kHz | -120 to +30 dBV | 0.02 Hz | 363 Hz | 3582A Spectrum Analyzer | | 701 |
| 0.02 Hz-40 MHz (Extendable to 18 GHz) | -130 to +30 dBm | 0.02 Hz | 30 kHz | 3047A Phase Noise Measurement System (Direct Spectrum Mode) | 8566B Spectrum Analyzer 8568B Spectrum Analyzer (Used as Downconverters) | 710 |
| 0.02 Hz-40 MHz (Offset from Carrier) 5 MHz to 18 GHz (Carrier Range) | -170 dBc | 0.02 Hz | 30kHz | 3047A Phase Noise Measurement System (Phase Noise Mode) | 8662A/8663A Synthesized Signal Generator 11729B Carrier Noise Test Set | 710 |
| 5 Hz-50 kHz | -150 to +30 dBm | 1 Hz | 300 Hz | 3580A Spectrum Analyzer | | 699 |
| 20 Hz-300 kHz | -142 to +10 dBm | 10 Hz | 10 kHz | 8556A Tuning Section Plug-In ¹ | | 688 |
| 20 Hz to 40.1 MHz | -137 dB to +30 dBm | 3 Hz | 30 kHz | 3585A Spectrum Analyzer | | 654 |
| 1 kHz-110 MHz | -140 to +10 dBm | 10 Hz | 300 kHz | 8553B Tuning Section Plug-In ¹ | 8443A Tracking Generator | 690 |
| 10 kHz-350 MHz | -117 to +20 dBm | 1 kHz | 3 MHz | 8557A Spectrum Analyzer Plug-In ² | | 680 |
| 100 kHz-1250 MHz | -122 to +10 dBm | 100 Hz | 300 kHz | 8554B Tuning Section Plug-In ¹ | 8444A Tracking Generator (500 kHz-1250 MHz) | 692 |
| 100 kHz-1500 MHz | -117 to +30 dBm | 1 kHz | 3MHz | 8558B Spectrum Analyzer Plug-In ² | 8444A Opt. 059 Tracking Generator (500 kHz-1500 MHz) | 682 |
| 100 Hz-1500 MHz | -137 dBm to +30 dBm | 10 Hz | 3 MHz | 8568B Spectrum Analyzer and 8568S Automatic Spectrum Analyzer | 8444A Opt. 059 Tracking Generator (500 kHz-1500 MHz) 85650A Quasi-Peak Adapter | 662 667 |
| 10 MHz-21 GHz | -111 dBm to +30 dBm | 1 kHz | 3 MHz | 8559A Spectrum Analyzer ² | | 684 |
| 100 Hz-2.9 GHz | -135 dBm to +30 dBm | 10 Hz | 3 MHz | 71100A Modular Spectrum Analyzer | 70300A Tracking Generator | 647 |
| 100 Hz-22 GHz ³ (Extendable to 300 GHz) | -134 dBm to +30 dBm | 10 Hz | 3 MHz | 8566B Spectrum Analyzer and 8566S Automatic Spectrum Analyzer | 85650A Quasi-Peak Adapter 11970K/A/Q/U/V/W Harmonic Mixers | 664 667 |
| 100 Hz-26.5 GHz | -133 dBm to +30 dBm | 10 Hz | 3 MHz | 71200A Modular Spectrum Analyzer | 70300A Tracking Generator | 647 |
| 10 MHz-22 GHz (Extendable to 40 GHz and above) | -122 dBm to +30 dBm | 100 Hz | 3 MHz | 8565A Spectrum Analyzer | 8750A Storage-Normalizer 8444A Opt. 059 Tracking Generator (10 MHz-1500 MHz) 11517A Harmonic Mixer | 678 |
| 10 MHz-22 GHz ⁴ (Extendable to 115 GHz and above) | -123 to +30 dBm | 100 Hz | 3 MHz | 8569B Spectrum Analyzer | 8444A Opt. 059 Tracking Generator (10 MHz-1500 MHz) 11971K/A/Q/U/V/W Harmonic Mixers | 674 |
| 10 MHz-18 GHz (Extendable to 40 GHz and above) | -127 to +10 dBm | 100 Hz | 300 kHz | 8555A Tuning Section Plug-In ¹ | 8444A Opt. 059 Tracking Generator (10 MHz-1500 MHz) 8445B Automatic Preselector (10 MHz-18 GHz) 11517A Harmonic Mixer | 694 |
| 18 GHz-110 GHz (Extendable from 2.7 to 325 GHz) | -130 dBm to -3 dBm | 10 Hz | 3 MHz | 71300A Modular Spectrum Analyzer | 11970K/A/Q/U/V/W Harmonic Mixers | 647 |

NOTE 1: For use in display mainframes HP 140T and 141T with IF section plug-ins HP 8552A or 8552B (page 686).

NOTE 2: For use in display mainframes HP 853A and 182T.

NOTE 3: Frequency range extendable to 110 GHz through the use of the HP 11970 series Harmonic Mixers. For higher frequency coverage, other external mixers are commercially available.

NOTE 4: Frequency range extendable to 71 GHz through the use of the HP 11971 series Harmonic Mixers. For higher frequency coverage, other external mixers are commercially available.

SIGNAL ANALYZERS

Wave, Distortion, Modulation, Spectrum and Fourier Analyzers (cont.)

Modulation Analyzers/Measuring Receivers

| Frequency Range | Modulation Measurements | Amplitude Measurement Range | Audio Frequency Count + Distortion Measurement | HP Model Number | Page |
|------------------------------|-------------------------|-----------------------------|--|-----------------|------|
| 150 kHz-1300 MHz | AM, FM, ϕ M | +30 to 0 dBm | No | 8901A | 719 |
| 150 kHz-1300 MHz | AM, FM, ϕ M | +30 to -20 dBm | Yes | 8901B | 719 |
| 150 kHz-1300 MHz | AM, FM, ϕ M | +30 to -127 dBm | Yes | 8902A | 715 |
| 150 kHz - 18 GHz or 26.5 GHz | AM, FM, ϕ M | +30 to -105 dBm | Yes | 8902S | 717 |

Dynamic Signal Analyzers

| Frequency Range | Amplitude Calibration Range | Resolution Points | | HP Model Description | Functions Available | Page |
|------------------------|---------------------------------------|-------------------|--|--|---|------|
| | | Max | | | | |
| 0.1-25 kHz | 7 steps from ± 0.125 to ± 8 V | 256 PS 128 TF | | 5427A Digital Vibration Control System (Analysis Mode) | Power Spectrum (PS) Transfer Function (TF) Transient Capture Shock Response Spectrum | 709 |
| 0.02 Hz-25.6 kHz | 9 steps from 3 mV to 30 V RMS | 256 VS 128 TF | | 3582A Spectrum Analyzer | Voltage Spectrum (VS) Phase Spectrum Transfer Function (TF) Coherence Function Digital Averaging | 701 |
| 0.0001 Hz - 100 kHz | 78 steps from 3 mV to 22 V RMS | 400 | | 3561A Dynamic Signal Analyzer | Voltage Spectrum Phase Spectrum 1/3 V and 1/1 Octave Spectrum Time Domain Waveform | 703 |
| 64 μ Hz to 100 kHz | 78 steps from +3.972 mV to +31.547 V | 801 | | 3562A Dynamic Signal Analyzer | Power Spectrum Linear Spectrum Frequency Response Coherence Function Histogram Correlation Impulse Response Waveform Recording Data Throughput Demodulation Vector Averaging Orbit Diagram | 706 |

Distortion/Audio Analyzers

| Fundamental Frequency Range | Minimum Distortion | Auto Set Level | Auto Nulling | True RMS | AM Detector | Filters | HP Model No. | Internal Source | HP-IB | Page |
|-----------------------------|--------------------|----------------|--------------|----------|-------------|---------|--------------|-----------------|-------|------|
| 5 Hz to 600 kHz | 0.03% (-70 dB) | | • | | • | • | 334A | | | 726 |
| 10 Hz-110 kHz | 0.0018% (-95 dB) | • | • | • | • | • | 334A Opt 002 | | | 726 |
| 20 Hz-100 kHz | 0.01% (-80 dB) | • | • | • | Note 1 | • | 8903B* | • | • | 722 |
| 20 Hz-100 kHz | 0.01% (-80dB) | • | • | • | Note 1 | • | 8903E** | • | • | 722 |

*The HP 8903B also performs Frequency Count, Signal/Noise, SINAD, watts, ac/dc voltage measurements.

NOTE 1: The HP 8901A Modulation Analyzer (page 719) provides complete demodulation of AM, FM, and ϕ M signals. **The HP 8903E also performs Frequency Count, SINAD, and ac/dc voltage measurements.

Wave Analyzers/Selective Level Meters

| Frequency Range | Selective Bandpass | Dynamic Range | | Freq. Readouts | Type of Inputs | Type of Outputs | Modes of Operation | HP Model Number | Page |
|-------------------|---|------------------------------|----------|--------------------------|---|---|-------------------------------|----------------------------------|-------------------|
| | | Absolute | Relative | | | | | | |
| 15 Hz to 50 kHz | 3 Hz 10 Hz 30 Hz 100 Hz 300 Hz | 0.1 μ V-300 V full scale | >85 dB | 5-place digital | Banana Jacks | rec: 5 V full scale, with pen lift BFO, Local Oscillator, tuning loudspeaker, and headphone jack | AFC, normal, BFO | 3581A/ 3581C | 727 142 |
| 50 Hz to 32.5 MHz | 20 Hz 400 Hz 3100 Hz | -130 to +20 dBm | >80 dB | LED 0.1 Hz Resolution | 50/75 Ω , BNC 600 Ω Banana Jacks | Tracking Generator Audio/Loud Speaker 1 MHz Ref. | Wideband Selective USB/LSB | 3586C (3336C*) | 657 457 |
| 50 Hz to 32.5 MHz | 20 Hz 400 Hz 1740/2000 Hz Optional 3100 Hz WTD | -130 to +20 dBm | >70 dB | LED 0.1 Hz Resolution | 75 Ω BNC/WECO 124 Ω WECO 135 Ω WECO 150 Ω Siemens 600 Ω WECO/ Siemens | Tracking Generator Audio/Loud Speaker 1 MHz Ref. | Wideband Selective SSB | 3586A/B (3336A/B*) (3335A) | 156 156 456 |

*Tracking Synthesizers.

Carrier Phase Noise Analysis

| Frequency Range | HP Model Number | Maximum Sensitivity dBc/Hz (depends on offset & method) | Functions Available | Page |
|-----------------|--|---|--|------|
| 5 MHz-18 GHz | 3047A Phase Noise Measurement System | -170 dBc/Hz (Required external reference source of equivalent performance) | Fully documented Software supporting: Phase Detector Mode, Frequency Discriminator Mode, Two Port Measurements | 710 |
| 5 MHz-18 GHz | 11729C Carrier Noise Test Set | -126 dBc/Hz (Including HP 8662A Reference Source) | Phase Detector Mode Frequency Discriminator Mode AM Noise Option, Pulsed Carrier | 713 |
| 5 MHz-18 GHz | 11740A/S Microwave Phase Noise Measurement System | -126 dBc/Hz (Including HP 8662A Reference Source) | Fully documented Software supporting: Phase Detector Mode, Frequency Discriminator Mode, Two Port Measurements | 714 |

SIGNAL ANALYZERS

HP 71000 Modular Spectrum Analyzers

647

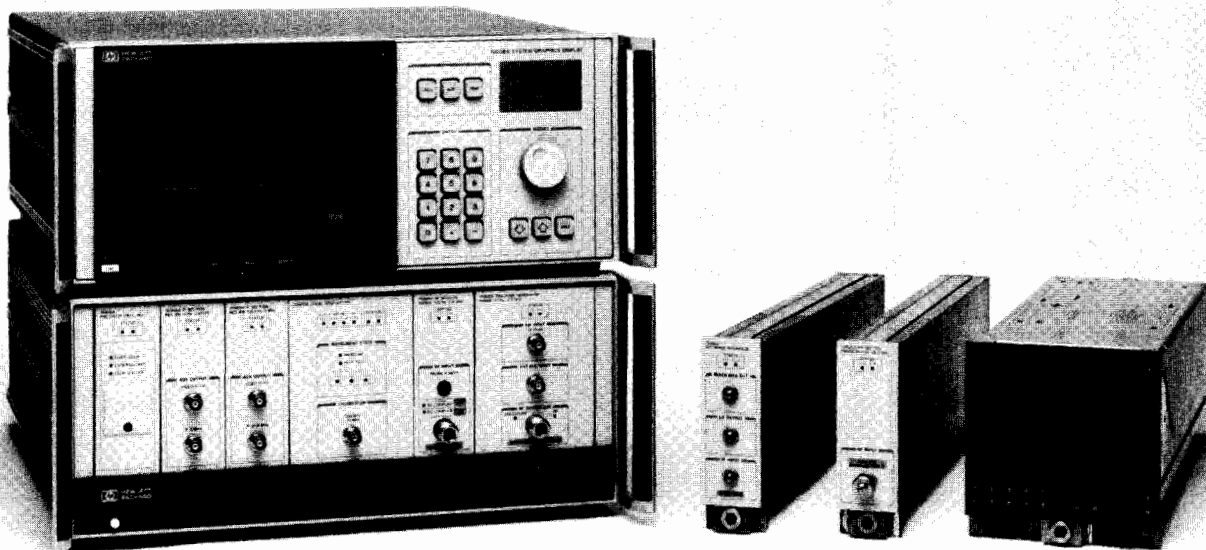

HP 71000 Modular Spectrum Analyzers

The HP 70000 Measurement System offers powerful new modular test instruments that make fast, precise measurements. Select just those components needed to match your measurement requirements, and as your needs change, expand or upgrade your system by adding new or different modules.

A rugged, reliable mainframe and two high-performance display/control units form the core of the HP 70000 System. These system building blocks combine with a variety of spectrum analyzer modules to create the HP 71000 Modular Spectrum Analyzers.

Choose Small or Large, Standard or Custom Systems

Put together the spectrum analyzer that best meets your needs by choosing from standard or custom systems, shipped from the factory ready for use.

Three standard HP 71000 Spectrum Analyzer systems cover RF, microwave, and millimetre frequency ranges. Each standard system consists of the HP 70001A Mainframe, 70205A Graphics Display, 70900A Local Oscillator, 70902A IF Section, and an RF section covering the frequency range of the analyzer. Options allow you to select the large, stand-alone 70206A System Graphics Display, the 70903A IF Section, and extended warranty coverage.

To assemble a custom system, use the HP 71000S System Reference Number which ensures the instrument will be sent ready for use. In addition, order HP Series 200 computers and peripherals using the HP 71000S System Reference number. Modules, displays, and mainframes can also be ordered individually.

HP 71100A RF Spectrum Analyzer: 100Hz-2.9GHz

The HP 71100A RF Spectrum Analyzer combines the power of the HP 70000 System with the superb performance of the RF Spectrum Analyzer modules to provide outstanding RF measurement capability. Its wide frequency range of 100 Hz to 2.9 GHz allows signal measurements from audio to microwave. The HP 70300A Tracking Generator, when combined with either the HP 71100A or 71200A Spectrum Analyzers, has a 125 dB dynamic range for making stimulus-response measurements easily.

HP 71200A Microwave Spectrum Analyzer:

50kHz-22/26.5GHz

The HP 71200A Microwave Spectrum Analyzer gives you low-cost spectrum analysis from 50 kHz to 22 GHz or from 50 kHz to 26.5 GHz. This unpreselected spectrum analyzer has automatic signal identification routines that directly read out the frequency of a displayed response at the touch of a single key. It provides excellent amplitude accuracy and sensitivity, and makes most signal measurements easily.

HP 71300A Millimetre Spectrum Analyzer: 2.7-325GHz

The HP 71300A Millimetre Spectrum Analyzer offers a variety of new millimetre capabilities at an attractive price. Used with the HP 11970 series of mixers from 18 to 110 GHz, the HP 71300A provides excellent sensitivity and amplitude accuracy and permits quick measurements through push-button signal identification and elimination of bias adjustments. For improved amplitude accuracy the analyzer can remove mixer frequency response variations without operator intervention. Flexibility in configuration is easily accomplished; you can, for example, add other HP 70907A interface modules to sequentially measure multiple frequency bands. And the HP 71300A can be used with existing mixers over a wide 2.7 to 325 GHz frequency range. (Also see page 550.)

Custom Spectrum Analyzer Systems

For work requiring specialized equipment, small or large custom spectrum analyzer systems can be assembled.

A small spectrum analyzer might consist of a standard spectrum analyzer system without a display. In certain Automatic Test Systems (ATS), the display can be omitted: a computer can control the HP 70000 Measurement System, read and interpret the data, and display the results.

A large spectrum analyzer system might consist of two or more spectrum analyzers operating with the same display. One of the analyzers could be a microwave spectrum analyzer with four External Mixer Interface Modules installed. This combination would allow coverage of 50 kHz to 110 GHz with a single spectrum analyzer. The second analyzer might be an RF spectrum analyzer with a tracking generator attached to make reflection and transmission stimulus-response measurements. The HP 70000 Measurement System can expand to fill many test instrument needs by the addition of new or different modules.

SIGNAL ANALYZERS

HP 71000 Modular Spectrum Analyzers (con't)



The modular HP 70000 System allows you to select just the right capability for every application.

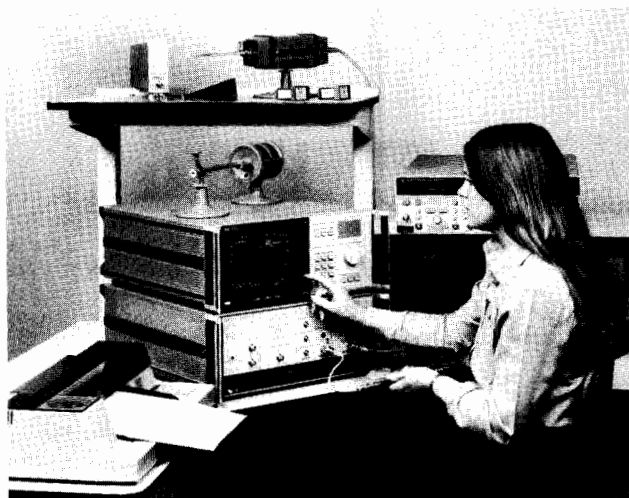

The modular system can be expanded to meet your future needs.

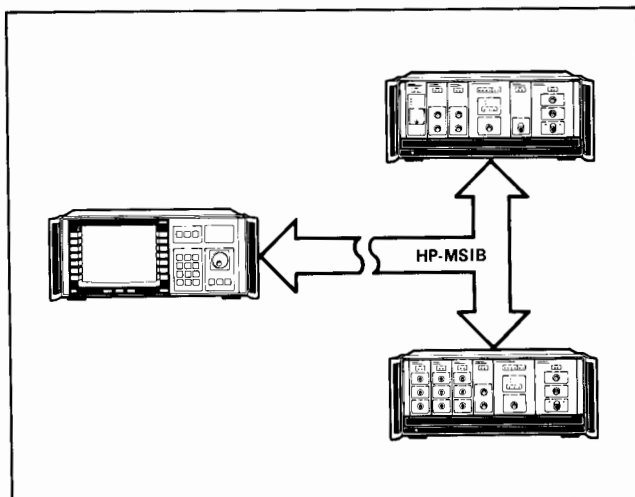

A single display can control multiple instruments separated up to 30 metres.

Adapts to Meet Your Needs

Just the Right Capability

The new HP 70000 Modular Measurement System lets you choose the capability you need, without the extra expense of unnecessary features. Select the frequency range you require: RF (100Hz - 2.9GHz), microwave (50kHz - 22 or 26.5GHz), or millimetre wave (18 - 110GHz and beyond). Get the frequency resolution you want by choosing from two separate IF sections with resolution bandwidths of 10Hz to 300kHz or 100kHz to 3MHz.

If your measurements call for more than just a standard spectrum analyzer, include other modules to provide the right capability. Add the HP 70310A Precision Frequency Reference module to achieve the best absolute frequency accuracy Hewlett-Packard offers in an RF or microwave spectrum analyzer. For automatic stimulus-response capability to 2.9 GHz, include the HP 70300A Tracking Generator to your RF or microwave system. Or, add complete millimetre wave coverage to any system by using one or more HP 70907A External Mixer Interface modules.

Expandable

As your needs change, expand your HP 70000 System by adding modules, rather than replacing your entire instrument. For example, purchase a standard RF analyzer now, and you have the option of increasing capability for microwave or millimetre wave coverage, reflection and transmission measurements, or high-precision absolute frequency accuracy. For an independent synthesized signal source, add a second local oscillator and tracking generator.

The central components of the system, the HP 70001A Mainframe and HP 70205A and 70206A Displays, are designed to accommodate a broad range of future modules. As the HP 70000 Measurement System product line continues to grow, it will meet your requirements for years to come. And, because changes are incremental, the HP 70000 System eliminates the hidden costs of replacing an instrument: installation time, operating and service training time, and reprogramming.

Centralized System Control

One HP 70000 Measurement System can contain many spectrum analyzers. A single HP 70206A or 70205A Display can control any of these analyzers using a simple set of softkey menus. This central display can present the outputs from up to four instruments at once. For example, a single spectrum analyzer can sequentially switch between four different inputs, and the four outputs can be displayed simultaneously. Or, for faster operation, several spectrum analyzers can sweep independently and show their results on a single display screen.

Like individual instruments, the displays and spectrum analyzers can be physically separated by up to 30 metres while linked by the HP 70000 System's own high-speed data bus. The display can be placed at a convenient location for the operator, and the analyzer can be placed at the measurement site. The display controls each instrument over HP-MSIB (Modular System Interface Bus), while the individual instruments execute their own measurement procedures without a computer.

Powerful, Yet Easy to Use

Easy, Even for Occasional Users

Three keys on the display (USER, MENU, and DISPLAY) let you control all instrument functions. These "hardkeys" access "softkey" menus on the display screen. Softkeys give you complete control of the powerful commands and functions incorporated into the system.

Although the menu-driven softkey structure is flexible and powerful, manual measurements are still made easily, even by first-time operators. Most spectrum analyzer measurements can be made using basic controls like center frequency, span, and the marker functions.

The most frequently used softkeys are immediately available by pressing the USER hardkey. The USER key calls up 14 commonly used keys such as CENTER FREQ, SPAN, MARKER DELTA, HIGHEST PEAK, and NEXT PEAK. For example, the harmonic distortion measurement at right was made quickly and accurately using only those softkeys.

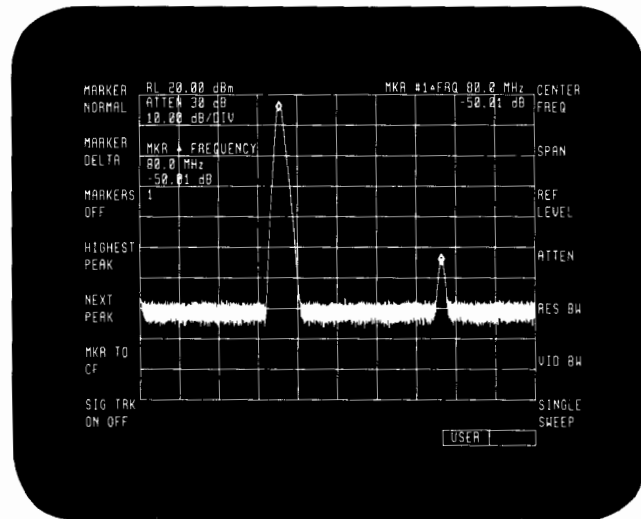

The fourteen most frequently used softkeys appear when the USER key is pressed.

Customized Softkeys

You can replace the softkeys found under the USER key with softkeys of your own choosing to create a customized keyboard. Over 180 softkeys under the MENU key are available for you to choose from.

By customizing the USER softkeys, any of the HP 71000 Spectrum Analyzer functions can be made available at the touch of a single key. For instance, if your measurements call for capturing and viewing single-shot spectra, you can make the SINGLE SWEEP softkey immediately available under USER. This is shown at right for a commercial broadcast FM band monitoring application. Note that CENTER FREQ and SPAN have been replaced by START FREQ and STOP FREQ.

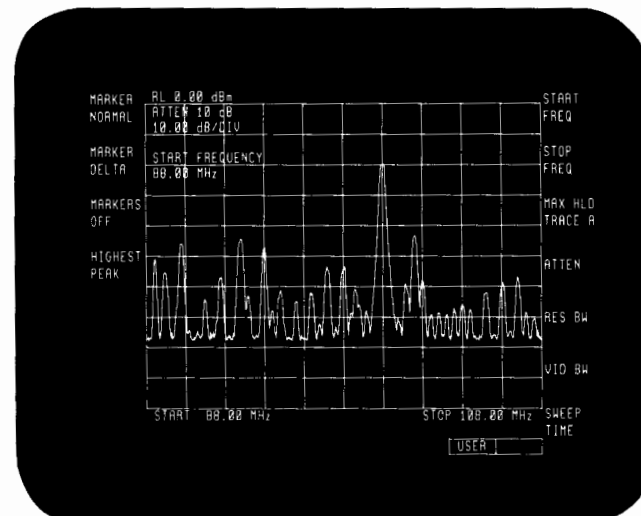

Replace softkeys under USER with keys such as START FREQ and STOP FREQ to create a customized keyboard.

One-Button Solutions

For complex measurements that are made routinely, one-button solutions are available to everybody, even first-time operators, by using the downloadable programming capability of the HP 71000 Series. An automatic procedure is created on a computer, downloaded into the non-volatile memory of the analyzer, and activated either manually or remotely.

All functions of the spectrum analyzer can be used in a downloadable program. You can create unique softkey labels for your programs and place these softkeys on the screen under the USER key.

Downloadable programs simplify manually performed tasks in many areas, ranging from field measurements to high-speed ATE systems. Programs can be used to compare measurement results against pre-set test limits, branch to other operations, prompt the user for input, and act as an HP-IB controller. For example, the screen at right is the result of a radar misfire measurement procedure called MISFIRE RATE.

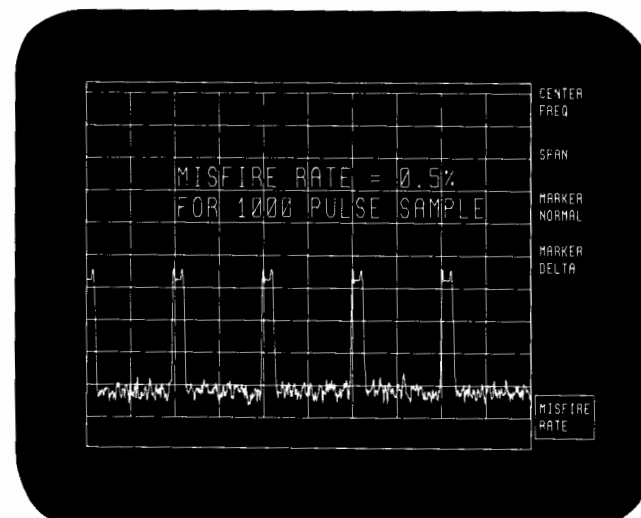

One-button solutions, such as MISFIRE RATE, can be created with downloadable programs to simplify manually performed tasks.

SIGNAL ANALYZERS

HP 71000 Modular Spectrum Analyzers (con't)

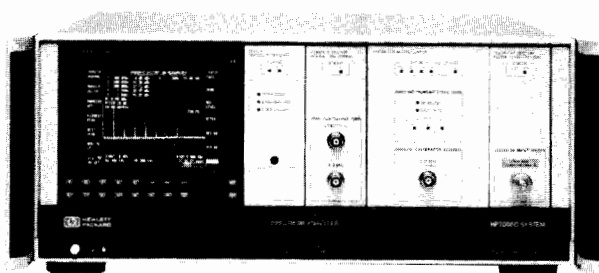

HP 71000 Standard Spectrum Analyzer Systems

Three standard factory-configured systems are offered for RF, microwave, and millimetre frequency ranges. Each system is assembled at the factory (with rear panel cabling and blank panels) and shipped with modules loaded into the mainframe ready to use. All standard systems use 7/8 of the mainframe capacity. A one-year, return-to-HP warranty is included with each standard or custom system.

HP 71100A RF Spectrum Analyzer

(100 Hz - 2.9 GHz)

- HP 70001A Mainframe
- HP 70205A Graphics Display
- HP 70900A Local Oscillator
- HP 70902A IF Section (Res BW 10 Hz - 300 kHz)
- HP 70904A RF Section (100 Hz - 2.9 GHz)

Price
\$31,000

HP 71200A Microwave Spectrum Analyzer

(50 kHz - 22 GHz)

- HP 70001A Mainframe
- HP 70205A Graphics Display
- HP 70900A Local Oscillator
- HP 70902A IF Section (Res BW 10 Hz - 300 kHz)
- HP 70905A RF Section (50 kHz - 22 GHz)

\$35,000

HP 71300A Millimetre Spectrum Analyzer

- HP 70001A Mainframe
- HP 70205A Graphics Display
- HP 70900A Local Oscillator
- HP 70902A IF Section (Res BW 10 Hz - 300 kHz)
- HP 70907A External Mixer Interface

\$33,000

System Options

(Except as noted, the options below apply to all standard systems)

- Option 001 Delete HP 70905A RF Section, add HP 70906A RF Section (50 kHz - 26.5 GHz) (HP 71200A only) (7/8 of mainframe used) \$1,600
- Option 002 Delete HP 70205A Graphics Display, add HP 70206A System Graphics Display (50/60 Hz Operation) (4/8 of mainframe used) \$1,800
- Option 003 Delete HP 70205A Graphics Display, add HP 70206A System Graphics Display (50/60/400 Hz Display Operation) (4/8 of mainframe used) \$2,150
- Option 004 Add HP 70903A IF Section (Res BW 100 kHz - 3 MHz) (8/8 of mainframe used) \$2,600
- Option 005 Delete HP 70902A IF Section, add HP 70903A IF Section (Res BW 100 kHz - 3 MHz) (7/8 of mainframe used) - \$700
- Option 908 Rack Flange Kit for mainframe or HP 70206A Display without handles \$35
- Option 913 Rack Flange Kit for mainframe or HP 70206A Display with handles \$40
- Option 915 Rack Mount Slide Kit for mainframe \$450
- Option 916 Rack Mount Slide Kit for HP 70206A Display \$200
- Option 910 Duplicate Manual Set \$250

System Support Options

The Option W30 (where available) provides an additional two years "return-to-HP" service support, commencing at the end of the standard one-year warranty. (For information on availability and terms of on-site service, contact your HP sales representative.)

- 71100A Option W30 \$2,150
- 71200A Option W30 \$2,325
- 71300A Option W30 \$2,150

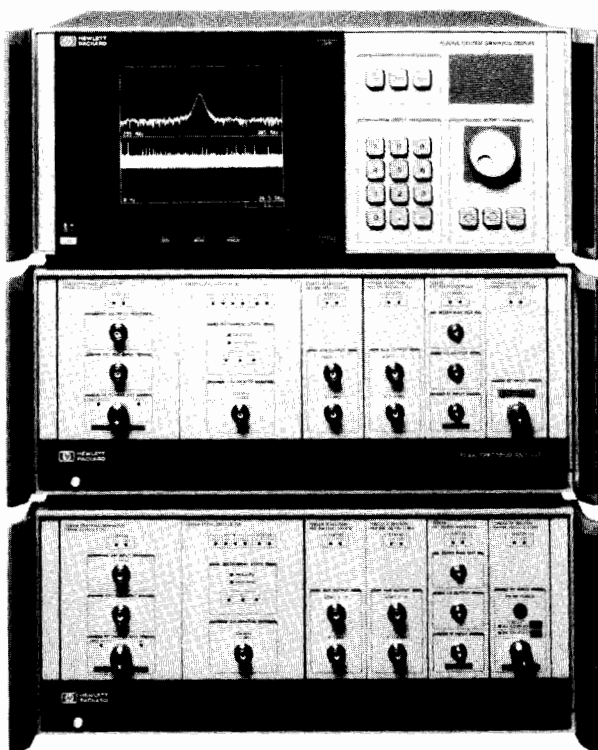

HP 71000 Custom Spectrum Analyzer Systems

Custom systems can be made up of a variety of the HP 70000 components listed on the facing page. You can start with a standard system including desired options and add modules and accessories or select all parts individually.

The HP 71000S System Reference Program is used to create custom systems. This model number ensures factory configuration of the spectrum analyzer and coordinated shipment of computers and peripherals. The HP 71000S systems are configured by the factory, supplied with necessary cabling and blank panels, and are loaded into mainframes at the factory. A one-year return-to-HP warranty is included with each system. HP 71000S Systems are shipped ready to use.

To order a custom system, follow the steps below:

1. Choose the HP 71000S System Reference.
2. Select one Standard Spectrum Analyzer System (optional).
3. Choose a display (optional).
4. Select those modules needed to complete your system. (One 70900A LO, one IF module, and one RF or 70907 module is required for each spectrum analyzer.)
5. Select as many mainframes as required to accommodate the modules selected. One mainframe is included with a standard system. Each mainframe accommodates eight 1/8-width modules.
6. Select desired Harmonic Mixers (optional).
7. Select desired support options.
8. Contact your local HP sales office.

(Ordering information is detailed in the HP 71000 Modular Spectrum Analyzer Ordering Guide, available from your local sales office.)

HP 71000 Automatic Spectrum Analyzer Systems

Automatic spectrum analyzer systems can also be ordered by using the HP 71000S System Reference Program, selecting a standard or custom spectrum analyzer system from the HP 71000S equipment list, and adding desired computers and peripherals.

To meet your automatic system needs, Hewlett-Packard offers a wide range of personal technical computers and peripherals. HP 9000 Series 200 Personal Technical Computers such as the 9816S, 9817H, 9826S, and 9836S are recommended for the HP 71000 Modular Spectrum Analyzers. Peripherals such as disc drives (9121D and 82901M), printers (2225A, 2673A, and 9876A), and plotters (7475A) are also recommended.

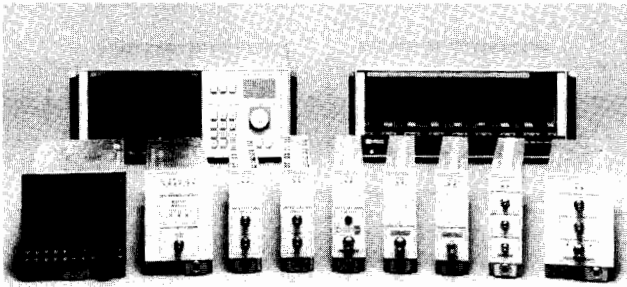

Components Of The HP 70000 Measurement System

The HP 71000 Modular Spectrum Analyzer family includes the components listed below. These components can be ordered individually to create or supplement a spectrum analyzer. (See the preceding page for standard HP 71000 Spectrum Analyzer Systems.)

HP 70001A System Mainframe

\$4,100

The HP 70001A System Mainframe provides the structural environment for plug-in instrument modules along with cooling, power, and digital communication interface buses. It is compatible with 1/8-, 1/4-, 3/8- and 1/2-width modules and has a maximum capacity of eight 1/8 modules. Sliding a module in place automatically connects the module to power and digital interface and supplies it with forced-air cooling. Standard EIA rack compatibility is provided and benchtop use is facilitated with integral bails and handles.

The Hewlett-Packard Interface Bus (HP-IB) provides communication between controllers and other HP-IB instruments and the Modular System Interface Bus (HP-MSIB) supports high speed digital communication between instrument modules.

Good EMC performance and rugged structural design make the mainframe suitable for sensitive measurements in tough industrial environments.

HP 70206A System Graphics Display

\$6,000

The HP 70206A System Graphics Display is a free-standing, menu-driven human interface for the HP 70000 Modular Measurement System. It displays configuration information and measurement results and has high resolution graphics, trace, text, and marker capability. Softkeys are used to establish an interactive front panel for any modular instrument.

A 9-inch CRT, easy-to-use menus, data and control keys, and an analog control knob make system operation friendly. The display may be stacked or racked with the HP 70001A System Mainframe or located up to 30 meters away from the analyzer without slowing operation.

HP 70205A Graphics Display

\$4,200

The HP 70205A Graphics Display is a 3/8-width module that provides a menu-driven human interface for the HP 70000 Measurement System. Its control and display capabilities are identical to those of the HP 70206A System Graphics Display.

HP 70900A Local Oscillator

\$14,100

The HP 70900A Local Oscillator is a 3/8-width module that performs three essential functions in spectrum analyzer systems, supplying a swept synthesized local oscillator signal of 3.0 - 6.6 GHz for RF modules, tracking generator modules, external mixer interface modules, and any other modules or devices requiring the LO signal. For spans of 10 MHz*N or less (N = harmonic mixing number) the signal is fully synthesized, while for spans greater than 10 MHz*N, lock-and-roll tuning is used. It serves as a video processor for the video signal received from an IF section, and it operates as the master controller for spectrum analyzer systems. In addition, the LO contains the system firmware, enabling it to control and coordinate measurements, and to output data to the display or to a computer.

HP 70902A IF Section (Res BW 10 Hz - 300 kHz)

\$3,300

HP 70903A IF Section (Res BW 100 kHz - 3 MHz)

\$2,600

The HP 70902A and HP 70903A IF Sections are each 1/8-width modules that process a 21.4 MHz IF signal received from a spectrum analyzer RF section or an external mixer interface module. A detected video signal is produced and routed to the video processor in the HP 70900A Local Oscillator. The modules contain resolution bandwidth filters, log amplifiers, detection circuitry, and video filters. Both IF sections may be used in a single system to provide resolution bandwidths of 10 Hz to 3 MHz.

HP 70904A RF Section (100 Hz - 2.9 GHz)

\$7,300

HP 70905A RF Section (50 kHz - 22 GHz)

\$10,300

HP 70906A RF Section (50 kHz - 26.5 GHz)

\$11,900

The HP 70904A, 70905A, and 70906A RF Sections are 1/8-width modules that serve as the front ends for RF and microwave spectrum analyzer systems. Each module contains an input attenuator and converts the incoming signal to a 21.4 MHz IF. All three front ends are unselected.

HP 70310A Precision Frequency Reference

\$4,200

Option 002 Delete Ovenized Oscillator

-\$2,400

The HP 70310A is a 1/8-width module that provides precision reference signals for HP 70000 instruments. Signals are phase-locked to an internal ovenized oscillator and are available at 10MHz and 100MHz. With the HP 70310A, the HP 71000 Spectrum Analyzer's frequency reference accuracy is improved from 13ppm (after 1 year) to 0.1ppm. An external reference input on the HP 70310A allows HP 71000 analyzers to be referenced to house standards or other external references at 1, 2, 5, or 10MHz.

HP 70300A Tracking Generator

\$9,950

Option 001 Attenuator (70dB)

\$1,200

The HP 70300A Tracking Generator is a 3/8-width module whose output signal tracks the tuned frequency of the spectrum analyzer. Stimulus-response measurements with a dynamic range of 125 dB can be made using this module in combination with the HP 71100A RF or HP 71200A Microwave Spectrum Analyzers. OPEN/SHORT and THRU normalization functions allow amplitude-normalized measurements to be made rapidly.

When the HP 70300A is added to the HP 70900A Local Oscillator, a swept synthesized source with a frequency range of 20 Hz - 2.9 GHz is created. Like the other modules in the system, the 70300A is fully automatic and easy to program and configure.

HP 70907A External Mixer Interface

\$8,300

The HP 70907A External Mixer Interface is a 1/8-width module that provides a friendly interface between external mixers and spectrum analyzer systems. It contains an LO amplifier, programmable diode bias supply, and downconversion circuitry to convert the 321.4 MHz input IF signal to a 21.4 MHz IF signal which it routes to one of the IF modules.

The frequency range of an HP 71000 spectrum analyzer can be extended to 110 GHz using this module with mixers from the HP 11970 series and to 325 GHz using it with mixers from other manufacturers. Applications requiring high sensitivity down to 2.7 GHz can also be addressed using this module with external mixers.

Harmonic Mixers

| | | |
|-----------|------------------------------------|---------|
| HP 11970K | Harmonic Mixer (18 GHz - 26.5 GHz) | \$1,500 |
| HP 11970A | Harmonic Mixer (26.5 GHz - 40 GHz) | \$1,500 |
| HP 11970Q | Harmonic Mixer (33 GHz - 50 GHz) | \$1,650 |
| HP 11970U | Harmonic Mixer (40 GHz - 60 GHz) | \$1,850 |
| HP 11970T | Mixer Package (18 GHz - 40 GHz) | \$3,100 |
| HP 11970V | Harmonic Mixer (50 GHz - 75 GHz) | \$2,250 |
| HP 11970W | Harmonic Mixer (75 GHz - 110 GHz) | \$2,550 |

Accessories

HP 70800A/B/C/D/E HP-MSIB Cables



SIGNAL ANALYZERS

HP 71000 Modular Spectrum Analyzers (con't)

Specifications

| Amplitude | HP 71100A | HP 71200A | HP 71300A |
|--|--|--|---|
| Total Amplitude Range | -135 to +30 dBm | -133 to +30 dBm | -130 to -3 dBm |
| Maximum Safe Input Power AC Average Continuous | +30dBm | +15dBm (0 dB attn.) +25dBm (10 dB attn.) +30dBm (>10 dB attn.) | +20dBm with HP 11970 Mixers |
| Pulse Power | 100 watts, 10 microsec pulse (≥20dB attenuation) | 100 watts, 10 microsec pulse (≥40dB attenuation) | 250 mW peak pulse power with <1 microsec pulse (+20 dBm ave. power) with HP 11970 mixers |
| DC | 0 volts (dc coupled) ± 25 volts (ac coupled) | 0 volts | N/A |
| Gain Compression Level | <-0.5 dB for signals ≤-10 dBm at input mixer | | Depends on External Mixer Used |
| Displayed Average Noise Level HP 70902A IF 10 Hz Res BW, 0dB attn. | 10MHz-2.0GHz <-135dBm 2.0GHz-2.9GHz <-132dBm | 10MHz-2.9GHz <-130dBm 2.7-6.2GHz <-133dBm 6.0-12.7GHz <-126dBm 12.5-19.9GHz <-121dBm 19.7-22/26.5GHz <-118dBm | 18-26.5GHz <-130dBm 26.5-40GHz <-128dBm 33-50GHz <-124dBm 40-60GHz <-124dBm |
| HP 70903A IF 100kHz Res BW, 0dB attn. | For frequencies >3MHz, displayed average noise level is 40dB higher than the above values. | | |
| Display Range Calibration: Log Linear | Scale: 10 Division CRT .01 - 20 dB/div in increments of 0.5% 10% of Reference Level Per Division | | |
| Spurious Responses For mixer levels ≤-40dBm, except as listed below (10dB attn) | Input 100Hz-10MHz 10MHz-2.9GHz | Spurious <-60dBc <-70dBc | Input 50kHz-10MHz 10MHz-22/26.5GHz |
| Second Harmonic Distortion for input at mixer ≤-40dBm (10dB attn) | Band 100Hz-10MHz 10MHz-2.9GHz | Second Harmon. <-60dBc <-70dBc | Band 50kHz-10MHz 10MHz-6.2GHz 6GHz-12.7GHz 12.5-19.9GHz 19.7-22/26.5GHz |
| Third-Order Intermodulation Distortion with 70902A IF Section. For two signals, each ≤-30dBm at mixer (10 dB attn) | Center Frequency 100Hz-10MHz 10MHz-2.9GHz | Intermod Products <-66dBc <-70dBc | Equiv TOI +3dBm +5dBc |
| | Center Frequency 50kHz-10MHz 10MHz-6.2GHz 6.0-22/26.5GHz | Intermod Products <-66dBc <-74dBc <-76dBc | Equiv TOI +3dBm +7dBm +8dBm |
| | Depends on External Mixer Used (TOI of system at 321.4MHz input = -10dBm) | | |
| Amplitude Accuracy | | | |
| Frequency Response (10 dB Input Attenuation) | Band 100 Hz - 2.5 GHz ±1dB 100 Hz - 2.9 GHz ±1.5 dB | Band 400 kHz - 2.9 GHz ±1 dB 50 kHz - 2.9 GHz ±2 dB 2.7 GHz - 6.2 GHz ±1 dB 6.0 GHz - 12.7 GHz ±1.5 dB 12.5 Hz - 19.9 GHz ±2 dB 19.7 GHz - 22/26.5 GHz ±2.5 dB | 11970 Band (GHz) 18-26.5 ±1.9 dB 26.5-40 ±1.9 dB 33-50 ±1.9 dB 40-60 ±1.9 dB |
| Frequency Response Ref. to 300MHz, -10dBm Calibrator (10dB Attn) | Band 100 Hz - 2.5 GHz ±1.3 dB 100 Hz - 2.9 GHz ±1.8 dB | Band 50 kHz - 29. GHz +1.3, -3.3 dB 400 kHz - 2.9 GHz ±1.3 dB 400 kHz - 6.2 GHz ±2.3 dB 400 kHz - 12.7 GHz ±2.8 dB 400 kHz - 19.9 GHz ±3.3 dB 400 kHz - 22/26.5 GHz ±3.8 dB | |
| Calibrator Uncertainty | ±0.3 dB (-10 dBm, 300 MHz) | | Internal ±.3dB (-35dBm, 321.4MHz) |
| Amplitude Temperature Drift | For -10 dBm reference level (-35 dBm for HP 71300A), 10 dB input attenuation, 100 Hz resolution bandwidth (HP 70902A IF) or 300 kHz resolution bandwidth (HP 70903A IF) drift is ±0.05 dB/°C (accumulated error eliminated by recalibration) | | |
| Resolution Bandwidth Switching Uncertainty | ±0.1 dB Corrected (1, 3, 10 Bandwidths) ±3 dB Uncorrected | | |
| Log Scale Switching Uncertainty | ±0.3 dB | | |
| IF Gain Uncertainty | 10 dB ±0.1 dB 20 dB ±0.1 dB | 30 dB ±0.2 dB 40 dB ±0.2 dB | 50 dB ±0.3 dB |
| Scale Fidelity HP 70902 IF | Bandwidths ≥30 Hz and ≤100 kHz (Corrected): ±0.5 dB over 0 to 90 dB display Bandwidths <30 Hz or >100 kHz (Corrected): ±0.8 dB over 0 to 90 dB display | | |
| HP 70903 IF | Bandwidths ≤1 MHz (Corrected): ±0.5 dB over 0 to 80 dB display (0 to 75dB in 71200A) Bandwidths >1 MHz (Corrected): ±0.7 dB over 0 to 80 dB display (0 to 75dB in 71200A) | | |
| HP 70902 & 70903 IF | All Bandwidths: ±3 dB over 80 dB display (Uncorrected) ±1 dB/dB incremental accuracy (Corrected) | | |
| Linear | ±7.5% of Reference Level | | |

Specifications

| Frequency | HP 71100A | HP 71200A | HP 71300A |
|---|---|---|--|
| Frequency Range | 100Hz-2.9GHz (DC Coupled) 100kHz-2.9GHz (AC Coupled) | 50kHz-22GHz 50kHz-26.5GHz (Option 001) | 18-110GHz with HP 11970 Mixers (2.7-325GHz with other mixers) |
| Noise Sidebands (dBc/Hz) | Offset 100 Hz-2.9GHz >1kHz -85 (dBc/Hz) >30kHz -97 >1MHz -128 | Offset 50kHz-6.2GHz >1kHz -85 (dBc/Hz) >30kHz -97 >1MHz -127 | (dBc/Hz) Using HP 11970A >1kHz -69 (characteristic) >30kHz -82 (characteristic) >1MHz -112 (characteristic) |
| Frequency Readout Accuracy (N=Harmonic mixing band number) | Span $\leq 10\text{MHz} \times N$: $\pm [(\text{Frequency Readout} \times \text{Frequency Reference Accuracy}) + 1\% \text{ of Span} + 10\text{Hz}]$ Span $> 10\text{MHz} \times N$: $\pm [(\text{Frequency Readout} \times \text{Frequency Reference Accuracy}) + 2\% \text{ of Span} + 10\text{Hz}]$ Aging $< 3 \times 10^{-6}/\text{year}$; Temperature Drift $< 1 \times 10^{-5}$ over $0^\circ - 55^\circ\text{C}$ (With HP 70310A, Aging is $< 1 \times 10^{-7}/\text{year}$; Temperature Drift $< 7 \times 10^{-9}$ over $0^\circ - 55^\circ\text{C}$) | | |
| Frequency Span Accuracy | Span $\leq 10\text{MHz} \times N$: $\pm [1\% \text{ of span} + (\text{span} \times \text{Frequency Reference Accuracy})]$ Span $> 10\text{MHz} \times N$: $\pm (2\% \text{ of span})$ | | |
| Frequency Drift | For spans $> 10\text{MHz} \times N$, frequency drift during one sweep is $+1\text{kHz}$ per second and $\pm 150\text{kHz}$ per $^\circ\text{C}$. Errors resulting from drift are not cumulative from sweep to sweep. | | |
| Resolution Bandwidths (-3dB) Range Accuracy Selectivity (-60dB/-3dB) Shape | 10Hz - 300kHz; 10 Hz-3MHz (Option 004) Adjustable in 1,3,10 sequence and 10% increments (except from 3kHz-10kHz) $\pm 20\%$ 10 Hz - 3kHz Bandwidths $< 12:1$ 10kHz - 3MHz Bandwidths $< 16:1$ Synchronously tuned, 5 poles (10 Hz - 3kHz), 4 poles (10kHz - 3MHz) Approximately Gaussian shape. | | |
| Video Bandwidth Range | 3Hz-300kHz in 1,3,10 increments (3Hz-3MHz with Option 004); Accuracy (characteristic) $\pm 20\%$ | | |
| Residual FM | Span $> 10\text{MHz} \times N$: $< 25\text{kHz} \times N$ p-p in 0.1 seconds (measurement BW=100kHz) Span $\leq 10\text{MHz} \times N$: In synthesized spans residual FM is determined by noise sidebands | | |
| Sweep Time Range Accuracy | 50 ms to 1000s in 500us increments Sweep times as low as 187us are available when traces with less than 801 points are defined $\pm 2\%$ | | |
| Trigger | Free Run, Line, Video, External | | |

I/O Common to HP 71100A, 71200A, 71300A Systems

70902A IF Section: Auxiliary Video Output, 3 MHz IF Output, 21.4 MHz Auxillary Output, 3 MHz Limited IF Output

70903A IF Section: Auxiliary Video Output, 21.4 MHz IF Output, 21.4 MHz Log IF Output

70900A LO Section: 300 MHz Calibrator Output, External Frequency Reference Input, Sweep Output/Input, Tune + Span Output, HSWP Output/Input

70205A/70206A Graphics Displays: Composite Video Output

Environmental

Temperature: Operation 0 to $+55^\circ\text{C}$; Storage -40 to $+75^\circ\text{C}$

Humidity: Operation 0 to 95% Relative Humidity at 40°C

EMI: Radiated interference is within the requirements of MIL-STD 461B, Class A1c, RE02

Warm-Up Time

One hour warm-up for cold start ($0-55^\circ\text{C}$)

Weight (characteristics)

Systems

| | |
|-----------------------|-------------------|
| HP 71100A RF Analyzer | 30.9 Kg (68.1 lb) |
| HP 71200A MW Analyzer | 30.6 Kg (67.5 lb) |
| HP 71300A MM Analyzer | 30.5 Kg (67.2 lb) |

System Components

| | |
|-----------------------------------|-------------------|
| HP 70001A Mainframe | 14.5 Kg (31.9 lb) |
| HP 70205A Graphics Display | 5.1 Kg (11.2 lb) |
| HP 70206A System Graphics Display | 18.6 Kg (41 lb) |

Modules

| | |
|------------------------------------|------------------|
| HP 70900A Local Oscillator | 5.7 Kg (12.6 lb) |
| HP 70902A IF Section | 2.4 Kg (5.3 lb) |
| HP 70903A IF Section | 2.3 Kg (5.1 lb) |
| HP 70904A RF Section | 3.2 Kg (7.1 lb) |
| HP 70905A RF Section | 2.9 Kg (6.4 lb) |
| HP 70906A RF Section | 2.9 Kg (6.4 lb) |
| HP 70907A External Mixer Interface | 2.8 Kg (6.2 lb) |
| HP 70300A Tracking Generator | 5.0 Kg (11.0 lb) |
| HP 70310A Precision Freq. Ref. | 3.0 Kg (6.6 lb) |

Dimensions

HP 70001A Mainframe: 177.0mm high, 425.4mm wide, 526.0mm long

HP 70206A Display: 177.0mm high, 425.4mm wide, 502.0mm long

Power Requirements

HP 70001A Mainframe: 100, 120, 220, and 240 VAC (+5%, -10%) 47-66 Hz (400 Hz operation is available as a special option. Contact your sales representative for information.)

650 VA Maximum

Modules: All power requirements are supplied by the mainframe.

HP 70206A Display: 100, 120, 220, 240 VAC (+5%, -10%) 47-66 Hz (47-66 Hz and 356-444 Hz with option 400) (100, 120 VAC Only)

300 VA Maximum

HP 70300A Tracking Generator

Frequency Range: 20Hz - 2.9GHz swept and CW

100Hz - 2.9GHz (71100A); 50kHz - 2.9GHz (71200A)

Resolution: $< 1\text{Hz}$

Accuracy: $\leq 10\text{MHz}$ span; $\pm [(\text{Output Freq} \times 13 \times 10^{-6} + 1\% \text{span} + 15\text{Hz})]$
 $> 10\text{MHz}$ span; $\pm [(\text{Output Freq} \times 13 \times 10^{-6} + 2\% \text{span} + 15\text{Hz})]$

Tracking Accuracy: Tracking drift (typical) 5Hz/Hr (1 Hr warm-up)

Output Amplitude: -10dBm to -21dBm (0.01 dB resolution)

Absolute Accuracy: 300MHz @ -10dBm ; $\pm 0.5\text{dB}$ @ 25°C $\pm 10^\circ\text{C}$

Level Flatness: 10MHz to 2.9GHz (relative to 300MHz) $\pm 0.5\text{dB}$
20Hz to 10MHz (relative to 1MHz) -0.7dB , $+1.2\text{dB}$

Dynamic Range: $> 125\text{dB}$, 10Hz ResBW, 0dB Atten; 10MHz-2.0GHz 71100A

AM Rates: Internal 400Hz & 1kHz ($\pm 3\%$)

External 20Hz-20kHz (3dB BW @ 30% AM)

Dimension: $\frac{3}{8}$ width module

HP 70310A Precision Frequency Reference

Aging: $< 5 \times 10^{-10}/\text{day}$ (7-day average), $< 1 \times 10^{-7}/\text{year}$
Temperature Stability: $< 7 \times 10^{-9}$ over 0° to 55°C (25°C reference)

100 MHz Output Power: 0 dBm (charact.)

10 MHz Output Power: 0 dBm (charact.)

External Reference Input:

Input Frequencies: 1, 2, 5, or 10 MHz

Input Power Range: -5 to $+21\text{dBm}$

Dimension: $\frac{1}{8}$ width module

SIGNAL ANALYZERS

20 Hz to 40 MHz Spectrum Analyzer

Model 3585A

- 80 dB dynamic range
- 3 Hz resolution bandwidth
- ± 0.4 dB amplitude accuracy
- Self-calibrating

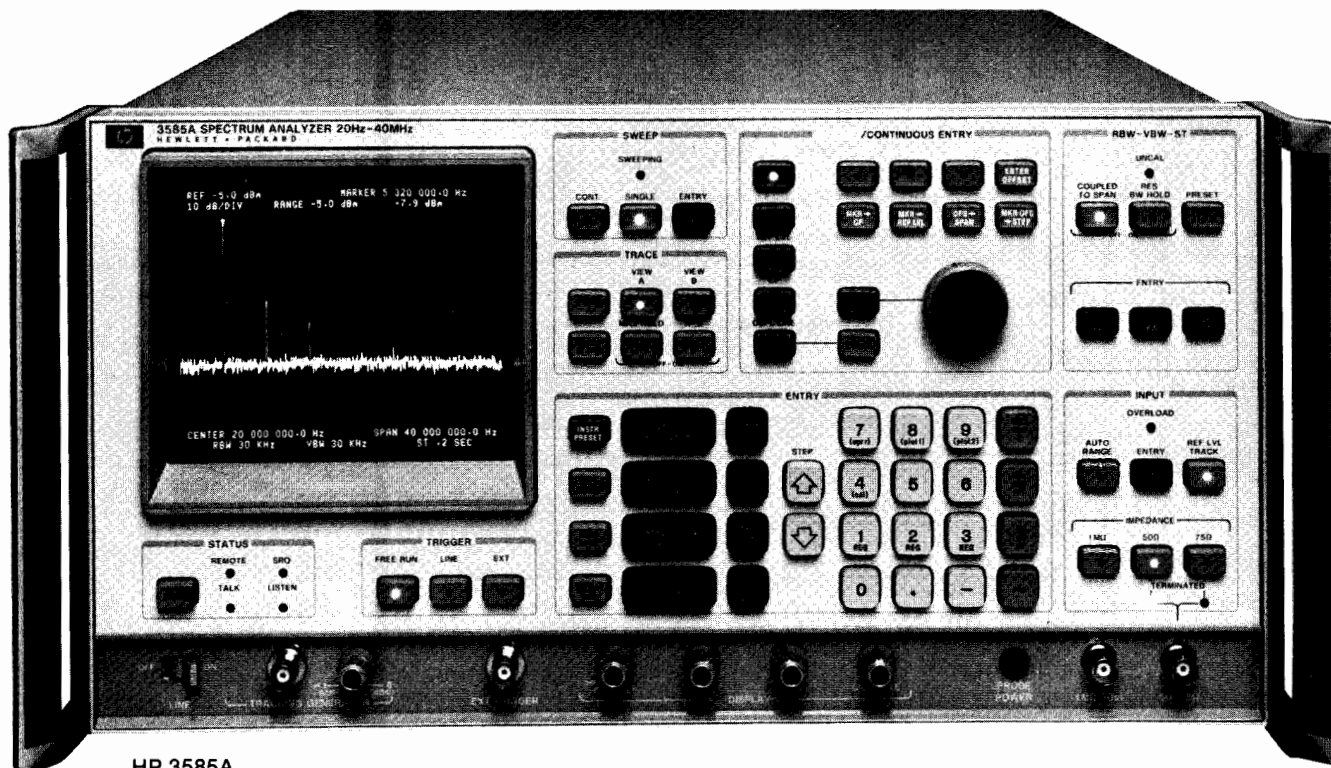

HP 3585A
(Shown with Opt. 907)



Description

The HP 3585A Spectrum Analyzer has a fully synthesized local oscillator controlled by a microprocessor. The result of this state-of-the-art contribution offers outstanding performance over its frequency range of 20 Hz to 40.1 MHz. Center frequency and span settings have 0.1 Hz resolution and 1×10^{-7} /mo. stability over its entire operating range. The frequency precision and stability enables the 3 Hz resolution bandwidth filter to be used for close-in analysis even at 40 MHz.

An automatic internal calibration routine, administered by the microprocessor, provides up to ± 0.4 dB accuracy over most of the measurement range. Improvements in measurement performance of this magnitude cannot be realized by the user unless the basic limitations of the CRT display are bypassed. This has been accomplished by digitizing the detected video signal, which is then stored in memory. Photographic documentation of the display is greatly simplified by displaying all the essential frequency, amplitude and resolution parameters alpha-numerically around the edge of the CRT.

The power of the microprocessor provides a bonus by making this analyzer easier to use. Several of the usually tedious operations, such as centering a signal, raising it to the reference level, etc., are now simplified with dedicated key operated routines working in conjunction with the display marker. Adjustment of resolution and video bandwidth when modifying span is now an automatic function unless individual manual selection is required. In addition, new functions have been added, such as noise power density measurements and off-set capability for both frequency and amplitude.

Measurement Power & Convenience

The power and convenience of the HP 3585A's microcomputer-based controls and CRT readout simplify and speed use in so many ways that previously impractical analysis now becomes routine. Functions such as center frequency and amplitude reference level may be keyboard-set with 0.1 Hz and 0.1 dB v precision, varied with an 'analog' knob (actually a rotary pulse-generator), or incrementally key-stepped. The autoranging input attenuator eliminates the error-prone task of adjusting the attenuator to achieve the correct mixer level.

A tunable marker in the HP 3585A makes basic measurements precise and quick by directly measuring a signal or by speeding the process of magnifying the portion of the spectrum to be analyzed. With the marker set to the signal peak, signal amplitude and frequency (with counter accuracy) are numerically displayed on the CRT. A second marker makes relative measurements instantly available with numerical display of the difference in amplitude and frequency between the two markers. This is useful for modulation, distortion measurements, and bandwidth measurement. For example, in the case of telecommunications applications, the second marker can be set at harmonic or channel spacing from the first so the operator can simply step frequencies to track higher order harmonics or additional channels.

Amplitude and frequency may be offset to normalize values to some reference signal such as a pilot tone or to reflect the relative value of a signal. Other amplitude units, such as dBV or volts, can be chosen. On any occasion all settings can be stored, then later recalled with a short key sequence. As many as three sets of settings may be stored.

Two different traces, each of 1001 horizontal points, may be taken, stored in memory, then shown separately or together as desired while comparisons among them may be calculated and displayed digitally on the CRT. A Max Hold key causes the largest amplitude in successive sweeps to be displayed, making it easy to measure residual FM or drift. A built-in tracking generator, with a maximum output of 0 dBm, enables frequency response measurements to be made.

Automatic Measurements

Not only are all HP 3585A functions remotely-programmable via the HP Interface Bus (IEEE Standard 488-1975), the instrument also can be commanded to transfer its measurements out via the bus for interpretation and further interaction by a computing controller. The analyzer can be remotely tuned with the precision of the synthesizer, while retaining analog sweep and exceptional spectral purity.

HP-IB Interface Functions:

SH1, AN1, T6, L4, SR1, RL1, TP0, DC1, DT1, C0

Frequency Accuracy

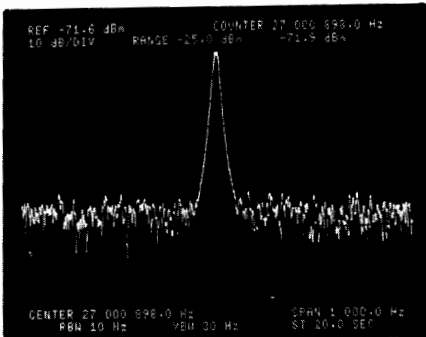

Counter measurements with spectrum analyzer selectivity and sensitivity can be made to 1×10^{-7} /mo. stability while sweeping or manually tuning.

Dynamic Range

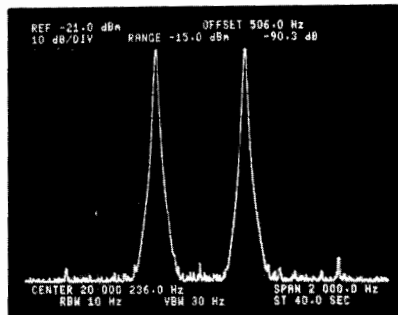

>80 dB spurious free dynamic range with full scale inputs of -25 dBm to +30 dBm in 5 dB steps. Autoranging input provides full dynamic range with no guesswork.

Internal Calibration

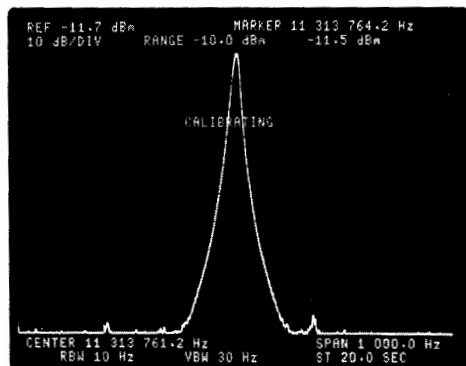

Maximum accuracy is assured at all times by an automatic internal calibration routine which compensates for frequency and amplitude errors in measurements made at the reference level at the center of the screen.

Swept Response Measurements

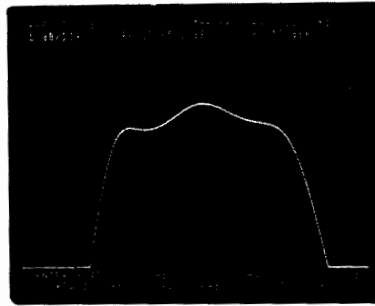

The built-in tracking generator offers superb stability and resolution for crystal filters as well as excellent flatness for wideband devices. The 1 dB/div. amplitude scale is used to expand and resolve small amplitude differences with .01 dB resolution using the marker-readout.

Marker Aided Measurements

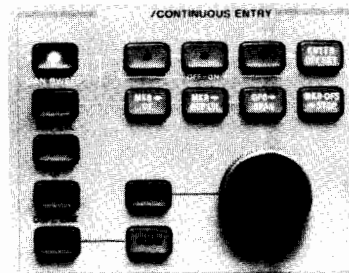

Along with the marker readout capability, there are three additional functions: counter measurements, noise level measurements, and offset (relative) measurements. The four operating aids just above the knob indicate that the marker or offset value can be directly entered into the center frequency, reference level, frequency span, or center frequency step size.

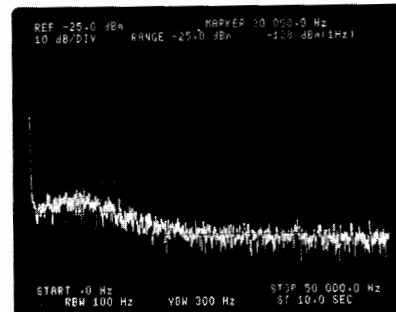

Noise Measurement

The noise level key displays RMS noise density normalized to a 1 Hz bandwidth at the marker position. All correction factors are accounted for in the internal measurement routine.

Terminal Interaction

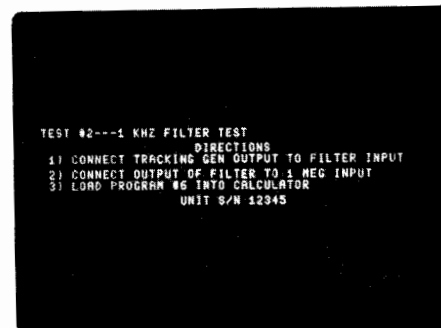

Measurement routines selected from the controller memory via the



SIGNAL ANALYZERS

20 Hz to 40 MHz Spectrum Analyzer (cont.)

analyzer keyboard, such as this filter test, can provide instructions to the operator to minimize errors and reduce training time for complex measurements.

Specifications

Frequency

Measurement range: 20 Hz to 40.1 MHz

Displayed Range

Frequency Span

Range: 0 Hz to 40.1 MHz variable with 0.1 Hz resolution or 10 Hz to 40 MHz in 1, 2, 5 steps

Accuracy: $-0\% + 0.2\%$ of frequency span setting

Center, Start/Stop, and Manual Frequency

Range: 0 Hz to 40.1 MHz with 0.1 Hz resolution

Accuracy: 1×10^{-7} /month of frequency

Marker

Readout accuracy: $\pm 0.2\%$ of frequency span \pm resolution bandwidth

Counter accuracy: ± 0.3 Hz $\pm 1 \times 10^{-7}$ /month of counted frequency for a signal 20 dB greater than other signals and noise in the resolution bandwidth setting

Resolution

Resolution Bandwidths

Range: 3 dB bandwidths of 3 Hz to 30 kHz in a 1, 3, 10 sequence

Accuracy: $\pm 20\%$ at the 3 dB points

Selectivity: 60 dB/3 dB $< 11:1$

Amplitude

Measurement range: -137 dBm to $+30$ dBm (50/75 Ω) or equivalent level in dBV or volts, 31 nV to 22 V (1 M Ω)

Displayed Range

Scale: 10 division CRT vertical axis with Reference Level at the top graticule line

Calibration: 10, 5, 2 and 1 dB/division from the Reference Level

Input range: -25 dBm to $+30$ dBm in 5 dB steps

Reference Level (relative to input range)

Range: -100 dB to $+10$ dB

Accuracy (using 1 or 2 dB/div., at midscreen with sweep rate reduced by 4 or at the manual frequency)

50/75 Ω Input

$+10$ dB -50 dB -70 dB -90 dB

| | | |
|--------------|--------------|--------------|
| ± 0.4 dB | ± 0.7 dB | ± 1.5 dB |
|--------------|--------------|--------------|

1 M Ω Input - add to above

20 Hz 10 MHz 40.1 MHz

| | |
|--------------|--------------|
| ± 0.7 dB | ± 1.5 dB |
|--------------|--------------|

Amplitude Linearity (referred to reference level)

0 dB -20 dB -50 dB -80 dB -95 dB

| | | | |
|--------------|--------------|--------------|--------------|
| ± 0.3 dB | ± 0.6 dB | ± 1.0 dB | ± 2.0 dB |
|--------------|--------------|--------------|--------------|

Frequency Response (referred to center of span)

50/75 Ω input: ± 0.5 dB

1 M Ω Input

20 Hz 10 MHz 40.1 MHz

| | |
|--------------|--------------|
| ± 0.7 dB | ± 1.5 dB |
|--------------|--------------|

Marker

Amplitude Accuracy

Midscreen at the reference level: use Reference Level accuracy from $+30$ dBm to -115 dBm, add Amplitude Linearity below -115 dBm.

Anywhere on screen: add Reference Level Accuracy, Amplitude Linearity and Frequency Response.

Dynamic Range

Spurious Responses (image, out of band, and harmonic distortion)

50/75 Ω input: < -80 dB referred to a single signal equal to or less than Input Range

1 M Ω input: < -80 dB except second harmonic distortion < -70 dB

Intermodulation Distortion

50/75 Ω input: < -80 dB referred to the larger of two signals

each ≥ 6 dB below Input Range except 2nd order IM from 10 MHz to 40 MHz < -70 dB

1 M Ω input: < -70 dB

Residual responses (no signal at input): < -120 dBm using -25 dBm range

Average Noise Level

50/75 Ω Input

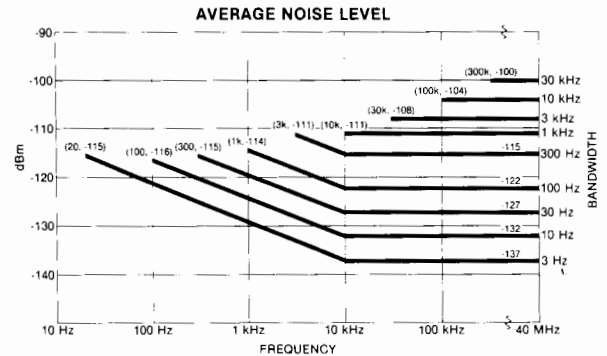

1 M Ω input: Below 500 kHz add 12 dB to above

Sweep

Modes: continuous, single or manual

Trigger: free Run, Line, or External

Time: 0.2 s full sweep to 200 s/Hz of Frequency Span (swept time excluding auto calibration cycles)

Input

Signal Inputs

50/75 Ω : > 26 dB return loss, BNC connector

1 M Ω : $\pm 3\%$ shunted by < 30 pF, BNC connector

Maximum Input Level

50/75 Ω : 13 V peak ac plus dc relay protected against overloads to 42 V peak.

1 M Ω input: 42 V peak ac plus dc (derate by factor of two for each octave above 5 MHz).

External trigger input: negative going TTL level or contact closure required to initiate sweep.

External reference input: 10MHz (or subharmonic to 1 MHz), 0 dBm minimum level

Output

Tracking Generator

Level: 0 dBm to -11 dBm with a single turn knob

Frequency accuracy: ± 1 Hz relative to analyzer tuning

Frequency response: ± 0.7 dB

Impedance: 50 Ω ; > 14 dB return loss

Probe power: $+15$ Vdc, -12.6 Vdc; 150 mA max.

Suitable for powering HP 1120A Active Probe

External Display

X, Y: 1 volt full deflection; Z: < 0 V to > 2.4 V

Recorder:

X Axis: 10 V full scale

Y Axis: 10 V full scale

Z — penlift output TTL

IF: 350 kHz, -11 dBV to -15 dBV at the reference level

Video: 10 V at the reference level

Frequency reference: 10.000 MHz $\pm 1 \times 10^{-7}$ /month, $+10$ dBm into 50 Ω

General

Environmental

Temperature: operating 0°C to 55°C

Humidity: $< 95\%$ RH except 300 Hz BW $< 40\%$ RH

Warm-up time: 20 minutes at ambient temperature

Power requirements: 115 V ($+11\% -25\%$), 48–440 Hz

230V ($+11\% -18\%$), 48–66 Hz

180 watts 3A max

Weight: 39.9 kg (88 lb)

Size: 229 mm (9") H \times 426 mm (16.75") W \times 635 mm (25") D

Ordering Information

Opt. 907: Front Handle Kit

add \$75

Opt. 908: Rack Flange Kit

add \$40

Opt. 909: Combined Opt. 907 and 908

add \$105

Opt. 910: Extra Manual

add \$200

HP 3585A Signal Analyzer

\$23,700

SIGNAL ANALYZERS

50 Hz to 32.5 MHz Selective Level Meter

Model 3586C

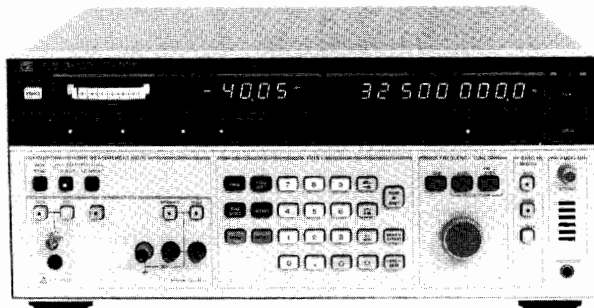

HP 3586C



Description

The HP 3586C selective Level Meter is designed for general purpose wave analysis applications in the design, manufacture, and maintenance of electronic systems.

Microprocessor control and HP-developed fractional-N synthesis provides precise frequency setting and time saving ease-of-use features, and the HP 3586C is fully HP-IB programmable.

The HP 3586C Selective Level Meter covers the frequency range from 50 Hz to 32.5 MHz, allowing measurement of audio, sonar, and other low frequency systems as well as high frequency communications and subsystems. Input impedances of 50, 75, or 600 Ω with 10 k Ω bridging adds measurement flexibility for a wide variety of applications.

Wideband power measurements can be made up to 32.5 MHz and down to -45 dBm. Measure selectively in LO distortion or LO noise modes or use USB or LSB for single sideband demodulation of a carrier.

Measurement Precision

Signal levels are measured with up to ± 0.2 dB accuracy down to -80 dBm with .01 dB resolution and bandwidth choices of 20, 400, or 3100 Hz. Automatic level calibration eliminates the need for manual calibration operations prior to critical level measurements. Frequency can be set precisely with 0.1 Hz resolution and $\pm 1 \times 10^{-5}$ stability ($\pm 2 \times 10^{-7}$ optional). The built-in frequency counter allows you to measure the frequency of a signal greater than -100 dBm within the filter bandwidth chosen and then tune the center of the filter passband precisely to that signal with one keystroke.

Selective Measurements

Make measurements on signals as close as 80 Hz spacing with 50 dB rejection using the 20 Hz filter. Use the extremely selective 3100 Hz filter for telecommunications channel level or noise measurements with 60 dB carrier rejection and 75 dB adjacent channel rejection, or demodulate the upper or lower sideband signal for further processing and listen to it with the speaker output.

Digital or Analog Frequency Control

Frequencies may be entered directly on the keyboard with 0.1 Hz resolution and then changed by entering any step size and stepping up or down in frequency, or use the analog frequency tune control. The analog frequency tune control will change frequency in automatically chosen steps proportional to the bandwidth chosen, or in the step size entered.

Tracking Synthesizer

The HP 3586C will operate in the frequency tracking mode with either the HP 3336C Synthesizer (see page 456) for measurements up to 20.9 MHz, or the HP 3335A Synthesizer (see page 455) for full frequency coverage up to 32.5 MHz. The tracking synthesizer will automatically tune to the frequency programmed on the HP 3586C in the tracking mode when their HP-IB interfaces are connected together with a bus cable.

Use the tracking mode to save time in amplitude-only network analysis or for loop-around measurements in telecommunications systems.

Frequency Response Measurements

The HP 3586C includes a rear panel tracking output of approximately 0 dBm amplitude and $\pm .5$ dB flatness at the same frequency as the passband center frequency. The tracking output has the same accuracy, stability and resolution as the HP 3586C center frequency specifications. This means the tracking output can be used for frequency response testing of high-Q filters and other selective networks. External attenuators can be used to adjust the input and output levels of the device under test to acceptable ranges.

For applications requiring improved amplitude accuracy and flatness, full amplitude range control without external attenuators, or better signal purity, use the HP 3336C or HP 3335A tracking synthesizer in place of the HP 3586C tracking output. By automatically tracking the frequency of the HP 3586C, the tracking synthesizers improve the accuracy and flexibility of frequency response measurements without increasing the measurement time.

Distortion Measurements

The front panel convenience features of the HP 3586C allow fast, accurate measurement of individual harmonic levels. To measure harmonic levels relative to the fundamental, first measure the fundamental signal level, and enter that level as an offset. Then, enter a frequency step size equal to the fundamental frequency. Now you can quickly step to the harmonic frequencies and measure the harmonic distortion directly without time-consuming calculations. When the exact fundamental frequency is unknown, the built-in counter can be used to measure the fundamental frequency, thereby ensuring precise tuning and accurate measurement.

Intermodulation distortion can also be measured quickly by storing the intermod frequencies and front panel settings in the non-volatile storage registers of the HP 3586C.

Verifying the total harmonic distortion specifications of sources and amplifiers is a laborious measurement unless a special purpose distortion analyzer is used. With a simple routine in a controller such as the HP 85B Personal Computer, the HP 3586C can be used to quickly measure total harmonic distortion as well as individual harmonic levels.

| TOTAL HARMONIC DISTORTION TEST | | | |
|--------------------------------|-------------|--------------|--|
| FUNDAMENTAL FREQ | | ABSOLUTE AMP | |
| 10.805 1 Hz | | 1.18 dBm | |
| HARMONIC FREQ | | RELATIVE AMP | |
| 2 | 21.610 2 Hz | -50.65 dB | |
| 3 | 32.415 3 Hz | -50.36 dB | |
| 4 | 43.220 4 Hz | -72.35 dB | |
| 5 | 54.025 5 Hz | -50.55 dB | |
| 6 | 64.830 6 Hz | -67.73 dB | |
| THD = -46.89 dB OR 0.45 % | | | |

The HP 3586C and an HP computer were used to characterize a function generator for total harmonic distortion as well as harmonic level.

SIGNAL ANALYZERS

50 Hz to 32.5 MHz Selective Level Meter

Model 3586C (con't)

HP 3586C Specifications

Frequency

Frequency range: 50/75 Ω unbalanced input, 50 Hz to 32.5 MHz; 600 Ω Balanced Input, 50 Hz to 108 kHz

Frequency resolution: 0.1 Hz

Center frequency accuracy: $\pm 1 \times 10^{-5}$ /year, ($\pm 2 \times 10^{-7}$ /year with option 004).

Counter accuracy: ± 1.0 Hz in addition to center frequency accuracy for signals within the 60 dB bandwidth of the IF filter chosen or greater than -100 dBm (largest signal is measured).

Frequency display: 9 digit LED

Selectivity

3 dB bandwidth,* $\pm 10\%$: 20 Hz, 400 Hz, 3100 Hz

*Noise bandwidth is the same as the 3 dB bandwidth

60 dB bandwidth: 3100 Hz BW, ± 1850 Hz; 400 Hz BW, ± 1100 Hz; 20 Hz BW, ± 90 Hz

Adjacent channel rejection: 75 dB minimum at ± 2850 Hz, 3100 Hz BW

Passband flatness ± 0.3 dB

Passband Flatness

| Bandwidth | Flatness Range | Flatness |
|-----------|----------------|-----------|
| 3100 Hz | ± 1000 Hz | ± 0.3 |
| 400 Hz | ± 50 Hz | dB |
| 20 Hz | ± 3 Hz | |

Amplitude

Measurement range: +20 to -120 dBm

Amplitude resolution: .01 dB

Level accuracy: 10 dB auto range, low distortion mode, after calibration, signal at ± 1 Hz from center frequency.

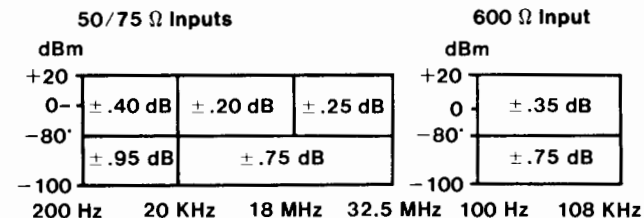

*20 Hz & 400 Hz BW below -90 dBm

Level accuracy: 100 dB range (after calibration), add correction to 10 dB auto-range accuracy for dB below full scale. (Not required when in 10 dB auto-range.)

| dB Below Full Scale | Accuracy Correction |
|---------------------|---------------------|
| 0 to -20 dB | $\pm .25$ dB |
| -20 to -40 dB | $\pm .50$ dB |
| -40 to -80 dB | ± 2.0 dB |

Wideband power accuracy: after calibration, 100 dB range, average on, -45 to +20 dBm.

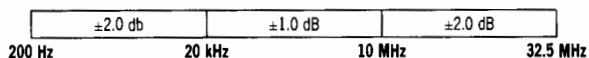

Dynamic Range

Spurious Responses

-110 dBm maximum or the following, whichever is greater:

Image rejection (100-132 MHz): -80 dBc

IF rejection: 15625 Hz, -80 dBc; 50 MHz, -60 dBc

Spurious signals: >1600 Hz offset, >-80 dBc; 300 Hz to 1600 Hz, >-75 dBc

Residual spurious: -110 dBm maximum; <350 Hz, -95 dBm

Distortion

Harmonic distortion: -75 dB below full scale, low distortion mode, above 4 kHz.

Intermodulation distortion: two-tone second and third order, separation 10 kHz to 1 MHz, -78 dB below full scale. Either tone ≥ 10 MHz, -70 dB.

Noise Floor (full scale setting -35 to -120 dBm)

| Frequency | Bandwidth | Noise Level |
|---------------------|---------------|-------------|
| 100 kHz to 32.5 MHz | 3100 | -114 dBm |
| | 20 Hz, 400 Hz | -120 dBm |
| 2 kHz to 100 kHz | All | -105 dBm |

The noise floor for full scale settings of -30 to +25 dBm will be 75 dB below full scale for >100 kHz, or 55 dB below full scale for <100 kHz.

Signal Inputs

| Impedance | Frequency | Mating Connector |
|-----------------------|-------------------|---------------------------------------|
| 50/75 ohms unbalanced | 50 Hz to 32.5 MHz | BNC |
| 600 ohms balanced | 50 Hz to 108 kHz | Dual Banana Plug 0.75 inch Spacing |

Return loss: 50/75 Ω , 30 dB; 600 Ω , 25 dB

Balance: 600 Ω ; 40 dB

Demodulated Audio Output

Output level: 0 dBm into a 600 Ω load

Output connector: 1/4" jack, mates with WECO 347.

Auxiliary Signal Inputs/Outputs

Tracking output: 0 dBm rear panel tracking output

Ext. reference input: 1 MHz to 10 MHz or sub-harmonic input.

Reference output: 10 MHz at 8 dBm output (also 10 MHz oven oscillator on instruments with option 004).

Probe power: front panel dc output for HP active high impedance accessory probes, (+15, -12 Vdc)

HP-IB Interface Functions: SH1, AH1, T6, L4, SR1, RL1, PP1, DC1, DT1, C1, C3, C28

Additional outputs: audio, phase jitter and meter output.

Options

Option 004: High stability frequency reference: 10 MHz oven stabilized reference oscillator improves frequency stability to $\pm 2 \times 10^{-7}$ /year.

General

Operating Environment

Temperature: 0° to 55°C

Relative humidity: 95%, 0° to 40°C

Altitude: $\leq 15,000$ ft., ≤ 4600 metres

Storage environment temperature: -40°C to 75°C

Storage altitude: $\leq 50,000$ ft., $\leq 15,240$ metres

Power: 100/120/220/240 V, +5%, -10%, 48 to 66 Hz, 150 VA

Weight: 23 kg. (50 lb) net; 30 kg. (65 lb) shipping

Size: 177 mm H x 425.5 mm W x 475.5 mm D (7" x 16.75" x 16.75")

HP 3586C Selective Level Meter*

\$10,000

Opt 004: High Stability Frequency Reference

add \$750

Opt 907: Front Panel Handles

add \$65

Opt 908: Rack Flange Kit

add \$35

Opt 909: Rack Flange & Handle Combination Kit

add \$90

Accessories

HP 1124A: High Impedance Probe

\$325

*HP-IB cables not supplied. See page 121.

SIGNAL ANALYZERS

Downloadable Programming Capability

Models 71000 Series, 8566B, 8567A & 8568B



- Expand your measurement capability
- Simplify your measurement tasks

The HP 71000, 8566B, 8567A, and 8568B spectrum analyzers give you built-in capability to store and run programs and to control other instruments over the HP-IB. Programs written on a computer are "downloaded" into the analyzer, which stores them in its battery-backed, continuous memory. The computer can then be disconnected, freeing it for other uses, because the spectrum analyzer alone executes the downloaded programs (DLPs). Complex tests can be made, even by a non-expert operator, with immediate results. You now have an easy-to-use, customized instrument that provides accurate, repeatable measurements and whose manual operation is friendlier than ever before.

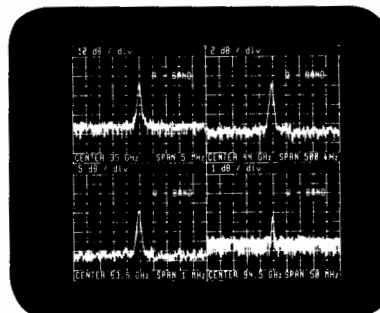
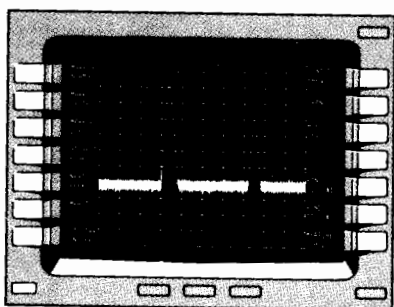

Automatic Multi-band Coverage

Under the control of a downloaded program, a single HP 71000 spectrum analyzer system can collect data and display results of multi-band coverage. By switching alternately between an RF section and three external mixer interface inputs, one analyzer can span the frequency range from 50 kHz to 75 GHz in just four broad-band sweeps. The DLP lets you view results from all bands in a single window or use multiple windows to display close-up sections of interest.

Customized Menus

Create your own softkey menus for one-button solutions to complicated measurement problems. A label on the CRT of an HP 71000 series modular spectrum analyzer indicates what downloaded function or test routine will be executed when the adjacent key is pressed.

Or, develop a menu of measurement routines and load it into the memory of an HP 8566B, 8567A, or 8568B Spectrum Analyzer. Then only the shift and number keys are needed to access each downloaded measurement routine contained in the downloaded menu.

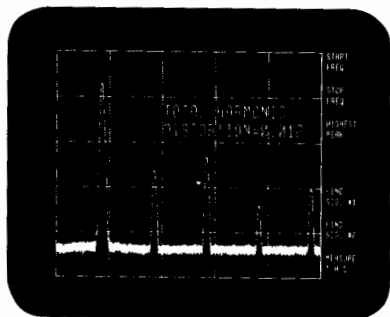

Programmed Efficiency

The following program excerpt directs the spectrum analyzer to measure Total Harmonic Distortion. A downloaded program like this executes a complete measurement routine in one easy step. The operator no longer has to manually perform a complex series of measurements and computations; the DLP provides repeatable results automatically.

```

2201 REPEAT
2301 CF UP;TS;MKPK HI
2401 ADD THD,THD,MKA
2501 ADD N,N,1
2601 UNTIL N,GE,5
2701 DIV THD,THD,FUNDAMENTAL
2901 TEXT#TOTAL HARMONIC DISTORTION = $
3001 DSPY THD,G,3
    
```

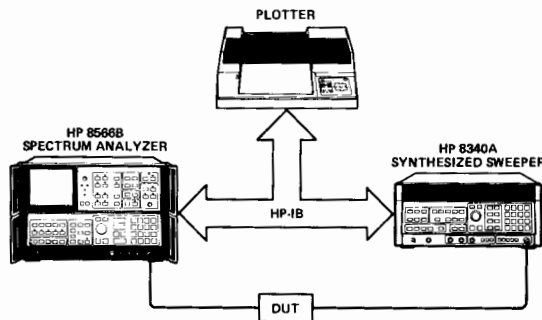

HP-IB Control

A downloaded program can automate stimulus-response testing by using a spectrum analyzer as the HP-IB controller. The DLP directs the analyzer to set the start and stop frequencies of a synthesized sweeper, via the HP-IB, to those of the spectrum analyzer. The downloaded program also regulates the collection and storage of data by the spectrum analyzer and the transmission of results over the HP-IB directly to a plotter.

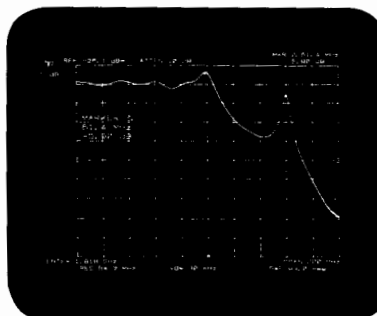



SIGNAL ANALYZERS

Spectrum Analyzers, 100 Hz to 300 GHz

Models 8568B, 8567A & 8566B

- 100 Hz to 1.5 GHz coverage with counter accuracy
- 10 kHz to 1.5 GHz coverage at a lower price
- 100 Hz to 300 GHz coverage with synthesizer accuracy
- 2 to 22 GHz preselected range
- 10 Hz resolution bandwidth
- Trace markers with amplitude and frequency readout
- 16K of RAM for trace data or custom routines
- Create and run routines without controller
- Plot results with or without controller

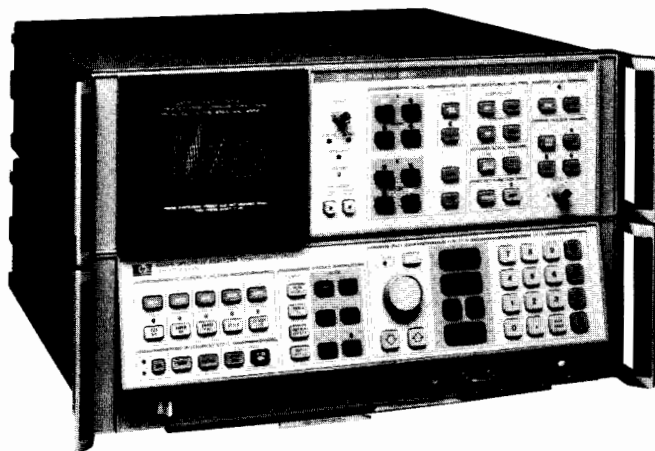

HP 8566B



HP 8568B



The HP 8568B and 8566B are high performance spectrum analyzers for bench and HP-IB system use. The HP 8568B operates over a 100 Hz to 1500 MHz frequency range. The HP 8567A operates over the 10 kHz to 1500 MHz frequency range. It is identical to the HP 8568B in all respects but lower price and reduced RF performance. The HP 8566B operates over a 100 Hz to 22 GHz range, and has preselection from 2 to 22 GHz. The HP 8566B frequency range may be extended to 300 GHz with commercially available mixers. (For external-mixing information, refer to Product Note 8566A-2 or contact your local HP field engineer.)

Each analyzer is designed around its own internal bus and controlled by its own microcomputer to yield significant improvements in operational and data processing features, and flexibility under program control. Each analyzer contains 16K of RAM for storing measurement and data processing routines, which can be created and stored with or without a controller. The performance specifications for the HP 8568B, 8567A and 8566B are on pages 662, 668 and 664, respectively.

Performance

Exceptional frequency stability in both the HP 8568B and 8566B makes measurements with 10 Hz resolution bandwidths possible. Superior spectral purity and narrow resolution let you measure clean oscillators directly at RF frequencies. The 10 Hz resolution bandwidth also yields sensitivities to -135 dBm, which makes greater than 85 dB spurious-free dynamic range achievable. A frequency reference error of 2.5×10^{-7} /year together with the analyzer resolution and sensitivity allow measurements of unequal accuracy of small signals in the presence of large signals.

For applications that don't require the high performance of the 8568B, the 8567A offers the same speed, versatility and automatic capability as the 8568B, at a lower price. Resolution bandwidths from 1 kHz to 3 MHz give sensitivities to -115 dBm and greater than 75 dB of spurious-free dynamic range. A frequency reference error of 5×10^{-6} /year gives the frequency accuracy necessary for many ATE systems. Close-in AM measurements (0.5 Hz - 25 kHz sideband resolution) are made accurately using the Fast Fourier Transform (FFT) function available on the HP 8566B, 8568B, and 8567A.

Usability

Control settings are conveniently notated on the CRT. To activate a function, press a front panel key, then select the function value using the knob, step keys, or numeric keyboard.

Make measurements following conventional "zoom" techniques, using the center frequency, frequency span, and reference level controls. Use the preset function to set all analyzer controls to a convenient starting point. Since certain functions are coupled, a calibrated display is easily maintained. For example, resolution bandwidth and sweptime change automatically when frequency span is reduced.

Use the four tunable markers to measure a signal, or to examine closely a portion of the spectrum. Set a marker at a signal peak to measure the signal amplitude and frequency, which are notated on the CRT. Two markers make relative measurements, such as modulation or distortion measurements, by displaying the amplitude and frequency difference between the markers. Marker information lets you step between evenly spaced portions of the spectrum, like communication channels or signal harmonics, or "zoom-in" on a portion of the spectrum. Other marker functions include converting the noise level at the marker to the RMS noise density normalized to a 1 Hz bandwidth.

Once analyzer controls are set, their configuration can be saved in memory and later recalled to repeat measurements. An internal battery protects memory contents if power fails.

Versatile CRT Display and Plotting Capabilities

All displayed information resides in digital memory which refreshes the CRT at a flicker-free rate. Display multiple traces to measure residual FM or drift, or to conduct real-time surveillance of a wide frequency range. The number of traces displayed is limited by the size of the CRT only. Display titles may be added.

By adding a graphics plotter, system measurements can be plotted for analysis, documentation, and presentation. Recommended HP-IB plotters include the 8-pen HP 7550A, the 6-pen 7475A, the 2-pen 7470A and 7090A Measurement Plotting System which records and annotates analog measurements as well as digital. Plot with or without a controller.

Softkey Programming Lets you Create the Spectrum Analyzer Measurement "Personality"

Softkey programming lets you create measurement routines tailored to your needs. Stored in the analyzer, they can be executed when needed as easily as the analyzer's built-in functions. By defining custom softkeys in the spectrum analyzer, you can create a measurement "personality" that makes the analyzer more efficient for your types of measurements.

Load a keystroke sequence into a softkey from the front panel, using the title function (**SHIFT E**), or load a keystroke sequence into a softkey from a computer:

```
10 OUTPUT 718;"KEYDEF 5,""
20 OUTPUT 718;"MKPK HI;TS;MT1;SP200KZ;"
30 END
```

Execute the stored routine pressing three keys:

SHIFT, a number, **HZ**

Because the HP 8566B, 8567A, and 8568B contain built-in, flow-of-control functions (**REPEAT**, **UNTIL**, **IF**, **THEN**, **ELSE**, and **ENDIF**), measurement routines can be created and stored without the use of a computer. This frees computer time for handling other system components or data processing.

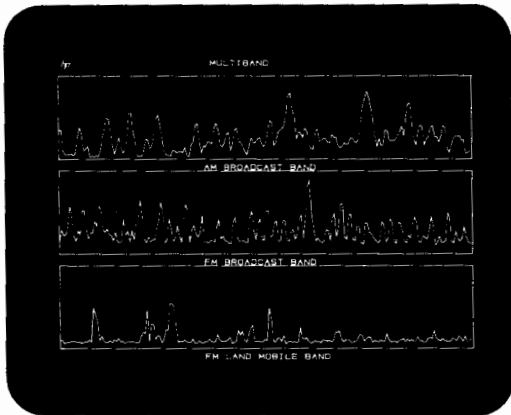

Surveillance Measurement of Multiple Bands Displayed Simultaneously

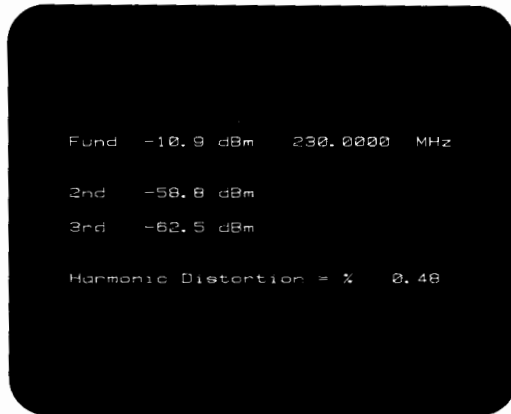

Harmonic Distortion Measurement

The HP 8568B, 8567A and 8566B are able to control HP-IB instruments without a computer connected through the use of softkey programming. See page 659 for more information on this capability.

Automatic Measurement Capability

Operate the HP 8566B, 8567A and 8568B via the HP Interface Bus (IEEE Standard 488-1975) to control all front panel functions, or manipulate or store trace information. The display is accessible for annotation and graphing purposes.

Analyzer and HP-IB commands are easy to understand. For example, CF 20 MZ sets the analyzer center frequency to 20 MHz. Built-in firmware features, such as instrument preset, peak search, and automatic zoom, and flow-of-control commands further simplify writing software.

New signal processing commands include PWRBW, which calculates power bandwidth of a signal, and PEAKS, which identifies all responses on the display. The RMS function finds the RMS value of trace data; MPY multiplies two traces point-by-point.

Flow-of-control functions let you implement your own routines. Since the analyzer can make more decisions and process more data, a system controller can devote more time to handling other measurement or processing tasks.

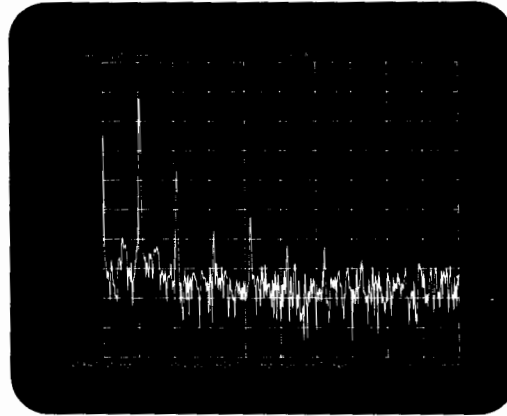

FFT. Performs a fast-fourier transform on the analyzer video signal.

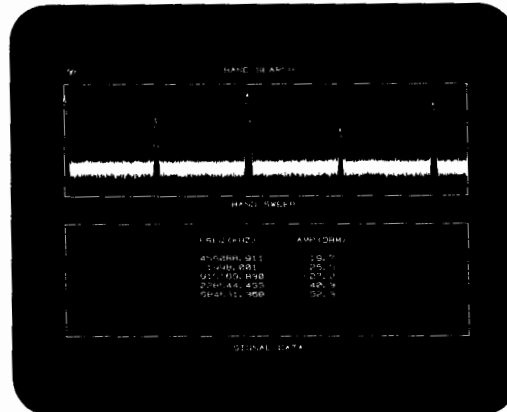

PEAKS. Identifies all responses on the display

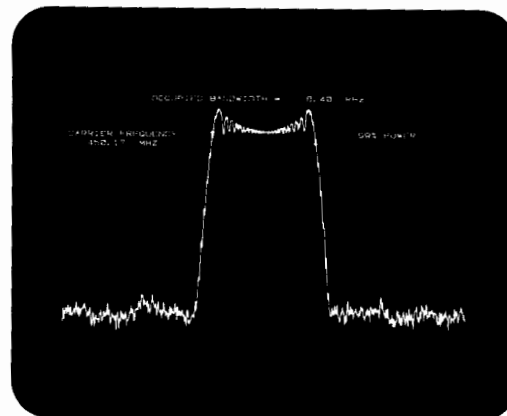

PWRBW. Returns the power bandwidth of a signal.

Compatibility and Retrofit for HP 8566A/8568A Users

Programs written for the HP 8566A or 8568A will also run on the HP 8566B and 8568B. The HP 85862A HPL Software PAC and HP 85863A BASIC Software Library are also compatible. If you would like to enhance your HP 8566A or 8568A with the HP 8566B or 8568B capabilities, contact your Hewlett-Packard service center for retrofit information.



SIGNAL ANALYZERS

Spectrum Analyzer, 100 Hz to 1500 MHz

Model 8568B

- 100 Hz to 1.5 GHz frequency range
- Frequency counter accuracy
- Powerful firmware feature set

- Direct plot capability
- Enhanced signal processing power
- 16K-bytes of user definable RAM

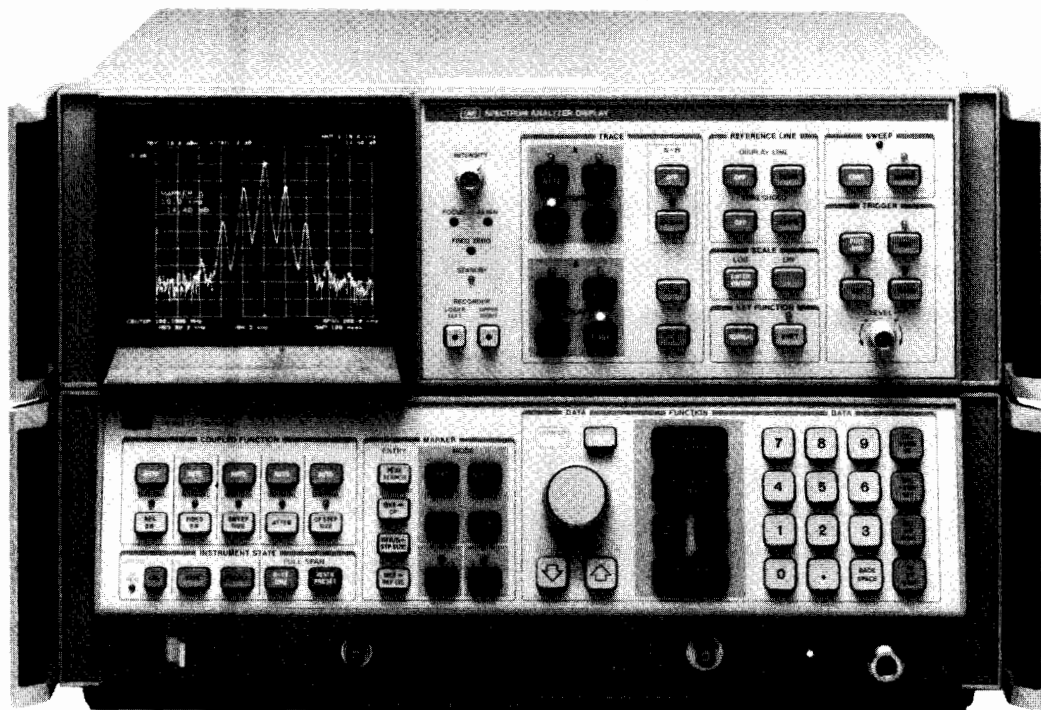

HP 8568B

The HP 8568B Spectrum Analyzer is a high performance spectrum analyzer for bench and remote operation which covers the 100 Hz to 1.5 GHz frequency range. Frequency stabilized local oscillators and an internal counter bring unequaled measurement precision to RF spectrum analysis. Exceptional frequency stability and local oscillator spectral purity enables the use of a 10 Hz resolution bandwidth to make difficult, close-in sideband measurements on RF signals.

The HP 8568B offers 16K of RAM for user defined routines which are accessible via HP-IB or from the front panel. This softkey programming opens new horizons of operator convenience features by allowing the operator to create measurement routines tailored to his or her particular application without the need for a controller. The HP 8568B can also control other HP-IB devices such as printers, signal generators, and power meters via softkey programming. See page 659.

All HP 8568B functions are programmable via HP-IB (IEEE 488-1975). Many high level functions are internally available and return results instead of data to the controller. This allows the controller to perform other tasks, thus execution time can be decreased. Friendly programming codes and easily recognizable mnemonics facilitate learning the analyzer language.

Programs written for the HP 8566A or 8568A will also run on the HP 8566B and 8568B. If you have an HP 8566A or 8568A and would like to enhance your analyzer by adding the capabilities of the "B" version, retrofit kits are available.

HP 8568B Specifications

Frequency

Displayed Range

Frequency span: 100 Hz to 1500 MHz.

Frequency span accuracy: for spans >1 MHz, $\pm(2\%$ of the indicated frequency separation between two points $+0.5\%$ span); for spans ≤ 1 MHz, $\pm(5\%$ of frequency separation $+0.5\%$ span).

Center frequency: 0 Hz to 1500 MHz.

Readout accuracy: span ≥ 100 Hz: $\pm(2\%$ of frequency span + frequency reference error \times tune frequency $+10$ Hz) after adjusting freq zero at stabilized temperature.

Start-stop frequency: permissible values must be consistent with those for center frequency and frequency span.

Readout accuracy: center frequency accuracy $+ 1/2$ frequency span accuracy.

Marker

Normal: frequency at the horizontal position of the tunable marker.

Accuracy: center frequency accuracy + frequency span accuracy between the marker and center frequencies.

Frequency count: displays the frequency signal on whose response the marker is positioned.

Accuracy: for span ≤ 100 kHz: frequency reference error \times displayed frequency $\pm 2 \times$ frequency counter resolution. For span >100 kHz but ≤ 1 MHz: freq. ref. error \times displayed frequency $\pm(10$ Hz $+ 2 \times$ frequency counter resolution). For span >1 MHz: $\pm(10$ kHz $+ 2 \times$ frequency counter resolution).

Frequency reference error: aging rate $< 1 \times 10^{-9}$ /day; temp stability $< 7 \times 10^{-9}$, 0° to 55° C (after 30 day warm-up).

Δ : frequency difference between the stationary and tunable markers.

Accuracy: same as frequency span accuracy; in the **FREQ COUNT** mode, twice the frequency count uncertainty plus drift during the period of the sweep (typically < 10 Hz/minute).

Resolution

Resolution bandwidth: 3 dB bandwidths of 10 Hz to 3 MHz in a 1, 3, 10 sequence.

Bandwidth accuracy: $\pm 10\%$, 1 MHz to 3 kHz; $\pm 20\%$, 1 kHz to 10 Hz, 3 MHz bandwidths.

Bandwidth selectivity: 60 dB/3 dB bandwidth ratio: $< 15:1$, 3 MHz to 100 kHz; $< 13:1$, 30 kHz to 10 kHz; $< 11:1$, 3 kHz to 30 Hz. 60 dB points on 10 Hz bandwidth are separated by < 100 Hz.

Stability

Residual FM: < 3 Hz peak-to-peak for sweep time ≤ 10 sec; span < 100 kHz, res. bandwidth ≤ 30 Hz, video bandwidth ≤ 30 Hz.

Drift: after 1 hr. warmup, < 10 Hz/min. of sweep time for spans ≤ 100 kHz; < 100 Hz/min. of sweep time for 100 kHz $<$ span ≤ 1 MHz; < 300 kHz/min. of sweep time for spans > 1 MHz.

Spectral Purity

Noise sidebands: > 80 dB at frequency offsets $\geq 30 \times$ res. bandwidth, for res. bandwidths ≤ 1 kHz.

Line related sidebands: > 85 dB below the peak of a CW signal.

Amplitude

Measurement range: -135 dBm to $+30$ dBm.

Displayed Range

Scale: over a 10 division CRT vertical axis.

Calibration

Log: 10 dB, 5 dB, 2 dB and 1 dB/division.

Linear: 10% of Reference Level/div when calibrated in voltage.

Fidelity

Log: (over 0 to 90 dB display)

Incremental accuracy: ± 0.1 dB/dB

Maximum cumulative error: (from the reference level)

$\leq \pm 1.0$ dB; ≥ 30 Hz resolution bandwidth

$\leq \pm 2.1$ dB; 10 Hz resolution bandwidth



Linear: $\pm 3\%$ of Reference Level.

Reference Level

Range

Log

+60.0¹ to -139.9 dBm or equivalent in dBmV, dB μ V, volts.

Linear

228.6¹ volts to 0.22 μ volts full scale.

Accuracy: the sum of the following factors determines the reference level accuracy. Depending upon the measurement technique followed after calibration, various of these sources of uncertainty may not be applicable. An internal error correction function calibrates and reduces the uncertainty introduced by analyzer control changes from the error calibration state.

Calibrator uncertainty: ± 0.2 dB.

Frequency response (flatness) uncertainty: (with ≥ 10 dB of RF attenuation) input #1: ± 1 dB, 100 Hz to 500 MHz; ± 1.5 dB 100 Hz to 1500 MHz; input #2: ± 1 dB, 100 kHz to 1500 MHz.

Amplitude temperature drift: at -10 dBm reference level with 10 dB input attenuation and 1 MHz resolution bandwidth, ± 0.05 dB/ $^{\circ}$ C (eliminated by recalibration).

Input connector switching uncertainty: ± 0.5 dB.

Input attenuation switching uncertainty: ± 1.0 dB.

Resolution bandwidth switching uncertainty:² (referenced to 1 MHz bandwidth)—corrected (uncorrected)

| Resolution BW | 20–30 $^{\circ}$ C | 0–55 $^{\circ}$ C |
|-----------------|------------------------------|-------------------|
| 10 Hz | ± 1.1 dB (± 2.0 dB) | (± 4.0 dB) |
| 30 Hz | ± 0.4 dB (± 0.8 dB) | (± 2.3 dB) |
| 100 Hz to 1 MHz | ± 0.2 dB (± 0.5 dB) | (± 2.0 dB) |
| 3 MHz | ± 0.2 dB (± 1.0 dB) | (± 2.0 dB) |

Log scale switching uncertainty: ± 0.1 dB corrected (± 0.5 dB uncorrected).

IF Gain uncertainty: corrected (uncorrected). Assuming: Reference level calibrated to -10 dBm, 10 dB input attenuation. Changes in reference level will contribute the following uncertainty.

| Reference Level | 20–30 $^{\circ}$ C | 0–55 $^{\circ}$ C |
|---------------------|------------------------------|-------------------|
| 0 to -55.9 dBm | | |
| 10 Hz Res BW | ± 1.0 dB (± 1.6 dB) | (± 2.0 dB) |
| ≥ 30 Hz Res BW | ± 0.1 dB (± 0.6 dB) | (± 1.0 dB) |
| -56.0 to -129.9 dBm | | |
| 10 Hz Res BW | (± 2.0 dB) ³ | (± 2.5 dB) |
| ≥ 30 Hz Res BW | (± 1.0 dB) ³ | (± 1.5 dB) |

RF Gain uncertainty (due to 2nd LO shift): ± 0.1 dB corrected (± 1.0 dB uncorrected)

Error correction accuracy: ± 0.4 dB.

Marker

Normal: amplitude at the vertical position of the tunable marker.

Accuracy: sum of calibrator uncertainty, reference level uncertainty, and scale fidelity between the reference level and marker position.

Δ : amplitude difference between the stationary and tunable markers.

Accuracy: sum of scale fidelity and frequency between the two markers.

Reference Lines (display line and threshold)

Accuracy: sum of calibrator uncertainty, reference level uncertainty, and scale fidelity between the reference level and reference line.

Dynamic Range

Spurious responses: for a total signal power ≤ -40 dBm at the input mixer, all image and out-of-band mixing responses, harmonic and intermodulation distortion products are > 75 dB below the total signal power for inputs 10 MHz to 1500 MHz; > 70 dB below the total signal power for input signals 100 Hz to 10 MHz.

Average noise level: (displayed) < -135 dBm for frequencies > 1 MHz with 10 Hz resolution bandwidth, 0 dB input attenuation, 1 Hz video filter.

Video bandwidth: variable from 1 Hz to 3 MHz in a 1, 3, 10 sequence.

Gain compression: < 0.5 dB for signal levels ≤ -10 dBm at the input mixer.

Sweep

Continuous

20 msec to 1500 sec in 1, 1.5, 3, 5, 7.5, 10 sequence.

Accuracy: sweep time ≤ 100 sec, $\pm 10\%$; > 100 sec, $\pm 20\%$.

Zero frequency span: 1 μ sec full sweep (10 divisions) to 10 msec full sweep in 1, 2, 5 sequence; 20 msec full sweep to 1500 sec full sweep in 1, 1.5, 2, 3, 5, 7.5, 10 sequence.

Accuracy: same as continuous.

Single: sweep ≥ 20 msec only.

¹Maximum input must not exceed +30 dBm (damage level).

²30 kHz and 100 kHz bandwidth switching uncertainty figures only applicable $\leq 90\%$ relative humidity.

³Correction only applies over the 0 dBm to -55.9 dBm range.

Input

RF Inputs

Input #1: 100 Hz to 1500 MHz, 50 Ω , BNC connector (Fused); dc coupled.

Reflection coefficient: typically < 0.20 (1.5 SWR) to 500 MHz, < 0.33 (2.0 SWR) 500 MHz to 1500 MHz; ≥ 10 dB input attenuation.

Input #2: 100 kHz to 1500 MHz, 50 Ω , Type N connector; ac coupled.

Reflection coefficient: typically < 0.20 (1.5 SWR); ≥ 10 dB input attenuation.

LO emission: typically < -75 dBm (0 dB RF Atten).

Isolation: > 85 dB between inputs.

Also available: input #1, 100 kHz to 1500 MHz, 75 Ω , BNC connector, ac coupled (Opt 001).

Maximum Input Level

AC: continuous power, +30 dBm (1 watt); 100 watts, 10 μ sec pulse into ≥ 50 dB attenuation.

DC: Input 1, 0 volts; Input 2, ± 50 volts.

Input attenuator: 70 dB range in 10 dB steps.

Accuracy: ± 1.0 dB over 10-70 dB range.

External frequency reference input (rear panel)

Must equal 10 MHz ± 100 Hz, 0 dBm (+10 dBm max.), 50 Ω nominal input impedance.

Quasi-peak (rear panel; nominal values)

Video input: 0–2 Volts. 139 Ω input impedance.

21.4 MHz input: input is nominally -11 dBm (with spectrum analyzer input attenuator set to 10 dB). 50 Ω input impedance.

Output

Calibrator: 20 MHz ± 20 MHz x frequency reference error (1 $\times 10^{-9}$ /Day), -10 dBm ± 0.2 dB; 50 Ω .

Probe power: +15 V, -12.6 V; 150 mA max.

Auxiliary (rear panel; nominal values)

Display: X, Y and Z outputs for auxiliary CRT displays. X, Y: 1 volt full deflection; Z: 0 to 1 V intensity modulation, -1 V blank.

Recorder

Horizontal sweep output (x axis): 0 V for left edge to +10 V for right edge.

Video output (y axis): Increases 100 mV/div from 0 to 1 V. Output impedance $\leq 475\Omega$.

Penlift output (z axis): 15 V blanking output during retrace.

21.4 MHz IF: 50 Ω , nominally -20 dBm for a signal at the reference level.

1st LO: 2–3.7 GHz, $> +4$ dBm; 50 Ω output impedance.

Frequency reference: 10.000 MHz, 0 dBm; 50 Ω output impedance.

Quasi-peak (rear panel; nominal values)

Video output: 0–2 volts. Output impedance $< 139\Omega$.

21.4 MHz output: output is nominally -11 dBm (with spectrum analyzer input attenuator set to 10 dB). 50 Ω output impedance.

HP-IB Interface Functions

SH1, AH1, T6, L4, SR1, RL1, PP0, DC1, DT1, C1, C2, C3, C27. For more on these codes, refer to the HP-IB section of this catalog.

General

Environmental

Temperature: operating 0 $^{\circ}$ C to 55 $^{\circ}$ C, storage -40 $^{\circ}$ C to +75 $^{\circ}$ C.

Humidity: operating $< 95\%$ R.H., 0 $^{\circ}$ C to 40 $^{\circ}$ C except as noted.

EMI: 8568B conducted and radiated interference is within the requirements of CE03 and RE02 of MIL STD 461A, VDE 0871, and CISPR pub'n 11.

Power requirements: 50 to 60 Hz; 100, 120, 220 or 240 volts (+5%, -10%); approximately 450 VA (40 VA in standby). 400 Hz operation is available as Opt 400.

Weight: total net, 45 kg (100 lb); Display/IF Section, 21 kg (46 lb); RF Section, 24 kg (54 lb). Shipping net, 72 kg (158 lb); Display/IF Section, 27 kg (60 lb); RF Section, 32 kg (70 lb); Manuals and Accessories, 13 kg (28 lb).

Size: 267 H x 425.5 W x 558.8 mm D (10.5" x 16.75" x 22").

Ordering Information

HP 8568B Spectrum Analyzer Price \$34,600

Opt 001: 75 Ω (BNC), 100 kHz to 1500 MHz RF Input #1 add \$200

Opt 010: Rack Slide Kit add \$450

Opt 400: 400 Hz Power Line Frequency Operation add \$400

Opt 908: Rack Flange Kit add \$60

Opt 910: Extra Manual add \$350

Opt 913: Rack Flange Kit to Mount Instruments With Handles add \$70

HP 8568A + 01K Retrofit Kit add \$2500

SIGNAL ANALYZERS

Spectrum Analyzer, 100 Hz to 300 GHz

Model 8566B

- 100 Hz to 22 GHz, external mixing to 300 GHz
- Synthesizer frequency accuracy
- Direct plot capability
- Expanded firmware feature set
- Enhanced signal processing power
- 16K-bytes of user RAM

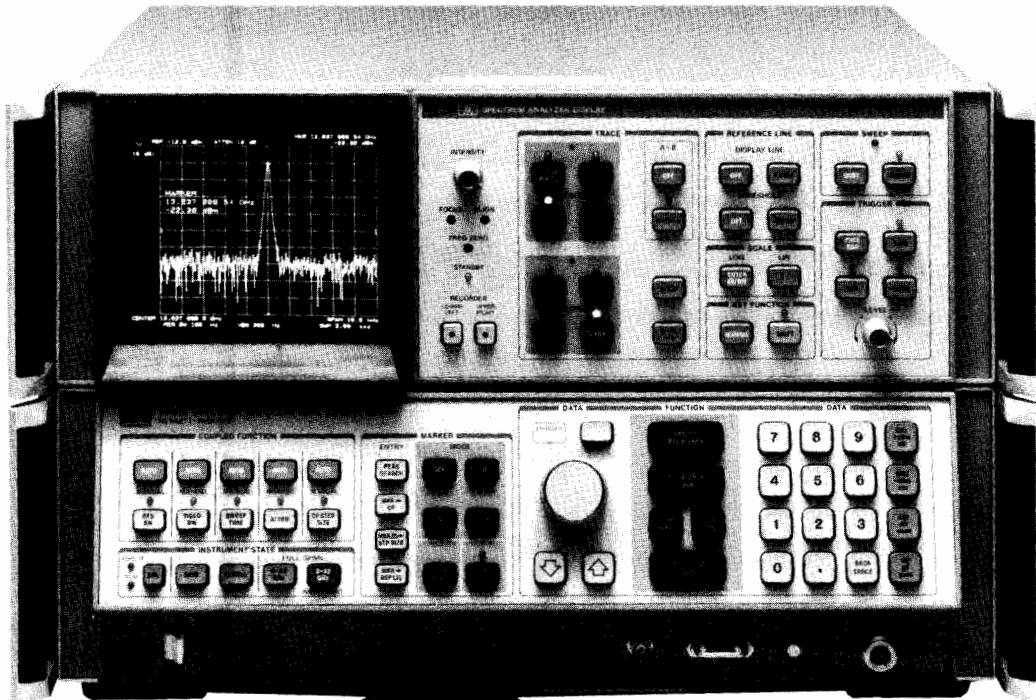

HP 8566B



The HP 8566B Spectrum Analyzer is a high performance spectrum analyzer for bench and remote operation which operates from 100 Hz to 22 GHz using internal mixing. The frequency range may be extended to 110 GHz with the 11970 series external mixers and to 300 GHz with commercially available mixers. (For more information on external mixing, see Product Note 8566A-2 or contact your local HP field engineer). A synthesized local oscillator yields counter-like accuracy at microwave and millimeter wave frequencies. 10 Hz resolution bandwidth an superior frequency stability allow difficult measurements such as line-related sideband characterization at 22 GHz.

The HP 8566B offers 16K of RAM for user defined routines which are accessible via HP-IB or from the front panel. This softkey programming opens new horizons of operator convenience features by allowing the operator to create measurement routines tailored to his or her particular application without the need for a controller. The HP 8566B can also control other HP-IB devices such as printers, signal generators and power meters via softkey programming. See page 659.

All HP 8566B functions are programmable via HP-IB (IEEE 488-1975). Many high level functions are internally available and return results instead of data to the controller. This allows the controller to perform other tasks, thus execution time can be decreased. Friendly programming codes and easily recognizable mnemonics facilitate learning the analyzer language.

A unique integrated preselector/mixer provides high sensitivity with preselection from 2 GHz to 22 GHz. For example, in a 10 Hz resolution bandwidth, the sensitivity at 18 GHz is < -119 dBm. Programs written for the HP 8566A or 8568A will also run on the HP 8566B and 8568B. If you have an HP 8566A or 8568A and would like to enhance your analyzer by adding the capabilities of the "B", retrofit kits are available.

HP 8566B Specifications

Frequency

Measurement range: 100 Hz to 22 GHz with internal mixer, dc coupled input; 18.6 GHz to 110 GHz with the 11970 series external mixer set; 110 GHz to 300 GHz with commercially available external mixers.

Displayed Values

Center frequency: 0 Hz to 300 GHz.

Readout accuracy: (AUTO resolution bandwidth after adjusting frequency zero at stabilized temperature, and using the error correction function, SHIFT W and SHIFT X) spans $\leq n \times 5$ MHz: $\pm(2\%$ of frequency span + frequency reference error \times center frequency + 10 Hz); spans $> n \times 5$ MHz: $\pm(2\%$ of frequency span + $n \times 100$ kHz + frequency reference error \times center frequency) where n is the harmonic number, depending on center frequency:

| n | Center Frequency (internal mixing) | n | Center Frequency (external mixing) |
|---|---------------------------------------|----|---------------------------------------|
| 1 | 0 Hz to 5.8 GHz | 6 | 18.6 GHz to 26.5 GHz |
| 2 | 5.8 GHz to 12.5 GHz | 8 | 26.5 GHz to 40.0 GHz |
| 3 | 12.5 GHz to 18.6 GHz | 10 | 40.0 GHz to 60.0 GHz |
| 4 | 18.6 GHz to 22 GHz | 14 | 50.0 GHz to 75.0 GHz |
| | | 18 | 75.0 GHz to 110.0 GHz |

Frequency span: 0 Hz to 22 GHz over 10 division CRT horizontal axis; variable in approximately 1% increments.

Full span: 0 to 2.5 GHz and 2 to 22 GHz. 2 to 22 GHz is selected with INSTR PRESET.

Readout accuracy: spans $\leq n \times 5$ MHz, $\pm 1\%$ of indicated frequency separation; spans $> n \times 5$ MHz, $\pm 3\%$ of indicated frequency separation.

**Start/stop frequency:****Readout accuracy:** same as center frequency.**Frequency reference error:** $<1 \times 10^{-9}$ /day and $<2.5 \times 10^{-7}$ /year.**Resolution****Resolution bandwidth:** 3 dB bandwidths of 10 Hz to 3 MHz in a 1, 3, 10 sequence. Bandwidth may be selected manually or coupled to frequency span.**Bandwidth accuracy:** calibrated to: $\pm 20\%$, 3 MHz to 10 Hz; $\pm 10\%$, 1 MHz to 3 kHz.**Bandwidth selectivity:** 60 dB/3 dB bandwidth ratio: $<15:1$, 3 MHz to 100 kHz; $<13:1$, 30 kHz to 10 kHz; $<11:1$, 3 kHz to 30 Hz. 60 dB points on 10 Hz bandwidth are separated by <100 Hz.**Stability****Residual FM (typical):** for fundamental mixing ($n = 1$); <50 kHz peak-to-peak, frequency span ≥ 5 MHz; <200 Hz peak-to-peak, frequency span ≤ 5 MHz; <5 Hz peak-to-peak, frequency span <100 kHz; <0.2 Hz peak-to-peak, frequency span <5 kHz.**Drift (typical):** after 1 hour warm-up at stabilized temperature. COUPLED FUNCTION not required.**Frequency Span** <100 kHz
100 kHz to 5 MHz
 ≥ 5 MHz**Center Frequency Drift** <10 Hz/minute of sweeptime
 <500 Hz/minute of sweeptime
 <5 kHz/minute of sweeptime

Because the analyzer is phase locked at the beginning of each sweep, drift occurs only during the time of one sweep.

Spectral Purity**Noise sidebands:** >85 dB below the peak of a 5.8 GHz CW signal at 1 kHz offset; >79 dB typical for 12.5 GHz signal; >75 dB typical for 18.6 GHz signal; >73 dB typical for 22 GHz signal; all for resolution bandwidth ≤ 100 Hz.**Power line related sidebands:** >80 dB below the peak of a 5.8 GHz CW signal, <360 Hz offset.**Amplitude****Measurement range:** -134 dBm to $+30$ dBm.**Display Range:****Scale:** over a 10 division CRT vertical axis with the Reference Level at the top graticule line.**Calibration****Log:** 10 dB/div for 90 dB display from Reference Level.

5 dB/div for 50 dB display

2 dB/div for 20 dB display

1 dB/div for 10 dB display

expanded from
Reference Level**Linear:** 10% of Reference Level/div when calibrated in voltage.**Fidelity****Log****Incremental** ± 0.1 dB/dB over
0 to 80 dB display**Cumulative** $< \pm 1.0$ dB max over 0 to 80
dB display, 20–30°C. $< \pm 1.5$ dB max over 0 to 90
dB display.**Linear:** $\pm 3\%$ of Reference Level**Reference Level****Range****Log:** $+30.0$ to -99.9 dBm or equivalent in dBmV, dB μ V, VoltsReadout expandable to $+60.0^1$ volts to -119.9 dBm (-139.9 dBm for <1 kHz resolution bandwidth) using SHIFT I.**Linear:** 7.07 volts to 2.2 μ volts full scale. Readout expandable to 223.6¹ volts to 2.2 μ volts (0.22 μ volts for <1 kHz resolution bandwidth) using SHIFT I.**Accuracy:** the sum of the following factors determines the accuracy of the reference level readout. Depending upon the measurement technique followed after calibration with the CAL signal, various of these sources of uncertainty may not be applicable. Specifications are with the

preselector tracking optimized with MARKER PRESELECTOR PEAK function.

An internal error correction function calibrates and reduces the uncertainty introduced by analyzer control changes from the error calibration state (-7 dBm reference level, and 100 MHz center frequency) when SHIFT W and SHIFT X are executed just prior to the signal measurement (i.e. at the same temperature) within 20–30°C. range.**Calibration uncertainty:** ± 0.3 dB.**Frequency response (flatness) uncertainty:** ± 0.6 dB, 100 Hz to 2.5 GHz; ± 1.7 dB, 2.0 GHz to 12.5 GHz; ± 2.2 dB, 12.5 GHz to 20 GHz; ± 3.0 dB, 20 GHz to 22 GHz; for 10 dB attenuator setting. Cumulative flatness ± 2.2 dB, 100 Hz to 20 GHz. COUPLED FUNCTION not required as long as display remains calibrated.**Amplitude temperature drift:** at -10 dBm reference level with 10 dB input attenuation and 1 MHz resolution bandwidth. ± 0.03 dB/°C (eliminated after recalibration).**Scale Fidelity****Log****Incremental** ± 0.1 dB/dB**Cumulative**over 0 to 90 dB display
 ± 1.0 dB ≥ 30 Hz Resolution BW
 ± 2.1 dB 10 Hz Resolution BW**Linear:** $\pm 3\%$ of reference level**Resolution bandwidth switching uncertainty²:** referenced to 1 MHz bandwidth, corrected (uncorrected).³**Resolution BW**10 Hz
30 Hz
100 Hz to 1 MHz
3 MHz**Uncertainty** ± 1.1 dB (± 2.0 dB)
 ± 0.4 dB (± 0.8 dB)
 ± 0.2 dB (± 0.5 dB)
 ± 0.5 dB (± 1.0 dB)**Log scale switching uncertainty:** corrected (uncorrected). ± 0.1 dB (± 0.5 dB).**IF gain uncertainty:** corrected (uncorrected). Assuming the internal calibration signal is used to calibrate the reference level at -10 dBm and the input attenuator is fixed at 10 dB, any changes to the reference level function value from -10 dBm will contribute IF gain uncertainty.**Range**0 to -55.9 dBm
10 Hz Resolution BW
 ≥ 30 Hz Resolution BW
 -56.0 to -129.9 dBm⁴
10 Hz Resolution BW
 ≥ 30 Hz Resolution BW**Uncertainty** ± 1.0 dB (± 1.6 dB)
0 dB (± 0.6 dB)
 ± 2.0 dB (± 2.0 dB)
 ± 1.0 dB (± 1.0 dB)

The range values change with different input attenuator settings. Each 10 dB decrease (or increase) in the amount of input attenuation at the time of calibration and measurement will cause a corresponding 10 dB decrease (increase) in absolute reference level settings described above.

RF gain uncertainty: corrected (uncorrected) 0 dB (± 0.2 dB). The gain change between preselected and non-preselected bands.**Error correction:** ± 0.4 dB

When the error correction function is used (SHIFT W and SHIFT X), amplitude uncertainty is introduced because additional IF gain is used to offset errors in the switching of resolution BW, amplitude scales and RF gain.

Dynamic Range**Spurious responses:** (signals generated by the analyzer due to input signals). For signals ≤ -40 dBm all harmonic and intermodulation distortion >70 dB below input signal.**Second order harmonic distortion:** for mixer levels ≤ -40 dBm: < -70 dBc, 100 Hz to 50 MHz; < -80 dBc, 50 MHz to 700 MHz; < -70 dBc, 700 MHz to 2.5 GHz. For mixer levels ≤ -10 dBm: < -100 dBc, 2 to 22 GHz.¹Maximum input must not exceed $+30$ dBm (damage level).²Accounted for under Error Correction Accuracy.³Uncorrected values apply over 20–30°C range.⁴Correction only applies over the 0 dBm to -55.9 dBm range.



SIGNAL ANALYZERS

Spectrum Analyzer, 100 Hz to 300 GHz

Model 8566B (cont.)

Third order intermodulation distortion: third order intercept (TOI): $>+5$ dBm, 100 Hz to 5 MHz; $>+7$ dBm, 5 MHz to 5.8 GHz; $>+5$ dBm, 5.8 to 18.6 GHz; $>+5$ dBm (typical), 18.6 GHz to 22 GHz; $>+5$ dBm (typical), 2 to 22 GHz for >100 MHz signal separation.

Image responses: (due to input signals 642.8 MHz above or below the tuned frequency) <-70 dBc, 100 Hz to 18.6 GHz; <-60 dBc, 18.6 GHz to 22 GHz.

Multiple responses: (due to the input signal mixing with more than one L.O. harmonic) <-70 dBc, 100 Hz to 22 GHz.

Out-of-band responses: (due to input signals outside the preselector's frequency span) <-60 dBc, 2 to 22 GHz.

Residual responses: (signals displayed by the analyzer independent of input signals) With 0 dB input attenuation and no input signal: <-100 dBm, 100 Hz to 5.8 GHz; <-95 dBm, 5.8 GHz to 12.5 GHz; <-85 dBm, 12.5 GHz to 18.6 GHz; <-80 dBm, 18.6 GHz to 22 GHz.

Gain compression: <1.0 dB, 100 Hz to 22 GHz with ≤ -5 dBm at input mixer.

Average noise level: with 0 dB input attenuation and 10 Hz resolution bandwidth. <-95 dBm, 100 Hz to 50 kHz; <-112 dBm, 50 kHz to 1.0 MHz; <-134 dBm, 1.0 MHz to 2.5 GHz; <-132 dBm, 2.0 GHz to 5.8 GHz; <-125 dBm, 5.8 GHz to 12.5 GHz; <-119 dBm, 12.5 GHz to 18.6 GHz; <-114 dBm, 18.6 GHz to 22 GHz.

Video bandwidth: post detection low pass filter used to average displayed noise bandwidth variable from 1 Hz to 3 MHz in a 1,3,10 sequence. Video bandwidth may be selected manually or coupled to resolution bandwidth.

Reference Lines

Display line: movable horizontal line with amplitude readout.

Threshold: movable horizontal trace threshold with amplitude readout.

Accuracy: equals the sum of calibrator uncertainty, and scale fidelity between the reference level and reference line.

Marker

Marker functions are the same as the HP 8568B with the exception of frequency count. (Page 662).

Preselector peak: with the marker at the peak of a displayed input signal, preselector peak automatically adjusts preselector tracking for maximum response.

Sweep

Trigger, continuous and single are the same as the HP 8568B, pages 662 and 663.

Sweeptime

Zero Frequency Span

With digital storage: 20 msec full sweep to 1500 sec full sweep $n \sim 1\%$ increments.

Without digital storage: 1 μ sec full sweep to 10 msec in 1, 2, 5 sequence.

Marker (sweeps >20 msec only)

Normal: displays time from beginning of sweep to marker position.

Δ : displays time difference between stationary and tunable marker.

Input

RF input: 100 Hz to 22 GHz, precision female type N connector, dc coupled.

SWR (typical): 1.2, 100 Hz to 2.5 GHz; 1.5, 2 GHz to 5.8 GHz; 1.9, 5.8 GHz to 22 GHz; with 10 dB input attenuation.

LO emission (typical): <-80 dBm when preselected; <-90 dBm when not preselected.

Maximum Input Level

AC: +30 dBm (1 watt), continuous power.

DC: <100 mA current damage level.

Input attenuator: 70 dB range in 10 dB steps.

Accuracy: ± 1.0 dB over 10–70 dB range.

IF Input

Maximum Input Level

AC: +10 dBm, continuous power, from 50 Ω source.

DC: 20 volts with rise time of <1 volt/ μ sec.

Sensitivity: -30 dBm at 321.4 MHz produces full-scale CRT deflection ± 1.0 dB when KSU has been executed.

Quasi-Peak (rear panel; nominal values)

Video input: 0–2 Volts. 139 Ω input impedance.

21.4 MHz input: input is nominally -11 dBm (with spectrum analyzer input attenuator set to 10 dB). 50 Ω input impedance.

Output

Calibrator: 100 MHz \pm (frequency reference error). -10 dBm ± 0.3 dB, 50 Ω impedance.

Auxiliary

Auxiliary outputs are the same as the HP 8568B, page 663.

21.4 MHz IF (rear panel): a 50 Ω , 21.4 MHz output related to the RF input to the analyzer. In log scales, the IF output is logarithmically related to the RF input signal; in linear, the output is linearly related. The output is nominally -20 dBm for a signal at the reference level. Bandwidth is controlled by the analyzer's resolution bandwidth setting; amplitude controlled by the input attenuator, and IF step gain positions.

IF Output (front panel)

Maximum Input Level

AC: +10 dBm, continuous power, from 50 Ω source.

DC: 20 volts with rise time of <1 volt/ μ sec.

1st LO output (front panel): 2.3 to 6.2 GHz, $>+5$ dBm., 50 Ω output impedance (nominal).

Frequency reference (rear panel): >-5 dBm, 50 Ω output impedance

Sweep plus tune output (rear panel): -1 volt per GHz 10 k Ω minimum load.

10 MHz output (rear panel): >-5 dBm, 50 Ω output impedance.

Sweep plus tune output (rear panel): -1.0 volt per GHz of tune frequency, >10 k Ω load.

Accuracy: -1 V/GHz $\pm 20\%$ ± 10 mV.

Quasi-Peak (rear panel; nominal values)

Video output: 0–2 volts. Output impedance >10 Ω .

21.4 MHz output: output is nominally -11 dBm (with spectrum analyzer input attenuator set to 10 dB). 50 Ω input impedance.

HP-IB Interface Functions

SH1, AH1, T6, L4, SR1, RL1, PP0, DC1, DT1, C1, C2, C3, C28. For more on these codes, refer to the HP-IB section of this catalog.

General

Environmental

Temperature: operating 0°C to 55°C, storage -40 °C to +75°C.

Humidity: operating $<95\%$ R.H., 0°C to 40°C except as noted.

EMI: conducted and radiated interference is within the requirements of CE03 and RE02 of MIL STD 461A, VDE 0871, and CISPR pub'n 11.

Power requirements: 50 to 60 Hz; 100, 120, 220, or 240 volts (+5%, -10%); approximately 650 VA (40 VA in standby). 400 Hz operation is available as Opt 400.

Weight: total net 50 kg (112 lb): Display/IF Section, 21 kg (47 lb); RF Section, 24 kg (53 lb). Shipping, Display/IF Section 31 kg (69 lb); RF Section 39 kg (87 lb).

Size: 267 H x 425.5 W x 598.5 mm D (10.5" x 16.75" x 23.56").

Ordering Information

HP 8566B Spectrum Analyzer

Opt 010: Rack Slide Kit

Opt 400: 400 Hz Power Line Frequency Operation

Opt 908: Rack Flange Kit

Opt 910: Extra Manual

Opt 913: Rack Flange Kit to Mount Instruments with Handles

HP 8566A+01K Retrofit Kit

Price

\$55,000

add \$450

add \$400

add \$60

add \$350

add \$70

\$2500

SIGNAL ANALYZERS

Automatic Spectrum Analyzers, 100 Hz to 22 GHz

Models 8566S, 8567S & 8568S



- HP 9000 Series 200 computer for powerful computer capability
- Assortment of printers and plotters to choose from
- Software to minimize program development time
- Ease of operation via HP-IB
- 16K of analyzer RAM for user-defined routines



HP 8568S

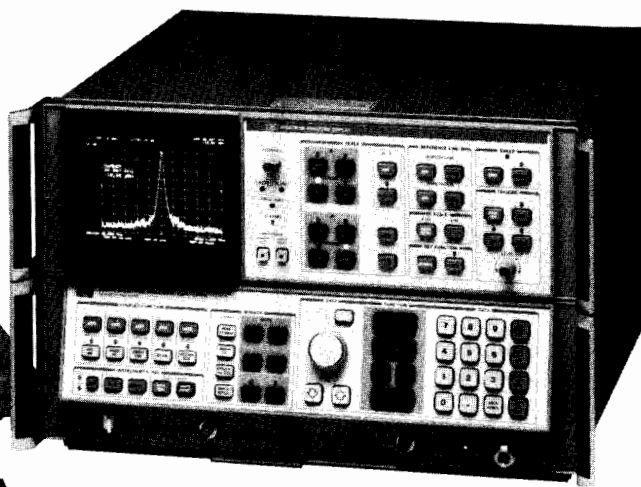

The HP 8566S, 8567S and 8568S Automatic Spectrum Analyzers are systems based on the HP 8566B, 8567A and 8568B Spectrum Analyzers respectively. They are ideal for automatic systems applications due to their synthesized local oscillators, full programmability, direct and indirect plotter output, high level firmware function set, and 16,000 bytes of non-volatile memory for user-defined routines. Each system has an HP 9000 Series 200 Desktop Computer, which has the powerful Motorola MC68000 16-bit microprocessor and up to 2 megabytes of main memory. System Software is available in BASIC language. A wide variety of HP-IB printers and plotters are available for this system to provide the user with a great deal of flexibility to tailor the system for his or her needs. Operator training is available through the HP 8566A +24D or 8568A +24D Spectrum Analyzer Operation Course which is an intensive 4-day course that illustrates basic programming techniques for remote operation of these two spectrum analyzers. Course size is purposely kept small and hands-on operation is emphasized to facilitate getting the full benefits of the course. The frequency range of the HP 8566S can be extended above 22 GHz by using external mixers. (See page 697 for more information on the HP 11970 series mixers.)

System Software

System software is available for the HP 8566B and 8568B in BASIC (HP 85863A Software Library) for maximum flexibility. This software pack supplies high level routines (subprograms) to aid the system programmer in developing custom programs for specific applications. In effect, the software library acts as extensions of the spectrum analyzer's built-in firmware, thus enabling a user to write on a more conceptual level. For example, many measurements require the maximum amount of dynamic range available on the spectrum analyzer, given its current settings of center frequency, resolution bandwidth, and the maximum input level expected. Choosing the correct value of input attenuation which will result in the greatest dynamic range normally requires knowledge of the spectrum analyzer's

distortion and sensitivity characteristics. Subprogram *OPT-RANGE will automatically compute the optimum value of attenuation and set the spectrum analyzer's attenuator accordingly. Thus, by including *OPT-RANGE as part of the program, a user no longer needs to be concerned with the details of this aspect of the measurement. The system software comes on a 5 1/4 inch flexible disc (3 1/2-inch discs are also available) for use with an HP Series 200 computer. Also included is a manual which provides extensive documentation and line-by-line annotation of each program.

Major System Components

| | |
|----------------------------|--|
| Spectrum Analyzer: | HP 8566B, 8567A, or 8568B |
| Desktop Computer: | HP Series 200, Model 216, 226, or 236 |
| Printer: | HP 2671A, 2671G, or 2673A |
| Plotter: | HP 7090A, 7470A, 7475A, or 7550A |
| Software: | 85863A (BASIC) for HP 8566B and 8568B only |
| Operation Training Course: | HP 8566A +24D or 8568A +24D |

Ordering Information

| | Price |
|---|-------|
| HP 8566S Automatic Spectrum Analyzer (HP 8566B based system) | \$0 |
| HP 8567S Automatic Spectrum Analyzer (HP 8567A based system) | \$0 |
| HP 8568S Automatic Spectrum Analyzer (HP 8568B based system) | \$0 |

For complete ordering information, prices, delivery, and available options, contact your local HP field engineer.

SIGNAL ANALYZERS

Spectrum Analyzer, 10 kHz to 1500 MHz

Model 8567A

- EMI measurement capability
- Close-in, accurate AM analysis
- Automatic signal monitoring
- Accurate, cost-effective component testing
- Direct plot capability
- Counter-like synthesis
- Powerful signal and trace processing functions
- Storage and execution of custom measurement routines

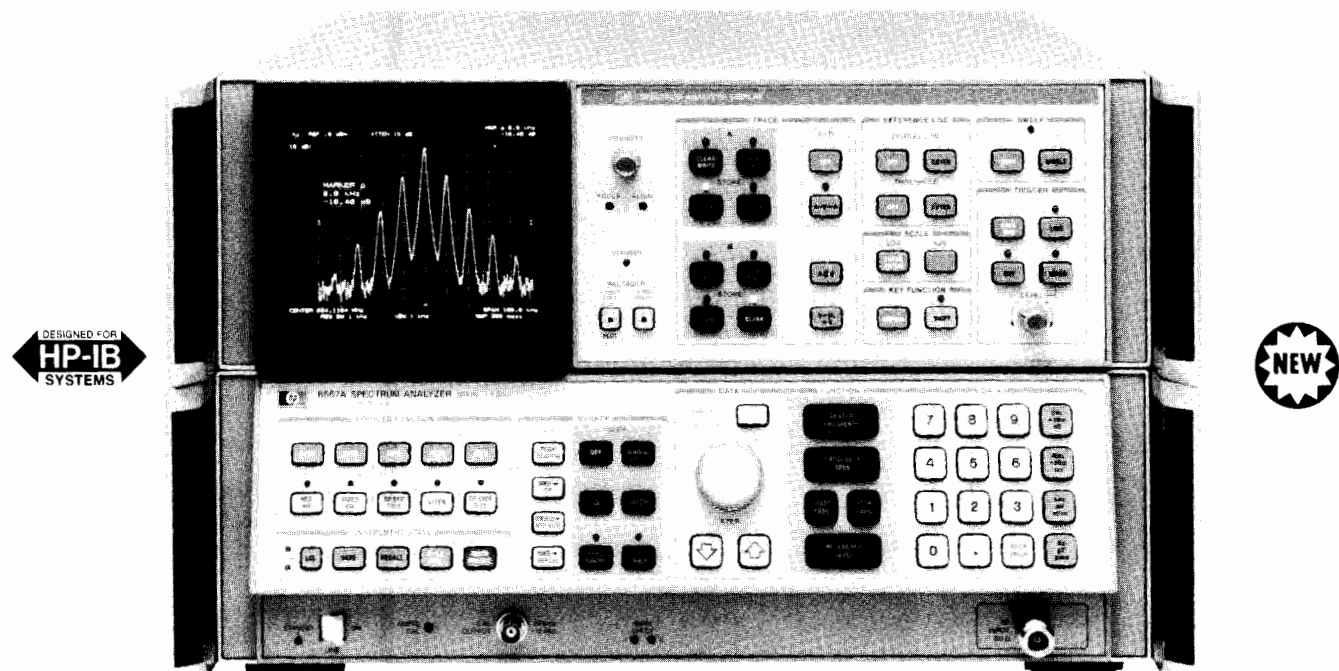

HP 8567A

The HP 8567A RF Spectrum Analyzer offers the performance and speed necessary for most bench and ATE uses at an affordable price. It covers the 10 kHz to 1.5 GHz frequency range. Difficult, close-in amplitude modulation measurements (0.5 Hz to 25 kHz) are made accurately, even in the presence of angle modulation, by using the Fast Fourier Transform (FFT) function, one of the many powerful HP 8567A firmware features.

Custom measurement routines are stored in the HP 8567A's 16K of RAM and executed via HP-IB or from the front panel. These custom routines open a new horizon of operator convenience, allowing the operator to create measurement routines tailored to his or her particular application; routines that can be run without a computer.

The HP 8567A fits into many application areas. This cost-effective spectrum analyzer is ideal for EMI testing, and you can turn the HP 8567A into a CISPR* receiver by combining it with the HP 85650A Quasi-Peak Adapter and 85685A RF Preselector. Automate MIL-STD and commercial EMI measurements with the HP 85864B EMI Measurement Software. Perform spectrum monitoring and broadband surveillance automatically by using the HP 8567A with the HP 85865A Signal Monitoring Software. Add scalar measurement capability to the HP 8567A at minimal cost using the HP 8444A Option 059 Tracking Generator.

HP 8567A Specifications

Frequency

Frequency range: 10 kHz to 1500 MHz

Frequency readout accuracy: $\pm(2\%$ of frequency span + frequency reference error \times tuned frequency + 10 Hz) in AUTO resolution bandwidth at stabilized temperature using the error correction function.

*C.I.S.P.R. is a specification for radio interference measuring apparatus and measurement methods.

Frequency reference accuracy: Aging rate $< 5 \times 10^{-6}$ /year; temperature stability $< 1 \times 10^{-5}$ over $5^\circ - 55^\circ\text{C}$

Frequency span: Range 100 Hz to 1500 MHz in approximately 1% increments

Accuracy: spans > 1 MHz, $\pm(2\%$ of frequency separation between two points + 0.5% span); spans ≤ 1 MHz, $\pm(5\%$ of frequency separation + 0.5% span)

Markers

Normal: same as HP 8568B (page 663)

Frequency count: displays the frequency signal on whose response the marker is positioned.

Accuracy: spans ≤ 1 MHz, \pm (frequency reference error \times displayed frequency) $\pm(10$ Hz + 2 \times frequency counter resolution); spans > 1 MHz, $\pm(10$ kHz + frequency counter resolution)

Delta: same as HP 8568B (page 663)

Resolution bandwidths: (-3 dB) Range 1 kHz to 3 MHz adjustable in a 1, 3, 10 sequence. AM sideband resolution is typically 0.5 Hz - 25 kHz using the FFT function.

Accuracy: $\pm 20\%$

Selectivity: (60dB/3dB) 1 kHz to 30 kHz, $< 13:1$; 100 kHz to 3 MHz, 15:1

Video bandwidth: Range 1 Hz to 3 MHz in 1, 3, 10 increments

Stability

Residual FM: 100 Hz peak-to-peak for sweep time ≤ 10 seconds, span < 100 kHz, resolution bandwidth 1 kHz, video bandwidth ≤ 30 Hz.

Frequency drift (after 1 hr. warmup at stabilized temperature): spans ≤ 1 kHz, < 100 Hz per minute of sweep time; 1 kHz $<$ span ≤ 1 MHz, < 1 kHz per minute of sweep time; spans > 1 MHz, < 300 kHz per minute of sweep time

Spectral purity: > 75 dBc, 30 kHz offset, 1 kHz resolution bandwidth.



Amplitude

Total amplitude range: -115 dBm to +30 dBm

Maximum safe input power: AC Average Continuous, +30 dBm (+137 dB μ V, 1 watt); pulse power, 100 watts for 10 μ sec pulse, \geq 50 dB attenuation; DC 0 volts (DC coupled)

Displayed average noise level: -115 dBm for frequencies > 1 MHz, -92 dBm for frequencies < 1 MHz but > 50 kHz. (1 kHz res. bandwidth, 0 dB input attenuation, 1 Hz video filter)

Gain compression level: < 1.0 dB for signal levels \leq -10 dBm at input mixer.

Display: 10-division CRT vertical axis.

Calibration: Log 10, 5, 2 and 1 dB/division; Linear 10% of reference level/division when calibrated in voltage.

Spurious responses: > 70 dB below total signal power for mixer levels \leq -40 dBm

Reference level range: Log, +60.0 to -119.9 dBm; Linear 223.6 Volts to 2.2 μ Volts full scale (maximum input must not exceed +30 dBm.)

Amplitude accuracy: The sum of the following factors determines the accuracy of the reference level readout. Depending upon the measurement technique followed after calibration, some of these sources of uncertainty may not be applicable. An internal error correction function reduces the uncertainty introduced by analyzer control changes from a state defined during the calibration of the instrument. Uncorrected values given in parentheses are typical values.

Frequency response: \pm 1 dB (\geq 10dB RF attenuation)

Calibrator uncertainty: \pm 0.2 dB

Amplitude temperature drift: \pm 0.5 dB/ $^{\circ}$ C (eliminated by recalibration) with -10 dBm reference level, 10 dB input attenuation, 1 MHz resolution bandwidth

Resolution bandwidth switching uncertainty¹: \pm 0.2 dB, (\pm 1.0 dB uncorrected) Reference bandwidth is 1 MHz, 20 $^{\circ}$ - 30 $^{\circ}$ C

Log scale switching uncertainty: \pm 0.1 dB, (\pm 1.0 dB uncorrected)

IF gain uncertainty: Assuming the internal calibration signal is used to calibrate the reference level at -10 dBm and the input attenuator is fixed at 10 dB, any changes in reference level in the following ranges will contribute to IF gain uncertainty: corrected (uncorrected)

| Reference Level | 20 $^{\circ}$ - 30 $^{\circ}$ C | 5 $^{\circ}$ - 55 $^{\circ}$ C |
|-------------------|---------------------------------|--------------------------------|
| 0 to -55.9 dBm | \pm 0.1dB (\pm 0.7dB) | (\pm 1.1dB) |
| -56.0 to -119 dBm | \pm 1.0dB(\pm 1.1dB) | (\pm 1.6dB) |

RF attenuator switching uncertainty: \pm 1.0 over 10 to 70 dB range

Scale fidelity

Log:

Incremental accuracy: \pm 0.1 dB/dB over 0 to 80 display

Maximum cumulative error: \pm 1.0 dB over 0 to 80 dB display, 20 $^{\circ}$ to 30 $^{\circ}$ C; \pm 1.5 dB over 0 to 90 dB display

Linear: \pm 3% of Reference Level

Error correction accuracy: \pm 0.4 dB (applicable when controls are changed from the calibration state)

Markers: same as HP 8568B (page 663).

Reference lines: same as HP 8568B (page 663).

Sweep

Sweep time: same as HP 8568B (page 663).

Inputs

RF input: 10 kHz to 1500 MHz, 50 ohm, Type N connector, dc coupled

Reflection coefficient: < 0.20(1.5SWR) (typical value, \geq 10 dB input attenuation)

Also available: 10 KHz to 1500 MHz, 75 ohm, BNC connector, dc coupled (Option 001).

Maximum input level: AC, Continuous power, +30 dBm (1 watt); Pulsed power (10 μ sec pulse into \geq 50 dB input attenuation), 100 watts; DC, 0 volts

Input attenuator: Range, 10 dB to 70 dB in 10 dB steps

Accuracy: \pm 1.0 dB

Damage level: +30 dBm

External sweep trigger input: 2.4 to 5 volts (rear panel); input impedance (nominal) 139 Ω

¹30 kHz and 100 kHz bandwidth switching uncertainty is only applicable \leq 90% relative humidity.

External frequency reference input: 10 MHz \pm 100Hz, 0 dBm to +10 dBm (rear panel); input impedance (nominal) 50 Ω

Quasi-peak: (rear panel, nominal values)

Video input: 0 to 2 volts, 139 Ω input impedance

21.4 MHz IF input: -11 dBm with 10 dB input attenuation, 50 Ω input impedance

Outputs

Calibrator: 20 MHz \pm (frequency reference error x days since calibration), -10 dBm \pm 0.2 dB, 50 Ω

Auxiliary: same as HP 8568B (page 663)

Direct plot output: Plots trace, graticule, and annotation shown on the CRT to an HP-IB plotter. Plotter must be set to address 705 and a computer should not be connected.

21.4 MHz IF: -20 dBm for a signal at the reference level

1st LO: 2 - 3.7 GHz, > +4 dBm, output impedance 50 Ω

Frequency reference output: 10 MHz, 0 dBm (nominal), output impedance 50 Ω

Quasi-peak: (rear panel, nominal values)

Video output: 0 - 2 Volts, output impedance < 139 Ω

21.4 MHz IF output: -11 dBm with 10 dB input attenuation, output impedance 50 Ω

General

Environmental

Temperature: Operating 5 $^{\circ}$ C to 55 $^{\circ}$ C, storage -40 $^{\circ}$ C to +75 $^{\circ}$ C

EMI: Conducted and radiated interference is within the requirements of Class Alc, RE02 of MIL STD 461B, VDE 0871, and CISPR pub'n 11.

Warm-up time

Operation: Requires 30-minute warm-up from cold start, 5 $^{\circ}$ - 55 $^{\circ}$ C.

Frequency reference: Aging rate attained after 1 hr. from cold start at 25 $^{\circ}$ C. Frequency is within 5 x 10⁻⁵ of final stabilized frequency within 30 minutes.

Power requirements: 50 - 60 Hz; 100, 120, 220 or 240 volts (+5%, -10%), 450 VA (approximately), 40 VA in standby. 400 Hz available as Option 400

Battery storage: Lithium battery holds information in RAM for typically 1 year.

Physical size characteristics

Net weight: Total, 45 kg (100 lb.); IF-Display Section, 21 kg (47 lb.); RF Section 24 kg (53 lb.)

Shipping: IF-Display Section, 27 kg (60 lb.); RF Section 32 kg (70 lb.)

Outside dimensions: 267 mm high x 425.5 mm wide x 558.8 mm deep; (10.5" x 16.75" x 22")

Interface codes: SH1, AH1, T6, L4, SR1, RL1, PP0, DC1, DT1, C1, C2, C3, C27.

Ordering Information

HP 8567A Spectrum Analyzer \$27,000

Opt 001: 75 Ohm (BNC), 10 kHz to 1500 MHz 200

Opt 400: 400 Hz Power Line Frequency Operation 400

Opt 908: Rack Flange Kit 60

Opt 913: Rack Flange Kit to Mount Instruments with Handles 70

Opt 010: Rack Mount Slide Kit 450

Opt 910: Extra Manual 350

Accessories

HP 85650A Quasi-Peak Adapter 4,980

HP 85685A RF Preselector 20,035

HP 8444A Option 059 Tracking Generator 4,760

HP 8447D Preamplifier (0.1 to 1300 MHz) 1,100

Transit Case

RF section P/N 1540-0662 625

IF section P/N 1540-0663 625

Software

HP 85864B EMI Software 3,020

HP 85865A Signal Monitoring Software 3,020

670



SIGNAL ANALYZERS

Signal Monitoring Software

Model 85865A

Automates the HP 8566B, 8567A and 8568B Spectrum Analyzers for

- Operator-controlled or unattended long-term signal monitoring
- Broadband surveillance and signal intelligence
- Communication system testing and maintenance

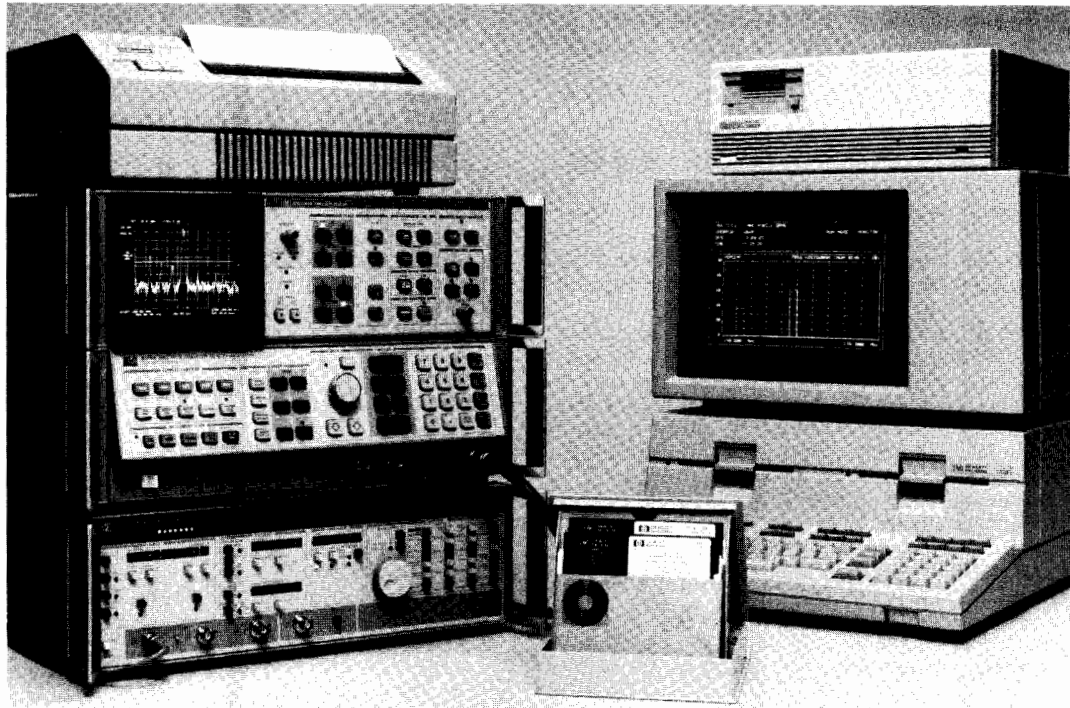

Typical system configuration using HP 85865A Signal Monitoring Software

Increase the power and flexibility of your HP 8566B, 8567A, or 8568B Spectrum Analyzer for signal monitoring and broadband surveillance. The HP 85865A Signal Monitoring Software automates your system for site surveillance applications and long-term attended or unattended monitoring operations. Menu options allow you to store command sequences and set the time of program execution. Monitor up to ten frequency bands of interest and measure percent occupancy using the software's frequency histogram display. A multiband display option lets you view four selected bands at one time on the analyzer's CRT, and you can easily obtain hard copy of statistical information on band usage and transmission length using your system's printer or plotter. Signal data, collected continuously or at intervals over long periods of time, are stored with date and time included to provide comprehensive reports on ambient signal activity.

Diverse Applications

The HP 85865A Signal Monitoring Software offers advantages in areas requiring long-term monitoring of signal environments. For example, to maintain quality over the lifetime of a communication system, the program provides information on current band usage for management of the frequency spectrum, and on signal parameters to assure that transmissions meet specified tolerances. A "task scheduler" directs the spectrum analyzer to execute a file of commands at a given time, enabling completely automatic, unattended testing. Large blocks of data are stored and retrieved easily with a Hewlett-Packard Winchester disc drive added to your system.

For surveillance operations, the software's run-mode options permit the spectrum analyzer to automatically "search" a defined band, tune to a signal, measure frequency and amplitude, and determine modulation format. Data can be reported selectively: set an "alarm" to notify you when signals meet pre-determined characteristics, or construct a "signal mask" to prevent unwanted signals from being reported. Adding the HP 5180A Waveform Recorder to your system lets you measure pulse parameters including pulse width, pulse repetition interval, peak power, and average power for use in radar detection and system testing.

Powerful Graphics

Powerful display formats transform your system's console into an effective tool to analyze and manipulate data. View multiple bands—up to four at one time—in the frequency as well as the time domain. A "parameter summary" displays such measured signal parameters as pulse width, modulation format, pulse repetition interval, amplitude, and frequency. For a time profile of a particular band, use the three dimensional "raster" display of frequency, amplitude, and time. The "histogram" options provide information on band usage, and the "timegram" reports signal data as a function of time. The "timegram summary" displays statistics on percent occupancy, maximum frequency and amplitude, and average message length of two-way communication signals at specific frequencies. Transfer all display formats directly to an HP-IB X-Y plotter or HP-IB printer for customized hard-copy output.

The HP 85865A Signal Monitoring Software, written in Pascal 3.0, requires an HP 8566B (100 Hz to 22 GHz), HP 8567A (10kHz to 1.5 GHz), or HP 8568B (100 Hz to 1.5 GHz) Spectrum Analyzer and a compatible computer. For pulse analysis, a waveform recorder must be added to the system, and it is recommended that your computer contain at least 1 Mbyte of memory. Contact your nearest HP field representative for a complete list of accessories, including mass-storage devices, printers, and plotters. Hardware can be ordered as a single shipment using the "S" system. See page 667.

Minimum System Components:

| | |
|-------------------|--|
| Spectrum Analyzer | HP 8566B, 8567A or 8568B |
| Computer | HP Series 200, Models 236A/C/S/CS Technical or 220A Modular |

Ordering Information

HP 85865A Signal Monitoring Software (specify one option)

Option 655 (5¼ inch discs)

Option 630 (3¼ inch discs)

Price

\$3020

\$0

\$0

SIGNAL ANALYZERS

Spectrum Analyzer/CISPR EMI Receiver 10kHz to 1.5GHz

Model 8574A

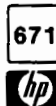

- Meets CISPR Publication 16* requirements
- Performs VDE and FCC Compliance Tests

- Makes diagnostic EMI measurements
- Automates VDE, FCC, and MIL-STD EMI tests

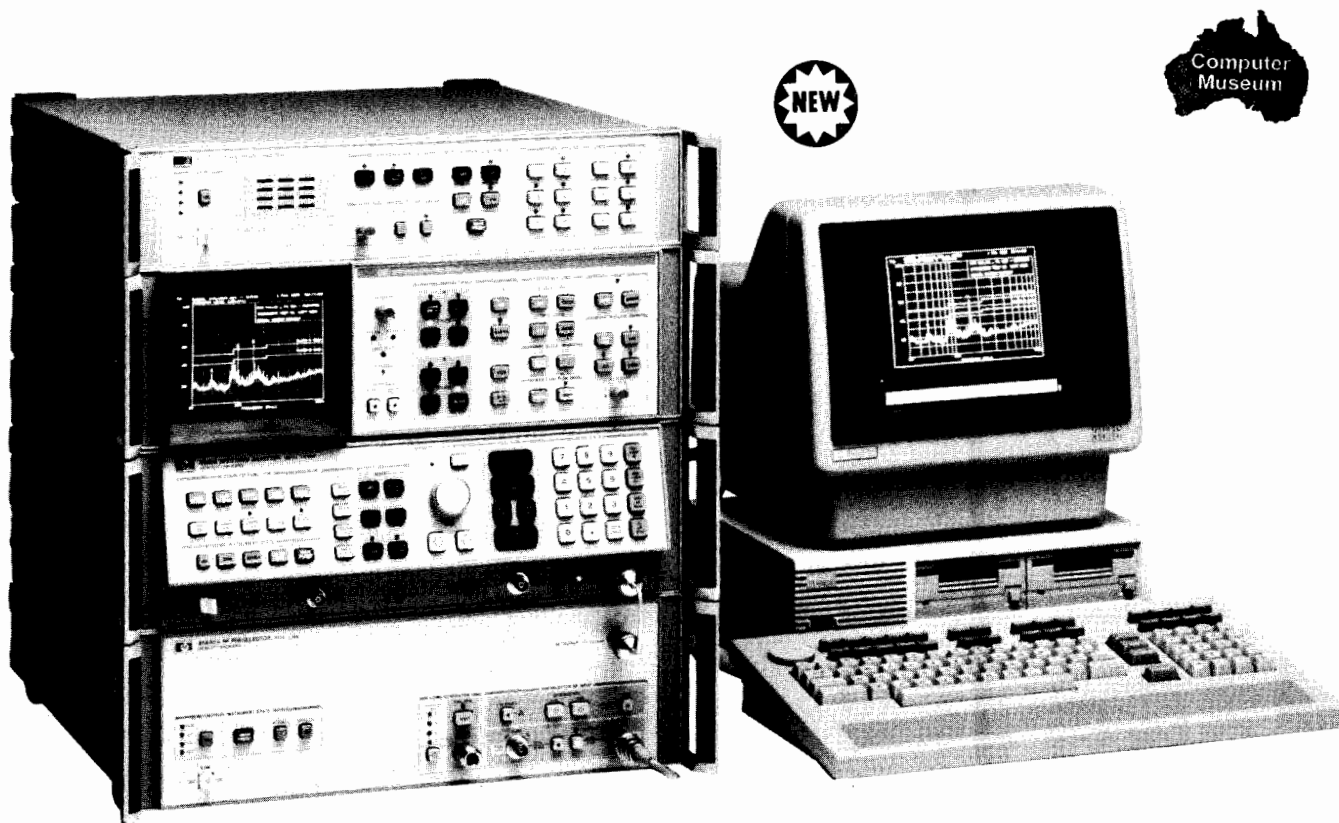

Typical HP 8574A Configuration with additional Controller

The new HP 8574A Spectrum Analyzer/CISPR EMI Receiver is designed for making fast, accurate EMI measurements. With improved sensitivity and overload protection, this powerful receiver meets CISPR Publication 16* recommendations as well as requirements of the FCC and VDE. And, because a versatile HP 8568B Spectrum Analyzer forms the heart of this system, full EMI diagnostic capabilities aid you throughout a product's evolution, from design stages to completion of final commercial and MIL-STD qualification tests.

CISPR/EMI Receiver Features and More

To meet CISPR Publication 16 specifications, the HP 85650A Quasi-Peak Adapter provides the HP 8574A Spectrum Analyzer/CISPR EMI Receiver with required bandwidths and quasi-peak detection. The new HP 85685A RF Preselector adds input overload protection and increased measurement sensitivity, and its built-in absolute amplitude calibration ensures $\pm 2\text{dB}$ amplitude accuracy. The preselector automatically tracks the spectrum analyzer during manual and remote operation. A low-frequency RF input tolerates large impulses and Line Impedance Stabilization Network (LISN) transients. Both the low-frequency and high-frequency inputs allow the use of CISPR calibration pulses.

Automatic Control for Remote Operations

The HP 8574A Spectrum Analyzer/CISPR EMI Receiver lets you automate emission measurements via the HP-IB for conducted or radiated tests using a variety of compatible system controllers, EMI accessories, and peripherals. You can write your own programs or

elect the HP 85864B EMI Measurement Software, which features an easy-to-use menu structure that leads you through EMI measurements from initial setup to final results. Choose from a library of FCC, VDE, and MIL-STD emission tests, or design your own. Results can be annotated and notes generated as part of your test documentation, and subroutines can be added to the software for automatic control of your EMI accessories.

EMI accessories available for FCC, VDE, and MIL-STD tests feature a LISN for commercial conducted measurements and current probes for MIL-STD conducted emission requirements. Transducer kits contain magnetic and electric field antennas for radiated emission testing from 10 kHz to 10 GHz. Other EMI accessories include preamplifiers, printers, plotters, and a system cabinet.

Ordering Information

| | Price |
|---|--------------|
| HP 8574A Spectrum Analyzer/CISPR EMI Receiver | \$59,615 |
| Option 001 HP 85900 System Cabinet (includes Option 913) | add \$2,850 |
| Option 630 HP 85684B EMI Measurement Software (3 1/2" discs) | add \$3,020 |
| Option 650 HP 85684B EMI Measurement Software (5 1/4" discs) | add \$3,020 |
| Option 908 Rack mounting kit without handles | add \$122.50 |
| Option 910 Extra set of operating manuals | add \$410 |
| Option 913 Rack mounting kit with handles | add \$135 |

*CISPR Publication 16 is the Comité International Spécial des Perturbations Radioélectriques specification for radio interference measuring apparatus and measurement methods.

SIGNAL ANALYZERS

RF Preselector, 20 Hz to 2 GHz

Model 85685A

- Automatic filter tracking
- Input overload protection
- Low system noise

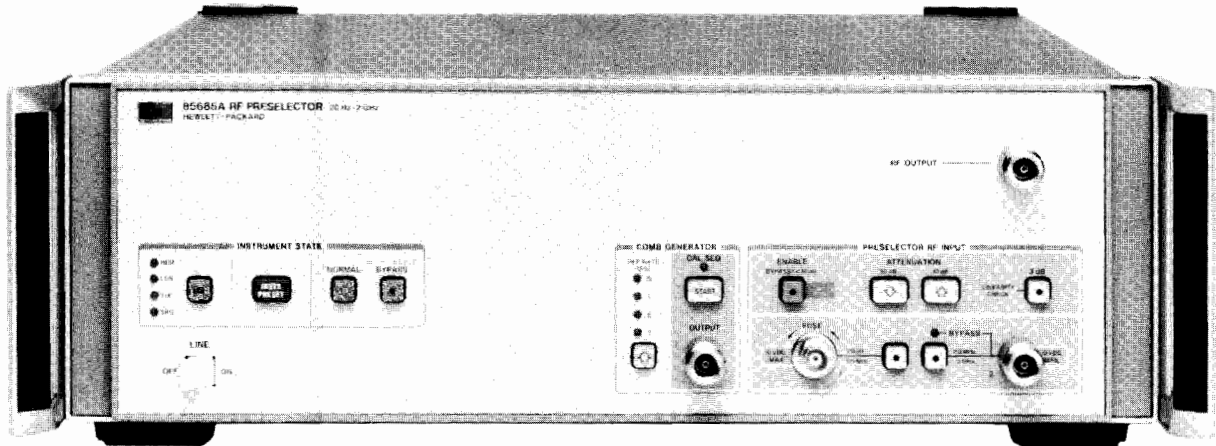

HP 85685A

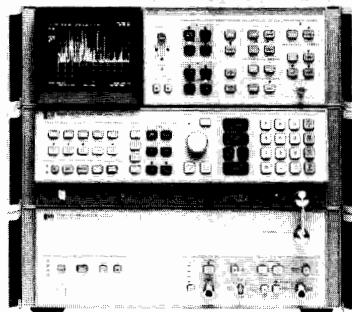

Test Receiver System

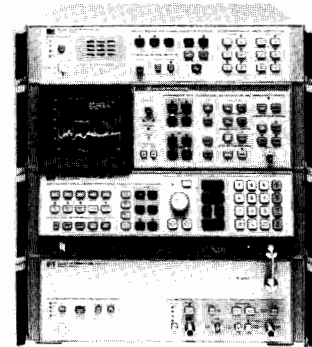

CISPR EMI Receiver System

The new HP 85685A RF Preselector makes a multi-purpose test receiver of an HP 8566B, 8567A, or 8568B Spectrum Analyzer. In addition to an instrument for general-purpose spectrum analysis, you now have a test receiver for specialized applications. The RF Preselector, with tracking filters and preamplifiers covering the 20 Hz to 2 GHz range, improves spectrum analyzer measurement sensitivity while providing overload protection from out-of-band signals. The resulting test receiver system, operating in the presence of high-level interference, has a measurement range 30 dB greater than that of a spectrum analyzer alone.

The spectrum analyzer/test receiver measures signals within the preselector filter passband and rejects out-of-band interference by 40 dB. This enables low-level signals to be monitored in the presence of high-level ambients. The preselector decreases input overload from out-of-band signals, thereby increasing the range for measuring low-level signals. Fast, wideband measurements mean a reduction in measurement time.

Combining the HP 85685A RF Preselector with an HP 8566B, 8567A, or 8568B Spectrum Analyzer and the HP 85650A Quasi-Peak Adapter gives you an EMI receiver that meets the recommendations of CISPR Publication 16*.

The RF Preselector adds the measurement sensitivity and overload protection needed for FCC and VDE radiated emission testing at

open sites. For commercial and MIL-STD conducted EMI tests, the low-frequency input tolerates large impulses and Line Impedance Stabilization Network (LISN) transients. A built-in calibrator ensures ± 2.0 dB absolute-amplitude accuracy as required by the FCC and VDE, and a convenient linearity check tests for system overload.

Operating the test receiver is easy. Use only the spectrum analyzer controls—the RF Preselector automatically adjusts input-filter tracking, and the spectrum analyzer reports preselector operating conditions on the CRT. The receiver system is fully HP-IB programmable, and the HP 85685A comes equipped with the hardware needed to connect it to any compatible spectrum analyzer.

Ordering Information

| | Price |
|---|--------------|
| HP 85685A RF Preselector | \$20,035.00 |
| Option 010 , Rack mount slide kit | add \$385.00 |
| Option 908 , Rack flange kit without handles | add \$32.50 |
| Option 910 , Extra manual | add \$50.00 |
| Option 913 , Rack flange kit with handles | add \$35.00 |

*CISPR Publication 16 is the Comite International Special des Perturbations Radioelectrique specification for radio interference measuring apparatus and measurement methods.

SIGNAL ANALYZERS



Quasi-Peak Adapter/EMI Measurement Software/EMI Accessories and Transducers
 Models 85650A, 85864B, 85685A

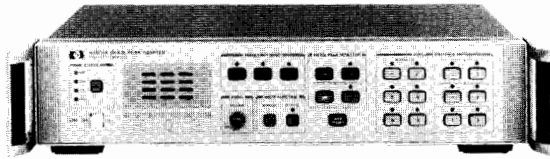

HP 85650A



HP 85650A Quasi-Peak Adapter

The HP 85650A Quasi-Peak Adapter works with the HP 8566B, 8567A, and 8568B Spectrum Analyzers and with the 85685A RF Preselector to complete an EMI test receiver system. The 85650A adds the CISPR bandwidth filters and quasi-peak detection capability specified in CISPR Publication 16*. These bandwidth filters of 6dB resolution (200 Hz, 9 kHz, and 120 kHz) may be selected using either peak or quasi-peak detection. A bypass switch enables the spectrum analyzer to bypass the quasi-peak adapter, and the HP 85650A is fully programmable over the HP-IB for automated measurements.

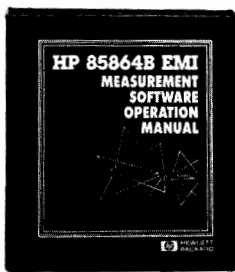

HP 85864B

HP 85864B EMI Measurement Software

The HP 85864B EMI Measurement Software automates commercial and military EMI measurements using the HP 8566B, 8567A, or 8568B Spectrum Analyzers or the HP 8574A Spectrum Analyzer/CISPR EMI Receiver. The software is written in BASIC 3.0 for the HP Series 200 Model Desktop Controllers**.

The software features an easy-to-use menu structure that takes you from initial test setup to output of final results. A library of FCC, VDE, and MIL-STD emission tests is available, or you can design your own. Transducer factors and test limits are loaded from their respective libraries or directly from the controller. You can construct measurement setups and review test data on the controller alone, leaving the rest of the system free to perform other operations.

Ordering Information

HP 85650A Quasi-Peak Adapter
 HP 85864B EMI Measurement Software

Price

\$4980
 \$3020

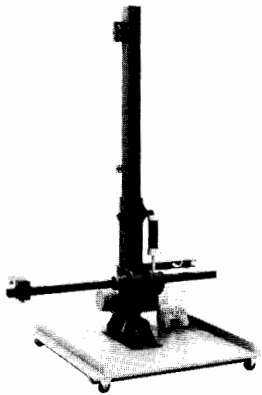

Antenna Positioning Tower



Log Periodic Antenna

EMI Accessories

Turntable for Radiated Emission Testing

Equipment Testing Turntable with HP-IB control.

HP 85685A Option K40: 50-60 Hz, 100-120 volt

HP 85685A Option K41: 50-60 Hz, 220-240 volt

Tower for Radiated Emission Testing

Antenna Positioning Tower with HP-IB and polarization control.

HP 85685A Option K42: 50-60 Hz, 100-120 volt

HP 85685A Option K43: 50-60 Hz, 220-240 volt

*CISPR Publication 16 is the Comite International Special des Perturbations Radioelectrique specification for radio interference measuring apparatus and measurement methods.

**Uses Series 200 Model 26 or 36 Computer with BASIC 3.0 Language and Extensions. Also requires 1.1 Megabytes of memory, unless used with Model 36C, which requires 1.3 Megabytes.

Recommended EMI Transducer Kits:

| Commercial | | | MIL-STD | | | |
|---|---------------|--------------------------|---------------------|-------------------|----------------------------------|------------------------------------|
| Test | Freq. Range | HP 85685A Option | Test | Freq. Range | HP 85685A Option | |
| VDE 0871 FCC PART 15J FCC PART 15J (only). | Radiated | 10 kHz-30 MHz | MIL-STD 461B/462 | Radiated RE-02 | 14 kHz-1 GHz | |
| | | | | | K01 50-60 Hz,100 volt | K20 (Circularly Polarized Antenna) |
| | | | | | K02 50-60 Hz,120 volt | K21 (Linearly Polarized Antenna) |
| | | | | | K03 50-60 Hz,220-240 volt | K22 (Circularly Polarized Antenna) |
| | | K04 50-60 Hz,100 volt | | | K23 (Linearly Polarized Antenna) | |
| | | 10 kHz-1 GHz | | | K05 50-60 Hz 120 volt | |
| Conducted | 10 kHz-30 MHz | K07 | Conducted CE-03 | 10 kHz-50 MHz | K24 | |
| Radiated | 30 MHz-1 GHz | K08 (Broadband Antennas) | | | | |
| | | K09 (Dipole Antennas) | | | | |
| Conducted | 10 kHz-30 MHz | K07 | | | | |

SIGNAL ANALYZERS

Microwave Spectrum Analyzer, 10 MHz to 115 GHz

Model 8569B

- 0.01 to 22 GHz, external mixing to 115 GHz & above
- Internal preselection, 1.7 to 22 GHz
- Wide resolution range, 100 Hz to 3 MHz
- Simple three knob operation
- Digital display of dual traces and control settings
- Direct plotter output - no controller needed

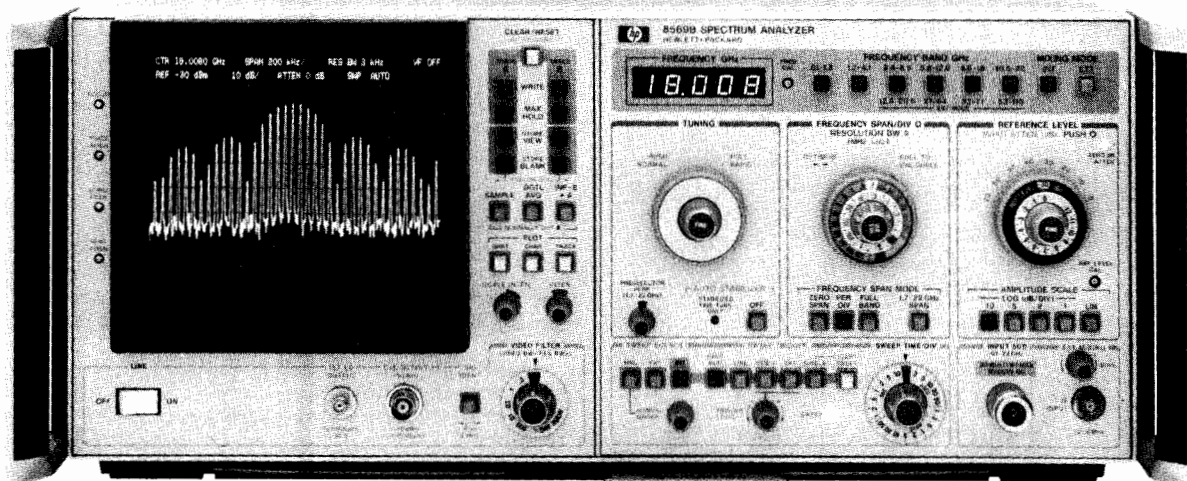

HP 8569B



HP 8569B Spectrum Analyzer

High performance and simple operation are combined with unique microprocessor-controlled capabilities in the HP 8569B Microwave Spectrum Analyzer. Excellent sensitivity and internal preselection assure the wide, spurious-free measurement range necessary for production applications, while the digital display and coupled controls speed measurement routines. The internal frequency range of 10 MHz to 22 GHz is extended using external mixers: to 40 GHz in two bands with the HP 8569B Option E02; to 71 GHz with other new HP 11971 series mixers; and to 115 GHz with other commercially available mixers. For more information on external harmonic mixers see page 697. For semi-automatic operation, connect a desktop computer to the HP 8569B via HP-IB to allow access to the displayed trace data and the control settings necessary to analyze or record measurements, or display operator messages and prompts on the CRT. Direct, hard copy output to a digital plotter is possible without the need of a controller or any programming.

Wide Range of Signal Resolution

Optimum resolution is possible for a wide range of signal characteristics with ten IF filters available from 100 Hz to 3 MHz. Fully automatic stabilization in narrow spans reduces residual FM to allow accurate measurements of closely spaced signals using the narrow bandwidths. The wide 1 and 3 MHz resolution bandwidths allow fast sweeps in wide spans and increased dynamic range for pulsed RF applications. All resolution filters are Gaussian-shaped for repeatable measurements, faster undistorted sweeps, and best pulse-response.

High Accuracy and Wide Dynamic Range

Absolute signal levels from -123 to +30 dBm are easily and accurately measured using IF substitution because the HP 8569B displays the reference level value directly on the CRT above the graticule. Damage to the mixer is prevented for signal levels of +30 dBm with a built-in limiter below 1.8 GHz and a preselector from 1.7 to 22 GHz. The internal preselector also ensures maximum use of this wide measurement range by reducing internal distortion products as much as 120 dB. In addition, flat frequency response ensures accuracy for relative as well as absolute power measurements.

Convenient Operation with Digital Display

Preset the HP 8569B to the color-coded, "basic operation" settings and use the coupled controls to make most measurements in three

easy steps: tune to the signal, select a span and raise it to the reference level. While in the AUTO sweeptime position, a calibrated amplitude display is ensured. However, the microprocessor also monitors manually-selected sweeptimes and displays a warning if the sweep speed chosen is too fast for calibrated measurements. Signals are displayed on either of two independent digitally stored traces with all major control settings annotated above the graticule area. Display processing capabilities include Max Hold, digital averaging and trace normalization for extended measurement capability.

HP-IB Includes Direct Plotter Control

A hard-copy record of the displayed traces, control settings and graticule can be made on a digital plotter via HP-IB quickly and simply using the HP 8569B's front-panel pushbuttons without need for a controller. For maximum capability, attach a controller to the HP 8569B to read the trace data and control settings for a measurement analysis or recording on tape. Also, you can illustrate the test parameters for each measurement with display lines and instruct the operator with messages on the analyzer CRT. The controller can verify correct control settings before taking the test data or going on to the next step.

HP 8444A Option 059 Tracking Generator

Characterize the frequency response of devices up to 1500 MHz by using the HP 8444A Option 059 Tracking Generator with the HP 8569B. Dynamic range is greater than 90 dB and system response errors can be removed using trace normalization. In addition, increase the analyzer's frequency accuracy to ± 10 kHz using a counter with the tracking generator.

HP 8569B Specifications

Frequency Specifications

Frequency range: 0.01 to 22 GHz with internal mixer. 18 to 40 GHz with HP 8569B Option E02. Extendable to 71 GHz with new HP 11971 Q/U/V Mixers. Extendable to 115 GHz with commercially available mixers. See page 697 for more information on external mixers.

Tuning Accuracy (digital frequency readout in any span mode)

10 MHz to 115 GHz: $\pm(5$ MHz or 0.2% of center frequency, whichever is greater, +20% of Frequency Span/Div).



Frequency Spans

1.7 to 22 GHz: multiband span from 1.7 to 22 GHz in one sweep.

Full band: displays spectrum of entire band selected.

Per division: 1 kHz to 500 MHz/div in a 1, 2, 5 sequence.

Span width accuracy: $\pm 5\%$, 500 MHz to 20 kHz/div unstabilized; $\pm 15\%$, 100 kHz to 1 kHz/div, stabilized.

Zero span: analyzer becomes a manually tuned receiver.

Spectral Resolution and Stability

Resolution bandwidths: resolution (3 dB) bandwidths from 100 Hz to 3 MHz in 1, 3, sequence. Bandwidth and span width are independently variable or may be coupled for optimum display when control markers are aligned (▶◀).

Resolution bandwidth accuracy: 3 dB points are $\pm 15\%$.

Selectivity: (60 dB/3 dB bandwidth ratio): $< 11:1$, 100 Hz to 1 kHz; $< 15:1$, 3 kHz to 3 MHz.

Total residual FM: (fundamental mixing 0.01 to 4.1 GHz): < 100 Hz p-p in 0.1 second. First LO automatically stabilized for frequency spans ≤ 100 kHz/div.

Noise sidebands: > 75 dB down, ≥ 30 kHz from signal in a 1 kHz Res. Bandwidth and a 10 Hz (0.01) Video Filter.

Amplitude Specifications

Amplitude Range—Internal Mixer

Total power: +30 dBm, +137 dB μ V (1 watt).

Damage levels: (50 ohm nominal source impedance):

dc: 0 V with 0 dB input attenuation (1 A), ± 7 V with ≥ 10 dB input attenuation (0.14 A).

Peak pulse power: +50 dBm (< 10 μ s pulse width, 0.01% duty cycle with ≥ 20 dB input attenuation).

Gain compression: < 1 dB for -7 dBm signal, 0 dB input atten.

Average noise level: see table below for max. avg. noise level with 1 kHz res. bandwidth (0 dB atten. and 3 Hz video filter).

| Frequency Band (GHz) | First IF in MHz | Harmonic Mode | Noise Level (dBm) | Frequency Response* (\pm dB max) |
|----------------------|-----------------|---------------|---|-------------------------------------|
| 0.01-1.8 | 2050 | 1- | -113 | 1.2 |
| 1.7-4.1 | 321.4 | 1- | -110 | 1.5 |
| 3.8-8.5 | 321.4 | 2- | -107 | 2.5 |
| 5.8-12.9 | 321.4 | 3- | -100 | 2.5 |
| 8.5-18 | 321.4 | 4+ | -95 | 3.0 |
| 10.5-22 | 321.4 | 5+ | -90 | 4.5 |
| 12.4-26.5 | 321.4 | 6+ | Use HP 11971 Series Mixers to 71 GHz and commercially available mixers to 115 GHz. Refer to page 697. | |
| 21-44 | 321.4 | 10+ | | |
| 33-71 | 321.4 | 16+ | | |
| | | | | |
| 53-115 | 321.4 | 26+ | | |

*Frequency response includes input attenuator, preselector and mixer frequency response plus mixing mode gain variation (band to band).

Reference Level

Reference level range: +60 dBm (+30 dBm max. input) to -112 dBm in 10 dB steps and continuous 0 to -12 dB calibrated vernier.

Reference level accuracy: auto Sweep setting of Sweep Time/Div control insures a calibrated display within these limits:

Calibrator output: (100 MHz ± 10 kHz): -10 dBm ± 0.3 dB.

Reference level variation: (input atten. at 0 dB, 20° to 30°C): -10 to -70 dBm: ± 0.5 dB; -80 to -100 dBm: ± 1.0 dB.

Vernier: (0 to -12 dB continuous); maximum error ± 0.5 dB.

Input attenuator: 0-70 dB in 10 dB steps.

Step size variation: ± 1.0 dB, 0.01 to 18 GHz; ± 1.5 dB, 0.01 to 22 GHz. Maximum cumulative error: ± 2.5 dB.

Frequency response: see table above.

Switching between bandwidths: 3 MHz to 100 Hz, ± 1.0 dB.

Calibrated Display Range

Log: 1, 2, 5, and 10 dB/div over 8 divisions.

Linear: 0.56 μ V to 224 V in 50 ohm.

Display Accuracy

Log: ± 0.1 dB/dB; maximum cumulative error ± 1.5 dB.

Linear: $< \pm 3\%$ over full 8 division deflection.

Residual responses (no signal present at input): < -90 dBm.

Signal identifier: available from 10 MHz to 115 GHz.

Signal Input/Output Characteristics

Input SWR (input impedance 50 ohm nominal)

Input atten. at 0 dB: < 1.5 , 0.01-1.8 GHz; < 2.0 , 1.7-22 GHz.

Input atten. at ≥ 10 dB: < 1.3 , 0.01-1.8 GHz; < 2.0 , 1.7-22 GHz.

LO emission from RF input (1.4 to 5.2 GHz): < -60 dBm, 0.01 to 1.8 GHz; < -80 dBm, 1.7 to 22 GHz.

Input Protection (for input signals from 0.01 to 22 GHz)

0.01 to 1.8 GHz: internal diode limiter.

1.7 to 22 GHz: preselector protects mixer to +30 dBm.

321.4 MHz IF input: SMA female connector is a port for bias current output (± 5 mA) and IF return from an external mixer.

LO output: 2 to 4.46 GHz with minimum power of +8 dBm.

Sweep Specifications

Sweep Time

Auto: sweep time is automatically controlled by Frequency Span/Div, Resolution Bandwidth and Video Filter controls to maintain an absolute amplitude calibrated display.

Calibrated sweep times: 2 μ s to 10 s/div in 1, 2, 5 sequence.

Digital Display

Traces: dual trace, digitally stored display with a resolution of 481 horizontal by 801 vertical points for each trace.

Control readout: major control settings annotated on the CRT include Center or Marker frequency, Frequency Span/Div, Resolution BW, Video Filter, Reference Level, Scale Factor, RF Input Attenuator and Sweep Time/Div.

Signal processing: Max Hold, trace normalization, sample detection mode, digital avg. and dB μ V Reference Level readout.

Internal service routines: front-panel pushbuttons access test patterns to perform maintenance of digital hardware.

HP-IB

Direct plotter control: all displayed information can be transferred to an HP-IB plotter by using only front-panel pushbuttons.

Controller Interface Functions

Trace data transfer: all trace data values can be transferred to or from an HP 8569B with a controller.

Control readout: all displayed control settings can be transferred to a controller to check measurement conditions.

Input messages: controller-input instructions or annotation can be displayed within two 63-character lines on the analyzer CRT.

Sweep control: sweeps can be initiated and monitored.

Note: HP-IB cables are not supplied with the HP 8569B.

HP-IB Interface Functions

AH1, DC1, L4, SH1, T7. For more information on these codes, refer to the HP-IB section of this catalog.

General Specifications

Temperature range: operating 0° to +55°C, storage -40° to +75°C.

Humidity range (operating): 95% R.H., 0°C to 40°C.

EMI: conducted and radiated interference is in compliance with MIL-STD 461A Methods CE03 and RE02, CISPR Publication 11 (1975), and Messemphaenger-Postverfuegung 526/527/79 (Kennzeichnung Mit F-Nummer/Funkschutzzeichen).

Power requirements: 48-66 Hz; 100, 120, 220 or 240 volts (-10% to +5%); 280 VA max (400 Hz operation available as Opt 400).

Size: 188 H x 426 W x 552 mm D (7" x 16.8" x 21.8").

Weight: net 29.2 kg (64 lb). Shipping 41 kg (90 lb).

Standard Options Available

Opt 001, Internal Comb Generator: 100 MHz comb signals visible through 22 GHz for increased frequency accuracy (error $< 0.007\%$, typically ± 1 MHz at 22 GHz) and preselector peaking verification.

Opt 002, Delete 100, 300 Hz Bandwidths: standard specifications apply except minimum resolution bandwidth is 1 kHz with 15:1 shape factor, residual FM < 200 Hz when stabilized.

Opt 003, High Power LO: provides $\geq +14$ dBm for direct use with mixer (e.g. HP 11971 series).

Opt 400, 50 to 400 Hz Power Supply

HP Part No. 1450-0654—Transit Case: Order HP Part No. 1490-0913 also for castors.

Ordering Information

HP 8569B Spectrum Analyzer

Price

\$29,075

Opt 001: Internal Comb Generator

add \$1,425

Opt 002: Delete 100, 300 Hz Bandwidths

less \$800

Opt 003: High Power LO Output

add \$1,000

Opt 400: 50 to 400 Hz Power Line Operation

add \$350

Opt 908: Rack Flange Kit Without Handles

add \$35

Opt 910: Extra Operating & Service Manual

add \$50

Opt 913: Rack Flange Kit with Handles

add \$40

Opt E02: Extend frequency range to 40 GHz

add \$3,950

HP 8444A Opt 059 Tracking Generator

\$4,760

HP 11971 Series Mixers extend frequency range to 71 GHz. See page 697.

SIGNAL ANALYZERS

Microwave Spectrum Analyzer, 10 MHz to 22 GHz

Model 8570A

- Internal preselection, 1.7 to 22 GHz
- Wide dynamic range, 103 dB
- Broad resolution selection, 1 kHz to 3 MHz
- Simple three-knob operation
- Digital display, dual traces & CRT annotation
- Direct-to-plotter output

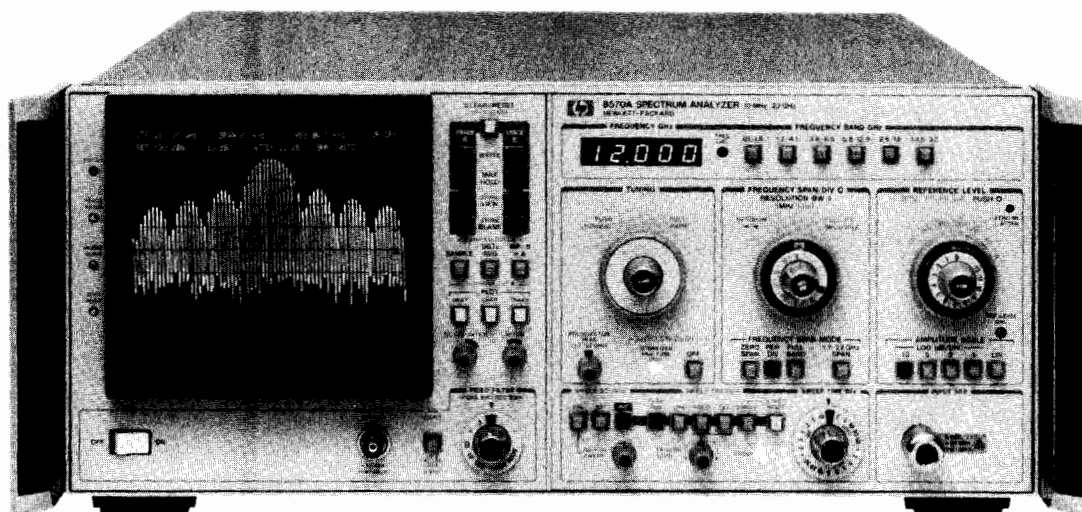

HP 8570A

HP 8570A Spectrum Analyzer

The performance and ease-of-use of the HP 8570A make it an ideal choice for lab, production, and field uses. The internal preselector provides wide dynamic range necessary for many applications while it simplifies signal identification. Precise measurements are made quickly and easily with features such as three-knob operation and digital display. Documented results are conveniently obtained with the direct-to-plotter HP-IB output.

Capable Performance

Measurements of signals from +30 to -110 dBm are possible with the HP 8570A. The internal preselector produces a wide 97 dB dynamic range for harmonic and widely-spaced intermodulation distortion measurements over its 1.7 to 22 GHz frequency range. Protection of the first mixer is provided by the built-in limiter to 1.8 GHz and by the preselector to 22 GHz.

Amplitude accuracies of ± 1.5 dB are possible over a 90 dB range using the reference level control (IF substitution), or over a 70 dB range reading directly from the CRT display. Frequency accuracies of 70 ppm (0.007%) are possible using the Option 001 Internal Comb Generator.

A broad selection of resolution bandwidths allows a diversity of signals to be measured. Broadband pulsed signals, such as pulsed RF radar or electromagnetic interference (EMI) noise signals, are easily measured with wide resolution bandwidths to 3 MHz. These synchronously-tuned filters, resulting in their Gaussian shape, ensure a repeatable pulse response for accurate amplitude measurements. Narrower bandwidths to 1 kHz provide resolution and sensitivity to satisfy most measurement needs, such as measuring closely-spaced or low-power signals, or both. Bandwidths available in a 1, 3, 10 sequence save measurement time by providing flexibility while maintaining fast sweep times.

Ease of Operation

Engineered with the user in mind, the HP 8570A Spectrum Analyzer is easy to operate. This reduces measurement time and errors. Color-coded and logically grouped controls simplify normal operation. Most measurements can be made in three steps: (1) Display all of the signals in the band using the FULL SPAN control and measure any signal frequency by moving the marker to the signal with the TUNE control. (2) Zoom in on the signal for close-in analysis using the FREQ SPAN control. The coupled functions—Resolution Bandwidth, Video Bandwidth, and Sweep Time—are all automatically adjusted to ensure calibrated results. (3) Measure the signal amplitude using the REF LEVEL control.

The digital display adds flexibility and convenience to every measurement. Dual traces facilitate signal comparisons. Traces can be updated and stored separately for analysis later. Trace processing functions such as maximum hold, digital averaging, peak or sample detection, and trace subtraction provide capability for special applications. The digital display simplifies measurements requiring slow sweep times since adjustments of CRT intensity and persistence are not required.

Measurement results are conveniently converted into hard-copy form using a HP-IB graphics plotter. The direct-to-plotter feature of the HP 8570A outputs the CRT traces, graticule, and annotation information to a plotter using front-panel buttons, eliminating the necessity for a computer.

Automatic Measurements

Add a computer to your measurement system to increase speed and reduce errors. Operator efficiency can be enhanced using the semi-automatic capabilities of the HP 8570A. For example, a procedure with test limits can be written on the CRT to swiftly guide an operator through simple or complex measurements. Control settings can be monitored to ensure compliance with test requirements. Completely automatic measurements use the computer to initiate sweeps and input trace information for immediate analysis or for record keeping. Programs use two-letter mnemonics that are easy to remember and understand.

HP 8570A Specifications

Frequency Specifications

Frequency Range: 10 MHz to 22 GHz

Center Frequency

Readout Resolution: ± 1 MHz

Accuracy: $\pm (9 \text{ MHz or } 0.3\% \text{ of center frequency, whichever is greater, plus } 20\% \text{ of frequency span per division})$

Stability (for fundamental mixing, 0.01 to 4.1 GHz)

Total Residual FM:

Stabilized mode: < 200 Hz peak-to-peak in 0.1 second

Unstabilized mode: < 20 kHz peak-to-peak in 0.1 second

Noise Sidebands: (1 kHz bandwidth and 10 Hz video bandwidth) < -70 dBc at ≥ 30 kHz offset from a CW signal

Frequency Span

Setting Range: 1 kHz to 500 MHz/div in a 1, 2, 5, 10 sequence

Accuracy:

Unstabilized Mode: $\pm 5\%$ for spans ≥ 20 kHz/div

Stabilized Mode: $\pm 20\%$ for spans ≤ 100 kHz/div

Resolution Bandwidth (-3 dB)

Setting Range: 1 kHz to 3 MHz in a 1, 3, 10 sequence



Accuracy: $\leq \pm 20\%$

Selectivity: (60 dB/3 dB) $\leq 15:1$, approx. Gaussian shape

Video Bandwidth Characteristic

Setting Range: 1 MHz to 3 Hz in a 1, 3, 10 sequence

Noise Averaging: 1 Hz nominal NOISE AVG setting

Accuracy: Typically $\pm 20\%$

Amplitude Specifications

Maximum Amplitude Range: +30 dBm to -110 dBm

Maximum Safe Input Power

Total Average Continuous Power: +30 dBm (1 watt)

Peak Pulse Power: +50 dBm with ≥ 20 dB input attenuation (< 10 us pulse width, 0.01 % duty cycle)

DC or AC Power: ($\ll 50$ ohms source impedance)

0 dB input attenuation: 0 volts, 1 ampere

≥ 10 dB input attenuation: ± 7 volts, 0.14 ampere

Input Mixer Protection:

0.01 to 1.8 GHz: Internal diode limiter

1.7 to 22 GHz: Saturation of YIG filter (preselector)

Display Range

Scale Size: 8 x 10 division internally etched CRT graticule

Scale Calibration: 10, 5, 2, and 1 dB/div and Linear

Reference Level Range: +60 to -112 dBm in 10 dB steps and continuous 0 to -12 dB calibrated vernier

Input Attenuator Range: 0 to 70 dB in 10 dB steps

Dynamic Range

Maximum Dynamic Range

Gain Compression to Noise: > 103 dB

Signal to Intermod Distortion: > 97 dB

Displayed Average Noise Level: (1 kHz RBW, 3 Hz VBW, 0 dB atten.)

| Frequency (GHz) | Average Noise (dBm) |
|-----------------|---------------------|
| 0.01 - 1.8 | -110 |
| 1.7 - 4.1 | -105 |
| 3.8 - 8.5 | -100 |
| 5.8 - 12.9 | -95 |
| 8.5 - 18 | -90 |
| 10.5 - 22 | -85 |

Gain Compression Level: ≤ -7 dBm at mixer for < 1 dB compression

Spurious Response Characteristics

All Spurious Responses: < -70 dBc (except as noted below)

Second Harmonic Distortion:

| Frequency Range (GHz) | Input Power at Mixer | Second Harmonic |
|-----------------------|----------------------|-----------------|
| 0.01 - 1.8 | -40 dBm | < -60 dBc |
| 1.7 - 22 | -10 dBm | < -100 dBc |

Third-order Intermodulation Distortion:

| Frequency Range (GHz) | Total Power at Mixer | Signal Spacing | Intermod Products | Equiv. TOI |
|-----------------------|----------------------|----------------|-------------------|------------|
| 0.01 - 22 | -30 dBm | ≥ 50 kHz | < -70 dBc | +5 dBm |
| 1.7 - 12.9 | -10 dBm | ≥ 70 MHz | < -100 dBc | +40 dBm |
| 1.7 - 22 | -10 dBm | ≥ 100 MHz | < -100 dBc | +40 dBm |

Image and Multiple Responses:

0.01 to 1.8 GHz: < -70 dBc

1.7 to 22 GHz: < -60 dBc

Residual Responses: < -90 dBm with 0 dB input attenuation (no signal at input and fundamental mixing, 0.01 to 4.1 GHz)

Amplitude Accuracy

Frequency Response: (Ref. to 100 MHz, -10 dBm with 10 dB atten.)

| Frequency (GHz) | Frequency Response (\pm dB max) |
|-----------------|------------------------------------|
| 0.01 - 1.8 | 1.5 |
| 0.01 - 4.1 | 2.0 |
| 0.01 - 12.9 | 3.0 |
| 0.01 - 18 | 3.5 |
| 0.01 - 22 | 5.5 |

Internal Calibrator: $< \pm 0.3$ dB

Reference Level Accuracy: (0 dB input attenuation)

IF Step Gain: $< \pm 1.5$ dB over -10 to -100 dBm range

Vernier: $< \pm 1.0$ dB over 0 to -12 dB range when read from the vernier control

Input Attenuator Accuracy:

0.01 to 18 GHz: $\leq \pm 1.0$ dB/step, ± 2.4 dB max, 0 to 60 dB

0.01 to 22 GHz: $\leq \pm 1.5$ dB/step, ± 2.5 dB max, 0 to 40 dB

Resolution Bandwidth Switching: $< \pm 1.5$ dB from the 3 MHz RBW

Scale Fidelity

Log: $< \pm 0.1$ dB/dB to ± 1.5 dB max, 0 to 70 dB range

Linear: $< \pm 5\%$ of reference level

Sweep Specifications

Sweep Time

Setting Range: 2 us to 10 s/div in a 1, 2, 5, 10 sequence

Accuracy:

2 us to 1 second: $\pm 15\%$

2 to 10 seconds: $\pm 20\%$

Sweep Trigger: Free Run, Line, Video, Single, or External

Input Output Characteristics

RF Input

Connector Type: Precision type N female

Input Impedance: 50 ohms nominal

SWR: (with ≥ 10 dB atten.) Typically < 2.0 to 18 GHz

LO Emission: (2.0 to 4.46 GHz)

| Frequency (GHz) | Power (dBm) |
|-----------------|-------------|
| 0.01 - 1.8 | < -60 |
| 1.7 - 22 | < -80 |

Calibrator Signal: 100 MHz ± 10 kHz, -10 dBm ± 0.3 dB

HP-IB Interface: Compatibility with IEEE STD 488-1978

Function Codes: AH1, C0, DC1, DT0, E2, L4, PP0, RL0, SH1, SR0 & T7

Auxiliary Inputs: Blanking, External Sweep and Trigger, Retrace

Auxiliary Outputs: Blanking, Horiz. Sweep, 21.4 MHz IF, Vertical

General Specifications

Environmental

Temperature Range:

Operating: 0 to +45°C

Storage: -40 to +75°C

Warm-Up Time:

1 hour

EMI: Conducted and radiated interference is in compliance with MIL-STD 461A methods CE03 and RE02, CISPR Publication 11 (1975), and Messemphaenger-Postverfuergung 526/527/79 (Kennzeichnung Mit F-Nummer/Funkschutzzeichen).

Power-Line Requirements

Operating Voltage: 100, 120, 220, or 240 (+5%, -10%) VAC

Operating Frequency: 48 to 66 Hz

Maximum Power: 280 VA

Net Weight: 26.8 kg (59 lb.)

Shipping Weight: 38.6 kg (85 lb.)

Size: 188 mm H x 426 mm W x 552 mm D (7.0 " x 16.8 " x 21.8 ")

Standard Options Available

Option 001, Internal Comb Generator: Enhances frequency accuracy.

Frequency Range: 0.1 to 22 GHz

Comb Frequency: 100 MHz

Frequency Accuracy: $\leq \pm 0.007\%$

Option 400, 400 Hz Power Line Operation: Extends line frequency.

Operating Frequency Range:

100 & 120 VAC lines: 48 to 440 Hz

100, 120, 220 & 240 VAC lines: 48 to 66 Hz

Ordering Information

HP 8570A Spectrum Analyzer

Option 001: Internal Comb Generator

Option 400: 50 to 400 Hz Power Line Operation

Option 908: Rack Flange Kit without handles

Option 910: Extra Technical Reference Manuals

Option 913: Rack Flange Kit with handles

Price

\$25,000

\$1,425

\$350

\$35

\$50

\$40

SIGNAL ANALYZERS

Spectrum Analyzer, 10 MHz to 40 GHz

Model 8565A

- 0.01 to 22 GHz, external mixing to 40 GHz
- Internal preselection 1.7 to 22 GHz
- Wide resolution range, 1 kHz to 3 MHz standard

- Simple three knob operation
- CRT bezel readout displays control settings

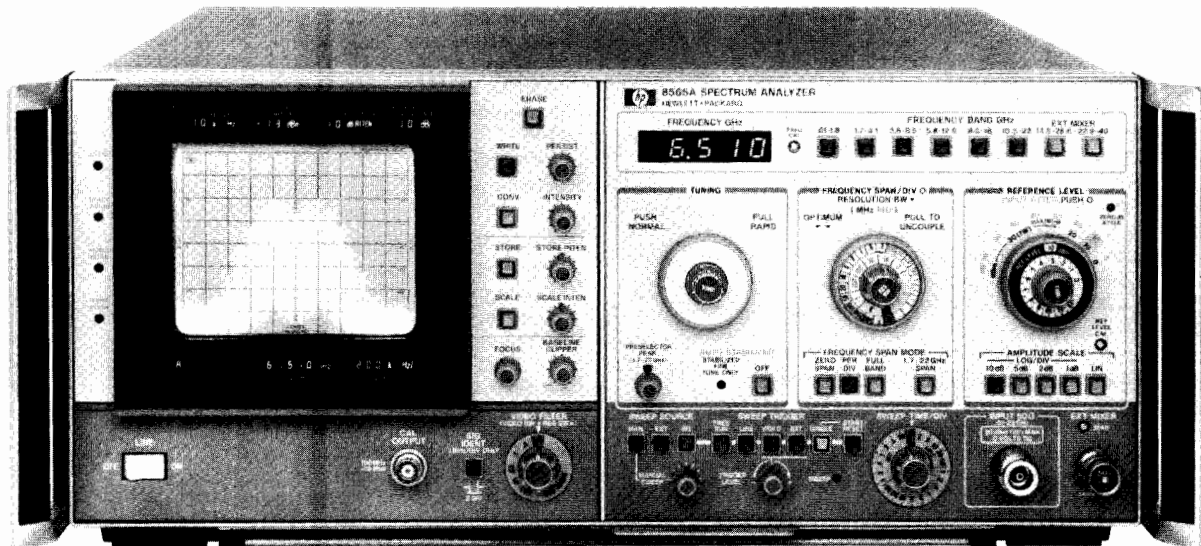

HP 8565A

HP 8565A Spectrum Analyzer

Covering from 0.01 to 22 GHz with its internal mixer, the HP 8565A has built-in preselection and brings accuracy plus convenience to microwave spectrum analysis. The wide range, spurious-free display, compact design and ease of use make it well suited for lab, production, or field applications requiring accurate measurement from IF through microwave frequencies. The HP 8565A can cover 0.01 to 22 GHz in just two spans for rapid location of signals prior to close-in analysis in one of six bands. Coverage is easily extended up to 40 GHz with the HP 11517A External Mixer.

High Resolution

Fully automatic stabilization in narrow spans reduces residual FM and drift. Standard resolution bandwidths range from 1 kHz to 3 MHz. The 1 and 3 MHz bandwidths allow fast sweeps in wide spans and increased dynamic range for pulsed RF; the narrow bandwidths allow measurement of closely spaced signals. Option 100 provides additional 100 Hz and 300 Hz IF bandwidth filters, and residual FM is <100 Hz when stabilized. This 100 Hz resolution is usable up to 8.5 GHz and the 300 Hz resolution bandwidth to 22 GHz. All resolution filters are Gaussian-shaped for repeatable measurements, faster undistorted sweeps and best pulse response.

Absolute Amplitude Calibration

Absolute signal levels from -112 dBm to +30 dBm are easily measured because the HP 8565A always displays the value of the reference line with LEDs in the CRT bezel and at the reference level control. Changes in RF, IF gain, and preselector loss are automatically included. In addition, flat frequency response ensures accuracy for relative as well as absolute power measurements.

Wide Dynamic Range

Internal preselection (1.7 to 22 GHz) enables you to measure distortion products as much as 100 dB down. Even for closely spaced signals or measurements below 1.7 GHz, all distortion products are more than 70 dB down. In either case, maximum dynamic range is ensured even for 1 watt signals with the 70 dB input attenuator. An input limiter (0.01 to 1.8 GHz) and the internal preselector (1.7 to 22 GHz) enable the HP 8565A to withstand RF signals up to +30 dBm for all input attenuator settings.

Designed for Convenience

Coupled controls allow you to make most measurements in 3 simple steps. Green color coded keys preset the HP 8565A for normal operation so a measurement only requires that you tune to a signal, select a desired span, and raise it to the reference level. Automatically selected sweep times ensure a calibrated display for all combinations of frequency span, resolution bandwidth and video filtering.

The CRT bezel LEDs display all pertinent control settings to give you all the information needed for signal evaluations in one central location. These data are also captured in CRT photos.

HP 8444A Option 059 Tracking Generator

Make swept frequency response measurements to ± 1.7 dB from 10 to 1300 MHz (± 2.7 dB up to 1500 MHz) with greater than 90 dB of dynamic range. The output is absolutely calibrated at 0 dBm and continuously variable to < -10 dBm. The frequency of unknown signals as well as the frequency of any point on the frequency response curve can be measured from the external counter output using the low-cost HP 5300/5305B Counter.

HP 8750A Storage-Normalizer

The analyzer is made even easier to use with the digital storage of the HP 8750A because there is no need to re-adjust intensity or persistence as the sweep time changes. With the push of a button, a signal can be frozen on the CRT and then compared directly to the current input signal. Traces can also be compared arithmetically (i.e., normalized) to automatically remove frequency response variations. This is especially useful when used with the HP 8444A Opt. 059 Tracking Generator.

HP 8565A Specifications

Frequency Specifications

Frequency range: 0.01 to 22 GHz with internal mixer, 14.5 to 40 GHz with HP 11517A External Mixer. Extendable to 220 GHz with other commercially available mixers and using signal ID as in Application Note 150-14.

Tuning Accuracy (digital frequency readout in any span mode)

Internal mixing: 0.01 to 2.5 GHz $< \pm(5 \text{ MHz} + 20\% \text{ of Frequency Span/Div.})$; 2.5 to 22 GHz $< \pm(0.2\% \text{ of center frequency} + 20\% \text{ of Frequency Span/Div.})$.

External mixing: 14.5 to 40 GHz $< \pm(0.7\% \text{ of center frequency} + 20\% \text{ of Frequency Span/Div.})$.

Frequency Spans

1.7 to 22 GHz: multiband span from 1.7 to 22 GHz in one sweep.

Full band: displays spectrum of entire band selected.

Per division: eighteen calibrated spans from 1 kHz per div. to 500 MHz per div. in a 1, 2, 5 sequence, plus a full band span, "F".

Span width accuracy: the frequency error for any two points on the display for spans from 500 MHz/div to 20 kHz/div (un-stabilized) is less than $\pm 5\%$ of the indicated separation; for stabilized spans 100 kHz/div and less, the error is less than $\pm 15\%$.

Zero span: analyzer becomes a manually tuned receiver.



Spectral Resolution and Stability

Resolution bandwidths: resolution (3 dB) bandwidths from 1 kHz to 3 MHz in 1, 3 sequence. Bandwidth and span width are independently variable or may be coupled for optimum display when control markers are aligned (▶◀).

Resolution bandwidth accuracy: 3 dB points $\pm 15\%$.

Selectivity (60 dB/3 dB bandwidth ratio): $< 15:1$.

Stability: total residual FM (fundamental mixing 0.01 to 4.1 GHz): stabilized, < 200 Hz p-p in 0.1 s; unstabilized < 10 kHz p-p in 0.1 s.

Stabilization range: first LO automatically stabilized for frequency spans 100 kHz/div or less. First LO residual FM typically 30 Hz p-p when stabilized.

Noise sidebands: > 70 dB down, > 30 kHz from center of CW signal in a 1 kHz Res. Bandwidth and a 10 Hz (0.01 x) Video Filter.

Amplitude Specifications

Amplitude Range – Internal Mixer

Measurement Range

Total power: +30 dBm (1 watt).

Damage levels (50 Ω nominal source impedance):

dc: 0 V with 0 dB input atten, ± 7 V with ≥ 10 dB input atten.

ac: 0 V with 0 dB input atten, 10 V peak with ≥ 10 dB input atten.

RF (signals above 10 MHz): +30 dBm for any attenuator setting.

Gain compression: < 1 dB for 0 dBm input level with 0 dB attenuation.

Average noise level: see table below for max. avg. noise level with 1 kHz Res. Bandwidth (0 dB atten and 3 Hz video filter).

| Frequency Band (GHz) | First IF in MHz | Harmonic Mode | Noise Level (dBm) | Frequency Response* (\pm dB MAX) |
|----------------------|-----------------|---------------|-------------------|-------------------------------------|
| 0.01-1.8 | 2050 | 1- | -112 | 1.2 |
| 1.7-4.1 | 321.4 | 1- | -109 | 1.7 |
| 3.8-8.5 | 321.4 | 2- | -103 | 2.5 |
| 5.8-12.9 | 321.4 | 3- | -94 | 2.5 |
| 8.5-18 | 321.4 | 4+ | -87 | 3.5 |
| 10.5-22 | 321.4 | 5+ | -75 | 4.5 |

*Frequency response includes input attenuator, preselector and mixer frequency response plus mixing mode gain variation (band to band).

Amplitude Range - HP 11517A External Mixer

Measurement range: saturation (gain compression < 1 dB), -15 dBm. Damage level $> +10$ dBm.

Sensitivity (average noise level in a 10 kHz IF bandwidth): 14.5-18 GHz < -80 dBm, 18-26.5 GHz < -70 dBm, 26.5-40 GHz < -60 dBm. Typical sensitivity is 10 dB better for each band.

> 40 GHz: for signal analysis above 40 GHz with commercially available mixers see Application Note 150-14.

Reference Level

Reference level range: +70 dBm (+30 dBm max. input) to -102 dBm in 10 dB steps and continuous 0 to -12 dB calibrated vernier.

Reference level accuracy: the Auto Sweep setting of the sweep time/div control insures a calibrated display within these limits:

Calibrator output (100 MHz \pm 10 kHz): -10 dBm ± 0.3 dB.

Reference level variation (input attenuator at 0 dB, 20° to 30°C): 10 dB steps $< \pm 0.5$ dB (0 to -70 dBm); $< \pm 1.0$ dB (0 to -90 dBm).

Vernier (0 to -12 dB) continuous: maximum error < 0.5 dB.

Input attenuator: (at preselector input, 0-70 dB in 10 dB steps).

Step size variation: $< \pm 1.0$ dB, 0.01 to 18 GHz; $< \pm 1.5$ dB, 0.01 to 22 GHz.

Maximum cumulative error over the 0 to 60 dB range: $< \pm 2.4$ dB, 0.01 to 18 GHz, 0 to 60 dB; $< \pm 2.5$ dB, 0.01 to 22 GHz, 0 to 40 dB.

Frequency response: see table above.

Switching between bandwidths: 3 MHz to 1 kHz, ± 1.0 dB

Calibrated Display Range

Log: (expanded from reference level down): 70 dB 10 dB/div, 40 dB 5 dB/div, 16 dB 2 dB/div and 8 dB 1 dB/div.

Linear: full scale from 1.8 μ V (-102 dBm in 50 Ω to 707 volts (+70 dBm) in 10 dB steps and continuous 0 to -12 dB vernier.

Display Accuracy

Log: $< \pm 0.1$ dB/dB, but $< \pm 1.5$ dB over full 70 dB display range.

Linear: $< \pm 3\%$ of reference level.

Residual responses (no signal present at input): with 0 dB input atten, fundamental mixing (0.01 to 4.1 GHz) < -90 dBm.

Signal identifier: available from 10 MHz to 40 GHz and in all Freq. Span/Div settings for signal identification.

Signal Input Characteristics

Input impedance: 50 ohm nominal, 0.01 to 22 GHz.

Input connector: precision Type N female.

Input SWR

Input attenuator at 0 dB: < 1.5 , 0.01 to 1.8 GHz; < 2.0 , 1.7 to 22 GHz.

Input attenuator at ≥ 10 dB: < 1.3 , 0.01 to 1.8 GHz; < 2.0 , 1.7 to 22 GHz.

LO Emission (2.00 to 4.46 GHz): -50 dBm, 0.01 to 1.8 GHz; -85 dBm, 1.7 to 22 GHz.

Input Protection (for input signals from 0.01 to 22 GHz)

0.01 to 1.8 GHz frequency band: internal diode limiter.

1.7 to 22 GHz frequency bands: saturation of YIG filter (pre-selector) occurs at total input signal power levels below input mixer damage.

External mixer input: BNC female connector is a port for LO power transfer, bias current and IF return.

Sweep Specifications

Sweep Time

Auto: sweep time is automatically controlled by Frequency Span/Div, Resolution Bandwidth and Video Filter controls to maintain an absolute amplitude calibrated display.

Calibrated sweep times: 21 internal sweep times from 2 μ s/div to 10 s/div in 1, 2, 5 sequence.

Display Characteristics

Cathode Ray Tube (aluminized P31 phosphor, 8 \times 10 div internal graticule)

Persistence

Conventional: natural persistence of P31 phosphor.

Write: continuously adjustable from 0.2 s to full storage.

Storage time: continuously adjustable from 1 minute (full brightness) to > 30 minutes (minimum brightness).

Write speed: continuously adjustable to vary CRT sensitivity to capture large signal deflections in fast sweeps.

CRT Bezel readout: bezel LEDs display the following measurement data (included in CRT photographs taken with the HP 197B Opt 001, 006 Oscilloscope Camera): Ampl. Scale Factor, Ref. Level, Input Atten., Res. Bandwidth, Sweptime/Div., Freq., Freq. Span/Div.

General Specifications

Temperature range: operating 0°C to 55°C, storage -40° to $+75^\circ$ C.

Humidity range (operating): $< 95\%$ R.H. 0°C to 40°C.

EMI: Conducted and radiated interference is in compliance with MIL-STD 461A Methods CE03 and RE02, CISPR publication 11 (1975), and Messemfänger-Postverfuegung 526/527/79 (Kennzeichnung Mit F-Nummer/Funkschutzzeichen).

Power requirements: 48-66 Hz; 100, 120, 200 or 240 volts (-10% to $+5\%$); 220 VA max (400 Hz operation available as Opt 400).

Size: 188 H x 426 W x 552 mm D (7" x 16.8" x 21.8").

Weight: net 29.5 kg (64 lb). Shipping 39 kg (85 lb).

Standard Options Available

Opt 100, 100 and 300 Hz resolution bandwidths: adds 100 Hz and 300 Hz resolution bandwidths with 11:1 shape factor, residual FM < 100 Hz when stabilized and improves sensitivity by 10 dB.

Opt 200—Calibration in dB μ V

Opt 400—400 Hz Power Supply

HP Part No. 1540-0654 - Transit Case. Order HP Part No. 1490-0913 also for castors.

Ordering Information

HP 8565A Spectrum Analyzer Price

Opt 100: 100 Hz and 300 Hz Resolution Bandwidths \$27,075

Opt 200: Calibration in dB μ V \$1,500

Opt 400: Internal 50 to 400 Hz Power Supply \$100

Opt 908: Rack Flange Kit \$250

Opt 910: Extra Operating and Service Manual \$35

Opt 913: Rack Flange Kit for instruments with handles \$50

HP 11517A External Mixer (taper section req'd) \$40

HP 11518A Taper Section, 12.4 to 18 GHz \$450

HP 11519A Taper Section, 18 to 26.5 GHz \$275

HP 11520A Taper Section, 26.5 to 40 GHz \$275

HP 8444A Opt 059 Tracking Generator, 10 to 1500 MHz \$275

HP 8750A Storage-Normalizer \$4,760

\$2,355

SIGNAL ANALYZERS

Spectrum Analyzer, 0.01 to 350 MHz

Models 8557A/853A

- Rugged portability
- Simple, three knob operation
- Direct plotter control

- Display annotation and storage accessories
- Digital display with trace arithmetic
- Resolution bandwidths from 1 kHz to 3 MHz
- Optional 75 Ω input with dBm or dBmV calibration

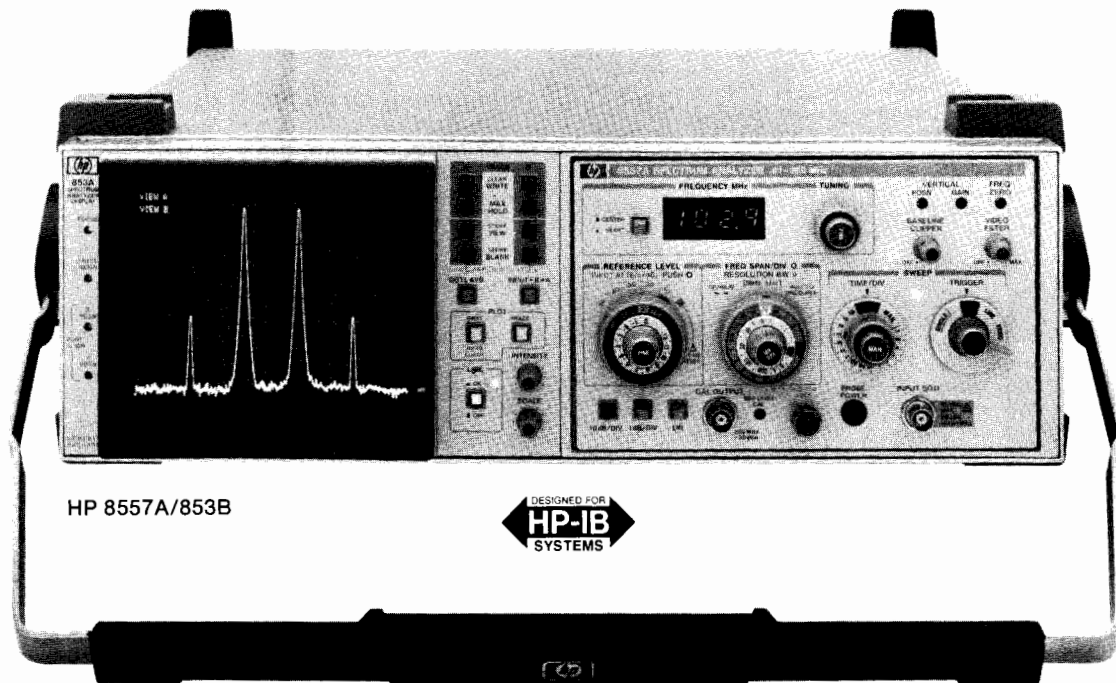

HP 8557A Spectrum Analyzer Plug-In Performance Plus Economy

The HP 8557A is a 10 kHz to 350 MHz spectrum analyzer plug-in for use with the HP 853A or 182T display. The high performance and convenient operation of this economical unit is ideally suited for a variety of applications in production, R & D or field service measurements.

Simple 3-Knob Operation

Preset the HP 8557A to the color-coded, "basic-operation" settings, and use the coupled controls to make most measurements in three easy steps. Tune to the signal; the LED readout displays its frequency. Zoom-in on the signal by reducing the span width; the resolution bandwidth, video filter, and sweep time automatically change to an optimum value for a calibrated display. Then, change the reference level to bring the peak of the signal to the top of the screen for the most accurate amplitude measurement.

Absolute Amplitude Calibration

Signal levels can be read directly from the CRT in dBm (dBmV for Option 002) without the use of external standards or calculations. The signal level represented by the top CRT graticule line is always indicated by the reference level control, and vertical scale factors of 10 dB/div, 1 dB/div or linear can be selected.

Optional 75 Ω Input

Two options are available which allow measurements in 75 Ω systems. Option 001 has 75 Ω impedance, but retains the dBm power calibration. Option 002 is also 75 Ω , but the amplitude is calibrated in dBmV for measurements on systems such as CATV.

HP 853A Spectrum Analyzer Display

Digital Display

The HP 853A is a digital display mainframe for use with the HP 8557A spectrum analyzer plug-in. Signals are displayed on either of two independently stored digital traces. Display processing capabilities include maximum hold, digital averaging, and trace normalization for extended measurement capability. A built-in microprocessor manages the display operation and provides built-in test routines for display calibration and test (accessible via the front panel).

HP-IB Capability Includes Direct Plotter Control

A hard-copy record of the displayed traces and graticule can be made on a digital plotter via HP-IB by simply using the HP 853A's

frontpanel pushbuttons; a controller is not required. Although the analyzer controls are not programmable, some HP-IB capabilities include using a controller for recording trace data or for operator prompts on the HP 853A CRT. The digital display and processing functions can be remotely programmed, and analyzer sweeps can be initiated via HP-IB.

Two Configurations

The display is offered in two styles. The HP 853A (pictured) is a ruggedized, portable mainframe complete with tilt-bail handle and drip proof, protective front cover. The HP 853A is ideally suited for rugged, field service environments and any areas where system mobility is required. The HP 853A Option 001 offers the digital display in a full module bench or rack mount configuration.

Software

The Solid State Camera Software, which runs on the HP 75D Portable Computer, provides a low cost, portable alternative to CRT photos. One program, "Camera," allows the user to permanently store spectrum analyzer display traces along with display annotations. After being stored in the computer's memory or on magnetic card or tape, the display information can later be recalled for viewing on the HP 853A display or for making hard copies with a plotter. Another program, "Limitgen," allows test limit lines to be drawn on the HP 853A display. For more details, see page 684 in the HP 8559A Spectrum Analyzer section.

HP 8557A Specifications

Frequency Specifications

Frequency range: 0.01 to 350 MHz.

Frequency Spans

Full band: displays entire spectrum, 0.01 to 350 MHz.

Per division: 5 kHz to 20 MHz/div in a 1, 2, 5 sequence.

Zero span: analyzer functions as a manually tuned receiver.

Frequency Accuracy

Tuning accuracy: $\pm (3 \text{ MHz} + 10\% \text{ of frequency span per division})$.

Frequency span accuracy: $\pm 10\%$ of displayed frequency separation.

Spectral Resolution

Resolution bandwidths: eight selectable resolution (3-dB) bandwidths from 1 kHz to 3 MHz in a 1, 3 sequence. Bandwidth and frequency span are independently variable or may be coupled for optimum display when control markers are aligned (▶◀).



Resolution bandwidth accuracy: 3-dB points are $\pm 20\%$ ($+10^\circ$ to $+40^\circ\text{C}$).

Selectivity: (60-dB/3-dB bandwidth ratio) $< 15:1$.

Spectral Stability

Residual FM: < 1 kHz p-p in 0.1 second.

Noise sidebands: ≥ 75 dB down, > 50 kHz from center of CW signal with 1 kHz resolution bandwidth and full video filtering.

Amplitude Specifications

Amplitude range: -117 dBm to $+20$ dBm.

Maximum Input (safe) Levels

Total power: $+20$ dBm (100 mW, 2.24 Vrms).

Voltage: ± 30 Vdc or 30 V RMS (< 100 Hz).

Gain compression: typically < 1 dB for -10 dBm signal, 0 dB input attenuation.

Average noise level: < -107 dBm with 10 kHz resolution bandwidth, 0 dB input attenuation, and maximum (MAX) video filtering.

Calibrated Display Range

Log: 70 dB with 10 dB/div scale; 8 dB with 1 dB/div scale.

Linear: 8 divisions with linear (LIN) amplitude scale.

Amplitude Accuracy

Calibrator: -30 dBm ± 1 dB (into 50 Ω), 250 MHz ± 50 kHz.

Reference level: 10 dB steps and a 12 dB vernier for calibrated adjustment from -112 dBm to $+40$ dBm¹.

Step accuracy (with 0 dB input attenuation): -10 to -80 dBm: ± 0.5 dB; -10 to -100 dBm: ± 1.0 dB.

Vernier accuracy: ± 0.5 dB.

Frequency response: $\leq \pm 0.75$ dB with 10 dB input attenuation (includes input attenuator and mixer flatness).

Input attenuator: 0 to 50 dB, selectable in 10 dB steps.

Step accuracy: $< \pm 0.5$ dB per 10 dB step.

Maximum cumulative error: $< \pm 1.0$ dB.

Bandwidth Switching (amplitude variation)

3 MHz to 300 kHz: $< \pm 0.5$ dB.

3 MHz to 1 kHz: $< \pm 1.0$ dB.

Display Fidelity

Log incremental accuracy: ± 0.1 dB/dB from Reference Level.

Log maximum cumulative error: $\leq \pm 1.5$ dB over 70 dB range.

Linear accuracy: $\pm 3\%$ of Reference Level.

Spurious Responses

Second harmonic distortion: > 70 dB below a -40 dBm signal (> 1 MHz) with 0 dB input attenuation; > 60 dB below for signals 20 kHz to 1 MHz.

Third order intermodulation distortion: > 70 dB below two -40 dBm input signals (> 1 MHz) separated by ≥ 50 kHz and with 0 dB input attenuation; > 60 dB below for signals 10 kHz to 1 MHz.

Image and multiple responses: > 70 dB below a -40 dBm input signal (> 1 MHz) with 0 dB input attenuation; > 60 dB below for signals 20 kHz to 1 MHz.

Residual responses: < -100 dBm with 0 dB input attenuation and no signal present at input.

Sweep Characteristics

Sweep Time

Automatic: sweep time is automatically adjusted to maintain absolute amplitude calibration for any combination of frequency span, resolution bandwidth, and video filter bandwidth.

Calibrated sweep times: 0.1 msec to 10 sec/div in 1, 2, 5 sequence with $\pm 10\%$ typical accuracy.

Manual sweep: spectrum analyzer may be swept manually in either direction with front panel control.

Signal Input Characteristics

Input impedance: 50 Ω nominal; type BNC female connector.

Input SWR: typically < 1.5 with ≥ 10 dB input attenuation.

Output Characteristics

Probe power: $+15$ V, -12.6 V, and GND (150 mA max). Use HP 1120A, 1121A, or 1124A high impedance probes.

HP 853A Characteristics

Digital Display

Traces: dual trace, digitally stored display with resolution of 481 horizontal by 801 vertical points for each trace.

Signal processing: maximum hold, digital averaging, and trace normalization.

Internal service routines: front panel pushbuttons access test rou-

tines to perform maintenance of digital hardware.

HP-IB

Direct plotter control: all displayed information can be transferred to an HP-IB plotter with front panel pushbuttons.

Controller Interface Functions

Trace data transfer: all trace data values can be transferred to or from the HP 853A with a controller.

Input messages: controller input instructions or annotation can be displayed on either of two 60 character lines.

Display control: all trace processing functions can be remotely controlled.

Sweep control: analyzer sweeps can be initiated and monitored.

HP-IB Interface Functions²: SH1, AH1, T5, L4, SR1, RL1, PP0, DC1, DT1, C0, and E2.

Output Characteristics (Rear Panel)

Vertical output, AUX A: BNC output (50 Ω) provides detected video from 0 to 0.8 V for 8 divisions deflection on CRT display.

Penlift/blanking, AUX B: BNC output provides 0V pen down/unblanking signal at low impedance; 15V penlift/blanking at 10 k Ω impedance.

21.4 MHz IF output, AUX C: BNC output (50 Ω) provides a signal which is proportional to the RF input. Level is about -10 dBm (into 50 Ω) with a signal displayed at the Reference Level. Output is controlled by settings of Resolution BW, Input Atten, and Reference Level.

Horizontal output, AUX D: BNC output (5 k Ω) provides horizontal sweep from -5 V to $+5$ V for full 10 division CRT horizontal deflection.

HP-IB interface port: 24 pin connector provides digital interface for IEEE 488-1978 standard parallel bus.

General

General Specifications

HP 182T compatibility: the HP 8557A Spectrum Analyzer is compatible with the HP 182T and 853A displays. The HP 182T is a normal persistence, cabinet style display which provides non-buffered, rear panel, auxiliary outputs (for unattenuated vertical, horizontal, and penlift outputs). However, the HP 182T does not offer the digital display, HP-IB and direct plotter control, or the portability features of the HP 853A.

Temperature range: operating 0° to $+55^\circ\text{C}$; storage -40° to $+75^\circ\text{C}$.

EMI: conducted and radiated interference is within requirements of Methods CE03 and RE02 of MIL-STD 461A, CISPR Publication 11 (1975), and Messempefaenger Postverfuegung 526/527/79 (Kennzeichnung Mit F-Nummer/Funkschutzzeichen).

Power: < 200 VA with display, 48 to 440 Hz (48 to 66 Hz at 220 or 240 Vac); with HP 853A: 100, 120, 220, or 240 Vac, $+5\%$, -10% ; with HP 182T: 115 or 230 Vac, $\pm 10\%$.

Weight

HP 8557A: net, 5.0 kg (10 lb). Shipping 8.5 kg (18 lb).

HP 853A: net, 15.9 kg (35 lb). Shipping 18.6 kg (41 lb).

HP 853A Opt 001: net, 14.5 kg (32 lb). Shipping, 17.3 kg (38 lb.)

Size

HP 853A/8557A: 158.8 H x 501.7 W x 524.5 mm D (6.25" x 19.75" x 20.65").

HP 853A Opt 001/8557A: 133 H x 425.5 W x 473.3 mm D (5.25" x 16.75" x 18.65").

Ordering Information

| | Price |
|---|------------|
| HP 8557A Spectrum Analyzer | \$6,520 |
| Opt 001: 75 ohm input, dBm calibration | add \$100 |
| Opt 002: 75 ohm input, dBmV calibration | add \$100 |
| Opt 910: Extra Operation and Service Manual | add \$17 |
| HP 853A Portable Spectrum Analyzer Display | \$5,550 |
| Opt 001: Full Module Bench/Rack Configuration | less \$200 |
| Opt 910: Extra Operation and Service Manual | add \$10 |
| Solid State Camera Software: HP part no. 75-00853 | \$50 |
| HP 182T Cabinet Style, Normal Persistence Display | \$4,030 |

¹ Input not to exceed maximum levels.

² A simple modification is required for HP 8557A plug-ins with serial prefix 2106A and lower (modification kit, HP part number 00853-60057).

³ For more on these codes refer to the HP-IB section of this catalog.



SIGNAL ANALYZERS

Spectrum Analyzer, 0.1 to 1500 MHz

Models 8558B/853A & 8444A Option 059

- Rugged portability
- Simple three knob operation
- Direct plotter control
- Display annotation and storage accessories

- Digital display with trace arithmetic
- Resolution bandwidths from 1 kHz to 3 MHz
- 0.5 to 1500 MHz tracking generator available
- Optional 75 Ω input with dBm or dBmV calibration

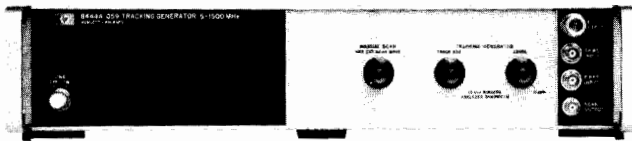
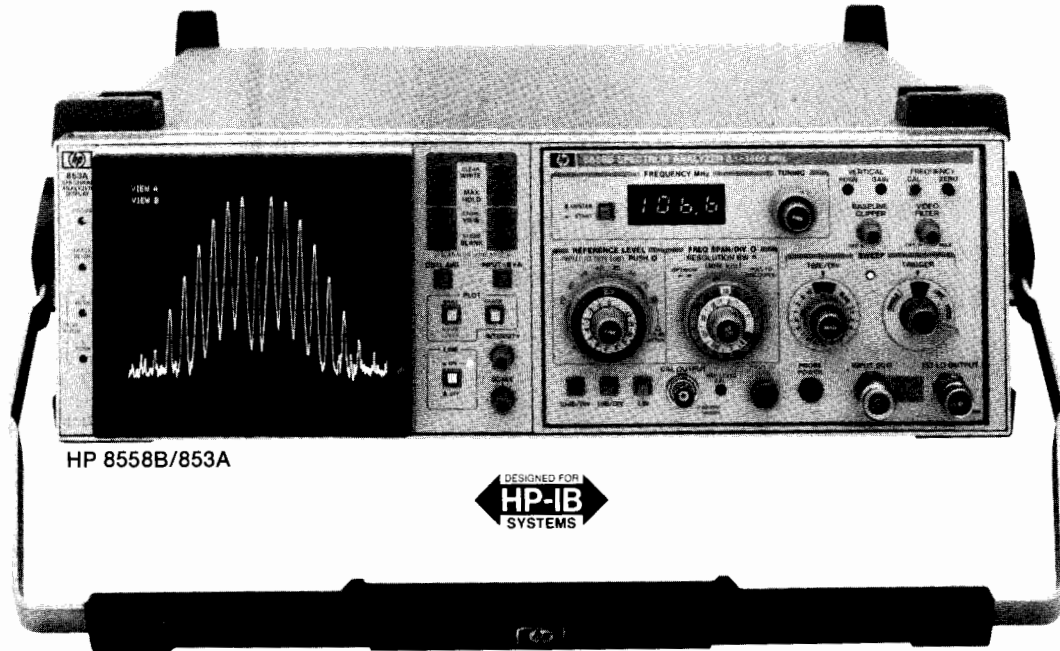

HP 8444A Opt. 059

HP 8558B Spectrum Analyzer Plug-in

Performance Plus Economy

The HP 8558B is a 100 kHz to 1500 MHz spectrum analyzer plug-in for use with the HP 853A or 182T display. The high performance and convenient operation of this economical unit is ideally suited for a variety of applications in production, R&D or field service measurements.

Simple, 3-knob Operation

Pre-set the HP 8558B to the color coded, "basic-operation" settings, and use the coupled controls to make most measurements in three easy steps. Tune to the signal; the LED readout displays its frequency. Zoom-in on the signal by reducing the span width; the resolution bandwidth, video filter, and sweep time automatically change to an optimum value for a calibrated display. Then, change the reference level to bring the peak of the signal to the top of the screen for the most accurate amplitude measurement.

Absolute Amplitude Calibration

Signal levels can be read directly from the CRT in dBm (dBmV for Option 002) without the use of external standards or calculations. The signal level represented by the top CRT graticule line is always indicated by the reference level control, and vertical scale factors of 10 dB/div, 1 dB/div, or linear can be selected.

Optional 75 Ohm Input

Two options are available which allow measurements in 75 ohm systems. Option 001 has 75 Ω impedance but retains the dBm power calibration. Option 002 is also 75 Ω , but the amplitude is calibrated in dBmV for measurements on systems such as CATV.

EMI Option H98

A hardware modification to the HP 8558B extends the low-frequency coverage to 10 kHz, calibrates the display in dB μ V, and provides resolution filters with 6-dB bandwidths of 9 kHz and 120 kHz. With these enhancements, the HP 8558B is useful for FCC and VDE emission testing.

EMI Measurement System Option E98

A portable, semi-automatic EMI measurement system is provided by combining HP 8558B Option H98 (above) with HP 853A computer accessories and software (see the "Software" section below). The system consists of HP 8558B Option H98, HP 853A Display, HP 75D Portable Computer, HP 82700A Memory Module, HP 82169A Interface, HP 82161A Cassette Drive, HP 82176A Cassettes, HP 82715A Card Holders, and Solid State Camera Software with user's manual (HP part number 75-00853). The following is a plot of test results with limit lines for an actual EMI test using Option E98:

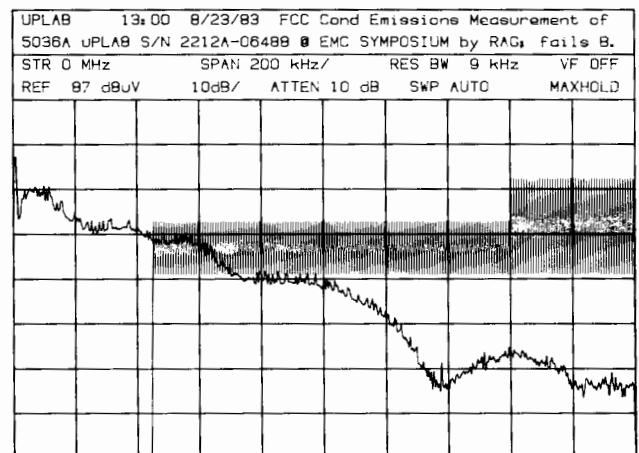

HP 8444A Option 059 Tracking Generator (0.5-1500 MHz)

Make swept frequency response measurements from 0.5 to 1500 MHz with greater than 90 dB of dynamic range. The output is absolutely calibrated at 0 dBm and continuously variable to -10 dBm. Frequency of an unknown signal, as well as any point on a frequency response curve, can be measured by using the external counter output and a frequency counter such as the HP 5300B/5305B.



HP 853A Spectrum Analyzer Display

Digital Display

The HP 853A is a digital display mainframe for use with the HP 8558B Spectrum Analyzer plug-in. Signals are displayed on either of two independently stored digital traces. Display processing capabilities include maximum hold, digital averaging, and trace normalization for extended measurement capability. A built-in microprocessor manages the display operation and provides built-in test routines for display calibration and test (accessible via the front panel).

HP-IB Capability Includes Direct Plotter Control

A hardcopy record of the displayed traces and graticules can be made on an HP-IB digital plotter by simply using the HP 853A's front-panel pushbuttons; a controller is not required. Although analyzer controls are not programmable, some HP-IB applications include using a controller for recording trace data or for placing operator prompts on the HP 853A CRT. The digital display and processing functions can be remotely programmed, and analyzer sweeps can be initiated via HP-IB.

Two Configurations

The display is offered in two styles. The HP 853A (pictured) is a ruggedized, portable mainframe complete with tilt-bail handle and drip-proof, protective front cover. The HP 853A is ideally suited for rugged, field environments and any areas where system mobility is required. The HP 853A Option 001 offers the digital display in a full module bench or rack mount configuration.

Software

The Solid State Camera Software provides a low cost, portable alternative to CRT photos. One program, "Camera," allows permanent storage of spectrum analyzer display traces along with display annotations. Another program, "Limitgen," allows test limit lines to be drawn on the HP 853A display. For more details, see page 684 in the HP 8559A Spectrum Analyzer section.

HP 8558B Specifications

Frequency Specifications

Frequency range: 0.1 to 1500 MHz.

Frequency Spans

Per division: 5 kHz to 100 MHz/div in a 1, 2, 5 sequence.

Zero span: analyzer functions as a manually tuned receiver.

Frequency Accuracy

Tuning accuracy: (+10°C to +40°C)

0-195 MHz: ±(1 MHz + 20% frequency span per division).

195-1500 MHz: ±(5 MHz + 20% frequency span per division).

Frequency span accuracy: ±5% of displayed frequency separation.

Spectral Resolution

Resolution bandwidths: eight selectable resolution (3-dB) bandwidths from 1 kHz to 3 MHz in a 1, 3 sequence. Bandwidth and frequency span are independently variable or may be coupled for optimum display when control markers are aligned (▶◀).

Resolution bandwidth accuracy: 3-dB points are ±20% (+10° to +40°C).

Selectivity: (60-dB/3-dB bandwidth ratio) <15:1.

Spectral Stability

Residual FM: <1 kHz p-p in 0.1 second.

Noise sidebands: ≥65 dB down, ≥50 kHz from center of CW signal with 1 kHz resolution bandwidth and full video filtering.

Amplitude Specifications

Amplitude range: -117 to +30 dBm.

Maximum Input (safe) Levels

Total power: +30 dBm (1W, 7.1 Vrms).

Voltage: ±50 V dc or 50 V RMS (<100 Hz).

Peak pulse power: +50 dBm (100W, <10 μs pulse width, 0.01% duty cycle) with ≥20 dB input attenuation.

Gain compression: typically <1 dB for -10 dBm signal, 0 dB input attenuation.

Average noise level: <-107 dBm with 10 kHz resolution bandwidth, 0 dB input attenuation, and video filter at MAX.

Calibrated Display Range

Log: 70 dB with 10 dB/div scale; 8 dB with 1 dB/div scale.

Linear: 8 divisions with linear (LIN) amplitude scale.

Amplitude Accuracy

Calibrator: -30 dBm ±1 dB (into 50 Ω), 280 MHz ± 300 kHz.

Reference level: 10 dB steps and a 12 dB vernier for calibrated adjustment from -112 dBm to +60 dBm.¹

Step accuracy (with 0 dB input attenuation): -10 to -80

dBm; ±0.5 dB; -10 to -100 dBm: ±1.0 dB.

Vernier accuracy: ±0.5 dB.

Frequency response: ≤ ±1.0 dB with 10 dB input attenuation

(includes input attenuator, mixer flatness, and internal limiter).

Input attenuator: 0 to 70 dB, selectable in 10 dB steps.

Step accuracy: <±0.5 dB per 10 dB step.

Maximum cumulative error: <±1.0 dB.

Bandwidth Switching (amplitude variation)

3 MHz to 300 kHz: <±0.5 dB.

3 MHz to 1 kHz: <±1.0 dB.

Display Fidelity

Log incremental accuracy: ±0.1 dB/dB from Reference Level.

Log maximum cumulative error: ≤ ±1.5 dB over 70 dB range.

Linear accuracy: ±3% of Reference Level.

Spurious Responses

Second harmonic distortion: >70 dB below a -40 dBm input signal with 0 dB input attenuation; >60 dB below for signals 100 kHz to 5 MHz.

Third order intermodulation distortion: >70 dB below two -30 dBm input signals (>5 MHz) separated by ≥50 kHz and with 0 dB input attenuation; >60 dB below for signals 100 kHz to 5 MHz.

Image and multiple responses: >70 dB below a -40 dBm input signal (>5 MHz) with 0 dB input attenuation; >60 dB below for signals 100 kHz to 5 MHz.

Residual responses: <-100 dBm with 0 dB input attenuation and no signal present at input.

Sweep Characteristics

Sweep Time

Automatic: sweep time is automatically adjusted to maintain absolute amplitude calibration for any combination of frequency span, resolution bandwidth, and video filter bandwidth.

Calibrated sweep times: 0.1 ms to 10 sec/div in 1, 2, 5 sequence with ±10% typical accuracy.

Manual sweep: spectrum analyzer may be swept manually in either direction with front panel control.

Signal Input Characteristics

Input impedance: 50 Ω nominal; precision Type-N female connector.

Input SWR: typically <1.5 with ≥10 dB input attenuation.

Output Characteristics

1st LO output: BNC output provides +10 dBm nominal signal (into 50 Ω), 2.05 to 3.55 GHz.

Probe power: +15 V, -12.6V, and GND (150 mA max). Use HP 1120A, 1121A, 1123A, or 1124A high impedance probes.

HP 853A Characteristics

For more information on the HP 853A Display, see page 681 in the HP 8557A Spectrum Analyzer section.

General

General Specifications

For information on HP 182T compatibility, temperature range, EMI compliance, and power requirements, see page 681 in the HP 8557A Spectrum Analyzer section.

Weight

HP 8558B: net, 5.5 kg (12 lb). Shipping 10.5 kg (23 lb).

HP 853A: net, 15.9 kg (35 lb). Shipping 18.6 kg (41 lb).

HP 853A Opt 001: net, 14.5 kg (32 lb.) Shipping, 17.3 kg (38 lb).

Size

HP 853A/8558B: 158.8 H x 501.7 W x 524.5 mm D (6.25" x 19.75" x 20.65").

HP 853A Opt 001/8558B: 133 H x 425.5 W x 473.3 mm D (5.25" x 16.75" x 18.65").

Ordering Information

| | Price |
|---|-------------|
| HP 8558B Spectrum Analyzer | \$7,925 |
| Opt 001: 75 Ω input, dBm calibration | add \$100 |
| Opt 002: 75 Ω input, dBmV calibration | add \$100 |
| Opt 910: Extra Operating and Service Manual | add \$20 |
| Opt E98: EMI Measurement System | add \$9,545 |
| Opt H17: Extended coverage to 1700 MHz | add \$550 |
| Opt H36: 6 MHz BW for CATV/LAN demodulation | add \$315 |
| Opt H98: EMI Option | add \$1190 |
| HP 853A Portable Spectrum Analyzer Display | \$5,550 |
| Opt 001: Full Module Bench/Rack Configuration | less \$200 |
| Opt 910: Extra Operation and Service Manual | add \$25 |
| Solid State Camera Software: HP part no. 75-00853 | \$50 |
| HP 182T Cabinet Style, Normal Persistence Display | \$4,030 |

¹ Input not to exceed maximum levels.

² A simple modification is required for HP 8558B plug-ins with serial prefix 2145A and lower (modification kit, HP part number 00853-60058).



SIGNAL ANALYZERS

Spectrum Analyzer, 0.01 to 21 GHz

Models 8559A/853A

- Rugged portability
- Simple three-knob operation
- Direct plotter control
- Display annotation and storage accessories
- Digital display with trace arithmetic
- Resolution bandwidths from 1 kHz to 3 MHz
- Absolute amplitude calibration in all bands



HP 8559A Spectrum Analyzer Plug-in Performance Plus Economy

The HP 8559A is a 0.01 to 21 GHz spectrum analyzer plug-in for use with the HP 853A or 182T display. The high performance and convenient operation of this economical unit is ideally suited for a variety of applications in production, R&D or field service environments.

Simple 3-Knob Operation

Pre-set the HP 8559A to the color coded, "basic operation" settings, and use the coupled controls to make most measurements in three easy steps. Tune to the signal; the LED readout displays its frequency. Zoom-in on the signal by reducing the span width; the resolution bandwidth, video filter, and sweep time automatically change to an optimum value for a calibrated display. Then, change the reference level to bring the peak of the signal to the top of the screen for the most accurate amplitude measurement. A signal identifier is available in all bands to provide assurance of correct measurements.

Absolute Amplitude Calibration

Signal levels can be read directly in dBm from the CRT without the use of external standards or calculations. The signal level represented by the top CRT graticule line is always indicated by the reference level control, and vertical scale factors of 10 dB/Div, 1 dB/Div, or linear can be selected.

HP 11870A Low Pass Filter (dc to 2.6 GHz)

For RF measurement applications needing extended coverage to 2.6 GHz, the HP 11870A low pass filter will reject signals above 3 GHz by more than 60 dB for image-free measurements over the entire 10 MHz to 2.6 GHz range.

HP 853A Spectrum Analyzer Display Digital Display

The HP 853A is a digital display mainframe for use with the HP 8559A spectrum analyzer plug-in. Signals are displayed on either of two independently stored digital traces. Display processing capabilities include maximum hold, digital averaging, and trace normalization for extended measurement capability. A built-in microprocessor manages the display operation and provides access to built-in test routines for display calibration and test (accessible via the front panel).

HP-IB Capability Includes Direct Plotter Control

A hard-copy record of the displayed traces and graticule can be made on a digital plotter via HP-IB by simply using the HP 853A's front-panel pushbuttons; a controller is not required. Although analyzer controls are not programmable, some HP-IB applications in-

clude using a controller for recording trace data or for operator prompts on the HP 853A CRT. The digital display and processing functions can be remotely programmed, and analyzer sweeps can be initiated via HP-IB.

Two Configurations

The display is offered in two styles. The HP 853A (pictured) is a ruggedized, portable mainframe complete with tilt-bail handle and drip proof, protective front cover. The HP 853A is ideally suited for rugged, field service environments and any areas where system mobility is required. The HP 853A Option 001 offers the digital display in a full module bench or rack mount configuration.

Software

The Solid State Camera Software provides a low cost, portable alternative to CRT photos. One program, "Camera," allows the user to annotate the display with a title and with spectrum analyzer control settings. Both trace and annotation can be permanently stored in the computer's memory (3 traces), on magnetic card (1 trace each), and on magnetic cassette (over 80 traces). After being stored, the display information can later be recalled for viewing on the HP 853A display or for making hard copies with a plotter. Another program, "Limitgen," allows test limit lines to be drawn on the HP 853A display.

The HP 853A software adds measurement capability to many spectrum analyzer applications: EMI measurements are aided by display limit line generation; FCC digital radio masks can be drawn on the display; recording spectrum analyzer display data is useful for proof-of-performance testing, electric field strength measurements, remote location testing, and communication band occupancy monitoring; and production measurements are enhanced by display comparison testing to specification lines or to ideal response shapes.

To implement the software for the HP 853A, the following parts and equipment configuration are needed (refer to other sections of this catalog for ordering and pricing information): HP 853A Spectrum Analyzer Display; HP 8557A, 8558B, or 8559A Spectrum Analyzer; HP 75D Portable Computer; HP 82700A 8k-Byte Memory Module; HP 82169A HP-IB Interface; HP 82708A Magnetic Cards; HP 82715A Card Holders; Solid State Camera Software HP part number 75-00853; HP 7470A or 7475A Plotter (optional); HP 82161A Cassette Drive (optional); and HP 82176A Cassettes (optional).

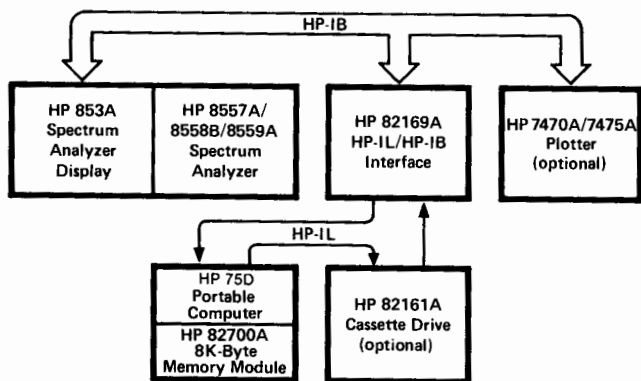

HP 8559A Specifications

Frequency Specifications

Frequency range: 0.01 to 21 GHz in six selectable ranges.

Frequency Spans

Fullband: displays entire spectrum of selected band.

Per division: 10 kHz to 200 MHz/div in a 1, 2, 5 sequence.

Zero span: analyzer functions as a manually tuned receiver.

Frequency Accuracy

Tuning accuracy: 0.01 to 3 GHz: $\pm(1 \text{ MHz} + 0.3\% \text{ of center frequency})$; 3 to 21 GHz: $\pm(5 \text{ MHz} + 0.2\% \text{ of center frequency})$.

Frequency span accuracy: $<\pm 5\%$ of displayed frequency separation.

Spectral Resolution

Resolution bandwidths: eight selectable resolution (3-dB) bandwidths from 1 kHz to 3 MHz in a 1, 3 sequence. Bandwidth and frequency span are independently variable or may be coupled for optimum display when control markers are aligned (▶◀).

Resolution bandwidth accuracy: 3-dB points are $<\pm 15\%$ (except for 3 MHz bandwidth: $<\pm 30\%$).

Selectivity: (60-dB/3-dB bandwidth ratio) $<15:1$

Spectral stability: (fundamental mixing, bands 0.01-3 GHz and 6-9 GHz)

Residual FM: $<2 \text{ kHz p-p}$ in 0.1 second.

Noise sidebands: $\geq 70 \text{ dB}$ down, $\geq 30 \text{ kHz}$ from center of CW signal with 1 kHz resolution bandwidth and video filter at MAX.

Amplitude Specifications

Amplitude range: -111 to +30 dBm.

Maximum Input (safe) Levels

Total power: +20 dBm (100 mW, 2.2 Vrms) with 0 dB input attenuation; +30 dBm (1 watt, 7.1 Vrms) with $\geq 10 \text{ dB}$ input attenuation.

Voltage: $\pm 7.1 \text{ Vdc}$ or 7.1 V RMS ($<100 \text{ Hz}$).

Peak pulse power: +50 dBm (100 watts, 10 μsec pulse width, 0.01% duty cycle) with $\geq 30 \text{ dB}$ input attenuation.

Gain compression: $<0.5 \text{ dB}$ for a -10 dBm input level, with 0 dB input attenuation.

Average noise level: see table below for maximum average noise level with 1 kHz resolution bandwidth, 0 dB input attenuation, and video filtering at MAX.

| Frequency Range (GHz) | Avg. Noise Level (dBm/1 kHz) | Frequency Response ($\pm \text{ dB max.}$) | Amplitude Accuracy ¹ ($\pm \text{ dB max.}$) |
|-----------------------|------------------------------|--|---|
| 0.01-3 | -111 | 1.0 | 2.3 |
| 6.0-9 | -108 | 1.0 | 2.3 |
| 3.0-9 | -103 | 1.5 | 2.8 |
| 9.0-15 | -98 | 1.8 | 3.1 |
| 6.0-15 | -93 | 2.1 | 3.4 |
| 12.1-18 | -92 | 2.3 | 3.6 |
| 18.0-21 | -90 | 3.0 | 4.3 |

Alternate IF: regular IF at 3.0075 GHz; alternate IF available at 2.9925 GHz for all frequency bands (minimum frequency is 25 MHz).

Calibrated Display Range

Log: 70 dB with 10 dB/div scale; 8 dB with 1 dB/div scale.

Linear: 8 divisions with linear (LIN) amplitude scale.

Amplitude Accuracy

Calibrator: -10 dBm $\pm 0.3 \text{ dB}$ (into 50 Ω), 35 MHz $\pm 400 \text{ kHz}$.

Reference level: 10 dB steps and a 12 dB vernier for calibrated adjustment from -112 dBm to +60 dBm².

Step accuracy (with 0 dB input attenuation): -10 to -80 dBm: $\pm 0.5 \text{ dB}$; -10 to -100 dBm: $\pm 1.0 \text{ dB}$.

Vernier accuracy: $\pm 0.5 \text{ dB}$.

Frequency response: see table above; includes input attenuator, mixer flatness, and mixing mode gain variation (band to band), with 0 or 10 dB input attenuation.

Input attenuator: 0 to 70 dB, selectable in 10 dB steps.

Step accuracy: $<\pm 1.0 \text{ dB}$ per 10 dB step (0 to 60 dB, 0.01 to 18 GHz).

Maximum cumulative error: $<\pm 2.4 \text{ dB}$ (0 to 60 dB, 0.01 to 18 GHz).

Bandwidth Switching (amplitude variation)

3 MHz to 300 kHz: $<\pm 0.5 \text{ dB}$.

3 MHz to 1 kHz: $<\pm 1.0 \text{ dB}$.

Display Fidelity

Log incremental accuracy: $\pm 0.1 \text{ dB/dB}$ from Reference Level.

Log maximum cumulative error: $\leq \pm 1.5 \text{ dB}$ over 70 dB range.

Linear accuracy: $\pm 3\%$ of Reference Level.

Spurious Responses

Second harmonic distortion: typically $>70 \text{ dB}$ below a -40 dBm signal with 0 dB input attenuation.

Third order intermodulation distortion: typically $>70 \text{ dB}$ below two -30 dBm input signals separated by $\geq 50 \text{ kHz}$ with 0 dB input attenuation.

Residual responses: $<-90 \text{ dBm}$ with 0 dB input attenuation and no signal present at input (0.01³-3 GHz, 6-9 GHz).

Signal identifier: available in all frequency bands and spans, useable from 10 MHz to 100 kHz/div.

Sweep Characteristics

Sweep Time

Automatic: sweep time is automatically adjusted to maintain absolute amplitude calibration for any combination of frequency span, resolution bandwidth and video filter bandwidth.

Calibrated sweep times: 2 μsec to 10 sec/div in a 1, 2, 5 sequence (except 2 sec/div), $\pm 10\%$ accuracy ($\pm 20\%$ for 5/10 sec/div).

Manual sweep: spectrum analyzer may be swept manually in either direction with front panel control.

Signal Input Characteristics

Input impedance: 50 Ω nominal; precision type-N female connector.

Input SWR: typically <2.0 , 0 dB input attenuation; <1.3 , 10 dB input attenuation.

HP 853A Characteristics

For information on the HP 853A Display, see page 681 in the HP 8557A Spectrum Analyzer section.

General

General Specifications

For information on HP 182T compatibility, temperature range, EMI compliance, and power requirements, see page 681 in the HP 8557A Spectrum Analyzer section.

Weight

HP 8559A: net, 5.5 kg (12.1 lb). Shipping 9.1 kg (20 lb).

HP 853A: net, 15.9 kg (35 lb). Shipping 18.6 kg (41 lb).

HP 853A Opt 001: net, 14.5 kg (32 lb). Shipping, 17.3 kg (38 lb).

Size

HP 853A/8559A: 158.8 H x 501.7 W x 524.3 mm D (6.25" x 19.75" x 20.65").

HP 853A Opt 001/8559A: 133 H x 425.5 W x 473.7 mm D (5.25" x 16.75" x 18.65").

Ordering Information

HP 8559A Spectrum Analyzer \$11,825

Opt 910: Extra Operating and Service Manual add \$20

HP 853A Portable Spectrum Analyzer Display \$5,550

Opt 001: Full Module Bench/Rack Configuration less \$200

Opt. 910: Extra Operation and Service Manual add \$25

Solid State Camera Software: HP part no. 75-00853 \$50

HP 182T Cabinet Style, Normal Persistence Display \$4,030

¹Using IF substitution, total accuracy is sum of frequency response, calibration, and reference level errors.

²Input level not to exceed maximum levels.

³25 MHz with Alternate IF ON.

⁴A simple modification is required for HP 8559A plug-ins with serial prefix 2208A and lower (modification kit, HP part number 00853-60059).

SIGNAL ANALYZERS

HP 141T Spectrum Analyzer System, 20 Hz to 40 GHz

Model 141T System

- 20 Hz to 18 GHz, external mixing to 40 GHz
- Absolute amplitude calibration
- Tracking generators for component test
- Tracking preselector simplifies measurements



Hewlett Packard's 141T Spectrum Analyzer system permits measurements at frequencies ranging from 20 Hz to 18 GHz with four plug-in tuning sections. For measurements in the 18 to 40 GHz region, an accessory external mixer may be used with the microwave tuning section. The modularity of the system allows you to keep pace with changing measurement requirements.

An HP 141T Spectrum Analyzer system is comprised of a mainframe/display, one tuning section, and one IF section. Each tuning section covers a different frequency range permitting purchase of those which best meet current requirements. The HP 8556A covers from 20 Hz to 300 kHz, the HP 8553B from 1 kHz to 110 MHz, the HP 8554B from 100 kHz to 1250 MHz, and the HP 8555A from 10 MHz to 18 GHz. The IF sections, the HP 8552A or HP 8552B, provide bandwidth/gain selection and detection. Unless otherwise noted, the specifications shown here apply to a spectrum analyzer which contains an HP 8552B IF section.

For swept frequency testing of components, the HP 8443A or HP 8444A Tracking Generator can function as a swept signal source which, through locking, accurately tracks the frequency to which the analyzer is tuned. A microwave tracking preselector, the HP 8445B, simplifies measurements and improves the dynamic range of the HP 8555A Tuning Section for dense signal environments.

The spectrum analyzer displays amplitude and frequency accurately with a large dynamic range.

The following pages contain detailed performance specifications for each configuration of the spectrum analyzer, preselector, and tracking generators.

Absolute Amplitude Calibration

Calibrated frequency and amplitude measurements may be made over the entire frequency range. Logarithmic or linear scaling allow display of amplitude in dBm or voltage respectively. A warning light is provided to indicate uncalibrated conditions due to improper control settings.

Frequency Calibration

Three scan modes allow simple, accurate measurements. In the FULL SCAN mode the entire tuning section band is displayed. A marker is provided to identify and select signals of interest.

After a signal is selected in the FULL SCAN mode, switching to PER DIVISION mode allows analysis of the signal in narrow scans. Noise sidebands and low deviation FM are examples of measurements that might be made in this mode.

The analyzer can be used as a fixed tuned receiver by selecting the ZERO SCAN mode. In this mode the analyzer provides a time domain display with a calibrated time base, controlled by the scan time setting. Demodulating AM radio is a simple example of a ZERO SCAN measurement.

High Resolution

In frequency domain analysis it is often necessary to resolve close-in sidebands, such as line related modulation. Bandwidths as narrow as 10 Hz are provided in the HP 8553B to obtain this resolution. Use of such narrow bandwidths is made possible by frequency stabilization.

High Sensitivity, Low Distortion

For best measurement accuracy, a wide dynamic range is essential. Wide dynamic range requires both high sensitivity and low internal distortion.

Signals as low as -142 dBm can be measured using the HP 8553B tuning section. For most measurements the HP 141T system offers in excess of 70 dB distortion free dynamic range. For many measurements with the HP 8555A Tuning section, the HP 8445B Preselector can increase dynamic range to greater than 100 dB.

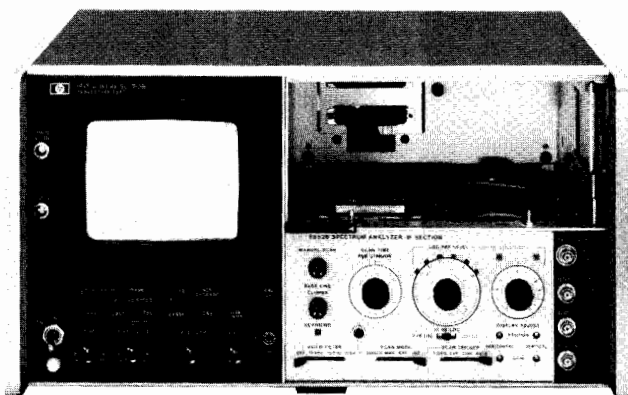

HP 141T, 8552B

Mainframe/Storage Display

The HP 141T Mainframe provides variable persistence and storage. When narrow bandwidths are selected, sweep time must be reduced to maintain amplitude calibration. Variable persistence permits displayed traces of constant intensity even for long sweep-times. The storage feature allows traces to be held for comparison or photographing.

IF Section Features

In addition to providing calibrated bandpass filtering the IF Section offers several user convenience features. Selectable video filters improve signal discernibility when S/N is low and permit display of average noise level. Recorder outputs, compatible with analog XY recorders, are provided. Amplitude and frequency calibration from the front panel are possible using the internal calibration source.

Tracking Generators for Component Test

Tracking generators—leveled sources which track the tuned frequency of the analyzer—allow precise frequency measurements on two port devices with high dynamic range. Three tracking generators permit characterization of device performance up to 1500 MHz with a nominal dynamic range of 100 dB. The HP 8556B includes a tracking generator and the HP 8443A and HP 8444A may be used with the HP 8553B and HP 8554B Tuning Sections respectively.

HP 8750A Storage-Normalizer

Digital trace storage and display with the HP 141T System is possible with the HP 8750A (Opt. 001) and an external oscilloscope. Digital storage provides a flicker-free display for any sweep speed and allows comparison of two traces. When a tracking generator is used, the normalization feature of the HP 8750A reduces the effect of system frequency response on the measurement.

General Specifications

HP 141T Spectrum Analyzer System

Input impedance: 50 Ω nominal. Reflection coefficient <0.30 (1.85 SWR), input attenuator ≥ 10 dB.

Maximum input level: peak or average power +13 dBm (1.4 V ac peak), ± 50 V dc.

Attenuator: 0 to 50 dB in 10 dB steps.

Scan time: 16 internal scan rates from 0.1 ms/div to 10 sec/div in a 1, 2, 5 sequence, and manual scan (8552B only).

Scan Time Accuracy

0.1 ms/div to 20 ms/div: $\pm 10\%$.

50 ms/div to 10 s/div: $\pm 20\%$.

Scan Mode

Int: analyzer repetitively scanned by internally generated ramp; synchronization selected by scan trigger

Single: single scan with front panel reset.

Ext: scan determined by 0 to +8 volt external signal.

Manual: scan determined by front panel control.

Scan trigger:

for internal scan mode, select between

Auto: scan free-runs.

Line: scan synchronized with power line frequency.

Ext: scan synchronized with >2 volt (20 volt max.) signal.

Video: scan internally synchronized to envelope of RF input.

Auxiliary Outputs

Vertical output: 0 to -0.8 V for full deflection.

Scan output: -5 V to $+5$ V for 10 div CRT deflection.

Pen lift output: 0 to 14 V (0 V, pen down).

Display Characteristics

HP 141T

Plug-ins: accepts Models 8552A/B, 8553B, 8554B, 8555A and 8556A.

Cathode-Ray Tube Type

Post-accelerator storage tube, 9000 volt accelerating potential; aluminumized P31 phosphor.

Cathode-Ray Tube Graticule

8 \times 10 division (approx, 7.1 cm \times 8.9 cm) parallax-free internal graticule.

Persistence

Normal: natural persistence of P31 phosphor (0.1 second).

Variable

Normal writing rate mode: continuously variable from less than 0.2 second to more than one minute.

Maximum writing rate mode: from 0.2 second to 15 seconds.

Erase: manual; erasure takes approximately 350 ms.

Storage time: normal writing rate; more than 2 hours at reduced brightness (typically 4 hours).

Fast writing speed: more than 15 minutes.

EMI: conducted and radiated interference is in compliance with MIL-STD 461A Methods CEO3 and REO2, CISPR publication 11 (1975), and Mesempfaenger-Postverfuegung 526/527/79 (Kennzeichnung Mit F-Nummer/Funkschutzzeichen).

Temperature range: operating, 0°C to $+55^{\circ}\text{C}$; storage, -40°C to $+75^{\circ}\text{C}$.

Power requirements: 100, 120, 220, or 240 V $\pm 5\%$, -10% . 50 to 60 Hz, normally less than 225 watts (includes plug-ins used).

Weight

Model 8552A or 8552B IF section: net, 4.1 kg (9 lb). Shipping 6.4 kg (14 lb).

Model 141T display section: net, 19.2 kg (43 lb). Shipping, 26 kg (57 lb).

Tuning section: see following pages.

Size: model 141T with plug-ins: 221 H \times 425 W \times 416 mm D (8.8" \times 16.8" \times 16.4").

Special order: chassis slides and adapter kit.

Ordering Information

HP 141T Variable Persistence Display

Opt 908: Rack Flange Kit

HP 8552A Economy IF Section

HP 8552B High Resolution IF Section

Price

\$4100

add \$27

\$4370

\$5320

SIGNAL ANALYZERS

HP 141T Spectrum Analyzer System: 20 Hz to 300 kHz

Model 8556A

- Accurate signal level measurements (± 0.95 dB)
- Accurate frequency measurements (± 3 Hz)
- High sensitivity (-152 dBV)
- Built-in tracking generator

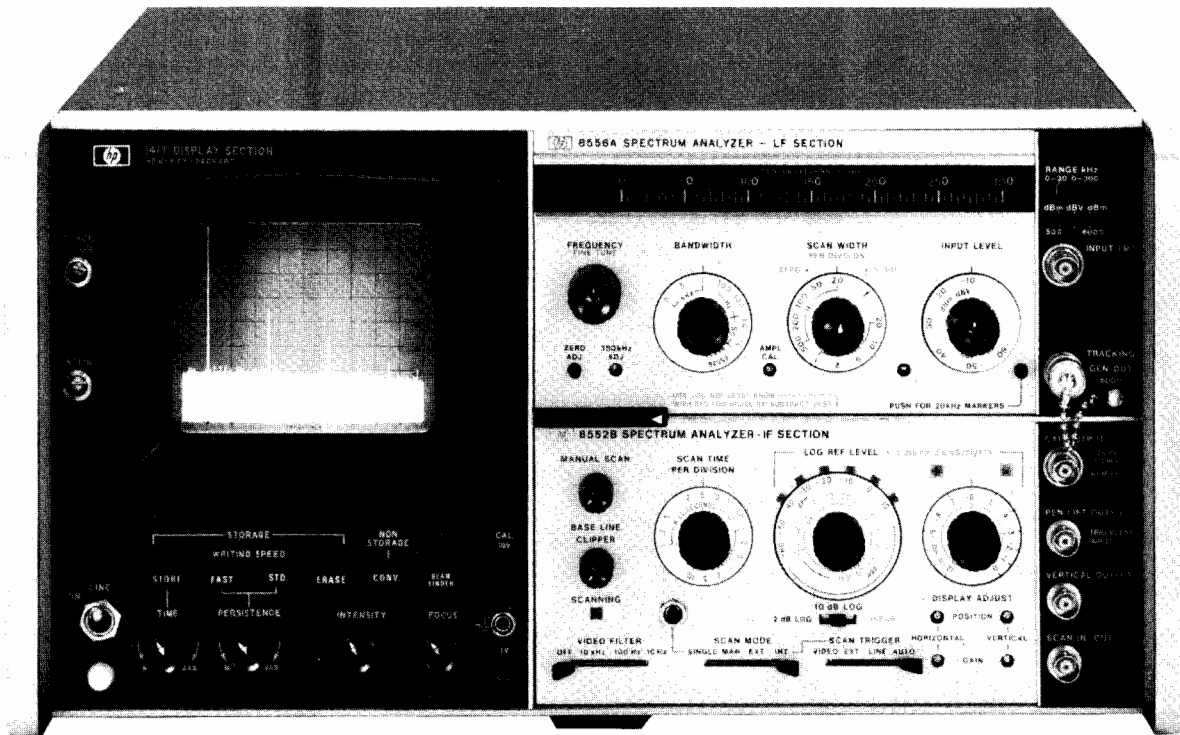

HP 8556A (141T, 8552B)

Measurement Flexibility

The HP 8556A offers a frequency range of 20 Hz to 300 kHz. It is compatible with impedances normally encountered at audio frequencies. The input may be either balanced or unbalanced and measurement units may be dBV, dBm or Volts.

Frequency Range

In addition to the 300 kHz tuning scale, a 30 kHz tuning scale is provided for greater tuning resolution at low frequencies. The HP 8556A may be swept about the tuned frequency, from 0 Hz to a selectable stop frequency, or fixed tuned to any frequency in its tuning range. Crystal markers with 20 kHz spacing may be selected to ensure accurate frequency measurements.

Amplitude Calibration

The HP 8556A is calibrated for dBm in 600 and 50 ohms, as well as dBV and volts. Accurate reference level control (± 0.2 dB) and vernier (± 0.25 dB) allow accurate amplitude measurements when using the IF substitution method.

Resolution—Sensitivity

Bandwidths of from 10 Hz to 10 kHz are provided with the HP 8556A. The 10 Hz bandwidth is useful for measurements close to the carrier such as power line sidebands. The 10 Hz bandwidth together with the low noise figure of the HP 8556A, allow signals as low as -152 dBV (25 nV) to be measured.

Isolated Input

The isolated input prevents spurious signal pickup due to ground currents between the analyzer and the signal source. The high input impedance permits the use of an oscilloscope probe. An optional balanced input is transformer coupled to provide isolation and high common mode rejection.

Tracking Generator

The frequency of low level signals can be measured to ± 3 Hz accuracy with a frequency counter connected to the output of the built-in tracking generator. Swept insertion loss measurements with 140 dB dynamic range and return loss measurements are also possible using the tracking generator.

Specifications—with HP 8552B IF Section

Frequency Specifications

Frequency range: 20 Hz to 300 kHz. Tuning dial ranges of 0–30 kHz and 0–300 kHz.

Scan width: (on a 10-division CRT horizontal axis)

Per division: 10 calibrated scan widths from 20 Hz/div to 20 kHz/div in a 1, 2, 5 sequence.

0–10 f: 10 calibrated preset scans, from 200 Hz to 200 kHz in a 1, 2, 5 sequence. Analyzer scans from zero frequency to ten times the scan width per division setting.

Zero: analyzer is a fixed tuned receiver.

Frequency Accuracy

Center frequency accuracy: 0–30 kHz Range: ± 500 Hz; 0–300 kHz Range: ± 3 kHz.

Marker accuracy: RF markers every 20 kHz accurate to within $\pm 0.01\%$. Markers controlled by front panel on/off switch.

Scan width accuracy: frequency error between any two points on the display is less than $\pm 3\%$ of the indicated frequency separation.



Stability

Residual FM: sidebands >60 dB down 50 Hz or more from CW signal, scan time ≥ 1 sec/div, 10 Hz bandwidth.

Noise sidebands: more than 90 dB below CW signal, 3 kHz away from signal, with a 100 Hz IF bandwidth.

Frequency drift: less than 200 Hz/10 min.

Resolution

Bandwidth ranges: IF bandwidths of 10 Hz to 10 kHz are provided in a 1, 3, 10 sequence.

Bandwidth accuracy: individual IF bandwidth 3 dB points calibrated to $\pm 20\%$ (10 kHz bandwidth $\pm 5\%$).

Bandwidth selectivity: 60 dB/3 dB IF bandwidth ratios, with IF section: <11:1 for IF bandwidths from 10 Hz to 3 kHz; <20:1 for 10 kHz bandwidth. For 10 Hz bandwidth, 60 dB points are separated by less than 100 Hz.

Amplitude Specifications

Absolute Amplitude Calibration

Log Calibration Modes

| | |
|------------------|---------------------------|
| dBV | 0 dBV = 1 V rms |
| dBm-600 Ω | 0 dBm = 1 mW-600 Ω |
| dBm-50 Ω | 0 dBm = 1 mW-50 Ω |

Input impedance is 1 M Ω . dBm ranges are referenced with input properly terminated externally.

Log calibration range: from -150 dBm/dBV to +10 dBm/dBV.

Log display range: 10 dB/div on a 70 dB display, or 2 dB/div on a 16 dB display.

Linear sensitivity: from 0.1 μ V/div to 1 V/div in a 1, 2, 10 sequence. Linear sensitivity vernier X1 to X0.25 continuously.

Dynamic Range

INPUT LEVEL control: -10 to -60 dBm/dBV in 10 dB steps. Accuracy ± 0.2 dB. Marking indicates maximum input levels for 70 dB spurious-free dynamic range.

Average noise level: (specified with a 600 Ω or less source impedance and INPUT LEVEL at -60 dBm/dBV)

| Mode | 1 kHz IF Bandwidth | 10 Hz IF Bandwidth |
|------------------|--------------------|--------------------|
| dBm-50 Ω | <-122 dBm (180 nV) | <-142 dBm (18 nV) |
| dBm-600 Ω | <-130 dBm (250 nV) | <-150 dBm (25 nV) |
| dBV | <-132 dBV (250 nV) | <-152 dBV (25 nV) |
| Linear | <400 nV | <40 nV |

Video filter: averages displayed noise; bandwidth of 10 kHz, 100 Hz, and 10 Hz. Bandwidth accuracy $\pm 20\%$.

Spurious responses: input signal level \leq INPUT LEVEL setting: out of band mixing responses, harmonic and intermodulation distortion products are all more than 70 dB below the input signal level 5 kHz to 300 kHz; 60 dB, 20 Hz to 5 kHz. Third order intermodulation products are more than 70 dB below the input signal level, 5 kHz to 300 kHz with signal separation >300 Hz.

Residual responses (no signal present at input): with the INPUT LEVEL at -60 dBm/dBV and the input terminated with 600 Ω or less, all line related residual responses from 0 to 500 Hz are below -120 dBm/dBV. All other residual responses are below -130 dBm/dBV.

Amplitude Accuracy

| | | |
|--------------------------|-------------------|---------------------|
| Frequency response | Log | Linear |
| Amplitude display | ± 0.2 dB | $\pm 2.3\%$ |
| | ± 0.25 dB/dB | $\pm 2.8\%$ of full |
| | but not more | 8 div display |
| | than ± 1.5 dB | |
| | over 70 dB | |
| | display range | |

Log reference level control: provides 90 dB IF gain control in 10 dB steps. Accurate to ± 0.2 dB ($\pm 2.3\%$).

Log reference level vernier: provides continuous 12 dB range. Accurate to ± 0.1 dB ($\pm 1.2\%$) in 0, -6, -12 dB positions; otherwise ± 0.25 dB ($\pm 2.8\%$).

Amplitude measurement accuracy: ± 0.95 dB with proper technique.

General

Scan time: 16 internal scan rates from 0.1 ms/div to 10 sec/div in a 1, 2, 5 sequence.

Scan Mode

Int: analyzer repetitively scanned internally.

Ext: scan determined by 0 to +8 volt external signal.

Single: single scan actuated by front panel button.

Manual: scan determined by front panel control.

Input level: provides 50 dB control of input preamplification and attenuation to prevent input overload. INPUT LEVEL markings of -60 dBm/dBV to -10 dBm/dBV indicate maximum input level for a minimum of 70 dB spurious-free dynamic range. Accuracy ± 0.2 dB (2.3%).

Input impedance: 1 M Ω shunted by ≈ 32 pF.

Maximum input level: 10 V rms, ± 200 V dc. Ground terminals of BNC input connectors are isolated from the analyzer chassis ground to minimize ground loop pickup at low frequencies.

Maximum voltage, isolated ground to chassis ground: ± 100 V dc.

Isolated ground to chassis ground impedance: 100 k Ω shunted by approximately 0.3 μ F.

Gain compression: for input signal level 20 dB above INPUT LEVEL setting, gain compression is less than 1 dB.

Tracking Generator Specifications

Frequency range: tracks the analyzer tuning, 20 Hz to 300 kHz.

Amplitude range: continuously variable from 100 mV rms to greater than 3 V rms into an open circuit.

Amplitude accuracy: with TRACKING GEN LEVEL in CAL position and 20 kHz markers off, output level at 100 kHz is 100 mV ± 0.3 dB into an open circuit.

Frequency response: ± 0.25 dB 50 Hz to 300 kHz.

Output impedance: 600 Ω .

Residual FM: <1 Hz peak-to-peak.

Power requirements: 100, 120, 200, or 240 V $\pm 5\%$, -10%, 50 to 60 Hz, normally less than 225 watts.

Weight: Model 8556A LF section: net, 3.7 kg (8 lb). Shipping, 5.3 kg (12 lb).

Size: 102 H x 226 W x 344 mm D (4" x 8.9" x 13.5").

Specifications with HP 8556A Options 001, 002-Balanced Input

Amplitude

Log Calibration Modes-Balanced (bridged) Input

dBm-135 Ω (Option 001) 0 dBm = 1 mW-135 Ω

dBm-150 Ω (Option 002) 0 dBm = 1 mW-150 Ω

dBm-600 Ω (Option 001 or 002) 0 dBm = 1 mW-600 Ω

dBm-900 Ω (Option 001 or 002) 0 dBm = 1 mW-900 Ω

Input impedance is typically 15 k Ω . dBm ranges are referenced with input properly terminated externally.

Input

Maximum input levels: normal Mode, ± 20 V rms or ± 150 V dc for normal mode (symmetrical) signals between input signal connectors; Common Mode, 200 V rms at 60 Hz or ± 500 V dc for common mode (asymmetrical) voltages between input signal connectors and GUARD or instrument chassis; GUARD, ± 100 V dc from GUARD to instrument chassis. (GUARD to chassis impedance is approximately 100 k Ω shunted by 0.3 μ F.)

Balance (symmetry): 0 -30kHz Range, greater than 80 dB, 50 Hz to 1 kHz; 1 -300 kHz range, greater than 60 dB, 1 kHz to 20 kHz.

Ordering Information

HP 8556A RF Section

Opt 001: Balanced input

Opt 002: Balanced input

Price

\$3395

add \$220

add \$220

SIGNAL ANALYZERS

HP 141T Spectrum Analyzer System: 1 kHz to 110 MHz

Models 8553B & 8443A

- 10 Hz resolution bandwidth
- High sensitivity (-140 dBm)
- Accurate amplitude measurements (± 1.25 dB)
- 10 Hz frequency accuracy with tracking generator



HP 8553B (141T, 8552B) 8443A

The HP 8553B covers the frequency range 1 kHz to 110 MHz. This frequency range includes audio, video, navigation aids, communications basebands, broadcast AM and FM, and TV. This analyzer features high sensitivity, stability and resolution. The HP 8443A Tracking Generator improves frequency measurement accuracy and provides a tracking source for swept frequency testing of components.

Frequency Range

The frequency range of the HP 8553B extends from audio through the FM broadcast band. In the PER DIVISION mode, scan widths from 200 Hz to 100 MHz can be selected. ZERO SCAN mode allows operation as a fixed tuned receiver with a time domain display. In addition to the full range dial scale, a 0-11 MHz dial scale provides better tuning resolution at low frequencies.

Resolution-Stability

Bandwidths ranging from 10 Hz to 300 kHz may be selected when using an HP 8553B. Wide bandwidths are useful for measurement of FM or other broadband spectra. The 10 Hz bandwidth allows measurement of 60 Hz sidebands which are greater than 60 dB down from the carrier. Low residual FM due to phase-lock stabilization makes this resolution possible. This low residual FM also permits characterization of oscillator stability.

Amplitude Calibration

The HP 8553B is calibrated for either dBm or Volts over the range -142 dBm (18 nV) to $+10$ dBm (0.7 V). An accurate amplitude reference is provided by the internal calibrator. This reference together with low frequency response variations (± 0.5 dB) make possible accurate measurements of absolute amplitude. Calibrated in-circuit made measurements may be made at frequencies from 100 kHz to 110 MHz when using the HP1121A Active Probe with the HP 8553B.

Sensitivity

Low noise figure and 10 Hz bandwidth result in high sensitivity for the HP 8553B. In a 10 Hz bandwidth signal levels of -140 dBm may be measured. With the addition of a low noise preamp, such as the HP 8447, sensitivity can be improved by at least 15 dB.

HP 8443A Tracking Generator-Counter

To complement the HP 8553B, the HP 8443A Tracking Generator provides a tracking source with a frequency range of 100 kHz to 110 MHz. A built-in counter permits precision frequency measurements and RF attenuators allow precise control of output amplitude.

Frequency Accuracy

Frequency measurements with an accuracy of ± 10 Hz are possible when using an HP 8443A. In the TRACK ANALYZER mode, the HP 8443A displays the counted frequency of a tunable marker. The RESTORE mode allows individual signals to be counted in a wide scan without fine tuning.

Swept Frequency Measurements

With the HP 8443A, the HP 8553B can be used to measure both insertion and return loss over the 100 kHz to 110 MHz frequency range. The excellent stability of the HP 8443A permits use of the 10 Hz bandwidth, providing a 130 dB dynamic range for swept frequency response measurements. A system (HP 8553B/8443A) frequency response of ± 1.0 dB insures accurate characterization of DUT frequency response.

Specifications—with HP 8552B IF Section

Frequency Specifications

Frequency range: 1 kHz–110 MHz (0–11 MHz and 0–110 MHz tuning ranges).

Scan Width (on 10-division CRT horizontal axis)

Per division: 18 calibrated scan widths from 20 Hz/div to 10 MHz/div in a 1, 2, 5 sequence.

Preset: 0–100 MHz, automatically selects 300 kHz bandwidth IF Filter.

Zero: analyzer is fixed tuned receiver with selectable bandwidth.

Frequency Accuracy

Center frequency accuracy: the dial indicates the display center frequency within ± 1 MHz on the 0–110 MHz tuning range; ± 200 kHz on the 0–11 MHz tuning range with FINE TUNE centered, and temperature range of 20°C to 30°C.

Scan width accuracy: scan widths 10 MHz/div to 2 MHz/div and 20 kHz/div to 20 Hz/div: Frequency error between two points on the display is less than $\pm 3\%$ of the indicated frequency separation between the two points. Scan widths 1 MHz/div to 50 kHz/div: Frequency error between two points on the display is less than $\pm 10\%$ of the indicated frequency separation.

Resolution

Bandwidth: IF Bandwidths of 10 Hz to 300 kHz are provided in a 1, 3, 10 sequence.

Bandwidth accuracy: individual IF bandwidths' 3 dB points calibrated $\pm 20\%$ (10 kHz bandwidth $\pm 5\%$).

Bandwidth selectivity: 60 dB/3 dB IF bandwidth ratios: 10 Hz to 3 kHz bandwidths, $< 11:1$, 10 kHz to 300 kHz bandwidths, $< 20:1$; 60 dB points on 10 Hz bandwidth separated by < 100 Hz.

Stability

Residual FM stabilized: sidebands > 60 dB down 50 Hz or more from CW signal, scan time ≥ 1 sec/div, 10 Hz bandwidth (typically less than 1 Hz peak-to-peak).

Residual FM unstabilized: < 1 kHz peak-to-peak.

Noise sidebands: more than 70 dB below CW signal, 50 kHz or more away from signal, with 1 kHz IF bandwidth.

Long term drift (after 1-hour warm-up), stabilized: 100 Hz/10 min; unstabilized: 5 kHz/min, 20 kHz/10 min.

Amplitude Specifications

Absolute Amplitude Calibration Range

Log: from -130 to $+10$ dBm, 10 dB/div on a 70 dB display or 2 dB/div on a 16 dB display.

Linear: from $0.1 \mu\text{V/div}$ to 100 mV/div in a 1, 2 sequence on an 8-division display.

Dynamic Range

Average noise level: < -110 dBm with 10 kHz IF bandwidth.

Video filter: averages displayed noise; 10 kHz, 100 Hz, and 10 Hz bandwidths.

Spurious responses: are below a -40 dBm signal at the input mixer as follows: All image and out-of-band mixing responses, -harmonic and intermodulation distortion more than 70 dB down, 2 MHz to 110 MHz; more than 60 dB down, 1 kHz to 2 MHz. Third order intermodulation products more than 70 dB down, 1 kHz to 110 MHz (Signal separation > 300 Hz).

Residual responses (no signal present at input): with input attenuation at 0 dB: < -110 dBm (200 kHz to 110 MHz); < -95 dBm (20 kHz to 200 kHz).

Amplitude Accuracy

Frequency response
(Flatness: attenuator
settings > 10 dB):

1 kHz to 110 MHz
Amplitude Display

| | Log | Linear |
|--|-----------------------------|----------------|
| | ± 0.5 dB | $\pm 5.8\%$ |
| | ± 0.25 dB/dB | $\pm 2.8\%$ of |
| | but not more than ± 1.5 | full 8 div |
| | dB over the full | deflection |
| | 70 dB display range | |

Calibrator amplitude: -30 dBm, ± 0.3 dB

Calibrator frequency: 30 MHz, ± 3 kHz.

Log reference level control: provides 70 dB range (60 dB below 200 kHz), in 10 dB steps. Accurate to ± 0.2 dB ($\pm 2.3\%$, Linear Sensitivity).

Log reference level vernier: provides continuous 12 dB range. Accurate to ± 0.1 dB ($\pm 1.2\%$) in 0, -6 , and -12 dB positions; otherwise ± 0.25 dB ($\pm 2.8\%$).

Amplitude measurement accuracy: ± 1.25 dB with proper technique.

General Characteristics

Input impedance: 50 Ω nominal, BNC connector. Reflection coefficient < 0.13 (1.3 SWR), input attenuator ≥ 10 dB. A special 75 Ω version of the HP 8553B/8552B is available, as is a 75 Ω matching transformer, the HP 11694A.

Maximum input level: peak or average power $+13$ dBm (1.4 V ac peak), ± 50 V dc, 1 dB compression point, -10 dBm.

Scan time: 16 internal scan rates from 0.1 ms/div to 10 sec/div in a 1, 2, 5 sequence, or manual scan.

Scan Mode

Int: analyzer repetitively scanned internally.

Ext: scan determined by 0 to $+8$ -volt external signal.

Manual: scan determined by front panel control.

Attenuator: 0 to 50 dB, in 10 dB increments, coupled to Log Reference Level indicator; automatically maintains absolute calibration. Attenuator accuracy ± 0.2 dB.

Power requirements: 100, 120, 220, or 240 V $+5\%$, -10% , 50 to 60 Hz, normally less than 225 watts.

Weight: Model 8553B RF Section: net, 5.5 kg (12 lb). Shipping, 7.8 kg (17 lb).

Size: 102 H x 226 W x 334 mm D (4" x 8.9" x 13.5").

Tracking Generator-Counter (HP 8443A)

Frequency range: 100 kHz to 110 MHz.

Amplitude range: < -120 dBm to $+10$ dBm in 10 and 1 dB steps with a continuous 1.2 dB vernier.

Amplitude Accuracy

Frequency response (flatness): ± 0.5 dB.

Absolute: 0 dBm at 30 MHz: ± 0.3 dB.

Output impedance: 50 Ω , BNC connector, ac coupled, reflection coefficient ≤ 0.09 (1.2 SWR) with output < 0 dBm.

Counter

Display: 7 digits with 1 digit over-range. Reads to ± 10 Hz increments.

Resolution (gate time): 1 kHz (1 ms), 100 Hz (10 ms), 10 Hz (100 ms).

Accuracy: ± 1 count \pm time base accuracy.

Time base aging rate: $< 3 \times 10^{-9}$ /day (0.3 Hz/day) after warm-up.

External counter inputs: 10 kHz to 120 MHz, 50 Ω , -10 dBm min.

Power: 100, 120, 220, or 240 V $+5\%$, -10% , 48 to 440 Hz 75 watts.

Weight: Model 8443A: net, 11.04 kg (24.3 lb). Shipping, 14.47 kg (31.9 lb).

Size: 88.2 H x 425 W x 467 mm D (3.5" x 16.8" x 18.4").

Ordering Information

HP 8553B RF Section

HP 8443A Tracking Generator-Counter

Price

\$4120

\$6980



SIGNAL ANALYZERS

HP 141T Spectrum Analyzer System: 100 kHz to 1250 MHz

Models 8554B & 8444A

- High resolution (100 Hz)
- Frequency response ± 1 dB
- Companion tracking generator
- Optional internal limiter



HP 8554B (141T, 8552B) 8444A

The HP 8554B RF Section covers the frequency range from 100 kHz to 1250 MHz. This band includes baseband, AM/FM Broadcast, VHF/UHF TV, mobile communications, and VHF/UHF navigation systems. Typical measurements include modulation, intermodulation, harmonics and spurious. Noise power density and carrier to noise ratio can also be measured. The frequency response of filters, amplifiers, mixers or modulators can be measured and displayed when a companion tracking generator is used.

Absolute Calibration

Amplitude measurements can be made with an accuracy of ± 2.8 dB over the range +10 to -122 dBm. This accuracy can be improved to $\leq \pm 1.75$ dB with IF substitution techniques. The log display mode (dBm) provides a 70 dB calibrated range, while the linear display mode (volts) provides maximum resolution of $1 \mu\text{V}$ per division. The calibrated reference level (top graticule line) can be set with IF gain to values from +10 to -72 dBm. An UNCAL light warns of control settings which may cause loss of amplitude calibration.

Frequency Response

Excellent flatness (± 1 dB) insures high accuracies for relative amplitude measurements such as harmonic distortion. Full band sweep allows display of the entire tuning range, 100 kHz to 1250 MHz.

Frequency Resolution

Low residual FM allows selection of bandwidths as narrow as 100 Hz. This bandwidth provides the resolution needed to measure close-in sidebands such as those due to power line harmonics or third order

intermodulation distortion. Available bandwidths range from 100 Hz to 300 kHz in a 1, 3, 10 sequence. The filters used are synchronously-tuned which have an excellent response to pulsed signals and permit the lowest sweep time for a given bandwidth.

Sensitivity

High sensitivity (-122 dBm/100 Hz) and low spurious levels (-65 dBc) allow accurate measurements of low level signals such as might be encountered in EMI applications. The sensitivity/spurious performance also provides the dynamic range required for signals with large amplitude separation such as intermodulation distortion or incidental AM.

Frequency Stabilization

Frequency stabilization reduces residual FM to less than 100 Hz peak-to-peak for scans of 200 kHz or less. The stabilization in narrow scans is implemented by phase-locking the local oscillators to a crystal reference.

HP 8444A Tracking Generator

The HP 8444A Tracking Generator utilizes the LOs of the HP 8554B to generate an output signal whose frequency equals the tuned frequency of the HP 8554B. The tracking generator can provide a swept source for frequency response measurements. The HP 8444A also provides control of output signal amplitude to prevent overdriving the DUT.

For precise frequency measurements of low level signals, the tracking generator provides a constant amplitude auxiliary output signal, which can be used to drive a frequency counter.

HP 8554B Specifications—with HP 8552B IF Section

Frequency Specifications

Frequency range: 100 kHz to 1250 MHz.

Scan Width (on 10-division CRT horizontal axis)

Per division: 15 calibrated scan widths from 100 MHz/div to 2 kHz/div in a 1, 2, 5 sequence.

Preset: 0-1250 MHz, automatically selects 300 kHz bandwidth IF filter.

Zero: analyzer is fixed-tuned receiver.

Frequency Accuracy

Center frequency accuracy: the dial indicates the display center frequency within 10 MHz.

Scan width accuracy: frequency error between two points on the display is less than 10% of the indicated separation.

Resolution

Bandwidth: IF bandwidths of 0.1 to 300 kHz provided in a 1, 3, 10 sequence.

Bandwidth accuracy: individual IF bandwidth 3 dB points calibrated to $\pm 20\%$ (10 kHz bandwidth $\pm 5\%$).

Bandwidth selectivity: 60 dB/3 dB IF bandwidth ratio $< 20:1$ for IF bandwidths from 10 kHz to 200 kHz. 60 dB/3 dB bandwidth ratio $< 11:1$ for IF bandwidths 100 Hz to 3 kHz.

Stability (residual FM)

Stabilized: < 100 Hz peak-to-peak.

Unstabilized: < 10 kHz peak-to-peak.

Noise sidebands: more than 70 dB below CW signal, 50 kHz or more away from signal, with 1 kHz IF bandwidth.

Amplitude Specifications

Absolute Amplitude Calibration Range

Log: from -122 to $+10$ dBm. 10 dB/div on a 70 dB display, or 2 dB/div on a 16 dB display.

Linear: from $0.1 \mu\text{V/div}$ to 100 mV/div in a 1, 2 sequence on an 8-division display.

Dynamic Range

Average noise level: < -102 dBm with 10 kHz IF bandwidth.

Spurious responses: all image and out-of-band mixing responses, harmonic and intermodulation distortion products are more than 65 dB below a -40 dBm signal at the input mixer.

Residual responses (no signal present at input): with input attenuation at 0 dB: < -100 dBm.

Amplitude Accuracy

| | Log | Linear |
|--|--|-------------------------------|
| Frequency response (flatness) | | |
| 100 kHz to 1250 MHz | ± 1 dB | $\pm 12\%$ |
| Switching between bandwidths (at 25°C) | ± 0.5 dB | $\pm 5.8\%$ |
| Amplitude display | ± 0.25 dB/dB but not more than ± 1.5 dB over the full 70 dB display range. | 2.8% of full 8 div deflection |

Calibrator Output

Amplitude: -30 dBm, ± 0.3 dB.

Frequency: 30 MHz, ± 3 kHz.

Log reference level control: provides 70 dB range (60 dB below 200 kHz), in 10 dB steps. Accurate to ± 0.2 dB ($\pm 2.3\%$, Linear Sensitivity).

Log reference level vernier: provides continuous 12 dB range. Accurate to ± 0.1 dB ($\pm 1.2\%$) in 0, -6 , and -12 dB positions; otherwise ± 0.25 dB ($\pm 2.8\%$).

Amplitude measurement accuracy: ± 1.75 dB with proper technique.

RF Input Specifications

Input impedance: 50Ω nominal. Typical reflection coefficient < 0.30 (1.85 SWR), input attenuator ≥ 10 dB.

Maximum input level: peak or average power $+13$ dBm (1.4 V ac peak), ± 50 V dc.

General

Scan time: 16 internal scan rates from 0.1 ms/div to 10 sec/div in a 1, 2, 5 sequence, and manual scan.

Scan Time Accuracy

0.1 ms/div to 20 ms/div: $\pm 10\%$.

50 ms/div to 10 s/div: $\pm 20\%$.

Weight

Model 8554B RF section: net, 4.7 kg (10.3 lb). Shipping 7.8 kg (17 lb).

Size: 102 H x 226 W x 344 mm D (4" x 8.9" x 13.5").

HP 8444A Specifications

Specifications for Swept Frequency Response Measurements

Dynamic range: > 90 dB from spectrum analyzer 1 dB gain compression point to average noise level (approximately -10 dBm to -100 dBm). Spurious responses not displayed.

Gain compression: for -10 dBm signal level at the input mixer, gain compression < 1 dB.

Absolute Amplitude Calibration Range

Tracking generator (drive level to test device: 0 to -10 dBm continuously variable. 0 dBm absolutely calibrated to ± 0.5 dB at 30 MHz).

Frequency range: 500 kHz to 1250 MHz.

Frequency resolution: 1 kHz.

Stability

Residual FM (peak-to-peak): stabilized, < 200 Hz; unstabilized, < 10 kHz.

Amplitude Accuracy

System frequency response: ± 1.50 dB.

Tracking generator calibration: 0 dBm at 30 MHz to ± 0.5 dB.

Specifications for Precision Frequency Measurements

Frequency accuracy: for unknown signals ± 10 kHz. (Tracking drift typically 50 kHz/10 min after 2-hour warm-up). For points on frequency response curve, counter accuracy \pm Residual FM (200 Hz).

Counter Mode of Operation

Manual scan: scan determined either by front panel control of HP 8552B IF Section or by external scan signal provided by the HP 8444A.

Zero scan: analyzer is fixed-tuned receiver. Counter reads center frequency to accuracy of tracking drift.

Counter output level: typically 0.1 V rms.

Specifications for Sweep/CW Generator

Frequency: controlled by spectrum analyzer. Range 500 kHz to 1250 MHz with HP 8554B. Scan widths are as enumerated on this page.

Frequency accuracy: ± 10 MHz using spectrum analyzer tuning dial. Can be substantially improved using external counter output.

Flatness: ± 0.5 dB.

Spectral Purity

Residual FM (peak-to-peak): 200 Hz.

Harmonic distortion: 25 dB below output level (typical).

Nonharmonic (spurious) signals: > 35 dB below output level.

Long term stability: drift typically less than 30 kHz/hour when stabilized after 2-hour warm-up.

Sweep width: 20 kHz to 1000 MHz.

Sweep rates: selected by Scan Time per Division on spectrum analyzer.

General

Temperature range: operation, 0°C to 55°C , storage -40°C to 75°C .

EMI: conducted and radiated interference is in compliance with MIL-STD 461A Methods CE03 and RE02, CISPR publication 11 (1975), and Messemptaenger-Postverfuegung 526/527/79 (Kennzeichnung Mit F-Nummer/Funkschutzzeichen).

Power: 115 V and 230 V, 48 to 440 Hz, 12 watts max.

Weight: net, 7.1 kg (15.6 lb). Shipping, 9.5 kg (21 lb).

Size: 88.2 H x 425 W x 467 mm D (3.5" x 16.8" x 18.4").

Ordering Information

HP 8554B RF Section

Opt 003: Internal Limiter

HP 8444A Tracking Generator

Price

\$6,970

\$170

\$4,260

SIGNAL ANALYZERS

HP 141T Spectrum Analyzer System: 10 MHz to 40 GHz

Models 8555A, 8444A Option 059 & 8445B

- 10 MHz to 18 GHz, external mixing to 40 GHz
- High sensitivity (-125 dBm)
- 100 Hz resolution
- Companion tracking generator to 1.5 GHz

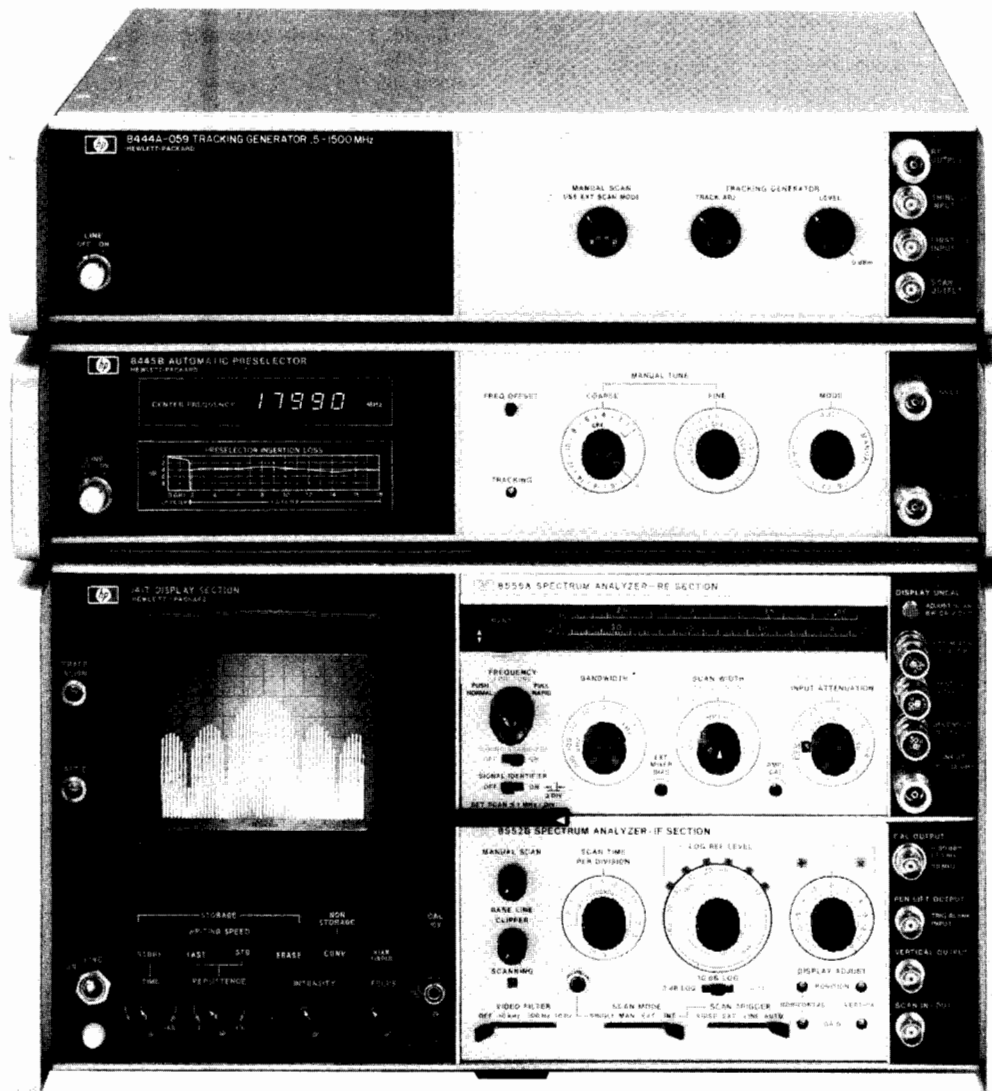

HP 8555A (141T, 8552B) 8444A Opt 059, 8445B

The HP 8555A Tuning Section offers multiband coverage from 10 MHz to 18 GHz. The range can be extended to 40 GHz with the HP 11517A external waveguide mixer (see page 697). The HP 8555A provides high sensitivity (-125 dBm), high resolution (100 Hz) and frequency scans as wide as 8 GHz. The HP 8555A is well suited for measurements necessary during both the design and production phases of microwave devices and systems.

Amplitude Calibration

Absolute amplitude calibration permits accurate amplitude measurements over the range from $+10$ to -125 dBm. The exceptional flatness of the HP 8555A, which is ± 2 dB out to 18 GHz, enhances the accuracy of relative power measurements.

High Sensitivity

With the 100 Hz bandwidth selected, the sensitivity of the HP 8555A is -125 dBm in the fundamental mixing band and -100 dBm in the 4th harmonic band. This sensitivity permits measurements of low level signals. When these signals are close to the noise floor, a video filter of 10 kHz, 100 Hz or 10 Hz can be selected to improve discernability of the signal.

High Resolution/Stability

The low residual FM of the HP 8555A (<100 Hz p-p) allows a 100 Hz bandwidth to be selected which permits the user to resolve sidebands due to low frequency modulations. The stability of the HP 8555A also allows measurement of the spectral purity of a DUT.

HP 8445B Tracking Preselector

The HP 8445B Tracking Preselector contains a YIG filter which tracks the tuned frequency of the analyzer over the range 1.8 to 18 GHz. The preselector suppresses the image and multiple responses which result from harmonic mixing. The preselector can also reduce distortion and increase dynamic range when signal separation exceeds the preselector bandwidth. For tuned frequencies below 1.8 GHz, a low pass filter prevents image and multiple responses.

An optional LED display provides a readout of marker frequency with 1 MHz resolution.

HP 8444A Option 059 Tracking Generator

The tracking generator provides a leveled, calibrated signal output with a frequency equal to the tuned frequency of the HP 8555A. This enables swept frequency tests such as insertion loss and return loss at frequencies up to 1500 MHz. With the addition of an external frequency counter, precise measurement of frequency is possible.

HP 8555A Specifications—with HP 8552B IF Section

Frequency Specifications

Frequency range: 0.01–40 GHz.

Tuning Range

With internal mixer: 0.01–18.0 GHz.

With external mixer: 12.4–40 GHz.

Harmonic Mixing Mode

Signal identification: not required when preselector is used. The signal identifier allows positive identification of all responses.

Scan Width

Full scan: the width of the scan depends on mixing mode. Scan width = $n \times 2000$ MHz, where n is the mixing mode; e.g. for $n = 2$, scan width is 4 GHz. Maximum scan width full screen is 8 GHz with coaxial mixer. Preselector necessary to make wide scans usable.

Per division: 16 calibrated scan widths from 2 kHz/div to 200 MHz/div in a 2, 5, 10 sequence.

Zero scan: analyzer becomes fixed-tuned receiver.

Frequency Accuracy

Dial accuracy: $n \times (\pm 15 \text{ MHz})$ where n is the mixing mode.

Scan accuracy: frequency error between two points on the display is less than $\pm 10\%$ of the indicated separation.

Stability: residual FM stabilized < 100 Hz peak-to-peak (fundamental mixing).

Noise sidebands: for fundamental mixing. More than 70 dB below CW signal 50 kHz or more away from signal, with 1 kHz IF bandwidth and 100 Hz video filter.

Frequency Drift

Long term drift: at fixed center frequency after 2-hour warm-up (Typical).

Stabilized: ± 3.0 kHz/10 min.

Unstabilized: ± 25 kHz/10 min.

Stabilization range: first LO can be automatically stabilized to internal crystal reference for scan widths of 100 kHz/div or less.

Resolution

Bandwidth range: selectable 3 dB bandwidths from 100 Hz to 300 kHz in a 1, 3, 10 sequence.

Bandwidth shape: approximately gaussian.

Bandwidth selectivity: 11:1 to 20:1 (60 dB/3 dB).

Bandwidth accuracy: individual IF bandwidth 3 dB points calibrated to $\pm 20\%$ (10 kHz bandwidth, $\pm 5\%$).

Amplitude Specifications

Measurement Range

Log reference level: from -60 dBm to $+10$ dBm.

Linear sensitivity: from $0.1 \mu\text{V/div}$ to 100 mV/div .

Sensitivity and frequency response with internal coaxial mixer noise level: specified for 1 kHz bandwidth.

Frequency Response with 10 dB Input Attenuator Setting

| Frequency Range (GHz) | Mixing Mode (n) | Average Noise Level (dBm max.) | Frequency Response* (dB max.) |
|-----------------------|-----------------|--------------------------------|-------------------------------|
| 0.01-2.05 | 1- | -115 | ± 1.0 |
| 1.50-3.55 | 1- | -117 | ± 1.0 |
| 2.07-6.15 | 2- | -108 | ± 1.3 |
| 2.60-4.65 | 1+ | -117 | ± 1.0 |
| 4.11-6.15 | 1+ | -115 | ± 1.0 |
| 4.13-10.25 | 3- | -103 | ± 1.5 |
| 6.17-10.25 | 2+ | -105 | ± 1.5 |
| 6.19-14.35 | 4- | -95 | ± 2.0 |
| 8.23-14.35 | 3+ | -100 | ± 2.0 |
| 10.29-18.00 | 4+ | -90 | ± 2.0 |

*Includes mixer frequency response, RF attenuator frequency response, mixing mode gain variation, RF input VSWR.

Sensitivity and Frequency Response with HP 11517A External Wave-guide Mixer and Appropriate Waveguide Tapers

Average Noise Level 10 kHz Bandwidth (dBm typical)

| Frequency Range (GHz) | Mixing Mode (n) | Average Noise Level (dBm) |
|-----------------------|-----------------|---------------------------|
| 12.4-18.0 | 6- | -90 |
| 18.0-26.5 | 6+ | -85 |
| 26.5-40.0 | 10+ | -75 |

Frequency response: typically ± 3 dB over 1 GHz frequency scans.

Residual responses: referred to input on fundamental mixing: < -90 dBm.

Display Range

Log: 70 dB, 10 dB/div and 2 dB/div, expanded on a 16 dB display.

Linear: from $0.1 \mu\text{V/div}$ to 100 mV/div in a 1, 2, sequence on an 8-division display.

Spurious Responses Due to Second Harmonic Distortion with Preselector

| Frequency Range | Power Incident on Input Mixer | 2nd Harmonic Distortion |
|-----------------|-------------------------------|-------------------------|
| 0.01-1.85 GHz | -40 dBm | -63 dB |
| 1.85-18.0 GHz | 0 dBm | -100 dB |

Spurious Responses Due to Third Order Intermodulation Distortion with Preselector

| Frequency Range | Signal Separation | Power Incident on Input Mixer | Third Order Intermodulation Distortion |
|-----------------|-------------------------|-------------------------------|--|
| 0.01-18.0 GHz | > 1 MHz < 20 MHz | -30 dBm | -70 dB |
| 0.01-1.85 GHz | > 70 MHz | -30 dBm | -70 dB |
| 1.85-18.0 GHz | > 70 MHz | 0 dBm | -100 dB |

Video filter: post detection filter used to average displayed noise. Nominal bandwidths: 10 kHz, 100 Hz, and 10 Hz.

Gain compression: for internal mixer gain compression < 1 dB for -10 dBm peak or average signal level to input mixer. 11517A External Mixer (12.4-40 GHz) gain compression < 1 dB for -15 dBm peak or average signal level to input mixer.

Amplitude Accuracy

IF gain variation with different bandwidth settings: (at 20°C .)

Log: ± 0.5 dB.

Linear: $\pm 5.8\%$

SIGNAL ANALYZERS

HP 141T Spectrum Analyzer System: 10 MHz to 40 GHz

Models 8555A, 8444A & 8445B (cont.)

Amplitude Display

Log: ± 0.25 dB/dB, but not more than ± 1.5 dB over the full 70 dB display range.

Linear: $\pm 2.8\%$ of full 8-division deflection.

Log reference level: accurate to ± 0.2 dB ($\pm 2.3\%$ linear sensitivity).

Log reference level vernier: accurate to ± 0.1 dB (1.2%) in 0, -6, and -12 dB positions; otherwise, ± 0.25 dB ($\pm 2.8\%$).

Input attenuator range: 0-50 dB in 10 dB steps, manual safety lockout for 0 dB position.

Frequency response: typically ± 0.6 dB from 10 MHz to 18 GHz.

Calibrator output: amplitude -30 dBm, ± 0.3 dB. Frequency 30 MHz ± 3 kHz.

Absolute calibration accuracy: overall accuracy is a function of measurement technique. With the appropriate technique, absolute accuracy of ± 1.6 dB (fundamental mixing) and ± 2.6 dB (4th harmonic mixing) is achievable.

Input Characteristics

Input impedance: 50 ohms nominal (0.01-18 GHz).

Reflection coefficient: < 0.13 (1.30 SWR) for 0.01-7.5 GHz; < 0.23 (1.6 SWR) for 7.5-18 GHz.

Maximum input level: peak or average power +13 dBm (1.0 V ac rms) incident on mixer (+30 dBm with Opt 002), +33 dBm incident on input attenuator.

RF input connector: type N female.

LO emission: -10 dBm without preselector, -80 dBm with preselector over recommended operating ranges (10 dB input attenuator setting).

General

Scan time: 16 internal scan rates from 0.1 ms/div to 10 sec/div in a 1, 2, 5 sequence.

Power requirements: 100, 120, 220 240 V +5%, -10%, 50-60 Hz, normally less than 225 watts (varies with plug-in units used).

Weight: net, 16.8 kg (14.9 lb). Shipping, 8.7 kg (19 lb).

Size: 102 H x 226 W x 344 mm D (4" x 8.9" x 13.5").

Specifications with Option 002;

Internal Limiter Installed

All specifications are the same as for the standard unit except the following:

Frequency range: 0.1-12.4 GHz, usable over 0.01-18 GHz range.

Maximum Input Level

Continuous: 1 W (+30 dBm).

Pulse: 75 watts peak, pulse width ≤ 1 μ s, 0.001 duty cycle.

Reflection coefficient: < 0.33 (2.0 SWR).

Frequency response (flatness): $< \pm 0.5$ dB degradation in response, 0.1-12.4 GHz.

HP 8445B Tracking Preselector

Frequency Specifications

Frequency range: dc-1.8 GHz low-pass filter. 1.8-18 GHz tracking filter.

Tracking filter 3 dB bandwidth: typically 20-45 MHz.

Tracking filter skirt roll-off: characteristics of a three-pole filter. (Nominal: 18 dB/octave.)

Insertion Loss

| | Frequency | Insertion Loss (Except Opt. 004) | Insertion Loss (Opt. 004) |
|-----------------|------------|----------------------------------|---------------------------|
| Low-Pass Filter | D-1.8 GHz | < 2.5 dB | * |
| | @2.05 GHz | > 50 dB | * |
| Tracking Filter | 1.8-12 GHz | < 8 dB | < 7 dB |
| | 12-18 GHz | < 10 dB | < 8 dB |

*Low-Pass Filter deleted with Opt 004.

Typical Preselector Minimum Insertion Loss at 25°C.

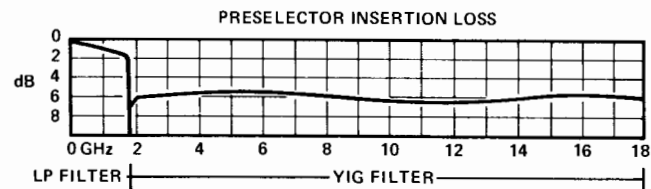

Out-of-band rejection: for YIG filter 1 GHz from center of pass-band > 70 dB.

Digital Frequency Readout (option 003)

Function

Full scan mode: displays frequency at inverted marker.

Per division scan: displays center frequency.

Manual or remote operation of preselector: displays tuned frequency of filter.

Resolution: 1 MHz.

Accuracy: 0.01-1.0 GHz: ± 6 MHz.

1.0-4.0 GHz: ± 8 MHz.

4.0-18 GHz: $\pm 0.2\%$

Input Specifications

Input connector: precision Type N female.

Input VSWR: typically < 2.0 (1.8-18 GHz).

Limiting level: (maximum input level for < 1 dB signal compression), $> +5$ dBm.

Damage level: $> +20$ dBm.

General

Remote function: YIG filter frequency can be set by externally supplied voltage.

Power requirements: 100, 120, 220, or 240 V + 5%, -10%, 48 to 440 Hz, less than 110 watts.

Weight: net, 8.8 kg (19.5 lb). Shipping, 11.9 kg (26 lb).

Size: 88.2 H x 425 W x 467 mm D (3.5" x 16.8" x 18.4").

HP 8444A Opt 059 Tracking Generator

Frequency range: 0.5 MHz to 1500 MHz.

Frequency resolution: 1 kHz.

Residual FM (peak-to-peak): 200 Hz (stabilized).

Amplitude Range

Spectrum analyzer display: from -130 dBm to +10 dBm, 10 dB/div on a 70 dB display or 2 dB/div on a 16 dB display (HP 8552B only).

Tracking generator (drive level to test device): 0 to -10 dBm continuously variable.

Amplitude Accuracy

System frequency response: ± 2.7 dB.

Tracking generator calibration: 0 dBm at 30 MHz to ± 0.5 dB.

Dynamic range: > 90 dB.

Counter output: typically 0.1 V rms.

General

Power: 115 V and 230 V, 48 to 440 Hz, 12 watts max.

Weight: net, 7.1 kg (15.6 lb). Shipping, 9.5 kg (21 lb).

Size: 85.2 H x 425 W x 467 mm D (3.5" x 16.8" x 18.4").

Ordering Information

HP 8555A Tuning Section

Opt 001: APC-7 connectors

Opt 002: Internal limiter

Opt 005: Video tape

HP 8445B Tracking Preselector, dc -18GHz

Opt 001: APC-7 connectors

Opt 002: Add manual controls

Opt 003: Add digital frequency readout

Opt 004: Delete low-pass filter

Opt 005: Delete interconnect rigid coax

HP 8444A Opt 059 Tracking Generator

HP 11517A External Mixer (taper section req'd)

HP 11518A Taper Section, 12.4 to 18 GHz

HP 11519A Taper Section, 18 to 26.5 GHz

HP 11520A Taper Section, 26.5 to 40 GHz

Price

\$10,920

add \$40

add \$210

add \$105

\$5,980

add \$155

add \$80

add \$670

less \$425

less \$50

\$4,760

\$450

\$275

\$275

\$275

SIGNAL ANALYZERS

Harmonic Mixers, 18 to 110 GHz

Models 11970 Series, 11971 Series & 11517A

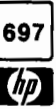

- Low conversion loss
- Individually amplitude calibrated

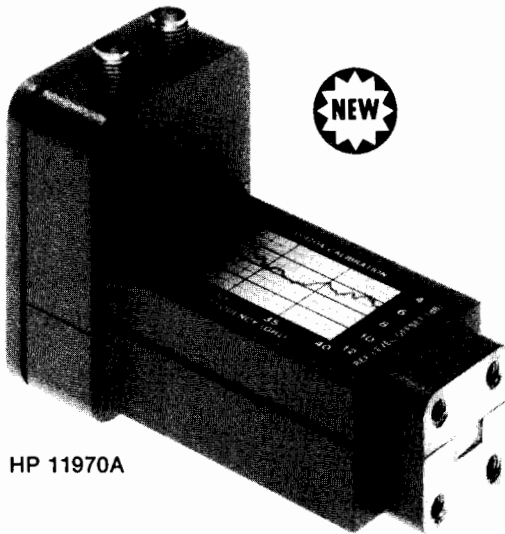

HP 11970A

HP 11970 and 11971: Exceptional Performance

The HP 11970 and 11971 series of waveguide Mixers are general purpose harmonic mixers employing state-of-the-art, dual diode design to achieve flat frequency response and low conversion loss. These mixers are available in six bands from 18 GHz through 110 GHz.

Easy to Use

The excellent frequency response and low conversion loss of the HP 11970 and 11971 series Harmonic Mixers are achieved without external dc bias or tuning stubs. Manual operation as well as computer controlled operation of hardware is simplified because no mixer adjustments are required.

HP 11517A Harmonic Mixer

This low-cost, wide-frequency-range harmonic mixer provides an economical solution for measurements not requiring amplitude calibration in the frequency range covering 12.4 to 40 GHz. Waveguide adapters are available to make measurements in more than one waveguide band.

The HP 11517A has an IF range of DC to 2 GHz and an LO range of 2 to 6 GHz, which makes this biased mixer compatible with a wide range of instruments.

Extends Spectrum Analysis Frequency

The HP 11970 and 11971 series Harmonic Mixers extend the frequency range of the HP 8566B, 8569B, and 71000 series microwave Spectrum Analyzers. The HP 11975A Amplifier provides the optimum LO power to the mixers when using the HP 8566B or 8569B Spectrum Analyzers. The HP 11517A external Harmonic Mixer extends the frequency range of the HP 8555A and 8565A Spectrum Analyzers.

Harmonic Mixer Selection Guide

| HP Spectrum Analyzer | HP Compatible Mixer Series | HP LO Drive Amplifier |
|----------------------|----------------------------|-----------------------|
| 8566B | 11970 | 11975A |
| 71000 | 11970 | 70907A |
| 8569B | 11971 | 11975A |
| 8569B Opt. 003 | 11971 | internal ¹ |
| 8555A | 11517A with adapters | 11975A (optional) |
| 8565A | 11517A with adapters | 11975A (optional) |

HP 11970 and 11971 Series Specifications

IF range: DC to 1300 MHz

LO amplitude range: +14 to +18 dBm, +16dBm optimum

Calibration accuracy: ±2.0dB with optimum LO amplitude

Typical RF input SWR: <2.2:1

Bias requirements: None

- No bias or tuning adjustments
- High 100 mW safe input level

Typical odd order harmonic suppression: >20dB

Maximum CW RF input level: +20dBm (100mW)

Maximum peak pulse power: 24dBm (250mW) with <1 usec pulse (avg. Power: +20dBm)

Environmental: Meets MIL-T-28800C, Type III, Class 3, Style C.

IF/LO connectors: SMA female

LO Range: HP 11970 Series, 3.0 to 6.1 GHz

HP 11971 Series, 2.0 to 4.5 GHz

| HP Model | Frequency Range | LO Harm. Number | Conversion Loss (dB) | Noise Level (dB) kHz (RBW) | Freq. ² Response (dB) | Gain Compression (dBm) |
|----------|-----------------|-----------------|----------------------|----------------------------|----------------------------------|------------------------|
| 11970K | 18-26.5 | 6+ | 24 | -110 | ±1.9 | -3 |
| 11970A | 26.5-40 | 8+ | 26 | -108 | ±1.9 | -5 |
| 11970Q | 33-50 | 10+ | 28 | -104 | ±1.9 | -7 |
| 11970U | 40-60 | 10+ | 28 | -104 | ±1.9 | -7 |
| 11970V | 50-75 | 12+ | 40 | -92 | ±2.1 | -3 |
| 11970W | 75-110 | 18+ | 46 | -85 | ±3.0 | -1 |
| 11971K | 18-26.5 | 6+ | 24 | -110 | ±2.1 | -3 |
| 11971A | 26.5-40 | 10+ | 28 | -106 | ±2.1 | -7 |
| 11971Q | 33-50 | 16+ | 40 | -92 | ±2.3 | -3 |
| 11971U | 40-60 | 16+ | 40 | -92 | ±2.3 | -3 |
| 11971V | 50-75* | 16+ | 42 | -89 | ±2.5 | -3 |

HP 11517A Characteristics

IF range: DC to 2 GHz

LO frequency range: 2.1 to 6.1 GHz

LO amplitude range: 0 to +10dBm (+10 dBm optimum)³

Typical flatness: ±3 dB over a 1 GHz span with biased peaked

Typical DC bias range: 0 to 3.5mA

Maximum CW RF input level: +10 dBm

Typical 3 dBm gain compression: -15dBm

Typical noise level: -85 dBm (using HP 8555A or 8565A with 1 kHz RBW)

12.4 to 18 GHz, -80 dBm 18 to 26.5 GHz, -70 dBm 26.5 to 40 GHz

Waveguide adapters:

12.4 to 18 GHz, HP 11518A; 18 to 26.5 GHz, HP 11519A; 26.5 to 40 GHz, HP 11520A

Ordering Information

| Model | Description | Price |
|-----------|--|-------------|
| HP 11970K | 18 to 26.5 GHz Mixer | \$1500. |
| HP 11970A | 26.5 to 40 GHz Mixer | \$1500. |
| HP 11970Q | 33 to 50 GHz Mixer | \$1650. |
| HP 11970U | 40 to 60 GHz Mixer | \$1850. |
| HP 11970V | 50 to 75 GHz Mixer | \$2250. |
| HP 11970W | 75 to 110 GHz Mixer | \$2550. |
| HP 11970T | 18 to 40 GHz Mixers and Case | \$3100. |
| Opt 001: | Adds 40 to 60 GHz Mixer to 11970T | add \$1850. |
| Opt 002: | Adds 33 to 50 GHz Mixer to 11970T | add \$1650. |
| HP 11971K | 18 to 26.5 GHz | \$1300. |
| HP 11971A | 26.5 to 40 GHz | \$1300. |
| HP 11971Q | 33 to 50 GHz | \$1500. |
| HP 11971U | 40 to 60 GHz | \$1800. |
| HP 11971V | 50 to 75 GHz | \$2000. |
| HP 11971T | 18 to 40 GHz Mixer Set and Case | \$2700. |
| Opt 009: | Mixer Connection Set contains three 1 meter low-loss SMA cables, a wrench, and an allen driver for use with any of the mixers listed above. Space is provided in carrying case for cables and tools. | \$250. |
| HP 11969A | Carrying Case for one to five mixers, SMA cables and tools | \$350. |
| HP 11517A | Harmonic Mixer (Waveguide Adapter required) | \$450. |
| HP 11518A | 12.4 to 18 GHz Waveguide Adapter | \$275. |
| HP 11519A | 18 to 26.5 GHz Waveguide Adapter | \$275. |
| HP 11520A | 26.5 to 40 GHz Waveguide Adapter | \$275. |
| HP 11975A | 2 to 8 GHz Amplifier | \$4100. |

¹Frequency response of the mixers is reduced by 1 dB for LO range of 14 to 18 dBm.

²Operates to 71 GHz with the HP 8569B.

³The HP 11975A Amplifier can be used to provide sufficient LO power to the mixers.

SIGNAL ANALYZERS

Spectrum Analyzer Accessories

Models 11975A, 8447 Series & 11970/11971 Series

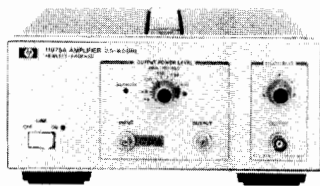

HP 11975A

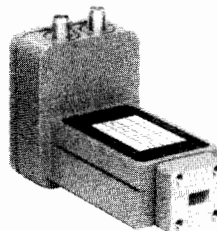

HP 11970/11971 Series

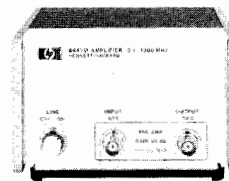

HP 8447 Series



HP 11693A



HP 11867A



HP 11694A

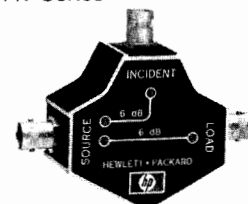

HP 8721A



HP 8406A

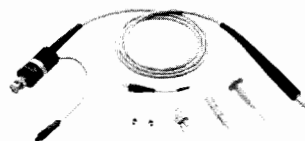

HP 1121A

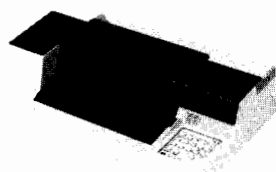

HP 7475A

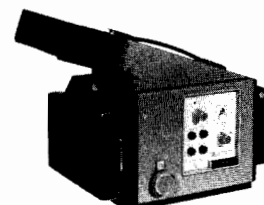

HP 197B

HP 8447 Series Amplifiers (0.1 to 1300 MHz)

The HP 8447 Series Amplifiers feature low noise and wide bandwidth. This makes them ideal for improving spectrum analyzer sensitivity and noise figure while providing input isolation. Accurate measurements over a wide frequency range are assured due to the broad frequency coverage, flat frequency response, and low distortion of these amplifiers. (See page 492.)

HP 11975A Amplifier (2 to 8 GHz)

A wide variety of sources can be leveled to ± 1 dB and amplitude calibrated up to +16 dBm using the HP 11975A in a stimulus response system. As a preamp, the small signal gain of the HP 11975A varies between 9 and 15 dB depending on the frequency. For measurements above 18 GHz, the HP 11975A is ideal for amplifying the local oscillator signal from a spectrum analyzer or network analyzer to drive a waveguide mixer like the HP 11970 or 11971 Series Harmonic Mixers. (See page 490.)

HP 11970 and 11971 Series Harmonic Mixers (18 to 60 GHz)

Each of these mixers provides low conversion loss and flat frequency response (typically ± 1.5 dB) over a full waveguide band of the 18 to 60 GHz frequency range. Optimized for 2 to 6 GHz local oscillator signals, the mixers are characterized for conversion loss and require no dc bias or tuning adjustments which could affect measurement accuracy and repeatability. (See page 697.)

HP 11867A and 11693A Limiters

The input circuits of spectrum analyzers, counters, amplifiers, and other instrumentation is protected against high power levels with minimum effect on measurement performance. The HP 11867A RF Limiter (dc-1800 MHz) begins reflecting signal levels over 1 milliwatt without damage up to 10 watts avg. power and 100 watts peak power. Insertion loss is < 0.75 dB. The HP 11693A Microwave Limiter (0.1-12.4 GHz, useable to 18 GHz) guards against input signals over 1 milliwatt up to 1 watt avg. power and 10 watts peak power.

HP 11694A 75 Ω Matching Transformer (3 to 500 MHz)

Allows measurements in 75 Ω systems while retaining amplitude calibration. VSWR is < 1.2 , and insertion loss is < 0.75 dB. See Options 001 and 002 for 75 Ω versions of the HP 8557A and 8558B.

HP 8721A Directional Bridge (100 kHz to 100 MHz)

Used for return-loss measurements made with a swept source such as the HP 8443A Tracking Generator and a spectrum analyzer. 6dB insertion loss and 6dB coupled to auxiliary arm. Frequency response ± 0.5 dB (0.1-110MHz). Directivity > 40 dB (1 to 110 MHz). Load part return loss < 0.03 . Max input power +20 dBm. 50 Ω ; Option 008: 75 Ω . (See page 561.)

HP 1121A Active Probe (0.1 to 500 MHz)

Provides high impedance input (> 100 k Ω shunted by < 3 pF) input to spectrum analyzer for measurements on sensitive circuits. Probe power is supplied by most HP Spectrum Analyzers and flat response with unity gain assures accurate, convenient measurements.

HP 8406A Frequency Comb Generator

Produces frequency markers at 1, 10, and 100 MHz increments accurate to $\pm 0.01\%$ and useable to beyond 5 GHz. An external oscillator can be used to generate precision interpolation sidebands. For an internal comb generator option to the HP 8569B, see page 675.

HP Plotters and Recorder

Produce hard copy records of measurement data either in a computer-based system or directly from a plotter-controlling instrument. Plotter controls on the HP 8569B Spectrum Analyzer or the HP 853A Spectrum Analyzer Display send the displayed information directly to an HP 7475A or 7090A. The HP 7090A is a combination Plotter-Recorder Waveform Sampler.

HP 197B CRT Camera

For a permanent record of a CRT display. See page 444 for the necessary adapters.

Ordering Information

| | Price |
|---|--------|
| HP 8447A 0.1 to 400 MHz Preamp | \$1075 |
| HP 8447D 0.1 to 1300 MHz Preamp | \$1100 |
| HP 8447E 0.1 to 1300 MHz Power Amplifier | \$1225 |
| HP 8447F 0.1 to 1300 MHz Preamp and Power Amplifier | \$1875 |
| HP 11975A 2 to 8 GHz Amplifier | \$4100 |
| HP 11970/11971 Series Harmonic Mixers see page 697. | |
| HP 11867A RF Limiter | \$410 |
| HP 11693A Microwave Limiter | \$460 |
| HP 11694A 75 Ω Matching Transformer | \$205 |
| HP 8721A Directional Bridge | \$325 |
| HP 1121A Active Probe | \$880 |
| HP 8406A Frequency Comb Generator | \$2175 |
| HP 7475A Plotter | \$1895 |
| HP 197B CRT Camera | \$1495 |

SIGNAL ANALYZERS

5 Hz to 50 kHz Spectrum Analyzer

Model 3580A

699

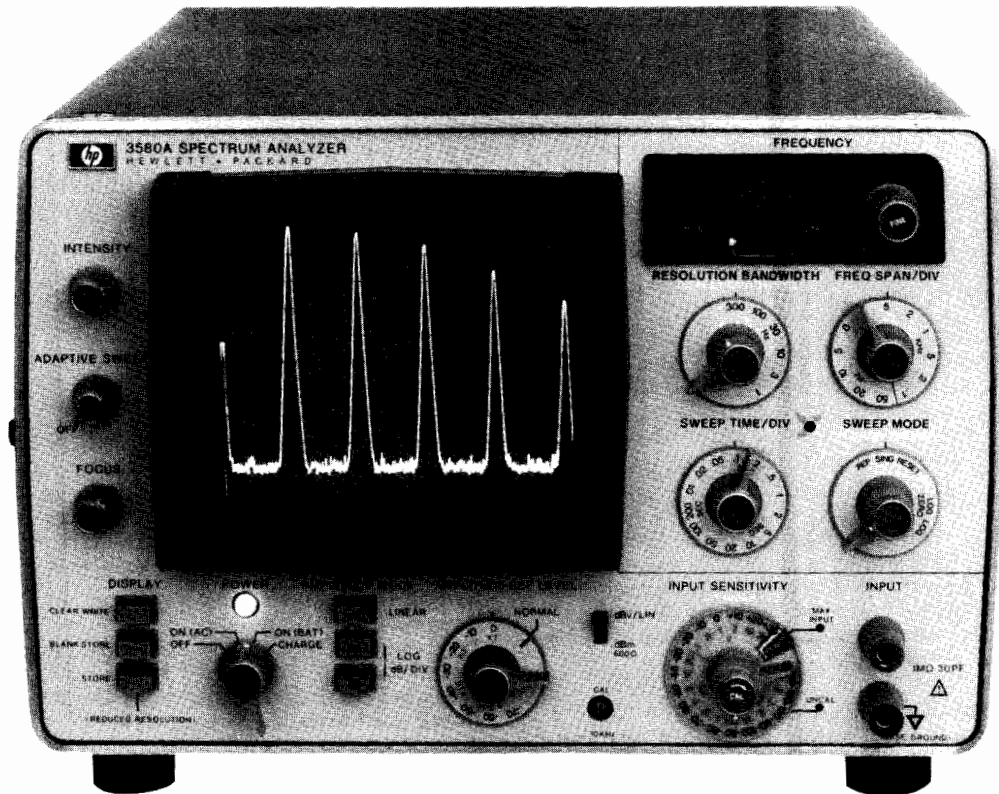

HP 3580A

Description

Hewlett-Packard's 3580A Spectrum Analyzer is a low frequency high performance analyzer. Its 1 Hz bandwidth allows the user to examine noise and extraneous signal content close in to a signal of interest.

For low frequency applications where sweep speeds can be slow and time-consuming, a special feature, adaptive sweep, allows the user to set a threshold above which only the spectra of interest are observed. In this mode, the CRT is rapidly swept. When a signal is encountered, the sweep slows down to reproduce full response. A factor of ten speed gain is possible.

Digital storage is another important feature which enhances the display for slowly swept low frequency signals. The analyzed signals are digitized and stored in memory. Trace information is then read from memory at a rate appropriate for obtaining an analog-like display.

Digital Storage for Spectra Comparison

Digital storage makes it possible to store one or two traces. When two are stored, both may be simultaneously displayed for easy comparison as shown below.

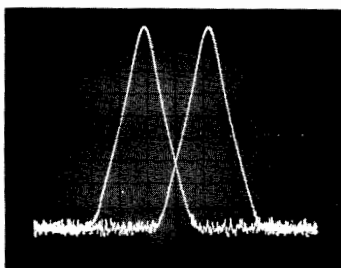

Adaptive Sweep

A tremendous savings in sweep time can be achieved by using adaptive sweep. In the left trace below, over 80 dB of dynamic range is used to look at low level signals and noise. Two hundred seconds were required to make the sweep. In the right trace, the baseline is raised to give 50 dB of dynamic range. Noise and other responses are not analyzed, so the sweep now takes only 14 seconds.

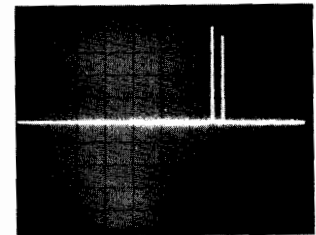
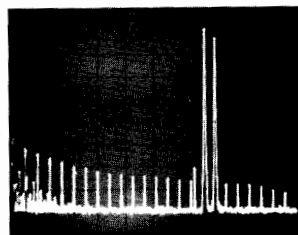

1 Hz Bandwidth

When using a 1 Hz bandwidth 60 Hz line related spectra are clearly exposed as shown in the left trace. An analysis of the same signal with a 10 Hz bandwidth will not resolve the line related spectra as shown on the right.

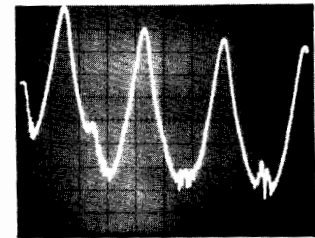
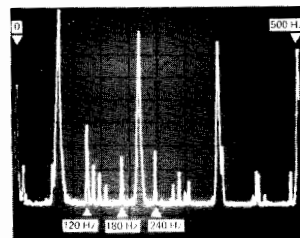

SIGNAL ANALYZERS

Dual-Channel, Dynamic Signal Analyzer 0.02 Hz to 25.5 kHz

Model 3582A



- Transfer function magnitude and phase measurements
- Coherence function measurement
- Phase spectrum measurement
- Transient capture and frequency domain analysis
- Internal periodic and random noise source
- Band selectable analysis for 0.02 Hz resolution
- Alphanumeric CRT annotation and marker readout

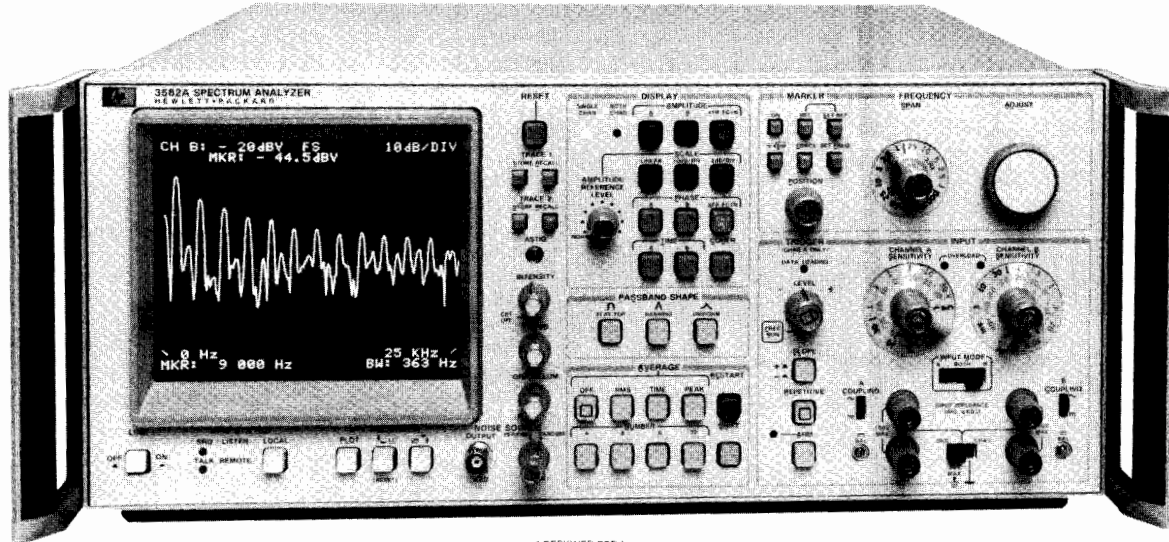

HP 3582A



Description

The HP 3582A offers outstanding value in a dual-channel, real-time spectrum analyzer that solves bench and systems measurement problems in the frequency range of 0.02 Hz to 25.599 kHz. Sophisticated LSI digital filtering combined with microcomputer execution of the Fast Fourier Transform (FFT) provides exceptional measurement capability and performance.

Exceptional Frequency Resolution

The ability to resolve closely spaced spectral components is often critical in the study of subtle phenomena such as structural transfer functions. Unlike conventional dynamic signal analysis which extends from dc to some maximum frequency, the HP 3582A can "zoom in" to analyze any selected band of frequencies with dramatically improved resolution. The start or center frequency of the 5 Hz to 25 kHz band analysis spans can be adjusted in 1 Hz increments to cover the entire frequency range of the instrument. This provides resolution down to 20 mHz across the entire range for spectrum analysis or 40 mHz for transfer functions, representing as much as 5000 to 1 improvement over conventional "baseband" analysis.

Excellent Low Frequency Coverage

Many electrical and physical measurements have significant spectral information in the audio and sub-audio range. With frequency ranges from 25 kHz down to 1 Hz full scale, the HP 3582A is extremely well suited to these types of measurements.

Real Time Measurement Speed

Long measurement times can be a major limitation of swept low frequency spectrum analyzers. In high volume testing or in applications requiring substantial on-line tuning these long measurement times are both expensive and inconvenient. Since the HP 3582A uses an advanced microcomputer to execute the Fast Fourier Transform (FFT), it can perform equivalent measurements as much as one to two orders of magnitude faster than a swept analyzer.

Wide Dynamic Range

In many applications the information of interest is contained not in the high amplitude fundamental, but rather in the low amplitude components. For a spectrum analyzer to provide useful information about these low level components in the presence of a large signal, it must offer wide dynamic range. The HP 3582A dynamic range is specified as 70 dB.

Phase Spectrum Measurement

Most spectrum analyzers can measure only the amplitude spectrum of a signal, yet complete characterization in the frequency domain also requires phase information. Signals with identical amplitude spectra, but different phase spectra can differ significantly. The advanced digital signal processing techniques incorporated in the HP 3582A provides direct measurement of phase spectra.

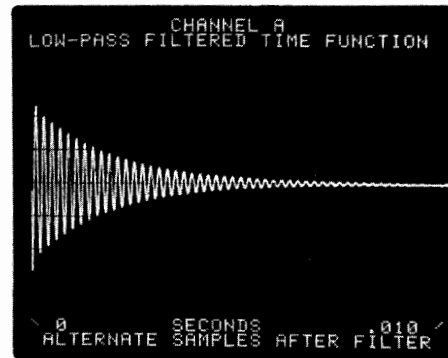

Figure 1: Captured transients can be measured in either the time or the frequency domain.

Transient Capture and Analysis

Many signals such as mechanical shocks and electrical transients may occur infrequently and spontaneously and may last only for a brief period of time. Swept spectrum analyzers generally cannot handle these transient signals. By using digital processing techniques, the HP 3582A can capture and analyze transients as short as a few milliseconds. This means that spectrum analysis and transfer function analysis are no longer limited to stable, time invariant signals.

Transfer Function Measurement with the Internal Noise Source

Many electrical circuits and mechanical systems can be treated as linear networks and can be characterized by the magnitude and phase of their transfer functions.

Most spectrum analyzers can measure only the magnitude portion of the transfer function—and even then only by assuming a flat drive signal. The HP 3582A directly measures the complete transfer function, both magnitude and phase. With dual channels analysis of

SIGNAL ANALYZERS

Single Channel, Dynamic Signal Analyzer 0.000125 Hz to 100 kHz

Model 3561A

703



- Spectrum and network analysis, waveform recording, $\frac{1}{3}$ and $\frac{1}{1}$ octave analysis
- High accuracy, ± 0.15 dB
- 80 dB dynamic range and full alias protection
- High speed (7.5 kHz Real Time Rate)
- Band selectable zoom analysis for 640 μ Hz resolution
- Full CRT annotation and softkey ease-of-use
- Auto-ranging, auto-calibration, auto-scaling
- Internal non-volatile memory stores 2 traces and 6 states. Optional bubble (non-volatile) memory stores 127 traces and states.



HP 3561A

Description

The HP 3561A is a versatile, single channel, real time spectrum analyzer with applications in electronics, vibration analysis, and acoustics. It is actually several instruments in one, operating in both the frequency domain and the time domain. In the frequency domain it serves as a spectrum analyzer with ± 0.15 dB amplitude accuracy and 2 degrees triggered phase accuracy. Utilizing the built-in tracking noise source, it also can serve as a network analyzer. (Trace math can be used when phase response or high accuracy is desired.) Digital signal processing allows the HP 3561A to digitally synthesize $\frac{1}{3}$ or $\frac{1}{1}$ octave filters, providing a high accuracy, drift free octave analyzer. Operating in the time domain the HP 3561A can be used as a low frequency digital storage oscilloscope. The HP 3561A contains a 40k-sample time buffer and complete triggering flexibility, so waveform recording is easy. Time or frequency measurements can be stored in an optional non-volatile "bubble" memory for later analysis. Annotated hardcopy is easily obtained by pressing "plot" ... the HP 3561A will control HP-GL plotters and raster dump printers directly. All of these capabilities in one portable instrument make the HP 3561A a powerful addition to any bench, and with a standard HP-IB interface, the HP 3561A makes an excellent systems instrument as well.

Spectrum Analysis

The HP 3561A offers swept analyzer performance with FFT speed. Up to two orders of magnitude speed improvement can be realized, especially in measurements requiring 1 Hz or better frequency resolution. The HP 3561A delivers 158 dB of automatically calibrated measurement range, from +27 dBV (22.4 volts RMS) to -131 dBV (0.28 microvolts RMS). Dynamic range is 80 dB, and amplitude accuracy is ± 0.15 dB on the +27 dBV to -40 dBV ranges (± 0.25 dB on the -41 dBV to -51 dBV ranges). Signals can be read in RMS volts, volts squared, milliwatts, dBV, dBm (with user-selected impedance), and user-defined engineering units. Band, harmonic and sideband

power can be computed directly using the built-in special marker functions. Frequencies spaced as narrow as 640 μ Hz can be resolved throughout the 100 kHz range, with frequency accuracy $\pm 0.003\%$ of display center frequency. Phase spectra relative to a trigger signal can be measured with up to 2 degrees phase accuracy, useful for machinery balancing.

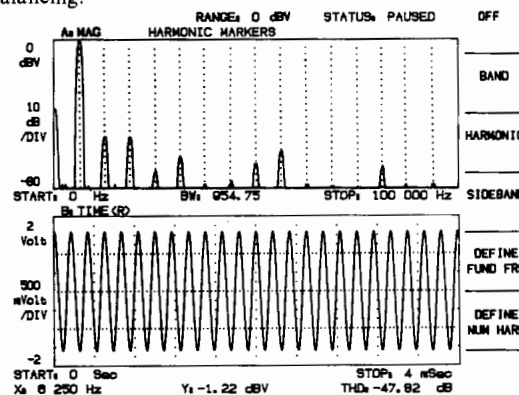

Harmonic marker function computes total harmonic distortion (THD) directly in dB or percent.

Network Analysis

A band-limited, band-translated noise source allows the HP 3561A to make amplitude and phase frequency response measurements. To make a network measurement, connect the internal noise source to the device under test, adjust the source amplitude, and measure the input spectrum. Store the input spectrum in memory and measure the response spectrum. A simple trace math operation produces the desired frequency response. Amplitude resolution is 0.01 dB and phase resolution is 0.1 degree.



SIGNAL ANALYZERS

Single Channel, Dynamic Signal Analyzer 0.000125 Hz to 100 kHz

Model 3561A (con't)

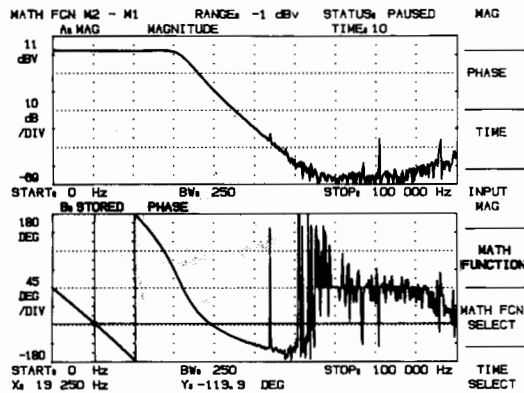

Figure 2: Network amplitude and phase response are measured using the unique internal noise source and trace math.

Waveform Recording

A high linearity 13 bit analog-to-digital converter makes the HP 3561A a natural for waveform recording. Forty-three sample rates ranging from 256 kHz to 0.026 Hz can be selected. If other sample rates are required, the analyzer can be made to sample on an external TTL clock signal. Up to 40k samples of time data can be stored internally in buffer memory, with complete trigger control. Trigger on an analog level with positive or negative slope and variable level. In either mode you can specify pre- or post-trigger values from 40k samples pre-trigger to 1023k samples of post-trigger delay. Data collected in the time domain is easily analyzed in the frequency domain, making the HP 3561A extremely useful in analyzing transients and other non-steady-state signals.

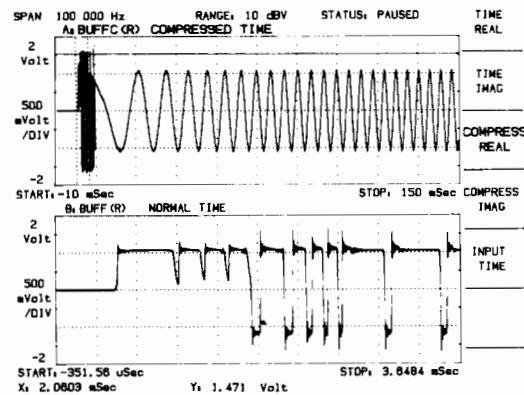

Figure 3: Up to 40,000 samples of a transient waveform can be captured, with analysis in either the time domain or the frequency domain.

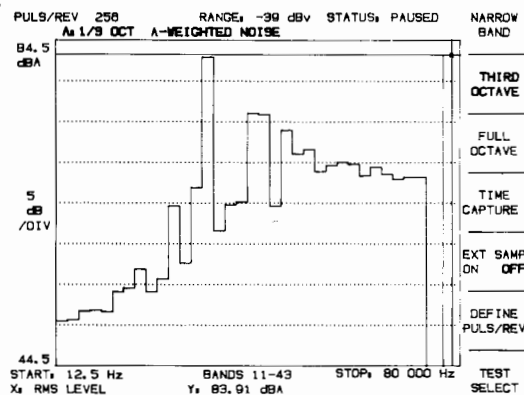

Figure 4: The combination of octave and narrowband analysis makes the HP 3561A a powerful instrument for noise and vibration analysis.

1/3 and 1/1 Octave Analysis

Octave analysis is often used in acoustic and vibration work for analyzing signals that are "proportional bandwidth". That is, they exhibit bandwidths that are proportional to their center frequencies. The HP 3561A digitally synthesizes a series of parallel bandpass filters, each with

bandwidth proportional to center frequency. The advantage of the digital technique is better stability and accuracy—there are no analog components to drift, age, or respond to temperature. A built-in hardware A-weight filter can be switched in for acoustic signals where the effects of the human ear must be taken into account.

Digital Averaging

Digital averaging is provided for improving a measurement in the presence of noise. RMS, RMS exponential, time and peak averaging are provided. Automatic overload signal rejection can be invoked to prevent an otherwise valid reading from being contaminated by one overloaded spectrum. A fast average display mode can be selected which speeds up the averaging process by turning off the display refresh during intermediate averages. This can result in a factor of 3 speed improvement over normal averaging mode. Coupled with its high real time rate, the HP 3561A can make averaged measurements in the same amount of time it formerly took to make an unaveraged measurement!

Flexible Display Formats and Complete Annotation

Display a single trace, two traces in upper/lower format, or two traces overlaid in front/back format. When several traces must be viewed at once, use the "spectral map" format which can display up to 60 separate traces stacked onto one display. Choose log or linear frequency spacing and log or linear amplitude units. Define your own units, give them a name, and the analyzer will read out in your units! Each trace is completely annotated and can be labeled with your own alphanumeric trace label. A view state display function is provided to quickly give you a summary of the analyzer's current setup state.

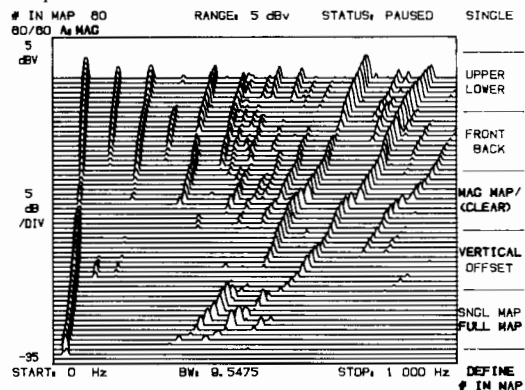

Figure 5: Spectral maps greatly reduce the time required to analyze changes in up to 60 successive measurements.

Internal Mass Storage

The standard HP 3561A contains 2 traces and 6 setup states of nonvolatile memory. When more storage is required, such as when you wish to store a 40,000-sample waveform captured in waveform recording mode, the "bubble memory" option can be installed. This non-volatile memory allows you to store any combination of 127 traces and states internally. Data stored in internal memory can be transferred via HP-IB to a computer for further analysis or archiving.

| FILENAME | INDEX | TYPE | SIZE | USE CAT | FILENAME |
|------------|-------|----------|------|---------|----------|
| SWEEP | | BUFFERED | 7 | | |
| AMP-ACC | | SETUP | 1 | | |
| SWEEP-TEST | | SETUP | 1 | | STORE |
| TEST-01 | | SETUP | 1 | | BUFFER |
| XFER | | SETUP | 1 | | |
| JIM_0 | | TRACE | 1 | | RECALL |
| JIM_2 | | TRACE | 1 | | BUFFER |
| JIM_4 | | TRACE | 1 | | |
| JIM_6 | | TRACE | 1 | | DELETE |
| | | | | | ABORT |

BUBBLE RECORDS AVAILABLE FOR NEW STORES: 112 CATALOG ON OFF

Figure 6: Traces and setups are stored in bubble memory by file name. The bubble memory catalog makes recall of stored files easy.

Annotated Hardcopy

You can obtain fast hardcopy of any display just by pressing the plot button. The HP 3561A controls HP-GL plotters and HP raster dump printers directly. A "marker plot" key allows you to annotate several locations on a plot with amplitude and frequency, or amplitude and time. Simply tune the cursor to the point of interest, press marker plot and the

analyzer annotates the location of interest. Do this as many times as you wish for complete, accurate documentation of measurements.

```

--DELAY 10 Sec          RANGE: 2 dBv      STATUS: PAUSED      SLOPE
                                                                POS  NEG
                                                                -----
NARROW BAND MODE          EXT SAMPLE OFF
FREQUENCY:
BASEBAND                  CENTER: 250 Hz          DEFINE
SPAN: 500 Hz              % OF RNC
TIME: 800 mSec
TRIGGER:
INTERNAL                  DELAY: 10 Sec        DELAY
AUTO ARM                  DN  OFF
AVERAGE:
OFF
                                                                -----
                                                                DEFINE
WINDW:
FLAT TOP                  BW: 4.77375 Hz       +-DELAY
SOURCE:
OFF
INPUT:
DC COUPLING              ICP CURRENT OFF     A WEIGHT FLTR OFF
UNITS:
X: Hz
Y: dBV
    
```

Figure 7: Plots of the view state display provide quick hard copy of instrument setup for complete measurement documentation.

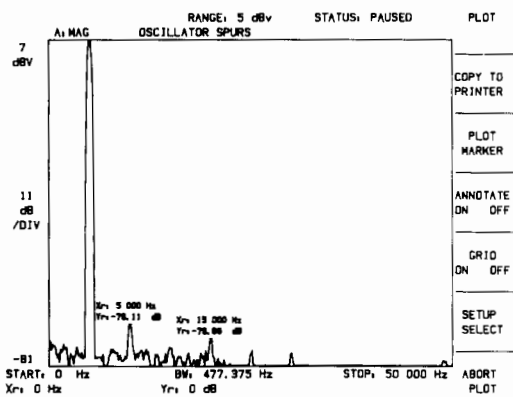

Figure 8: The marker plot function prints x and y marker values for any number of points on the plot.

Other Features

In most noise and vibration measurements, a transducer is used to convert the physical phenomena to voltage. These transducers generally require some type of signal conditioning. The HP 3561A contains an internal power supply for ICP type (integrated circuit piezoelectric) transducers. This eliminates an extra piece of equipment, which enhances portability and saves money. Trace math operations are provided that allow you to manipulate traces like numbers on a calculator. This is useful for converting units, compensating for systematic errors, and displaying spectra as a percentage of some reference value.

HP 3561A Specifications

Frequency

Range: 0.000125 Hz to 100 kHz
Spans: 0.01024 Hz to 100 kHz in a 1, 2, 2.5, 5, 10 sequence. Other spans are available but are too numerous to list here.
Accuracy: ± 0.003% of display center frequency.
Resolution: 0.25% of frequency span.
Window: Flat Top, Hann, Uniform, and Exponential.

Bandwidth

| | Flat Top | Hann | Uniform |
|---|----------|-------|---------|
| 3 dB Bandwidth (% of frequency span) | 0.90% | 0.37% | 0.25% |

Real Time Bandwidth: (Typical) Single display, 3.0 kHz. Fast average display, 7.5 kHz.

Amplitude

Measurement Range: +27 to -120 dBV noise floor (22.4 VRMS to 1µV noise floor.) Input range is selected in 1-dB steps from +27 to -51 dBV. Optimum range is determined automatically in the autorange mode.
Dynamic range: 80 dB

Accuracy at the Passband Center:

± 0.15 dB +27 to -40 dBV input ranges
 ± 0.25 dB -41 to -51 dBV input ranges

Flat Top window: +0, -0.01 dB

Hann window: +0, -1.5 dB

Uniform window: +0, -4.0 dB

Note: Overall accuracy is the sum of the accuracy at the passband center plus the selected window accuracy.

Resolution

Log: 0.01 dB

Linear: 4 digits

Phase

Accuracy: ±2 degrees, dc-10 kHz; ± 10 degrees, 10-100 kHz (signals no more than 40 dB below full range).

Resolution: 0.1 degree.

Input

Impedance: 1X10⁶ ohms ± 5% shunted by 95 pF maximum.

Isolation: Input low may be connected to chassis ground or floated up to 30 volts RMS (42 volts peak) above ground.

Coupling: signal by be ac or dc coupled. Low frequency 3-dB point < 1 Hz in ac mode.

A-weighting: Hardware A-weighting filter conforms to ANSI standard S1.4-1971 (R1976).

ICP current: Nominal 4 mA current source provided, compatible with integrated circuit piezoelectric accelerometers.

Output

Source: Band-limited, band-translated, pseudo-random, random, or impulse, or TTL "synch" signals are available on rear panel. Level is selectable between 0.7 and 0.007 volts RMS, nominal. Impedance 50Ω ± 5Ω.

Print/Plot: Controls HP-GL plotters and HP raster dump printers directly.

Display

General: Magnitude, phase, time and math traces may be selected. Units available are; Horizontal: Hz, seconds, RPM, orders; linear or log spacing. Vertical: dBV, dBm (selectable Z), volts, volts squared, and user-defined units.

Scale: Linear or log magnitude scales may be selected. Full scale, dB/division, and degrees/division are user definable. Center scale user definable in phase or time traces.

Math: Arithmetic operations can be performed on new or recalled frequency spectra. Add, subtract, multiply, divide, integrate, differentiate and user-defined constants are provided. 1/BW is provided for Power Spectral Density (PSD) computations.

Internal Memory

| | Non-volatile | Volatile |
|------------------|--|-----------------|
| Standard: | 2 traces, 6 states | 40 time records |
| Optional: | Traces + states + (1 + 2* time capture records) = 127 40 time records | |

Marker

Single, relative, harmonic, sideband, and power cursors are provided. THD can be calculated from up to 20 harmonics. Sideband power relative to specified carrier can be calculated from up to 10 sidebands. MKR to peak, MKR to center, MKR to full scale and marker peak track are provided.

General

Power: 100/120 Vac +5%, -10%, 48-440 Hz; 220/240 Vac +5%, -10%, 48-66 Hz.

Weight: 15 kg (33 lb) net, 21.6 kg (47.5 lb) shipping.

Dimensions: 335 mm W x 595 mm D x 197 mm H (13.2" x 23.4" x 7.8")

***HP -IB Interface Functions:** Implementation of IEEE Std. 488-1978 SH1, AH1, T5, TE0, L4, LE0, SR1, RL1, PP0, DC1, DT1, C0.

Ordering Information

| | Price |
|---|--------------|
| HP 3561A Dynamic Signal Analyzer | \$ 10,300 |
| Option 001 Extended Non-volatile Memory | add \$ 1,500 |

SIGNAL ANALYZERS

Dual-Channel, Dynamic Signal Analyzer 64 μ Hz to 100 kHz

Model 3562A

- Network analysis
- Spectrum analysis
- Transient analysis
- Waveform recording
- Frequency response analyzer
- Modulation analysis
- Direct control of disc drives
- Direct control of HP-GL plotters

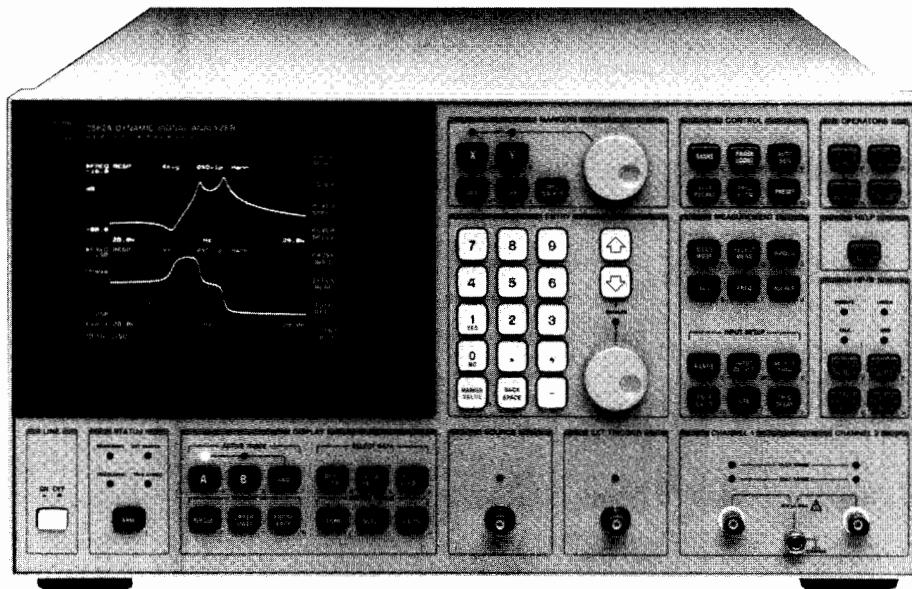

HP 3562A

The HP 3562A Dynamic Signal Analyzer is a dual-channel fast-Fourier transform-based network, spectrum and waveform analyzer which provides analysis capabilities in both the time and frequency domains. The dc-to-100 kHz frequency range, 150 dB measurement range and 80 dB dynamic range of the analyzer makes it a powerful solution for testing and analysis in electronics, mechanics and electro-mechanical control systems.

Two high performance input channels and a built-in signal source (noise and sine signals) address network analysis on the bench or in a test system. Zoom analysis with frequency resolution to 25.6 μ Hz plus a powerful AM, FM and PM demodulation function makes the HP 3562A a versatile spectrum analyzer. For transient or waveform analysis, signals can be sampled, digitized then stored in an internal memory, or directed via HP-IB to an external disc drive (without a computer). The stored waveforms can be recalled and analyzed in the time and frequency domains (baseband and zoom analysis).

Additional features include a full range of data analysis capabilities such as vector averaging, block-operation Waveform Math, a 40-pole/40-zero Curve Fitter and Frequency Response Synthesis. Front panel operations can be automated without a computer with built-in Auto Sequence programming, or with computers through complete HP-IB programmability. For documentation of results with hardcopy or mass storage, the HP 3562A can control digital plotters and external disc drives directly via HP-IB.

Network Analysis

Accurate, high resolution frequency response measurements of electronic and mechanical systems can be performed with Linear Resolution FFT, Logarithmic Resolution and Swept Sine analysis. A built-in signal source provides a variety of random noise and sinewave signals to meet the requirements of the system under test.

Linear Resolution is the measurement technique common to all Dynamic Signal Analyzers. In the HP 3562A, 2048-point time records are Fourier-transformed into 801-line frequency spectra. For

network analysis, frequency response magnitude and phase, as well as input and output power spectra, can be measured with 801 lines of resolution. Accuracy for the frequency response magnitude and phase is ± 0.1 dB and $\pm 0.5^\circ$.

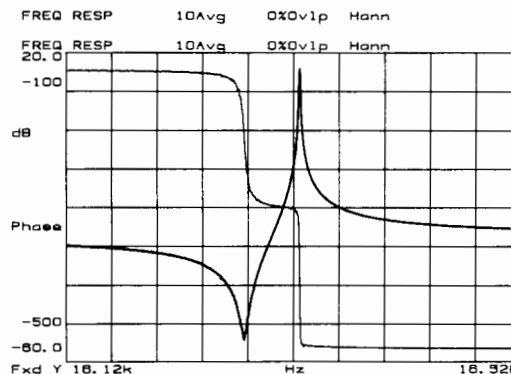

Logarithmic Resolution uses the speed of Linear Resolution FFT measurements to create frequency responses similar to a log-sweep swept sine test. Linear Resolution points are combined internally (rather than just reformatted), on the fly, to create 80-point-per-decade measurements over 1 to 5 decades. Start and stop frequencies can be selected in a 1-2-5 sequence from 0.1 Hz to 100 kHz (for a 0.1 Hz start frequency the maximum stop frequency is 10 kHz — 5 decades).

The Swept Sine mode reconfigures the HP 3562A as a powerful swept sine frequency response analyzer. The source can generate linear or logarithmic sweeps with increasing or decreasing frequency; user-selectable sweep rate and resolution are also standard source

functions. Input channel functions include user-selectable averaging and integration time; automatic input ranging can be activated to provide over 130 dB of dynamic range for measurements of high performance systems.

Spectrum Analysis

On-line analysis of distortion, drift, modulation and phase noise can benefit from the speed and accuracy of the HP 3562A. High resolution measurements are typically 100 times faster than tuned spectrum analyzers — and, since the HP 3562A is an FFT-based analyzer, you can see transient events that a tuned analyzer would probably miss.

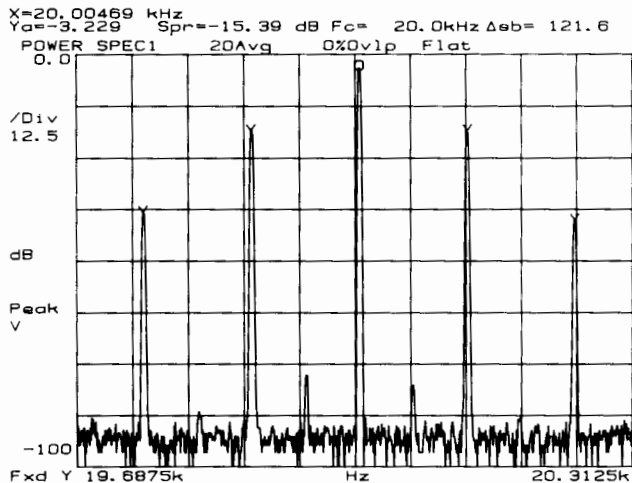

The HP 3562A is essentially a dual-channel spectrum analyzer which provides resolution to 25.6 μ Hz anywhere within the dc-to-100 kHz measurement range. Single channel accuracy is ± 0.15 dB with 80 dB of dynamic range. Modulation analysis can be performed on either or both channels with harmonic and sideband markers as well as with the built-in demodulation capability: zoom measurements can be AM, FM or PM demodulated with carrier frequencies up to 99.9 kHz.

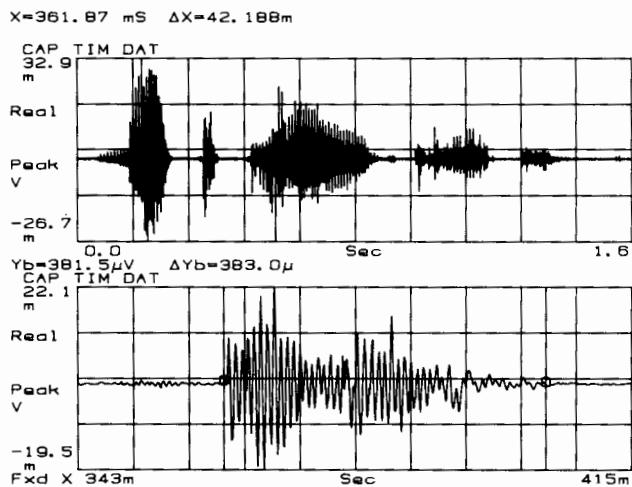

Waveform and Transient Analysis

Perform complete analysis of waveforms and transients in the time and frequency domains. Sampled and digitized waveforms can be

stored in internal memory (single-channel Time Capture) or on disc in an external disc drive (single- or dual-channel Time Throughput). Data can be recalled for time domain analysis as single time records or as a compressed display of up to 10 time records (Time Capture mode). Data can also be recalled for baseband and zoom analysis in the frequency domain, with vector averaging if needed.

A complete array of triggering capabilities are included to enhance both waveform recording modes. Pre- and post-trigger delays can be specified to capture the rising edge of a transient or to compensate for delays in the system under test.

Data Throughput to a Disc Drive

When access to prototypes is limited, make your test time more efficient with the Time Throughput capability: through direct control of external disc drives, the HP 3562A can store time data directly to disc without a computer. Set up a measurement and specify the quantity of single- or dual-channel data to be collected. Time data will be sampled, digitized and stored on disc for later analysis as individual time records or as baseband and zoom frequency spectra.

Hardcopy and Mass Storage with Plotters and Disc Drives

To speed and simplify documentation of results, direct control of plotters and disc drives via HP-IB is a standard feature in the HP 3562A. Literally anything displayed on the analyzer screen can be plotted or saved on disc: measurement results, setup state tables, synthesis tables, curve fit tables and Auto Sequence or Auto Math program listings. Plotting is enhanced with user-selectable line types, pens and paging controls. For mass storage operations, files can be given 8-letter user-defined names; and disc catalog can be recalled and displayed to show file name, type (data, setup, etc.) and date and time of storage.

Automation for Improved Productivity

Versatile automation capabilities and a wide range of response-only or stimulus/response measurement functions in the HP 3562A help you create productive solutions for your automated testing needs. As a standalone solution, the analyzer can "learn" a series of keystrokes and then perform them on command (Auto Sequence programming). Up to five Auto Sequence programs can be stored internally, with additional programs stored in an external disc drive.

For networked HP-IB systems, the HP 3562A provides complete HP-IB programmability. Custom display graphics and messages can be created through direct programming of the high resolution vector display — user-defined softkey menus can also be created to simplify interactive testing. Rear-panel outputs for large screen displays are also standard.

HP 3562A Specifications

Frequency

Measurement Range: 64 μ Hz to 100 kHz, both channels, single- or dual-channel operation

Accuracy: $\pm 0.004\%$ of frequency reading

Resolution: Span/800, both channels, single- or dual-channel operation

Spans:

| | Baseband | Zoom |
|------------------------------|-----------|-----------|
| Number of spans | 66 | 64 |
| Min span | 10.24 mHz | 20.48 mHz |
| Max span | 100 kHz | 100 kHz |
| Time record (seconds) | 800/span | 800/span |

Window Functions: Hann, Flat Top, Uniform, Force, Exponential, and User Defined

Window Parameters:

| | Flat Top | Hann | Uniform |
|----------------------------|----------|-------|---------|
| 3 dB BW (% of span) | 0.45 | 0.185 | 0.125 |

Typical Real Time Bandwidth: 10 kHz single-channel, 5 kHz dual-channel, with fast averaging on.



SIGNAL ANALYZERS

Dual-Channel, Dynamic Signal Analyzer 64 μ Hz to 100 kHz

Model 3562A (cont.)

Amplitude

Accuracy (Linear Resolution)

Defined as Full Scale Accuracy at any of the 800 calculated frequency points. Overall accuracy is the sum of absolute accuracy, window flatness and noise level.

Absolute Accuracy

Single Channel (Channel 1 or Channel 2) ± 0.15 dB $\pm 0.015\%$ of input range (+27 dBV to -40 dBV)

± 0.25 dB $\pm 0.025\%$ of input range (-41 dBV to -51 dBV)

Frequency Response Channel Match:

± 0.1 dB, ± 0.5 degree

Window Flatness

Flat Top: +0, -0.01 dB

Hann: +0, -1.5 dB

Uniform: +0, -4.0

Noise Floor: (Flat top window, 50 Ω source, 50 Ω input termination)

20 Hz to 1 kHz (1 kHz span) < -126 dBV (-134 dBV/ $\sqrt{\text{Hz}}$)

1 kHz to 100 kHz (100 kHz span) < -116 dBV (-144 dBV/ $\sqrt{\text{Hz}}$)

Dynamic Range: All distortion (intermodulation and harmonic), spurious and alias products ≥ 80 dB below full scale input range

Phase

Accuracy: Single channel, referenced to the trigger point.

< 10 kHz $\pm 2.5^\circ$

10 kHz to 100 kHz $\pm 12.0^\circ$

Inputs

Input Impedance: 1 M Ω $\pm 5\%$ shunted by 100 pF maximum

Input Coupling: The inputs may be ac or dc coupled; ac rolloff is < 3 dB at 1 Hz

Crosstalk: -140 dB (50 Ω source, 50 Ω input termination, input connectors shielded)

Common Mode Rejection:

0 Hz to 66 Hz 80 dB

66 Hz to 500 Hz 65 dB

Common Mode Voltage: dc to 500 Hz

Input Range (dBV rms) Maximum (ac + dc)

+27 to -12 ± 42.0 Vpeak

-13 to -51 ± 18.0 Vpeak*

*For the -43 to -51 dBV input ranges, common mode signal levels cannot exceed ± 18 Vpeak or (Input Range) + (Common Mode Rejection), whichever is the lesser level.

Common Mode Voltage: 500 Hz to 100kHz. The ac part of the signal is limited to 42 Vpeak or (Input Range) + (10dB), whichever is the lesser level.

Common Mode Distortion: For the levels specified, distortion of common mode signals will be less than the level of the rejected common mode signal.

External Trigger Input Impedance: Typically 50 k Ω $\pm 5\%$

External Sampling Input: TTL compatible input for signals ≤ 256 kHz (nominal maximum sample rate).

External Reference Input

Input Frequencies: 1, 2, 5 or 10 MHz $\pm 0.01\%$

Amplitude Range: 0 dBm to +20 dBm (50 Ω)

Trigger

Trigger Modes: Free Run, Input Channel 1, Input Channel 2, Source and External Trigger. Free Run applies to all Measurement Modes; Input Channel 1, Input Channel 2, Source and External Trigger apply to the Linear Resolution, Time Capture and Time Throughput measurement modes.

Trigger Conditions

Free Run: A new measurement is initiated by the completion of the previous measurement.

Input: A new measurement is initiated when the input signal to either Channel 1 or Channel 2 meets the specified trigger conditions. Trigger Level range is $\pm 110\%$ of Full Scale Input Range; Trigger Level is user-selected in steps proportional to the input range.

Source: Measurements are synchronized with the periodic signal types (burst random, sine chirp and burst chirp).

External: A new measurement is initiated by a signal applied to the front panel External Trigger input. Trigger Level range is ± 10 V peak; Trigger Level is user selected in 80 mV steps.

Trigger Delay

Pre-Trigger: The measurement can be based on data from 1 to 4096 samples (1/2048 to 2 time records) prior to trigger conditions being met. Resolution is 1 sample (1/2048 of a time record).

Post-Trigger: The measurement is initiated from 1 to 65 536 samples (1/2048 to 32 time records) after the trigger conditions are met. Resolution is 1 sample (1/2048 of a time record).

Source

Source Types: Band limited, band translated random noise, burst random, sine chirp, and burst chirp, as well as fixed sine and swept sine signals are available from the front panel Source output. DC Offset is also user-selectable.

Output Impedance: 50 Ω ± 5 Ω

Output Level: $\leq \pm 10$ V peak (ac + dc) into a ≥ 10 k Ω , < 1000 pF load. Maximum current = 50 mA.

AC Level: ± 5 V peak (≥ 10 k Ω , < 1000 pF load)

DC Offset: ± 10 V peak in 100 mV steps. Residual offset at 0 V offset ≤ 10 mV.

In-Band Energy (1 kHz span, 5 kHz center frequency)

Random Noise: 70%

Sine Chirp: 85%

Accuracy and Purity: Fixed or Swept Sine

Flatness: ± 1 dB

Distortion (including subharmonics):

dc to 10 kHz -60 dB

10 kHz to 100 kHz -40 dB

General

Specifications apply within 5°C and 2 hrs of last internal calibration.

Ambient temperature: 0° to 55° C.

Relative Humidity: $\leq 95\%$ at 40° C.

Altitude: $\leq 4,572$ m (15,000 ft.)

Storage

Temperature: -40° to +75° C.

Altitude: $\leq 15,240$ m (50,000 ft)

Power:

115 VAC +10%, -25%, 48 to 440 Hz

230 VAC +10%, -15%, 48 to 66 Hz

450 VA maximum

Weight:

26 kg (56 lb) net

35 kg (77 lb) shipping

Dimensions:

222 mm (8.75 in) high

426 mm (16.75 in) wide

578 mm (22.75 in) deep

HP-IB

Implementation of IEEE Std 488-1978

HP-IB Interface Functions: SH1 AH1 T5 TE0 L4 LE0 SR1 RL1 PP0 DC1 DT1 C0. Supports the 91XX and 794X families of HP disc drives, as well as Hewlett-Packard Graphic Language (HP-GL) digital plotters.

Accessories Supplied

Operating, Programming and Service Manuals

Accessories Available

Transit Case for one HP 3562A: HP P/N 9211-2663

Ordering Information

HP 3562A Dynamic Signal Analyzer

Option 907 Front Handle Kit

Option 908 Rack Mount Kit

Option 909 Rack Mount and Front Handle Kit

Option 910 Extra Operating Manuals

Option 914 Delete Service Manuals

*For more on these codes refer to the HP-IB section of this catalog.

Price

\$23,900

\$ 75

\$ 40

\$ 100

\$ 175

base \$ 100

SIGNAL ANALYZERS

Digital Vibration Test Control System

Model 5427A

709



- Random test flexibility for use with MIL, IEC, and other standards
- Automatic out-of-tolerance detection protects device under test

- Economical expansion for sine and transient control
- Ultra-high random control resolution: 512 lines standard (1024 lines optional)

Description

Closed-loop control of environmental and/or developmental vibration test stimuli for random, transient, and sine testing is available in the HP 5427A.

The basic HP 5427A Vibration Test Control system consists of: 2-channel (expandable to 4) analog-to-digital converter for processing feedback information; 21MX-E series, microcoded digital processor; HP 1335A Persistence CRT display; HP 2623A Graphics Terminal with built-in printer; pushbutton control unit; HP 9885M Flexible Disc storage unit; cabinet and programs for random control.

The HP 5427A is the ideal vibration control system for production vibration testing where random, transient and sine testing are required and offers a selectable set of analysis routines especially designed for easy operation by laboratory personnel. The following vibration test control capabilities apply to the HP 5427A.

System Operation

Random, sine and transient control follow the same logical operational phases. First, the appropriate disc is loaded and the test program or setup (envelope, alarm and abort limits, test time, calibrations, etc.) is loaded from disc storage in response to search codes or names. If a new program or modifications are desired, a friendly question-and-answer sequence is used. Once a new setup has been generated or changes made, it can be assigned a new name and stored for later use.

After a satisfactory setup is obtained, the operate phase allows control of the actual test via pushbuttons on the central control panel. Removable snap-on overlay panels clearly label buttons for the type of test desired. Choices of on-line displays and a save button allow saving of data for later plotting, including auxiliary PSD measurements during random control.

After the test, results and all saved data are available for review or documentation. The graphics terminal or an optional HP-IB compatible digital plotter provide fully labeled, report-quality plots of test results. In random control, fully labeled plots can be obtained while the test is running (open loop) using the terminal or an optional HP-IB plotter such as the HP 7470A.

Specification Summary

Random Control

Resolution: 64, 128, 256, or 512 lines (1024 lines optional)

Bandwidth: Δf to 5000 Hz

Loop time: <0.9s for 256 lines, 2500 Hz bandwidth, one control channel and full display

Dynamic range: >65 dB

Accuracy rms PSD accuracy: $\pm 2\%$

Control PSD accuracy: ± 1.0 dB (90% confidence level) Higher accuracies are typically achievable with increased control spectrum averaging.

Sine Control

Frequency range: 0.1 to 5000 Hz. Upper and Lower sweep frequency limits and starting frequency may be specified anywhere in the frequency range (resolution: 0.1 Hz).

Sweep rate: 0.001 to 100 octaves/minute log, 1 to 100,000 Hz/minute linear, operator selectable.

Harmonic components: >60 dB below full level fundamental output



HP 5427A

Sweep time accuracy: $\pm 0.25\%$ or ± 52 ms, whichever is greater

Amplitude accuracy: the greater of ± 2.5 mV or $\pm 1\%$ of specified reference value.

Output dynamic range: 72 dB

Transient Control

Classical reference waveforms: half-sine, terminal peak sawtooth, triangle or rectangle

Polarity: positive or negative

Duration range: 0.5 to 100 ms

Duration accuracy: $\pm 5\%$ for half-sine and terminal peak sawtooth at pulse baseline crossover points

Shock response spectrum synthesis: time domain waveforms are synthesized from a user-specified shock response spectrum (SRS) off-line in the setup mode

Resolution: 1/N octave, N is any integer from 1 to 9

Frequency range: 2 decades nominal, 2.6 decades maximum

Maximum frequency: 1/Nth octave below 10,240 Hz

Ordering Information

HP 5427A Vibration Test Control System

Option 070 High resolution random (1024 lines)

Option 075 Transient control

Option 080 Sine control

Price

\$55,400

\$1,205

\$3,020

\$3,020

SIGNAL ANALYZERS

Automated Spectrum Analysis

Model 3047A Phase Noise Measurement System

Calibrated, Automated Phase Noise Measurements with

- Specified amplitude accuracy of ± 2 dB
- Offset frequency range of 0.02 Hz to 40 MHz
- Carrier frequency range from 5 MHz to beyond 18 GHz
- Spurs separated from noise spectra
- Optimization for several measurement techniques

The HP 3047A Phase Noise Measurement System uses the power of a comprehensive software pack to automate the measurement of the phase noise of a carrier signal. The basic HP 3047 system includes the HP 3582A and 3585A Spectrum Analyzers, an interface box containing phase detectors and phase lock loop circuitry, the system rack, the measurement software, system installation and operator training. Additionally, other items can be ordered as needed, e.g., the HP 9836A or 9816A Desktop Controllers (for which the system software is designed), reference oscillators including the HP 8662A or 8663A Signal Generators, printers and plotters. The hardware of the HP 3047A demodulates the phase noise of a carrier in the frequency range of 5 MHz to 18 GHz (and beyond with external, user-supplied mixers) and measures the resulting baseband signal with the spectrum analyzers under control of the system software. Measurement menus are used to allow the operator to specify the measurement to be made and the system software controls the measurement process including the calibration of the system. Several output formats are available to the user including plots of the single sideband phase fluctuations or fractional frequency fluctuations. A real-time measurement mode is available to monitor the level of phase noise and discrete spurs as changes are made to the device under test.

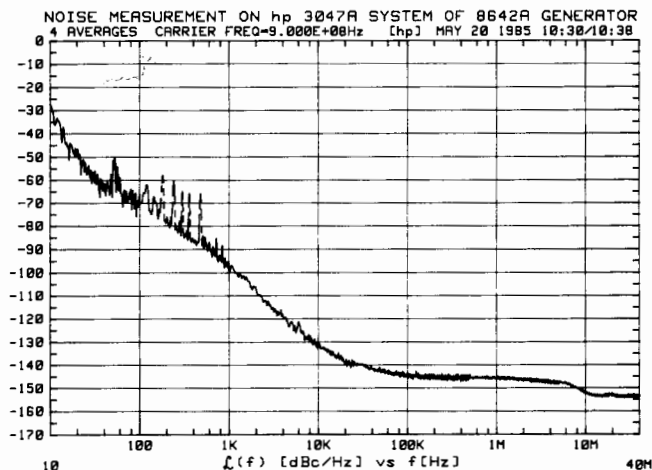

Typical single sideband phase noise measurement of an HP 8642A Synthesized Signal Generator by the HP 3047A Phase Noise Measurement System.

As measured by the HP 3047A, the term "phase noise" includes all forms of a signal's frequency and phase instabilities. Randomly occurring frequency and phase noise modulation, as well as discrete sidebands resulting from power-line phase modulation and phase jitter, are detected and accurately measured. Coherent signals are displayed at the power level that was detected while random phase signals are normalized for a 1 Hz bandwidth. The HP 3047A system is optimized for several measurement techniques that are chosen based on the stability and tuning capability of the signal to be measured and the availability of comparable reference oscillators. The two primary techniques for demodulating the phase noise of a signal use either a phase detector or a frequency discriminator as the following diagrams illustrate.

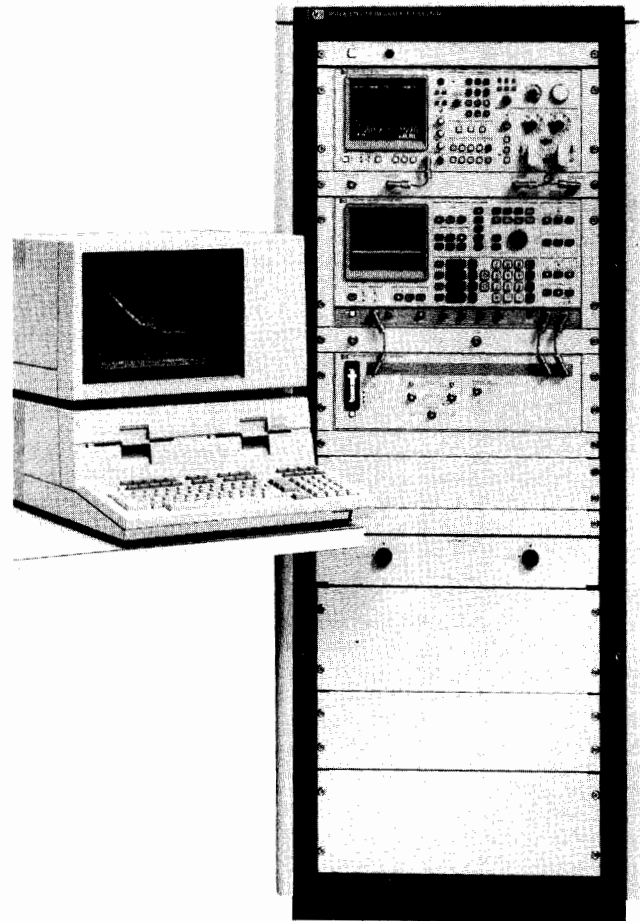

HP 3047A Phase Noise Measurement System is controlled by either the HP 9836A or 9816A Desktop Computer.

Operation with a Phase Detector

This measurement technique uses a double-balanced mixer included in the HP 3047A system as a phase detector and a separate reference oscillator to demodulate the phase noise from the carrier being tested. With the two signals in quadrature, the phase detector offers excellent sensitivity to reveal very low level phase noise sidebands of the carrier. Based on the tuning range of the source under control, the system automatically sets up a phase lock loop to hold the two signals in quadrature. An offset range of 0.02 Hz to 40 MHz can be measured regardless of the bandwidth of the phase lock loop as the software measures the loop's bandwidth and removes its effects from the measured phase noise. Due to this combination of excellent sensitivity and broadband operation, the HP 3047A system can provide calibrated (± 2 dB) phase noise plots of almost any type of source ranging from frequency standards to free-running VCOs.

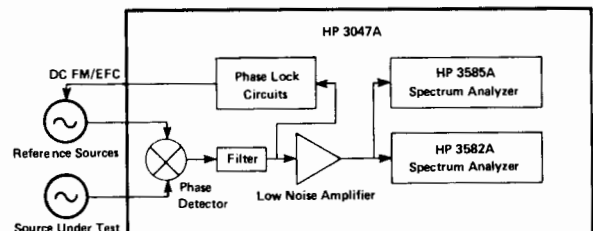

Typical test set-up for measuring the phase noise of relatively stable oscillators.

Operation with a Frequency Discriminator

With the HP 3047A, fully calibrated phase noise measurements of drifting or less stable signals are possible with user-supplied frequency discriminators. The HP 3047A software calibrates the system for the discriminator that is used to maintain the ± 2 dB amplitude accuracy of the measurement. Although the frequency discriminator limits the system's sensitivity close-in to the carrier, it does allow measurement of noisy or drifting sources that cannot be phase locked to a reference oscillator. It is also a very simple technique to implement.

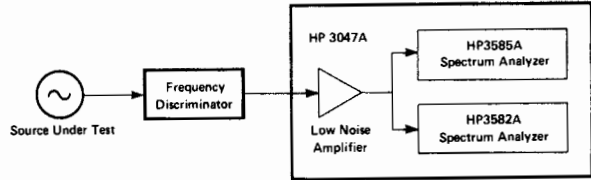

Typical test set-up for measuring the phase noise of drifting and less stable sources.

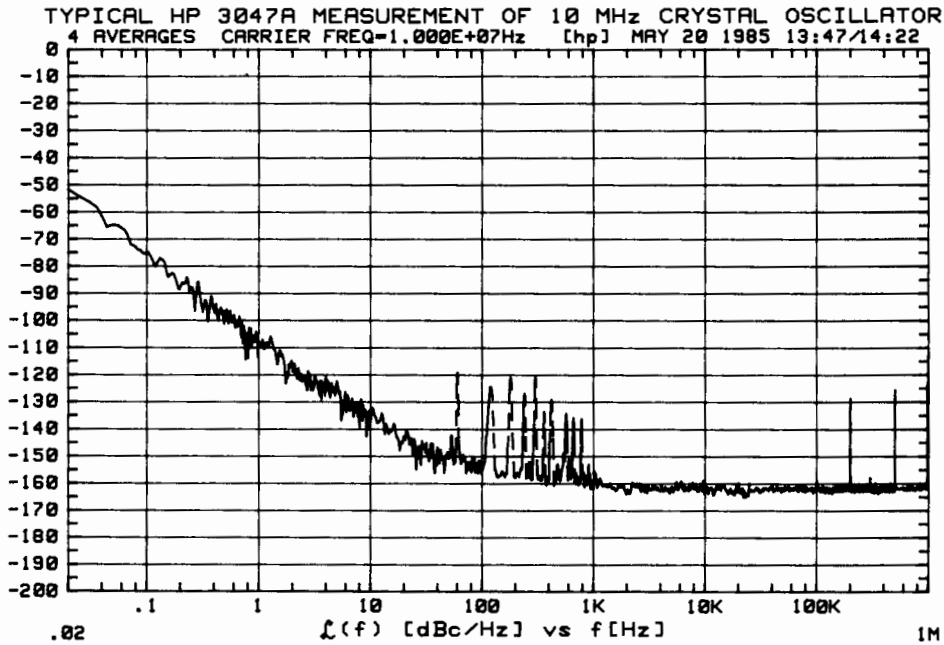

Typical HP 3047 system measurement results for a 10 MHz crystal oscillator.

Specifications Summary

Sensitivity:

The system's sensitivity is a function of the measurement technique that is used. The following graph indicates the sensitivity of the system as limited by its own internally-generated noise for a signal under test of +15 dBm. Also plotted is the typical noise of the HP 8662A or 8663A tuned to a 1 GHz output which would be the system's sensitivity using these reference sources for measurement of a 1 GHz signal.

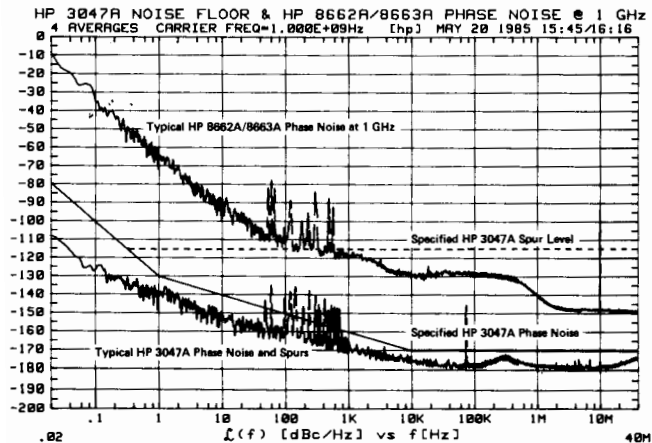

Carrier Frequency Range

Internal Mixer: 5 MHz to 18 GHz.

External (user-supplied) Mixer:

The frequency range of the carrier is only limited by the frequency range of the external mixer or the frequency discriminator that is used.

Offset Frequency Range:

0.02 Hz to 40 MHz for carrier frequencies at or above 95 MHz, 0.02 to 1 MHz for carrier frequencies below 95 MHz.

Amplitude Accuracy:

± 2 dB. This accuracy is verified by the system at the time of the measurement. The system advises the user of any potential accuracy degradations detected during measurement set-up.

Ordering Information

HP 3047A System Instrumentation

Includes HP 3582A and 3585A Spectrum Analyzers, system interface accessory, equipment rack, measurement software, system installation and operator training.

Price

\$55,500

HP 9836S Opt. 001 Desktop Computer (with 1 megabyte of memory required for system operation)

16,060

Optional Reference Oscillators:

Opt. 400 HP 8662A 0.01 to 1280 MHz Signal Generator

32,540

Opt. 500 HP 8663A 0.01 to 2560 MHz Signal Generator

43,790

Full details on available system options and ordering information are given in the HP 3047S System Ordering Information Guide.

SIGNAL ANALYZERS

Carrier Noise Test Set

Model 11729C

- 10 MHz to 18 GHz
- Phase noise and AM noise measurements
- Low system noise floor

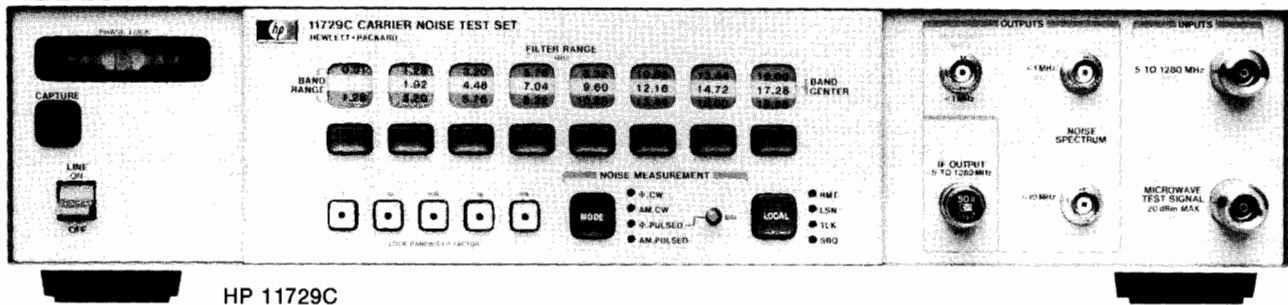

HP 11729C Carrier Noise Test Set Versatile Noise Measurements

The HP 11729C, combined with an HP 8662A synthesized signal generator and a baseband spectrum analyzer, form a complete broadband measurement system for phase noise and AM noise testing of microwave oscillators, 10 MHz to 18 GHz. With one versatile measurement system, direct AM noise measurements and two methods of phase noise measurements can be made, at offsets from the carrier of <math>< 1\text{ Hz}</math> to 10 MHz. These three operating modes allow a wide variety of sources, from low noise stabilized sources to free-running sources with high drift to be measured. The HP 11729C may be ordered with either full frequency coverage, or in a number of band configurations to better match the application.

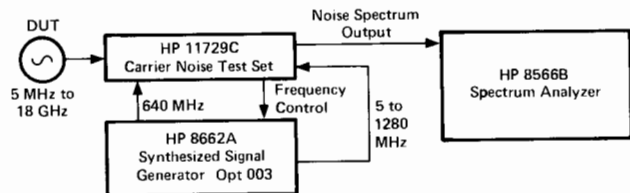

Complete carrier noise characterization system can be assembled from standard instruments.

Built-in Low Noise Reference

The HP 11729C/8662A combination includes the critical low noise microwave reference signal (which determines the system noise floor). The wide frequency range and low system noise floor of the HP 11729C/8662A enable a single system to be used on a broad range of sources. Typical system noise for a 10 GHz source is less than -123 dBc/Hz at a 10 kHz offset, allowing characterization of most high-performance sources.

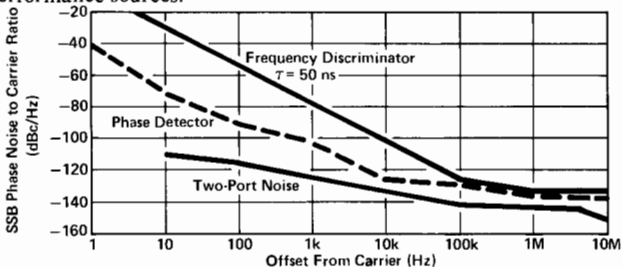

Figure 1. Typical HP 11729C/8662A system sensitivity using the phase detector and frequency discriminator methods at X-Band. Typical HP 11729C two-port noise.

Self-oscillator Mode

The HP 11729C features a new Surface-Acoustic-Wave (SAW) filter, which can be configured into an internal SAW oscillator. This built-in oscillator allows the HP 11729C to be used as a low-cost frequency discriminator system for measurements on free-running oscillators. This discriminator mode uses the HP 11729C in a "stand-alone" configuration, combined with a simple length of external delay line (such as RG 223 cable) and an available baseband analyzer (such as the HP 8566A/B or HP 3561A), as shown in Figure 2. For the lowest cost solution for band-oriented applications, the HP 11729C

can be ordered with a choice of several 2.56 GHz wide bands (see HP 11729B Ordering Information in the Technical Data Sheet).

The maximum sensitivity of the HP 11729C in the frequency discriminator mode is determined by the noise floor of the SAW oscillator; actual operating sensitivity is dependent on the delay time and attenuation of the delay line used. Figure 3 shows the typical absolute phase noise of the SAW oscillator translated to 10 GHz. Actual measurement sensitivity using a 100 ns delay line (with attenuation less than 12 dB at 1200 MHz) is also shown. At some IF frequencies and with low loss cable, longer delays can improve the close-in sensitivity closer to the noise floor limit set by the SAW oscillator.

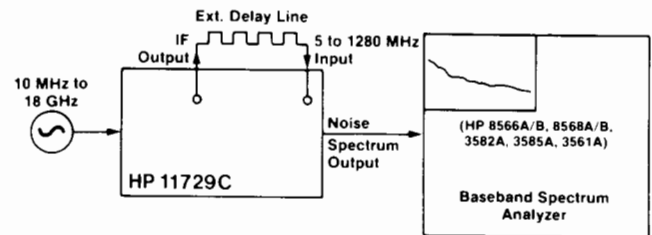

Figure 2. An HP 11729C, configured with an external delay line and a baseband spectrum analyzer, is a cost-effective solution for phase noise measurement on free-running sources.

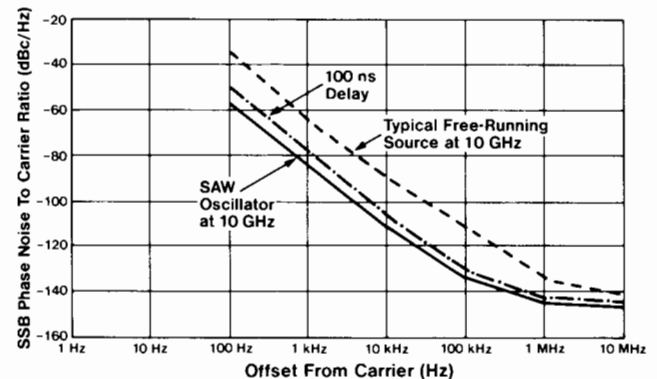

Figure 3. The HP 11729C in the stand-alone discriminator mode has the needed sensitivity for phase noise measurements on free-running sources.

Pulsed AM and Phase Noise Measurement Capability

The HP 11729C also features new circuitry to aid in making phase noise measurements on pulsed sources using the phase detector method. Selecting pulse mode switches in a user-supplied external low pass filter (LPF) used to remove the pulse repetition frequency (PRF) feedthrough. The LPF is necessary to prevent overloading of the low noise amplifier or phase-lock-loop. This same switching occurs when pulsed AM is selected, placing an external LPF following the AM detector for PRF rejection.



Two Phase Noise Measurement Modes

A choice of two phase noise measurement methods optimizes the measurement to the type of oscillator being measured. The phase detector method is ideal for synthesizers or stable free-running sources. The HP 11729C/8662A simplifies the phase detector method by providing all the necessary circuitry, including the low noise microwave reference source, the loop VCO, and a variable bandwidth phase-lock-loop.

The frequency discriminator method is best suited for sources with high level, low-rate phase noise such as free-running sources. The HP 11729C/8662A implements a convenient frequency discriminator (delay line/mixer technique), allowing sources to 18 GHz to be tested with a discriminator operating at an IF frequency less than 1.3 GHz. The HP 11729C/8662A contain all necessary hardware, except a simple user-supplied delay element that can be as simple as a length of inexpensive 50-ohm coaxial cable.

Direct AM Noise Measurements

The HP 11729C Option 130 offers convenient, direct AM noise measurements with typical sensitivity of less than -165 dBc/Hz. The HP 8662A provides a convenient calibration signal, and the same baseband analyzer used for phase noise measurements can be used for AM noise measurements.

Fully Programmable for System Integration

The fully HP-IB programmable HP 11729C/8662A is easily configured into manual or automatic carrier noise measurement systems with available spectrum analyzers (such as the HP 8566B, 8568B, 3561A, 3585A, or 3582A). In addition, the HP 11729C/8662A is an integral part of the HP 11740S automatic phase noise measurement system. The choice of analyzer determines the offset frequencies that can be measured. System noise floor is set by the HP 11729C/8662A. (For more information, refer to the HP 11729C Product Notes.)

Abbreviated HP 11729C/8662A

Specifications

Frequency Range: 10 MHz to 18 GHz in 8 bands.

Absolute System Noise Floor, Phase Detector Method

System noise is specified only when the HP 11729C is used with an HP 8662A Option 003. (The HP 8663A Option 003, operated below 1280 MHz, may be used in place of the HP 8662A with no change in system performance.) These system noise specifications apply for the phase detector method, locking via the EFC of the HP 8662A crystal oscillator. Locking via the HP 8662A dc FM changes the noise on the tunable HP 8662A signal, and therefore total system noise. See the HP 11729C data sheet for more information.

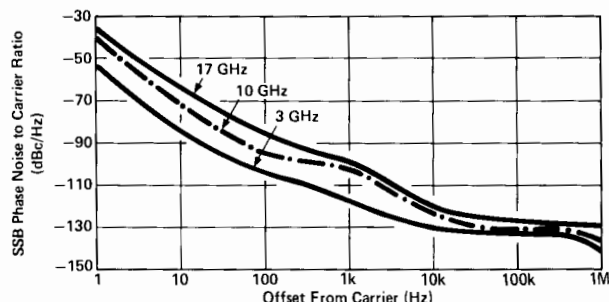

Typical HP 11729C/8662A System Noise (phase detector method, locking via EFC).

Test Signal Requirements

Amplitude: +7 dBm minimum to +18 dBm maximum (typically useable to -15 dBm with noise floor degradation).

RF Source Requirements

HP 8662A or 8663A Option 003.

HP 11729C Outputs

IF Output

Bandwidth: 5 to 1280 MHz.

Level: +7 dBm minimum.

Noise Spectrum Outputs

- 1) Noise Spectrum Output <1 MHz: dc coupled, 600 Ω nominal.
- 2) Noise Spectrum Output <10 MHz: 10 Hz to 10 MHz, 50 Ω nominal, nominal 40 dB of gain over <1 MHz output.
- 3) Auxiliary Noise Spectrum Output: dc coupled, 600 Ω nominal.

Phase Lock Loop Function

Frequency Control Outputs

To crystal oscillator: $\pm 10V$.

To dc FM: $\pm 1V$.

Lock bandwidth factor: nominal 1, 10, 100, 1k, 10k selectable.

Loop characteristics: dependent on method of phase lock chosen; typical loop bandwidths can range from 0.5 Hz to 100 kHz.

Remote Programming

All front panel functions are HP-IB programmable. In addition, the HP 11729C can output current settings and out-of-lock indication.

Interface functions: AH1, SH1, T5, L3, TE0, LE0, SR1, RL1, PP1, DC1, DT0, C0.

AM Noise Detection (Option 130)

Frequency: 10 MHz to 18 GHz.

Input level: 0 dBm minimum to +18 dBm maximum.

AM noise floor (at +10 dBm input level, dBc/Hz):

| Offset from Carrier (Hz) | Typical | Specified |
|--------------------------|---------|-----------|
| 1k | -147 | -138 |
| 10k | -152 | -145 |
| 100k | -161 | -155 |
| 1M | -165 | -160 |

General

Operating temperature range: 0° to +55°C.

Power: 100, 120, 220, 240 V, +5%, -10%; 48 to 66 Hz; <75 VA max.

Weight: net, 10.4 kg (23 lb); shipping, 13.2 kg (29 lb).

Size: 425 W x 99 H x 551 mm D (21.7 x 16.8 x 3.9 in.). 1 MW x 3 1/2 H x 20 D System II module.

Ordering Information

HP 11729C Carrier Noise Test Set (10 MHz to 18 GHz) \$21,500

Note: Each of options 003 to 027 (only one may be ordered) also includes 0.005 to 1.28 GHz coverage

Option 003 (1.28 to 3.2 GHz) less \$8500

Option 007 (3.2 to 5.76 GHz) less \$8500

Option 011 (5.76 to 8.32 GHz) less \$8500

Option 015 (8.32 to 10.88 GHz) less \$8500

Option 019 (10.88 to 13.44 GHz) less \$8500

Option 023 (13.44 to 16.0 GHz) less \$8500

Option 027 (16.0 to 18.0 GHz) less \$8500

Option 130: AM noise detection \$1100

Option 140: Rear panel connectors \$500

Option 907: Front panel handle kit \$43

Option 908: Rack mounting flange kit \$25

Option 909: Front panel handle plus rack mounting flange kit \$65

Option 910: Extra operating and service manual \$30

SIGNAL ANALYZERS

Automated Phase Noise Analysis

Model 11740A/S

- Fully automated
- Built-in low noise reference
- High accuracy

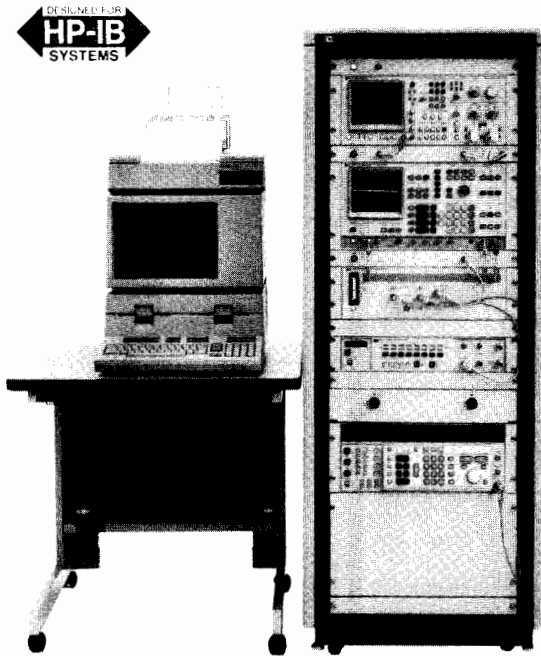

HP 11740S

HP 11740A Microwave Phase Noise Measurement System

The HP 11740A Microwave Phase Noise Measurement System is a complete, automatic system for phase noise measurements on carriers from 5 MHz to 18 GHz. It combines the specified low noise floor of the HP 11729C/8662A with all the capabilities of the HP 3047A Phase Noise Measurement System. The integrated HP 11729C/8662A is used as a low noise reference and downconverter, translating the input signal to an intermediate frequency (IF). This IF signal is phase detected against the tunable HP 8662A front panel signal using the HP 3047A hardware. The detected baseband signal is then measured automatically by the spectrum analyzers resident in the HP 3047A.

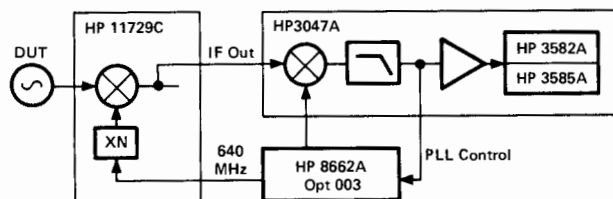

HP 11740A simplified block diagram.

Integrated Low Noise Reference

When used as a fully automatic system in the phase detector method of phase noise measurement, the software automatically controls the HP 11729C/8662A as the critical reference oscillator for sources > 1.28 GHz, or the HP 8662A (or HP 8663A) is controlled for measurements on sources less than 1.28 GHz (2.56 GHz). The HP 11729C/8662A provides the lowest noise floor for a microwave reference offered by HP. Typical system noise for a 10 GHz source is less than -123 dBc/Hz at a 10 kHz offset, allowing characterization of most high-performance sources. If desired, a user-supplied reference source can be set manually.

- Powerful measurement software
- Absolute and two-port phase noise measurements

System Accuracy

The HP 11740A has specified system noise floor and excellent specified system accuracy (measurement of all phase noise present at the input to the phase detector) of ± 2 dB. (If the phase noise of the test source is >10 dB higher than the noise of the HP 11729C/8662A, then the noise of the test source alone can be measured with typically +2.5/-2.0 dB accuracy.) This complete system includes automatic characterization of the phase lock loop, allowing phase noise measurements to be made at offsets from <1 Hz to 40 MHz from the carrier, on synthesized or free-running oscillators.

Powerful Measurement Software

All measurement modes and capabilities of the HP 3047A are preserved. As well as the phase noise mode (phase detector or frequency discriminator methods), direct spectrum mode and noise sideband mode are also available. The powerful data manipulations of the HP 11740A allow the data to be displayed as $S_{\Phi}(f)$, $\mathcal{A}(f)$, $S_{\Delta f}(f)$, or $S_y(f)$.

Absolute and Two-Port Phase Noise

As well as providing a complete solution for automatic absolute phase noise measurements on sources, the HP 11740A can also be used for two-port phase noise measurements on devices. The built-in HP 8662A (8663A) can be used as a reference for devices to 1.28 (2.56) GHz.

Abbreviated Specifications

(Phase Noise Mode, phase detector method, using the integrated HP 11729C/8662A as the reference source.)

Test Signal Input

Frequency range: 5 MHz to 18 GHz.

Amplitude: for test frequencies >1.28 GHz; +7 dBm minimum to +20 dBm maximum. For test frequencies <1.28 GHz; -5 dBm minimum to +23 dBm maximum.

System Specifications

Accuracy: the system will measure the combined noise output of the phase detector with ± 2 dB accuracy for offsets from 0.02 Hz to 1 MHz, and ± 4 dB accuracy for offsets from 1 MHz to 40 MHz.

Absolute system noise floor:

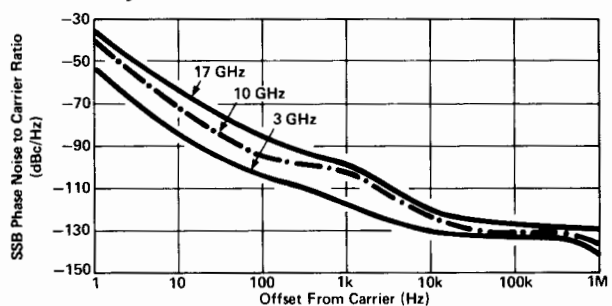

Typical HP 11729C/8662A system noise (phase detector method, locking via EFC).

Other measurement modes: standard HP 3047A specifications apply to all other measurement conditions.

Ordering Information

HP 11740S Microwave Phase Noise Measurement System

Price

HP 11740A System Instrumentation

\$0

Includes HP 11729C Carrier Noise Test Set, HP 8662A Synthesized Signal Generator, HP 3582A and 3585A Spectrum Analyzers, HP 35601A Spectrum Analyzer Interface, system software, and system rack with all associated power and signal cabling.

Requires HP Series 200 Model 36 or Model 16 Computer System appropriately configured. Full details are available from your local HP sales office.

\$113,810

SIGNAL ANALYZERS

Measuring Receiver, 150 kHz to 1300 MHz

Model 8902A

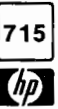

- RF power: digital power meter accuracy
- Tuned RF level: 0 dBm to -127 dBm dynamic range
- Carrier Noise: AM and phase noise measurements to -140 dBc/Hz

- AM and FM, 1% accuracy; \emptyset M, 3% accuracy
- RF frequency: 10 Hz resolution
- Audio: frequency, level and distortion

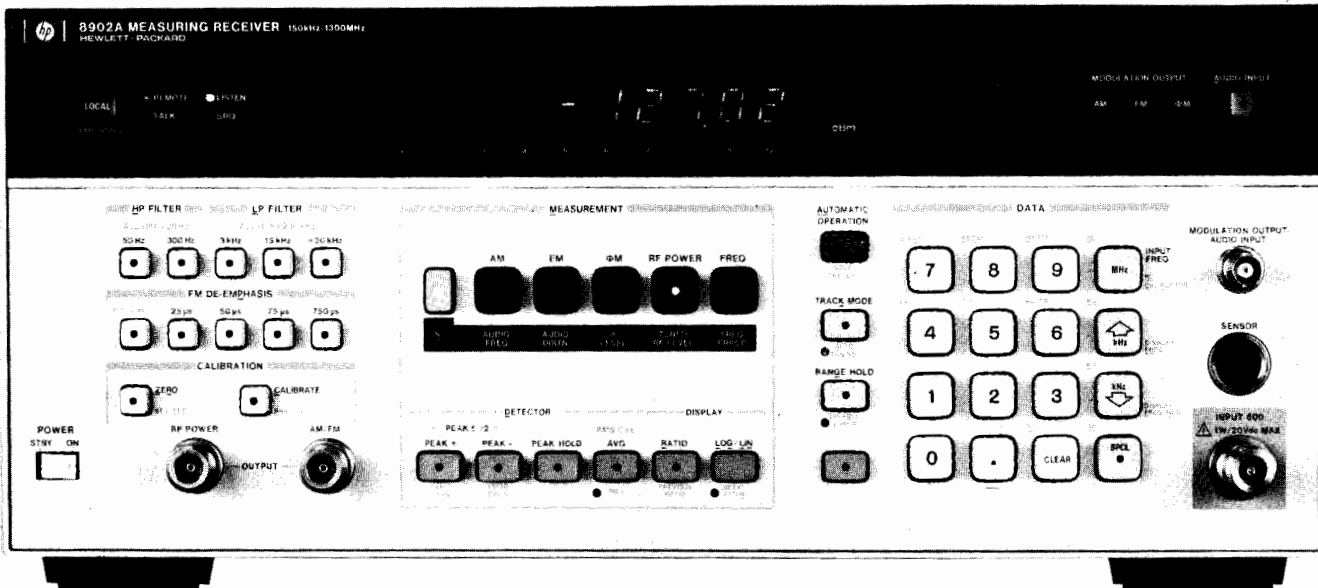

HP 8902A

HP 8902A Measuring Receiver

The HP 8902A Measuring Receiver combines six precise measurement functions into one fully automatic, HP-IB programmable instrument. It accurately measures RF power, tuned RF level, carrier noise/adjacent channel power, modulation and RF frequency, and characterizes audio signals. For precise signal analysis, the HP 8902A Measuring Receiver provides the performance you need.

RF Power delivers the accuracy and resolution of a high performance power meter. The HP 8902A with the HP 11722A Sensor Module measures power from +30 dBm to -20 dBm at frequencies from 100 kHz to 2.6 GHz. The HP 8902A also accepts all HP 8480 series power sensors for extended measurement capability.

Tuned RF Level's minimum sensitivity of -127 dBm with exceptional accuracy is a major contribution of the HP 8902A. You can make relative level measurements with accuracy you would only expect from a transfer standard: ± 0.02 dB ± 1 digit (worst case) for up to 10 dB step, increasing to ± 0.30 dB ± 1 digit at 110 dB step.

Carrier noise, phase noise and adjacent channel power measurements are simple, fast and accurate with the HP 8902A's high selectivity options (030-037). You select the noise filter bandwidth, measure the source under test's carrier power, tune the analyzer to the frequency offset desired (5 kHz to 1300 MHz) and measure the noise in seconds. The analyzer's measurement accuracy is better than ± 0.5 dB to -129 dBc/Hz, typically better than ± 1 dB to -140 dBc/Hz. The noise floor is -150 dBc/Hz.

AM and FM measurements offer 1% accuracy (3% accuracy for \emptyset M) and fast one-key operation. The HP 8902A has extremely low internal noise, and very low AM/ \emptyset M and \emptyset M/AM conversion, for accurately measuring residual and incidental AM, FM and \emptyset M on a wide range of simple and complex modulated signals.

RF frequency of complex modulated signals can be difficult to measure, but not with the HP 8902A. It tunes to the largest input signal or to any user specified frequency. The HP 8902A counts signals with 1 Hz resolution.

Audio distortion, frequency and level measurements provide comprehensive characterization of the modulation signal.

Metrology and Calibration

The HP 8902A Measuring Receiver makes signal generator and attenuator calibration easier than ever before.

The HP 8902A quickly and accurately measures your signal generator's RF frequency, RF level flatness, output level accuracy to -127 dBm, incidental and residual AM, FM and phase modulation, phase noise to < -140 dBc/Hz and characterizes the demodulated audio signals.

For attenuator calibration and other relative measurements, the HP 8902A gives you the accuracy and dynamic range you need. Tuned RF Level makes relative measurements with 127 dB dynamic range and 0.001 dB resolution. The combined dynamic range of Tuned RF Level and RF Power is 157 dB.

RF Signal Characterization

The HP 8902A Measuring Receiver is an excellent lab and production tool for accurately characterizing RF signals from 150 kHz to 1300 MHz.

Level measurements down to -127 dBm with superb accuracy make the HP 8902A ideal for testing devices such as antennas, multiplexers, log/linear amplifiers, filters and mixers. Unlike diode detectors, the HP 8902A's power meter accurately measures signals with harmonics and spurious.

The HP 8902A makes accurate AM to \emptyset M and AM to AM conversion measurements of phase and amplitude sensitive devices such as bandpass filters and multiple channel receivers. Excellent isolation between AM and FM makes it simple to separate the AM and \emptyset M of AM stereo, incidental AM of FM transmitters and the AM, FM and \emptyset M components of complex signals.

Automatic Test Systems

The HP 8902A is an important component of automatic RF test systems. All functions — power, level, frequency count, carrier noise, modulation, audio analysis — are fully automatic and easily programmed. With these measurements combined into one instrument, interfacing requirements, hardware costs, and software development time are reduced.

The HP 8902A's excellent measurement accuracy and dynamic range also make it a valuable tool for calibrating automatic test systems.

SIGNAL ANALYZERS

Measuring Receiver, Sensor Module

Models 8902A, 11722A

HP 8902A Specifications

RF Power (with HP 11722A Sensor Module)

Range: +30 dBm (1W) to -20 dBm (10 μW).

Frequency range: 0.1 MHz to 2.6 GHz.

Linearity: ±0.02 dB (within range) ±0.02 dB per range change from reference range ± 1 count LSD.

Input SWR: <1.15.

Tuned RF Level

Range: 0 dBm to -127 dBm.

Frequency range: 2.5 MHz to 1300 MHz.

Relative accuracy: ±0.02 dB ± 0.02 dB per IF range change ±0.04 dB per RF range change ± 1 digit.

Selective power measurements (carrier noise, options 030-037)

Frequency range: 10 MHz to 1300 MHz

Carrier power range:

+30 dBm to -20 dBm; 12.5 kHz, 25 kHz and 30 kHz filters.

+30 dBm to -10 dBm; carrier noise filter.

Relative measurement accuracy:

±0.5 dB; levels > -95 dBc; 12.5 kHz, 25 kHz and 30 kHz filters.

±0.5 dB; levels > -129 dBc/Hz; carrier noise filter.

Filter bandwidths: 2.5 kHz, Carrier Noise filter; 8.0 kHz, 12.5 kHz filter; 16.0 kHz, 25 kHz filter; 30.0 kHz, Cellular Radio filter.

RF Frequency

Range: 150 kHz to 1300 MHz.

Maximum resolution: 1 Hz, to 1 GHz; 10 Hz to 1.3 GHz.

Amplitude Modulation

Rates: 20 Hz to 100 kHz.

Depths: to 99%.

Accuracy: ±1% of reading ±1 digit, for rates 50 Hz to 50 kHz and depths ≥ 5%.

Frequency Modulation

Rates: 20 Hz to 200 kHz.

Deviations: to 400 kHz.

Accuracy: ±1% of reading ±1 digit, for rates 50 Hz to 100 kHz.

Phase Modulation

Rates: 200 Hz to 20 kHz.

Deviations: to 400 radians.

Accuracy: ±3% of reading ±1 digit.

Audio Level, Frequency and Distortion Capability

Audio Level

Accuracy: ±4% of reading, 100 mV to 3V.

Audio Frequency

Display resolution: 6 digits, to 250 kHz.

Audio Distortion

Accuracy: ± 1 dB, 400 Hz and 1 kHz.

Ordering Information

HP 8902A Measuring Receiver

Price

\$21,000

Option 001: rear panel instead of front panel connections for input, modulation output, and calibrators

add \$200

Option 002: 1X10⁻⁹/day internal reference oscillator

add \$650

Option 003: Rear panel connections which allow use with an external local oscillator

add \$400

Option 004: Operation from 48 Hz to 400 Hz power line (temp. <40°C)

add \$275

Option 021: Add HP 11722A Sensor Module

add \$1900

Option 030: High selectivity (select only two filter options)

\$2400

(Options 032-037 require Option 030. Option 030 includes Option 003 connections for external local oscillator.)

Option 032: 12.5 kHz filter

N/C

Option 033: 25.0 kHz filter

N/C

Option 035: Cellular Radio filter

N/C

Option 037: Carrier Noise filter

N/C

Option 907: Front panel handle kit

add \$65

Option 908: Rack mounting flange kit

add \$35

Option 909: Front panel handle plus rack mounting flange kit

add \$90

Option 910: Add manuals

add \$275

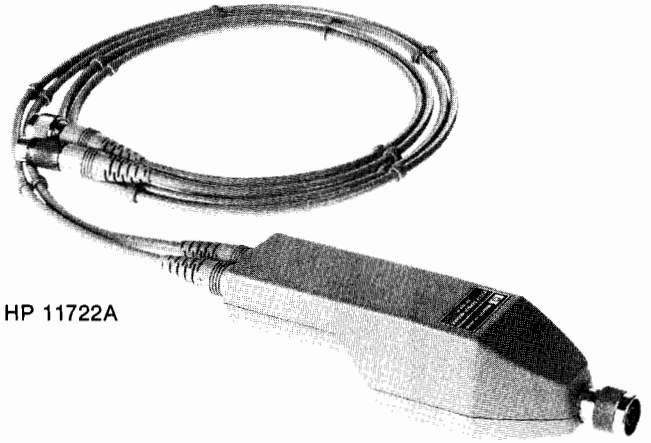

HP 11722A

HP 11722A Sensor Module

The HP 11722A Sensor Module was designed for use with the HP 8901B Modulation Analyzer and HP 8902A Measuring Receiver. The HP 11722A contains a silicon monolithic thermocouple as a power sensing element.

With the HP 11722A Sensor Module, you get all the performance of the HP 8901B or HP 8902A, plus superb power measurement accuracy, at a single connector. You can characterize a signal without switching back and forth between the power sensor and the analyzer's RF input.

Each HP 11722A Sensor Module is individually calibrated, traceable to the U.S. National Bureau of Standards. The calibration factors are printed on the sensor module for easy reference. Enter these factors into the HP 8901B or 8902A's non-volatile memory and the instrument automatically compensates for the power sensor's efficiency and mismatch loss at each frequency.

HP 11722A Specifications

Frequency range: 100 kHz to 2.6 GHz.

Power range: +30 dBm (1 watt) to -20 dBm (10 μW).

Input SWR (Connected to an HP 8901B or 8902A): <1.15, for RF power measurements.

Power sensor linearity: +2%, -4%; +30 dBm to +20 dBm. Negligible deviation, levels <+20 dBm.

Calibration factors: each HP 11722A Sensor Module is individually calibrated. The calibration factors are printed on the HP 11722A Sensor Module for easy reference.

Cal Factor Uncertainty

| Frequency | RSS Uncertainty | Worst Case Uncertainty |
|------------|-----------------|------------------------|
| 0.1 MHz | 0.7% | 1.6% |
| 0.3 MHz | 0.7% | 1.6% |
| 1.0 MHz | 0.8% | 1.7% |
| 3.0 MHz | 0.8% | 1.7% |
| 10.0 MHz | 0.9% | 2.0% |
| 30.0 MHz | 0.9% | 2.0% |
| 50.0 MHz | 0.0% (ref.) | 0.0% (ref.) |
| 100.0 MHz | 1.1% | 2.2% |
| 300.0 MHz | 1.1% | 2.2% |
| 1000.0 MHz | 1.1% | 2.2% |
| 2600.0 MHz | 1.2% | 2.3% |

Ordering Information

HP 11722A Sensor Module

Option 910: Extra manual

Price

\$1900

add \$15

SIGNAL ANALYZERS

150 kHz to 26.5 GHz

Models 8902S, 11792A, 11793A, 11794A

717



- RF power: digital power meter accuracy
- Tuned RF level: 0 dBm to -105 dBm dynamic range
- AM and FM: 1% accuracy Φ M: 3% accuracy

- Carrier Noise (AM and phase noise measurements): ± 0.5 dB accuracy
- RF frequency: 10 Hz resolution
- Audio: frequency, level and distortion

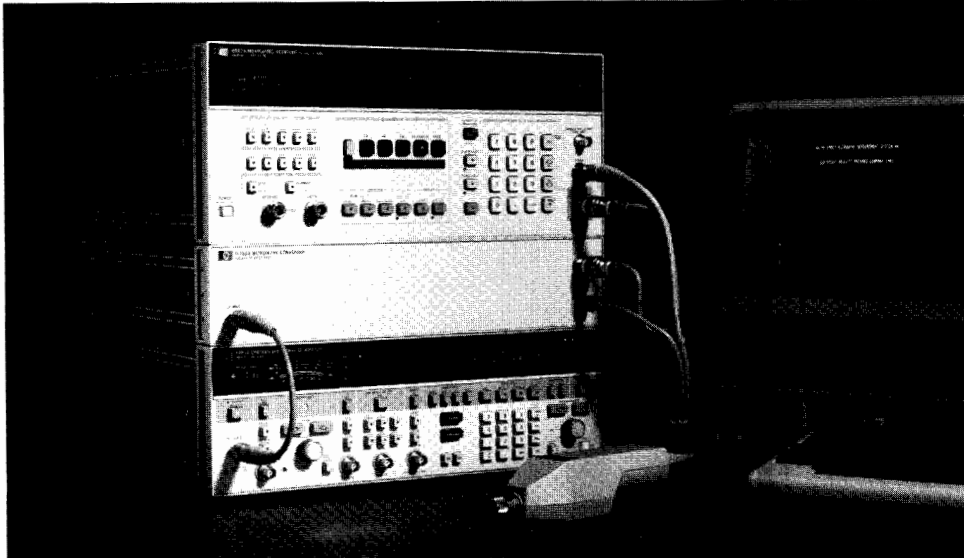

HP 8902S

HP 8902S Microwave Measurement System

The HP 8902S Microwave Measurement System extends the superb measurement performance of the HP 8902A Measuring Receiver to microwave frequencies. The HP 8902S system delivers the accuracy and resolution of a high performance power meter at frequencies from 50 MHz to 26.5 GHz and levels from +30 dBm to -105 dBm. It accurately measures AM, FM and Φ M, including residuals and incidentals, with a single keystroke. Adding options 030-037 to the HP 8902A extends the system's capability to include carrier noise measurements (AM and phase noise) with ± 0.5 dB accuracy to 26.5 GHz and down to the noise floor of the system's local oscillator. The HP 8902S counts signals to 26.5 GHz with 10 Hz resolution and excellent long-term frequency stability.

The HP 8902S Microwave Measurement System consists of the HP 8902A Measuring Receiver, HP 11793A Microwave Converter, HP 11792A Sensor Module, an instrument controller, HP 11794A Software Pac and a choice of microwave local oscillators. You can choose from the HP 8672A and 8673B/D/E Synthesized Signal Generators and the HP 8340A and 8341A Sweep Oscillators.

Improves Quality

The HP 8902S minimizes measurement errors. The system's high performance instruments deliver superb accuracy: AM and FM, $\pm 1\%$; level and power, ± 0.02 dB ± 0.02 dB/10 dB; and carrier frequency, 10 Hz resolution.

Special care is taken to minimize the HP 8902S's input SWR, RFI susceptibility and insertion loss. 26.5 GHz hardware and a specially-designed flexible RF input cable with extremely stable insertion loss and input SWR help make your measurements repeatable.

Saves Time

The HP 8902S is both easy to use and fast. It functions as a single instrument. You select the frequency and measurement from the front panel of the HP 8902A and the system, under the control of the HP 11794A software, does the rest. In seconds the software asks the HP 8902A for the frequency you entered, calculates and sets the local oscillator (LO) frequency, and releases the HP 8902A to make the measurement and display the results.

Even difficult tasks such as measuring levels down to -105 dBm, residual FM down to <17 Hz, and incidental Φ M of <0.03 radians in the presence of 50% AM, are performed in a few seconds.

The HP 8902S can be assembled and running in minutes. For critical down-time applications, move the HP 8902S to the device under test and test it in place.

Increases Confidence

The HP 8902S performs fast, accurate and repeatable microwave measurements traceable to the U.S. National Bureau of Standards. The HP 8902S consists of general purpose HP-IB programmable equipment which can also be used separately for other applications. Add the HP 8903A Audio Analyzer and HP 11795A Software Pac and the system expands to become an HP 8952S Microwave Signal Generator Test System.

HP 11793A Microwave Converter

The HP 11793A Microwave Converter down converts microwave signals to the frequency range of the HP 8902A Measuring Receiver. When you want to make a tuned RF level, modulation or frequency measurement above 1.3 GHz, the HP 11793A Microwave Converter routes the signal through its internal mixer. Below 1.3 GHz, signals are routed directly to the input of the HP 8902A.

The HP 11793A requires +8 dBm leveled output from the local oscillator. For LOs with insufficient power above 18 GHz, the HP 11793A offers an optional 18 to 26.5 GHz amplifier.

HP 11792A Sensor Module (50 MHz to 26.5 GHz)

When used with the HP 11793A Microwave Converter, the HP 11792A Sensor Module gives you all the performance of the HP 8902S system, plus superb power measurement accuracy, at a single connector. You can characterize a signal without manually switching back and forth between the power sensor and the receiver input.

Each HP 11792A Sensor Module is individually calibrated, traceable to the U.S. National Bureau of Standards. The calibration factors are printed on the sensor module for easy reference. Enter these factors into the HP 8902A's non-volatile memory and the instrument automatically compensates for the power sensor's efficiency and mismatch loss at each frequency. The 11792A is available with either a 3.5 mm precision or Type-N connector.

SIGNAL ANALYZERS

Microwave Measurement System, Signal Generator Test Set

Models 8902S, 8952A, 11795A



HP 8902S Specifications

RF Power (with HP 11792A Sensor Module)

Range: +30 dBm (1W) to -20 dBm (10 μW).

Frequency range: 50 MHz to 26.5 GHz.

Linearity: ±0.02 dB (within range) ±0.02 dB per range change from reference range ±1 digit.

Input SWR: <1.10, $f_c \leq 2.0$ GHz.

<1.28, 2.0 GHz < $f_c \leq 18$ GHz.

<1.40, 18.0 GHz < $f_c \leq 26.5$ GHz.

Tuned RF Level¹

Frequency range²: 2.5 MHz to 26.5 GHz.

Range:

+10 dBm to -116 dBm, 2.5 MHz ≤ f_c ≤ 1300 MHz.

0 dBm to -100 dBm, 1300 MHz < f_c ≤ 18.0 GHz.

0 dBm to -95 dBm, 18.0 GHz < f_c ≤ 26.5 GHz.

Relative accuracy: ±0.02 dB ±0.02 dB per IF range change ±0.04 dB per RF range change ±1 digit.

RF Frequency

Range²: 150 kHz to 26.5 GHz.

Maximum resolution: 10 Hz.

Time base aging rate: <5X10⁻¹⁰/day, for HP 8672A, HP 8673B/D/E; <1X10⁻⁹/day, for HP 8340A, HP 8341A.

Amplitude Modulation

Frequency range²: 150 kHz to 26.5 GHz.

Rates: 20 Hz to 100 kHz.

Depths: to 99%.

Accuracy: ±1% of reading ±1 digit, for rates 50 Hz to 50 kHz and depths ≥5%.

Frequency Modulation

Frequency range²: 150 kHz to 26.5 GHz.

Rates: 20 Hz to 200 kHz.

Deviations: to 400 kHz.

Accuracy: ±1% of reading ±1 digit, for rates 50 Hz to 100 kHz.

Phase Modulation

Frequency range²: 150 kHz to 26.5 GHz.

Rates: 200 Hz to 20 kHz.

Deviations: to 400 radians.

Accuracy: ±3% of reading ±1 digit.

General

Temperature: Operating, 15° C to 35° C; storage, -25° C to 60° C.

Power: 100, 120, 220, or 240V (+5%, -10%); 48-66 Hz; 1300 VA maximum (worst case).

Weight: Net 122.3 kg (270 lb); shipping, 153.3 kg (338.3 lb) worst case.

Ordering Information

HP 8902S Microwave Measurement System

The HP 8902S system consists of an HP 8902A Measuring Receiver, HP 11792A Sensor Module, HP 11793A Microwave Converter, HP 11794A Software Pac, a controller, two HP 10833 HP-IB cables, three accessory cables (included with HP 11793A) and a choice of synthesized microwave local oscillators. For complete ordering information, see the "HP 8902S Microwave Measurement System Ordering Information" guide, or call your HP sales office.

¹An HP 11722A Sensor Module may be used with the HP 8902S to make tuned RF level measurements from 2.5 MHz to 1300 MHz at levels from 0 dBm to -127 dBm.

²Frequency range may be limited by the frequency range of the LO.

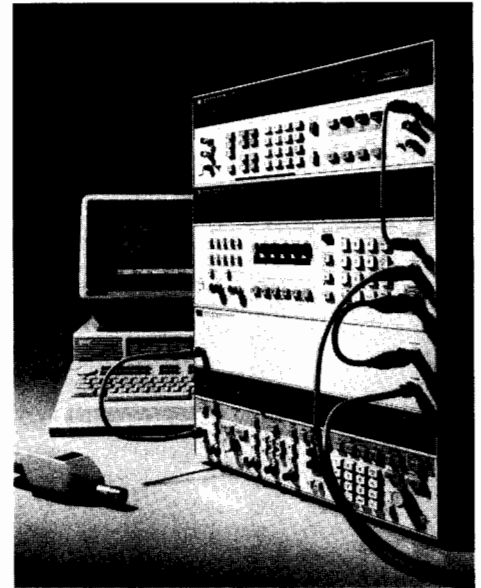

HP 8952S

HP 8952S Signal Generator Test System

The HP 8952S Signal Generator Test System eases your signal generator calibration workload, performing automatic performance verification for incoming inspection, maintenance, and calibration. The HP 8952S includes the HP 8902A Measuring Receiver, the HP 8903B Audio Analyzer, a printer, and your choice of four HP 9000 controllers: Model 216S, 220S, 226S, and 236S. The frequency range of the HP 8952S can be extended from 1.3 GHz to 26.5 GHz by adding the HP 11792A Sensor Module, the HP 11793A Microwave Converter and a synthesized microwave signal generator. With these instruments you can perform 80% of all tests typically required to verify both RF and microwave signal generator performance.

The HP 8952S Test System makes fast, accurate and repeatable measurements and provides you with a hardcopy output of the results. The system is easy to use and is easily expanded to include additional instruments.

To test your HP signal generators, select from the HP 11795A Software Pac series. Each Software Pac follows the verification procedures called out by the appropriate signal generator service manual.

The HP 11795A Performance Verification Option 209 (HP 8656B) uses either the HP 8658A/B or HP 8566A/B Spectrum Analyzer to perform harmonic, spurious and, with an HP 8952A-K01 Phase Noise Demodulator and another HP 8656B, phase noise measurements. Option 204 (HP 8640B) now uses the HP 8116A Pulse/Function Generator and HP 1980B Oscilloscope Measurement System to characterize pulse modulation. Future software pacs will use these new instruments to perform complete testing of signal generator performance.

Ordering Information

HP 8952A Signal Generator Test Set

Price

\$30,562

HP 11795A Software Pac

N/C

(Must order one option in addition to one disc media option)

Option 101, User Interface \$1000

(Required to run Performance Verification software options)

Performance Verification Options (select one or more):

204, HP 8640B Performance Verification software \$500

208, HP 8656A Performance Verification software \$500

209, HP 8656B Performance Verification software \$500

214, HP 8662A Performance Verification software \$500

216, HP 8663A Performance Verification software \$500

317, HP 8672A Performance Verification software \$750

Disc Medium Options (select only one)

630, 3.5 inch disc medium for HP 9121D or

HP 9122D or HP 9133D

N/C

650, 5.25 inch disc medium for HP 9125S

N/C

655, 5.25 inch disc medium for HP 9826S/9836S

N/C

SIGNAL ANALYZERS

Modulation Analyzer, 150 kHz to 1300 MHz

Models 8901A, 8901B



- Measures AM and FM to 1% accuracy
- Measures RF frequency
- Measures RF Power

- Low internal noise
- Completely automatic

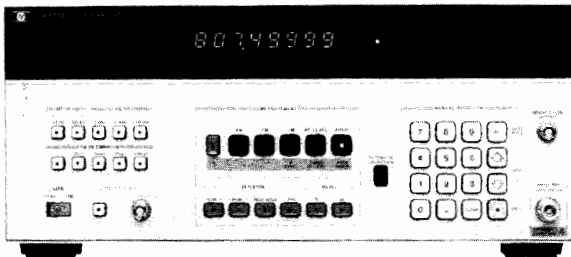

HP 8901A

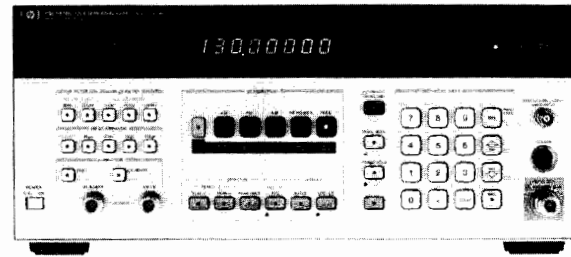

HP 8901B

HP 8901A and HP 8901B Modulation Analyzers

The HP 8901A and HP 8901B Modulation Analyzers combine the capabilities of several RF instruments to give complete, accurate characterization of modulated signals in the 150 kHz to 1300 MHz frequency range. Both instruments very accurately measure modulation and recover the modulation signal. They determine RF frequency and measure RF power. The major additional capabilities of the HP 8901B are its improved power meter accuracy, its ability to use external power sensors, to make adjacent channel power measurements or carrier noise measurements (with options 030-037) and its ability to count audio frequencies and measure distortion on 400 Hz and 1 kHz signals. Both instruments are fully automatic and make all major measurements with the push of a key or under HP-IB control.

Modulation Measurement Accuracy

Very accurate modulation measurements along with very low internal noise enable the HP 8901A/B to characterize even high performance signal sources. Their detection systems are configured for wideband recovery of the entire modulation spectrum so that highly precise measurements such as signal-to-noise or distortion can be made on the modulation signal. Modulation depth and deviation accuracy is generally $\pm 1\%$ of reading. Residual AM noise in a 50 Hz to 3 kHz bandwidth is $< 0.01\%$ while FM noise is < 8 Hz for 1300 MHz carrier frequencies, decreasing linearly to < 1 Hz below 100 MHz. Because the AM and FM demodulators are independent and highly insensitive to each other and because the analyzer has very low residual AM and FM, accurate incidental AM and FM measurements can be made.

Three detectors are available for depth and deviation measurements: positive peak, negative peak, and an average-responding detector with rms (sinewave) calibration. A PEAK HOLD function captures and displays the maximum peak modulation of a signal and is ideal for making transient measurements such as modulation limiting on mobile radios. The HP 8901B also has a true rms detector and the ability to measure peak to peak divided by two.

For measuring convenience, two high-pass (50 Hz and 300 Hz) and three low-pass (3 kHz, 5 kHz and > 20 kHz) post-detection filters for filtering the recovered modulation are included. The > 20 kHz Bessel filter minimizes overshoot on square-wave modulation. This allows accurate measurement of signals which are digitally modulated, such as FSK. Four de-emphasis networks commonly used in FM systems (25, 50, 75, and 750 μ s) are also provided.

A modulation output provides calibrated signal levels relative to the displayed modulation reading. The HP 8901B can make measurements on this demodulated signal such as frequency and distortion level.

Modulation calibrators (standard on the HP 8901B, Option 010 on the HP 8901A) provide two precision modulation standards. One is an amplitude modulated signal whose depth is calibrated to better than 0.1% accuracy. The second standard is a frequency modulated signal with peak deviation calibrated to 0.1% accuracy. The HP 11715A AM/FM Test Source is necessary to fully test and calibrate other modulation parameters.

Frequency Measurements

The HP 8901A/B Modulation Analyzers are more than just high quality modulation meters. They also perform as frequency counters. Resolution for the HP 8901A's 150 kHz to 1300 MHz frequency counter is 10 Hz below 1000 MHz and 100 Hz above 1000 MHz. Resolution is 10 Hz for the HP 8901B. Sensitivity is -25 dBm (12 mV rms) below 650 MHz and -20 dBm (22 mV rms) above 650 MHz. The standard instrument's time base stability is 1×10^{-6} /month, or an optional time base is available with 1×10^{-9} /day stability.

RF Power Measurements

The HP 8901A uses a diode detection circuit to measure RF input power. This technique measures peak voltage and is calibrated from 1 mW to 1W for sinewave inputs. The RF level measurement accuracy is ± 1.5 dB from 150 MHz to 1300 MHz.

The HP 8901B delivers the accuracy and resolution of a high performance power meter. The HP 8901B, with the HP 11722A Sensor Module, measures power from $+30$ dBm to -20 dBm at frequencies from 100 kHz to 2.6 GHz. The HP 8901B also accepts all HP 8480 series power sensors for extended measurement capability.

Adjacent Channel Power and Direct Spectrum Noise Measurements

The HP 8901B offers optional selective power measurement capability (options 030-037). With this capability you can quickly and accurately make adjacent channel power measurements to CEPT standards. The HP 8901B provides a choice of selectable filters for testing transceivers with 12.5, 25 and 30 kHz channel spacings.

To meet the CEPT standard at frequencies greater than 300 MHz, the HP 8901B requires an external local oscillator (LO) such as the HP 8656B Synthesized Signal Generator. Dedicating a signal generator as the external LO is not necessary. When not being used as the LO, a built-in RF switch in the HP 8901B routes the signal generator's output out the back panel.

Used with a low-phase-noise external LO, the HP 8901B also makes single-sideband (SSB) noise measurements to 1.3 GHz. To make the noise measurement, you just select the carrier noise filter and the frequency offset from the carrier (5 kHz to 1300 MHz). The HP 8901B then makes a selective power measurement (2.5 kHz BW) and converts the power to a 1 Hz bandwidth. The noise floor of the HP 8901B is -150 dBc/Hz. The HP 8901B's measurement accuracy is better than ± 0.5 dB down to -139 dBc.

Phase noise usually dominates the carrier-noise measurement at most offsets of interest, so direct-spectrum noise measurements provide a convenient and simple way to measure phase noise of many sources. Adding the HP 11793A Microwave Converter and a low-phase-noise microwave source such as the HP 8673B Synthesized Signal Generator extends this measurement to 26.5 GHz.

HP 8901A/8901B Specifications

RF Input

Frequency range: 150 kHz to 1300 MHz



SIGNAL ANALYZERS

Modulation Analyzer, 150 kHz to 1300 MHz

Models 8901A, 8901B

Operating Level

150 kHz–650 MHz: 12 mVrms to 7 Vrms

650 MHz–1300 MHz: 22 mVrms to 7 Vrms

Input impedance: 50Ω nominal

Tuning: manual frequency entry, automatic, or track (frequencies >10 MHz only).

Acquisition time (automatic operation): ~1.5 seconds.

Maximum safe input level (typical): ac: 35 Vrms (25W for source SWR <4); dc: 40V.

Frequency Modulation

Rates

150 MHz–10 MHz: 20 Hz to 10 kHz

10 MHz–1300 MHz: 20 Hz to 200 kHz

10 MHz–1300 MHz: 20 Hz to 20 kHz with 750 μs filter.

Deviations

150 kHz–10 MHz: 40 kHz peak maximum

10 MHz–1300 MHz: 400 kHz peak maximum

10 MHz–1300 MHz: 40 kHz peak maximum with 750 μs filter.

Accuracy^{1,2}

250 kHz–10 MHz: ±2% of reading ±1 digit, 20 Hz to 10 kHz rates.

10 MHz–1300 MHz: ±1% of reading ±1 digit, 50 Hz to 100 kHz rates; ±5% of reading ±1 digit, 20 Hz to 200 kHz rates.

Demodulated Output Distortion³

400 kHz–10 MHz: <0.1% THD, deviations <10 kHz.

10 MHz–1300 MHz: <0.1% THD, rates and deviations <100 kHz.

AM rejection (for 50% AM at 400 Hz and 1 kHz rates)¹: <20 Hz peak deviation measured in a 50 Hz to 3 kHz BW.

Residual FM (50 Hz to 3 kHz BW): <8 Hz rms @ 1300 MHz, decreasing linearly with frequency to <1 Hz rms for 100 MHz and below.

Maximum Deviation Resolution

0.1 Hz (rms detector on HP 8901B only), <4 kHz peak deviation

1 Hz, <4 kHz peak deviation

10 Hz, 4 kHz to 40 kHz peak deviation

100 Hz, 40 kHz to 400 kHz peak deviation

Resolution is increased one digit with 750 μs de-emphasis and pre-display "on" and with rms detector.

Stereo separation (50 Hz to 15 kHz): >47 dB typical.

Phase Modulation

Carrier frequency: 10 MHz to 1300 MHz.

Rates: 200 Hz to 20 kHz; typically usable from 20 Hz to 100 kHz with degraded performance.

Deviation and Maximum Resolution

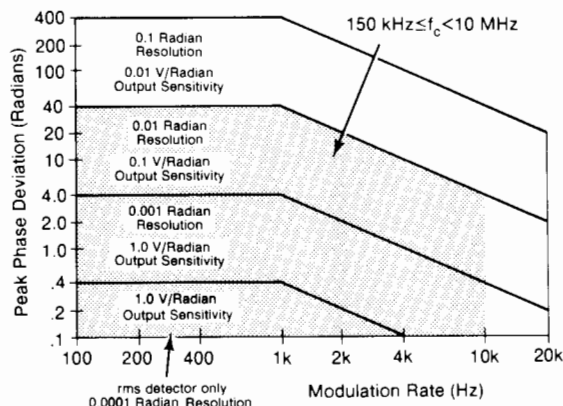

Accuracy¹: ±3% of reading ±1 digit

Demodulated output distortion: <0.1% THD

AM rejection (for 50% AM at 1 kHz rate)¹: <0.03 radian peak deviation (50 Hz to 3 kHz BW)

Amplitude Modulation

Rates

150 kHz–10 MHz: 20 Hz to 10 kHz

10 MHz–1300 MHz: 20 Hz to 100 kHz.

Depth: to 99%

Accuracy^{1,2,4}

150 kHz–10 MHz: ±2% of reading ±1 digit, 50 Hz to 10 kHz rates, >5% depth; ±3% of reading ±1 digit, 20 Hz to 10 kHz rates.

10 MHz–1300 MHz: ±1% of reading ±1 digit, 50 Hz to 50 kHz rates, >5% depth; ±3% of reading ±1 digit, 20 Hz to 100 kHz rates.

Flatness (variation in indicated AM depth for constant depth on input signal): 10 MHz to 1300 MHz: ±0.3% of reading ±1 digit, 90 Hz to 10 kHz rates, 20% to 80% depth.

Demodulated output distortion: <0.3% THD for ≤50% depth; <0.6% THD for ≤95% depth.

FM Rejection (at 400 Hz and 1 kHz rates, 50 Hz to 3 kHz BW)¹

250 kHz to 10 MHz: <0.2% AM for <5 kHz peak deviation.

10 MHz to 1300 MHz: <0.2% AM for <50 kHz peak deviation.

Residual AM (50 Hz to 3 kHz BW): <0.01% rms.

Maximum Depth Resolution

0.01% for depths ≤39.99%; 0.1% for depths ≥40%. Resolution increases 1 digit with rms detector (HP 8901B only).

Frequency Counter

Range: 150 kHz–1300 MHz.

Accuracy: ±3 counts of least significant digit ± reference accuracy.

Internal Reference

Frequency: 10 MHz.

Aging rate: <1x10⁻⁶/month (optional⁵: 1x10⁻⁹/day).

Maximum Resolution

HP 8901A: 10 Hz for frequencies <1 GHz; 100 Hz for frequencies ≥1 GHz.

HP 8901B: 10 Hz.

HP 8901A RF Level (Peak Voltage Responding, RMS Sine Wave Power Calibrated)

Range: 1 mW to 1W.

Instrumentation accuracy: ±1.5 dB (150 kHz to 1300 MHz); 0.7 dB typical.

SWR: ≤650 MHz: ≤1.3; 1300 MHz: ≤1.5.

Resolution: 0.1 mW for levels 0.1W to 1W.

0.01 mW for levels 0.01W to 0.1W.

0.001 mW for levels <0.01W.

HP 8901B RF Level (True RMS)

Frequency range with HP 11722A: 100 kHz to 2.6 GHz.

Power range: -20 dBm to +30 dBm.

RF Range Linearity (Using Recorder Output)

±0.02 dB, RF ranges 2 – 5

±0.03 dB, RF range 1

Using front-panel display, add ±1 count of least-significant digit.

RF Range-to-Range Change Error

±0.02 dB/RF range change from reference range.

Input SWR: <1.15, using HP 11722A Sensor Module.

Zero Set (Digital Settability of Zero)

±0.07% of full scale on lowest range.

Decrease by a factor of 10 for each high range.

RF Power Resolution

0.1% of full scale in watts or volts mode,

0.01 in dBm or dB relative mode.

¹ Peak residuals must be accounted for in peak readings.

² But not to exceed: 50 Hz to 40 kHz rates for stated accuracy with rms detector (HP 8901B only).

³ With 750 μs de-emphasis and pre-display "off", distortion is not specified for modulation outputs >4V peak. This can occur near maximum deviation for a measurement range at rates <2 kHz.

⁴ For peak measurements only, AM accuracy may be affected by distortion generated by the Modulation Analyzer. In the worst case, this can decrease accuracy by 0.1% of reading for each 0.1% of distortion.

⁵ After 30 day warm-up.

SIGNAL ANALYZERS

Modulation Analyzer, 150 kHz to 1300 MHz; AM/FM Test Source

Models 8901A, 8901B, 11715A

721



HP 8901B Selective Power Measurements (options 030-037)

Frequency range: 10 MHz to 1.3 GHz.
Carrier power range: +30 dBm to -20 dBm, 12.5, 25 and 30 kHz filters; +30 dBm to -10 dBm, Carrier Noise Filter.
Dynamic range: 115 dB.
Carrier rejection (temp. $\leq 35^\circ\text{C}$): >90 dB, for offsets ≥ 1 channel spacing or 5 kHz, whichever is larger.
Relative accuracy: ± 0.5 dB, levels ≥ -95 dBc or levels ≥ -129 dBc/Hz.
Filter bandwidths: 2.5 kHz, Carrier Noise Filter
 8.0 kHz, 12.5 kHz Filter
 16.0 kHz, 25 kHz Filter
 30.0 kHz, Cellular Radio Filter

Power Reference

Power output: 1.00 mW. Factory set to $\pm 0.7\%$, traceable to the U.S. National Bureau of Standards.
Accuracy: $\pm 1.2\%$ worst case ($\pm 0.9\%$ rss) for one year (0°C to 55°C).

Audio Filters

High pass (3 dB cutoff frequency): 50 Hz and 300 Hz
Low pass (3 dB cutoff frequency except >20 kHz filter): 3 kHz, 15 kHz, >20 kHz.
De-emphasis filters: 25 μs , 50 μs , 75 μs , and 750 μs .

Calibrators (Standard HP 8901B, Option 010 HP 8901A)

AM calibrator depth and accuracy: 33.33% depth, nominal; internally calibrated to an accuracy of $\pm 0.1\%$.
FM calibrator deviation and accuracy: 34 kHz peak deviation, nominal; internally calibrated to an accuracy of $\pm 0.1\%$.

General Characteristics

Operating temperature range: 0° to 55°C .
Power requirements: 100, 120, 220, or 240V ac (+5, -10%); 48-66 Hz; 200 VA max.
Weight: HP 8901A—net 20 kg (44 lb), shipping 25 kg (55 lb); HP 8901B—net 23 kg (52 lb), shipping 31 kg (69 lb).
Size: HP 8901A, 190 mm H x 425 mm W x 468 mm D (7.5 in. x 16.8 in. x 18.4 in.); HP 8901B, 190 mm H x 425 mm W x 551 mm D (7.5 in. x 16.8 in. x 21.7 in.).

Ordering Information

| | Price |
|--|---------|
| HP 8901A Modulation Analyzer | \$9240 |
| Option 001: Rear panel connectors | \$100 |
| Option 002: 1×10^{-9} /day internal reference | \$650 |
| Option 003: Connections for external local oscillator | \$400 |
| Option 004: Operation from 48 to 440 Hz power (Temp. $< 40^\circ\text{C}$) | \$275 |
| Option 010: AM and FM calibrators | \$625 |
| HP 8901B Modulation Analyzer | \$13040 |
| Option 001: Rear panel connectors | \$200 |
| Option 002: 1×10^{-9} /day internal reference | \$650 |
| Option 003: Connections for external local oscillator | \$400 |
| Option 004: Operation from 48 to 440 Hz power (Temp. $< 40^\circ\text{C}$) | \$275 |
| Option 030: High selectivity (select only 2 filter options) (Options 032-037 require Option 030; Option 030 includes Option 003 connections for external local oscillators.) | \$2400 |
| Option 032: 12.5 kHz filter | N/C |
| Option 033: 20.0/25.0 kHz filter | N/C |
| Option 035: Cellular Radio Filter | N/C |
| Option 037: Carrier Noise Filter | N/C |

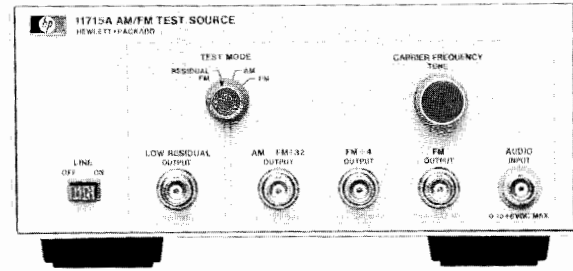

HP 11715A

HP 11715A AM/FM Test Source

The HP 11715A AM/FM Test Source provides very flat, wide-bandwidth, and low distortion amplitude or frequency modulated RF signals. Designed primarily for performance tests and adjustments of the HP 8901A/8901B Modulation Analyzer and HP 8902A Measuring Receiver, it will also serve as a high quality modulated test oscillator where its frequency ranges apply.

The major components of the HP 11715A are a low-noise voltage controlled oscillator (VCO), two digital dividers, and a double-balanced mixer. The VCO is the primary signal source, with a typical frequency range of 330 to 470 MHz at the FM OUTPUT. FM is produced by directly coupling the external modulation source to the VCO's tune input, providing very wide bandwidth modulation with low phase shift. This design also ensures very little incidental AM.

The HP 11715A can also be used in conjunction with an HP 8901A/8901B/8902A as a calibrated signal source for special applications. In particular, the U.S. commercial FM broadcast band of 88 to 108 MHz is covered by the FM \div 4 OUTPUT of the HP 11715A.

HP 11715A Specifications

FM Outputs

Frequency Range

AM FM \div 32 output: 11 to 13.5 MHz

FM \div 4 output: 88 to 108 MHz

FM output: 352 to 432 MHz

Peak Deviation

11 to 13.15 MHz carrier: >12.5 kHz

88 to 108 MHz carrier: >100 kHz

352 to 432 MHz carrier: >400 kHz

Distortion

<0.025% THD (< -72 dB) for

| Carrier frequency | Peak deviation | Modulation rate |
|-------------------|----------------|-----------------|
| 12.5 MHz | 12.5 kHz | <10 kHz |
| 100 MHz | 100 kHz | <100 kHz |
| 400 MHz | 400 kHz | <100 kHz |

Flatness

dc to 100 kHz rates: $\pm 0.1\%$

dc to 200 kHz rates: $\pm 0.25\%$

Stereo separation (88 to 108 MHz carrier, 75 kHz peak deviation, 1 kHz rate): >60 dB typical

AM Output

Frequency range (AM FM \div 32 output): 11 to 13.5 MHz

Depth: to 99%

Distortion

50% AM, 20 Hz to 100 kHz rates: <0.05% THD (< -66 dB)

95% AM, 20 Hz to 100 kHz rates: <0.1% THD (< -60 dB)

Flatness: 50 Hz to 50 kHz rates, $\pm 0.1\%$;

20 Hz to 100 kHz rates, $\pm 0.25\%$

Linearity: <95% AM, $\pm 0.1\%$; <99% AM, $\pm 0.2\%$

Ordering Information

HP 11715A AM/FM Test Source

Price

\$2200



SIGNAL ANALYZERS

Audio Analyzer, 20 Hz to 100 kHz; Distortion Analyzer, 20 Hz to 100 kHz

Models 8903B, 8903E

- Measures distortion, SINAD, signal-to-noise
- Measures true-rms ac volts, dc volts, frequency
- Low-distortion programmable source

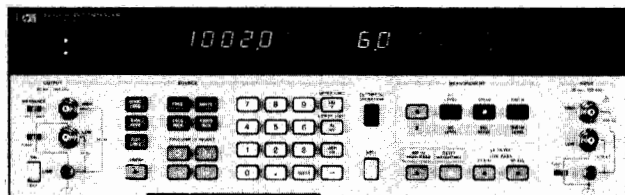

HP 8903B

HP 8903B Audio Analyzer

The HP 8903B Audio Analyzer provides unparalleled versatility and performance for audio measurements from 20 Hz to 100 kHz. The HP 8903B combines the functionality of a low-distortion audio source, high-performance distortion analyzer, frequency counter, ac voltmeter, dc voltmeter and SINAD meter into one compact package. With microprocessor control of source and analyzer, the HP 8903B can perform stimulus-response measurements, such as signal-to-noise ratio and swept distortion, automatically with no additional equipment.

For ease of use, most measurements are made with only one or two keystrokes. The HP 8903B automatically tunes and autoranges for maximum accuracy and resolution. For quick identification of input signals, the analyzer counts and displays the input frequency in all ac measurement modes. Stand alone swept measurement capability and simple HP-IB programming make the HP 8903B an extremely versatile tool for general audio and system applications.

The HP 8903B uses true-rms detection for accurate measurement of complex waveforms and noise. Average (rms-calibrated) detection is also available via front panel control. Accurate distortion measurements typically can be made down to less than -90 dB (0.003%) from 20 Hz to 20 kHz.

Audio Applications

The HP 8903B has many features which make difficult audio measurements easy. These include flexible data display formats, fully balanced analyzer input, plug-in filters, automatic notch filter tuning, convenient audio oscillator controls and swept measurements. With the ratio key, you can establish a reference in % or dB and directly make frequency response and 3 dB bandwidth measurements without computation. Fully balanced analyzer input allows testing of bridged power amplifiers found in many radios and car stereos as well as professional balanced audio equipment.

With two internal plug-in filter slots and six optional filters to choose from, the HP 8903B simplifies your audio measurements by providing the filter networks required by international standards (see next page for list of filters). The standard HP 8903B includes 30 kHz and 80 kHz low-pass filters to remove unwanted signals and noise. Fully-automatic notch-filter tuning coupled with automatic input ranging reduce operator workload while ensuring accurate distortion measurements. Distortion measurements down to <-90 dB (0.003%) typically can be made from 20 Hz to 20 kHz. In conjunction with an X-Y recorder, the HP 8903B can generate hard copy records of swept measurements such as frequency response and swept distortion.

- Measures distortion, SINAD
- Measures true-rms ac volts, dc volts, frequency

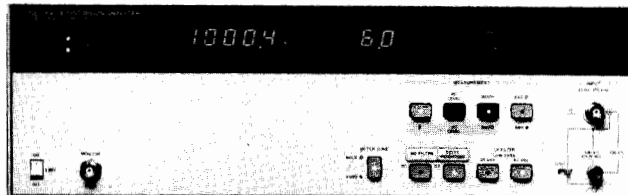

HP 8903E

Transmitter and Receiver Tests

Many features of the HP 8903B have been optimized for transmitter and receiver testing. These include SINAD measurements, optional plug-in weighting filters for testing to CEPT, EIA, CCIR, and Bell standards, rms detection for accurate noise readings and signal-to-noise ratio measurements. SINAD measurements, which are one of the most common FM receiver tests, must be made repeatedly when checking receiver sensitivity or adjacent-channel selectivity. In order to smooth out the noisy signals found in receiver testing, SINAD measurements in the HP 8903B employ extra filtering and parallel detection for high speed (>2 readings per second) and excellent repeatability. The HP 8903B overcomes the tendency of many automatic analyzers to become unlocked in SINAD mode by tuning its notch filter to the source frequency.

The HP 8903B uses true-rms detection (for all signals with crest factor <3) for accurate measurement of complex signals. Average detection is also available via front panel control. Just as SINAD measurements are most often performed on FM receivers, signal-to-noise ratio measurements are usually employed as a measure of signal quality on AM receivers. The HP 8903B automatically makes signal-to-noise ratio measurements by monitoring the ac level while turning its source on and off.

HP 8903E Distortion Analyzer

The HP 8903E Distortion Analyzer is a high performance tool for audio signal analysis from 20 Hz to 100 kHz. The HP 8903E Distortion Analyzer is the ANALYZER portion of an HP 8903B Audio Analyzer (HP 8903E has no source). Automatic distortion, SINAD, ac voltage, frequency, and dc voltage measurements are available on the HP 8903E.

The HP 8903E is simple to use. Fully automatic tuning and autoranging, coupled with single keystroke measurement selection, make accurate measurements easy to obtain with the HP 8903E. Many audio measurements either require a separate audio source or are made on playback-only systems. For such applications, the HP 8903E is the ideal, lower-cost solution.

With a selectable balanced or unbalanced input, the HP 8903E Distortion Analyzer can be used to characterize most types of audio equipment. For receiver testing, a front-panel key allows the operator to lock the notch filter at any given input frequency in the distortion and SINAD modes. This feature ensures that the HP 8903E will not become unlocked when measuring receiver sensitivity and selectivity. For rejection of unwanted signals and noise, the HP 8903E has 30 kHz and 80 kHz low-pass filters. Floating the input (balanced operation), can help break insidious ground loops, typically providing over 75 dB of common mode rejection at the line frequency.

Internal Plug-in Filter Options

Both the HP 8903B and HP 8903E have TWO internal plug-in filter slots, each of which will accept one of six optional filters. The standard HP 8903B and HP 8903E come with 30 kHz and 80 kHz low-pass filters, but with NO PLUG-IN FILTERS. The appropriate filter options must be ORDERED for the analyzers to have any of the filters listed below. Each filter option has TWO option numbers: the 010 series for the left filter slot and the 050 series for the right filter slot. Each filter option ordered (maximum of two) adds additional cost to the instrument.

| Filters | Option Numbers Filter Position | |
|----------------------------|-----------------------------------|------------|
| | Left Slot | Right slot |
| 400 Hz High-Pass | 010 | 050 |
| CCITT Weighting Filter | 011 | 051 |
| CCIR Weighting Filter | 012 | 052 |
| C-MESSAGE Weighting Filter | 013 | 053 |
| CCIR/ARM Weighting Filter | 014 | 054 |
| "A" Weighting Filter | 015 | 055 |

HP 8903B and HP 8903E Specifications

System Specifications

(HP 8903B only, source and analyzer combined)

Distortion

Residual Distortion and Noise (the higher of):

80 kHz BW: -80 dB (0.01%) or 17 μ V, 20 Hz to 20 kHz.

500 kHz BW: -70 dB (0.032%) or 50 μ V, 20 Hz to 50 kHz.
-65 dB (0.056%) or 50 μ V, 50 kHz to 100 kHz.

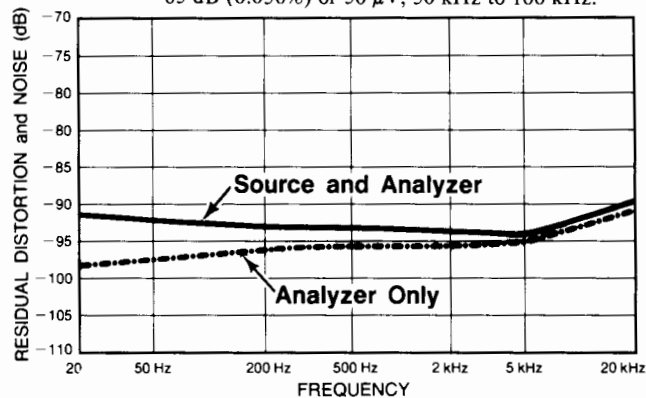

Typical residual THD + noise of source and analyzer combined (source voltage set to 1.5V, 80 kHz BW). Dashed line represents typical residual THD + noise for the analyzer only.

Signal-to-Noise

Frequency range: 50 Hz to 100 kHz.

Display range: 0 to 99.99 dB.

Accuracy: ± 1 dB.

Input voltage range: 50 mV to 300V.

Residual noise (the higher of): -85 dB or 17 μ V, 80 kHz BW; -70 dB or 50 μ V, 500 kHz BW.

Resolution: same as listed under SINAD.

Operation: the analyzer displays the ratio of the input voltages as the internal source is automatically switched on and off.

Source Specifications (HP 8903B only)

Frequency

Range: 20 Hz to 100 kHz.

Resolution: 0.3%.

Accuracy: 0.3% of setting.

Output Level

Range: 0.6 mV to 6V open circuit.

Resolution: 0.3% or better.

Accuracy (open circuit): 2% of setting 60 mV to 6V, 20 Hz to 50 kHz; 3% of setting 6 mV to 6V, 20 Hz to 100 kHz; 5% of setting 0.6 mV to 6 mV, 20 Hz to 100 kHz.

Flatness (1 kHz reference): $\pm 0.7\%$ (± 0.06 dB), 20 Hz to 20 kHz; $\pm 2.5\%$ (± 0.22 dB), 20 Hz to 100 kHz.

Distortion and noise (the higher of):

80 kHz BW: -80 dB (0.01%) or 15 μ V, 20 Hz to 20 kHz.

500 kHz BW: -70 dB (0.032%) or 38 μ V, 20 Hz to 50 kHz.

-65 dB (0.056%) or 38 μ V, 50 kHz to 100 kHz.

Impedance: 600 Ω $\pm 1\%$ or 50 Ω $\pm 2\%$, front-panel switchable. (Not HP-IB programmable.)

Sweep mode: log sweep with up to 500 points per decade or 255 points total between entered start and stop frequencies.

HP 8903B and HP 8903E Analyzer Specifications

Distortion

Fundamental frequency range: 20 Hz to 100 kHz.

Display range: 0.001% to 100% (-99.99 to 0 dB).

Accuracy: ± 1 dB, 20 Hz to 20 kHz; ± 2 dB, 20 kHz to 100 kHz.

Input voltage range: 50 mV to 300V.

Residual distortion and noise (the higher of):

80 kHz BW: -80 dB (0.01%) or 15 μ V, 20 Hz to 20 kHz.

500 kHz BW: -70 dB (0.032%) or 45 μ V, 20 Hz to 50 kHz.

-65 dB (0.056%) or 45 μ V, 50 kHz to 100 kHz.

3 dB measurement bandwidth: 10 Hz to 500 kHz.

Detection: true rms or rms calibrated average.

Displayed resolution: 0.0001%, for <0.1% distortion; 0.001%, 0.1% to 3% distortion; 0.01%, 3% to 30% distortion; 0.1%, >30% distortion.

Sinad

Fundamental frequency range: 20 Hz to 100 kHz.

Display range: 0 to 99.99 dB.

Residual distortion and noise: same as listed under Distortion.

Accuracy: ± 1 dB, 20 Hz to 20 kHz; ± 2 dB, 20 kHz to 100 kHz.

Input voltage range: 50 mV to 300V.

Detection: true rms or rms-calibrated average.

Resolution: HP 8903B: 0.01 dB for SINAD ratios >25 dB. For ratios <25 dB the display is rounded to the nearest 0.5 dB to reduce digit flickering of noisy signals (full resolution is available via special function 16.1). HP 8903E: powers up with special function 16.1 active for 0.01 dB resolution at all SINAD ratios.

Analog meter (HP 8903B only): Active in SINAD mode and for SINAD ratios ≤ 18 dB (≤ 24 dB using special function 7.1).

Tuning: HP 8903B: notch filter is tuned to the internal source frequency. HP 8903E: notch filter is tuned to the counted input frequency. Notch filter hold function available on front panel.

AC Level

Full range display: 300.0V, 30.00V, 3.000V, .3000V, 30.00 mV, 3.000 mV, 0.3000 mV.

Overrange: 33%, except on 300V range.

Accuracy: $\pm 2\%$, 50 mV to 300V, 20 Hz to 20 kHz; $\pm 4\%$, 0.3 mV to 50 mV, 20 Hz to 100 kHz; $\pm 4\%$, 50 mV to 300V, 20 kHz to 100 kHz.

AC converter: true-rms responding for signals with crest factor up to 3, or rms-calibrated average detection.

3 dB measurement bandwidth: >500 kHz.

DC Level

Full range display: 300.0V, 48.00V, 16.00V, 4.000V.

Overrange: 33%, except on 300V range.

Accuracy: $\pm 1.0\%$ of reading, 600 mV to 300V.

± 6 mV, $V_{in} < 600$ mV.

Frequency Measurement

Measurement range: 20 Hz to 150 kHz. (20 Hz to 100 kHz in distortion and SINAD modes.)

Resolution: 5 digits (0.01 Hz for input frequencies <100 Hz).

Accuracy: $\pm(0.004\% + 1$ digit).

Sensitivity: 50 mV in distortion and SINAD modes, 5.0 mV in ac level and signal-to-noise (HP 8903B only) modes.

Counting technique: reciprocal with 2 MHz timebase.



SIGNAL ANALYZERS

Audio Analyzer, 20 Hz to 100 kHz; Distortion Analyzer, 20 Hz to 100 kHz

Models 8903B, 8903E (cont.)

Standard Audio Filters

30 kHz Low-Pass Filter

3 dB cutoff frequency: 30 kHz \pm 2 kHz.

Rolloff: third-order Butterworth; 18 dB/octave or 60 dB/decade.

80 kHz Low-Pass Filter

3 dB cutoff frequency: 80 kHz \pm 4 kHz.

Rolloff: third-order Butterworth; 18 dB/octave or 60 dB/decade.

Plug-in Audio Filters (optional)

400 Hz High-Pass Filter

3 dB cutoff frequency: 400 Hz \pm 40 Hz.

Rolloff: seventh-order Butterworth; 42 dB/octave or 140 dB/decade

CCITT Weighting Filter (CCITT rec. P53)

Deviation from ideal response: \pm 0.2 dB at 800 Hz; \pm 1.0 dB, 300 Hz to 3 kHz; \pm 2.0 dB, 50 Hz to 3.5 kHz; \pm 3.0 dB, 3.5 kHz to 5 kHz.

CCIR Weighting Filter (CCIR rec. 468-2)

Deviation from ideal response: \pm 0.1 dB at 6.3 kHz; \pm 0.2 dB, 6.3 kHz to 7.1 kHz; \pm 0.4 dB, 7.1 kHz to 10 kHz; \pm 0.5 dB, 200 Hz to 6.3 kHz; \pm 1.0 dB, 31.5 Hz to 200 Hz, 10 kHz to 20 kHz; \pm 2.0 dB, 20 kHz to 31.5 kHz.

C-Message Weighting Filter (Per BSTM 41004)

Deviation from ideal response: \pm 0.1 dB at 1 kHz; \pm 1.0 dB, 60 Hz to 5 kHz.

CCIR/ARM Weighting Filter (CCIR rec. 468-2, average-responding meter, Dolby Labs bulletin No. 19/4)

Deviation from ideal response: same as listed under CCIR Filter.

"A" Weighting Filter (IEC rec. 179 and ANSI S1.4)

Deviation from ideal response: \pm 0.1 dB at 1 kHz; \pm 0.5 dB, 20 Hz to 10 kHz; \pm 1.0 dB, 10 kHz to 20 kHz.

Front/Rear-Panel Outputs

Recorder outputs (HP 8903B only):

X-axis: 0-10 Vdc corresponding to log of oscillator frequency. Output resistance 1k Ω .

Y-axis: 0-10 Vdc corresponding to displayed value and entered plot limits. Output resistance 1 k Ω .

Pen lift: TTL output.

Monitor output: In ac level mode provides a scaled output of the input signal. In SINAD, distortion, and distortion-level modes provides scaled output of input signal with the fundamental removed.

Analyzer Input

Input type: Balanced (full differential).

Input impedance: 100 k Ω \pm 1% shunted by <300 pF, each side to ground. (In dc-level mode the input resistance is 101 k Ω \pm 1%)

Max input (maximum peak input voltage, any combination of ac/dc):

HP 8903B: 425 volts peak, applied differentially or between either input to ground.

HP 8903E: 42 volts peak, Low side to ground.
425 volts peak, differentially or High side to ground.

CMRR: >60 dB, 20 Hz to 1 kHz, V_{in} <2V; >45 dB, 20 Hz to 1 kHz; >30 dB, 20 Hz to 20 kHz.

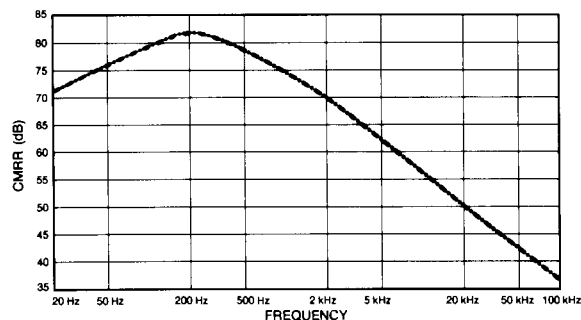

Typical CMRR from 20 Hz to 100 kHz with input voltage of 6 volts.

General

Temperature: operating, 0°C to 55°C; storage, -55°C to 75°C.

Remote operation: HP-IB, all functions except line switch, low-terminal ground switches, source output-impedance switch (HP 8903B only), and the X10 and \div 10 increment keys (HP 8903B only), are remotely controllable. The HP 8903E has many special functions which can only be accessed via HP-IB commands.

HP-IB compatibility: SH1, AH1, T5, TE0, L3, LE0, SR1, RL1, PP0, DC1, DTI, C0, E1.

Power: 100, 120, 220, or 240V (+5, -10%); 48-66 Hz. 100 or 120V +5, -10%); 48-440 Hz. 100 VA maximum.

Weight: HP 8903B: net 12.3 kg (27 lb.); shipping 16.4 kg (36 lb.) HP 8903E: net 11.8 kg (26 lb.); shipping 15.9 kg (35 lb.)

Dimensions: 146 mm H x 425 mm W x 462 mm D. (5.75 x 16.8 x 18.2 in.)

HP system II size: 5/4 H x 1 MW x 17 D.

EM: conducted and radiated interference is within the requirement of methods CE03 and RE02 of MIL STD 461B and FTZ 526/527.

Conducted and radiated susceptibility: meets the requirements of methods CS01, CS02, and RS03 (1 V/m) of MIL STD 461B dated 1980.

Ordering Information

Analyzer Mainframes

HP 8903B Audio Analyzer \$5800.00

Option 001: rear panel input and output add \$100.00

Option 915: add service manual add \$34.00

Option 910: extra operating and service manual add \$50.00

HP 8903E Distortion Analyzer \$3900.00

Option 001: rear panel input and output add \$200.00

Option 915: add service manual add \$34.00

Option 910: extra operating and service manual add \$35.00

Options for both HP 8903B and HP 8903E

Option 010 or 050: 400 Hz High-Pass filter add \$200.00

Option 011 or 051: CCITT Weighting filter add \$200.00

Option 012 or 052: CCIR Weighting filter add \$200.00

Option 013 or 053: C-Message Weighting filter add \$200.00

Option 014 or 054: CCIR/ARM Weighting filter add \$200.00

Option 015 or 055: "A" Weighting filter add \$200.00

Option 907: front panel handle kit add \$55.00

Option 908: rack mounting flange kit add \$32.50

Option 909: front panel handle plus rack flange kit add \$80.00

- Ultra low distortion measurements
- Built-in low distortion oscillator
- Automatic
- True RMS detection

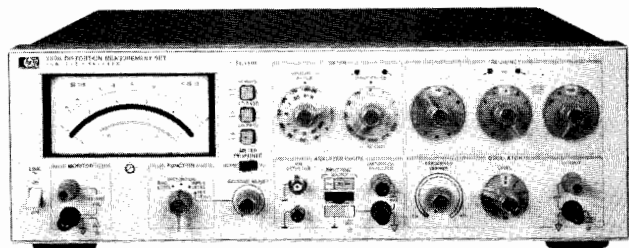

HP 339A

Description

Hewlett-Packard's Model 339A Distortion Measurement Set is an ultra low distortion measuring system complete with total harmonic distortion (THD) analyzer, true-rms voltmeter, and sine-wave oscillator. This small, lightweight bench measurement set allows you to make THD distortion measurements as low as 0.0018% over a 10 Hz to 110 kHz frequency band including harmonics to 330 kHz.

For fast and easy THD measurements the built-in tracking oscillator in HP's 339A saves test time because you tune one instrument instead of two. Frequency and level measurements are easy to do with HP's 339A's voltmeter, which offers you a 1 mV to 300 V measurement range. The Relative Level mode has been included to further simplify frequency response measurements. Just set a 0 dBm reference at any frequency from 10 Hz to 110 kHz. Gain measurements can be read directly from the easy-to-read meter.

Operation Simplicity

Automatic frequency tuning and set-level features allow you to make rapid, error free THD measurements. The HP 339A's built-in tracking oscillator eliminates the need to find the fundamental frequency and tune the analyzer for a null. Just select your oscillator frequency and the rest is automatic. Automatic set-level saves time by automatically setting 0 dB (100%) reference in the distortion measuring mode. Front panel directional indicators light when the input range setting is improper insuring accurate and repeatable measurements. Automatic set-level also greatly simplifies measurements where distortion as a function of level (SINAD¹, for example) is desired. Without this feature, measurements are very time consuming and tedious.

When an external stimulus is used, analyzer tuning is simplified by directional indicator lights for reaching the fundamental null quickly and easily.

¹SINAD is a sensitivity measurement computed from the ratio of signal plus noise and distortion to noise and distortion.

Specifications

Distortion

Fundamental frequency range: 10 Hz to 110 kHz continuous frequency coverage in 4 decade ranges with 2-digit resolution. Distortion analyzer and oscillator are simultaneously tuned.

Distortion measurement range: 0.01% full scale to 100% full scale (-80 dB to 0 dB) in 9 ranges.

Detection and meter indication: true rms detection for waveforms with crest factor ≤ 3 . Meter reads dB and % THD (Total Harmonic Distortion). Meter response can be changed from NORMAL to VU ballistics with a front panel switch.

Distortion Measurement Accuracy

| | |
|--------------------|--------------|
| 20 Hz to 20 kHz: | ± 1 dB |
| 10 Hz to 50 kHz: | + 1, -2 dB |
| 50 kHz to 110 kHz: | + 1.5, -4 dB |

Note: the above specifications apply for harmonics ≤ 330 kHz.

Fundamental Rejection (3 V scale or above)

| | |
|--------------------|----------|
| 10 Hz to 20 kHz: | > 100 dB |
| 20 kHz to 50 kHz: | > 90 dB |
| 50 kHz to 110 kHz: | > 83 dB |

Distortion Introduced by Instrument (input > 1V rms)

| | |
|--------------------|------------------------|
| 10 Hz to 10 kHz: | < -95 dB (0.0018%) THD |
| 10 kHz to 20 kHz: | < -92 dB (0.0035%) THD |
| 20 kHz to 30 kHz: | < -90 dB (0.0056%) THD |
| 30 kHz to 50 kHz: | < -85 dB (0.01%) THD |
| 50 kHz to 110 kHz: | < -70 dB (0.032%) THD |

Residual noise (fundamental frequency settings < 20 kHz, 80 kHz filter IN, source resistance ≤ 1 k Ω shielded): < -92 dB referenced to 1V.

Input level for distortion measurements: 30 mV to 300 V rms (100 mV range minimum).

Input impedance: 100 k Ω \pm 1% shunted by < 100 pF input High to Low.

Monitor: provides scaled presentation of input signal after fundamental is removed for further analysis using oscilloscope or low frequency spectrum analyzer. Output voltage: 1V rms \pm 5% open circuit for full scale meter indication, proportional to meter deflection. Output resistance: 1k Ω \pm 5%.

Auto set level: no set level adjustment required. Distortion measurements are made directly over 10 dB range selected by input range switch. Two LED annunciators provide a fast visual indication to change input range for valid distortion measurement. Correct range is indicated when both annunciators are extinguished.

Automatic fine tuning: using internal oscillator: No separate analyzer tuning necessary when using internal oscillator as signal source. Oscillator frequency controls simultaneously tune the analyzer. Using external frequency source: Two LED annunciators provide a quick visual indication for the operator to increase or decrease the frequency. When the analyzer is rough tuned to within one least significant digit of the fundamental frequency, the indicator lights are extinguished and the HP 339A auto-null circuitry takes over to provide a fast, accurate null without tedious operator tuning.

Input filters (usable on all functions): low pass: 30 kHz -3 dB point at 30 kHz, + 2.6 kHz, -3 kHz with 60 dB/decade rolloff. Provides band limiting required by FCC for proof-of-performance broadcast testing. 80 kHz -3 dB point at 80 kHz, + 7 kHz, -7.9 kHz with 60 dB/decade rolloff. Normally used with fundamental frequencies < 20 kHz to reduce the effect of higher frequency noise present in the measured signal. High Pass: 400 Hz -3 dB point at 400 Hz, + 35 Hz, -40 Hz with 60 dB/decade rolloff. Normally used with fundamental frequencies > 1 kHz to reduce the effect of hum components in the input signal.

DC isolation: input low may be connected to chassis ground or floated to 30 V to reduce the effects of ground loops on the measurement.

Relative Input Level Mode

Provides a ratio measurement relative to an operator selected reference level with readout directly in dBV or dBm (600 Ω). Voltage range, frequency range, accuracy specifications, and monitor are the same as in Voltmeter mode. (Accuracy is relative to 0 dB set level input.)

Oscillator

Frequency range: 10 Hz to 100 kHz in 4 overlapping decade ranges with 2 digit resolution. Frequency vernier provides continuous frequency tuning between 2nd digit switch settings.



SIGNAL ANALYZERS

Distortion Analyzers

Model 339A (cont.), 334A

Output level: variable from < 1 mV to > 3 V rms into 600 Ω with 10 dB/step Level control and > 10 dB Vernier adjustment. OSC Level position on function switch allows a quick check of oscillator level without disconnecting leads to device under test. Off position on Oscillator Level control provides fast signal-to-noise measurement capability. Oscillator output terminals remain terminated in 600 Ω .

Frequency accuracy: $\pm 2\%$ of selected frequency (with Frequency Vernier in Cal position).

Level flatness: 20 Hz to 20 kHz: $\leq \pm 0.1$ dB
10 Hz to 110 kHz: $\leq \pm 0.2$ dB

Distortion ($\geq 600\Omega$ load, $\leq 3V$ output)

10 Hz to 20 kHz: < -93 dB (0.0022%) THD
20 kHz to 30 kHz: < -85 dB (0.0056%) THD
30 kHz to 50 kHz: < -80 dB (0.01%) THD
50 kHz to 80 kHz: < -70 dB (0.032%) THD
80 kHz to 110 kHz: < -65 dB (0.056%) THD

Output resistance: 600 $\Omega \pm 5\%$

Voltmeter

Voltage range: 1 mV rms full scale to 300 V rms full scale (-60 dB to +50 dB full scale, meter calibrated in dBV and dBm into 600 Ω).

Detection and meter indication: true rms detection for waveforms with crest factor ≤ 3 . Meter reads true rms volts, dBm into 600 Ω , and dBV.

Accuracy (% of range setting)

20 Hz to 20 kHz: $\pm 2\%$

10 Hz to 110 kHz: $\pm 4\%$

Frequency range: 10 Hz to 110 kHz.

Input impedance: 100 k $\Omega \pm 1\%$ shunted by < 100 pF between input High to Low.

Monitor: provides scaled presentation of input signal for further analysis using oscilloscope or low frequency spectrum analyzer. Output voltage: 1 V rms $\pm 5\%$ open circuit for full scale meter indication, proportional to meter deflection. Output resistance: 1 k $\Omega \pm 5\%$.

Option 001

Voltage range: 0.1 mV rms full scale to 300 V rms full scale (-80 dBV to +50 dBV full scale); (.1 mV and .3 mV ranges—external source resistance must be < 10 k Ω .)

Accuracy: 1 mV to 300 V Ranges

20 Hz to 20 kHz $\pm 2\%$

10 Hz to 110 kHz

.1 mV and .3 mV Ranges

20 Hz to 20 kHz: $\pm 2\%$

10 Hz to 30 kHz: $\pm 4\%$

30 kHz to 80 kHz: +10/-30%

Noise Floor (600 Ω source impedance)

30 kHz filter < 6 μ V

80 kHz filter < 8 μ V

AM Detector

Frequency range: carrier frequencies: 550 kHz to 1.6 MHz. Modulation frequencies: 20 Hz to 20 kHz.

Distortion introduced by AM detector (with 30 kHz filter switched IN): up to 85% Modulation: < -36 dB (1.6%) THD
85% to 95% Modulation: < -30 dB (3%) THD

Input level: maximum: 60V peak. Modulation signal level: 2V rms minimum; 10V rms maximum.

Monitor (with modulated RF carrier applied to AM detector input).

Distortion mode: provides scaled presentation of demodulated input signal after fundamental is removed.

Voltmeter and relative input mode: provides scaled presentation of demodulated input signal. Output voltage and output resistance are the same as in Distortion mode.

General

Power: 100/120/220/240 V $\pm 5\%$, -10% 48 Hz to 66 Hz line operation, 200 mA maximum.

Size: 146 mm H x 426 mm W x 375 mm D (5.75" x 16.75" x 14.75").

Weight: net 8.2 kg (18 lb). Shipping 11.3 kg (25 lb).

**HP 339A Distortion Measurement Set
Option 001**

\$3250
add \$275

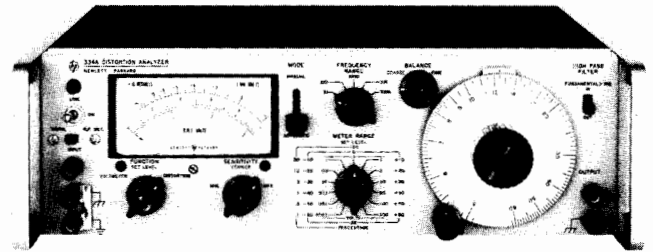

HP 334A

Description

Hewlett-Packard's model HP 334A Distortion Analyzer measures total distortion down to 0.1% full scale at any fundamental frequency between 5 Hz and 600 kHz; harmonics are indicated up to 3 MHz. Noise levels as low as 25 microvolts can be measured. The HP 334A includes automatic fundamental nulling and amplitude modulation detector. A Meter with VU ballistic characteristics and a 30 kHz low pass filter are optional.

HP 334A Specifications

Input level for distortion measurements: 0.3 V rms for 100% set level or 0.245 V for 0 dB set level (up to 300 V may be attenuated to set level reference).

Harmonic Measurement Accuracy (full scale)

Fundamental Input Less Than 30 V

| Range | $\pm 3\%$ | $\pm 6\%$ | $\pm 12\%$ |
|-----------|---------------|---------------|---------------|
| 100%-0.3% | 10 Hz-1 MHz | 10 Hz-3 MHz | |
| 0.1% | 30 Hz-300 kHz | 20 Hz-500 kHz | 10 Hz-1.2 MHz |

Fundamental rejection: > 80 dB

Residual distortion: > -70 dB (0.03%) from 5 Hz to 200 kHz; > -64 dB (0.06%) from 200 kHz to 600 kHz. Meter indication is proportional to average value of a sine wave.

Frequency calibration accuracy: better than $\pm 5\%$ from 5 Hz to 300 kHz. Better than $\pm 10\%$ from 300 to 600 kHz.

Input impedance: distortion mode: 1 M $\Omega \pm 5\%$ shunted by < 70 pF.

DC isolation: signal ground may be ± 400 V dc from external chassis

Voltmeter range: 300 μ V to 300 V rms full scale (13 ranges) 10 dB per range. Average responding calibrated in rms.

Noise measurements: voltmeter residual noise on the 300 μ V range: < 25 μ V rms, when terminated in 600 (shielded) ohms.

Output: 0.1 ± 0.01 V rms open circuit.

Output impedance: 2 k Ω

Automatic nulling mode: set level: at least 0.2 V rms

Frequency ranges: X1, manual null tuned to less than 3% set level: total frequency hold-in $\pm 0.5\%$ about true manual null. X10 through X10k, manual null tuned to less than 10% of set level; total frequency hold-in $\pm 1\%$ about true manual null.

Automatic null accuracy: 5 Hz to 100 Hz: meter reading within 0 to +3 dB of manual null. 100 Hz to 600 kHz: meter reading within 0 to +1.5 dB of manual null.

High pass filter: 3 dB point at 400 Hz with 18 dB per octave roll off.

AM detector: 550 kHz to 65 MHz; 40 Vp-p max input.

Distortion introduced by detector: carrier frequency: 550 kHz-1.6 MHz: < 50 dB (0.3%) for 3-8 V rms carriers modulated 30%. 1.6 MHz-65 MHz: < 40 dB (1%) for 3-8 V rms carriers modulated 30%.

General

Power: 115 or 230 V $\pm 10\%$. 48 to 66 Hz.

Size: 426 mm W x 126 mm H x 337 mm D (16.75" x 5" x 13.25").

Weight: net 7.89 kg (17.75 lb). Shipping 10.35 kg (23 lb).

HP 334A Distortion Analyzer
Opt 001 VU Characteristics \$2800
Opt 002 30 kHz low pass filter \$25
Opt 003 (combined 001 and 002) \$125
\$150

Price
\$2800
\$25
\$125
\$150

SIGNAL ANALYZERS

15 Hz to 50 kHz Wave Analyzer

Model 3581A

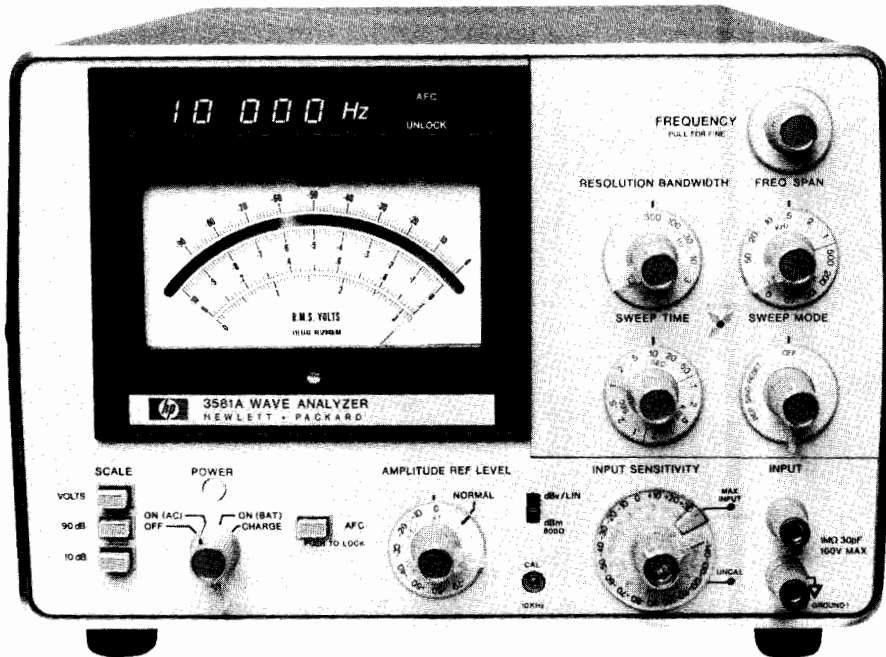

HP 3581A

Description

Hewlett-Packard's 3581A Wave Analyzer resolves and measures the amplitude and frequency of spectral components. This instrument offers accurate amplitude and good frequency resolution in the form of a portable, easy-to-use measuring tool. Since not all signals originate from a stable frequency source, the HP 3581A incorporates an AFC circuit which locks to a drifting signal for stable, accurate measurements.

The HP 3581A has other important features that are necessary when making measurements of small voltages from transducers and harmonic signals. Its 30 nV sensitivity becomes important for these measurements. Battery operation can be used to reduce the line related interference common in low level measurements so only the real spectrum is measured.

Digital readout of tuned frequency is located above the analog meter. It has been grouped with the meter for ease of reading. Resolution of the digital readout is 1 Hz for any frequency between 15 Hz and 50 kHz. Readout is updated five times per second so delay between tuning and reading is minimized.

Four meter scales are used to provide a wide range of displays. Two scales are used for linear voltage readings. Two log scales provide either a 90 dB or 10 dB display. In any case, the large meter with its mirror backing can present readings in dBV, dBm or volts. A meter was specifically chosen for amplitude display rather than digital readout because it is easier to peak a meter reading and because it's much easier to get a feel for noise or other amplitude variations by watching the meter. The same voltage used to drive the meter is also available on the rear panel for driving X-Y recorders.

Specifications

Frequency Characteristics

Range: 15 Hz to 50 kHz.

Display: 5 digit LED readout.

Resolution: 1Hz.

Accuracy: ± 3.5 Hz., 0 to 55°C.

Typical stability: ± 10 Hz/hour after 1 hour and ± 5 Hz/°C.

Automatic frequency control (AFC) hold-in range: ± 800 Hz.

Amplitude Characteristics

Instrument Range

Linear: 30 V to 100 nV full scale.

Log: +30 dBm or dBV to -150 dBm or dBV.

Amplitude Accuracy

Frequency response,
15 Hz-50 kHz

Log
 ± 0.4 dB

Linear
 $\pm 4\%$

Dynamic range: >80 dB.

Noise sidebands: greater than 70 dB below CW signal. 10 bandwidths away from signal.

Spurious responses: >80 dB below input reference level.

Sweep Characteristics

Scan width: 50 Hz to 50 kHz, adjustable in a 1-2-5 sequence from 50 Hz to the full frequency range.

Sweep error light: this LED indicates a sweep that is too fast to capture full response. When the light is on, response will be lower than it should be.

External trigger: a short to ground stops the normal sweep. Opening the short then enables a sweep.

Input Characteristics

Impedance: 1 M Ω , 30 pF.

Maximum input level: 100 V rms, ± 100 V dc.

Output Characteristics

Tracking generator output: (also known as BFO or tracking oscillator output).

Range: 0 to >1 V rms into 600 Ω .

Frequency response: $\pm 3\%$ 15 Hz to 50 kHz.

X-Y Recorder Analog Outputs

Vertical: 0 to +5 V $\pm 2.5\%$.

Horizontal: 0 to +5 V $\pm 2.5\%$.

Impedance: 1 k Ω .

Recommended Accessory: HP 7090A Measurement Plotting System.

Pen lift: contact closure to ground during sweep.

Restored output: acts as a narrow band amplifier.

General

Power requirements: 100 V, 120 V, 220 V, or 240 V +5% -10%, 48 Hz to 440 Hz, 10 VA typical.

Size: 412.8 mm H x 203.2 mm W x 285.8 mm D (16 $\frac{1}{4}$ " x 8" x 11 $\frac{1}{4}$ ").

Weight: 11.5 kg (23 lb). Opt 001: 13.5 kg (30 lb).

Options

HP 3581A Wave Analyzer

001: Internal battery 12 hours from full charge. Internal battery is protected from deep discharge by an automatic turnoff. Useful battery life is over 100 cycles.

003: Rack mount

910: Extra set manuals

Price
\$5,500

add \$700

\$330

add \$35



TRANSCEIVER TEST EQUIPMENT

HP 8955A RF Test System

- High performance measurements of AM and FM transmitters, receivers, and their modules
- Frequency range from 150 kHz to 1000 MHz
- System calibration, verification and diagnostics

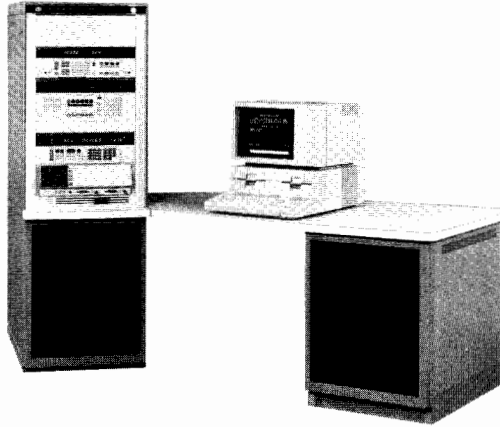

HP 8955A

8955A RF Test System

The HP 8955A RF Test System is a flexible combination of instrumentation and software used in the testing of transmitters, receivers, and subassemblies. The basic system consists of four measurement instruments: HP 8901A Modulation Analyzer, HP 8903B Audio Analyzer, HP 8656B Signal Generator and HP 436A Power Meter. To these instruments is added the HP 8956A System Interface to provide flexibility and easy system integration. The system is automated with a powerful software package that is executed on the HP Series 200, Model 16 or 36 Computer System. All hardware is mounted in a HP 29402C cabinet and a desk is mounted off one side.

HP 11791A Software Package

The HP 11791A Software Package for the HP 9816S or HP 9836S assure comprehensive transceiver testing on the same day the system is turned on. The software package is a powerful combination of operating system and measurement test routines. The operating system allows you to learn about system operation through its HELP command, verify system operation, reconfigure the system if new instruments are added or generate and execute a program from HP supplied test routines. While the test package is executing, you can interact with the system: halt execution to modify parameters, repeat certain tests, or learn more about system operation. There are over 60 measurement test routines which use the Electronic Industry Association (EIA) and Conference of European Postal and Telecommunications Administration (CEPT) standards for AM and FM receivers, transmitters, and their circuitry.

Additional software includes a powerful verification program, calibration program and configuration program which allows you to change the instrument configuration.

Options

The system offers a variety of options to meet your needs. These options include instrumentation for SSB testing, out-of-channel testing, spurious response testing, power supplies, and cabinet hardware. All options are fully supported and integrated at the factory. Comprehensive documentation is included with every system and installation is offered as an option.

Optional Instrumentation

HP 8662A Synthesized Signal Generator
 HP 8642A/B Synthesized Signal Generator
 HP 8568B Spectrum Analyzer
 HP 3325A Synthesizer/Function Generator
 Second HP 29402C Cabinet
 Second Desk

- A fully automatic operating system with easy softkey interaction
- Automatic program generator
- Over 60 tests using EIA and CEPT standards

HP 8955A SYSTEM SPECIFICATIONS (INCLUDES SOFTWARE CALIBRATION)

RF Signal Measurements (transmitter tests)

Frequency range: 150 kHz to 1000 MHz.

Frequency measurement accuracy: refer to HP 8901.

Power Measurement Range

With the 30 dB attenuator: 50 mW to 120W.

Without the 30 dB attenuator: 100 μ W to 0.5W.

Power Measurement Accuracy

With the 30 dB Attenuator

Within 2 MHz of calibration frequencies: $< \pm 0.5$ dB (± 0.3 dB typical).

1 MHz to 1000 MHz: $< \pm 0.45$ dB typical.

Input VSWR

With the 30 dB attenuator

dc to 1000 MHz: ≤ 1.2 .

Modulation measurements (AM, FM, PM): refer to HP 8901.

RF Signal Source (receiver tests)

Frequency range: 100 kHz to 990 MHz.

Option 112 or 122: 10 kHz to 1280 MHz.

Output Level Range

With the 30 dB attenuator: -27 dBm to -130 dBm.

Without the 30 dB attenuator: $+0$ dBm to -130 dBm.

Output Level Accuracy

With the 30 dB Attenuator

Within 2 MHz of calibration frequencies: $< \pm 1.8$ dB.

100 kHz to 990 MHz: $< \pm 1.5$ dB typical.

Option 112 or 122

Within 2 MHz of calibration frequencies: $< \pm 1.3$ dB.

10 kHz to 1000 MHz: $< \pm 1.1$ dB typical.

Output VSWR

With the 30 dB attenuator:

dc to 1000 MHz: ≤ 1.2 .

Modulation: refer to signal generator specifications.

Audio Measurements

Frequency range: refer to HP 8903B.

Voltage measurement range: 50 mV to 30V.

Voltage measurement accuracy: refer to HP 8903B.

Distortion measurement: refer to HP 8903B.

Audio Source

Frequency range: 20 Hz to 100 kHz.

Output voltage range: refer to HP 8903B.

Output voltage accuracy: refer to HP 8903B.

Current drain measurement range: 0 to 30A.

Current Drain Measurement Accuracy

$I < 10A$: $\pm (2.5\%$ of reading $+ 12$ mA).

$I > 10A$: $\pm (4\%$ of reading $+ 12$ mA).

Timing Measurements

Closure of relay to half RF power (Carrier Attack Time).

Application of an RF signal to 90% rated audio power (Receiver Attack Time).

Removal of an RF signal to squelch closure (Receiver Squelch Closing Time).

Timing accuracy: ± 5 msec typical.

Timing interval: 500 msec maximum

Timing resolution: 0.1 msec.

General Specifications

System operating temperature: 15° to 35° C.

System storage temperature: -40° to $+75^\circ$ C.

Ambient humidity: 5% to 80%.

Power: 115V, 60 Hz; Standard system less controller: Approximately 600 VA worse case.

Net weight (less controller): 150 kg (330 lb).

Shipping weight (less controller): 212 kg (467 lb).

Cabinet dimensions: 163 cm H x 53 cm W x 70 cm D (64.25" x 21.0" x 27.6").

TRANSCIVER TEST EQUIPMENT

RF Interfaces

Models 8954A, 8956A

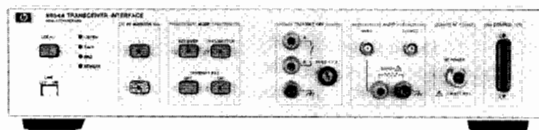

HP 8954A



HP 8954A Rear View

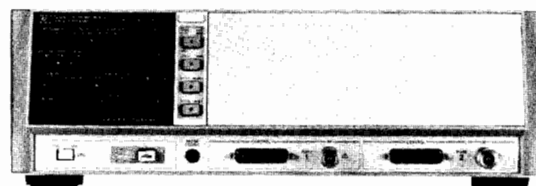

HP 8956A

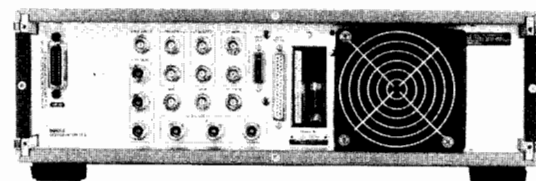

HP 8956A Rear View

HP 8954A Transceiver Interface

The HP 8954A is Hewlett-Packard's lowest priced transceiver test interface. It is fully programmable and designed for dc to 18 GHz measurement applications.

The HP 8954A interface has connections for the three measurement instruments; the HP 8901A or HP 8901B Modulation Analyzers, HP 8903B Audio Analyzer and HP 8656B Signal Generator. You can add a second signal generator, a second RF monitor such as a power meter or a spectrum analyzer, and route a power supply's output through the interface to the front panel transceiver connector. External devices may be controlled with the HP 8954A's sixteen programmable form-A contact relays.

Using the annunciator front panel keys, you can manually control the Receive/Transmit signal path, select either RF monitor, or key the transmitter. The HP 8954A Transceiver Interface provides the flexibility needed for most AM, FM and SSB receiver and transmitter testing.

8954A Specifications

RF frequency range: 100 kHz to 1300 MHz. (usable dc to 18 GHz.)

VSWR (RF Port to RF Monitor): ≤ 1.15

VSWR (RF Source to RF Port): ≤ 1.15

RF insertion loss: (RF Port to RF Monitor) ≤ 0.5 dB

RF insertion loss: (RF Source to RF Port) 6.0 dB +0.45 dB -0.35 dB

Audio frequency range: 20 Hz to 100 kHz. (dc coupled)

Audio insertion loss: 0.03 dB, 20 Hz to 20 kHz. 0.3 dB, 20 kHz to 100 kHz.

Supplemental Characteristics

DC Power Supply Circuit

Current: 30A (Voltage <28 Vdc)

Voltage: 50 Vdc (Current <15A)

Transmit Key Relay

Current: 1.5A (Voltage <28 Vdc)

Voltage: 50 Vdc (Current <0.5A)

Auxiliary Relays (16 Form-A contact)

Current: 0.5A (Voltage <20 Vdc)

Voltage: 50 Vdc (Current <0.2A)

HP-IB interface functions: SH1, AH1, T6, L4, SR1, RL1, PP0, DC1, DT0, C0 and E1.

Ordering Information

HP 8954A Transceiver Interface

\$3700

HP 8956A System Interface

The HP 8956A System Interface, with its multiple paths and connections, provides flexibility in the designing of systems in the frequency range from dc to 1000 MHz. It can integrate up to three signal generators, three RF measurement instruments, two audio sources, two audio measurement instruments and a dc power supply.

A front panel keyboard makes it easy to control all switching operations making it a valuable component in system integration. Store/Recall keys of the front panel settings give extra versatility in manual operation.

The HP 8956A System Interface has two RF test ports for duplex testing, stimulus/response testing or for connect/unconnect of one unit under test while another is being tested. Next to each RF port is a control connector that contains all the audio and power signals.

Other additional functions of the HP 8956A include current drain and timing measurements.

8956A Specifications

Frequency range: dc to 1000 MHz

Maximum Input Power to RF Ports

With the 30 dB attenuator: 120W CW

Without the 30 dB attenuator: 0.5W CW

VSWR

RF Ports: (Instrument connections terminated in 50 ohms):

With the 30 dB attenuator: dc to 1000 MHz: ≤ 1.2

Audio

Frequency Range: dc to 100 kHz

Supplemental Specifications

Insertion Loss

Maximum variation of insertion loss with frequency: <5 dB.

Insertion loss of major RF source and monitor paths with the attenuator inserted can be characterized by: $A(\text{dB}) = A_0 + k\sqrt{f}$ A_0 = Loss at dc, k = Constant, f = Frequency (MHz).

HP-IB interface functions: SH1, AH1, T6, L4, SR1, RL1, PP1, DC1, DT0, C0 and E2.

Ordering Information

HP 8956A System Interface

\$12,000

Option 001 Rear Panel RF and Control Ports

\$100

TRANSCEIVER TEST EQUIPMENT

Cellular Radio Test Equipment

Models 8957S, 8958A

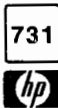

- Compatible with AMPS and TACS protocols
- Fully automatic operation
- Complete RF testing
- Over-the-air signalling simulation
- Up to six RF instruments - add a spectrum analyzer or signal generator for more complete measurements

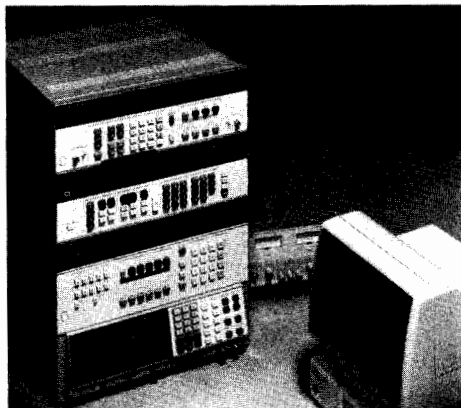

HP 8957S Cellular Radio Test System

The HP 8957S Cellular Radio Test System helps save time and money by improving productivity and quality. A fully-automatic test system, the HP 8957S is the flexible, cost-effective answer needed in the highly-competitive cellular radio marketplace.

Simplifies Workflow

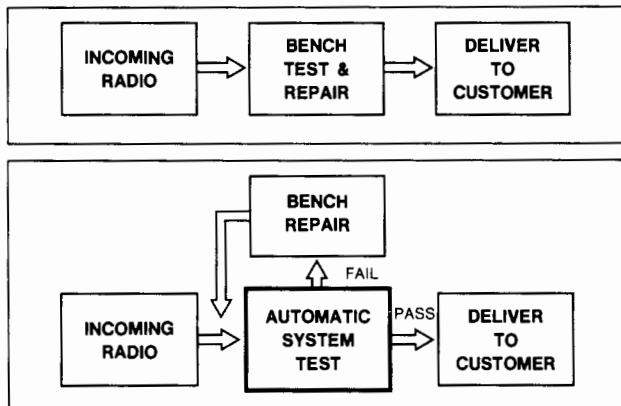

The top diagram shows a typical workflow using manual test equipment. In this case, a technician must manually test each radio and repair it if there is a problem. Then, he checks the radio again to verify that the fault was corrected. Because these tests are tedious and time-consuming, often only a cursory check is performed. In the second diagram, see the effect of an automatic test system. This system quickly and completely tests the radio. If a fault is found, the technician makes the necessary repairs and the system verifies proper operation. Often, the system quickly finds that an incoming radio is operating properly, saving valuable technician time.

Ensures Quality

An automatic test system can make a thorough test of every radio, helping to find latent problems. Its speed lets you make more measurements at more data points in less time than with manual testing. And, it follows the same exact procedure each time.

Improves Productivity

Time is saved with an automatic test system. This frees technicians for more productive work and allows for expansion to meet the growing demand for cellular products and services. Because it performs the tedious and repetitive tasks, the system helps to increase job satisfaction as well.

Maximizes Flexibility

With total control over the measurement parameters, you get the flexibility needed to optimize quality and productivity. The HP 8957S Cellular Radio Test System includes a wide selection of tests and you can easily modify or add to the test routines provided.

As your cellular business grows, you can add to your system. The HP 8958A Cellular Radio Interface includes connections for additional RF instrumentation, including extra signal generators and a spectrum analyzer—up to six RF instruments in all.

HP 8958A Cellular Radio Interface

The HP 8958A Cellular Radio Interface gives your system the features needed to fully test a cellular radio. With its Channel Simulator's flexible operating modes, you can simulate cell-site operation, verify signalling protocol, or even perform highly complex and sophisticated tests by using an external controller to generate and analyze data message content.

Audio and Power Switching and Control

The HP 8958A Cellular Radio Interface controls the audio and dc paths between the test instrumentation and the unit under test. These functions include the audio source and analyzer paths, dc power to the Transceiver Unit (TU) and Control Unit (CU), access to the audio test points in the Test Bus Interface, and a programmer for the TU/CU power supply.

Keys are also provided to control vehicle ignition simulation and the audio compander. With the built-in loudspeaker, you can listen to the baseband signals being generated or analyzed by the system Audio Analyzer.

Channel Simulator

The channel simulator, used with an RF signal generator and modulation analyzer, simulates a base station for over-the-air RF and signalling tests. Built-in test routines and utility functions greatly simplify protocol testing.

Built-in tests include placing and receiving a call and checking the signalling protocols of a handoff. To make these tests, you set the signal generator and modulation analyzer to fixed states. For more comprehensive testing, like that performed by the HP 8957S Cellular Radio Test System, you can use an external controller to generate and interpret the data message content. For example, with an external controller, you can make tests such as full hand-off testing, which require interaction between RF and signalling protocols.

Test Bus Interface

The test bus interface (provided on AMPS-standard cellular telephones) lets you test the internal operation of the transceiver unit (TU) and control unit (CU). You can also use the test bus interface to suspend normal operation and set the transceiver unit to fixed states, which simplifies RF testing.

RF Interconnection

The HP 8958A Cellular Radio Interface simplifies interconnection with its built-in RF combiner. Connections are provided for up to six signal generators and analyzers (one of these ports is a low-SWR, controlled-loss path intended for high-accuracy power measurements) and the antenna port of the radio being tested. Option 002 adds a second antenna connection and RF switch for diversity testing. Option 003 provides one 4-GHz, low-loss path for conducted spurious tests.

Ordering Information

The HP 8957S Cellular Radio Test System consists of an HP 8958A Cellular Radio Interface, HP 8901B Modulation Analyzer, HP 8903B Audio Analyzer, HP 8656B Signal Generator, HP 8482A Power Sensor, HP 6024A Power Supply, any optional instrumentation, a controller and peripherals, an HP 11797A Software/Documentation Package, and cables and accessories. For complete ordering information, see the "HP 8957S Cellular Radio Test System Ordering Information" guide or contact your HP sales office.

DIMENSIONAL MEASUREMENTS

Laser Measurement System

Model 5528A

- Improve production performance and parts quality
- Lower production costs



Magnetic disc research and development



The HP 5528A Laser Measurement System fundamentally measures distance. A patented two-frequency design uses a low power Helium-Neon laser to obtain resolutions up to 0.01 micrometre (1.0 microinch) — over distances up to 40 metres (130 feet). The same basic principles are used to measure pitch, yaw, flatness, straightness, squareness, parallelism and velocity.

This system offers a combination of accuracy, versatility and ease of use unmatched by any other system or method. Application examples are found everywhere:

- in R&D (positioning of magnetic disc heads)
- in fabrication (calibration of machine tools and coordinate measuring machines)
- in metrology (calibration of scales, gages and surface plates).

The laser makes an ideal standard for lab applications because it is unaffected by wear or aging. Its rugged construction and portability make it equally attractive for shop environments.

Metrology System

System capabilities are also enhanced by the addition of a personal computer and software. The HP 55288S Dimensional Metrology Analysis System automatically collects, analyzes and plots data from the HP 5528A system. Special features include statistical analysis (mean and standard deviation).

Hard copy output is available in several forms. Data can be printed and plotted on the HP 85B's thermal printer. Report quality plots can be made on the optional HP 7470A Graphics Plotter.

The time saved over manually recording and calculating the results is enormous. These savings are especially important to fabrication shops, where machine tool errors are quickly identified and downtime is kept to a minimum.

Modular Design

The basic system consists of the HP 5508A Measurement Display, the HP 5518A Laser Head and the HP 10753A Laser Tripod. System capabilities are determined by adding the optical components for the desired measurements. Optical components and their mounting fixtures are available in five convenient kits:

- Reduce calibration time
- Minimize maintenance downtime

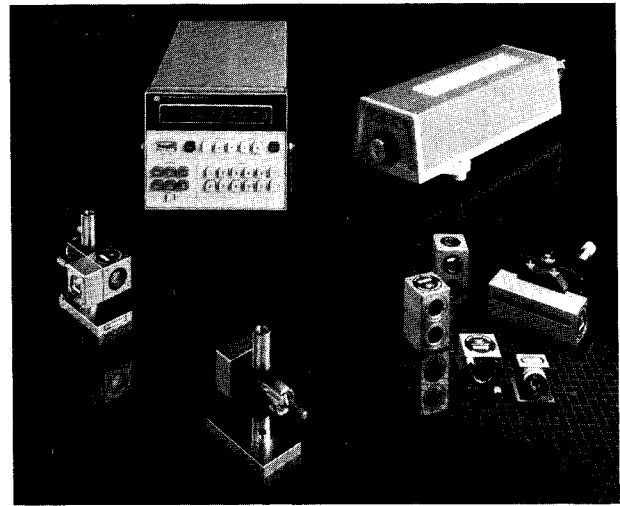

HP 5528A Laser Measurement System

- HP 55280A Linear Measurement Kit (distance and velocity)
- HP 55281A Angular Optics Kit (pitch and yaw)
- HP 55282A Flatness Accessory Kit (flatness)
- HP 55283A Straightness Measurement Kit (straightness and parallelism)
- HP 10777A Optical Square (squareness).

In this way, the HP 5528A system can be configured to meet the needs of the present while offering economical expansion in the future.

Manual or Automatic Compensation

The absolute accuracy of distance measurements depends on the velocity of light in air. This is a function of temperature, pressure and relative humidity. Manual compensation consists of measuring these conditions, finding a compensation factor in a set of tables, and entering this number into the HP 5508A Measurement Display.

Automatic compensation is provided by the HP 10751A Air Sensor. This multi-purpose probe monitors air conditions and automatically updates the compensation factor. Automatic compensation is essential for continuously changing environments.

Distance measurements are also affected by the thermal expansion of the measured object. Its temperature can be manually entered into the HP 5508A Measurement Display, or automatically monitored and updated by one to three HP 10757A Material Temperature Sensors.

Specifications

The following specifications are for distance measurements at 15-25 degrees Celsius. Please refer to the technical data sheet for complete specifications.

Accuracy: ± 0.1 part per million in a vacuum. ± 1.7 parts per million using the HP 10751A Air Sensor.

Resolution: $0.01 \mu\text{m}$ (1.0 μin).

Measurement Range: 40m (130 ft).

Measurement Velocity: 18.3 m/min (720 ft/min) maximum.

Display Update Rate: 40/second nominal.

Power: 100, 120, 220, 240 Vac (+5%, -10%), 48-66 Hz, 175 VA maximum.

Ordering Information

For complete specifications and ordering information, please contact any Hewlett-Packard Sales Office. System prices range from \$17,500 to \$49,500 depending on customer requirements.

DIMENSIONAL MEASUREMENTS

Laser Transducer System

Model 5501A

733



- An Industry Standard for Sub-Micron-Level Position Feedback
- High Precision Measurements

- Widespread Applications
- Proven Reliability

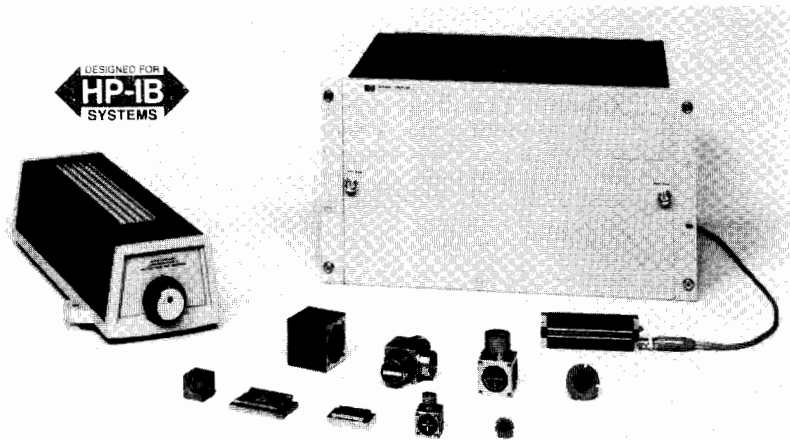

HP 5501A Laser Transducer System

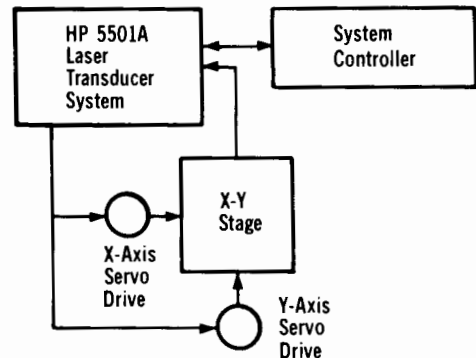

Block diagram of two-axis closed-loop system

The HP 5501A Laser Transducer System is a linear-displacement measuring system that delivers the accuracy of laser interferometry to builders and users of precision-positioning equipment. Customers can select from a variety of optics and electronics depending on application. This flexibility benefits both end users and original equipment manufacturers (OEMs). Applications can be found in three main areas:

- Integrated circuit manufacturing (wafer steppers, projection aligners, electron beam machines and reticle/mask inspection equipment)
- Disc manufacturing (magnetic and optical track writers)
- Precision machining (diamond turning and coordinate measuring machines).

Laser Source

The HP 5517A Laser Head is a new high-stability laser source for the HP 5501A Laser Transducer System. This new laser head features improved performance and reliability over the previous laser transducer head. The wavelength of light from the laser is used as the length standard for this transducer system. The HP 5517A Laser Head is accurate to 0.1 part per million and this accuracy remains in calibration indefinitely. With a single laser head, up to 4 axes of motion may be monitored simultaneously.

Optics

Three linear measurement techniques are available with the laser transducer, with one of three sets of optics:

- The HP 10702A Linear Interferometer and HP 10703A Linear Retroreflector are used in general applications.
- The HP 10705A Single Beam Interferometer and the HP 10704A Single Beam Retroreflector are used where space is severely limited, or for non-contact measurements.
- The HP 10706A Plane Mirror Interferometer is ideal for monitoring position of an x-y stage. It also provides twice the measurement resolution as the other interferometers and can be used for non-contact measurements.

Each axis requires an interferometer, a reflector and HP 10780A Receiver. Using the HP 10700A and HP 10701A Beam Splitters and the HP 10707A Beam Bender, a multiple axis system can be configured.

Electronics

All signal processing and interfacing are performed by a series of printed circuit boards housed in the HP 10740A Coupler Box. The modular structure of the electronics provides the flexibility to tailor the HP 5501A Laser Transducer System to a specific measurement control application.

Customers can choose one of several output formats from the system electronics:

1. Binary Interface Open-Loop Electronics—provides binary information of position data to digital processors and controllers.
2. HP-IB Interface Open-Loop Electronics—outputs position data for use with HP personal and desktop computers.
3. Closed-Loop Position Control Electronics—provides high-speed positioning feedback to closed-loop control systems.
4. English/Metric Output Electronics—provides microinch or micrometre pulses to machine tool numerical controllers.
5. Pulse Converter—provides TTL or A-Quad-B format pulses of quarter-wavelength value.

Compensation is provided by the HP 10756A Manual Compensation, or the HP 5510A Automatic Compensator and one to three HP 10563A Material Temperature Sensors. Other components include the HP 10783A Numeric Display and cables for measurement, reference and power.

Specifications

The following is a partial list of system specifications. Please refer to the technical data sheets for a complete list.

Laser: Helium-Neon. Continuous wave. Two-frequency. 1.0 mW output maximum.

Accuracy: ± 0.1 part per million in a vacuum.

Resolution: from 0.16 μm (6.0 $\mu\text{in.}$) to .005 μm (0.2 $\mu\text{in.}$) depending on electronics and optics being used.

Measurement Range: 40m (130 ft) maximum depending on system configuration and environment. Sum of axes for multi-axis system.

Axes: 4 maximum depending on system configuration and environment.

Measurement Velocity: 18.3 m/min. (720 in/min) maximum. The maximum measurement velocity depends on resolution extension and optics being used.

Maximum Data Transfer Rate: 700 Hz-300 kHz depending on number of axes, type of electronics and type of controller used.

Power: HP Model 63312F Power Supply is recommended for all configurations of HP 5501A Laser Transducer System.

Ordering Information: For complete ordering information, please contact any Hewlett-Packard Sales Office. System prices range from \$15,000 to \$45,000 depending on customer requirements.



PRESSURE & TEMPERATURE

Quartz Pressure Probe, Quartz Pressure Set, & Pressure Signal Processor

Models 2813C/D, 2816A

- 0.001 psi resolution (6,9 Pa)
- High performance

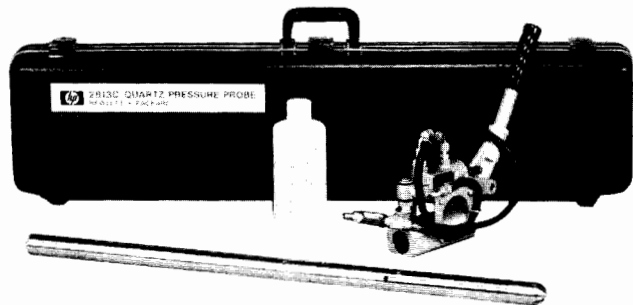

HP 2813C Quartz Pressure Probe

Introduction

The quartz technology that Hewlett-Packard first introduced to the oil- and gas-well industry in 1970 is still the standard for pressure measurement applications requiring extremely high accuracy, resolution and repeatability. These features, combined with its rugged construction, make the probe ideally suited for petroleum applications, oceanographic research and subterranean hydrodynamic studies.

High Precision, Resolution and Repeatability

Capable of sensing wellbore pressure changes as small as 0.001 psi, the probe's measurements can be instantly observed and recorded on the surface. With an accuracy better than ± 1.0 psi and $\pm 0.01\%$ of the pressure reading, the HP 2813C/D gives you confidence in the precision of your measurements. Also, with a repeatability of 0.4 psi over the full calibrated pressure range (200 - 11,000 psia) at constant temperature, you can be confident that changes in successive measurements are due to changes in the well, not probe measurement error.

Advanced Calibration Procedures

Advanced calibration procedures also contribute to the probe's high performance, with each probe being checked at 105 discrete calibration points over its full operating pressure and temperature range. The calibration data is processed by computer to yield coefficients of an equation that describe the relationship between frequency output, applied pressure and temperature.

Faster Thermal Restabilization

Based on the earlier Model HP 2813B, the HP 2813C thermally restabilizes two to five times faster than the HP 2813B. This improvement, due to a redesigned mechanical package, shortens costly test time.

Higher Temperature Range

Improvements in the sensor crystal's processing have increased the probe's temperature range from 302°F to 350°F.

Rugged and Reliable

Though a precision instrument, the HP 2813C is rugged and reliable in an oil field environment. Housed in a 1 $\frac{1}{8}$ inch OD case made of 17-4PH stainless steel, the probe can withstand pressures of up to 12,000 psia and temperatures of up to 350°F.

Easy to Use and Service

The simplicity of the HP 2813C's mechanical design makes it easy to use and service in the field.

Quick Factory Service

Your probe receives immediate attention when we receive it. An exchange set of the reference crystal, sensor crystal and electronics pc board is available, reducing repair time to one week. Standard recalibrations and repairs take four weeks or less.

- Rugged and reliable
- Simple operation



HP 2813D Quartz Pressure Set

Adapt to Your Own Instrumentation System

The reference crystal, sensor crystal and electronics pc board are available as matched components in the HP 2813D Quartz Pressure Set. This enables designing the essential pressure-measuring components of the HP 2813C into your own downhole instrumentation package.

How It Works

The essential pressure-measuring components of the HP 2813C Quartz Pressure Probe are its sensor crystal, reference crystal and electronics pc board. The sensor crystal, which is in direct fluid communication with the well, changes the frequency of its oscillations in response to pressure. The reference crystal, which is protected from applied pressure, subtracts the effects of temperature changes from the sensor crystal's frequency.

The resulting frequency is then transmitted by the electronics pc board through a center conductor, armored-electric line to an HP 2816A Signal Processor on the surface. This processor conditions the pressure-related signal to drive a frequency counter. The counter's signal can then be converted to a pressure reading when processed with the calibration data in a desktop computer.

The sensor crystal's high resolution is essentially constant and independent of operating pressure and temperature. Its stability minimizes hysteresis and zero drift, thus eliminating the need for frequent recalibration.

The HP 2816A Signal Processor

Specifically designed to process the pressure-related signal from the HP 2813C/D, this processor conditions the signal to drive a frequency counter. The processed output frequency changes about 105 Hz/psi, allowing a resolution of 0.001 psi. It also supplies dc operating power to the probe through a center conductor, armored-electric line.

HP 2813C/D Specifications

Operating Environment

Calibrated pressure range: 200-11,000 psi (1,38-75,8 MPa)

Calibrated temperature range: 95-350°F (35-177°C)

Static Measurement (pressure and temperature are constant)

Accuracy: $\pm [1.0$ psi (6,9 kPa) (due to curve fit error) + 0.01% of actual pressure (due to calibration system error)]

Repeatability: ± 1.0 psi (6,9 kPa) over the entire calibrated pressure and temperature range; or, ± 0.4 psi (2,76 kPa) over the entire calibrated pressure range with temperature held to a single value.

Aging: Error due to aging of sensor and reference crystal pair is typically less than ± 0.5 psi (3,45 kPa) per year.

Temperature uncertainty error: $(\Delta T) * (0.28$ psi + 0.02% of actual pressure in psi) for temperature in degrees F.

Resolution: 0.001 psi (6,9 Pa) when sampling for 1-second.

Sensitivity: 105 Hz/psi (15,2 Hz/kPa) nominal at output of HP 2816A Signal Processor. The HP 2816A multiplies the incoming signal from the HP 2813C/D by 72 as part of the signal processing.

Non-Operating Characteristics (HP 2813C)

Outside diameter: 1 $\frac{1}{8}$ " (37 mm)

Length: 34" (865 mm)

Weight: 11 lbs (5 kg)

Static Tensile Pull Strength: 7,000 lbs (3175 kg)

Steel Case Material: 17-4PH stainless steel, condition H1150

| | |
|--------------------------------|----------|
| HP 2813C Quartz Pressure Probe | \$20,900 |
| HP 2813D Quartz Pressure Set | 17,900 |
| HP 2816A Signal Processor | 2,100 |

PRESSURE & TEMPERATURE

Quartz Thermometer

Model 2804A



- $\pm 0.04^\circ\text{C}$ absolute accuracy
- 0.0001°C or 0.001°F resolution
- -80° to $+250^\circ\text{C}$ range
- Display of absolute or differential temperature
- Flexible HP-IB system interface
- Variable resolution analog output
- Easy ice-point or triple-point adjustment

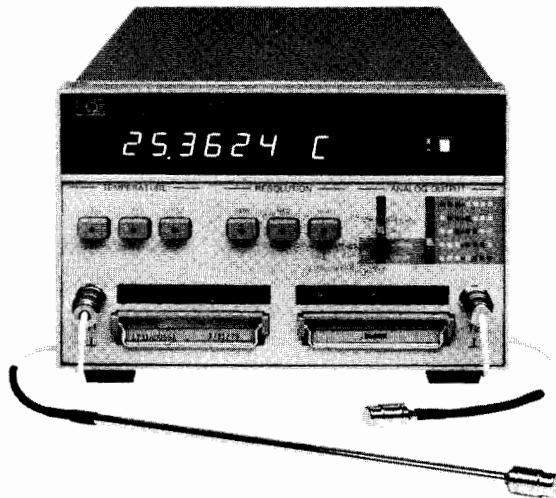

HP 2804A

The HP 2804A Quartz Thermometer allows you to easily measure temperature with exceptionally high accuracy and resolution. Absolute accuracy is ± 40 millidegrees Celsius over the range of -50°C to 150°C , NBS traceable to IPTS-68. The useable resolution of 0.0001°C allows you to measure temperature changes that could not be detected by other digital thermometers.

The HP 2804A can be used with one or two temperature sensing probes. The temperature of either probe, or their difference, can be measured and displayed under pushbutton control. Display resolution is selectable from 0.01 to 0.0001°C (0.1 to 0.001°F) by pushbuttons. An internal switch allows you to easily select measurement in the Celsius or Fahrenheit temperature scale.

Temperature is measured and displayed automatically with the microprocessor and electronics provided in the HP 2804A package. There is no need to balance a bridge, perform calculations using resistance- or voltage-temperature tables or curves, or to use calibration correction tables. The only adjustment necessary to remove effects of thermal history on the sensor is a simple ice point or triple point calibration adjustment using the front panel thumbwheel switches.

How It Works

The HP 2804A temperature sensor is a quartz crystal whose precise angle of cut gives a stable and repeatable relationship between resonant frequency and temperature. Each quartz sensor is individually calibrated at the factory over the full temperature range. The calibration data for each sensor is processed and stored in a calibration module which is supplied with the probe.

In operation, a microprocessor in the thermometer performs the complex control and calculation operations to accurately measure temperature from the quartz sensor frequency and probe calibration information in the calibration module. The microprocessor also performs self-checks to detect fault conditions. If a problem occurs that would give an improper measurement, an error message is displayed to indicate the source of the problem.

System Oriented Design

The HP-IB (standard) offers you a simple, yet flexible, way to connect the Quartz Thermometer to either an HP computing controller or printer. Temperature data can easily be sent to a computer for processing and recording. All front panel controls can be operated automatically by commands sent on the bus.

The analog output (standard) converts any three consecutive digits to a voltage between 0 and +10 volts to drive a chart recorder. Front panel controls allow easy adjustment of pen zero and full scale as well as normal or offset (center-zero) operation. Any three digits can be selected for conversion, allowing you to change the full scale value on the recorder.

HP 2804A Specifications

Performance

Range: -80 to 250°C .

Absolute accuracy: HP 2804A with HP 18110A, or HP 18111A Quartz Probe —

$\pm 0.040^\circ\text{C}$ from -50 to 150°C

$\pm 0.075^\circ\text{C}$ from -80 to 250°C

NBS traceable to IPTS-68

Resolution: three levels can be selected:

| Level of selection | Resolution | | Nominal time between readings in seconds | |
|--------------------|------------------|------------------|--|---------|
| | $^\circ\text{C}$ | $^\circ\text{F}$ | T1 or T2 | T1 - T2 |
| Low | 0.01 | 0.1 | 0.1 | 0.2 |
| Medium | 0.001 | 0.01 | 1 | 2 |
| High | 0.0001 | 0.001 | 10 | 20 |

General

Display: 7-digit LED with polarity, decimal, and degree C or F annunciator.

Probes: laboratory probes are available for use with the HP 2804A. Refer to the data sheet for specifications and sheath configurations.

Power Required

100, 120, 220, or 240 Vac, $\pm 5\%$ – 10% , 48 to 66 Hz, < 30 VA.

Accessories and Probes

| | |
|--|----------------|
| HP 18107A External Oscillator | Price \$400 |
| HP 18110A Laboratory Probe and cal module, 25 mm (1") | \$1750 |
| HP 18111A Laboratory Probe and cal module, 230 mm (9.1") | \$1750 |

HP 2804A Quartz Thermometer **\$4600**

ANALYTICAL INSTRUMENTS FOR CHEMISTRY

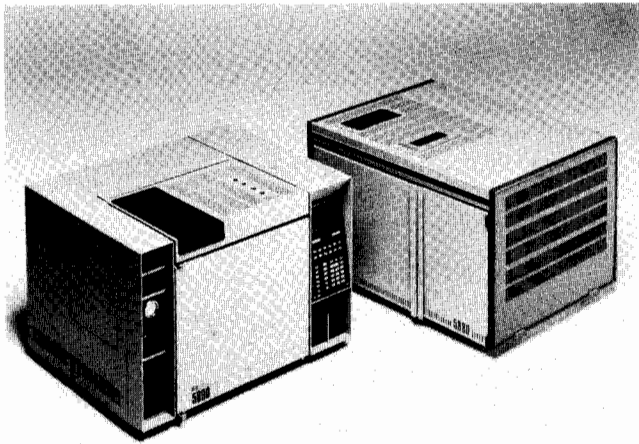

HP 5890A and HP 5880A Gas Chromatographs

Gas Chromatography Products. The HP 5880A GC offers the maximum in chromatographic and data handling capability. The HP 5890A GC is a high performance, low cost model, ideal for the routine laboratory. Enhancing these quality GC's are HP's single-user GC workstations with a wide variety of software relevant to chromatographer's needs. The new HP 19395A Headspace Sampler

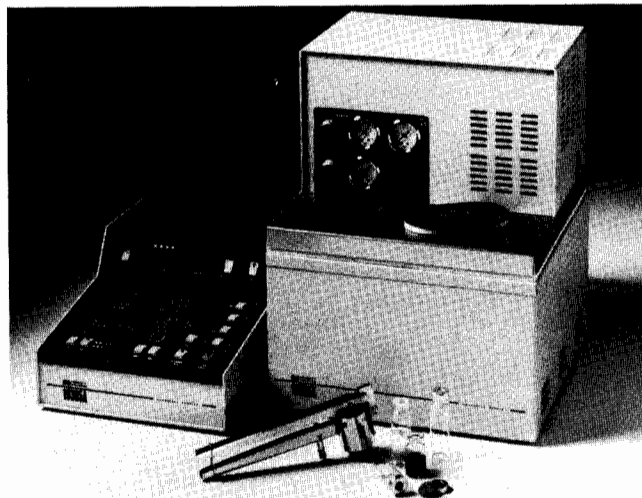

HP 19395A Headspace Sampler

offers the additional benefit of elimination of sample preparation for many GC analyses. The new HP 7673A automatic sampler sets new standards for injection and sample throughput. Also, available is a wide range of columns, detectors, including the powerful HP 5970B Mass Selective Detector, and a full line of consumables.

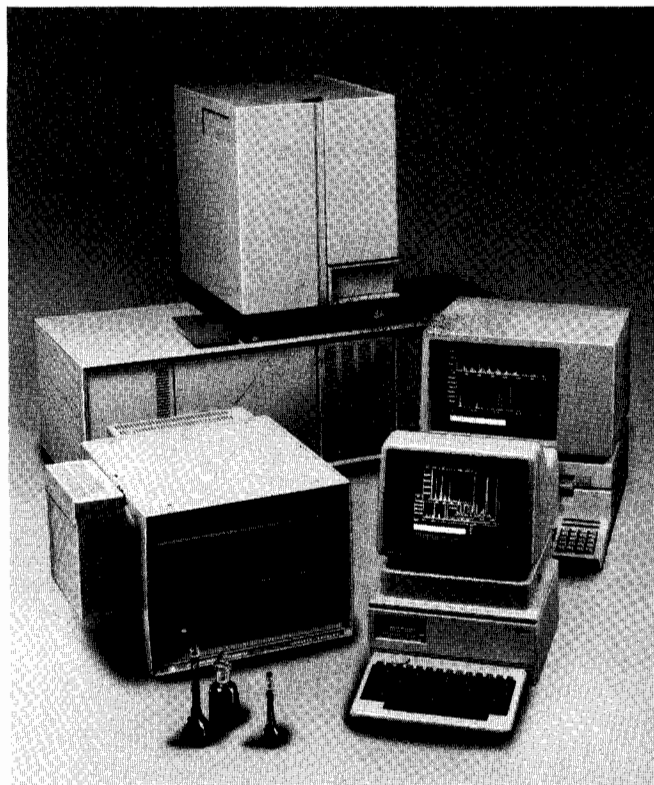

HP 5970 Mass Selective Detector (Front row)
HP 5995C Benchtop GC/MS (Back row)

Hewlett-Packard GC/MS products begin with the economical HP 5970B Mass Selective Detector, which can be used with most gas chromatographs. The HP 5995C GC/MS system offers many big-system features in a compact benchtop unit. The HP 5988A

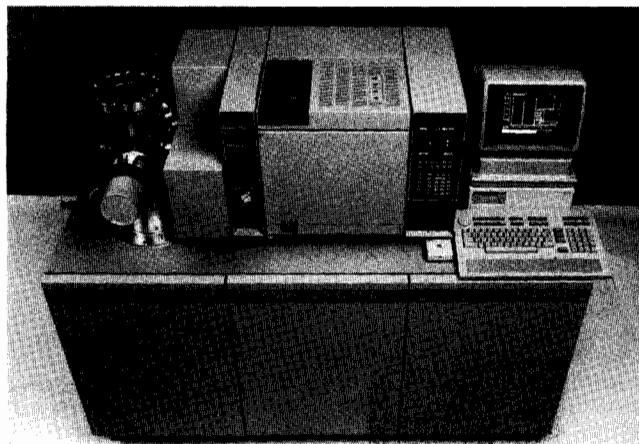

HP 5988A GC/Mass Spectrometer

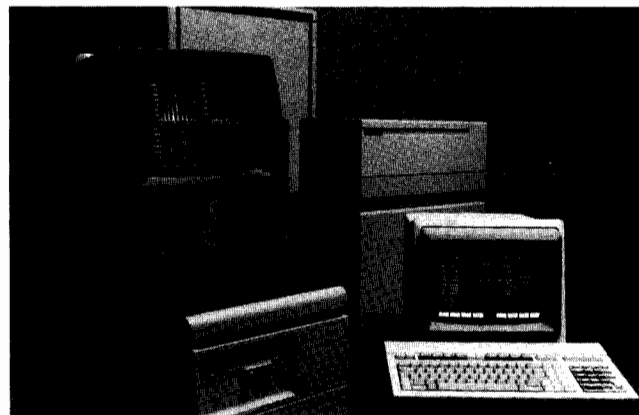

HP 1000 RTE-6/VM Data System

GC/MS system is HP's most versatile and capable GC/MS and LC/MS system. The HP 5970B, HP 5995C, and HP 5988A are all offered with either HP's single-user workstations for ease of control, automation and data handling or with the multi-user, multi-tasking, multi-instrument HP 1000 RTE-6/VM data system.

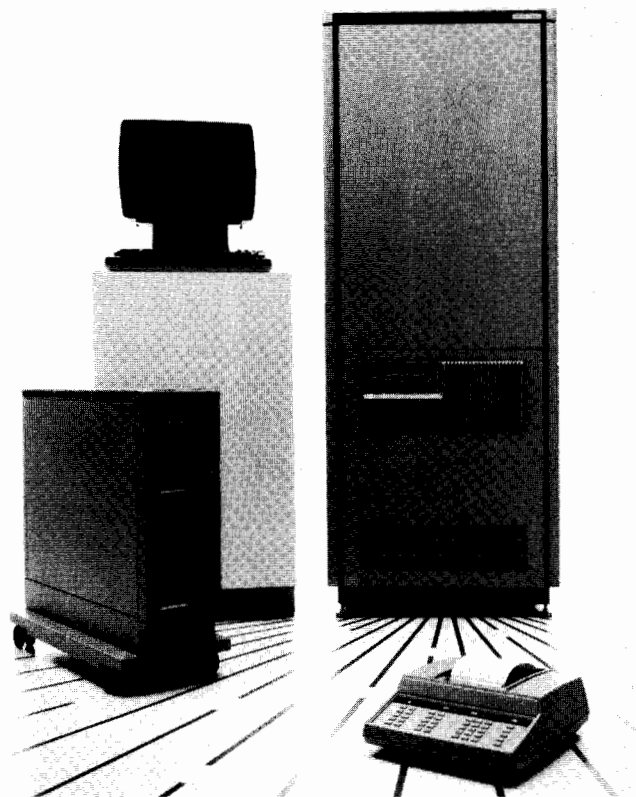

HP 3550A Lab Automation Systems Function in Analytical Networks.

Laboratory Automation Systems. Whatever size your laboratory, HP integrators, workstations, and systems for laboratory automation and information management can help you increase productivity. HP 3350A Systems with LABSAM and LABQUEST software can increase throughput by automating your analytical procedures, providing data reduction, and managing the flow of samples, information, and materials throughout the lab. The HP 3362A/B single-user GC, and LC workstations offers powerful data acquisition and software routines for the chromatographer. The HP 3390 series integrators offer smaller labs the first economical step in integration and instrument control, as well as communication with HP 3350 Systems and other large computers.

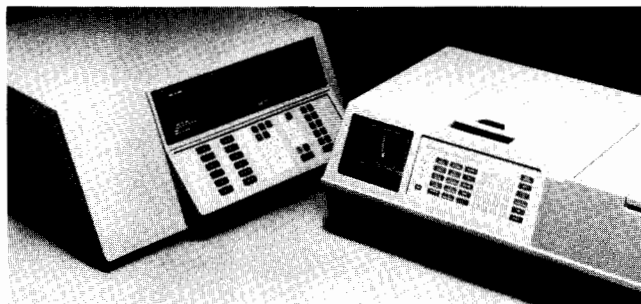

HP 8450A and HP 8451A Diode Array Spectrophotometer

Diode Array Spectrophotometers. These powerful computer-controlled UV/VIS instruments utilize diode array technology to greatly speed complex analyses. They measure and display in *seconds*: multi-component analyses, a full spectrum, and lists of analysis conditions and concentration. Choose the more powerful HP 8450A, or the new HP 8451A with built-in printer/plotter and optional alphanumeric keyboard. A new automated dissolution testing system for drug companies is available using either the HP 8450A or HP 8451A.

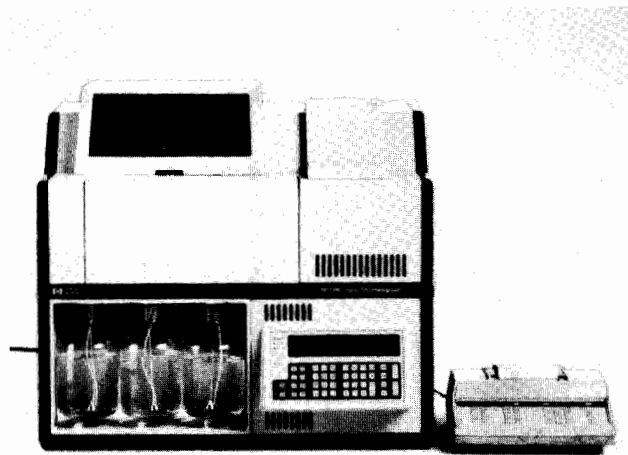

HP 1090 Series L Liquid Chromatographs

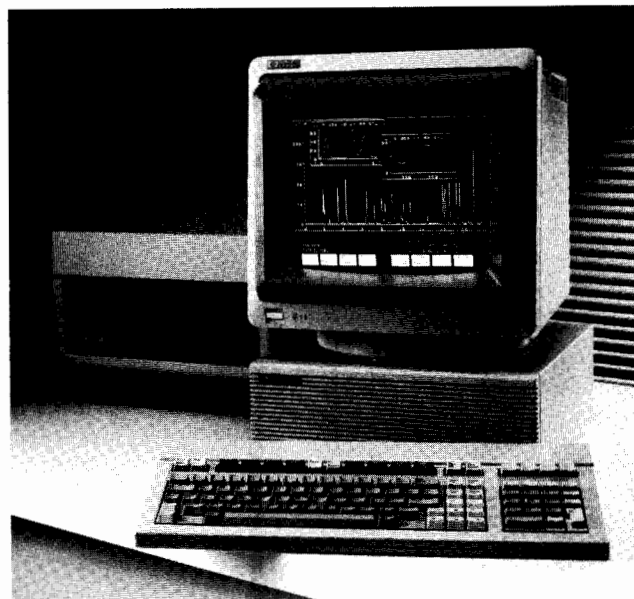

HP 1040M Diode Array Detector for HPLC

Liquid Chromatography Products

For a cost-effective solution to your application problems, the HP 1090 Series L High Performance Liquid Chromatograph is available in a range of configurations, is easy-to-use and fits nicely into any data-handling environment. For highest versatility, choose the HP 1090 Series M systems with advanced diode array detection and new LC workstation with software for total system control, automation and interactive data evaluation. Also available are a range of columns, consumables and stand-alone HPLC detectors, including the powerful HP 1040 diode array detector and the new HP 1046A programmable fluorescence detector.

For further information on Hewlett-Packard instruments and computers for chemical analysis, call your local HP office listed in the white pages of your telephone directory and ask for an analytical representative. Or write: Hewlett-Packard Analytical Group, 1820 Embarcadero Road, Palo Alto, CA 94303.

SOLID STATE DEVICES

Components

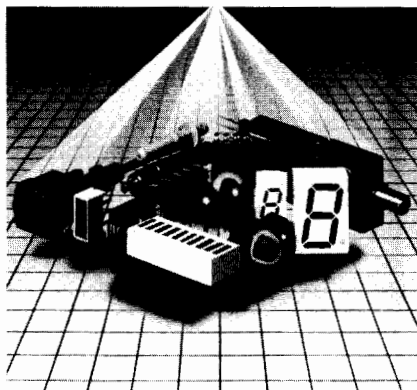

HP's Growing Optoelectronic Family

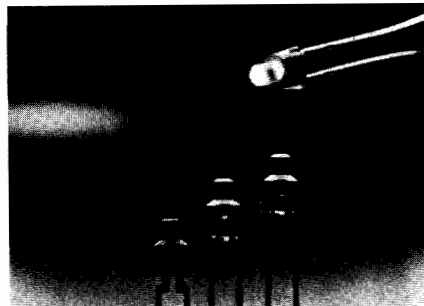

LED Lamps

LED Solid State Lamps, Light Bars & Arrays

Hewlett-Packard is a world leader in the area of LED technology, and offers a broad variety of LED indicator products available in red, high efficiency red, yellow and high performance green. Emphasizing high brightness and superior reliability, Hewlett-Packard's most recent product introductions include a family of high-performance green indicators, ultrabright LED lamps (125 mod at 20mA), and LED bar graph arrays of 10- and 101-elements. Recent advancements in the fundamental semiconductor material have generated new areas of contribution, particularly in sunlight viewability, low power consumption, and brightness.

Solid State Displays

Hewlett-Packard offers a complete line of seven-segment displays in red, high efficiency red, yellow and high performance green and in a wide variety of package sizes. The newest member is the micro-bright display which has a 0.3-inch character height in a 0.5-inch by 0.3-inch package.

LED alphanumeric displays in monolithic and dot matrix versions are also available. Some of these rugged displays are screened and tested for use in military applications and harsh environments.

The aesthetic appearance and reliable performance of LED displays make them appropriate for use in instruments, point-of-sale,

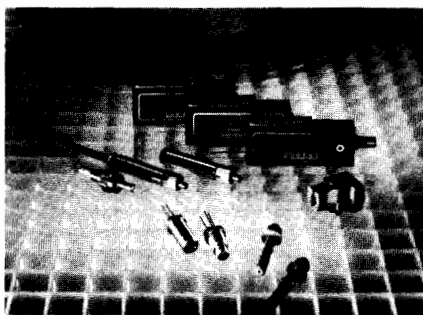

Fiber Optic Family

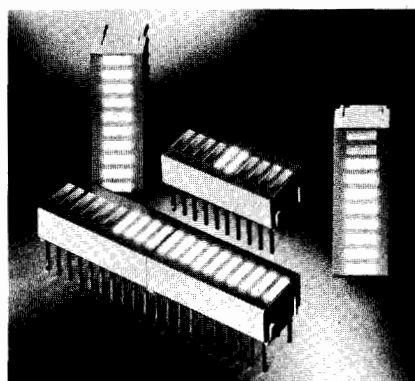

Light Bars

appliance, automobile, telephone and other high-ambient light front-panel displays.

Optocouplers

Hewlett-Packard's family of logic compatible, high-performance optocouplers provides solutions to problems caused by ground loops and induced common mode noise for both analog and digital applications in commercial, industrial and military products.

Types of optocouplers available include high-speed and high-gain devices ac/dc to logic interface optocouplers, and optocouplers which interface directly with microprocessors.

Fiber Optic Components

Hewlett-Packard offers three families of fiber optic components which include transmitters, receivers, cable, connectors and connector assembly tools.

Plastic Snap-In Link Components

Low cost and ease of use make this family of link components well-suited for applications connecting computers to terminals, printers, plotters and industrial-control equipment. These links use rugged, 1 millimetre diameter plastic fiber cable. Assembling the plastic snap-in connectors onto the cable is extremely easy. The HFBR-0500 evaluation kit contains a complete working link including transmitter, receiver, 5 metres of connected cable, extra connectors, polishing kit and technical literature.

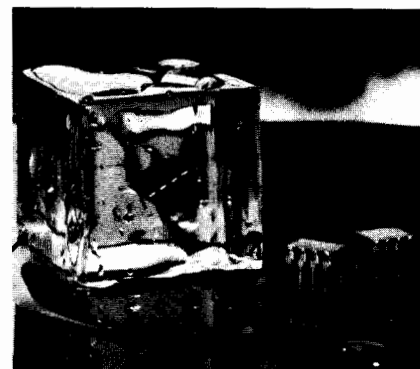

Hermetic Optocouplers

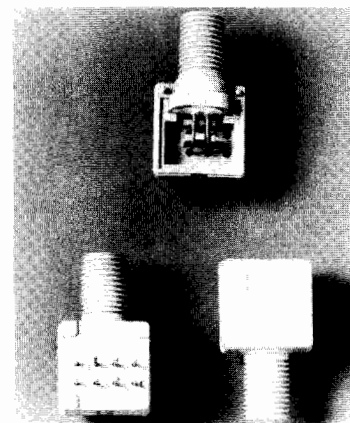

Low-Price Miniature Fiber Optic Components

Miniature Link Components

This family offers a wide range of price/performance choices for computer, industrial-control and military applications. The unique design of the lensed optical coupling system makes this family of components very reliable. The low cost miniature line (HFBR-0400 series) features a Dual-in-line package which requires no mounting hardware or receptacle for use with SMA-style connectors. The standard miniature line (HFBR-0200 series) features a precision metal package for rugged applications. Both HP-style and SMA-style connectors are available for this line. An evaluation kit is available for sampling purposes. The HFBR-0200 kit contains transmitter, receiver, 10 metres of cable and technical literature.

High Performance Modules

Transparent TTL-TTL link capability and independence from data format restrictions make this family of modules easy to use in a variety of applications. A link monitor on the receiver provides a digital indication of link continuity, independent of the presence of data. The modules are compatible with HP-style connectors and small-diameter glass fiber cable. A transmitter, receiver, 10 metres of connected cable and technical literature are contained in the HFBR-0010 evaluation kit.

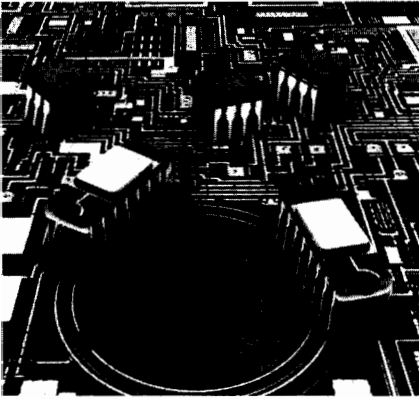

High Performance Optocouplers

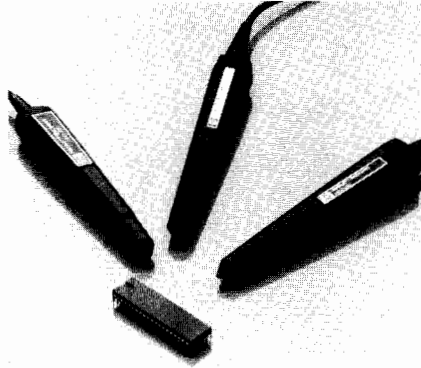

Bar Code Components

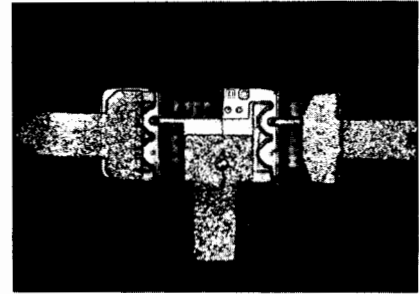

Schottky Beam Lead Pair

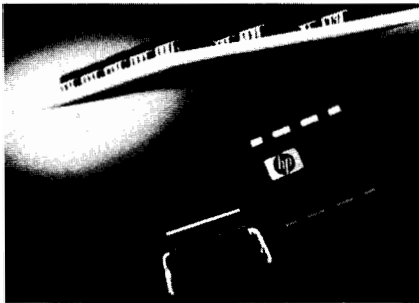

Surface Mount Optocouplers

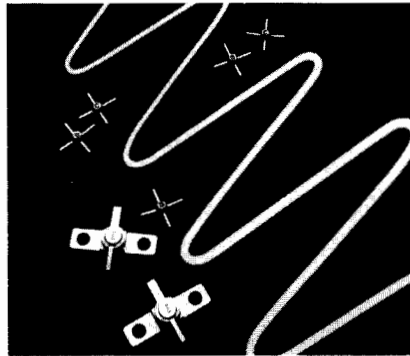

Bipolar Transistors

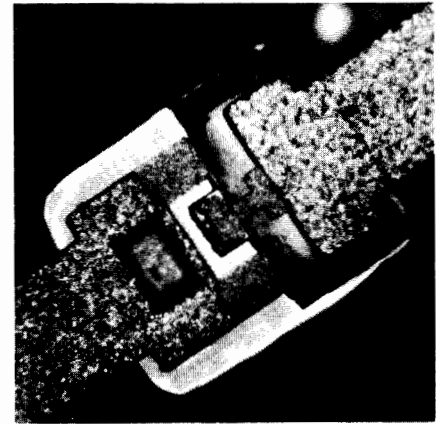

Beam Lead Single

Silicon Bipolar Transistors

Device-to-device uniformity and superior performance are combined in the HXTR series of microwave transistors which have been individually designed for low noise (HXTR-6000 series), high gain (HXTR-2000 series), low distortion linear power (HXTR-5000 series). With guaranteed RF performance specifications from 1000 to 4000 MHz, these devices are well suited for high-reliability, space military, and industrial applications at frequencies up to 6000 MHz.

Diodes

Schottky Barrier Diodes combine extremely high rectification efficiency with picosecond switching speeds, low series resistance, and low noise characteristics. This combination makes the Schottky an excellent mixer/detector diode.

Pin Diodes: Pin diodes function as variable resistors at microwave frequencies. By controlling the dc bias, the RF resistance of a PIN diode can be varied from 1 ohm to about 10 ohms. This property of the PIN diode

makes it extremely useful as a switch attenuator, modulator, phase shifter, limiter or AGC element at all frequencies from 1 MHz to 18 GHz and above.

Step Recovery Diodes: The step recovery diode is most graphically described as a charge-controlled switch. That is, a forward bias stores charge, a reverse bias depletes this stored charge, and when fully depleted the SRD ceases to conduct current.

Diodes for Hybrid Integrated Circuits: These circuits are used to achieve circuits with light weight, small size, operation to high frequencies, repeatable characteristics and lower end-product costs. HP offers a wide range of PIN, Schottky and SRD single diodes in beam lead and chip configurations as well as Schottky lead pair and quad diodes.

Integrated Products: Hewlett-Packard manufactures a broad line of components for the control, conversion, and generation of RF and microwave signals. This line of integrated products (combinations of chip and beam lead diodes with hybrid thin film circuit technology) includes SPST switches, absorptive

modulators, attenuators, limiters, comb generators, double-balanced mixers, and mixer/detectors.

High Reliability Testing

Many Hewlett-Packard components are space qualified. The reliability of these devices is established by one of the finest high reliability testing facilities in the microwave component industry. Hewlett-Packard's High Reliability Test Group maintains military approved JAN and JANTX parts in stock and can recommend HP standard screening programs, patterned after MIL-S-19500, for any HP component.

Write For More Information

Specifications of Hewlett-Packard's component products are available in individual data sheets or complete designer catalogs. These are available free of charge from your local HP sales office or authorized distributor, or return the Information Request Card located at the back of this catalog.

MEDICAL INSTRUMENTATION

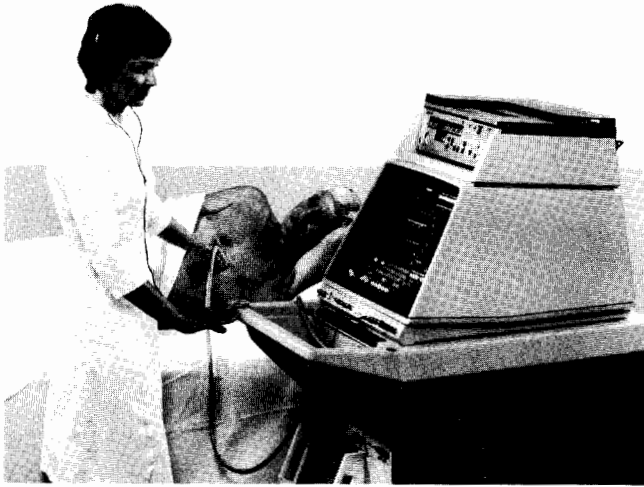

Ultrasound Imaging

- Real-time phased array systems
- HP 77020AC system configured specifically for the cardiologist—totally mobile—VCR and strip chart - Doppler option
- HP 77020AR system configured specifically for economical abdominal, obstetrical and pelvic imaging - Doppler option
- Small lightweight transducers

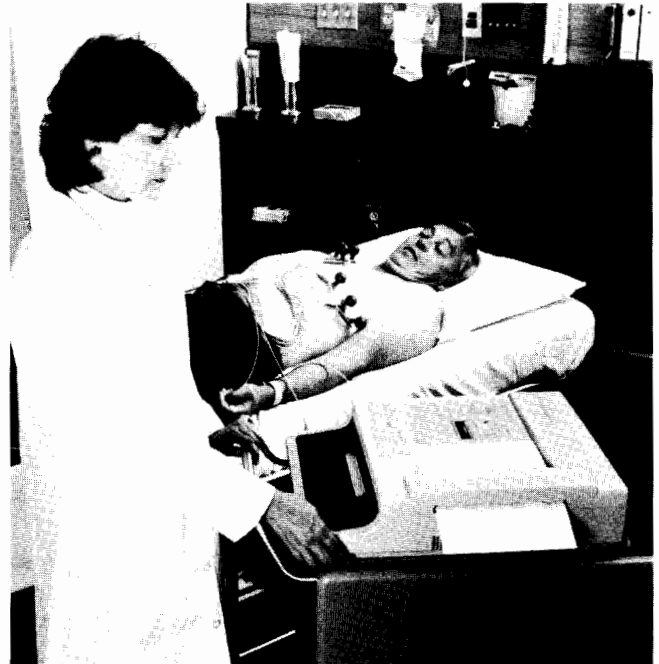

Cardiology Instrumentation

- New HP 4760A1 PageWriter Interpretive Cardiograph
- ECG Management Systems for computer-aided interpretation of electrocardiograms

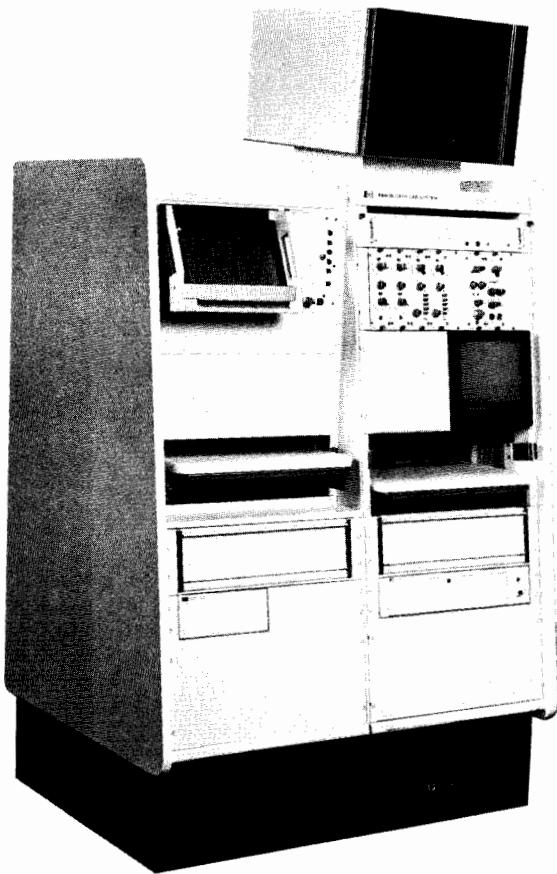

Cardiovascular Instrumentation

- Computerized catheterization data analysis system automates on-line data collection analysis
- Complete choice of plug-in signal conditioners and transducers



Obstetrical and Neonatal Instrumentation

- Fetal/maternal monitoring equipment includes antepartum and intrapartum fetal monitors, and central stations
- Telemetry for birthing centers
- Neonatal monitoring includes heart rate, temperature, respiration, ambient oxygen



Arrhythmia Monitoring

- Detection and classification by algorithm
- Advanced information management capabilities

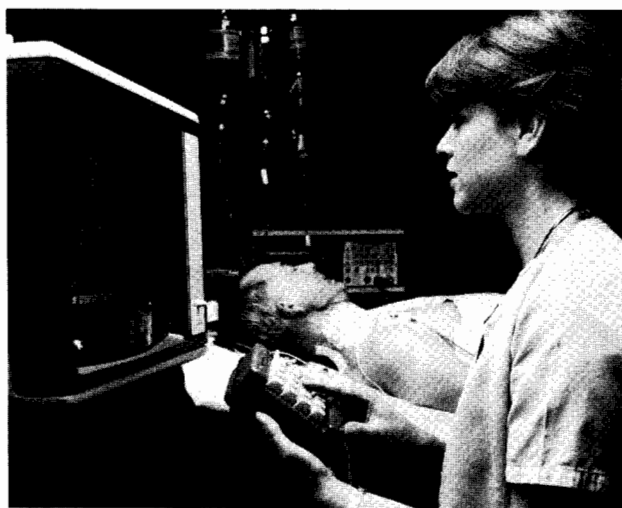

Patient Data Management

- Rapid access to progress notes, vital signs, intake/output, lab data and trends
- Organization and calculating data

Resuscitation

- Easy to use - 3 step operation
- Five Year guarantee
- Lightweight - 23 lbs.
- Low Cost
- Video training tapes

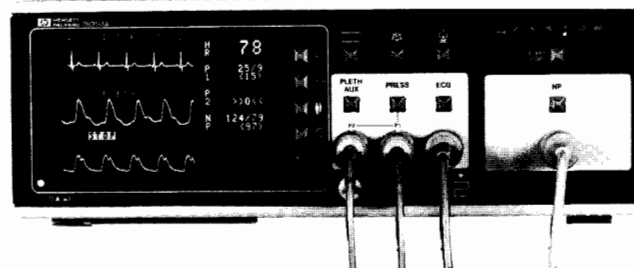

Patient Monitoring

- Monitor/Terminal with Overview feature
- Patient Information Centers
- Telemetry

OR Monitoring

- New microprocessor-based monitor with full networking capability
- Configurable over 7 parameters plus non-invasive blood pressure option

For Additional Information on HP Medical instrumentation, request literature in one or more of the following categories:

- Patient Monitoring
 - Ultrasound Imaging
 - Cardiography Instrumentation
 - Cardiovascular Instrumentation
 - Obstetrical and Neonatal Instrumentation
 - Arrhythmia Monitoring
 - Patient Data Management
 - OR Monitoring
 - Resuscitation
 - Healthcare Information Systems
 - Healthcare Personal Computers
 - Supplies, Consumables, Pressure Transducers
- Please use request card at back of catalog.

An Invitation for you to become a subscriber to **ADVANCES FOR MEDICINE**, the Hewlett-Packard medical products magazine. To receive **ADVANCES** free of charge, simply fill in and return the request card at the back of this catalog.

CABLES & ADAPTERS

Cables, Adapters & Typical SWR Performance

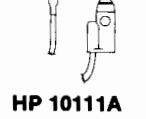
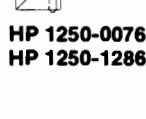
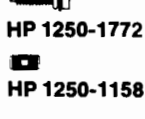
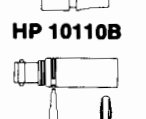
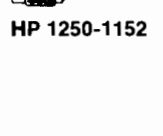
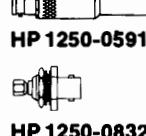
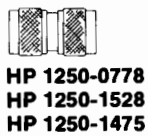
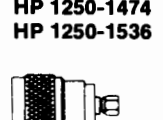
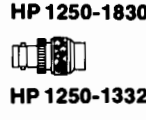
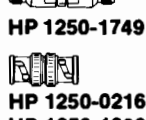
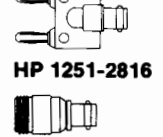
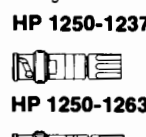
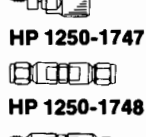
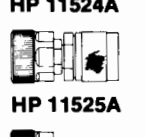
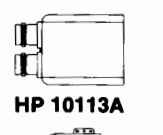
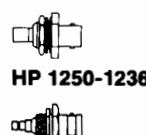
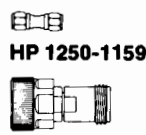
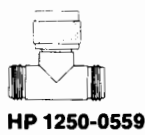
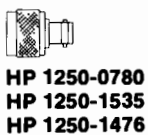
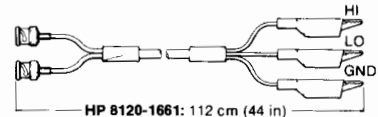
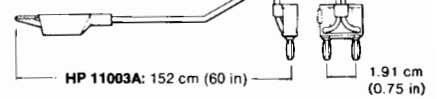
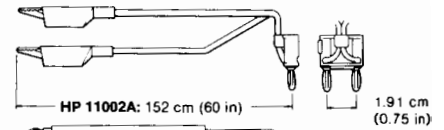
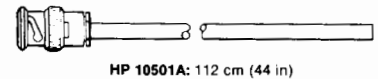
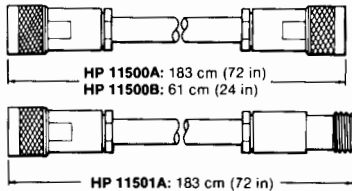
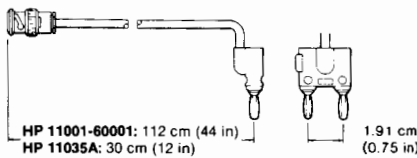
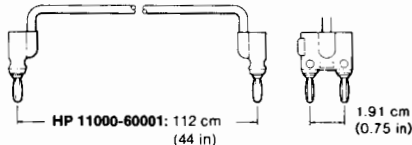
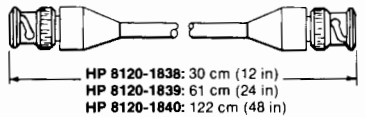
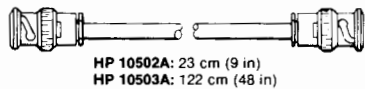

Coaxial Connector & Adapter Performance

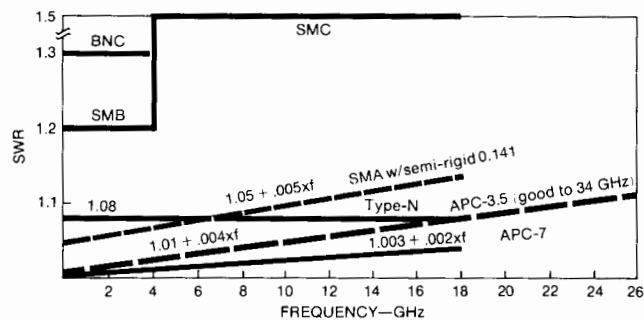

Typical SWR for connector pairs.

The performance curves in the graph will help you in choosing and applying HP cables, connectors and adapters. SWR curves show design specifications for mated pairs of connectors of the type indicated. You can expect typical performance in that range.

For cross-series adapters, use the curve with the highest SWR in each case. For applications of Tee-adapters such as HP 1250-0559, 1250-0846 and 1250-0781, be sure to consider the extra shunt capacitance of the Tee.

Of course when HP mounts various connectors onto RF and microwave products, the product specification predominates and SWR is often far superior to that shown in these utility curves. For example, the HP "precision" Type-N adapters shown on these pages are for high accuracy use dc-1.3 GHz where SWR < 1.03.

For more information on history and performance of various coax connectors, see pages 90-91 in HP's *Coaxial & Waveguide Measurement Accessories Catalog*. (Lit # 5952-8262).



| HP Part Number | Price | HP Part Number | Price |
|--|----------|----------------|-------|
| Cable Assemblies | | | |
| HP 10501A: 112 cm 50Ω coax with one UG-88C/U BNC (m) connector | \$13.00 | | |
| HP 10502A: 23 cm 50Ω coax with UG-88C/U BNC (m) connectors | \$18.00 | | |
| HP 10503A: like HP 10503A, but 122 cm | \$18.00 | | |
| HP 8120-1838: 30 cm 50Ω coax with two BNC (m) connectors | \$19.50 | | |
| HP 8120-1839: like HP 8120-1838, but 61 cm | \$20.00 | | |
| HP 8120-1840: like HP 8120-1838, but 122 cm | \$23.50 | | |
| HP 11000-60001: 112 cm 50Ω coax with dual banana plugs | \$29.00 | | |
| HP 11001-60001: 112 cm 50Ω coax, UG-88C/U BNC (m) to dual banana plug | \$26.00 | | |
| HP 11035A: like HP 11001-60001, but 30 cm | \$20.00 | | |
| HP 11500A: 183 cm 50Ω coax with UG-21D/U Type N (m) connectors | \$100.00 | | |
| HP 11500B: like HP 11500A, but 61 cm | \$100.00 | | |
| HP 11501A: 183 cm 50Ω coax with UG-21D/U (m) and UG-23D (f) type N connectors | \$100.00 | | |
| HP 11002A Test Leads: 152 cm, alligator clips to dual banana plug | \$20.00 | | |
| HP 11003A Test Leads: 152 cm, probe and alligator clip to dual banana plug | \$20.00 | | |
| HP 8120-1661: 112 cm, dual BNC (m) to alligator clips | \$90.00 | | |
| Adapters Type N, Standard 50 Ω | | | |
| 1250-0077 N(f) to BNC(m) | \$12.00 | | |
| 1250-0082 N(m) to BNC(m) | \$13.50 | | |
| 1250-0176 N(m) to N(f) right angle (use below 12 GHz) | \$55.00 | | |
| 1250-0559 N tee, (m)(f)(f) | \$38.00 | | |
| 1250-0777 N(f) to N(f) | \$12.00 | | |
| 1250-0778 N(m) to N(m) | \$11.00 | | |
| 1250-0780 N(m) to BNC(f) | \$14.50 | | |
| 1250-0846 N tee (f)(f)(f) | \$17.00 | | |
| 1250-1250 N(m) to SMA(f) | \$42.00 | | |
| 1250-1562 N(f) to SMA(m) | \$50.00 | | |
| 1250-1636 N(m) to SMA(m) | \$145.00 | | |
| 1250-1772 N(f) to SMA(f) | \$67.50 | | |
| Adapters Type N, Precision 50 Ω^[1] | | | |
| 1250-1472 N(f) to N(f) | \$27.00 | | |
| 1250-1473 N(m) to BNC(m) | \$28.00 | | |
| 1250-1474 N(f) to BNC(f) | \$18.50 | | |
| 1250-1475 N(m) to N(m) | \$42.00 | | |
| 1250-1476 N(m) to BNC(f) | \$24.50 | | |
| 1250-1477 N(f) to BNC(m) | \$23.50 | | |
| Adapters Type N, Standard 75 Ω^[2] | | | |
| 1250-0597 N(m) (50Ω) to N(f)(75Ω) | \$15.50 | | |
| 1250-1528 N(m) to N(m) | \$44.00 | | |
| 1250-1529 N(f) to N(f) | \$28.00 | | |
| 1250-1533 N(m) to BNC(m) | \$29.00 | | |
| 1250-1534 N(f) to BNC(m) | \$22.00 | | |
| 1250-1535 N(m) to BNC(f) | \$26.00 | | |
| 1250-1536 N(f) to BNC(f) | \$19.00 | | |
| Adapters APC-3.5 | | | |
| 1250-1743 APC-3.5(m) to N(m) | \$100.00 | | |
| 1250-1744 APC-3.5(f) to N(m) | \$160.00 | | |
| 1250-1745 APC-3.5(f) to N(f) | \$115.00 | | |
| 1250-1746 APC-3.5(m) to APC-7 | \$160.00 | | |
| 1250-1747 APC-3.5(f) to APC-7 | \$180.00 | | |
| 1250-1748 APC-3.5(m) to APC-3.5(m) | \$145.00 | | |
| 1250-1749 APC-3.5(f) to APC-3.5(f) | \$175.00 | | |
| 1250-1750 APC-3.5(m) to N(f) | \$135.00 | | |
| Adapters SMA | | | |
| 1250-1158 SMA(f) to SMA(f) | \$13.50 | | |
| 1250-1159 SMA(m) to SMA(m) | \$16.50 | | |
| Adapters APC-7[®] | | | |
| 11524A APC-7 to N(f) | \$160.00 | | |
| 11525A APC-7 to N(m) | \$160.00 | | |
| 11533A APC-7 to SMA (m) | \$225.00 | | |
| 11534A APC-7 to SMA (f) | \$225.00 | | |
| Adapter Banana Plug | | | |
| 1251-2816 Dual banana plug | \$5.50 | | |
| Adapters BNC, Standard 50 Ω | | | |
| 1250-0069 BNC(m) to UHF(f) | \$23.00 | | |
| 1250-0071 BNC(f) to UHF(m) | \$11.00 | | |
| 1250-0076 Right angle BNC(UG-306/D) | \$9.75 | | |
| 1250-0080 BNC(f) to BNC(f) (UG-914/U) | \$6.00 | | |
| 1250-0216 BNC(m) to BNC(m) | \$9.50 | | |
| 1250-0591 BNC(f) to WECO Video (m) | \$30.00 | | |
| 1250-0595 BNC(f) to BNC Triaxial (m) | \$15.00 | | |
| 1250-0781 BNC tee(m)(f)(f) | \$11.00 | | |
| 1250-1263 BNC(m) to single banana plug | \$16.50 | | |
| 1250-1264 BNC(m) to dual banana plug | \$27.00 | | |
| 1250-1332 BNC (f) to TNC (m) | \$28.00 | | |
| 1250-1830 BNC (f) to BNC Triaxial (f) | \$70.00 | | |
| 1251-2277 BNC(f) to dual banana plug | \$12.00 | | |
| 10110B BNC(m) to dual banana plug | \$77.00 | | |
| 10111A BNC(f) to shielded banana plug | \$40.00 | | |
| 10113A Dual BNC(f) to triple banana plug | \$35.00 | | |
| Adapters BNC, Standard 75 Ω^[3] | | | |
| 1250-1286 Right angle BNC | \$15.00 | | |
| 1250-1287 BNC(f) to BNC(f) | \$7.50 | | |
| 1250-1288 BNC(m) to BNC(m) | \$11.00 | | |
| Adapters SMB, SMC^[4] | | | |
| 1250-0831 SMC(m) to BNC(m) | \$26.00 | | |
| 1250-0832 SMC(f) to BNC(f) | \$30.00 | | |
| 1250-1023 SMC(m) to N(m) | \$35.00 | | |
| 1250-1152 SMC(f) to N(m) | \$52.50 | | |
| 1250-1153 SMC(f) to N(f) | \$57.50 | | |
| 1250-1236 SMB(f) to BNC(f) | \$32.00 | | |
| 1250-1237 SMB(m) to BNC(f) | \$32.00 | | |

[1] "Precision": typically ≥36 dB return loss to 1.3 GHz.

[2] Type N outer conductor; center pin sized for 75 Ω characteristic.

[3] BNC outer conductor; center pin sized for 75 Ω characteristic.

[4] SMB & SMC are used often inside HP instruments for inter-module connections.

SMB is Snap-on configuration

SMC is Screw-on configuration

CABINET ACCESSORIES

System II—Handles and Rack Flanges, Bail Handle Kit

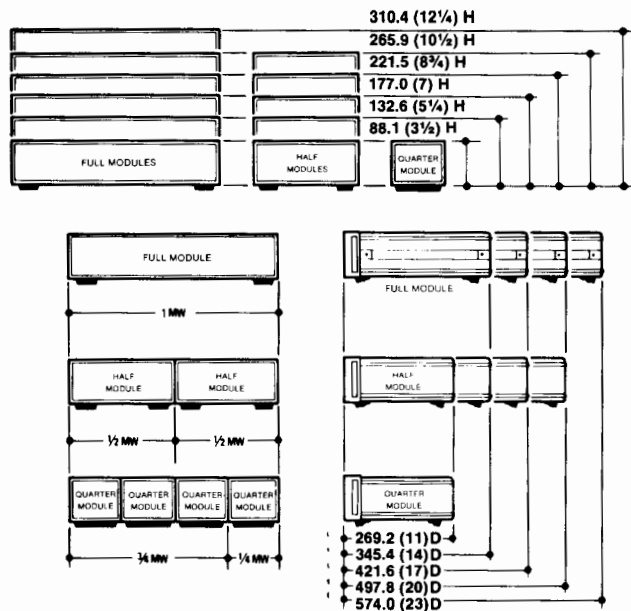

System II Cabinet Design

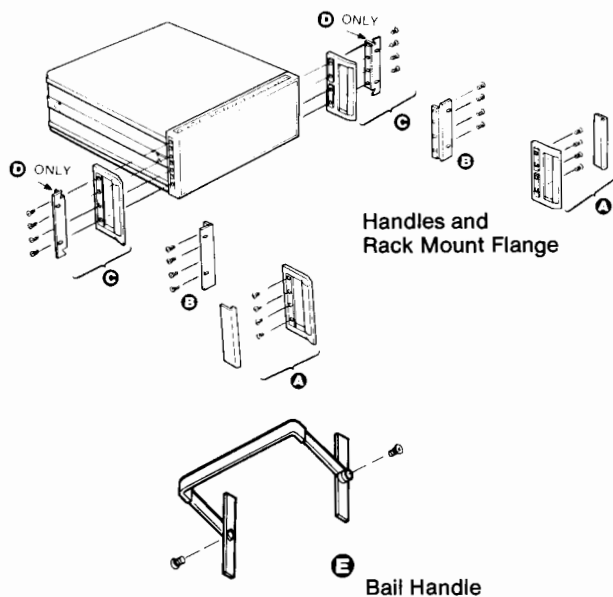

NOTICE—Most of the cabinet accessory kits shown on these pages include both inch and metric fasteners to make them compatible with the new metric-fastener-cabinets, as well as the older inch-fastener-cabinets which are still in service. It is most important for the user to be aware of these different fasteners to avoid thread damage when attaching the accessory kits. Metric-fastener-cabinets are identified with a yellow label on the rear which reads "Caution—metric and inch hardware", a "metric" embossment in the front bezel casting under the plastic trim strip, and on the middle of the rear bezel casting.

System II Cabinet Design

HP's modular cabinet system offers bench-stacking and rack mounting versatility. Many of HP's newer instruments are packaged in this System II frame, easily recognized by the cast aluminum front and rear frames. System II uses optional front corner handles characterized by a slight outward flare.

The family of System II modules is designed for compatibility with EIA and IEC racking standards, both in width and height. Each HP instrument specification contains dimensional information to tell you which module size is used.

Handles and Rack Mount Flanges

Handles and rack flanges are available for all System II cabinets, although they find most use on full width modules or combinations of narrower modules locked together to form 1 MW (module width).

Certain instruments are supplied with front handles as part of the selling price. Handles and rack flanges can be supplied with most instruments by specifying the appropriate option from the following list, at the time of order. The extra cost of each option is usually specified on the instrument data sheet.

- Option 907 Front Handles
- Option 908 Rack Mount Flanges
- Option 909 Handles with Rack Flanges
- Option 913 Rack Mount Flanges (If handles already furnished) (HP 5061-9769 Version)

The table below describes kits available for use after receipt of equipment. Field installation is very straight-forward. A plastic trim strip is easily removed and the handle or flange attached with screws supplied in the kit. Before rack mounting, bottom feet must be removed.

Bail Handle Kit

For 1/2 MW cabinets, you can attach this front bail handle for easy portability. Attaching hardware furnished.

| HP Part No. | Name | Price |
|-------------|--|---------|
| 5061-9701 | Bail Handle Kit for 88.1 (3 1/2) Module | \$38.00 |
| 5061-9702 | Bail Handle Kit for 132.6 (5 1/4) Module | 35.00 |
| 5061-9703 | Bail Handle Kit for 177.0 (7) Module | 33.00 |

Handle and Rack Flanges

| Instrument Module Height mm (inch) | A Front Handle Kit | | B Rack Mount Flange Kit [3] | | C Rack Mount Flange Kits with Handles | | D Rack Mount Flange Kit for Instruments With Previously Supplied Handles | |
|------------------------------------|---|----------|-----------------------------|---------|---------------------------------------|----------|--|------------|
| | HP Part No. | Price | HP Part No. | Price | HP Part No. | Price | HP Part No. | Price |
| 88.1 (3 1/2)H | 5061-9688 | \$ 50.00 | 5061-9674[1] | \$30.00 | 5061-9675[1] | \$ 72.50 | 5061-9769[1] | \$21.00[4] |
| 88.1 (3 1/2)H | — | — | 5061-9676[2] | 30.00 | 5061-9682[2] | 72.50 | 5061-9770[2] | 36.00[4] |
| 132.6 (5 1/4)H | 5061-9689 | 55.00 | 5061-9677 | 32.50 | 5061-9683 | 80.00 | 5061-9771 | 28.00 |
| 177.0 (7)H | 5061-9690 | 65.00 | 5061-9678 | 35.00 | 5061-9684 | 90.00 | 5061-9772 | 32.00 |
| 221.5 (8 3/4)H | 5061-9691 | 75.00 | 5061-9679 | 40.00 | 5061-9685 | 105.00 | 5061-9773 | 36.00 |
| 265.9 (10 1/2)H | 5061-9692 | 95.00 | 5061-9680 | 45.00 | 5061-9686 | 120.00 | 5061-9774 | 40.00 |
| 310.4 (12 1/4)H | 5061-9693 | 140.00 | 5061-9681 | 50.00 | 5061-9687 | 160.00 | 5061-9775 | 49.00 |
| Kit includes | 2 Handles + 2 Trim Strips + Mtg. Screws | | 2 Flanges + Mtg. Screws | | 2 Handles + 2 Flanges + Mtg. Screws | | 2 Flanges + Mtg. Screws | |

[1] HP 5061-9674/9675/9769 Kits use standard flanges with 1.75" hole spacing.
 [2] HP 5061-9676/9682/9770 Kits use special flange with 3.00" hole spacing.

[3] Will not fit onto instruments with previously supplied handles.
 [4] Option 913 ordered on instruments supplies HP 5061-9769. For 3.00" spacing order HP 5061-9770 instead of Opt. 913.

CABINET ACCESSORIES

System II—Support Shelves, Filler Panels

NOTICE—Most of the cabinet accessory kits shown on these pages include both inch and metric fasteners to make them compatible with the new metric-fastener-cabinets, as well as the older inch-fastener-cabinets which are still in service. It is most important for the user to be aware of these different fasteners to avoid thread damage when attaching the accessory kits. Metric-fastener-cabinets are identified with a yellow label on the rear which reads “Caution—metric and inch hardware”, a “metric” embossment in the front bezel casting under the plastic trim strip, and on the middle of the rear bezel casting.

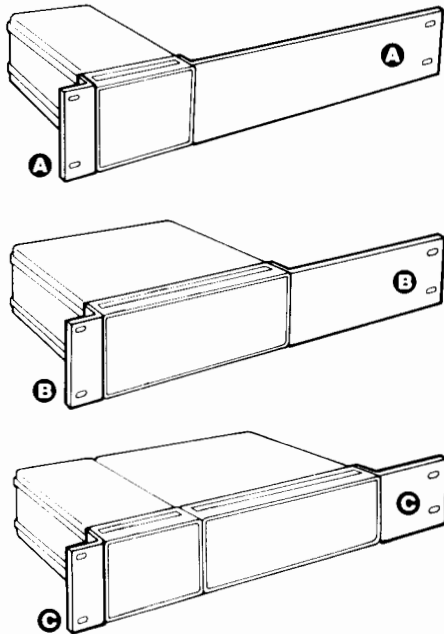

Rack Mount Adapter Kits

Modules of less than 1 MW can be rack mounted using these kits. Individual ¼ MW or ½ MW modules use the kits shown below directly. Combinations of ¼ MW and ½ MW (of equal depth) are first joined side-by-side with the Lock Link Kit (HP 5061-9694) (following page), then have end flanges applied. Combinations adding to 1 MW use regular rack flange kit (previous page). Kits include attaching screws but not front panel rack mounting screws. Hole patterns conform to EIA and IEC standards.

Rack Mount Adapter Kits

| Module Height mm (inch) | A Mounts ¼ MW Module | | B Mounts ½ MW or 2 ea. ¼ MW[2] Modules | | C Mounts ¾ MW (3 ea. ¼ MW[1] or ¼ & ½ MW side-by-side[2]) | |
|----------------------------|---|---------|---|---------|---|---------|
| | HP Part No. | Price | HP Part No. | Price | HP Part No. | Price |
| 88.1 (3½)H | 5061-9673 | \$56.00 | 5061-9672 | \$49.00 | 5061-9671 | \$43.00 |
| 132.6 (5¼)H | — | — | 5061-9657 | 60.00 | 5061-9658 | 50.00 |
| 177.0 (7)H | — | — | 5061-9660 | 65.00 | 5061-9661 | 70.00 |
| 265.9 (10½)H | — | — | 5061-9666 | 77.50 | 5061-9667 | 72.50 |
| Kit includes | 1 ea. rack flange 1 ea. ¼ MW extension adapter flange and screws | | 1 ea. rack flange 1 ea. ½ MW extension adapter flange and screws | | 1 ea. rack flange 1 ea. ¾ MW extension adapter flange and screws | |

[1] ¼ MW can be center mounted using 2 of these kits.

[2] Side-by-side modules of equal depth require lock link kit (HP 5061-9694).

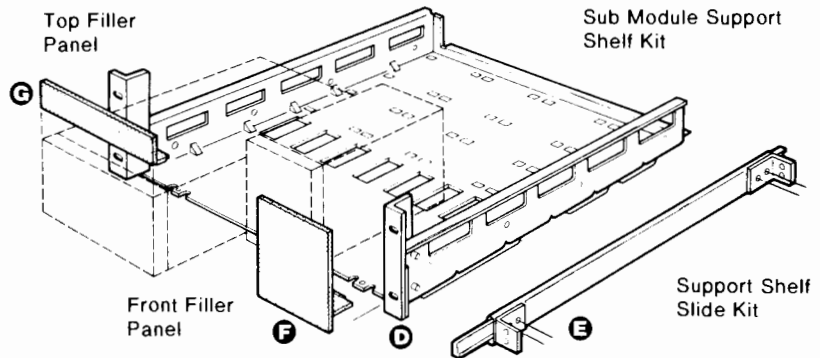

Support Shelf, Slide, and Filler Panels

Submodules of differing heights, widths, and depths (up to 20 D) may be rack-mounted using these support shelves. Any combination of ¼ MW and ½ MW will fit side-by-side up to 1 MW. Filler panels close up vacant spaces either on top of short modules or side-by-side. The slide kit provides ready access to internal shelf areas and is designed for HP racks with 24-inch depth vertical support rails. Slide kit includes brackets and mounting screws.

| HP Part No. | Name | Price |
|-------------|---|----------|
| 5061-9696 | D Support Shelf for 88.1 (3½)H Modules | \$195.00 |
| 5061-9697 | D Support Shelf for 132.6 (5¼)H Modules | 195.00 |
| 5061-9698 | D Support Shelf for 177.0 (7)H Modules | 210.00 |
| 1494-0041 | E Slide Kit (2 ea slides, brackets, hardware) | 245.00 |

Filler Panels

| Description | Size | HP Part No. | Price |
|--|--------------|-------------|---------|
| G For 88.1 (3½) H support shelf partially filled with instruments, and having the following front panel space to fill: | ¼ MW to fill | 5061-9721 | \$67.50 |
| | ½ MW to fill | 5061-9722 | 80.00 |
| | ¾ MW to fill | 5061-9723 | 92.50 |
| G For 132.6 (5¼) H support shelf, and having the following front panel space to fill: | ¼ MW to fill | 5061-9724 | \$80.00 |
| | ½ MW to fill | 5061-9725 | 87.50 |
| G For 177.0 (7) H support shelf, and having the following front panel space to fill: | ¼ MW to fill | 5061-9766 | \$75.00 |
| | ½ MW to fill | 5061-9727 | 110.00 |
| G For ¼ MW and having the following vertical space to fill: | 43.2 (1¾)H | 5061-2035 | \$55.00 |
| | 87.6 (3½)H | 5061-2036 | 55.00 |
| G For ½ MW and having the following vertical space to fill: | 43.2 (1¾) H | 5061-2037 | \$50.00 |
| | 87.6 (3½) H | 5061-2038 | 46.00 |



CABINET ACCESSORIES

System II—Lock Link Kits, Rack Mount Slide Kits

NOTICE—Some of the cabinet accessory kits shown on these pages include both inch and metric fasteners to make them compatible with the new metric-fastener-cabinets, as well as the older inch-fastener-cabinets which are still in service. It is most important for the user to be aware of these different fasteners to avoid thread damage when attaching the accessory kits. Metric-fastener-cabinets are identified with a yellow label on the rear which reads "Caution—metric and inch hardware", a "metric" embossment in the front bezel casting under the plastic trim strip, and on the middle of the rear bezel casting. Due to design considerations, the slide-mount kits shown on this page are offered in both inch and metric fastener versions.

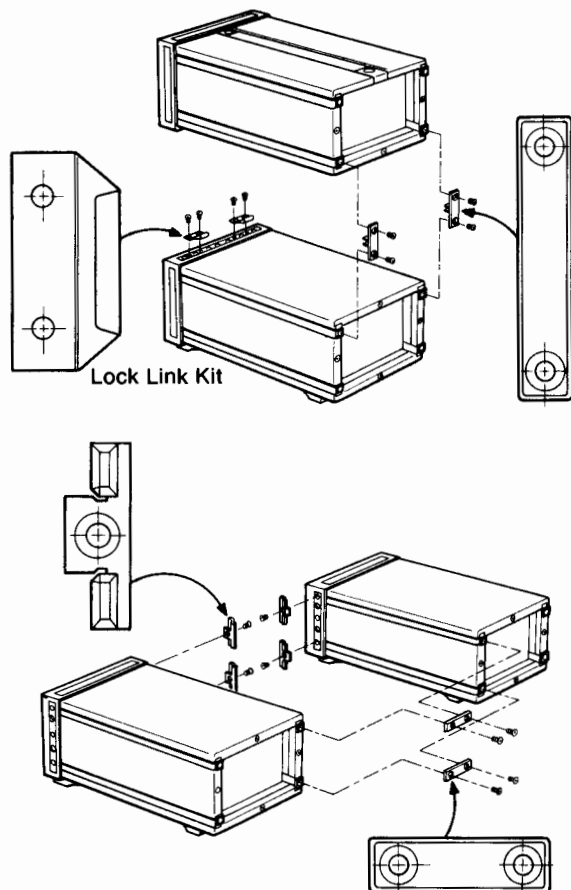

Lock Link Kits HP 5061-9694 (includes inch screws)

All sub-module cabinets of equal depths can be linked together over-under or side-by-side with hardware in the lock link kit. Cabinet frames are already pre-threaded to allow quick assembly. For side-by-side connections the kit contains 12 front hooks and six rear links, enough for 3 side-by-side joints. For vertical connections, the kit also contains four front hooks and four rear links enough for two over-under joints. Kit includes screws. Locking cabinets together horizontally in a configuration wider than 1 MW is not recommended.

If the over-under linked combination is to include rear standoff feet (HP 5061-9709), then the over-under locking feet kit HP 5061-9699 (next page) should be used for over-under connection.

The HP 5061-9694 Lock Link Kit is not recommended for full module over/under combinations. Use Kit HP 5061-9699 Locking Feet Kit (next page) to handle those larger weights.

Slide Kits and Rack Brackets

Rack slides are available for full-width System II cabinets to permit easy access to internal spaces. Each kit consists of two slides which mount directly to System II cabinet side handle recess spaces (after removing side handles). The slides also mount directly to vertical support rails in HP-racks. HP 1494-0060 mounts 345.4D and 421.6D depth System II cabinets. HP 1494-0059; 497.8D and 574.0D.

Standard weight slides carry 38.6 kg (85 lbs) max. load. Tilting versions are available in standard duty only. (HP 1494-0062 and 1494-0063.)

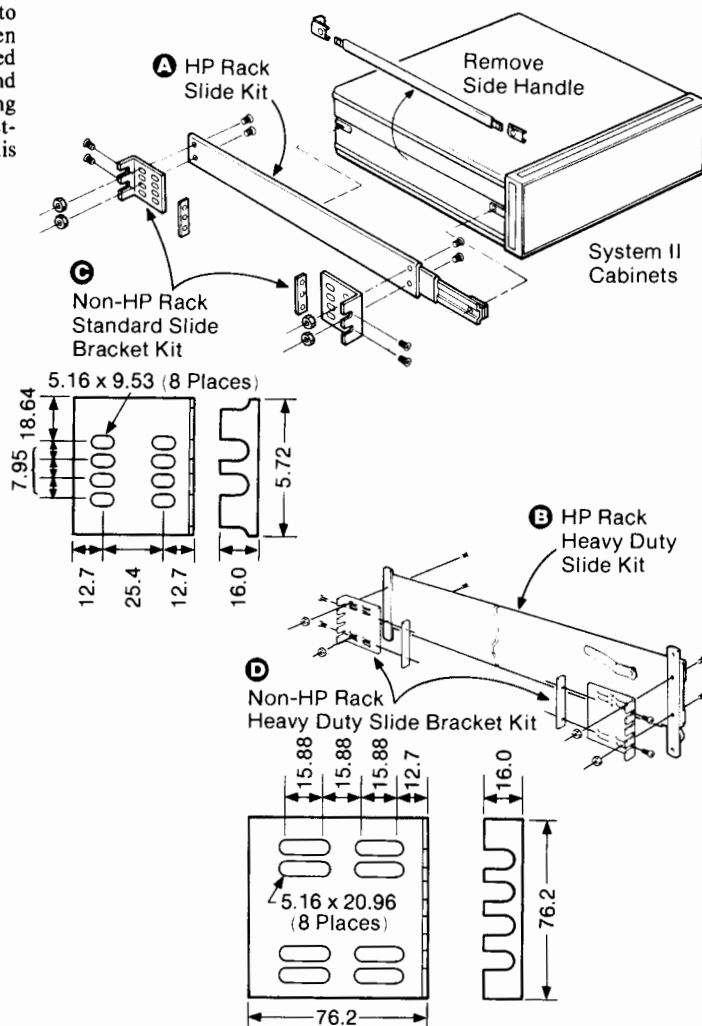

For non-HP-racks, end bracket kits are available for both standard and heavy duty slide kits. Slotted hole arrays in the brackets provide for front-to-back rack rail spacing of 24, 26, and 28-inch nominal centers. They also allow choice of two vertical positions. Each kit of four brackets includes screws and four bar nuts. These general purpose mounting brackets fit most common non-HP-racks such as GE, Honeywell, etc.

| HP Part No. | Name | Price |
|--|---|----------|
| Metric (Inch) 5061-9694 | Lock Link Kit | \$ 25.00 |
| 1494-0060 (1494-0018) | A Non-Tilting, Std. Slide Kit, Fits 345.4D & 421.6D Cabinets | 97.50 |
| 1494-0059 (1494-0017) | A Non-Tilting, Std. Slide Kit, Fits 497.8D & 574.0D Cabinets | 92.50 |
| 1494-0062 (1494-0025) | Tilting, Std. Slide Kit, Fits 345.4D & 421.6D Cabinets | 190.00 |
| 1494-0063 (1494-0026) | Tilting, Std. Slide Kit, Fits 497.8D & 574.0D Cabinets | 170.00 |
| 1494-0058 (1494-0016) | B Non-Tilting, Heavy Duty Slide Kits (497.8D & 574.0D Cabinets Only) | 290.00 |
| 1494-0061 (1494-0023) | C (4) End Brackets for Non-HP Racks, Std. Slides | 44.00 |
| 1494-0064 (1494-0042) | D (4) End Brackets for Non-HP Racks, Heavy Duty Slides | 60.00 |

NOTICE—Most of the cabinet accessory kits shown on these pages include both inch and metric fasteners to make them compatible with the new metric-fastener-cabinets, as well as the older inch-fastener-cabinets which are still in service. It is most important for the user to be aware of these different fasteners to avoid thread damage when attaching the accessory kits. Metric-fastener-cabinets are identified with a yellow label on the rear which reads “Caution—metric and inch hardware”, a “metric” embossment in the front bezel casting under the plastic trim strip, and on the middle of the rear bezel casting.

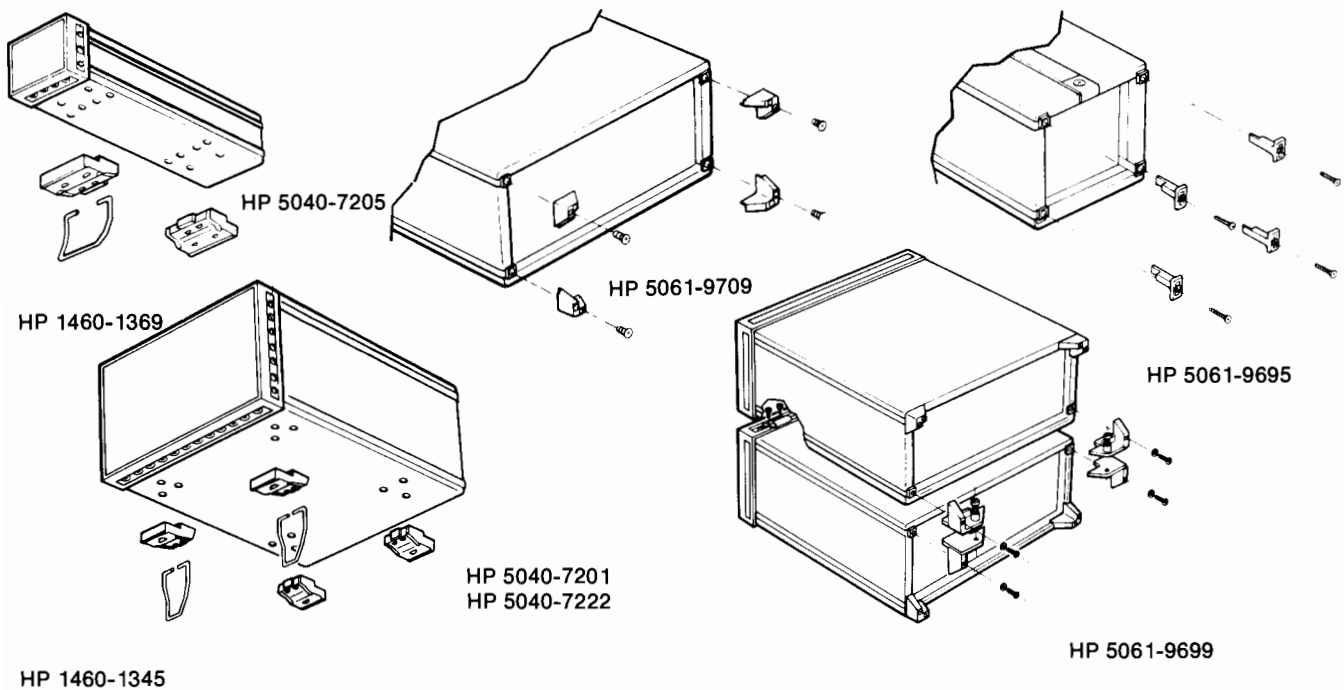

Bottom and Rear Cabinet Feet

Cabinet Rear Standoff Feet HP 5061-9709 (includes inch screws)

Kit HP 5061-9709 provides four corner feet which give 25.4 mm (1-in.) stand-off protection to the rear panel of instruments. It is used when instruments are to be operated or stored vertically on their rear panels. (Fits all but 1/4 MW by (88.1) 3½H). Includes mounting screws.

Cord Wrap Feet Kit HP 5061-9695 (includes inch screws)

Kit HP 5061-9695 contains four ribbed corner posts on which you can wrap power cords or signal cables for transport or storage. (Recommended for 1/4 MW and 1/2 MW cabinets weighing less than 11 kg, (24 lbs). Includes mounting screws.

Cabinet Bottom Feet and Tilt Stands

The standard foot HP 5040-7201 fits the bottom of full width and 1/2 MW cabinets. It fits front or rear and four are required. HP 5040-7222 foot is a non-skid version. Used in pairs it can prevent bench-top creeping. Tilt-stand HP 1460-1345 fits into the standard or non-skid foot and is used in pairs (front or rear) to tilt the instrument up or down for better viewing.

For 1/4 MW cabinets, foot HP 5040-7205 fits front or rear (two required). Tilt stand HP 1460-1369 fits the standard 1/4 MW foot and can be used front or rear depending on whether you want an upward or downward display.

Rear Panel Locking Foot Kit

When full module cabinets are to be linked vertically, and rear standoff feet are planned, use this kit. It consists of right and left foot linking pairs and 2 front hooks, enough for one over-under joint.

Also requires one HP 5061-9709 foot kit to supply the remaining 4 corner feet.

| HP Part No. | Name | Price |
|-------------|---------------------------------|----------|
| 5061-9709 | Rear Standoff Feet Kit (4 Feet) | \$8.75 |
| 5061-9695 | Cord Wrap Feet Kit (4 Feet) | 25.00 |
| 5040-7201 | Standard Foot | 1.55 ea. |
| 5040-7222 | Non-Skid Foot | 3.30 ea. |
| 1460-1345 | Tilt Stand | 0.95 ea. |
| 5040-7205 | 1/4 MW Foot | 5.50 ea. |
| 1460-1369 | 1/4 MW Tilt Stand | 8.25 ea. |
| 5061-9699 | 1 MW Cabinet Lock-Foot Kit | 60.00 |

CABINET ACCESSORIES

SYSTEM I—Rack Hardware and Accessories

System I Cabinet Design

System I Cabinets are still used on older HP instruments. System I can be identified by its front handles being integral with the side casting frame. These two pages describe accessories for use with System I Cabinets and small modular instruments.

HP 1051A

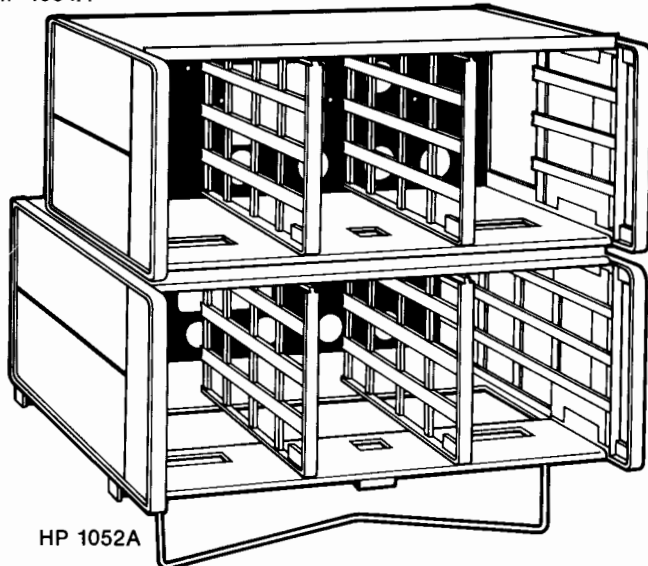

HP 1052A

Combining Cases, HP 1051A, 1052A

HP 1051A and HP 1052A combining cases conveniently rack or bench mount combinations of small modular Hewlett-Packard SYSTEM I instruments. Both cases accept $\frac{1}{3}$ or $\frac{1}{2}$ instrument modules, 130mm or 198 mm wide ($5\frac{1}{8}$ or $7\frac{25}{32}$ inches). The basic difference is that the HP 1052A is 130 mm ($5\frac{1}{8}$ in.) deeper and will accept modules up to 416mm deep ($16\frac{3}{8}$ in.). The HP 1051A accepts instruments up to 286mm deep ($11\frac{1}{4}$ in.). Each case is furnished with two dividers.

Accessory drawer HP 5060-8756 supplies storage space $\frac{1}{3}$ width and 77 mm ($3-1/32$ " high. Use an HP 5060-8758 filler panel above or below.

HP 1051A, 1052A, 5060-8756 Specifications

- | | | |
|--|--|-----------------|
| Size | | Price |
| HP 1051A: 178 H x 482.6 W x 337 mm D ($7" \times 19" \times 13\frac{3}{4}$). | | \$570.00 |
| HP 1052A: 178 H x 482.6 W x 467 mm D ($7" \times 19" \times 18\frac{3}{8}$). | | \$570.00 |
| Weight | | |
| HP 1051A: net, 4.5 kg (10 lb). Shipping, 6.7 kg (15 lb). | | |
| HP 1052A: net, 5.4 kg (12 lb). Shipping, 8.1 kg (18 lb). | | |
| Opt 908: Rack Mount Kit | | \$40.00 |
| Opt 910: Extra Manual | | \$1.00 |
| HP 5060-8756 Accessory Drawer | | \$215.00 |

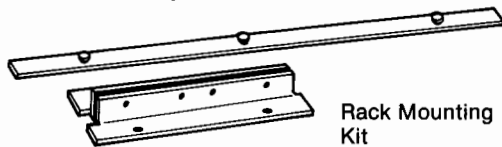

Rack Mounting Kit

Rack Mounting Kits, HP 5060-8739 to 5060-8744

With these kits all Hewlett-Packard products in full rack-width cabinets of the integral side frame-handle style (see HP 1051A, 1052A, Combining Cases above) can be easily prepared for rack mounting. Each kit contains two flanges, a filler strip, and mounting screws.

Rack Mounting Kit Ordering Information

| HP Part Number | Nominal Cabinet Height | | Price |
|----------------|------------------------|------------------|---------|
| | Millimetres | Inches | |
| 5060-8739 | 88.1 | 3 $\frac{1}{2}$ | \$38.00 |
| 5060-8740 | 132.6 | 5 $\frac{1}{4}$ | \$41.00 |
| 5060-8741* | 177 | 7 | \$39.00 |
| 5060-8742 | 221.5 | 8 $\frac{3}{4}$ | \$45.00 |
| 5060-8743 | 265.9 | 10 $\frac{1}{2}$ | \$47.00 |
| 5060-8744 | 310.4 | 12 $\frac{1}{4}$ | \$52.00 |

*Also used to rack mount Combining Kits HP 1051A & 1052A shown above.

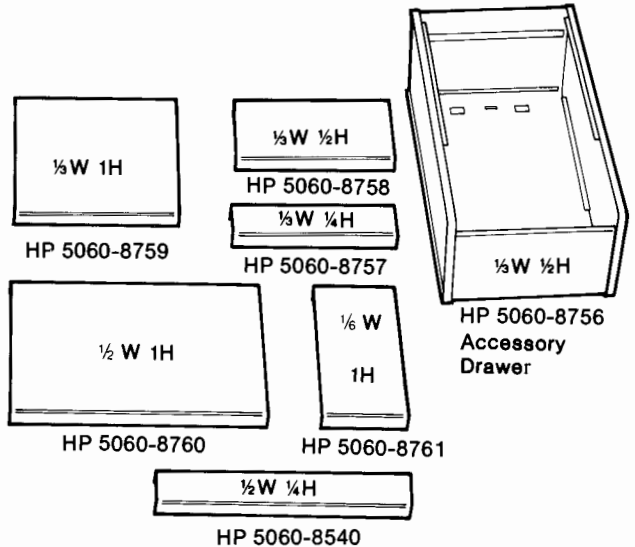

Filler Panels, HP 5060-8540, 5060-8757 to 5060-8761

Filler panels can be used to close off any leftover space after instruments are mounted in combining cases (left) or adapter frames (below). Panels are available in a variety of widths and heights.

| HP Part No. | Module Case Height x Width | Filler Panel Dimensions | | Price |
|-------------|----------------------------------|-------------------------|---------------------------------------|---------|
| | | Millimetres | Inches | |
| 5060-8540 | $\frac{1}{4} \times \frac{1}{2}$ | 38 x 198 | $1\frac{1}{2} \times 7\frac{25}{32}$ | \$53.50 |
| 5060-8757 | $\frac{1}{4} \times \frac{1}{3}$ | 38 x 130 | $1\frac{1}{2} \times 5\frac{1}{8}$ | \$50.00 |
| 5060-8758 | $\frac{1}{2} \times \frac{1}{3}$ | 77 x 130 | $3\frac{1}{32} \times 5\frac{1}{8}$ | \$43.00 |
| 5060-8759 | full x $\frac{1}{3}$ | 155 x 130 | $6\frac{3}{32} \times 5\frac{1}{8}$ | \$43.00 |
| 5060-8760 | full x $\frac{1}{2}$ | 155 x 198 | $6\frac{3}{32} \times 7\frac{25}{32}$ | \$50.00 |
| 5060-8761 | full x $\frac{1}{6}$ | 155 x 63 | $6\frac{3}{32} \times 2\frac{31}{64}$ | \$61.00 |

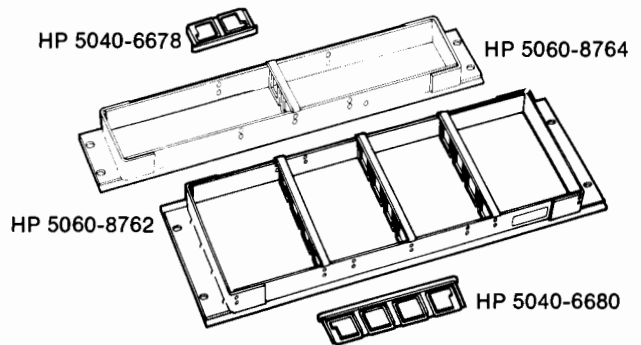

Rack Adapter Frames, HP 5060-8762, 5060-8764

These frames can be used to hold combinations of $\frac{1}{3}$ and $\frac{1}{2}$ module-width HP instruments. Each frame is furnished with mounting hardware and three dividers. Two models are available for different instrument heights. Adapter frames are for permanent or semi-permanent rack mounting. Where quick removal and reinstallation of instruments is desirable, the HP 1051A and HP 1052A should be used.

HP 5060-8762 is 178 mm (7 in.) high and accepts instruments heights of $\frac{1}{4}H$, $\frac{1}{2}H$, and 1H. HP 5060-8764 is 89 mm ($3\frac{1}{2}$ in.) high and accepts instruments of $\frac{1}{4}H$ and $\frac{1}{2}H$.

| HP Part No. | Name | Price |
|-------------|---|----------|
| 5060-8762 | Rack Adapter 178mm (7-in) | \$150.00 |
| 5060-8764 | Rack Adapter 89mm ($3\frac{1}{2}$ -in) | \$150.00 |
| 5040-6678 | Extra Vertical Dividers for 5060-8764 | \$25.00 |
| 5040-6680 | Extra Vertical Dividers for 5060-8762 | \$16.50 |

CABINET ACCESSORIES

System 1 - Slide Kits, Fans, Joining Brackets, Cases

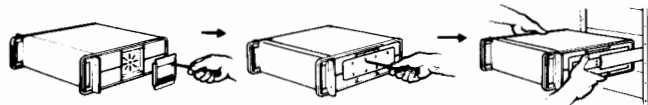

Remove Handles and Feet

Attach Adapter

Mount Slides

Rack Mount Slide Kits and Cabinet Adapters

By removing the side handle of full width system 1 cabinets, rack mount slides can be attached for easy access to internal space. Both tilting and non-tilt are available, while max. load factor is 31.7 kg (70 lb). The cabinet adapter plate attaches to the handle recess then to the slide. Slide kits include four angle brackets which mount to rack rails with front-to-back nominal spacings of 24, 26 and 28-inches.

Rack Mount Slide Kits, HP 1490-0713 to 1490-0720

| HP Part Number ¹ | Slide Type | Cabinet Depth | Extension Length | Price |
|-----------------------------|------------|---------------|-------------------------|----------|
| 1490-0713 | fixed | All Sizes | 482.6 (19) ² | \$140.00 |
| 1490-0714 | fixed | All Sizes | 635.0 (25) ³ | \$160.00 |
| 1490-0715 | tilting | 279.4 (11) | 482.6 (19) ² | \$220.00 |
| 1490-0716 | tilting | 406.4 (16) | 482.6 (19) ² | \$230.00 |
| 1490-0717 | tilting | 279.4 (11) | 533.4 (21) ³ | \$280.00 |
| 1490-0718 | tilting | 406.4 (16) | 558.8 (22) ³ | \$245.00 |
| 1490-0719 | tilting | 482.6 (19) | 635.0 (25) ³ | \$220.00 |
| 1490-0720 | tilting | 558.8 (22) | 635.0 (25) ³ | \$205.00 |

1. Cabinet Adapters, below, must be added to slides
 2. Slide's stationary mounting depth: 406.4 (16)
 3. Slide's stationary mounting depth: 558.8 (22)

Cabinet Adapters

| HP Part No. | Name | Price |
|-------------|---|----------|
| 1490-0722 | Adapter plate for 88.9mm H(3½ in.) cabinets | \$135.00 |
| 1490-0721 | Adapter plate for 133mm H(5¼ in.) and higher cabinets | \$260.00 |

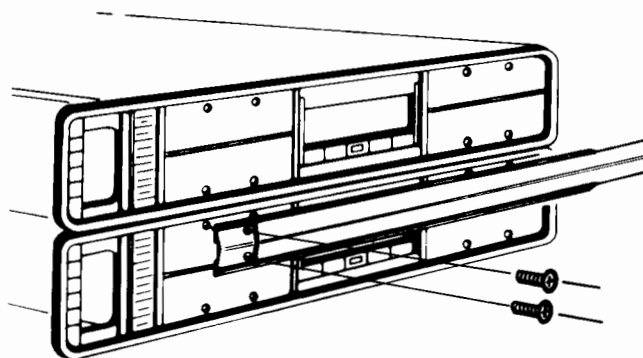
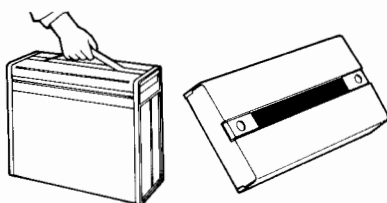

Joining Bracket Kits, HP 5060-8541 to 5060-8545

These kits join HP System I instruments of the same width and length into easily handled single stacks. Each kit consists of two brackets, mounting hardware and trim. They are available to fit the three most common instrument depths:

| HP Part Number | Price |
|--|----------|
| 5060-8541: 279 mm (11 in.) EIA panel depth | \$96.00 |
| 5060-8543: 406 mm (16 in.) EIA panel depth | \$108.00 |
| 5060-8545: 480 mm (19 in.) EIA panel depth | \$120.00 |

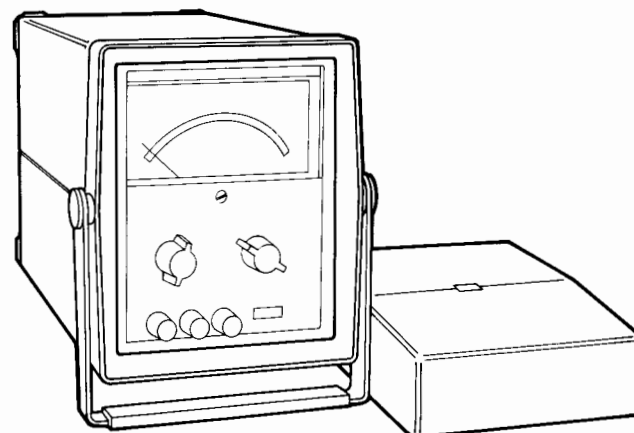

Control Panel Covers, HP 5060-8766 to 5060-8771

A series of control panel covers equipped with carrying handles are available for full rack width instruments. These covers protect instrument front panels and make rack mounted instruments tamper-proof.

One of these covers, the HP 5060-8768, fits both the HP 1051A and the HP 1052A Combining Case (previous page). Other covers are available to fit the six modular enclosures with front panel heights ranging from 88.1 to 310.4 mm (3½ to 12¼ in.). Cover locks securely to front handles.

| HP Part Number | Price |
|--|----------|
| 5060-8766: 88.1 mm (3½ in.) EIA panel height | \$270.00 |
| 5060-8767: 132.6 mm (5¼ in.) EIA panel height | \$235.00 |
| 5060-8768: 177 mm (7 in.) EIA panel height | \$270.00 |
| 5060-8769: 221.5 mm (8 ¾ in.) EIA panel height | \$330.00 |
| 5060-8770: 265.9 mm (10½ in.) EIA panel height | \$350.00 |
| 5060-8771: 310.4 mm (12¼ in.) EIA panel height | \$430.00 |

Module Instrument Cases, HP 11075A, 11076A

Rugged, high impact plastic instrument cases for HP System I ½ module instruments. Instruments can be operated, stored or carried in this splashproof case. Storage compartment for power cord in rear of case is accessible through a removable hatch. Front lid contains adequate storage space for cables, test leads, etc. The dual purpose tilt stand also serves as a carrying case handle. The HP 11075A holds instruments 203 mm D (8 in.); HP 11076A carries modules up to 279 mm D (11 in.).

| HP Part Number | Price |
|--------------------------------|----------|
| 11075A: Module Instrument Case | \$297.00 |
| 11076A: Module Instrument Case | \$327.00 |

TRANSIT CASES

Rugged Protection for Instruments

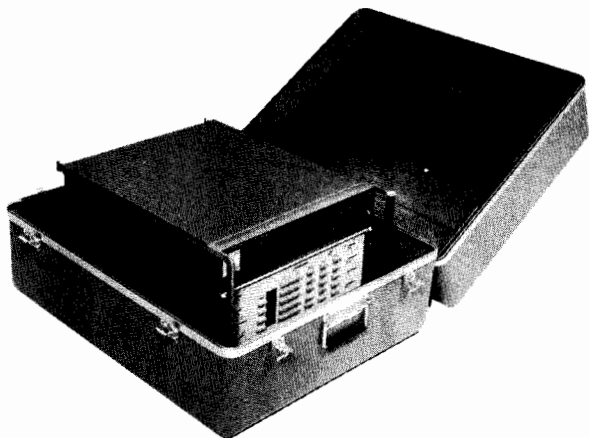

Typical System II Transit Case

Hewlett-Packard transit cases are rugged protective outer shells for use when instruments must be frequently transported or used away from laboratory conditions. HP cases protect your instruments from hostile environments, shock, vibration, moisture, and impact while providing a secure enclosure for shipping. The cases are molded from a structural composite which is 65% lighter than aluminum, yet which provides excellent strength and durability. Tests of the composite show tensile and compressive strength exceeding 33,000 PSI and flexural strength exceeding 45,000 PSI.

Typical Uses

Transit cases are a necessity whenever equipment is frequently transported from one operating location or test site to another, or is shipped for testing and calibration. Transit cases are particularly valuable for instruments used by service and repair personnel. For example, telephone companies frequently use transit cases for the instruments they use to repair line faults. Transit cases are also valuable when instruments must be transported over rough roads, or are used in dusty environments or outdoors.

Product Detail

HP transit cases are pressure molded of an extremely strong and light fiberglass and resin laminate which provides an excellent strength to weight ratio. All cases seal tightly with O-ring gaskets and clamping latches. They are rainproof under the test conditions of MIL-STD-108. Carrying handles are conveniently placed, and fold flat when not in use.

Transit cases are typically provided with foam cushions that are designed to cradle the instrument securely. Maximum protection is provided against damage from handling, dropping, or crushing. The cushion inserts are typically molded polyurethane, or are fabricated from slabs of polyurethane or polyethylene flexible foams. Each case/cushion unit is designed as its own shock and vibration damping system.

Hewlett-Packard's standard transit cases provide effective protection from all but the most abusive treatment. To ensure maximum protection for your instrument, transit cases are also available in versions that meet the specified requirements of MIL-STD-108, MIL-T-21200, MIL-T-28800, MIL-T-4734, and MIL-C-4150.

Removable swivel casters are available as an option on certain HP transit cases. These cases are identified with an asterisk (*) in the case selection tables on pages 752 and 753.

How to Select the Proper Transit Case

Transit cases are available for almost all HP instruments. If you are ordering a case for one of HP's 80 most popular instruments and computation products, you can use the quick cross-reference table below. To order a case for any other instrument, please refer to "Accurate Measurements Assure Proper Fit" and use the tables for ordering System I and System II style cases.

HP Product Number to Transit Case Number Cross Reference

| | | | | | | | |
|-------------|-----------|-----------|-----------|--------|-----------|---------|------------------------|
| 1630A | 9211-1294 | 3586A/B/C | 9211-2650 | 5334A | 9211-2642 | 8640B | 9211-0839 |
| 1645A | 9211-1289 | 3702B | 9211-1294 | 5342A | 9211-2682 | 8642A/B | 9211-2661 |
| 1725A | 9211-2459 | 3710A | 9211-1293 | 5340A | 9211-1292 | 8654A | 9211-1895 |
| 1740A | 9211-2459 | 3730A | 9211-0839 | 5343A | 9211-2682 | 8654B | 9211-1290 |
| 1741A | 9211-2459 | 3964A | 9211-2557 | 5345A | 9211-1296 | 8656B | 9211-2661 |
| 197B | 9211-2675 | 3968A | 9211-2557 | 5423A | 9211-2661 | 8660A/C | 9211-2662 |
| 262X Series | 9211-4677 | 432A/B | 9211-1318 | 59306A | 9211-2667 | 8662A | 9211-2662 |
| 264X Series | 9211-4676 | 435B | 9211-1318 | 59313A | 9211-2671 | 8663A | 9211-2662 |
| 2671G | 9211-2649 | 436A | 9211-2667 | 59401A | 9211-2682 | 8671A | 9211-2661 |
| 2673G | 9211-2649 | 438A | 9211-2676 | 7475A | 9211-2655 | 8672A | 9211-2661 |
| 2816A | 9211-1315 | 4145A | 9211-2663 | 82509B | 9211-4684 | 8673B | 9211-2661 |
| 334A | 9211-1289 | 4191A | 9211-2663 | 8350B | 9211-2649 | 8673C/D | 9211-2663 |
| 339A | 9211-2643 | 4192A | 9211-2663 | 8403A | 9211-1292 | 8683A/B | 9211-2655 |
| 3325A | 9211-2655 | 4328A | 9211-1318 | 8405A | 9211-1293 | 8684A/B | 9211-2655 |
| 3336A/B/C | 9211-2655 | 4935A | 9211-1290 | 8445B | 9211-1292 | 8754A | 9211-2661 |
| 3406A | 9211-1315 | 4937A | 9211-1289 | 85B | 9211-4120 | 8756A | 9211-2656 |
| 3455A | 9211-2654 | 4945A | 9211-2650 | 8505A | 9211-2665 | 8901A/B | 9211-1293 |
| 3456A | 9211-2654 | 4951B | 9211-1290 | 8555A | 9211-2671 | 9826A | 9211-2662 |
| 3466A | 9211-2666 | 4953A | 9211-2644 | 8565A | 9211-2656 | 9836A | 9211-2652 ¹ |
| 3561A | 9211-2459 | 4955A | 9211-2663 | 8566A | 9211-1297 | 9836A | 9211-2662 ² |
| 3562A | 9211-2663 | 5061A | 9211-1294 | 8568A | 9211-2655 | 9876A | 9211-4679 |
| 3577A | 9211-2663 | 5065A | 9211-0839 | 8614A | 9211-0839 | | |
| 3582A | 9211-2656 | 5150A | 9211-2673 | 8616A | 9211-0839 | | |
| 3585A | 9211-2663 | 5345A | 9211-1296 | 8620C | 9211-1289 | | |

¹Top half

²Bottom half

TRANSIT CASES

Rugged Protection for Instruments



Instrument Cabinet System Styles

Hewlett-Packard produces two styles of cabinet systems: System I and System II. The most visible difference is handle configuration; the handles on System I instruments are a part of the instrument side frame, and project at 90 degrees from the instrument face. The handles on System II modules also project at 90 degrees from the instrument face, but are not a part of the instrument frame, are easily removable, and are turned outward at the handle grip. Each of the cabinet styles requires a different cushion insert configuration. This difference makes it important to order your case from the correct selection table.

Transit Case Styles

Each transit case is coded according to its style in the following tables: Valise (V), hinged with the handle opposite the hinge; Transit (T), a completely removable cover with a handle at each end; and Valise Transit (VT), a hinged transit case with a handle opposite the hinge and a handle at each end. Each case is designed and manufactured in the style which best suits the configuration of its instrument. If a style other than the standard is more appropriate for your application, a special case can be ordered.

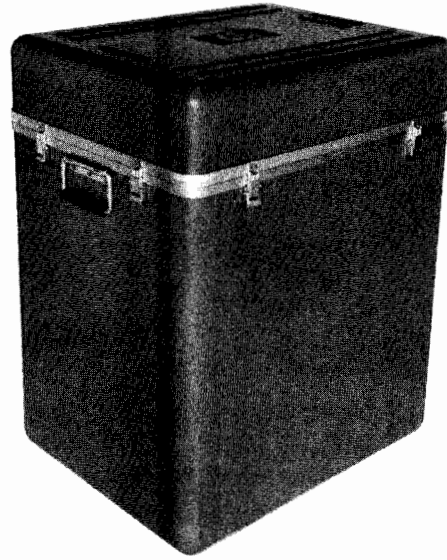

Typical transit (T) style case

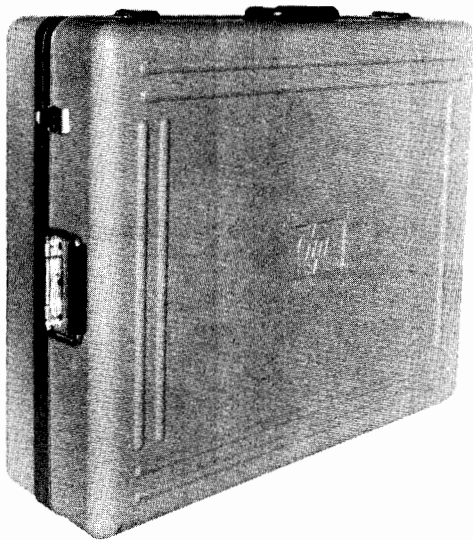

Typical valise transit (VT) style case



Typical valise (V) style case

Special or Custom Transit Cases

When HP began providing standardized cases, it was understood that there would be certain instruments that would not fit into the standard cases. For that reason, special or custom cases are available.

Proper fit is very important in protecting your instrument, and the dimensional measurements of your instrument are critical. It is recommended that when ordering a custom case you provide your Hewlett-Packard sales office with the instrument's exact height, width, and depth, the serial and model number, and any other pertinent information that may affect the design of the case or cushions. In designing your own case, you may wish to have additional space available for the protected storage of materials necessary for your instrument's on-site operation. Space can be provided for storing power/data cables, operating supplies, accessories, additional printed circuit boards, and documentation or manuals. All specifications and measurements should be on hand when discussing your needs with a representative from your local HP sales office.

Colors

HP transit cases are produced in "Hewlett-Packard Pearl Gray Cabinet," a standard color used in whole or in part on a majority of the instruments HP produces. Transit cases in any other color must be a special order at additional cost.

Accurate Measurements Assure Proper Fit

To assure proper fit, each instrument must be measured carefully. The three measurements necessary are:

WIDTH: The distance across the entire body of the instrument, not including rack mounting accessories. Instruments set up to be rack mounted require special cushion designs (custom transit cases).

DEPTH: The depth of the instrument from the front panel face to the rearmost projection at the back of the instrument. On a System II instrument add two inches if the instrument has handles.

HEIGHT: The actual instrument height from the base to the top of the cabinet.

The selection tables include American standard and metric measurements. The addition of any options, accessories, or standoff devices will affect the instrument's overall configuration and must be taken into consideration when ordering a transit case.



TRANSIT CASES

Rugged Protection for Instruments

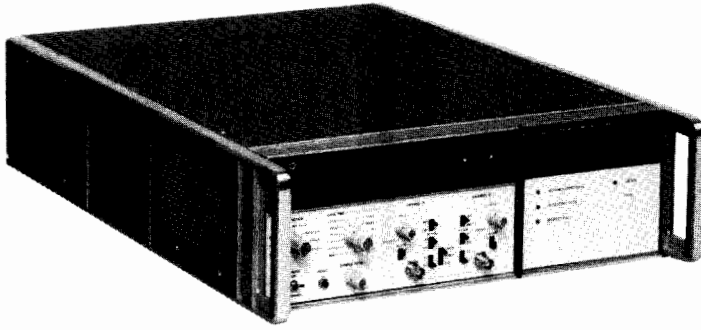

Typical full module System I style cabinet

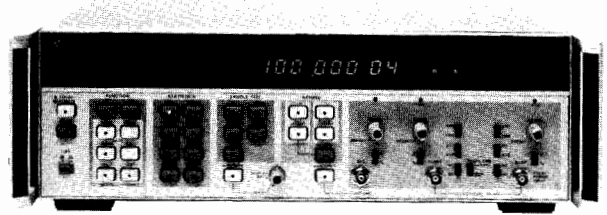

Typical full module System II style cabinet

System I Cabinet Style Transit Cases

| Full Module Width Instruments | | | | | |
|---------------------------------------|-------|-------|----------------|-------|------|
| Instrument Width - 16.75 in. 425.5 mm | | | | | |
| Instrument Depth - 11.25 in. 285.8 mm | | | | | |
| Inst. Height | | Style | HP Part Number | Price | |
| in. | mm | | | 1-4 | 5-49 |
| 3.50 | 88.9 | VT* | 9211-1288 | \$370 | 330 |
| 5.25 | 133.4 | VT* | 9211-1289 | \$380 | 340 |
| 7.00 | 177.8 | VT* | 9211-1290 | \$390 | 360 |
| 8.75 | 222.3 | T* | 9211-1291 | \$420 | 380 |
| Instrument Depth - 16.25 in. 412.8 mm | | | | | |
| Inst. Height | | Style | HP Part Number | Price | |
| in. | mm | | | 1-4 | 5-49 |
| 3.50 | 88.9 | VT* | 9211-1292 | \$400 | 370 |
| 5.25 | 133.4 | VT* | 9211-0839 | \$420 | 380 |
| 7.00 | 177.8 | VT* | 9211-1293 | \$430 | 390 |
| 8.75 | 222.8 | VT* | 9211-1294 | \$430 | 390 |
| 10.50 | 266.7 | T* | 9211-1295 | \$430 | 390 |
| 12.25 | 311.2 | T* | 9211-1313 | \$450 | 410 |
| Instrument Depth - 19.25 in. 489.0 mm | | | | | |
| Inst. Height | | Style | HP Part Number | Price | |
| in. | mm | | | 1-4 | 5-49 |
| 5.25 | 133.4 | VT* | 9211-1296 | \$440 | 400 |
| 7.00 | 177.8 | VT* | 9211-1735 | \$450 | 410 |
| Instrument Depth - 22.25 in. 565.2 mm | | | | | |
| Inst. Height | | Style | HP Part Number | Price | |
| in. | mm | | | 1-4 | 5-49 |
| 12.25 | 311.2 | T | 9211-1297 | \$480 | 430 |

*Removable casters are an option.

| Two-thirds Module Width Instruments | | | | | |
|---------------------------------------|-------|-------|----------------|-------|------|
| Instrument Width - 10.50 in. 266.7 mm | | | | | |
| Instrument Depth - 11.00 in. 270.4 mm | | | | | |
| Inst. Height | | Style | HP Part Number | Price | |
| in. | mm | | | 1-4 | 5-49 |
| 6.5 | 165.1 | V | 9211-1895 | \$330 | 300 |

| Half Module Width Instruments | | | | | |
|---------------------------------------|-------|-------|----------------|-------|------|
| Instrument Width - 7.75 in. 196.9 mm | | | | | |
| Instrument Depth - 8.00 in. 203.2 mm | | | | | |
| Inst. Height | | Style | HP Part Number | Price | |
| in. | mm | | | 1-4 | 5-49 |
| 6.5 | 165.1 | V | 9211-1316 | \$300 | 270 |
| Instrument Depth - 11.00 in. 279.4 mm | | | | | |
| Inst. Height | | Style | HP Part Number | Price | |
| in. | mm | | | 1-4 | 5-49 |
| 6.5 | 165.1 | V | 9211-1315 | \$310 | 280 |
| Instrument Depth - 16.00 in. 406.4 mm | | | | | |
| Inst. Height | | Style | HP Part Number | Price | |
| in. | mm | | | 1-4 | 5-49 |
| 6.5 | 165.1 | V | 9211-1734 | \$330 | 300 |

| One-third Module Width Instruments | | | | | |
|---------------------------------------|-------|-------|----------------|-------|------|
| Instrument Width - 5.125 in. 130.2 mm | | | | | |
| Instrument Depth - 8.00 in. 203.2 mm | | | | | |
| Inst. Height | | Style | HP Part Number | Price | |
| in. | mm | | | 1-4 | 5-49 |
| 6.5 | 165.1 | V | 9211-1317 | \$290 | 260 |
| Instrument Depth - 11.00 in. 279.4 mm | | | | | |
| Inst. Height | | Style | HP Part Number | Price | |
| in. | mm | | | 1-4 | 5-49 |
| 6.5 | 165.1 | V | 9211-1318 | \$300 | 270 |

System II Cabinet Style Transit Cases

| Full Module Width Instruments | | | | | |
|---------------------------------------|-------|-------|----------------|-------|------|
| Instrument Width - 16.75 in. 425.5 mm | | | | | |
| Instrument Depth - 15.25 in. 387.4 mm | | | | | |
| Inst. Height | | Style | HP Part Number | Price | |
| in. | mm | | | 1-4 | 5-49 |
| 3.50 | 88.9 | VT | 9211-2642 | \$430 | 390 |
| 5.25 | 133.4 | VT | 9211-2643 | \$430 | 390 |
| 7.00 | 177.8 | VT | 9211-2644 | \$430 | 390 |
| 8.75 | 222.3 | VT | 9211-2645 | \$430 | 390 |
| 10.50 | 266.7 | T* | 9211-2646 | \$430 | 390 |
| 12.25 | 311.2 | T* | 9211-2647 | \$430 | 390 |
| Instrument Depth - 18.25 in. 463.6 mm | | | | | |
| Inst. Height | | Style | HP Part Number | Price | |
| in. | mm | | | 1-4 | 5-49 |
| 3.50 | 88.9 | VT | 9211-2648 | \$480 | 430 |
| 5.25 | 133.4 | VT | 9211-2649 | \$480 | 430 |
| 7.00 | 177.8 | VT | 9211-2650 | \$480 | 430 |
| 8.75 | 222.3 | T* | 9211-2651 | \$480 | 430 |
| 10.50 | 266.7 | T* | 9211-2652 | \$480 | 430 |
| 12.25 | 311.2 | T* | 9211-2653 | \$480 | 430 |
| Instrument Depth - 21.50 in. 546.1 mm | | | | | |
| Inst. Height | | Style | HP Part Number | Price | |
| in. | mm | | | 1-4 | 5-49 |
| 3.50 | 88.9 | VT | 9211-2654 | \$520 | 470 |
| 5.25 | 133.4 | VT | 9211-2655 | \$520 | 470 |
| 7.00 | 177.8 | VT | 9211-2656 | \$520 | 470 |
| 8.75 | 222.3 | T* | 9211-2657 | \$520 | 470 |
| 10.50 | 266.7 | T* | 9211-2658 | \$520 | 470 |
| 12.25 | 311.2 | T* | 9211-2659 | \$520 | 470 |
| Instrument Depth - 24.50 in. 622.3 mm | | | | | |
| Inst. Height | | Style | HP Part Number | Price | |
| in. | mm | | | 1-4 | 5-49 |
| 3.50 | 88.9 | VT | 9211-2660 | \$550 | 500 |
| 5.25 | 133.4 | VT | 9211-2661 | \$550 | 500 |
| 7.00 | 177.8 | T* | 9211-2662 | \$550 | 500 |
| 8.75 | 222.3 | T* | 9211-2663 | \$550 | 500 |
| 10.50 | 266.7 | T* | 9211-2664 | \$550 | 500 |
| 12.25 | 311.2 | T* | 9211-2665 | \$550 | 500 |

*Removable casters are an option.



Typical System II half module instrument

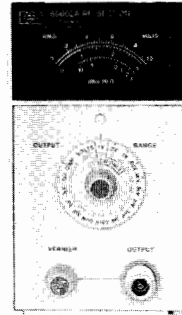

Typical System II quarter module instrument

System II Cabinet Style Transit Cases (Continued)

| Half Module Width Instruments | | | | | |
|---------------------------------------|-------|-------|-------------------|-------|------|
| Instrument Width – 8.50 in. 215.9 mm | | | | | |
| Instrument Depth – 9.75 in. 247.7 mm | | | | | |
| Inst. Height in. | mm | Style | HP Part Number | Price | |
| | | | | 1-4 | 5-49 |
| 3.50 | 88.9 | V | 9211-2666 | \$330 | 300 |
| 5.25 | 133.4 | V | 9211-2667 | \$330 | 300 |
| 7.00 | 177.8 | V | 9211-2668 | \$330 | 300 |
| 8.75 | 222.3 | V | 9211-2669 | \$330 | 300 |
| 10.50 | 266.7 | V* | 9211-2670 | \$330 | 300 |
| Instrument Depth – 12.75 in. 323.9 mm | | | | | |
| Inst. Height in. | mm | Style | HP Part Number | Price | |
| | | | | 1-4 | 5-49 |
| 3.50 | 88.9 | V | 9211-2671 | \$390 | 350 |
| 5.25 | 133.4 | V | 9211-2672 | \$390 | 350 |
| 7.00 | 177.8 | V | 9211-2673 | \$390 | 350 |
| 8.75 | 222.3 | V | 9211-2674 | \$390 | 350 |
| 10.50 | 266.7 | V | 9211-2675 | \$390 | 350 |
| Instrument Depth – 15.75 in. 400.1 mm | | | | | |
| Inst. Height in. | mm | Style | HP Part Number | Price | |
| | | | | 1-4 | 5-49 |
| 3.50 | 88.9 | V | 9211-2676 | \$400 | 360 |
| 5.25 | 133.4 | V | 9211-2677 | \$400 | 360 |
| 7.00 | 177.8 | V | 9211-2678 | \$400 | 360 |
| 8.75 | 222.3 | V | 9211-2679 | \$400 | 360 |
| 10.50 | 266.7 | V | 9211-2680 | \$400 | 360 |
| Instrument Depth – 18.75 in. 476.3 mm | | | | | |
| Inst. Height in. | mm | Style | HP Part Number | Price | |
| | | | | 1-4 | 5-49 |
| 3.50 | 88.9 | V | 9211-2681 | \$400 | 360 |
| 5.25 | 133.4 | V | 9211-2682 | \$400 | 360 |
| 7.00 | 177.8 | V | 9211-2683 | \$400 | 360 |
| 8.75 | 222.3 | V | 9211-2684 | \$400 | 360 |
| 10.50 | 266.7 | V | 9211-2685 | \$400 | 360 |

* Removable casters are an option.

| Quarter Module Width Instruments | | | | | |
|---------------------------------------|-------|-------|-------------------|-------|------|
| Instrument Width – 4.125 in. 104.8 mm | | | | | |
| Instrument Depth – 9.75 in. 247.7 mm | | | | | |
| Inst. Height in. | mm | Style | HP Part Number | Price | |
| | | | | 1-4 | 5-49 |
| 3.50 | 88.9 | V | 9211-2686 | \$280 | 250 |
| 5.25 | 133.4 | V | 9211-2687 | \$280 | 250 |
| 7.00 | 177.8 | V | 9211-2688 | \$280 | 250 |
| Instrument Depth – 12.75 in. 323.9 mm | | | | | |
| Inst. Height in. | mm | Style | HP Part Number | Price | |
| | | | | 1-4 | 5-49 |
| 3.50 | 88.9 | V | 9211-2689 | \$290 | 260 |
| 5.25 | 133.4 | V | 9211-2690 | \$290 | 260 |
| 7.00 | 177.8 | V | 9211-2691 | \$290 | 250 |
| Instrument Depth – 15.75 in. 400.1 mm | | | | | |
| Inst. Height in. | mm | Style | HP Part Number | Price | |
| | | | | 1-4 | 5-49 |
| 3.50 | 88.9 | V | 9211-2676 | \$400 | 360 |
| 5.25 | 133.4 | V | 9211-2677 | \$400 | 360 |
| 7.00 | 177.8 | V | 9211-2678 | \$400 | 360 |

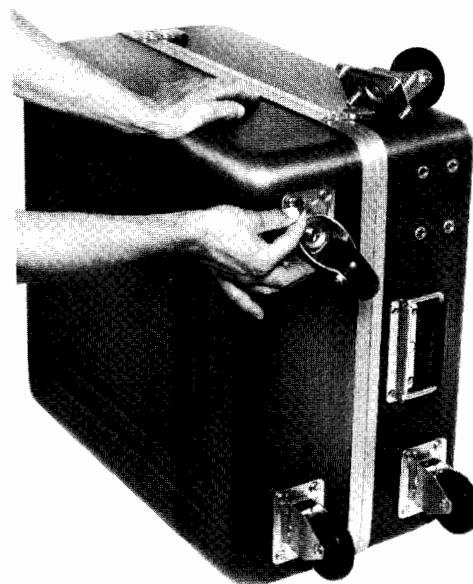

Field installed swivel caster kit. HP part number 1490-0913

OPERATING CASES

Rugged Protection for Instruments

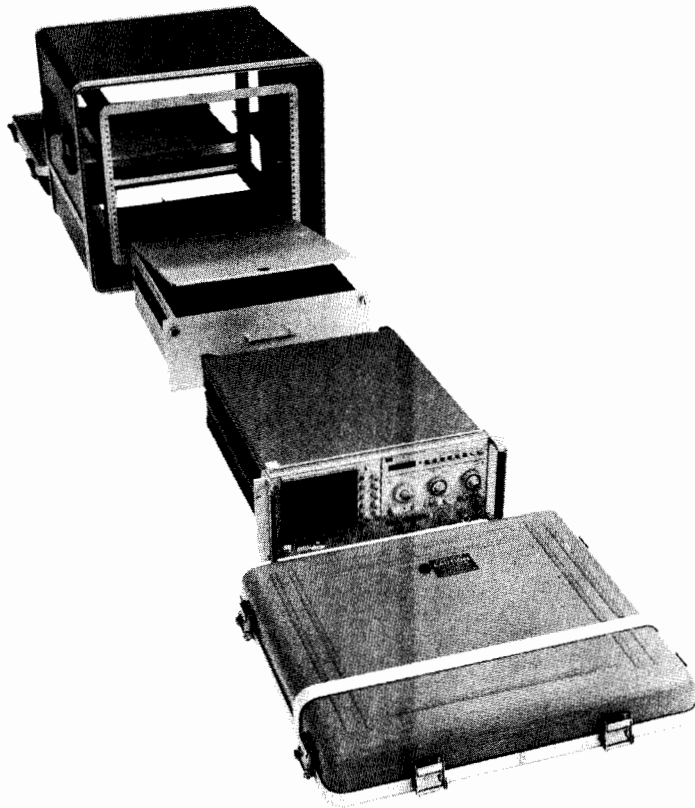

Exploded view of an Operating Case with an instrument and drawer ready for mounting.

Operating Cases

Hewlett-Packard operating cases are rugged protective enclosures, used when instruments are transported and used on-site. They are constructed of the same pressure molded fiberglass/resin laminate as Hewlett-Packard transit cases. Hewlett-Packard's standard hardware provides excellent protection from damage and the elements. Conveniently placed handles fold flat when not in use. Front and back covers seal with O-ring gaskets and clamping latches. All transit cases are rainproof under MIL-STD-108.

Interior Configuration

Operating cases are equipped with shock mounted aluminum frames that accept any standard 19-inch rack mounting instrument (EIA-RETMA standard), up to the height of the frames. Most full sized instruments and modular combinations of instruments can be rack mounted in one of our operating cases. The frame arrangement and the ability to remove the front and back covers allows the convenience of operation without removing the instrument. As a result, the instrument can be set up for operation with a minimum of delay. At the same time, environmental protection is afforded. Both Hewlett-Packard System I and System II cabinet styles can be mounted in operating cases (including System I module combining cases).

Rack mounting offers a number of conveniences. Total systems configured of individual instruments and accessories can be combined in one or more operating cases. Patch cable, HP-IB, and HP-IL connections can be left in place within the case, so that instruments are ready to be put into use with a minimum of delay.

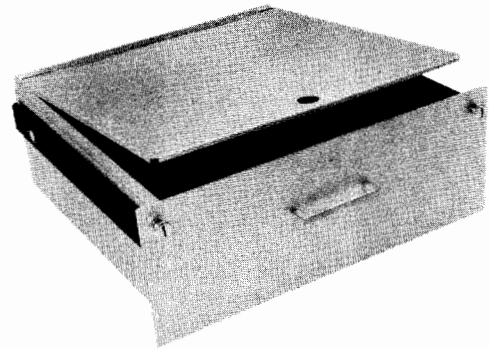

Sturdy drawers that accommodate various HP accessories and operating supplies are available in three sizes, and come with smooth operating ball bearing slides.

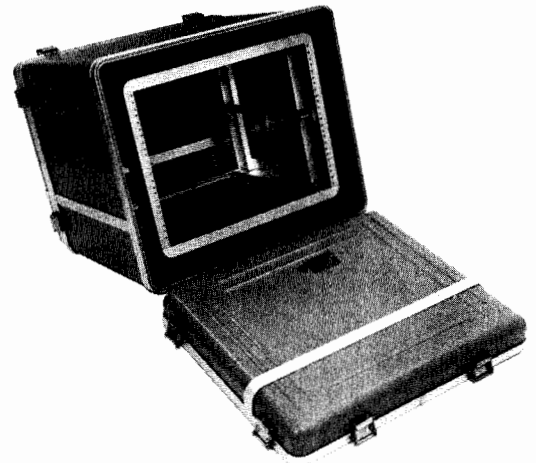

Elastomeric shock mounted frames provide outstanding shock and vibration attenuation. A set of standard shock mounts can be provided for any equipment weight and fragility.

Accessories and Options

A number of accessories and options are available to provide maximum flexibility. Drawers are available in three heights so that small accessories, supplies, and tools can be kept inside the case with the instrument (cut foam cushions can be designed to accommodate any of these items). Aluminum skids, stacking feet, internal power receptacles, and many other items are available as options on special orders, or as accessories for customer installation when ordered separately.

How to Order

Operating cases, like transit cases, are ordered through your local HP sales office. Because of the wide variety of options available and the number of configurations possible, it is recommended that you discuss your needs with an HP representative before you order.

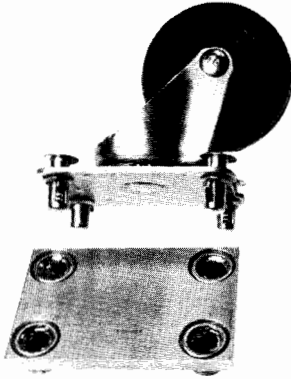

Heavy duty removable caster and mounting plate

Operating Case Selection Guide

Case Width = 24.00 in./609.6 mm (standard)

Case Depth = 28.50 in./723.9 mm (standard)

| Nominal Rack Height in. ISO | Instrument Weight | | | | Case Height in. mm | HP Part Number | Price | |
|--------------------------------|-------------------|-------------------|--------------|-----------|-----------------------|----------------|-------|--|
| | maximum lbs kg | minimum lbs kg | 1 4 | 5 49 | | | | |
| 5.25 3U | 75 34.0 | 20 9.1 | 10.75 273.1 | 9211-1302 | \$1,350 | 1,080 | | |
| 8.75 5U | 75 34.0 | 20 9.1 | 15.20 386.1 | 9211-1303 | \$1,450 | 1,160 | | |
| 10.50 6U | 130 59.0 | 30 13.6 | 17.00 431.8 | 9211-2635 | \$1,650 | 1,320 | | |
| 12.25 7U | 130 59.0 | 30 13.6 | 18.87 479.3 | 9211-1163 | \$1,750 | 1,400 | | |
| 14.00 8U | 130 59.0 | 30 13.6 | 20.50 520.7 | 9211-1241 | \$1,800 | 1,450 | | |
| 15.75 9U | 130 59.0 | 30 13.6 | 22.25 565.2 | 9211-1242 | \$1,800 | 1,450 | | |
| 19.25 11U | 130 59.0 | 30 13.6 | 25.75 654.1 | 9211-1244 | \$1,800 | 1,450 | | |
| 21.00 12U | 250 113.4 | 50 22.7 | 28.00 711.2 | 9211-1245 | \$1,800 | 1,450 | | |
| 22.75 13U | 250 113.4 | 50 22.7 | 29.75 755.7 | 9211-2636 | \$1,800 | 1,450 | | |
| 24.50 14U | 250 113.4 | 50 22.7 | 31.50 800.1 | 9211-1911 | \$2,200 | 1,750 | | |
| 26.25 15U | 250 113.4 | 50 22.7 | 33.25 844.6 | 9211-2637 | \$2,000 | 1,600 | | |
| 28.00 16U | 250 113.4 | 50 22.7 | 35.00 889.0 | 9211-2638 | \$2,200 | 1,750 | | |
| 29.75 17U | 250 113.4 | 50 22.7 | 36.75 933.5 | 9211-2639 | \$2,200 | 1,750 | | |
| 31.50 18U | 250 113.4 | 50 22.7 | 38.50 977.9 | 9211-2640 | \$2,200 | 1,750 | | |
| 33.25 19U | 250 113.4 | 50 22.7 | 40.25 1022.4 | 9211-1713 | \$2,200 | 1,750 | | |
| 47.25 27U | 320 145.2 | 70 31.8 | 53.88 1368.6 | 9211-2641 | \$2,700 | 2,150 | | |

Standard Features

Inner rack frame with provision for infinitely adjustable T-bar instrument support bracket. Standard 20" depth.

Inner rack frame with RETMA hole pattern drilled in rear rails.

Standard color: pearl grey cabinet.

Manual pressure relief valve.

Special Features Available

- A. Mating feet for stacking one case on top of another. \$50
- B. Special color. Please specify. \$40
- C. Modified inner rack frame depth. Standard depth 20" from front panel mounting surface to rear surface of frame. This option includes an appropriate change in the overall depth of the enclosure. Please specify desired inner frame depth. Maximum 23", minimum 12". \$300
- D. Chassis track C-300 instrument slide pair to mount on either side of inner frame using RETMA hole pattern drilled in front and rear rails. \$90
- E. Special shock mounts for unusual instrument weights. Please specify weights. \$40
- F. Increased front cover depth. Maximum depth 6". Please specify. \$250
- G. Increased rear cover depth. Maximum depth 6". Please specify. \$250
- H. Latches recessed into the surface of the case. \$250
- I. Handles recessed into the surface of the case. \$90
- J. Hermetically sealed case tested by the hot water method. \$90
- K. MIL-C-4150 certification with the exception of design and preproduction testing. Case will have increased wall thickness, hardware anodized to military specification, and will be hermetically tested using the hot water method. \$290
- L. Automatic pressure relief valve. \$50
- M. Addition of four permanently mounted, 3½" diameter swivel casters. \$120
- N. Addition of four removable, 3½" diameter swivel casters. Also available in kit form. \$250
- O. Addition of two aluminum hat-section skids to the case bottom. \$120
- P. Addition of lift rings to either side of the case. \$50
- Q. 3½ H (88.9 mm) Drawer with ball bearing slides. \$330
- R. 5¼ H (133.4 mm) Drawer with ball bearing slides. \$350
- S. 7 H (177.8 mm) Drawer with ball bearing slides. \$370
- T. Pair of T-Bar instrument support brackets. \$30
- U. AC power receptacle strip with four outlets mounted on bottom rear of inner rack frame. Power cord 1 meter (3' 3") long. NEMA connectors. \$50

Accessories (when ordered separately)

- 9211-1164** 3½ H (88.9 mm) Drawer with ball bearing slides. \$380
- 9211-1165** 5¼ H (133.4 mm) Drawer with ball bearing slides. \$400
- 9211-1166** 7 H (177.8 mm) Drawer with ball bearing slides. \$480
- 0950-0122** AC power receptacle strip with four outlets mounted on bottom rear of inner rack frame. Power cord 1 m (3.3') long, NEMA connectors. \$50
- 9211-1173** Pair T-Bar instrument support brackets. \$46
- 1490-0913** Caster kit, four removable 3½" (88.9 mm) swivel casters. For transit cases only. Recommended to be removed before transit. \$210
- 5081-5831** Operating Case Latch \$7.75 each
- 5081-5832** Aluminum hat section skids (2) for case bottom \$155
- 5081-5834** Caster kit, four removable 3½" (88.9 mm) swivel casters. Heavy duty for Transit or Operating Cases. Recommended to be removed before transit. \$300

On request, cases can be fabricated that meet the environmental requirements of Military Specifications. Specifications other than military are subject to change without notice.

X-RAY EQUIPMENT

Scientific and Industrial X-Ray Systems

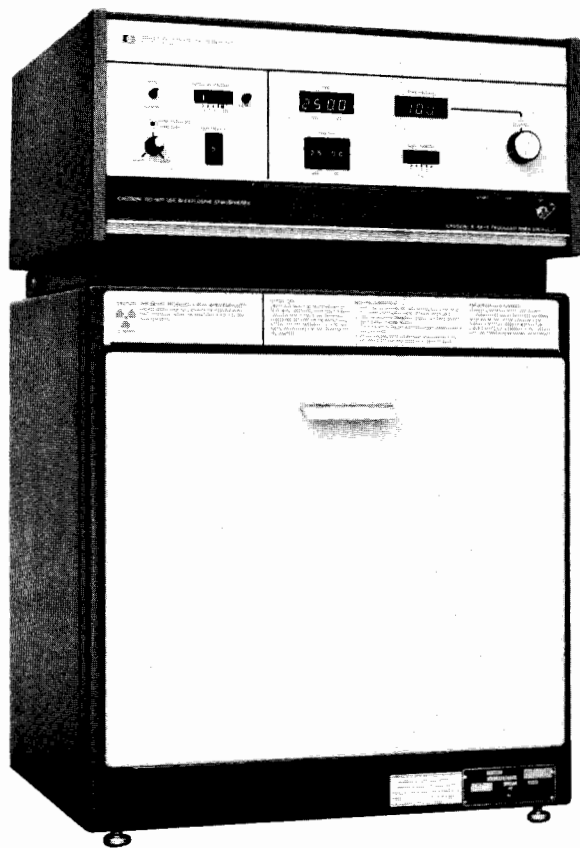

Model 43855A Option A02

Faxitron® Cabinet Systems

Radiography, the art and science of making pictures with X-rays, has an important place in modern technology. It is one of the major nondestructive test methods available to industry, provides an indispensable tool in scientific investigations and is a valuable aid to law enforcement agencies. Hewlett-Packard makes a major contribution to these activities with X-ray equipment that offers a "better way" through advanced technology and design. This equipment makes radiographs easier and safer to take.

Industrial Inspection

Industrial quality control and inspection procedures, especially in the field of electronics, benefit from nondestructive testing by radiography. The advantages of a testing method which does not harm the test objects are obvious. Radiography, therefore, offers benefits in design engineering, incoming inspection, production quality control, product reliability and failure analysis. X-rays are used to detect misregistration or plate-thru problems in multi-layer P.C. boards; porosity, poor substrate bonding and wiring or lead location in transistors and integrated circuits; voids and other encapsulation problems in potted components; and solder balls or other defects in sealed relays.

Die casting is another industry that benefits from the nondestructive aspects and ability to "see inside" provided by radiography. Porosity, gas voids, tramp metal inclusion and other common defects can be easily detected and the cause determined. Expensive machining time can be avoided for castings found to be defective through X-ray inspection. The integrity of welds, alignment of connectors, inspection for proper assembly and mechanical defects are further examples of tests which radiography performs for industry. The benefits of X-ray testing are reduced production costs, better quality assurance and product safety. The results are increased profits.

Medical Applications

HP Faxitron Cabinet X-ray Systems are used by the medical profession for specimen radiography in support of diagnostic surgical procedures and in biological research. Specimen radiographs of biopsy samples are correlated with preoperative mammograms, for example, and in the evaluation of mastectomy specimens. Typical research applications include microradiography of thin bone specimens and microangiographic studies of vasculature.

Scientific Applications

Oceanography, geology, marine biology, paleontology, pathology, botany, forestry and agricultural research are a few examples of scientific disciplines that use X-rays. Applications range from the study of the interior anatomy of fossils to determining the viability of seeds.

These are among the many applications served by HP Faxitron Cabinet X-ray Systems. They offer a unique combination of high quality radiographic capability, simplicity of operation and convenience of use which is expanding the capabilities of scientific and industrial concerns throughout the world.

HP 43700 Series Flash X-Ray Systems

High-speed (flash) radiography is used to record and study dynamic events where interposed material, smoke, flame, debris, or pressure variations exclude the use of high-speed cameras. Typical events include ballistics, shaped charges, explosives, behind-armor studies, shock waves in solids, aerospace phenomena, and crash-injury studies.

The basic performance requirement of a flash X-ray system used for the study of transient mechanisms is to provide high resolution radiographs with exposure times short enough to eliminate motion blur. HP series 43700 flash X-ray systems produce X-ray pulses of sub-microsecond duration and are designed specifically for "stop motion" radiographic applications. All HP 43700 series systems utilize the same basic components, the same electrical theory, and are modular in concept. Standard systems include 150 kV, 300 kV, 450 kV, 1 MV, and 2.3 MV models.

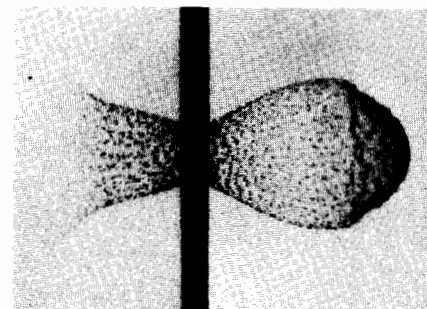

An HP basic single "channel" flash X-ray system, composed of a pulse generator, high-voltage power supply, cold-cathode field emission X-ray tube, and associated controls, provides a single radiograph per event. Additional pulser/X-ray tube sets (add-on channels) may be combined with the initial single-channel system to provide multiple-channel "systems." Multiple channel systems may be of identical output voltage or may use varied output voltage pulser/tube combinations.

For specific information and consultation regarding HP X-ray systems, contact Hewlett-Packard, 1700 S. Baker Street, McMinnville, Oregon 97128. Telephone (800) 952-2212.

FREE PUBLICATIONS

Aids to Selecting, Using & Maintaining HP Products

757

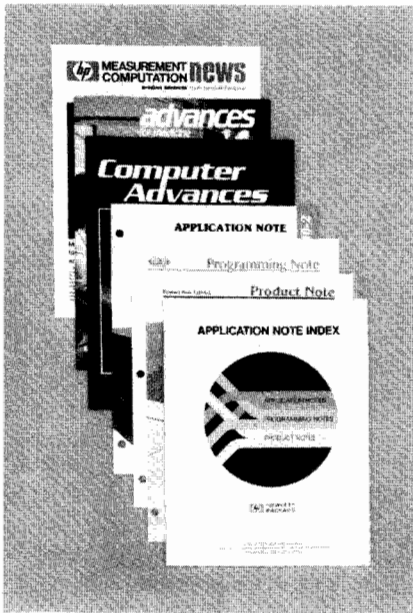

HP offers a variety of free publications to help you choose the HP products that best fill your needs, to help you benefit from applications knowledge acquired by users inside and outside of HP, and to help you maintain your HP products. These publications range from new-product announcements, catalogs, product family brochures, and single-product technical data through application notes, product notes, and programming aids to service notes and general maintenance periodicals. Since the number and types of publications vary with product type, an outline of available publications organized by product type is provided below for your convenience.

Instruments and Systems Product Information

Measurement/Computation News
Data Sheets and Brochures
Catalogs

Instruments Direct
DC Power Supplies
Recorder Supplies
Coaxial & Waveguide Measurement Accessories
Digital IC Tester Program
DesignCenter magazine

HP Journal

Application Information

Application Notes
Product Notes
Programming Notes

Service Information

Service Notes
Bench Briefs

Computers, Peripherals & Calculators

Product Information

Computer Advances
Measurement/Computation News
Data Sheets & Brochures
Catalogs
Computer Users Catalog
HP Journal

Application Information

Application Notes
Application Briefs

Medical

Product Information

Advances for Medicine
Data Sheets & Brochures
HP Journal

Application Information

Application Notes

Analytical

Product Information

Data Sheets & Brochures
HP Journal

Application Information

Application Notes

Components

Product Information

Catalogs
Diode and Transistor Designer's Catalog
Optoelectronics Designer's Catalog
Microwave Integrated Products
Data Sheets
HP Journal

Application Information

Application Notes
Application Bulletins

Measurement/Computation News

Six times a year M/C News brings you announcements of HP's latest electronic measuring instruments and their accessories; personal, desktop, and larger computers, their software, peripherals, and accessories; opto-electronic and semiconductor components; and new no-charge literature such as catalogs and application notes.

Computer Advances

Published every two months for decision makers, *Computer Advances* communicates results-oriented application stories from every sector of HP. *Computer Advances* also provides information on new computers, software, peripherals and services.

Advances for Medicine

Advances for Medicine is a quarterly magazine that presents articles demonstrating the contributions of HP medical products to medical productivity, quality patient care, and efficient healthcare management.

DesignCenter

DesignCenter is published quarterly for users of HP 64000 Logic Development System products. This full-color magazine features customer application stories, announcements of new HP 64000 products, and interesting research projects from the University Associates Program.

Application Briefs, Bulletins, and Notes

These aids to solving your measurement, computation, and design problems offer the benefit of the applications research and experience of both HP customers and HP engineers. Some are tutorial, others describe how-to procedures.

Product Notes

Product Notes augment the Operating and Service Manuals supplied with HP electronic instruments by providing information on various topics that include specifications and characteristics, operation and use, applications and performance.

Programming Notes

Programming Notes provide product-specific information on the use and operation of instruments in HP-IB systems. Some notes address the needs of inexperienced users and cover basic operation of an HP-IB instrument using a specific HP desktop computer. Others address the needs of experienced users.

Application Note Index

The AN index lists and describes the contents of all Application Notes, Programming Notes, and Product Notes on electronic instruments, instrument systems, and solid-state components.

Hewlett-Packard Journal

Published monthly to communicate technical information from the laboratories of HP to all of the fields served by HP, the Journal contains descriptions of current hardware and software products as well as more general information such as advances in technology.

Service Notes

Service Notes contain product-specific service information for HP's electronic instruments. Subjects include product improvements, modifications, and procedures for troubleshooting, maintenance, and repair. Service Notes are published as appropriate throughout the life of a product. All new Notes are announced in Bench Briefs.

Bench Briefs

Bench Briefs provides those who maintain HP instruments with timely information that has both specific and general application. Subjects include troubleshooting tips and descriptions of new technologies, components, tools, and equipment. Also, new Service Notes are listed in Bench Briefs as they become available.

How to Obtain Free Publications

To obtain any of the publications described on this page, contact your nearest Hewlett-Packard office. Locations of HP offices are listed on the back pages of this catalog.

HP offices are also your best source of current information on the topics covered by Application Briefs, Application Bulletins, Application Notes, Product Notes, and Programming Notes.

ORDERING INFORMATION

Shipping, Prices, and Terms of Sale



Communicating With HP

Hewlett-Packard is committed to providing convenient local support and the best possible attention to customer needs on a worldwide basis. There are more than 100 sales and support offices in the U.S. and some 220 sales and support offices and distributorships in 70 other countries; a listing of these offices starts on page 774.

Your entry point to the resources of Hewlett-Packard is through the local HP office nearest you. Our sales representatives and order support specialists there are well-equipped to provide you with pre-sale assistance in product selection, as well as related business information such as current product availability and price delivered to your location.

Most HP sales offices are tied into a sophisticated intra-company communications system. This not only means prompt transmission of orders to any HP product responsible division—it also speeds the flow of regular messages among HP sales offices and factories. The objective, of course, is to provide the fastest possible response to your product interests.

Budgetary Prices

Price information which may be supplied with this catalog provides you with helpful budgetary guidance.

Please call your nearby Hewlett-Packard sales office to determine a product's delivered price.

Prices furnished with this catalog are net prices prevailing at the time of printing. Hewlett-Packard reserves the right to change prices, and those prices prevailing at the time an order is received will apply.

Quotations and Pro Forma Invoices

Destination prices and other details you may need to know before ordering can be quickly obtained via telephone. Just call your nearest HP office.

If you are an international customer requiring formal paperwork such as pro forma invoices or quotations, please contact the Hewlett-Packard office or representative serving your area. Exportation or importation assistance is also available.

Placing Your Order

Hewlett-Packard people at the sales office nearest you will be pleased to provide assistance in selecting the HP equipment most appropriate to your needs, and to help you prepare your order.

The information in this catalog will, in many cases, be sufficient for you to decide to buy a particular HP product. In those instances, a telephone call to the nearest HP office will provide you with (1) information on product availability, and (2) the product's price.

HP wants to be sure the product delivered to you is exactly the one you want. Therefore, when placing your order, please specify the product's catalog (model, accessory, or part) number, as well as the product's name. Be as complete as possible in specifying exactly what you'd like, including standard options.

In the event you want special features or capabilities such as different color or a non-standard power line voltage, ask your HP sales representative about availability and cost of these "specials" first—and then, to prevent misunderstandings, include special instructions and specification details with your order.

Terms of Sale

Inside the USA: Hewlett-Packard's standard credit terms for established customers in the USA are net 30 days from invoice date.

Leasing and extended financial terms are available. However, the associated costs are not included in any product prices furnished with this catalog. Your nearby HP office will be pleased to discuss your requirements and work with you in setting up an appropriate program.

Outside the USA: terms for orders placed on Hewlett-Packard Company by customers outside the USA are irrevocable letters of credit or cash in advance—unless other terms have been previously arranged. Please contact authorized Hewlett-Packard international subsidiaries or distributors regarding terms for orders placed with them.

J.S. Government Sales

Some products in this catalog are covered on GSA federal supply schedule multi-award contracts.

Product Changes

Although product information and illustrations in this catalog were current at the time it was approved for printing, Hewlett-Packard, in a continuing effort to offer excellent products at a fair value, reserves the right to change specifications, designs, and models without notice.

Shipping Methods

Inside the USA: shipments to destinations in the USA are made directly from factories or local warehouses. All prices include HP standard transportation and routing to any U.S. destination. If a different shipping method is needed, we will gladly ship to satisfy your requirements. In this case, the shipment will typically be sent freight collect.

Outside the USA: shipments to destinations outside the USA are made from the appropriate Hewlett-Packard facility by either surface or air, as requested. Sea shipments usually require commercial export packaging at a nominal extra charge.

Introduction

When Performance is Measured by Results . . .

Success in today's business environment depends on obtaining high productivity from both people and equipment. Selecting the right measurement and/or computer system is essential to achieving proper results.

. . . Results can be Assured by Support

At Hewlett-Packard, we understand that achieving the best results from a measurement or computer solution involves much more than just purchasing the right equipment. That's why we are a world leader in customer support and satisfaction.

HP's Complete Solution to Your Success

We want you to be successful with your HP solution. So we've designed flexible support that can be tailored to meet your individual productivity needs

HP support helps you to quickly realize the full potential of your HP solution:

*Customer Education provides you with the expertise to take full advantage of your system's advanced technology and capabilities so you can become more productive faster.

*Application Consulting helps you implement your HP solution quickly and smoothly, and to customize systems solutions to meet your own unique needs.

*Hardware support helps minimize productivity interruption for maintenance and calibration so that you can prolong your system's useful life.

*Software support ensures that your system software is as current and productive as possible so you can maintain your competitive edge.

When you purchase HP equipment and support together, you are purchasing a complete productivity solution.

Make HP Your Partner in Productivity

Hewlett-Packard can be your partner in success. From your first consideration of an application solution through the entire life cycle of your system's implementation and use, HP stands behind your success with a complete range of worldwide support services. Choose Hewlett-Packard as your partner in success and you are assured of state-of-the-art hardware, software and support productivity.

Ordering Support is Easy

If you wish to design your own support program you may select the services you need from the product descriptions which follow. Or, if you prefer HP to configure a support plan for you, just contact your local HP sales office.



Your HP system implementation can be viewed as an application "life cycle". Each step of this cycle provides an opportunity to improve the use of your instruments or computers to increase productivity. Whether you are in the decision, implementation or sustained operation phase of your application life cycle, HP can provide the tools, knowledge, experience and support to ensure success

THE APPLICATION LIFE CYCLE

Planning and Evaluation

Needs Analysis and Requirements Definition • Authorization and Financing • System and Support Specifications • Cost of Ownership Analysis • Vendor Selection • Equipment Order

Getting Ready

Implementation Planning • Application and Operator Training • Site Survey and Preparation • Information Gathering

When the System Arrives

Hardware & Software Delivery • Racking, Cabling and Installation • Functional Test Design and Coding

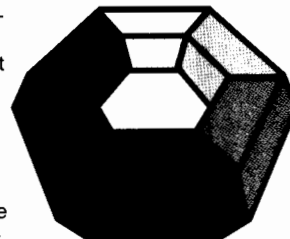

Extending System Life

System Expansion or Reconfiguration • Hardware Upgrades and Refurbishment • System Software Upgrades • Application Software Performance Improvement • System Replacement

Keeping the System Productive

System Calibration & Preventative Maintenance • Remedial Maintenance • System Software Updates and Support • Supplies Availability

Putting the System to Productive Use

Application & Test Design • Program Coding • Program and Test Documentation • Fixture Installation • Staff Training



CUSTOMER SUPPORT

Customer Education



Training For Your Success

Proper knowledge of computing and electronic measurement techniques and system capabilities will make you more productive. HP Customer Education is designed to be a cost-effective method of quickly acquiring the knowledge and skills necessary to obtain maximum success with your HP solution.

With HP Customer Education you can gain a competitive advantage by minimizing start-up delays due to insufficient understanding of your system or its operation. Training can also acquaint you with new applications and operating techniques which can significantly improve your productivity.

Learn More . . .

HP Customer Education provides you with an in-depth understanding of advanced technology and operating techniques. Students will learn more in an HP class than they could reasonably expect to learn by spending the same amount of time teaching themselves.

Learn Faster . . .

HP Customer Education is an intensive learning experience. Courses are designed to teach you quickly and efficiently how to use your equipment in new and productive ways.

Course material is presented in a logical and businesslike manner so that students can quickly assimilate vital information. No time is wasted on "salesy" presentations - the student's time is fully devoted to learning.

Learn Better . . .

The structured learning environment provided in an HP training course allows for full retention of course materials. A student will find that he or she can more quickly apply principles learned in a class, instead of trying to constantly learn through hit-or-miss experimentation.

The courses introduce key concepts and principles through illustrated study materials and lectures. Students then apply what they have learned through hands-on exercises and labs. In this way principles are immediately reinforced through actual use.

. . . For Your Success

In today's fast-paced business environment, gaining the most productivity from your people and equipment is essential to your success.

HP Customer Education can help you achieve this success. Choose from the computer and/or instrument courses described below, or contact your local HP Sales Office and ask for a copy of our free course catalog.

HP-IB Systems Oriented

The courses below will help you integrate various HP instruments into your own HP-IB configured system, and then help you gain maximum value from their operation.

HP-IB Instrument Programming With HP 1000 E/F Series Controllers

This three-day, hands-on training will teach you how to enhance the measurement power of your instruments by coupling them to an HP 1000 E/F Series computer. Learn how to program, monitor and implement a complete HP-IB system. To attend this course, order HP 50016E.

HP-IB Instrument Control Using Series 200 BASIC

This five-day lab-oriented course will enable you to set up and customize an HP-IB system to do various automatic test or measurement/control tasks. You will learn to create and document HP-IB programs by applying structured programming techniques using HP Series 200 Desktop Computers. To attend this course order HP 50011B.

HP 1980B Waveform Measurement System Training

This two-day lab-oriented course will speed your ability to make completely automated time domain measurements using the HP 1980B Oscilloscope in conjunction with the HP 1900A Waveform Measurement Library and HP 9826/9836 controllers. You will learn measurement algorithms and data structures that measure waveform voltage and timing parameters, and be able to create custom applications programs. Ask for course HP 1980B+24A.

HP 6944A Multiprogrammer User's Course

This three-day course teaches you how to make measurements and perform stimulus/response or control for automation applications using the HP 6944A and the HP 85 computer. The course emphasizes practical applications and extensive hands-on experience with this important system component. Ask for HP 6944A+24D.

Logic Related Courses

Today's microprocessor technology demands high logic development and analysis skills. HP offers a variety of courses to meet your needs in this important technology.

HP 64000 Logic Development Concepts and Measurements

To increase your productivity with the HP 64000 System, HP offers a group of courses.



The HP 64000 System Concepts and Measurements course teaches general system operation and capabilities including emulation. Ask for HP 64100A+24D.

HP 64000 System Pascal Programming

HP offers two courses to help you use Pascal on your HP 64000 System. HP 64000 System Pascal Programming Course is a three-day introduction to the language using HOST Pascal. HP 64000 Pascal Microprocessors Course is a two-day applications oriented session designed to improve your microprocessor productivity using Pascal. If you are a software engineer, ask for HP 64000 System Pascal Programming Course. Also ask about HP 64000 Pascal training for specific microprocessors.

Advanced Timing/Hardware Analysis Training

This one-day course teaches the concepts, applications and configurations of timing analysis using an HP 64600S 8-channel timing analyzer. You will learn to identify and solve timing related problems, understand the interaction of the timing and state modules, and theories and effects of skew and asynchronous triggering. Ask for HP 64600S+24F.

Software Performance Analysis Training

This one-day course will help you simplify your complex software development process using the HP 64310A Software Performance Analyzer. You will learn to measure memory activity and evaluate program activity, as well as determine time distribution of a module's execution and transitions, and evaluate Intermodule Bus measurements.

This course will help streamline all phases of your software development. Ask for HP 64310A+24A.

HP 1630 Logic Analysis Measurement Techniques

This one-day lab-intensive course offers a systematic approach to problem solving using state, timing and software performance analysis with the HP 1630 logic analyzer. You will learn to match appropriate measurement techniques to specific problems using the interactive state and timing capabilities of the HP 1630. Ask for HP 1630A/D+24A.



Board Test Courses

The accurate testing of IC boards is crucial to the productivity of many businesses. HP offers a variety of board test courses designed to enhance your use of HP board test equipment.

HP 3060A, 3061A, 3062A User's Course

This ten-day course presents the knowledge necessary for testing analog and hybrid circuits with the HP 3060A/61A/62A board test systems. Included is software instruction on the HP Series 200 Desktop Computers, the Board Test Language (BTL) and the In-Circuit Program Generator (IPG). Time is spent on testing philosophies involving shorts, in-circuit and functional testing as well as semiconductor tests, guarding, phase-synchronous detection, digital testing and signature analysis. Ask for HP 3060A/61A/62A Board Test System User's Course.

HP 3065 Board Test System User Training

This two-week course provides detailed programming and operating instruction for the HP 3065 board test system. Topics covered include system software and program development, board test topology, in-circuit testing digital scanner hardware, test language and test structure. Also included are reviews of BT BASIC, test optimization, fixturing, data logging, networking links and IPG II. Ask for HP 3065C+24D Training.

RF & Microwave Related Courses

HP's RF & Microwave related courses provide you with practical training for your measurement applications.

Basic Measurements Using the HP 8510 Network Analyzer System

This three-day, lab-intensive training will allow you to better apply the HP 8510 to your needs. You will learn microwave and network analyzer fundamentals, system op-

eration, maintenance and self-test, as well as error correction, time domain and advanced operating techniques. This training will allow you to quickly take full advantage of the advanced capabilities of the HP 8510 Network Analyzer. Ask for HP 8510+24D Training.

HP 8566A/8568A Spectrum Analyzer Operation

This four-day program will help accelerate the integration of your HP 8566A or HP 8568A into automatic test systems. You will learn to effectively use signal acquisition and process capabilities; as well as how to analyze and optimize accuracy, sensitivity, dynamic range and resolution in a system environment. To attend this training, order HP 8566A/8568A+24D.

Additional Instrumentation Courses

HP offers a number of other courses to help you understand instrumentation applications and to help you use your HP equipment more effectively.

Data Acquisition and Control Fundamentals

This three-day course is a hands-on introduction to the basic principles and concepts of data acquisition and control. After an overview of various system types, you will learn the techniques needed to measure various physical phenomena such as temperature and pressure. To gain a deeper understanding of what data acquisition and control automation can do for you, ask for HP 50015A.

HP 4955A Protocol Analyzer User Training

This one-day lab-intensive course is built around the concept of a short tutorial on troubleshooting techniques, immediately reinforced by gaining hands-on experience with the HP 4955A Protocol Analyzer. You will learn to configure the analyzer for character-oriented and byte-oriented protocols, custom data codes, and Level 2/Level 3 triggers. Ask for HP 4955A+24A Training.

HP 8180A/8182A Operating and Programming Techniques

These courses will teach you how to use and program the HP 8180A Data Generator and HP 8182A Data Analyzer to perform basic propagation delay, set-up and hold time measurements for devices under test. The format of this course allows for maximum hands-on activities so that you will gain real-time practice in operating the instruments and developing programs.

Other Test & Measurement System Courses

HP offers many more courses for electronic instrumentation, and others are being developed all the time. If you are using HP Semiconductor Test Equipment, look for **HP 4062B Operating and Programming Training**

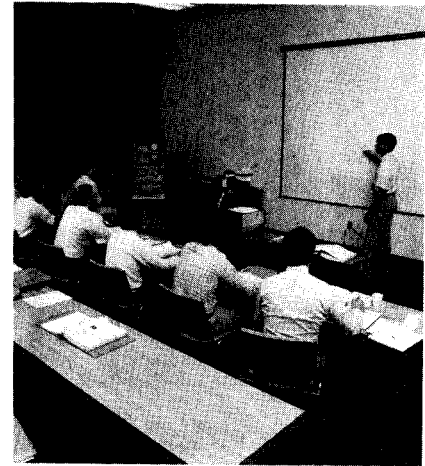

and HP 9430A Memory Test System Training. Other useful courses include HP 8409C Automatic Network Analyzer User's Course and HP 55280A Basic, and HP 55283A Advanced Laser Measurement System Training.

Computer Systems Customer Education

HP also offers a comprehensive range of training courses for the HP 3000, HP 1000, HP 9000 and HP Series 100 and HP Series 80 computers. These courses cover a variety of application and operation subjects so that you can use your computer systems as efficiently as possible.

Of particular interest to engineering oriented applications are:

*HP-UX curriculum for UNIX™ users, programmers and system administrators

*Engineering applications on the HP 9000 Series, including Fundamentals of EGS/200 and Advanced EGS/200

*HP 1000 Series process monitoring and control, statistical quality control and automatic test systems programming courses

In addition, HP's computer systems curriculum includes a wide variety of software courses designed to help your business - from data base management and quality decision management to advanced graphics and financial analysis.

Also available are fundamental and advanced computer system maintenance courses to help your inhouse maintenance team sharpen their technical skills.

Ordering Information

HP's flexible computer and instrument systems training courses allow you to create a customized training plan. To help you meet your training needs, your HP representative will work with you to develop the proper training curriculum for your particular situation.

To enroll in any of the courses listed here, or to obtain more information on these and the many other courses HP offers, just contact your local HP Sales Office. They will provide you with complete course details, local class schedules and registration information.

UNIX is a US trademark of Bell Laboratories



CUSTOMER SUPPORT

Application Support



Application Support

- Industry Leader
- Worldwide, Quality Support
- Extensive Experience
- One-Vendor Solution

Hewlett-Packard's applications consulting experience can be yours. Trained systems and applications experts are available to work with you to develop customized solutions to your unique needs. Choose from among the programs described below for test and measurement and data processing/computing solutions to your application requirements.

Instrument Application Service for Measurement Systems

When you purchase a test or measurement system, you want to make sure that the payback starts quickly. HP's Instrument Application Service (HP 5600B) provides assistance in developing your staff to ensure the most effective use of your system. Instrument Application Service (IAS) features the expertise of an HP Systems Engineer trained in your application area, and can be tailored to meet your own specific needs.

Customized Training Improves Utilization

If your application requires training that falls outside the scope of HP's formal training courses, our Systems Engineer (SE) can provide customized training to fit the demands of your particular application.

An HP SE skilled in your application area will work with you to determine the topics to be covered and the structure of the material to be presented. The training can cover basic system startup and operational techniques or can include more advanced material on your application. Each day of SE training could save your staff several days of startup time and could improve your overall capabilities and operating efficiency.

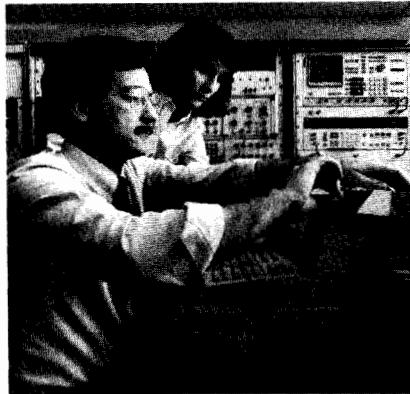

Application Support Speeds Solutions

Even if you require assistance beyond training, IAS can help. Under IAS, an HP SE can provide application support designed to help you achieve the highest possible level of success with your HP ATE, data acquisition board test, logic development, or other system.

System Level Expertise Increases Productivity

If you have an existing measurement or test system and have partially or fully developed software or fixturing, IAS can help you fine tune the final implementation. An SE will travel to your site and work with you to analyze system performance parameters and make recommendations to help optimize performance.

Interactive Help

The interactive nature of IAS allows for maximum flexibility to improve your productivity. Since your needs determine the best mix of training, application advice or performance evaluation, an initial discussion with your HP representative will help define how IAS can benefit you. Our SE will then perform any research and preparation necessary.

The services provided by IAS are flexible and can be purchased in increments of one day (plus preparation time) or in larger blocks spaced out over longer periods.

Application Development and Implementation Services for Measurement Systems

Whether you are a small test lab or a large production facility, start-up time can be unproductive time. All new system installations have associated set-up and application programming time. HP wants you to quickly obtain use of your HP-IB, data acquisition, circuit test, or other HP products. Application Development and Implementation Services (AD&I) offers you the most rapid and cost-effective method of getting your system into production. AD&I provides all or part of initial application development and program coding for your system.



Problem-Solving Experts

HP's System Engineers are experienced with test and measurement systems and in solving application problems. Our SE will work with you to identify the procedures needed for your initial application. The SE can also develop the software and prepare your staff to maintain the package upon implementation.

Flexible to Meet Your Needs

AD&I is a flexible service which is tailored to your needs. Applications problems are solved using an incremental approach which helps in the development of clear project checkpoints and division of responsibility for each phase.

The project specification is structured so that both HP and you are ensured of success upon completion. The SE will work with you to design and specify the system's application software. You benefit from the SE's experience in software development and receives a detailed document including:

- a flow chart of the system controller application package
- a description of how the subsystems interact, and combine to meet overall requirements
- fixturing specification
- acceptance test procedure specification for each of the tasks, software sub-systems, and the completed system

Substantial Benefits

With the Project Specification, the customer knows exactly what is being purchased. And mutually agreed upon acceptance criteria assure project completion with a minimum of "hassles". With AD&I, you get minimized and controlled project costs, increased in-house expertise, and decreased future maintenance costs for customer configured systems. And the quality of your applications implementation is maximized.

Application Project Centers for Computer and Instrument Applications

Application Project Centers represent HP's commitment to ensuring that all your unique business requirements are met. They provide you with a comprehensive range of project services.



From Idea to Solution

When combined with HP products and support services, your ideas are transformed into quality solutions. HP can provide the hardware and application software and, through an Application Project Center, provide many services to assist in your system's implementation.

The Project Center Approach to Quality Solutions

The Definition Stage incorporates system analysis, functional and design specifications, and HP's consulting resources. A written proposal includes hardware, software, training, and support issues. The Software Development Stage integrates HP's experience, use standards, and productivity tools with subcontract management. This results in custom software development which interfaces to computers and instrumentation. This is especially important to customers who want to augment HP standard application products while maintaining a single vendor approach to implement the project.

A detailed Custom Implementation Plan is then created which pulls together all the preceding work with HP's special support services. It incorporates HP's implementation services for software products and addresses all the customer's training and support needs. It may include customized education which is specific both to the application and to the environment in which it is being implemented.

Through a Working Partnership

HP's project team is a unique combination of people, expertise, equipment, and systems. The HP team works with your project team to develop and implement a quality solution.

Application Project Center services, coupled with HP's hardware and application software, gives HP the ability to provide the high quality, single source vendor that your company deserves.

HP-ASSIST for Computer Applications

Helping your people use computer applications successfully is the goal of HP-ASSIST. Implementation of application software requires good planning, training, and a systematic approach to project management. At all these stages, HP-ASSIST helps your people obtain results.

More than Just Installation

To integrate application software into your daily operations, your people must understand how to use the system to its fullest capabilities. HP-ASSIST helps people adjust to changes in their computerized environment.

Saves You Time and Money

HP-ASSIST uses a systematic approach to implementation. You can reduce application software integration time. Your people learn the most efficient operating procedures from the start, which helps avoid problems once the system is in operation.

Teamwork Works

Successful implementation requires teamwork. Your project team provides a clear understanding of how your business functions. We add our specialized skills. This combination results in productive solutions.

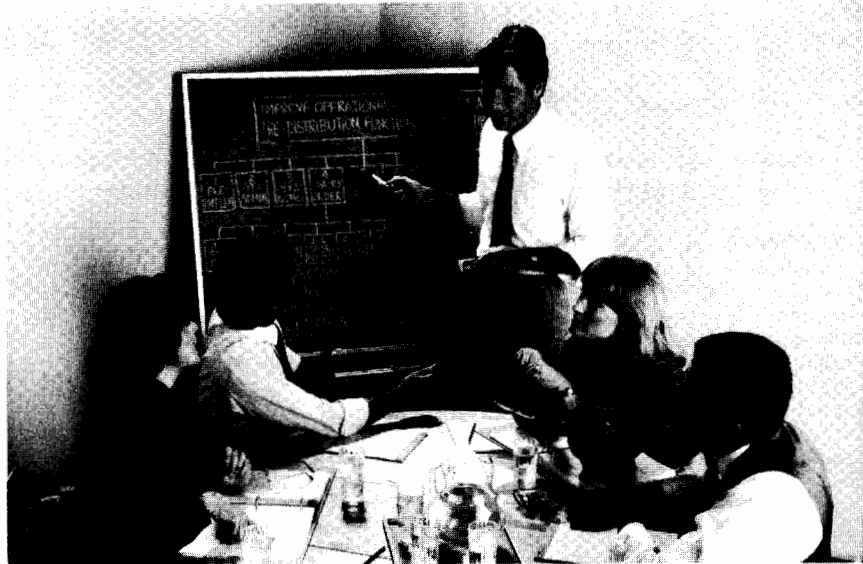

training end users, and monitoring the effective execution of the plan.

Planning for Success

HP-ASSIST consists of three phases. Customer Application Analysis is the key to the rest of the project implementation. This phase involves an analysis of your current business procedures. A written analysis documents how the application will be used to meet your needs. In the Implementation Team Training phase, a customer Project Team is formed. An HP project manager will provide the team with an overview in planning and project management. Once a solution is agreed on and a Project Team is in place, HP and the customer will work together to implement the solution. This Project Implementation Assistance phase involves developing a detailed Implementation Plan,

On-Going Services

After your application is implemented, HP's on-going hardware and software support services make sure your computer system continues to operate smoothly and effectively.

Solutions Backed by Services

HP is committed to high quality solutions backed by high quality implementation services.

How to Order

To learn more about application support services, contact the nearest HP sales office or talk with your HP Sales Representative.



CUSTOMER SUPPORT

Software Support

- Broad Range of Services World-wide
- Flexible Options to Suit your Budget
- Assured Lasting Value for your HP Computer Products

Software Support

Your investment in system software doesn't end with the purchase of an instrument or computer system. It continues as you develop or improve programs specific to your application needs. Through HP's software support services (available for computers and specific instrument systems), you will gain valuable tools to keep your system software and programmers operating at peak efficiency.

Real Benefits

Software support allows you to stay current with changes in system software. Access to an HP Systems Engineer means that programmers save time during test development. Above all, software support can help you stay competitive. Because software support keeps you constantly informed of software changes, additions and enhancements, your system's operation cannot become outmoded.

Flexible Services

Because we realize that individual needs vary between users as well as over time, HP offers several types of software. We offer training courses, predefined and unstructured consulting assistance, and a variety of support agreements as well as assistance on a time and material basis.

Software Support Agreements

Our software support agreements provide the initial and ongoing technical information your staff requires. The assistance provided can range from documentation updates to personalized technical assistance, depending on the urgency and complexity of your needs. You can adapt your selection of services to meet the changing requirements of your computer system over time.

Account Management Support (Computers Only)

This service provides the expertise of an account-assigned support representative who gets to know you and your system. This in-depth knowledge of your situation allows our representative to make recommendations for managing your software with maximum effectiveness. It also contributes to prompt remedial action when necessary.

Telephone access to the Response Center is an integral part of this service. The Response Center provides an almost immediate response to urgent questions and a response within two hours to all others.

If on-site assistance is needed to identify a problem or develop a workaround, it is also included in this level of support. Additionally, you receive all support materials necessary to stay current with changes and improvements in HP software.

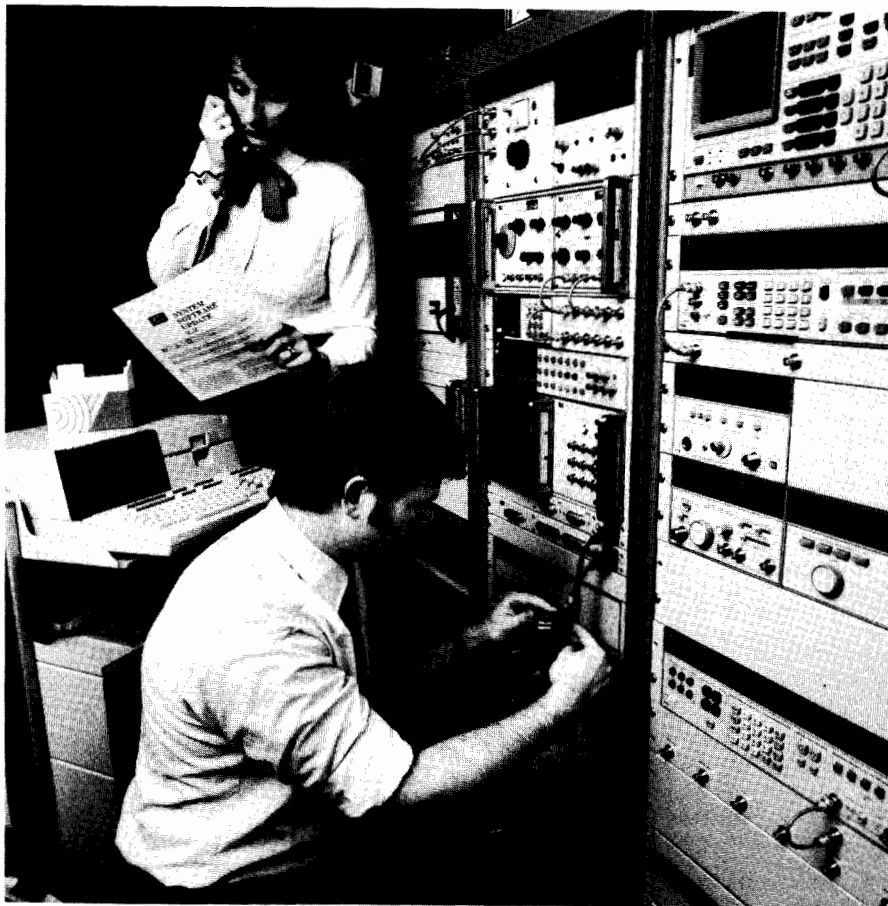

Response Center Support (Computers and Selected Instruments)

Response Center Support provides help from experienced professionals via the telephone. Teams of support engineers respond to urgent questions almost immediately and answer other questions within two hours. If on-site assistance is needed, it is available on a time and material basis. With Response Center Support, all of the software support materials necessary to maintain your system at current levels are included.

Software Materials Subscription (Computers and Selected Instruments)

If you want to stay current with developments in your system's software and are experienced on the use and operation of the software, then Software Materials Subscription (SMS) is for you. With SMS you will automatically receive Software Updates. These include improvements to software performance, additional software elements, resolution of specific anomalies, and increases in software capabilities.

You will receive Reference Manual Updates, Software Status Bulletins, and a User's Newsletter—all of which contain information on the use, application, configuration, and developments in HP software. For computers, this subscription is an integral part of both Account Management Support and Response Center Support, but is also

available separately. On-site assistance can be obtained on a time and material basis.

Custom Support Plan (Computers Only)

For additional assistance beyond the level provided by Account Management Support, we offer our Custom Support Plan. You work with your support representative to define the exact combination of services which will meet your needs. For consulting, reviewing or coordinating on a regular basis, this plan allows you to project all your software support needs in advance.

Support to Cover Multiple Systems

If you have several systems under a single System Manager, various optional services can be added to your support program to provide coverage for them at a significant cost savings.

Time And Material Service

HP software support assistance is also available on a time and material basis for purchase as needed.

How to Order

When expert technical support is important to the ongoing success of your application, consider HP's software support services. Details on software support availability and on ordering software support may be obtained by contacting your HP Sales Representative.



Hardware Support

- Flexible and Comprehensive Service Plans
- Personalized Service
- Factory Trained Service Personnel

Hardware Support for Your Productivity

You will gain a powerful tool when you invest in the engineering quality of HP products. Yet simply choosing productive HP products is often not enough to maintain your increased productivity. High performance equipment demands high performance maintenance in order to sustain your productivity. At HP, we use our more than 40 years of engineering experience to design hardware support services that match the quality and performance of our computer and measurement systems.

A Spectrum of Hardware Support Services

There's a complete spectrum of support products for you. If you want cost-effective Maintenance Agreements that offer insurance-like protection, or per-incident service at low standardized prices, we have a plan for you. If you need on-site service for your systems, or fast return to HP service for your components, HP offers a plan for you. If you need instrument repair only or just calibration backup for your cal lab, or both—there's a plan which fits your needs.

Hardware Maintenance Services

All HP computer and measurement prod-

ucts can be covered by one of HP's maintenance agreement services. These services assure continuous operation and availability at a standard monthly charge. They are provided by highly trained Customer Engineers and include travel, labor, and parts. You can select from a variety of services, depending on your requirements for response time, coverage hours, and cost.

Full Service Agreements allow you to reduce downtime by eliminating quotation and approval required with per-incident services. Agreements also save you the risk of having to finance unusually costly repairs, and the fixed yearly charge gives you a known, budgetable service cost.

The first two services listed below (SSMS, BSMS) are Full Service Agreements. A Customer Engineer (CE) is assigned to your account. The CE becomes familiar with your environment and takes personal responsibility for managing your system maintenance program. Preventive maintenance is performed on a regular basis, scheduled in advance, to maintain your system at its optimum performance specifications.

Standard System Maintenance Service

This agreement provides coverage from 8 a.m. to 9 p.m. Monday through Friday (excluding HP holidays). This coverage allows all scheduled maintenance services to be performed after normal working hours. Customers within 100 miles of a Support Responsible Office will receive an on-site visit within 4

hours. Extended coverage options can provide service up to 7 days per week, 24 hours per day.

Basic System Maintenance Service

This service provides economical coverage from 8 a.m. to 5 p.m. during the normal workweek (excluding HP holidays). If you are located within 100 miles of a Support Responsible Office, this service offers next-day response for on-site visits. Longer response times are offered beyond 100 miles. (Improved response time and After Coverage Hours service are also available at additional cost on a per-incident basis.) Desktop computers configured with system peripherals gain the account management and system support essential for these configurations. Desktops used in standalone situations can be covered under workstation services.

For Measurement Systems

Full Service Agreements A Full Service Agreement (Standard or Basic Maintenance Service) offers a number of practical advantages (see Full Service Agreement section). You can obtain the benefits of repair and calibration services at a cost savings compared to purchasing the services separately.

Calibration Agreements Calibration Agreements provide checking of instrument specifications by performing all the tests specified in the Performance Test Section of the Instrument Manual. A certificate of conformance verifying that the equipment meets HP's published specifications and that the measurements are traceable to NBS or equivalent standards body is provided.

Instrument Repair Center Agreement

When you purchase an Instrument Repair Center Agreement, you receive many of the same benefits described under our Full Service Agreements. Agreements are available to provide repair service, calibration service or both on return to HP bench. When your instrument arrives at one of our conveniently located Instrument Repair Centers around the world, it is given priority response and attended to by a skilled bench technician. All labor and parts required to perform the services are included.

Per-incident Instrument Repair If your maintenance needs are more limited, or if you prefer to manage your own maintenance program, HP Instrument Repair Center per-incident services offer you cost-effective maintenance.

Standard repair and calibration prices have been established for some 700 current instruments. These standard prices cover routine repair and calibration of HP instruments that break down in normal use. Even though our maintenance effort may vary from incident to incident, the work quality and prices remain standard.

Warranty Services After installation, HP provides on-site maintenance services for all hardware initially purchased with the system for a 90-day warranty period. If you purchase a maintenance agreement when your computer system is installed, you will receive that level of service during the entire warranty period at no additional charge.

CUSTOMER SUPPORT

Hardware Support

For Computer Systems Workstation Services

Refer to the Personal Computer section for information on maintenance services designed for terminal, personal computers, plotters, and printers used with your system. While some of these products can be covered under your system maintenance agreement, it is usually more economical to obtain workstation coverage for them.

System Installation Services

When you purchase an HP computer or measurement system, support services begin even before your system is installed. A Customer Engineer routinely provides site planning, site environmental survey, and installation services. This advance planning ensures the sustained, reliable operation of your system.

Per-Incident Maintenance

Time and Material Service is available for HP computer systems not covered by a maintenance agreement. When you purchase this service, you receive a three-day response during coverage hours of 8 a.m. to 5 p.m., Monday through Friday, excluding HP holidays. You will be billed for all travel, parts, and labor involved in the service call.

Cooperative Support Services

Self-support is an expensive support solution. However, you may have the very large installed base of HP computer equipment and the technical expertise needed to make it cost-effective. If you meet these qualifications, HP has several services under the Cooperative Support Program to meet your needs.

Customer Maintenance Training is available for the HP 3000 Series 40 and 44, the HP 1000, HP desktop computers, and selected peripherals associated with these products. A balance of theory and practical experience provides customers with the skills needed to troubleshoot, repair, and maintain these products to the major subassembly level.

Hardware Subscription Service furnishes current service information for products covered by Cooperative Support. It includes a monthly newsletter for prompt notification of changes to maintenance procedures, periodic bulletins for procedural changes not yet included in manual updates, service manual updates and revisions, and a quarterly newsletter for current schedules and other information of HP's maintenance training program.

Technical Assistance Service provides access to the HP Customer Engineering Organization through phone-in consulting. It also includes all the features of Hardware Subscription Service to keep you current on procedures and training schedules. In addition, this service provides an account-assigned Customer Engineer to ensure that you are making the most effective use of all HP hardware services.

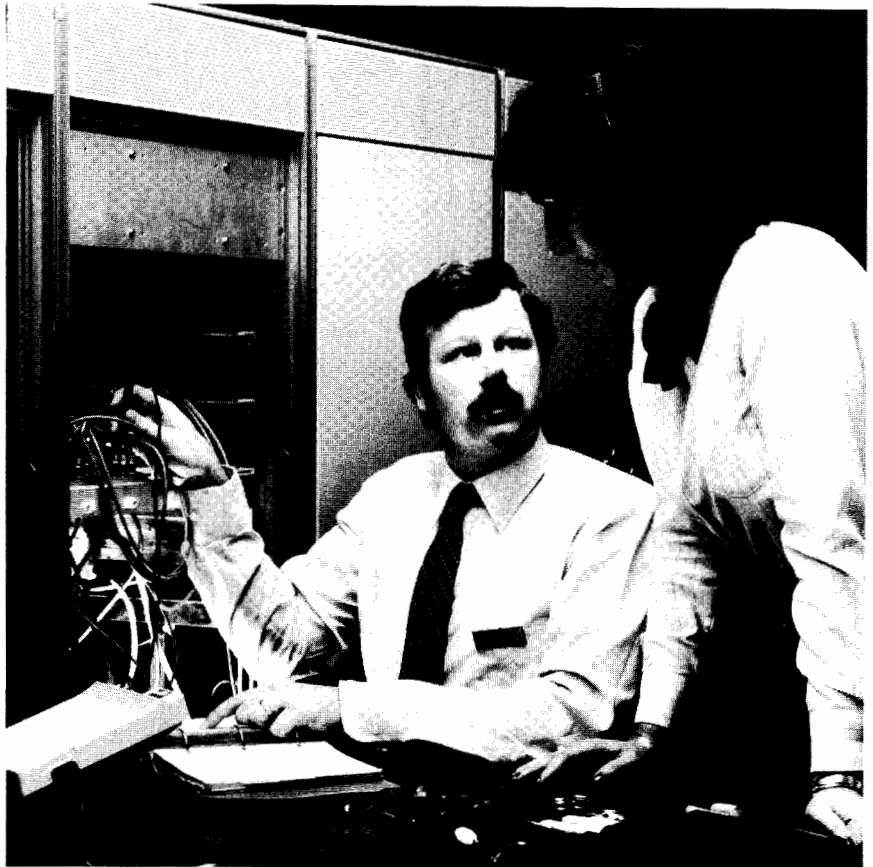

The Assembly Exchange Program

offers customers who perform their own maintenance a fast, economical method of exchanging defective assemblies for refurbished ones. The modular design of our products enables the easy removal of the defective assembly and the easy installation of its replacement. In addition, the refurbished assembly is automatically updated to the latest revision level.

HP Service Locations Worldwide

HP maintains computer sales and support offices in more than 30 countries around the

world. Refer to the listing of addresses at the back of this catalog for specific information. Selection is easy!

Whatever your level of need, our hardware support program offers you an appropriate level of service. For your computer service needs use the convenient Service Selection Guide on the next page to compare features and benefits. Then contact your local HP sales office for additional information on the service you require. Your HP sales representative can likewise help you choose the proper service level for your instrument and instrument system needs.

- Wide range of service offerings

Computer Service Selection Guide

| SUMMARY FEATURES | SERVICE | | | | | | | |
|---|--|--|--|--------------------------------------|---------------------------|---|---------------------------------|---|
| | GUS | STANDARD | BASIC | PRIORITY ON-SITE SERVICE | NEXT DAY ON-SITE SERVICE | SCHEDULED ON-SITE SERVICE | COURIER RETURN SERVICE | CUSTOMER RETURN SERVICE |
| Response time (or total turnaround time) | 4 Hours | 4 Hours ² | 1 Day ² | 4 Hours ² | 1 Day ² | 3 Days Average (scheduled weekly visit) | 4 - 6 Days ³ | ≥5 Days Total ⁴ |
| Coverage Hours | 24 Hours/Day (7 Days/Week) | 8 AM - 9 PM ¹ (5-7 Days/Week) | 8 AM - 5 PM (5 Days/Week) | 8 AM - 5 PM (5 Days/Week) | 8 AM - 5 PM (5 Days/Week) | 8 AM - 5 PM | 8 AM - 5 PM | - |
| Relative Cost | 1.6 | 1.0 | 0.8 | 0.8 | 0.5 | 0.25 | 0.3 | 0.25 |
| Commercial Systems | Available only on new & current HP 3000 products Recommended only for critical applications | | | | | | | |
| Small Business Systems | | | | | | | | |
| Technical Systems | | Good for manufacturing systems needing multiple shift coverage | | | | | | |
| System-Workstations Personal Computers & Terminals | | | Recommended only on System Console (P) | Recommended only on System Console | | Recommended with purchase of spare units for backup | Recommended for maximum economy | Recommended where Courier Return Service is not available |
| Standalone Workstations Personal & Desktop Computers | | Recommended only on System Console (P) | Recommended only on System Console (P) | Recommended in critical applications | | | Recommended for maximum economy | |



NOT AVAILABLE



NOT RECOMMENDED



RECOMMENDED

¹Extended hours are available

²Within 100 miles of a Primary SRO

³Within coverage zones specified. Call HP for coverage and availability.

⁴Total time varies according to your proximity to an FRC. Total time estimated here includes shipping time.



CUSTOMER SUPPORT

Instruments Direct

- Hewlett-Packard products as close as your telephone
- A convenient approach to buying instruments
- A broad selection of instrument accessories
- Most orders ship within 24 hours of your call
- Catalog organized for easy reading and product location
- In the U.S. call 800-523-2121 for your catalog

| | |
|--------------------------------|----|
| Basic Instruments | 2 |
| PC Instruments | 29 |
| Instrument Accessories | 38 |
| Cables & Adapters | 69 |
| Software & Controller Supplies | 78 |
| Indexes | 89 |
| How to Order | 96 |

Instruments Direct is a new service from Hewlett-Packard, featuring a broad line of basic instruments, PC instruments and instrument-related items.

What Is the New Instruments Direct Service?

A catalog-sales service with broad selection, the convenience of telephone ordering, and fast shipment. Only in the U.S.A at this time.

What Products Does Instruments Direct Offer?

Our 96-page catalog contains a wide variety of many of our most popular HP basic instruments, our new PC instruments for use with your HP, IBM or IBM-compatible personal computer, and instrument-related accessories, cables and adapters for your testing needs. We support requirements from digital circuit troubleshooting to component evaluation and microwave adapters.

What Product Areas Do You Offer?

Basic Instruments, PC Instruments, Instrument Accessories, Cables and Adapters, and Software and Controller Supplies. More detailed information on these five catalog product areas appears on the next three pages.

What Makes Instruments Direct Convenient?

Our toll-free ordering number is open from 9 am (East Coast time) until 5 pm (West Coast time) in the U.S.A. All you need to place your order over the phone is your credit card or a company purchase order number. How could it be any easier?

How Soon Will My Order Ship?

Because our toll-free line connects you directly to the Instruments Direct distribution center, where we carry an extensive inventory, we ship most orders within 24 hours. We also have premium delivery service available if you need it.

How Do I Get My Catalog?

It's as easy as placing an order with Instruments Direct. Call 800-523-2121 in the U.S.A. and request a catalog, or contact your local Hewlett-Packard sales office.



2 Basic Instruments

- Digital Multimeters ... 3
- Electronic Counters ... 8
- Logic Test Products ... 14
- Video Tapes ... 18
- Power Supplies ... 21
- Graphics Plotters ... 23
- Handheld Calculators ... 24
- Handheld Computers ... 27



PC Instruments 29

Basic Instruments

In this section of the catalog, we have included the most popular and economical basic instruments. We offer digital multimeters, like the reliable and field proven HP 3468A. We offer universal and frequency counters for operation up to 1.0 GHz. We've included the popular HP 5315A and the new HP 5385A.

Basic instruments includes our logic test family of logic probes, pulsers and current tracers for board level troubleshooting. We also carry logic kits that group these probes together in a portable package for complete testing.

We also have instructional aids that will make your training programs more effective. The HP 5036A Microprocessor Lab is a course in a briefcase that will let you learn hardware, software and troubleshooting at your own pace. We have video tapes on topics from "Understanding Microprocessors" to "How To Solder."

We can meet your power supply needs with a broad selection of both single and multiple output supplies. Our catalog shows detailed performance information to make your selection easy.

If you need to record or analyze test results, we can help there as well. We carry the HP 7475A Graphics Plotter, which provides hard copy records of CRT data from selected HP instruments. Our Series 40 hand-held calculators, HP-71B computer and associated software will support both control and computation requirements when portability and small size are important.

PC Instruments

We have PC instruments, HP's new family of measurement modules that take advantage of the PC on your bench. If you already own a PC instrument system, we can help you expand it quickly and conveniently with additional modules.

These instruments create simple, powerful, easy-to-use test and measurement systems when interfaced with your HP 150 Touchscreen or IBM PC/XT/AT. With them, you can create automatic test systems on your bench for prototype testing, incoming inspection, temperature monitoring, component evaluation and more. Modules include a Digital Multimeter, a Digitizing Oscilloscope, a Function Generator, a Universal Counter, a Dual Voltage D-to-A Converter, a Relay Multiplexer, Digital I/O and a Relay Actuator.

The software uses English language commands which make programming simple. We have friendly, accessible, flexible software with the ability to pass data to other software packages.

We also offer packaged systems for data acquisition. These packages include all the key components to get up and running, including software. You need only to add your own specific transducers to complete your system. We carry accessories to complete your system, including a systems power unit, a terminal block for the digital I/O module, and a binder/slipcase to house applications software and additional PC Instrument manuals. A rack shelf is available which will mount up to four PC Instrument modules and their power packs in a standard 19-inch rack.



Instrument Accessories

Instrument accessories are those small items that are essential for productive use of your instruments. Our catalog has color photos and clear descriptions of each item, organized to make the item you need easy to find.

We have a large selection of accessories that expand the use of your electronic counters, voltmeters, and logic testers. For example, we have temperature, high frequency, high voltage and touch-and-hold probes for your voltmeter. We also have test and calibration kits for the HP 3577A Network Analyzer. We carry a wide selection of accessories to help you get the most out of your component or LCR measurement equipment, such as lead connectors, test fixtures and DC bias controllers for products like the HP 4274A, 4275A, 4061A and 4292A.

To support your HP 64000S microprocessor development system, we offer PROM programming modules for the popular PROMs and EPROMs from most semiconductor manufacturers.

We also have accelerometers and hammer kits from a respected manufacturer. These work with your HP 3561A, 3562A, 5423A or 5424A Signal Analyzers, as well as with other HP data acquisition systems.

Our extensive selection of rackmount hardware is tied to a clear step-by-step selection guide that makes ordering easy.

If you need batteries for your HP instrument, our catalog also makes them available quickly and easily by phone within the U.S.A.

Cables And Adapters

When you need a cable or adapter, the project you're working on cannot wait for weeks. This is one area where our ability to ship within 24 hours should be particularly important to you.

We stock a broad selection of general-purpose 50-ohm coaxial cables, test leads and Type N, BNC, APC-3.5, SMA and SMC coaxial connector adapters to meet your measurement needs.

We stock HP-IB (IEEE-488) Interface Cables, including a right angle version for tight spaces. These cables are designed to minimize crosstalk and to maintain the IEEE specified 1 Mbit/second data rate. We also have the HP 32703A HP-IB Extender which allows you to locate system components up to 1000 meters away with no loss in data transmission performance.

Shared Resource Management Cables will allow you to interface several desktop computers with a single printer, plotter or disc drive.

We also have HP-IL System Cables that enable you to interface our Series 70 handheld computers, Series 80 computers, and The Portable (HP 110) to battery operated, low-cost peripherals and test equipment for field use.

All of our cables and adapters have the high quality and reliability you have come to expect from Hewlett-Packard.

74 Software & Controller Supplies



| | |
|---------------------------------|----|
| Engineering Software | 75 |
| Magnetic Media | 80 |
| ThinkJet Printer Supplies | 81 |
| Thermal Printer Supplies | 82 |
| Impact Printer Supplies | 83 |
| Plotter Supplies | 84 |
| Power Line Conditioners | 88 |
| Power Cords | 88 |

Many of the software and controller supplies in this catalog are available from your local authorized HP dealer. To get the name of the dealer closest to you, call 800-716-HP/PC.

FAST DELIVERY OF QUALITY PRODUCTS FROM HP INSTRUMENTS DIRECT **800-523-2121**



HEWLETT PACKARD
P.O. Box 94417, Sunnyvale, California 94089
ADDRESS CORRECTION REQUESTED

Please refer to CALL CODE T 150 when ordering

SOLE RATE U.S. POSTAGE PAID HEWLETT-PACKARD

805 Printed in U.S.A. 904-01300

Software & Controller Supplies

We've included software and controller supplies in our catalog to make Instruments Direct a convenient place for you to buy from Hewlett-Packard. We want any engineer or technician who is already planning to order other accessories to be able to obtain all he needs with one call. We carry a full line of floppy discs, microfloppies, and mini data cartridges for HP disc and tape drives, all manufactured to the industry's highest engineering standards.

We have cartridges and paper for Thinkjet, thermal and impact printers, in addition to blank plotter paper, overhead transparency and polyester films, 24-hour recording paper, fiber-tip pens and refillable drafting pens for the most popular HP plotters.

We stock the most popular software packages to help you increase the usefulness of your Series 80 Personal Computer, 200 Series Computer or The Integral PC. Among the packages we offer are circuit design, circuit analysis, statistics, graphics, waveform analysis and word processing.

We can also provide you with power line conditioners to improve your equipment's efficiency and reliability when noisy environments or weather disturbances cause line transients.

Instruments Direct Means Convenience

Nothing could be more convenient than a toll-free telephone call to order the instruments, accessories, software and supplies you need, particularly when the item you need will be shipped within 24 hours of your call. Convenience means that you can place your order any time between 9 am and 5 pm, no matter where you are in the U.S.A. Being able to use your credit card or a company purchase order is also convenient.

Instruments Direct Means Selection

The proof is our 96-page catalog. It's filled with a wide variety of our most popular basic instruments, PC instruments, instrument accessories, cables, adapters, batteries and software. We can help you meet a wide variety of instrumentation needs.

Instruments Direct Means Speed

When we say we ship most orders within 24 hours, we mean it. We also have premium delivery service for those who need it.

Instruments Direct Means Quality

Instruments Direct lets you order Hewlett-Packard quality over your own telephone. Hewlett-Packard has been synonymous with quality for over forty years.

Our catalog could prove to be one of the most useful items on your desk. Call us today at 800-523-2121 in the U.S.A. and we'll send you a catalog. Or call your local Hewlett-Packard sales office for a copy.



Support Life - Maintaining Your Productivity

Hewlett-Packard fully supports all products for a minimum of five years after production ceases, with selected products being supported for a minimum of ten years. After the expiration of the specified support period, HP will continue to offer support on a best effort basis. In this way HP can help assure your ability to use your equipment productively for as long as possible.

Service Publications—Help You Maintain Your Instruments

The *Operating and Service Manual* supplied with Hewlett-Packard instrumentation contains maintenance, calibration, diagnostic and repair procedures, with troubleshooting charts, circuit diagrams and replacement parts lists. Most operating and service manuals, manual updates, and Service Notes are now available on COSATI standard, positive microfiche.

Bench Briefs, a periodic newsletter, has information to help repair and maintenance personnel get maximum performance from Hewlett-Packard instruments. It describes new Service Notes and other company publications as they become available. To become a regular subscriber, ask your local HP office to place your name on the mailing list.

Warranty—Confidence in Quality and Reliability

As an expression of confidence that our products will continue to meet the high standards of reliability and performance that our customers expect, Hewlett-Packard products carry the following warranty:

HP hardware products are warranted against defects in materials and workmanship. If HP receives notice of such defects during the warranty period, HP shall, at its option, either repair or replace hardware products which prove to be defective.

HP software and firmware products which are designated by HP for use with a hardware product, when properly installed on that hardware product, are warranted not to fail to execute their programming instructions due to defects in materials and workmanship. If HP receives notice of such defects during the warranty period, HP shall repair or replace software media and firmware which do not execute their programming instructions due to such defects. HP does not warrant that the operation of the software, firmware or hardware shall be uninterrupted or error free.

If HP is unable, within a reasonable time, to repair or replace any product to a condition as warranted, Buyer shall be entitled to a refund of the purchase price upon return of the product to HP.

a. **SUPPLEMENTAL STATEMENT:** Supplemental statements setting forth the duration and implementation of warranty and installation are available for most product types. These statements, if applicable to purchased products, are attached hereto and incorporated herein.

b. **DURATION AND COMMENCEMENT OF WARRANTY PERIOD:** The warranty period for each product is specified in the supplemental statement of warranty and installation attached hereto and incorporated herein. The warranty period begins either on the date of shipment or, where the purchase price includes installation by HP, on the date of installation. If Buyer schedules or delays installation more than thirty (30) days after delivery, the warranty period begins on the thirty first (31st) day from the date of shipment.

c. **PLACE OF PERFORMANCE:** Within HP service travel areas, warranty and installation services for products installed by HP and

certain other products designated by HP will be performed at Buyer's facility at no charge. Outside HP's service travel areas, warranty and installation services will be performed at Buyer's facility only upon HP's prior agreement and Buyer shall pay HP's round trip travel expenses and applicable additional expenses for such services.

On-site warranty services are provided only at the initial installation point. If products eligible for on-site warranty and installation services are moved from the initial installation point, the warranty will remain in effect only if Buyer purchases additional inspection or installation services at the new site.

Installation and on-site warranty services are available outside the country of initial purchase only if Buyer pays HP international prices. If Buyer transports a product from the country of initial purchase without having paid HP international prices, any remaining warranty covers parts and labor only and applies only if the product is returned to HP. However, Buyer may obtain on-site warranty service if the location is one where HP can normally provide on-site service for the product and the Buyer pays HP established travel charges. Service outside the country of initial purchase is subject to the conditions regarding HP service travel areas and initial installation point described above.

For product warranties requiring return to HP, products must be returned to a service facility designated by HP. Warranties requiring return to HP are not limited to the country of purchase. Buyer shall prepay shipping charges (and shall pay all duties and taxes) for products returned to HP for warranty service. Except for products returned to Buyer from another country, HP shall pay for return of products to Buyer.

d. **LIMITATION OF WARRANTY:** The foregoing warranty shall not apply to defects resulting from:

1. Improper or inadequate maintenance by Buyer;
2. Buyer supplied software or interfacing;
3. Unauthorized modification or misuse;
4. Operation outside of the environmental specifications of the product; or
5. Improper site preparation and maintenance.

THE WARRANTY SET FORTH ABOVE IS EXCLUSIVE AND NO OTHER WARRANTY, WHETHER WRITTEN OR ORAL, IS EXPRESSED OR IMPLIED. HP SPECIFICALLY DISCLAIMS THE IMPLIED WARRANTIES OF MERCHANTABILITY AND FITNESS FOR A PARTICULAR PURPOSE.

EXCLUSIVE REMEDIES

The remedies provided herein are Buyer's sole and exclusive remedies. In no event shall HP be liable for direct, indirect, special, incidental or consequential damages (including loss of profits) whether based on contract, tort, or any other legal theory.

Certification—Traceability of Measurements to Known Standards

Products provided by Hewlett-Packard are thoroughly tested and calibrated to meet their published specifications. A letter of Conformance (certifying that the product meets its published specifications to the extent possible) is available upon request at the time of purchase.

Hewlett-Packard's calibration measurements are traceable to National Standards—the National Bureau of Standards in the United States and to Standards authorities of comparable standing in other countries of manufacture.



SALES & SUPPORT OFFICES

Arranged alphabetically by country

Product Line Sales/Support Key

Key Product Line

- A** Analytical
- CM** Components
- C** Computer Systems
- E** Electronic Instruments & Measurement Systems
- M** Medical Products
- P** Personal Computation Products
- * Sales only for specific product line
- ** Support only for specific product line

IMPORTANT: These symbols designate general product line capability. They do not insure sales or support availability for all products within a line, at all locations. Contact your local sales office for information regarding locations where HP support is available for specific products.

HEADQUARTERS OFFICES

If there is no sales office listed for your area, contact one of these headquarters offices.

NORTH/CENTRAL AFRICA

Hewlett-Packard S.A.
7, rue du Bois-du-Lan
CH-1217 MEYRIN 1, Switzerland
Tel: (022) 83 12 12
Telex: 27835 hmea
Cable: HEWPACKSA Geneve

ASIA

Hewlett-Packard Asia Ltd.
47/F, 26 Harbour Rd.,
Wanchai, HONG KONG
G.P.O. Box 863, Hong Kong
Tel: 5-8330833
Telex: 76793 HPA HX
Cable: HPASIAL TD

CANADA

Hewlett-Packard (Canada) Ltd.
6877 Goreway Drive
MISSISSAUGA, Ontario L4V 1M8
Tel: (416) 678-9430
Telex: 610-492-4246

EASTERN EUROPE

Hewlett-Packard Ges.m.b.h.
Liebigasse 1
P.O. Box 72
A-1222 VIENNA, Austria
Tel: (222) 2500-0
Telex: 1 3 4425 HEPA A

NORTHERN EUROPE

Hewlett-Packard S.A.
Uilenstede 475
P.O. Box 999
NL-1183 AG AMSTELVEEN
The Netherlands
Tel: 20 437771
Telex: 18 919 hpner nl

SOUTH EAST EUROPE

Hewlett-Packard S.A.
World Trade Center
110 Avenue Louis Casai
1215 Cointrin, GENEVA, Switzerland
Tel: (022) 98 96 51
Telex: 27225 hpser

MEDITERRANEAN AND MIDDLE EAST

Hewlett-Packard S.A.
Mediterranean and Middle East
Operations
Atrina Centre
32 Kifissias Ave.
Paradissos-Amarousion, ATHENS
Greece
Tel: 682 88 11
Telex: 21-6588 HPAT GR
Cable: HEWPACKSA Athens

UNITED KINGDOM

Hewlett-Packard Ltd.
Nine Mile Ride
Easthampstead, WOKINGHAM
Berkshire, IRGII 3LL
Tel: 0344 773100
Telex: 848805

EASTERN USA

Hewlett-Packard Co.
4 Choke Cherry Road
ROCKVILLE, MD 20850
Tel: (301) 258-2000

MIDWESTERN USA

Hewlett-Packard Co.
5201 Tollview Drive
ROLLING MEADOWS, IL 60008
Tel: (312) 255-9800

SOUTHERN USA

Hewlett-Packard Co.
2000 South Park Place
P.O. Box 105005
ATLANTA, GA 30348
Tel: (404) 955-1500

WESTERN USA

Hewlett-Packard Co.
3939 Lankershim Blvd.
P.O. Box 3919
LOS ANGELES, CA 91604
Tel: (213) 506-3700

OTHER INTERNATIONAL AREAS

Hewlett-Packard Co.
Intercontinental Headquarters
3495 Deer Creek Road
PALO ALTO, CA 94304
Tel: (415) 857-1501
Telex: 034-8300
Cable: HEWPACK

ANGOLA

Telectra Angola LDA
Empresa Técnica de Equipamentos
Rua Conselheiro Julio de Vilhema, 16
Caixa Postal 6487

LUANDA

Tel: 35515,35516
Telex: 3134
E,C*

ARGENTINA

Hewlett-Packard Argentina S.A.
Montaneses 2140/50
1428 BUENOS AIRES
Tel: 783-4886/4836/4730
Cable: HEWPACKARG
A,C,CM,E,P
Biotron S.A.C.I.e.I.
Av. Paso Colon 221, Piso 9
1399 BUENOS AIRES
CM

Laboratorio Rodriguez
Corswant S.R.L.
Misiones, 1156 - 1876
Bernal, Oeste

BUENOS AIRES
Tel: 252-3958, 252-4991
A

Argentina Esanco S.R.L.
Avasco 2328
1416 BUENOS AIRES
Tel: 541-58-1981, 541-59-2767
A

AUSTRALIA

Adelaide, South Australia Office

Hewlett-Packard Australia Ltd.
153 Greenhill Road
PARKSIDE, S.A. 5063
Tel: 272-5911
Telex: 82536
Cable: HEWPARD Adelaide
A*,C,CM,E,M,P

Brisbane, Queensland Office

Hewlett-Packard Australia Ltd.
10 Payne Road
THE GAP, Queensland 4061
Tel: 30-4133
Telex: 42133
Cable: HEWPARD Brisbane
A,C,CM,E,M,P

Canberra, Australia Capital Territory Office

Hewlett-Packard Australia Ltd.
121 Wollongong Street
FYSHWICK, A.C.T. 2609
Tel: 80 4244
Telex: 62650
Cable: HEWPARD Canberra
C,CM,E,P

Melbourne, Victoria Office

Hewlett-Packard Australia Ltd.
31-41 Joseph Street
BLACKBURN, Victoria 3130
Tel: 895-2895
Telex: 31-024
Cable: HEWPARD Melbourne
A,C,CM,E,M,P

Perth, Western Australia Office

Hewlett-Packard Australia Ltd.
261 Stirling Highway
CLAREMONT, W.A. 6010
Tel: 383-2188
Telex: 93859
Cable: HEWPARD Perth
A,C,CM,E,M,P

Sydney, New South Wales Office

Hewlett-Packard Australia Ltd.
17-23 Talavera Road
P.O. Box 308
NORTH RYDE, N.S.W. 2113
Tel: 888-4444
Telex: 21561
Cable: HEWPARD Sydney
A,C,CM,E,M,P

AUSTRIA

Hewlett-Packard Ges.m.b.h.
Verkausbüro Graz
Grottenhofstrasse 94
A-8052 GRAZ
Tel: (0316) 291 56 60
Telex: 32375
C,E

Hewlett-Packard Ges.m.b.h.
Liebigasse 1
P.O. Box 72
A-1222 VIENNA
Tel: (0222) 2500-0
Telex: 134425 HEPA A
A,C,CM,E,M,P

BAHRAIN

Green Salon
P.O. Box 557
MANAMA
Tel: 255503-255950
Telex: 8441
P

Wael Pharmacy

P.O. Box 648

MANAMA

Tel: 256123
Telex: 8550 WAEL BN
E,M

Zayani Computer Systems
218 Shaik Mubarak Building
Government Avenue
P.O. Box 5918

MANAMA

Tel: 276278

Telex: 9015

P

**BELGIUM**

Hewlett-Packard Belgium S.A./N.V.
Blvd de la Woluwe, 100
Woluwedal
B-1200 **BRUSSELS**
Tel: (02) 762-32-00
Telex: 23-494 paloben bru
A,C,CM,E,M,P

BENIN

Applied Computer Technologies
Atlantic House Building
Par-La-Ville Road
Hamilton 5
Tel: 295-1616
P

BRASIL

Hewlett-Packard do Brasil
I.e.C. Ltda.
Alameda Rio Negro, 750
Alphaville
06400 **BARUERI SP**
Tel: (011) 421.1311
Telex: (011) 33872 HPBR-BR
Cable: HEWPACK Sao Paulo
A,C,CM,E,M,P
Hewlett-Packard do Brasil
I.e.C. Ltda.
Praia de Botafogo 228
6° Andar-conj 614
Edificio Argentina - Ala A
22250 **RIO DE JANEIRO**
Tel: (021) 552-6422
Telex: 21905 HPBR-BR
Cable: HEWPACK Rio de Janeiro
A,C,CM,E,M,P
Convex/Van Den
Rua Jose Bonifacio
458 Todos Os Santos
CEP 20771
RIO DE JANEIRO, RJ
Tel: 591-0197
Telex: 33487 EGLB BR
A
ANAMED I.C.E.I. Ltda.
Rua Bage, 103
04012 **SAO PAULO, SP**
Tel: (011) 572-6537
Telex: 24720 HPBR-BR
M
Datatronix Electronica Ltda.
Av. Pacaembu 746-C11
SAO PAULO, SP
Tel: (118) 260111
CM
CAMEROON
Beriac
B. P. 23
DOUALA
Tel: 420153
Telex: 5351
C,P
CANADA
Alberta
Hewlett-Packard (Canada) Ltd.
3030 3rd Avenue N.E.
CALGARY, Alberta T2A 6T7
Tel: (403) 235-3100
A,C,CM,E*,M,P*

Hewlett-Packard (Canada) Ltd.
11120-178th Street
EDMONTON, Alberta T5S 1P2
Tel: (403) 486-6666
A,C,CM,E,M,P

British Columbia

Hewlett-Packard (Canada) Ltd.
10691 Shellbridge Way
RICHMOND,
British Columbia V6X 2W7
Tel: (604) 270-2277
Telex: 610-922-5059
A,C,CM,E*,M,P*

Hewlett-Packard (Canada) Ltd.
121 - 3350 Douglas Street
VICTORIA, British Columbia V8Z 3L1
Tel: (604) 381-6616
C

Manitoba

Hewlett-Packard (Canada) Ltd.
1825 Inkster Blvd.
WINNIPEG, Manitoba R2X 1R3
Tel: (204) 694-2777
A,C,CM,E,M,P*

New Brunswick

Hewlett-Packard (Canada) Ltd.
814 Main Street
MONCTON, New Brunswick E1C 1E6
Tel: (506) 855-2841
C

Nova Scotia

Hewlett-Packard (Canada) Ltd.
Suite 111
900 Windmill Road
DARTMOUTH, Nova Scotia B3B 1P7
Tel: (902) 469-7820
C,CM,E*,M,P*

Ontario

Hewlett-Packard (Canada) Ltd.
3325 N. Service Rd., Unit 3
BURLINGTON, Ontario L7N 3G2
Tel: (416) 335-8644
C,M*

Hewlett-Packard (Canada) Ltd.
496 Days Road
KINGSTON, Ontario K7M 5R4
Tel: (613) 384-2088
C

Hewlett-Packard (Canada) Ltd.
552 Newbold Street
LONDON, Ontario N6E 2S5
Tel: (519) 686-9181
A,C,CM,E*,M,P*

Hewlett-Packard (Canada) Ltd.
6877 Goreway Drive
MISSISSAUGA, Ontario L4V 1M8
Tel: (416) 678-9430
A,C,CM,E,M,P

Hewlett-Packard (Canada) Ltd.
2670 Queensview Dr.
OTTAWA, Ontario K2B 8K1
Tel: (613) 820-6483
A,C,CM,E*,M,P*

Hewlett-Packard (Canada) Ltd.
The Oaks Plaza, Unit #9
2140 Regent Street
SUDBURY, Ontario, P3E 5S8
Tel: (705) 522-0202
C

Hewlett-Packard (Canada) Ltd.
3790 Victoria Park Ave.
WILLOWDALE, Ontario M2H 3H7
Tel: (416) 499-2550
C

Quebec

Hewlett-Packard (Canada) Ltd.
17500 Trans Canada Highway
South Service Road
KIRKLAND, Quebec H9J 2X8
Tel: (514) 697-4232
A,C,CM,E,M,P*

Hewlett-Packard (Canada) Ltd.
1150 rue Claire Fontaine
QUEBEC CITY, Quebec G1R 5G4
Tel: (418) 648-0726
C

Hewlett-Packard (Canada) Ltd.
130 Robin Crescent
SASKATOON, Saskatchewan S7L 6M7
Tel: (306) 242-3702
C

CHILE

ASC Ltda.
Austria 2041
SANTIAGO
Tel: 223-5946, 223-6148
Telex: 340192 ASC CK
C,P

Isical Ltda.
Av. Italia 634 Santiago
Casilla 16475
SANTIAGO 9
Tel: 222-0222
Telex: 440283 JCYCL CZ
CM,E,M

Metrolab S.A.
Monjitas 454 of. 206
SANTIAGO
Tel: 395752, 398296
Telex: 340866 METLAB CK
A

Olympia (Chile) Ltda.
Av. Rodrigo de Araya 1045
Casilla 256-V
SANTIAGO 21
Tel: 225-5044
Telex: 340892 OLYMP
Cable: Olympiachile Santiagochile
C,P

CHINA, Peoples Republic of
China Hewlett-Packard, Ltd.
47/F China Resources Bldg.
26 Harbour Road
HONG KONG
Tel: 5-8330833
Telex: 76793 HPA HX
Cable: HP ASIA LTD
A*,M*

China Hewlett-Packard, Ltd.
P.O. Box 9610, Beijing
4th Floor, 2nd Watch Factory Main Bldg.
Shuang Yu Shu, Bei San Huan Rd.
Hai Dian District

BEIJING

Tel: 28-0567
Telex: 22601 CTSHP CN
Cable: 1920 Beijing
A,C,CM,E,M,P

COLOMBIA

Instrumentación
H. A. Langebaek & Kier S.A.
Carrera 4A No. 52A-26
Apartado Aereo 6287
BOGOTA 1, D.E.
Tel: 212-1466
Telex: 44400 INST CO
Cable: AARIS Bogota
CM,E,M

Nefromedicas Ltda.
Calle 123 No. 9B-31
Apartado Aereo 100-958
BOGOTA D.E., 10
Tel: 213-5267, 213-1615
Telex: 43415 HEGAS CO
A

Compumundo
Avenida 15 # 107-80
BOGOTA D.E.
Tel: 214-4458
Telex: 45466 MARICO
P

Carvajal, S.A.
Calle 29 Norte No. 6A-40
Apartado Aereo 46
CALI
Tel: 368-1111
Telex: 55650
C,E,P

CONGO

Seric-Congo
B. P. 2105
BRAZZAVILLE
Tel: 815034
Telex: 5262

COSTA RICA

Cientifica Costarricense S.A.
Avenida 2, Calle 5
San Pedro de Montes de Oca
Apartado 10159
SAN JOSÉ
Tel: 24-38-20, 24-08-19
Telex: 2367 GALGUR CR
CM,E,M

CYPRUS

Telerexa Ltd.
P.O. Box 4809
14C Stassinou Avenue
NICOSIA
Tel: 62698
Telex: 2894 LEVIDO CY
E,M,P

DENMARK

Hewlett-Packard A/S
Datavej 52
DK-3460 **BIRKEROD**
Tel: (02) 81-66-40
Telex: 37409 hpas dk
A,C,CM,E,M,P

SALES & SUPPORT OFFICES

Arranged alphabetically by country

DENMARK (Cont'd)

Hewlett-Packard A/S
Rølgædsvej 32
DK-8240 **RISSKOV**, Aarhus
Tel: (06) 17-60-00
Telex: 37409 hpas dk
C,E

DOMINICAN REPUBLIC

Microprog S.A.
Juan Tomás Mejía y Cotes No. 60
Arroyo Hondo
SANTO DOMINGO
Tel: 565-6268
Telex: 4510 ARENTA DR (RCA)
P

ECUADOR

CYEDE Cia. Ltda.
Avenida Eloy Alfaro 1749
y Belgica
Casilla 6423 CCI
QUITO
Tel: 450-975, 243-052
Telex: 22548 CYEDE ED
CM,E,P
Medtronics
Valladolid 524 Madrid
P.O. 9171, **QUITO**
Tel: 223-8951
Telex: 2298 ECKAME ED
A

Hospitalar S.A.
Robles 625
Casilla 3590
QUITO
Tel: 545-250, 545-122
Telex: 2485 HOSPTL ED
Cable: HOSPITALAR-Quito
M
Ecuador Overseas Agencies C.A.
Calle 9 de Octubre #818
P.O. Box 1296, Guayaquil
QUITO
Tel: 306022
Telex: 3361 PBCGYE ED
M

EGYPT

Sakrcio Enterprises
70, Mossadak Str.
Dokki, Giza
CAIRO
Tel: 706440
Telex: 93146
C
International Engineering Associates
24 Hussein Hegazi Street
Kasr-el-Ain
CAIRO
Tel: 23829, 21641
Telex: 93830 IEA UN
Cable: INTEGASSO
E,M*
S.S.C. Medical
40 Gezerat El Arab Street
Mohandessin
CAIRO
Tel: 803844, 805998, 810263
Telex: 20503 SSC UN
M*

EL SALVADOR

IPESA de El Salvador S.A.
29 Avenida Norte 1223
SAN SALVADOR
Tel: 26-6858, 26-6868
Telex: 20539 IPESA SAL
A,C,CM,E,P

ETHIOPIA

Seric-Ethiopia
P.O. Box 2764
ADDIS ABABA
Tel: 185114
Telex: 21150
C,P

FINLAND

Hewlett-Packard Oy
Piispankalliontie 17
02200 **ESPOO**
Tel: 00358-0-88721
ADDIS ABABA
Tel: 185114
Telex: 21150
C,P

FRANCE

Hewlett-Packard France
Z.I. Mercure B
Rue Berthelot
13763 Les Milles Cedex
AIX-EN-PROVENCE
Tel: (42) 59-41-02
Telex: 410770F
A,C,E,M,P*

Hewlett-Packard France
64, rue Marchand Saillant
61000 **ALENCON**
Tel: (33) 29 04 42

Hewlett-Packard France
28 rue de la République
Boîte Postale 503
25026 **BESANCON** Cedex
Tel: (81) 83-16-22
Telex: 361157
C,M

Hewlett-Packard France
Chemin des Mouilles
Boîte Postale 162
69130 **ECULLY** Cedex (Lyon)
Tel: (78) 833-81-25
Telex: 310617F
A,C,E,M

Hewlett-Packard France
Parc d'activités du Bois Briard
2, avenue du Lac
91040 **EVRY** Cedex
Tel: 6 077-96 60
Telex: 692315F
E

Hewlett-Packard France
5, avenue Raymond Chanas
38320 **EYBENS** (Grenoble)
Tel: (76) 62-57-98
Telex: 980124 HP GRENOB EYBE
C

Hewlett-Packard France
Rue Fernand. Forest
Z.A. Kergaradec
29239 **GOUESNOU**
Tel: (98) 41-87-90

Hewlett-Packard France
Centre d'affaires Paris-Nord
Bâtiment Ampère
Rue de la Commune de Paris
Boîte Postale 300
93153 **LE BLANC-MESNIL**
Tel: (1) 865-44-52
Telex: 211032F
C,E,M
Hewlett-Packard France
Parc d'activités Cadera
Quartier Jean-Mermoz
Avenue du Président JF Kennedy
F-33700 **MÉRIGNAC** (Bordeaux)
Tel: (56) 34-00-84
Telex: 550105F
C,E,M

Hewlett-Packard France
Immuable "Les 3 B"
Nouveau chemin de la Garde
ZAC du Bois Briand
44085 **NANTES** Cedex
Tel: (40) 50-32-22
Telex: 711085F
C**

Hewlett-Packard France
125, rue du Faubourg Bannier
45000 **ORLEANS**
Tel: (38) 68 01 63

Hewlett-Packard France
Zone Industrielle de Courtaboëuf
Avenue des Tropiques
91947 Les Ulis Cedex **ORSAY**
Tel: (6) 907-78-25
Telex: 600048F
A,C,CM,E,M,P

Hewlett-Packard France
Paris Porte-Maillet
15, boulevard de L'Amiral-Bruix
75782 **PARIS** Cedex 16
Tel: (1) 502-12-20
Telex: 613663F
C,M,P

Hewlett-Packard France
124, Boulevard Tourasse
64000 **PAU**
Tel: (59) 80 38 02

Hewlett-Packard France
2 Allée de la Bourgonnette
35100 **RENNES**
Tel: (99) 51-42-44
Telex: 740912F
C,CM,E,M,P*

Hewlett-Packard France
98 avenue de Bretagne
76100 **ROUEN**
Tel: (35) 63-57-66
Telex: 770035F
C

Hewlett-Packard France
4, rue Thomas-Mann
Boîte Postale 56
67033 **STRASBOURG** Cedex
Tel: (88) 28-56-46
Telex: 890141F
C,E,M,P*

Hewlett-Packard France
La Péripole III
20, chemin du Pigeonnier de la Céprière
F-31083 **TOULOUSE** Cedex
Tel: (61) 40-11-12
Telex: 531639F
A,C,E,P*

Hewlett-Packard France
9, rue Baudin
26000 **VALENCE**
Tel: (75) 42 76 16

Hewlett-Packard France
Carolor
ZAC de Bois Briand
57640 **VIGY** (Metz)
Tel: (8) 771 20 22
C

Hewlett-Packard France
Parc d'activité des Prés
1, rue Papin
59658 **VILLENEUVE D'ASCQ** Cedex
Tel: (20) 47 78 78
Telex: 160124F
C,E,M,P*

GABON

Sho Gabon
P.O. Box 89
LIBREVILLE
Tel: 721 484
Telex: 5230

GERMAN FEDERAL REPUBLIC

Hewlett-Packard GmbH
Geschäftsstelle
Keithstrasse 2-4
D-1000 **BERLIN** 30
Tel: (030) 21 99 04-0
Telex: 018 3405 hpbld n
A,C,E,M,P

Hewlett-Packard GmbH
Vertriebszentrum Südwest
Schickardstrasse 2
D-7030 **BÖBLINGEN**
Tel: (07031) 645-0
Telex: 7265 743 hep
A,C,CM,E,M,P

Hewlett-Packard GmbH
Vertriebszentrum West
Berliner Strasse III
D-4030 **RATINGEN** 3
Tel: (02102) 494-0
Telex: 589 070 hprad
A,C,E,M,P

Hewlett-Packard GmbH
Geschäftsstelle
Schleefstr. 28a
D-4600 **DORTMUND**-41
Tel: (0231) 45001
Telex: 822858 hepdad
A,C,E

Hewlett-Packard GmbH
Vertriebszentrum Mitte
Hewlett-Packard-Strasse
D-6380 **BAD HOMBURG**
Tel: (06172) 400-0
Telex: 410 844 hpbhg
A,C,E,M,P

**GERMAN FEDERAL
REPUBLIC (Cont'd)**

Hewlett-Packard GmbH
Vertriebszentrum Nord
Kapstadtring 5
D-2000 **HAMBURG** 60
Tel: (040) 63804-1
Telex: 021 63 032 hphh d
A,C,E,M,P

Hewlett-Packard GmbH
Geschäftsstelle
Heidering 37-39
D-3000 **HANNOVER** 61
Tel: (0511) 5706-0
Telex: 092 3259
A,C,CM,E,M,P

Hewlett-Packard GmbH
Geschäftsstelle
Rosslauer Weg 2-4
D-6800 **MANNHEIM**
Tel: (0621) 70 05-0
Telex: 0462105
A,C,E

Hewlett-Packard GmbH
Geschäftsstelle
Messerschmittstrasse 7
D-7910 **NEU ULM**
Tel: (0731) 70 73-0
Telex: 0712816 HP ULM-D
A,C,E*

Hewlett-Packard GmbH
Geschäftsstelle
Emmericher Strasse 13
D-8500 **NÜRNBERG** 10
Tel: (0911) 5205-0
Telex: 0623 860 hpnbg
C,CM,E,M,P

Hewlett-Packard GmbH
Vertriebszentrum Süd
Eschenstrasse 5
D-8028 **TAUFKIRCHEN**
Tel: (089) 61 20 7-0
Telex: 0524985
A,C,CM,E,M,P

Hewlett-Packard GmbH
Geschäftsstelle
Ermisallee
7517 **WALDBRONN** 2
Tel: (07243) 602-0
Telex: 782 838 hepik
A,C,E

**GREAT BRITAIN
See United Kingdom**

GREECE

Hewlett-Packard A.E.
178, Kifissias Avenue
6th Floor
Halandri-ATHENS
Greece
Tel: 647 1543, 647 1673, 647 2971
Telex: 221 286 HPHLGR
A,C,CM** ,E,M,P
Kostas Karayannis S.A.
8, Omirou Street
ATHENS 133
Tel: 32 30 303, 32 37 371
Telex: 215962 RKAR GR
A,C*,CM,E

Impexin
Intellect Div.
209 Mesogion
11525 **ATHENS**
Tel: 647 4481/2
Telex: 216286
P
Haril Company
38, Mihalakopoulou
ATHENS 612
Tel: 7236071
Telex: 218767
M*
Hellamco
P.O. Box 87528
18507 **PIRAEUS**
Tel: 4827049
Telex: 241441
A

GUATEMALA

IPESA
Avenida Reforma 3-48, Zona 9
GUATEMALA CITY
Tel: 316627, 314786
Telex: 3055765 IPESA GU
A,C,CM,E,M,P

HONG KONG

Hewlett-Packard Hong Kong, Ltd.
G.P.O. Box 795
5th Floor, Sun Hung Kai Centre
30 Harbour Road
HONG KONG
Tel: 5-8323211
Telex: 66678 HEWPA HX
Cable: HEWPACK Hong Kong
E,C,P

CET Ltd.
10th Floor, Hua Asia Bldg.
64-66 Gloucester Road
HONG KONG
Tel: (5) 200922
Telex: 85148 CET HX
CM

Schmidt & Co. (Hong Kong) Ltd.
18th Floor, Great Eagle Centre
23 Harbour Road
HONG KONG
Tel: 5-8330222
Telex: 74766 SCHMC HX
A,M

ICELAND

Hewlett-Packard Iceland
Hoefdabakka 9
110 **Reykjavik**
Tel: (1) 67 1000
A,C,CM,E,M,P

INDIA

Computer products are sold through
Blue Star Ltd. All computer repairs and
maintenance service is done through
Computer Maintenance Corp.

Blue Star Ltd.
Sabri Complex 2nd Floor
24 Residency Rd.
BANGALORE 560 025
Tel: 55660, 578881
Telex: 0845-430
Cable: BLUESTAR
A,C*,CM,E

Blue Star Ltd.
Band Box House
Prabhadevi
BOMBAY 400 025
Tel: 4933101, 4933222
Telex: 011-71051
Cable: BLUESTAR
A,M
Blue Star Ltd.
Sahas
414/2 Vir Savarkar Marg
Prabhadevi
BOMBAY 400 025
Tel: 422-6155, 422-6556
Telex: 011-71193 BSSS IN
Cable: FROSTBLUE
A,C*,CM,E,M
Blue Star Ltd.
Kalyan, 19 Vishwas Colony
Alkapuri, **BORODA**, 390 005
Tel: 65235, 65236
Cable: BLUE STAR
A

Blue Star Ltd.
7 Hare Street
CALCUTTA 700 001
Tel: 230131, 230132
Telex: 021-7655
Cable: BLUESTAR
A,M

Blue Star Ltd.
133 Kodambakkam High Road
MADRAS 600 034
Tel: 472056, 470238
Telex: 041-379
Cable: BLUESTAR
A,M

Blue Star Ltd.
13 Community Center
New Friends Colony
NEW DELHI 110 065
Tel: 633773, 634473
Telex: 031-61120
Cable: BLUEFROST
A,C*,CM,E,M

Blue Star Ltd.
15/16 C Wellesley Rd.
PUNE 411 011
Tel: 22775
Cable: BLUE STAR
A

Blue Star Ltd.
2-2-47/1108 Bolarum Rd.
SECUNDERABAD 500 003
Tel: 72057, 72058
Telex: 0155645
Cable: BLUEFROST
A,E

Blue Star Ltd.
T.C. 7/603 Poornima
Maruthunkuzhi
TRIVANDRUM 695 013
Tel: 65799, 65820
Telex: 0884-259
Cable: BLUESTAR
E

Computer Maintenance Corporation
Ltd.
115, Sarojini Devi Road
SECUNDERABAD 500 003
Tel: 310-184, 345-774
Telex: 031-2960
C**

INDONESIA

BERCA Indonesia P.T.
P.O.Box 496/Jkt.
Jl. Abdul Muis 62
JAKARTA
Tel: 21-373009
Telex: 46748 BERSAL IA
Cable: BERSAL JAKARTA
P
BERCA Indonesia P.T.
P.O.Box 2497/Jkt
Antara Bldg., 12th Floor
Jl. Medan Merdeka Selatan 17
JAKARTA-PUSAT
Tel: 21-340417, 341445
Telex: 46748 BERSAL IA
A,C,E,M

BERCA Indonesia P.T.
Jalan Kutai 24
SURABAYA
Tel: 67118
Telex: 31146 BERSAL SB
Cable: BERSAL-SURABAYA
A*,E,M,P

IRAQ

Hewlett-Packard Trading S.A.
Service Operation
Al Mansoor City 9B/3/7
BAGHDAD
Tel: 551-49-73
Telex: 212-455 HEPAIRAQ IK
C

IRELAND

Hewlett-Packard Ireland Ltd.
82/83 Lower Leeson Street
DUBLIN 2
Tel: 0001 608800
Telex: 30439
A,C,CM,E,M,P
Cardiac Services Ltd.
Kilmore Road
Artane
DUBLIN 5
Tel: (01) 351820
Telex: 30439
M

ISRAEL

Eldan Electronic Instrument Ltd.
P.O.Box 1270
JERUSALEM 91000
16, Ohaliav St.
JERUSALEM 94467
Tel: 533 221, 553 242
Telex: 25231 AB/PAKRD IL
A,M
Computation and Measurement
Systems (CMS) Ltd.
11 Masad Street
TEL-AVIV
Tel: 388 388
Telex: 33569 Motil IL
C,CM,E,P

SALES & SUPPORT OFFICES

Arranged alphabetically by country

ITALY

Hewlett-Packard Italiana S.p.A.
Traversa 99C
Via Giulio Petroni, 19
I-70124 **BARI**
Tel: (080) 41-07-44
C,M

Hewlett-Packard Italiana S.p.A.
Via Emilia, 51/C
I-40011 **BOLOGNA** Anzola Dell'Emilia
Tel: (051) 731061
Telex: 511630
C,E,M

Hewlett-Packard Italiana S.p.A.
Via Principe Nicola 43G/C
I-95126 **CATANIA**
Tel: (095) 37-10-87
Telex: 970291
C

Hewlett-Packard Italiana S.p.A.
Via G. Di Vittorio 9
I-20063 **CERNUSCO SUL NAVIGLIO**
(Milano)
Tel: (02) 4459041
Telex: 334632
A,C,CM,E,M,P

Hewlett-Packard Italiana S.p.A.
Via C. Colombo 49
I-20090 **TREZZANO SUL NAVIGLIO**
(Milano)
Tel: (02) 4459041
Telex: 322116
C

Hewlett-Packard Italiana S.p.A.
Via Nuova San Rocco a Capodimonte, 62/A
I-80131 **NAPOLI**
Tel: (081) 7413544
Telex: 710698
A*,C,E,M

Hewlett-Packard Italiana S.p.A.
Viale G. Modugno 33
I-16156 **GENOVA PEGLI**
Tel: (010) 68-37-07
Telex: 215238
C,E

Hewlett-Packard Italiana S.p.A.
Via Pelizzo 15
I-35128 **PADOVA**
Tel: (049) 664888
Telex: 430315
A,C,E,M

Hewlett-Packard Italiana S.p.A.
Viale C. Pavese 340
I-00144 **ROMA EUR**
Tel: (06) 54831
Telex: 610514
A,C,E,M,P*

Hewlett-Packard Italiana S.p.A.
Via di Casellina 57/C
I-50018 **SCANDICCI-FIRENZE**
Tel: (055) 753863
C,E,M

Hewlett-Packard Italiana S.p.A.
Corso Svizzera, 185
I-10144 **TORINO**
Tel: (011) 74 4044
Telex: 221079
A*,C,E

IVORY COAST

S.I.T.E.L.
Societe Ivoirienne de
Telecommunications
Bd. Giscard d'Estaing
Carrefour Marcory
Zone 4.A.
Boite postale 2580
ABIDJAN 01
Tel: 353600
Telex: 43175
E

S.I.T.I.
Immeuble "Le General"
Av. du General de Gaulle
01 BP 161
ABIDJAN 01
Tel: 321227
C,P

JAPAN
Yokogawa-Hewlett-Packard Ltd.
152-1, Onna
ATSUGI, Kanagawa, 243
Tel: (0462) 25-0031
C,CM,E

Yokogawa-Hewlett-Packard Ltd.
Meiji-Seimei Bldg. 6F
3-1 Hon Chiba-Cho
CHIBA, 280
Tel: 472 25 7701
C,E

Yokogawa-Hewlett-Packard Ltd.
Yasuda-Seimei Hiroshima Bldg.
6-11, Hon-dori, Naka-ku
HIROSHIMA, 730
Tel: 82-241-0611

Yokogawa-Hewlett-Packard Ltd.
Towa Building
2-3, Kaigan-dori, 2 Chome Chuo-ku
KOBE, 650
Tel: (078) 392-4791
C,E

Yokogawa-Hewlett-Packard Ltd.
Kumagaya Asahi 82 Bldg
3-4 Tsukuba
KUMAGAYA, Saitama 360
Tel: (0485) 24-6563
C,CM,E

Yokogawa-Hewlett-Packard Ltd.
Asahi Shinbun Daiichi Seimei Bldg.
4-7, Hanabata-cho
KUMAMOTO, 860
Tel: (096) 354-7311
C,E

Yokogawa-Hewlett-Packard Ltd.
Shin-Kyoto Center Bldg.
614, Higashi-Shiokoji-cho
Karasuma-Nishiiru
Shiokoji-dori, Shimogyo-ku
KYOTO, 600
Tel: 075-343-0921
C,E

Yokogawa-Hewlett-Packard Ltd.
Mito Mitsui Bldg
4-73, Sanno-maru, 1 Chome
MITO, Ibaraki 310
Tel: (0292) 25-7470
C,CM,E

Yokogawa-Hewlett-Packard Ltd.
Meiji-Seimei Kokubun Bldg. 7-8
Kokubun, 1 Chome, Sendai
MIYAGI, 980
Tel: (0222) 25-1011
C,E

Yokogawa-Hewlett-Packard Ltd.
Nagoya Kokusai Center Building
47-1, Nagono, 1 Chome
Nakamura-ku
NAGOYA, 450
Tel: (052) 571-5171
C,CM,E,M

Yokogawa-Hewlett-Packard Ltd.
Saikyoren Building
1-2 Dote-machi, **OHMIYA**
Saitama 330
Tel: (0486) 45-8031

Yokogawa-Hewlett-Packard Ltd.
Chuo Bldg.,
4-20 Nishinakajima, 5 Chome
Yodogawa-ku
OSAKA, 532
Tel: (06) 304-6021
Telex: YHPOSA 523-3624
A,C,CM,E,M,P*

Yokogawa-Hewlett-Packard Ltd.
27-15, Yabe, 1 Chome
SAGAMIHARA Kanagawa, 229
Tel: 0427 59-1311

Yokogawa-Hewlett-Packard Ltd.
Daiichi Seimei Bldg.
7-1, Nishi Shinjuku, 2 Chome
Shinjuku-ku, **TOKYO** 160
Tel: 03-348-4611
C,E

Yokogawa-Hewlett-Packard Ltd.
29-21 Takaido-Higashi, 3 Chome
Suginami-ku **TOKYO** 168
Tel: (03) 331-6111
Telex: 232-2024 YHPTOK
A,C,CM,E,M,P*

Yokogawa Hokushin Electric Corp.
9-32 Nokacho 2 Chome
2 Chome Musashino-shi
TOKYO, 180
Tel: (0422) 54-1111
Telex: 02822-421 YEW MTK J
A

Yokogawa-Hewlett-Packard Ltd.
Meiji-Seimei
Utsunomiya Odori Building
1-5 Odori, 2 Chome
UTSUNOMIYA, Tochigi 320
Tel: (0286) 33-1153
C,E

Yokogawa-Hewlett-Packard Ltd.
Yasuda Seimei Yokohama Nishiguchi
Bldg.
30-4 Tsuruya-cho, 3 Chome
YOKOHAMA 221
Tel: (045) 312-1252
C,E

JORDAN
Scientific and Medical Supplies Co.
P.O. Box 1387
AMMAN
Tel: 24907, 39907
Telex: 21456 SABCO JO
C,E,M,P

KENYA

ADCOM Ltd., Inc., Kenya
P.O. Box 30070
NAIROBI
Tel: 331955
Telex: 22639
E,M

KOREA
Samsung Hewlett-Packard Co. Ltd.
Dongbang Yeoeuido Building
12-16th Floors
36-1 Yeoeuido-dong
Yongdeungpo-ku
SEOUL
Tel: 784-2666, 784-4666
Telex: 25166 SAMSAN K
A,C,CM,E,M,P

Young In Scientific Co., Ltd.
Youngwha Building
547 Shinsa Dong, Kangnam-ku
SEOUL 135
Tel: 5467771
Telex: K23457 GINSCO
A

QATAR
Al-Khaldiya Trading & Contracting
P.O. Box 830
SAFAT
Tel: 424910, 411726
Telex: 22481 AREEG KT
Cable: VISCOUNT
E,M,A

Gulf Computing Systems
P.O. Box 25125
SAFAT
Tel: 435969
Telex: 23648
P

Photo & Cine Equipment
P.O. Box 270
SAFAT
Tel: 2445111
Telex: 22247 MATIN KT
Cable: MATIN KUWAIT
P

W.J. Towell Computer Services
P.O. Box 5897
SAFAT
Tel: 2462640
Telex: 30336 TOWELL KT
C

SINGAPORE
Computer Information Systems S.A.L
Chammas Building
P.O. Box 11-6274 Dora
BEIRUT
Tel: 89 40 73
Telex: 42309
C,E,M,P

SWITZERLAND
Unichemicals Inc.
P.O. Box 1509
MONROVIA
Tel: 224282
Telex: 4509
E

**MADAGASCAR**

Technique et Precision
12, rue de Nice
P.O. Box 1227
101 **ANTANANARIVO**
Tel: 22090
Telex: 22255
P

LUXEMBOURG

Hewlett-Packard Belgium S.A./N.V.
Blvd de la Woluwe, 100
Woluwedal
B-1200 **BRUSSELS**
Tel: (02) 762-32-00
Telex: 23-494 paloben bru
A,C,CM,E,M,P

MALAYSIA

Hewlett-Packard Sales (Malaysia)
Sdn. Bhd.
9th Floor
Chung Khiaw Bank Building
46, Jalan Raja Laut
KUALA LUMPUR
Tel: 03-986555
Telex: 3 1011 HPSM MA
A,C,E,M,P*
Protel Engineering
P.O.Box 1917
Lot 6624, Section 64
23/4 Pending Road
Kuching, **SARAWAK**
Tel: 36299
Telex: 70904 PROMAL MA
Cable: PROTELENG
A,E,M

MALTA

Philip Toledo Ltd.
Birkirkara P.O. Box 11
Notabile Rd.
MRIEHEL
Tel: 447 47, 455 66
Telex: 1649
E,M,P

MAURITIUS

Blanche Birger Co. Ltd.
18, Jules Koenig Street
PORT LOUIS
Tel: 20828
Telex: 4296
P

MEXICO

Hewlett-Packard de Mexico, S.A.
Francisco J. Allan #30
Colonia Nueva
Los Angeles 27140
COAHUILA, Torreón
Tel: 37220
P
Hewlett-Packard de Mexico, S.A.
Monti Morelos 299
Fraccionamiento Loma Bonita 45060
GUADALAJARA, Jalisco
Tel: 316630/314600
Telex: 0684 186 ECOME
P

Microcomputadoras Hewlett-Packard,
S.A.
Monti Pelvoux 115
LOS LOMAS, Mexico, D.F.
Tel: 520-9127
P

Hewlett-Packard Mexicana, S.A.
de C.V.
Av. Periferico Sur No. 6501
Tepepan, Xochimilco
16020 **MEXICO D.F.**
Tel: 6-76-46-00
Telex: 17-74-507 HEWPACK MEX
A,C,CM,E,M,P
Hewlett-Packard De Mexico (Polanco)
Avenida Ejercito Nacional #579
2da y 3er piso
Colonia Granada 11560
MEXICO D.F.
Tel: 254-4433
P

Hewlett-Packard De Mexico, S.A.
de C.V.
Czda. del Valle
409 Ote. 4th Piso
Colonia del Valle
Municipio de Garza García
66220 **MONTERREY, Nuevo León**
Tel: 78 42 41
Telex: 038 410
P

MOROCCO

Etablissement Hubert Dolbeau & Fils
81 rue Karatchi
B.P. 11133
CASABLANCA
Tel: 3041-82, 3068-38
Telex: 23051, 22822
E
Gerep
2, rue Agadir
Boite Postale 156
CASABLANCA 01
Tel: 272093, 272095
Telex: 23 739
P

Sema-Maroc
Dept. Seric
6, rue Lapebie
CASABLANCA
Tel: 260980
Telex: 21641
C,P

NETHERLANDS

Hewlett-Packard Nederland B.V.
Startbaan 16
1187 XR **AMSTELVEEN**
P.O. Box 667
NL 1180 AR **AMSTELVEEN**
Tel: (020) 547-6911
Telex: 13 216 HEPA NL
A,C,CM,E,M,P
Hewlett-Packard Nederland B.V.
Bongerd 2
NL 2906VK **CAPELLE A/D IJSSEL**
P.O. Box 41
NL 2900AA **CAPELLE A/D IJSSEL**
Tel: (10) 51-64-44
Telex: 21261 HEPAC NL
C,E

Hewlett-Packard Nederland B.V.
Pastoor Petersstraat 134-136
NL 5612 LV **EINDHOVEN**
P.O. Box 2342
NL 5600 CH **EINDHOVEN**
Tel: (040) 326911
Telex: 51484 hepae nl
A,C,E,M,P

NEW ZEALAND

Hewlett-Packard (N.Z.) Ltd.
5 Owens Road
P.O. Box 26-189
Epsom, **AUCKLAND**
Tel: 687-159
Cable: HEWPAK Auckland
C,CM,E,P*
Hewlett-Packard (N.Z.) Ltd.
4-12 Cruickshank Street
Kilbirnie, **WELLINGTON 3**
P.O. Box 9443
Courtenay Place, **WELLINGTON 3**
Tel: 877-199
Cable: HEWPACK Wellington
C,CM,E,P
Northrop Instruments & Systems Ltd.
369 Khyber Pass Road
P.O. Box 8602
AUCKLAND
Tel: 794-091
Telex: 60605
A,M

Northrop Instruments & Systems Ltd.
110 Mandeville St.
P.O. Box 8388
CHRISTCHURCH
Tel: 488-873
Telex: 4203
A,M
Northrop Instruments & Systems Ltd.
Sturdee House
85-87 Ghuznee Street
P.O. Box 2406
WELLINGTON
Tel: 850-091
Telex: NZ 3380
A,M

NIGERIA

Elmeco Nigeria Ltd.
46, Calcutta Crescent Apapa
P.O. Box 244and
LAGOS
E

NORTHERN IRELAND

See **United Kingdom**

NORWAY

Hewlett-Packard Norge A/S
Folke Bernadottes vei 50
P.O. Box 3558
N-5033 **FYLLINGSDALEN (Bergen)**
Tel: 0047/5/16 55 40
Telex: 76621 hpnas n
C,E,M
Hewlett-Packard Norge A/S
Osterndalen 16-18
P.O. Box 34
N-1345 **ØSTERÅS**
Tel: 0047/2/17 11 80
Telex: 76621 hpnas n
A,C,CM,E,M,P

OMAN

Khimi Ramdas
P.O. Box 19
MUSCAT/SULTANATE OF OMAN
Tel: 745601
Telex: 5289 BROKER MB MUSCAT
P

Suhail & Saud Bahwan
P.O.Box 169
MUSCAT/SULTANATE OF OMAN
Tel: 734201
Telex: 5274 BAHWAN MB
E

Imtac LLC
P.O. Box 8676
MUTRAH/SULTANATE OF OMAN
Tel: 601695
Telex: 5741 Tawoos On
A,C,M

PAKISTAN

Mushko & Company Ltd.
House No. 16, Street No. 16
Sector F-6/3
ISLAMABAD
Tel: 824545
Cable: FEMUS Islamabad
A,E,M,P*
Mushko & Company Ltd.
Oosman Chambers
Abdullah Haroon Road
KARACHI 0302
Tel: 524131, 524132
Telex: 2894 MUSKO PK
Cable: COOPERATOR Karachi
A,E,M,P*

PANAMA

Electronico Balboa, S.A.
Calle Samuel Lewis, Ed. Alfa
Apartado 4929
PANAMA 5
Tel: 64-2700
Telex: 3483 ELECTRON PG
A,CM,E,M,P

PERU

Cía Electro Médica S.A.
Los Flamencos 145, Ofc. 301/2
San Isidro
Casilla 1030
LIMA 1
Tel: 41-4325, 41-3705
Telex: Pub. Booth 25306 PEC PISIDR
CM,E,M,P

SAMS

Arenida Republica de Panama 3534
San Isidro, LIMA
Tel: 419928/417108
Telex: 20450 PE LIBERTAD
A,C,P

PHILIPPINES

The Online Advanced Systems Corp.
2nd Floor, Electra House
115-117 Esteban Street
Legaspi Village, Makati
P.O. Box 1510
Metro **MANILA**
Tel: 815-38-10 (up to 16)
Telex: 63274 ONLINE PN
A,C,E,M,P



SALES & SUPPORT OFFICES

Arranged alphabetically by country

PORTUGAL

Mundinter Intercambio
Mundial de Comércio S.A.R.L.
Av. Antonio Augusto Aguiar 138
Apartado 2761

LISBON

Tel: (19) 53-21-31, 53-21-37
Telex: 16691 munter p
M

Soquimica

Av. da Liberdade, 220-2
1298 LISBOA Codex
Tel: 56-21-82
Telex: 13316 SABASA

A

Telectra-Empresa Técnica de
Equipamentos Eléctricos S.A.R.L.
Rua Rodrigo da Fonseca 103
P.O. Box 2531

LISBON 1

Tel: (19) 68-60-72
Telex: 12598
CM,E

C.P.C.S.I.

Rua de Costa Cabral 575
4200 PORTO
Tel: 499174/495173
Telex: 26054

C,P

PUERTO RICO

Hewlett-Packard Puerto Rico
101 Muñoz Rivera Av
Esu. Calle Ochoa

HATO REY, Puerto Rico 00918

Tel: (809) 754-7800
A,C,CM,M,E,P

QATAR

Computer Arabia
P.O. Box 2750

DOHA

Tel: 428555
Telex: 4806 CHPARB
P

Nasser Trading & Contracting
P.O.Box 1563

DOHA

Tel: 422170
Telex: 4439 NASSER DH
M

SAUDI ARABIA

Modern Electronics Establishment
Hewlett-Packard Division
P.O. Box 281
Thouqbah

AL-KHOBAR 31952

Tel: 895-1760, 895-1764
Telex: 671 106 HPMEEK SJ
Cable: ELECTA AL-KHOBAR
C,E,M

Modern Electronics Establishment
Hewlett-Packard Division
P.O. Box 1228

JEDDAH

Tel: 644 96 28
Telex: 4027 12 FARNAS SJ
Cable: ELECTA JEDDAH
A,C,CM,E,M,P

Modern Electronics Establishment

Hewlett-Packard Division
P.O.Box 22015
RIYADH 11495
Tel: 476-3030
Telex: 202049 MEERYD SJ
A,C,CM,E,M,P

Abdul Ghani El Ajou Corp.
P.O. Box 78

RIYADH

Tel: 40 41 717
Telex: 200 931 EL AJOU
P

SCOTLAND

See United Kingdom

SENEGAL

Societe Hussein Ayad & Cie.
76, Avenue Georges Pompidou
B.P. 305

DAKAR

Tel: 32339
Cable: AYAD-Dakar
E

Moneger Distribution S.A.
1, Rue Parent
B.P. 148

DAKAR

Tel: 215 671
Telex: 587
P

Système Service Conseil (SSC)
14, Avenue du Parachois

DAKAR ETOILE

Tel: 219976
Telex: 577
C,P

SINGAPORE

Hewlett-Packard Singapore (Sales)
Pte. Ltd.

#08-00 Inchcape House
450-2 Alexandra Road
Alexandra P.O. Box 58
SINGAPORE, 9115

Tel: 4731788
Telex: 34209 HPSGSO RS
Cable: HEWPACK, Singapore
A,C,E,M,P

Dynamar International Ltd.

Unit 05-11 Block 6
Kolam Ayer Industrial Estate
SINGAPORE 1334

Tel: 747-6188
Telex: 26283 RS
CM

SOUTH AFRICA

Hewlett-Packard So Africa (Pty.) Ltd.
P.O. Box 120
Howard Place CAPE PROVINCE 7450
Pine Park Center, Forest Drive, Pine-
lands

CAPE PROVINCE 7405

Tel: (021) 53 7954
Telex: 57-20006
A,C,CM,E,M,P

Hewlett-Packard So Africa (Pty.) Ltd.
2nd Floor Juniper House

92 Overport Drive

DURBAN 4067
Tel: (031) 28-4178
Telex: 6-22954
C

Hewlett-Packard So Africa (Pty.) Ltd.

6 Linton Arcade
511 Cape Road
Linton Grange
PORT ELIZABETH 6001
Tel: 041-301201
Telex: 24-2916
C

Hewlett-Packard So Africa (Pty.) Ltd.

Fountain Center
Kalkden Str.
Monument Park Ext 2
PRETORIA 0105
Tel: (012) 45 57258
Telex: 3-21063
C,E

Hewlett-Packard So Africa (Pty.) Ltd.

Private Bag Wendywood
SANDTON 2144
Tel: 802-5111, 802-5125
Telex: 4-20877 SA
Cable: HEWPACK Johannesburg
A,C,CM,E,M,P

SPAIN

Hewlett-Packard Española S.A.
Calle Entenza, 321
08029 BARCELONA
Tel: 3/322 24 51, 321 73 54
Telex: 52603 hpbee
A,C,E,M,P

Hewlett-Packard Española S.A.

Calle San Vicente S/N
Edificio Albia II-7B
48001 BILBAO
Tel: 4/423 83 06
A,C,E,M

Hewlett-Packard Española S.A.
Crta. de la Coruña, Km. 16, 400
Las Rozas

E-MADRID

Tel: (1) 637.00.11
Telex: 23515 HPE
C,M

Hewlett-Packard Española S.A.
Avda. S. Francisco Javier, S/N
Planta 10. Edificio Sevilla 2
41005 SEVILLA

Tel: 54/64 44 54
Telex: 72933
A,C,M,P

Hewlett-Packard Española S.A.

Isabel La Católica, 8
46004 VALENCIA
Tel: 0034/6/351 59 44
C,P

SWEDEN

Hewlett-Packard Sverige AB

Östra Tullgatan 3
S-21128 MALMÖ
Tel: (040) 70270
Telex: (854) 17886 (via Spånga
office)
C,P

Hewlett-Packard Sverige AB

Skalholtsgatan 9, Kista
Box 19
S-16393 SPÅNGA
Tel: (08) 750-2000
Telex: (854) 17886
Telefax: (08) 7527781
A,C,CM,E,M,P

Hewlett-Packard Sverige AB

Frötällsgatan 30
S-42132 VÄSTRA-FRÖLUNDA (Gothen-
burg)
Tel: (031) 49-09-50
Telex: (854) 17886 (via Spånga
office)
A,C,CM,E,M,P

SUDAN

Mediterranean Engineering & Trading
Co. Ltd.

P.O. Box 1025

KHARTOUM

Tel: 41184
Telex: 24052
C,P

SWITZERLAND

Hewlett-Packard (Schweiz) AG
Clarastrasse 12
CH-4058 BASEL
Tel: (61) 33-59-20
A

Hewlett-Packard (Schweiz) AG

7, rue du Bois-du-Lan
Case postale 365
CH-1217 MEYRIN 1
Tel: (0041) 22-83-11-11
Telex: 27333 HPAG CH
C,CM

Hewlett-Packard (Schweiz) AG

Allmend 2
CH-8967 WIDEN
Tel: (0041) 57 31 21 11
Telex: 53933 hpag ch
Cable: HPAG CH
A,C,CM,E,M,P

SYRIA

General Electronic Inc.
Nuri Basha Ahnaf Ebn Kays Street
P.O. Box 5781

DAMASCUS

Tel: 33-24-87
Telex: 411 215
Cable: ELECTROBOR DAMASCUS
E

Middle East Electronics

P.O.Box 2308
Abu Rumaneh

DAMASCUS

Tel: 33 45 92
Telex: 411 771
M

TAIWAN

Hewlett-Packard Taiwan
Kaohsiung Office
11/F, 456, Chung Hsiao 1st Road
KAOHSIUNG
Tel: (07) 2412318
C,E

Hewlett-Packard Taiwan

8th Floor, Hewlett-Packard Building
337 Fu Hsing North Road
TAIPEI
Tel: (02) 712-0404
Telex: 24439 HEWPACK
Cable: HEWPACK Taipei
A,C,CM,E,M,P



TAIWAN (Cont'd)

Ingl Lih Trading Co.
3rd Floor, 7 Jen-Ai Road, Sec. 2

TAIPEI 100

Tel: (02) 3948191
Cable: INGLIH Taipei
A

THAILAND

Unimesa Co. Ltd.
30 Patpong Ave., Suriwong

BANGKOK 5

Tel: 235-5727
Telex: 84439 Simonco TH
Cable: UNIMESA Bangkok
A,C,E,M

Bangkok Business Equipment Ltd.
5/5-6 Dejo Road

BANGKOK

Tel: 234-8670, 234-8671
Telex: 87699-BEQUIPT TH
Cable: BUSIQUIPT Bangkok
P

TOGO

Societe Africaine De Promotion
Immeuble Sagap

22, Rue d'Atakpame
B.P. 4150

LOME

Tel: 21-62-88
Telex: 5304
P

TRINIDAD & TOBAGO

Caribbean Telecoms Ltd.
Corner McAllister Street &
Eastern Main Road, Laventille
P.O. Box 732

PORT-OF-SPAIN

Tel: 624-4213
Telex: 22561 CARTEL WG
Cable: CARTEL, PORT OF SPAIN
CM,E,M,P

Computer and Controls Ltd.
P.O. Box 51

66 Independence Square

PORT-OF-SPAIN

Tel: 62-279-85
Telex: 3000 POSTLX WG, ACCT
LOO90 AGENCY 1264
A,P

Feral Assoc.
8 Fitzgerald Lane

PORT-OF-SPAIN

Tel: 62-36864, 62-39255
Telex: 22432 FERALCO
Cable: FERALCO
M

TUNISIA

Precision Electronique S.A.R.L.
31 Avenue de la Liberte

TUNIS

Tel: 893937
Telex: 13238
P

Tunisie Electronique S.A.R.L.
94, Av. Jugurtha, Mutuelleville

1002 TUNIS-BELVEDERE

Tel: 280144
Telex: 13238
C,E,P

Corema S.A.

23, bis Rue de Marseille

TUNIS

Tel: 253-821
Telex: 14812 CABAM TN
M

TURKEY

E.M.A

Mediha Eldem Sokak No. 41/6
Yenisehir

ANKARA

Tel: 319175
Telex: 46912 KTX TR
Cable: EMATRADE ANKARA
M

Teknim Company Ltd.

Iran Caddesi No. 7

Kavaklidere

ANKARA

Tel: 275800
Telex: 42155 TKNM TR
E,CM

Saniva Bilgisayar Sistemleri A.S.

Buyukdere Caddesi 103/6

Gayrettene

ISTANBUL

Tel: 1727030
Telex: 26345 SANI TR
C,P

Best Inc.

Esentepe, Gazeteciler Sitesi

Keskin Kalemy

Sokak 6/3, Gayrettepe

ISTANBUL

Tel: 1721328
Telex: 42490
A

UNITED ARAB EMIRATES

Emitac Ltd.

P.O. Box 1641

SHARJAH

Tel: 591181
Telex: 68136 EMITAC EM
Cable: EMITAC SHARJAH
E,C,M,P,A

Emitac Ltd.

P.O. Box 2711

ABU DHABI

Tel: 820419-20
Cable: EMITACH ABUDHABI

Emitac Ltd.

P.O. Box 8391

DUBAI,

Tel: 377591

Emitac Ltd.

P.O. Box 473

RAS AL KHAIMAH

Tel: 28133, 21270

UNITED KINGDOM

GREAT BRITAIN

Hewlett-Packard Ltd.

Trafalgar House

Navigation Road

ALTRINCHAM

Cheshire WA14 1NU

Tel: 061 928 6422

Telex: 668068

A,C,E,M,P

Hewlett-Packard Ltd.

Miller House

The Ring, BRACKNELL

Berks RG12 1XN

Tel: 0344 424898

Telex: 848733

E

Hewlett-Packard Ltd.

Elstree House, Elstree Way

BOREHAMWOOD, Herts WD6 1SG

Tel: 01 207 5000

Telex: 8952716

C,E

Hewlett-Packard Ltd.

Oakfield House, Oakfield Grove

Clifton BRISTOL, Avon BS8 2BN

Tel: 0272 736806

Telex: 444302

C,E,P

Hewlett-Packard Ltd.

Bridewell House

9 Bridewell Place

LONDON EC4V 6BS

Tel: 01 583 6565

Telex: 298163

C,P

Hewlett-Packard Ltd.

Pontefract Road

NORMANTON, West Yorkshire WF6 1RN

Tel: 0924 895566

Telex: 557355

C,P

Hewlett-Packard Ltd.

The Quadrangle

106-118 Station Road

REDHILL, Surrey RH1 1PS

Tel: 0737 68655

Telex: 947234

C,E,P

Hewlett-Packard Ltd.

Avon House

435 Stratford Road

Shirley, SOLIHULL, West Midlands

B90 4BL

Tel: 021 745 8800

Telex: 339105

C,E,P

Hewlett-Packard Ltd.

West End House

41 High Street, West End

SOUTHAMPTON

Hampshire SO3 3DQ

Tel: 0703 476767

Telex: 477138

C,P

Hewlett-Packard Ltd.

Harmon House

No. 1 George Street

UXBRIDGE, Middlesex UX8 1YH

Tel: 895 720 20

Telex: 893134/5

C,CM,E,M,P

Hewlett-Packard Ltd.

King Street Lane

Winnersh, WOKINGHAM

Berkshire RG11 5AR

Tel: 0734 784774

Telex: 847178

A,C,E,M,P

IRELAND

NORTHERN IRELAND

Hewlett-Packard (Ireland) Ltd.

Carrickfergus Industrial Centre

75 Belfast Road, Carrickfergus

BELFAST BT38 8PH

Tel: 09603 67333

Telex: 747626

C,E

SCOTLAND

Hewlett-Packard Ltd.

8 Woodside Place

GLASGOW, G3 7QF

Tel: 041 332 6232

Telex: 779615

C,E

Hewlett-Packard Ltd.

SOUTH QUEENSFERRY

West Lothian, EH30 9TG

Tel: 031 331 1188

Telex: 72682

C,CM,E,M,P

UNITED STATES

Alabama

Hewlett-Packard Co.

700 Century Park South, Suite 128

BIRMINGHAM, AL 35226

Tel: (205) 822-6802

A,C,M,P*

Hewlett-Packard Co.

420 Wynn Drive

HUNTSVILLE, AL 35805

Tel: (205) 830-2000

C,CM,E,M*

Alaska

Hewlett-Packard Co.

3601 C St., Suite 1416

ANCHORAGE, AK 99503

Tel: (907) 563-8855

C,E

Arizona

Hewlett-Packard Co.

8080 Pointe Parkway West

PHOENIX, AZ 85044

Tel: (602) 273-8000

A,C,CM,E,M,P

Hewlett-Packard Co.

3400 East Britannia Dr.

Bldg. C, Suite 124

TUCSON, AZ 85706

Tel: (602) 573-7400

C,E,M**

California

Hewlett-Packard Co.

99 South Hill Dr.

BRISBANE, CA 94005

Tel: (415) 330-2500

C

Hewlett-Packard Co.

5060 E. Clinton Avenue, Suite 102

FRESNO, CA 93727

Tel: (209) 252-9652

C,M

SALES & SUPPORT OFFICES

Arranged alphabetically by country

UNITED STATES (Cont'd)

Hewlett-Packard Co.
1421 S. Manhattan Av.
FULLERTON, CA 92631
Tel: (714) 999-6700
C,CM,E,M

Hewlett-Packard Co.
7408 Hollister Ave. #A
GOLETA, CA 93117
Tel: (805) 685-6100
C,E

Hewlett-Packard Co.
5400 W. Rosecrans Blvd.
LAWDALE, CA 90260
Tel: (213) 643-7500
Telex: 910-325-6608
C,M

Hewlett-Packard Co.
2525 Grand Avenue
Long Beach, CA 90815
Tel: (213) 498-1111
C

Hewlett-Packard Co.
3155 Porter Drive
PALO ALTO, CA 94304
Tel: (415) 857-8000
C,E

Hewlett-Packard Co.
4244 So. Market Court, Suite A
SACRAMENTO, CA 95834
Tel: (916) 929-7222
A*,C,E,M

Hewlett-Packard Co.
9606 Aero Drive
SAN DIEGO, CA 92123
Tel: (619) 279-3200
C,CM,E,M

Hewlett-Packard Co.
5725 W. Las Positas Blvd.
Pleasanton, CA 94566
Tel: (415) 460-0282
C

Hewlett-Packard Co.
3003 Scott Boulevard
SANTA CLARA, CA 95054
Tel: (408) 988-7000
Telex: 910-338-0586
A,C,CM,E

Hewlett-Packard Co.
2150 W. Hillcrest Dr.
THOUSAND OAKS, CA 91320
(805) 373-7000
C,CM,E

Colorado
Hewlett-Packard Co.
2945 Center Green Court South
Suite A
BOULDER, CO 80301
Tel: (303) 938-3005
A,C,E

Hewlett-Packard Co.
24 Inverness Place, East
ENGLEWOOD, CO 80112
Tel: (303) 649-5000
A,C,CM,E,M

Connecticut

Hewlett-Packard Co.
500 Sylvan Av.
BRIDGEPORT, CT 06606
Tel: (203) 371-6454
C,E

Hewlett-Packard Co.
47 Barnes Industrial Road South
WALLINGFORD, CT 06492
Tel: (203) 265-7801
A,C,CM,E,M

Florida

Hewlett-Packard Co.
2901 N.W. 62nd Street
FORT LAUDERDALE, FL 33309
Tel: (305) 973-2600
C,E,M,P*

Hewlett-Packard Co.
6800 South Point Parkway
Suite 301
JACKSONVILLE, FL 32216
Tel: (904) 398-0663
C*,M**

Hewlett-Packard Co.
6177 Lake Ellenor Drive
ORLANDO, FL 32809
Tel: (305) 859-2900
A,C,CM,E,P*

Hewlett-Packard Co.
4700 Bayou Blvd.
Building 5
PENSACOLA, FL 32503
Tel: (904) 476-8422
A,C,M

Hewlett-Packard Co.
5550 W. Idlewild, #150
TAMPA, FL 33614
Tel: (813) 884-3282
C,E,M,P

Georgia

Hewlett-Packard Co.
2000 South Park Place
ATLANTA, GA 30339
Tel: (404) 955-1500
Telex: 810-766-4890
A,C,CM,E,M,P*

Hewlett-Packard Co.
3607 Parkway Lane
Suite 300
NORCROSS, GA 30092
Tel: (404) 448-1894
C,E,P

Hawaii

Hewlett-Packard Co.
Kawaihahao Plaza, Suite 190
567 South King Street
HONOLULU, HI 96813
Tel: (808) 526-1555
A,C,E,M

Idaho

Hewlett-Packard Co.
11309 Chinden Blvd.
BOISE, ID 83707
Tel: (208) 323-2700
C

Illinois

Hewlett-Packard Co.
304 Eldorado Road
P.O. Box 1607
BLOOMINGTON, IL 61701
Tel: (309) 662-9411
C,M**

Hewlett-Packard Co.
525 W. Monroe, #1308
CHICAGO, IL 60606
Tel: (312) 930-0010
C

Hewlett-Packard Co.
1200 East Diehl Road
NAPERVILLE, IL 60566
Tel: (312) 357-8800
C

Hewlett-Packard Co.
5201 Tollview Drive
ROLLING MEADOWS, IL 60008
Tel: (312) 255-9800
Telex: 910-687-1066
A,C,CM,E,M

Indiana

Hewlett-Packard Co.
11911 N. Meridian St.
CARMEL, IN 46032
Tel: (317) 844-4100
A,C,CM,E,M

Hewlett-Packard Co.
3702 Rupp Drive
FT. WAYNE, IN 46815
Tel: (219) 482-4283
C,E

Iowa

Hewlett-Packard Co.
4070 22nd Av. SW
CEDAR RAPIDS, IA 52404
Tel: (319) 390-4250
C,E,M

Hewlett-Packard Co.
4201 Corporate Dr.
WEST DES MOINES, IA 50265
Tel: (515) 224-1435
A**,C,M**

Kansas

Hewlett-Packard Co.
7804 East Funston Road, #203
WICHITA, KS 67207
Tel: (316) 684-8491
C,E

Kentucky

Hewlett-Packard Co.
10300 Linn Station Road, #100
LOUISVILLE, KY 40223
Tel: (502) 426-0100
A,C,M

Louisiana

Hewlett-Packard Co.
160 James Drive East
ST. ROSE, LA 70087
P.O. Box 1449
KENNER, LA 70063
Tel: (504) 467-4100
A,C,E,M,P

Maryland

Hewlett-Packard Co.
3701 Koppers Street
BALTIMORE, MD 21227
Tel: (301) 644-5800
Telex: 710-862-1943
A,C,CM,E,M

Hewlett-Packard Co.
2 Choke Cherry Road
ROCKVILLE, MD 20850
Tel: (301) 948-6370
A,C,CM,E,M

Massachusetts

Hewlett-Packard Co.
1775 Minuteman Road
ANDOVER, MA 01810
Tel: (617) 682-1500
A,C,CM,E,M,P*

Hewlett-Packard Co.
32 Hartwell Avenue
LEXINGTON, MA 02173
Tel: (617) 861-8960
C,E

Michigan

Hewlett-Packard Co.
4326 Cascade Road S.E.
GRAND RAPIDS, MI 49506
Tel: (616) 957-1970
C,M

Hewlett-Packard Co.
39550 Orchard Hill Place Drive
NOVI, MI 48020
Tel: (313) 349-9200
A,C,E,M

Hewlett-Packard Co.
1771 W. Big Beaver Road
TROY, MI 48084
Tel: (313) 643-6474
C

Minnesota

Hewlett-Packard Co.
2025 W. Larpenteur Ave.
ST. PAUL, MN 55113
Tel: (612) 644-1100
A,C,CM,E,M

Missouri

Hewlett-Packard Co.
1001 E. 101st Terrace Suite 120
KANSAS CITY, MO 64131-3368
Tel: (816) 941-0411
A,C,CM,E,M

Hewlett-Packard Co.
13001 Hollenberg Drive
BRIDGETON, MO 63044
Tel: (314) 344-5100
A,C,E,M

Nebraska

Hewlett-Packard
10824 Old Mill Rd., Suite 3
OMAHA, NE 68154
Tel: (402) 334-1813
C,E,M

New Jersey

Hewlett-Packard Co.
120 W. Century Road
PARAMUS, NJ 07653
Tel: (201) 265-5000
A,C,CM,E,M



UNITED STATES (Cont'd)

Hewlett-Packard Co.
20 New England Av. West
PISCATAWAY, NJ 08854
Tel: (201) 562-6100
A,C,CM,E

New Mexico

Hewlett-Packard Co.
7801 Jefferson N.E.
ALBUQUERQUE, NM 87109
Tel: (505) 292-1330
C,E,M

New York

Hewlett-Packard Co.
5 Computer Drive South
ALBANY, NY 12205
Tel: (518) 458-1550
A,C,E,M
Hewlett-Packard Co.
9600 Main Street
CLARENCE, NY 14031
Tel: (716) 759-8621
C,E

Hewlett-Packard Co.
200 Cross Keys Office Park
FAIRPORT, NY 14450
Tel: (716) 223-9950
A,C,CM,E,M

Hewlett-Packard Co.
7641 Henry Clay Blvd.
LIVERPOOL, NY 13088
Tel: (315) 451-1820
A,C,CM,E,M

Hewlett-Packard Co.
No. 1 Pennsylvania Plaza
55th Floor
34th Street & 8th Avenue
MANHATTAN NY 10119
Tel: (212) 971-0800
C,M*

Hewlett-Packard Co.
15 Myers Corner Rd.
Hollowbrook Park, Suite 20
WAPPINGER FALLS, NY 12590
CM,E

Hewlett-Packard Co.
250 Westchester Avenue
WHITE PLAINS, NY 10604
Tel: (914) 684-6100
C,CM,E

Hewlett-Packard Co.
3 Crossways Park West
WOODBURY, NY 11797
Tel: (516) 682-7800
A,C,CM,E,M

North Carolina

Hewlett-Packard Co.
305 Gregson Dr.
CARY, NC 27511
Tel: (919) 467-6600
C,CM,E,M,P*

Hewlett-Packard Co.
9600-H Southern Pine Blvd.
CHARLOTTE, NC 28210
Tel: (704) 527-8780
C*

Hewlett-Packard Co.
5605 Roanne Way
GREENSBORO, NC 27420
Tel: (919) 852-1800
A,C,CM,E,M,P*

Ohio

Hewlett-Packard Co.
2717 S. Arlington Road
AKRON, OH 44312
Tel: (216) 644-2270
C,E

Hewlett-Packard Co.
23200 Chagrin Blvd #100
BEACHWOOD, OH 44122
Tel: (216) 292-4677
C,P

Hewlett-Packard Co.
9920 Carver Road
CINCINNATI, OH 45242
Tel: (513) 891-9870
C,M

Hewlett-Packard Co.
16500 Sprague Road
CLEVELAND, OH 44130
Tel: (216) 243-7300
A,C,CM,E,M

Hewlett-Packard Co.
9080 Springboro Pike
MIAMISBURG, OH 45342
Tel: (513) 433-2223
A,C,CM,E*,M

Hewlett-Packard Co.
One Maritime Plaza, 5th Floor
720 Water Street
TOLEDO, OH 43604
Tel: (419) 242-2200
C

Hewlett-Packard Co.
675 Brooksedge Blvd.
WESTERVILLE, OH 43081
Tel: (614) 891-3344
C,CM,E*

Oklahoma

Hewlett-Packard Co.
3525 N.W. 56th St.
Suite C-100
OKLAHOMA CITY, OK 73112
Tel: (405) 946-9499
C,E*,M

Hewlett-Packard Co.
3840 S. 103rd E. Ave., #100
TULSA, OK 74146
Tel: (918) 665-3300
A**,C,E,M*,P*

Oregon

Hewlett-Packard Co.
9255 S. W. Pioneer Court
WILSONVILLE, OR 97070
Tel: (503) 682-8000
A,C,E*,M

Pennsylvania

Hewlett-Packard Co.
50 Dorchester Rd.
HARRISBURG, PA 17112
Tel: (717) 657-5900
C

Hewlett-Packard Co.
111 Zeta Drive
PITTSBURGH, PA 15238
Tel: (412) 782-0400
A,C,E,M

Hewlett-Packard Co.
2750 Monroe Boulevard
VALLEY FORGE, PA 19482
Tel: (215) 666-9000
A,C,CM,E,M

South Carolina

Hewlett-Packard Co.
Brookside Park, Suite 122
1 Harbison Way
COLUMBIA, SC 29210
Tel: (803) 732-0400
C,M

Hewlett-Packard Co.
555 N. Pleasantburg Dr.
Suite 107
GREENVILLE, SC 29607
Tel: (803) 232-8002
C

Tennessee

Hewlett-Packard Co.
One Energy Centr. #200
Pellissippi Pkwy.
KNOXVILLE, TN 37932
Tel: (615) 966-4747
A,C,M

Hewlett-Packard Co.
3070 Directors Row
Directors Square
MEMPHIS, TN 38131
Tel: (901) 346-8370
A,C,M

Hewlett-Packard Co.
220 Great Circle Road, Suite 116
NASHVILLE, TN 37228
Tel: (615) 255-1271
C,M,P*

Texas

Hewlett-Packard Co.
1826-P Kramer Lane
AUSTIN, TX 78758
Tel: (512) 835-6771
C,E,P*

Hewlett-Packard Co.
5700 Cromo Dr
EL PASO, TX 79912
Tel: (915) 833-4400
C,E*,M**

Hewlett-Packard Co.
3952 Sandshell Drive
FORT WORTH, TX 76137
Tel: (817) 232-9500
C

Hewlett-Packard Co.
10535 Harwin Drive
HOUSTON, TX 77036
Tel: (713) 776-6400
A,C,E,M,P*

Hewlett-Packard Co.
511 E. John W. Carpenter Fwy.
Royal Tech. Center #100
IRVING, TX 75062
Tel: (214) 556-1950
C,E

Hewlett-Packard Co.
109 E. Toronto, Suite 100
McALLEN, TX 78503
Tel: (512) 630-3030
C

Hewlett-Packard Co.
930 E. Campbell Rd.
RICHARDSON, TX 75081
Tel: (214) 231-6101
A,C,CM,E,M,P*

Hewlett-Packard Co.
1020 Central Parkway South
SAN ANTONIO, TX 78216
Tel: (512) 494-9336
A,C,E,M,P*

Utah

Hewlett-Packard Co.
3530 W. 2100 South
SALT LAKE CITY, UT 84119
Tel: (801) 974-1700
A,C,E,M

Virginia

Hewlett-Packard Co.
4305 Cox Road
GLEN ALLEN, VA 23060
Tel: (804) 747-7750
A,C,E,M,P*

Hewlett-Packard Co.
Tanglewood West Bldg.
Suite 240
3959 Electric Road
ROANOKE, VA 24018
Tel: (703) 774-3444
C,E,P

Washington

Hewlett-Packard Co.
15815 S.E. 37th Street
BELLEVUE, WA 98006
Tel: (206) 643-4000
A,C,CM,E,M
Hewlett-Packard Co.
708 North Argonne Road
SPOKANE, WA 99212-2793
Tel: (509) 922-7000
C

West Virginia

Hewlett-Packard Co.
501 56th
CHARLESTON, WV 25304
Tel: (304) 925-0492
A,C,M

Wisconsin

Hewlett-Packard Co.
275 N. Corporate Dr.
BROOKFIELD, WI 53005
Tel: (414) 784-8800
A,C,E*,M

URUGUAY

Pablo Ferrando S.A.C. e I.
Avenida Italia 2877
Casilla de Correo 370
MONTEVIDEO
Tel: 80-2586
Telex: 802586
A,CM,E,M



SALES & SUPPORT OFFICES

Arranged alphabetically by country

URUGUAY (Cont'd)

Olympia de Uruguay S.A.
Maquinas de Oficina
Avda. del Libertador 1997
Casilla de Correos 6644

MONTEVIDEO

Tel: 91-1809, 98-3807
Telex: 6342 OROU UY
P

VENEZUELA

Hewlett-Packard de Venezuela C.A.
3A Transversal Los Ruices Norte
Edificio Segre 2 & 3
Apartado 50933

CARACAS 1071

Tel: 239-4133
Telex: 251046 HEWPACK
A,C,CM,E,M,P

Hewlett-Packard de Venezuela, C.A.
Centro Ciudad Comercial Tamanaco
Nivel C-2 (Nueva Etapa)
Local 53H05

Chua, CARACAS

Tel: 928291
P

Albis Venezolana S.R.L.
Av. Las Marias, Ota. Alix,
El Pedregal
Apartado 81025

CARACAS 1080A

Tel: 747984, 742146
Telex: 24009 ALBIS VC
A

Tecnologica Medica del Caribe, C.A.
Multicentro Empresarial del Este
Ave. Libertador
Edif. Libertador
Nucleo "C" - Oficina 51-52

CARACAS

Tel: 339867/333780
M

Hewlett-Packard de Venezuela C.A.
Residencias Tia Betty Local 1
Avenida 3 y con calle 75

MARACAIBO, Estado Zulia

Apartado 2646
Tel: (061) 75801-75805-75806-
80304

Telex: 62464 HPMAR
C,E*

Hewlett-Packard de Venezuela C.A.
Urb. Lomas de Este
Torre Trebol — Piso 11

VALENCIA, Estado Carabobo

Apartado 3347
Tel: (041) 222992/223024
C,P

YUGOSLAVIA

Do Hermes
General Zdanova 4
YU-11000 BEOGRAD
Tel: 340 327, 342 641
Telex: 11433

A,C,E,P

Hermes

Titova 50

YU-61000 LJUBLJANA

Tel: 324 856, 324 858

Telex: 31583

C,E,M,P

Elektrotehna

Titova 51

YU-61000 LJUBLJANA

CM

ZAIRE

Computer & Industrial Engineering
25, Avenue de la Justice
B.P. 12797

KINSHASA, Gombe

Tel: 32063

Telex: 21552

C,P

ZAMBIA

R.J. Tilbury (Zambia) Ltd.
P.O. Box 32792

LUSAKA

Tel: 215590

Telex: 40128

E

ZIMBABWE

Field Technical Sales (Private) Limited
45, Kelvin Road North
P.O. Box 3458

HARARE

Tel: 705 231

Telex: 4-122 RH

E,P

August 1985

