

ViewSonic®

VP201b
VP201s

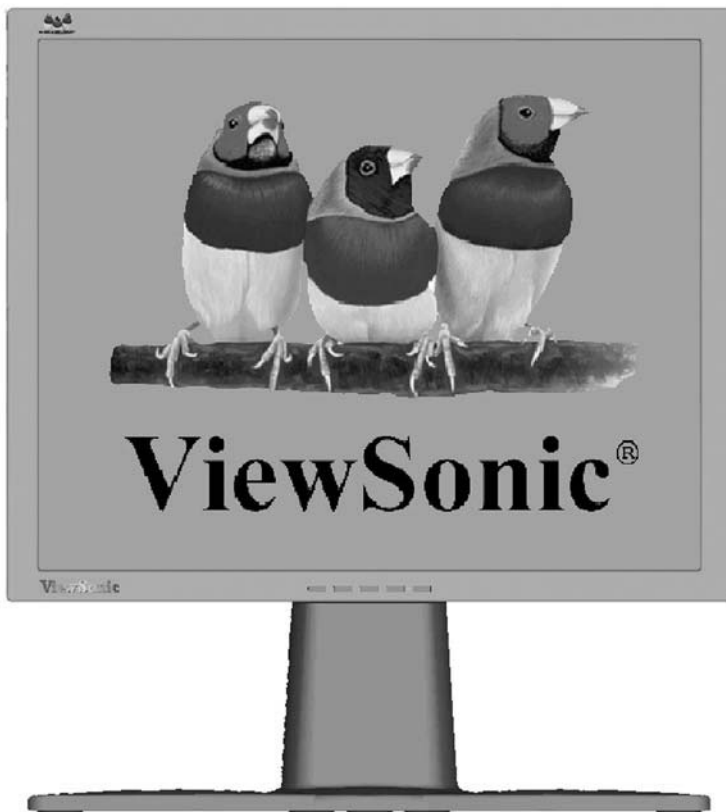

Full 20.1" Diagonal Viewable Screen

LCD Display

User Guide

Guide de l'utilisateur

Bedienungsanleitung

Guía del usuario

Guida dell'utente

Guia do usuário

Användarhandbok

Käyttöopas

Руководство пользователя

Használati útmutató

Podręcznik użytkownika

Uživatelská příruka

ユーザーズ ガイド

使用手冊

使用手冊

사용자 안내서

دليل المستخدم

Contents

Product Registration	2
For Your Records	2

Getting Started

Package Contents	3
Precautions	3
Quick Installation	4
Landscape/Portrait Modes	5
To Raise and Lower the display	5
Installation of Wall Mount (Optional)	6

Using the LCD Display

Setting the Timing Mode	7
OSD and Power Lock Settings.....	7
Adjusting the Screen Image	8
Main Menu Controls	10

Other Information

Specifications	14
Troubleshooting.....	15
Customer Support	16
Cleaning the LCD Display	17
Limited Warranty	18

Appendix

Safety Guidelines	19
Compliance Information for U.S.A.....	20
CE Conformity for Europe	20

Copyright © ViewSonic Corporation, 2004. All rights reserved.

Macintosh and Power Macintosh are registered trademarks of Apple Computer, Inc.

Microsoft, Windows, Windows NT, and the Windows logo are registered trademarks of Microsoft Corporation in the United States and other countries.

ViewSonic, the three birds logo, OnView, ViewMatch, and ViewMeter are registered trademarks of ViewSonic Corporation.

VESA is a registered trademark of the Video Electronics Standards Association. DPMS and DDC are trademarks of VESA.

ENERGY STAR® is a registered trademark of the U.S. Environmental Protection Agency (EPA).

As an ENERGY STAR® partner, ViewSonic Corporation has determined that this product meets the ENERGY STAR® guidelines for energy efficiency.

Disclaimer: ViewSonic Corporation shall not be liable for technical or editorial errors or omissions contained herein; nor for incidental or consequential damages resulting from furnishing this material, or the performance or use of this product.

In the interest of continuing product improvement, ViewSonic Corporation reserves the right to change product specifications without notice. Information in this document may change without notice.

No part of this document may be copied, reproduced, or transmitted by any means, for any purpose without prior written permission from ViewSonic Corporation.

Product Registration

To meet your future needs, and to receive any additional product information as it becomes available, please register your product on the Internet at: www.viewsonic.com. The ViewSonic® Wizard CD-ROM also provides an opportunity for you to print the registration form, which you may mail or fax to ViewSonic.

For Your Records

Product Name:	ViewSonic VP201b/VP201s
Model Number:	VLCDS26064-2W/4W
Document Number:	A-CD-VP201b-1/A-CD-VP201s-1
Serial Number:	_____
Purchase Date:	_____

Product disposal at end of product life

ViewSonic is concerned about the preservation of our environment. Please dispose of this product properly at the end of its useful life. For TCO'03 recycling information, please refer to our website:

1. USA: www.viewsonic.com/pdf/recyclePlus.pdf
2. Europe: www.viewsoniceurope.com
3. Taiwan: recycle.epa.gov.tw

Getting Started

Congratulations on your purchase of a ViewSonic® LCD display.

Important! Save the original box and all packing material for future shipping needs.

NOTE: The word “Windows” in this user guide refers to the following Microsoft operating systems: Windows ‘95, Windows NT, Windows ‘98, Windows 2000, Windows Me (Millennium), and Windows XP.

Package Contents

Your LCD display package includes:

- LCD display
- Power cord
- Video cables (VGA and DVI)
- USB cable
- ViewSonic Wizard CD-ROM
- Perfect Portrait™ Software CD-ROM
(Not included with VP201b-H/VP201s-H)

NOTE: The CD jacket contains the Quick Start Guide, and the CD includes the User Guide PDF files and INF/ICM display optimization files. The INF file ensures compatibility with Windows operating systems, and the ICM file (Image Color Matching) ensures accurate on-screen colors. ViewSonic recommends that you install both files.

Precautions

-
- Sit at least 18" from your LCD display.
 - **Avoid touching the screen.** Skin oils are difficult to remove.
 - **Never remove the rear cover.** Your LCD display contains high-voltage parts. You may be seriously injured if you touch them.
 - Avoid exposing your LCD display to direct sunlight or another heat source. Orient your LCD display away from direct sunlight to reduce glare.
 - Always handle your LCD display with care when moving it.
 - Place your LCD display in a well-ventilated area. Do not place anything on your LCD display that prevents heat dissipation.
 - Ensure the area around the LCD display is clean and free of moisture.
 - Do not place heavy objects on the LCD display, video cable, or power cord.
 - If smoke, abnormal noise, or strange odor is present, immediately switch the LCD display off and call your dealer or ViewSonic. It is dangerous to continue using the LCD display.
-

Quick Installation

1 Connect power cord

2 Connect video cable

- Make sure both the LCD display and computer are turned OFF
- Remove rear panel covers if necessary
- Connect the video cable from the LCD display to the computer

Macintosh users: Models older than G3 require a Macintosh adapter. Attach the adapter to the computer and plug the video cable into the adapter.

To order a ViewSonic® Macintosh adapter, contact ViewSonic Customer Support.

3 Turn ON LCD Display and computer

Turn ON the LCD display, then turn ON the computer. This sequence (LCD display before computer) is important.

NOTE: Windows users may receive a message asking them to install the INF file. This is on the CD.

4 Insert the ViewSonic Wizard CD into the computer's CD drive.

Follow the on-screen instructions.

If your computer does not have a CD-ROM drive, see "Customer Support."

4 Wizard CD (continued)

(1) Wait for the CD-ROM to auto-start.

NOTE: If the CD-ROM does not auto-start: double-click on the CD-ROM icon in the Windows Explorer, then double-click on **viewsonic.exe**.

(2) Follow the on-screen instructions.

5 Windows users: Set the timing mode (resolution and refresh rate)

Example: 1600 x 1200 @ 60 Hz.

For instructions on changing the resolution and refresh rate, see the graphic card's user guide.

Installation is complete. Enjoy your new ViewSonic, LCD display.

To be best prepared for any future customer service needs: print this user guide and write the serial number in "For Your Records" on page 2. (See back of LCD display.)

You can register your product online at the website for your region. See the Customer Support table in this guide.

The ViewSonic Wizard CD-ROM also provides an opportunity for you to print the registration form which you may mail or fax to ViewSonic.

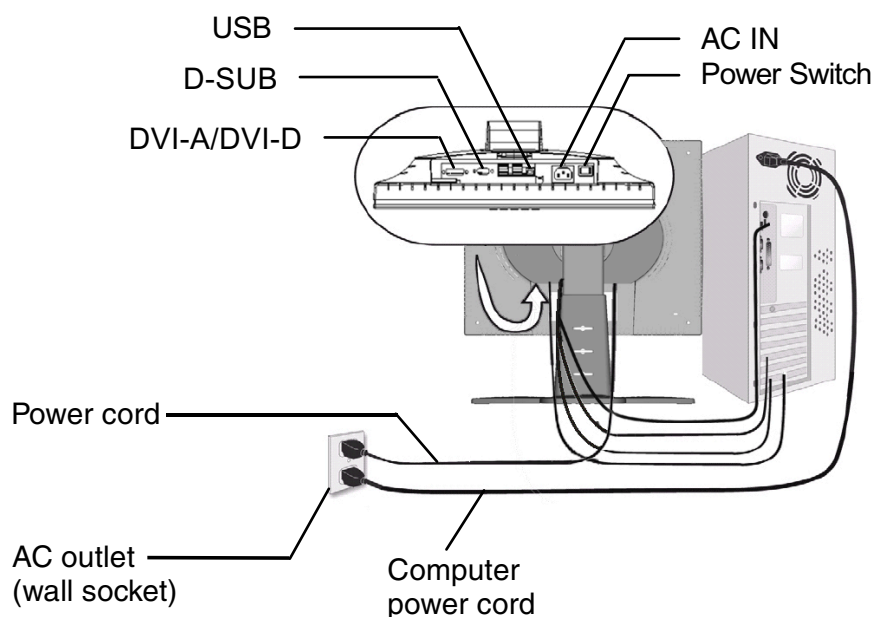

Landscape/Portrait Modes

The LCD display can operate in either Landscape or Portrait mode. Follow the instructions that accompany the Perfect Portrait software.

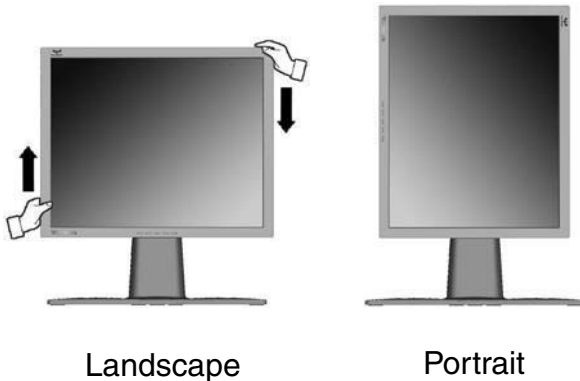

Note: Before using the portrait display mode, first install the Perfect Portrait™ software included with your LCD display.

Perfect Portrait software is compatible with most PCI and AGP graphics (video) cards.

For information about compatible graphics cards and approved hardware configurations, go to the ViewSonic website, <http://www.viewsonic.com>

To switch from Landscape (default) to Portrait mode, do the following:

- 1 From the front, gently raise the LCD display to allow more clearance.
- 2 Pull the bottom of the LCD display outward and away from the base.
- 3 Manually rotate the LCD display clockwise 90 degrees as shown above.

To Raise and Lower the display

You can easily raise and lower the display panel (the head) manually. As you face the front of the display, take hold of each side of the head and pull up or down. The panel should move easily.

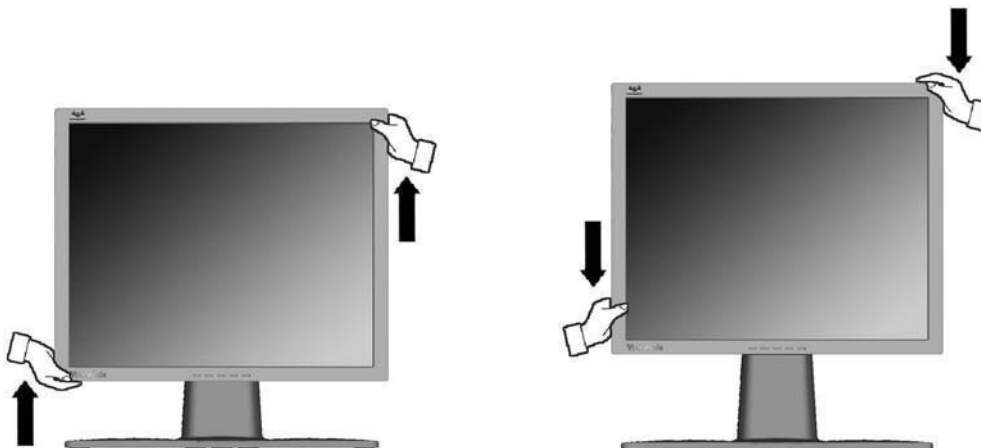

Installation of Wall Mount (Optional)

To obtain a wall-mounting kit, contact ViewSonic or your local dealer. Refer to the instructions that come with the base mounting kit. To convert your LCD display from a desk-mounted to a wall-mounted display, do the following:

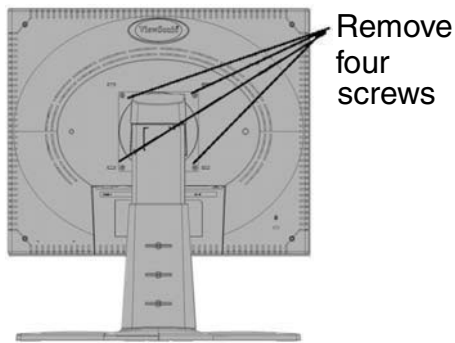
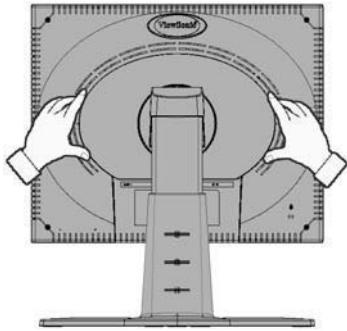

- 1 Disconnect Power.
- 2 Lay the LCD display face down on a towel or blanket.
- 3 Pull the back plate away from the head of the LCD display. Let the plate hang on the neck of the LCD display as shown on the left. Notice the four screws.
- 4 Remove the four screws from the back plate.
- 5 Attach the mounting bracket from the VESA compatible wall-mounting kit (100 mm x 100 mm distance).
- 6 Attach the LCD display to the wall, following the instructions in the wall-mounting kit.

Using the LCD Display

Setting the Timing Mode

Setting the timing mode is important for maximizing the quality of the screen image and minimizing eye strain. The **timing mode** consists of the **resolution** (example 1600 x 1200) and **refresh rate** (or vertical frequency; example 60 Hz). After setting the timing mode, use the OnView® controls to adjust the screen image.

For the best picture quality set your LCD display timing mode to:

VESA 1600 x 1200 @ 60Hz.

To set the Timing Mode:

- 1 Set the resolution: Right-click on the Windows desktop > **Properties** > **Settings** > set the resolution.
- 2 Set the refresh rate: See your graphic card's user guide for instructions.

WARNING: Do not set the graphics card in your computer to exceed the maximum refresh rate of 85Hz; doing so may result in permanent damage to your LCD display .

OSD and Power Lock Settings

- **OSD Lock:** Press and hold [1] and the up arrow ▲ for 10 seconds. If any buttons are pressed the message *OSD Locked* will display for 5 seconds.
- **OSD Unlock:** Press and hold [1] and the up arrow ▲ again for 10 seconds.
- **Power Button Lock:** Press and hold [1] and the down arrow ▼ for 10 seconds. If the power button is pressed the message *Power Button Locked* will display for 5 seconds. With or without this setting, after a power failure, your LCD display's power will automatically turn ON when power is restored.

Power Button Unlock: Press and hold [1] and the down arrow ▼ again for 10 seconds.

Adjusting the Screen Image

Use the buttons on the front control panel to display and adjust the OnView® controls which display on the screen. The OnView controls are explained at the top of the next page and are defined in "Main Menu Controls" on page 9.

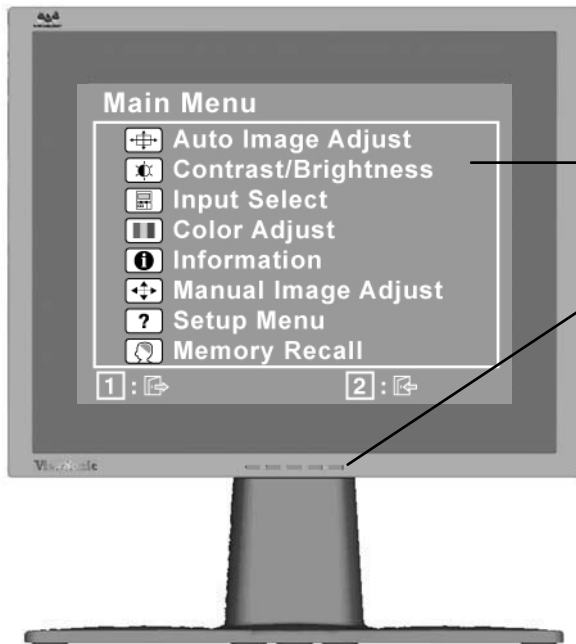

Main Menu with OnView controls

Front Control Panel shown below in detail

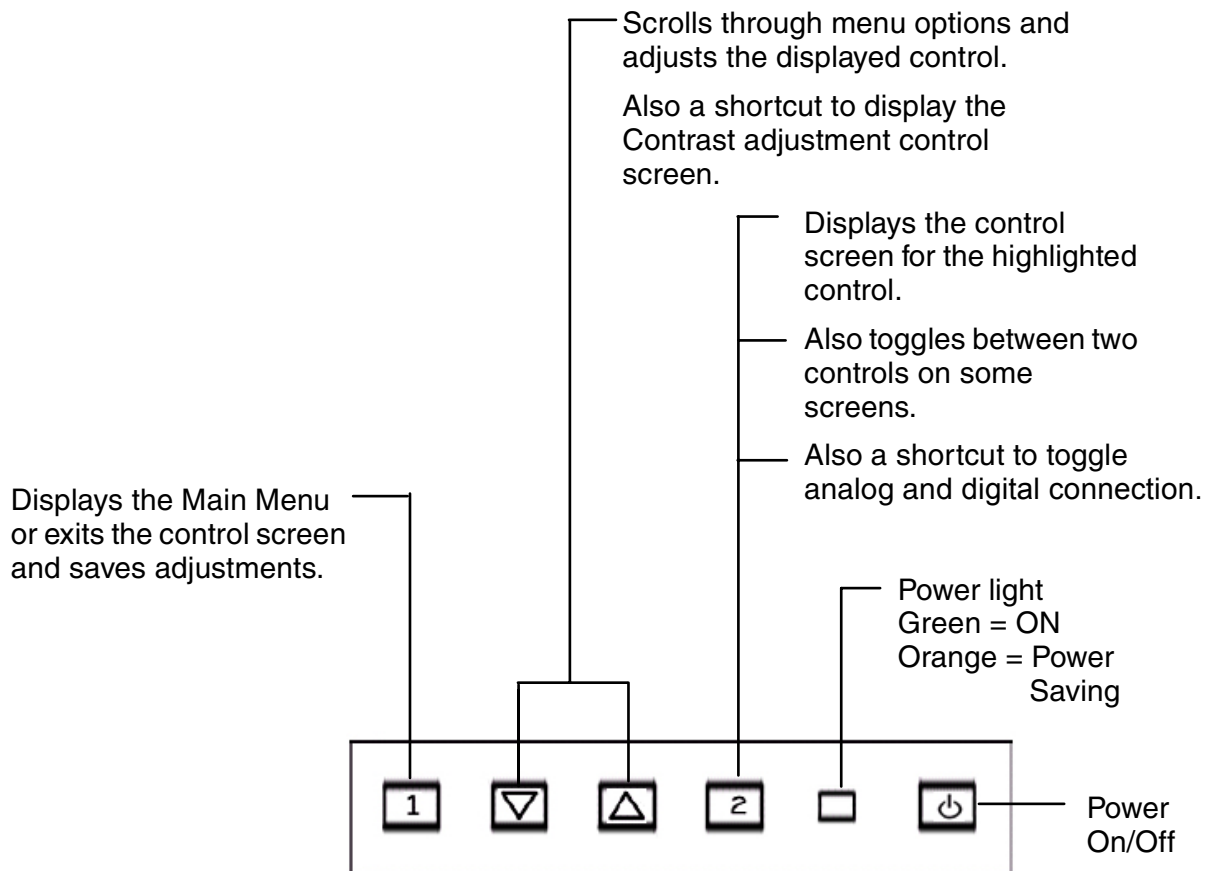

Do the following to adjust the screen image:

- 1 To display the Main Menu, press button [1].

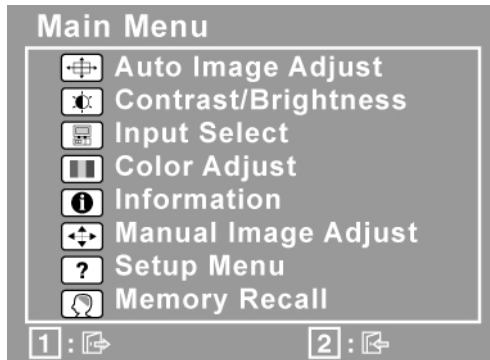

NOTE: All OnView menus and adjustment screens disappear automatically after about 30 seconds.

- 2 To select a control you want to adjust, press ▲ or ▼ to scroll up or down the Main Menu.
- 3 After the control is selected, press button [2].
- 4 To adjust the control, press the up ▲ or down ▼ buttons.
- 5 To save the adjustments and exit the menu, press button [1] *twice*.

The following tips may help you optimize your display:

- Adjust your computer's graphic card so that it outputs a video signal 1600 x 1200 @ 60 Hz to the LCD display. (Look for instructions on "changing the refresh rate" in your graphic card's user guide.)
- If necessary, make small adjustments using H POSITION and V POSITION until the screen image is completely visible. (The black border around the edge of the screen should barely touch the illuminated "active area" of the LCD display.)

Main Menu Controls

Adjust the menu items shown below by using the up ▲ and down ▼ buttons.

Control	Explanation
---------	-------------



Auto Image Adjust automatically sizes, centers, and fine tunes the video signal to eliminate waviness and distortion.

Press the [2] button to obtain a sharper image.

NOTE: Auto Image Adjust works with most common video cards. If this function does not work on your LCD display, then lower the video refresh rate to 60 Hz and set the resolution to its pre-set value.



Contrast adjusts the difference between the image background (black level) and the foreground (white level).



Brightness adjusts background black level of the screen image.



Input Select allows you to toggle between an analog and a digital signal.



Color Adjust provides several color adjustment modes: preset color temperatures and **RGB** which allows you to adjust red (**R**), green (**G**), and blue (**B**) separately. The factory setting for this product is 6500K (6500 Kelvin).

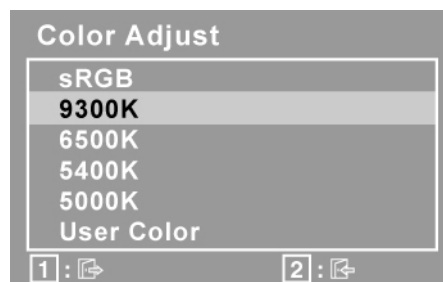

sRGB — sRGB is quickly becoming the industry standard for color management, with support being included in many of the latest applications. Enabling this setting allows the LCD display to more accurately display colors the way they were originally intended. Enabling the sRGB setting will cause the Contrast and Brightness adjustments to be disabled.

9300K — Adds blue to the screen image for cooler white (used in most office settings with fluorescent lighting).

6500K — Adds red to the screen image for warmer white and richer red.

Control Explanation

5400K— Adds green to the screen image for a darker color.

5000K— Adds blue and green to the screen image for a darker color.

User Color— Individual adjustments for red (R), green (G), and blue (B).

1 To select color (R, G or B) press button [2].

2 To adjust selected color, press ▲ or ▼.

Important: If you select RECALL from the Main Menu when the product is set to a Preset Timing Mode, colors return to the 6500K factory preset.



Information displays the timing mode (video signal input) coming from the graphics card in your computer. See your graphic card's user guide for instructions on changing the resolution and refresh rate (vertical frequency).

NOTE: VESA 1600 x 1200 @ 60 Hz (recommended) means that the resolution is 1600 x 1200 and the refresh rate is 60 Hertz.

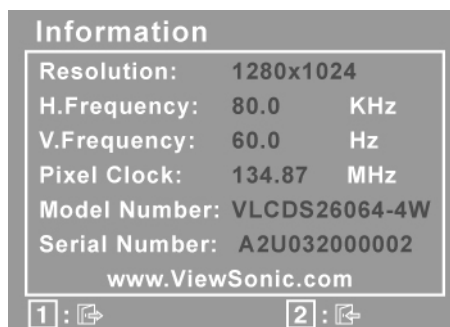

Manual Image Adjust displays the Manual Image Adjust menu.

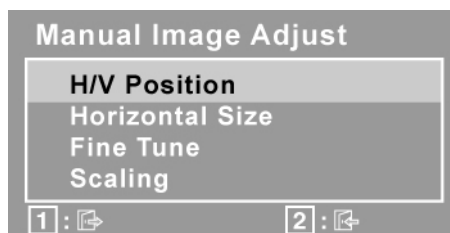

The **Manual Image Adjust** controls are explained below:

Horizontal Position moves the screen image left or right.

Vertical Position moves the screen image up or down.

Horizontal Size adjusts the width of the screen image.

Fine Tune sharpens focus by aligning the illuminated text and/or graphic characters.

Control Explanation

Scaling adjusts the video input signal to the screen size other than 1600 x 1200 using the following options.

1:1 adjusts the video signal so that the height and width of the picture are the same.

Fill all adjusts the video signal to fill the screen.

Fill Aspect Ratio maintains the correct video signal proportions for different resolutions.

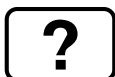

Setup Menu displays the menu shown below.

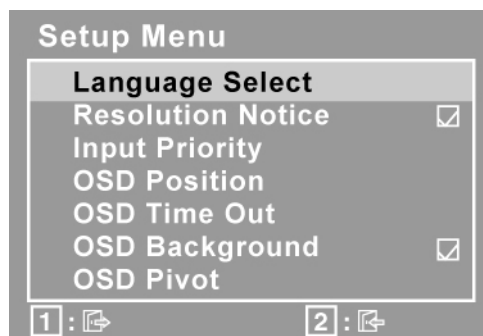

The **Setup Menu** controls are explained below:

Language allows you to choose the language used in the menus and control screens.

Resolution Notice displays the Resolution Notice menu shown below.

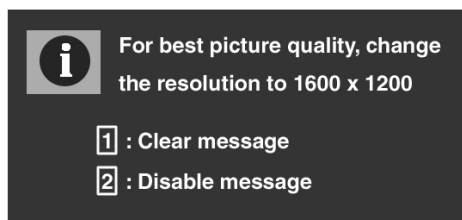

Resolution Notice advises the optimal resolution to use.

Input Priority If multiple computers will be connected to the display, this function can be used to select which computer has priority. Depending on the selected Input Priority, the display will do a one time detection for available inputs when first powered on.

Control Explanation



OSD Position allows you to move the on-screen display menus and control screens.

OSD Timeout sets the length of time an on-screen display screen is displayed. For example, with a "15 second" setting, if a control is not pushed within 15 seconds, the display screen disappears.

OSD Background allows you to turn the On-Screen-Display background on or off.

OSD Pivot This function is used to rotate the OSD menu, when the display is changed from Landscape to Portrait mode.



Memory Recall returns adjustments to the original factory settings if the display is operating in a factory Preset Timing Mode listed in this user guide.

Exception: This control does not affect changes made with the User Color control.

Other Information

Specifications

LCD	Type	20.1" (full 20.1" viewable diagonal area), TFT (Thin Film Transistor), Active Matrix UXGA LCD, 0.255 mm pixel pitch	
	Color Filter Glass surface	RGB vertical stripe Anti-Glare	
Input signal	Analog	RGB analog (0.7/1.0 Vp-p, 75 ohms) Composite Sync, Separate Sync, Sync on Green f_h :30-92 kHz, f_v :30-85 Hz	
	Digital	TMDS f_h :30-92 kHz, f_v :30-85 Hz	
Compatibility	PC	Up to 1600 x 1200 Non-interlaced	
	Macintosh ¹	Power Macintosh up to 1280 x 1024	
Resolution	Recommended and supported	1600 x 1200 @ 60 Hz	
		1280 x 1024 @ 60, 75 Hz	
		1024 x 768 @ 60, 70, 72, 75, 85 Hz	
		800 x 600 @ 56, 60, 72, 75, 85 Hz	
		640 x 480 @ 60, 75, 85 Hz	
		720 x 400 @ 70 Hz	
USB HUB		V2.0	
Power	Voltage	100-240 VAC, 50/60 Hz (auto switch)	
Display area	Full Scan	408mm (H) x 306mm (V) 16.1" (H) x 12.0" (V)	
Operating conditions	Temperature	32° F to + 104° F (0° C to + 40° C)	
	Humidity	10% to 90% (no condensation)	
	Altitude	To 10,000 feet	
Storage conditions	Temperature	-4° F to + 140° F (-20° C to + 60° C)	
	Humidity	10% to 90% (no condensation)	
	Altitude	To 40,000 feet	
Dimensions	Physical	448.0 mm (W) x 370.0 mm (H) x 267.0 mm (D) 17.6" (W) x 14.5" (H) x 10.5" (D)	
Weight	Net	18.7 lb (8.5 kg)	
Regulations		UL, FCC-B, ENERGY STAR [®] , c-UL, Ic-B, CE, MPRII, TCO'03 for VP201s, TCO'99 for VP201b, PCT (AR46), TUV/GS, BSMI, B-Mark, TUV-S, PSB, CCC, VCCI, C-Tick	
Power saving modes	On	Normal	(green LED)
	Active Off	<4W	(orange LED)

Preset Timing Mode (pre-adjusted to VESA[®] 1600 x 1200 @ 60 Hz)

Warning: Do not set the graphics card in your computer to exceed these refresh rates; doing so may result in permanent damage to the LCD display.

¹ Macintosh computers older than G3 require a ViewSonic[®], Macintosh adapter. To order an adapter, contact ViewSonic.

Troubleshooting

No power

- Make sure power button (or switch) is ON.
- Make sure A/C power cord is securely connected to the LCD display.
- Plug another electrical device (like a radio) into the power outlet to verify that the outlet is supplying proper voltage.

Power is ON but no screen image

- Make sure the video cable supplied with the LCD display is tightly secured to the video output port on the back of the computer. If the other end of the video cable is not attached permanently to the LCD display, tightly secure it to the LCD display.
- Adjust brightness and contrast.
- If you are using an Macintosh older than G3, you need a Macintosh adapter.

Wrong or abnormal colors

- If any colors (red, green, or blue) are missing, check the video cable to make sure it is securely connected. Loose or broken pins in the cable connector could cause an improper connection.
- Connect the LCD display to another computer.
- If you have an older graphics card, contact ViewSonic for a non-DDC adapter.

Control buttons do not work

- Press only one button at a time.

Customer Support

For technical support or product service, see the table below or contact your reseller.

NOTE: You will need the product serial number.

Country/ Region	Web site	T = Telephone F = FAX	Email
United States	www.viewsonic.com/ support	T: (800) 688-6688 F: (909) 468-1202	service.us@ viewsonic.com
Canada	www.viewsonic.com/ support	T: (800) 688-6688 F: (909) 468-1202	service.ca@ viewsonic.com
United Kingdom	www.viewsoniceurope.com	T: 0800 833 648 F: (01293) 643910	service.eu@ viewsoniceurope.com
Europe, Middle East, Baltic countries, and North Africa	www.viewsoniceurope.com	Contact your reseller	service.eu@ viewsoniceurope.com
Australia and New Zealand	www.viewsonic.com.au	T: +61 2 9906 6277 F: +61 2 9906 6377	service@au. viewsonic.com
Singapore/ Malaysia/Thailand	www.viewsonic.com.sg	T: 65 273 4018 F: 65 273 1566	service@sg. viewsonic.com
South Africa/ Other countries	www.viewsonic.com	T: 886 2 2246 3456 F: 886 2 8242 3668	service@sd. viewsonic.com
Hong Kong	www.hk.viewsonic.com	T: 886 2 2246 3456 F: 886 2 8242 3668	service@hk. viewsonic.com

Cleaning the LCD Display

- MAKE SURE THE LCD DISPLAY IS TURNED OFF.
- NEVER SPRAY OR POUR ANY LIQUID DIRECTLY ONTO THE SCREEN OR CASE.

To clean the screen:

- 1 Wipe the screen with a clean, soft, lint-free cloth. This removes dust and other particles.
- 2 If still not clean, apply a small amount of non-ammonia, non-alcohol based glass cleaner onto a clean, soft, lint-free cloth, and wipe the screen.

To clean the case:

- 1 Use a soft, dry cloth.
- 2 If still not clean, apply a small amount of a non-ammonia, non-alcohol based, mild non-abrasive detergent onto a clean, soft, lint-free cloth, then wipe the surface.

Disclaimer

ViewSonic does not recommend the use of any ammonia or alcohol-based cleaners on the LCD display screen or case. Some chemical cleaners have been reported to damage the screen and/or case of the LCD display display. ViewSonic will not be liable for damage resulting from use of any ammonia or alcohol-based cleaners.

Limited Warranty

VIEWSONIC LCD DISPLAY

What the warranty covers:

ViewSonic® warrants its products to be free from defects in material and workmanship during the warranty period. If a product proves to be defective in material or workmanship during the warranty period, **ViewSonic** will, at its sole option, repair or replace the product with a like product. Replacement product or parts may include remanufactured or refurbished parts or components.

How long the warranty is effective:

ViewSonic LCD displays are warranted for three (3) years for all parts including the light source and three (3) years for all labor from the date of the first consumer purchase.

Who the warranty protects:

This warranty is valid only for the first consumer purchaser.

What the warranty does not cover:

1. Any product on which the serial number has been defaced, modified or removed.
2. Damage, deterioration or malfunction resulting from:
 - a. Accident, misuse, neglect, fire, water, lightning, or other acts of nature, unauthorized product modification, or failure to follow instructions supplied with the product.
 - b. Repair or attempted repair by anyone not authorized by **ViewSonic**.
 - c. Any damage of the product due to shipment.
 - d. Removal or installation of the product.
 - e. Causes external to the product, such as electrical power fluctuations or failure.
 - f. Use of supplies or parts not meeting **ViewSonic**'s specifications.
 - g. Normal wear and tear.
 - h. Any other cause which does not relate to a product defect.
3. Removal, installation, and set-up service charges.

How to get service:

1. For information about receiving service under warranty, contact **ViewSonic Customer Support**. You will need to provide your product's serial number.
2. To obtain service under warranty, you will be required to provide (a) the original dated sales slip, (b) your name, (c) your address, (d) a description of the problem, and (e) the serial number of the product.
3. Take or ship the product freight prepaid in the original container to an authorized **ViewSonic** service center or **ViewSonic**.
4. For additional information or the name of the nearest **ViewSonic** service center, contact **ViewSonic**.

Limitation of implied warranties:

THERE ARE NO WARRANTIES, EXPRESS OR IMPLIED, WHICH EXTEND BEYOND THE DESCRIPTION CONTAINED HEREIN INCLUDING THE IMPLIED WARRANTY OF MERCHANTABILITY AND FITNESS FOR A PARTICULAR PURPOSE.

Exclusion of damages:

VIEWSONIC'S LIABILITY IS LIMITED TO THE COST OF REPAIR OR REPLACEMENT OF THE PRODUCT. VIEWSONIC SHALL NOT BE LIABLE FOR:

1. DAMAGE TO OTHER PROPERTY CAUSED BY ANY DEFECTS IN THE PRODUCT, DAMAGES BASED UPON INCONVENIENCE, LOSS OF USE OF THE PRODUCT, LOSS OF TIME, LOSS OF PROFITS, LOSS OF BUSINESS OPPORTUNITY, LOSS OF GOODWILL, INTERFERENCE WITH BUSINESS RELATIONSHIPS, OR OTHER COMMERCIAL LOSS, EVEN IF ADVISED OF THE POSSIBILITY OF SUCH DAMAGES.
2. ANY OTHER DAMAGES, WHETHER INCIDENTAL, CONSEQUENTIAL OR OTHERWISE.
3. ANY CLAIM AGAINST THE CUSTOMER BY ANY OTHER PARTY.

Effect of state law:

This warranty gives you specific legal rights, and you may also have other rights which vary from state to state. Some states do not allow limitations on implied warranties and/or do not allow the exclusion of incidental or consequential damages, so the above limitations and exclusions may not apply to you.

Sales outside the U.S.A. and Canada:

For warranty information and service on **ViewSonic** products sold outside of the U.S.A. and Canada, contact **ViewSonic** or your local **ViewSonic** dealer.

ViewSonic LCD Warranty (V3.0)

Release Date: 01-29-2002

Appendix

Safety Guidelines

CAUTION: The socket-outlet should be installed near the equipment and should be easily accessible.

CAUTION: Use a power cable that is properly grounded. Always use the appropriate AC cord that is certified for the individual country. Some examples are listed below:

USA..... UL	Switzerland SEV
Canada..... CSA	Britain BASE/BS
Germany VDE	Japan Electric Appliance Control Act

IMPORTANT NOTICE CONCERNING POWER CORD SELECTION

The power cord set for this unit has been enclosed and has been selected according to the country of destination and must be used to prevent electric shock. Use the following guidelines if it is necessary to replace the original cord set, or if the cord set is not enclosed.

The female receptacle of the cord set must meet IEC-60320 requirements and may look like (Figure A1 below):



For the United States and Canada

In the United States and Canada the male plug is a NEMA5-15 style (Figure A2), UL Listed, and CSA Labeled. For units which are mounted on a desk or table, type SVT or SJT cord sets may be used. For units which sit on the floor, only SJT type cord sets may be used. The cord set must be selected according to the current rating for your unit. Please consult the table below for the selection criteria for power cords used in the United States and Canada.

Cord Type	Size of Conductors in Cord	Maximum Current Rating of Unit
SJT	18 AWG	10 Amps
	16 AWG	12 Amps
	14 AWG	12 Amps
SVT	18 AWG	10 Amps
	17 AWG	12 Amps

For European Countries

In Europe you must use a cord set which is appropriate for the receptacles in your country. The cord set is HAR-Certified, and a special mark that will appear on the outer sheath, or on the insulation of one of the inner conductors.

AC PLUG CORD PRECAUTIONS FOR THE UNITED KINGDOM

FOR YOUR SAFETY PLEASE READ THE FOLLOWING TEXT CAREFULLY.

IF THE FITTED MOULDED PLUG IS UNSUITABLE FOR THE SOCKET OUTLET THEN THE PLUG SHOULD BE CUT OFF AND DISPOSED OF SAFELY.

THERE IS A DANGER OF SEVERE ELECTRICAL SHOCK IF THE CUT OFF PLUG IS INSERTED INTO AN APPROPRIATE SOCKET.

If a new plug is to be fitted, please observe the wiring code as shown below.

If in any doubt, please consult a qualified electrician.

WARNING: THIS APPLIANCE MUST BE EARTHED.

IMPORTANT: The wires in this mains lead are coloured in accordance with the following code:

- Green-and-Yellow: Earth
- Blue: Neutral
- Brown: Live

If the coloured wires of the mains lead of this appliance do not correspond with the coloured markings identifying the terminals in your plug, proceed as follows:

The wire which is coloured GREEN-AND-YELLOW must be connected to the terminal in the plug which is marked by the letter E or by the Earth symbol or coloured GREEN or GREEN-AND-YELLOW.

The wire which is coloured BLUE must be connected to the terminal in the plug which is marked with the letter N or coloured BLACK. The wire which is coloured BROWN must be connected to the terminal in the plug which is marked with the letter L or coloured RED.

If you have any questions concerning which proper power cord to use, please consult with the dealer from whom you have purchased the product.

Compliance Information for U.S.A.

This equipment has been tested and found to comply with the limits for a Class B digital device, pursuant to part 15 of the FCC Rules. These limits are designed to provide reasonable protection against harmful interference in a residential installation. This equipment generates, uses, and can radiate radio frequency energy, and if not installed and used in accordance with the instructions, may cause harmful interference to radio communications. However, there is no guarantee that interference will not occur in a particular installation. If this equipment does cause harmful interference to radio or television reception, which can be determined by turning the equipment off and on, the user is encouraged to try to correct the interference by one or more of the following measures:

- Reorient or relocate the receiving antenna.
- Increase the separation between the equipment and receiver.
- Connect the equipment into an outlet on a circuit different from that to which the receiver is connected.
- Consult the dealer or an experienced radio/TV technician for help.

FCC Warning

To assure continued FCC compliance, the user must use grounded power supply cord and the provided shielded video interface cable with bonded ferrite cores. If a BNC cable is going to be used, use only a shielded BNC(5) cable. Also, any unauthorized changes or modifications not expressly approved by the party responsible for compliance could void the user's authority to operate this device.

CE Conformity for Europe



The device complies with the requirements of the EEC directive 89/336/EEC as amended by 92/31/EEC and 93/68/EEC Art.5 with regard to "Electromagnetic compatibility," and 73/23/EEC as amended by 93/68/EEC Art.13 with regard to "Safety."

ViewSonic[®] Corporation