



# CONCRETE

## INFORMATION

## Design and Construction of Joints for Concrete Streets

To ensure that the concrete pavements we are building now will continue to serve our needs well into the future, it is essential to take into account all design and construction aspects. This includes thickness design, subgrade and subbase preparation, and jointing. This publication addresses the design and construction of jointing systems for concrete street pavements. Two other ACPA publications, *Design of Concrete Pavements for City Streets* and *Subgrades and Subbases for Concrete Pavements*, address city street thickness design and subgrade/subbase preparation.

Typically street pavement slabs range from 5 to 8 in. (125 to 200 mm) in thickness. The recommendations for jointing in this publication are for pavements within this general range and purpose. Special considerations for other concrete pavement joint systems (highways, parking areas, and airports) are covered in other ACPA publications. A proper jointing system for concrete street pavements ensures that the structural capacity and riding quality of the pavement is maintained at the highest level at the lowest annual cost. A proper jointing system will:

1. control cracking.
2. divide the pavement into practical construction increments.
3. accommodate slab movements.
4. provide load transfer.

The development of concrete pavement joint design has evolved from theoretical studies, laboratory tests, experimental pavements, and performance evaluations of in-service pavements. A careful study of the performance of pavements subject to similar traffic and environmental conditions as the proposed pavement is of great value and should be considered in the design of slab dimensions and jointing details.

### Jointing Considerations

The need for a jointing system in concrete pavements results from the desire to control the location and geometry of transverse and longitudinal cracking. Cracking results from stresses caused by concrete drying shrink-

age, temperature and moisture differentials, and applied traffic loadings. If these stresses are not relieved, uncontrolled cracking will occur.

In determining a proper jointing system, the designer must consider climate and environmental conditions, slab thickness, load transfer, shoulder/curb and gutter construction, and traffic. Past performance of local streets is also an excellent source for establishing joint design. Moreover, improvements to past designs using current technology can significantly improve performance.

Proper and timely construction practices, in addition to proper design, are key in obtaining a properly performing jointing system for street pavements. Late or inadequate joint formation may cause cracks to develop at locations other than those intended. In most cases, sealing is necessary to assure the proper function of street joints.

### Jointing for Crack Control

Proper jointing is based on controlling cracks that occur from the natural actions of the concrete pavement. Joints are placed in the pavement to control the crack location and pattern. Observing the slab behavior of unjointed plain pavements in service for many years can illustrate how joints are used to control cracking.

To attain adequate workability for placing and finishing concrete, more mixing water is used than is needed to hydrate the cement. As the concrete consolidates and hardens, most of the excess water bleeds to the surface and evaporates. With the loss of water, the concrete contracts and occupies somewhat less volume. A second major source of early shrinkage is caused by the pavement's temperature change. The heat of hydration and temperature of the concrete normally peak a short time after final set. After peaking, the temperature of concrete declines due to reduced cement hydration and lower air temperature during the first night of pavement life. As the temperature drops, the concrete pavement contracts.

The pavement's contraction is resisted by subgrade friction, which creates tensile stresses in the concrete slab. These tensile stresses cause a transverse crack pattern like that shown in Figure 1.

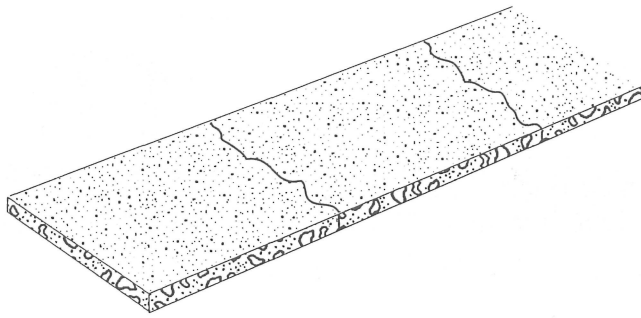

**Fig. 1. Initial cracking in unjointed pavement**

Spacing of the initial cracks varies from about 40 to 150 ft (12.0 to 45.0 m) depending on concrete properties, point-to-point variations in subgrade friction, and climatic conditions during and after placement.

After the pavement hardens, curling and warping stresses develop from temperature and moisture gradients in the concrete that also affect the cracking pattern. Evaluating the combined effect of restrained temperature curling and moisture warping is complicated due to their opposing nature. For instance, when the top of the slab is warmer than the bottom, causing the top to expand, the bottom of the slab usually has a higher moisture content causing it to expand. Hence, the amount of stress developed in the slab will be less than the stress due to temperature or moisture gradients alone. Repetitive traffic loads compound the problem. In any case, restrained curling and warping in combination with loads will cause additional transverse cracks between the initial contraction cracks shown in Figure 1. Also, a longitudinal crack will form along the approximate centerline of pavements with two lanes of traffic. The resulting crack pattern is shown in Figure 2a. The interval between transverse cracks is normally about 10 to 20 ft (3.0 to 6.0 m), depending on factors such as pavement thickness, shrinkage properties of the concrete, sub-base and subgrade conditions, and climatic conditions. Figure 2b shows a proper jointing system used to control slab cracking.

## Load Transfer

For jointed concrete pavements to perform adequately, traffic loadings must be transferred effectively from one side of the joint to the other. This is called load transfer.

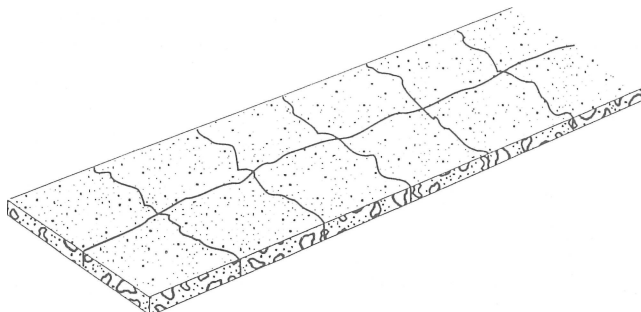

**Fig. 2a. Crack pattern in unjointed pavement due to environmental and load stresses**

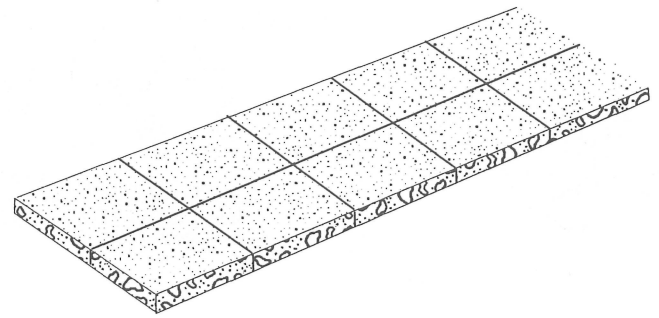

**Fig. 2b. Properly jointed pavement**

Adequate load transfer results in lower deflections, which reduces faulting, spalling, and corner breaks, thereby increasing pavement life. Load transfer across joints for street pavements is developed either by aggregate interlock or dowel bars.

## Aggregate Interlock

Aggregate interlock is the interlocking action between aggregate particles at the face of the joint. It relies on the shear interaction between aggregate particles at the irregular crack faces that form below the saw cut. This form of load transfer has been found to be most effective on roadways with short spacings and low truck volumes. A 1985 study by the Minnesota DOT<sup>1</sup> found that aggregate interlock load transfer provides acceptable pavement performance when truck semi-trailer volumes are fewer than 80 to 120 trucks per day per lane. In dry, non-freeze environments, greater truck volumes may be accommodated. Other studies have indicated that at least four to five million AASHTO 18,000-pound Equivalent Single Axle Loads (ESAL's) are required to produce objectionable faulting in undoweled pavements.<sup>2,3</sup>

Laboratory<sup>4,5,6,7</sup> and field studies<sup>3,7</sup> have shown that aggregate interlock load transfer is improved with subgrade strength; size, angularity, and durability of the aggregate; joint face roughness; and slab thickness. Furthermore, these studies found that shorter slabs increase aggregate interlock effectiveness by reducing the movement and opening at each joint.

## Dowel Bars

Dowel bars are round, smooth, steel bars placed across transverse joints to transfer loads without restricting horizontal joint movements due to thermal and moisture contractions and expansions. They also keep slabs in horizontal and vertical alignment. Dowels reduce deflections and stresses due to traffic loads. This in turn prevents or reduces faulting, pumping, and corner breaking on roadways that carry a large number of trucks and/or have longer joint spacings.

The use of dowel bars for minimizing faulting and pumping should be considered when the slabs are longer than 20 ft (6.0 m), when truck semi-trailer traffic exceeds 80 to 120 per day per lane, or when the accumulated design traffic exceeds four to five million AASHTO ESAL's per lane. Typically, this truck traffic level requires an 8-in.-thick (200-mm) slab or greater. Since most city streets do not experience these truck traffic levels and

recommended joint spacings are not greater than 15 ft (4.5 m), dowels are generally not necessary. For 8-in. (200-mm) slabs or greater, dowels and/or the following methods are recommended for most highway applications<sup>8</sup>:

1. Thicker slabs
2. Stiffer subbase/subgrade (higher effective k-value)
3. Less erodable subbase (e.g. cement-treated or lean concrete subbase)
4. Edge support (e.g. tied concrete shoulders or tied/integral curb and gutter)
5. Coarse grained subgrade soils (improved drainage).
6. Longitudinal edge drains.

If jointed reinforced pavements are used, dowels should be placed across joints to assist in load transfer. Due to the longer joint spacing, the joint opening is wider and load transfer by aggregate interlock becomes ineffective. Recommended dowel dimensions and spacings for jointed reinforced pavements with joint spacings greater than 20 ft (6.0 m) are given in Table 1.

**Table 1. Dowel size for jointed reinforced pavements\* and construction joints**

Slab Depth, in. (mm)	Dowel diameter, in. (mm)	Dowel embedment, in. (mm)	Total dowel length, in. (mm)
6.0 (150)	3/4 (20)	5 (125)	14 (360)
6.5 (165)	7/8 (22)	5 (125)	14 (360)
7.0 (180)	1 (25)	6 (150)	16 (400)
7.5 (190)	1-1/8 (28)	7 (180)	16 (400)
8.0 (200)	1-1/4 (32)	8 (200)	17 (430)

All dowels spaced at 12-in. (300 mm) centers.  
 Embedment in on each side of the joint.  
 Total dowel length has allowances for joint openings and minor errors in placement.  
 Generally, jointed reinforced concrete pavements are not constructed under 6 in. (150 mm).

## Types of Joints

There are four general classifications of joints for concrete street pavements. The types and their functions are:

1. Transverse Contraction Joints: Joints that are constructed transverse to the street's centerline and spaced to control transverse slab cracking.
2. Transverse Construction Joints: Joints installed at the end of a day-long paving operation, or other placement interruption. Whenever possible, these joints should be installed at the location of a planned joint.

3. Longitudinal Joints: Joints parallel to the pavement centerline that control cracking and delineate lanes of traffic.
4. Isolation and Expansion Joints: Joints placed to allow movement of the pavement without damaging adjacent pavements, intersecting streets, drainage structures, or other fixed objects.

## Transverse Contraction Joints

Transverse contraction joints primarily control the natural cracking in the pavement. Their spacing, saw cut depth, and timing of joint formation are all critical to the joints' performance. Proper transverse joint design for both plain and reinforced pavements will specify the joint interval that will control cracks and provide adequate load transfer across joints.

### Joint Spacing

In plain jointed concrete pavements, the joint is designed to provide a plane of weakness that will control the formation of transverse cracks. The joint interval is designed so that intermediate (random) transverse cracks do not form. Figure 3 shows how random or uncontrolled transverse cracking increases with panel length<sup>10</sup>.

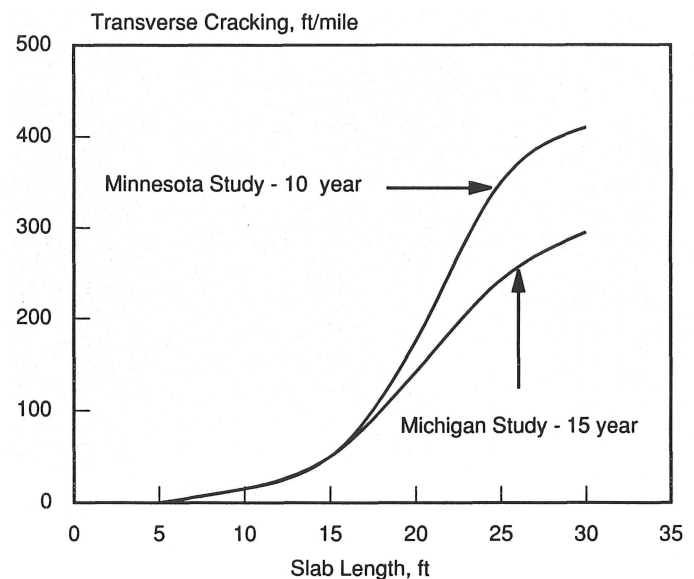

**Fig. 3. Sensitivity of transverse cracking to slab length from studies in Minnesota and Michigan<sup>(10)</sup>**

Table 2 suggests joint spacings for various pavement thicknesses. Typically, for jointed plain concrete streets, the joint spacing should be 24 to 30 times the pavement thickness with a maximum spacing of 15 ft (4.5 m). It is also important to keep slabs as square as possible. Transverse joint spacing should not exceed 125% to 150% of the longitudinal joint spacing. As always, local service records are the best guide for determining transverse joint spacings.

**Table 2. Recommended joint spacing for plain concrete pavements**

Pavement Thickness	Joint Spacing
5 in. (125 mm)	10-12.5 ft (3.0-3.8 m)
6 in. (150 mm)	12-15 ft (3.7-4.6 m)
7 in. (175 mm)	14-15 ft (4.3-4.6 m)
8 in. (200 mm) or more	15 ft (4.6 m)

For jointed reinforced concrete pavements, the maximum advisable joint spacing is 30 ft (9.0 m). Longer slabs have a greater tendency to develop working mid-panel cracks, which causes yielding or rupture of the steel reinforcement. The longer panels also have greater joint movements, which are detrimental to sealant performance. If jointed reinforced pavements are used, dowels should be placed across joints to assist in load transfer. Studies have shown that the faulting rate increases as the joint spacing increases beyond 30 ft (9.0 m).<sup>9</sup>

In highway applications, some agencies have used skewed, randomly spaced joints to eliminate harmonic induced ride quality problems caused by faulting. However, this is not necessary for city streets because low truck volumes will seldom induce joint faulting. Therefore, evenly spaced, right-angle joints will perform well for all street applications.

### Contraction Joint Formation

Contraction joints may be of two types: sawed or formed groove. Whether sawed or formed, contraction joints are designed to reduce the slab cross section at given points so that stresses in the concrete will result in cracking at the joints rather than elsewhere in the slab. Good workmanship is essential in constructing the joint so that a smooth and durable surface free from spalling is obtained.

Sawing is the most common method of creating transverse contraction joints. The initial saw cut provides a plane of weakness where cracking will begin. The initial saw cut in hardened concrete should be at least one-fourth the thickness of the slab ( $D/4$ ) and have a minimum width of 1/8 in. (3 mm). For pavements built on stabilized subbases, the initial saw cut should be increased to one-third the slab thickness ( $D/3$ ). The timing of this saw cut is critical. Sawing too soon results in spalling and raveling along the joint face. Sawing too late results in cracks developing elsewhere in the slab. The sawing should begin as soon as the concrete has obtained adequate strength to resist raveling of the joint edges, generally between 4 and 24 hours. Weather conditions (temperature, temperature change, wind, humidity, and direct sunlight) have a large influence on concrete strength gain and thus on the optimal time to begin sawing. The concrete mix design also affects proper timing. Mixes made with softer limestone aggregates require less strength development before sawing than do mixes with harder coarse aggregates. The joints must be flushed or blown clean immediately after sawing to keep residue

from setting up. Figures 4a and 4b give details for undoweled and doweled joints for street pavements. If dowels are used, care must be taken to ensure that the saw cut is centered over the dowels.

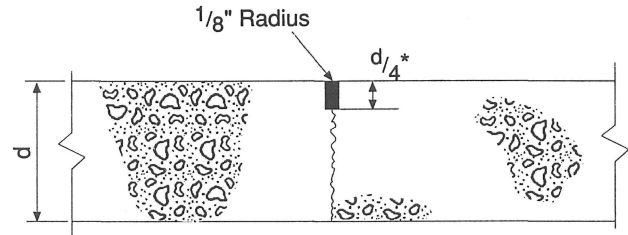

**Fig. 4a. Undoweled contraction joint**

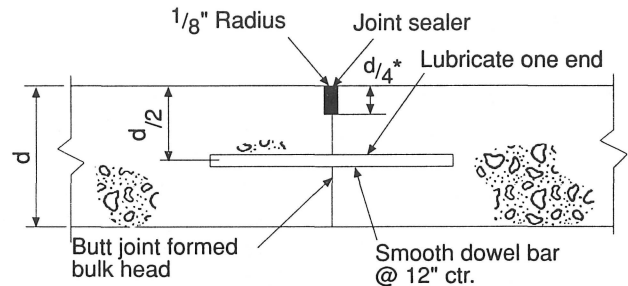

**Fig. 4b. Doweled contraction joint**

Formed-groove joints are made by impressing a T-shaped bar into the plastic concrete surface either manually with handles at each end of the bar or by a special joint cutter that rides on the side forms or straddles the slab behind the slipform paver. The depth of the formed-groove joint should be  $D/4$  or  $D/3$  depending on subbase type. A metal or wood template of the proper dimensions is then placed in the groove to prevent slumping of the concrete before some degree of stiffness is attained. The template should be removed before the concrete has completely hardened and the joint must be edged to remove sharp corners that could break off under traffic. The template should be cleaned and oiled after each use to facilitate removal when next used.

When a transverse contraction joint at normal spacing falls within 5 ft (1.5 m) of a catch basin, manhole, or other structure, the transverse joint spacing of one or more panels on either side of the opening can be shortened or skewed to permit the joint to meet the structure. Also, the contraction joint must be carried through the adjacent curbs or curb and gutter sections. If not, cracks will form in the curb and gutter sections at each pavement contraction joint location.

## Transverse Construction Joints

Transverse construction joints are used at planned interruptions such as at the end of each day's paving, at bridge leave-outs and intersections, and where unplanned interruptions suspend operations for an extended time. These are the location at which paving will resume. Figures 5 and 6 show typical details for planned and unplanned construction joints. Figure 5 shows where

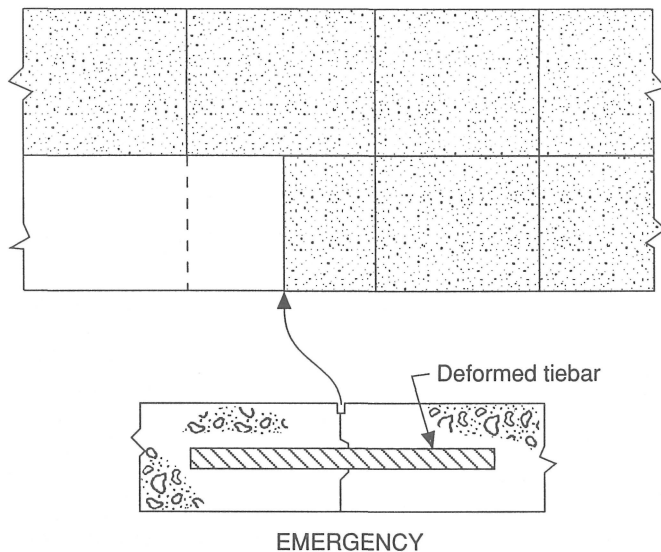
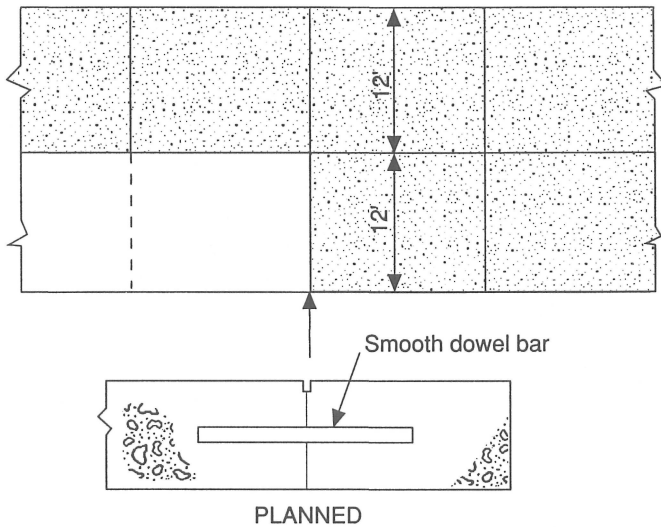

**Fig. 5. Planned and emergency construction joints for lane-at-a-time paving**

one or more abutting lanes of a roadway are constructed separately from the adjoining lanes. Planned construction joints, such as those used at the end of a day's paving, are installed at normal joint locations. These are butt-type joints that need dowels since there is no aggregate interlock to provide load transfer. Dowel size and spacing are the same as given in Table 1. To perform properly, the dowel ends extending through the butt joint must be lubricated before paving is resumed.

If an unplanned construction joint occurs at or near the location of a planned construction joint, a butt-type joint with dowels is recommended. If the unplanned construction joint occurs in the middle two-thirds of the normal joint interval, a keyed joint with tiebars should be used, as shown in Figure 5. This prevents the joint from cracking the adjacent lane. Typically #4 tiebars [1/2x24 in. (12 x 600 mm)] at 30 in. (750 mm) are used in street paving.

Figure 6 shows typical details for planned and unplanned transverse construction joints for full-width paving. The emergency joint in full-width paving can be either a butt joint with dowels or a tied keyway joint. The latter is often used because it costs less. The keyway provides the load transfer and the deformed tiebar or tiebolt keeps the joint closed to ensure joint effectiveness.

### Construction Joint Formation

The most common method of constructing transverse construction joints is to end the paving operation at a header board. Installing a header board requires handwork, which can lead to a rough surface. Therefore, extra attention should be given during finishing to ensure a smooth riding surface at construction joints. Dowels are placed through the header board in pre-drilled locations. Additional concrete consolidation with hand-held vibra-

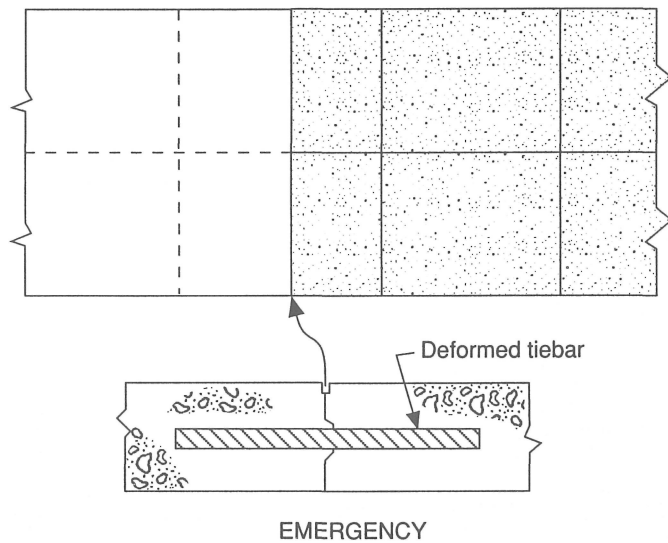
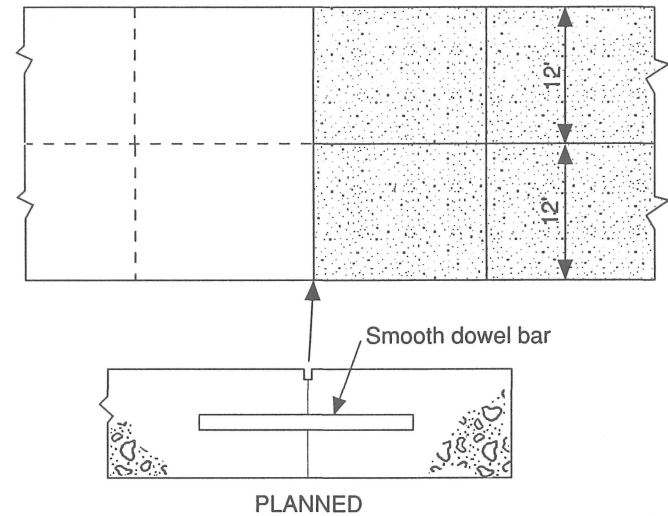

**Fig. 6. Planned and emergency construction joints for full-width paving**

tors should assure satisfactory encasement of the dowels. Before paving is resumed, the header board is removed. Transverse construction joints falling at planned locations for contraction or isolation joints are built and sealed to conform with the specifications for those joints, except that transverse construction joints do not require initial sawing. For an emergency (tied and keyed) construction joint, a 1-in.-deep (25-mm) saw cut is made and sealed.

## Longitudinal Joints

Longitudinal joints prevent irregular longitudinal cracks that would otherwise occur, as shown in Figure 2a. Such cracks normally develop from the combined effects of load and restrained warping after pavements are subjected to traffic. On two-lane and multilane street pavements, a spacing of 10 to 13 ft (3.0 to 4.0 m) serves the dual purpose of crack control and lane delineation. Longitudinal joints on arterial streets should also be spaced to provide traffic and parking-lane delineation. On these streets it is customary to allow 10 to 12 ft (3.0 to 3.7 m) for each travel lane and 10 to 12 ft (3.0 to 3.7 m) for parking that can also be used as a travel or turning lane.

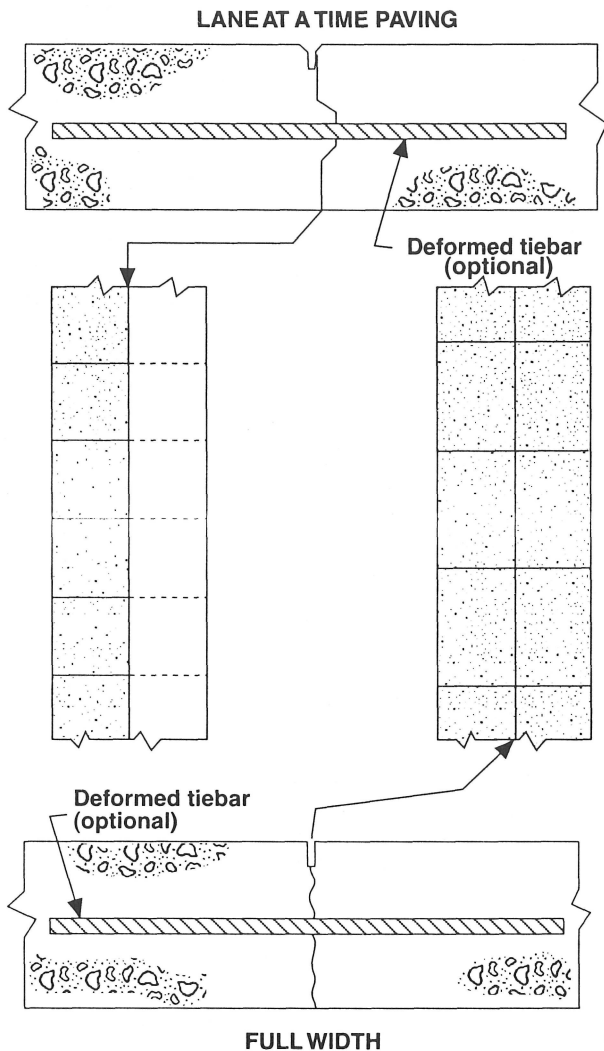

Fig. 7. Longitudinal joints

The two types of longitudinal centerline or lane-dividing joints in current use are shown in Figure 7. The longitudinal construction joint shown at the top of Figure 7 is used for lane-at-a-time construction. This includes adjacent lanes, shoulders, and curb and gutters. This joint may or may not be keyed depending on the slab thickness, lateral restraint, and traffic volumes. The longitudinal contraction joint shown at the bottom of Figure 7 is used where two or more lanes are paved at a time. With slipform paving two-, three-, or four-lane pavements can be placed in one pass. These joints depend on the tiebar to maintain aggregate interlock, structural capacity, and serviceability.

On most streets, the pavement is laterally restrained by the backfill behind the curbs and there is no need to tie longitudinal joints with deformed tiebars. However, on streets not restrained from lateral movement, tiebars must be placed at mid-depth of the slab to prevent the joint from opening due to the contraction of the concrete slabs. Typically, for concrete street pavements, #4 tiebars at 30 in. (750 mm) spacings are used. Tiebars should not be placed within 15 in. (380 mm) of transverse joints or they may interfere with the joint movement. Tiebars should not be coated with grease, oil, or other material that prevents bond to the concrete.

## Longitudinal Joint Formation

Longitudinal construction joints are used between construction lanes. These are usually keyed joints. A keyed joint is formed in the slab edge either by extrusion with a slipform paver or by attaching to the side form a metal or wooden key of the correct shape and dimensions at the proper depth. Typically, the keyway is a half round or trapezoidal shape meeting the dimensions shown in Figure 8. The keyway should be located at mid-depth of the slab to provide maximum strength. It is important that these keyway dimensions are used. Larger keys reduce the strength of the joint and may result in keyway failures. If wooden keyway forms are used, they must be maintained in good condition and well oiled before each use. When slipform pavers are used, the keyway is formed by the traveling slipform as it advances.

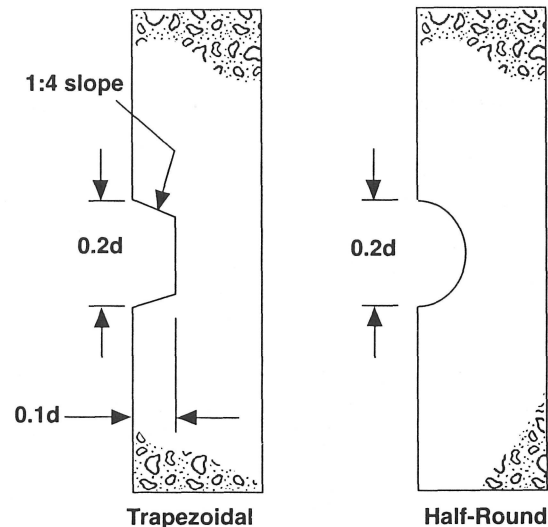

Fig. 8. Standard keyway dimensions

Longitudinal contraction joints are formed by sawing the hardened concrete or by forming grooves in the fresh concrete, much in the same way as transverse contraction joints, however the depth of the saw cut or groove should be one-third the slab thickness (D/3). Timing of the initial sawing is usually not as critical as for transverse construction joints since the transverse shrinkage movement is not as great as the longitudinal shrinkage. Typically, sawing should be completed in 48 hours and before any heavy equipment or vehicles are allowed on the pavement. Still, under certain conditions, such as a large drop in air temperature during the first or second night, longitudinal cracks may occur early. As a result, it is good practice to saw these joints as early as practicable.

## Sealant Considerations

The role of joint sealant is to minimize infiltration of surface water and incompressibles into the pavement joint. Incompressibles cause point bearing pressures, which may lead to spalling and, when longer joint spacings are used, "blow ups". For city streets with short joint spacings, the amount of joint opening and closing is small. As a result, the effectiveness of joint sealing for city streets is not as critical as it is for long joint spacings and for highway pavements with high truck volumes.

Where joint sealants are specified, the expected joint movement should help determine the selection of sealant material. Little movement is expected at transverse contraction joints with short spacings (15 ft (4.5 m) or less) or at longitudinal joints, which are usually tied or laterally restrained. Tied transverse construction joints have virtually no movement. However, transverse contraction joints in longer, reinforced panels will move significantly, and therefore the joint sealant must have the

ability to withstand repeated extension and compression as the pavement expands and contracts with temperature and moisture changes.

There are many acceptable materials available for sealing joints in concrete pavements. Sealants are most simply classified as liquid (field molded) and pre-formed (compression). Liquid sealants may be hot or cold poured, single or two component, and self-leveling or toolable. They assume the shape of the sealant reservoir and depend on long-term adhesion to the joint face for successful sealing. Pre-formed sealants are shaped during manufacture and depend on long-term compression recovery for successful sealing. Table 3 lists specifications for most available sealants.

Prior to sealing, the joint openings should be thoroughly cleaned of curing compound, residue, laitance, and any other foreign material. Joint face cleanliness directly affects the adherence of the sealant to the concrete. Improper or poor cleaning reduces the adherence of the sealant to the joint interface, which significantly decreases the life and effectiveness of the sealant. Therefore, proper cleaning is essential in order to obtain a joint surface that will not impair bond or adhesion with the sealant. Cleaning can be done with sand blasting, water, compressed air, wire brushing, or a number of other ways, depending on the joint surface condition and sealant manufacturer's recommendations.

For liquid sealants, the surfaces should be dry and the sealant should not be placed during cold weather. Attention to workmanship should be taken to ensure that sealant material is not spilled on the top exposed surfaces of the concrete. Pre-formed compression seals require the application of a lubricant/adhesive to the reservoir side walls. While the lubricant/adhesive used during installation has some adhesive qualities, its pri-

**Table 3. Joint sealant materials**

Hot Pour Sealants	Specification	Properties
Polymeric Asphalt Based	AASHTO M0173	Self Leveling
	ASTM D3405	Self Leveling
	SS-S-1401 C	Self Leveling
	ASTM D1190	Self Leveling
Polymeric Sealant Low Modulus	ASTM D3405 Modified	Self Leveling Self Leveling
Elastomeric Sealant Coal Tar, PVC	SS-S-1614 ASTM D3406	Self Leveling Self Leveling
<b>Cold Pour Sealants / Single Components</b>		
Silicone Sealant	No National Standard Specifications currently exist.	Self Leveling, non sag low to ultra-low modulus
Nitrile Rubber Sealant		Self Leveling, non sag
Polysulfide Sealant		Self Leveling, Low Modulus
<b>Preformed Polychloroprene Elastomeric (Compression Seals)</b>		
Preformed Compression Seals Lubricant Adhesive	ASTM D2628-81 ASTM D2835	20-50% allowable Strain

mary function is to provide lubrication during installation. Its adhesive qualities should not be considered in design. The size of the reservoir is chosen to ensure that the seal remains in compression at all times. During installation, care must be taken to avoid twisting and stretching the sealant more than 5 percent.

For streets, in contrast to highway pavements, a second sawing operation for reservoir widening is usually not done. However, for long panels, a second saw cut to provide a widened reservoir will enable the sealant to be more effective. In this case, reservoir dimensions should reflect the sealant properties, local environmental conditions, and service records of sealants and pavements similar to the project being designed. For best results, follow the liquid and pre-formed compression sealant manufacturer's recommendations for reservoir dimensions that suit their product.

## Isolation Joints and Expansion Joints

Isolation and expansion joints allow anticipated differential horizontal and vertical movements to occur between a pavement and another structure without damaging the pavement or the structure. Because pavement performance can be significantly affected by the planned use and location of these joints, much care should be taken in the design process. Though the terms are often used interchangeably, isolation joints are not the same as expansion joints.

### Isolation Joints

Isolation joints isolate the pavement from a structure, another paved area, or an immovable object. Proper use of these joints lessens compressive stresses that develop between the pavement and a structure or between two pavement sections. In this publication, isolation joints include full-depth, full-width joints found at bridge abutments, T- and unsymmetrical intersections, ramps, or between old and new pavements. The term isolation joint also applies to joints around in-pavement structures, such as drainage inlets, manholes, lighting structures, and footings. Figures 9a, 9b, and 9c show typical details for these isolation joints.

Isolation joints used at structures such as bridges should have dowels to provide load transfer and increase pavement performance. The end of the dowel must be equipped with a closed-end expansion cap into which the dowel can move as the joint expands and contracts. The cap must be long enough to cover 2 in. (50 mm) of the dowel and have a suitable stop to hold the end of the cap at least the width of the isolation joint plus 1/4 in. (6 mm) from the end of the dowel bar (at the time of concrete placement). The cap must fit the dowel bar tightly and be watertight. The capped-end of the dowel must be coated to prevent bond and permit horizontal movement. Doweled isolation joints, should meet the same dowel dimensions shown in Table 1 for doweled contraction joints. Figure 9a shows a doweled isolation joint.

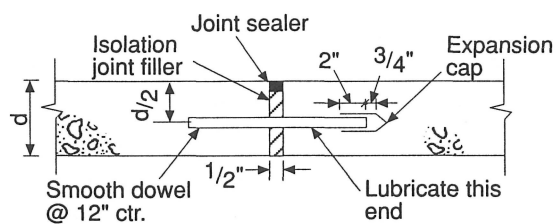

Fig. 9a. Doweled isolation joint

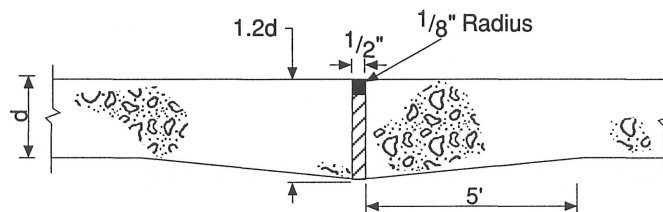

Fig. 9b. Thickened edge isolation joint

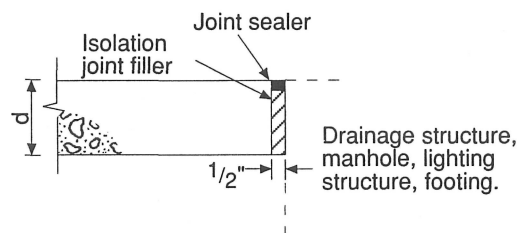

Fig. 9c. Undoweled isolation joint

Isolation joints at T- and unsymmetrical intersections or ramps are not doweled so that horizontal movements can occur without damaging the abutting pavement. Undoweled isolation joints are normally made with thickened edges to reduce the stresses developed at the slab bottom. The abutting edges of both pavements are thickened by 20 percent starting on a taper 5 ft (1.5 m) from the joint. The isolation joint filler material must extend completely through the entire thickened-edge slab. Figure 9b shows a thickened-edge isolation joint.

Isolation joints used at drainage inlets, manholes, lighting structures, and buildings do not have thickened edges or dowels since they are placed around objects and do not require load transfer. Figure 9c, 10, and 11 show details and locations of this isolation joint.

Isolation joints should be 1/2 to 1 in. (12 to 25 mm) wide. Excessive movement may occur with greater widths. A pre-formed joint filler material occupies the gap between the slabs and is continuous from one pavement edge to the other and through curb and gutter sections. This filler material is usually a non-absorbent, non-reactive, non-extruding material typically made from either a closed-cell foam rubber or a bitumen-treated fiber board. No plug or sliver of concrete should extend over, under, through, around, or between sections of the joint filler, or it will cause spalling of the concrete. Fillers may be held in place by stakes in the subgrade. After the concrete hardens, the top of the filler may be recessed about 3/4 in. (20 mm) to allow space for joint sealant.



**Fig. 10. Manhole covers**

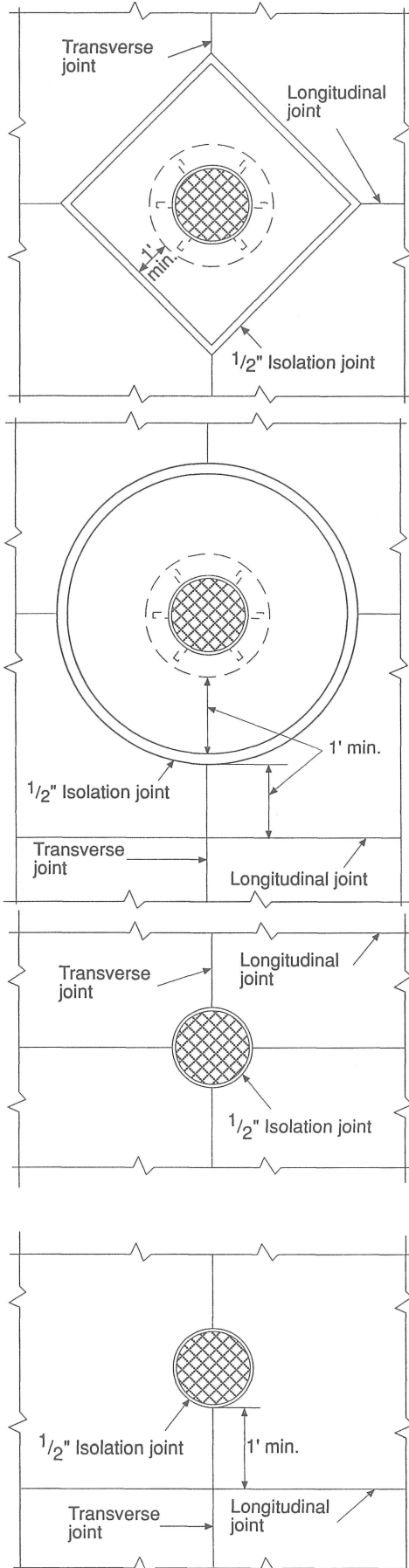

**Fig. 11. Drainage inlets**

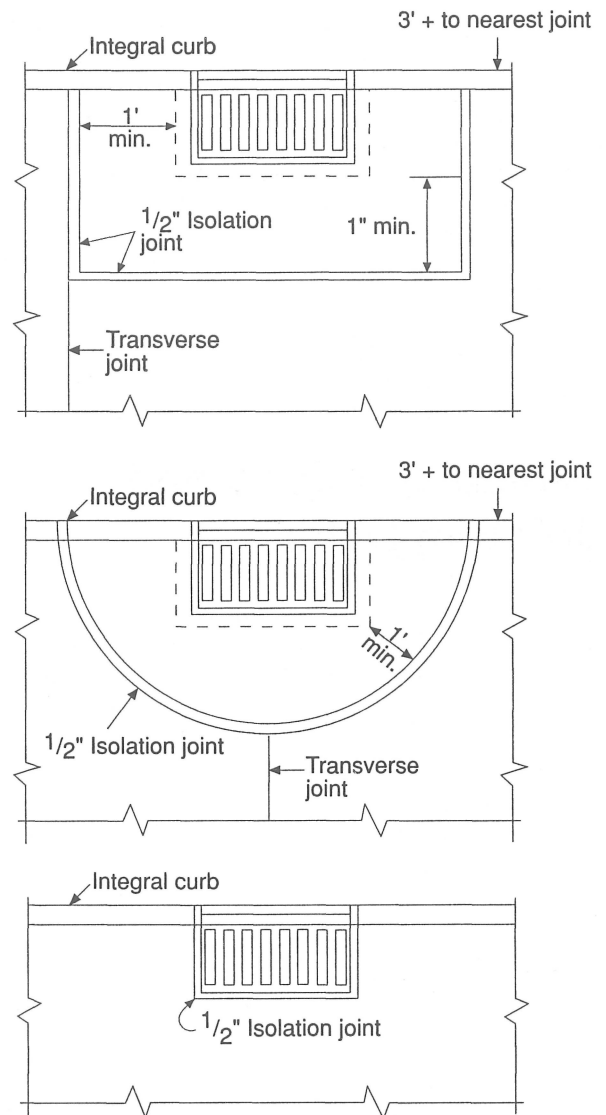

### Expansion Joints

Expansion joints are defined in this publication as full-depth, full-width transverse joints placed at regular intervals of 50 to 500 ft (15 to 150 m) (with contraction joints in between). This is an old practice that was used to relieve compressive forces in the pavement. Unfortunately, this practice often caused other problems in the pavement such as spalling, pumping, faulting, and corner breaks.

Good design, construction, and maintenance of contraction joints has virtually eliminated the need for expansion joints, except under special conditions. In addition to the problems listed above, the improper use of expansion joints can lead to high construction and maintenance costs, opening of adjacent contraction joints, loss of aggregate interlock, sealant failure, joint infiltration, and pavement growth<sup>11</sup>. By eliminating unnecessary expansion joints, these problems are removed and the pavement will provide better performance.

Pavement expansion joints are only needed when:

1. the pavement is divided into long panels (60 ft (18.0 m) or more) without contraction joints in between to control transverse cracking.
2. the pavement is constructed while ambient temperatures are below 40°F (4°C).
3. the contraction joints are allowed to be infiltrated by large incompressible materials.
4. the pavement is constructed of materials that in the past have shown high expansion characteristics.

Under most normal concrete paving situations, these criteria do not apply. Therefore, expansion joints should not normally be used.

## Typical Sections and Jointing Details

For a joint design to provide the best performance possible, it must be carefully thought out and designed. A well designed jointing layout can eliminate unsightly random cracking, can enhance the appearance of the pavement, and can provide years of low maintenance service. The following recommendations will help in the design of a proper jointing system.

1. Avoid odd-shaped slabs.
2. Maximum transverse joint spacing for streets should either be 24 to 30 times the slab thickness or 15 ft (4.5 m), whichever is less; or 30 ft (9.0 m) or less for jointed reinforced pavements.
3. Longitudinal joint spacing should not exceed 12.5 ft (3.8 m).

4. Keep slabs as square as possible. Long narrow slabs tend to crack more than square ones.
5. All transverse contraction joints must be continuous through the curb and have a depth equal to 1/4 to 1/3 the pavement thickness depending on subbase type.
6. In isolation joints, the filler must be full depth and extend through the curb.
7. If there is no curb, longitudinal joints should be tied with deformed tiebars.
8. Offsets at radius points should be at least 1.5 ft (0.5 m) wide. Joint intersection angles less than 60° should be avoided.
9. Minor adjustments in joint location made by shifting or skewing to meet inlets and manholes will improve pavement performance.
10. When the pavement area has drainage structures, place joints to meet the structures if possible.

General layouts showing the details of these recommendations can be seen in Figures 12, 13, and 14.

## Summary

This publication presents the principles of design and construction of joints for concrete streets. Joints in concrete street pavements control cracking, divide the pavement into convenient working areas, provide adequate load transfer, and provide lane delineation. Proper jointing keeps the concrete pavement in smooth riding condition for its full design life at a low annual cost. The design and construction of joints for an individual project should use the principles presented in this publication and the performance of local street pavements subjected to similar traffic and environmental conditions.

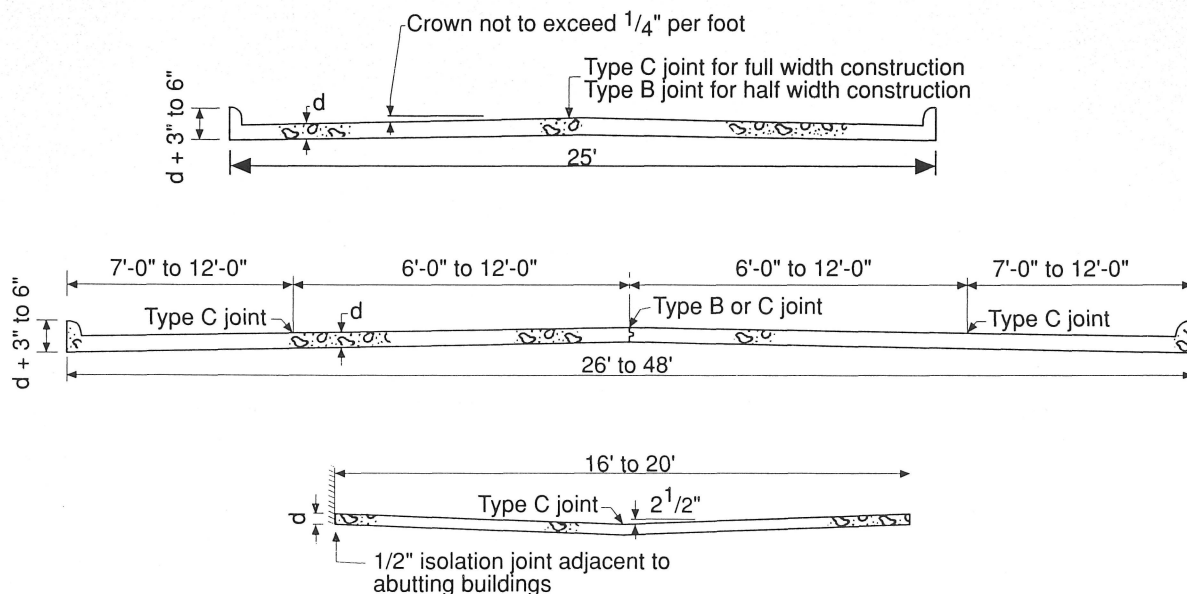
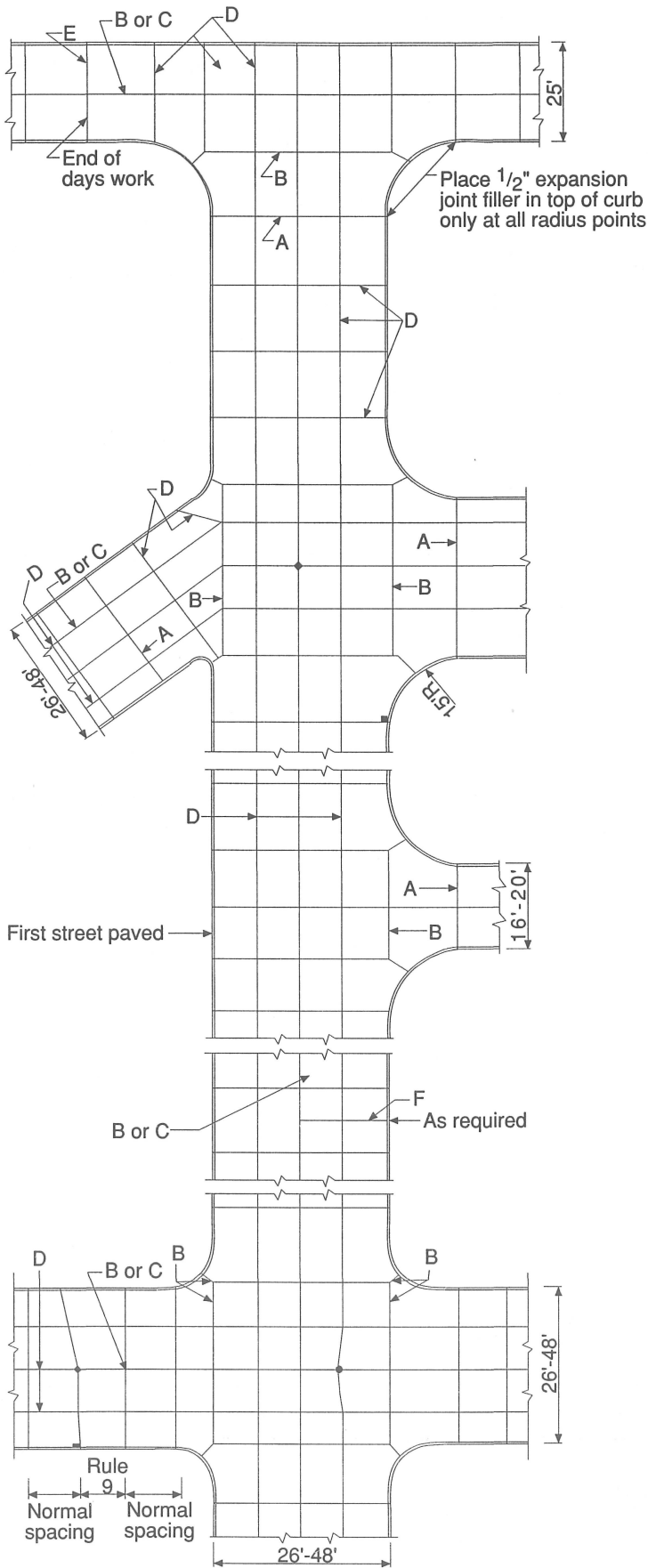

Fig. 12. Pavement cross-sections—joint locations



Notes for Fig. 12-14

- A. Isolation joints
- B. Longitudinal construction joints
- C. Longitudinal contraction joints
- D. Transverse contraction joint
- E. Planned transverse construction joint
- F. Emergency transverse construction joint

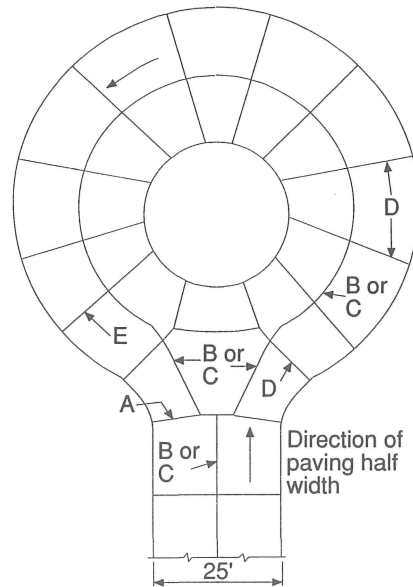
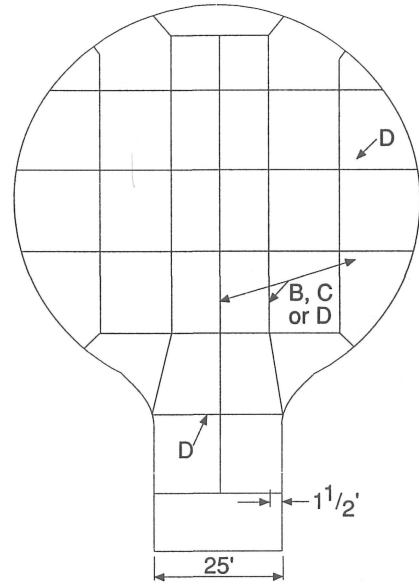

Fig. 14. Plan of joint location for cul-de-sac

Fig. 13. Pavement joints and cross section details

## References

1. "Review of Minnesota's Concrete Pavement Design," Concrete Design Task Force, Minnesota Department of Transportation, March 4, 1985.
2. Hudson, et al., *Aggregate and Paved Surface Design and Rehabilitation Manual for Low Volume Roads*, Federal Highway Administration, Washington, D.C.
3. Darter, M. I.; Becker, J.M.; Snyder, M.B.; and Smith, R.E., "Portland Cement Concrete Pavement Evaluation (COPEs)," *National Cooperative Highway Research Report 277*, Transportation Research Board, Washington, D.C., 1985.
4. Colley, B.E., and Humphrey, H.A., "Aggregate Interlock at Joints in Concrete Pavements," *Highway Research Record No. 189*, Highway Research Board, National Research Council, Washington, D.C., 1967.
5. Nowlen, W.J., "Influence of Aggregate Properties on the Effectiveness of Interlock Joints in Concrete Pavements," *Journal of the PCA Research and Development Laboratories*, Vol. 10, No. 2, Portland Cement Association, Skokie, Ill., May 1968, pp. 2-8.
6. Ioannides, A.M. and Korovesis, G.T., "Aggregate Interlock: A Pure-Shear Load Transfer Mechanism" Paper No. 89-0189, Transportation Research Board, Washington, D.C., March 1990.
7. Henrichs, K.W.; Liu, M.J.; Darter, M.I.; Carpenter, S.H.; and Ioannides, A.M., "Rigid Pavement Analysis and Design," FHWA-RD-88-068, Federal Highway Administration, Washington, D.C., June 1989.
8. "Design and Construction of Joints for Concrete Highways", American Concrete Pavement Association, TB010P, Skokie, Ill., 1991.
9. "Concrete Pavement Joints," Technical Advisory 5040.30, Federal Highway Administration, Washington, D.C., June 1990.
10. Darter, M. I., "Design of Zero Maintenance Plain Jointed Pavements," FHWA-RD-77-111, Federal Highway Administration, Washington, D.C., June 1977.
11. "Construction and Maintenance of Rigid Pavements," *XVIII World Road Congress*, Permanent International Association of Road Congresses, Brussels, Belgium, September 1987.

---

This publication is intended SOLELY for use by PROFESSIONAL PERSONNEL who are competent to evaluate the significance and limitations of the information provided herein, and who will accept total responsibility for the application of this information. The Portland Cement Association and American Concrete Pavement Association DISCLAIM any and all RESPONSIBILITY and LIABILITY for the accuracy of and the application of the information contained in this publication to the full extent permitted by law.

---

American Concrete Pavement Association 5420 Old Orchard Road, Suite ACPA, Skokie, Illinois 60077-1083 (847) 966-2272

---



A national organization with the mission to increase the use of concrete pavement in construction and rehabilitation of transportation facilities in North America, by continually providing a quality product that is safe, cost effective and environmentally sound.