

PROCEEDINGS
of
**The Helminthological Society
of Washington**

*A semiannual journal of research devoted to
Helminthology and all branches of Parasitology*

Supported in part by the
Brayton H. Ransom Memorial Trust Fund

Subscription \$15.00 a Volume; Foreign, \$15.50

CONTENTS

AMIN, OMAR M.	Helminth Parasites of some Southwestern Lake Michigan Fishes	210
AUGUSTINE, P. C., J. M. VETTERLING AND D. J. DORAN.	<i>Eimeria tenella</i> : Growth Characteristics of Drug-resistant Strains in Chicks and Cell Culture	147
CAMPBELL, WILLIAM C.	Can Alcoholic Beverages Provide Protection Against Trichinosis?	120
CAMPBELL, RONALD A.	New Tetraphyllidean and Trypanorhynch Cestodes from Deep-sea Skates in the Western North Atlantic	191
CARNEY, W. P., PURNOMO, P. F., D. VAN PEENEN, R. J. BROWN AND M. SUDOMO.	<i>Schistosoma incognitum</i> from Mammals of Central Sulawesi, Indonesia	150
CHUTE, ANNE M., EVERETT E. LUND AND GARY C. WILKINS.	Comparative Responses of Indian Red Jungle Fowl, Light Brahma Chickens, and Three Other Galliform Birds to Experimental Infections with <i>Histomonas meleagridis</i> and <i>Heterakis gallinarum</i>	126
CORRUM, KENNETH C. AND HUGH M. TURNER.	<i>Alloglossoides caridicola</i> gen. et sp. n. (Trematoda: Macroderoididae) from a Louisiana Crayfish	176
DAVIDSON, WILLIAM R., GARY L. DOSTER, SAMUEL R. PURSLOVE JR. AND ANNIE K. PRESTWOOD.	Helminth Parasites of Ruffed Grouse (<i>Bonasa umbellus</i>) from the Eastern United States	156

(Continued on Back Cover)

THE HELMINTHOLOGICAL SOCIETY OF WASHINGTON

THE SOCIETY meets once a month from October through May for the presentation and discussion of papers in any and all branches of parasitology or related sciences. All interested persons are invited to attend.

Persons interested in membership in the Helminthological Society of Washington may obtain application blanks from the Recording Secretary, Dr. Ronald Fayer, Animal Parasitology Institute, ARS-USDA, Beltsville, Maryland 20705. A year's subscription to the Proceedings is included in the annual dues (\$8.00).

OFFICERS OF THE SOCIETY FOR 1977

President: KENDALL G. POWERS

Vice President: HARLEY G. SHEFFIELD

Corresponding Secretary-Treasurer: J. RALPH LICHTENFELS

Assistant Corresponding Secretary-Treasurer: MILFORD N. LUNDE

Recording Secretary: RONALD FAYER

Librarian: JUDITH M. SHAW (1962-)

Archivist: JUDITH M. SHAW (1970-)

Representative to the Washington Academy of Sciences: ROBERT S. ISENSTEIN (1976-)

Representative to the American Society of Parasitologists: HARRY HERLICH (1975-)

Executive Committee Members-at-Large: JAMES C. BURKE, 1977

AUREL O. FOSTER, 1977

NANCY D. PACHECO, 1978

EVERETT L. SCHILLER, 1978

THE PROCEEDINGS OF THE HELMINTHOLOGICAL SOCIETY OF WASHINGTON

THE PROCEEDINGS are published semiannually at Lawrence, Kansas by the Helminthological Society of Washington. Papers need not be presented at a meeting to be published in the Proceedings.

MANUSCRIPTS should be sent to the EDITOR, A. James Haley, Department of Zoology, University of Maryland, College Park, Maryland 20742. Manuscripts must be typewritten, double spaced, and in finished form. The original and two copies are required. Photocopies of figures and drawings may be submitted for review purposes; originals will be requested after acceptance of the manuscript. Papers are accepted with the understanding that they will be published only in the Proceedings.

REPRINTS may be ordered from the PRINTER at the same time the corrected proof is returned to the EDITOR.

BACK VOLUMES of the Proceedings are available. Inquiries concerning back volumes and current subscriptions should be directed to: Helminthological Society of Washington, c/o Allen Press, Inc., 1041 New Hampshire St., Lawrence, Kansas 66044, U.S.A.

BUSINESS OFFICE. The Society's business office is at Lawrence, Kansas. All inquiries concerning subscriptions or back issues and all payments for dues, subscriptions, and back issues should be addressed to: Helminthological Society of Washington, c/o Allen Press, Inc., 1041 New Hampshire St., Lawrence, Kansas 66044, U.S.A.

EDITORIAL BOARD

A. JAMES HALEY, Editor

1977

MURRAY D. DAILEY
JOHN E. HALL
BETTY JUNE MYERS
STEWART C. SCHELL
GENE B. SOLOMON

1978

NEWTON KINGSTON
RALPH J. LICHTENFELS
JOHN S. MACKIEWICZ
ROBIN M. OVERSTREET
GERALD D. SCHMIDT

1979

DOMINIC DE GIUSTI
DONALD J. FORRESTER
KENNETH C. KATES
JOHN D. MIZELLE
MARTIN J. ULMER

PROCEEDINGS OF THE HELMINTHOLOGICAL SOCIETY OF WASHINGTON

VOLUME 44

JULY 1977

NUMBER 2

Differences in Cuticular Ridges Among *Cooperia* spp. of North American Ruminants with an Illustrated Key to Species

J. RALPH LICHTENFELS

Animal Parasitology Institute, Agricultural Research Center, Agricultural Research Service, U.S. Department of Agriculture, Beltsville, Maryland 20705

ABSTRACT: Trichostrongylin nematodes are usually identified by characteristics of the male. In an effort to find additional diagnostic characteristics of both sexes of 6 common species of *Cooperia* of cattle and sheep, cuticular ridges were studied. All 6 species have 10 large ridges in dorsal and ventral fields of 5 each. In addition, all have 2 to 8 smaller ridges in each lateral field; the number is greater posteriorly. A study of males identified by other characteristics revealed differences among the species in the pattern of large and small ridges. Patterns of ridges observed in males were also found in females. The 6 species can be separated into 2 groups by the anterior pattern of the lateralmost large ridges. In *Cooperia pectinata*, *Cooperia punctata*, *Cooperia oncophora*, and *Cooperia surnabada*, the anterior ends of the lateralmost large ridges join to form a caret-like point considerably behind the anterior ends of the other large ridges that extend to the cephalic expansion (closed pattern). In *Cooperia curticei* and *Cooperia spatulata*, the lateralmost ridges do not come together and they extend to the cephalic expansion (open pattern). Variations in number and pattern of small lateral ridges are useful in further separating the 2 groups of species. The pattern of distribution of the anterior pair of small ridges in the cervical region combined with the number of small ridges posteriorly makes possible the identification of both males and females of all 6 species. After identification of females by cuticular ridge characteristics, differences in vulval morphology were combined with spicular and cuticular differences to construct an illustrated key to the 6 species.

Six species of the genus *Cooperia* are found in sheep and cattle in North America (Table 1). As with most Trichostrongylin nematodes, they can be identified by characteristics of the males. Females, however, usually cannot be identified in infections involving more than one species. The distribution of *Cooperia spatulata* and *Cooperia punctata* has been confused by the difficulty in separating even the males of these 2 species (Walker and Becklund, 1968). Experimental strains of *Cooperia oncophora* may also contain *Cooperia surnabada* (Isenstein, 1971a; Lichtenfels, unpublished observation). Isenstein (1971a) considered *C. surnabada* to be a polymorphic form of *C. oncophora*, but males of the 2 species are as different as are most species of the genus. Clearly, additional characteristics are needed

for identifying males and females of these nematodes.

Longitudinal ridges are present on the cuticle of most trichostrongylinas and some other nematodes. The morphology and number of cuticular ridges are useful characteristics in understanding the evolution of the Heligmosomatoidea (Desset, 1964; Durette-Desset, 1969, 1970, 1971, and others). Lichtenfels (1974) showed the number and distribution of cuticular ridges of *Nippostrongylus brasiliensis* to be stable under various environmental stresses and, therefore, to be useful systematic characteristics when differences among species are found.

The 6 common species of *Cooperia* of ruminants of North America have a common number of 10 cuticular ridges for most of their

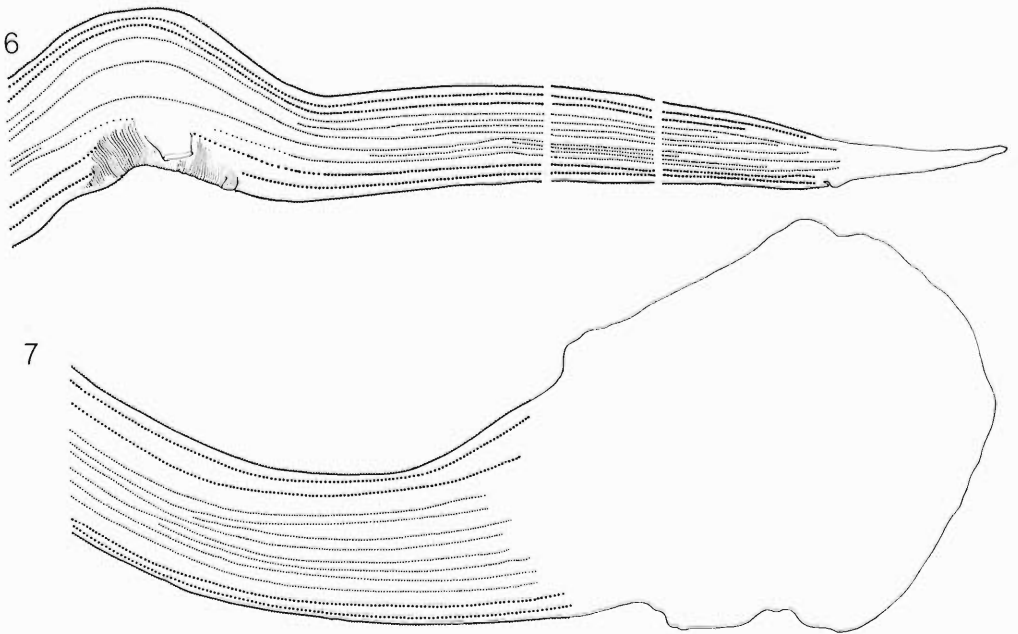
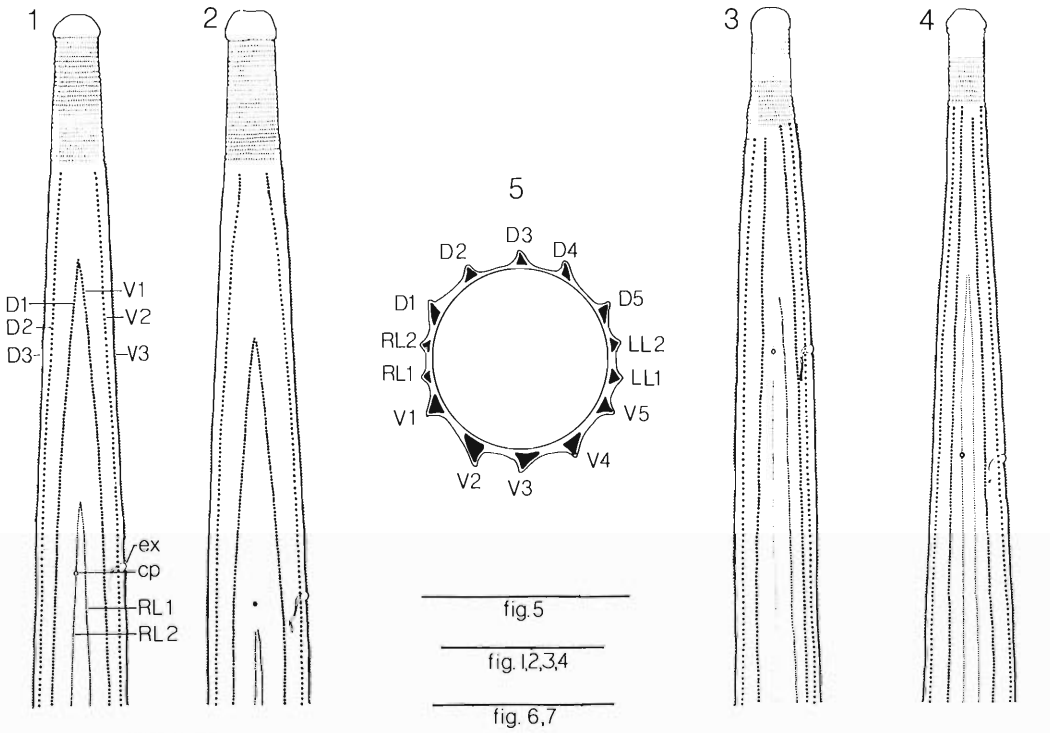

Table 1. *Cooperia* spp. of North American ruminants. List of species and synonyms.*

<i>Cooperia curticei</i> (Railliet, 1893a) Railliet and Henry, 1909a†
= <i>Strongylus ventricosus</i> Rudolphi, 1809a, of Curtice, 1890c
= <i>Strongylus curticii</i> Giles, 1892d (renamed <i>S. ventricosus</i> Rudolphi, 1809a, of Curtis, 1890c)
= <i>Strongylus curticei</i> Railliet, 1893a
= <i>Cooperia curticii</i> (Giles, 1892d) Ransom, 1907k
<i>Cooperia oncophora</i> (Railliet, 1898b) Ransom, 1907k
= <i>Strongylus radiatus</i> Rudolphi, 1803a (in part, see Schneider, 1866a)
= <i>Strongylus ventricosus</i> Rudolphi, 1809a, of Schneider, 1866a (in part)
= <i>Strongylus oncophorus</i> Railliet, 1898b (<i>S. ventricosus</i> Rudolphi, 1809a, of Schneider, 1866a, renamed)
= <i>Cooperia bisonis</i> Cram, 1925b
<i>Cooperia punctata</i> (Linstow, 1907) Ransom, 1907k
= <i>Strongylus</i> sp. Schnyder, 1906a
= <i>Strongylus punctatus</i> Linstow in Schnyder 1907d
= <i>Cooperia punctata</i> (Schnyder, 1907d) Ransom, 1907k
= <i>Strongyloides bovis</i> Vrijburg, 1907k
= <i>Cooperia brasiliensis</i> Travassos, 1914d
<i>Cooperia pectinata</i> Ransom, 1907k
= <i>Cooperia nicoli</i> Baylis, 1929k
<i>Cooperia surnabada</i> Antipin, 1931a
= <i>Cooperia surnabada</i> Antipin, 1931a
= <i>Cooperia mcmasteri</i> Gordon, 1932b
<i>Cooperia spatulata</i> Baylis, 1938b

* None of the synonyms listed are original.

† Letters following dates refer the reader to complete references listed in the Index-Catalogue of Medical and Veterinary Zoology (U.S. Department of Agriculture, 1932-1977).

length and 2 to 10 additional smaller ridges in the lateral fields (Figs. 1-7). The present study was designed to determine whether differences exist among the 6 species in the number or distribution of the cuticular ridges.

Materials and Methods

Specimens

Preserved nematodes originally obtained from naturally occurring infections were available in the USDA Parasite Collection or were solicited from various current researchers. Living nematodes of *C. oncophora* and *C. surnabada* were obtained from an experimental strain maintained at the Animal Parasitology Institute by Dr. Harry Herlich. Samples were studied

of each species from at least 5 sources. Numbers and sources of specimens studied are listed in Table 2.

Methods

The nematodes were cleared in phenol alcohol and studied as whole mounts. A few specimens were sectioned in paraffin, stained, and mounted; or sections were cut freehand from cleared specimens with a cataract knife. Male nematodes were identified using characteristics of the spicules and bursa before the cuticular ridges were studied. Females were paired with conspecific males first by being found with the males and later by comparing number and distribution of cuticular ridges. Study of the

←

Figures 1-7. Diagrammatic drawings of *Cooperia* spp. of North American ruminants showing pattern of distribution and number of cuticular ridges. All lateral views except cross section (Fig. 5). Scale bars 100 μ . Abbreviations: D, large dorsal ridge; V, large ventral ridge; RL, right small lateral ridge; LL, left small lateral ridge; ex, excretory pore; cp, cervical papilla. 1. Closed pattern found in cervical region of *C. punctata* and *C. pectinata*, showing small lateral ridges anterior to level of excretory pore and cervical papilla. 2. Closed pattern found in cervical region of *C. oncophora* and *C. surnabada*, showing small lateral ridges ending posterior to level of excretory pore and cervical papilla. 3. Open pattern found in cervical region of *C. curticei*. 4. Open pattern found in cervical region of *C. spatulata*. 5. Cross section showing dorsal and ventral groups of 5 large ridges each and lateral groups of 2 small ridges each. 6. Three segments of posterior end of female showing 8 small lateral ridges. 7. Posterior end of male showing 6 small lateral ridges.

Table 2. *Cooperia* spp. of North American ruminants. Specimens studied by host, geographical locality, number, and sex.

Species of <i>Cooperia</i>	Nematode lots studied by host, locality, number, and sex
<i>C. curticei</i> :	<i>Ovis aries</i> , sheep
	Georgia — 2 males
	Maryland — 3 males, 2 females
	Mississippi — 7 males, 7 females
	West Virginia—43 males, 41 females
Uruguay — 4 males, 5 females	
<i>C. oncophora</i> :	<i>Ovis aries</i> , sheep
	West Virginia—30 males, 28 females
	<i>Ovis canadensis</i> , bighorn sheep
	Montana —11 males, 70 females
	<i>Bos taurus</i> , cattle
Montana —14 males, 41 females	
Nebraska — 2 males	
Oregon — 6 males, 14 females	
<i>C. punctata</i> :	<i>Ovis aries</i> , sheep
	Georgia — 6 males
	West Virginia—12 males, 8 females
	<i>Bos taurus</i> , cattle
	Florida —24 males, 15 females
	Louisiana — 7 males, 6 females
	Maryland — 3 males
	Mississippi — 4 males, 6 females
	Nebraska —11 males, 12 females
	<i>Odocoileus virginianus</i> , white-tailed deer
S. Carolina —61 males, 18 females	
<i>C. pectinata</i> :	<i>Ovis aries</i> , sheep
	Georgia — 4 males, 9 females
	<i>Bos taurus</i> , cattle
	Florida —15 males, 2 females
	Georgia —19 males, 21 females
Louisiana — 6 males, 6 females	
Mississippi — 2 males, 7 females	
<i>C. surnabada</i> :	<i>Ovis aries</i> , sheep
	West Virginia— 6 males, 2 females
	<i>Ovis canadensis</i> , bighorn sheep
	Montana —17 males, 31 females
	<i>Bos taurus</i> , cattle
Georgia —14 males	
Massachusetts — 2 males, 1 female	
Montana — 7 males, 2 females	
Vermont — 5 males, 2 females	
<i>C. spatulata</i> :	<i>Ovis aries</i> , sheep
	Georgia — 2 males
	Mississippi — 2 males
	<i>Bos taurus</i> , cattle
	Georgia —10 males, 3 females
	Florida — 6 males, 1 female
Hawaii —32 males, 18 females	
<i>Odocoileus virginianus</i> , white-tailed deer	
S. Carolina —25 males, 4 females	

morphology of the vulva was facilitated by bisecting the body just anterior to the vulva so that specimens could be rolled by pressure on the coverglass. Drawings were prepared with the aid of a camera lucida. Photomicrographs were taken with a 35-mm camera and a microscope equipped with a differential interference contrast attachment.

Results

Nematodes almost always coil ventrally to some extent so that a lateral view is obtained when they are mounted. The entire lateral fields of most specimens were studied without difficulty. Ridge patterns were bilaterally symmetrical. The number and pattern of distribution of the cuticular ridges are illustrated in diagrammatic drawings (Figs. 1–7) and in photomicrographs (Figs. 8–39).

The 6 species of *Cooperia* of North American ruminants have 2 distinct patterns of distribution of the large cuticular ridges in the lateral cervical region. In 4 of the species (*C. oncophora*, *C. surnabada*, *C. pectinata*, and *C. punctata*), 6 of the 10 large ridges extend anteriorly to the cephalic expansion, but the 2 lateralmost ridges on each side join to form a caret-like point posterior to the cephalic expansion. This pattern is referred to herein as the closed pattern (Figs. 1, 2, 18, 23, 28). In 2 species (*C. curticei* and *C. spatulata*), all 10 large cuticular ridges extend anteriorly to the cephalic expansion. This pattern is referred to herein as the open pattern (Figs. 3, 4, 8, 13). These 2 patterns were found in both males and females with no intermediate forms. Other characteristics of nematodes with each pattern will be discussed separately.

→
 Figures 8–22. *Cooperia* spp. of North American ruminants. Scale bars 50 μ . Figures 8–12. *Cooperia curticei*. 8. Cephalic region, lateral view, showing open pattern and ventral small lateral ridge (arrow). 9. Cervical region showing small lateral ridges, thicker ventral ridge (upper arrow) and much thinner and shorter dorsal ridge and cervical papilla (lower arrow). 10. Spicule. 11. Vagina and vulva (arrow), lateral view. 12. Vulva, ventral view. Figures 13–17. *Cooperia spatulata*. 13. Cephalic region lateral view, showing open pattern. 14. Cervical region showing small lateral ridges (arrows) and cervical papilla (upper arrow). 15. Spicule, lateral view, showing concavity (arrow). 16. Vagina and unlobed vulva. 17. Lobed vulva. Figures 18–22. *Cooperia punctata*. 18. Cervical region showing small lateral ridges extending anterior to cervical papilla (arrow). 19. Spicule, lateral view, showing concavity (arrow). 20. Spicules, ventral view, showing concavities (arrow). 21. Vulva. 22. Posterior region of female showing 6 small lateral ridges between arrows.

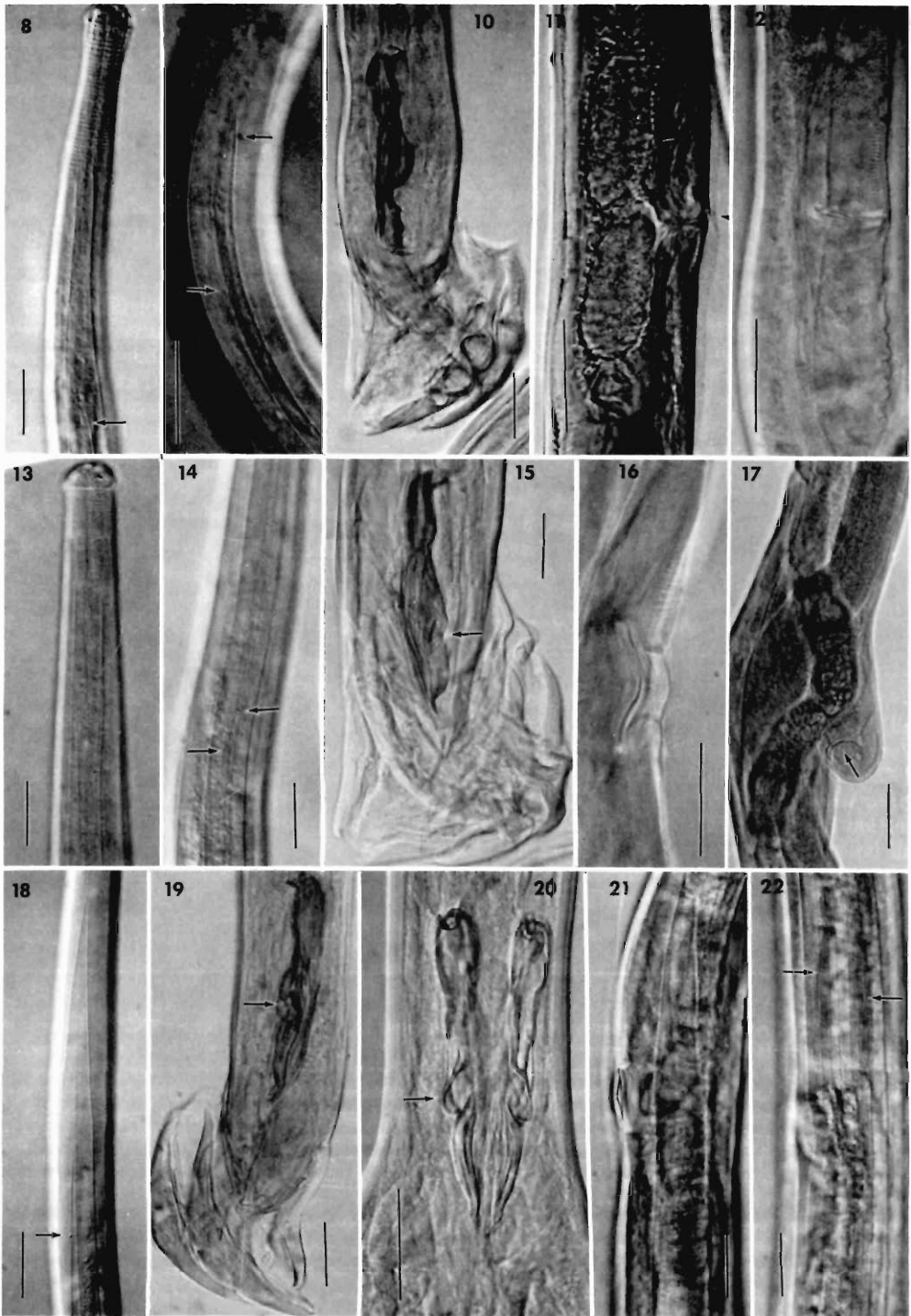

Species with closed pattern

Two characteristics of the small lateral ridges exhibited variation among these species: pattern of distribution anteriorly and number posteriorly. Among the 4 species with the closed pattern of large ridges 2 species (*C. punctata* and *C. pectinata*) have a pair of small lateral ridges that extend well anterior to the level of the excretory pore and the cervical papillae (Figs. 1, 18, 24). The other 2 species with the closed pattern of large ridges (*C. oncophora* and *C. surnabada*) have a pair of small lateral ridges that usually extend only to the level of the excretory pore and cervical papillae (Figs. 2, 28); rarely, one of the small ridges extends slightly anterior to this level. These differences were consistent but were sometimes difficult to see. The number of small lateral ridges increases posteriorly in both male and female *Cooperia* (Figs. 6, 7). Among the 4 species with the closed pattern of large ridges, 2 species (*C. punctata* and *C. surnabada*) have 6 (very rarely 7) small lateral ridges on each side of the posterior region of the body (Figs. 22, 34). The other 2 species (*C. oncophora* and *C. pectinata*) usually have 8, occasionally 9 or 10, and very rarely 6 or 7 (Figs. 6, 7, 27, 32). Two of 63 male *C. oncophora* had only 6 small laterals posteriorly on each side.

Very few collections of female *C. oncophora* and *C. surnabada* from naturally occurring infections were available for study. In one such collection from bighorn sheep, females with 6 small lateral ridges were found to occur about as frequently as male *C. surnabada* (30% of a population composed entirely of *C. oncophora* and *C. surnabada*).

Living *C. oncophora* were examined to determine whether the ridges could be studied in living nematodes. The ridges were easily seen, more clearly than in most fixed specimens.

Species with open pattern

These 2 species (*C. curticei* and *C. spatulata*) can be separated by the character of the anteriormost parts of the small lateral ridges in the cervical region of nematodes. In *C. curticei*, the ventral of the pair of small lateral ridges is much thicker and extends farther anteriorly than the dorsal of the pair on each side (Figs. 3, 8, 9). In contrast, *C. spatulata* has a pair of small thinner lateral ridges of uniform thickness and length in the cervical region (Figs. 4, 14).

Discussion

Recognition of the closed and open patterns of the large ridges is especially useful in separating 2 species that have been historically confused. *Cooperia punctata* and *C. spatulata* have very similar spicules and the difficulty in separating even males of the 2 species has led to a poor knowledge of their distribution (Walker and Becklund, 1968). With the new knowledge of the cuticular ridges, males and, for the first time, females of these 2 species can be separated easily because *C. punctata* has the closed pattern and *C. spatulata* has the open pattern.

The separations based on the small lateral ridges are more difficult because the ridges are thinner and vary somewhat. As can be seen in

→

Figures 23–39. *Cooperia* spp. of North American ruminants. Scale bars 50 μ . Figures 23–27. *Cooperia pectinata*. 23. Cephalic region showing caret-like point formed by lateralmost large ridges in closed pattern. 24. Cervical region showing small lateral ridges extending well anterior to cervical papilla (arrow). 25. Spicules. 26. Vagina with heavily cuticularized walls and vulva with distinctive posterior lip. 27. Posterior region of male showing 8 small lateral ridges between arrows. Figures 28–33. *Cooperia oncophora*. 28. Cervical region showing 2 small lateral ridges ending posterior to cervical papilla (arrow). 29. Spicule. 30. Vagina showing lightly sclerotized walls, vulva (arrow), and hypertrophied ventral cuticular ridge above and below vulva. 31. Vulva, ventrolateral view, showing longitudinal character. 32. Posterior region of female showing 8 small lateral ridges between arrows. 33. Dorsal ray. Figures 34–39. *Cooperia surnabada*. 34. Posterior body of female showing 6 small lateral ridges between arrows. 35. Spicule. 36. Vagina with heavily cuticularized walls (arrow), vulva, and hypertrophied ventral cuticular ridge anterior and posterior to vulva. 37. Same specimen as in 36, ventral view, showing transverse vulva. 38. Vulva (arrow) and hypertrophied cuticular ridge. 39. Dorsal ray.



the key below, however, the characteristics of the cuticular ridges combined with other characters in a dichotomous key make it possible for the first time to separate females of all 6 common species of *Cooperia* of North American ruminants.

The marked differences in vulval morphology among 4 of the *Cooperia* species have been reported previously (Ransom, 1911; and Skrjabin et al., 1954). Those noted for *C. spatulata* and *C. oncophora* are reported for the first time. Previously (Skrjabin et al., 1954), *C. oncophora* was believed to have a transverse vulva. Ransom (1911), however, was uncertain of the vulval morphology of *C. oncophora*. This confusion may have been caused in part by the inability to separate female *C. surnabada* from *C. oncophora*. The present study found that the orientation of the vulva of *C. oncophora* (identified as having 8 or more small lateral ridges posterior to the vulva) was longitudinal in unlobed specimens (Figs. 30, 31). In the few unlobed specimens of female *C. surnabada* (identified as having 6 small lateral ridges posterior to the vulva) the vulva was transverse (Figs. 36, 37, 38). In most specimens, however, there was lobation and twisting of the vulva making it impossible to reliably determine the original orientation.

The differences in cuticular ridges between *C. oncophora* and *C. surnabada* described herein provide additional evidence that both are real species. Previously described differences between the 2 species include the markedly different spicules (Figs. 29, 35), dorsal bursal rays (Figs. 33, 39), and genital cones (Stringfellow, 1970). The experiments of Isenstein (1971a) and the fact that *C. surnabada* has apparently been found only in association with *C. oncophora* indicated that *C. oncophora* and *C. surnabada* might be polymorphs of a single species. The morphological differences between *C. surnabada* and *C. oncophora* summarized above, however, are as great or greater than those occurring among most other species of *Cooperia*, in fact among most species of nematodes. At present, therefore, I prefer to recognize both *C. surnabada* and *C. oncophora*. The new data provided herein should facilitate additional study of these nematodes.

Experimental strains of *C. oncophora* commonly also include *C. surnabada*. With the

new capability of identifying female *Cooperia* to species level the kinds of studies that become feasible are greatly increased. It should now be possible to develop monospecific infections of *C. oncophora* or *C. surnabada* in order to answer some of the confusing questions surrounding these similar species. Experiments in hybridization or in intraspecific variation such as those of Isenstein (1971a, 1971b) will be much more meaningful with identified females.

Illustrated Key to *Cooperia* spp. of North American Ruminants

- 1a. All 10 large cuticular ridges extend to cephalic expansion; the open pattern described above (Figs. 3, 4, 8, 13) 2
- b. Only 6 of 10 large cuticular ridges extend to cephalic expansion; 2 lateral-most ridges on each side join to form caret-like point in cervical region (Figs. 1, 2, 18, 23, 28) 3
- 2a. Anterior ends of paired small lateral ridges asymmetrical in cervical region with ventral of each pair thicker and longer (Figs. 3, 8, 9). Spicules with corrugated flange, without concavity, with small ventral fin in distal third, and distal end sharply curved ventrally (Fig. 10). Vagina supported by beak-like sclerotization (Fig. 11); vulva unlobed transverse slit with larger posterior lip (Fig. 12) *Cooperia curticei*
- b. Anterior ends of paired small lateral ridges symmetrical in cervical region, both extremely thin (Figs. 4, 14). Spicules with concavity formed by corrugated ventral flange, large ventral fin in distal third, and straight distal end (Fig. 15). Vagina supported by ring or shallow dome-shaped sclerotization, vulva longitudinal slit (Fig. 16), may be lobed (Fig. 17) ... *Cooperia spatulata*
- 3a. Paired small lateral cuticular ridges extend well anterior to level of excretory pore and cervical papillae (Figs. 1, 18, 24). Spicules with either prominent corrugated ventral flange or large concavity near middle formed by ventral flange (Figs. 19, 20, 25). Vulva unlobed without hypertrophied ventral cuticular ridge

- but may have prominent cuticular lips (Figs. 21, 26) 4
- b. Paired small lateral cuticular ridges usually extend only to level of excretory pore and cervical papillae (Figs. 2, 28). Spicules without prominent ventral flange or concavity (Figs. 29, 35). Vulva with hypertrophied ventral cuticular ridge anteriorly and posteriorly, may be lobed (Figs. 30, 31, 36-38) 5
- 4a. Posterior body region bears 8 to 10 small lateral ridges on each side (Fig. 27). Spicules 220-390 μ long with prominent corrugated ventral flange (Fig. 25). Vagina supported by beak-like sclerotization; vulva a transverse slit with prominent cuticular lips (Fig. 26) *Cooperia pectinata*
- b. Posterior body region bears 6 small lateral ridges on each side (Fig. 22). Spicules 125-214 μ long with large concavity near middle (Figs. 19, 20). Vagina supported by ringlike sclerotization; vulva longitudinal slit without prominent lips (Fig. 21) *Cooperia punctata*
- 5a. Posterior body region bears 8 to 10 small lateral ridges on each side (Figs. 6, 7, 32). Spicules with small ventral flange and broadened blunt distal tip (Fig. 29). Vagina weakly sclerotized, vulva longitudinal slit in unlobed specimens (Figs. 30, 31) .. *Cooperia oncophora*
- b. Posterior body region bears 6 small lateral ridges on each side (Fig. 34). Spicules straight, without ventral flange, with pointed triangular tip (Fig. 35). Vagina strongly sclerotized, vulva transverse slit in unlobed specimens (Figs. 36-38) *Cooperia surnabada*

Acknowledgments

For providing nematodes for study thanks are expressed to Drs. David E. Worley, Montana State University, Bozeman; Harry Herlich, Robert S. Isenstein and Frank Stringfellow, USDA, Animal Parasitology Institute (API), Beltsville, Maryland, and Samuel R. Purselove, Jr., S. E. Cooperative Wildlife Disease Study, University of Georgia, Athens. Donald E. Thompson (deceased), API, provided serial

sections in paraffin. Drawings were prepared by Robert B. Ewing, API.

Literature Cited

Desset, Marie-Claude. 1964. Les systèmes d'arêtes cuticulaires chez les Nématodes Héligmosomes. Etude de cinq espèces parasites de Rongeurs de la Maboke. Cah. Maboke 2: 39-78.

Durette-Desset, Marie-Claude. 1969. Les systèmes d'arêtes cuticulaires chez les Nématodes Héligmosomes parasites de Muridés australiens. Ann. Parasitol. Hum. Comp. 44: 733-747.

———. 1970. Le genre *Nippostrongylus* Lane, 1923, (Nématode-Heligmosomatidé). Ann. Parasitol. Hum. Comp. 45: 815-821.

———. 1971. Essai d'interprétation de l'évolution de la famille des héligmosomes (Nématodes Strongylida) en fonction de la Paléobiogéographie de leurs hôtes. Bull. Soc. Ecol. 2: 178-188.

Isenstein, R. S. 1971a. The polymorphic relationship of *Cooperia oncophora* (Railliet, 1898) Ransom, 1907, to *Cooperia surnabada* Antipin, 1931 (Nematoda: Trichostrongylidae). J. Parasitol. 57: 316-319.

———. 1971b. Hybridization of two species of nematodes parasitic in ruminants, *Cooperia oncophora* (Railliet, 1898) Ransom, 1907, and *Cooperia pectinata* Ransom, 1907. J. Parasitol. 57: 320-326.

Lichtenfels, J. R. 1974. Number and distribution of ridges in the cuticle of *Nippostrongylus brasiliensis* (Travassos, 1914) (Nematoda: Heligmosomatoidea). J. Parasitol. 60: 285-288.

Ransom, B. H. 1911. The nematodes parasitic in the alimentary tract of cattle, sheep, and other ruminants. Bull. (127) Bureau Animal Industry, U.S. Dept. Agric., May, 132 p.

Skrjabin, K. I., N. P. Shikhobalova, and R. S. Shul'ts. 1954. [Trichostrongylids of animals and man.] Osnovy nematodologii, Vol. 3. 683 p. Acad. Sci. USSR, Moscow. (English translation, 1960. Washington, D.C., U.S. Dept. Commerce.)

Stringfellow, F. 1970. Comparative morphology of the genital cones of *Cooperia* (Nematoda: Trichostrongylidae) from cattle and sheep in the United States with a key to the common species. J. Parasitol. 56: 1189-1198.

Walker, M. L., and W. W. Becklund. 1968. A note on the morphology of *Cooperia punctata* (Linstow, 1907) and *Cooperia spatulata* Baylis, 1938. Proc. Helminthol. Soc. Wash. 35: 49-51.

Can Alcoholic Beverages Provide Protection Against Trichinosis?*

WILLIAM C. CAMPBELL

Merck Institute for Therapeutic Research, Rahway, New Jersey 07065

ABSTRACT: The parenteral (muscle) larvae of *Trichinella spiralis* were found much more susceptible than previously reported to the deleterious effect of ethanol *in vitro*. Larvae were reversibly paralyzed when immersed for 6 hours in water containing 6% ethanol; at concentrations of 12–25%, the paralysis was irreversible. When trichinous meat was digested in artificial gastric juice containing 6–12% ethanol, there was only slight impairment of the release of larvae from capsules; but subsequent inoculation of the freed larvae into mice revealed very marked suppression of infectivity.

Experiments in rats and pigs (using free larvae as well as infected flesh) indicated that the prophylactic effect of ethanol or commercial whiskey is dependent more on the concentration of ethanol administered than on the dosage of ethanol as a function of body weight. Rats were fully protected from infection by a single dose of 2.5 ml 30% ethanol; but they were only partially protected when the same total dosage was administered as single or multiple doses of 15% ethanol.

Because of the critical importance of a high ethanol concentration, and the necessity of imbibing the ethanol at or about the time of ingestion of infective meat, alcoholic beverages are unlikely to play a practical role in the prevention of trichinosis. Where prevention is achieved experimentally, or under unusual practical circumstances, the effect can be attributed both to an impaired release of larvae from flesh and to a direct deleterious effect on the larvae.

The alleged benefit of alcohol in providing protection against trichinosis is almost exactly as old as our knowledge of trichinosis as a clinical disease. One evening, just over a hundred years ago, a man drank large amounts of whiskey for several days after dining on pork. He had been dining with his wife and mother-in-law; and while this may or may not have had a bearing on his intake of whiskey, it is of significance in the light of subsequent events. The man got trichinosis and lived, while his abstemious companions got trichinosis and died. Soon there were other similar stories, and before long alcohol was being recommended by some as a safeguard against trichinosis (Gould, 1945).

There were contrary opinions, of course, but it wasn't until the late 1930's that the possible prophylactic efficacy of ethanol was subjected to experimental study. On the basis of experiments *in vitro* and in rats, McNaught and Pierce, of Stanford University, concluded that "a concentration of 25% alcohol has little direct action on trichinella *in vitro*" and that protective action observed in rats "was due to alcoholic interference with the digestive liber-

ation of encysted trichinella" (Pierce and McNaught, 1937; McNaught and Pierce, 1939). Their views have become entrenched in reviews and textbooks and have been so generally accepted that practically nobody now believes that ethanol has a specific prophylactic effect in trichinosis.

The question was reopened by a past-President of this Society—Dr. Benjamin H. Kean. Several years ago Dr. Kean and Dr. D. W. Hoskins presented to the Society at least suggestive evidence of an inverse relationship between the number of cocktails consumed at a party and the severity of the trichinosis that resulted from the consumption of pork *hors d'oeuvres* at that party. In view of this report, we decided to try to confirm the work of McNaught and Pierce. We were astonished to find that we disagreed completely with the finding that *Trichinella* larvae were unaffected *in vitro* by the concentrations of ethanol that were used.

Closer inspection of the Stanford data revealed that our observations were in agreement—but our conclusions were radically different. For example, Pierce and McNaught (*loc. cit.*) reported that there were "no changes" in larvae that were immersed for 6 hours in concentra-

* A talk given at a meeting of the New York Society of Tropical Medicine, November 1973.

Table 1. Effect of ethanol on number and condition of larvae recovered by digestion of infected muscle in 1% pepsin with 1% hydrochloric acid. In Part A the duration of digestion was 18 hr; in Parts B-D it was 2-2.5 hr. Ratio of fluid to tissue in parentheses. N.D. = not done.

% Ethanol in digest	Larvae/g	% Encapsulated	% Dead	% Loss in infectivity
A. Rat muscle (20-26 ml/g); from Pierce and McNaught				
0	2,600	0	0	N.D.
0	2,700	0	0	N.D.
0	2,300	0	0	N.D.
9	1,500	0	98	N.D.
17	800	10	100	N.D.
23	530	30	100	N.D.
B. Mouse muscle (50 ml/g)				
0	5,600	0	2	—
1	5,500	0	4	0
6	4,200	0	16	92
12	5,800	22	13	100
C. Mouse muscle (25 ml/g)				
0	8,400	0	0	—
1	8,800	0	3	33
6	8,600	0	13	72
12	6,800	13	6	99
D. Pig muscle (25 ml/g)				
0	2,800	0	13	—
1	2,100	0	10	0
6	2,500	5	35	100
12	230	0	100	N.D.

tions of ethanol up to 25%. At 12 hours all larvae were dead, but they resisted concentrations up to 12% for more than 12 hours. The Stanford workers concluded from this work that *Trichinella* larvae were "unaffected" by the lower concentrations of alcohol. We would not agree—and we think that confusion has arisen because they assumed that coiled or moving larvae were not only alive but unaffected. What seems to have been overlooked is that alcohol makes *Trichinella* larvae coil up into even tighter spirals than usual. Far from being "unaffected," they are "uptight" to the point of paralysis.

If the concentration of alcohol is 1-6% the larvae will revive when transferred to plain water. But if the concentration is high enough (12-25%) they will not revive; so we would disagree yet more vehemently with the report that the larvae are unaffected by 25% alcohol after 6 hours. We would say that after only 2 hours in this concentration, the larvae have been lethally affected—so that while they may not be dead at the moment of observation, they are irrevocably moribund.

But, you will say, the larvae that are of

public health importance are not in water—but in meat, and bathed in acid and enzyme. What does alcohol do in this situation? The Stanford workers found that if trichinous meat was digested in certain concentrations of alcohol some of the larvae were not liberated from their capsules (Table 1, Part A). They properly concluded that alcohol had interfered with digestion of the meat—and that is all they concluded. But what of those larvae that were liberated?—they were virtually all dead! We would conclude that alcohol had interfered with digestion and had killed the larvae that had been liberated.

But that Stanford experiment was based on digestion for 18 hours—and even in our most dyspeptic or most inebriated condition we are not likely to have meat and alcohol in our stomachs for such a period. So here are the results of a 2-hour digestion period (Table 1, Part B). It is apparent that after 2 hours the ethanol had slightly retarded the release of the encapsulated larvae at a concentration of 12%, but not at 6%; and that only a small portion of the larvae had been killed. Since our primary interest was the possible protection against infection, the encapsulated and free larvae were then administered to mice! and the resultant worm burden of each ethanol group was compared to that of the control group in order to calculate a percentage loss of infectivity. We conclude from the results shown that ethanol at concentrations as low as 6% (less than that of the average table wine) almost completely destroyed the infectivity of the trichinous meat in a period of 2 hours. With a concentration of 12% (still within the range of table wines) the loss of infectivity was total.

Now some sharp-eyed purist might say "That's too much digestive fluid for the amount of meat; it is twice what Pierce and McNaught used, so it might not show the same inhibition of digestion." Well, here is our experiment with the Stanford (and pretty standard) ratio of meat to fluid (Table 1, Part C). While the effect of 6% ethanol was less pronounced than in the previous experiment, the virtually complete loss of infectivity following digestion in 12% ethanol was confirmed.

But that purist may ask "how many of us eat mouse meat?" To answer him again here is

Table 2. Number of adult *T. spiralis* in small intestine of rats given water, laboratory ethanol or whiskey. Treatment given immediately after ingestion of infective mouse flesh (except where noted otherwise).

Experiment A			
Rats given water 1 × 4 ml	Rats given 30% ethanol 1 × 4 ml		
1,360	0		
1,460	0		
1,600	0		
Experiment B			
Rats given water 1 × 5 ml	Rats given whiskey (% ethanol)		
	4 × 1.25 ml (15%)*	1 × 5 ml (15%)	1 × 2.5 ml (30%)
2,280	365	119	0
3,020	371	244	0
3,330	2,010	257	0

* Treated at 15 min intervals, with ingestion of meat just before 3rd treatment.

the experiment done with pork from an experimentally infected pig (Table 1, Part D). It will be seen that the results are essentially the same with pig meat as with mouse meat. Even the 6% concentration of ethanol rendered the uncooked pork completely harmless, not by preventing the release of encapsulated larvae but by affecting the larvae directly.

But still, this is all in vitro. Does it have any bearing on the in vivo situation? We did confirm the Stanford finding that rats can be protected from trichinosis by a single oral dose of alcohol given at the time of exposure to infection. In the experiments of McNaught and Pierce, ethanol gave a 50% protection (on the basis of number of larvae in the muscles) when administered together with an inoculum of free (decapsulated) *Trichinella* larvae, and an 80% protection when given with an inoculum of trichinous meat. Nevertheless they concluded that it is the inhibition of digestive liberation of larvae that "is responsible for the protective action of a single dose of alcohol taken simultaneously with infected meat." In our experiment (Table 2, Experiment A) the degree of protection was 100% when the same amount of alcohol was given with infected meat. In the course of an ancillary experiment, dead larvae were recovered from the gut of alcohol-treated mice but not from untreated mice. Together with the above in vitro tests,

this suggests that both the direct and the indirect mechanism contribute to the protection of the host.

Now, few people drink unadulterated ethanol; and it has been reported that the physiological impact of alcohol is affected by such things as the tannins and organic acids in alcoholic beverages (Ritchie, 1970). We therefore felt it necessary to use a commercial alcoholic beverage. The preparation used was John Jameson 7-year-old, 86-proof Irish Whiskey (not supplied by courtesy of the manufacturers). This preparation was diluted with water to give concentrations of 15 and 30% ethanol. Administration of 5 ml of the 15% concentration to rats (either as one dose or divided into four doses) gave some degree of protection, while a single dose of 2.5 ml of the 30% concentration gave 100% protection (Table 2, Experiment B). The experiment thus demonstrated the efficacy of a commercial beverage, and confirmed the importance of ethanolic concentration as distinct from ethanolic dosage.

But rats allegedly metabolize alcohol much faster than man (Newman and Lehman, 1938) and so we decided to do an experiment on pigs, using the same commercial beverage as before. Each pig (mean weight 9.4 kg) was given four whiskey "high-balls" at 15-minute intervals. Each high-ball consisted of 30 ml whiskey and 60 ml spring water (a common diluent for Irish Whiskey), giving a total dosage of 5.5 ml ethanol per kilogram of body weight. Immediately before the 3rd high-ball each pig received trichinous mouse flesh. Control pigs received only spring water and infective meat.

The alcohol-treated pigs soon acquired the unsteady gait associated with excessive alcohol intake; their skin became flushed; they frequently fell down, and in the recumbent position were much given to nibbling each other's ankles; they eventually remained recumbent and after a few hours they lapsed into unconsciousness. On the following morning the pigs were standing up, quietly huddled together. They seemed to display an exaggerated response to loud noise, but no attempt was made to evaluate this objectively.

At necropsy, 21 days later, the alcohol-treated pigs had infections that were similar to

Table 3. Number* of adult and larval *T. spiralis* recovered from pigs given 4 treatments with water or 14% ethanol as whiskey. Treatments (see text) given at 15 min-intervals, with oral administration of infective ground mouse flesh just prior to 3rd treatment. Amount of flesh administered was adjusted to give intake of 10,000 larvae (2 g flesh) per kg body weight.

	Adult worms (day 21)	Larvae/gram (day 21)
Ethanol-treated pigs		
1	13,900	4,400
2	14,700	2,300
3	13,200	3,900
4	16,000	1,800
Mean	14,500	3,100
Water-treated pigs		
A	11,400	3,900
B	15,400	3,700
C	15,900	5,100
D	33,800	9,900
Mean	19,100	5,700

* Determined by sampling methods and rounded to nearest hundred.

those of the controls in regard to the number of worms in the gut and the number of larvae in the muscles (Table 3). Further, the sex-ratio of the worms was similar in both groups of pigs, as was the infectivity of the larvae when inoculated into mice.

Thus, pigs were not at all protected by having four human-type cocktails in the period of 1 hour—on an empty stomach. This is by no means an unheard-of rate of alcohol intake for man. But on a bodyweight basis, the intake of these very young pigs corresponded to a person drinking an entire "fifth" of whiskey (757 ml) in one hour—on an empty stomach. It would seem pointless to test higher dosages.

When we presented the results of that pig experiment at a meeting of the American Society of Parasitology in 1966 (Campbell and Cuckler, 1966) we said that, although the pigs had not been protected, we still found it fairly easy to believe that ethanol had in fact protected the man who had drunk whiskey copiously after eating pork that was lethal to his companions. Some incidental experiments had suggested to us that it is not the bodyweight dosage of alcohol that is important—it is the concentration of alcohol in the beverage being consumed.

Table 4. Number* of adult and larval *T. spiralis* recovered from pigs given 3 treatments with water or 29% ethanol as whiskey. Treatments (see text) given 5, 25 and 45 min after ingestion of infective ground pork. Amount of flesh administered was adjusted to give intake of 15,000 larvae (5 g flesh) per kg body weight.

	Adult worms† (day 4)	Larvae/ gram (day 40)	% gain or loss in body weight
Ethanol-treated pigs			
1	68,000 (14%)	---	---
2	---	9,900	+28
3	---	9,800	+55
4	---	7,000	+43
Mean		8,900	+42
Water-treated pigs			
A	180,400 (25%)	---	---
B	---	21,700	-18
C	---	11,700	+26
D	---	18,800	+20
Mean		17,200	+28

* Determined by sampling methods and rounded to nearest hundred.

† Percentage of inoculum in parentheses.

We tried to check this out in 1969 and again in 1970 by treating pigs not with "high-balls" but with fairly stiff "short" drinks. In the 1970 experiment each drink consisted of 1 fluid ounce of Irish Whiskey plus half an ounce of water. This would not be an uncommon mixture for human consumption (at least in the land of origin of this particular whiskey). In laboratory terms it amounts to 45 ml of 26% ethanol. It is not a very high dosage, being less than a tenth of an ounce of whiskey per kg—equivalent, for a 70 kg person, to only four strong cocktails in 45 minutes. The drinks were administered approximately 5, 25, and 45 minutes after infection.

The results, shown in Table 4, suggest tentatively that treatment greatly reduced the number of adult worms that became established; they clearly show that the treated pigs acquired only about half as many larvae in their musculature, and gained substantially more weight than the untreated control pigs. Thus we see that by three different parameters there is evidence of an appreciable protection against trichinosis.

Table 5. Number* of adult *Trichinella* recovered from gut of rats given 630 young (3 weeks old) larvae or old (25 weeks old) larvae. Rats were given 1.5 ml 30% ethanol (or water) 1 min and 30 min after inoculation.

Water treatment			Ethanol treatment			
No. rats	No. worms range	Mean \pm S.E.	No. rats	No. worms range	Mean \pm S.E.	% Reduction
Young larvae						
10	82-184	131 \pm 11	10	3-79	41 \pm 7	69
Old larvae						
10	203-600	396 \pm 37	10	42-235	120 \pm 19	70

* Determined by direct counting of all worms recovered from each rat, after incubation of opened intestine in saline.

If the apparent effects recorded in this one experiment are indeed real effects then it is not unreasonable to suppose that under certain circumstances alcoholic beverages may reduce the severity of clinical trichinosis in man, and that they may on occasion have meant the difference between life and death. In the summer of 1969 we happened to have just two young pigs on hand, and so we decided to try an all-or-nothing experiment in which both pigs would be exposed to an overwhelming *Trichinella* infection and one of them would be treated.

The pigs were each given trichinous mouse flesh representing an inoculum of 18,000 larvae/kg body weight. One pig (43 kg) was given three drinks of whiskey at 15-minute intervals starting at the time of ingestion of meat. Each drink consisted of 20 ml whiskey and 15 ml water. The treated pig thus received a total of only 2 oz whiskey over a half-hour period, but the ethanol content of each drink was fairly high (25%). (A human being might conceivably down three shots of undiluted whiskey, containing 43% ethanol, in a similar period; but it was thought that subjecting naive pigs to such strong drink might be beyond the acceptable bounds of laboratory conduct.) The treatment actually administered represented a very low body weight dosage—corresponding to only two or three cocktails for a 70 kg person in half an hour. The second pig (45 kg) got a comparable regimen of plain spring water.

The control (water-treated) pig became

prostrate 21 days after ingestion of infected flesh and died on the 25th day. The alcohol-treated pig had lost 4% of its initial body weight by day 30 of infection, but had fully recovered by day 35 and continued to gain weight until killed for necropsy on day 49. The number of acid-pepsin-resistant larvae in the untreated pig had undoubtedly not reached its maximum when the pig died—especially since the sex-ratio of the 97,000 adult worms recovered from the gut indicated that immunological expulsion had not yet occurred. Nevertheless, the number of larvae recovered per gram of diaphragm, masseter and thigh muscles was 10,500, 11,800, and 8,250 respectively. In contrast, the corresponding, and maximal, numbers of larvae in the alcohol-treated pig were 3,030, 2,000, and 1,200. While these numbers do not lend themselves to statistical analysis, they are in accord with the observed fact that, of two pigs exposed to overwhelming infection, one got whiskey and lived—while the other got plain water and died.

We do not suggest that liquor has a practical place in the prevention of trichinosis, but we conclude that under certain conditions alcoholic beverages might well provide a measure of protection against trichinosis in man. The concentration of alcohol imbibed (not the total dosage) and the time at which it is consumed in relation to the ingestion of infective meat, would be critical factors in preventing or reducing infection. Finally, the protective effect of alcohol is probably due in part to a direct effect on *Trichinella* larvae, and should not be attributed solely to an inhibition of the digestive liberation of larvae from infected flesh.

Postscript

We have recently learned that Spaldonova and her colleagues found that exposure of *Trichinella* larvae in vitro to 25% ethanol for 2 hours resulted in the death of 75% of them. They found no protective effect of ethanol in mice inoculated with free (decapsulated) *Trichinella* larvae, but 64% protection in mice fed infective meat (Spaldonova, personal communication; Spaldonova et al., 1965; Hovorka and Spaldonova, 1974). They attributed this protection to the impaired digestive release of larvae in treated mice. Although we had for the most part eschewed the use of decapsulated

larvae as being remote from the natural situation, we have now conducted several experiments using such larvae as an inoculum for rats. The results of one experiment, summarized in Table 5, show that ethanol provided a substantial degree of protection against trichinosis (approximately 70% reduction as compared to water-treated control rats). This is contrary to the findings of Spaldonova et al. (loc. cit.) but on this point we are roughly in agreement with McNaught and Pierce (1939). However, the results of our experiments with decapsulated larvae were erratic.

In one experiment with decapsulated larvae, five ethanol-treated rats yielded a mean of 9 ± 5 worms while five water-treated rats yielded 78 ± 17 worms—representing an 89% protection. In another experiment no protection was shown, and in other experiments some individual rats showed almost complete protection while other individuals showed none. In no experiment did rats with exceptionally low worm counts occur in the water-treated groups; so we conclude that the exceptionally low counts were due, not to a variable infection rate, but to variable effects of treatment among individual rats. Preliminary data suggested that suspension of larvae in 1% gelatin as a suspending medium interfered with the protective effect of ethanol, and larvae were therefore suspended in water in the experiments reported. In the experiment in which 89% protection was recorded, the larvae had been harvested from mice after only 3 weeks' infection. However, in the experiment pre-

sented in Table 5, young larvae, while less infective than old larvae, were not more susceptible to the deleterious effect of ethanol.

Acknowledgments

The author is greatly indebted to Ms. L. S. Blair and Mr. R. K. Hartman for steadfast assistance, and to Dr. A. C. Cuckler for tolerance beyond the call of duty.

Literature Cited

- Campbell, W. C., and A. C. Cuckler. 1966. Alcoholic beverages in relation to the prophylaxis of trichinosis. Program and Abstracts, 41st Meeting of the American Society of Parasitologists, San Juan, Puerto Rico.
- Gould, S. E. 1945. Trichinosis. Charles C Thomas, Springfield, Ill., 356 p.
- Hovorka, J., and R. Spaldonova. 1974. The influence of alcohol on larvae of *Trichinella spiralis*. Acta Parasitol. Litu. 12: 153-157.
- McNaught, J. B., and G. N. Pierce. 1939. The protective action of alcohol in experimental trichinosis. Amer. J. Clin. Pathol. 9: 52-57.
- Newman, H. W., and A. J. Lehman. 1938. Nature of acquired tolerance to alcohol. J. Pharmacol. Exp. Ther. 62: 301-306.
- Pierce, G. N., and J. B. McNaught. 1937. Effects of alcohol on *Trichinella spiralis*. Proc. Soc. Exp. Biol. Med. 36: 579-581.
- Ritchie, J. M. 1970. The aliphatic alcohols. In L. S. Goodman and A. Gilman (eds.), The Pharmacological Basis of Therapeutics. Macmillan Company, New York, p. 135-150.
- Spaldonova, R., K. Podhajecky, and F. Corba. 1965. Vplyv alkoholu na povodcu trichinel-ozy. Cs. fysiolo. 14: 315.

Announcement

4th International Congress of Parasitology
 Warsaw, Poland
 August 19-26, 1978

For further information contact:
 Prof. Dr. Bernard Bezubik
 Secretary General of ICOPA IV
 Department of Parasitology
 University of Warszawa
 00-927 Warszawa, Poland

Comparative Responses of Indian Red Jungle Fowl, Light Brahma Chickens, and Three Other Galliform Birds to Experimental Infections with *Histomonas meleagridis* and *Heterakis gallinarum*

ANNE M. CHUTE, EVERETT E. LUND, AND GARY C. WILKINS

United States Department of Agriculture, Animal Parasitology Institute, Agricultural Research Service, Beltsville, Maryland 20705

ABSTRACT: Experimental infections with *Histomonas meleagridis* and *Heterakis gallinarum* in Indian Red Jungle Fowl and Light Brahma chickens were compared with those in ring-necked pheasants, New Hampshire chickens, and Beltsville Small White turkeys. The potential of each kind of bird for disseminating these parasites was estimated. Jungle fowl, which have been imported and established in areas already occupied by wild turkeys, were highly susceptible to histomoniasis, but had such a low potential for disseminating histomonad-bearing eggs of *H. gallinarum* that they are unlikely to endanger susceptible birds occupying the same range. Light Brahma chickens, although more susceptible than either pheasants or New Hampshire chickens to histomoniasis, had the highest potential for disseminating the parasites.

In previous reports we have described the responses of various galliform species (Lund and Chute, 1972c, 1974) and breeds (Lund, 1967; Chute et al., 1976) to experimental infections with *Histomonas meleagridis* and *Heterakis gallinarum*, including the potential of each kind of bird for transmitting these parasites. The present study was conducted to obtain comparable information about two kinds of birds not previously tested: the Light Brahma chicken, a large Asiatic breed that is both morphologically and physiologically different from the lighter Mediterranean breeds (Hutt, 1949), and the Indian Red Jungle Fowl (*Gallus gallus murghi* Robinson and Kloss, 1920), an import that has recently been established within the range of our wild turkeys (Bohl and Bump, 1970). Ring-necked pheasants (*Phasianus colchicus* L., 1758), Beltsville Small White turkeys and New Hampshire chickens were included for comparison.

Materials and Methods

The jungle fowl (JF) and Light Brahmas (LBr) were purchased¹ as day-old chicks. The pheasants (Ph), turkeys (BSWT), and New Hampshire chickens (NH) were from flocks maintained at the Animal Parasitology Institute. All birds were incubator hatched and were brooded and maintained in wire-floored

brooders and cages suspended over droppings pans. All except LBr were 4 to 6 weeks old when the experiment began; LBr were 8 weeks old. Each of 48 Ph and BSWT and 49 LBr, NH, and JF was given *per os* by pipette 100 ± 9.6 (S.E.) embryonated heterakid eggs prepared as previously described (Lund and Chute, 1972b) from heterakids harvested from naturally infected chickens and turkeys. This population of heterakids was known to transmit *Histomonas meleagridis*. Another seven birds of each kind served as uninoculated controls. Experimental birds (usually seven) and one control of each kind were killed and examined at each of seven intervals: 10, 14, 17, 21, 28, 35, and 42 days after inoculation. Necropsy procedures included gross examination of ceca and livers for lesions of histomoniasis, phase contrast microscopic examination of cecal contents and cecal and liver lesions for histomonads, and recovery of heterakids from the ceca. All heterakids were counted and sexed, and up to 10 of each sex from each bird were measured. Data on length and recovery of worms were subjected to analysis of variance, and significant differences were identified by the Newman-Keuls multiple range test or by Scheffe's multiple contrasts (Zar, 1974). Gravid females were kept at room temperature in 0.5% formalin solution until their eggs had embryonated. The embryonated eggs in at least 10% of the females from each bird were

¹ From Northwest Farms, Inc., Portland, Oregon.

Table 1. Susceptibility of galliform birds to infection with *Histomonas meleagridis* and to resulting disease after oral inoculation with approximately 100 embryonated heterakid eggs from a population known to carry *H. meleagridis*.

	Pheasant	NH chicken	LBr chicken	Jungle fowl	BSW turkey
No. of birds inoculated	48	49	49	49	48
Infected (%)*					
10 to 17 days PI†	38	38	48	59	95
Overall	35	29	36	53	81
Cecal lesions‡					
Severity	mild	moderate	moderate to severe	moderate to severe	severe
Duration (days PI)	21	35	42	42	42
Liver lesions (% , 14 to 42 days PI)	0	0	0	0	66
Mortality (% , 17 to 42 days PI)	0	0	0	0	62

* Based on either presence of *H. meleagridis* or characteristic lesions of histomoniasis at necropsy. Because many infections are short lived and healing may obliterate gross lesions, the figures for overall percentage of infection are probably too low.

† PI = postinoculation.

‡ Severity of cecal lesions: mild = thickening and hyperemia of cecal wall, and/or small soft core; moderate = medium cores, hemorrhage; severe = severe inflammation of cecal wall, with or without peritonitis, and/or ceca greatly distended by large firm cores.

then counted, and the reproductive potential (number of embryonated eggs produced for each given) (Lund and Chute, 1974) was calculated for heterakids in each kind of bird. Intact females and pooled embryonated eggs from each source were fed to young BSWT (Table 3) to test for transmission of *H. meleagridis*, and the potential of each kind of bird for such transmission (Chute and Lund, 1974) was estimated. *Histomonas* infections in the BSWT in the transmission test were diagnosed at necropsy 14 to 21 days after inoculation.

Results

All uninoculated control birds were negative for *Heterakis gallinarum* and *Histomonas meleagridis*.

The results with regard to *H. meleagridis* in inoculated birds are summarized in Table 1. The kinds of birds are listed in order of increasing susceptibility. Pheasants and NH had the same relatively low incidence of infection during the acute stage of histomoniasis (10 to 17 days after inoculation), but cecal lesions were milder and more transitory in Ph than in NH. In LBr, the incidence of infection was slightly higher than that in Ph and NH, and the pathological changes were more severe and longer lasting. Jungle fowl were intermediate between LBr and BSWT; only BSWT suffered liver lesions and mortality. Twenty-one BSWT

died of histomoniasis from 17 to 21 days after inoculation. A few JF examined on the 10th and 14th days had cream-colored or grayish nodules or discrete ulcers along the mucosal surface, in contrast to the generalized inflammatory response of the ceca in the other kinds of birds.

The results with regard to *Heterakis gallinarum* are summarized in Table 2. In general, worm recovery in each kind of bird declined with the increasing age of the infection, but the decline varied from slight in Ph to pronounced in BSWT. Statistically significant ($P < 0.05$) drops in worm recovery occurred at different times in LBr (between the 14th and 17th days), JF (between the 28th and 35th days), and BSWT (between the 10th and 14th days).

Heterakids recovered from Ph were usually larger than those of the same age and sex recovered from the other kinds of birds; this difference was statistically significant ($P < 0.05$) for 10-, 14- and 28-day worms. Worms recovered from JF at 10 and 14 days, from BSWT at 17 days and from LBr at 28 through 42 days were the smallest for their age and sex. The average lengths \pm S.E. of 42-day worms are shown in Table 2. The sex ratio for mature worms approximated 1:1 in all birds except the BSWT, in which there were more than five males for each female. The reproductive

Table 2. Infections with *Heterakis gallinarum* in galliform birds fed approximately 100 embryonated eggs from a population known to carry *Histomonas meleagridis*.

	Pheasant	NH chicken	LBr chicken	Jungle fowl	BSW turkey
Worm recovery (%) from birds examined:					
10 to 14 days PI*	45.6	39.5	47.2	34.5	21.5
17 to 28 days PI	47.3	29.2	24.1	27.4	8.5
35 to 42 days PI	37.9	21.8	13.9	10.5	8.0
Avg. length \pm S.E. (n) at 42 days (in mm)					
Females	12.2 \pm 0.2(50)	10.6 \pm 0.1(31)	9.8 \pm 0.2(24)	10.9 \pm 0.1(26)	11.1 \pm 0.4(3)
Males	10.1 \pm 0.1(46)	8.8 \pm 0.1(30)	8.0 \pm 0.1(33)	8.8 \pm 0.1(38)	8.8 \pm 0.5(3)
Avg. No. mature (35- and 42-day) females	19.6	10.1	6.9	4.5	1.5
Avg. No. \pm S.E. (n) embryonated eggs per female	88.4 \pm 11.5(28)	67.8 \pm 16.4(16)	38.5 \pm 6.5(12)	58.3 \pm 19.4(9)	37.3 \pm 8.3(9)
Avg. No. embryonated eggs per bird	1732	685	266	261	56
Reproductive potential†	17.3	6.8	2.7	2.6	0.6

* PI = postinoculation.

† See text for explanation.

potential was highest by far for worms in Ph and lowest by far for those in BSWT.

Results of the test for transmission of *Histomonas meleagridis* by heterakids from each kind of bird are summarized in Table 3. Pooled embryonated eggs from worms from LBr were by far the most effective in transmitting *H. meleagridis*.

Discussion

The comparative responses of Ph, NH, and BSWT to experimental infections with *Heterakis gallinarum* and *Histomonas meleagridis* were consistent with previous findings (Lund and Chute, 1972a, c). By exceeding NH in percentage of infection with *H. meleagridis* and in severity and duration of cecal involve-

Table 3. Transmission of *Histomonas meleagridis* to turkey poults by intact females or pooled eggs of *Heterakis gallinarum* from experimentally infected galliform birds.

	Source bird				
	Pheasant	NH chicken	LBr chicken	Jungle fowl	BSW turkey
Intact females					
Avg. No. (and range) of embryonated eggs in each of 10 females tested	97(10 to 191)	75(8 to 220)	41(6 to 67)	58(16 to 226)	53(20 to 90)
No. poults with <i>H. meleagridis</i> /No. inoculated	0/10	1/10	1/10	1/10	0/5
Pooled embryonated eggs					
Avg. No. \pm S.E. (n = 10) fed per bird	97 \pm 10.2	74 \pm 9.5	40 \pm 8.3	58 \pm 11.7	29 \pm 4.8
No. poults with <i>H. meleagridis</i> /No. inoculated	2/10	1/10	6/10	0/10	0/5
Avg. No. pooled embryonated eggs fed per infection with <i>H. meleagridis</i> *	485	740	67	—	—
No. poults to which each source bird could potentially transmit <i>H. meleagridis</i> †	3.5	1	4	(<1)†	—

* Total No. pooled embryonated eggs fed to poults/No. poults becoming infected with *H. meleagridis*.

† Avg. No. embryonated eggs produced per bird (from Table 2)/No. fed per *Histomonas* infection.

‡ 580 pooled embryonated eggs (the potential output of more than two jungle fowl) failed to produce a single case of histomoniasis in the poults, but one of 10 female worms fed intact transmitted histomonads.

ment, LBr rank among the more susceptible breeds of domestic chickens that we have studied (Lund, 1967; Chute et al., 1976). That JF may be equally or even more susceptible to histomoniasis is suggested not only by our results, but also by two earlier reports: Chaddock (1948) mentioned (but did not describe) naturally acquired histomoniasis in JF, and Kellogg et al. (1971) stated that a young pen-raised JF died of histomoniasis, with both cecal and liver involvement.

Birds that are relatively susceptible to histomoniasis are frequently rather poor hosts for *Heterakis gallinarum* when virulent histomonads are also present (Lund and Chute, 1974), apparently because severe lesions destroy or greatly impair the worms' habitat, the cecal lumen. In the present study, by ranking the kinds of birds according to increasing severity of cecal lesions (Table 1), we have also ranked them according to decreasing reproductive potential (number of embryonated eggs produced per each given) of *H. gallinarum* (Table 2). Only Ph supported a reproductive potential sufficient to maintain a population of *H. gallinarum* for long periods under natural conditions, but worms in NH had a higher reproductive potential than is usual with a virulent strain of *Histomonas meleagridis* (Lund and Chute, 1974).

The birds that endanger species that are susceptible to histomoniasis are those that contaminate the soil most heavily with heterakid eggs capable of transmitting *H. meleagridis*. In this experiment, not more than one intact female worm in 10 from any kind of bird transmitted *H. meleagridis*. The more frequent transmission by the same number of pooled embryonated heterakid eggs as had been fed in the intact females (LBr and Ph, Table 3) indicates that those females that carried transmissible *H. meleagridis* probably carried enough to initiate infections in more than one poult (Lund and Burtner, 1957). The figure of 67 heterakid eggs from LBr for each *Histomonas* infection seems low, whereas 485 and 740 for Ph and NH, respectively, seem high; the averages for the latter two kinds of birds in our previous tests were 213 and 227, respectively (Lund and Chute, 1974).

A recent report by Fine (1975) on the transmission of *H. meleagridis*' closest relative,

Parahistomonas wenrichi, suggests that the percentage of heterakid eggs carrying the parasite(s) may be much higher than our calculations indicate. His method involves testing very small numbers of heterakid eggs when the exact number fed per bird is known. He lists several plausible hypotheses by which his findings and ours might be reconciled, but the problem warrants further investigation.

Although by our calculations the number of poult to which each LBr could theoretically transmit *H. meleagridis* was nearly the same as that for each Ph, and these figures were much higher than those for the other kinds of birds, different factors were responsible. Light Brahmas had a lower potential output of embryonated heterakid eggs, but those eggs transmitted *H. meleagridis* much more frequently than did eggs from Ph.

In JF, both the potential output of embryonated heterakid eggs and the frequency with which these transmitted *H. meleagridis* were low, so this bird appears to present no hazard as a source of contamination of soil. Its introduction into territory already occupied by wild turkeys should not increase their risk of histomoniasis.

Within the species *Gallus gallus* (including Red Jungle Fowl and all domestic chickens), both susceptibility to histomoniasis and ability to perpetuate *Heterakis gallinarum* have been found to differ, not only between JF and chickens in this experiment, but also between different breeds of chickens in this and other experiments (Lund, 1967; Al-Khateeb and Hansen, 1974; Chute et al., 1976). To some extent, differences such as these probably develop as concomitants of selective breeding for more obvious characteristics such as morphology and productivity. However, Hutt (1949) suggested that certain physiological differences between breeds, including susceptibility to some diseases, may reflect either different ancestry or "natural selection under exposures to different environments." Comparisons of the traditional feeding habits, habitat, and ecology of the various hosts of *H. gallinarum* and *Histomonas meleagridis* may reveal differences influencing the long-term level of exposure to these parasites; we believe the latter to be an important factor in determining host response to infection. For example, in neighboring pop-

ulations of Red Jungle Fowl and unconfined domestic chickens in India (Collias and Collias, 1967) and the Philippines (Rand and Rabor, 1960), the most pertinent differences appear to be the greater mobility and much lower population density of the JF. The level of exposure to infective stages of heterakids carrying histomonads should therefore be higher for the relatively sedentary and crowded domestic chicken than for the JF. Assuming that a long-term high level of exposure to infection favors the development of mutual tolerance between host and parasite, we might expect long-domesticated chickens to be better hosts for *Heterakis gallinarum* and more resistant to histomoniasis than are wild JF.

Literature Cited

- Al-Khateeb, G. H., and M. F. Hansen. 1974. Plasma enzymes as a measure of susceptibility of chickens and turkeys to infection with *Histomonas meleagridis*. *Avian Dis.* 18: 507-514.
- Bohl, W. H., and G. Bump. 1970. Summary of foreign game bird liberations 1960 to 1968 and propagation 1966 to 1968. Special Scientific Report—Wildlife No. 130. Bureau of Sport Fisheries and Wildlife, U.S. Dept. of Interior, Washington, 61 p.
- Chaddock, T. T. 1948. Some facts relative to disease as found in wildlife. *North Am. Vet.* 29: 560-567.
- Chute, A. M., and E. E. Lund. 1974. *Heterakis gallinarum* in the guinea fowl, *Numida meleagris*: survival and comparative potential for transmitting *Histomonas meleagridis*. *Exp. Parasitol.* 35: 102-109.
- , ———, and G. C. Wilkins. 1976. Comparative responses of White Leghorn and New Hampshire chickens to experimental infections with *Histomonas meleagridis* and *Heterakis gallinarum*. *Poult. Sci.* 55: 710-713.
- Collias, N. E., and E. C. Collias. 1967. A field study of the Red Jungle Fowl in north-central India. *Condor* 69: 360-386.
- Fine, P. E. M. 1975. Quantitative studies on the transmission of *Parahistomonas wenrichi* by ova of *Heterakis gallinarum*. *Parasitology* 70: 407-417.
- Hutt, F. B. 1949. Genetics of the Fowl. McGraw-Hill Book Co., New York, 590 p.
- Kellogg, F. E., G. L. Doster, and J. K. Johnson. 1971. Diseases and parasites encountered in pen-raised Indian red junglefowl. *J. Wildl. Dis.* 7: 186-187.
- Lund, E. E. 1967. Response of four breeds of chickens and one breed of turkeys to experimental *Heterakis* and *Histomonas* infections. *Avian Dis.* 11: 491-502.
- , and R. H. Burtner, Jr. 1957. Infectivity of *Heterakis gallinae* eggs with *Histomonas meleagridis*. *Exp. Parasitol.* 6: 189-193.
- , and A. M. Chute. 1972a. The ring-necked pheasant (*Phasianus colchicus torquatus*) as a host for *Heterakis gallinarum* and *Histomonas meleagridis*. *Am. Midl. Nat.* 87: 1-7.
- , and ———. 1972b. Transfer of ten-day *Heterakis gallinarum* larvae: effect on retention and development of the heterakids, and liberation of *Histomonas* and *Parahistomonas*. *Exp. Parasitol.* 31: 361-369.
- , and ———. 1972c. Reciprocal responses of eight species of galliform birds and three parasites: *Heterakis gallinarum*, *Histomonas meleagridis*, and *Parahistomonas wenrichi*. *J. Parasitol.* 58: 940-945.
- , and ———. 1974. The reproductive potential of *Heterakis gallinarum* in various species of galliform birds: implications for survival of *H. gallinarum* and *Histomonas meleagridis* to recent times. *Int. J. Parasitol.* 4: 455-461.
- Rand, A. L., and D. S. Rabor. 1960. Birds of the Philippine Islands: Siquijor, Mount Malindang, Bohol, and Samar. *Fieldiana, Zool.* 35: 223-441.
- Zar, J. H. 1974. *Biostatistical Analysis*. Prentice-Hall, Inc., Englewood Cliffs, N.J., 620 p.

Helminth Parasites of River Otters (*Lutra canadensis*) from Southeastern Alabama¹

W. JAMES FLEMING,² C. F. DIXON,³ AND J. W. LOVETT⁴

ABSTRACT: The viscera of 18 river otters (*Lutra canadensis*) collected in Alabama during the winter of 1972-73 were examined for helminths. Two of three trematode, one of three nematode, and none of two acanthocephalan species found in the intestine were considered true parasites of the otter. Kidneys of an additional 24 otters were examined. Thirty-one of the 42 sets of kidneys examined were parasitized by *Gnathostoma miyazakii* Anderson, 1964. The frequency distribution of *G. miyazakii* was overdispersed and fitted a Negative Binomial distribution ($P > .1$).

An extensive literature review on parasitic helminths of the otter in North America is presented.

Information on the helminth fauna of the river otter (*Lutra canadensis*) in North America is scattered in the literature and has often been hidden in survey reports on individual helminth species, or as incidental findings associated with other types of studies. Table 1 represents a comprehensive review of the literature and serves as a host list when combined with the results of our study.

Materials and Methods

During the winter of 1972-73, otter carcasses from five coastal plain counties in southeastern Alabama were collected from fur trappers by personnel of the Alabama Cooperative Wildlife Research Unit. Forty-two otters were examined for kidney parasites and 18 were also examined for helminths of the digestive and respiratory systems. Urinary tracts were examined immediately after collection. Reproductive tracts were preserved for other studies and thus were not examined for parasites. The remainder of the viscera were frozen and examined at a later date.

Kidneys were examined by removing the pelvis of the kidney and opening the ureters and collecting tubules with a pair of small

scissors. The bronchioles of the lungs were aspirated and the fluid examined for larvae. Some lungs were also baermannized in warm water. The mucosal surface of the intestines was scraped with a dull knife. The mucosa and intestinal contents were then washed over a 0.105-mm mesh sieve and examined under a dissecting microscope. Helminths were fixed in 70% ethanol. Nematodes were cleared in lactophenol for examination.

Results and Discussion

Two acanthocephalan, three trematode and four nematode species were recovered and identified (Table 2).

Trematoda

The incidence and parasitic burden of *Baschkirovitrema incrassatum* and *Enhydriidiplostomum alarioides* in our sample differs slightly from those reported by Miller and Harkema (1968). They found a 70% prevalence of *B. incrassatum* and 35% for *E. alarioides* in river otters in North Carolina and reported maximum burdens of these two trematodes as 89 and 400 respectively. Both species have also been reported from mink (Miller and Harkema, 1964).

Telorchis sp. was recognized mixed in with a pooled collection of *B. incrassatum* from the otters we examined but were not suitable for species diagnosis. Wharton reported that this genus mainly parasitized turtles. We believe this parasite was only an incidental finding.

Nematoda

Gnathostoma miyazakii was recovered from the collecting tubules of the kidneys of 31 of

¹ A contribution of the Alabama Cooperative Wildlife Research Unit, Auburn University Agricultural Experiment Station, Game and Fish Division of the Alabama Department of Conservation and Natural Resources, The U.S. Fish and Wildlife Service and Wildlife Management Institute, cooperating.

² Alabama Cooperative Wildlife Research Unit, Auburn University, Auburn, Alabama. Present address: Department of Natural Resources, N.Y.S. College of Agriculture and Life Sciences, Cornell University, Ithaca, New York.

³ Department of Zoology and Entomology, Auburn University, Auburn, Alabama.

⁴ Alabama Cooperative Wildlife Research Unit, Auburn University, Auburn, Alabama.

Table 1. Parasitic helminths of river otters (*Lutra canadensis*) in North America.

	Investigator	Location
TREMATODES		
<i>Alaria canis</i> LaRue and Fallis, 1936	Lankester and Crichton, 1972	Ontario
Mesocercaria in subcutaneous fat		
<i>Baschkirovitrema incrassatum</i> (Diesing, 1850)	Miller and Harkema, 1968	North Carolina
Small intestine, stomach	Sawyer, 1961	Georgia, New York
<i>Enhydridiplostomum alarioides</i> (Dubois, 1937)	Miller and Harkema, 1968	North Carolina
Small intestine	Sawyer, 1961	Georgia
<i>Euparyphium melis</i> (Schrank, 1788)	Beaver, 1941	Michigan
<i>Nanophytes salmincola</i> (Chapin, 1926)	Schlegel et al., 1968	
CESTODES		
<i>Diphyllobothrium mansonioides</i> Mueller, 1935	McIntosh, 1937	
Pleurocercoids		
<i>Ligula intestinalis</i> Linnaeus, 1758	Green, 1955	Montana
Proglottids in feces		
<i>Schiotoccephalus solidus</i> (Mueller, 1776)*	Smith and Threlfall, 1973	Newfoundland
NEMATODES		
<i>Capillaria plica</i> Rudolphi, 1819	Miller and Harkema, 1968	North Carolina
Urinary bladder		
<i>Crenosoma goblei</i> Dougherty, 1945	Miller and Harkema, 1968	North Carolina
Respiratory tract		
<i>Dirofilaria lutrae</i> Orihel, 1965	Orihel, 1965	Florida, Louisiana
Subcutaneous tissue		
<i>Dracunculus</i> sp.	Cheatum and Cook, 1948	New York
Subcutaneous tissue		
<i>Dracunculus lutrae</i> Crichton and Beverly-Burton, 1973	Crichton and Beverly-Burton, 1973	Ontario
Subcutaneous tissue		
<i>Eustrongyloides</i> sp.	Abram and Lichtenfels, 1974	Maryland
Larvae		
<i>Filaroides canadensis</i> Anderson, 1963	Anderson, 1963	Ontario
Nodules in lungs		
<i>Gnathostoma miyazakii</i> Anderson, 1964	Anderson, 1964	Ontario
Kidney	Miller and Harkema, 1968	
<i>Physaloptera</i> sp.	Morgan, 1941	
Intestine		
<i>Skrjabinogylus lutrae</i> Lankester and Crichton, 1972	Lankester and Crichton, 1972	Ontario
Frontal sinuses		
<i>Strongyloides lutrae</i> Little, 1966	Little, 1966	Louisiana
Small intestine		
Unknown microfilaria	Rothenbacher, 1962	Michigan (Zoo)
ACANTHOCEPHALANS		
<i>Metechinorhynchus lateralis</i> Leidy, 1851*	Smith and Threlfall, 1973	Newfoundland
<i>Paracanthocephalus rauschi</i> Schmidt, 1969*	Schmidt, 1969	Alaska

* Authors reported as incidental findings.

42 otters examined. Anderson (1964) described this parasite from a river otter from Ontario and compared it to the only other known North American gnathostome from mustelids, *G. sociale* (Leidy, 1858) from the mink. The only record of *G. miyazakii* in the United States was reported by Miller and Harkema (1968) from four otters in North Carolina.

Our measurements of spicule and body lengths, female tail lengths, and vulva to tail distances of *G. miyazakii* agree favorably with those of Anderson (1964). However, our specimens differed from Anderson's slightly in that the body scales from the first few rows behind the neck often had five points instead of three to four. In addition, our specimens

generally had two preanal and one anal or post-anal papillae (as did Anderson's paratype) instead of three preanal papillae as he described for his holotype (Fig. 1). Careful examination of Anderson's specimens borrowed from the USNM Helm. Coll. (No. 60163) yielded no other morphologic differences.

Anderson (1964) and Miller and Harkema (1968) reported this parasite in the fibrous connective tissue of the kidney. Dissection of the kidneys indicated that the gnathostomes we recovered were in the lumen of the tubules of the kidney, with their posterior ends oriented toward the urinary bladder. The anterior portion appeared to be winding in and out of the tubules and may have perforated the tubules and have been in the connective tissue.

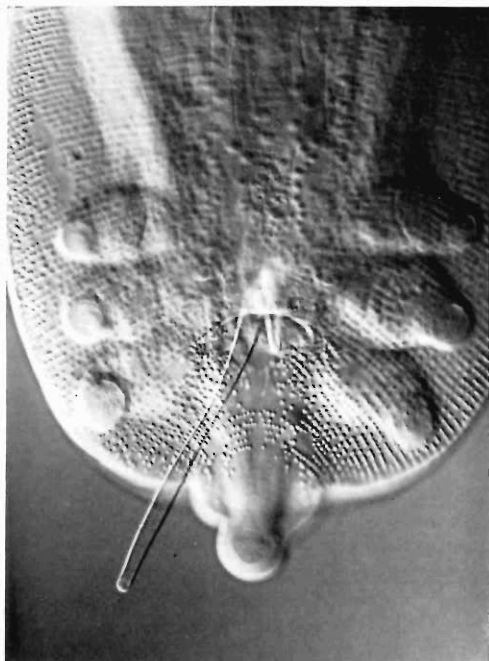

Figure 1. Ventral view, posterior end of *Gnathostoma miyazakii* Anderson, 1964 from a river otter (168X).

Noting the length ($\bar{x} = 41$ mm, $N = 30$) of these gnathostomes, it is interesting to examine the parasitic burden presented by the infection (Fig 2). The maximum number occurring in a set of otter kidneys was eight. The maximum number per kidney was five. The total number of gnathostomes recovered was 108, and the sex of 75 adults examined was 33 males and 42 females.

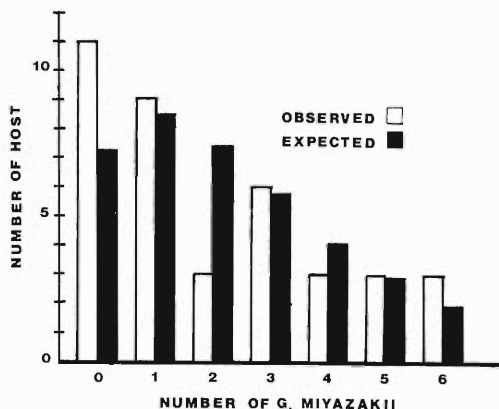

Figure 2. A comparison of a fitted Negative Binomial distribution and an observed frequency distribution of *Gnathostoma miyazakii* Anderson 1964 from 42 river otters trapped in Alabama during the winter of 1972-73.

The frequency distribution of *G. miyazakii* closely follows a Negative Binomial distribution (Chi-square Test $P > .1$) (Fig. 2). Crofton (1971a, b) stated that the frequency distribution of most helminths, except those multiplying within the host, follows a Negative Binomial distribution $(q - p)^{-k}$ where $q = 1 + p$ and $k > 0$.

The specimens of *Physaloptera* were immature females and therefore identification to species was not possible. *Spinitectus gracilis* is believed to have only been an incidental finding as it is normally a parasite of fish (Ali, 1956).

Strongyloides sp. were slightly smaller (1.0-

Table 2. Helminths of river otters collected in Alabama during 1971.

Helminths	Location	Frequency	Number of helminths		Ref. collection No. and location
			Mean	Range	
<i>Baschkirovitrema incrassatum</i>	sm. intest.	6/18	12	1-25	74373*
<i>Enhydridiplostomum alarioides</i>	sm. intest.	8/18	7.9	1-25	74374*
<i>Telorchis</i> sp.	sm. intest.	ND	ND	ND	74377*
<i>Gnathostoma miyazakii</i>	kidneys	31/42	3.4	1-8	74372*
<i>Physaloptera</i> sp.	sm. intest.	2/18	1	1	lost
<i>Spinitectus gracilis</i>	lg. intest.	1/18	8	8	74378*
<i>Strongyloides lutrae</i>	sm. and lg. intest.	12/18	ND	ND	74375*
<i>Acanthocephalus</i> sp.	lg. intest.	2/18	1	1	†
<i>Pomphorhynchus</i> sp.	lg. intest.	1/18	1	1	77-9‡

ND Not determined.

* USNM

† Collection of Dr. G. D. Schmidt, U. of N. Colorado.

‡ Dept. Parasit., N.Y.S. College Vet. Med., Cornell Univ.

1.1 mm, $N = 16$ vs. 1.6–2.5 mm, $N = 25$) than those described by Little (1966) for *S. lutrae*, but morphological features were proportionate in size. The length of the esophagus of our specimens was more than 40% of the body length, a factor which Little considered important in the identification of this species. Little examined some of our specimens and concluded that they were probably *S. lutrae*, a positive diagnosis being impossible due to the deteriorated condition of many of the specimens.

Strongyloides larvae were recovered from the lungs of five otters. Only a few were collected in each case by aspirating the bronchioles. About 100 living larvae were collected from one set of lungs by using a Baermann technique. This set of lungs had been frozen for about 2 months prior to examination. Attempts to collect other live larvae from previously frozen lung tissue failed.

One immature acanthocephalan was found in the large intestine of each of two otters and were identified as *Acanthocephalus* sp. (Echinorhynchidae), possibly an undescribed species.

Pomphorhynchus sp., a genus normally found in fish (Yamaguiti, 1963) and *Acanthocephalus* sp. were both considered to be incidental findings indicative of the otter's food habits.

Host-Parasite Ecology

The river otter is a far ranging, semi-aquatic predator. During the course of a year, individuals may cover 50–60 miles of stream and family groups may cover 3 to 10 miles (Liers, 1951). Rarely do they remain as long as 2 days at a time in one location except when the young are small. Population densities have been estimated to range from one otter per 367 to 1,100 acres in untrapped North Carolina refuges to one otter per 70 sq. miles on national forest lands in Washington State (Wilson, 1959). The social status of the otter is unclear, but most authors feel that the most frequently observed aggregations of otters are family groups.

Otters establish "latrine" sites near beaver houses, on logs fallen in water and on dry land. Use of individual latrine sites varies with the season but follows a pattern of 1 day of use followed by 2–3 days of absence, with the ab-

sence time increasing to more than 15 days with changing seasons (Greer, 1955). We believe that the species and low prevalence of most of the otter's parasites may be a function of its habits and habitat.

Examination of the parasitic species represented in the otter reveals that ascarids, strongylids and trichostrongylids are conspicuously absent. These parasite groups are commonly associated with both terrestrial and semiaquatic, mammalian carnivores and generally have direct life cycles. The otter's degree of social contact, low population density, and large home range may be an ecological barrier to these direct life cycle parasite groups. Infrequent visitation of particular latrine sites and the proximity of these sites to water, present a possibility that exposure to contaminated feces is low and that water may serve as a dilution factor for egg and larvae concentrations. Intermediate hosts serve to distribute infective stages of parasites in both time and space. Cloning in intermediate hosts also provides an increased chance of infection by moving the maximum number of infective stages one step closer to reaching the definitive host.

We therefore hypothesize that due to the habits and habitat of the otter, it is of advantage to otter parasites to distribute their infective stages in time and space, but in a concentrated enough form to insure infection if ingested. That is to say that otter parasites utilizing intermediate hosts are at an advantage due to the habitat and habits of the otter. The only reported otter parasite in North America that has a known direct life cycle is *S. lutrae*. However, this exception adds strength to the hypothesis since *S. lutrae* offers an alternative, effective transmission adaptation. *Strongyloides* are skin penetrators, though not restricted to this route of entry, and most species may develop to the infective stage within 24 hours. Thus an otter could easily reinfect itself prior to leaving an area or could infect others, even though interaction time with other individuals is low.

Acknowledgments

Appreciation is expressed to Dr. M. D. Little, School of Public Health and Tropical Medicine, Tulane University and Dr. Gerald D. Schmidt,

Department of Zoology-Parasitology, University of Northern Colorado for their aid in identification of specimens. We also thank Dr. Jay Georgi and Mr. Don Cleveland, New York State College of Veterinary Medicine, Cornell University, for the excellent photograph and technical help respectively and to Dr. Edward Hill, Alabama Cooperative Wildlife Research Unit for suggesting this study and providing otter carcasses. Cooperative support of the New York Cooperative Wildlife Research Unit in the typing of this manuscript is also appreciated.

Literature Cited

- Abram, J. B., and J. R. Lichtenfels.** 1974. Larval *Eustrongyloides* sp. (Nematoda:Diocrophymatoidea) from otter, *Lutra canadensis*, in Maryland. Proc. Helminthol. Soc. Wash. 41: 253.
- Ali, S. M.** 1956. Studies on nematode parasites of fishes and birds found in Hyderabad State. Indian J. Helminthol. 8: 1-83.
- Anderson, R. C.** 1963. Further studies on the taxonomy of *Metastrongyles* (Nematoda: *Metastrongyloidea*) of Mustelidae in Ontario. Can. J. Zool. 41: 801-809.
- . 1964. *Gnathostoma miyazakii* n. sp. from the otter (*Lutra c. canadensis*) with comments on *G. sociale* (Leidy, 1858) of mink (*Mustela vison*). Can. J. Zool. 42: 249-254.
- Beaver, P. C.** 1941. Studies on the life history of *Euparyphium melis* (Trematoda: Echinostomidae). J. Parasitol. 27: 35-44.
- Cheatum, E. L., and A. H. Cook.** 1948. On the occurrence of the North American guinea worm in mink, otter, raccoon, and skunk in New York State. Cornell Vet. 38: 421-423.
- Crichton, V. F. J., and M. Beverly-Burton.** 1973. *Dracunculus lutrae* n. sp. (Nematoda: Dracunculoidea) from the otter, *Lutra canadensis*, in Ontario, Canada. Can. J. Zool. 51: 521-529.
- Crofton, H. D.** 1971a. A quantitative approach to parasitism. Parasitology 62: 179-193.
- . 1971b. A model of host-parasite relationships. Parasitology 63: 343-364.
- Greer, K. R.** 1955. Yearly food habits of the river otter in the Thompson Lakes Region, northwestern Montana, as indicated by scat analysis. Am. Midl. Nat. 54: 299-313.
- Lankester, M. W., and V. J. Crichton.** 1972. *Skrjabingylus lutrae* n. sp. (Nematoda: *Metastrongyloidea*) from otters (*Lutra canadensis*). Can. J. Zool. 50: 337-340.
- Liers, E. E.** 1951. Notes on the river otter (*Lutra canadensis*). J. Mammal. 32: 1-9.
- Little, M. D.** 1966. Seven new species of *Strongyloides* (Nematoda) from Louisiana. J. Parasitol. 52: 85-97.
- McIntosh, A.** 1937. New host records for *Diphyllobothrium mansonoides* Mueller, 1935. J. Parasitol. 23: 313-315.
- Miller, G. C., and R. Harkema.** 1964. Studies on helminths of North Carolina vertebrates. V. Parasites of the mink, *Mustela vison*, Schreber. J. Parasitol. 50: 717-720.
- , and ———. 1968. Helminths of some wild mammals in the southeastern United States. Proc. Helminthol. Soc. Wash. 35: 118-125.
- Morgan, B. B.** 1941. Additional notes on North American Physalopterinae (Nematoda). Proc. Helminthol. Soc. Wash. 8: 63-64.
- Orihel, T. C.** 1965. *Dirofilaria lutrae* sp. n. (Nematoda: Filarioidea) from otters in the southeastern United States. J. Parasitol. 51: 409-413.
- Pearson, J. C.** 1956. Studies on the life cycles and morphology of larval stages of *Alaria arisaemoides* Augustine and Uribe, 1927, and *Alaria canis* LaRue and Fallis, 1936 (Trematoda: Diplostomidae). Can. J. Zool. 34: 295-387.
- Rothenbacher, H.** 1962. Acute microfilariasis of unknown etiology in an otter. Mich. State Univ. Vet. 23: 43-45.
- Sawyer, T. K.** 1961. The American Otter, *Lutra canadensis vaga* as a host for two species of trematodes previously unreported from North America. Proc. Helminthol. Soc. Wash. 28: 175-176.
- Schlegel, M. W., S. E. Knapp, and R. E. Millemann.** 1968. "Salmon Poisoning" disease. V. Definitive host of the trematode vector, *Nanophytes salmincola*. J. Parasitol. 54: 770-774.
- Schmidt, G. D.** 1969. *Paracanthocephalus rauschi* sp. n. (Acanthocephala: Paracanthocephalidae) from grayling, *Thymallus arcticus* (Pallas) in Alaska. Can. J. Zool. 47: 383-385.
- Smith, F. R., and W. Threlfall.** 1973. Helminths of some mammals from Newfoundland. Am. Midl. Nat. 90: 215-218.
- Wharton, G. W.** 1940. The genera *Telorchis*, *Protenes*, and *Auridistomum* (Trematoda: Reniferidae). J. Parasitol. 26: 497-518.
- Wilson, K. A.** 1959. The otter in North Carolina. Proc. Annu. Conf. Southeastern Assoc. Game and Fish Commissioners 13: 267-277.
- Yamaguti, S.** 1963. Systema Helminthum. V. Acanthocephala. Interscience Pub. N.Y., London, 423 p.

Ultrastructural Development of the Excretory Bladder in Early Metacercariae of *Ochetosoma aniarum* (Leidy, 1891)

EDWIN C. POWELL

Department of Zoology, Iowa State University, Ames, Iowa 50011

ABSTRACT: The excretory bladder epithelium of the *Ochetosoma aniarum* (Leidy, 1891) metacercaria undergoes drastic morphological changes within 24 hours of cercarial penetration into tadpoles. The previously smooth luminal surface develops numerous folds and lamellar structures. The spongiform granules so common in cercariae disappear, and simultaneously calcareous concretion formation begins. The concretions are seen to develop intracellularly and they do not appear to have a "nucleus" of membranous organelles.

In an earlier study, Powell (1972) described the development of the excretory bladder in cercariae of *Ochetosoma aniarum* (Leidy, 1891). The cercarial excretory bladder lining was seen to be a secretory syncytium containing nuclei in cytoplasmic outpockets distal to the luminal surface, many spongiform secretory granules, mitochondria, rough endoplasmic reticulum, and Golgi complexes. The luminal surface of the lining was fairly smooth without any folds, microvilli, lamellae or other surface elaborations. As a continuation of that study, the early ultrastructural development of the metacercarial excretory bladder of *Ochetosoma aniarum* is herein reported.

Materials and Methods

Laboratory reared snails, *Physella anatina*, experimentally infected with *Ochetosoma aniarum* were used to obtain naturally shed cercariae which were placed in small finger bowls with laboratory reared *Rana pipiens* tadpoles. Cercarial penetration into tadpoles was observed by use of a dissecting microscope. Metacercariae were dissected out of tadpoles at intervals of 1, 4, 8, 12, 24, 48 hours and 3 weeks after cercarial penetration. Using microdissecting needles fashioned from sharpened insect pins, the metacercariae were excysted and prepared for electron microscopy using the

techniques of Lumsden (1970). Sections were cut with glass or diamond knives on a Sorvall MT-2 ultramicrotome. Sections displaying silver or grey interference colors were picked up on naked or parlodion coated grids, double stained with uranyl acetate and lead citrate, and examined with a Siemens Elmiskope IA operated at 80 kV.

Results

At one hour post penetration the bladder epithelium (Fig. 1) began to undergo rather drastic changes. The previously smooth luminal surface was thrown into numerous folds and lamellae. The rough endoplasmic reticulum (RER) began to lose some of the parallel arrangement, and the granules seen in cercarial bladder linings were still present.

At four hours post penetration (Fig. 2) continued formation of folds and lamellae were noted in the bladder. At this time much of the lumen is filled with outfoldings; even some of the nuclei were found in this area. The RER had lost the parallel arrangement, and the granules were still present.

By 8 to 12 hours after penetration of tadpoles (Figs. 3 and 4), the cercarial type granules were no longer present, but excretory concretion formation had begun. The concretions developed intracellularly, and the center of the

→

Figures 1 and 2. Excretory bladder epithelium of *Ochetosoma aniarum* metacercariae. 1. Bladder epithelium one hour after penetration into tadpole. Note folds (F) into lumen (L), granules (G), endoplasmic reticulum (ER), and nucleus (N). $\times 12,500$. 2. Bladder epithelium four hours post penetration. Note the very extensive outfolding into the bladder lumen. $\times 15,000$.

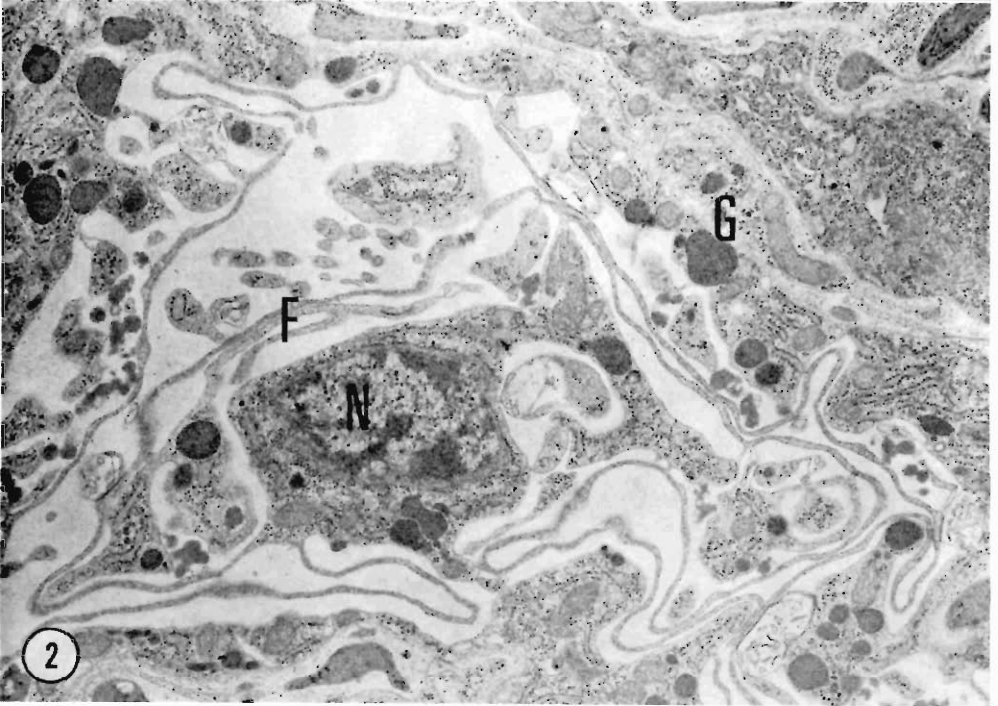
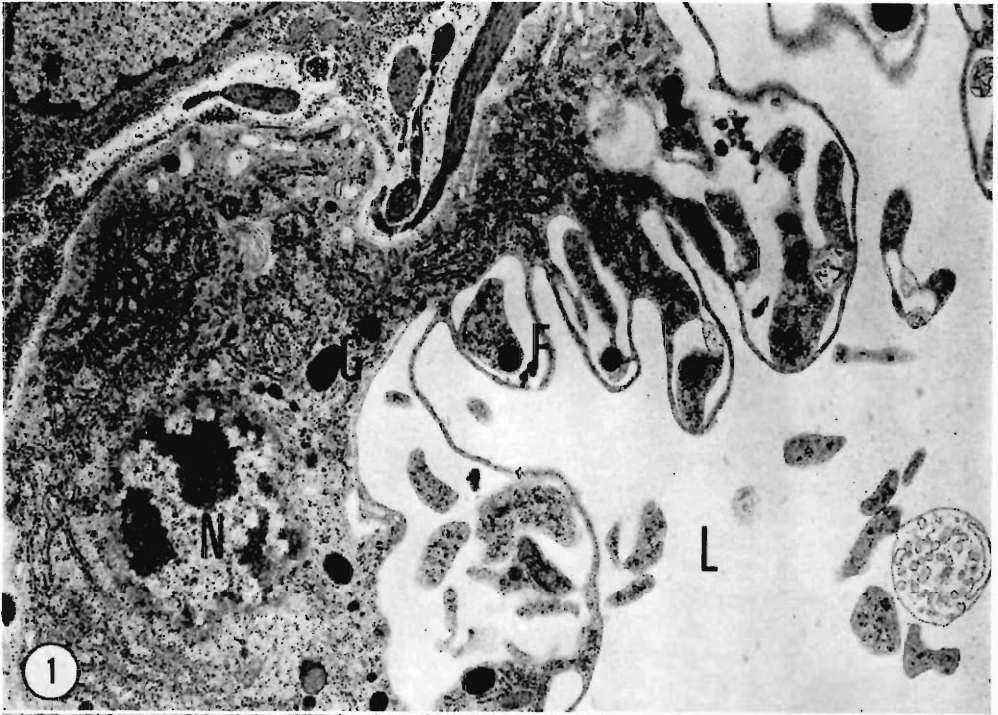



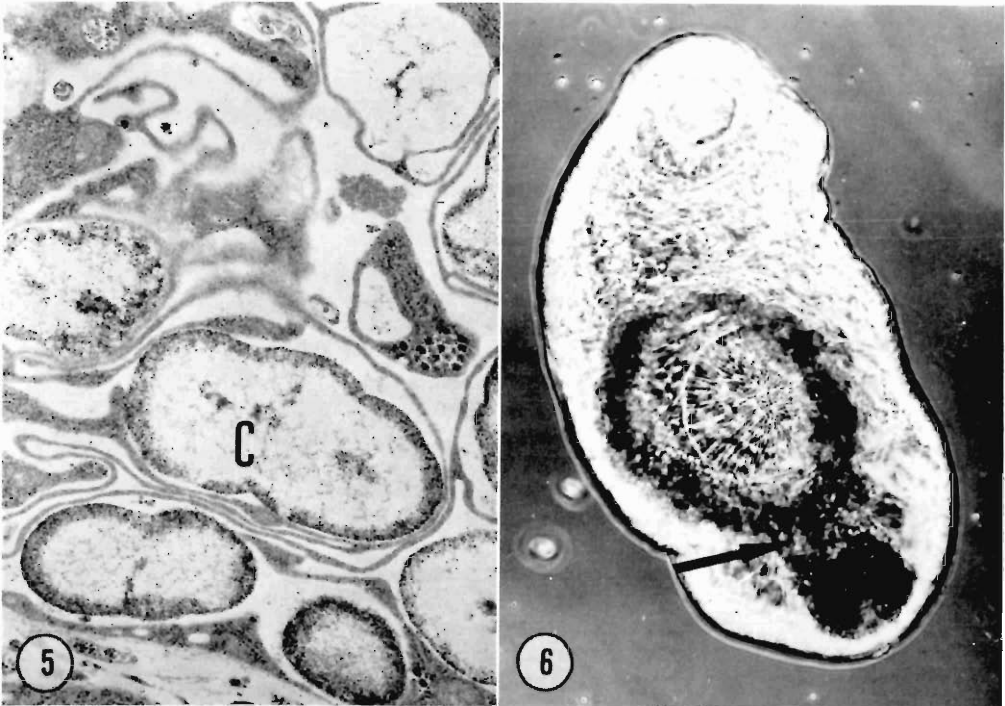

Figures 5 and 6. Excretory concretions of *Ochetosoma aniarum*. 5. Excretory concretions found 24 hours post penetration. Note the dense outer edge. $\times 16,000$. 6. Light micrograph of metacercaria 3 weeks post penetration. Note the large numbers of excretory corpuscles (arrow) which fill the bladder and arms of the bladder. $\times 145$.

concretions appeared to be amorphous without a membranous nucleus.

At about 24 hours after penetration the excretory concretions were very dense and had become difficult to section (Fig. 5). The outer area of the concretions appeared to be quite compact in comparison with the early stages.

Older metacercarial stages were not observed ultrastructurally because of extreme difficulties in sectioning the excretory concretions. Light level observations (Fig. 6) indicated that the bladder arms appeared to join anterior to the acetabulum and that the entire lumen of the bladder was full of excretory concretions.

Discussion

The rapid morphological changes occurring in the bladder epithelium of *O. aniarum* within 24 hours after penetration of cercariae into tadpoles indicate a period of great physiological change or activity. The formation of excretory concretions occurs very rapidly during this time. The part that these structures play in the worm's physiology is unknown. Cable (1965) suggested that the bladder epithelium may be important in the detoxification of metabolic wastes of the encysted metacercariae. Martin and Bils (1964) indicated that excretory concretions might be important in CO_2 fixation to

←

Figures 3 and 4. *Ochetosoma aniarum* excretory bladder epithelium. 3. Bladder epithelium 8 hours post penetration. Note the intracellular development of the excretory concretions (C) which have an amorphous center (arrow). $\times 20,000$. 4. Bladder epithelium 12 hours post penetration. $\times 10,000$.

produce calcium carbonate. It also seems possible that these may function as do the calcareous corpuscles of the cestodes, which von Brand (1966) has suggested serve as important buffers in the neutralization of acids and as phosphate reserves. Gibson (1973) thought that the "excretory corpuscles" seen in some adult digeneans might be involved with osmoregulation. At the present time, there is no experimental information as to the function of the concretions.

Martin and Bils (1964) studied the granular concretions often seen in the lumen of the excretory system of immature trematodes. By staining, microchemical, and ultrastructural analyses of these concretions in the echinostome *Acanthoparyphium spinulosum*, they found the granules to consist of calcium carbonate and some phosphate that is laid in concentric rings around a nucleus appearing to be derived from mitochondria and cellular membranes. Electron microscopy revealed that the concretion material entered the main excretory vessel in a flocculent state and condensed around mitochondria, and possibly other membranes as well as electron-dense deposits. These membranes appear to have their origin from the cells lining the tubules. Erasmus (1967) noted in *Cyathocotyle bushiensis*, a strigeoid worm, that concretions were secreted in a manner similar to lipid droplet secretion.

My observations do not support Martin and Bils' (1964) findings of a "nucleus" of various membranous organelles in the concretions, but this might be due to possible differences in concretion formation found in diverse groups of digeneans. My observations also indicate a possible intracellular formation for these structures. More studies are needed to resolve these problems. It appears possible that the abundant secretory granules found in the cercarial bladder are important in the production of the excretory concretions. The sudden disappearance of these granules and the simultaneous appearance of the concretions suggest such a relationship. However, Leong and Howell (1971) noted that material from the excretory bladder was involved in the formation of the cyst wall of a heterophyid trematode, and Goodchild (1943) also saw cyst material extruded from the excretory pore of a gorgodariid.

Thus the exact function of these secretory granules is not known.

The elaboration of lamellae on the luminal surface of the bladder lining is suggestive of an increase in surface area for secretion or absorption. At the present time there is no information to aid in understanding the function of these structures.

The excretory concretions defied sectioning after 24 hours of development. Since they are believed to be calcareous, the difficulties encountered here were probably similar to those found in cestodes by Nieland and von Brand (1969) who stated: ". . . sectioning becomes singularly difficult either because of their hardness or lack of penetration of the embedding medium. . . ." Gouronton (1968) noted a similar difficulty in studying calcareous granules in midgut cells of insect larvae.

Literature Cited

- Brand, T. von.** 1966. Biochemistry of Parasites. Acad. Press, N.Y., 428 p.
- Cable, R. M.** 1965. "Thereby Hangs a Tail." J. Parasitol. 51: 3-12.
- Erasmus, D. A.** 1967. Ultrastructural observations on the reserve bladder system of *Cyathocotyle bushiensis* Khan 1962 (Trematoda: Strigeoidea) with special reference to lipid excretion. J. Parasitol. 53: 525-536.
- Gibson, D. I.** 1973. Some ultrastructural studies on the excretory bladder of *Podocotyle staf-fordi* Miller, 1941, Digenea. Bull. Br. Mus. (Nat. Hist.) Zool. 24: 461-465.
- Goodchild, C. G.** 1943. The life-history of *Phyllodistomum solidum* Rankin, 1937, with observations on the morphology, development and taxonomy of the Gorgoderinae (Trematoda). Biol. Bull. 84: 59-86.
- Gouronton, J.** 1968. Composition, structure et mode de formation des concrétion minérales dans l'intestin moyen des Homoptères cerco-pides. J. Cell. Biol. 37: 316-328.
- Leong, C. H. D., and M. J. Howell.** 1971. Formation and structure of the cyst wall of *Stictodora lari* (Trematoda: Heterophyidae). Z. Parasitenk. 35: 340-350.
- Lumsden, R. D.** 1970. Preparatory technique for electron microscopy. In A. J. MacInnis and M. Voge (eds.), Experiments and Techniques in Parasitology. Freeman Press, San Francisco.
- Martin, W. E., and R. F. Bils.** 1964. Trematode excretory concretions: Formation and fine structure. J. Parasitol. 50: 337-344.

Nieland, M. L., and T. von Brand. 1969. Electron microscopy of cestode calcareous corpuscle formation. *Exp. Parasitol.* 24: 274-289.

Powell, E. C. 1972. Optical and electron microscope studies on the excretory bladder of the supposed epitheliocystid cercaria of *Achetosoma aniarum*. *Z. Parasitenk.* 40: 19-30.

Dactylogyrus unguiformis sp. n. (Monogenea) from the Mottled Sculpin, *Cottus bairdi* Girard, in Idaho, with Some Taxonomic Considerations in the Genus *Dactylogyrus*¹

D. C. KRITSKY, R. J. KAYTON, AND P. D. LEIBY

College of Health-Related Professions, Idaho State University, Pocatello, Idaho 83209

ABSTRACT: *Dactylogyrus unguiformis* sp. n. is figured and described from the mottled sculpin, *Cottus bairdi* Girard, in Idaho. It closely resembles *D. colonus* Bogolepova, 1950, from which it differs primarily by having a chelate accessory piece and by lacking a distal dilation of the shaft of the anchor. Based on a study of type specimens the following synonymies are proposed: *Dactylogyrus cernyi* Hanek et al., 1975 with *D. flagristylus* Chien, 1974; *D. micropogoni* Hanek et al., 1975 with *D. aviunguis* Chien, 1974; *D. jaini* Price, 1968 with *D. ericymbae* Rogers, 1967; and *D. atratuli* Hanek and Fernando, 1972 with *D. cheloideus* Rogers, 1967. The junior homonyms, *D. jaini* Rizvi, 1974 and *D. mollis* Chien, 1974, are renamed *D. rizvii* nom. nov. and *D. flexibilis* nom. nov., respectively. The following species names which were previously declared *nomina nuda* are reassigned: *D. phenacobi* (Kimpel, 1939) to *D. seamsteri* Price, 1967; *D. whipplius* (Kimpel, 1939) to *D. moorei* Monaco and Mizelle, 1955; *D. superficialis* (Kimpel, 1939) to *D. bullosus* Mizelle and Donahue, 1944; *D. semotilus* (Kimpel, 1939) to *D. lineatus* Mizelle and Klucka, 1953; *D. umbratilis* (Kimpel, 1939) to *D. attenuatus* Mizelle and Klucka, 1953; and *D. campostomus* (Kimpel, 1939) to *D. acus* Mueller, 1938. The parasite-host list of North American *Dactylogyrus* spp. of Mizelle and McDougal (1970) is updated.

Only two species of *Dactylogyrus* are known from cottid fishes. *Dactylogyrus colonus* Bogolepova, 1950 was described from the gills of *Limnocottus godlewskii* and *L. bergianus* from Lake Baikal in Russia. Recently Dechtiar (1974) described *D. buddi* from the gills of *Cottus bairdi* and *C. cognatus* from Lake of the Woods, Lake Huron, and Lake Eric (all) in Ontario, Canada.

In the present study, *D. unguiformis* sp. n. is described from *C. bairdi* in Idaho. This monogene occurred on sculpins collected by electric shocking from Siphon Ponds located about 6.8 km NW of Chubbuck (Bannock Co.). *Dactylogyrids* were dislodged from the host by vigorously shaking several fish in a small volume of pond water. Helminths were re-

covered alive from the sediments and fixed in AFA. Some were mounted unstained in Gray and Wess' medium for study of sclerotized structures; other specimens were stained with Mayer's acid carmulum for observing internal features. Measurements, all in microns, were made according to the procedures of Mizelle and Klucka (1953). Illustrations were prepared with the aid of a camera lucida and microprojector. Terminology is as proposed by Mizelle and Kritsky (1967) and Mizelle et al. (1968). Type specimens are in the U.S. National Museum Helminthological Collection.

Dactylogyrus unguiformis sp. n. (Figs. 1-8)

HOST AND LOCALITY: *Cottus bairdi* Girard, mottled sculpin, Cottidae; Siphon Ponds near

¹ Supported by a grant from the Council of Academic Deans, Idaho State University.

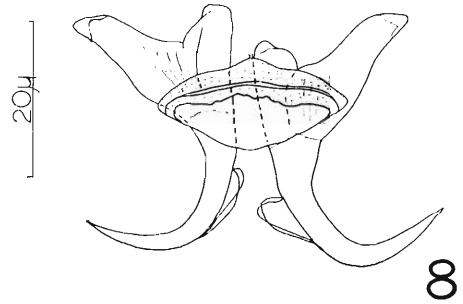
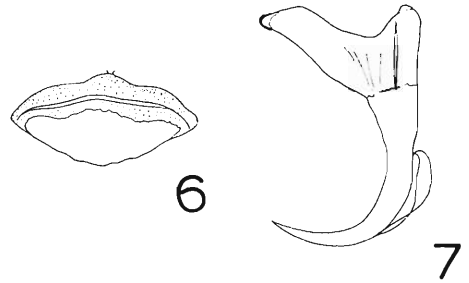
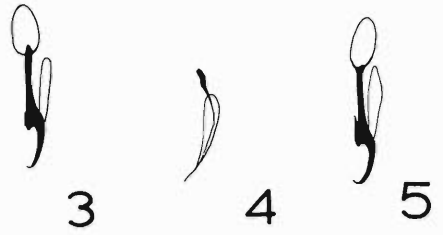
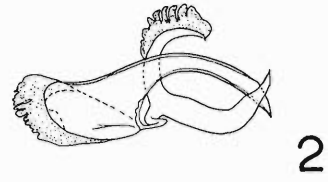
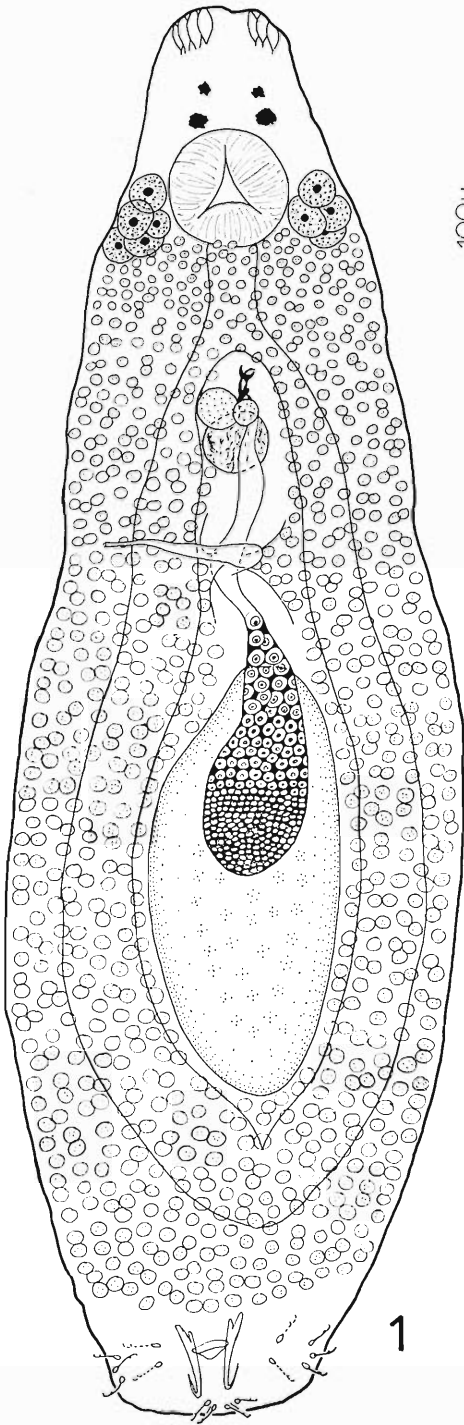

Siphon Road, 6.8 km NW of Chubbuck, Bannock Co. (March, 1976).

LOCATION: External surface.

SPECIMENS STUDIED: 16.

TYPE SPECIMENS: Holotype, No. 74104; paratypes, No. 74105.

DESCRIPTION: With characters of the genus as emended by Mizelle and McDougal (1970). Body fusiform, widest at level of gonads (Fig. 1), 642 (489–724) long by 192 (146–235) wide. Tegument thin, smooth. Eyes 4; members of posterior pair larger, usually farther apart than those of anterior pair; accessory eye granules occasionally scattered in cephalic region; one atypical specimen with 7 clusters of eye granules. Cephalic margin rounded or with 2 incipient bilateral lobes; each lobe (or area) with 2 to 4 head organs. Cephalic glands in 2 bilateral groups posterolateral to pharynx, each group with about 4 cells. Mouth subterminal, ventral. Pharynx spherical, 64 (53–70) in diameter, with triradiate lumen. Esophagus short; intestinal crura confluent posteriorly. Peduncle nonexistent or short, broad. Haptor small, knoblike, 40 (29–49) long, 93 (63–107) wide; hook distribution normal (Mizelle, 1936) except prs. 1, 5 situated on terminal haptor margin posterior to prs. 2, 3, 4. Hooks (except 4A) similar, 22 (19–28) long; each with inflated base, depressed thumb; filamentous hooklet loop extending to basal inflation. Hook 4A lacking thumb, 13–14 long, lying near hook pr. 5. Anchor 35 (32–39) long, with well-developed roots, evenly curved shaft and point; transverse shallow groove and longitudinal striations delimiting union of shaft and base; anchor filament well-developed; base 20 (18–21) wide. Dorsal bar rod shaped, 25 (21–27) long, with transverse groove and delicate posterior shield. Ventral bar absent. Gonads in posterior half of trunk, intercecal, overlapping; common genital pore midventral. Ovary pyriform, 121 (87–146) long, 50 (44–55) wide, ventral to testis; oviduct intercecal; oötype situated near midline of body; vagina dextroventral, delicate, unsclerotized; seminal receptacle an inconspicuous proximal dilation of vagina; uterus

extending along midline of trunk, with thin wall. Egg ellipsoidal, with short subtriangular filament. Vitellaria coextensive with gut, lying ventral and dorsal to crura. Vitelline ducts ventral in trunk, emptying individually into oötype. Testis ellipsoidal, 148 (97–252) long, 62 (48–70) wide; seminal vesicle large, spherical, lying dorsal to two small prostatic reservoirs; vas deferens, prostates not observed; cirrus 34 (29–35) long, a simple curved tube with variable base. Accessory piece 15 (11–18) long, cheliform; short ramus with fleshy accessory structure.

Remarks

Dactylogyrus unguiformis closely resembles *D. colonus* Bogolepova, 1950 from cottid fishes in Russia, in that both have well-developed roots of the anchor bases and a shieldlike process on the posterior margin of the dorsal bar. It differs from *D. colonus* by possessing a chelate accessory piece without recurved rami-tips (tips of rami are folded in *D. colonus*) and by lacking a distal swelling of the anchor shaft (a slight swelling of the shaft occurs in *D. colonus*). For further differences in morphology of sclerotized parts compare Figs. 2–8 herein and Fig. 1 in Bogolepova (1950). *Dactylogyrus unguiformis* differs from *D. buddi* Dechtiar, 1974, the only other daetylgyrid from *C. bairdi*, by having well-developed anchor roots, (reduced in *D. buddi*) and an accessory piece with two rami (three in *D. buddi*). A sclerotized vagina, present in *D. buddi*, is absent in *D. unguiformis*.

The specific name is from Latin (*ungui* = claw + *forma* = shaped) and refers to the structure of the accessory piece.

Other Taxonomic Considerations

A total of 120 species of *Dactylogyrus* is known from freshwater fishes in North America (Table 1; and Mizelle and McDougal, 1970). Apparently without knowledge of Chien's (1974) description of *D. flagristylus*

←

Figures 1–8. *Dactylogyrus unguiformis* sp. n. 1. Ventral view of holotype. 2. Copulatory complex. 3, 4, 5. Hooks. 6. Dorsal bar. 7. Dorsal anchor. 8. Anchor-bar complex.

Table 1. North American *Dactylogyrus* spp. not included in the Parasite-Host List of Mizelle and McDougal (1970).*

Parasite	Host and locality
<i>D. ancylostylus</i> Chien, 1974.	<i>Nocomis leptocephalus interocularis</i> Lachner and Wiley, South Carolina (Chien, 1974a).
<i>D. asper</i> Chien, 1974.	<i>Nocomis asper</i> Lachner and Jenkins, Arkansas (Chien, 1974a).
<i>D. atripinnei</i> Timmons and Rogers, 1977	<i>Moxostoma atripinne</i> Bailey, Tennessee (Timmons and Rogers, 1977).
<i>D. aviunguis</i> Chien, 1974. (Syn. <i>D. micropogoni</i> Hanek et al., 1975)	<i>Nocomis biguttatus</i> (Kirtland), Michigan (Chien, 1974a); <i>N. micropogon</i> (Cope), Ontario (Hanek et al., 1975).
<i>D. buddi</i> Dechtiar, 1974.	<i>Cottus bairdi</i> Girard, <i>C. cognatus</i> Richardson, Ontario (Dechtiar, 1974).
<i>D. carolinensis</i> Legge, 1971.	<i>Notropis albeolus</i> Jordan, North Carolina (Legge, 1971).
<i>D. chrosomi</i> Hanek, Molnar and Fernando, 1975.	<i>Phoxinus eos</i> (Cope), Ontario (Hanek et al., 1975).
<i>D. effusus</i> Chien, 1971.	<i>Nocomis effusus</i> Lachner and Jenkins, Tennessee (Chien, 1971).
<i>D. eos</i> Hanek, Molnar and Fernando, 1975.	<i>Phoxinus eos</i> (Cope), Ontario (Hanek et al., 1975).
<i>D. flagristylus</i> Chien, 1974. (Syn. <i>D. cernyi</i> Hanek et al. 1975)	<i>Nocomis effusus</i> Lachner and Jenkins, Tennessee (Chien, 1974b); <i>N. biguttatus</i> (Kirtland), <i>N. asper</i> Lachner and Jenkins, (Chien, 1974b); <i>N. micropogon</i> (Cope), Ontario (Hanek et al., 1975).
<i>D. flexibilis</i> nom. nov. † (Syn. <i>D. mollis</i> Chien, 1974)	<i>Nocomis raneyi</i> Lachner and Jenkins, North Carolina (Chien, 1974b); <i>N. micropogon</i> (Cope), (Chien, 1974b).
<i>D. hankinsoni</i> Hanek, Molnar and Fernando, 1975.	<i>Hybognathus hankinsoni</i> Hubbs, Ontario (Hanek et al., 1975).
<i>D. heterolepis</i> Hanek, Molnar and Fernando, 1975.	<i>Notropis heterolepis</i> Eigenmann and Eigenmann, Ontario (Hanek et al., 1975).
<i>D. intermedius</i> Wegener 1909. ‡ (Syn. <i>D. mizellei</i> Price, 1967)	<i>Xiphophorus helleri</i> Heckel, Cordell's Farm Supply Company, Milledgeville, Georgia (Guatemala) (Price, 1967b).
<i>D. lachneri</i> Chien, 1971.	<i>Nocomis biguttatus</i> (Kirtland), Michigan (Chien, 1971); <i>N. effusus</i> Lachner and Jenkins, <i>N. asper</i> Lachner and Jenkins, (Chien, 1971).
<i>D. latirictus</i> Chien, 1974.	<i>Nocomis biguttatus</i> (Kirtland), Arkansas (Chien, 1974a).
<i>D. leptostylus</i> Chien, 1974.	<i>Nocomis l. leptocephalus</i> (Girard), South Carolina (Chien, 1974a); <i>N. l. interocularis</i> Lachner and Wiley, (Chien, 1974a).
<i>D. malleolus</i> Chien, 1974.	<i>Nocomis l. leptocephalus</i> (Girard), Virginia (Chien, 1974b); <i>N. micropogon</i> (Cope), (Chien, 1974b).
<i>D. megastylus</i> Chien, 1974.	<i>Nocomis l. leptocephalus</i> (Girard), Virginia (Chien, 1974a).
<i>D. millieae</i> Chien, 1974.	<i>Nocomis effusus</i> Lachner and Jenkins, Tennessee (Chien, 1974a).
<i>D. mississippiensis</i> Chien, 1974.	<i>Nocomis leptocephalus bellicus</i> Girard, Louisiana (Chien, 1974a).
<i>D. navarroensis</i> Mizelle and Kritsky, 1969.	<i>Hesperoleucas navarroensis</i> (Snyder), California (Mizelle and Kritsky, 1969).
<i>D. unguiformis</i> sp. n.	<i>Cottus bairdi</i> Girard, Idaho (<i>nobis</i>).
<i>D. wegneri</i> Kulwicz, 1927.	<i>Carassius auratus</i> (L.), California (Price and Mizelle, 1964); Texas (Nowlin et al., 1967).

* *D. arcus* Rogers, 1967 was placed in synonymy with *D. dubius* Mizelle & Klucka, 1953 (Hanek et al., 1975).

† Mizelle and Donahue (1944) synonymized *Neodactylogyrus* Price, 1938 with *Dactylogyrus* "... because the presence of the vestigial ventral bar required for assignment of species, thereto, is differentially developed, not always visible in fixed specimens, and results in unnecessary synonymy." The generic status of *Neodactylogyrus* was also rejected by Mizelle and McDougal (1970). We concur with the actions of these authors. Thus, *D. mollis* Chien, 1974 becomes a junior secondary homonym of *D. mollis* (Wedl, 1857) Diesing, 1858 (formerly *N. mollis* (Wedl, 1857) Price, 1938) and must be rejected since we believe these two species are congeneric. The new name is from Latin (*flexibilis* = flexible) and refers to the cirrus.

‡ *D. mizellei* Price, 1967 is considered to be conspecific with *D. intermedius* Wegener, 1909 by Gushev (personal communication).

and *D. aviunguis*, Hanek et al. (1975) described *D. cernyi* and *D. micropogoni* from *Nocomis micropogon* in Ontario. Our examination of the paratypes (USNM Helm. Coll. Nos. 72179, *D. flagristylus*; 71078, *D. aviunguis*; 73151, *D. cernyi*; 73160, *D. micropogoni*) verified that *D. cernyi* and *D. micropogoni* are junior synonyms of *D. flagristylus* and *D. aviunguis*, respectively. Also, Price (1968) described *D. jaini* from *Ericymba bucata* but did not mention Rogers' (1967) de-

scription of *D. ericymbae* from the same host. Comparison of holotypes (USNM Helm. Coll. Nos. 61352, *D. jaini*; 61381, *D. ericymbae*) showed *D. jaini* to be a junior synonym of *D. ericymbae*.

Rizvi (1974) described *D. jaini* from *Barbus sarana* in Pakistan. Since this name is a junior homonym of *D. jaini* Price, 1968, the species is renamed *D. rizvii* nom. nov. in memory of the original author.

Hanek and Fernando (1972) described *D.*

atratali from *Rhinichthys atratulus* and separated it from *D. cheloideus* Rogers, 1967 by differences in the haptor armament. Comparison of type specimens of both species (*D. atratali* holotype, USNM Helm. Coll. 72347; *D. cheloideus* paratype, 61376) revealed that *D. atratali* is conspecific with *D. cheloideus*. This is supported by the fact that the original illustrations of *D. atratali* show poorly developed anchor roots, while the holotype possesses roots comparable to those depicted for *D. cheloideus* by Rogers (1967). Also, the copulatory complexes in these type specimens are identical, and the large hook 4A reported for *D. atratali* by Hanek and Fernando (1972) could not be found on the holotype. Hanek and Fernando's description and illustration of the copulatory complex is more representative of the species.

Kimpel (1939) in an unpublished thesis named six species of *Neodactylogyrus* (= *Dactylogyrus*) from cyprinid fishes in Illinois: *D. phenacobius* from *Phenacobius mirabilis*; *D. umbratilis* from *Notropis umbratilis atripes*; *D. whipplius* from *N. whipplii*; *D. campostomus* from *Campostoma anomalum*; *D. semotilus* from *Semotilus atromaculatus*; and *D. superficialis* from *Ericymba buccata*. These names have frequently appeared in the literature even though Kimpel did not meet the requirements for publication as set forth in the International Code of Zoological Nomenclature. For this reason Yamaguti (1963) designated them *nomina nuda*.

Through the courtesy of Dr. F. J. Kruidenier, University of Illinois, Urbana, we had the opportunity to examine slides of five of Kimpel's species. All slides had Kimpel's personalized label and were originally in the parasite collection of H. J. VanCleave (University of Illinois). Our study of these specimens, other dactylogyrids collected from Illinois, and the thesis allowed us to assign Kimpel's names to available (*sensu* the code) names. These assignments are desirable since Kimpel's unavailable names have crept into the literature.

The single slide with one complete specimen of *D. phenacobius* from *P. mirabilis* showed that the morphology of the haptor armament and copulatory complex closely resembles that reported for *D. seamsteri* Price, 1967, which was described from the same host in Georgia.

Therefore, we assign *D. phenacobius* to *D. seamsteri*.

The vestigial process near the midlength of the accessory piece, the elongate cirrus, and the morphology of the haptor armament of *D. whipplius* clearly show it to be conspecific with *D. moorei* Monaco and Mizelle, 1955. Our observations are based on two complete specimens from *N. whipplii*. *Dactylogyrus moorei* has also been reported from this host in Alabama (Rogers, 1967).

One slide with a single crushed specimen of *D. superficialis* was examined. We consider this name to be a synonym of *D. bullosus* Mizelle and Donahue, 1944. Kimpel's specimen closely resembled *D. bullosus* in the morphology of the anchors and copulatory complex but differed from it by possessing a well-developed process near the midlength of the accessory piece. However, the process on the accessory piece of many *Dactylogyrus* species exhibits wide intraspecific variation and therefore cannot be considered alone to separate *D. superficialis* from *D. bullosus*. Kimpel's drawing of the anchor is misleading in that the angular bends of the shaft and point are not illustrated.

Kimpel's description of *D. superficialis* gives *Ericymba buccata* as the type host while his slide (used by us) has the parasite labeled as having been collected from *N. whipplii*. It is doubtful that Kimpel's specimens were taken from *E. buccata*, as this fish is known to be parasitized over a wide area of its geographic range by only *D. julicae* and *D. ericymbae* (Rogers, 1967; Price, 1968). Also, examinations of *E. buccata* from areas near the type localities of *D. superficialis* in Illinois yielded only the latter two dactylogyrids (Kritsky, unpublished). Therefore, it appears likely that *N. whipplii* was the correct host for *D. superficialis*, and the designation of *E. buccata* as the type host was erroneous. This constitutes a new host record for *D. bullosus*.

Our study of one complete specimen of *D. semotilus* (of Kimpel, not *D. semotilus* Wood and Mizelle, 1951) from *S. atromaculatus* showed it to be conspecific with *D. lineatus* Mizelle and Klucka, 1953. Kimpel's original drawing of the copulatory complex is misleading in that the cirrus is too short and the medial process on the accessory piece is ex-

aggerated. Also, we should point out that *D. semotilus* Wood and Mizelle, 1957, cannot be a secondary homonym of the nomen nudum, *D. semotilus* (Kimpel), since the latter name is unavailable.

Based on the comparative morphology of the cirrus, hooks, haptor bars and the delicate V-shaped accessory piece, we consider *D. umbratilis* to be a synonym of *D. attenuatus* Mizelle and Klucka, 1953. The specimen examined from Kruidenier's collection was obtained from *N. umbratilis atripes*, which represents a new host record for *D. attenuatus*.

None of Kimpel's original specimens of *D. campostomus* was available. However, examination of four *Campostoma anomalum* (three infected) from a drainage ditch located near Rantoul, Illinois (type host and locality for *D. campostomus*) yielded 13 specimens of this species. Based on the morphology of the copulatory complex and haptor armament, we assign these specimens to *D. acus* Mueller, 1938, which has not been reported since its original description from *Notropis cornutus* and *C. anomalum* in New York (Mueller, 1938).

Acknowledgments

The authors are grateful to Dr. Robert Anderson for providing certain laboratory equipment and to Drs. Allan Linder and Donald Johnson for information on hosts. Dr. J. Ralph Lichtenfels kindly provided type specimens on several occasions from the USNM Helminthological Collection.

Literature Cited

- Bogolepova, I. I.** 1950. Some monogenetic trematodes of the endemic fishes of the Baikal Sea. Dokl. Akad. Nauk SSSR, N.S. 72: 229-232.
- Chien, S. M.** 1971. Dactylogyrids from North American cyprinids of the genus *Nocomis*. The *reciprocus* species group. J. Parasitol. 57: 1211-1214.
- . 1974a. Dactylogyrids from North American cyprinids of the genus *Nocomis*. The *bellicus* group. J. Parasitol. 60: 585-594.
- . 1974b. Dactylogyrids from North American cyprinids of the genus *Nocomis*. The *limulus* and the *mollis* groups. J. Parasitol. 60: 773-776.
- Dechtiar, A. O.** 1974. *Dactylogyrus buddi* n. sp. (Monogenoidea: Dactylogyridae) from the gills of the sculpins of Lake Huron. Can. J. Zool. 52: 861-863.
- Hanek, G., and C. H. Fernando.** 1972. Monogenetic trematodes from the Bay of Quinte area, Ontario. IV. Genus *Dactylogyrus* Diesing, 1850, with provisional host-parasite and parasite-host lists. Can. J. Zool. 50: 1313-1317.
- , **K. Molnar, and C. H. Fernando.** 1975. New and previously known *Dactylogyrus* spp. from southern Ontario fishes. J. Parasitol. 61: 421-426.
- Kimpel, H. G.** 1939. Studies on the taxonomy of the genus *Neodactylogyrus*, with descriptions of new species, and the immunity of freshwater fishes to gill trematodes (Gyrodactyloidea). Unpubl. thesis, Univ. of Illinois, Urbana.
- Legge, T. N.** 1971. *Dactylogyrus carolinensis* sp. n., a monogenetic trematode from the White Shiner. J. Elisha Mitchell Soc. 87: 36-38.
- Mizelle, J. D.** 1936. New species of trematodes from the gills of Illinois fishes. Am. Midl. Nat. 17: 785-806.
- , and **M. A. Donahue.** 1944. Studies on monogenetic trematodes. XI. Dactylogyridae from Algonquin Park Fishes. Am. Midl. Nat. 31: 600-624.
- , and **A. R. Klucka.** 1953. Studies on monogenetic trematodes. XIV. Dactylogyridae from Wisconsin fishes. Am. Midl. Nat. 49: 720-733.
- , and **D. C. Kritsky.** 1967. Studies on monogenetic trematodes. XXX. Five new species of *Gyrodactylus* from the Pacific tomcod, *Microgadus proximus* (Girard). J. Parasitol. 53: 263-269.
- , and ———. 1969. Studies on monogenetic trematodes. XL. New species from marine and freshwater fishes. Am. Midl. Nat. 82: 417-428.
- , ———, and **J. W. Crane.** 1968. Studies on monogenetic trematodes. XXXVIII. Ancyrocephalinae from South America with the proposal of *Jainus* gen. n. Am. Midl. Nat. 80: 186-198.
- , and **H. D. McDougal.** 1970. Studies on monogenetic trematodes. XLV. The genus *Dactylogyrus* in North America. Key to species, host-parasite and parasite-host lists, localities, emendations and description of *D. kritskyi* sp. n. Am. Midl. Nat. 84: 444-462.
- Mueller, J. F.** 1938. Additional species of North American Gyrodactyloidea (Trematoda). Am. Midl. Nat. 19: 220-235.
- Nowlin, W. J., C. E. Price, and E. A. Schlueter.** 1967. First report of freshwater monogenetic trematodes of Texas. Tex. J. Sci. 19: 110-111.

- Price, C. E. 1967a. A revised definition of the monogenetic trematode genus *Dactylogyrus*, with descriptions of four new species. Proc. Helminthol. Soc. Wash. 34: 117-124.
- . 1967b. *Dactylogyrus mizellei*, a new monogenetic trematode from Latin America. Ann. Zool. 5: 65-68.
- . 1968. A new gill trematode from Georgia. Q. J. Fl. Acad. Sci. 30: 111-114.
- , and J. D. Mizelle. 1964. Studies on monogenetic trematodes. XXVI. Dactylogyrinae from California with the proposal of a new genus, *Pellucidhaptor*. J. Parasitol. 50: 572-578.
- Rizvi, S. S. H. 1974. Monogenea of Pakistan fishes. Part III. *Dactylogyrus zulfikari*, n. sp., and *D. jaini*, n. sp., from the gills of *Barbus sarana* (Ham.). Pak. J. Sci. Ind. Res. 17: 215-216.
- Rogers, W. A. 1967. Studies on Dactylogyrinae (Monogenea) with descriptions of 24 new species of *Dactylogyrus*, 5 new species of *Pellucidhaptor*, and the proposal of *Aplodiscus* gen. n. J. Parasitol. 53: 501-524.
- Timmons, J. J., and W. A. Rogers. 1977. *Dactylogyrus atripinnei* sp. n. from the blackfin sucker in Tennessee. J. Parasitol. 63: 238-239.
- Yamaguti, S. 1963. Systema helminthum. Volume IV. Monogenea and Aspidocotylea. Interscience Publishers, New York

Eimeria tenella: Growth Characteristics of Drug-resistant Strains in Chicks and Cell Culture

P. C. AUGUSTINE, J. M. VETTERLING,¹ AND D. J. DORAN

U.S. Department of Agriculture, Poultry Protozoan Diseases Laboratory, Animal Parasitology Institute, Beltsville, Maryland 20705

ABSTRACT: Infectivity, rate of development and oocyst production of strains of *Eimeria tenella* with acquired resistance to amprolium and buquinolate were compared with those of a drug-sensitive control strain. Oocyst production in chicks and oocyst production and infectivity in cell culture were statistically similar for all three strains. However, development of the first generation of the amprolium-resistant strain was significantly retarded.

Few studies have been reported in which the authors compare the development of different strains of *Eimeria tenella*. Doran, Vetterling and Augustine (1974) found that strains of *E. tenella* from different sources differed in their ability to develop in chicks and cell culture. In chicks, weight gain, mortality and oocyst production varied with the isolate; in cell culture, the numbers of oocysts produced per intracellular sporozoite found 4 hr after inoculation (oocyst index) also varied. Jeffers (1975) described a precocious strain of *E. tenella* selected for unusually early development of oocysts. It developed at a faster rate and produced fewer oocysts in chicks than did a control strain derived from the same parent stock. When sporozoites of the strain were inoculated into cell cultures, immature mac-

rogamonts were found after 64 hr and oocysts after 90 hr (McDougald and Jeffers, 1976).

On the basis of our earlier study, we speculated that the growth characteristics of drug-resistant strains of *E. tenella* might differ from those of drug-sensitive strains. To examine this possibility, we compared amprolium- and buquinolate-resistant strains of this species with a drug-sensitive strain with respect to (1) oocyst production in chicks and (2) infectivity, rate of development and oocyst production in primary chick kidney cell cultures.

Materials and Methods

The drug-resistant strains and drug-sensitive control strain were derived from the same parent stock (Beltsville strain) to minimize the variability inherent in the organisms (McLoughlin and Gardiner, 1968; McLoughlin,

¹ Present address: Federal Building, Fort Collins, Colorado 80522.

Table 1. Development of drug-resistant and drug-sensitive strains of *Eimeria tenella* in chicks.

Strain	Oocysts inoculated/ chick $\times 10^3$	No. of chicks	Oocysts produced/ chick $\times 10^6$
A	100	30	1.5 ± 0.033
B	100	30	1.8 ± 0.037
C	100	30	2.0 ± 0.033

A = Amprolium-resistant; B = buquinolate-resistant; C = control (drug-sensitive).
* Mean \pm SE.

1970). The control strain was known to be sensitive to both amprolium and buquinolate.

Primary chick kidney cell cultures prepared and maintained by the method of Doran (1971) were inoculated with sporozoites of the drug-resistant strains or the control strain of *E. tenella*. After 4, 48 and 72 hr and after 8 days, three coverslips from each group were fixed and stained. Infectivity at 4 hr, percentage of development (the ratio of developmental stages to total number of parasites) at 48 and 72 hr and oocyst index at eight days were determined for each group (Doran, 1971). Each test was replicated three times.

Concurrently, 3-week-old White Leghorn cockerels were inoculated by gavage with oocysts of the same strains. Five cage-groups of six chicks each were used for each strain. After 7 days, the ceca were removed from the birds in each group, homogenized in 0.7% NaCl solution and acidified to pH 5 with 0.1N HCl. The oocysts per cage-homogenate were counted with a white blood cell counting chamber. The mean number of oocysts per bird was then calculated.

Oocyst production by the strains in cell culture was compared statistically by nested analysis of variance; oocyst production in chicks

and infectivity and development in cell culture after 48 and 72 hr were evaluated by Student's *t* test or single factor analysis of variance as applicable (Zar, 1974). A probability of < 0.05 was considered significant.

Results

Oocyst production by the amprolium- and buquinolate-resistant strains was not statistically different from that of the control strain in either chicks (Table 1) or cell culture (Table 2). The number of sporozoites of each strain that penetrated the cell layer (infectivity) was also similar. However, analysis of the 48 hr counts showed a highly significant ($P < 0.001$) lag in the development of the first generation of the amprolium-resistant strain in cell culture. The ratio of developmental stages to total parasites was lower for this strain than for either the buquinolate-resistant or control strain. Normal first-generation development occurred in both the buquinolate-resistant and drug-sensitive strains. The ratio of mature to immature schizonts was similar for all strains. After 72 hr, little difference in development of the three strains was observed (Table 2).

Discussion

Amprolium is a thiamin antagonist; it competes with thiamin for absorption in the intestine of birds and creates a deficiency of the vitamin by reducing its uptake (Polin et al., 1963). As a result, less thiamin is available to *E. tenella* in the intestinal cells in the presence of amprolium. Amprolium also affects the uptake of thiamin by *E. tenella* (Ryley, 1972). Warren (1968) found that thiamin is required by *E. tenella* for gametogeny; Strout and Ouel-

Table 2. Development of drug-resistant and drug-sensitive strains of *Eimeria tenella* in cell culture.

Strain	Sporozoites inoculated/tube $\times 10^3$	% Infectivity* (4 hr)	% Developmental stages*		Oocyst index* (8 days)
			(48 hr)	(72 hr)	
A	56	30 ± 2.61	57 ± 3.25	95 ± 0.88	0.647 ± 0.18
B	50	27 ± 2.32	74 ± 4.10	98 ± 0.63	1.253 ± 0.24
C	50	32 ± 2.07	75 ± 2.05	98 ± 0.41	1.072 ± 0.18

A = Amprolium resistant; B = buquinolate resistant; C = control (drug-sensitive).
* Mean \pm SE of 7-9 coverslips.

lette (1973) determined that it is also required for normal development of first-generation schizonts.

Apparently, in order to survive in the presence of amprolium and subsequently become resistant to the drug, this strain of *E. tenella* experienced some changes which altered its dependence on thiamin and retarded its developmental rate. The strain may have responded to the thiamin deficiency by functioning within its existing pathways at lower than optimal levels or by developing alternative but less efficient metabolic pathways for those that required thiamin.

Alternatively, a selection may have occurred in the presence of amprolium, and only that part of the population with lower thiamin requirements and growth rate survived.

The development of the buquinolate-resistant strain closely paralleled that of the control strain at all of the intervals that were evaluated. Quinolone anticoccidial drugs stop the growth of *E. tenella* by blocking its mitochondrial respiration. However, no differences in mitochondrial physical properties, cytochrome content or respiratory activity could be detected between a quinolone (amquinate)-resistant strain and a drug-sensitive strain of *E. tenella* (Wang, 1975). If buquinolate-resistant strains of *E. tenella* exhibit these same similarities to wild strains, it is not surprising that changes that occurred in this strain as it became resistant to buquinolate were not reflected in its ability to develop in vitro.

Acknowledgments

The authors thank Dr. D. K. McLoughlin for providing the "seed stock" of drug-resistant and sensitive strains.

Literature Cited

- Doran, D. J. 1971. Increasing the yield of *Eimeria tenella* oocysts in cell culture. *J. Parasitol.* 57: 891-900.
- , J. M. Vetterling, and P. C. Augustine. 1974. *Eimeria tenella*: An *in vivo* and *in vitro* comparison of the Wisconsin, Weybridge and Beltsville strains. *Proc. Helminthol. Soc. Wash.* 41: 77-80.
- Jeffers, T. K. 1975. Attenuation of *Eimeria tenella* through selection for precociousness. *J. Parasitol.* 61: 1083-1090.
- McDougald, L. R., and T. K. Jeffers. 1976. *Eimeria tenella* (Sporozoa, coccidia): Gametogony following a single asexual generation. *Science* 192: 258-259.
- McLoughlin, D. K. 1970. Efficacy of buquinolate against ten strains of *Eimeria tenella* and the development of a resistant strain. *Avian Dis.* 14: 126-130.
- , and J. Gardiner. 1968. Drug resistance in *Eimeria tenella*. VI. The experimental development of an amprolium-resistant strain. *J. Parasitol.* 54: 582-584.
- Polin, D., E. R. Wynosky, and C. C. Porter. 1963. *In vivo* adsorption of amprolium and its competition with thiamin. *Proc. Soc. Exp. Biol. Med.* 114: 273-277.
- Ryley, J. F. 1972. Biochemistry of coccidia. *In Comparative Biochemistry of Parasites*. H. Van den Bossche (ed.), Academic Press, N.Y.
- Strout, R. G., and Ouellette, C. A. 1973. *Eimeria tenella*: Screening of chemotherapeutic compounds in cell cultures. *Exp. Parasitol.* 33: 477-485.
- Wang, C. C. 1975. Studies of the mitochondria from *Eimeria tenella* and inhibition of the electron transport by quinolone coccidiostats. *Biochim. Biophys. Acta* 396: 210-219.
- Warren, E. W. 1968. Vitamin requirements of the coccidia of the chicken. *Parasitology* 58: 137-148.
- Zar, J. H. 1974. *Biostatistical Analysis*. W. D. McElroy and C. P. Swanson (eds.). Prentice-Hall, Inc., N.J.

Announcement

In response to numerous requests for reprints of the publication, "Identification of Parasitic Metazoa in Tissue Sections," by May Belle Chitwood and J. Ralph Lichtenfels, it has been reprinted by the U.S. Department of Agriculture. Copies are available from J. Ralph Lichtenfels, Animal Parasitology Institute, USDA, ARS, BARC East Bldg. 1180, Beltsville, Maryland 20705.

Schistosoma incognitum from Mammals of Central Sulawesi, Indonesia¹

W. P. CARNEY,² PURNOMO,³ P. F. D. VAN PEENEN,⁴ R. J. BROWN,⁵ AND M. SUDOMO⁶

ABSTRACT: *Schistosoma incognitum* Chandler, 1926 were isolated from *Rattus exulans*, *R. hoffmanni*, *R. nitidus* and *Cervus timorensis* and found to be enzootic to five regions of Central Sulawesi, Indonesia. The Sulawesi strain of *S. incognitum* is figured and described. *Schistosoma incognitum* and *S. japonicum* were demonstrated to be sympatric in the Lindu and Napu Valleys of Central Sulawesi. The zoonotic potential of *S. incognitum* and the possible hybridization of *S. incognitum* with *S. japonicum* are discussed.

While documenting the distribution of *Schistosoma japonicum* throughout Central Sulawesi (Celebes), Indonesia, new geographic and host records for *Schistosoma incognitum*, Chandler, 1926 were obtained. In Southeast Asia, *S. incognitum* previously was reported from small mammals in Thailand (Lee and Wykoff, 1966) and recently from West Java, Indonesia (Carney et al., in press).

This paper reports the distribution and hosts of *S. incognitum* in Central Sulawesi, describes morphological characteristics of the Sulawesi strain, and discusses the zoonotic potential and possible hybridization of *S. incognitum* with *S. japonicum*.

Materials and Methods

From 1971–1974, field trips were made throughout Central Sulawesi in search of mammalian reservoirs of *S. japonicum*. Small mammals were live or snap-trapped, and examined immediately for helminth parasites; large mammals were usually obtained from local hunters.

Trematodes were fixed in 10% formalin, stained with Gower's carmine and mounted on slides for species confirmation. Measurements are in microns unless otherwise indicated; mean values in parentheses. Stool specimens were fixed in 10% formalin for later examination by the direct smear and ether concentration.

Results

Host occurrence

Approximately 5,000 mammals were examined from Central Sulawesi. *Schistosoma incognitum* was found in three species of rodents; *Rattus exulans*, *R. hoffmanni* and *R. nitidus* and in the deer, *Cervus timorensis* (Table 1). This schistosome was not detected in a variety of other rodents, insectivores, carnivores or herbivores which were necropsied or from which fecal specimens were examined.

Distribution (Fig. 1) and prevalence

LINDU VALLEY: ex 20/1,185, *R. exulans* (of 1,185 *R. exulans* examined from the following locations, 20 were infected). Anca (1°19'S: 120°03'E), 950 m alt.; Bamba (1°17'S: 120°06'E), 950 m alt.; Dono (1°18'S: 120°08'E), 955 m alt.; Kalinco (1°17'S: 120°04'E), 950 m alt.; Kalomea (1°23'S: 120°10'E), 960 m alt.; Lembo (1°20'S: 120°03'E), 970 m alt.; Malapi (1°18'S: 120°03'E), 950 m alt.; Paku (1°17'S: 120°04'E), 950 m alt.; Palili (1°17'S: 120°07'E), 950 m alt.; Puroo (1°22'S: 120°02'E), 960 m alt.; Tomado (1°19'S: 120°03'E), 955 m alt.; Wongkodono (1°20'S:

¹This study was supported by funds provided by the Indonesian Ministry of Health and by the U.S. Naval Medical Research and Development Command, Navy Department, for Work Unit MF51.524.009.0030BF61. The opinions and assertions contained herein are those of the authors and are not to be construed as official or reflecting the views of the Indonesian Ministry of Health or the U.S. Navy Department.

²U.S. Naval Medical Research Unit No. 2 (NAMRU-2), Taipei, Taiwan, Republic of China.

³NAMRU-2 Detachment, Jakarta, Indonesia.

⁴Uniformed Services University of the Health Sciences, Bethesda, Maryland, U.S.A.

⁵Naval Aerospace Medical Research Laboratory, Pensacola, Florida, U.S.A.

⁶National Institute for Medical Research, Ministry of Health, Jakarta, Indonesia.

Reprint requests to: Publications Office, NAMRU-2, Box 14, APO San Francisco 96263 or 7-1 Kung Yuan Rd., Taipei, Taiwan, Republic of China.

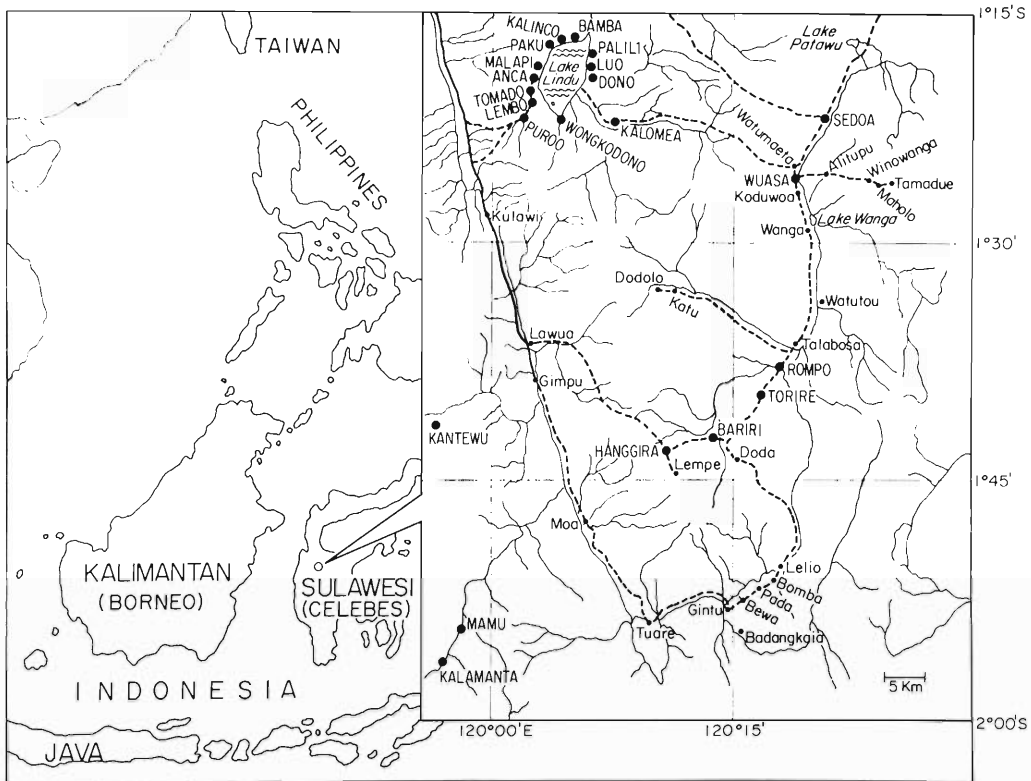

Figure 1. Map of Central Sulawesi. Large dots pinpoint localities where *Schistosoma incognitum* is endemic. At locations north of 1°30'S latitude *Schistosoma japonicum* and *S. incognitum* are sympatric.

120°05'E), 955 m alt.; ex 1/22, *C. timorensis*. Lindu Valley (1°19'S: 120°04'E), 950 m alt.

NAPU VALLEY: ex 10/57, *R. exulans*. Sedoa (1°22'S: 120°21'E), 1,127 m alt.; Wuasa (1°26'S: 120°19'E), 1,055 m alt.

BESOA VALLEY: ex 8/76, *R. exulans*. Hanggira (1°43'S: 120°11'E), 1,127 m alt.; Rompo (1°38'S: 120°18'E), 1,063 m alt.; Torire (1°39'S: 120°16'E), 1,037 m alt.; ex 1/2, *R. hoffmanni*. Bariri (1°42'S: 120°14'E), 1,152 m alt.

KANTEWU VALLEY: ex 3/3 *R. hoffmanni* (1°42'S: 119°54'E), 1,000 m alt.; ex 1/20 *R. nitidus* (1°42'S: 119°54'E), 1,000 m alt.

KALAMANTA-MAMU: ex 8/42 *R. exulans*. Kalamanta (1°57'S: 119°56'E), 1,100 m alt.; Mamu (1°56'S: 119°59'E), 1,060 m alt.; ex 1/4 *R. hoffmanni*. Mamu (1°56'S: 119°59'E), 1,060 m alt.

Description of *Schistosoma incognitum* from Central Sulawesi rodents

MALE: Twenty-one selected specimens measured: length 4.2–7.6 mm (5.8 mm); width posterior to ventral sucker 230–480 (330); diameter of oral sucker 130–230 (181); diameter of ventral sucker 170–250 (202); distance between oral and ventral suckers 190–470 (288); tubercles average 10 in height and 17 in diameter at base, distance between tubercles averages 32, number of spines per tubercle 120–210 (172), anterior portion of esophageal gland 100–200 (162) in length, posterior portion 100–190 (145) in length; distance from cecal termination to posterior end 140–300 (241); distance from excretory bifurcation to posterior end (two specimens) 115 and 200; number of testes 4–7 (6), an-

Table 1. Mammalian hosts and distribution of *Schistosoma incognitum* in Central Sulawesi, Indonesia.

Species	Locality				
	Lindu	Besoa	Napu	Kan-tewu	Kalamanta-Mamu
<i>Rattus exulans</i>	×	×	×		×
<i>Rattus hoffmanni</i>		×		×	×
<i>Rattus nitidus</i>				×	
<i>Cervus timorensis</i>	×				

terior testis 50–92 (68) long and 40–76 (56) wide, length of testes chain 100–320 (243), distance between ventral sucker and anterior testis 80–250 (189).

FEMALE: Nine selected specimens measured: length 4.3–7.1 mm (5.9 mm); width 110–150 (134); diameter of oral sucker 46–80 (57); diameter of ventral sucker 46–60 (57); distance between oral and ventral suckers 92–160 (135); anterior portion of esophageal gland 46–81 (64); posterior portion 34–58 (49); distance from cecal termination to posterior end 220–301 (261); distance from vitelline glands to posterior end 220–390 (305); length of ovary 250–400 (342); distance between ventral sucker and ovary 0.75–0.98 mm (0.88 mm).

EGG: (Figs. 2 and 3): Suboval with one side having slightly less curvature; short, stout, subterminal spine present. Forty eggs in fixed liver squashes measured: 92–127 (116) in length; 46–69 (60) in width; spine 4.6–11.5 (7.5).

Specimens have been deposited in the U.S. National Museum Helminth Collection: No. 74334. Remaining specimens are in the Helminth Collection, NAMRU-2, Jakarta, Indonesia.

Sympatric occurrence of *S. japonicum* and *S. incognitum*

In the Lindu and Napu Valleys, *S. japonicum* and *S. incognitum* were found in different individuals of the same rodent species, *R. exulans*, at 15 specific locations (Fig. 1). Both schistosome species were found concurrently in the same host on two occasions, once in Malapi and once in Tomado. In the Tomado case, a heterologous pair, a *S. incognitum* male and a *S. japonicum* female, were found in copula.

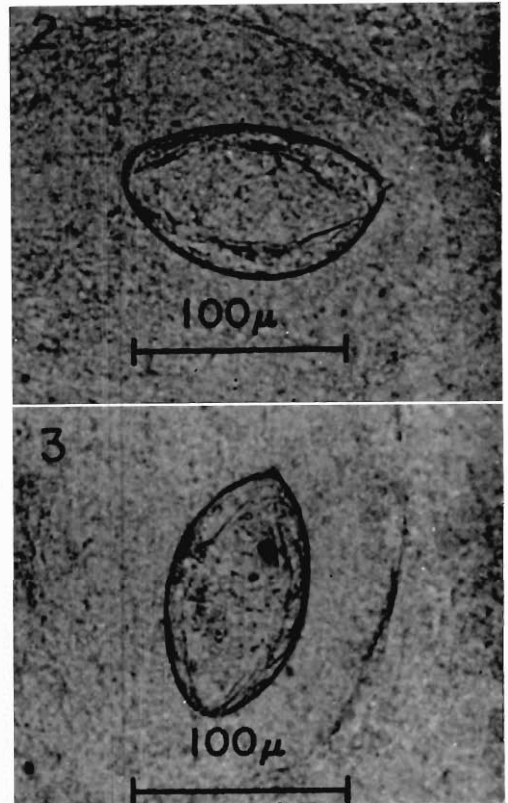

Figures 2 and 3. Eggs of *Schistosoma incognitum* in liver squash preparations illustrating position of spine in lateral and dorsal-ventral views.

Discussion

Comparable meristic characters of known geographic strains of *S. incognitum* are tabulated in Table 2. Specimens of the Sulawesi strain were generally smaller than those isolated from ricefield rats in Java (Carney et al., in press), but were larger than specimens recovered from rodents in Thailand (Lee and Wykoff, 1966) or from laboratory rats and mice in India (Sinha and Srivastava, 1965). Eggs of the Sulawesi strain closely approximated eggs of the Indian strain in size but were noticeably larger than those obtained from the Javanese strain.

Bonne et al., (1942) and Faust and Bonne (1948) described an immature mammalian schistosome which was originally obtained in

Table 2. Comparison of select meristic characters of *Schistosoma incognitum* from four geographical areas.

	Males			
	India	Thailand	Java	Sulawesi
Length*	2.43-8.86 (5.8)	2.6-5.6 (4.3)	4.4-7.5 (6.3)	4.2-7.6 (5.8)
Width	100-457 (296)	220-420 (290)	240-550 (330)	230-480 (330)
Oral sucker dia.	100-200 × 80-180 (150 × 120)	114-146 (128)	140-210 (176)	130-230 (181)
Ventral sucker dia.	85-260 (160)	135-177 (157)	190-240 (215)	170-250 (202)
No. of testes	2-7	6-8	5-7 (6)	4-7 (6)
Females				
Length*	2.57-7.57 (5.72)	2.6-5.6 (4.2)	5.5-7.5 (6.5)	4.3-7.1 (5.3)
Width	50-140 (110)	81-120 (100)	120-150 (133)	110-150 (134)
Oral sucker dia.	51-100 × 28-70 (78 × 50)	60-94 × 37-46 (77 × 41)	35-69 (57)	46-80 (57)
Ventral sucker dia.	30-57 (50)	28-48 (39)	40-76 (58)	46-60 (57)
Length of ovary	300-470 (357)	—	210-390 (286)	240-400 (342)
Eggs				
Length	97-148 (118)	85-106 (97)	86-136 (100)	92-127 (116)
Width	45-81 (61)	44-55 (50)	35-62 (49)	46-69 (60)
Length of spine	5-13 (7)	—	2.3-6.9 (4.7)	4.6-11.5 (7.5)
Source	Sinha and Srivastava, 1956	Lee and Wykoff, 1966	Carney et al., in press	This paper

* Length given in millimeters. All other measurements in microns.

the cercarial stage from lymnaeid mollusks. It was referred to as "The Lake Poso Blood Fluke." In view of the results of the present study, this schistosome may have been an immature *S. incognitum*. Although the molluscan host of the Sulawesi strain has not been determined, lymnaeids are confirmed intermediate hosts of *S. incognitum* in India (Sinha and Srivastava, 1960), Thailand (Harinasuta and Kruatrachue, 1967) and Java (Carney et al., in press). Likewise, extensive surveys throughout Central Sulawesi have revealed only two mammalian schistosomes, *S. incognitum* and *S. japonicum* (Carney et al., 1974d). However, some information about the Poso schistosome does not coincide with what has been reported for *S. incognitum* from other areas. When laboratory rats (2) and mice (2) were exposed to the Poso schistosome cercariae, development only took place in mice and flukes were still immature after eight weeks. The Javanese strain usually was patent by the eighth week (Carney et al., in press) and according to Sinha and Srivastava (1960) the Indian strain was patent after 36 days. Likewise, when Faust and Bonne (1948) described and discussed the identity of the Poso schistosome, they noted that, in contrast to other *Schistosoma* cercariae, these had only three pairs of penetration glands and they were all postacetabular. *Schistosoma incognitum* cercariae, as described by Sinha and Srivastava

(1960), possess five pairs of penetration glands, three postacetabular and two preacetabular. The preacetabular glands may have been present, but not readily visible, in formalin mixed specimens, examined years after they were collected. According to Stirewalt and Kruidenier (1961) preacetabular glands stain only after fixation in a neutral fluid and following a dehydration process which omits the lower alcohols. Studies of the helminth fauna in the Boejoempondoli area of the Poso Valley will be necessary to further clarify the identity of the Lake Poso Blood Fluke.

The occurrence of *S. incognitum* in *R. exulans*, *R. hoffmanni*, *R. nitidus* and *C. timorensis* from the high mountain valleys of Central Sulawesi, constitute new host and geographic distribution records for this helminth. Previously, it was known to be enzootic only in India (Sinha and Srivastava, 1956), Thailand (Lee and Wykoff, 1966) and Java, Indonesia (Carney et al., in press). Natural infections in rodents were previously reported by Lee and Wykoff (1966), Harinasuta and Kruatrachue (1967) and Carney et al. (in press).

An interesting, yet unexplained parallel, is found in the respective distributions of *S. japonicum* and *S. incognitum* in Sulawesi. To date, *S. incognitum* has only been found at higher elevations (more than 950 m) in the Lariang and Palu Valley drainage systems.

Oriental schistosomiasis transmission in Sulawesi is currently only confirmed in these same drainages and at elevations of 950 or more meters above sea level (Carney et al., 1975). Extensive studies of rodent parasites have been conducted throughout the Palu Valley at elevations of 100 meters or less but *S. incognitum* was not encountered (Van Peenen et al., 1974). Lymnaeid mollusks, *Radix auricularia rubiginosa* are abundant and widely distributed throughout the lowlands of Central Sulawesi and a variety of rodents live in close association with lymnaeids in ricefield areas. In Java, *S. incognitum* was hyperzootic in ricefield rats and lymnaeids at an elevation of 60 meters above sea level (Carney et al., in press). The reasons for the apparent absence in suitable lowland habitats in Sulawesi are unknown.

In India, dogs, pigs, and sheep were the only reported natural hosts of *S. incognitum* (Rao and Ayyar, 1933; Dutt and Srivastava, 1963), but experimentally the Indian strain developed in a wide range of mammals (Sinha and Srivastava, 1965). Monkeys (*Macaca mulatta*), however, were reportedly refractory. On the other hand, Dutt (1965 and 1967) infected 6 of 13 (46%) rhesus monkeys which he exposed to *S. incognitum* cercariae. Of those, only one yielded mature worms at necropsy and although mature eggs were found in liver squashes, none were detected in the intestinal wall or in feces 47 days post exposure. Subsequently, Ahluwalia (1972) attempted to further elucidate the zoonotic potential of the Indian strain of *S. incognitum*, but concluded that rhesus monkeys were poor hosts. Apparently, the schistosomes metamorphosed and developed normally for approximately 20 days; thereafter they succumbed to host defense mechanisms and were eliminated.

Surveys for intestinal parasites of humans throughout areas of Central Sulawesi where this schistosome is enzootic have not revealed a single instance of *S. incognitum* eggs in human stool specimens (Carney et al., 1974a, 1974b, 1974c; Clarke et al., 1974; Van Peenen et al., unpublished data). Similarly, in the Cikurai area of Java, where *S. incognitum* is hyperzootic in ricefield rats (Carney et al., in press; Joeseof et al., unpublished data) did

not report a human case. These studies agree with those conducted in India, subsequent to Chandler's (1926) original report of this blood fluke from human stools. However, in view of Dutt's (1965 and 1967) studies and those of Murrell et al. (1973) with strains of *S. japonicum*, caution should be exercised in assessing a schistosome's zoonotic potential only by studies in experimental animals and by only using the presence or absence of eggs in the feces as a criterion. Extensive disease, especially in the liver, can occur in the absence of eggs in stool specimens. The zoonotic potential of the Indian strain of *S. incognitum* is still an equivocal issue deserving further study. Furthermore, the zoonotic potential of strains of *S. incognitum* from Java, Sulawesi and Thailand, where this parasite has a snail-rodent cycle should be investigated.

Both the Indian strain of *S. incognitum* and classical *S. japonicum* possess the ability to infect and develop in a wide range of mammalian species. Further experimental work with Javanese, Thai and Sulawesi strains of *S. incognitum* may demonstrate similar flexibility in adapting to a wide range of mammalian species.

The heterologous pairings of two schistosome species reported herein raises questions concerning their potential hybridization. The occurrence of Oriental schistosomiasis is presently limited to the distribution of *Oncomelania hupensis*, with the exception of the Mekong strain of *S. japonicum* which utilizes another hydrobiid mollusk, *Lithoglyphopsis aperta* (Kitikoon et al., 1973) and, in fact, experimentally the Mekong strains will not develop in *O. hupensis* (Lo et al., 1971). *Schistosoma incognitum* utilizes lymnaeid mollusks which are ubiquitous throughout Asia. If hybridization produced viable offspring infective to humans, yet capable of using an ubiquitous intermediate host such as a lymnaeid, the hybrid schistosome would have potential range extending over much of Southeast Asia and other tropical and subtropical zones. For a schistosome, compatibility with a successful and widely distributed molluscan species would further insure survival by extending its distribution over a much larger geographic area.

Literature Cited

- Ahluwalia, S. S. 1972. Zoonotic potentials of *Schistosoma incognitum*. Indian J. Anim. Sci. 42: 962-964.
- Bonne, C., A. J. P. Borstlap, K. J. Lic, W. J. J. Molenkamp, and W. Nanning. 1942. Voortgezet bilharzia onderzoek in Celebes. Geneeskundig Tijdschrift voor Nederlandsch-India. 82: 21-36.
- Carney, W. P., S. Masri, Salludin, and J. Putrali. 1974a. The Napu Valley, a new schistosomiasis area in Sulawesi, Indonesia. Southeast Asian J. Trop. Med. Public Health 5: 246-251.
- , J. Putrali, S. Masri, and Salludin. 1974b. Intestinal parasites and malaria in the Bada and Gimpu areas of Central Sulawesi, Indonesia. Southeast Asian J. Trop. Med. Public Health 5: 534-540.
- , ———, and J. W. Caleb. 1974c. Intestinal parasites and malaria in the Poso Valley, Central Sulawesi, Indonesia. Southeast Asian J. Trop. Med. Public Health 5: 368-373.
- , Purnomo, M. Sudomo, P. F. D. Van Peenen, and J. Sulianti Saroso. 1974d. Mammalian schistosomes in Indonesia. Proceedings Third Int. Cong. Parasitol., Munich, Germany, 25-31 August 2: 801.
- , S. Masri, M. Sudomo, J. Putrali, and G. M. Davis. 1975. Distribution of *Oncomelania hupensis* in the Napu Valley of Central Sulawesi, Indonesia. Southeast Asian J. Trop. Med. Public Health 6: 211-218.
- , R. J. Brown, Purnomo, B. Ibrahim, P. F. D. Van Peenen, and C. R. Kocsharjono. *Schistosoma incognitum* from Cikurai, West Java, Indonesia. Int. J. Parasitol. In press.
- Chandler, A. C. 1926. A new schistosome infection of man, with notes on other human fluke infections in India. Indian J. Med. Res. 14: 179-183.
- Clarke, M. D., W. P. Carney, J. H. Cross, P. Hadidaja, S. Oemijati, and A. Joesoef. 1974. Schistosomiasis and other human parasitoses of Lake Lindu in Central Sulawesi (Celebes), Indonesia. Am. J. Trop. Med. Hyg. 23: 385-392.
- Dutt, S. C. 1965. On the susceptibility of *Macaca mulatta* to infection with *Schistosoma incognitum*. Curr. Sci. 34: 49-50.
- . 1967. Susceptibility of *Macaca mulatta* to *Schistosoma incognitum* with observations on pathology of the infection. Indian J. Med. Res. 55: 1173-1180.
- , and H. D. Srivastava. 1963. Incidence of schistosome infections in sheep. Proc. 50th Ind. Sc. Cong. III: 500.
- Faust, E. C., and C. Bonne. 1948. Mammalian blood flukes of Celebes. J. Parasitol. 34: 124-131.
- Harinasuta, C., and M. Kruatrachue. 1967. Studies on the morphology and life cycle of *Schistosoma incognitum* and its incidence in rats. The final technical report of the Bangkok School of Tropical Medicine to U.S. Army Medical R. and D. Command, Washington, Grant No. DA-MD-49-193-63-6166.
- Lee, H. F., and D. E. Wykoff. 1966. Schistosomes from wild rats in Thailand. J. Parasitol. 52: 323-326.
- Lo, C. T., E. G. Berry, and T. Iijima. 1971. Studies on schistosomiasis in the Mekong Basin. II. Malacological investigations on human *Schistosoma* from Laos. Chin. J. Microbiol. 4: 168-181.
- Kitihoon, V., C. R. Schneider, S. Sornmani, C. Harinasuta, and G. R. Lanza. 1973. Mekong schistosomiasis: 2. Evidence of natural transmission of *Schistosoma japonicum*, Mekong Strain, at Khong Island, Laos. Southeast Asian J. Trop. Med. Public Health 4: 350-358.
- Murrell, K. D., M. G. Yogore, Jr., R. M. Lewart, W. G. Clutter, and W. E. Vannier. 1973. Immunization with a zoophilic strain of *Schistosoma japonicum*: a re-evaluation of the formosan strain of *S. japonicum* in rhesus monkeys. Am. J. Trop. Med. Hyg. 22: 723-733.
- Rao, M. A. N., and L. S. P. Ayyar. 1933. *Schistosoma suis* n. sp. A schistosome found in pigs in Madras. Indian J. Vet. Sci. Anim. Husband. 3: 321-324.
- Sinha, P. K., and H. D. Srivastava. 1956. Studies on *Schistosoma incognitum* Chandler, 1926. I. On the synonymy and morphology of the blood-fluke. Parasitology 46: 91-100.
- , and ———. 1960. Studies on *Schistosoma incognitum* Chandler, 1926. II. On the life history of the blood fluke. J. Parasitol. 46: 629-641.
- , and ———. 1965. Studies on *Schistosoma incognitum* Chandler, 1926. On the host specificity of the blood fluke. Indian Vet. J. 42: 335-341.
- Stirewalt, M. A., and F. J. Kruidenier. 1961. Activity of the acetabular secretory apparatus of cercariae of *Schistosoma mansoni* under experimental conditions. Exp. Parasitol. 11: 191-211.
- Van Peenen, P. F. D., W. P. Carney, M. Sudomo, and J. Sulianti Saroso. 1974. Parasites of mammals in Gumbasa Valley, Central Sulawesi, Indonesia. Trop. Geogr. Med. 26: 352-358.

Helminth Parasites of Ruffed Grouse (*Bonasa umbellus*) from the Eastern United States*

WILLIAM R. DAVIDSON, GARY L. DOSTER, SAMUEL R. PURSGLOVE, JR., AND ANNIE K. PRESTWOOD

Southeastern Cooperative Wildlife Disease Study, Department of Parasitology, College of Veterinary Medicine, University of Georgia, Athens, 30602

ABSTRACT: During a 10-year period, 23 species of helminth parasites, including 9 trematodes, 3 cestodes, and 11 nematodes, were recovered from 327 ruffed grouse (*Bonasa umbellus*) from seven localities in the United States. Seventeen species, *Athesmia heterolecithodes*, *Brachylecithum orfi*, *Echinoparyphium* sp., *Leucochloridium pricei*, *Prosthogonimus* sp., *Tanasia zarudnyi*, *Davainea tetraoensis*, *Hymenolepis* sp., *Raillietina* sp., *Aproctella stoddardi*, *Ascaridia bonasae*, *Cheilospirura spinosa*, *Dispharynx nasuta*, *Diplotrianaoides* sp., *Heterakis bonasae*, *Oxspirura petrowi*, and *Syngamus trachea* were previously known from grouse, whereas six species, *Brachylaima virginiana*, *E. recurvatum*, *Strigea* sp., *Capillaria caudinflata*, *Gongylonema* sp., and *Strongyloides* sp. represented new host-parasite associations. Helminth parasitisms were more prevalent, intense, and diverse in juvenile birds when compared with adults. Only *D. nasuta* and *S. trachea* produced gross lesions. The helminth fauna of grouse from Pocahontas County, West Virginia, differed markedly from the helminth fauna of birds from Cheboygan and Otsego counties, Michigan. Grouse from adjacent, but distinct, habitats in Pocahontas County, West Virginia, had similar helminth faunas.

An extensive checklist of parasites from grouse of North America (Braun and Willers, 1967) included 28 genera and at least 37 species from ruffed grouse (*Bonasa umbellus*). These authors emphasized that the checklist generally was based on examinations of relatively few birds from few localities. Information on parasites of grouse of the southern Appalachian area was not available.

The present study compared the usual helminth fauna of ruffed grouse from two widely separated areas (Pocahontas County, West Virginia, and Cheboygan/Otsego counties, Michigan) over an extended period. Parasitologic data on grouse from additional areas supplemented these observations. Notes on pathogenicity of helminth parasites for ruffed grouse also are presented.

Materials and Methods

Ruffed grouse were searched for helminth parasites utilizing conventional parasitologic techniques. All birds were collected between

August and October by shooting. Studies in West Virginia included 200 birds and incorporated annual collections of 15 to 22 birds from 1965 to 1974. Birds examined from this study area were from two adjacent, but distinct, forest types (oak-hickory and northern hardwood). Eighty birds, 10 collected annually from 1967 through 1974, were obtained from Cheboygan and Otsego counties, Michigan. Additional studies in Georgia, Kentucky, Maine, Michigan (Iron County), and New York involved single collections of 6, 11, 10, 10, and 10 birds, respectively.

Age and sex of each bird was ascertained on the basis of internal anatomy. Where multiple collections of birds were examined, parasite faunas were compared by an index of similarity (Holmes and Podesta, 1968), and parasite dominance was studied by parasite profiles (Uhazy and Holmes, 1971).

Total monthly precipitation recorded by two weather stations (Buckeye and Seneca State Forest) near the West Virginia study area for a 5-month period immediately prior to each collection was obtained from the National Oceanic and Atmospheric Administration, U.S. Department of Commerce. Trends of precipitation were compared to trends of mean numbers of selected parasites.

* This study was supported by an appropriation from the Congress of the United States. Funds were administered and research coordinated under the Federal Aid in Wildlife Restoration Act (50 Stat. 917) and through Contract No. 14-16-0008-676, Fish and Wildlife Service, U.S. Department of the Interior.

Table 1. Helminth parasites recovered from 327 ruffed grouse from seven localities in the United States.

Location County(s) State No. birds examined	Towns/ Union, GA 6	Harlan/ Letcher, KY 11	Somerset, ME 10	Iron, MI 10	Cheboygan/ Otsego, MI 80	Jefferson/ Lewis, NY 10	Poca- hontas, WV 200
HELMINTH							
<i>Athesmia heterolecithodes</i> (Braun 1899) (74033)*	—	—	—	—	—	—	1% NA NA
<i>Brachylaima virginiana</i> (Dickerson 1930) (74034, 5 & 6)	—	55%† 3 1-9	—	—	6% 1 1-2	20% 9 5-12	12% 5 1-48
<i>Brachylecithum orfi</i> Kingston and Freeman, 1959 (74037)	—	—	—	40% 5 4-6	20% 15 3-53	—	—
<i>Echinoparyphium recurvatum</i> (Linstow 1873) (74038)	—	—	—	—	13% 27 1-209	—	—
<i>Echinoparyphium</i> sp. (74039)	—	—	20% 1 1	—	—	—	—
<i>Leucochloridium pricei</i> (McIntosh 1932) (74040)	—	—	10% 11 11	—	—	—	—
<i>Prosthogonimus</i> sp.	—	—	—	—	1% 1 1	—	—
<i>Strigea</i> sp.	—	—	—	—	1% 7 7	—	—
<i>Tanasia zarudnyi</i> (Skrjabin 1924)	—	—	—	—	4% NA NA	—	—
<i>Davainea tetraoensis</i> Fuhrmann, 1919 (74041)	—	—	—	40% 6 1-12	8% 5 1-15	10% 17 17	6% 70 1-293
<i>Hymenolepis</i> sp.	—	—	—	—	4% 1 1-2	10% 1	3% 4 1-7
<i>Raillietina</i> sp.	—	—	—	—	—	—	1% 18 4-31
<i>Aproctella stoddardi</i> Cram, 1931 (74042)	—	—	—	—	1% 11 11	—	—
<i>Ascaridia bonasae</i> Wehr, 1940 (74043)	100% 8 1-26	64% 5 1-19	80% 8 1-50	80% 2 1-5	50% 3 1-18	70% 2 1-7	32% 3 1-21
<i>Capillaria caudinflata</i> (Molin 1858)	16% 2 2	—	70% 2 1-3	20% 5 1-9	9% 2 1-3	50% 2 1-4	2% 1 1
<i>Cheilospirura spinosa</i> Cram, 1927 (74044)	—	—	—	—	6% 1 1-3	—	8% 2 1-5
<i>Diplotrriaenoides</i> sp. (74045)	—	—	—	—	3% 1 1	—	—
<i>Dispharynx nasuta</i> (Rudolphi, 1819) (74046)	—	—	10% 1 1	—	10% 3 1-8	—	6% 10 1-46
<i>Gongylonema</i> sp.	—	—	—	—	—	—	3% 1 1-2
<i>Heterakis bonasae</i> Cram, 1927 (74047)	100% 141 18-370	100% 645 49-2,002	—	10% 4 4	—	—	100% 485 7-2,924
<i>Oxspirura petrowi</i> (Skrjabin, 1929) (74048)	—	—	—	10% 2 2	58% 3 1-15	—	3% 1 1-3
<i>Strongyloides</i> sp. (74049)	—	—	—	—	—	20% 17 4-29	2% 7 2-18
<i>Syngamus trachea</i> (Montagu, 1811) (74050)	—	—	—	—	—	—	7% 1 1-4

* Numbers in parentheses represent USNM Helm. Coll. numbers.
 † Numbers in series are percent prevalence, average per infected bird, and range.
 NA = Information not available.

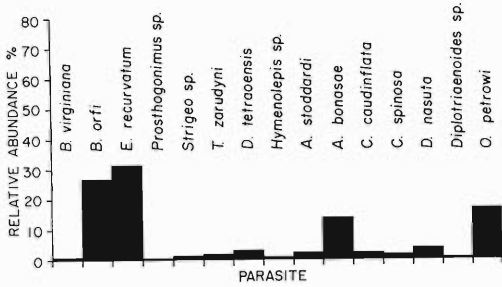

Figure 1. Helminth profile depicting the relative abundance (%) of each helminth in the parasite fauna of 80 ruffed grouse from Cheboygan and Otsego counties, Michigan.

Results

Twenty-three species of helminth parasites were recovered, including 9 trematodes, 3 cestodes, and 11 nematodes (Table 1). Ninety-eight percent of the grouse harbored at least one species of helminth. Specimens of parasites have been deposited in the U.S.N.M. Helminthological Collection (Table 1).

Compared with adult birds, juveniles had higher prevalences and/or intensities of infections with *Echinoparyphium recurvatum*, *Davainea tetraoensis*, *Ascaridia bonasae*, *Capillaria caudinflata*, *Dispharynx nasuta*, *Heterakis bonasae*, and *Syngamus trachea*. *Echinoparyphium recurvatum* occurred only in juvenile birds from Cheboygan and Otsego counties, Michigan whereas *S. trachea* occurred only in juvenile birds from the oak-hickory area in West Virginia. Adult birds had a higher prevalence and intensity of infection with *Brachylecithum orfi*. The remaining helminths generally occurred equivalently in juveniles and adults.

Parasite induced lesions were encountered infrequently. A proliferative proventriculitis, frequently with necrosis and sloughing of mucosa adjacent to the worms, was associated with *D. nasuta* infections. These lesions ranged from mild to severe and were noted in birds infected with only one worm. Similar lesions occasionally found in birds which did not harbor *D. nasuta* were attributed to previous infection with this parasite. Mild to severe tracheitis occasionally with the development of

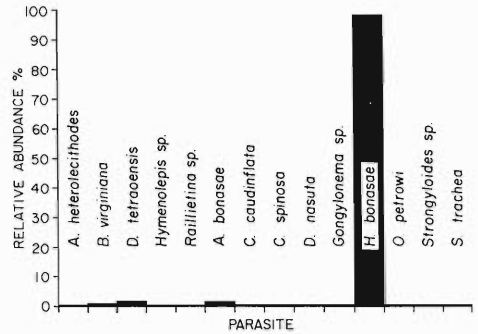

Figure 2. Helminth profile depicting the relative abundance (%) of each helminth in the parasite fauna of 200 ruffed grouse from Pocahontas County, West Virginia.

nodules in peritracheal tissues were attributed to infections with *S. trachea*.

Comparisons of Helminth faunas

Sufficient numbers of birds were examined from two areas, Pocahontas County, West Virginia, and Cheboygan and Otsego counties, Michigan, to permit computation of indices of similarity. An index of similarity of 34.1% was calculated for helminth species occurring in birds from these two areas. Separate indices for trematodes, cestodes, and nematodes were 13.3, 90.0, and 30.7%, respectively. Parasite profiles illustrating the relative abundance of helminths in birds from the two areas are presented in Figs. 1 and 2.

An index of similarity of 78.3% was calculated for helminths in birds from northern hardwood and oak-hickory habitats in Pocahontas County, West Virginia. Separate indices for trematodes, cestodes, and nematodes were 74.7, 59.4, and 83.8%, respectively. *Heterakis bonasae* comprised 99.0% of the total number of helminths in the northern hardwood birds and 95.9% in the oak-hickory birds.

Differences in the number of heterakids per infection were noted in birds from the two habitat types in West Virginia. Mean numbers of worms were consistently higher in birds from the northern hardwood area than in birds from the oak-hickory site. Average numbers of *H. bonasae* in northern hardwood grouse

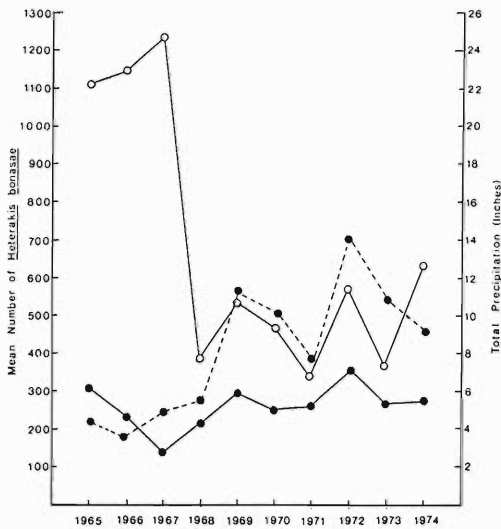

Figure 3. Precipitation for June and July and mean numbers of *Heterakis bonasae* in ruffed grouse from northern hardwood and oak-hickory habitats in Pocahontas County, West Virginia. Dashed line designates precipitation, open circle solid line designates grouse from northern hardwood areas, and solid circle solid line designates grouse from oak-hickory areas.

ranged between 339 and 1,231 worms, whereas average numbers of oak-hickory birds were between 140 and 350.

Yearly fluctuations in the number of heterakids also were observed with the most noticeable differences occurring in birds from the northern hardwoods. The mean number of heterakids per bird in the northern hardwoods declined precipitously between 1967 and 1968 and thereafter exhibited considerable fluctuations. From 1968 through 1973, the average number of heterakids in birds from these two study areas had similar trends; however, during other years trends were dissimilar.

From 1968 through 1973, total precipitation for a 5-month period prior to sampling and the mean number of heterakids had similar trends. The closest fit of precipitation and mean numbers of heterakids were obtained when total precipitation for the months of June and July were combined (Fig. 3). Correlation values for this period were " r " = 0.68 ($r_{.10}$ = 0.608) for the oak-hickory study site and " r " = 0.77

($r_{.05}$ = 0.707) for the northern hardwood site. Trends of precipitation and heterakids were dissimilar during the remaining years of the study.

Discussion

Most helminths recovered were previously known to infect ruffed grouse (Braun and Willers, 1967), although six species, *B. virginiana*, *E. recurvatum*, *Strigea* sp., *C. caudiflata*, *Gongylonema* sp., and *Strongyloides* sp., reported herein represent new host-parasite associations. Previous reports of ruffed grouse as new hosts of *A. heterolecithodes* (Byrd et al., 1967) and *Diplotrriaenoides* sp. (Eve and Davidson, 1976) also were from birds in this study.

In most cases, infection prevalences and intensities agreed with earlier studies (Connell and Doremus, 1937; Mueller, 1941; Levine and Goble, 1947; Erickson et al., 1949; and Spaulding, 1958). Infections with *D. nasuta* generally were less severe than those reported from grouse in New York (Goble and Kutz, 1945a; Levine and Goble, 1947). Similarly, numbers of *D. tetraoensis* were substantially lower than those reported in birds from Ontario (Dick and Burt, 1971). Numbers of *H. bonasae* in birds from Georgia, Kentucky, and West Virginia were much higher than all previous reports.

Juvenile grouse generally had higher prevalences and intensities of infection than adults. Helminth diversity also was higher in juveniles than adults with juveniles harboring 96% and adults only 59% of the species. The majority of the helminth species recovered utilize invertebrate intermediate hosts. Invertebrates are principal food items for grouse chicks, whereas adults utilize mainly plant food (Bump and Jones, 1947). The disparity in helminth distributions in the two age classes therefore appears to be related to diet. Differential age distributions in the intensity of helminth infections also have been noted in several passerine birds (Cooper and Crites, 1976), although these authors reported a more diverse helminth community in adults.

Only *D. nasuta* and *S. trachea* produced lesions severe enough to warrant consideration as primary pathogens. Goble and Kutz (1945a) estimated that of 142 grouse infected with *D.*

nasuta, 30% of the juveniles and 33% of the adults would succumb as a direct result of the parasites. Some *D. nasuta* infections encountered during this study were comparable to infections Goble and Kuntz (1945a) described as ultimately resulting in death of the host. These authors also noted that grouse from certain regions in New York were heavily parasitized whereas grouse from other areas were not infected. Data from the present study substantiated Goble and Kuntz's (1945a) conclusion that *D. nasuta* is not a significant problem in all areas.

Goble and Kutz (1945a) also reported a clinically ill juvenile grouse infected with four pairs of *S. trachea*. Based on their report and on observations in domestic poultry (Wehr, 1972), some juvenile grouse infected with *S. trachea* probably die as a direct result of the infection.

The absence of significant lesions attributable to other helminths, at least in the numbers encountered, suggests that these helminths are unimportant as primary pathogens in ruffed grouse.

The low index of similarity (34.1%) and marked differences in parasite profiles (Figs. 1 and 2) for grouse from Pocahontas County, West Virginia, and Cheboygan and Otsego counties, Michigan, confirm that birds from these two areas support strikingly different helminth communities. Principal differences between the helminth faunas of the two areas were the frequent occurrences of *B. orfi*, *E. recurvatum*, and *O. petrowi* in grouse from Michigan and the dominance of *H. bonasae* in West Virginia. Although only limited numbers of birds were available, *H. bonasae* also predominated in Georgia and Kentucky, suggesting that this helminth is the most common parasite of grouse in the southern Appalachian region. Birds from outside the southern Appalachian region did not exhibit striking similarities in helminth communities, although *H. bonasae* was noticeably absent from most areas.

The helminth faunas of grouse from adjacent northern hardwood and oak-hickory habitats in West Virginia had a high index of similarity (78.3%), with *H. bonasae* as the dominant species in birds from both areas. Although basically similar, there were detectable differences in parasite communities of birds

from the two areas as evidenced by the absence of *S. trachea* and the lower numbers of *H. bonasae* in birds from the oak-hickory area.

Differences in helminth communities probably were due to distributions of suitable intermediate hosts and other definitive hosts and differences in habitat as Hon et al. (1975) postulated for wild turkey (*Meleagris gallopavo*) helminths. Regional variations in helminth communities suggest that future evaluations of helminth parasitism in ruffed grouse should be made on a regional basis since extrapolation of data may lead to incorrect conclusions.

For 6 of 10 years, numbers of *H. bonasae* in grouse from West Virginia appeared related to the amount of precipitation prior to sampling. Similar trends between precipitation and numbers of *Heterakis* spp. in wild turkeys were observed by Prestwood (1968). Lund et al. (1966) further noted that acquisition of *H. gallinarum* often occurred within 1 to 2 days after a rain. This phenomenon was attributed to the fact that earthworms, which act as concentrating agents for heterakid larvae, are more readily available following rains (Lund et al., 1966; Reid, 1967). Other factors—viz., grouse population density—also probably interact to influence the numbers of *H. bonasae* since numbers of worms did not appear to be related to precipitation during all years.

Data from this study indicate that multiple variables, such as host age, habitat, region, and environmental conditions, should be considered when evaluating parasitism among ruffed grouse. Delineation of these variables in conjunction with baseline parasitologic data presented herein should be useful for comparative purposes during future studies.

Acknowledgments

The authors wish to thank personnel of the game and fish agencies of Georgia, Kentucky, Maine, Michigan, New York, and West Virginia for invaluable assistance during this study. The efforts of past and present co-researchers during this long-term study also contributed immensely to its completion.

Literature Cited

Braun, C. E., and W. B. Willers. 1967. The helminth and protozoan parasites of North

- American grouse (Family: Tetraonidae): A checklist. *Avian Dis.* 72: 241-245.
- Bump, G. A., and J. C. Jones.** 1947. Food habits and requirements, p. 181. *In* G. Bump et al. (eds.), *The Ruffed Grouse: Life History, Propagation, and Management*. The Holling Press, Inc., Buffalo, N.Y.
- Byrd, E. E., A. K. Prestwood, F. E. Kellogg, and R. W. Heard.** 1967. New hosts and locality records for the large liver fluke, *Athesmia heterolecithodes* (Braun, 1899) Looss, 1899 (Dicrocoeliidae) of birds and mammals. *J. Parasitol.* 53: 1116-1117.
- Connell, F. H., and H. M. Doremus.** 1937. Endoparasitism in ruffed grouse near Hanover, New Hampshire. *Auk* 54: 321-323.
- Cooper, C. L., and J. L. Crites.** 1976. Community ecology of helminth parasitism in an insular passerine avifauna. *J. Parasitol.* 62: 105-110.
- Dick, T. A., and M. D. B. Burt.** 1971. The life cycle and seasonal variation of *Davainea tetraoensis* Fuhrmann 1919, a cestode parasite of ruffed grouse, *Bonasa umbellus* (L.). *Can. J. Zool.* 49: 109-119.
- Erickson, A. B., P. R. Highby, and C. E. Carlson.** 1949. Ruffed grouse populations in Minnesota in relation to blood and intestinal parasitism. *J. Wildl. Manage.* 13: 188-194.
- Eve, J. H., and W. R. Davidson.** 1976. Blood parasites of ruffed grouse (*Bonasa umbellus*) from Kentucky, Maine, Michigan, and West Virginia. *J. Parasitol.* 62: 142-144.
- Goble, F. C., and H. L. Kutz.** 1945a. The genus *Dispharynx* (Nematoda: Acuariidae) in galliform and passeriform birds. *J. Parasitol.* 31: 323-331.
- , and ———. 1945b. Notes on the gape-worms (Nematoda: Syngamidae) of galliform and passeriform birds in New York State. *J. Parasitol.* 31: 394-400.
- Holmes, J. C., and R. Podesta.** 1968. The helminths of wolves and coyotes from the forested regions of Alberta. *Can. J. Zool.* 46: 1193-1204.
- Hon, L. T., D. J. Forrester, and L. E. Williams, Jr.** 1975. Helminths of wild turkeys in Florida. *Proc. Helminthol. Soc. Wash.* 42: 119-127.
- Levine, P. P., and F. C. Goble.** 1947. Parasitism and disease, p. 401. *In* G. Bump et al. (eds.), *The Ruffed Grouse: Life History, Propagation, and Management*. The Holling Press, Inc., Buffalo, N.Y.
- Lund, E. E., E. E. Wehr, and D. J. Ellis.** 1966. Earthworm transmission of *Heterakis* and *Histomonas* to turkeys and chickens. *J. Parasitol.* 52: 899-902.
- Mueller, J. F.** 1941. Some parasites newly recorded for the ruffed grouse, *Bonasa umbellus*, in the United States. *Proc. Helminthol. Soc. Wash.* 8: 14-15.
- Prestwood, A. K.** 1968. Parasitism among wild turkeys (*Meleagris gallopavo silvestris*) of the Mississippi delta. Ph.D. dissertation, Univ. of Georgia, Athens, 67 p. + appendix.
- Reid, W. M.** 1967. Etiology and dissimulation of the blackhead disease syndrome in turkeys and chickens. *Exp. Parasitol.* 21: 249-275.
- Spaulding, W. M.** 1958. A survey of parasites of the ruffed grouse (*Bonasa umbellus*) in Ottawa National Forest. M.S. thesis, Univ. of Michigan, Ann Arbor, 56 p.
- Uhazy, L. E., and J. C. Holmes.** 1971. Helminths of the Rocky Mountain bighorn sheep in western Canada. *Can. J. Zool.* 49: 507-512.
- Wehr, E. E.** 1972. Nematodes and acanthocephalans, p. 844. *In* M. S. Hofstad et al. (eds.), *Diseases of Poultry*. 6th ed. Iowa State Univ. Press, Ames.

Editor's Note

Authors submitting manuscripts of a survey or taxonomic nature for publication in the Proceedings of the Helminthological Society of Washington are urged to deposit representative specimens in a recognized depository such as the National Parasite Collection at Beltsville, Maryland and include the accession numbers in the manuscript.

Redescription of *Choledocystus hepaticus* (Lutz, 1928) n. comb., and the status of *C. linguatula* (Rudolphi, 1819) (Trematoda: Plagiorchioidea)¹

JAMES J. SULLIVAN²

Department of Zoology, University of Georgia, Athens, Georgia 30601

ABSTRACT: *Choledocystus hepaticus* (= *Plagiorchis h.*) is redescribed and figured from specimens collected in northeastern Venezuela, considered a senior synonym of *C. intermedius* Caballero y C., and included in the Plagiorchiidae Lühe, 1901. The relative sizes of the suckers and pharynx are evaluated as taxonomic characters by size allometry. *Glythelmins parva*, *G. simulans*, *C. eucharis*, *C. vesicalis*, and *C. elegans* are considered synonyms of *C. linguatula* which is distinguished from *C. hepaticus* by egg size, sucker ratios, and extent of the vitellaria.

In June 1969, a total of 19 digenetic trematodes recovered from the hepatic ducts of one of seven *Bufo marinus* (L.) in Turrialba, Costa Rica were identified as a species of *Choledocystus* Pereira and Cuocolo, 1941. In September 1970, this same species was found in eight of 39 *B. marinus* collected in several localities in northeastern Venezuela; these eight *B. marinus* harbored from four to 36 worms in the liver and/or gall bladder with the exception of one toad in which three worms were found in the small intestine in addition to four found in the liver. Two other specimens of this fluke were recovered from the intestine of one of five *Hyla crepitans* Weid collected near Campoma, Venezuela.

Although referable to *Choledocystus*, this species agrees morphologically with *Plagiorchis hepaticus* Lutz, 1928. Caballero y C. and Diaz-Ungria (1958) synonymized *P. hepaticus* and *Choledocystus intermedius* Caballero y C., Bravo H. and Cerecero, 1944, but designated *P. hepaticus nomen nudum*. Yamaguti (1958, 1971) accepted *P. hepaticus* as valid, but he (1971) did not restate his (1958) referral of this species to *Ochetosoma monstrosus* Braun, 1901. However, Yamaguti (1971) recognized his (1958) transfer of *C. intermedius* to *Glythelmins* Stafford, 1905.

Choledocystus was initially distinguished from *Glythelmins* by the absence of a seminal receptacle in the former (Pereira and Cuocolo, 1941), and later by the configuration of the ascending uterus and the presence, in *Choledocystus*, of a small suckerlike structure surrounding the genital atrium (Ruiz, 1949). Ruiz (1949) transferred *Glythelmins elegans* Travassos, 1926, to *Choledocystus*, a position not inconsistent with Rankin's (1944) findings that *G. elegans* and *C. linguatula* (Rudolphi, 1819) "... show characters that may possibly eliminate them from ..." *Glythelmins*. Noting that *G. elegans*, *C. eucharis* Pereira and Cuocolo, 1941, and *C. vesicalis* Ruiz and Leao, 1942, were all reported from Sao Paulo, Brazil, but acknowledging differences in anuran hosts and sites of infection, Ruiz (1949) synonymized the three and designated *C. elegans* as type by priority with *C. intermedius* as the only other valid species in the genus.

Ruiz (1949) regarded uterine configuration and the shape of the plagiorchid excretory bladder as optimal generic characters but cautioned that in the case of transitional bladder forms, the establishment of a fixed limit for generic determination was an artificial though practical concept. Although the bladders of *C. elegans*, *C. eucharis*, and *C. vesicalis* were respectively described as Y-shaped (Travassos, 1926), tubular (Pereira and Cuocolo, 1941), and Y-shaped with short arms and a long trunk (Ruiz and Leao, 1942), Ruiz (1949) interpreted these as being transitional between the I- and Y-shaped forms.

Babero (1951) accepted *Choledocystus*, and using Rankin's (1944) differential criteria, sug-

¹ This study was supported in part by a Grant-in-Aid of Research from the Society of the Sigma Xi, by travel funds provided by the Department of Zoology, University of Georgia, and in part by Grant AI 10051 (UC ICMR) to the Department of International Health, School of Medicine, University of California, San Francisco, from the National Institute of Allergy and Infectious Diseases, National Institutes of Health, U.S. Public Health Service.

² Present address: Central America Research Station, c/o U.S. Embassy, APO New York, N.Y. 09889.

gested transfer of *Glythelminis festina* Cordero, 1944, to that genus, and synonymy of *G. simulans* Teixeira de Freitas, 1941, and *G. sera* Cordero, 1944, with *G. linguatula*. Babero also indicated that a new genus could be created for South American species of *Glythelminis* or that that genus could be emended to include them. Alternatively, Babero (1951) suggested division of *Glythelminis* into two groups based on the presence or absence of pharyngeal glands and development of pretesticular uterine coils. He included *G. linguatula* and *G. simulans*, among others, in the group, representing a new genus, characterized by lacking pharyngeal glands but having pretesticular uterine coils. Babero (1951) also noted the apparent intermediate position of *G. parva* Travassos, 1924, which lacked both pharyngeal glands and pretesticular uterine coils.

Excepting *G. festina*, Cheng (1959) transferred all South American species of *Glythelminis* to *Margeana* Cort, 1919, the only substantial difference between the two being the presence or absence of pharyngeal glands. In suppressing Cheng's reinstatement of *Margeana*, Byrd and Maples (1963) maintained that the unreliable staining characteristics of pharyngeal glands rendered these glands taxonomically "worthless," a position originally held by Miller (1930) and supported by Nasir (1966). In their revision of the glythelminth trematodes, Byrd and Maples (1963) assigned the species to *Glythelminis*, *Choledocystus* or *Repandum* Byrd and Maples, 1963, on the bases of the inter- or extracecal configuration of the uterus coupled with the presence or absence of pretesticular uterine coils. However, Nasir (1966) retained all previously described glythelminths as well as two new species in *Glythelminis*. Travassos et al. (1969) and Martin (1969) accepted *Choledocystus*, but Martin (1969) considered Byrd and Maples (1963) transfer of *G. pennsylvaniensis* Cheng, 1961, to that genus premature. Sullivan and Byrd (1970) provisionally retained *G. pennsylvaniensis* in *Choledocystus*, stressing uterine configuration in separating *Glythelminis* and *Choledocystus*.

Nasir and Diaz (1970) recognized 13 valid species in *Glythelminis* including *G. linguatula* (= *G. festina*), *G. parva* (= *G. elegans*, *G.*

simulans, and *C. eucharis*), and *G. vesicalis* (= *G. intermedia*). Sullivan (1976) divided the glythelminths into two groups based on the I- or Y-shaped bladder; North American, one Central American and Asian glythelminths were characterized by I-shaped bladders, and retained in *Glythelminis* in the Macroderoididae McMullen, 1937.

The present study considers those South American forms, chiefly allied to *Choledocystus linguatula* Byrd and Maples, 1963, and the one Central American species which are characterized by a Y-shaped bladder and which also demonstrate an extracecal uterine configuration as well as development of pretesticular uterine coils. The predominantly Neotropical glythelminths which have a Y-shaped bladder but an intercecal uterus with pretesticular coiling have been considered elsewhere (Sullivan, 1977). Additionally, *Plagiorchis hepaticus* is transferred to *Choledocystus* and designated *Choledocystus hepaticus* n. comb. Since the original description of *C. hepaticus* consisted only of a figure, a written description of the species is included below. However, the well-executed figure of Lutz (1928) leaves no doubt to the specific identity of *C. hepaticus*.

Providing for analysis of changes in the size relationships between body and organs, size allometry has been recently used in studying several species of digenetic trematodes (Thomas, 1965; Rohde, 1966; Fischthal and Kuntz, 1967). Accordingly, size allometry is used to examine the taxonomic value of the size relationships of the suckers and pharynx, characters used to separate forms allied to *C. hepaticus*. Basic trends in size allometry are examined by use of the allometric equations, $Y = bX^\alpha$, in which Y = organ size, X = body size; b and α are constants termed the initial growth constant and the allometric constant, respectively (Simpson et al., 1960). When $\alpha = 1$, rate of increase of organ size equals that of body size. When $\alpha < 1$, rate of increase of organ size is less than that of body size, and when $\alpha > 1$, organ size increases at a rate greater than that of body size.

Materials and Methods

Trematodes used for whole-mounts were heat-killed in 0.7% saline under slight cover-

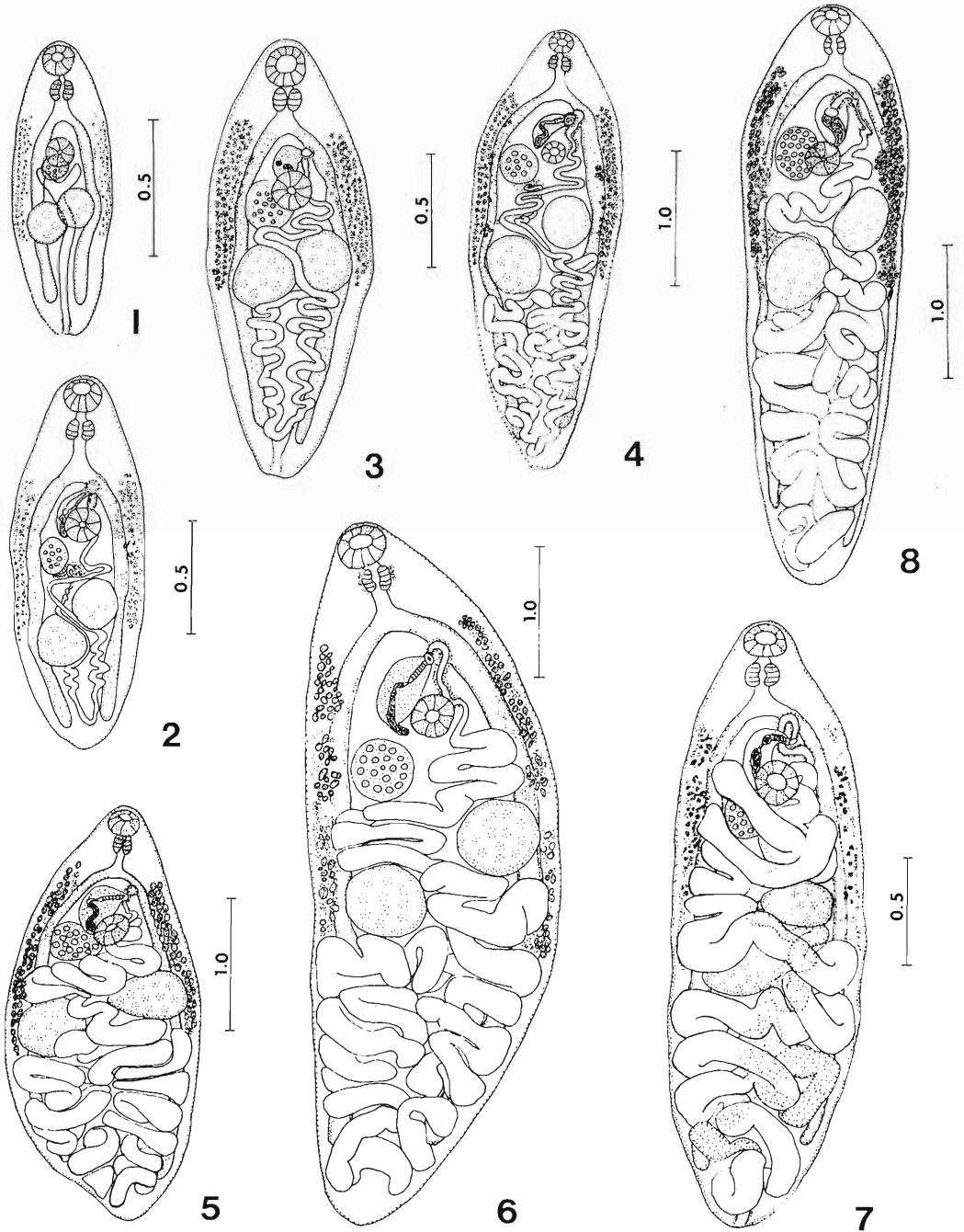

Figures 1-8. *Choledocystus hepaticus* n. comb. (Scales in mm). 1-3. Young specimens from the liver of *Bufo marinus* (Sucre, Venezuela). Note the form of the excretory bladder (Fig. 1), uterine configurations, and the relative body lengths posterior to the testes. 4-5. Somewhat more mature specimens from

slip pressure, fixed in alcohol-formalin-acetic acid solution (AFA), and stained with Harris hematoxylin. Eight μm sections were prepared from specimens fixed in AFA without flattening and stained with Harris hematoxylin and eosin. Sectioned and entire worms were mounted in Permount. In addition to specimens collected by the author, two *G. intermedia* from *B. marinus* collected in 1947 by M. Bravo H. in Tuxtepec, Oaxaca, Mexico were examined as were two *G. linguatula* of Nasir and Diaz (1970) from *B. granuloso* from La Llanada de San Juan, Sucre, Venezuela. Unless otherwise indicated, all measurements are in μm with the mean in parentheses. Figures were drawn with the aid of a Wild drawing tube. Size allometry data were derived from body and organ sizes calculated as the product of the length (L) times width (W) divided by 2, $[(L \times W)/2]$. Constants of the allometric equation ($Y = bX^\alpha$) and correlation coefficients (r) (Table 1) were determined using a linear regression program on an IBM 350 (Model 65) computer. Individual measurements for trematodes used in this study are available elsewhere (Sullivan, 1972).

Choledocystus hepaticus (Lutz, 1928)
n. comb.
(Figs. 1-10)

SYNONYMS: *Plagiorchis hepaticus* Lutz, 1928; *Choledocystus intermedius* Caballero y C., Bravo H. and Cerecero, 1944; *Glypthelminis intermedia* (Caballero y C., Bravo H. and Cerecero, 1944) Yamaguti, 1958.

DESCRIPTION (measurements based on 71 specimens from the livers of *Bufo marinus* collected in Venezuela): Body elongate, 1,110-6,210 (3,800) long by 380-2,470 (1,420) wide at level of testes; spines distributed over entire body surface. Oral sucker subterminal, 120-380 (230) by 130-370 (270); acetabulum medial, usually in anterior third of body, 130-440 (280) by 140-460 (270). Ratio of

Table 1. Constants of the allometric equation, $Y = bX^\alpha$, for the suckers and pharynx of Venezuelan *Choledocystus hepaticus* ($n = 71$), $r =$ correlation coefficient, $P =$ significance probability.

	b	α	r	P
Oral Sucker	.016	.675	.928	<.001
Ventral Sucker	.016	.845	.959	<.001
Pharynx	.008	.591	.905	<.001

acetabulum to oral sucker 1.08 ± 0.08 . Prepharynx present. Pharynx muscular, 90-250 (170) by 90-260 (180). Esophagus variable in length from 60 to 340. Ceca reaching to near posterior extremity. Testes spherical to transversely elongate, regular in outline, diagonally situated in midregion of body; anterior testis sinistral, 160-740 (440) by 150-750 (510); posterior testis 180-700 (490) by 160-850 (560). Cirrus pouch sacculate, 110-870 (490) by 60-370 (250), containing uncoiled seminal vesicle with posterior portion of vesicle occasionally protruding from base of cirrus pouch, sometimes overlapped by acetabulum. Ovary dextral, spherical, regular in outline, pretesticular from zone of anterior testis to zone of acetabulum, 120-510 (370) by 110-590 (410). Laurer's canal present, extending dorsally from proximal portion of oviduct to opening on dorsal body wall behind Mehlis' gland. Mehlis' gland situated dorsally to posterior portion of ovary and extending into postovarian region. Uterine seminal receptacle present. Uterus extracecal with transverse coils filling entire body posterior to testes; preacetabular uterine coiling developed with coils occasionally filling entire forebody to level of genital pore. Metraterm straight or coiled, approximately as long as cirrus pouch. Genital pore preacetabular, median to submedian in position. Vitellaria follicular, in lateral fields of body, overlapping ceca dorsally and ventrally, commencing at level of bifurcation and

←

B. marinus. Note pretesticular uterine development. 6. Mature specimen from *B. marinus* showing extracecal development of the uterus, and protrusion of the seminal receptacle from the base of the cirrus pouch. 7. Mature specimen from small intestine of *Hyla crepitans*; descending uterus is indicated by stippling; note uterine development in ovarian zone. 8. Specimen from the liver of *B. marinus* from Tuxtepec, Oaxaca, Mexico (Original).

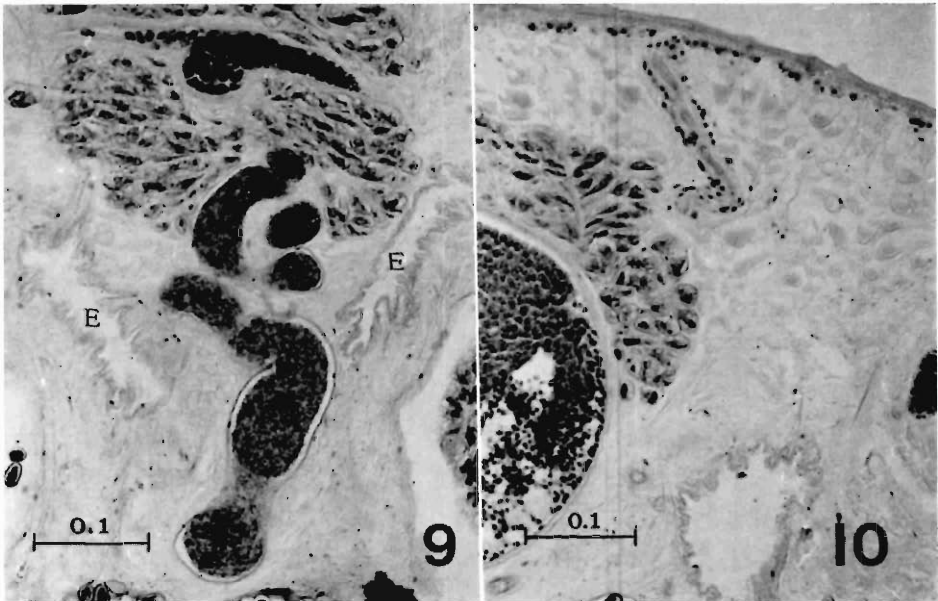

Figures 9–10. *Choledocystus hepaticus* n. comb. (Scales in mm). 9. Cross section at the level of the yolk reservoir showing uterine seminal receptacle (proximal portion of the uterus) and two arms of the excretory bladder (E). 10. Cross section at ovarian level showing Laurer's canal.

extending to or slightly beyond level of posterior testis. Eggs operculated, 17–24 (21) by 8–14 (11) (based on 30 eggs in whole-mounted worms). Excretory bladder Y-shaped with long trunk bifurcating between testes; arms reaching to acetabular level.

HOSTS AND LOCALITIES (*new locality record, †new host record): *Bufo granulosus* Spix, La Llanada de San Juan, Cumaná, Venezuela (Nasir and Diaz, 1970); *B. horribilis* (Weigmann), La Carrasquilla, Panama (Caballero y C. et al., 1956); *B. marinus* (L.), Maracay, Aragua, Venezuela (Lutz, 1928), Huixtla, Chiapas, Mexico (Caballero y C. et al., 1944), Tuxtpec, Oaxaca, Mexico (Bravo H., 1948), Piedades de Santa Ana, San Jose, Costa Rica (Caballero y C. et al., 1957), Turrialba, Costa Rica (Sullivan and Byrd, 1970), La Llanada de San Juan, Cumaná, Venezuela (Nasir and Diaz, 1970), *Bordones, *Cumanacoa, *Cocolar, and *Campoma, Venezuela (present study); †*Hyla crepitans* Weid., *Campoma, Venezuela (present study).

SITES OF INFECTION: Liver and small intestine.

SPECIMENS: USNM Helm. Coll. No. 72276. Other specimens in the author's collection.

Discussion

Comparison of Mexican and Costa Rican *Choledocysts intermedius* with *C. hepaticus* collected by the author in Venezuela supports the synonymy of the two advanced by Caballero y C. and Diaz-Ungria (1958). However, since Lutz' (1928) account of *P. hepaticus* satisfies Articles 12 and 16 of the International Code of Zoological Nomenclature, Caballero y C. and Diaz-Ungria erred in designating *P. hepaticus nomen nudum*. Consequently, *C. hepaticus* has priority over *C. intermedius*.

In the writer's opinion, the *Glyphthelmins vesicalis* and *G. linguatula* of Nasir and Diaz (1970) are *C. hepaticus* recovered primarily from the biliary ducts and gall bladder of *B. marinus* and the intestine of *B. granulosus*, respectively. Nasir and Diaz state that the oral sucker is smaller than the ventral in *G. vesicalis* but equal to the ventral in *G. linguatula*. However, these authors reported that *G. vesicalis* is somewhat larger (3.584–4.704

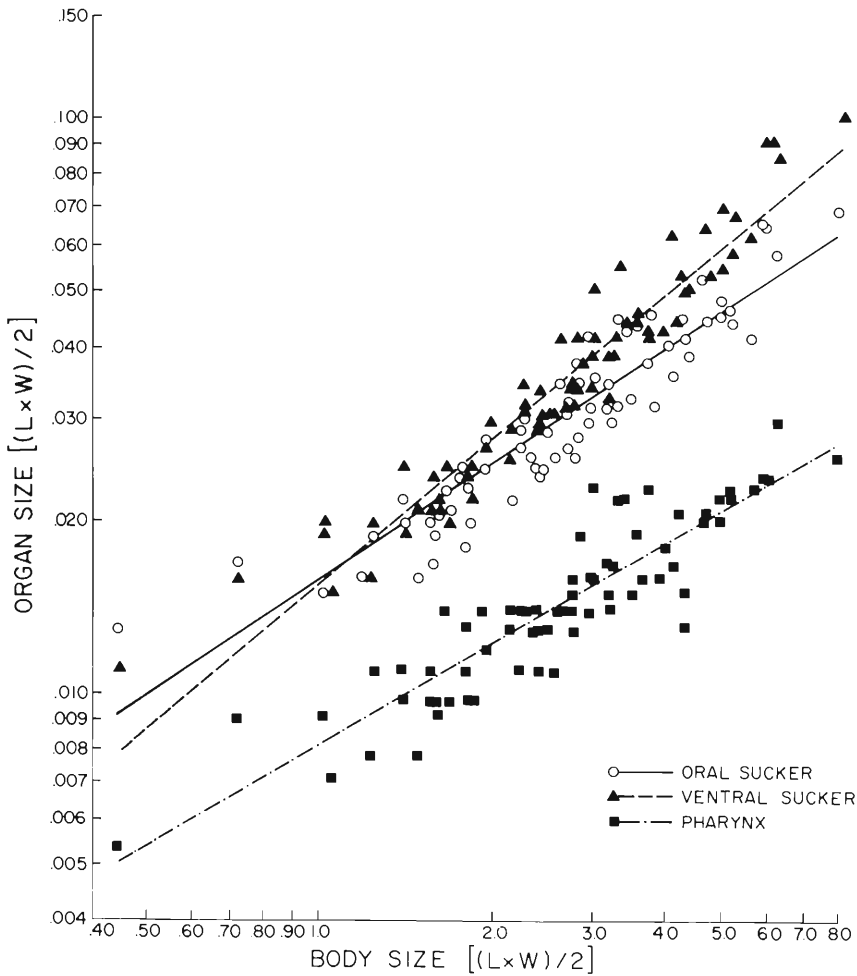

Figure 11. Allometric relationships between oral and ventral suckers and pharynx and body size in Venezuelan *C. hepaticus*.

mm by 1.344–2.240 mm) than *G. linguatula* (1.472–2.412 mm by 0.576–0.798 mm), but that in both forms, the ratio between the pharynx and oral sucker was identical (1.0 : 1.6).

Size allometry for the oral and ventral suckers and pharynx for 71 Venezuelan *C. hepaticus* (see description for size range of worms) indicates a strong relationship between the sizes of these organs and body size (Table 1). The evidence suggests that the size increase of the ventral sucker occurs at a faster rate than that of the oral sucker (Fig. 11), so that, al-

though the ventral sucker is smaller than the oral in small specimens, this size relationship is reversed in larger worms. Similarly, size allometry of the pharynx shows that this organ is consistently smaller than the oral sucker throughout the size range of worms examined (Fig. 11).

This writer accepts the synonymies *C. elegans* (= *C. eucharis* and *C. vesicalis*) and *G. linguatula* (= *G. simulans*) advanced by Ruiz (1949) and Babero (1951), respectively, and agrees with the transfer of *G. festina* and *G. linguatula* to *Choledocystus* by Byrd and

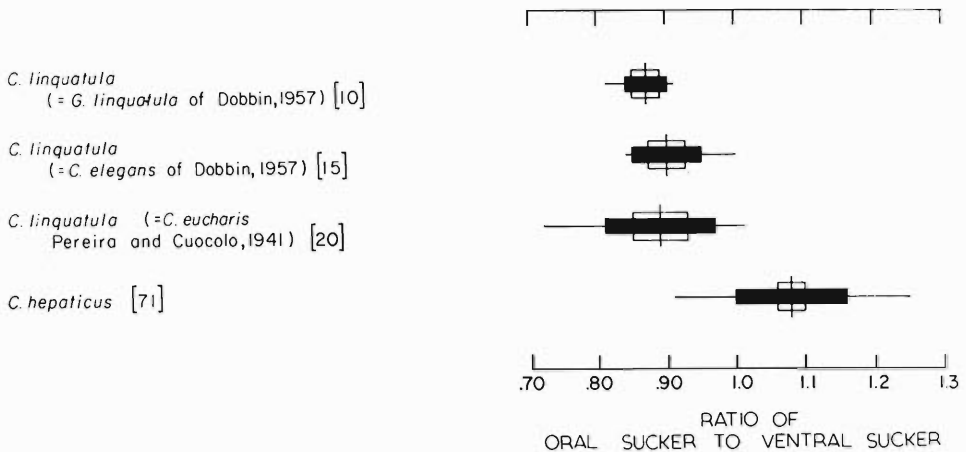

Figure 12. Sucker ratios (oral sucker = 1) of *C. linguatula* and *C. hepaticus*. The vertical line is the mean, the horizontal line the range; the solid rectangle represents one standard deviation on either side of the mean, and the open rectangle the 95% confidence interval of the mean. The numbers in brackets are the numbers of individual measurements.

Maples (1963). However, comparison of Dobbin's (1957) figures of *C. linguatula* and *C. elegans* obviates Travassos' (1926) separation of these two species by uterine configuration and body form. Dobbin (1957) separated the two by the presence of a seminal receptacle in *C. linguatula* and its absence in *C. elegans* and by the presence of the former in the intestine and the latter in the gall bladder. However, Dobbin recorded a seminal receptacle in only 20% of his *C. linguatula* while his second distinction is not supported by Travassos (1926) who reported *C. elegans* in the small intestine of its anuran host. A similar situation obtains for *C. hepaticus* which can be found in both the hepatic system and the intestine of its hosts. Therefore, *C. elegans* is considered a junior synonym of *C. linguatula*.

In separating *G. linguatula* from *G. parva*, Nasir and Diaz (1970) indicated that the ovary was smaller than the testes in the former but equal in size to the testes in the latter. This distinction is not substantiated by the original description (Travassos, 1924), in which ovarian size is not stated, but for which the accompanying figure shows the ovary to be distinctly smaller than the testes. Travassos (1924) described *G. parva* (1.3 mm long) as a "miniature" of *G. linguatula* (2.2–3.3 mm long) from which it was also distinguished by

relative size of the gonads and disposition of the vitellaria. Size allometry indicates that the relative size of the gonads in several glypt-helminth species can change with respect to body size (Sullivan, 1972); this consideration and the variation in the position of the vitellaria noted for both *G. linguatula* and *G. parva* by Travassos (1924) indicates that *G. parva* is a synonym of *C. linguatula*. Interpretation of *G. parva* as an immature rather than a "miniature" form of *C. linguatula* could explain Babero's (1951) observation that pretesticular uterine coils were not developed in *G. parva*, which would be consistent with similar findings for immature *C. hepaticus*.

Morphological considerations indicate that *C. hepaticus* is most closely related to *C. linguatula*, but the two can be distinguished by sucker ratios (Fig. 12) and egg size. Further, the vitellaria in *C. hepaticus* are confined to the area extending from the esophageal zone to the level of the posterior testis, whereas the vitellaria in *C. linguatula* extend more posteriorly, occasionally reaching the cecal ends.

Nasir and Diaz' (1970) synonymy of *G. festina* with *G. linguatula* is questionable. Although the two are morphologically similar, Cordero's (1944) description of *G. festina* stresses the relatively short ceca extending to the level of the posterior testis, which would

distinguish it from *C. linguatula* and *C. hepaticus*. Therefore, *G. festina* is provisionally retained as a valid species of *Choledocystus* for the reasons proposed by Babero (1951) and Byrd and Maples (1963).

Excepting *G. facioi* Brenes Madrigal, Arroyo Sancho, Jimenez-Quiros, and Delgado Flores, 1959, and the recently described *G. robustus* Brooks, 1976, the South and Central American glythelminths are characterized by a Y-shaped excretory bladder (Sullivan, 1976). Consequently, synonymy of *Choledocystus* with *Glythelmins* is precluded by the presence of a Y-shaped excretory bladder in species of *Choledocystus*, hence assignment to the Plagiorchiidae, and the I-shaped bladder in species of *Glythelmins* which has been included in the Macroderoididae (Sullivan, 1976). Nasir (1966) maintained that characters used to separate *Choledocystus* as well as certain other genera from *Glythelmins* show variation and depend on the maturity of the worms and fixation. While it is clear that certain characters depend on the maturity of worms for full evaluation, uterine configuration in *Choledocystus* can be seen in a series of specimens. Although the uterus is not well developed in immature specimens (Figs. 1-3), more mature specimens (Figs. 4-8) clearly show the uterus extending into the extracecal area. This uterine configuration was observed in all mature *C. hepaticus* examined. Sullivan and Byrd (1970) have shown progressive stages of uterine development in laboratory-reared *C. pennsylvaniensis*, a species also characterized as an adult by extension of the uterus into the extracecal fields. However, *C. pennsylvaniensis* possesses an I-shaped bladder which dictates its removal from *Choledocystus*. However, certain characters which do not permit placement in *Glythelmins* as originally proposed by Cheng (1961) will be considered elsewhere.

As a result of the present study, the following emendation of the generic diagnosis of *Choledocystus* is proposed.

Family Plagiorchiidae Lühe, 1901
***Choledocystus* Pereira and Cuocolo, 1941,**
Char. Emend.

DIAGNOSIS: Body ovate to elongate, spined. Oral sucker subterminal, larger or smaller than

acetabulum. Acetabulum medial, pre-equatorial. Pharynx well developed. Esophagus present, variable in length. Ceca terminating in posterior quarter or body, rarely in testicular zone. Testes postacetabular, diagonal to symmetrical, equatorial or pre-equatorial. Cirrus pouch elongate to sacculate, often overlapped by acetabulum. Ovary pretesticular in acetabular zone. Seminal receptacle or uterine seminal receptacle present. Laurer's canal present. Uterus transversely coiled, coils extending extracecally, reaching posterior extremity of body; coils well developed anterior to testes. Metraterm nonmuscular, glandular. Genital pore preacetabular. Vitellaria follicular or dendritic in lateral body margins, occasionally overlapping ceca, variable in longitudinal extent. Excretory bladder Y-shaped with a long stem and short arms. Parasitic in intestine and hepatic system of amphibians.

TYPE SPECIES: *Choledocystus linguatula* (Rudolphi, 1819) Byrd and Maples, 1963.

Acknowledgments

I would like to thank the late Dr. Elon E. Byrd, Zoology Department, University of Georgia, for his comments and suggestions, and Dr. Pir Nasir, Biology Department, Universidad de Oriente, Cumaná, Venezuela for his aid while I was in Venezuela and for donating additional specimens. I would also like to thank the late Dr. Harold W. Manter, Zoology Department, University of Nebraska, for loan of specimens, Mrs. Thelma Richardson, Institute of Ecology, University of Georgia, for computer analysis, and Mrs. Margaret Lim and Miss Kam Lim Poh for their help in preparation of the manuscript.

Literature Cited

- Babero, B. B.** 1951. Notes on the trematode genus *Glythelmins* Stafford, 1905. Proc. Helminthol. Soc. Wash. 18: 103-106.
- Bravo H., M.** 1948. Descripción de dos especies de trematodos parasitos de *Bufo marinus* L. procedentes de Tuxtepec, Oaxaca. An. Inst. Biol. Univ. Nac. Auton. Mex. 19: 153-161.
- Byrd, E. E., and W. P. Maples.** 1963. The glythelminths (Trematoda: Digenea), with a redescription of one species and the erection of a new genus. Z. Parasitenk. 22: 521-536.
- Caballero y C., E., and C. Diaz-Ungria.** 1958. Intento de un catalogo de los trematodos

- digeneos registrados en territorio venezolano. Mem. Soc. Cien. Nat. La Salle (49), 18: 19-36.
- , **M. Bravo H.**, and **M. C. Cerecero**. 1944. Estudios helmintologicos de la region oncocercosa de Mexico y de la Republica de Guatemala. Trematoda. I. An. Inst. Biol. Univ. Nac. Auton. Mex. 15: 59-72.
- , **R. R. Brenes**, and **O. Jimenez-Quiros**. 1957. Helminths of the Republica de Costa Rica. IV. Algunos trematodos de animales domesticos y silvestres. Rev. Biol. Trop. 4: 161-177.
- , **L. Flores Barroeta**, and **R. G. Grocott**. 1956. Helminths of the Republica de Panama. V. Redescriptiones de algunos trematodos ya conocidos pero nuevos en la fauna helmintologica de este pais. Rev. Biol. Trop. 4: 161-177.
- Cheng, T. C.** 1959. Studies on the trematode family Brachycoeliidae. II. Revision of the genera *Glypthelmins* (Stafford, 1900) Stafford, 1905, and *Margeana* Cort, 1919; and the description of *Reynoldstrema* n. gen. (Glypthelminae, n. subfam.). Amer. Midl. Nat. 61: 68-88.
- . 1961. Description, life history and developmental pattern of *Glypthelmins pennsylvaniensis* n. sp. (Trematoda: Brachycoeliidae), new parasite of frogs. J. Parasitol. 47: 469-477.
- Cordero, E. H.** 1944. Dos nuevas especies de trematodos del genero *Glypthelmins* de los batracios del Uruguay. An. Acad. Brasil. Cienc. 16: 1-8.
- Dobbin, J. E., Jr.** 1957. Fauna helmintologica de batracios de Pernambuco, Brasil. I. Trematoda. An. Soc. Biol. Pernambuco 15: 23-61.
- Fischthal, J. H.**, and **R. E. Kuntz**. 1967. Annotated record of some previously described digenetic trematodes of amphibians and reptiles from the Philippines, Korea and Matsu Island. Proc. Helminthol. Soc. Wash. 34: 104-113.
- Lutz, A.** 1928. Estudios de zoologia y parasitologia venezolana. Rio de Janeiro, 133 p.
- Martin, G. W.** 1969. Description and life cycle of *Glypthelmins hyloureus* sp. n. (Digenea: Plagiorchiidae). J. Parasitol. 55: 747-752.
- Miller, E. L.** 1930. Studies on *Glypthelmins quieta* Stafford. J. Parasitol. 16: 237-243.
- Nasir, P.** 1966. Two new species of digenetic trematodes from Venezuelan amphibians. Proc. Helminthol. Soc. Wash. 33: 166-170.
- , and **M. T. Diaz**. 1970. A redescription of *Glypthelmins linguatula* (Rudolphi, 1819) Travassos, 1924 and *G. vesicalis* (Ruiz and Leao, 1942) Yamaguti, 1958 with a key to the valid species. Riv. Parassitol. 31: 261-274.
- Pereira, C.**, and **R. Cuocolo**. 1941. Processo papilomatoso das vias biliares de "*Leptodactylus oscellatus* (L.)," determinado por "*Choledocystus eucharis*" n. gen., n. sp. (Trematoda: Plagiorchiidae). Arch. Inst. Biol. (Sao Paulo) 12: 311-323.
- Rankin, J. S., Jr.** 1944. A review of the genus *Glypthelmins* Stafford, 1905, with an account of the life cycle of *G. quieta* (Stafford, 1900) Stafford, 1905. Trans. Am. Microsc. Soc. 63: 30-43.
- Rohde, K.** 1966. On the trematode genus *Lutztrema* Travassos, 1941 and *Anchitrema* Looss, 1899 from Malayan bats, with a discussion of allometric growth in helminths. Proc. Helminthol. Soc. Wash. 33: 184-199.
- Ruiz, J. M.** 1949. Considerações sobre o genero "*Choledocystus*" Pereira y Cuocolo, 1941 (Trematoda: Plagiorchiidae). Rev. Bras. Biol. 9: 167-174.
- , and **A. T. Leao**. 1942. Notas helmintologicas. 4. *Choledocystus vesicalis* n. sp., parasita de vesicula biliar de *Bufo marinus* (L.) (Trematoda: Plagiorchiidae). Mem. Inst. Butantan 16: 209-212.
- Simpson, G. G.**, **A. Roe**, and **R. C. Lewontin**. 1960. Quantitative Zoology. Harcourt, Brace and World, Inc., New York, 440 p.
- Sullivan, J. J.** 1972. The status of the "glypthelminth" trematodes with an account of the life cycle of *Hylotrema pennsylvaniensis* (Cheng, 1961) n. gen., n. comb. Unpubl. Ph.D. Dissertation, Univ. of Georgia, Athens.
- . 1976. The trematode genus *Glypthelmins* Stafford, 1905 (Plagiorchioidea: Macroderoididae) with a redescription of *G. facioi* from Costa Rican frogs. Proc. Helminthol. Soc. Wash. 43: 116-125.
- . 1977. Revision of the genus *Rauschella* Babero, 1951 (Digenea: Plagiorchiidae) with a redescription of *R. palmipedis* (Lutz, 1928) n. comb. from Venezuelan frogs. Proc. Helminthol. Soc. Wash. 44: 82-86.
- , and **E. E. Byrd**. 1970. *Choledocystus pennsylvaniensis*: Life history. Trans. Amer. Microsc. Soc. 89: 384-396.
- Thomas, J. D.** 1965. The anatomy, life history and size allometry of *Mesocoelium monodi* Dollfus, 1929. J. Zool. 146: 413-446.
- Travassos, L.** 1924. Contribuições para o conhecimento dos helmintos dos batracios do Brasil. Ciencia Medica 2: 618-628.
- . 1926. Trematodeos novos. (V). Bol. Biol., S. Paulo 1: 16-20.

———, J. F. Teixeira de Freitas, and A. Kohn. 1969. Trematodeos do Brasil. Mem. Inst. Oswaldo Cruz 67:1-886.
 Yamaguti, S. 1958. Systema Helminthum. Vol. I. The Digenetic Trematodes of Vertebrates.

(Part I). Interscience Publishers, New York, 979 p.

———. 1971. Synopsis of Digenetic Trematodes of Vertebrates. Vol. I. Keigaku Publishing Co., Ltd., Tokyo, 1,100 p.

Echinorhynchus canyonensis sp. n. (Acanthocephala) from *Maynea californica* (Osteichthyes: Zoarcidae) from the Monterey Submarine Canyon, California

DAVID G. HUFFMAN AND RICHARD G. KLIEVER

Aquatic Station, Southwest Texas State University, San Marcos, Texas and Moss Landing Marine Laboratories, Moss Landing, California

ABSTRACT: *Echinorhynchus canyonensis* sp. n. is described from *Maynea californica* (Osteichthyes: Zoarcidae) from the Monterey Submarine Canyon off California. The new species most closely resembles *E. abyssicola*, which was described from a Mediterranean zoarcid but which is ten times longer than the new species and has 13 hooks/row rather than seven to nine. Ninety-seven percent of the 240 fish examined were infected, and the mean intensity was 41 worms/host. Some quantitative aspects of the population are included in the description.

Prior to the winter of 1972-73, only 18 specimens of *Maynea californica* Gilbert, 1915 (Osteichthyes: Zoarcidae) had been collected. At that time, 92 individuals were taken from the Monterey Submarine Canyon about 120 km south of San Francisco (Cailliet and Lea, in press). During 1974-75, R. G. K. studied the natural history of *M. californica* in the canyon and found a high incidence of infection with an undescribed species of *Echinorhynchus*.

Materials and Methods

Acanthocephalans used in the description were taken from *M. californica* collected on 6 November 1975, at a depth of 137 m in the Monterey Submarine Canyon. The fish were kept alive in an aquarium until it was convenient to examine them for parasites. Subsequently some specimens were shipped to D. G. H. where they were stained by Lynch's precipitated method using Grenacher's alcoholic borax-carmin. They were then dehydrated and cleared in an ethanol-xylene series and mounted in Canada balsam prior to being drawn and measured. Many of these delicate specimens were damaged in shipment or pro-

cessing and only nine mature females and six mature males were in suitable condition for measuring most anatomical characteristics.

Circular distribution methods were utilized to test the significance of seasonal trends following Zar (1974). These methods involve calculating two useful statistics: (1) r which varies from 0.0 (uniform seasonal distribution) to 1.0 (all parasites on same day and none on other days); (2) a which is the mean angle of occurrence for the parasites and which can be converted to mean day by considering 0 degrees to represent Jan. 1 and 360 degrees to represent Dec. 31, etc. The mean date indicates when the bulk of the parasites occur and the value of r indicates how concentrated the seasonal distribution of parasites is around that mean date.

The position of hooks along the proboscis is reported in "percent-position," in which the counted posteriad position of a hook is multiplied by 100 and then divided by $n + 1$, where n is the number of hooks in the row. This expresses the position of each hook as if it were in a "standard" hook row consisting of 101 hypothetical hook locations. Body measurements are in micrometers and are presented in

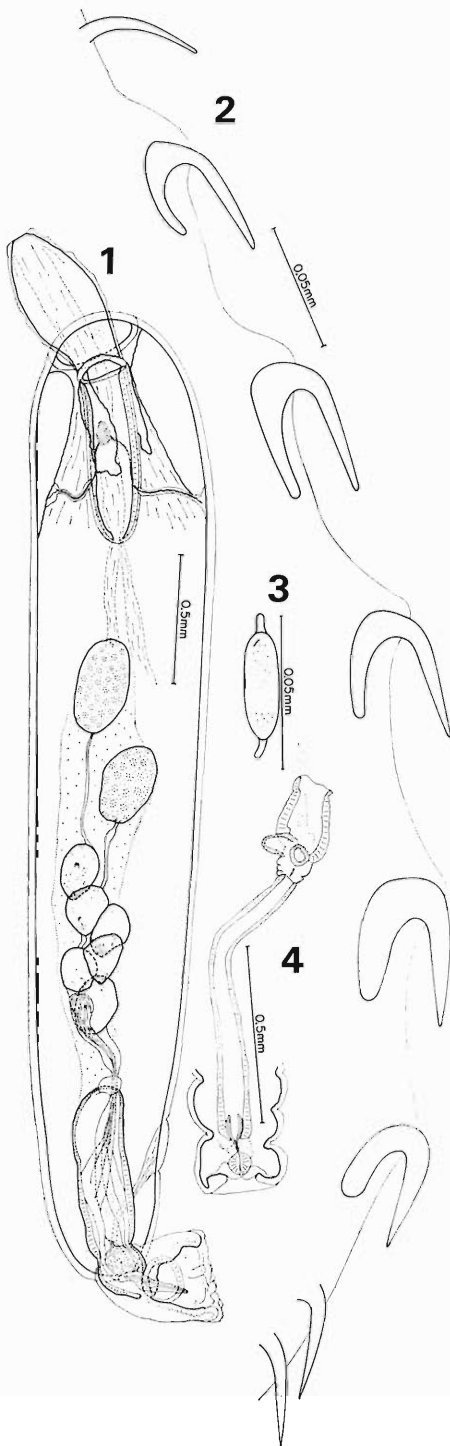

the form: mean (standard error, sample size). Females are listed before males for nonsexual characters.

Ecological data were obtained using worms removed from 20 specimens of *M. californica* selected each month from August 1974 through July 1975. These fish were caught in habitat traps baited with seaweed at depths between 119 m and 457 m in the Monterey Submarine Canyon.

Results

Morphological Description

Echinorhynchus canyonensis sp. n. (Figs. 1-4)

DESCRIPTION (9 females, 6 males): With the characters of *Echinorhynchus* Zoega in Mueller, 1776 (sensu Yamaguti, 1963). Worms very fragile with hooks and body easily crushed and distorted by processing fluids. Some evidence of sexual dimorphism in measurements, most of which can be attributed to the larger body of females. Total body length, including everted proboscis, 4,790 (240,7) and 3,990 (260,6); maximum trunk width near tip of proboscis receptacle 848 (27,0,8) and 690 (34,6); posterior end of body distinctly truncated in both sexes due to inversion of genital orifice, width at truncation 322 (15,8,9) and 320 (34,5). Proboscis nearly cylindrical to obovate, length 673 (12,5,7) and 570 (37,6), maximum width 359 (18,7,8) and 278 (13,3,6). Proboscis hooks delicate, arranged in 12 to 15 rows of 7 to 9 hooks, with alternating rows frequently differing by one hook. Anterior hook length 60.4 (2,41,8) and 51 (3,8,4); longest female hook length 65 (4,5, 11) occurring at 31 (4,6,11) percent-position and for males 61 (3,3,6) at 37 (4,8,6) percent-position; posterior hook length 48.8 (1,58,8) and 44.9 (1,90,4). Hook roots simple, slightly swollen near posterior end; ranging in length from half as long as blade for anterior hooks

←

Figures 1-4. Camera lucida drawings of mounted specimens of *Echinorhynchus canyonensis*. 1. Holotype male, lateral aspect. 2. A complete longitudinal hook row from holotype male. 3. Egg (a delicate outer membrane was observed but not figured). 4. Typical female reproductive tract.

to nearly as long as blade for hooks near 65 percent-position posteriad; penultimate hooks with small circular roots and ultimate hooks with no roots. Neck short, conical; length 77(8.0,6) and 78(4.8,4); maximum width 255(5.6,6) and 233(17.5,4). Lemnisci usually much shorter than receptacle and appearing atrophied and with highly irregular surface, longest of pair 380(40,9) and 330(39,6). Proboscis receptacle double-walled; length 880(39,9) and 640(41,6); width 277(29.1,8) and 200(26,6); distance from retinacula to receptacle tip 359(23.3,9) and 248(24.7,6); distance from posterior margin of ganglion to receptacle tip (everted probosces only) 553(21.9,8) and 367(29.4,6). Receptacle retractors two, stout, attaching to body wall at nearly equal distances posteriad, length 850(95,8) and 550(28.9,6). Female reproductive system: uterine bell with diagonal anterior margin, length 209(14.7,7); uterus cylindrical, length 733(37.9,9), width 74(5.3,9); vagina length 188(5.21,9). Eggs: measurements taken through body wall of mounted females and representing extremes of the thickened shell membrane; length 49.6(1.28,9), maximum width 11.8(0.32,9). Male reproductive system: testes tandem, separate, equal in size, slightly elongated, length 332(14.3,6); cement glands rarely in perfect moniliform arrangement and rarely appearing in pairs, almost always with two or more glands overlapping, individual length 150(6.1,11); Saeftigen's pouch length (bursa not everted) 610(42,4); bursa opens at nearly right angle to body axis, diameter of opening 380(—,1); penis length 120(6.8,3).

HOST: *Maynea californica*.

SITE: Caudal third of intestine.

LOCALITY: Monterey Submarine Canyon, 36.803 N. lat. and 121.807 W. long.

HOLOTYPE: USNM Helminth Coll. No. 74459.

PARATYPES: USNM Coll. No. 74461. Univ. Neb. State Mus., H. W. Manter Lab. No. 20839.

Additional Descriptive Data

It is becoming increasingly apparent that many helminth populations cannot be adequately characterized with line drawings and a list of morphometrics, especially in this genus. Accordingly, we have included a com-

puterized analysis of hook shape, and estimates of certain distributional parameters in the hopes that they will be useful in the future.

MERISTOGRAM: It has been previously shown that certain similar species of *Echinorhynchus* can be readily distinguished by studying the posteriad rate of change in hook characteristics through "meristogram" analysis (Huffman and Bullock, 1975). Therefore, a meristogram is provided in Fig. 5 to facilitate differentiation of *E. canyonensis* from other Pacific populations, should meristograms for the latter become available. Note that the meristogram pattern of the new species resembles the "arched" pattern exhibited by one of the New England populations of *Echinorhynchus* (Huffman and Bullock, 1975).

ECOLOGICAL DATA: Ninety-seven percent of the 240 fish examined were infected with *E. canyonensis* at a mean intensity of 41 worms per fish examined. Seasonal effects upon the number of hosts infected were negligible, but intensity was significantly affected by season of collection, with an r value (Zar, 1974, p. 313) of 0.198 [$p(r = 0) < 0.001$] and mean date of occurrence of July 14 (converted from mean angle of occurrence, $a = 194$). Mean monthly intensity was highest in June and July (80 and 63) and never descended below 18.8 (March). Mean intensity increased significantly with the length (mm) of the host [$p(b = 0) < 0.001$, $b = .495$, $a = -25$]. Forty-nine fish between 30 and 80 mm in length contained an average of 5.8 worms per fish and the intensity increased to a high of 92 worms per fish between 180 and 190 mm, and then declined to 62 worms per fish between 200 and 230 mm in length.

The distribution of worms among hosts was very overdispersed with an overall variance/mean ratio of 56. The variance/mean ratio varied seasonally with mean intensity and with the maximum individual intensity. The seasonal high for the variance/mean ratio was 91 in June and the low of 14 occurred in October. The maximum number of worms in any fish was 289 (June), and the modal frequency of nine fish occurred at the one worm class. The parameters of the negative binomial distribution were estimated by the maximum likelihood method of Bliss and Fisher, 1953, and found to be: $p = 50.0467$, $k = 0.81424$.

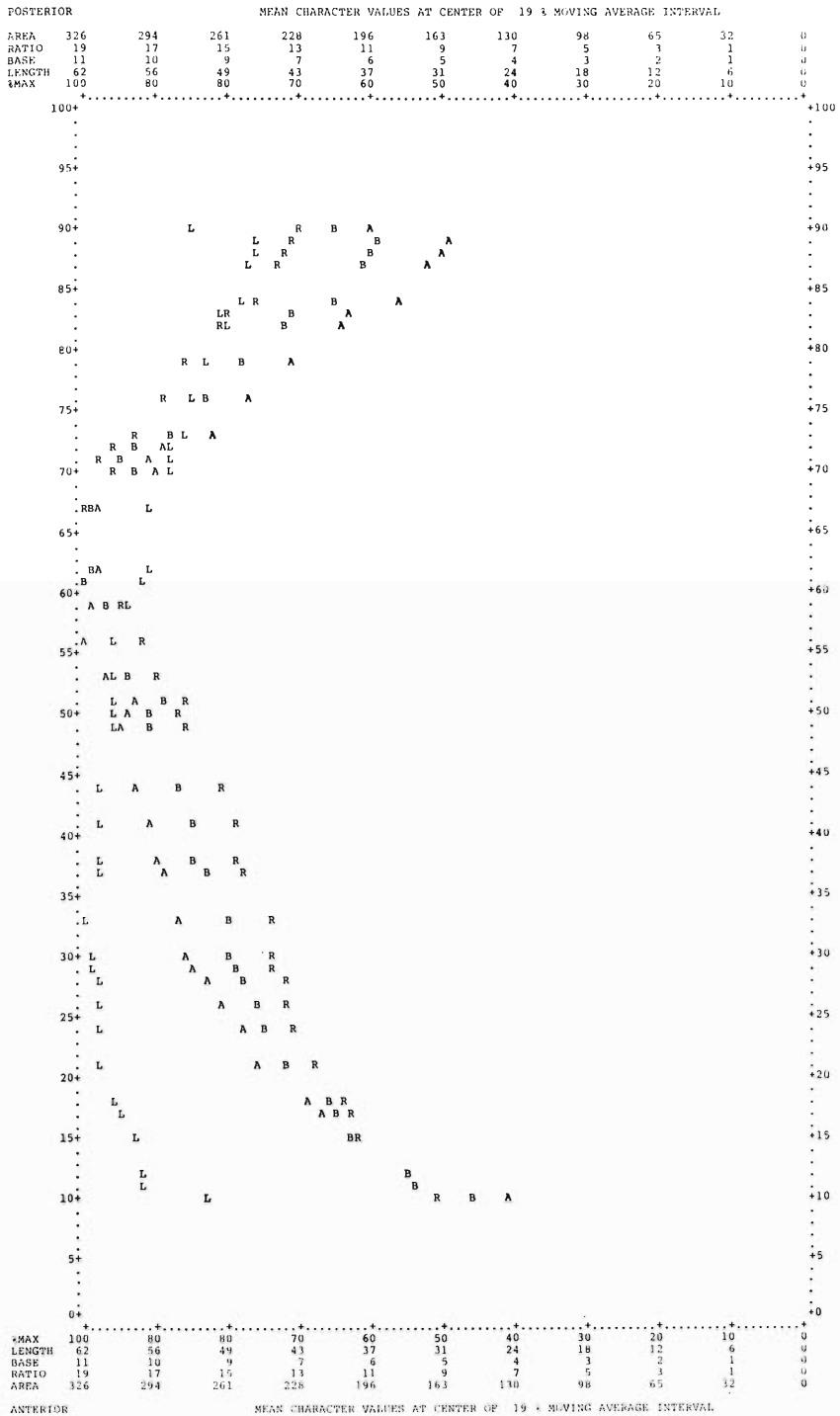

Amphipods of 12 species constituted 89% of the host diet by volume and 86% by frequency. The three most common amphipod species were *Orchomene obtusa*, *Valettiopsis dentatus*, and *Oradarea longimana*. Numerous amphipods were examined for acanthellae but no infections were observed. There was noticeable agreement between seasonal variation in mean intensity of infected fish and seasonal variation in relative abundance of amphipods in the diet of the fish and in the traps in which they were collected. The ages of fish were estimated from otoliths of 71 fish collected in March 1975. The mean length in mm (standard error, sample size) for each year class were as follows: 1 = 67(6.7,5); 2 = 97(7.5, 15); 3 = 129(5.4,20); 4 = 159(4.9,16); 5 = 166(8.5,13); 6 = 161(—,2).

Discussion

Other species of *Echinorhynchus* having similar hook counts are: *E. alpinus* Linstow, 1901 from central Asia, which is much larger; *E. campbelli* (Leiper and Atkinson, 1914) from Antarctica, which has flagellate lemnisci; *E. lageniformis* Ekbaum, 1938, the largest body diameter of which is near the posterior end; and *E. abyssicola* Dollfus, 1931, which was described from a deep-water zoarcid fish of the Mediterranean and which resembles the new species in many respects except for the much larger body of *E. abyssicola* and in having 13 hooks per row rather than seven to nine.

The cement glands of most specimens of the new species conform to the diagnosis of the genus *Metechinorhynchus* Petrochenko, 1956. However, it is our opinion that division of the genus *Echinorhynchus* Zoega in Mueller, 1776 strictly on the basis of cement gland arrangement as envisioned by Petrochenko has caused more confusion than it has eliminated. We agree with Moore (1976) who indicated; "It is often considered good policy, when consistent characters can be found, to split large

unwieldy genera into two or more smaller genera. This should not be done if in so doing it creates two or more genera which are difficult to identify in place of a single easily recognized genus." *Echinorhynchus* Zoega in Mueller is not so large a genus as to be unwieldy and it is very well defined. It is not difficult to decide that a population does, or does not conform to the diagnosis of this genus. However, when Petrochenko split the genus in 1956, he created three genera which are not well defined, the most ambiguous of which is *Metechinorhynchus*. Much confusion would be generated if workers were encouraged to determine the average cement gland arrangement in a collection of these worms and then to compare that collection only with those species described as having the same type of arrangement. For example, many specimens in a New England population studied extensively by D. G. H. exhibited overlap between adjacent cement glands while other specimens in the same population exhibited a strictly moniliform arrangement. Even the number of cement glands varied from three to twelve! It was probably knowledge of the extensive variability in the number and arrangement of cement glands in this genus which prompted Yamaguti (1963, p. 38) to write of Petrochenko's preoccupation with differing cement gland arrangements; ". . . it is doubtful whether this difference is of generic importance." Consequently, though the new species could be marginally assigned to *Metechinorhynchus* on the basis of cement gland overlap, we prefer *Echinorhynchus* Zoega in Mueller, 1776 (*sensu* Yamaguti, 1963), until a more reliable division of the genus can be formulated.

Acknowledgments

This research was supported in part by an organized research grant from S.W.T.S.U. Use of the facilities of the Moss Landing Marine Laboratories during field collections and host

←

Figure 5. 'Meristogram' produced from 12 specimens of *Echinorhynchus canyonensis*, mixed sexes. Left extreme of graph represents anterior end of proboscis and right extreme is posterior end. Vertical axis represents the relative magnitude of average hooks in that region of the average proboscis as measured on four variables: L = hook length, B = length of hook base, R = B*100/L, A = L*B/2. (Graph must be observed from right side of page).

studies is gratefully acknowledged. We appreciate the assistance of Drs. W. C. Young and D. W. Tuff of S.W.T.S.U. who critically read the manuscript.

Literature Cited

- Bliss, C. I., and R. A. Fisher. 1953. Fitting the negative binomial distribution to biological data. *Biometrics* 9: 176-200.
- Cailliet, G. M., and R. N. Lea. In press. Abundance of the "rare" zoarcid, *Maynea californica* Gilbert, 1915, in the Monterey Submarine Canyon, Monterey Bay, California. *Calif. Fish Game*.
- Huffman, D. G., and W. L. Bullock. 1975. Meristograms: Graphical analysis of serial variation of proboscis hooks of *Echinorhynchus* (Acanthocephala). *Syst. Zool.* 24: 333-345.
- Moore, I. 1976. Splitting well defined genera and the use of cryptic characters for delimiting genera. *Syst. Zool.* 25: 81.
- Petrochenko, V. I. 1956. Acanthocephala of Wild and Domestic Animals. Moscow, 943 p. Israel Program for Scientific Translations, Numbers 5901 and 5902.
- Yamaguti, S. 1963. *Systema Helminthum*. Vol. 5: Acanthocephala. Interscience Publishers, New York, 423 p.
- Zar, J. H. 1974. *Biostatistical Analysis*. Prentice Hall, 620 p.

Alloglossoides caridicola gen. et sp. n. (Trematoda: Macroderoididae) from a Louisiana Crayfish

KENNETH C. CORKUM AND HUGH M. TURNER

Department of Zoology & Physiology, Louisiana State University, Baton Rouge, Louisiana 70803

ABSTRACT: *Alloglossoides caridicola* gen. et sp. n. is described from infections in the antennal glands of *Procambarus acutus acutus* (Girard) collected in the vicinity of Baton Rouge, Louisiana. Like several other macroderoidids, this species attains sexual maturity in an invertebrate host. *Alloglossoides* resembles *Alloglossidium* Simer, 1929, but differs in extent of tegumental spination, position of the genital pore relative to the acetabulum, extent and character of the vitellaria, having a unipartite seminal vesicle, and location of the testes.

Specimens of *Procambarus acutus acutus* (Girard) collected in the vicinity of Baton Rouge, Louisiana, have been found to be infected with what we consider to be a new genus and species of macroderoidid. Of the crayfishes collected, 65% had from one to several worms sinusously coiled in the cortex or labyrinth of one or both antennal glands. The worms ranged from immature to fully gravid, but in no case was there any indication of encystment nor were the worms found in any other location.

Worms used in the following description were dissected out of the antennal gland and either fixed in AFA or studied live. Entire, infected glands were also removed and studied in section to determine precise location of the worms in the excretory organ of the crayfish. The morphometric data are based on 20 worms

and the drawing was made with the aid of a microprojector. All measurements are given in microns unless stated otherwise. Ranges are presented with averages in parentheses.

Alloglossoides gen. n.

DESCRIPTION: Body very elongate. Tegument finely spined anteriorly. Oral sucker terminal, larger than acetabulum, which is in anterior 1/10 of body. Acetabulum weak, near anterior end. Prepharynx and pharynx present, esophagus short, cecal bifurcation preacetabular, ceca reaching to near posterior end. Genital pore preacetabular. Cirrus sac overlapping acetabulum. Seminal vesicle unipartite. Testes elongate, in mid third of body. Ovary pretesticular. Laurer's canal present. Proximal portion of uterus serving as seminal receptacle. Uterus with simple posterior and anterior coil.

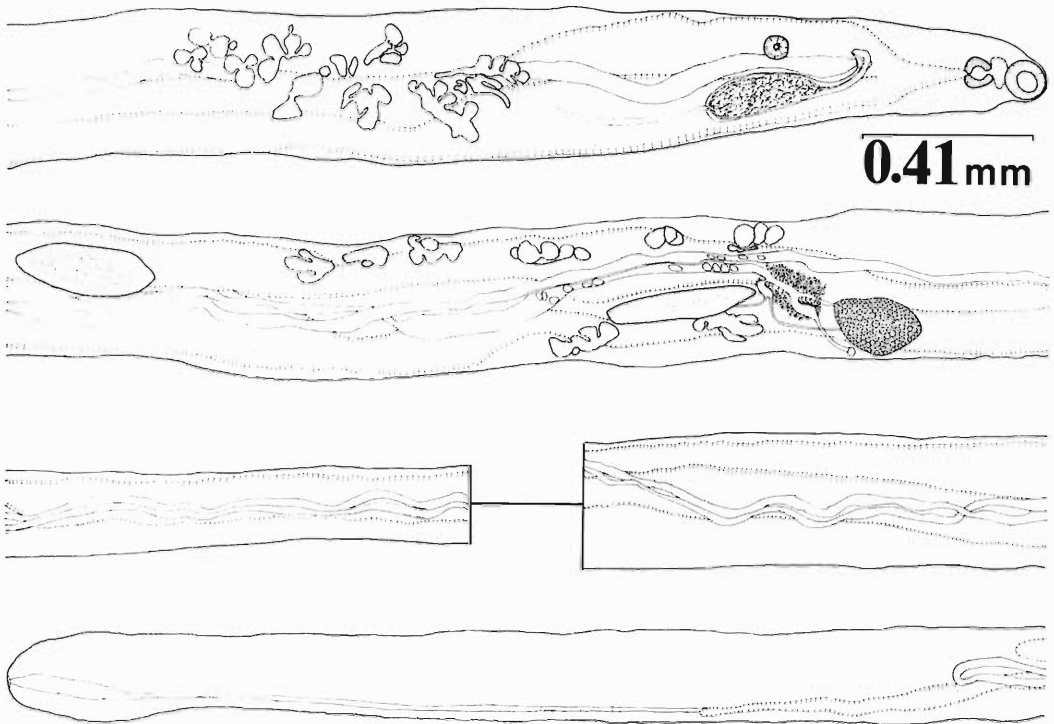

Figure 1. *Alloglossoides caridicola* gen. et sp. n. from *Procambarus acutus acutus*. Adult worm with 2.8 mm of uterus-intestine region omitted.

Vitelline field preovarian to intertesticular zone. Vitelline follicles lobose. Excretory bladder thin-walled, tubular.

Alloglossoides caridicola sp. n.
(Fig. 1)

DESCRIPTION: Body filiform, 7.66–15.79 (12.71) mm long by 0.15–0.33 (0.24) mm wide at acetabulum. Tegument with minute spines in annular rows anteriorly but extending posteriorly only to level of genital pore. Oral sucker terminal, 68–128 (101) by 72–124 (99). Mouth slightly subterminal. Acetabulum weak, 56–104 (80) in diameter; 0.41–0.88 (0.72) mm from anterior end. Prepharynx thick-walled, 16–100 (52) long. Pharynx muscular, 56–88 (71) by 70–110 (87). Esophagus about three times as long as pharynx, thick-walled. Cecal bifurcation preacetabular. Ceca unequal in length, extending to near posterior end. Genital pore well sepa-

rated from acetabulum, at level of cecal bifurcation. Cirrus present, cirrus sac overlapping acetabulum in most specimens, 300–560 (387) by 56–88 (65). Seminal vesicle unipartite, elongate. Ejaculatory duct more or less straight. Testes elongate, well separated, in mid third of body. Anterior testis 376–1,136 (563) by 76–216 (134). Posterior testis 328–1,504 (758) by 88–216 (139). Vasa efferentia uniting with vas deferens slightly anterior to ovary. Ovary pretesticular in anterior third of body, 184–440 (274) by 116–224 (173). Oviduct directed posteriorly. Mehlis' gland and ootype present. Laurer's canal directed anteriorly alongside ovary, basal portion slightly expanded. Proximal portion of uterus serving as seminal receptacle. Uterus directed posteriorly from ovarian complex and proceeding as a single coil to level slightly anterior to terminus of longest cecum before coursing anteriorly. Metraterm thick-walled, opening into

common genital atrium. Vitelline field from anterior to ovary to intertesticular zone; occasionally divided into distinct pre- and post-ovarian fields. Follicles lobose. Vitelline reservoir formed by union of ducts from pre- and postovarian part of field. Eggs 17–23 by 9–12. Excretory bladder thin-walled, tubular, extending to level of posterior testis before receiving primary ducts.

TYPE HOST: *Procambarus acutus acutus* (Girard).

HABITAT: Antennal gland.

TYPE LOCALITY: Rosedale, Iberville Parish, Louisiana.

TYPE SPECIMENS: USNM Helm. Coll., Holotype No. 7445; Paratype No. 7446.

Discussion

Of the genera placed in the family Macroderoididae McMullen, 1937, by Odening (1964) or Yamaguti (1971), *Alloglossoides* most nearly resembles members of the genus *Alloglossidium* Simer, 1929. It differs, however, in the following: the tegumental spination is limited; the genital pore is well anterior to the acetabulum; the ovarian complex is more anteriorly disposed; the vitellaria are less extensive but more lobose; the seminal vesicle is not bipartite and the testes are more anterior.

There is increasing evidence that progenicity is well established among the macroderoidids. In recent years, seven species have been described from infections in invertebrate hosts. Five species have been reported from leeches (Schmidt and Chaloupka, 1969; Beckerdite and Corkum, 1974; Fish and Vande Vusse, 1976; Neumann and Vande Vusse, 1976) and two from crustaceans (Sullivan and Heard, 1969; Font and Corkum, 1975). Of these species, only *Alloglossidium progeneticum* (Sullivan and Heard, 1969) is contained within a cyst as an adult worm and is, therefore, dependent upon predation or death of the host for egg dispersal. In *Alloglossidium*

renale Font and Corkum, 1975 and *Alloglossoides caridicola*, which occur unencysted in crustacean antennal glands, eggs can exit through the host's excretory pores. In those species parasitizing leeches, eggs may leave via the host's feces. It is apparent, therefore, that among some macroderoidids, the invertebrate host is not merely serving as an intermediate but rather as a definitive host and that the usual role of the vertebrate host has been supplanted.

Literature Cited

- Beckerdite, F. W., and K. C. Corkum.** 1974. *Alloglossidium macrobdellensis* sp. n. (Trematoda: Macroderoididae) from the leech *Macrobdella ditetra* Moore, 1953. J. Parasitol. 60: 434–436.
- Fish, T. D., and F. J. Vande Vusse.** 1976. *Hirudicolotrema richardsoni* gen. et sp. n. (Trematoda: Macroderoididae) from Minnesota hirudinid leeches. J. Parasitol. 62: 899–900.
- Fout, W. F., and K. C. Corkum.** 1975. *Alloglossidium renale* n. sp. (Digenea: Macroderoididae) from a fresh-water shrimp and *A. progeneticum* n. comb. Trans. Amer. Microsc. Soc. 94: 421–424.
- Neumann, M. P., and F. J. Vande Vusse.** 1976. Two new species of *Alloglossidium* Simer 1929 (Trematoda: Macroderoididae) from Minnesota leeches. J. Parasitol. 62: 556–559.
- Odening, K.** 1964. Zur taxonomic der Trematodenunterordnung Plagiorchiata. Monatsber. Dtsch. Akad. Wiss. Berlin 6: 191–198.
- Schmidt, G. D., and K. Chaloupka.** 1969. *Alloglossidium hirudicola* sp. n., a neotenic trematode (Plagiorchiidae) from leeches, *Hae-mopsis* sp. J. Parasitol. 55: 1185–1186.
- Sullivan, J. J., and R. W. Heard, III.** 1969. *Macroderoides progeneticus* n. sp., a progenetic trematode (Digenea: Macroderoididae) from the antennary gland of the crayfish, *Procambarus spiculifer* (Leconte). Trans. Amer. Microsc. Soc. 88: 304–308.
- Yamaguti, S.** 1971. Synopsis of the Digenetic Trematodes of Vertebrates. Keigaku, Tokyo, 1880 p.

Trypanosoma cervi Kingston and Morton, 1975 in White-tailed Deer, *Odocoileus virginianus*, in the Southeastern United States^{1, 2}

NEWTON KINGSTON³ AND JAMES CRUM

Southeastern Cooperative Wildlife Disease Study, College of Veterinary Medicine, University of Georgia, Athens, Georgia 30602

ABSTRACT: Bloodstream trypomastigotes collected from 12 white-tailed deer (*Odocoileus virginianus*) in the spring of 1976 in Georgia, North Carolina, and Alabama were determined by mensural analysis to be conspecific with *Trypanosoma cervi* Kingston and Morton, 1975, previously described from elk (*Cervus canadensis*) and mule deer (*Odocoileus hemionus*). Dividing stages were seen in peripheral blood of white-tailed deer examined in July, 1975. Distribution of trypanosomes reported in North American Cervidae is indicated on a map.

Trypanosomes were first reported from cervids in North America by Kistner and Hanson in 1969. Using culture techniques (veal infusion medium-VIM) these authors found 76.3% of 38 white-tailed deer, *Odocoileus virginianus*, in the southeastern United States to be infected. In rapid succession, trypanosomes were reported (using similar culture methods) from other Cervidae: viz., mule deer, *Odocoileus hemionus*, in Colorado and New Mexico (Clark, 1972), and elk, *Cervus canadensis*, in Wyoming (Kingston and Morton, 1973).

Culture methods have also revealed white-tailed deer (WTD) to be infected in Michigan (Stuht, 1975), New York (Krinsky, 1975) and Wyoming (Morton and Kingston, 1976), while infected elk were found in Colorado and New Mexico (Davies and Clark, 1974), and Michigan (Stuht, 1975). A captive black-tailed deer, *Odocoileus hemionus columbianus*, and mule deer were found culture-positive in Wyoming (Morton and Kingston, 1976).

Positive identifications of the trypanosomes found by culture techniques were not made nor possible, and the trypanosomes have been referred to as "theileri-like."

Samuel and Trainer (1970) found a single

infection of an unidentified species of *Trypanosoma* during examination of blood slides from 232 white-tailed deer from South Texas. (See Fig. 9 for distribution of trypanosomes in cervids in North America.)

Bloodstream trypomastigotes were collected and first described from elk in Wyoming as *Trypanosoma cervi* by Kingston and Morton (1975). Bloodstream forms from mule deer in Wyoming were reported later that year (Kingston et al., 1975) and subsequently were identified as conspecific with *T. cervi* (Matthews et al., 1977).

The present report is concerned with the identity of the trypanosomes in white-tailed deer in the southeastern United States, specifically Georgia, North Carolina, and Alabama.

Materials and Methods

Twenty-six white-tailed deer from Georgia, five white-tailed deer from North Carolina, and five white-tailed deer from Alabama were used in this study. Approximately equal numbers of each sex were sampled and both adults and fawns were examined.

Deer were bled from the jugular vein into Vacutainer[®]-EDTA tubes. Subsequently, the blood was taken up into microhematocrit capillary tubes and centrifuged at 13,000 g for 5 minutes. While still retained within the microhematocrit tube, the plasma above the buffy coat was examined microscopically (using a 16 × phase contrast objective) for living trypanosomes. When trypanosomes were

¹Supported in part by the Federal Aid in Wildlife Restoration Act (50 Stat. 917) and Contract No. 14-16-0008-2026, U.S. Fish and Wildlife Service.

²Published with the approval of the Director, Agriculture Experiment Station, College of Agriculture, University of Wyoming, Laramie, Wyoming 82071 as JA 898.

³Permanent address: Division of Microbiology and Veterinary Medicine, College of Agriculture, Box 3354, University of Wyoming, Laramie, Wyoming 82071 USA. (The senior author was on sabbatical leave at the University of Georgia in 1976.)

Table 1. Comparison of mensural values of *Trypanosoma cervi* from white-tailed deer, elk, and mule deer with mensural values for *Trypanosoma theileri* from bovines and *Trypanosoma* sp. from white-tailed deer (egg embryo culture).*

	PK	KN	PN	NA	BL	FF	L	W	FF : BL	NI	KI
<i>Trypanosoma cervi</i>											
Elk (<i>Cervus canadensis</i>)†	12.6‡ (5-20)	7 (4-9)	19.2 (11-32)	25.2 (20-30)	54.4 (32-56)	6.5 (3-12)	52 (40-61)	4.4 (3-8)	1 : 8.1	0.77 (0.5-1.3)	2.86 (1.7-5)
Mule deer (<i>Odocoileus hemionus</i>)‡	7.5 (3-15)	5.8 (2-13)	13.1 (8-19)	17 (10-26)	30.3 (21-42)	7 (1-16)	37.3 (26-51)	5.2 (2-9)	1 : 6.03	0.79	2.43
White-tailed deer (<i>Odocoileus virginianus</i>)§	13.5 (5-27)	8.3 (2-14)	22 (14-34)	26.3 (12-41)	48.2 (31-74)	9.5 (3-21)	57.7 (40-83)	5.6 (3-15)	1 : 5.7	0.88	2.86
Grand mean	10.4 (3-27)	6.99 (2-14)	17.2 (8-34)	21.5 (10-41)	38.7 (21-74)	7.9 (1-21)	46.6 (26-83)	5.3 (2-15)	1 : 6.13	0.82	2.64
<i>Trypanosoma</i> sp.											
White-tailed deer (egg embryo)‖	16.68	5.32	21.94	19.39	41.53ψ	13.04	54.57	—	1 : 3.1ψ	1.23	4.31
<i>Trypanosoma theileri</i>											
Bovine (egg embryo)¶	12.8	5.5	18.3	15.4	33.7	13.9	47.6	2.62	1 : 2.4	1.2	3.3

* Figures out of parentheses represent means; figures in parentheses represent ranges.

PK = Posterior end to kinetoplast. KN = Nucleus to kinetoplast. PN = Posterior end to nucleus. NA = Nucleus to anterior end. BL = L - FF, Length minus length of free flagellum. FF = Free flagellum. L = Length. W = Width. NI = PN/NA. KI = PN/KN.

† Kingston and Morton, 1975.

‡ Matthews, Kingston, and Morton, 1977.

§ This paper.

‖ Stuht, 1975; ψ calculated.

¶ Woo et al., 1970.

‖ Represent recalculated means, ranges, and indices for these values in elk (cf. these values in Kingston and Morton, 1975; and Matthews et al., 1977).

detected, blood slides were prepared by breaking the hematocrit tube just above the buffy coat and expressing the trypanosomes, plasma, buffy coat, and some red cells onto a slide. A conventional thin film was then prepared, fixed in osmium tetroxide vapor, and allowed to dry. The film was subsequently fixed in absolute methyl alcohol and stained with Giemsa. Conventional thin films prepared from blood collected in July, 1975 from 10 white-tailed deer from North Carolina and Georgia for routine differential hematology also revealed numerous trypanosomes. Trypanosomes were photographed on color transparency film or black and white film using a 35mm SLR camera. The photomicrographs were projected from a standard distance and the images traced. The tracings were measured using a calibrated map reader following the scheme of Hoare (1972). The mensural values obtained were compared using an analysis of variance with values obtained from similar measurements of trypanosomes from elk (Kingston and Morton, 1975)

and mule deer (Matthews et al., 1977); comparisons also were made with culture (egg embryo) trypanosomes from bovines (Woo et al., 1970) and white-tailed deer (Stuht, 1975). Selected tracings were transferred to drawing paper and inked.

One of the white-tailed deer studied suffered a severe bacteremia resulting from an infected flank wound. During the course of treatment of this injury, blood samples were taken every few days and trypanosomes recovered, numbers estimated, and the trypanosomes studied.

Results

Bloodstream trypomastigotes were recovered from three of the deer from Georgia (Floyd and Clarke counties), the remaining positive animals were culture-positive using VIM (Floyd, Clarke and McIntosh counties, Georgia); from all the deer from North Carolina (Bladen County); and from four of the five deer from Alabama (Clarke County).

Mensural values of 41 bloodstream trypano-

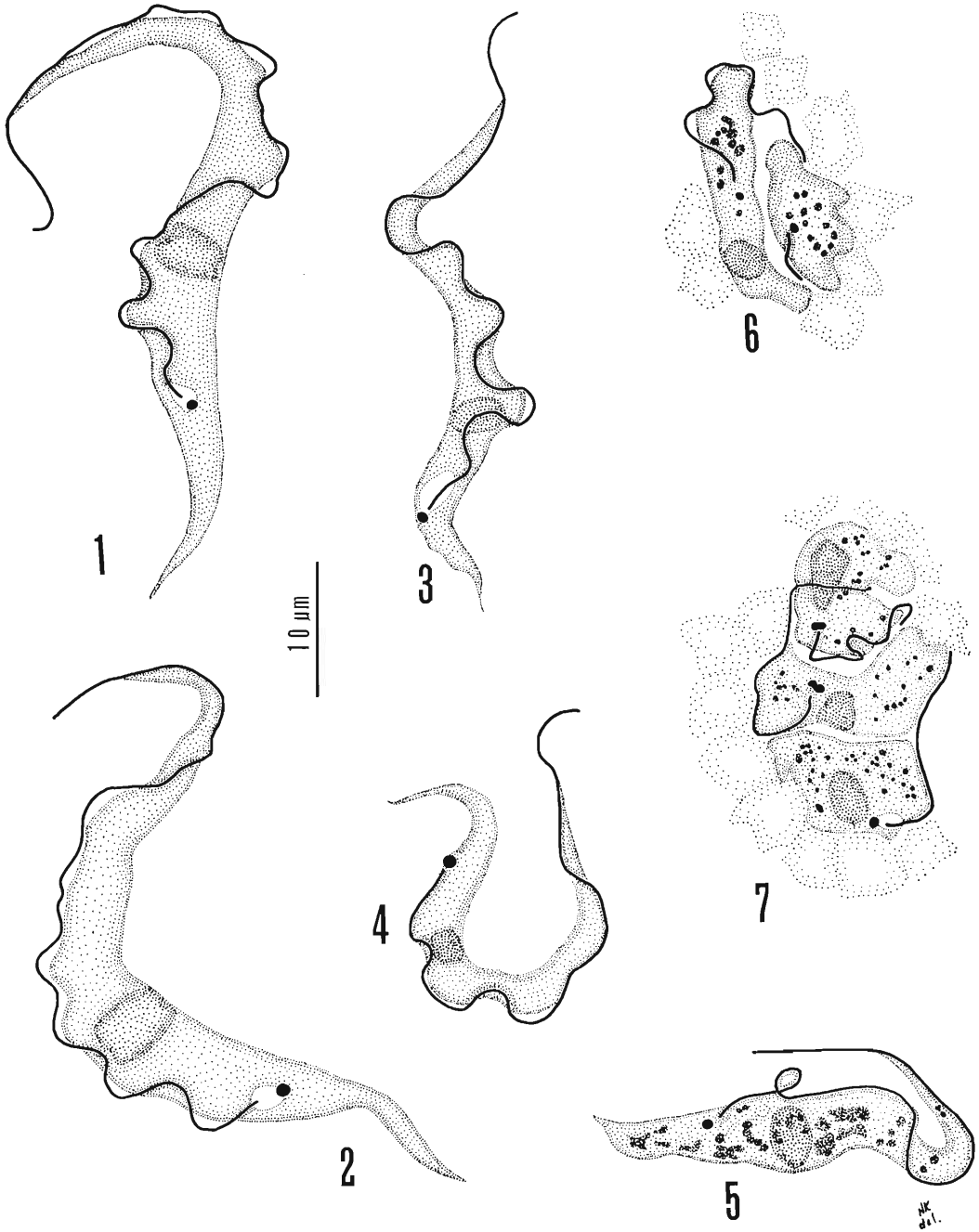

Figures 1-7. Bloodstream stages of *Trypanosoma cervi* from white-tailed deer in the southeastern United States. 1, 2. Long, broad trypomastigotes. 3. Long, thin trypomastigote. 4. Short, thin trypomastigote. 5. Broad trypomastigote considered to be predividing form, body filled with metachromatic granules (July specimen). 6. Paired, recently divided epimastigotes from blood of July deer. Note short flagellum on daughter cell. 7. Dividing bloodstream epimastigotes from July deer. Kinetoplasts are duplicated and anterior to nucleus.

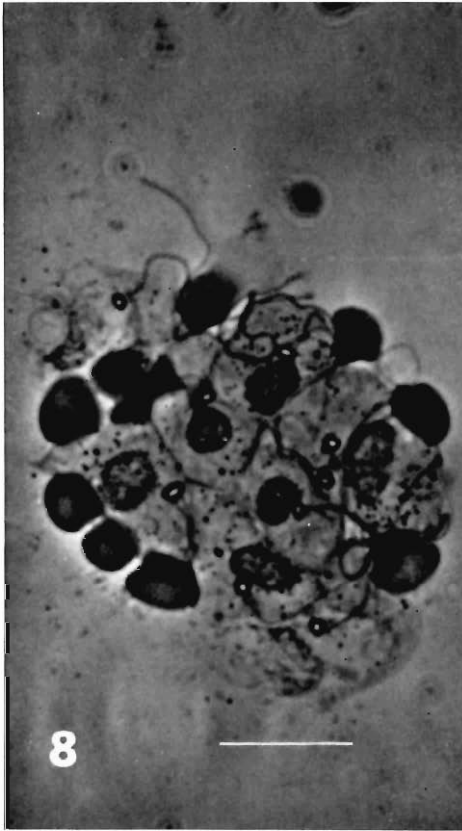

Figure 8. Photomicrograph of nine dividing bloodstream epimastigotes forming rosette. Refractile bodies are kinetoplasts, dark granular bodies are parasite nuclei, flagella are primarily external. Dark homogeneous bodies are RBCs (phase contrast). Scale = 10 micrometers. Distortions in Figs. 6-8 are related to the marginal position of the parasites in the blood film. Lightly stippled structures in Figs. 6, 7 are RBCs.

mastigotes from two white-tailed deer (one male, one female) from Georgia (one free-ranging and one captive deer) were compared with the means of similar values for populations of trypanosomes from elk and mule deer (Table 1). Also included in Table 1 are measurement data for trypanosomes from deer and cattle (*T. theileri*) raised in chick embryos (Stuht, 1975; Woo et al., 1970). Typical bloodstream trypomastigotes from the white-tailed deer are shown in Figs. 1-4. Trypanosomes collected from white-tailed deer in North

Carolina and Georgia in July, 1974 are shown in Figs. 5-8. Many of the latter (Fig. 5) were wide forms, contained numerous metachromatic granules, and were comparable to pre-division forms seen in mule deer from Wyoming in the spring (Kingston et al., 1975; Matthews et al., 1977). Dividing forms (Figs. 6-8) seen were paired, in tetrads, or grouped in larger numbers forming rosettes. Measurements of these dividing trypanosomes were not included in the measurements for trypanosomes from white-tailed deer in Table 1 because of their variability. In the injured deer the numbers of trypanosomes seemed to increase as the infection progressed and many of these showed typical pre-division forms including very wide forms and many with numerous metachromatic granules. Inasmuch as no actual dividing forms were seen in the peripheral blood, the measurements of some of these forms were included in Table 1.

Discussion

Comparison of mensural values of bloodstream trypomastigotes from white-tailed deer with those from elk and mule deer revealed significant differences ($P < 0.01$) in values of the PK, KN, PN, NA, BL, and L. (See Table 1 for explanation of abbreviations.) Mensural values of trypanosomes from mule deer were significantly smaller (by Scheffe's single range test) than those of trypanosomes from elk and white-tailed deer.

The values for PN and L were also larger for white-tailed deer than for elk. These differences in absolute measurements for these values are, of course, functions of body length. Considering the absolute smaller size of mule deer and elk bloodstream trypomastigotes, such differences are to be expected. Trypanosomes from white-tailed deer have an FF value absolutely greater than in elk but not different from that measurement in mule deer trypanosomes.

Of greater significance than the absolute mensural values for these parameters are the FF : BL ratios and the kinetoplast and nuclear indices (KI and NI), which are *not significantly* different ($P < 0.01$). The values for W : BL are, as expected, significantly smaller for mule deer ($P < 0.01$) when compared with white-tailed deer and elk; no differences were seen in this value between white-tailed deer

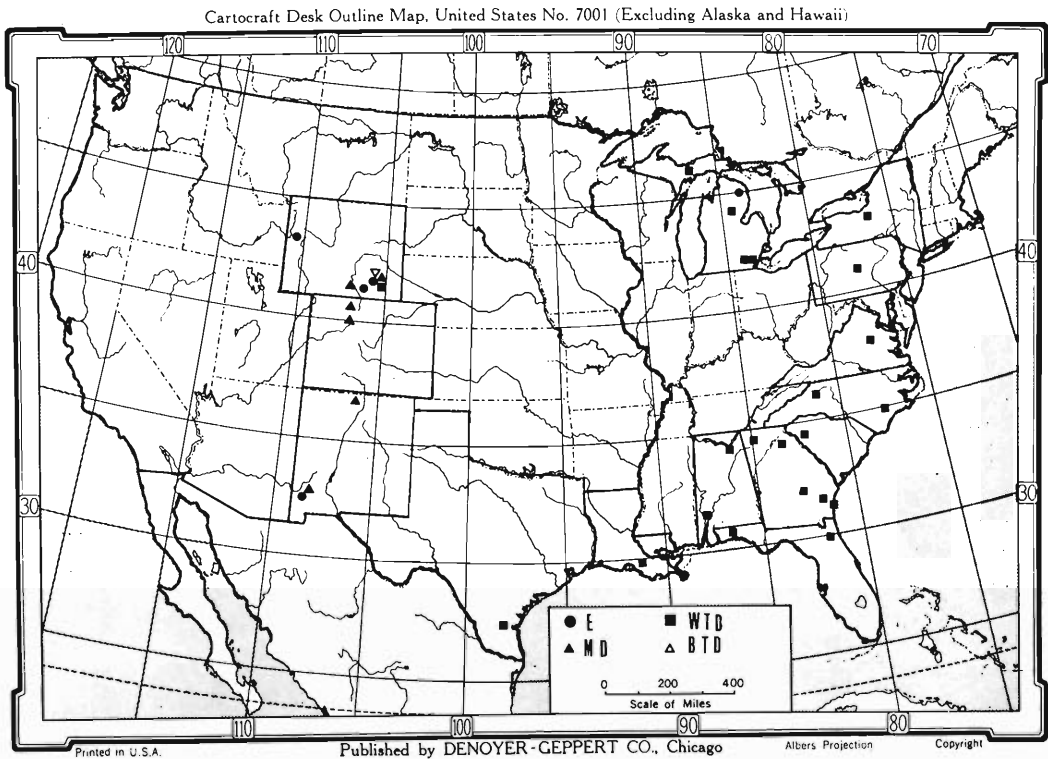

Figure 9. Distribution of trypanosomes in the family Cervidae in North America (E = elk; MD = mule deer; WTD = white-tailed deer; BTD = black-tailed deer). References for distributions are as follows. Elk: Davies and Clark, 1974; Kingston and Morton, 1973; Kingston and Morton, 1975,* Morton and Kingston, 1976; Stuht, 1975. Mule deer: Clark, 1972; Kingston, Morton, and Matthews, 1975; Morton and Kingston, 1976; Matthews, Kingston, and Morton, 1977.* White-tailed deer: Kistner and Hanson, 1969; Morton and Kingston, 1976; Stuht, 1975; Straneva, 1976 (pers. comm.); Samuel and Trainer, 1970; Krinsky, 1975; present paper.* Black-tailed deer: Morton and Kingston, 1976.

* *Trypanosoma cervi* from examination and identification of bloodstream trypomastigotes; other reports refer to trypanosomes in culture or unidentified bloodstream forms, and it is not possible to determine with certainty their identity; they are probably *T. cervi*.

and elk. Thus, while it may be said that there is considerable variability in absolute measurements between trypanosomes from elk, mule deer, and white-tailed deer in North America, it is apparent that these differences are eliminated when various ratios (FF : BL, KI, and NI) are compared. It appears, therefore, that trypanosomes from cervids (at least from these species examined) in North America represent a single trypanosome species, viz., *Trypanosoma cervi*, Kingston and Morton, 1975, which shows considerable plasticity in mensural values. The overall means of the 111 trypanosome

specimens dealt with in this and preceding papers (Kingston and Morton, 1975; Matthews et al., 1977) are presented in Table 1 and can be used to characterize *Trypanosoma cervi*. *Trypanosoma cervi*, therefore, is a large trypanosome with a long, pointed posterior end; the kinetoplast is far from the posterior end and relatively close to the nucleus, characteristic of the subgenus *Megatrypanum* (Fig. 1), the nucleus is somewhat posterior to the middle of the body, and the free flagellum is short, with an FF : BL ratio greater than 1 : 5. Thus, *T. cervi* readily can be seen to differ from

T. theileri from bovines (Woo et al., 1970), where the kinetoplast is equidistant from the nucleus and posterior end (KI = 1.9) and the FF : BL = 1 : 2.4.

Bloodstream trypomastigotes of *Trypanosoma cervi* from white-tailed deer are similar, particularly in size, to the culture trypomastigotes (egg embryo) from white-tailed deer as described by Stuhlt (1975), but differ in having a shorter FF length and smaller NI and KI ratios. The FF : BL ratio in bloodstream trypomastigotes of *T. cervi* is always large (<1 : 5) owing to the relative shortness of the flagellum, and the nucleus is consistently posterior to the middle of the body (NI = 0.82), while the kinetoplast is located farther from the nucleus (KI = 2.64) than it is in Stuhlt's material (NI = 1.23) (KI = 4.31). The egg embryo trypomastigotes from WTD as reported by Stuhlt resemble similar elk trypomastigotes raised at 37 C and in egg embryos (E): BL = 45, FF = 8.69 and 15.6 (E), FF : BL ratios = 1.4.1. and 1.2.3. (E), NI = 1.3, KI = 4.48 and 9.9 (E), as reported by Kingston and Morton, 1975.

Stuhlt's culture material also resembles in these features the culture trypanosomes (egg embryo) as described by Woo et al. (1970). It is our opinion that such culture material cannot be used in characterizing species of *Trypanosoma* but reliance must be placed on the examination of bloodstream forms.

TYPE SPECIMENS: Paratypes of *Trypanosoma cervi* from white-tailed deer from Georgia (USNM Helm. Coll. No. 74496), from mule deer from Wyoming (USNM Helm. Coll. No. 74495), and the Parasitological Collection, University of Wyoming.

Acknowledgments

We would like to express our appreciation to Bill Collins and Ron Little of the Georgia Department of Natural Resources; to Wayne Vickers of Berry College, Rome, Georgia; Dr. J. H. Jenkins, School of Forest Resources, University of Georgia; and to our colleagues at the Southeastern Cooperative Wildlife Disease Study (SCWDS) for aid during this study. We would like to acknowledge Dr. Leroy Maki, Division of Microbiology and Veterinary Medi-

cine, University of Wyoming for the statistical analysis. We especially acknowledge Dr. Frank A. Hayes, Director of SCWDS, without whose support this study would not have been possible.

Literature Cited

- Clark, G. G. 1972. Trypanosomes from mule deer in New Mexico and Colorado. *J. Wildl. Dis.* 8: 325-326.
- Davies, R. B., and G. G. Clark. 1974. Trypanosomes from elk and horseflies in New Mexico. *J. Wildl. Dis.* 10: 63-65.
- Hoare, C. D. 1972. *The Trypanosomes of Mammals*. Blackwell Scientific Publications, Oxford. 749 p.
- Kingston, N., and J. K. Morton. 1973. Trypanosomes from elk (*Cervus canadensis*) in Wyoming. *J. Parasitol.* 59: 1132-1133.
- , ———. 1975. *Trypanosoma cervi* sp. n. from elk (*Cervus canadensis*) in Wyoming. *J. Parasitol.* 61: 17-23.
- , ———, and M. Matthews. 1975. Trypanosomes from mule deer, *Odocoileus hemionus*, in Wyoming. *J. Wildl. Dis.* 11: 519-521.
- Kistner, T. P., and W. L. Hanson. 1969. Trypanosomiasis in white-tailed deer. *Bull. Wildl. Dis. Ass.* 5: 398-399.
- Krinsky, W. L. 1975. Trypanosomes from white-tailed deer (*Odocoileus virginianus*) in New York. *J. Parasitol.* 61: 145-146.
- , and L. L. Pechuman. 1975. Trypanosomes in horseflies and deer flies in central New York State. *J. Parasitol.* 61: 12-16.
- Matthews, M. J., N. Kingston, and J. K. Morton. 1977. *Trypanosoma cervi* Kingston and Morton, 1975 from mule deer, *Odocoileus hemionus*, in Wyoming. *J. Wildl. Dis.* 13: 33-39.
- Morton, J. K., and N. Kingston. 1976. Further studies on trypanosomes in game animals in Wyoming. *J. Wildl. Dis.* 12: 233-236.
- Samuel, W. M., and D. O. Trainer. 1970. *Amblyomma* (Acarina: Ixodidae) on white-tailed deer, *Odocoileus virginianus* (Zimmerman), from South Texas with implication for theileriasis. *J. Med. Entomol.* 7: 567-574.
- Straneva, J. E. 1976. Pers. Comm. Indiana University of Pennsylvania, Indiana, Pa.
- Stuhlt, J. N. 1975. Morphology of trypanosomes from white-tailed deer and wapiti in Michigan. *J. Wildl. Dis.* 11: 256-262.
- Woo, P., M. A. Soltys, and A. C. Gillick. 1970. Trypanosomes in cattle in southern Ontario. *Can. J. Comp. Med.* 34: 142-147.

Pratylenchoides alkani sp. n. and *P. erzurumensis* sp. n.
(Nematoda: Tylenchoidea) from Soil in Turkey

HASAN Ş. YÜKSEL

University of Atatürk, Department of Entomology, Erzurum, Turkey

ABSTRACT: *Pratylenchoides alkani* sp. n. most closely resembles *P. ritteri* from which it differs in usually having punctations or spots only on lateral field, a longer body, stylet knobs directed posteriad and phasmids in anterior portion of tail. *Pratylenchoides erzurumensis* sp. n. can be distinguished from the closely related species, *P. laticauda* and *P. crenicauda*, by the truncate tail tip, areolated outer bands of lateral field on tail and absence of lateral canals.

Pratylenchoides alkani sp. n. and *P. erzurumensis* sp. n. were discovered by the author in washings obtained from soil collected about the roots of snap bean and mulberry, respectively. *Pratylenchoides alkani* is found in snap bean soil in Kan-İspir and *P. erzurumensis* in mulberry soil in Pazaryolu, Erzurum. Both species are wide-spread in these areas. *P. alkani* closely resembles *P. ritteri* Sher, 1970. The second new species, *P. erzurumensis*, has similarity with *P. laticauda* Braun and Loof, 1966 and *P. crenicauda* Winslow, 1958.

Pratylenchoides alkani sp. n.

(Fig. 1)

DESCRIPTION: Females (N = 10): L = 0.97 (0.82–1.21) mm; a = 31 (29–35); b = 4.5 (4.0–4.9); c = 16 (14–17); V = 2155^{22} ; stylet = 23.3 (22–25) μ m. Males (N = 10): L = 0.90 (0.79–1.18) mm; a = 32 (28–37); b = 6.4 (5.6–7.1); c = 14 (12–15); T = 21 (18–23); stylet = 20 (19–21) μ m; spicules = 23–25 μ m; gubernaculum = 8–9 μ m.

Female (holotype): L = 1.01 mm; a = 34; b = 4.5; c = 15; V = 2155^{22} ; stylet = 22 μ m.

Body tapering slightly anteriorly and posteriorly, curved to C-shape when killed by gentle heat. Cuticle marked by annules averaging 2 μ m in width at mid body, slightly smaller near head, larger on dorsal side of tail.

Lateral canals absent. Lateral field with 6 incisures (occasionally 4) about mid region of body, usually punctate or spotted through the lateral field length.

Rounded lip region with 4–5 annules. Stylet robust, knobs directed slightly posteriad. Dorsal oesophageal gland orifice about 3 μ m be-

hind stylet base. Oesophagus well developed, with oblong median bulb. Isthmus about 1.5 times as long as median bulb. Nerve-ring encircling isthmus near middle. Oesophageal glands overlapping intestine 1–2 body widths. Hemizonid 2 body annules anterior to excretory pore. Deirids conspicuous, at excretory pore level. Rounded spherical spermatheca filled with nearly round sperm, spermathecae equidistant from vulva. Oocytes in a single file.

Tail with 18–27 annules, cylindroid with a bluntly rounded, coarsely and irregularly annulated terminus; tail cuticle thickened near tip. Phasmids 1/10 of the tail length anterior to middle of tail. Tail about 3 anal body diameters long.

Male (allotype) 3: L = 0.91 mm; a = 31; b = 6.1; c = 15; T = 20; stylet = 20 μ m; spicules = 24 μ m; gubernaculum = 9 μ m.

Lip region distinctly higher, conoid; 3–4 more annules than in female. Stylet weaker and shorter. Oesophagus and oesophageal glands not as well developed as in female. Rarely inner incisures broken up into oblique lines and ends of these incisures somewhat bent outwards or inwards. Gubernaculum linear, slightly curved proximally.

HOLOTYPE: Female collected 10 September 1971 by H. Ş. Yüksel, slide number X–10, University of Atatürk, Department of Entomology, Nematode Collection, Erzurum, Turkey.

ALLOTYPE: Male, same data as holotype, slide number X–11.

PARATYPES: Thirty-two females, 18 males, 12 juveniles, University of Atatürk, Department of Entomology, Erzurum, Turkey; 8 fe-

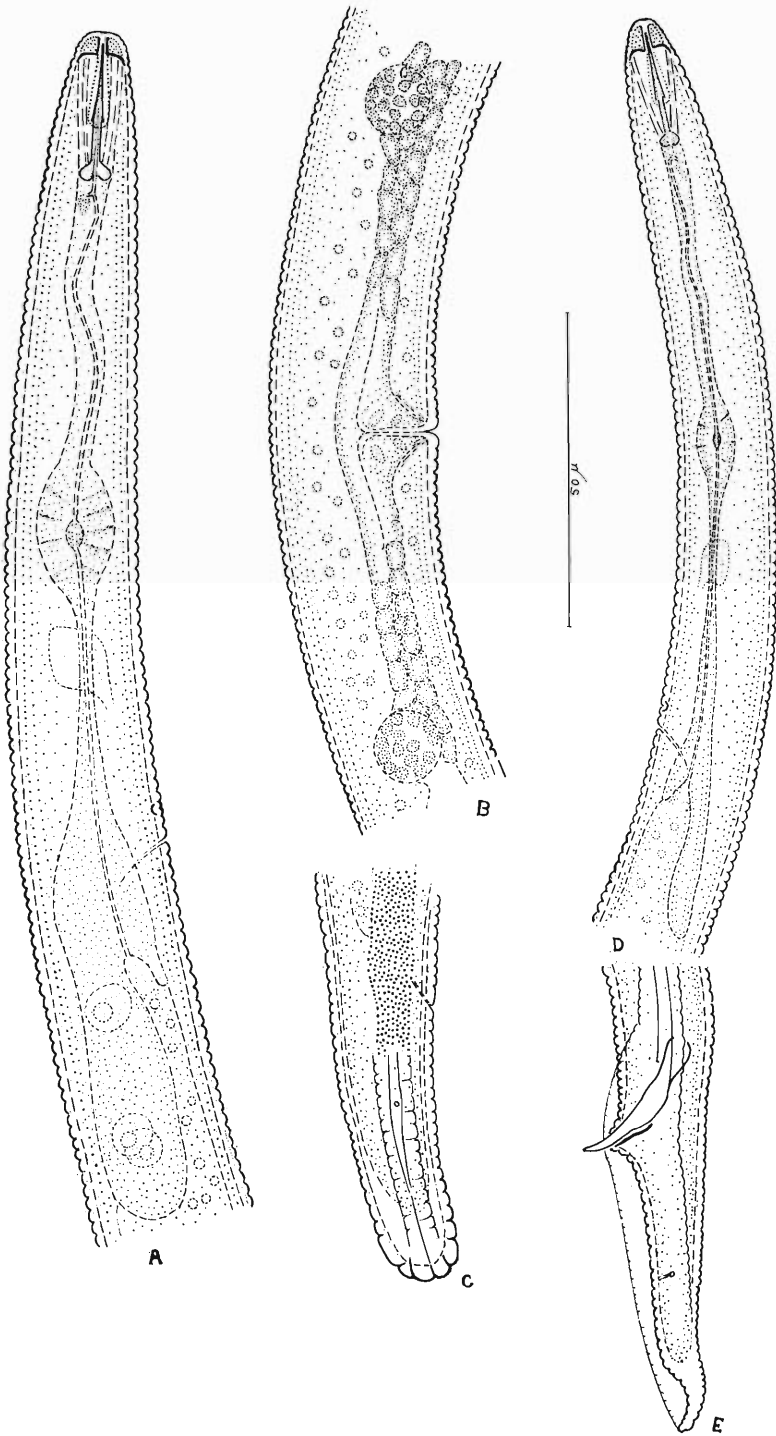

males, 10 males, 4 juveniles, Department of Nematology, University of California, Riverside, USA.

TYPE HABITAT: Soil about the roots of snap bean (*Phaseolus vulgaris* L.).

TYPE LOCALITY: Kan-Ispir, Erzurum, Turkey.

DIAGNOSIS: *Pratylenchoides alkani* sp. n. most closely resembles *P. ritteri* from which it differs in usually having punctation or spots only on the lateral field and a longer body, curved to a C-shape when killed by gentle heat. Stylet knobs are directed posteriad. In addition, phasmids are in the anterior portion of the tail and the lateral field usually has six incisures.

Pratylenchoides erzurumensis sp. n.
(Fig. 2)

DESCRIPTION: Females (N = 12): L = 0.60 (0.55–0.67) mm; a = 25 (24–26); b = 4.4 (3.9–4.8); c = 19 (15–20); V = 2759^{22} ; stylet = 21 (21–22) μ m. Male: Unknown.

Female (holotype): L = 0.64 mm; a = 27; b = 4.8; c = 20; V = 2759^{24} .

Body outstretched when killed by gentle heat; cylindroid, tapering anteriorly in front of median bulb, tapering posteriorly at about midpoint between vulva and anus. Body annules uniform, averaging 1.5 μ m wide except in posterior end of tail region. Lateral canals absent. Six incisures in lateral field, 2 disappearing anteriorly and posteriorly.

Lip region slightly or not set off, 3–4 annules; roundish. Spear robust with well developed, angular basal knobs 5–6 μ m in width, directed slightly posteriad. Dorsal oesophageal gland orifice about 3 μ m behind spear base. Isthmus twice as long as median bulb. Nerving surrounding isthmus near end of median oesophageal bulb. Oesophageal glands surrounding oesophago-intestinal junction on all sides; dorsal and one ventro-sublateral glands reaching somewhat further backward than other ventro-sublateral one. Oesophageal glands overlapping intestine half to 1 body

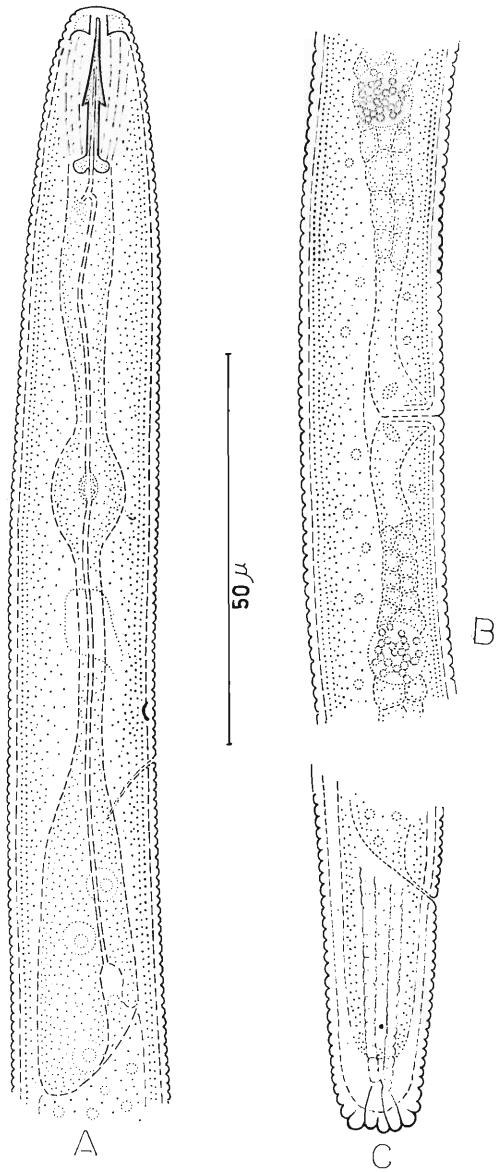

Figure 2. *Pratylenchoides erzurumensis* sp. n. A: female, oesophageal region; B: vulvar region; C: female tail.

←

Figure 1. *Pratylenchoides alkani* sp. n. A: female, oesophageal region; B: vulvar region; C: female tail; D: male, oesophageal region; E: male tail.

width. Excretory pore located about at end of isthmus. Hemizonid located 4 body annules anterior to excretory pore. Deirids conspicuous, at excretory pore level.

Rounded spermatheca; anterior spermatheca 46 (40–56) μm , posterior spermatheca 33 (26–39) μm at distance from vulva, rarely with rounded sperm.

Tail with 24 (17–33) annules, cylindroid, tail tip coarsely and irregularly annulated, truncate in lateral view; cuticle thickened near tip. Outer bands of lateral field areolated in tail region. Phasmids in anterior portion of tail. Tail about 2 anal body diameters long.

Male: Unknown.

HOLOTYPE: Female collected 22 September 1971 by H. Ş. Yüksel, slide number X-12, University of Atatürk, Department of Entomology, Nematode Collection, Erzurum, Turkey.

PARATYPES: Forty-one females, 14 juveniles, University of Atatürk, Department of Entomology, Nematode Collection, Erzurum, Turkey; 4 females, Department of Nematology, University of California, Riverside, USA.

TYPE HABITAT: Soil about the roots of mulberry (*Morus alba*).

TYPE LOCALITY: Pazaryolu, Erzurum.

DIAGNOSIS: *Pratylenchoides erzurumensis* can be distinguished from the closely related species *P. laticauda* and *P. crenicauda* by the truncate tail tip, areolated outer bands of the lateral field on the tail, and absence of lateral canals. It can be further distinguished from *P. laticauda* by the smaller body size, shorter overlap of the oesophageal glands, and absence of males; and from *P. crenicauda* by the smaller number of annules on the female tail.

Acknowledgment

I am deeply indebted to Dr. S. A. Sher for his criticism and amendment of the manuscript.

Literature Cited

- Braun, A. L., and P. A. A. Loof. 1966. *Pratylenchoides laticauda* n. sp., a new endoparasitic phytonematode. *Neth. J. Plant Pathol.* 72: 241–245.
- Sher, S. A. 1970. Revision of the genus *Pratylenchoides* Winslow, 1958 (Nematoda: Tylenchoidea). *Proc. Helminthol. Soc. Wash.* 37: 154–166.
- Winslow, R. D. 1958. The taxonomic position of *Amguillulina obtusa* Goodey, 1932 and 1940. *Nematologica* 3: 136–139.

Eimeria dunsingi Farr, 1960: A Coccidium of the Parakeet, *Melopsittacus undulatus*¹

KENNETH S. TODD, JR.,² ANTHONY M. GALLINA,³ AND JAMES M. SCHMIDT³

ABSTRACT: Oocysts of *Eimeria dunsingi* were found in feces of naturally infected birds, and sexual stages of the parasite were present in the small intestine. Oocysts were ovoid and 25 to 36 μm by 22 to 28 μm . Micropyle, oocyst residuum, and usually polar granules were absent. Sporocysts contained a granular sporocyst residuum. No pathologic changes were observed in tissue sections containing the parasites. *Eimeria* sp. n. Brada, 1966 is considered to be a synonym of *Eimeria dunsingi* Farr, 1960.

Only four reports of intestinal coccidia in psittaciform birds have been previously made (Brada, 1966; Chakravarty and Kar, 1947; Farr, 1960; Morelli, 1956). The purpose of

the present report is to describe *Eimeria dunsingi* Farr, 1960 in naturally infected parakeets, *Melopsittacus undulatus*.

Materials and Methods

The birds were from a Florida wholesale dealer who originally obtained the birds from Texas. Feces from five infected birds were placed in 2.5% potassium dichromate solution

¹ Supported in part by General Research Support Grant RR05460 from the National Institutes of Health. The figures were prepared by Timothy P. Howland.

² College of Veterinary Medicine, University of Illinois, Urbana, Illinois 61801.

³ Present address: Department of Veterinary Pathology, Washington State University, Pullman, Washington 99163.

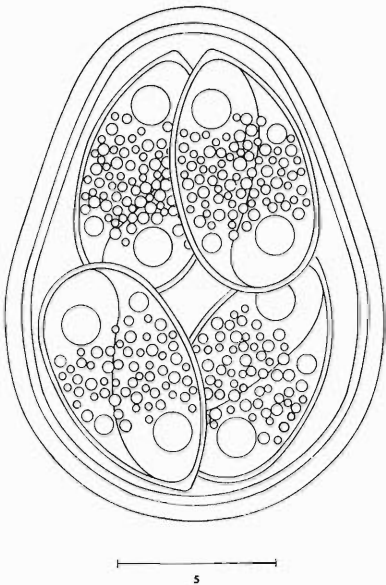

Figure 1. Sporulated oocyst of *Eimeria dunsingi*.

and aerated for 5 days to allow sporulation of the oocysts. Oocysts were concentrated by the modified Sheather's sugar flotation technique (Sloss, 1970). Portions of the intestinal tract were fixed in neutral buffered formalin and processed by routine histologic methods. Five-micron-thick sections were stained with hematoxylin and eosin. Endogenous stages and oocysts were measured and photographed with a Zeiss Universal microscope with planapochromatic objectives. The following description is based on measurements of 50 oocysts and 50 sporocysts.

Results

Sporulated oocysts were ovoid and 25 to 36 μm by 22 to 28 μm (mean 33 by 24 μm) (Fig. 1). The length-to-width ratio was 1.2 to 1.5 (mean 1.4). Polar granules were observed in 12% of the oocysts examined. A micropyle and oocyst residuum were absent. The oocyst wall was approximately 2 μm thick and composed of two layers. The outer layer comprised about two-thirds of the total wall thickness, was slightly rough, and light brown. The inner layer was light blue.

Sporocysts were elongate ovoid and 12 to 17

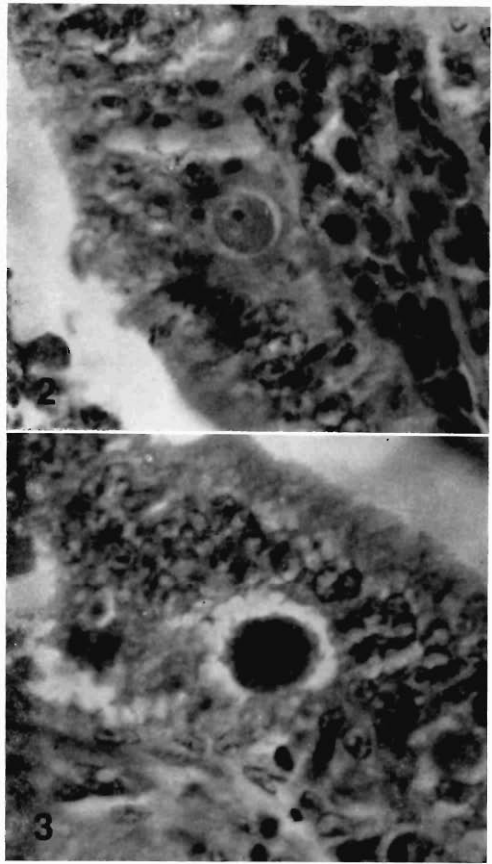

Figures 2, 3. Endogenous stages of *Eimeria dunsingi* stained with hematoxylin and eosin. $\times 7,700$. 2. Macrogamete. 3. Microgamont.

μm by 8 to 10 μm (mean 15 to 9 μm). A prominent Stieda body was present. The sporocyst residuum was composed of granules of different sizes which were scattered throughout the sporocysts. The sporozoites lay lengthwise within the sporocysts. One end was broader than the other. A large posterior refractile globule and a smaller anterior globule were present in each sporozoite. Nuclei were not observed in the sporozoites.

Sporulated oocysts were fed to 10 parakeets, but no patent infections resulted during 3 weeks after inoculation.

Only sexual stages were present in sections of the small intestines of naturally infected birds. The parasites were found along the

length of the small intestine and were located in epithelial cells of the crypts of Lieberkühn and the lower one-third of the villi. In hematoxylin and eosin sections, the nuclei of macrogametes were vesicular, lightly stained, and contained highly basophilic nucleoli (Fig. 2). Mature macrogametes contained large eosinophilic wall-forming bodies, which became arranged at the periphery of the parasites as the oocyst wall began to develop. Developing microgamonts contained numerous basophilic nuclei (Fig. 3). As the microgametes increased in size, the nuclei elongated to form microgametes. Little or no inflammatory response was noted around the parasites.

Discussion

The oocysts of *E. dunsingi* are similar to those previously described (Farr, 1960) except that we observed polar granules in some oocysts. Brada (1966) described a new species of *Eimeria* from the parakeet *M. undulatus* but failed to give the new species a specific name. Because he failed to cite the original description of *E. dunsingi* and the similarity of the oocysts he described to that of *E. dunsingi*, we consider *Eimeria dunsingi* Farr, 1960 and *Eimeria* sp. n. Brada, 1966 to be synonyms. Coccidiosis in "budgies" was described from Washington, but no attempts to diagnose the disease were reported (Morelli, 1956).

Birds infected with *E. dunsingi* had a mucoid liquid feces and the small intestine had a hyperemic mucosa (Brada, 1966). After Farr (1960) fed a parakeet sporulated oocysts of

E. dunsingi, it ate little, developed diarrhea on the sixth day after inoculation, and died on the seventh day. The duodenum was enlarged and contained large numbers of macrogametes. Histologic sections from the anterior portion of the small intestine contained "ring forms" and gamonts in epithelial cells of the villi and in the lamina propria; in areas where there were large numbers of parasites the tissues were "disorganized or destroyed." In the present study no pathologic changes were noted in naturally infected birds or in birds fed oocysts.

The only other intestinal coccidium reported from psittaciform birds is *Isospora psittaculae*, which was described from an Indian parakeet, *Psittacula eupatria nipalensis*, and a red-whiskered bulbul, *Elathea jocosa emeria* (Chakravaty and Kar, 1947).

Literature Cited

- Brada, W. 1966. Estudos sôbre a eimeriose das aves. Isolamento dum coccidio em periquitos (*Melopsittacus undulatus*). Pesqui. Agropecu. Bras. 1: 287-288.
- Chakravarty, M., and A. B. Kar. 1947. A study on the coccidia of Indian birds. Proc. R. Soc. Edinburgh, Sect. B 62: 225-233.
- Farr, M. M. 1960. *Eimeria dunsingi* n. sp. (Protozoa: Eimeriidae) from the intestine of a parakeet, *Melopsittacus undulatus* (Shaw). Libro Homenaje als Dr. Eduardo Caballero y Caballero. p. 31-35.
- Morelli, P. 1956. Coccidiosis in budgies. Canary-Budgie World 13: 9.
- Sloss, M. W. 1970. Veterinary Clinical Parasitology, 4th ed. Iowa State University Press, Ames. 250 p.

New Tetrphyllidean and Trypanorhynch Cestodes from Deep-sea Skates in the Western North Atlantic

RONALD A. CAMPBELL

Department of Biology, Southeastern Massachusetts University, North Dartmouth, Massachusetts 02747

ABSTRACT: Two new tetrphyllidean cestodes, *Echeneibothrium pollonae* sp. n. and *Onchobothrium magnum* sp. n., are described from *Bathyraja richardsoni* (Garrick 1961) taken in the vicinity of Hudson Submarine Canyon. A new trypanorhynch, *Grillotia* (*Paragrillotia*) *rowei* sp. n., is described from plerocerci recovered from *Coryphaenoides* (*Nematonurus*) *armatus* (Hector 1875) and an immature adult from the spiral valve of *B. richardsoni*. *Echeneibothrium dubium abyssorum* ssp. n. is described from *Raja radiata* Donovan 1807, and represents an example of parasitism by a congener in a different part of the host's geographic range. Additional specimens of *E. bathyphilum* Campbell 1975 from *R. bathyphila* Holt and Byrne 1908 are reported.

The four cestodes described herein were recovered from fishes caught during ecological studies of deep-sea benthic communities in Hudson Submarine Canyon. They represent part of the collection obtained thus far in an attempt to utilize the helminth fauna as a means of assessing community interrelationships (see Campbell, 1975a-c, 1977a, b; Campbell and Munroe, 1977). A new species of *Grillotia* (*Paragrillotia*) Dollfus 1969 is described from plerocerci obtained from macrourids and its adult stage from a large (63.6 kg) skate tentatively identified as *Bathyraja richardsoni* (Garrick 1961). Numerous plerocerci of *G. (Pa.) rowei* sp. n. have been obtained from *Coryphaenoides* (*Nematonurus*) *armatus* (Hector 1875) at depths of 1,947 to 4,815 meters, giving this species the greatest vertical distribution of all the helminths recovered in these studies thus far. Hosts were captured in a 12.3-meter Gulf of Mexico shrimp trawl or 7-meter beam trawl. Living worms were studied and relaxed in sea water prior to fixation or fixed *in situ* with AFA or 10% formalin without pressure. Whole mounts were stained with Mayer's paracarmine and serial sections with Harris' hematoxylin and eosin. Descriptive measurements include the mean, standard deviation, and range in parentheses. Measurements are expressed as length by width and are in micrometers unless otherwise indicated. Figures were drawn with the aid of a drawing tube and microprojector.

Grillotia (*Paragrillotia*) *rowei* sp. n. (Figs. 9-12)

DESCRIPTION (measurements based on 10 plerocerci and one immature adult): Trypanorhyncha; Grillotiidae; *Grillotia* (*Paragrillotia*). Scolex 7.9 mm (6.1 to 10.1 mm), by 1.9 mm (1.4 to 2.6 mm), delimited from strobila by a constriction; two triangular bothridia present. *Pars bothridialis* 2.2 mm (1.7 to 2.7 mm); *pars vaginalis* 3.7 mm (2.8 to 4.6 mm); *pars bulbosa* 1.9 mm (1.7 to 2.2 mm); *pars post-bulbosa* 2.1 mm (1.4 to 3.5 mm). Bulbs 1.7 mm (1.2 to 2.1 mm) by 369 (276 to 437); retractor muscle inserted into base. Tentacles 2.1 to 3.2 mm by 130 to 150 (exclusive of hooks). Armature poeciloacanthous. No special basal armature; hooks at basal region reduced in form and number. Rows begin on internal face and end on external face. Principal rows alternate, consisting of ascending half spirals of six to seven hooks each. Hooks 1(1') rose-thorn shaped; length 57 to 65, base 40 to 46, height 31 to 34. Remaining hooks of principal rows spiniform with transverse bases, gradually decreasing in size: 2(2') length 50 to 70, base 26 to 29, height 38 to 56; 3(3') length 26 to 43, base 21 to 36, height 16 to 29; 4(4') length 26 to 31, base 7 to 10; hooks 5(5') and 6(6') similar to intercalating hooks. Armature of external face consists of a longitudinal band of spiniform hooks comprised of a single, central, longitudinal row and adjacent files with which hooks 5(5') and 6(6')

of principal rows merge. Viewed from the bothridial or antbothridial faces, a single row of two or three intercalating hooks may be seen between principal rows. Intercalating hooks spiniform, bases transverse; base length 13 to 23, length 31 to 34. Segments acraspedote, wider than long, immature.

Hosts: *Bathyraja richardsoni* (Garrick 1961), definitive host; *Coryphaenoides* (*Nematonurus*) *armatus* (Hector 1875), *C. (Lionurus) carapinus* Goode and Bean 1883, *C. (Chalinura) leptolepis* Gunther 1877, intermediate hosts.

HABITAT: Adult worm in spiral valve; plerocerci encysted within liver, mesenteries and tunica serosa of stomach, pyloric ceca, and intestine of macrourids.

LOCALITY: Hudson Submarine Canyon in northwest Atlantic, adjacent continental rise and abyssal plain at depths of 1,947 to 4,815 m.

HOLOTYPE AND PARATYPES: USNM Helm. Coll. Nos. 74487 and 74488.

ETYMOLOGY: The species is named after Dr. Gilbert T. Rowe of Woods Hole Oceanographic Institution.

Remarks

Dollfus (1969) created the subgenus *Paragrillotia* to accommodate species of *Grillotia* having nonpatelliform bothridia and no demarcation between the rows of intercalating hooks and the continuous longitudinal row on the middle of the external face. The only species in this subgenus to date is *G. (Pa.) simmonsii* Dollfus 1969, which may be distinguished from the new species by: the presence of irregular hooks in the basal region of the tentacle; smaller principal hooks; hooks 3(3') larger than hooks 1(1') and 2(2'); U-shaped bothridia with a thick marginal bourrelet; scolex formula of 1 : 1.5 : 1.3; and lack of transverse

bases on all hooks. The original description of *G. (Pa.) simmonsii* was based on immature specimens; therefore, no details of the reproductive system are known. Plerocerci of *G. (Pa.) rowei* were recovered in 92 of 149 *C. armatus* examined in the Hudson Canyon area. Additional plerocerci were recovered from *C. carapinus* and *C. leptolepis*. The recovery of an immature adult from the spiral valve of *Bathyraja richardsoni* (?) along with the bones of large macrourids indicates that rat-tails are the usual second intermediate hosts in the life history of this cestode. Unfortunately the skate was not saved by the scientific party and positive identification cannot be made.

Onchobothrium magnum sp. n. (Figs. 3, 6-8)

DESCRIPTION (based on 18 specimens): Tetracyphyllidea; Onchobothriidae; with characters of the genus *Onchobothrium*. Strobila serrate, anapolytic. Mature specimens (8 worms) 40.6 cm (20.5 to 81.5 cm) long; 2.9 mm (1.8 to 4.5 mm) wide. Immature specimens (10 worms) 1.2 cm to 19 cm long; consisting of 50 to 482 segments. Mature specimens consist of 1,018 (352 to 1,586) segments. Scolex 982 (782 to 1.2 mm) by 1.4 mm (966 to 1.9 mm). No accessory suckers. Bothridia 790 (598 to 920) by 514 (460 to 575); anterior loculus 331 (184 to 390); middle loculus 190 (138 to 250); posterior loculus 123 (90 to 200). Hooks stout, slightly curved, occasionally joined by irregular cross piece; one pair per bothridium posterior to prominent muscular pad. Total hook length (8 worms, 42 hooks) 148 ± 17 (110 to 190); handles 46 ± 14 (50 to 85); prongs equal, 77 ± 17 (70 to 120). No cephalic peduncle. Neck 12.5 mm (8 to 17 mm) by 1.3 mm (1.2 to 1.5 mm). Immature and mature segments wider than long; gravid segments initially wider than long,

→

Plate 1

Cestodes from deep-sea skates

Figures 1-12. Figs. 1-3, Scolex of: 1, *Echeneibothrium pollonae*; 2, *E. dubium abyssorum*; 3, *Onchobothrium magnum*. Figs. 4-6, Mature segment of: 4, *E. dubium abyssorum*; 5, *E. pollonae*; 6, *O. magnum*. Figs. 7, 8, *O. magnum*: 7, Gravid segment; 8, Hooks. Figs. 9-12, *Grillotia (Paragrillotia) rowei*: 9, Scolex; 10, Internal face, metabasal armature; 11, Antbothridial face, metabasal armature; 12, External face, metabasal armature.

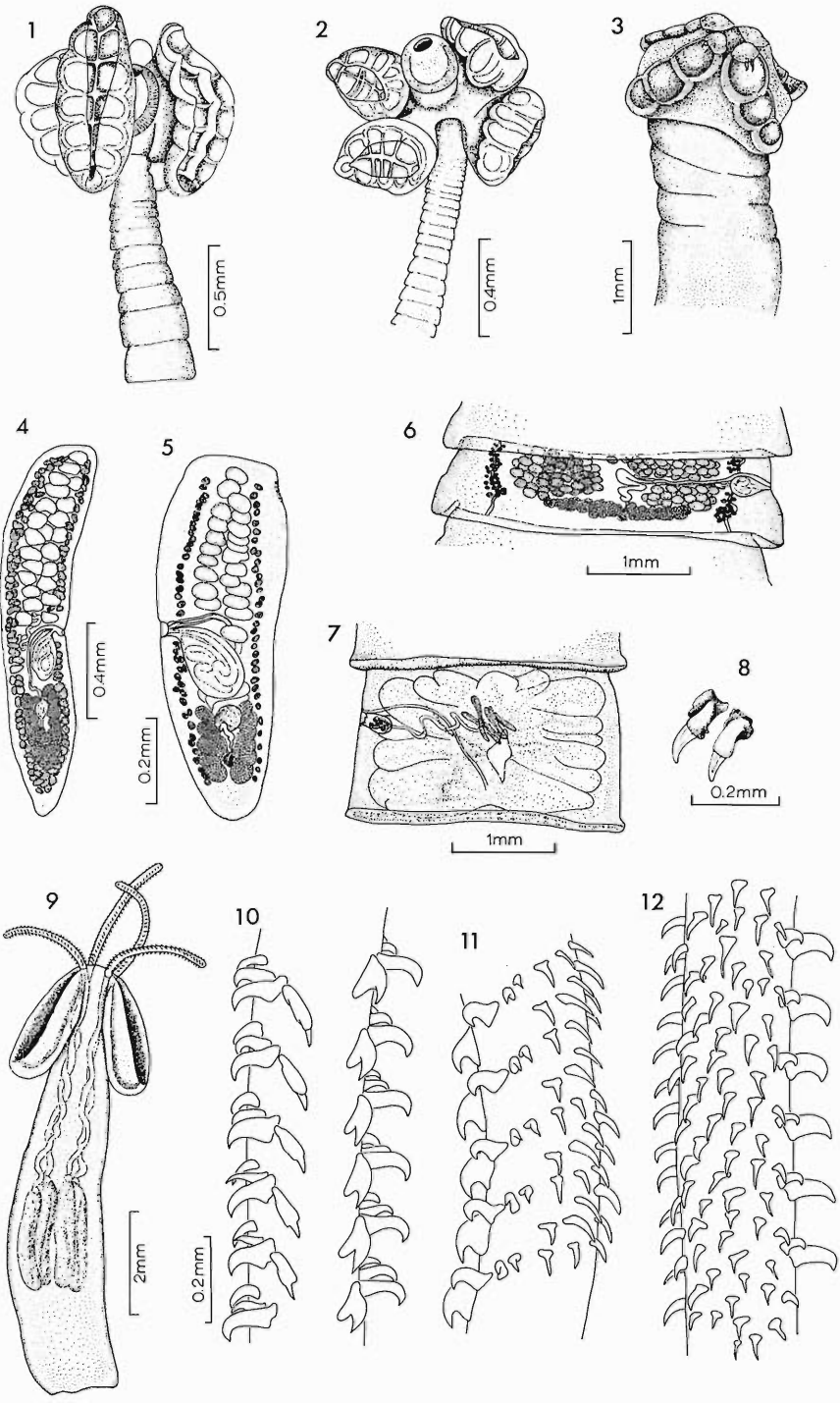

terminal segments almost square. Mature segments 515 (480 to 550) by 4.1 mm (3.8 to 4.5 mm); terminal gravid segments 2.5 mm (989 to 3.5 mm) by 2.9 mm (1.8 to 4.1 mm). Cirrus pouch (8 worms, 40 pouches), 505 \pm 26 (330 to 600) by 297 \pm 23.3 (220 to 322), situated almost completely lateral to vitelline bands. Cirrus armed; spines 10 long. Genital pores pre-equatorial; irregularly alternate. Genital atrium large. Testes subspherical, 132 to 149 by 83 to 100; 148 \pm 11.3 (136 to 173) testes per segment (8 worms, 40 segments). Testes distributed in: prevaginal, 38 \pm 2.6 (34 to 41); postvaginal, 36 \pm 10.7 (27 to 59); and antiporal, 75 \pm 7.8 (60 to 84) fields. Ovarian lobes small, follicular and transversely elongate; at posterior margin of segment; isthmus short and rodlike; lobes 730 to 830 by 166 to 216. Uterus developing as a multilobed sac that eventually forms five to six lateral pairs of saccate branches. Vitelline follicles about 70 in diameter, forming dense lateral bands. Eggs 50 to 60 in diameter; oncospheres 30 to 35 in diameter.

HOST: *Bathyraja richardsoni* (Garrick 1961).

HABITAT: Spiral valve.

LOCALITY: Northwest Atlantic, 39°33'N; 70°44'W at a mean depth of 2,397 m.

HOLOTYPE AND PARATYPES: USNM Helm. Coll. Nos. 74481 and 74482.

Remarks

Members of this genus are infrequently encountered. Southwell (1925) discussed and tabulated the four species known at that time. Presently there are six species of *Onchobothrium*: *O. uncinatum* (Rudolphi 1819); *O. convolutum* (Yoshida 1917); *O. farmeri* (Southwell 1911); *O. schizacanthum* Loenberg 1893; *O. ganfnii* Mola 1927; and *O. lintoni* (sic *lintonni*) Mola 1927. Linton (1897, 1901, 1905, 1911, 1924) reported *O. uncinatum* from *Dasyatis centroura* in New England waters several times. He also described *O. tortum* Linton 1916, but Baer and Euzet (1962) correctly placed this species in *Acanthobothrium*. The only previous records of *Onchobothrium* from deep-sea skates are those of Ronald (1958) of an unidentified species from *Raja jenseni* taken in the Gulf of St. Lawrence and Templeman's report (1973) of *O. pseudo-uncinatum* (syn. *uncinatum*) from

Bathyraja richardsoni collected in the northwest Atlantic. Those specimens, deposited in the British Museum (Natural History), agree with *O. magnum* but differ from *O. uncinatum* as noted below.

Several characteristics distinguish *O. magnum* from other members of the genus. They are: its large size; anapolytic; separate and slightly curved hooks; lack of accessory suckers; serrate strobila; pre-equatorial genital pores; testes number and distribution; size and location of cirrus pouch and length of cirrus spines; eggs; and deep-sea host. The most conspicuous feature differentiating the new species is its large size. Although size alone is not a sound criterion for differentiation of cestodes, its significance cannot be ignored when coupled with knowledge of their initial size at maturity. The largest mature specimens of any previously reported species of *Onchobothrium* is smaller than the largest immature specimens of *O. magnum*. The largest mature specimen of *O. magnum* is 81.5 cm long despite the absence of most of its larger gravid segments, indicating that this species attains a larger size and is one of the largest cestodes ever reported from an elasmobranch. Hook morphology further separates *O. magnum* from other species. The hooks of *O. convolutum* and *O. uncinatum* are joined. In the former they are markedly unequal in size and the worms are 5.5 to 11 cm long at maturity; in the latter the hooks are rose-thorn shaped, have a lateral tubercle, and are joined by a well-defined horseshoe-shaped plate. Mature specimens of *O. uncinatum* are reported to be 6 to 18 cm long when mature, segments are craspedote but the strobila is not serrate, terminal segments are longer than wide, genital pores are mid-marginal, and the strobila is apolytic. Euzet (1959) described his specimens as having accessory suckers about 150 μ m in diameter, although this conflicts with the original description, Southwell (1925), and with specimens collected by Ulmer and Campbell (unpublished) from *Raja clavata* in the Bay of Naples, Italy. Hooks of *O. uncinatum* from *R. clavata* in Naples are joined by a distinct horseshoe-shaped plate and are distinctly curved (see Wardle and McLeod 1952, fig. 128b), cirrus pouch averages 250 by 140, cirrus spines are 5 μ m long, oncospheres average 20 μ m in diameter, and fully gravid seg-

ments occur 22 mm behind the scolex. The hooks of *O. schizacanthum* and *O. farmeri* are separate instead of being joined in a common base as in *O. uncinatum*, but those of *O. schizacanthum* are rose-thorn shaped and in *O. farmeri* they are unequal. Further differences include testes number and distribution (lack of postvaginal testes), development of the muscular system, position of the genital pore, and the size at which maturity is attained. Mola's (1927) descriptions of *O. ganfinii* from *Scylliorhinus canicula* L. and *O. lintoni* from *S. stellaris* L. from the Gulf of Naples, Italy warrant their being considered as *incertae sedis* until they can be verified and correctly described and figured. He characterizes the genus *Onchobothrium* as equivalent with several other onchobothriid genera, his descriptions are of forked hooks, and no figures are given. Hook lengths (120) and accessory suckers are described for *O. lintoni*, but the reproductive system is unknown. The description of *O. ganfinii* includes numerous measurements such as total length (20 mm), number of proglottids (40 to 60), and testes number (50 to 60). The accessory suckers are not well developed and hooks are unequal. However, inconsistent and apparently erroneous measurements of structures such as neck length, 0.42 mm (p. 484) and 3 mm (p. 485), and description of eight forked hooks per scolex with a length of about 17 mm are given, making redescription necessary for identification.

***Echeneibothrium pollonae* sp. n.**
(Figs. 1, 5)

DESCRIPTION (measurements based on 10 specimens): Tetracystidae; Phyllobothriidae; with characters of *Echeneibothrium* as defined by Williams (1966). Strobila short, slender, craspedote, and apolytic. Length 5.8 mm (4.1 to 9.6 mm); width 354 (294 to 414). Number of segments 28 (18 to 47); immature segments wider than long, becoming longer than wide in mature segments. Scolex with subspherical rostellum and four pedicellated bothridia; peduncle absent. Neck short, averaging 138 by 191. Pedicels short (150), contractile. Bothridia pyriform, 744 (510 to 930) by 453 (370 to 540). Dorsal surfaces of bothridia covered by spines about 4.8 long. Bothridia divided into 12 loculi by a single longitudinal

and six transverse septa forming five pairs of loculi with a single loculus at each end. Rostellum 305 (250 to 350) by 261 (230 to 300). Mature segments 751 (600 to 960) by 345 (300 to 400). Gravid segments 700 to 1.1 mm by 340 to 391. Cirrus pouch subspherical, located in median field immediately anterior to ovary; 210 ± 22.4 (160 to 270) by 124 ± 15 (100 to 150). Cirrus armed; spines 12 long. Genital atrium present. Genital pore in posterior half of segment; irregularly alternate. Testes subspherical, 50 to 130 by 20 to 80, in median field anterior to cirrus pouch. Number of testes per segment (20 segments), 18 ± 2.3 (16 to 22). Ovarian lobes posterior, reniform, 150 to 350 by 60 to 110, forming a V-shaped mass; cirrus pouch may overlap ovarian lobes, vas deferens and seminal receptacle located between ovarian lobes. Eggs 14 in diameter; oncospheres 8. Vitelline follicles subspherical, 24 to 36 in diameter, forming lateral bands extending to posterior margin of ovary.

HOST: *Bathyraja richardsoni* (Garrick 1961).

HABITAT: Spiral valve.

LOCALITY: As above.

HOLOTYPE AND PARATYPES: USNM Helm. Coll. Nos. 74483 and 74484.

ETYMOLOGY: Species named after Ms. Pamela T. Polloni, WHOI, for her assistance in providing collection data.

Remarks

This species is clearly distinguished from all other members of the genus in having 12 loculi per bothridium, 16 to 21 testes per segment, and in having a deep-sea host. The only other species of *Echeneibothrium* from deep-sea hosts are *E. bathyphilum* Campbell 1975 and *E. dubium abyssorum* (see below) also from the Hudson Canyon area. *Echeneibothrium pollonae* may be distinguished from these species by scolex morphology (8 and 10 loculi), testes number (25 and 22), and egg size (19 and 22).

***Echeneibothrium dubium abyssorum* ssp. n.**
(Figs. 2, 4)

DESCRIPTION (measurements of 36 specimens): Tetracystidae; Phyllobothriidae; *Echeneibothrium* as defined by Williams (1966). Strobila craspedote, apolytic; total length 7.9

mm (3.2 to 11.5 mm), width 339 (250 to 529). Number of segments 42 (24 to 52). Scolex with subspherical rostellum 217 (160 to 270) by 215 (170 to 260), and four pedicelated bothridia; peduncle absent. Neck about 138 by 111. Pedicels, 180 to 380, contractile. Bothridia broadly oval, 448 (350 to 520) by 303 (200 to 380); divided by a single longitudinal septum and five transverse septa into 10 loculi (four pairs with a single loculus at each end). Septa well defined in living and fixed specimens. Mature segments longer than wide, length (16 segments), 902 (420 to 1.5 mm); width (16 segments), 343 (250 to 570). Cirrus pouch globose, extending into median field; length (50 pouches), 204 ± 27.9 (130 to 320), width 131 ± 26.7 (80 to 171). Cirrus armed; genital atrium present. Genital pore slightly postequatorial; irregularly alternate. Testes subspherical, 65 to 110 by 40 to 65, in median field anterior to cirrus pouch. Testes number (32 segments), 21.6 ± 2.6 (17 to 26). Ovarian lobes subequal, 272 (200 to 340) by 89 (50 to 130), forming a distinct V-shape; isthmus markedly posterior. Seminal receptacle about 115 by 60. Uterus simple, median. Vitelline follicles large, 20 to 65 by 20 to 40, irregular, forming lateral bands extending posterior to ovary. Eggs 21.6 to 24 in diameter.

HOST: *Raja radiata* Donovan 1807.

HABITAT: Spiral valve.

LOCALITY: Western North Atlantic, 39° 28'N; 72°24'W; mean depth 498 m.

HOLOTYPE AND PARATYPES: USNM Helm. Coll. Nos. 74485 and 74486.

Remarks

These specimens closely resemble *Echeneibothrium dubium* Beneden 1858, a well known species from *Raja batis* L. in European waters. Although *R. radiata* is sympatric with *R. batis* in European waters, it does not harbor *E. dubium* (Dr. H. Harford Williams, pers. comm.). Euzet (1959) reported *E. dubium* from *R. batis* and three other species of skates in Mediterranean waters but never from *R. radiata*. It is therefore surprising to find *Raja radiata* infested with cestodes almost identical to *E. dubium* from such a distant locality. Scolex morphology (10 loculi), testes number (22), cirrus pouch dimensions, eggs (22), and

extent and development of vitellaria agree with or overlap the descriptions of Euzet (1959) and Williams (1966). Comparisons of whole mounts and sectioned specimens of *E. dubium* loaned by Dr. Williams have revealed more subtle differences between the two populations. The 36 mature specimens from *R. radiata* are shorter (3.2 to 11.5 mm vs. 15 to 20 mm), have a smaller rostellum (160 to 270 vs. 300 to 650), and fewer segments (24 to 52 vs. 100 to 150), but larger cirrus pouch (130 to 320 vs. 150 to 200), and broader segments (250 to 529 vs. 250 to 300). Sectioned specimens reveal that the ovarian isthmus is more posteriorly located in the subspecies than in specimens from *R. batis*. In sections, eggs are about the same size as *E. dubium sensu* Euzet (1959) but no polar filaments were observed. There are no records of *E. dubium* or *R. batis* from continental waters of North America. However, in view of the lack of knowledge concerning speciation in these hermaphrodites, their life histories, intraspecific variation, displacement due to competition, distribution of hosts, etc., I believe this population is best defined as a subspecies at present because of its basic similarities to *E. dubium* from *R. batis*. This decision is tempered by the recent examination of five mature *Dasyatis pastinaca* L. in the laboratory of Dr. Richard L. Haedrich at the Woods Hole Oceanographic Institution, which were caught by commercial fishermen off George's Banks east of New England (unpublished). Although the intestinal contents had deteriorated prior to preservation, the fish are in excellent condition. This observation lends caution to assumptions of geographical isolation of batoid hosts and cestode populations across the Atlantic Ocean basin. The recovery of *E. dubium abyssorum* from *R. radiata* supports the contention of Campbell (1969) that the same host species may harbor a different species of the genus (of cestodes) in a different part of its geographical range.

Echeneibothrium bathyphilum Campbell 1975

HOST: *Raja bathyphila* Holt and Byrne 1908.

HABITAT: Spiral valve (anterior half).

LOCALITIES: From 39°17'N to 39°43'N; 71° 12'W to 79°59'W at mean depths of 1,691 to 2,119 m.

Remarks

Eight additional specimens of this cestode were recovered from two *R. bathyphila* subsequent to the original description. Tegumental spines on the strobila are short, dense, and best seen at the margins. Arrangement of the testes depends upon the state of contraction of the segments but agrees in number with the original description.

Acknowledgments

Thanks are due to Dr. Richard L. Haedrich of the Woods Hole Oceanographic Institution for collection and identification of hosts and for making research space available to me aboard ship; Dr. H. Harford Williams of the Open University in Wales, Cardiff for loan of specimens; Dr. W. Templeman, Queen's College, Newfoundland and Dr. Rodney Bray of the British Museum (Natural History) for comparative data from specimens from *Bathyrāja richardsoni*. This research was supported in part by NSF Grants 22339 and DEB76-20103.

Literature Cited

- Baer, J. G., and L. Euzet.** 1962. Revision critique des cestodes tetracéphalides décrits par T. Southwell. Bull. Soc. Neuchâtel. Sci. Nat. 85: 143-172.
- Campbell, R. A.** 1969. New species of *Acanthobothrium* (Cestoda: Tetracéphalidea) from Chesapeake Bay, Virginia. J. Parasitol. 55: 559-570.
- . 1975a. Two new species of *Echeneibothrium* (Cestoda: Tetracéphalidea) from skates in the western North Atlantic. J. Parasitol. 61: 95-99.
- . 1975b. *Hudsonia agassizi* gen. et sp. n. (Zoogonidae: Hudsoniinae subf. n.) from a deep-sea fish in the western North Atlantic. J. Parasitol. 61: 409-412.
- . 1975c. *Abyssotrema pritchardae* gen. et sp. n. (Digenea: Fellodistomidae) from the deep-sea fish, *Alepocephalus agassizi* Goode and Bean 1883. J. Parasitol. 61: 661-664.
- . 1977a. *Degeneria halosauri* (Bell 1887) gen. et comb. n. (Digenea: Gorgoderidae) from *Halosaurus macrochir*. J. Parasitol. 63: 76-79.
- . 1977b. A new family of pseudophyllidean cestodes from the deep-sea teleost *Acanthochaenus lutkenii*. J. Parasitol. 63: 301-305.
- , and **T. A. Munroe.** 1977. New hemiurid trematodes (Digenea: Hemiuridae) from deep-sea fishes of the western North Atlantic. J. Parasitol. 63: 285-294.
- Dollfus, R. Ph.** 1969. Quelques espèces de cestodes Tétracéphalides de la côte Atlantique des États Unis, dont l'une n'était pas connue à l'état adulte. J. Fish. Res. Board Can. 26: 1037-1061.
- Euzet, L.** 1959. Thèses présentées à la Faculté des Sciences de Montpellier pour obtenir le grade de Docteur des Sciences Naturelles: 1. Recherches sur les cestodes tetracéphalides des Sélaciens des côtes de France. Causse, Graille and Castelneau, Montpellier. 263 p.
- Linton, E.** 1897. Notes on cestode parasites of fishes. Proc. U. S. Nat. Mus. 20: 423-456.
- . 1901. Parasites of fishes of the Woods Hole region. Bull. U. S. Comm. Fish and Fisheries for 1899, Washington, 19: 405-492.
- . 1905. Parasites of fishes of Beaufort, North Carolina. Bull. Bur. Fish. 24: 321-428.
- . 1911. Notes on the distribution of Entozoa of North American marine fishes. Proc. 7th Int. Zool. Congr., Boston, 1907, 686-696.
- . 1916. Notes on two cestodes from the spotted sting ray. J. Parasitol. 3: 34-38.
- . 1924. Notes on cestode parasites of sharks and skates. Proc. U. S. Nat. Mus. 64: 1-114.
- Mola, P.** 1927. Due nuove specie di *Onchobothrium* de Blainville (1828). Studi Sassar. Sez. 2, Sec. 2, 5(6): 481-486.
- Ronald, K.** 1958. The metazoan parasites of the heterosomata of the Gulf of St. Lawrence. IV. Cestodes. Can. J. Zool. 36: 429-434.
- Southwell, T.** 1925. A monograph on the Tetracéphalidea, with notes on related cestodes. Mem. Liverpool School Trop. Med. New Ser., 2. Liverpool Univ. Press. 368 p.
- Templeman, W.** 1973. First records, descriptions, distribution, and notes on the biology of *Bathyrāja richardsoni* (Carrick) from the Northwest Atlantic. J. Fish. Res. Board Can. 22: 259-279.
- Wardle, R. A., and J. A. McLeod.** 1952. The Zoology of Tapeworms. Univ. Minnesota Press, Minneapolis, Minnesota. 780 p.
- Williams, H. H.** 1966. The ecology, functional morphology and taxonomy of *Echeneibothrium* Beneden, 1849 (Cestoda: Tetracéphalidea), a revision of the genus and comments on *Discobothrium* Beneden, 1870, *Pseudanthobothrium* Baer, 1956, and *Phormobothrium* Alexander, 1963. Parasitology 56: 227-285.

The Life Cycle of *Cephalogonimus vesicaudus* (Digenea: Cephalogonimidae) from *Trionyx spiniferus* from Texas

NORMAN O. DRONEN, JR. AND HAROLD T. UNDERWOOD

Laboratory of Microbiology and Parasitology, Department of Biology, Texas A&M University, College Station, Texas 77843

ABSTRACT: Mother and daughter sporocysts and xiphidiocercariae develop in *Helisoma trivolvis*. Cercariae penetrate tadpoles of *Rana sphenocephala*, in which they encyst. Adults develop in the small intestines of *Trionyx spiniferus* within 20 days after ingestion of an infected second intermediate host. The life cycle of *Cephalogonimus vesicaudus* in turtles is similar to that reported for species of *Cephalogonimus* in amphibians.

Cephalogonimus Poirier, 1886 is a common genus of intestinal fluke in aquatic amphibians and reptiles of North America. Life cycle data have been published for four species of this genus: *C. americanus* Stafford, 1902 by Lang (1968), *C. europaeus* Blaizot, 1910 by Combes and Coll (1974), and *C. brevicirrus* Ingles, 1932 by Brooks and Welch (1976), all from raniid frogs, and *C. salamandrus* Dronen and Lang, 1974 by Dronen and Lang (1974) from an ambystomid salamander. No life cycles have been completed for members of this genus from turtles.

Cephalogonimus vesicaudus Nickerson, 1912 is a common intestinal fluke of the spiny soft-shell turtle, *Trionyx spiniferus* Lesueur, in Brazos County, Texas. Although this species of fluke has been reported from a domestic duck by Alvey (1932) and from *Rana clamitans* Latreille by Najarian (1955), it is normally a parasite of turtles. *Cephalogonimus vesicaudus* has been previously reported from numerous turtle genera, including: *Aspidonectes* and *Amyda* (*Trionyx*) by Nickerson (1912) and *Trionyx*, *Pseudemys* (*Chrysemys*), *Graptemys*, and *Kinosternon* by McKnight (1959).

Materials and Methods

Naturally infected *Helisoma trivolvis* Say were collected from several ponds in Brazos County, Texas for laboratory life cycle studies. Cercariae were studied alive with and without vital strains. Cercariae were placed with uninfected tadpoles of *Rana sphenocephala* Cope, 1886 to establish metacercariae for the infection of turtles. Metacercariae were studied at 2 hours and at 21 days after infection.

Trionyx spiniferus from a local pond where infections of *C. vesicaudus* do not occur were starved in the laboratory for two weeks prior to exposure and then force-fed tadpoles infected with the metacercariae of this parasite. Turtles were necropsied at 20 days after exposure. Most recovered flukes were studied live, heat-killed, stored in AFA, and stained in Semichon's carmine for further studies.

Eggs were teased from some experimental adult flukes and allowed to develop in pond water for 20 days, then were fed to young laboratory-reared *H. trivolvis*. Snails were examined at intervals after exposure to observe intramolluscan stages.

All measurements are in micrometers, the mean followed by the range in parentheses, unless otherwise indicated.

Results

Cercaria (Figs. 1, 2)

Body of 25 relaxed cercariae from natural infections, spinose, 272 (230 to 310) by 82 (70 to 110). Tail straight, 115 (100 to 130) long, no finfold; inserted in a candal pocket with spines on each side. Oral sucker 65 (58 to 70) in diameter. Acetabulum 58.6 (51 to 61) in diameter. Prepharynx 19 (16 to 21) long, pharynx 16 (14 to 18) by 14 (11 to 17), esophagus 34 (31 to 37) long. Ceca extending to or slightly past posterior margin of acetabulum. Stylet: length 30 (28 to 31), width at wing 8 (7 to 9), width at base 6 (5 to 7), width at narrowest point on shaft 5 (4 to 5) (Fig. 2). Body with 50–100 refractile globules per side. Cystogenous glands extending from

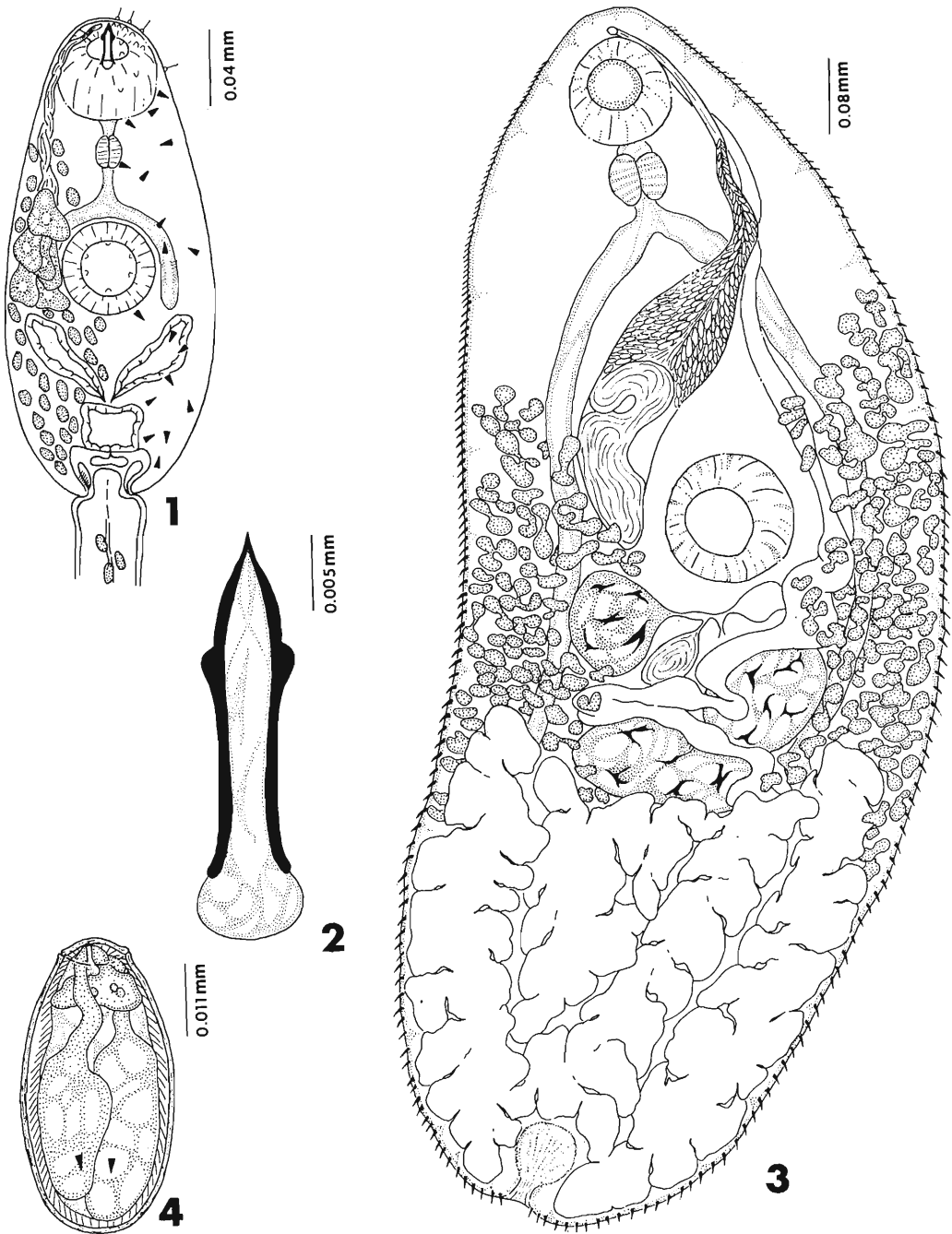

Figures 1-4. Stages in the life cycle of *Cephalogonimus vesicaudus*. 1. Ventral view of cercariae with flame cell pattern and oral sucker papillae arrangement shown on one side. 2. Stylet of the cercariae. 3. Twenty-day-old adult. 4. Fully embryonated egg.

level of pharynx to posterior end of body, primarily in lateral fields, 20 to 40 per side. Six pairs of penetration glands in acetabular zone with individual ducts emptying near tip of stylet. Twenty papillae on oral sucker and 6 in acetabulum. Excretory bladder y-shaped, primary excretory tubules entering posterior to tips of arms, 18 pairs of flame cells; flame cell formula $2 [(3 + 3 + 3) + (3 + 3 + 3)]$.

Metacercaria

Metacercariae 125 by 128 at 21 days after infection of tadpoles.

Mature flukes (Fig. 3)

Flukes from experimental infections were fully mature at 20 days postinfection and were indistinguishable from those collected from naturally infected *Trionyx spiniferus*. Fifty stained and mounted specimens were 1,426 (850 to 2,370) by 679 (475 to 1,000).

Egg and miracidium (Fig. 4)

Eggs examined from the uterus of stained and mounted experimental flukes were 39 (33 to 42) by 21 (18 to 23). Twenty live, fully embryonated eggs were 45 (42 to 48) by 23 (21 to 25). The miracidium was entirely covered with cilia but epidermal plates were not evident. The miracidium is similar to that reported for *C. salamandrus* by Dronen and Lang (1974), with two larger penetration glands in the posterior half of the body and a single large gland in the anterior half. There appeared to be at least three nuclei in the anterior gland, but this could not be seen in all specimens even with staining.

Sporocyst generations

Mother sporocysts are highly branched and indistinguishable from those described for other members of the genus. Mature daughter sporocysts were unbranched, saclike, 240 (187 to 380) by 94 (82 to 110), located in the hepatopancreas of the snail, and contained 5 to 9 fully developed cercariae. Cercariae are shed

from daughter sporocysts at about 45 days postinfection.

Remarks

The life cycle of *C. vesicaudus* is very similar to that reported for other species of the genus in North America and Europe. It is interesting to note that life cycle studies have shown that planorbid snails of the genus *Helisoma* serve as the primary molluscan host in North America, while *C. europeus* utilizes a species of *Lymnaea* in Europe. In the life cycle of *C. vesicaudus* mother and daughter sporocysts and xiphidiocercariae develop in *H. trivolvis*. Released cercariae penetrate tadpoles, where they encyst in the skin. Adults develop in 20 days in the intestine of *Trionyx spiniferus*, as well as numerous other turtles, after ingestion of infected tadpoles.

Literature Cited

- Alvey, C. H. 1932. A species of *Cephalogonimus* from the domestic duck. *J. Parasitol.* 19: 174.
- Brooks, D. R., and N. J. Welch. 1976. Parasites of amphibians of the Great Plains. I. The cercariae of *Cephalogonimus brevicirrus* Ingles, 1932 (Trematoda: Cephalogonimidae). *Proc. Helminthol. Soc. Wash.* 43: 92-93.
- Combes, C., and A.-M. Coll. 1974. Cycle biologique de *Cephalogonimus europaeus* Blazot, 1910 (Trematoda: Cephalogonimidae). *Bull. Soc. Neuchatel. Sci. Nat.* 97: 203-214.
- Dronen, N. O., and B. Z. Lang. 1974. The life cycle of *Cephalogonimus salamandrus* sp. n. (Digenea: Cephalogonimidae) from *Ambystoma tigrinum* (Green) from Eastern Washington. *J. Parasitol.* 60: 75-79.
- Lang, B. Z. 1968. The life cycle of *Cephalogonimus americanus* Stafford. *J. Parasitol.* 54: 945-949.
- McKnight, J. 1959. A taxonomic study of the helminth parasites of the turtles of Lake Texoma. Unpubl. Ph.D. dissertation, University of Oklahoma, Norman, Oklahoma. *Diss. Abstr.* 20: 1106.
- Najarjan, H. 1955. Trematode parasites in the salientia in the vicinity of Ann Arbor, Michigan. *Am. Midl. Nat.* 53: 195-197.
- Nickerson, W. S. 1912. On *Cephalogonimus vesicaudus* sp. n. *Zool. Jahrb. Syst.* Band 33: 249-256.

The Lacunar System and Tubular Muscles in Acanthocephala¹

DONALD M. MILLER AND T. T. DUNAGAN

Department of Physiology, Southern Illinois University, Carbondale, Illinois 62901

ABSTRACT: The longitudinal and circular muscles of *Oligacanthorhynchus tortuosa*, *Macracanthorhynchus hirudinaceus*, and *Macracanthorhynchus ingens* have been studied using scanning electron microscopy as well as standard histological techniques. Our conclusions are that these muscles are tubelike with patent cores filled with material that could circulate throughout the anastomosing network of muscles. Moreover, in these three acanthocephalans the fluid-filled space of the circular muscles is connected to the lacunar system via canals (radial canals) and it is probable that the entire system acts to facilitate waste removal from the muscles as well as to provide nutrients.

The muscles of Acanthocephala are among the most uniquely organized tissues of any group of animals. Their syncytial nature, numerous anastomosing interconnectives, and hollow, tubelike cores provide the investigator an intriguing array of distinguishing characteristics. This unusual histology has a correspondingly unique physiology. The muscles are electrically inexcitable, have low membrane potentials, and are slow conductors (Hightower et al., 1975).

Although these helminths have never occupied the limelight of parasitological interests, their unusual histology was recognized, according to Rauther (1930), as early as 1818 by Nitzsch. The work of Hamann (1891), Saeftigen (1884), and Kaiser (1893a) provide the morphological basis for our current interpretations of the structural organization of Acanthocephala. Some details have since been added to their observations but the general framework remains.

Schneider (1868) first recognized the tubelike nature of the body wall muscles. Working on *Macracanthorhynchus hirudinaceus*, he described these muscles as "cells . . . in which the contractile substance is divided among cylinders. The fibrillar substance forms the integumentary layer of the cylinder while the space is filled with a 'sap' . . ." Furthermore, the pattern formed by the longitudinal and circular muscles is a characteristic of the species in question, a point which Kaiser (1893b) re-

peatedly makes. Kaiser (1893a) described the histology of the body musculature as composed of contractile elements (Zusammengesetzte Myofibrille) whose distribution varies around a core of sarcoplasm which has been spoken of as Markraum, Plasmasaülen, Sarcoplasmamassen, and/or Muskelplasma. Kaiser called this arrangement a muscle tube (Hauptmuskelschlauches) and indicated that these tubes branch or commute through openings which partially develop as a result of a division of myofibers or an occasional absence of a fiber wall. He stated: "Ferner aber sehen wir die Markraum der einzelnen Röhren unter sich Kommunizieren, und zwar durch Oeffnungen, die theils einer Faserspaltung, theils dem stellenweisen Ausfalle der Faserwand ihre Entstehung verdanken." He further stated that this anastomosing network of interconnecting muscle tubes circulates "Muskelflüssigkeit," indicating that the material enclosed by the myofibers moves freely through this labyrinth. He sometimes called this a system which functioned in the even distribution of nutritive substances in the muscle layer.

Rauther (1930, p. 455) reviewed previously published information on acanthocephala and described the "äusseren Ringfaserschicht und einer inneren Längsfaserschicht" as a "vielkerniges Syncytium . . . die Fasern zeigen vielfache Aufteilungen und netzförmige Verbindungen miteinander." He described the histology of the muscles as consisting of a sarcoplasm surrounded by contractile units and illustrated this (Fig. 488, p. 453) with a figure previously published by Kaiser (1913).

Kaiser (1893a, pt. 1, p. 77) also pointed

¹ This study was supported in part by grant AI-12883 from the National Institutes of Health, the American Museum of Natural History, and the Molecular Science Program at Southern Illinois University.

out that in circular muscle the contractile fibers were restricted to the outside of the myofiber whereas in longitudinal muscles the contractile elements were evenly distributed around the outer surface of the myofibers.

Because of very unique and different results that we observed in previous studies on the lacunar system (Miller and Dunagan, 1976) and the electrophysiology of this worm (Hightower et al, 1975), we restudied the musculature by means of injection, light microscopy, and scanning electron microscopy.

Materials and Methods

The specimens were collected from opossum (*Didelphis virginianus*), in the vicinity of Southern Illinois; from raccoons (*Procyon lotor*), on St. Catherines Island, Georgia; and from hogs (*Sus scrofa*), at Hunter Packing Company, East St. Louis, Illinois. In the laboratory the worms were separated from tissue adhering to the proboscis and cleaned of any mucous material and chyme. The latter was accomplished by several washings in 30% sea water. For scanning electron microscope studies, razor sections of the worms were fixed in osmium tetroxide and dehydrated in a Pearse-Edwards vacuum dryer. After mounting, the holders were placed in a Denton vacuum evaporator for metal coating. Specimens were examined in a Cambridge Stereoscan IIA microscope.

For light microscopy the worms were fixed for four hours in a solution of 0.15% formalin containing 0.03 M bromoacetate and 0.3 M sucrose, and then were moved into a glycerol-water series up to 30% glycerol. If sections were required, the specimens were then dehydrated, embedded in 56°C paraffin wax and sectioned following the technique of Miller and Dunagan (1971). Injection techniques have been previously described (Miller and Dunagan, 1976).

Results

Figures 1-6 are a series of scanning electron microscope pictures of the body wall of *Oligacanthorhynchus tortuosa* showing the arrangement of myofilaments in circular and longitudinal muscles. Also evident in each of the pictures is the tubular nature of these muscles as well as the anastomosing interconnections of each muscle tube. Figure 1 is a cross section of the body wall at the level of one of the testes. Note that the longitudinal muscles are interrupted medial to both dorsal and ventral lacunar channels. The close packing of these muscles is evident and all seem to be arranged as hollow tubes permeated with channels and with the contractile elements along the periphery of the tube. The area within the white square has been enlarged in Fig. 4.

Figure 2 is a longitudinal section of the body wall along the line of the medial longitudinal channel, showing the circular muscles in cross section. The contrast in myofiber content between the two muscle groups is evident. The longitudinal muscles have thinner walls and more evenly distributed myofibers (small white L). Vertical and horizontal innerconnections between and within each longitudinal muscle layer are evident. Note that in the circular muscles (small white C) the myofibers are concentrated on the side adjacent to the tegument (white T) and the lumen is adjacent to the longitudinal muscles, and much more ramified than those of the longitudinal muscles. The medial longitudinal channel (large black L) is very thin and filmy but consists of a series of highly interconnected compartments which give off radial canals. Injection studies with *M. hirudinaceus*, *O. tortuosa*, and *Macracanthorhynchus ingens* have shown that the intramuscular channels are connected with the medial longitudinal channel by radial canals and in fact, in our previous injection study (Miller and Dunagan, 1976), these secondary

→

Figures 1-6. 1. Cross section of *Oligacanthorhynchus tortuosa* at the level of the testis. Outlined area enlarged in Fig. 4. Tegument is marked with a T, longitudinal muscles with an L, and pseudocoel with a P. 2. Enlargement of a longitudinal section which cuts through the median longitudinal channel (black L), the longitudinal muscles (white L), the circular muscles (C), and the tegument (T). 3. A cross section of the body wall in the area of the dorsal lacunar channel. Longitudinal muscles (L) do not cover the channel. 4, 5. Cross section of longitudinal (L) and circular muscles (C). 6. Perpendicular view of area shown in Fig. 3. Asterisk provides orientation.

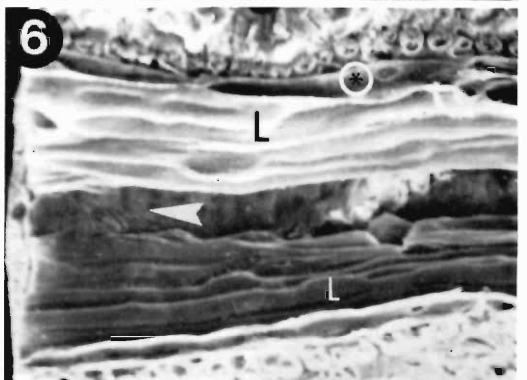
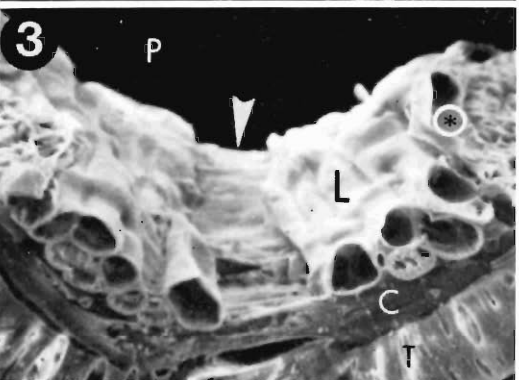
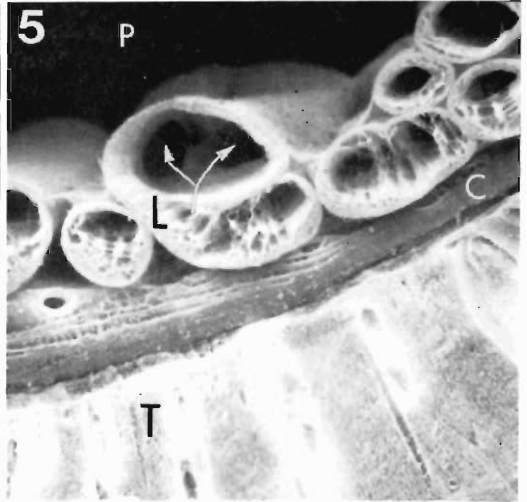
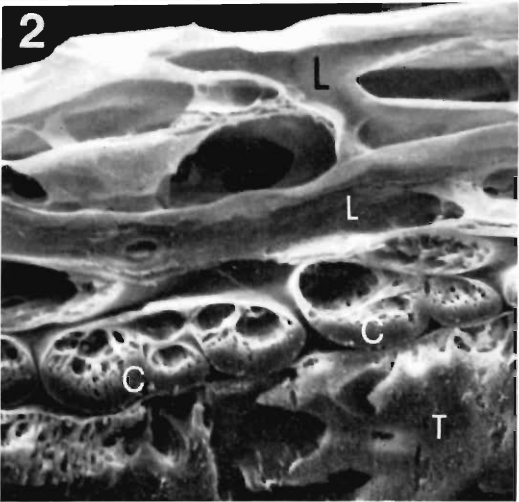
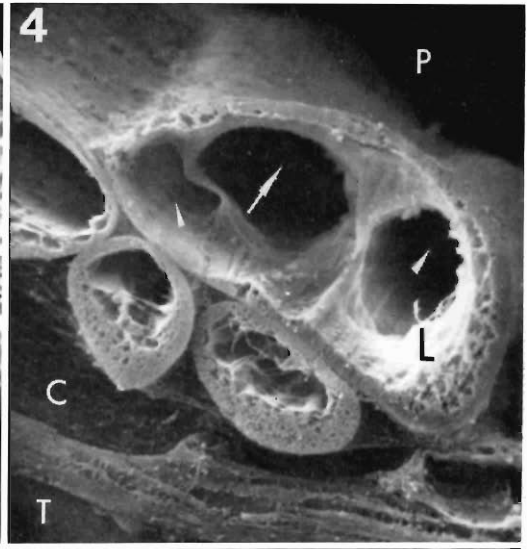
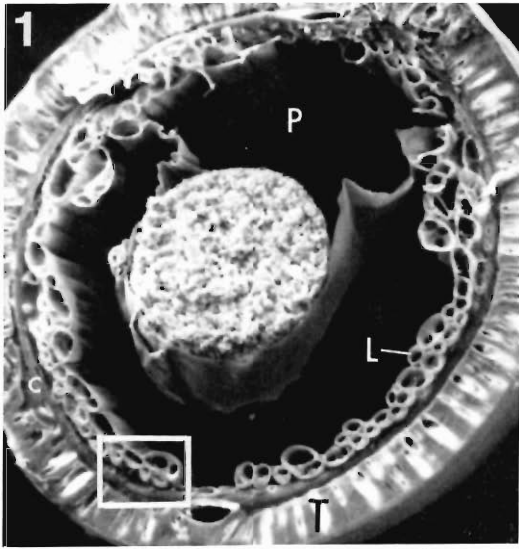

ring channels of the lacunar system of *M. hirudinaceus* are the same as the intramuscular canals.

Figure 3 is a cross-sectional view in the region of the dorsal lacunar channel. It shows (arrow) that there are no longitudinal muscles medial to this channel; and although it is not shown here, this is true throughout the length of the worm. Figure 6 is a vertical view of Fig. 3. Notice the asterisk for proper orientation.

Figure 4 is an enlargement of the area enclosed in the white box in Fig. 1. It shows the hollow nature of both circular and longitudinal muscles. The arrows indicate three separate openings from a common cavity and emphasize the branching nature of these muscle tubes. Note that those longitudinal muscles adjacent to the circular muscles have thicker layers of myofibers and that they are unequally distributed around the tube. A higher magnification of this area would show that the myofiber layer is spongelike rather than a solid mass of contractile elements.

Figure 5 is an enlarged cross section of the area above the "T" in Fig. 1. This picture provides a good comparison of the thickness of the longitudinal and circular muscle layers. It also shows several different sizes and internal organizational patterns for the longitudinal muscles.

Discussion

Hightower et al. (1975) studied the circular and longitudinal muscles in *M. hirudinaceus* and observed that longitudinal muscle contractions required 4 to 7 seconds with a fusion frequency between 1 and 3 Hz. Indeed the time for contraction to reach peak tension was slower (at room temperature) than the 4 seconds required for the lantern retractor muscle in holothurians (Prosser, 1969). However, at higher temperatures (39°C) acanthocephalan body muscles are as fast as intestinal smooth muscle found in mammals (Hightower et al., 1975). Since speed is correlated with structural and enzymatic properties of muscle, slow nonstriated acanthocephalan muscle would be expected to correspond to other invertebrate muscles of this type with regard to patterns of innervation, glycogen reserve, and development of the sarcoplasmic reticulum. However,

because of the wide variety of poikilothermic and homeothermic hosts in which acanthocephala live, gradations in speed of movement, number of motor units involved, and types and relative amounts of structural protein (myosin, actins, etc.) might be expected. What was unexpected when we began this study was finding the organization of the myofibers around a hollow lumen which was continuous with the lacunar system. The resulting "muscle tube" organization not only provides surface area for a diffusion system in the muscles but also serves as a distribution network for lacunar fluid. Because the muscles are arranged as an anastomosing network of tubes, they effectively provide for their own nourishment and waste removal in an organism that does not possess a "vascular" system per se. Whether or not material in the lumen actually circulates in a prescribed fashion has not been determined. There is some evidence (personal observation) that valves or sphincters do exist in the system, specifically in association with the median longitudinal channel. In addition, contraction of longitudinal muscles forces lacunar fluid into circular components and contraction of circular muscles tends to force lacunar fluid into longitudinal components of the lacunar system.

The concentration of the myofibers away from the medial surface was first mentioned by Hamann (1891) and more recently by the reviews of Rauther (1930) and Hyman (1951). Crompton and Lee (1965) described the circular muscles of *Polymorphus minutus* as containing myofilaments "adjacent to the body wall and a non-contractile part nearer the body cavity." They show the 'non-contractile' part as containing large numbers of mitochondria and a small amount of endoplasmic reticulum. However, they did not mention that the muscles were tubelike or that there was movement of fluid material through the muscles. Others (Nicholas and Mercer, 1965; Byram and Fisher, 1973, 1974) have also studied the tegument and transportation therein, but have not indicated that the muscles were interconnected or that a fluid *actually circulated* throughout the separate components.

The extensive anastomosing between muscle tubes has previously been depicted by Hamann (1891) and Kilian (1932), who indicated that the muscles were a syncytium

forming a fibrous network. Unfortunately, these early discussion did not lead to studies on the functioning of these unusual muscles until very recently (Hightower et al., 1975). We now know that the secondary ring canals which we recently described in *M. hirudinaceus* (Miller and Dunagan, 1976) were actually components of some larger circular muscles and that the lacunar system is connected to the muscles by the extensive duct work which we described. The circulatory components now seem to be integrated into one vast system, except that we have not yet been able to discover how the rete system (described by Miller and Dunagan, 1976) in *M. hirudinaceus* enters this complex arrangement of tubes and ducts. It is clear that the radial channels provide the passageway between the lacunar channels and both the muscle tubes and the median longitudinal channel.

The construction and functioning of Acanthocephala is very different from that of other helminths. It might be expected that investigators of these animals are still in for a few surprises.

Literature Cited

- Byram, J. E., and F. M. Fisher, Jr. 1973. The absorptive surface of *Moniliformis dubius* (Acanthocephala). I. Fine structure. *Tissue Cell* 5: 553-579.
- , and ———. 1974. The absorptive surface of *Moniliformis dubius* (Acanthocephala). II. Functional aspects. *Tissue Cell* 6: 21-42.
- Crompton, D. W. T., and D. L. Lee. 1965. The fine structure of the body wall of *Poly-morphus minutus* (Goeze, 1782) (Acanthocephala). *Parasitology* 55: 357-364.
- Hamann, O. 1891. Monographie der Acanthocephalen (Echinorhynchen). Ihre Entwicklung, Histogenie, Anatomie, nebst Beiträgen zur Systematik und Biologie. *Jena. Z. Naturwiss.* 25: 113-231.
- Hightower, K., D. M. Miller, and T. T. Dunagan. 1975. Physiology of the body wall muscles in an acanthocephalan. *Proc. Helminthol. Soc. Wash.* 42: 71-80.
- Hyman, L. H. 1951. *The Invertebrates*. Vol. III, Acanthocephala, Aschelminthes, and Entoprocta. McGraw-Hill, New York.
- Kaiser, J. E. 1893a. *Die Acanthocephalen und ihre Entwicklung*. 1. theil, Cassel (Leuckart, K. G. F. R., and C. Chun, *Biblioth. Zool.* Heft 7).
- . 1893b. *Die Acanthocephalen und ihre Entwicklung*. 2. theil, Cassel (Leuckart, K. G. F. R., and C. Chun, *Biblioth. Zool.* Heft 7).
- . 1913. *Die Acanthocephalen und ihre Entwicklung*. Beiträgen zur Kenntnis der Histologie, Ontogenie und Biologie einiger einheimischer Echinorhynchen. Leipzig. P. 1-66.
- Kilian, R. 1932. Zur Morphologie und Systematik der Giganthorhynchidae (Acanthocephala). *A. Wiss. Zoll.* 141: 246-345.
- Miller, D. M., and T. T. Dunagan. 1971. Studies on the rostellor hooks of *Macracanthorhynchus hirudinaceus* (Acanthocephala) from swine. *Trans. Am. Microsc. Soc.* 90: 329-335.
- , and ———. 1976. Body wall organization of the acanthocephalan, *Macracanthorhynchus hirudinaceus*: A reexamination of the lacunar system. *Proc. Helminthol. Soc. of Wash.* 43: 99-106.
- Nicholas, W. L., and E. H. Mercer. 1965. The ultrastructure of the tegument of *Moniliformis dubius* (Acanthocephala). *Q. J. Microsc. Sci.* 106: 137-146.
- Prosser, C. L. 1969. Comparative physiology of non-striated muscle. In C. A. G. Wiersma (ed.), *Invertebrate Nervous Systems*. University of Chicago Press, Chicago. P. 133-149.
- Rauther, M. 1930. Sechste Klasse des Cladus Nematelminthes Acanthocephala-Krätzwürmer. In Willy Kükenthal and T. Krumbach, (eds.) *Handbuch der Zoologie*, 2 Band, 1 Hälfte. P. 449-482.
- Saeffliger, A. 1884. Zur Organisation der Echinorhynchen. *Morphol. Jahrb.* Bd. 10, pp. 120-171.
- Schneider, A. F. 1868. Ueber den Bau der Acanthocephalen. *Arch. Anat. Physiol. u. Wissensch. Med.* 5: 584-597.

The First Asexual Generation in the Life Cycle of *Sarcocystis bovicanis*

RONALD FAYER

United States Department of Agriculture, Animal Parasitology Institute, Agricultural Research Service, Beltsville, Maryland 20705

ABSTRACT: *Sarcocystis bovicanis* undergoes at least three generations of asexual development in the bovine host; the first generation is described herein, the second generation was found previously as schizonts in endothelial cells of capillaries in many organs, and the third generation is the cyst in striated muscle and nervous tissue. Schizonts considered to be of the first generation were found in endothelial cells of small and medium-sized arteries in the cecum, large intestine, kidney, pancreas, and cerebrum of three calves killed 15 and 16 days after oral inoculation with *S. bovicanis* sporocysts. The schizonts averaged 20.8 by 28.6 μm ($N = 18$) and contained an average of 103.1 nuclei ($N = 15$). This finding appears to complete the life cycle of *S. bovicanis* in the bovine intermediate host.

The cyst stage of *Sarcocystis* was first observed in the muscles of a mouse by Miescher in 1843. Cysts were subsequently described in muscles of numerous other vertebrates; but until recently no other stage in the life cycle nor the method of infection was known. The first additional life cycle stages observed were male and female gametes and an oocyst-like stage that developed in cell cultures inoculated with *Sarcocystis*-bradyzoites from grackles (Fayer, 1970, 1972). Successful transmission to definitive hosts was accomplished when oocysts and sporocysts similar to *Isoospora* were produced by dogs, cats, and humans fed intramuscular sarcocysts from cattle, sheep, and swine (Heydorn and Rommel, 1972; Rommel and Heydorn, 1972; Rommel, Heydorn, and Gruber, 1972). The host cycle was completed when calves were orally inoculated with *Sarcocystis bovicanis* Heydorn, Gestrich, Mehlhorn and Rommel, 1975. (*Syn. S. fusiformis*) sporocysts from dogs; schizonts developed intravascularly in calves followed by the development of intramuscular cysts (Fayer and Johnson, 1973, 1974; Heydorn et al., 1975).

Concurrent with schizont development from 26 to 33 days after oral inoculation, calves became acutely ill; the illness was marked by elevated temperature and other clinical signs (Fayer and Johnson, 1973). Of 11 cows and 25 calves that had been inoculated with *S. bovicanis*, most cows but only a few calves had elevated temperatures between 15 and 20 days after inoculation (Fig. 1) (Fayer, unpublished data). The present study was conducted to

determine whether the elevated temperatures of the cows was associated with development of an early schizogonic generation that had not previously been seen but that theoretically seemed necessary to account for the large number of schizonts present throughout the body at 26 to 33 days.

Materials and Methods

Five Holstein-Friesian calves, 1 to 3 days old, were obtained from local dairy farms and reared at the Animal Parasitology Institute in the absence of dogs. Four calves, 3 to 4½ months old, were orally inoculated with an aqueous suspension of 200,000 *S. bovicanis* sporocysts; one calf was an uninoculated control. One calf was killed 15 days after inoculation (DAI), two calves were killed 16 DAI, and one inoculated and one control calf were killed 17 DAI. A thorough postmortem examination was performed. Tissues from the following organs were fixed in 10% neutral buffered formalin and prepared for histologic examination: adrenal glands, cecum, cerebellum, cerebrum, colon, diaphragm, esophagus, eye, heart, kidney, liver, lung, lymph nodes (hepatic, mediastinal, mesenteric, renal), pancreas, rumen, skeletal muscle, small intestine, spinal cord, spleen, thymus, and tongue.

Results

Schizonts were found in all three experimentally inoculated calves killed 15 and 16 DAI but were not found in the calf killed 17

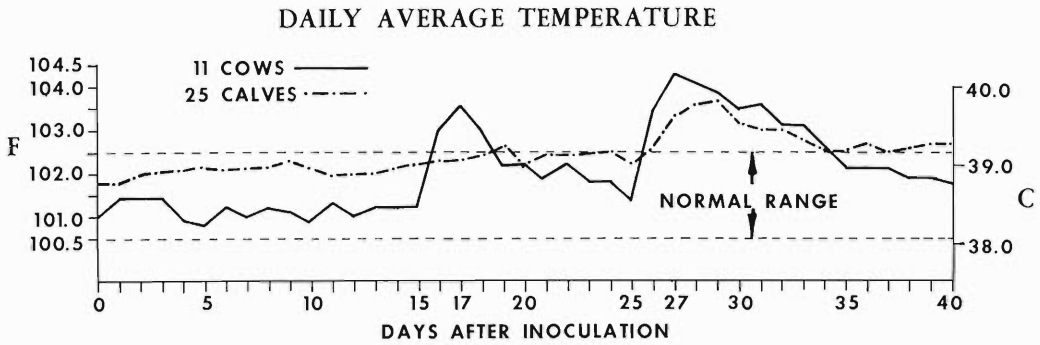
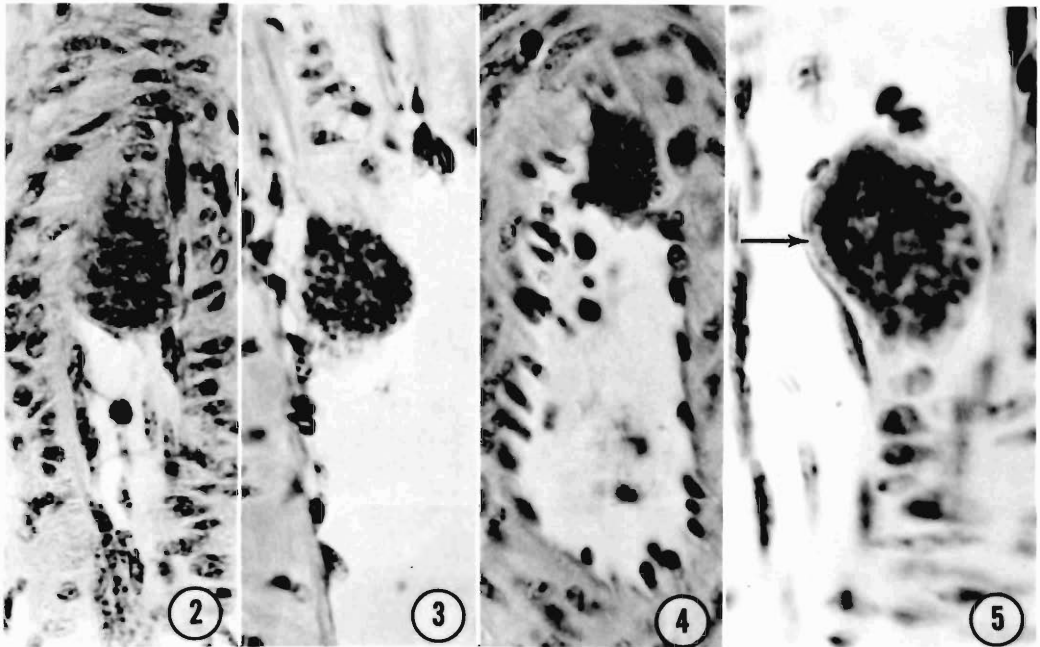

Figure 1. Daily average body temperatures of cows and calves experimentally inoculated with *Sarcocystis bovicanis* sporocysts.

DAI or in the control calf. Schizonts were located in endothelial cells of small and medium-sized arteries in the cecum, large intestine, kidney, pancreas, and cerebrum. Few schizonts were observed; they were most numerous in the arciform arteries of the kidney. Schiz-

onts often occluded the lumen of smaller arteries (Fig. 2), but in medium-sized arteries neither those schizonts that projected into the lumen (Figs. 3, 5) nor those that projected towards the tunica media (Fig. 4) were large enough to occlude the lumen. Schizonts aver-



Figures 2-5. Photomicrographs of histological sections of bovine kidney. First-generation schizonts of *Sarcocystis bovicanis* in arteries. 2. Schizont occluding small artery, 15 DAI. $\times 500$. 3. Schizont protruding into lumen of medium-sized artery, 15 DAI. $\times 525$. 4. Schizont embedded in wall of artery, 16 DAI. $\times 500$. 5. Schizont with peripheral row of immature merozoites (arrow), 16 DAI. $\times 850$.

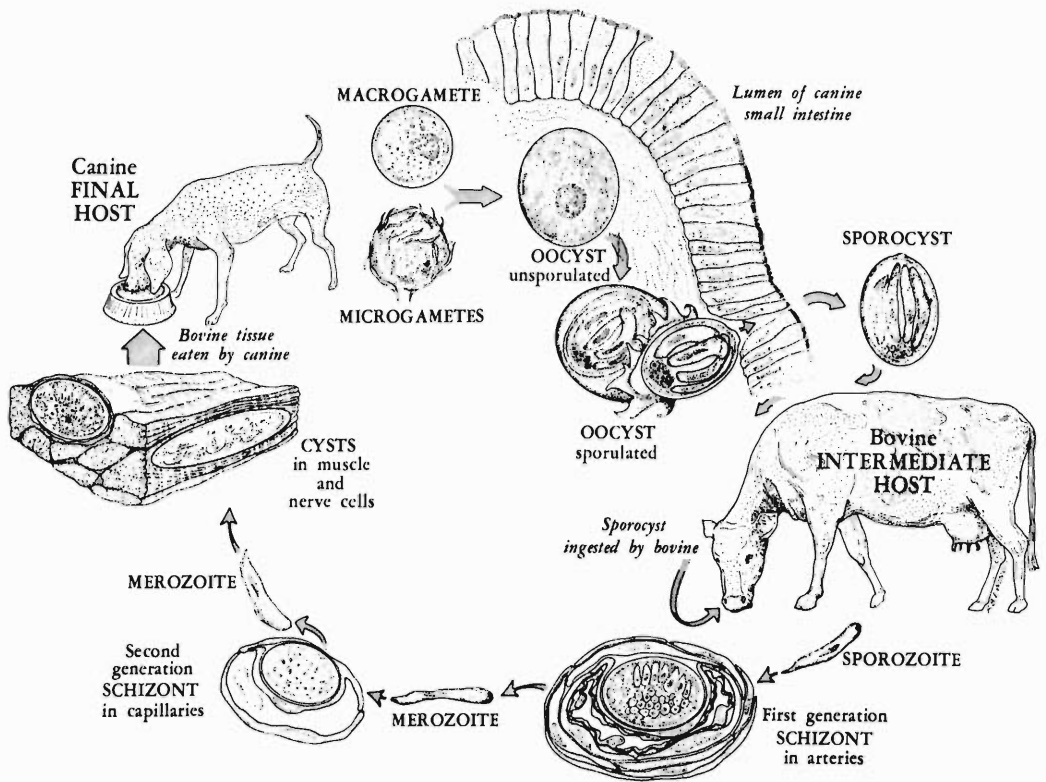

Figure 6. Diagrammatic representation of life cycle of *Sarcocystis bovicanis*.

aged 20.8 by 28.6 μm with a range of 7.4–27.8 by 16.7–51.8 μm ($N = 18$). They contained an average of 103.1 nuclei with a range of 8–200 nuclei ($N = 15$). Fully mature schizonts were not observed, but some schizonts contained a peripheral row of merozoites (Fig. 5). The finding of this schizont stage provides data necessary for the construction of a diagrammatic life cycle (Fig. 6) showing the chronology of developmental stages of *S. bovicanis* in the bovine host.

Discussion

Schizonts found in experimentally inoculated calves in the present study are considered to be the first asexual generation of *S. bovicanis*. This interpretation is based on (1) the inability of Fayer and Johnson (1974) to find schizonts in tissues of experimentally infected calves earlier than those found in the present study

and (2) distinct differences in time of development, size, and location of schizonts found in the present study versus those found by Fayer and Johnson (1973, 1974). In the present study, schizonts considered to be first-generation were found 15 and 16 DAI, averaged 20.8 by 28.6 μm with an average 103.1 nuclei, and were located in endothelial cells of small and medium-sized arteries. No schizonts were found in the calf at 17 DAI probably because the schizonts had already matured, released their merozoites, and therefore were no longer present. In previous studies (Fayer and Johnson, 1973; 1974), schizonts considered to be second-generation were found 26 to 33 DAI, averaged 9.1 by 14.8 μm with an average of 27.3 nuclei, and were located in endothelial cells of capillaries.

The presence of the first-generation schizonts in endothelial cells of arteries explains

how relatively few infective forms (sporozoites) result in moderate numbers of (second-generation) schizonts in the capillaries in nearly every organ of the body. For example, oral administration of 100,000 sporocysts, each containing 4 sporozoites, could result in the development of 400,000 first-generation schizonts; approximately 40 million second-generation schizonts could then be produced (estimating an average 100 merozoites per first-generation schizont).

The reason most experimentally inoculated cows and only a few experimentally infected calves had elevated temperatures between 15 and 20 DAI is not known, but in light of the current findings the following explanation is proposed to account for the phenomenon. Most elevated temperatures in bovines experimentally inoculated with *Sarcocystis* occur when the host manifests a great inflammatory response (Johnson, Hildebrandt, and Fayer, 1975). That this inflammatory response may essentially be a response to parasite antigen is reflected by the finding that cows, because of previous experience with *Sarcocystis* antigens, are prepared to respond to antigen from the first-generation schizonts. Therefore, upon re-exposure, they elicit the temperature increase recorded in association with this stage. Alternatively, calves that have had little or no experience with the antigen elicit no such response to first-generation schizonts. However, both cows and calves, after experience with antigen from the first-generation schizonts, elicit great inflammatory responses and elevated temperatures when the second-generation schizonts develop. One may also speculate that the inflammatory response and elevated temperature associated with the second-generation schizont reflect the relative number of stages based on findings in this study. If, as estimated, the increase in the number of second-generation schizonts above the number of first-generation schizonts is 100-fold, then a great deal more antigen is probably present during the second generation to stimulate host reaction.

Finally, the finding of the first-generation schizont appears to complete the life cycle of *S. bovicanis* in the intermediate host. Because more is known about the life cycle of *S.*

bovicanis than of any other species of *Sarcocystis*, this life cycle (Fig. 6) may serve as a guide for the study of other members of this genus.

Acknowledgments

The author thanks L. T. Young for preparation of histologic specimens and R. B. Ewing for preparation of the illustrations.

Literature Cited

- Fayer, R. 1970. *Sarcocystis*: Development in cultured avian and mammalian cells. *Science* 168: 1104-1105.
- . 1972. Gametogony of *Sarcocystis* sp. in cell culture. *Science* 175: 65-67.
- , and A. J. Johnson. 1973. Development of *Sarcocystis fusiformis* in calves infected with sporocysts from dogs. *J. Parasitol.* 59: 1135-1137.
- , and ———. 1974. *Sarcocystis fusiformis*: Development of cysts in calves infected with sporocysts from dogs. *Proc. Helminthol. Soc. Wash.* 41: 105-108.
- Heydorn, A.-O., and M. Rommel. 1972. Beiträge zum Lebenszyklus der Sarkosporidien. II. Hund und Katze als Überträger der Sarkosporidien des Rindes. *Berl. Muench. Tieraerztl. Wochenschr.* 85: 121-123.
- Heydorn, A.-O., R. Gestrich, H. Mehlhorn and M. Rommel. 1975. Proposal for a new nomenclature of the *Sarcosporidia*. *Z. f. Parasitenk.* 48: 73-82.
- Johnson, A. J., P. K. Hildebrandt, and R. Fayer. 1975. Experimentally induced *Sarcocystis* infection in calves: Pathology. *Am. J. Vet. Res.* 36: 995-999.
- Miescher, F. 1843. Über eigenthumliche Schlauche in den Muskeln einer Hausmaus. *Ber. Verh. Naturforsch. Ges. Basel* 5: 198-202.
- Rommel, M., and A.-O. Heydorn. 1972. Beiträge zum Lebenszyklus der Sarkosporidien. III. *Isospora hominis* (Railliet und Lucet, 1891) Wenyon, 1923, eine Dauerform der Sarkosporidien des Rindes und des Schweins. *Berl. Muench. Tieraerztl. Wochenschr.* 85: 143-145.
- , ———, and F. Gruber. 1972. Beiträge zum Lebenszyklus der Sarkosporidien. I. Die Sporocyste von *S. tenella* in den Fazes der Katze. *Berl. Muench. Tieraerztl. Wochenschr.* 85: 101-105.

Helminth Parasites of some Southwestern Lake Michigan Fishes

OMAR M. AMIN

Science Division, University of Wisconsin-Parkside, Kenosha, Wisconsin 53140

ABSTRACT: Eight species of parasitic helminths, one acanthocephalan, four cestodes, one trematode, one nematode, and one leech species, are reported from various hosts: *Acanthocephalus parksidei* is reported from 12 host species with 10 new host records; first record in Lake Michigan. Host-*A. parksidei* associations are discussed. *Echinorhynchus salmonis* was also recovered. Morphological observations of most parasites are included with particular reference to *Cyathocephalus truncatus* (new host record in slimy sculpin) and *Eubothrium salvelini* (new host in bloater and locality records). Other parasites recovered include *Glaridacris catostomi*, *Proteocephalus exiguus*, *Triganodistomum attenuatum* (new locality record), *Dacnitoidea cotylophora*, and *Placobdella parasitica* (new host and locality records). The description of *E. salvelini* is supplemented and the diagnosis of the genera *Cyathocephalus* and *Dacnitoidea* emended.

Eighteen species of fishes were collected from southwestern Lake Michigan during 1973–1974. Nine species of parasitic helminths were recovered. One of these, *Echinorhynchus salmonis* Müller, 1784, was discussed elsewhere (Amin and Burrows, 1977). The objective of this study is to report the distribution of the remaining eight parasites in their Lake Michigan hosts and their morphological variations.

Materials and Methods

Fishes were collected at three sites near the Wisconsin-Illinois state line between November 1973 and October 1974 by gill netting and/or trawling about twice monthly. Trematodes and cestodes were stained in Semichon's carmine, cleared in xylene, and whole mounted in Canada balsam. Acanthocephalans and nematodes were refrigerated in distilled water overnight, stained in Mayer's acid carmine, cleared in terpineol, and mounted in Canada balsam. Other materials and methods are as in Amin and Burrows (1977).

Results and Discussions

A listing of the 18 species of fishes examined and the 10 families to which they belong appears below followed by the number examined and annotations if any. Clupeidae: Alewife, *Alosa pseudoharengus*, 149. Salmonidae: Lake whitefish, *Coregonus clupeaformis*, 8; Bloater, *C. hoyi*, 79; Coho salmon, *Onchorhynchus*

kisutch, 15; Chinook salmon, *O. tshawytscha*, 6 (an additional 37 fishes on their spawning run in and near the mouth of the Root River, SE Wisconsin, were examined during September, 1976); Rainbow trout, *Salmo gairdneri*, 8; Brown trout, *S. trutta*, 16; Lake trout, *Salvelinus n. namaycush*, 7. Osmeridae: Rainbow smelt, *Osmerus mordax*, 446 (the only species with complete seasonal collections of 12 to 71 fishes per month). Cyprinidae: Carp, *Cyprinus carpio*, 3; Spottail shiner, *Notropis hudsonius*, 15. Catostomidae: White sucker, *Catostomus commersoni*, 24. Ictaluridae: Black bullhead, *Ictalurus melas*, 1. Percopsidae: Trout perch, *Percopsis omiscomaycus*, 1. Gadidae: Burbot, *Lota lota*, 1. Cottidae: Slimy sculpin, *Cottus cognatus*, 37. Percidae: Yellow perch, *Perca flavescens*, 11.

Acanthocephalus parksidei Amin, 1974 (Acanthocephala: Echinorhynchidae)

Acanthocephalus parksidei was recently described from 11 fish hosts in the Pike River, southeastern Wisconsin (Amin, 1975a). Twelve species of fishes were infected with 224 *A. parksidei* (84 males, 140 females). A listing of these hosts is followed by information on the frequency of infection (percent), number of *A. parksidei* recovered, month recovered (months of fish collections). *Alosa pseudoharengus*, 0.6%, 1, XI (XI, V–IX); *C. hoyi*, 1.3%, 1, VII (XI, III, VII–X); *O. kisutch*, 6.7%, 1, III (III, IV, IX); *O. tshawytscha*, at

least two females were recovered from two of 37 fishes examined during IX, 1976 (in progress); *S. gairdneri*, 12.5%, 1, II (XI, I-III, VIII); *S. trutta*, 6.2%, 3, I (I-III, V, VIII, X); *S. n. namaycush*, 14.3%, 1, V (XI, III, V, VIII); *O. mordax*, 5.4%, 32, XI-IV, VII-X (all); *C. carpio*, 33.3%, 5, IV (IV); *C. commersoni*, 20.1%, 91, I, III, V (I, III-V, IX); *L. lota*, 100%, 2, IX (IX); *C. cognatus*, 37.8%, 86, III (III). All are new locality records and all but *S. gairdneri* and *C. commersoni* represent new host records.

White suckers were much more heavily parasitized by *A. parksidei* than by *Echinorhynchus salmonis* Müller, 1784. Sculpins were infected with both acanthocephalan species, but infections with *E. salmonis* were relatively heavier. In all other infected fishes, infection was scarce with *A. parksidei* and heavier with *E. salmonis*. The above information suggests that at least white suckers and slimy sculpins significantly support *A. parksidei* populations in this part of Lake Michigan. Females with cement plugs from these two hosts and rainbow smelt were observed. White suckers, through their spring spawning migration, might provide a link between the heavier infections in the Pike River (Amin, 1975b), and those of Lake Michigan fishes. White suckers and rainbow trout were more frequently and heavily infected in the Pike River than in southwestern Lake Michigan. Frequencies and means of infection in the river were 29 to 100% and 1.1 to 95.56 in suckers and 100% and 106 in trout (Amin, 1975b).

White suckers were infected with *A. parksidei* in the posterior $\frac{3}{4}$ of the intestinal tract (past the first limb). Concurrent infections of both acanthocephalan species were observed in the posterior half of the intestines of all other infected hosts, where *A. parksidei* invariably occupied the anteriormost portion of this range.

Females of *A. parksidei* in all stages of development were recovered (from most hosts) during all months (except June). None of 8 white suckers examined during September were infected while 5 of the 10 examined during January and March were infected with 45 males and 45 females. The developmental stages of female worms (21 with ovarian balls, 24 with embryos) and the equal sex ratio indicate a young population at that time. In con-

trast, infections of older worms with proportionally many more females (mostly distended with embryos only) were characteristic of early spring peak populations in the same host from the Pike River where seasonal periodicity was very pronounced. Slimy sculpins (available only in March) were infected with 27 males and 59 females (29 of which were with ovarian balls only).

Cyathocephalus truncatus (Pallas, 1781) (Cestoda: Cyathocephalidae)

One female *Coregonus clupeaformis* and four *Cottus cognatus* (three males, one female) were infected with six and seven cestodes in the anterior and posterior halves of the gut, respectively, during March. *C. truncatus* was previously reported from *C. clupeaformis* in Lake Michigan by Cooper (1918). The record from *C. cognatus* is a new host record.

Body and other measurements of my specimens are almost identical to those provided by Cooper (1918) who, however, reported 10-20 sets of reproductive organs in his specimens; only seven to eight are present in mine.

Genus *Cyathocephalus* has been described by many investigators since Pallas; see Vilk (1954) for details. *C. truncatus* was first reported in North America from *C. clupeaformis* in Lake Superior by Linton (1898). Cooper (1918) regarded his material from the same host species in Lakes Huron and Michigan as distinct from *C. truncatus* based on 12 points and created *C. americanus* for the American material. Nybelin (1922) subsequently synonymized the two species, and his revised description of *C. truncatus* agrees closely with Cooper's (1918) description of *C. americanus* except for the occurrence in the European material but not in Cooper's of sphincter muscles around the genital openings. In my Lake Michigan material as well as that from western Canada (Wardle, 1932), sphincter muscles were observed, which suggests that North American and European forms are identical.

Cyathocephalus truncatus is evidently a highly variable species with European forms being markedly larger, more developed, and with more reproductive sets than American ones. For example, in North America, worm length and number of reproductive sets were 7.00 mm and 12 sets (Fig. 6, Plate 28, Linton

1898), up to 11.00 and 10–20 (Cooper, 1918), 8.00–15.00 and 8–30 (Wardle, 1932), and 6.72–8.40 and 7–8 (this paper). In Europe, worms can reach 40.00 mm in length and contain up to 45 reproductive sets; minimum figures are 6.00 and 15 (Kraemer 1892, Nybelin 1922, Wisniewski 1933, and Vik 1954). Measurements of various organs are also correspondingly greater in European than in American material.

In presenting the generic diagnosis of *Cyathocephalus*, Yamaguti (1959), in referring to the characters of the family Cyathocephalidae, includes "Strobila with a series of 20–45 sets of reproductive organs, without distinct external segmentation." This should be emended to read "Strobila with a series of 7–45 sets of reproductive organs. . . ."

In one of my whole mounted specimens, a portion of a *C. clupearformis* gut mucosa, partially transformed into a fibrous mass, was sucked into the worm's funnel-shaped scolex. *C. truncatus* is known to cause serious damage as reported by Huitfeldt-Kaas (1927, trout mass mortality), Wisniewski (1933, host growth retardation), Vik (1954, local swelling and perforations), Šenk (1956, damage to trout ovaries), Awachie (1966, erosion of epithelium from trout with infected pyloric ceca) and Aisa (1971, lesions).

***Eubothrium salvelini* (Schrank, 1790) (Cestoda: Amphicotyliidae)**

This cestode is commonly reported from European and Canadian fishes, but rarely in the U.S., e.g., Fritts (1959). It is reported here for the first time in Lake Michigan. Twenty worms were recovered from four fish species as follows: one mature adult from a female brown trout during October, one young and 14 mature adults from one male and four female lake trout during November, March, May, August, one young adult from bloater during November, and three larger young adults from a male rainbow trout during March. The record from bloater is a new host record. Worms were found in the second limb of the gut except in bloater (in rectum).

Eubothrium salvelini mature adults were described by Nybelin (1922), Wardle (1932), Ekbaum (1933), Wardle and McLeod (1952) and Vik (1963). No accounts of young adults

or immature and gravid proglottids of mature adults were given except for the reference to the uterus in "reifen" proglottids as "meistens mit starken seitlichen Ausbuchtungen" by Nybelin (1922) and as "sac-like, ½ the proglottid width" by Wardle (1932). Local material are herein described with emphasis on the previously undescribed characters (above) as well as on the scolex, which is at variance with others described elsewhere. All measurements of this species are in microns unless otherwise specified.

YOUNG ADULTS: Body length and maximum width 2.04–6.92 and 0.42–0.74 mm, respectively. Smallest specimen with 17 proglottids and somewhat subglobular scolex that is not distinctly separate from anterior proglottids (Figs. 1, 2). Two pairs of excretory canals present. Scolex 378–560 long by 266–406 wide. Apical disc not pronounced and with diameter smaller (252–364) than widest scolex diameter. Bothria and its pronounced rim occupying slightly more than anterior half of scolex (as in mature adults); posterior region about as wide. Inner margin of bothria 154–336 long by 112–168 wide. First segment 70–84 long by 350–406 wide. Scolex of larger young adults (Fig. 3) with more distinct anterior and posterior regions and a conspicuous apical disc with relatively deep indentation (Fig. 4).

MATURE ADULTS: Specimens at least 63.84 to 113.80 mm long. Scolex elongate, 840–1,260 long, 420–476 wide, and 406–462 deep. Bothria deep, 448–490 long by 154–210 wide (at inner margin) and with strong oval rim in anterior region of scolex. Apical disc conspicuous with slightly convex apex and deep indentation, and at least as wide as scolex; 308–518 in diameter (Figs. 5–7). Posterior region of scolex clearly distinct and narrower than anterior region. First proglottid about as wide and deep as posterior end of scolex; 140–224 long, 406–518 wide, and 322–392 deep.

First evidence of undifferentiated reproductive system primordia (dark patches, Fig. 11) appear in segments 120–240 long, 1,160–1,168 wide and 650–1,000 deep, at about 61 mm from the anterior extremity of the longest worm (> 113.80 mm). Further development to stages shown in Figs. 12 and 13 was evident at

about 80–90 mm from the anterior extremity of the same worm. The male reproductive system appears to develop first. Lateral genital openings irregularly alternate in groups rather than in individual proglottids.

Fully mature proglottids first appear about 110 mm from anterior extremity. They generally fit the description of Nybelin (1922), Wardle (1932), and Ekbaum (1933) with minor variations; 200–250 long, 1,360–2,440 wide, and 480–720 deep. Each contains 40–60 oval testes, occasionally more. Eggs are oval; 35–51 by 25–32.

Gravid proglottids are 200–640 long, 1,320–2,920 wide, and 720–1,040 deep. Ripening involves characteristic changes in uterine outline, egg content, and associated reproductive structures (Figs. 14–16). First, a relatively small number of eggs is contained in a somewhat sac-shaped uterus (Fig. 14). Testes seem to occupy the median field more frequently than in mature proglottids. Subsequently, the uterus expands laterally reaching the longitudinal muscle layer as it contains more and somewhat larger eggs (Fig. 15) with the testes, cirrus pouch, vitellaria, and ovary persisting. The fully ripened proglottid (Fig. 16) contains a greatly expanded uterus, with multiple outpouchings and a massive number of eggs that occupies most of the medullary region anteriorly with little evidence of testes, vitellaria or ovary.

In my specimens, testes and/or eggs are relatively smaller than those measured by Nybelin (1922), Wardle (1932), and Ekbaum (1933) but the scolex is markedly larger. Only Wardle (1932) indicated the number of testes as 40 per segment. Differences in scolex structure, however, represent the most notable variations between my Lake Michigan specimens (Figs. 4–7), European (Figs. 8, 9), and Canadian material (Fig. 10). In my mature specimens: (1) the apical disc is much more prominent and with deeper indentation, (2) the two regions of the scolex are clearly distinct, the anterior one with oval outline and deeper bothria and the posterior one longer and more slender in comparison, and (3) the anteriormost segments are narrower and less deep than anterior region of scolex.

Infections with *E. salvelini* appear to adversely affect host health and were shown to

reduce substantially the growth and stamina and to affect survival of sockeye salmon, *Oncorhynchus nerka* (Smith and Margolis, 1970; Smith, 1973).

***Glaridacris catostomi* Cooper, 1920 (Cestoda: Caryophyllaeidae)**

Twenty-six gravid and eight younger specimens were recovered from the anterior half of the intestine of 9 of 14 *Catostomus commersoni* examined during January, March, and April. None was recovered from eight suckers examined during September. This cestode was previously reported from "sucker" (species not given), among other hosts, in Lake Michigan by Pearse (1924) and from *C. commersoni* in the Pike River with notes on its ecology (Amin, 1975c) and competitive exclusion of *Acanthocephalus parksidei* (Amin, 1975b). The gravid specimens are 10.40–19.60 mm long, 0.96–1.76 mm in maximum width, and 0.72–1.20 mm in scolex width, and fall within the normal range of variation of this species.

***Proteocephalus exiguus* La Rue, 1911 (Cestoda: Proteocephalidae)**

Four gravid specimens were recovered from the anterior part of the intestine of a female *Coregonus clupeaformis* during March. *P. exiguus* was previously reported in Lake Michigan from three other species of *Coregonus* by La Rue (1911), ciscoes (species not given) by Pearse (1924), and sea lamprey, *Petromyzon marinus*, by Guilford (1954).

My specimens are morphologically more similar to those described by Benedict (1900, in La Rue 1914) than those described by La Rue (1914) in that proglottids are wider than long to squarish rather than longer than wide and that the cirrus pouch opens above the middle of the proglottid rather than at the middle.

***Triganodistomum attenuatum* Mueller and Van Cleave, 1932 (Trematoda: Lissorchiidae)**

Three gravid specimens were recovered from the posteriormost intestinal coil of a female *Catostomus commersoni* during September. This is the first record of this trematode from

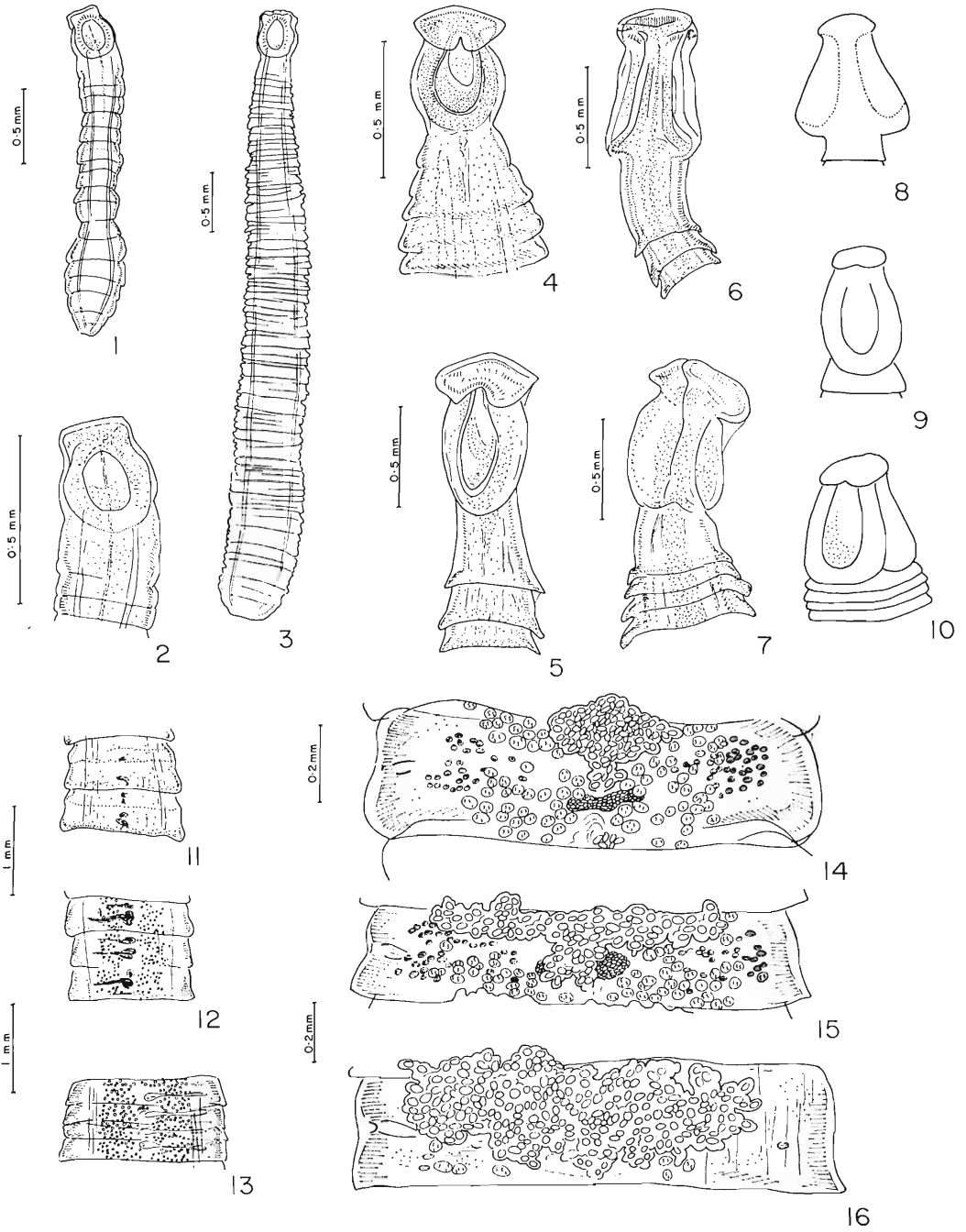

Lake Michigan. It was previously reported from the same host in the Pike and Root rivers, which drain into Lake Michigan only a few kilometers north of the lake collecting sites, by Amin (1974, 1975c) with notes on its morphology and host associations. The lake specimens are 2.84–3.28 mm long by 0.60–0.68 in maximum width and morphologically similar to those reported from the river (Amin, 1974) except for having more prominent body spines.

***Dacnitoides cotylophora* (Ward and Magath, 1917) (Nematoda: Cucullanidae)**

One male and one female were recovered from the midgut of a male *Perca flavescens* during November. This nematode species was previously reported from the same host in Lake Michigan by Pearse (1924). Both specimens are 4.20 mm long and 0.17 mm (male) and 0.26 mm (female) in diameter. Other measurements and morphological features are similar to those reported by Ward and Magath (1917) and Smedley (1934) except that my specimens have shorter intestinal ceca (similar to that drawn by Van Cleave and Mueller, 1934) and two ovaries (instead of one). This species was removed to genus *Dichelyne* Jägerskiöld, 1902 and the two genera synonymized based on the intestinal cecum being dorsal (Törnquist, 1931 in Mueller 1933) and the presence of two ovaries (Mueller, 1933; Van Cleave and Mueller, 1934); both characters are confirmed in present material. However, in the generic diagnosis of *Dichelyne*, as indicated in Yamaguti (1961), males were described as "without preanal sucker" and Van Cleave and Mueller's (1934) own *Dichelyne robusta* (later assigned to genus *Neocucullanus* by Campana-Rouget, 1957) lacks such a sucker. In addition, male *Dacnitoides* have no gubernaculum. Accordingly, this nematode species is retained in genus *Dacnitoides* as emended below. It was previously emended to indicate the presence of caudal alae (Smedley, 1934). It is

herein further emended as follows: "One pair of cervical papillae. Female: two ovaries; uterine branches opposed. Male: five to six pairs of preanal papillae; six pairs of postanal papillae; a single papilla at anterior rim of sucker."

***Placobdella parasitica* (Say, 1924) (Hirudinae: Glossiphoniidae)**

One specimen was strongly attached to the pelvic fin of a chinook salmon during September, 1976. This leech species is widely distributed on the snapping turtle, *Chelydra serpentina*, among others, but infrequently attacks tadpoles and fish (Sawyer, 1972; Meyer, pers. comm., 1976). The above represents new host and locality records.

This specimen is 1.9 mm long and 0.9 in maximum width after fixation. It differs from others described by Moore (1959) and Sawyer (1972) in the following characters. When alive, the body was considerably longer, narrower and elongate anteriorly, and broader and more robust posteriorly. The anterior sucker is more set off from body. One pair of eyes is present; not united in common pigment mass. Dorsum (when alive) has a narrow and bright orange mid-dorsal stripe and many narrower bright yellow latero-dorsal bands against a green-brown background. These bands were horizontally interrupted at regular intervals to produce the impression of multiple short broad bands extending along the width of the dorsum. Dorsal tubercles are distinct in longitudinal rows on the dorsum and extend less conspicuously on the posterior sucker and head in a radiating fashion. They are most prominent on the dorsum anteriorly, where they are in five rows, and posteriorly, where the mid-dorsal row is replaced by two longitudinal short pipillated ridges.

Acknowledgments

For identification or confirmation of my identification of some of the above reported

←

Figures. 1–16. *Eubothrium salvelini*, all local material from Lake Michigan except Figs. 8–10. 1. Young adult from bloater. 2. Scolex of specimen in Fig. 1 enlarged. 3. Larger young adult from lake trout. 4. Scolex of a large young adult from rainbow trout. 5–7. Scolices of three mature adults from lake trout (6, 7: lateral views). 8, 9. Scolices, from Nybelin (1922). 10. Scolex, from Wardle (1932). 11–13. Stages of development in immature proglottids. 14–16. Stages of development in gravid proglottids.

parasites (in parentheses) I am grateful to G. L. Hoffman, Fish Farming Experimental Station, Stuttgart, Arkansas (*C. truncatus*, *E. salvelini*, *P. exiguus*, *D. cotylophora*), L. Margolis, Pacific Biology Station, Nanaimo, B.C., Canada (*E. salvelini*), J. H. Fischthal, State University of New York, Binghamton (*T. attenuatum*), and M. C. Meyer, University of Maine, Orono (*P. parasitica*). M. C. Cochran, Industrial Bio-test Laboratories, Inc., Northbrook, Illinois made fish collections available under project "Fish Populations and History Programs" funded by Commonwealth Edison Company, Chicago, Illinois. This project was supported in part by the National Oceanic and Atmospheric Administration's Office of Sea Grant, U.S. Department of Commerce through an institutional grant to the University of Wisconsin.

Literature Cited

- Aisa, E. 1971. Infestione da *Cyathocephalus truncatus* Pall. (Cestoda: Cyathocephalidae) in una popolazione di *Tinca tinca* L. del Lago Trasimeno. Atti. Soc. Ital. Sci. Vet. 25: 470-471.
- Amin, O. M. 1974. Intestinal helminths of the white sucker, *Catostomus commersoni* (Lacépède), in S.E. Wisconsin. Proc. Helminthol. Soc. Wash. 41: 81-88.
- . 1975a. *Acanthocephalus parksidei* sp. n. (Acanthocephala: Echinorhynchidae) from Wisconsin fishes. J. Parasitol. 61: 301-306.
- . 1975b. Host and seasonal associations of *Acanthocephalus parksidei* Amin, 1974 (Acanthocephala: Echinorhynchidae) in Wisconsin fishes. J. Parasitol. 61: 318-329.
- . 1975c. Intestinal helminths of some southeastern Wisconsin fishes. Proc. Helminthol. Soc. Wash. 42: 43-46.
- Amin, O. M., and J. M. Burrows. 1977. Host and seasonal associations of *Echinorhynchus salmonis* (Acanthocephala: Echinorhynchidae) in Lake Michigan Fishes. J. Fish. Res. Board Can. 34: 325-331.
- Awachie, J. B. E. 1966. Observations on *Cyathocephalus truncatus* Pallas, 1781 (Cestoda: Spathebothriidea) in its intermediate and definitive hosts in a trout stream, North Wales. J. Helminthol. 40: 1-10.
- Campana-Rouget, Y. 1957. Sur quelques especes de Cucullanidae. Révision de la sous-famille. Bull. Inst. Fr. Afr. Noire, 19: 417-473.
- Cooper, A. R. 1918. North American pseudophyllidean cestodes from fishes. Ill. Biol. Monogr. 4: 288-541.
- Ekbaum, E. K. 1933. A study of the cestode genus *Eubothrium* of Nybelin in Canadian fishes. Contrib. Can. Biol. Fish. 8: 89-98.
- Fritts, D. H. 1959. Helminth parasites of the fishes of Northern Idaho. Trans. Am. Microsc. Soc. 78: 194-202.
- Guilford, H. G. 1954. Parasites found in the sea lamprey, *Petromyzon marinus*, from Lake Michigan. J. Parasitol. 40: 364.
- Huitfeldt-Kaas, H. 1927. *Cyathocephalus truncatus* Pall. als Ursache von Fisch-Epizootien. NYT Mag. Nat. vid. 65: 143-151.
- Kraemer, A. 1892. Beiträge zur Anatomie und Histologie der Cestoden der Süßwasser-fische. Z. Wiss. Zool. 53: 646-722.
- La Rue, G. R. 1911. A revision of the cestode family Proteocephalidae. Zool. Anz. 38: 473-482.
- . 1914. A revision of the cestode family Proteocephalidae. Ill. Biol. Monogr. 1: 1-351.
- Linton, E. 1898. Notes on cestode parasites of fishes. Proc. U.S. Nat. Mus. 20: 423-456.
- Moore, J. P. 1959. Hirudinea, p. 542-557. In H. B. Ward and G. C. Whipple, Freshwater Biology. John Wiley and Sons, New York, 1248 p.
- Mueller, J. F. 1933. On the status of genus *Dacnitoidea*. J. Parasitol. 20: 76.
- Nybelin, O. 1922. Anatomisch-systematischen studien ueber Pseudophyllidien. Göteborgs Kgl. Vetenskapsakad. Handl. 26: 1-211.
- Pearse, A. S. 1924. The parasites of lake fishes. Wisc. Acad. Sci., Arts, Lett. 21: 161-194.
- Sawyer, R. T. 1972. North American freshwater leeches, exclusive of the Piscicolidae, with a key to all species. Ill. Biol. Monogr. 46: 1-54.
- Šenk, O. 1956. *Cyathocephalus truncatus*, Pallas—Its influence on the reproductive organs of trout (*Salmo trutta* Fario). Veterinaria (Sarajevo) 5: 607-615.
- Smedley, E. M. 1934. Some parasitic nematodes from Canadian fishes. J. Helminthol. 12: 205-220.
- Smith, H. D. 1973. Observations on the cestode *Eubothrium salvelini* in juvenile sockeye salmon (*Onchorhynchus nerka*) at Babine Lake, British Columbia. J. Fish. Res. Board Can. 30: 947-964.
- , and L. Margolis. 1970. Some effects of *Eubothrium salvelini* (Schränk 1970) on sockeye salmon, *Oncorhynchus nerka* (Walbaum) in Babine Lake, British Columbia. J. Parasitol. 56: 321-322.
- Van Cleave, H. J., and J. F. Mueller. 1934. Parasites of Oneida Lake fishes, Part III. A biological and ecological survey of the worm

- parasites. Roosevelt Wildlife Ann. 3: 161-334.
- Vik, R.** 1954. Investigations on the pseudophyllidean cestodes of fish, birds, and mammals in the Anøya water system in Trøndelag. Part I. *Cyathocephalus truncatus* and *Schistocephalus solidus*. NYTT Mag. Zool. 2: 5-51.
- . 1963. Studies of the helminth fauna of Norway. IV. Occurrence and distribution of *Eubothrium crassum* (Bloch, 1779) and *E. salvelini* (Schrank, 1790) (Cestoda) in Norway, with notes on their life cycles. NYTT Mag. Zool. 11: 47-73.
- Ward, H. B., and T. B. Magath.** 1917. Notes on some nematodes from freshwater fishes. J. Parasitol. 3: 57-64.
- Wardle, R. A.** 1932. The cestoda of Canadian fishes II. The Hudson Bay drainage system. Contrib. Can. Biol. Fish. 7: 377-403.
- , and **J. A. McLeod.** 1952. The zoology of tapeworms. Hafner Publ. Co., New York. 780 p.
- Wisniewski, L. W.** 1933. *Cyathocephalus truncatus Pallas*. I. Die Postembryonalentwicklung und Biologie. II. Allgemeine Morphologie. Bull. Acad. Pol. Sci. Ser. Sci. Math. Nat. B, 3: 237-252, 311-327.
- Yamaguti, S.** 1959. Systema Helminthum. Vol. II. The cestodes of vertebrates. Interscience, New York. 860 p.
- . 1961. Systema Helminthum. Vol. III. The nematodes of vertebrates. Interscience, New York. 679 p.

Announcement

The Manter Memorial Symposium
 HOST-PARASITE INTERFACES
 5-7 OCTOBER 1977

For details contact:

Dr. Brent B. Nickol
 Chairman, Symposium Committee
 School of Life Sciences
 University of Nebraska-Lincoln
 Lincoln, Nebraska 68588

Research Note

Efficiency of the Seinhorst Filter for the Recovery of *Eimeria tenella* Oocysts, from Feces

A method of recovering helminth ova from soil has been described by Seinhorst (1956, *Nematologica* 1: 249–267). Matteson (1966, *J. Econ. Entomol.* 59: 223–224) used a similar technique to recover beetle ova from soil. Wassal and Denham (1969, *Parasitology* 59: 279–282) modified this method to recover nematode ova and coccidian oocysts from feces, but did not determine the efficiency for any species except the nematode *Nematodirus fillicollis*. Vetterling (1969, *J. Parasitol.* 55: 412–417) described a method for separating oocysts from large quantities of fecal debris by a differential density flotation method using a continuous-flow chemical centrifuge. He also compared the efficiency of his and several previously applied methods of coccidian oocyst recovery. The continuous-flow differential density flotation does require some specialized equipment not commonly available to investigators in small colleges or isolated areas.

This study attempts to determine the efficiency of the Seinhorst filter, as described by Wassal and Denham, for the recovery of *Eimeria tenella* oocysts from large quantities of feces as compared to three previously applied methods; coverslip flotation, gravity pan flotation, and zonal gradient centrifugation. Fecal material from infected chickens was collected and stored in a single large container and in 2.5% $K_2Cr_2O_7$ until the recovery attempts. The number of oocysts per ml in this combined sample suspension was 2.27×10^8 (mean) as determined by 18 hemocytometer counts (SD 1.72). The number of oocysts used in each method could be calculated by multiplying by the number of mls used. The technique described by Wassal and Denham was followed except that a concentrated sugar solution (Sheather's) was substituted for the common salt solution. The method uses a cyclic flow of a concentrated sugar solution mixed with fecal material. A current is produced by a low pressure O_2 source, and constant agitation is provided by a magnetic stirring bar. Oocysts float to the surface of the

concentrated solution in the funnel and are recovered by draining. The drained contents are poured through a 300-mesh screen to collect the oocysts (Fig. 1). Coverslip flotation, gravity pan flotation, and zonal gradient centrifugation were performed as described by Vetterling (loc. cit.).

The number of oocysts recovered by each of the four methods was determined by counting several samples from at least four trials in a hemocytometer and multiplying by the number of mls in the recovered sample. The percent recovery was calculated by dividing the mean number of oocysts recovered by the mean number of oocysts in the original samples. The results below represent the means of each recovery technique and the standard deviation is indicated for the final recovery percentage.

The accumulative recovery from the Seinhorst filter at 4, 8, 20, 24, and 48 hours was 5, 24, 65, 72, and 89% (SD 1.33) of the oocysts, respectively. The range of recovery in 48 hours in four trials was 81% to 95%.

Recovery by coverslip flotation was 57% (SD 1.91). The range of recovery by the



Figure 1. Modified Seinhorst filtering apparatus.

coverslip method was 36% to 61%. Accumulated recovery by gravity pan flotation at 2, 4, 8, 16, 24 and 48 hours was 15, 27, 39, 44, and 51% (SD 2.01) respectively. Forty-eight-hour gravity pan flotation, without intervening agitation, yielded only 12% of the total oocysts so that the range of recovery was 12% to 56%. Recovery by gradient centrifugation was 69% (SD 1.56). The range was 52% to 73%.

Wassal and Denham reported 100% recovery of *Nematodirus* ova after 3 hours and Vetterling reported 100% recovery of coccidian oocysts at the rate of 1 man hr/l, whereas with the Seinhorst method the maximum recovery of *Eimeria tenella* oocysts ranged from 81% to

95% in 48 hours. This is, however, a higher range of recovery than was found with the alternate methods investigated, and does not require elaborate equipment or constant attention.

GARY MCCALLISTER
Division of Biological Sciences
Mesa College
Grand Junction, Colorado 81501

LARI M. COWGILL
Department of Zoology
Brigham Young University
Provo, Utah 84602

Research Note

Helminth Parasites of Hooded Mergansers, *Lophodytes cucullatus* (L.), from Ontario

The mergansers as a group are cosmopolitan in their distribution (Scott, 1968, A Coloured Key to the Waterfowl of the World, Wildfowl Trust, London, 91 p.). Three species are frequently found in the Nearctic: the common merganser, *Mergus merganser* (L.), the red-breasted merganser, *M. serrator* (L.), and the hooded merganser, *Lophodytes cucullatus* (L.). The latter is restricted to this region (Kortright, 1967, The Ducks, Geese, and Swans of North America, Stackpole Co., Harrisburg, Pa. and Wildl. Mgmt. Inst., Washington, D.C., 476 p.). The parasite fauna of *M. merganser* and *M. serrator* is well known (vide Lapage, 1961, Parasitology 51: 1-109; McDonald, 1969a, U.S. Fish. Wildl. Serv. Spec. Sci. Rep. Wildl. 125, 333 p.; 1969b, *ibid.* 126, 692 p.) However, little work has been done on that of *L. cucullatus*. The majority of works in which this species is mentioned are qualitative and not quantitative in approach, Lapage (1961, *op. cit.*) and McDonald (1969a, *b, op. cit.*) having provided host-parasite and parasite-host lists, respectively, and bibliographies. The present study was undertaken to determine the helminth fauna, if any, of *L. cucul-*

latus from Ontario and constitutes the first detailed study of the parasite fauna of this host.

The viscera of 32 *L. cucullatus* (9 adults and 23 immatures) were collected by hunters during September and October, 1974 at two locations in Ontario: Cache Bay, Lake Nipissing (46°22'N, 79°59'W) and Long Point, Lake Erie (42°40'N, 80°10'W). All material was deep frozen and examined at a later date using conventional parasitological techniques, which included separating the various organs so that they could be examined individually, and washing the gut contents through a screen with a 250- μ m mesh to collect the parasites. Techniques employed in the preparation of all parasites prior to identification were listed by Andrews and Threlfall (1975, Proc. Helminthol. Soc. Wash. 42: 24-28). Specimens of all the parasites recovered have been placed in the collection of the junior author. Infections are recorded as prevalence (i.e., percent of birds infected) and intensity (i.e., average number of helminths per infected individual).

Twenty species of parasites (excluding Cestoda) were recovered from the host species during the present study, of which 17 were

Table 1. Helminths of 32 hooded mergansers from Ontario.

Parasite	Prevalence No. (%) birds infected	Intensity/infected bird		Most common location in bird*
		average	range	
<i>Diplostomum mergi</i> Dubois, 1932†	4 (13)	6	1-13	3 (b)
<i>Tylodelphys conifera</i> (Mehlis, 1846) †‡	1 (3)	4	4	3 (a), 4
<i>Apatemon gracilis</i> (Rudolphi, 1819)	10 (31)	5	1-14	3 (a)
<i>Cotylurus cornutus</i> (Rudolphi, 1808) §	15 (47)	8	1-28	3 (a)
<i>Cotylurus erraticus</i> (Rudolphi, 1809) §	6 (19)	12	1-41	3 (a)
<i>Notocotylus attenuatus</i> (Rudolphi, 1809) §	2 (6)	3	1-4	3 (c), 5
<i>Echinostoma revolutum</i> (Froelich, 1802) §	4 (13)	2	1-4	3, 4
<i>Echinoparyphium recurvatum</i> (Linstow, 1873) §	6 (19)	2	1-5	3 (c)
<i>Echinoparyphium alegans</i> (Looss, 1899) §	1 (3)	4	4	3 (b)
<i>Microphallus primas</i> (Jagerskiold, 1908) §	2 (6)	2	1-2	3 (c)
<i>Prosthogonimus cuneatus</i> (Rudolphi, 1809) §	14 (44)	3	1-2	4, 6, 7
<i>Zygodontolepis lunata</i> (Diesing, 1836) §	1 (3)	1	1	3 (c)
<i>Psilostomum</i> sp. §	9 (28)	8	2-27	3
<i>Stephanoprora mergi</i> Cannon, 1938 §	1 (3)	4	4	3 (c), 4
<i>Capillaria anatis</i> (Schrank, 1790) §	9 (28)	4	1-15	3 (c), 5
<i>Tetrameres</i> sp. (gravid female) §	1 (3)	1	1	1
<i>Streptocara crassicauda</i> (Creplin, 1829)	2 (6)	2	1-2	2
<i>Streptocara formosensis</i> Sugimoto, 1930 §	4 (13)	1	1	2
<i>Polymorphus cucullatus</i> Van Cleave and Starrett, 1940	1 (3)	1	1	3 (c)
<i>Corynosoma constrictum</i> Van Cleave, 1918 §	1 (3)	2	2	3 (c)

* 1, proventriculus wall; 2, below gizzard lining; 3, small intestine, (a) anterior, (b) mid, (c) posterior; 4, large intestine; 5, caeca; 6, Bursa of Fabricius; 7, cloaca.

§ New host record.

† New host/North American record.

‡ New record for Anatidae.

new host records, two were new records for North America, and one was a new record for the Anatidae. Among those collected were 14 species of Trematoda (12 genera), four of Nematoda (three genera), and two of Acanthocephala (two genera) (Table 1). Twenty-eight (87%) of the birds were infected. The *Psilostomum* sp. that was recovered did not fit the description of any of the known species and will be described in the future. Cestodes were recovered from 14 (44%) of the birds examined. The majority of specimens were too poorly preserved to make exact determinations of numbers or species. However, it was possible to identify *Schistocephalus solidus* (Muel-ler, 1776) in six (19%) of the birds, two *Hymenolepis* spp. in seven (22%) of the birds, and unidentified cestodes in two (7%).

The number of parasite species recovered from hosts during the present study—range 1-9 (mean 3) per infected bird—closely approximates those found by Turner and Threlfall (1975, Proc. Helminthol. Soc. Wash. 42: 157-169), who reported 20 species of helminth in *Anas crecca* L. (range 1-7, mean 2) and 18 in *Anas discors* L. (range 1-8, mean 2) from eastern Canada, and Bishop and Threlfall (1974, Proc. Helminthol. Soc. Wash. 41: 25-35), who recovered 23 helminth species (range 1-13, mean 8) from *Somateria mollissima* (L.)

in Newfoundland. However, it should be noted that the results presented herein do not represent the whole picture with regard to the "normal" parasite burden of *L. cucullatus* due to several factors. Firstly, most host specimens (97%) were collected in one location on the same day within four hours of each other. Hosts examined by Turner and Threlfall (1975, op. cit.) and Bishop and Threlfall (1974, op. cit.) were taken in several areas. Secondly, the hosts collected during this study were taken during the period of fall migration and at no other time of the year. Buscher (1965, J. Wildl. Mgmt. 29: 772-781) studied the seasonal dynamics of helminth populations of three species of anatids and provided evidence that there is a change in the parasite burden of a host at different times of the year.

Prior to this study nine species of helminths had been recorded from this host (vide McDonald, 1969b, op. cit.) (three of Trematoda, four of Cestoda, one of Nematoda, and one of Acanthocephala). Perhaps the reason that few parasite species have previously been recovered is that in the past relatively few hosts were examined thoroughly. The sample size was not large enough to compare statistically the helminth burdens of adults (9) with immatures (23). However, the data point to the immature birds being more frequently infected

and having a higher intensity of infection than the adults. Buscher (1965, op. cit.) suggested that this is probably because the young birds had not developed an age immunity to parasite infections. Also the feeding habits may differ between the age classes; until a study of the stomach contents has been done this can not be proven conclusively.

It is interesting to note that during this study one species of parasite, *Microphallus primas*, which is known to have a marine intermediate host (Deblock and Pearson, 1969, Ann. Parasitol. 44: 391-414) was recovered. Codfrey (1966, The Birds of Canada, Queen's Printer, Ottawa, 428 p.) and Kortright (1967, op. cit.) both report *L. cucullatus* as being found infrequently in areas of salt water; where it has been recorded from the marine habitat, it was during the winter. To date no evidence has been found to show that *L. cucullatus* frequents areas of salt water during the nesting and post-nesting (migration) season.

Thanks are due to the National Research

Council of Canada for the grant (NRCC-A3500) to Dr. Threlfall which funded the field work. We thank Mr. Harry G. Lumsden and Dr. Robert M. Alison of the Ontario Ministry of Natural Resources for help while the senior author was in Ontario. This work would not have been possible without the help of Peter Bain, Bill MacIntyre, Trevor Alcock, and many other residents of Cache Bay, Ontario who collected the majority of the host specimens.

GEOFFREY A. BAIN
Dept. of Zoology
University of Western Ontario
London, Ontario
N6A 5B7

WILLIAM THRELFALL
Dept. of Biology
Memorial University
St. John's
Newfoundland
A1C 5S7

Research Note

New Geographic Record and Redescription of the Sporulated Oocyst of *Eimeria pellita* Supperer 1952 from Alabama Cattle

During a survey of coccidia in cattle in eastern Alabama, oocysts of *Eimeria pellita* were found in fecal samples from three Holstein-Friesian bull calves in Lee County and a 2-year-old Hereford steer in Russell County. *Eimeria pellita* was originally described from cattle in Austria (Supperer, 1952, Oster. Zool. Z. 3: 591-601). Since the original description, the oocysts have been reported from cattle in England (Joyner et al., 1966, Parasitology 56: 531-541) and reported and redescribed from cattle in India (Gill, 1968, Proc. Zool. Soc. (Calcutta) 21: 101-121). Although Joyner et al. (loc. cit.) illustrated the oocyst of *E. pellita*, they did not describe it. This report records *E. pellita* from the North American continent for the first time and presents a redescription of the sporulated oocyst.

Eimeria pellita oocysts were cleaned, concentrated, and allowed to sporulate for 2 weeks at room temperature (22 to 25°C); methods of Soekardono et al. (1975, Vet. Parasitol. 1: 19-33) were used. Sporulated oocysts were concentrated on coverslips by flotation with Sheather's sugar solution (Levine, 1973, Protozoan Parasites of Domestic Animals and of Man, Burgess Publishing Company, Minneapolis, Minnesota) and examined with a microscope fitted with a 100× planapochromatic oil immersion objective. Measurements were made with a calibrated ocular micrometer. In the following description and discussion, all measurements are in microns, and the means are in parentheses after the ranges.

The sporulated oocysts we observed were ovoid (Figs. 1-4) with a wall composed of two

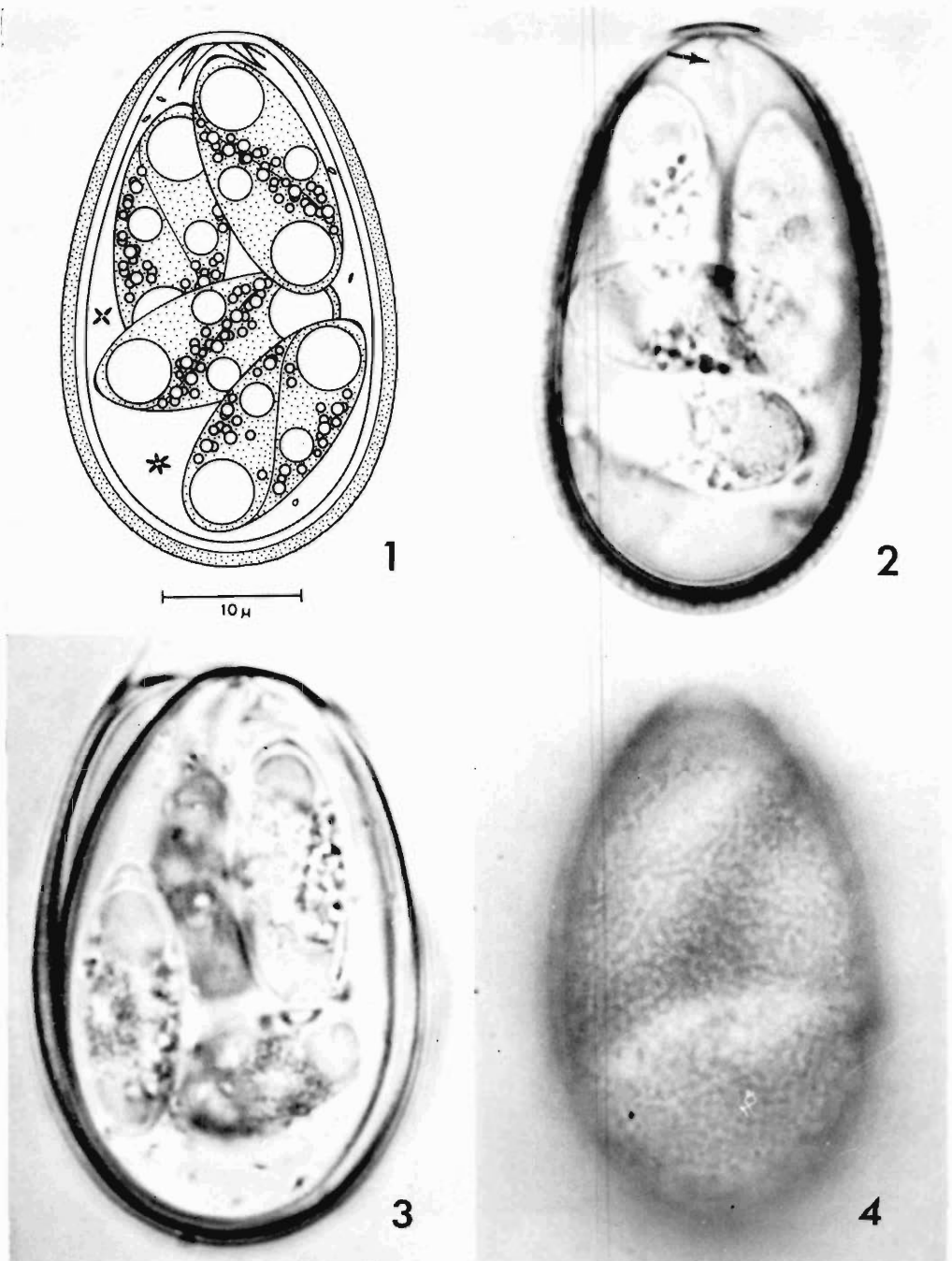

Figures 1-4. Sporulated oocysts of *Eimeria pellita*. 1. Line drawing. 2-4. Photomicrographs. 2. Note wrinkling of membrane that lines the inner layer of the wall (arrow). 3. Two layers of wall separated. 4. Surface of wall showing velvety appearance.

layers (Fig. 3). The outer layer was yellowish brown, about 1 thick, thinning at the micropylar end, and was heavily pitted, which gave the surface of the oocyst a velvety appearance (Fig. 4). The inner layer was smooth, light yellow, about 0.75 thick, and was lined by a thin membrane that was often wrinkled at the micropylar end (Fig. 1, 2). A micropyle, 5 to 7 (6.0) wide, was present at the small end of the oocyst. Sporulated oocysts ($N = 100$) measured 32 to 42 by 22 to 27 (38.2 by 24.2); length-width ratios were 1.4 to 1.8 (1.59). A typical oocyst residuum was absent, but a few to several rod-shaped bodies were scattered throughout the oocyst; some were in groups of four or more with the longitudinal axis radiating from a central point. A polar granule was absent. The sporocysts were elongate-ellipsoidal and had small flattened Stieda bodies at the pointed ends. Sporocysts ($N = 100$) measured 17 to 20 by 7 to 9 (18.5 by 8.3). The sporocyst residuum was composed of several homogenous granules. The sporozoites were elongate, lying lengthwise in sporocysts, partly curled around each other, with a larger posterior and a smaller anterior refractile globule in each; more than two refractile globules were occasionally present.

Oocysts of *E. pellita* described by Supperer (loc. cit.) were 36 to 41 by 27 to 30, those described by Gill (loc. cit.) were 35 to 48 by 23 to 31, and those described in the present report were 32 to 42 by 22 to 27. Both Supperer and Gill reported that the oocyst wall had a velvety appearance due to many blunt

pointed protuberances on the surface of the wall. Our observations indicate that the wall has many small, irregularly sized pits, which give it the velvety appearance. Supperer did not mention the number of layers in the oocyst wall. Gill, however, stated that the oocyst wall had two layers. We also found the oocyst wall to be two-layered (Fig. 3). Supperer (loc. cit.) did not mention a Stieda body on the sporocyst, and one was not included in his drawings. Gill (loc. cit.) stated that the sporocyst had a "triangular hyaline mucus plug at the pointed end." We observed that a flattened Stieda body was present at the pointed end of the *E. pellita* sporocysts. Although we did not determine the chemical nature of the Stieda body, other workers have shown it to be composed of protein in other species (Pattilo and Becker, 1955, J. Morphol. 96: 61-65; Hammond et al., 1970, J. Parasitol. 56: 618-619). The oocysts that Joyner et al. (loc. cit.) illustrated as *E. pellita* were more ellipsoid than those described by Supperer (loc. cit.) and Gill (loc. cit.) and than those we found.

JOHN V. ERNST
Regional Parasite Research Laboratory
USDA-ARS-SR, P.O. Drawer 952
Auburn, Alabama 36830

KENNETH S. TODD, JR.
College of Veterinary Medicine
University of Illinois
Urbana, Illinois 61801

Research Note

The Use of Selected Ratios as an Additional Comparative Tool in the Systematics of some Digenetic Trematodes (Ochetosomatidae)

Helminth systematics, being primarily based on adult morphology, is largely dependent on a comparison of the sizes of characteristic structures. Besides absolute dimensional values, nematologists have also used certain ratios, such as those in de Man's and Cobb's formu-

las, with good results. A similar technique for platyhelminths has been much slower to develop because these worms are far less rigid than nematodes. Wardle and McLeod in "The Zoology of the Tapeworms" (1968) noted that absolute dimensions are almost useless, but that

Table 1. Measurements and ratios for *O. ellipticum*.

	Live	Fixed	Percent shrinkage
Body length	4550.7 (3586 to 5508)	3754.0 (2525 to 5228)	1.75 (5.1 to 29.7)
Body width	1123.7 (929 to 1426)	908 (638 to 1145)	19.6 (3.4 to 31.4)
Body length/body width	1 : 4.05 (1 : 3.82 to 1 : 4.58)	1 : 4.15 (1 : 3.75 to 1 : 4.46)	—
Oral sucker width	382.8 (324 to 482)	324.4 (250 to 420)	15.3 (4.6 to 28.6)
Acetabulum width	453.1 (378 to 580)	398.9 (330 to 530)	12.0 (2.3 to 28.9)
Acetabulum width/ oral sucker width	1 : 1.18 (1 : 1.06 to 1 : 1.29)	1 : 1.22 (1 : 1.06 to 1 : 1.37)	—
Pharynx width	203 (167 to 248)	172.7 (130 to 220)	14.9 (6.9 to 26.8)
Oral sucker width/ pharynx width	1 : 1.89 (1 : 1.82 to 1 : 2.05)	1 : 1.88 (1 : 1.80 to 1 : 2.05)	—
Prepharynx length	40.9 (0 to 86)	52.3 (25 to 80)	*
Esophagus length	283.2 (154 to 378)	242.7 (160 to 389)	*
Ovary width	158.6 (124 to 184)	129.7 (100 to 173)	18.2 (4.0 to 38.3)
Left testis width	294.7 (227 to 346)	240.9 (140 to 324)	18.3 (4.0 to 40.3)
Right testis width	281.9 (205 to 362)	231.1 (150 to 330)	18.0 (4.1 to 33.9)
\bar{x} Testis width/ovary width	1 : 1.82 (1 : 1.53 to 1 : 2.50)	1 : 1.82 (1 : 1.61 to 1 : 2.15)	—
\bar{x} Egg length	43.3 (38.0 to 49.0)	39.1 (36.0 to 46.0)	9.7 (2.2 to 18.4)
\bar{x} Egg width	22.4 (20.7 to 24.0)	22.4 (19.0 to 23.0)	—

* Some measurements increased with fixation.

relative values, that is, proportional comparisons, are of great use in cestode taxonomy. These same conditions apply to trematode taxonomy as well, but work in this area has received little attention. Although a few ratios, like that of the proportional widths of the oral and ventral suckers, are sometimes used and seem valid, the value of other ratios has not been substantiated. Also, fixation techniques are not standardized, and although some flukes have been described from live specimens, most authors have used measurements of fixed specimens. The degree that fixation alters absolute size or comparative ratios is unknown. The purpose of this study was to use *Ochetosoma ellipticum* (Pratt, 1903) and *O. aniarum* (Leidy, 1891) to examine the differences between live and fixed measurements of

morphological features commonly used in the description of adult flukes and to determine if some simple ratios remain constant enough to be of taxonomic value.

Thirty-nine adult *O. ellipticum* ranging from 3,586 to 5,508 microns in length and 17 adult *O. aniarum* ranging from 3,308 to 4,255 microns in length were removed from the mouths of two specimens of *Lanpropeltis getulus hobbrooki* Steineger collected from Brazos County, Texas. Each fluke was relaxed for 20 minutes at 10°C in 0.85% saline and the following morphological features measured: body length and width; width of oral sucker, pharynx, acetabulum, ovary, and testes; length of prepharynx and esophagus; and length and width of eggs. Flukes were then individually heat-fixed on a slide under slight coverslip pressure, placed in

Table 2. Measurements and ratios for *O. aniarum*.

	Live	Fixed	Percent shrinkage
Body length	3698.8 (3308 to 4255)	3233.6 (2576 to 3736)	12.5 (3.1 to 22.1)
Body width	1097.4 (994 to 1188)	959.2 (765 to 1097)	12.6 (4.1 to 23.0)
Body length/body width	1 : 3.37 (1 : 3.08 to 1 : 3.65)	1 : 3.37 (1 : 3.16 to 1 : 3.59)	—
Oral sucker width	335 (292 to 378)	298 (240 to 360)	11.0 (4.8 to 17.9)
Acetabulum width	568 (529 to 605)	542 (470 to 610)	*
Acetabulum width/ oral sucker width	1 : 1.80 (1 : 1.57 to 1 : 1.81)	1 : 1.82 (1 : 1.69 to 1 : 1.81)	*
Pharynx width	158 (146 to 173)	141.6 (130 to 165)	10.4 (4.1 to 17.2)
Oral sucker width/ pharynx width	1 : 2.1 (1 : 1.86 to 1 : 2.37)	1 : 2.1 (1 : 1.85 to 1 : 2.25)	—
Prepharynx length	36.8 (0 to 76)	22 (0 to 40)	*
Esophagus length	196.6 (97 to 291)	184 (110 to 270)	*
Ovary width	216.2 (184 to 238)	179.6 (150 to 215)	16.9 (7.6 to 30.6)
Left testis width	358.4 (335 to 389)	308 (270 to 340)	14.1 (4.5 to 24.2)
Right testis width	355 (313 to 346)	276 (250 to 325)	17.6 (3.0 to 28.4)
\bar{x} Testis width/ovary width	1 : 1.60 (1 : 1.45 to 1 : 1.76)	1 : 1.63 (1 : 1.54 to 1 : 1.77)	—
\bar{x} Egg length	40.8 (36 to 43)	37.8 (36 to 40)	7.4 (3.1 to 14.1)
\bar{x} Egg width	20.4 (18 to 23)	23.0 (19 to 27)	11.3 (2.0 to 19.7)

* Some measurements increased with fixation.

AFA for 24 hours, stained in Semichon's Carmine, dehydrated in ethanol, cleared in xylene, mounted in Permount and these same morphological features remeasured for each fluke. All measurements are in microns, the mean followed by the range unless otherwise indicated.

Of the features monitored, the prepharynx and esophagus lengths were the most variable characters in both species (Tables 1, 2). Most measurements were smaller in fixed specimens. In some specimens of *O. aniarum*, however, the transverse diameter of the acetabulum became greater. A very similar species, *O. acetabulare* (Crow, 1913), is distinguished primarily by a disproportionately large acetabulum. This evidence indicates that this difference may be artificial. Despite use of the same technique and technician on all specimens, the amount of shrinkage was extremely variable from one specimen to another as well as from one feature to another in the same specimen (Tables 1, 2). However, the ratios between body width and length; oral sucker width and acetabulum width; pharynx width and oral

sucker width; and ovary width and the average width of the two testes were constant in *O. ellipticum* and did not change with fixation (Table 1). These ratios were equally constant in *O. aniarum*, with the exception of the ratio of the width of the oral sucker to the width of the acetabulum (Table 2).

Although allometric growth undoubtedly occurs in these flukes, in adults where exact ages are not known, these individual ratios do not vary significantly for members of the same species. Because these ratios for each morphological feature compared in this manner remained constant and do not change with fixation, they may be useful as a comparative tool for some species of flukes.

NORMAN O. DRONEN AND
EDMUND V. GUIDRY

Laboratory of Microbiology and Parasitology
Department of Biology
Texas A&M University
College Station, Texas 77843

Research Note

New Snail Host for *Spirorchis scripta* Stunkard, 1923 (Digenea: Spirorchiidae) with a Note on Seasonal Incidence

Goodchild and Kirk (1960, J. Parasitol. 46: 219–229) described the larval stages of *Spirorchis elegans* Stunkard, 1923 from experimentally infected *Helisoma anceps* (Menke) as well as naturally infected planorbid snails, *Menetus dilatatus* (Gould) in Georgia. Holliman and Fisher (1968, J. Parasitol. 54: 310–318) described the larval stages of *S. scripta* Stunkard, 1923, emended the species description, and reported the planorbid *H. anceps* as a natural host in Virginia. Goodchild and Martin (1969, J. Parasitol. 55: 1169–1173) synonymized *S. elegans* and *S. picta* Stunkard, 1923 with *S. scripta*, which had priority.

Smith (1967, J. Parasitol. 53: 287–291) noted unidentified spirorchiid trematode infections in Michigan ancyliid snails; *Ferrissia*

fragilis (Tyron), *F. parallela* (Haldeman), and *Laevapex fuscus* (Adams).

Our 16-month survey of over 20,000 specimens, representing three species of southeastern Louisiana ancyliids, revealed a single spirorchiid trematode, which parasitized only *F. fragilis*. Apparent specificity was demonstrated even when infected *F. fragilis* were sympatric with the other ancyliids, *L. fuscus* and *Hebetanelys excentricus* (Morelet).

Ten hatchling turtles *Chrysemys scripta*, which were reared in the laboratory from eggs, were each exposed to 10 spirorchiid cercariae from *F. fragilis*. Turtles were necropsied at intervals from 90 to 180 days post exposure. Twelve adult trematodes, which fit the emended description of *S. scripta* given by

Holliman and Fisher (loc. cit.), were recovered from hearts, arteries, and veins of six turtles. No worms were recovered from two turtles necropsied at 180 days; however, spirorchiid eggs were abundant throughout their tissues.

Snails harboring spirorchiids were collected only during the months of April through

July, with a peak incidence of 1.3% occurring in the last month.

HUGH M. TURNER AND KENNETH C. CORKUM
Department of Zoology and Physiology
Louisiana State University
Baton Rouge, Louisiana 70803

Research Note

Observations on the Epidemiology of *Dirofilaria immitis* in Urban Ames, Iowa¹

Surveys to determine the prevalence of canine filariasis have been conducted in many parts of the United States and have been reviewed by Graham (1974, *J. Parasitol.* 60: 322-326). These surveys, however, concern only a single sample and provide no indication of the number of new infections that may be acquired each season. Data also are lacking on *Dirofilaria immitis* prevalence rates in the vector population as they may relate to the acquisition of new infections in susceptible dogs.

This study was initiated as a result of the recovery of *D. immitis*-infected mosquitoes in Ames, Iowa (Christensen and Andrews, 1976, *J. Parasitol.* 62: 276-280). An attempt was made to determine the number of new infections acquired in susceptible dogs in an area in which the prevalence of *D. immitis* in the mosquito population was known.

A survey of all available dogs was conducted in August and September, 1975, in an area of Ames, Iowa (Fig. 1), where the recovery of *D. immitis* from field-collected *Aedes trivittatus* mosquitoes had occurred (Christensen and Andrews, 1976, loc. cit.). All dogs negative for filariasis in 1975 were examined again in May 1976. One-ml blood samples were drawn and examined by a modified Knott's technique. After centrifugation, the bottom 0.5 ml of fluid and sediment was spread on a

slide and examined immediately with phase contrast optics at 100X. After drying, these slides were methanol fixed and stored for future reference. Differentiation of microfilariae was based on the criteria reported by Lindsey (1965, *J. Am. Vet. Med. Assoc.* 146: 1106-1114).

Seventy-three dogs were located within the study area, but 26 (36%) were on prophylactic medication for *D. immitis* and were not examined. Of the 47 dogs examined, 27 (57%) were housed predominantly inside, 13 (28%) predominantly outside, and seven (15%) both inside and outside.

Prevalence rates of *D. immitis* for all types of dogs and for both years are shown in Table 1. No infections of *Dipetalonema reconditum* were detected in any of the dogs examined. Five young dogs examined in 1976 had their first exposure to *D. immitis* during the summer of 1975, and two had a demonstrable microfilaremia. Both of these animals were housed outside. Of the three young dogs that were negative for microfilariae, one was housed outside and two were inside animals. The third dog showing a microfilaremia in 1976 was nine years of age. Only two dogs examined in 1975 had their first exposure during the summer of 1974, and both were negative for microfilariae. Of the four dogs with detectable microfilaremias, two were three years old and the others were five and thirteen years of age.

The prevalence of *D. immitis* in the dogs examined in each year of this study is similar to

¹ Journal Paper No. J-8665 of the Iowa Agriculture and Home Economics Experiment Station, Ames, Iowa. Project No. 1955.

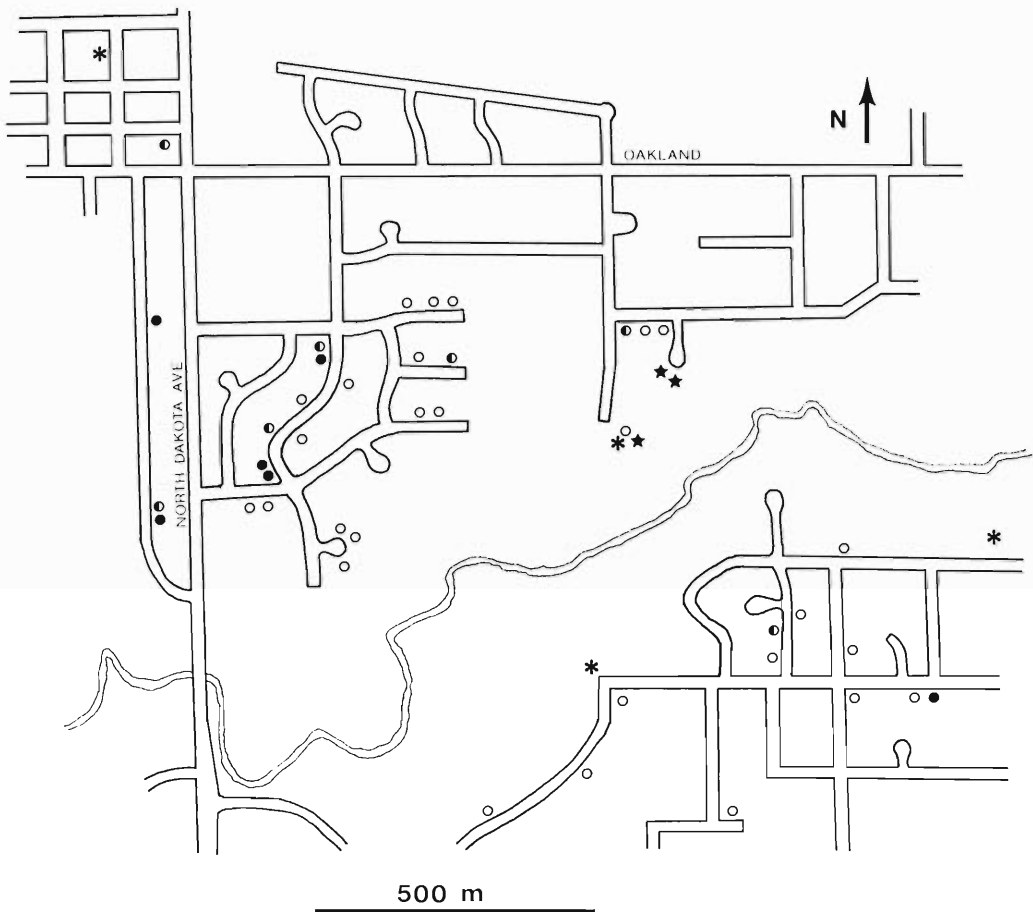

Figure 1. Map of an area of Ames, Iowa, surveyed for *Dirofilaria immitis* in 1975 and 1976. Symbols: white circle, uninfected dog, housed inside; black and white circle, uninfected dog housed inside and outside; black circle, uninfected dog, housed outside; asterisk, patent infection, 1975; star, patent infection, 1976.

the 6.5% reported by Alls and Greve (1974, J. Am. Vet. Med. Assoc. 165: 532-533) when they examined 385 dogs from throughout the state of Iowa. This indicates a relatively low enzootic level for *D. immitis* in Iowa. The prevalence of *D. immitis* in dogs housed predominantly outside, however, probably is much higher. Six of the seven animals with detectable microfilaremias in this study were housed outside, and no infections were detected in dogs housed predominantly inside (Table 1).

In 1975, approximately 1.0% of the *A. trivittatus*

examined contained "infective-stage" *D. immitis*. Two *Anopheles punctipennis* harbored early developmental stages and this was the only other mosquito species found infected (Christensen and Andrews, 1976, loc. cit.). Infected *A. trivittatus* were recovered within approximately 300 m of the two young dogs that acquired infections in 1975. These data furnish circumstantial evidence that suggest a relationship in time between the recovery of "infective-stage" *D. immitis* from field-collected *A. trivittatus* and the appearance of patent infections in the susceptible dog population. This

Table 1. *Dirofilaria immitis* in dogs from an area of Ames, Iowa in 1975 and 1976.

Year	No. individuals examined	Location and No. infected dogs (percent)			Total
		Inside	Outside	Inside and outside	
1975	47	0 (0)	4 (20)	0 (0)	4 (9)
1976	43	0 (0)	2 (22)	1 (14)	3 (7)
1975 + 1976	47	0 (0)	6 (46)	1 (14)	7 (14)

is one of the criteria Barnett (1960, XI Int. Congr. Entomol. 2: 341-345) considered necessary for the establishment of an arthropod as a principal vector of a pathogen.

The fact that only outside dogs housed in close proximity to an infective dog acquired *D. immitis* in 1975 suggests that the vector's

motility might be adversely affected by the infection. This has been shown quantitatively to be the case for other filarial worm-mosquito vector systems (Hockmeyer et al., 1975, Exp. Parasitol. 38: 1-5; Townson, 1970, Ann. Trop. Med. Parasitol. 64: 411-420). Studies are in progress to determine quantitatively the effect of *D. immitis* on the flight ability of *A. trivittatus*.

I wish to acknowledge Ms. Debra Tabor for her assistance during this study and Drs. Wayne A. Rowley and Martin J. Ulmer for their guidance and support.

BRUCE M. CHRISTENSEN
Department of Entomology
Iowa State University
Ames, Iowa 50011

Research Note

Proteocephalus buplanensis Mayes, 1976 (Cestoda: Proteocephalidea) from *Semotilus atromaculatus* in Wisconsin

While studying the helminth parasites of various southeastern Wisconsin fishes, the authors recovered an undescribed proteocephalid cestode from the creek chub, *Semotilus atromaculatus* (Mitchill), in the Pike and Root rivers (Racine, Milwaukee, and Kenosha counties). Infected fish from the Pike River were found during the autumn of 1972 (September and October) and 1973 (November) and the spring of 1972 (May) and 1974 (March) (Table 1). Of 66 chubs examined from the Root River during the autumn of 1971-1974, one was infected with five specimens. This cestode was recognized as undescribed (Amin, 1975a, Proc. Helminthol. Soc. Wash. 42: 43-46) and designated as *Proteocephalus* sp. (SA) by Amin (1975b, J. Parasitol. 61: 318-329). This cestode is now assigned to *P. buplanensis*, recently described from the same host in Nebraska by Mayes (1976, Proc. Helminthol. Soc. Wash. 43: 34-37); its recovery from Wisconsin extends its known geographical distribution.

Relaxed specimens were identical to the holotype and the identification was kindly verified by Dr. Mayes as *P. buplanensis*. Other contracted specimens, however, showed differences from the Nebraska material. For example, although the size of the scolices and acetabular suckers and the number and size of testes were generally within the range of Nebraska material, proglottids were proportionally much wider than long, vitelline follicles were larger, and the vitellaria extended beyond the ovary, unlike the condition in *P. buplanensis*. It is probable that some of these differences can be attributed to the condition of the worms (i.e. contracted); on the other hand, the possibility that *S. atromaculatus* may harbor more than one species of *Proteocephalus* cannot be dismissed.

Additional information (Table 1) indicates the presence of a seasonal cycle involving light infections with small young worms in the autumn and heavier and more frequent infections with larger and mature specimens in the

Table 1. Seasonal comparison of *Proteocephalus buplanensis** infections of *Semotilus atromaculatus* from the Pike River, 1972-1974.

	Autumn†	Spring‡
Fishes examined	334	70
Fish length (cm)	5-25 ($\bar{x} = 10$)	12-20 ($\bar{x} = 14$)
Percent infected	9	23
Cestodes recovered	89	92
Mean per fish	0.27	1.31
Maximum per fish	20	20
Percent gravid	12	100
Intestinal distribution		
Anterior third	42%	44%
Middle third	46%	48%
Posterior third	12%	88%
Worm size (mm)		
N	72	30
Length	1.12-26.00 ($\bar{x} = 5.47$)	22.00-106.00 ($\bar{x} = 58.72$)

* A small number of specimens that did not perfectly fit the description of *P. buplanensis* might have been included.

† September, October, November.

‡ March, May.

spring. None of nine chubs examined during the summer of 1974 was infected. No significant seasonal changes of worm distribution in the host intestine were observed. Competitive exclusion between *P. buplanensis* and *Acanthocephalus parksidei* in chubs infected with both parasites was previously reported by Amin (1975b, loc. cit.).

The authors express their appreciation to Dr. M. Mayes, University of Nebraska, for examining some of our material and to Dr. J.

Ralph Lichtenfels of the Animal Parasitology Institute, USDA, for loan of the holotype of *P. buplanensis*.

OMAR M. AMIN

University of Wisconsin-Parkside
Kenosha, Wisconsin 53140

JOHN S. MACKIEWICZ

State University of New York
Albany, New York 12222

Research Note

Larval Trematodes in the Rough Periwinkle, *Littorina saxatilis* (Olivi), from Newfoundland

Marine gastropods that serve as a component in the diet of many seabirds were examined for helminth larvae as part of an ecological study of helminth parasites of seabirds and ducks in eastern Canada. All three species of *Littorina* (*L. saxatilis*, *L. littorea*, and *L. obtusata*) found in Newfoundland are known to be intermediate hosts for a variety of digenetic trematodes (Combescot-Lang, 1976, Ann. Parasitol., 51: 27-36; James, 1968a, Field Studies 2: 615-650; Pohley and Brown, 1975, Proc. Helminthol. Soc. Wash., 42: 178-179) as well as being utilized as food by many species of marine birds. A study was, therefore, initiated to determine the nature of infection of

L. saxatilis with trematode larvae and its intensity and extensity in Newfoundland.

Three hundred and thirty specimens of *L. saxatilis* (121 male, 209 female) were collected, by hand, on Gull Island, Witless Bay (47°15'N, 52°46'W) during May-September, 1973, and an additional 450 specimens (209 male, 241 female) were taken at this site in June-August, 1974. Smaller numbers of *L. saxatilis* were collected from Newman's Sound (54°38'N, 48°33'W); 7 males and 13 females were taken in 1973, and 15 males and 35 females in 1974. The gastropods from Gull Island were taken from localities around the whole island in 1973, while in 1974 they were

Table 1. Male and female *Littorina saxatilis* examined and infected with trematode larvae.

Date	Male		Female		Total	
	No. examined	No. (percent) infected	No. examined	No. (percent) infected	No. examined	No. (percent) infected
June 1973	36	18 (50)	64	17 (27)	100	35 (35)
July 1973	39	10 (26)	61	22 (36)	100	32 (32)
Aug. 1973	35	3 (9)	65	13 (20)	100	16 (16)
Sept. 1973	11	0 (0)	19	3 (16)	30	3 (10)
Total	121	31 (26)	209	55 (26)	330	86 (26)
June 1974	60	13 (22)	90	25 (28)	150	38 (25)
July 1974	80	14 (18)	70	12 (17)	150	26 (17)
Aug. 1974	69	14 (20)	81	20 (25)	150	34 (23)
Total	209	41 (20)	241	57 (24)	450	98 (22)
Totals (1973-1974)	330	72 (22)	450	112 (25)		

collected systematically from several well-defined areas differing in both exposure and with regard to concentrations of seabirds. Snails were measured, before examination for parasites, and placed in one of three categories (small, <7.0 mm; medium, 7.0-9.9 mm; large, >10.0 mm). The shell was then removed, with notes being kept of the colour of the visceral mass and foot. The penis was measured and, in females, the presence or absence of young in the brood pouch was noted. The snails were then dissected and the number of parasites per infected organism estimated. Infections were categorized as light (<2,000 larvae), moderate (half digestive gland and gonads infected, mean no. larvae 5,500), heavy (mean no. larvae 8,500) or extremely heavy (whole digestive gland and gonads filled with larvae, mean no. 10,000). Once these data were obtained, sporocysts, rediae, cercariae, and metacercariae were removed with a Pasteur pipette, relaxed in a 1% ethyl carbamate solution, fixed in 70% ethanol, and placed in labeled 5-dram vials. Later the parasites were stained in Meyer's HCl Carmine, dehydrated, cleared, and mounted in Canada balsam.

Of the 780 snails taken on Gull Island, 57 (7%) were small, 387 (50%) were medium, and 336 (43%) were large. The number and percentage of each category infected with larval trematodes are detailed in Tables 1 and 2. No significant difference was noted in the number of males and females infected, nor was there any difference in the overall infection in 1973 and 1974 (26% and 22% respectively). A decrease in the number of snails infected, from June to September, was noted in 1973,

whereas in 1974 no such trend was seen. No significant differences were noted in the numbers of individuals infected in each of the various size classes examined (Table 2). Details of the intensity of infection in the various size classes are given in Table 3. No significant differences were noted in the intensity of infection of males and females and in the intensity of infection in the various size classes. It is of some interest to note, however, that only one specimen was extremely heavily infected. It may well be that once the infection reaches a certain level, death will result.

Two groups of larvae were recovered, namely those of *Microphallus pygmaeus* (Levensen, 1881) and those of *Cercaria parvicaudata* Stunkard and Shaw, 1931. The total number of snails infected was 184 (24%), 153 (20%) with *M. pygmaeus* and 35 (4%) with *C. parvicaudata*. In four cases (one medium female, three large females) double infections were recorded, all the snails involved being taken in the intertidal zone.

James (1968b, J. Nat. Hist. 2: 155-172) studied the life cycle of *M. pygmaeus* in *L. saxatilis tenebrosa* in Wales, noting that it involves no free-living stages and that the species has metacercariae that remain unencysted within the daughter sporocyst in the first and only intermediate host. He also noted variations in the percentage infection of the intermediate host with regard to height above chart datum, size of host, and season. Adults of this species have been found in a variety of anseriform and charadriiform birds in Europe and North America (Yamaguti, 1971, Synopsis of

Table 2. *Littorina saxatilis* examined and infected with larval trematodes, by size and month.

Date	Small (<7.0 mm)		Medium (7.0-9.9 mm)		Large (>10.0 mm)	
	No. examined	No. (percent) infected	No. examined	No. (percent) infected	No. examined	No. (percent) infected
June 1973	2	1 (50)	36	12 (33)	62	22 (35)
July 1973	2	0 (—)	47	14 (30)	51	18 (35)
Aug. 1973	26	6 (23)	55	5 (9)	19	5 (26)
Sept. 1973	0	0 (—)	19	2 (11)	11	1 (9)
Total	30	7 (23)	157	33 (21)	143	46 (32)
June 1974	11	4 (36)	78	14 (18)	61	20 (33)
July 1974	4	0 (—)	70	10 (14)	76	16 (21)
Aug. 1974	12	6 (50)	82	17 (21)	56	11 (20)
Total	27	10 (37)	230	41 (18)	193	47 (24)
Totals (1973-1974)	57	17 (30)	387	74 (19)	336	93 (28)

Digenetic Trematodes of Vertebrates, Keigaku Publ. Co., Tokyo, Vol. 1, p. 598).

Infection with parasites did appear to affect the reproductive capacity of the snails. Uninfected females with a shell length over 7 mm normally bore young in their brood pouch (mean 75; range 15-100). In no case did an infected female have young in her brood pouch. In only three cases did females with a shell length of less than 7.0 mm have young in the brood pouch (1 of 30 from Gull Island with 10 young, 2 of 12 from Newman's Sound each with 20 young). Berry (1961, J. Anim. Ecol. 30: 27-45) stated that in normal reproductive males the penis is 4.5 mm or more in length and that while parasites did not directly affect its size they prevented its re-growth in fall. In the present study it was found that there was a statistically significant difference in penis size between the various size groups and the infected and uninfected

snails (Table 4). An alpha level of 0.05 was chosen as the level of significance, and the "null hypothesis" (H_0 there is no difference between means) was tested against the "alternate hypothesis" (H_1 there is a difference between means) utilising the product of the penis length and penis width.

The location of collection on the island seemed to be of little significance, the number of infected snails varying randomly and bearing no relation to the density of nesting birds. It was found, however, that the snails from the high tide mark and above contained only larvae of *M. pygmaeus* while those collected at the low tide mark hosted only *C. parvicaudata*. One area, which was subject to extreme wave action, was an exception to the above, with *C. parvicaudata* being found at distances well above the high-water mark. In the intertidal zone snails containing either of the two species were found. The presence

Table 3. Intensity of infection in *Littorina saxatilis* with trematode larvae (percentage of total infected in size group in parentheses).

Size of snail	Sex	Intensity of infection			
		Light	Moderate	Heavy	Extremely heavy
Small	Male	2 (50)	—	2 (50)	—
	Female	3 (23)	4 (31)	5 (38)	1 (8)
	Total	5 (29)	4 (24)	7 (41)	1 (6)
Medium	Male	3 (14)	9 (41)	10 (45)	—
	Female	11 (22)	18 (37)	20 (41)	—
	Total	14 (20)	27 (38)	30 (42)	—
Large	Male	8 (20)	17 (40)	17 (40)	—
	Female	12 (26)	20 (43)	14 (31)	—
	Total	20 (23)	37 (42)	31 (35)	—
Total	Male	13 (19)	26 (38)	29 (43)	—
	Female	26 (24)	42 (39)	39 (37)	—
	Total*	39 (22)	68 (39)	68 (39)	1 (<1)

* Less 8 specimens (3 medium female, 4 large male, 1 large female) in which the larvae were not counted.

Table 4. Size of the penis in uninfected and infected snails in the various size classes and results of "t" tests between groups. All measurements are in mm.

	Mean, length × width	Range, length × width	
Small	0.65 × 0.1	0.60–0.70 × 0.1	
Medium	3.30 × 1.67	2.1–4.1 × 1.0–2.2	
Large	3.89 × 1.96	2.1–5.8 × 1.2–2.7	
	"t"	Critical to .05, n ₁ + n ₂ - 2	H ₀ rejected
Small v medium	4.35	2.01	Yes
Medium v large	4.62	1.99	Yes
Uninfected small v infected small	2.30	2.45	No
Uninfected medium v infected medium	10.55	2.16	Yes
Uninfected large v infected large	6.93	2.15	Yes

of *M. pygmaeus* in regions above the high-water mark may be a reflection of the life cycle of the creature, as suggested by James (1968b, op. cit.). The identity of the above larvae was confirmed by administering, orally, pieces of infected snail tissues and daughter sporocysts to a total of 18 mice during 1973 and 1974. One hundred and fifteen adult worms were recovered from 10 mice that were autopsied from 2 to 4 days after infection, while no specimens were found in eight mice that were examined after 14 days. The latter result may be explained in a variety of ways: e.g., the life span of this organism in an "abnormal" host may be short, or the mice may acquire an immunity to the infection. In all experiments controls were kept, with negative results.

Large numbers of seabirds nest on Gull Island each summer (Maunder and Threlfall, 1972, Auk, 89: 789–816; Haycock and Threlfall, 1975, Auk, 92: 678–697; Threlfall, 1975, Can. Geogr. J. 91(4): 4–11) and are present in the area for approximately seven months of the year. During the winter large flocks, up to 1,500 individuals, of common eider ducks (*Somateria mollissima*) are seen in the vicinity of Gull Island. *M. pygmaeus* was recovered from the latter host, often in large numbers, by Bishop and Threlfall (1974, Proc. Helminthol. Soc. Wash. 41: 25–35) in the present study area. Threlfall (1968, Can. J. Zool. 46: 1119–1126) reported on the helminths recovered from herring gulls (*Larus argentatus*) taken in the Witless Bay Sea Bird Sanctuary, but did not record any *M. pygmaeus*. It appears that the source of infection for the periwinkles in the study area is almost certainly the eider ducks, but this does not preclude future studies of seabirds revealing that other definitive hosts are also involved in the life cycle.

Wiley and Gross (1957, J. Parasitol. 43: 324–327) noted that orange pigmentation was evident in the foot of *L. littorea* during infections of larval *C. lingua*. Apparently, infected snails could easily be distinguished by observation of the foot color against the side of a glass aquarium. James (1965, Parasitology, 55: 93–115) noted this sometimes occurs in *L. saxatilis*. During the present investigation the color of the foot was recorded in all cases. However, there appeared to be no consistency; that is, periwinkles showing orange to brown pigmentation in the foot could very well be unparasitized and healthy; also, feet showing no pigmentation could belong to periwinkles extremely heavily infected with *M. pygmaeus* or *C. parvicaudata*.

Only one of the 70 *L. saxatilis* examined from Newman's Sound was infected with larval digeneans (*M. pygmaeus*). A low concentration of aquatic birds including ducks, in the area is the most likely reason for the low prevalence of parasites.

Thanks are due to the National Research Council of Canada for the grant (NRCC-A3500) to W. Threlfall that funded the fieldwork and to Memorial University for the facilities provided.

WILLIAM THRELFALL
Department of Biology
Memorial University of Newfoundland
St. John's, Newfoundland
Canada A1C 5S7

R. IAN GOUDIE
P. O. Box 9340
Postal Station B
St. John's, Newfoundland
Canada A1A 2Y3

*Research Note**Dirofilaria immitis* in Wild Canidae from Indiana

Canine heartworm disease has been recognized with increasing frequency and concern in the midwest during the last 10 to 15 years (Otto, 1975, *In* H. C. Morgan et al., Proceedings of the Heartworm Symposium '74). Several reports of this infection in dogs are available from states bordering Indiana (see Otto, 1975, *ibid.*, for references). There are fewer reports, however, of heartworm disease in wild canines from the midwest and none we are aware of from the State of Indiana. *Dirofilaria immitis* has been recovered from red foxes (*Vulpes fulva*) in Minnesota (Schlotthauer, 1964, *J. Parasitol.* 50: 801-802) and Michigan (Stuht and Youatt, 1972, *J. Wildl. Manage.* 36: 166-170) and from coyotes (*Canis latrans*) in Iowa and Kansas (see Fran-son et al., 1976, *J. Wildl. Dis.* 12: 165-166, for references).

From November 1975 to February 1976, seven red foxes, four gray foxes (*Urocyon cinerogenteus*), one coyote, and one coyote-dog cross were trapped from Lake, LaGrange, and Tippecanoe counties in the State of Indiana. Following sexing, approximate aging, and removal of the heart and lungs from each animal, the right ventricle, right atrium, and pulmonary arteries were incised and examined for the presence of *D. immitis*. Worms were fixed in 10% neutral buffered formalin. Blood samples were not examined for microfilariae, as the carcasses were usually in a poor state of preservation when examined. At a later time, all worms were sexed and measured (nearest millimeter). No attempt was made to ascertain the degree of maturity of the male worms. Each female worm was severed immediately caudal to the vulva. The entire contents of the worm from about 2 cm caudal to the vulva was extruded onto a slide using a pair of forceps. One drop of saline and one drop of methylene blue stain (1:1,000) were added, the preparation was mixed, and a coverslip was added. The slide was then examined for developing embryos and microfilariae.

Data concerning the infected canines and

their heartworms are presented in Table 1. All worms were recovered from the right ventricle and/or pulmonary arteries. None of the female worms recovered from the red fox contained developing embryos, whereas all of the females recovered from the coyote contained developing embryos. However, fully developed microfilariae were seen only in the larger (20.3, 22.3, 24.0 cm) female worms from the coyote. Only the coyote showed gross lesions consistent with heartworm infection, consisting of moderate hypertrophy and dilatation of the right ventricle of the heart. As in infected dogs, this might be a compensatory change. Many of the worms extended from the pulmonary trunk into the right ventricle and thus could have led to pulmonary valve obstruction and incompetence.

As pointed out by Stuht and Youatt (1972, *loc. cit.*) there is little information in the literature regarding development and maturation of the heartworm in wild canines. Most investigators seem to consider wild canines to be less than optimal hosts for *D. immitis*, as worms recovered from wild canines are generally smaller, less fecund, and perhaps in fewer numbers than those from domestic canines. For this reason it is commonly held that wild canines do not constitute an important reservoir for this infection at the present time (Schlotthauer, *loc. cit.* 1964; Otto, 1975, *loc. cit.*). Be that as it may, one facet of the importance of this infection with regard to wild canines lies in the fact that the pathology resulting from infection appears to be similar to that reported in dogs (Otto, 1975, *ibid.*). Hirth and Nielson (1966, *J. Am. Vet. Med. Assoc.* 149: 915-919) found significant vascular lesions in the two infected red foxes they recovered from Connecticut, which included atheromatous-like focal intimal plaques, diffuse subintimal accumulations of inflammatory cells, and exudative villose endarteritis. Stuht and Youatt (1972, *loc. cit.*) reported right ventricular hypertrophy in an infected red fox from Michigan. Ross and Suzuki (1973, *J. Am.*

Table 1. *Dirofilaria immitis* recovered from wild canines in Indiana.

Species	Host:			<i>D. immitis</i> recovered		
	Sex	Age (approx.)	Locality (county)	Number	Sex	Length (cm)
Red fox	F	adult	Lake	1	M	10.3
Red fox	F	adult	Lake	1	M	10.5
				3	F	9.4, 15.8, 16.5
Gray fox	F	young of year	Tippecanoe	1	M	11.2
Coyote	F	adult	Tippecanoe	7	M	13.1, 13.9, 14.1, 14.3, 15.7, 17.1, 18.6
				6	F	12.5, 13.3, 18.8, 20.3, 22.3, 24.0

Vet. Med. Assoc. 163: 582-585) found angiocardigraphic abnormalities in four of five infected young coyotes from Texas, which consisted of arterial filling defects and an extensive increase in collateral circulation to the lungs. As stated by Stuht and Youatt (1972, loc. cit.), any cardiopulmonary deficiency would be exceptionally hard on a highly active predator.

Although wild canines appear for the most part to be victims of the high prevalence of *D. immitis* in domestic dogs, they may contribute to the perpetuation of this parasite in nature. Both Stuht and Youatt (1972, *ibid.*) and Monson et al. (1973, N.Y. Fish Game J. 20: 48-53) found fully developed microfilariae within female worms recovered from red foxes. Monson et al. (1973, *ibid.*) also noted microfilariae in the blood of a coyote which had adult worms. Stone (1974, N.Y. Fish Game J. 21: 87) described a gray fox infected with

seven adult heartworms, which also had numerous *D. immitis* microfilariae in its blood.

As a result of increasing levels of exposure of wild populations to this parasite, it is possible that *D. immitis* may become increasingly prevalent in these animals in many geographic locations. Continuing surveillance of wild canines is therefore necessary to determine if they may assume a more significant role in the epizootiology of this infection.

The author wishes to thank wildlife students Eric Edberg, Steven Backs, and Richard Meade for their assistance and contributions to this study.

KEVIN R. KAZACOS

Department of Veterinary Microbiology,
Pathology and Public Health
School of Veterinary Medicine
Purdue University
West Lafayette, Indiana 47907

Research Note

Development of Abnormal Eggs from Young Female Trichostrongylid Worms¹

Monnig (1926, Union of S. Africa, 11th-12th Ann. Rept., Dir. Vet. Ed. and Res. Pt., 1: 231-251.) and Douvres (1957, Proc. Helminthol. Soc. Wash. 24: 4-14) have stated that larvae of *Trichostrongylus colubriformis*

were in the fifth stage of development on day 15 postinoculation (PID 15), at which time the majority of the eggs in the uteri of the female worms were in the late morula stage of development. Kates and Turner, (1955, Am. J. Vet. Res. 16: 105-115) indicated the time to patency of *Nematodirus spathiger* to be "only about 2 weeks" but that "the majority of

¹ Published with the approval of the Director, Agricultural Experiment Station, Laramie, Wyoming, 82071 as JA-906.

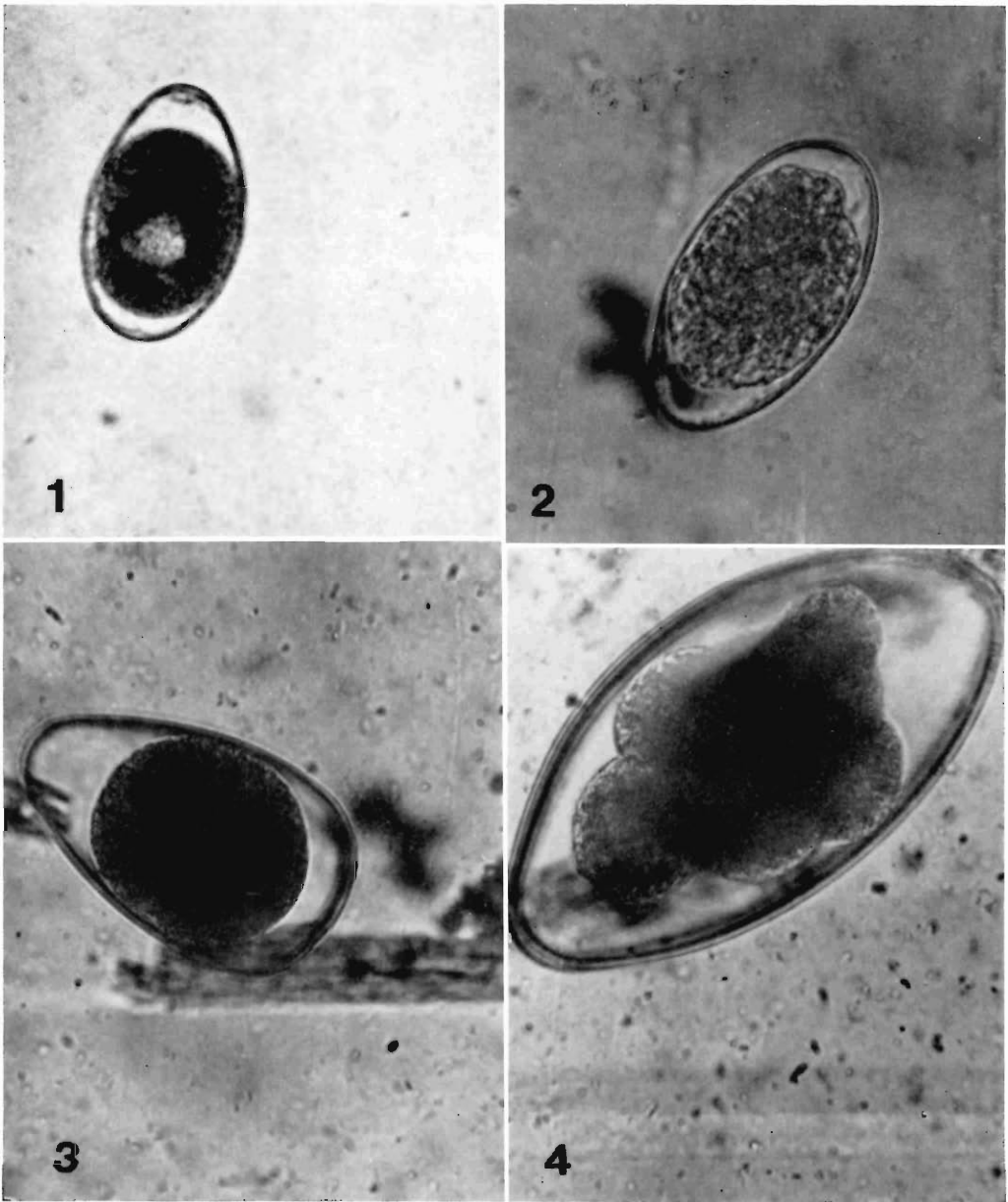

Figures 1-4. Comparison of normal and abnormal trichostrongylid eggs recovered from sheep feces on day 15 postinoculation of third-stage trichostrongylid larvae. 1. Abnormal *T. colubriformis* egg (cleaving from 1 to 2 cell stage). 2. Normal *T. colubriformis* egg (morula stage). 3. Abnormal *N. spathiger* egg (I cell stage). 4. Normal *N. spathiger* egg (8 cell stage). All eggs recovered from feces by sugar flotation with centrifugation at 2,000 rpm. All photomicrographs at 430 X.

infective larvae of this species develop to sexual maturity during the third week of parasitic life. . . ." This communication reports the occurrence of abnormal trichostrongylid eggs in sheep feces and patency of these two trichostrongylid species PID 15.

During the past 13 years, the writers have passed a strain of *T. colubriformis*² through sheep 25 times and through cattle 4 times. Invariably, abnormal eggs have appeared in feces of the inoculated host animal on the 15th day. Such "early" eggs are abnormal in that they are in the 2–8 cell stage of cleavage rather than in the normal, morula stage (16–32 cells) as they leave the host (Figs. 1, 2).

Development of the abnormal eggs, when incubated in fecal material at 21 C, was slow as compared to normal eggs. Abnormal eggs of the species advanced from the 2–8 cell stage to the morula stage within 7 days, the embryo stage after 14 days, and were dead or vacuolated and disintegrating after 21 days of incubation at 21 C. Over 95% of such eggs did not hatch. In a recent trial with 180 eggs, three larvae were recovered after three attempts via Baermann funnel on day 10, 14, and 24 of incubation at 21 C. Therefore, only 1.7% of the eggs produced viable larvae that developed to the third stage. Eggs of *T. colubriformis* normally hatch and produce third-stage larvae after 7–10 days of incubation at 21 C at Laramie, Wyoming (elev. 7,165').

Nematodirus spathiger eggs from feces of sheep PID 15 are in the 1 or 2 cell stage of development (Fig. 3) and may be grossly different in size and shape than the normal 4–8 cell stage (Fig. 4). Abnormal *N. spathiger* eggs ranged in length from 102–180 μm and

in width from 65–85 μm (Fig. 3). Less than 10% of such eggs hatched after 30 days of incubation at 21 C. Normal *N. spathiger* eggs develop quite slowly and third-stage larvae are found in the egg and/or some have just emerged from the egg membranes after 16–20 days of incubation at 21 C. Since development time of the early trichostrongylid eggs is extended so much under near-optimal environmental conditions in the laboratory, it would appear that the chances of survival of such eggs in a natural or field environment would be very poor.

Identification of day 15 eggs in routine diagnostic examinations would be very difficult. Egg lengths, widths, shape, and, therefore, size ratios as well as blastomeric numbers vary to the extent that variations in most measurements exceed the means. Measurements, therefore, would have little or no significance for identification purposes. It would appear advisable, when collecting fecal material from an infected source animal, to delay collections until about the 19th–21st PID so that a larger number of eggs per gram of feces would be available and these eggs have at least a moderate chance of producing viable larvae. Day 20 eggs of the two trichostrongylid species mentioned above will usually produce from 30–50% viable third-stage larvae after 10 days (*T. colubriformis*) and 20 days (*N. spathiger*) of incubation at 21 C.

R. C. BERGSTROM

Division of Microbiology and Veterinary
Medicine
University of Wyoming
Laramie, Wyoming 82071

B. A. WERNER

Box 950, Laramie, Wyoming 82070
Wyoming State Veterinary Laboratory

² A strain graciously supplied by Dr. Robert Isenstein, then of the Parasitology Laboratory, ARS, USDA, Experiment, Georgia (1963).

Research Note

New Records of Proterodiplostome Digeneans from *Alligator mississippiensis* and *Caiman crocodilus fuscus*

Examination of the crocodilians *Alligator mississippiensis* Daudin and *Caiman crocodilus fuscus* (Cope) from southeastern United States and Costa Rica, respectively, revealed six species of proterodiplostome digeneans. We report new localities for five. Representative specimens of all species collected have been deposited in the University of Nebraska State Museum, Harold W. Manter Laboratory (Nos. 20844 to 20850).

Nine species of proterodiplostomes have been reported from Central American crocodilians, four from *Caiman crocodilus fuscus* (usually listed as *C. fuscus*). We found two. The first, *Prolectithodiplostomum constrictum* Dubois, 1937, parasitized *C. c. fuscus* from Palmar Sur, Puntarenas Province and the vicinity of La Selva, Heredia Province. Previous studies (Dubois, 1936, Rev. Suisse Zool. 43: 507-515; 1937, Bull. Soc. Neuchatel. Sci. Nat. 61: 5-80; Caballero, Hidalgo, and Grocott, 1957, Acta Cienc. Potosina 1: 99-116) reported *P. constrictum* from Panama in *C. c. fuscus* (listed as *C. fuscus*) and from Brazil in *C. c. crocodilus* (listed as both *C. crocodilus* and *C. scelrops*). Costa Rica represents a northern extension for *P. constrictum*. The second digenean, *Proterodiplostomum medusae* (Dubois, 1937) Caballero, Hidalgo, and Grocott, 1957, infected caimans from La Selva. Caballero and Brenes (1959, An. Inst. Biol., Univ. Nac. Mexico 29: 165-179) reported this species from Costa Rica in *Crocodilus acutus* Cuvier (listed as *C. c. acutus*), Dubois (1937, *ibid.*) reported it from *Caiman crocodilus crocodilus* (listed as *C. sclerops*) in Brazil, and Caballero and co-workers (1957, *ibid.*) reported it from *C. c. fuscus* (listed as *C. fuscus*) in Panama. This is the first report of *P. medusae* parasitizing *C. c. fuscus* in Costa Rica.

Alligator mississippiensis from Alachua and Lake counties in Florida contained *Archaeodiplostomum acetabulata* (Byrd and Reiber, 1942) Dubois, 1944 and *Polycotyle ornata* Willemoes-Suhm, 1870. Alligators examined at

Rockefeller Wildlife Refuge, Cameron Parish, Louisiana, contained *A. acetabulata* and *P. ornata* as well as *Pseudocrocodilicola georgiana* Byrd and Reiber, 1942 and *Crocodilicola pseudostoma* (Willemoes-Suhm, 1870) Poche, 1926. All localities represent new records. To date, *Polycotyle ornata* has been reported from South Carolina by Willemoes-Suhm (1870, Z. Wiss. Zool. 21: 175-203) and from Midville, Georgia, and Tallahassee and Silver Springs, Florida, by Byrd and Reiber (1942, J. Parasitol. 28: 51-73). We add Alachua and Lake counties, Florida, and Cameron Parish, Louisiana. *Archaeodiplostomum acetabulata* also occurred in Midville, Georgia, and Tallahassee and Silver Springs, Florida (Byrd and Reiber, 1942, *ibid.*), as well as in Alachua and Lake counties and Cameron Parish. *Pseudocrocodilicola georgiana* had been previously reported only from Midville, Georgia, by Byrd and Reiber (1942, *ibid.*). We found it in Cameron Parish. *Crocodilicola pseudostoma* reportedly occurs in South Carolina (Willemoes-Suhm, *ibid.*), Silver Springs, Florida (Byrd and Reiber, *ibid.*), and Mexico (Caballero, 1948, An. Ecs. Nac. Cienc. Biol., Mexico City 5: 217-221) in addition to the Louisiana locality reported in this study. The report of Caballero (1948) listed *Crocodilus morletti* Dumeril, Bibron, and Dumeril as host for *C. pseudostoma*; all other reports give *Alligator mississippiensis* as host. One other species of proterodiplostome, *Pseudocrocodilicola americanense* Byrd and Reiber, 1942, parasitizes *A. mississippiensis*. We did not collect specimens of *P. americanense*, a species known only from its type locality in Midville, Georgia.

Based on examination of more than 60 alligators from fresh to brackish habitats, we noted the highest prevalence of proterodiplostomes in alligators from exclusively freshwater areas. The two Costa Rican localities are also freshwater habitats.

We express appreciation to W. Guthrie Perry and Ted Joanen, Rockefeller Wildlife Refuge,

Cameron Parish, Louisiana, for allowing us to examine alligators from Louisiana; to Drs. J. M. Kinsella, Donald J. Forrester, and Annie K. Prestwood for the loan of specimens from Florida; and to Ned Whately and Ronnie Palmer for technical assistance.

DANIEL R. BROOKS
Gulf Coast Research Laboratory
Ocean Springs, Mississippi 39564

ROBIN M. OVERSTREET
Gulf Coast Research Laboratory
Ocean Springs, Mississippi 39564

DANNY B. PENCE
Department of Pathology
Texas Tech University Health Sciences
Centers School of Medicine
Lubbock, Texas 79409

Editorial Acknowledgment

In addition to the members of the Editorial Board, I wish to thank the following persons for their help in reviewing manuscripts for Volume 44 of the *Proceedings*.—Ed.

John I. Bruce, Wilbur L. Bullock, Raymond Cable, John L. Crites, David J. Doran, R. P. Esser, Jacob H. Fischthal, Louis C. Gasbarre,

William J. Higgins, John C. Holmes, Harry W. Huizinga, Leo A. Jachowski, Irving G. Kagan, Norman D. Levine, Richard D. Lumsden, Monte A. Mayes, Michael F. Newborg, William R. Nickle, Brent B. Nickol, Gilbert F. Otto, D. J. Raski, Everett L. Schiller, Horace W. Stunkard.

In Memoriam

NORMAN RUDOLPH STOLL

September 4, 1892–December 30, 1977

The scientific world, and particularly the community of scholars active in parasitology, suffered a great loss in the death of Norman Stoll at the age of 84. Norman was a meticulous scientist and a kindly, fatherly, and effective counselor and teacher. He was a dedicated servant to the scientific community.

Norman Stoll was born in North Tonawanda, New York. He attended Mt. Union College (Alliance, Ohio, B.S. 1915), University of Michigan (M.S. 1918), and The Johns Hopkins University (Sc.D. 1923). He served in the military during both world wars, as a Lieutenant in the field artillery in World War I and as Lieutenant Commander in NMRU 2 on Guam in World War II. He spent most of his professional career, except for his Navy service in World War II, at the Rockefeller Institute–Rockefeller University, having joined the Rockefeller Institute in 1927.

Many other biographical details that might be appropriate for inclusion herein are omitted. By coincidence, a comprehensive account of Stoll's life by Malcolm Ferguson, a close associate and long-time friend, was nearing completion at the time of Norman's death and will appear in *Experimental Parasitology* (1977, 41: 253–271) and has been summarized in *Tropical Medicine and Hygiene News* (1977, 26: 13–14); another account will appear in an early issue of the *Journal of Parasitology* in addition to the obituary notice (1977, 63: 79).

Norman is perhaps best known for his contributions to our knowledge of the biology, ecology, and epidemiology of hookworm disease. This includes the development of the first practical method for estimating the number of worm eggs in human feces. This method, generally known as the Stoll Dilution Egg Counting Method, is still the most generally applied technique in field evaluation of hookworm and other nematode infections of humans. This technique has been used extensively in monitoring experimental canine hookworm infections. Variations and modifications of it have been used to study helminth, particularly nematode, infections of many do-

mestic animals and experimental infections of laboratory animals. Stoll developed this widely used egg-counting method while still a graduate student. He gave it practical field evaluation in the second of the "hookworm expeditions" developed by the late William Walter Cort and financed by the Rockefeller Foundation. This was in Puerto Rico in 1922; subsequent field studies in which he participated directly were in China (1923–24) and Panama (1926). A total of nearly 50 contributions have been identified with these early field studies on hookworm disease. He contributed further to our knowledge of the epidemiology of hookworm disease during World War II on Guam and more recently with WHO in western Africa.

Nevertheless, Norman Stoll's contributions to our knowledge of the epidemiology of hookworm disease reflect only a portion of his productive scientific activity although they dominated the first five or six years of his professional career, including his years as a graduate student. Two other major activities dealt with the extent and nature of acquired resistance to nematode infections and the axenic cultivation of parasites, both protozoa and nematodes.

Using *Haemonchus contortus* in sheep, he was the first to demonstrate that an otherwise healthy and previously parasite-free animal subjected to continuous exposure to the worm infection gradually lost the worms initially acquired and was thereafter refractory to challenge infections. He introduced the phrase "self-cure" to describe the phenomenon.

His studies on axenic cultivation began in 1937 in collaboration with the late Rudolph Glaser. It resulted in the successful rearing of *Neoaeplectana glaseri*, of the Japanese beetle, through multiple generations. Two decades later he succeeded in exenic cultivation of a snake parasite, *Entamoeba invadens*. As he approached retirement, and for some time after retirement, Norman was actively pursuing the axenic cultivation of *Entamoeba histolytica*.

Norman Stoll was particularly proud of his association with and membership in the Helminthological Society of Washington. In his first decade as a member, the records show

that he presented 10 papers at Helmsoc meetings, including the first record of the Stoll Dilution Egg Counting Method at the 62nd meeting on October 21, 1922 (1923, J. Parasitol. 9: 236) and the first record of his successful immunization of sheep against *H. contortus* at the 111th meeting on March 17, 1928 (1929, J. Parasitol. 15: 217).

The Society formally recognized its deep appreciation of Norman Stoll's accomplishments and contributions by electing him, at the Society's 500th meeting on May 15, 1976, an Honorary Member.

—Gilbert F. Otto and Aurel O. Foster.

Report on the Brayton H. Ransom Memorial Trust Fund

Balance on hand, 1 January 1976	\$3,956.11
Receipts: Interest received in 1976	271.14
	<u>\$4,227.25</u>
Disbursements: Grant to Helminthological Society of Washington	\$ 10.00
On hand, 31 December 1976	<u>\$4,217.25</u>

A. MORGAN GOLDEN
Secretary-Treasurer

M I N U T E S

Five Hundred First Through Five Hundred Eighth Meetings

501st Meeting: University of Maryland, College Park, Maryland, October 15, 1977. Dr. George Luttermoser, Chairman of the Awards Committee, presented the 1976 Anniversary Award to Dr. Leo A. Jachowski, Jr. The following slate of officers was presented: Kendall Powers (President), Harley Sheffield (Vice President), Ralph Lichtenfels (Corresponding Secretary-Treasurer), Ronald Fayer (Recording Secretary). Papers presented: "Filariasis: Vector-parasite relationships studied with radio-isotopes," Bryce Redington; "Parasitological experiences in Panama," Larry Hendricks; "Effects of *Plasmodium berghei* on a *Trypanosoma lewisi* infection in the rat host," Michael Newborg.

502nd Meeting: Animal Parasitology Institute, Beltsville, Maryland, November 19, 1976. The slate of officers presented at the 501st meeting was elected. Papers presented: "Carbohydrate metabolism of filarial parasites," Robert Rew; "Glucose metabolism in *Babesia equi*," Patricia Allen; "Schizonts of *Eimeria tenella* as observed by scanning electron microscopy," Philip Madden; "Ribonucleases of the excretory gland cells of *Stephanurus dentatus*," Robert Romanowski; "Pheromones in *Pelodera strongyloides*," Frank Stringfellow; "The life cycle of *Aponoma lucasi* Warburton (Acarina: Ixodidae), a one host tick on Malaysian reptiles," David Stiller.

503rd Meeting: Animal Parasitology Institute, Beltsville, Maryland (Sponsored by the Biological Laboratory, National Marine Fisheries Service, Oxford, Maryland), December 17, 1976. Officers elected at 502nd meeting were installed. Papers presented: "Some important disease of marine fishes and their histologic recognition," Robert Murchelano; "Some parasites from marine crustacea of different geographic areas," Sharon MacLean; "A national registry of marine pathology," Haskell Tubiash; "Pathogenic amoebae (Acanthamoebidae from brackish and oceanic sediments)," T. K. Sawyer, G. S. Visvesvara, B. A. Harke.

504th Meeting: Laboratory of Parasitic Diseases, National Institute of Allergy and In-

fectious Diseases, Bethesda, Maryland, January 21, 1977. President Kendall Powers announced the death of Dr. Norman A. Stoll on December 30, 1976. Copies of proposed constitutional changes were made available to the membership. Papers presented: "Cell surface properties of *Leishmania donovani*," Dennis Dwyer; "An immunological polysaccharide of *Trypanosoma cruzi*," Michael Gottlieb; "The effect of BCG on the source of cutaneous leishmaniasis in mice," Jonathan Weintraub; "Innate resistance factors to falciparum malaria in Nigerian children," Samuel Martin.

505th Meeting: Nematology Laboratory, Plant Protection Institute, U.S. Department of Agriculture, Beltsville, Maryland, February 25, 1977. The following changes to the Constitution and bylaws were accepted by the membership:

Constitution. Article 3, Section 3. Any person who has rendered conspicuous and continuous service as a member of the Society for a period of not less than 15 years, and has reached the age of retirement, may be elected to life membership. Life members shall have all the privileges of regular members but shall be exempted from payment of dues. The number of life members shall not exceed 5% of the membership at the time of election.

Bylaws. Article 3, Section 1. Candidates for election to regular membership may be sponsored and proposed only by members in good standing. The candidate shall submit a duly executed and signed application to the Recording secretary, who in turn shall submit the application to the Executive Committee. The Committee shall review the application and submit its findings to the Society. Voting may be either by voice or by ballot. The Corresponding Secretary-Treasurer shall inform the candidate of the action of the Society.

Article 3, Section 3. Nominations for Honorary and Life Membership, approved by the Executive Committee, will be submitted to the membership for election at a regular meeting.

Article 10, Section 9. The Executive Committee shall pass on all nominations for membership and on the reinstatement of delinquent members, except as otherwise provided, and shall make its recommendations to the Society. Article 11, Section 3. The Awards Committee shall be charged with the duty of recommending candidates for the Anniversary Award which may be given annually or less frequently at the discretion of the Committee.

Article 11, Section 5. The individual recommended shall be subject to approval by the Executive Committee.

Papers presented: "Developments in new control methods for plant-parasitic nematodes," J. Feldmesser; "Ultrastructure of anterior sensory organs of the root-knot nematode *Meloidogyne incognita*," B. Y. Endo and W. P. Wergin; "Short report on how the mosquito nematode parasite turned out," W. R. Nickle; "Current and potential nematode problems of soybeans at the national and local level," R. V. Rebois; "Morphology and ultrastructure of a bacterial parasite of the plant nematode, *Meloidogyne incognita*," R. M. Sayre and W. P. Wergin.

506th Meeting: Walter Reed Army Institute of Research, Washington, D.C. March 18, 1977. Papers presented: "Cellular immunity to *Trypanosoma rhodesiense*," Ray Perry; "The therapeutic efficacies of the hycanthone analogs, IA-3N-Oxide and IA-4N-Oxide, against *Schistosoma mansoni* infections in Rhesus monkeys," Willis Reid; "Immune complex glomerulo-nephritis in the bovine associated with *Sarcocystis* infection," Anthony Johnson; "*Mansonella ozzardi* among Tikuna Indians of North Brazil," James Lovelace.

507th Meeting: Naval Medical Research Institute, Bethesda, Maryland, April 15, 1977. Dr. Martin Ulmer, President of the American Society of Parasitologists attended this meeting of the Helminthological Society of Washington as part of his attempt to visit all affiliate societies of the ASP. Papers presented: "The effects of BCG on visceral leishmaniasis in BALB/c mice," Lloyd Smrkovski; "Comple-

ment in experimental rodent trypanosomiasis," Julie Jarvinen; "The structure and function of scolex glands in three caryophyllid tapeworms," Eugene Hayunga.

508th Meeting: University of Pennsylvania, New Bolton Center, Kennatt Square, Pennsylvania, May 14, 1977. Papers presented: "Egg production: an assay for in vitro maintenance of *Schistosoma mansoni*," Barbara Doughty; "In vivo and in vitro studies of *Schistosoma mansoni* structure and function," Sue Ernst; "Schistosomiasis in the nude mouse," S. Michael Phillips; "Characterization of antigen-reactive and effector cell populations in the lymphoid tissue of murine schistosomiasis mansoni," Philip Khoury. A selection of worm songs was then presented.

The following 50 new members were elected at the meetings indicated: *501st:* Leon Wilson Bone, Bruce M. Christensen, Richard S. Demaree, Jr., William George Deutsch, Walker James Fleming, III, Alan C. Fusco, Abdul Aziz Khan, Philip T. LoVerde, Fernando Mane-Garzon, Billy Smith McDonald, Jr., Jerry Young Neiderkorn, Nancy D. Pacheco, Sharon Patton, Edwin C. Powell, Robert G. Scholtens, Douglass Tillery Simpson, Rosamund W. Wendt, Hasan S. Yuksel. *503rd:* Chris H. Gardiner, Wesley George Knollenberg, Carolyn Ann West, Nyebuchi Jonathan Wosu. *504th:* Alvin Daniel Ashton, Robert Willis Edwards, Jeremy M. Jay, Peter S. Loizeaux, Roy Daniel Melendez, Norman Wright. *505th:* Edmund V. Guidry, III, Eugene G. Hayunga, Chong Ngo Long, Eric Marc Mishkin, Robert Edward Morcock, John Paul Smith. *506th:* Thomas L. Deardorff, Jeffrey M. Lotz. *507th:* Barry G. Campbell, Gary J. Peck, Michael D. Ruff, Lloyd L. Smrkovski, G. Thomas Strickland, Michael T. Suderman, Shannon Farrell Timmers, Duell E. Wood. *508th:* Larry R. Cruthers, William T. McGeachin, Jerry D. Reinisch.

RONALD FAYER
Recording Secretary

INDEX TO VOLUME 44

Acanthocephala, lacunar system and tubular muscles of	201
<i>Acanthocephalus parksidei</i> of Lake Michigan fishes	210
Alcohol, protection against trichinosis	120
<i>Alligator mississippiensis</i> , proterodiplostomes of	237
AMIN, OMAR M. Helminth parasites of some southwestern Lake Michigan Fishes	210
AMIN, OMAR M. and JOHN S. MACKIEWICZ. <i>Proteocephalus buplanensis</i> Mayes, 1967 (Cestoda: Proteocephalidea) from <i>Semotilus atromaculatus</i> in Wisconsin	228
Announcements	
Anniversary Award for 1976	109
Beltsville Symposium on Biosystematics	62
Editorial acknowledgment to reviewers	238
Editor's Note	43, 161
In Memoriam, Mario Mollari	59
In Memoriam, Norman Rudolph Stoll	239
Index to Volume 44	243
International Congress of Parasitology	125
Manter Memorial Symposium	217
Minutes—Five hundred first through five hundred eighth meetings	241
New Honorary Member	72
New Life Members	50
Report of the Brayton H. Ransom Memorial Trust Fund	240
Reprints of "Identification of Parasitic Metazoa in Tissue Sections" by M. B. Chitwood and J. R. Lichtenfels	95, 149
ASHMEAD, ROBERT R. (see Cooper)	96
AUGUSTINE, P. C., J. M. VETTERLING and D. J. DORAN. <i>Eimeria tenella</i> : Growth characteristics of drug-resistant strains in chicks and cell culture	147
BAIN, GEOFFREY A. and WILLIAM THRELFALL. Helminth parasites of hooded mergansers, <i>Lophodytes cucullatus</i> (L.), from Ontario	219
BERGSTROM, R. C. and B. A. WERNER. Development of abnormal eggs from young female trichostrongylid worms	234
BICKEL, STANLEY (see Pence)	104
BLANKESPOOR, HARVEY D. Notes on the biology of <i>Plagiorchis noblei</i> Park, 1936 (Trematoda: Plagiorchiidae)	44
<i>Blarina brevicauda</i> , new cestode of from Nebraska	60
BROOKS, DANIEL R. Six new species of tetraphyllidean cestodes, including a new genus from a marine stingray, <i>Himantura schmardae</i> (Werner, 1904) from Colombia	51
BROOKS, DANIEL R. and RICHARD W. HEARD III. Parasites of the clapper rail, <i>Rallus longirostris</i> Boddaert. III. Description of <i>Notocotylus schmidti</i> sp. n. (Digenea: Notocotylidae)	63
BROOKS, DANIEL R. and MONTE A. MAYES. <i>Hymenolepis asketus</i> sp. n. (Cestoidea: Hymenolepididae) from the short-tailed shrew, <i>Blarina brevicauda</i> Say, from Nebraska	60
BROOKS, DANIEL R., ROBIN M. OVERSTREET and DANNY B. PENCE. New records of proterodiplostome digeneans from <i>Alligator mississippiensis</i> and <i>Caiman</i> <i>crocodilus fuscus</i>	237
BROWN, R. J. (see Carney)	150
<i>Bufo marinus</i> , <i>Choledocystus hepaticus</i> from in Venezuela	162
<i>Bufo marinus</i> , trematodes of in Venezuela	82
<i>Caiman crocodilus fuscus</i> , proterodiplostomes of	237
CAMPBELL, RONALD A. New tetraphyllidean and trypanorhynch cestodes from deep-sea skates in the western North Atlantic	191
CAMPBELL, W. C. Can alcoholic beverages provide protection against trichinosis?	120
CAMPBELL, W. C. The control of parasites: The role of drugs	17
CARNEY, W. P., PURNOMO, P. F. D. VAN PEENEN, R. J. BROWN and M. SUDOMO. <i>Schistosoma incognitum</i> from mammals of central Sulawesi, Indonesia	150
<i>Cephalogonimus vesicaudus</i> of turtle from Texas	198

Cestodes from rats in Taiwan	101
Cestode, new species from shrew	60
Cestodes, new species from skates in the North Atlantic	191
Cestodes, new species from catostomid fishes	91
Cestodes, new species from marine stingray	51
CHENG, THOMAS C. The control of parasites: The role of the parasite	2
<i>Choledocystus hepaticus</i> , n. comb. and redescription	162
<i>Choledocystus linguatula</i> , status of	162
CHRISTENSEN, BRUCE M. Observations on the epidemiology of <i>Dirofilaria immitis</i> in urban Ames, Iowa	226
CHUTE, ANNE M., EVERETT E. LUND and GARY C. WILKINS. Comparative responses of Indian red jungle fowl, light brahma chickens and three other galliform birds to experimental infections with <i>Histomonas meleagridis</i> and <i>Heterakis gallinarum</i>	126
Control of parasites, role of drugs	17
Control of parasites, role of host	28
Control of parasites, role of parasite	2
COOPER, C. LAWRENCE, ROBERT R. ASHMEAD and JOHN L. CRITES. Prevalence of certain endoparasitic helminths of the yellow perch from western Lake Erie	96
<i>Cooperia</i> spp., differences in cuticular ridges and key	111
CORKUM, KENNETH C. (see Turner)	65
CORKUM, KENNETH C. (see Turner)	225
CORKUM, KENNETH C. and HUGH M. TURNER. <i>Alloglossoides caridicola</i> gen. et sp. n. (Trematoda: Macroderoididae) from a Louisiana crayfish	176
<i>Cottus bairdi</i> , new <i>Dactylogyrus</i> from	141
COURTNEY, CHARLES H. (see Ernst)	97
COWGILL, LARI M. (see McCallister)	218
CRAIG, GEORGE B. JR. (see Terwedow)	86
Crayfish, new trematode of from Louisiana	176
CRITES, JOHN L. (see Cooper)	96
CRUM, JAMES (see Kingston)	179
<i>Cyathocephalus truncatus</i> of Lake Michigan fishes	210
<i>Dacnitoides cotylophora</i> of Lake Michigan fishes and genus emended	210
DAVIDSON, WILLIAM R., GARY L. DOSTER, SAMUEL R. PURSGLOVE JR. and ANNIE K. PRESTWOOD. Helminth parasites of ruffed grouse (<i>Bonasa umbellus</i>) from the eastern United States	156
<i>Derogenes varicus</i> of fishes from Bering Sea	73
<i>Dirofilaria immitis</i> , epidemiology of in urban Iowa	226
<i>Dirofilaria immitis</i> , of wild canids from Indiana	233
DIXON, C. F. (see Fleming)	131
DORAN, D. J. (see Augustine)	147
DOSTER, GARY L. (see Davidson)	156
DRONEN, NORMAN O. JR. Studies on the population structures of two species of <i>Haematoloechus</i> Looss, 1899 (Digenea: Plagiorchiidae) in ranid frogs in New Mexico	68
DRONEN, NORMAN O. and EDMUND V. GUIDRY. The use of selected ratios as an additional comparative tool in the systematics of some digenetic trematodes (Ochetosomatidae)	223
DRONEN, NORMAN O. JR. and HAROLD T. UNDERWOOD. The life cycle of <i>Cephalogonimus vesicaudus</i> (Digenea: Cephalogonimidae) from <i>Trionyx spiniferus</i> from Texas	198
DUNAGAN, T. T. (see Miller)	201
<i>Echeneibothrium bathyphilum</i> , of North Atlantic skates	191
<i>Eimeria dunsingi</i> of parakeet	188
<i>Eimeria pellita</i> , of cattle from Alabama	221
<i>Eimeria subspherica</i> , development and redescription of	97
<i>Eimeria tenella</i> , activity of flutamide against	102
<i>Eimeria tenella</i> , growth of drug-resistant strain	147
<i>Eimeria tenella</i> , recovery of from feces	218

ERNST, JOHN V. and CHARLES H. COURTNEY. Prepatent and patent periods of the bovine coccidium <i>Eimeria subspherica</i> Christensen, 1941, with a redescription of the sporulated oocyst	97
ERNST, JOHN V. and KENNETH S. TODD JR. New geographic record and redescription of the sporulated oocyst of <i>Eimeria pellita</i> Supperer 1952 from Alabama cattle	221
<i>Eubothrium salvelini</i> of Lake Michigan fishes	210
Excretory bladder, ultrastructural development in <i>Ochetosoma aniarum</i>	136
FAYER, RONALD. The first asexual generation in the life cycle of <i>Sarcocystis bovicanis</i>	206
FLEMING, W. JAMES, C. F. DIXON and J. W. LOVETT. Helminth parasites of river otters (<i>Lutra canadensis</i>) from southeastern Alabama	131
Frogs, trematode population structure of	68
GALLINA, ANTHONY M. (see Todd)	188
<i>Glariadacris catostomi</i> of Lake Michigan fishes	210
GOUDIE, R. IAN (see Threlfall)	229
GUIDRY, EDMUND V. (see Dronen)	223
<i>Haematoloechus</i> , population structure in raniid frogs in New Mexico	68
HEARD, RICHARD W. III. (see Brooks)	63
Helminth parasites, of fishes in Lake Michigan	210
Helminth parasites, of mergansers from Ontario	219
Helminth parasites, of otters from Alabama	131
Helminth parasites, of ruffed grouse from United States	156
Helminth parasites, of white-tailed deer	107
Helminth parasites, of wild turkeys in Texas	104
Helminth parasites, of yellow perch from Lake Erie	96
<i>Hepatozoon canis</i> , from the Philippines	98
<i>Heterakis gallinarum</i> and <i>Histomonas meleagridis</i> , in galliform birds	126
<i>Himantura schmardae</i> , new cestodes of from Colombia	51
<i>Histomonas meleagridis</i> , experimental infections in galliform birds	126
HUFFMAN, DAVID G. and RICHARD G. KLIEVER. <i>Echinorhynchus canyonensis</i> sp. n. (Acanthocephala) from <i>Maynea californica</i> (Osteichthyes: Zoarcidae) from the Monterey submarine canyon, California	171
KAYTON, R. J. (see Kritsky)	141
KAZACOS, KEVIN R. <i>Dirofilaria immitis</i> in wild Canidae from Indiana	233
KINGSTON, NEWTON and JAMES CRUM. <i>Trypanosoma cervi</i> Kingston and Morton, 1975 in white-tailed deer, <i>Odocoileus virginianus</i> , in the southeastern United States	179
KLIEVER, RICHARD G. (see Huffman)	171
KRITSKY, D. C., R. J. KAYTON and P. D. LEIBY. <i>Dactylogyrus unguiformis</i> sp. n. (Monogenea) from the mottled sculpin, <i>Cottus bairdi</i> Girard, in Idaho, with some taxonomic considerations of the genus <i>Dactylogyrus</i>	141
KRUSE, GÜNTHER O. W. Some digenetic trematodes from fishes of the Bering Sea with descriptions of <i>Proisorhynchus mizellei</i> sp. n. (Bucephalidae) and <i>Pseudopecoelus nossamani</i> sp. n. (Opecoelidae)	73
KUNTZ, ROBERT E. (see Olsen)	101
KWAPIEN, R. P. (see Novilla)	98
Lacunar system and tubular muscles of Acanthocephala	201
LEIBY, P. D. (see Kritsky)	141
LICHTENFELS, J. RALPH. Differences in cuticular ridges among <i>Cooperia</i> spp. of North American ruminants with an illustrated key to species	111
Life cycle, first asexual generation in <i>Sarcocystis bovicanis</i>	206
Life cycle, of <i>Cephalogonimus vesicaudus</i>	198
<i>Littorina saxatilis</i> , Larval trematodes of from Newfoundland	229
<i>Lophodytes cucullatus</i> , helminth parasites of	219
LOVETT, J. W. (see Fleming)	131
LUND, EVERETT E. (see Chute)	126
<i>Lutra canadensis</i> , helminths of	131
MACKIEWICZ, JOHN S. (see Amin)	228
MAYES, MONTE A. (see Brooks)	60

<i>Maynea californica</i> , new acanthocephalan of from California	171
MCCALLISTER, GARY and LARI M. COWGILL. Efficiency of the Seinhorst filter for the recovery of <i>Eimeria tenella</i> oocysts, from feces	218
<i>Melopsittacus undulatus</i> , <i>Eimeria dunsingi</i> of	188
<i>Metamicrocotyla macracantha</i> , on gills of mullet	106
MILLER, DONALD M. and T. T. DUNAGAN. The lacunar system and tubular muscles in Acanthocephala	201
MINCHEW, C. DOUGLAS. The occurrence of a "coiled" <i>Metamicrocotyla macracantha</i> on the gills of the mullet, <i>Mugil cephalus</i>	106
Nematodes, histochemical studies of infections in calves	76
Nematodes, new species from soil in Turkey	185
New combination, <i>Choledocystus hepaticus</i> from <i>Bufo marinus</i> in Venezuela	162
New combination, <i>Rauschiella palmipedis</i> from Venezuelan frogs	82
New Species (new genus indicated by *)	
* <i>Acanthobothroides himanturi</i> Brooks 1977	51
* <i>Acanthobothroides tasajerasi</i> Brooks 1977	51
* <i>Acanthobothroides thorsoni</i> Brooks 1977	51
* <i>Allocorrigia filiformis</i> Turner and Corkum 1977	65
* <i>Alloglossoides caridicola</i> Corkum and Turner 1977	176
<i>Caulobothrium anacolum</i> Brooks 1977	51
<i>Dactylogyrus unguiformis</i> Kritsky, Kayton and Leiby 1977	141
<i>Echeneibothrium dubium abyssorum</i> Campbell 1977	191
<i>Echeneibothrium pollonae</i> Campbell 1977	191
<i>Echinorhynchus canyonensis</i> Huffman and Kleiver 1977	171
<i>Grillotia (Paragrillotia) rowei</i> Campbell 1977	191
<i>Hymenolepis asketus</i> Brooks and Mayes 1977	60
<i>Isoglaridacris chetekensis</i> Williams 1977	91
<i>Isoglaridacris wisconsinensis</i> Williams 1977	91
<i>Notocotylus schmidti</i> Brooks and Heard 1977	63
<i>Onchobothrium magnum</i> Campbell 1977	191
<i>Pratylenchoides alkani</i> Yüksel 1977	185
<i>Pratylenchoides erzurumensis</i> Yüksel 1977	185
<i>Prosorhynchus mizellei</i> Kruse 1977	73
<i>Pseudopecoelus nossamani</i> Kruse 1977	73
<i>Rhinebothrium magniphallum</i> Brooks 1977	51
<i>Rhinebothrium tetralobatum</i> Brooks 1977	51
NOVILLA, M. N., R. P. KWAPIEN and R. S. PENEYRA. Occurrence of canine hepatozoonosis in the Philippines	98
<i>Ochetosoma aniarum</i> , development of bladder in metacercariae of	136
<i>Odocoileus virginianus</i> , helminths of	107
<i>Odocoileus virginianus</i> , <i>Trypanosoma cervi</i> of	179
OLSEN, O. WILFORD and ROBERT E. KUNTZ. Cestodes from <i>Rattus Fischer</i> in Taiwan	101
<i>Ostertagia ostertagi</i> , histochemical studies of infected calves	76
OVERSTREET, ROBIN M. (see Brooks)	237
PENCE, DANNY B. (see Brooks)	237
PENCE, DANNY B. and STANLEY BICKEL. Helminths of wild turkeys in west Texas	104
PENEYRA, R. S. (see Novilla)	98
<i>Perca flavescens</i> , helminths of from Lake Erie	96
<i>Placobdella parasitica</i> of Lake Michigan fishes	210
<i>Plagiorchis noblei</i> , biology of	44
POWELL, EDWIN C. Ultrastructural development of the excretory bladder in early metacercariae of <i>Ochetosoma aniarum</i> (Leidy, 1891)	136
PRESTWOOD, ANNIE K. (see Davidson)	156
<i>Procambarus clarkii</i> , new trematode of from Louisiana	65
<i>Proteocephalus exiguus</i> of Lake Michigan fishes	210
<i>Proteocephalus buplanensis</i> of creek chubs from Wisconsin	228

PURNOMO (see Carney)	150
PURSGLOVE, SAMUEL R. JR. Helminth parasites of white-tailed deer (<i>Odocoileus virginianus</i>) from New Jersey and Oklahoma	107
PURSGLOVE, SAMUEL R. JR. (see Davidson)	156
<i>Rallus longirostris</i> , new trematode of from Georgia and Mississippi	63
<i>Rana catesbeiana</i> , filarial parasite of	86
<i>Rattus</i> , cestodes from in Taiwan	101
<i>Rauschiella</i> Babero, 1951 Char. Emend.	82
<i>Rauschiella palmipedis</i> (Lutz, 1928) n. comb.	82
<i>Sarcocystis bovicanis</i> , life cycle of	206
<i>Schistosoma incognitum</i> from Indonesia	150
SCHMIDT, JAMES M. (see Todd)	188
<i>Semotilus atromaculatus</i> , <i>Proteocephalus buplanensis</i> from	228
Snails, intermediate hosts of <i>Plagiorchus noblei</i>	44
SOULSBY, E. J. L. The control of parasites: Introduction	1
SOULSBY, E. J. L. The control of parasites: The role of the host	28
<i>Spirorchis scripta</i> , new snail host of	225
STRINGFELLOW, FRANK. Histochemical studies of abomasal tissue from calves with monospecific and dual species infections of <i>Ostertagia ostertagi</i> and <i>Trichostrongylus axei</i>	76
SUDOMO, M. (see Carney)	150
SULLIVAN, JAMES J. Redescription of <i>Choledocystus hepaticus</i> (Lutz, 1928) n. comb., and the status of <i>C. linguatula</i> (Rudolphi, 1819) (Trematoda: Plagiorchioidea)	162
SULLIVAN, JAMES J. Revision of the genus <i>Rauschiella</i> Babero, 1951 (Digenea: Plagiorchiidae) with a redescription of <i>R. palmipedis</i> (Lutz, 1928) n. comb. from Venezuelan frogs	82
TERWEDOW, HENRY A., JR. and GEORGE B. CRAIG JR. Development of <i>Waltonella flexicauda</i> , a filarial parasite of <i>Rana catesbeiana</i> , in <i>Aedes aegypti</i> and other culicine mosquitoes	86
THRELFALL, WILLIAM (see Bain)	219
THRELFALL, WILLIAM and R. IAN GOUDIE. Larval trematodes in the rough periwinkle, <i>Littorina saxatilis</i> (Olivi), from Newfoundland	229
TODD, KENNETH S. JR. (see Ernst)	221
TODD, KENNETH S. JR., ANTHONY M. GALLINA and JAMES M. SCHMIDT. <i>Eimeria dunsingi</i> Farr, 1960: A coccidium of the parakeet, <i>Melopsittacus undulatus</i>	188
Trematodes, from fishes of Bering Sea	73
Trematode, new species from clapper rail	63
Trematode, new species from crayfish	65
Trematodes of raniid frogs	68
Trematode, redescribed from Venezuelan frogs	82
Trematodes, use of ratios in systematics of	223
Trichinosis, alcohol and protection against	120
Trichostrongylid eggs, abnormal, development of	234
<i>Trichostrongylus axei</i> , histochemical studies of infected calves	76
<i>Triganodistomum attenuatum</i> of Lake Michigan fishes	210
<i>Trionyx spiniferus</i> , trematode of from Texas	198
<i>Trypanosoma cervi</i> of deer in United States	179
Turkeys, helminths of in Texas	104
TURNER, HUGH M. (see Corkum)	176
TURNER, HUGH M. and KENNETH C. CORKUM. <i>Allocorrigia filiformis</i> gen. et sp. n. (Trematoda: Dicrocoeliidae) from the crayfish, <i>Procambarus clarkii</i> (Girard, 1852)	65
TURNER, HUGH M. and KENNETH C. CORKUM. New snail host for <i>Spirorchis scripta</i> Stunkard, 1923 (Digenea: Spirorchidae) with a note on seasonal incidence	225
UNDERWOOD, HAROLD T. (see Dronen)	198
VAN PEENEN, P. F. D. (see Carney)	150
VETTERLING, J. M. (see Augustine)	147
<i>Waltonella flexicauda</i> , development in mosquitoes	86

WERNER, B. A. (see Bergstrom)	234
WILKINS, GARY C. (see Chute)	126
WILLIAMS, DENNIS D. <i>Isoglaridacris chetekensis</i> sp. n. and <i>I. wisconsinensis</i> sp. n. (Cestoda: Caryophyllaeidae) from Red Cedar River, Wisconsin catostomid fishes	91
YUKSEL, HASAN S. <i>Pratylenchoides alkani</i> sp. n. and <i>P. erzurumensis</i> sp. n. (Nematoda: Tylenchoidea) from soil in Turkey	185

MEMBERS OF THE HELMINTHOLOGICAL SOCIETY OF WASHINGTON

(Missouri through Venezuela; first half in January issue)

Missouri
Dropkin, Victor H.

Montana
Kinsella, J. M.
Seese, Floyd M.
Speer, C. A.
Worley, D. E.

Nebraska
Ashley, D. C.
Kruse, G.
Mayes, M. A.
Nickol, B. B.
Oettinger, D. F.
Pritchard, Mary H.
Riffle, J. W.

Nevada

New Hampshire
Bullock, W. L.
Burn, P. R.
Burn, Peter R.
Harrises, A. E.
Muzzall, P. M.
Porter, C. A.

New Jersey
Cali, Ann
Campbell, W. C.
Cuckler, A. C.
Dosoher, Mary Ehlers
Goble, F. C.
Green, D. F.
Hayes, T. J.
Ingalls, J. W., Jr.
Jenkins, W. R.
Kantor, Sidney
Katz, F. F.
Koepf, S. J.
Pantiz, E.
Pankavich, J. A.
Phillips, P. J.
**Stoll, N. R.
Tiner, J. D.
Wiest, L. M., Jr.

New Mexico
Allen, R. W.
Duszynski, D. W.
Hopper, F. A., Jr.

New York
Acholouu, A. D.
Braun, A. J.
Caveness, F. E.
Fischthal, J. H.
Fleming, W. J., III
Granek, I.
Grey, A. J.
Krupa, P. L.
Kuzia, E. J.
Lacey, R. J.
Levin, Norman L.
Mackiewicz, J. S.
Mai, W. F.
Meyers, T. R.
Mueller, J. F.
Pike, Eileen H.
*Schartz, Benjamin
Stunkard, H. W.
Tanowitz, H. B.

New York (APO)
Hendricks, L. D.
Sullivan, J. J.

New York (FPO)
Palmer, T. T.
Schinski, V. D.

North Carolina
Barker, K. R.
Chang, J.
Grant, W. C.
Grimes, L. R.
Harkema, R.
Johnson, C. A. III
Khan, Sekender A.
Lapp, N. A.
Laurie, J. S.

* Life Member

** Honorary Member

† Spouse Member

‡ Life Member deceased

McDaniel, J. S.
Miller, G. C.
Moncol, D. J.
Schneider, C. M.
Shepperson, Jacqueline R.
Tilton, Beverly E.
Triantaphyllou,
Hedwig H.

North Dakota
Holloway, H. L.
Larson, O. R.

Ohio
Burkhart, D. M.
Crites, J. L.
Dubey, J. P.
Etges, F. J.
Harwood, P. D.
Martin, D. R.
Rabalais, F. C.
Riedel, Richard M.
Wharton, G. W.
Zapotosky, J. E.

Oklahoma
Jordan, Helen E.
Kocan, A. Alan
Self, J. T.
Smith, P. E.

Oregon
Fendrick, J. L.
Jensen, H. J.
Kistner, T. F.
Knapp, S. E.
Lucker, J. T.
Macy, R. W.
Martin, C. W.
Simon, Michael J.
Williams, Dennis D.

Pennsylvania
Bergquist, E. J.
Cypress, R. H.
Davis, G. M.
Fried, B.
Hendrix, S. S.
Leventhal, Ruth
Martin, H. M.
Meinkoth, N. A.
Muncey, D. W.
Ogren, R. E.
Price, D. L.
Schad, G. A.
Solomon, G. B.
Soulsby, E. J. L.
Stromberg, B. E.
Theodorides, V. J.
Uricchio, W. A.

Puerto Rico
Frame, Anne D.
Roman, J.
Williams, E. H., Jr.

South Dakota
Huggins, E. J.
Johnson, A. D.
McDaniel, B., Jr.

Tennessee
Buhler, G. A.
Carter, O. S.
Schneider, M. D.
Scholtens, R. G.

Texas
Armstrong, Howard W.
Canaris, A. G.
Dronen, N. O., Jr.
Hopkins, S. H.
Huffman, D. G.
Kuntz, R. E.
Meade, T. G.
Moore, D. V.
Morrison, E. O.
Myers, Betty June
Pence, D. B.
Smith, W. N.

Sogandares-Bernal, F.
Thames, W. H., Jr.
Ubelaker, J. E.

Utah
Grundmann, A. W.

Virginia
Ebert, D. J.
Eckerlin, Ralph
†Ernst, Carl H.
Ernst, Evelyn M.
Fisher, J. E.
Hill, C. H.
John, D. T.
Kimbell, J. W.
Limber, D. P.
Miller, L. I.
Segal, Dorothy B.
Seidenberg, A. J.
Sinclair, N. R.

Washington
Becker, C. Dale
Foreyt, W. J.
Senger, C. M.

West Virginia
Hall, J. E.
Jarroll, E. L., Jr.
White, Glenn E.

Wisconsin
Amin, Omar M.
Font, W. F., Jr.
Grisi, L.
Peterson, Priscilla M.
Taft, S. J.
†Thorne, G.
Todd, A. C.
Witrock, D. D.

Wyoming
Bergstrom, R. C.
Croft, R. E.
Hones, R. F.
Jolley, W. R.
Kingston, N.

Argentina
Gonzalez, Stella M.
Schmunis, G. A.

Australia
Hobbs, R. P.
Sprent, J. F. A.

Belgium
Coomans, A.

Brazil
Franco, E.
Ichinohe, M.
Lordello, L. G. E.
Thatcher, V. E.

Canada
Anderson, R. C.
Anderson, R. V.
Arthur, J. R.
Bosher, J. E.
Ching, Hilda Lei
*Christie, J. R.
Kimpinski, Joe
Metrick, D.
Mudry, D. R.
Platt, T. R.
Rausch, R. L.
Samuel, W. M.
Threlfall, W.
Wanson, W.
Webster, W. A.

Canal Zone
Rossan, R. N.
Waltton, Bryce C.

Chile
Carvajal, J.
Tagle, Isaias V.

Colombia
Lightner, L.

Costa Rica
Salas, F., L. A.

Egypt
Ibrahim, I. K. A.
Oteifa, B. A.

France
Dollfus, R. Ph.
Vitiello, P.

Gt. Brit. & N. Ireland
Franklin, Mary T.
Mathews, H. J.
Shumard, R. F.
Siddiqi, M. R.
Williams, I. C.

India
Ahmad, J.
Gupta, S. P.
Mahajan, R.
Premvati, Dr. G.
Saxena, S. K.

Iran
Kheiri, A.

Israel
Paperna, I.
Wertheim, Gata

Italy
Lamberti, F.

Japan
Inatomi, S.
Mamiya, Y.
Yamaguti, S.
Yokoo, T.

Malaysia
Betterton, Christine

Mexico
Briseño, C. H.
Caballero, G.
Vargas-Mena, Jose
Vázquez, José T.

Netherlands
Dorsman, W.

New Zealand
Yeates, G. W.

Nigeria
Amosu, Olakunle
Simaren, J. O.

Peru
Guerrero, C. A.
Jatala, Parviz

Philippines
Velasquez, Carmen C.

Portugal
N. de A. Santos,
Maria Susana

South Africa
Heyns, J.

Spain
Tarazona, J. M.

Switzerland
Dubois, G.
Hornig, B.

Taiwan
Chiu, Jui-Kuang

Thailand

U.S.S.R.
**Ershov, V. S.

Venezuela
Dao Dao, F.
Meredith, Julia A.
Nasir, P.

CONTENTS

(Continued from Front Cover)

DRONEN, NORMAN O. JR. AND HAROLD T. UNDERWOOD. The Life Cycle of <i>Cephalogonimus vesicaudus</i> (Digenea: Cephalogonimidae) from <i>Trionyx spiniferus</i> from Texas	198
FAYER, RONALD. The First Asexual Generation in the Life Cycle of <i>Sarcocystis bovicanis</i>	206
FLEMING, W. JAMES, C. F. DIXON AND J. W. LOVETT. Helminth Parasites of River Otters (<i>Lutra canadensis</i>) from Southeastern Alabama	131
HUFFMAN, DAVID G. AND RICHARD G. KLEEVER. <i>Echinorhynchus canyonensis</i> sp. n. (Acanthocephala) from <i>Maynea californica</i> (Osteichthyes: Zoarcidae) from the Monterey Submarine Canyon, California	171
KINGSTON, NEWTON AND JAMES CRUM. <i>Trypanosoma cervi</i> Kingston and Morton, 1975 in White-tailed Deer, <i>Odocoileus virginianus</i> , in the Southeastern United States	179
KRITSKY, D. C., R. J. KAYTON AND P. D. LEIBY. <i>Dactylogyrus unguiformis</i> sp. n. (Monogenea) from the Mottled Sculpin, <i>Cottus bairdi</i> Girard, in Idaho, with Some Taxonomic Considerations in the Genus <i>Dactylogyrus</i>	141
LICHTENFELS, J. RALPH. Differences in Cuticular Ridges Among <i>Cooperia</i> spp. of North American Ruminants with an Illustrated Key to Species	111
MILLER, DONALD M. AND T. T. DUNAGAN. The Lacunar System and Tubular Muscles in Acanthocephala	201
POWELL, EDWIN C. Ultrastructural Development of the Excretory Bladder in Early Metacercariae of <i>Ochetosoma aniarum</i> (Leidy, 1891)	136
SULLIVAN, JAMES J. Redescription of <i>Choledocystus hepaticus</i> (Lutz, 1928) n. comb., and the Status of <i>C. linguatula</i> (Rudolphi, 1819) (Trematoda: Plagiorchioidea)	162
TODD, KENNETH S. JR., ANTHONY M. GALLINA AND JAMES M. SCHEMIDT. <i>Eimeria dunsingi</i> Farr, 1960: A Coccidium of the Parakeet, <i>Melopsittacus undulatus</i>	188
YÜKSEL, HASAN Ş. <i>Pratylenchoides alkani</i> sp. n. and <i>P. erzurumensis</i> sp. n. (Nematoda: Tylenchoidea) from Soil in Turkey	185

RESEARCH NOTES

AMIN, OMAR M. AND JOHN S. MACKIEWICZ. <i>Proteocephalus buplanensis</i> Mayes, 1976 (Cestoda: Proteocephalidea) from <i>Semotilus atromaculatus</i> in Wisconsin	228
BAIN, GEOFFREY A. AND WILLIAM THRELFALL. Helminth Parasites of Hooded Mergansers, <i>Lophadytes cucullatus</i> (L.), from Ontario	219
BERGSTROM, R. C. AND B. A. WERNER. Development of Abnormal Eggs from Young Female Trichostrongylid Worms	234
BROOKS, DANIEL R., ROBIN M. OVERSTREET AND DANNY B. PENCE. New Records of Proterodiplostome Digeneans from <i>Alligator mississippiensis</i> and <i>Caiman crocodylus fuscus</i>	237
CHRISTENSEN, BRUCE M. Observations on the Epidemiology of <i>Dirofilaria immitis</i> in Urban Ames, Iowa	226
DRONEN, NORMAN O. AND EDMUND V. GUIDRY. The Use of Selected Ratios as an Additional Comparative Tool in the Systematics of some Digenetic Trematodes (Ochetosomatidae)	223
ERNST, JOHN V. AND KENNETH S. TODD, JR. New Geographic Record and Redescription of the Sporulated Oocyst of <i>Eimeria pellita</i> Supperer 1952 from Alabama Cattle	221
KAZACOS, KEVIN R. <i>Dirofilaria immitis</i> in Wild Canidae from Indiana	233
MCCALLISTER, GARY AND LARI M. COWGILL. Efficiency of the Seinhorst Filter for the Recovery of <i>Eimeria tenella</i> Oocysts, from Feces	218
THRELFALL, WILLIAM AND R. IAN GOUDIE. Larval Trematodes in the Rough Periwinkle, <i>Littorina saxatilis</i> (Olivi) from Newfoundland	229
TURNER, HUGH M. AND KENNETH C. CORKUM. New Snail Host for <i>Spirorchis scripta</i> Stunkard, 1923 (Digenea: Spirorchidae) with a Note on Seasonal Incidence	225

ANNOUNCEMENTS

Editorial Acknowledgment	238
Editor's Note	161
In Memoriam	239
Index	243
International Congress of Parasitology	125
Manter Memorial Symposium	217
Minutes—Five Hundred First Through Five Hundred Eighth Meetings	241
Report of the Brayton H. Ransom Memorial Trust Fund	240
Reprints of "Identification of Parasitic Metazoa in Tissue Sections" by M. B. Chitwood and J. R. Lichtenfels	149

Date of publication, 24 August 1977

* * *

ALLEN PRESS, INC.

PRINTED
IN
U.S.A.

LAWRENCE, KANSAS