



Innodisk's Flash and DRAM Storage for Server Applications

innodisk

www.innodisk.com

Innodisk Server Products Introduction

Innodisk has designed a line of flash and DRAM products that have the power and stamina for data center designers and end users.

Our Server DRAM boasts high capacities, up to 64GB, to ensure easy storage of large data sets in server applications, data centers, and HPC designs. Our Flash Products are ideal for 1U Blade Servers, and have capacities of up to 1TB. Innodisk's firmware can be tailored for any systems design, and works across multiple platforms. With challenging amounts of data, it is crucial to have a product that will perform to its full potential.

Innodisk is committed to designing products with high performance, high capacities, and high reliability in multiple form factors. Partners can be sure that they are getting a customized solution to suit their needs.

Requirements for Server Applications:

- *Sustained performance*
- *Quality assurance*
- *Product longevity and support*
- *Customization*
- *Compatibility*

The Features of Our Products



- Golden Finger 30μ"
- RoHS Compliant
- Thermal Sensor
- CMTL Certified
- High Capacities, up to 128GB
- High Data Transfer Performance
- JEDEC Compliant

DRAM Products Features

Flash Products Features

- Customizable Firmware, Designed In-House
- Powerful Boot Drives
- Small Form Factors
- Extremely High Performance – SATA III Speeds up to 500/340 MB/s
- High Capacities, up to 256GB
- iSMART Tool Included
- Optional Power Pin 7 and 8

Innodisk is a professional DRAM solution provider dedicated to server applications which deliver capabilities up to 128GB. These memory modules design based on variety combinations of IC configurations in order to meet different demands and scopes of networking and telecommunications which are not only CMTL certified but supported by majority of current motherboard and systems brands, including SuperMicro, Gigabyte, ASUS, Intel, Tyan, ASRock, etc... Please verify the compatibility with your provider.



A photograph of a server rack filled with network equipment. The units are dark grey or black, with various ports and indicators. Numerous blue Ethernet cables are plugged into the front panels and bundled together. The perspective is from a low angle, looking up into the rack. The lighting is somewhat dim, highlighting the metallic surfaces and the vibrant blue of the cables. The text is overlaid in the bottom left corner in a white, sans-serif font.

Innodisk's industrial embedded flash storage meets all of today's server application requirements.

Introduction

Innodisk ServerDOM™ is dedicated to the future of server design. By using ServerDOM™ as a boot drive, there is more space for hot-swappable data storage.

Innodisk ServerDOM™ is designed with SATA III interface and compliant with server grade standard, such as supporting for Intel® RSTe. Furthermore, with our excellent development team, we are able to provide customized services to fulfill different inquiries; hardware design or software integration, such as IPMI.

Advantage 1 :

Independent OS

- Independent OS storage without taking up a HDD bay or storage space.
- Free the limitations of HDDs—more flexible hot swap and back-up solutions.

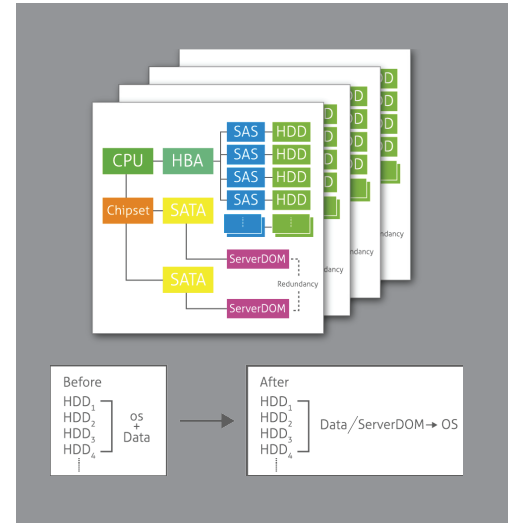

Advantage 2 :

OS Redundancy

Since ServerDOM™ contains the OS and critical software, a secondary ServerDOM™ can automatically reconfigure as a boot drive in the primary ServerDOM™ suffering from unrecoverable situation.

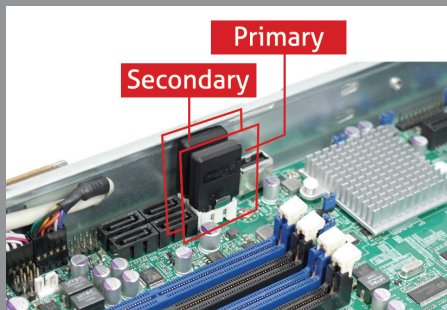

Advantage 3 :

Pin 7 / Pin 8

Cable-less Power Supply —Patented Pin 7 / Pin 8 design.

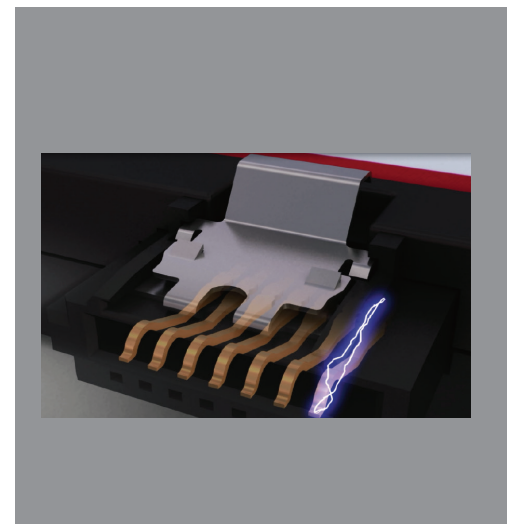

ServerDOM™

Innodisk ServerDOM™ is designed for more board configuration flexibility. ServerDOM™ as a boot drive has more space for hot-swappable data storage and supports Intel RSTe. Furthermore, with our excellent development team, we are able to provide customized services to fulfill different inquires; hardware design or software integration, such as IPMI.

Benefits & Features

- Tiny form factor to fit in blade or 1U servers without mechanical interference
- Compatible with Intel RSTe
- Cost effective OS storage solution
- Optional Power Pin 7/8 design
- Customized to support IPMI
- Compatible with Windows and Linux operating systems

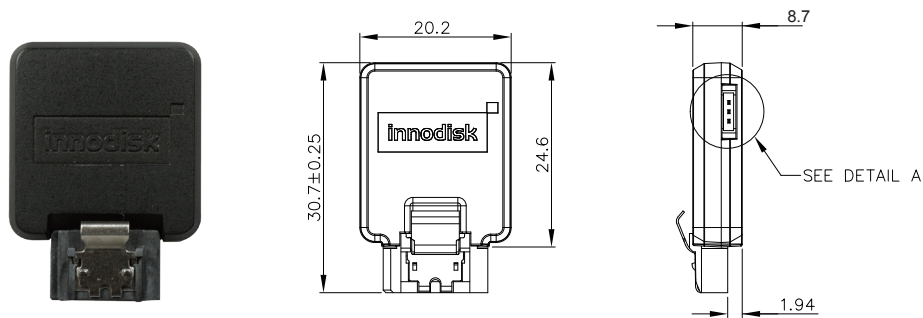

| Form Factor | ServerDOM-L | | | ServerDOM-H | | | ServerDOM-V | | |
|----------------------|--------------------|----------|----------|---------------------|----------|----------|----------------------|----------|----------|
| Model Name | 3ME | 3IE | 3SE | 3ME | 3IE | 3SE | 3ME | 3IE | 3SE |
| Type | MLC | iSLC | SLC | MLC | iSLC | SLC | MLC | iSLC | SLC |
| Interface | SATA III 6Gb/s | | | SATA III 6Gb/s | | | SATA III 6Gb/s | | |
| Capacity | 8GB-64GB | 8GB-32GB | 2GB-16GB | 8GB-64GB | 8GB-32GB | 2GB-16GB | 8GB-64GB | 8GB-32GB | 2GB-16GB |
| Performance (MB/s) | 480/160 | 480/270 | 450/200 | 480/160 | 480/270 | 450/200 | 480/160 | 480/270 | 450/200 |
| Dimension (WxLxH/mm) | 25 X 29.4 X 7.2 mm | | | 25 X 21.7 X 13.2 mm | | | 20.2 X 30.7 X 8.7 mm | | |

SATADOM

Innodisk's Serial ATA Disk on Module (SATADOM) is the world's smallest form factor with exclusive cable-less SATA power technology built-in, which simplifies motherboard design. Since it has no external cables, it is more robust and enhances the disk functions of various industrial and enterprise applications. Innodisk's SATADOM also supports the SATA II and SATA III interface with faster data transfer rates and is available in capacities ranging from 512MB up to 256GB.

Recommendation for Pin 7 and Pin 8 VCC issues

Innodisk suggests that customers who want to use products with the Pin7 and Pin 8 VCC feature do so as a design-in feature, including a fuse circuit to prevent over-current issues. We recommend our reference circuit to protect the motherboard and device by using either a "POWER SWITCH" or "JUMPER + FUSE"

*Warning DO NOT lay out 5V VCC on the SATA socket directly.

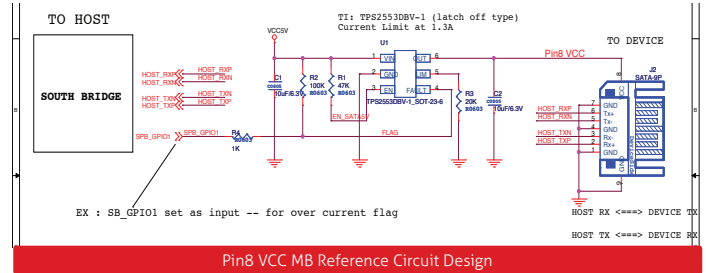
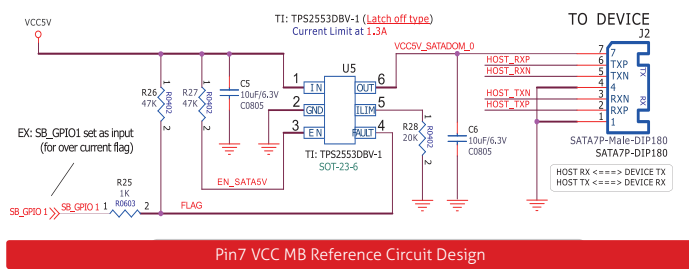

SATADOM advantage

- Smallest high speed SATA storage, supports low profile 1U Rack-mounted
- Up to 256GB, great for SATA storage device
- Reliable industrial grade quality wide temperature
- No moving parts for better vibration and shock resistance
- Custom Firmware service available
- Qualified by Intel and Supermicro
- Available in Standard & Industrial temperature



| Model Name | SATADOM-SL 3ME3 V2 | SATADOM-SL 3IE3 V2 | SATADOM-SV 3ME3 V2 | SATADOM-SV 3IE3 V2 | SATADOM-SH 3IE3 V2 | SATADOM-ML 3ME3 V2 |
|------------------------------|--|---|---|---|---|--|
| Key Features | 1.Vertical and low-profile design for 1U server 2. High IOPS 3. Best boot drive solution 4. Lower power consumption 5. Cable-Less SATA Power Technology | 1.Corpatible with VMware ESX: 6.0.0 2. Lifespan 7 times longer than MLC 3. Performance and data quality congruent to SLC 4. Cable-Less SATA Power Technology | 1. Vertical version 2. High IOPS 3. Best boot drive solution 4. Cable-Less SATA Power Technology | 1.Corpatible with VMware ESX: 6.0.0 2. Lifespan 7 times longer than MLC 3. Performance and data quality congruent to SLC 4. Cable-Less SATA Power Technology | 1. Low profile horizontal design 2. High IOPS 3. Cable-Less SATA Power Technology | 1. Vertical and low-profile design for 1U server 2. High IOPS 3. Best boot drive solution 4. Lower power consumption 5. Cable-Less SATA Power Technology |
| Interface | SATA III 6.0Gb/s | SATA III 6.0Gb/s | SATA III 6.0Gb/s | SATA III 6.0Gb/s | SATA III 6.0Gb/s | SATA III 6.0Gb/s |
| Flash Type | MLC | iSLC | MLC | iSLC | iSLC | MLC |
| Capacity | 8GB-128GB | 8GB-64GB | 8GB-128GB | 8GB-64GB | 8GB-64GB | 8GB-256GB |
| Max. Channel | 2 | 2 | 2 | 2 | 2 | 4 |
| Sequential R/W (MB/sec, max) | 200/80 | 240/160 | 200/80 | 240/160 | 240/160 | 400/140 |
| Max. Power Consumption | 0.65W(5V x 125mA) | 0.65W(5V x 125mA) | 0.65W(5V x 125mA) | 0.65W(5V x 125mA) | 0.65W(5V x 126mA) | 1.2W(5V x 239mA) |
| Thermal Sensor | STD : N , W/T : Y | | | | | |
| External DRAM Buffer | N | N | N | N | N | N |
| iCell | Y | Y | Y | Y | Y | Y |
| TRIM | Y | Y | Y | Y | Y | Y |
| ATA Security | Y | Y | Y | Y | Y | Y |
| S.M.A.R.T | Y | Y | Y | Y | Y | Y |
| Dimension (WxLxH/mm) | 30 X 28.4 X 7.4 | 30 X 28.4 X 7.4 | 18 X 39.2 X 7.56 | 18 X 39.2 X 7.56 | 18.0 x 30.3 x 12.5 | 33.6 x 30.35 x 7.32 |
| Environment | Vibration: 20G@7-2000Hz Shock: 1500G@0.5ms Storage Temperature: -55°C ~ +95°C MTBF: >3 million | | | | | |
| Standard Temp.OP(0°C~+70°C) | DESSL-XXXX09BC***# | DHSSL-XXXX09BC***# | DESSV-XXXX09BC***# | DHSSV-XXXX09BC***# | DHSSH-XXXX09BC***# | DESML-XXXX08BC***# |
| Wide Temp.OP (-40°C~+85°C) | DESSL-XXXX09BW***# | DHSSL-XXXX09BW***# | DHSSL-XXXX09%W***#(F) | DHSSV-XXXX09BW***# | DHSSH-XXXX09BW***# | DESML-XXXX08BW***# |
| Notes | XXX = density (02GB=02G, 04GB=04G, 08GB=08G, 16GB=16G, 32GB=32G, 64GB=64G, 128GB=A28, 256GB=B56, 512GB=C12) ***= flash configuration (internal control code) #=power supply method(A=pin 8/ external power cable, B=Pin 7+ Pin 8) | | | | | |



| Model Name | SATADOM-SV 3SE | SATADOM-ML 3SE-P | SATADOM-ML 3SE | SATADOM-SL 3SE |
|-------------------------------|--|---|---|---|
| Key Features | 1. Vertical version 2. Anti-vibration mechanical design | 1. Vertical and low-profile design for 1U server 2. High IOPS 3. Write protect 4. High performance | 1. Vertical and low-profile design for 1U server 2. Write protect 3. High performance | 1. Vertical and low-profile design for 1U server 2. Write protect 3. High performance |
| Interface | SATA III 6.0Gb/s | SATA III 6.0Gb/s | SATA III 6.0Gb/s | SATA III 6.0Gb/s |
| Flash Type | SLC | SLC | SLC | SLC |
| Capacity | 512MB-32GB | 8GB-64GB | 8G-64GB | 512MB-32GB |
| Max. Channel | 2 | 4 | 4 | 2 |
| Sequential R/W (MB/sec, max.) | 300/130 | 480/240 | 490/250 | 300/130 |
| Max. Power Consumption | 0.9W (5V x 180mA) | 2W(5V x 400mA) | 2W(5V x 400mA) | 0.9W (5V x 180mA) |
| Thermal Sensor | STD : N , W/T : Y | | | |
| External DRAM Buffer | N | Y | N | N |
| iCell | N | N | N | N |
| TRIM | N | Y | N | N |
| ATA Security | Y | Y | Y | Y |
| S.M.A.R.T | Y | Y | Y | Y |
| Dimension (WxLxH/mm) | 20.9 x 39.5 x 7.9 | 35.5 x 30 x 9.5 | 35.5x30x9.5 | 32.9x29.5x8 |
| Environment | Vibration: 20G@7~2000Hz Shock: 1500G@0.5ms Storage Temperature: -55°C ~ +95°C MTBF: >3 million | | | |
| Standard Temp. OP (0°C~+70°C) | DESSV-XXXD07SC*** (F) | DESML-XXXD67SC*** (F) | DESML-XXXD06SC*** (F) | DESSL-XXXD07*C*** (F) |
| Wide Temp. OP (-40°C~+85°C) | DESSV-XXXD07SW*** (F) | DESML-XXXD67SW*** (F) | DESML-XXXD06SW*** (F) | DESSL-XXXD07*W*** (F) |
| Notes | XXX = density (02GB=02G, 04GB=04G, 08GB=08G, 16GB=16G, 32GB=32G, 64GB=64G, 128GB=A28, 256GB=B56, 512GB=C12) ***= flash configuration (internal control code) %=Flash Type | | | |



| Model Name | SATADOM-MH 3SE | SATADOM-SH 3SE | SATADOM-SH Type C 3SE | SATADOM-SH Type D 3SE |
|-------------------------------|--|--|---|-------------------------------|
| Key Features | 1. Low-profile design 2. Write protect 3. High performance | 1. Low profile horizontal design 2. Only expose 12mm height on the motherboard when applying in practical | 1. Low profile horizontal design 2. Opposite direction of SATADOM-SH | Low profile horizontal design |
| Interface | SATA III 6.0Gb/s | SATA III 6.0Gb/s | SATA III 6.0Gb/s | SATA III 6.0Gb/s |
| Flash Type | SLC | SLC | SLC | SLC |
| Capacity | 4GB-32GB | 512MB-32GB | 512MB-32GB | 512MB-32GB |
| Max. Channel | 2 | 2 | 2 | 2 |
| Sequential R/W (MB/sec, max.) | 260/130 | 300/130 | 300/130 | 300/120 |
| Max. Power Consumption | 1.8W (5Vx360mA) | 0.9W (5V x 180mA) | 0.9W (5V x 180mA) | 0.9W (5V x 180mA) |
| Thermal Sensor | STD : N , W/T : Y | | | |
| External DRAM Buffer | N | N | N | N |
| iCell | N | N | N | N |
| TRIM | N | N | N | N |
| ATA Security | Y | Y | Y | Y |
| S.M.A.R.T | Y | Y | Y | Y |
| Dimension (WxLxH/mm) | 40.0 x 30.0 x 12.3 | 18.0 x 30.3 x 12.5 | 30.3 x 18 x 10.4 | 30.3 x 20.3 x 12.0 |
| Environment | Vibration: 20G@7~2000Hz Shock: 1500G@0.5ms Storage Temperature: -55°C ~ +95°C CMTBF: >3 million hours | | | |
| Standard Temp. OP (0°C~+70°C) | DESMH-XXXD07SC*** (F) | DESSH-XXXD07*C*** (F) | DESSF-XXXD07*C*** (F) | DESSF-XXXD07*C*** (F) |
| Wide Temp. OP (-40°C~+85°C) | DESMH-XXXD07SW*** (F) | DESSH-XXXD07*W*** (F) | DESSF-XXXD07*W*** (F) | DESSF-XXXD07*W*** (F) |
| Notes | XXX = density (02GB=02G, 04GB=04G, 08GB=08G, 16GB=16G, 32GB=32G, 64GB=64G, 128GB=A28, 256GB=B56, 512GB=C12) ***= flash configuration (internal control code) %=Flash Type | | | |

M.2-SATA(NGFF)

M.2-SATA (NGFF) stands for Next Generation Form Factor, which is comprised of several interfaces and the corresponding system interconnect based on 67pin edge card connectors. The Innodisk M.2-SATA (NGFF) offers wide range capacities in several standard form factors to fulfill different applications, including type 2242, type 2260, type 2280, and 22110.

Benefits

- Small form factor, M.2 (S42) save about 40% PCB dimension compared to Mini PCIe form factor
- Innodisk's exclusive iData Guard ensures reliable data transfers in the event of an abnormal power failure
- Fully compliant with industrial standard
- Suitable for ultra-thin or compact system

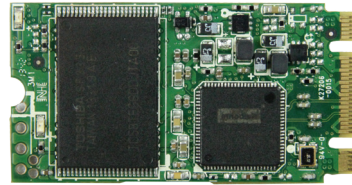

M.2-2242

Features

- Adopted SATA III 6.0 Gb/s interface, compliant with M.2 (NGFF) type 2242 and 2280
- Excellent data transfer speed in small form factor
- iCell technology for data protection(Optional)
- Supports iSMART disk health monitoring



M.2-2280



| Model Name | M.2 (S80) 3MG2-P | M.2 (S80) 3SE3 |
|-------------------------------|--|--|
| Key Features | 1. Type 2280-D2-B-M 2. High Sequential/IOPS performance 3. Support DEVSLP 4. iData Guard Protection | 1. Type 2280-D2-B-M 2. High quality SLC-based solution 3. iData Guard Protection |
| Interface | SATA III 6.0Gb/s | SATA III 6.0Gb/s |
| Flash Type | MLC | SLC |
| Capacity | 16GB-1TB | 8GB-128GB |
| Max. Channel | 4 | 4 |
| Sequential R/W (MB/sec, max.) | 520/450 | 380/230 |
| Max. Power Consumption | 3.07W (3.3Vx0.93A) | 1.3W (3.3V x390mA) |
| Thermal Sensor | STD : Y , W/T : Y | STD : N , W/T : Y |
| External DRAM Buffer | Y | N |
| iCell | N | N |
| TRIM | Y | Y |
| ATA Security | Y | Y |
| S.M.A.R.T | Y | Y |
| Dimension (WxLxH/mm) | 22.0 X 80.0 X 3.5 | 22.0 x 80.0 x 3.5 |
| Environment | Shock: 1500G@0.5ms Storage Temperature: -55°C ~ +95°C MTBF: >3 million hours | |
| Standard Temp. OP (0°C~+70°C) | DGM28-XXXD81%*** | DEM28-XXXD08SC*** |
| Wide Temp. OP (-40°C~+85°C) | DGM28-XXXD81%W*** | DEM28-XXXD08SW*** |
| Note | XXX = density (02GB=02G, 04GB=04G, 08GB=08G, 16GB=16G, 32GB=32G, 64GB=64G, 128GB=A28, 256GB=B56, 512GB=C12) ***= flash configuration (internal control code) %=Flash Type | |



| Model Name | M.2 (S42) 3ME2 | M.2 (S42) 3ME3 |
|-------------------------------|---|--|
| Key Features | 1. Type 2242-D1-B-M 2. High IOPS with DRAM-less design 3. Budget-friendly MLC-based solution | 1. Type 2242-D1-B-M 2. Excellent data transfer speed and high IOPS 3. iData Guard Protection |
| Interface | SATA III 6.0Gb/s | SATA III 6.0Gb/s |
| Flash Type | MLC | MLC |
| Capacity | 16GB-256GB | 8GB-128GB |
| Max. Channel | 4 | 2 |
| Sequential R/W (MB/sec, max.) | 500/160 | 200/80 |
| Max. Power Consumption | 1.09W (3.3V x330 mA) | 1W (3.3V x300 mA) |
| Thermal Sensor | STD : Y , W/T : Y | STD : N , W/T : Y |
| External DRAM Buffer | N | N |
| iCell | N | N |
| TRIM | Y | Y |
| ATA Security | Y | Y |
| S.M.A.R.T | Y | Y |
| Dimension (WxLxH/mm) | 22.0 x 42.0 x 3.2 | 22.0 x 42.0 x 3.2 |
| Environment | Shock: 1500G@0.5ms Storage Temperature: -55°C ~ +95°C MTBF: >3 million hours | |
| Standard Temp. OP (0°C~+70°C) | DEM24-XXXD72%C*** | DEM24-XXXD09%C*** |
| Wide Temp. OP (-40°C~+85°C) | DEM24-XXXD72%W*** | DEM24-XXXD09%W*** |
| Note | XXX = density (02GB=02G, 04GB=04G, 08GB=08G, 16GB=16G, 32GB=32G, 64GB=64G) ***= flash configuration (internal control code) %=Flash Type | |





| Model Name | M.2 (S42) 3IE3 | M.2 (S42) 3SE3 |
|-------------------------------|---|--|
| Key Features | 1. Type 2242-D1-B-M 2. Cost-effective industrial flash with iSLC 3. iData Guard Protection | 1. Type 2242-D1-B-M 2. High quality SLC-based solution 3. iData Guard Protection |
| Interface | SATA III 6.0Gb/s | SATA III 6.0Gb/s |
| Flash Type | iSLC | SLC |
| Capacity | 8GB-64GB | 4GB-32GB |
| Max. Channel | 2 | 2 |
| Sequential R/W (MB/sec, max.) | 240/170 | 210/110 |
| Max. Power Consumption | 1W (3.3V x300mA) | 1W (3.3V x300mA) |
| Thermal Sensor | STD : N , W/T : Y | |
| External DRAM Buffer | N | N |
| iCell | N | N |
| TRIM | Y | Y |
| ATA Security | Y | Y |
| S.M.A.R.T | Y | Y |
| Dimension (WxLxH/mm) | 22.0 x 42.0 x 3.2 | 22.0 x 42.0 x 2.85 |
| Environment | Shock: 1500G@0.5ms Storage Temperature: -55°C ~ +95°C MTBF: >3 million hours | |
| Standard Temp. OP (0°C~+70°C) | DHM24-XXXD09%C*** | DEM24-XXXD09SC*** |
| Wide Temp. OP (-40°C~+85°C) | DHM24-XXXD09%W*** | DEM24-XXXD09SW*** |
| Note | XXX = density (02GB=02G, 04GB=04G, 08GB=08G, 16GB=16G, 32GB=32G, 64GB=64G) ***= flash configuration (internal control code) %=Flash Type | |

DRAM Products

One of the newest emerging memory is DDR4. DDR4 will be a primary requirement for all of the next generation motherboards. Other benefits are reduced power consumption, higher frequencies, and higher memory density. There is a minimum of 30% performance increase from DDR3 to DDR4. It is clear that there is a 20% reduction in power usage when transitioning 1.5V for DDR3 to 1.2V for DDR4. Per scale this is a much more significant savings for datacenters.

DDR4 introduction - Comparison with DDR3

| | DDR3 | DDR4 | Description |
|---|----------------------------------|-----------------------------------|---|
|  Voltage | 1.35~1.5V | 1.2V | DDR4 has an estimated 11~20% lower voltage usage compares to DDR3. |
|  Speed | 800/1066/1333/ 1600/1866/2133 | 1600/1866/2133/ 2400/2666/3200 | DDR4 operates with frequency mainly range from 2133 MHz , compared to DDR3's mainstream frequency between 1333 and 1600 MHz. |
|  IC Density | 1Gb/2Gb/4Gb | 4Gb/8Gb | The density of a DDR4 IC doubles that of a DDR3 IC. Due to the introduction of new 3D TSV technology, the new high-density and high performance module up to 32GB now is available which will play a key role in supporting the enterprise servers and cloud-based applications, as well as further diversification of data center solutions. |

100% Monitor Program by Innodisk's Exclusive System





Innodisk is proud to offer you wide selections of DDR3 and DDR4 industrial grade DRAM modules for server level applications including RDIMM, LR DIMM, VLP RDIMM, UDIMM w/ ECC, and SO DIMM w/ ECC. In order to ensure the highest customer satisfaction and commitment of absolute service to our customers, Innodisk run through serial tests strictly. We have also utilized our in-house software system- iRAM Test specifically for all RDIMM products. We guarantee 100% test on every piece of RDIMM we ship out.

iRAM Test Features:

- Customized test standards by dynamic module timing parameters adjustments based on applications
- Real-time ECC monitoring and detection
- In-house software design for RDIMM verifications in order to monitor errors and potential defects
- Pre-programmed multiple patterns for complete test cycle

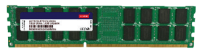
DDR4

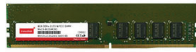



Featured here are 4 of Innodisk's advanced DRAM products for server applications.

| | | | | | |
|-----------------------|---|---|--|---|---|
| Server DRAM |  |  |  |  |  |
| Module Type | DDR4 LRDIMM | DDR4 RDIMM | DDR4 Unbuffered DIMM w/ECC Solution | DDR4 Unbuffered SODIMM w/ECC Solution | DDR4 VLP Registered DIMM |
| Frequency | 2133MHz/2400MHz | 2133MHz/2400MHz | 2133MHz/2400MHz | 2133MHz/2400MHz | 2133MHz/2400MHz |
| Capacity | 32GB/64GB/ up to 128 GB | 4GB/8GB/16GB/ 32GB/64GB up to 128GB | 4GB/8GB/16GB | 4GB/8GB/16GB | 4GB/8GB/16GB up to 32GB |
| Function | Load Reduced ECC memory | Registered ECC memory | Unbuffered memory with ECC | Unbuffered SODIMM memory with ECC | Very Low Profile Registered ECC memory |
| Pin Number | 288 pin | 288 pin | 288 pin | 260 pin | 288pin |
| Width | 72 bits | 72 bits | 72 bits | 72 bits | 72 bits |
| Voltage | 1.2V | 1.2V | 1.2V | 1.2V | 1.2V |
| Dimension | 133.35x31.25mm | 133.35x31.25mm | 133.35x31.25mm | 69.60 x 30mm | 133.35x18.75mm |
| Operation Temperature | 0°C ~ 85°C | 0°C ~ 85°C | 0°C ~ 85°C | 0°C ~ 85 °C | 0°C ~ 85 °C |
| Storage Temperature | -55°C ~ 100°C | -55°C ~ 100°C | -55°C ~ 100°C | -55°C ~ 100°C | -55°C ~ 100°C |
| Part Number | M4L0-BGSUHCRCG M4L0-CGS4RCRCG | M4R0-4GSSACRG M4R0-8GSQECRCG M4R0-AGSQGCRCG M4R0-BGS3GCRCG M4R0-CGS5UCRCG | M4CR-4GSSLC0G M4CR-8GSSMCOG M4CR-8GS1LC0G M4CR-AGS1MCOG | M4D0-4GSSPCRCG M4D0-8GSSQCRCG M4D0-8GS1PCRCG M4D0-AGS1QCRCG | M4R0-4GSSCCRCG M4R0-8GSSDCRCG M4R0-8GS1CCRCG M4R0-AGSUFRCG |

Remark : Listed part numbers are based on 2133MHz module specification. Please consult your regional sales representative for other frequency options or most updated solutions.

DDR3

Featured here are 4 of Innodisk's advanced DDR3 products for server applications.

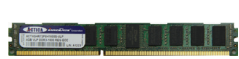
| | | | | | |
|-----------------------|---|--|--|---|---|
| Server DRAM |  |  |  |  |  |
| Module Type | DDR3 LRDIMM | DDR3 RDIMM | DDR3 Unbuffered DIMM w/ECC Solution | DDR3 Unbuffered SODIMM w/ECC Solution | DDR3 VLP Registered DIMM |
| Frequency | 1066/1333/1600MHz | 1066/1333/ 1600/1866MHz | 1066/1333/ 1600MHz | 1066/1333/1600MHz | 1066/1333/1600MHz |
| Capacity | 32GB | 2GB/4GB/ 8GB/16GB/32GB | 2GB/4GB/8GB/16GB | 2GB/4GB/8GB/16GB | 2GB/4GB/8GB/16GB |
| Function | Load Reduced ECC memory | Registered ECC Memory | Unbuffered memory with ECC | Unbuffered SODIMM memory with ECC | Very Low Profile Registered ECC memory |
| Pin Number | 240 pin | 240 pin | 240 pin | 204 pin | 240 pin |
| Width | 72 bits | 72 bits | 72 bits | 72 bits | 72 bits |
| Voltage | 1.35V/1.5V | 1.35V/1.5V | 1.35V/1.5V | 1.35V/1.5V | 1.35V/1.5V |
| Dimension | 133.35x30mm | 133.35x30mm | 133.35x30mm | 69.60 x 30mm | 133.35x18.75mm |
| Operation Temperature | 0°C ~ 85°C | 0°C ~ 85°C | 0°C ~ 85°C | 0°C ~ 85°C | 0°C ~ 85°C |
| Storage Temperature | -50°C ~ 100°C | -50°C ~ 100°C | -50°C ~ 100°C | -50°C ~ 100°C | -55°C ~ 100°C |
| Part Number | ACT32GLR72T4K1600S-LV | ACT2GHR72N8H1600S-LV ACT4GHR72N8J1600S-LV ACT8GHR72P8J1600S-LV ACT8GHR72P4J1600S-LV ACT16GHR72U4J1600S-LV ACT32GHR72Q4K1333S-LV | M3C0-2GS11LPC M3C0-4GSJ3LPC M3C0-8GSS3LPC M3C0-AGM13LPC | M3D0-2GSJ2LPC M3D0-4GSS2LPC M3D0-8GSS6LPC M3D0-AGM16LPC | ACT2GHR72N8H1600S-LVP ACT4GHR72N8J1600S-LVP ACT8GHR72P8J1600S-LVP ACT16GHR72W4K1600S-LVP |

Remark : Listed part numbers are based on 1.35V/1600 MHz module specification. Please consult your regional sales representative for other frequency and capacity options.

iSMART

Introducing our latest transparent and easy to use Innodisk SSD monitoring tool.

Innodisk's iSMART 5.0.0 is designed to simplify the SMART information and provide an easy to read interface for all our users. The iSMART tool monitors the health and lifespan of Innodisk's SSD as well as providing details on usage patterns and setting up alert settings before total failure. With iSMART, our customers are able to properly integrate Innodisk's SSDs into their solutions by carefully monitoring the behavior and lifespan during development, integration, and mass production.

Dashboard

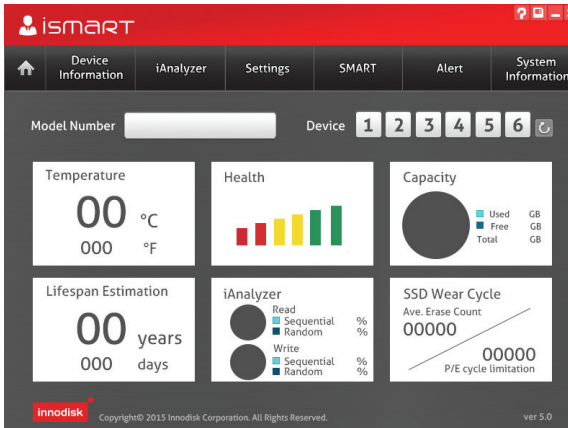

The Dashboard's home tab aims to provide a summary or quick snapshot of each installed disks in the system. This page offers accurate data information regarding Temperature, Health, Capacity, Lifespan, iAnalyzer, and Notifications.

Device Information

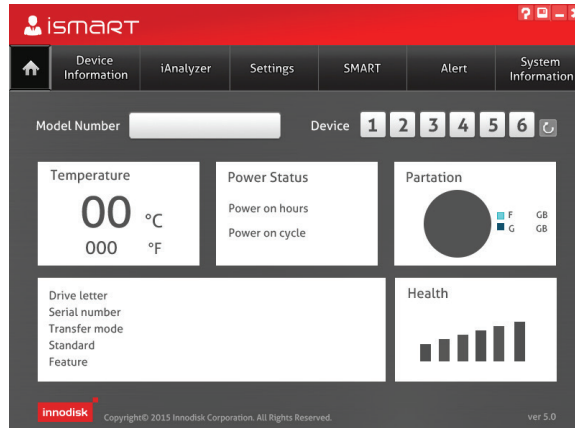

The Device Information page provides additional functions, such as Power Status, Partitions, and detailed information of the device such as Serial Number, Firmware Version, Interface, and Features. To learn more about SMART information, go to SMART values and refer to the SMART tab.

iAnalyzer

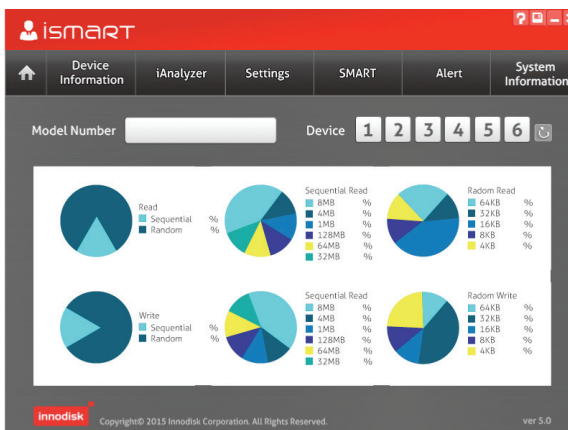

When activated, the iAnalyzer tab displays the read/write behaviors of the SSD in real time. This allows the user to understand their application usage of the SSD. Sequential and Random I/Os are easily broken down into percentages making them easy to read.

Alert

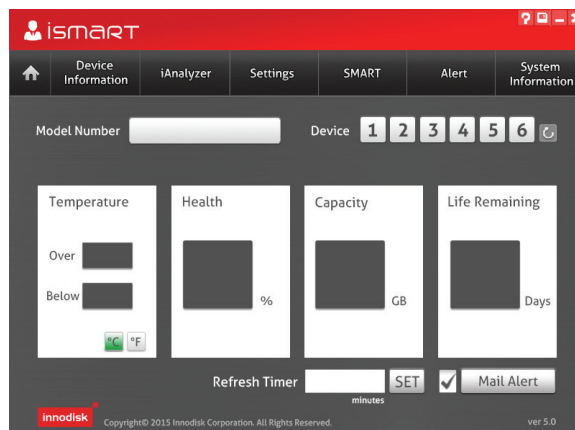

The Alert tab helps the user set trigger points with Temperature, Health percentage, Remaining Capacity or Life Remaining. If these trigger points exceed their boundaries, the iSMART utility can send a warning and email to the user notifying them that something may fail.

About Innodisk

Innodisk is a service driven provider of flash devices, DRAM products, and embedded peripherals for the industrial and enterprise applications. Our team has the experience and expertise that comes directly from our focus on the industrial segment, and is bolstered by having our own firmware team and factory. With satisfied customers across embedded, aerospace and defense, in-vehicle computing and more, we have set ourselves apart with a commitment to dependable products and unparalleled service. This has resulted in products including embedded peripherals designed to supplement existing industrial solutions. The expanded business lines are leading the way to our next step in becoming a comprehensive solution and service provider in the industrial storage industry.

Absolute Service

Service is not just what we do. It's who we are.

Absolute Service is our pledge and our guide. It infuses everything we do at Innodisk.

Absolute Service is our promise to deliver the most comprehensive service in every situation. It's the philosophy that guides us in all interactions with our customers and business partners. It's the spirit of friendliness and enthusiasm that fills each member of the Innodisk team.

Absolute Service is our absolute commitment to our customers.

Headquarters

Innodisk Corporation

5F., No.237, Sec. 1, Datong Rd., Xizhi Dist.,
New Taipei City, 221, Taiwan

T +886-2-7703-3000

F +886-2-7703-3555

E sales@innodisk.com

Branch Offices

Japan

K.I Bldg 2F/4F, 1-1-14,
Nihonbashiningyocho Chuo-ku,

Tokyo 103-0013 Japan

T +81-3-6667-0161

F +81-3-6667-0162

E jpsales@innodisk.com

Europe

Telexweg 4,
5641 TL Eindhoven,
Netherlands

T +31-(0)40 282 1818

F +31-(0)40 282 1850

E eusales@innodisk.com

USA

42996 Osgood Road,
Fremont, CA 94539 USA

T +1-510-770-9421

F +1-510-770-9424

E usasales@innodisk.com

9 Timber Ln, Marlboro NJ 07746

T +1-732-8530455

F +1-732-7846401

China

602,6 Floor,building A ,Hengyue
Center, No.19 Dengliang Road,
Nanshan Dist.,Shenzhen

T +86-755-2167-3689

+86-755-2167-3690

F +86-755-2167-3691

E sales_cn@innodisk.com

Shanghai **T** +86-21-31593340

T +86-21-31593341

Beijing **T** +86-10-62669919

For more warranty details, please contact the Innodisk Sales Department or visit our website:

www.innodisk.com