

SAMSUNG

SAMSUNG DIGIT*all*
everyone's invited™

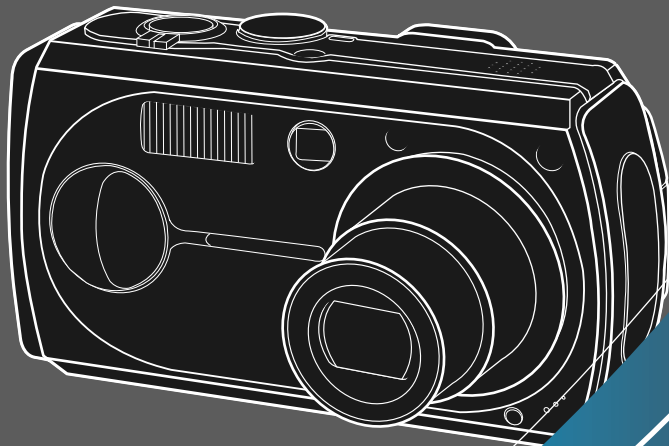

ENGLISH



SAMSUNG CAMERA

User's Manual

Digimax V50

Thank you for buying a Samsung Camera.

This manual will guide you through using the camera, including capturing images, downloading images and using the application software. Please read this manual carefully before using your new camera.

Instructions

- Use this camera in the following order

Set up the camera driver

Before connecting the camera to a PC, via the USB cable, you will need to set up the camera driver. Install the camera driver that is contained in the Application S/W CD-ROM.(p.101)

Take a picture

Take a picture (p.23)

Insert the USB cable

Insert the supplied USB cable into the PC's USB port and the camera's USB connection terminal.(p.109)

Check the camera's power

Check the camera's power
If the power is turned off, press the camera button to power it on.(p.29)

Check [Removable Disk]

Open Window's EXPLORER and search for [Removable Disk].(p.110)

- To play back a video shot with this camera, be sure to use the QuickTime player supplied on the software CD-ROM. Applications that do not support the MPEG-4 codec (e.g., Windows Media Player) may not be able to play back the video.
- If you use a card reader to copy the images on the memory card to your PC, the images could be damaged. When transferring the images taken with the camera to your PC, be sure to use the supplied USB cable to connect the camera to your PC. Please note that the manufacturer holds no responsibility for loss or damage of images on the memory card due to the use of a card reader.

Contents

READY

● Getting to know your camera	5
● About the icons	5
● Danger	6
● Warning	6
● Caution	7
● An FCC warning	7
● This digital camera can be used for	8
● Manufacturer's contents	10
● Identification of features	11
■ Front & Top	11
■ Back & Bottom	12
■ Side/ 5-function button	13
■ Mode dial	13
● Connecting to a Power Source	16
■ Using the batteries	16
■ Removing the battery	16
■ Using the AC power adapter (SAC-51, 5.0V)	17
● Instructions on how to use the memory card	18
● Inserting the memory card	20
● Removing the memory card	20
● When Using the Camera for the First Time ...	21

RECORDING

● LCD monitor indicator	22
● Starting the recording mode	23
● Things to Watch Out for When Taking Pictures	28
● Using the camera buttons to adjust the camera	29
■ POWER button	29
■ SHUTTER button/ Jog dial	29
■ ZOOM W/T button	29

■ TELE Zoom	30
■ WIDE Zoom	30
● Voice memo/ UP button	32
■ Recording a voice memo	32
● Macro/ Down button (Focusing)	33
● Focus lock	34
● FLASH/ LEFT button	35
● Self-timer / Remote / Right button	37
● MENU/ OK button	39
● S button	39
● MF button	45
● LCD button	46
● AEL button (Automatic Exposure Lock) ...	46
● Using the LCD monitor to adjust the camera settings	47
● How to use the menu	49
● Size	49
● Quality	50
● Metering	51
● Effect	51
● Sharpness	52
● Continuous shot	52
● Save / Load the camera configuration ...	53
● Scene	54

PLAY

● Starting play mode	55
■ Playing back a still image	55
■ Playing back a movie clip	56
■ Playing back a recorded voice	56
● LCD monitor indicator	57
● Using the camera buttons to adjust the camera	58
● Thumbnail/ Enlargement button	58
● Voice memo/ Up button	59
● Play & Pause/ Down button	60

Contents

●LEFT/ RIGHT/ MENU/ OK button	61	●Quick view	87
●LCD button	61	●Connecting an External Device (USB)	87
●Delete button	62	●Initialization(RESET ALL)	88
●COPY button	63	●Select card	88
●Setting up the play back function using the LCD monitor	64	●Setting up the MYCAM menu	89
●Deleting images	66	●Start up image	89
●Copy Pictures	67	●Start up sound	90
●Protecting images	68	●Shutter sound	90
●Starting the slide show	69	●Important notes	91
●Resize	70	●Warning indicator	93
●Rotating an image	71	●Before contacting a service center	94
●DPOF	71	●Specifications	97
●DPOF : STANDARD	72		
●DPOF : INDEX	72		
●DPOF : PRINT SIZE	73		
●DPOF : CANCEL	73		
●PictBridge	74		
●PictBridge: Picture Selection	75		
●PictBridge: Print Setting	76		
●PictBridge: Picture Printing	77		
●PictBridge : DPOF AUTO PRINT	78		
●PictBridge : RESET	78		

SETUP

●Setup menu	79	●Software Notes	99
●File name	80	●System Requirements	99
●Auto power off	81	●About the software	100
●Language	82	●Setting up the application software	101
●Formatting a memory card	82	●Starting PC Mode	109
●Setting up the Date/ Time/ Date type	83	●Removing the USB Driver for Windows 98SE	112
●Imprinting the recording date	83	●Removable Disk	113
●Function lamp	84	●Removing the removable disk	114
●Sound	85	●Setting up the USB Driver for MAC	115
●LCD brightness	85	●Using the USB Driver for MAC	115
●Selecting Video out type	86	●Digimax Viewer 2.1	116
		●Using PhotolImpression	117
		●FAQ	119

SOFTWARE

Getting to know your camera

Thank you for buying a Samsung Digital Camera.

- Prior to using this camera, please read the user manual thoroughly.
 - When you require After Sales service, please bring the camera and the cause of the camera malfunction (such as Batteries, Memory card etc.) to the A/S center.
 - Please check that the camera is operating properly prior to when you intend to use it (e.g. for a trip or an important event) to avoid disappointment. Samsung camera takes no responsibility for any loss or damages that may result from camera malfunction.
 - Keep the manual in a safe place.
- * Microsoft, Windows and Windows logo are registered trademarks of Microsoft Corporation incorporated in the United States and/or other countries.
- * Apple, Mac and QuickTime logo are registered trademarks of Apple computer.
- * Memory Stick Duo is a registered trademark of Sony Corporation.
- * All brand and product names appearing in this manual are registered trademarks of their respective companies.

About the icons

This manual contains instructions on using this camera that will help you to use this camera safely and correctly. This will help prevent danger and injury to others.



DANGER

DANGER indicates an imminently hazardous situation which, if not avoided, will result in death or serious injury.



WARNING

WARNING indicates a potentially hazardous situation, which, if not avoided, could result in death or serious injury.



CAUTION

CAUTION indicates a potentially hazardous situation, which, if not avoided, may result in a minor or moderate injury.

Danger

- Do not attempt to modify this camera in any way. This may result in fire, injury, electric shock or severe damage to you or your camera. Internal inspection, maintenance and repairs should be carried out by your dealer or Samsung Camera Service Center.
- Please do not use this product in close proximity to flammable or explosive gases, as this could increase the risk of explosion.
- Should any form of liquid or a foreign object enter the camera, do not use it. Switch off the camera, and then disconnect the power source (batteries or AC Power Adapter). You must contact your dealer or Samsung Camera Service Center. Do not continue to use the camera as this may cause a fire or electric shock.
- Do not insert or drop metallic or inflammable foreign objects into the camera through access points e.g. the memory card slot and battery chamber. This may cause a fire or electric shock.
- Do not operate this camera with wet hands. This could pose a risk of electric shock.

DANGER

Warning

- Do not use the flash in close proximity to people or animals. Positioning the flash too close to your subject's eyes, may cause eyesight damage.
- When taking photographs, never point the lens of the camera directly into very strong light. This may result in permanent damage to your eyesight.
- For safety reasons keep this product and accessories out of reach of children or animals to prevent accidents e.g.:
 - Swallowing batteries or small camera accessories. If an accident should occur, please consult a doctor immediately.
 - There is the possibility of injury from the camera's moving parts.
- Batteries and camera may become hot during prolonged use and it may result in camera malfunction. Should this be the case, allow the camera to sit idle for a few minutes to allow it time to cool.
- Do not recharge non rechargeable batteries. This may cause an explosion.
- Do not leave this camera in places subject to extremely high temperatures, such as a sealed vehicle, direct sunlight or other places of extreme variances in temperature. Exposure to extreme temperatures may adversely affect the camera's internal components and could cause a fire.
- When in use, do not cover the camera or AC Power Adapter. This may cause heat to build up and distort the camera body or cause a fire. Always use the camera and its accessories in a well-ventilated area.

Caution

- Leaking, overheating, or burst batteries could result in fire or injury.
 - Use batteries with the correct specification for the camera.
 - Do not short circuit, heat or dispose of batteries in fire.
 - Do not insert the batteries with the reverse polarities.
- Remove the batteries when not planning to use the camera for a long period of time. Batteries may leak corrosive electrolyte and irreparably damage the camera's components.
- Do not fire the flash while it is in contact with hands or objects. Do not touch the flash after using it continuously. It may cause burns.
- Do not move the camera while it is switched on, if you are using the AC Power Adapter. After use, always switch off the camera before unplugging the adapter from the wall socket. Then make sure that any connector cords or cables to other devices are disconnected before moving the camera. Failure to do so may damage the cords or cables and cause a fire or electric shock.
- A non-rechargeable (disposable) battery can be used but has a short lifespan because of its relatively low battery capacity. We recommend the rechargeable battery which has a bigger capacity and longer lifespan than the non rechargeable type. (Rechargeable batteries may not be available everywhere).

An FCC warning

• This device has been tested in accordance with the limits of a class B digital device under item 15 of the FCC rules. These limits are designed to provide protection against harmful interference in commercial installation. This equipment generates, absorbs and can emit radio frequency energy. If it is not installed and used in accordance with the instructions, it may cause harmful interference to radio communication. There is however, no guarantee that interference will not occur in some situations. Should any interference occur when this device is in operation, please try one or more of the following measures.

- Change the location and direction of any aerial.
- Increase distance between the camera and the affected device.
- Use a different socket away from the affected device.
- Please contact a Samsung agent or a radio/TV engineer.

- This device complies with part 15 of the FCC Rules.
- Changes or modifications not expressly approved by the party responsible for compliance could void user's authority to operate the equipment.

This digital camera can be used for

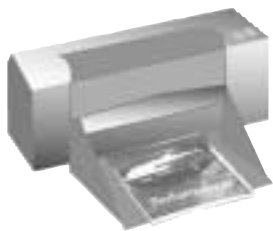

Printing images using a dedicated printer, DPOF and PictBridge compatible printer or a DPOF-equipped photo lab.
(refer to page 71~78)



Viewing images on a TV.
(refer to page 86)



Down loading image files from camera to computer.
(refer to page 110)



Taking a picture.
(refer to page 23~54)



Editing images on a PC.
(refer to page 117)

This digital camera can be used for

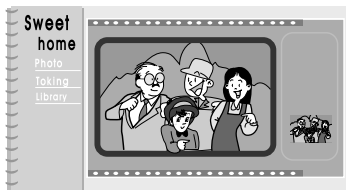

Creation of a digital photo album.

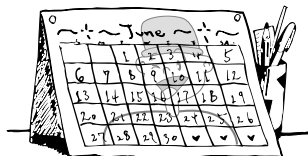

Taking a self-portrait and using the image to personalize calendar.



Recording your voice.
(refer to page 25)

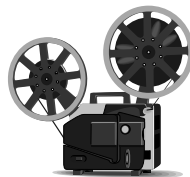

Recording a movie clip.
(refer to page 26)



You can even create your own unique gift wrap paper by using your digital images.



Inserting images directly into any electronic document.

Manufacturer's contents

Please check that you have the correct contents before using this product.
 [] marked contents are optional.

Digital Camera



Pouch



AV cable



USB cable



Camera strap



User manual



Product warranty



Software CD



Remote control



SD memory card



Memory Stick Duo

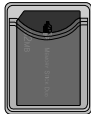

AC adapter
(SAC-51, 5.0V)



2 AA Alkaline
Batteries



Digimax Power Pack : SLB-1437A KIT

Digimax Battery I-Pack : SBP-1303 KIT

Battery charger
(SBC-L2)



Rechargeable
battery



AC cord



Battery
charger



Rechargeable
battery



AC cord



Identification of features

Front & Top

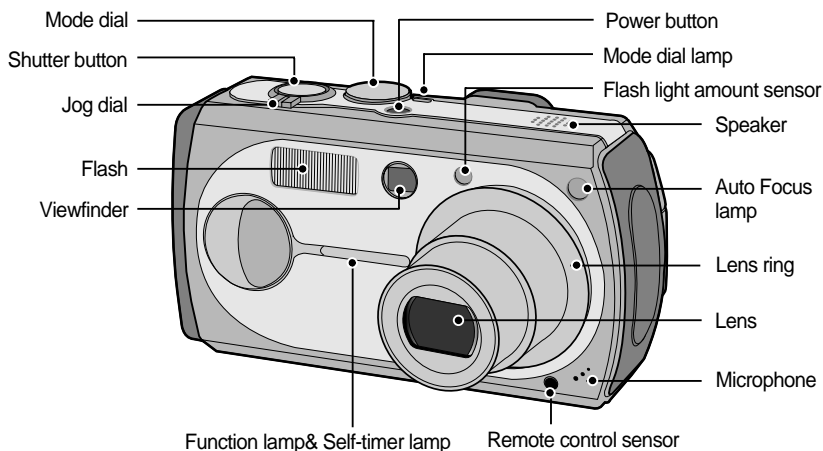

※ SCL-T3755/W3755 conversion lens and SLA-3537 connection adapter are designed for the Digimax digital cameras. They are sold separately depends on the camera model. Please check local retailers for the purchase. Please see page 31 or included manual for the usage.

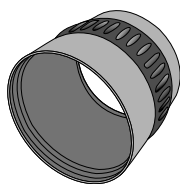

Conversion lens adapter

- Model Name: SLA-3537
- Used to attach a WIDE/ TELE conversion lens to the camera.

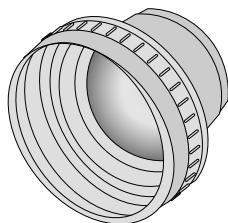

TELE Conversion lens

- Model Name: SCL-T3755
- Extends camera lens focus to 1.7 times.

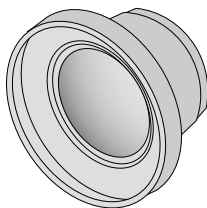

WIDE conversion lens

- Model Name: SCL-W3755
- Extends camera lens focus to 0.7 times.

Identification of features

Back & Bottom

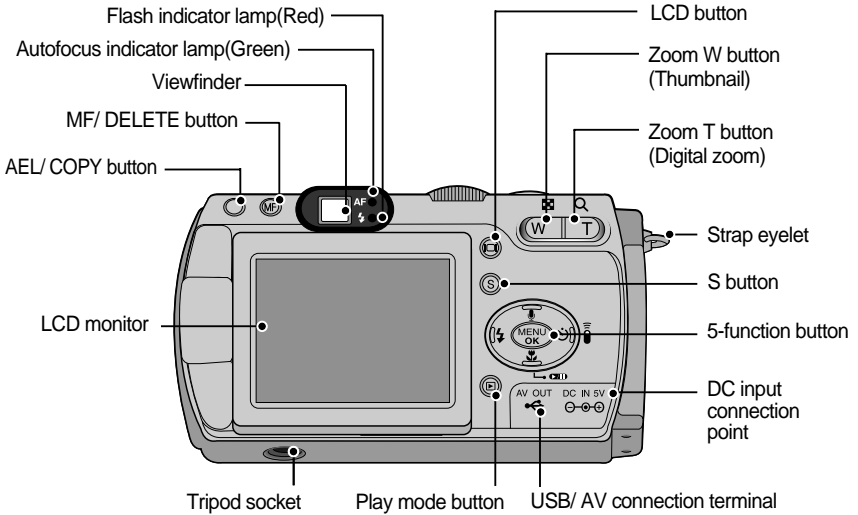

* When using the digital zoom to take a picture, the composition of the picture may be different depending on whether you are using the LCD monitor or the viewfinder. The picture will be taken in the composition of the picture as it appears on the LCD monitor.

INFORMATION

- Please keep the LCD monitor closed while not using the camera.
- Please do not over twist the rotational LCD monitor to prevent camera damage.
Rotational range : 180 degrees horizontal to the camera.

180 degrees to forward and 90 degrees to backward while opened.

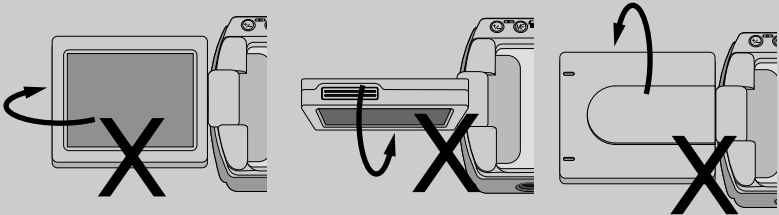

Please do not flip or twist the LCD monitor to the arrow direction.

Identification of features

Side/ 5-function button

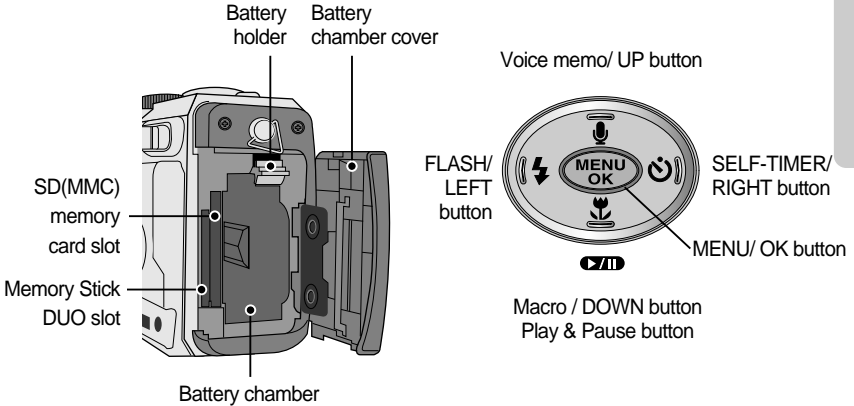

Mode dial

- You can select the desired working mode by using the mode dial located on the top of the camera. This digital camera has 8 recording modes. These are listed below.

- AUTO mode

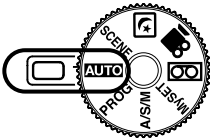

Please select this mode for quick and easy picture taking with minimal user interaction.

- PROGRAM mode

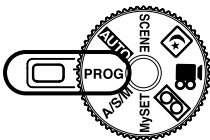

Selecting the automatic mode will configure the camera with optimal settings. You can still manually configure all functions except the iris and shutter speed.

Identification of features

● A/S/M mode

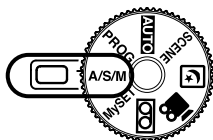

The Aperture and Shutter can be set manually in the ASM mode.

- A : Aperture priority mode
- S : Shutter priority mode
- M : Manual mode

● MySET mode

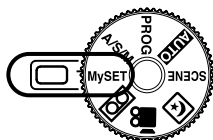

This mode allows users to save frequently used shooting settings for later use.

● VOICE RECORDING mode

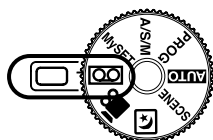

A voice recording can be recorded for as long as the available recording time of the memory capacity allows.(Max : 1 hour)

- Voice recording file type : *.wav

● MOVIE CLIP mode

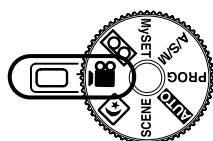

A movie clip can be recorded for as long as the available recording time of the memory capacity allows.

- Image size : 640x480, 320x240 (user selectable)
- Movie clip file type : *.mov

● NIGHT SCENE mode

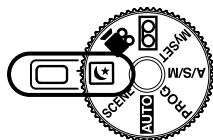

This mode is used at night or against a dark background.

● SCENE mode

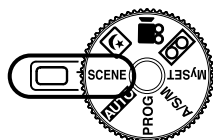

Use the menu to easily configure optimal settings for a variety of shooting situations including portrait, children, landscape, close-up, sunset, dawn, backlight, fireworks, beach scenes, and snowscape.

Identification of features

■ Function lamp & Self-timer lamp

Function	Description
Power on	Blue light blinks and then turns off when the camera is ready to take a picture.
After taking a picture	Blue lamp blinks once.
While movie recording	Blue lamp blinks at a 1-second interval.
While voice recording	Blue lamp blinks at a 1-second interval.
After selecting the remote controller mode	Blue lamp blinks at a 1-second interval.
While the self timer is functioning	For the first 7 seconds, the lamp blinks at 1 second intervals. For the final 3 seconds, the lamp blinks quickly at 0.25 second intervals. * The lamp will function while using the self-timer even if the configuration is set to off the lamp. (Based on 10-second Self-timer; see p. 37)

■ Auto focus indicator lamp

Color	Status	Camera Status
Green	Blinking	Recording Mode (lightly press the shutter button): Not focused. PC Mode: Transmitting Data.
	On	Recording Mode (lightly press the shutter button): Focused. PC Mode: When the USB cable is inserted.

■ Mode dial lamp

Color	Status	Camera Status
Green	On	Turned off the LCD with the LCD button.

■ Flash indicator lamp

Color	Status	Camera Status
Red	Blinking	Flash in the process of charging.
	On	Flash ready.

■ Mode icons

MODE	AUTO	PROGRAM	A/S/M			MySET	VOICE RECORDING	MOVIE CLIP	NIGHT SCENE	PLAY
Icon										
MODE	SCENE									
	PORTRAIT	CHILDREN	LANDSCAPE	CLOSE-UP	SUNSET	DAWN	BACKLIGHT	FIREWORKS	BEACH&SNOW	
Icon										

Connecting to a Power Source

■ There are two ways in which to provide the camera with power. You can use batteries or alternatively, you can use an AC(100 ~ 250V) Adapter (DC 5.0V 2.0A).

■ We recommend using batteries for a digital camera (Within a year from the date of manufacture). The batteries are listed below.

Non rechargeable batteries : AA type - Alkaline(High capacity), Ni-Mn(High capacity), Ni-Zn(High capacity), Lithium

CR-V3 type - Lithium

Rechargeable batteries : AA type - Ni-MH (over 2300mAh), Ni-Cd (over 1100mAh)

CR-V3 type - SBP-1303

Exclusive type - SLB-1437

Using the batteries

: If the camera does not turn on after you have inserted batteries, please check whether the batteries are inserted with the correct polarity(+/-).

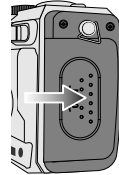
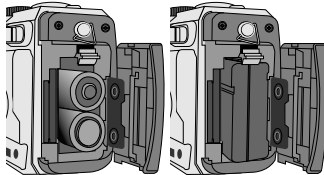
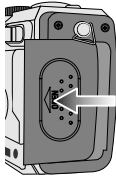

1. Open the battery chamber cover by pushing in the direction of the arrow.

2. Insert the batteries taking note of the polarity (+ / -).

3. To close the battery chamber cover, push it until it clicks.

Removing the battery

: Please use the following steps to remove the manufacturer's rechargeable battery SLB-1437.

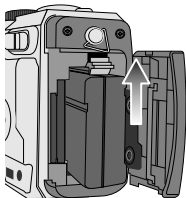

1. Turn off the camera power. Open the battery chamber cover and move the battery holder aside. The battery will be released.

2. Take out the battery and close the battery chamber cover.

■ There are 3 indicators for battery condition that are displayed on the LCD monitor.

Battery indicator			
Battery status	The batteries are fully charged.	Prepare new batteries.	There is no battery capacity. Replace with new batteries.

Connecting to a Power Source

INFORMATION

Important information about battery usage

- As for the AA type alkaline battery, you can only use the high capacity type. Do not use the normal type alkaline battery.
- When the camera is not used, turn off the camera power.
- Do not recharge the non rechargeable batteries. It may cause an explosion.
- Please remove the batteries if the camera will not be used for long periods. Batteries can lose power over time and are prone to leaking if kept inside the camera.
- We recommend high capacity ALKALINE batteries as manganese batteries cannot deliver sufficient power.
- Low temperatures (below 0 °C) can affect the performance of the batteries and you may experience reduced battery life.
- Batteries will usually recover at normal temperatures.
- Do not use old and new batteries at the same time.
- During extended use of the camera, the camera body may become warm. This is perfectly normal.
- If the lamps blink once and camera doesn't turn on by pressing the power button, it means that there is no battery capacity. In this case, change the battery with new one.

Using the AC power adapter (SAC-51, 5.0V)

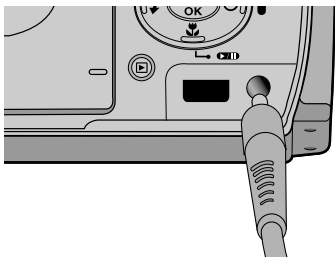

If you have access to a mains supply, using an AC Adapter (SAC-51, 5.0V) allows the camera to be used for long periods of time.

Plug the adapter into the connection point (DC IN 5.0V) on the camera.

Remove the batteries from the camera when using an AC adapter.

DANGER

- Always turn off the power before taking the AC adapter out of the mains supply.
- As with all mains powered devices, safety is important. Ensure that neither the camera nor adapter comes into contact with water or metallic materials.
- Please ensure that you use an AC adapter (SAC-51, 5.0V) with the correct specification for the camera. Failure to do so may affect your warranty.

Instructions on how to use the memory card

Maintenance of the memory card

- Be sure to format the memory card (see p. 82) if you are using a newly purchased memory for the first time, if it contains data that the camera cannot recognize, or if it contains images captured with a different camera.
- Turn off the camera power whenever the memory card is being inserted or removed.
- Repeated use of the memory card will eventually reduce the memory card's performance. Should this be the case, you will need to purchase a new memory card.
Wear and tear on the memory card is not covered by the Samsung warranty.
- The memory card is an electronic precision device.
Do not bend, drop or subject the memory card to any heavy impact.
- Do not store the memory card in an environment with strong electronic or magnetic fields, e.g. near loud speakers or TV receivers.
- Please do not use or store in an environment where there are extremes in temperature.
- Do not allow the memory card to become dirty or to come into contact with any liquid.
Should this happen, clean the memory card with a soft cloth.
- Please keep the memory card in its case when not in use.
- During and after periods of extended use, you may notice that the memory card is warm.
This is perfectly normal.
- Do not use a memory card that is used in another digital camera or memory card reader.
- Do not use a memory card formatted by another digital camera or memory card reader.

Preserving the memory card data

- If the memory card is subjected to any of the following, the recorded data may become corrupted :
 - When the memory card is used incorrectly.
 - If the power is switched off or the memory card is removed while recording, deleting (formatting) or reading.
- Samsung cannot be held responsible for lost data.
- It is advisable to copy important data onto other media as back-up e.g. floppy disks, hard disks, CD etc.
- If there is insufficient memory available : If you press the shutter button for the shot, a [CARD FULL !] message will appear and the camera will not operate.
To optimize the amount of memory in the camera, replace the memory card or delete unnecessary images stored on the memory.

Instructions on how to use the memory card

INFORMATION

- If you open the battery chamber cover when the camera power is turned on, the power will turn off automatically.(Except for the exclusive type SLB-1437 battery)
- Don't remove the memory card when the Auto focus lamp(Green) is blinking as this may cause damage to data in the memory card.

- The camera can use SD Memory Cards, MMC (Multi Media Card), and Memory Stick Duo. Please consult the enclosed manual for using the MMC and Memory Stick Duo.

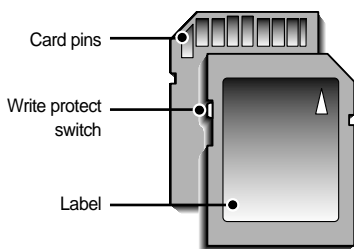

[SD(Secure Digital) memory card]

The SD memory card has a write protect switch that prevents image files from being deleted or formatted.

By sliding the switch to the bottom of the SD memory card, the data will be protected.

By sliding the switch to the top of the SD memory card, the data protection will be canceled. Slide the switch to the top of the SD memory card before taking a picture.

- When using a 32MB SD memory card, the specified shooting capacity will be as follows. (These figures are intended as an indication of expected performance). These figures are approximate as image capacities can be affected by variables such as subject matter.

Recorded image size		TIFF	SUPER FINE	FINE	NORMAL	30 FPS	15FPS
Still image	2592X1944	1	11	23	35	-	-
	2272X1704	2	15	30	45	-	-
	2048X1536	3	18	36	53	-	-
	1600X1200	5	30	61	91	-	-
	1024X768	12	70	130	183	-	-
	640X480	29	183	305	457	-	-
Movie clip	640X480	-	-	-	-	1MIN 50SEC	3MIN 35SEC
	320X240	-	-	-	-	3MIN 35SEC	6MIN 47SEC

Inserting the memory card

1. Turn off the camera's power and pull the battery chamber cover in the direction of the arrow to open.

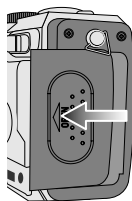

2. Have the front of the memory card facing toward the front of the camera (lens) and the card pins toward the back of the camera (LCD monitor), and then push the memory card into the card slot until you hear a click.

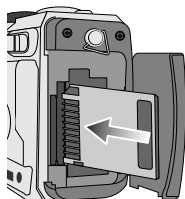

- * When inserting the Memory Stick Duo, please have the card pins side facing up (toward the lens). Be careful not to insert the Memory Stick Duo into the SD memory card slot.

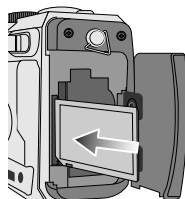

3. To close, push the battery chamber cover until you hear a click. If the memory card does not slide in smoothly, do not attempt to insert it by force. Check the direction of insertion, and then insert it correctly. Do not insert the memory card the wrong way round. Doing so may damage the memory card slot.

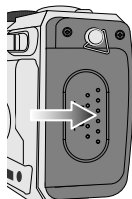

Removing the memory card

1. Turn the power off using the power button. Open the battery chamber cover and press the memory card as shown in the image and release.
2. Remove the memory card and close the battery chamber cover.

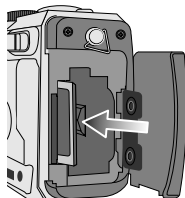

When Using the Camera for the First Time

- If the camera is turned on for the first time, a menu will be displayed to set date, time and language in the LCD monitor. This menu will not be displayed after setting up the date, time and language. Set up the date, time and language before using this camera.

- Setting up the date, time and date type

1. Select the [DATE.TIME] menu by pressing the UP/DOWN button and press the RIGHT button.
2. Press the UP/DOWN/LEFT/RIGHT button to select the desired sub menu and press the OK button.

RIGHT button : Selects YEAR/ MONTH/ DAY/ HOUR / MINUTE/DATE TYPE

LEFT button : Moves the cursor to the [DATE. TIME] main menu if the cursor is at the first item of the date and time setup. In all other instances, the cursor will be shifted to the left of its current position.

UP/ DOWN button : changes the value of each item.



- Setting up the language

1. Select the [LANGUAGE] menu by pressing the UP/DOWN button and press the RIGHT button.
2. Select the desired sub menu by pressing the UP/ DOWN button and press the OK button.



INFORMATION

- Following languages are supported.
Type A : English, French, German, Spanish, Italian, Russian, Dutch and Portuguese.
Type B : English, Korean, Simplified Chinese, Traditional Chinese, Danish, Swedish, Thai, and Malaysian.
- Even if the camera is restarted, the language setting will be maintained.

LCD monitor indicator

■ The LCD monitor displays information about the shooting functions and selections.

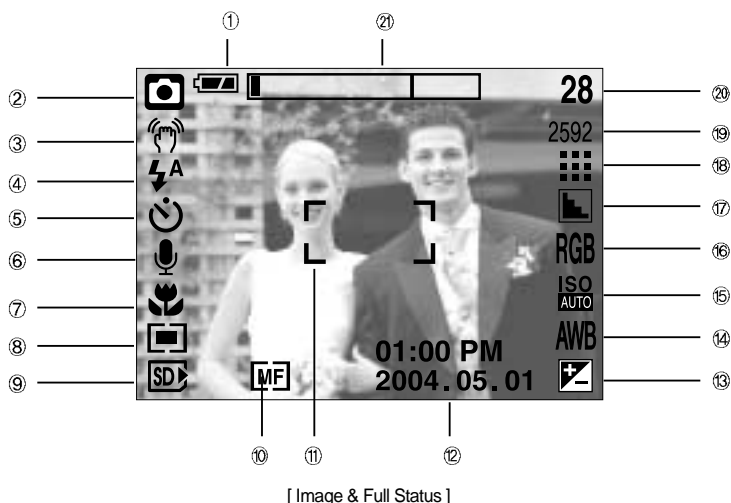

No.	Description	Icons	Page
1	Battery		p.16
2	Recording mode		p.13-14
3	Camera shake warning		p.28
4	Flash		p.35
5	Self-timer		p.37
6	Voice memo		p.32
7	Macro		p.33
8	Metering		p.51
9	SD card/ MS DUO indicator		
10	Manual/ Continuous auto focus		p.45
11	Auto focus frame		
12	Date/ Time	2004.05.01 01:00 PM	
13	Exposure compensation		p.40

LCD monitor indicator

14	White Balance		p.41
15	ISO		p.42
16	RGB	RGB	p.42
17	Sharpness		p.52
18	Image quality		p.50
19	Image size / Continuous shot	2592, 2272, 2048, 1600, 1024, 640 /	p.49
20	Number of available shots remaining	28	
	Remaining time (Movie clip/ Voice recording)	00:01:30/ 01:00:00	
21	Optical/ Digital Zoom bar		

Starting the recording mode

■ How to use the AUTO mode (**AUTO**)

1. Insert the batteries (p.16). Insert the batteries taking note of the polarity (+ / -).
2. Insert the memory card. (p.20)
3. Close the battery chamber cover.
4. Press the power button to turn on the camera.
(If the date/time that is displayed on the LCD monitor is incorrect, reset the date/time before taking a picture.)
5. Select the AUTO mode by rotating the mode dial.
6. Point the camera towards the subject and compose the image by using either the viewfinder or LCD monitor.
7. Press the shutter button to capture an image.

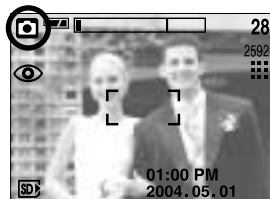
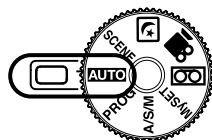

[AUTO mode]

INFORMATION

- If the auto focus frame turns to red when you press the shutter button down half way, it means that the camera cannot focus on the subject. Should this be the case, the camera is unable to capture an image clearly.

Starting the recording mode

■ How to use the PROGRAM mode (PROG)

Selecting the automatic mode will configure the camera with optimal settings. You can still manually configure all functions except the aperture value and shutter speed.

Steps from 1-4 are the same as those for AUTO mode.

5. Select the PROGRAM mode by rotating the mode dial.

6. Press the menu button to configure advanced functions

such as image size (p.49), quality (p.50), metering (p.51), picture effects (p.51), sharpness (p.52), continuous shooting (p.52) and saving MYSET settings(p.53).

7. Point the camera towards the subject and compose the image by using either the viewfinder or LCD monitor.

8. Press the shutter button to capture an image.

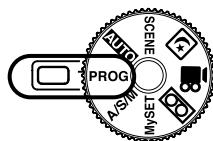

[PROGRAM mode]

■ How to use the A/S/M mode (A/S/M)

The Aperture and Shutter can be set manually in the A/S/M mode.

Steps from 1-4 are the same as those for AUTO mode.

5. Select the A/S/M mode by rotating the mode dial.

6. Press the S button. If the ASM icon is not displayed, press the Up and Down button to select the ASM icon.

7. Use the Left and Right buttons to select desired shooting mode. A (Aperture priority mode), S (Shutter speed priority mode), and M (Manual mode).

8. Press the OK button to load the selected shooting mode.

9. Press the shutter button to capture an image.

Please see page 43 for details of the A/S/M shooting mode.

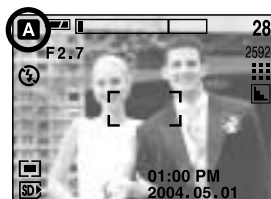
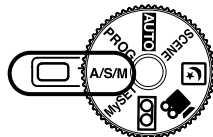

[A/S/M mode]

Starting the recording mode

■ How to use the MySET mode (MySET)

This mode allows users to save frequently used shooting settings for later use.

Steps from 1-4 are the same as those for AUTO mode.

5. Select the MySET mode by rotating the mode dial.
6. Press the menu button.
7. Use the Left/Right buttons to select the [LOAD] menu tap. Use the Up/Down buttons to select desired MYSET number.
8. Press the OK button to load the camera configuration saved in the MYSET number and close the menu screen.
9. Point the camera towards the subject and compose the image by using either the viewfinder or LCD monitor.
10. Press the shutter button to capture an image.

Please see page 53 for details of the MYSET shooting mode and menus.

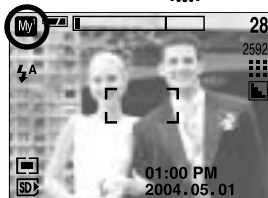
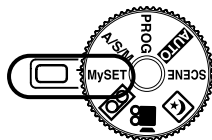

[MySET mode]

■ How to use the VOICE RECORDING mode ()

Steps from 1-4 are the same as those for AUTO mode.

5. Select the VOICE RECORDING mode by rotating the mode dial.
6. Press the shutter button to record a voice.
 - Press the shutter button once and voice is recorded for as long as the available recording time (Max : 1 hour) allows.
 - The recording time will be displayed on the LCD monitor.
 - Voice will still be recorded if the shutter button is released.
 - If you wish to stop recording, press the shutter button again.
 - File type : *.wav

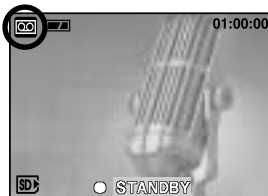
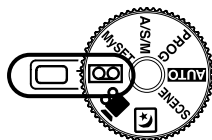

[VOICE RECORDING mode]

※ A distance of 40cm between you and the camera (microphone) is the best distance to record sound.

Starting the recording mode

■ How to use the MOVIE CLIP mode ()

Steps from 1-4 are the same as those for AUTO mode.

5. Select the MOVIE CLIP mode by rotating the mode dial.
6. The MOVIE CLIP mode icon and available recording time will display on the LCD monitor.

7. Point the camera towards the subject and compose the image by using either the viewfinder or LCD monitor.

Press the shutter button and movie clips are recorded for as long as the available recording time.

Movie clips will still be recorded if the shutter button is released. The auto focus lamp(green) will blink during the movie clip recording.

* If you wish to stop recording, press the shutter button again.

* Image size and type are listed below.

- Image size : 640x480, 320x240(Selectable)

- File type : *.mov

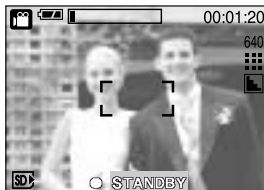
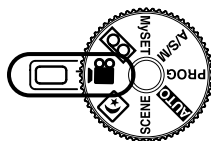

[MOVIE CLIP mode]

■ NIGHT SCENE mode ()

This mode is used at night or against a dark background.

It is possible that camera shake will occur. If this is the case, use a tripod to eliminate this.

Configure the shutter speed by zoom scale (Long Time shutter) with the S button.

Please see page 44 for a detailed description for Long Time shutter.

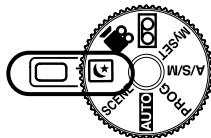

[NIGHT SCENE mode]

Starting the recording mode

■ How to use the SCENE mode (**SCENE**)

Use the menu to easily configure optimal settings for a variety of shooting situations including portrait, children, landscape, close-up, sunset, dawn, backlight, fireworks, beach scenes and snowscape.

Steps from 1-4 are the same as those for AUTO mode.

5. Select the SCENE mode by rotating the mode dial.

6. Press the MENU button and the SCENE mode menu will be displayed.

7. Use the LEFT and RIGHT buttons to select the [SCENE] menu tab.

8. Select the desired [SCENE] sub menu by pressing the UP and DOWN buttons and press the OK button.

Please see page 54 for detailed descriptions for each screen.

9. The current scene icon is displayed at the top left of the LCD.

10. Point the camera towards the subject and compose the image by using either the viewfinder or LCD monitor.

11. Press the shutter button to capture an image.

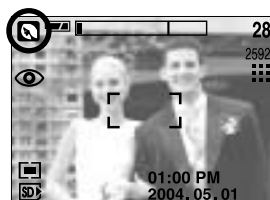
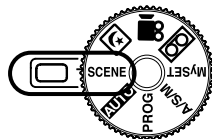

[SCENE mode]

Things to Watch Out for When Taking Pictures

- Pressing the shutter button down half way.

Lightly press the shutter button to confirm focus and flash battery charge. (See page. 29)

Press the shutter button all way down to take the picture.

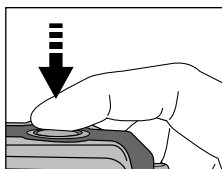

[Lightly press the shutter button]

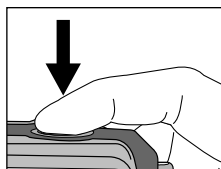

[Press the shutter button]

- The available recording time may vary depending on shooting conditions and camera settings.
- When the Flash Off or Slow synchro mode is selected in a low lighting condition, the camera shake warning indicator () may appear on the LCD monitor. In this case, use a tripod, support the camera on a solid surface or change the flash mode to flash shot mode.
- Compensated shooting against the light : Please do not take pictures to the sunlight direction.
Taking a picture against the sun may make the picture dark. To take a picture against the sun, please use the [BACKLIGHT] in the scene shooting mode (see page 54), forced flash (see page 35), spot side light (see page 51), or exposure compensation (see page 40).
- Avoid obstructing the lens or the flash when you capture an image.
- As there can be some differences between what is seen through the Viewfinder and the resulting image when taken at a range closer than 1.5m, it is recommended that you use the LCD monitor to compose these shots.
- Using the LCD monitor extensively will drain the batteries.
We recommend turning off the LCD monitor and using the optical viewfinder as often as possible in order to extend battery life.
- Under certain conditions the auto focus system may not perform as expected.
 - When photographing a subject that has little contrast.
 - If the subject is highly reflective or shiny.
 - If the subject is moving at high speed.
 - When there is strong reflected light, or when the background is very bright.
 - When the subject matter has only horizontal lines or the subject is very narrow (such as a stick or flagpole).
 - When the surroundings are dark.

Using the camera buttons to adjust the camera

- The RECORDING(AUTO, PROGRAM, A/S/M, MySET, VOICE RECORDING, MOVIE CLIP, NIGHT SCENE, SCENE) mode function can be set up by using the camera buttons.

POWER button

- Used for turning the camera's power on / off.
- If there is no operation during the specified time, the camera's power will be turned off automatically to save battery life. Pressing the power button for over 3 seconds will deactivate the start-up sound function.

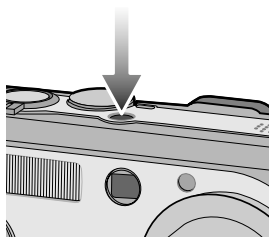

SHUTTER button/ Jog dial

- Used for taking an image or recording voice in the RECORDING mode.
- In MOVIE CLIP mode
: Pressing the shutter button down fully starts the process for recording a movie clip. Press the shutter button once and the movie clip is recorded for as long as the available recording time in the memory allows. If you wish to stop recording, press the shutter button again.
- In STILL IMAGE mode
Pressing the shutter button down halfway activates the auto focus and checks the condition of the flash.
Pressing the shutter button down fully takes the image and stores the relevant data regarding the shot. If you select voice memo recording, the recording will start after the camera has finished storing the image data.
- Jog dial : Set focus distance while using the manual focusing (see page 45). Set the aperture value and shutter speed in the A/S/M shooting mode (see page 43).

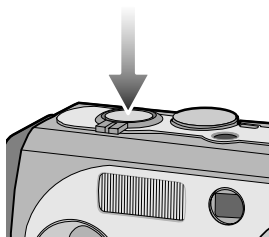

ZOOM W/T button

- If the menu is not displayed, this button works as the OPTICAL ZOOM or DIGITAL ZOOM button.

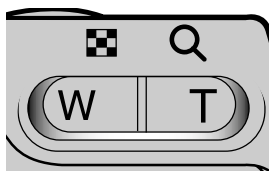

ZOOM W/T button

- This camera has a 3X optical zoom and a 5X digital zoom function. Using both will offer a total zoom ratio of 15X.

● TELE Zoom

Optical zoom TELE : Pressing the ZOOM T button. This will zoom into the subject i.e. the subject will appear nearer.

Digital zoom TELE : When the maximum (3X) optical zoom is selected, pressing the ZOOM T button activates the digital zoom software. Releasing ZOOM T button stops the digital zooming at the required setting. Once the maximum digital zoom (5X) is achieved, pressing the ZOOM T button will have no effect.

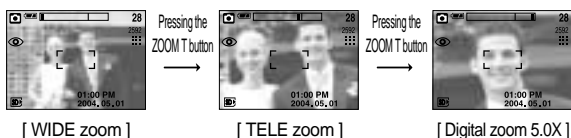
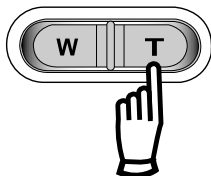

● WIDE Zoom

Optical zoom WIDE : Pressing the ZOOM W button. This will zoom out from the subject i.e. the subject will appear further away. Pressing the ZOOM W button continuously will set the camera to its minimum zoom setting i.e. the subject appears at its furthest from the camera.

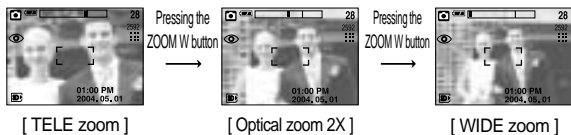
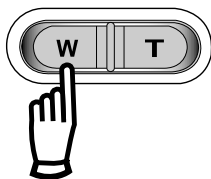

Digital zoom WIDE : When the digital zoom is in operation, pressing the ZOOM W button will reduce the digital zooming in steps. Releasing ZOOM W button stops digital zooming. Pressing the ZOOM W button will reduce the digital zoom and then it will continue to reduce the optical zoom until the minimum setting is reached.

Optical zoom

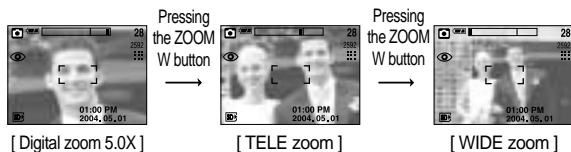
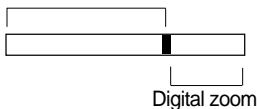

ZOOM W/T button

■ Use the conversion lens

Use the optional conversion lens for more flexibility in setting the focus distance.

● Types of the conversion lens

1. WIDE conversion lens : Install the WIDE conversion lens (model name: SCL-W3755) to change the focus of camera lens in 0.7 times.
2. TELE conversion lens : Install the TELE conversion lens (model name: SCL-T3755) to change the focus of camera lens in 1.7 times.

● Focus distance and shooting range for each lens

Types of lens		Using the 3X camera lens	SCL-W3755 installed	SCL-T3755 installed	
Focus		7.7 ~ 23.1mm	5.4mm	39.3 mm	
35mm conversion distance		38 ~ 114mm	26.6mm	193.8 mm	
Shooting range	Auto	80cm ~ Infinity	WIDE : 40cm ~ Infinity	TELE : 230cm ~ Infinity	
	Macro	WIDE	4 ~ 80cm	WIDE : 1 ~ 40cm	TELE : 80 ~ 230cm
		TELE	30 ~ 80cm		

● Installing the conversion lens

1. Turn the lens ring in the front of the camera to the left to remove it.
2. Install the conversion lens adapter by turning it to the right.
3. Install the WIDE or TELE conversion lens by turning it to the right.

* While installing the adapter or conversion lens, make sure that they are securely fixed.

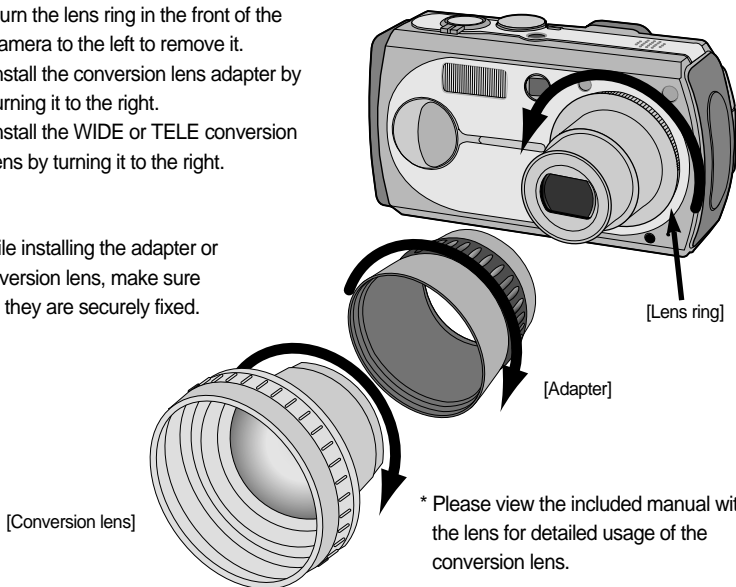



* Please view the included manual with the lens for detailed usage of the conversion lens.

ZOOM W/T button

INFORMATION

- To use the digital zoom the LCD monitor has to be turned on.
- Images taken using the digital zoom may take a little longer for the camera to process. Allow time for this to take place.
- The zoom function can't be activated during the movie clip recording.
- You may notice a decrease in image quality when using the digital zoom.
- Take care not to touch the lens to avoid taking an unclear image and possibly causing camera malfunction. If the image is dim, turn the camera power off and on again to modify the lens position.
- Take care not to press the lens as this may cause a camera malfunction.
- When the camera is turned on, take care not to touch the camera's moving lens parts as this may cause the resulting image to be dim and unclear.
- Take care not to touch the lens during zoom operation as this may cause damage.

Voice memo() / UP button

- While the menu is showing, press the UP button to move up the submenu cursor.
 - When the menu is not displayed on the LCD monitor, the UP button operates as the voice memo () button. You can add your voice-over to a stored still image.
- Recording a voice memo
1. Rotate the MODE DIAL to select a RECORDING mode with the exception of MOVIE CLIP and VOICE RECORDING modes.
 2. Press the VOICE MEMO () button.
- If the voice memo indicator is displayed on the LCD monitor, the setting is completed.



[Preparing for Voice Memo]



[Recording Voice Memo]

Voice memo() / UP button

3. Press the shutter button and take a picture. The picture is stored on the memory card.
4. Voice memo will be recorded for ten seconds from the moment the picture is stored. In the middle of the sound recording, pressing the shutter button will stop the voice memo.

INFORMATION

- A distance of 40cm between you and the camera (microphone) is the best distance to record sound.

Macro() / Down button (Focusing)

- While the menu is showing, press the DOWN button to move from the main menu to a submenu, or to move down the submenu cursor.
- When the menu is not showing, you can use the MACRO/ DOWN button to take macro pictures (within the distance range of 4-80 cm).

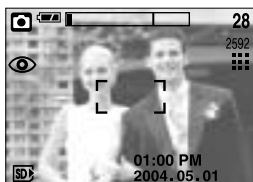

[Auto focus]

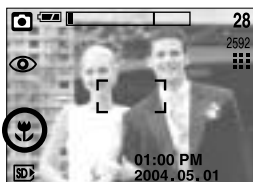

[Macro]

- Types of focus modes and focus ranges (W: Wide, T: Tele)













Focus type	Auto	Macro ()	
Focus range	80cm ~ Infinity	W : 4 ~ 80cm	T : 30 ~ 80cm

INFORMATION

- When the macro mode is selected, it is possible that camera shake will occur. If this is the case, use a tripod to eliminate this.
- When you take a picture within 30cm(MACRO focus), select the FLASH OFF mode.

Macro() / Down button (Focusing)

■ Available focusing method, by recording mode(O : Selectable , X : Not selectable, ∞: Infinity focus range)

Mode		P	A	S	M	My			
Auto	O	O	O	O	O	O	O	O	
Macro	O	O	O	O	O	O	O	X	
Mode									
Auto	O	O	∞	X	∞	∞	O	∞	O
Macro	X	X	X	O	X	X	X	X	X

Focus lock

■ To focus on the subject positioned outside of the center, use the focus lock function.

● Using the Focus Lock

1. Ensure the subject in the center of the autofocus frame.
2. Press the SHUTTER button halfway. When the green auto lights up, it means the camera is focused on the subject. Be careful not to press the SHUTTER button all the way down to avoid taking an unwanted pictured.
3. With the SHUTTER button still pressed down only halfway, move the camera to recompose your picture as desired, and then press the SHUTTER button completely to take the picture. If you release your finger from the SHUTTER button, the focus lock function will be canceled.

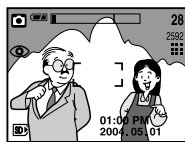

[The image to be captured]

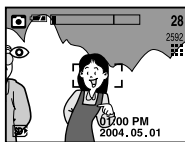

[Press the SHUTTER button]
halfway and focus on the subject

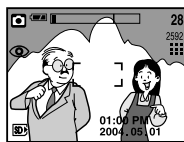

[Recompose the picture]
and fully depress the
SHUTTER button

FLASH(⚡) / LEFT button

- When the menu is displayed on the LCD monitor, pressing the LEFT button makes the cursor shift to the left tab.
- When the menu is not displayed on the LCD monitor, the LEFT button operates as the FLASH (⚡) button.

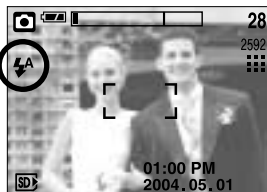

[Selecting the Auto flash]

- Selecting the flash mode
 1. Rotate the MODE DIAL to select a RECORDING mode with the exception of MOVIE CLIP and VOICE RECORDING modes.
 2. Press the Flash button until the desired flash mode indicator displays on the LCD monitor.
 3. A flash mode indicator will be displayed on the LCD monitor. Use the correct flash to suit the environment.

● Flash range

Unit : m







ISO	AUTOFOCUS		MACRO	
	WIDE	TELE	WIDE	TELE
AUTO	0.8~3.0	0.8~2.0	0.3~0.8	0.3~0.8

INFORMATION





















- Using the flash frequently will reduce the life of the batteries.
- Under normal operating conditions the charging time for the flash is normally within 6 seconds. If the batteries are weak, the charging time will be longer.
- During the continuous shot, movie clip mode, the flash function will not operate.
- Take photographs within the flash range.
- The image quality is not guaranteed if the subject is too close or highly reflective.
- The LCD monitor is turned off for a while after using the flash to recharge it.

FLASH () / LEFT button

● Flash mode indicator

Icon	Flash mode	Description
	Auto flash	If the subject or background is dark, the camera flash will operate automatically.
	Auto & Red eye reduction	If a subject or background is dark, the camera flash will work automatically and will reduce the red-eye effect by using the red-eye reduction function.
	Fill in flash	The flash fires regardless of available light. The intensity of the flash will be controlled, according to the prevailing conditions. The brighter the background or subject is, the less intense the flash will be.
	Slow synchro	The flash will operate in conjunction with a slow shutter speed in order to obtain the correct exposure. We recommend using a tripod for this function. When you take an image in a condition with poor light, the camera shake warning indicator () will display on the LCD monitor.
	Flash off	The flash does not fire. Select this mode when capturing images in a place or situation where flash photography is prohibited. When you capture an image in a poorly lit condition, the camera shake warning indicator () will display on the LCD monitor.

● Available flash mode, by recording mode

																
	X	O	X	X	X	O	X	X	X	X	X	X	X	X	X	O
	O	O	X	X	X	O	X	O	O	X	X	X	X	X	X	X
	X	O	O	O	O	O	X	X	X	X	X	X	X	O	X	X
	X	O	X	X	X	O	O	X	X	X	X	X	X	X	X	X
	O	O	O	O	O	O	O	X	X	O	O	O	O	X	O	X

Self-timer (⌚) / Remote (📡) / Right button

- When the menu is displayed on the LCD monitor, pressing the Right button makes the cursor shift to the right tab.
- When the menu is not displayed on the LCD monitor, the RIGHT button operates as the Self-timer (⌚) and Remote (📡) button. This function is used when the photographer would also like to be in the image.

● Selecting the self-timer

1. Rotate the MODE DIAL to select a RECORDING mode with the exception of VOICE RECORDING mode.
2. Press the SELF-TIMER (⌚) button until the desired mode indicator displays on the LCD monitor.

A 2 second self-timer or 10 second self-timer icon appears on the LCD monitor.

· 2SEC self-timer (⌚^{2S}) :

Pressing the shutter button will allow an interval of 2 seconds before the image is taken.

· 10SEC self-timer (⌚) :

Pressing the shutter button will allow an interval of 10 seconds before the image is taken.

3. When you press the SHUTTER button, the picture will be taken after the specified time has elapsed.

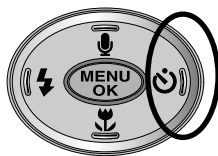

[Selecting the 10 SEC self-timer]

INFORMATION

- When taking a picture using the self-timer, the self-timer lamp works as follows:
 - 2 second self-timer setting : The self-timer lamp blinks at 0.25 second interval for 2 seconds.
 - 10 second self-timer setting : The self-timer lamp blinks at 1 second interval for the first 7 seconds. It blinks at 0.25 second interval for the remaining 3 seconds.
- If you operate the Mode dial and Self-timer button during the self-timer operation, the self-timer function is cancelled.
- Use a tripod to prevent the camera from shaking.
- While the remote controller icon is selected, the self-timer lamp in front of the camera blinks in 1 second cycle.

Self-timer(☺) / Remote(📡) / Right button

● Using the remote controller.

1. Turn the mode dial to select shooting mode except the voice recording mode.
2. Press the self-timer (☺) button repeatedly until the remote controller icon (📡) is displayed in the LCD.
3. Press the remote controller shutter button for a 2 seconds delayed shooting.

[Remote controller shutter button]

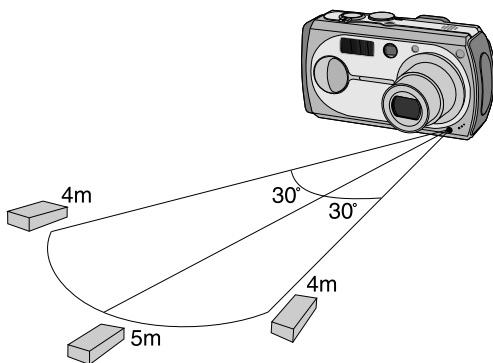
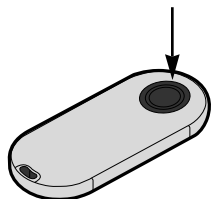

● Replacing batteries for the remote controller

Make sure the + polarity is toward the top and the - polarity is toward the bottom while installing batteries for the remote controller.

Replace batteries for the remote controller in the local service center.

Use the CR 2025 3V batteries.

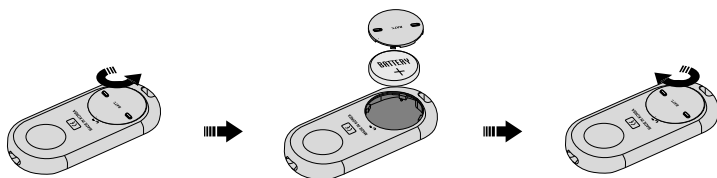

MENU/ OK button

- If the menu is displayed, use the 5-Function buttons to change the data values and for your changes to be accepted
- If the menu is not displayed, press the MENU/OK button to display a menu for the current camera mode on the LCD monitor. Press the button again to return to the previous state.

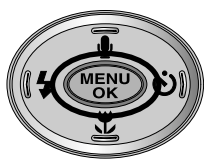

[Menu off]

Pressing
the MENU
button

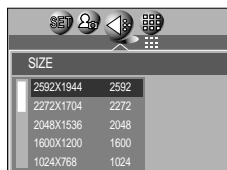

[Menu on]



- There is no menu for VOICE RECORDING mode.
- The menu screen may not show on the LCD when another button is pressed or image data is being processed. (The green lamp next to the view finder blinks)
- When the menu is showing on the LCD monitor, it is not possible to operate the shutter button i.e. capture an image. To capture an image, simply cancel the menu display by pressing the MENU button.

S button

- You can use the S button to adjust the values for the exposure compensation, white balance, ISO, RGB, A/S/M mode and longtime shutter.

Main menu	Sub menu	Available camera mode
Exposure compensation	-2.0 ~ 0.0 ~ +2.0(0.5EV steps)	 SCENE
WHITE BALANCE	AUTO, DAYLIGHT, CLOUDY, FLUORESCENT H, FLUORESCENT L, TUNGSTEN, CUSTOM.	 SCENE
ISO	AUTO, 50, 100, 200, 400	

S button

Main menu	Sub menu	Available camera mode
RGB	R(Red), G(Green), B(Blue)	
A/S/M mode	A (Aperture priority mode) S (Shutter priority mode) M (Manual mode)	
LT	Shutter speed, Aperture value (Changed by zoom scale)	

- Exposure compensation : This camera automatically adjusts the exposure according to the ambient lighting conditions. You can also select the exposure value by using the S button.

● Compensating Exposure

1. Press the S button, and then use the UP and DOWN buttons to select the exposure compensation icon ().
The exposure compensation menu bar will appear as shown.
2. Use the LEFT and RIGHT buttons to set the desired exposure compensation factor.
3. Press the OK button.

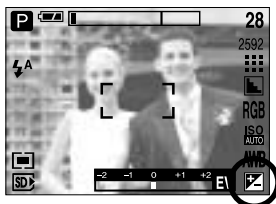

The value you set will be saved and the Exposure Compensation setup mode will close.

If you change the exposure value, the exposure indicator () will be displayed on the bottom of the LCD monitor.

* A negative exposure compensation value reduces the exposure.

Note that a positive exposure compensation value increases the exposure and the LCD monitor will appear white or you may not get good pictures.

S button

- White balance : The white balance control allows you to adjust the colours to appear more natural looking.

● Selecting a White Balance

1. Press the S button, and then use the UP and DOWN buttons to select the white balance icon (**AWB**).
The white balance menu bar will appear as shown.
2. Use the LEFT and RIGHT buttons to set the white balance to the desired value. The value you set will be displayed on the LCD monitor.

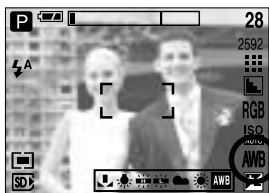

- AUTO** **AWB** : The camera automatically selects the appropriate white balance settings, depending on the prevailing lighting conditions.
- DAYLIGHT** ☀️ : For taking images outside.
- CLOUDY** ☁️ : For taking images under a cloudy and overcast sky.
- Fluorescent H** 🌊 : For shooting under daylight fluorescent types of three-way fluorescent lighting.
- Fluorescent L** 🌊 : Shooting under white fluorescent lighting.
- TUNGSTEN** 🌞 : For shooting under tungsten (standard light bulb) lighting.
- CUSTOM** 📏 : Allows the user to set the white balance according to the shooting condition.

Different lighting conditions may cause a colour cast on your images.

3. Press the OK button. The value you set will be saved and White Balance setup mode will end.

● Using the Custom White Balance

White balance settings may vary slightly depending on the shooting environment.

You can select the most appropriate white balance setting for a given shooting environment by setting up the custom white balance.

1. Select the CUSTOM() menu of the White Balance.
2. Place a sheet of white paper in front of the camera so that the LCD monitor shows only white, and then press the shutter button.
3. Your custom white balance value is stored.
 - The custom white balance value will be applied, starting with the next picture you take.
 - The user configured white balance will remain effective until it is overwritten.

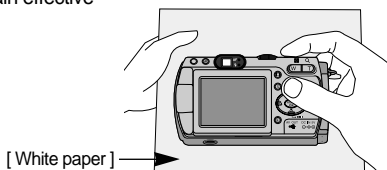

S button

- ISO : You can select the ISO sensitivity when taking pictures.

The speed or specific light-sensitivity of a camera is rated by ISO numbers.

- Selecting an ISO Sensitivity

1. Press the S button, and then use the UP and DOWN buttons to select the ISO icon (ISO).

The ISO menu bar will appear as shown.

2. Use the LEFT and RIGHT buttons to select the desired ISO sensitivity value.

- AUTO : The camera's sensitivity is automatically changed by variables such as lighting value or subject brightness.
- 50, 100, 200, 400 : You can increase the shutter speed while the same amount of light is present, by increasing the ISO sensitivity.

However, the image may be saturated in high luminance.

The higher the ISO value, the higher the camera's sensitivity to light is and therefore the greater its capacity to take pictures in dark conditions. However, the noise level in the image will increase as the ISO value increases, making the image appear coarse.

3. When you press the OK button, the value you set will be saved and ISO setup mode will end.

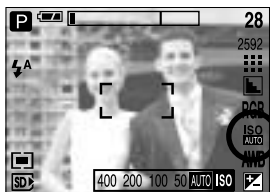

- RGB : Allows the user to adjust the R (Red), G (Green), and B (Blue) values of the images to be captured.

- Setting RGB Values

1. Press the S button, and then use the UP and DOWN buttons to select the RGB icon (RGB). The RGB menu bar will appear as shown.

2. Use the UP/ DOWN/ LEFT and RIGHT buttons to select the desired RGB value.

- Up/ Down Button : Navigates between R, G, and B icons.

- Left/ Right Button : Changes value of each icon.

3. When you press the OK button, the value you set will be saved and RGB setup mode will end.

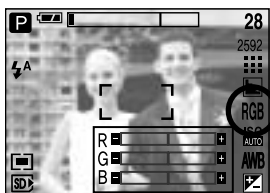

S button

■ A/S/M : The user can manually set shutter speed or aperture value in the menu.

● Selecting the A/S/M shooting mode.

1. Turn the mode dial to select the ASM shooting mode.
2. Press the S button and use the Up and Down buttons to select the A/S/M shooting mode icon (ASM) to open the A/S/M shooting mode menu as shown in the picture.
3. Press the Left and Right buttons to select desired option for the A/S/M shooting mode and press the S button.

- A (Aperture priority) shooting mode

: Set the aperture value for automatic exposure depends on the brightness of the object by automatic shutter speed setting in the camera. Turn the jog dial to the left or right to change the aperture value.

- S (Shutter priority) shooting mode

: Set the shutter speed for automatic exposure depends on the brightness of the object by automatic aperture value setting in the camera.

Turn the jog dial to the left or right to change the shutter speed.

- M (Manual) shooting mode

: The user can manually set both the aperture value and the shutter speed.

Press the AEL button to select shutter speed or aperture value.

Rotate the jog dial to change the values.



- If the set aperture value or shutter speed is out of supported range (Between ± 2.0), the deviation of exposure value is displayed red in the LCD by pressing the shutter button down half way.

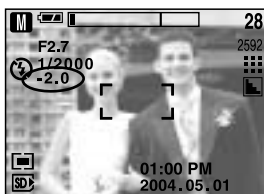

Please adjust the shutter speed so that the red warning message becomes white.

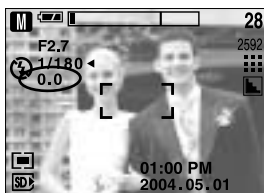

S button

- Long Time shutter : This camera automatically adjusts the shutter speed and aperture values to the shooting environment. However, in NIGHT SCENE mode, you can set the shutter speed and aperture values to your preference.

- Adjusting the shutter speed and aperture values

1. Select the NIGHT SCENE mode by rotating the mode dial.
2. Press S button and Long Time shutter menu (LT, For selecting shutter speed and aperture value) will be displayed.
3. Configure the Long Time shutter value with the up/ down/ left/ right button.

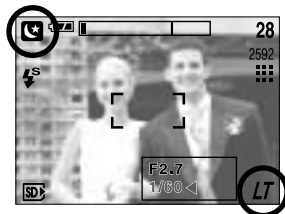

Up/ Down Button : Select the Aperture value / shutter speed.

Left/ Right Button : Change the value. Available aperture value options, depending on zoom step will be displayed on the menu.

4. Press the OK button. The value you set will be saved and the mode will switch to NIGHT SCENE mode. Press the SHUTTER button to take the picture.

- Aperture values and shutter speeds that can be selected for each zoom position are as follows :

- Aperture range : AUTO, F2.7 ~ F11
- Shutter speed range : AUTO, 1/2,000 ~ 15S

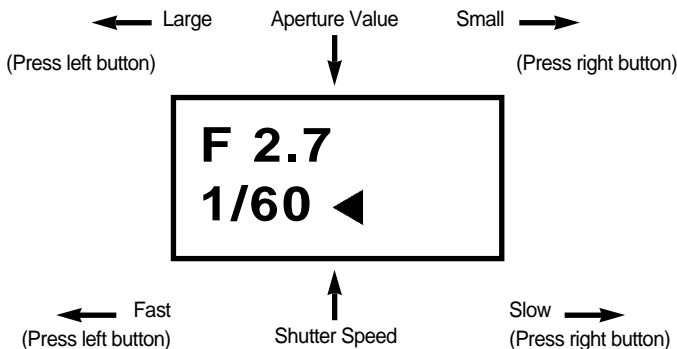

MF button

Use this button to select the focusing method. Repeatedly press the MF button to rotate [Manual focusing] → [Continuous automatic focusing] → [Automatic focusing].

- Automatic focusing : Slightly press the shutter to let the camera measure distance to the object and select the best focusing. If successfully focused with the slight press of the shutter, the automatic focusing mark is turned green.
- Manual focusing : Where the automatic focusing is not available such as very dark place, use the manual focusing. Picture may become blurring. Please be careful while using the manual focusing.
- Continuous automatic focusing : The camera keeps focusing while the object is moving even if the shutter button is not slightly pressed.
Note that using the Continuous automatic focusing uses more battery than the Automatic focusing does.

- Modes where the Continuous automatic focusing is available

: Program, A/S/M mode, Children mode in the scene shooting modes, and MySET mode.
If selected, the CAF icon is displayed in the bottom of the LCD.

- Manual focusing.

1. Press the MF button to display the MF bar.

The MF icon is displayed in the bottom of the LCD.

2. Use the jog dial to set the focus distance.

Turn to the left : Move the focus farther.

Turn to the right : Move the focus closer.

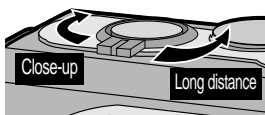
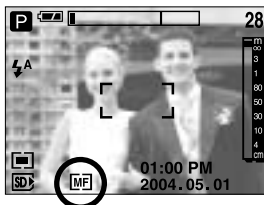

INFORMATION

- Focus distance of 0.04~0.3m are only supported in the Wide zoom.
The flash is fixed as not available.
- The focus value displayed in the LCD while manually focusing is measured from the end of the lens

LCD button

- You can check the recording status in the LCD monitor.
In any mode with the exception of VOICE RECORDING mode, pressing the LCD button will change the display as shown below.

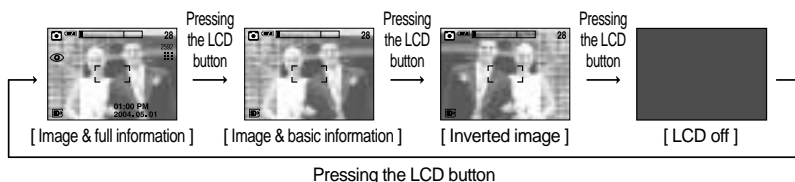

- When taking photographs from the front, the video output may be displayed inverted on the LCD monitor (upside down when shooting vertically, right and left flipped when shooting horizontally). For such cases, press the LCD button twice to flip the video output 180 degrees to restore normal view on the LCD monitor.
- If the background image is too bright to view the menus, press the LCD button and the background image turn to black to view clear menus.
- If the LCD monitor is turned off, the mode dial lamp will light up.

AEL button (Automatic Exposure Lock)

- The camera measures brightness of the object and automatically set the best exposure value. If difference between the exposure values of the object and background is too great, use the AEL button to manually set the exposure value against sunlight or in strong light. This button is available in the AUTO, PROGRAM, MOVIE CLIP, SCENE mode.
- Use the automatic exposure lock.
 1. Ensure the subject in the center of the autofocus frame.
 2. Move the camera to point the automatic focus mark on the object of desired exposure.
 3. Press the AEL button to lock the exposure and display the AEL icon in the bottom of the LCD.
 4. Focus the camera again and press the shutter button again for shooting.
 - The automatic exposure lock function is automatically unset after taking one picture.



[Screen for shooting]



[Focus to the object and
press the AEL button]



[Refocus and fully press]
the shutter button]













Using the LCD monitor to adjust the camera settings

- You can use the menu on the LCD monitor to set up recording functions. In any mode with the exception of VOICE RECORDING mode, pressing the MENU button displays the menu on the LCD monitor.









INFORMATION

- The menu will not be displayed on the LCD monitor in the following circumstances:
 - When another button is being operated.
 - While image data is being processed. (when the green lamp next to the viewfinder blinks)
 - When there is no battery capacity.
- When the menu is showing on the LCD monitor, it is not possible to operate the shutter button i.e. capture an image. To capture an image, simply cancel the menu display by pressing the MENU button.

- The following functions are available, depending on the mode you have selected. The items indicated by are default settings.

Menu tab	Main menu	Sub menu	Camera working mode	Page
	SIZE	2592X1944	  A/S/M  SCENE	p.49
		2272X1704		
		2048X1536		
		1600X1200		
		1024X768		
		640X480		
		640X480		
		320X240		
	FRAME RATE	30FPS		p.50
		15FPS		
	QUALITY	TIFF	  A/S/M  SCENE	p.50
		S.FINE		
		FINE		
		NORMAL		
	METERING	MULTI	 A/S/M	p.51
		SPOT		

Using the LCD monitor to adjust the camera settings

Menu tab	Main menu	Sub menu	Camera working mode	Page	
	EFFECT	NORMAL	P A/S/M 	p.51	
		B & W			
		SEPIA			
		NEGATIVE			
	SHARPNESS	SOFT	P A/S/M 	p.52	
		NORMAL			
		VIVID			
	SHOOTING	SINGLE	P A/S/M	p.52	
		CONTINUOUS			
		AEB			
	LOAD	MYSET1	My	p.53	
		MYSET2			
		MYSET3			
	SAVE	MYSET1	P A/S/M 	p.53	
		MYSET2			
		MYSET3			
	SCENE	PORTRAIT	CHILDREN	SCENE	p.54
		LANDSCAPE	CLOSE UP		
		SUNSET	DAWN		
		BACKLIGHT	FIREWORKS		
		BEACH&SNOW			

* Menus are subject to change without prior notice.

How to use the menu

1. Turn on the camera and press the MENU button. A menu for each camera mode appears. However, there is no menu for Voice Recording mode ().
2. Use the LEFT and RIGHT buttons to navigate through the menus.



3. Use the UP and DOWN buttons to select a sub menu.



4. Select a sub menu, and then press the OK button. The value you set will be saved and the menu will disappear.

Size

- You can select the image size appropriate for your application.

Mode	STILL IMAGE mode						MOVIE CLIP mode	
Icon	2592	2272	2048	1600	1024	640	640	320
Size	2592X1944	2272X1704	2048X1536	1600X1200	1024X768	640X480	640X480	320X240



[PROGRAM mode]

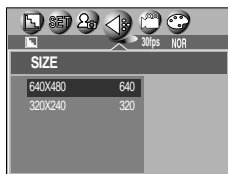

[MOVIE CLIP mode]

INFORMATION

- The higher the resolution, the lower the number of available shots will be because high resolution images require more memory than lower resolution images.

Quality

- You can select the compression ratio appropriate for your application of the captured images. The higher the compression ratio, the lower the picture quality.



[PROGRAM mode]

Mode	STILL IMAGE mode				MOVIE CLIP mode	
Icon	TIFF					
Sub menu	TIFF	S.FINE	FINE	NORMAL	30FPS	15FPS
File Format	tif	jpeg	jpeg	jpeg	mov	mov

INFORMATION

- TIFF is the highest quality and NORMAL is the lowest setting. Choose the setting appropriate for your needs.
- The TIFF file format is for professionals and provides the best quality. However, large file size reduces number of available pictures to take and increases saving time to the memory card.
- [PLEASE WAIT !] message is displayed while saving a TIFF file to the memory card.
- This file format complies with the DCF(Design rule for Camera File system).
- JPEG (Joint Photographic Experts Group): JPEG is the image compression standard developed by the Joint Photographic Experts Group. This type of compression is most commonly used for compressing photos and graphics because it can compress the files efficiently without damaging the data.

Metering

- If you cannot obtain suitable exposure conditions, you can change the metering method to take brighter pictures.

MULTI () : Exposure will be calculated based on an average of the available light in the image area.

However, the calculation will be biased towards the centre of the image area.

This is suitable for general use.

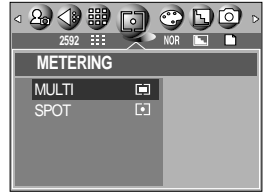

[PROGRAM mode]

SPOT () : Only the rectangular area in the center of the LCD monitor will be metered for light.

This is suitable when the subject in the center is exposed correctly, regardless of the back lighting.

Effect

- By using the camera's digital processor, it is possible to add special effects to your images.

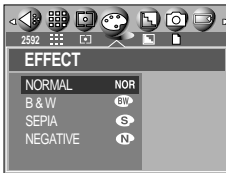

[PROGRAM mode]

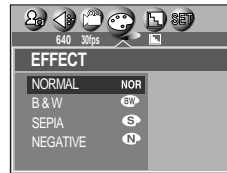

[MOVIE CLIP mode]

NORMAL : No effect is added to the image.

B & W : Converts the image to black and white.

SEPIA : Captured images will be stored in a sepia tone (a gradient of yellowish brown colours).

NEGATIVE : Save the image in negative mode.

Sharpness

- You can adjust the sharpness of the picture you want to take. You cannot check the sharpness effect on the LCD monitor before you take a picture, because this function is applied only when the captured image is stored on the memory.



[PROGRAM mode]

Sub menu	Icon	Description
SOFT		The edges of the image are softened. This effect is suitable for editing images on your PC.
NORMAL		The edges of the image are sharp. This is suitable for printing.
VIVID		The edges of the image are emphasized. The edges will appear sharp, but noise may occur in the recorded image.

Continuous shot

- If you select CONTINUOUS or AEB, the flash will automatically be set to Flash Off.

[SINGLE] : Take one picture only

[CONTINUOUS] : Take three pictures in a series by pressing the shutter button only once.

[AEB] : Take three pictures in a series in different exposures: over exposure (+0.5EV), standard exposure (0.0EV), and short exposure (-0.5EV). Use the mode if it is hard to decide exposure of the object.

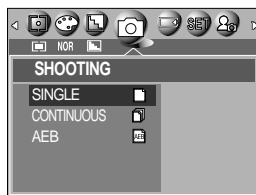

[PROGRAM mode]

INFORMATION

- If less than 3 pictures are available in the memory, the Sequential and the AEB shooting are not available.
- It is best to use a triangular support for the AEB shooting for saving time is long and hand shaking may occur.
- The Digital zoom is not supported in the Sequential and AEB shootings.

Save / Load the camera configuration (MySET)

■ Use the MySET mode to save frequently used camera settings (SAVE) and use it later (LOAD)

● Saving the camera configuration : Available in the PROGRAM, A/S/M and NIGHT SCENE shooting modes.

1. Use the camera buttons and menu to set desired camera configuration.
2. Press the menu button in any modes except AUTO, VOICE RECORDING, MySET, MOVIE CLIP or SCENE mode.
3. Press the Left/Right buttons to select the [SAVE] menu tap.
4. Press the Up/Down buttons to select desired MySET slot number to save.
5. Press the OK button to save the current configuration in the selected MySET slot and close the menu.

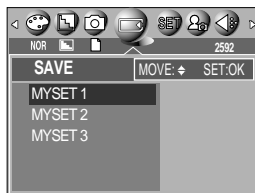

[PROGRAM mode]

● Loading the saved camera configuration: available in the MySET shooting mode.

1. Turn the mode dial to select the MySET shooting mode and press the menu button.
2. Press the Left/Right buttons to select the [LOAD] menu tap.
3. Press the Up/Down buttons to select a MySET slot number to load.
4. Press the OK button to set the camera configuration as saved in the MySET slot.

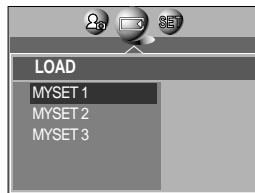

[MySET mode]

* The current MySET slot number is displayed in the top left of the LCD.

INFORMATION

● Saving is available for the following camera functions.

Functions using the camera buttons - Macro, flash, white balance, ISO, Aperture value and Shutter speed.

Functions using the menu screen - Size, quality, metering, effect, sharpness and continuous shot.

Scene

- Select the [SCENE] submenu to automatically configure optimal settings, depending on the selected scene. Only available in the Scene Mode.

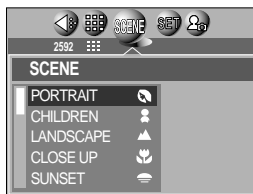

[SCENE mode]

Sub menu	Icon	Description
PORTRAIT		To take picture of a person.
CHILDREN		Take a still picture of capturing moving children.
LANDSCAPE		Scenery with green woods or blue sky.
CLOSE UP		Close-up shooting for small objects such as plants and insects.
SUNSET		Splendor of the setting sun.
DAWN		Daybreak scenes.
BACKLIGHT		Portrait without shadows caused by back light.
FIREWORKS		Firework scenes.
BEACH & SNOW		For ocean, lake, beach and snowscape scenes.

INFORMATION

- When the close-up, sunset, dawn, fireworks are selected, it is possible that camera shake will occur. If this is the case, use a tripod to eliminate this.

Starting play mode

- Turn the camera on and select Play mode by pressing the play mode button ().
The camera can now play back the images stored in the memory.
- If you have turned on the camera by pressing the POWER button, you can press the PLAY MODE button once to switch to Play mode and press it again to switch to Recording mode.
You can turn the power on with the play mode button.
- You can set up the PLAY mode function by using the camera buttons and LCD monitor.
- If both the SD memory card and MS DUO are inserted, and all images in the current memory card are played, images in the other memory card are automatically played.
If only one memory card is inserted, and all images in the memory card are played, the first image is played again. If both the SD memory card and MS DUO are inserted, press the S button and you can select a memory card that will be played back.
- If you press PLAY button to switch to Play mode, the camera lens will retract into the camera body for protection of the lens in about 30 seconds.

● Playing back a still image

1. Select the PLAY mode by pressing the play mode button ().

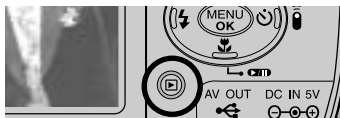

2. The last image stored on the memory is displayed on the LCD monitor.



3. Select an image that you want to play back by pressing the LEFT / RIGHT button.

- ※ Press and hold the LEFT or RIGHT button to play back the images quickly.
- ※ Use the jog dial to fast display only saved image numbers instead of the actual images in the LCD. This function is useful for browsing many images.

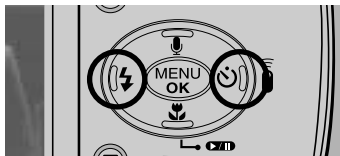



- Manner mode : Pressing the power button for more than 3 seconds changes the buzzer and start-up sound setting to OFF, even though you may have set these to ON.
- Even if the camera's power is off, you can start the play mode by pressing the play mode button.

Starting play mode

■ Playing back a movie clip

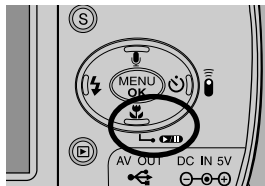

Steps from 1-2 are the same as those to play back a still image.

3. Select the recorded movie clip that you want to play back by using the LEFT/RIGHT button. If you select a movie clip, the movie clip indicator () will be displayed on the LCD monitor.
4. Press the play & pause button () to play back a movie clip file.
 - To pause a movie clip file while playing it back, press the play & pause button again.
 - Pressing the play & pause button again will cause the movie clip file will restart.
 - To rewind the movie clip while it is playing, press the LEFT button. To fast forward the movie clip, press the RIGHT button.
 - To stop playback of the movie clip, press the play & pause button, and then press the LEFT or RIGHT button.



■ Playing back a recorded voice

Steps from 1-2 are the same as those to play back a still image.

3. Select the recorded voice that you want to play back by using the LEFT/RIGHT button. If you select a recorded voice file, the voice indicator () will be displayed on the LCD monitor.
4. Press the play & pause button () to play back a recorded voice file.
 - To pause a recorded voice file, while playing it back, press the play & pause button again.
 - To resume playback of the voice file, press the play & pause button.
 - To rewind the voice file while it is playing, press the LEFT button. To fast forward the voice file, press the RIGHT button.
 - To stop playback of the voice file, press the play & pause button, and then press the LEFT or RIGHT button.



LCD monitor indicator

- The LCD monitor displays information about the shooting conditions.



No.	Description	Icon	Page
1	Battery		p.16
2	Play mode		
3	File Type		
4	Voice memo		p.59
5	Protect indicator		p.68
6	DPOF indicator		p.71
7	Current memory card		
8	Stored image number	10/10	

- If you press the LCD button, you can check the following recording information:

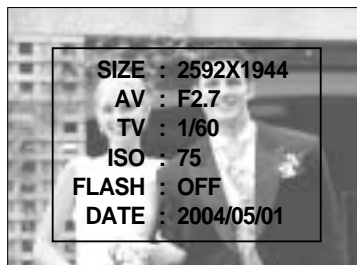

SIZE	: 2592X1944	Size
AV	: F2.7	Aperture value
TV	: 1/60	Shutter speed
ISO	: 75	ISO sensitivity
FLASH	: OFF	Whether or not the flash is used.
DATE	: 2004/05/01	Recording date

Using the camera buttons to adjust the camera



- In Play mode, you can use the buttons on the camera to conveniently set up the Play mode functions.

Thumbnail () / Enlargement () button

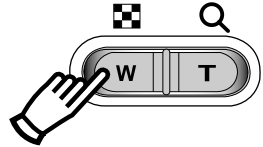
- You can view multiple pictures, enlarge a selected picture, and crop and save a selected area of an image.
- Thumbnail display
 1. While an image is displayed full screen, press the thumbnail button.
 2. The thumbnail display will highlight the image that had been showing at the time the thumbnail mode was selected.
 3. Press the 5 function button to move to a desired image.
 4. To view an image separately, press the enlargement button ().



[Normal display mode]

Pressing the thumbnail button ()
Pressing the enlargement button ()
Highlighted image

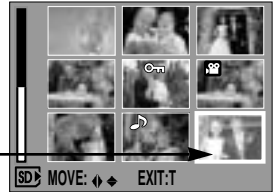

[Thumbnail display mode]

- Image enlargement
 1. Select an image that you want to enlarge and press the enlargement button.
 2. Different parts of the image can be viewed by pressing the 5 function button.
 3. Pressing the thumbnail button will zoom back to the original full sized image.
 - You can tell whether the image displayed is an enlarged view by checking the image enlargement indicator shown at the bottom left of the LCD monitor. (If the image is not an enlarged view, the indicator will not be displayed.) You can also check the area of enlargement.
 - TIFF, Movie clips and WAV files can't be enlarged.
 - If an image is enlarged, a loss of quality may occur.

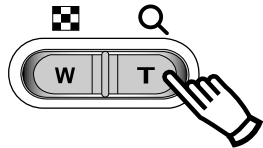

Thumbnail() / Enlargement() button

- The maximum enlargement rate in proportion to the image size.

Image size	2592	2272	2048	1600	1024	640
Maximum enlargement rate	×9.00	×6.45	×5.33	×5.00	×4.00	×3.33

- Trimming : You can extract part of the image that you want and save it separately.

1. Select an image that you want to enlarge and press the enlargement button.
2. Different parts of the image can be viewed by pressing the 5 function button.
3. Press the MENU button and a message will be displayed as shown alongside.
4. Press the OK button to save the trimmed image with a new file name.



The trimmed image will be displayed on the LCD monitor.

Press the LEFT button to return to the image before it was selected.

- If there is little memory space to save the trimmed image, the image can't be trimmed.

Voice () memo / Up button

- When the menu is displayed on the LCD monitor, pressing the UP button makes the menu cursor move up.
- When the menu is not displayed on the LCD monitor, the UP button operates as the voice memo button. You can add your voice to a stored still image.

- Adding a Voice Memo to a Still Image

1. Press the LEFT/ RIGHT button to select an image that you wish to add sound to.
2. Press the voice memo button () and the voice memo indicator will display. The camera is now ready to record a voice memo.



Voice () memo / Up button

3. Press the shutter button to start recording and voice will be recorded to the still image for 10 seconds. While the voice is recording, the recording status window will be displayed as shown alongside.



4. The recording can be stopped by pressing the shutter button again.

5. The () icon will be displayed on the LCD monitor after voice memo recording has finished.

- Voice memos can't be recorded onto movie clip files.
- A distance of 40cm between you and the camera (microphone) is the best distance to record sound.
- The voice memo will be saved in *.wav format, but has the same file name as the still image to which it corresponds.
- If you add a new voice memo to the still image that already has a voice memo, the existing voice memo will be erased.



Play & Pause () / Down button

■ In Play mode, the play & pause/ down button works as follows:

- If the menu is displayed

Press the DOWN button to move from the main menu to a sub menu, or to move down the sub menu cursor.

- If a still image with a voice memo, a voice file, or a movie clip is playing

In Stop mode : Plays a still image with a voice memo, a voice file, or a movie clip.

During playback : Temporarily stops playback.

In Pause mode : Resumes playback



[Voice recording is stopped]



[Voice recording is playing]



[Voice recording is paused]

LEFT/ RIGHT/ MENU/ OK button

■ LEFT / RIGHT/ MENU/ OK buttons activate the following.

- LEFT button : While the menu is showing, press the LEFT button to select the menu tab to the left of the cursor.
- RIGHT button : While the menu is showing, press the RIGHT button to select the menu tab to the right of the cursor, or to move an secondary menu.
- MENU button : When you press the MENU button, the play mode menu will be displayed on the LCD monitor. Pressing it again will return the LCD to the initial display.
- OK button : When the menu is displayed on the LCD monitor, the OK button is used for confirming data that is changed by using the 5 function button.

LCD (I/O) button

■ The shooting information will be displayed on the LCD monitor.

The last image stored in the memory is displayed on the LCD monitor by pressing the play mode button.

Pressing the LCD (I/O) button in the PLAY mode will change the display as shown below. [Image & Icons] → [Image & Information] → [Image only]

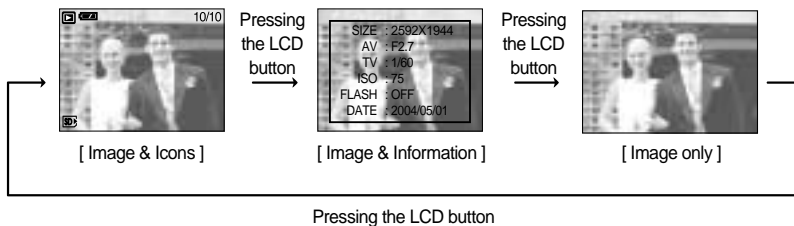

■ If the background image is too bright to view the menus, press the LCD button and the background image turn to black to view clear menus.

Delete() button

■ This deletes images stored on the memory card.

● Deleting Images in Play Mode

1. Select an image that you want to delete by pressing the LEFT / RIGHT button and press the DELETE() button.

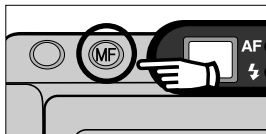

2. A message will display as shown alongside on the LCD monitor.

3. Press the OK button to delete the image.



INFORMATION

● Before deleting images from the camera, you should protect or download images to your computer that you wish to keep.

COPY button

■ This function is used to copy images in a memory card to another memory card.

● Copying an image

1. Press the play mode button and use the Left/Right buttons to select an image to copy.

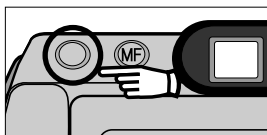

2. Press the Copy button to display the following message.

3. Press the OK button : The image is copied.

Press the Left button : Cancel the copy operation.

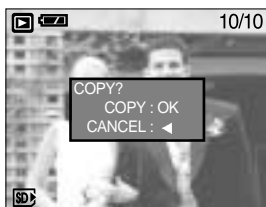







INFORMATION



- If there is not enough space in the memory card to save the image, [CARD FULL!] message is displayed.
- All memory slots need to be loaded for the function.

Setting up the play back function using the LCD monitor

- PLAY mode functions can be changed by using the LCD monitor. In the PLAY mode, pressing the MENU button displays the menu on the LCD monitor. The menus you can set up in Play mode are as follows. To capture an image after setting up the play menu, press the PLAY button. The items indicated by are default settings.

Menu tab	Main menu		Sub menu	Secondary menu		Page	
	DELETE		SELECT	 MS, SD/MMC		p. 66	
			ALL				
	COPY		SELECT	MS, SD/MMC		p. 67	
			ALL	MS, SD/MMC			
	PROTECT		ONE PIC	UNLOCK / LOCK		p. 68	
			SELECT				
			ALL PICs				
	SLIDE		INTERVAL	01 ~ 10SEC		p. 69	
			REPEAT	OFF, ON			
			START				
	RESIZE		2272X1704	1024X768		p. 70	
			2048X1536	640X480			
			1600X1200	LOGO			
	ROTATE		RIGHT(90°)			p. 71	
			LEFT(90°)				
			UPDOWN(180°)				
	D	S	T	SELECT	▲ 0 ~ 30 PRINTS ▼		p. 72
				ALL PICs			
	P	O	F	NO	-		p. 72
				YES			
	O	F	F	SELECT	3X5	4X6	p. 73
					5X7	8X10	
				DEFAULT			
				ALL PICs	3X5	4X6	
					5X7	8X10	

Setting up the play back function using the LCD monitor

Menu tab	Main menu		Sub menu	Secondary menu	Page	
	D P O F	CANCEL	STANDARD	-	p. 73	
			INDEX	-		
			SIZE	-		
	P I C T B R I D G E	SELECT	ONE PIC	-	p. 75	
			ALL PICs	-		
		PRINTER SETUP	C U S T O M I Z E	DEFAULT	-	p. 76
				PAPER SIZE	POSTCARD	
					4X6, 8X10	
					A6, A4, B5	
				LAYOUT	FULL	
					1, 2, 4, 6, 8	
					INDEX	
				PAPER TYPE	PLAIN	
					PHOTO	
					FASTPHO.	
				PRINT QUALITY	DRAFT	
					NORMAL	
					FINE	
				DATE PRINT	ON	
		OFF				
		FILE NAME	ON			
			OFF			
		PRINT	STANDARD	-	p. 77	
INDEX	-					
DPOF PRINT			-	p. 78		
RESET	NO	-	p. 78			
	YES	-				

※ Menus are subject to change without prior notice.

Deleting images

- Of all the files stored in the memory card, the unprotected files in the DCIM subfolder will be deleted. Remember that this will permanently delete unprotected images. Important shots should be stored on a computer before deletion takes place. The startup image is stored in the camera's internal memory (i.e., not on the memory card) and it will not be deleted even if you delete all files on the memory card.

● Deleting images

1. Press the play mode button and press the menu button.
2. Press the LEFT/ RIGHT button and select the [DELETE] menu tab.
3. Select a desired sub menu by pressing the UP/ DOWN button.

[SELECT] : Press the OK button and a window for selecting the image to be deleted is opened.

1) Up/Down/Left/Right : Select an image

S button : Select an image to delete.

If an image is selected, the image becomes dim.

- 2) Press the OK button and the selected images will be deleted.

[ALL] : Press the right button and menu for selecting memory card to be deleted will display.

- 1) Use the Up/Down buttons to select the desired memory card and press the OK button.
- 2) The delete confirmation window is opened.
Press the OK button again to delete all unprotected images. If there is no protected image, [NO IMAGES!] message is displayed.
4. After deletion, the screen will be changed to the play mode screen.

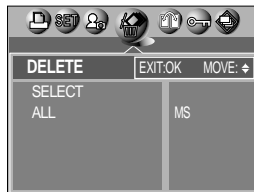

Copy Pictures

- If all memory card slots are full, use this function to copy images in one memory card to another.

● Copy Pictures

1. Press the play mode button and press the menu button.
2. Press the LEFT/ RIGHT button and select the [COPY] menu tab.
3. Select a desired sub menu by pressing the UP/ DOWN button and press the RIGHT button.

[SELECT] : Menu to select source memory card is displayed.

- 1) Use the Up/Down buttons to select a desired memory card and press the OK button.
- 2) Selection window for an image to copy is displayed.
 - Up/Down/Left/Right : Select an image.
 - S Button : Confirm the selection.  mark is displayed if an image is selected.
- 3) Press the OK button to copy the confirmed image to the other memory card.

[ALL] : Menu to select source memory card is displayed.

- 1) Use the Up/Down buttons to select a desired memory card and press the OK button.
- 2) The copy confirmation window is displayed.
Press the OK button again to copy all images to the other memory card.

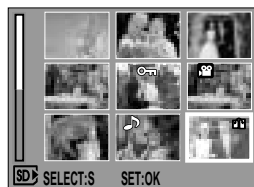
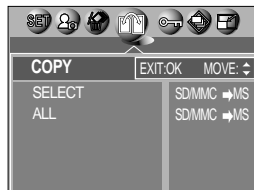

INFORMATION

- All memory slots need to be loaded for the function.
- If the destination is smaller than the source, the remaining files are not copied.
Please delete unneeded files to free up enough memory space before copying.
- While copying a picture, the destination file is automatically renamed to the next sequential filename after the last saved file to avoid filename duplication.

Protecting images

- This is used to protect specific shots from being accidentally erased (LOCK).

It also unprotects images that have been previously protected (UNLOCK).

● Protecting Images

1. Press the play mode button and press the menu button.
2. Press the LEFT/ RIGHT button and select the [PROTECT] menu tab.

3. Select a desired sub menu by pressing the UP/ DOWN button and press the OK button.

[ONE PIC] : Only an image that is displayed on the LCD monitor is protected or unprotected.

- UP/DOWN Button : Protect/release the image.
- OK button : Your changes will be saved and the menu will disappear.

[SELECT] : Selection window for an image to be protected/released is displayed.

- Up/ Down/ Left/ Right : Select an image
- S Button : Protect/ release the image
- OK button : Your changes will be saved and the menu will disappear.

[ALL PICs] : Protect/ release all saved images

- 1) Select [ALL PICs] menu and press the right button.
- 2) Select a memory card to be protected by pressing the UP/ DOWN button and press the OK button.

UP/ DOWN Button : Protect/release the images.

OK button : Your changes will be saved and the menu will disappear.

- If you protect an image, the protect icon will be displayed on the LCD monitor. (An unprotected image has no indicator)

- An image in LOCK mode will be protected from the delete function or [DELETE] functions, but will NOT be protected from the [FORMAT] function.

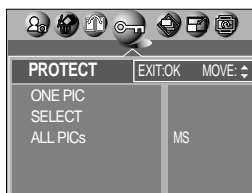

Starting the slide show

■ Images can be displayed continuously at pre-set intervals. You can view the slide show by connecting the camera to an external monitor.

1. Press the play mode button and press the menu button.
2. Press the LEFT/ RIGHT button and select the [SLIDE] menu tab.

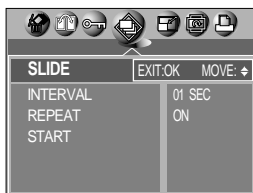

- Setting play interval: Set the slide show play interval.
 1. Use the Up/Down buttons to select the [INTERVAL] menu and press the Right button.
 2. Use the Up/Down buttons to select the desired interval.
 3. Press the OK button to save the configuration.
- Repeat setting : Repeat or not the slide show after finishing the first cycle.
 1. Use the Up/Down buttons to select the [REPEAT] menu and press the Right button.
 2. Use the Up/Down buttons to select the desired sub menu.
 - [ON] selected : The slide show is repeated until canceled.
 - [OFF] Selected : The slide show is closed after one cycle.
 3. Press the OK button to save the configuration.
- Start the slide show: The slide show can start only in the [START] menu.
 1. Use the Up/Down buttons to select the [START] menu.
 2. Press the OK button to start the slide show.
 - Press the Pause button to pause the slide show.
 - Press the Pause button () again to resume the slide show.
 - Press the Menu button to stop the slide show.

INFORMATION

- The loading time depends on the image size and quality.
- The slide show will start from an image that was displayed on the LCD monitor. The [PWR OFF] function can't be activated.
- While the slide show is playing, only the first frame of an MOVIE file is displayed.

Resize

- Change the resolution (size) of pictures taken. Select [LOGO] to save an image to be the start-up image. The resized image will have a new file name.

1. Press the play mode button and press the menu button.
2. Press the LEFT/ RIGHT button and select the [RESIZE] menu tab.
3. Select a desired sub menu by pressing the UP/ DOWN button and press the OK button.



● Image Resize Types

Resize	2272X 1704	2048X 1536	1600X 1200	1024X 768	640X 480	LOGO
2592	O	O	O	O	O	O
2272	X	O	O	O	O	O
2048	X	X	O	O	O	O
1600	X	X	X	O	O	O
1024	X	X	X	X	O	O
640	X	X	X	X	X	O

INFORMATION

- A large sized image can be resized to a smaller sized image, but not vice versa.
- Only still image(JPEG) images can be resized. TIFF, Movie clip(MOV) and Voice recording(WAV) files can't be resized.
- You can change the resolution of only those files compressed in the JPEG 4:2:2 format.
- The resized image will have a new file name. The [LOGO] image is stored not on the memory card but on the internal memory.
- Only one [LOGO] image can be saved. If you save a new [LOGO] image, the existing startup image will be deleted.
- If the memory capacity is insufficient to store the resized image, a [CARD FULL!] message will display on the LCD monitor and the resized image will not be stored.

Rotating an image

- You can rotate the stored images by 90, 180, or 270 degrees. You can view a picture in its proper orientation if the picture has been taken with the camera oriented vertically or up-side-down. The rotated image can't be enlarged or trimmed.

1. Press the play mode button and use the Left / Right buttons to select an image to rotate.
2. Press the menu button and use the Left / Right buttons to select the [ROTATE] menu tap.
3. Select a desired sub menu by pressing the UP/ DOWN button.

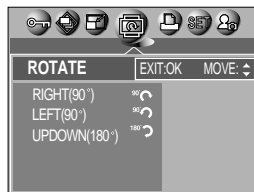

[RIGHT] : Rotate picture in a clock-wise direction

[LEFT] : Rotate picture in a counter-clock-wise direction

[UPDOWN] : Rotate picture 180 degrees



[Picture after 90 degrees]
CW rotation



[Picture after 90 degrees]
CCW rotation



[Picture after 180 degrees]
rotation

4. Press the OK button. The rotated image will be displayed and the menu will disappear. If you display the rotated image on the LCD monitor, empty spaces may appear to the left and right of the image.

DPOF

- DPOF(Digital Print Order Format) allows you to embed printing information on your memory card's MISC folder. Select the pictures to be printed and how many prints to make.
- The DPOF indicator will display on the LCD monitor when an image that has DPOF information plays back. Images can then be printed on DPOF printers, or at an increasing number of photo labs.
- This function is not available for Movie clips and Voice recording files.

DPOF : STANDARD

■ This function allows you to embed print quantity information on a stored image.

1. Press the play mode button and press the menu button.
2. Press the LEFT/ RIGHT button and select the [DPOF] menu tab.
3. Select the [STANDARD] menu by pressing the UP/ DOWN button and press the RIGHT button.
4. Select a desired sub menu by pressing the UP/ DOWN button and press the OK button.

[SELECT] : A window for selecting the image to be printed is opened.

- Up/ Down/ Left/ Right : Select an image

- S button : Confirming an image

- W/T button : Select a number of prints

[ALL PICs] : Set the number of copies to print for each picture, excluding movie clips and voice recordings.

- Up/ Down button : Select a number of prints

5. Press the OK button to confirm the setting.

If an image carries DPOF instructions, the DPOF indicator () will show.

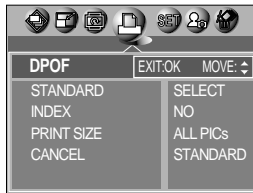

DPOF : INDEX

■ Images (except for movie clips and voice file) are printed as index type.

1. Press the play mode button and press the menu button.
2. Press the LEFT/ RIGHT button and select the [DPOF] menu tab.
3. Select the [INDEX] menu by pressing the UP/ DOWN button and press the RIGHT button.
4. Select a desired sub menu by pressing the UP/ DOWN button.

If [NO] is selected : The image will not be printed in index format.

If [YES] is selected : The image will be printed in index format.

5. Press the OK button to confirm the setting.



DPOF : PRINT SIZE

- You can specify the print size when printing images stored on the memory card.
The [PRINT SIZE] menu is available only for DPOF 1.1 compatible printers.

● Setting the Print Size

1. Press the play mode button and press the menu button.
2. Press the LEFT/ RIGHT button and select the [DPOF] menu tab.
3. Select the [PRINT SIZE] menu by pressing the UP/ DOWN button and press the RIGHT button.
4. Select a desired sub menu by pressing the UP/ DOWN button and press the OK button.

[SELECT] : A window for selecting the print size is opened.

Up/ Down/ Left/ Right : Select an image

W/ T button : Select a print size

S button : Selecting an image or cancel the selection

[ALL PICs] : print size of all images are changed.

SIZE : DEFAULT, 3X5, 4X6, 5X7, 8X10

- * The [DEFAULT] print size varies depending on the printer manufacturer.

For your printer's default value, please refer to the user's guide that came with your printer.

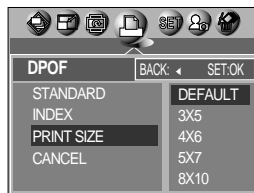
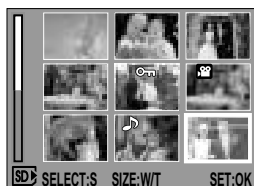

DPOF : CANCEL

- You can cancel the [STANDARD], [INDEX], or [SIZE] settings. Cancel the setting to reset the value to its default.

1. Press the play mode button and press the menu button.
2. Press the LEFT/ RIGHT button and select the [DPOF] menu tab.
3. Select the [CANCEL] menu by pressing the UP/ DOWN button and press the RIGHT button.
4. Select a desired sub menu by pressing the UP/ DOWN button.

If [STANDARD] is selected: Cancels the standard print setting.

If [INDEX] is selected : Cancels the index print setting.

If [SIZE] is selected : Cancels the print size setting.

5. Press the OK button to confirm the setting.

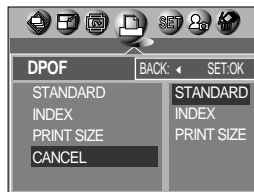

PictBridge

- You can use the USB cable to connect this camera to a printer that supports PictBridge (sold separately) and print the stored images directly. TIFF, Movie clips and voice files cannot be printed. You can set up the following settings from the PictBridge menu.

SELECT	: Setting up the scope of PictBridge
PRINTER SETUP	: Setting up printing
PRINT	: Printing pictures
DPOF PRINT	: Printing the DPOF files
RESET	: Initializing the PictBridge functions

● Connecting the Camera to a Printer

1. Press the POWER button to turn on the camera.
2. In a mode other than Voice Recording mode, press the MENU button.
3. Press the LEFT/ RIGHT button and select [SETUP] menu tab.
4. Select [USB] menu by pressing the UP/ DOWN button and press the RIGHT button.
5. Select [PRINTER] menu by pressing the UP/ DOWN button and press the OK button.
6. Press the menu button twice and the menu will disappear.
7. Use the supplied USB cable to connect the camera to the printer as shown below.
8. Turn on the printer to connect the camera to the printer.

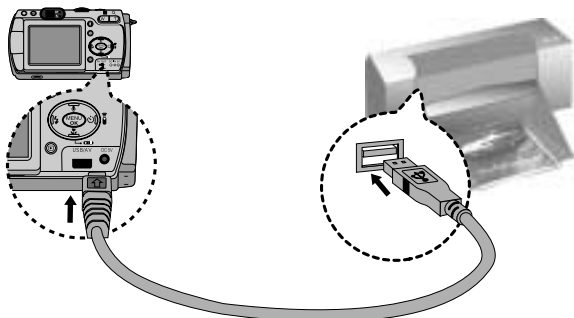
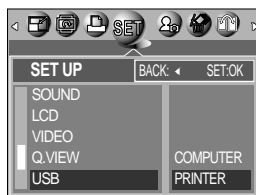

- ※ If you selected [Computer] in Step 5, when you connect the camera to your printer, the [USB I/F COMPUTER] message will display and the connection will not be established. In this case, disconnect the USB cable, and then follow the procedure from Step 2 and onward.

PictBridge: Picture Selection

- You can select the scope of the PictBridge function.

1. Connect the camera to your printer.

The USB menu must be set to [PRINTER] before you connect the camera to the printer. (See p.74)

2. The [PICTBRIDGE] menu will appear.
3. Select the [SELECT] menu by pressing the UP/ DOWN button and press the RIGHT button.
4. Use the UP and DOWN buttons to select the desired submenu value, and then press the OK button.

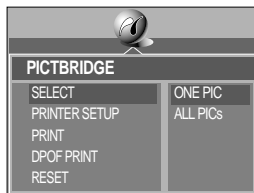

When [ONE PIC] is selected : The PictBridge function will be applied only to the picture currently displayed.

When [ALL PICs] is selected : The PictBridge function will be applied to all pictures, excluding TIFF, movie clips and voice files.

- Setting the Number of Copies to Print

- Select [ONE PIC] or [ALL PICs].

A screen where you can set the number of copies to print will appear as shown below.

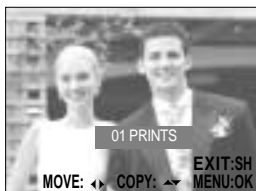

[When [ONE PIC] is selected]

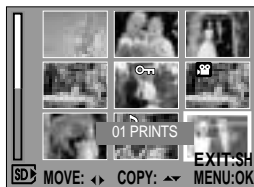

[When [ALL PICs] is selected]

- Use the UP and DOWN buttons to select the number of copies to print and then press the OK button.

The number of copies you wish to make : 01~30

Unless you press the OK button, the changed number of prints will not be applied.

- When selecting [ONE PIC] in Step 4, you can use the LEFT and RIGHT buttons to move to the previous or next picture.
- Press the SHUTTER button to return to the PictBridge menu.

PictBridge: Print Setting

- You can select the Paper Size, Print Format, Paper Type, Print Quality, Date Print, and File Name Print menus for printed pictures.

1. Connect the camera to your printer.

The USB menu must be set to [PRINTER] before you connect the camera to the printer. (See p.74)

2. The [PICTBRIDGE] menu will appear.
3. Select the [PRINTER SETUP] menu by pressing the UP/DOWN button and press the RIGHT button.
4. Use the UP and DOWN buttons to select the desired submenu value, and then press the OK button.

If [DEFAULT] is selected

: The print format will be set to the printer's default values.

If [CUSTOM] is selected

: A window from which the user can set up the print format with the desired values will appear.

Use the UP and DOWN buttons to select a submenu value, and then press the RIGHT button.

Auxiliary menu will appear. Use the UP and DOWN buttons to select the desired auxiliary menu, and then press the OK button.

The menus you can set up are as follows:

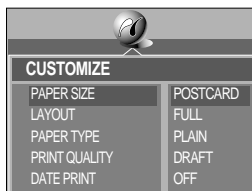
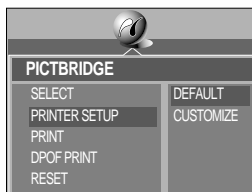

Menu	Function	Sub menu
SIZE	Setting the size of the printing paper	POSTCARD, 4X6, 8X10, A6, A4, B5
LAYOUT	Setting the number of pictures to be printed on a sheet of paper	FULL, INDEX, 1, 2, 4, 6, 8
PAPER	Setting the quality of the printing paper	PLAIN, PHOTO, FASTPHOTO
QUALITY	Setting the quality of the picture to be printed	DRAFT, NORMAL, FINE
DATE	Setting whether to print the date	OFF, ON
FILENAME	Setting whether to print the file name	OFF, ON

- ※ Depending on the manufacturer and model of your printer, some menus are inaccessible. Even though these menus will still appear on the LCD monitor, but you will not be able to select them.

PictBridge: Picture Printing

■ Printing Pictures

1. Connect the camera to your printer.

The USB menu must be set to [PRINTER] before you connect the camera to the printer. (See p.74)

2. The [PICTBRIDGE] menu will appear.
3. Select the [PRINT] menu by pressing the UP/ DOWN button and press the RIGHT button.
4. Select a desired sub menu by pressing the UP/ DOWN button and press the OK button.

[STANDARD] : Print a selected image according to the number of copies required.

[INDEX] : Print all images displayed in the Index format.

5. The screen shown on the right will appear and the picture will be printed. If no picture is selected, the [NO IMAGE!] message will be displayed. If you press the SHUTTER button during printing, printing will be cancel and the menu from Step 2 will appear.
6. If an error occurs during printing, the screen shown below will appear.

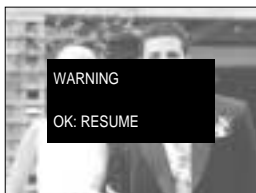
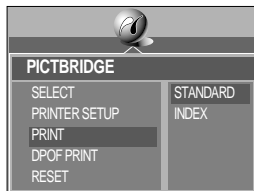

[Fatal error]

Press the OK button to cancel printing.
Follow the Steps 1 to 4 again to print the picture(s).

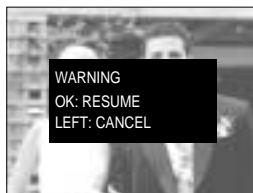

[Recoverable error]

Press the OK button to resume printing,
or press the LEFT button to cancel printing.

INFORMATION

- When printing pictures by connecting the camera to the printer, use the AC adapter.
- If the printer is turned off during printing, the printing will stop and the paper will be dispelled.
- If there are continuous print error, please check the print condition.

PictBridge : DPOF AUTO PRINT

- This allows you to directly print the files with DPOF information.
For instructions on how to set up DPOF, refer to pages 72 to 73.

1. Connect the camera to your printer.
The USB menu must be set to [PRINTER] before you connect the camera to the printer. (See p.74)
2. The [PICTBRIDGE] menu will appear.
3. Select the [DPOF PRINT] menu using the UP/DOWN button and press the RIGHT button. Next, select [YES] using the Up/Down button, and then press the OK button.
4. The screen shown on the right will appear and the picture will be printed. If no picture is selected, the [NO IMAGE!] message will be displayed. If you press the SHUTTER button during printing, printing will be cancel and the menu from Step 2 will appear.
5. If an error occurs during printing, the error message number 6 on page 77 will be displayed.
For details, please refer to page 77.

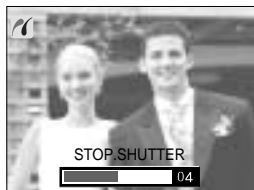
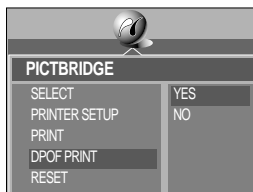

PictBridge : RESET

- This allows you to restore the values of the PictBridge menu, which was changed in CUSTOMIZE, to their default values.

1. Connect the camera to your printer.
The USB menu must be set to [PRINTER] before you connect the camera to the printer. (See p.74)
2. The [PICTBRIDGE] menu will appear.
3. Select the [RESET] menu by pressing the UP/ DOWN button and press the RIGHT button.
4. Select a desired sub menu by pressing the UP/ DOWN button and press the OK button.
 - If [NO] is selected : Settings will not be reset.
 - If [YES] is selected : All print and image settings will be reset.

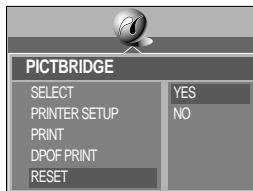

- ※ Default print setting varies depending on the printer manufacturer.
For your printer's default setting, refer to the user's guide that came with your printer.

Setup menu

■ In this mode, you can set up basic settings. You can use the setup menu in all camera modes, except Voice Recording mode.

The items indicated by  are default settings.

Menu tab	Main menu	Sub menu	Secondary menu	Page	
	FILE	RESET		p.80	
		SERIES			
	PWR SAVE	OFF, 01 ~ 03 ~ 10MIN		p.81	
	LANGUAGE	A T Y P E	ENGLISH	ENGLISH	p.82
			FRENCH	KOREAN	
			GERMAN	S.CHINESE	
			SPANISH	T.CHINESE	
			ITALIAN	DANISH	
			RUSSIAN	SWEDISH	
			DUTCH	THAI	
			PORTUGUESE	MALAYSIAN	
	FORMAT	MS		p.82	
		SD/MMC			
	DATE. TIME	▲ 04/05/01 13:00 ▼		p.83	
		YY/MM/DD			
		MM/DD/YY			
		DD/MM/YY			
	IMPRINT	OFF		p.83	
		DATE			
		DATE & TIME			
	LAMP	OFF		p.84	
		ON			
	SOUND	OFF		p.85	
LOW					
MEDIUM					
HIGH					

Setup menu

Menu tab	Main menu	Sub menu	Secondary menu	Page
	LCD	DARK		p.85
		NORMAL		
		BRIGHT		
	VIDEO	NTSC		p.86
		PAL		
	Q.VIEW	OFF		p.87
		▲ 1 ~ 5 SEC ▼		
	USB	COMPUTER		p.87
		PRINTER		
	RESET	NO		p.88
		YES		
	CARD SELECT	SD/MMC		p.88
		MS		

File name

■ This function allows the user to select the file naming format.

● Assigning File Names

1. In any mode other than Voice Recording mode, press the MENU button.
2. Press the LEFT/ RIGHT button and select the [SETUP] menu tab.
3. Select the [FILE] menu by pressing the UP/ DOWN button and press the RIGHT button.
4. Select a desired sub menu by pressing the UP/ DOWN button and press the OK button.

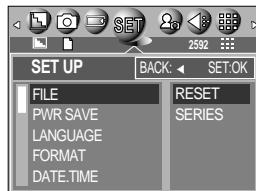

[RESET] : After using the reset function, the next file name will be set from 0001 even after formatting, deleting all or inserting a new memory card.

[SERIES] : Under this system, the file name will directly follow the last stored file name, regardless of any actions such as file deletion or formatting.

File name

INFORMATION

- The first stored folder name is 100SSCAM, and the first file name is SA500001.
- Whenever you store an image, the file number is increased by 1.
The file numbers are named from SA500001 to SA509999 automatically, 9999 files will be stored in a folder.
- The folder number is assigned sequentially from 100 to 999 as follows: 100SSCAM → 101SSCAM → ~ → 999SSCAM.
- The files used with the memory card conform to the DCF(Design rule for Camera File systems) format.

Auto power off

- This function switches the camera off after a set amount of time in order to prevent unnecessary battery drainage.

● Setting Power Off

1. In any mode other than Voice Recording mode, press the MENU button.
2. Press the LEFT/ RIGHT button and select the [SETUP] menu tab.
3. Select the [PWR SAVE] menu by pressing the UP/ DOWN button and press the RIGHT button.
4. Select a desired sub menu by pressing the UP/ DOWN button and press the OK button.

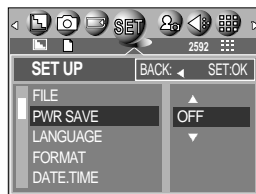

Selecting [OFF] : The power off function will not operate.

Selecting [1-10MIN] : The power will turn off automatically if not used for the period of time specified.

INFORMATION

- Even if the batteries or AC adapter are removed and inserted again, the power off setting will be preserved.
- Note that the automatic power off function will not operate if the camera is in PC mode, slide show, playing back a voice recording or movie clip.

Language

- There is a choice of languages that can be displayed on the LCD monitor.
Even if the batteries or AC adapter are removed and inserted again, the language setting will be preserved.

● Setting Language

1. In any mode other than Voice Recording mode, press the MENU button.
2. Press the LEFT/ RIGHT button and select the [SETUP] menu tab.
3. Select the [LANGUAGE] menu by pressing the UP/ DOWN button and press the RIGHT button.
4. Select a desired sub menu by pressing the UP/ DOWN button and press the OK button.



LANGUAGE sub menu

- Type A : English, French, German, Spanish, Italian, Russian, Dutch and Portuguese.
- Type B : English, Korean, Simplified Chinese, Traditional Chinese, Danish, Swedish, Thai, and Malaysian.

Formatting a memory card

- This is used for formatting the memory card. If you run [FORMAT] on the memory card, all images, including the protected images, will be deleted. Be sure to download important images to your PC before formatting the memory card.

● Formatting a Memory Card

1. In any mode other than Voice Recording mode, press the MENU button.
2. Press the LEFT/ RIGHT button and select the [SETUP] menu tab.
3. Select the [FORMAT] menu by pressing the UP/ DOWN button and press the RIGHT button.
4. Press the Up/Down button to select desired sub menu.
5. Press the OK button. The [PLEASE WAIT!] message is displayed while the memory card is being formatted.

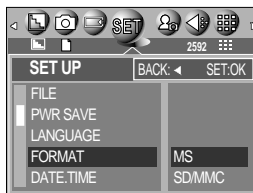

- Be sure to run [FORMAT] on the following types of memory card.

- A new memory card, or an unformatted memory card.
- A memory card that has a file this camera can't recognize or one that has been taken from another camera.

- Always format the memory card using this camera. If you insert a memory card that has been formatted using other cameras, memory card readers, or PCs, you will get a [CARD ERROR!] message.

Setting up the Date/ Time/ Date type

- You can change the date and time that will be displayed on the captured images and set up the date type.

● Setting Date/Time & Selecting Date type

1. In any mode other than Voice Recording mode, press the MENU button.
2. Press the LEFT/ RIGHT button and select the [SETUP] menu tab.
3. Select the [DATE. TIME] menu by pressing the UP/ DOWN button and press the RIGHT button.
4. Use the UP, DOWN, LEFT, and RIGHT buttons to select the desired submenu value, and then press the OK button.

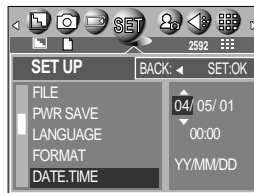

RIGHT button : Selects the year/month/day/hour/minute/date type.

LEFT button : Moves the cursor to the [DATE. TIME] main menu if the cursor is at the first item of the date and time setup. In all other cases, the cursor will be shifted to the left of its current position.

UP and DOWN buttons: Changes the setting value.

- Date type

[YY/MM/DD] : year/ month/ day

[MM/DD/YY] : month/ day/ year

[DD/MM/YY] : day/ month/ year

Imprinting the recording date

- There is an option to include DATE/TIME on still images.

● Date Imprinting

1. In any mode other than Voice Recording mode, press the MENU button.
2. Press the LEFT/ RIGHT button and select the [SETUP] menu tab.
3. Select the [IMPRINT] menu by pressing the UP/ DOWN button and press the RIGHT button.
4. Use the UP and DOWN buttons to select the desired date imprint type, and then press the OK button.

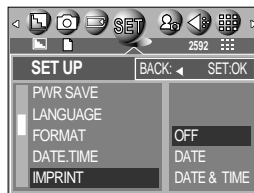

[OFF] : The DATE & TIME will not be imprinted on the image file.

[DATE] : Only the DATE will be imprinted on the image file.

[DATE&TIME] : The DATE & TIME will be imprinted on the image file.

Imprinting the recording date

INFORMATION

- The Date & Time are imprinted at the bottom right side of the still image.
- The date will be imprinted as a DATE TYPE setting.
- TIME is imprinted in the following way : [Hour : Minute: Second] and hours are shown using the 24 hour clock.
- The imprint function is applied only to still images.

Function lamp

■ You can turn on and off the function lamp located on the front of the camera.

● Setting the function lamp

1. In any mode other than Voice Recording mode, press the MENU button.
2. Press the LEFT/ RIGHT button and select the [SETUP] menu tab.
3. Select the [LAMP] menu by pressing the UP/ DOWN button and press the RIGHT button.
4. Select a desired sub menu by pressing the UP/ DOWN button and press the OK button.

If [OFF] is selected : The function lamp will not light up.

If [ON] is selected : The function lamp will light up.

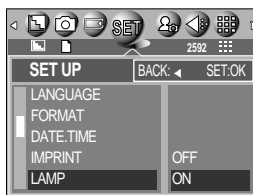

● Description of the Function lamp

Function	Description
Power on	Blue light blinks and then turns off when the camera is ready to take a picture.
After taking a picture	Blue lamp blinks once.
While movie recording	Blue lamp blinks at a 1-second interval.
While voice recording	Blue lamp blinks at a 1-second interval.
After selecting the remote controller mode	Blue lamp blinks at a 1-second interval.
While the self timer is functioning	* The lamp will function while using the self-timer even if the configuration is set to off the lamp. (See p. 37)

Sound

- If you set the operation sound to ON, various sounds will be activated for camera startup, when button are pressed, and if there is a card error, so that you can be aware of the camera operation status.

● Setting Operation Sounds

1. In any mode other than Voice Recording mode, press the MENU button.
2. Press the LEFT/ RIGHT button and select the [SETUP] menu tab.
3. Select the [SOUND] menu by pressing the UP/ DOWN button and press the RIGHT button.
4. Select a desired sub menu by pressing the UP/ DOWN button and press the OK button.
 - [SOUND] sub menu : OFF/ LOW/MEDIUM/ HIGH

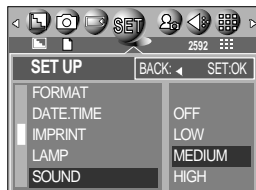

LCD brightness

- You can adjust the LCD brightness.

● Adjusting LCD Brightness

1. In any mode other than Voice Recording mode, press the MENU button.
2. Press the LEFT/ RIGHT button and select the [SETUP] menu tab.
3. Select the [LCD] menu by pressing the UP/ DOWN button and press the RIGHT button.
4. Select a desired sub menu by pressing the UP/ DOWN button and press the OK button.
 - [LCD] sub menu : DARK, NORMAL, BRIGHT

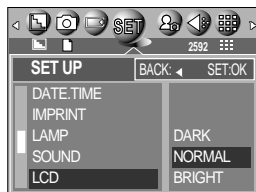

Selecting Video out type

- The Movie output signal from the camera can be NTSC or PAL.

Your choice of output will be governed by the type of device (monitor or TV, etc.) to which the camera is connected. PAL mode can support only BDGHI.

● Setting the Video Out Type

1. In any mode other than Voice Recording mode, press the MENU button.
2. Press the LEFT/ RIGHT button and select the [SETUP] menu tab.
3. Select the [VIDEO] menu by pressing the UP/ DOWN button and press the RIGHT button.
4. Select a desired sub menu by pressing the UP/ DOWN button and press the OK button.
 - [VIDEO] sub menu : NTSC, PAL

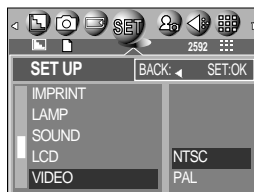

● Connecting to an external monitor

In RECORDING/ PLAY mode, you can view the stored still images or movie clips by connecting the camera to an external monitor via the A/V cable. When the camera is connected to an external monitor, the LCD monitor will be turned off automatically.

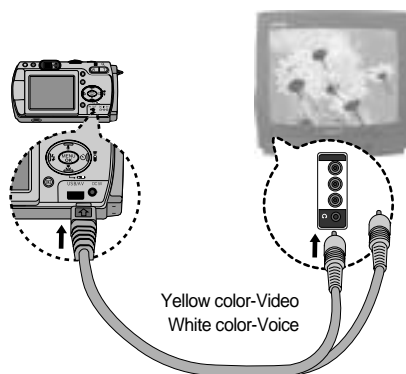

INFORMATION

- NTSC : U.S.A, Canada, Japan, South Korea, Taiwan, Mexico.
- PAL : Australia, Austria, Belgium, China, Denmark, Finland, Germany, U.K., Holland, Italy, Kuwait, Malaysia, New Zealand, Singapore, Spain, Sweden, Switzerland, Thailand, Norway.
- When using a TV as an external monitor, you will need to select the external or AV channel of the TV.
- There will be a digital noise on the external monitor, but it is not a malfunction.
- If the image is not in the centre of the screen, use the TV controls to centre it.
- When using a PAL type monitor, there will be a black frame on the lower part of the monitor.
- When the camera is connected to an external monitor, the menu will be visible on the external monitor and the menu functions are the same as those indicated on the LCD monitor.

Quick view

- If you enable Quick View before capturing an image, you can view the image you just captured on the LCD monitor for the duration set in the [Q.VIEW] setup. Quick view is possible only with still images.

● Setting Quick View

1. In any mode other than Voice Recording mode, press the MENU button.
2. Press the LEFT/ RIGHT button and select the [SETUP] menu tab.
3. Select the [Q.VIEW] menu by pressing the UP/ DOWN button and press the RIGHT button.
4. Select a desired sub menu by pressing the UP/ DOWN button and press the OK button.

[OFF] : The quick view function can't be activated.

[1 ~ 5 SEC] : The captured image is briefly displayed during the selected time.

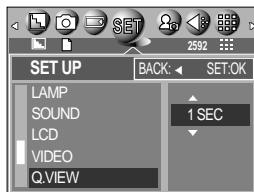

Connecting an External Device (USB)

- You can select an external device to which you want to connect the camera using the USB cable.

● Selecting an External Device

1. In any mode other than Voice Recording mode, press the MENU button.
2. Press the LEFT/ RIGHT button and select the [SETUP] menu tab.
3. Select the [USB] menu by pressing the UP/ DOWN button and press the RIGHT button.
4. Select a desired sub menu by pressing the UP/ DOWN button and press the OK button.

[COMPUTER] : Select this if you want to connect the camera to your PC. Refer to page 109 for instructions on how to connect the camera to your PC.

[PRINTER] : Select this if you want to connect the camera to your printer. Refer to page 74 for instructions on how to connect the camera to your printer.

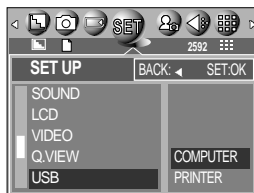

Initialization(RESET ALL)

- All camera menu and function settings will be restored to their default values. However, values for DATE/TIME, LANGUAGE, and VIDEO OUT will not be changed.

● Initializing the Camera

1. In any mode other than Voice Recording mode, press the MENU button.
2. Press the LEFT/ RIGHT button and select the [SETUP] menu tab.
3. Select the [RESET] menu by pressing the UP/ DOWN button and press the RIGHT button.
4. Select a desired sub menu by pressing the UP/ DOWN button and press the OK button.
If [NO] is selected : Settings will not be restored to their defaults.
If [YES] is selected : All settings will be restored to their defaults.



Select card

- The camera has multi memory slots for an SD Memory Card (Multi Media Card) and Memory Stick Duo. Select a memory card to use when both memory slots are loaded with a memory card.

● Memory card selection

1. In any mode with the exception of Voice Recording mode, press the MENU button.
2. Press the LEFT/ RIGHT button and select the [SETUP] menu tab.
3. Select the [CARD SELECT] menu by pressing the UP/ DOWN button and press the RIGHT button.
4. Use the UP and DOWN buttons to select the desired sub menu, and then press the OK button.

[MS] : Selects Memory Stick DUO

[SD/MMC] : Selects SD card or Multi Media Card



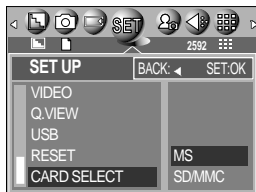

* If all the slots are full, make sure that the card you want is selected before taking a picture.

* Configure the submenu of the [CARD SELECT] menu to use the free space in the auxiliary memory card when a [CARD FULL !] message is displayed.



Setting up the MYCAM menu

- You can set up a start up image, start up sound and shutter sound. Every camera working mode (with the exception of Voice recording mode) has the MyCAM menu. The items indicated by  are default settings.

Menu tab	Main menu	Sub menu		Page
	START IMAGE	OFF	 IMAGE 1	p.89
		IMAGE 2	IMAGE 3	
	START SOUND	OFF	 SOUND 1	p.90
		SOUND 2	SOUND 3	
	SH.SOUND	OFF	 SH.SOUND 1	p.90
		SH.SOUND 2	SH.SOUND 3	

* Menus are subject to change without prior notice.

Start up image

- You can select the image that is first displayed on the LCD monitor whenever the camera is turned on.

● Setting a Startup Image

1. In any mode with the exception of Voice Recording mode, press the MENU button.
2. Press the LEFT/ RIGHT button and select the [MYCAM] menu tab.
3. Select the [START IMAGE] menu by pressing the UP/ DOWN button and press the RIGHT button.
4. Select a desired sub menu by pressing the UP/ DOWN button and press the OK button.



INFORMATION

- Use a saved image for the start-up image with the [LOGO] in the [RESIZE] menu in the play mode.
- The start-up image will not be deleted by deleting all images or [FORMAT] menu.

Start up sound

■ You can select the sound that is activated whenever the camera is turned on.

● Setting the Startup Sound

1. In any mode with the exception of Voice Recording mode, press the MENU button.
2. Press the LEFT/ RIGHT button and select the [MYCAM] menu tab.
3. Select the [START SOUND] menu by pressing the UP/ DOWN button and press the RIGHT button.
4. Select a desired sub menu by pressing the UP/ DOWN button and press the OK button.



Shutter sound

■ You can select the shutter sound.

● Selecting the Shutter Sound

1. In any mode with the exception of Voice Recording mode, press the MENU button.
2. Press the LEFT/ RIGHT button and select the [MYCAM] menu tab.
3. Select the [SH.SOUND] menu by pressing the UP/ DOWN button and press the RIGHT button.
4. Select a desired sub menu by pressing the UP/ DOWN button and press the OK button.

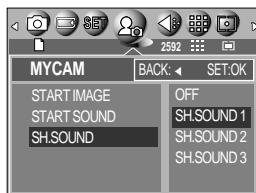

Important notes

Be sure to observe the following precautions!

- This unit contains precision electronic components. Do not use or store this unit in the following locations.
 - Areas exposed to severe changes in temperature and humidity.
 - Areas exposed to dust and dirt.
 - Areas exposed to direct sunlight or the inside of a vehicle in hot weather.
 - Environments where there is high magnetism or excessive vibration.
 - Areas with high explosives or highly flammable materials.

- Do not let the unit come into contact with dust, vinyl goods, or chemicals, such as insecticides, for an extended period of time.

- Sand can be particularly troublesome to cameras.
 - Do not let sand get inside the unit when using it on beaches, coastal dunes, or other areas where there is lots of sand.
 - Doing so may result in failure or may permanently render the unit unusable.

- Extremes in temperature may cause problems.
 - If the camera is transferred from a cold to a warm and humid environment, condensation can form on the delicate electronic circuitry. If this occurs, turn the camera off and wait for at least 1 hour until all moisture is dispersed. Moisture build up can also occur in the memory card. If this happens, turn off the camera and remove the memory card. Wait until the moisture has dispersed.

- Caution on Using the Lens
 - If the lens is subjected to direct sunlight, it could result in discoloration and deterioration of the image sensor.
 - Pay attention not to get fingerprints or foreign substances on the surface of the lens.

- If the digital camera is not used for a long period, an electric discharge can occur. It is a good idea to remove the batteries and the memory card if you do not intend using the camera for an extended period of time.

Important notes

- If the camera is exposed to an electronic interference, it will turn itself off to protect the memory card.

- Camera Maintenance
 - Use a soft brush (available from photo stores) to gently clean the lens and LCD assemblies. If this does not work, lens-cleaning paper with lens cleaning fluid can be used.
 - Clean the camera body with a soft cloth. Do not allow this camera to come into contact with solvent materials such as benzol, insecticide, thinners etc. This may damage the body shell of the camera and also affect its performance. Rough handling can damage the LCD monitor. Take care to avoid damage and keep the camera in its protective carry case at all times when not in use.

- Do not attempt to disassemble or modify the camera.

- Under certain conditions, static electricity can cause the flash unit to fire. This is not harmful to the camera and is not a malfunction.

- When images are uploaded or downloaded, the data transfer may be affected by static electricity. In this case, disconnect and re-connect the USB cable before trying the transfer again.

Warning indicator

- There are several warnings that may appear on the LCD display

Warning indicator	Causes	Remedy
CARD ERROR !	<ul style="list-style-type: none">- Memory card error	<ul style="list-style-type: none">- Turn off the camera power and turn it on again- Insert the memory card again- Format the memory card (p.82)
CARD FULL !	<ul style="list-style-type: none">- There is insufficient memory capacity to take an image	<ul style="list-style-type: none">- Insert a new memory card- Delete unnecessary image files to free up some memory
NO IMAGE !	<ul style="list-style-type: none">- There are no images stored on the memory card	<ul style="list-style-type: none">- Take images- Insert a memory card that is holding some images
NO CARD !	<ul style="list-style-type: none">- A memory card is not inserted- The camera can't recognize the memory card	<ul style="list-style-type: none">- Insert a memory card- Insert the memory card again- Turn off the camera power and turn it on again
FILE ERROR !	<ul style="list-style-type: none">- File error- Memory card error	<ul style="list-style-type: none">- Format the memory card- Contact a camera service center
LOW BATTERY !	<ul style="list-style-type: none">- There is low battery capacity	<ul style="list-style-type: none">- Insert fresh batteries
CARD LOCKED !	<ul style="list-style-type: none">- The memory card is locked	<ul style="list-style-type: none">- MS DUO : Slide the write protect switch to the bottom of the memory card- SD : Slide the write protect switch to the top of the memory card
LOW LIGHT !	<ul style="list-style-type: none">- When taking pictures in dark places	<ul style="list-style-type: none">- Use a tripod and take pictures in Flash Photography mode

Before contacting a service center

■ Please check the following

Symptom	Causes	Remedy
The camera doesn't switch on	<ul style="list-style-type: none"> - There is low battery capacity - An AC Power Adapter is not connected - Batteries are inserted incorrectly with the reverse polarities 	<ul style="list-style-type: none"> - Insert fresh batteries - Connect an AC Power Adapter - Insert the batteries according to the polarity marks (+, -)
The camera power ceases whilst in use	<ul style="list-style-type: none"> - The batteries are exhausted - The Camera is turned off automatically - The Adapter plug is not connected securely 	<ul style="list-style-type: none"> - Insert fresh batteries - Press the power button to reactivate camera - Remove and re-insert the plug
Batteries drain quickly	<ul style="list-style-type: none"> - The Camera is being used in low temperatures 	<ul style="list-style-type: none"> - Keep the camera in warm conditions (i.e. inside a coat or jacket) and only remove it in order to take images
Camera does not take images when pressing the Shutter button	<ul style="list-style-type: none"> - The memory card is not inserted - There is insufficient memory capacity - The memory card has not been formatted - The memory card is exhausted - The camera's power is off - The batteries are exhausted - The memory card is locked - Batteries are inserted incorrectly with the reverse polarities 	<ul style="list-style-type: none"> - After turning the camera off, insert a new memory card - Delete unnecessary image files - Format the memory card (p.82) - Insert a new memory card - Turn the camera power on - Insert fresh batteries - Refer to [CARD LOCKED!] error message (p.93) - Insert the batteries according to the polarity marks (+, -)
The camera suddenly stops working while in use	<ul style="list-style-type: none"> - The camera was stopped due to a malfunction 	<ul style="list-style-type: none"> - Remove /re-insert batteries and switch the camera on

Before contacting a service center

Symptom	Causes	Remedy
The images are unclear	<ul style="list-style-type: none"> - A picture was taken within 0.8 m from the subject without setting an appropriate macro mode - Taking a picture beyond the flash range - The lens is smudged or dirty 	<ul style="list-style-type: none"> - If the subject is closer than 0.8m, select macro shot mode - Take a picture within the flash range - Clean the lens
The flash does not fire	<ul style="list-style-type: none"> - Flash off mode has been selected 	<ul style="list-style-type: none"> - Dis-engage flash off mode
Incorrect date and time is displayed	<ul style="list-style-type: none"> - The date and time have been set incorrectly or the camera has adopted the default settings 	<ul style="list-style-type: none"> - Reset the date and time correctly
The camera buttons do not operate	<ul style="list-style-type: none"> - Camera malfunction 	<ul style="list-style-type: none"> - Remove /re-insert batteries and switch the camera on
A card error has occurred while the memory card is in the camera.	<ul style="list-style-type: none"> - Incorrect memory card format 	<ul style="list-style-type: none"> - Re-format the memory card (p.82)
The images don't play back	<ul style="list-style-type: none"> - Incorrect file name (Violation of DCF format) 	<ul style="list-style-type: none"> - Do not change the image file name

Before contacting a service center

Symptom	Causes	Remedy
Colour of image is different to the original scene	<ul style="list-style-type: none"> - White balance setting is incorrect 	<ul style="list-style-type: none"> - Select appropriate White balance
Images are too bright	<ul style="list-style-type: none"> - Exposure is excessive 	<ul style="list-style-type: none"> - Reset exposure compensation
No image on external monitor	<ul style="list-style-type: none"> - The external monitor has not been connected properly with the camera - There are incorrect files in the memory card 	<ul style="list-style-type: none"> - Check the connection cables - Insert a memory card that has correct files
When using the PC's explorer, the [Removable Disk] file does not show	<ul style="list-style-type: none"> - Cable connection is incorrect - The camera is off - There are no batteries, the batteries are exhausted or the AC adapter is not connected. - The operating system is not Windows 98, 98SE, 2000, ME, XP/ Mac OS 9.0 ~ 10.2. Alternatively the PC does not support USB - The camera driver is not installed 	<ul style="list-style-type: none"> - Check the connection - Turn the camera on - Insert new batteries or check the adapter connection - Install Windows 98, 98SE, 2000, ME, XP/ Mac OS 9.0 ~ 10.2 to PC that supports USB - Install a [USB Storage Driver]

Specifications

Image Sensor	Type	1/1.8" CCD
	Effective Pixel	Approx. 5.0 Mega-pixel
	Total Pixel	Approx. 5.3 Mega-pixel
Lens	Focal Length	Schneider Lens f = 7.7 ~ 23.1mm (35mm film equivalent : 38~114mm)
	F No.	F2.7 ~ F4.9
	Digital Zoom	Still Image mode : 1.0X ~ 5.0X Play mode : 1.0X ~ 9.0X (depends on image size)
Viewfinder	Optical Viewfinder	Real image optical viewfinder
	LCD Monitor	2.0" color TFT LCD(117,600 dots, Rotating LCD)
Focusing	Type	TTL auto focus, Manual focus
	Range	Normal : 80cm ~ infinity Macro : 4 ~ 80cm (Wide), 30 ~ 80cm (Tele)
Shutter	Type	Mechanical and Electronic shutter
	Speed	2 ~ 1/2,000 sec. (Manual, Night Scene Mode : 15 ~ 1/2,000 sec.)
Exposure	Control	Program AE, Shutter Priority AE, Aperture Priority AE or Manual Exposure Metering : Multi, Spot
	Compensation	±2EV (0.5EV steps)
	ISO Equivalent	Auto, 50, 100, 200, 400
Flash	Modes	Auto, Auto & Red-eye reduction, Slow sync., Fill-in flash, Flash off
	Range	Wide : 0.3 ~ 3.0m, Tele : 0.3 ~ 2.0m
	Recharging Time	Approx. 6 sec.
Sharpness		Soft, Normal, Vivid
Effect		Normal, B&W, Sepia, NEGATIVE ,RGB
White Balance		Auto, Daylight, Cloudy, Fluorescent_L, Fluorescent_H, Tungsten, Custom
Voice Recording		Voice Recording (max. 1 hour) Voice Memo in Still Image (max. 10 sec.)
Date Imprinting		Date &Time, Date, Off (user selectable)
Shooting	Still Image	Modes : Auto, Program, Myset, A/S/M, Voice, Night Scene, Scene * Scene : Portrait, Children, Landscape, Close-up, Sunset, Dawn, Backlight, Fireworks, Beach & Snow Continuous : Single, Continuous, AEB Self-timer : 2 sec., 10 sec., Remote control (optional)
	Movie Clip	With Audio (recording time : memory capacity dependent) Size : 640x480, 320x240 Frame rate : 30 fps, 15 fps
Storage	Media	Multi Memory Card Slot (SD/MMC, Memory Stick Duo/ Pro Duo compatible) - SD : up to 512MB guaranteed - Memory Stick Duo/ Pro Duo : up to 512MB guaranteed

Specifications

Storage	File Format	Still Image : JPEG (DCF), EXIF 2.2, DPOF 1.1, PictBridge 1.0 Movie Clip : MOV (MPEG-4) Audio : WAV (G.711)
	Image Size	2592 : 2592x1944 pixels, 2272 : 2272x1704 pixels, 2048 : 2048x1536 pixels, 1600 : 1600x1200 pixels, 1024 : 1024x768 pixels, 640 : 640x480 pixels
	Capacity (32MB)	2592 : TIFF 1, S.Fine 11, Fine 23, Normal 35 2272 : TIFF 2, S.Fine 15, Fine 30, Normal 45 2048 : TIFF 3, S.Fine 18, Fine 36, Normal 53 1600 : TIFF 5, S.Fine 30, Fine 61, Normal 91 1024 : TIFF 12, S.Fine 70, Fine 130, Normal 183 640 : TIFF 29, S.Fine 183, Fine 305, Normal 457 * These figures are measured under Samsung's standard conditions and may vary depending on shooting conditions and camera settings.
Image Play	Type	Single image, Thumbnails, Slide show, Movie clip
	Editing	Trimming, Resizing
Interface		Digital output connector : USB 2.0 Audio : Mono Video output : NTSC, PAL (user selectable) DC power input connector : 5.0V
Power Source		Primary battery : 2xAA alkaline(High capacity), Lithium, Ni-Mn(High capacity), Ni-Zn(High capacity) / 1xCR-V3 Rechargeable battery : 3.7V Li-ion (SLB-1437), 2xAA Ni-MH(Over 2300mAh), Ni-Cd(Over 1100mAh) / 1x1-Pack (SBP-1303) AC Adapter : SAC-51 * Included power source may vary depending on sales region.
Dimensions (WxHxD)		106.5 x 57 x 38.5 mm
Weight		190g (without batteries and card)
Operating Temperature		0 ~ 40 °C
Operating Humidity		5 ~ 85 %
Software	Camera Driver	Storage Driver (Windows98/98SE/2000/ME/XP, Mac OS 9.0 ~ 10.2)
	Application	Digimax Viewer, QuickTime Player, ArcSoft Photolmpression
Special Features		MPEG-4 VGA 30fps Movie Clip, 2.0" Rotating LCD monitor A World Unique 9 Different Power Source A World Superior Schneider Lens Multi Memory Card Slot (SD/MMC, Memory Stick Duo/ Pro Duo compatible) Superb 4cm Macro

* Specifications are subject to change without prior notice.

* All trademarks are the property of their respective owners.

Software Notes

Please ensure that you read the instruction manual carefully before use.

- . The attached software is a camera driver and image editing software tool for Windows.
- . Under no circumstances should all or part of either the software or the user manual be reproduced.
- . Copyrights for software are licensed only for use with a camera.
- . In the unlikely event of a manufacturing fault, we will repair or exchange your camera. We cannot, however, be held responsible in any way for damage caused by inappropriate use.
- . Using a Hand-made PC or a PC and OS that has not been guaranteed by the manufacturer is not covered by the Samsung warranty.
- . Before reading this manual, you should have a basic knowledge of computers and O/S (Operating Systems).

System Requirements

For Windows	For Macintosh
PC with processor better than MMX Pentium 233MHz (XP : Pentium II 300MHz)	Power Mac G3 or later
Windows 98/98SE/2000/ME/XP	Mac OS 9.0 ~ 10.2
Minimum 32MB RAM (XP : 128MB) 140MB of available hard-disk space	Minimum 64MB RAM 110MB of available hard-disk space
USB port	USB port
CD-ROM drive	CD-ROM drive
800x600 pixels, 16-bit colour display compatible monitor (24-bit color display recommended)	QuickTime 6.0 or later for Movie Clip

About the software

After inserting the CD-ROM provided with this camera into the CD-ROM drive, the following window should automatically run.



Before connecting the camera to the PC, you should first install the camera driver.

- **Camera driver** : This enables images to transfer between the camera and PC.
This camera uses the USB Storage Driver as the camera driver. You can use the camera as a USB card reader. After installing the driver and connecting this camera to the PC, you can find [Removable Disk] in [Windows Explorer] or [My computer]. A USB Storage Driver is provided only for Windows. A USB Driver for MAC is not included with the Application CD. But you can use the camera with Mac OS 9.0 ~ 10.2.
- **QuickTime Player** : The program for playing back QuickTime movies (.mov). It can also play video files compressed with MPEG4 codec.
- **Digimax Viewer** : This is a program for viewing stored images.
You can see the stored images in the memory directly on a PC monitor. You can also copy, move or delete the images and enlarge/downscale the image sizes with Digimax Viewer. This software is only compatible with Windows.
- **PhotoImpression** : Image editing program.
You can edit or store still images that you download from the camera. This software is only compatible with Windows.

INFORMATION

- Be sure to check the system requirements (page 99) before installing the driver.
- You should allow 5~10 seconds for running the automatic setup program according to the capability of the computer. If the frame does not show, run the [Windows Explorer] and select [Samsung.exe] in the CD-ROM Drive root directory.

Setting up the application software

To use this camera with a PC, install the application software first.

After this has been done, the stored images in the camera can be moved to the PC and can be edited by an image editing program.

INFORMATION

- Close other programs before installing the application software.
- Before installing the application software, disconnect the USB connection.

You can visit the Samsung web-site through the internet.

<http://www.samsungcamera.com> : English

<http://www.samsungcamera.co.kr> : Korean

1. Click the [Install] menu in the Autorun frame.
The camera driver is installed automatically.

[Click !]



2. Installation is complete.
Click the [Finish] button.

[Click !]



3. Click [Next >] to begin installing QuickTime.

[Click !]



4. A Welcome window will appear.
Click [Next >] to proceed to the next screen.

[Click !]



Setting up the application software

5. The Software License Agreement window will open, asking you to agree to the licensing. Use the button on the bottom left to select the language of your choice, and then click [Agree] to accept the license agreement. The installation will proceed to the next stage. If you do not agree to the license agreement, click [Disagree]. The installation will be canceled. If the language of your choice is not listed, please select [English].



6. A window will open, asking you to select a destination folder where the files will be copied to. Click [Next >]. To copy the files to another folder, click [Browse..] Browse to a folder you want to copy the files to.



[Click !] →

7. The Choose Installation Type window will open. Click [Next >].

- [Minimum] : Installs required files only.
- [Recommended] : Installs required files and the most commonly used optional files.
- [Custom] : Allows you to install only the components you choose.



↑
[Click !]

8. A window will open, asking you to choose a folder to which program icons will be added. Click [Next >]. If you want to add the program icons to a different folder, choose another folder, and then click [Next >].



[Click !] →

9. The Enter Registration window appears.

Enter your name and organization in the respective fields, and then click [Next >].

You do not have to enter a registration number.



[Click !] →

Setting up the application software

- ※ The QuickTime program folder will appear. Click on the Close button to close the folder.
- 10. The QuickTime Settings - Introduction window appears. Click [Next >].

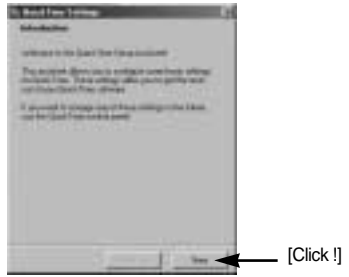

- 11. Set the transfer rate for downloading content from the Internet, and then click [Next >].
- 12. Set up your browser for QuickTime plug-in. Click [Next >].

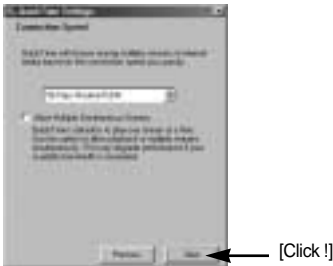

- 13. Specify the file types you want to associate with QuickTime. Click [Finish].
- 14. Installation is complete. Click [Close].

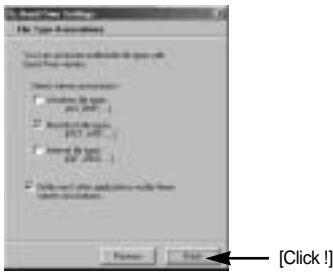

Setting up the application software

* The QuickTime Player will launch, the readme file will open, and the Step 15 window will open. Click on the Close 1 and Close 2 buttons to exit the program.



[Close 1 button]



[Close 2 button]

15. A window where you can choose the program you want to install will appear. Click [Install]. For information on application software, please refer to page 100.



[Click !]

※ If you select [Cancel], the application program installation will be cancelled.

16. The [Digimax Viewer 2.1] installation window will be displayed as shown alongside. Click the [Next] button.



[Click !]

INFORMATION

- If you select [Cancel] at step 16, a window for installing Photolmpression will be displayed.

17. The Software License Agreement window will be displayed. If you agree to this, click [Yes], the window will then move to the next step. If you disagree, click [No] and the installation program will be canceled.

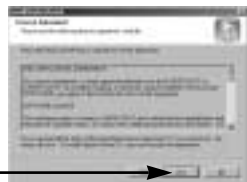

[Click !]

Setting up the application software

18. A destination selection window will open.
Click [Next >]. To copy to the files to another folder, click [Browse..] and choose a folder you want.



19. A window will open, asking you to choose a folder to which program icons will be added.
Click [Next >] button.
If you want to add the program icons to a different folder, choose another folder, and then click [Next >] button.

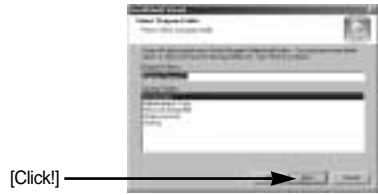

20. Digimax Viewer installation is successfully completed. Click the [Finish] button to install PhotoImpression. The system will not reboot even the [Yes, I want to restart the computer now] option is selected.
*The frame 20 may not appear according to the system requirements.



21. Digimax Viewer Installation is completed.
The PhotoImpression installation window will be displayed as shown alongside.
Click the [OK] button.



INFORMATION

- If you click [Cancel] in Step 21, the PhotoImpression installation will be canceled and the Restart Computer window will appear.

22. A Welcome window will be displayed.
Click the [Next >] button.

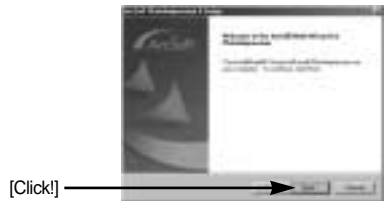

Setting up the application software

23. The Software License Agreement window will be displayed. If you agree to this, click [Yes], the window will then move to the next step. If you disagree, click [No] and the installation program will be canceled.

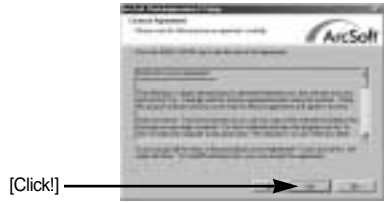

24. A destination selection window will open. Click [Next >]. To copy to the files to another folder, click [Browse...] and choose a folder you want.

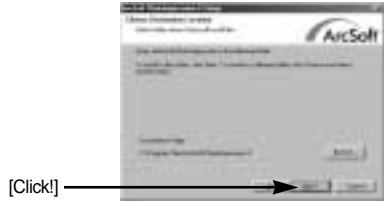

25. The [Select Components] window will appear. Click [Next >] button.



26. A window will open, asking you to choose a folder to which program icons will be added. Click [Next >] button.
If you want to add the program icons to a different folder, choose another folder, and then click [Next >] button.



Setting up the application software

27. Installation is complete. To apply changes, you must restart the computer.
Select [Yes, I want to restart my computer now], and then click [Finish].

[Click!]



28. After restarting the computer, connect the PC to the camera with the USB cable.

29. Turn the camera power on.

[Found New Hardware Wizard] will open and the computer will recognize the camera.

- ※ If you have ever installed an image viewer program or your OS is Windows XP, an image viewer program will open.
If the image viewer program opens, the camera driver was setup successfully.



30. If you can see [Removable Disk] under [My computer], the camera driver installation was successful.
Now you can transfer image files from the camera to PC via the USB cable.



Setting up the application software

INFORMATION

- If you have installed the camera driver, [Found New Hardware Wizard] may not open.
- On a Windows 98 or 98 SE system, the Found New Hardware Wizard dialog box opens and a window asking you to select a driver file may appear. In this case, specify "USB Driver" in the CD supplied. (for Windows 98 and 98 SE).
- When connecting the camera to your PC, it is recommended that you use an AC power adapter.
- Before connecting the camera to the PC, You should first install the camera driver.
- After installing the camera driver, you have to restart your PC.
- If you connect the camera to the PC before installing the camera driver, the [Found New Hardware Wizard] will open.
In this case, cancel the [Found New Hardware Wizard] and disconnect the camera.
Install the camera driver and connect the camera to the PC again.
- Should the computer not find the camera driver after installation, please try one or more of the following measures.
 1. Delete the camera driver (p.112), and re-install the driver.
 2. Refer to FAQ (p.119) to check for a possible solution to the problem.
 3. If your PC's central processing unit is VIA chip (This is shown in the USB Host Controller), download the patch file from the Samsung Camera web page. (<http://www.samsungcamera.com>)

Starting PC Mode

- If you connect the USB cable to a USB port on your PC and then turn on the power, the camera will automatically switch to "computer connection mode".
- In this mode, you can download stored images to your PC through the USB cable.
- The LCD monitor is always turned off in PC mode.
- The auto focus lamp will blink when the files are transferring via the USB connection.

■ Connecting the camera to a PC

1. Turn the PC power on.
2. Turn the camera power on.
3. In any mode other than Voice Recording mode, press the MENU button.
4. Press the LEFT/ RIGHT button and select the [SETUP] menu tab.
5. Select the [USB] menu by pressing the UP/ DOWN button and press the RIGHT button.
6. Use the UP and DOWN buttons to select [COMPUTER], and then press the OK button.
7. Press the menu button twice and the menu will disappear.
8. Connect the PC and the camera via the USB cable.
 - Insert the small plug of the USB cable into the camera USB connection terminal.
 - Insert the large connector of the USB cable into the USB port of the PC.
 - The plugs must be firmly inserted.

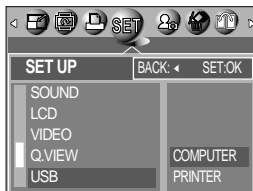

- ※ If you selected [PRINTER] in Step 6, when you connect the camera to your computer, the [CONNECTING...] message will be displayed on the LCD monitor and the connection will not be established. In this case, disconnect the USB cable, and then follow the procedure from Step 3 and onward.

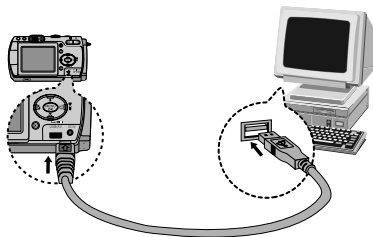

- ## ■ Disconnecting the camera and PC : Refer to page 114 (Removing the removable disk).

INFORMATION

- The camera driver must be installed before using PC mode.
- To save battery power, it is recommended that you use an AC adapter (Optional) when connecting the camera to a computer.

Starting PC Mode

■ Downloading stored images

You can download the still images stored on the camera to your PC's hard disk and print them or use a photo editing software to edit them.

1. Connect the camera to your PC with the USB cable.

2. On your computer's desktop display, select [My computer] and double click [Removable Disk → DCIM → 100SSCAM].

The image files will then be displayed.

※ If both the SD memory card and MS DUO are inserted, two [REMOVEABLE DISK] will be displayed.



3. Select an image and press the right mouse button.



4. A pop-up menu will open.

Click [Cut] or [Copy] menu.

- [Cut] : cuts a selected file.

- [Copy] : copies files.



5. Click a folder where you want to paste the file.

Starting PC Mode

6. Press the right mouse button and a pop-up menu will open. Click [Paste].



7. An image file is transferred from the camera to your PC.



- By using [Digimax Viewer], you can see the stored images in the memory directly on the PC monitor and you can copy or move the image files.

Removing the USB Driver for Windows 98SE

■ To remove the USB driver, refer to the process shown below.

1. Trace [Start → Settings] and click [Control Panel].



2. Double-click [Add/Remove programs].



3. The [Add/Remove Programs Properties] window will open. Click [Digimax V50] and click the [Add/Remove] button.

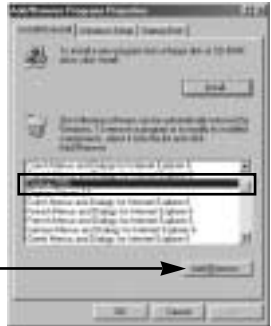

4. Uninstallation is complete.

Click the [Finish] button and the window will disappear.



Removable Disk

■ To use this camera as a Removable Disk, install (p.101) the USB Driver.

1. Before turning the camera power on, connect the camera to the PC with the USB cable.
2. Click [Removable Disk] under [My computer] or [Windows Explorer].
3. Image files stored in the Removable Disk (DCIM → 100SSCAM) can be transferred to the PC.

INFORMATION

Important information whilst using the Removable Disk

- The [Removable Disk] indicator will not show when the camera power is off or the USB cable is removed.
- We recommend that you should copy the images to the PC to view them. Opening images directly from the removable disk may be subject to unexpected disconnection.
- When uploading images from the PC to the camera, ensure that the uploaded file names are not the same as those already stored on the memory.
- When you upload a file that is not taken by this camera to Removable Disk, the [FILE ERROR!] message will be displayed on the LCD monitor in the PLAY mode, and nothing is displayed in THUMBNAIL mode.
- The auto focus lamp will blink, when a file is transferred (copy or deletion) between the PC and the camera. Do not remove the USB cable until the lamp stops blinking. To remove the USB cable in Windows 2000/ME/XP, use the [Unplug or Eject Hardware] icon on the task bar.
- If your PC wasn't patched with Windows 2000 Service Packs 4, the Memory Stick Duo isn't recognized as a removable disk. To use the Memory Stick Duo as a removable disk, you have to download and install the Windows Service Packs 4.

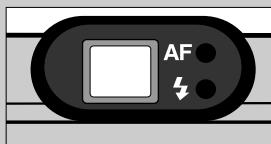

Removing the removable disk

■ Windows 98SE

1. Check whether the camera and PC are transferring a file. If the auto focus lamp blinks, you have to wait until the lamp illuminates.
2. Unplug the USB cable.

■ Windows 2000/ME/XP

(The illustrations may be different from the real display in accordance with the Windows O/S.)

1. Check whether the camera and PC are transferring a file. If the auto focus lamp blinks, you have to wait until the lamp illuminates.
2. Double-click the [Unplug or Eject Hardware] icon on the task bar.



[Double-click!]

3. The [Unplug or Eject Hardware] window will open. Select the [USB Mass Storage Device] and click the [Stop] button.



4. The [Stop a Hardware device] window will open. Select the [USB Mass Storage Device] and click the [OK] button.

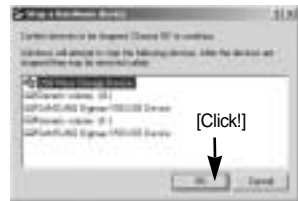

5. A [Safe to Remove Hardware] window will open. Click the [OK] button.



[Click!]

Removing the removable disk

6. A [Unplug or Eject Hardware] window will open. Click the [Close] button and the removable disk will be removed safely.



7. Unplug the USB cable.

[Click!]

Setting up the USB Driver for MAC

1. A USB Driver for MAC is not included with the software CD as MAC OS supports the camera driver.
2. Check the MAC OS. You can check the MAC OS version during MAC OS start-up. This camera is compatible with MAC OS 9.0 ~ 10.2.
3. Connect the camera to the Macintosh and turn the camera power on.
4. A new icon will be displayed on the desktop after connecting the camera to the MAC.

Using the USB Driver for MAC

1. Double click a new icon on the desktop and the folder in the memory will be displayed.
2. Select an image file and copy or move it to MAC.

CAUTION

- For Mac OS 10.0 or later : First complete uploading from computer to camera and then remove the removable disk with the Extract command.
- Memory Stick Duo/ Pro Duo can only be recognized in the Mac OS 10.0 or later.

Digimax Viewer 2.1

- This software is only compatible with Windows.



1. To open Digimax Viewer, click the [Start → Programs → Samsung → Digimax Viewer 2.1 → Digimax Viewer 2.1] and Digimax Viewer 2.1 will then open.

2. If the [Auto Launch] option is selected, this program will be executed automatically with recognizing the camera.



3. You can easily use the Digimax viewer 2.1 program as it offers a FILE menu and TOOL bar. And, you can use the pop up menu. Click an image and press the right mouse button.

Digimax Viewer functions are listed below.

- Basic functions : Copy, Move, Delete, Rotate, Rename, changing file type, Resize, Property.
- Advanced functions : Print, Slide show, Export, Sending e-mail, On-line print, Web album etc.

INFORMATION

- Before deleting images from the camera, you should protect or download images to your computer that you wish to keep.
- Refer to the [Help] menu in Digimax viewer 2.1 for further information.

Using Photolmpression





With Photolmpression, you can edit or store still images that you downloaded from the camera. This software is only available in Windows version.

To start the program, click [Start → Programs → ArcSoft Photolmpression → Photolmpression]. The following screen will appear.













You can use Photolmpression to perform the following tasks.

■ Command Button

Button	Description
	Imports a picture from an album, a source folder, or the camera/scanner, or captures screen shots of what is being viewed on the current monitor.
	Selects Cut, Resize, Edit Image, Insert Text, Enhance Picture, Insert Effects, or Layer.
	Performs Insert Frame, Insert Borders, Insert Calendar, Insert Greeting Cards, Insert Template, or Connect with Other Software.
	Saves the edited picture, and sends an e-mail or uses it as the background image.
	Outputs the edited picture according to your preferences.

Using Photolmpression

■ Tool Bar

Button	Description	Button	Description
	Resize Layer		Rotate Layer
	Flip Layer Horizontally		Rotate All Layers
	Undo		Redo
	Copy		Paste
	Delete Layer		Close Picture

INFORMATION

- For detailed instructions on how to use Photolmpression, please refer to the program's Help.

FAQ

■ Please check the following if the USB connection malfunctions.

[Case 1] The camera power is off.
→ Turn the camera power on. We recommend using an AC power adapter in PC mode.

[Case 2] USB Driver is not installed correctly.
→ Install the USB Driver correctly. Refer to page 101.

[Case 3] The USB cable is not connected or you are using a cable with an incorrect specification.
→ Use a USB cable with the correct specification.

[Case 4] The camera is not recognized by your PC.
Sometimes, the camera may appear under [Unknown Devices] in Device Manager.
→ Install the camera driver correctly.
Turn off the camera, remove the USB cable, plug in the USB cable again, and then turn on the camera.

[Case 5] There is an unexpected error during file transfer
→ Turn the camera power off and on again. Transfer the file again.

[Case 6] How do I know my computer supports a USB Interface?
→ Check the USB port in your computer or keyboard.
→ Check the OS version. A USB Interface is available in Windows 98, 98SE, 2000, ME .XP.
→ Check [Universal Serial Bus controllers] in Device Manager. Do the following to check [Universal Serial Bus controllers].
Win 98/ME : Trace [Start → Settings → Control Panel → System → Device Manager → Universal Serial Bus controllers].
Win 2000 : Trace [Start → Settings → Control Panel → System → Hardware → Device Manager → Universal Serial Bus controllers].

Win XP : Trace [Start → Control Panel → Performance and Maintenance → System → Hardware → Device Manager → Universal Serial Bus controllers].

There must be USB Host Controller and USB root hub under [Universal Serial Bus controllers].

In addition, double-click on the USB Universal Host Controller and the USB Root Hub to check if the Device Status states "This device is working properly". If the Device Status says the device is "not working properly", click the "Driver" tab and then click [Update Driver] or [Reinstall Driver].

- When all the conditions mentioned above are met, the computer can support the USB interface.

[Case 7]

When using the USB hub.

- There may be a problem in connecting the camera to the PC through the USB hub if the PC and the hub are not compatible. Wherever possible, connect the camera to the PC directly.

[Case 8]

Are other USB cables connected to the PC?

- The camera may malfunction when it is connected to the PC at the same time as another USB cable. In this case, disconnect the other USB cable, and connect only one USB cable to the camera.

[Case 9]

When I open the Device Manager (by clicking Start → (Settings) → Control Panel → (Performance and Maintenance) → System → (Hardware) → Device Manager), there are 「Unknown Devices」 or 「Other Devices」 entries with a yellow question mark(?) beside them or devices with an exclamation mark(!) beside them.

- Right-click on the entry with the question(?) or exclamation (!) mark and select "Remove". Restart the PC and connect the camera the again. For Windows 98 PC, remove the camera driver also, restart the PC, and then reinstall the camera driver.
- Double-click on the entry with the question (?) or exclamation (!) mark, click the "Driver" tab, and click [Update Driver] or [Reinstall Driver]. If a message appears asking you to specify the location of the appropriate device driver, specify "USB Driver" in the CD supplied.

MEMO

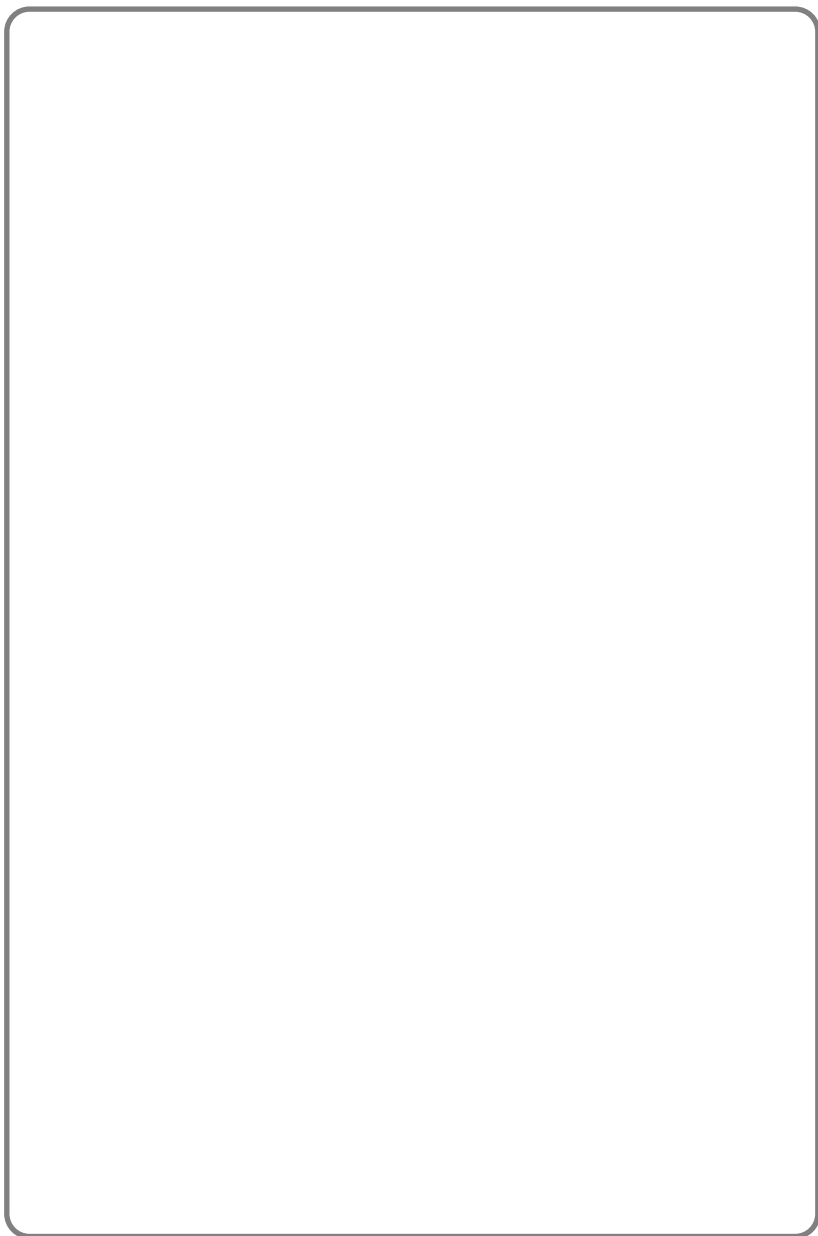

MEMO

A large, empty rectangular box with rounded corners, intended for writing a memo. The box is white and occupies most of the page area below the header.

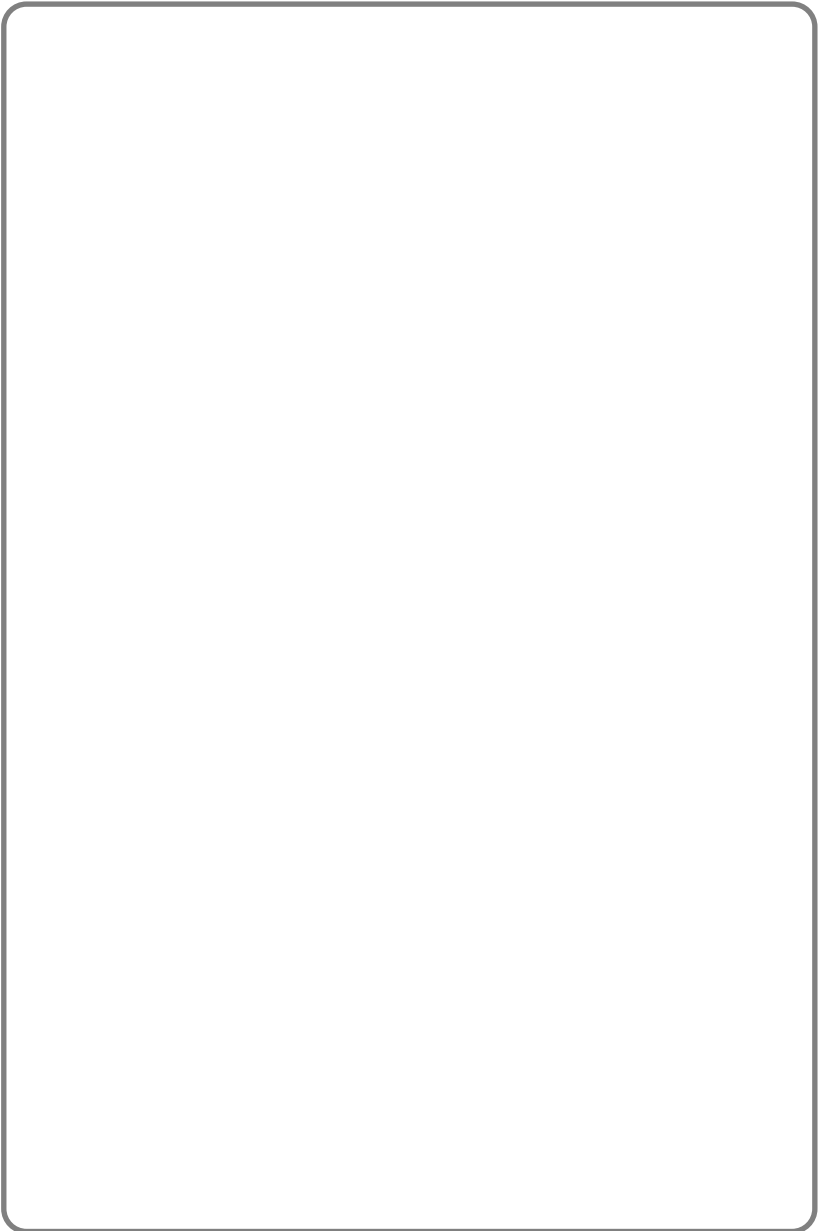



SAMSUNG

SAMSUNG TECHWIN CO., LTD.
OPTICS & DIGITAL IMAGING DIVISION
145-3, SANGDAEWON 1-DONG, JUNGWON-
GU, SUNGNAM-CITY, KYUNGKI-DO, KOREA
462-121
TEL : (82) 31-740-8086, 8088, 8090, 8092, 8099
FAX : (82) 31-740-8398, 8111

SAMSUNG OPTO-ELECTRONICS AMERICA, INC.
HEADQUARTERS
40 SEAVIEW DRIVE, SECAUCUS, NJ07094, U.S.A.
TEL : (1) 201-902-0347
FAX : (1) 201-902-9342

WESTERN REGIONAL OFFICE
18600 BROADWICK ST.,
RANCHO DOMINGUEZ, CA 90220, U.S.A.
TEL : (1) 310-900-5263/5264
FAX : (1) 310-537-1566

SAMSUNG OPTO-ELECTRONICS UK LIMITED
SAMSUNG HOUSE
1000 HILLSWOOD DRIVE
HILLSWOOD BUSINESS PARK
CHERTSEY KT16 OPS U.K.
TEL : +44 (0) 1932 455300
FAX : +44 (0) 1932 455325

SAMSUNG OPTO-ELECTRONICS GMBH
AM KRONBERGER HANG 6
D-65824 SCHWALBACH/TS., GERMANY
TEL : (49) 6196 66 53 03
FAX : (49) 6196 66 53 66

SAMSUNG FRANCE S.A.S.
BP 51 TOUR MAINE MONTPARNASSE
33, AV. DU MAINE
75755, PARIS CEDEX 15, FRANCE
HOTLINE PHOTO NUMÉRIQUE :
00 800 22 26 37 27 (Numéro Vert-Appel Gratuit)
TEL : (33) 1-4279-2282/5
FAX : (33) 1-4320-4510

SAMSUNG TECHWIN MOSCOW OFFICE
RUSSIA, 125167, MOSCOW LENNINGRADSKY,
PR-KT, 37-A, KORP14
TEL : (7) 095-258-9299/96/98
FAX : (7) 095-258-9297
<http://www.samsungcamera.ru>

TIANJIN SAMSUNG OPTO-ELECTRONICS CO., LTD.
7 PINGCHANG ROAD NANKAI DIST., TIANJIN
P.R CHINA
POST CODE: 300190
TEL : (86) 22-2761-8867
FAX : (86) 22-2761-8864

* Internet address - [http : //www.samsungcamera.com/](http://www.samsungcamera.com/)



The CE Mark is a Directive conformity
mark of the European Community (EC)

6806-1998